

ETSI TS 136 133 V15.21.1 (2024-03)



**LTE;
Evolved Universal Terrestrial Radio Access (E-UTRA);
Requirements for support of radio resource management
(3GPP TS 36.133 version 15.21.1 Release 15)**



Reference

RTS/TSGR-0436133vfl1

Keywords

LTE

ETSI

650 Route des Lucioles
F-06921 Sophia Antipolis Cedex - FRANCE

Tel.: +33 4 92 94 42 00 Fax: +33 4 93 65 47 16

Siret N° 348 623 562 00017 - APE 7112B
Association à but non lucratif enregistrée à la
Sous-Préfecture de Grasse (06) N° w061004871

Important notice

The present document can be downloaded from:

<https://www.etsi.org/standards-search>

The present document may be made available in electronic versions and/or in print. The content of any electronic and/or print versions of the present document shall not be modified without the prior written authorization of ETSI. In case of any existing or perceived difference in contents between such versions and/or in print, the prevailing version of an ETSI deliverable is the one made publicly available in PDF format at www.etsi.org/deliver.

Users of the present document should be aware that the document may be subject to revision or change of status.

Information on the current status of this and other ETSI documents is available at

<https://portal.etsi.org/TB/ETSIDeliverableStatus.aspx>

If you find errors in the present document, please send your comment to one of the following services:

<https://portal.etsi.org/People/CommitteeSupportStaff.aspx>

If you find a security vulnerability in the present document, please report it through our
Coordinated Vulnerability Disclosure Program:

<https://www.etsi.org/standards/coordinated-vulnerability-disclosure>

Notice of disclaimer & limitation of liability

The information provided in the present deliverable is directed solely to professionals who have the appropriate degree of experience to understand and interpret its content in accordance with generally accepted engineering or other professional standard and applicable regulations.

No recommendation as to products and services or vendors is made or should be implied.

No representation or warranty is made that this deliverable is technically accurate or sufficient or conforms to any law and/or governmental rule and/or regulation and further, no representation or warranty is made of merchantability or fitness for any particular purpose or against infringement of intellectual property rights.

In no event shall ETSI be held liable for loss of profits or any other incidental or consequential damages.

Any software contained in this deliverable is provided "AS IS" with no warranties, express or implied, including but not limited to, the warranties of merchantability, fitness for a particular purpose and non-infringement of intellectual property rights and ETSI shall not be held liable in any event for any damages whatsoever (including, without limitation, damages for loss of profits, business interruption, loss of information, or any other pecuniary loss) arising out of or related to the use of or inability to use the software.

Copyright Notification

No part may be reproduced or utilized in any form or by any means, electronic or mechanical, including photocopying and microfilm except as authorized by written permission of ETSI.

The content of the PDF version shall not be modified without the written authorization of ETSI.

The copyright and the foregoing restriction extend to reproduction in all media.

© ETSI 2024.
All rights reserved.

Intellectual Property Rights

Essential patents

IPRs essential or potentially essential to normative deliverables may have been declared to ETSI. The declarations pertaining to these essential IPRs, if any, are publicly available for **ETSI members and non-members**, and can be found in ETSI SR 000 314: "*Intellectual Property Rights (IPRs); Essential, or potentially Essential, IPRs notified to ETSI in respect of ETSI standards*", which is available from the ETSI Secretariat. Latest updates are available on the ETSI Web server (<https://ipr.etsi.org/>).

Pursuant to the ETSI Directives including the ETSI IPR Policy, no investigation regarding the essentiality of IPRs, including IPR searches, has been carried out by ETSI. No guarantee can be given as to the existence of other IPRs not referenced in ETSI SR 000 314 (or the updates on the ETSI Web server) which are, or may be, or may become, essential to the present document.

Trademarks

The present document may include trademarks and/or tradenames which are asserted and/or registered by their owners. ETSI claims no ownership of these except for any which are indicated as being the property of ETSI, and conveys no right to use or reproduce any trademark and/or tradename. Mention of those trademarks in the present document does not constitute an endorsement by ETSI of products, services or organizations associated with those trademarks.

DECT™, **PLUGTESTS™**, **UMTS™** and the ETSI logo are trademarks of ETSI registered for the benefit of its Members. **3GPP™** and **LTE™** are trademarks of ETSI registered for the benefit of its Members and of the 3GPP Organizational Partners. **oneM2M™** logo is a trademark of ETSI registered for the benefit of its Members and of the oneM2M Partners. **GSM®** and the GSM logo are trademarks registered and owned by the GSM Association.

Legal Notice

This Technical Specification (TS) has been produced by the ETSI 3rd Generation Partnership Project (3GPP).

The present document may refer to technical specifications or reports using their 3GPP identities. These shall be interpreted as being references to the corresponding ETSI deliverables.

The cross reference between 3GPP and ETSI identities can be found under <https://webapp.etsi.org/key/queryform.asp>.

Modal verbs terminology

In the present document "**shall**", "**shall not**", "**should**", "**should not**", "**may**", "**need not**", "**will**", "**will not**", "**can**" and "**cannot**" are to be interpreted as described in clause 3.2 of the [ETSI Drafting Rules](#) (Verbal forms for the expression of provisions).

"**must**" and "**must not**" are **NOT** allowed in ETSI deliverables except when used in direct citation.

Contents

Intellectual Property Rights	2
Legal Notice	2
Modal verbs terminology.....	2
Foreword.....	87
1 Scope	88
2 References	88
3 Definitions, symbols and abbreviations	90
3.1 Definitions	90
3.2 Symbols.....	92
3.3 Abbreviations	93
3.4 Test tolerances.....	96
3.5 Additional notation.....	96
3.5.1 Groups of bands.....	96
3.6 General	98
3.6.1 Applicability of requirements in this specification version	98
3.6.1.1 Applicability of requirements for UE capable of network-based CRS interference mitigation	104
3.6.1.2 Applicability of requirements with CRS muting for category M1 UE capable of CRS muting.....	105
3.6.1.3 Applicability of requirements with CRS muting for category M2 UE capable of CRS muting.....	107
3.6.2 Applicability of requirements for EN-DC operation	108
3.6.3 Applicability of requirements for NE-DC operation	109
3.6.4 Applicability of requirements for NGEN-DC operation.....	109
4 E-UTRAN RRC_IDLE state mobility.....	110
4.1 Cell Selection	110
4.2 Cell Re-selection	110
4.2.1 Introduction.....	110
4.2.2 Requirements	110
4.2.2.1 Measurement and evaluation of serving cell.....	111
4.2.2.2 Void.....	112
4.2.2.3 Measurements of intra-frequency E-UTRAN cells	112
4.2.2.4 Measurements of inter-frequency E-UTRAN cells	113
4.2.2.5 Measurements of inter-RAT cells	116
4.2.2.5.1 Measurements of UTRAN FDD cells.....	116
4.2.2.5.2 Measurements of UTRAN TDD cells	117
4.2.2.5.3 Measurements of GSM cells.....	119
4.2.2.5.4 Measurements of HRPD cells.....	120
4.2.2.5.5 Measurements of cdma2000 1X	121
4.2.2.5.6 Measurements of NR cells.....	122
4.2.2.6 Evaluation of cell re-selection criteria.....	123
4.2.2.7 Maximum interruption in paging reception.....	123
4.2.2.8 void	124
4.2.2.9 UE measurement capability	124
4.2.2.9a UE measurement capability (Increased UE carrier monitoring)	125
4.2.2.10 Reselection to CSG cells	125
4.2.2.10.1 Reselection from a non CSG to an inter-frequency CSG cell.....	125
4.2.2.10.2 Reselection from a non CSG to an inter-RAT UTRAN FDD CSG cell.....	126
4.2.2.11 Void.....	127
4.2.2.12 Void.....	127
4.2.2.13 Void.....	127
4.3 Minimization of Drive Tests (MDT)	127
4.3.1 Introduction.....	127
4.3.2 Measurements	127
4.3.2.1 Requirements	127
4.3.3 Relative Time Stamp Accuracy	128
4.3.3.1 Requirements	128

4.3.4	Relative Time Stamp Accuracy for RRC Connection Establishment Failure Log Reporting	128
4.3.4.1	Requirements	128
4.3.5	Relative Time Stamp Accuracy for Radio Link Failure and Handover Failure Log Reporting.....	128
4.3.5.1	Requirements for <i>timeSinceFailure</i>	128
4.4	MBSFN Measurements	128
4.4.1	Introduction.....	128
4.4.2	MBSFN RSRP measurements	129
4.4.3	MBSFN RSRQ measurements.....	129
4.4.4	MCH BLER measurements	129
4.5	Proximity-based Services	129
4.5.1	Introduction.....	129
4.5.2	Requirements	129
4.5.2.1	Interruptions with ProSe Direct Discovery	129
4.5.2.2	Interruptions with ProSe Direct Communication	130
4.5.2.3	Initiation/Cease of SLSS transmissions with ProSe Direct Discovery.....	130
4.5.2.4	Initiation/Cease of SLSS transmissions with ProSe Direct Communication	130
4.6	Cell Selection and Re-selection Requirements for UE category NB1	131
4.6.1	Cell Selection.....	131
4.6.2	Cell Re-selection.....	131
4.6.2.1	Measurement and evaluation of serving NB-IoT cell for UE category NB1 in normal coverage.....	131
4.6.2.1A	Measurement and evaluation of serving NB-IoT cell for HD-FDD UE category NB1 in normal coverage when configured with WUS.....	132
4.6.2.2	Measurements of intra-frequency NB-IoT cells for UE category NB1 in normal coverage	133
4.6.2.3	Measurement and evaluation of serving NB-IoT cell for UE category NB1 in enhanced coverage ...	134
4.6.2.3A	Measurement and evaluation of serving NB-IoT cell for HD-FDD UE category NB1 in enhanced coverage when configured with WUS.....	135
4.6.2.4	Measurements of intra-frequency NB-IoT cells for UE category NB1 in enhanced coverage	136
4.6.2.5	Measurements of inter-frequency NB cells for UE category NB1 in normal coverage	137
4.6.2.6	Measurements of inter-frequency NB-IoT cells for UE category NB1 in enhanced coverage	138
4.6.2.7	Maximum interruption in paging reception in normal coverage	139
4.6.2.7A	Maximum interruption in paging reception in enhanced coverage	140
4.6.2.8	UE measurement capability	140
4.6.2.9	WUS receptions for NB1	140
4.7	Cell Selection and Re-selection Requirements for UE category M1	140
4.7.1	Cell Selection.....	140
4.7.2	Cell Re-selection.....	140
4.7.2.1	Cell Re-selection requirements for UE category M1 in normal coverage.....	141
4.7.2.1.1	Measurement and evaluation of serving cell for UE category M1 in normal coverage.....	141
4.7.2.1.2	Measurements of intra-frequency cells for UE category M1 in normal coverage	141
4.7.2.1.3	Measurements of inter-frequency cells for UE category M1 in normal coverage	142
4.7.2.1.4	Maximum allowed layers for multiple monitoring for UE category M1 in normal coverage	144
4.7.2.1.5	Maximum interruption in paging reception for Category M1 UEs in normal coverage.....	144
4.7.2.2	Cell Re-selection requirements for UE category M1 in enhanced coverage.....	145
4.7.2.2.1	Measurement and evaluation of serving cell for UE category M1 in enhanced coverage	145
4.7.2.2.2	Measurements of intra-frequency cells for UE category M1 in enhanced coverage	146
4.7.2.2.3	Measurements of inter-frequency cells for UE category M1 in enhanced coverage	147
4.7.2.2.4	Maximum allowed layers for multiple monitoring for UE category M1 in enhanced coverage ...	149
4.7.2.2.5	Maximum interruption in paging reception for Category M1 UEs in enhanced coverage	149
4.7.2.3	WUS receptions for UE category M1	150
4.8	Idle State Positioning Measurement Requirements for UE category NB1	150
4.8.1	OTDOA Intra-Frequency RSTD Measurements for UE category NB1 for normal coverage	150
4.8.1.1	RSTD Measurement Reporting Delay	152
4.8.2	OTDOA Intra-Frequency RSTD Measurements for UE category NB1 for enhanced coverage	152
4.8.2.1	RSTD Measurement Reporting Delay	154
4.8.3	OTDOA Inter-Frequency RSTD Measurements for UE category NB1 for normal coverage	154
4.8.3.1	RSTD Measurement Reporting Delay	155
4.8.4	OTDOA Inter-Frequency RSTD Measurements for UE category NB1 for enhanced coverage	156
4.8.4.1	RSTD Measurement Reporting Delay	157
4.8.5	Intra-Frequency E-CID NRSRP and NRSRQ Measurements for UE category NB2 for normal coverage.....	158
4.8.5.1	Measurement Reporting Delay.....	159

4.8.6	Intra-Frequency E-CID NRSRP and NRSRQ Measurements for UE category NB2 for enhanced coverage	159
4.8.6.1	Measurement Reporting Delay	160
4.8.7	Inter-Frequency E-CID NRSRP and NRSRQ Measurements for UE category NB2 for normal coverage	160
4.8.7.1	Measurement Reporting Delay	161
4.8.8	Inter-Frequency E-CID NRSRP and NRSRQ Measurements for UE category NB2 for enhanced coverage	162
4.8.8.1	Measurement Reporting Delay	163
4.9	Idle Mode CA Measurement	163
4.9.1	Introduction	163
4.9.2	Requirement	163
4.9.2.1	Detected cell requirement during state transition and Idle mode	163
4.9.2.2	Measurements of inter-frequency CA candidate cells	164
4.9.2.3	Measurements on serving cell	164
4A	E-UTRAN RRC_INACTIVE state mobility	164
4A.1	Cell Re-selection	164
4A.1.1	Introduction	164
4A.1.2	Requirements	165
4A.1.2.1	UE measurement capability	165
4A.1.2.2	Measurement and evaluation of serving cell	165
4A.1.2.3	Measurements of intra-frequency E-UTRAN cells	165
4A.1.2.4	Measurements of inter-frequency E-UTRAN cells	165
4A.1.2.5	Evaluation of cell re-selection criteria	165
4A.1.2.6	Maximum interruption in paging reception	165
4A.1.2.7	Measurements of inter-RAT NR cells	165
5	E-UTRAN RRC_CONNECTED state mobility	165
5.1	E-UTRAN Handover	166
5.1.1	Introduction	166
5.1.2	Requirements	166
5.1.2.1	E-UTRAN FDD – FDD	166
5.1.2.1.1	Handover delay	166
5.1.2.1.2	Interruption time	166
5.1.2.2	E-UTRAN FDD – TDD	167
5.1.2.2.1	(Void)	168
5.1.2.2.2	(Void)	168
5.1.2.3	E-UTRAN TDD – FDD	168
5.1.2.3.1	(Void)	168
5.1.2.3.2	(Void)	168
5.1.2.4	E-UTRAN TDD – TDD	168
5.1.2.4.1	Handover delay	168
5.1.2.4.2	Interruption time	168
5.1.2.5	E-UTRAN HD–FDD	170
5.1.2.5.1	Handover delay	170
5.1.2.5.2	Interruption time	170
5.2	Void	171
5.3	Handover to other RATs	171
5.3.1	E-UTRAN - UTRAN FDD Handover	171
5.3.1.1	Introduction	171
5.3.1.1.1	Handover delay	172
5.3.1.1.2	Interruption time	172
5.3.2	E-UTRAN - UTRAN TDD Handover	172
5.3.2.1	Introduction	172
5.3.2.2	Requirements	172
5.3.2.2.1	Handover delay	173
5.3.2.2.2	Interruption time	173
5.3.3	E-UTRAN - GSM Handover	173
5.3.3.1	Introduction	173
5.3.3.2	Requirements	173
5.3.3.2.1	Handover delay	173

5.3.3.2.2	Interruption time	174
5.3.4	E-UTRAN - NR FR1 Handover	174
5.3.4.1	Introduction	174
5.3.4.2	Handover delay	174
5.3.4.3	Interruption time	174
5.3.5	E-UTRAN - NR FR2 Handover	175
5.3.5.1	Introduction	175
5.3.5.2	Handover delay	175
5.3.5.3	Interruption time	175
5.4	Handover to Non-3GPP RATs	176
5.4.1	E-UTRAN – HRPD Handover.....	176
5.4.1.1	Introduction	176
5.4.1.1.1	Handover delay.....	176
5.4.1.1.2	Interruption time	176
5.4.2	E-UTRAN – cdma2000 1X Handover.....	177
5.4.2.1	Introduction	177
5.4.2.1.1	Handover delay.....	177
5.4.2.1.2	Interruption time	177
5.5	E-UTRAN Handover for Cat-M1 UEs.....	178
5.5.1	Introduction.....	178
5.5.2	Requirements in CEModeA.....	178
5.5.2.1	E-UTRAN FDD – FDD for Cat-M1 FDD UEs	178
5.5.2.1.1	Handover delay.....	178
5.5.2.1.2	Interruption time	178
5.5.2.2	E-UTRAN FDD – FDD for Cat-M1 HD – FDD UEs.....	179
5.5.2.3	E-UTRAN TDD – TDD for Cat-M1 TDD UEs.....	179
5.5.2.3.1	Void.....	179
5.5.2.3.2	Void.....	179
5.5.3	Requirements in CEModeB	179
5.5.3.1	E-UTRAN FDD – FDD for Cat-M1 FDD UEs	179
5.5.3.1.1	Handover delay.....	179
5.5.3.1.2	Interruption time	179
5.5.3.2	E-UTRAN FDD – FDD for Cat-M1 HD – FDD UEs.....	180
5.5.3.3	E-UTRAN TDD – TDD for Cat-M1 TDD UEs.....	180
5.6	Void.....	180
6	RRC Connection Mobility Control	180
6.1	RRC Re-establishment	180
6.1.1	Introduction.....	180
6.1.2	Requirements	180
6.1.2.1	UE Re-establishment delay requirement.....	180
6.2	Random Access.....	181
6.2.1	Introduction.....	181
6.2.2	Requirements	181
6.2.2.1	Contention based random access.....	181
6.2.2.1.1	Correct behaviour when receiving Random Access Response reception	181
6.2.2.1.2	Correct behaviour when not receiving Random Access Response reception	181
6.2.2.1.3	Correct behaviour when receiving a NACK on msg3	181
6.2.2.1.4	Void.....	181
6.2.2.1.5	Correct behaviour when receiving a message over Temporary C-RNTI.....	181
6.2.2.1.6	Correct behaviour when contention Resolution timer expires.....	182
6.2.2.2	Non-Contention based random access	182
6.2.2.2.1	Correct behaviour when receiving Random Access Response.....	182
6.2.2.2.2	Correct behaviour when not receiving Random Access Response.....	182
6.2.3	Requirements for Cat-M1 UEs	182
6.3	RRC Connection Release with Redirection.....	182
6.3.1	Introduction.....	182
6.3.2	Requirements	182
6.3.2.1	RRC connection release with redirection to UTRAN FDD	182
6.3.2.2	RRC connection release with redirection to GERAN	183
6.3.2.3	RRC connection release with redirection to UTRAN TDD.....	183
6.3.2.4	RRC connection release with redirection to NR	184

6.4	CSG Proximity Indication for E-UTRAN and UTRAN.....	185
6.4.1	Introduction.....	185
6.4.2	Requirements	185
6.5	RRC Re-establishment for NB-IoT UEs	185
6.5.1	Introduction.....	185
6.5.2	Requirements	185
6.5.2.1	UE Re-establishment delay requirement in normal coverage	185
6.5.2.2	UE Re-establishment delay requirement in enhanced coverage.....	186
6.6	Random Access for UE category NB1	186
6.6.1	Introduction.....	186
6.6.2	Requirements	186
6.6.2.1	Correct behaviour when receiving Random Access Response reception.....	187
6.6.2.2	Correct behaviour when not receiving Random Access Response reception.....	187
6.6.2.3	Correct behaviour when receiving a NACK on msg3.....	187
6.6.2.4	Correct behaviour when receiving a message over Temporary C-RNTI	187
6.6.2.5	Correct behaviour when contention Resolution timer expires	187
6.6.2.6	MSG3-based channel quality report for UE Category NB1	187
6.6.3	Requirements for NPRACH configuration.....	188
6.7	RRC Re-establishment for Cat-M1 UEs	188
6.7.1	Introduction.....	188
6.7.2	Requirements	188
6.7.2.1	UE Re-establishment delay requirement for CEModeA	188
6.7.2.2	UE Re-establishment delay requirement for CEModeB	189
6.8	RRC Connection Release with Redirection for Cat-M1 UEs.....	189
6.8.1	Introduction.....	189
6.8.2	Requirements	189
6.8.2.1	RRC connection release with redirection to E-UTRAN with CE Mode A	189
6.9	RRC Connection Redirection to Non-anchor Carrier in NB-IoT	190
6.9.1	Introduction.....	190
6.9.2	Requirements	190
7	Timing and signalling characteristics.....	191
7.1	UE transmit timing	191
7.1.1	Introduction.....	191
7.1.2	Requirements	191
7.2	UE timer accuracy	192
7.2.1	Introduction.....	192
7.2.2	Requirements	192
7.3	Timing Advance	193
7.3.1	Introduction.....	193
7.3.2	Requirements	193
7.3.2.1	Timing Advance adjustment delay.....	193
7.3.2.2	Timing Advance adjustment accuracy	193
7.4	Cell phase synchronization accuracy (TDD).....	193
7.4.1	Definition.....	193
7.4.2	Minimum requirements.....	194
7.5	Synchronization Requirements for E-UTRAN to 1xRTT and HRPD Handovers.....	194
7.5.1	Introduction.....	194
7.5.2	eNodeB Synchronization Requirements	194
7.5.2.1	Synchronized E-UTRAN	194
7.5.2.2	Non-Synchronized E-UTRAN	195
7.6	Radio Link Monitoring.....	195
7.6.1	Introduction.....	195
7.6.2	Requirements	196
7.6.2.1	Minimum requirement when no DRX is used.....	196
7.6.2.2	Minimum requirement when DRX is used.....	197
7.6.2.3	Minimum requirement at transitions	198
7.6.2.4	Minimum requirement during SI Acquisition with autonomous gaps	198
7.6.2.5	Minimum requirement under IDC Interference	198
7.7	SCell Activation and Deactivation Delay for E-UTRA Carrier Aggregation	199
7.7.1	Introduction.....	199
7.7.2	SCell Activation Delay Requirement for Deactivated SCell	199

7.7.3	SCell Deactivation Delay Requirement for Activated SCell	200
7.7.4	SCell Activation Delay Requirement for Deactivated SCell with Multiple Downlink SCells	201
7.7.5	SCell Deactivation Delay Requirement for Activated SCell with Multiple Downlink SCells	203
7.7.6	SCell Activation Delay Requirement for Deactivated PUCCH SCell	203
7.7.7	SCell Activation Delay Requirement for Deactivated PUCCH SCell with Multiple SCells	204
7.7.8	SCell Deactivation Delay Requirement for Activated PUCCH SCell	205
7.7.9	SCell Deactivation Delay Requirement for Activated PUCCH SCell with Multiple SCells	205
7.7.10	SCell Activation Delay Requirement for Deactivated SCell under Frame Structure 3	205
7.7.11	SCell Deactivation Delay Requirement for Activated SCell under Frame Structure 3	207
7.7.12	SCell Activation Delay Requirement for Deactivated SCell with Multiple Downlink SCells under Frame Structure 3	207
7.7.13	SCell Deactivation Delay Requirement for Activated SCell with Multiple Downlink SCells under Frame Structure 3	208
7.7.14	SCell Activation Delay Requirement for Dormant SCell	209
7.7.15	SCell Hibernation Delay Requirement for Activated SCell	210
7.7.16	SCell Hibernation Delay Requirement for Deactivated SCell	211
7.7.17	SCell Deactivation Delay Requirement for Dormant SCell	212
7.7.18	Direct SCell Activation and Hibernation Delay Requirement	212
7.7.19	Direct SCell Activation and Hibernation Delay Requirement at RRC Reconfiguration during Handover	214
7.8	Interruptions with Carrier Aggregation	216
7.8.1	Introduction	216
7.8.2	Requirements	217
7.8.2.1	Interruptions at SCell addition/release for intra-band CA	217
7.8.2.2	Interruptions at SCell addition/release for inter-band CA	217
7.8.2.3	Interruptions at SCell activation/deactivation for intra-band CA	217
7.8.2.4	Interruptions at SCell activation/deactivation for inter-band CA	217
7.8.2.5	Interruptions during measurements on SCC for intra-band CA	217
7.8.2.6	Interruptions during measurements on SCC for inter-band CA	217
7.8.2.7	Interruptions at SCell addition/release with multiple downlink SCells	218
7.8.2.8	Interruptions at SCell activation/deactivation with multiple downlink SCells	218
7.8.2.9	Interruptions during measurements on SCC with multiple downlink SCells	218
7.8.2.10	Interruptions at overlapping addition/release/activation/deactivation of SCells	219
7.8.2.11	Interruptions during RSSI measurements on one SCC under Frame Structure 3	219
7.8.2.12	Interruptions during RSSI measurements on multiple SCCs under Frame Structure 3	220
7.8.2.13	Interruptions at SRS carrier based switching	220
7.8.2.14	Interruptions at SCell activation and deactivation of dormant SCell for intra-band CA	221
7.8.2.15	Interruptions at SCell activation and deactivation of dormant SCell for inter-band CA	221
7.8.2.16	Interruptions at SCell activation and deactivation of multiple dormant SCells	221
7.8.2.17	Interruptions during CQI measurement on dormant SCell	222
7.8.2.18	Interruptions during RRM measurement on dormant SCell for intra-band CA	222
7.8.2.19	Interruptions during RRM measurement on dormant SCell for inter-band CA	222
7.8.2.20	Interruptions at SCell hibernation	222
7.8.2.21	Interruptions at direct SCell activation and hibernation	223
7.9	Maximum Transmission Timing Difference in Carrier Aggregation	223
7.9.1	Introduction	223
7.9.2	Minimum Requirements for Interband Carrier Aggregation	223
7.9.3	Minimum Requirements for Intra-band non-contiguous Carrier Aggregation	224
7.9.4	Minimum Requirements for Inter-Band Carrier Aggregation under Frame Structure 3	224
7.10	Interruptions with RSTD Measurements with Carrier Aggregation	224
7.10.1	Introduction	224
7.10.2	Requirements	224
7.10.2.1	Interruptions during RSTD measurements on SCC for intra-band CA with one downlink SCell	225
7.10.2.2	Interruptions during RSTD measurements on SCC for inter-band CA with one downlink SCell	225
7.10.2.3	Interruptions during RSTD measurements on SCC with multiple downlink SCells	225
7.10.2.4	Interruptions at overlapping RSTD and inter-frequency measurements	226
7.11	Radio Link Monitoring for UE Category 0	226
7.11.1	Introduction	226
7.11.2	Requirements for FD-FDD and TDD	227
7.11.2.1	Minimum requirement when no DRX is used	227
7.11.2.2	Minimum requirement when DRX is used	227
7.11.2.3	Minimum requirement at transitions	228

7.11.3	Requirements for HD-FDD	228
7.11.3.1	Minimum requirement when no DRX is used.....	228
7.11.3.2	Minimum requirement when DRX is used.....	228
7.11.3.3	Minimum requirement at transitions	229
7.12	Interruptions with Dual Connectivity	229
7.12.1	Introduction.....	229
7.12.2	Requirements	230
7.12.2.1	Interruptions at PSCell addition/release	230
7.12.2.2	Interruptions at transitions between active and non-active during DRX.....	230
7.12.2.3	Interruptions at transitions from non-DRX to DRX.....	230
7.12.2.4	Interruptions at SCell addition/release	230
7.12.2.5	Interruptions at SCell activation/deactivation	231
7.12.2.6	Interruptions during measurements on SCC	231
7.12.2.7	Interruptions at SRS carrier based switching	232
7.13	Cell phase synchronization accuracy (Synchronized mode of dual connectivity).....	232
7.13.1	Definition.....	232
7.13.2	Minimum requirements.....	232
7.14	PSCell Addition and Release Delay for E-UTRA Dual Connectivity.....	233
7.14.1	Introduction.....	233
7.14.2	PSCell Addition Delay Requirement	233
7.14.3	PSCell Release Delay Requirement.....	233
7.15	Maximum Receive Timing Difference in Dual Connectivity	234
7.15.1	Introduction.....	234
7.15.2	Minimum Requirements for Inter-band Dual Connectivity	234
7.16	Proximity-based Services	234
7.16.1	Introduction.....	234
7.16.2	Requirements	234
7.16.2.1	ProSe UE transmission timing	234
7.16.2.1.1	Serving cell or PCell as timing reference	234
7.16.2.1.2	SCell or non-serving cell as timing reference.....	235
7.16.3	Interruptions with ProSe	235
7.16.3.1	Interruptions at ProSe Direct Discovery configuration	235
7.16.3.2	Interruptions at ProSe Direct Communication configuration.....	235
7.16.3.3	Interruptions during ProSe Direct Discovery	235
7.16.3.4	Interruptions during ProSe Direct Discovery with discovery gaps	236
7.16.3.5	Interruptions during ProSe Direct Communication.....	236
7.16.4	Cell reselection for ProSe Direct Discovery on non-serving frequency	236
7.16.4.1	Measurement and evaluation of selected cell.....	237
7.16.4.2	Measurement of intra-frequency E-UTRAN cells	237
7.16.5	Selection / Reselection of ProSe relay UE.....	237
7.16.6	ProSe operation under deactivated SCell.....	238
7.17	Maximum Transmission Timing Difference in Dual Connectivity	238
7.17.1	Introduction.....	238
7.17.2	Minimum Requirements for maximum transmission timing difference Inter-band Dual Connectivity ...	238
7.18.1	Introduction.....	238
7.18.2	SCell Activation Delay Requirement for Deactivated SCell	239
7.18.3	SCell Deactivation Delay Requirement for Activated SCell	239
7.19	Radio Link Monitoring for UE Category M1	239
7.19.1	Introduction.....	239
7.19.2	Requirements for FD-FDD and TDD CE mode A.....	239
7.19.2.1	Minimum requirement when no DRX is used.....	240
7.19.2.2	Minimum requirement when DRX is used.....	241
7.19.2.3	Minimum requirement at transitions	242
7.19.3	Requirements for HD-FDD with CE mode A.....	242
7.19.3.1	Minimum requirement when no DRX is used.....	242
7.19.3.2	Minimum requirement when DRX is used.....	242
7.19.3.3	Minimum requirement at transitions	244
7.19.4	Requirements for FD-FDD and TDD with CE mode B.....	244
7.19.4.1	Minimum requirement when no DRX is used.....	245
7.19.4.2	Minimum requirement when DRX is used.....	246
7.19.4.3	Minimum requirement at transitions	247
7.19.5	Requirements for HD-FDD with CE mode B	247

7.19.5.1	Minimum requirement when no DRX is used.....	247
7.19.5.2	Minimum requirement when DRX is used.....	247
7.19.5.3	Minimum requirement at transitions	248
7.20	UE transmit timing for NB-IoT	248
7.20.1	Introduction.....	248
7.20.2	Requirements	249
7.21	UE timer accuracy for NB-IoT.....	249
7.21.1	Introduction.....	249
7.21.2	Requirements	249
7.22	Timing Advance for NB-IoT.....	250
7.22.1	Introduction.....	250
7.22.2	Requirements	250
7.22.2.1	Timing Advance adjustment delay.....	250
7.22.2.2	Timing Advance adjustment accuracy	250
7.23	Radio Link Monitoring for Category NB1 UE.....	250
7.23.1	Introduction.....	250
7.23.2	Requirements for Category NB1 UE	250
7.23.2.1	Minimum requirement when no DRX is used.....	251
7.23.2.2	Minimum requirement when DRX is used.....	251
7.23.2.3	Minimum requirement at transitions	252
7.24	UE transmit timing for Category M1	252
7.24.1	Introduction.....	252
7.24.2	Requirements	252
7.25	Cell phase synchronization accuracy for MBMS services (FDD).....	253
7.25.1	Definition.....	253
7.25.2	Minimum requirements.....	253
7.26	UE transmit timing for Category M2	253
7.26.1	Introduction.....	253
7.26.2	Requirements	254
7.27	UE timer accuracy for category M1	254
7.27.1	Introduction.....	254
7.27.2	Requirements	254
7.28	Timing Advance for Category M1	254
7.28.1	Introduction.....	254
7.28.2	Requirements	254
7.29	Interruptions requirements with FeMBMS.....	254
7.29.1	Introduction.....	254
7.29.2	Requirements	254
7.30	Numerology switching delay requirements with FeMBMS	254
7.30.1	Introduction.....	254
7.30.2	Requirements	255
7.31	NR PSCell Addition and Release Delay for E-UTRA - NR Dual Connectivity	255
7.31.1	Introduction.....	255
7.31.2	NR PSCell Addition Delay Requirement.....	255
7.31.3	NR PSCell Release Delay Requirement	256
7.32	Interruptions with EN-DC	256
7.32.1	Introduction.....	256
7.32.2	Requirements	256
7.32.2.1	Interruptions at PSCell addition/release	256
7.32.2.2	Interruptions at transitions between active and non-active during DRX.....	257
7.32.2.3	Interruptions at transitions from non-DRX to DRX.....	257
7.32.2.4	Interruptions at SCell addition/release	257
7.32.2.5	Interruptions at SCell activation/deactivation	257
7.32.2.6	Interruptions during measurements on SCC	257
7.32.2.6.1	Interruptions during measurements on deactivated NR SCC	257
7.32.2.6.2	Interruptions during measurements on deactivated E-UTRA SCC	258
7.32.2.7	Interruptions at active BWP switching.....	258
7.33	Maximum Transmit/Receive Timing Difference in Carrier Aggregation for sTTI and 1ms-TTI with 3 subframe HARQ processing.....	259
7.33.1	Introduction.....	259
7.33.2	Requirements	259
7.34	Void.....	259

7.35	Interruptions with SFTD measurements	259
7.35.1	Introduction.....	259
7.35.2	Requirements	259
7.36	Interruptions with NE-DC	260
7.32.1	Introduction.....	260
7.36.2	Requirements	260
7.36.2.1	Interruptions at transitions between active and non-active during DRX.....	260
7.36.2.2	Interruptions at transitions from non-DRX to DRX.....	260
7.36.2.3	Interruptions at SCell addition/release	260
7.36.2.4	Interruptions at SCell activation/deactivation	261
7.36.2.5	Interruptions during measurements on SCC	261
7.36.2.5.1	Interruptions during measurements on deactivated NR SCC	261
7.36.2.5.2	Interruptions during measurements on deactivated E-UTRA SCC	261
7.36.2.6	Interruptions at active BWP switching.....	261
8	UE Measurements Procedures in RRC_CONNECTED State	262
8.1	General Measurement Requirements.....	262
8.1.1	Introduction.....	262
8.1.2	Requirements	262
8.1.2.1	UE measurement capability	262
8.1.2.1.1	Monitoring of multiple layers using gaps	269
8.1.2.1.1a	Monitoring of multiple layers using gaps (Increased UE carrier monitoring).....	270
8.1.2.1.1b	Monitoring of multiple layers using gaps (E-UTRA-NR dual connectivity)	271
8.1.2.1.1c	Monitoring of multiple layers using gaps (NE-DC)	273
8.1.2.1.2	Network controlled small gap.....	273
8.1.2.2	E-UTRAN intra frequency measurements	275
8.1.2.2.1	E-UTRAN FDD intra frequency measurements.....	275
8.1.2.2.2	E-UTRAN TDD intra frequency measurements	279
8.1.2.2.3	E-UTRAN FDD intra frequency measurements with autonomous gaps	283
8.1.2.2.4	E-UTRAN TDD intra frequency measurements with autonomous gaps.....	284
8.1.2.2.5	E-UTRAN FDD intra-frequency measurements on carrier with FeMBMS/Unicast mixed cells.....	285
8.1.2.3	E-UTRAN inter frequency measurements	285
8.1.2.3.1	E-UTRAN FDD – FDD inter frequency measurements.....	286
8.1.2.3.2	E-UTRAN TDD – TDD inter frequency measurements	291
8.1.2.3.3	E-UTRAN TDD – FDD inter frequency measurements.....	298
8.1.2.3.4	E-UTRAN FDD – TDD inter frequency measurements.....	298
8.1.2.3.5	E-UTRAN FDD-FDD inter frequency measurements with autonomous gaps.....	298
8.1.2.3.6	E-UTRAN TDD-FDD inter frequency measurements using autonomous gaps	299
8.1.2.3.7	E-UTRAN TDD-TDD inter frequency measurements with autonomous gaps	301
8.1.2.3.8	E-UTRAN FDD-TDD inter frequency measurements using autonomous gaps	302
8.1.2.3.9	E-UTRAN FDD – FDD inter frequency measurements with FeMBMS/Unicast mixed cells	303
8.1.2.3.10	E-UTRAN TDD – FDD inter frequency measurements with FeMBMS/Unicast mixed cells	309
8.1.2.4	Inter RAT measurements	309
8.1.2.4.1	E-UTRAN FDD – UTRAN FDD measurements	309
8.1.2.4.2	E-UTRAN TDD – UTRAN FDD measurements	313
8.1.2.4.3	E-UTRAN TDD – UTRAN TDD measurements.....	314
8.1.2.4.4	E-UTRAN FDD – UTRAN TDD measurements	318
8.1.2.4.5	E-UTRAN FDD – GSM measurements	318
8.1.2.4.6	E-UTRAN TDD – GSM measurements	323
8.1.2.4.7	E-UTRAN FDD – UTRAN FDD measurements for SON.....	323
8.1.2.4.8	E-UTRAN TDD – UTRAN FDD measurements for SON.....	325
8.1.2.4.9	E-UTRAN FDD – cdma2000 1xRTT measurements.....	325
8.1.2.4.9.1A	E-UTRAN FDD – cdma2000 1xRTT measurements when no DRX is used	325
8.1.2.4.10	E-UTRAN TDD – cdma2000 1xRTT measurements.....	325
8.1.2.4.11	E-UTRAN FDD – HRPD measurements	326
8.1.2.4.12	E-UTRAN TDD – HRPD measurements	326
8.1.2.4.13	E-UTRAN TDD – UTRAN TDD measurements for SON	326
8.1.2.4.14	E-UTRAN FDD – UTRAN TDD measurements for SON.....	327
8.1.2.4.15	E-UTRAN FDD – cdma2000 1xRTT measurements for SON ANR.....	327
8.1.2.4.16	E-UTRAN TDD – cdma2000 1xRTT measurements for SON ANR.....	328
8.1.2.4.17	E-UTRAN FDD-UTRAN FDD measurements with autonomous gaps	328

8.1.2.4.18	E-UTRAN TDD-UTRAN FDD measurements with autonomous gaps	329
8.1.2.4.19	E-UTRAN FDD – WLAN measurements	329
8.1.2.4.20	E-UTRAN TDD – WLAN measurements	331
8.1.2.4.21	E-UTRAN FDD – NR measurements	331
8.1.2.4.22	E-UTRAN TDD – NR measurements	334
8.1.2.4.23	Void	334
8.1.2.4.24	Void	334
8.1.2.4.25	E-UTRAN FDD – NR SFTD Measurements	334
8.1.2.4.26	E-UTRAN TDD – NR SFTD Measurements	335
8.1.2.5	E-UTRAN OTDOA Intra-Frequency RSTD Measurements	336
8.1.2.5.1	E-UTRAN FDD Intra-Frequency OTDOA Measurements	336
8.1.2.5.2	E-UTRAN TDD Intra-Frequency OTDOA Measurements	337
8.1.2.5.3	E-UTRAN FDD Intra-Frequency OTDOA Measurements for UE Category 1bis	339
8.1.2.5.4	E-UTRAN TDD Intra-Frequency OTDOA Measurements for UE Category 1bis	341
8.1.2.6.5	Void	342
8.1.2.6.6	Void	342
8.1.2.6.7	Void	342
8.1.2.6.8	Void	342
8.1.2.6	E-UTRAN Inter-Frequency OTDOA Measurements	342
8.1.2.6.1	E-UTRAN FDD-FDD Inter-Frequency OTDOA Measurements	343
8.1.2.6.2	E-UTRAN TDD-FDD Inter-Frequency OTDOA Measurements	345
8.1.2.6.3	E-UTRAN TDD-TDD Inter-Frequency OTDOA Measurements	346
8.1.2.6.4	E-UTRAN FDD-TDD Inter-Frequency OTDOA Measurements	348
8.1.2.6.5	E-UTRAN FDD-FDD Inter-Frequency OTDOA Measurements for UE Category 1bis	350
8.1.2.6.6	E-UTRAN TDD-FDD Inter-Frequency OTDOA Measurements for UE Category 1bis	351
8.1.2.6.7	E-UTRAN TDD-TDD Inter-Frequency OTDOA Measurements for UE Category 1bis	353
8.1.2.6.8	E-UTRAN FDD-TDD Inter-Frequency OTDOA Measurements for UE Category 1bis	355
8.1.2.7	E-UTRAN E-CID Measurements	357
8.1.2.7.1	E-UTRAN FDD UE Rx-Tx Time Difference Measurements	357
8.1.2.7.2	E-UTRAN TDD UE Rx-Tx Time Difference Measurements	358
8.1.2.7.3	E-UTRAN FDD Intra-frequency E-CID RSRP and RSRQ Measurements	359
8.1.2.7.4	E-UTRAN TDD Intra-frequency E-CID RSRP and RSRQ Measurements	360
8.1.2.8	E-UTRAN intra-frequency measurements under time domain measurement resource restriction	360
8.1.2.8.1	E-UTRAN FDD intra-frequency measurements	360
8.1.2.8.2	E-UTRAN TDD intra-frequency measurements	363
8.1.2.8.3	E-UTRAN FDD intra-frequency measurements with CRS assistance information	366
8.1.2.8.4	E-UTRAN TDD intra-frequency measurements with CRS assistance information	370
8.1.2.9	E-UTRAN E-CID Measurements when Time Domain Measurement Resource Restriction Pattern is Configured	373
8.1.2.9.1	E-UTRAN FDD UE Rx-Tx Time Difference Measurements	373
8.1.2.9.2	E-UTRAN TDD UE Rx-Tx Time Difference Measurements	374
8.1.2.9.3	E-UTRAN FDD UE Rx-Tx Time Difference Measurements with CRS Assistance Information	374
8.1.2.9.4	E-UTRAN TDD UE Rx-Tx Time Difference Measurements with CRS Assistance Information	374
8.1.2.10	Void	375
8.2	Capabilities for Support of Event Triggering and Reporting Criteria	375
8.2.1	Introduction	375
8.2.2	Requirements	375
8.3	Measurements for E-UTRA carrier aggregation	378
8.3.1	Introduction	378
8.3.2	Measurements of the primary component carrier	378
8.3.3	Measurements of a secondary component carrier	378
8.3.3.1	Measurements of a secondary component carrier with active SCell	378
8.3.3.2	Measurements of a secondary component carrier with deactivated SCell	379
8.3.3.2.1	E-UTRAN secondary component carrier measurements when no common DRX is used	379
8.3.3.2.2	E-UTRAN secondary component carrier measurements when common DRX is used	380
8.3.3.3	Measurements on a secondary component carrier with FeMBMS/Unicast mixed cells and activated SCell	381
8.3.3.4	Measurements on a secondary component carrier with FeMBMS/Unicast mixed cells and deactivated SCell	382
8.4	OTDOA RSTD Measurements for E-UTRAN carrier aggregation	382

8.4.1	Introduction.....	382
8.4.2	Measurements on the primary component carrier.....	382
8.4.3	Measurements on a secondary component carrier	383
8.4.4	Measurements on both primary component carrier and a secondary component carrier	384
8.4.5	Measurements on different secondary component carriers.....	385
8.5	Measurements for UE category 0	386
8.5.1	Introduction.....	386
8.5.2	Requirements	386
8.5.2.1	E-UTRAN intra frequency measurements	386
8.5.2.1.1	E-UTRAN FDD intra frequency measurements.....	386
8.5.2.1.2	E-UTRAN intra frequency measurements for HD-FDD	389
8.5.2.1.3	E-UTRAN TDD intra frequency measurements	391
8.5.2.1.4	E-UTRAN FDD intra frequency measurements with autonomous gaps for UE category 0	395
8.5.2.1.5	E-UTRAN intra frequency measurements with autonomous gaps for HD-FDD UE category 0 ..	395
8.5.2.1.6	E-UTRAN TDD intra frequency measurements with autonomous gaps for UE category 0	396
8.6	Discovery signal measurements	397
8.6.1	Introduction.....	397
8.6.2	Requirements for CRS based discovery signal measurements	397
8.6.2.1	E-UTRAN intra frequency measurements	397
8.6.2.1.1	E-UTRAN FDD intra frequency measurements.....	397
8.6.2.1.2	E-UTRAN TDD intra frequency measurements	400
8.6.2.2	E-UTRAN inter frequency measurements	402
8.6.2.2.1	E-UTRAN FDD – FDD inter-frequency measurements	403
8.6.2.2.2	E-UTRAN TDD – TDD inter frequency measurements	405
8.6.2.2.3	E-UTRAN TDD – FDD inter frequency measurements.....	408
8.6.2.2.4	E-UTRAN FDD – TDD inter frequency measurements.....	408
8.6.3	Requirements for CSI-RS based discovery signal measurements.....	408
8.6.3.1	E-UTRAN intra frequency measurements	408
8.6.3.1.1	E-UTRAN FDD intra frequency measurements.....	409
8.6.3.1.2	E-UTRAN TDD intra frequency measurements	411
8.6.3.2	E-UTRAN inter frequency measurements	413
8.6.3.2.1	E-UTRAN FDD – FDD inter frequency measurements.....	414
8.6.3.2.2	E-UTRAN TDD – TDD inter frequency measurements	416
8.6.3.2.3	E-UTRAN TDD – FDD inter frequency measurements.....	419
8.6.3.2.4	E-UTRAN FDD – TDD inter frequency measurements.....	419
8.7	Discovery signal measurements for E-UTRA carrier aggregation	419
8.7.1	Introduction.....	419
8.7.2	Requirements for CRS based discovery signal measurements for E-UTRA carrier aggregation	420
8.7.2.1	Measurements of the primary component carrier.....	420
8.7.2.2	Measurements of a secondary component carrier	420
8.7.2.3	Measurements of a secondary component carrier with active SCell.....	420
8.7.2.4	Measurements of a secondary component carrier with deactivated SCell	420
8.7.2.4.1	E-UTRAN secondary component carrier measurements when no common DRX is used	420
8.7.2.4.2	E-UTRAN secondary component carrier measurements when common DRX is used.....	421
8.7.3	Requirements for CSI-RS based discovery signal measurements for E-UTRA carrier aggregation	423
8.7.3.1	Measurements of the primary component carrier.....	423
8.7.3.2	Measurements of a secondary component carrier	423
8.7.3.3	Measurements of a secondary component carrier with active SCell.....	423
8.7.3.4	Measurements of a secondary component carrier with deactivated SCell	423
8.7.3.4.1	E-UTRAN secondary component carrier measurements when no common DRX is used	423
8.7.3.4.2	E-UTRAN secondary component carrier measurements when common DRX is used.....	425
8.8	Measurements for E-UTRA dual connectivity	426
8.8.1	Introduction.....	426
8.8.2	Intra-frequency measurements requirements on PCell	426
8.8.3	Intra-frequency measurements requirements on PSCell	427
8.8.4	Inter-frequency and inter-RAT measurement requirements	427
8.8.5	Intra-frequency measurements with autonomous gaps	427
8.8.5.1	Identification of a new CGI of E-UTRA cell with autonomous gaps	427
8.8.5.2	ECGI reporting delay	428
8.8.6	Inter-frequency measurements with autonomous gaps	428
8.8.6.1	Identification of a new CGI of E-UTRA cell with autonomous gaps	428
8.8.6.2	ECGI reporting delay	429

8.8.7	SSTD Measurements	429
8.8.7.1	Introduction	429
8.8.7.2	SSTD Measurement requirements	429
8.8.7.3	SSTD Measurement Reporting Delay	430
8.8.8	Intra-frequency measurements requirements on SCell	430
8.9	MBSFN Measurements	430
8.9.1	Introduction	430
8.9.2	MBSFN RSRP Measurements	430
8.9.3	MBSFN RSRQ Measurements	431
8.9.4	MCH BLER Measurements	431
8.10	Proximity-based Services	431
8.10.1	Introduction	431
8.10.2	Requirements	431
8.10.2.1	Initiation/Cease of SLSS transmissions with ProSe Direct Discovery	431
8.10.2.2	Initiation/Cease of SLSS transmissions with ProSe Direct Communication	432
8.11	Discovery Signal Measurements under Operation with Frame Structure 3	432
8.11.1	Introduction	432
8.11.2	CRS based discovery signal measurements	433
8.11.2.1	E-UTRAN intra-frequency measurements	433
8.11.2.1.1	Requirements	433
8.11.2.1.1.1	Requirements when no DRX is used	433
8.11.2.1.1.1.1	Measurement Reporting Requirements	434
8.11.2.1.1.2	Requirements when DRX is used	435
8.11.2.1.1.2.1	Measurement Reporting Requirements	437
8.11.2.2	E-UTRAN inter-frequency measurements	437
8.11.2.2.1	E-UTRAN FDD-FS3 inter-frequency measurements	438
8.11.2.2.2	E-UTRAN TDD – FS3 inter-frequency measurements	442
8.11.3	CSI-RS based discovery signal measurements	442
8.11.3.1	E-UTRAN intra-frequency measurements	442
8.11.3.1.1	Requirements	442
8.11.3.1.1.1	Requirements when no DRX is used	442
8.11.3.1.1.1.1	Measurement Reporting Requirements	443
8.11.3.1.1.2	Requirements when DRX is used	444
8.11.3.1.1.2.1	Measurement Reporting Requirements	445
8.11.3.2	E-UTRAN inter-frequency measurements	446
8.11.3.2.1	E-UTRAN FDD – FS3 inter-frequency measurements	446
8.11.3.2.2	E-UTRAN TDD – FS3 inter-frequency measurements	449
8.11.4	RSSI measurements	449
8.11.4.1	E-UTRAN intra-frequency measurements	449
8.11.4.2	E-UTRAN inter-frequency measurements	450
8.11.5	Channel occupancy measurements	450
8.11.5.1	E-UTRAN intra-frequency channel occupancy measurements	450
8.11.5.2	E-UTRAN inter-frequency channel occupancy measurements	450
8.12	Discovery Signal Measurements for E-UTRA Carrier Aggregation under Operation with Frame Structure 3	451
8.12.1	Introduction	451
8.12.2	CRS based discovery signal measurements for E-UTRA carrier aggregation	451
8.12.2.1	Introduction	451
8.12.2.2	Measurements of a secondary component carrier	451
8.12.2.3	Measurements of a secondary component carrier with active SCell	451
8.12.2.4	Measurements of a secondary component carrier with deactivated SCell	451
8.12.2.4.1	E-UTRAN secondary component carrier measurements when no common DRX is used	451
8.12.2.4.2	E-UTRAN secondary component carrier measurements when common DRX is used	453
8.12.3	Requirements for CSI-RS based discovery signal measurements for E-UTRA carrier aggregation	456
8.12.3.1	Introduction	456
8.12.3.2	Measurements of a secondary component carrier	456
8.12.3.3	Measurements of a secondary component carrier with active SCell	456
8.12.3.4	Measurements of a secondary component carrier with deactivated SCell	456
8.12.3.4.1	E-UTRAN secondary component carrier measurements when no common DRX is used	456
8.12.3.4.2	E-UTRAN secondary component carrier measurements when common DRX is used	458
8.13	Measurements for UE Category M1	460
8.13.1	Introduction	460

8.13.2	Requirements for UE category M1 with CE mode A	460
8.13.2.1	E-UTRAN intra frequency measurements by UE category M1 with CE mode A	460
8.13.2.1.1	E-UTRAN FDD intra frequency measurements.....	460
8.13.2.1.2	E-UTRAN intra frequency measurements for HD-FDD	464
8.13.2.1.3	E-UTRAN TDD intra frequency measurements	466
8.13.2.2	Void.....	470
8.13.2.3	E-UTRAN OTDOA Intra-Frequency RSTD Measurements for Cat-M1 UE in CEModeA.....	470
8.13.2.3.1	E-UTRAN FDD Intra-Frequency OTDOA Measurements	471
8.13.2.3.2	E-UTRAN TDD Intra-Frequency OTDOA Measurements.....	473
8.13.2.3.3	E-UTRAN HD-FDD Intra-Frequency OTDOA Measurements	476
8.13.2.4	E-UTRAN OTDOA Inter-Frequency RSTD Measurements for Cat-M1 UE in CEModeA.....	476
8.13.2.4.1	E-UTRAN FDD Inter-Frequency OTDOA Measurements	476
8.13.2.4.2	E-UTRAN TDD Inter-Frequency OTDOA Measurements.....	478
8.13.2.4.3	E-UTRAN HD-FDD Inter-Frequency OTDOA Measurements	481
8.13.2.5	E-UTRAN E-CID Measurements Requirements for UE category M1 with CE mode A	481
8.13.2.5.1	Intra-frequency FDD E-CID RSRP and RSRQ Measurements for Cat-M1 UE in CEModeA	481
8.13.2.5.2	Intra-frequency HD-FDD E-CID RSRP and RSRQ Measurements for Cat-M1 UE in CEModeA.....	482
8.13.2.5.3	Intra-frequency TDD E-CID RSRP and RSRQ Measurements for Cat-M1 UE in CEModeA	482
8.13.2.5.4	Inter-frequency FDD E-CID RSRP and RSRQ Measurements for Cat-M1 UE in CEModeA	482
8.13.2.5.5	Inter-frequency HD-FDD E-CID RSRP and RSRQ Measurements for Cat-M1 UE in CEModeA.....	483
8.13.2.5.6	Inter-frequency TDD E-CID RSRP and RSRQ Measurements for Cat-M1 UE in CEModeA	483
8.13.2.5.7	E-UTRAN FDD UE Rx-Tx Time Difference Measurements for UE category M1 in CEModeA.....	483
8.13.2.5.8	E-UTRAN TDD UE Rx-Tx Time Difference Measurements for UE category M1 in CEModeA.....	484
8.13.2.5.9	E-UTRAN HD-FDD UE Rx-Tx Time Difference Measurements for UE category M1 in CEModeA.....	485
8.13.2.6	E-UTRAN inter frequency measurements by UE category M1 with CE mode A	486
8.13.2.6.1	E-UTRAN FDD - FDD inter frequency measurements	486
8.13.2.6.2	E-UTRAN inter-frequency measurements for HD-FDD.....	490
8.13.2.6.3	E-UTRAN TDD inter frequency measurements	492
8.13.2.7	Maximum allowed layers for multiple monitoring for UE category M1 with CE mode A.....	496
8.13.3	Requirements for UE category M1 with CE mode B	496
8.13.3.1	E-UTRAN intra frequency measurements by UE category M1 with CE mode B	496
8.13.3.1.1	E-UTRAN FDD intra frequency measurements.....	497
8.13.3.1.2	E-UTRAN intra frequency measurements for HD-FDD	501
8.13.3.1.3	E-UTRAN TDD intra frequency measurements	503
8.13.3.1.4	E-UTRAN FDD intra frequency measurements with autonomous gaps for UE category M1 with CE mode B	508
8.13.3.1.5	E-UTRAN intra frequency measurements with autonomous gaps for HD-FDD UE category M1 with CE mode B.....	509
8.13.3.1.6	E-UTRAN TDD intra frequency measurements with autonomous gaps for UE category M1 with CE mode B	509
8.13.3.2	Void.....	510
8.13.3.3	E-UTRAN OTDOA Intra-Frequency RSTD Measurements for Cat-M1 UE in CEModeB	510
8.13.3.3.1	E-UTRAN FDD Intra-Frequency OTDOA Measurements	511
8.13.3.3.2	E-UTRAN TDD Intra-Frequency OTDOA Measurements.....	513
8.13.3.3.3	E-UTRAN HD-FDD Intra-Frequency OTDOA Measurements	516
8.13.3.4	E-UTRAN E-CID Measurements Requirements for UE category M1 with CE mode B.....	516
8.13.3.4.1	Intra-frequency E-CID FDD RSRP and RSRQ Measurements for Cat-M1 UE in CEModeB	516
8.13.3.4.2	Intra-frequency HD-FDD E-CID RSRP and RSRQ Measurements for Cat-M1 UE in CEModeB.....	517
8.13.3.4.3	Intra-frequency TDD E-CID RSRP and RSRQ Measurements for Cat-M1 UE in CEModeB	517
8.13.3.4.4	Inter-frequency E-CID FDD RSRP and RSRQ Measurements for Cat-M1 UE in CEModeB	517
8.13.3.4.5	Inter-frequency HD-FDD E-CID RSRP and RSRQ Measurements for Cat-M1 UE in CEModeB.....	518
8.13.3.4.6	Inter-frequency TDD E-CID RSRP and RSRQ Measurements for Cat-M1 UE in CEModeB	518
8.13.3.5	E-UTRAN inter frequency measurements by UE category M1 with CE Mode B.....	519
8.13.3.5.1	E-UTRAN FDD - FDD inter frequency measurements	519
8.13.3.5.2	E-UTRAN inter-frequency measurements for HD-FDD.....	523

8.13.3.5.3	E-UTRAN TDD inter frequency measurements	525
8.13.3.6	Maximum allowed layers for multiple monitoring for UE category M1 with CE mode B	530
8.13.3.7	E-UTRAN OTDOA Inter-Frequency RSTD Measurements for Cat-M1 UE in CEModeB	530
8.13.3.7.1	E-UTRAN FDD Inter-Frequency OTDOA Measurements	530
8.13.3.7.2	E-UTRAN TDD Inter-Frequency OTDOA Measurements	532
8.13.3.7.3	E-UTRAN HD-FDD Inter-Frequency OTDOA Measurements	535
8.14	Measurements for UE category NB1	535
8.14.1	Introduction	535
8.14.2	NB-IoT intra frequency measurements under normal coverage	535
8.14.2.1	NB-IoT intra frequency measurements when no DRX is used	535
8.14.2.2	NB-IoT intra frequency measurements when DRX is used	536
8.14.3	NB-IoT intra frequency measurements under enhanced coverage	536
8.14.3.1	NB-IoT intra frequency measurements when no DRX is used	536
8.14.3.2	NB-IoT intra frequency measurements when DRX is used	536
8.15	Void	536
8.16	Measurements for UE Category M2	536
8.16.1	Introduction	536
8.16.2	Requirements for UE category M2 with CE mode A	537
8.16.2.1	E-UTRAN FDD UE Rx-Tx Time Difference Measurements for UE category M2 in CEModeA	537
8.16.2.1.1	UE Rx-Tx Measurement Reporting Delay	537
8.16.2.2	E-UTRAN TDD UE Rx-Tx Time Difference Measurements for UE category M2 in CEModeA	537
8.16.2.2.1	UE Rx-Tx Measurement Reporting Delay	538
8.16.2.2a	E-UTRAN HD-FDD UE Rx-Tx Time Difference Measurements for UE category M2 in CEModeA	538
8.16.2.2a.1	UE Rx-Tx Measurement Reporting Delay	539
8.16.2.3	E-UTRAN OTDOA Intra-Frequency RSTD Measurements for Cat-M2 UE in CEModeA	539
8.16.2.3.1	E-UTRAN FDD Intra-Frequency OTDOA Measurements	539
8.16.2.3.2	E-UTRAN TDD Intra-Frequency OTDOA Measurements	542
8.16.2.3.3	E-UTRAN HD-FDD Intra-Frequency OTDOA Measurements	544
8.16.2.4	E-UTRAN OTDOA Inter-Frequency RSTD Measurements for Cat-M2 UE in CEModeA	545
8.16.2.4.1	E-UTRAN FDD Inter-Frequency OTDOA Measurements	545
8.16.2.4.2	E-UTRAN TDD Inter-Frequency OTDOA Measurements	547
8.16.2.4.3	E-UTRAN HD-FDD Inter-Frequency OTDOA Measurements	549
8.16.3	Requirements for UE category M2 with CE mode B	550
8.16.3.1	E-UTRAN OTDOA Intra-Frequency RSTD Measurements for Cat-M2 UE in CEModeB	550
8.16.3.1.1	E-UTRAN FDD Intra-Frequency OTDOA Measurements	550
8.16.3.1.2	E-UTRAN TDD Intra-Frequency OTDOA Measurements	553
8.16.3.1.3	E-UTRAN HD-FDD Intra-Frequency OTDOA Measurements	555
8.16.3.2	E-UTRAN OTDOA Inter-Frequency RSTD Measurements for Cat-M2 UE in CEModeB	555
8.16.3.2.1	E-UTRAN FDD Inter-Frequency OTDOA Measurements	556
8.16.3.2.2	E-UTRAN TDD Inter-Frequency OTDOA Measurements	558
8.16.3.2.3	E-UTRAN HD-FDD Inter-Frequency OTDOA Measurements	560
8.17	Measurements for E-UTRA – NR Dual Connectivity	561
8.17.1	Introduction	561
8.17.1.1	Measurement Gap Sharing	561
8.17.1A	Intrafrequency Measurements	561
8.17.2	SFTD Measurements	562
8.17.2.1	Introduction	562
8.17.2.2	SFTD Measurement requirements	562
8.17.2.3	SFTD Measurement Reporting Delay	562
8.17.3	E-UTRA Inter-frequency Measurements when Configured with E-UTRA-NR Dual Connectivity Operation	563
8.17.3.1	Introduction	563
8.17.3.2	E-UTRAN FDD inter frequency measurements	563
8.17.3.2.1	E-UTRAN FDD inter frequency measurements when no DRX is used	563
8.17.3.2.2	E-UTRAN FDD inter frequency measurements when DRX is used	564
8.17.3.3	E-UTRAN TDD inter frequency measurements	566
8.17.3.3.1	E-UTRAN TDD inter frequency measurements when no DRX is used	566
8.17.3.3.2	E-UTRAN TDD inter frequency measurements when DRX is used	568
8.17.4	E-UTRA Inter-RAT NR Measurements when Configured with E-UTRA-NR Dual Connectivity Operation	570
8.17.4.1	E-UTRAN FDD – NR measurements when configured with E-UTRA-NR Dual connectivity	570

8.17.4.1.1	NR Inter-RAT cell identification.....	570
8.17.4.1.2	NR Inter-RAT measurement	572
8.17.4.1.3	NR Inter-RAT measurement reporting	572
8.17.4.2	E-UTRAN TDD – NR measurements when configured with E-UTRA-NR Dual connectivity	573
8.17.5	E-UTRAN FDD – UTRAN FDD measurements when Configured with E-UTRA-NR Dual Connectivity.....	573
8.17.5.1	Introduction.....	573
8.17.5.2	E-UTRAN FDD – UTRAN FDD measurements when no DRX is used	573
8.17.5.2.1	Identification of a new UTRA FDD cell	573
8.17.5.2.2	Enhanced UTRA FDD cell identification requirements	574
8.17.5.2.3	UE UTRA FDD CPICH measurement capability	574
8.17.5.2.4	Periodic Reporting.....	574
8.17.5.2.5	Event Triggered Reporting	574
8.17.5.2.6	Event-triggered Periodic Reporting.....	575
8.17.5.3	E-UTRAN FDD – UTRAN FDD measurements when DRX is used	575
8.17.5.3.1	Periodic Reporting.....	576
8.17.5.3.2	Event Triggered Reporting	576
8.17.5.3.3	Event-triggered Periodic Reporting.....	577
8.17.6	E-UTRAN TDD – UTRAN FDD measurements when Configured with E-UTRA-NR Dual Connectivity.....	577
8.17.7	E-UTRAN FDD – UTRAN FDD measurements for SON when Configured with E-UTRA-NR Dual Connectivity.....	577
8.17.7.1	Introduction.....	577
8.17.7.2	Identification of a new UTRA FDD cell for SON	577
8.17.7.2.1	Requirements when no DRX is used	577
8.17.7.2.2	Requirements when DRX is used	578
8.17.7.2.3	Reporting Delay.....	578
8.17.8	E-UTRAN TDD – UTRAN FDD measurements for SON when Configured with E-UTRA-NR Dual Connectivity.....	579
8.17.9	E-UTRAN TDD – UTRAN TDD measurements when Configured with E-UTRA-NR Dual Connectivity.....	579
8.17.9.1	Introduction.....	579
8.17.9.2	E-UTRAN FDD – UTRAN TDD measurements when no DRX is used	579
8.17.9.2.1	Identification of a new UTRA FDD cell	579
8.17.9.2.2	Enhanced UTRA TDD cell identification requirements.....	579
8.17.9.2.3	UE UTRA TDD P-CCPCH RSCP measurement capability.....	580
8.17.9.2.4	Periodic Reporting.....	580
8.17.9.2.5	Event Triggered Reporting	580
8.17.9.2.6	Event-triggered Periodic Reporting.....	580
8.17.9.3	E-UTRAN TDD – UTRAN TDD measurements when DRX is used.....	581
8.17.9.3.1	Periodic Reporting.....	582
8.17.9.3.2	Event Triggered Reporting	582
8.17.9.3.3	Event-triggered Periodic Reporting.....	582
8.17.10	E-UTRAN FDD – UTRAN TDD measurements when Configured with E-UTRA-NR Dual Connectivity.....	582
8.17.11	E-UTRAN TDD – UTRAN TDD measurements for SON when Configured with E-UTRA-NR Dual Connectivity.....	582
8.17.11.1	Introduction.....	582
8.17.11.2	Identification of a new UTRA TDD cell for SON	583
8.17.11.2.1	Requirements when no DRX is used	583
8.17.11.2.2	Requirements when DRX is used	583
8.17.11.2.3	Reporting Delay.....	584
8.17.12	E-UTRAN FDD – UTRAN TDD measurements for SON when Configured with E-UTRA-NR Dual Connectivity.....	584
8.17.13	E-UTRAN FDD – GSM measurements when Configured with E-UTRA-NR Dual Connectivity	584
8.17.13.1	Introduction.....	584
8.17.13.2	E-UTRAN FDD – GSM measurements when no DRX is used	584
8.17.13.2.1	GSM carrier RSSI.....	584
8.17.13.2.2	BSIC verification.....	585
8.17.13.2.3	Enhanced BSIC verification	586
8.17.13.2.4	Periodic Reporting.....	587
8.17.13.2.5	Event Triggered Reporting	587

8.17.13.2.6	Event-triggered Periodic Reporting	587
8.17.13.3	E-UTRAN FDD – GSM measurements when DRX is used	587
8.17.13.3.1	GSM carrier RSSI.....	587
8.17.13.3.2	BSIC verification.....	588
8.17.13.3.3	Periodic Reporting.....	589
8.17.13.3.4	Event Triggered Reporting	589
8.17.13.3.5	Event-triggered Periodic Reporting.....	589
8.17.14	E-UTRAN TDD – GSM measurements when Configured with E-UTRA-NR Dual Connectivity	590
8.17.15	E-UTRAN Inter-Frequency RSTD measurements when configured with E-UTRA-NR Dual Connectivity.....	590
8.17.15.1	E-UTRAN FDD-FDD Inter-Frequency RSTD measurements when configured with E-UTRA-NR Dual Connectivity.....	590
8.17.15.1.1	RSTD measurement Reporting Delay	590
8.17.15.2	E-UTRAN TDD-FDD Inter-Frequency RSTD measurements when configured with E-UTRA-NR Dual Connectivity.....	590
8.17.15.2.1	RSTD measurement Reporting Delay	591
8.17.15.3	E-UTRAN TDD-TDD Inter-Frequency RSTD measurements when configured with E-UTRA-NR Dual Connectivity.....	591
8.17.15.3.1	RSTD measurement Reporting Delay	591
8.17.15.4	E-UTRAN FDD-TDD Inter-Frequency RSTD measurements when configured with E-UTRA-NR Dual Connectivity.....	591
8.17.15.4.1	RSTD measurement Reporting Delay	592
8.18	Measurements for non-BL/CE UE	592
8.18.1	Introduction.....	592
8.18.2	Requirements for non-BL/CE UE with CE Mode B.....	592
8.18.2.1	E-UTRAN intra frequency measurements	592
8.18.2.1.1	E-UTRAN FDD intra frequency measurements with autonomous gaps for non-BL/CE with CE Mode B	592
8.18.2.1.2	E-UTRAN intra frequency measurements with autonomous gaps for HD-FDD non-BL/CE with CE Mode B	593
8.18.2.1.3	E-UTRAN TDD intra frequency measurements with autonomous gaps for non-BL/CE with CE Mode B	593
8.19	Measurements for NR – E-UTRA Dual Connectivity	594
8.19.1	Introduction.....	594
8.19.2	Intra-frequency Measurements	594
8.19.3	Inter-frequency Measurements	595
8.19.4	Void	595
8.19.5	Intra-frequency E-CID Measurements.....	595
9	Measurements performance requirements for UE.....	595
9.1	E-UTRAN measurements.....	595
9.1.1	Introduction.....	595
9.1.2	Intra-frequency RSRP Accuracy Requirements.....	596
9.1.2.1	Absolute RSRP Accuracy	596
9.1.2.2	Relative Accuracy of RSRP	596
9.1.2.3	Absolute RSRP Accuracy under Time Domain Measurement Resource Restriction	597
9.1.2.4	Relative Accuracy of RSRP under Time Domain Measurement Resource Restriction	598
9.1.2.5	Absolute RSRP Accuracy under Time Domain Measurement Resource Restriction with CRS assistance information.....	599
9.1.2.6	Relative Accuracy of RSRP under Time Domain Measurement Resource Restriction with CRS assistance information.....	599
9.1.2.7	Absolute RSRP Accuracy for UE Category 1bis	600
9.1.2.8	Relative Accuracy of RSRP for UE Category 1bis	601
9.1.2A	Intra-frequency RSRP Accuracy Requirements in High Doppler Conditions	602
9.1.2A.1	Absolute RSRP Accuracy in high Doppler conditions.....	602
9.1.2A.2	Relative Accuracy of RSRP in high Doppler conditions	602
9.1.2B	Intra-frequency RSRP Accuracy requirements for CA Idle Mode Measurements	603
9.1.2B.1	Introduction.....	603
9.1.2B.2	Intra-frequency Absolute RSRP Accuracy for CA Idle Mode Measurements.....	603
9.1.3	Inter-frequency RSRP Accuracy Requirements.....	604
9.1.3.1	Absolute RSRP Accuracy	604
9.1.3.2	Relative Accuracy of RSRP	604

9.1.3.3	Absolute RSRP Accuracy for UE Category 1bis	605
9.1.3.4	Relative Accuracy of RSRP for UE Category 1bis	606
9.1.3A	Inter-frequency RSRP Accuracy Requirements in High Doppler Conditions	606
9.1.3A.1	Absolute RSRP Accuracy in high Doppler conditions.....	606
9.1.3A.2	Relative Accuracy of RSRP in high Doppler conditions	607
9.1.3B	Inter-frequency RSRP Accuracy requirements for CA Idle Mode Measurements	608
9.1.3B.1	Introduction.....	608
9.1.3B.2	Inter-frequency Absolute RSRP Accuracy for Overlapping Carrier	608
9.1.3B.3	Inter-frequency Absolute RSRP Accuracy for Overlapping and Non-overlapping Carrier	608
9.1.4	RSRP Measurement Report Mapping.....	609
9.1.5	Intra-frequency RSRQ Accuracy Requirements	609
9.1.5.1	Absolute RSRQ Accuracy.....	609
9.1.5.2	Absolute RSRQ Accuracy under Time Domain Measurement Resource Restriction.....	610
9.1.5.3	Absolute RSRQ Accuracy under Time Domain Measurement Resource Restriction with CRS assistance information.....	611
9.1.5.4	Absolute WB-RSRQ Accuracy.....	612
9.1.5.5	Absolute RSRQ Accuracy for UE Category 1bis.....	612
9.1.5A	Intra-frequency RSRQ Accuracy Requirements in High Doppler Conditions	613
9.1.5A.1	Absolute RSRQ Accuracy in high Doppler conditions	613
9.1.5B	Intra-frequency RSRQ Accuracy requirements for CA Idle Mode Measurements.....	614
9.1.5B.1	Introduction.....	614
9.1.5B.2	Intra-frequency Absolute RSRQ Accuracy for CA Idle Mode Measurements	614
9.1.6	Inter-frequency RSRQ Accuracy Requirements	615
9.1.6.1	Absolute RSRQ Accuracy.....	615
9.1.6.2	Relative Accuracy of RSRQ	615
9.1.6.3	Absolute WB-RSRQ Accuracy	616
9.1.6.4	Relative WB-RSRQ Accuracy	616
9.1.6.5	Absolute RSRQ Accuracy for UE Category 1bis.....	617
9.1.6.6	Relative Accuracy of RSRQ for UE Category 1bis	618
9.1.6A	Inter-frequency RSRQ Accuracy Requirements in High Doppler Conditions	618
9.1.6A.1	Absolute RSRQ Accuracy in high Doppler conditions	619
9.1.6A.2	Relative Accuracy of RSRQ in high Doppler conditions.....	619
9.1.6B	Inter-frequency absolute RSRQ Accuracy requirements for CA Idle Mode Measurements	620
9.1.6B.1	Introduction.....	620
9.1.6B.2	Inter-frequency Absolute RSRQ Accuracy for Overlapping Carrier	620
9.1.6B.3	Inter-frequency absolute RSRQ Accuracy for Overlapping and Non-overlapping Carrier.....	621
9.1.7	RSRQ Measurement Report Mapping	621
9.1.8	Power Headroom	622
9.1.8.1	Period.....	622
9.1.8.2	Reporting Delay	622
9.1.8.3	Void.....	622
9.1.8.4	Report Mapping	622
9.1.9	UE Rx – Tx time difference.....	623
9.1.9.1	Measurement Requirement	623
9.1.9.2	Measurement Report mapping	623
9.1.9.3	Measurement Requirement under Time Domain Measurement Resource Restriction	624
9.1.9.4	Measurement Requirement when Time Domain Measurement Resource Restriction Pattern is Configured with CRS Assistance Information	625
9.1.10	Reference Signal Time Difference (RSTD).....	626
9.1.10.1	Intra-Frequency Accuracy Requirement	626
9.1.10.2	Inter-Frequency Accuracy Requirement	627
9.1.10.3	RSTD Measurement Report Mapping.....	628
9.1.10.4	Higher-Resolution RSTD Measurement Report Mapping	629
9.1.10.5	Intra-Frequency Accuracy Requirement for UE Category 1bis	629
9.1.10.6	Inter-Frequency Accuracy Requirement for UE Category 1bis	630
9.1.11	Carrier aggregation measurement accuracy	631
9.1.11.1	Primary component carrier accuracy requirement	631
9.1.11.2	Secondary component carrier accuracy requirement.....	632
9.1.11.3	Primary and secondary component carrier relative accuracy requirement.....	632
9.1.11.4	Secondary component carrier relative accuracy requirement.....	632
9.1.12	Reference Signal Time Difference (RSTD) Measurement Accuracy Requirements for Carrier Aggregation	632

9.1.13	Measurement accuracy for UE category 0	633
9.1.13.1	Intra-frequency Absolute RSRP Accuracy for UE category 0	633
9.1.13.2	Intra-frequency Relative Accuracy of RSRP for UE category 0	633
9.1.13.3	Intra-frequency Absolute RSRQ Accuracy for UE category 0	634
9.1.14	Accuracy requirements for Discovery Signal Measurements	635
9.1.14.1	Introduction	635
9.1.14.2	RSRP measurements in discovery signal occasions	635
9.1.14.3	CSI-RSRP measurements in discovery signal occasions	635
9.1.14.3.1	Intra-frequency CSI-RSRP measurements	635
9.1.14.3.1.1	Absolute CSI-RSRP measurement requirements	635
9.1.14.3.1.2	Relative CSI-RSRP measurement requirements	636
9.1.14.3.2	Inter-frequency CSI-RSRP measurements	636
9.1.14.3.2.1	Absolute CSI-RSRP measurement requirements	636
9.1.14.3.2.2	Relative CSI-RSRP measurement requirements	637
9.1.14.3.3	CSI-RSRP measurement report mapping	637
9.1.14.4	RSRQ measurements in discovery signal occasions	638
9.1.15	Discovery signal measurements accuracy for E-UTRAN carrier aggregation	638
9.1.15.1	Requirements for CRS based discovery signal measurements accuracy for E-UTRAN carrier aggregation	638
9.1.15.1.1	Primary component carrier accuracy requirement	638
9.1.15.1.2	Secondary component carrier accuracy requirement	638
9.1.15.1.3	Primary and secondary component carrier relative accuracy requirement	638
9.1.15.1.4	Secondary component carrier relative accuracy requirement	639
9.1.15.2	Requirements for CSI-RS based discovery signal measurements accuracy for E-UTRAN carrier aggregation	639
9.1.15.2.1	Primary component carrier accuracy requirement	639
9.1.15.2.2	Secondary component carrier accuracy requirement	639
9.1.15.2.3	Primary and secondary component carrier relative accuracy requirement	639
9.1.15.2.4	Secondary component carrier relative accuracy requirement	639
9.1.16	Accuracy requirements for RSRQ measurement on all OFDM symbols	639
9.1.17	RS-SINR Measurements	640
9.1.17.1	Measurement Report Mapping	640
9.1.17.2	Intra-frequency RS-SINR Measurement Accuracy Requirements	640
9.1.17.2.1	Absolute RS-SINR Measurement Accuracy Requirements	640
9.1.17.3	Inter-frequency RS-SINR Measurement Accuracy Requirements	641
9.1.17.3.1	Absolute RS-SINR Measurement Accuracy Requirements	641
9.1.17.3.2	Relative RS-SINR Measurement Accuracy Requirements	641
9.1.18	Accuracy Requirements for Measurements under Operation with Frame Structure 3	642
9.1.18.1	Introduction	642
9.1.18.2	RSRP measurements	642
9.1.18.2.1	RSRP measurement report mapping	642
9.1.18.2.2	Inter-frequency absolute RSRP measurement accuracy requirements	642
9.1.18.2.3	Inter-frequency relative RSRP measurement accuracy requirements	643
9.1.18.2.4	Intra-frequency absolute RSRP measurement accuracy requirements	643
9.1.18.2.5	Intra-frequency relative RSRP measurement accuracy requirements	644
9.1.18.3	RSRQ measurements	644
9.1.18.3.1	RSRQ measurement report mapping	644
9.1.18.3.2	Inter-frequency absolute RSRQ measurement accuracy requirements	644
9.1.18.3.3	Inter-frequency relative RSRQ measurement accuracy requirements	645
9.1.18.3.4	Intra-frequency absolute RSRQ measurement accuracy requirements	645
9.1.18.4	CSI-RSRP measurements	646
9.1.18.4.1	CSI-RSRP measurement report mapping	646
9.1.18.4.2	Inter-frequency absolute CSI-RSRP measurement accuracy requirements	646
9.1.18.4.3	Inter-frequency relative CSI-RSRP measurement accuracy requirements	646
9.1.18.4.4	Intra-frequency absolute CSI-RSRP measurement accuracy requirements	647
9.1.18.4.5	Intra-frequency relative CSI-RSRP measurement accuracy requirements	647
9.1.18.5	RSSI measurements	648
9.1.18.5.1	RSSI measurement report mapping	648
9.1.18.5.2	Intra-frequency absolute RSSI measurement accuracy requirements	648
9.1.18.5.3	Inter-frequency absolute RSSI measurement accuracy requirements	649
9.1.18.6	Channel occupancy measurements	649
9.1.18.6.1	Intra-frequency channel occupancy measurement accuracy requirements	649

9.1.18.6.2	Inter-frequency channel occupancy measurement accuracy requirements	649
9.1.19	Accuracy Requirements for Carrier Aggregation for Measurements under Operation with Frame Structure 3	650
9.1.19.1	Introduction	650
9.1.19.2	Accuracy requirements for measurements on SCC	650
9.1.19.3	Relative accuracy requirements for measurements on different SCCs	650
9.1.19.4	Relative accuracy requirements for measurements on SCC and PCC	650
9.1.20	SFN and Subframe Time Difference (SSTD)	651
9.1.20.1	SSTD Accuracy Requirement	651
9.1.20.2	SSTD Measurement Report Mapping	651
9.1.21	Measurement accuracy for UE category M1	652
9.1.21.1	Intra-frequency Absolute RSRP Accuracy for UE category M1 with CE mode A	652
9.1.21.2	Intra-frequency Relative Accuracy of RSRP for UE category M1 with CE mode A	653
9.1.21.3	Intra-frequency Absolute RSRP Accuracy for UE category M1 with CE mode B	654
9.1.21.4	Intra-frequency Relative Accuracy of RSRP for UE category M1 with CE mode B	655
9.1.21.5	RSRP Measurement Report Mapping	656
9.1.21.6	Intra-frequency Absolute Accuracy of RSRQ for UE category M1 with CE mode A	656
9.1.21.7	Intra-frequency Absolute Accuracy of RSRQ for UE category M1 with CE mode B	657
9.1.21.8	RSRQ Measurement Report Mapping	658
9.1.21.9	Inter-frequency Absolute RSRP Accuracy for UE category M1 with CE mode A	658
9.1.21.10	Inter-frequency Relative Accuracy of RSRP for UE category M1 with CE mode A	659
9.1.21.11	Inter-frequency Absolute RSRP Accuracy for UE category M1 with CE mode B	660
9.1.21.12	Inter-frequency Relative Accuracy of RSRP for UE category M1 with CE mode B	661
9.1.21.13	Inter-frequency Absolute Accuracy of RSRQ for UE category M1 in CE mode A	662
9.1.21.14	Inter-frequency Relative Accuracy of RSRQ for UE category M1 in CE mode A	663
9.1.21.15	Inter-frequency Absolute Accuracy of RSRQ for UE category M1 in CE mode B	664
9.1.21.16	Inter-frequency Relative Accuracy of RSRQ for UE category M1 in CE mode B	665
9.1.21.17	Inter-Frequency RSTD Accuracy Requirement for UE category M1 in CE mode A	666
9.1.21.18	Inter-Frequency RSTD Accuracy Requirement for UE category M1 in CE mode B	667
9.1.21.19	UE RX-TX time difference Accuracy Requirement for Cat-M1	668
9.1.21.20	Intra-Frequency RSTD Accuracy Requirement for UE category M1 in CE mode A	669
9.1.21.21	Intra-Frequency RSTD Accuracy Requirement for UE category M1 in CE mode B	670
9.1.22	Measurement accuracy for UE Category NB1	671
9.1.22.1	Intra-frequency Absolute NRSRP Accuracy for UE Category NB1	671
9.1.22.2	Void	672
9.1.22.3	Intra-frequency Absolute NRSRQ Accuracy for UE Category NB1	672
9.1.22.4	Void	673
9.1.22.5	Inter-frequency Absolute NRSRP Accuracy for UE Category NB1	673
9.1.22.6	Void	674
9.1.22.7	Inter-frequency Absolute NRSRQ Accuracy for UE Category NB1	674
9.1.22.8	Void	675
9.1.22.9	NRSRP Measurement Report Mapping	675
9.1.22.10	Intra-Frequency RSTD Accuracy Requirement for NB1 for normal coverage	675
9.1.22.11	Inter-Frequency RSTD Accuracy Requirement for NB1 for normal coverage	676
9.1.22.12	Intra-Frequency RSTD Accuracy Requirement for NB1 for enhanced coverage	677
9.1.22.13	Inter-Frequency RSTD Accuracy Requirement for NB1 for enhanced coverage	678
9.1.22.14	NRSRQ Measurement Report Mapping	678
9.1.22.15	MSG3-based Measurement Report Mapping for UE Category NB1	679
9.1.22.16	Downlink Channel Quality Measurement Accuracy for UE Category NB1	679
9.1.23	Power Headroom for UE Category NB1	680
9.1.23.1	Period	680
9.1.23.2	Reporting Delay	680
9.1.23.3	Report Mapping for UE Category NB1	680
9.1.23.3.1	Void	682
9.1.23.3.2	Void	682
9.1.23.4	Report Mapping for UE Category NB1 for UE Power Class 6	682
9.1.24	Void	683
9.1.25	Measurement accuracy for UE category M2	683
9.1.25.1	Inter-Frequency RSTD Accuracy Requirement for UE category M2 in CE mode A	683
9.1.25.2	Inter-Frequency RSTD Accuracy Requirement for UE category M2 in CE mode B	684
9.1.25.3	UE RX-TX time difference Accuracy Requirement for Cat-M2	684
9.1.25.4	Intra-Frequency RSTD Accuracy Requirement for UE category M2 in CE mode A	685

9.1.25.5	Intra-Frequency RSTD Accuracy Requirement for UE category M2 in CE mode B	686
9.1.26	Measurement Accuracy for non-BL CE UE	687
9.1.26.1	Intra-frequency Absolute Accuracy of RSRP for non-BL CE UE in CE mode A	688
9.1.26.2	Intra-frequency Relative Accuracy of RSRP for non-BL CE UE in CE mode A	688
9.1.26.3	Intra-frequency Absolute Accuracy of RSRP for non-BL CE UE in CE mode B	689
9.1.26.4	Intra-frequency Relative Accuracy of RSRP for non-BL CE UE in CE mode B.....	690
9.1.26.5	RSRP Measurement Report Mapping	691
9.1.26.6	Intra-frequency Absolute Accuracy of RSRQ for non-BL CE UE in CE mode A.....	691
9.1.26.7	Intra-frequency Absolute Accuracy of RSRQ for non-BL CE UE in CE mode B.....	691
9.1.26.8	RSRQ Measurement Report Mapping	692
9.1.26.9	Inter-frequency Absolute Accuracy of RSRP for non-BL CE UE in CE mode A	692
9.1.26.10	Inter-frequency Relative Accuracy of RSRP for non-BL CE UE in CE mode A	693
9.1.26.11	Inter-frequency Absolute Accuracy of RSRP for non-BL CE UE in CE mode B	694
9.1.26.12	Inter-frequency Relative Accuracy of RSRP for non-BL CE UE in CE mode B.....	695
9.1.26.13	Inter-frequency Absolute Accuracy of RSRQ for non-BL CE UE in CE mode A.....	696
9.1.26.14	Inter-frequency Relative Accuracy of RSRQ for non-BL CE UE in CE mode A.....	696
9.1.26.15	Inter-frequency Absolute Accuracy of RSRQ for non-BL CE UE in CE mode B.....	696
9.1.26.16	Inter-frequency Relative Accuracy of RSRQ for non-BL CE UE in CE mode B.....	697
9.1.27	SFN and frame Timing Difference (SFTD).....	698
9.1.27.1	SFTD Accuracy Requirement	698
9.2	UTRAN FDD Measurements	699
9.2.1	UTRAN FDD CPICH RSCP	700
9.2.2	Void	700
9.2.3	UTRAN FDD CPICH Ec/No.....	700
9.3	UTRAN TDD Measurements.....	701
9.3.1	UTRAN TDD P-CCPCH RSCP	701
9.3.2	Void	701
9.3.3	Void	701
9.4	GSM Measurements	701
9.4.1	GSM carrier RSSI.....	701
9.5	CDMA2000 1x RTT Measurements	702
9.5.1	CDMA2000 1x RTT Pilot Strength.....	702
9.6	$P_{\text{CMAX,c}}$	702
9.6.1	Report Mapping	702
9.6.2	Estimation Period.....	702
9.6.3	Reporting Delay	702
9.7	IEEE802.11 Measurements	703
9.7.1	WLAN RSSI.....	703
9.7.2	WLAN RSSI Measurement Report Mapping	703
9.8	MBSFN Measurements	703
9.8.1	Introduction.....	703
9.8.2	MBSFN RSRP	703
9.8.2.1	Absolute MBSFN RSRP measurement accuracy requirements	703
9.8.2.2	MBSFN RSRP measurement report mapping	704
9.8.2.3	MBSFN RSRP measurement report mapping for 7.5 kHz subcarrier spacing.....	704
9.8.2.4	MBSFN RSRP measurement report mapping for 1.25 kHz subcarrier spacing.....	705
9.8.3	MBSFN RSRQ	705
9.8.3.1	Absolute MBSFN RSRQ measurement accuracy requirements	705
9.8.3.2	MBSFN RSRQ measurement report mapping	706
9.8.3.3	MBSFN RSRQ measurement report mapping for 7.5 kHz subcarrier spacing.....	706
9.8.3.4	MBSFN RSRQ measurement report mapping for 1.25 kHz subcarrier spacing.....	706
9.8.4	MCH BLER	706
9.8.4.1	Measurement report mapping for MCH BLER.....	706
9.8.4.2	Measurement report mapping for MCH Block Number	707
9.9	ProSe Measurements	708
9.9.1	Introduction.....	708
9.9.2	Intra-Frequency S-RSRP Measurement Accuracy Requirements.....	708
9.9.2.1	Absolute S-RSRP Accuracy.....	708
9.9.2.2	Relative Accuracy of S-RSRP.....	709
9.9.3	Intra-Frequency SD-RSRP Measurement Accuracy Requirements.....	709
9.9.3.1	Absolute SD-RSRP Accuracy.....	710
9.9.3.2	Relative Accuracy of SD-RSRP.....	710

9.10	V2X Measurements	711
9.10.1	Introduction.....	711
9.10.2	Intra-Frequency S-RSRP Measurement Accuracy Requirements.....	711
9.10.2.1	Absolute S-RSRP Accuracy.....	711
9.10.2.2	Relative Accuracy of S-RSRP.....	712
9.10.3	PSSCH-RSRP Measurement Accuracy Requirements	712
9.10.3.1	Intra-frequency Absolute PSSCH-RSRP Accuracy	712
9.10.4	S-RSSI Measurement Accuracy Requirements	713
9.10.4.1	Intra-frequency absolute S-RSSI measurement accuracy requirements.....	713
9.10.4.2	Intra-frequency relative S-RSSI measurement accuracy requirements	713
9.11	NR Measurements	714
9.11.1	NR SS-RSRP Measurements	714
9.11.2	NR SS-RSRQ Measurements	714
9.11.3	NR SS-SINR Measurements.....	715
10	Measurements Performance Requirements for E-UTRAN	715
10.1	Received Interference Power.....	715
10.1.1	Absolute accuracy requirement.....	715
10.1.2	Relative accuracy requirement.....	715
10.1.3	Received Interference Power measurement report mapping.....	716
10.2	Angle of Arrival (AOA)	716
10.2.1	Range/mapping	716
10.3	Timing Advance (T_{ADV})	716
10.3.1	Report mapping	716
11	ProSe Requirements in Any Cell Selection state	717
11.1	Introduction	717
11.2	UE Transmit Timing for ProSe in Any Cell Selection State	717
11.2.1	Introduction.....	717
11.2.2	ProSe UE transmission timing.....	717
11.3	Initiation/Cease of SLSS Transmissions	717
11.3.1	Introduction.....	717
11.3.2	Requirements	717
11.4	Measurements for ProSe in Any Cell Selection State	718
11.4.1	Introduction.....	718
11.4.2	Requirements	718
11.4.2.1	E-UTRA FDD.....	718
11.4.2.2	E-UTRA TDD.....	718
11.5	Selection / Reselection of ProSe Synchronization Reference	719
11.5.1	Introduction.....	719
11.5.2	Selection/Reselection to intra-frequency SyncRef UE	719
11.5.2.1	Introduction.....	719
11.5.2.2	Requirements	719
11.6	Void.....	719
11.7	Selection / Reselection of ProSe relay UE	719
11.7.1	Introduction.....	719
11.7.2	Selection / Reselection of intra-frequency ProSe relay UE	720
12	V2V Sidelink Communication Requirements for V2V Operation on Dedicated V2V Carrier	720
12.1	Introduction	720
12.2	Transmit Timing.....	720
12.2.1	GNSS as timing reference.....	720
12.3	Interruption.....	721
12.4	Reliability of GNSS signal	721
13	V2X Requirements	721
13.1	Introduction	721
13.2	UE Transmit Timing	721
13.2.1	Introduction.....	721
13.2.2	GNSS as synchronization reference source	721
13.2.3	Serving cell/PCell as synchronization reference source	722
13.2.4	SyncRef UE as synchronization reference source	722
13.3	Initiation/Cease of SLSS Transmissions	722

13.3.1	Introduction.....	722
13.3.1.1	Initiation/Cease of SLSS transmissions with Serving cell / PCell as synchronization reference source	722
13.3.1.2	Initiation/Cease of SLSS transmissions with GNSS as synchronization reference source	723
13.3.1.3	Initiation/Cease of SLSS transmissions with SyncRef UE as synchronization reference source.....	723
13.4	Selection / Reselection of V2X Synchronization Reference Source	723
13.5	Autonomous Resource Selection/Reselection measurements	724
13.5.1	Introduction.....	724
13.5.2	PSSCH-RSRP measurements	724
13.5.3	S-RSSI measurements.....	724
13.6	Congestion Control measurements.....	725
13.7	Interruption.....	725
13.7.1	Interruptions to WAN due to V2X Sidelink Communication.....	725
13.7.2	V2X Sidelink Communication Dropping due to synchronization reference source change	725
13.7.3	Interruptions to WAN due to V2X Carrier Aggregation.....	726
13.8	Reliability of GNSS signal	726
13.9	Component Carrier Addition and Release Delay for V2X Sidelink Carrier Aggregation.....	726
13.10	Selection / Reselection of V2X Synchronization Reference Source for V2X Carrier Aggregation.....	726
Annex A (normative): Test Cases		728
A.1	Purpose of annex	728
A.2	Requirement classification for statistical testing.....	728
A.2.1	Types of requirements in TS 36.133	728
A.2.1.1	Time and delay requirements on UE higher layer actions	728
A.2.1.2	Measurements of power levels, relative powers and time	728
A.2.1.3	Implementation requirements	729
A.2.1.4	Physical layer timing requirements.....	729
A.3	RRM test configurations	729
A.3.1	Reference Measurement Channels	729
A.3.1.1	PDSCH	729
A.3.1.1.1	FDD.....	729
A.3.1.1.2	TDD	732
A.3.1.1.3	FDD for UE category 0.....	735
A.3.1.1.4	HD-FDD for UE category 0.....	735
A.3.1.1.5	TDD for UE category 0.....	736
A.3.1.1.6	Frame Structure 3.....	737
A.3.1.2	PCFICH/PDCCH/PHICH.....	737
A.3.1.2.1	FDD.....	737
A.3.1.2.2	TDD	738
A.3.1.2.3	HD-FDD for UE category 0.....	738
A.3.1.2.4	FS 3	738
A.3.1.3	MPDCCH Reference Channels for Cat-M1 UEs.....	739
A.3.1.3.1	FDD in CEModeA	739
A.3.1.3.2	HD-FDD in CEModeA	739
A.3.1.3.3	TDD in CEModeA	740
A.3.1.3.4	FDD in CEModeB	740
A.3.1.3.5	HD-FDD in CEModeB	740
A.3.1.3.6	TDD in CEModeB	741
A.3.1.4	PDSCH Reference Channel for Cat-M1 UEs	741
A.3.1.4.1	FDD in CEModeA	741
A.3.1.4.2	HD-FDD in CEModeA	742
A.3.1.4.3	TDD in CEModeA	742
A.3.1.4.4	FDD in CEModeB	743
A.3.1.4.5	HD-FDD in CEModeB	744
A.3.1.4.6	TDD in CEModeB	744
A.3.1.5	NPDSCH Reference Channel for UE category NB1	745
A.3.1.5.1	HD-FDD in-band operation	745
A.3.1.5.2	Void.....	745
A.3.1.5.3	HD-FDD standalone operation.....	745
A.3.1.5.4	Void.....	746

A.3.1.5.5	HD-FDD guard band operation.....	746
A.3.1.5.6	Void.....	746
A.3.1.5.7	TDD in-band operation.....	746
A.3.1.5.8	TDD standalone operation.....	747
A.3.1.5.9	TDD guard band operation.....	747
A.3.1.6	NPDCCH Reference Channel for UE category NB1.....	748
A.3.1.6.1	In-band operation.....	748
A.3.1.6.2	Void.....	748
A.3.1.6.3	Standalone operation.....	748
A.3.1.6.4	Void.....	749
A.3.1.6.5	Guard band operation.....	749
A.3.1.6.6	Void.....	749
A.3.2	OFDMA Channel Noise Generator (OCNG).....	749
A.3.2.1	OCNG Patterns for FDD.....	749
A.3.2.1.1	OCNG FDD pattern 1: outer resource blocks allocation in 10 MHz.....	750
A.3.2.1.2	OCNG FDD pattern 2: full bandwidth allocation in 10 MHz.....	751
A.3.2.1.3	OCNG FDD pattern 3: outer resource blocks allocation in 1.4 MHz.....	751
A.3.2.1.4	OCNG FDD pattern 4: full bandwidth allocation in 1.4 MHz.....	752
A.3.2.1.5	OCNG FDD pattern 5: outer resource blocks allocation in 10 MHz (without MBSFN).....	752
A.3.2.1.6	OCNG FDD pattern 6: full bandwidth allocation in 10 MHz (without MBSFN).....	753
A.3.2.1.7	OCNG FDD pattern 7: full bandwidth allocation in 1.4 MHz (without MBSFN).....	753
A.3.2.1.8	OCNG FDD pattern 8: outer resource blocks allocation in 10 MHz for MBSFN ABS.....	754
A.3.2.1.9	OCNG FDD pattern 9: full bandwidth allocation in 10 MHz for MBSFN ABS.....	754
A.3.2.1.10	OCNG FDD pattern 10: outer resource blocks allocation in 10 MHz with user data in every subframe (without MBSFN).....	755
A.3.2.1.11	OCNG FDD pattern 11: outer resource blocks allocation in 20 MHz.....	755
A.3.2.1.12	OCNG FDD pattern 12: full bandwidth allocation in 20 MHz.....	756
A.3.2.1.13	OCNG FDD pattern 13: outer resource blocks allocation in 20 MHz (without MBSFN).....	756
A.3.2.1.14	OCNG FDD pattern 14: full bandwidth allocation in 20 MHz (without MBSFN).....	757
A.3.2.1.15	OCNG FDD pattern 15: outer resource blocks allocation in 5 MHz.....	757
A.3.2.1.16	OCNG FDD pattern 16: full bandwidth allocation in 5 MHz.....	758
A.3.2.1.17	OCNG FDD pattern 17: outer resource blocks allocation in 20 MHz with user data in every subframe (without MBSFN).....	758
A.3.2.1.18	OCNG FDD pattern 18: outer resource blocks allocation in 5 MHz (without MBSFN).....	758
A.3.2.1.19	OCNG FDD pattern 19: full bandwidth allocation in 5 MHz (without MBSFN).....	759
A.3.2.1.20	OCNG FDD pattern 20: outer resource blocks allocation in 5 MHz with user data in every subframe (without MBSFN).....	759
A.3.2.1.21	OCNG FDD pattern 21: Generic resource blocks allocation (without MBSFN).....	760
A.3.2.1.22	OCNG FDD pattern 22: Generic resource blocks allocation in 5MHz (without MBSFN).....	760
A.3.2.2	OCNG Patterns for TDD.....	761
A.3.2.2.1	OCNG TDD pattern 1: outer resource blocks allocation in 10 MHz.....	761
A.3.2.2.2	OCNG TDD pattern 2: full bandwidth allocation in 10 MHz.....	762
A.3.2.2.3	OCNG TDD pattern 3: outer resource blocks allocation in 1.4 MHz.....	762
A.3.2.2.4	OCNG TDD pattern 4: full bandwidth allocation in 1.4 MHz.....	763
A.3.2.2.5	OCNG TDD pattern 5: outer resource blocks allocation in 10 MHz for MBSFN ABS.....	763
A.3.2.2.6	OCNG TDD pattern 6: full bandwidth allocation in 10 MHz for MBSFN ABS.....	765
A.3.2.2.7	OCNG TDD pattern 7: outer resource blocks allocation in 20 MHz.....	765
A.3.2.2.8	OCNG TDD pattern 8: full bandwidth allocation in 20 MHz.....	766
A.3.2.2.9	OCNG TDD pattern 9: outer resource blocks allocation in 5 MHz.....	766
A.3.2.2.10	OCNG TDD pattern 10: full bandwidth allocation in 5 MHz.....	767
A.3.2.2.11	OCNG TDD pattern 11: Generic resource blocks allocation (without MBSFN).....	768
A.3.2.3	OCNG Patterns for Narrowband IoT.....	768
A.3.2.3.1	Narrowband IoT OCNG FDD pattern 1: In-band NB-IoT in 10 MHz EUTRAN cell.....	770
A.3.2.3.2	Narrowband IoT OCNG FDD pattern 2: guard band NB-IoT in 10 MHz EUTRAN cell.....	771
A.3.2.3.3	Narrowband IoT OCNG FDD pattern 3: standalone NB-IoT.....	771
A.3.2.3.4	Narrowband IoT OCNG FDD pattern 4: In-band NB-IoT in 5 MHz EUTRAN cell.....	772
A.3.2.3.5	Narrowband IoT OCNG FDD pattern 5: guard band NB-IoT in 5 MHz EUTRAN cell.....	773
A.3.2.3.6	Narrowband IoT OCNG TDD pattern 1: In-band NB-IoT in 10 MHz EUTRAN cell.....	773
A.3.2.3.7	Narrowband IoT OCNG TDD pattern 2: guard band NB-IoT in 10 MHz EUTRAN cell.....	774
A.3.2.3.8	Narrowband IoT OCNG TDD pattern 3: standalone NB-IoT.....	775
A.3.2.4	OCNG Patterns for V2X sidelink.....	775
A.3.2.4.1	V2X sidelink OCNG TDD pattern 1: outer resource blocks allocation in 10 MHz.....	776

A.3.2.4.2	V2X sidelink OCNG TDD pattern 2: outer resource blocks allocation in 10 MHz.....	776
A.3.3	Reference DRX Configurations	777
A.3.4	ABS Transmission Configurations.....	777
A.3.4.1	Non-MBSFN ABS Transmission Configurations.....	777
A.3.4.1.1	Non-MBSFN ABS Transmission, 1x2 antenna with PBCH.....	777
A.3.4.1.2	Non-MBSFN ABS Transmission, 2x2 antenna without PBCH.....	777
A.3.4.2	MBSFN ABS Transmission Configurations.....	778
A.3.4.2.1	MBSFN ABS Transmission, 1x2 antenna.....	778
A.3.4.2.2	MBSFN ABS Transmission, 2x2 antenna.....	778
A.3.5	Impact of Reference Sensitivity Degradation with Carrier Aggregation on Test Cases.....	779
A.3.5.1	Impact of Reference Sensitivity Degradation due to Insertion Loss.....	779
A.3.6	Carrier Aggregation Test Cases with Different Channel Bandwidth Combinations	779
A.3.6.1	Introduction.....	779
A.3.7	Test Cases with Different Channel Bandwidths.....	779
A.3.7.1	Introduction.....	779
A.3.7.2	Principle of testing.....	780
A.3.8	Antenna Configuration.....	780
A.3.8.1	Antenna connection for 4 Rx capable UEs.....	780
A.3.8.1.1	Introduction.....	780
A.3.8.1.2	Principle of testing.....	780
A.3.8.1.2.1	Single carrier tests	780
A.3.8.1.2.2	Carrier aggregation and Dual connectivity tests.....	781
A.3.8.1.2.3	Antenna connection for bands where 2RX is supported.....	781
A.3.8.1.2.4	Antenna connection for bands where 4RX is supported.....	781
A.3.8.2	Antenna connection for 8 Rx capable UEs.....	782
A.3.8.2.1	Introduction.....	782
A.3.8.2.2	Principle of testing	782
A.3.8.2.2.1	Single carrier tests	782
A.3.8.2.2.2	Carrier aggregation and Dual connectivity tests.....	782
A.3.8.2.2.3	Antenna connection for bands where 2RX is supported.....	782
A.3.8.2.2.4	Antenna connection for bands where 4RX is supported.....	782
A.3.8.2.2.5	Antenna connection for bands where 8RX is supported.....	782
A.3.9	Carrier Aggregation Test Cases with Different Duplex Modes.....	783
A.3.9.1	Introduction.....	783
A.3.9.2	Principle of testing.....	783
A.3.10	Carrier Aggregation Test Cases with Different CA Configurations.....	783
A.3.10.1	Introduction.....	783
A.3.10.2	Principle of testing.....	783
A.3.11	Test Cases for Synchronous and Asynchronous Dual Connectivity	783
A.3.11.1	Introduction.....	783
A.3.11.2	Principle of Testing.....	783
A.3.12	Proximity-based Services.....	783
A.3.12.1	Introduction.....	783
A.3.12.2	Reference DRX configurations for ProSe tests.....	784
A.3.12.3	Test Cases with Different Channel Bandwidths	784
A.3.12.3.1	Introduction.....	784
A.3.12.3.2	Principle of testing	784
A.3.12.4	Reference resource pool configurations for ProSe Direct Discovery	784
A.3.12.5	Reference resource pool configurations for ProSe Direct Communication	788
A.3.12.6	Reference Measurement Channels for ProSe Direct Discovery	790
A.3.12.6.1	FDD.....	790
A.3.12.7	Reference measurement channels for ProSe Direct Communication	790
A.3.12.7.1	FDD.....	790
A.3.12.8	ProSe Receive Traffic Generator	791
A.3.12.8.1	ProSe Direct Communication Receive Traffic Generator for FDD	791
A.3.12.8.2	ProSe Direct Discovery Receive Traffic Generator for FDD.....	791
A.3.13	Time Offset between Cells	792
A.3.13.1	Introduction.....	792
A.3.13.2	Definition.....	792
A.3.14	Carrier Aggregation under operation with Frame Structure 3 Test Cases with Different Duplex Modes.....	792
A.3.14.1	Introduction.....	792
A.3.14.2	Principle of testing.....	792

A.3.15	Dual connectivity test cases with different combination of duplex mode	792
A.3.15.1	Introduction.....	792
A.3.15.2	Principle of testing	792
A.3.16	Reference PRACH Configurations.....	792
A.3.17	Listen before talk model.....	793
A.3.17.1	Introduction.....	793
A.3.17.2	Definition.....	793
A.3.18	Reference NPRACH Configurations.....	794
A.3.19	Dual connectivity test cases with different bandwidth combinations.....	795
A.3.19.1	Introduction.....	795
A.3.19.2	Principle of testing.....	795
A.3.20	Category M1 UE Test Cases	795
A.3.20.1	Introduction.....	795
A.3.20.2	Principle of Cat-M1 UE Testing	795
A.3.20.3	Principle of Cat-M1 UE testing for inter-frequency RSTD measurement period requirements with measurement gaps.....	796
A.3.21	V2V Sidelink Communication on Dedicated V2V Carrier	797
A.3.21.1	Introduction.....	797
A.3.21.2	Reference resource pool configurations for V2V Sidelink Communication.....	797
A.3.21.3	Reference measurement channels for V2V Sidelink Communication.....	797
A.3.22	Category 1bis UE Test Cases	798
A.3.22.1	Introduction.....	798
A.3.22.2	Principle of Category 1bis UE Testing	798
A.3.23	Category NB2 UE Test Cases	801
A.3.23.1	Introduction.....	801
A.3.23.2	Principle of Category NB2 UE Testing	801
A.3.24	V2X sidelink communication.....	802
A.3.24.1	Introduction.....	802
A.3.24.2	Reference resource pool configurations for V2X Sidelink Communication.....	803
A.3.24.3	Reference measurement channels for V2X Sidelink Communication.....	805
A.3.25	Category M2 UE Test Cases	807
A.3.25.1	Introduction.....	807
A.3.25.2	Principle of Cat-M2 UE Testing	807
A.3.25.3	Principle of Cat-M2 UE testing for inter-frequency RSTD measurement period requirements with measurement gaps.....	808
A.3.26	sTTI and processing time reduction test cases with different sTTI/processing time reduction scheme	808
A.3.26.1	Introduction.....	808
A.3.26.2	Principle of testing.....	808
A.3.27	LTE INACTIVE Cell Re-selection Test Cases	808
A.3.27.1	Introduction.....	808
A.3.27.2	Principle of INACTIVE cell re-selection Testing.....	808
A.4	E-UTRAN RRC_IDLE state	809
A.4.2	Cell Re-Selection.....	809
A.4.2.1	E-UTRAN FDD – FDD Intra frequency case.....	809
A.4.2.1.1	Test Purpose and Environment	809
A.4.2.1.2	Test Requirements.....	810
A.4.2.2	E-UTRAN TDD – TDD Intra frequency case	811
A.4.2.2.1	Test Purpose and Environment	811
A.4.2.2.2	Test Requirements.....	812
A.4.2.3	E-UTRAN FDD – FDD Inter frequency case.....	813
A.4.2.3.1	Test Purpose and Environment	813
A.4.2.3.2	Test Requirements.....	814
A.4.2.4	E-UTRAN FDD – TDD Inter frequency case.....	815
A.4.2.4.1	Test Purpose and Environment	815
A.4.2.4.2	Test Requirements.....	816
A.4.2.5	E-UTRAN TDD – FDD Inter frequency case.....	817
A.4.2.5.1	Test Purpose and Environment	817
A.4.2.5.2	Test Requirements.....	818
A.4.2.6	E-UTRAN TDD – TDD: Inter frequency case	819
A.4.2.6.1	Test Purpose and Environment	819
A.4.2.6.2	Test Requirements.....	820

A.4.2.7	E-UTRAN FDD – FDD Inter frequency case in the existence of non-allowed CSG cell	820
A.4.2.7.1	Test Purpose and Environment	820
A.4.2.7.2	Test Requirements.....	822
A.4.2.8	E-UTRAN TDD – TDD Inter frequency case in the existence of non-allowed CSG cell	822
A.4.2.8.1	Test Purpose and Environment	822
A.4.2.8.2	Test Requirements.....	823
A.4.2.9	E-UTRAN FDD – FDD Intra frequency case for 5MHz bandwidth	824
A.4.2.9.1	Test Purpose and Environment	824
A.4.2.9.2	Test Requirements.....	824
A.4.2.10	E-UTRAN FDD – FDD reselection using an increased number of carriers	824
A.4.2.10.1	Test Purpose and Environment	824
A.4.2.10.2	Test Requirements.....	827
A.4.2.11	E-UTRAN TDD – TDD reselection using an increased number of carriers.....	827
A.4.2.11.1	Test Purpose and Environment	827
A.4.2.11.2	Test Requirements.....	830
A.4.2.12	E-UTRAN FDD – FDD Intra frequency case for Cat-M1 UE in normal coverage.....	830
A.4.2.12.1	Test Purpose and Environment	830
A.4.2.12.2	Test Requirements.....	832
A.4.2.13	E-UTRAN HD – FDD Intra frequency case for Cat-M1 UE in normal coverage	833
A.4.2.13.1	Test Purpose and Environment	833
A.4.2.13.2	Test Requirements.....	834
A.4.2.14	E-UTRAN TDD – TDD Intra frequency case for Cat-M1 UE in normal coverage	835
A.4.2.14.1	Test Purpose and Environment	835
A.4.2.14.2	Test Requirements.....	836
A.4.2.15	E-UTRAN FDD – FDD Intra frequency case for Cat-M1 UE in enhanced coverage.....	837
A.4.2.15.1	Test Purpose and Environment	837
A.4.2.15.2	Test Requirements.....	838
A.4.2.16	E-UTRAN HD – FDD Intra frequency case for Cat-M1 UE in enhanced coverage	839
A.4.2.16.1	Test Purpose and Environment	839
A.4.2.16.2	Test Requirements.....	840
A.4.2.17	E-UTRAN TDD – TDD Intra frequency case for Cat-M1 UE in enhanced coverage	841
A.4.2.17.1	Test Purpose and Environment	841
A.4.2.17.2	Test Requirements.....	842
A.4.2.18	HD – FDD Intra frequency case for UE Category NB1 In-Band mode in normal coverage.....	843
A.4.2.18.1	Test Purpose and Environment	843
A.4.2.18.2	Test Requirements.....	844
A.4.2.19	HD – FDD Intra frequency case for UE Category NB1 In-Band mode in enhanced coverage	845
A.4.2.19.1	Test Purpose and Environment	845
A.4.2.19.2	Test Requirements.....	847
A.4.2.20	E-UTRAN FDD – FDD Intra frequency case for UE Category 1bis.....	847
A.4.2.20.1	Test Purpose and Environment	847
A.4.2.20.2	Test Requirements.....	849
A.4.2.21	E-UTRAN TDD – TDD Intra frequency case for UE Category 1bis	849
A.4.2.21.1	Test Purpose and Environment	849
A.4.2.21.2	Test Requirements.....	851
A.4.2.22	E-UTRAN FDD – FDD Intra frequency case for UE configured with highSpeedEnhancedMeasFlag....	851
A.4.2.22.1	Test Purpose and Environment	851
A.4.2.22.2	Test Requirements.....	853
A.4.2.23	E-UTRAN TDD – TDD Intra frequency case for UE configured with highSpeedEnhancedMeasFlag ..	854
A.4.2.23.1	Test Purpose and Environment	854
A.4.2.23.2	Test Requirements.....	855
A.4.2.24	HD – FDD Inter frequency case for UE Category NB1 In-Band mode in enhanced coverage	856
A.4.2.24.1	Test Purpose and Environment	856
A.4.2.24.2	Test Requirements.....	858
A.4.2.25	E-UTRAN FDD – FDD Inter frequency case for Cat-M1 UE in normal coverage.....	858
A.4.2.25.1	Test Purpose and Environment	858
A.4.2.25.2	Test Requirements.....	860
A.4.2.26	E-UTRAN HD – FDD Inter frequency case for Cat-M1 UE in normal coverage	860
A.4.2.26.1	Test Purpose and Environment	860
A.4.2.26.2	Test Requirements.....	861
A.4.2.27	E-UTRAN TDD – FDD Inter frequency case for Cat-M1 UE in normal coverage.....	862
A.4.2.27.1	Test Purpose and Environment	862

A.4.2.27.2	Test Requirements.....	863
A.4.2.28	E-UTRAN FDD – FDD Inter frequency case for Cat-M1 UE in enhanced coverage	864
A.4.2.28.1	Test Purpose and Environment	864
A.4.2.28.2	Test Requirements.....	865
A.4.2.29	E-UTRAN HD – FDD Inter frequency case for Cat-M1 UE in enhanced coverage	866
A.4.2.29.1	Test Purpose and Environment	866
A.4.2.29.2	Test Requirements.....	867
A.4.2.30	E-UTRAN TDD Inter frequency case for Cat-M1 UE in enhanced coverage.....	867
A.4.2.30.1	Test Purpose and Environment	867
A.4.2.30.2	Test Requirements.....	869
A.4.2.31	E-UTRAN FDD – FDD Inter frequency case for UE Category 1bis.....	869
A.4.2.31.1	Test Purpose and Environment	869
A.4.2.31.2	Test Requirements.....	871
A.4.2.32	E-UTRAN FDD – TDD Inter frequency case for UE Category 1bis	871
A.4.2.32.1	Test Purpose and Environment	871
A.4.2.32.2	Test Requirements.....	873
A.4.2.33	E-UTRAN TDD – FDD Inter frequency case for UE Category 1bis	873
A.4.2.33.1	Test Purpose and Environment	873
A.4.2.33.2	Test Requirements.....	875
A.4.2.34	E-UTRAN TDD – TDD: Inter frequency case for UE Category 1bis.....	875
A.4.2.34.1	Test Purpose and Environment	875
A.4.2.34.2	Test Requirements.....	877
A.4.2.35	E-UTRAN TDD - TDD Intra frequency case for UE Category NB1 In-Band mode in normal coverage.....	877
A.4.2.35.1	Test Purpose and Environment	877
A.4.2.35.2	Test Requirements.....	879
A.4.2.36	E-UTRAN TDD – TDD Intra frequency case for UE Category NB1 In-Band mode in enhanced coverage.....	879
A.4.2.36.1	Test Purpose and Environment	879
A.4.2.36.2	Test Requirements.....	881
A.4.2.37	E-UTRAN TDD – TDD Inter frequency case for UE Category NB1 In-Band mode in enhanced coverage.....	882
A.4.2.37.1	Test Purpose and Environment	882
A.4.2.37.2	Test Requirements.....	884
A.4.2.38	HD – FDD Intra frequency case for UE Category NB1 In-Band mode in normal coverage with serving cell RRM measurement relaxation.....	884
A.4.2.38.1	Test Purpose and Environment	884
A.4.2.38.2	Test Requirements.....	886
A.4.3	E-UTRAN to UTRAN Cell Re-Selection	887
A.4.3.1	E-UTRAN FDD – UTRAN FDD:	887
A.4.3.1.1	EUTRA FDD-UTRA FDD cell reselection: UTRA FDD is of higher priority.....	887
A.4.3.1.1.1	Test Purpose and Environment.....	887
A.4.3.1.1.2	Test Requirements	888
A.4.3.1.2	EUTRA FDD-UTRA FDD cell reselection: UTRA FDD is of lower priority.....	889
A.4.3.1.2.1	Test Purpose and Environment.....	889
A.4.3.1.2.2	Test Requirements	891
A.4.3.1.3	EUTRA FDD-UTRA FDD cell reselection in fading propagation conditions: UTRA FDD is of lower priority.....	891
A.4.3.1.3.1	Test Purpose and Environment.....	891
A.4.3.1.3.2	Test Requirements	893
A.4.3.1.4	EUTRA FDD-UTRA FDD cell reselection: UTRA FDD is of lower priority for 5MHz bandwidth.....	893
A.4.3.1.4.1	Test Purpose and Environment.....	893
A.4.3.1.4.2	Test Requirements	893
A.4.3.1.5	Idle mode FDD to UTRA FDD interRAT reselection	893
A.4.3.1.5.1	Test Purpose and Environment.....	893
A.4.3.1.5.2	Test Requirements	896
A.4.3.2	E-UTRAN FDD – UTRAN TDD:	897
A.4.3.2.1	Test Purpose and Environment	897
A.4.3.2.1.1	Void.....	897
A.4.3.2.1.2	1.28Mcps TDD option.....	897
A.4.3.2.1.3	Void.....	898

A.4.3.2.2	Test Requirements.....	898
A.4.3.2.2.1	1.28Mcps TDD option.....	898
A.4.3.2A	E-UTRA FDD to UTRA TDD cell re-selection for IncMon	899
A.4.3.2A.1	Test Purpose and Environment	899
A.4.3.2A.2	Test Requirements.....	902
A.4.3.3	E-UTRAN TDD – UTRAN FDD:	902
A.4.3.3.1	Test Purpose and Environment	902
A.4.3.3.2	Test Requirements.....	904
A.4.3.3A	Idle mode TDD to UTRA FDD interRAT reselection	904
A.4.3.3A.1	Test Purpose and Environment	904
A.4.3.3A.2	Test Requirements.....	907
A.4.3.4	E-UTRAN TDD – UTRAN TDD:.....	908
A.4.3.4.1	E-UTRA to UTRA TDD cell re-selection: UTRA is of higher priority	908
A.4.3.4.1.1	Test Purpose and Environment.....	908
A.4.3.4.1.2	Test Requirements	910
A.4.3.4.2	E-UTRA to UTRA TDD cell re-selection: UTRA is of lower priority	910
A.4.3.4.2.1	Test Purpose and Environment.....	910
A.4.3.4.2.2	Test Requirements	912
A.4.3.4.3	EUTRA TDD-UTRA TDD cell reselection in fading propagation conditions: UTRA TDD is of lower priority.....	912
A.4.3.4.3.1	Test Purpose and Environment.....	912
A.4.3.4.3.2	Test Requirements	914
A.4.3.4.4	E-UTRA TDD to UTRA TDD cell re-selection for IncMon	914
A.4.3.4.4.1	Test Purpose and Environment.....	914
A.4.3.4.4.2	Test Requirements	917
A.4.4	E-UTRAN to GSM Cell Re-Selection.....	918
A.4.4.1	E-UTRAN FDD – GSM:	918
A.4.4.1.1	Test Purpose and Environment	918
A.4.4.1.2	Test Requirements.....	919
A.4.4.2	E-UTRAN TDD – GSM:	920
A.4.4.2.1	Test Purpose and Environment	920
A.4.4.2.2	Test Requirements.....	921
A.4.5	E-UTRAN to HRPD Cell Re-Selection.....	921
A.4.5.1	E-UTRAN FDD – HRPD	921
A.4.5.1.1	E-UTRAN FDD – HRPD Cell Reselection: HRPD is of Lower Priority	921
A.4.5.1.1.1	Test Purpose and Environment.....	921
A.4.5.1.1.2	Test Requirements.....	924
A.4.5.2	E-UTRAN TDD – HRPD	924
A.4.5.2.1	E-UTRAN TDD – HRPD Cell Reselection: HRPD is of Lower Priority	924
A.4.5.2.1.1	Test Purpose and Environment.....	924
A.4.5.2.1.2	Test Requirements	927
A.4.6	E-UTRAN to cdma2000 1X Cell Re-Selection.....	927
A.4.6.1	E-UTRAN FDD – cdma2000 1X.....	927
A.4.6.1.1	E-UTRAN FDD – cdma2000 1X Cell Reselection: cdma2000 1X is of Lower Priority	927
A.4.6.1.1.1	Test Purpose and Environment	927
A.4.6.1.1.2	Test Requirements.....	930
A.4.6.2	E-UTRAN TDD – cdma2000 1X	930
A.4.6.2.1	E-UTRAN TDD –cdma2000 1X Cell Reselection: cdma2000 1X is of Lower Priority.....	930
A.4.6.2.1.1	Test Purpose and Environment.....	930
A.4.6.2.1.2	Test Requirements	933
A.4.7	Idle State Positioning Measurement for UE category NB1	933
A.4.7.1	HD – FDD Intra frequency case for UE Category NB1 standalone mode in enhanced coverage	933
A.4.7.1.1	Test Purpose and Environment	933
A.4.7.1.2	Test Requirements.....	936
A.4.7.2	HD – FDD Inter frequency case for UE Category NB1 standalone mode in enhanced coverage	937
A.4.7.2.1	Test Purpose and Environment	937
A.4.7.2.2	Test Requirements.....	940
A.4.7.3	TDD Intra frequency case for UE Category NB1 standalone mode in enhanced coverage.....	941
A.4.7.3.1	Test Purpose and Environment	941
A.4.7.3.2	Test Requirements.....	944
A.4.7.4	TDD Inter frequency case for UE Category NB1 standalone mode in enhanced coverage.....	945
A.4.7.4.1	Test Purpose and Environment	945

A.4.7.4.2	Test Requirements.....	948
A.5	E-UTRAN RRC CONNECTED Mode Mobility.....	948
A.5.1	E-UTRAN Handover.....	948
A.5.1.1	E-UTRAN FDD - FDD Intra frequency handover	948
A.5.1.1.1	Test Purpose and Environment	948
A.5.1.1.2	Test Requirements	950
A.5.1.2	E-UTRAN TDD - TDD Intra frequency handover.....	950
A.5.1.2.1	Test Purpose and Environment	950
A.5.1.2.2	Test Requirements.....	952
A.5.1.3	E-UTRAN FDD – FDD Inter frequency handover.....	952
A.5.1.3.1	Test Purpose and Environment	952
A.5.1.3.2	Test Requirements.....	954
A.5.1.4	E-UTRAN TDD – TDD Inter frequency handover	954
A.5.1.4.1	Test Purpose and Environment	954
A.5.1.4.2	Test Requirements.....	956
A.5.1.5	E-UTRAN FDD – FDD Inter frequency handover: unknown target cell	956
A.5.1.5.1	Test Purpose and Environment	956
A.5.1.5.2	Test Requirements.....	958
A.5.1.6	E-UTRAN TDD – TDD Inter frequency handover; unknown Target Cell.....	958
A.5.1.6.1	Test Purpose and Environment	958
A.5.1.6.2	Test Requirements.....	960
A.5.1.7	E-UTRAN FDD – TDD Inter frequency handover.....	960
A.5.1.7.1	Test Purpose and Environment	960
A.5.1.7.2	Test Requirements.....	963
A.5.1.8	E-UTRAN TDD – FDD Inter frequency handover.....	963
A.5.1.8.1	Test Purpose and Environment	963
A.5.1.8.2	Test Requirements.....	965
A.5.1.9	E-UTRAN FDD - FDD Intra frequency handover for 5MHz bandwidth	965
A.5.1.9.1	Test Purpose and Environment	965
A.5.1.9.2	Test Requirements.....	966
A.5.1.10	E-UTRAN FDD - FDD Intra frequency handover for UE category 0.....	966
A.5.1.10.1	Test Purpose and Environment	966
A.5.1.10.2	Test Requirements.....	967
A.5.1.11	E-UTRAN HD - FDD Intra frequency handover for UE category 0	967
A.5.1.11.1	Test Purpose and Environment	967
A.5.1.11.2	Test Requirements.....	968
A.5.1.12	E-UTRAN TDD - TDD Intra frequency handover for UE category 0	969
A.5.1.12.1	Test Purpose and Environment	969
A.5.1.12.2	Test Requirements.....	970
A.5.1.13	E-UTRAN FDD-FDD Intra frequency handover for Cat-M1 UEs in CEModeA	970
A.5.1.13.1	Test Purpose and Environment	970
A.5.1.13.2	Test Requirements.....	972
A.5.1.14	E-UTRAN HD-FDD Intra frequency handover for Cat-M1 UEs in CEModeA.....	972
A.5.1.14.1	Test Purpose and Environment	972
A.5.1.14.2	Test Requirements.....	973
A.5.1.15	E-UTRAN TDD Intra frequency handover for Cat-M1 UEs in CEModeA	974
A.5.1.15.1	Test Purpose and Environment	974
A.5.1.15.2	Test Requirements.....	975
A.5.1.16	E-UTRAN FDD-FDD Intra frequency handover for Cat-M1 UEs in CEModeB.....	976
A.5.1.16.1	Test Purpose and Environment	976
A.5.1.16.2	Test Requirements.....	977
A.5.1.17	E-UTRAN HD-FDD Intra frequency handover for Cat-M1 UEs in CEModeB.....	977
A.5.1.17.1	Test Purpose and Environment	977
A.5.1.17.2	Test Requirements.....	979
A.5.1.18	E-UTRAN TDD Intra frequency handover for Cat-M1 UEs in CEModeB.....	979
A.5.1.18.1	Test Purpose and Environment	979
A.5.1.18.2	Test Requirements.....	981
A.5.1.19	E-UTRAN FDD - FDD Intra frequency handover for UE Category 1bis	981
A.5.1.19.1	Test Purpose and Environment	981
A.5.1.19.2	Test Requirements	982
A.5.1.20	E-UTRAN TDD - TDD Intra frequency handover for UE Category 1bis.....	983

A.5.1.20.1	Test Purpose and Environment	983
A.5.1.20.2	Test Requirements.....	984
A.5.1.21	E-UTRAN FDD - FDD Intra frequency RACH-less handover	985
A.5.1.21.1	Test Purpose and Environment	985
A.5.1.21.2	Test Requirements.....	986
A.5.1.22	E-UTRAN TDD - TDD Intra frequency RACH-less handover.....	986
A.5.1.22.1	Test Purpose and Environment	986
A.5.1.22.2	Test Requirements.....	988
A.5.1.23	E-UTRAN FDD – FDD Inter frequency RACH-less handover.....	988
A.5.1.23.1	Test Purpose and Environment	988
A.5.1.23.2	Test Requirements.....	990
A.5.1.24	E-UTRAN TDD – TDD Inter frequency RACH-less handover	990
A.5.1.24.1	Test Purpose and Environment	990
A.5.1.24.2	Test Requirements.....	992
A.5.1.25	E-UTRAN FDD - FDD Intra frequency make-before-break handover	992
A.5.1.25.1	Test Purpose and Environment	992
A.5.1.25.2	Test Requirements.....	994
A.5.1.26	E-UTRAN TDD - TDD Intra frequency make-before-break handover	994
A.5.1.26.1	Test Purpose and Environment	994
A.5.1.26.2	Test Requirements.....	996
A.5.1.27	E-UTRAN FDD inter frequency handover for Cat-M1 UEs in CEModeA.....	997
A.5.1.27.1	Test Purpose and Environment	997
A.5.1.27.2	Test Requirements.....	998
A.5.1.28	E-UTRAN HD-FDD inter frequency handover for Cat-M1 UEs in CEModeA.....	998
A.5.1.28.1	Test Purpose and Environment	998
A.5.1.28.2	Test Requirements.....	1000
A.5.1.29	E-UTRAN TDD inter frequency handover for Cat-M1 UEs in CEModeA.....	1000
A.5.1.29.1	Test Purpose and Environment	1000
A.5.1.29.2	Test Requirements.....	1002
A.5.1.30	E-UTRAN FDD inter frequency handover for Cat-M1 UEs in CEModeB	1002
A.5.1.30.1	Test Purpose and Environment	1002
A.5.1.30.2	Test Requirements.....	1003
A.5.1.31	E-UTRAN HD-FDD inter frequency handover for Cat-M1 UEs in CEModeB	1004
A.5.1.31.1	Test Purpose and Environment	1004
A.5.1.31.2	Test Requirements.....	1005
A.5.1.32	E-UTRAN TDD inter frequency handover for Cat-M1 UEs in CEModeB.....	1005
A.5.1.32.1	Test Purpose and Environment	1005
A.5.1.32.2	Test Requirements.....	1007
A.5.1.33	E-UTRAN FDD-FDD Intra frequency handover for Cat-M1 UEs in CEModeA without SFN acquisition.....	1007
A.5.1.33.1	Test Purpose and Environment	1007
A.5.1.33.2	Test Requirements.....	1009
A.5.1.34	E-UTRAN HD-FDD Intra frequency handover for Cat-M1 UEs in CEModeA without SFN acquisition.....	1009
A.5.1.34.1	Test Purpose and Environment	1009
A.5.1.34.2	Test Requirements.....	1010
A.5.1.35	E-UTRAN TDD Intra frequency handover for Cat-M1 UEs in CEModeA without SFN acquisition....	1011
A.5.1.35.1	Test Purpose and Environment	1011
A.5.1.35.2	Test Requirements.....	1012
A.5.1.36	E-UTRAN FDD-FDD Intra frequency handover for Cat-M1 UEs in CEModeB without SFN acquisition.....	1013
A.5.1.36.1	Test Purpose and Environment	1013
A.5.1.36.2	Test Requirements.....	1014
A.5.1.37	E-UTRAN HD-FDD Intra frequency handover for Cat-M1 UEs in CEModeB without SFN acquisition.....	1014
A.5.1.37.1	Test Purpose and Environment	1014
A.5.1.37.2	Test Requirements.....	1016
A.5.1.38	E-UTRAN TDD Intra frequency handover for Cat-M1 UEs in CEModeB without SFN acquisition....	1016
A.5.1.38.1	Test Purpose and Environment	1016
A.5.1.38.2	Test Requirements.....	1018
A.5.1.39	E-UTRAN FDD - FDD Intra frequency handover with direct SCell activation.....	1018
A.5.1.39.1	Test Purpose and Environment	1018

A.5.1.39.2	Test Requirements.....	1019
A.5.1.40	E-UTRAN TDD - TDD Intra frequency handover with direct SCell activation	1020
A.5.1.40.1	Test Purpose and Environment	1020
A.5.1.40.2	Test Requirements.....	1021
A.5.2	E-UTRAN Handover to other RATs	1022
A.5.2.1	E-UTRAN FDD – UTRAN FDD Handover.....	1022
A.5.2.1.1	Test Purpose and Environment	1022
A.5.2.1.2	Test Requirements.....	1024
A.5.2.2	E-UTRAN TDD - UTRAN FDD Handover	1025
A.5.2.2.1	Test Purpose and Environment	1025
A.5.2.2.2	Test Requirements.....	1027
A.5.2.3	E-UTRAN FDD- GSM Handover	1027
A.5.2.3.1	Test Purpose and Environment.....	1027
A.5.2.3.2	Test Requirements	1028
A.5.2.4	E-UTRAN TDD - UTRAN TDD Handover.....	1029
A.5.2.4.1	Test Purpose and Environment	1029
A.5.2.4.1.1	Void.....	1029
A.5.2.4.1.2	1.28 Mcps TDD option.....	1029
A.5.2.4.1.3	Void.....	1031
A.5.2.4.2	Test Requirements.....	1031
A.5.2.4.2.1	Void.....	1031
A.5.2.4.2.2	1.28 Mcps TDD option.....	1031
A.5.2.4.2.3	Void.....	1031
A.5.2.5	E-UTRAN FDD – UTRAN TDD Handover	1031
A.5.2.5.1	Test Purpose and Environment	1031
A.5.2.5.1.3	Void.....	1033
A.5.2.5.2	Test Requirements.....	1033
A.5.2.5.2.1	Void.....	1033
A.5.2.5.2.2	1.28 Mcps TDD option.....	1033
A.5.2.5.2.3	Void.....	1033
A.5.2.6	E-UTRAN TDD - GSM Handover	1033
A.5.2.6.1	Test Purpose and Environment.....	1033
A.5.2.6.2	Test Requirements	1035
A.5.2.7	E-UTRAN FDD – UTRAN FDD Handover; Unknown Target Cell.....	1035
A.5.2.7.1	Test Purpose and Environment	1035
A.5.2.7.2	Test Requirements.....	1038
A.5.2.8	E-UTRAN FDD - GSM Handover; Unknown Target Cell.....	1038
A.5.2.8.1	Test Purpose and Environment	1038
A.5.2.8.2	Test Requirements.....	1039
A.5.2.9	E-UTRAN TDD - GSM Handover; Unknown Target Cell	1040
A.5.2.9.1	Test Purpose and Environment	1040
A.5.2.9.2	Test Requirements.....	1041
A.5.2.10	E-UTRAN TDD to UTRAN TDD handover: unknown target cell	1042
A.5.2.10.1	Test Purpose and Environment	1042
A.5.2.10.2	Test Requirements.....	1043
A.5.2.10A	E-UTRAN FDD – UTRAN FDD Multicarrier Handover with two target cells	1044
A.5.2.10A.1	Test Purpose and Environment	1044
A.5.2.10A.2	Test Requirements.....	1046
A.5.2.10B	E-UTRAN TDD – UTRAN FDD Multicarrier Handover with two target cells	1046
A.5.2.10B.1	Test Purpose and Environment	1046
A.5.2.10B.2	Test Requirements.....	1048
A.5.2.11	E-UTRAN FDD – UTRAN FDD Handover for 5MHz Bandwidth	1048
A.5.2.11.1	Test Purpose and Environment	1048
A.5.2.11.2	Test Requirements.....	1049
A.5.3	E-UTRAN Handover to Non-3GPP RATs	1049
A.5.3.1	E-UTRAN FDD – HRPD Handover	1049
A.5.3.1.1	Test Purpose and Environment	1049
A.5.3.1.2	Test Requirements.....	1052
A.5.3.2	E-UTRAN FDD – cdma2000 1X Handover	1052
A.5.3.2.1	Test Purpose and Environment	1052
A.5.3.2.2	Test Requirements.....	1055
A.5.3.3	E-UTRAN FDD – HRPD Handover; Unknown Target Cell.....	1055

A.5.3.3.1	Test Purpose and Environment	1055
A.5.3.3.2	Test Requirements.....	1057
A.5.3.4	E-UTRAN FDD – cdma2000 1X Handover; Unknown Target cell	1058
A.5.3.4.1	Test Purpose and Environment	1058
A.5.3.4.2	Test Requirements.....	1059
A.5.3.5	E-UTRAN TDD – HRPD Handover	1059
A.5.3.5.1	Test Purpose and Environment	1059
A.5.3.5.2	Test Requirements.....	1061
A.5.3.6	E-UTRAN TDD – cdma2000 1X Handover.....	1062
A.5.3.6.1	Test Purpose and Environment	1062
A.5.3.6.2	Test Requirements.....	1064
A.6	RRC Connection Control	1064
A.6.1	RRC Re-establishment	1064
A.6.1.1	E-UTRAN FDD Intra-frequency RRC Re-establishment.....	1064
A.6.1.1.1	Test Purpose and Environment	1064
A.6.1.1.2	Test Requirements.....	1065
A.6.1.2	E-UTRAN FDD Inter-frequency RRC Re-establishment.....	1066
A.6.1.2.1	Test Purpose and Environment	1066
A.6.1.2.2	Test Requirements.....	1067
A.6.1.3	E-UTRAN TDD Intra-frequency RRC Re-establishment	1068
A.6.1.3.1	Test Purpose and Environment	1068
A.6.1.3.2	Test Requirements.....	1069
A.6.1.4	E-UTRAN TDD Inter-frequency RRC Re-establishment	1069
A.6.1.4.1	Test Purpose and Environment	1069
A.6.1.4.2	Test Requirements.....	1071
A.6.1.5	E-UTRAN FDD Intra-frequency RRC Re-establishment for 5MHz bandwidth.....	1071
A.6.1.5.1	Test Purpose and Environment	1071
A.6.1.5.2	Test Requirements.....	1072
A.6.1.6	E-UTRAN FD-FDD Intra-frequency RRC Re-establishment for UE category 0.....	1072
A.6.1.6.1	Test Purpose and Environment	1072
A.6.1.6.2	Test Requirements.....	1073
A.6.1.7	E-UTRAN HD-FDD Intra-frequency RRC Re-establishment for UE category 0.....	1074
A.6.1.7.1	Test Purpose and Environment	1074
A.6.1.7.2	Test Requirements.....	1075
A.6.1.8	E-UTRAN TDD Intra-frequency RRC Re-establishment for UE category 0.....	1076
A.6.1.8.1	Test Purpose and Environment	1076
A.6.1.8.2	Test Requirements.....	1077
A.6.1.9	E-UTRAN FD-FDD Intra-frequency RRC Re-establishment for Cat-M1 UE in CEModeA.....	1077
A.6.1.9.1	Test Purpose and Environment	1077
A.6.1.9.2	Test Requirements.....	1079
A.6.1.10	E-UTRAN HD-FDD Intra-frequency RRC Re-establishment for Cat-M1 UE in CEModeA	1079
A.6.1.10.1	Test Purpose and Environment	1079
A.6.1.10.2	Test Requirements.....	1080
A.6.1.11	E-UTRAN TDD Intra-frequency RRC Re-establishment for Cat-M1 UE in CEModeA	1081
A.6.1.11.1	Test Purpose and Environment	1081
A.6.1.11.2	Test Requirements.....	1082
A.6.1.12	E-UTRAN FD-FDD Intra-frequency RRC Re-establishment for Cat-M1 UE in CEModeB	1083
A.6.1.12.1	Test Purpose and Environment	1083
A.6.1.12.2	Test Requirements.....	1084
A.6.1.13	E-UTRAN HD-FDD Intra-frequency RRC Re-establishment for Cat-M1 UE in CEModeB	1085
A.6.1.13.1	Test Purpose and Environment	1085
A.6.1.13.2	Test Requirements.....	1086
A.6.1.14	E-UTRAN TDD Intra-frequency RRC Re-establishment for Cat-M1 UE in CEModeB	1086
A.6.1.14.1	Test Purpose and Environment	1086
A.6.1.14.2	Test Requirements.....	1088
A.6.1.15	HD-FDD Intra-frequency RRC Re-establishment for UE category NB1 in In-Band mode under enhanced coverage.....	1088
A.6.1.15.1	Test Purpose and Environment	1088
A.6.1.15.2	Test Requirements.....	1090
A.6.1.16	HD-FDD Inter-frequency RRC Re-establishment for UE category NB1 in In-Band mode under normal coverage.....	1091

A.6.1.16.1	Test Purpose and Environment	1091
A.6.1.16.2	Test Requirements.....	1092
A.6.1.17	E-UTRAN FD-FDD Inter-frequency RRC Re-establishment for Cat-M1 UE in CEModeA.....	1093
A.6.1.17.1	Test Purpose and Environment	1093
A.6.1.17.2	Test Requirements.....	1094
A.6.1.18	E-UTRAN HD-FDD Inter-frequency RRC Re-establishment for Cat-M1 UE in CEModeA	1095
A.6.1.18.1	Test Purpose and Environment	1095
A.6.1.18.2	Test Requirements.....	1096
A.6.1.19	E-UTRAN TDD-TDD Inter-frequency RRC Re-establishment for Cat-M1 UE in CEModeA	1097
A.6.1.19.1	Test Purpose and Environment	1097
A.6.1.19.2	Test Requirements.....	1098
A.6.1.20	E-UTRAN FD-FDD Inter-frequency RRC Re-establishment for Cat-M1 UE in CEModeB.....	1099
A.6.1.20.1	Test Purpose and Environment	1099
A.6.1.20.2	Test Requirements.....	1100
A.6.1.21	E-UTRAN HD-FDD Inter-frequency RRC Re-establishment for Cat-M1 UE in CEModeB	1101
A.6.1.21.1	Test Purpose and Environment	1101
A.6.1.21.2	Test Requirements.....	1102
A.6.1.22	E-UTRAN TDD Inter-frequency RRC Re-establishment for Cat-M1 UE in CEModeB	1102
A.6.1.22.1	Test Purpose and Environment	1102
A.6.1.22.2	Test Requirements.....	1104
A.6.1.23	E-UTRAN TDD Inter-frequency RRC Re-establishment for UE category NB1 in In-Band mode under normal coverage.....	1104
A.6.1.23.1	Test Purpose and Environment	1104
A.6.1.23.2	Test Requirements.....	1106
A.6.1.24	E-UTRAN TDD - TDD Intra-frequency RRC Re-establishment for UE category NB1 in In-Band mode under enhanced coverage	1107
A.6.1.24.1	Test Purpose and Environment	1107
A.6.1.24.2	Test Requirements.....	1108
A.6.2	Random Access	1109
A.6.2.1	E-UTRAN FDD – Contention Based Random Access Test.....	1109
A.6.2.1.1	Test Purpose and Environment	1109
A.6.2.1.2	Test Requirements.....	1110
A.6.2.1.2.1	Random Access Response Reception.....	1110
A.6.2.1.2.2	No Random Access Response Reception	1110
A.6.2.1.2.3	Receiving a NACK on msg3	1111
A.6.2.1.2.4	Reception of an Incorrect Message over Temporary C-RNTI.....	1111
A.6.2.1.2.5	Reception of a Correct Message over Temporary C-RNTI.....	1111
A.6.2.1.2.6	Contention Resolution Timer expiry	1111
A.6.2.2	E-UTRAN FDD – Non-Contention Based Random Access Test.....	1111
A.6.2.2.1	Test Purpose and Environment	1111
A.6.2.2.2	Test Requirements.....	1112
A.6.2.2.2.1	Random Access Response Reception.....	1112
A.6.2.2.2.2	No Random Access Response Reception	1113
A.6.2.3	E-UTRAN TDD – Contention Based Random Access Test.....	1113
A.6.2.3.1	Test Purpose and Environment	1113
A.6.2.3.2	Test Requirements.....	1114
A.6.2.3.2.1	Random Access Response Reception.....	1114
A.6.2.3.2.2	No Random Access Response reception	1114
A.6.2.3.2.3	Receiving a NACK on msg3	1115
A.6.2.3.2.4	Reception of an Incorrect Message over Temporary C-RNTI.....	1115
A.6.2.3.2.5	Reception of a Correct Message over Temporary C-RNTI.....	1115
A.6.2.3.2.6	Contention Resolution Timer expiry	1115
A.6.2.4	E-UTRAN TDD – Non-Contention Based Random Access Test.....	1115
A.6.2.4.1	Test Purpose and Environment	1115
A.6.2.4.2	Test Requirements.....	1116
A.6.2.4.2.1	Random Access Response Reception.....	1116
A.6.2.4.2.2	No Random Access Response Reception	1117
A.6.2.5	E-UTRAN FDD – Contention Based Random Access Test for 5MHz bandwidth	1117
A.6.2.5.1	Test Purpose and Environment	1117
A.6.2.5.2	Test Requirements.....	1117
A.6.2.6	E-UTRAN FDD – Non-contention Based Random Access Test for 5MHz bandwidth	1118
A.6.2.6.1	Test Purpose and Environment	1118

A.6.2.6.2	Test Requirements.....	1118
A.6.2.7	E-UTRAN FDD – Non-Contention Based Random Access Test For SCell.....	1118
A.6.2.7.1	Test Purpose and Environment	1118
A.6.2.7.2	Test Requirements.....	1119
A.6.2.7.2.1	Random Access Response Reception	1119
A.6.2.7.2.2	No Random Access Response Reception	1120
A.6.2.7.2.3	Stop Preamble transmission if maximum number of preamble transmission counter has been reached.....	1120
A.6.2.8	E-UTRAN TDD – Non-Contention Based Random Access Test For SCell	1120
A.6.2.8.1	Test Purpose and Environment	1120
A.6.2.8.2	Test Requirements.....	1122
A.6.2.8.2.1	Random Access Response Reception	1122
A.6.2.8.2.2	No Random Access Response Reception	1122
A.6.2.8.2.3	Stop Preamble transmission if maximum number of preamble transmission counter has been reached.....	1122
A.6.2.9	3DL/3UL TDD CA Non-Contention Based Random Access Test for 2 SCells.....	1122
A.6.2.9.1	Test Purpose and Environment	1122
A.6.2.9.2	Test Requirements.....	1124
A.6.2.9.2.1	Random Access Response Reception	1124
A.6.2.9.2.2	No Random Access Response Reception	1125
A.6.2.9.2.3	Stop Preamble transmission if maximum number of preamble transmission counter has been reached.....	1125
A.6.2.10	E-UTRAN FDD Contention Based Random Access Test for Cat-M1 UEs in Normal Coverage.....	1126
A.6.2.10.1	Test Purpose and Environment	1126
A.6.2.10.2	Test Requirements.....	1128
A.6.2.10.2.1	Random Access Response Reception	1128
A.6.2.10.2.2	No Random Access Response Reception	1128
A.6.2.10.2.3	Receiving a NACK on msg3	1128
A.6.2.10.2.4	Reception of an Incorrect Message over Temporary C-RNTI.....	1128
A.6.2.10.2.5	Reception of a Correct Message over Temporary C-RNTI	1129
A.6.2.10.2.6	Contention Resolution Timer expiry	1129
A.6.2.10.2.7	PRACH Resource Selection	1129
A.6.2.11	E-UTRAN HD-FDD Contention Based Random Access Test for Cat-M1 UEs in Normal Coverage...	1129
A.6.2.11.1	Test Purpose and Environment	1129
A.6.2.11.2	Test Requirements.....	1131
A.6.2.11.2.1	Random Access Response Reception	1131
A.6.2.11.2.2	No Random Access Response Reception	1131
A.6.2.11.2.3	Receiving a NACK on msg3	1131
A.6.2.11.2.4	Reception of an Incorrect Message over Temporary C-RNTI.....	1131
A.6.2.11.2.5	Reception of a Correct Message over Temporary C-RNTI	1132
A.6.2.11.2.6	Contention Resolution Timer expiry	1132
A.6.2.11.2.7	PRACH Resource Selection	1132
A.6.2.12	E-UTRAN TDD Contention Based Random Access Test for Cat-M1 UEs in Normal Coverage.....	1132
A.6.2.12.1	Test Purpose and Environment	1132
A.6.2.12.2	Test Requirements.....	1134
A.6.2.12.2.1	Random Access Response Reception	1134
A.6.2.12.2.2	No Random Access Response Reception	1134
A.6.2.12.2.3	Receiving a NACK on msg3	1134
A.6.2.12.2.4	Reception of an Incorrect Message over Temporary C-RNTI.....	1135
A.6.2.12.2.5	Reception of a Correct Message over Temporary C-RNTI	1135
A.6.2.12.2.6	Contention Resolution Timer expiry	1135
A.6.2.12.2.7	PRACH Resource Selection	1135
A.6.2.13	E-UTRAN FDD Contention Based Random Access Test for Cat-M1 UEs in Enhanced Coverage	1135
A.6.2.13.1	Test Purpose and Environment	1135
A.6.2.13.2	Test Requirements.....	1137
A.6.2.13.2.1	Random Access Response Reception	1137
A.6.2.13.2.2	No Random Access Response Reception	1137
A.6.2.13.2.3	Receiving a NACK on msg3	1138
A.6.2.13.2.4	Reception of an Incorrect Message over Temporary C-RNTI.....	1138
A.6.2.13.2.5	Reception of a Correct Message over Temporary C-RNTI	1138
A.6.2.13.2.6	Contention Resolution Timer expiry	1138
A.6.2.13.2.7	PRACH Resource Selection	1138

A.6.2.14	E-UTRAN HD-FDD Contention Based Random Access Test for Cat-M1 UEs in Enhanced Coverage	1138
A.6.2.14.1	Test Purpose and Environment	1138
A.6.2.14.2	Test Requirements.....	1140
A.6.2.14.2.1	Random Access Response Reception	1140
A.6.2.14.2.2	No Random Access Response Reception	1140
A.6.2.14.2.3	Receiving a NACK on msg3	1141
A.6.2.14.2.4	Reception of an Incorrect Message over Temporary C-RNTI.....	1141
A.6.2.14.2.5	Reception of a Correct Message over Temporary C-RNTI	1141
A.6.2.14.2.6	Contention Resolution Timer expiry	1141
A.6.2.14.2.7	PRACH Resource Selection	1141
A.6.2.15	E-UTRAN TDD Contention Based Random Access Test for Cat-M1 UEs in Enhanced Coverage	1141
A.6.2.15.1	Test Purpose and Environment	1141
A.6.2.15.2	Test Requirements.....	1143
A.6.2.15.2.1	Random Access Response Reception.....	1143
A.6.2.15.2.2	No Random Access Response Reception	1144
A.6.2.15.2.3	Receiving a NACK on msg3	1144
A.6.2.15.2.4	Reception of an Incorrect Message over Temporary C-RNTI.....	1144
A.6.2.15.2.5	Reception of a Correct Message over Temporary C-RNTI	1144
A.6.2.15.2.6	Contention Resolution Timer expiry	1144
A.6.2.15.2.7	PRACH Resource Selection	1144
A.6.2.16	Contention Based Random Access Test for UE category NB1 UEs In-band mode in normal coverage.....	1144
A.6.2.16.1	Test Purpose and Environment	1144
A.6.2.16.2	Test Requirements.....	1147
A.6.2.16.2.1	Random Access Response Reception.....	1147
A.6.2.16.2.2	No Random Access Response Reception	1147
A.6.2.16.2.3	Receiving a NACK on msg3	1147
A.6.2.16.2.4	Reception of an Incorrect Message over Temporary C-RNTI.....	1147
A.6.2.16.2.5	Reception of a Correct Message over Temporary C-RNTI	1148
A.6.2.16.2.6	Contention Resolution Timer expiry	1148
A.6.2.16.2.7	NPRACH Resource Selection	1148
A.6.2.17	Contention Based Random Access Test for UE category NB1 UEs In-band mode in Enhanced Coverage.....	1148
A.6.2.17.1	Test Purpose and Environment	1148
A.6.2.17.2	Test Requirements.....	1150
A.6.2.17.2.1	Random Access Response Reception.....	1150
A.6.2.17.2.2	No Random Access Response Reception	1151
A.6.2.17.2.3	Receiving a NACK on msg3	1151
A.6.2.17.2.4	Reception of an Incorrect Message over Temporary C-RNTI.....	1151
A.6.2.17.2.5	Reception of a Correct Message over Temporary C-RNTI	1151
A.6.2.17.2.6	Contention Resolution Timer expiry	1151
A.6.2.17.2.7	NPRACH Resource Selection	1151
A.6.2.18	Contention Based Random Access on Non-anchor Carrier Test for UE category NB1 UEs In-band mode in Enhanced Coverage	1152
A.6.2.18.1	Test Purpose and Environment	1152
A.6.2.18.2	Test Requirements.....	1154
A.6.2.18.2.1	Random Access Response Reception.....	1154
A.6.2.18.2.2	No Random Access Response Reception	1154
A.6.2.18.2.3	Receiving a NACK on msg3	1155
A.6.2.18.2.4	Reception of an Incorrect Message over Temporary C-RNTI.....	1155
A.6.2.18.2.5	Reception of a Correct Message over Temporary C-RNTI	1155
A.6.2.18.2.6	Contention Resolution Timer expiry	1155
A.6.2.18.2.7	NPRACH Resource Selection	1155
A.6.2.19	TDD Contention Based Random Access Test for UE category NB1 UEs In-band mode in normal coverage.....	1155
A.6.2.19.1	Test Purpose and Environment	1155
A.6.2.19.2	Test Requirements.....	1157
A.6.2.19.2.1	Random Access Response Reception.....	1157
A.6.2.19.2.2	No Random Access Response Reception	1158
A.6.2.19.2.3	Receiving a NACK on msg3	1158
A.6.2.19.2.4	Reception of an Incorrect Message over Temporary C-RNTI.....	1158

A.6.2.19.2.5	Reception of a Correct Message over Temporary C-RNTI	1158
A.6.2.19.2.6	Contention Resolution Timer expiry	1158
A.6.2.19.2.7	NPRACH Resource Selection	1158
A.6.2.20	TDD Contention Based Random Access Test for UE category NB1 UEs In-band mode in enhanced coverage	1159
A.6.2.20.1	Test Purpose and Environment	1159
A.6.2.20.2	Test Requirements	1161
A.6.2.20.2.1	Random Access Response Reception	1161
A.6.2.20.2.2	No Random Access Response Reception	1161
A.6.2.20.2.3	Receiving a NACK on msg3	1161
A.6.2.20.2.4	Reception of an Incorrect Message over Temporary C-RNTI	1161
A.6.2.20.2.5	Reception of a Correct Message over Temporary C-RNTI	1162
A.6.2.20.2.6	Contention Resolution Timer expiry	1162
A.6.2.20.2.7	NPRACH Resource Selection	1162
A.6.2.21	TDD Contention Based Random Access on Non-anchor Carrier Test for UE category NB1 UEs In-band mode in Enhanced Coverage	1162
A.6.2.21.1	Test Purpose and Environment	1162
A.6.2.21.2	Test Requirements	1164
A.6.2.21.2.1	Random Access Response Reception	1164
A.6.2.21.2.2	No Random Access Response Reception	1164
A.6.2.21.2.3	Receiving a NACK on msg3	1165
A.6.2.21.2.4	Reception of an Incorrect Message over Temporary C-RNTI	1165
A.6.2.21.2.5	Reception of a Correct Message over Temporary C-RNTI	1165
A.6.2.21.2.6	Contention Resolution Timer expiry	1165
A.6.2.21.2.7	NPRACH Resource Selection	1165
A.6.3	RRC Connection Release with Redirection	1165
A.6.3.1	Redirection from E-UTRAN FDD to UTRAN FDD	1165
A.6.3.1.1	Test Purpose and Environment	1165
A.6.3.1.2	Test Requirements	1167
A.6.3.2	Redirection from E-UTRAN TDD to UTRAN FDD	1168
A.6.3.2.1	Test Purpose and Environment	1168
A.6.3.2.2	Test Requirements	1169
A.6.3.3	Redirection from E-UTRAN FDD to GERAN when System Information is provided	1170
A.6.3.3.1	Test Purpose and Environment	1170
A.6.3.3.2	Test Requirements	1171
A.6.3.4	Redirection from E-UTRAN TDD to GERAN when System Information is provided	1171
A.6.3.4.1	Test Purpose and Environment	1171
A.6.3.4.2	Test Requirements	1173
A.6.3.5	E-UTRA TDD RRC connection release redirection to UTRA TDD	1173
A.6.3.5.1	Test Purpose and Environment	1173
A.6.3.5.2	Test Requirements	1175
A.6.3.6	E-UTRA FDD RRC connection release redirection to UTRA TDD	1175
A.6.3.6.1	Test Purpose and Environment	1175
A.6.3.6.2	Test Requirements	1177
A.6.3.7	E-UTRA TDD RRC connection release redirection to UTRA TDD without SI provided	1177
A.6.3.7.1	Test Purpose and Environment	1177
A.6.3.7.2	Test Requirements	1179
A.6.3.8	E-UTRA FDD RRC connection release redirection to UTRA TDD without SI provided	1179
A.6.3.8.1	Test Purpose and Environment	1179
A.6.3.8.2	Test Requirements	1181
A.6.3.9	Redirection from E-UTRAN FDD to UTRAN FDD without System Information	1181
A.6.3.9.1	Test Purpose and Environment	1181
A.6.3.9.2	Test Requirements	1183
A.6.3.10	Redirection from E-UTRAN FDD to GERAN when System Information is not provided	1183
A.6.3.10.1	Test Purpose and Environment	1183
A.6.3.10.2	Test Requirements	1185
A.6.3.11	Redirection from E-UTRAN TDD to GERAN when System Information is not provided	1185
A.6.3.11.1	Test Purpose and Environment	1185
A.6.3.11.2	Test Requirements	1186
A.6.3.12	E-UTRAN TDD RRC connection release redirection to UTRAN FDD without SI provided	1187
A.6.3.12.1	Test Purpose and Environment	1187
A.6.3.12.2	Test Requirements	1188

A.7	Timing and Signalling Characteristics	1190
A.7.1	UE Transmit Timing	1190
A.7.1.1	E-UTRAN FDD – UE Transmit Timing Accuracy Tests	1190
A.7.1.1.1	Test Purpose and Environment	1190
A.7.1.1.2	Test Requirements.....	1191
A.7.1.2	E-UTRAN TDD - UE Transmit Timing Accuracy Tests	1192
A.7.1.2.1	Test Purpose and Environment	1192
A.7.1.2.2	Test Requirements.....	1193
A.7.1.3	E-UTRAN FDD – UE Transmit Timing Accuracy Tests for SCell.....	1194
A.7.1.3.1	Test Purpose and Environment	1194
A.7.1.3.2	Test Requirements.....	1196
A.7.1.4	E-UTRAN TDD - UE Transmit Timing Accuracy Tests for SCell	1196
A.7.1.4.1	Test Purpose and Environment	1196
A.7.1.4.2	Test Requirements.....	1198
A.7.1.4A	E-UTRAN TDD - UE Transmit Timing Accuracy Tests for SCell for 20 MHz + 10 MHz.....	1198
A.7.1.4A.1	Test Purpose and Environment	1198
A.7.1.4A.2	Test Requirements.....	1199
A.7.1.5	E-UTRAN FDD – UE Transmit Timing Accuracy Tests for 5MHz Bandwidth.....	1199
A.7.1.5.1	Test Purpose and Environment	1199
A.7.1.5.2	Test Requirements.....	1199
A.7.1.6	E-UTRAN FDD – UE Transmit Timing Accuracy Tests for SCell in sTAG.....	1199
A.7.1.6.1	Test Purpose and Environment	1199
A.7.1.6.2	Test Requirements.....	1201
A.7.1.7	E-UTRAN TDD - UE Transmit Timing Accuracy Tests for SCell in sTAG	1201
A.7.1.7.1	Test Purpose and Environment	1201
A.7.1.7.2	Test Requirements.....	1203
A.7.1.7A	E-UTRAN TDD - UE Transmit Timing Accuracy Tests for SCell in sTAG for 20MHz +20MHz	1203
A.7.1.7A.1	Test Purpose and Environment	1203
A.7.1.7A.2	Test Requirements.....	1204
A.7.1.7B	E-UTRAN TDD - UE Transmit Timing Accuracy Tests for SCell in sTAG for 20MHz +10MHz	1204
A.7.1.7B.1	Test Purpose and Environment	1204
A.7.1.7B.2	Test Requirements.....	1204
A.7.1.8	Void.....	1204
A.7.1.8.1	Void.....	1204
A.7.1.8.2	Void.....	1204
A.7.1.9	Void	1204
A.7.1.9.1	Void.....	1204
A.7.1.9.2	Void.....	1204
A.7.1.10	E-UTRAN FDD – UE Transmit Timing Accuracy Tests for Cat-M1 UE in CEModeA	1204
A.7.1.10.1	Test Purpose and Environment	1204
A.7.1.10.2	Test Requirements.....	1206
A.7.1.11	E-UTRAN HD-FDD – UE Transmit Timing Accuracy Tests for Cat-M1 UE in CEModeA	1206
A.7.1.11.1	Test Purpose and Environment	1206
A.7.1.11.2	Test Requirements.....	1208
A.7.1.12	E-UTRAN TDD - UE Transmit Timing Accuracy Tests for Cat-M1 UE in CEModeA.....	1208
A.7.1.12.1	Test Purpose and Environment	1208
A.7.1.12.2	Test Requirements.....	1209
A.7.1.13	3DL/3UL TDD CA UE Transmit Timing Accuracy Tests for 2 SCells	1210
A.7.1.13.1	Test Purpose and Environment	1210
A.7.1.13.2	Test Requirements.....	1212
A.7.1.14	E-UTRAN FDD – UE Transmit Timing Accuracy Tests for Cat-M1 UE in CEModeB.....	1212
A.7.1.14.1	Test Purpose and Environment	1212
A.7.1.14.2	Test Requirements.....	1213
A.7.1.15	E-UTRAN HD-FDD – UE Transmit Timing Accuracy Tests for Cat-M1 UE in CEModeB.....	1214
A.7.1.15.1	Test Purpose and Environment	1214
A.7.1.15.2	Test Requirements.....	1215
A.7.1.16	E-UTRAN TDD - UE Transmit Timing Accuracy Tests for Cat-M1 UE in CEModeB	1215
A.7.1.16.1	Test Purpose and Environment	1215
A.7.1.16.2	Test Requirements.....	1216
A.7.1.17	E-UTRAN HD-FDD – UE Transmit Timing Accuracy Tests for Category NB1 UE In-Band mode under normal coverage.....	1217
A.7.1.17.1	Test Purpose and Environment	1217

A.7.1.17.2	Test Requirements.....	1218
A.7.1.18	E-UTRAN HD-FDD – UE Transmit Timing Accuracy Tests for Category NB1 UE In-band mode under enhanced coverage.....	1219
A.7.1.18.1	Test Purpose and Environment	1219
A.7.1.18.2	Test Requirements.....	1221
A.7.1.19	E-UTRAN FDD - UE Transmit Timing Accuracy Test for RACH-less Handover.....	1221
A.7.1.19.1	Test Purpose and Environment	1221
A.7.1.19.2	Test Requirements.....	1223
A.7.1.20	E-UTRAN TDD - UE Transmit Timing Accuracy Test for RACH-less Handover	1223
A.7.1.20.1	Test Purpose and Environment	1223
A.7.1.20.2	Test Requirements.....	1225
A.7.1.21	E-UTRAN FDD – UE Transmit Timing Accuracy Tests for Cat-M2 UE in CEModeA	1225
A.7.1.21.1	Test Purpose and Environment	1225
A.7.1.21.2	Test Requirements.....	1227
A.7.1.22	E-UTRAN HD-FDD – UE Transmit Timing Accuracy Tests for Cat-M2 UE in CEModeA	1227
A.7.1.22.1	Test Purpose and Environment	1227
A.7.1.22.2	Test Requirements.....	1228
A.7.1.23	E-UTRAN TDD - UE Transmit Timing Accuracy Tests for Cat-M2 UE in CEModeA.....	1229
A.7.1.23.1	Test Purpose and Environment	1229
A.7.1.23.2	Test Requirements.....	1230
A.7.1.24	E-UTRAN FDD – UE Transmit Timing Accuracy Tests for Cat-M2 UE in CEModeB.....	1231
A.7.1.24.1	Test Purpose and Environment	1231
A.7.1.24.2	Test Requirements.....	1232
A.7.1.25	E-UTRAN HD-FDD – UE Transmit Timing Accuracy Tests for Cat-M2 UE in CEModeB.....	1232
A.7.1.25.1	Test Purpose and Environment	1232
A.7.1.25.2	Test Requirements.....	1233
A.7.1.26	E-UTRAN TDD - UE Transmit Timing Accuracy Tests for Cat-M2 UE in CEModeB	1234
A.7.1.26.1	Test Purpose and Environment	1234
A.7.1.26.2	Test Requirements.....	1235
A.7.1.27	E-UTRAN TDD – UE Transmit Timing Accuracy Tests for Category NB1 UE In-Band mode under normal coverage.....	1235
A.7.1.27.1	Test Purpose and Environment	1235
A.7.1.27.2	Test Requirements.....	1237
A.7.1.28	E-UTRAN TDD – UE Transmit Timing Accuracy Tests for Category NB1 UE In-band mode under enhanced coverage.....	1237
A.7.1.28.1	Test Purpose and Environment	1237
A.7.1.28.2	Test Requirements.....	1239
A.7.2	UE Timing Advance.....	1240
A.7.2.1	E-UTRAN FDD – UE Timing Advance Adjustment Accuracy Test	1240
A.7.2.1.1	Test Purpose and Environment	1240
A.7.2.1.2	Test Requirements.....	1241
A.7.2.2	E-UTRAN TDD – UE Timing Advance Adjustment Accuracy Test.....	1241
A.7.2.2.1	Test Purpose and Environment	1241
A.7.2.2.2	Test Requirements.....	1243
A.7.2.3	E-UTRAN FDD – UE Timing Advance Adjustment Accuracy Test for 5MHz	1243
A.7.2.3.1	Test Purpose and Environment	1243
A.7.2.3.2	Test Requirements.....	1244
A.7.2.4	E-UTRAN FDD – UE Timing Advance Adjustment Accuracy Test for SCell in sTAG	1244
A.7.2.4.1	Test Purpose and Environment	1244
A.7.2.4.2	Test Requirements.....	1246
A.7.2.5	E-UTRAN TDD – UE Timing Advance Adjustment Accuracy Test for Scell in sTAG.....	1246
A.7.2.5.1	Test Purpose and Environment	1246
A.7.2.5.2	Test Requirements.....	1248
A.7.2.5A	E-UTRAN TDD – UE Timing Advance Adjustment Accuracy Test for Scell in sTAG for 20 MHz +20 MHz.....	1248
A.7.2.5A.1	Test Purpose and Environment	1248
A.7.2.5A.2	Test Requirements.....	1248
A.7.2.5B	E-UTRAN TDD – UE Timing Advance Adjustment Accuracy Test for Scell in sTAG for 20 MHz +10 MHz.....	1249
A.7.2.5B.1	Test Purpose and Environment	1249
A.7.2.5B.2	Test Requirements.....	1249
A.7.2.6	E-UTRAN FDD Timing Advance Adjustment Accuracy Test for Cat-M1 UE in CEModeA.....	1249

A.7.2.6.1	Test Purpose and Environment	1249
A.7.2.6.2	Test Requirements.....	1251
A.7.2.7	E-UTRAN HD-FDD UE Timing Advance Adjustment Accuracy Test for Cat-M1 UE in CEModeA..	1251
A.7.2.7.1	Test Purpose and Environment	1251
A.7.2.7.2	Test Requirements.....	1253
A.7.2.8	E-UTRAN TDD Timing Advance Adjustment Accuracy Test for Cat-M1 UE in CEModeA.....	1253
A.7.2.8.1	Test Purpose and Environment	1253
A.7.2.8.2	Test Requirements.....	1255
A.7.2.9.2	Test Requirements.....	1257
A.7.2.10	E-UTRAN FDD UE Timing Advance Adjustment Accuracy Test in CEModeB	1257
A.7.2.10.1	Test Purpose and Environment	1257
A.7.2.10.2	Test Requirements.....	1258
A.7.2.11	E-UTRAN HD-FDD UE Timing Advance Adjustment Accuracy Test in CEModeB	1258
A.7.2.11.1	Test Purpose and Environment	1258
A.7.2.11.2	Test Requirements.....	1260
A.7.2.12	E-UTRAN TDD UE Timing Advance Adjustment Accuracy Test in CEModeB	1260
A.7.2.12.1	Test Purpose and Environment	1260
A.7.2.12.2	Test Requirements.....	1261
A.7.2.13	E-UTRAN FDD – UE Timing Advance Adjustment delay Test for sTTI and <i>ShortProcessingTime=TRUE</i>	1262
A.7.2.13.1	Test Purpose and Environment	1262
A.7.2.13.2	Test Requirements.....	1263
A.7.2.14	E-UTRAN TDD – UE Timing Advance Adjustment delay Test for sTTI and <i>ShortProcessingTime=TRUE</i>	1264
A.7.2.14.1	Test Purpose and Environment	1264
A.7.2.14.2	Test Requirements.....	1265
A.7.2.15	E-UTRAN TDD – TDD UE Timing Advance Adjustment Accuracy Test for UE Category NB1 in Standalone Mode under Enhanced Coverage	1265
A.7.2.15.1	Test Purpose and Environment	1265
A.7.2.15.2	Test Requirements.....	1267
A.7.3	Radio Link Monitoring.....	1267
A.7.3.1	E-UTRAN FDD Radio Link Monitoring Test for Out-of-sync	1267
A.7.3.1.1	Test Purpose and Environment	1267
A.7.3.1.2	Test Requirements.....	1271
A.7.3.2	E-UTRAN FDD Radio Link Monitoring Test for In-sync	1271
A.7.3.2.1	Test Purpose and Environment	1271
A.7.3.2.2	Test Requirements.....	1273
A.7.3.3	E-UTRAN TDD Radio Link Monitoring Test for Out-of-sync	1274
A.7.3.3.1	Test Purpose and Environment	1274
A.7.3.3.2	Test Requirements.....	1277
A.7.3.4	E-UTRAN TDD Radio Link Monitoring Test for In-sync	1277
A.7.3.4.1	Test Purpose and Environment	1277
A.7.3.4.2	Test Requirements.....	1279
A.7.3.5	E-UTRAN FDD Radio Link Monitoring Test for Out-of-sync in DRX.....	1280
A.7.3.5.1	Test Purpose and Environment	1280
A.7.3.5.2	Test Requirements.....	1283
A.7.3.6	E-UTRAN FDD Radio Link Monitoring Test for In-sync in DRX	1284
A.7.3.6.1	Test Purpose and Environment	1284
A.7.3.6.2	Test Requirements.....	1286
A.7.3.7	E-UTRAN TDD Radio Link Monitoring Test for Out-of-sync in DRX	1286
A.7.3.7.1	Test Purpose and Environment	1286
A.7.3.7.2	Test Requirements.....	1289
A.7.3.8	E-UTRAN TDD Radio Link Monitoring Test for In-sync in DRX.....	1289
A.7.3.8.1	Test Purpose and Environment	1289
A.7.3.8.2	Test Requirements.....	1292
A.7.3.9	E-UTRAN FDD Radio Link Monitoring Test for Out-of-sync under Time Domain Measurement Resource Restriction and Non-MBSFN ABS.....	1292
A.7.3.9.2	Test Requirements.....	1294
A.7.3.10	E-UTRAN TDD Radio Link Monitoring Test for Out-of-sync under Time Domain Measurement Resource Restriction with Non-MBSFN ABS.....	1295
A.7.3.10.1	Test Purpose and Environment	1295
A.7.3.11	E-UTRAN FDD Radio Link Monitoring Test for In-sync for Non-MBSFN ABS.....	1297

A.7.3.11.1	Test Purpose and Environment	1297
A.7.3.11.2	Test Requirements.....	1300
A.7.3.12	E-UTRAN TDD Radio Link Monitoring Test for In-sync for Non-MBSFN ABS	1300
A.7.3.12.1	Test Purpose and Environment	1300
A.7.3.12.2	Test Requirements.....	1303
A.7.3.13	E-UTRAN FDD Radio Link Monitoring Test for Out-of-sync under Time Domain Measurement Resource Restriction with MBSFN ABS.....	1304
A.7.3.13.1	Test Purpose and Environment	1304
A.7.3.13.2	Test Requirements.....	1306
A.7.3.14	E-UTRAN TDD Radio Link Monitoring Test for Out-of-sync under Time Domain Measurement Resource Restriction with MBSFN ABS.....	1306
A.7.3.14.1	Test Purpose and Environment	1306
A.7.3.14.2	Test Requirements.....	1309
A.7.3.15	E-UTRAN FDD Radio Link Monitoring Test for In-sync under Time Domain Measurement Resource Restriction with MBSFN ABS.....	1309
A.7.3.15.1	Test Purpose and Environment	1309
A.7.3.15.2	Test Requirements.....	1312
A.7.3.16	E-UTRAN TDD Radio Link Monitoring Test for In-sync under Time Domain Measurement Resource Restriction with MBSFN ABS.....	1312
A.7.3.16.1	Test Purpose and Environment	1312
A.7.3.16.2	Test Requirements.....	1315
A.7.3.17	E-UTRAN FDD Radio Link Monitoring Test for Out-of-sync under Time Domain Measurement Resource Restriction with CRS Assistance Information and Non-MBSFN ABS	1315
A.7.3.17.1	Test Purpose and Environment	1315
A.7.3.17.2	Test Requirements.....	1318
A.7.3.18	E-UTRAN TDD Radio Link Monitoring Test for Out-of-sync under Time Domain Measurement Resource Restriction with CRS Assistance Information and Non-MBSFN ABS	1318
A.7.3.18.1	Test Purpose and Environment	1318
A.7.3.18.2	Test Requirements.....	1321
A.7.3.19	E-UTRAN FDD Radio Link Monitoring Test for In-sync under Time Domain Measurement Resource Restriction with CRS assistance information and Non-MBSFN ABS	1321
A.7.3.19.1	Test Purpose and Environment	1321
A.7.3.19.2	Test Requirements.....	1324
A.7.3.20	E-UTRAN TDD Radio Link Monitoring Test for In-sync under Time Domain Measurement Resource Restriction with CRS assistance information and Non-MBSFN ABS	1324
A.7.3.20.1	Test Purpose and Environment	1324
A.7.3.20.2	Test Requirements.....	1328
A.7.3.21	E-UTRAN FDD Radio Link Monitoring Test for In-sync under Time Domain Measurement Resource Restriction with CRS assistance information and MBSFN ABS	1328
A.7.3.21.1	Test Purpose and Environment	1328
A.7.3.21.2	Test Requirements.....	1331
A.7.3.22	E-UTRAN TDD Radio Link Monitoring Test for In-sync under Time Domain Measurement Resource Restriction with CRS assistance information and MBSFN ABS	1331
A.7.3.22.1	Test Purpose and Environment	1331
A.7.3.22.2	Test Requirements.....	1335
A.7.3.23	E-UTRAN FDD Radio Link Monitoring Test for Out-of-sync for 5MHz Bandwidth.....	1335
A.7.3.23.1	Test Purpose and Environment	1335
A.7.3.23.2	Test Requirements.....	1336
A.7.3.24	E-UTRAN FDD Radio Link Monitoring Test for In-sync for 5MHz Bandwidth	1336
A.7.3.24.1	Test Purpose and Environment	1336
A.7.3.24.2	Test Requirements.....	1337
A.7.3.25	E-UTRAN FDD Radio Link Monitoring Test for In-sync in DRX for 5MHz Bandwidth.....	1337
A.7.3.25.1	Test Purpose and Environment	1337
A.7.3.25.2	Test Requirements.....	1338
A.7.3.26	E-UTRAN FD-FDD Radio Link Monitoring Test for Out-of-sync for UE Category 0	1338
A.7.3.26.1	Test Purpose and Environment	1338
A.7.3.26.2	Test Requirements.....	1340
A.7.3.27	E-UTRAN FD-FDD Radio Link Monitoring Test for In-sync for UE Category 0.....	1340
A.7.3.27.1	Test Purpose and Environment	1340
A.7.3.27.2	Test Requirements.....	1342
A.7.3.28	E-UTRAN FD-FDD Radio Link Monitoring Test for Out-of-sync in DRX for UE category 0.....	1342
A.7.3.28.1	Test Purpose and Environment	1342

A.7.3.28.2	Test Requirements.....	1346
A.7.3.29	E-UTRAN FD-FDD Radio Link Monitoring Test for In-sync in DRX for UE Category 0	1346
A.7.3.29.1	Test Purpose and Environment	1346
A.7.3.29.2	Test Requirements.....	1348
A.7.3.30	E-UTRAN HD-FDD Radio Link Monitoring Test for Out-of-sync for UE Category 0.....	1349
A.7.3.30.1	Test Purpose and Environment	1349
A.7.3.30.2	Test Requirements.....	1351
A.7.3.31	E-UTRAN HD-FDD Radio Link Monitoring Test for In-sync for UE Category 0.....	1351
A.7.3.31.1	Test Purpose and Environment	1351
A.7.3.31.2	Test Requirements.....	1353
A.7.3.32	E-UTRAN HD-FDD Radio Link Monitoring Test for Out-of-sync in DRX for UE category 0	1353
A.7.3.32.1	Test Purpose and Environment	1353
A.7.3.32.2	Test Requirements.....	1355
A.7.3.33	E-UTRAN HD-FDD Radio Link Monitoring Test for In-sync in DRX for UE Category 0.....	1356
A.7.3.33.1	Test Purpose and Environment	1356
A.7.3.33.2	Test Requirements.....	1358
A.7.3.34	E-UTRAN TDD Radio Link Monitoring Test for Out-of-sync for UE Category 0.....	1358
A.7.3.34.1	Test Purpose and Environment	1358
A.7.3.34.2	Test Requirements.....	1360
A.7.3.35	E-UTRAN TDD Radio Link Monitoring Test for In-sync for UE category 0.....	1361
A.7.3.35.1	Test Purpose and Environment	1361
A.7.3.35.2	Test Requirements.....	1363
A.7.3.36	E-UTRAN TDD Radio Link Monitoring Test for Out-of-sync in DRX for UE category 0.....	1363
A.7.3.36.1	Test Purpose and Environment	1363
A.7.3.36.2	Test Requirements.....	1365
A.7.3.37	E-UTRAN TDD Radio Link Monitoring Test for In-sync in DRX for UE category 0	1366
A.7.3.37.1	Test Purpose and Environment	1366
A.7.3.37.2	Test Requirements.....	1368
A.7.3.38	E-UTRAN FDD-FDD DC Radio Link Monitoring Test for Out-of-sync in DRX in synchronous DC ..	1368
A.7.3.38.1	Test Purpose and Environment	1368
A.7.3.38.2	Test Requirements.....	1371
A.7.3.39	E-UTRAN FDD-FDD DC Radio Link Monitoring Test for Out-of-sync in DRX in asynchronous DC.....	1371
A.7.3.39.1	Test Purpose and Environment	1371
A.7.3.39.2	Test Requirements.....	1374
A.7.3.40	E-UTRAN TDD-TDD DC Radio Link Monitoring Test for Out-of-sync in DRX in synchronous DC ..	1374
A.7.3.40.1	Test Purpose and Environment	1374
A.7.3.40.2	Test Requirements.....	1377
A.7.3.41	E-UTRAN FDD-FDD Radio Link Monitoring Test for In-sync in DRX in synchronous dual connectivity.....	1377
A.7.3.41.1	Test Purpose and Environment	1377
A.7.3.41.2	Test Requirements.....	1380
A.7.3.42	E-UTRAN FDD-FDD DC Radio Link Monitoring Test for In-sync in DRX in asynchronous DC.....	1380
A.7.3.42.1	Test Purpose and Environment	1380
A.7.3.42.2	Test Requirements.....	1383
A.7.3.43	E-UTRAN TDD-TDD Radio Link Monitoring Test for In-sync in DRX in synchronous dual connectivity.....	1383
A.7.3.43.1	Test Purpose and Environment	1383
A.7.3.43.2	Test Requirements.....	1386
A.7.3.44	E-UTRAN TDD-FDD DC Radio Link Monitoring Test for Out-of-sync in DRX in synchronous DC with PCell in FDD	1386
A.7.3.44.1	Test Purpose and Environment	1386
A.7.3.44.2	Test Requirements.....	1389
A.7.3.45	E-UTRAN TDD-FDD DC Radio Link Monitoring Test for Out-of-sync in DRX in synchronous DC with PCell in TDD	1389
A.7.3.45.1	Test Purpose and Environment	1389
A.7.3.45.2	Test Requirements.....	1391
A.7.3.46	E-UTRAN TDD-FDD Radio Link Monitoring Test for In-sync in DRX for PSCell in synchronous DC with PCell in FDD.....	1392
A.7.3.46.1	Test Purpose and Environment	1392
A.7.3.46.2	Test Requirements.....	1394

A.7.3.47	E-UTRAN TDD-FDD Radio Link Monitoring Test for In-sync in DRX for PSCell in synchronous DC with PCell in TDD.....	1395
A.7.3.47.1	Test Purpose and Environment	1395
A.7.3.47.2	Test Requirements.....	1397
A.7.3.48	E-UTRAN FD-FDD Radio Link Monitoring Test for Out-of-sync for Cat-M1 UE in CEMode A	1398
A.7.3.48.1	Test Purpose and Environment	1398
A.7.3.48.2	Test Requirements.....	1400
A.7.3.49	E-UTRAN FD-FDD Radio Link Monitoring Test for In-Sync for Cat-M1 UE in CEMode A.....	1400
A.7.3.49.1	Test Purpose and Environment	1400
A.7.3.49.2	Test Requirements.....	1402
A.7.3.50	E-UTRAN FD-FDD Radio Link Monitoring Test for Out-of-sync in DRX for UE category M1 configured in CEMode A.....	1402
A.7.3.50.1	Test Purpose and Environment	1402
A.7.3.50.2	Test Requirements.....	1404
A.7.3.51	E-UTRAN FD-FDD Radio Link Monitoring Test for In-sync in DRX for UE Category M1 configured in CEMode A.....	1405
A.7.3.51.1	Test Purpose and Environment	1405
A.7.3.51.2	Test Requirements.....	1407
A.7.3.52	E-UTRAN HD-FDD Radio Link Monitoring Test for Out-of-sync for Cat-M1 UE in CEMode A.....	1407
A.7.3.52.1	Test Purpose and Environment	1407
A.7.3.52.2	Test Requirements.....	1409
A.7.3.53	E-UTRAN HD-FDD Radio Link Monitoring Test for In-Sync for Cat-M1 UE in CEMode A	1409
A.7.3.53.1	Test Purpose and Environment	1409
A.7.3.53.2	Test Requirements.....	1411
A.7.3.54	E-UTRAN HD-FDD Radio Link Monitoring Test for Out-of-sync in DRX for UE category M1 configured in CEMode A.....	1412
A.7.3.54.1	Test Purpose and Environment	1412
A.7.3.54.2	Test Requirements.....	1414
A.7.3.55	E-UTRAN HD-FDD Radio Link Monitoring Test for In-sync in DRX for UE Category M1 configured in CEMode A.....	1415
A.7.3.55.1	Test Purpose and Environment	1415
A.7.3.55.2	Test Requirements.....	1417
A.7.3.56	E-UTRAN TDD Radio Link Monitoring Test for Out-of-sync for Cat-M1 UE in CEMode A	1417
A.7.3.56.1	Test Purpose and Environment	1417
A.7.3.56.2	Test Requirements.....	1419
A.7.3.57	E-UTRAN TDD Radio Link Monitoring Test for In-Sync for Cat-M1 UE in CEMode A	1419
A.7.3.57.1	Test Purpose and Environment	1419
A.7.3.57.2	Test Requirements.....	1422
A.7.3.58	E-UTRAN TDD Radio Link Monitoring Test for Out-of-sync in DRX for UE category M1 configured in CEMode A.....	1422
A.7.3.58.1	Test Purpose and Environment	1422
A.7.3.58.2	Test Requirements.....	1425
A.7.3.59	E-UTRAN TDD Radio Link Monitoring Test for In-sync in DRX for UE Category M1 configured in CEMode A.....	1425
A.7.3.59.1	Test Purpose and Environment	1425
A.7.3.59.2	Test Requirements.....	1427
A.7.3.60	HD-FDD Radio Link Monitoring Test for Out-of-sync in DRX for UE category NB1 In-band mode in normal coverage.....	1427
A.7.3.60.1	Test Purpose and Environment	1427
A.7.3.60.2	Test Requirements.....	1430
A.7.3.61	HD-FDD Radio Link Monitoring Test for Out-of-sync in DRX for UE category NB1 In-band mode in enhanced coverage.....	1430
A.7.3.61.1	Test Purpose and Environment	1430
A.7.3.61.2	Test Requirements.....	1433
A.7.3.62	HD-FDD Radio Link Monitoring Test for In-sync with DRX for UE Category NB1 In-Band mode in Enhanced Coverage	1433
A.7.3.62.1	Test Purpose and Environment	1433
A.7.3.62.2	Test Requirements.....	1436
A.7.3.63	HD-FDD Radio Link Monitoring Test for In-sync with DRX for UE Category NB1 In-Band mode in Normal Coverage.....	1437
A.7.3.63.1	Test Purpose and Environment	1437
A.7.3.63.2	Test Requirements.....	1440

A.7.3.64	HD-FDD Radio Link Monitoring Test for In-sync without DRX for UE Category NB1 In-Band mode in Normal Coverage	1440
A.7.3.64.1	Test Purpose and Environment	1440
A.7.3.64.2	Test Requirements.....	1443
A.7.3.65	HD-FDD Radio Link Monitoring Test for In-sync without DRX for UE Category NB1 In-Band mode in Enhanced Coverage	1443
A.7.3.65.1	Test Purpose and Environment	1443
A.7.3.65.2	Test Requirements.....	1446
A.7.3.66	HD-FDD Radio Link Monitoring Test for Out-of-sync without DRX for UE Category NB1 Standalone mode in Normal Coverage	1446
A.7.3.66.1	Test Purpose and Environment	1446
A.7.3.66.2	Test Requirements.....	1448
A.7.3.67	HD-FDD Radio Link Monitoring Test for Out-of-sync without DRX for UE Category NB1 guard band mode in Enhanced Coverage.....	1448
A.7.3.67.1	Test Purpose and Environment	1448
A.7.3.67.2	Test Requirements.....	1451
A.7.3.68	E-UTRAN FD-FDD Early Out-of-sync reporting Test for Cat-M1 UE in CEMode A.....	1451
A.7.3.68.1	Test Purpose and Environment	1451
A.7.3.68.2	Test Requirements.....	1453
A.7.3.69	E-UTRAN HD-FDD Early Out-of-sync reporting Test for Cat-M1 UE in CEMode A	1453
A.7.3.69.1	Test Purpose and Environment	1453
A.7.3.69.2	Test Requirements.....	1455
A.7.3.70	E-UTRAN TDD Early Out-of-sync reporting Test for Cat-M1 UE in CEMode A	1455
A.7.3.70.1	Test Purpose and Environment	1455
A.7.3.70.2	Test Requirements.....	1457
A.7.3.71	E-UTRAN FD-FDD Early In-Sync reporting Test for Cat-M1 UE in CEModeA	1457
A.7.3.71.1	Test Purpose and Environment	1457
A.7.3.71.2	Test Requirements.....	1459
A.7.3.72	E-UTRAN HD-FDD Early In-Sync reporting Test for Cat-M1 UE in CEModeA.....	1459
A.7.3.72.1	Test Purpose and Environment	1459
A.7.3.72.2	Test Requirements.....	1461
A.7.3.73	E-UTRAN TDD Early In-Sync reporting Test for Cat-M1 UE in CEModeA.....	1461
A.7.3.73.1	Test Purpose and Environment	1461
A.7.3.73.2	Test Requirements.....	1463
A.7.3.74	E-UTRAN FD-FDD Radio Link Monitoring Test for Out-of-sync for non-BL CE UE in CEMode A ..	1463
A.7.3.74.1	Test Purpose and Environment	1463
A.7.3.74.2	Test Requirements.....	1465
A.7.3.75	E-UTRAN FD-FDD Radio Link Monitoring Test for In-Sync for non-BL CE UE in CEMode A.....	1465
A.7.3.75.1	Test Purpose and Environment	1465
A.7.3.75.2	Test Requirements.....	1467
A.7.3.76	E-UTRAN FD-FDD Radio Link Monitoring Test for Out-of-sync in DRX for non-BL CE UE configured in CEMode A.....	1468
A.7.3.76.1	Test Purpose and Environment	1468
A.7.3.76.2	Test Requirements.....	1470
A.7.3.77	E-UTRAN FD-FDD Radio Link Monitoring Test for In-sync in DRX for non-BL CE UE configured in CEMode A	1471
A.7.3.77.1	Test Purpose and Environment	1471
A.7.3.77.2	Test Requirements.....	1473
A.7.3.78	E-UTRAN TDD Radio Link Monitoring Test for Out-of-sync for non-BL CE UE in CEMode A	1473
A.7.3.78.1	Test Purpose and Environment	1473
A.7.3.78.2	Test Requirements.....	1475
A.7.3.79	E-UTRAN TDD Radio Link Monitoring Test for In-Sync for non-BL CE UE in CEMode A	1476
A.7.3.79.1	Test Purpose and Environment	1476
A.7.3.79.2	Test Requirements.....	1478
A.7.3.80	E-UTRAN TDD Radio Link Monitoring Test for Out-of-sync in DRX for non-BL CE UE configured in CEMode A.....	1478
A.7.3.80.1	Test Purpose and Environment	1478
A.7.3.80.2	Test Requirements.....	1481
A.7.3.81	E-UTRAN TDD Radio Link Monitoring Test for In-sync in DRX for non-BL CE UE configured in CEMode A	1481
A.7.3.81.1	Test Purpose and Environment	1481
A.7.3.81.2	Test Requirements.....	1483

A.7.3.82	E-UTRAN FD-FDD Early Out-of-sync reporting Test for Cat-M1 UE in CEModeB	1483
A.7.3.82.1	Test Purpose and Environment	1483
A.7.3.82.2	Test Requirements.....	1485
A.7.3.83	E-UTRAN FD-FDD Early In-Sync reporting Test for Cat-M1 UE in CEModeB.....	1485
A.7.3.83.1	Test Purpose and Environment	1485
A.7.3.83.2	Test Requirements.....	1487
A.7.3.84	E-UTRAN HD-FDD Early Out-of-sync reporting Test for Cat-M1 UE in CEModeB	1487
A.7.3.84.1	Test Purpose and Environment	1487
A.7.3.84.2	Test Requirements.....	1489
A.7.3.85	E-UTRAN HD-FDD Early In-Sync reporting Test for Cat-M1 UE in CEModeB	1489
A.7.3.85.1	Test Purpose and Environment	1489
A.7.3.85.2	Test Requirements.....	1491
A.7.3.86	E-UTRAN TDD Early Out-of-sync reporting Test for Cat-M1 UE in CEModeB	1491
A.7.3.86.1	Test Purpose and Environment	1491
A.7.3.86.2	Test Requirements.....	1493
A.7.3.87	E-UTRAN TDD Early In-Sync reporting Test for Cat-M1 UE in CEModeB.....	1493
A.7.3.87.1	Test Purpose and Environment	1493
A.7.3.87.2	Test Requirements.....	1495
A.7.3.88	TDD Radio Link Monitoring Test for Out-of-sync in DRX for UE category NB1 In-band mode in normal coverage.....	1495
A.7.3.88.1	Test Purpose and Environment	1495
A.7.3.88.2	Test Requirements.....	1498
A.7.3.89	TDD Radio Link Monitoring Test for Out-of-sync in DRX for UE category NB1 In-band mode in enhanced coverage	1498
A.7.3.89.1	Test Purpose and Environment	1498
A.7.3.89.2	Test Requirements.....	1501
A.7.3.90	TDD Radio Link Monitoring Test for In-sync with DRX for UE Category NB1 In-Band mode in Normal Coverage.....	1501
A.7.3.90.1	Test Purpose and Environment	1501
A.7.3.90.2	Test Requirements.....	1504
A.7.3.91	TDD Radio Link Monitoring Test for In-sync with DRX for UE Category NB1 In-Band mode in Enhanced Coverage	1504
A.7.3.91.1	Test Purpose and Environment	1504
A.7.3.91.2	Test Requirements.....	1507
A.7.3.92	TDD Radio Link Monitoring Test for In-sync without DRX for UE Category NB1 In-Band mode in Normal Coverage.....	1508
A.7.3.92.1	Test Purpose and Environment	1508
A.7.3.92.2	Test Requirements.....	1510
A.7.3.93	TDD Radio Link Monitoring Test for In-sync without DRX for UE Category NB1 In-Band mode in Enhanced Coverage	1511
A.7.3.93.1	Test Purpose and Environment	1511
A.7.3.93.2	Test Requirements.....	1513
A.7.3.94	TDD Radio Link Monitoring Test for Out-of-sync without DRX for UE Category NB1 Standalone mode in Normal Coverage.....	1514
A.7.3.94.1	Test Purpose and Environment	1514
A.7.3.94.2	Test Requirements.....	1516
A.7.3.95	TDD Radio Link Monitoring Test for Out-of-sync without DRX for UE Category NB1 guard band mode in Enhanced Coverage	1516
A.7.3.95.1	Test Purpose and Environment	1516
A.7.3.95.2	Test Requirements.....	1518
A.7.4	Interruption for Dual Connectivity.....	1519
A.7.4.1	E-UTRAN FDD-FDD DC interruption at transitions between active and non-active during DRX in synchronous DC.....	1519
A.7.4.1.1	Test Purpose and Environment	1519
A.7.4.1.2	Test Requirements.....	1520
A.7.4.2	E-UTRAN TDD-TDD DC interruption at transitions between active and non-active during DRX in synchronous DC.....	1520
A.7.4.2.1	Test Purpose and Environment	1520
A.7.4.2.2	Test Requirements.....	1522
A.7.4.3	E-UTRAN FDD-FDD Interruption at transitions between active and non-active during DRX in asynchronous dual connectivity.....	1522
A.7.4.3.1	Test Purpose and Environment	1522

A.7.4.3.2	Test Requirements.....	1524
A.7.4.4	E-UTRAN FDD-TDD DC interruption at transitions between active and non-active during DRX in synchronous DC.....	1524
A.7.4.4.1	Test Purpose and Environment	1524
A.7.4.4.2	Test Requirements.....	1526
A.7.4.5	E-UTRAN TDD-FDD DC interruption at transitions between active and non-active during DRX in synchronous DC.....	1526
A.7.4.5.1	Test Purpose and Environment	1526
A.7.4.5.2	Test Requirements.....	1528
A.7.4.6	E-UTRAN FDD-TDD DC interruption at SRS carrier based switching	1528
A.7.4.6.1	Test Purpose and Environment	1528
A.7.4.6.2	Test Requirements.....	1530
A.7.4.7	E-UTRAN TDD-TDD DC interruption at SRS carrier based switching	1530
A.7.4.7.1	Test Purpose and Environment	1530
A.7.4.7.2	Test Requirements.....	1532
A.7.5	Proximity-based Services	1532
A.7.5.1	E-UTRAN FDD – UE ProSe Direct Discovery Transmission Timing Accuracy Test.....	1532
A.7.5.1.1	Test Purpose and Environment	1532
A.7.5.1.2	Test Requirements.....	1533
A.7.5.2	E-UTRAN TDD – UE ProSe Direct Discovery Transmission Timing Accuracy Test.....	1534
A.7.5.2.1	Test Purpose and Environment	1534
A.7.5.1.2	Test Requirements.....	1535
A.7.5.3	E-UTRAN FDD - Interruptions due to ProSe Direct Discovery.....	1535
A.7.5.3.1	Test Purpose and Environment	1535
A.7.5.3.2	Test Requirements.....	1537
A.7.5.4	E-UTRAN FDD – UE ProSe Direct Communication Transmission Timing Accuracy Test.....	1537
A.7.5.4.1	Test Purpose and Environment	1537
A.7.5.4.2	Test Requirements.....	1538
A.7.5.5	E-UTRAN FDD - Interruptions due to ProSe Direct Communication	1538
A.7.5.5.1	Test Purpose and Environment	1538
A.7.5.5.2	Test Requirements.....	1540
A.7.5.6	E-UTRAN FDD - Interruptions due to ProSe Direct Discovery with discovery period less than 320ms.....	1540
A.7.5.6.1	Test Purpose and Environment	1540
A.7.5.6.2	Test Requirements.....	1542
A.7.5.7	E-UTRAN FDD-FDD - Interruptions due to ProSe Direct Discovery	1542
A.7.5.7.1	Test Purpose and Environment	1542
A.7.5.7.2	Test Requirements.....	1544
A.7.5.8	E-UTRAN FDD-FDD - Cell reselection and timing accuracy for ProSe Direct Discovery transmission on non-serving frequency	1544
A.7.5.8.1	Test Purpose and Environment	1544
A.7.5.8.2	Test Requirements.....	1546
A.7.5.9	E-UTRAN FDD-FDD - Interruptions due to ProSe Direct Discovery reception on non-serving frequency	1547
A.7.5.9.1	Test Purpose and Environment	1547
A.7.5.9.2	Test Requirements.....	1549
A.7.5.10	E-UTRAN FDD-FDD - Interruptions due to ProSe Direct Discovery transmission on non-serving frequency	1549
A.7.5.10.1	Test Purpose and Environment	1549
A.7.5.10.2	Test Requirements.....	1551
A.7.5.11	E-UTRAN FDD-FDD - Interruptions due to ProSe Direct Communication on non-serving frequency	1551
A.7.5.11.1	Test Purpose and Environment	1551
A.7.5.11.2	Test Requirements.....	1553
A.7.5.12	E-UTRAN FDD - Selection / Reselection of ProSe relay UE	1554
A.7.5.12.1	Test Purpose and Environment	1554
A.7.5.12.2	Test Requirements.....	1556
A.7.6	Interruption for carrier aggregation	1557
A.7.6.1	E-UTRAN FDD-TDD CA interruption at SRS carrier based switching	1557
A.7.6.1.1	Test Purpose and Environment	1557
A.7.6.1.2	Test Requirements.....	1559
A.7.6.2	E-UTRAN TDD-TDD CA interruption at SRS carrier based switching	1559
A.7.6.2.1	Test Purpose and Environment	1559

A.7.6.2.2	Test Requirements.....	1561
A.8	UE Measurements Procedures.....	1561
A.8.1	E-UTRAN FDD Intra-frequency Measurements.....	1561
A.8.1.1	E-UTRAN FDD-FDD intra-frequency event triggered reporting under fading propagation conditions in asynchronous cells.....	1561
A.8.1.1.1	Test Purpose and Environment	1561
A.8.1.1.2	Test Requirements.....	1562
A.8.1.2	E-UTRAN FDD-FDD intra-frequency event triggered reporting under fading propagation conditions in synchronous cells.....	1562
A.8.1.2.1	Test Purpose and Environment	1562
A.8.1.2.2	Test Requirements.....	1564
A.8.1.3	E-UTRAN FDD-FDD intra-frequency event triggered reporting under fading propagation conditions in synchronous cells with DRX	1564
A.8.1.3.1	Test Purpose and Environment	1564
A.8.1.3.2	Test Requirements.....	1566
A.8.1.4	Void	1566
A.8.1.5	E-UTRAN FDD - FDD Intra-frequency identification of a new CGI of E-UTRA cell using autonomous gaps	1566
A.8.1.5.1	Test Purpose and Environment	1566
A.8.1.5.2	Test Requirements.....	1567
A.8.1.6	E-UTRAN FDD - FDD Intra-frequency identification of a new CGI of E-UTRA cell using autonomous gaps with DRX	1568
A.8.1.6.1	Test Purpose and Environment	1568
A.8.1.6.2	Test Requirements.....	1570
A.8.1.7	E-UTRAN FDD-FDD Intra-Frequency Event-Triggered Reporting under Time Domain Measurement Resource Restriction with Non-MBSFN ABS	1570
A.8.1.7.1	Test Purpose and Environment	1570
A.8.1.7.2	Test Requirements.....	1572
A.8.1.8	E-UTRAN FDD-FDD Intra-Frequency Event-Triggered Reporting under Time Domain Measurement Resource Restriction with CRS Assistance Information and Non-MBSFN ABS	1572
A.8.1.8.1	Test Purpose and Environment	1572
A.8.1.8.2	Test Requirements.....	1574
A.8.1.9	E-UTRAN FDD-FDD intra-frequency event triggered reporting under fading propagation conditions in asynchronous cells for 5MHz bandwidth	1574
A.8.1.9.1	Test Purpose and Environment	1574
A.8.1.9.2	Test Requirements.....	1575
A.8.1.10	E-UTRAN FDD-FDD Intra-Frequency Event Triggered Reporting under Fading Propagation Conditions in Synchronous Cells with DRX for 5 MHz Bandwidth	1575
A.8.1.10.1	Test Purpose and Environment	1575
A.8.1.10.2	Test Requirements.....	1576
A.8.1.11	E-UTRAN FDD-FDD intra-frequency event triggered reporting under fading propagation conditions in asynchronous cells for UE category 0	1576
A.8.1.11.1	Test Purpose and Environment	1576
A.8.1.11.2	Test Requirements.....	1577
A.8.1.12	E-UTRAN FDD-FDD intra-frequency event triggered reporting under fading propagation conditions in synchronous cells for UE category 0	1577
A.8.1.12.1	Test Purpose and Environment	1577
A.8.1.12.2	Test Requirements.....	1579
A.8.1.13	E-UTRAN FDD-FDD intra-frequency event triggered reporting under fading propagation conditions in synchronous cells with DRX for UE category 0.....	1579
A.8.1.13.1	Test Purpose and Environment	1579
A.8.1.13.2	Test Requirements.....	1581
A.8.1.14	E-UTRAN HD-FDD intra-frequency event triggered reporting under fading propagation conditions in asynchronous cells for UE category 0	1581
A.8.1.14.1	Test Purpose and Environment	1581
A.8.1.14.2	Test Requirements.....	1583
A.8.1.15	E-UTRAN HD-FDD intra-frequency event triggered reporting under fading propagation conditions in synchronous cells for UE category 0	1583
A.8.1.15.1	Test Purpose and Environment	1583
A.8.1.15.2	Test Requirements.....	1584

A.8.1.16	E-UTRAN HD-FDD intra-frequency event triggered reporting under fading propagation conditions in synchronous cells with DRX for UE category 0.....	1585
A.8.1.16.1	Test Purpose and Environment	1585
A.8.1.16.2	Test Requirements.....	1586
A.8.1.17	Void.....	1587
A.8.1.18	Void.....	1587
A.8.1.19	E-UTRAN FDD-FDD Intra-frequency identification of a new CGI of E-UTRA cell using autonomous gaps for UE category 0.....	1587
A.8.1.19.1	Test Purpose and Environment	1587
A.8.1.19.2	Test Requirements.....	1588
A.8.1.20	E-UTRAN FDD - FDD Intra-frequency identification of a new CGI of E-UTRA cell using autonomous gaps with DRX for UE category 0.....	1589
A.8.1.20.1	Test Purpose and Environment	1589
A.8.1.20.2	Test Requirements.....	1590
A.8.1.21	E-UTRAN HD - FDD Intra-frequency identification of a new CGI of E-UTRA cell using autonomous gaps for UE category 0.....	1591
A.8.1.21.1	Test Purpose and Environment	1591
A.8.1.21.2	Test Requirements.....	1592
A.8.1.22	E-UTRAN HD - FDD Intra-frequency identification of a new CGI of E-UTRA cell using autonomous gaps with DRX for UE category 0.....	1592
A.8.1.22.1	Test Purpose and Environment	1592
A.8.1.22.2	Test Requirements.....	1594
A.8.1.23	E-UTRAN FDD-FDD intra-frequency event triggered reporting under fading propagation conditions in asynchronous cells for Cat-M1 UE in CEModeA	1594
A.8.1.23.1	Test Purpose and Environment	1594
A.8.1.23.2	Test Requirements.....	1596
A.8.1.24	E-UTRAN FDD-FDD intra-frequency event triggered reporting under fading propagation conditions in synchronous cells for Cat-M1 UE in CEModeA	1596
A.8.1.24.1	Test Purpose and Environment	1596
A.8.1.24.2	Test Requirements.....	1597
A.8.1.25	E-UTRAN FDD-FDD intra-frequency event triggered reporting under fading propagation conditions in synchronous cells for Cat-M1 UE in CEModeA in DRX.....	1598
A.8.1.25.1	Test Purpose and Environment	1598
A.8.1.25.2	Test Requirements.....	1600
A.8.1.26	E-UTRAN HD-FDD intra-frequency event triggered reporting under fading propagation conditions in asynchronous cells for Cat-M1 UE in CEModeA	1600
A.8.1.26.1	Test Purpose and Environment	1600
A.8.1.27	E-UTRAN HD-FDD intra-frequency event triggered reporting under fading propagation conditions in synchronous cells for Cat-M1 UE in CEModeA	1602
A.8.1.27.1	Test Purpose and Environment	1602
A.8.1.27.2	Test Requirements.....	1603
A.8.1.28	E-UTRAN HD-FDD intra-frequency event triggered reporting under fading propagation conditions in synchronous cells for Cat-M1 UE in CEModeA in DRX.....	1603
A.8.1.28.1	Test Purpose and Environment	1603
A.8.1.28.2	Test Requirements.....	1605
A.8.1.29	E-UTRAN TDD intra-frequency event triggered reporting under fading propagation conditions in synchronous cells for Cat-M1 UE in CEModeA	1606
A.8.1.29.1	Test Purpose and Environment	1606
A.8.1.29.2	Test Requirements.....	1607
A.8.1.30	E-UTRAN TDD intra-frequency event triggered reporting under fading propagation conditions in synchronous cells for Cat-M1 UE in CEModeA in DRX.....	1607
A.8.1.30.1	Test Purpose and Environment	1607
A.8.1.30.2	Test Requirements.....	1609
A.8.1.31	E-UTRAN FDD-FDD intra-frequency event triggered reporting under fading propagation conditions in asynchronous cells for Cat-M1 UE in CEModeB.....	1609
A.8.1.31.1	Test Purpose and Environment	1609
A.8.1.31.2	Test Requirements.....	1611
A.8.1.32	E-UTRAN FDD-FDD intra-frequency event triggered reporting under fading propagation conditions in synchronous cells for Cat-M1 UE in CEModeB.....	1611
A.8.1.32.1	Test Purpose and Environment	1611
A.8.1.32.2	Test Requirements.....	1612

A.8.1.33	E-UTRAN HD-FDD intra-frequency event triggered reporting under fading propagation conditions in asynchronous cells for Cat-M1 UE in CEModeB.....	1613
A.8.1.33.1	Test Purpose and Environment	1613
A.8.1.33.2	Test Requirements.....	1614
A.8.1.34	E-UTRAN HD-FDD intra-frequency event triggered reporting under fading propagation conditions in synchronous cells for Cat-M1 UE in CEModeB	1614
A.8.1.34.1	Test Purpose and Environment	1614
A.8.1.34.2	Test Requirements.....	1615
A.8.1.35	E-UTRAN TDD intra-frequency event triggered reporting under fading propagation conditions in synchronous cells for Cat-M1 UE in CEModeB.....	1616
A.8.1.35.1	Test Purpose and Environment	1616
A.8.1.35.2	Test Requirements.....	1617
A.8.1.36	E-UTRAN FDD Intra-frequency identification of a new CGI of E-UTRA cell using autonomous gaps for Cat-M1 UE in CEModeB.....	1617
A.8.1.36.1	Test Purpose and Environment	1617
A.8.1.36.2	Test Requirements.....	1619
A.8.1.37	E-UTRAN FDD Intra-frequency identification of a new CGI of E-UTRA cell using autonomous gaps with DRX for Cat-M1 UE in CEModeB	1619
A.8.1.37.1	Test Purpose and Environment	1619
A.8.1.37.2	Test Requirements.....	1621
A.8.1.38	E-UTRAN HD - FDD Intra-frequency identification of a new CGI of E-UTRA cell using autonomous gaps for Cat-M1 UE in CEModeB	1621
A.8.1.38.1	Test Purpose and Environment	1621
A.8.1.38.2	Test Requirements.....	1622
A.8.1.39	E-UTRAN HD - FDD Intra-frequency identification of a new CGI of E-UTRA cell using autonomous gaps with DRX for Cat-M1 UE in CEModeB.....	1623
A.8.1.39.1	Test Purpose and Environment	1623
A.8.1.39.2	Test Requirements.....	1624
A.8.1.40	E-UTRAN FDD-FDD intra-frequency event triggered reporting with DRX for UE configured with <i>highSpeedEnhancedMeasFlag</i>	1625
A.8.1.40.1	Test Purpose and Environment	1625
A.8.1.40.2	Test Requirements.....	1626
A.8.1.41	E-UTRAN FDD intra-frequency event triggered reporting for serving cell under fading propagation conditions for UE category M1 in CEModeA without gap	1627
A.8.1.41.1	Test Purpose and Environment	1627
A.8.1.41.2	Test Requirement	1628
A.8.1.42	E-UTRAN HD-FDD intra-frequency event triggered reporting for serving cell under fading propagation conditions for UE category M1 in CEModeA without gap.....	1628
A.8.1.42.1	Test Purpose and Environment	1628
A.8.1.42.2	Test Requirement	1629
A.8.2	E-UTRAN TDD Intra-frequency Measurements	1630
A.8.2.1	E-UTRAN TDD-TDD intra-frequency event triggered reporting under fading propagation conditions in synchronous cells	1630
A.8.2.1.1	Test Purpose and Environment	1630
A.8.2.1.2	Test Requirements.....	1631
A.8.2.2	E-UTRAN TDD-TDD intra-frequency event triggered reporting under fading propagation conditions in synchronous cells with DRX.....	1631
A.8.2.2.1	Test Purpose and Environment	1631
A.8.2.2.2	Test Requirements.....	1633
A.8.2.3	E-UTRAN TDD - TDD Intra-frequency identification of a new CGI of E-UTRA cell using autonomous gaps	1633
A.8.2.3.1	Test Purpose and Environment	1633
A.8.2.3.2	Test Requirements.....	1635
A.8.2.4	E-UTRAN TDD - TDD Intra-frequency identification of a new CGI of E-UTRA cell using autonomous gaps with DRX	1635
A.8.2.4.1	Test Purpose and Environment	1635
A.8.2.4.2	Test Requirements.....	1637
A.8.2.5	E-UTRAN TDD-TDD Intra-Frequency Event-Triggered Reporting under Time Domain Measurement Resource Restriction with Non-MBSFN ABS	1637
A.8.2.5.1	Test Purpose and Environment	1637
A.8.2.5.2	Test Requirements.....	1639

A.8.2.6	E-UTRAN TDD-TDD Intra-Frequency Event-Triggered Reporting under Time Domain Measurement Resource Restriction with CRS Assistance Information and Non-MBSFN ABS	1639
A.8.2.6.1	Test Purpose and Environment	1639
A.8.2.6.2	Test Requirements.....	1642
A.8.2.7	E-UTRAN TDD Intra-frequency identification of a new CGI of E-UTRA cell using autonomous gaps.....	1642
A.8.2.7.1	Test Purpose and Environment	1642
A.8.2.7.2	Test Requirements.....	1643
A.8.2.8	E-UTRAN TDD Intra-frequency identification of a new CGI of E-UTRA cell using autonomous gaps with DRX	1644
A.8.2.8.1	Test Purpose and Environment	1644
A.8.2.8.2	Test Requirements.....	1646
A.8.2.9	E-UTRAN TDD Intra-frequency identification of a new CGI of E-UTRA cell using autonomous gaps for Cat-M1 UE in CEModeB.....	1646
A.8.2.9.1	Test Purpose and Environment	1646
A.8.2.9.2	Test Requirements.....	1647
A.8.2.10	E-UTRAN TDD Intra-frequency identification of a new CGI of E-UTRA cell using autonomous gaps with DRX for Cat-M1 UE in CEModeB	1648
A.8.2.10.1	Test Purpose and Environment	1648
A.8.2.10.2	Test Requirements.....	1650
A.8.2.11	E-UTRAN TDD-TDD intra-frequency event triggered reporting with DRX for UE configured with <i>highSpeedEnhancedMeasFlag</i>	1650
A.8.2.11.1	Test Purpose and Environment	1650
A.8.2.11.2	Test Requirements.....	1652
A.8.2.12	E-UTRAN TDD-TDD intra-frequency event triggered reporting under fading propagation conditions in synchronous cells for UE category 0.....	1652
A.8.2.12.1	Test Purpose and Environment	1652
A.8.2.12.2	Test Requirements.....	1653
A.8.2.13	E-UTRAN TDD-TDD intra-frequency event triggered reporting under fading propagation conditions in synchronous cells with DRX for UE category 0	1654
A.8.2.13.1	Test Purpose and Environment	1654
A.8.2.13.2	Test Requirements.....	1656
A.8.2.14	E-UTRAN TDD intra-frequency event triggered reporting for serving cell under fading propagation conditions for UE category M1 in CEModeA without gap	1656
A.8.2.14.1	Test Purpose and Environment	1656
A.8.2.14.2	Test Requirement	1657
A.8.3	E-UTRAN FDD - FDD Inter-frequency Measurements	1658
A.8.3.1	E-UTRAN FDD-FDD Inter-frequency event triggered reporting under fading propagation conditions in asynchronous cells	1658
A.8.3.1.1	Test Purpose and Environment	1658
A.8.3.1.2	Test Requirements.....	1659
A.8.3.2	E-UTRAN FDD-FDD Inter-frequency event triggered reporting when DRX is used under fading propagation conditions in asynchronous cells	1659
A.8.3.2.1	Test Purpose and Environment	1659
A.8.3.2.2	Test Requirements.....	1661
A.8.3.3	E-UTRAN FDD-FDD inter-frequency event triggered reporting under AWGN propagation conditions in asynchronous cells with DRX when L3 filtering is used	1661
A.8.3.3.1	Test Purpose and Environment	1661
A.8.3.3.2	Test Requirements.....	1664
A.8.3.4	E-UTRAN FDD - FDD Inter-frequency identification of a new CGI of E-UTRA cell using autonomous gaps	1664
A.8.3.4.1	Test Purpose and Environment	1664
A.8.3.4.2	Test Requirements.....	1665
A.8.3.5	E-UTRAN FDD - FDD Inter-frequency identification of a new CGI of E-UTRA cell using autonomous gaps with DRX	1666
A.8.3.5.2	Test Requirements.....	1667
A.8.3.6	E-UTRAN FDD-FDD Inter-frequency event triggered reporting without measurement gaps under AWGN propagation conditions in asynchronous cells	1668
A.8.3.6.1	Test Purpose and Environment	1668
A.8.3.6.2	Test Requirements.....	1669

A.8.3.7	E-UTRAN FDD-FDD Inter-frequency event triggered reporting under fading propagation conditions in asynchronous cells for Increased Carrier Monitoring without Reduced Performance Group	1669
A.8.3.7.1	Test Purpose and Environment	1669
A.8.3.7.2	Test Requirements.....	1672
A.8.3.8	FDD-FDD Interfrequency correct reporting of measurement events with reduced performance group configured, non DRX.....	1672
A.8.3.8.1	Test Purpose and Environment	1672
A.8.3.8.2	Test Requirements.....	1675
A.8.3.9	FDD-FDD Inter-frequency correct reporting of measurement events with reduced performance group configured, DRX	1675
A.8.3.9.1	Test Purpose and Environment	1675
A.8.3.9.2	Test Requirements.....	1678
A.8.3.10	E-UTRAN FDD-FDD Inter-frequency event triggered reporting with MGL=3ms under fading propagation conditions in synchronous cells	1679
A.8.3.10.1	Test Purpose and Environment	1679
A.8.3.10.2	Test Requirements.....	1680
A.8.3.11	E-UTRAN FDD-FDD Inter-frequency event triggered reporting under fading propagation conditions in asynchronous cells with burst gap.....	1680
A.8.3.11.1	Test Purpose and Environment	1680
A.8.3.11.2	Test Requirement	1681
A.8.3.12	E-UTRAN FDD-FDD Inter-frequency event triggered reporting under fading propagation conditions in asynchronous cells for UE category M1 with discontinuous MPDCCH monitoring in CEModeA	1682
A.8.3.12.1	Test Purpose and Environment	1682
A.8.3.12.2	Test Requirement	1683
A.8.3.13	E-UTRAN HD-FDD Inter-frequency event triggered reporting under fading propagation conditions in asynchronous cells for UE category M1 with discontinuous MPDCCH monitoring in CEModeA ...	1683
A.8.3.13.1	Test Purpose and Environment	1683
A.8.3.13.2	Test Requirement	1685
A.8.3.14	E-UTRAN FDD-FDD inter-frequency event triggered reporting under fading propagation conditions in asynchronous cells for UE category M1 with discontinuous MPDCCH monitoring in CEModeB ...	1685
A.8.3.14.1	Test Purpose and Environment	1685
A.8.3.14.2	Test Requirement	1686
A.8.3.15	E-UTRAN HD-FDD inter-frequency event triggered reporting under fading propagation conditions in asynchronous cells for UE category M1 with discontinuous MPDCCH monitoring in CEModeB ...	1687
A.8.3.15.1	Test Purpose and Environment	1687
A.8.3.15.2	Test Requirement	1688
A.8.3.16	E-UTRAN FDD-FDD Inter-frequency event triggered reporting under fading propagation conditions in asynchronous cells for UE category M1 in CEModeA when DRX is used	1688
A.8.3.16.1	Test Purpose and Environment	1688
A.8.3.16.2	Test Requirement	1690
A.8.3.17	E-UTRAN HD-FDD inter-frequency event triggered reporting under fading propagation conditions in asynchronous cells for UE category M1 in CEModeA in DRX	1691
A.8.3.17.1	Test Purpose and Environment	1691
A.8.3.17.2	Test Requirement	1692
A.8.3.18	E-UTRAN FDD-FDD inter-frequency event triggered reporting under fading propagation conditions in asynchronous cells for UE category M1 in CEModeB in DRX	1693
A.8.3.18.1	Test Purpose and Environment	1693
A.8.3.18.2	Test Requirement	1695
A.8.3.19	E-UTRAN HD-FDD inter-frequency event triggered reporting under fading propagation conditions in asynchronous cells for UE category M1 in CEModeB in DRX	1695
A.8.3.19.1	Test Purpose and Environment	1695
A.8.3.19.2	Test Requirement	1697
A.8.4	E-UTRAN TDD - TDD Inter-frequency Measurements.....	1697
A.8.4.1	E-UTRAN TDD-TDD Inter-frequency event triggered reporting under fading propagation conditions in synchronous cells	1697
A.8.4.1.1	Test Purpose and Environment	1697
A.8.4.1.2	Test Requirements.....	1699
A.8.4.2	E-UTRAN TDD-TDD Inter-frequency event triggered reporting when DRX is used under fading propagation conditions in synchronous cells	1699
A.8.4.2.1	Test Purpose and Environment	1699

A.8.4.2.2	Test Requirements.....	1701
A.8.4.3	E-UTRAN TDD-TDD inter-frequency event triggered reporting under AWGN propagation conditions in synchronous cells with DRX when L3 filtering is used	1701
A.8.4.3.1	Test Purpose and Environment	1701
A.8.4.3.2	Test Requirements.....	1703
A.8.4.4	E-UTRAN TDD - TDD Inter-frequency identification of a new CGI of E-UTRA cell using autonomous gaps	1703
A.8.4.4.1	Test Purpose and Environment	1703
A.8.4.4.2	Test Requirements.....	1705
A.8.4.5	E-UTRAN TDD - TDD Inter-frequency identification of a new CGI of E-UTRA cell using autonomous gaps with DRX	1705
A.8.4.5.1	Test Purpose and Environment	1705
A.8.4.5.2	Test Requirements.....	1707
A.8.4.6	E-UTRAN TDD-TDD Inter-frequency event triggered reporting for TDD UL/DL configuration 0	1707
A.8.4.6.1	Test Purpose and Environment	1707
A.8.4.6.2	Test Requirements.....	1708
A.8.4.7	E-UTRAN TDD-TDD Inter-frequency event triggered reporting under fading propagation conditions in synchronous cells for Increased Carrier Monitoring without Reduced Performance Group.....	1709
A.8.4.7.1	Test Purpose and Environment	1709
A.8.4.7.2	Test Requirements.....	1711
A.8.4.8	TDD-TDD Interfrequency correct reporting of measurement events with reduced performance group configured, non DRX.....	1711
A.8.4.8.1	Test Purpose and Environment	1711
A.8.4.8.2	Test Requirements.....	1714
A.8.4.9	TDD-TDD Inter-frequency correct reporting of measurement events with reduced performance group configured, DRX	1714
A.8.4.9.1	Test Purpose and Environment	1714
A.8.4.9.2	Test Requirements.....	1718
A.8.4.10	E-UTRAN TDD-TDD Inter-frequency event triggered reporting with MGL=3ms under fading propagation conditions in synchronous cells	1719
A.8.4.10.1	Test Purpose and Environment	1719
A.8.4.10.2	Test Requirements.....	1720
A.8.4.11	E-UTRAN TDD-TDD Inter-frequency event triggered reporting under fading propagation conditions in synchronous cells with burst gap.....	1720
A.8.4.11.1	Test Purpose and Environment	1720
A.8.4.11.2	Test Requirement	1721
A.8.4.12	E-UTRAN TDD-TDD Inter-frequency event triggered reporting under fading propagation conditions in asynchronous cells for UE category M1 with discontinuous MPDCCH monitoring in CEModeA	1722
A.8.4.12.1	Test Purpose and Environment	1722
A.8.4.12.2	Test Requirement	1723
A.8.4.13	E-UTRAN TDD-TDD inter-frequency event triggered reporting under fading propagation conditions in asynchronous cells for UE category M1 with discontinuous MPDCCH monitoring in CEModeB	1723
A.8.4.13.1	Test Purpose and Environment	1723
A.8.4.13.2	Test Requirement	1725
A.8.4.14	E-UTRAN TDD-TDD inter-frequency event triggered reporting under fading propagation conditions in asynchronous cells for UE category M1 in CEModeA in DRX.....	1725
A.8.4.14.1	Test Purpose and Environment	1725
A.8.4.14.2	Test Requirement	1727
A.8.4.15	E-UTRAN TDD-TDD inter-frequency event triggered reporting under fading propagation conditions in asynchronous cells for UE category M1 in CEModeB in DRX.....	1727
A.8.4.15.1	Test Purpose and Environment	1727
A.8.4.15.2	Test Requirement	1729
A.8.5	E-UTRAN FDD - UTRAN FDD Measurements	1730
A.8.5.1	E-UTRAN FDD - UTRAN FDD event triggered reporting under fading propagation conditions.....	1730
A.8.5.1.1	Test Purpose and Environment	1730
A.8.5.1.2	Test Requirements.....	1731
A.8.5.2	E-UTRAN FDD - UTRAN FDD SON ANR cell search reporting under AWGN propagation conditions.....	1731
A.8.5.2.1	Test Purpose and Environment	1731

A.8.5.2.2	Test Requirements.....	1733
A.8.5.3	E-UTRAN FDD-UTRAN FDD event triggered reporting when DRX is used under fading propagation conditions.....	1733
A.8.5.3.1	Test Purpose and Environment	1733
A.8.5.3.2	Test Requirements.....	1736
A.8.5.4	E-UTRAN FDD - UTRAN FDD enhanced cell identification under AWGN propagation conditions ..	1736
A.8.5.4.1	Test Purpose and Environment	1736
A.8.5.4.2	Test Requirements.....	1738
A.8.5.5	E- UTRAN FDD - UTRAN FDD identification of a new CGI of UTRAN cell using autonomous gaps.....	1738
A.8.5.5.1	Test Purpose and Environment	1738
A.8.5.5.2	Test Requirements.....	1740
A.8.5.6	E-UTRAN FDD - UTRAN FDD event triggered reporting without measurement gaps under AWGN propagation conditions.....	1740
A.8.5.6.1	Test Purpose and Environment	1740
A.8.5.6.2	Test Requirements.....	1741
A.8.5.7	E-UTRAN FDD - UTRAN FDD Event Triggered Reporting under Fading Propagation Conditions for 5 MHz Bandwidth.....	1742
A.8.5.7.1	Test Purpose and Environment	1742
A.8.5.7.2	Test Requirements.....	1742
A.8.5.8	E-UTRA FDD InterRAT UTRA FDD correct reporting of measurement events with reduced performance group configured, non DRX	1742
A.8.5.8.1	Test Purpose and Environment	1742
A.8.5.8.2	Test Requirements.....	1744
A.8.6	E-UTRAN TDD - UTRAN FDD Measurements	1745
A.8.6.1	E-UTRAN TDD - UTRAN FDD event triggered reporting under fading propagation conditions.....	1745
A.8.6.1.1	Test Purpose and Environment	1745
A.8.6.1.2	Test Requirements.....	1746
A.8.6.2	E- UTRAN TDD - UTRAN FDD identification of a new CGI of UTRAN cell using autonomous gaps.....	1746
A.8.6.2.1	Test Purpose and Environment	1746
A.8.6.2.2	Test Requirements.....	1748
A.8.6.3	E-UTRA TDD InterRAT UTRA FDD correct reporting of measurement events with reduced performance group configured, non DRX	1749
A.8.6.3.1	Test Purpose and Environment	1749
A.8.6.3.2	Test Requirements.....	1751
A.8.7	E-UTRAN TDD – UTRAN TDD Measurements	1751
A.8.7.1	E-UTRAN TDD to UTRAN TDD cell search under fading propagation conditions	1751
A.8.7.1.1	Test Purpose and Environment	1751
A.8.7.1.1.1	Void.....	1751
A.8.7.1.1.2	1.28 Mcps TDD option.....	1751
A.8.7.1.1.3	Void.....	1753
A.8.7.1.2	Test Requirements.....	1753
A.8.7.1.2.1	Void.....	1753
A.8.7.1.2.2	1.28 Mcps TDD option.....	1753
A.8.7.1.2.3	Void.....	1753
A.8.7.2	E-UTRAN TDD-UTRAN TDD cell search when DRX is used under fading propagation conditions ..	1753
A.8.7.2.1	Test Purpose and Environment	1753
A.8.7.2.2	Test Requirements.....	1755
A.8.7.3	E-UTRAN TDD - UTRAN TDD SON ANR cell search reporting in AWGN propagation conditions.	1756
A.8.7.3.1	Test Purpose and Environment	1756
A.8.7.3.2	Test Parameters	1756
A.8.7.3.3	Test Requirements.....	1757
A.8.7.4	E-UTRAN TDD - UTRAN TDD enhanced cell identification under AWGN propagation conditions..	1758
A.8.7.4.1	Test Purpose and Environment	1758
A.8.7.4.2	Test Requirements.....	1759
A.8.7.5	E-UTRA TDD InterRAT UTRA TDD correct reporting of measurement events with reduced performance group configured, non DRX	1760
A.8.7.5.1	Test Purpose and Environment	1760
A.8.7.5.2	Test Requirements.....	1762
A.8.7A	E-UTRAN FDD – UTRAN TDD Measurements	1762

A.8.7A.1	E-UTRA FDD InterRAT UTRA TDD correct reporting of measurement events with reduced performance group configured, non DRX	1762
A.8.7A.1.1	Test Purpose and Environment	1762
A.8.7A.1.2	Test Requirements.....	1764
A.8.8	E-UTRAN FDD – GSM Measurements.....	1764
A.8.8.1	E-UTRAN FDD – GSM event triggered reporting in AWGN	1764
A.8.8.1.1	Test Purpose and Environment	1764
A.8.8.1.2	Test Requirements.....	1766
A.8.8.2	E-UTRAN FDD-GSM event triggered reporting when DRX is used in AWGN	1766
A.8.8.2.1	Test Purpose and Environment	1766
A.8.8.2.2	Test Requirements.....	1768
A.8.8.3	E-UTRAN FDD – GSM event triggered reporting in AWGN with enhanced BSIC identification	1768
A.8.8.3.1	Test Purpose and Environment	1768
A.8.8.3.2	Test Requirements.....	1770
A.8.9	E-UTRAN FDD - UTRAN TDD measurements.....	1770
A.8.9.1	E-UTRAN FDD - UTRAN TDD event triggered reporting in fading propagation conditions.....	1770
A.8.9.1.1	Test Purpose and Environment	1770
A.8.9.1.2	Test Requirements.....	1772
A.8.9.2	E-UTRAN FDD - UTRAN TDD enhanced cell identification under AWGN propagation conditions ..	1772
A.8.9.2.1	Test Purpose and Environment	1772
A.8.9.2.2	Test Requirements.....	1774
A.8.10	E-UTRAN TDD – GSM Measurements.....	1774
A.8.10.1	E-UTRAN TDD – GSM event triggered reporting in AWGN	1774
A.8.10.1.1	Test Purpose and Environment	1774
A.8.10.1.2	Test Requirements.....	1775
A.8.10.2	E-UTRAN TDD-GSM event triggered reporting when DRX is used in AWGN	1776
A.8.10.2.1	Test Purpose and Environment	1776
A.8.10.2.2	Test Requirements.....	1778
A.8.11	Monitoring of Multiple Layers.....	1778
A.8.11.1	Multiple E-UTRAN FDD-FDD Inter-frequency event triggered reporting under fading propagation conditions.....	1778
A.8.11.1.1	Test Purpose and Environment	1778
A.8.11.1.2	Test Requirements.....	1780
A.8.11.2	E-UTRAN TDD – E-UTRAN TDD and E-UTRAN TDD Inter-frequency event triggered reporting under fading propagation conditions	1780
A.8.11.2.1	Test Purpose and Environment	1780
A.8.11.2.2	Test Requirements.....	1781
A.8.11.3	E-UTRAN FDD-FDD Inter-frequency and UTRAN FDD event triggered reporting under fading propagation conditions.....	1781
A.8.11.3.1	Test Purpose and Environment	1781
A.8.11.3.2	Test Requirements.....	1783
A.8.11.4	InterRAT E-UTRA TDD to E-UTRA TDD and UTRA TDD cell search test case	1784
A.8.11.4.1	Test Purpose and Environment	1784
A.8.11.4.2	Test Requirements.....	1786
A.8.11.5	Combined E-UTRAN FDD – E-UTRA FDD and GSM cell search. E-UTRA cells in fading; GSM cell in static propagation conditions.....	1786
A.8.11.5.1	Test Purpose and Environment	1786
A.8.11.5.2	Test Requirements.....	1788
A.8.11.6	Combined E-UTRAN TDD – E-UTRA TDD and GSM cell search. E-UTRA cells in fading; GSM cell in static propagation conditions.....	1788
A.8.11.6.1	Test Purpose and Environment	1788
A.8.11.6.2	Test Requirements.....	1790
A.8.12	RSTD Intra-frequency Measurements.....	1790
A.8.12.1	E-UTRAN FDD intra-frequency RSTD measurement reporting delay test case.....	1790
A.8.12.1.1	Test Purpose and Environment	1790
A.8.12.1.2	Test Requirements.....	1793
A.8.12.1.2A	Test Requirements for UE Category 1bis.....	1794
A.8.12.2	E-UTRAN TDD intra-frequency RSTD measurement reporting delay test case	1794
A.8.12.2.1	Test Purpose and Environment	1794
A.8.12.2.2	Test Requirements.....	1797
A.8.12.2.2A	Test Requirements for UE Category 1bis.....	1798
A.8.12.3	E-UTRAN FDD intra-frequency RSTD measurement period test case in CE Mode A	1798

A.8.12.3.1	Test Purpose and Environment	1798
A.8.12.3.2	Test Requirements.....	1801
A.8.12.4	E-UTRAN HD-FDD intra-frequency RSTD measurement period test case in CE Mode A	1802
A.8.12.4.1	Test Purpose and Environment	1802
A.8.12.4.2	Test Requirements.....	1805
A.8.12.5	E-UTRAN TDD intra-frequency RSTD measurement period test case in CE Mode A	1806
A.8.12.5.1	Test Purpose and Environment	1806
A.8.12.5.2	Test Requirements.....	1809
A.8.12.6	E-UTRAN FDD intra-frequency RSTD measurement period test case in CE Mode B.....	1809
A.8.12.6.1	Test Purpose and Environment	1809
A.8.12.6.2	Test Requirements.....	1813
A.8.12.7	E-UTRAN HD-FDD intra-frequency RSTD measurement period test case in CE Mode B.....	1813
A.8.12.7.1	Test Purpose and Environment	1813
A.8.12.7.2	Test Requirements.....	1816
A.8.12.8	E-UTRAN TDD intra-frequency RSTD measurement period test case in CE Mode B	1817
A.8.12.8.1	Test Purpose and Environment	1817
A.8.12.8.2	Test Requirements.....	1820
A.8.12.9	E-UTRAN FDD intra-frequency RSTD measurement period test case in CE Mode A with longer PRS occasions.....	1821
A.8.12.9.1	Test Purpose and Environment	1821
A.8.12.9.2	Test Requirements.....	1824
A.8.12.10	E-UTRAN HD-FDD intra-frequency RSTD measurement period test case in CE Mode A with longer PRS occasions.....	1824
A.8.12.10.1	Test Purpose and Environment	1824
A.8.12.10.2	Test Requirements.....	1828
A.8.12.11	E-UTRAN TDD intra-frequency RSTD measurement period test case in CE Mode A with longer PRS occasions.....	1828
A.8.12.11.1	Test Purpose and Environment	1828
A.8.12.11.2	Test Requirements.....	1832
A.8.12.12	E-UTRAN FDD intra-frequency RSTD measurement period test case in CE Mode B with longer PRS occasions.....	1832
A.8.12.12.1	Test Purpose and Environment	1832
A.8.12.12.2	Test Requirements.....	1836
A.8.12.13	E-UTRAN HD-FDD intra-frequency RSTD measurement period test case in CE Mode B with longer PRS occasions.....	1836
A.8.12.13.1	Test Purpose and Environment	1836
A.8.12.13.2	Test Requirements.....	1840
A.8.12.14	E-UTRAN TDD intra-frequency RSTD measurement period test case in CE Mode B with longer PRS occasions.....	1840
A.8.12.14.1	Test Purpose and Environment	1840
A.8.12.14.2	Test Requirements.....	1844
A.8.13	RSTD Inter-frequency Measurements.....	1845
A.8.13.1	E-UTRAN FDD-FDD inter-frequency RSTD measurement reporting delay test case with the reference cell on the serving carrier frequency.....	1845
A.8.13.1.1	Test Purpose and Environment	1845
A.8.13.1.2	Test Requirements.....	1848
A.8.13.1.2A	Test Requirements for UE Category 1bis.....	1848
A.8.13.2	E-UTRAN TDD-TDD inter-frequency RSTD measurement reporting delay test case with the reference cell on the serving carrier frequency.....	1849
A.8.13.2.1	Test Purpose and Environment	1849
A.8.13.2.2	Test Requirements.....	1853
A.8.13.2.2A	Test Requirements for UE Category 1bis.....	1853
A.8.13.3	E-UTRAN FDD inter-frequency RSTD measurement period test case in CE Mode A	1854
A.8.13.3.1	Test Purpose and Environment	1854
A.8.13.3.2	Test Requirements.....	1857
A.8.13.4	E-UTRAN HD-FDD inter-frequency RSTD measurement period test case in CE Mode A	1858
A.8.13.4.1	Test Purpose and Environment	1858
A.8.13.4.2	Test Requirements.....	1861
A.8.13.5	E-UTRAN TDD inter-frequency RSTD measurement period test case in CE Mode A	1862
A.8.13.5.1	Test Purpose and Environment	1862
A.8.13.5.2	Test Requirements.....	1866
A.8.13.6	E-UTRAN FDD inter-frequency RSTD measurement period test case in CE Mode B.....	1866

A.8.13.6.1	Test Purpose and Environment	1866
A.8.13.6.2	Test Requirements.....	1870
A.8.13.7	E-UTRAN HD-FDD inter-frequency RSTD measurement period test case in CE Mode B.....	1870
A.8.13.7.1	Test Purpose and Environment	1870
A.8.13.7.2	Test Requirements.....	1874
A.8.13.8	E-UTRAN TDD inter-frequency RSTD measurement period test case in CE Mode B	1874
A.8.13.8.1	Test Purpose and Environment	1874
A.8.13.8.2	Test Requirements.....	1878
A.8.13.9	E-UTRAN FDD inter-frequency RSTD measurement period test case in CE Mode A with longer PRS occasions.....	1879
A.8.13.9.1	Test Purpose and Environment	1879
A.8.13.9.2	Test Requirements.....	1882
A.8.13.10	E-UTRAN HD-FDD inter-frequency RSTD measurement period test case in CE Mode A with longer PRS occasions.....	1883
A.8.13.10.1	Test Purpose and Environment	1883
A.8.13.10.2	Test Requirements.....	1887
A.8.13.11	E-UTRAN TDD inter-frequency RSTD measurement period test case in CE Mode A with longer PRS occasions.....	1887
A.8.13.11.1	Test Purpose and Environment	1887
A.8.13.11.2	Test Requirements.....	1891
A.8.13.12	E-UTRAN FDD inter-frequency RSTD measurement period test case in CE Mode B with longer PRS occasions.....	1891
A.8.13.12.1	Test Purpose and Environment	1891
A.8.13.12.2	Test Requirements.....	1895
A.8.13.13	E-UTRAN HD-FDD inter-frequency RSTD measurement period test case in CE Mode B with longer PRS occasions.....	1896
A.8.13.13.1	Test Purpose and Environment	1896
A.8.13.13.2	Test Requirements.....	1899
A.8.13.14	E-UTRAN TDD inter-frequency RSTD measurement period test case in CE Mode B with longer PRS occasions.....	1900
A.8.13.14.1	Test Purpose and Environment	1900
A.8.13.14.2	Test Requirements.....	1904
A.8.14	E-UTRAN TDD - FDD Inter-frequency Measurements	1904
A.8.14.1	E-UTRAN TDD-FDD Inter-frequency event triggered reporting under fading propagation conditions in asynchronous cells	1904
A.8.14.1.1	Test Purpose and Environment	1904
A.8.14.1.2	Test Requirements.....	1906
A.8.14.2	E-UTRAN TDD-FDD Inter-frequency event triggered reporting when DRX is used under fading propagation conditions in asynchronous cells	1907
A.8.14.2.1	Test Purpose and Environment	1907
A.8.14.2.2	Test Requirements.....	1909
A.8.14.3	E-UTRAN TDD - FDD Inter-frequency identification of a new CGI of E-UTRA cell using autonomous gaps	1909
A.8.14.3.1	Test Purpose and Environment	1909
A.8.14.3.2	Test Requirements.....	1910
A.8.15	E-UTRAN FDD - TDD Inter-frequency Measurements	1911
A.8.15.1	E-UTRAN FDD-TDD Inter-frequency event triggered reporting under fading propagation conditions in asynchronous cells	1911
A.8.15.1.1	Test Purpose and Environment	1911
A.8.15.1.2	Test Requirements.....	1912
A.8.15.2	E-UTRAN FDD-TDD Inter-frequency event triggered reporting when DRX is used under fading propagation conditions in asynchronous cells	1913
A.8.15.2.1	Test Purpose and Environment	1913
A.8.15.2.2	Test Requirements.....	1915
A.8.15.3	E-UTRAN FDD - TDD Inter-frequency identification of a new CGI of E-UTRA cell using autonomous gaps	1915
A.8.15.3.1	Test Purpose and Environment	1915
A.8.15.3.2	Test Requirements.....	1916
A.8.16	E-UTRAN Carrier Aggregation Measurements	1917
A.8.16.1	E-UTRAN FDD event triggered reporting under deactivated SCell in non-DRX.....	1917
A.8.16.1.1	Test Purpose and Environment	1917
A.8.16.1.2	Test Requirements.....	1919

A.8.16.2	E-UTRAN TDD event triggered reporting under deactivated SCell in non-DRX.....	1919
A.8.16.2.1	Test Purpose and Environment	1919
A.8.16.2.2	Test Requirements.....	1921
A.8.16.3	E-UTRAN FDD-FDD Event triggered reporting on deactivated SCell with PCell interruption in non-DRX	1921
A.8.16.3.1	Test Purpose and Environment	1921
A.8.16.3.2	Test Requirements.....	1923
A.8.16.3A	E-UTRAN FDD-FDD Event triggered reporting on deactivated SCell with network controlled PCell interruption in non-DRX.....	1923
A.8.16.3A.1	Test Purpose and Environment	1923
A.8.16.3A.2	Test Requirements.....	1925
A.8.16.4	E-UTRAN TDD-TDD Event triggered reporting on deactivated SCell with PCell interruption in non-DRX	1925
A.8.16.4.1	Test Purpose and Environment	1925
A.8.16.4.2	Test Requirements.....	1927
A.8.16.4A	E-UTRAN TDD-TDD Event triggered reporting on deactivated SCell with PCell interruption in non-DRX	1927
A.8.16.4A.1	Test Purpose and Environment	1927
A.8.16.4A.2	Test Requirements.....	1929
A.8.16.5	E-UTRAN FDD event triggered reporting under deactivated SCell in non-DRX for 20 MHz bandwidth	1929
A.8.16.5.1	Test Purpose and Environment	1929
A.8.16.5.2	Test Requirements.....	1930
A.8.16.6	E-UTRAN TDD event triggered reporting under deactivated SCell in non-DRX for 20 MHz bandwidth	1930
A.8.16.6.1	Test Purpose and Environment	1930
A.8.16.6.2	Test Requirements.....	1931
A.8.16.7	E-UTRA FDD event triggered reporting on deactivated SCell with PCell interruption in non-DRX for 20 MHz bandwidth.....	1931
A.8.16.7.1	Test Purpose and Environment	1931
A.8.16.7.2	Test Requirements.....	1931
A.8.16.8	E-UTRA TDD event triggered reporting on deactivated SCell with PCell interruption in non-DRX for 20 MHz bandwidth.....	1932
A.8.16.8.1	Test Purpose and Environment	1932
A.8.16.8.2	Test Requirements.....	1932
A.8.16.9	E-UTRAN FDD event triggered reporting under deactivated SCell in non-DRX for 10MHz+5MHz... 1932	
A.8.16.9.1	Test Purpose and Environment	1932
A.8.16.9.2	Test Requirements.....	1933
A.8.16.10	E-UTRAN TDD event triggered reporting under deactivated SCell in non-DRX for 10MHz+5MHz .. 1933	
A.8.16.10.1	Test Purpose and Environment	1933
A.8.16.10.2	Test Requirements.....	1934
A.8.16.11	E-UTRAN FDD event triggered reporting on deactivating SCell with PCell interruption in non-DRX for 10MHz+5MHz	1934
A.8.16.11.1	Test Purpose and Environment	1934
A.8.16.11.2	Test Requirements.....	1935
A.8.16.12	E-UTRAN TDD event triggered reporting on deactivating SCell with PCell interruption in non-DRX for 10MHz+5MHz.....	1935
A.8.16.12.1	Test Purpose and Environment	1935
A.8.16.12.2	Test Requirements.....	1935
A.8.16.13	E-UTRAN FDD event triggered reporting under deactivated SCell in non-DRX for 5MHz +5 MHz bandwidth	1936
A.8.16.13.1	Test Purpose and Environment	1936
A.8.16.13.2	Test Requirements.....	1936
A.8.16.14	E-UTRAN TDD event triggered reporting under deactivated SCell in non-DRX for 5 MHz +5 MHz bandwidth	1936
A.8.16.14.1	Test Purpose and Environment	1936
A.8.16.14.2	Test Requirements.....	1937
A.8.16.15	E-UTRA FDD event triggered reporting on deactivated SCell with PCell interruption in non-DRX for 5 +5 MHz bandwidth	1937
A.8.16.15.1	Test Purpose and Environment	1937
A.8.16.7.2	Test Requirements.....	1938

A.8.16.16	E-UTRA TDD event triggered reporting on deactivated SCell with PCell interruption in non-DRX for 5+5 MHz bandwidth	1938
A.8.16.16.1	Test Purpose and Environment	1938
A.8.16.16.2	Test Requirements.....	1938
A.8.16.17	E-UTRAN FDD activation and deactivation of known SCell in non-DRX	1938
A.8.16.17.1	Test Purpose and Environment	1938
A.8.16.17.2	Test Requirements.....	1940
A.8.16.17A	E-UTRAN FDD activation and deactivation of known SCell in non-DRX for 20MHz.....	1941
A.8.16.17A.1	Test Purpose and Environment	1941
A.8.16.17A.2	Test Requirements.....	1941
A.8.16.17B	E-UTRAN FDD activation and deactivation of known SCell in non-DRX for 10MHz + 5MHz	1941
A.8.16.17B.1	Test Purpose and Environment	1941
A.8.16.17B.2	Test Requirements.....	1942
A.8.16.17C	E-UTRAN FDD activation and deactivation of known SCell in non-DRX for 5MHz + 5MHz	1942
A.8.16.17C.1	Test Purpose and Environment	1942
A.8.16.17C.2	Test Requirements.....	1942
A.8.16.18	E-UTRAN TDD activation and deactivation of known SCell in non-DRX	1942
A.8.16.18.1	Test Purpose and Environment	1942
A.8.16.18.2	Test Requirements.....	1944
A.8.16.18A	E-UTRAN TDD activation and deactivation of known SCell in non-DRX for 20MHz	1945
A.8.16.18A.1	Test Purpose and Environment	1945
A.8.16.18A.2	Test Requirements.....	1945
A.8.16.18B	E-UTRAN TDD activation and deactivation of known SCell in non-DRX for 10MHz + 5MHz	1945
A.8.16.18B.1	Test Purpose and Environment	1945
A.8.16.18B.2	Test Requirements.....	1946
A.8.16.18C	E-UTRAN TDD activation and deactivation of known SCell in non-DRX for 5MHz + 5MHz	1946
A.8.16.18C.1	Test Purpose and Environment	1946
A.8.16.18C.2	Test Requirements.....	1946
A.8.16.18D	E-UTRAN TDD activation and deactivation of known SCell in non-DRX for 20MHz + 10MHz	1946
A.8.16.18D.1	Test Purpose and Environment	1946
A.8.16.18D.2	Test Requirements.....	1947
A.8.16.19	E-UTRAN FDD activation and deactivation of unknown SCell in non-DRX	1947
A.8.16.19.1	Test Purpose and Environment	1947
A.8.16.19.2	Test Requirements.....	1949
A.8.16.19A	E-UTRAN FDD activation and deactivation of unknown SCell in non-DRX for 20MHz.....	1949
A.8.16.19A.1	Test Purpose and Environment	1949
A.8.16.19A.2	Test Requirements.....	1950
A.8.16.19B	E-UTRAN FDD activation and deactivation of unknown SCell in non-DRX for 10MHz + 5MHz	1950
A.8.16.19B.1	Test Purpose and Environment	1950
A.8.16.19B.2	Test Requirements.....	1950
A.8.16.19C	E-UTRAN FDD activation and deactivation of unknown SCell in non-DRX for 5MHz + 5MHz	1950
A.8.16.19C.1	Test Purpose and Environment	1950
A.8.16.19C.2	Test Requirements.....	1951
A.8.16.20	E-UTRAN TDD activation and deactivation of unknown SCell in non-DRX	1951
A.8.16.20.1	Test Purpose and Environment	1951
A.8.16.20.2	Test Requirements.....	1953
A.8.16.20A	E-UTRAN TDD activation and deactivation of unknown SCell in non-DRX for 20MHz	1953
A.8.16.20A.1	Test Purpose and Environment	1953
A.8.16.20A.2	Test Requirements.....	1954
A.8.16.20B	E-UTRAN TDD activation and deactivation of unknown SCell in non-DRX for 10MHz + 5MHz	1954
A.8.16.20B.1	Test Purpose and Environment	1954
A.8.16.20B.2	Test Requirements.....	1954
A.8.16.20C	E-UTRAN TDD activation and deactivation of unknown SCell in non-DRX for 5MHz + 5MHz	1954
A.8.16.20C.1	Test Purpose and Environment	1954
A.8.16.20C.2	Test Requirements.....	1955
A.8.16.20D	E-UTRAN TDD activation and deactivation of unknown SCell in non-DRX for 20MHz + 10MHz	1955
A.8.16.20D.1	Test Purpose and Environment	1955
A.8.16.20D.2	Test Requirements.....	1955
A.8.16.21	E-UTRAN TDD event triggered reporting under deactivated SCell in non-DRX for 20MHz+10MHz	1955
A.8.16.21.1	Test Purpose and Environment	1955
A.8.16.21.2	Test Requirements.....	1957

A.8.16.22	E-UTRAN TDD event triggered reporting on deactivating SCell with PCell interruption in non-DRX for 20MHz+10MHz.....	1957
A.8.16.22.1	Test Purpose and Environment	1957
A.8.16.22.2	Test Requirements.....	1959
A.8.16.23	E-UTRAN TDD-FDD CA Event Triggered Reporting Under Deactivated SCell in Non-DRX with PCell in FDD	1959
A.8.16.23.1	Test Purpose and Environment	1959
A.8.16.23.2	Test Requirements.....	1961
A.8.16.24	E-UTRAN TDD-FDD CA Event Triggered Reporting Under Deactivated SCell in Non-DRX with PCell in TDD	1961
A.8.16.24.1	Test Purpose and Environment	1961
A.8.16.24.2	Test Requirements.....	1963
A.8.16.25	E-UTRAN TDD-FDD CA Event triggered reporting on deactivated SCell with PCell interruption in non-DRX with PCell in FDD.....	1964
A.8.16.25.1	Test Purpose and Environment	1964
A.8.16.25.2	Test Requirements.....	1966
A.8.16.26	E-UTRAN TDD-FDD CA Event triggered reporting on deactivated SCell with PCell interruption in non-DRX with PCell in TDD	1966
A.8.16.26.1	Test Purpose and Environment	1966
A.8.16.26.2	Test Requirements.....	1968
A.8.16.27	3 DL PCell in FDD CA Event Triggered Reporting with 2 Deactivated SCells in Non-DRX.....	1968
A.8.16.27.1	Test Purpose and Environment	1968
A.8.16.27.2	Test Requirements.....	1972
A.8.16.28	3 DL PCell in TDD CA Event Triggered Reporting with 2 Deactivated SCells in Non-DRX.....	1972
A.8.16.28.1	Test Purpose and Environment	1972
A.8.16.28.2	Test Requirements.....	1976
A.8.16.29	3 DL FDD CA Event Triggered Reporting under Deactivated SCells in Non-DRX.....	1976
A.8.16.29.1	Test Purpose and Environment	1976
A.8.16.29.2	Test Requirements.....	1980
A.8.16.30	3 DL TDD CA Event Triggered Reporting under Deactivated SCells in Non-DRX.....	1980
A.8.16.30.1	Test Purpose and Environment	1980
A.8.16.30.2	Test Requirements.....	1984
A.8.16.31	E-UTRAN TDD-FDD 3 DL CA Event Triggered Reporting on Deactivated SCell with PCell and SCell Interruptions in Non-DRX and with PCell in FDD.....	1984
A.8.16.31.1	Test Purpose and Environment	1984
A.8.16.31.2	Test Requirements.....	1988
A.8.16.32	E-UTRAN TDD-FDD 3 DL CA Event Triggered Reporting on Deactivated SCell with PCell and SCell Interruptions in Non-DRX and with PCell in TDD	1988
A.8.16.32.1	Test Purpose and Environment	1988
A.8.16.32.2	Test Requirements.....	1992
A.8.16.33	E-UTRAN FDD 3 DL CA Event Triggered Reporting on Deactivated SCell with PCell and SCell Interruptions in Non-DRX.....	1992
A.8.16.33.1	Test Purpose and Environment	1992
A.8.16.33.2	Test Requirements.....	1996
A.8.16.34	E-UTRAN TDD 3 DL CA Event Triggered Reporting on Deactivated SCell with PCell and SCell Interruptions in Non-DRX	1996
A.8.16.34.1	Test Purpose and Environment	1996
A.8.16.34.2	Test Requirements.....	2000
A.8.16.35	3 DL PCell in FDD CA Activation and Deactivation of Known SCell in Non-DRX	2000
A.8.16.35.1	Test Purpose and Environment	2000
A.8.16.35.2	Test Requirements.....	2002
A.8.16.36	3 DL PCell in TDD CA Activation and Deactivation of Known SCell in Non-DRX	2003
A.8.16.36.1	Test Purpose and Environment	2003
A.8.16.36.2	Test Requirements.....	2005
A.8.16.37	3 DL FDD CA activation and deactivation of known SCell in non-DRX	2005
A.8.16.37.1	Test Purpose and Environment	2005
A.8.16.37.2	Test Requirements.....	2007
A.8.16.38	3 DL TDD CA activation and deactivation of known SCell in non-DRX.....	2008
A.8.16.38.1	Test Purpose and Environment	2008
A.8.16.38.2	Test Requirements.....	2010
A.8.16.39	E-UTRA TDD-FDD 3DL CA Activation and Deactivation of Unknown SCell in Non-DRX with PCell in FDD	2010

A.8.16.39.1	Test Purpose and Environment	2010
A.8.16.39.2	Test Requirements.....	2013
A.8.16.40	E-UTRA TDD-FDD 3DL CA Activation and Deactivation of Unknown SCell in Non-DRX with PCell in TDD	2013
A.8.16.40.1	Test Purpose and Environment	2013
A.8.16.40.2	Test Requirements.....	2015
A.8.16.41	3 DL FDD CA activation and deactivation of unknown SCell in non-DRX	2016
A.8.16.41.1	Test Purpose and Environment	2016
A.8.16.41.2	Test Requirements	2018
A.8.16.42	3 DL TDD CA activation and deactivation of unknown SCell in non-DRX	2018
A.8.16.42.1	Test Purpose and Environment	2018
A.8.16.42.2	Test Requirements	2020
A.8.16.43	E-UTRAN TDD-FDD CA activation and deactivation of known SCell in non-DRX with PCell in FDD	2021
A.8.16.43.1	Test Purpose and Environment	2021
A.8.16.43.2	Test Requirements.....	2023
A.8.16.44	E-UTRAN TDD-FDD CA activation and deactivation of unknown SCell in non-DRX with PCell in FDD	2023
A.8.16.44.1	Test Purpose and Environment	2023
A.8.16.44.2	Test Requirements.....	2025
A.8.16.45	E-UTRAN TDD-FDD CA activation and deactivation of known SCell in non-DRX with PCell in TDD.....	2026
A.8.16.45.1	Test Purpose and Environment	2026
A.8.16.45.2	Test Requirements.....	2028
A.8.16.46	E-UTRAN TDD-FDD CA activation and deactivation of unknown SCell in non-DRX with PCell in TDD.....	2028
A.8.16.46.1	Test Purpose and Environment	2028
A.8.16.46.2	Test Requirements.....	2030
A.8.16.47	2DL/2UL FDD CA activation and deactivation of known PUCCH SCell without valid TA in non-DRX.....	2030
A.8.16.47.1	Test Purpose and Environment	2030
A.8.16.47.2	Test Requirements.....	2032
A.8.16.48	2DL/2UL TDD CA activation and deactivation of known PUCCH SCell without valid TA in non-DRX.....	2033
A.8.16.48.1	Test Purpose and Environment	2033
A.8.16.48.2	Test Requirements.....	2035
A.8.16.49	2DL/2UL TDD-FDD CA (FDD PCell) activation and deactivation of known PUCCH SCell without valid TA in non-DRX	2035
A.8.16.49.1	Test Purpose and Environment	2035
A.8.16.49.2	Test Requirements.....	2037
A.8.16.50	2DL/2UL TDD-FDD CA (TDD PCell) activation and deactivation of known PUCCH SCell without valid TA in non-DRX	2038
A.8.16.50.1	Test Purpose and Environment	2038
A.8.16.50.2	Test Requirements.....	2040
A.8.16.51	E-UTRAN 4 DL FDD CA Event Triggered Reporting with 3 deactivated SCells in Non-DRX	2040
A.8.16.51.1	Test Purpose and Environment	2040
A.8.16.51.2	Test Requirements.....	2044
A.8.16.52	E-UTRAN 4 DL TDD CA Event Triggered Reporting with 3 deactivated SCells in Non-DRX	2044
A.8.16.52.1	Test Purpose and Environment	2044
A.8.16.52.2	Test Requirements.....	2048
A.8.16.53	4 DL PCell in FDD CA Event Triggered Reporting with 3 Deactivated SCells in Non-DRX.....	2048
A.8.16.53.1	Test Purpose and Environment	2048
A.8.16.53.2	Test Requirements.....	2052
A.8.16.54	4 DL PCell in TDD CA Event Triggered Reporting with 3 Deactivated SCells in Non-DRX.....	2052
A.8.16.54.1	Test Purpose and Environment	2052
A.8.16.54.2	Test Requirements.....	2056
A.8.16.55	E-UTRAN FDD 4 DL CA Event Triggered Reporting on Deactivated SCell with PCell and SCell Interruptions in Non-DRX	2056
A.8.16.55.1	Test Purpose and Environment	2056
A.8.16.55.2	Test Requirements.....	2061
A.8.16.56	E-UTRAN TDD 4 DL CA Event Triggered Reporting on Deactivated SCell with PCell and SCell Interruptions in Non-DRX.....	2061

A.8.16.56.1	Test Purpose and Environment	2061
A.8.16.56.2	Test Requirements.....	2066
A.8.16.57	E-UTRAN FDD 4DL CA activation and deactivation of know SCell in non-DRX.....	2066
A.8.16.57.1	Test Purpose and Environment	2066
A.8.16.57.2	Test Requirements.....	2068
A.8.16.58	E-UTRAN TDD 4DL CA activation and deactivation of know SCell in non-DRX	2068
A.8.16.58.1	Test Purpose and Environment	2068
A.8.16.58.2	Test Requirements.....	2070
A.8.16.59	E-UTRAN PCell in FDD FDD-TDD 4 DL CA activation and deactivation of known SCell in non-DRX.....	2071
A.8.16.59.1	Test Purpose and Environment	2071
A.8.16.59.2	Test Requirements.....	2074
A.8.16.60	E-UTRAN PCell in TDD FDD-TDD 4 DL CA activation and deactivation of known SCell in non-DRX.....	2074
A.8.16.60.1	Test Purpose and Environment	2074
A.8.16.60.2	Test Requirements.....	2077
A.8.16.61	E-UTRAN FDD 4DL CA activation and deactivation of unknown SCell in non-DRX.....	2078
A.8.16.61.1	Test Purpose and Environment	2078
A.8.16.61.2	Test Requirements.....	2080
A.8.16.62	E-UTRAN TDD 4DL CA activation and deactivation of unknown SCell in non-DRX	2080
A.8.16.62.1	Test Purpose and Environment	2080
A.8.16.62.2	Test Requirements.....	2082
A.8.16.63	E-UTRAN PCell in FDD FDD-TDD 4 DL CA activation and deactivation of unknown SCell in non-DRX	2083
A.8.16.63.1	Test Purpose and Environment	2083
A.8.16.63.2	Test Requirements.....	2086
A.8.16.64	E-UTRAN PCell in TDD FDD-TDD 4 DL CA activation and deactivation of unknown SCell in non-DRX	2086
A.8.16.64.1	Test Purpose and Environment	2086
A.8.16.64.2	Test Requirements.....	2090
A.8.16.65	5 DL FDD-TDD with PCell in FDD CA Event Triggered Reporting with 4 Deactivated SCells in Non-DRX.....	2090
A.8.16.65.1	Test Purpose and Environment	2090
A.8.16.65.2	Test Requirements.....	2094
A.8.16.66	5 DL FDD-TDD with PCell in TDD CA Event Triggered Reporting with 4 Deactivated SCells in Non-DRX.....	2094
A.8.16.66.1	Test Purpose and Environment	2094
A.8.16.66.2	Test Requirements.....	2098
A.8.16.67	5 DL FDD-TDD with PCell in FDD CA activation and deactivation of Unknown SCell in non-DRX.....	2098
A.8.16.67.1	Test Purpose and Environment	2098
A.8.16.67.2	Test Requirements.....	2102
A.8.16.68	5 DL FDD-TDD with PCell in TDD CA activation and deactivation of Unknown SCell in non-DRX.....	2102
A.8.16.68.1	Test Purpose and Environment	2102
A.8.16.68.2	Test Requirements.....	2105
A.8.16.69	5 DL FDD CA activation and deactivation of unknown SCell in non-DRX	2106
A.8.16.69.1	Test Purpose and Environment	2106
A.8.16.69.2	Test Requirements.....	2108
A.8.16.70	5 DL TDD CA activation and deactivation of unknown SCell in non-DRX	2108
A.8.16.70.1	Test Purpose and Environment	2108
A.8.16.70.2	Test Requirements.....	2111
A.8.16.71	5 DL FDD CA Event Triggered Reporting with Deactivated SCells in Non-DRX.....	2112
A.8.16.71.1	Test Purpose and Environment	2112
A.8.16.71.2	Test Requirements.....	2116
A.8.16.72	5 DL TDD CA Event Triggered Reporting with Deactivated SCells in Non-DRX.....	2116
A.8.16.72.1	Test Purpose and Environment	2116
A.8.16.72.2	Test Requirements.....	2120
A.8.16.73	5 DL FDD CA Event Triggered Reporting on Deactivated SCell with PCell and SCell Interruptions in Non-DRX.....	2120
A.8.16.73.1	Test Purpose and Environment	2120
A.8.16.73.2	Test Requirements.....	2125
A.8.16.74	5 DL TDD CA Event Triggered Reporting on Deactivated SCell with PCell and SCell Interruptions in Non-DRX.....	2125

A.8.16.74.1	Test Purpose and Environment	2125
A.8.16.74.2	Test Requirements.....	2130
A.8.16.75	5 DL FDD-TDD with PCell in FDD CA activation and deactivation of known SCell in non-DRX.....	2130
A.8.16.75.1	Test Purpose and Environment	2130
A.8.16.75.2	Test Requirements.....	2133
A.8.16.76	5 DL FDD-TDD with PCell in TDD CA activation and deactivation of known SCell in non-DRX	2134
A.8.16.76.1	Test Purpose and Environment	2134
A.8.16.76.2	Test Requirements.....	2137
A.8.16.77	5 DL FDD CA activation and deactivation of know SCell in non-DRX	2138
A.8.16.77.1	Test Purpose and Environment	2138
A.8.16.77.2	Test Requirements.....	2140
A.8.16.78	5 DL TDD CA activation and deactivation of know SCell in non-DRX.....	2141
A.8.16.78.1	Test Purpose and Environment	2141
A.8.16.78.2	Test Requirements.....	2143
A.8.16.79	E-UTRAN PCell in FDD FDD-TDD 4 DL CA Event Triggered Reporting on Deactivated SCell with PCell and SCell Interruptions in Non-DRX.....	2144
A.8.16.79.1	Test Purpose and Environment	2144
A.8.16.79.2	Test Requirements.....	2149
A.8.16.80	E-UTRAN PCell in TDD TDD-FDD 4 DL CA Event Triggered Reporting on Deactivated SCell with PCell and SCell Interruptions in Non-DRX.....	2149
A.8.16.80.1	Test Purpose and Environment	2149
A.8.16.80.2	Test Requirements.....	2154
A.8.16.81	E-UTRAN PCell in FDD FDD-TDD 5 DL CA Event Triggered Reporting on Deactivated SCell with PCell and SCell Interruptions in Non-DRX.....	2154
A.8.16.81.1	Test Purpose and Environment	2154
A.8.16.81.2	Test Requirements.....	2159
A.8.16.82	E-UTRAN PCell in TDD TDD-FDD 5 DL CA Event Triggered Reporting on Deactivated SCell with PCell and SCell Interruptions in Non-DRX.....	2159
A.8.16.82.1	Test Purpose and Environment	2159
A.8.16.82.2	Test Requirements.....	2164
A.8.16.83	3 DL CA Event Triggered Reporting under Deactivated SCells in Non-DRX with generic duplex modes.....	2164
A.8.16.83.1	Test Purpose and Environment	2164
A.8.16.83.2	Test Requirements.....	2168
A.8.16.84	3 DL CA Event Triggered Reporting on Deactivated SCell with PCell and SCell Interruptions in Non-DRX with generic duplex modes.....	2168
A.8.16.84.1	Test Purpose and Environment	2168
A.8.16.84.2	Test Requirements.....	2173
A.8.16.85	3 DL CA Activation and Deactivation of Known SCell in Non-DRX with generic duplex modes	2173
A.8.16.85.1	Test Purpose and Environment	2173
A.8.16.85.2	Test Requirements.....	2175
A.8.16.86	3 DL CA Activation and Deactivation of Unknown SCell in Non-DRX with generic duplex modes ...	2176
A.8.16.86.1	Test Purpose and Environment	2176
A.8.16.86.2	Test Requirements.....	2179
A.8.16.87	4 DL CA Event Triggered Reporting under Deactivated SCells in Non-DRX with generic duplex modes.....	2179
A.8.16.87.1	Test Purpose and Environment	2179
A.8.16.87.2	Test Requirements.....	2184
A.8.16.88	4 DL CA Event Triggered Reporting on Deactivated SCell with PCell and SCell Interruptions in Non-DRX with generic duplex modes.....	2184
A.8.16.88.1	Test Purpose and Environment	2184
A.8.16.88.2	Test Requirements.....	2190
A.8.16.89	4 DL CA Activation and Deactivation of Known SCell in Non-DRX with generic duplex modes	2190
A.8.16.89.1	Test Purpose and Environment	2190
A.8.16.89.2	Test Requirements.....	2194
A.8.16.90	4 DL CA Activation and Deactivation of Unknown SCell in Non-DRX with generic duplex modes ...	2194
A.8.16.90.1	Test Purpose and Environment	2194
A.8.16.90.2	Test Requirements.....	2197
A.8.16.91	5 DL CA Event Triggered Reporting under Deactivated SCells in Non-DRX with generic duplex modes.....	2198
A.8.16.91.1	Test Purpose and Environment	2198
A.8.16.91.2	Test Requirements.....	2202

A.8.16.92	5 DL CA Event Triggered Reporting on Deactivated SCell with PCell and SCell Interruptions in Non-DRX with generic duplex modes.....	2203
A.8.16.92.1	Test Purpose and Environment	2203
A.8.16.92.2	Test Requirements.....	2209
A.8.16.93	5 DL CA Activation and Deactivation of Known SCell in Non-DRX with generic duplex modes	2209
A.8.16.93.1	Test Purpose and Environment	2209
A.8.16.93.2	Test Requirements.....	2213
A.8.16.94	5 DL CA Activation and Deactivation of Unknown SCell in Non-DRX with generic duplex modes ...	2213
A.8.16.94.1	Test Purpose and Environment	2213
A.8.16.94.2	Test Requirements.....	2217
A.8.16.95	6 DL CA Event Triggered Reporting under Deactivated SCells in Non-DRX with generic duplex modes.....	2217
A.8.16.95.1	Test Purpose and Environment	2217
A.8.16.95.2	Test Requirements.....	2223
A.8.16.96	6 DL CA Event Triggered Reporting on Deactivated SCell with PCell and SCell Interruptions in Non-DRX with generic duplex modes.....	2224
A.8.16.96.1	Test Purpose and Environment	2224
A.8.16.96.2	Test Requirements.....	2231
A.8.16.97	6 DL CA Activation and Deactivation of Known SCell in Non-DRX with generic duplex modes	2231
A.8.16.97.1	Test Purpose and Environment	2231
A.8.16.97.2	Test Requirements.....	2235
A.8.16.98	6 DL CA Activation and Deactivation of Unknown SCell in Non-DRX with generic duplex modes ...	2235
A.8.16.98.1	Test Purpose and Environment	2235
A.8.16.98.2	Test Requirements.....	2240
A.8.16.99	7 DL CA Event Triggered Reporting under Deactivated SCells in Non-DRX with generic duplex modes.....	2240
A.8.16.99.1	Test Purpose and Environment	2240
A.8.16.99.2	Test Requirements.....	2245
A.8.16.100	7 DL CA Event Triggered Reporting on Deactivated SCell with PCell and SCell Interruptions in Non-DRX with generic duplex modes.....	2246
A.8.16.100.1	Test Purpose and Environment	2246
A.8.16.100.2	Test Requirements.....	2253
A.8.16.101	7 DL CA Activation and Deactivation of Known SCell in Non-DRX with generic duplex modes	2253
A.8.16.101.1	Test Purpose and Environment	2253
A.8.16.101.2	Test Requirements.....	2258
A.8.16.102	7 DL CA Activation and Deactivation of Unknown SCell in Non-DRX with generic duplex modes ...	2259
A.8.16.102.1	Test Purpose and Environment	2259
A.8.16.102.2	Test Requirements.....	2265
A.8.16.103	Hibernation and Activation of Known SCell in Non-DRX with generic duplex modes	2265
A.8.16.103.1	Test Purpose and Environment	2265
A.8.16.103.2	Test Requirements.....	2268
A.8.16.104	Hibernation and Activation of Unknown SCell in Non-DRX with generic duplex modes.....	2269
A.8.16.104.1	Test Purpose and Environment	2269
A.8.16.104.2	Test Requirements.....	2272
A.8.16.105	Idle Mode measurements of inter-frequency CA candidate cells for early reporting	2273
A.8.16.105.1	Test Purpose and Environment	2273
A.8.16.105.2	Test Requirements.....	2276
A.8.16.106	Direct Activation of Known SCell in Non-DRX with generic duplex modes	2276
A.8.16.106.1	Test Purpose and Environment	2276
A.8.16.106.2	Test Requirements.....	2279
A.8.17	RSTD Measurements for E-UTRAN Carrier Aggregation	2279
A.8.17.1	E-UTRAN FDD RSTD measurement reporting delay test case	2279
A.8.17.1.1	Test Purpose and Environment	2279
A.8.17.1.2	Test Requirements.....	2283
A.8.17.2	E-UTRAN TDD RSTD measurement reporting delay test case	2283
A.8.17.2.1	Test Purpose and Environment	2283
A.8.17.2.2	Test Requirements.....	2287
A.8.17.3	E-UTRAN FDD RSTD Measurement Reporting Test Case for 20 MHz.....	2288
A.8.17.3.1	Test Purpose and Environment	2288
A.8.17.3.2	Test Requirements.....	2289
A.8.17.4	E-UTRAN TDD RSTD Measurement Reporting Test Case for 20 MHz.....	2289
A.8.17.4.1	Test Purpose and Environment	2289

A.8.17.4.2	Test Requirements.....	2290
A.8.17.5	E-UTRAN FDD RSTD Measurement Reporting Test Case for 10MHz+5MHz.....	2290
A.8.17.5.1	Test Purpose and Environment	2290
A.8.17.5.2	Test Requirements.....	2291
A.8.17.6	E-UTRAN TDD RSTD Measurement Reporting Test Case for 10MHz+5MHz	2291
A.8.17.6.1	Test Purpose and Environment	2291
A.8.17.6.2	Test Requirements.....	2292
A.8.17.7	E-UTRAN FDD RSTD Measurement Reporting Test Case for 5 + 5 MHz Bandwidth	2292
A.8.17.7.1	Test Purpose and Environment	2292
A.8.17.7.2	Test Requirements.....	2293
A.8.17.8	E-UTRAN TDD RSTD Measurement Reporting Test Case for 5+5 MHz bandwidth.....	2293
A.8.17.8.1	Test Purpose and Environment	2293
A.8.17.8.2	Test Requirements.....	2294
A.8.17.9	E-UTRAN TDD RSTD Measurement Reporting Test Case for 20MHz+10MHz	2294
A.8.17.9.1	Test Purpose and Environment	2294
A.8.17.9.2	Test Requirements.....	2295
A.8.17.10	E-UTRAN 3 DL FDD CA RSTD Measurement Reporting Delay Test Case	2295
A.8.17.10.1	Test Purpose and Environment	2295
A.8.17.10.2	Test Requirements.....	2299
A.8.17.11	E-UTRAN 3 DL TDD CA RSTD Measurement Reporting Delay Test Case	2300
A.8.17.11.1	Test Purpose and Environment	2300
A.8.17.11.2	Test Requirements.....	2305
A.8.18	E-UTRAN TDD – HRPD Measurements	2306
A.8.18.1	E-UTRAN TDD-HRPD event triggered reporting under fading propagation conditions.....	2306
A.8.18.1.1	Test Purpose and Environment	2306
A.8.18.1.2	Test Requirements.....	2307
A.8.19	E-UTRAN TDD – CDMA2000 1X Measurements	2308
A.8.19.1	E-UTRAN TDD – CDMA2000 1X event triggered reporting under fading propagation conditions.....	2308
A.8.19.1.1	Test Purpose and Environment	2308
A.8.19.1.2	Test Requirements.....	2309
A.8.20	Inter-frequency/RAT Measurements in CA mode	2310
A.8.20.1	E-UTRAN FDD-FDD Inter-frequency event triggered reporting under fading propagation conditions in asynchronous cells	2310
A.8.20.1.1	Test Purpose and Environment	2310
A.8.20.1.2	Test Requirements.....	2311
A.8.20.2	E-UTRAN TDD-TDD Inter-frequency event triggered reporting under fading propagation conditions in synchronous cells	2311
A.8.20.2.1	Test Purpose and Environment	2311
A.8.20.2.2	Test Requirements.....	2313
A.8.20.2A	E-UTRAN TDD-TDD Inter-frequency event triggered reporting under fading propagation conditions in synchronous cells for 20 MHz +20 MHz bandwidth.	2314
A.8.20.2A.1	Test Purpose and Environment	2314
A.8.20.2A.2	Test Requirements.....	2314
A.8.20.2B	E-UTRAN TDD-TDD Inter-frequency event triggered reporting under fading propagation conditions in synchronous cells for 20 MHz +10 MHz bandwidth.	2314
A.8.20.2B.1	Test Purpose and Environment	2314
A.8.20.2B.2	Test Requirements.....	2316
A.8.20.3	E-UTRAN FDD - UTRAN FDD event triggered reporting under fading propagation conditions.....	2316
A.8.20.3.1	Test Purpose and Environment	2316
A.8.20.3.2	Test Requirements.....	2318
A.8.20.4	E-UTRAN TDD to UTRAN TDD cell search under fading propagation conditions	2318
A.8.20.4.1	Test Purpose and Environment	2318
A.8.20.4.1.1	1.28 Mcps TDD option.....	2318
A.8.20.4.2	Test Requirements.....	2320
A.8.20.4.2.1	1.28 Mcps TDD option.....	2320
A.8.20.4A	E-UTRAN TDD with 20 MHz +20 MHz bandwidth to UTRAN TDD cell search under fading propagation conditions.....	2320
A.8.20.4A.1	Test Purpose and Environment	2320
A.8.20.4A.1.1	1.28 Mcps TDD option.....	2320
A.8.20.4A.2	Test Requirements.....	2321
A.8.20.4A.2.1	1.28 Mcps TDD option.....	2321

A.8.20.4B	E-UTRAN TDD with 20 MHz +10 MHz bandwidth to UTRAN TDD cell search under fading propagation conditions.....	2321
A.8.20.4B.1	Test Purpose and Environment	2321
A.8.20.4B.1.1	1.28 Mcps TDD option.....	2321
A.8.20.4B.2	Test Requirements.....	2322
A.8.20.4B.2.1	1.28 Mcps TDD option.....	2322
A.8.21	CSG Proximity Indication Testing Case for E-UTRAN FDD – FDD Inter frequency	2322
A.8.21.1	Test Purpose and Environment	2323
A.8.21.2	Test Requirements	2325
A.8.22	E-UTRAN Discovery Signal Measurements.....	2325
A.8.22.1	E-UTRAN FDD-FDD intra-frequency event triggered reporting under fading propagation conditions in synchronous cells in DRX based on CRS based discovery signal.....	2325
A.8.22.1.1	Test Purpose and Environment	2325
A.8.22.1.2	Test Requirements.....	2327
A.8.22.2	E-UTRAN TDD-TDD intra-frequency event triggered reporting under fading propagation conditions in synchronous cells in DRX based on CRS based discovery signal	2328
A.8.22.2.1	Test Purpose and Environment	2328
A.8.22.2.2	Test Requirements.....	2330
A.8.22.3	E-UTRAN FDD-FDD inter-frequency event triggered reporting under fading propagation conditions in DRX based on CRS based discovery signal	2330
A.8.22.3.1	Test Purpose and Environment	2330
A.8.22.3.2	Test Requirements.....	2332
A.8.22.4	E-UTRAN TDD-TDD inter-frequency event triggered reporting under fading propagation conditions in DRX based on CRS based discovery signal.....	2332
A.8.22.4.1	Test Purpose and Environment	2332
A.8.22.4.2	Test Requirements.....	2334
A.8.22.5	E-UTRAN FDD-FDD intra-frequency event triggered reporting in DRX based on CSI-RS based discovery signal	2335
A.8.22.5.1	Test Purpose and Environment	2335
A.8.22.5.2	Test Requirements.....	2337
A.8.22.6	E-UTRAN TDD-TDD intra-frequency event triggered reporting in DRX based on CSI-RS based discovery signal	2337
A.8.22.6.1	Test Purpose and Environment	2337
A.8.22.6.2	Test Requirements.....	2339
A.8.22.7	E-UTRAN FDD-FDD Inter-frequency event triggered reporting in DRX based on CSI-RS based discovery signal	2339
A.8.22.7.1	Test Purpose and Environment	2339
A.8.22.7.2	Test Requirements.....	2342
A.8.22.8	E-UTRAN TDD-TDD inter-frequency event triggered reporting under fading propagation condition in DRX based on CSI-RS based discovery signal	2342
A.8.22.8.1	Test Purpose and Environment	2342
A.8.22.8.2	Test Requirements.....	2344
A.8.22.9	E-UTRAN FDD event triggered reporting under deactivated SCell in non-DRX based on CRS based discovery signal	2344
A.8.22.9.1	Test Purpose and Environment	2344
A.8.22.9.2	Test Requirements.....	2346
A.8.22.10	E-UTRAN TDD event triggered reporting under deactivated SCell in non-DRX based on CRS based discovery signal	2347
A.8.22.10.1	Test Purpose and Environment	2347
A.8.22.10.2	Test Requirements.....	2348
A.8.22.11	E-UTRAN FDD event triggered reporting under deactivated SCell in non-DRX based on CSI-RS based discovery signal	2349
A.8.22.11.1	Test Purpose and Environment	2349
A.8.22.11.2	Test Requirements.....	2351
A.8.22.12	E-UTRAN TDD event triggered reporting under deactivated SCell in non-DRX based on CSI-RS based discovery signal	2351
A.8.22.12.1	Test Purpose and Environment	2351
A.8.22.12.2	Test Requirements.....	2353
A.8.23	E-UTRAN Dual Connectivity Measurements	2354
A.8.23.1	E-UTRAN FDD-FDD DC intra-frequency event triggered reporting with DRX in synchronous DC ...	2354
A.8.23.1.1	Test Purpose and Environment	2354
A.8.23.1.2	Test Requirements.....	2356

A.8.23.2	E-UTRAN FDD-FDD DC intra-frequency event triggered reporting with DRX in asynchronous DC	2357
A.8.23.2.1	Test Purpose and Environment	2357
A.8.23.2.2	Test Requirements	2359
A.8.23.3	E-UTRAN TDD-TDD DC intra-frequency event triggered reporting with DRX in synchronous DC	2359
A.8.23.3.1	Test Purpose and Environment	2359
A.8.23.3.2	Test Requirements	2362
A.8.23.4	E-UTRAN FDD-FDD DC inter-frequency event triggered reporting with DRX in synchronous DC	2362
A.8.23.4.1	Test Purpose and Environment	2362
A.8.23.4.2	Test Requirements	2364
A.8.23.5	E-UTRAN FDD-FDD DC inter-frequency event triggered reporting with DRX in asynchronous DC	2364
A.8.23.5.1	Test Purpose and Environment	2364
A.8.23.5.2	Test Requirements	2366
A.8.23.6	E-UTRAN TDD-TDD DC inter-frequency event triggered reporting with DRX in synchronous DC	2367
A.8.23.6.1	Test Purpose and Environment	2367
A.8.23.6.2	Test Requirements	2369
A.8.23.7	E-UTRAN FDD-FDD Addition and Release Delay of known PSCell in Synchronous DC	2369
A.8.23.7.1	Test Purpose and Environment	2369
A.8.23.7.2	Test Requirements	2371
A.8.23.8	E-UTRAN FDD-FDD Addition and Release Delay of known PSCell in Asynchronous DC	2372
A.8.23.8.1	Test Purpose and Environment	2372
A.8.23.8.2	Test Requirements	2374
A.8.23.9	E-UTRAN TDD Addition and Release Delay of known PSCell in Synchronous DC	2375
A.8.23.9.1	Test Purpose and Environment	2375
A.8.23.9.2	Test Requirements	2377
A.8.23.10	E-UTRAN TDD-FDD DC intra-frequency event triggered reporting with DRX in synchronous DC with PCell in FDD	2378
A.8.23.10.1	Test Purpose and Environment	2378
A.8.23.10.2	Test Requirements	2380
A.8.23.11	E-UTRAN TDD-FDD DC intra-frequency event triggered reporting with DRX in synchronous DC with PCell in TDD	2380
A.8.23.11.1	Test Purpose and Environment	2380
A.8.23.11.2	Test Requirements	2383
A.8.23.12	E-UTRAN TDD-FDD DC inter-frequency event triggered reporting with DRX in synchronous DC with PCell in FDD	2383
A.8.23.12.1	Test Purpose and Environment	2383
A.8.23.12.2	Test Requirements	2385
A.8.23.13	E-UTRAN TDD-FDD DC inter-frequency event triggered reporting with DRX in synchronous DC with PCell in TDD	2385
A.8.23.13.1	Test Purpose and Environment	2385
A.8.23.13.2	Test Requirements	2388
A.8.23.14	E-UTRAN TDD-FDD Addition and Release Delay of known PSCell in Synchronous DC with PCell in FDD	2388
A.8.23.14.1	Test Purpose and Environment	2388
A.8.23.14.2	Test Requirements	2391
A.8.23.15	E-UTRAN TDD-FDD Addition and Release Delay of known PSCell in Synchronous DC with PCell in TDD	2391
A.8.23.15.1	Test Purpose and Environment	2391
A.8.23.15.2	Test Requirements	2394
A.8.23.16	E-UTRAN FDD-FDD DC SSTD measurement reporting delay with no DRX in asynchronous DC	2394
A.8.23.16.1	Test Purpose and Environment	2394
A.8.23.16.2	Test Requirements	2395
A.8.23.17	E-UTRAN FDD-FDD DC SSTD measurement reporting delay with DRX in asynchronous DC	2395
A.8.23.17.1	Test Purpose and Environment	2395
A.8.23.17.2	Test Requirements	2397
A.8.23.18	E-UTRAN FDD - FDD DC Intra-frequency identification of a new CGI of E-UTRA cell using autonomous gaps in synchronous DC	2397
A.8.23.18.1	Test Purpose and Environment	2397
A.8.23.18.2	Test Requirements	2399
A.8.23.19	E-UTRAN FDD - FDD DC Intra-frequency identification of a new CGI of E-UTRA cell using autonomous gaps in asynchronous DC	2399
A.8.23.19.1	Test Purpose and Environment	2399
A.8.23.19.2	Test Requirements	2401

A.8.23.20	E-UTRAN TDD - TDD DC Intra-frequency identification of a new CGI of E-UTRA cell using autonomous gaps in synchronous DC	2401
A.8.23.20.1	Test Purpose and Environment	2401
A.8.23.20.2	Test Requirements.....	2403
A.8.23.21	E-UTRAN FDD - FDD DC Inter-frequency identification of a new CGI of E-UTRA cell using autonomous gaps in synchronous DC	2403
A.8.23.21.1	Test Purpose and Environment	2403
A.8.23.21.2	Test Requirements.....	2404
A.8.23.22	E-UTRAN FDD - FDD DC Inter-frequency identification of a new CGI of E-UTRA cell using autonomous gaps in asynchronous DC	2405
A.8.23.22.1	Test Purpose and Environment	2405
A.8.23.22.2	Test Requirements.....	2406
A.8.23.23	E-UTRAN TDD - TDD DC Inter-frequency identification of a new CGI of E-UTRA cell using autonomous gaps in synchronous DC	2407
A.8.23.23.1	Test Purpose and Environment	2407
A.8.23.23.2	Test Requirements.....	2408
A.8.23.24	E-UTRAN FDD-FDD DC activation and deactivation of known SCell in Non-DRX in synchronous DC.....	2409
A.8.23.24.1	Test Purpose and Environment	2409
A.8.23.24.2	Test Requirements.....	2411
A.8.23.25	E-UTRAN FDD-FDD DC activation and deactivation of known SCell in Non-DRX in asynchronous DC.....	2411
A.8.23.25.1	Test Purpose and Environment	2411
A.8.23.25.2	Test Requirements.....	2413
A.8.23.26	E-UTRAN TDD-TDD DC activation and deactivation of known SCell in Non-DRX in synchronous DC.....	2413
A.8.23.26.1	Test Purpose and Environment	2413
A.8.23.26.2	Test Requirements.....	2415
A.8.23.27	E-UTRAN FDD-FDD DC event triggered reporting under deactivated SCell with PCell and PSCell interruption in non-DRX in synchronous DC	2416
A.8.23.27.1	Test Purpose and Environment	2416
A.8.23.27.2	Test Requirements.....	2417
A.8.23.28	E-UTRAN FDD-FDD DC event triggered reporting under deactivated SCell with PCell and PSCell interruption in non-DRX in asynchronous DC	2418
A.8.23.28.1	Test Purpose and Environment	2418
A.8.23.28.2	Test Requirements.....	2419
A.8.23.29	E-UTRAN TDD-TDD DC event triggered reporting under deactivated SCell with PCell and PSCell interruption in non-DRX in synchronous DC	2420
A.8.23.29.1	Test Purpose and Environment	2420
A.8.23.29.2	Test Requirements.....	2422
A.8.24	Proximity-based Services	2422
A.8.24.1	E-UTRAN FDD - Initiation/Cease of SLSS Transmission with ProSe Direct Discovery.....	2422
A.8.24.1.1	Test Purpose and Environment	2422
A.8.24.1.2	Test Requirements.....	2423
A.8.24.2	E-UTRAN TDD - Initiation/Cease of SLSS Transmission with ProSe Direct Discovery.....	2424
A.8.24.2.1	Test Purpose and Environment	2424
A.8.24.2.2	Test Requirements.....	2425
A.8.24.3	E-UTRAN FDD - Initiation/Cease of SLSS Transmission with ProSe Direct Communication.....	2425
A.8.24.3.1	Test Purpose and Environment	2426
A.8.24.3.2	Test Requirements.....	2427
A.8.25	E-UTRAN-WLAN Measurements	2427
A.8.25.1	E-UTRAN FDD-WLAN Event Triggered Reporting in non-DRX under AWGN.....	2427
A.8.25.1.1	Test Purpose and Environment	2427
A.8.25.1.2	Test Requirements.....	2430
A.8.25.2	E-UTRAN TDD-WLAN Event Triggered Reporting in non-DRX under AWGN.....	2430
A.8.25.2.1	Test Purpose and Environment	2430
A.8.25.2.2	Test Requirements.....	2432
A.8.26	Frame Structure 3 (FS3)	2432
A.8.26.1	E-UTRAN FDD-FS3 Activation and deactivation of known FS3 SCell with FDD PCell in non-DRX	2432
A.8.26.1.1	Test Purpose and Environment	2432
A.8.26.1.2	Test Requirements.....	2434
A.8.26.2	E-UTRAN TDD-FS3 Activation and deactivation of known FS3 SCell with TDD PCell in non-DRX	2434

A.8.26.2.1	Test Purpose and Environment	2434
A.8.26.2.2	Test Requirements.....	2436
A.8.26.3	E-UTRAN FDD-FS3 Event triggered reporting on deactivated FS3 SCell and FDD PCell interruption in non-DRX.....	2437
A.8.26.3.1	Test Purpose and Environment	2437
A.8.26.3.2	Test Requirements.....	2438
A.8.26.3A	E-UTRAN FDD-TDD 3DL Event triggered reporting on deactivated FS3 SCell and FDD PCell interruption in non-DRX.....	2439
A.8.26.3A.1	Test Purpose and Environment	2439
A.8.26.3A.2	Test Requirements.....	2441
A.8.26.4	E-UTRAN TDD-FS3 Event triggered reporting on deactivated FS3 SCell and TDD PCell interruption in non-DRX.....	2441
A.8.26.4.1	Test Purpose and Environment	2441
A.8.26.4.2	Test Requirements.....	2443
A.8.26.4A	E-UTRAN TDD-TDD 3DL Event triggered reporting on deactivated FS3 SCell and FDD PCell interruption in non-DRX.....	2443
A.8.26.4A.1	Test Purpose and Environment	2443
A.8.26.4A.2	Test Requirements.....	2445
A.8.26.5	E-UTRAN FDD-FS3 Intra-frequency event triggered reporting in non-DRX for CRS based discovery signal	2445
A.8.26.5.1	Test Purpose and Environment	2445
A.8.26.5.2	Test Requirements.....	2447
A.8.26.5A	E-UTRAN FDD-FS3 Intra-frequency event triggered reporting in non-DRX for CRS based discovery signal with 2 SCells.....	2447
A.8.26.5A.1	Test Purpose and Environment	2447
A.8.26.5A.2	Test Requirements.....	2449
A.8.26.6	E-UTRAN TDD-FS3 Intra-frequency event triggered reporting in non-DRX for CRS based discovery signal	2450
A.8.26.6.1	Test Purpose and Environment	2450
A.8.26.6.2	Test Requirements.....	2451
A.8.26.6A	E-UTRAN TDD-FS3 Intra-frequency event triggered reporting in non-DRX for CRS based discovery signal with 2 SCells.....	2452
A.8.26.6A.1	Test Purpose and Environment	2452
A.8.26.6A.2	Test Requirements.....	2454
A.8.26.7	E-UTRAN FDD-FS3 Intra-frequency event triggered reporting in DRX for CRS based discovery signal.....	2454
A.8.26.7.1	Test Purpose and Environment	2454
A.8.26.7.2	Test Requirements.....	2456
A.8.26.8	E-UTRAN TDD-FS3 Intra-frequency event triggered reporting in DRX for CRS based discovery signal.....	2456
A.8.26.8.1	Test Purpose and Environment	2456
A.8.26.8.2	Test Requirements.....	2458
A.8.26.9	E-UTRAN FDD-FS3 Inter-frequency event triggered reporting under fading propagation conditions in synchronous cells.....	2459
A.8.26.9.1	Test Purpose and Environment	2459
A.8.26.9.2	Test Requirements.....	2460
A.8.26.10	E-UTRAN TDD-FS3 inter-frequency event triggered reporting under fading propagation conditions in synchronous cells.....	2461
A.8.26.10.1	Test Purpose and Environment	2461
A.8.26.10.2	Test Requirements.....	2463
A.9	Measurement Performance Requirements.....	2464
A.9.1	RSRP.....	2464
A.9.1.1	FDD Intra frequency case	2464
A.9.1.1.1	Test Purpose and Environment	2464
A.9.1.1.2	Test parameters	2464
A.9.1.1.3	Test Requirements.....	2465
A.9.1.2	TDD Intra frequency case.....	2465
A.9.1.2.1	Test Purpose and Environment	2465
A.9.1.2.2	Test parameters	2465
A.9.1.2.3	Test Requirements.....	2466
A.9.1.3	FDD—FDD Inter frequency case	2467

A.9.1.3.1	Test Purpose and Environment	2467
A.9.1.3.2	Test parameters	2467
A.9.1.3.3	Test Requirements.....	2468
A.9.1.4	TDD—TDD Inter frequency case.....	2468
A.9.1.4.1	Test Purpose and Environment	2468
A.9.1.4.2	Test parameters	2468
A.9.1.4.3	Test Requirements.....	2470
A.9.1.5	FDD—TDD Inter frequency case.....	2470
A.9.1.5.1	Test Purpose and Environment	2470
A.9.1.5.2	Test parameters	2470
A.9.1.5.3	Test Requirements.....	2472
A.9.1.6	FDD RSRP for E-UTRAN Carrier Aggregation	2472
A.9.1.6.1	Test Purpose and Environment	2472
A.9.1.6.2	Test parameters	2472
A.9.1.6.3	Test Requirements.....	2474
A.9.1.7	TDD RSRP for E-UTRAN Carrier Aggregation	2474
A.9.1.7.1	Test Purpose and Environment	2474
A.9.1.7.2	Test parameters	2474
A.9.1.7.3	Test Requirements.....	2476
A.9.1.8	FDD RSRP under Time-Domain Measurement Resource Restriction with Non-MBSFN ABS.....	2476
A.9.1.8.1	Test Purpose and Environment	2476
A.9.1.8.2	Test parameters	2476
A.9.1.8.3	Test Requirements.....	2478
A.9.1.9	TDD RSRP under Time-Domain Measurement Resource Restriction with Non-MBSFN ABS.....	2478
A.9.1.9.1	Test Purpose and Environment	2478
A.9.1.9.2	Test parameters	2478
A.9.1.9.3	Test Requirements.....	2480
A.9.1.10	FDD RSRP under Time-Domain Measurement Resource Restriction with MBSFN ABS.....	2480
A.9.1.10.1	Test Purpose and Environment	2480
A.9.1.10.2	Test parameters	2480
A.9.1.10.3	Test Requirements.....	2482
A.9.1.11	TDD RSRP under Time-Domain Measurement Resource Restriction with MBSFN ABS.....	2483
A.9.1.11.1	Test Purpose and Environment	2483
A.9.1.11.2	Test parameters	2483
A.9.1.11.3	Test Requirements.....	2485
A.9.1.12	FDD RSRP for E-UTRAN Carrier Aggregation for 20MHz.....	2485
A.9.1.12.1	Test Purpose and Environment	2485
A.9.1.12.2	Test parameters	2485
A.9.1.12.3	Test Requirements.....	2485
A.9.1.13	TDD RSRP for E-UTRAN Carrier Aggregation for 20MHz	2486
A.9.1.13.1	Test Purpose and Environment	2486
A.9.1.13.2	Test parameters	2486
A.9.1.13.3	Test Requirements.....	2486
A.9.1.14	FDD RSRP under Time-Domain Measurement Resource Restriction with CRS Assistance Information and Non-MBSFN ABS	2486
A.9.1.14.1	Test Purpose and Environment	2486
A.9.1.14.2	Test parameters	2486
A.9.1.14.3	Test Requirements.....	2489
A.9.1.15	TDD RSRP under Time-Domain Measurement Resource Restriction with CRS Assistance Information and Non-MBSFN ABS	2489
A.9.1.15.1	Test Purpose and Environment	2489
A.9.1.15.2	Test parameters	2489
A.9.1.15.3	Test Requirements.....	2491
A.9.1.16	FDD Intra frequency case for 5MHz Bandwidth.....	2491
A.9.1.16.1	Test Purpose and Environment	2491
A.9.1.16.2	Test parameters	2491
A.9.1.16.3	Test Requirements.....	2492
A.9.1.17	FDD—FDD Inter frequency case for 5MHz Bandwidth.....	2492
A.9.1.17.1	Test Purpose and Environment	2492
A.9.1.17.2	Test parameters	2492
A.9.1.17.3	Test Requirements.....	2493
A.9.1.18	FDD RSRP for E-UTRAN Carrier Aggregation for 10MHz + 5MHz	2494

A.9.1.18.1	Test Purpose and Environment	2494
A.9.1.18.2	Test parameters	2494
A.9.1.18.3	Test Requirements.....	2495
A.9.1.19	TDD RSRP for E-UTRAN Carrier Aggregation for 10MHz + 5MHz	2495
A.9.1.19.1	Test Purpose and Environment	2495
A.9.1.19.2	Test parameters	2495
A.9.1.19.3	Test Requirements.....	2495
A.9.1.20	FDD RSRP for E-UTRAN Carrier Aggregation for 5MHz + 5MHz bandwidth.....	2495
A.9.1.20.1	Test Purpose and Environment	2496
A.9.1.20.2	Test parameters	2496
A.9.1.20.3	Test Requirements.....	2497
A.9.1.21	TDD RSRP for E-UTRAN Carrier Aggregation for 5MHz + 5MHz bandwidth	2497
A.9.1.21.1	Test Purpose and Environment	2497
A.9.1.21.2	Test parameters	2497
A.9.1.21.3	Test Requirements.....	2497
A.9.1.22	RSRP for E-UTRAN TDD-FDD Carrier Aggregation with PCell in FDD	2498
A.9.1.22.1	Test Purpose and Environment	2498
A.9.1.22.2	Test parameters	2498
A.9.1.22.3	Test Requirements.....	2500
A.9.1.23	RSRP for E-UTRAN TDD-FDD Carrier Aggregation with PCell in TDD.....	2500
A.9.1.23.1	Test Purpose and Environment	2500
A.9.1.23.2	Test parameters	2501
A.9.1.23.3	Test Requirements.....	2503
A.9.1.24	TDD RSRP for E-UTRAN Carrier Aggregation for 20MHz + 10MHz	2503
A.9.1.24.1	Test Purpose and Environment	2503
A.9.1.24.2	Test parameters	2503
A.9.1.24.3	Test Requirements.....	2504
A.9.1.25	FDD intra-frequency absolute and relative RSRP accuracies in CRS based discovery signal	2504
A.9.1.25.1	Test Purpose and Environment	2504
A.9.1.25.2	Test parameters	2504
A.9.1.25.3	Test Requirements.....	2505
A.9.1.26	TDD intra-frequency absolute and relative RSRP accuracies in CRS based discovery signal.....	2506
A.9.1.26.1	Test Purpose and Environment	2506
A.9.1.26.2	Test parameters	2506
A.9.1.26.3	Test Requirements.....	2507
A.9.1.27	FDD—FDD inter-frequency absolute and relative RSRP accuracies in CRS based discovery signal ...	2507
A.9.1.27.1	Test Purpose and Environment	2507
A.9.1.27.2	Test parameters	2507
A.9.1.27.3	Test Requirements.....	2509
A.9.1.28	TDD—TDD inter-frequency absolute and relative RSRP accuracies in CRS based discovery signal ..	2509
A.9.1.28.1	Test Purpose and Environment	2509
A.9.1.28.2	Test parameters	2509
A.9.1.28.3	Test Requirements.....	2510
A.9.1.29	FDD intra frequency absolute and relative CSI-RSRP accuracies in CSI-RS based discovery signal ...	2510
A.9.1.29.1	Test Purpose and Environment	2510
A.9.1.29.2	Test parameters	2510
A.9.1.29.3	Test Requirements.....	2512
A.9.1.30	TDD intra frequency absolute and relative CSI-RSRP accuracies in CSI-RS based discovery signal ...	2512
A.9.1.30.1	Test Purpose and Environment	2512
A.9.1.30.2	Test parameters	2513
A.9.1.30.3	Test Requirements.....	2514
A.9.1.31	FDD—FDD inter-frequency absolute and relative CSI-RSRP accuracies in CSI-RS based discovery signal.....	2514
A.9.1.31.1	Test Purpose and Environment	2514
A.9.1.31.2	Test parameters	2514
A.9.1.31.3	Test Requirements.....	2516
A.9.1.32	TDD—TDD inter-frequency absolute and relative CSI-RSRP accuracies in CSI-RS based discovery signal.....	2516
A.9.1.32.1	Test Purpose and Environment	2516
A.9.1.32.2	Test parameters	2516
A.9.1.32.3	Test Requirements.....	2518

A.9.1.33	FDD absolute and relative RSRP accuracies for E-UTRAN Carrier Aggregation in CRS based discovery signal	2518
A.9.1.33.1	Test Purpose and Environment	2518
A.9.1.33.2	Test parameters	2518
A.9.1.33.3	Test Requirements.....	2520
A.9.1.34	TDD absolute and relative RSRP accuracies for E-UTRAN Carrier Aggregation in CRS based discovery signal	2520
A.9.1.34.1	Test Purpose and Environment	2520
A.9.1.34.2	Test parameters	2520
A.9.1.34.3	Test Requirements.....	2521
A.9.1.35	FDD absolute and relative CSI-RSRP accuracies for E-UTRAN Carrier Aggregation in CSI-RS based discovery signal	2522
A.9.1.35.1	Test Purpose and Environment	2522
A.9.1.35.2	Test parameters	2522
A.9.1.35.3	Test Requirements.....	2524
A.9.1.36	TDD absolute and relative CSI-RSRP accuracies for E-UTRAN Carrier Aggregation in CSI-RS based discovery signal	2524
A.9.1.36.1	Test Purpose and Environment	2524
A.9.1.36.2	Test parameters	2524
A.9.1.36.3	Test Requirements.....	2526
A.9.1.37	3 DL PCell in FDD RSRP for E-UTRAN in Carrier Aggregation	2526
A.9.1.37.1	Test Purpose and Environment	2526
A.9.1.37.2	Test parameters	2526
A.9.1.37.3	Test Requirements.....	2528
A.9.1.38	3 DL PCell in TDD RSRP for E-UTRAN in Carrier Aggregation	2528
A.9.1.38.1	Test Purpose and Environment	2528
A.9.1.38.2	Test parameters	2528
A.9.1.38.3	Test Requirements.....	2530
A.9.1.39	3 DL FDD RSRP for E-UTRAN in Carrier Aggregation	2531
A.9.1.39.1	Test Purpose and Environment	2531
A.9.1.39.2	Test parameters	2531
A.9.1.39.3	Test Requirements.....	2534
A.9.1.40	3 DL TDD RSRP for E-UTRAN in Carrier Aggregation	2534
A.9.1.40.1	Test Purpose and Environment	2534
A.9.1.40.2	Test parameters	2535
A.9.1.40.3	Test Requirements.....	2537
A.9.1.41	FD-FDD RSRP Intra frequency case for UE category 0	2538
A.9.1.41.1	Test Purpose and Environment	2538
A.9.1.41.2	Test parameters	2538
A.9.1.41.3	Test Requirements.....	2539
A.9.1.42	HD-FDD RSRP Intra frequency case for UE category 0.....	2539
A.9.1.42.1	Test Purpose and Environment	2539
A.9.1.42.2	Test parameters	2539
A.9.1.42.3	Test Requirements.....	2540
A.9.1.43	TDD RSRP Intra frequency case for UE category 0.....	2541
A.9.1.43.1	Test Purpose and Environment	2541
A.9.1.43.2	Test parameters	2541
A.9.1.43.3	Test Requirements.....	2542
A.9.1.44	4 DL CA PCell in FDD FDD-TDD RSRP for E-UTRAN in Carrier Aggregation	2542
A.9.1.44.1	Test Purpose and Environment	2542
A.9.1.44.2	Test parameters	2542
A.9.1.44.3	Test Requirements.....	2546
A.9.1.45	4 DL CA PCell in TDD FDD-TDD RSRP for E-UTRAN in Carrier Aggregation	2546
A.9.1.45.1	Test Purpose and Environment	2546
A.9.1.45.2	Test parameters	2546
A.9.1.45.3	Test Requirements.....	2550
A.9.1.46	4 DL FDD RSRP for E-UTRAN in Carrier Aggregation	2550
A.9.1.46.1	Test Purpose and Environment	2550
A.9.1.46.2	Test parameters	2550
A.9.1.46.3	Test Requirements.....	2555
A.9.1.47	4 DL TDD RSRP for E-UTRAN in Carrier Aggregation.....	2556
A.9.1.47.1	Test Purpose and Environment	2556

A.9.1.47.2	Test parameters	2556
A.9.1.47.3	Test Requirements.....	2560
A.9.1.48	5 DL FDD-TDD with PCell in FDD RSRP for E-UTRAN in Carrier Aggregation.....	2560
A.9.1.48.1	Test Purpose and Environment	2560
A.9.1.48.2	Test parameters	2560
A.9.1.48.3	Test Requirements.....	2566
A.9.1.49	5 DL FDD-TDD with PCell in TDD RSRP for E-UTRAN in Carrier Aggregation.....	2566
A.9.1.49.1	Test Purpose and Environment	2566
A.9.1.49.2	Test parameters	2567
A.9.1.49.3	Test Requirements.....	2572
A.9.1.50	5 DL FDD RSRP for E-UTRAN in Carrier Aggregation	2573
A.9.1.50.1	Test Purpose and Environment	2573
A.9.1.50.2	Test parameters	2573
A.9.1.50.3	Test Requirements.....	2577
A.9.1.51	5 DL TDD RSRP for E-UTRAN in Carrier Aggregation.....	2578
A.9.1.51.1	Test Purpose and Environment	2578
A.9.1.51.2	Test parameters	2578
A.9.1.51.3	Test Requirements.....	2581
A.9.1.52	FD-FDD RSRP Intra frequency case for Cat-M1 UE in CEModeA	2582
A.9.1.52.1	Test Purpose and Environment	2582
A.9.1.52.2	Test parameters	2582
A.9.1.52.3	Test Requirements.....	2583
A.9.1.52A	FD-FDD RSRP Intra frequency case for Cat-M1 UE for 5MHz Bandwidth in CEModeA	2583
A.9.1.52A.1	Test Purpose and Environment	2583
A.9.1.52A.2	Test parameters	2583
A.9.1.52A.3	Test Requirements.....	2584
A.9.1.53	HD-FDD RSRP Intra frequency case for Cat-M1 UE in CEModeA.....	2584
A.9.1.53.1	Test Purpose and Environment	2584
A.9.1.53.2	Test parameters	2584
A.9.1.53.3	Test Requirements.....	2585
A.9.1.53A	HD-FDD RSRP Intra frequency case for Cat-M1 UE for 5MHz Bandwidth in CEModeA.....	2586
A.9.1.53A.1	Test Purpose and Environment	2586
A.9.1.53A.2	Test parameters	2586
A.9.1.53A.3	Test Requirements.....	2587
A.9.1.54	TDD RSRP Intra frequency case for Cat-M1 UE in CEModeA.....	2587
A.9.1.54.1	Test Purpose and Environment	2587
A.9.1.54.2	Test parameters	2587
A.9.1.54.3	Test Requirements.....	2588
A.9.1.55	FS3 Intra frequency absolute and relative RSRP accuracies with FDD PCell.....	2588
A.9.1.55.1	Test Purpose and Environment	2588
A.9.1.55.2	Test parameters	2588
A.9.1.55.3	Test Requirements.....	2591
A.9.1.56	FS3 Intra frequency absolute and relative RSRP accuracies with TDD PCell	2591
A.9.1.56.1	Test Purpose and Environment	2591
A.9.1.56.2	Test parameters	2591
A.9.1.56.3	Test Requirements.....	2593
A.9.1.57	FD-FDD RSRP Intra frequency case for Cat-M1 UE in CEModeB.....	2593
A.9.1.57.1	Test Purpose and Environment	2593
A.9.1.57.2	Test parameters	2593
A.9.1.57.3	Test Requirements.....	2595
A.9.1.57A	FD-FDD RSRP Intra frequency case for Cat-M1 UE for 5MHz Bandwidth in CEModeB	2595
A.9.1.57A.1	Test Purpose and Environment	2595
A.9.1.57A.2	Test parameters	2595
A.9.1.57A.3	Test Requirements.....	2596
A.9.1.58	HD-FDD RSRP Intra frequency case for Cat-M1 UE in CEModeB	2596
A.9.1.58.1	Test Purpose and Environment	2596
A.9.1.58.2	Test parameters	2596
A.9.1.58.3	Test Requirements.....	2597
A.9.1.58A	HD-FDD RSRP Intra frequency case for Cat-M1 UE for 5MHz Bandwidth in CEModeB	2597
A.9.1.58A.1	Test Purpose and Environment	2597
A.9.1.58A.2	Test parameters	2597
A.9.1.58A.3	Test Requirements.....	2598

A.9.1.59	TDD RSRP Intra frequency case for Cat-M1 UE in CEModeB	2598
A.9.1.59.1	Test Purpose and Environment	2598
A.9.1.59.2	Test parameters	2598
A.9.1.59.3	Test Requirements.....	2600
A.9.1.60	FS3 Absolute and relative CSI-RSRP accuracies in CSI-RS based discovery signal with FDD PCell ..	2600
A.9.1.60.1	Test Purpose and Environment	2600
A.9.1.60.2	Test parameters	2600
A.9.1.60.3	Test Requirements.....	2602
A.9.1.61	FS3 Absolute and relative CSI-RSRP accuracies in CSI-RS based discovery signal with TDD PCell ..	2602
A.9.1.61.1	Test Purpose and Environment	2602
A.9.1.61.2	Test parameters	2602
A.9.1.61.3	Test Requirements.....	2604
A.9.1.62	FD-FDD RSRP Inter frequency case for Cat-M1 UE in CEModeA	2604
A.9.1.62.1	Test Purpose and Environment	2604
A.9.1.62.2	Test parameters	2604
A.9.1.62.3	Test Requirements.....	2605
A.9.1.63	HD-FDD RSRP Inter frequency case for Cat-M1 UE in CEModeA.....	2606
A.9.1.63.1	Test Purpose and Environment	2606
A.9.1.63.2	Test parameters	2606
A.9.1.63.3	Test Requirements.....	2607
A.9.1.64	TDD RSRP Inter frequency case for Cat-M1 UE in CEModeA.....	2607
A.9.1.64.1	Test Purpose and Environment	2607
A.9.1.64.2	Test parameters	2607
A.9.1.64.3	Test Requirements.....	2608
A.9.1.65	FD-FDD RSRP Inter frequency case for Cat-M1 UE in CEModeB.....	2608
A.9.1.65.1	Test Purpose and Environment	2608
A.9.1.65.2	Test parameters	2608
A.9.1.65.3	Test Requirements.....	2611
A.9.1.66	HD-FDD RSRP Inter frequency case for Cat-M1 UE in CEModeB	2611
A.9.1.66.1	Test Purpose and Environment	2611
A.9.1.66.2	Test parameters	2611
A.9.1.66.3	Test Requirements.....	2613
A.9.1.67	TDD RSRP Inter frequency case for Cat-M1 UE in CEModeB.....	2613
A.9.1.67.1	Test Purpose and Environment	2613
A.9.1.67.2	Test parameters	2613
A.9.1.67.3	Test Requirements.....	2614
A.9.1.68	3 DL RSRP for E-UTRAN in Carrier Aggregation with generic duplex modes	2615
A.9.1.68.1	Test Purpose and Environment	2615
A.9.1.68.2	Test parameters	2615
A.9.1.68.3	Test Requirements.....	2617
A.9.1.69	4 DL RSRP for E-UTRAN in Carrier Aggregation with generic duplex modes	2618
A.9.1.69.1	Test Purpose and Environment	2618
A.9.1.69.2	Test parameters	2618
A.9.1.69.3	Test Requirements.....	2621
A.9.1.70	5 DL RSRP for E-UTRAN in Carrier Aggregation with generic duplex modes	2622
A.9.1.70.1	Test Purpose and Environment	2622
A.9.1.70.2	Test parameters	2622
A.9.1.70.3	Test Requirements.....	2629
A.9.1.71	6 DL RSRP for E-UTRAN in Carrier Aggregation with generic duplex modes	2630
A.9.1.71.1	Test Purpose and Environment	2630
A.9.1.71.2	Test parameters	2630
A.9.1.71.3	Test Requirements.....	2637
A.9.1.72	7 DL RSRP for E-UTRAN in Carrier Aggregation with generic duplex modes	2638
A.9.1.72.1	Test Purpose and Environment	2638
A.9.1.72.2	Test parameters	2638
A.9.1.72.3	Test Requirements.....	2647
A.9.2	RSRQ	2648
A.9.2.1	FDD Intra frequency case	2648
A.9.2.1.1	Test Purpose and Environment	2648
A.9.2.1.2	Test parameters	2648
A.9.2.1.3	Test Requirements.....	2649
A.9.2.2	TDD Intra frequency case.....	2649

A.9.2.2.1	Test Purpose and Environment	2649
A.9.2.2.2	Test parameters	2650
A.9.2.2.3	Test Requirements.....	2652
A.9.2.3	FDD—FDD Inter frequency case	2652
A.9.2.3.1	Test Purpose and Environment	2652
A.9.2.3.2	Test parameters	2652
A.9.2.3.3	Test Requirements.....	2653
A.9.2.4	TDD—TDD Inter frequency case.....	2653
A.9.2.4.1	Test Purpose and Environment	2653
A.9.2.4.2	Test parameters	2654
A.9.2.4.3	Test Requirements.....	2656
A.9.2.4A	FDD—TDD Inter frequency case.....	2657
A.9.2.4A.1	Test Purpose and Environment	2657
A.9.2.4A.2	Test parameters	2657
A.9.2.4A.3	Test Requirements.....	2658
A.9.2.5	FDD RSRQ for E-UTRA Carrier Aggregation.....	2659
A.9.2.5.1	Test Purpose and Environment	2659
A.9.2.5.2	Test parameters	2659
A.9.2.5.3	Test Requirements.....	2660
A.9.2.6	TDD RSRQ for E-UTRA Carrier Aggregation	2661
A.9.2.6.1	Test Purpose and Environment	2661
A.9.2.6.2	Test parameters	2661
A.9.2.6.3	Test Requirements.....	2662
A.9.2.7	FDD RSRQ under Time Domain Measurement Resource Restriction with Non-MBSFN ABS.....	2662
A.9.2.7.1	Test Purpose and Environment	2662
A.9.2.7.2	Test parameters	2662
A.9.2.7.3	Test Requirements.....	2665
A.9.2.8	TDD RSRQ under Time Domain Measurement Resource Restriction with Non-MBSFN ABS	2665
A.9.2.8.1	Test Purpose and Environment	2665
A.9.2.8.2	Test parameters	2665
A.9.2.8.3	Test Requirements.....	2667
A.9.2.9	FDD RSRQ under Time Domain Measurement Resource Restriction with MBSFN ABS.....	2667
A.9.2.9.1	Test Purpose and Environment	2667
A.9.2.9.2	Test parameters	2667
A.9.2.9.3	Test Requirements.....	2670
A.9.2.10	TDD Intra frequency case under time domain measurement resource restriction with MBSFN ABS ...	2670
A.9.2.10.1	Test Purpose and Environment	2670
A.9.2.10.2	Test parameters	2670
A.9.2.10.3	Test Requirements.....	2672
A.9.2.11	FDD RSRQ for E-UTRA Carrier Aggregation (20MHz bandwidth)	2672
A.9.2.11.1	Test Purpose and Environment	2672
A.9.2.11.2	Test parameters	2672
A.9.2.11.3	Test Requirements.....	2673
A.9.2.12	TDD RSRQ for E-UTRA Carrier Aggregation (20MHz bandwidth).....	2673
A.9.2.12.1	Test Purpose and Environment	2673
A.9.2.12.2	Test parameters	2673
A.9.2.12.3	Test Requirements.....	2674
A.9.2.13	Void	2674
A.9.2.13.1	Void.....	2674
A.9.2.13.2	Void.....	2674
A.9.2.13.3	Void.....	2674
A.9.2.14	Void	2674
A.9.2.14.1	Void.....	2674
A.9.2.14.2	Void.....	2674
A.9.2.14.3	Void.....	2674
A.9.2.15	FDD RSRQ under Time Domain Measurement Resource Restriction with CRS Assistance Information and Non-MBSFN ABS	2674
A.9.2.15.1	Test Purpose and Environment	2674
A.9.2.15.2	Test parameters	2675
A.9.2.15.3	Test Requirements.....	2677
A.9.2.16	TDD RSRQ under Time Domain Measurement Resource Restriction with CRS Assistance Information and Non-MBSFN ABS	2677

A.9.2.16.1	Test Purpose and Environment	2677
A.9.2.16.2	Test parameters	2678
A.9.2.16.3	Test Requirements.....	2680
A.9.2.17	FDD Intra frequency case for 5 MHz bandwidth.....	2680
A.9.2.17.1	Test Purpose and Environment	2680
A.9.2.17.2	Test parameters	2680
A.9.2.17.3	Test Requirements.....	2681
A.9.2.18	FDD—FDD Inter frequency case for 5MHz bandwidth.....	2681
A.9.2.18.1	Test Purpose and Environment	2681
A.9.2.18.2	Test parameters	2681
A.9.2.18.3	Test Requirements.....	2683
A.9.2.19	FDD-FDD Inter Frequency WB-RSRQ.....	2683
A.9.2.19.1	Test Purpose and Environment	2683
A.9.2.19.2	Test parameters	2683
A.9.2.19.3	Test Requirements.....	2684
A.9.2.20	TDD—TDD Inter Frequency WB-RSRQ.....	2684
A.9.2.20.1	Test Purpose and Environment	2684
A.9.2.20.2	Test parameters	2684
A.9.2.20.3	Test Requirements.....	2686
A.9.2.21	FDD RSRQ for E-UTRAN Carrier Aggregation for 10MHz+5MHz.....	2686
A.9.2.21.1	Test Purpose and Environment	2686
A.9.2.21.2	Test parameters	2686
A.9.2.21.3	Test Requirements.....	2688
A.9.2.22	TDD RSRQ for E-UTRAN Carrier Aggregation for 10MHz+5MHz	2688
A.9.2.22.1	Test Purpose and Environment	2688
A.9.2.22.2	Test parameters	2688
A.9.2.22.3	Test Requirements.....	2689
A.9.2.23	FDD RSRQ for E-UTRA Carrier Aggregation (5MHz + 5MHz bandwidth).....	2689
A.9.2.23.1	Test Purpose and Environment	2689
A.9.2.23.2	Test parameters	2689
A.9.2.23.3	Test Requirements.....	2690
A.9.2.24	TDD RSRQ for E-UTRA Carrier Aggregation (5MHz + 5MHz bandwidth).....	2690
A.9.2.24.1	Test Purpose and Environment	2690
A.9.2.24.2	Test parameters	2690
A.9.2.24.3	Test Requirements.....	2691
A.9.2.25	RSRQ for E-UTRAN TDD-FDD Carrier Aggregation with PCell in FDD	2691
A.9.2.25.1	Test Purpose and Environment	2691
A.9.2.25.2	Test parameters	2691
A.9.2.25.3	Test Requirements.....	2694
A.9.2.26	RSRQ for E-UTRAN TDD-FDD Carrier Aggregation with PCell in TDD	2694
A.9.2.26.1	Test Purpose and Environment	2694
A.9.2.26.2	Test parameters	2694
A.9.2.26.3	Test Requirements.....	2696
A.9.2.27	TDD RSRQ for E-UTRAN Carrier Aggregation for 20MHz+10MHz	2697
A.9.2.27.1	Test Purpose and Environment	2697
A.9.2.27.2	Test parameters	2697
A.9.2.27.3	Test Requirements.....	2697
A.9.2.28	FDD intra-frequency absolute RSRQ accuracy with CRS based discovery signal.....	2698
A.9.2.28.1	Test Purpose and Environment	2698
A.9.2.28.2	Test parameters	2698
A.9.2.28.3	Test Requirements.....	2699
A.9.2.29	TDD intra-frequency absolute RSRQ accuracy with CRS based discovery signal	2699
A.9.2.29.1	Test Purpose and Environment	2699
A.9.2.29.2	Test parameters	2699
A.9.2.29.3	Test Requirements.....	2700
A.9.2.30	FDD-FDD inter-frequency absolute and relative RSRQ accuracies with CRS based discovery signal ..	2701
A.9.2.30.1	Test Purpose and Environment	2701
A.9.2.30.2	Test parameters	2701
A.9.2.30.3	Test Requirements.....	2702
A.9.2.31	TDD-TDD inter-frequency absolute and relative RSRQ accuracies with CRS based discovery signal ..	2702
A.9.2.31.1	Test Purpose and Environment	2702
A.9.2.31.2	Test parameters	2702

A.9.2.31.3	Test Requirements.....	2704
A.9.2.32	FDD absolute and relative RSRQ accuracy for E-UTRAN Carrier Aggregation in CRS based discovery signal	2704
A.9.2.32.1	Test Purpose and Environment	2704
A.9.2.32.2	Test parameters	2704
A.9.2.32.3	Test Requirements.....	2706
A.9.2.33	TDD absolute and relative RSRQ accuracy for E-UTRAN Carrier Aggregation in CRS based discovery signal	2706
A.9.2.33.1	Test Purpose and Environment	2706
A.9.2.33.2	Test parameters	2706
A.9.2.33.3	Test Requirements.....	2707
A.9.2.34	FDD—FDD Inter frequency new RSRQ	2708
A.9.2.34.1	Test Purpose and Environment	2708
A.9.2.34.2	Test parameters	2708
A.9.2.34.3	Test Requirements.....	2709
A.9.2.35	TDD—TDD Inter frequency new RSRQ.....	2709
A.9.2.35.1	Test Purpose and Environment	2709
A.9.2.35.2	Test parameters	2709
A.9.2.35.3	Test Requirements.....	2710
A.9.2.36	FDD—FDD Inter frequency RSRQ measured on all OFDM symbols.....	2711
A.9.2.36.1	Test Purpose and Environment	2711
A.9.2.36.2	Test parameters	2711
A.9.2.36.3	Test Requirements.....	2712
A.9.2.37	TDD—TDD Inter frequency RSRQ measurement on all OFDM symbols	2712
A.9.2.37.1	Test Purpose and Environment	2712
A.9.2.37.2	Test parameters	2712
A.9.2.37.3	Test Requirements.....	2713
A.9.2.38	3 DL PCell in FDD RSRQ for E-UTRAN in Carrier Aggregation.....	2714
A.9.2.38.1	Test Purpose and Environment	2714
A.9.2.38.2	Test parameters	2714
A.9.2.38.3	Test Requirements.....	2716
A.9.2.39	3 DL PCell in TDD RSRQ for E-UTRAN in Carrier Aggregation	2717
A.9.2.39.1	Test Purpose and Environment	2717
A.9.2.39.2	Test parameters	2717
A.9.2.39.3	Test Requirements.....	2719
A.9.2.40	3 DL FDD RSRQ for E-UTRAN in Carrier Aggregation	2719
A.9.2.40.1	Test Purpose and Environment	2719
A.9.2.40.2	Test parameters	2720
A.9.2.40.3	Test Requirements.....	2721
A.9.2.41	3 DL TDD RSRQ for E-UTRAN in Carrier Aggregation	2722
A.9.2.41.1	Test Purpose and Environment	2722
A.9.2.41.2	Test parameters	2722
A.9.2.41.3	Test Requirements.....	2723
A.9.2.42	FD-FDD RSRQ Intra frequency case for UE category 0.....	2724
A.9.2.42.1	Test Purpose and Environment	2724
A.9.2.42.2	Test parameters	2724
A.9.2.42.3	Test Requirements.....	2725
A.9.2.43	HD-FDD RSRQ Intra frequency case for UE category 0	2725
A.9.2.43.1	Test Purpose and Environment	2725
A.9.2.43.2	Test parameters	2725
A.9.2.43.3	Test Requirements.....	2727
A.9.2.44	TDD RSRQ Intra frequency case for UE category 0.....	2727
A.9.2.44.1	Test Purpose and Environment	2727
A.9.2.44.2	Test parameters	2727
A.9.2.44.3	Test Requirements.....	2728
A.9.2.45	4 DL CA PCell in FDD FDD-TDD RSRQ for E-UTRAN in Carrier Aggregation.....	2728
A.9.2.45.1	Test Purpose and Environment	2728
A.9.2.45.2	Test parameters	2728
A.9.2.45.3	Test Requirements.....	2731
A.9.2.46	4 DL CA PCell in TDD TDD-FDD RSRQ for E-UTRAN in Carrier Aggregation	2732
A.9.2.46.1	Test Purpose and Environment	2732
A.9.2.46.2	Test parameters	2732

A.9.2.46.3	Test Requirements.....	2735
A.9.2.47	5 DL FDD-TDD with PCell in FDD RSRQ for E-UTRAN in Carrier Aggregation	2735
A.9.2.47.1	Test Purpose and Environment	2735
A.9.2.47.2	Test parameters	2735
A.9.2.47.3	Test Requirements.....	2737
A.9.2.48	5 DL FDD-TDD with PCell in TDD RSRQ for E-UTRAN in Carrier Aggregation	2738
A.9.2.48.1	Test Purpose and Environment	2738
A.9.2.48.2	Test parameters	2738
A.9.2.48.3	Test Requirements.....	2741
A.9.2.49	5 DL FDD RSRQ for E-UTRAN in Carrier Aggregation	2741
A.9.2.49.1	Test Purpose and Environment	2741
A.9.2.49.2	Test parameters	2742
A.9.2.49.3	Test Requirements.....	2745
A.9.2.50	5 DL TDD RSRQ for E-UTRAN in Carrier Aggregation	2746
A.9.2.50.1	Test Purpose and Environment	2746
A.9.2.50.2	Test parameters	2746
A.9.2.50.3	Test Requirements.....	2749
A.9.2.51	FS3 Intra frequency absolute and relative RSRQ accuracies with FDD PCell.....	2749
A.9.2.51.1	Test Purpose and Environment	2749
A.9.2.51.2	Test parameters	2749
A.9.2.51.3	Test Requirements.....	2752
A.9.2.52	FS3 Intra frequency absolute and relative RSRQ accuracies with TDD PCell.....	2752
A.9.2.52.1	Test Purpose and Environment	2752
A.9.2.52.2	Test parameters	2752
A.9.2.52.3	Test Requirements.....	2754
A.9.2.53	4DL FDD RSRQ for E-UTRAN in Carrier Aggregation	2754
A.9.2.53.1	Test Purpose and Environment	2754
A.9.2.53.2	Test parameters	2754
A.9.2.53.3	Test Requirements.....	2758
A.9.2.54	4DL TDD RSRQ for E-UTRAN in Carrier Aggregation	2758
A.9.2.54.1	Test Purpose and Environment	2758
A.9.2.54.2	Test parameters	2758
A.9.2.54.3	Test Requirements.....	2761
A.9.2.55	3 DL RSRQ for E-UTRAN in Carrier Aggregation with generic duplex modes	2762
A.9.2.55.1	Test Purpose and Environment	2762
A.9.2.55.2	Test parameters	2762
A.9.2.55.3	Test Requirements.....	2765
A.9.2.56	4 DL RSRQ for E-UTRAN in Carrier Aggregation with generic duplex modes	2765
A.9.2.56.1	Test Purpose and Environment	2765
A.9.2.56.2	Test parameters	2766
A.9.2.56.3	Test Requirements.....	2769
A.9.2.57	5 DL RSRQ for E-UTRAN in Carrier Aggregation with generic duplex modes	2769
A.9.2.57.1	Test Purpose and Environment	2769
A.9.2.57.2	Test parameters	2769
A.9.2.57.3	Test Requirements.....	2772
A.9.2.58	6 DL RSRQ for E-UTRAN in Carrier Aggregation with generic duplex modes	2773
A.9.2.58.1	Test Purpose and Environment	2773
A.9.2.58.2	Test parameters	2773
A.9.2.58.3	Test Requirements.....	2776
A.9.2.59	7 DL RSRQ for E-UTRAN in Carrier Aggregation with generic duplex modes	2776
A.9.2.59.1	Test Purpose and Environment	2776
A.9.2.59.2	Test parameters	2777
A.9.2.59.3	Test Requirements.....	2780
A.9.3	UTRAN FDD CPICH RSCP.....	2781
A.9.3.1	E-UTRAN FDD	2781
A.9.3.1.1	Test Purpose and Environment	2781
A.9.3.1.2	Parameters	2781
A.9.3.1.3	Test Requirements.....	2782
A.9.3.2	E-UTRAN TDD	2783
A.9.3.2.1	Test Purpose and Environment	2783
A.9.3.2.2	Parameters	2783
A.9.3.2.3	Test Requirements.....	2784

A.9.3.3	E-UTRAN FDD for 5MHz Bandwidth.....	2785
A.9.3.3.1	Test Purpose and Environment	2785
A.9.3.3.2	Parameters	2785
A.9.3.3.3	Test Requirements.....	2786
A.9.4	UTRAN FDD CPICH Ec/No	2786
A.9.4.1	E-UTRAN FDD.....	2786
A.9.4.1.1	Test Purpose and Environment	2786
A.9.4.1.2	Parameters	2786
A.9.4.1.3	Test Requirements.....	2787
A.9.4.2	E-UTRAN TDD.....	2788
A.9.4.2.1	Test Purpose and Environment	2788
A.9.4.2.2	Parameters	2788
A.9.4.2.3	Test Requirements.....	2790
A.9.4.3	E-UTRAN FDD for 5MHz Bandwidth.....	2790
A.9.4.3.1	Test Purpose and Environment	2790
A.9.4.3.2	Parameters	2791
A.9.4.3.3	Test Requirements.....	2791
A.9.5	UTRAN TDD measurement.....	2792
A.9.5.1	P-CCPCH RSCP absolute accuracy for E-UTRAN FDD.....	2792
A.9.5.1.1	Test Purpose and Environment	2792
A.9.5.1.2	Test parameters	2792
A.9.5.1.3	Test Requirements.....	2793
A.9.5.2	P-CCPCH RSCP absolute accuracy for E-UTRAN TDD	2793
A.9.5.2.1	Test Purpose and Environment	2793
A.9.5.2.2	Test parameters	2793
A.9.5.2.3	Test Requirements.....	2795
A.9.6	GSM Carrier RSSI.....	2795
A.9.6.1	E-UTRAN FDD.....	2795
A.9.6.1.1	Test Purpose and Environment	2795
A.9.6.1.2	Test Requirements.....	2796
A.9.6.2	E-UTRAN TDD.....	2796
A.9.6.2.1	Test Purpose and Environment	2796
A.9.6.2.2	Test Requirements.....	2798
A.9.7	UE Rx – Tx Time Difference	2798
A.9.7.1	E-UTRAN FDD UE Rx – Tx time difference case.....	2798
A.9.7.1.1	Test Purpose and Environment	2798
A.9.7.1.2	Test parameters	2798
A.9.7.1.3	Test Requirements.....	2799
A.9.7.2	E-UTRA TDD UE Rx – Tx time difference case	2799
A.9.7.2.1	Test Purpose and Environment	2799
A.9.7.2.2	Test parameters	2800
A.9.7.2.3	Test Requirements.....	2801
A.9.7.3	E-UTRAN FDD UE Rx–Tx Time Difference under Time-Domain Measurement Resource Restriction with Non-MBSFN ABS	2801
A.9.7.3.1	Test Purpose and Environment	2801
A.9.7.3.2	Test parameters	2801
A.9.7.3.3	Test Requirements.....	2803
A.9.7.4	E-UTRAN TDD UE Rx-Tx Time Difference under Time-Domain Measurement Resource Restriction with Non-MBSFN ABS	2803
A.9.7.4.1	Test Purpose and Environment	2803
A.9.7.4.2	Test Parameters	2803
A.9.7.4.3	Test Requirements.....	2805
A.9.7.5	E-UTRAN FDD UE Rx–Tx time difference under Time Domain Measurement Resource Restriction with CRS Assistance Information and Non-MBSFN ABS.....	2805
A.9.7.5.1	Test Purpose and Environment	2805
A.9.7.5.2	Test parameters	2805
A.9.7.5.3	Test Requirements.....	2808
A.9.7.6	E-UTRAN TDD UE Rx-Tx Time Difference under Time-Domain Measurement Resource Restriction with CRS Assistance Information and Non-MBSFN ABS	2808
A.9.7.6.1	Test Purpose and Environment	2808
A.9.7.6.2	Test Parameters	2808
A.9.7.6.3	Test Requirements.....	2810

A.9.7.7	E-UTRAN FDD UE Rx-Tx time difference case for Cat-M1/M2 UE in CEModeA	2810
A.9.7.7.1	Test Purpose and Environment	2810
A.9.7.7.2	Test parameters	2810
A.9.7.7.3	Test Requirements.....	2811
A.9.7.8	E-UTRAN HD-FDD UE Rx-Tx time difference case for Cat-M1/M2 UE in CEModeA	2812
A.9.7.8.1	Test Purpose and Environment	2812
A.9.7.8.2	Test parameters	2812
A.9.7.8.3	Test Requirements.....	2813
A.9.7.9	E-UTRAN TDD UE Rx-Tx time difference case for Cat-M1/M2 UE in CEModeA	2813
A.9.7.9.1	Test Purpose and Environment	2813
A.9.7.9.2	Test parameters	2813
A.9.7.9.3	Test Requirements.....	2814
A.9.8	RSTD.....	2814
A.9.8.1	E-UTRAN FDD RSTD intra frequency case.....	2814
A.9.8.1.1	Test Purpose and Environment	2814
A.9.8.1.2	Test Requirements.....	2816
A.9.8.1.2A	Test Requirements for UE Category 1bis.....	2816
A.9.8.2	E-UTRAN TDD RSTD intra frequency case	2816
A.9.8.2.1	Test Purpose and Environment	2816
A.9.8.2.2	Test Requirements.....	2819
A.9.8.2.2A	Test Requirements for UE Category 1bis.....	2819
A.9.8.3	E-UTRAN FDD-FDD RSTD inter frequency case	2819
A.9.8.3.1	Test Purpose and Environment	2819
A.9.8.3.2	Test Requirements.....	2821
A.9.8.3.2A	Test Requirements for UE Category 1bis.....	2821
A.9.8.4	E-UTRAN TDD-TDD RSTD inter frequency case	2821
A.9.8.4.1	Test Purpose and Environment	2821
A.9.8.4.2	Test Requirements.....	2823
A.9.8.4.2A	Test Requirements for UE Category 1bis.....	2823
A.9.8.5	E-UTRAN FDD RSTD Measurement Accuracy in Carrier Aggregation.....	2823
A.9.8.5.1	Test Purpose and Environment	2823
A.9.8.5.2	Test Requirements.....	2825
A.9.8.6	E-UTRAN TDD RSTD Measurement Accuracy in Carrier Aggregation.....	2825
A.9.8.6.1	Test Purpose and Environment	2825
A.9.8.6.2	Test Requirements.....	2827
A.9.8.7	E-UTRAN FDD RSTD Measurement Accuracy in Carrier Aggregation for 20MHz bandwidth	2827
A.9.8.7.1	Test Purpose and Environment	2827
A.9.8.7.2	Test Requirements.....	2828
A.9.8.8	E-UTRAN TDD RSTD Measurement Accuracy in Carrier Aggregation for 20MHz bandwidth	2828
A.9.8.8.1	Test Purpose and Environment	2828
A.9.8.8.2	Test Requirements.....	2829
A.9.8.9	E-UTRAN FDD RSTD Measurement Accuracy in Carrier Aggregation for 10MHz+5MHz.....	2829
A.9.8.9.1	Test Purpose and Environment	2829
A.9.8.9.2	Test Requirements.....	2830
A.9.8.10	E-UTRAN TDD RSTD Measurement Accuracy in Carrier Aggregation for 10MHz+5MHz	2830
A.9.8.10.1	Test Purpose and Environment	2830
A.9.8.10.2	Test Requirements.....	2830
A.9.8.11	E-UTRAN FDD RSTD Measurement Accuracy in Carrier Aggregation for 5 + 5MHz bandwidth	2830
A.9.8.11.1	Test Purpose and Environment	2830
A.9.8.11.2	Test Requirements.....	2831
A.9.8.12	E-UTRAN TDD RSTD Measurement Accuracy in Carrier Aggregation for 5+5MHz bandwidth.....	2831
A.9.8.12.1	Test Purpose and Environment	2831
A.9.8.12.2	Test Requirements.....	2832
A.9.8.13	E-UTRAN TDD RSTD Measurement Accuracy in Carrier Aggregation for 20MHz+10MHz	2832
A.9.8.13.1	Test Purpose and Environment	2832
A.9.8.13.2	Test Requirements.....	2833
A.9.8.14	E-UTRAN FDD RSTD Measurement Accuracy in 3DL Carrier Aggregation	2833
A.9.8.14.1	Test Purpose and Environment	2833
A.9.8.14.2	Test Requirements.....	2836
A.9.8.15	E-UTRAN TDD RSTD Measurement Accuracy in 3DL Carrier Aggregation	2836
A.9.8.15.1	Test Purpose and Environment	2836
A.9.8.15.2	Test Requirements.....	2839

A.9.8.16	HD – FDD Intra frequency case for UE Category NB1 inband mode in normal coverage	2839
A.9.8.16.1	Test Purpose and Environment	2839
A.9.8.16.2	Test Requirements.....	2842
A.9.8.17	HD – FDD Inter frequency case for UE Category NB1 inband mode in normal coverage	2842
A.9.8.17.1	Test Purpose and Environment	2842
A.9.8.17.2	Test Requirements.....	2844
A.9.8.18	HD – FDD Intra frequency case for UE Category NB1 inband mode in enhanced coverage	2844
A.9.8.18.1	Test Purpose and Environment	2844
A.9.8.18.2	Test Requirements.....	2847
A.9.8.19	HD – FDD Inter frequency case for UE Category NB1 inband mode in enhanced coverage	2847
A.9.8.19.1	Test Purpose and Environment	2847
A.9.8.19.2	Test Requirements.....	2849
A.9.8.20	E-UTRAN FDD RSTD intra-frequency measurement accuracy in CE Mode A.....	2849
A.9.8.20.1	Test Purpose and Environment	2849
A.9.8.20.2	Test Requirements.....	2851
A.9.8.21	E-UTRAN HD-FDD RSTD intra-frequency measurement accuracy in CEModeA.....	2852
A.9.8.21.1	Test Purpose and Environment	2852
A.9.8.21.2	Test Requirements.....	2854
A.9.8.22	E-UTRAN TDD RSTD intra-frequency measurement accuracy in CE Mode A	2854
A.9.8.22.1	Test Purpose and Environment	2854
A.9.8.22.2	Test Requirements.....	2856
A.9.8.23	E-UTRAN FDD RSTD intra-frequency measurement accuracy in CE Mode B	2856
A.9.8.23.1	Test Purpose and Environment	2856
A.9.8.23.2	Test Requirements.....	2858
A.9.8.24	E-UTRAN HD-FDD RSTD intra-frequency measurement accuracy in CE Mode B	2858
A.9.8.24.1	Test Purpose and Environment	2858
A.9.8.24.2	Test Requirements.....	2860
A.9.8.25	E-UTRAN TDD RSTD intra-frequency measurement accuracy in CE Mode B.....	2861
A.9.8.25.1	Test Purpose and Environment	2861
A.9.8.25.2	Test Requirements.....	2863
A.9.8.26	E-UTRAN FDD-FDD RSTD inter-frequency measurement accuracy in CE Mode A	2863
A.9.8.26.1	Test Purpose and Environment	2863
A.9.8.26.2	Test Requirements.....	2865
A.9.8.27	E-UTRAN HD-FDD RSTD inter-frequency measurement accuracy in CE Mode A.....	2865
A.9.8.27.1	Test Purpose and Environment	2865
A.9.8.27.2	Test Requirements.....	2867
A.9.8.28	E-UTRAN TDD RSTD inter-frequency measurement accuracy in CE Mode A	2867
A.9.8.28.1	Test Purpose and Environment	2867
A.9.8.28.2	Test Requirements.....	2869
A.9.8.29	E-UTRAN FDD-FDD RSTD inter-frequency measurement accuracy in CE Mode B.....	2869
A.9.8.29.1	Test Purpose and Environment	2869
A.9.8.29.2	Test Requirements.....	2872
A.9.8.30	E-UTRAN HD-FDD RSTD inter-frequency measurement accuracy in CE Mode B	2872
A.9.8.30.1	Test Purpose and Environment	2872
A.9.8.30.2	Test Requirements.....	2874
A.9.8.31	E-UTRAN TDD RSTD inter-frequency measurement accuracy in CE Mode B.....	2875
A.9.8.31.1	Test Purpose and Environment	2875
A.9.8.31.2	Test Requirements.....	2877
A.9.8.32	TDD Intra frequency case for UE Category NB1 inband mode in normal coverage.....	2877
A.9.8.32.1	Test Purpose and Environment	2877
A.9.8.32.2	Test Requirements.....	2880
A.9.8.33	TDD Inter frequency case for UE Category NB1 inband mode in normal coverage.....	2880
A.9.8.33.1	Test Purpose and Environment	2880
A.9.8.33.2	Test Requirements.....	2882
A.9.8.34	TDD Intra frequency case for UE Category NB1 inband mode in enhanced coverage.....	2882
A.9.8.34.1	Test Purpose and Environment	2882
A.9.8.34.2	Test Requirements.....	2884
A.9.8.35	TDD Inter frequency case for UE Category NB1 inband mode in enhanced coverage.....	2884
A.9.8.35.1	Test Purpose and Environment	2884
A.9.8.35.2	Test Requirements.....	2886
A.9.9	RSRP and RSRQ on the serving cell.....	2887
A.9.9.1	FDD Intra frequency serving cell case.....	2887

A.9.9.1.1	Test Purpose and Environment	2887
A.9.9.1.2	Test parameters	2887
A.9.9.1.3	Test Requirements.....	2888
A.9.9.2	TDD Intra frequency serving cell case	2888
A.9.9.2.1	Test Purpose and Environment	2888
A.9.9.2.2	Test parameters	2888
A.9.9.2.3	Test Requirements.....	2890
A.9.10	SSTD.....	2890
A.9.10.1	EUTRAN FDD-FDD SSTD accuracy in asynchronous DC.....	2890
A.9.10.1.1	Test Purpose and Environment	2890
A.9.10.1.2	Test parameters	2890
A.9.10.1.3	Test Requirements.....	2891
A.9.10.2	Void	2891
A.9.10.3	Void	2891
A.9.10.4	Void	2891
A.9.11	RSSI	2891
A.9.11.1	FS3 average RSSI accuracy case (PCell using FDD)	2891
A.9.11.1.1	Test Purpose and Environment	2891
A.9.11.1.2	Test parameters	2892
A.9.11.1.3	Test Requirements.....	2893
A.9.11.2	FS3 average RSSI accuracy case (PCell using TDD).....	2893
A.9.11.2.1	Test Purpose and Environment	2893
A.9.11.2.2	Test parameters	2893
A.9.12	Channel occupancy.....	2894
A.9.12.1	FS3 channel occupancy test (PCell using FDD).....	2894
A.9.12.1.1	Test Purpose and Environment	2894
A.9.12.1.2	Test parameters	2895
A.9.12.1.3	Test Requirements.....	2896
A.9.12.2	FS3 channel occupancy test (PCell using TDD).....	2896
A.9.12.2.1	Test Purpose and Environment	2896
A.9.12.2.2	Test parameters	2896
A.9.12.2.3	Test Requirements.....	2898
A.9.13	RS-SINR	2898
A.9.13.1	FDD Intra-Frequency Case	2898
A.9.13.1.1	Test Purpose and Environment	2898
A.9.13.1.2	Test parameters	2898
A.9.13.1.3	Test Requirements.....	2900
A.9.13.2	TDD Intra-Frequency Case.....	2900
A.9.13.2.1	Test Purpose and Environment	2900
A.9.13.2.2	Test parameters	2900
A.9.13.2.3	Test Requirements.....	2902
A.9.13.3	FDD—FDD Inter frequency case	2902
A.9.13.3.1	Test Purpose and Environment	2902
A.9.13.3.2	Test parameters	2902
A.9.13.3.3	Test Requirements.....	2905
A.9.13.4	TDD—TDD Inter frequency case.....	2905
A.9.13.4.1	Test Purpose and Environment	2905
A.9.13.4.2	Test parameters	2905
A.9.13.4.3	Test Requirements.....	2909
A.9.13.5	FDD—TDD Inter frequency case.....	2909
A.9.13.5.1	Test Purpose and Environment	2909
A.9.13.5.2	Test parameters	2909
A.9.13.5.3	Test Requirements.....	2912
A.9.13.6	TDD—FDD Inter frequency case	2912
A.9.13.6.1	Test Purpose and Environment	2912
A.9.13.6.2	Test parameters	2912
A.9.13.6.3	Test Requirements.....	2915
A.9.14	Channel quality reporting accuracy.....	2915
A.9.14.1	E-UTRAN HD-FDD Downlink channel quality reporting accuracy for UE Category NB1 Standalone mode under normal coverage	2915
A.9.14.1.1	Test Purpose and Environment	2915
A.9.14.1.2	Test parameters	2916

A.9.14.1.3	Test Requirements.....	2916
A.9.14.2	E-UTRAN HD-FDD Downlink channel quality reporting accuracy for UE Category NB1 Standalone mode under enhanced coverage	2917
A.9.14.2.1	Test Purpose and Environment	2917
A.9.14.2.2	Test parameters	2917
A.9.14.2.3	Test Requirements.....	2918
A.10	Proximity-based Services in Any Cell Selection State.....	2918
A.10.1	E-UTRAN FDD – UE ProSe Direct Communication Transmission Timing Accuracy Test	2918
A.10.1.1	Test Purpose and Environment	2918
A.10.1.2	Test Requirements	2919
A.10.2	E-UTRAN FDD – Initiation/Cease of SLSS Transmission with ProSe Direct Communication.....	2919
A.10.2.1	Test Purpose and Environment	2919
A.10.2.2	Test Requirements	2920
A.10.3	E-UTRAN FDD – SyncRef UE Selection / Reselection Test	2921
A.10.3.1	Test Purpose and Environment	2921
A.10.3.2	Test Requirements	2922
A.10.4	E-UTRAN FDD – Cell Identification on downlink frequency associated with ProSe frequency (when UE is transmitting for ProSe).....	2923
A.10.4.1	Test Purpose and Environment	2923
A.10.4.2	Test Requirements.....	2924
A.11	V2V Sidelink Communication for V2V Operation on Dedicated V2V Carrier.....	2925
A.11.1	V2V UE Transmission Timing Accuracy Test.....	2925
A.11.1.1	Test Purpose and Environment	2925
A.11.1.2	Test requirements.....	2925
A.11.2	Interruptions due to V2V sidelink communication	2925
A.11.2.1	Test Purpose and Environment	2925
A.11.2.2	Test Requirements	2927
A.12	2927	
A.12.1	V2X UE Transmission Timing Accuracy Test.....	2927
A.12.1.1	V2X UE Transmission Timing Accuracy Test for eNB as Timing Reference	2927
A.12.1.1.1	Test Purpose and Environment	2927
A.12.1.1.2	Test requirements.....	2928
A.12.1.2	V2X UE Transmission Timing Accuracy Test for SyncRef UE as Timing Reference	2928
A.12.1.2.1	Test Purpose and Environment	2928
A.12.1.2.2	Test Requirements.....	2929
A.12.2	Initiation/Cease of SLSS Transmission with V2X Sidelink Communication	2929
A.12.2.1	Initiation/Cease of SLSS Transmission with V2X Sidelink Communication for eNB as Timing Reference	2929
A.12.2.1.1	Test Purpose and Environment	2929
A.12.2.1.2	Test Requirements.....	2930
A.12.2.2	Initiation/Cease of SLSS Transmission with V2X Sidelink Communication for SyncRef UE as Timing Reference	2931
A.12.2.2.1	Test Purpose and Environment	2931
A.12.2.2.2	Test Requirements.....	2932
A.12.3	V2X Synchronization Reference Selection/Reselection Tests	2932
A.12.3.1	V2X Synchronization Reference Selection/Reselection Tests for GNSS configured as the highest priority	2932
A.12.3.1.1	Test Purpose and Environment	2932
A.12.3.1.2	Test Requirements.....	2934
A.12.3.2	V2X Synchronization Reference Selection/Reselection Tests for eNB configured as the highest priority	2935
A.12.3.2.1	Test Purpose and Environment	2935
A.12.3.2.2	Test Requirements.....	2936
A.12.4	Congestion Control Measurement Test for V2X UE	2937
A.12.4.1	Test Purpose and Environment	2937
A.12.4.2	Test Requirements	2939
A.12.5	Interruptions due to V2X Sidelink Communication.....	2939
A.12.5.1	Test Purpose and Environment	2939
A.12.5.2	Test Requirements	2941
A.12.6	V2X UE Autonomous Resource Selection/Reselection Measurement Test.....	2941

A.12.6.1	V2X UE Autonomous Resource Selection/Reselection Tests for PSSCH-RSRP measurements.....	2941
A.12.6.1.1	Test Purpose and Environment	2941
A.12.6.1.2	Test Requirements.....	2943
A.12.6.2	V2X UE Autonomous Resource Selection/Reselection Tests for S-RSSI measurements.....	2943
A.12.6.2.1	Test Purpose and Environment	2943
A.12.6.1.2	Test Requirements.....	2944
A.12.7	V2X Synchronization Reference Selection/Reselection Tests for V2X Carrier Aggregation.....	2944
A.12.7.1	Test Purpose and Environment	2944
A.12.7.2	Test Requirements	2947
A.12.8	Interruptions due to V2X Carrier Aggregation.....	2947
A.12.8.1	Interruptions on a FDD PCell	2947
A.12.8.1.1	Test Purpose and Environment	2947
A.12.8.1.2	Test Requirements.....	2949
A.12.8.2	Interruptions on a TDD PCell	2949
A.12.8.2.1	Test Purpose and Environment	2949
A.12.8.2.2	Test Requirements.....	2950

Annex B (normative): Conditions for RRM requirements applicability for operating bands .2951

B.1	Conditions for E-UTRAN RRC_IDLE state mobility	2951
B.1.1	Conditions for measurements of intra-frequency E-UTRAN cells for cell re-selection.....	2951
B.1.2	Conditions for measurements of inter-frequency E-UTRAN cells for cell re-selection.....	2951
B.1.3	Conditions for measurements of intra-frequency E-UTRAN cells for cell re-selection for UE Category M1	2951
B.1.4	Conditions for measurements of intra-frequency NB-IoT cells for cell re-selection for UE Category NB1	2953
B.1.5	Conditions for measurements of inter-frequency NB-IoT cells for cell re-selection for UE Category NB1	2953
B.1.6	Conditions for measurements of intra-frequency E-UTRAN cells for cell re-selection for UE Category 1bis.....	2954
B.1.7	Conditions for measurements of E-UTRAN cells for cell re-selection for UE Category M2	2954
B.1.7.1	Conditions for measurements of intra-frequency E-UTRAN cells for cell selection.....	2954
B.1.7.2	Condition for measurements of inter-frequency E-UTRAN cells for cell selection	2955
B.1.8	Conditions for measurements of inter-frequency E-UTRAN cells for cell re-selection for UE Category M1	2957
B.2	Conditions for UE Measurements Procedures in RRC_CONNECTED State	2957
B.2.1	Conditions for E-UTRAN intra-frequency measurements	2957
B.2.2	Conditions for E-UTRAN intra-frequency measurements with autonomous gaps	2957
B.2.3	Conditions for E-UTRAN inter-frequency measurements	2958
B.2.4	Conditions for E-UTRAN inter-frequency measurements with autonomous gaps	2958
B.2.5	Conditions for E-UTRAN OTDOA intra-frequency RSTD Measurements.....	2959
B.2.6	Conditions for E-UTRAN OTDOA inter-frequency RSTD Measurements.....	2959
B.2.7	Conditions for Measurements of the secondary component carrier with deactivated SCell	2959
B.2.8	Conditions for E-UTRAN Intra-Frequency Measurements under Time Domain Measurement Resource Restriction	2960
B.2.9	Conditions for E-UTRAN Intra-Frequency Measurements under Time Domain Measurement Resource Restriction with CRS Assistance Information.....	2960
B.2.10	Conditions for E-UTRAN intra-frequency discovery signal measurements	2961
B.2.10.1	Conditions for E-UTRAN intra-frequency CRS-based measurements.....	2961
B.2.10.2	Conditions for E-UTRAN intra-frequency CSI-RS based measurements	2961
B.2.11	Conditions for E-UTRAN inter-frequency discovery signal measurements	2961
B.2.11.1	Conditions for E-UTRAN inter-frequency CRS-based measurements.....	2961
B.2.11.2	Conditions for E-UTRAN inter-frequency CSI-RS based measurements	2962
B.2.12	Conditions for E-UTRAN intra-frequency discovery signal measurements under operation with frame structure 3.....	2962
B.2.13	Conditions for E-UTRAN inter-frequency discovery signal measurements under operation with frame structure 3.....	2962
B.2.13.1	Conditions for E-UTRAN inter-frequency CRS-based measurements.....	2962
B.2.13.2	Conditions for E-UTRAN inter-frequency CSI-RS based measurements	2963
B.2.14	Conditions for E-UTRAN intra-frequency measurements by UE Category M1	2963
B.2.15	Conditions for NB-IoT intra-frequency measurements by UE Category NB1.....	2964
B.2.16	Conditions for NB-IoT intra-frequency RSTD measurements by UE Category NB1.....	2965

B.2.17	Conditions for NB-IoT inter-frequency RSTD measurements by UE Category NB1.....	2966
B.2.18	Conditions for E-UTRAN inter-frequency measurements by UE Category M1	2967
B.2.19	Conditions for E-UTRAN measurements by UE Category M2	2968
B.2.19.1	Conditions for E-UTRAN intra-frequency measurements.....	2968
B.2.19.2	Conditions for E-UTRAN inter-frequency measurements.....	2968
B.2.20	Conditions for E-UTRAN inter-frequency RSTD measurements by UE Category M1	2968
B.2.21	Conditions for E-UTRAN inter-frequency RSTD measurements by UE Category M2.....	2969
B.2.22	Conditions for E-UTRAN intra-frequency RSTD measurements by UE Category M1	2969
B.2.23	Conditions for E-UTRAN intra-frequency RSTD measurements by UE Category M2.....	2971
B.3	Conditions for measurements performance requirements for UE	2971
B.3.1	Conditions for intra-frequency RSRP and RSRQ Accuracy Requirements	2971
B.3.2	Void.....	2971
B.3.3	Conditions for inter-frequency RSRP and RSRQ Accuracy Requirements	2971
B.3.4	Conditions for inter-frequency relative RSRP and RSRQ Accuracy Requirements	2971
B.3.5	Conditions for UE Rx – Tx time difference	2971
B.3.6	Conditions for intra-frequency Reference Signal Time Difference (RSTD) measurements	2972
B.3.7	Conditions for inter-frequency RSTD measurements	2972
B.3.8	Conditions for Intra-Frequency Relative RSRP Accuracy Requirements	2972
B.3.9	Conditions for Intra-Frequency Absolute RSRP and RSRQ Accuracy Requirements under Time Domain Measurement Resource Restriction	2972
B.3.10	Conditions for Intra-Frequency Relative RSRP Accuracy Requirements under Time Domain Measurement Resource Restriction	2972
B.3.11	Conditions for Intra-Frequency Absolute RSRP and RSRQ Accuracy Requirements under Time Domain Measurement Resource Restriction with CRS Assistance Information.....	2973
B.3.12	Conditions for Intra-Frequency Relative RSRP Accuracy Requirements under Time Domain Measurement Resource Restriction with CRS Assistance Information.....	2973
B.3.13	Conditions for UE Rx–Tx Time Difference Measurement under Time Domain Measurement Resource Restriction with CRS Assistance Information	2973
B.3.14	Conditions for Intra-Frequency Absolute Discovery Signal Measurement Accuracy Requirements.....	2973
B.3.14.1	Conditions for Intra-frequency CRS-based measurements	2973
B.3.14.2	Conditions for Intra-frequency CSI-RS-based measurements	2973
B.3.15	Conditions for Intra-Frequency Relative Discovery Signal Measurement Accuracy Requirements.....	2974
B.3.15.1	Conditions for Intra-frequency CRS-based measurements	2974
B.3.15.2	Conditions for Intra-frequency CSI-RS-based measurements	2974
B.3.16	Conditions for Inter-Frequency Absolute Discovery Signal Measurement Accuracy Requirements.....	2974
B.3.16.1	Conditions for Inter-frequency CRS-based measurements	2974
B.3.16.2	Conditions for Inter-frequency CSI-RS-based measurements	2974
B.3.17	Conditions for Inter-Frequency Relative Discovery Signal Measurement Accuracy Requirements.....	2975
B.3.17.1	Conditions for Inter-frequency CRS-based measurements	2975
B.3.17.2	Conditions for Inter-frequency CSI-RS-based measurements	2975
B.3.18	Conditions for Intra-frequency Absolute RS-SINR Accuracy Requirements	2975
B.3.19	Conditions for Inter-frequency Absolute RS-SINR Accuracy Requirements	2975
B.3.20	Conditions for Inter-frequency Relative RS-SINR Accuracy Requirements	2975
B.3.21	Conditions for Intra-Frequency Absolute Accuracy Requirements for Measurements under Operation with Frame Structure 3	2975
B.3.21.1	Conditions for RSRP measurements.....	2975
B.3.21.2	Conditions for RSRQ measurements	2976
B.3.21.3	Conditions for CSI-RSRP measurements	2976
B.3.22	Conditions for Intra-Frequency Relative Accuracy Requirements for Measurements under Operation with Frame Structure 3	2976
B.3.22.1	Conditions for RSRP measurements.....	2976
B.3.22.2	Void.....	2976
B.3.22.3	Conditions for CSI-RSRP measurements	2976
B.3.23	Conditions for Inter-Frequency Absolute Accuracy Requirements for Measurements under Operation with Frame Structure 3	2977
B.3.23.1	Conditions for RSRP measurements.....	2977
B.3.23.2	Conditions for RSRQ measurements	2977
B.3.23.3	Conditions for CSI-RSRP measurements	2977
B.3.24	Conditions for Inter-Frequency Relative Accuracy Requirements for Measurements under Operation with Frame Structure 3	2977
B.3.24.1	Conditions for RSRP measurements.....	2977

B.3.24.2	Conditions for RSRQ measurements	2977
B.3.24.3	Conditions for CSI-RSRP measurements	2977
B.3.25	Conditions for NB-IoT intra-frequency Absolute NRSRP and NRSRQ Accuracy Requirements for UE Category NB1.....	2978
B.3.26	Conditions for NB-IoT inter-frequency Absolute NRSRP and NRSRQ Accuracy Requirements for UE Category NB1.....	2978
B.3.27	Conditions for intra-frequency RSRP and RSRQ Accuracy Requirements for Category 0	2978
B.3.28	Conditions for Intra-Frequency Relative RSRP Accuracy Requirements for Category 0.....	2978
B.3.29	Conditions for intra-frequency Reference Signal Time Difference (RSTD) measurements for NB1	2979
B.3.30	Conditions for inter-frequency Reference Signal Time Difference (RSTD) measurements for NB1	2979
B.3.31	Conditions for inter-frequency Reference Signal Time Difference (RSTD) measurements for Cat M1.....	2979
B.3.32	Conditions for inter-frequency Reference Signal Time Difference (RSTD) measurements for Cat M2.....	2979
B.3.33	Conditions for intra-frequency Reference Signal Time Difference (RSTD) measurements for Cat M1.....	2979
B.3.34	Conditions for intra-frequency Reference Signal Time Difference (RSTD) measurements for Cat M2.....	2979
B.4	RRM Requirements Exceptions	2979
B.4.1	General	2979
B.4.2	Receiver sensitivity relaxation for UE supporting CA	2979
B.4.3	Receiver sensitivity relaxation for UE configured with CA.....	2980
B.4.3.1	Inter-band carrier aggregation.....	2980
B.4.3.2	Intra-band non-contiguous carrier aggregation.....	2980
B.4.3.3	Inter-band carrier aggregation with operating bands without uplink band	2980
B.5	Conditions for Measurement Performance Requirements for ProSe UE	2980
B.5.1	Conditions for S-RSRP Accuracy Requirements	2980
B.5.2	Conditions for Relative S-RSRP Accuracy Requirements	2981
B.5.3	Conditions for Selection/Reselection to Intra-frequency SyncRef UE.....	2981
B.5.4	Conditions for SD-RSRP Accuracy Requirements	2982
B.5.5	Conditions for Relative SD-RSRP Accuracy Requirements	2982
B.6	Conditions for V2X.....	2982
B.6.1	Test parameters for GNSS signals.....	2982
B.6.2	Conditions for Absolute S-RSRP Accuracy Requirements	2983
B.6.3	Conditions for Relative S-RSRP Accuracy Requirements	2983
B.6.4	Conditions for Selection/Reselection to Intra-frequency SyncRef UE.....	2983
B.6.5	Conditions for Absolute PSSCH-RSRP Accuracy Requirements	2983
B.7	Conditions for sTTI and 1ms-TTI with 3 Subframe HARQ Processing.....	2984
B.7.1	Conditions for Maximum Timing Difference Between Uplink and Downlink Carriers in Carrier Aggregation.....	2984
Annex C (informative):	Change history:	2986
History		3044

Foreword

This Technical Specification has been produced by the 3rd Generation Partnership Project (3GPP).

The contents of the present document are subject to continuing work within the TSG and may change following formal TSG approval. Should the TSG modify the contents of the present document, it will be re-released by the TSG with an identifying change of release date and an increase in version number as follows:

Version x.y.z

where:

- x the first digit:
 - 1 presented to TSG for information;
 - 2 presented to TSG for approval;
 - 3 or greater indicates TSG approved document under change control.
- y the second digit is incremented for all changes of substance, i.e. technical enhancements, corrections, updates, etc.
- z the third digit is incremented when editorial only changes have been incorporated in the document.

1 Scope

The present document specifies requirements for support of Radio Resource Management for the FDD and TDD modes of Evolved UTRA. These requirements include requirements on measurements in UTRAN and the UE as well as requirements on node dynamical behaviour and interaction, in terms of delay and response characteristics.

2 References

The following documents contain provisions which, through reference in this text, constitute provisions of the present document.

- References are either specific (identified by date of publication, edition number, version number, etc.) or non-specific.
- For a specific reference, subsequent revisions do not apply.
- For a non-specific reference, the latest version applies. In the case of a reference to a 3GPP document (including a GSM document), a non-specific reference implicitly refers to the latest version of that document *in the same Release as the present document*.

- [1] 3GPP TS 36.304: "Evolved Universal Terrestrial Radio Access (E-UTRA); User Equipment (UE) procedures in idle mode"
- [2] 3GPP TS 36.331: "Evolved Universal Terrestrial Radio Access (E-UTRA); Radio Resource Control (RRC) protocol specification".
- [3] 3GPP TS 36.213: "Evolved Universal Terrestrial Radio Access (E-UTRA); Physical layer procedures"
- [4] 3GPP TS 36.214: "Evolved Universal Terrestrial Radio Access (E-UTRA); Physical layer; Measurements"
- [5] 3GPP TS 36.101: "Evolved Universal Terrestrial Radio Access (E-UTRA); User Equipment (UE) radio transmission and reception"
- [6] 3GPP TS 25.302: "Services provided by the Physical Layer".
- [7] 3GPP TS 25.331: "RRC Protocol Specification".
- [8] 3GPP TS 45.008: "Radio subsystem link control".
- [9] 3GPP TS 45.005: "Radio transmission and reception".
- [10] 3GPP TS 45.010: "Radio subsystem synchronization".
- [11] 3GPP2 C.S0024-B: "cdma2000 High Rate Packet Data Air Interface Specification".
- [12] 3GPP2 C.S0002-D: "Physical Layer Standard for cdma2000 Spread Spectrum Systems - Release A".
- [13] 3GPP2 C.S0033-B: "Recommended Minimum Performance Standards for cdma2000 High Rate Packet Data Access Terminal".
- [14] 3GPP2 C.S0011-C: "Recommended Minimum Performance Standards for cdma2000 Spread Spectrum Mobile Stations".
- [15] 3GPP2 C.S0005-D: Upper Layer (Layer 3) Signaling Specification for cdma2000 Spread Spectrum Systems
- [16] 3GPP TS 36.211: "Evolved Universal Terrestrial Radio Access (E-UTRA); Physical Channels and Modulation"
- [17] 3GPP TS 36.321: "Evolved Universal Terrestrial Radio Access (E-UTRA); Medium Access Control (MAC) protocol specification".

- [18] 3GPP TS 25.133: "Requirements for Support of Radio Resource Management (FDD)".
- [19] 3GPP TS 25.123: "Requirements for Support of Radio Resource Management (TDD)".
- [20] 3GPP TS 25.214: "Physical layer procedures (FDD)".
- [21] 3GPP TS 36.212: "Evolved Universal Terrestrial Radio Access (E-UTRA); Multiplexing and channel coding".
- [22] 3GPP TS 36.302: "Evolved Universal Terrestrial Radio Access (E-UTRA); Services provided by the physical layer".
- [23] 3GPP TS 36.521-3: "Evolved Universal Terrestrial Radio Access (E-UTRA); User Equipment (UE) conformance specification; Radio transmission and reception; Part 3: Radio Resource Management conformance testing".
- [24] 3GPP TS 36.355: "Evolved Universal Terrestrial Radio Access (E-UTRA); LTE Positioning Protocol (LPP)".
- [25] 3GPP TS 36.300: "Evolved Universal Terrestrial Radio Access (E-UTRA) and Evolved Universal Terrestrial Radio Access Network (E-UTRAN); Overall description; Stage 2"
- [26] 3GPP TR 21.905: "Vocabulary for 3GPP Specifications".
- [27] 3GPP TS 37.320: "Universal Terrestrial Radio Access (UTRA) and Evolved Universal Terrestrial Radio Access (E-UTRA); Radio measurement collection for Minimization of Drive Tests (MDT); Overall description; Stage 2"
- [28] 3GPP TS 36.423: "Evolved Universal Terrestrial Radio Access Network (E-UTRAN); X2 Application Protocol (X2AP)".
- [29] 3GPP TS 25.101: "UE Radio transmission and reception (FDD)".
- [30] 3GPP TS 36.104: "Evolved Universal Terrestrial Radio Access (E-UTRA); Base Station (BS) radio transmission and reception".
- [31] 3GPP TS 36.306: "Evolved Universal Terrestrial Radio Access (E-UTRA); User Equipment (UE) radio access capabilities".
- [32] IEEE Standard 802.11: Wireless LAN Medium Access Control (MAC) and Physical Layer (PHY) Specifications.
- [33] 3GPP TS 23.303: "Technical Specification Group Services and System Aspects; Proximity-based services (ProSe); Stage 2".
- [34] 3GPP TS 24.008: "Mobile radio interface Layer 3 specification; Core network protocols; Stage 3".
- [35] 3GPP TS 36.171: " Requirements for Support of Assisted Global Navigation Satellite System (A-GNSS)".
- [36] 3GPP TS 36.305: " Stage 2 functional specification of User Equipment (UE) positioning in E-UTRAN".
- [37] 3GPP TS 38.304: "NR; User Equipment (UE) procedures in idle mode".
- [38] 3GPP TS 38.331: "NR; Radio Resource Control (RRC); Protocol specification".
- [39] 3GPP TS 38.213: "NR; Physical layer procedures for control".
- [40] 3GPP TS 37.340: "Evolved Universal Terrestrial Radio Access (E-UTRA) and NR; Multi-connectivity", Stage 2.
- [41] 3GPP TS 38.101: "NR; User Equipment (UE) radio transmission and reception".
- [42] 3GPP TS 38.211: "NR; Physical channels and modulation".
- [43] 3GPP TS 38.321: "NR; Medium Access Control (MAC) protocol specification".

- [44] 3GPP TS 38.212 "NR; Multiplexing and channel coding".
- [45] 3GPP TS 38.202: "NR; Physical layer services provided by the physical layer".
- [46] 3GPP TS 38.300: "NR; Overall description; Stage-2".
- [47] 3GPP TS 38.423: "NG-RAN; Xn Application Protocol (XnAP)".
- [48] 3GPP TS 38.104: "NR; Base Station (BS) radio transmission and reception".
- [49] 3GPP TS 38.306: "NR; User Equipment (UE) radio access capabilities".
- [50] 3GPP TS 38.133: "NR; Requirements for support of radio resource management "
- [51] 3GPP TS 38.214: " New Radio (NR); Physical layer procedures".
- [52] 3GPP TS 38.101-1: "NR; User Equipment (UE) radio transmission and reception; Part 1: Range 1 Standalone".
- [53] 3GPP TS 38.101-2: "NR; User Equipment (UE) radio transmission and reception; Part 2: Range 2 Standalone".
- [54] 3GPP TS 38.101-3: "NR; User Equipment (UE) radio transmission and reception; Part 3: Range 1 and Range 2 Interworking operation with other radios".
- [55] 3GPP TS 38.101-4: "NR; User Equipment (UE) radio transmission and reception; Part 4: Performance requirements".
- [56] 3GPP TS 24.368: "Non-Access Stratum (NAS) configuration Management Object (MO
- [57] Void
- [58] Void
- [59] 3GPP TS 37.355: "LTE Positioning Protocol (LPP)"

3 Definitions, symbols and abbreviations

3.1 Definitions

For the purposes of the present document, the terms and definitions given in TR 21.905 [26] and the following apply. A term defined in the present document takes precedence over the definition of the same term, if any, in TR 21.905 [26].

Any Cell Selection state: as defined in TS 36.304 [1]

Asynchronous Dual Connectivity: As defined in TS 36.331 [2].

Carrier aggregation: aggregation of two or more component carriers in order to support wider transmission bandwidths TS 36.104 [30].

Dual Connectivity: As defined in TS 36.331 [2].

EN-DC: E-UTRA-NR Dual Connectivity as defined in TS 37.340 [41, Section 4.1.2].

en-gNB: As defined in TS 37.340 [41].

Extended IDLE-mode DRX: extended DRX cycles in IDLE mode as specified in TS 24.008 [34], where one extended DRX cycle is a time period between two first paging occasions within two consecutive PTWs.

Extended CONNECTED-mode DRX: extended DRX cycles in CONNECTED mode as specified in TS 36.331 [2].

FeMBMS/Unicast mixed cell: an MBMS/Unicast cell performing MBMS transmissions as defined in TS 36.300 [25].

Frame Structure 3: frame structure type 3 as defined in TS 36.211 [16]

gNB: as defined in TS 38.300 [46]

High operating band: an operating band with a higher downlink frequency with respect to another, low, operating band.

Inter-band carrier aggregation: carrier aggregation of component carriers in different operating bands TS 36.104 [30].

Intra-band contiguous carrier aggregation: contiguous carriers aggregated in the same operating band TS 36.104 [30].

Intra-band non-contiguous carrier aggregation: non-contiguous carriers aggregated in the same operating band TS 36.104 [30].

IDC autonomous denial subframes: The maximum number of uplink subframes in which the UE is allowed not to transmit E-UTRAN signals when configured with IDC autonomous denial (TS 36.331 [2]).

IDC autonomous denial validity: It is the period over which the autonomous denial subframes are counted (TS 36.331 [2]).

IDC solution: This refers to DRX or IDC autonomous denial configured by eNodeB in response to receiving InDeviceCoexIndication from the UE (TS 36.331 [2]).

Low operating band: an operating band with a lower downlink frequency with respect to another, high, operating band.

Master Cell Group: As defined in TS 36.331 [2].

Master eNB: As defined in TS 36.300 [25].

MBSFN ABS: ABS configured in MBSFN-configurable subframe.

NB-IoT Cell: A cell for NB-IoT.

NB-IoT: As defined in TS 36.331 [2].

ng-eNB: As defined in TS 38.300 [46].

NE-DC: NR-E-UTRA Dual Connectivity as defined in clause 4.1.3.2 of TS 37.340 [41].

NGEN-DC: NG-RAN E-UTRA-NR Dual Connectivity as defined in clause 4.1.3.1 of TS 37.340 [41].

Non-MBSFN ABS: ABS configured in any downlink subframe.

Normal Performance Group: For UE which supports Increased UE carrier monitoring UTRA or E-UTRA the group of inter-frequency carriers or inter-RAT carriers is divided into two groups. The group which has a better delay performance compared to the other group is referred to as the normal performance group.

Paging Time Window: As defined in TS 24.008 [34].

Primary Cell: As defined in TS 36.331 [2].

ProSe Direct Communication: As defined in TS 23.303 [33]

ProSe Direct Discovery: As defined in TS 23.303 [33]

Primary SCell: As defined in TS 36.331 [2].

Primary Secondary Timing Advance Group: Timing Advance Group containing the PSCell.

Primary Timing Advance Group: Timing Advance Group containing the PCell.

Reduced Performance Group: For UE which supports Increased UE carrier monitoring UTRA or E-UTRA the group of inter-frequency carriers or inter-RAT carriers is divided into two groups. The group which has worse delay performance compared to the other group is referred to as the reduced performance group

Secondary Cell: As defined in TS 36.331 [2].

Secondary eNB: As defined in TS 36.300 [25].

Serving Cell: As defined in TS 36.331 [2].

Secondary Cell Group: As defined in TS 36.331 [2].

Secondary Timing Advance Group: As defined in TS 36.331 [2].

SSB: SS/PBCH block as defined in TS 38.211 [42, section 7.4.3].

sTTI : A transmission time interval (TTI) of either one slot or one subslot transmission duration as defined in TS 36.211 [16] on either uplink or downlink.

Synchronous Dual Connectivity: As defined in TS 36.331 [2].

TDD-FDD carrier aggregation: Carrier aggregation of component carriers in E-UTRA TDD and E-UTRA FDD operating bands TS 36.104 [30].

Timing Advance Group: As defined in TS 36.331 [2].

WLAN RSSI: As defined in TS36.214 [4].

x_RA: x-to-RS EPRE ratio for the channel or physical signal x in all transmitted OFDM symbols not containing RS.

x_RB: x-to-RS EPRE ratio for the channel or physical signal x in all transmitted OFDM symbols containing RS.

3.2 Symbols

For the purposes of the present document, the following symbols apply:

[...]	Values included in square bracket must be considered for further studies, because it means that a decision about that value was not taken.
BW_{Channel}	Channel bandwidth, defined in TS 36.101 subclause 3.2
$CPICH_Ec$	Average energy per PN chip for the CPICH
$CPICH_Ec/Io$	The ratio of the received energy per PN chip for the CPICH to the total received power spectral density at the UE antenna connector.
E_c	Average energy per PN chip.
\hat{E}_s	Received energy per RE (power normalized to the subcarrier spacing) during the useful part of the symbol, i.e. excluding the cyclic prefix, at the UE antenna connector
I_o	The total received power density, including signal and interference, as measured at the UE antenna connector.
I_{oc}	The power spectral density (integrated in a noise bandwidth equal to the chip rate and normalized to the chip rate) of a band limited noise source (simulating interference from cells, which are not defined in a test procedure) as measured at the UE antenna connector.
I_{ot}	The received power spectral density of the total noise and interference for a certain RE (power integrated over the RE and normalized to the subcarrier spacing) as measured at the UE antenna connector
$NSCH_RP$	Received (linear) average power of the resource elements that carry Narrowband synchronisation signal, measured at the UE antenna connector
N_{oc}	The power spectral density of a white noise source (average power per RE normalised to the subcarrier spacing), simulating interference from cells that are not defined in a test procedure, as measured at the UE antenna connector
N_{PRS}	Number of consecutive downlink positioning subframes as defined in clause 6.10.4.3 in TS 36.211
n_{PRB}	Physical Resource Block number as defined in clause 3.1 in TS 36.211.
N_{TA}	Timing offset between uplink and downlink radio frames at the UE, as defined in clause 3.1 in TS 36.211.
$N_{TA\text{offset}}$	Fixed timing advance offset, as defined in clause 3.1 in TS 36.211.
P_{CMAX}	Configured UE transmitted power as defined in clause 6.2.5 in TS 36.101.
P_{CMAXc}	Configured UE transmitted power on a serving cell c as defined in clause 6.2.5A in TS 36.101.
PRP	Received (linear) average power of the resource elements that carry E-UTRA PRS, measured at the UE antenna connector.

S	Cell Selection Criterion defined in TS 36.304, subclause 5.2.3.2 for E-UTRAN
SCH_Ec/Ior	The ratio of the transmit energy per PN chip of the SCH to the total transmit power spectral density at the UTRA Node B antenna connector
SCH_RP	Received (linear) average power of the resource elements that carry E-UTRA synchronisation signal, measured at the UE antenna connector
Srxlev	Cell selection RX level, defined in TS 36.304, subclause 5.2.3.2
Squal	Cell selection quality, defined in TS 36.304, subclause 5.2.3.2
Sintersearch	Defined in TS 25.304, subclause 5.2.6.1.5
Sintrasearch	Defined in TS 25.304, subclause 5.2.6.1.5 for UTRAN and in TS 36.304 , subclause 5.2.4.7 for E-UTRAN
Snonintrasearch	Defined in TS 36.304 , subclause 5.2.4.7
SsearchRAT	Defined in TS 25.304, subclause 5.2.6.1.5
Thresh _{x, high}	Defined in TS 36.304 , subclause 5.2.4.7
Thresh _{x, low}	Defined in TS 36.304 , subclause 5.2.4.7
Thresh _{servicing, low}	Defined in TS 36.304 , subclause 5.2.4.7
T_{PRS}	Cell-specific positioning subframe configuration period as defined in clause 6.10.4.3 in TS 36.211
T _{RE-ESTABLISH-REQ}	The RRC Re-establishment delay requirement, the time between the moment when erroneous CRCs are applied, to when the UE starts to send preambles on the PRACH.
Treselection	Defined in TS 25.304, subclause 5.2.6.1.5
Treselection _{RAT}	Defined in TS 36.304 , subclause 5.2.4.7
Treselection _{EUTRA}	Defined in TS 36.304 , subclause 5.2.4.7
Treselection _{UTRA}	Defined in TS 36.304 , subclause 5.2.4.7
Treselection _{GERA}	Defined in TS 36.304 , subclause 5.2.4.7
T _s	Basic time unit, defined in TS 36.211, clause 4
T _c	Reference time unit, defined in TS 38.211, subclause 4.1

3.3 Abbreviations

For the purposes of the present document, the abbreviations given in TR 21.905 [26] and the following apply. An abbreviation defined in the present document takes precedence over the definition of the same abbreviation, if any, in TR 21.905 [26].

1x RTT	CDMA2000 1x Radio Transmission Technology
ABS	Almost Blank Subframe
ARQ	Automatic Repeat Request
AP	Access Point
AWGN	Additive White Gaussian Noise
BCCH	Broadcast Control Channel
BCH	Broadcast Channel
CA	Carrier Aggregation
CC	Component Carrier
CCCH SDU	Common Control Channel SDU
CE	Coverage Enhancement
CGI	Cell Global Identifier
CPICH	Common Pilot Channel
CPICH Ec/No	CPICH Received energy per chip divided by the power density in the band
CRS	Cell-specific Reference Signals
C-RNTI	Cell RNTI
CSI	Channel-State Information
CSI-RS	CSI Reference Signal
DC	Dual Connectivity
DCCH	Dedicated Control Channel
DL	Downlink
DMTC	Discovery signal Measurement Timing Configuration
DRX	Discontinuous Reception
DTCH	Dedicated Traffic Channel
DUT	Device Under Test
E-CID	Enhanced Cell-ID (positioning method)
ECGI	Evolved CGI
eDRX_IDLE	Extended IDLE-mode DRX

eDRX_CONN	Extended CONNECTED-mode DRX
eNB	E-UTRAN NodeB
EN-DC	E-UTRA-NR Dual Connectivity
E-SMLC	Enhanced Serving Mobile Location Centre
E-UTRA	Evolved UTRA
E-UTRAN	Evolved UTRAN
FDD	Frequency Division Duplex
FS3	Frame Structure type 3
GERAN	GSM EDGE Radio Access Network
GNSS	Global Navigational Satellite System
GSM	Global System for Mobile communication
HARQ	Hybrid Automatic Repeat Request
HD-FDD	Half-Duplex FDD
HO	Handover
HRPD	High Rate Packet Data
IDC	In-Device Coexistence
IEEE	Institute of Electrical and Electronics Engineers
LBT	Listen before talk
LPP	LTE Positioning Protocol
LWA	LTE-WLAN Aggregation
MAC	Medium Access Control
MCG	Master Cell Group
MeNB	Master eNB
MBMS	Multimedia Broadcast Multicast Service
MBSFN	Multimedia Broadcast multicast service Single Frequency Network
MBSFN ABS	MBSFN Almost Blank Subframe
MDT	Minimization of Drive Tests
MGRP	Measurement Gap Repetition Period
MIB	Master Information Block
MPDCCH	MTC Physical Downlink Control Channel
NCSG	Network Controlled Small Gap
NE-DC	NR-E-UTRA Dual Connectivity
NG-RAN	NG Radio Access Network
NGEN-DC	NG-RAN E-UTRA-NR Dual Connectivity
NR	New Radio
NSA	Non-standalone
NPBCH	Narrowband Physical Broadcast CHannel
NPDCCH	Narrowband Physical Downlink Control CHannel
NPDSCH	Narrowband Physical Downlink Shared CHannel
NPRACH	Narrowband Physical Random Access CHannel
NPUSCH	Narrowband Physical Uplink Shared CHannel
NPSS	Narrowband Primary Synchronization Signal
NRS	Narrowband Reference Signal
NRSRP	Narrowband Reference Signal Received Power
NRSRQ	Narrowband Reference Signal Received Quality
NSCH	Narrowband Synchronization Channel
NSSS	Narrowband Secondary Synchronization Signal
OCNG	OFDMA Channel Noise Generator
OFDM	Orthogonal Frequency Division Multiplexing
OFDMA	Orthogonal Frequency Division Multiple Access
OTDOA	Observed Time Difference of Arrival
PBCH	Physical Broadcast Channel
PCC	Primary Component Carrier
P-CCPCH	Primary Common Control Physical Channel
PCell	Primary Cell
PCFICH	Physical Control Format Indicator CHannel
PDCCH	Physical Downlink Control CHannel
PDSCH	Physical Downlink Shared CHannel
PHICH	Physical Hybrid-ARQ Indicator CHannel
PLMN	Public Land Mobile Network
PMCH	Physical Multicast Channel
PRACH	Physical Random Access CHannel

ProSe	Proximity-based Services
PRS	Positioning Reference Signal
PSBCH	Physical Sidelink Broadcast CHannel
PSCCH	Physical Sidelink Control Channel
PSCell	Primary SCell
PSS	Primary Synchronization Signal
PSSCH	Physical Sidelink Shared CHannel
psTAG	Primary Secondary Timing Advance Group
pTAG	Primary Timing Advance Group
PTW	Paging Time Window
PUCCH	Physical Uplink Control CHannel
PUSCH	Physical Uplink Shared Channel
RS-SINR	Reference Signal to Noise and Interference Ratio
RSRP	Reference Signal Received Power
RSRQ	Reference Signal Received Quality
RSSI	Received Signal Strength Indicator
RSTD	Reference Signal Time Difference
QAM	Quadrature Amplitude Modulation
RACH	Random Access Channel
RAT	Radio Access Technology
RNC	Radio Network Controller
RNTI	Radio Network Temporary Identifier
RRC	Radio Resource Control
RRM	Radio Resource Management
SCC	Secondary Component Carrier
SCE	Small Cell Enhancement
SCH	Synchronization Channel
SCell	Secondary Cell
SCG	Secondary Cell GroupSDU Service Data Unit
SCS	Subcarrier spacing
SeNB	Secondary eNB
SFN	System Frame Number
SI	System Information
SIB	System Information Block
SLSS	SideLink Synchronization Sequence
SON	Self Optimized Network
SPDCCH	Short Physical Downlink Control channel
SPUCCH	Short Physical Uplink Control channel
SRS	Sounding Reference Signal
SS-RSRP	Synchronization Signal based Reference Signal Received Power
SS-RSRQ	Synchronization Signal based Reference Signal Received Quality
SS-SINR	Synchronization Signal based Signal to Noise and Interference Ratio
SSB	Synchronization Signal Block
SSS	Secondary Synchronization Signal
SSTD	SFN and subframe time difference
sTAG	Secondary Timing Advance Group
TAG	Timing Advance Group
TDD	Time Division Duplex
TP	Transmission Point
TTI	Transmission Time Interval
UE	User Equipment
UL	Uplink
UMTS	Universal Mobile Telecommunication System
UTRA	Universal Terrestrial Radio Access
UTRAN	Universal Terrestrial Radio Access Network
V2V	Vehicle to Vehicle
V2X	Vehicle to Everything
WLAN	Wireless Local Area Network
WB-RSRQ	Wide Bandwidth RSRQ

3.4 Test tolerances

The requirements given in the present document make no allowance for measurement uncertainty. The test specification 36.521-3 [23] defines the test tolerances. These test tolerances are individually calculated for each test. The test tolerances are then added to the limits in this specification to create test limits. The measurement results are compared against the test limits as defined by the shared risk principle.

Shared Risk is defined in [ETR 273 Part 1 sub-part 2 clause 6.5].

3.5 Additional notation

3.5.1 Groups of bands

The intention with the band grouping below is to increase the readability of the specification.

Table 3.5.1-1: E-UTRA band groups

Group	E-UTRA FDD		E-UTRA TDD		E-UTRA Frame Structure 3	
	Band group notation	Operating bands	Band group notation	Operating bands	Band group notation	Operating bands
A	FDD_A	1, 4, 6, 10, 11, 18, 19, 21, 23, 24, 32 ^{Note 2} , 67 ^{Note 2} , 69 ^{Note 2} , 70 ^{Note 7} , 75 ^{Note 2} , 76 ^{Note 2}	TDD_A	33, 34, 35, 36, 37, 38, 39, 40, 45, 50, 51	FS3_A	-
B	FDD_B1	65, 66 ^{Note 5}	TDD_B	-	FS3_B	-
	FDD_B2	74 ^{Note 8}				
C	FDD_C	9, 30	TDD_C	42, 43, 48, 52	FS3_C	-
D	FDD_D	28, 68	TDD_D	-	FS3_D	-
E	FDD_E	2, 5, 7, 27	TDD_E	41, 44	FS3_E	-
F	FDD_F	26 ^{Note 3}	TDD_F	-	FS3_F	-
G	FDD_G	3, 8, 12, 13, 14, 17, 20, 22, 29 ^{Note 2} , 71, 85	TDD_G	47 ^{Note 4}	FS3_G	46 ^{Note 2} , 49 ^{Note 2}
H	FDD_H	25	TDD_H	-	FS3_H	-
I	FDD_I	-	TDD_I	-	FS3_I	-
J	FDD_J	-	TDD_J	-	FS3_J	-
K	FDD_K	-	TDD_K	-	FS3_K	-
L	FDD_L	-	TDD_L	-	FS3_L	-
M	FDD_M	-	TDD_M	-	FS3_M	-
N	FDD_N	31, 72, 73	TDD_N	-	FS3_N	-

NOTE 1: The bands within the same group have the same Io conditions in a corresponding requirement in this specification.
 NOTE 2: This band is used only for E-UTRA carrier aggregation with other E-UTRA bands.
 NOTE 3: The minimum Io condition for Band 26 is reduced by 0.5 dB when the carrier frequency of the assigned E-UTRA channel bandwidth is within 865-894 MHz.
 NOTE 4: This band is used only for V2V operation.
 NOTE 5: The range 2180-2200 MHz of the DL operating band 66 is restricted to E-UTRA operation when carrier aggregation is configured.
 NOTE 6: Void
 NOTE 7: The range 2010-2020 MHz of the DL operating band is restricted to E-UTRA operation when carrier aggregation is configured and TX-RX separation is 300 MHz The range 2005-2020 MHz of the DL operating band is restricted to E-UTRA operation when carrier aggregation is configured and TX-RX separation is 295 MHz
 NOTE 8: The minimum Io condition for Band 74 is reduced by 0.5 dB when the carrier frequency of the assigned E-UTRA channel bandwidth is within 1475.9-1510.9 MHz.

Table 3.5.1-2: Band groups for NB-IoT

Group	E-UTRA FDD		E-UTRA TDD	
	Band group notation	Operating bands	Band group notation	Operating bands
A	NFDD_A	-	NTDD_A	-

B	NFDD_B	-	NTDD_B	-
C	NFDD_C	-	NTDD_C	-
D	NFDD_D	-	NTDD_D	-
E	NFDD_E	-	NTDD_E	-
F	NFDD_F	-	NTDD_F	-
G	NFDD_G	1, 2, 3, 4, 5, 8, 11, 12, 13, 14, 17, 18, 19, 20, 21, 25, 26, 28, 31, 66, 70, 71, 72, 73, 74, 85	NTDD_G	41
H	NFDD_H	-	NTDD_H	-
I	NFDD_I	-	NTDD_I	-
J	NFDD_J	-	NTDD_J	-
K	NFDD_K	-	NTDD_K	-
L	NFDD_L	-	NTDD_L	-
M	NFDD_M	-	NTDD_M	-
N	NFDD_N	-	NTDD_N	-

Table 3.5.1-3: Band groups for Category 0

Group	E-UTRA FDD		E-UTRA TDD	
	Band group notation	Operating bands	Band group notation	Operating bands
A	FDD-0_A	4	TDD-0_A	39
B	FDD-0_B	-	TDD-0_B	-
C	FDD-0_C	-	TDD-0_C	-
D	FDD-0_D	-	TDD-0_D	-
E	FDD-0_E	2, 5	TDD-0_E	41
F	FDD-0_F	26 ^{Note 1}	TDD-0_F	-
G	FDD-0_G	3, 8, 13, 20	TDD-0_G	-
H	FDD-0_H	25	TDD-0_H	-
I	FDD-0_I	-	TDD-0_I	-
J	FDD-0_J	-	TDD-0_J	-
K	FDD-0_K	-	TDD-0_K	-
L	FDD-0_L	-	TDD-0_L	-
M	FDD-0_M	-	TDD-0_M	-
N	FDD-0_N	-	TDD-0_N	-

NOTE 1: The minimum Io condition for Band 26 is reduced by 0.5 dB when the carrier frequency of the assigned E-UTRA channel bandwidth is within 865-894 MHz.

Table 3.5.1-4: Band groups for Category M1

Group	E-UTRA FDD		E-UTRA TDD	
	Band group notation	Operating bands	Band group notation	Operating bands
A	FDD-M1_A	1, 4, 11, 18, 19, 21	TDD-M1_A	39, 40
B	FDD-M1_B	66 ^{Note 2} , 74 ^{Note 3}	TDD-M1_B	-
C	FDD-M1_C	-	TDD-M1_C	-
D	FDD-M1_D	28	TDD-M1_D	-
E	FDD-M1_E	2, 5, 7, 27	TDD-M1_E	41
F	FDD-M1_F	26 ^{Note 1}	TDD-M1_F	-
G	FDD-M1_G	3, 8, 12, 13, 20, 85	TDD-M1_G	-
H	FDD-M1_H	25	TDD-M1_H	-
I	FDD-M1_I	-	TDD-M1_I	-
J	FDD-M1_J	-	TDD-M1_J	-
K	FDD-M1_K	-	TDD-M1_K	-
L	FDD-M1_L	-	TDD-M1_L	-
M	FDD-M1_M	-	TDD-M1_M	-
N	FDD-M1_N	31, 72, 73	TDD-M1_N	-

NOTE 1: The minimum Io condition for Band 26 is reduced by 0.5 dB when the carrier frequency of the assigned E-UTRA channel bandwidth is within 865-894 MHz.

NOTE 2: The range 2180-2200 MHz of the DL operating band 66 is restricted to E-UTRA operation when carrier aggregation is configured.

NOTE 3: The minimum Io condition for Band 74 is reduced by 0.5 dB when the carrier frequency of the assigned E-UTRA channel bandwidth is within 1475.9-1510.9 MHz.

3.6 General

3.6.1 Applicability of requirements in this specification version

In this specification,

- 'cell', 'PCell', 'PSCell' and 'SCell' refer to E-UTRA cell, E-UTRA PCell, E-UTRA PSCell and E-UTRA SCell, respectively,
- NR cells are referred to as 'NR cell', 'NR PCell', 'NR PSCell' and 'NR SCell',
- 'dual connectivity' refers to Intra-E-UTRA dual connectivity,
- E-UTRA-NR dual connectivity or EN-DC refer to when E-UTRA is the master,
- NR-E-UTRA dual connectivity or NE-DC refer to when NR is the master.
- The requirements for TDD-FDD carrier aggregation are specified for two downlink and one uplink component carriers. The requirements are specified for both cases when the PCell belongs to TDD or FDD.
- All the requirements for intra-band contiguous and non-contiguous CA apply under the assumption of the same uplink-downlink and special subframe configurations [16] in the PCell and SCell.
- All the requirements for inter-band CA apply for the same uplink-downlink and special subframe configurations [16] in the PCell and SCell. Different uplink-downlink and special subframe configurations [16] in the PCell and SCell are supported for inter-band CA for UEs which:
 - do not support simultaneous reception and transmission for inter-band TDD CA specified in TS 36.331 [2], and
 - are compliant to the requirements specified in TS 36.101 for inter-band CA with uplink in one E-UTRA band and without simultaneous Rx/Tx.
- All the inter-frequency requirements and requirements for measurements on deactivated carrier apply for the same uplink-downlink and special subframe configurations [16] in the PCell and SCell. Different uplink-downlink and special subframe configurations [16] in the PCell and SCell are supported for inter-frequency for UEs which:
 - do not support simultaneous reception and transmission for inter-band TDD CA specified in TS 36.331 [2], and are compliant to the requirements specified in TS 36.101 for inter-band CA with uplink in one E-UTRA band and without simultaneous Rx/Tx.
- Requirements for E-UTRA carrier aggregation are applicable for the CA capable UE which has been configured with at least one downlink SCell, but:
 - up to four downlink CCs intra-band contiguous and up to three downlink CCs inter-band and one uplink CC for carrier aggregation, or
 - up to three downlink CCs intra-band contiguous and up to four downlink CCs inter-band and one uplink CC for carrier aggregation, or
 - up to four downlink CCs and up to two uplink CCs for inter-band carrier aggregation, or
 - up to five downlink CCs and up to two uplink CCs for intra-band contiguous carrier aggregation, or
 - up to four downlink CCs and one uplink CCs for inter-band carrier aggregation, or
 - up to two downlink/uplink CCs intra-band contiguous and one downlink/uplink inter-band carrier aggregation, or
 - up to two downlink CCs intra-band contiguous and up to three downlink inter-bands and up to two uplink CCs for inter-band carrier aggregation, or
 - up to two downlink CCs intra-band non-contiguous and up to three downlink inter-bands and up to two uplink CCs for inter-band carrier aggregation, or

- up to three downlink CCs intra-band contiguous and one downlink intra-band non-contiguous and up to two uplink CCs intra-band contiguous for carrier aggregation, or
 - two sub-blocks intra-band non-contiguous with two downlink CCs intra-band contiguous per sub-blocks and up to two uplink CCs intra-band contiguous for carrier aggregation, or
 - two sub-blocks intra-band non-contiguous with two downlink CCs intra-band contiguous and three downlink CCs intra-band contiguous per sub-block and up to two uplink CCs intra-band contiguous for carrier aggregation, or
 - two downlink CCs intra-band contiguous and three downlink CCs inter-band and one uplink CC for carrier aggregation, or
 - two downlink CCs intra-band contiguous and two downlink CCs intra-band contiguous and one downlink CC inter-band and one uplink CC for carrier aggregation, or
 - up to two downlink CCs and up to two uplink CCs for intra-band non-contiguous carrier aggregation, or
 - up to two downlink CCs and up to two uplink CCs for inter-band carrier aggregation, or
 - up to two downlink CCs intra-band contiguous and one downlink inter-band and one uplink CC for carrier aggregation, or
 - up to two downlink CCs intra-band non-contiguous and one downlink inter-band and one uplink CC for carrier aggregation, or
 - up to two downlink CCs and one uplink CC for intra-band non-contiguous carrier aggregation.
- Requirements for E-UTRA carrier aggregation for discovery signal measurements are applicable for CA capable UE which has been configured with at least one downlink SCell, but:
- up to four downlink CCs intra-band contiguous and up to three downlink CCs inter-band and one uplink CC for carrier aggregation, or
 - up to three downlink CCs intra-band contiguous and up to four downlink CCs inter-band and one uplink CC for carrier aggregation, or
 - up to four downlink CCs and up to two uplink CCs for inter-band carrier aggregation, or
 - up to five downlink CCs and up to two uplink CCs for intra-band contiguous carrier aggregation, or
 - up to four downlink CCs and up to one uplink CCs for inter-band carrier aggregation, or
 - up to two downlink/uplink CCs intra-band contiguous and one downlink/uplink inter-band carrier aggregation, or
 - up to two downlink CCs intra-band contiguous and up to three downlink inter-band and up to two uplink CCs for inter-band carrier aggregation, or
 - up to two downlink CCs intra-band non-contiguous and up to three downlink inter-band and up to two uplink CCs for inter-band carrier aggregation, or
 - up to three downlink CCs intra-band contiguous and one downlink intra-band non-contiguous and up to two uplink CCs intra-band contiguous for carrier aggregation, or
 - two sub-blocks intra-band non-contiguous with two downlink CCs intra-band contiguous per sub-blocks and up to two uplink CCs intra-band contiguous for carrier aggregation, or
 - two sub-blocks intra-band non-contiguous with two downlink CCs intra-band contiguous and three downlink CCs intra-band contiguous per sub-block and up to two uplink CCs intra-band contiguous for carrier aggregation, or
 - two downlink CCs intra-band contiguous and three downlink CCs inter-band and one uplink CC for carrier aggregation, or
 - two downlink CCs intra-band contiguous and two downlink CCs intra-band contiguous and one downlink CC inter-band and one uplink CC for carrier aggregation, or

- up to two downlink CCs and up to two uplink CCs for intra-band non-contiguous carrier aggregation, or
- up to two downlink CCs and up to two uplink CCs for inter-band carrier aggregation, or
- up to two downlink CCs intra-band contiguous and one downlink inter-band and one uplink CC for carrier aggregation, or
- up to two downlink CCs intra-band non-contiguous and one downlink inter-band and one uplink CC for carrier aggregation, or
- up to two downlink CCs and one uplink CC for intra-band non-contiguous carrier aggregation.
- Requirements for E-UTRA carrier aggregation, where the PCell is FDD PCell or TDD PCell and at least one downlink SCell follows the frame structure 3 and no UL SCell following the frame structure type 3 [16], are applicable for the CA capable UE, which has been configured with at least one downlink SCell but:
 - up to four downlink CCs intra-band contiguous and up to three downlink CCs inter-band and one uplink CC for carrier aggregation, or
 - up to three downlink CCs intra-band contiguous and up to four downlink CCs inter-band and one uplink CC for carrier aggregation, or
 - up to five downlink CCs and up to two uplink CCs for inter-band carrier aggregation.
- Requirements for E-UTRA carrier aggregation, where the PCell is FDD PCell or TDD PCell, and at least one downlink SCell and one uplink SCell follow the frame structure type 3 [16], are applicable for the CA capable UE, which has been configured with at least one downlink SCell and at least one uplink SCell but:
 - up to five downlink CCs and two uplink CCs for inter-band carrier aggregation.
- The requirements for UE configured with eDRX_CONN cycle do not apply for CA requirements and dual connectivity requirements.
- The requirements for a UE category 0 are derived assuming UE category 0 [31] and a single antenna receiver.
- The requirements for UE category M1 are derived assuming: DL Category M1 and Uplink Category M1, operation in any LTE system bandwidth but with a channel bandwidth of 1.4 MHz and transmission bandwidth of 6 PRBs in downlink and uplink, and a single antenna receiver. DL UE category M1 and UL UE category M1 are defined in TS 36.306 [31].
- The requirements for normal coverage in idle mode shall apply provided the UE category M1 is with the radio condition that $SCH \hat{E}_s/I_{ot} \geq -6$ dB and $CRS \hat{E}_s/I_{ot} \geq -6$ dB.
- The requirements for enhanced coverage in idle mode shall apply provided the UE category M1 is capable of ce-ModeB [2] and is with the radio condition that $SCH \hat{E}_s/I_{ot} \geq -15$ dB and $CRS \hat{E}_s/I_{ot} \geq -15$ dB.
- The requirements for CEMode A shall apply provided the UE category M1 is configured with CEMode A, $SCH \hat{E}_s/I_{ot} \geq -6$ dB and $CRS \hat{E}_s/I_{ot} \geq -6$ dB. The CEMode A and the number of repetition levels for different physical channels are defined in TS 36.213 [3].
- The requirements for CEMode B shall apply provided the UE category M1 is configured with CEMode B, $SCH \hat{E}_s/I_{ot} \geq -15$ dB and $CRS \hat{E}_s/I_{ot} \geq -15$ dB. The CEMode B and the number of repetition levels for different physical channels are defined in TS 36.213 [3].
- The requirements for CEMode B shall apply provided the UE category M1 is configured with CEMode A and capable of ce-ModeB [2], -15 dB $\leq SCH \hat{E}_s/I_{ot} \leq -6$ dB and -15 dB $\leq CRS \hat{E}_s/I_{ot} \leq -6$ dB.
- The requirement for UE category M2 are derived assuming downlink category M2 and uplink category M2, operation in any LTE system bandwidth but with a channel bandwidth not exceeding 5MHz, transmission bandwidth not exceeding 24RB in downlink and 5MHz in uplink, and a single antenna receiver. DL UE category M2 and UL UE category M2 are defined in TS 36.306 [31].
- The requirements for normal coverage in idle mode shall apply provided the UE category M2 is with the radio condition that $SCH \hat{E}_s/I_{ot} \geq -6$ dB and $CRS \hat{E}_s/I_{ot} \geq -6$ dB.

- The requirements for enhanced coverage in idle mode shall apply provided the UE category M2 is capable of ce-ModeB [2] and is with the radio condition that $SCH \hat{E}s/Iot \geq -15$ dB and $CRS \hat{E}s/Iot \geq -15$ dB.
- The requirements for CEMode A shall apply provided the UE category M2 is configured with CEMode A, $SCH \hat{E}s/Iot \geq -6$ dB and $CRS \hat{E}s/Iot \geq -6$ dB. The CEMode A and the number of repetition levels for different physical channels are defined in TS 36.213 [3].
- The requirements for CEMode B shall apply provided the UE category M2 is configured with CEMode B, $SCH \hat{E}s/Iot \geq -15$ dB and $CRS \hat{E}s/Iot \geq -15$ dB. The CEMode B and the number of repetition levels for different physical channels are defined in TS 36.213 [3].
- The requirements for CEMode B shall apply provided the UE category M2 is configured with CEMode A and capable of ce-ModeB [2], -15 dB $\leq SCH \hat{E}s/Iot \leq -6$ dB and -15 dB $\leq CRS \hat{E}s/Iot \leq -6$ dB.
- Unless explicitly defined the following additional requirements are applicable to UE category M2:
 - Cell Selection and Re-selection Requirements in section 4.7
 - Handover requirements in section 5.5 and 5.6
 - Random access requirements in section 6.2.3
 - RRC re-establishment requirements in section 6.7
 - RRC connection release with redirection requirements in section 6.8
 - Radio Link monitoring requirements in section 7.19
 - Timing advance requirements in section 7.28
 - UE timer accuracy requirement in section 7.27
 - E-UTRAN intra frequency measurement requirements in section 8.13.2.1 and 8.13.3.1
 - E-UTRAN inter frequency measurement requirements in section 8.13.2.6 and 8.13.3.5
 - UE measurement capability in section 8.13.2.7 and 8.13.3.6
 - E-UTRAN E-CID measurements requirements in section 8.13.2.5.1, 8.13.2.5.2, 8.13.2.5.3, 8.13.2.5.4, 8.13.2.5.5, 8.13.2.5.6 and 8.13.3.4
 - Measurement accuracy requirements in section 9.1.21.1 to 9.1.21.16.
- The requirements for non-BL CE UE are derived assuming: DL and UL category other than Category 0/M1/M2/NB1/NB2, operation in any LTE system bandwidth but with a channel bandwidth not exceeding 20MHz, transmission bandwidth not exceeding 96RB in downlink and 5MHz in uplink, and dual antenna receiver, when in RRC_IDLE mode camped on a cell acquired using SIB1-BR, or in RRC_CONNECTED configured with CE mode A/B. Non-BL CE UE is defined in [31].
- The Cat-M2 UE requirements for normal coverage in idle mode shall apply provided the UE is non-BL/CE and with the radio condition that the serving cell $SCH \hat{E}s/Iot \geq -6$ dB and $CRS \hat{E}s/Iot \geq -6$ dB, unless corresponding individual non-BL CE requirements are specified.
- The Cat-M2 UE requirements for enhanced coverage in idle mode shall apply provided the UE is non-BL/CE capable of ce-ModeB [2] and with the radio condition that the serving cell -6 dB $\geq SCH \hat{E}s/Iot \geq -15$ dB and -6 dB $\geq CRS \hat{E}s/Iot \geq -15$ dB, unless corresponding individual non-BL CE requirements are specified.
- The Cat-M2 UE requirements for CEMode A shall apply provided the UE is non-BL CE and is configured with CEModeA, the serving cell $SCH \hat{E}s/Iot \geq -6$ dB and $CRS \hat{E}s/Iot \geq -6$ dB, unless corresponding individual non-BL CE requirements are specified. The CEMode A and the number of repetition levels for different physical channels are defined in [3].
- The Cat-M2 UE requirements for CEMode B shall apply provided the UE is non-BL CE and is configured with CEMode B, the serving cell $SCH \hat{E}s/Iot \geq -15$ dB and $CRS \hat{E}s/Iot \geq -15$ dB, unless corresponding individual non-BL CE requirements are specified. The CEMode B and the number of repetition levels for different physical channels are defined in [3].

- Unless explicitly defined the following additional requirements are applicable to non-BL CE UE:
 - Cell Selection and Re-selection Requirements in section 4.7
 - Handover requirements in section 5.5 and 5.6
 - Random access requirements in section 6.2.3
 - RRC re-establishment requirements in section 6.7
 - RRC connection release with redirection requirements in section 6.8
 - UE transmit timing requirements in section 7.26
 - Radio Link monitoring requirements in section 7.19
 - Timing advance requirements in section 7.28
 - UE timer accuracy requirement in section 7.27
 - E-UTRAN intra frequency measurement requirements in section 8.13.2.1 and 8.13.3.1.1, 8.13.3.1.2, and 8.13.3.1.3
 - except when configured with *highSpeedMeasGapCE-ModeA* [2]
 - except measurement requirements with autonomous gaps requiring support of cross-TTI MIB/SIB1-BR decoding
 - E-UTRAN inter frequency measurement requirements in section 8.13.2.6 and 8.13.3.5
 - except when configured with *highSpeedMeasGapCE-ModeA* [2]
 - except measurement requirements with autonomous gaps requiring support of cross-TTI MIB/SIB1-BR decoding
 - UE measurement capability in section 8.13.2.7 and 8.13.3.6
 - E-UTRAN E-CID measurements requirements in section 8.13.2.5.1, 8.13.2.5.2, 8.13.2.5.3, 8.13.2.5.4, 8.13.2.5.5, 8.13.2.5.6, 8.16.2.1, 8.16.2.2, 8.16.2.2a and 8.13.3.4
 - E-UTRAN OTDOA RSTD measurements requirements in section 8.16.2.3, 8.16.2.4, 8.16.3.1 and 8.16.3.2 except those requiring any of the measurement gap pattern in Table 8.1.2.1-3.
 - Measurement accuracy requirements in section 9.1.25
 - Measurement accuracy requirements in section 9.1.21 if the UE is of category 1bis.
- Requirements for E-UTRA ProSe Direct Discovery and E-UTRA ProSe Direct Communication are applicable for ProSe operation on either the uplink frequency of PCC, or SCC, or a non-serving carrier, but:
 - with ProSe operation limited to one carrier on a given subframe.
- Requirements for interruptions due to ProSe Direct Discovery and/or ProSe Direct Communications specified in clause 7.16.3 apply, but:
 - with configured serving carriers of up to two downlink CCs, unless the UE is configured with reception gap for ProSe operation, and
 - with configured serving carriers of up to two uplink CCs, unless the UE is configured with transmission gap for ProSe operation.
- The requirements for UE category NB1 are derived assuming UE category NB1 and a single antenna receiver. UE category NB1 is defined in TS 36.306 [31].
- The requirements for normal coverage shall apply for UE category NB1 provided that the radio condition of its serving cell are: $NSCH \hat{E}_s/I_{ot} \geq -6$ dB and $NRS \hat{E}_s/I_{ot} \geq -6$ dB.

- The requirements for enhanced coverage shall apply for UE category NB1 provided that the radio condition of its serving cell are: $-15 \text{ dB} \leq \text{NSCH } \hat{\epsilon}_s/\text{Tot} < -6 \text{ dB}$ and $-15 \text{ dB} \leq \text{NRS } \hat{\epsilon}_s/\text{Tot} < -6 \text{ dB}$.
- The measurement accuracy requirements in section 9.1.22 for intra-frequency and inter-frequency absolute NRSRQ accuracy for UE Category NB1 apply only in idle mode.
- The measurement accuracy requirements in section 9.1.22 for intra-frequency absolute NRSRP accuracy for UE Category NB1 apply in idle and connected mode.
- The measurement accuracy requirements in section 9.1.22 for inter-frequency absolute NRSRP accuracy for UE Category NB1 apply only in idle mode.
- The requirements for SRS carrier based switching shall apply when the UE capable of SRS carrier based switching is configured to perform SRS carrier based switching for transmitting SRS and/or RACH in one or more CCs in the same or different time resources.
- The requirements for a UE category 1bis are derived assuming UE category 1bis [31] and a single antenna receiver. Following requirements are applicable to UE category 1bis.
 - Cell re-selection requirements in section 4.2.2.1 to 4.2.2.10
 - Handover requirements in section 5.1, 5.2, 5.3 and 5.4
 - RRC re-establishment requirements in section 6.1
 - Random access requirements in section 6.2
 - RRC connection release with redirection requirements in section 6.3
 - UE transmit timing requirements in section 7.1
 - UE timer accuracy requirements in section 7.2
 - Timing advance requirements in section 7.3
 - Radio link monitoring requirements in section 7.11
 - UE measurement capability in section 8.1.2.1
 - E-UTRAN intra frequency measurement requirements in section 8.5.2.1.1 and 8.5.2.1.3
 - E-UTRAN inter frequency measurement requirements in section 8.1.2.3.1, 8.1.2.3.2, 8.1.2.3.3 and 8.1.2.3.4
 - Inter RAT measurement requirements in section 8.1.2.4
 - OTDOA Intra-Frequency measurement requirements in section 8.1.2.5.3, 8.1.2.5.4
 - OTDOA Inter-Frequency measurement requirements in section 8.1.2.6.5, 8.1.2.6.6, 8.1.2.6.7 and 8.1.2.6.8
 - E-UTRAN E-CID measurement requirements in section 8.1.2.7
 - CGI reading requirements for UE category 0 in section 8.5.2.1.4 and 8.5.2.1.6
 - Intra-frequency RSRP Accuracy Requirements in section 9.1.2.7 and 9.1.2.8
 - Inter-frequency RSRP Accuracy Requirements in section 9.1.3.3 and 9.1.3.4
 - Intra-frequency RSRQ Accuracy Requirements in section 9.1.5.5
 - Inter-frequency RSRQ Accuracy Requirements in section 9.1.6.5 and 9.1.6.6
 - RSTD Intra-Frequency Accuracy Requirement in section 9.1.10.5
 - RSTD Inter-Frequency Accuracy Requirement in section 9.1.10.6
 - UE Rx – Tx time difference measurement accuracy requirements in section 9.1.9.1 and 9.1.9.2

- The requirements for UE category NB2 are derived assuming UE category NB2 and a single antenna receiver. UE category NB2 is defined in TS 36.306 [31]. Following requirements are applicable to UE category NB2.
 - Cell selection and re-selection requirements in section 4.6.1 and 4.6.2
 - UE Positioning measurement in idle state in section 4.8
 - RRC Re-establishment requirements in section 6.5
 - Random access requirements in section 6.6
 - RRC connection redirection to non-anchor carrier requirements in section 6.9
 - UE transmit timing requirements in section 7.20
 - UE timer accuracy requirements in section 7.21
 - Timing advance requirements in section 7.22
 - Radio link monitoring requirements in section 7.23
 - UE RRC_CONNECTED state measurement requirement in section 8.14
 - UE measurement accuracy requirements in section 9.1.22
 - Power headroom requirements in section 9.1.23
- All requirements in this specification for UE receiving PMCH in FeMBMS/Unicast-mixed cells apply only for FeMBMS/Unicast-mixed cells configured based on frame structure 1.
- Requirements for E-UTRA carrier aggregation with one or more FeMBMS/Unicast-mixed SCells shall apply, provided the total number of SCCs, including SCCs with FeMBMS/Unicast-mixed SCells, does not exceed the maximum number of SCCs the UE is capable of.

3.6.1.1 Applicability of requirements for UE capable of network-based CRS interference mitigation

If network-based CRS interference mitigation is enabled in a cell, then the UE capable of network-based CRS interference mitigation [31] can assume the following rules:

- CRS is transmitted over full bandwidth of the cell during active time periods (T1) and over at least 6 central resource blocks of the cell during the inactive time periods (T2), and
- CRS is transmitted over full bandwidth of the cell during at least N1 number of non-MBSFN DL subframes immediately before the T1 time period, and
- CRS is transmitted over full bandwidth of the cell during at least N2 number of DL subframes after the T1 time period when UE receives the downlink physical channel during the T1 time period, and
- CRS is transmitted over full bandwidth of the cell in a subframe which is comprised in any non-zero length T1, N1, or N2, and
- The active time period T1 at least includes any period of the time where
 - UE monitors/receives the downlink physical channels: PDCCH, SPDCCH, EPDCCH, MPDCCH, PDSCH, PMCH, PCFICH, PHICH, or
 - UE receives the downlink physical signals: DM-RS, NZP CSI-RS, MBSFN-RS, and PRS, or
 - UE transmits the uplink physical channels: PUCCH, SPUCCH, PUSCH, and PRACH, or
 - UE transmits the uplink physical signals: DM-RS and SRS.

The values of the parameters T1, T2, N1 and N2 are specified for relevant requirements in their corresponding sections. The inactive time periods T2 shall not contain any subframe where the UE requires CRS over the full cell bandwidth for any purpose to meet the requirements in this specification.

UE can additionally assume the following active time period T1 after the PRACH transmission:

- for UE performing random access, the time from the start of RAR window until MSG2 and MSG4 is received and DRX is configured.
- for UE transmitting PRACH due to handover, the time from the start of RAR window until the handover/RRC connection reconfiguration is complete;
- for UE transmitting a scheduling request over PRACH, the time from the start of RAR window until MSG2 is received.

For a UE capable of supporting dual connectivity and/or carrier aggregation, UE can additionally assume that no inactive time period T2 is present in any of its serving cell(s) in the following period of the time:

- the time from receiving the PSCell addition command until UE starts the PSCell release period,
- the time from receiving of SCell activation command until UE starts the SCell deactivation period,
- the time from receiving of SCell configuration command until UE sends *RRCConnectionReconfigurationComplete*.

For UE in RRC_IDLE and configured with eDRX_IDLE, UE shall assume that inactive time periods T2 comprises any subframe that is outside PTW which is not comprised in the N1 and N2 number of DL subframe before and after any active time period T1 within PTW.

For measurements on neighbor cells that is indicated by the high layer to support the network-based CRS interference mitigation,

- if the UE is configured with *widebandRSRQ-Meas* [2] to measure WB-RSRQ then the UE shall assume that CRS are available in the measured cell over the *AllowedMeasBandwidth* [2],
- otherwise the UE shall assume the *AllowedMeasBandwidth* [2] is 6 RBs and inactive time periods T2 may be used in a neighbor cell.

If network-based CRS interference mitigation is enabled in a cell, all the requirements in this specification shall be met for UE capable of network-based CRS interference mitigation, provided that:

- $N1 = 8$ and $N2 = 1$ unless other specified below;
- for UE configured with DRX or eDRX_CONN, the active time periods T1 also includes the periods where no DRX is used (see Section 5 for the definition of the no DRX used state) by the UE, preceded by N1 and followed by N2;
- for UE operating in HD-FDD mode, provided CRS are available in the concerned cell during UL gaps [16] occurring during the UE's UL transmission, with $N1=N2=0$ subframes before and after the UL gaps [16] occurring during the UE's UL transmission;
- for UE monitoring or receiving paging, the active time periods T1 also includes all configured paging occasions, with $N1 = 8$ and $N2 = 1$ subframes before and after each paging occasion respectively;
- for UE in RRC_IDLE and RRC_CONNECTED and receiving SIB1 or SIB1-BR, the active time periods T1 also includes all subframes with SIB1, where $N1 = 8$ and $N2 = 1$ subframes;
- for UE receiving NRS signals [16], provided CRS are available in the concerned cell in all NRS subframes configured for the UE which are comprised in the active time periods T1 within the UE bandwidth;
- for UE monitoring/receiving PRS, the active time periods T1 also includes all PRS subframes, where $N2=0$ subframes.

3.6.1.2 Applicability of requirements with CRS muting for category M1 UE capable of CRS muting

If network has indicated that CRS muting is enabled in a cell using the system information broadcast [2], for a UE capable of supporting CRS muting [31], the CRS is transmitted during the active time periods at the following frequency locations within the cell bandwidth:

- over the 6-PRB bandwidth within the cell bandwidth where the UE reception is configured, and
- 2 additional PRBs where each one is adjacent to the UE configured bandwidth for reception, and
- K number of PRBs within the center of the cell bandwidth indicated by the system information broadcast [2]

During the inactive periods (T2), CRS is transmitted over at least K number of PRBs within center of the cell bandwidth. The UE acquires the values of K from system information broadcast [2] and defined as in Table 3.6.1.2-1.

Table 3.6.1.2-1: Number of PRBs (K) containing CRS within the center of cell BW

crs-IntfMitigNumPRBs [2]	K
'0'	6 PRBs
'1'	24 PRBs

The UE active period (T1) comprises the time period during which UE is engaged in receiving or monitoring any downlink channel/signal. Otherwise, UE is considered to be in inactive period (T2).

The CRS is transmitted over the 6-PRB bandwidth within the cell bandwidth where the UE reception is configured during at least N1 number of subframes immediately before and N2 number of subframes immediately after the T1 time period, which are excluded for the inactive time periods T2. The values of the parameters T1, T2 and N1 are specified for relevant requirements in their corresponding sections.

For a UE that is not pre-provisioned with EARFCN and geographical information [1, 56],

- CRS is transmitted in 1 subframe every 10 ms or 20 ms over full cell bandwidth if K=6 PRBs or 24 PRBs, respectively, and
- CRS is transmitted at least over the central 6 or 24RBs of the cell bandwidth if K=6 PRBs or 24 PRBs, respectively.

For a UE that is pre-provisioned with EARFCN and geographical information [1, 56],

- CRS is transmitted at least over the central 6 or 24RBs of the cell bandwidth if K=6 PRBs or 24 PRBs, respectively.

For measurements on intra-frequency neighbor cells, if *intraFreqNeighCellMeasCenterPRBs* [2] is enabled then the UE shall assume center 6 PRBs for measurements.

If network has indicated that CRS muting is enabled in a cell using the system information broadcast [2], the requirements for UE category M1 in this specification shall be met

- if CRS is transmitted over the 6-PRB bandwidth within the cell bandwidth where the UE reception is configured in a subframe which is comprised in any non-zero length T1, N1, or N2.
- for UE not configured with DRX or eDRX_CONN, the UE being considered to be always in the active period T1 and the requirements being non-DRX requirements are assumed for the UE.
- for UE configured with DRX or eDRX_CONN, provided the active time periods T1 comprise the periods where the UE is not using DRX, while N1=1 and N2=0 subframe.
- For UE receiving PDSCH receptions, provided CRS are available in the concerned cell in all subframes which are comprised in the active time periods T1, with N1=1, and N2=1 subframe.
- For UE in RRC_IDLE and RRC_CONNECTED and receiving SIB1-BR, provided the active time periods T1 comprise all subframes with SIB1-BR, where N1=1 and N1=8 for UEs which are not capable of supporting CRS muting, and N2=1 subframe.
- For UE receiving random access MSG2 and MSG4, provided the active time period T1 comprises the time from the start of RAR window until MSG2 and MSG4 is received and DRX is configured, where N1=N2=1.
- for UE performing MPDCCH monitoring, provided CRS are available in the concerned cell in all MPDCCH subframes configured for the UE to monitor which are comprised in the active time periods T1, with N1=1 and N2=0 subframes before the MPDCCH subframes.

- for UE operating in HD-FDD mode, provided CRS are available in the concerned cell during UL gaps occurring during UL transmission as defined in TS 36.211 [16], with $N1=N2=0$ subframes before and after the UL gaps occurring during UL transmission which are comprised in the active time periods T1 within the UE measurement bandwidth;
- provided the UE is configured with measurement gap also for the serving cell measurements according to gap pattern ID # 0 or gap pattern ID # 1 defined in Table 8.1.2.1-1.

3.6.1.3 Applicability of requirements with CRS muting for category M2 UE capable of CRS muting

If network has indicated that CRS muting is enabled in a cell using the system information broadcast [2], for a UE capable of supporting CRS muting [31], the CRS is transmitted during the active time periods at the following frequency locations within the cell bandwidth:

- over the 6-PRB or 24-PRB bandwidth within the cell bandwidth where the UE reception is configured, and
- K number of PRBs within the center of the cell bandwidth indicated by the system information broadcast [2], and
- when the UE is configured with downlink bandwidth of 1.4MHz, 2 additional PRBs where each one is adjacent to the 6-PRB bandwidth within the cell bandwidth where UE is configured bandwidth for reception.

During the inactive periods (T2), CRS is transmitted over at least K number of PRBs within center of the cell bandwidth. The UE acquires the values of K from system information broadcast [2] and defined as in Table 3.6.1.3-1.

Table 3.6.1.3-1: Number of PRBs (K) containing CRS within the center of cell BW

crs-IntfMitigNumPRBs [2]	K
'0'	6 PRBs
'1'	24 PRBs

The UE active period (T1) comprises the time period during which UE is engaged in receiving or monitoring any downlink channel/signal. Otherwise, UE is considered to be in inactive period (T2).

The CRS is transmitted over the 6-PRB or 24-PRB bandwidth within the cell bandwidth where the UE reception is configured during at least N1 number of subframes immediately before and N2 number of subframes immediately after the T1 time period, which are excluded for the inactive time periods T2. The values of the parameters T1, T2 and N1 are specified for relevant requirements in their corresponding sections.

For a UE that is not pre-provisioned with EARFCN and geographical information [1, 56],

- CRS is transmitted in 1 subframe every 10 ms or 20 ms over full cell bandwidth if $K=6$ PRBs or 24 PRBs, respectively, and
- CRS is transmitted at least over the central 6 or 24RBs of the cell bandwidth if $K=6$ PRBs or 24 PRBs, respectively.

For a UE that is pre-provisioned with EARFCN and geographical information [1, 56],

- CRS is transmitted at least over the central 6 or 24RBs of the cell bandwidth if $K=6$ PRBs or 24 PRBs, respectively.

For measurements on intra-frequency neighbor cells, if *intraFreqNeighCellMeasCenterPRBs* [2] is enabled then the UE shall assume center 6 PRBs for measurements.

If network has indicated that CRS muting is enabled in a cell using the system information broadcast [2], for a UE capable of supporting CRS muting and configured with downlink bandwidth of 1.4MHz and $K = 6$ in Table 3.6.1.3-1, or for a UE capable of supporting CRS muting and configured with downlink bandwidth of 5MHz and $K = 24$ in Table 3.6.1.3-1, or for a UE capable of supporting CRS muting and not configured with downlink bandwidth and $K = 6$ or 24 in Table 3.6.1.3-1, the requirements for UE category M2 in this specification shall be met

- if CRS is transmitted over the 6-PRB or 24-PRB bandwidth within the cell bandwidth where the UE reception is configured in a subframe which is comprised in any non-zero length T1, N1, or N2.

- for UE not configured with DRX or eDRX_CONN, the UE being considered to be always in the active period T1 and the requirements being non-DRX requirements are assumed for the UE.
- for UE configured with DRX or eDRX_CONN, provided the active time periods T1 comprise the periods where the UE is not using DRX, while N1=1 and N2=0 subframe.
- For UE receiving PDSCH receptions, provided CRS are available in the concerned cell in all subframes which are comprised in the active time periods T1, with N1= 1, and N2=1 subframe.
- For UE in RRC_IDLE and RRC_CONNECTED and receiving SIB1-BR, provided the active time periods T1 comprise all subframes with SIB1-BR, where N1=1 and N1=8 for UEs which are not capable of supporting CRS muting, and N2=1 subframe.
- For UE receiving random access MSG2 and MSG4, provided the active time period T1 comprises the time from the start of RAR window until MSG2 and MSG4 is received and DRX is configured, where N1=N2=1.
- for UE performing MPDCCH monitoring, provided CRS are available in the concerned cell in all MPDCCH subframes configured for the UE to monitor which are comprised in the active time periods T1, with N1=1 and N2=0 subframes before the MPDCCH subframes.
- for UE operating in HD-FDD mode, provided CRS are available in the concerned cell during UL gaps occurring during UL transmission as defined in TS 36.211 [16], with N1=N2=0 subframes before and after the UL gaps occurring during UL transmission which are comprised in the active time periods T1 within the UE measurement bandwidth;
- provided the UE is configured with measurement gap also for the serving cell measurements according to gap pattern ID # 0 or gap pattern ID # 1 defined in Table 8.1.2.1-1.

3.6.2 Applicability of requirements for EN-DC operation

Requirements for EN-DC operation are applicable for the UE which has been configured with the following number of E-UTRA CCs and NR CCs:

- up to 5 E-UTRA DL CCs in total with 1 E-UTRA UL CC in MCG. The applicable number of NR CC for EN-DC in the SCG is specified in clause 3.6.2 of TS 38.133 [50].

In addition to the requirements explicitly defined for a UE configured with EN-DC the following requirements shall also apply for the UE configured with EN-DC:

- Handover requirements in sections 5.1, 5.3.1, 5.3.2 and 5.3.3,
- RRC Re-establishment requirements in section 6.1,
- Random access requirements in section 6.2,
- RRC connection release with redirection requirements in section 6.3,
- UE transmit timing requirements defined in section 7.1 for UE configured with only pTAG,
- UE timer accuracy requirements in section 7.2,
- Timing advance requirements defined in section 7.3 for 1ms TTI and 4 subframe HARQ processing,
- Radio link monitoring requirements in section 7.6,
- SCell activation and deactivation delay requirements for E-UTRA carrier aggregation defined in section 7.7 for 1ms TTI and 4 subframe HARQ processing except those for CA with frame structure # 3,
- Requirements on received time difference between the PCell and SCell or between SCells defined in sections 7.9 except those defined for CA with frame structure # 3, .
- E-UTRAN intra frequency measurement requirements in section 8.1.2.2, except requirements specified for UE configured with *highSpeedEnhancedMeasFlag*
- E-UTRAN OTDOA intra-frequency RSTD measurements requirements defined in section 8.1.2.5 except those for UE category 1bis,

- E-UTRAN E-CID measurements requirements in section 8.1.2.7,
- Requirements on measurements for E-UTRA carrier aggregation in section 8.3,
- OTDOA RSTD measurement requirements for E-UTRAN carrier aggregation in section 8.4,
- Requirements in Section 9 for intra-frequency RSRP, RSRQ, RS-SINR, and RSTD measurements accuracy for PCell carrier frequency,
- Requirements in Section 9 for inter-frequency RSRP, RSRQ, RS-SINR, and RSTD measurements accuracy for non-serving E-UTRA carrier frequencies,
- Requirements in Section 9 for carrier aggregation RSRP, RSRQ, RS-SINR, and RSTD measurements accuracy for PCC, SCC, or both,
- Requirements in Section 9 for inter-RAT E-UTRA–UTRA measurements accuracy and inter-RAT E-UTRA–GSM measurements accuracy for UTRA and GSM carriers,
- Power headroom requirements in Section 9 for PSCell and SCell(s).

3.6.3 Applicability of requirements for NE-DC operation

Requirements for NE-DC operation are applicable for the UE which has been configured with the following number of E-UTRA CCs and NR CCs:

- up to 5 E-UTRA DL CCs in total with 1 E-UTRA UL CC in SCG. The applicable number of NR CC for EN-DC in the SCG is specified in clause 3.6.2 of TS 38.133 [50].

In addition to the requirements explicitly defined for a UE configured with NE-DC the following requirements shall also apply for the UE configured with NE-DC:

- Random access requirements in section 6.2 for random access procedures on PSCell and activated SCell(s),
- UE transmit timing requirements in section 7.1 for psTAG using PSCell as a reference cell and sTAG(s),
- UE timer accuracy requirements in section 7.2 for UE operation on PSCell and SCell(s),
- Timing advance requirements in section 7.3 for 1ms TTI and 4 subframe HARQ processing,
- Radio link monitoring requirements in section 7.6 for PSCell,
- SCell activation and deactivation delay requirements for E-UTRA carrier aggregation in section 7.7 for 1ms TTI and 4 subframe HARQ processing except those for CA with frame structure # 3,
- E-UTRAN intra-frequency measurement requirements in section 8.1.2.2 for PSCC and SCC, except requirements specified for UE configured with *highSpeedEnhancedMeasFlag*,
- E-UTRAN inter-frequency measurement requirements in section 8.1.2.3 for non-serving E-UTRA carrier frequencies, except requirements specified for UE configured with *highSpeedEnhancedMeasFlag*,
- E-UTRAN E-CID measurements requirements in section 8.19.5 for PSCell and SCell carrier frequencies, and in section 8.19.3 for non-serving E-UTRA carrier frequencies,
- Requirements in Section 9 for intra-frequency RSRP, RSRQ and RS-SINR measurements accuracy on PSCC and SCC,
- Requirements in Section 9 for inter-frequency RSRP, RSRQ and RS-SINR measurements accuracy on non-serving E-UTRA carrier frequencies,
- Power headroom requirements in Section 9 for PSCell and SCell(s).

3.6.4 Applicability of requirements for NGEN-DC operation

All the requirements in this specification applicable for EN-DC are also applicable for NGEN-DC.

4 E-UTRAN RRC_IDLE state mobility

4.1 Cell Selection

After a UE has switched on and a PLMN has been selected, the Cell selection process takes place, as described in TS36.304. This process allows the UE to select a suitable cell where to camp on in order to access available services. In this process the UE can use stored information (*Stored information cell selection*) or not (*Initial cell selection*).

4.2 Cell Re-selection

4.2.1 Introduction

The cell reselection procedure allows the UE to select a more suitable cell and camp on it.

When the UE is in either *Camped Normally* state or *Camped on Any Cell* state on a cell, the UE shall attempt to detect, synchronise, and monitor intra-frequency, inter-frequency and inter-RAT cells indicated by the serving cell. For intra-frequency and inter-frequency cells the serving cell may not provide explicit neighbour list but carrier frequency information and bandwidth information only. UE measurement activity is also controlled by measurement rules defined in TS36.304, allowing the UE to limit its measurement activity.

4.2.2 Requirements

The UE shall search every layer of higher priority at least every $T_{\text{higher_priority_search}} = (60 * N_{\text{layers}})$ seconds when the UE is not configured with eDRX_IDLE cycle, and at least every $T_{\text{higher_priority_search}} = \text{MAX}(60 * N_{\text{layers}}, \text{one eDRX_IDLE cycle})$ when UE is configured with eDRX_IDLE cycle, where N_{layers} is the total number of configured higher priority E-UTRA, UTRA FDD, UTRA TDD, CDMA2000 1x, HRPD and NR carrier frequencies and is additionally increased by one if one or more groups of GSM frequencies is configured as a higher priority.

In the requirements of Section 4.2.2 for the UE capable of CA, the applicable exceptions for side conditions are specified in Annex B, Section B.4.2.

For a UE which supports increased carrier monitoring E-UTRA or increased carrier monitoring UTRA, the reselection performance for different carriers may be configured by higher layers to be either normal or reduced. The following definitions are used in the requirements:

K_{carrier} : Total number of interfrequency carriers in the neighbour cell list

$K_{\text{carrier,normal}} = K_{\text{carrier}} - K_{\text{carrier,reduced}}$: Number of interfrequency carriers to be monitored in the normal performance group

$K_{\text{carrier,normal,FDD}}$: Number of interfrequency FDD carriers to be monitored in the normal performance group

$K_{\text{carrier,normal,TDD}}$: Number of interfrequency TDD carriers to be monitored in the normal performance group

$K_{\text{carrier,reduced}}$: Number of interfrequency carriers to be monitored in the reduced performance group

$N_{\text{UTRA_carrier}}$: Total number of configured UTRA FDD carriers in the neighbour cell list

$N_{\text{UTRA_carrier,normal}} = N_{\text{UTRA_carrier}} - N_{\text{UTRA_carrier,reduced}}$: Number of UTRA FDD carriers to be monitored in the normal performance group

$N_{\text{UTRA_carrier,reduced}}$: Number of UTRA FDD carriers to be monitored in the reduced performance group

$N_{\text{UTRA_carrier_TDD}}$: Total number of configured UTRA TDD carriers in the neighbour cell list

$N_{\text{UTRA_carrier_TDD,normal}} = N_{\text{UTRA_carrier_TDD}} - N_{\text{UTRA_carrier_TDD,reduced}}$: Number of UTRA TDD carriers to be monitored in the normal performance group

$N_{\text{UTRA_carrier_TDD,reduced}}$: Number of UTRA TDD carriers to be monitored in the reduced performance group

The minimum performance requirements for a UE which supports Increased UE carrier monitoring E-UTRA [2, 31] are calculated as defined in section 4.2.2.4 provided that $K_{\text{carrier,normal}} \leq 3$ for a UE capable of either FDD E-UTRA carrier monitoring or TDD E-UTRA carrier monitoring or $K_{\text{carrier,normal}} \leq 6$ for a UE capable of both FDD and TDD E-UTRA

carrier monitoring provided $K_{\text{carrier,normal,FDD}} \leq 3$ and $K_{\text{carrier,normal,TDD}} \leq 3$ and the minimum performance requirements for a UE which supports Increased UE carrier monitoring UTRA [2, 31] are calculated as defined in section 4.2.2.5 provided that $N_{\text{UTRA_carrier_normal}} \leq 3$ and $N_{\text{UTRA_carrier_TDD,normal}} \leq 3$. In case the limits for the number of normal performance carriers is exceeded considering the broadcast neighbour cell list and the bands supported by the UE, the UE which supports Increased UE carrier monitoring E-UTRA shall measure at least 3 interfrequency carriers with normal performance and the UE which supports Increased UE carrier monitoring UTRA shall measure at least 3 UTRA carriers with normal performance. For a UE capable of monitoring E-UTRAN FDD and TDD carriers, in case the limits for the number of normal performance carriers is exceeded considering the broadcast neighbour cell list and the bands supported by the UE, the UE shall measure at least 3 FDD and 3 TDD E-UTRAN interfrequency carriers with normal performance. Additionally, reduced performance requirements shall be met for carriers for which the *Reduced measurement performance* IE is indicated, up to the UE measurement capability in section 4.2.2.9a. The minimum performance requirements for a UE which does not support Increased UE carrier monitoring E-UTRA [2,31] are calculated assuming all E-UTRA carriers required to be monitored for such UE, are having normal performance and are in normal performance group, i.e. $K_{\text{carrier,normal}} = K_{\text{carrier}}$ and $K_{\text{carrier,reduced}} = 0$. The minimum performance requirements for a UE which does not support Increased UE carrier monitoring UTRA [2,31] are calculated assuming all UTRA carriers required to be monitored for such UE, are having normal performance and are in normal performance group, i.e. $N_{\text{UTRA_carrier,normal}} = N_{\text{UTRA_carrier}}$, $N_{\text{UTRA_carrier_TDD,normal}} = N_{\text{UTRA_carrier_TDD}}$ and $N_{\text{UTRA_carrier,reduced}} = 0$ and $N_{\text{UTRA_carrier_TDD,reduced}} = 0$. No reduced performance carrier requirement applies to a UE not supporting Increased UE carrier monitoring E-UTRA or UTRA [2, 31]. Capabilities for number of carriers to monitor for a UE which does not support Increased carrier monitoring E-UTRA or Increased carrier monitoring UTRA are specified in section 4.2.2.9

4.2.2.1 Measurement and evaluation of serving cell

The UE shall measure the RSRP and RSRQ level of the serving cell and evaluate the cell selection criterion S defined in [1] for the serving cell at least every DRX cycle.

The UE shall filter the RSRP and RSRQ measurements of the serving cell using at least 2 measurements. Within the set of measurements used for the filtering, at least two measurements shall be spaced by, at least DRX cycle/2.

If the UE is not configured with eDRX_IDLE cycle and has evaluated according to Table 4.2.2.1-1 in N_{serv} consecutive DRX cycles that the serving cell does not fulfil the cell selection criterion S, the UE shall initiate the measurements of all neighbour cells indicated by the serving cell, regardless of the measurement rules currently limiting UE measurement activities. If the UE is configured with eDRX_IDLE cycle and has evaluated according to Table 4.2.2.1-2 in N_{serv} consecutive DRX cycles within a single PTW that the serving cell does not fulfil the cell selection criterion S, the UE shall initiate the measurements of all neighbour cells indicated by the serving cell, regardless of the measurement rules currently limiting UE measurement activities.

If the UE in RRC_IDLE has not found any new suitable cell based on searches and measurements using the intra-frequency, inter-frequency and inter-RAT information indicated in the system information during the time T, the UE shall initiate cell selection procedures for the selected PLMN as defined in [1], where $T=10$ s if the UE is not configured with eDRX_IDLE cycle, and $T=\text{MAX}(10 \text{ s, one eDRX_IDLE cycle})$ if the UE is configured with eDRX_IDLE cycle.

Table 4.2.2.1-1: N_{serv}

DRX cycle length [s]	N_{serv} [number of DRX cycles]
0.32	4
0.64	4
1.28	2
2.56	2

Table 4.2.2.1-2: N_{serv} for UE configured with eDRX_IDLE cycle

eDRX_IDLE cycle length [s]	DRX cycle length [s]	PTW length [s] (number of 1.28s periods)	N_{serv} [number of DRX or eDRX cycles ^{Note 3]}
5.12	N/A	N/A	2
$10.24 \leq \text{eDRX_IDLE cycle length} \leq 2621.44$	0.32	≥ 1.28 (1)	2
	0.64	≥ 1.28 (1)	2
	1.28	≥ 2.56 (2)	2

	2.56	≥ 5.12 (4)	2
NOTE 1: The number of DRX cycles in this table is given for the DRX cycles within PTWs.			
NOTE 2: The eDRX_IDLE cycle lengths are as specified in Section 10.5.5.32 of TS 24.008 [34].			
NOTE 3: Number of eDRX cycles when eDRX_IDLE cycle length equals 5.12s, number of DRX cycles otherwise.			

For any requirement in this section, when the UE transitions between any two states when being configured with eDRX_IDLE, being configured with eDRX_IDLE cycle, changing eDRX_IDLE cycle length, or changing PTW configuration, the UE shall meet the transition requirement, which is the less stringent requirement of the two requirements corresponding to the first state and the second state, during the transition time interval which is the time corresponding to the transition requirement. After the transition time interval, the UE has to meet the requirement corresponding to the second state.

4.2.2.2 Void

4.2.2.3 Measurements of intra-frequency E-UTRAN cells

The UE shall be able to identify new intra-frequency cells and perform RSRP and RSRQ measurements of identified intra-frequency cells without an explicit intra-frequency neighbour list containing physical layer cell identities.

The UE shall be able to evaluate whether a newly detectable intra-frequency cell meets the reselection criteria defined in TS36.304 within $T_{\text{detect,EUTRAN_Intra}}$ when that $T_{\text{reselection}} = 0$. An intra frequency cell is considered to be detectable according to RSRP, RSRP \hat{E}_s/I_{ot} , SCH_{RP} and SCH \hat{E}_s/I_{ot} defined in

- Annex B.1.3 for Cat-M1 UE
- Annex B.1.6 for category 1bis UE
- Annex B.1.1, otherwise

for a corresponding Band.

The UE shall measure RSRP and RSRQ at least every $T_{\text{measure,EUTRAN_Intra}}$ for intra-frequency cells that are identified and measured according to the measurement rules.

The UE shall filter RSRP and RSRQ measurements of each measured intra-frequency cell using at least 2 measurements. Within the set of measurements used for the filtering, at least two measurements shall be spaced by at least $T_{\text{measure,EUTRAN_Intra}}/2$

The UE shall not consider a E-UTRA neighbour cell in cell reselection, if it is indicated as not allowed in the measurement control system information of the serving cell.

For an intra-frequency cell that has been already detected, but that has not been reselected to, the filtering shall be such that the UE shall be capable of evaluating that the intra-frequency cell has met reselection criterion defined [1] within $T_{\text{evaluate,E-UTRAN_intra}}$ when $T_{\text{reselection}} = 0$, provided that the cell is

- at least 4dB better ranked for Cat-M1 UE and category 1bis UE
- at least 3 dB better ranked, otherwise

When evaluating cells for reselection, the side conditions for RSRP and SCH apply to both serving and non-serving intra-frequency cells.

If $T_{\text{reselection}}$ timer has a non zero value and the intra-frequency cell is better ranked than the serving cell, the UE shall evaluate this intra-frequency cell for the $T_{\text{reselection}}$ time. If this cell remains better ranked within this duration, then the UE shall reselect that cell.

For UE neither configured with eDRX_IDLE cycle nor configured with *highSpeedEnhancedMeasFlag*, $T_{\text{detect,EUTRAN_Intra}}$, $T_{\text{measure,EUTRAN_Intra}}$ and $T_{\text{evaluate,E-UTRAN_intra}}$ are specified in Table 4.2.2.3-1. For UE configured with eDRX_IDLE cycle, $T_{\text{detect,EUTRAN_Intra}}$, $T_{\text{measure,EUTRAN_Intra}}$ and $T_{\text{evaluate,E-UTRAN_intra}}$ are specified in Table 4.2.2.3-2, where the requirements apply provided that the serving cell is configured with eDRX_IDLE and is the same in all PTWs during any of $T_{\text{detect,EUTRAN_Intra}}$, $T_{\text{measure,EUTRAN_Intra}}$ and $T_{\text{evaluate,E-UTRAN_intra}}$ when multiple PTWs are used. For UE

configured with *highSpeedEnhancedMeasFlag*, $T_{\text{detect,EUTRAN_Intra}}$, $T_{\text{measure,EUTRAN_Intra}}$ and $T_{\text{evaluate,E-UTRAN_intra}}$ are specified in Table 4.2.2.3-3.

Table 4.2.2.3-1 : $T_{\text{detect,EUTRAN_Intra}}$, $T_{\text{measure,EUTRAN_Intra}}$ and $T_{\text{evaluate,E-UTRAN_intra}}$

DRX cycle length [s]	$T_{\text{detect,EUTRAN_Intra}}$ [s] (number of DRX cycles)	$T_{\text{measure,EUTRAN_Intra}}$ [s] (number of DRX cycles)	$T_{\text{evaluate,E-UTRAN_intra}}$ [s] (number of DRX cycles)
0.32	11.52 (36)	1.28 (4)	5.12 (16)
0.64	17.92 (28)	1.28 (2)	5.12 (8)
1.28	32(25)	1.28 (1)	6.4 (5)
2.56	58.88 (23)	2.56 (1)	7.68 (3)

Table 4.2.2.3-2: $T_{\text{detect,EUTRAN_Intra}}$, $T_{\text{measure,EUTRAN_Intra}}$ and $T_{\text{evaluate,E-UTRAN_intra}}$ for UE configured with eDRX_IDLE cycle

eDRX_IDLE cycle length [s]	DRX cycle length [s]	PTW length [s] (number of 1.28s periods)	$T_{\text{detect,EUTRAN_Intra}}$ [s] (number of DRX or eDRX cycles ^{Note 3})	$T_{\text{measure,EUTRAN_Intra}}$ [s] (number of DRX or eDRX cycles ^{Note 3})	$T_{\text{evaluate,E-UTRAN_intra}}$ [s] (number of DRX or eDRX cycles ^{Note 3})
5.12	N/A	N/A	117.76 (23)	5.12 (1)	10.24 (2)
10.24 ≤ eDRX_IDLE cycle length ≤ 2621.44	0.32	≥1.28 (1)	$eDRX_cycle_length \times \left\lceil \frac{23}{PTW / DRX_cycle_length} \right\rceil$ (23)	0.32 (1)	0.64 (2)
	0.64	≥1.28 (1)		0.64 (1)	1.28 (2)
	1.28	≥2.56 (2)		1.28 (1)	2.56 (2)
	2.56	≥5.12 (4)		2.56 (1)	5.12 (2)

NOTE 1: The number of DRX cycles in this table is given for the DRX cycles within PTWs.
 NOTE 2: The eDRX_IDLE cycle lengths are as specified in Section 10.5.5.32 of TS 24.008 [34].
 NOTE 3: Number of eDRX cycles when eDRX_IDLE cycle length equals 5.12s, number of DRX cycles otherwise.

Table 4.2.2.3-3 : $T_{\text{detect,EUTRAN_Intra}}$, $T_{\text{measure,EUTRAN_Intra}}$ and $T_{\text{evaluate,E-UTRAN_intra}}$ for UE configured with *highSpeedEnhancedMeasFlag*

DRX cycle length [s]	$T_{\text{detect,EUTRAN_Intra}}$ [s] (number of DRX cycles)	$T_{\text{measure,EUTRAN_Intra}}$ [s] (number of DRX cycles)	$T_{\text{evaluate,E-UTRAN_intra}}$ [s] (number of DRX cycles)
0.32	3.2 (10)	0.32(1)	0.96(3)
0.64	6.4 (10)	0.64 (1)	1.92 (3)
1.28	12.8(10)	1.28 (1)	3.84 (3)
2.56	58.88 (23)	2.56 (1)	7.68 (3)

For any requirement in this section, when the UE transitions between any two states when being configured with eDRX_IDLE, being configured with eDRX_IDLE cycle, changing eDRX_IDLE cycle length, or changing PTW configuration, the UE shall meet the transition requirement, which is the less stringent requirement of the two requirements corresponding to the first state and the second state, during the transition time interval which is the time corresponding to the transition requirement. After the transition time interval, the UE has to meet the requirement corresponding to the second state.

4.2.2.4 Measurements of inter-frequency E-UTRAN cells

The UE shall be able to identify new inter-frequency cells and perform RSRP or RSRQ measurements of identified inter-frequency cells if carrier frequency information is provided by the serving cell, even if no explicit neighbour list with physical layer cell identities is provided.

If $S_{rxlev} > S_{nonIntraSearchP}$ and $S_{qual} > S_{nonIntraSearchQ}$ then the UE shall search for inter-frequency layers of higher priority at least every $T_{\text{higher_priority_search}}$ where $T_{\text{higher_priority_search}}$ is described in clause 4.2.2.

If $S_{rxlev} \leq S_{nonIntraSearchP}$ or $S_{qual} \leq S_{nonIntraSearchQ}$ then the UE shall search for and measure inter-frequency layers of higher, equal or lower priority in preparation for possible reselection. In this scenario, the minimum rate at which the UE is required to search for and measure higher priority layers shall be the same as that defined below.

If the UE is not configured with eDRX_IDLE cycle or configured with an eDRX_IDLE cycle not longer than 20.48 s, the UE shall be able to evaluate whether a newly detectable inter-frequency cell in normal performance group meets the reselection criteria defined in TS36.304 within $K_{carrier,normal} * T_{detect,EUTRAN_Inter}$, and able to evaluate whether a newly detectable inter-frequency cell in reduced performance group meets the reselection criteria defined in TS36.304 within $6 * K_{carrier,reduced} * T_{detect,EUTRAN_Inter}$ if at least carrier frequency information is provided for inter-frequency neighbour cells by the serving cells when $T_{reselction} = 0$ provided that the reselection criteria is met by a margin of at least 5dB for reselections based on ranking or 6dB for RSRP reselections based on absolute priorities or 4dB for RSRQ reselections based on absolute priorities. If the UE is configured with eDRX_IDLE cycle longer than 20.48 s, the UE shall be able to evaluate whether a newly detectable inter-frequency cell in normal performance group meets the reselection criteria defined in TS36.304 within $K_{carrier,normal} * T_{detect,EUTRAN_Inter}$, and when $S_{rxlev} < 3$ dB or $S_{qual} < 3$ dB and able to evaluate whether a newly detectable inter-frequency cell in reduced performance group meets the reselection criteria defined in TS36.304 within $6 * K_{carrier,reduced} * T_{detect,EUTRAN_Inter}$ if at least carrier frequency information is provided for inter-frequency neighbour cells by the serving cells when $T_{reselction} = 0$ provided that the reselection criteria is met by a margin of at least 5dB for reselections based on ranking or 6dB for RSRP reselections based on absolute priorities or 4dB for RSRQ reselections based on absolute priorities. An inter-frequency cell is considered to be detectable according to RSRP, RSRP \hat{E}_s/I_{ot} , SCH_RP and SCH \hat{E}_s/I_{ot} defined in Annex B.1.2 for a corresponding Band.

For UE category 1bis, if the UE is not configured with eDRX_IDLE cycle or configured with an eDRX_IDLE cycle not longer than 20.48 s, the UE shall be able to evaluate whether a newly detectable inter-frequency cell in normal performance group meets the reselection criteria defined in TS36.304 within $K_{carrier,normal} * T_{detect,EUTRAN_Inter}$, and able to evaluate whether a newly detectable inter-frequency cell in reduced performance group meets the reselection criteria defined in TS36.304 within $6 * K_{carrier,reduced} * T_{detect,EUTRAN_Inter}$ if at least carrier frequency information is provided for inter-frequency neighbour cells by the serving cells when $T_{reselction} = 0$ provided that the reselection criteria is met by a margin of at least 5.5dB for reselections based on ranking or 6.5dB for RSRP reselections based on absolute priorities or 5dB for RSRQ reselections based on absolute priorities. If the UE is configured with eDRX_IDLE cycle longer than 20.48 s, the UE shall be able to evaluate whether a newly detectable inter-frequency cell in normal performance group meets the reselection criteria defined in TS36.304 within $K_{carrier,normal} * T_{detect,EUTRAN_Inter}$, and when $S_{rxlev} < 3$ dB or $S_{qual} < 3$ dB and able to evaluate whether a newly detectable inter-frequency cell in reduced performance group meets the reselection criteria defined in TS36.304 within $6 * K_{carrier,reduced} * T_{detect,EUTRAN_Inter}$ if at least carrier frequency information is provided for inter-frequency neighbour cells by the serving cells when $T_{reselction} = 0$ provided that the reselection criteria is met by a margin of at least 5.5dB for reselections based on ranking or 6.5dB for RSRP reselections based on absolute priorities or 5dB for RSRQ reselections based on absolute priorities. An inter-frequency cell is considered to be detectable according to RSRP, RSRP \hat{E}_s/I_{ot} , SCH_RP and SCH \hat{E}_s/I_{ot} defined in Annex B.1.2 for a corresponding Band.

When higher priority cells are found by the higher priority search, they shall be measured at least every $T_{measure,EUTRAN_Inter}$. If, after detecting a cell in a higher priority search, it is determined that reselection has not occurred then the UE is not required to continuously measure the detected cell to evaluate the ongoing possibility of reselection. However, the minimum measurement filtering requirements specified later in this clause shall still be met by the UE before it makes any determination that it may stop measuring the cell. If the UE detects on a E-UTRA carrier a cell whose physical identity is indicated as not allowed for that carrier in the measurement control system information of the serving cell, the UE is not required to perform measurements on that cell.

If the UE is configured with eDRX_IDLE cycle not longer than 20.48 s, the UE shall measure RSRP or RSRQ at least every $K_{carrier,normal} * T_{measure,EUTRAN_Inter}$ for identified lower or equal priority inter-frequency cells in normal performance group, and at least every $6 * K_{carrier,reduced} * T_{measure,EUTRAN_Inter}$ for identified lower or equal priority inter-frequency cells in reduced performance group. If the UE is configured with eDRX_IDLE cycle longer than 20.48 s, the UE shall measure RSRP or RSRQ at least every $K_{carrier,normal} * T_{measure,EUTRAN_Inter}$ for identified lower or equal priority inter-frequency cells in normal performance group, and when $S_{rxlev} < 3$ dB or $S_{qual} < 3$ dB at least every $6 * K_{carrier,reduced} * T_{measure,EUTRAN_Inter}$ for identified lower or equal priority inter-frequency cells in reduced performance group. If the UE detects on a E-UTRA carrier a cell whose physical identity is indicated as not allowed for that carrier in the measurement control system information of the serving cell, the UE is not required to perform measurements on that cell.

The UE shall filter RSRP or RSRQ measurements of each measured higher, lower and equal priority inter-frequency cell using at least 2 measurements. Within the set of measurements used for the filtering, at least two measurements shall be spaced by at least $T_{measure,EUTRAN_Inter}/2$.

The UE shall not consider a E-UTRA neighbour cell in cell reselection, if it is indicated as not allowed in the measurement control system information of the serving cell.

If the UE is configured with eDRX_IDLE cycle not longer than 20.48 s, for an inter-frequency cell that has been already detected, but that has not been reselected to, the filtering shall be such that the UE shall be capable of evaluating that the inter-frequency cell in normal performance group has met reselection criterion defined TS 36.304 within $K_{carrier,normal} * T_{evaluate,E-UTRAN_Inter}$, and capable of evaluating that the inter-frequency cell in reduced performance group has met reselection criterion defined TS 36.304 within $6 * K_{carrier,reduced} * T_{evaluate,E-UTRAN_Inter}$, when $T_{reselection} = 0$ provided that the reselection criteria is met by a margin of at least 5dB for reselections based on ranking or 6dB for RSRP reselections based on absolute priorities or 4dB for RSRQ reselections based on absolute priorities. If the UE is configured with eDRX_IDLE cycle longer than 20.48 s, for an inter-frequency cell that has been already detected, but that has not been reselected to, the filtering shall be such that the UE shall be capable of evaluating that the inter-frequency cell in normal performance group has met reselection criterion defined TS 36.304 within $K_{carrier,normal} * T_{evaluate,E-UTRAN_Inter}$, and when $Srxlev < 3$ dB or $Squal < 3$ dB capable of evaluating that the inter-frequency cell in reduced performance group has met reselection criterion defined TS 36.304 within $6 * K_{carrier,reduced} * T_{evaluate,E-UTRAN_Inter}$, when $T_{reselection} = 0$ provided that the reselection criteria is met by a margin of at least 5dB for reselections based on ranking or 6dB for RSRP reselections based on absolute priorities or 4dB for RSRQ reselections based on absolute priorities. When evaluating cells for reselection, the side conditions for RSRP and SCH apply to both serving and inter-frequency cells.

If $T_{reselection}$ timer has a non zero value and the inter-frequency cell is better ranked than the serving cell, the UE shall evaluate this inter-frequency cell for the $T_{reselection}$ time. If this cell remains better ranked within this duration, then the UE shall reselect that cell.

For UE not configured with eDRX_IDLE cycle, $T_{detect,EUTRAN_Inter}$, $T_{measure,EUTRAN_Inter}$ and $T_{evaluate,E-UTRAN_inter}$ are specified in Table 4.2.2.4-1. For UE configured with eDRX_IDLE cycle, $T_{detect,EUTRAN_Inter}$, $T_{measure,EUTRAN_Inter}$ and $T_{evaluate,E-UTRAN_inter}$ are specified in Table 4.2.2.4-2, where the requirements apply provided that the serving cell is configured with eDRX_IDLE and is the same in all PTWs during any of $T_{detect,EUTRAN_Inter}$, $T_{measure,EUTRAN_Inter}$ and $T_{evaluate,E-UTRAN_inter}$ when multiple PTWs are used.

Table 4.2.2.4-1 : $T_{detect,EUTRAN_Inter}$, $T_{measure,EUTRAN_Inter}$ and $T_{evaluate,E-UTRAN_Inter}$

DRX cycle length [s]	$T_{detect,EUTRAN_Inter}$ [s] (number of DRX cycles)	$T_{measure,EUTRAN_Inter}$ [s] (number of DRX cycles)	$T_{evaluate,E-UTRAN_Inter}$ [s] (number of DRX cycles)
0.32	11.52 (36)	1.28 (4)	5.12 (16)
0.64	17.92 (28)	1.28 (2)	5.12 (8)
1.28	32(25)	1.28 (1)	6.4 (5)
2.56	58.88 (23)	2.56 (1)	7.68 (3)

Table 4.2.2.4-2: $T_{detect,EUTRAN_Inter}$, $T_{measure,EUTRAN_Inter}$ and $T_{evaluate,E-UTRAN_inter}$ for UE configured with eDRX_IDLE cycle

eDRX_IDLE cycle length [s]	DRX cycle length [s]	PTW length [s] (number of 1.28s periods)	$T_{detect,EUTRAN_Inter}$ [s] (number of DRX or eDRX cycles <small>Note 3</small>)	$T_{measure,EUTRAN_Inter}$ [s] (number of DRX or eDRX cycles <small>Note 3</small>)	$T_{evaluate,E-UTRAN_inter}$ [s] (number of DRX or eDRX cycles <small>Note 3</small>)
5.12	N/A	N/A	117.76 (23)	5.12 (1)	10.24 (2)
$10.24 \leq$ eDRX_IDLE cycle length ≤ 2621.44	0.32	≥ 1.28 (1)	$eDRX_cycle_length \times \left\lceil \frac{23}{\lceil PTW / DRX_cycle_length \rceil} \right\rceil$ (23)	0.32 (1)	0.64 (2)
	0.64	≥ 1.28 (1)		0.64 (1)	1.28 (2)
	1.28	≥ 2.56 (2)		1.28 (1)	2.56 (2)
	2.56	≥ 5.12 (4)		2.56 (1)	5.12 (2)

NOTE 1: The number of DRX cycles in this table is given for the DRX cycles within PTWs.
 NOTE 2: The eDRX_IDLE cycle lengths are as specified in Section 10.5.5.32 of TS 24.008 [34].
 NOTE 3: Number of eDRX cycles when eDRX_IDLE cycle length equals 5.12s, number of DRX cycles otherwise.

For higher priority cells, a UE may optionally use a shorter value for $T_{\text{measureE-UTRA_Inter}}$, which shall not be less than $\text{Max}(0.64 \text{ s}, \text{one DRX cycle})$.

For any requirement in this section, when the UE transitions between any two states when being configured with eDRX_IDLE, being configured with eDRX_IDLE cycle, changing eDRX_IDLE cycle length, or changing PTW configuration, the UE shall meet the transition requirement, which is the less stringent requirement of the two requirements corresponding to the first state and the second state, during the transition time interval which is the time corresponding to the transition requirement. After the transition time interval, the UE has to meet the requirement corresponding to the second state.

4.2.2.5 Measurements of inter-RAT cells

If $S_{\text{rxlev}} > S_{\text{nonIntraSearchP}}$ and $S_{\text{qual}} > S_{\text{nonIntraSearchQ}}$ then the UE shall search for inter-RAT layers of higher priority at least every $T_{\text{higher_priority_search}}$ where $T_{\text{higher_priority_search}}$ is described in clause 4.2.2

If $S_{\text{rxlev}} \leq S_{\text{nonIntraSearchP}}$ or $S_{\text{qual}} \leq S_{\text{nonIntraSearchQ}}$ then the UE shall search for and measure inter-RAT layers of higher, lower priority in preparation for possible reselection. In this scenario, the minimum rate at which the UE is required to search for and measure higher priority inter-RAT layers shall be the same as that defined below for lower priority RATs.

For any requirement in this section, when the UE transitions between any two states when being configured with eDRX_IDLE, being configured with eDRX_IDLE cycle, changing eDRX_IDLE cycle length, or changing PTW configuration, the UE shall meet the transition requirement, which is the less stringent requirement of the two requirements corresponding to the first state and the second state, during the transition time interval which is the time corresponding to the transition requirement. After the transition time interval, the UE has to meet the requirement corresponding to the second state.

4.2.2.5.1 Measurements of UTRAN FDD cells

When the measurement rules indicate that UTRA FDD cells are to be measured, the UE shall measure CPICH Ec/Io and CPICH RSCP of detected UTRA FDD cells in the neighbour frequency list at the minimum measurement rate specified in this section. The UE shall filter CPICH Ec/Io and CPICH RSCP measurements of each measured UTRA FDD cell using at least 2 measurements. Within the set of measurements used for the filtering, at least two measurements shall be spaced by at least half the minimum specified measurement period.

If the UE is not configured with eDRX_IDLE cycle or configured with eDRX_IDLE cycle not longer than 20.48 s, the UE shall evaluate whether newly detectable UTRA FDD cells in normal performance group have met the reselection criteria in TS 36.304 within time $N_{\text{UTRA_carrier,normal}} * T_{\text{detectUTRA_FDD}}$, and evaluate whether newly detectable UTRA FDD cells in reduced performance group have met the reselection criteria in TS 36.304 within time $6 * N_{\text{UTRA_carrier,reduced}} * T_{\text{detectUTRA_FDD}}$ when $S_{\text{rxlev}} \leq S_{\text{nonIntraSearchP}}$ or $S_{\text{qual}} \leq S_{\text{nonIntraSearchQ}}$ when $T_{\text{reselectionRAT}} = 0$ provided that the reselection criteria is met by a margin of at least 6dB for reselections based on RSCP, or a margin of at least 3dB for reselections based on Ec/Io. If the UE is configured with eDRX_IDLE cycle longer than 20.48 s, the UE shall evaluate whether newly detectable UTRA FDD cells in normal performance group have met the reselection criteria in TS 36.304 within time $(N_{\text{UTRA_carrier,normal}}) * T_{\text{detectUTRA_FDD}}$, and when $S_{\text{rxlev}} < 3 \text{ dB}$ or $S_{\text{qual}} < 3 \text{ dB}$ evaluate whether newly detectable UTRA FDD cells in reduced performance group have met the reselection criteria in TS 36.304 within time $6 * N_{\text{UTRA_carrier,reduced}} * T_{\text{detectUTRA_FDD}}$ when $S_{\text{rxlev}} \leq S_{\text{nonIntraSearchP}}$ or $S_{\text{qual}} \leq S_{\text{nonIntraSearchQ}}$ when $T_{\text{reselectionRAT}} = 0$ provided that the reselection criteria is met by a margin of at least 6dB for reselections based on RSCP, or a margin of at least 3dB for reselections based on Ec/Io.

If the UE is not configured with eDRX_IDLE cycle or configured with eDRX_IDLE cycle not longer than 20.48 s, cells which have been detected shall be measured at least every $N_{\text{UTRA_carrier,normal}} * T_{\text{measureUTRA_FDD}}$ for the cells in normal performance group, and at least every $6 * N_{\text{UTRA_carrier,reduced}} * T_{\text{measureUTRA_FDD}}$ for the cells in reduced performance group when $S_{\text{rxlev}} \leq S_{\text{nonIntraSearchP}}$ or $S_{\text{qual}} \leq S_{\text{nonIntraSearchQ}}$. If the UE is configured with eDRX_IDLE cycle longer than 20.48 s, cells which have been detected shall be measured at least every $(N_{\text{UTRA_carrier,normal}}) * T_{\text{measureUTRA_FDD}}$ for the cells in normal performance group, and when $S_{\text{rxlev}} < 3 \text{ dB}$ or $S_{\text{qual}} < 3 \text{ dB}$ at least every $6 * N_{\text{UTRA_carrier,reduced}} * T_{\text{measureUTRA_FDD}}$ for the cells in reduced performance group when $S_{\text{rxlev}} \leq S_{\text{nonIntraSearchP}}$ or $S_{\text{qual}} \leq S_{\text{nonIntraSearchQ}}$.

When higher priority UTRA FDD cells are found by the higher priority search, they shall be measured at least every $T_{\text{measure,UTRA_FDD}}$. If, after detecting a cell in a higher priority search, it is determined that reselection has not occurred then the UE is not required to continuously measure the detected cell to evaluate the ongoing possibility of reselection. However, the minimum measurement filtering requirements specified later in this clause shall still be met by the UE before it makes any determination that it may stop measuring the cell.

If the UE is not configured with eDRX_IDLE cycle or configured with eDRX_IDLE cycle not longer than 20.48 s, for a cell that has been already detected, but that has not been reselected to, the filtering shall be such that the UE shall be

capable of evaluating that an already identified UTRA FDD cell has met reselection criterion defined in TS 36.304 [1] within $N_{\text{UTRA_carrier,normal}} * T_{\text{evaluateUTRA_FDD}}$ if the cell is in normal performance group and within $6 * N_{\text{UTRA_carrier,reduced}} * T_{\text{evaluateUTRA_FDD}}$ if the cell is in reduced performance group when $T_{\text{reselection}} = 0$ provided that the reselection criteria is met by a margin of at least 6dB for reselections based on RSCP, or a margin of at least 3dB for reselections based on Ec/Io. If the UE is configured with eDRX_IDLE cycle longer than 20.48 s, for a cell that has been already detected, but that has not been reselected to, the filtering shall be such that the UE shall be capable of evaluating that an already identified UTRA FDD cell has met reselection criterion defined in TS 36.304 [1] within $(N_{\text{UTRA_carrier,normal}}) * T_{\text{evaluateUTRA_FDD}}$ if the cell is in normal performance group and when $Srxlev < 3$ dB or $Squal < 3$ dB within $6 * N_{\text{UTRA_carrier,reduced}} * T_{\text{evaluateUTRA_FDD}}$ if the cell is in reduced performance group when $T_{\text{reselection}} = 0$ provided that the reselection criteria is met by a margin of at least 6dB for reselections based on RSCP, or a margin of at least 3dB for reselections based on Ec/Io.

If $T_{\text{reselection}}$ timer has a non zero value and the UTRA FDD cell is satisfied with the reselection criteria which are defined in [1], the UE shall evaluate this UTRA FDD cell for the $T_{\text{reselection}}$ time. If this cell remains satisfied with the reselection criteria within this duration, then the UE shall reselect that cell.

For UE not configured with eDRX_IDLE cycle, $T_{\text{detectUTRA_FDD}}$, $T_{\text{measureUTRA_FDD}}$ and $T_{\text{evaluateUTRA_FDD}}$ are specified in Table 4.2.2.5.1-1. For UE configured with eDRX_IDLE cycle, $T_{\text{detectUTRA_FDD}}$, $T_{\text{measureUTRA_FDD}}$ and $T_{\text{evaluateUTRA_FDD}}$ are specified in Table 4.2.2.5.1-2, where the requirements apply provided that the serving cell is configured with eDRX_IDLE and is the same in all PTWs during any of $T_{\text{detectUTRA_FDD}}$, $T_{\text{measureUTRA_FDD}}$ and $T_{\text{evaluateUTRA_FDD}}$ when multiple PTWs are used.

Table 4.2.2.5.1-1: $T_{\text{detectUTRA_FDD}}$, $T_{\text{measureUTRA_FDD}}$, and $T_{\text{evaluateUTRA_FDD}}$

DRX cycle length [s]	$T_{\text{detectUTRA_FDD}}$ [s]	$T_{\text{measureUTRA_FDD}}$ [s] (number of DRX cycles)	$T_{\text{evaluateUTRA_FDD}}$ [s] (number of DRX cycles)
0.32	30	5.12 (16)	15.36 (48)
0.64		5.12 (8)	15.36 (24)
1.28		6.4(5)	19.2 (15)
2.56	60	7.68 (3)	23.04 (9)

Table 4.2.2.5.1-2: $T_{\text{detectUTRA_FDD}}$, $T_{\text{measureUTRA_FDD}}$ and $T_{\text{evaluateUTRA_FDD}}$ for UE configured with eDRX_IDLE cycle

eDRX_IDLE cycle length [s]	DRX cycle length [s]	PTW length [s] (number of 1.28s periods)	$T_{\text{detectUTRA_FDD}}$ [s] (number of DRX or eDRX cycles ^{Note 4})	$T_{\text{measureUTRA_FDD}}$ [s] (number of DRX or eDRX cycles ^{Note 4})	$T_{\text{evaluateUTRA_FDD}}$ [s] (number of DRX or eDRX cycles ^{Note 4})
5.12	N/A	N/A	117.76 (23)	15.36 (3)	46.08 (9)
$10.24 \leq$ eDRX_IDLE cycle length \leq 2621.44	0.32	≥ 1.28 (1)	Note 3 (23)	0.96 (3)	Note 3 (9)
	0.64	≥ 2.56 (2)		1.92 (3)	Note 3 (9)
	1.28	≥ 3.84 (3)		3.84 (3)	Note 3 (9)
	2.56	≥ 7.68 (6)		7.68 (3)	Note 3 (9)
NOTE 1: The number of DRX cycles in this table is given for the DRX cycles within PTWs. NOTE 2: The eDRX_IDLE cycle lengths are as specified in Section 10.5.5.32 of TS 24.008 [34]. NOTE 3: The time is calculated depending on the number N of DRX cycles as follows: $eDRX_cycle_length \times \left\lceil \frac{N}{\lceil PTW / DRX_cycle_length \rceil} \right\rceil$					
NOTE 4: Number of eDRX cycles when eDRX_IDLE cycle length equals 5.12s, number of DRX cycles otherwise.					

For higher priority cells, a UE may optionally use a shorter value for $T_{\text{measureUTRA_FDD}}$, which shall not be less than $\text{Max}(0.64 \text{ s, one DRX cycle})$.

4.2.2.5.2 Measurements of UTRAN TDD cells

When the measurement rules indicate that UTRA TDD cells are to be measured, the UE shall measure P-CCPCH RSCP of detected UTRA TDD cells in the neighbour frequency list at the minimum measurement rate specified in this section. The UE shall filter P-CCPCH RSCP measurements of each measured UTRA TDD cell using at least 2 measurements.

Within the set of measurements used for the filtering, at least two measurements shall be spaced by at least half the minimum specified measurement period. If the UE is not configured with eDRX_IDLE cycle, P-CCPCH RSCP of UTRAN TDD cells shall not be filtered over a longer period than that specified in table 4.2.2.5.2-1. If the UE is configured with eDRX_IDLE cycle, P-CCPCH RSCP of UTRAN TDD cells shall not be filtered over a longer period than that specified in table 4.2.2.5.2-2.

If the UE is not configured with eDRX_IDLE cycle or configured with eDRX_IDLE cycle not longer than 20.48 s, the UE shall evaluate whether newly detectable UTRA TDD cells in normal performance group have met the reselection criteria in TS 36.304 within time $N_{\text{UTRA_carrier_TDD,normal}} * T_{\text{detectUTRA_TDD}}$, and evaluate whether newly detectable UTRA TDD cells in reduced performance group have met the reselection criteria in TS 36.304 within time $6 * N_{\text{UTRA_carrier_TDD,reduced}} * T_{\text{detectUTRA_TDD}}$ when $S_{\text{rxlev}} \leq S_{\text{nonIntraSearchP}}$ or $S_{\text{qual}} \leq S_{\text{nonIntraSearchQ}}$ when $T_{\text{reselection}} = 0$ provided that the reselection criteria is met by a margin of at least 6dB. If the UE is configured with eDRX_IDLE cycle longer than 20.48 s, the UE shall evaluate whether newly detectable UTRA TDD cells in normal performance group have met the reselection criteria in TS 36.304 within time $(N_{\text{UTRA_carrier_TDD,normal}}) * T_{\text{detectUTRA_TDD}}$, and when $S_{\text{rxlev}} < 3$ dB or $S_{\text{qual}} < 3$ dB evaluate whether newly detectable UTRA TDD cells in reduced performance group have met the reselection criteria in TS 36.304 within time $6 * N_{\text{UTRA_carrier_TDD,reduced}} * T_{\text{detectUTRA_TDD}}$ when $S_{\text{rxlev}} \leq S_{\text{nonIntraSearchP}}$ or $S_{\text{qual}} \leq S_{\text{nonIntraSearchQ}}$ when $T_{\text{reselection}} = 0$ provided that the reselection criteria is met by a margin of at least 6dB.

If the UE is not configured with eDRX_IDLE cycle or configured with eDRX_IDLE cycle not longer than 20.48 s, cells which have been detected shall be measured at least every $N_{\text{UTRA_carrier_TDD,normal}} * T_{\text{measureUTRA_TDD}}$ for the cells in normal performance group, and at least every $6 * N_{\text{UTRA_carrier_TDD,reduced}} * T_{\text{measureUTRA_TDD}}$ for the cells in reduced performance group, when $S_{\text{rxlev}} \leq S_{\text{nonIntraSearchP}}$ or $S_{\text{qual}} \leq S_{\text{nonIntraSearchQ}}$. If the UE is configured with eDRX_IDLE cycle longer than 20.48 s, cells which have been detected shall be measured at least every $(N_{\text{UTRA_carrier_TDD,normal}}) * T_{\text{measureUTRA_TDD}}$ for the cells in normal performance group, and when $S_{\text{rxlev}} < 3$ dB or $S_{\text{qual}} < 3$ dB at least every $6 * N_{\text{UTRA_carrier_TDD,reduced}} * T_{\text{measureUTRA_TDD}}$ for the cells in reduced performance group, when $S_{\text{rxlev}} \leq S_{\text{nonIntraSearchP}}$ or $S_{\text{qual}} \leq S_{\text{nonIntraSearchQ}}$.

When higher priority UTRA TDD cells are found by the higher priority search, they shall be measured at least every $T_{\text{measureUTRA_TDD}}$. If, after detecting a cell in a higher priority search, it is determined that reselection has not occurred then the UE is not required to continuously measure the detected cell to evaluate the ongoing possibility of reselection. However, the minimum measurement filtering requirements specified later in this clause shall still be met by the UE before it makes any determination that it may stop measuring the cell.

If the UE is not configured with eDRX_IDLE cycle or configured with eDRX_IDLE cycle not longer than 20.48 s, for a cell that has been already detected, but that has not been reselected to, the filtering shall be such that the UE shall be capable of evaluating that an already identified UTRA TDD cell has met reselection criterion defined in [1] within $N_{\text{UTRA_carrier_TDD,normal}} * T_{\text{evaluateUTRA_TDD}}$ if the cell is in normal performance group and within $6 * N_{\text{UTRA_carrier_TDD,reduced}} * T_{\text{evaluateUTRA_TDD}}$ if the cell is in reduced performance group when $T_{\text{reselection}} = 0$ provided that the reselection criteria is met by a margin of at least 6dB. If the UE is configured with eDRX_IDLE cycle longer than 20.48 s, for a cell that has been already detected, but that has not been reselected to, the filtering shall be such that the UE shall be capable of evaluating that an already identified UTRA TDD cell has met reselection criterion defined in [1] within $N_{\text{UTRA_carrier_TDD,normal}} * T_{\text{evaluateUTRA_TDD}}$ if the cell is in normal performance group and when $S_{\text{rxlev}} < 3$ dB or $S_{\text{qual}} < 3$ dB within $6 * N_{\text{UTRA_carrier_TDD,reduced}} * T_{\text{evaluateUTRA_TDD}}$ if the cell is in reduced performance group when $T_{\text{reselection}} = 0$ provided that the reselection criteria is met by a margin of at least 6dB.

If $T_{\text{reselection}}$ timer has a non zero value and the UTRA TDD cell is satisfied with the reselection criteria which are defined in [1], the UE shall evaluate this UTRA TDD cell for the $T_{\text{reselection}}$ time. If this cell remains satisfied with the reselection criteria within this duration, then the UE shall reselect that cell.

For UE not configured with eDRX_IDLE cycle, $T_{\text{detectUTRA_TDD}}$, $T_{\text{measureUTRA_TDD}}$ and $T_{\text{evaluateUTRA_TDD}}$ are specified in Table 4.2.2.5.2-1. For UE configured with eDRX_IDLE cycle, $T_{\text{detectUTRA_TDD}}$, $T_{\text{measureUTRA_TDD}}$ and $T_{\text{evaluateUTRA_TDD}}$ are specified in Table 4.2.2.5.2-2, where the requirements apply provided that the serving cell is configured with eDRX_IDLE and is the same in all PTWs during any of $T_{\text{detectUTRA_TDD}}$, $T_{\text{measureUTRA_TDD}}$ and $T_{\text{evaluateUTRA_TDD}}$ when multiple PTWs are used.

Table 4.2.2.5.2-1: $T_{\text{detectUTRA_TDD}}$, $T_{\text{measureUTRA_TDD}}$ and $T_{\text{evaluateUTRA_TDD}}$

DRX cycle length [s]	$T_{\text{detectUTRA_TDD}}$ [s]	$T_{\text{measureUTRA_TDD}}$ [s] (number of DRX cycles)	$T_{\text{evaluateUTRA_TDD}}$ [s] (number of DRX cycles)
0.32	30	5.12 (16)	15.36 (48)
0.64		5.12 (8)	15.36 (24)
1.28		6.4(5)	19.2 (15)
2.56	60	7.68 (3)	23.04 (9)

Table 4.2.2.5.2-2: $T_{\text{detectUTRA_TDD}}$, $T_{\text{measureUTRA_TDD}}$ and $T_{\text{evaluateUTRA_TDD}}$ for UE configured with eDRX_IDLE cycle

eDRX_IDLE cycle length [s]	DRX cycle length [s]	PTW length [s] (number of 1.28s periods)	$T_{\text{detectUTRA_TDD}}$ [s] (number of DRX or eDRX cycles ^{Note 4})	$T_{\text{measureUTRA_TDD}}$ [s] (number of DRX or eDRX cycles ^{Note 4})	$T_{\text{evaluateUTRA_TDD}}$ [s] (number of DRX or eDRX cycles ^{Note 4})
5.12	N/A	N/A	117.76 (23)	15.36 (3)	46.08 (9)
10.24 ≤ eDRX_IDLE cycle length ≤ 2621.44	0.32	≥1.28 (1)	Note 3 (23)	0.96 (3)	Note 3 (9)
	0.64	≥2.56 (2)		1.92 (3)	Note 3 (9)
	1.28	≥3.84 (3)		3.84 (3)	Note 3 (9)
	2.56	≥7.68 (6)		7.68 (3)	Note 3 (9)
NOTE 1: The number of DRX cycles in this table is given for the DRX cycles within PTWs. NOTE 2: The eDRX_IDLE cycle lengths are as specified in Section 10.5.5.32 of TS 24.008 [34]. NOTE 3: The time is calculated depending on the number N of DRX cycles as follows: $eDRX_cycle_length \times \left\lceil \frac{N}{PTW / DRX_cycle_length} \right\rceil$ NOTE 4: Number of eDRX cycles when eDRX_IDLE cycle length equals 5.12s, number of DRX cycles otherwise.					

For higher priority cells, a UE may optionally use a shorter value for $T_{\text{measureUTRA_TDD}}$, which shall not be less than Max(0.64 s, one DRX cycle).

4.2.2.5.3 Measurements of GSM cells

When the measurement rules defined in [1] indicate that E-UTRAN inter-frequencies or inter-RAT frequency cells are to be measured, the UE shall measure the signal level of the GSM BCCH carriers if the GSM BCCH carriers are indicated in the measurement control system information of the serving cell. GSM BCCH carriers of lower priority than the serving cell shall be measured at least every $T_{\text{measure,GSM}}$.

When higher priority GSM BCCH carriers are found by the higher priority search, they shall be measured at least every $T_{\text{measure,GSM}}$, and the UE shall decode the BSIC of the GSM BCCH carrier. If, after detecting a cell in a higher priority search, it is determined that reselection has not occurred then the UE is not required to continuously measure the detected cell to evaluate the ongoing possibility of reselection, or to continuously verify the BSIC of the GSM BCCH carrier every 30s. However, the minimum measurement filtering requirements specified later in this clause shall still be met by the UE before it makes any determination that it may stop measuring the cell.

The UE shall maintain a running average of 4 measurements for each GSM BCCH carrier. The measurement samples for each cell shall be as far as possible uniformly distributed over the averaging period.

If continuous GSM measurements are required by the measurement rules in [1], the UE shall attempt to verify the BSIC at least every 30 seconds for each of the 4 strongest GSM BCCH carriers. If a change of BSIC is detected for one GSM cell then that GSM BCCH carrier shall be treated as a new GSM neighbour cell. If the UE detects on a BCCH carrier a BSIC which is indicated as not allowed for that carrier in the measurement control system information of the serving cell, the UE is not required to perform BSIC re-confirmation for that cell.

The UE shall not consider the GSM BCCH carrier in cell reselection, if the UE cannot demodulate the BSIC of that GSM BCCH carrier. Additionally, the UE shall not consider a GSM neighbour cell in cell reselection, if it is indicated as not allowed in the measurement control system information of the serving cell.

If $T_{\text{reselection}}$ timer has a non zero value and the GSM cell is satisfied with the reselection criteria which are defined in [1], the UE shall evaluate this GSM cell for the $T_{\text{reselection}}$ time. If this cell remains satisfied with the reselection criteria within this duration, then the UE shall reselect that cell.

For UE not configured with eDRX_IDLE cycle, $T_{\text{measure,GSM}}$ is specified in Table 4.2.2.5.3-1. For UE configured with eDRX_IDLE cycle, $T_{\text{measure,GSM}}$ is specified in Table 4.2.2.5.3-2, where the requirements apply provided that the serving cell is configured with eDRX_IDLE and is the same in all PTWs during $T_{\text{measure,GSM}}$ when multiple PTWs are used.

Table 4.2.2.5.3-1: $T_{\text{measure,GSM}}$

DRX cycle length [s]	$T_{\text{measure,GSM}}$ [s] (number of DRX cycles)
----------------------	---

0.32	5.12 (16)
0.64	5.12 (8)
1.28	6.4(5)
2.56	7.68 (3)

Table 4.2.2.5.3-2: $T_{\text{measure,GSM}}$ for UE configured with eDRX_IDLE cycle

eDRX_IDLE cycle length [s]	DRX cycle length [s]	PTW length [s] (number of 1.28s periods)	$T_{\text{measure,GSM}}$ [s] (number of DRX or eDRX cycles Note 3)
5.12	N/A	N/A	15.36 (3)
$10.24 \leq$ eDRX_IDLE cycle length ≤ 2621.44	0.32	≥ 1.28 (1)	0.96 (3)
	0.64	≥ 2.56 (2)	1.92 (3)
	1.28	≥ 3.84 (3)	3.84 (3)
	2.56	≥ 7.68 (6)	7.68 (3)
NOTE 1: The number of DRX cycles in this table is given for the DRX cycles within PTWs. NOTE 2: The eDRX_IDLE cycle lengths are as specified in Section 10.5.5.32 of TS 24.008 [34]. NOTE 3: Number of eDRX cycles when eDRX_IDLE cycle length equals 5.12s, number of DRX cycles otherwise.			

4.2.2.5.4 Measurements of HRPD cells

In order to perform measurement and cell reselection to HRPD cell, the UE shall acquire the timing of HRPD cells.

When the measurement rules indicate that HRPD cells are to be measured, the UE shall measure CDMA2000 HRPD Pilot Strength of HRPD cells in the neighbour cell list at the minimum measurement rate specified in this section.

The parameter ‘Number of HRPD Neighbor Frequency’, which is transmitted on E-UTRAN BCCH, is the number of carriers used for all HRPD cells in the neighbour cell list.

When the E-UTRA serving cell fulfils $S_{\text{rxlev}} > S_{\text{nonIntraSearchP}}$ and $S_{\text{qual}} > S_{\text{nonIntraSearchQ}}$, the UE shall search for CDMA2000 HRPD layers of higher priority at least every $T_{\text{higher_priority_search}}$ where $T_{\text{higher_priority_search}}$ is defined in clause 4.2.2.

For CDMA2000 HRPD cells which have been detected, the UE shall measure CDMA2000 HRPD Pilot Strength at least every (Number of HRPD Neighbor Frequency)* $T_{\text{measureHRPD}}$, when the E-UTRA serving cell $S_{\text{rxlev}} \leq S_{\text{nonIntraSearchP}}$ or $S_{\text{qual}} \leq S_{\text{nonIntraSearchQ}}$.

The UE shall be capable of evaluating that the CDMA2000 HRPD cell has met cell reselection criterion defined in [1] within $T_{\text{evaluateHRPD}}$.

For UE not configured with eDRX_IDLE cycle, Table 4.2.2.5.4-1 gives values of $T_{\text{measureHRPD}}$ and $T_{\text{evaluateHRPD}}$. For UE configured with eDRX_IDLE cycle, $T_{\text{measureHRPD}}$ and $T_{\text{evaluateHRPD}}$ are specified in Table 4.2.2.5.4-2, where the requirements apply provided that the serving cell is configured with eDRX_IDLE and is the same in all PTWs during any of $T_{\text{measureHRPD}}$ and $T_{\text{evaluateHRPD}}$ when multiple PTWs are used.

Table 4.2.2.5.4-1: $T_{\text{measureHRPD}}$ and $T_{\text{evaluateHRPD}}$

DRX cycle length [s]	$T_{\text{measureHRPD}}$ [s] (number of DRX cycles)	$T_{\text{evaluateHRPD}}$ [s] (number of DRX cycles)
0.32	5.12 (16)	15.36 (48)
0.64	5.12 (8)	15.36 (24)
1.28	6.4 (5)	19.2 (15)
2.56	7.68 (3)	23.04 (9)

Table 4.2.2.5.4-2: $T_{\text{measureHRPD}}$ and $T_{\text{evaluateHRPD}}$ for UE configured with eDRX_IDLE cycle

eDRX_IDLE cycle length [s]	DRX cycle length [s]	PTW length [s] (number of 1.28s periods)	$T_{\text{measureHRPD}}$ [s] (number of DRX or eDRX cycles ^{Note 4)})	$T_{\text{evaluateHRPD}}$ [s] (number of DRX or eDRX cycles ^{Note 4)})
5.12	N/A	N/A	15.36 (3)	46.08 (9)
10.24 ≤ eDRX_IDLE cycle length ≤ 2621.44	0.32	≥1.28 (1)	0.96 (3)	Note 3 (9)
	0.64	≥2.56 (2)	1.92 (3)	Note 3 (9)
	1.28	≥3.84 (3)	3.84 (3)	Note 3 (9)
	2.56	≥7.68 (6)	7.68 (3)	Note 3 (9)
NOTE 1: The number of DRX cycles in this table is given for the DRX cycles within PTWs. NOTE 2: The eDRX_IDLE cycle lengths are as specified in Section 10.5.5.32 of TS 24.008 [34]. NOTE 3: The time is calculated depending on the number N of DRX cycles as follows: $eDRX_cycle_length \times \left\lceil \frac{N}{\lceil PTW / DRX_cycle_length \rceil} \right\rceil$ NOTE 4: Number of eDRX cycles when eDRX_IDLE cycle length equals 5.12s, number of DRX cycles otherwise.				

If $T_{\text{reselection}}$ timer has a non zero value and the CDMA2000 HRPD cell is satisfied with the reselection criteria which are defined in [1], the UE shall evaluate this CDMA2000 HRPD cell for the $T_{\text{reselection}}$ time. If this cell remains satisfied with the reselection criteria within this duration, then the UE shall reselect that cell.

4.2.2.5.5 Measurements of cdma2000 1X

In order to perform measurement and cell reselection to cdma2000 1X cell, the UE shall acquire the timing of cdma2000 1X cells.

When the measurement rules indicate that cdma2000 1X cells are to be measured, the UE shall measure cdma2000 1x RTT Pilot Strength of cdma2000 1X cells in the neighbour cell list at the minimum measurement rate specified in this section.

The parameter ‘Number of CDMA2000 1X Neighbor Frequency’, which is transmitted on E-UTRAN BCCH, is the number of carriers used for all cdma2000 1X cells in the neighbour cell list.

When the E-UTRA serving cell fulfils $S_{rxlev} > S_{\text{nonIntraSearchP}}$ and $S_{qual} > S_{\text{nonIntraSearchQ}}$, the UE shall search for cdma2000 1X layers of higher priority at least every $T_{\text{higher_priority_search}}$ where $T_{\text{higher_priority_search}}$ is defined in clause 4.2.2.

For CDMA2000 1X cells which have been detected, the UE shall measure CDMA2000 1xRTT Pilot Strength at least every (Number of CDMA2000 1X Neighbor Frequency)* $T_{\text{measureCDMA2000_1X}}$, when the E-UTRA serving cell $S_{rxlev} \leq S_{\text{nonIntraSearchP}}$ or $S_{qual} \leq S_{\text{nonIntraSearchQ}}$. The UE shall be capable of evaluating that the cdma2000 1X cell has met cell reselection criterion defined in [1] within $T_{\text{evaluateCDMA2000_1X}}$.

For UE not configured with eDRX_IDLE cycle, Table 4.2.2.5.5-1 gives values of $T_{\text{measureCDMA2000_1X}}$ and $T_{\text{evaluateCDMA2000_1X}}$. For UE configured with eDRX_IDLE cycle, $T_{\text{measureCDMA2000_1X}}$ and $T_{\text{evaluateCDMA2000_1X}}$ are specified in Table 4.2.2.5.5-2 where the requirements apply provided that the serving cell is configured with eDRX_IDLE and is the same in all PTWs during any of $T_{\text{measureCDMA2000_1X}}$ and $T_{\text{evaluateCDMA2000_1X}}$ when multiple PTWs are used.

Table 4.2.2.5.5-1: $T_{\text{measureCDMA2000_1X}}$ and $T_{\text{evaluateCDMA2000_1X}}$

DRX cycle length [s]	$T_{\text{measureCDMA2000_1X}}$ [s] (number of DRX cycles)	$T_{\text{evaluateCDMA2000_1X}}$ [s] (number of DRX cycles)
0.32	5.12 (16)	15.36 (48)
0.64	5.12 (8)	15.36 (24)
1.28	6.4 (5)	19.2 (15)
2.56	7.68 (3)	23.04 (9)

Table 4.2.2.5.5-2: $T_{\text{measureCDMA2000_1X}}$ and $T_{\text{evaluateCDMA2000_1X}}$ for UE configured with eDRX_IDLE cycle

eDRX_IDLE cycle length [s]	DRX cycle length [s]	PTW length [s] (number of 1.28s periods)	$T_{\text{measureCDMA2000_1X}}$ [s] (number of DRX or eDRX cycles ^{Note 4})	$T_{\text{evaluateCDMA2000_1X}}$ [s] (number of DRX or eDRX cycles ^{Note 4})
5.12	N/A	N/A	15.36 (3)	46.08 (9)
10.24 ≤ eDRX_IDLE cycle length ≤ 2621.44	0.32	≥1.28 (1)	0.96 (3)	Note 3 (9)
	0.64	≥2.56 (2)	1.92 (3)	Note 3 (9)
	1.28	≥3.84 (3)	3.84 (3)	Note 3 (9)
	2.56	≥7.68 (6)	7.68 (3)	Note 3 (9)
<p>NOTE 1: The number of DRX cycles in this table is given for the DRX cycles within PTWs.</p> <p>NOTE 2: The eDRX_IDLE cycle lengths are as specified in Section 10.5.5.32 of TS 24.008 [34].</p> <p>NOTE 3: The time is calculated depending on the number N of DRX cycles as follows: $eDRX_cycle_length \times \left\lceil \frac{N}{PTW / DRX_cycle_length} \right\rceil$</p> <p>NOTE 4: Number of eDRX cycles when eDRX_IDLE cycle length equals 5.12s, number of DRX cycles otherwise.</p>				

If $T_{\text{reselection}}$ timer has a non zero value and the CDMA2000 1X cell is satisfied with the reselection criteria which are defined in [1], the UE shall evaluate this CDMA2000 1X cell for the $T_{\text{reselection}}$ time. If this cell remains satisfied with the reselection criteria within this duration, then the UE shall reselect that cell.

4.2.2.5.6 Measurements of NR cells

If $S_{\text{rxlev}} > S_{\text{nonIntraSearchP}}$ and $S_{\text{qual}} > S_{\text{nonIntraSearchQ}}$ then the UE shall search for inter-RAT NR layers of higher priority at least every $T_{\text{higher_priority_search}}$ where $T_{\text{higher_priority_search}}$ is described in clause 4.2.2.

If $S_{\text{rxlev}} \leq S_{\text{nonIntraSearchP}}$ or $S_{\text{qual}} \leq S_{\text{nonIntraSearchQ}}$ then the UE shall search for and measure inter-RAT NR layers of higher, lower priority in preparation for possible reselection. In this scenario, the minimum rate at which the UE is required to search for and measure higher priority inter-RAT NR layers shall be the same as that defined below for lower priority RATs.

The requirements in this section apply for inter-RAT NR measurements. When the measurement rules indicate that inter-RAT NR cells are to be measured, the UE shall measure SS-RSRP and SS-RSRQ of detected NR cells in the neighbour frequency list at the minimum measurement rate specified in this section. The parameter $N_{\text{NR_carrier}}$ is the total number of configured NR carriers in the neighbour frequency list. The UE shall filter SS-RSRP and SS-RSRQ measurements of each measured NR cell using at least 2 measurements. Within the set of measurements used for the filtering, at least two measurements shall be spaced by at least half the minimum specified measurement period.

The UE shall be able to evaluate whether a newly detectable inter-RAT NR cell meets the reselection criteria defined in TS 36.304 [1] within $(N_{\text{NR_carrier}}) * T_{\text{detectNR}}$ when $S_{\text{rxlev}} \leq S_{\text{nonIntraSearchP}}$ or $S_{\text{qual}} \leq S_{\text{nonIntraSearchQ}}$ when $T_{\text{reselection}} = 0$ provided that the reselection criteria is met by a margin of at least 6 dB in FR1 or 7.5 dB in FR2 for SS-RSRP reselections based on absolute priorities or 4 dB in FR1 and 4 dB in FR2 for SS-RSRQ reselections based on absolute priorities.

When higher priority cells are found by the higher priority search, they shall be measured at least every $T_{\text{measure,NR}}$. If, after detecting a cell in a higher priority search, it is determined that reselection has not occurred then the UE is not required to continuously measure the detected cell to evaluate the ongoing possibility of reselection. However, the minimum measurement filtering requirements specified later in this section shall still be met by the UE before it makes any determination that it may stop measuring the cell.

If the UE detects on an inter-RAT NR carrier a cell whose physical identity is indicated as not allowed for that carrier in the measurement control system information of the serving cell, the UE is not required to perform measurements on that cell.

The UE shall not consider an inter-RAT NR cell in cell reselection, if it is indicated as not allowed in the measurement control system information of the serving cell.

Cells which have been detected shall be measured at least every $(N_{NR_carrier}) * T_{measureNR}$ when $S_{rxlev} \leq S_{nonIntraSearchP}$ or $S_{qual} \leq S_{nonIntraSearchQ}$.

For a cell that has been already detected, but that has not been reselected to, the filtering shall be such that the UE shall be capable of evaluating that an already identified inter-RAT NR cell has met reselection criterion defined in TS 36.304 [1] within $(N_{NR_carrier}) * T_{evaluateNR}$ when $T_{reselection} = 0$ as specified in Table 4.2.2.5.6-1 provided that the reselection criteria is met by a margin of at least 6 dB in FR1 or 7.5 dB in FR2 for SS-RSRP reselections based on absolute priorities or 4 dB in FR1 and 4 dB in FR2 for SS-RSRQ reselections based on absolute priorities.

If $T_{reselection}$ timer has a non zero value and the inter-RAT NR cell is satisfied with the reselection criteria which are defined in TS 36.304 [1], the UE shall evaluate this NR cell for the $T_{reselection}$ time. If this cell remains satisfied with the reselection criteria within this duration, then the UE shall reselect that cell.

Table 4.2.2.5.6-1: $T_{detect, NR}$, $T_{measureNR}$, and $T_{evaluate, NR}$

DRX cycle length [s]	Scaling Factor (N1)		$T_{detect, NR}$ [s] (number of DRX cycles)	$T_{measure, NR}$ [s] (number of DRX cycles)	$T_{evaluate, NR}$ [s] (number of DRX cycles)
	FR1	FR2 ^{Note1}			
0.32	1	8	$11.52 \times 1.5 \times N1$ ($36 \times 1.5 \times N1$)	$1.28 \times 1.5 \times N1$ ($4 \times 1.5 \times N1$)	$5.12 \times 1.5 \times N1$ ($16 \times 1.5 \times N1$)
0.64		5	$17.92 \times N1$ ($28 \times N1$)	$1.28 \times N1$ ($2 \times N1$)	$5.12 \times N1$ ($8 \times N1$)
1.28		4	$32 \times N1$ ($25 \times N1$)	$1.28 \times N1$ ($1 \times N1$)	$6.4 \times N1$ ($5 \times N1$)
2.56		3	$58.88 \times N1$ ($23 \times N1$)	$2.56 \times N1$ ($1 \times N1$)	$7.68 \times N1$ ($3 \times N1$)
NOTE 1: Applies for UE supporting power class 2&3&4. For UE supporting power class 1, $N1 = 8$ for all DRX cycle length.					

4.2.2.6 Evaluation of cell re-selection criteria

The UE shall evaluate the intra-frequency, inter-frequency and inter-RAT cell reselection criteria defined in [1] at least every DRX cycle. When a non zero value of $T_{reselection}$ is used, the UE shall only perform reselection on an evaluation which occurs simultaneously to, or later than the expiry of the $T_{reselection}$ timer.

For UE configured with eDRX_IDLE cycle, the cell reselection criteria shall be evaluated within at least every DRX cycle within the PTW.

4.2.2.7 Maximum interruption in paging reception

UE shall perform the cell re-selection with minimum interruption in monitoring downlink channels for paging reception. When the UE is configured with eDRX_IDLE cycle, the UE shall not miss any paging in a PTW provided the paging is sent in at least 2 DRX cycles before the end of that PTW.

At intra-frequency and inter-frequency cell re-selection, the UE shall monitor the downlink of serving cell for paging reception until the UE is capable to start monitoring downlink channels of the target intra-frequency and inter-frequency cell for paging reception. The interruption time shall not exceed $T_{SI-UTRA} + 50$ ms.

At inter-RAT cell re-selection, the UE shall monitor the downlink of serving cell for paging reception until the UE is capable to start monitoring downlink channels for paging reception of the target inter-RAT cell. For E-UTRAN to UTRA cell re-selection the interruption time must not exceed $T_{SI-UTRA} + 50$ ms. For E-UTRAN to GSM cell re-selection the interruption time must not exceed $T_{BCCH} + 50$ ms. For E-UTRAN to NR cell re-selection the interruption time must not exceed $T_{SI-NR} + 2 * T_{target_cell_SMTC_period}$ ms.

$T_{SI-UTRA}$ is the time required for receiving all the relevant system information data according to the reception procedure and the RRC procedure delay of system information blocks defined in TS 36.331 [2] for a E-UTRAN cell.

$T_{SI-UTRA}$ is the time required for receiving all the relevant system information data according to the reception procedure and the RRC procedure delay of system information blocks defined in [7] for a UTRAN cell.

T_{BCCH} is the maximum time allowed to read BCCH data from a GSM cell defined in [8].

$T_{\text{SI-NR}}$ is the time required for receiving all the relevant system information data according to the reception procedure and the RRC procedure delay of system information blocks defined in TS 38.331 [38] for an NR cell.

$T_{\text{target_cell_SMTC_period}}$ is the periodicity of the SMTC occasions configured for the target NR cell. $T_{\text{target_cell_SMTC_period}} = 5\text{ms}$ if *measTimingConfig-r15* is not configured.

These requirements assume sufficient radio conditions, so that decoding of system information can be made without errors and does not take into account cell re-selection failure.

At cell re-selection to HRPD, the UE shall monitor the downlink of serving cell for paging reception until the UE is capable of starting to monitor downlink channels for paging reception of the target HRPD cell. For HRPD cell re-selection the interruption time must not exceed $T_{\text{SI-HRPD}} + 50\text{ ms}$.

$T_{\text{SI-HRPD}}$ is the time required for receiving all the relevant system information data according to the reception procedure and the upper layer (Layer 3) procedure delay of system information blocks defined in [11] in for HRPD cell.

At cell re-selection to cdma2000 1X, the UE shall monitor the downlink of serving cell for paging reception until the UE is capable of starting to monitor downlink channels for paging reception of the target cdma2000 1X cell. For cdma2000 1X cell re-selection the interruption time must not exceed $T_{\text{SI-cdma2000_1X}} + 50\text{ ms}$.

$T_{\text{SI-cdma2000_1X}}$ is the time required for receiving all the relevant system information data according to the reception procedure and the upper layer (Layer 3) procedure delay of system information blocks defined in [15] for cdma2000 1X cell.

For any requirement in this section, when the UE transitions between any two states when being configured with eDRX_IDLE, being configured with eDRX_IDLE cycle, changing eDRX_IDLE cycle length, or changing PTW configuration, the UE shall meet the transition requirement, which is the less stringent requirement of the two requirements corresponding to the first state and the second state, during the transition time interval which is the time corresponding to the transition requirement. After the transition time interval, the UE has to meet the requirement corresponding to the second state.

4.2.2.8 void

4.2.2.9 UE measurement capability

For idle mode cell re-selection purposes, the UE shall be capable of monitoring at least:

- Intra-frequency carrier, and
- Depending on UE capability, 3 FDD E-UTRA inter-frequency carriers, and
- Depending on UE capability, 3 TDD E-UTRA inter-frequency carriers, and
- Depending on UE capability, 3 FDD UTRA carriers, and
- Depending on UE capability, 3 TDD UTRA carriers, and
- Depending on UE capability, 32 GSM carriers, and
- Depending on UE capability, 3 cdma2000 1x carriers, and
- Depending on UE capability, 3 HRPD carriers.
- Depending on UE capability, 8 NR inter-RAT carriers.

In addition to the requirements defined above, a UE supporting E-UTRA measurements and any of the above inter-RAT measurements excluding NR measurements in RRC_IDLE state shall be capable of monitoring a total of at least 8 carrier frequency layers, which includes serving layer, comprising of any above defined combination of E-UTRA FDD, E-UTRA TDD, UTRA FDD, UTRA TDD, GSM (one GSM layer corresponds to 32 cells), cdma2000 1x and HRPD layers.

In addition to the requirements defined above, the UE which supports E-UTRA measurements and any of the above inter-RAT measurements including NR measurements in RRC_IDLE state shall be capable of monitoring a total of at least 10 effective carrier frequency layers, which includes serving layer, comprising of any above defined combination

of E-UTRA FDD, E-UTRA TDD, UTRA FDD, UTRA TDD, GSM (one GSM layer corresponds to 32 carriers), cdma2000 1x, HRPD and NR layers.

4.2.2.9a UE measurement capability (Increased UE carrier monitoring)

UE which support Increased UE carrier monitoring E-UTRA according to the capabilities in [2,31] shall be capable of monitoring at least

- Depending on UE capability, 8 FDD E-UTRA inter-frequency carriers, and
- Depending on UE capability, 8 TDD E-UTRA inter-frequency carriers

UE which support increased UE carrier monitoring UTRA according to the capabilities in [2,31] shall additionally be capable of monitoring at least

- Depending on UE capability, 6 FDD UTRA carriers, and
- Depending on UE capability, 7 TDD UTRA carriers, and

In addition to the requirements defined above, a UE supporting E-UTRA measurements in RRC_IDLE state and supporting Increased UE carrier monitoring E-UTRA or increased UE carrier monitoring UTRA according to the capabilities in [2,31] shall be capable of monitoring a total of at least 13 carrier frequency layers, which includes serving layer, comprising of any above defined combination of E-UTRA FDD, E-UTRA TDD, UTRA FDD, UTRA TDD, GSM (one GSM layer corresponds to 32 cells), cdma2000 1x and HRPD layers.

In addition to the requirements defined above, the UE which indicates support for Increased UE carrier monitoring E-UTRA or increased UE carrier monitoring UTRA according to the capabilities in [2,31], and also supports standalone NR, shall be capable of monitoring a total of at least 15 carrier frequency layers comprising of any above defined combination of E-UTRA FDD, E-UTRA TDD, UTRA FDD, UTRA TDD, GSM (one GSM layer corresponds to 32 carriers), cdma2000 1x, HRPD and NR layers.

The requirements in this section apply for UE regardless of their capability to support eDRX_IDLE.

4.2.2.10 Reselection to CSG cells

Note: Requirements in this clause are minimum requirements defined to ensure the testability of autonomous CSG search. Further information on autonomous search times in practical deployments is available in [25].

Reselection from non CSG to CSG cells may be performed using UE autonomous search as defined in [1] when at least one CSG ID is included in the UE's CSG whitelist. The requirements in this clause are valid for reselection to CSG cells previously visited by the UE when the radio configuration parameters, including the carrier frequency and physical cell identity of the CSG cell, non CSG cell and other neighbour cells are unchanged from the most recent previous visit.

NOTE: According to [1], the UE autonomous search function, per UE implementation, determines when and/or where to search for allowed CSG cells.

4.2.2.10.1 Reselection from a non CSG to an inter-frequency CSG cell

The UE shall perform search and reselection to an allowed inter-frequency CSG cell that has met CSG reselection criterion defined in [1] and that is in its whitelist, within 6 minutes in the conditions shown in table 4.2.2.10.1-1. There is no need for statistical testing of this requirement.

Table 4.2.2.10.1-1: Parameters for CSG inter-frequency reselection

Parameter	Unit	Cell 1	Cell 2
EARFCN ^{Note1}		Channel 1	Channel 2
CSG indicator		False	True
Physical cell identity ^{Note1}		1	2
CSG identity		Not sent	Sent (Already stored in UE whitelist from previous visit)
Propagation conditions		Static, non multipath	

CSG cell previously visited by UE		Yes	
PBCH_RA	dB	0	0
PBCH_RB	dB		
PSS_RA	dB		
SSS_RA	dB		
PCFICH_RB	dB		
PHICH_RA	dB		
PHICH_RB	dB		
PDCCH_RA	dB		
PDCCH_RB	dB		
PDSCH_RA	dB		
PDSCH_RB	dB		
OCNG_RA ^{Note 1}	dB		
OCNG_RB ^{Note 1}	dB		
Qrxlevmin	dBm		
N_{oc}	dBm/15 kHz	Off	
RSRP ^{Note2}	dBm/15 KHz	-110	-110
<p>Note 1: For this requirement to be applicable, the EARFCN and physical cell identity for cell 1 and cell 2 shall be unchanged from when the CSG cell was visited previously</p> <p>Note 2: Chosen to ensure that CSG autonomous search has a high probability of success on every attempt made by UE</p>			

4.2.2.10.2 Reselection from a non CSG to an inter-RAT UTRAN FDD CSG cell

The UE shall perform search and reselection to an allowed inter-RAT UTRAN FDD CSG cell that has met CSG reselection criterion defined in [1] and that is in its whitelist, within 6 minutes in the conditions shown in table 4.2.2.10.2-1. There is no need for statistical testing of this requirement.

Table 4.2.2.10.2-1: Parameters for CSG inter-RAT UTRAN FDD reselection

Parameter	Unit	Cell 1	Cell 2
EARFCN ^{Note1}		Channel 1	N/A
UARFCN ^{Note1}		N/A	Channel 2
CSG indicator		False	True
Physical cell identity ^{Note1}		1	N/A
Primary scrambling code ^{Note1}		N/A	Scrambling code 2
CSG identity		Not sent	Sent (Already stored in UE whitelist from previous visit)
Propagation conditions		Static, non multipath	
CSG cell previously visited by UE		Yes	
PBCH_RA	dB	0	N/A
PBCH_RB	dB		
PSS_RA	dB		
SSS_RA	dB		
PCFICH_RB	dB		
PHICH_RA	dB		
PHICH_RB	dB		
PDCCH_RA	dB		
PDCCH_RB	dB		
PDSCH_RA	dB		
PDSCH_RB	dB		
OCNG_RA ^{Note 1}	dB		
OCNG_RB ^{Note 1}	dB		
Qrxlevmin	dBm		
N_{oc}	dBm/15 kHz	Off	
RSRP ^{Note2}	dBm/15 KHz	-110	

CPICH_RSCP ^{Note2}	dBm	N/A	-100
CPICH_Ec/Ior	dB		-10
PCCPCH_Ec/Ior	dB		-12
SCCPCH_Ec/Ior	dB		-12
AICH_Ec/Ior	dB		-15
SCH_Ec/Ior	dB		-15
PICH_Ec/Ior	dB		-15
I_{oc}	dBm/3.84 MHz		Off
Note 1:	For this requirement to be applicable, the EARFCN and physical cell identity for cell 1 and the UARFCN and scrambling code for cell 2 shall be unchanged from when the CSG cell was visited previously		
Note 2:	Chosen to ensure that CSG autonomous search has a high probability of success on every attempt made by UE		

4.2.2.11 Void

4.2.2.12 Void

4.2.2.13 Void

4.3 Minimization of Drive Tests (MDT)

UE supporting minimisation of drive tests in RRC_IDLE shall be capable of:

- logging measurements in RRC_IDLE, reporting the logged measurements and meeting requirements in this clause;
- logging of RRC connection establishment failure, reporting the logged failure and meeting requirements in this clause;
- logging of radio link failure and handover failure, reporting the logged failure and meeting requirements in this clause.

4.3.1 Introduction

The logged MDT requirements consist of measurement requirements as specified in clause 4.3.2 and relative time stamp accuracy requirements as specified in clause 4.3.3. Both sets of requirements are applicable for intra-frequency, inter-frequency and inter-RAT cases in RRC_IDLE state. The MDT procedures are described in [27].

For RRC connection establishment failure logging and reporting, the MDT requirements consist of requirements for measurements performed and logged in RRC_IDLE state specified in clause 4.3.2 and relative time stamp accuracy requirement for RRC connection establishment failure log reporting as specified in clause 4.3.4.

4.3.2 Measurements

The requirements specified in this clause apply for the measurements (GSM carrier RSSI, UTRA CPICH RSCP, UTRA CPICH Ec/Io, P-CCPCH RSCP for UTRA 1.28 TDD, E-UTRA RSRP, E-UTRA RSRQ, MBSFN RSRP, MBSFN RSRQ, and MCH BLER) performed and logged by the UE for MDT in RRC_IDLE. The requirements apply for the measurements included in logged MDT reports and RRC connection establishment failure reports.

4.3.2.1 Requirements

The measurement values that are used to meet

- serving cell and reselection requirements as specified in sections 4.2.2.1, 4.2.2.3, 4.2.2.4, 4.2.2.5,
- MBSFN measurement requirements as specified in section 4.4,

shall also apply to values logged for MDT measurements in RRC_IDLE state.

4.3.3 Relative Time Stamp Accuracy

The relative time stamp for a logged measurement is defined as the time from the moment the MDT configuration was received at the UE until the measurement was logged, see TS 36.331 [2].

4.3.3.1 Requirements

The accuracy of the relative time stamping is such that the drift of the time stamping shall be not more than ± 2 seconds per hour.

4.3.4 Relative Time Stamp Accuracy for RRC Connection Establishment Failure Log Reporting

Relative time stamp for RRC connection establishment failure log reporting is defined as the time elapsed from the last RRC connection establishment failure to the time when the log is included in the report TS 36.331 [2]. The UE shall report the RRC connection establishment failure log, while meeting the accuracy requirement specified in clause 4.3.4.1.

4.3.4.1 Requirements

The accuracy of the relative time stamping for RRC connection establishment failure log reporting is such that the drift of the time stamping shall not be larger than ± 0.72 seconds per hour and ± 10 seconds over 48 hours. The relative time stamp accuracy requirements shall apply provided that:

- no power off or detach occurs after the RRC connection establishment failure had been detected and until the log is time-stamped.

NOTE: This requirement does not need to be tested.

4.3.5 Relative Time Stamp Accuracy for Radio Link Failure and Handover Failure Log Reporting

The UE shall report the radio link and handover failure log, while meeting the accuracy requirements specified in this section.

4.3.5.1 Requirements for *timeSinceFailure*

Relative time stamp accuracy requirements for *timeSinceFailure* reported for MDT in a radio link failure or handover failure log are specified in this clause. *timeSinceFailure* determines the time elapsed from the last radio link failure or handover failure in E-UTRA to the time when the log is included in the report TS 36.331 [2].

The accuracy of the relative time stamping for *timeSinceFailure* is such that the drift of the time stamping shall not be larger than ± 0.72 seconds per hour and ± 10 seconds over 48 hours. These relative time stamp accuracy requirements shall apply provided that:

- no power off or detach occurs after the RLF or handover failure had been detected and until the log is time-stamped.

4.4 MBSFN Measurements

4.4.1 Introduction

The requirements specified in Section 4.4 apply for MBSFN measurements (MBSFN RSRP, MBSFN RSRQ, and MCH BLER defined in [4]), which are performed in RRC_IDLE state and logged for MDT by UEs which are MBMS-capable and also indicate their MBSFN measurement logging capability [2].

UE shall measure MBSFN RSRP, MBSFN RSRQ and MCH BLER only in subframes and on carriers where UE is decoding PMCH. The requirements are specified for any carrier where PMCH is received by UE. The requirements specified in this section apply for any carrier frequency with configured MBSFN subframes with PMCH, which may be the same as or different from any serving unicast carrier.

The UE receiving PMCH on any non-serving carrier and performing MBSFN measurements shall not cause interruptions on any serving carrier in the subframes with paging and non-MBSFN multicast transmissions such as system information.

4.4.2 MBSFN RSRP measurements

For UE in RRC_IDLE, the physical layer shall be capable of performing the MBSFN RSRP measurement [4] within the MBSFN RSRP measurement period and log the measurement, while meeting the MBSFN RSRP measurement accuracy requirements specified in section 9.8.2. The MBSFN RSRP measurement logging shall be according to the MBSFN RSRP measurement report mapping specified in Section 9.8.2.2.

The MBSFN RSRP measurement period is defined as MAX(640 ms, period during which the UE decodes [5, Section 10] 5 subframes containing PMCH transmissions).

The same requirement applies for UE configured with DRX or eDRX_IDLE.

4.4.3 MBSFN RSRQ measurements

For UE in RRC_IDLE, the physical layer shall be capable of performing the MBSFN RSRQ measurement [4] within the MBSFN RSRP measurement period and report the measurement, while meeting the MBSFN RSRQ measurement accuracy requirements specified in section 9.8.3. The MBSFN RSRQ measurement logging shall be according to the MBSFN RSRQ measurement report mapping specified in Section 9.8.3.2.

The MBSFN RSRQ measurement period is defined as MAX(640 ms, period during which the UE decodes [5, Section 10] 5 subframes containing PMCH transmissions).

The same requirement applies for UE configured with DRX or eDRX_IDLE.

4.4.4 MCH BLER measurements

The UE physical layer shall be capable of performing and logging the MCH BLER measurement [4] within the MCH BLER measurement period.

The MCH BLER measurement period is equal to the MBSFN logging interval configured by higher layers [2].

The MCH BLER logging shall be according to the MCH BLER measurement report mapping specified in Section 9.8.4.

The same requirement applies for UE configured with DRX or eDRX_IDLE.

4.5 Proximity-based Services

4.5.1 Introduction

This section contains the requirements for the UE capable of ProSe Direct Communication and/or ProSe Direct Discovery in RRC_IDLE state.

4.5.2 Requirements

When a UE in RRC_IDLE state is participating in transmissions and/or reception for ProSe Direct Discovery and/or ProSe Direct Communication, the UE shall meet all the requirements of Section 4.

Note: The UE may need to interrupt ProSe operation in order to meet the requirements of Section 4.

4.5.2.1 Interruptions with ProSe Direct Discovery

A UE capable of ProSe direct discovery in RRC_IDLE state shall not cause any interruption for the reception of paging and system information:

- while switching reception between ProSe Direct Discovery and a serving cell, or
- when receiving ProSe direct discovery signals or
- while switching receiver chain ON/OFF for ProSe Direct Discovery reception if the UE has a dedicated receiver chain for ProSe Direct Discovery

4.5.2.2 Interruptions with ProSe Direct Communication

A UE capable of ProSe direct communication in RRC_IDLE state shall not cause any interruption for the reception of paging and system information:

- while switching reception between ProSe Direct Communication and a serving cell, or
- when receiving ProSe direct communication signals, or
- while switching receiver chain ON/OFF for ProSe Direct Communications reception.

4.5.2.3 Initiation/Cease of SLSS transmissions with ProSe Direct Discovery

The requirements in this subclause are applicable to a UE capable of ProSe Direct Discovery and SLSS transmission and reception.

The requirements apply when the conditions for SLSS transmissions specified in [2] are met; *networkControlledSyncTx* is not configured; and *syncTxThreshIC* is included in *SystemInformationBlockType19*. The UE shall be capable of measuring the RSRP of the cell used to transmit ProSe Direct Discovery announcements and evaluate to initiate/cease SLSS transmissions within $T_{\text{evaluate,SLSS}}$ as specified in Table 4.5.2.3-1.

Table 4.5.2.3-1: $T_{\text{evaluate,SLSS}}$ with ProSe Direct Discovery

DRX cycle length [s]	$T_{\text{evaluate,SLSS}}$ [s] (number of DRX cycles)
0.32	1.92 (6)
0.64	3.84 (6)
1.28	7.68 (6)
2.56	15.36 (6)

For the cell used to transmit ProSe Direct Discovery announcements:

- RSRP related side conditions given in Sections 9.1.2.1 and 9.1.2.2 and RSRQ related side conditions given in Clause 9.1.5.1 are fulfilled for a corresponding Band,
- SCH_{RP} and SCH_{Es/Iot} according to Annex B.2.1 for a corresponding Band are fulfilled.

4.5.2.4 Initiation/Cease of SLSS transmissions with ProSe Direct Communication

The requirements in this subclause are applicable to a UE capable of ProSe Direct Communication.

The requirements apply when the conditions for SLSS transmissions specified in [2] are met; *networkControlledSyncTx* is not configured; and *syncTxThreshIC* is included in *SystemInformationBlockType18*. The UE shall be capable of measuring the RSRP of the cell used to transmit ProSe Direct Communication and evaluate to initiate/cease SLSS transmissions within $T_{\text{evaluate,SLSS}}$ as specified in Table 4.5.2.4-1.

Table 4.5.2.4-1: $T_{\text{evaluate,SLSS}}$ with ProSe Direct Communication

DRX cycle length [s]	$T_{\text{evaluate,SLSS}}$ [s] (number of DRX cycles)
0.32	1.92 (6)
0.64	3.84 (6)
1.28	7.68 (6)
2.56	15.36 (6)

For the cell used to transmit ProSe Direct Communication:

- RSRP related side conditions given in Sections 9.1.2.1 and 9.1.2.2 and RSRQ related side conditions given in Clause 9.1.5.1 for a corresponding Band are fulfilled,
- SCH_{RP} and SCH_{Es/Iot} according to Annex B.2.1 for a corresponding Band are fulfilled.

4.6 Cell Selection and Re-selection Requirements for UE category NB1

The NB-IoT applicability of the requirements in section 4.6 is defined in Section 3.6.1.

4.6.1 Cell Selection

After a UE has switched on and a PLMN has been selected, the Cell selection process takes place, as described in TS36.304. This process allows the UE to select a suitable cell where to camp on in order to access available services. In this process the UE can use stored information (*Stored information cell selection*) or not (*Initial cell selection*).

4.6.2 Cell Re-selection

The cell reselection procedure allows the UE to select a more suitable cell and camp on it.

When the UE is in either *Camped Normally* state or *Camped on Any Cell* state on a cell, the UE shall attempt to detect, synchronise, and monitor intra-frequency and inter-frequency cells indicated by the serving NB-IoT cell. For intra-frequency and inter-frequency cells the serving NB-IoT cell may not provide explicit neighbour list but carrier frequency information and bandwidth information only. UE measurement activity is also controlled by measurement rules defined in TS36.304, allowing the UE to limit its measurement activity.

4.6.2.1 Measurement and evaluation of serving NB-IoT cell for UE category NB1 in normal coverage

The UE shall measure the NRSRP and NRSRQ level of the serving NB-IoT cell and evaluate the cell selection criterion S defined in [1] for the serving NB-IoT cell at least every DRX cycle.

The UE shall filter the NRSRP and NRSRQ measurements of the NB-IoT serving cell using at least 2 measurements. Within the set of measurements used for the filtering, at least two measurements shall be spaced by, at least DRX cycle/2.

If the UE is not configured with eDRX_IDLE cycle and has evaluated according to Table 4.6.2.1-1 in $N_{\text{serv_NB-IoT-NC}}$ consecutive DRX cycles that the serving NB-IoT cell does not fulfil the cell selection criterion S, the UE shall initiate the measurements of all neighbour cells indicated by the serving NB-IoT cell, regardless of the measurement rules currently limiting UE measurement activities. If the UE is configured with eDRX_IDLE cycle and has evaluated according to Table 4.6.2.1-2 in $N_{\text{serv_NB-NC}}$ consecutive DRX cycles within a single PTW that the serving NB-IoT cell does not fulfil the cell selection criterion S, the UE shall initiate the measurements of all neighbour cells indicated by the serving NB-IoT cell, regardless of the measurement rules currently limiting UE measurement activities.

If the UE in RRC_IDLE has not found any new suitable cell based on searches and measurements using the intra-frequency and inter-frequency information indicated in the system information during the time T, the UE shall initiate cell selection procedures for the selected PLMN as defined in [1], where $T=40$ s if the UE is not configured with eDRX_IDLE cycle, and $T=\text{MAX}(40 \text{ s, one eDRX_IDLE cycle})$ if the UE is configured with eDRX_IDLE cycle.

Table 4.6.2.1-1: $N_{\text{serv_NB-NC}}$

DRX cycle length [s]	$N_{\text{serv_NB-IoT-NC}}$ [number of DRX cycles]
1.28	2
2.56	2
5.12	2
10.24	2

Table 4.6.2.1-2: $N_{\text{serv_NB-NC}}$ for UE configured with eDRX_IDLE cycle

eDRX_IDLE cycle length [s]	DRX cycle length [s]	PTW length [s] (number of 2.56s periods)	$N_{\text{serv_NB-NC}}$ [number of DRX cycles]
$20.48 \leq \text{eDRX_IDLE cycle length} \leq 10485.76$	1.28	≥ 5.12 (2)	2
	2.56	≥ 7.68 (3)	2
	5.12	≥ 12.8 (5)	2
	10.24	≥ 23.04 (9)	2
NOTE 1: The number of DRX cycles in this table is given for the DRX cycles within PTWs.			
NOTE 2: The eDRX_IDLE cycle lengths are as specified in Section X of TS 24.008 [34].			

For any requirement in this section, when the UE transitions between any two states when being configured with eDRX_IDLE, being configured with eDRX_IDLE cycle, changing eDRX_IDLE cycle length, or changing PTW configuration, the UE shall meet the transition requirement, which is the less stringent requirement of the two requirements corresponding to the first state and the second state, during the transition time interval which is the time corresponding to the transition requirement. After the transition time interval, the UE has to meet the requirement corresponding to the second state.

4.6.2.1A Measurement and evaluation of serving NB-IoT cell for HD-FDD UE category NB1 in normal coverage when configured with WUS

The UE which supports *wakeUpSignal* [2] shall meet the requirement defined for the DRX cycle length of $N \cdot \text{DRX_cycle}$ in Section 4.6.2.1, provided the following conditions are met:

- WUS has been configured in the serving NB-IoT cell using *WUS-Config-NB-r15* [2], and
- The serving cell measurement relaxation is signalled as n by the network using *numDRX-CycleRelaxed-r15*, and
- Serving cell S criteria is met with at least 2 dB margin.
- the relaxed monitoring criteria for neighbour cells in TS 36.304 [1] clause 5.2.4.12.1 is fulfilled, and

, where the relaxation factor N is given by Table 4.6.2.1A-1. Otherwise the requirements defined for the configured DRX cycle length in Section 4.6.2.1 shall apply.

The UE shall further meet the requirements in section 4.6.2.1 during time period T_0 after following occasions:

- after the end of reception of latest paging message, or
- from the moment UE has switched from RRC_CONNECTED state to RRC_IDLE state.

$T_0 = N \cdot \text{DRX_cycle}$ if the UE is not configured with eDRX_IDLE cycle where the value of N specified in Table 4.6.2.1A-1;

$T_0 = \text{one eDRX_IDLE cycle}$ if the UE is configured with eDRX_IDLE cycle;

Table 4.6.2.1A-1: The relaxation factor N for a UE not configured with eDRX_IDLE cycle

DRX cycle length [s]	Value
1.28	$\text{Min}(n, 8)$
2.56	$\text{Min}(n, 4)$
5.12	$\text{Min}(n, 2)$
10.24	1
NOTE: n is signalled by the network by using <i>numDRX-CycleRelaxed-r15</i> defined in TS 36.331 [2].	

Table 4.6.2.1A-2: The relaxation factor N for a UE configured with eDRX_IDLE cycle

DRX cycle length [s]	Value

	$5.12 \leq \text{PTW length [s]} < 7.68$	$7.68 \leq \text{PTW length [s]} < 12.8$	$12.8 \leq \text{PTW length [s]} < 23.04$	$23.04 \leq \text{PTW length [s]}$
1.28	1	$\text{Min}(n, 2)$	$\text{Min}(n, 4)$	$\text{Min}(n, 8)$
2.56	N/A	1	$\text{Min}(n, 2)$	$\text{Min}(n, 4)$
5.12	N/A	N/A	1	$\text{Min}(n, 2)$
10.24	N/A	N/A	N/A	1
NOTE: n is signalled by the network by using <i>numDRX-CycleRelaxed-r15</i> defined in TS 36.331 [2].				

4.6.2.2 Measurements of intra-frequency NB-IoT cells for UE category NB1 in normal coverage

The UE shall be able to identify new intra-frequency cells and perform NRSRP measurements of identified intra-frequency cells without an explicit intra-frequency neighbour list containing physical layer cell identities.

The UE shall be able to evaluate whether a newly detectable intra-frequency cell meets the reselection criteria defined in TS36.304 within $T_{\text{detect,NB_Intra_NC}}$ when $T_{\text{reselection}}=0$. An intra frequency cell is considered to be detectable according to NRSRP, $\text{NRSRP } \hat{E}_s/\text{Iot}$, NSCH_RP and $\text{NSCH } \hat{E}_s/\text{Iot}$ defined in Annex B.1.4 for a corresponding Band.

The UE shall measure NRSRP at least every $T_{\text{measure,NB_Intra_NC}}$ for intra-frequency cells that are identified and measured according to the measurement rules.

The UE shall filter NRSRP measurements of each measured intra-frequency cell using at least 2 measurements. Within the set of measurements used for the filtering, at least two measurements shall be spaced by at least $T_{\text{measure,NB_Intra_NC}}/2$

The UE shall not consider an NB-IoT neighbour cell in cell reselection if it is indicated as not allowed in the measurement control system information of the serving NB-IoT cell.

For an intra-frequency cell that has been already detected, but that has not been reselected to, the filtering shall be such that the UE shall be capable of evaluating that the intra-frequency cell has met reselection criterion defined [1] within $T_{\text{evaluate,NB_intra_NC}}$ when $T_{\text{reselection}} = 0$, provided that the cell is at least XdB better ranked, where ‘X’ is specified in Table 4.6.2.4-3. When evaluating cells for reselection, the side conditions for NRSRP, $\text{NRSRP } \hat{E}_s/\text{Iot}$, NSCH_RP and $\text{NSCH } \hat{E}_s/\text{Iot}$ apply to both serving and non-serving NB-IoT intra-frequency cells.

If $T_{\text{reselection}}$ timer has a non zero value and the intra-frequency cell is better ranked than the serving NB-IoT cell, the UE shall evaluate this intra-frequency cell for the $T_{\text{reselection}}$ time. If this cell remains better ranked within this duration, then the UE shall reselect that cell.

For UE not configured with eDRX_IDLE cycle, $T_{\text{detect,NB_Intra_NC}}$, $T_{\text{measure,NB_Intra_NC}}$ and $T_{\text{evaluate, NB_intra_NC}}$ are specified in Table 4.6.2.2-1. For UE configured with eDRX_IDLE cycle, $T_{\text{detect,NB_Intra_NC}}$, $T_{\text{measure,NB_Intra_NC}}$ and $T_{\text{evaluate, NB_intra_NC}}$ are specified in Table 4.6.2.2-2, where the requirements apply provided that the serving NB-IoT cell is configured with eDRX_IDLE and is the same in all PTWs during any of $T_{\text{detect,NB_Intra_NC}}$, $T_{\text{measure,NB_Intra_NC}}$ and $T_{\text{evaluate, NB_intra_NC}}$ when multiple PTWs are used.

Table 4.6.2.2-1 : $T_{\text{detect,NB_Intra_NB-IoT-NC}}$, $T_{\text{measure,NB_Intra_NB-IoT-NC}}$ and $T_{\text{evaluate, NB_intra_NB-IoT-NC}}$

DRX cycle length [s]	$T_{\text{detect,NB_Intra_NC}}$ [s] (number of DRX cycles)	$T_{\text{measure,NB_Intra_NB_NC}}$ [s] (number of DRX cycles)	$T_{\text{evaluate,NB_intra_NB_NC}}$ [s] (number of DRX cycles)
1.28	51 (40)	1.28 (1)	6.5 (5)
2.56	51 (20)	2.56 (1)	7.68 (3)
5.12	102 (20)	5.12 (1)	10.24 (2)
10.24	102 (10)	10.24 (1)	20.48 (2)

Table 4.6.2.2-2: $T_{\text{detect,NB_Intra_NC}}$, $T_{\text{measure,NB_Intra_NC}}$ and $T_{\text{evaluate,NB_intra_NC}}$ for UE configured with eDRX_IDLE cycle

eDRX_IDLE cycle length [s]	DRX cycle length [s]	PTW length [s] (number of 2.56s periods)	$T_{\text{detect,NB_Intra_NB-IoT-NC}}$ [s] (number of DRX cycles)	$T_{\text{measure,NB_Intra_NC}}$ [s] (number of DRX cycles)	$T_{\text{evaluate,NB_intra_NC}}$ [s] (number of DRX cycles)

20.48 ≤ eDRX_IDLE cycle length ≤ 10485.76	1.28	≥ 5.12 (2)	$eDRX_cycle_length \times \left\lceil \frac{20}{PTW / DRX_cycle_length} \right\rceil (20)$	1.28 (1)	2.56 (2)
	2.56	≥ 7.68 (3)		2.56 (1)	5.12 (2)
	5.12	≥ 12.8 (5)		5.12 (1)	10.24 (2)
	10.24	≥ 23.04 (9)		10.24 (1)	20.48 (2)
NOTE 1: The number of DRX cycles in this table is given for the DRX cycles within PTWs.					
NOTE 2: The eDRX_IDLE cycle lengths are as specified in Section X of TS 24.008 [34].					

For any requirement in this section, when the UE transitions between any two states when being configured with eDRX_IDLE, being configured with eDRX_IDLE cycle, changing eDRX_IDLE cycle length, or changing PTW configuration, the UE shall meet the transition requirement, which is the less stringent requirement of the two requirements corresponding to the first state and the second state, during the transition time interval which is the time corresponding to the transition requirement. After the transition time interval, the UE has to meet the requirement corresponding to the second state.

If all the relaxed monitoring criteria defined in clause 5.2.4.12 [1] are fulfilled then the UE’s intra-frequency measurement is not required to meet T_{detect,NB_Intra_NC} , $T_{measure,NB_Intra_NC}$ and $T_{evaluate,NB_intra_NC}$ as defined in Table 4.6.2.2-1 and Table 4.6.2.2-2.

4.6.2.3 Measurement and evaluation of serving NB-IoT cell for UE category NB1 in enhanced coverage

The UE shall measure the NRSRP and NRSRQ level of the serving NB-IoT cell and evaluate the cell selection criterion S defined in [1] for the serving NB-IoT cell at least every DRX cycle.

The UE shall filter the NRSRP and NRSRQ measurements of the serving NB-IoT cell using at least 4 measurements. Within the set of measurements used for the filtering, at least two measurements shall be spaced by, at least DRX cycle/2.

If the UE is not configured with eDRX_IDLE cycle and has evaluated according to Table 4.6.2.3-1 in $N_{serv_NB_EC}$ consecutive DRX cycles that the serving NB-IoT cell does not fulfil the cell selection criterion S, the UE shall initiate the measurements of all neighbour cells indicated by the serving NB-IoT cell, regardless of the measurement rules currently limiting UE measurement activities. If the UE is configured with eDRX_IDLE cycle and has evaluated according to Table 4.6.2.3-2 in $N_{serv_NB_IoT_EC}$ consecutive DRX cycles within a single PTW that the serving NB-IoT cell does not fulfil the cell selection criterion S, the UE shall initiate the measurements of all neighbour cells indicated by the serving NB-IoT cell, regardless of the measurement rules currently limiting UE measurement activities.

If the UE in RRC_IDLE has not found any new suitable cell based on searches and measurements using the intra-frequency and inter-frequency information indicated in the system information during the time T, the UE shall initiate cell selection procedures for the selected PLMN as defined in [1], where T= 80 s if the UE is not configured with eDRX_IDLE cycle, and T=MAX(80 s, one eDRX_IDLE cycle) if the UE is configured with eDRX_IDLE cycle.

Table 4.6.2.3-1: $N_{serv_NB_EC}$

DRX cycle length [s]	$N_{serv_NB_IoT_EC}$ [number of DRX cycles]
1.28	4
2.56	4
5.12	4
10.24	4

Table 4.6.2.3-2: $N_{serv_NB_EC}$ for UE configured with eDRX_IDLE cycle

eDRX_IDLE cycle length [s]	DRX cycle length [s]	PTW length [s] (number of 2.56s periods)	$N_{serv_NB_EC}$ [number of DRX cycles]
20.48 ≤ eDRX_IDLE cycle length ≤ 10485.76	1.28	≥ 7.68 (3)	4

	2.56	≥ 12.8 (5)	4
	5.12	≥ 23.04 (9)	4
	10.24	≥ 43.52 (17)	4
NOTE 1: The number of DRX cycles in this table is given for the DRX cycles within PTWs.			
NOTE 2: The eDRX_IDLE cycle lengths are as specified in Section X of TS 24.008 [34].			

For any requirement in this section, when the UE transitions between any two states when being configured with eDRX_IDLE, being configured with eDRX_IDLE cycle, changing eDRX_IDLE cycle length, or changing PTW configuration, the UE shall meet the transition requirement, which is the less stringent requirement of the two requirements corresponding to the first state and the second state, during the transition time interval which is the time corresponding to the transition requirement. After the transition time interval, the UE has to meet the requirement corresponding to the second state.

4.6.2.3A Measurement and evaluation of serving NB-IoT cell for HD-FDD UE category NB1 in enhanced coverage when configured with WUS

The UE which supports *wakeUpSignal* [2] shall meet the requirement defined for the DRX cycle length of $N \cdot \text{DRX_cycle}$ in Section 4.6.2.3, provided the following conditions are met:

- WUS has been configured in the serving NB-IoT cell using *WUS-Config-NB-r15* [2], and
- The serving cell measurement relaxation is signalled as n by the network using *numDRX-CycleRelaxed-r15*, and
- Serving cell S criteria is met with at least 2 dB margin.
- the relaxed monitoring criteria for neighbour cells in TS 36.304 [1] clause 5.2.4.12.1 is fulfilled, and

, where the relaxation factor N is given by Table 4.6.2.3A-1. Otherwise the requirements defined for the configured DRX cycle length in Section 4.6.2.3 shall apply.

The UE shall further meet the requirements in section 4.6.2.3 during time period T_0 after following occasions:

- after the end of reception of latest paging message, or
- from the moment UE has switched from RRC_CONNECTED state to RRC_IDLE state.

$T_0 = N \cdot \text{DRX_cycle}$ if the UE is not configured with eDRX_IDLE cycle where the value of N specified in Table 4.6.2.3A-1;

$T_0 = \text{one eDRX IDLE cycle}$ if the UE is configured with eDRX_IDLE cycle;

Table 4.6.2.3A-1: The relaxation factor N for a UE not configured with eDRX IDLE cycle

DRX cycle length [s]	Value
1.28	$\text{Min}(n, 8)$
2.56	$\text{Min}(n, 4)$
5.12	$\text{Min}(n, 2)$
10.24	1
NOTE: n is signalled by the network by using <i>numDRX-CycleRelaxed-r15</i> defined in TS 36.331 [2].	

Table 4.6.2.3A-2: The relaxation factor N for a UE configured with eDRX IDLE cycle

DRX cycle length [s]	Value			
	$7.68 \leq \text{PTW length [s]} < 12.8$	$12.8 \leq \text{PTW length [s]} < 23.04$	$23.04 \leq \text{PTW length [s]} < 43.52$	$43.52 \leq \text{PTW length [s]}$
1.28	1	$\text{Min}(n, 2)$	$\text{Min}(n, 4)$	$\text{Min}(n, 8)$
2.56	N/A	1	$\text{Min}(n, 2)$	$\text{Min}(n, 4)$
5.12	N/A	N/A	1	$\text{Min}(n, 2)$
10.24	N/A	N/A	N/A	1
NOTE: n is signalled by the network by using <i>numDRX-CycleRelaxed-r15</i> defined in TS 36.331 [2].				

4.6.2.4 Measurements of intra-frequency NB-IoT cells for UE category NB1 in enhanced coverage

The UE shall be able to identify new intra-frequency cells and perform NRSRP measurements of identified intra-frequency cells without an explicit intra-frequency neighbour list containing physical layer cell identities.

The UE shall be able to evaluate whether a newly detectable intra-frequency cell meets the reselection criteria defined in TS36.304 within $T_{\text{detect,NB_Intra_EC}}$ when that $T_{\text{reselection}}=0$. An intra frequency cell is considered to be detectable according to NRSRP, $\text{NRSRP } \hat{E}_s/\text{Iot}$, NSCH_RP and $\text{NSCH } \hat{E}_s/\text{Iot}$ defined in Annex B.1.4 for a corresponding Band.

The UE shall measure NRSRP at least every $T_{\text{measure,NB_Intra_EC}}$ for intra-frequency cells that are identified and measured according to the measurement rules.

The UE shall filter NRSRP measurements of each measured intra-frequency cell using at least 2 measurements. Within the set of measurements used for the filtering, at least two measurements shall be spaced by at least $T_{\text{measure,NB_Intra_EC}}/2$

The UE shall not consider a NB-IoT neighbour cell in cell reselection, if it is indicated as not allowed in the measurement control system information of the serving NB-IoT cell.

For an intra-frequency cell that has been already detected, but that has not been reselected to, the filtering shall be such that the UE shall be capable of evaluating that the intra-frequency cell has met reselection criterion defined [1] within $T_{\text{evaluate,NB_intra_EC}}$ when $T_{\text{reselection}} = 0$, provided that the cell is at least XdB better ranked, where ‘X’ is specified in Table 4.6.2.4-3. When evaluating cells for reselection, the side conditions for NRSRP, $\text{NRSRP } \hat{E}_s/\text{Iot}$, NSCH_RP and $\text{NSCH } \hat{E}_s/\text{Iot}$ apply to both serving and non-serving NB-IoT intra-frequency cells.

If $T_{\text{reselection}}$ timer has a non zero value and the intra-frequency cell is better ranked than the serving NB-IoT cell, the UE shall evaluate this intra-frequency cell for the $T_{\text{reselection}}$ time. If this cell remains better ranked within this duration, then the UE shall reselect that cell.

For UE not configured with eDRX_IDLE cycle, $T_{\text{detect,NB_Intra_EC}}$, $T_{\text{measure,NB_Intra_EC}}$ and $T_{\text{evaluate,NB_intra_EC}}$ are specified in Table 4.6.2.4-1. For UE configured with eDRX_IDLE cycle, $T_{\text{detect,NB_Intra_EC}}$, $T_{\text{measure,NB_Intra_EC}}$ and $T_{\text{evaluate,NB_intra_EC}}$ are specified in Table 4.6.2.4-2, where the requirements apply provided that the serving NB-IoT cell is configured with eDRX_IDLE and is the same in all PTWs during any of $T_{\text{detect,NB_Intra_EC}}$, $T_{\text{measure,NB_Intra_EC}}$ and $T_{\text{evaluate,NB_intra_EC}}$ when multiple PTWs are used.

Table 4.6.2.4-1 : $T_{\text{detect,NB_Intra_EC}}$, $T_{\text{measure,NB_Intra_EC}}$ and $T_{\text{evaluate,NB_intra_EC}}$

SCH \hat{E}_s/lot of neighboring cell: Q2	DRX cycle length [s]	$T_{\text{detect,NB_Intra_EC}}$ [s] (number of DRX cycles)	$T_{\text{measure,NB_Intra_EC}}$ [s] (number of DRX cycles)	$T_{\text{evaluate,NB_intra_EC}}$ [s] (number of DRX cycles)
$-15 \leq Q2 < -6$	1.28	532 (415)	1.28 (1)	12.8 (10)
	2.56	532 (208)	2.56 (1)	15.36 (6)
	5.12	1063 (208)	5.12 (1)	20.48 (4)
	10.24	1063 (104)	10.24 (1)	30.72 (3)
$Q2 \geq -6$	1.28	58 (45)	1.28 (1)	12.8 (10)
	2.56	59 (23)	2.56 (1)	15.36 (6)
	5.12	113 (22)	5.12 (1)	20.48 (4)
	10.24	113 (11)	10.24 (1)	30.72 (3)

Table 4.6.2.4-2: $T_{\text{detect,NB_Intra_EC}}$, $T_{\text{measure,NB_Intra_EC}}$ and $T_{\text{evaluate,NB_intra_EC}}$ for UE configured with eDRX_IDLE cycle

eDRX_IDLE cycle length [s]	DRX cycle length [s]	PTW length [s] (number of 2.56s periods)	$T_{\text{detect,NB_Intra_EC}}$ [s] (number of DRX cycles)	$T_{\text{measure,NB_Intra_EC}}$ [s] (number of DRX cycles)	$T_{\text{evaluate,NB_intraEC}}$ [s] (number of DRX cycles)
$20.48 \leq \text{eDRX_IDLE cycle length} \leq 10485.76$	1.28	≥ 15.36 (6)	$e\text{DRX_cycle_length} \times \left\lceil \frac{[406]}{\left\lfloor \frac{\text{PTW} / \text{DRX_cycle_length}}{(406)} \right\rfloor} \right\rceil$	1.28 (1)	12.8 (10)
	2.56	≥ 17.92 (7)		2.56 (1)	15.36 (6)
	5.12	≥ 23.04 (9)		5.12 (1)	20.48 (4)

	10.24	≥ 33.28 (13)		10.24 (1)	30.72 (3)
NOTE 1: The number of DRX cycles in this table is given for the DRX cycles within PTWs.					
NOTE 2: The eDRX_IDLE cycle lengths are as specified in Section X of TS 24.008 [34].					

Table 4.6.2.4-3: Conditions on NSCH \hat{E} s/lot of identified and of the neighbour cell

NSCH \hat{E} s/lot of already identified cell including serving cell: Q1	Neighbouring cell NSCH \hat{E} s/lot: Q2	Cell Reselection Margin 'X'
$-15 \leq Q1 < -6$	$-15 \leq Q2 < -6$	8.3
$-15 \leq Q1 < -6$	$Q2 \geq -6$	8.3
$Q1 \geq -6$	$Q2 \geq -6$	4

For any requirement in this section, when the UE transitions between any two states when being configured with eDRX_IDLE, being configured with eDRX_IDLE cycle, changing eDRX_IDLE cycle length, or changing PTW configuration, the UE shall meet the transition requirement, which is the less stringent requirement of the two requirements corresponding to the first state and the second state, during the transition time interval which is the time corresponding to the transition requirement. After the transition time interval, the UE has to meet the requirement corresponding to the second state.

If all the relaxed monitoring criteria defined in clause 5.2.4.12 [1] are fulfilled then the UE's intra-frequency measurement is not required to meet $T_{\text{detect,NB_Intra_EC}}$, $T_{\text{measure,NB_Intra_EC}}$ and $T_{\text{evaluate,NB_intra_EC}}$ as defined in Table 4.6.2.4-1 and Table 4.6.2.4-2.

4.6.2.5 Measurements of inter-frequency NB cells for UE category NB1 in normal coverage

The UE shall be able to identify new inter-frequency cells and perform NRSRP measurements of identified inter-frequency cells if carrier frequency information is provided by the serving NB-IoT cell, even if no explicit neighbour list with physical layer cell identities is provided.

If $S_{\text{rxlev}} \leq S_{\text{nonIntraSearchP}}$ then the UE shall search for and measure inter-frequency layers in preparation for possible reselection.

The UE shall be able to evaluate whether a newly detectable inter-frequency cell meets the reselection criteria defined in TS36.304 within $P_{\text{carrier}} * T_{\text{detect,NB_Inter_NC}}$, if at least carrier frequency information is provided for inter-frequency neighbour cells by the serving NB-IoT cells when $T_{\text{reselection}} = 0$ provided that the reselection criteria is met by a margin of at least Y dB, where P_{carrier} is the number of inter-frequency carriers for which carrier frequency information was provided by the serving NB-IoT cell and 'Y' is specified by Table 4.6.2.6-3 (when $Q1 \geq -6$ dB). An inter-frequency cell is considered to be detectable according to NRSRP, NRSRP \hat{E} s/lot, NSCH_RP and NSCH \hat{E} s/lot defined in Annex B.1.5 for a corresponding Band.

The UE shall filter NRSRP measurements of each measured inter-frequency cell using at least [2] measurements. Within the set of measurements used for the filtering, at least two measurements shall be spaced by at least $T_{\text{measure, Inter_NB_IoT_NC}}/2$.

If an inter-frequency cell has been already detected but that has not been reselected to the filtering shall be such that the UE shall be capable of evaluating that the inter-frequency cell has met reselection criterion defined TS 36.304 within $P_{\text{carrier}} * T_{\text{evaluate,NB_Inter_NC}}$. When evaluating cells for reselection, the side conditions for NRSRP, NRSRP \hat{E} s/lot, NSCH_RP and NSCH \hat{E} s/lot apply to both serving and inter-frequency cells.

If $T_{\text{reselection}}$ timer has a non zero value and the inter-frequency cell is better ranked than the serving NB-IoT cell, the UE shall evaluate this inter-frequency cell for the $T_{\text{reselection}}$ time. If this cell remains better ranked within this duration, then the UE shall reselect that cell.

For UE not configured with eDRX_IDLE cycle, $T_{\text{detect,NB_Inter_NC}}$, $T_{\text{measure,NB_Inter_NC}}$ and $T_{\text{evaluate, NB_inter_NC}}$ are specified in Table 4.6.2.5-1. For UE configured with eDRX_IDLE cycle, $T_{\text{detect,NB_Inter_NC}}$, $T_{\text{measure,NB_Inter_NC}}$ and $T_{\text{evaluate, NB_inter_NC}}$ are specified in Table 4.6.2.5-2, where the requirements apply provided that the serving NB-IoT cell is configured with eDRX_IDLE and is the same in all PTWs during any of $T_{\text{detect,NB_Inter_NC}}$, $T_{\text{measure,NB_Inter_NC}}$ and $T_{\text{evaluate, NB_inter_NC}}$ when multiple PTWs are used.

Table 4.6.2.5-1 : $T_{\text{detect,NB_Inter_NC}}$, $T_{\text{measure,NB_Inter_NC}}$ and $T_{\text{evaluate,NB_Inter_NC}}$

DRX cycle length [s]	$T_{\text{detect,NB_Inter_NC}}$ [s] (number of DRX cycles)	$T_{\text{measure,NB_Inter_NC}}$ [s] (number of DRX cycles)	$T_{\text{evaluate,NB_Inter_NC}}$ [s] (number of DRX cycles)
1.28	51 (40)	1.28 (1)	6.5 (5)
2.56	51 (20)	2.56 (1)	7.68 (3)
5.12	102 (20)	5.12 (1)	10.24 (2)
10.24	102 (10)	10.24 (1)	20.48 (2)

Table 4.6.2.5-2: $T_{\text{detect,NB_Inter_NC}}$, $T_{\text{measure,NB_Inter_NC}}$ and $T_{\text{evaluate,NB_inter_NC}}$ for UE configured with eDRX_IDLE cycle

eDRX_IDLE cycle length [s]	DRX cycle length [s]	PTW length [s] (number of 2.56s periods)	$T_{\text{detect,NB_Inter_NC}}$ [s] (number of DRX cycles)	$T_{\text{measure,NB_Inter_NC}}$ [s] (number of DRX cycles)	$T_{\text{evaluate,NB_inter_NC}}$ [s] (number of DRX cycles)
$20.48 \leq$ eDRX_IDLE cycle length ≤ 10485.76	1.28	≥ 5.12 (2)	$eDRX_cycle_length \times \left\lceil \frac{[20]}{PTW / DRX_cycle_length} \right\rceil$ (20)	1.28 (1)	2.56 (2)
	2.56	≥ 7.68 (3)		2.56 (1)	5.12 (2)
	5.12	≥ 12.8 (5)		5.12 (1)	10.24 (2)
	10.24	≥ 23.04 (9)		10.24 (1)	20.48 (2)

NOTE 1: The number of DRX cycles in this table is given for the DRX cycles within PTWs.

NOTE 2: The eDRX_IDLE cycle lengths are as specified in Section X of TS 24.008 [34].

For any requirement in this section, when the UE transitions between any two states when being configured with eDRX_IDLE, being configured with eDRX_IDLE cycle, changing eDRX_IDLE cycle length, or changing PTW configuration, the UE shall meet the transition requirement, which is the less stringent requirement of the two requirements corresponding to the first state and the second state, during the transition time interval which is the time corresponding to the transition requirement. After the transition time interval, the UE has to meet the requirement corresponding to the second state.

If all the relaxed monitoring criteria defined in clause 5.2.4.12 [1] are fulfilled then the UE's inter-frequency measurement is not required to meet $T_{\text{detect,NB_Intra_EC}}$, $T_{\text{measure,NB_Intra_EC}}$ and $T_{\text{evaluate,NB_intra_EC}}$ as defined in Table 4.6.2.5-1 and Table 4.6.2.5-2.

4.6.2.6 Measurements of inter-frequency NB-IoT cells for UE category NB1 in enhanced coverage

The UE shall be able to identify new inter-frequency cells and perform NRSRP measurements of identified inter-frequency cells if carrier frequency information is provided by the serving NB-IoT cell, even if no explicit neighbour list with physical layer cell identities is provided.

The UE shall be able to evaluate whether a newly detectable inter-frequency cell meets the reselection criteria defined in TS36.304 within $P_{\text{carrier}} * T_{\text{detect,NB_Inter_EC}}$. An inter-frequency cell is considered to be detectable according to NRSRP, NRSRP \hat{E}_s/I_{ot} , NSCH_RP and NSCH \hat{E}_s/I_{ot} defined in Annex B.1.5 for a corresponding Band.

The UE shall not cause any interruption to the paging reception and acquisition of SI while performing measurement on serving or any neighbor cells.

The UE shall filter NRSRP measurements of each measured inter-frequency cell using at least 2 measurements. Within the set of measurements used for the filtering, at least two measurements shall be spaced by at least $T_{\text{measure,NB_Inter_NB-IoT_EC}}/2$.

If an inter-frequency cell has been already detected but that has not been reselected to the filtering shall be such that the UE shall be capable of evaluating that the inter-frequency cell has met reselection criterion defined TS 36.304 within $P_{\text{carrier}} * T_{\text{evaluate,NB_Inter_EC}}$, provided that the cell is at least YdB better ranked, where 'Y' is specified in Table 4.6.2.6-3. When evaluating cells for reselection, the side conditions for NRSRP, NRSRP \hat{E}_s/I_{ot} , NSCH_RP and NSCH \hat{E}_s/I_{ot} apply to both serving and inter-frequency NB-IoT cells.

If $T_{\text{reselection}}$ timer has a non zero value and the inter-frequency cell is better ranked than the serving NB-IoT cell, the UE shall evaluate this inter-frequency cell for the $T_{\text{reselection}}$ time. If this cell remains better ranked within this duration, then the UE shall reselect that cell.

For a UE not configured with eDRX_IDLE cycle, $T_{\text{detect,NB_Inter_EC}}$, $T_{\text{measure,NB_Inter_EC}}$ and $T_{\text{evaluate,NB_inter_EC}}$ are specified in Table 4.6.2.6-1. For UE configured with eDRX_IDLE cycle, $T_{\text{detect,NB_Inter_EC}}$, $T_{\text{measure,NB_Inter_EC}}$ and $T_{\text{evaluate,NB_inter_EC}}$ are specified in Table 4.6.2.6-2 for the UE in enhanced coverage, where the requirements apply provided that the serving NB-IoT cell is configured with eDRX_IDLE and is the same in all PTWs during any of $T_{\text{detect,NB_Inter_EC}}$, $T_{\text{measure,NB_Inter_EC}}$ and $T_{\text{evaluate,NB_inter_EC}}$ when multiple PTWs are used.

Table 4.6.2.6-1 : $T_{\text{detect,NB_Inter_EC}}$, $T_{\text{measure,NB_Inter_EC}}$ and $T_{\text{evaluate,NB_Inter_EC}}$

SCH \hat{E} s/lot of neighboring cell: Q2	DRX cycle length [s]	$T_{\text{detect,NB_Inter_EC}}$ [s] (number of DRX cycles)	$T_{\text{measure,NB_Inter_EC}}$ [s] (number of DRX cycles)	$T_{\text{evaluate,NB_Inter_EC}}$ [s] (number of DRX cycles)
$-15 \leq Q2 < -6$	1.28	532 (415)	1.28 (1)	12.8 (10)
	2.56	532 (208)	2.56 (1)	15.36 (6)
	5.12	1063 (208)	5.12 (1)	20.48 (4)
	10.24	1063 (104)	10.24 (1)	30.72 (3)
$Q2 \geq -6$	1.28	58 (45)	1.28 (1)	12.8 (10)
	2.56	59 (23)	2.56 (1)	15.36 (6)
	5.12	113 (22)	5.12 (1)	20.48 (4)
	10.24	113 (11)	10.24 (1)	30.72 (3)

Table 4.6.2.6-2: $T_{\text{detect,NB_Inter_EC}}$, $T_{\text{measure,NB_Inter_EC}}$ and $T_{\text{evaluate,NB_inter_EC}}$ for UE configured with eDRX_IDLE cycle

eDRX_IDLE cycle length [s]	DRX cycle length [s]	PTW length [s] (number of 2.56s periods)	$T_{\text{detect,NB_Inter_EC}}$ [s] (number of DRX cycles)	$T_{\text{measure,NB_Inter_EC}}$ [s] (number of DRX cycles)	$T_{\text{evaluate,NB_inter_EC}}$ [s] (number of DRX cycles)
$20.48 \leq$ eDRX_IDLE cycle length ≤ 10485.76	1.28	≥ 15.36 (6)	$eDRX_cycle_length \times \left\lceil \frac{[406]}{PTW / DRX_cycle_length} \right\rceil$ (406)	1.28 (1)	12.8 (10)
	2.56	≥ 17.92 (7)		2.56 (1)	15.36 (6)
	5.12	≥ 23.04 (9)		5.12 (1)	20.48 (4)
	10.24	≥ 33.28 (13)		10.24 (1)	30.72 (3)
NOTE 1: The number of DRX cycles in this table is given for the DRX cycles within PTWs.					
NOTE 2: The eDRX_IDLE cycle lengths are as specified in Section X of TS 24.008 [34].					

Table 4.6.2.6-3: Conditions on NSCH \hat{E} s/lot of identified and of the neighbour cell

NSCH \hat{E} s/lot of already identified cell including serving cell: Q1	Neighbouring cell NSCH \hat{E} s/lot: Q2	Cell Reselection Margin 'Y'
$-15 \leq Q1 < -6$	$-15 \leq Q2 < -6$	9.3
$-15 \leq Q1 < -6$	$Q2 \geq -6$	9.3
$Q1 \geq -6$	$Q2 \geq -6$	5

For any requirement in this section, when the UE transitions between any two states when being configured with eDRX_IDLE, being configured with eDRX_IDLE cycle, changing eDRX_IDLE cycle length, or changing PTW configuration, the UE shall meet the transition requirement, which is the less stringent requirement of the two requirements corresponding to the first state and the second state, during the transition time interval which is the time corresponding to the transition requirement. After the transition time interval, the UE has to meet the requirement corresponding to the second state.

If all the relaxed monitoring criteria defined in clause 5.2.4.12 [1] are fulfilled then the UE's inter-frequency measurement is not required to meet $T_{\text{detect,NB_Intra_EC}}$, $T_{\text{measure,NB_Intra_EC}}$ and $T_{\text{evaluate,NB_intra_EC}}$ as defined in Table 4.6.2.6-1 and Table 4.6.2.6-2.

4.6.2.7 Maximum interruption in paging reception in normal coverage

UE shall perform the cell re-selection with minimum interruption in monitoring downlink channels for paging reception. When the UE is configured with eDRX_IDLE cycle, the UE shall not miss any paging in a PTW provided the paging is sent in at least 2 DRX cycles before the end of that PTW.

At intra-frequency and inter-frequency cell re-selection, the UE shall monitor the downlink of serving NB-IoT cell for paging reception until the UE is capable to start monitoring downlink channels of the target intra-frequency and inter-frequency cell for paging reception. The interruption time shall not exceed $T_{SI-NB1-NC} + 100$ ms.

4.6.2.7A Maximum interruption in paging reception in enhanced coverage

UE shall perform the cell re-selection with minimum interruption in monitoring downlink channels for paging reception. When the UE is configured with eDRX_IDLE cycle, the UE shall not miss any paging in a PTW provided the paging is sent in at least 2 DRX cycles before the end of that PTW.

At intra-frequency and inter-frequency cell re-selection, the UE shall monitor the downlink of serving NB-IoT cell for paging reception until the UE is capable to start monitoring downlink channels of the target intra-frequency and inter-frequency cell for paging reception. The interruption time shall not exceed $T_{SI-NB1-EC} + 100$ ms.

4.6.2.8 UE measurement capability

For idle mode cell re-selection purposes, the UE shall be capable of monitoring at least:

- Depending on UE capability, an intra-frequency carrier.
- Depending on UE capability, at least 2 inter-frequency carriers.

4.6.2.9 WUS receptions for NB1

This clause contains requirements on the UE regarding WUS reception provided that the WUS has been configured in the serving NB-IoT cell.

The UE shall be capable of receiving the WUS signals of the serving NB-IoT cell provided that the minimum number of repetitions configured in the NB-IoT serving cell is according to Table 4.6.2.9-1 for normal coverage and Table 4.6.2.9-2 for enhanced coverage.

Table 4.6.2.9-1: Conditions for WUS reception for UE normal coverage level

DRX cycle length [s]	Required number of repetition of WUS signal with 1 transmit antenna	Required number of repetition of WUS signal with 2 transmit antennas
≤ 5.12	64	32
>5.12	128	64

Table 4.6.2.9-2: Conditions for WUS reception for UE enhanced coverage level

DRX cycle length [s]	Required number of repetition of WUS signal with 1 transmit antenna	Required number of repetition of WUS signal with 2 transmit antennas
≤ 5.12	128	64
> 5.12	256	128

4.7 Cell Selection and Re-selection Requirements for UE category M1

The UE category M1 applicability of the requirements in section 4.7 is defined in Section 3.6.1. The requirements in this subclause apply if category M1 UE is in normal and enhanced coverage area of the serving cell. The category M1 normal and enhanced coverage applicability of the requirements is defined in section 3.6.1.

4.7.1 Cell Selection

The requirements defined in section 4.1 apply for this section.

4.7.2 Cell Re-selection

The cell reselection procedure allows the UE to select a more suitable cell and camp on it.

When the UE is in either *Camped Normally* state or *Camped on Any Cell* state on a cell, the UE shall attempt to detect, synchronise, and monitor intra-frequency and inter-frequency cells indicated by the serving cell. For intra-frequency

and inter-frequency cells the serving cell may not provide explicit neighbour list but carrier frequency information and bandwidth information only. UE measurement activity is also controlled by measurement rules defined in TS36.304, allowing the UE to limit its measurement activity.

If the UE is in normal coverage as defined in section 3.6.1, the requirements in section 4.7.2.1 apply. If the UE is in enhanced coverage as defined in section 3.6.1, the requirements in section 4.7.2.2 apply.

4.7.2.1 Cell Re-selection requirements for UE category M1 in normal coverage

4.7.2.1.1 Measurement and evaluation of serving cell for UE category M1 in normal coverage

The requirements in this subclause apply if UE is in the normal coverage area of the serving cell. The UE is considered to be in normal coverage area of serving cell according to RSRP, RSRP \hat{E}_s/I_{ot} , SCH_RP and SCH \hat{E}_s/I_{ot} of the serving cell defined in Annex B.1.3 for a corresponding Band.

The requirements defined in section 4.2.2.1 apply for this section.

4.7.2.1.2 Measurements of intra-frequency cells for UE category M1 in normal coverage

The requirements in this subclause apply if UE is in the normal coverage area of the serving cell. The UE is considered to be in normal coverage area of serving cell according to RSRP, RSRP \hat{E}_s/I_{ot} , SCH_RP and SCH \hat{E}_s/I_{ot} of the serving cell defined in Annex B.1.3 for a corresponding Band.

The UE shall be able to identify new intra-frequency cells and perform RSRP and RSRQ measurements of identified intra-frequency cells without an explicit intra-frequency neighbour list containing physical layer cell identities.

The UE shall be able to evaluate whether a newly detectable intra-frequency cell meets the reselection criteria defined in TS36.304 within $T_{\text{detect,EUTRAN_Intra_NC}}$ when that $T_{\text{reselection}} = 0$. An intra frequency cell is considered to be detectable according to RSRP, RSRP \hat{E}_s/I_{ot} , SCH_RP and SCH \hat{E}_s/I_{ot} defined in Annex B.1.3 for a corresponding Band.

The UE shall measure RSRP and RSRQ at least every $T_{\text{measure,EUTRAN_Intra_NC}}$ for intra-frequency cells that are identified and measured according to the measurement rules.

The UE shall filter RSRP and RSRQ measurements of each measured intra-frequency cell using at least 2 measurements. Within the set of measurements used for the filtering, at least two measurements shall be spaced by at least $T_{\text{measure,EUTRAN_Intra_NC}}/2$.

The UE shall not consider a E-UTRA neighbour cell in cell reselection, if it is indicated as not allowed in the measurement control system information of the serving cell.

For an intra-frequency cell that has been already detected, but that has not been reselected to, the filtering shall be such that the UE shall be capable of evaluating that the intra-frequency cell has met reselection criterion defined [1] within $T_{\text{evaluate,E-UTRAN_Intra_NC}}$ when $T_{\text{reselection}} = 0$, provided that the cell is at least 4dB better ranked for Cat-M1 UE.

If $T_{\text{reselection}}$ timer has a non zero value and the intra-frequency cell is better ranked than the serving cell, the UE shall evaluate this intra-frequency cell for the $T_{\text{reselection}}$ time. If this cell remains better ranked within this duration, then the UE shall reselect that cell.

For UE not configured with eDRX_IDLE cycle, $T_{\text{detect,EUTRAN_Intra_NC}}$, $T_{\text{measure,EUTRAN_Intra_NC}}$ and $T_{\text{evaluate,E-UTRAN_Intra_NC}}$ are specified in Table 4.7.2.1.2-1. For UE configured with eDRX_IDLE cycle, $T_{\text{detect,EUTRAN_Intra_NC}}$, $T_{\text{measure,EUTRAN_Intra_NC}}$ and $T_{\text{evaluate,E-UTRAN_Intra_NC}}$ are specified in Table 4.7.2.1.2-2, where the requirements apply provided that the serving cell is configured with eDRX_IDLE and is the same in all PTWs during any of $T_{\text{detect,EUTRAN_Intra_NC}}$, $T_{\text{measure,EUTRAN_Intra_NC}}$ and $T_{\text{evaluate,E-UTRAN_Intra_NC}}$ when multiple PTWs are used.

Table 4.7.2.1.2-1 : $T_{\text{detect,EUTRAN_Intra_NC}}$, $T_{\text{measure,EUTRAN_Intra_NC}}$ and $T_{\text{evaluate,E-UTRAN_Intra_NC}}$

DRX cycle length [s]	$T_{\text{detect,EUTRAN_Intra_NC}}$ [s] (number of DRX cycles)	$T_{\text{measure,EUTRAN_Intra_NC}}$ [s] (number of DRX cycles)	$T_{\text{evaluate,E-UTRAN_Intra_NC}}$ [s] (number of DRX cycles)
0.32	11.52 (36)	1.28 (4)	5.12 (16)
0.64	17.92 (28)	1.28 (2)	5.12 (8)

1.28	32(25)	1.28 (1)	6.4 (5)
2.56	58.88 (23)	2.56 (1)	7.68 (3)

Table 4.7.2.1.2-2: $T_{\text{detect,EUTRAN_Intra_NC}}$, $T_{\text{measure,EUTRAN_Intra_NC}}$ and $T_{\text{evaluate,E-UTRAN_Intra_NC}}$ for UE configured with eDRX_IDLE cycle

eDRX_IDLE cycle length [s]	DRX cycle length [s]	PTW length [s] (number of 1.28s periods)	$T_{\text{detect,EUTRAN_Intra_NC}}$ [s] (number of DRX or eDRX cycles ^{Note 3})	$T_{\text{measure,EUTRAN_Intra_NC}}$ [s] (number of DRX or eDRX cycles ^{Note 3})	$T_{\text{evaluate,E-UTRAN_Intra_NC}}$ [s] (number of DRX or eDRX cycles ^{Note 3})
5.12	N/A	N/A	117.76 (23)	5.12 (1)	10.24 (2)
10.24 ≤ eDRX_IDLE cycle length ≤ 2621.44	0.32	≥1.28 (1)	$eDRX_cycle_length \times \left\lceil \frac{23}{PTW / DRX_cycle_length} \right\rceil$ (23)	0.32 (1)	0.64 (2)
	0.64	≥1.28 (1)		0.64 (1)	1.28 (2)
	1.28	≥2.56 (2)		1.28 (1)	2.56 (2)
	2.56	≥5.12 (4)		2.56 (1)	5.12 (2)

NOTE 1: The number of DRX cycles in this table is given for the DRX cycles within PTWs.
 NOTE 2: The eDRX_IDLE cycle lengths are as specified in Section 10.5.5.32 of TS 24.008 [34].
 NOTE 3: Number of eDRX cycles when eDRX_IDLE cycle length equals 5.12s, number of DRX cycles otherwise.

For any requirement in this section, when the UE transitions between any two states when being configured with eDRX_IDLE, being configured with eDRX_IDLE cycle, changing eDRX_IDLE cycle length, or changing PTW configuration, the UE shall meet the transition requirement, which is the less stringent requirement of the two requirements corresponding to the first state and the second state, during the transition time interval which is the time corresponding to the transition requirement. After the transition time interval, the UE has to meet the requirement corresponding to the second state.

If all the relaxed monitoring criteria defined in clause 5.2.4.12 of TS 36.304 [1] are fulfilled then the UE's intra-frequency measurement is not required to meet $T_{\text{detect,EUTRAN_Intra_NC}}$, $T_{\text{measure,EUTRAN_Intra_NC}}$ and $T_{\text{evaluate,E-UTRAN_Intra_NC}}$ as defined in Table 4.7.2.1.2-1 and Table 4.7.2.1.2-2.

4.7.2.1.3 Measurements of inter-frequency cells for UE category M1 in normal coverage

The requirements in this subclause apply if UE is in the normal coverage area of the serving cell. The UE is considered to be in normal coverage area of serving cell according to RSRP, RSRP \hat{E}_s/I_{ot} , SCH_RP and SCH \hat{E}_s/I_{ot} of the serving cell defined in Annex B.1.3 for a corresponding Band.

The UE shall be able to identify new inter-frequency cells and perform RSRP or RSRQ measurements of identified inter-frequency cells if carrier frequency information is provided by the serving cell, even if no explicit neighbour list with physical layer cell identities is provided. The UE shall not cause any interruption to the paging reception and acquisition of SI while performing measurement on serving or any neighbor cells.

If $S_{rxlev} > S_{nonIntraSearchP}$ and $S_{qual} > S_{nonIntraSearchQ}$ then the UE shall search for inter-frequency layers of higher priority at least every $T_{\text{higher_priority_search}}$ where $T_{\text{higher_priority_search}}$ is described in clause 4.2.2.

If $S_{rxlev} \leq S_{nonIntraSearchP}$ Or $S_{qual} \leq S_{nonIntraSearchQ}$ then the UE shall search for and measure inter-frequency layers of higher, equal or lower priority in preparation for possible reselection. In this scenario, the minimum rate at which the UE is required to search for and measure higher priority layers shall be the same as that defined below.

The UE shall be able to evaluate whether a newly detectable inter-frequency cell meets the reselection criteria defined in TS36.304 within $K_{\text{carrier}} * T_{\text{detect,EUTRAN_Intra_NC}}$, if at least carrier frequency information is provided for inter-frequency neighbour cells by the serving cells when $T_{\text{reselection}} = 0$ provided that the reselection criteria is met by a margin of at least 8 dB for reselections based on ranking or 8 dB for RSRP reselections based on absolute priorities or 5.5 dB for RSRQ reselections based on absolute priorities. K_{carrier} is the number of inter-frequency carriers in the neighbour cell list. An inter frequency cell is considered to be detectable according to RSRP, RSRP \hat{E}_s/I_{ot} , SCH_RP and SCH \hat{E}_s/I_{ot} defined in Annex B.1.8 for a corresponding Band.

When higher priority cells are found by the higher priority search, they shall be measured at least every $T_{measure,E-UTRAN_Inter_NC}$. If, after detecting a cell in a higher priority search, it is determined that reselection has not occurred then the UE is not required to continuously measure the detected cell to evaluate the ongoing possibility of reselection. However, the minimum measurement filtering requirements specified later in this clause shall still be met by the UE before it makes any determination that it may stop measuring the cell. If the UE detects on a E-UTRA carrier a cell whose physical identity is indicated as not allowed for that carrier in the measurement control system information of the serving cell, the UE is not required to perform measurements on that cell.

The UE shall measure RSRP or RSRQ at least every $K_{carrier} * T_{measure,E-UTRAN_Inter_NC}$ for identified lower or equal priority inter-frequency cells. If the UE detects on a E-UTRA carrier a cell whose physical identity is indicated as not allowed for that carrier in the measurement control system information of the serving cell, the UE is not required to perform measurements on that cell.

The UE shall measure RSRP or RSRQ at least every $T_{measure,E-UTRAN_Inter_NC}$ for identified lower or equal priority inter-frequency cells. If the UE detects on a E-UTRA carrier a cell whose physical identity is indicated as not allowed for that carrier in the measurement control system information of the serving cell, the UE is not required to perform measurements on that cell.

The UE shall filter RSRP or RSRQ measurements of each measured higher, lower and equal priority inter-frequency cell using at least 2 measurements. Within the set of measurements used for the filtering, at least two measurements shall be spaced by at least $T_{measure,E-UTRAN_Inter_NC}/2$.

The UE shall not consider a E-UTRA neighbour cell in cell reselection, if it is indicated as not allowed in the measurement control system information of the serving cell.

For an inter-frequency cell that has been already detected, but that has not been reselected to, the filtering shall be such that the UE shall be capable of evaluating that the inter-frequency cell has met reselection criterion defined TS 36.304 within $K_{carrier} * T_{evaluate,E-UTRAN_Inter_NC}$, when $T_{reselection} = 0$ provided that the reselection criteria is met by a margin of at least 7 dB for reselections based on ranking or 7 dB for RSRP reselections based on absolute priorities or 5 dB for RSRQ reselections based on absolute priorities.

If $T_{reselection}$ timer has a non zero value and the inter-frequency cell is better ranked than the serving cell, the UE shall evaluate this inter-frequency cell for the $T_{reselection}$ time. If this cell remains better ranked within this duration, then the UE shall reselect that cell.

For UE not configured with eDRX_IDLE cycle, $T_{detect,E-UTRAN_Inter_NC}$, $T_{measure,E-UTRAN_Inter_NC}$ and $T_{evaluate,E-UTRAN_Inter_NC}$ are specified in Table 4.7.2.1.3-1. For UE configured with eDRX_IDLE cycle, $T_{detect,E-UTRAN_Inter_NC}$, $T_{measure,E-UTRAN_Inter_NC}$ and $T_{evaluate,E-UTRAN_Inter_NC}$ are specified in Table 4.7.2.1.3-2. Additionally, the requirements in Table 4.7.2.1.3-2 apply provided that the serving cell is configured with eDRX_IDLE and is the same in all PTWs during any of $T_{detect,E-UTRAN_Inter_NC}$, $T_{measure,E-UTRAN_Inter_NC}$ and $T_{evaluate,E-UTRAN_Inter_NC}$ when multiple PTWs are used.

Table 4.7.2.1.3-1 : $T_{detect,E-UTRAN_Inter_NC}$, $T_{measure,E-UTRAN_Inter_NC}$ and $T_{evaluate,E-UTRAN_Inter_NC}$

DRX cycle length [s]	$T_{detect,E-UTRAN_Inter_NC}$ [s] (number of DRX cycles)	$T_{measure,E-UTRAN_Inter_NC}$ [s] (number of DRX cycles)	$T_{evaluate,E-UTRAN_Inter_NC}$ [s] (number of DRX cycles)
0.32	11.52 (36)	1.28 (4)	5.12 (16)
0.64	17.92 (28)	1.28 (2)	5.12 (8)
1.28	32(25)	1.28 (1)	6.4 (5)
2.56	58.88 (23)	2.56 (1)	7.68 (3)

Table 4.7.2.1.3-2: $T_{detect,E-UTRAN_Inter_NC}$, $T_{measure,E-UTRAN_Inter_NC}$ and $T_{evaluate,E-UTRAN_inter_NC}$ for UE configured with eDRX_IDLE cycle

eDRX_IDLE cycle length [s]	DRX cycle length [s]	PTW length [s] (number of 1.28s periods)	$T_{detect,E-UTRAN_Inter_NC}$ [s] (number of DRX or eDRX cycles ^{Note 3})	$T_{measure,E-UTRAN_Inter_NC}$ [s] (number of DRX or eDRX cycles ^{Note 3})	$T_{evaluate,E-UTRAN_inter_NC}$ [s] (number of DRX or eDRX cycles ^{Note 3})
5.12	N/A	N/A	117.76 (23)	5.12 (1)	10.24 (2)

10.24 ≤ eDRX_IDLE cycle length ≤ 2621.44	0.32	≥1.28 (1)	$eDRX_cycle_length \times \left\lceil \frac{23}{PTW / DRX_cycle_length} \right\rceil$ (23)	0.32 (1)	(2)
	0.64	≥1.28 (1)		0.64 (1)	(2)
	1.28	≥1.28 (1)		1.28 (1)	(2)
	2.56	≥2.56 (2)		2.56 (1)	(2)
NOTE 1: The number of DRX cycles in this table is given for the DRX cycles within PTWs.					
NOTE 2: The eDRX_IDLE cycle lengths are as specified in Section 10.5.5.32 of TS 24.008 [34].					
NOTE 3: Number of eDRX cycles when eDRX_IDLE cycle length equals 5.12s, number of DRX cycles otherwise.					

For higher priority cells, a UE may optionally use a shorter value for $T_{measure,EUTRAN_Inter_NC}$, which shall not be less than Max(0.64 s, one DRX cycle).

For any requirement in this section, when the UE transitions between any two states when being configured with eDRX_IDLE, being configured with eDRX_IDLE cycle, changing eDRX_IDLE cycle length, or changing PTW configuration, the UE shall meet the transition requirement, which is the less stringent requirement of the two requirements corresponding to the first state and the second state, during the transition time interval which is the time corresponding to the transition requirement. After the transition time interval, the UE has to meet the requirement corresponding to the second state.

If all the relaxed monitoring criteria defined in clause 5.2.4.12 of TS 36.304 [1] are fulfilled then the UE's inter-frequency measurement is not required to meet $T_{detect,EUTRAN_Inter_NC}$, $T_{measure,EUTRAN_Inter_NC}$ and $T_{evaluate,E-UTRAN_inter_NC}$ as defined in Table 4.7.2.1.3-1 and Table 4.7.2.1.3-2.

4.7.2.1.4 Maximum allowed layers for multiple monitoring for UE category M1 in normal coverage

The UE category M1 in normal coverage shall be capable of monitoring at least:

- Depending on UE capability, 2 FDD E-UTRA inter-frequency carriers, and
- Depending on UE capability, 2 TDD E-UTRA inter-frequency carriers.

In addition to the requirements defined above, the UE shall be capable of monitoring a total of at least 5 carrier frequency layers, which include one serving carrier frequency and any of the above defined combination of E-UTRA FDD inter-frequency and E-UTRA TDD inter-frequency layers.

4.7.2.1.5 Maximum interruption in paging reception for Category M1 UEs in normal coverage

UE shall perform the cell re-selection with minimum interruption in monitoring downlink channels for paging reception. When the UE is configured with eDRX_IDLE cycle, the UE shall not miss any paging in a PTW provided the paging is sent in at least [2] DRX cycles before the end of that PTW.

At intra-frequency cell re-selection, the UE shall monitor the downlink of serving cell for paging reception until the UE is capable to start monitoring downlink channels of the target intra-frequency cell for paging reception. The interruption time shall not exceed $T_{SI-EUTRA-M1-NC} + 50$ ms.

$T_{SI-EUTRA-M1-NC}$ is the time required for receiving all the relevant system information data, which include MIB and relevant SIB, according to the reception procedure and the RRC procedure delay of system information blocks defined in TS 36.331 [2] for an E-UTRAN cell.

These requirements assume normal coverage radio conditions and do not take into account cell re-selection failure.

For any requirement in this section, when the UE transitions between any two states when being configured with eDRX_IDLE, being configured with eDRX_IDLE cycle, changing eDRX_IDLE cycle length, or changing PTW configuration, the UE shall meet the transition requirement, which is the less stringent requirement of the two requirements corresponding to the first state and the second state, during the transition time interval which is the time corresponding to the transition requirement. After the transition time interval, the UE has to meet the requirement corresponding to the second state.

4.7.2.2 Cell Re-selection requirements for UE category M1 in enhanced coverage

4.7.2.2.1 Measurement and evaluation of serving cell for UE category M1 in enhanced coverage

The requirements in this subclause apply if UE is in the enhanced coverage area of the serving cell. The UE is considered to be in enhanced coverage area of serving cell according to RSRP, $RSRP \hat{E}_s/I_{ot}$, SCH_RP and $SCH \hat{E}_s/I_{ot}$ of the serving cell defined in Annex B.1.3 for a corresponding Band.

The UE shall measure the RSRP and RSRQ level of the serving cell and evaluate the cell selection criterion S defined in [1] for the serving cell at least every DRX cycle.

The UE shall filter the RSRP and RSRQ measurements of the serving cell using at least 4 measurements. Within the set of measurements used for the filtering, at least two measurements shall be spaced by, at least DRX cycle/2.

If the UE is not configured with eDRX_IDLE cycle and has evaluated according to Table 4.7.2.2.1-1 in N_{serv_EC} consecutive DRX cycles that the serving cell does not fulfil the cell selection criterion S, the UE shall initiate the measurements of all neighbour cells indicated by the serving cell, regardless of the measurement rules currently limiting UE measurement activities.

If the UE is configured with eDRX_IDLE cycle and has evaluated according to Table 4.7.2.2.1-2 in N_{serv_EC} consecutive DRX cycles within a single PTW that the serving cell does not fulfil the cell selection criterion S, the UE shall initiate the measurements of all neighbour cells indicated by the serving cell, regardless of the measurement rules currently limiting UE measurement activities.

If the UE in RRC_IDLE has not found any new suitable cell based on searches and measurements using the intra-frequency, inter-frequency and inter-RAT information indicated in the system information during the time T, the UE shall initiate cell selection procedures for the selected PLMN as defined in [1], where $T=20$ s if the UE is not configured with eDRX_IDLE cycle, and $T=MAX(20$ s, one eDRX_IDLE cycle) if the UE is configured with eDRX_IDLE cycle.

Table 4.7.2.2.1-1: N_{serv_EC}

DRX cycle length [s]	N_{serv_EC} [number of DRX cycles]
0.32	8
0.64	8
1.28	4
2.56	4

Table 4.7.2.2.1-2: N_{serv_EC} for UE configured with eDRX_IDLE cycle

eDRX_IDLE cycle length [s]	DRX cycle length [s]	PTW length [s] (number of 1.28s periods)	N_{serv} [number of DRX or eDRX cycles Note 3]
5.12	N/A	N/A	2
$10.24 \leq eDRX_IDLE$ cycle length ≤ 2621.44	0.32	≥ 1.28 (1)	4
	0.64	≥ 2.56 (2)	4
	1.28	≥ 5.12 (4)	4
	2.56	≥ 10.24 (8)	4
NOTE 1: The number of DRX cycles in this table is given for the DRX cycles within PTWs.			
NOTE 2: The eDRX_IDLE cycle lengths are as specified in Section 10.5.5.32 of TS 24.008 [34].			
NOTE 3: Number of eDRX cycles when eDRX_IDLE cycle length equals 5.12s, number of DRX cycles otherwise.			

For any requirement in this section, when the UE transitions between any two states when being configured with eDRX_IDLE, being configured with eDRX_IDLE cycle, changing eDRX_IDLE cycle length, or changing PTW configuration, the UE shall meet the transition requirement, which is the less stringent requirement of the two

requirements corresponding to the first state and the second state, during the transition time interval which is the time corresponding to the transition requirement. After the transition time interval, the UE has to meet the requirement corresponding to the second state.

4.7.2.2.2 Measurements of intra-frequency cells for UE category M1 in enhanced coverage

The requirements in this subclause apply if UE is in the enhanced coverage area of the serving cell. The UE is considered to be in enhanced coverage area of serving cell according to RSRP, RSRP \hat{E}_s/I_{ot} , SCH_RP and SCH \hat{E}_s/I_{ot} of the serving cell defined in Annex B.1.3 for a corresponding Band.

The UE shall be able to identify new intra-frequency cells and perform RSRP and RSRQ measurements of identified intra-frequency cells without an explicit intra-frequency neighbour list containing physical layer cell identities. The UE shall not cause any interruption to the paging reception and acquisition of SI while performing measurement on serving or any neighbor cells.

The UE shall be able to evaluate whether a newly detectable intra-frequency cell meets the reselection criteria defined in TS36.304 within $T_{detect,EUTRAN_Intra_EC}$ when that $T_{reselection} = 0$. An intra-frequency cell is considered to be detectable according to RSRP, RSRP \hat{E}_s/I_{ot} , SCH_RP and SCH \hat{E}_s/I_{ot} defined in Annex B.1.3 for a corresponding Band.

The UE shall measure RSRP and RSRQ at least every $T_{measure,EUTRAN_Intra_EC}$ for intra-frequency cells that are identified and measured according to the measurement rules.

The UE shall filter RSRP and RSRQ measurements of each measured intra-frequency cell using at least 4 measurements. Within the set of measurements used for the filtering, at least two measurements shall be spaced by at least $T_{measure,EUTRAN_Intra_EC}/2$.

The UE shall not consider an E-UTRA neighbour cell in cell reselection, if it is indicated as not allowed in the measurement control system information of the serving cell.

For an intra-frequency cell that has been already detected, but that has not been reselected to, the filtering shall be such that the UE shall be capable of evaluating that the intra-frequency cell has met reselection criterion defined [1] within $T_{evaluate,E-UTRAN_intra_EC}$ when $T_{reselection} = 0$, provided that the cell is at least 5dB better ranked.

If $T_{reselection}$ timer has a non zero value and the intra-frequency cell is better ranked than the serving cell, the UE shall evaluate this intra-frequency cell for the $T_{reselection}$ time. If this cell remains better ranked within this duration, then the UE shall reselect that cell.

For UE not configured with eDRX_IDLE cycle, $T_{detect,EUTRAN_Intra_EC}$, $T_{measure,EUTRAN_Intra_EC}$ and $T_{evaluate,E-UTRAN_intra_EC}$ are specified in Table 4.7.2.2.2-1. For UE configured with eDRX_IDLE cycle, $T_{detect,EUTRAN_Intra_EC}$, $T_{measure,EUTRAN_Intra_EC}$ and $T_{evaluate,E-UTRAN_intra_EC}$ are specified in Table 4.7.2.2.2-2. Additionally, the requirements in Table 4.7.2.2.2-2 apply provided that the serving cell is configured with eDRX_IDLE and is the same in all PTWs during any of $T_{detect,EUTRAN_Intra_EC}$, $T_{measure,EUTRAN_Intra_EC}$ and $T_{evaluate,E-UTRAN_intra_EC}$ when multiple PTWs are used.

Table 4.7.2.2.2-1 : $T_{detect,EUTRAN_Intra_EC}$, $T_{measure,EUTRAN_Intra_EC}$ and $T_{evaluate,E-UTRAN_intra_EC}$

SCH \hat{E}_s/I_{ot} of neighboring cell: Q2 [dB]	DRX cycle length [s]	$T_{detect,EUTRAN_Intra_EC}$ [s] (number of DRX cycles)	$T_{measure,EUTRAN_Intra_EC}$ [s] (number of DRX cycles)	$T_{evaluate,E-UTRAN_intra_EC}$ [s] (number of DRX cycles)
$-15 \leq Q2 < -6$	0.32	330.24 (1032)	1.28 (4)	10.24 (32)
	0.64	330.24 (516)	1.28 (2)	10.24 (16)
	1.28	524.8 (410)	1.28 (1)	12.8 (10)
	2.56	1039.36 (406)	2.56 (1)	15.36 (6)
$Q2 \geq -6$	0.32	16.64 (52)	1.28 (4)	10.24 (32)
	0.64	23.04 (36)	1.28 (2)	10.24 (16)
	1.28	38.4 (30)	1.28 (1)	12.8 (10)
	2.56	66.56 (26)	2.56 (1)	15.36 (6)

Table 4.7.2.2.2-2: $T_{\text{detect,EUTRAN_Intra_EC}}$, $T_{\text{measure,EUTRAN_Intra_EC}}$ and $T_{\text{evaluate,E-UTRAN_intra_EC}}$ for UE configured with eDRX_IDLE cycle

eDRX_IDLE cycle length [s]	DRX cycle length [s]	PTW length [s] (number of 1.28s periods)	$T_{\text{detect,EUTRAN_Intra_EC}}$ [s] (number N of DRX or eDRX cycles ^{Note 4}) for neighboring cell with SCH Es/IoT: $-15 \leq Q2 < -6$ [dB]	$T_{\text{detect,EUTRAN_Intra_EC}}$ [s] (number N of DRX or eDRX cycles ^{Note 4}) for neighboring cell with SCH Es/IoT: $Q2 \geq -6$ [dB]	$T_{\text{measure,EUTRAN_Intra_EC}}$ [s] (number N of DRX or eDRX cycles ^{Note 4})	$T_{\text{evaluate,E-UTRAN_intra_EC}}$ [s] (number N of DRX or eDRX cycles ^{Note 4})
5.12	N/A	N/A	2078.72 (406)	133.12 (26)	5.12 (1)	30.72 (6)
$10.24 \leq$ eDRX_IDLE cycle length ≤ 2621.44	0.32	≥ 1.28 (1)	Note 3 (406)	Note 3 (26)	0.32 (1)	Note 3 (6)
	0.64	≥ 1.28 (1)			0.64 (1)	Note 3 (6)
	1.28	≥ 2.28 (1)			1.28 (1)	Note 3 (6)
	2.56	≥ 2.56 (2)			2.56 (1)	Note 3 (6)
<p>NOTE 1: The number of DRX cycles in this table is given for the DRX cycles within PTWs.</p> <p>NOTE 2: The eDRX_IDLE cycle lengths are as specified in Section 10.5.5.32 of TS 24.008 [34].</p> <p>NOTE 3: The detection period and the evaluation period depend on the number N of DRX cycles and are calculated according to the formula below:</p> $eDRX_cycle_length \times \left\lceil \frac{N}{PTW / DRX_cycle_length} \right\rceil$ <p>NOTE 4: Number of eDRX cycles when eDRX_IDLE cycle length equals 5.12s, number of DRX cycles otherwise.</p>						

For any requirement in this section, when the UE transitions between any two states when being configured with eDRX_IDLE, being configured with eDRX_IDLE cycle, changing eDRX_IDLE cycle length, or changing PTW configuration, the UE shall meet the transition requirement, which is the less stringent requirement of the two requirements corresponding to the first state and the second state, during the transition time interval which is the time corresponding to the transition requirement. After the transition time interval, the UE has to meet the requirement corresponding to the second state.

If all the relaxed monitoring criteria defined in clause 5.2.4.12 of TS 36.304 [1] are fulfilled then the UE's intra-frequency measurement is not required to meet $T_{\text{detect,EUTRAN_Intra_EC}}$, $T_{\text{measure,EUTRAN_Intra_EC}}$ and $T_{\text{evaluate,E-UTRAN_intra_EC}}$ as defined in Table 4.7.2.2.2-1 and Table 4.7.2.2.2-2.

4.7.2.2.3 Measurements of inter-frequency cells for UE category M1 in enhanced coverage

The requirements in this subclause apply if UE is in the enhanced coverage area of the serving cell. The UE is considered to be in enhanced coverage area of serving cell according to RSRP, RSRP \hat{E}_s/I_{ot} , SCH_RP and SCH \hat{E}_s/I_{ot} of the serving cell defined in Annex B.1.3 for a corresponding Band.

The UE shall be able to identify new inter-frequency cells and perform RSRP or RSRQ measurements of identified inter-frequency cells if carrier frequency information is provided by the serving cell, even if no explicit neighbour list with physical layer cell identities is provided. The UE shall not cause any interruption to the paging reception and acquisition of SI while performing measurement on serving or any neighbor cells.

If $S_{rxlev} > S_{nonIntraSearchP}$ and $S_{qual} > S_{nonIntraSearchQ}$ then the UE shall search for inter-frequency layers of higher priority at least every $T_{\text{higher_priority_search}}$ where $T_{\text{higher_priority_search}}$ is described in clause 4.2.2.

If $S_{rxlev} \leq S_{nonIntraSearchP}$ or $S_{qual} \leq S_{nonIntraSearchQ}$ then the UE shall search for and measure inter-frequency layers of higher, equal or lower priority in preparation for possible reselection. In this scenario, the minimum rate at which the UE is required to search for and measure higher priority layers shall be the same as that defined below.

The UE shall be able to evaluate whether a newly detectable inter-frequency cell meets the reselection criteria defined in TS36.304 within $K_{\text{carrier}} * T_{\text{detect,EUTRAN_Inter_EC}}$, if at least carrier frequency information is provided for inter-frequency neighbour cells by the serving cells when $T_{\text{reselection}} = 0$ provided that the reselection criteria is met by a margin of at least 8 dB for reselections based on ranking. K_{carrier} is the number of inter-frequency carriers in the neighbour cell list. An inter frequency cell is considered to be detectable according to RSRP, RSRP \hat{E}_s/I_{ot} , SCH_RP and SCH \hat{E}_s/I_{ot} defined in Annex B.1.8 for a corresponding Band.

When higher priority cells are found by the higher priority search, they shall be measured at least every $T_{\text{measure,E-UTRAN_Inter_EC}}$. If, after detecting a cell in a higher priority search, it is determined that reselection has not occurred then the UE is not required to continuously measure the detected cell to evaluate the ongoing possibility of reselection. However, the minimum measurement filtering requirements specified later in this clause shall still be met by the UE before it makes any determination that it may stop measuring the cell. If the UE detects on a E-UTRA carrier a cell whose physical identity is indicated as not allowed for that carrier in the measurement control system information of the serving cell, the UE is not required to perform measurements on that cell.

The UE shall measure RSRP or RSRQ at least every $K_{\text{carrier}} * T_{\text{measure,E-UTRAN_Inter_EC}}$ for identified lower or equal priority inter-frequency cells. If the UE detects on a E-UTRA carrier a cell whose physical identity is indicated as not allowed for that carrier in the measurement control system information of the serving cell, the UE is not required to perform measurements on that cell.

The UE shall filter RSRP or RSRQ measurements of each measured higher, lower and equal priority inter-frequency cell using at least 4 measurements. Within the set of measurements used for the filtering, at least two measurements shall be spaced by at least $T_{\text{measure,E-UTRAN_Inter_EC}}/2$.

The UE shall not consider a E-UTRA neighbour cell in cell reselection, if it is indicated as not allowed in the measurement control system information of the serving cell.

For an inter-frequency cell that has been already detected, but that has not been reselected to, the filtering shall be such that the UE shall be capable of evaluating that the inter-frequency cell has met reselection criterion defined TS 36.304 within $K_{\text{carrier}} * T_{\text{evaluate,E-UTRAN_Inter_EC}}$, when $T_{\text{reselection}} = 0$ provided that the reselection criteria is met by a margin of at least 8 dB for reselections based on ranking.

If $T_{\text{reselection}}$ timer has a non zero value and the inter-frequency cell is better ranked than the serving cell, the UE shall evaluate this inter-frequency cell for the $T_{\text{reselection}}$ time. If this cell remains better ranked within this duration, then the UE shall reselect that cell.

For UE not configured with eDRX_IDLE cycle, $T_{\text{detect,E-UTRAN_Inter_EC}}$, $T_{\text{measure,E-UTRAN_Inter_EC}}$ and $T_{\text{evaluate,E-UTRAN_inter_EC}}$ are specified in Table 4.7.2.2.3-1. For UE configured with eDRX_IDLE cycle, $T_{\text{detect,E-UTRAN_Inter_EC}}$, $T_{\text{measure,E-UTRAN_Inter_EC}}$ and $T_{\text{evaluate,E-UTRAN_inter_EC}}$ are specified in Table 4.7.2.2.3-3. Additionally, the requirements in Table 4.7.2.2.3-3 apply provided that the serving cell is configured with eDRX_IDLE and is the same in all PTWs during any of $T_{\text{detect,E-UTRAN_Inter_EC}}$, $T_{\text{measure,E-UTRAN_Inter_EC}}$ and $T_{\text{evaluate,E-UTRAN_inter_EC}}$ when multiple PTWs are used.

Table 4.7.2.2.3-1: $T_{\text{detect,E-UTRAN_Inter_EC}}$, $T_{\text{measure,E-UTRAN_Inter_EC}}$ and $T_{\text{evaluate,E-UTRAN_Inter_EC}}$

SCH Es/lot of neighboring cell: Q2 [dB]	DRX cycle length [s]	$T_{\text{detect,E-UTRAN_Inter_EC}}$ [s] (number of DRX cycles)	$T_{\text{measure,E-UTRAN_Inter_EC}}$ [s] (number of DRX cycles)	$T_{\text{evaluate,E-UTRAN_inter_EC}}$ [s] (number of DRX cycles)
$-15 \leq Q2 < -6$	0.32	330.24 (1032)	1.28 (4)	10.24 (32)
	0.64	330.24 (516)	1.28 (2)	10.24 (16)
	1.28	524.8 (410)	1.28 (1)	12.8 (10)
	2.56	1039.36 (406)	2.56 (1)	15.36 (6)
$Q2 \geq -6$	0.32	16.64 (52)	1.28 (4)	10.24 (32)
	0.64	23.04 (36)	1.28 (2)	10.24 (16)
	1.28	38.4 (30)	1.28 (1)	12.8 (10)
	2.56	66.56 (26)	2.56 (1)	15.36 (6)

Table 4.7.2.2.3-2: Void

Table 4.7.2.2.3-3: $T_{\text{detect,EUTRAN_Inter_EC}}$, $T_{\text{measure,EUTRAN_Inter_EC}}$ and $T_{\text{evaluate,E-UTRAN_inter_EC}}$ for UE configured with eDRX_IDLE cycle

eDRX_IDLE cycle length [s]	DRX cycle length [s]	PTW length [s] (number of 1.28s periods)	$T_{\text{detect,EUTRAN_Inter_EC}}$ [s] (number of DRX or eDRX cycles ^{Note 4}) for neighboring cell with SCH Es/IoT: $-15 \leq Q2 < -6$ [dB]	$T_{\text{detect,EUTRAN_Inter_EC}}$ [s] (number of DRX or eDRX cycles ^{Note 4}) for neighboring cell with SCH Es/IoT: $Q2 \geq -6$ [dB]	$T_{\text{measure,EUTRAN_Inter_EC}}$ [s] (number of DRX or eDRX cycles ^{Note 4})	$T_{\text{evaluate,E-UTRAN_inter_EC}}$ [s] (number of DRX or eDRX cycles ^{Note 4})
5.12	N/A	N/A	2078.72 (406)	133.12 (26)	5.12 (1)	30.72 (6)
$10.24 \leq$ eDRX_IDLE cycle length ≤ 2621.44	0.32	≥ 1.28 (1)	Note 3 (406)	Note 3 (26)	0.32 (1)	Note 3 (6)
	0.64	≥ 1.28 (1)			0.64 (1)	Note 3 (6)
	1.28	≥ 1.28 (1)			1.28 (1)	Note 3 (6)
	2.56	≥ 2.56 (2)			2.56 (1)	Note 3 (6)
<p>NOTE 1: The number of DRX cycles in this table is given for the DRX cycles within PTWs. NOTE 2: The eDRX_IDLE cycle lengths are as specified in Section 10.5.5.32 of TS 24.008 [34]. NOTE 3: The detection period and the evaluation period depend on the number N of DRX cycles and are calculated according to the formula below:</p> $eDRX_cycle_length \times \left\lceil \frac{N}{\lceil PTW / DRX_cycle_length \rceil} \right\rceil$ <p>NOTE 4: Number of eDRX cycles when eDRX_IDLE cycle length equals 5.12s, number of DRX cycles otherwise.</p>						

For higher priority cells, a UE may optionally use a shorter value for $T_{\text{measure,EUTRAN_Inter_EC}}$, which shall not be less than $\text{Max}(0.64 \text{ s}, \text{one DRX cycle})$.

For any requirement in this section, when the UE transitions between any two states when being configured with eDRX_IDLE, being configured with eDRX_IDLE cycle, changing eDRX_IDLE cycle length, or changing PTW configuration, the UE shall meet the transition requirement, which is the less stringent requirement of the two requirements corresponding to the first state and the second state, during the transition time interval which is the time corresponding to the transition requirement. After the transition time interval, the UE has to meet the requirement corresponding to the second state.

If all the relaxed monitoring criteria defined in clause 5.2.4.12 of TS 36.304 [1] are fulfilled then the UE's inter-frequency measurement is not required to meet $T_{\text{detect,EUTRAN_Inter_EC}}$, $T_{\text{measure,EUTRAN_Inter_EC}}$ and $T_{\text{evaluate,E-UTRAN_inter_EC}}$ as defined in Table 4.7.2.2.3-1 and Table 4.7.2.2.3-3.

4.7.2.2.4 Maximum allowed layers for multiple monitoring for UE category M1 in enhanced coverage

The UE category M1 in enhanced coverage shall be capable of monitoring at least:

- Depending on UE capability, 2 FDD E-UTRA inter-frequency carriers, and
- Depending on UE capability, 2 TDD E-UTRA inter-frequency carriers.

In addition to the requirements defined above, the UE shall be capable of monitoring a total of at least 5 carrier frequency layers, which include one serving carrier frequency and any of the above defined combination of E-UTRA FDD inter-frequency and E-UTRA TDD inter-frequency layers.

4.7.2.2.5 Maximum interruption in paging reception for Category M1 UEs in enhanced coverage

UE shall perform the cell re-selection with minimum interruption in monitoring downlink channels for paging reception. When the UE is configured with eDRX_IDLE cycle, the UE shall not miss any paging in a PTW provided the paging is sent in at least 2 DRX cycles before the end of that PTW.

At intra-frequency cell re-selection, the UE shall monitor the downlink of serving cell for paging reception until the UE is capable to start monitoring downlink channels of the target intra-frequency cell for paging reception. The interruption time shall not exceed $T_{\text{SI-EUTRA-M1-EC}} + 50 \text{ ms}$.

$T_{SI-EUTRA-MI-EC}$ is the time required for receiving all the relevant system information data, which include MIB and relevant SIB, according to the reception procedure and the RRC procedure delay of system information blocks defined in TS 36.331 [2] for an E-UTRAN cell.

These requirements assume extended coverage radio conditions and do not take into account cell re-selection failure.

For any requirement in this section, when the UE transitions between any two states when being configured with eDRX_IDLE, being configured with eDRX_IDLE cycle, changing eDRX_IDLE cycle length, or changing PTW configuration, the UE shall meet the transition requirement, which is the less stringent requirement of the two requirements corresponding to the first state and the second state, during the transition time interval which is the time corresponding to the transition requirement. After the transition time interval, the UE has to meet the requirement corresponding to the second state.

4.7.2.3 WUS receptions for UE category M1

This clause contains requirements on the UE regarding WUS reception provided that WUS has been configured in the serving cell.

The UE shall be capable of receiving the WUS signals of the serving cell provided that the minimum number of repetitions configured in the serving cell is according to Table 4.7.2.3-1 for normal coverage and Table 4.7.2.3-2 for enhanced coverage and the higher layer parameter *wus-PowerBoost* as indicated in SIB is configured to be 0 dB.

Table 4.7.2.3-1: Conditions for WUS reception for UE normal coverage level

DRX cycle length [s]	Required number of repetition of WUS signal with 1 transmit antenna	Required number of repetition of WUS signal with 2 transmit antennas
≤ 1.28	32	4
> 1.28	64	4

Table 4.7.2.3-2: Conditions for WUS reception for UE enhanced coverage level

DRX cycle length [s]	Required number of repetition of WUS signal with 1 transmit antenna	Required number of repetition of WUS signal with 2 transmit antennas
≤ 1.28	128	32
> 1.28	256	64

4.8 Idle State Positioning Measurement Requirements for UE category NB1

4.8.1 OTDOA Intra-Frequency RSTD Measurements for UE category NB1 for normal coverage

The UE shall follow the procedure for RRC_IDLE state positioning measurements as defined in TS 36.305 [36] clause 7.1.3.

When the physical layer cell identities of the neighbour cells together with the OTDOA assistance data have been provided and the UE has entered the RRC_IDLE state, the UE shall be able to detect and measure intra-frequency RSTD, specified in TS 36.214 [4], for at least $n = 16$ cells, including the reference cell, on the same carrier frequency f_1 as that of the reference cell within $T_{RSTDIntraFreqNB}$ ms as given below:

$$T_{RSTDIntraFreqNB} = T_{NPRS} \cdot (M-1) + \Delta \quad ms,$$

where

$T_{RSTDIntraFreqNB}$ is the total time for detecting and measuring at least n cells;

T_{NPRS} is the cell-specific positioning subframe configuration period as defined in TS 36.355 [24] if Part B subframe configuration is provided; otherwise if only Part A subframe configuration is provided, the T_{NPRS} equals to the length of the subframe pattern,

M is the number of NPRS positioning occasions as defined in Table 4.8.1-1,

$\Delta = T_{NPRS} \cdot \left\lceil \frac{n}{M} \right\rceil$ ms is the measurement time for a single NPRS positioning occasion which includes the sampling time and the processing time;

N_{NPRS} is the cell-specific number of NPRS subframes within a NPRS occasion as defined in TS36.355[24] if Part B subframe configuration is provided; if only Part A subframe configuration is provided, the NPRS occasion length is 10 ms,

N_{NPRS_total} is the minimum number of NPRS subframes per cell measurement as specified in Section 9.1.22.10.

T_{NPRS} , N_{NPRS} , and N_{NPRS_total} are the parameters of the same cell, for which $T_{NPRS} \cdot \left\lceil \frac{N_{NPRS_total}}{N_{NPRS}} \right\rceil$ is the largest among all the measured cells.

Table 4.8.1-1: Number of NPRS positioning occasions within $T_{RSTDIntraFreqNB}$

Positioning subframe configuration period T_{NPRS}	Number of NPRS positioning occasions M	
	f1 ^{Note1}	f1 and f2 ^{Note2}
160 ms	$16^* \left\lceil \frac{N_{NPRS_total}}{N_{NPRS}} \right\rceil$	$32^* \left\lceil \frac{N_{NPRS_total}}{N_{NPRS}} \right\rceil$
>160 ms	$8^* \left\lceil \frac{N_{NPRS_total}}{N_{NPRS}} \right\rceil$	$16^* \left\lceil \frac{N_{NPRS_total}}{N_{NPRS}} \right\rceil$
Note 1: When only intra-frequency RSTD measurements are performed over cells belonging to the serving carrier frequency f1. Note 2: When intra-frequency RSTD and inter-frequency RSTD measurements are performed over cells belonging to the serving carrier frequency f1 and one inter-frequency carrier frequency f2, respectively.		

The UE physical layer shall be capable of reporting RSTD for the reference cell and all the neighbor cells i out of at least $(n-1)$ neighbor cells within $T_{RSTDIntraFreqNB}$ provided:

$$\left(\text{NPRS } \hat{E}_s / \text{Iot} \right)_{ref} \geq -6 \text{ dB for all Frequency Bands for the reference cell,}$$

$$\left(\text{NPRS } \hat{E}_s / \text{Iot} \right)_i \geq -13 \text{ dB for all Frequency Bands for neighbour cell } i,$$

$\left(\text{NPRS } \hat{E}_s / \text{Iot} \right)_{ref}$ and $\left(\text{NPRS } \hat{E}_s / \text{Iot} \right)_i$ conditions apply for all subframes of at least $L = \frac{M}{2}$ NPRS positioning occasions,

NPRP 1,2_{dBm} according to Annex B.2.16 for a corresponding Band

$\text{NPRS } \hat{E}_s / \text{Iot}$ is defined as the ratio of the average received energy per PRS RE during the useful part of the symbol to the average received power spectral density of the total noise and interference for this RE, where the ratio is measured over all REs which carry NPRS.

The time $T_{\text{RSTDIntraFreqNB}}$ starts from the point when the UE has received both the OTDOA-RequestLocationInformation message and the OTDOA assistance data in the OTDOA-ProvideAssistanceData message as specified in TS 36.355 [24], and the message and data have been delivered to the physical layer of the UE and the UE has entered the RRC_IDLE state.

The RSTD measurement accuracy for all measured neighbor cells i shall fulfill the requirements specified in sub-clause 9.1.22.10.

4.8.1.1 RSTD Measurement Reporting Delay

The reported measurements contained in the event triggered measurement reports shall meet the requirements in clause 9.1.22.10.

The UE shall not send any measurement reports, as long as no reporting criteria are fulfilled.

After receiving both the OTDOA-RequestLocationInformation message and the OTDOA assistance data in the OTDOA-ProvideAssistanceData message as specified in TS 36.355 [24], the UE shall be sent to RRC_IDLE state. The measurement reporting delay is defined as the time between the point when the UE has entered the RRC_IDLE state, and the point when the UE is ready to transmit the measurement report over the air interface and starts to establish a signalling connection with the MME. This requirement assumes that the measurement report is not delayed by other RRC signalling on the DCCH. This measurement reporting delay excludes a delay uncertainty resulted when inserting the measurement report to the TTI of the uplink DCCH. The delay uncertainty is $N_{rep} \times TTI_{\text{DCCH}}$, where N_{rep} [21] is the maximum number of NPUSCH repetitions configured for the UE, otherwise the uncertainty is defined as $2 \times TTI_{\text{DCCH}}$. This measurement reporting delay excludes the delay caused by not having UL resources for the UE to send the measurement report. This measurement reporting delay excludes any delay caused by RRC connection release before the RRC_IDLE mode measurement. This measurement reporting delay excludes any delay caused by establishing a signalling connection with the MME (including random access procedure) as defined in TS 36.305 [36] for LPP measurement reporting.

The measurement reporting delay shall be less than $T_{\text{RSTDIntraFreqNB}}$ defined in Clause 4.8.1.

4.8.2 OTDOA Intra-Frequency RSTD Measurements for UE category NB1 for enhanced coverage

The UE shall follow the procedure for RRC_IDLE state positioning measurements as defined in TS 36.305 [36] clause 7.1.3.

When the physical layer cell identities of neighbour cells together with the OTDOA assistance data have been provided and the UE has entered the RRC_IDLE state, the UE shall be able to detect and measure intra-frequency RSTD, specified in TS 36.214 [4], for at least $n = 16$ cells, including the reference cell, on the same carrier frequency f_1 as that of the reference cell within $T_{\text{RSTDIntraFreqNB}}$ ms as given below:

$$T_{\text{RSTDIntraFreqNB}} = T_{\text{NPRS}} \cdot (M-1) + \Delta \quad \text{ms},$$

where

$T_{\text{RSTDIntraFreqNB}}$ is the total time for detecting and measuring at least n cells;

T_{NPRS} is the cell-specific positioning subframe configuration period as defined in TS 36.355 [24] if Part B subframe configuration is provided; otherwise if only Part A subframe configuration is provided, the T_{NPRS} equals to the length of the subframe pattern,

M is the number of NPRS positioning occasions as defined in Table 4.8.2-1,

$\Delta = T_{\text{NPRS}} \cdot \left\lceil \frac{n}{M} \right\rceil$ ms is the measurement time for a single NPRS positioning occasion which includes the sampling time and the processing time;

N_{NPRS} is the cell-specific number of NPRS subframes within a NPRS occasion as defined in TS 36.355[24] if Part B subframe configuration is provided; if only Part A subframe configuration is provided, the NPRS occasion length is 10 ms,

$N_{\text{NPRS_total}}$ is the minimum number of NPRS subframes per cell measurement as specified in Section 9.1.22.12.

T_{NPRS} , N_{NPRS} , and $N_{\text{NPRS_total}}$ are the parameters of the same cell, for which $T_{\text{NPRS}} \cdot \left\lceil \frac{N_{\text{NPRS_total}}}{N_{\text{NPRS}}} \right\rceil$ is the largest among all the measured cells.

Table 4.8.2-1: Number of NPRS positioning occasions within $T_{\text{RSTDIntraFreqNB}}$

Positioning subframe configuration period T_{NPRS}	Number of NPRS positioning occasions M	
	f1 ^{Note1}	f1 and f2 ^{Note2}
160 ms	$16^* \left\lceil \frac{N_{\text{NPRS_total}}}{N_{\text{NPRS}}} \right\rceil$	$32^* \left\lceil \frac{N_{\text{NPRS_total}}}{N_{\text{NPRS}}} \right\rceil$
>160 ms	$8^* \left\lceil \frac{N_{\text{NPRS_total}}}{N_{\text{NPRS}}} \right\rceil$	$16^* \left\lceil \frac{N_{\text{NPRS_total}}}{N_{\text{NPRS}}} \right\rceil$
Note 1: When only intra-frequency RSTD measurements are performed over cells belonging to the serving carrier frequency f1. Note 2: When intra-frequency RSTD and inter-frequency RSTD measurements are performed over cells belonging to the serving carrier frequency f1 and one inter-frequency carrier frequency f2, respectively.		

The UE physical layer shall be capable of reporting RSTD for the reference cell and all the neighbor cells i out of at least $(n-1)$ neighbor cells within $T_{\text{RSTDIntraFreqNB}}$ provided:

$$\left(\text{NPRS } \hat{E}_s / \text{Iot} \right)_{\text{ref}} \geq -15 \text{ dB for all Frequency Bands for the reference cell,}$$

$$\left(\text{NPRS } \hat{E}_s / \text{Iot} \right)_i \geq -15 \text{ dB for all Frequency Bands for neighbour cell } i,$$

$\left(\text{NPRS } \hat{E}_s / \text{Iot} \right)_{\text{ref}}$ and $\left(\text{NPRS } \hat{E}_s / \text{Iot} \right)_i$ conditions apply for all subframes of at least $L = \frac{M}{2}$ NPRS positioning occasions,

NPRP 1,2_{dBm} according to Annex B.2.16 for a corresponding Band

$\text{NPRS } \hat{E}_s / \text{Iot}$ is defined as the ratio of the average received energy per PRS RE during the useful part of the symbol to the average received power spectral density of the total noise and interference for this RE, where the ratio is measured over all REs which carry NPRS.

The time $T_{\text{RSTDIntraFreqNB}}$ starts from the point when the UE has received both the OTDOA-RequestLocationInformation message and the OTDOA assistance data in the OTDOA-ProvideAssistanceData message as specified in TS 36.355 [24], and the message and the data have been delivered to the physical layer of the UE, and the UE has entered the RRC_IDLE state.

The RSTD measurement accuracy for all measured neighbor cells i shall fulfill the requirements specified in sub-clause 9.1.22.12.

4.8.2.1 RSTD Measurement Reporting Delay

The reported measurements contained in the event triggered measurement reports shall meet the requirements in clause 9.1.22.12.

The UE shall not send any measurement reports, as long as no reporting criteria are fulfilled.

After receiving both the OTDOA-RequestLocationInformation message and the OTDOA assistance data in the OTDOA-ProvideAssistanceData message as specified in TS 36.355 [24], the UE shall be sent to RRC_IDLE state. The measurement reporting delay is defined as the time between the point when the UE has entered the RRC_IDLE state, and the point when the UE is ready to transmit the measurement report over the air interface and starts to establish a signalling connection with the MME. This requirement assumes that the measurement report is not delayed by other RRC signalling on the DCCH. This measurement reporting delay excludes a delay uncertainty resulted when inserting the measurement report to the TTI of the uplink DCCH. The delay uncertainty is $N_{rep} \times TTI_{DCCH}$, where N_{rep} [21] is the maximum number of NPUSCH repetitions configured for the UE, otherwise the uncertainty is defined as $2 \times TTI_{DCCH}$. This measurement reporting delay excludes the delay caused by not having UL resources for the UE to send the measurement report. This measurement reporting delay excludes any delay caused by RRC connection release before the RRC_IDLE mode measurement. This measurement reporting delay excludes any delay caused by establishing a signalling connection with the MME (including random access procedure) as defined in TS 36.305 [36] for LPP measurement reporting.

The measurement reporting delay shall be less than $T_{RSTDIntraFreqNB}$ defined in Clause 4.8.2.

4.8.3 OTDOA Inter-Frequency RSTD Measurements for UE category NB1 for normal coverage

The UE shall support NPRS configuration in more than one resource block [24]. The UE shall follow the procedure for RRC_IDLE state positioning measurement as defined in TS 36.305 [36] clause 7.1.3.

All positioning subframes indicated in the OTDOA assistance data and specified in sub-clause 9.1.22.11 are available for RSTD measurements in the measured and reference cell.

When the physical layer cell identities of neighbour cells together with the OTDOA assistance data have been provided and the UE has entered the RRC_IDLE state, the UE shall be able to detect and measure inter-frequency RSTD, specified in TS 36.214 [4], for at least $n = 16$ cells, including the reference cell within $T_{RSTDInterFreq, NB}$ ms as given below:

$$T_{RSTDInterFreq, NB} = T_{NPRS} \cdot (M-1) + \Delta \quad ms,$$

where

$T_{RSTDInterFreq, NB}$ is the total time for detecting and measuring at least n cells;

T_{NPRS} is the cell-specific positioning subframe configuration period as defined in TS 36.355 [24] if Part B subframe configuration is provided; otherwise if only Part A subframe configuration is provided, the T_{NPRS} equals to the length of the subframe pattern,

M is the number of NPRS positioning occasions as defined in Table 4.8.1-1,

$\Delta = T_{NPRS} \cdot \left\lceil \frac{n}{M} \right\rceil$ ms is the measurement time for a single NPRS positioning occasion which includes the sampling time and the processing time;

N_{NPRS} is the cell-specific number of NPRS subframes within a NPRS occasion as defined in TS36.355 [24] if Part B subframe configuration is provided; if only Part A subframe configuration is provided, the NPRS occasion length is 10 ms,

N_{NPRS_total} is the minimum number of NPRS subframes per cell measurement as specified in Section 9.1.22.11.

T_{NPRS} , N_{NPRS} , and N_{NPRS_total} are the parameters of the same cell, for which $T_{NPRS} \cdot \left\lceil \frac{N_{NPRS_total}}{N_{NPRS}} \right\rceil$ is the largest among all the measured cells.

Table 4.8.1-1: Number of NPRS positioning occasions within $T_{RSTD_InterFreq_NB}$

Positioning subframe configuration period T_{NPRS}	Number of NPRS positioning occasions M	
	f1 ^{Note1}	f1 and f2 ^{Note2}
160 ms	$16^* \left\lceil \frac{N_{total_NPRS}}{N_{NPRS}} \right\rceil$	$32^* \left\lceil \frac{N_{total_NPRS}}{N_{NPRS}} \right\rceil$
>160 ms	$8^* \left\lceil \frac{N_{total_NPRS}}{N_{NPRS}} \right\rceil$	$16^* \left\lceil \frac{N_{total_NPRS}}{N_{NPRS}} \right\rceil$
Note 1:	When only intra-frequency RSTD measurements are performed over cells belonging to the serving carrier frequency f1.	
Note 2:	When intra-frequency RSTD and inter-frequency RSTD measurements are performed over cells belonging to the serving carrier frequency f1 and one inter-frequency carrier frequency f2, respectively.	

The UE physical layer shall be capable of reporting RSTD for the reference cell and all the neighbor cells i out of at least $(n-1)$ neighbor cells within $T_{RSTD_InterFreq_NB}$ provided:

$$\left(\text{NPRS } \hat{E}_s / \text{Iot} \right)_{ref} \geq -6 \text{ dB for all Frequency Bands for the reference cell,}$$

$$\left(\text{NPRS } \hat{E}_s / \text{Iot} \right)_i \geq -13 \text{ dB for all Frequency Bands for neighbour cell } i,$$

$$\left(\text{NPRS } \hat{E}_s / \text{Iot} \right)_{ref} \text{ and } \left(\text{NPRS } \hat{E}_s / \text{Iot} \right)_i \text{ conditions apply for all subframes of at least } L = \frac{M}{2} \text{ NPRS positioning occasions,}$$

NPRP 1,2_{dBm} according to Annex B.2.17 for a corresponding Band

$\text{NPRS } \hat{E}_s / \text{Iot}$ is defined as the ratio of the average received energy per PRS RE during the useful part of the symbol to the average received power spectral density of the total noise and interference for this RE, where the ratio is measured over all REs which carry NPRS.

The time $T_{RSTD_InterFreq_NB}$ starts from the point when the UE has received both the OTDOA-RequestLocationInformation message and the OTDOA assistance data in the OTDOA-ProvideAssistanceData message as specified in TS 36.355 [24], and the message and data have been delivered to the physical layer of the UE and the UE has entered the RRC_IDLE state.

The RSTD measurement accuracy for all measured neighbor cells i shall fulfill the requirements specified in sub-clause 9.1.22.11.

4.8.3.1 RSTD Measurement Reporting Delay

The reported measurement contained in the event triggered measurement reports shall meet the requirements in clause 9.1.22.11.

The UE shall not send any measurement reports, as long as no reporting criteria are fulfilled.

After receiving both the OTDOA-RequestLocationInformation message and the OTDOA assistance data in the OTDOA-ProvideAssistanceData message as specified in TS 36.355 [24], the UE shall be sent to RRC_IDLE state. The measurement reporting delay is defined as the time between the point when the UE has entered the RRC_IDLE state,

and the point when the UE is ready to transmit the measurement report over the air interface and starts to establish a signalling connection with the MME. This requirement assumes that the measurement report is not delayed by other RRC signalling on the DCCH. This measurement reporting delay excludes a delay uncertainty resulted when inserting the measurement report to the TTI of the uplink DCCH. The delay uncertainty is $N_{rep} \times TTI_{DCCH}$, where N_{rep} [21] is the maximum number of NPUSCH repetitions configured for the UE, otherwise the uncertainty is defined as $2 \times TTI_{DCCH}$. This measurement reporting delay excludes the delay caused by not having UL resources for the UE to send the measurement report. This measurement reporting delay excludes any delay caused by RRC connection release before the RRC_IDLE mode measurement. This measurement reporting delay excludes any delay caused by establishing a signalling connection with the MME (including random access procedure) as defined in TS 36.305 [36] for LPP measurement reporting.

The measurement reporting delay shall be less than $T_{RSTD\text{InterFreq,NB}}$ defined in Clause 4.8.3.

4.8.4 OTDOA Inter-Frequency RSTD Measurements for UE category NB1 for enhanced coverage

The UE shall support NPRS configuration in more than one resource block [24]. The UE shall follow the procedure for RRC_IDLE state positioning measurement as defined in TS 36.305 [36] clause 7.1.3.

All positioning subframes indicated in the OTDOA assistance data and specified in sub-clause 9.1.22.13 are available for RSTD measurements in the measured and reference cell.

When the physical layer cell identities of neighbour cells together with the OTDOA assistance data have been provided and the UE has entered the RRC_IDLE state, the UE shall be able to detect and measure inter-frequency RSTD, specified in TS 36.214 [4], for at least $n = 16$ cells, including the reference cell within $T_{RSTD\text{InterFreq,NB}}$ ms as given below:

$$T_{RSTD\text{InterFreq,NB}} = T_{NPRS} \cdot (M-1) + \Delta \quad ms,$$

where

$T_{RSTD\text{InterFreq,NB}}$ is the total time for detecting and measuring at least n cells;

T_{NPRS} is the cell-specific positioning subframe configuration period as defined in TS 36.355 [24] if Part B subframe configuration is provided; otherwise if only Part A subframe configuration is provided, the T_{NPRS} equals to the length of the subframe pattern,

M is the number of NPRS positioning occasions as defined in Table 4.8.1-1,

$\Delta = T_{NPRS} \cdot \left\lceil \frac{n}{M} \right\rceil$ ms is the measurement time for a single NPRS positioning occasion which includes the sampling time and the processing time;

N_{NPRS} is the cell-specific number of NPRS subframes within a NPRS occasion as defined in TS36.355[24] if Part B subframe configuration is provided; if only Part A subframe configuration is provided, the NPRS occasion length is 10 ms,

N_{NPRS_total} is the minimum number of NPRS subframes per cell measurement as specified in Section 9.1.22.13.

$T_{NPRS} N_{NPRS}$, and N_{NPRS_total} are the parameters of the same cell, for which $T_{NPRS} \cdot \left\lceil \frac{N_{NPRS_total}}{N_{NPRS}} \right\rceil$ is the largest among all the measured cells.

Table 4.8.1-1: Number of NPRS positioning occasions within $T_{\text{RSTD InterFreq, NB}}$

Positioning subframe configuration period T_{NPRS}	Number of NPRS positioning occasions M	
	f1 ^{Note1}	f1 and f2 ^{Note2}
160 ms	16* $N_{\text{total_NPRS}} / N_{\text{NPRS}}$	32* $N_{\text{total_NPRS}} / N_{\text{NPRS}}$
>160 ms	8* $N_{\text{total_NPRS}} / N_{\text{NPRS}}$	16* $N_{\text{total_NPRS}} / N_{\text{NPRS}}$
Note 1: When only intra-frequency RSTD measurements are performed over cells belonging to the serving carrier frequency f1. Note 2: When intra-frequency RSTD and inter-frequency RSTD measurements are performed over cells belonging to the serving carrier frequency f1 and one inter-frequency carrier frequency f2, respectively.		

The UE physical layer shall be capable of reporting RSTD for the reference cell and all the neighbor cells i out of at least $(n-1)$ neighbor cells within $T_{\text{RSTD InterFreq, NB}}$ provided:

$$\left(\text{NPRS } \hat{E}_s / \text{Iot} \right)_{\text{ref}} \geq -15 \text{ dB for all Frequency Bands for the reference cell,}$$

$$\left(\text{NPRS } \hat{E}_s / \text{Iot} \right)_i \geq -15 \text{ dB for all Frequency Bands for neighbour cell } i,$$

$$\left(\text{NPRS } \hat{E}_s / \text{Iot} \right)_{\text{ref}} \text{ and } \left(\text{NPRS } \hat{E}_s / \text{Iot} \right)_i \text{ conditions apply for all subframes of at least } L = \frac{M}{2} \text{ NPRS}$$

positioning occasions,

NPRP 1,2_{dBm} according to Annex B.2.17 for a corresponding Band

$\text{NPRS } \hat{E}_s / \text{Iot}$ is defined as the ratio of the average received energy per PRS RE during the useful part of the symbol to the average received power spectral density of the total noise and interference for this RE, where the ratio is measured over all REs which carry NPRS.

The time $T_{\text{RSTD IntraFreq, NB}}$ starts from the point when the UE has received both the OTDOA-

RequestLocationInformation message and the OTDOA assistance data in the OTDOA-ProvideAssistanceData message as specified in TS 36.355 [24], and the message and data have been delivered to the physical layer of the UE and the UE has entered the RRC_IDLE state.

The RSTD measurement accuracy for all measured neighbor cells i shall fulfill the requirements specified in sub-clause 9.1.22.13.

4.8.4.1 RSTD Measurement Reporting Delay

The reported measurements contained in the event triggered measurement reports shall meet the requirements in clause 9.1.22.13.

The UE shall not send any measurement reports, as long as no reporting criteria are fulfilled.

After receiving both the OTDOA-RequestLocationInformation message and the OTDOA assistance data in the OTDOA-ProvideAssistanceData message as specified in TS 36.355 [24], the UE shall be sent to RRC_IDLE state. The measurement reporting delay is defined as the time between the point when the UE has entered the RRC_IDLE state, and the point when the UE is ready to transmit the measurement report over the air interface and starts to establish a signalling connection with the MME. This requirement assumes that the measurement report is not delayed by other RRC signalling on the DCCH. This measurement reporting delay excludes a delay uncertainty resulted when inserting the measurement report to the TTI of the uplink DCCH. The delay uncertainty is $N_{\text{rep}} \times \text{TTI}_{\text{DCCH}}$, where N_{rep} [21] is the maximum number of NPUSCH repetitions configured for the UE, otherwise uncertainty is defined as $2 \times \text{TTI}_{\text{DCCH}}$. This measurement reporting delay excludes the delay caused by not having UL resources for the UE to send the measurement report. This measurement reporting delay excludes any delay caused by RRC connection release before the RRC_IDLE mode measurement. This measurement reporting delay excludes any delay caused by establishing a

signalling connection with the MME (including random access procedure) as defined in TS 36.305 [36] for LPP measurement reporting.

The measurement reporting delay shall be less than $T_{RSTD_{InterFreq,NB}}$ defined in Clause 4.8.4.

4.8.5 Intra-Frequency E-CID NRSRP and NRSRQ Measurements for UE category NB2 for normal coverage

UE shall follow the procedure for idle state positioning measurement as defined in [36] section 7.1.3.

The UE shall be able to identify a new detectable intra frequency cell within $T_{identify_intra_NC_ECID}$ provided that the UE has received ECID-RequestLocationInformation message from E-SMLC via LPP requesting the UE to report E-CID intra-frequency NRSRP and NRSRQ measurements [24] and UE has entered the idle state.

For UE not configured with eDRX_IDLE cycle, $T_{identify_intra_NC_ECID}$ is as shown in Table 4.8.5-1. For UE configured with eDRX_IDLE cycle, $T_{identify_intra_NC_ECID}$ is as shown in Table 4.8.5-2.

Table 4.8.5-1: Requirement to identify a newly detectable intra-frequency cell for E-CID NRSRP/NRSRQ measurement

DRX cycle length [s]	$T_{detect,NB_Intra_NC_ECID}$ [s] (number of DRX cycles)	$T_{measure_Intra_NC_ECID}$ [s] (number of DRX cycles)
1.28	58 (45)	1.28 (1)
2.56	59 (23)	2.56 (1)
5.12	113 (22)	5.12 (1)
10.24	113 (11)	10.24 (1)

Table 4.8.5-2: Requirement to identify a newly detectable intra-frequency cell for E-CID NRSRP/NRSRQ measurement for UE configured with eDRX_IDLE cycle

eDRX_IDLE cycle length [s]	DRX cycle length [s]	PTW length [s] (number of 2.56s periods)	$T_{detect,NB_Intra_NC_ECID}$ [s] (number of DRX cycles)	$T_{measure_Intra_NC_ECID}$ [s] (number of DRX cycles)
20.48 ≤ eDRX_IDLE cycle length ≤ 10485.76	1.28	≥15.36 (6)	$eDRX_cycle_length \times \left\lceil \frac{20}{PTW / DRX_cycle_length} \right\rceil$ (20)	1.28 (1)
	2.56	≥17.92 (7)		2.56 (1)
	5.12	≥23.04 (9)		5.12 (1)
	10.24	≥33.28 (13)		10.24 (1)
NOTE 1: The number of DRX cycles in this table is given for the DRX cycles within PTWs.				
NOTE 2: The eDRX_IDLE cycle lengths are as specified in Section X of TS 24.008 [34].				

An intra frequency cell is considered to be detectable when the conditions for NRSRP, $NRSRP \hat{E}s/Iot$, NSCH_RP and NSCH $\hat{E}s/Iot$ defined in Annex B.1.4 are met for a corresponding Band.

For UE not configured with eDRX_IDLE cycle, the measurement period for intra frequency measurements is $T_{measure_intra_NC_ECID}$ as shown in Table 4.8.5-1. For UE configured with eDRX_IDLE cycle, the measurement period for intra frequency measurements is $T_{measure_intra_NC_ECID}$ as shown in Table 4.8.5-2.

The UE shall be capable of performing NRSRP and NRSRQ measurement for [1] identified intra-frequency cell, and the UE physical layer shall be capable of reporting measurements to higher layers with the measurement period of $T_{measure_intra_NC_ECID}$.

The NRSRP measurement accuracy for all measured cells shall be as specified in the sub-clauses 9.1.22.1. The NRSRQ measurement accuracy for all measured cells shall be as specified in the sub-clause 9.1.22.3.

4.8.5.1 Measurement Reporting Delay

Reported measurement contained in event triggered measurement reports shall meet the requirements in sections 9.1.22.1 and 9.1.22.3.

The UE shall not send any measurement reports, as long as no reporting criteria are fulfilled. The measurement reporting delay is defined as the time between the point when UE receive ECID-RequestLocationInformation message and the point when the UE starts to transmit the measurement report over the air interface. This requirement assumes that the measurement report is not delayed by other RRC signalling on the DCCH. This measurement reporting delay excludes a delay uncertainty resulted when inserting the measurement report to the TTI of the uplink DCCH. The delay uncertainty is: $N_{rep} \times TTI_{DCCH}$, where N_{rep} [21] is the maximum number of NPUSCH repetitions configured for the UE, otherwise uncertainty is defined as $2 \times TTI_{DCCH}$. This measurement reporting delay excludes a delay which caused by no UL resources for UE to send the measurement report. This measurement reporting delay excludes any delay caused by RRC connection release before the idle mode measurement. This measurement reporting delay excludes any delay caused by establishing a signalling connection with the MME (including random access procedure) as defined in [36] for LPP measurement reporting.

4.8.6 Intra-Frequency E-CID NRSRP and NRSRQ Measurements for UE category NB2 for enhanced coverage

UE shall follow the procedure for idle state positioning measurement as defined in [36] section 7.1.3.

The UE shall be able to identify a new detectable intra frequency cell within $T_{identify_intra_EC_ECID}$ provided that the UE has received ECID-RequestLocationInformation message from E-SMLC via LPP requesting the UE to report E-CID intra-frequency NRSRP and NRSRQ measurements [24] and UE has entered the idle state.

For UE not configured with eDRX_IDLE cycle, $T_{identify_intra_EC_ECID}$ is as shown in Table 4.8.6-1. For UE configured with eDRX_IDLE cycle, $T_{identify_intra_EC_ECID}$ is as shown in Table 4.8.6-2.

Table 4.8.6-1: Requirement to identify a newly detectable intra-frequency cell for E-CID NRSRP/NRSRQ measurement

SCH Es/lot of neighboring cell: Q2	DRX cycle length [s]	$T_{detect,NB_Intra_EC_ECID}$ [s] (number of DRX cycles)	$T_{measure,NB_Intra_EC_ECID}$ [s] (number of DRX cycles)
-15 ≤ Q2 < -6	1.28	532 (415)	1.28 (1)
	2.56	532 (208)	2.56 (1)
	5.12	1063 (208)	5.12 (1)
	10.24	1063 (104)	10.24 (1)
Q2 ≥ -6	1.28	58 (45)	1.28 (1)
	2.56	59 (23)	2.56 (1)
	5.12	113 (22)	5.12 (1)
	10.24	113 (11)	10.24 (1)

Table 4.8.6-2: Requirement to identify a newly detectable intra-frequency cell for E-CID NRSRP/NRSRQ measurement for UE configured with eDRX_IDLE cycle

SCH Es/lot of neighboring cell: Q2	eDRX_IDLE cycle length [s]	DRX cycle length [s]	PTW length [s] (number of 2.56s periods)	$T_{detect,NB_Intra_EC_ECID}$ [s] (number of DRX cycles)	$T_{measure,NB_Intra_EC_ECID}$ [s] (number of DRX cycles)
-15 ≤ Q2 < -6	20.48 ≤ eDRX_IDLE cycle length ≤ 10485.76	1.28	≥15.3 6 (6)	$eDRX_cycle_length \times \left\lceil \frac{[406]}{PTW / DRX_cycle_length} \right\rceil$ (406)	1.28 (1)
		2.56	≥17.9 2 (7)		2.56 (1)
		5.12	≥23.0 4 (9)		5.12 (1)
		10.24	≥33.2 8 (13)		10.24 (1)
Q2 ≥ -6	20.48 ≤ eDRX_IDLE	1.28	≥15.3 6 (6)		1.28 (1)

	E cycle length \leq 10485.76	2.56	≥ 17.9 2 (7)	$eDRX_cycle_length \times \left\lceil \frac{20}{\lceil PTW / DRX_cycle_length \rceil} \right\rceil$ (20)	2.56 (1)
		5.12	≥ 23.0 4 (9)		5.12 (1)
		10.2 4	≥ 33.2 8 (13)		10.24 (1)
NOTE 1: The number of DRX cycles in this table is given for the DRX cycles within PTWs.					
NOTE 2: The eDRX_IDLE cycle lengths are as specified in Section X of TS 24.008 [34].					

An intra frequency cell is considered to be detectable according to NRSRP, NRSRP \hat{E}_s/I_{ot} , NSCH_RP and NSCH \hat{E}_s/I_{ot} defined in Annex B.1.4 for a corresponding Band.

For UE not configured with eDRX_IDLE cycle, the measurement period for intra frequency measurements is $T_{measure_intra_EC_ECID}$ as shown in Table 4.8.6-1. For UE configured with eDRX_IDLE cycle, the measurement period for intra frequency measurements is $T_{measure_intra_EC_ECID}$ as shown in Table 4.8.6-2.

The UE shall be capable of performing NRSRP and NRSRQ measurement for at least 1 identified intra-frequency cell, and the UE physical layer shall be capable of reporting measurements to higher layers with the measurement period of $T_{measure_intra_EC_ECID}$.

The NRSRP measurement accuracy for all measured cells shall be as specified in the sub-clauses 9.1.22.1. The NRSRQ measurement accuracy for all measured cells shall be as specified in the sub-clause 9.1.22.3.

4.8.6.1 Measurement Reporting Delay

Reported measurement contained in event triggered measurement reports shall meet the requirements in sections 9.1.22.1 and 9.1.22.3.

The UE shall not send any measurement reports, as long as no reporting criteria are fulfilled.

The measurement reporting delay is defined as the time between the point when UE receive ECID-RequestLocationInformation message and the point when the UE starts to transmit the measurement report over the air interface. This requirement assumes that the measurement report is not delayed by other RRC signalling on the DCCH. This measurement reporting delay excludes a delay uncertainty resulted when inserting the measurement report to the TTI of the uplink DCCH. The delay uncertainty is: $N_{rep} \times TTI_{DCCH}$, where N_{rep} [21] is the maximum number of NPUSCH repetitions configured for the UE, otherwise uncertainty is defined as $2 \times TTI_{DCCH}$. This measurement reporting delay excludes a delay which caused by no UL resources for UE to send the measurement report. This measurement reporting delay excludes any delay caused by RRC connection release before the idle mode measurement. This measurement reporting delay excludes any delay caused by establishing a signalling connection with the MME (including random access procedure) as defined in [36] for LPP measurement reporting.

4.8.7 Inter-Frequency E-CID NRSRP and NRSRQ Measurements for UE category NB2 for normal coverage

UE shall follow the procedure for idle state positioning measurement as defined in [36] section 7.1.3.

The UE shall be able to identify a new detectable inter frequency cell according to the following expression provided that the UE has received ECID-RequestLocationInformation message from E-SMLC via LPP requesting the UE to report E-CID inter-frequency NRSRP and NRSRQ measurements [24] and UE has entered the idle state:

$$T_{identify_inter_NC_ECID} = N_{freq_NB_ECID} \cdot T_{identify_inter_NC_perCC_ECID}$$

Where $N_{freq_NB_ECID}$ is the total number of inter frequency carriers UE measures provided that the UE has received ECID-RequestLocationInformation message from E-SMLC via LPP requesting the UE to report E-CID intra-frequency NRSRP and NRSRQ measurements [24] and UE has entered the idle state.

For UE not configured with eDRX_IDLE cycle, $T_{identify_inter_NC_perCC_ECID}$ is as shown in Table 4.8.7-1. For UE configured with eDRX_IDLE cycle, $T_{identify_inter_NC_perCC_ECID}$ is as shown in Table 4.8.7-2.

Table 4.8.7-1: Requirement to identify a newly detectable inter-frequency cell for E-CID NRSRP/NRSRQ measurement

DRX cycle length [s]	$T_{\text{detect,NB_Inter_NC_perCC_ECID}}$ [s] (number of DRX cycles)	$T_{\text{measure_Intra_NC_ECID}}$ [s] (number of DRX cycles)
1.28	58 (45)	1.28 (1)
2.56	59 (23)	2.56 (1)
5.12	113 (22)	5.12 (1)
10.24	113 (11)	10.24 (1)

Table 4.8.7-2: Requirement to identify a newly detectable inter-frequency cell for E-CID NRSRP/NRSRQ measurement for UE configured with eDRX_IDLE cycle

eDRX_IDLE cycle length [s]	DRX cycle length [s]	PTW length [s] (number of 2.56s periods)	$T_{\text{detect,NB_Intra_NC_ECID}}$ [s] (number of DRX cycles)	$T_{\text{measure_Intra_NC_ECID}}$ [s] (number of DRX cycles)
$20.48 \leq \text{eDRX_IDLE cycle length} \leq 10485.76$	1.28	≥ 15.36 (6)	$e\text{DRX_cycle_length} \times \left\lceil \frac{20}{\lceil \text{PTW} / \text{DRX_cycle_length} \rceil} \right\rceil$ (20)	1.28 (1)
	2.56	≥ 17.92 (7)		2.56 (1)
	5.12	≥ 23.04 (9)		5.12 (1)
	10.24	≥ 33.28 (13)		10.24 (1)
NOTE 1: The number of DRX cycles in this table is given for the DRX cycles within PTWs. NOTE 2: The eDRX_IDLE cycle lengths are as specified in Section X of TS 24.008 [34].				

An inter frequency cell is considered to be detectable according to NRSRP, NRSRP \hat{E}_s/I_{ot} , NSCH_RP and NSCH \hat{E}_s/I_{ot} defined in Annex B.1.5 for a corresponding Band.

For UE not configured with eDRX_IDLE cycle, the measurement period for inter frequency measurements is $T_{\text{measure_inter_NC_ECID}}$ as shown in Table 4.8.7-1. For UE configured with eDRX_IDLE cycle, the measurement period for inter frequency measurements is $T_{\text{measure_inter_NC_ECID}}$ as shown in Table 4.8.7-2.

The UE shall be capable of performing NRSRP and NRSRQ measurement for at least 1 identified inter-frequency cell per inter-frequency for at least 1 inter-frequency carrier, and the UE physical layer shall be capable of reporting measurements to higher layers with the measurement period of $T_{\text{measure_intra_NC_ECID}}$.

The NRSRP measurement accuracy for all measured cells shall be as specified in the sub-clauses 9.1.22.5. The NRSRQ measurement accuracy for all measured cells shall be as specified in the sub-clause 9.1.22.7.

4.8.7.1 Measurement Reporting Delay

Reported measurement contained in event triggered measurement reports shall meet the requirements in sections 9.1.22.5 and 9.1.22.7.

The UE shall not send any measurement reports, as long as no reporting criteria are fulfilled.

The measurement reporting delay is defined as the time between the point when UE receive ECID-RequestLocationInformation message and the point when the UE starts to transmit the measurement report over the air interface. This requirement assumes that the measurement report is not delayed by other RRC signalling on the DCCH. This measurement reporting delay excludes a delay uncertainty resulted when inserting the measurement report to the TTI of the uplink DCCH. The delay uncertainty is: $N_{rep} \times TTI_{DCCH}$, where N_{rep} [21] is the maximum number of NPUSCH repetitions configured for the UE, otherwise uncertainty is defined as $2 \times TTI_{DCCH}$. This measurement reporting delay excludes a delay which caused by no UL resources for UE to send the measurement report. This measurement reporting delay excludes any delay caused by RRC connection release before the idle mode measurement. This measurement reporting delay excludes any delay caused by establishing a signalling connection with the MME (including random access procedure) as defined in [36] for LPP measurement reporting.

4.8.8 Inter-Frequency E-CID NRSRP and NRSRQ Measurements for UE category NB2 for enhanced coverage

UE shall follow the procedure for idle state positioning measurement as defined in [36] section 7.1.3.

The UE shall be able to identify a new detectable inter frequency cell according to the following expression provided the UE has received ECID-RequestLocationInformation message from E-SMLC via LPP requesting the UE to report E-CID inter-frequency NRSRP and NRSRQ measurements [24] and UE has entered the idle state:

$$T_{\text{identify_inter_EC}} = N_{\text{freq_NB_ECID}} \cdot T_{\text{identify_inter_EC_perCC_ECID}}$$

Where $N_{\text{freq_NB_ECID}}$ is the total number of inter frequency carriers UE measures provided that the UE has received ECID-RequestLocationInformation message from E-SMLC via LPP requesting the UE to report E-CID intra-frequency NRSRP and NRSRQ measurements [24] and UE has entered the idle state. $T_{\text{identify_inter_EC_perCC_ECID}}$ is shown in Table 4.8.8-1

For UE not configured with eDRX_IDLE cycle, $T_{\text{identify_inter_EC_perCC_ECID}}$ is as shown in Table 4.8.8-1. For UE configured with eDRX_IDLE cycle, $T_{\text{identify_inter_EC_perCC_ECID}}$ is as shown in Table 4.8.8-2.

Table 4.8.8-1: Requirement to identify a newly detectable inter-frequency cell for E-CID NRSRP/NRSRQ measurement

SCH Es/lot of neighboring cell: Q2	DRX cycle length [s]	$T_{\text{detect,NB_Intra_EC_perCC_ECID}}$ [s] (number of DRX cycles)	$T_{\text{measure,NB_Intra_EC_ECID}}$ [s] (number of DRX cycles)
$-15 \leq Q2 < -6$	1.28	532 (415)	1.28 (1)
	2.56	532 (208)	2.56 (1)
	5.12	1063 (208)	5.12 (1)
	10.24	1063 (104)	10.24 (1)
$Q2 \geq -6$	1.28	58 (45)	1.28 (1)
	2.56	59 (23)	2.56 (1)
	5.12	113 (22)	5.12 (1)
	10.24	113 (11)	10.24 (1)

Table 4.8.8-2: Requirement to identify a newly detectable inter-frequency cell for E-CID NRSRP/NRSRQ measurement for UE configured with eDRX_IDLE cycle

SCH Es/lot of neighboring cell: Q2	eDRX_IDLE cycle length [s]	DRX cycle length [s]	PTW length [s] (number of 2.56s periods)	$T_{\text{detect,NB_Intra_EC_perCC_ECID}}$ [s] (number of DRX cycles)	$T_{\text{measure,NB_Intra_EC_ECID}}$ [s] (number of DRX cycles)
$-15 \leq Q2 < -6$	$20.48 \leq \text{eDRX_IDLE cycle length} \leq 10485.76$	1.28	≥ 15.36 (6)	$\text{eDRX_cycle_length} \times \left\lceil \frac{[406]}{PTW / DRX_cycle_length} \right\rceil$ (406)	1.28 (1)
		2.56	≥ 17.92 (7)		2.56 (1)
		5.12	≥ 23.04 (9)		5.12 (1)
		10.24	≥ 33.28 (13)		10.24 (1)
$Q2 \geq -6$	$20.48 \leq \text{eDRX_IDLE cycle length} \leq 10485.76$	1.28	≥ 15.36 (6)	$\text{eDRX_cycle_length} \times \left\lceil \frac{20}{PTW / DRX_cycle_length} \right\rceil$ (20)	1.28 (1)
		2.56	≥ 17.92 (7)		2.56 (1)
		5.12	≥ 23.04 (9)		5.12 (1)
		10.24	≥ 33.28 (13)		10.24 (1)

NOTE 1: The number of DRX cycles in this table is given for the DRX cycles within PTWs.

NOTE 2: The eDRX_IDLE cycle lengths are as specified in Section X of TS 24.008 [34].

An inter frequency cell is considered to be detectable according to NRSRP, $NRSRP \hat{E}_s/I_{ot}$, NSCH_RP and NSCH \hat{E}_s/I_{ot} defined in Annex B.1.5 for a corresponding Band.

For UE not configured with eDRX_IDLE cycle, the measurement period for inter frequency measurements is $T_{\text{measure_inter_EC_ECID}}$ as shown in Table 4.8.8-1. For UE configured with eDRX_IDLE cycle, the measurement period for inter frequency measurements is $T_{\text{measure_inter_EC_ECID}}$ as shown in Table 4.8.8-2.

The UE shall be capable of performing NRSRP and NRSRQ measurement for at least 1 identified inter-frequency cell per inter-frequency for at least 1 inter-frequency carrier, and the UE physical layer shall be capable of reporting measurements to higher layers with the measurement period of $T_{\text{measure_intra_EC_ECID}}$.

The NRSRP measurement accuracy for all measured cells shall be as specified in the sub-clauses 9.1.22.5. The NRSRQ measurement accuracy for all measured cells shall be as specified in the sub-clause 9.1.22.7.

4.8.8.1 Measurement Reporting Delay

Reported measurement contained in event triggered measurement reports shall meet the requirements in sections 9.1.22.5 and 9.1.22.7.

The UE shall not send any measurement reports, as long as no reporting criteria are fulfilled.

The measurement reporting delay is defined as the time between the point when UE receive ECID-RequestLocationInformation message and the point when the UE starts to transmit the measurement report over the air interface. This requirement assumes that the measurement report is not delayed by other RRC signalling on the DCCH. This measurement reporting delay excludes a delay uncertainty resulted when inserting the measurement report to the TTI of the uplink DCCH. The delay uncertainty is: $N_{rep} \times TTI_{DCCH}$, where N_{rep} [21] is the maximum number of NPUSCH repetitions configured for the UE, otherwise uncertainty is defined as $2 \times TTI_{DCCH}$. This measurement reporting delay excludes a delay which caused by no UL resources for UE to send the measurement report. This measurement reporting delay excludes any delay caused by RRC connection release before the idle mode measurement. This measurement reporting delay excludes any delay caused by establishing a signalling connection with the MME (including random access procedure) as defined in [36] for LPP measurement reporting.

4.9 Idle Mode CA Measurement

4.9.1 Introduction

A UE supporting *ca-IdleModeMeasurements* shall perform the idle mode measurement on the inter-frequency CA candidate frequencies/cells indicated by higher layers and meet the requirement specified in this section.

Additionally, a UE supporting *ca-IdleModeMeasurements* shall perform the idle mode measurement on serving cell and meet the requirement specified in this section.

4.9.2 Requirement

For a UE which supports *ca-IdleModeMeasurements* the UE shall support the idle mode CA measurements on the serving cell, overlapping and non-overlapping carriers. An overlapping carrier is defined as a carrier configured by higher layer for early measurement reporting and inter-frequency mobility measurements. A non-overlapping carrier is defined as a carrier configured by higher layer for early measurement reporting while not configured for inter-frequency mobility measurements.

4.9.2.1 Detected cell requirement during state transition and Idle mode

This subclause defines the requirements for the detected cell status for the idle mode CA measurement when UE transitions from RRC Connected mode to Idle mode and after UE has entered Idle mode. The requirements are applicable to an E-UTRAN carrier aggregation capable UE which has been configured with one or more downlink SCells during the Connected mode and which supports *ca-IdleModeMeasurements*. The requirements are applicable for E-UTRAN FDD and TDD SCell(s).

Upon releasing the connection and if the UE has been configured with idle mode CA measurement reporting, following requirements apply concerning the detected cells in Connected mode upon state transitioning to Idle mode and during Idle mode:

- A cell which is detected cell in Connected mode prior to connection release, shall remain detected after UE has entered Idle mode and during Idle mode, provided that the following conditions are met:

- The UE has been provided with a list of cells and/or carrier frequencies for early measurement reporting by dedicated RRC signaling and
- The detected cell is among the list of cells or on a carrier frequency provided for early measurement reporting, and
- The UE is provided with a valid timer T331 by dedicated RRC signaling, and
- The detected cell remains detectable until UE reconnects to the network and transmits the early measurement report.
- The carrier frequency of the detected cell and the carrier frequency of the serving cell are among the supported band combination of the UE.

An inter-frequency cell is considered detectable according to RSRP, RSRP \hat{E}_s/I_{ot} , SCH_{RP} and SCH \hat{E}_s/I_{ot} defined in Annex B.1.1 and Annex B.1.2 for a corresponding Band.

In the absence or expiration of T331, it is up to UE implementation to apply the requirements on the detected cell status in this subclause.

4.9.2.2 Measurements of inter-frequency CA candidate cells

While T331 is running, the UE shall perform measurement on the configured overlapping and non-overlapping inter-frequency carriers for idle mode measurement reporting.

A UE which supports *ca-IdleModeMeasurements* shall support the idle mode CA measurements of at least 1 non-overlapping inter-frequency carrier and 1 overlapping inter-frequency carrier.

For overlapping carriers, the inter-frequency measurement requirements in section 4.2.2.4 apply.

For non-overlapping carriers, at least prior to transmission of the idle mode measurement report, the UE shall perform at least a single measurement on detected cells on the non-overlapping inter-frequency carrier(s) configured to be measured for early measurement reporting.

In the absence or expiration of T331, it is up to UE implementation to perform the idle mode CA measurement.

For overlapping carriers, the UE shall be capable of performing RSRP and RSRQ measurements of the overlapping carriers, and the UE physical layer shall be capable of reporting RSRP and RSRQ measurements of the overlapping carriers to higher layers, with measurement accuracy as specified in sub-clauses 9.1.3B.2 and 9.1.6B.2, respectively. The UE shall be able to report idle mode CA measurements when idle mode CA measurement reporting is requested by the network.

4.9.2.3 Measurements on serving cell

The UE shall measure the RSRP and RSRQ level of the serving cell and evaluate the cell selection criterion S defined in section 4.2.2.1 and the UE physical layer shall be capable of reporting RSRP and RSRQ measurements of the serving cell to higher layers, with measurement accuracy as specified in sub-clauses 9.1.2B.2 and 9.1.5B.2, respectively.

4A E-UTRAN RRC_INACTIVE state mobility

4A.1 Cell Re-selection

Editor's note: the E-UTRAN RRC_INACTIVE state mobility defined in section 4A.1 applies under the scope of LTE connectivity to NGCN.

4A.1.1 Introduction

The E-UTRAN RRC_INACTIVE state requirements defined in this section applies for the UE when connected to NGCN with the conditions that,

- the UE is not configured with eDRX
- the UE is not configured with *highSpeedEnhancedMeasFlag*

4A.1.2 Requirements

4A.1.2.1 UE measurement capability

The capability defined in section 4.2.2.9 should apply for this section.

4A.1.2.2 Measurement and evaluation of serving cell

The requirements defined in section 4.2.2.1 should apply.

4A.1.2.3 Measurements of intra-frequency E-UTRAN cells

The requirements defined in section 4.2.2.3 should apply.

4A.1.2.4 Measurements of inter-frequency E-UTRAN cells

The requirements defined in section 4.2.2.4 should apply.

4A.1.2.5 Evaluation of cell re-selection criteria

The requirements defined in section 4.2.2.6 should apply.

4A.1.2.6 Maximum interruption in paging reception

The requirements defined in section 4.2.2.7 should apply.

4A.1.2.7 Measurements of inter-RAT NR cells

The requirements defined in section 4.2.2.5.6 should apply.

5 E-UTRAN RRC_CONNECTED state mobility

Note 1: For the performance requirements specified hereafter, the state when no DRX is used is defined as follows:

- DRX and eDRX_CONN parameters are not configured; or
- DRX or eDRX_CONN parameters are configured and
 - o drx-InactivityTimer is running; or
 - o drx-RetransmissionTimer is running; or
 - o mac-ContentionResolutionTimer is running; or
 - o a Scheduling Request sent on PUCCH/SPUCCH is pending; or
 - o an uplink grant for a pending HARQ retransmission can occur and there is data in the corresponding HARQ buffer; or
 - o a PDCCH/SPDCCH indicating a new transmission addressed to the C-RNTI of the UE has not been received after successful reception of a Random Access Response for the explicitly signaled preamble (only applicable to UEs in RRC_CONNECTED).

Otherwise

- It is the state when DRX is used.

Note 2: Unless otherwise stated, the requirements in sections 5.1, 5.1.2.2, 5.1.2.3, 5.1.2.4, 5.3 and 5.4 are also applicable when a UE is configured with Scell(s) or PSCell.

5.1 E-UTRAN Handover

5.1.1 Introduction

5.1.2 Requirements

5.1.2.1 E-UTRAN FDD – FDD

The requirements in this clause are applicable to both intra-frequency and inter-frequency handovers.

5.1.2.1.1 Handover delay

Procedure delays for all procedures that can command a handover are specified in TS 36.331 [2].

When the UE receives a RRC message implying handover the UE shall be ready to start the transmission of the new uplink PRACH channel within D_{handover} seconds from the end of the last TTI containing the RRC command when UE is configured with normal or make-before-break handover.

When the UE receives a RRC message implying handover, the UE shall be ready to start the transmission of the new uplink PUSCH channel within D_{handover} seconds from the end of the last TTI containing the RRC command when UE is configured with RACH-less or combination of RACH-less and make-before-break handover.

Where:

D_{handover} equals the maximum RRC procedure delay to be defined in clause 11.2 in TS 36.331 [2] plus the interruption time stated in clause 5.1.2.1.2.1.

D_{handover} equals the maximum RRC procedure delay to be defined in clause 11.2 in TS 36.331 [2] plus the interruption time stated in clause 5.1.2.1.2.2 when UE is configured with RACH-less handover.

D_{handover} equals the maximum RRC procedure delay to be defined in clause 11.2 in TS 36.331 [2] plus the interruption time stated in clause 5.1.2.1.2.1 when UE is configured with make-before-break handover.

D_{handover} equals the maximum RRC procedure delay to be defined in clause 11.2 in TS 36.331 [2] plus the interruption time stated in clause 5.1.2.1.2.2 when UE is configured with combination of make-before-break and RACH-less handover.

5.1.2.1.2 Interruption time

The interruption time is the time between end of the last TTI containing the RRC command on the old PDSCH and the time the UE starts transmission of the new PRACH when UE is configured with normal or make-before-break handover, or the time the UE starts transmission of new PUSCH when UE is configured with RACH-less or combination of make-before-break and RACH-less handover, excluding the RRC procedure delay. This requirement applies when UE is not required to perform any synchronisation procedure before transmitting on the new PRACH or on the new PUSCH.

5.1.2.1.2.1 Interruption time for normal handover

When intra-frequency or inter-frequency handover is commanded, the interruption time shall be less than $T_{\text{interrupt}}$

$$T_{\text{interrupt}} = T_{\text{search}} + T_{\text{IU}} + 20 \text{ ms}$$

Where:

T_{search} is the time required to search the target cell when the target cell is not already known when the handover command is received by the UE. If the target cell is known, then $T_{\text{search}} = 0$ ms. If the target cell is unknown and signal quality is sufficient for successful cell detection on the first attempt, then $T_{\text{search}} = 80$ ms. Regardless of whether DRX is in use by the UE, T_{search} shall still be based on non-DRX target cell search times.

T_{IU} is the interruption uncertainty in acquiring the first available PRACH occasion in the new cell. T_{IU} can be up to 30 ms.

NOTE: The actual value of T_{IU} shall depend upon the PRACH configuration used in the target cell.

In the interruption requirement a cell is known if it has been meeting the relevant cell identification requirement during the last 5 seconds otherwise it is unknown. Relevant cell identification requirements are described in Clause 8.1.2.2.1 for intra-frequency handover and Clause 8.1.2.3.1 for inter-frequency handover.

5.1.2.1.2.2 Interruption time for RACH-less handover

When intra-frequency or inter-frequency RACH-less handover is commanded, the interruption time shall be less than $T_{\text{interrupt}}$

$$T_{\text{interrupt}} = T_{\text{search}} + T_{\text{IU}} + 20 \text{ ms}$$

Where:

T_{search} is the time required to search the target cell when the target cell is not already known when the handover command is received by the UE. If the target cell is known, then $T_{\text{search}} = 0$ ms. If the target cell is unknown and signal quality is sufficient for successful cell detection on the first attempt, then $T_{\text{search}} = 80$ ms. Regardless of whether DRX is in use by the UE, T_{search} shall still be based on non-DRX target cell search times.

T_{IU} is the interruption uncertainty in acquiring the first PUSCH transmission occasion when UE is configured with RACH-less handover in the new cell.

- T_{IU} can be up to 10 ms if UL grant is configured in RRC command.

NOTE: The actual value of T_{IU} shall depend upon the UL grant configuration in RRC command.

- T_{IU} can be up to $T_{\text{UL_grant}}$ if UL grant is not configured in RRC command.

NOTE: $T_{\text{UL_grant}}$ is the time required to acquire and process uplink grant from the target Pcell.

In the interruption requirement a cell is known if it has been meeting the relevant cell identification requirement during the last 5 seconds otherwise it is unknown. Relevant cell identification requirements are described in Clause 8.1.2.2.1 for intra-frequency handover and Clause 8.1.2.3.1 for inter-frequency handover.

5.1.2.1.2.3 Interruption time for make-before-break handover

When intra-frequency make-before-break handover is commanded, the interruption time shall be less than $T_{\text{interrupt}}$

$$T_{\text{interrupt}} = 5 \text{ ms}$$

NOTE: The same bandwidth of source cell and target cell is assumed.

5.1.2.1.2.4 Interruption time for combination of make-before-break and RACH-less handover

When intra-frequency combination of make-before-break and RACH-less handover is commanded, the interruption time shall be less than $T_{\text{interrupt}}$

$$T_{\text{interrupt}} = 5 + T_{\text{UL_grant}} \text{ ms}$$

Where:

- $T_{\text{UL_grant}} = 0$ ms if UL grant is provided in RRC command.
- $T_{\text{UL_grant}}$ is the time required to acquire and process uplink grant from the target Pcell if UL grant is not provided in RRC command.

NOTE: The same bandwidth of source cell and target cell is assumed.

5.1.2.2 E-UTRAN FDD – TDD

The requirements in this clause are applicable to handover from FDD to TDD. The requirements in this clause shall apply to UE supporting FDD and TDD.

The requirements in clause 5.1.2.4 apply for this section.

5.1.2.2.1 (Void)

5.1.2.2.2 (Void)

5.1.2.3 E-UTRAN TDD – FDD

The requirements in this clause are applicable to handover from TDD to FDD. The requirements in this clause shall apply to UE supporting FDD and TDD.

The requirements in clause 5.1.2.1 apply for this section.

5.1.2.3.1 (Void)

5.1.2.3.2 (Void)

5.1.2.4 E-UTRAN TDD – TDD

The requirements in this clause are applicable to both intra-frequency and inter-frequency handovers.

5.1.2.4.1 Handover delay

Procedure delays for all procedures that can command a handover are specified in TS 36.331 [2].

When the UE receives a RRC message implying handover, the UE shall be ready to start the transmission of the new uplink PRACH channel within D_{handover} seconds from the end of the last TTI containing the RRC command when UE is configured with normal or make-before-break handover.

When the UE receives a RRC message implying handover, the UE shall be ready to start the transmission of the new uplink PUSCH channel within D_{handover} seconds from the end of the last TTI containing the RRC command when UE is configured with RACH-less or combination of RACH-less and make-before-break handover.

Where:

D_{handover} equals the maximum RRC procedure delay to be defined in clause 11.2 in TS 36.331 [2] plus the interruption time stated in clause 5.2.2.4.2.1.

D_{handover} equals the maximum RRC procedure delay to be defined in clause 11.2 in TS 36.331 [2] plus the interruption time stated in clause 5.1.2.4.2.2 when UE is configured with RACH-less handover.

D_{handover} equals the maximum RRC procedure delay to be defined in clause 11.2 in TS 36.331 [2] plus the interruption time stated in clause 5.1.2.4.2.1 when UE is configured with make-before-break handover.

D_{handover} equals the maximum RRC procedure delay to be defined in clause 11.2 in TS 36.331 [2] plus the interruption time stated in clause 5.1.2.4.2.2 when UE is configured with combination of make-before-break and RACH-less handover.

5.1.2.4.2 Interruption time

The interruption time is the time between end of the last TTI containing the RRC command on the old PDSCH and the time the UE starts transmission of the new PRACH when UE is configured with normal or make-before-break handover, or the time the UE starts transmission of new PUSCH when UE is configured with RACH-less or combination of make-before-break and RACH-less handover, excluding the RRC procedure delay. This requirement applies when UE is not required to perform any synchronisation procedure before transmitting on the new PRACH or on the new PUSCH.

5.1.2.4.2.1 Interruption time for normal handover

When intra-frequency or inter-frequency handover is commanded, the interruption time shall be less than $T_{\text{interrupt}}$

$$T_{\text{interrupt}} = T_{\text{search}} + T_{\text{IU}} + 20 \text{ ms}$$

Where

T_{search} is the time required to search the target cell when the target cell is not already known when the handover command is received by the UE. If the target cell is known, then $T_{\text{search}} = 0$ ms. If the target cell is unknown and

signal quality is sufficient for successful cell detection on the first attempt, then $T_{\text{search}} = 80$ ms. Regardless of whether DRX is in use by the UE, T_{search} shall still be based on non-DRX target cell search times.

T_{IU} is the interruption uncertainty in acquiring the first available PRACH occasion in the new cell. T_{IU} can be up to 30 ms.

NOTE: The actual value of T_{IU} shall depend upon the PRACH configuration used in the target cell.

In the interruption requirement a cell is known if it has been meeting the relevant cell identification requirement during the last 5 seconds otherwise it is unknown. Relevant cell identification requirements are described in Clause 8.1.2.2.2 for intra-frequency handover and Clause 8.1.2.3.4 for inter-frequency handover.

5.1.2.4.2.2 Interruption time for RACH-less handover

When intra-frequency or inter-frequency RACH-less handover is commanded, the interruption time shall be less than $T_{\text{interrupt}}$

$$T_{\text{interrupt}} = T_{\text{search}} + T_{\text{IU}} + 20 \text{ ms}$$

Where:

T_{search} is the time required to search the target cell when the target cell is not already known when the handover command is received by the UE. If the target cell is known, then $T_{\text{search}} = 0$ ms. If the target cell is unknown and signal quality is sufficient for successful cell detection on the first attempt, then $T_{\text{search}} = 80$ ms. Regardless of whether DRX is in use by the UE, T_{search} shall still be based on non-DRX target cell search times.

T_{IU} is the interruption uncertainty in acquiring the first PUSCH transmission occasion when UE is configured with RACH-less handover in the new cell.

- T_{IU} can be up to 10 ms if UL grant is configured in RRC command.

NOTE: The actual value of T_{IU} shall depend upon the UL grant configuration in RRC command.

- T_{IU} can be up to $T_{\text{UL_grant}}$ if UL grant is not configured in RRC command.

NOTE: $T_{\text{UL_grant}}$ is the time required to acquire and process uplink grant from the target Pcell.

In the interruption requirement a cell is known if it has been meeting the relevant cell identification requirement during the last 5 seconds otherwise it is unknown. Relevant cell identification requirements are described in Clause 8.1.2.2.2 for intra-frequency handover and Clause 8.1.2.3.2 for inter-frequency handover.

5.2.2.4.2.3 Interruption time for make-before-break handover

When intra-frequency make-before-break handover is commanded, the interruption time shall be less than $T_{\text{interrupt}}$

$$T_{\text{interrupt}} = 5 \text{ ms}$$

NOTE: The same bandwidth of source cell and target cell is assumed.

5.2.2.4.2.4 Interruption time for combination of make-before-break and RACH-less handover

When intra-frequency combination of make-before-break and RACH-less handover is commanded, the interruption time shall be less than $T_{\text{interrupt}}$

$$T_{\text{interrupt}} = 5 + T_{\text{UL_grant}} \text{ ms}$$

Where:

- $T_{\text{UL_grant}} = 0$ ms if UL grant is provided in RRC command.
- $T_{\text{UL_grant}}$ is the time required to acquire and process uplink grant from the target Pcell if UL grant is not provided in RRC command.

NOTE: The same bandwidth of source cell and target cell is assumed.

5.1.2.5 E-UTRAN HD-FDD

The requirements in this clause are applicable to intra-frequency handovers.

5.1.2.5.1 Handover delay

Procedure delays for all procedures that can command a handover are specified in TS 36.331 [2].

When the UE receives a RRC message implying handover the UE shall be ready to start the transmission of the new uplink PRACH channel within D_{handover} seconds from the end of the last TTI containing the RRC command when UE is configured with normal or make-before-break handover.

When the UE receives a RRC message implying handover, the UE shall be ready to start the transmission of the new uplink PUSCH channel within D_{handover} seconds from the end of the last TTI containing the RRC command when UE is configured with RACH-less or combination of RACH-less and make-before-break handover.

Where:

D_{handover} equals the maximum RRC procedure delay to be defined in clause 11.2 in TS 36.331 [2] plus the interruption time stated in clause 5.1.2.5.2.1.

D_{handover} equals the maximum RRC procedure delay to be defined in clause 11.2 in TS 36.331 [2] plus the interruption time stated in clause 5.1.2.5.2.2 when UE is configured with RACH-less handover.

D_{handover} equals the maximum RRC procedure delay to be defined in clause 11.2 in TS 36.331 [2] plus the interruption time stated in clause 5.1.2.5.2.1 when UE is configured with make-before-break handover.

D_{handover} equals the maximum RRC procedure delay to be defined in clause 11.2 in TS 36.331 [2] plus the interruption time stated in clause 5.1.2.5.2.2 when UE is configured with combination of make-before-break and RACH-less handover.

5.1.2.5.2 Interruption time

The interruption time is the time between end of the last TTI containing the RRC command on the old PDSCH and the time the UE starts transmission of the new PRACH when UE is configured with normal or make-before-break handover, or the time the UE starts transmission of new PUSCH when UE is configured with RACH-less or combination of make-before-break and RACH-less handover, excluding the RRC procedure delay. This requirement applies when UE is not required to perform any synchronisation procedure before transmitting on the new PRACH or on the new PUSCH.

5.1.2.5.2.1 Interruption time for normal handover

When intra-frequency handover is commanded, the interruption time shall be less than $T_{\text{interrupt}}$

$$T_{\text{interrupt}} = T_{\text{search}} + T_{\text{IU}} + 20 \text{ ms}$$

Where:

T_{search} is the time required to search the target cell when the target cell is not already known when the handover command is received by the UE. If the target cell is known, then $T_{\text{search}} = 0$ ms. If the target cell is unknown and signal quality is sufficient for successful cell detection on the first attempt, then $T_{\text{search}} = 80$ ms. Regardless of whether DRX is in use by the UE, T_{search} shall still be based on non-DRX target cell search times.

T_{IU} is the interruption uncertainty in acquiring the first available PRACH occasion in the new cell. T_{IU} can be up to 30 ms.

NOTE: The actual value of T_{IU} shall depend upon the PRACH configuration used in the target cell.

In the interruption requirement a cell is known if it has been meeting the relevant cell identification requirement during the last 5 seconds otherwise it is unknown. Relevant cell identification requirements are described in Clause 8.5.2.1.2 for intra-frequency handover.

5.1.2.5.2.2 Interruption time for RACH-less handover

When intra-frequency RACH-less handover is commanded, the interruption time shall be less than $T_{\text{interrupt}}$

$$T_{\text{interrupt}} = T_{\text{search}} + T_{\text{IU}} + 20 \text{ ms}$$

Where:

T_{search} is the time required to search the target cell when the target cell is not already known when the handover command is received by the UE. If the target cell is known, then $T_{\text{search}} = 0$ ms. If the target cell is unknown and signal quality is sufficient for successful cell detection on the first attempt, then $T_{\text{search}} = 80$ ms. Regardless of whether DRX is in use by the UE, T_{search} shall still be based on non-DRX target cell search times.

T_{IU} is the interruption uncertainty in acquiring the first PUSCH transmission occasion when UE is configured with RACH-less handover in the new cell.

- T_{IU} can be up to 10 ms if UL grant is configured in RRC command.

NOTE: The actual value of T_{IU} shall depend upon the UL grant configuration in RRC command.

- T_{IU} can be up to $T_{\text{UL_grant}}$ if UL grant is not configured in RRC command.

NOTE: $T_{\text{UL_grant}}$ is the time required to acquire and process uplink grant from the target Pcell.

In the interruption requirement a cell is known if it has been meeting the relevant cell identification requirement during the last 5 seconds otherwise it is unknown. Relevant cell identification requirements are described in Clause 8.5.2.1.2 for intra-frequency handover.

5.2.2.5.2.3 Interruption time for make-before-break handover

When intra-frequency make-before-break handover is commanded, the interruption time shall be less than $T_{\text{interrupt}}$

$$T_{\text{interrupt}} = 5 \text{ ms}$$

NOTE: The same bandwidth of source cell and target cell is assumed.

5.2.2.5.2.4 Interruption time for combination of make-before-break and RACH-less handover

When intra-frequency combination of make-before-break and RACH-less handover is commanded, the interruption time shall be less than $T_{\text{interrupt}}$

$$T_{\text{interrupt}} = 5 + T_{\text{UL_grant}} \text{ ms}$$

Where:

- $T_{\text{UL_grant}} = 0$ ms if UL grant is provided in RRC command.
- $T_{\text{UL_grant}}$ is the time required to acquire and process uplink grant from the target Pcell if UL grant is not provided in RRC command.

NOTE: The same bandwidth of source cell and target cell is assumed.

5.2 Void

5.3 Handover to other RATs

5.3.1 E-UTRAN - UTRAN FDD Handover

5.3.1.1 Introduction

The purpose of inter-RAT handover from E-UTRAN to UTRAN FDD is to change the radio access mode from E-UTRAN to UTRAN FDD. The handover procedure is initiated from E-UTRAN with a RRC message that implies a hard handover as described in TS 36.331 [2].

5.3.1.1.1 Handover delay

When the UE receives a RRC message implying handover to UTRAN the UE shall be ready to start the transmission of the new UTRA uplink DPCH within D_{handover} seconds from the end of the last E-UTRAN TTI containing the RRC MOBILITY FROM E-UTRA command.

where:

- D_{handover} equals the RRC procedure delay, which is 50 ms plus the interruption time stated in clause 5.3.1.1.2.

5.3.1.1.2 Interruption time

The interruption time is the time between the end of the last TTI containing the RRC command on the E-UTRAN PDSCH and the time the UE starts transmission on the uplink DPCH in UTRAN FDD, excluding the RRC procedure delay. The interruption time depends on whether the target cell is known to the UE or not.

The target cell is known if it has been measured by the UE during the last 5 seconds otherwise it is unknown. The UE shall always perform a UTRA synchronisation procedure as part of the handover procedure.

If the target cell is known the interruption time shall be less than $T_{\text{interrupt1}}$

$$T_{\text{interrupt1}} = T_{\text{IU}} + T_{\text{sync}} + 50 + 10 * F_{\text{max}} + T_{\text{MC}} \text{ ms}$$

If the target cell is unknown the interruption time shall be less than $T_{\text{interrupt2}}$

$$T_{\text{interrupt2}} = T_{\text{IU}} + T_{\text{sync}} + 150 + 10 * F_{\text{max}} + T_{\text{MC}} \text{ ms}$$

This requirement shall be met, provided that there is one target cell in the MOBILITY FROM E-UTRA command. Performance requirements for E-UTRA to UTRA soft handover are not specified. When UE is connected to an E-UTRA cell, UTRA SFN timing measurements are not reported. This implies that the timing of the DPCH of the UTRA target cells in the active set cannot be configured by UTRAN to guarantee that all target cells fall within the UE reception window of $T_0 \pm 148$ chips.

Where:

T_{IU}	is the interruption uncertainty when changing the timing from the E-UTRAN to the new UTRAN cell. T_{IU} can be up to one UTRA frame (10 ms).
F_{max}	denotes the maximum number of radio frames within the transmission time intervals of all transport channels that are multiplexed into the same CCTrCH on the UTRA target cell. If HS-PDSCH is configured in the UTRA target cell, F_{max} is 4 radio frames.
T_{sync}	is the time required for measuring the downlink DPCH channel as stated in TS 25.214 [20], clause 4.3.1.2. In case higher layers indicate the usage of a post-verification period $T_{\text{sync}}=0$ ms. Otherwise $T_{\text{sync}}=40$ ms.
T_{MC}	T_{MC} is 0ms if a single UTRA cell is configured as the handover target, otherwise 20ms if handover to UTRA with 1, 2 or 3 UTRA carriers with secondary HS-PDSCH is configured.

The phase reference is the primary CPICH.

The requirements in this clause assume that N312 has the smallest possible value i.e. only one insync is required.

5.3.2 E-UTRAN - UTRAN TDD Handover

5.3.2.1 Introduction

The purpose of inter-RAT handover from E-UTRAN to UTRAN TDD is to change the radio access mode from E-UTRAN to UTRAN TDD. The handover procedure is initiated from E-UTRAN with a RRC message that implies a hard handover as described in TS 36.331 [2].

5.3.2.2 Requirements

The requirements in this clause shall apply to UE supporting E-UTRAN and UTRAN TDD.

5.3.2.2.1 Handover delay

When the UE receives a RRC message implying E-UTRAN/UTRAN TDD handover the UE shall be ready to start the transmission of the SYNC-UL within D_{handover} seconds from the end of the last TTI containing the RRC MOBILITY FROM E-UTRA command.

Where:

- D_{handover} equals the RRC procedure delay, which is 50 ms plus the interruption time stated in clause 5.3.2.2.2.

5.3.2.2.2 Interruption time

The interruption time is the time between the end of the last TTI containing the RRC command on the E-UTRAN PDSCH and the time the UE starts transmission on the SYNC-UL in UTRAN TDD, excluding the RRC procedure delay. The interruption time depends on whether the target cell is known to the UE or not.

The UE shall always perform a UTRA synchronisation procedure as part of the handover procedure.

If the target cell has been measured by the UE during the last 5 seconds, the interruption time shall be less than $T_{\text{interrupt1}}$

$$T_{\text{interrupt1}} = T_{\text{offset}} + T_{\text{UL}} + 30 * F_{\text{SFN}} + 20 \text{ ms}$$

If the target cell has not been measured by the UE during the last 5 seconds, the interruption time shall be less than $T_{\text{interrupt2}}$

$$T_{\text{interrupt2}} = T_{\text{offset}} + T_{\text{UL}} + 30 * F_{\text{SFN}} + 180 \text{ ms}$$

Where:

T_{offset}	Equal to 10 ms, the frame timing uncertainty between the old cell and the target cell and the time that can elapse until the appearance of a Beacon channel
T_{UL}	Equal to 10 ms, the time that can elapse until the appearance of the UL timeslot in the target cell
F_{SFN}	Equal to 1 if SFN decoding is required and equal to 0 otherwise

The interruption time requirements for an unknown target cell shall apply only if the signal quality of the unknown target cell is sufficient for successful synchronisation with one attempt.

5.3.3 E-UTRAN - GSM Handover

5.3.3.1 Introduction

The purpose of inter-RAT handover from E-UTRAN to GSM is to transfer a connection between the UE and E-UTRAN to GSM. The handover procedure is initiated from E-UTRAN with a RRC message (MOBILITY FROM E-UTRA). The procedure is described in in TS 36.331 [2].

5.3.3.2 Requirements

The requirements in this clause shall apply to UE supporting E-UTRAN and GSM.

The requirements given below in Tables 5.3.3.2.1-1 and 5.3.3.2.2-1 for the case where the UE has not synchronised to the GSM cell before receiving the RRC MOBILITY FROM E-UTRA command are valid when the signal quality of the GSM cell is sufficient for successful synchronisation with one attempt. If the UE is unable to synchronise to the GSM cell on the first attempt, it shall continue to search for synchronisation information for up to 800 ms duration. If after 800 ms the UE has not synchronised to the GSM cell it shall follow the handover failure procedure specified in TS 36.331 [2].

5.3.3.2.1 Handover delay

When the UE receives a RRC MOBILITY FROM E-UTRA command the UE shall be ready to transmit (as specified in [10]) on the channel of the new RAT within the value in table 5.3.3.2.1-1 from the end of the last TTI containing the RRC command. The UE shall process the RRC procedures for the MOBILITY FROM E-UTRA command within 50 ms, which is noted as RRC procedure delay.

Table 5.3.3.2.1-1: E-UTRAN/GSM handover - handover delay

UE synchronisation status	handover delay [ms]
The UE has synchronised to the GSM cell before the RRC MOBILITY FROM E-UTRA COMMAND is received	90
The UE has not synchronised to the GSM cell before the RRC MOBILITY FROM E-UTRA COMMAND is received	190

5.3.3.2.2 Interruption time

The interruption time is the time between the end of the last TTI containing the RRC command on the E-UTRAN PDSCH and the time the UE starts transmission on the uplink channel in GSM, excluding the RRC procedure delay. The interruption time depends on whether the UE has synchronized to the target GSM cell or not and shall be less than the value specified in table 5.3.3.2.2-1.

Table 5.3.3.2.2-1: E-UTRAN/GSM handover - interruption time

Synchronisation status	Interruption time [ms]
The UE has synchronised to the GSM cell before the RRC MOBILITY FROM E-UTRA COMMAND is received	40
The UE has not synchronised to the GSM cell before the RRC MOBILITY FROM E-UTRA COMMAND is received	140

5.3.4 E-UTRAN - NR FR1 Handover

5.3.4.1 Introduction

The purpose of inter-RAT handover from E-UTRAN to NR in FR1 is to transfer a connection between the UE and E-UTRAN to NR in FR1. The handover procedure is initiated from E-UTRAN with a RRC message (MOBILITY FROM E-UTRA). The procedure is described in in TS 36.331 [2].

5.3.4.2 Handover delay

When the UE receives a RRC message implying inter-RAT handover to the UE shall be ready to start the transmission of the uplink PRACH channel in NR within D_{handover} seconds from the end of the last TTI containing the RRC command. D_{handover} is defined as

$$D_{\text{handover}} = T_{\text{RRC_procedure_delay}} + T_{\text{interruption}}$$

Where:

$T_{\text{RRC_procedure_delay}}$: it is the RRC procedure delay which is 50 ms.

$T_{\text{interruption}}$: it is the time between end of the last TTI containing the RRC command on the PDSCH in E-UTRAN and the time the UE starts transmission of the PRACH in NR, excluding $T_{\text{RRC_procedure_delay}}$. $T_{\text{interruption}}$ is defined in clause 5.3.4.3.

5.3.4.3 Interruption time

When inter-RAT handover to NR is commanded, the interruption time shall be less than $T_{\text{interrupt}}$

$$T_{\text{interrupt}} = T_{\text{search}} + T_{\text{IU}} + T_{\text{rs}} + T_{\text{processing}} + T_{\text{margin}} \text{ ms}$$

Where:

T_{search} is the time required to search the target cell when the target cell is not already known when the handover command is received by the UE. If the target cell is known, then $T_{\text{search}} = 0$ ms. If the target cell is an unknown cell and target cell $E_s/I_{ot} \geq -2$ dB, then $T_{\text{search}} = 3 \cdot T_{\text{rs}}$ ms. Regardless of whether DRX is in use by the UE, T_{search} shall still be based on non-DRX target cell search times.

$T_{\text{processing}}$ is time for UE processing. $T_{\text{processing}}$ can be up to 20 ms.

T_{margin} is time for SSB post-processing. T_{margin} can be up to 2 ms.

T_{IU} is the interruption uncertainty in acquiring the first available PRACH occasion in the new cell. T_{IU} can be up to the summation of SSB to PRACH occasion association period and 10 ms. SSB to PRACH occasion associated period is defined in the table 8.1-1 of TS 38.213 [39].

NOTE: The actual value of T_{IU} shall depend upon the PRACH configuration used in the target cell.

T_{rs} is the SMTC period of the target NR cell if the UE has been provided with an SMTC configuration for the target cell prior to, or in the handover command, otherwise T_{rs} is the target cell SSB transmission period, if such is provided. If the UE is not provided with an SMTC configuration or SSB transmission period, the requirement in this section is applied with $T_{\text{rs}} = 5$ ms assuming the SSB transmission periodicity is 5ms. There is no requirement if the SSB transmission periodicity is not 5ms. If UE is provided with both SMTC configuration and SSB transmission period the requirement shall be based on SMTC periodicity.

In the interruption requirement a cell is known if it has been meeting the relevant cell identification requirement during the last 5 seconds otherwise it is unknown. Relevant cell identification requirements are described in clause 8.1.2.4.20, 8.1.2.4.22, 8.1.2.4.22 and 8.1.2.4.20.

5.3.5 E-UTRAN - NR FR2 Handover

5.3.5.1 Introduction

The purpose of inter-RAT handover from E-UTRAN to NR in FR2 is to transfer a connection between the UE and E-UTRAN to NR in FR2. The handover procedure is initiated from E-UTRAN with a RRC message (MOBILITY FROM E-UTRA). The procedure is described in in TS 36.331 [2].

5.3.5.2 Handover delay

When the UE receives a RRC message implying inter-RAT handover to the UE shall be ready to start the transmission of the uplink PRACH channel in NR within D_{handover} seconds from the end of the last TTI containing the RRC command. D_{handover} is defined as

$$D_{\text{handover}} = T_{\text{RRC_procedure_delay}} + T_{\text{interruption}}$$

Where:

$T_{\text{RRC_procedure_delay}}$: it is the RRC procedure delay which is 50 ms.

$T_{\text{interruption}}$: it is the time between end of the last TTI containing the RRC command on the PDSCH in E-UTRAN and the time the UE starts transmission of the PRACH in NR, excluding $T_{\text{RRC_procedure_delay}}$. $T_{\text{interruption}}$ is defined in clause 5.3.5.3.

5.3.5.3 Interruption time

When intra-frequency or inter-frequency handover is commanded, the interruption time shall be less than $T_{\text{interrupt}}$

$$T_{\text{interrupt}} = T_{\text{search}} + T_{\text{IU}} + T_{\text{rs}} + T_{\text{processing}} + T_{\text{margin}} \text{ ms}$$

Where:

T_{search} is the time required to search the target cell when the handover command is received by the UE. If the target cell is a known cell, then $T_{\text{search}} = 0$ ms. If the target cell is unknown and the target cell $E_s/I_{\text{ot}} \geq -2$ dB, then $T_{\text{search}} = 24 \cdot T_{\text{rs}}$ periodicity. Regardless of whether DRX is in use by the UE, T_{search} shall still be based on non-DRX target cell search times.

$T_{\text{processing}}$ is time for UE processing. $T_{\text{processing}}$ can be up to 40 ms.

T_{margin} is time for SSB post-processing. T_{margin} can be up to 2 ms.

T_{IU} is the interruption uncertainty in acquiring the first available PRACH occasion in the new cell. T_{IU} can be up to the summation of SSB to PRACH occasion association period and 10 ms. SSB to PRACH occasion associated period is defined in the table 8.1-1 of TS 38.213 [39].

NOTE: The actual value of T_{IU} shall depend upon the PRACH configuration used in the target cell.

T_{rs} is the SMTC period of the target NR cell if the UE has been provided with an SMTC configuration for the target cell prior to, or in the handover command, otherwise T_{rs} is the target cell SSB transmission period, if such is provided. If the UE is not provided with an SMTC configuration or SSB transmission period, the requirement in this section is applied with $Tr_s = 5$ ms assuming the SSB transmission periodicity is 5ms. There is no requirement if the SSB transmission periodicity is not 5ms. If UE is provided with both SMTC configuration and SSB transmission period the requirement shall be based on SMTC periodicity.

Relevant cell identification requirements are described in clause 8.1.2.4.20, 8.1.2.4.22, 8.1.2.4.22 and 8.1.2.4.20.

In FR2, the target cell is known if it has been meeting the following conditions:

During the last 5 seconds before the reception of the handover command:

- the UE has sent a valid measurement report for the target cell and
- One of the SSBs measured from the NR target cell being configured remains detectable according to the cell identification conditions specified in clause 9.3 of TS 38.133 [29],
- One of the SSBs measured from the target cell also remains detectable during the handover delay according to the cell identification conditions specified in clause 9.3 of TS 38.133 [29].

otherwise it is unknown.

5.4 Handover to Non-3GPP RATs

5.4.1 E-UTRAN – HRPD Handover

5.4.1.1 Introduction

The handover procedure from E-UTRAN to HRPD is initiated when E-UTRAN sends handover command to the UE through dedicated RRC signalling.

5.4.1.1.1 Handover delay

The handover delay ($D_{handover}$) is defined as the sum of the RRC procedure delay, which is 50 ms and the interruption time specified in clause 5.4.1.1.2.

When the UE receives a RRC message implying handover to HRPD, the UE shall be ready to start the transmission of the new reverse control channel in HRPD within $D_{handover}$ from the end of the last E-UTRAN TTI containing the RRC command.

5.4.1.1.2 Interruption time

The interruption time is the time between the end of the last TTI containing the RRC command on the E-UTRAN PDSCH and the time the UE starts transmission of the reverse control channel in HRPD, excluding the RRC procedure delay. The interruption time depends on whether the target cell is known to the UE or not.

An HRPD cell is known if it has been measured by the UE during the last 5 seconds otherwise it is unknown. Under the reference conditions specified in sub-clause 6.6 of [13], the interruption time shall be less than $T_{interrupt}$

$$T_{interrupt} = T_{IU} + 40 + 10 * KC * SW_K + 10 * OC * SW_O \text{ ms}$$

Where:

T_{IU} It is the interruption uncertainty when changing the timing from the E-UTRAN to the new HRPD cell. T_{IU} can be up to one HRPD frame (26.66 ms).

SW_K is $SW_K = \left\lceil \frac{srch_win_k}{60} \right\rceil$ where $srch_win_k$ is the number of HRPD chips indicated by the search window for known target HRPD cells in the message

SW_O is $SW_O = \left\lceil \frac{\text{srch_win_o}}{60} \right\rceil$ where srch_win_o is the number of HRPD chips indicated by the search window for unknown target HRPD cells in the message

KC It is the number of known target HRPD cells in the message, and

OC It is the number of unknown target HRPD cells in the message.

Note: An additional delay in the interruption time may occur due to the reverse link silence interval [11], which is specific to HRPD.

5.4.2 E-UTRAN – cdma2000 1X Handover

5.4.2.1 Introduction

The handover procedure from E-UTRAN to cdma2000 1X is initiated when E-UTRAN sends handover command to the UE through dedicated RRC signalling.

5.4.2.1.1 Handover delay

The handover delay (D_{handover}) is defined as the sum of the RRC procedure delay, which is 130 ms and the interruption time specified in clause 5.4.2.1.2.

When the UE receives a RRC message implying handover to cdma2000 1X, the UE shall be ready to start the transmission of the new reverse control channel in cdma2000 1X within D_{handover} from the end of the last E-UTRAN TTI containing the RRC command.

5.4.2.1.2 Interruption time

The interruption time is the time between the end of the last TTI containing the RRC command on the E-UTRAN PDSCH and the time the UE starts transmission of the reverse control channel in cdma2000 1X, excluding the RRC procedure delay. The interruption time depends on whether the target cell is known to the UE or not.

A cdma2000 1X cell is known if it has been measured by the UE during the last 5 seconds otherwise it is unknown. Under the reference conditions specified in sub-clause 4.2.1 of [14], the interruption time shall be less than $T_{\text{interrupt}}$:

$$T_{\text{interrupt}} = T_{\text{IU}} + 140 + 10 \cdot \text{KC} \cdot \text{SW}_K + 10 \cdot \text{OC} \cdot \text{SW}_O \text{ ms}$$

Where:

T_{IU} It is the interruption uncertainty when changing the timing from the E-UTRAN to the new cdma2000 1X cell. T_{IU} can be up to one cdma2000 1X frame (20 ms).

SW_K is $SW_K = \left\lceil \frac{\text{srch_win_k}}{300} \right\rceil$ where srch_win_k is the number of cdma2000 1x chips indicated by the search window for known target cdma2000 1x cells in the message

SW_O is $SW_O = \left\lceil \frac{\text{srch_win_o}}{300} \right\rceil$ where srch_win_o is the number of cdma2000 1x chips indicated by the search window for unknown target cdma2000 1x cells in the message

KC It is the number of known target cdma2000 1X cells in the message, and

OC It is the number of unknown target cdma2000 1X cells in the message.

5.5 E-UTRAN Handover for Cat-M1 UEs

5.5.1 Introduction

This section defines the E-UTRAN intra-frequency handover requirements and inter-frequency handover requirements for Cat-M1 UEs in CEModeA as required by TS 36.300 [25].

5.5.2 Requirements in CEModeA

5.5.2.1 E-UTRAN FDD – FDD for Cat-M1 FDD UEs

The requirements in this clause are applicable to FDD intra-frequency handovers and FDD inter-frequency handovers for a Cat-M1 FDD UE in CEModeA.

5.5.2.1.1 Handover delay

Procedure delays for all procedures that can command a handover are specified in TS 36.331 [2].

When the UE receives a RRC message implying handover the UE shall finish the transmission of all repetitions of the new uplink PRACH channel within D_{handover} seconds from the end of the last TTI containing the RRC command,

Where:

D_{handover} equals the maximum RRC procedure delay to be defined in clause 11.2 in TS 36.331 [2] plus the interruption time stated in clause 5.5.2.1.2.

5.5.2.1.2 Interruption time

The interruption time is the time between the end of the last TTI containing the RRC command on the old PDSCH and the moment the UE has transmitted all repetitions of PRACH in the target cell, excluding the RRC procedure delay. This requirement applies when UE is not required to perform any synchronisation procedure before transmitting on the new PRACH.

When intra-frequency handover or inter-frequency handover is commanded and the field *sameSFN-Indication* and *mib-RepetitionStatus* [2] are included in the handover command then the interruption time shall be less than $T_{\text{interrupt}}$

$$T_{\text{interrupt}} = T_{\text{search}} + T_{\text{IU}} + 20 \text{ ms}$$

When intra-frequency handover or inter-frequency handover is commanded and the field *sameSFN-Indication* or *mib-RepetitionStatus* [2] is not included in the handover command then UE the interruption time shall be less than $T_{\text{interrupt}}$

$$T_{\text{interrupt}} = T_{\text{search}} + T_{\text{MIB}} + T_{\text{IU}} + 20 \text{ ms}$$

Where:

- T_{search} is the time required to search the target cell when the handover command is received by the UE. If the target cell is known, then $T_{\text{search}} = 0$ ms. If the target cell is unknown and signal quality is sufficient for successful cell detection on the first attempt, then $T_{\text{search}} = 80$ ms. Otherwise, T_{search} shall be according to the non-DRX cell identification requirements specified in Clause 8.13.2.1 for intra-frequency handover for a UE configured with CEModeA or T_{search} shall be according to the non-DRX cell identification requirements specified in Clause 8.13.2.6 for inter-frequency handover for a UE configured with CEModeA. Regardless of whether DRX is in use by the UE, T_{search} shall still be based on non-DRX target cell search times.
- T_{MIB} is the time required for acquiring the MIB information of the target cell.
- T_{IU} is the time required to complete the transmission of PRACH in the target cell. The actual value of T_{IU} shall depend upon the uncertainty in acquiring the first available PRACH occasion based on the PRACH configuration used in the target cell and the PRACH coverage enhancement level used by the UE for sending the random access preamble to the target cell.
- In the interruption requirement a cell is known if it has been meeting the relevant cell identification requirement for a time duration equal or longer than the time duration required for the cell identification. Otherwise, it is unknown. For intra-frequency handover the time duration required for the cell identification is specified in

relevant intra-frequency cell identification requirements as described in Clause 8.13.2.1 for CEModeA. For inter-frequency handover the time duration required for the cell identification is specified in relevant inter-frequency cell identification requirements as described in Clause 8.13.2.6 for CEModeA.

5.5.2.2 E-UTRAN FDD – FDD for Cat-M1 HD – FDD UEs

The requirements defined in clause 5.5.2.1 are applicable to FDD intra-frequency handovers and FDD inter-frequency handovers for a Cat-M1 HD-FDD UE in CEModeA.

5.5.2.3 E-UTRAN TDD – TDD for Cat-M1 TDD UEs

The requirements defined in clause 5.5.2.1 are applicable to TDD intra-frequency handovers and TDD inter-frequency handovers for a Cat-M1 TDD UE in CEModeA.

5.5.2.3.1 Void

5.5.2.3.2 Void

5.5.3 Requirements in CEModeB

5.5.3.1 E-UTRAN FDD – FDD for Cat-M1 FDD UEs

The requirements in this clause are applicable to FDD intra-frequency handovers and FDD inter-frequency handover for a Cat-M1 FDD UE configured with CEModeB.

5.5.3.1.1 Handover delay

Procedure delays for all procedures that can command a handover are specified in TS 36.331 [2].

When the UE receives a RRC message implying handover the UE shall finish the transmission of all repetitions of the new uplink PRACH channel within D_{handover} seconds from the end of the last TTI containing the RRC command,

Where:

D_{handover} equals the maximum RRC procedure delay to be defined in clause 11.2 in TS 36.331 [2] plus the interruption time stated in clause 5.5.3.1.2.

5.5.3.1.2 Interruption time

The interruption time is the time between end of the last TTI containing the RRC command on the old PDSCH and the time the UE starts transmission of the new PRACH, excluding the RRC procedure delay. This requirement applies when UE is not required to perform any synchronisation procedure before transmitting on the new PRACH.

When intra-frequency handover or inter-frequency handover is commanded and the field *sameSFN-Indication* and *mib-RepetitionStatus* [2] are included in the handover command then the interruption time shall be less than $T_{\text{interrupt}}$

$$T_{\text{interrupt}} = T_{\text{search}} + T_{\text{IU}} + 20 \text{ ms}$$

When intra-frequency handover or inter-frequency handover is commanded and the field *sameSFN-Indication* or *mib-RepetitionStatus* [2] is not included in the handover command then the interruption time shall be less than $T_{\text{interrupt}}$

$$T_{\text{interrupt}} = T_{\text{search}} + T_{\text{MIB}} + T_{\text{IU}} + 20 \text{ ms}$$

Where:

- T_{search} is the time required to search the target cell when the handover command is received by the UE. If the target cell is known, then $T_{\text{search}} = 0$ ms. If the target cell is unknown and signal quality is sufficient for successful cell detection on the first attempt, then $T_{\text{search}} = 80$ ms. Otherwise, T_{search} shall be according to the non-DRX cell identification requirements specified in Clause 8.13.3.1 for intra-frequency handover for a UE configured with CEModeB or T_{search} shall be according to the non-DRX cell identification requirements specified in Clause 8.13.3.5 for inter-frequency handover for a UE configured with CEModeB. Regardless of whether DRX is in use by the UE, T_{search} shall still be based on non-DRX target cell search times.
- T_{MIB} is the time required for acquiring the MIB information of the target cell.

- T_{IU} is the time required to complete the transmission of PRACH in the target cell. The actual value of T_{IU} shall depend upon the uncertainty in acquiring the first available PRACH occasion based on the PRACH configuration used in the target cell and the PRACH coverage enhancement level used by the UE for sending the random access preamble to the target cell.
- In the interruption requirement a cell is known if it has been meeting the relevant cell identification requirement for a time duration equal or longer than the time duration required for the cell identification. Otherwise, it is unknown. For intra-frequency handover the time duration required for the cell identification is specified in relevant intra-frequency cell identification requirements as described in Clause 8.13.3.1 for CEModeB. For inter-frequency handover the time duration required for the cell identification is specified in relevant inter-frequency cell identification requirements as described in Clause 8.13.3.5 for CEModeB.

5.5.3.2 E-UTRAN FDD – FDD for Cat-M1 HD – FDD UEs

The requirements defined in clause 5.5.3.1 are applicable to FDD intra-frequency handovers and FDD inter-frequency handovers for a Cat-M1 HD-FDD UE configured with CEModeB.

5.5.3.3 E-UTRAN TDD – TDD for Cat-M1 TDD UEs

The requirements defined in clause 5.5.3.1 are applicable to TDD intra-frequency handovers and TDD inter-frequency handovers for a Cat-M1 TDD UE configured with CEModeB.

5.6 Void

6 RRC Connection Mobility Control

6.1 RRC Re-establishment

The requirements in this clause are applicable to both E-UTRAN FDD and TDD.

6.1.1 Introduction

RRC connection re-establishment is initiated when a UE in RRC connected mode loses RRC connection due to any of these reasons: radio link failure, handover failure or radio link problem. The RRC re-establishment procedure is specified in clause 5.3.7 in TS 36.331 [2].

6.1.2 Requirements

In RRC connected mode the UE shall be capable of sending *RRCConnectionReestablishmentRequest* message within $T_{re-establish_delay}$ seconds from the moment it detects a loss in RRC connection. The total RRC connection delay ($T_{re-establish_delay}$) shall be less than:

$$T_{re-establish_delay} = T_{UL_grant} + T_{UE_re-establish_delay}$$

T_{UL_grant} : It is the time required to acquire and process uplink grant from the target PCell. The uplink grant is required to transmit *RRCConnectionReestablishmentRequest* message.

The UE re-establishment delay ($T_{UE_re-establish_delay}$) is specified in clause 6.1.2.1.

6.1.2.1 UE Re-establishment delay requirement

The UE re-establishment delay ($T_{UE_re-establish_delay}$) is the time between the moments when any of the conditions requiring RRC re-establishment as defined in clause 5.3.7 in TS 36.331 [2] is detected by the UE to the time when the UE sends PRACH to the target PCell. The UE re-establishment delay ($T_{UE_re-establish_delay}$) requirement shall be less than:

$$T_{UE_re-establish_delay} = 50 \text{ ms} + N_{freq} * T_{search} + T_{SI} + T_{PRACH}$$

T_{search} : It is the time required by the UE to search the target PCell.

T_{search} = It is 100 ms if the target PCell is known by the UE; the target PCell is known if it has been measured by the UE in the last 5 seconds.

T_{search} = It is 800 ms if the target PCell is unknown by the UE; the target PCell is unknown if it has not been measured by the UE in the last 5 seconds.

T_{SI} = It is the time required for receiving all the relevant system information according to the reception procedure and the RRC procedure delay of system information blocks defined in TS 36.331 [2] for the target PCell.

T_{PRACH} = The additional delay caused by the random access procedure; it will be at least 10 ms due to random access occasion and there might be additional delay due to ramping procedure.

N_{freq} : It is the total number of E-UTRA frequencies to be monitored for RRC re-establishment; $N_{freq} = 1$ if the target PCell is known.

There is no requirement if the target cell does not contain the UE context.

6.2 Random Access

6.2.1 Introduction

The random access procedure is used when establishing the layer 1 communication between the UE and E-UTRAN. The random access is specified in clause 6 of TS 36.213[3] and the control of the RACH transmission is specified in clause 5.1 of TS 36.321[17]. Contention based random access procedures can only be carried out on PCell and PSCell, while non-contention based random access procedures can be carried out on PCell, one or two activated SCell(s), and PSCell. For UEs supporting CA with FS3 SCells, the random access procedures can only be carried out on PCell.

6.2.2 Requirements

The UE shall have capability to calculate PRACH transmission power according to the PRACH power formula defined in TS 36.213[3] and apply this power level at the first preamble or additional preambles. The absolute power applied to the first preamble shall have an accuracy as specified in table 6.3.5.1.1-1 of TS 36.101[5]. The relative power applied to additional preambles shall have an accuracy as specified in table 6.3.5.2.1-1 of 36.101[5].

The UE shall indicate a Random Access problem to upper layers if the maximum number of preamble transmission counter has been reached for the random access procedure on PCell or PSCell as specified in clause 5.1.4 in TS 36.321 [17].

The UE shall stop preamble transmission if maximum number of preamble transmission counter has been reached for the random access procedure on an activated SCell as specified in clause 5.1.4 in TS 36.321 [17].

6.2.2.1 Contention based random access

6.2.2.1.1 Correct behaviour when receiving Random Access Response reception

The UE may stop monitoring for Random Access Response(s) and shall transmit the msg3 if the Random Access Response contains a Random Access Preamble identifier corresponding to the transmitted Random Access Preamble.

The UE shall re-select a preamble and transmit with the calculated PRACH transmission power when the backoff time expires if all received Random Access Responses contain Random Access Preamble identifiers that do not match the transmitted Random Access Preamble.

6.2.2.1.2 Correct behaviour when not receiving Random Access Response reception

The UE shall re-select a preamble and transmit with the calculated PRACH transmission power when the backoff time expires if no Random Access Response is received within the RA Response window defined in clause 5.1.4 TS 36.321.

6.2.2.1.3 Correct behaviour when receiving a NACK on msg3

The UE shall re-transmit the msg3 upon the reception of a NACK on msg3.

6.2.2.1.4 Void

6.2.2.1.5 Correct behaviour when receiving a message over Temporary C-RNTI

The UE shall send ACK if the Contention Resolution is successful.

The UE shall re-select a preamble and transmit with the calculated PRACH transmission power when the backoff time expires unless the received message includes a UE Contention Resolution Identity MAC control element and the UE Contention Resolution Identity included in the MAC control element matches the CCCH SDU transmitted in the uplink message.

6.2.2.1.6 Correct behaviour when contention Resolution timer expires

The UE shall re-select a preamble and transmit with the calculated PRACH transmission power when the backoff time expires if the Contention Resolution Timer expires.

6.2.2.2 Non-Contention based random access

6.2.2.2.1 Correct behaviour when receiving Random Access Response

The UE may stop monitoring for Random Access Response(s) if the Random Access Response contains a Random Access Preamble identifier corresponding to the transmitted Random Access Preamble.

The UE shall re-transmit the preamble with the calculated PRACH transmission power if all received Random Access Responses contain Random Access Preamble identifiers that do not match the transmitted Random Access Preamble.

The UE is not allowed to re-transmit the preamble on SCells without PUSCH on the SCCs to which SRS carrier based switching is performed, even if all received Random Access Responses contain Random Access Preamble identifiers do not match the transmitted Random Access Preamble, unless the UE receives the corresponding new PDCCH order.

6.2.2.2.2 Correct behaviour when not receiving Random Access Response

The UE shall re-transmit the preamble with the calculated PRACH transmission power.

The UE is not allowed to re-transmit the preamble on SCells without PUSCH on the SCCs to which SRS carrier based switching is performed, unless the UE receives the corresponding new PDCCH order.

6.2.3 Requirements for Cat-M1 UEs

In addition to the requirements defined in 6.2.1 and 6.2.2, a Cat-M1 UE shall also execute the random access procedure defined in clause 5.1 in TS 36.321 [17] using the PRACH configuration contained in *PRACH-ConfigSIB* in TS 36.331 [2]

- Determines the enhanced coverage level based on the RSRP measurement and the configured criterion (*RSRP-ThresholdsPrach* [2]) as defined in section 5.1.1, TS 36,321 [17],
- Selects PRACH resources [2] configured for the corresponding enhanced coverage level as determined in the previous step and;
- Transmits or re- transmits PRACH preamble using the selected PRACH resources and PRACH configuration.

6.3 RRC Connection Release with Redirection

6.3.1 Introduction

RRC connection release with redirection is initiated by the UE upon receiving the “*RRCConnectionRelease*” message from the E-UTRAN, TS 36.331 [2]. The RRC connection release with redirection procedure is specified in clause 5.3.8 in TS 36.331 [2].

The requirements in this clause are applicable to both E-UTRAN FDD and TDD.

6.3.2 Requirements

6.3.2.1 RRC connection release with redirection to UTRAN FDD

The UE shall be capable of performing the RRC connection release with redirection to the target UTRAN FDD cell within $T_{\text{connection_release_redirect_UTRA FDD}}$.

The time delay ($T_{\text{connection_release_redirect_UTRA FDD}}$) is the time between the end of the last TTI containing the RRC command, “*RRCConnectionRelease*” (TS 36.331 [2]) on the E-UTRAN PDSCH and the time the UE starts to send random access to the target UTRA FDD cell. The time delay ($T_{\text{connection_release_redirect_UTRA FDD}}$) shall be less than:

$$T_{\text{connection_release_redirect_UTRA FDD}} = T_{\text{RRC_procedure_delay}} + T_{\text{identify-UTRA FDD}} + T_{\text{SI-UTRA FDD}} + T_{\text{RA}}$$

The target UTRA FDD cell shall be considered detectable when:

- CPICH $E_c/I_o \geq -15$ dB,
- SCH $E_c/I_o \geq -15$ dB for at least one channel tap and SCH E_c/I_o is equally divided between primary synchronisation code and secondary synchronisation code.

$T_{\text{RRC_procedure_delay}}$: It is the RRC procedure for processing the received message “*RRCConnectionRelease*”. It shall be less than 110 ms.

$T_{\text{identify-UTRA FDD}}$: It is the time to identify the target UTRA FDD cell. It shall be less than 500 ms.

$T_{\text{SI-UTRA FDD}}$: It is the time required for acquiring all the relevant system information of the target UTRA FDD cell. This time depends upon whether the UE is provided with the relevant system information of the target UTRA FDD cell or not by the E-UTRAN before the RRC connection is released.

T_{RA} : It is the delay caused due to the random access procedure when sending random access to the target UTRA FDD cell.

6.3.2.2 RRC connection release with redirection to GERAN

The UE shall be capable of performing the RRC connection release with redirection to the target GERAN cell within $T_{\text{connection_release_redirect_GERAN}}$.

The time delay ($T_{\text{connection_release_redirect_GERAN}}$) is the time between the end of the last TTI containing the RRC command, “*RRCConnectionRelease*” (TS 36.331 [2]) on the E-UTRAN PDSCH and the time the UE starts to send random access to the target GERAN cell. The time delay ($T_{\text{connection_release_redirect_GERAN}}$) shall be less than:

$$T_{\text{connection_release_redirect_GERAN}} = T_{\text{RRC_procedure_delay}} + T_{\text{identify-GERAN}} + T_{\text{SI-GERAN}} + T_{\text{RA}}$$

The target GERAN cell shall be considered detectable when the UE receives the GERAN cell at levels down to 10 dB + the reference sensitivity level or reference interference levels as specified in [9].

$T_{\text{RRC_procedure_delay}}$: It is the RRC procedure for processing the received message “*RRCConnectionRelease*”. It shall be less than 110 ms.

$T_{\text{identify-UTRA GERAN}}$: It is the time to identify the BSIC of the target GERAN cell. It shall be less than 1 second.

$T_{\text{SI-UTRA GERAN}}$: It is the time required for acquiring all the relevant system information of the target GERAN cell. This time depends upon whether the UE is provided with the relevant system information of the target GERAN cell or not by the E-UTRAN before the RRC connection is released.

T_{RA} : It is the delay caused due to the random access procedure when sending random access burst to the target GERAN cell.

6.3.2.3 RRC connection release with redirection to UTRAN TDD

The UE shall be capable of performing the RRC connection release with redirection to the target UTRAN TDD cell within $T_{\text{connection_release_redirect_UTRA TDD}}$.

The time delay ($T_{\text{connection_release_redirect_UTRA TDD}}$) is the time between the end of the last TTI containing the RRC command, “*RRCConnectionRelease*” (TS 36.331 [2]) on the E-UTRAN PDSCH and the time the UE starts to send random access to the target UTRA TDD cell. The time delay ($T_{\text{connection_release_redirect_UTRA TDD}}$) shall be less than:

$$T_{\text{connection_release_redirect_UTRA TDD}} = T_{\text{RRC_procedure_delay}} + T_{\text{identify-UTRA TDD}} * N_{\text{redirect-UTRA TDD}} + T_{\text{SI-UTRA TDD}} + T_{\text{RA}}$$

The target UTRA TDD cell shall be considered detectable when:

- P-CCPCH $E_c/I_o \geq -6$ dB,

- DwPCH_Ec/Io \geq -1 dB.

$T_{\text{RRC_procedure_delay}}$: It is the RRC procedure for processing the received message “*RRCConnectionRelease*”. It shall be less than 110 ms.

$T_{\text{identify-UTRA TDD}}$: It is the time to identify the target UTRA TDD cell. It shall be less than 500 ms.

$T_{\text{SI-UTRA TDD}}$: It is the time required for acquiring all the relevant system information of the target UTRA TDD cell. This time depends upon whether the UE is provided with the relevant system information of the target UTRA TDD cell or not by the E-UTRAN before the RRC connection is released.

T_{RA} : It is the delay caused due to the random access procedure when sending random access to the target UTRA TDD cell.

$N_{\text{redirect-UTRA TDD}}$: It is the total number of target UTRA TDD frequencies included in RedirectedCarrierInfo in “*RRCConnectionRelease*” message. It can be up to 4 UTRA TDD frequencies.

6.3.2.4 RRC connection release with redirection to NR

The UE shall be capable of performing the RRC connection release with redirection to the target NR cell within $T_{\text{connection_release_redirect_NR}}$.

The time delay ($T_{\text{connection_release_redirect_NR}}$) is the time between the end of the last TTI containing the RRC command, “*RRCConnectionRelease*” (TS 36.331 [2]) on the E-UTRAN PDSCH and the time the UE starts to send random access to the target NR cell. The time delay ($T_{\text{connection_release_redirect_NR}}$) shall be less than:

$$T_{\text{connection_release_redirect_NR}} = T_{\text{RRC_procedure_delay}} + T_{\text{identify-NR}} + T_{\text{SI-NR}} + T_{\text{RACH}}$$

The target NR cell shall be considered detectable when for each relevant SSB:

- SSB_{RP} and SSB \hat{E}_s/I_{ot} according to Annex B.2.5 of TS 38.133 [50] for a corresponding NR Band.

$T_{\text{RRC_procedure_delay}}$: It is the RRC procedure delay for processing the received message “*RRCConnectionRelease*” as defined in clause 6.2.2 of TS 36.331 [2]. It shall be less than 110 ms.

$T_{\text{identify-NR}}$: It is the time to identify the target NR cell and depends on the frequency range (FR) of the target NR cell. It is defined in table 6.3.2.4-1. $T_{\text{identify-NR}} = T_{\text{PSS/SSS-sync}} + T_{\text{meas}}$, where $T_{\text{PSS/SSS-sync}}$ is the cell search time and T_{meas} is the measurement time due to cell selection criteria evaluation.

$T_{\text{SI-NR}}$: It is the time required for acquiring all the relevant system information of the target NR cell. This time depends upon whether the UE is provided with the relevant system information of the target NR cell or not by the old NR cell before the RRC connection is released.

T_{RACH} : It is the delay caused due to the random access procedure when sending random access to the target NR cell. T_{RACH} can be up to the summation of SSB to PRACH occasion association period and 10 ms. SSB to PRACH occasion associated period is defined in the table 8.1-1 of TS 38.213 [39].

T_{rs} is the SMTC periodicity of the target NR cell if the UE has been provided with an SMTC configuration for the target cell in the redirection command, otherwise T_{rs} is the SMTC periodicity configured in the *measObjectNR* having the same SSB frequency and subcarrier spacing configured for the RRC connection release with redirection. If the *measObjectNR*s having the same SSB frequency and subcarrier spacing configured by MN and SN have different SMTC, T_{rs} is the periodicity of one of the SMTC which is up to UE implementation. If the UE is not provided with SMTC configuration or measurement object for the frequency which is also configured for the RRC connection release with redirection then:

- the requirement in this section is applied with $T_{\text{rs}} = 20$ ms assuming the SSB transmission periodicity is not larger than 20 ms,
- there is no requirement if the SSB transmission periodicity is larger than 20 ms.

Table 6.3.2.4-1: Time to identify target NR cell for RRC connection release with redirection to NR

Frequency range (FR) of target NR cell	$T_{\text{identify-NR}}$
FR1	MAX (680 ms, 11 x T_{rs})
FR2	MAX (880 ms, 88 x T_{rs})

6.4 CSG Proximity Indication for E-UTRAN and UTRAN

6.4.1 Introduction

The requirements defined in this section are applicable to a UE supporting and configured with CSG proximity indication and are valid when a UE is entering the proximity of one or more CSG member cell(s) or leaving the proximity of all CSG member cell(s) on a UTRA or E-UTRA frequency as specified in [2].

The detection of CSG proximity is based on a UE autonomous search function.

6.4.2 Requirements

The UE shall initiate transmission of the ProximityIndication message with “entering” according to [2] within 6 minutes after entering the proximity of one or more CSG member cell(s) on a UTRA or E-UTRA frequency.

The UE shall initiate transmission of the ProximityIndication message with “leaving” according to [2] within 6 minutes after leaving the proximity of all CSG member cell(s) on a UTRA or E-UTRA frequency.

There is no need for statistical testing of this requirement.

NOTE: Entering the proximity of one or more CSG member cell(s) means that the UE is near a cell whose CSG ID is in the UE’s CSG whitelist (as determined based on autonomous search procedures). Leaving the proximity of one or more CSG member cell(s) means that the UE is no longer near any cell whose CSG ID is in the UE’s CSG whitelist.

6.5 RRC Re-establishment for NB-IoT UEs

6.5.1 Introduction

RRC connection re-establishment is initiated when a UE in RRC connected mode loses RRC connection due to any of these reasons: radio link failure or radio link problem. The RRC re-establishment procedure is specified in clause 5.3.7 in TS 36.331 [2].

6.5.2 Requirements

In RRC connected mode the UE shall be capable of sending *RRCConnectionReestablishmentRequest* message within $T_{\text{re-establish_delay_NB-IoT}}$ seconds from the moment it detects a loss in RRC connection. The total RRC connection delay ($T_{\text{re-establish_delay_NB-IoT}}$) shall be less than:

$$T_{\text{re-establish_delay_NB-IoT}} = T_{\text{UL_grant}} + T_{\text{UE_re-establish_delay_NB-IoT}}$$

$T_{\text{UL_grant}}$: It is the time required to acquire and process uplink grant from the target cell. The uplink grant is required to transmit *RRCConnectionReestablishmentRequest* message.

The UE re-establishment delay ($T_{\text{UE_re-establish_delay_NB-IoT}}$) is specified in clause 6.5.2.1 for a UE in normal coverage and in clause 6.5.2.2 for a UE in enhanced coverage.

These requirements are not applicable for UEs that only support the Control Plane CIoT EPS optimisation (see TS 24.301). Connection control in NB-IoT is defined in Clause 5.3.1.4 in TS 36.331 [2].

6.5.2.1 UE Re-establishment delay requirement in normal coverage

The UE re-establishment delay ($T_{\text{UE_re-establish_delay_NB-IoT}}$) is the time between the moments when any of the conditions requiring RRC re-establishment as defined in clause 5.3.7 in TS 36.331 [2] is detected by the UE to the time when the UE sends PRACH preamble to the target cell. The UE re-establishment delay ($T_{\text{UE_re-establish_delay_NB-IoT}}$) requirement shall be less than:

$$T_{\text{UE-re-establish_delay_NB-IoT}} = 100 \text{ ms} + N_{\text{NB-IoT-freq}} * T_{\text{search_NB1-NC}} + T_{\text{SL_NB1-NC}} + T_{\text{PRACH_NB-IoT}}$$

$T_{\text{search_NB1-NC}}$: It is the time required by the UE to search the target cell:

If the target cell is known, then $T_{\text{search_NB1-NC}} = 0$ ms. If the target cell is unknown and signal quality is sufficient for successful cell detection on the first attempt, then $T_{\text{search_NB1-NC}} = 80$ ms. Otherwise, $T_{\text{search_NB1-NC}} = 1400$ ms.

$T_{\text{SL_NB1-NC}}$: It is the time required for receiving all the relevant system information according to the reception procedure and the RRC procedure delay of system information blocks defined in TS 36.331 [2] for the target cell for a UE in normal coverage.

$T_{\text{PRACH_NB-IoT}}$: The additional delay caused by the random access procedure. The actual value of $T_{\text{PRACH_NB-IoT}}$ shall depend upon the NPRACH configuration used in the target cell and the number of repetition used by UE for sending random access to the target cell. There might be additional delay due to ramping procedure.

$N_{\text{NB-IoT-freq}}$: It is the total number of NB-IoT frequencies to be monitored for RRC re-establishment; $N_{\text{NB-IoT-freq}} = 1$ if the target cell is known.

There is no requirement if the target cell does not contain the UE context.

6.5.2.2 UE Re-establishment delay requirement in enhanced coverage

The UE re-establishment delay ($T_{\text{UE-re-establish_delay_NB-IoT}}$) is the time between the moments when any of the conditions requiring RRC re-establishment as defined in clause 5.3.7 in TS 36.331 [2] is detected by the UE to the time when the UE sends PRACH preamble to the target cell. The UE re-establishment delay ($T_{\text{UE-re-establish_delay_NB-IoT}}$) requirement shall be less than:

$$T_{\text{UE-re-establish_delay_NB-IoT}} = 100 \text{ ms} + N_{\text{NB-IoT-freq}} * T_{\text{search_NB1-EC}} + T_{\text{SL_NB1-EC}} + T_{\text{PRACH_NB-IoT}}$$

- $T_{\text{search_NB1-EC}}$: It is the time required by the UE to search the target cell:
 - If the target cell is known, then $T_{\text{search_NB1-EC}} = 0$ ms. If the target cell is unknown and signal quality is sufficient for successful cell detection on the first attempt, then $T_{\text{search_NB1-EC}} = 80$ ms. Otherwise, $T_{\text{search_NB1-EC}} = 14800$ ms.
- $T_{\text{SL_NB1-EC}}$: It is the time required for receiving all the relevant system information according to the reception procedure and the RRC procedure delay of system information blocks defined in TS 36.331 [2] for the target cell for a UE in enhanced coverage.
- $T_{\text{PRACH_NB-IoT}}$: The additional delay caused by the random access procedure. The actual value of $T_{\text{PRACH_NB-IoT}}$ shall depend upon the NPRACH configuration used in the target cell and the number of repetition used by UE for sending random access to the target cell. There might be additional delay due to ramping procedure.
- $N_{\text{NB-IoT-freq}}$: It is the total number of NB-IoT frequencies to be monitored for RRC re-establishment; $N_{\text{NB-IoT-freq}} = 1$ if the target cell is known.

There is no requirement if the target cell does not contain the UE context.

6.6 Random Access for UE category NB1

6.6.1 Introduction

The random access procedure is used when establishing the layer 1 communication between the UE and NB-IoT. The random access is specified in clause 6 of TS 36.213[3] and the control of the RACH transmission is specified in clause 5.1 of TS 36.321[17]. The UE category NB1 supports only contention-based random access transmission on anchor carrier and on non-anchor carrier.

The requirements in this section are applicable for the random access transmission by the UE category NB1 to an anchor carrier or to a non-anchor carrier under the following conditions:

- The anchor and non-anchor carrier frequencies are within 20 MHz and
- The anchor and the non-anchor carrier frequencies are in the same base station or in co-located base stations.

6.6.2 Requirements

The UE shall have capability to calculate NPRACH transmission power according to the NPRACH power formula defined in TS 36.213[3] and apply this power level at the first preamble or additional preambles. The absolute power

applied to the first preamble shall have an accuracy as specified in TS 36.101[5]. The relative power applied to additional preambles shall have an accuracy as specified in 36.101[5].

The UE shall indicate a Random Access problem to upper layers if the maximum number of preamble transmission counter has been reached for the random access procedure on target cell as specified in clause 5.1.4 in TS 36.321 [17].

6.6.2.1 Correct behaviour when receiving Random Access Response reception

The UE may stop monitoring for Random Access Response(s) and shall transmit the msg3 if the Random Access Response contains a Random Access Preamble identifier corresponding to the transmitted Random Access Preamble.

The UE shall re-select a preamble and transmit with the calculated NPRACH transmission power when the backoff time expires if all received Random Access Responses contain Random Access Preamble identifiers that do not match the transmitted Random Access Preamble.

6.6.2.2 Correct behaviour when not receiving Random Access Response reception

The UE shall re-select a preamble and transmit with the calculated NPRACH transmission power when the backoff time expires if no Random Access Response is received within the RA Response window defined in clause 5.1.4 TS 36.321.

6.6.2.3 Correct behaviour when receiving a NACK on msg3

The UE shall re-transmit the msg3 upon the reception of a NACK on msg3.

6.6.2.4 Correct behaviour when receiving a message over Temporary C-RNTI

The UE shall send ACK if the Contention Resolution is successful.

The UE shall re-select a preamble and transmit with the calculated NPRACH transmission power when the backoff time expires unless the received message includes a UE Contention Resolution Identity MAC control element and the UE Contention Resolution Identity included in the MAC control element matches the CCCH SDU transmitted in the uplink message.

6.6.2.5 Correct behaviour when contention Resolution timer expires

The UE shall re-select a preamble and transmit with the calculated NPRACH transmission power when the backoff time expires if the Contention Resolution Timer expires.

6.6.2.6 MSG3-based channel quality report for UE Category NB1

The requirements in this clause shall apply for UE supporting DL channel quality reporting for UE Category NB1 as defined in TS 36.331 [2] section 5.3.3.3, 5.3.3.3a, and 5.3.7.4.

The DL channel quality provides the serving eNB with information about the minimum NPDCCH repetition level to satisfy the hypothetical NPDCCH block error rate of 1% with the parameters specified in Table 6.6.2.6-1.

Table 6.6.2.6-1: NPDCCH transmission parameters for downlink quality reporting.

Parameters	Values
DCI format	Format N1
Number of information bits (excluding CRC)	23bits
System bandwidth	200kHz
Aggregation level	2
DRX	OFF

The reported NPDCCH repetition level shall be derived from the channel quality measured in the period T1 or T2 in the carrier where the random access response is transmitted, where

- T1 is the period before NPRACH transmission used for NRSRP measurement for enhanced coverage level estimation
- T2 is the period from the beginning of the random access response to the beginning of PUSCH format 1 for DL channel quality reporting.

The NPDCCH repetition level for CQI-NPDCCH-NB and CQI-NPDCCH-Short-NB is chosen from the supported NPDCCH repetition levels [3]. The report mapping is defined in 9.1.22.15.

The UE shall satisfy the downlink channel quality measurement accuracy requirements as specified in 9.1.22.16.

6.6.3 Requirements for NPRACH configuration

In addition to the requirements defined in 6.6.2, UE shall also execute the random access procedure defined in clause 5.1 in TS 36.321 [17] using the NPRACH configuration contained in *NPRACH-ConfigSIB-NB* in TS 36.331 [2].

The UE shall apply the following procedure:

- Determines the enhanced coverage level based on the NRSRP intra-frequency measurement performed on the anchor carrier, for NPRACH transmission to the anchor carrier or for NPRACH transmission to the non-anchor carrier, and the configured criterion as defined in section 5.1.1, TS 36,321 [17],
- Selects NPRACH resources [2] configured for the corresponding enhanced coverage level as determined in the previous step and;
- Transmits or re-transmits NPRACH preamble using the selected NPRACH resources and NPRACH configuration.

6.7 RRC Re-establishment for Cat-M1 UEs

6.7.1 Introduction

RRC connection re-establishment is initiated when a Cat-M1 UE either configured with CEModeA or CEModeB in RRC connected mode loses RRC connection due to any of these reasons: radio link failure or radio link problem. The RRC re-establishment procedure is specified in clause 5.3.7 in TS 36.331 [2].

6.7.2 Requirements

In RRC connected mode the UE shall be capable of sending *RRCConnectionReestablishmentRequest* message within $T_{\text{re-establish_delay}}$ seconds from the moment it detects a loss in RRC connection. The total RRC connection delay ($T_{\text{re-establish_delay}}$) shall be less than:

$$T_{\text{re-establish_delay}} = T_{\text{UL_grant}} + T_{\text{UE_re-establish_delay}}$$

$T_{\text{UL_grant}}$: It is the time required to acquire and process uplink grant from the target cell. The uplink grant is required to transmit *RRCConnectionReestablishmentRequest* message.

The UE re-establishment delay ($T_{\text{UE_re-establish_delay}}$) is specified in clause 6.7.2.1 for a UE configured with CEModeA and in clause 6.7.2.2 for a UE configured with CEModeB.

6.7.2.1 UE Re-establishment delay requirement for CEModeA

The UE re-establishment delay ($T_{\text{UE_re-establish_delay}}$) is the time between the moments when any of the conditions requiring RRC re-establishment as defined in clause 5.3.7 in TS 36.331 [2] is detected by the UE to the moment the UE has transmitted all repetitions of the PRACH preamble to the target cell. The UE re-establishment delay ($T_{\text{UE_re-establish_delay}}$) requirement for a UE configured with CEModeA shall be less than:

$$T_{\text{UE-re-establish_delay}} = 50 \text{ ms} + N_{\text{freq}} * T_{\text{search}} + T_{\text{SI-EUTRA-M1-CEModeA}} + T_{\text{PRACH}}$$

- T_{search} is the time required by the UE to search the target cell. $T_{\text{search}} = 100 \text{ ms}$ if the target cell is known by the UE. Otherwise, T_{search} is specified in relevant intra-frequency cell identification requirements as described in Clause 8.13.2.1 for a UE configured with CEModeA. Regardless of whether DRX is in use by the UE, T_{search} shall still be based on non-DRX target cell search times.

In the above requirement, a cell is known if it has been meeting the relevant cell identification requirement for a time duration equal to or longer than the time duration required for the cell identification. Otherwise, it is unknown.

- T_{SI} : It is the time required for receiving all the relevant system information according to the reception procedure and the RRC procedure delay of system information blocks defined in TS 36.331 [2] for the target cell for a UE

configured with CEModeA. $T_{SI-EUTRA-M1-CEModeA}$ includes the time to acquire the MIB and all the relevant SIBs of the target cell.

- T_{PRACH} is the interruption uncertainty in acquiring the first available PRACH occasion in the target cell. The actual value of T_{PRACH} shall depend upon the PRACH configuration used in the target cell and the PRACH coverage enhancement level used by the UE for sending the random access to the target cell.
- N_{freq} : It is the total number of frequencies to be monitored for RRC re-establishment; $N_{freq} = 1$ if the target cell is known.

There is no requirement if the target cell does not contain the UE context.

6.7.2.2 UE Re-establishment delay requirement for CEModeB

The UE re-establishment delay ($T_{UE_re-establish_delay}$) is the time between the moments when any of the conditions requiring RRC re-establishment as defined in clause 5.3.7 in TS 36.331 [2] is detected by the UE to the moment the UE has transmitted all repetitions of PRACH preamble to the target cell. The UE re-establishment delay ($T_{UE_re-establish_delay}$) requirement for a UE configured with CEModeB shall be less than:

$$T_{UE_re-establish_delay} = 50 \text{ ms} + N_{freq} * T_{search} + T_{SI-EUTRA-M1-CEModeB} + T_{PRACH}$$

- T_{search} is the time required by the UE to search the target cell. $T_{search} = 100 \text{ ms}$ if the target cell is known by the UE. Otherwise, T_{search} is specified in relevant intra-frequency cell identification requirements as described in Clause 8.13.3.1 for a UE configured with CEModeB. Regardless of whether DRX is in use by the UE, T_{search} shall still be based on non-DRX target cell search times.

In the above requirement, a cell is known if it has been meeting the relevant cell identification requirement for a time duration equal to or longer than the time duration required for the cell identification. Otherwise, it is unknown.

- $T_{SI-EUTRA-M1-CEModeB}$: It is the time required for receiving all the relevant system information according to the reception procedure and the RRC procedure delay of system information blocks defined in TS 36.331 [2] for the target cell for a UE configured with CEModeA; $T_{SI-EUTRA-M1-CEModeB}$ includes the time to acquire the MIB and all the relevant SIBs of the target cell.
- T_{PRACH} is the interruption uncertainty in acquiring the first available PRACH occasion in the target cell. The actual value of T_{PRACH} shall depend upon the PRACH configuration used in the target cell and the PRACH coverage enhancement level used by the UE for sending the random access to the target cell.
- N_{freq} : It is the total number of frequencies to be monitored for RRC re-establishment; $N_{freq} = 1$ if the target cell is known.

There is no requirement if the target cell does not contain the UE context.

6.8 RRC Connection Release with Redirection for Cat-M1 UEs

6.8.1 Introduction

RRC connection release with redirection is initiated by the UE upon receiving the “*RRCConnectionRelease*” message from the E-UTRAN, TS 36.331 [2]. The RRC connection release with redirection procedure is specified in clause 5.3.8 in TS 36.331 [2].

The requirements in this clause are applicable for UE category M1 capable of E-UTRA FDD, TDD or HD-FDD operation.

6.8.2 Requirements

6.8.2.1 RRC connection release with redirection to E-UTRAN with CE Mode A

The UE shall be capable of performing the RRC connection release with redirection to the target E-UTRA cell within $T_{connection_release_redirect_E-UTRA \text{ cat-M1}}$.

The time delay ($T_{connection_release_redirect_E-UTRA \text{ cat-M1}}$) is the time between the end of the last subframe in the repetition period of PDSCH containing the IE, “*RRCConnectionRelease*” and the end of the last subframe in the repetition period

of the PRACH transmission to the target E-UTRA cell. The time delay ($T_{\text{connection_release_redirect_E-UTRA cat-M1}}$) shall be less than:

$$T_{\text{connection_release_redirect_E-UTRA cat-M1}} = T_{\text{RRC_procedure_delay}} + T_{\text{identify-E-UTRA cat-M1}} + T_{\text{SI-E-UTRA cat-M1}} + T_{\text{RA cat-M1}}$$

The target E-UTRA FDD or TDD cell shall be considered detectable for a category M1 UE capable of E-UTRA FDD or TDD provided that:

- RSRP related side conditions given in Section 9.1.21.2 are fulfilled for a corresponding Band,
- SCH_RP and $SCH\ \hat{E}s/Iot$ according to Annex Table B.2.14-1 for a corresponding Band.

The target E-UTRA FDD cell shall be considered detectable for a category M1 UE capable of E-UTRA HD-FDD provided that:

- RSRP related side conditions given in Section 9.1.21.2 are fulfilled for a corresponding Band,
- SCH_RP and $SCH\ \hat{E}s/Iot$ according to Annex Table B.2.14-2 for a corresponding Band.

$T_{\text{RRC_procedure_delay}}$: It is the RRC procedure for processing the received message “*RRCConnectionRelease*”. It shall be less than 110 ms.

$T_{\text{identify-E-UTRA cat-M1}}$: It is the time required to identify the target E-UTRA cell. It shall be less than 960 ms.

$T_{\text{SI-E-UTRA cat-M1}}$: It is the time required for acquiring all the relevant system information (SI) of the target E-UTRA cell. If old E-UTRA serving cell, before the release of the RRC connection, provides the UE with the SI (including MIB and all relevant SIBs) of the target E-UTRA cell, then $T_{\text{SI-E-UTRA FDD}} = 0$ ms. The value of $T_{\text{SI-E-UTRA cat-M1}}$ depends on the repetitions of PBCH and PDSCH used in the target cell.

$T_{\text{RA cat-M1}}$: It is the delay caused due to the random access procedure when sending random access to the target E-UTRA cell. The value of T_{RA} depends on the PRACH configuration and the repetition used in the target cell.

6.9 RRC Connection Redirection to Non-anchor Carrier in NB-IoT

6.9.1 Introduction

RRC connection redirection to a non-anchor carrier is initiated by the UE upon receiving the IE, “*CarrierConfigDedicated-NB*”, from the E-UTRAN, TS 36.331 [2]. The RRC redirection to procedure is specified in clause 6.7.3.2 in TS 36.331 [2].

The requirements in this section are applicable under the following conditions:

- The anchor and non-anchor carrier frequencies are within 20 MHz and
- The anchor and the non-anchor carrier frequencies are in the same base station or in co-located base stations.

6.9.2 Requirements

The UE shall be capable of performing the RRC connection redirection to the non-anchor carrier within

$T_{\text{connection_redirect_non-anchor}}$.

The time delay ($T_{\text{connection_redirect_non-anchor}}$) is the time between the end of the last subframe in the repetition period of NPDSCH containing the IE, “*CarrierConfigDedicated-NB*” received on the anchor carrier and the end of the last subframe in the repetition period of NPUSCH transmitted on the target non-anchor carrier. The time delay ($T_{\text{connection_redirect_non-anchor}}$) shall be less than:

$$T_{\text{connection_redirect_non-anchor}} = T_{\text{RRC_procedure_delay}} + T_{\text{period_DL_bitmap}} + T_{\text{UL_grant}} + T_{\text{DL-UL switch}} + T_{\text{NPUSCH}}$$

$T_{\text{RRC_procedure_delay}}$: It is the RRC procedure for processing the received message “*CarrierConfigDedicated-NB*”. It shall be less than 110 ms.

$T_{\text{period_DL_bitmap}}$: It is the periodicity of the downlink subframe configuration for downlink transmission on the non-anchor carrier. It is configured via IE *DL-Bitmap-NB* [2] and can be 10 ms or 40 ms.

T_{UL_grant} : It is the time required to acquire uplink grant from the non-anchor carrier for transmitting NPUSCH on the non-anchor carrier. The value of T_{UL_grant} depends on $T_{period_DL_bitmap}$ and the number of repetitions of NPDCCH used in the non-anchor carrier.

$T_{DL-UL\ switch}$: It is the time between the end of the last subframe in the repetition period of NPDCCH received on the non-anchor carrier and the start of the first subframe in the repetition period of the corresponding NPUSCH transmitted on the non-anchor carrier. $T_{DL-UL\ switch}$ is 8 ms.

T_{NPUSCH} : It is the time required to transmit NPUSCH on the non-anchor carrier. The value of T_{NPUSCH} depends on the number of repetitions of NPUSCH used in the non-anchor carrier.

When the NPUSCH ACK transmission for the received RRC message takes longer than 110ms, the overall RRC connection redirection delay may be extended.

7 Timing and signalling characteristics

7.1 UE transmit timing

7.1.1 Introduction

The UE shall have capability to follow the frame timing change of the connected eNode B. The uplink frame transmission takes place $(N_{TA} + N_{TAoffset}) \times T_s$ before the reception of the first detected path (in time) of the corresponding downlink frame from the reference cell. The UE shall be configured with a pTAG containing the PCell. The pTAG may also contain up to six SCells, if configured. The UE capable of supporting multiple timing advances [2] may also be configured with one or two serving cells with uplink in one or two sTAG and pTAG.

The other downlink SCell(s), if configured, will be contained in either the pTAG or the sTAG(s). In pTAG, UE shall use the PCell as the reference cell for deriving the UE transmit timing for cells in the pTAG. When the UE capable of supporting multiple timing advance [2] is configured with one or two sTAG(s), the UE shall use an activated SCell from the sTAG for deriving the UE transmit timing for cells in the sTAG. UE initial transmit timing accuracy, maximum amount of timing change in one adjustment, minimum and maximum adjustment rate are defined in the following requirements. The requirements in clause 7 apply to all TAGs.

The UE capable of supporting dual connectivity shall be configured with one pTAG and may also be configured with one psTAG. The pTAG shall contain the PCell and may also contain one SCell, if configured. The psTAG shall contain the PSCell and may also contain one SCell, if configured. In pTAG, UE shall use the PCell as the reference cell for deriving the UE transmit timing for pTAG, and in psTAG, UE shall use the PSCell as the reference cell for deriving the UE transmit timing for psTAG. UE initial transmit timing accuracy, maximum amount of timing change in one adjustment, minimum and maximum adjustment rate are defined in the following requirements. The requirements in clause 7 apply to both TAGs.

The UE supporting carrier aggregation with FS3 SCells shall be configured with one pTAG and may also be configured with one sTAG. The pTAG shall contain the PCell and may also contain up to six FS3 or non-FS3 SCells. In pTAG, UE shall use the PCell as the reference cell for deriving the UE transmit timing for the cells in the pTAG. When the UE capable of supporting multiple timing advance [2] is configured with an sTAG, the sTAG shall contain at least one non-FS3 SCell and the UE shall use an activated non-FS3 SCell for deriving the UE transmit timing for cells in the sTAG. UE initial transmit timing accuracy, maximum amount of timing change in one adjustment, minimum and maximum adjustment rate are defined in the following requirements. The requirements in clause 7 apply to all TAGs.

7.1.2 Requirements

The UE initial transmission timing error shall be less than or equal to $\pm T_e$ where the timing error limit value T_e is specified in Table 7.1.2-1. This requirement applies when it is the first transmission in a DRX, eDRX_CONN cycle for PUCCH, SPUCCH, PUSCH of subframe, slot or subslot duration and SRS or it is the first transmission after RACH-less handover or it is the PRACH transmission. The reference point for the UE initial transmit timing control requirement shall be the downlink timing of the reference cell minus $(N_{TA_Ref} + N_{TAoffset}) \times T_s$. The downlink timing is defined as the time when the first detected path (in time) of the corresponding downlink frame is received from the reference cell. N_{TA_Ref} for PRACH is defined as 0. $(N_{TA_Ref} + N_{TAoffset})$ (in T_s units) for other channels is the difference between UE transmission timing and the Downlink timing immediately after when the last timing advance in clause 7.3 was applied. N_{TA_Ref} for other channels is not changed until next timing advance is received.

Table 7.1.2-1: T_e Timing Error Limit

Downlink Bandwidth (MHz)	T_e
1.4	$24 \cdot T_s$
≥ 3	$12 \cdot T_s$
Note: T_s is the basic timing unit defined in TS 36.211	

When it is not the first transmission in a DRX or eDRX_CONN cycle or there is no DRX or no eDRX_CONN cycle, and when it is the transmission for PUCCH, SPUCCH, PUSCH of subframe, slot or subslot duration and SRS transmission or it is not the first transmission after RACH-less handover, the UE shall be capable of changing the transmission timing according to the received downlink frame of the reference cell except when the timing advance in clause 7.3 is applied.

When in a TAG the transmission timing error between the UE and the reference timing exceeds $\pm T_e$, or in a sTAG the UE changes the downlink SCell for deriving the UE transmit timing for cells in the sTAG configured with one or two uplinks, the UE is required to adjust its timing to within $\pm T_e$ in that TAG, as long as,

- the UE is configured with a pTAG and one or two sTAG, the transmission timing difference between TAGs does not exceed the maximum transmission timing difference (i.e., 32.47us) after such adjustment, or
- the UE is configured with synchronous dual connectivity, the transmission timing difference between pTAG and psTAG does not exceed the maximum transmission timing difference (i.e., 35.21us) after such adjustment.

If the transmission timing difference after such adjustment is bigger than the maximum transmission timing difference UE may stop adjustment in this TAG. For a UE configured with more than one serving cell and with *ShortTTI-r15* or with *ShortProcessingTime=TRUE*, UE may stop the transmit timing adjustment if the conditions specified in the subclause B.7.1 cannot be fulfilled after such adjustment. The reference timing shall be $(N_{TA_Ref} + N_{TAoffset}) \times T_s$ before the downlink timing of the reference cell. All adjustments made to the UE uplink timing under the above mentioned scenarios shall follow these rules:

- 1) The maximum amount of the magnitude of the timing change in one adjustment shall be T_q seconds.
- 2) The minimum aggregate adjustment rate shall be $7 \cdot T_s$ per second.
- 3) The maximum aggregate adjustment rate shall be T_q per 200ms.

where the maximum autonomous time adjustment step T_q is specified in Table 7.1.2-2.

Table 7.1.2-2: T_q Maximum Autonomous Time Adjustment Step

Downlink Bandwidth (MHz)	T_q
1.4	$17.5 \cdot T_s$
3	$9.5 \cdot T_s$
5	$5.5 \cdot T_s$
≥ 10	$3.5 \cdot T_s$
Note: T_s is the basic timing unit defined in TS 36.211	

7.2 UE timer accuracy

7.2.1 Introduction

UE timers are used in different protocol entities to control the UE behaviour.

7.2.2 Requirements

For UE timers specified in TS 36.331 [2], UE shall comply with the timer accuracies according to Table 7.2.2-1.

The requirements are only related to the actual timing measurements internally in the UE. They do not include the following:

- Inaccuracy in the start and stop conditions of a timer (e.g. UE reaction time to detect that start and stop conditions of a timer is fulfilled), or

- Inaccuracies due to restrictions in observability of start and stop conditions of a UE timer (e.g. TTI alignment when UE sends messages at timer expiry).

Table 7.2.2-1

Timer value [s]	Accuracy
timer value < 4	$\pm 0.1\text{s}$
timer value ≥ 4	$\pm 2.5\%$

7.3 Timing Advance

7.3.1 Introduction

The timing advance is initiated from E-UTRAN with MAC message that implies and adjustment of the timing advance, see TS 36.321 [17] clause 5.2.

7.3.2 Requirements

7.3.2.1 Timing Advance adjustment delay

When *ShortTTI-r15* is not configured and *ShortProcessingTime=FALSE*, the UE shall adjust the timing of its uplink transmission timing at sub-frame $n+6$ for a timing advance command received in sub-frame n .

When *ShortTTI-r15* is configured or *ShortProcessingTime=TRUE* and the TA command is received at subframe /slot/ subslot n , the timing advance adjustment delay is shown in Table 7.3.2.1-1. The UE shall adjust the uplink timing at the first subframe boundary following the time shown in Table 7.3.2.1-1.

The same requirement applies also when the UE is not able to transmit a configured uplink transmission due to the channel assessment procedure.

Table 7.3.2.1-1: Timing advance adjustment delay requirement for sTTI and for *ShortProcessingTime=TRUE* [2]

TTI duration	Processing time	Requirement to update timing	Units
<i>ShortTTI-r15</i> not configured ^{Note 1}	<i>ShortProcessingTime=TRUE</i>	$n+5$	Subframe
<i>dl-STTI-Length-r15=slot</i> ^{Note 1}	N/A	$n+8$	Slot
<i>dl-STTI-Length-r15=subslot</i> ^{Note 1}	<i>proc-Timeline-r15= nplus4set1</i>	$n+16$	Subslot
<i>dl-STTI-Length-r15=subslot</i> ^{Note 1}	<i>proc-Timeline-r15= nplus6set1</i> or <i>proc-Timeline-r15= nplus6set2</i>	$n+18$	Subslot
<i>dl-STTI-Length-r15=subslot</i> ^{Note 1}	<i>proc-Timeline-r15= nplus8set2</i>	$n+20$	Subslot
Note 1: If the PDSCH HARQ processing time is modified by RRC signalling during an ongoing connection, the requirement to update timing is not defined from the time when the RRC command is received by the UE until the UE has applied the updated PDSCH HARQ processing time			

7.3.2.2 Timing Advance adjustment accuracy

The UE shall adjust the timing of its transmissions with a relative accuracy better than or equal to $\pm 4 * T_s$ seconds to the signalled timing advance value compared to the timing of preceding uplink transmission. The timing advance command is expressed in multiples of $16 * T_s$ and is relative to the current uplink timing.

7.4 Cell phase synchronization accuracy (TDD)

7.4.1 Definition

Cell phase synchronization accuracy is defined as the maximum absolute deviation in frame start timing between any pair of cells on the same frequency that have overlapping coverage areas.

7.4.2 Minimum requirements

For Wide Area BS, the cell phase synchronization accuracy measured at BS antenna connectors shall be better than the requirement specified in table 7.4.2-1. If a cell's coverage area overlaps with another cell with different cell radius then the cell phase synchronization accuracy corresponding to the larger of the two cell sizes applies to the overlapping cells with different radii.

Table 7.4.2-1 Cell phase synchronization requirement for wide area BS (TDD)

Cell Type	Cell Radius	Requirement
Small cell	≤ 3 km	≤ 3 μ s
Large cell	> 3 km	≤ 10 μ s

For Home BS, the cell phase synchronization accuracy measured at BS antenna connectors shall be better than the requirement specified in table 7.4.2-2.

Table 7.4.2-2 Cell phase synchronization requirement for Home BS (TDD)

Source Cell Type	Propagation Distance	Requirement
Small cell	≤ 500 m	≤ 3 μ s
Large cell	> 500 m	$\leq 1.33 + T_{propagation}$ μ s

Note 1: $T_{propagation}$ is the propagation delay between the Home BS and the cell selected as the network listening synchronization source. In terms of the network listening synchronization source selection, the best accurate synchronization source to GNSS should be selected.

Note 2: If the Home BS obtains synchronization without using network listening, the small cell requirement applies.

7.5 Synchronization Requirements for E-UTRAN to 1xRTT and HRPD Handovers

7.5.1 Introduction

This clause contains the synchronization requirements for eNodeB capable of supporting E-UTRAN to CDMA 1xRTT and HRPD handovers. To facilitate E-UTRAN to CDMA 1xRTT and HRPD handovers, the CDMA System Time reference needs to be provided to the UE in order for the UE to report the pilot PN phases of the target 1xRTT or HRPD cells. This is achieved through the SIB8 message broadcasted by the serving eNodeB:

If the eNodeB is synchronized to the GPS time and the LTE system frame is aligned with the start of CDMA System Time, then the size of CDMA System Time information is 39 bits and the unit is 10 ms based on a 1.2288 Mcps chip rate.

If the eNodeB is not synchronized to the GPS time or if the eNodeB is synchronized to the GPS time but its LTE system frame not aligned with the start of CDMA System time, then the size of CDMA System Time information is 49 bits and the unit is 8 CDMA chips based on 1.2288 Mcps chip rate.

The CDMA system time reference provided by the serving eNodeB has to be within a certain level of accuracy in order to facilitate accurate reporting of the pilot PN phases of the target 1xRTT or HRPD cells and enable reliable handover to the 1xRTT or HRPD networks.

7.5.2 eNodeB Synchronization Requirements

7.5.2.1 Synchronized E-UTRAN

The eNodeB shall be synchronized to the GPS time. With external source of CDMA System Time disconnected, the eNodeB shall maintain the timing accuracy within ± 10 μ s of CDMA System Time for a period of not less than 8 hours.

The timing deviation between the SFN boundary at or immediately after the ending boundary of the SI-window in which *SystemInformationBlockType8* is transmitted and the broadcasted CDMA System Time shall be within 10 μ s.

7.5.2.2 Non-Synchronized E-UTRAN

The timing deviation between the SFN boundary at or immediately after the end of the boundary of the SI-window in which *SystemInformationBlockType8* is transmitted and the broadcasted CDMA System Time shall be within 10 μ s. With external source of CDMA System Time disconnected the SFN boundary at or immediately after the broadcasted CDMA System Time in the SIB8 message shall maintain the timing accuracy within ± 10 μ s of CDMA System Time for a period of not less than 8 hours.

7.6 Radio Link Monitoring

7.6.1 Introduction

The UE shall meet the radio link monitoring requirements specified for PSCell in section 7.6 provided that the UE is configured with the parameters T313, N313 and N314 defined in [2].

The UE shall monitor the downlink link quality based on the cell-specific reference signal in order to detect the downlink radio link quality of the PCell and PSCell as specified in [3].

The UE shall estimate the downlink radio link quality and compare it to the thresholds Q_{out} and Q_{in} for the purpose of monitoring downlink radio link quality of the PCell and PSCell.

The threshold Q_{out} is defined as the level at which the downlink radio link cannot be reliably received and shall correspond to 10% block error rate of a hypothetical PDCCH transmission taking into account the PCFICH errors with transmission parameters specified in Table 7.6.1-1.

The threshold Q_{in} is defined as the level at which the downlink radio link quality can be significantly more reliably received than at Q_{out} and shall correspond to 2% block error rate of a hypothetical PDCCH transmission taking into account the PCFICH errors with transmission parameters specified in Table 7.6.1-2.

When higher-layer signalling indicates certain subframes for restricted radio link monitoring, the radio link quality shall be monitored as specified in [3].

The requirements in sections 7.6.2.1, 7.6.2.2 and 7.6.2.3 shall also apply when a time domain measurement resource restriction pattern for performing radio link monitoring measurements is configured by higher layers (TS 36.331 [2]), with or without CRS assistance information, provided that also the following additional condition is fulfilled:

The time domain measurement resource restriction pattern configured for the measured cell indicates at least one subframe per radio frame for performing the radio link monitoring measurements,

When the CRS assistance information is provided, the transmission bandwidth [30] in all intra-frequency cells in the CRS assistance information [2] is the same or larger than the transmission bandwidth of the PCell for which radio link monitoring is performed.

When the CRS assistance information is provided, the requirements in Section 7.6 shall also be met when the number of transmit antenna ports [16] of one or more cells whose CRS assistance information is provided [2] is different from the number of transmit antenna ports of the cell for which radio link monitoring is performed.

NOTE: If the UE is not provided with the CRS assistance information (TS 36.331 [2]) or the CRS assistance data is not valid throughout the entire evaluation period, then similar Release 8 and 9 requirements apply for time domain measurements restriction under colliding CRS with ABS configured in non-MBSFN subframes.

The UE capable of SRS carrier based switching when configured to perform SRS carrier based switching for transmitting SRS and/or RACH over one or more SCells without PUSCH shall perform radio link monitoring and meet the requirements defined in Section 7.6 provided the following condition is met:

- at least one downlink subframe is available for doing radio link monitoring at the UE in the PCell;
- at least one downlink subframe is available for doing radio link monitoring at the UE in the PSCell if the UE is configured with PSCell.

Table 7.6.1-1 PDCCH/PCFICH transmission parameters for out-of-sync

Attribute	Value
-----------	-------

DCI format	1A
Number of control OFDM symbols	2; Bandwidth ≥ 10 MHz 3; $3 \text{ MHz} \leq \text{Bandwidth} \leq 10 \text{ MHz}$ 4; Bandwidth = 1.4 MHz
Aggregation level (CCE)	4; Bandwidth = 1.4 MHz 8; Bandwidth ≥ 3 MHz
Ratio of PDCCH RE energy to average RS RE energy	4 dB; when single antenna port is used for cell-specific reference signal transmission by the PCell or PSCell. 1 dB; when two or four antenna ports are used for cell-specific reference signal transmission by the PCell or PSCell.
Ratio of PCFICH RE energy to average RS RE energy	4 dB; when single antenna port is used for cell-specific reference signal transmission by the PCell or PSCell. 1 dB; when two or four antenna ports are used for cell-specific reference signal transmission by the PCell or PSCell.
Note 1:	DCI format 1A is defined in clause 5.3.3.1.3 in TS 36.212 [21].
Note 2:	A hypothetical PCFICH transmission corresponding to the number of control symbols shall be assumed.

Table 7.6.1-2 PDCCH/PCFICH transmission parameters for in-sync

Attribute	Value
DCI format	1C
Number of control OFDM symbols	2; Bandwidth ≥ 10 MHz 3; $3 \text{ MHz} \leq \text{Bandwidth} \leq 10 \text{ MHz}$ 4; Bandwidth = 1.4 MHz
Aggregation level (CCE)	4
Ratio of PDCCH RE energy to average RS RE energy	0 dB; when single antenna port is used for cell-specific reference signal transmission by the PCell or PSCell. -3 dB; when two or four antenna ports are used for cell-specific reference signal transmission by the PCell or PSCell.
Ratio of PCFICH RE energy to average RS RE energy	4 dB; when single antenna port is used for cell-specific reference signal transmission by the PCell or PSCell. 1 dB; when two or four antenna ports are used for cell-specific reference signal transmission by the PCell or PSCell.
Note 1:	DCI format 1C is defined in clause 5.3.3.1.4 in TS 36.212 [21].
Note 2:	A hypothetical PCFICH transmission corresponding to the number of control symbols shall be assumed.

7.6.2 Requirements

7.6.2.1 Minimum requirement when no DRX is used

When the downlink radio link quality of the PCell or PSCell estimated over the last 200 ms period becomes worse than the threshold Q_{out} , Layer 1 of the UE shall send an out-of-sync indication for the PCell or PSCell to the higher layers within 200 ms Q_{out} evaluation period. A Layer 3 filter shall be applied to the out-of-sync indications as specified in TS 36.331 [2].

When the downlink radio link quality of the PCell or PSCell estimated over the last 100 ms period becomes better than the threshold Q_{in} , Layer 1 of the UE shall send an in-sync indication for the PCell or PSCell to the higher layers within 100 ms Q_{in} evaluation period. A L3 filter shall be applied to the in-sync indications as specified in TS 36.331 [2].

When the UE creates autonomous gaps for identification the CGI of an E-UTRA intra-frequency cell or an E-UTRA inter-frequency cell and when higher-layer signalling indicates certain subframes for restricted radio link monitoring, the UE shall also perform radio link monitoring. In this case, the Q_{out} evaluation period ($T_{Evaluate_Q_{out}}$) is 200 ms, and the Q_{in} evaluation period ($T_{Evaluate_Q_{in}}$) is 100 ms ^{Note 1}.

Note 1: This RLM requirement does not need to be tested.

The out-of-sync and in-sync evaluations of the PCell or PSCell shall be performed as specified in clause 4.2.1 in [3]. Two successive indications from Layer 1 shall be separated by at least 10 ms.

The transmitter power of the UE shall be turned off within 40 ms after expiry of T310 timer and the transmitter power of PSCell if configured shall be turned off within 40 ms after expiry of T313 timer as specified in clause 5.3.11 in TS 36.331 [2]. The UE shall not perform LBT procedure on any of FS3 SCell after the expiry of T310.

7.6.2.2 Minimum requirement when DRX is used

When DRX is used the Q_{out} evaluation period ($T_{Evaluate_Q_{out_DRX}}$) and the Q_{in} evaluation period ($T_{Evaluate_Q_{in_DRX}}$) specified in Table 7.6.2.2-1 will be used.

When higher-layer signalling indicates certain subframes for restricted radio link monitoring, the Q_{out} evaluation period ($T_{Evaluate_Q_{out_DRX}}$) and the Q_{in} evaluation period ($T_{Evaluate_Q_{in_DRX}}$) specified in Table 7.6.2.2-2 will be used.

When eDRX_CONN cycle is used, the Q_{out} evaluation period ($T_{Evaluate_Q_{out_DRX}}$) and the Q_{in} evaluation period ($T_{Evaluate_Q_{in_DRX}}$) specified in Table 7.6.2.2-3 will be used.

When the UE creates autonomous gaps for identification the CGI of an E-UTRA intra-frequency cell or an E-UTRA inter-frequency cell and when higher-layer signalling indicates certain subframes for restricted radio link monitoring, the UE shall also perform radio link monitoring. In this case, the Q_{out} evaluation period ($T_{Evaluate_Q_{out_DRX}}$) and the Q_{in} evaluation period ($T_{Evaluate_Q_{in_DRX}}$) specified in Table 7.6.2.2-2 will be used ^{Note 1}.

Note 1: This RLM requirement does not need to be tested.

When the downlink radio link quality of the PCell or PSCell estimated over the last $T_{Evaluate_Q_{out_DRX}}$ [s] period becomes worse than the threshold Q_{out} , Layer 1 of the UE shall send out-of-sync indication for the PCell or PSCell to the higher layers within $T_{Evaluate_Q_{out_DRX}}$ [s] evaluation period. A Layer 3 filter shall be applied to the out-of-sync indications as specified in TS 36.331 [2].

When the downlink radio link quality of the PCell or PSCell estimated over the last $T_{Evaluate_Q_{in_DRX}}$ [s] period becomes better than the threshold Q_{in} , Layer 1 of the UE shall send in-sync indications for the PCell or PSCell to the higher layers within $T_{Evaluate_Q_{in_DRX}}$ [s] evaluation period. A L3 filter shall be applied to the in-sync indications as specified in TS 36.331 [2].

The out-of-sync and in-sync evaluations of the PCell or PSCell shall be performed as specified in clause 4.2.1 in [3]. When DRX is used, two successive indications from Layer 1 shall be separated by at least $\max(10 \text{ ms}, DRX_cycle_length)$. When the UE is configured with dual connectivity, then two successive indications from Layer 1 shall be separated by at least $\max(10 \text{ ms}, MCG_DRX_cycle_length)$ for PCell and by at least $\max(10 \text{ ms}, SCG_DRX_cycle_length)$ for PSCell. When eDRX_CONN is used, two successive indications from Layer 1 shall be separated by at least $\max(10 \text{ ms}, eDRX_CONN \text{ cycle length})$.

Upon start of T310 timer or T313 timer as specified in clause 5.3.11 in TS 36.331 [2], the UE shall monitor the link of PCell or PSCell for recovery using the evaluation period and Layer 1 indication interval corresponding to the non-DRX mode until the expiry or stop of T310 timer or T313 timer. While the T310 or T313 timer is running, the UE capable of supporting network-based CRS interference mitigation can assume that the inactive time periods T2 specified in Section 3.6.1.1 for network-based CRS interference mitigation are not configured, regardless of the most recent DRX configuration.

The transmitter power of the UE shall be turned off within 40 ms after expiry of T310 timer and the transmitter power of PSCell if configured shall be turned off within 40 ms after expiry of T313 timer as specified in clause 5.3.11 in TS 36.331 [2]. The UE shall not perform LBT procedure on any of FS3 SCells after the expiry of T310.

Table 7.6.2.2-1: Q_{out} and Q_{in} Evaluation Period in DRX

DRX cycle length (s)	$T_{Evaluate_Q_{out_DRX}}$ and $T_{Evaluate_Q_{in_DRX}}$ (s) ^{Note 1}
≤ 0.01	Non-DRX requirements in clause 7.6.2.1 are applicable.
$0.01 < DRX \text{ cycle} \leq 0.04$	$20 * T_{DRX}$
$0.04 < DRX \text{ cycle} \leq 0.64$	$10 * T_{DRX}$
$0.64 < DRX \text{ cycle} \leq 2.56$	$5 * T_{DRX}$

Note 1:	Evaluation period length in time depends on the length of the DRX cycle in use. T_{DRX} is the DRX cycle length.
Note 2:	MCG's DRX configuration is applied for PCell RLM evaluation and SCG's DRX configuration is applied for PSCell RLM evaluation

Table 7.6.2.2-2: Q_{out} and Q_{in} Evaluation Period in DRX when higher-layer signalling restricted measurement resource

DRX cycle length (s)	$T_{Evaluate_Q_{out_DRX}}$ and $T_{Evaluate_Q_{in_DRX}}$ (s) ^{Note 1}
≤ 0.01	Non-DRX requirements in clause 7.6.2.1 are applicable.
$0.01 < \text{DRX cycle} \leq 0.04$	$40 * T_{DRX}$
$0.04 < \text{DRX cycle} \leq 0.16$	$20 * T_{DRX}$
$0.16 < \text{DRX cycle} \leq 0.64$	$10 * T_{DRX}$
$0.64 < \text{DRX cycle} \leq 2.56$	$5 * T_{DRX}$
Note 1:	Evaluation period length in time depends on the length of the DRX cycle in use. T_{DRX} is the DRX cycle length.
Note 2:	MCG's DRX configuration is applied for PCell RLM evaluation and SCG's DRX configuration is applied for PSCell RLM evaluation

Table 7.6.2.2-3: Q_{out} and Q_{in} Evaluation Period when eDRX_CONN cycle is configured

eDRX_CONN cycle length [s]	$T_{Evaluate_Q_{out_DRX}}$ and $T_{Evaluate_Q_{in_DRX}}$ [s] ^{Note}
$2.56 < \text{eDRX_CONN cycle} \leq 10.24$	$5 * T_{eDRX_CONN}$
Note:	Evaluation period length in time depends on the length of the eDRX_CONN cycle in use. T_{eDRX_CONN} is the eDRX_CONN cycle length.

7.6.2.3 Minimum requirement at transitions

When the UE transitions between any two of DRX, eDRX_CONN and non-DRX or when DRX or eDRX_CONN cycle periodicity changes, for a duration of time equal to the evaluation period corresponding to the second mode after the transition occurs, the UE shall use an evaluation period that is no less than the minimum of evaluation periods corresponding to the first mode and the second mode. Subsequent to this duration, the UE shall use an evaluation period corresponding to the second mode. This requirement shall be applied to both out-of-sync evaluation and in-sync evaluation of the PCell and PSCell.

7.6.2.4 Minimum requirement during SI Acquisition with autonomous gaps

For E-UTRAN FDD-UTRAN FDD measurements with autonomous gaps, for identification of the CGI of a UTRA FDD cell (clause 8.1.2.4.17), the UE shall also perform radio link monitoring. In this case the out-of sync and in-sync evaluation periods can be longer than those defined in sections 7.6.2.1-7.6.2.3.

For E-UTRAN TDD-UTRAN FDD measurements with autonomous gaps, for identification of the CGI of a UTRA FDD cell (clause 8.1.2.4.18), the UE shall also perform radio link monitoring. In this case the out-of sync and in-sync evaluation periods can be longer than those defined in sections 7.6.2.1-7.6.2.3.

7.6.2.5 Minimum requirement under IDC Interference

When the UE is provided with IDC solution, the UE shall also perform radio link monitoring and meet the corresponding requirements in clause 7.6.2.

7.7 SCell Activation and Deactivation Delay for E-UTRA Carrier Aggregation

7.7.1 Introduction

This section defines requirements for the delay within which the UE shall be able to activate a deactivated or dormant SCell, deactivate an activated or dormant SCell, or hibernate a deactivated or activated SCell in E-UTRA carrier aggregation. The requirements are applicable to an E-UTRA carrier aggregation capable UE which has been configured with up to six downlink SCells.

This section also defines requirements for the delay within which the UE shall be able to directly activate or directly hibernate a SCell in E-UTRA carrier aggregation. The requirements for dormant SCell are applicable for up to 4 SCell(s).

If multiple downlink SCells are activated or deactivated in the same MAC control element as defined in [17], the requirements shall apply to each of the SCells in the MAC control element.

For UE configured with one or more FeMBMS/Unicast-mixed SCells, the requirements in Section 7.7 apply also when one or more FeMBMS/Unicast-mixed SCells are activated or deactivated.

7.7.2 SCell Activation Delay Requirement for Deactivated SCell

The requirements in this section shall apply for the UE configured with one downlink SCell. The requirements in this section are applicable for E-UTRA FDD, E-UTRA TDD and E-UTRA TDD-FDD carrier aggregation. The requirements in this clause are also applicable for EN-DC. The requirements in this clause are also applicable for the UE operating in NE-DC.

The delay within which the UE shall be able to activate the deactivated SCell depends upon the specified conditions.

Upon receiving SCell activation command in subframe n , the UE shall be capable to transmit valid CSI report and apply actions related to the activation command as specified in [17] for the SCell being activated no later than in subframe $n+N_{\text{act_known}}$ provided the following conditions are met for the SCell:

- During the period equal to $\max(5 \text{ measCycleSCell}, 5 \text{ DRX cycles})$ before the reception of the SCell activation command:
 - the UE has sent a valid measurement report for the SCell being activated and
 - the SCell being activated remains detectable according to the cell identification conditions specified in section 8.3.3.2,
- SCell being activated also remains detectable during the SCell activation delay according to the cell identification conditions specified in section 8.3.3.2 where

$N_{\text{act_known}} = 24;$

$N_{\text{act_known}} = 23$ if the activation command is transmitted on the PDSCH with *ShortProcessingTime*=TRUE;

$N_{\text{act_known}} = 22$ if the activation command is transmitted on the PDSCH with *ShortTTI-r15* configured;

Otherwise upon receiving the SCell activation command in subframe n , the UE shall be capable to transmit valid CSI report and apply actions related to the activation command as specified in [17] for the SCell being activated no later than in subframe $n+N_{\text{act_unknown}}$ provided the SCell can be successfully detected on the first attempt where

$N_{\text{act_unknown}} = 34;$

$N_{\text{act_unknown}} = 33$ if the activation command is transmitted on the PDSCH with *ShortProcessingTime*=TRUE;

$N_{\text{act_unknown}} = 32$ if the activation command is transmitted on the PDSCH with *ShortTTI-r15* configured;

If there is no reference signal received for the CSI measurement over the delay corresponding to the minimum requirements specified above, then the UE shall report corresponding valid CSI for the activated SCell on the next available uplink reporting resource after receiving the reference signal.

The SCell activation delay specified in this section can be extended with each SRS carrier based switching to any carrier occurring during the SCell activation procedure.

If there are no uplink resources for reporting the valid CSI in subframe $n+N_{\text{act_known}}$ or $n+N_{\text{act_unknown}}$ or uplink transmission is interrupted due to SRS carrier based switching then the UE shall use the next available uplink resource for reporting the corresponding valid CSI.

The valid CSI is based on the UE measurement and corresponds to any CQI value specified in [3] with the exception of CQI index = 0 (out of range) provided:

- the conditions in section 7.7 are met over the entire SCell activation delay and
- the conditions for CQI reporting defined in Section 7.2.3 of [3] are met.

In addition to CSI reporting defined above, UE shall also apply other actions related to the activation command specified in [17] for an SCell at the first opportunities for the corresponding actions once the SCell is activated.

When PCell belongs to E-UTRA FDD, the PCell interruption specified in section 7.8.2 shall

- not occur before subframe $n+5$ and not occur after subframe $n+9$ if the activation command is transmitted on the PDSCH with *ShortTTI-r15* not configured and *ShortProcessingTime=FALSE*;
- not occur before subframe $n+4$ and not occur after subframe $n+8$ if the activation command is transmitted on the PDSCH with *ShortTTI-r15* not configured and *ShortProcessingTime=TRUE*;
- not occur before subframe $n+3$ and not occur after subframe $n+7$ if the activation command is transmitted on the PDSCH with *dl-STTI-Length-r15=slot*;
- not occur before subframe $n+2$ and not occur after subframe $n+6$ if the activation command is transmitted on the PDSCH with *dl-STTI-Length-r15=subslot* and *proc-Timeline-r15= nplus4set1*, *proc-Timeline-r15= nplus6set1* or *proc-Timeline-r15= nplus6set2*;
- not occur before subframe $n+3$ and not occur after subframe $n+7$ if the activation command is transmitted on the PDSCH with *dl-STTI-Length-r15=subslot* and *proc-Timeline-r15= nplus8set2*,

When PCell belongs to E-UTRA TDD, the PCell interruption specified in section 7.8.2 shall

- not occur before subframe $n+5$ and not occur after subframe $n+11$ if the activation command is transmitted on the PDSCH with *ShortTTI-r15* not configured and *ShortProcessingTime=FALSE*;
- not occur before subframe $n+4$ and not occur after subframe $n+10$ if the activation command is transmitted on the PDSCH with *ShortTTI-r15* not configured and *ShortProcessingTime=TRUE*;
- not occur before subframe $n+3$ and not occur after subframe $n+9$ if the activation command is transmitted on the PDSCH with *dl-STTI-Length-r15=slot*.

When the UE operating in EN-DC is configured with NR PSCell and NR SCell in SCG, the interruption requirements defined above apply for PCell interruptions specified in clause 7.32.2.5 and NR PSCell and NR SCell interruptions specified in clause 8.2.1.4.2 of TS 38.133 [50].

When the UE is operating in NE-DC and has PSCell and up to one SCell configured in SCG, the interruption requirements defined above apply for PSCell interruptions specified in clause 7.36 and NR PCell and NR SCell interruptions specified of TS 38.133 [50].

Starting from the subframe specified in section 4.3 of [3] and until the UE has completed the SCell activation, the UE shall report CQI index = 0 (out of range) if the UE has available uplink resources to report CQI for the SCell.

7.7.3 SCell Deactivation Delay Requirement for Activated SCell

The requirements in this section shall apply for the UE configured with one downlink SCell. The requirements in this section are applicable for E-UTRA FDD, E-UTRA TDD and E-UTRA TDD-FDD carrier aggregation. The requirements in this clause are also applicable for EN-DC. The requirements in this clause are also applicable for the UE operating in NE-DC.

Upon receiving SCell deactivation command or upon expiry of the *sCellDeactivationTimer* in subframe n , the UE shall accomplish the deactivation actions specified in [17] for the SCell being deactivated no later than in subframe $n+N_{\text{deact}}$ where

$$N_{\text{deact}}=8$$

$N_{\text{deact}}=7$ if the deactivation command is transmitted on the PDSCH with *ShortProcessingTime*=TRUE;

$N_{\text{deact}}=6$ if the deactivation command is transmitted on the PDSCH with *ShortTTI-r15* configured;

The SCell deactivation delay specified in this section can be extended with each SRS carrier based switching to any carrier occurring during the SCell deactivation procedure.

When PCell belongs to E-UTRA FDD, the PCell interruption specified in section 7.8.2 shall

- not occur before subframe $n+5$ and not occur after subframe $n+9$ if the deactivation command is transmitted on the PDSCH with *ShortTTI-r15* not configured and *ShortProcessingTime*=FALSE;
- not occur before subframe $n+4$ and not occur after subframe $n+8$ if the deactivation command is transmitted on the PDSCH with *ShortTTI-r15* not configured and *ShortProcessingTime*=TRUE;
- not occur before subframe $n+3$ and not occur after subframe $n+7$ if the deactivation command is transmitted on the PDSCH with *dl-STTI-Length-r15*=slot;
- not occur before subframe $n+2$ and not occur after subframe $n+6$ if the deactivation command is transmitted on the PDSCH with *dl-STTI-Length-r15*=subslot and *proc-Timeline-r15*= nplus4set1, *proc-Timeline-r15*= nplus6set1 or *proc-Timeline-r15*= nplus6set2;
- not occur before subframe $n+3$ and not occur after subframe $n+7$ if the deactivation command is transmitted on the PDSCH with *dl-STTI-Length-r15*=subslot and *proc-Timeline-r15*= nplus8set2,

When PCell belongs to E-UTRA TDD, the PCell interruption specified in section 7.8.2 shall

- not occur before subframe $n+5$ and not occur after subframe $n+11$ if the deactivation command is transmitted on the PDSCH with *ShortTTI-r15* not configured and *ShortProcessingTime*=FALSE;
- not occur before subframe $n+4$ and not occur after subframe $n+10$ if the deactivation command is transmitted on the PDSCH with *ShortTTI-r15* not configured and *ShortProcessingTime*=TRUE;
- not occur before subframe $n+3$ and not occur after subframe $n+9$ if the deactivation command is transmitted on the PDSCH with *dl-STTI-Length-r15*=slot.

When the UE operating in EN-DC is configured with NR PSCell and NR SCell in SCG, the interruption requirements defined above apply for PCell interruptions specified in clause 7.32.2.5 and NR PSCell and NR SCell interruptions specified in clause 8.2.1.2.4 of TS 38.133 [50].

When the UE is operating in NE-DC and has PSCell and up to one SCell configured in SCG, the interruption requirements defined above apply for PSCell interruptions specified in clause 7.36 and NR PCell and NR SCell interruptions specified in TS 38.133 [50].

7.7.4 SCell Activation Delay Requirement for Deactivated SCell with Multiple Downlink SCells

The requirements in this section shall apply for the UE configured with up to six downlink SCells. The requirements in this section are applicable for E-UTRA FDD, E-UTRA TDD and E-UTRA TDD-FDD carrier aggregation. The requirements in this clause are also applicable for EN-DC. The requirements in this clause are also applicable for the UE operating in NE-DC.

While activating a SCell if the UE does not receive any command to activate, deactivate, configure or deconfigure any other SCell during the SCell activation delay then the UE shall meet the SCell activation delay requirements specified in section 7.7.2.

While activating a SCell if any other SCell is activated, deactivated, configured or deconfigured by the UE then the UE shall meet the SCell activation delay requirements ($T_{\text{activate_total}}$) according to the following expression:

$$T_{\text{activate_total}} = T_{\text{activate_basic}} + 5 \times \sum_{i=1}^{N-1} K_i$$

Where:

$T_{\text{activate_total}}$ is the total time to activate a SCell and is expressed in subframes.

$T_{\text{activate_basic}}$ is the SCell activation delay specified in section 7.7.2;

K_i ($0 \leq K_i \leq 3$) is the number of times the other i^{th} SCell is activated, deactivated, configured or deconfigured while the SCell is being activated.

N ($2 \leq N \leq 6$) is the maximum number of SCells supported by the UE.

While activating an SCell:

- The interruption on the PCell and/or on the activated SCell due to the SCell activation specified in section 7.8.2 shall
 - not occur before subframe $n+5$ and not occur after subframe $n+11$ if the activation command is transmitted on the PDSCH with *ShortTTI-r15* not configured and *ShortProcessingTime=FALSE*;
 - not occur before subframe $n+4$ and not occur after subframe $n+10$ if the activation command is transmitted on the PDSCH with *ShortTTI-r15* not configured and *ShortProcessingTime=TRUE*;
 - not occur before subframe $n+3$ and not occur after subframe $n+9$ if the activation command is transmitted on the PDSCH with *dl-STTI-Length-r15=slot*.

if:

- the PCell and/or the activated SCell being interrupted and the SCell being activated belong to E-UTRA TDD, or
- the activated SCell being interrupted and the SCell being activated belong to E-UTRA FDD and the PCell belongs to E-UTRA TDD.
- Otherwise, the interruption on PCell and/or on the activated SCell due to the SCell activation specified in section 7.8.2 shall
 - not occur before subframe $n+5$ and not occur after subframe $n+9$ if the activation command is transmitted on the PDSCH with *ShortTTI-r15* not configured and *ShortProcessingTime=FALSE*;
 - not occur before subframe $n+4$ and not occur after subframe $n+8$ if the activation command is transmitted on the PDSCH with *ShortTTI-r15* not configured and *ShortProcessingTime=TRUE*;
 - not occur before subframe $n+3$ and not occur after subframe $n+7$ if the activation command is transmitted on the PDSCH with *dl-STTI-Length-r15=slot*;
 - not occur before subframe $n+2$ and not occur after subframe $n+6$ if the activation command is transmitted on the PDSCH with *dl-STTI-Length-r15=subslot* and *proc-Timeline-r15= nplus4set1*, *proc-Timeline-r15= nplus6set1* or *proc-Timeline-r15= nplus6set2*;
 - not occur before subframe $n+3$ and not occur after subframe $n+7$ if the activation command is transmitted on the PDSCH with *dl-STTI-Length-r15=subslot* and *proc-Timeline-r15= nplus8set2*.

When the UE operating in EN-DC is configured with NR PSCell and NR SCell in SCG, the interruption requirements defined above apply for PCell and SCell interruptions specified in clause 7.32.2.5 and NR PSCell and NR SCell interruptions specified in clause 8.2.1.2.4 of TS 38.133 [50].

When the UE is operating in NE-DC and has PSCell and up to one SCell configured in SCG, the interruption requirements defined above apply for PSCell and SCell interruptions specified in clause 7.36 and NR PCell and NR SCell interruptions specified in TS 38.133 [50].

Starting from the subframe specified in section 4.3 of [3] and until the UE has completed the SCell activation, the UE shall report CQI index = 0 (out of range) if the UE has available uplink resources to report CQI for an SCell.

7.7.5 SCell Deactivation Delay Requirement for Activated SCell with Multiple Downlink SCells

The requirements in this section shall apply for the UE configured with up to six downlink SCells. The requirements in this section are applicable for E-UTRA FDD, E-UTRA TDD and E-UTRA TDD-FDD carrier aggregation. The requirements in this clause are also applicable for EN-DC. The requirements in this clause are also applicable for the UE operating in NE-DC.

The UE shall deactivate a SCell and meet the SCell deactivation delay requirements specified in section 7.7.3 regardless of whether any other SCell is activated, deactivated, configured or deconfigured or not by the UE during the SCell deactivation delay.

While deactivating a SCell:

- The interruption on the PCell and/or on the activated SCell due to the SCell deactivation specified in section 7.8.2 shall
 - not occur before subframe $n+5$ and not occur after subframe $n+11$ if the deactivation command is transmitted on the PDSCH with *ShortTTI-r15* not configured and *ShortProcessingTime=FALSE*;
 - not occur before subframe $n+4$ and not occur after subframe $n+10$ if the deactivation command is transmitted on the PDSCH with *ShortTTI-r15* not configured and *ShortProcessingTime=TRUE*;
 - not occur before subframe $n+3$ and not occur after subframe $n+9$ if the deactivation command is transmitted on the PDSCH with *dl-STTI-Length-r15=slot*.

if:

- the PCell and/or the activated SCell being interrupted and the SCell being deactivated belong to E-UTRA TDD or
- the activated SCell being interrupted and the SCell being deactivated belong to E-UTRA FDD and the PCell belongs to E-UTRA TDD.
- Otherwise, the interruption on PCell and/or the activated SCell due to the SCell deactivation specified in section 7.8.2 shall
 - not occur before subframe $n+5$ and not occur after subframe $n+9$ if the deactivation command is transmitted on the PDSCH with *ShortTTI-r15* not configured and *ShortProcessingTime=FALSE*;
 - not occur before subframe $n+4$ and not occur after subframe $n+8$ if the deactivation command is transmitted on the PDSCH with *ShortTTI-r15* not configured and *ShortProcessingTime=TRUE*;
 - not occur before subframe $n+3$ and not occur after subframe $n+7$ if the deactivation command is transmitted on the PDSCH with *dl-STTI-Length-r15=slot*;
 - not occur before subframe $n+2$ and not occur after subframe $n+6$ if the deactivation command is transmitted on the PDSCH with *dl-STTI-Length-r15=subslot* and *proc-Timeline-r15= nplus4set1*, *proc-Timeline-r15= nplus6set1* or *proc-Timeline-r15= nplus6set2*;
 - not occur before subframe $n+3$ and not occur after subframe $n+7$ if the deactivation command is transmitted on the PDSCH with *dl-STTI-Length-r15=subslot* and *proc-Timeline-r15= nplus8set2*.

When the UE operating in EN-DC is configured with NR PSCell and NR SCell in SCG, the interruption requirements defined above apply for PCell and SCell interruptions specified in clause 7.32.2.5 and NR PSCell and NR SCell interruptions specified in clause 8.2.1.2.4 of TS 38.133 [50].

When the UE is operating in NE-DC and has PSCell and up to one SCell configured in SCG, the interruption requirements defined above apply for PSCell and SCell interruptions specified in clause 7.36 and NR PCell and NR SCell interruptions specified in TS 38.133 [50].

7.7.6 SCell Activation Delay Requirement for Deactivated PUCCH SCell

The requirements in this section shall apply for the UE configured with one downlink SCell and when PUCCH is configured for the SCell being activated.

If the UE has a valid TA for transmitting on an SCell then the UE shall be able to transmit valid CSI report and apply actions related to the SCell activation command as specified in [17] for the SCell being activated on the PUCCH SCell no later than in subframe $n+T_{\text{activate_basic}}$:

Where:

- A TA is considered to be valid provided that the *TimeAlignmentTimer* [2] associated with the TAG containing the PUCCH SCell is running.
- $T_{\text{activate_basic}}$ is the SCell activation delay as defined in section 7.7.2.

If the UE does not have a valid TA for transmitting on an SCell then the UE shall be capable to perform downlink actions related to the SCell activation command as specified in [17] for the SCell being activated on the PUCCH SCell no later than in subframe $n+T_{\text{activate_basic}}$ and shall be capable to perform uplink actions related to the SCell activation command as specified in [17] for the SCell being activated on the PUCCH SCell no later than in subframe $n+T_{\text{delay_PUCCH SCell}}$ and shall transmit valid CSI report for the SCell being activated on the PUCCH SCell no later than in subframe $n+T_{\text{delay_PUCCH SCell}}$, where:

$$T_{\text{delay_PUCCH SCell}} = T_{\text{activate_basic}} + T_1 + T_2 + T_3$$

Where:

- T_1 is the delay uncertainty in acquiring the first available PRACH occasion in the PUCCH SCell. T_1 is up to 25 subframes and the actual value of T_1 shall depend upon the PRACH configuration used in the PUCCH SCell.
- T_2 is the delay for obtaining a valid TA command for the sTAG to which the SCell configured with PUCCH belongs. T_2 is up to 13 subframes.
- T_3 is the delay for applying the received TA for uplink transmission. T_3 is 6 subframes.

The above delay requirement ($T_{\text{delay_PUCCH SCell}}$) shall apply provided that:

- The UE has received a PDCCH order to initiate RA procedure on the PUCCH SCell within $T_{\text{activate_basic}}$ otherwise additional delay to activate the SCell is expected; and
- The RA on PUCCH SCell is not interrupted by the RA on PCell otherwise additional delay to activate the SCell is expected; and
- No SRS carrier based switching occurs during the SCell activation procedure otherwise the PUCCH SCell activation delay ($T_{\text{delay_PUCCH SCell}}$) can be extended.

The interruption on the PCell specified in section 7.8.2 shall meet all applicable requirements in clause 7.7.2.

7.7.7 SCell Activation Delay Requirement for Deactivated PUCCH SCell with Multiple SCells

The requirements in this section shall apply for the UE configured with up to six downlink SCells and when PUCCH is configured for the SCell being activated.

If the UE has a valid TA for transmitting on a PUCCH SCell then the UE shall be able to transmit valid CSI report and apply actions related to the SCell activation command as specified in [17] for the SCell being activated on the PUCCH SCell no later than in subframe $n+ T_{\text{activate_total}}$:

Where:

- A TA is considered to be valid provided that the *TimeAlignmentTimer* [2] associated with the TAG containing the PUCCH SCell is running.
- $T_{\text{activate_total}}$ is the SCell activation delay as defined in section 7.7.4.

If the UE does not have a valid TA for transmitting on an SCell then the UE shall be capable to perform downlink actions related to the SCell activation command as specified in [17] for the SCell being activated on the PUCCH SCell no later than in subframe $n+T_{\text{activate_basic}}$ and shall be capable to perform uplink actions related to the SCell activation command as specified in [17] for the SCell being activated on the PUCCH SCell no later than in subframe

$n+T_{\text{delay_PUCCH_multiple_SCells}}$ and shall transmit valid CSI report for the SCell being activated on the PUCCH SCell no later than in subframe $n+T_{\text{delay_PUCCH_multiple_SCells}}$, where:

$$T_{\text{delay_PUCCH_multiple_SCells}} = T_{\text{activate_total}} + T_1 + T_2 + T_3$$

Where:

- T_1 , T_2 and T_3 are defined in section 7.7.6

The above delay requirement ($T_{\text{delay_PUCCH_multiple_SCells}}$) shall apply provided that:

- The UE has received a PDCCH order to initiate RA procedure on the PUCCH SCell within $T_{\text{activate_basic}}$ otherwise additional delay to activate the SCell is expected; and
- The RA on PUCCH SCell is not interrupted by the RA on PCell otherwise additional delay to activate the SCell is expected; and
- No SRS carrier based switching occurs during the SCell activation procedure otherwise the PUCCH SCell activation delay ($T_{\text{delay_PUCCH_multiple_SCells}}$) can be extended.

The interruption on the PCell and/or on the activated SCell specified in section 7.8.2 shall meet all applicable requirements in clause 7.7.4.

7.7.8 SCell Deactivation Delay Requirement for Activated PUCCH SCell

The requirements in this section shall apply for the UE configured with one downlink SCell and when PUCCH is configured for the SCell being activated.

The UE shall deactivate a SCell configured with PUCCH and meet the SCell deactivation delay requirements specified in section 7.7.3.

The interruption on the PCell specified in section 7.8.2 shall meet all applicable requirements in clause 7.7.3.

7.7.9 SCell Deactivation Delay Requirement for Activated PUCCH SCell with Multiple SCells

The requirements in this section shall apply for the UE configured with up to six downlink SCells and when PUCCH is configured for the SCell being deactivated.

The UE shall deactivate a SCell configured with PUCCH and meet the SCell deactivation delay requirements specified in section 7.7.5.

The interruption on the PCell and/or on the activated SCell specified in section 7.8.2 shall meet all applicable requirements in clause 7.7.5.

7.7.10 SCell Activation Delay Requirement for Deactivated SCell under Frame Structure 3

The requirements in this section shall apply for E-UTRA carrier aggregation of one FDD PCell or one TDD PCell and one SCell following the frame structure type 3 [16].

The delay within which the UE shall be able to activate the deactivated SCell depends upon the specified conditions.

Upon receiving SCell activation command in subframe n , the UE shall be capable to transmit valid CSI report and apply actions related to the activation command as specified in [17] for the SCell being activated no later than in subframe $n+T_{\text{activate_basic_FS3}}$, provided the following conditions are met for the SCell:

- During the period equal to $\max(5 \text{ measCycleSCell}, 5 \text{ DRX cycles})$ before the reception of the SCell activation command:
 - the UE has sent a valid measurement report for the SCell being activated and
 - the SCell being activated remains detectable according to the cell identification conditions specified in section 8.3.3.2,

- SCell being activated also remains detectable during the SCell activation delay according to the cell identification conditions specified in section 8.3.3.2.

$T_{\text{activate_basic_FS3}} = 16 \text{ ms} + T_{\text{DMTC_duration}} + (L+2) * T_{\text{DMTC_periodicity}}$, where

$T_{\text{DMTC_duration}} = 6 \text{ ms}$ is the DMTC duration [2],

$T_{\text{DMTC_periodicity}}$ is the periodicity of the DMTC [2],

L is the number of times the discovery signal occasion is not available at the UE during the SCell activation time.

Otherwise upon receiving the SCell activation command in subframe n , the UE shall be capable to transmit a valid CSI report and apply actions related to the activation command as specified in [17] for the SCell being activated no later than in subframe $n + T_{\text{activate_basic_FS3}}$, provided the SCell can be successfully detected on the first attempt. In this case, $T_{\text{activate_basic_FS3}}$ is defined as follows.

$T_{\text{activate_basic_FS3}} = 16 \text{ ms} + T_{\text{DMTC_duration}} + (L+3) * T_{\text{DMTC_periodicity}}$, where

$T_{\text{DMTC_duration}} = 6 \text{ ms}$ is the DMTC duration [2],

$T_{\text{DMTC_periodicity}}$ is the periodicity of the DMTC [2],

L is the number of times the discovery signal occasion is not available at the UE during the SCell activation time.

If there is no reference signal received for the CSI measurement over the delay corresponding to the minimum requirements specified above, then the UE shall report corresponding valid CSI for the activated SCell on the next available uplink reporting resource after receiving the reference signal.

If there are no uplink resources for reporting the valid CSI in subframe $n + T_{\text{activate_basic_FS3}}$ then the UE shall use the next available uplink resource for reporting the corresponding valid CSI.

The valid CSI is based on the UE measurement and corresponds to any CQI value specified in [3] with the exception of CQI index = 0 (out of range) provided:

- the conditions in section 7.7 are met over the entire SCell activation delay and
- the conditions for CQI reporting defined in Section 7.2.3 of [3] are met.

In addition to CSI reporting defined above, UE shall also apply other actions related to the activation command specified in [17] for an SCell at the first opportunities for the corresponding actions once the SCell is activated.

When PCell belongs to E-UTRA FDD, the PCell interruption specified in section 7.8.2 shall

- not occur before subframe $n+5$ and not occur after subframe $n+9$ if the activation command is transmitted on the PDSCH with ShortTTI- r15 not configured and ShortProcessingTime=FALSE;
- not occur before subframe $n+4$ and not occur after subframe $n+8$ if the activation command is transmitted on the PDSCH with ShortTTI- r15 not configured and ShortProcessingTime=TRUE;
- not occur before subframe $n+3$ and not occur after subframe $n+7$ if the activation command is transmitted on the PDSCH with $dl\text{-}STTI\text{-}Length\text{-}r15 = \text{slot}$;
- not occur before subframe $n+2$ and not occur after subframe $n+6$ if the activation command is transmitted on the PDSCH with $dl\text{-}STTI\text{-}Length\text{-}r15 = \text{subslot}$ and $proc\text{-}Timeline\text{-}r15 = \text{nplus4set1}$, $proc\text{-}Timeline\text{-}r15 = \text{nplus6set1}$ or $proc\text{-}Timeline\text{-}r15 = \text{nplus6set2}$;
- not occur before subframe $n+3$ and not occur after subframe $n+7$ if the activation command is transmitted on the PDSCH with $dl\text{-}STTI\text{-}Length\text{-}r15 = \text{subslot}$ and $proc\text{-}Timeline\text{-}r15 = \text{nplus8set2}$,

When PCell belongs to E-UTRA TDD, the PCell interruption specified in section 7.8.2 shall

- not occur before subframe $n+5$ and not occur after subframe $n+11$ if the activation command is transmitted on the PDSCH with ShortTTI- r15 not configured and ShortProcessingTime=FALSE;
- not occur before subframe $n+4$ and not occur after subframe $n+10$ if the activation command is transmitted on the PDSCH with ShortTTI- r15 not configured and ShortProcessingTime=TRUE;

- not occur before subframe $n+3$ and not occur after subframe $n+9$ if the activation command is transmitted on the PDSCH with $dl-STTI\text{-}Length\text{-}r15=\text{slot}$.

Starting from the subframe specified in Section 4.3 of [3] and until the UE has completed the SCell activation, the UE shall send CSI with CQI index = 0 (out of range) if the UE has available uplink resources to report for the SCell.

7.7.11 SCell Deactivation Delay Requirement for Activated SCell under Frame Structure 3

The requirements in this section shall apply for the UE configured with one downlink SCell. The requirements in this section shall apply for E-UTRA carrier aggregation of one FDD PCell or one TDD PCell and the SCell following the frame structure type 3 [16].

Upon receiving SCell deactivation command or upon expiry of the *sCellDeactivationTimer* in subframe n , the UE shall accomplish the deactivation actions specified in [17] for the SCell being deactivated no later than in subframe $n+8$.

When PCell belongs to E-UTRA FDD, the PCell interruption specified in section 7.8.2 shall

- not occur before subframe $n+5$ and not occur after subframe $n+9$ if the deactivation command is transmitted on the PDSCH with *ShortTTI-r15* not configured and *ShortProcessingTime=FALSE*;
- not occur before subframe $n+4$ and not occur after subframe $n+8$ if the deactivation command is transmitted on the PDSCH with *ShortTTI-r15* not configured and *ShortProcessingTime=TRUE*;
- not occur before subframe $n+3$ and not occur after subframe $n+7$ if the deactivation command is transmitted on the PDSCH with $dl-STTI\text{-}Length\text{-}r15=\text{slot}$;
- not occur before subframe $n+2$ and not occur after subframe $n+6$ if the deactivation command is transmitted on the PDSCH with $dl-STTI\text{-}Length\text{-}r15=\text{subslot}$ and *proc-Timeline-r15= nplus4set1*, *proc-Timeline-r15= nplus6set1* or *proc-Timeline-r15= nplus6set2*;
- not occur before subframe $n+3$ and not occur after subframe $n+7$ if the deactivation command is transmitted on the PDSCH with $dl-STTI\text{-}Length\text{-}r15=\text{subslot}$ and *proc-Timeline-r15= nplus8set2*,

When PCell belongs to E-UTRA TDD, the PCell interruption specified in section 7.8.2 shall

- not occur before subframe $n+5$ and not occur after subframe $n+11$ if the deactivation command is transmitted on the PDSCH with *ShortTTI-r15* not configured and *ShortProcessingTime=FALSE*;
- not occur before subframe $n+4$ and not occur after subframe $n+10$ if the deactivation command is transmitted on the PDSCH with *ShortTTI-r15* not configured and *ShortProcessingTime=TRUE*;
- not occur before subframe $n+3$ and not occur after subframe $n+9$ if the deactivation command is transmitted on the PDSCH with $dl-STTI\text{-}Length\text{-}r15=\text{slot}$.

7.7.12 SCell Activation Delay Requirement for Deactivated SCell with Multiple Downlink SCells under Frame Structure 3

While activating a SCell, if any other SCell is activated, deactivated, configured or deconfigured by the UE, the UE shall meet the SCell activation delay requirements ($T_{\text{activate_total_FS3}}$) according to the following expression:

$$T_{\text{activate_total_FS3}} = T_{\text{activate_basic_FS3}} + T_{\text{DMTC_periodicity}} \times \sum_{i=1}^{N-1} K_i$$

where

$T_{\text{activate_total_FS3}}$ is the total time to activate a SCell and is expressed in subframes,

$T_{\text{activate_basic_FS3}}$ is the SCell activation delay for the SCell, as specified in section 7.7.10,

$T_{\text{DMTC_periodicity}}$ is the periodicity of the DMTC [2],

K_i ($0 \leq K_i \leq 3$) is the number of times the other i^{th} SCell is activated, deactivated, configured or deconfigured while the SCell is being activated,

N ($2 \leq N \leq 4$) is the maximum number of SCells supported by the UE.

While activating a SCell:

- When PCell belongs to E-UTRA FDD, the interruption on the PCell and/or on the activated SCell specified in section 7.8.2 shall
 - not occur before subframe $n+5$ and not occur after subframe $n+9$ if the activation command is transmitted on the PDSCH with *ShortTTI-r15* not configured and *ShortProcessingTime=FALSE*;
 - not occur before subframe $n+4$ and not occur after subframe $n+8$ if the activation command is transmitted on the PDSCH with *ShortTTI-r15* not configured and *ShortProcessingTime=TRUE*;
 - not occur before subframe $n+3$ and not occur after subframe $n+7$ if the activation command is transmitted on the PDSCH with *dl-STTI-Length-r15=slot*;
 - not occur before subframe $n+2$ and not occur after subframe $n+6$ if the activation command is transmitted on the PDSCH with *dl-STTI-Length-r15=subslot* and *proc-Timeline-r15= nplus4set1*, *proc-Timeline-r15= nplus6set1* or *proc-Timeline-r15= nplus6set2*;
 - not occur before subframe $n+3$ and not occur after subframe $n+7$ if the activation command is transmitted on the PDSCH with *dl-STTI-Length-r15=subslot* and *proc-Timeline-r15= nplus8set2*,
- When the PCell belongs to E-UTRA TDD, the interruption on the PCell and/or on the activated SCell specified in section 7.8.2 shall
 - not occur before subframe $n+5$ and not occur after subframe $n+11$ if the activation command is transmitted on the PDSCH with *ShortTTI-r15* not configured and *ShortProcessingTime=FALSE*;
 - not occur before subframe $n+4$ and not occur after subframe $n+10$ if the activation command is transmitted on the PDSCH with *ShortTTI-r15* not configured and *ShortProcessingTime=TRUE*;
 - not occur before subframe $n+3$ and not occur after subframe $n+9$ if the activation command is transmitted on the PDSCH with *dl-STTI-Length-r15=slot*.

Starting from the subframe specified in section 4.3 of [3] and until the UE has completed the SCell activation, the UE shall send CSI with CQI index = 0 (out of range) if the UE has available uplink resources to report for the SCell being activated.

7.7.13 SCell Deactivation Delay Requirement for Activated SCell with Multiple Downlink SCells under Frame Structure 3

The UE shall deactivate a SCell and meet the SCell deactivation delay requirements specified in section 7.7.11 regardless of whether any other SCell is activated, deactivated, configured or deconfigured or not by the UE during the SCell deactivation delay.

While deactivating a SCell:

- When PCell belongs to E-UTRA FDD, the interruption on the PCell and/or on the activated SCell specified in section 7.8.2 shall
 - not occur before subframe $n+5$ and not occur after subframe $n+9$ if the deactivation command is transmitted on the PDSCH with *ShortTTI-r15* not configured and *ShortProcessingTime=FALSE*;
 - not occur before subframe $n+4$ and not occur after subframe $n+8$ if the deactivation command is transmitted on the PDSCH with *ShortTTI-r15* not configured and *ShortProcessingTime=TRUE*;
 - not occur before subframe $n+3$ and not occur after subframe $n+7$ if the deactivation command is transmitted on the PDSCH with *dl-STTI-Length-r15=slot*;
 - not occur before subframe $n+2$ and not occur after subframe $n+6$ if the deactivation command is transmitted on the PDSCH with *dl-STTI-Length-r15=subslot* and *proc-Timeline-r15= nplus4set1*, *proc-Timeline-r15= nplus6set1* or *proc-Timeline-r15= nplus6set2*;

- not occur before subframe $n+3$ and not occur after subframe $n+7$ if the deactivation command is transmitted on the PDSCH with $dl-STTI\text{-}Length\text{-}r15=\text{subslot}$ and $proc\text{-}Timeline\text{-}r15=\text{nplus8set2}$,
- When PCell belongs to E-UTRA TDD, the interruption on the PCell and/or on the activated SCell specified in section 7.8.2 shall
 - not occur before subframe $n+5$ and not occur after subframe $n+11$ if the deactivation command is transmitted on the PDSCH with $ShortTTI\text{-}r15$ not configured and $ShortProcessingTime=FALSE$;
 - not occur before subframe $n+4$ and not occur after subframe $n+10$ if the deactivation command is transmitted on the PDSCH with $ShortTTI\text{-}r15$ not configured and $ShortProcessingTime=TRUE$;
 - not occur before subframe $n+3$ and not occur after subframe $n+9$ if the deactivation command is transmitted on the PDSCH with $dl-STTI\text{-}Length\text{-}r15=\text{slot}$.

7.7.14 SCell Activation Delay Requirement for Dormant SCell

The requirements in this section shall apply for the UE capable of supporting *dormantSCellState* [2] and configured with one downlink SCell in dormant state. The requirements in this section are applicable for E-UTRA FDD, E-UTRA TDD and E-UTRA TDD-FDD carrier aggregation.

The delay within which the UE shall be able to activate the dormant SCell depends upon the specified conditions.

Upon receiving SCell activation command in subframe n , the UE shall be ready to receive the downlink grant and apply actions related to the activation command as specified in TS 36.321 [17] for the SCell being activated no later than in subframe $n+N_{act_dormant}$ provided the following conditions are met for the SCell:

- UE has been periodically sending a valid CQI report for the dormant SCell being activated before the reception of the SCell activation command:
 - the SCell being activated remains detectable according to the cell identification conditions specified in section 8.3.3.2,
- MBSFN subframes are not configured in the PCell
- SCell being activated also remains detectable during the SCell activation delay according to the cell identification conditions specified in section 8.3.3.2 where

when PCell belongs to E-UTRAN FDD,

$$N_{act_dormant} = 8;$$

$$N_{act_dormant} = 7 \text{ if the activation command is transmitted on the PDSCH with } ShortProcessingTime=TRUE;$$

$$N_{act_dormant} = 6 \text{ if the activation command is transmitted on the PDSCH with } ShortTTI\text{-}r15 \text{ configured};$$

and when the PCell belongs to E-UTRAN TDD,

$$N_{act_dormant} = 11;$$

$$N_{act_dormant} = 10 \text{ if the activation command is transmitted on the PDSCH with } ShortProcessingTime=TRUE;$$

$$N_{act_dormant} = 9 \text{ if the activation command is transmitted on the PDSCH with } ShortTTI\text{-}r15 \text{ configured};$$

Otherwise, upon receiving the SCell activation command for a dormant SCell, the SCell activation delay requirement as specified by subclause 7.7.2 shall apply to the dormant SCell being activated.

The SCell activation delay specified in this section can be extended with each SRS carrier-based switching to any carrier occurring during the SCell activation procedure.

Scell activation delay and interruption requirements are defined assuming that MBSFN subframe(s) are not configured. Additional delay may be expected if MBSFN subframe(s) are configured.

In addition to the CSI reporting defined above, UE shall also apply other actions related to the activation command specified in TS 36.321 [17] for an SCell at the first opportunities for the corresponding actions once the SCell is activated.

When PCell belongs to E-UTRA FDD, the PCell interruption specified in section 7.8.2 shall

- not occur before subframe $n+5$ and not occur after subframe $n+7$ if the activation command is transmitted on the PDSCH with *ShortTTI-r15* not configured and *ShortProcessingTime=FALSE*;
- not occur before subframe $n+4$ and not occur after subframe $n+6$ if the activation command is transmitted on the PDSCH with *ShortTTI-r15* not configured and *ShortProcessingTime=TRUE*;
- not occur before subframe $n+3$ and not occur after subframe $n+5$ if the activation command is transmitted on the PDSCH with *dl-STTI-Length-r15=slot*;
- not occur before subframe $n+2$ and not occur after subframe $n+4$ if the activation command is transmitted on the PDSCH with *dl-STTI-Length-r15=subslot* and *proc-Timeline-r15= nplus4set1*, *proc-Timeline-r15= nplus6set1* or *proc-Timeline-r15= nplus6set2*;
- not occur before subframe $n+3$ and not occur after subframe $n+5$ if the activation command is transmitted on the PDSCH with *dl-STTI-Length-r15=subslot* and *proc-Timeline-r15= nplus8set2*,

When PCell belongs to E-UTRA TDD, the PCell interruption specified in section 7.8.2 shall

- not occur before subframe $n+5$ and not occur after subframe $n+10$ if the activation command is transmitted on the PDSCH with *ShortTTI-r15* not configured and *ShortProcessingTime=FALSE*;
- not occur before subframe $n+4$ and not occur after subframe $n+9$ if the activation command is transmitted on the PDSCH with *ShortTTI-r15* not configured and *ShortProcessingTime=TRUE*;
- not occur before subframe $n+3$ and not occur after subframe $n+8$ if the activation command is transmitted on the PDSCH with *dl-STTI-Length-r15=slot*.

7.7.15 SCell Hibernation Delay Requirement for Activated SCell

The requirements in this section shall apply for the UE capable of supporting *dormantSCellState* [2] and configured with one activated downlink SCell. The requirements in this section are applicable for E-UTRA FDD, E-UTRA TDD and E-UTRA TDD-FDD carrier aggregation.

Upon receiving SCell hibernation command or upon expiry of the *sCellHibernationTimer* in subframe n , the UE shall accomplish the hibernation actions specified in TS 36.321 [17] for the SCell being hibernated no later than in subframe $n+N_{\text{hibernate}}$ where

$N_{\text{hibernate}} = 8N_{\text{hibernate}} = 7$ if the hibernation command is transmitted on the PDSCH with *ShortProcessingTime=TRUE*;

$N_{\text{hibernate}} = 6$ if the hibernation command is transmitted on the PDSCH with *ShortTTI-r15* configured;

The PCell interruption upon receiving the hibernation command specified in section 7.8.2 shall

- not occur before subframe $n+5$ and not occur after subframe $n+9$ if the deactivation command is transmitted on the PDSCH with *ShortTTI-r15* not configured and *ShortProcessingTime=FALSE*;
- not occur before subframe $n+4$ and not occur after subframe $n+8$ if the deactivation command is transmitted on the PDSCH with *ShortTTI-r15* not configured and *ShortProcessingTime=TRUE*;
- not occur before subframe $n+3$ and not occur after subframe $n+7$ if the deactivation command is transmitted on the PDSCH with *dl-STTI-Length-r15=slot*;
- not occur before subframe $n+2$ and not occur after subframe $n+6$ if the deactivation command is transmitted on the PDSCH with *dl-STTI-Length-r15=subslot* and *proc-Timeline-r15= nplus4set1*, *proc-Timeline-r15= nplus6set1* or *proc-Timeline-r15= nplus6set2*;
- not occur before subframe $n+3$ and not occur after subframe $n+7$ if the deactivation command is transmitted on the PDSCH with *dl-STTI-Length-r15=subslot* and *proc-Timeline-r15= nplus8set2*,

When PCell belongs to E-UTRA TDD, the PCell interruption specified in section 7.8.2 shall

- not occur before subframe $n+5$ and not occur after subframe $n+11$ if the deactivation command is transmitted on the PDSCH with *ShortTTI-r15* not configured and *ShortProcessingTime=FALSE*;

- not occur before subframe $n+4$ and not occur after subframe $n+10$ if the deactivation command is transmitted on the PDSCH with *ShortTTI-r15* not configured and *ShortProcessingTime=TRUE*;
- not occur before subframe $n+3$ and not occur after subframe $n+9$ if the deactivation command is transmitted on the PDSCH with *dl-STTI-Length-r15=slot*.

7.7.16 SCell Hibernation Delay Requirement for Deactivated SCell

The requirements in this section shall apply for the UE capable of supporting *dormantSCellState* [2] and configured with one downlink SCell. The requirements in this section are applicable for E-UTRA FDD, E-UTRA TDD and E-UTRA TDD-FDD carrier aggregation.

The delay within which the UE shall be able to hibernate the deactivated SCell depends upon the specified conditions.

Upon receiving SCell hibernation command in subframe n , the UE shall be capable to transmit valid CSI report and apply actions related to the activation command as specified in TS 36.321 [17] for the SCell being in the dormant state no later than in subframe $n+N_{\text{hibernate_known}}$ provided the following conditions are met for the SCell:

- During the period equal to $\max(5 \text{ measCycleSCell}, 5 \text{ DRX cycles})$ before the reception of the SCell hibernation command:
 - the UE has sent a valid measurement report for the SCell being hibernated and
 - the SCell being hibernated remains detectable according to the cell identification conditions specified in section 8.3.3.2,
- SCell being hibernated also remains detectable during the SCell hibernation delay according to the cell identification conditions specified in section 8.3.3.2 where

$N_{\text{hibernate_known}} = 24$;

$N_{\text{hibernate_known}} = 23$ if the hibernation command is transmitted on the PDSCH with *ShortProcessingTime=TRUE*;

$N_{\text{hibernate_known}} = 22$ if the hibernation command is transmitted on the PDSCH with *ShortTTI-r15* configured;

Otherwise upon receiving the SCell hibernation command in subframe n , the UE shall be capable to transmit valid CSI report and apply actions related to the hibernation command as specified in TS 36.321 [17] for the SCell being in the dormant state no later than in subframe $n+N_{\text{hibernate_unknown}}$ provided the SCell can be successfully detected on the first attempt where

$N_{\text{hibernate_unknown}} = 34$;

$N_{\text{hibernate_unknown}} = 33$ if the hibernation command is transmitted on the PDSCH with *ShortProcessingTime=TRUE*;

$N_{\text{hibernate_unknown}} = 32$ if the hibernation command is transmitted on the PDSCH with *ShortTTI-r15* configured;

If there is no reference signal received for the CSI measurement over the delay corresponding to the minimum requirements specified above, then the UE shall report corresponding valid CSI for the dormant SCell on the next available uplink reporting resource after receiving the reference signal.

The SCell hibernation delay specified in this section can be extended with each SRS carrier based switching to any carrier occurring during the SCell activation procedure.

If there are no uplink resources for reporting the valid CSI in subframe $n+N_{\text{hibernate_known}}$ or $n+N_{\text{hibernate_unknown}}$ or uplink transmission is interrupted due to SRS carrier based switching then the UE shall use the next available uplink resource for reporting the corresponding valid CSI.

The valid CSI is based on the UE measurement and corresponds to any CQI value specified in TS 36.213 [3] with the exception of CQI index = 0 (out of range) provided:

- the conditions in section 7.7 are met over the entire SCell hibernation delay and
- the conditions for CQI reporting defined in Section 7.2.3 of TS 36.213 [3] are met.

In addition to CSI reporting defined above, UE shall also apply other actions related to the hibernation command specified in TS 36.321 [17] for an SCell at the first opportunities for the corresponding actions once the SCell is activated.

When PCell belongs to E-UTRA FDD, the PCell interruption specified in section 7.8.2 shall

- not occur before subframe $n+5$ and not occur after subframe $n+9$ if the hibernation command is transmitted on the PDSCH with *ShortTTI-r15* not configured and *ShortProcessingTime=FALSE*;
- not occur before subframe $n+4$ and not occur after subframe $n+8$ if the hibernation command is transmitted on the PDSCH with *ShortTTI-r15* not configured and *ShortProcessingTime=TRUE*;
- not occur before subframe $n+3$ and not occur after subframe $n+7$ if the hibernation command is transmitted on the PDSCH with *dl-STTI-Length-r15=slot*;
- not occur before subframe $n+2$ and not occur after subframe $n+6$ if the hibernation command is transmitted on the PDSCH with *dl-STTI-Length-r15=subslot* and *proc-Timeline-r15= nplus4set1*, *proc-Timeline-r15= nplus6set1* or *proc-Timeline-r15= nplus6set2*;
- not occur before subframe $n+3$ and not occur after subframe $n+7$ if the hibernation command is transmitted on the PDSCH with *dl-STTI-Length-r15=subslot* and *proc-Timeline-r15= nplus8set2*,

When PCell belongs to E-UTRA TDD, the PCell interruption specified in section 7.8.2 shall

- not occur before subframe $n+5$ and not occur after subframe $n+11$ if the hibernation command is transmitted on the PDSCH with *ShortTTI-r15* not configured and *ShortProcessingTime=FALSE*;
- not occur before subframe $n+4$ and not occur after subframe $n+10$ if the hibernation command is transmitted on the PDSCH with *ShortTTI-r15* not configured and *ShortProcessingTime=TRUE*;
- not occur before subframe $n+3$ and not occur after subframe $n+9$ if the hibernation command is transmitted on the PDSCH with *dl-STTI-Length-r15=slot*.

Starting from the subframe specified in section 4.3 of TS 36.213 [3] and until the UE has completed the SCell hibernation, the UE shall report CQI index = 0 (out of range) if the UE has available uplink resources to report CQI for the SCell.

7.7.17 SCell Deactivation Delay Requirement for Dormant SCell

The requirements in this section shall apply for the UE capable of supporting *dormantSCellState* [2] and configured with one dormant downlink SCell. The requirements in this section are applicable for E-UTRA FDD, E-UTRA TDD and E-UTRA TDD-FDD carrier aggregation.

The SCell deactivation delay of the dormant SCell shall meet the requirement as specified in sub-clauses 7.7.3.

7.7.18 Direct SCell Activation and Hibernation Delay Requirement

The requirements in this section are applicable for E-UTRA FDD, E-UTRA TDD and E-UTRA TDD-FDD carrier aggregation.

If the parameter *sCellState* is set to *activated* for the SCell within RRC reconfiguration message [2] then the UE capable of the direct SCell activation shall configure that SCell in activated state upon successful completion of the RRC reconfiguration procedure within the specified delay. If the parameter *sCellState* is set to *dormant* for the SCell within RRC reconfiguration message [2] then the UE capable of the direct SCell hibernation shall configure that SCell in dormant state upon successful completion of the RRC reconfiguration procedure within the specified delay. The UE capable of the direct SCell activation shall support direct activation to active state within N_{direct} for at least 1 inter-band SCell or 1 intra-band SCell. The UE capable of the direct SCell hibernation shall support direct hibernation to dormant state within N_{direct} for at least 1 inter-band SCell or 1 intra-band SCell.

The delay within which the UE shall be able to configure one or more direct configured SCells in activated or dormant state depends upon the specified conditions.

Upon receiving directly activated or directly hibernated SCell configuration in subframe n , the UE shall be capable to transmit valid CSI report and apply actions as specified in [17] for the directly activated or directly hibernated SCell no later than in subframe $n+N_{direct}$

Where:

$$N_{direct} = T_{RRC_Process} + T_1 + T_{time_direct}$$

$T_{RRC_Process}$: It is the RRC procedure delay defined in section 11.2 of TS 36.331 [2],

T_1 : Delay from subframe $n + T_{RRC_Process}$ until the transmission of RRCConnectionReconfigurationComplete message

Note: T_1 is UE implementation dependent.

T_{time_direct} is the direct SCell activation delay.

If the SCell is known, then T_{time_direct} is 20ms. If the SCell is unknown, then T_{time_direct} is 30ms provided the SCell can be successfully detected on the first attempt.

The SCell is known provided the following conditions are met for the SCell:

- During the last 5 seconds before the reception of the direct SCell configuration command:
 - the UE has sent a valid measurement report for the SCell being directly activated or directly hibernated, and
 - the SCell being directly activated or directly hibernated remains detectable according to the cell identification conditions specified in section 8.3.3.2,
- SCell being directly activated or directly hibernated also remains detectable during the SCell activation delay according to the cell identification conditions specified in section 8.3.3.2

Otherwise, the SCell is unknown.

The UE capable of the direct SCell activation shall support direct activation of up to 2 SCell(s). The UE capable of the direct SCell hibernation shall support direct hibernation of up to 2 SCell(s). If more than one SCells are directly activated simultaneously to active state or directly hibernated simultaneously to dormant state, the direct activation or hibernation delay requirements shall be fulfilled for at least one of the SCells being directly activated or hibernated, and additional relaxation in the activation delay or hibernation delay is allowed for the rest of SCells being directly activated or hibernated simultaneously. Upon receiving the RRC reconfiguration message in subframe n , the UE shall be capable to transmit valid CSI report and apply actions related to the RRC reconfiguration of j^{th} SCell ($j > 1$) in dormant or activated state as specified in [17] no later than in subframe $n + N_{direct} + (j-1) * T_{time_direct}$ provided the SCell can be successfully detected on the first attempt.

Where:

- j ($1 < j \leq M$) denotes the index of SCell indicated in the RRC reconfiguration message, where M is the number of SCells included in the RRC reconfiguration message and shall not exceed the maximum number of SCells supported by the UE, N .

If there is no reference signal received for the CSI measurement over the delay corresponding to the minimum requirements specified above, then the UE shall report corresponding valid CSI for the activated SCell or hibernated SCell on the next available uplink reporting resource after receiving the reference signal.

If there are no uplink resources for reporting the valid CSI in subframe $n + N_{direct} + (j-1) * T_{time_direct}$ for the j -th SCells being activated or hibernated or uplink transmission is interrupted due to SRS carrier-based switching, then the UE shall use the next available uplink resource for reporting the corresponding valid CSI.

The valid CSI is based on the UE measurement and corresponds to any CQI value specified in [3] with the exception of CQI index = 0 (out of range) provided:

- the conditions in section 7.7 are met over the entire SCell activation delay and
- the conditions for CQI reporting defined in Section 7.2.3 of [3] are met.

In addition to CSI reporting defined above, UE shall also apply other actions related to the activation or hibernation command specified in [17] for an SCell at the first opportunities for the corresponding actions once the SCell is activated or hibernated.

The SCell direct activation delay and direct hibernation delay specified in this section can be extended if SRS carrier-based switching occurs during the SCell direct activation or direct hibernation procedure.

If the UE is configured with only PCell then the interruption shall occur on PCell due to the direct SCell activation or hibernation of the j -th SCell as follows:

- When PCell belongs to E-UTRA FDD, the PCell interruption specified in section 7.8.2 shall not occur before subframe $n+T_{RRC_Process}+T_1+(j-1)*T_{time_direct}$ and not occur after subframe $n+T_{RRC_Process}+T_1+T_{interrupt_window}+(j-1)*T_{time_direct}$, where $T_{interrupt_window}=5$ ms.
- When PCell belongs to E-UTRA TDD, the PCell interruption specified in section 7.8.2 shall not occur before subframe $n+T_{RRC_Process}+T_1+(j-1)*T_{time_direct}$ and not occur after subframe $n+T_{RRC_Process}+T_1+T_{interrupt_window}+(j-1)*T_{time_direct}$, where $T_{interrupt_window}=7$ ms.

If the UE is configured with at least one SCell in activated state then the interruption shall occur on PCell and on all the SCells in activated state due to the direct SCell activation or hibernation of the j -th SCell as follows:

- The interruption on the PCell and/or on the SCell in activated state shall not occur before subframe $n+T_{RRC_Process}+T_1+(j-1)*T_{time_direct}$ and not occur after subframe $n+T_{RRC_Process}+T_1+T_{interrupt_window}+(j-1)*T_{time_direct}$ if:
 - the PCell and/or the SCell in activated state being interrupted and the SCell being configured in activated state belong to E-UTRA TDD, where $T_{interrupt_window}=7$ ms, or
 - the the SCell in activated state being interrupted and the SCell being configured in activated or dormant state belong to E-UTRA FDD and the PCell belongs to E-UTRA TDD, where $T_{interrupt_window}=7$ ms.
- Otherwise, the interruption on PCell and/or on the SCell in activated or dormant state shall not occur before subframe $n+T_{RRC_Process}+T_1+(j-1)*T_{time_direct}$ and not occur after subframe $n+T_{RRC_Process}+T_1+T_{interrupt_window}+(j-1)*T_{time_direct}$, where $T_{interrupt_window}=5$ ms.

Starting from the subframe $n+T_{RRC_Process}+T_1$ until the UE has completed the direct SCell activation to activated state or the direct SCell hibernation to dormant state, the UE shall report CQI index = 0 (out of range) if the UE has available uplink resources to report CQI for the SCell.

7.7.19 Direct SCell Activation and Hibernation Delay Requirement at RRC Reconfiguration during Handover

The requirements in this section are applicable for E-UTRA FDD, E-UTRA TDD and E-UTRA TDD-FDD carrier aggregation. The requirements apply for when the parameter $sCellState$ is included to indicate the direct SCell activation is received in a handover command.

The requirements in this section apply for normal handover.

Editor's Note: Requirements for RACH-less handover, Make-before-break handover and combined make-before break and RACH-less handover are FFS.

If the parameter $sCellState$ is set to *activated* for the SCell within RRC reconfiguration message [2] then the UE capable of the direct SCell activation shall configure that SCell in activated state upon successful completion of the RRC reconfiguration procedure within the specified delay. If the parameter $sCellState$ is set to *dormant* for the SCell within RRC reconfiguration message [2] then the UE capable of the direct SCell hibernation shall configure that SCell in dormant state upon successful completion of the RRC reconfiguration procedure within the specified delay. The UE capable of the direct SCell activation shall support direct activation or direct hibernation of one SCell within N_{direct} for at least 1 inter-band SCell or 1 intra-band SCell. The UE capable of the direct SCell hibernation shall support direct hibernation to dormant state within N_{direct} for at least 1 inter-band SCell or 1 intra-band SCell.

The delay within which the UE shall be able to configure one or more direct configured SCells in activated or dormant state depends upon the specified conditions.

Upon receiving a handover command including directly activated or directly hibernated SCell configuration in subframe n , the UE shall be capable to transmit valid CSI report and apply actions as specified in TS 36.321 [17] for the directly activated or directly hibernated SCell no later than in subframe $n+N_{direct}$

where:

$$N_{direct} = T_{RRC_process} + T_{interrupt} + T_2 + T_3 + T_{time_direct}$$

$T_{RRC_Process}$ = 20ms which is the RRC procedure delay defined for SCell addition in section 11.2 of TS 36.331 [2],

$T_{interrupt}$ is the interruption time as defined in subclause 5.1.2.1.2.

T_2 is the delay for obtaining a valid TA command for the target PCell from the target PCell and the scheduling grant for sending valid CSI report in the target PCell. T_2 is up to 13 subframes.

T_3 is the delay for applying the received TA for uplink transmission in the target PCell, and greater than or equal to 6 subframes.

T_{time_direct} is the direct SCell activation delay.

If the SCell is known, then T_{time_direct} is 20ms. If the SCell is unknown, then T_{time_direct} is 30ms provided the SCell can be successfully detected on the first attempt.

The SCell is known provided the following conditions are met for the SCell:

- During the last 5 seconds before the reception of the handover including the direct SCell configuration command:
 - the UE has sent a valid measurement report for the SCell being directly activated or directly hibernated, and
 - the SCell being directly activated or directly hibernated remains detectable according to the cell identification conditions specified in section 8.3.3.2,
- SCell being directly activated or directly hibernated also remains detectable during the SCell activation delay according to the cell identification conditions specified in section 8.3.3.2

Otherwise, the SCell is unknown.

The UE capable of the direct SCell activation shall support direct activation in handover command of up to 2 SCell(s). The UE capable of the direct SCell hibernation shall support direct hibernation in handover command of up to 2 SCell(s). If the handover command includes that more than one SCells are directly activated simultaneously to active state or directly hibernated simultaneously to dormant state, the direct activation or hibernation delay requirements shall be fulfilled for at least one of the SCells being directly activated or hibernated, and additional relaxation in the activation delay or hibernation delay is allowed for the rest of SCells being directly activated or hibernated simultaneously. Upon receiving the handover command message in subframe n , the UE shall be capable to transmit valid CSI report and apply actions related to the RRC reconfiguration of j^{th} SCell ($j > 1$) in dormant or activated state as specified in TS 36.321 [17] no later than in subframe $n + N_{direct} + (j-1) * T_{time_direct}$ provided the SCell can be successfully detected on the first attempt.

Where:

- j ($1 < j \leq M$) denotes the index of SCell indicated in the handover command message, where M is the number of SCells included in the handover command message and shall not exceed the maximum number of SCells supported by the UE, N .

If there is no reference signal received for the CSI measurement over the delay corresponding to the minimum requirements specified above, then the UE shall report corresponding valid CSI for the activated SCell or hibernated SCell on the next available uplink reporting resource after receiving the reference signal.

If there are no uplink resources for reporting the valid CSI in subframe $n + N_{direct}$ for the first SCell being activated or hibernated, or $n + N_{direct} + (j-1) * T_{time_direct}$ for the j -th SCells being activated or hibernated, or uplink transmission is interrupted due to SRS carrier-based switching, then the UE shall use the next available uplink resource for reporting the corresponding valid CSI.

The valid CSI is based on the UE measurement and corresponds to any CQI value specified in TS 36.213 [3] with the exception of CQI index = 0 (out of range) provided:

- the conditions in section 7.7 are met over the entire SCell activation delay and
- the conditions for CQI reporting defined in Section 7.2.3 of TS 36.213 [3] are met.

In addition to CSI reporting defined above, UE shall also apply other actions related to the activation or hibernation command specified in TS 36.321 [17] for an SCell at the first opportunities for the corresponding actions once the SCell is activated or hibernated.

The SCell direct activation delay and direct hibernation delay specified in this section can be extended if SRS carrier-based switching occurs during the SCell direct activation or direct hibernation procedure.

Any interruption on PCell due to the direct SCell activation or hibernation of the first SCell shall occur as follows:

- When PCell belongs to E-UTRA FDD, the PCell interruption specified in section 7.8.2 shall not occur before subframe $n+T_{RRC_Process} + T_{interrupt} + T_2 + T_3$ and not occur after subframe $n+T_{RRC_Process} + T_{interrupt} + T_2 + T_3 + T_{interrupt_window}$, where $T_{interrupt_window} = 5$ ms.
- When PCell belongs to E-UTRA TDD, the PCell interruption specified in section 7.8.2 shall not occur before subframe $n+T_{RRC_Process} + T_{interrupt} + T_2 + T_3$ and not occur after subframe $n+T_{RRC_Process} + T_{interrupt} + T_2 + T_3 + T_{interrupt_window}$, where $T_{interrupt_window} = 5$ ms.

If the UE is configured with more than one SCell in activated or hibernation state, any interruption on PCell and on all the SCells in activated state due to the direct SCell activation or hibernation of the j -th SCell shall occur as follows:

- The interruption on the PCell and/or on the SCell in activated state shall not occur before subframe $n+T_{RRC_Process} + T_{interrupt} + T_2 + T_3 + (j-1)*T_{time_direct}$ and not occur after subframe $n+T_{RRC_Process} + T_{interrupt} + T_2 + T_3 + T_{interrupt_window} + (j-1)*T_{time_direct}$ if:
 - the PCell and/or the SCell in activated state being interrupted and the SCell being configured in activated state belong to E-UTRA TDD, where $T_{interrupt_window}=7$ ms, or
 - the the SCell in activated state being interrupted and the SCell being configured in activated or dormant state belong to E-UTRA FDD and the PCell belongs to E-UTRA TDD, where $T_{interrupt_window}=7$ ms.
- Otherwise, the interruption on PCell and/or on the SCell in activated or dormant state shall not occur before subframe $n+T_{RRC_Process} + T_{interrupt} + T_2 + T_3 + (j-1)*T_{time_direct}$ and not occur after subframe $n+T_{RRC_Process} + T_{interrupt} + T_2 + T_3 + T_{interrupt_window} + (j-1)*T_{time_direct}$, where $T_{interrupt_window}=5$ ms.

Starting from the subframe $n+ T_{RRC_Process} + T_{interrupt} + T_2 + T_3 + T_{interrupt_window}$ until the UE has completed the direct SCell activation to activated state or the direct SCell hibernation to dormant state, the UE shall report CQI index = 0 (out of range), provided that the UE has available uplink resources to report CQI for the SCell.

7.8 Interruptions with Carrier Aggregation

7.8.1 Introduction

This section contains the requirements related to the interruptions on PCell and activated SCell if configured, when up to six SCells are configured, deconfigured, hibernated, activated, dormant or deactivated, or when SRS carrier based switching is performed between the configured component carriers. Unless explicitly stated otherwise, the requirements in Section 7.8 shall apply for:

- E-UTRA FDD CA,
- E-UTRA TDD CA,
- E-UTRA TDD-FDD CA,
- inter-band CA where PCell is FDD or TDD and all the SCells are following the frame structure type 3 [16],
- E-UTRA CA where at least one SCell is FeMBMS/Unicast-mixed SCell.

A UE causing interruptions during measurements on deactivated SCC shall indicate to the network a need for an interruption control pattern.

Note: interruptions at SCell addition and release, activation, deactivation and hibernation and during measurements on SCC may not be required by all UEs.

Note: interruptions during SRS carrier based switching between the configured component carriers may not be required by all UEs.

Editor's Note: The interruptions shall not interrupt RRC signalling or ACK/NACKs related to RRC reconfiguration procedure [2] for SCell addition, release and hibernation or MAC control signalling [17] for SCell activation, deactivation and hibernation command. How to specify this is FFS.

7.8.2 Requirements

7.8.2.1 Interruptions at SCell addition/release for intra-band CA

When an intra-band SCell is added or released as defined in [2] the UE is allowed an interruption of up to 5 subframes on PCell during the RRC reconfiguration procedure [2]. This interruption is for both uplink and downlink of PCell.

7.8.2.2 Interruptions at SCell addition/release for inter-band CA

When an inter-band SCell is added or released as defined in [2] the UE that requires interruption is allowed an interruption of up to 1 subframe on PCell during the RRC reconfiguration procedure [2]. This interruption is for both uplink and downlink of PCell.

7.8.2.3 Interruptions at SCell activation/deactivation for intra-band CA

When an intra-band SCell is activated or deactivated as defined in [17] the UE is allowed an interruption of up to 5 subframes on PCell during the activation/deactivation delay defined in Section 7.7. This interruption is for both uplink and downlink of PCell.

7.8.2.4 Interruptions at SCell activation/deactivation for inter-band CA

When an inter-band SCell is activated or deactivated as defined in [17] the UE that requires interruption is allowed an interruption of up to 1 subframe on PCell during the activation/deactivation delay defined in Section 7.7. This interruption is for both uplink and downlink of PCell.

7.8.2.5 Interruptions during measurements on SCC for intra-band CA

If the UE supports *ncsg-r14* and has been configured with gap pattern with ID 0,1 and there is no inter-frequency and inter-RAT frequency layer to be monitored, the UE shall not make any autonomous interruptions outside of the configured gap patterns.

PCell interruptions due to measurements on SCC when the SCell is deactivated are allowed with up to 0.5% probability of missed ACK/NACK when the configured *measCycleSCell* [2] is 640 ms or longer.

If indicated by the network using IE *allowInterruptions* [2], PCell interruptions due to measurements on SCC when the SCell is deactivated are allowed with up to 0.5% probability of missed ACK/NACK regardless of the configured *measCycleSCell* [2].

Each interruption shall not exceed 5 subframes.

7.8.2.6 Interruptions during measurements on SCC for inter-band CA

If the UE supports *ncsg-r14* and has been configured with NCSG pattern with ID 0,1,2,3, the UE shall not make any autonomous interruptions outside of the configured gap patterns.

If the UE has been configured with gap pattern with ID 0,1 and there is no inter-frequency and inter-RAT frequency layer to be monitored, the UE shall not make any autonomous interruptions outside of the configured gap patterns. If the UE does not support *ncsg-r14* or has not been configured with gap pattern with ID 0,1 or NCSG pattern with ID 0,1,2,3 or the UE has been configured with gap pattern with ID 0,1 to monitor inter-frequency/inter-RAT frequency layers, PCell interruptions due to measurements on SCC when the SCell is deactivated are allowed with up to 0.5% probability of missed ACK/NACK when the configured *measCycleSCell* [2] is 640 ms or longer.

If the UE does not support *ncsg-r14* or has not been configured with gap pattern with ID 0,1 or NCSG pattern with ID 0,1,2,3 or the UE has been configured with gap pattern with ID 0,1 to monitor inter-frequency/inter-RAT frequency layers, and if indicated by the network using IE *allowInterruptions* [2], PCell interruptions due to measurements on SCC when the SCell is deactivated are allowed with up to 0.5% probability of missed ACK/NACK regardless of the configured *measCycleSCell* [2].

Each interruption shall not exceed 1 subframe.

7.8.2.7 Interruptions at SCell addition/release with multiple downlink SCells

When any number of SCells between one and six is added or released using the same *RRCConnectionReconfiguration* message as defined in [2], the UE is allowed an interruption on PCell and on any activated SCell during the RRC reconfiguration procedure as follows:

- an interruption on PCell:
 - of up to 1 subframe, if the PCell is not in the same band as any of the SCells being added or released, or
 - of up to 5 subframes, if the PCell is in the same band as any of the SCells being added or released;
- an interruption on any activated SCell:
 - of up to 1 subframe, if the activated SCell is not in the same band as any of the SCells being added or released, or
 - of up to 5 subframes, if the activated SCell is in the same band as any of the SCells being added or released.

7.8.2.8 Interruptions at SCell activation/deactivation with multiple downlink SCells

When any number of SCells between one and six is activated or deactivated using the same MAC control element as defined in [17], the UE is allowed an interruption on PCell and on any activated SCell during the SCell activation/deactivation procedure [17] as follows:

- an interruption on PCell:
 - of up to 1 subframe, if the PCell is not in the same band as any of the SCells being activated or deactivated, or
 - of up to 5 subframes, if the PCell is in the same band as any of the SCells being activated or deactivated;
- an interruption on any activated SCell:
 - of up to 1 subframe, if the activated SCell is not in the same band as any of the SCells being activated or deactivated, or
 - of up to 5 subframes, if the activated SCell is in the same band as any of the SCells being activated or deactivated.

7.8.2.9 Interruptions during measurements on SCC with multiple downlink SCells

If the PCell is not in the same band as any of the SCells being activated or deactivated and if the UE supports *ncsg-r14* and has been configured with NCSG pattern with ID 0,1,2,3, the UE shall not make any autonomous interruptions outside of the configured gap patterns.

If the PCell is not in the same band as any of the SCells being activated or deactivated and if the UE has been configured with gap pattern with ID 0,1 and there is no inter-frequency and inter-RAT frequency layer to be monitored, the UE shall not make any autonomous interruptions outside of the configured gap patterns.

If the PCell is in the same band as any of the SCells being activated or deactivated or if the UE does not support *ncsg-r14* or has not been configured with gap pattern with ID 0,1 or NCSG pattern with ID 0,1,2,3 or the UE has been configured with gap pattern with ID 0,1 to monitor inter-frequency/inter-RAT frequency layers, when one SCell is deactivated, the UE is allowed due to measurements on the SCC with deactivated SCell:

- an interruption on PCell with up to 0.5% probability of missed ACK/NACK when the configured *measCycleSCell* [2] for the deactivated SCell is 640 ms or longer.
- an interruption on PCell with up to 0.5% probability of missed ACK/NACK regardless of the configured *measCycleSCell* [2] for the deactivated SCell if indicated by the network using IE *allowInterruptions* [2],

Each interruption shall not exceed:

- 1 subframes if the PCell is not in the same band as the deactivated SCell
- 5 subframes if the PCell is in the same band as the deactivated SCell

- an interruption on any activated SCell with up to 0.5% probability of missed ACK/NACK when the configured *measCycleSCell* [2] for the deactivated SCell is 640 ms or longer .
- an interruption on any activated SCell with up to 0.5% probability of missed ACK/NACK regardless of the configured *measCycleSCell* [2] for the deactivated SCell if indicated by the network using IE *allowInterruptions* [2].

Each interruption shall not exceed:

- 1 subframes if the activated SCell is not in the same band as the deactivated SCell
- 5 subframes if the activated SCell is in the same band as the deactivated SCell

If the PCell is in the same band as any of the SCells being activated or deactivated or if the UE does not support ncsgr14 or has not been configured with gap pattern with ID 0,1 or NCSG pattern with ID 0,1,2,3 or the UE has been configured with gap pattern with ID 0,1 to monitor inter-frequency/inter-RAT frequency layers, when two, three, four, five, or six SCells are deactivated, the UE is allowed due to measurements on the SCCs with deactivated SCells:

- an interruption on PCell with up to 0.5% probability of missed ACK/NACK when any of the configured *measCycleSCell* [2] for the deactivated SCells is 640 ms or longer.
- an interruption on PCell with up to 0.5% probability of missed ACK/NACK regardless of the configured *measCycleSCell* [2] for the deactivated SCells if indicated by the network using IE *allowInterruptions* [2].
- an interruption on an activated SCell with up to 0.5% probability of missed ACK/NACK when any of the configured *measCycleSCell* [2] for the deactivated SCells is 640 ms or longer.
- an interruption on an activated SCell with up to 0.5% probability of missed ACK/NACK regardless of the configured *measCycleSCell* [2] for the deactivated SCells if indicated by the network using IE *allowInterruptions* [2].

Each interruption on the PCell shall not exceed:

- 1 subframes if the PCell is not in the same band as any of the deactivated SCells
- 5 subframes if the PCell is in the same band as any of the deactivated SCells

Each interruption on the activated Cell shall not exceed:

- 1 subframe if the activated SCell is not in the same band as any of the deactivated SCells
- 5 subframes if the the activated SCell is in the same band as any of the deactivated SCells

7.8.2.10 Interruptions at overlapping addition/release/activation/deactivation of SCells

If a UE is commanded by the network to sequentially add/release/activate/deactivate SCells, and a new procedure of addition/release/activation/deactivation of SCell(s) takes place before the completion of previous procedure of addition/release/activation/deactivation of SCell(s), the interruptions on PCell due to sequential addition/release/activation/deactivation of SCells shall not exceed the sum of the allowed interruptions on the PCell caused by each of the addition/release/activation/deactivation procedures, and the interruptions on already activated SCell due to sequential addition/release/activation/deactivation of SCells shall not exceed the sum of the allowed interruptions on the SCell caused by each of the addition/release/activation/deactivation procedures, as defined in above sections.

7.8.2.11 Interruptions during RSSI measurements on one SCC under Frame Structure 3

PCell interruptions due to RSSI measurements on SCC when the SCell is deactivated are allowed with up to 0.5% probability of missed ACK/NACK when any of the configured *rmtc-Period* [2] and *measCycleSCell* [2] is 640 ms or longer.

Each allowed interruption on the PCell shall not exceed 1 subframe.

7.8.2.12 Interruptions during RSSI measurements on multiple SCCs under Frame Structure 3

If the UE supports *ncsg-r14* and has been configured with NCSG pattern with ID 0,1,2,3, the UE shall not make any autonomous interruptions outside of the configured gap patterns.

If the UE has been configured with gap pattern with ID 0,1 and there is no inter-frequency and inter-RAT frequency layer to be monitored, the UE shall not make any autonomous interruptions outside of the configured gap patterns.

If the UE does not support *ncsg-r14* or has not been configured with gap pattern with ID 0,1 or NCSG pattern with ID 0,1,2,3 or the UE has been configured with gap pattern with ID 0,1 to monitor inter-frequency/inter-RAT frequency layers, and if one SCell is deactivated,

- the UE is allowed due to RSSI measurements on the SCC with deactivated SCell:

- an interruption on PCell with up to 0.5% probability of missed ACK/NACK when any of the configured *rmtc-Period* [2] and the configured *measCycleSCell* [2] for the deactivated SCell is 640 ms or longer,
- an interruption on any activated SCell with up to 0.5% probability of missed ACK/NACK when any of the configured *rmtc-Period* [2] and the configured *measCycleSCell* [2] for the deactivated SCell is 640 ms or longer.

- no interruption is allowed if both of the configured *rmtc-Period* [2] and the configured *measCycleSCell* [2] for the deactivated SCell are below 640 ms.

If the UE does not support *ncsg-r14* or has not been configured with gap pattern with ID 0,1 or NCSG pattern with ID 0,1,2,3 or the UE has been configured with gap pattern with ID 0,1 to monitor inter-frequency/inter-RAT frequency layers and if two, three, four, five, or six SCells are deactivated,

- the UE is allowed due to RSSI measurements on the SCCs with deactivated SCells:

- an interruption on PCell with up to 0.5% probability of missed ACK/NACK when:

any of the configured *rmtc-Period* [2] and the configured *measCycleSCell* [2] for the deactivated SCells is 640 ms or longer, or

RSSI windows with the length of *measDuration* [2] for at least some of the SCCs with the deactivated SCells within their respective *rmtc-Period* [2] are not within 20 ms;

- an interruption on an activated SCell with up to 0.5% probability of missed ACK/NACK when:

any of the configured *rmtc-Period* [2] and the configured and the configured *measCycleSCell* [2] for the deactivated SCells is 640 ms or longer, or

RSSI windows with the length of *measDuration* [2] for at least some of the SCCs with the deactivated SCells within their respective *rmtc-Period* [2] are not within 20 ms.

- no interruption is allowed if both of the configured *rmtc-Period* [2] and the configured *measCycleSCell* [2] for the deactivated SCell are below 640 ms and RSSI windows with the length of *measDuration* [2] for all the SCCs with the deactivated SCells within their respective *rmtc-Period* [2] are within 20 ms.

Each allowed interruption shall not exceed:

- 1 subframe on the PCell, and
- 5 subframes on the activated SCell.

7.8.2.13 Interruptions at SRS carrier based switching

A PUSCH-less SCC is a TDD SCC without PUCCH/PUSCH configured. When a UE needs to transmit periodic or aperiodic SRS [16] and/or non-contention based PRACH on a PUSCH-less SCC, the UE can perform carrier based switching to one or more PUSCH-less SCCs from a CC with PUSCH or from another PUSCH-less SCC prior to transmitting SRS and/or PRACH, provided that:

- switching is from a configured CC to another activated TDD CC;

- the PUSCH-less SCCs to which SRS carrier based switching is performed is indicated by DCI SRS request field for aperiodic SRS transmission or configured via RRC [2] for periodic SRS transmission or indicated by PDCCH for PRACH;
- the serving cell, from which SRS carrier based switching is performed and whose UL transmission may therefore be interrupted, is indicated by *srs-SwitchFromServCellIndex* [2];
- the SRS switching is not colliding with any other transmission with higher priority defined in [3];
- the SRS switching is not colliding with PDCCH in subframe 0 and 5 as specified in [3];
- for UE, which does not support simultaneous reception and transmission for inter-band TDD CA specified in TS 36.331 [2], and is compliant to the requirements for inter-band CA with uplink in one E-UTRA band and without simultaneous Rx/Tx specified in TS 36.101 [5], the SRS or RACH transmission are not simultaneously scheduled with DL subframe #0 or DL subframe #5 on other CCs.

The UE shall not perform SRS carrier based switching if the above conditions cannot be met.

The interruption on PCC and each of the activated SCCs during the switching to the PUSCH-less SCC shall not exceed 2 subframes including the first subframe where SRS transmission is configured on the PUSCH-less SCC.

The interruption on PCC and each of the activated SCCs during the switching from the PUSCH-less SCC shall not exceed 2 subframes including the last subframe where SRS transmission is configured on the PUSCH-less SCC.

7.8.2.14 Interruptions at SCell activation and deactivation of dormant SCell for intra-band CA

When an intra-band FDD dormant SCell is activated and deactivated as defined in TS 36.321 [17] the UE capable of supporting *dormantSCellState* [2] is allowed an interruption of up to 2 subframes on PCell during the activation and deactivation defined in Section 7.7, provided that MBSFN subframes are not configured in the PCell. This interruption is for both uplink and downlink of PCell.

When an intra-band TDD dormant SCell is activated and deactivated as defined in TS 36.321 [17] the UE capable of supporting *dormantSCellState* [2] is allowed an interruption of up to 5 subframes on PCell during the activation and deactivation defined in Section 7.7, provided that MBSFN subframes are not configured in the PCell. This interruption is for both uplink and downlink of PCell.

7.8.2.15 Interruptions at SCell activation and deactivation of dormant SCell for inter-band CA

When an inter-band dormant SCell is activated and deactivation as defined in TS 36.321 [17] the UE that is capable of supporting *dormantSCellState* [2] and requires interruption is allowed an interruption of up to 1 subframe on PCell during the activation and deactivation defined in Section 7.7. This interruption is for both uplink and downlink of PCell.

7.8.2.16 Interruptions at SCell activation and deactivation of multiple dormant SCells

When any number of SCells in a dormant state between one and six is activated or deactivated using the same MAC control element as defined in TS 36.321 [17], the UE capable of supporting *dormantSCellState* [2] is allowed an interruption on PCell and on any activated SCell during the SCell activation and deactivation procedure [17] as follows:

- an interruption on PCell:
 - of up to 1 subframe, if the PCell is not in the same band as any of the SCells being activated or deactivated, or
 - of up to 2 subframes, if the PCell is in the same band as any of the FDD SCells being activated or deactivated, and the PCell is not configured with the MBSFN subframes;
 - of up to 5 subframes, otherwise.
- an interruption on any activated SCell:
 - of up to 1 subframe, if the activated SCell is not in the same band as any of the SCells being activated or deactivated, or

- of up to 2 subframes, if the activated SCell is in the same band as any of the FDD SCells being activated or deactivated and the activated SCell is not configured with the MBSFN subframes.
- of up to 5 subframes, otherwise.

7.8.2.17 Interruptions during CQI measurement on dormant SCell

For a UE capable of supporting *dormantSCellState* [2] and configured with one or more number of dormant SCell(s), an interruption on PCell or any activated SCell(s) due to the periodic CQI measurements of the dormant SCell(s) is allowed with up to 0.5% probability of missed ACK/NACK.

Each interruption shall not exceed

- 1 subframe, if the PCell or the activated SCell is not in the same band as any of the dormant SCells, or
- 2 subframes, if the PCell or the activated SCell is in the same band as any of the FDD dormant SCells, and the PCell or the activated SCell is not configured with the MBSFN subframes;
- 5 subframes, otherwise.

The interruption is for both uplink and downlink of PCell and activated SCell(s).

7.8.2.18 Interruptions during RRM measurement on dormant SCell for intra-band CA

For a UE capable of supporting *dormantSCellState* [2] and configured with one or more number of dormant SCell(s), an interruption on PCell or any activated SCell(s) due to measurements of a dormant SCell(s) is allowed with up to 0.5% probability of missed ACK/NACK.

Each interruption shall not exceed

- 1 subframe, if the PCell or the activated SCell is not in the same band as any of the dormant SCells, or
- 2 subframes, if the PCell or the activated SCell is in the same band as any of the FDD dormant SCells, and the PCell or the activated SCell is not configured with the MBSFN subframes;
- 5 subframes, otherwise.

The interruption is for both uplink and downlink of PCell and activated SCell(s).

7.8.2.19 Interruptions during RRM measurement on dormant SCell for inter-band CA

For a UE capable of supporting *dormantSCellState* [2] and configured with one or more number of dormant SCell(s), an interruption on PCell or any activated SCell(s) due to measurements of a dormant SCell(s) is allowed with up to 0.5% probability of missed ACK/NACK.

Each interruption shall not exceed

- 1 subframe, if the PCell or the activated SCell is not in the same band as any of the dormant SCells, or
- 2 subframes, if the PCell or the activated SCell is in the same band as any of the FDD dormant SCells, and the PCell or the activated SCell is not configured with the MBSFN subframes;
- 5 subframes, otherwise.

The interruption is for both uplink and downlink of PCell and activated SCell(s).

7.8.2.20 Interruptions at SCell hibernation

When any number of SCells between one and six in a activated or deactivated state is hibernated using the same MAC control element as defined in TS 36.321 [17], the UE capable of supporting *dormantSCellState* [2] is allowed an interruption on PCell and on any activated SCell during the SCell hibernation procedure [17] as follows:

- an interruption on PCell:
 - of up to 1 subframe, if the PCell is not in the same band as any of the SCells being hibernated, or

- of up to 2 subframes, if the PCell is in the same band as any of the FDD SCells being hibernated, and the PCell is not configured with the MBSFN subframes;
- of up to 5 subframes, otherwise.
- an interruption on any activated SCell:
 - of up to 1 subframe, if the activated SCell is not in the same band as any of the SCells being hibernated, or
 - of up to 2 subframes, if the activated SCell is in the same band as any of the FDD SCells being hibernated and the activated SCell is not configured with the MBSFN subframes.
 - of up to 5 subframes, otherwise.

7.8.2.21 Interruptions at direct SCell activation and hibernation

When any number of SCells between one and M is directly activated or hibernated using the same RRC message as defined in TS 36.331 [2], for each of SCell(s) to be directly activated or hibernated, the UE is allowed an interruption on PCell and on any activated SCell during the direct SCell activation and hibernation procedure [2] as follows:

- an interruption on PCell:
 - of up to 2 subframe, if the PCell is not in the same band as any of the SCells being directly activated or hibernated, or
 - of up to 5 subframes, if the PCell is in the same band as any of the SCells being directly activated or hibernated;
- an interruption on any activated SCell:
 - of up to 2 subframe, if the activated SCell is not in the same band as any of the SCells being directly activated or hibernated, or
 - of up to 5 subframes, if the activated SCell is in the same band as any of the SCells being directly activated or hibernated.

where M is the number of SCells included in the RRC reconfiguration message and shall not exceed the maximum number of SCells supported by the UE.

The interruption shall be within the direct SCell activation and hibernation delay as defined in 7.7.18 and 7.7.19.

7.9 Maximum Transmission Timing Difference in Carrier Aggregation

7.9.1 Introduction

A UE shall be capable of handling a relative received time difference between the PCell and SCell to be aggregated in inter-band CA and intra-band non-contiguous CA.

7.9.2 Minimum Requirements for Interband Carrier Aggregation

The UE shall be capable of handling at least a relative received timing difference between the subframe timing boundaries of the signals received from the PCell and the SCell at the UE receiver of up to 30.26 μs when one SCell is configured.

When two, three, or four SCells are configured, the UE shall be capable of handling at least a relative propagation delay difference between the subframe timing boundaries of the signals received from any pair of the serving cells (PCell and the SCells) at the UE receiver of up to 30.26 μs .

The UE shall be capable of handling a maximum uplink transmission timing difference between the pTAG and the sTAG of at least 32.47 μs provided that the UE is:

- configured with inter-band CA and
- configured with the pTAG and the sTAG,

A UE configured with pTAG and sTAG may stop transmitting on the SCell if after timing adjusting due to received TA command the uplink transmission timing difference between PCell and SCell exceeds the maximum value the UE can handle as specified above.

The UE shall be capable of handling a maximum uplink transmission timing difference between the pTAG and any of the two sTAGs or between the two sTAGs of at least 32.47 μ s provided that the UE is:

- configured with inter-band CA and
- configured with the two sTAGs,

A UE configured with two sTAGs may stop transmitting on the SCell if after timing adjusting due to received TA command the uplink transmission timing difference between SCell in one sTAG and SCell in other sTAG exceeds the maximum value the UE can handle as specified above.

7.9.3 Minimum Requirements for Intra-band non-contiguous Carrier Aggregation

The UE shall be capable of handling at least a relative received timing difference between the subframe timing boundaries of the signals received from the PCell and the SCell at the UE receiver of up to 30.26 μ s.

The UE shall be capable of handling a maximum uplink transmission timing difference between the pTAG and the sTAG of at least 32.47 μ s provided that the UE is:

- configured with intra-band non-contiguous CA and
- configured with the pTAG and the sTAG,

A UE configured with pTAG and sTAG may stop transmitting on the SCell if after timing adjusting due to received TA command the uplink transmission timing difference between PCell and SCell exceeds the maximum value the UE can handle as specified above.

7.9.4 Minimum Requirements for Inter-Band Carrier Aggregation under Frame Structure 3

The UE shall be capable of handling at least a relative received timing difference between the subframe timing boundaries of the signals received from the PCell and the SCell at the UE receiver of up to 30.26 μ s when one SCell is configured.

When two or three SCells are configured, the UE shall be capable of handling at least a relative propagation delay difference between the subframe timing boundaries of the signals received from any pair of the serving cells (PCell and the SCells) at the UE receiver of up to 30.26 μ s.

7.10 Interruptions with RSTD Measurements with Carrier Aggregation

7.10.1 Introduction

This section contains the requirements related to the interruptions on PCell and activated SCell if configured, when performing RSTD measurements on cells belonging to at least one SCC with deactivated SCell.

Note: Interruptions during RSTD measurements on PCell and activated SCell if configured may not be required by all UEs.

7.10.2 Requirements

When common DRX is used, no interruption is allowed for all carrier aggregation configurations while the On Duration timer is running.

The interruption requirement considers only missed ACK/NACK due to reconfiguration of the receiver bandwidth, and not due to other causes such as RF impairments or channel conditions.

7.10.2.1 Interruptions during RSTD measurements on SCC for intra-band CA with one downlink SCell

If the UE supports ncs-g-r14 and has been configured with gap pattern with ID 0,1 and there is no inter-frequency and inter-RAT frequency layer to be monitored, the UE shall not make any autonomous interruptions outside of the configured gap patterns.

PCell interruptions due to RSTD measurements on SCC when the SCell is deactivated are allowed with up to 0.5% probability of missed ACK/NACK when the PRS periodicity T_{PRS} is 640 ms or longer. Each interruption shall not exceed 5 subframes.

7.10.2.2 Interruptions during RSTD measurements on SCC for inter-band CA with one downlink SCell

If the UE supports ncs-g-r14 and has been configured with NCSG pattern with ID 0,1,2,3, the UE shall not make any autonomous interruptions outside of the configured gap patterns.

If the UE has been configured with gap pattern with ID 0,1 and there is no inter-frequency and inter-RAT frequency layer to be monitored, the UE shall not make any autonomous interruptions outside of the configured gap patterns.

If the UE does not support ncs-g-r14 or has not been configured with gap pattern with ID 0,1 or NCSG pattern with ID 0,1,2,3 or the UE has been configured with gap pattern with ID 0,1 to monitor inter-frequency/inter-RAT frequency layers, PCell interruptions due to RSTD measurements on SCC when the SCell is deactivated are allowed with up to 0.5% probability of missed ACK/NACK when the PRS periodicity T_{PRS} is 640 ms or longer. Each interruption shall not exceed 1 subframe.

7.10.2.3 Interruptions during RSTD measurements on SCC with multiple downlink SCells

If the PCell is not in the same band as any of the SCells being activated or deactivated and if the UE supports ncs-g-r14 and has been configured with NCSG pattern with ID 0,1,2,3, the UE shall not make any autonomous interruptions outside of the configured gap patterns.

If the PCell is not in the same band as any of the SCells being activated or deactivated and if the UE has been configured with gap pattern with ID 0,1 and there is no inter-frequency and inter-RAT frequency layer to be monitored, the UE shall not make any autonomous interruptions outside of the configured gap patterns.

If the PCell is in the same band as any of the SCells being activated or deactivated or if the UE does not support ncs-g-r14 or has not been configured with gap pattern with ID 0,1 or NCSG pattern with ID 0,1,2,3 or the UE has been configured with gap pattern with ID 0,1 to monitor inter-frequency/inter-RAT frequency layers, when one SCell is activated and the other SCell is deactivated, then due to RSTD measurements on the SCC with deactivated SCell the UE is allowed:

- an interruption on PCell with up to 0.5% probability of missed ACK/NACK when the PRS periodicity T_{PRS} is 640 ms or longer. Each interruption shall not exceed:
 - 1 subframe if the PCell is not in the same band as the deactivated SCell
 - 5 subframes if the PCell is in the same band as the deactivated SCell
- an interruption on the activated SCell with up to 0.5% probability of missed ACK/NACK when the PRS periodicity T_{PRS} is 640 ms or longer. Each interruption shall not exceed:
 - 1 subframe if the activated SCell is not in the same band as the deactivated SCell
 - 5 subframes if the activated SCell is in the same band as the deactivated SCell

If the PCell is in the same band as any of the SCells being activated or deactivated or if the UE does not support ncs-g-r14 or has not been configured with gap pattern with ID 0,1 or NCSG pattern with ID 0,1,2,3 or the UE has been configured with gap pattern with ID 0,1 to monitor inter-frequency/inter-RAT frequency layers, when both SCells are deactivated, then due to RSTD measurements on one or both SCCs with deactivated SCells the UE is allowed:

- an interruption on PCell with up to 1.0% probability of missed ACK/NACK when the configured PRS periodicity T_{PRS} is 640 ms or longer in any of the SCCs. Each interruption shall not exceed:
 - 1 subframe if the PCell is not in the same band as any of the deactivated SCells
 - 5 subframes if the PCell is in the same band as any of the deactivated SCells

7.10.2.4 Interruptions at overlapping RSTD and inter-frequency measurements

If the UE is configured for RSTD measurements on cells belonging to a SCC with deactivated SCell(s) and also with a *measCycleSCell* for performing E-UTRA carrier aggregation measurements as defined in Section 8.3 on the same SCC as configured for the RSTD measurements, then the total allowed interruption on the active serving cell(s) is the maximum of the interruption due to E-UTRA carrier aggregation measurements specified in Section 7.8 and the interruption due to the RSTD measurements on SCC specified in this Section.

7.11 Radio Link Monitoring for UE Category 0

7.11.1 Introduction

The UE category 0 applicability of the requirements for performing radio link monitoring in subclause 7.11 is defined in Section 3.6.1.

The UE shall monitor the downlink link quality based on the cell-specific reference signal in order to detect the downlink radio link quality of the PCell as specified in [3].

The UE shall estimate the downlink radio link quality and compare it to the thresholds Q_{out_Cat0} and Q_{in_Cat0} for the purpose of monitoring downlink radio link quality of the PCell.

The threshold Q_{out_Cat0} is defined as the level at which the downlink radio link cannot be reliably received and shall correspond to 10% block error rate of a hypothetical PDCCH transmission taking into account the PCFICH errors with transmission parameters specified in Table 7.11.1-1.

The threshold Q_{in_Cat0} is defined as the level at which the downlink radio link quality can be significantly more reliably received than at Q_{out_Cat0} and shall correspond to 2% block error rate of a hypothetical PDCCH transmission taking into account the PCFICH errors with transmission parameters specified in Table 7.11.1-2.

Table 7.11.1-1 PDCCH/PCFICH transmission parameters for out-of-sync for UE category 0

Attribute	Value
DCI format	1A
Number of control OFDM symbols	2; Bandwidth \geq 10 MHz 3; 3 MHz \leq Bandwidth < 10 MHz 4; Bandwidth = 1.4 MHz
Aggregation level (CCE)	4; Bandwidth = 1.4 MHz 8; Bandwidth \geq 3 MHz
Ratio of PDCCH RE energy to average RS RE energy	4 dB; when single antenna port is used for cell-specific reference signal transmission by the PCell. 4 dB; when two or four antenna ports are used for cell-specific reference signal transmission by the PCell.
Ratio of PCFICH RE energy to average RS RE energy	4 dB; when single antenna port is used for cell-specific reference signal transmission by the PCell. 1 dB; when two or four antenna ports are used for cell-specific reference signal transmission by the PCell.
Note 1:	DCI format 1A is defined in clause 5.3.3.1.3 in TS 36.212 [21].
Note 2:	A hypothetical PCFICH transmission corresponding to the number of control symbols shall be assumed.

Table 7.11.1-2 PDCCH/PCFICH transmission parameters for in-sync for UE category 0

Attribute	Value
DCI format	1C
Number of control OFDM symbols	2; Bandwidth ≥ 10 MHz 3; $3 \text{ MHz} \leq \text{Bandwidth} < 10 \text{ MHz}$ 4; Bandwidth = 1.4 MHz
Aggregation level (CCE)	4
Ratio of PDCCH RE energy to average RS RE energy	1 dB; when single antenna port is used for cell-specific reference signal transmission by the PCell. 1 dB; when two or four antenna ports are used for cell-specific reference signal transmission by the PCell.
Ratio of PCFICH RE energy to average RS RE energy	4 dB; when single antenna port is used for cell-specific reference signal transmission by the PCell. 1 dB; when two or four antenna ports are used for cell-specific reference signal transmission by the PCell.
Note 1:	DCI format 1C is defined in clause 5.3.3.1.4 in TS 36.212 [21].
Note 2:	A hypothetical PCFICH transmission corresponding to the number of control symbols shall be assumed.

7.11.2 Requirements for FD-FDD and TDD

7.11.2.1 Minimum requirement when no DRX is used

When the downlink radio link quality of the PCell estimated over the last 200 ms period becomes worse than the threshold $Q_{\text{out_Cat0}}$, Layer 1 of the UE shall send an out-of-sync indication for the PCell to the higher layers within 200ms $Q_{\text{out_Cat0}}$ evaluation period. A Layer 3 filter shall be applied to the out-of-sync indications as specified in TS 36.331 [2].

When the downlink radio link quality of the PCell estimated over the last 100 ms period becomes better than the threshold $Q_{\text{in_Cat0}}$, Layer 1 of the UE shall send an in-sync indication for the PCell to the higher layers within 100 ms $Q_{\text{in_Cat0}}$ evaluation period. A L3 filter shall be applied to the in-sync indications as specified in TS 36.331 [2].

The out-of-sync and in-sync evaluations of the PCell shall be performed as specified in clause 4.2.1 in [3]. Two successive indications from Layer 1 shall be separated by at least 10ms.

The transmitter power of the UE shall be turned off within 40 ms after expiry of T310 timer as specified in clause 5.3.11 in TS 36.331 [2].

7.11.2.2 Minimum requirement when DRX is used

When DRX is used for FD-FDD and TDD category 0 UEs, the $Q_{\text{out_Cat0}}$ evaluation period ($T_{\text{Evaluate_}Q_{\text{out_DRX_Cat0}}}$) and the $Q_{\text{in_Cat0}}$ evaluation period ($T_{\text{Evaluate_}Q_{\text{in_DRX_Cat0}}}$) specified in Table 7.11.2.2-1 will be used.

When eDRX_CONN is used for FD-FDD and TDD category 0 UEs, the $Q_{\text{out_Cat0}}$ evaluation period ($T_{\text{Evaluate_}Q_{\text{out_DRX_Cat0}}}$) and the $Q_{\text{in_Cat0}}$ evaluation period ($T_{\text{Evaluate_}Q_{\text{in_DRX_Cat0}}}$) specified in Table 7.11.2.2-2 will be used.

When the downlink radio link quality of the PCell estimated over the last $T_{\text{Evaluate_}Q_{\text{out_DRX_Cat0}}}$ [s] period becomes worse than the threshold $Q_{\text{out_Cat0}}$, Layer 1 of the UE shall send out-of-sync indication for the PCell to the higher layers within $T_{\text{Evaluate_}Q_{\text{out_DRX_Cat0}}}$ [s] evaluation period. A Layer 3 filter shall be applied to the out-of-sync indications as specified in TS 36.331 [2].

When the downlink radio link quality of the PCell estimated over the last $T_{\text{Evaluate_}Q_{\text{in_DRX_Cat0}}}$ [s] period becomes better than the threshold $Q_{\text{in_Cat0}}$, Layer 1 of the UE shall send in-sync indications for the PCell to the higher layers within $T_{\text{Evaluate_}Q_{\text{in_DRX_Cat0}}}$ [s] evaluation period. A L3 filter shall be applied to the in-sync indications as specified in TS 36.331 [2].

The out-of-sync and in-sync evaluations of the PCell shall be performed as specified in clause 4.2.1 in [3]. When DRX is used, two successive indications from Layer 1 shall be separated by at least $\max(10\text{ms}, \text{DRX_cycle_length})$. When

eDRX_CONN is used, two successive indications from Layer 1 shall be separated by at least $\max(10\text{ms}, \text{eDRX_CONN cycle length})$.

Upon start of T310 timer as specified in clause 5.3.11 in TS 36.331 [2], the UE shall monitor the link for recovery using the evaluation period and Layer 1 indication interval corresponding to the non-DRX mode until the expiry or stop of T310 timer.

The transmitter power of the UE shall be turned off within 40 ms after expiry of T310 timer as specified in clause 5.3.11 in TS 36.331 [2].

Table 7.11.2.2-1: Q_{out} and Q_{in} Evaluation Period in DRX for FD-FDD and TDD UE category 0

DRX cycle length (s)	$T_{\text{Evaluate_}Q_{\text{out_DRX_Cat0}}}$ and $T_{\text{Evaluate_}Q_{\text{in_DRX_Cat0}}}$ (s) (DRX cycles)
≤ 0.01	Non-DRX requirements in clause 7.11.2.1 are applicable.
$0.01 < \text{DRX cycle} \leq 0.04$	Note (20)
$0.04 < \text{DRX cycle} \leq 0.64$	Note (10)
$0.64 < \text{DRX cycle} \leq 2.56$	Note (5)
Note:	Evaluation period length in time depends on the length of the DRX cycle in use

Table 7.11.2.2-2: Q_{out} and Q_{in} Evaluation Period for FD-FDD and TDD UE category 0 when eDRX_CONN cycle is used

eDRX_CONN cycle length [s]	$T_{\text{Evaluate_}Q_{\text{out_DRX_Cat0}}}$ and $T_{\text{Evaluate_}Q_{\text{in_DRX_Cat0}}}$ [s] (eDRX_CONN cycles)
$2.56 < \text{eDRX_CONN cycle} \leq 10.24$	Note (5)
Note:	Evaluation period length in time depends on the length of the eDRX_CONN cycle in use

7.11.2.3 Minimum requirement at transitions

When the UE transitions between any two of DRX, eDRX_CONN, and non-DRX or when DRX or eDRX_CONN cycle periodicity changes, for a duration of time equal to the evaluation period corresponding to the second mode after the transition occurs, the UE shall use an evaluation period that is no less than the minimum of evaluation periods corresponding to the first mode and the second mode. Subsequent to this duration, the UE shall use an evaluation period corresponding to the second mode. This requirement shall be applied to both out-of-sync evaluation and in-sync evaluation of the PCell.

7.11.3 Requirements for HD-FDD

7.11.3.1 Minimum requirement when no DRX is used

The HD-FDD category 0 UE shall meet all applicable requirements specified in clause 7.11.2.1 under the following conditions

- at least 1 DL subframe per radio frame of PCell is available at the UE during $Q_{\text{in_Cat0}}$ and $Q_{\text{out_Cat0}}$ evaluation periods.

7.11.3.2 Minimum requirement when DRX is used

When DRX is used for HD-FDD category 0 UEs, the Q_{out} evaluation period ($T_{\text{Evaluate_}Q_{\text{out_DRX_Cat0}}}$) and the Q_{in} evaluation period ($T_{\text{Evaluate_}Q_{\text{in_DRX_Cat0}}}$) specified in Table 7.11.3.2-1 will be used.

When eDRX_CONN is used for HD-FDD category 0 UEs, the Q_{out} evaluation period ($T_{\text{Evaluate_}Q_{\text{out_DRX_Cat0}}}$) and the Q_{in} evaluation period ($T_{\text{Evaluate_}Q_{\text{in_DRX_Cat0}}}$) specified in Table 7.11.3.2-2 will be used.

When the downlink radio link quality of the PCell estimated over the last $T_{\text{Evaluate_}Q_{\text{out_DRX_Cat0}}}$ [s] period becomes worse than the threshold $Q_{\text{out_Cat0}}$, Layer 1 of the UE shall send out-of-sync indication for the PCell to the higher layers within

$T_{\text{Evaluate_Q}_{\text{out_DRX_Cat0}}}$ [s] evaluation period. A Layer 3 filter shall be applied to the out-of-sync indications as specified in TS 36.331 [2].

When the downlink radio link quality of the PCell estimated over the last $T_{\text{Evaluate_Q}_{\text{in_DRX_Cat0}}}$ [s] period becomes better than the threshold $Q_{\text{in_Cat0}}$, Layer 1 of the UE shall send in-sync indications for the PCell to the higher layers within $T_{\text{Evaluate_Q}_{\text{in_DRX_Cat0}}}$ [s] evaluation period. A L3 filter shall be applied to the in-sync indications as specified in TS 36.331 [2].

The out-of-sync and in-sync evaluations of the PCell shall be performed as specified in clause 4.2.1 in [3]. When DRX is used, two successive indications from Layer 1 shall be separated by at least $\max(10\text{ms}, \text{DRX_cycle_length})$. When eDRX_CONN is used, two successive indications from Layer 1 shall be separated by at least $\max(10\text{ms}, \text{eDRX_CONN cycle length})$.

Upon start of T310 timer as specified in clause 5.3.11 in TS 36.331 [2], the UE shall monitor the link for recovery using the evaluation period and Layer 1 indication interval corresponding to the non-DRX mode until the expiry or stop of T310 timer.

The transmitter power of the UE shall be turned off within 40 ms after expiry of T310 timer as specified in clause 5.3.11 in TS 36.331 [2].

Table 7.11.3.2-1: Q_{out} and Q_{in} Evaluation Period in DRX for HD-FDD UE category 0

DRX cycle length (s)	$T_{\text{Evaluate_Q}_{\text{out_DRX}}}$ and $T_{\text{Evaluate_Q}_{\text{in_DRX}}}$ (s) (DRX cycles)
≤ 0.01	Non-DRX requirements in clause 7.11.2.1 are applicable.
$0.01 < \text{DRX cycle} \leq 0.04$	Note (40)
$0.04 < \text{DRX cycle} \leq 0.16$	Note (20)
$0.16 < \text{DRX cycle} \leq 0.64$	Note (10)
$0.64 < \text{DRX cycle} \leq 2.56$	Note (5)
Note: Evaluation period length in time depends on the length of the DRX cycle in use	

Table 7.11.3.2-2: Q_{out} and Q_{in} Evaluation Period for HD-FDD UE category 0 when eDRX_CONN cycle is used

eDRX_CONN cycle length [s]	$T_{\text{Evaluate_Q}_{\text{out_DRX}}}$ and $T_{\text{Evaluate_Q}_{\text{in_DRX}}}$ [s] (eDRX_CONN cycles)
$2.56 < \text{eDRX_CONN cycle} \leq 10.24$	Note (5)
Note: Evaluation period length in time depends on the length of the eDRX_CONN cycle in use	

7.11.3.3 Minimum requirement at transitions

The minimum requirements at transitions defined in clause 7.11.2.3 also apply for this section under the following conditions:

at least 1 DL subframe per radio frame of PCell is available at the UE during $Q_{\text{in_Cat0}}$ and $Q_{\text{out_Cat0}}$ evaluation periods.

7.12 Interruptions with Dual Connectivity

7.12.1 Introduction

This section contains the requirements related to the interruptions on PCell, PSCell, and SCell, when

PSCell is added or released, or

transitions between active and non-active during DRX, or

transitions from non-DRX to DRX, or

SCell in either MCG or SCG is added or released, or
SCell in either MCG or SCG is activated or deactivated, or
measurements on SCC with deactivated SCell in either MCG or SCG, or
SRS carrier based switching.

The requirements shall apply for E-UTRA FDD, E-UTRA TDD and E-UTRA TDD-FDD dual connectivity.

7.12.2 Requirements

7.12.2.1 Interruptions at PSCell addition/release

When a PSCell is added or released as defined in [2] the UE is allowed an interruption of up to 1 subframe on PCell and the activated SCell in MCG if configured during the RRC reconfiguration procedure [2] in synchronous dual connectivity. This interruption is for both uplink and downlink of PCell.

The UE is allowed an interruption of up to 2 subframes on PCell and the activated SCell in MCG if configured during the RRC reconfiguration procedure [2] in asynchronous dual connectivity. This interruption is for both uplink and downlink of PCell.

7.12.2.2 Interruptions at transitions between active and non-active during DRX

When PCell is in non-DRX and PSCell is in DRX, interruptions on PCell and the activated SCell in MCG if configured due to transitions from active to non-active and from non-active to active during PSCell DRX are allowed with up to 1% probability of missed ACK/NACK when the configured PSCell DRX cycle is less than 640 ms, and 0.625% probability of missed ACK/NACK is allowed when the configured PSCell DRX cycle is 640 ms or longer. Each interruption shall not exceed 1 subframe.

When PSCell is in non-DRX and PCell is in DRX, interruptions on PSCell on the activated SCell in SCG if configured due to transitions from active to non-active and from non-active to active during PCell DRX are allowed with up to 1% probability of missed ACK/NACK when the configured PCell DRX cycle is less than 640 ms, and 0.625% probability of missed ACK/NACK is allowed when the configured PCell DRX cycle is 640 ms or longer. Each interruption shall not exceed 1 subframe.

When both PCell and PSCell are in DRX, no interruption is allowed.

7.12.2.3 Interruptions at transitions from non-DRX to DRX

Interruption on PCell and the activated SCell in MCG if configured due to PSCell transitions from non-DRX to DRX when PCell is in non-DRX shall not exceed 1 subframe.

Interruption on PSCell and the activated SCell in SCG if configured due to PCell transitions from non-DRX to DRX when PSCell is in non-DRX shall not exceed 1 subframe.

7.12.2.4 Interruptions at SCell addition/release

The requirements in this clause shall apply for the UE configured with PSCell.

In synchronous dual connectivity, when one SCell is added or released as defined in [2]:

- an interruption on PCell shall meet requirements in clause 7.8.2.7,
- an interruption on PSCell shall meet requirements in clause 7.8.2.7, where the term PCell in clause 7.8.2.7 shall be deemed to be replaced with PSCell.

In asynchronous dual connectivity, when one SCell belonging to MCG is added or released as defined in [2]:

- an interruption on PCell shall meet requirements in clause 7.8.2.7,
- an interruption on PSCell shall meet requirements in clause 7.8.2.7 except for the number of subframe, where the term PCell in clause 7.8.2.7 shall be deemed to be replaced with PSCell. The UE is allowed an interruption on PSCell of up to 2 subframes.

In asynchronous dual connectivity, when one SCell belonging to SCG is added or released as defined in [2]:

- an interruption on PCell shall meet requirements in clause 7.8.2.7 except for the number of subframe. The UE is allowed an interruption on PCell of up to 2 subframes.
- an interruption on PSCell shall meet requirements in clause 7.8.2.7, where the term PCell in clause 7.8.2.7 shall be deemed to be replaced with PSCell.

7.12.2.5 Interruptions at SCell activation/deactivation

The requirements in this clause shall apply for the UE configured with PSCell and one SCell.

In synchronous dual connectivity, when one SCell is activated or deactivated as defined in [17]:

- an interruption on PCell shall meet requirements in clause 7.8.2.8,
- an interruption on PSCell shall meet requirements in clause 7.8.2.8, where the term PCell in clause 7.8.2.8 shall be deemed to be replaced with PSCell.

In asynchronous dual connectivity, when one SCell belonging to MCG is activated or deactivated as defined in [17]:

- an interruption on PCell shall meet requirements in clause 7.8.2.8,
- an interruption on PSCell shall meet requirements in clause 7.8.2.8 except for the number of subframe, where the term PCell in clause 7.8.2.8 shall be deemed to be replaced with PSCell. The UE is allowed an interruption on PSCell of up to 2 subframes.

In asynchronous dual connectivity, when one SCell belonging to SCG is activated or deactivated as defined in [17]:

- an interruption on PCell shall meet requirements in clause 7.8.2.8 except for the number of subframe. The UE is allowed an interruption on PCell of up to 2 subframes,
- an interruption on PSCell shall meet requirements in clause 7.8.2.8, where the term PCell in clause 7.8.2.8 shall be deemed to be replaced with PSCell.

7.12.2.6 Interruptions during measurements on SCC

The requirements in this clause shall apply for the UE configured with PSCell and one SCell.

In synchronous dual connectivity, when one SCell is deactivated, the UE is allowed due to measurements on the SCC with the deactivated SCell:

- an interruption on PCell shall meet requirements in clause 7.8.2.9,
- an interruption on PSCell shall meet requirements in clause 7.8.2.9, where the term PCell in clause 7.8.2.8 shall be deemed to be replaced with PSCell.

In asynchronous dual connectivity, when one SCell belonging to MCG is deactivated, the UE is allowed due to measurements on the SCC with the deactivated SCell:

- an interruption on PCell shall meet requirements in clause 7.8.2.9,
- an interruption on PSCell shall meet requirements in clause 7.8.2.9 except for the number of subframe, where the term PCell in clause 7.8.2.9 shall be deemed to be replaced with PSCell. The UE is allowed an interruption on PSCell of up to 2 subframes.

In asynchronous dual connectivity, when one SCell belonging to SCG is deactivated, the UE is allowed due to measurements on the SCC with the deactivated SCell:

- an interruption on PCell shall meet requirements in clause 7.8.2.9 except for the number of subframe. The UE is allowed an interruption on PCell of up to 2 subframes
- an interruption on PSCell shall meet requirements in clause 7.8.2.9, where the term PCell in clause 7.8.2.9 shall be deemed to be replaced with PSCell.

7.12.2.7 Interruptions at SRS carrier based switching

A PUSCH-less SCC is a TDD SCC without PUCCH/PUSCH configured. When a UE needs to transmit periodic or aperiodic SRS [16] and/or non-contention based PRACH on a PUSCH-less SCC, the UE can perform carrier based switching to one or more PUSCH-less SCCs from a CC with PUSCH or from another PUSCH-less SCC prior to transmitting SRS and/or PRACH, provided that:

- switching is from a configured CC to another activated TDD CC;
- the PUSCH-less SCCs to which SRS carrier based switching is performed is indicated by DCI SRS request field for aperiodic SRS transmission or configured via RRC [2] for periodic SRS transmission or indicated by PDCCH for PRACH;
- the serving cell, from which SRS carrier based switching is performed and whose UL transmission may therefore be interrupted, is indicated by srs-SwitchFromServCellIndex [2];
- the SRS switching is not colliding with any other transmission with higher priority defined in [3];
- the SRS switching is not colliding with PDCCH in subframe 0 and 5 as specified in [3];
- for UE, which does not support simultaneous reception and transmission for inter-band TDD CA specified in TS 36.331 [2], and is compliant to the requirements for inter-band CA with uplink in one E-UTRA band and without simultaneous Rx/Tx specified in TS 36.101 [5], the SRS or RACH transmission are not simultaneously scheduled with DL subframe #0 or DL subframe #5 on other CCs.

The UE shall not perform SRS carrier based switching if the above conditions cannot be met.

The interruption on PCC, PSCC and each of the activated SCCs during the switching to the PUSCH-less SCC shall not exceed 2 subframes including the first subframe where SRS transmission is configured on the PUSCH-less SCC.

The interruption on PCC, PSCC and each of the activated SCCs during the switching from the PUSCH-less SCC shall not exceed 2 subframes including the last subframe where SRS transmission is configured on the PUSCH-less SCC.

7.13 Cell phase synchronization accuracy (Synchronized mode of dual connectivity)

7.13.1 Definition

Cell phase synchronization accuracy is defined as the maximum absolute timing mismatch between subframes which are transmitted by MeNB and SeNB and are scheduled for the same UE. The cell phase synchronization accuracy is defined only for synchronized mode of dual connectivity operation.

7.13.2 Minimum requirements

The cell phase synchronization accuracy shall not exceed the sum of absolute timing accuracy values declared by the manufacturer(s) for each BS. The cell phase synchronization accuracy requirement is optional.

NOTE: The sum of absolute timing accuracy values in synchronized mode of dual connectivity is assumed to be related to MRTD according to the following inequality:

$$T_{\text{CPSA}} + T_{\text{RPTD}} \leq \text{MRTD at the UE}$$

Where:

T_{CPSA} is the sum of absolute timing accuracy values declared by the manufacturer(s).

T_{RPTD} is the absolute propagation time difference between MeNB and SeNB, which serve the same UE.

MRTD is the Maximum Received Timing Difference at the UE. MRTD is equal to 33 μs .

7.14 PSCell Addition and Release Delay for E-UTRA Dual Connectivity

7.14.1 Introduction

This section defines requirements for the delay within which the UE shall be able to configure a PSCell in E-UTRA dual connectivity. The requirements are applicable to an E-UTRA dual connectivity capable UE. The requirements shall apply for E-UTRA FDD, E-UTRA TDD and E-UTRA TDD-FDD dual connectivity.

7.14.2 PSCell Addition Delay Requirement

The requirements in this section shall apply for the UE configured with only PCell.

Upon receiving PSCell addition in subframe n , the UE shall be capable to transmit PRACH preamble towards PSCell no later than in subframe $n + T_{\text{config_PSCell}}$:

Where:

$$T_{\text{config_PSCell}} = 20\text{ms} + T_{\text{activation_time}} + 50\text{ms} + T_{\text{PCell_DU}} + T_{\text{PSCell_DU}}$$

$T_{\text{activation_time}}$ is the PSCell activation delay. If the PSCell is known, then $T_{\text{activation_time}}$ is 20ms. If the PSCell is unknown, then $T_{\text{activation_time}}$ is 30ms provided the PSCell can be successfully detected on the first attempt.

$T_{\text{PCell_DU}}$ is the delay uncertainty due to PCell PRACH preamble transmission. $T_{\text{PCell_DU}}$ is up to 20ms if PSCell activation is interrupted by a PCell PRACH preamble transmission, otherwise it is 0.

$T_{\text{PSCell_DU}}$ is the delay uncertainty in acquiring the first available PRACH occasion in the PSCell. $T_{\text{PSCell_DU}}$ is up to 30ms.

PSCell is known if it has been meeting the following conditions:

During the last 5 seconds before the reception of the PSCell configuration command:

- the UE has sent a valid measurement report for the PSCell being configured and
- the PSCell being configured remains detectable according to the cell identification conditions specified in section 8.8,
- PSCell being configured also remains detectable during the PSCell configuration delay according to the cell identification conditions specified in section 8.8.

otherwise it is unknown. The PCell interruption specified in section 7.12 is allowed only during the RRC reconfiguration procedure [2].

The PSCell addition delay specified in this section can be extended if SRS carrier based switching occurs during the PSCell addition procedure.

7.14.3 PSCell Release Delay Requirement

The requirements in this section shall apply for a UE configured with PCell and one PSCell.

Upon receiving PSCell release in subframe n , the UE shall accomplish the release actions specified in [2] no later than in subframe $n + 20$.

The PCell interruption specified in section 7.12 is allowed only during the RRC reconfiguration procedure [2].

The PSCell release delay specified in this section can be extended if SRS carrier based switching occurs during the PSCell release procedure.

7.15 Maximum Receive Timing Difference in Dual Connectivity

7.15.1 Introduction

A UE shall be capable of handling a relative receive timing difference between subframe timing boundaries of the PCell and PSCell to be aggregated for E-UTRA FDD-FDD, E-UTRA-TDD-TDD, E-UTRA TDD-FDD dual connectivity.

7.15.2 Minimum Requirements for Inter-band Dual Connectivity

The UE shall be capable of handling at least a relative receive timing difference between the subframe timing of the signals received from a cell belonging to the MCG and a cell belonging to the SCG at the UE receiver of up to 33 μ s provided the UE indicates that it is capable of synchronous dual connectivity [2]. The requirements for synchronous dual connectivity are only applicable for TDD-TDD, FDD-FDD, and TDD-FDD inter-band dual connectivity.

The UE shall be capable of handling at least a relative receive timing difference between the subframe timing of the signals received from a cell belonging to the MCG and a cell belonging to the SCG at the UE receiver of up to 500 μ s provided the UE indicates that it is capable of asynchronous dual connectivity [2]. The requirements for asynchronous dual connectivity are only applicable for FDD-FDD inter-band dual connectivity.

The UE shall be capable of handling a relative receive timing difference between the subframe timing of the signals received from any pair of the serving cells belonging to the same cell group according to the requirements in clause 7.9.2.

7.16 Proximity-based Services

7.16.1 Introduction

The requirements in this clause are applicable for UE performing transmissions and/or reception for ProSe Direct Discovery and/or ProSe Direct Communication in both RRC_IDLE and RRC_CONNECTED state.

7.16.2 Requirements

7.16.2.1 ProSe UE transmission timing

For ProSe transmission of sidelink channels and signals, UE shall have the capability to follow the timing change of the reference synchronization source.

7.16.2.1.1 Serving cell or PCell as timing reference

The requirements in this subclause are applicable when the reference timing used for ProSe transmissions is the serving cell (RRC_IDLE) or PCell (RRC_CONNECTED). The sidelink transmissions takes place $(N_{TA,SL} + N_{TA,offset}) \cdot T_s$ before the reception of the first detected path (in time) of the corresponding downlink frame from the reference cell, where $N_{TA,offset}$ is specified in Section 8.1 of [16]. The value of $N_{TA,SL}$ differs between sidelink channels and signals, and is either $N_{TA,SL} = N_{TA}$ or $N_{TA,SL} = 0$ as specified in Section 9.9 of [16].

7.16.2.1.1.1 Requirements when $N_{TA,SL} = 0$

For ProSe transmission of sidelink channels and signals employing $N_{TA,SL} = 0$, the requirements in Section 7.1 as specified for PRACH transmissions shall apply.

7.16.2.1.1.2 Requirements when $N_{TA,SL} = N_{TA}$

For ProSe transmission of sidelink channels and signals while employing $N_{TA,SL} = N_{TA}$, the requirements in Section 7.1 as specified for PUSCH shall apply.

When it is the first sidelink transmission in a DRX cycle, the requirements in Section 7.1 as specified for the first PUSCH transmission in a DRX cycle shall apply. The reference point for the UE initial transmit timing control requirement shall be $(N_{TA,SL-ref} + N_{TA,offset}) \cdot T_s$ seconds before the reception of the first detected path (in time) of the corresponding downlink frame from the reference cell. $(N_{TA,SL-ref} + N_{TA,offset})$ (in T_s units) for sidelink transmissions is

the difference between UE transmission timing and the downlink timing immediately after when the last timing advance in Section 7.3 was applied.

When it is not the first sidelink transmission in a DRX cycle or there is no DRX cycle, the requirements as specified in Section 7.1 for PUSCH transmissions when the PUSCH transmission is not the first transmissions in a DRX cycle shall apply.

7.16.2.1.2 SCell or non-serving cell as timing reference

The requirements in this subclause are applicable when the reference timing used for ProSe transmissions is either a SCell (RRC_CONNECTED) or a non-serving cell selected on a non-serving ProSe carrier (RRC_IDLE or RRC_CONNECTED).

The transmission timing requirements are as specified in subclause 7.16.2.1.1, with reference cell as either the SCell or the selected non-serving cell.

7.16.3 Interruptions with ProSe

This section contains the requirements related to the interruptions on PCell and activated SCell(s) due ProSe Direct Discovery and ProSe Direct Communication. When ProSe is on a serving cell frequency, then the requirements in this subclause are applicable only to ProSe on E-UTRA FDD bands. When ProSe is on non-serving frequency, then the requirements are applicable to ProSe on both E-UTRA FDD and TDD bands.

When a UE capable of ProSe Direct Communication and/or ProSe Direct Discovery is configured with DRX and DRX is in use, interruptions specified in this section are not allowed while the *onDurationTimer*[17] is running.

Note: ProSe interruption requirements were derived assuming *ShortTTI-r15* is not configured and interruption duration is expected to be shorter in both UL and DL when *ShortTTI-r15* is configured.

7.16.3.1 Interruptions at ProSe Direct Discovery configuration

A UE capable of ProSe Direct Discovery may indicate its interest (initiation or termination) in ProSe Direct Discovery to the connected eNodeB using IE *SidelinkUEInformation* [2].

The UE is allowed an interruption of up to 1 subframe on PCell and on any activated SCell during the RRC reconfiguration procedure that includes the ProSe Direct Discovery configuration message *sl-DiscConfig* [2] (setup and release). This interruption is for both uplink and downlink of PCell and activated SCell(s).

7.16.3.2 Interruptions at ProSe Direct Communication configuration

A UE capable of ProSe Direct Communication may indicate its interest (initiation or termination) in ProSe Direct Communication to the connected eNodeB using IE *SidelinkUEInformation* [2].

The UE is allowed an interruption of up to 1 subframe on PCell and on any activated SCell during the RRC reconfiguration procedure that includes the ProSe Direct Communication configuration message *sl-CommConfig* [2] (setup and release). This interruption is for both uplink and downlink of PCell and activated SCell(s).

7.16.3.3 Interruptions during ProSe Direct Discovery

When ProSe Direct Discovery operation is on a serving cell (PCell/SCell) and when no request for transmission and/or reception gaps are signalled by the ProSe UE, the UE is allowed an interruption of up to 1 subframe that is N subframes before and after a UL subframe configured for ProSe Direct Discovery by a serving eNodeB. For discovery period less than 320ms, the allowed interruptions are additionally limited up to 0.625%.

The value of N is $\text{ceil}(w1 / 1\text{ms})$ subframes when the parameter *discSyncWindow*[2] is configured with value $w1$ in the sidelink synchronization resource configuration associated with the ProSe Direct Discovery subframe.

The value of N is 1 subframe otherwise.

When ProSe Direct Discovery is on a non-serving carrier, and when no request for transmission and/or reception gaps is signalled by the UE, interruptions to serving cell(s) is allowed with up to $\min\left(0.5\%, \frac{6}{\text{discPeriod}(ms)} \times 100\%\right)$ probability of missed ACK/NACK. Furthermore, when ProSe Direct Discovery is on more than one non-serving carrier, and no request for transmission and/or reception gaps is signalled by the UE, the aggregate interruptions to serving

cells(s) are allowed with up to $\min\left(2\%, \sum_{i=1}^N \min\left(0.5\%, \frac{6}{discPeriod_i (ms)} \times 100\%\right)\right)$ probability of missed ACK/NACK with N non-serving carriers.

The interruptions are for both uplink and downlink of PCell and any activated SCell. The interruption for the ProSe UE may occur:

- while switching a receiver chain ON/OFF for ProSe Direct Discovery if the UE has a dedicated receiver chain for discovery, and/or
- while switching a transmitter chain ON/OFF for ProSe Direct Discovery transmissions on a non-serving carrier, and if the UE has a dedicated transmitted chain for discovery.

7.16.3.4 Interruptions during ProSe Direct Discovery with discovery gaps

When ProSe Direct Discovery is either on a serving cell (PCell/SCell) or a non-serving frequency, and when discovery reception and/or transmission gaps are configured by the serving cell, then only the following interruptions to the PCell and any activated SCell(s) are allowed:

- Uplink interruption is allowed on a subframe configured as downlink reception gap (using *discRxGapConfig*) if either the subframe immediately preceding or immediately following that subframe is not configured as reception gap; and,
- If ProSe Direct Discovery is on a non-serving FDD carrier and that carrier is used for ProSe synchronization, then uplink interruption is additionally allowed on 1 subframe in a discovery period. The interrupted subframe(s) shall be within the subframes configured as reception gap using *discRxGapConfig*; and,
- If ProSe Direct Discovery transmissions are on carrier that is not configured for uplink, then UE is allowed to additionally interrupt the serving cell(s) on up to 2 subframes for each discovery/SLSS transmission configured in a discovery period. The interrupted subframe(s) shall be within the subframes configured as transmission gaps using *discTxGapConfig*.

NOTE: The request and grant of discovery gaps is left up to UE and eNodeB implementations, respectively. When ProSe Direct Discovery is on a non-serving carrier and that carrier is used for ProSe synchronization, then the UE requested / eNodeB configured gaps may depend if inter-frequency measurements are additionally configured for that non-serving frequency.

7.16.3.5 Interruptions during ProSe Direct Communication

When ProSe Direct Communication is on a non-serving carrier and the PCell is not broadcasting SIB18, then interruptions to serving cell(s) is allowed with up to 0.5% probability of missed ACK/NACK. Furthermore, when ProSe Direct Communication is on more than one non-serving carrier, the aggregate interruptions to serving cell(s) is allowed with up to $\min(2\%, 0.5\% \times N)$ probability of missed ACK/NACK with N non-serving carriers.

The interruptions are for both uplink and downlink of PCell and any activated SCell.

7.16.4 Cell reselection for ProSe Direct Discovery on non-serving frequency

The requirements in this subclause apply when ProSe Direct Discovery transmissions are configured on a non-serving carrier and that non-serving carrier is used for downlink synchronization and measurements for ProSe Direct Discovery transmission, and provided the parameters required for cell selection / reselection are provided by the serving cell using *discCellSelectionInfo*.

NOTE: The requirements do not apply if the UE is required to acquire the cell selection/reselection parameters that are broadcast from the concerned cell for evaluation.

If the UE signals request for transmission and/or reception gaps, then the requirements apply if the gaps are configured as requested by the UE.

7.16.4.1 Measurement and evaluation of selected cell

The UE shall measure the RSRP and RSRQ level of the selected reference cell on the non-serving carrier used for ProSe Direct Discovery synchronization and evaluate the cell selection criterion S defined in [1] for the selected cell at least every discovery period.

The UE shall filter the RSRP and RSRQ measurements of the selected cell using at least 2 measurements. Within the set of measurements used for the filtering, at least two measurements shall be spaced by, at least $\text{discPeriod} / 2$.

7.16.4.2 Measurement of intra-frequency E-UTRAN cells

The UE shall be able to identify new intra-frequency cells on the non-serving carrier used for ProSe Direct Discovery transmission and perform RSRP and RSRQ measurements of identified intra-frequency cells.

The UE shall be able to evaluate whether a newly detectable intra-frequency cell meets the reselection criteria defined in TS36.304 [1, 11.4] within $T_{\text{detect,EUTRAN_ProSe_Intra}}$ when $T_{\text{reselection}} = 0$ (within *discCellSelectionInfo*). An intra frequency cell is considered to be detectable according to RSRP, $\text{RSRP } \hat{E}_s/\text{Iot}$, SCH_RP and $\text{SCH } \hat{E}_s/\text{Iot}$ defined in Annex B.1.1 for a corresponding Band.

The UE shall measure RSRP and RSRQ at least every $T_{\text{measure,EUTRAN_ProSe_Intra}}$ (see table 7.16.4.2-1) for intra-frequency cells that are identified and measured according to the measurement rules.

The UE shall filter RSRP and RSRQ measurements of each measured intra-frequency cell using at least 2 measurements. Within the set of measurements used for the filtering, at least two measurements shall be spaced by at least $T_{\text{measure,EUTRAN_ProSe_Intra}}/2$

For an intra-frequency cell that has been already detected, but that has not been reselected to, the filtering shall be such that the UE shall be capable of evaluating that the intra-frequency cell has met reselection criterion defined [1] within $T_{\text{evaluate,E-UTRAN_ProSe_Intra}}$ when $T_{\text{reselection}} = 0$ (within *discCellSelectionInfo*) as specified in table 7.16.4.2-1 provided that the cell is at least 3dB better ranked. When evaluating cells for reselection, the side conditions for RSRP and SCH apply to both the non-serving cell that is currently selected and the non-serving cell being reselected to for ProSe Direct Discovery synchronization.

If $T_{\text{reselection}}$ timer (within *discCellSelectionInfo*) has a non-zero value and the intra-frequency cell being reselected to is better ranked than the currently selected reference cell, the UE shall evaluate this intra-frequency cell for the $T_{\text{reselection}}$ time. If this cell remains better ranked within this duration, then the UE shall reselect that cell.

Table 7.16.4.2-1: $T_{\text{detect,EUTRAN_ProSe_Intra}}$, $T_{\text{measure,EUTRAN_ProSe_Intra}}$ and $T_{\text{evaluate,E-UTRAN_ProSe_Intra}}$

Discovery Period [s]	$T_{\text{detect,EUTRAN_ProSe_Intra}}$ (number of discovery periods)	$T_{\text{measure,EUTRAN_ProSe_Intra}}$ (number of discovery periods)	$T_{\text{evaluate,E-UTRAN_ProSe_Intra}}$ (number of discovery periods)
Discovery Period ≤ 0.32	Note 1 (36)	Note 1 (4)	Note 1 (16)
$0.32 < \text{Discovery Period} \leq 0.64$	Note 1 (28)	Note 1 (2)	Note 1 (8)
$0.64 < \text{Discovery Period} \leq 1.28$	Note 1 (25)	Note 1 (1)	Note 1 (5)
$1.28 < \text{Discovery Period} \leq 10.24$	Note 1 (23)	Note 1 (1)	Note 1 (3)
NOTE 1: Time depends upon the configured Discovery period.			

7.16.5 Selection / Reselection of ProSe relay UE

This subclause contains the requirements related to selection and reselection of ProSe relay UE if the serving frequency is used for ProSe Direct Communication via a ProSe relay UE.

For a remote UE configured by upper layer for relay operation, when the RSRP measurement of the serving cell (RRC_IDLE) or the PCell (RRC_CONNECTED) is below *threshHigh* (within *remoteUE-Config*), the remote UE shall search for candidate relay UEs for selection and/or reselection every discovery period.

If the remote UE has a selected sidelink relay UE, then the remote UE shall measure the SD-RSRP of the selected relay once in every four discovery periods and evaluate if it meets the relay selection criterion as defined in [TS 36.331, 5.10.11.4].

The remote UE shall measure SD-RSRP of the candidate relay UEs every $T_{\text{measure, ProSe_Relay_Intra}}$ for intra-frequency relay UEs that are detected and measured according to the measurement rules.

For an intra-frequency relay UEs that are detected, but that has not been selected or reselected to, the remote UE shall be capable of evaluating that the intra-frequency relay UE has met selection or reselection criterion defined in [2, 5.10.11.4] within $T_{\text{evaluate, ProSe_Relay_Intra}}$ as specified in table 7.16.5-1.

The minimum requirements are required to meet when the selected and candidate relay UEs are transmitting relay discovery message every discovery period.

Table 7.16.5-1: $T_{\text{measure, ProSe_Relay_Intra}}$ and $T_{\text{evaluate, ProSe_Relay_intra}}$

Discovery Period [s]	$T_{\text{measure, ProSe_Relay_Intra}}$ [s] (number of discovery periods)	$T_{\text{evaluate, ProSe_Relay_intra}}$ [s] (number of discovery periods)
$0.04 \leq \text{Discovery period} \leq 10.24$	Note 1 (4)	Note 1 (16)
NOTE 1: Time depends upon the configured Discovery period.		

7.16.6 ProSe operation under deactivated SCell

If the UE is configured for ProSe operation on a sidelink of an SCell then UE is allowed to perform ProSe operation on the sidelink of that SCell regardless of whether that SCell is activated or deactivated provided that there is no additional interruptions beyond what is specified in section 7.8.

7.17 Maximum Transmission Timing Difference in Dual Connectivity

7.17.1 Introduction

A UE shall be capable of handling a relative transmission timing difference between subframe timing boundaries of the PCell and PSCell to be aggregated for E-UTRA FDD-FDD, E-UTRA-TDD-TDD, E-UTRA TDD-FDD dual connectivity.

7.17.2 Minimum Requirements for maximum transmission timing difference Inter-band Dual Connectivity

The UE shall be capable of handling a maximum uplink transmission timing difference between PCell and PSCell of at least 35.21 μs provided the UE indicates that it is capable of synchronous dual connectivity [2]. The requirements for synchronous dual connectivity are only applicable for TDD-TDD, FDD-FDD, and TDD-FDD inter-band dual connectivity.

The UE shall be capable of handling a maximum uplink transmission timing difference between PCell and PSCell of at least 500 μs provided the UE indicates that it is capable of asynchronous dual connectivity [2]. The requirements for asynchronous dual connectivity are only applicable for FDD-FDD and inter-band dual connectivity.

If the UE is configured with higher layer parameter `powerControlMode<1>`, then the UE may stop transmission on the PSCell if the UL transmission timing difference exceeds 35.21 μs . If a UE supports both synchronous and asynchronous dual connectivity and if the UE is configured with higher layer parameter `powerControlMode<2>`, then the UE needs to constitute new subframes pair if the UL transmission timing difference exceeds 500 μs . 7.18 SCell Activation and Deactivation Delay for E-UTRA Dual Connectivity

7.18.1 Introduction

This section defines requirements for the delay within which the UE shall be able to activate a deactivated SCell and deactivate an activated SCell in E-UTRA dual connectivity. The requirements are applicable to an E-UTRA dual connectivity capable UE which has been configured with one SCell in either MCG or SCG and PSCell. In case where the SCell belongs to SCG, the term PCell in clause 7.7 shall be replaced with PSCell. The requirements shall apply for E-UTRA FDD, E-UTRA TDD and E-UTRA TDD-FDD dual connectivity.

7.18.2 SCell Activation Delay Requirement for Deactivated SCell

The requirements in this clause shall apply for a UE configured with PSCell and one SCell.

The SCell activation delay shall meet the requirements in clause 7.7.2.

7.18.3 SCell Deactivation Delay Requirement for Activated SCell

The requirements in this clause shall apply for a UE configured with PSCell and one SCell.

The SCell deactivation delay shall meet the requirements in clause 7.7.3.

7.19 Radio Link Monitoring for UE Category M1

7.19.1 Introduction

The UE category M1 applicability of the requirements for performing radio link monitoring in subclause 7.19 is defined in Section 3.6.

All the requirements in Section 7.19 apply, provided that:

- the UE is not configured with any of the measurement gap patterns defined in Table 8.1.2.1-3, or
- the UE is configured with a measurement gap pattern for RSTD measurements specified in Table 8.1.2.1-3 and there is no overlap between these measurement gaps and configured MPDCCH subframes for UE monitoring.

If the UE is configured with a measurement gap pattern for RSTD measurements specified in Table 8.1.2.1-3 and there is overlap between these measurement gaps and configured MPDCCH subframes for UE monitoring, the UE shall also perform RLM according to Section 7.19, but the out-of-sync evaluation period ($T_{\text{Evaluate_}Q_{\text{out_CatM1}}}$) and in-sync evaluation periods can be longer than those defined in 7.19.

The UE shall monitor the downlink link quality based on the cell-specific reference signal in order to detect the downlink radio link quality of the PCell as specified in TS 36.213 [3].

7.19.2 Requirements for FD-FDD and TDD CE mode A

The requirements defined in this subclause 7.19.2 for performing radio link monitoring are applicable for UE category M1 defined in Section 3.6.

The UE shall estimate the downlink radio link quality and compare it to the thresholds $Q_{\text{out_Cat M1}}$ and $Q_{\text{in_Cat M1}}$ for the purpose of monitoring downlink radio link quality of the PCell.

The threshold $Q_{\text{out_Cat M1}}$ is defined as the level at which the downlink radio link cannot be reliably received and shall correspond to 10% block error rate of a hypothetical MPDCCH transmission with transmission parameters specified in Table 7.19.2-1.

The threshold $Q_{\text{in_Cat M1}}$ is defined as the level at which the downlink radio link quality can be significantly more reliably received than at $Q_{\text{out_Cat M1}}$ and shall correspond to 2% block error rate of a hypothetical MPDCCH transmission with transmission parameters specified in Table 7.19.2-1.

Table 7.19.2-1 M-PDCCH transmission parameters for out-of-sync and in-sync for UE category M1 with CE mode A

Attribute	Out-of-sync	In-sync
DCI format	6-1A	6-1A
Starting OFDM symbols	2; Bandwidth \geq 10MHz 3; 3MHz \leq Bandwidth < 10MHz 4; Bandwidth = 1.4MHz	2; Bandwidth \geq 10MHz 3; 3MHz \leq Bandwidth < 10MHz 4; Bandwidth = 1.4MHz
Maximum M-PDCCH repetition level	R_{max} ^{Note1}	$R_{\text{max}}/2$ ^{Note1}
Aggregation level (ECCE)	L'_{max} ^{Note2}	$L'_{\text{max}-2}$ ^{Note2}
M-PDCCH Transmission type	Distributed	Distributed
NOTE 1: R_{max} is determined by the configurable parameter <i>mPDCCH-NumRepetition</i> defined in 36.331 and $R_{\text{max}} > 1$.		
NOTE 2: L'_{max} and $L'_{\text{max}-2}$ is derived from the configurable parameter <i>numberPRB-Pairs</i> defined in 36.331. L'_{max} is 24, 16 and 8, if <i>numberPRB-Pairs</i> is 6, 4 and 2, respectively. $L'_{\text{max}-2}$ is the aggregation level two levels below L'_{max} , and $L'_{\text{max}-2}$ is 8, 4 and 2, if <i>numberPRB-Pairs</i> is 6, 4 and 2, respectively.		

In addition to the requirements defined above, UE configured with *rlm-ReportConfig* has to

- Estimate the downlink radio link quality and compare it to the thresholds $Q_{E1_out_CatM1}$ and $Q_{E2_in_CatM1}$ for the purpose of monitoring downlink radio link quality of the PCell.

The threshold $Q_{E1_out_CatM1}$ is defined as the level at which the downlink radio link cannot be reliably received and shall correspond to 10% block error rate of a hypothetical MPDCCH transmission with transmission parameters specified in Table 7.19.2-2.

The threshold $Q_{E2_in_CatM1}$ is defined as the level at which the downlink radio link quality can be significantly more reliably received than at $Q_{E1_out_CatM1}$ and shall correspond to 2% block error rate of a hypothetical MPDCCH transmission with transmission parameters specified in Table 7.19.2-2.

Table 7.19.2-2 M-PDCCH transmission parameters for event E1 and event E2 for UE category M1 with CE mode A

Attribute	Event E1	Event E2
DCI format	6-1A	6-1A
Starting OFDM symbols	2; Bandwidth ≥ 10 MHz 3; 3MHz \leq Bandwidth < 10 MHz 4; Bandwidth = 1.4MHz	2; Bandwidth ≥ 10 MHz 3; 3MHz \leq Bandwidth < 10 MHz 4; Bandwidth = 1.4MHz
Maximum M-PDCCH repetition level	$R_{max}/2$ ^{Note1}	$R_{max}/8$ ^{Note1}
Aggregation level (ECCE)	L'_{max-1} ^{Note2}	L'_{max-2} ^{Note2}
M-PDCCH Transmission type	Distributed	Distributed
NOTE 1: R_{max} is determined by the configurable parameter <i>mPDCCH-NumRepetition</i> defined in 36.331 and $R_{max} \geq 2$ to trigger Event E1 and $R_{max} \geq 8$ to trigger Event E2.		
NOTE 2: L'_{max-1} and L'_{max-2} is derived from the configurable parameter <i>numberPRB-Pairs</i> defined in 36.331. L'_{max-1} is 16, 8 and 4, if <i>numberPRB-Pairs</i> is 6, 4 and 2, respectively. L'_{max-2} is the aggregation level one level below L'_{max-1} , and L'_{max-2} is 8, 4 and 2, if <i>numberPRB-Pairs</i> is 6, 4 and 2, respectively.		

7.19.2.1 Minimum requirement when no DRX is used

When the downlink radio link quality of the PCell estimated over the last $T_{Evaluate_Q_{out_CatM1}}$ period becomes worse than the threshold Q_{out_CatM1} , Layer 1 of the UE shall send an out-of-sync indication for the PCell to the higher layers within $T_{Evaluate_Q_{out_CatM1}}$ evaluation period. A Layer 3 filter shall be applied to the out-of-sync indications as specified in TS 36.331 [2].

When the downlink radio link quality of the PCell estimated over the last $T_{Evaluate_Q_{in_CatM1}}$ period becomes better than the threshold Q_{in_CatM1} , Layer 1 of the UE shall send an in-sync indication for the PCell to the higher layers within $T_{Evaluate_Q_{in_CatM1}}$ evaluation period. A L3 filter shall be applied to the in-sync indications as specified in TS 36.331 [2].

The out-of-sync and in-sync evaluations of the PCell shall be performed as specified in clause 4.2.1 in [3]. Two successive indications from Layer 1 shall be separated by at least $\max(10\text{ms}, r_{max} * G)$.

The transmitter power of the UE shall be turned off within 40 ms after expiry of T310 timer as specified in clause 5.3.11 in TS 36.331 [2].

$T_{Evaluate_Q_{out_CatM1}} = 5 * r_{max} * G$ ms and $T_{Evaluate_Q_{in_CatM1}} = 5 * r_{max} * G$ ms, provided the below conditions are met, where $r_{max} * G$ is MPDCCH monitoring cycle length and parameters r_{max} and G are as specified in [3]:

$$r_{max} * G \geq 80 \text{ ms, and}$$

$$G > 1, \text{ and}$$

UE is not receiving PDSCH,

otherwise $T_{Evaluate_Q_{out_CatM1}} = 400$ ms and $T_{Evaluate_Q_{in_CatM1}} = 200$ ms.

A UE configured with *rlm-ReportConfig* has to additionally meet the following requirements

- When the downlink radio link quality of the PCell estimated over the last Q_{out_CatM1} evaluation period becomes worse than the threshold $Q_{E1_out_CatM1}$, Layer 1 of the UE shall trigger event E1 and send a report to the higher

layers within Q_{out_CatM1} evaluation period. A Layer 3 filter shall be applied to the E1 event indications as specified in TS 36.331 [2].

- When the downlink radio link quality of the PCell estimated over the last Q_{in_CatM1} period becomes better than the threshold $Q_{E2_in_CatM1}$, Layer 1 of the UE shall trigger event E2 and send a report to the higher layers within Q_{in_CatM1} evaluation period. A L3 filter shall be applied to the event E2 indications as specified in TS 36.331 [2]. The UE may also include the excess number of repetitions in the reported event report using the RRC parameter *excessRep-MPDCCH* as defined in TS 36.331 [2]. The reportable values of *excessRep-MPDCCH* are defined in Table 7.19.2.1-1.

Table 7.19.2.1-1: Reportable values of *excessRep-MPDCCH*

Parameter: <i>excessRep-MPDCCH-r14</i>	Value
' <i>excessRep1</i> '	2 ^{Note1}
' <i>excessRep2</i> '	4 ^{Note1}
NOTE 1: <i>excessRep-MPDCCH-r14</i> is the factor by which UE recommends eNB to scale down R_{max} (as per the formula $R_{max} / excessRep-MPDCCH-r14$), where R_{max} is determined by the configurable parameter <i>mPDCCH-NumRepetition</i> defined in 36.331.	

7.19.2.2 Minimum requirement when DRX is used

The requirements in this section apply regardless of the MPDCCH search space and parameter G [3] configuration.

When DRX is used for FD-FDD and TDD UE category M1 UEs, the Q_{out_CatM1} evaluation period ($T_{Evaluate_Q_{out_DRX_CatM1}}$) and the Q_{in_CatM1} evaluation period ($T_{Evaluate_Q_{in_DRX_CatM1}}$) specified in Table 7.19.2.2-1 will be used.

When eDRX_CONN cycle is used for FD-FDD and TDD UE category M1 UEs, the Q_{out_CatM1} evaluation period ($T_{Evaluate_Q_{out_DRX_CatM1}}$) and the Q_{in_CatM1} evaluation period ($T_{Evaluate_Q_{in_DRX_CatM1}}$) specified in Table 7.19.2.2-2 will be used.

When the downlink radio link quality of the PCell estimated over the last $T_{Evaluate_Q_{out_DRX_CatM1}}$ [s] period becomes worse than the threshold Q_{out_CatM1} , Layer 1 of the UE shall send out-of-sync indication for the PCell to the higher layers within $T_{Evaluate_Q_{out_DRX_CatM1}}$ [s] evaluation period. A Layer 3 filter shall be applied to the out-of-sync indications as specified in TS 36.331 [2].

When the downlink radio link quality of the PCell estimated over the last $T_{Evaluate_Q_{in_DRX_CatM1}}$ [s] period becomes better than the threshold Q_{in_CatM1} , Layer 1 of the UE shall send in-sync indications for the PCell to the higher layers within $T_{Evaluate_Q_{in_DRX_CatM1}}$ [s] evaluation period. A L3 filter shall be applied to the in-sync indications as specified in TS 36.331 [2].

The out-of-sync and in-sync evaluations of the PCell shall be performed as specified in clause 4.2.1 in [3]. When DRX is used, two successive indications from Layer 1 shall be separated by at least $\max(10\text{ms}, DRX_cycle_length)$. When eDRX_CONN is used, two successive indications from Layer 1 shall be separated by at least $\max(10\text{ ms}, eDRX_CONN\ cycle\ length)$.

Upon start of T310 timer as specified in clause 5.3.11 in TS 36.331 [2], the UE shall monitor the link for recovery using the evaluation period and Layer 1 indication interval corresponding to the non-DRX mode until the expiry or stop of T310 timer.

The transmitter power of the UE shall be turned off within 40 ms after expiry of T310 timer as specified in clause 5.3.11 in TS 36.331 [2].

Table 7.19.2.2-1: Q_{out_CatM1} and Q_{in_CatM1} Evaluation Period in DRX for FD-FDD and TDD UE category M1

DRX cycle length (s)	$T_{Evaluate_Q_{out_DRX_CatM1}}$ and $T_{Evaluate_Q_{in_DRX_CatM1}}$ (s) (DRX cycles)
≤ 0.01	Non-DRX requirements in clause 7.19.2.1 are applicable.
$0.01 < DRX\ cycle \leq 0.04$	Note (20)

$0.04 < \text{DRX cycle} \leq 0.64$	Note (10)
$0.64 < \text{DRX cycle} \leq 2.56$	Note (5)
NOTE: Evaluation period length in time depends on the length of the DRX cycle in use	

Table 7.19.2.2-2: $Q_{\text{out_CatM1}}$ and $Q_{\text{in_CatM1}}$ evaluation period when eDRX_CONN cycle is configured for FD-FDD and TDD UE category M1

eDRX_CONN cycle length (s)	$T_{\text{Evaluate_}Q_{\text{out_DRX_CatM1}}}$ and $T_{\text{Evaluate_}Q_{\text{in_DRX_CatM1}}}$ (eDRX_CONN cycles)
$2.56 < \text{eDRX_CONN cycle} \leq 10.24$	Note (5)
NOTE: Evaluation period length in time depends on the length of the eDRX_CONN cycle in use	

The requirements defined in clause 7.19.2.2 also apply for this section.

A UE configured with *rlm-ReportConfig* has to additionally meet the following requirements

- When the downlink radio link quality of the PCell estimated over the last $T_{\text{Evaluate_}Q_{\text{out_DRX_CatM1}}}$ [s] period becomes worse than the threshold $Q_{\text{E1_out_CatM1}}$, Layer 1 of the UE shall trigger event E1 and send a report to the higher layers within $T_{\text{Evaluate_}Q_{\text{out_DRX_CatM1}}}$ [s] evaluation period. A Layer 3 filter shall be applied to the E1 event indications as specified in TS 36.331 [2].
- When the downlink radio link quality of the PCell estimated over the last $T_{\text{Evaluate_}Q_{\text{in_DRX_CatM1}}}$ [s] period becomes better than the threshold $Q_{\text{E2_in_CatM1}}$, Layer 1 of the UE shall trigger event E2 and send a report to the higher layers within $T_{\text{Evaluate_}Q_{\text{in_DRX_CatM1}}}$ [s] evaluation period. A L3 filter shall be applied to the E2 event indications as specified in TS 36.331 [2]. The UE may also include the excess number of repetitions in the reported event report using the RRC parameter *excessRep-MPDCCH* as defined in TS 36.331 [2]. The reportable values of *excessRep-MPDCCH* are defined in Table 7.19.2.1-1.

7.19.2.3 Minimum requirement at transitions

When the UE transitions between any two of DRX, eDRX_CONN and non-DRX or when DRX or eDRX_CONN cycle periodicity changes, for a duration of time equal to the evaluation period corresponding to the second mode after the transition occurs, the UE shall use an evaluation period that is no less than the minimum of evaluation periods corresponding to the first mode and the second mode. Subsequent to this duration, the UE shall use an evaluation period corresponding to the second mode. This requirement shall be applied to both out-of-sync evaluation and in-sync evaluation of the PCell.

7.19.3 Requirements for HD-FDD with CE mode A

The requirements defined in this subclause 7.19.3 for performing radio link monitoring are applicable for UE category M1 defined in Section 3.6.

7.19.3.1 Minimum requirement when no DRX is used

The HD-FDD category M1 with CE mode A UE shall meet all applicable requirements specified in clause 7.19.2.1 under the following conditions

- at least 1 DL subframe per radio frame of PCell is available at the UE during $Q_{\text{in_CatM1}}$ and $Q_{\text{out_CatM1}}$ evaluation periods.

7.19.3.2 Minimum requirement when DRX is used

The requirements in this section apply regardless of the MPDCCH search space and parameter G [3] configuration.

When DRX is used for HD-FDD category M1 with CE mode A UEs, the $Q_{\text{out_CatM1}}$ evaluation period ($T_{\text{Evaluate_}Q_{\text{out_DRX_CatM1}}}$) and the $Q_{\text{in_CatM1}}$ evaluation period ($T_{\text{Evaluate_}Q_{\text{in_DRX_CatM1}}}$) specified in Table 7.19.3.2-1 will be used.

When eDRX_CONN cycle is used for HD-FDD category M1 with CE mode A UEs, the Q_{out_CatM1} evaluation period ($T_{Evaluate_Q_{out_DRX_CatM1}}$) and the Q_{in_CatM1} evaluation period ($T_{Evaluate_Q_{in_DRX_CatM1}}$) specified in Table 7.19.3.2-2 will be used.

When the downlink radio link quality of the PCell estimated over the last $T_{Evaluate_Q_{out_DRX_CatM1}}$ [s] period becomes worse than the threshold Q_{out_CatM1} , Layer 1 of the UE shall send out-of-sync indication for the PCell to the higher layers within $T_{Evaluate_Q_{out_DRX_CatM1}}$ [s] evaluation period. A Layer 3 filter shall be applied to the out-of-sync indications as specified in TS 36.331 [2].

When the downlink radio link quality of the PCell estimated over the last $T_{Evaluate_Q_{in_DRX_CatM1}}$ [s] period becomes better than the threshold Q_{in_CatM1} , Layer 1 of the UE shall send in-sync indications for the PCell to the higher layers within $T_{Evaluate_Q_{in_DRX_CatM1}}$ [s] evaluation period. A L3 filter shall be applied to the in-sync indications as specified in TS 36.331 [2].

The out-of-sync and in-sync evaluations of the PCell shall be performed as specified in clause 4.2.1 in [3]. When DRX is used, two successive indications from Layer 1 shall be separated by at least $\max(10\text{ms}, \text{DRX_cycle_length})$. When eDRX_CONN is used, two successive indications from Layer 1 shall be separated by at least $\max(10\text{ ms}, \text{eDRX_CONN cycle length})$.

Upon start of T310 timer as specified in clause 5.3.11 in TS 36.331 [2], the UE shall monitor the link for recovery using the evaluation period and Layer 1 indication interval corresponding to the non-DRX mode until the expiry or stop of T310 timer.

The transmitter power of the UE shall be turned off within 40 ms after expiry of T310 timer as specified in clause 5.3.11 in TS 36.331 [2].

Table 7.19.3.2-1: Q_{out_CatM1} and Q_{in_CatM1} Evaluation Period in DRX for HD-FDD UE category M1 with CE mode A

DRX cycle length (s)	$T_{Evaluate_Q_{out_DRX_CatM1}}$ and $T_{Evaluate_Q_{in_DRX_CatM1}}$ (s) (DRX cycles)
≤ 0.01	Non-DRX requirements in clause 7.19.3.1 are applicable.
$0.01 < \text{DRX cycle} \leq 0.04$	Note (40)
$0.04 < \text{DRX cycle} \leq 0.16$	Note (20)
$0.16 < \text{DRX cycle} \leq 0.64$	Note (10)
$0.64 < \text{DRX cycle} \leq 2.56$	Note (5)
Note: Evaluation period length in time depends on the length of the DRX cycle in use	

Table 7.19.3.2-2: Q_{out_CatM1} and Q_{in_CatM1} evaluation period when eDRX_CONN cycle is configured for HD-FDD UE category M1 with CE mode A

eDRX_CONN cycle length (s)	$T_{Evaluate_Q_{out_DRX_CatM1}}$ and $T_{Evaluate_Q_{in_DRX_CatM1}}$ (s) (eDRX_CONN cycles)
$2.56 < \text{eDRX_CONN cycle} \leq 10.24$	Note (5)
NOTE: Evaluation period length in time depends on the length of the eDRX_CONN cycle in use	

The requirements defined in clause 7.19.3.2 also apply for this section.

A UE configured with *rlm-ReportConfig* has to additionally meet the following requirements

- When the downlink radio link quality of the PCell estimated over the last $T_{Evaluate_Q_{out_DRX_CatM1}}$ [s] period becomes worse than the threshold $Q_{E1_out_CatM1}$, Layer 1 of the UE shall trigger event E1 and send a report to the higher layers within $T_{Evaluate_Q_{out_DRX_CatM1}}$ [s] evaluation period. A Layer 3 filter shall be applied to the E1 event indications as specified in TS 36.331 [2].
- When the downlink radio link quality of the PCell estimated over the last $T_{Evaluate_Q_{in_DRX_CatM1}}$ [s] period becomes better than the threshold $Q_{E2_in_CatM1}$, Layer 1 of the UE shall trigger event E2 and send a report to the higher layers within $T_{Evaluate_Q_{in_DRX_CatM1}}$ [s] evaluation period. A L3 filter shall be applied to the E2 event

indications as specified in TS 36.331 [2]. The UE may also include the excess number of repetitions in the reported event report using the RRC parameter *excessRep-MPDCCH* as defined in TS 36.331 [2]. The reportable values of *excessRep-MPDCCH* are defined in Table 7.19.2.1-1.

7.19.3.3 Minimum requirement at transitions

The minimum requirements at transitions defined in clause 7.19.2.3 also apply for this section under the following conditions:

- at least 1 DL subframe per radio frame of PCell is available at the UE during Q_{in_CatM1} and Q_{out_CatM1} evaluation periods.

7.19.4 Requirements for FD-FDD and TDD with CE mode B

The requirements defined in this subclause 7.19.4 for performing radio link monitoring are applicable for UE category M1 defined in Section 3.6.

The UE shall estimate the downlink radio link quality and compare it to the thresholds $Q_{out_Cat M1}$ and $Q_{in_Cat M1}$ for the purpose of monitoring downlink radio link quality of the PCell.

The threshold $Q_{out_Cat M1}$ is defined as the level at which the downlink radio link cannot be reliably received and shall correspond to 10% block error rate of a hypothetical MPDCCH transmission with transmission parameters specified in Table 7.19.4-1.

The threshold $Q_{in_Cat M1}$ is defined as the level at which the downlink radio link quality can be significantly more reliably received than at $Q_{out_Cat M1}$ and shall correspond to 2% block error rate of a hypothetical MPDCCH transmission with transmission parameters specified in Table 7.19.4-1.

Table 7.19.4-1 M-PDCCH transmission parameters for out-of-sync and in-sync for UE category M1 with CE mode B

Attribute	Out-of-sync	In-sync
DCI format	6-1B	6-1B
Starting OFDM symbols	2; Bandwidth ≥ 10 MHz 3; $3\text{MHz} \leq \text{Bandwidth} < 10\text{MHz}$ 4; Bandwidth = 1.4MHz	2; Bandwidth ≥ 10 MHz 3; $3\text{MHz} \leq \text{Bandwidth} < 10\text{MHz}$ 4; Bandwidth = 1.4MHz
Maximum M-PDCCH repetition level	R_{max}^{Note1}	$R_{max}/2^{Note1}$
Aggregation level (ECCE)	L'_{max}^{Note2}	L'_{max-2}^{Note2}
M-PDCCH Transmission type	Distributed	Distributed
NOTE 1: R_{max} is determined by the configurable parameter <i>mPDCCH-NumRepetition</i> defined in 36.331 and $R_{max} > 1$.		
NOTE 2: L'_{max} and L'_{max-2} is derived from the configurable parameter <i>numberPRB-Pairs</i> defined in 36.331. L'_{max} is 24, 16 and 8, if <i>numberPRB-Pairs</i> is 6, 4 and 2, respectively. L'_{max-2} is the aggregation levels two levels below L'_{max} , and L'_{max-2} is 8, 4 and 2, if <i>numberPRB-Pairs</i> is 6, 4 and 2, respectively.		

In addition, a UE configured with *rlm-ReportConfig* has to meet the following requirements

- Estimate the downlink radio link quality and compare it to the thresholds $Q_{E1_out_CatM1}$ and $Q_{E2_in_CatM1}$.

The threshold $Q_{E1_out_CatM1}$ is defined as the level at which the downlink radio link cannot be reliably received and shall correspond to 10% block error rate of a hypothetical MPDCCH transmission with transmission parameters specified in Table 7.19.4-2.

The threshold $Q_{E2_in_Cat M1}$ is defined as the level at which the downlink radio link quality can be significantly more reliably received than at $Q_{out_Cat M1}$ and shall correspond to 2% block error rate of a hypothetical MPDCCH transmission with transmission parameters specified in Table 7.19.4-2.

Table 7.19.4-2 M-PDCCH transmission parameters for event E1 and event E2 for UE category M1 with CE mode B

Attribute	Event E1	Event E2
DCI format	6-1B	6-1B
Starting OFDM symbols	2; Bandwidth ≥ 10 MHz 3; $3\text{MHz} \leq \text{Bandwidth} < 10\text{MHz}$ 4; Bandwidth = 1.4MHz	2; Bandwidth ≥ 10 MHz 3; $3\text{MHz} \leq \text{Bandwidth} < 10\text{MHz}$ 4; Bandwidth = 1.4MHz

Maximum M-PDCCH repetition level	$R_{\max}/2$ ^{Note1}	$R_{\max}/8$ ^{Note1}
Aggregation level (ECCE)	$L'_{\max-1}$ ^{Note2}	$L'_{\max-2}$ ^{Note2}
M-PDCCH Transmission type	Distributed	Distributed
NOTE 1: R_{\max} is determined by the configurable parameter <i>mPDCCH-NumRepetition</i> defined in 36.331 and $R_{\max} \geq 2$ to trigger Event E1 and $R_{\max} \geq 8$ to trigger Event E2.		
NOTE 2: $L'_{\max-1}$ and $L'_{\max-2}$ is derived from the configurable parameter <i>numberPRB-Pairs</i> defined in 36.331. $L'_{\max-1}$ is 16, 8 and 4, if <i>numberPRB-Pairs</i> is 6, 4 and 2, respectively. $L'_{\max-2}$ is the aggregation level one levels below $L'_{\max-1}$, and $L'_{\max-2}$ is 8, 4 and 2, if <i>numberPRB-Pairs</i> is 6, 4 and 2, respectively.		

7.19.4.1 Minimum requirement when no DRX is used

When the downlink radio link quality of the PCell estimated over the last $T_{\text{Evaluate_}Q_{\text{out_CatM1}}}$ period becomes worse than the threshold $Q_{\text{out_CatM1}}$, Layer 1 of the UE shall send an out-of-sync indication for the PCell to the higher layers within $T_{\text{Evaluate_}Q_{\text{out_CatM1}}}$ evaluation period. A Layer 3 filter shall be applied to the out-of-sync indications as specified in TS 36.331 [2].

When the downlink radio link quality of the PCell estimated over the last $T_{\text{Evaluate_}Q_{\text{in_CatM1}}}$ period becomes better than the threshold $Q_{\text{in_CatM1}}$, Layer 1 of the UE shall send an in-sync indication for the PCell to the higher layers within $T_{\text{Evaluate_}Q_{\text{in_CatM1}}}$ evaluation period. A L3 filter shall be applied to the in-sync indications as specified in TS 36.331 [2].

The out-of-sync and in-sync evaluations of the PCell shall be performed as specified in clause 4.2.1 in [3]. Two successive indications from Layer 1 shall be separated by at least $\max(10\text{ms}, r_{\max} * G)$.

The transmitter power of the UE shall be turned off within 40 ms after expiry of T310 timer as specified in clause 5.3.11 in TS 36.331 [2].

$T_{\text{Evaluate_}Q_{\text{out_CatM1}}} = 5 * r_{\max} * G$ ms and $T_{\text{Evaluate_}Q_{\text{in_CatM1}}} = 5 * r_{\max} * G$ ms, provided the below conditions are met, where $r_{\max} * G$ is MPDCCH monitoring cycle length and parameters r_{\max} and G are as specified in [3]:

$r_{\max} * G \geq 800$ ms, and

$G > 1$, and

UE is not receiving PDSCH,

otherwise $T_{\text{Evaluate_}Q_{\text{out_CatM1}}} = 4000$ ms and $T_{\text{Evaluate_}Q_{\text{in_CatM1}}} = 2000$ m

The requirements defined in clause 7.19.4.1 also apply for this section.

A UE configured with *rlm-ReportConfig* has to additionally meet the following requirements

- When the downlink radio link quality of the PCell estimated over the last $Q_{\text{out_CatM1}}$ evaluation period becomes worse than the threshold $Q_{\text{E1_out_CatM1}}$, Layer 1 of the UE shall trigger event E1 and send a report to the higher layers within $Q_{\text{out_CatM1}}$ evaluation period. A Layer 3 filter shall be applied to the E1 event indications as specified in TS 36.331 [2].
- When the downlink radio link quality of the PCell estimated over the last $Q_{\text{in_CatM1}}$ evaluation period becomes better than the threshold $Q_{\text{E2_in_CatM1}}$, Layer 1 of the UE shall trigger event E2 and send a report to the higher layers within $Q_{\text{in_CatM1}}$ evaluation period. A L3 filter shall be applied to the E2 event indications as specified in TS 36.331 [2]. The UE may also include the excess number of repetitions in the reported event report using the RRC parameter *excessRep-MPDCCH* as defined in TS 36.331 [2]. The reportable values of *excessRep-MPDCCH* are defined in Table 7.19.4.1-1.

Table 7.19.4.1-1: Reportable values of *excessRep-MPDCCH*

Parameter: <i>excessRep-MPDCCH-r14</i>	Value
' <i>excessRep1</i> '	2 ^{Note1}
' <i>excessRep2</i> '	4 ^{Note1}
NOTE 1: <i>excessRep-MPDCCH-r14</i> is the factor by which UE recommends eNB to scale down R_{\max} (as per the formula $R_{\max} / \text{excessRep-MPDCCH-r14}$), where R_{\max} is determined by the configurable parameter <i>mPDCCH-NumRepetition</i> defined in 36.331.	

7.19.4.2 Minimum requirement when DRX is used

The requirements in this section apply regardless of the MPDCCH search space and parameter G [3] configuration.

When DRX is used for FD-FDD and TDD UE category M1 UEs, the Q_{out_CatM1} evaluation period ($T_{Evaluate_Q_{out_DRX_CatM1}}$) and the Q_{in_CatM1} evaluation period ($T_{Evaluate_Q_{in_DRX_CatM1}}$) specified in Table 7.19.4.2-1 will be used.

When eDRX_CONN cycle is used for FD-FDD and TDD UE category M1 UEs, the Q_{out_CatM1} evaluation period ($T_{Evaluate_Q_{out_DRX_CatM1}}$) and the Q_{in_CatM1} evaluation period ($T_{Evaluate_Q_{in_DRX_CatM1}}$) specified in Table 7.19.4.2-2 will be used.

When the downlink radio link quality of the PCell estimated over the last $T_{Evaluate_Q_{out_DRX_CatM1}}$ [s] period becomes worse than the threshold Q_{out_CatM1} , Layer 1 of the UE shall send out-of-sync indication for the PCell to the higher layers within $T_{Evaluate_Q_{out_DRX_CatM1}}$ [s] evaluation period. A Layer 3 filter shall be applied to the out-of-sync indications as specified in TS 36.331 [2].

When the downlink radio link quality of the PCell estimated over the last $T_{Evaluate_Q_{in_DRX_CatM1}}$ [s] period becomes better than the threshold Q_{in_CatM1} , Layer 1 of the UE shall send in-sync indications for the PCell to the higher layers within $T_{Evaluate_Q_{in_DRX_CatM1}}$ [s] evaluation period. A L3 filter shall be applied to the in-sync indications as specified in TS 36.331 [2].

The out-of-sync and in-sync evaluations of the PCell shall be performed as specified in clause 4.2.1 in [3]. When DRX is used, two successive indications from Layer 1 shall be separated by at least $\max(10\text{ms}, \text{DRX_cycle_length})$. When eDRX_CONN is used, two successive indications from Layer 1 shall be separated by at least $\max(10\text{ ms}, \text{eDRX_CONN cycle length})$.

Upon start of T310 timer as specified in clause 5.3.11 in TS 36.331 [2], the UE shall monitor the link for recovery using the evaluation period and Layer 1 indication interval corresponding to the non-DRX mode until the expiry or stop of T310 timer.

The transmitter power of the UE shall be turned off within 40 ms after expiry of T310 timer as specified in clause 5.3.11 in TS 36.331 [2].

Table 7.19.4.2-1: Q_{out_CatM1} and Q_{in_CatM1} Evaluation Period in DRX for FD-FDD and TDD UE category M1

DRX cycle length (s)	$T_{Evaluate_Q_{out_DRX_CatM1}}$ and $T_{Evaluate_Q_{in_DRX_CatM1}}$ (s) (DRX cycles)
≤ 0.16	Non-DRX requirements in clause 7.19.4.1 are applicable.
$0.160 < \text{DRX cycle} \leq 0.320$	Note (20)
$0.320 < \text{DRX cycle} \leq 0.64$	Note (10)
$0.64 < \text{DRX cycle} \leq 2.56$	Note (5)
NOTE: Evaluation period length in time depends on the length of the DRX cycle in use	

Table 7.19.4.2-2: Q_{out_CatM1} and Q_{in_CatM1} evaluation period when eDRX_CONN cycle is configured for FD-FDD and TDD UE category M1

eDRX_CONN cycle length (s)	$T_{Evaluate_Q_{out_DRX_CatM1}}$ and $T_{Evaluate_Q_{in_DRX_CatM1}}$ (s) (eDRX_CONN cycles)
$2.56 < \text{eDRX_CONN cycle} \leq 10.24$	Note (5)
NOTE: Evaluation period length in time depends on the length of the eDRX_CONN cycle in use	

The requirements defined in clause 7.19.4.2 also apply for this section.

A UE configured with *rlm-ReportConfig* has to additionally meet the following requirements

- When the downlink radio link quality of the PCell estimated over the last $T_{\text{Evaluate_}Q_{\text{out_DRX_CatM1}}}$ [s] period becomes worse than the threshold $Q_{E1_out_CatM1}$, Layer 1 of the UE shall trigger event E1 and send a report to the higher layers within $T_{\text{Evaluate_}Q_{\text{out_DRX_CatM1}}}$ [s] evaluation period. A Layer 3 filter shall be applied to the E1 event indications as specified in TS 36.331 [2].
- When the downlink radio link quality of the PCell estimated over the last $T_{\text{Evaluate_}Q_{\text{in_DRX_CatM1}}}$ [s] period becomes better than the threshold $Q_{E2_in_CatM1}$, Layer 1 of the UE shall trigger event E2 and send a report to the higher layers within $T_{\text{Evaluate_}Q_{\text{in_DRX_CatM1}}}$ [s] evaluation period. A L3 filter shall be applied to the E2 event indications as specified in TS 36.331 [2]. The UE may also include the excess number of repetitions in the reported event report using the RRC parameter *excessRep-MPDCCH* as defined in TS 36.331 [2]. The reportable values of *excessRep-MPDCCH* are defined in Table 7.19.4.1-1.

7.19.4.3 Minimum requirement at transitions

When the UE transitions between any two of DRX, eDRX_CONN and non-DRX or when DRX or eDRX_CONN cycle periodicity changes, for a duration of time equal to the evaluation period corresponding to the second mode after the transition occurs, the UE shall use an evaluation period that is no less than the minimum of evaluation periods corresponding to the first mode and the second mode. Subsequent to this duration, the UE shall use an evaluation period corresponding to the second mode. This requirement shall be applied to both out-of-sync evaluation and in-sync evaluation of the PCell.

7.19.5 Requirements for HD-FDD with CE mode B

The requirements defined in this subclause 7.19.5 for performing radio link monitoring are applicable for UE category M1 defined in Section 3.6.

7.19.5.1 Minimum requirement when no DRX is used

The HD-FDD category M1 with CE mode B UE shall meet all applicable requirements specified in clause 7.19.4.1 under the following conditions

- at least 1 DL subframe per radio frame of PCell is available at the UE during $Q_{\text{in_CatM1}}$ and $Q_{\text{out_CatM1}}$ evaluation periods.

7.19.5.2 Minimum requirement when DRX is used

The requirements in this section apply regardless of the MPDCCH search space and parameter G [3] configuration.

When DRX is used for HD-FDD category M1 with CE mode B UEs, the $Q_{\text{out_CatM1}}$ evaluation period ($T_{\text{Evaluate_}Q_{\text{out_DRX_CatM1}}}$) and the $Q_{\text{in_CatM1}}$ evaluation period ($T_{\text{Evaluate_}Q_{\text{in_DRX_CatM1}}}$) specified in Table 7.19.5.2-1 will be used.

When eDRX_CONN cycle is used for HD-FDD category M1 with CE mode B UEs, the $Q_{\text{out_CatM1}}$ evaluation period ($T_{\text{Evaluate_}Q_{\text{out_DRX_CatM1}}}$) and the $Q_{\text{in_CatM1}}$ evaluation period ($T_{\text{Evaluate_}Q_{\text{in_DRX_CatM1}}}$) specified in Table 7.19.5.2-2 will be used.

When the downlink radio link quality of the PCell estimated over the last $T_{\text{Evaluate_}Q_{\text{out_DRX_CatM1}}}$ [s] period becomes worse than the threshold $Q_{\text{out_CatM1}}$, Layer 1 of the UE shall send out-of-sync indication for the PCell to the higher layers within $T_{\text{Evaluate_}Q_{\text{out_DRX_CatM1}}}$ [s] evaluation period. A Layer 3 filter shall be applied to the out-of-sync indications as specified in TS 36.331 [2].

When the downlink radio link quality of the PCell estimated over the last $T_{\text{Evaluate_}Q_{\text{in_DRX_CatM1}}}$ [s] period becomes better than the threshold $Q_{\text{in_CatM1}}$, Layer 1 of the UE shall send in-sync indications for the PCell to the higher layers within $T_{\text{Evaluate_}Q_{\text{in_DRX_CatM1}}}$ [s] evaluation period. A L3 filter shall be applied to the in-sync indications as specified in TS 36.331 [2].

The out-of-sync and in-sync evaluations of the PCell shall be performed as specified in clause 4.2.1 in [3]. When DRX is used, two successive indications from Layer 1 shall be separated by at least $\max(10\text{ms}, \text{DRX_cycle_length})$. When eDRX_CONN is used, two successive indications from Layer 1 shall be separated by at least $\max(10\text{ ms}, \text{eDRX_CONN cycle length})$.

Upon start of T310 timer as specified in clause 5.3.11 in TS 36.331 [2], the UE shall monitor the link for recovery using the evaluation period and Layer 1 indication interval corresponding to the non-DRX mode until the expiry or stop of T310 timer.

The transmitter power of the UE shall be turned off within 40 ms after expiry of T310 timer as specified in clause 5.3.11 in TS 36.331 [2].

Table 7.19.5.2-1: Q_{out_CatM1} and Q_{in_CatM1} Evaluation Period in DRX for HD-FDD UE category M1 with CE mode B

DRX cycle length (s)	$T_{Evaluate_Q_{out_DRX_CatM1}}$ and $T_{Evaluate_Q_{in_DRX_CatM1}}$ (s) (DRX cycles)
≤ 0.08	Non-DRX requirements in clause 7.19.5.1 are applicable.
$0.08 < \text{DRX cycle} \leq 0.160$	Note (40)
$0.160 < \text{DRX cycle} \leq 0.320$	Note (20)
$0.320 < \text{DRX cycle} \leq 0.64$	Note (10)
$0.64 < \text{DRX cycle} \leq 2.56$	Note (5)
NOTE: Evaluation period length in time depends on the length of the DRX cycle in use	

Table 7.19.5.2-2: Q_{out_CatM1} and Q_{in_CatM1} evaluation period when eDRX_CONN cycle is configured for HD-FDD UE category M1 with CE mode B

eDRX_CONN cycle length (s)	$T_{Evaluate_Q_{out_DRX_CatM1}}$ and $T_{Evaluate_Q_{in_DRX_CatM1}}$ (s) (eDRX_CONN cycles)
$2.56 < \text{DRX cycle} \leq 10.24$	Note (5)
NOTE: Evaluation period length in time depends on the length of the eDRX_CONN cycle in use	

The requirements defined in clause 7.19.5.2 also apply for this section.

A UE configured with *rlm-ReportConfig* has to additionally meet the following requirements

- When the downlink radio link quality of the PCell estimated over the last $T_{Evaluate_Q_{out_DRX_CatM1}}$ [s] period becomes worse than the threshold $Q_{E1_out_CatM1}$, Layer 1 of the UE shall trigger event E1 and send a report to the higher layers within $T_{Evaluate_Q_{out_DRX_CatM1}}$ [s] evaluation period. A Layer 3 filter shall be applied to the E1 event indications as specified in TS 36.331 [2].
- When the downlink radio link quality of the PCell estimated over the last $T_{Evaluate_Q_{in_DRX_CatM1}}$ [s] period becomes better than the threshold $Q_{E2_in_CatM1}$, Layer 1 of the UE shall trigger event E2 and send a report to the higher layers within $T_{Evaluate_Q_{in_DRX_CatM1}}$ [s] evaluation period. A L3 filter shall be applied to the E2 event indications as specified in TS 36.331 [2]. The UE may also include the excess number of repetitions in the reported event report using the RRC parameter *excessRep-MPDCCH* as defined in TS 36.331 [2]. The reportable values of *excessRep-MPDCCH* are defined in Table 7.19.4.1-1.

7.19.5.3 Minimum requirement at transitions

The minimum requirements at transitions defined in clause 7.19.4.3 also apply for this section under the following conditions:

- at least 1 DL subframe per radio frame of PCell is available at the UE during Q_{in_CatM1} and Q_{out_CatM1} evaluation periods.

7.20 UE transmit timing for NB-IoT

7.20.1 Introduction

The Category NB1 UE shall have capability to follow the frame timing change of the connected eNode B. The uplink frame transmission takes place $(N_{TA_Ref} + N_{TAoffset}) \times T_s$ before the reception of the first detected path (in time) of the corresponding downlink frame from the reference NB-IoT cell.

UE shall use the serving NB-IoT cell as the reference cell for deriving the UE transmit timing. UE initial transmit timing accuracy, maximum amount of timing change in one adjustment, minimum and maximum adjustment rate are defined in the following requirements.

7.20.2 Requirements

The UE initial transmission timing error shall be less than or equal to $\pm T_e$ where the timing error limit value T_e is specified in Table 7.20.2-1. This requirement applies when it is the first transmission in a DRX cycle or the first transmission in a repetition period ($R>1$) for NPUSCH and NPRACH, the first transmission after an uplink transmission gap in a repetition period ($R>1$) for NPUSCH and NPRACH transmission. The reference point for the UE initial transmit timing control requirement shall be the downlink timing of the serving NB-IoT cell minus $(N_{TA_Ref} + N_{TAoffset}) \times T_s$. The downlink timing is defined as the time when the first detected path (in time) of the corresponding downlink frame is received from the serving NB-IoT cell. N_{TA_Ref} for NPRACH is defined as 0. $(N_{TA_Ref} + N_{TAoffset})$ (in T_s units) for other channels is the difference between UE transmission timing and the Downlink timing immediately after when the last timing advance in clause 7.22 was applied. N_{TA_Ref} for other channels is not changed until next timing advance is received.

Table 7.20.2-1: T_e Timing Error Limit

Downlink Bandwidth (MHz)	T_e
0.18	$80 \times T_s$
Note 1: T_s is the basic timing unit defined in TS 36.211	

When it is not the first transmission in a DRX cycle or there is no DRX cycle, and when it is the transmission for NPUSCH the UE shall, when no repetitions are configured on the uplink or the repetition period is $R=1$, be capable of changing the transmission timing according to the received downlink frame of the serving NB-IoT cell except when the timing advance in clause 7.22 is applied such that the UE transmission timing error shall be less than or equal to $\pm T_e$, where the timing error limit value T_e is specified in Table 7.20.2-1.

When no repetition period is configured, or the configured repetition period is $R=1$, all adjustments made to the UE uplink timing shall follow these rules:

- 1) The maximum amount of the magnitude of the timing change in one adjustment shall be $58.33 \times T_s$ seconds.
- 2) The minimum aggregate adjustment rate shall be $7 \times T_s$ per second.
- 3) The maximum aggregate adjustment rate shall be $58.33 \times T_s$ per 200ms.

When a repetition period is configured on the uplink for which $R>1$, the UE shall not adjust the uplink transmission timing autonomously during an ongoing repetition period other than at initial transmission as defined above.

7.21 UE timer accuracy for NB-IoT

7.21.1 Introduction

UE timers are used in different protocol entities to control the UE behaviour.

7.21.2 Requirements

For UE timers specified in TS 36.331 [2], UE shall comply with the timer accuracies according to Table 7.21.2-1.

The requirements are only related to the actual timing measurements internally in the UE. They do not include the following:

- Inaccuracy in the start and stop conditions of a timer (e.g. UE reaction time to detect that start and stop conditions of a timer is fulfilled), or
- Inaccuracies due to restrictions in observability of start and stop conditions of a UE timer (e.g. TTI alignment when UE sends messages at timer expiry).

Table 7.21.2-1

Timer value [s]	Accuracy
timer value < 4	$\pm 0.1s$
timer value ≥ 4	$\pm 2.5\%$

7.22 Timing Advance for NB-IoT

7.22.1 Introduction

The timing advance is initiated from E-UTRAN with MAC message that implies and adjustment of the timing advance, see TS 36.321 [17] clause 5.2.

7.22.2 Requirements

7.22.2.1 Timing Advance adjustment delay

UE shall adjust the timing of its uplink transmission timing at sub-frame $n+12$ for a timing advance command received in sub-frame n . In case repetitions are used on the downlink, sub-frame n refers to the last subframe in the repetition period in which the message containing the MAC control information was received. The UE shall not apply a TA command during an uplink repetition period.

7.22.2.2 Timing Advance adjustment accuracy

The UE shall adjust the timing of its transmissions with a relative accuracy better than or equal to $\pm 13.33 * T_S$ seconds to the signalled timing advance value compared to the timing of preceding uplink transmission. The timing advance command is expressed in multiples of $16 * T_S$ and is relative to the current uplink timing.

7.23 Radio Link Monitoring for Category NB1 UE

7.23.1 Introduction

The applicability of the requirements for performing radio link monitoring for Category NB1 UE in subclause 7.23 is defined in Section 3.1.

The UE shall monitor the downlink link quality based on the narrowband reference signal in order to detect the downlink radio link quality of the NB-IoT cell as specified in [3].

7.23.2 Requirements for Category NB1 UE

The requirements defined in this subclause 7.23.2 for performing radio link monitoring are applicable for Category NB1 UE defined in Section 3.1.

The UE shall meet all applicable requirements specified in clause 7.23.2 under the following condition:

- at least 1 DL subframe per radio frame of serving NB-IoT cell is available at the UE during Q_{out_NB-IoT} and Q_{in_NB-IoT} evaluation periods.

The UE shall estimate the downlink radio link quality and compare it to the thresholds Q_{out_NB-IoT} and Q_{in_NB-IoT} for the purpose of monitoring downlink radio link quality of the NB-IoT cell.

The threshold Q_{out_NB-IoT} is defined as the level at which the downlink radio link cannot be reliably received and shall correspond to 10% block error rate of a hypothetical NPDCCH transmission with transmission parameters specified in Table 7.23.2-1.

The threshold Q_{in_NB-IoT} is defined as the level at which the downlink radio link quality can be significantly more reliably received than at Q_{out_NB-IoT} and shall correspond to 2% block error rate of a hypothetical NPDCCH transmission with transmission parameters specified in Table 7.23.2-1.

Table 7.23.2-1 NPDCCH transmission parameters for out-of-sync and in-sync for Category NB1 UE

Attribute	Out-of-sync	In-sync
-----------	-------------	---------

DCI format	Format N1	Format N1
Number of information bits	23 bits	23 bits
System Bandwidth	200kHz	200kHz
Antenna configuration	2x1	2x1
Maximum NPDCCH Repetition level	R_{\max}^{Note1}	$R_{\max}/4^{\text{Note1}}$
Aggregation level	2	2
DRX	OFF	OFF
NOTE 1: R_{\max} is a configurable parameter defined in TS 36.331 [2].		

7.23.2.1 Minimum requirement when no DRX is used

When the downlink radio link quality of the NB-IoT cell estimated over the last $T_{\text{Evaluate_}Q_{\text{out_NB-IoT}}}$ period becomes worse than the threshold $Q_{\text{out_NB-IoT}}$, Layer 1 of the UE shall send an out-of-sync indication for the NB-IoT cell to the higher layers within $T_{\text{Evaluate_}Q_{\text{out_NB-IoT}}}$ evaluation period. A Layer 3 filter shall be applied to the out-of-sync indications as specified in TS 36.331 [2].

When the downlink radio link quality of the NB-IoT cell estimated over the last $T_{\text{Evaluate_}Q_{\text{in_NB-IoT}}}$ period becomes better than the threshold $Q_{\text{in_NB-IoT}}$, Layer 1 of the UE shall send an in-sync indication for the NB-IoT cell to the higher layers within $T_{\text{Evaluate_}Q_{\text{in_NB-IoT}}}$ evaluation period. A L3 filter shall be applied to the in-sync indications as specified in TS 36.331 [2].

The out-of-sync and in-sync evaluations of the NB-IoT cell shall be performed as specified in clause 4.2.1 in [3]. Two successive indications from Layer 1 shall be separated by at least 10ms.

The transmitter power of the UE shall be turned off within 40ms after expiry of T310 timer as specified in clause 5.3.11 in TS 36.331 [2]. The following table 7.23.2.1-1 defines the $T_{\text{Evaluate_}Q_{\text{out_NB-IoT}}}$ and $T_{\text{Evaluate_}Q_{\text{in_NB-IoT}}}$.

Table 7.23.2.1-1 Q_{out} and Q_{in} Evaluation Period in non-DRX for Category NB1 UE

Configured NPDCCH R_{\max}	$T_{\text{Evaluate_}Q_{\text{out_NB-IoT}}}$	$T_{\text{Evaluate_}Q_{\text{in_NB-IoT}}}$
$R_{\max} \leq 64$	400ms	200ms
$R_{\max} > 64$	4000ms	2000ms

7.23.2.2 Minimum requirement when DRX is used

When DRX is used for Category NB1 UE UEs, the $Q_{\text{out_NB-IoT}}$ evaluation period ($T_{\text{Evaluate_}Q_{\text{out_DRX_NB-IoT}}}$) and the $Q_{\text{in_NB-IoT}}$ evaluation period ($T_{\text{Evaluate_}Q_{\text{in_DRX_NB-IoT}}}$) is specified in Table 7.23.2.2-1 will be used.

When the downlink radio link quality of the NB-IoT cell estimated over the last $T_{\text{Evaluate_}Q_{\text{out_DRX_NB-IoT}}}$ [s] period becomes worse than the threshold $Q_{\text{out_NB-IoT}}$, Layer 1 of the UE shall send out-of-sync indication for the NB-IoT cell to the higher layers within $T_{\text{Evaluate_}Q_{\text{out_DRX_NB-IoT}}}$ [s] evaluation period. A Layer 3 filter shall be applied to the out-of-sync indications as specified in TS 36.331 [2].

When the downlink radio link quality of the NB-IoT cell estimated over the last $T_{\text{Evaluate_}Q_{\text{in_DRX_NB-IoT}}}$ [s] period becomes better than the threshold $Q_{\text{in_NB-IoT}}$, Layer 1 of the UE shall send in-sync indications for the NB-IoT cell to the higher layers within $T_{\text{Evaluate_}Q_{\text{in_DRX_NB-IoT}}}$ [s] evaluation period. A L3 filter shall be applied to the in-sync indications as specified in TS 36.331 [2].

The out-of-sync and in-sync evaluations of the NB-IoT cell shall be performed as specified in clause 4.2.1 in [3]. Two successive indications from Layer 1 shall be separated by at least $\max(10\text{ms}, \text{DRX_cycle_length})$.

Upon start of T310 timer as specified in clause 5.3.11 in TS 36.331 [2], the UE shall monitor the link for recovery using the evaluation period and Layer 1 indication interval corresponding to the non-DRX mode until the expiry or stop of T310 timer.

The transmitter power of the UE shall be turned off within 40 ms after expiry of T310 timer as specified in clause 5.3.11 in TS 36.331 [2].

Table 7.23.2.2-1: Q_{out} and Q_{in} Evaluation Period in DRX for Category NB1 UE

DRX cycle length (s)	$T_{\text{Evaluate_}Q_{\text{out_DRX_NB-IoT}}}$ and $T_{\text{Evaluate_}Q_{\text{in_DRX_NB-IoT}}}$ (s)
----------------------	--

	DRX cycles for $R_{\max} \leq 64$	DRX cycles for $R_{\max} > 64$
$0.256 < \text{DRX cycle} \leq 1.024$	Note 1 (20)	Note 1 (40)
$1.024 < \text{DRX cycle} \leq 3.072$	Note 1 (10)	Note 1 (20)
$4.096 < \text{DRX cycle} \leq 10.24$	Note 1 (5)	Note 1 (10)
NOTE 1: Evaluation period length in time depends on the length of the DRX cycle in use		

7.23.2.3 Minimum requirement at transitions

When the UE transitions between DRX and non-DRX or when DRX cycle periodicity changes, for a duration of time equal to the evaluation period corresponding to the second mode after the transition occurs, the UE shall use an evaluation period that is no less than the minimum of evaluation periods corresponding to the first mode and the second mode. Subsequent to this duration, the UE shall use an evaluation period corresponding to the second mode. This requirement shall be applied to both out-of-sync evaluation and in-sync evaluation of the NB-IoT cell.

7.24 UE transmit timing for Category M1

7.24.1 Introduction

The Category M1 UE shall have the capability to follow the frame timing change of the connected eNode B. The uplink frame transmission takes place $(N_{TA} + N_{TAoffset}) \times T_s$ before the reception of the first detected path (in time) of the corresponding downlink frame from the reference cell.

The UE shall use the serving cell as the reference cell for deriving the UE transmit timing. UE initial transmit timing accuracy, maximum amount of timing change in one adjustment, minimum and maximum adjustment rate are defined in the following requirements.

7.24.2 Requirements

The UE initial transmission timing error shall be less than or equal to $\pm T_e$ where the timing error limit value T_e is specified in Table 7.24.2-1. This requirement applies when it is the first transmission in a DRX cycle, eDRX_CONN cycle, or the first transmission in a repetition period ($R > 1$) for PUCCH, PUSCH, and SRS, or the first transmission after an uplink transmission gap in a repetition period ($R > 1$) for PUCCH or PUSCH, or it is the PRACH transmission. The reference point for the UE initial transmit timing control requirement shall be the downlink timing of the serving cell minus $(N_{TA_Ref} + N_{TAoffset}) \times T_s$. The downlink timing is defined as the time when the first detected path (in time) of the corresponding downlink frame is received from the serving cell. N_{TA_Ref} for PRACH is defined as 0. $(N_{TA_Ref} + N_{TAoffset})$ (in T_s units) for other channels is the difference between UE transmission timing and the Downlink timing immediately after when the last timing advance in clause 7.3 was applied. N_{TA_Ref} for other channels is not changed until the next timing advance is received.

Table 7.24.2-1: T_e Timing Error Limit

CE Mode	T_e
A	$24 \times T_s$
B	$48 \times T_s$
NOTE 1: T_s is the basic timing unit defined in TS 36.211. NOTE 2: This requirement applies regardless of the downlink carrier bandwidth.	

When it is not the first transmission in a DRX or eDRX_CONN cycle or there is no DRX or no eDRX_CONN cycle, and when it is the transmission for PUCCH, PUSCH and SRS transmission, the UE shall, when no repetitions are configured on the uplink or the repetition period is $R=1$, be capable of changing the transmission timing according to the received downlink frame of the serving cell except when the timing advance in clause 7.3 is applied such that the UE transmission timing error shall be less than or equal to $\pm T_e$ where the timing error limit value T_e is specified in Table 7.24.2-1.

When no repetition period is configured, or the configured repetition period is $R=1$, all adjustments made to the UE uplink timing shall follow these rules:

- 1) The maximum amount of the magnitude of the timing change in one adjustment shall be T_q seconds.
- 2) The minimum aggregate adjustment rate shall be $7 \cdot T_s$ per second.
- 3) The maximum aggregate adjustment rate shall be T_q per 200ms.

where the maximum autonomous time adjustment step T_q is specified in Table 7.24.2-2.

Table 7.24.2-2: T_q Maximum Autonomous Time Adjustment Step

CE Mode	T_q
A	$17.5 \cdot T_s$
B	$17.5 \cdot T_s$
NOTE 1: T_s is the basic timing unit defined in TS 36.211.	
NOTE 2: This requirement applies regardless of the downlink carrier bandwidth.	

When a repetition period is configured on the uplink for which $R > 1$, the UE shall not adjust the uplink transmission timing autonomously during an ongoing repetition period other than at initial transmission as defined above.

7.25 Cell phase synchronization accuracy for MBMS services (FDD)

7.25.1 Definition

Cell phase synchronization accuracy is defined as the maximum absolute deviation in frame start timing between any pair of cells that have overlapping coverage areas in the same MBSFN area.

7.25.2 Minimum requirements

For eNodeB capable of supporting MBMS services, the cell phase synchronization accuracy measured at BS antenna connectors shall be better than the requirement specified in table 7.25.2-1.

Table 7.25.2-1: Cell phase synchronization requirement for MBMS services (FDD)

CP length for MBSFN subframe	Requirement
16.67 μ s	$\leq 5 \mu$ s
33.33 μ s	$\leq 5 \mu$ s
200 μ s	$\leq 5 \mu$ s

Note 1: When MBSFN subframe using $\Delta f = 15$ kHz is configured for a MBSFN area, the CP length for MBSFN subframes is 16.67 μ s. When MBSFN subframe using $\Delta f = 7.5$ kHz is configured for a MBSFN area, the CP length for MBSFN subframes is 33.33 μ s. When MBSFN subframe using $\Delta f = 1.25$ kHz is configured for a MBSFN area, the CP length for MBSFN subframes is 200 μ s.

7.26 UE transmit timing for Category M2

7.26.1 Introduction

The Category M1 UE shall have the capability to follow the frame timing change of the connected eNode B. The uplink frame transmission takes place $(N_{TA} + N_{TA\text{offset}}) \times T_s$ before the reception of the first detected path (in time) of the corresponding downlink frame from the reference cell.

The UE shall use the serving cell as the reference cell for deriving the UE transmit timing. UE initial transmit timing accuracy, maximum amount of timing change in one adjustment, minimum and maximum adjustment rate are defined in the following requirements.

7.26.2 Requirements

The requirements defined in clause 7.24 also apply for this section with following change for the UE initial transmission timing error which shall be less than or equal to $\pm T_e$ where the timing error limit value T_e is specified in Table 7.26.2-1.

Table 7.26.2-1: T_e Timing Error Limit

CE Mode	Downlink Bandwidth (MHz)	T_e
A	1.4	$24 * T_s$
A	5	$12 * T_s$
B	1.4	$48 * T_s$
B	5	$40 * T_s$

NOTE 1: T_s is the basic timing unit defined in TS 36.211.
NOTE 2: This requirement applies regardless of the downlink carrier bandwidth.

7.27 UE timer accuracy for category M1

7.27.1 Introduction

UE timers are used in different protocol entities to control the UE behaviour.

7.27.2 Requirements

The requirements defined in clause 7.21.2 also apply for this section.

7.28 Timing Advance for Category M1

7.28.1 Introduction

The timing advance is initiated from E-UTRAN with MAC message that implies and adjustment of the timing advance, see TS 36.321 [17] clause 5.2.

7.28.2 Requirements

The requirements defined in clause 7.3.2 also apply for this section.

7.29 Interruptions requirements with FeMBMS

7.29.1 Introduction

The requirements in this section shall apply for the UE which is capable of receiving PMCH in MBSFN subframes using at least one of the following numerologies:

- subcarrier spacing of 7.5 kHz and the cyclic prefix length of 1024 T_s and
- subcarrier spacing of 1.25 kHz and the cyclic prefix length of 6144 T_s .

7.29.2 Requirements

When UE receives signals or channels in MBSFN subframes based on a numerology which is different than the numerology used in a preceding or succeeding downlink non-MBSFN subframe, the UE shall switch between the two numerologies without causing any interruption to the UE operations in the non-MBSFN subframes.

7.30 Numerology switching delay requirements with FeMBMS

7.30.1 Introduction

The requirements in this section shall apply for the UE which is capable of receiving PMCH in MBSFN subframes using at least one of the following numerologies:

- subcarrier spacing of 7.5 kHz and the cyclic prefix length of 1024 T_s and

- subcarrier spacing of 1.25 kHz and the cyclic prefix length of 6144 Ts.

7.30.2 Requirements

When UE receives MBSFN subframes with PMCH based on a numerology which is different than the numerology used in a preceding or succeeding downlink non-MBSFN subframe, the UE shall switch between the two numerologies without causing any delay to the UE operations in the non-MBSFN subframes.

7.31 NR PSCell Addition and Release Delay for E-UTRA - NR Dual Connectivity

7.31.1 Introduction

This section defines requirements for the delay within which the UE shall be able to configure an NR PSCell in EN-DC. The requirements are applicable to an E-UTRA-FDD – NR and E-UTRA-TDD – NR dual connectivity capable UE.

7.31.2 NR PSCell Addition Delay Requirement

The requirements in this section shall apply for the UE which is configured with PCell, and may also be configured with one or more SCells.

Upon receiving NR PSCell addition in subframe n , the UE shall be capable to transmit PRACH preamble towards NR PSCell no later than in subframe $n + T_{\text{config PSCell}}$:

Where:

$$T_{\text{config PSCell}} = T_{\text{RRC_delay}} + T_{\text{processing}} + T_{\text{search}} + T_{\Delta} + T_{\text{PSCell_DU}} + 2 \text{ ms}$$

$T_{\text{RRC_delay}}$ is the RRC procedure delay as specified in [2].

$T_{\text{processing}}$ is the SW processing time needed by UE, including RF warm up period. $T_{\text{processing}} = 20 \text{ ms}$ if NR PSCell is in FR1, $T_{\text{processing}} = 40 \text{ ms}$ if NR PSCell is in FR2.

T_{search} is the time for AGC settling and PSS/SSS detection.

- For NR PSCell in FR1: if the target cell is a known cell, $T_{\text{search}} = 0 \text{ ms}$. If the target cell is an unknown cell and the target cell $E_s/I_{\text{ot}} \geq -2 \text{ dB}$, then $T_{\text{search}} = 3 * T_{\text{rs}} \text{ ms}$;
- For NR PSCell in FR2: if the target cell is a known cell, $T_{\text{search}} = 0 \text{ ms}$. If the target cell is an unknown cell and the target cell $E_s/I_{\text{ot}} \geq -2 \text{ dB}$, then $T_{\text{search}} = 24 * T_{\text{rs}} \text{ ms}$.

T_{Δ} is time for fine time tracking and acquiring full timing information of the target cell. $T_{\Delta} = 1 * T_{\text{rs}} \text{ ms}$ for a known or unknown PSCell.

$T_{\text{PSCell_DU}}$ is the delay uncertainty in acquiring the first available PRACH occasion in the NR PSCell. $T_{\text{PSCell_DU}}$ is up to the summation of SSB to PRACH occasion association period and 10 ms. SSB to PRACH occasion associated period is defined in the table 8.1-1 of TS 38.213 [39].

T_{rs} is the SMTC periodicity of the target NR cell if the UE has been provided with an SMTC configuration for the target cell in PSCell addition message, otherwise T_{rs} is the SMTC configured in the measObjectNR having the same SSB frequency and subcarrier spacing. If the UE is not provided SMTC configuration or measurement object on this frequency, the requirement in this section is applied with $T_{\text{rs}} = 5 \text{ ms}$ assuming the SSB transmission periodicity is 5 ms. There is no requirement if the SSB transmission periodicity is not 5 ms.

In FR1 and FR2, the NR PSCell is known if it has been meeting the following conditions:

During the last 5 seconds before the reception of the NR PSCell configuration command:

- the UE has sent a valid measurement report for the NR PSCell being configured and
- One of the SSBs measured from the NR PSCell being configured remains detectable according to the cell identification conditions specified in section 9.3 of TS 38.133 [50],

- One of the SSBs measured from NR PSCell being configured also remains detectable during the NR PSCell configuration delay according to the cell identification conditions specified in section 9.3 of TS 38.133 [50].

otherwise it is unknown.

The PCell interruption specified in section 7.32 is allowed only during the RRC reconfiguration procedure [2].

7.31.3 NR PSCell Release Delay Requirement

The requirements in this section shall apply for a UE which is configured with PCell and NR PSCell, and may also be configured with one or more SCells and/or NR SCells.

Upon receiving NR PSCell release in subframe n , the UE shall accomplish the release actions specified in [2] no later than in subframe $n + T_{\text{RRC_delay}}$.

Where

$T_{\text{RRC_delay}}$ is the RRC procedure delay as specified in [2].

The PCell interruption specified in section 7.32 is allowed only during the RRC reconfiguration procedure [2].

7.32 Interruptions with EN-DC

7.32.1 Introduction

This section contains the requirements related to the interruptions on PCell, and MCG SCell when

- NR PSCell is added or released, or
- transitions between active and non-active during NR PSCell DRX, or
- transitions from NR PSCell non-DRX to DRX, or
- SCell in either E-UTRA MCG or NR SCG is added or released, or
- SCell in either E-UTRA MCG or NR SCG is activated or deactivated, or
- measurements on SCC with deactivated SCell in either E-UTRA MCG or NR SCG, or
- a downlink bandwidth part (BWP) and/or an uplink BWP is switched in NR PSCell or in any NR SCell.

The requirements shall apply for EN-DC.

This section contains interruption requirements when the victim cell is PCell or SCell belonging to MCG. Requirements for interruptions where victim cell is the NR PSCell or an NR SCell belonging to SCG are specified in [50].

For a UE which does not support per-FR measurement gaps, interruptions to the PCell or active MCG SCells may be caused by NR PSCell or NR SCells on any frequency range. For UE which support per-FR gaps, interruptions to the PCell or active MCG SCells may be caused by NR PSCell or NR SCells on FR1 only.

7.32.2 Requirements

7.32.2.1 Interruptions at PSCell addition/release

The UE is allowed an interruption of up to $X1$ subframes (synchronous EN-DC) or $X1+1$ subframes (asynchronous EN-DC) on PCell and activated SCells in MCG if configured during the RRC reconfiguration procedure in intraband EN-DC. This interruption is for both uplink and downlink of PCell. For PSCell addition $X1$ is equal to the duration of the SMTTC of the PSCell being added + 1 ms. For PSCell release $X1$ is equal to 1ms. The interruption is based on assumption that the cell specific reference signals from both cells are available in the same slot.

The UE is allowed an interruption of up to 1 subframe (synchronous EN-DC) or 2 subframes (asynchronous EN-DC) on PCell and activated SCells in MCG if configured during the RRC reconfiguration procedure in interband EN-DC. This interruption is for both uplink and downlink of PCell.

7.32.2.2 Interruptions at transitions between active and non-active during DRX

When PCell is in non-DRX and NR PSCell is in DRX, interruptions on PCell and the activated MCG SCells if configured due to transitions from active to non-active and from non-active to active during NR PSCell DRX are allowed with up to 1 % probability of missed ACK/NACK when the configured NR PSCell DRX cycle is less than 640ms, and 0.625% probability of missed ACK/NACK is allowed when the configured NR PSCell DRX cycle is 640ms or longer. Each interruption shall not exceed 2 subframes for asynchronous EN-DC or 1 subframe for synchronised EN-DC.

When both PCell and NR PSCell are in DRX, no interruption is allowed.

7.32.2.3 Interruptions at transitions from non-DRX to DRX

Interruption on PCell and the activated SCell in MCG if configured due to NR PSCell transitions from non-DRX to DRX when PCell is in non-DRX shall not exceed 5 subframes for asynchronous EN-DC or 1 subframe for synchronised EN-DC.

7.32.2.4 Interruptions at SCell addition/release

When one SCell belonging to MCG is added or released:

- the requirements in clause 7.8.2.7 shall apply.

When one NR SCell belonging to SCG is added or released:

- an interruption on PCell or activated SCell in MCG shall not exceed X1 subframes for synchronous intraband EN-DC, X1+1 subframes for asynchronous intraband EN-DC, 1 subframe for synchronous interband EN-DC or 2 subframes for asynchronous interband EN-DC. For SCell addition X1 is equal to the duration of the SMTC of the SCell being added + 1 ms. If SSB configuration (*absoluteFrequencySSB*) but no SMTC configuration is provided for the SCell being added, the SSB transmission periodicity is assumed to be 5ms and $T_{SMTC\ duration}$ for the SCell being added is x ms, where x = the number of consecutive subframes containing all SSBs in one SSB burst transmitted by the SCell being added. If no SSB configuration (*absoluteFrequencySSB*) nor SMTC configuration is provided for the SCell being added, $T_{SMTC\ duration}$ for the SCell being added is 0ms.
- The interruption is based on assumption that the cell specific reference signals from both cells are available in the same slot. For SCell release X1 is equal to 1ms.

7.32.2.5 Interruptions at SCell activation/deactivation

When one SCell belonging to MCG is activated or deactivated:

- the requirements in clause 7.8.2.8 shall apply.

When one NR SCell belonging to SCG is activated or deactivated

- an interruption on PCell or activated SCell in MCG shall not exceed X1 subframes for synchronous intraband EN-DC, X1+1 subframes for asynchronous intraband EN-DC, 1 subframe for synchronous interband EN-DC or 2 subframes for asynchronous interband EN-DC. For SCell activation X1 is equal to the duration of the SMTC of the SCell being activated + 1 ms. If SSB configuration (*absoluteFrequencySSB*) but no SMTC configuration is provided for the SCell being activated, the SSB transmission periodicity is assumed to be 5ms and $T_{SMTC\ duration}$ for the SCell being activated is x ms, where x = the number of consecutive subframes containing all SSBs in one SSB burst transmitted by the SCell being activated. If no SSB configuration (*absoluteFrequencySSB*) nor SMTC configuration is provided for the SCell being activated, $T_{SMTC\ duration}$ for the SCell being activated is 0ms.
- The interruption is based on assumption that the cell specific reference signals from both cells are available in the same slot. For SCell deactivation X1 is equal to 1ms.

7.32.2.6 Interruptions during measurements on SCC

7.32.2.6.1 Interruptions during measurements on deactivated NR SCC

PCell or activated SCell(s) interruptions due to measurements when an NR SCell is deactivated are allowed with up to 0.5% probability of missed ACK/NACK when the configured *measCycleSCell* [2] is 640 ms or longer.

- For inter-band EN-DC, the UE is only allowed to cause interruptions immediately before and immediately after an SMTC. Each interruption shall not exceed 1 subframe for synchronous inter-band EN-DC or 2 subframes for asynchronous inter-band EN-DC.
- For synchronous intra-band EN-DC, the UE is only allowed to cause an interruption no earlier than 1 subframe before an SMTC and no later than 1 subframe after the SMTC. The interruption shall not exceed the duration of the SMTC of the deactivated NR SCell + 2 subframes. The interruption is based on assumption that the cell specific reference signals from both cells are available in the same slot.

7.32.2.6.2 Interruptions during measurements on deactivated E-UTRA SCC

PCell interruptions due to measurements when an SCell is deactivated are allowed with up to 0.5% probability of missed ACK/NACK when the configured *measCycleSCell* [2] is 640 ms or longer. Each interruption shall not exceed:

- 1 subframes if the PCell is not in the same band as the deactivated SCell
- 5 subframes if the PCell is in the same band as the deactivated SCell

SCell interruptions due to measurements when an SCell is deactivated are allowed with up to 0.5% probability of missed ACK/NACK when the configured *measCycleSCell* [2] is 640 ms or longer. Each interruption shall not exceed:

- 1 subframes if the SCell is not in the same band as the deactivated SCell
- 5 subframes if the SCell is in the same band as the deactivated SCell

7.32.2.7 Interruptions at active BWP switching

The requirements in this clause shall apply for the UE configured with only NR PSCell or with NR PSCell and one or more NR SCells. The requirements in the section only apply to the case that the BWP switch is performed on a single CC.

DCI-based or timer-based downlink BWP and/or uplink BWP switching due to change in any of the parameters listed in Table 8.2.1.2.7-2 of TS 38.133 [50] or SCS in NR PSCell or in any NR SCell may cause an interruption on PCell or on activated SCell(s) in the MCG. Interruptions are not allowed during BWP switch involving other parameter change.

The starting time of interruption due to DCI-based or timer-based downlink BWP and/or uplink BWP switching is only allowed within the BWP switching delay $T_{\text{BWPswitchDelay}}$ as defined in clause 8.6.2 of TS 38.133 [50].

RRC-based downlink BWP and/or uplink BWP switching due to change in any of the parameters listed in Table 8.2.1.2.7-2 of TS 38.133 [50] or SCS in NR PSCell or in any NR SCell may cause an interruption on PCell or on activated SCell(s) in the MCG. Interruptions are not allowed during BWP switch involving other parameter change.

The interruption due to RRC-based downlink BWP and/or uplink BWP switching is allowed anywhere within the BWP switching delay ($T_{\text{RRCprocessingDelay}} + T_{\text{BWPswitchDelayRRC}}$) defined in clause 8.6.3 of TS 38.133 [50]. The interruption due to RRC-based downlink BWP and/or uplink BWP switching defined in this clause is applicable provided that:

- the RRC reconfiguration requires the UE to only switch its active BWP and
- the BWP switching occurs on only one NR serving cell.

When BWP switch involves SCS changes,

the UE is allowed to cause interruption on PCell or on any activated SCell(s) regardless of the frequency range of the NR PCell or NR SCell on which the BWP switching occurs.

Otherwise,

the UE capable of per UE measurement gap [2] is allowed to cause interruption on PCell or on any activated SCell(s) regardless of the frequency range of the NR PSCell or NR SCell on which the BWP switching occurs;

the UE capable of per FR measurement gap [2] is allowed to cause interruption on PCell or on any activated SCell(s) provided that the NR PSCell or NR SCell on which the BWP switching occurs belongs to FR1.

The interruption on PCell or on any activated SCell(s) shall not exceed:

- 1 subframe in synchronous EN-DC,
- 2 subframes in asynchronous EN-DC.

7.33 Maximum Transmit/Receive Timing Difference in Carrier Aggregation for sTTI and 1ms-TTI with 3 subframe HARQ processing

7.33.1 Introduction

This section defines the requirements for the transmit and receive timing difference in carrier aggregation when *ShortTTI-r15* is configured or *ShortProcessingTime=TRUE*. Requirements in this section apply to a UE capable of any sTTI combination indicated in *sTTI-SupportedCombinations-r15* and/or *frameStructureType-SPT* when the UE is configured with one or more serving cell(s) where *ShortTTI-r15* is configured and/or *ShortProcessingTime=TRUE*.

7.33.2 Requirements

A UE configured with the inter-band carrier aggregation shall meet the maximum received timing difference requirement and the maximum transmit timing difference requirement in the subclause 7.9.2, provided that the conditions defined in the subclause B.7.1 are fulfilled.

For a UE not configured with sTAG, the UE is not expected to handle the combination of the received timing difference(s) between any pair of the serving cells and the timing advance in pTAG if the conditions defined in the subclause B.7.1 cannot be fulfilled under such combination.

For a UE configured with sTAG, the UE is not expected to handle the combination of the received timing difference(s) between any pair of the serving cells, the transmit timing difference between pTAG and sTAG, and the timing advances in pTAG and sTAG if the conditions defined in the subclause B.7.1 cannot be fulfilled under such combination.

7.34 Void

7.35 Interruptions with SFTD measurements

7.35.1 Introduction

This section contains the requirements for UE supporting E-UTRAN FDD – NR dual connectivity related to the interruptions on PCell and activated SCells in MCG if configured, when performing inter-RAT SFTD measurements on NR cells without measurement gaps when no NR PSCell is configured. The inter-RAT SFTD measurement can only be configured for E-UTRA - NR band combinations that are supported by the UE.

7.35.2 Requirements

The UE is allowed an interruption of up to 10 subframes on PCell and activated SCells if configured during $T_{\text{measure_SFTD1}}$ as specified in 8.1.2.4.25 due to intraband SFTD measurements on NR cells. This interruption is for both uplink and downlink of PCell and activated SCells if configured.

The UE is allowed an interruption on PCell and activated SCells if configured during $T_{\text{measure_SFTD1}}$ as specified in 8.1.2.4.25 due to interband SFTD measurements on NR cells with maximum percentage of interrupted subframes on uplink and downlink as specified in Table 7.35.2-1.

Each interruption shall not exceed 1 subframe.

Table 7.35.2-1: Requirements on maximum percentage of interrupted subframes

SFTD configuration	SMTC periodicity					
	5 ms	10 ms	20 ms	40 ms	80 ms	160 ms
With RSRP report	8.4%	6.3%	8.4%	6.3%	5.3%	4.7%
Without RSRP report	11.4%	8.6%	7.8%	6.8%	6.3%	6.0%

7.36 Interruptions with NE-DC

7.32.1 Introduction

This clause contains the requirements related to the interruptions on PSCell and SCG SCells when

- transitions between active and non-active during NR PCell DRX, or
- transitions from NR PCell non-DRX to DRX, or
- SCell in either NR MCG or E-UTRA SCG is added or released, or
- SCell in either NR MCG or E-UTRA SCG is activated or deactivated, or
- measurements on SCC with deactivated SCell in either NR MCG or E-UTRA SCG, or
- a downlink bandwidth part (BWP) and/or an uplink BWP is switched in NR PCell or in any NR SCell.

The requirements shall apply for NE-DC.

This clause contains interruption requirements when the victim cell is PSCell or SCell belonging to SCG. Requirements for interruptions where victim cell is the NR PCell or an NR SCell belonging to MCG are specified in TS 38.133 [50].

For a UE which does not support per-FR measurement gaps, interruptions to the PSCell or active SCG SCells may be caused by NR PCell or NR SCells on any frequency range. For UE which support per-FR gaps, interruptions to the PSCell or active SCG SCells may be caused by NR PCell or NR SCells on FR1 only.

7.36.2 Requirements

7.36.2.1 Interruptions at transitions between active and non-active during DRX

When PSCell is in non-DRX and NR PCell is in DRX, interruptions on PSCell and the activated SCG SCells if configured due to transitions from active to non-active and from non-active to active during NR PCell DRX are allowed with up to 1 % probability of missed ACK/NACK when the configured NR PCell DRX cycle is less than 640 ms, and 0.625 % probability of missed ACK/NACK is allowed when the configured NR PCell DRX cycle is 640 ms or longer. Each interruption shall not exceed 2 subframes for asynchronous NE-DC or 1 subframe for synchronised NE-DC.

When both PSCell and NR PCell are in DRX, no interruption is allowed.

7.36.2.2 Interruptions at transitions from non-DRX to DRX

Interruption on PSCell and the activated SCell in SCG if configured due to NR PCell transitions from non-DRX to DRX when PSCell is in non-DRX shall not exceed 5 subframes for asynchronous NE-DC or 1 subframe for synchronised NE-DC.

7.36.2.3 Interruptions at SCell addition/release

When one SCell belonging to SCG is added or released:

- the requirements in clause 7.8.2.7 shall apply.

When one NR SCell belonging to MCG is added or released:

- an interruption on PSCell or activated SCell in SCG shall not exceed $X1$ subframes for synchronous intraband NE-DC, $X1+1$ subframes for asynchronous intraband NE-DC, 1 subframe for synchronous interband NE-DC or 2 subframes for asynchronous interband NE-DC. For SCell addition $X1$ is equal to the duration of the SMTC of the SCell being added + 1 ms. If SSB configuration (*absoluteFrequencySSB*) but no SMTC configuration is provided for the SCell being added, the SSB transmission periodicity is assumed to be 5ms and $T_{SMTC\ duration}$ for the SCell being added is x ms, where x = the number of consecutive subframes containing all SSBs in one SSB burst transmitted by the SCell being added. If no SSB configuration (*absoluteFrequencySSB*) nor SMTC configuration is provided for the SCell being added, $T_{SMTC\ duration}$ for the SCell being added is 0ms.
- The interruption is based on assumption that the cell specific reference signals from both cells are available in the same slot. For SCell release $X1$ is equal to 1 ms.

7.36.2.4 Interruptions at SCell activation/deactivation

When one SCell belonging to SCG is activated or deactivated:

- the requirements in clause 7.8.2.8 shall apply.

When one NR SCell belonging to MCG is activated or deactivated

- an interruption on PSCell or activated SCell in SCG shall not exceed $X1$ subframes for synchronous intraband NE-DC, $X1+1$ subframes for asynchronous intraband NE-DC, 1 subframe for synchronous interband NE-DC or 2 subframes for asynchronous interband NE-DC. For SCell activation $X1$ is equal to the duration of the SMTC of the NR SCell being activated + 1 ms. If SSB configuration (*absoluteFrequencySSB*) but no SMTC configuration is provided for the SCell being activated, the SSB transmission periodicity is assumed to be 5ms and $T_{SMTC\ duration}$ for the SCell being activated is x ms, where x = the number of consecutive subframes containing all SSBs in one SSB burst transmitted by the SCell being activated. If no SSB configuration (*absoluteFrequencySSB*) nor SMTC configuration is provided for the SCell being activated, $T_{SMTC\ duration}$ for the SCell being activated is 0ms.
- The interruption is based on assumption that the cell specific reference signals from both cells are available in the same slot. For SCell deactivation $X1$ is equal to 1 ms.

7.36.2.5 Interruptions during measurements on SCC

7.36.2.5.1 Interruptions during measurements on deactivated NR SCC

Interruption on PSCell or other activated SCell(s) during measurement on the deactivated NR SCC shall meet requirements in clause 7.32.2.6.1, where the term PCell and EN-DC in clause 8.2.2.2.3 shall be deemed to be replaced with PSCell and NE-DC, respectively.

7.36.2.5.2 Interruptions during measurements on deactivated E-UTRA SCC

PSCell interruptions due to measurements when an SCell is deactivated are allowed with up to 0.5% probability of missed ACK/NACK when the configured *measCycleSCell* [2] is 640 ms or longer. Each interruption shall not exceed:

- 1 subframes if the PSCell is not in the same band as the deactivated SCell
- 5 subframes if the PSCell is in the same band as the deactivated SCell

SCell interruptions due to measurements when an SCell is deactivated are allowed with up to 0.5% probability of missed ACK/NACK when the configured *measCycleSCell* [2] is 640 ms or longer. Each interruption shall not exceed:

- 1 subframes if the SCell is not in the same band as the deactivated SCell
- 5 subframes if the SCell is in the same band as the deactivated SCell

7.36.2.6 Interruptions at active BWP switching

The requirements in this clause shall apply for the UE configured with LTE PSCell only or with LTE PSCell and one or more LTE SCells. The requirements in this section only apply to the case that the BWP switch is performed on a single CC.

DCI-based or timer-based downlink BWP and/or uplink BWP switching due to change in any of the parameters listed in Table 8.2.2.2.5-2 in TS 38.133 [50] or SCS on NR PCell or on any NR SCell may cause an interruption on PSCell or on activated SCell(s) in the SCG. Interruptions are not allowed during BWP switch involving other parameter change.

The starting time of interruption due to DCI-based or timer-based downlink BWP and/or uplink BWP switching is only allowed within the BWP switching delay $T_{BWPswitchDelay}$ as defined in clause 8.6.2 of TS 38.133 [50].

RRC-based downlink BWP and/or uplink BWP switching due to change in any of the parameters listed in Table 8.2.1.2.7-2 of TS 38.133 [50] or SCS in NR PSCell or in any NR SCell may cause an interruption on PCell or on activated SCell(s) in the MCG. Interruptions are not allowed during BWP switch involving other parameter change.

The interruption due to RRC-based downlink BWP and/or uplink BWP switching is allowed anywhere within the BWP switching delay ($T_{RRCprocessingDelay} + T_{BWPswitchDelayRRC}$) defined in clause 8.6.3 of TS 38.133 [50]. The interruption due to RRC-based downlink BWP and/or uplink BWP switching defined in this clause is applicable provided that:

- the RRC reconfiguration requires the UE to only switch its active BWP and
- the BWP switching occurs on only one NR serving cell.

Table 7.36.2.6-1: Void

When BWP switch involves SCS changes,

the UE is allowed to cause interruption on PCell or on any activated SCell(s) regardless of the frequency range of the NR PCell or NR SCell on which the BWP switching occurs.

Otherwise,

the UE capable of per UE measurement gap [2] is allowed to cause interruption on PCell or on any activated SCell(s) regardless of the frequency range of the NR PCell or NR SCell on which the BWP switching occurs;

the UE capable of per FR measurement gap [2] is allowed to cause interruption on PCell or on any activated SCell(s) provided that the NR PCell or NR SCell on which the BWP switching occurs belongs to FR1.

The interruption on PCell or on any activated SCell(s) shall not exceed:

- 1 subframe in synchronous NE-DC,
- 2 subframes in asynchronous NE-DC.

8 UE Measurements Procedures in RRC_CONNECTED State

8.1 General Measurement Requirements

8.1.1 Introduction

This clause contains requirements on the UE regarding measurement reporting in RRC_CONNECTED state. The requirements are split in E-UTRA intra frequency, E-UTRA inter frequency, Inter-RAT UTRA FDD, UTRA TDD and GSM measurements. These measurements may be used by the E-UTRAN, e.g. for handover decisions. The measurement quantities are defined in [4], the measurement model is defined in [22] and measurement accuracies are specified in clause 9. Control of measurement reporting is specified in TS 36.331 [2].

When the UE is provided with IDC solution, the UE shall also perform RRM measurements and meet the corresponding requirements in clause 8.

In the requirements of Section 8.1 for the UE capable of CA and the UE configured with up to six SCells, the applicable exceptions for side conditions are specified in Annex B, Sections B.4.2 and B.4.3, respectively.

In the requirements of Section 8.1 for the UE capable of DC and the UE configured with one PCell, the applicable exceptions for side conditions are specified in Annex B, Sections B.4.2 and B.4.3, respectively.

The requirements in Section 9 are applicable for a UE performing measurements according to Section 8.1.

8.1.2 Requirements

8.1.2.1 UE measurement capability

If the UE requires measurement gaps to identify and measure inter-frequency and/or inter-RAT cells and the UE does not support `perServingCellMeasurementGap-r14` or is not configured with per serving cell measurement gaps, in order for the requirements in the following subsections to apply the E-UTRAN must provide a single measurement gap pattern with constant gap duration for concurrent monitoring of all frequency layers and RATs. If the UE requires measurement gaps to identify and measure inter-frequency and/or inter-RAT cells and the UE supports `perServingCellMeasurementGap-r14` and is configured with per serving cell measurement gaps, in order for the requirements in the following subsections to apply the E-UTRAN must provide gap pattern(s) on at least each serving component carrier (per-CC) where the UE has indicated in the `perCC-ListGapIndication` IE that gaps are required. No

gap pattern is required to be provided on the serving component carrier where UE has indicated in the the *perCC-ListGapIndication* IE that gaps are not required. The requirements apply if the gap on each serving cell is at least that which the UE has indicated with *gapIndication* in the *perCC-ListGapIndication* IE, and if the *gapOffset*, *MGRP* and *MGL* are the same for each serving component carrier. During the measurement gaps the UE:

During the measurement gaps the UE:

- shall not transmit any data
- is not expected to tune its receiver on any of the E-UTRAN carrier frequencies of PCell and any SCell.
- is not expected to tune its receiver on any of the E-UTRAN carrier frequencies of PCell, PSCell, and SCell.

If the UE supporting dual connectivity is configured with PSCell, during the total interruption time as shown in Figure 8.1.2.1-1, the UE shall not transmit and receive any data in SCG.

In addition, for UE supporting E-UTRA-NR dual connectivity, if MG timing advance of 0.5ms is applied, the UE:

- shall not transmit any data
- is not expected to tune its receiver on any of the E-UTRAN carrier frequencies of PCell and any SCell.
- is not expected to tune its receiver on any of the E-UTRAN carrier frequencies of PCell, PSCell, and SCell.

in subframes fully or partially overlapping with the measurement gaps on E-UTRAN serving cells. The total interruption time on E-UTRAN serving cells is $(MGL+1)$ subframes.

When MG timing advance of 0.5 ms is not applied, in the uplink subframe occurring immediately after the measurement gap,

- if the following conditions are met then it is up to UE implementation whether or not the UE can transmit data:
 - all the serving cells belong to E-UTRAN TDD;
 - the measurement objects do not include any NR carrier frequency;
 - if the subframe occurring immediately before the measurement gap is an uplink subframe.
- Otherwise the UE shall not transmit any data.

When MG timing advance of 0.5 ms is applied, in the uplink subframe occurring immediately after the subframe partially overlapped with measurement gap,

- it is up to UE implementation whether or not the UE can transmit data

In determining the above UE behaviour in the uplink subframe occurring immediately after the measurement gap or after the subframe partially overlapped with measurement gap, the UE shall treat a special subframe as an uplink subframe if the special subframe occurs immediately before the measurement gap.

Inter-frequency and inter-RAT measurement requirements within this clause rely on the UE being configured with one measurement gap pattern unless the UE has signaled that it is capable according to the capability *interFreqNeedForGaps* or *interRATNeedForGaps* of conducting such measurements without gaps and without interruption. UEs shall only support those measurement gap patterns listed in Table 8.1.2.1-1 and table 8.1.2.1.-2 that are relevant to its measurement capabilities. UEs supporting network controlled small gap and which have signaled that they are capable of measurements without gap but requiring NCSG, can be configured with a network controlled small gap pattern in table 8.1.2.1.3-1 on all component carrier(s) to perform inter-frequency and inter-RAT measurement.

ProSe capable UE is allowed to perform ProSe transmissions during the measurement gaps that are not used for measurements if the requirements specified in section 8 for inter-frequency and inter-RAT measurements are fulfilled.

In E-UTRA-NR dual connectivity mode, NR - E-UTRA dual connectivity mode and E-UTRA standalone mode, all gap patterns #0~11 in Table 8.1.2.1-1 can be configured for measurements of NR carriers only, and gap pattern #0, 1, 2, 3, 4, 6, 7, 8, 10 can be configured for measurements of E-UTRA carriers with the applicability as specified in Table 8.1.2.1-1.

Table 8.1.2.1-1: Gap Pattern Configurations supported by the UE

Gap Pattern Id	Measurement Gap Length (MGL, ms)	Measurement Gap Repetition Period (MGRP, ms)	Minimum available time for inter-frequency and inter-RAT measurements during 480ms period (T_{inter1} , ms)	Measurement Purpose
0	6	40	60	Inter-Frequency E-UTRAN FDD and TDD, UTRAN FDD, GERAN, LCR TDD, HRPD, CDMA2000 1x, inter-RAT NR
1	6	80	30	Inter-Frequency E-UTRAN FDD and TDD, UTRAN FDD, GERAN, LCR TDD, HRPD, CDMA2000 1x, inter-RAT NR
2	3	40	24 ^{NOTE 1,2}	Inter-Frequency E-UTRAN FDD and TDD for cells with time difference as specified below. inter-RAT NR
3	3	80	12 ^{NOTE 1,2}	Inter-Frequency E-UTRAN FDD and TDD for cells with time difference according as specified below. inter-RAT NR
4	6	20	120 ^{Note 1}	inter-RAT NR, Inter-Frequency E-UTRAN FDD and TDD ^{Note 6}
5	6	160	Note 3	inter-RAT NR
6	4	20	72 ^{Note 1, 5, 7}	inter-RAT NR, Inter-Frequency E-UTRAN FDD and TDD ^{Note 6}
7	4	40	36 ^{Note 1, 5, 8}	inter-RAT NR, Inter-Frequency E-UTRAN FDD and TDD ^{Note 6}
8	4	80	18 ^{Note 1, 5, 9}	inter-RAT NR, Inter-Frequency E-UTRAN FDD and TDD ^{Note 6}
9	4	160	Note 3	inter-RAT NR
10	3	20	48 ^{Note 1, 5}	inter-RAT NR, Inter-Frequency E-UTRAN FDD and TDD ^{Note 6}
11	3	160	Note 3	inter-RAT NR

NOTE 1: When determining UE requirements using T_{inter1} for GP2, 3, 4, 6, 7, 8, 10, $T_{inter1} = 60$ for GP2, GP4, GP6, GP7, GP10 and $T_{inter1} = 30$ for GP3 and GP8 shall be used.

NOTE 2: Void.

NOTE 3: This gap pattern can be used only for measurement of NR carriers, and T_{inter} is not applicable.

NOTE 4: Void

NOTE 5: Void.

NOTE 6: This gap pattern is supported by UEs which are configured to perform both E-UTRA inter-frequency measurement and inter-RAT NR measurement or supported by UEs configured to perform inter-RAT NR measurement only.

NOTE 7: When this gap pattern is used, the T_{inter} for E-UTRA interfrequency measurements is 48ms corresponding to the first 3ms of the 4ms gap

NOTE 8: When this gap pattern is used, the T_{inter} for E-UTRA interfrequency measurements is 24ms corresponding to the first 3ms of the 4ms gap

NOTE 9: When this gap pattern is used, the T_{inter} for E-UTRA interfrequency measurements is 12ms corresponding to the first 3ms of the 4ms gap

Table 8.1.2.1-2: Gap Pattern Configurations for UE supporting low density burst gap patterns

Gap Pattern Id	Measurement Gap Length (MGL, ms)	Measurement Gap Repetition Period (MGRP, ms)	Number of gaps per burst	Burst repetition period T_{burst}	Measurement Purpose
nonUniform1	6	40	13	1.28s	Inter-Frequency E-UTRAN FDD and TDD
nonUniform2	6	40	13	2.56s	Inter-Frequency E-UTRAN FDD and TDD
nonUniform3	6	40	13	5.12s	Inter-Frequency E-UTRAN FDD and TDD
nonUniform4	6	40	13	10.24s	Inter-Frequency E-UTRAN FDD and TDD
NOTE 1: When determining UE requirements nonUniform1, nonUniform2, nonUniform3 or nonUniform4, 60ms shall be assumed as the minimum available time for inter-frequency and inter-RAT measurements during each burst..					
NOTE 2: The Gap patterns nonUniform1, nonUniform2, nonUniform3 and nonUniform4 cannot be combined with IncMon reduced performance group					

NOTE 1: When inter-frequency RSTD measurements are configured and the UE requires measurement gaps for performing such measurements, only Gap Pattern 0 can be used. For defining the inter-frequency and inter-RAT requirements $T_{inter1}=30ms$ shall be assumed.

NOTE 2: A measurement gap starts at the end of the latest subframe occurring immediately before the measurement gap among MCG serving cells subframes. If the measurement objects include at least one NR carrier frequency, the measurement gap starts at time T_{MG} ms if configured advanced to the end of the latest DL E-UTRA subframe occurring immediately before the configured measurement gap among MCG serving cells.

NOTE 2a: In EN-DC mode, the measurement gap starts at time T_{MG} ms if configured advanced to the end of the latest E-UTRA DL subframe occurring immediately before the configured measurement gap among MCG serving cells subframes.

NOTE 2b: In NE-DC mode,

- if per-UE measurement gap is configured with MG timing advance of T_{MG} ms, the measurement gap starts at time T_{MG} ms advanced to the end of the latest NR DL subframe occurring immediately before the configured measurement gap among MCG serving cells subframes.
- if per-FR measurement gap for FR1 is configured with MG timing advance of T_{MG} ms and UE has NR serving cell in FR1, the measurement gap for FR1 starts at time T_{MG} ms advanced to the end of the latest NR DL subframe occurring immediately before the configured measurement gap among MCG serving cells subframes in FR1.
- if per-FR measurement gap for FR1 is configured with MG timing advance of T_{MG} ms and UE doesn't have NR serving cell in FR1, the measurement gap for FR1 starts at time T_{MG} ms advanced to the end of the latest DL E-UTRA subframe occurring immediately before the configured measurement gap among SCG serving cells subframes.

T_{MG} is the MG timing advance value provided in mgta according to TS 36.331 [2].

NOTE 3: MGL is the time from start of tuning to end of retuning, which is aligned between MCG and SCG.

NOTE 4: For GP0 and GP1 The total interruption time on SCG is 6 subframes for synchronous dual connectivity, and the total interruption time on SCG is 7 subframes for asynchronous dual connectivity. As shown in Figure 8.1.2.1-1, MCG subframes from $i+1$ to $i+6$ are included in total interruption time together with SCG subframes from $j+1$ to $j+6$ for synchronous dual connectivity and $j+1$ to $j+7$ for asynchronous dual connectivity.

NOTE 5: For GP0 and GP1 and asynchronous dual connectivity as shown in Figure 8.1.2.1-1 (b), subframe j is regarded as the subframe occurring immediately before the measurement gap for SCG, similarly, subframe $j+8$ is regarded as the subframe occurring immediately after the measurement gap for SCG.

- NOTE 6: For GP2 and GP3 the total interruption time on SCG is 3 subframes for synchronous dual connectivity, and the total interruption time on SCG is 4 subframes for asynchronous dual connectivity. The total interrupt is applied in same spirit as shown in Figure 8.1.2.1-1. I.e. For MCG subframes from $i+1$ to $i+3$ are included in total interruption time together with SCG subframes from $j+1$ to $j+3$ for synchronous dual connectivity and $j+1$ to $j+4$ for asynchronous dual connectivity.
- NOTE 7: For GP2 and GP3 and asynchronous dual connectivity as shown in Figure 8.1.2.1-1 (b) with measurement gap length 3, subframe j is regarded as the subframe occurring immediately before the measurement gap for SCG, similarly, subframe $j+5$ is regarded as the subframe occurring immediately after the measurement gap for SCG.
- NOTE 8: nonUniform1 – nonUniform4 gap patterns are shown in figure 8.1.2.1-2. A burst repetition period T_{burst} is consisted of T1 and T2. During T1, UE performs measurement during the gap. During T2, UE suspends measurement gap. Both UE and eNB can assume there is no gap during T2. T1 equals to number of gaps per burst in Table 8.1.2.1-2. T_{burst} is configured by the higher layers. For nonUniform1 – nonUniform4 the total interruption time on SCG is same as for GP0 and GP1 for both synchronous and asynchronous dual connectivity as shown in Figure 8.1.2.1-1. For asynchronous dual connectivity as shown in Figure 8.1.2.1-1 (b), subframe j is regarded as the subframe occurring immediately before the measurement gap for SCG, similarly, subframe $j+8$ is regarded as the subframe occurring immediately after the measurement gap for SCG.
- NOTE 9: When UE is in NE-DC, the total interruption time on SCG is MGL subframes for synchronous NE-DC, and the total interruption time on SCG is (MGL+1) subframes for asynchronous NE-DC. Subframe occurring immediately before the measurement gap for SCG is the latest subframe in SCG which is before and fully non-overlapped with the measurement gap, similarly, subframe occurring immediately after the measurement gap for SCG is the earliest subframe in SCG which is after and fully non-overlapped with the measurement gap.

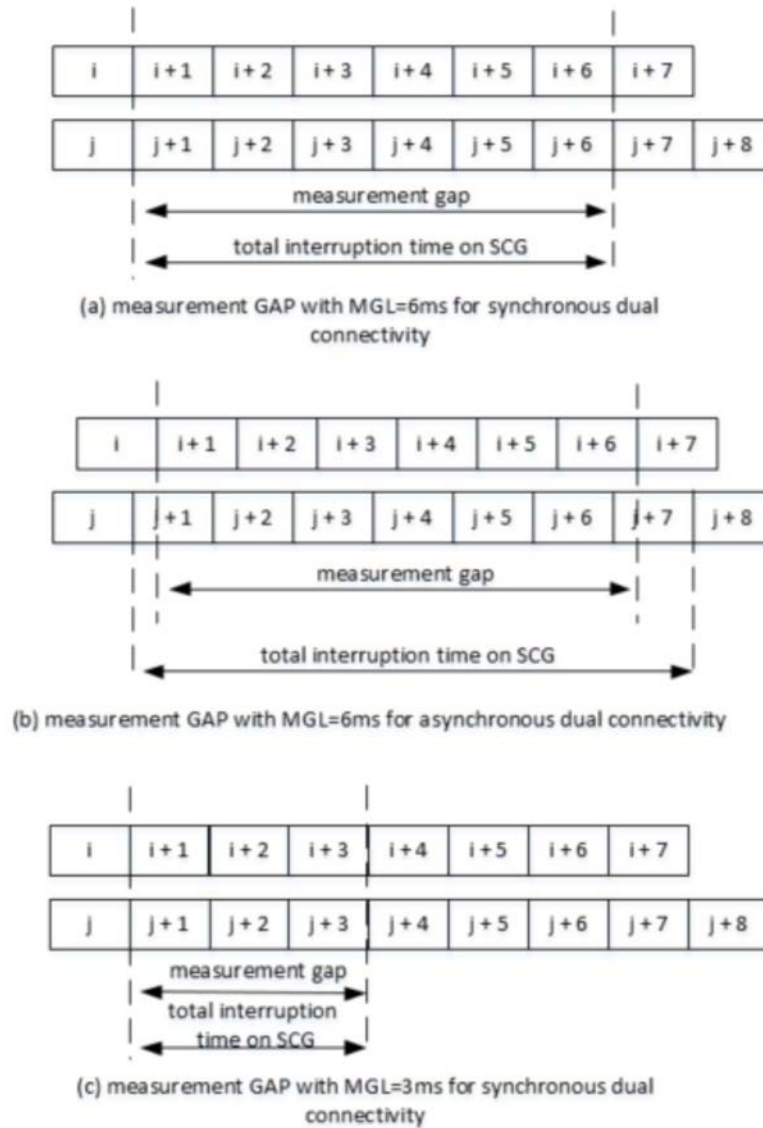

Figure 8.1.2.1-1: Measurement GAP and total interruption time on MCG and SCG

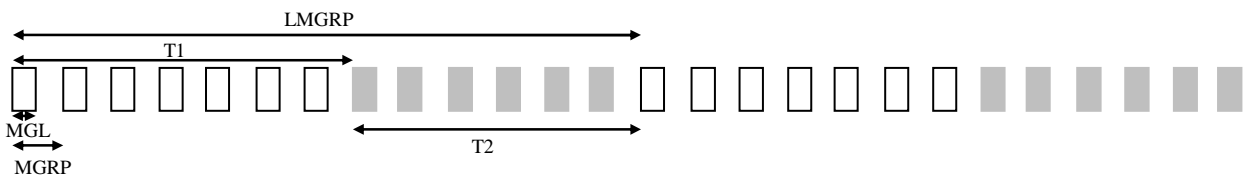

Figure 8.1.2.1-2: Non-uniform gap pattern

A UE that is capable of identifying and measuring inter-frequency and/or inter-RAT cells without gaps shall follow requirements as if Gap Pattern Id #0 had been used and the minimum available time T_{inter1} of 60 ms shall be assumed for the corresponding requirements.

A UE configured with gap pattern Id 2, 3 or 10, shall be able to detect a target cell if the sub frame #0 or #5 of the target cell begins no earlier than 500uS from the start of the measurement gap and if the sub frame #0 or #5 of the target cell ends no later than 500uS before the end of the measurement gap in case of FDD, and no later than [750]us before the end of measurement gap in case of TDD.

A UE configured with gap pattern Id 6, 7 or 8 shall be able to detect a target cell if the sub frame #0 or #5 of the target cell begins no earlier than 500uS from the start of the measurement gap and if the sub frame #0 or #5 of the target cell

ends no later than 1500us before the end of the measurement gap in case of FDD, and no later than 1750us before the end of measurement gap in case of TDD.

If the UE supporting E-UTRA carrier aggregation when configured with up to six SCCs is performing measurements on cells on PCC, inter-frequency measurements, or inter-RAT measurements, and interruption occurs on PCell or any activated SCell or both due to measurements performed on cells on an SCC with a deactivated SCell according to section 8.3, then the UE shall meet the requirements specified for each measurement in Section 8 and Section 9.

If the UE supporting E-UTRA dual connectivity when configured with a PSCell is performing measurements on cells on PCC, inter-frequency measurements, or inter-RAT measurements, then the UE shall meet the requirements specified for each measurement in Section 8 and Section 9.

A UE which indicate support for Increased UE carrier monitoring E-UTRA according to the capabilities in [2, 31] and which is capable of identifying and measuring inter-frequency and/or inter-RAT cells without gaps, shall be able to monitor maximum number of layers as defined in 8.1.2.1.1.a, and apply the *MeasScaleFactor* [2] defining the relaxation to the requirements for the configured carriers according to section 8.1.2.1.a.

A UE configured via LPP [24] to perform RSTD measurements requiring measurement gaps and provided with the OTDOA assistance data, which is comprising at least one PRS configuration with $N_{PRS} > 6$ consecutive downlink positioning subframes defined in TS 36.211 [16] in at least one cell, can be configured for performing the RSTD measurements with the following measurement gap patterns and shall not be used outside the corresponding RSTD measurement period:

- measurement gap pattern with Id 0 specified in Table 8.1.2.1-1, or
- an applicable measurement gap pattern specified in Table 8.1.2.1-3, provided the following conditions are met:
 - the UE is Cat M1 or Cat M2 UE, and
 - the applicability conditions are met for the UE.

Table 8.1.2.1-3: Additional Measurement Gap Pattern Configurations supported by the UE

Gap Pattern Id	Measurement Gap Length (MGL, ms)	Measurement Gap Repetition Period (MGRP, ms)	Applicability
rstd0	10	80	NOTE 1, 2
rstd1	10	160	
rstd2	10	320	
rstd3	10	640	
rstd4	10	1280	
rstd5	14	160	NOTE 1, 2
rstd6	14	320	
rstd7	14	640	
rstd8	14	1280	
rstd9	24	320	NOTE 1, 2
rstd10	24	640	
rstd11	24	1280	
rstd12	32	320	NOTE 1, 2
rstd13	32	640	
rstd14	32	1280	
rstd15	54	640	NOTE 2
rstd16	54	1280	
rstd17	64	640	NOTE 2
rstd18	64	1280	
rstd19	80	640	NOTE 3
rstd20	80	1280	
NOTE 1: For FDD, (MGL-2) shall not be larger than the required minimum number of available measurement subframes specified in Section 9 in the corresponding RSTD measurement accuracy requirements.			
NOTE 2: For TDD, the number of DL subframes within the available measurement time of the measurement gap shall not be larger than the required minimum number of available measurement subframes specified in Section 9 in the corresponding RSTD measurement accuracy requirements.			
NOTE 3: At least one cell in the OTDOA assistance data is configured with multiple PRS configurations			

If the UE is configured with any of the measurement gap patterns specified in Table 8.1.2.1-3 for performing RSTD measurements, using of any other measurement gap pattern configured to the UE is suspended during the RSTD measurement period.

8.1.2.1.1 Monitoring of multiple layers using gaps

When monitoring of multiple inter-frequency E-UTRAN and inter-RAT (UTRAN, GSM, NR) using gaps (or without using gaps provided the UE supports such capability) is configured, the UE shall be capable of performing one measurement of the configured measurement type (RSRP, RSRQ, RSTD, UTRAN TDD P-CCPCH RSCP, UTRAN FDD CPICH measurements, GSM carrier RSSI, NR SS-RSRP, NR SS-RSRQ, NR SS-SINR, etc.) of detected cells on all the layers

The effective total number of frequencies excluding the frequencies of the PCell, SCells, and PSCell being monitored is N_{freq} , which is defined as:

$$N_{\text{freq}} = N_{\text{freq, E-UTRA}} + N_{\text{freq, UTRA}} + M_{\text{gsm}} + N_{\text{freq, cdma2000}} + N_{\text{freq, HRPD}} + N_{\text{freq, NR}}$$

where

$N_{\text{freq, E-UTRA}}$ is the number of E-UTRA carriers being monitored (FDD and TDD)

$N_{\text{freq, UTRA}}$ is the number of UTRA carriers being monitored (FDD and TDD)

M_{GSM} is an integer which is a function of the number of GSM carriers on which measurements are being performed. M_{GSM} is equal to 0 if no GSM carrier is being monitored. For a MGRP of 40 ms, M_{GSM} is equal to 1 if cells on up to 32 GSM carriers are being measured. For a MGRP of 80 ms, M_{GSM} is equal to $\text{ceil}(N_{\text{carriers, GSM}} / 20)$ where $N_{\text{carriers, GSM}}$ is the number of GSM carriers on which cells are being measured.

$N_{\text{freq, cdma2000}}$ is the number of cdma2000 1x carriers being monitored.

$N_{\text{freq, HRPD}}$ is the number of HRPD carriers being monitored.

$N_{\text{freq, NR}}$ is the number of NR inter-RAT carriers being monitored.

8.1.2.1.1.1 Maximum allowed layers for multiple monitoring

The UE shall be capable of monitoring at least per RAT group:

- Depending on UE capability, 3 FDD E-UTRA inter-frequency carriers, and
- Depending on UE capability, 1 FDD E-UTRA inter-frequency carrier for RSTD measurements, and
- Depending on UE capability, 3 TDD E-UTRA inter-frequency carriers, and
- Depending on UE capability, 1 TDD E-UTRA inter-frequency carrier for RSTD measurements, and
- Depending on UE capability, 3 FDD UTRA carriers, and
- Depending on UE capability, 3 TDD UTRA carriers, and
- Depending on UE capability, 32 GSM carriers (one GSM layer corresponds to 32 carriers), and
- Depending on UE capability, 5 cdma2000 1x carriers, and
- Depending on UE capability, 5 HRPD carriers, and
- Depending on UE capability, 8 NR inter-RAT carriers

In addition to the requirements defined above, the UE shall be capable of monitoring a total of at least 7 effective carrier frequency layers comprising of any above defined combination of E-UTRA FDD, E-UTRA TDD, UTRA FDD, UTRA TDD, GSM (one GSM layer corresponds to 32 carriers), cdma2000 1x, and HRPD layers.

In addition to the requirements defined above, the UE which supports NR inter-RAT measurements or EN-DC but is not configured with NR PSCell shall be capable of monitoring a total of at least 9 effective carrier frequency layers comprising of any above defined combination of E-UTRA FDD, E-UTRA TDD, UTRA FDD, UTRA TDD, GSM (one GSM layer corresponds to 32 carriers), cdma2000 1x, HRPD and NR layers.

8.1.2.1.1.1a Maximum allowed layers for multiple monitoring (Increased UE carrier monitoring)

UE which indicate support for Increased UE carrier monitoring E-UTRA according to the capabilities in [2,31] shall be capable of monitoring at least

- Depending on UE capability, 8 FDD E-UTRA inter-frequency carriers, and
- Depending on UE capability, 8 TDD E-UTRA inter-frequency carriers

UE which indicate support for increased UE carrier monitoring UTRA according to the capabilities in [2,31] shall be capable of monitoring at least

- Depending on UE capability, 6 FDD UTRA carriers, and
- Depending on UE capability, 7 TDD UTRA carriers, and

In addition to the requirements defined above, the UE which indicate support for Increased UE carrier monitoring E-UTRA or increased UE carrier monitoring UTRA according to the capabilities in [2,31] shall be capable of monitoring a total of at least 12 carrier frequency layers comprising of any above defined combination of E-UTRA FDD, E-UTRA TDD, UTRA FDD, UTRA TDD, GSM (one GSM layer corresponds to 32 carriers), cdma2000 1x and HRPD layers

The minimum performance requirements for a UE which does not indicate support for Increased UE carrier monitoring E-UTRA [2,31] are calculated assuming all E-UTRA carriers which the UE is required to monitor, are having normal performance, i.e. $N_{\text{freq, E-UTRA, reduced}}=0$. The minimum performance requirements for a UE which does not indicate support for Increased UE carrier monitoring UTRA [2,31] are calculated assuming all UTRA carriers which the UE is required to monitor, are having normal performance, i.e. $N_{\text{freq, UTRA, reduced}}=0$. Capabilities for number of carriers to monitor for UE which do not support increased carrier monitoring E-UTRA or increased carrier monitoring UTRA are specified in section 8.1.2.1.1.1. A UE which do not indicate support for Increased UE carrier monitoring E-UTRA or UTRAN [2,31] does not have any reduced performance carrier requirements and $K_n=1$.

In addition to the requirements defined above, the UE which indicates support for Increased UE carrier monitoring E-UTRA or increased UE carrier monitoring UTRA according to the capabilities in [2,31], and also supports NR inter-RAT measurement or EN-DC but is not configured with NR PSCell, shall be capable of monitoring a total of at least 14 carrier frequency layers comprising of any above defined combination of E-UTRA FDD, E-UTRA TDD, UTRA FDD, UTRA TDD, GSM (one GSM layer corresponds to 32 carriers), cdma2000 1x, HRPD and NR layers.

The minimum performance requirements for a UE configured with inter-RAT NR layers are calculated assuming all E-UTRA carriers which the UE is required to monitor are having normal performance.

8.1.2.1.1a Monitoring of multiple layers using gaps (Increased UE carrier monitoring)

For UE which support increased carrier monitoring E-UTRA or increased carrier monitoring UTRA, the measurement performance for different carriers may be configured by higher layers to be either normal or reduced performance. A measurement scaling factor, *MeasScaleFactor* [2], defining the relaxation to be applied to the requirements for carriers measured with reduced measurement performance is signalled by higher layers and has the possible settings shown in table 8.1.2.1.1-1.

Table 8.1.2.1.1-1: Measurement Scaling factor Configurations supported by the UE

	<i>MeasScaleFactor</i> information element setting	K_n	K_r
sf-EUTRA-cf1	8	8/7	8
sf-EUTRA-cf2	16	16/15	16

If no reduced performance group carrier is configured, the UE shall consider all carriers to have normal performance

If no *MeasScaleFactor* is configured, a UE indicating support for increased carrier monitoring E-UTRA or increased carrier monitoring UTRA shall monitor at least the number of carriers specified in section 8.1.2.1.1.1 and is not required to monitor the increased number of carriers specified in section 8.1.2.1.1.1a.

The following definitions are used in the performance requirements:

$$N_{\text{freq}} = N_{\text{freq},n} + N_{\text{freq},r}$$

Where:

$N_{\text{freq},n} = N_{\text{freq}, \text{E-UTRA}, \text{normal}} + N_{\text{freq}, \text{UTRA}, \text{normal}} + M_{\text{gsm}} + N_{\text{freq}, \text{cdma2000}} + N_{\text{freq}, \text{HRPD}}$: Total number of interfrequency carriers to be monitored with normal measurement performance

$N_{\text{freq},r} = N_{\text{freq}, \text{E-UTRA}, \text{reduced}} + N_{\text{freq}, \text{UTRA}, \text{reduced}}$: Total number of interfrequency carriers to be monitored with reduced measurement performance

Where :

$N_{\text{freq}, \text{E-UTRA}, \text{normal}}$: Number of interfrequency carriers to be monitored with normal performance

$N_{\text{freq}, \text{E-UTRA}, \text{normal}, \text{FDD}}$: Number of interfrequency FDD carriers to be monitored with normal performance

$N_{\text{freq}, \text{E-UTRA}, \text{normal}, \text{TDD}}$: Number of interfrequency TDD carriers to be monitored with normal performance

$N_{\text{freq}, \text{E-UTRA}, \text{reduced}}$: Number of interfrequency carriers to be monitored with reduced performance

$N_{\text{freq}, \text{UTRA}, \text{normal}}$: Number of UTRA carriers (FDD and TDD) to be monitored with normal performance

$N_{\text{freq}, \text{E-UTRA}, \text{normal}, \text{FDD}}$: Number of interfrequency FDD carriers to be monitored with normal performance

$N_{\text{freq}, \text{E-UTRA}, \text{normal}, \text{TDD}}$: Number of interfrequency TDD carriers to be monitored with normal performance

$N_{\text{freq}, \text{UTRA}, \text{reduced}}$: Number of UTRA carriers (FDD and TDD) to be monitored with reduced performance

For interfrequency carriers, if $N_{\text{freq}, \text{E-UTRA}, \text{reduced}}$ is not equal to zero then K_n and K_r are as shown in table 8.1.2.1.1-1. Otherwise $K_n=1$ and all interfrequency layers have normal performance.

For UTRAN carriers, if $N_{\text{freq}, \text{UTRA}, \text{reduced}}$ is not equal to zero then K_n and K_r are as shown in table 8.1.2.1.1-1. Otherwise $K_n=1$ and all UTRA frequency layers have normal performance.

The minimum performance requirements for a UE which indicates support for Increased UE carrier monitoring E-UTRA [2, 31] are calculated as defined in sections 8.1.2.3.1 and 8.1.2.3.2 provided that $N_{\text{freq}, \text{E-UTRA}, \text{normal}} \leq 3$ for a UE capable of either FDD E-UTRA carrier monitoring or TDD E-UTRA carrier monitoring or $N_{\text{freq}, \text{E-UTRA}, \text{normal}} \leq 6$ for a UE capable of both FDD and TDD E-UTRA carrier monitoring provided $N_{\text{freq}, \text{E-UTRA}, \text{normal}, \text{FDD}} \leq 3$ E-UTRA carriers and $N_{\text{freq}, \text{E-UTRA}, \text{normal}, \text{TDD}} \leq 3$ TDD E-UTRA carriers or if $N_{\text{freq}, n} = N_{\text{freq}}$. The minimum performance requirements for a UE which indicates support for Increased UE carrier monitoring UTRA [2, 31] are calculated as defined in sections 8.1.2.4.1, 8.1.2.4.3, 8.1.2.4.7 and 8.1.2.4.13 provided that $N_{\text{freq}, \text{UTRA}, \text{normal}} \leq 3$ for UE capable of either FDD UTRA carrier monitoring or TDD UTRA carrier monitoring or $N_{\text{freq}, \text{UTRA}, \text{normal}} \leq 6$ for a UE capable of both FDD and TDD UTRA carrier monitoring provided $N_{\text{freq}, \text{UTRA}, \text{normal}, \text{FDD}} \leq 3$ FDD UTRA carriers and $N_{\text{freq}, \text{UTRA}, \text{normal}, \text{TDD}} \leq 3$ TDD UTRA carriers or if $N_{\text{freq}, n} = N_{\text{freq}}$. Capabilities for number of carriers to monitor for a UE which supports Increased carrier monitoring E-UTRA or Increased carrier monitoring UTRA are specified in section 8.1.2.1.1.a. Minimum performance requirements as defined in sections 8.1.2.3.1 and 8.1.2.3.2 are not applicable if $N_{\text{freq}, r} > 0$ and NR interRAT, NR intrafrequency measurements with gaps or NR interfrequency measurements are configured.

8.1.2.1.1b Monitoring of multiple layers using gaps (E-UTRA-NR dual connectivity)

The requirements in this section are applicable for EN-DC capable UE, which is configured with NR PSCell.

When monitoring of multiple inter-frequency E-UTRAN and inter-RAT (UTRAN, GSM, NR) carriers as configured by PCell, and inter-frequency NR carriers as configured by NR PSCell using gaps (or without using gaps provided the UE supports such capability) is configured, the UE shall be capable of performing one measurement of the configured measurement type (RSRP, RSRQ, RS-SINR, UTRAN TDD P-CCPCH RSCP, UTRAN FDD CPICH measurements, GSM carrier RSSI, NR SS-RSRP, NR SS-RSRQ, NR SS-SINR, etc.) of detected cells on all the layers.

The effective total number of frequencies excluding the frequencies of the PCell, SCells, NR PSCell and NR SCells being monitored is $N_{\text{freq}, \text{NSA}}$, which is defined as:

$$N_{\text{freq}, \text{NSA}} = N_{\text{freq}, \text{NSA}, \text{E-UTRA}} + N_{\text{freq}, \text{NSA}, \text{NR}} + N_{\text{freq}, \text{NSA}, \text{UTRA}} + M_{\text{NSA}, \text{gsm}}$$

where

$N_{\text{freq, NSA, E-UTRA}}$ is the number of E-UTRA (FDD and TDD) inter-frequency carriers being monitored as configured by PCell

$$N_{\text{freq, NSA, NR}} \leq N_{\text{freq, NSA, NR, inter-RAT}} + N_{\text{freq, NSA, NR, inter-freq}}$$

where

$N_{\text{freq, NSA, NR, inter-RAT}}$ is the number of NR inter-RAT carriers excluding NR serving carrier(s) being monitored as configured by Pcell,

$N_{\text{freq, NSA, NR, inter-freq}}$ is the number of NR inter-frequency carriers being monitored as configured by NR PSCell [50] or via LPP [24],

$N_{\text{freq, NSA, UTRA}}$ is the number of UTRA inter-RAT carriers being monitored as configured by E-UTRA PCell (FDD and TDD),

$M_{\text{NSA, GSM}}$ is an integer which is a function of the number of GSM inter-RAT carriers as configured by E-UTRA PCell on which measurements are being performed. $M_{\text{NSA, GSM}}$ is equal to 0 if no GSM carrier is being monitored. For a MGRP of 40 ms, $M_{\text{NSA, GSM}}$ is equal to 1 if cells on up to 32 GSM carriers are being measured. For a MGRP of 80 ms, $M_{\text{NSA, GSM}}$ is equal to $\text{ceil}(N_{\text{carriers, GSM}} / 20)$ where $N_{\text{carriers, GSM}}$ is the number of GSM carriers on which cells are being measured.

8.1.2.1.1b.1 Maximum allowed layers for multiple monitoring for UE in NSA operation

The UE configured with NR PSCell shall be capable of monitoring at least per RAT group:

- Depending on UE capability, 6 FDD E-UTRA inter-frequency carriers configured by PCell, and
- Depending on UE capability, 6 TDD E-UTRA inter-frequency carriers configured by PCell, and
- Depending on UE capability, 7 NR inter-RAT carriers excluding NR serving carrier(s) configured by PCell, and
- Depending on UE capability, 7 NR inter-frequency carriers configured by NR PSCell [50].
- Depending on UE capability, 3 FDD UTRA carriers, and
- Depending on UE capability, 3 TDD UTRA carriers, and
- Depending on UE capability, 32 GSM carriers (one GSM layer corresponds to 32 carriers), and
- Depending on UE capability, 1 FDD E-UTRA inter-frequency carrier for RSTD measurements configured via LPP [24], and
- Depending on UE capability, 1 TDD E-UTRA inter-frequency carrier for RSTD measurements configured via LPP [24].

In addition to the requirements defined above, the UE shall be capable of monitoring a total of at least 13 effective carrier frequency layers comprising of any above defined combination of E-UTRA FDD, E-UTRA TDD, UTRA FDD, UTRA TDD, GSM (one GSM layer corresponds to 32 carriers) and NR layers.

The UE shall be capable of monitoring a total of at least 7 effective NR carrier frequency layers excluding NR serving carrier(s), comprising of any above defined combination of NR inter-RAT carriers excluding NR serving carrier(s) configured by PCell and NR inter-frequency carriers configured by NR PSCell.

When PCell and NR PSCell configure the same NR carrier frequency layer to be monitored by the UE in synchronous intra-band EN-DC, this layer shall be counted only once to the total number of effective carrier frequency layers provided that the SFN-s and slot boundaries are aligned, unless the configured NR carrier frequency layers to be monitored have

- different RSSI measurement resources or
- different deriveSSB-IndexFromCell indications or
- different SMTTC configurations.

NOTE 1: The EN-DC capable UE configured with NR PSCell shall fulfil the requirements defined in only one of Section 8.2.1.1b.1 and Section 9.1.3.2 of TS 38.133 [50].

8.1.2.1.1c Monitoring of multiple layers using gaps (NE-DC)

The requirements in this section are applicable for UE capable of and configured with the NE-DC operation mode.

When monitoring of multiple inter-frequency E-UTRAN carriers as configured by PCell, inter-RAT E-UTRAN carriers as configured by NR PCell, and inter-frequency NR carriers as configured by NR PCell using gaps (or without using gaps provided the UE supports such capability) is configured, the UE shall be capable of performing one measurement of the configured measurement type (NR SS-RSRP, NR SS-RSRQ, NR SS-SINR, SFTD, RSRP, RSRQ, and RS-SINR measurements, etc.) of detected cells on all the layers.

For UE configured with the NE-DC operation, the effective total number of frequencies excluding the frequencies of the NR PCell, NR SCells, PCell, and SCells being monitored is $N_{\text{freq, NE-DC}}$, which is defined as:

$$N_{\text{freq, NE-DC}} = N_{\text{freq, NE-DC, NR}} + N_{\text{freq, NE-DC, E-UTRA}},$$

where

$N_{\text{freq, NE-DC, NR}}$ is the number of NR inter-frequency carriers being monitored as configured by NR PCell.

$$N_{\text{freq, NE-DC, E-UTRA}} \leq N_{\text{freq, NE-DC, E-UTRA, inter-RAT}} + N_{\text{freq, NE-DC, E-UTRA, inter-freq}}$$

where

$N_{\text{freq, NE-DC, E-UTRA, inter-RAT}}$ is the number of E-UTRA inter-RAT carriers (FDD and TDD) excluding E-UTRA serving carrier(s) being monitored as configured by NR PCell [50] or via LPP [59],

$N_{\text{freq, NE-DC, E-UTRA, inter-freq}}$ is the number of E-UTRA inter-frequency carriers (FDD and TDD) being monitored as configured by PCell.

8.1.2.1.1c.1 NE-DC: Maximum allowed layers for multiple monitoring

If a UE is configured with NE-DC operation, the UE shall be capable of monitoring at least per RAT group:

- Depending on UE capability, 7 NR inter-frequency carriers configured by NR PCell [50], and
- Depending on UE capability, 6 E-UTRA TDD inter-RAT carriers excluding E-UTRA serving carriers configured by NR PCell [50], and
- Depending on UE capability, 6 E-UTRA FDD inter-RAT carriers excluding E-UTRA serving carriers configured by NR PCell [50], and
- Depending on UE capability, 6 E-UTRA TDD inter-frequency carriers configured by PCell, and
- Depending on UE capability, 6 E-UTRA FDD inter-frequency carriers configured by PCell, and
- Depending on UE capability, 1 E-UTRA FDD inter-RAT carrier for RSTD measurements configured via LPP [59], and
- Depending on UE capability, 1 E-UTRA TDD inter-RAT carrier for RSTD measurements configured via LPP [59].

In addition to the requirements defined above, the UE shall be capable of monitoring a total of at least 13 effective carrier frequency layers comprising of any above defined combination of NR, E-UTRA FDD, and E-UTRA TDD layers. The UE shall be capable of monitoring a total of at least 6 effective E-UTRA carrier frequency layers, excluding E-UTRA serving carrier(s), comprising of any above defined combination of E-UTRA inter-RAT carriers excluding E-UTRA serving carrier(s) configured by NR PCell and E-UTRA inter-frequency carriers configured by PCell.

8.1.2.1.2 Network controlled small gap

A UE may reconfigure the receiver bandwidth, carrier frequency or turn on/off one of the RF chains when performing measurements on PCell, activated SCell/PCell, deactivated SCell and/or unused RF chain. This may cause interruptions on PCell or activated SCell(s) or both that are specified in Section 7.8.

If the UE requires network controlled small gap (NCSG) to prevent the interruption and UE is not configured with asynchronous DC,

- When UE is not configured with measurement gap, the E-UTRAN can explicitly provide a single NCSG pattern with constant repetition period per UE.
- When UE is configured with Gap Pattern ID #0 on some of, but not all, serving carriers including PCC and SCC(s), a single NCSG pattern with NCSG Pattern ID #0 in Table 8.1.2.1.2-1 can be implicitly configured on the serving carrier(s), where measurement gap is not configured.
- When UE is configured with Gap Pattern ID #1 on some of, but not all, serving carriers including PCC and SCC(s), a single NCSG pattern with NCSG Pattern ID #1 in Table 8.1.2.1.2-1 can be implicitly configured on the serving carrier(s), where measurement gap is not configured.
- When UE measurement gap is configured on all serving carriers including PCC and SCC(s), NCSG should not be configured.

Note: As shown in Figure 8.1.2.1.2-1, subframes of serving carrier 1 from $i+1$ to $i+6$ are used as measurement gap. The NCSG can be implicitly configured on other serving carrier subframes from $j+1$ to $j+6$, where no measurement gap is configured.

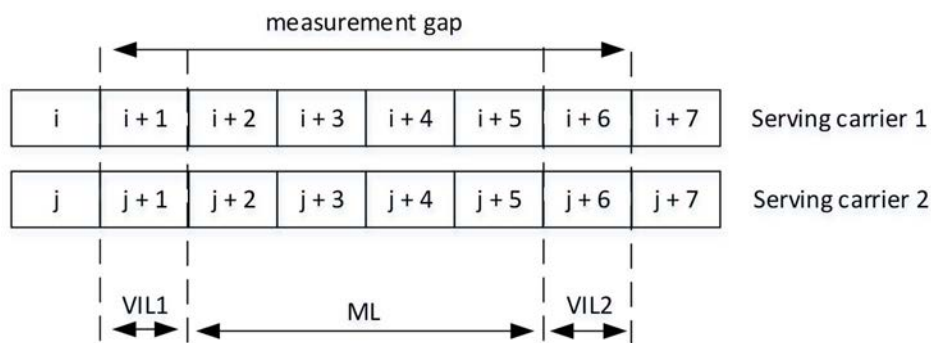

Figure 8.1.2.1.2-1: Measurement GAP and NCSG

If the UE requires NCSG to prevent the interruption and the UE supporting asynchronous DC is configured with PSCell which is asynchronous with PCell,

- When there is no measurement gap configured among MCG and SCG cell subframes, the E-UTRAN can explicitly provide a single NCSG pattern with constant repetition period per serving carrier.
- When Gap Pattern ID #0 is configured for UE on MCG (or SCG) and no measurement gap is configured on SCG (or MCG), a single NCSG pattern with NCSG Pattern ID #2 can be implicitly configured on SCG (or MCG).
- When Gap Pattern ID #1 is configured for UE on MCG (or SCG) and no measurement gap is configured on SCG (or MCG), a single NCSG pattern with NCSG Pattern ID #3 can be implicitly configured on SCG (or MCG).

Note: As shown in Figure 8.1.2.1.2-2, one serving carrier subframes from $i+1$ to $i+6$ are used as measurement gap. The NCSG can be implicitly configured on other serving carrier subframes from $j+1$ to $j+7$, where no measurement gap is configured.

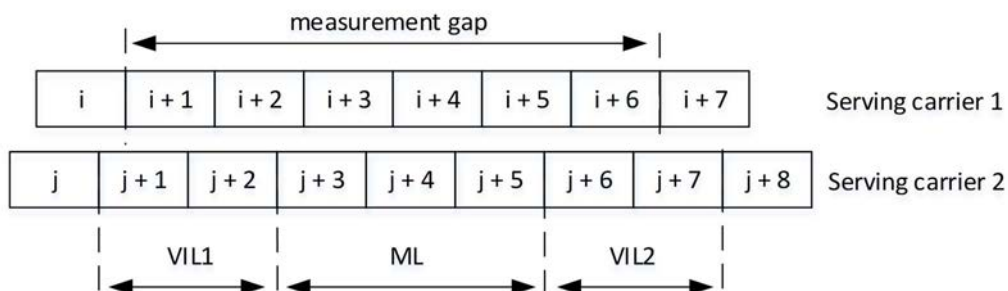

Figure 8.1.2.1.2-2: Measurement GAP and NCSG for dual connectivity

UEs shall only support those NCSG patterns listed in Table 8.1.2.1.2-1 that are relevant to its measurement capabilities.

Table 8.1.2.1.2-1: NCSG Configurations supported by the UE

NCSG Pattern Id	Visible interruption length before measurement (VIL1, ms)	Measurement Length during which there is no gap (ML, ms)	Visible interruption length after measurement (VIL2, ms)	Visible interruption Repetition Period (VIRP, ms)	Purpose
0	1	4	DL: 1 UL: 2	40	Interruption control according to requirements in sections 7.8.2.5, 7.8.2.6, 7.8.2.9, 7.8.2.12, 7.10.2.1, 7.10.2.2, 7.10.2.3
1	1	4	DL: 1 UL: 2	80	Interruption control according to requirements in sections 7.8.2.5, 7.8.2.6, 7.8.2.9, 7.8.2.12, 7.10.2.1, 7.10.2.2, 7.10.2.3
2	2	3	2	40	Interruption control according to requirements in sections 7.8.2.5, 7.8.2.6, 7.8.2.9, 7.8.2.12, 7.10.2.1, 7.10.2.2, 7.10.2.3
3	2	3	2	80	Interruption control according to requirements in sections 7.8.2.5, 7.8.2.6, 7.8.2.9, 7.8.2.12, 7.10.2.1, 7.10.2.2, 7.10.2.3

During the VIL1 and VIL2, the UE is not expected to transmit and receive any data. During ML, the UE is expected to transmit and receive data on the corresponding serving carrier(s).

A UE that is capable of identifying and measuring inter-frequency and/or inter-RAT cells without gaps, but needs interruption, and is configured with the network controlled small gap for such measurement (NCSG Pattern Id #0-3) shall follow requirements as if Gap Pattern Id #0 or Gap Pattern Id #1 had been used and shall not make any autonomous interruption outside the visual interruption of the configured network controlled small gap for the measurement, and the minimum available time $T_{\text{inter}}1$ of 60 ms and 30 ms shall be assumed for the corresponding requirement for visible interruption repetition period (VIRP) of 40 ms and 80 ms, respectively.

8.1.2.2 E-UTRAN intra frequency measurements

The UE shall be able to identify new intra-frequency cells and perform RSRP, RSRQ, and RS-SINR measurements of identified intra-frequency cells without an explicit intra-frequency neighbour cell list containing physical layer cell identities. During the RRC_CONNECTED state the UE shall continuously measure identified intra frequency cells and additionally search for and identify new intra frequency cells.

8.1.2.2.1 E-UTRAN FDD intra frequency measurements

8.1.2.2.1.1 E-UTRAN intra frequency measurements when no DRX is used

When no DRX is in use the UE shall be able to identify a new detectable FDD intra frequency cell within

$$T_{\text{identify_intra}} = T_{\text{basic_identify_E-UTRA_FDD_intra}} \cdot \frac{T_{\text{Measurement_Period_Intra}}}{T_{\text{Intra}}} \quad \text{ms}$$

where

$T_{\text{basic_identify_E-UTRA_FDD_intra}}$ is 800 ms

A cell shall be considered detectable when

- RSRP related side conditions given in Sections 9.1.2.1 and 9.1.2.2 are fulfilled for a corresponding Band,
- RSRQ related side conditions given in Clause 9.1.5.1 are fulfilled for a corresponding Band,
- RS-SINR related side conditions given in Section 9.1.17.2.1 are fulfilled for a corresponding Band,

- SCH_RP and SCH \hat{E}_s/I_{ot} according to Annex B.2.1 for a corresponding Band.

T_{Intra} : This is the minimum time that is available for intra frequency measurements, during the measurement period with an arbitrarily chosen timing. Time is assumed to be available for performing intra frequency measurements whenever the receiver is guaranteed to be active on the intra frequency carrier.

Identification of a cell shall include detection of the cell and additionally performing a single measurement with measurement period of $T_{Measurement_Period, Intra}$. If higher layer filtering is used, an additional cell identification delay can be expected.

In the RRC_CONNECTED state the measurement period for intra frequency measurements is 200 ms. When no measurement gaps are activated, the UE shall be capable of performing RSRP, RSRQ, and RS-SINR measurements for 8 identified-intra-frequency cells, and the UE physical layer shall be capable of reporting measurements to higher layers with the measurement period of 200 ms. When measurement gaps are activated, including nonUniform1 – nonUniform4 gaps, the UE shall be capable of performing measurements for at least $Y_{measurement\ intra}$ cells, where $Y_{measurement\ intra}$ is defined in the following equation. If the UE has identified more than $Y_{measurement\ intra}$ cells, the UE shall perform measurements of at least 8 identified intra- frequency cells but the reporting rate of RSRP, RSRQ, and RS-SINR measurements of cells from UE physical layer to higher layers may be decreased.

$$Y_{measurement\ intra} = \text{Floor} \left\{ X_{basic\ measurement\ FDD} \cdot \frac{T_{Intra}}{T_{Measurement_Period, Intra}} \right\} \text{ cells}$$

where

$X_{basic\ measurement\ FDD} = 8$ (cells),

$T_{Measurement_Period, Intra} = 200$ ms is the measurement period for intra frequency RSRP, RSRQ, and RS-SINR measurements.

The RSRP measurement accuracy for all measured cells shall be as specified in the sub-clauses 9.1.2.1 and 9.1.2.2, the RSRQ measurement accuracy for all measured cells shall be as specified in the sub-clause 9.1.5.1, and RS-SINR measurement accuracy for all measured cells shall be as specified in the sub-clause 9.1.17.2.1.

8.1.2.2.1.1.1 Measurement Reporting Requirements

8.1.2.2.1.1.1.1 Periodic Reporting

Reported RSRP, RSRQ, and RS-SINR measurements contained in periodically triggered measurement reports shall meet the requirements in sections 9.1.2.1, 9.1.2.2, 9.1.5.1, and 9.1.17.2.1, respectively.

8.1.2.2.1.1.1.2 Event-triggered Periodic Reporting

Reported RSRP, RSRQ, and RS-SINR measurements contained in event triggered periodic measurement reports shall meet the requirements in sections 9.1.2.1, 9.1.2.2, 9.1.5.1, and 9.1.17.2.1, respectively.

The first report in event triggered periodic measurement reporting shall meet the requirements specified in clause 8.1.2.2.1.1.1.3.

8.1.2.2.1.1.1.3 Event Triggered Reporting

Reported RSRP, RSRQ, and RS-SINR measurements contained in event triggered measurement reports shall meet the requirements in sections 9.1.2.1, 9.1.2.2, 9.1.5.1, and 9.1.17.2.1, respectively.

The UE shall not send any event triggered measurement reports, as long as no reporting criteria are fulfilled.

The measurement reporting delay is defined as the time between an event that will trigger a measurement report and the point when the UE starts to transmit the measurement report over the air interface. This requirement assumes that the measurement report is not delayed by other RRC signalling on the DCCH. This measurement reporting delay excludes a delay uncertainty resulted when inserting the measurement report to the TTI of the uplink DCCH. The delay uncertainty is: $2 \times TTI_{DCCH}$ where TTI_{DCCH} is the duration of subframe or slot or subslot when the measurement report is transmitted on the PUSCH with subframe or slot or subslot duration. This measurement reporting delay excludes a delay which caused by no UL resources for UE to send the measurement report.

The event triggered measurement reporting delay, measured without L3 filtering shall be less than $T_{\text{identify_intra}}$ defined in Clause 8.1.2.2.1.1. When L3 filtering is used or IDC autonomous denial is configured or the UE is performing reception and/or transmission for ProSe Direct Discovery and/or ProSe Direct Communication, or the UE is configured to perform SRS carrier based switching, an additional delay can be expected.

If a cell which has been detectable at least for the time period $T_{\text{identify_intra}}$ defined in clause 8.1.2.2.1.1 becomes undetectable for a period ≤ 5 seconds and then the cell becomes detectable again and triggers an event, the event triggered measurement reporting delay shall be less than $T_{\text{Measurement_Period, Intra}}$ provided the timing to that cell has not changed more than $\pm 50 T_s$ and the L3 filter has not been used. When L3 filtering is used or IDC autonomous denial is configured or the UE is performing reception and/or transmission for ProSe Direct Discovery and/or ProSe Direct Communication, or the UE is configured to perform SRS carrier based switching, an additional delay can be expected.

8.1.2.2.1.2 E-UTRAN intra frequency measurements when DRX is used

When DRX is in use the UE shall be able to identify a new detectable FDD intra frequency cell within $T_{\text{identify_intra}}$ as shown in table 8.1.2.2.1.2-1. When eDRX_CONN is in use the UE shall be able to identify a new detectable FDD intra frequency cell within $T_{\text{identify_intra}}$ as shown in table 8.1.2.2.1.2-1A. When *highSpeedEnhancedMeasFlag* is configured the UE shall be able to identify a new detectable FDD intra-frequency cell within $T_{\text{identify_intra}}$ as shown in table 8.1.2.2.1.2-1B.

Table 8.1.2.2.1.2-1: Requirement to identify a newly detectable FDD intrafrequency cell

DRX cycle length (s)	$T_{\text{identify_intra}}$ (s) (DRX cycles)
≤ 0.04	0.8 (Note1)
$0.04 < \text{DRX-cycle} \leq 0.08$	Note2 (40)
0.128	3.2 (25)
$0.128 < \text{DRX-cycle} \leq 2.56$	Note2(20)
Note1: Number of DRX cycle depends upon the DRX cycle in use.	
Note2: Time depends upon the DRX cycle in use.	

Table 8.1.2.2.1.2-1A: Requirement to identify a newly detectable FDD intra-frequency cell when eDRX_CONN cycle is used

eDRX_CONN cycle length (s)	$T_{\text{identify_intra}}$ (s) (eDRX_CONN cycles)
$2.56 < \text{eDRX_CONN cycle} \leq 10.24$	Note(20)
Note: Time depends upon the eDRX_CONN cycle in use	

Table 8.1.2.2.1.2-1B: Requirement to identify a newly detectable FDD intrafrequency cell for UE configured with *highSpeedEnhancedMeasFlag*

DRX cycle length (s)	$T_{\text{identify_intra}}$ (s) (DRX cycles)
≤ 0.04	0.8 (Note1)
$0.04 < \text{DRX-cycle} \leq 0.08$	Note2(15)
$0.08 < \text{DRX-cycle} \leq 1.28$	Note2(10)
$1.28 < \text{DRX-cycle} \leq 2.56$	Note2(20)
Note1: Number of DRX cycle depends upon the DRX cycle in use.	
Note2: Time depends upon the DRX cycle in use.	

A cell shall be considered detectable when

- RSRP related side conditions given in Sections 9.1.2.1 and 9.1.2.2 are fulfilled for a corresponding Band,
- RSRQ related side conditions given in Clause 9.1.5.1 are fulfilled for a corresponding Band,
- RS-SINR related side conditions given in Section 9.1.17.2.1 are fulfilled for a corresponding Band,
- SCH_RP and SCH \hat{E}_s/I_{ot} according to Annex B.2.1 for a corresponding Band.

When DRX is used in the RRC_CONNECTED state the measurement period for intra frequency measurements is $T_{measure_intra}$ as shown in table 8.1.2.2.1.2-2. When eDRX_CONN is used in the RRC_CONNECTED state the measurement period for intra frequency measurements is $T_{measure_intra}$ as shown in table 8.1.2.2.1.2-3. When *highSpeedEnhancedMeasFlag* is configured in the RRC_CONNECTED state the measurement period for intra frequency measurements is $T_{measure_intra}$ as shown in table 8.1.2.2.1.2-4. The UE shall be capable of performing RSRP, RSRQ, and RS-SINR measurements for 8 identified-intra-frequency cells, and the UE physical layer shall be capable of reporting measurements to higher layers with the measurement period of $T_{measure_intra}$.

Table 8.1.2.2.1.2-2: Requirement to measure FDD intrafrequency cells

DRX cycle length (s)	$T_{measure_intra}$ (s) (DRX cycles)
≤ 0.04	0.2 (Note1)
$0.04 < DRX\text{-}cycle \leq 2.56$	Note2 (5)
Note1: Number of DRX cycle depends upon the DRX cycle in use.	
Note2: Time depends upon the DRX cycle in use.	

Table 8.1.2.2.1.2-3: Requirement to measure FDD intra-frequency cells when eDRX_CONN cycle is used

eDRX_CONN cycle length (s)	$T_{measure_intra}$ (s) (eDRX_CONN cycles)
$2.56 < eDRX_CONN\ cycle \leq 10.24$	Note (5)
Note: Time depends upon the eDRX_CONN cycle in use	

Table 8.1.2.2.1.2-4: Requirement to measure FDD intrafrequency cells for UE configured with *highSpeedEnhancedMeasFlag*

DRX cycle length (s)	$T_{measure_intra}$ (s) (DRX cycles)
≤ 0.04	0.2 (Note1)
$0.04 < DRX\text{-}cycle \leq 0.08$	Note2 (4)
$0.08 < DRX\text{-}cycle \leq 1.28$	Note2 (3)
$1.28 < DRX\text{-}cycle \leq 2.56$	Note2 (5)
Note1: Number of DRX cycle depends upon the DRX cycle in use.	
Note2: Time depends upon the DRX cycle in use.	

The RSRP measurement accuracy for all measured cells shall be as specified in the sub-clauses 9.1.2.1 and 9.1.2.2, the RSRQ measurement accuracy for all measured cells shall be as specified in the sub-clause 9.1.5.1, and RS-SINR measurement accuracy for all measured cells shall be as specified in the sub-clause 9.1.17.2.1.

8.1.2.2.1.2.1 Measurement Reporting Requirements

8.1.2.2.1.2.1.1 Periodic Reporting

Reported RSRP, RSRQ, and RS-SINR measurements contained in periodically triggered measurement reports shall meet the requirements in sections 9.1.2.1, 9.1.2.2, 9.1.5.1, and 9.1.17.2.1, respectively.

8.1.2.2.1.2.1.2 Event-triggered Periodic Reporting

Reported RSRP, RSRQ, and RS-SINR measurements contained in event triggered periodic measurement reports shall meet the requirements in sections 9.1.2.1, 9.1.2.2, 9.1.5.1, and 9.1.17.2.1, respectively.

The first report in event triggered periodic measurement reporting shall meet the requirements specified in clause 8.1.2.2.1.2.1.3.

8.1.2.2.1.2.1.3 Event Triggered Reporting

Reported RSRP, RSRQ, and RS-SINR measurements contained in event triggered measurement reports shall meet the requirements in sections 9.1.2.1, 9.1.2.2, 9.1.5.1, and 9.1.17.2.1, respectively.

The UE shall not send any event triggered measurement reports, as long as no reporting criteria are fulfilled.

The measurement reporting delay is defined as the time between an event that will trigger a measurement report and the point when the UE starts to transmit the measurement report over the air interface. This requirement assumes that the measurement report is not delayed by other RRC signalling on the DCCH. This measurement reporting delay excludes a delay uncertainty resulted when inserting the measurement report to the TTI of the uplink DCCH. The delay uncertainty is: $2 \times TTI_{DCCH}$ where TTI_{DCCH} is the duration of subframe or slot or subslot when the measurement report is transmitted on the PUSCH with subframe or slot or subslot duration. This measurement reporting delay excludes a delay which caused by no UL resources for UE to send the measurement report.

The event triggered measurement reporting delay, measured without L3 filtering shall be less than $T_{identify_intra}$ defined in Clause 8.1.2.2.1.2. When L3 filtering is used or IDC autonomous denial is configured or the UE is performing reception and/or transmission for ProSe Direct Discovery and/or ProSe Direct Communication, or the UE is configured to perform SRS carrier based switching, an additional delay can be expected.

If a cell which has been detectable at least for the time period $T_{identify_intra}$ defined in clause 8.1.2.2.1.2 becomes undetectable for a period ≤ 5 seconds and then the cell becomes detectable again and triggers an event, the event triggered measurement reporting delay shall be less than $T_{measure_intra}$ provided the timing to that cell has not changed more than $\pm 50 T_s$ and the L3 filter has not been used. When L3 filtering is used or IDC autonomous denial is configured or the UE is performing reception and/or transmission for ProSe Direct Discovery and/or ProSe Direct Communication, or the UE is configured to perform SRS carrier based switching, an additional delay can be expected.

8.1.2.2.2 E-UTRAN TDD intra frequency measurements

8.1.2.2.2.1 E-UTRAN intra frequency measurements when no DRX is used

When no DRX is in use the UE shall be able to identify a new detectable TDD intra frequency cell within

$$T_{identify_intra} = T_{basic_identify_E-UTRA_TDD, intra} \cdot \frac{T_{Measurement\ Period, Intra}}{T_{Intra}} \quad ms$$

where

$T_{basic_identify_E-UTRA_TDD, intra}$ is 800 ms

A cell shall be considered detectable when

- RSRP related side conditions given in Sections 9.1.2.1 and 9.1.2.2 are fulfilled for a corresponding Band,
- RSRQ related side conditions given in Clause 9.1.5.1 are fulfilled for a corresponding Band,
- RS-SINR related side conditions given in Section 9.1.17.2.1 are fulfilled for a corresponding Band,
- SCH_RP and $SCH\ \hat{E}s/Iot$ according to Annex B.2.1 for a corresponding Band.

T_{Intra} : This is the minimum time that is available for intra frequency measurements, during the measurement period with an arbitrarily chosen timing. Time is assumed to be available for performing intra frequency measurements whenever the receiver is guaranteed to be active on the intra frequency carrier.

Identification of a cell shall include detection of the cell and additionally performing a single measurement with measurement period of $T_{Measurement_Period\ Intra}$. If higher layer filtering is used, an additional cell identification delay can be expected.

In the RRC_CONNECTED state the measurement period for intra frequency measurements is 200 ms. When no measurement gaps are activated, the UE shall be capable of performing RSRP, RSRQ, and RS-SINR measurements for 8 identified-intra-frequency cells, and the UE physical layer shall be capable of reporting measurements to higher layers with the measurement period of 200 ms. When measurement gaps are activated the UE shall be capable of performing measurements for at least $Y_{\text{measurement intra}}$ cells, where $Y_{\text{measurement intra}}$ is defined in the following equation. If the UE has identified more than $Y_{\text{measurement intra}}$ cells, the UE shall perform measurements of at least 8 identified intra-frequency cells but the reporting rate of RSRP, RSRQ, and RS-SINR measurements of cells from UE physical layer to higher layers may be decreased.

$$Y_{\text{measurement intra}} = \text{Floor} \left\{ X_{\text{basic measurement TDD}} \cdot \frac{T_{\text{Intra}}}{T_{\text{Measurement_Period, Intra}}} \right\} \text{ cells}$$

where

$$X_{\text{basic measurement TDD}} = 8 \text{ (cells),}$$

$T_{\text{Measurement_Period Intra}} = 200 \text{ ms}$ is the measurement period for intra frequency RSRP, RSRQ, and RS-SINR measurements.

The RSRP measurement accuracy for all measured cells shall be as specified in the sub-clauses 9.1.2.1 and 9.1.2.2, the RSRQ measurement accuracy for all measured cells shall be as specified in the sub-clause 9.1.5.1, and RS-SINR measurement accuracy for all measured cells shall be as specified in the sub-clause 9.1.17.2.1.

8.1.2.2.2.1.1 Measurement Reporting Requirements

8.1.2.2.2.1.1.1 Periodic Reporting

Reported RSRP, RSRQ, and RS-SINR measurements contained in periodically triggered measurement reports shall meet the requirements in sections 9.1.2.1, 9.1.2.2, 9.1.5.1, and 9.1.17.2.1, respectively.

8.1.2.2.2.1.1.2 Event-triggered Periodic Reporting

Reported RSRP, RSRQ, and RS-SINR measurements contained in event triggered periodic measurement reports shall meet the requirements in sections 9.1.2.1, 9.1.2.2, 9.1.5.1, and 9.1.17.2.1, respectively.

The first report in event triggered periodic measurement reporting shall meet the requirements specified in clause 8.1.2.2.2.1.1.3.

8.1.2.2.2.1.1.3 Event Triggered Reporting

Reported RSRP, RSRQ, and RS-SINR measurements contained in event triggered measurement reports shall meet the requirements in sections 9.1.2.1, 9.1.2.2, 9.1.5.1, and 9.1.17.2.1, respectively.

The UE shall not send any event triggered measurement reports, as long as no reporting criteria are fulfilled.

The measurement reporting delay is defined as the time between an event that will trigger a measurement report and the point when the UE starts to transmit the measurement report over the air interface. This requirement assumes that the measurement report is not delayed by other RRC signalling on the DCCH. This measurement reporting delay excludes a delay uncertainty resulted when inserting the measurement report to the TTI of the uplink DCCH. The delay uncertainty is: $2 \times TTI_{\text{DCCH}}$ where TTI_{DCCH} is the duration of subframe or slot or subslot when the measurement report is transmitted on the PUSCH with subframe or slot or subslot duration. This measurement reporting delay excludes a delay which caused by no UL resources for UE to send the measurement report.

The event triggered measurement reporting delay, measured without L3 filtering shall be less than $T_{\text{identify intra}}$ defined in Clause 8.1.2.2.2.1. When L3 filtering is used or IDC autonomous denial is configured or the UE is performing reception and/or transmission for ProSe Direct Discovery and/or ProSe Direct Communication, or the UE is configured to perform SRS carrier based switching, an additional delay can be expected.

If a cell which has been detectable at least for the time period $T_{\text{identify intra}}$ defined in clause 8.1.2.2.2.1 becomes undetectable for a period ≤ 5 seconds and then the cell becomes detectable again and triggers an event, the event triggered measurement reporting delay shall be less than $T_{\text{Measurement_Period Intra}}$ provided the timing to that cell has not changed more than $\pm 50 T_s$ and the L3 filter has not been used. When L3 filtering is used or IDC autonomous denial is configured or the UE is performing reception and/or transmission for ProSe Direct Discovery and/or ProSe Direct Communication, or the UE is configured to perform SRS carrier based switching, an additional delay can be expected.

8.1.2.2.2.2 E-UTRAN intra frequency measurements when DRX is used

When DRX is in use the UE shall be able to identify a new detectable TDD intra frequency cell within $T_{\text{identify_intra}}$ as shown in table 8.1.2.2.2.2-1. When eDRX_CONN is in use, the UE shall be able to identify a new detectable TDD intra frequency cell within $T_{\text{identify_intra}}$ as shown in table 8.1.2.2.2.2-1A. When *highSpeedEnhancedMeasFlag* is configured the UE shall be able to identify a new detectable TDD intra-frequency cell within $T_{\text{identify_intra}}$ as shown in table 8.1.2.2.2.2-1B.

Table 8.1.2.2.2-1: Requirement to identify a newly detectable TDD intrafrequency cell

DRX cycle length (s)	$T_{\text{identify_intra}}$ (s) (DRX cycles)
≤ 0.04	0.8 (Note1)
$0.04 < \text{DRX-cycle} \leq 0.08$	Note2 (40)
0.128	3.2 (25)
$0.128 < \text{DRX-cycle} \leq 2.56$	Note2(20)
Note1: Number of DRX cycle depends upon the DRX cycle in use.	
Note2: Time depends upon the DRX cycle in use.	

Table 8.1.2.2.2-1A: Requirement to identify a newly detectable TDD intra-frequency cell when eDRX_CONN cycle is used

eDRX_CONN cycle length (s)	$T_{\text{identify_intra}}$ (s) (eDRX_CONN cycles)
$2.56 < \text{eDRX_CONN cycle} \leq 10.24$	Note(20)
Note: Time depends upon the eDRX_CONN cycle in use	

Table 8.1.2.2.2-1B: Requirement to identify a newly detectable TDD intrafrequency cell for UE configured with *highSpeedEnhancedMeasFlag*

DRX cycle length (s)	$T_{\text{identify_intra}}$ (s) (DRX cycles)
≤ 0.04	0.8 (Note1)
$0.04 < \text{DRX-cycle} \leq 0.08$	Note2(15)
$0.08 < \text{DRX-cycle} \leq 1.28$	Note2(10)
$1.28 < \text{DRX-cycle} \leq 2.56$	Note2(20)
Note1: Number of DRX cycle depends upon the DRX cycle in use.	
Note2: Time depends upon the DRX cycle in use.	

A cell shall be considered detectable when

- RSRP related side conditions given in Clause 9.1.2.1 and 9.1.2.2 are fulfilled for a corresponding Band,
- RSRQ related side conditions given in Clause 9.1.5.1 are fulfilled for a corresponding Band,
- RS-SINR related side conditions given in Clause 9.1.17.2.1 are fulfilled for a corresponding Band,
- SCH_{RP} and SCH_{Ês}/Iot according to Annex B.2.1 for a corresponding Band.

When DRX is in use in the RRC_CONNECTED state the measurement period for intra frequency measurements is $T_{\text{measure_intra}}$ as shown in table 8.1.2.2.2.2-2. When eDRX_CONN is in use in the RRC_CONNECTED state, the measurement period for intra frequency measurements is $T_{\text{measure_intra}}$ as shown in table 8.1.2.2.2.2-3. When *highSpeedEnhancedMeasFlag* is configured in the RRC_CONNECTED state the measurement period for intra frequency measurements is $T_{\text{measure_intra}}$ as shown in table 8.1.2.2.2.2-4. The UE shall be capable of performing RSRP, RSRQ, and RS-SINR measurements for 8 identified intra-frequency cells and the UE physical layer shall be capable of reporting measurements to higher layers with the measurement period of $T_{\text{measure_intra}}$.

Table 8.1.2.2.2-2: Requirement to measure TDD intra frequency cells

DRX cycle length (s)	T _{measure_intra} (s) (DRX cycles)
≤0.04	0.2 (Note1)
0.04<DRX-cycle≤2.56	Note2 (5)
Note1: Number of DRX cycle depends upon the DRX cycle in use. Note2: Time depends upon the DRX cycle in use.	

Table 8.1.2.2.2-3: Requirement to measure TDD intra-frequency cells when eDRX_CONN cycle is used

eDRX_CONN cycle length (s)	T _{measure_intra} (s) (eDRX_CONN cycles)
2.56<eDRX_CONN cycle≤10.24	Note (5)
Note: Time depends upon the eDRX_CONN cycle in use.	

Table 8.1.2.2.2-4: Requirement to measure TDD intrafrequency cells for UE configured with *highSpeedEnhancedMeasFlag*

DRX cycle length (s)	T _{measure_intra} (s) (DRX cycles)
≤0.04	0.2 (Note1)
0.04<DRX-cycle≤0.08	Note2 (4)
0.08<DRX-cycle≤1.28	Note2 (3)
1.28<DRX-cycle≤2.56	Note2 (5)
Note1: Number of DRX cycle depends upon the DRX cycle in use. Note2: Time depends upon the DRX cycle in use.	

The RSRP measurement accuracy for all measured cells shall be as specified in the sub-clauses 9.1.2.1 and 9.1.2.2, the RSRQ measurement accuracy for all measured cells shall be as specified in the sub-clause 9.1.5.1, and the RS-SINR measurement accuracy for all measured cells shall be as specified in the sub-clause 9.1.17.2.1.

8.1.2.2.2.2.1 Measurement Reporting Requirements

8.1.2.2.2.2.1.1 Periodic Reporting

Reported RSRP, RSRQ, and RS-SINR measurements contained in periodically triggered measurement reports shall meet the requirements in sections 9.1.2.1, 9.1.2.2, 9.1.5.1, and 9.1.17.2.1, respectively.

8.1.2.2.2.2.1.2 Event-triggered Periodic Reporting

Reported RSRP, RSRQ, and RS-SINR measurements contained in event triggered periodic measurement reports shall meet the requirements in sections 9.1.2.1, 9.1.2.2, 9.1.5.1, and 9.1.17.2.1, respectively.

The first report in event triggered periodic measurement reporting shall meet the requirements specified in clause 8.1.2.2.2.1.3.

8.1.2.2.2.2.1.3 Event Triggered Reporting

Reported RSRP, RSRQ, and RS-SINR measurements contained in event triggered measurement reports shall meet the requirements in sections 9.1.2.1, 9.1.2.2, 9.1.5.1, and 9.1.17.2.1, respectively.

The UE shall not send any event triggered measurement reports, as long as no reporting criteria are fulfilled.

The measurement reporting delay is defined as the time between an event that will trigger a measurement report and the point when the UE starts to transmit the measurement report over the air interface. This requirement assumes that that the measurement report is not delayed by other RRC signalling on the DCCH. This measurement reporting delay

excludes a delay uncertainty resulted when inserting the measurement report to the TTI of the uplink DCCH. The delay uncertainty is: $2 \times TTI_{DCCH}$ where TTI_{DCCH} is the duration of subframe or slot or subslot when the measurement report is transmitted on the PUSCH with subframe or slot or subslot duration. This measurement reporting delay excludes a delay which caused by no UL resources for UE to send the measurement report.

The event triggered measurement reporting delay, measured without L3 filtering shall be less than $T_{identify_intra}$ defined in Clause 8.1.2.2.2. When L3 filtering is used or IDC autonomous denial is configured or the UE is performing reception and/or transmission for ProSe Direct Discovery and/or ProSe Direct Communication, or the UE is configured to perform SRS carrier based switching, an additional delay can be expected.

If a cell which has been detectable at least for the time period $T_{identify_intra}$ defined in clause 8.1.2.2.2 becomes undetectable for a period ≤ 5 seconds and then the cell becomes detectable again and triggers an event, the event triggered measurement reporting delay shall be less than $T_{measure_intra}$ provided the timing to that cell has not changed more than $\pm 50 T_s$ and the L3 filter has not been used. When L3 filtering is used or IDC autonomous denial is configured or the UE is performing reception and/or transmission for ProSe Direct Discovery and/or ProSe Direct Communication, or the UE is configured to perform SRS carrier based switching, an additional delay can be expected.

8.1.2.2.3 E-UTRAN FDD intra frequency measurements with autonomous gaps

8.1.2.2.3.1 Identification of a new CGI of E-UTRA cell with autonomous gaps

No explicit neighbour list is provided to the UE for identifying a new CGI of E-UTRA cell. The UE shall identify and report the CGI when requested by the network for the purpose 'reportCGI'. The UE may make autonomous gaps in downlink reception and uplink transmission for receiving MIB and SIB1 message according to clause 5.5.3.1 of TS 36.331 [2]. Note that a UE is not required to use autonomous gap if si-RequestForHO is set to false. If autonomous gaps are used for measurement with the purpose of 'reportCGI', regardless of whether DRX or eDRX_CONN is used or not, or whether SCell(s) are configured or not, the UE shall be able to identify a new CGI of E-UTRA cell within:

$$T_{identify_CGI,intra} = T_{basic_identify_CGI,intra} \quad ms$$

Where

$T_{basic_identify_CGI,intra} = 150$ ms. This is the time period used in the above equation where the maximum allowed time for the UE to identify a new CGI of an E-UTRA cell is defined, provided that the E-UTRA cell has been already identified by the UE.

A cell shall be considered identifiable following conditions are fulfilled:

- RSRP related side conditions given in Clause 9.1 are fulfilled for a corresponding Band,
- SCH_RP and SCH \hat{E} s/Iot according to Annex B.2.2 for a corresponding Band

The MIB of an E-UTRA cell whose CGI is identified shall be considered decodable by the UE provided the PBCH demodulation requirements are met according to [5].

The requirement for identifying a new CGI of an E-UTRA cell within $T_{basic_identify_CGI,intra}$ is applicable when no DRX is used as well as when any of the DRX or eDRX_CONN cycles specified in TS 36.331 [2] is used.

Within the time, $T_{identify_CGI,intra}$ ms, over which the UE identifies the new CGI of E-UTRA cell, the UE shall transmit at least 60 ACK/NACKs on PCell or each of activated SCell(s), provided that:

- there is continuous DL data allocation,
- no DRX and no eDRX_CONN cycle is used,
- no measurement gaps are configured,
- only one code word is transmitted in each subframe,
- no MBSFN subframes are configured in the PCell or each of activated SCell(s).

Note : ACK requirements for CGI reading were derived assuming *ShortTTI-r15* is not configured. When *ShortTTI-r15* is configured is used, a greater number of transmitted ACK/NACK is expected.

For the UE capable of SRS carrier based switching when configured to perform SRS carrier based switching for SRS transmission and/or RACH transmission via one or more SCells without PUSCH (NOTE: The requirement on the number of ACK/NACKs transmitted during SRS carrier based switching does not need to be tested):

- the requirements defined in this section shall be met provided during :
 - the SRS carrier based switching does not cause any interruption on the PCell or on any activated SCell during and
 - DL subframe #0 and DL subframe #5 per radio frame of the target E-UTRA are available at the UE.
- otherwise the time to acquire the new CGI of the E-UTRA cell may be extended or the UE may not be able to transmit the required number of ACK/NACKs on PCell or each of the activated SCell(s).

8.1.2.2.3.2 ECGI Reporting Delay

The ECGI reporting delay occurs due to the delay uncertainty when inserting the ECGI measurement report to the TTI of the uplink DCCH. The delay uncertainty is twice the TTI of the uplink DCCH. In case DRX is used, the ECGI reporting may be delayed until the next DRX cycle. In case eDRX_CONN is used, the ECGI reporting may be delayed until the next eDRX_CONN cycle. If IDC autonomous denial is configured, an additional delay can be expected.

8.1.2.2.4 E-UTRAN TDD intra frequency measurements with autonomous gaps

8.1.2.2.4.1 Identification of a new CGI of E-UTRA cell with autonomous gaps

No explicit neighbour list is provided to the UE for identifying a new CGI of E-UTRA cell. The UE shall identify and report the CGI when requested by the network for the purpose 'reportCGI'. The UE may make autonomous gaps in downlink reception and uplink transmission for receiving MIB and SIB1 messages according to clause 5.5.3.1 of TS 36.331 [2]. Note that a UE is not required to use autonomous gap if si-RequestForHO is set to false. If autonomous gaps are used for measurement with the purpose of 'reportCGI', regardless of whether DRX or eDRX_CONN is used or not, or whether SCell(s) are configured or not, the UE shall be able to identify a new CGI of E-UTRA cell within:

$$T_{\text{identify_CGI,intra}} = T_{\text{basic_identify_CGI,intra}} \quad \text{ms}$$

Where

$T_{\text{basic_identify_CGI, intra}} = 150$ ms. This is the time period used in the above equation where the maximum allowed time for the UE to identify a new CGI of an E-UTRA cell is defined, provided that the E-UTRA cell has been already identified by the UE.

A cell shall be considered identifiable when the following conditions are fulfilled:

- RSRP related side conditions given in Clause 9.1 are fulfilled for a corresponding Band,
- SCH_RP and SCH \hat{E} s/Iot according to Annex B.2.2 for a corresponding Band

The MIB of an E-UTRA cell whose CGI is identified shall be considered decodable by the UE provided the PBCH demodulation requirements are met according to [5].

The requirement for identifying a new CGI of an E-UTRA cell within $T_{\text{basic_identify_CGI, intra}}$ is applicable when no DRX is used as well as when any of the DRX or eDRX_CONN cycles specified in TS 36.331 [2] is used.

Within the time, $T_{\text{identify_CGI,intra}}$ ms, over which the UE identifies the new CGI of E-UTRA cell, the UE shall be able to transmit at least the number of ACK/NACKs stated in Table 8.1.2.2.4.1-1 on PCell or each of activated SCell(s), provided that:

- there is continuous DL data allocation,
- no DRX and no eDRX_CONN cycle is used,
- no measurement gaps are configured,
- only one code word is transmitted in each subframe,
- no MBSFN subframes are configured in the PCell or each of activated SCell(s).

Table 8.1.2.2.4.1-1: Requirement on minimum number of ACK/NACKs to transmit during $T_{\text{basic_identify_CGI, intra-}}$

UL/DL configuration	Minimum number of transmitted ACK/NACKs
0 (Note 1)	18
1	35
2	43
3	36
4	39
5	42
6	30
Note 1: When a UE is configured with EIMTA- <i>MainConfigServCell</i> via RRC signalling [2] only this requirement shall apply.	

Note : ACK requirements for CGI reading were derived assuming *ShortTTI-r15* is not configured. When *ShortTTI-r15* is configured is used, a greater number of transmitted ACK/NACK is expected.

For the UE capable of SRS carrier based switching when configured to perform SRS carrier based switching for SRS transmission and/or RACH transmission via one or more SCells without PUSCH (NOTE: The requirement on the number of ACK/NACKs transmitted during SRS carrier based switching does not need to be tested):

- the requirements defined in this section shall be met provided during :
 - the SRS carrier based switching does not cause any interruption on the PCell or on any activated SCell during and
 - DL subframe #0 and DL subframe #5 per radio frame of the target E-UTRA are available at the UE.
- otherwise the time to acquire the new CGI of the E-UTRA cell may be extended or the UE may not be able to transmit at least the number of ACK/NACKs as specified in Table 8.1.2.2.4.1-1 on PCell or each of the activated SCell(s).

8.1.2.2.4.2 ECGI Reporting Delay

The ECGI reporting delay occurs due to the delay uncertainty when inserting the ECGI measurement report to the TTI of the uplink DCCH. The delay uncertainty is twice the TTI of the uplink DCCH. In case DRX is used, the ECGI reporting may be delayed until the next DRX cycle. In case eDRX_CONN is used, the ECGI reporting may be delayed until the next eDRX_CONN cycle. If IDC autonomous denial is configured, an additional delay can be expected.

8.1.2.2.5 E-UTRAN FDD intra-frequency measurements on carrier with FeMBMS/Unicast mixed cells

Requirements in this section apply for UE configured to perform intra-frequency measurements on a carrier with one or more FeMBMS/Unicast mixed cells and which are capable of unicast reception from FeMBMS/Unicast mixed cell and capable of receiving at least one of *SystemInformationBlockType15* or *fembms-MixedCarrier-r14* indication and are provided with the information that one or more FeMBMS/Unicast mixed cells are present on the intra-frequency to be measured.

The UE shall meet the requirements in Section 8.1.2.2.1, when performing intra-frequency measurements on a carrier with at least one FeMBMS/Unicast mixed cell. The minimum number of cells that the UE shall be able to measure on includes also FeMBMS/Unicast mixed cells.

8.1.2.3 E-UTRAN inter frequency measurements

The UE shall be able to identify new inter-frequency cells and perform RSRP, RSRQ, and RS-SINR measurements of identified inter-frequency cells if carrier frequency information is provided by the PCell, even if no explicit neighbour list with physical layer cell identities is provided.

The requirements in this section shall also apply, when the UE is configured to perform SRS carrier based switching and using measurement gaps.

8.1.2.3.1 E-UTRAN FDD – FDD inter frequency measurements

8.1.2.3.1.1 E-UTRAN FDD – FDD inter frequency measurements when no DRX is used

When measurement gaps other than nonUniform1 – nonUniform4 are scheduled, or the UE supports capability of conducting such measurements without gaps, the UE shall be able to identify a new FDD inter-frequency within $T_{\text{Identify_Inter}}$ according to the following expression:

$$T_{\text{Identify_Inter}} = T_{\text{Basic_Identify_Inter}} \cdot \frac{480}{T_{\text{Inter1}}} \cdot N_{\text{freq},n} \cdot K_n \quad \text{ms (normal performance) and}$$

$$T_{\text{Identify_Inter}} = T_{\text{Basic_Identify_Inter}} \cdot \frac{480}{T_{\text{Inter1}}} \cdot N_{\text{freq},r} \cdot K_r \quad \text{ms (reduced performance)}$$

Where:

$T_{\text{Basic_Identify_Inter}} = 480$ ms. It is the time period used in the inter frequency equation where the maximum allowed time for the UE to identify a new FDD inter-frequency cell is defined.

$N_{\text{freq},n}$, $N_{\text{freq},r}$, K_n and K_r are defined in clause 8.1.2.1.1 and T_{Inter1} is defined in clause 8.1.2.1

When measurement gaps nonUniform1 – nonUniform4 are scheduled, the UE shall be able to identify a new FDD inter-frequency within $T_{\text{Identify_Inter}}$ according to the following expressions:

$$T_{\text{Identify_Inter}} = 8 \cdot T_{\text{burst}} \cdot N_{\text{freq}} \quad \text{ms}$$

If the UE requires measurement gaps to identify and measure inter-frequency and/or inter-RAT cells and the UE supports perServingCellMeasurementGap-r14 and is configured with per per-CC, or the UE supports parallel measurements, the UE shall be able to identify a new FDD inter-frequency within $T_{\text{Identify_Inter_perCC}}$ according to the following expression:

$$T_{\text{Identify_Inter_perCC}} = T_{\text{Basic_Identify_Inter}} \cdot \frac{480}{T_{\text{Inter1}}} \cdot N_{\text{freq},n,\text{effective}} \cdot K_n \quad \text{ms (normal performance) and}$$

$$T_{\text{Identify_Inter_perCC}} = T_{\text{Basic_Identify_Inter}} \cdot \frac{480}{T_{\text{Inter1}}} \cdot N_{\text{freq},r,\text{effective}} \cdot K_r \quad \text{ms (reduced performance)}$$

where:

$T_{\text{Basic_Identify_Inter}} = 480$ ms. It is the time period used in the inter frequency equation where the maximum allowed time for the UE to identify a new FDD inter-frequency cell is defined.

If the UE supports perServingCellMeasurementGap-r14 and is configured with per-CC gap, or the UE supports parallel measurements, $N_{\text{freq},n} = N_{\text{freq},n,\text{effective}}$ shall be used in section 8.1.2.3.1 when deriving the UE requirements. $N_{\text{freq},n,\text{effective}}$, $N_{\text{freq},r,\text{effective}}$ are defined as effective number of layers to be monitored by the UE for normal performance group and reduced performance group. They are reported by the UE. $N_{\text{freq},n,\text{effective}}$ should be equal or less than $N_{\text{freq},n}$ defined in clause 8.1.2.1.1. and $N_{\text{freq},r,\text{effective}}$ should be equal or less than $N_{\text{freq},r}$ defined in clause 8.1.2.1.1. K_n and K_r are defined in clause 8.1.2.1.1 and T_{Inter1} is defined in clause 8.1.2.1. For UE other than category 1bis UE, a cell shall be considered detectable provided following conditions are fulfilled:

- RSRP_{dBm} and RSRP Ês/Iot according to Annex B.2.3 for a corresponding Band,
- other RSRP related side conditions given in Sections 9.1.3.1 and 9.1.3.2 are fulfilled for a corresponding Band,
- RSRQ related side conditions given in Sections 9.1.6.1 and 9.1.6.2 are fulfilled for a corresponding Band,
- RS-SINR related side conditions given in Sections 9.1.17.3.1 and 9.1.17.3.2 are fulfilled for a corresponding Band,
- SCH_RP_{dBm} and SCH Ês/Iot according to Annex B.2.3 for a corresponding Band.

For category 1bis UE, a cell shall be considered detectable provided following conditions are fulfilled:

- $RSRP_{dBm}$ and $RSRP \hat{E}s/Iot$ according to Annex B.2.3 for a corresponding Band,
- other RSRP related side conditions given in Sections 9.1.3.3 and 9.1.3.4 are fulfilled for a corresponding Band,
- RSRQ related side conditions given in Sections 9.1.6.5 and 9.1.6.6 are fulfilled for a corresponding Band,
- SCH_RP_{dBm} and $SCH \hat{E}s/Iot$ according to Annex B.2.3 for a corresponding Band.

When measurement gaps are scheduled for FDD inter frequency measurements, or the UE supports capability of conducting such measurements without gaps, the UE physical layer shall be capable of reporting RSRP, RSRQ, and RS-SINR measurements to higher layers with measurement accuracy as specified in sub-clauses 9.1.3.1, 9.1.3.2, 9.1.6.1, 9.1.6.2, 9.1.17.3.1 and 9.1.17.3.2, respectively, with measurement period given by table 8.1.2.3.1.1-1.

Table 8.1.2.3.1.1-1: Measurement period and measurement bandwidth

Configuration	Physical Layer Measurement period: $T_{Measurement_Period_Inter_FDD}$ [ms] (normal performance)	Physical Layer Measurement period: $T_{Measurement_Period_Inter_FDD}$ [ms] (reduced performance)	Measurement bandwidth [RB]
0	$480 \times K_n \times N_{freq,n}$	$480 \times K_r \times N_{freq,r}$	6
1 (Note 1)	$240 \times K_n \times N_{freq,n}$	$240 \times K_r \times N_{freq,r}$	50
2 (Note 2)	$T_{burst} \times N_{freq}$	N/A	6
3 (Note 3)	$\frac{1}{2} \cdot T_{burst} \times N_{freq}$	N/A	50
Note 1: This configuration is optional			
Note 2: This configuration is for when nonUniform1 – nonUniform4 are configured			
Note 3: This configuration is optional and when nonUniform1 – nonUniform4 are configured			

The UE shall be capable of performing RSRP, RSRQ, and RS-SINR measurements of at least 4 inter-frequency cells per FDD inter-frequency for up to 3 FDD inter-frequencies or 8 FDD inter-frequencies if the UE supports Increased UE carrier monitoring E-UTRA and the UE physical layer shall be capable of reporting RSRP, RSRQ, and RS-SINR measurements to higher layers with the measurement period defined in Table 8.1.2.3.1.1-1.

For category 1bis UE, when measurement gaps are scheduled for FDD inter frequency measurements, or the UE supports capability of conducting such measurements without gaps, the UE physical layer shall be capable of reporting RSRP and RSRQ measurements to higher layers with measurement accuracy as specified in sub-clauses 9.1.3.3, 9.1.3.4, 9.1.6.5 and 9.1.6.6, respectively, with measurement period given by table 8.1.2.3.1.1-2.

Table 8.1.2.3.1.1-2: Measurement period and measurement bandwidth (category 1bis UE)

Configuration	Physical Layer Measurement period: $T_{Measurement_Period_Inter_FDD}$ [ms] (normal performance)	Physical Layer Measurement period: $T_{Measurement_Period_Inter_FDD}$ [ms] (reduced performance)	Measurement bandwidth [RB]
0	$960 \times K_n \times N_{freq,n}$	$960 \times K_r \times N_{freq,r}$	6
1 (Note)	$480 \times K_n \times N_{freq,n}$	$480 \times K_r \times N_{freq,r}$	50
Note: This configuration is optional			

The category 1bis UE shall be capable of performing RSRP and RSRQ measurements of at least 4 inter-frequency cells per FDD inter-frequency for up to 3 FDD inter-frequencies or 8 FDD inter-frequencies if the UE supports Increased UE carrier monitoring E-UTRA and the UE physical layer shall be capable of reporting RSRP and RSRQ measurements to higher layers with the measurement period defined in Table 8.1.2.3.1.1-2.

8.1.2.3.1.1.1 Measurement Reporting Requirements

8.1.2.3.1.1.1.1 Periodic Reporting

Reported RSRP, RSRQ, and RS-SINR measurements contained in periodically triggered measurement reports shall meet the requirements in sections 9.1.3.1, 9.1.3.2, 9.1.6.1, 9.1.6.2, 9.1.17.3.1 and 9.1.17.3.2, respectively.

8.1.2.3.1.1.1.2 Event-triggered Periodic Reporting

Reported RSRP, RSRQ, and RS-SINR measurements contained in event triggered periodic measurement reports shall meet the requirements in sections 9.1.3.1, 9.1.3.2, 9.1.6.1, 9.1.6.2, 9.1.17.3.1 and 9.1.17.3.2, respectively.

The first report in event triggered periodic measurement reporting shall meet the requirements specified in clause 8.1.2.3.1.1.1.3.

8.1.2.3.1.1.1.3 Event Triggered Reporting

Reported RSRP, RSRQ, and RS-SINR measurements contained in event triggered measurement reports shall meet the requirements in sections 9.1.3.1, 9.1.3.2, 9.1.6.1, 9.1.6.2, 9.1.17.3.1 and 9.1.17.3.2, respectively.

The UE shall not send any event triggered measurement reports, as long as no reporting criteria are fulfilled.

The measurement reporting delay is defined as the time between an event that will trigger a measurement report and the point when the UE starts to transmit the measurement report over the air interface. This requirement assumes that that the measurement report is not delayed by other RRC signalling on the DCCH. This measurement reporting delay excludes a delay uncertainty resulted when inserting the measurement report to the TTI of the uplink DCCH . The delay uncertainty is: $2 \times TTI_{DCCH}$ where TTI_{DCCH} is the duration of subframe or slot or subslot when the measurement report is transmitted on the PUSCH with subframe or slot or subslot duration. This measurement reporting delay excludes a delay which caused by no UL resources for UE to send the measurement report.

The event triggered measurement reporting delay, measured without L3 filtering shall be less than $T_{identify_inter}$ or $T_{identify_inter-perCC}$ when per-CC based measurement gap configured defined in clause 8.1.2.3.1.1. When L3 filtering is used or IDC autonomous denial is configured or the UE is performing reception and/or transmission for ProSe Direct Discovery and/or ProSe Direct Communication, or the UE is configured to perform SRS carrier based switching, an additional delay can be expected.

If a cell which has been detectable at least for the time period $T_{identify_inter}$ or $T_{identify_inter-perCC}$ when per-CC based measurement gap configured defined in clause 8.1.2.3.1.1 and then triggers the measurement report as per TS 36.331 [2], the event triggered measurement reporting delay shall be less than $T_{Measurement_Period_Inter_FDD}$ defined in clause 8.1.2.3.1.1 provided the timing to that cell has not changed more than $\pm 50 T_s$ while measurement gap has not been available and the L3 filter has not been used. When L3 filtering is used or IDC autonomous denial is configured or the UE is performing reception and/or transmission for ProSe Direct Discovery and/or ProSe Direct Communication, or the UE is configured to perform SRS carrier based switching, an additional delay can be expected.

8.1.2.3.1.2 E-UTRAN FDD – FDD inter frequency measurements when DRX is used

When DRX or eDRX_CONN is in use, either measurement gaps are scheduled or the UE supports capability of conducting such measurements without gaps, the UE shall be able to identify a new detectable E-UTRAN FDD inter frequency cell within $T_{identify_inter}$ or $T_{identify_inter-perCC}$ when per-CC based measurement gap configured. When DRX is in use, $T_{identify_inter}$ is as defined in Table 8.1.2.3.1.2-1, and when eDRX_CONN is in use, $T_{identify_inter}$ is as defined in Table 8.1.2.3.1.2-1A for GP0 and GP1. If UE is configured with nonUniform1 – nonUniform4 $T_{identify_inter}$ is as defined in Table 8.1.2.3.1.2-1B.

Table 8.1.2.3.1.2-1: Requirement to identify a newly detectable FDD interfrequency cell

DRX cycle length (s)	$T_{identify_inter}$ (s) (DRX cycles), normal performance		$T_{identify_inter}$ (s) (DRX cycles), reduced performance	
	Gap period = 40 ms, 20ms	Gap period = 80 ms	Gap period = 40 ms	Gap period = 80 ms
≤ 0.16	Non DRX Requirements in clause 8.1.2.3.1.1 are applicable	Non DRX Requirements in clause 8.1.2.3.1.1 are applicable	Non DRX Requirements in clause 8.1.2.3.1.1 are applicable	Non DRX Requirements in clause 8.1.2.3.1.1 are applicable
0.256	$5.12 \cdot K_n \cdot N_{freq,n}$ ($20 \cdot K_n \cdot N_{freq,n}$)	$7.68 \cdot K_n \cdot N_{freq,n}$ ($30 \cdot K_n \cdot N_{freq,n}$)	$5.12 \cdot K_r \cdot N_{freq,r}$ ($20 \cdot K_r \cdot N_{freq,r}$)	$7.68 \cdot K_r \cdot N_{freq,r}$ ($30 \cdot K_r \cdot N_{freq,r}$)
0.32	$6.4 \cdot K_n \cdot N_{freq,n}$ ($20 \cdot K_n \cdot N_{freq,n}$)	$7.68 \cdot K_n \cdot N_{freq,n}$ ($24 \cdot K_n \cdot N_{freq,n}$)	$6.4 \cdot K_r \cdot N_{freq,r}$ ($20 \cdot K_r \cdot N_{freq,r}$)	$7.68 \cdot K_r \cdot N_{freq,r}$ ($24 \cdot K_r \cdot N_{freq,r}$)
$0.32 < DRX-cycle \leq 2.56$	Note ($20 \cdot K_n \cdot N_{freq,n}$)	Note ($20 \cdot K_n \cdot N_{freq,n}$)	Note ($20 \cdot K_r \cdot N_{freq,r}$)	Note ($20 \cdot K_r \cdot N_{freq,r}$)
Note: Time depends upon the DRX cycle in use				

Table 8.1.2.3.1.2-1A: Requirement to identify a newly detectable FDD inter-frequency cell when eDRX_CONN cycle is used

eDRX_CONN cycle length (s)	T _{identify_inter} (s) (eDRX_CONN cycles), normal performance		T _{identify_inter} (s) (eDRX_CONN cycles), reduced performance	
	Gap period = 40 ms, 20ms	Gap period = 80 ms	Gap period = 40 ms	Gap period = 80 ms
2.56 < eDRX_CONN cycle ≤ 10.24	Note (20 * K _n * N _{freq,n})	Note (20 * K _n * N _{freq,n})	Note (20 * K _r * N _{freq,r})	Note (20 * K _r * N _{freq,r})
Note: Time depends upon the eDRX_CONN cycle in use				

Table 8.1.2.3.1.2-1B: Requirement to identify a newly detectable FDD inter-frequency cell when non-uniform gap pattern nonUniform1 – nonUniform4 is used

DRX_CONN cycle length (s)	T _{identify_inter} (DRX cycles)			
	T _{burst} = 1280 ms	T _{burst} = 2560 ms	T _{burst} = 5120 ms	T _{burst} = 10240 ms
≤ 0.16	Non DRX Requirements in clause 8.1.2.3.1.1 are applicable	Non DRX Requirements in clause 8.1.2.3.1.1 are applicable	Non DRX Requirements in clause 8.1.2.3.1.1 are applicable	Non DRX Requirements in clause 8.1.2.3.1.1 are applicable
0.16 < DRX-cycle < 2.56	Note (20 * N _{freq} * ceil(T _{burst} /480))	Note (20 * N _{freq} * ceil(T _{burst} /480))	Note (20 * N _{freq} * ceil(T _{burst} /480))	Note (20 * N _{freq} * ceil(T _{burst} /480))
Note: Time depends upon the DRX cycle in use				

For UE other than category 1bis UE, a cell shall be considered detectable provided following conditions are fulfilled:

- RSRP_{dBm} and RSRP Ês/Iot according to Annex B.2.3 for a corresponding Band,
- other RSRP related side conditions given in Clause 9.1.3.1 and 9.1.3.2 are fulfilled for a corresponding Band,
- RSRQ related side conditions given in Sections 9.1.6.1 and 9.1.6.2 are fulfilled for a corresponding Band,
- RS-SINR related side conditions given in Sections 9.1.17.3.1 and 9.1.17.3.2 are fulfilled for a corresponding Band,
- SCH_RP_{dBm} SCH Ês/Iot according to Annex B.2.3 for a corresponding Band.

For category 1bis UE, a cell shall be considered detectable provided following conditions are fulfilled:

- RSRP_{dBm} and RSRP Ês/Iot according to Annex B.2.3 for a corresponding Band,
- other RSRP related side conditions given in Clause 9.1.3.3 and 9.1.3.4 are fulfilled for a corresponding Band,
- RSRQ related side conditions given in Sections 9.1.6.5 and 9.1.6.6 are fulfilled for a corresponding Band,
- SCH_RP_{dBm} SCH Ês/Iot according to Annex B.2.3 for a corresponding Band.

When DRX or eDRX_CONN is in use, the UE shall be capable of performing RSRP, RSRQ, and RS-SINR measurements of at least 4 inter-frequency cells per FDD inter-frequency and the UE physical layer shall be capable of reporting RSRP, RSRQ, and RS-SINR measurements to higher layers with the measurement period T_{measure_inter}, either measurement gaps are scheduled or the UE supports capability of conducting such measurements without gaps. When DRX is used, T_{measure_inter} is as defined in Table 8.1.2.3.1.2-2, and when eDRX_CONN is in use, T_{measure_inter} is as defined in Table 8.1.2.3.1.2-3 for GP0 and GP1. If UE is configured with nonUniform1 – nonUniform4 T_{identify_inter} is as defined in Table 8.1.2.3.1.2-4.

Table 8.1.2.3.1.2-2: Requirement to measure FDD interfrequency cells

DRX cycle length (s)	T _{measure_inter} (s) (DRX cycles) (normal performance)	T _{measure_inter} (s) (DRX cycles) (reduced performance)

≤ 0.08	Non DRX Requirements in clause 8.1.2.3.1.1 are applicable	Non DRX Requirements in clause 8.1.2.3.1.1 are applicable
$0.08 < \text{DRX-cycles} \leq 2.56$	Note ($5 \cdot K_n \cdot N_{\text{freq},n}$)	Note ($5 \cdot K_r \cdot N_{\text{freq},r}$)
Note: Time depends upon the DRX cycle in use		

Table 8.1.2.3.1.2-3: Requirement to measure FDD inter-frequency cells when eDRX_CONN cycle is used

eDRX_CONN cycle length (s)	$T_{\text{measure_inter}}$ (s) (eDRX_CONN cycles) (normal performance)	$T_{\text{measure_inter}}$ (s) (eDRX_CONN cycles) (reduced performance)
$2.56 < \text{eDRX_CONN cycle} \leq 10.24$	Note ($5 \cdot K_n \cdot N_{\text{freq},n}$)	Note ($5 \cdot K_r \cdot N_{\text{freq},r}$)
Note: Time depends upon the eDRX_CONN cycle in use		

Table 8.1.2.3.1.2-4: Requirement to measure FDD inter-frequency cells when non-uniform gap pattern nonUniform1 – nonUniform4 is used

DRX_CON N cycle length (s)	$T_{\text{measure_inter}}$ (DRX cycles)			
	$T_{\text{burst}} = 1280 \text{ ms}$	$T_{\text{burst}} = 2560 \text{ ms}$	$T_{\text{burst}} = 5120 \text{ ms}$	$T_{\text{burst}} = 10240 \text{ ms}$
DRX-cycle ≤ 2.56	Note ($5 \cdot N_{\text{freq}} \cdot \text{ceil}(T_{\text{burst}}/480)$)	Note ($5 \cdot N_{\text{freq}} \cdot \text{ceil}(T_{\text{burst}}/480)$)	Note ($5 \cdot N_{\text{freq}} \cdot \text{ceil}(T_{\text{burst}}/480)$)	Note ($5 \cdot N_{\text{freq}} \cdot \text{ceil}(T_{\text{burst}}/480)$)
Note: Time depends on the DRX cycles in use				

The RSRP measurement accuracy for all measured cells shall be as specified in the sub-clauses 9.1.3.1 and 9.1.3.2, the RSRQ measurement accuracy for all measured cells shall be as specified in the sub-clauses 9.1.6.1 and 9.1.6.2, and the RS-SINR measurement accuracy for all measured cells shall be as specified in the sub-clauses 9.1.17.3.1 and 9.1.17.3.2.

For category 1bis UE, when DRX or eDRX_CONN is in use, the UE shall be capable of performing RSRP and RSRQ measurements of at least 4 inter-frequency cells per FDD inter-frequency and the UE physical layer shall be capable of reporting RSRP and RSRQ measurements to higher layers with the measurement period $T_{\text{measure_inter}}$, either measurement gaps are scheduled or the UE supports capability of conducting such measurements without gaps. When DRX is used, $T_{\text{measure_inter}}$ is as defined in Table 8.1.2.3.1.2-5, and when eDRX_CONN is in use, $T_{\text{measure_inter}}$ is as defined in Table 8.1.2.3.1.2-6.

Table 8.1.2.3.1.2-5: Requirement to measure FDD interfrequency cells (category 1bis UE)

DRX cycle length (s)	$T_{\text{measure_inter}}$ (s) (DRX cycles) (normal performance)	$T_{\text{measure_inter}}$ (s) (DRX cycles) (reduced performance)
≤ 0.08	Non DRX Requirements in clause 8.1.2.3.1.1 are applicable	Non DRX Requirements in clause 8.1.2.3.1.1 are applicable
$0.08 < \text{DRX-cycles} \leq 2.56$	Note ($10 \cdot K_n \cdot N_{\text{freq},n}$)	Note ($10 \cdot K_r \cdot N_{\text{freq},r}$)
Note: Time depends upon the DRX cycle in use		

Table 8.1.2.3.1.2-6: Requirement to measure FDD inter-frequency cells when eDRX_CONN cycle is used (category 1bis UE)

eDRX_CONN cycle length (s)	$T_{\text{measure_inter}}$ (s) (eDRX_CONN cycles) (normal performance)	$T_{\text{measure_inter}}$ (s) (eDRX_CONN cycles) (reduced performance)
$2.56 < \text{eDRX_CONN cycle} \leq 10.24$	Note ($10 \cdot K_n \cdot N_{\text{freq},n}$)	Note ($5 \cdot K_r \cdot N_{\text{freq},r}$)
Note: Time depends upon the eDRX_CONN cycle in use		

The RSRP measurement accuracy for all measured cells shall be as specified in the sub-clauses 9.1.3.3 and 9.1.3.4 and the RSRQ measurement accuracy for all measured cells shall be as specified in the sub-clauses 9.1.6.5 and 9.1.6.6.

8.1.2.3.1.2.1 Measurement Reporting Requirements

8.1.2.3.1.2.1.1 Periodic Reporting

Reported RSRP, RSRQ, and RS-SINR measurements contained in periodically triggered measurement reports shall meet the requirements in sections 9.1.3.1, 9.1.3.2, 9.1.6.1, 9.1.6.2, 9.1.17.3.1 and 9.1.17.3.2, respectively.

8.1.2.3.1.2.1.2 Event-triggered Periodic Reporting

Reported RSRP, RSRQ, and RS-SINR measurements contained in event triggered periodic measurement reports shall meet the requirements in sections 9.1.3.1, 9.1.3.2, 9.1.6.1, 9.1.6.2, 9.1.17.3.1 and 9.1.17.3.2, respectively.

The first report in event triggered periodic measurement reporting shall meet the requirements specified in clause 8.1.2.3.1.2.1.3.

8.1.2.3.1.2.1.3 Event Triggered Reporting

Reported RSRP, RSRQ, and RS-SINR measurements contained in event triggered measurement reports shall meet the requirements in sections 9.1.3.1, 9.1.3.2, 9.1.6.1, 9.1.6.2, 9.1.17.3.1 and 9.1.17.3.2, respectively.

The UE shall not send any event triggered measurement reports, as long as no reporting criteria are fulfilled.

The measurement reporting delay is defined as the time between an event that will trigger a measurement report and the point when the UE starts to transmit the measurement report over the air interface. This requirement assumes that the measurement report is not delayed by other RRC signalling on the DCCH. This measurement reporting delay excludes a delay uncertainty resulted when inserting the measurement report to the TTI of the uplink DCCH. The delay uncertainty is: $2 \times TTI_{DCCH}$ where TTI_{DCCH} is the duration of subframe or slot or subslot when the measurement report is transmitted on the PUSCH with subframe or slot or subslot duration. This measurement reporting delay excludes a delay which caused by no UL resources for UE to send the measurement report.

The event triggered measurement reporting delay, measured without L3 filtering shall be less than $T_{identify_inter}$ defined in clause 8.1.2.3.1.2. When L3 filtering is used or IDC autonomous denial is configured or the UE is performing reception and/or transmission for ProSe Direct Discovery and/or ProSe Direct Communication, or the UE is configured to perform SRS carrier based switching, an additional delay can be expected.

If a cell which has been detectable at least for the time period $T_{identify_inter}$ defined in clause 8.1.2.3.1.2 and then triggers the measurement report as per TS 36.331 [2], the event triggered measurement reporting delay shall be less than $T_{measure_inter}$ defined in clause 8.1.2.3.1.2 provided the timing to that cell has not changed more than $\pm 50 T_s$ while measurement gap has not been available and the L3 filter has not been used. When L3 filtering is used or IDC autonomous denial is configured or the UE is performing reception and/or transmission for ProSe Direct Discovery and/or ProSe Direct Communication, or the UE is configured to perform SRS carrier based switching, an additional delay can be expected.

8.1.2.3.2 E-UTRAN TDD – TDD inter frequency measurements

8.1.2.3.2.1 E-UTRAN TDD – TDD inter frequency measurements when no DRX is used

When measurement gaps other than nonUniform1 – nonUniform4 are scheduled, or the UE supports capability of conducting such measurements without gaps, the UE shall be able to identify a new TDD inter-frequency within $T_{Identify_Inter}$ according to the following expression:

- When configuration 0 or configuration 1 in Table 8.1.2.3.2.1-1 is applied,

$$T_{Identify_Inter} = T_{Basic_Identify_Inter} \cdot \frac{480}{T_{Inter1}} \cdot N_{freq} \quad ms,$$

- When configuration 2 or configuration 3 in Table 8.1.2.3.2.1-1 is applied,

$$T_{Identify_Inter} = T_{Basic_Identify_Inter} \cdot \frac{480}{T_{Inter1}} \cdot N_{freq} + 240 \cdot N_{freq} \quad ms,.$$

$T_{\text{Basic_Identify_Inter}} = 480$ ms. It is the time period used in the inter frequency equation where the maximum allowed time for the UE to identify a new TDD inter-frequency cell is defined.

N_{freq} is defined in clause 8.1.2.1.1 and T_{inter1} is defined in clause 8.1.2.1

When measurement gaps nonUniform1 – nonUniform4 are scheduled, the UE shall be able to identify a new FDD inter-frequency within $T_{\text{Identify_Inter}}$ according to the following expression:

- When configuration 0 or configuration 1 in Table 8.1.2.3.2.1-1 is applied,

$$T_{\text{Identify_Inter}} = 8 \cdot T_{\text{burst}} \cdot N_{\text{freq}} \quad \text{ms}$$

- When configuration 2 or configuration 3 in Table 8.1.2.3.2.1-1 is applied,

$$T_{\text{Identify_Inter}} = 8 \cdot T_{\text{burst}} \cdot N_{\text{freq}} + \frac{1}{2} T_{\text{burst}} \cdot N_{\text{freq}} \quad \text{ms}$$

If the UE requires measurement gaps to identify and measure inter-frequency and/or inter-RAT cells and the UE supports perServingCellMeasurementGap-r14 and is configured per-CC, or the UE supports parallel measurements, the UE shall be able to identify a new TDD inter-frequency within $T_{\text{Identify_Inter_perCC}}$ according to the following expression:

- When configuration 0 or configuration 1 in Table 8.1.2.3.2.1-1 is applied,

$$T_{\text{Identify_Inter_perCC}} = T_{\text{Basic_Identify_Inter}} \cdot \frac{480}{T_{\text{Inter1}}} \cdot N_{\text{freq},n,\text{effective}} \cdot K_n \quad \text{ms (normal performance) and}$$

$$T_{\text{Identify_Inter_perCC}} = T_{\text{Basic_Identify_Inter}} \cdot \frac{480}{T_{\text{Inter1}}} \cdot N_{\text{freq},r,\text{effective}} \cdot K_r \quad \text{ms (reduced performance)}$$

- When configuration 2 or configuration 3 in Table 8.1.2.3.2.1-1 is applied,

$$T_{\text{Identify_Inter_perCC}} = T_{\text{Basic_Identify_Inter}} \cdot \frac{480}{T_{\text{Inter1}}} \cdot N_{\text{freq},n,\text{effective}} \cdot K_n + 240 \cdot N_{\text{freq}} \quad \text{ms (normal performance) and}$$

$$T_{\text{Identify_Inter_perCC}} = T_{\text{Basic_Identify_Inter}} \cdot \frac{480}{T_{\text{Inter1}}} \cdot N_{\text{freq},r,\text{effective}} \cdot K_r + 240 \cdot N_{\text{freq}} \quad \text{ms (reduced performance)}$$

where:

$T_{\text{Basic_Identify_Inter}} = 480$ ms. It is the time period used in the inter frequency equation where the maximum allowed time for the UE to identify a new TDD inter-frequency cell is defined.

If the UE supports perServingCellMeasurementGap-r14 and is configured with per-CC gap, or the UE supports parallel measurements, $N_{\text{freq},n} = N_{\text{freq},n,\text{effective}}$ shall be used in section 8.1.2.3.2 when deriving the UE requirements.

$N_{\text{freq},n,\text{effective}}$ and $N_{\text{freq},r,\text{effective}}$ are defined as effective number of layers to be monitored by the UE for normal performance group and reduced performance group. They are reported by the UE. $N_{\text{freq},n,\text{effective}}$ should be equal or less than $N_{\text{freq},n}$ defined in clause 8.1.2.1.1. and $N_{\text{freq},r,\text{effective}}$ should be equal or less than $N_{\text{freq},r}$ defined in clause 8.1.2.1.1. K_n and K_r are defined in clause 8.1.2.1.1 and T_{inter1} is defined in clause 8.1.2.1.

For UE other than category 1bis UE, a cell shall be considered detectable provided following conditions are fulfilled:

- RSRP_{dBm} and $\text{RSRP} \hat{\text{E}}\text{s}/\text{Iot}$ according to Annex B.2.3 for a corresponding Band,
- other RSRP related side conditions given in Clause 9.1.3.1 and 9.1.3.2 are fulfilled for a corresponding Band,
- RSRQ related side conditions given in Sections 9.1.6.1 and 9.1.6.2 are fulfilled for a corresponding Band,
- RS-SINR related side conditions given in Sections 9.1.17.3.1 and 9.1.17.3.2 are fulfilled for a corresponding Band,

- SCH_RP_{dBm} and $SCH\ \hat{E}s/Iot$ according to Annex B.2.3 for a corresponding Band.

For category 1bis UE, a cell shall be considered detectable provided following conditions are fulfilled:

- $RSRP_{dBm}$ and $RSRP\ \hat{E}s/Iot$ according to Annex B.2.3 for a corresponding Band,
- other RSRP related side conditions given in Clause 9.1.3.3 and 9.1.3.4 are fulfilled for a corresponding Band,
- RSRQ related side conditions given in Sections 9.1.6.5 and 9.1.6.6 are fulfilled for a corresponding Band,
- SCH_RP_{dBm} and $SCH\ \hat{E}s/Iot$ according to Annex B.2.3 for a corresponding Band.

When measurement gaps are scheduled for TDD inter frequency measurements, or the UE supports capability of conducting such measurements without gaps, the UE physical layer shall be capable of reporting RSRP, RSRQ, and RS-SINR measurements to higher layers with measurement accuracy as specified in sub-clauses 9.1.3.1, 9.1.3.2, 9.1.6.1, 9.1.6.2, 9.1.17.3.1 and 9.1.17.3.2, respectively, with measurement period ($T_{Measurement_Period_TDD_Inter}$) given by table 8.1.2.3.2.1-1:

Table 8.1.2.3.2.1-1: $T_{Measurement_Period_TDD_Inter}$ for different configurations

Configuration	Measurement bandwidth [RB]	Number of UL/DL sub-frames per half frame (5 ms)		DwPTS		$T_{Measurement_Period_TDD_Inter}$ [ms] (normal performance)	$T_{Measurement_Period_TDD_Inter}$ [ms] (reduced performance)
		DL	UL	Normal CP	Extended CP		
0	6	2	2	$19760 \cdot T_s$	$20480 \cdot T_s$	$480 \times K_n \times N_{freq,n}$	$480 \times K_r \times N_{freq,r}$
1 (Note 1)	50	2	2	$19760 \cdot T_s$	$20480 \cdot T_s$	$240 \times K_n \times N_{freq,n}$	$240 \times K_r \times N_{freq,r}$
2	6	1	3	$19760 \cdot T_s$	$20480 \cdot T_s$	$720 \times K_n \times N_{freq,n}$	$720 \times K_r \times N_{freq,r}$
3 (Note 1)	50	1	3	$19760 \cdot T_s$	$20480 \cdot T_s$	$480 \times K_n \times N_{freq,n}$	$480 \times K_r \times N_{freq,r}$
4	6	2	2	$19760 \cdot T_s$	$20480 \cdot T_s$	$T_{burst} \times N_{freq}$	$T_{burst} \times N_{freq}$
5 (Note 3)	50	2	2	$19760 \cdot T_s$	$20480 \cdot T_s$	$\frac{1}{2} \times T_{burst} \times N_{freq}$	$\frac{1}{2} \times T_{burst} \times N_{freq}$
6	6	1	3	$19760 \cdot T_s$	$20480 \cdot T_s$	$\frac{3}{2} \times T_{burst} \times N_{freq}$	$\frac{3}{2} \times T_{burst} \times N_{freq}$
7 (Note 3)	50	1	3	$19760 \cdot T_s$	$20480 \cdot T_s$	$T_{burst} \times N_{freq}$	$T_{burst} \times N_{freq}$

Note 1: This configuration is optional
Note 2: T_s is defined in TS 36.211 [16]
Note 3: This configuration is optional and when nonUniform1 – nonUniform4 are configured

The UE shall be capable of performing RSRP, RSRQ, RS-SINR measurements of at least 4 inter-frequency cells per TDD inter-frequency and the UE physical layer shall be capable of reporting RSRP, RSRQ, and RS-SINR measurements to higher layers with the measurement period $T_{Measurement_Period_TDD_Inter}$.

For category 1bis UE, when measurement gaps are scheduled for TDD inter frequency measurements, or the UE supports capability of conducting such measurements without gaps, the UE physical layer shall be capable of reporting RSRP and RSRQ measurements to higher layers with measurement accuracy as specified in sub-clauses 9.1.3.3, 9.1.3.4, 9.1.6.5 and 9.1.6.6, respectively, with measurement period ($T_{Measurement_Period_TDD_Inter}$) given by table 8.1.2.3.2.1-2:

Table 8.1.2.3.2.1-2: $T_{Measurement_Period_TDD_Inter}$ for different configurations (category 1bis UE)

Configuration	Measurement bandwidth [RB]	Number of UL/DL sub-frames per half frame (5 ms)		DwPTS		$T_{Measurement_Period_TDD_Inter}$ [ms] (normal performance)	$T_{Measurement_Period_TDD_Inter}$ [ms] (reduced performance)
		DL	UL	Normal CP	Extended CP		
0	6	2	2	$19760 \cdot T_s$	$20480 \cdot T_s$	$960 \times K_n \times N_{freq,n}$	$960 \times K_r \times N_{freq,r}$
1 (Note 1)	50	2	2	$19760 \cdot T_s$	$20480 \cdot T_s$	$480 \times K_n \times N_{freq,n}$	$480 \times K_r \times N_{freq,r}$
2	6	1	3	$19760 \cdot T_s$	$20480 \cdot T_s$	$1440 \times K_n \times N_{freq,n}$	$1440 \times K_r \times N_{freq,r}$

3 (Note 1)	50	1	3	$19760 T_s$	$20480 T_s$	$960 \times K_n \times N_{\text{freq},n}$	$960 \times K_r \times N_{\text{freq},r}$
Note 1: This configuration is optional							
Note 2: T_s is defined in TS 36.211 [16]							

The category 1bis UE shall be capable of performing RSRP and RSRQ measurements of at least 4 inter-frequency cells per TDD inter-frequency and the UE physical layer shall be capable of reporting RSRP and RSRQ measurements to higher layers with the measurement period $T_{\text{Measurement_Period_TDD_Inter}}$ given by table 8.1.2.3.2.1-2.

8.1.2.3.2.1.1 Measurement Reporting Requirements

8.1.2.3.2.1.1.1 Periodic Reporting

Reported RSRP, RSRQ, and RS-SINR measurements contained in periodically triggered measurement reports shall meet the requirements in sections 9.1.3.1, 9.1.3.2, 9.1.6.1, 9.1.6.2, 9.1.17.3.1 and 9.1.17.3.2, respectively.

8.1.2.3.2.1.1.2 Event-triggered Periodic Reporting

Reported RSRP, RSRQ, and RS-SINR measurements contained in event triggered periodic measurement reports shall meet the requirements in sections 9.1.3.1, 9.1.3.2, 9.1.6.1, 9.1.6.2, 9.1.17.3.1 and 9.1.17.3.2, respectively.

The first report in event triggered periodic measurement reporting shall meet the requirements specified in clause 8.1.2.3.2.1.1.3.

8.1.2.3.2.1.1.3 Event Triggered Reporting

Reported RSRP, RSRQ, and RS-SINR measurements contained in event triggered measurement reports shall meet the requirements in sections 9.1.3.1, 9.1.3.2, 9.1.6.1, 9.1.6.2, 9.1.17.3.1 and 9.1.17.3.2, respectively.

The UE shall not send any event triggered measurement reports, as long as no reporting criteria are fulfilled.

The measurement reporting delay is defined as the time between an event that will trigger a measurement report and the point when the UE starts to transmit the measurement report over the air interface. This requirement assumes that the measurement report is not delayed by other RRC signalling on the DCCH. This measurement reporting delay excludes a delay uncertainty resulted when inserting the measurement report to the TTI of the uplink DCCH. The delay uncertainty is: $2 \times T_{\text{TTI}_{\text{DCCH}}}$ where $T_{\text{TTI}_{\text{DCCH}}}$ is the duration of subframe or slot or subslot when the measurement report is transmitted on the PUSCH with subframe or slot or subslot duration. This measurement reporting delay excludes a delay which caused by no UL resources for UE to send the measurement report.

The event triggered measurement reporting delay, measured without L3 filtering shall be less than $T_{\text{Identify_Inter}}$ or $T_{\text{identify_inter-perCC}}$ when per-CC based measurement gap configured defined in clause 8.1.2.3.2.1. When L3 filtering is used or IDC autonomous denial or the UE is performing reception and/or transmission for ProSe Direct Discovery and/or ProSe Direct Communication, or the UE is configured to perform SRS carrier based switching, is configured an additional delay can be expected.

If a cell which has been detectable at least for the time period $T_{\text{Identify_Inter}}$ or $T_{\text{identify_inter-perCC}}$ when per-CC based measurement gap configured defined in clause 8.1.2.3.2.1 and then triggers the measurement report as per TS 36.331 [2], the event triggered measurement reporting delay shall be less than $T_{\text{Measurement_Period_TDD_Inter}}$ defined in clause 8.1.2.3.2.1 provided the timing to that cell has not changed more than $\pm 50 T_s$ while measurementgap has not been available and the L3 filter has not been used. When L3 filtering is used or IDC autonomous denial is configured or the UE is performing reception and/or transmission for ProSe Direct Discovery and/or ProSe Direct Communication, or the UE is configured to perform SRS carrier based switching, an additional delay can be expected.

8.1.2.3.2.2 E-UTRAN TDD – TDD inter frequency measurements when DRX is used

When DRX or eDRX_CONN is in use, either measurement gaps are scheduled or the UE supports capability of conducting such measurements without gaps, the UE shall be able to identify a new detectable E-UTRAN TDD inter frequency cell within $T_{\text{identify_inter}}$ or $T_{\text{identify_inter-perCC}}$ when per-CC based measurement gap configured. When DRX is in use, $T_{\text{identify_inter}}$ is as defined in Table 8.1.2.3.2.2-1, and when eDRX_CONN is in use $T_{\text{identify_inter}}$ is as defined in Table 8.1.2.3.2.2-1A for GP0 and GP1. If UE is configured with nonUniform1 – nonUniform4 $T_{\text{identify_inter}}$ is as defined in Table 8.1.2.3.2.2-1B.

Table 8.1.2.3.2.2-1: Requirement to identify a newly detectable TDD interfrequency cell

DRX cycle length (s)	T _{identify_inter} (s) (DRX cycles) (normal performance)		T _{identify_inter} (s) (DRX cycles) (reduced performance)	
	Gap period = 40 ms, 20ms	Gap period = 80 ms	Gap period = 40 ms	Gap period = 80 ms
≤0.16	Non DRX Requirements in clause 8.1.2.3.2.1 are applicable	Non DRX Requirements in clause 8.1.2.3.2.1 are applicable	Non DRX Requirements in clause 8.1.2.3.2.1 are applicable	Non DRX Requirements in clause 8.1.2.3.2.1 are applicable
0.256	$5.12 \cdot K_n \cdot N_{freq,n}$ ($20 \cdot K_n \cdot N_{freq,n}$)	$7.68 \cdot K_n \cdot N_{freq,n}$ ($30 \cdot K_n \cdot N_{freq,n}$)	$5.12 \cdot K_r \cdot N_{freq,r}$ ($20 \cdot K_r \cdot N_{freq,r}$)	$7.68 \cdot K_r \cdot N_{freq,r}$ ($30 \cdot K_r \cdot N_{freq,r}$)
0.32	$6.4 \cdot K_n \cdot N_{freq,n}$ ($20 \cdot K_n \cdot N_{freq,n}$)	$7.68 \cdot K_n \cdot N_{freq,n}$ ($24 \cdot K_n \cdot N_{freq,n}$)	$6.4 \cdot K_r \cdot N_{freq,r}$ ($20 \cdot K_r \cdot N_{freq,r}$)	$7.68 \cdot K_r \cdot N_{freq,r}$ ($24 \cdot K_r \cdot N_{freq,r}$)
0.32 < DRX-cycle ≤ 2.56	Note ($20 \cdot K_n \cdot N_{freq,n}$)	Note ($20 \cdot K_n \cdot N_{freq,n}$)	Note ($20 \cdot K_r \cdot N_{freq,r}$)	Note ($20 \cdot K_r \cdot N_{freq,r}$)
Note: Time depends upon the DRX cycle in use				

Table 8.1.2.3.2.2-1A: Requirement to identify a newly detectable TDD inter-frequency cell when eDRX_CONN cycle is used

eDRX_CONN cycle length (s)	T _{identify_inter} (s) (eDRX_CONN cycles) (normal performance)		T _{identify_inter} (s) (eDRX_CONN cycles) (reduced performance)	
	Gap period = 40 ms, 20ms	Gap period = 80 ms	Gap period = 40 ms	Gap period = 80 ms
2.56 < eDRX_CONN cycle ≤ 10.24	Note ($20 \cdot K_n \cdot N_{freq,n}$)	Note ($20 \cdot K_n \cdot N_{freq,n}$)	Note ($20 \cdot K_r \cdot N_{freq,r}$)	Note ($20 \cdot K_r \cdot N_{freq,r}$)
Note: Time depends upon the eDRX_CONN cycle in use				

Table 8.1.2.3.2.2-1B: Requirement to identify a newly detectable TDD inter-frequency cell when non-uniform gap pattern nonUniform1 – nonUniform4 is used

DRX_CONN cycle length (s)	T _{identify_inter} (DRX cycles)			
	T _{burst} = 1280 ms	T _{burst} = 2560 ms	T _{burst} = 5120 ms	T _{burst} = 10240 ms
≤0.16	Non DRX Requirements in clause 8.1.2.3.1.1 are applicable	Non DRX Requirements in clause 8.1.2.3.1.1 are applicable	Non DRX Requirements in clause 8.1.2.3.1.1 are applicable	Non DRX Requirements in clause 8.1.2.3.1.1 are applicable
0.16 < DRX-cycle < 2.56	Note ($20 \cdot N_{freq} \cdot \text{ceil}(T_{burst}/480)$)	Note ($20 \cdot N_{freq} \cdot \text{ceil}(T_{burst}/480)$)	Note ($20 \cdot N_{freq} \cdot \text{ceil}(T_{burst}/480)$)	Note ($20 \cdot N_{freq} \cdot \text{ceil}(T_{burst}/480)$)
Note: Time depends upon the DRX cycle in use				

For UE other than category 1bis UE, a cell shall be considered detectable provided following conditions are fulfilled:

- RSRP_{dBm} and RSRP Ês/Iot according to Annex B.2.3 for a corresponding Band,
- other RSRP related side conditions given in Clause 9.1.3.1 and 9.1.3.2 are fulfilled for a corresponding Band,
- RSRQ related side conditions given in Sections 9.1.6.1 and 9.1.6.2 are fulfilled for a corresponding Band,
- RS-SINR related side conditions given in Sections 9.1.17.3.1 and 9.1.17.3.2 are fulfilled for a corresponding Band_i
- SCH_RP_{dBm} and SCH Ês/Iot according to Annex B.2.3 for a corresponding Band.

For category 1bis UE, a cell shall be considered detectable provided following conditions are fulfilled:

- RSRP_{dBm} and RSRP Ês/Iot according to Annex B.2.3 for a corresponding Band,
- other RSRP related side conditions given in Clause 9.1.3.3 and 9.1.3.4 are fulfilled for a corresponding Band,
- RSRQ related side conditions given in Sections 9.1.6.5 and 9.1.6.6 are fulfilled for a corresponding Band,
- SCH_RP_{dBm} and SCH Ês/Iot according to Annex B.2.3 for a corresponding Band.

When DRX or eDRX_CONN is in use, the UE shall be capable of performing RSRP, RSRQ, and RS-SINR measurements of at least 4 inter-frequency cells per TDD inter-frequency for up to 3 TDD inter-frequencies and the UE physical layer shall be capable of reporting RSRP, RSRQ, and RS-SINR measurements to higher layers with the measurement period $T_{\text{measure_inter}}$, either measurement gaps are scheduled or the UE supports capability of conducting such measurements without gaps. When DRX is in use, $T_{\text{measure_inter}}$ is as defined in Table 8.1.2.3.2.2-2, and when eDRX_CONN is in use, $T_{\text{measure_inter}}$ is as defined in Table 8.1.2.3.2.2-3 for GP0 and GP1. If UE is configured with nonUniform1 – nonUniform4 $T_{\text{identify_inter}}$ is as defined in Table 8.1.2.3.2.2-4.

Table 8.1.2.3.2.2-2: Requirement to measure TDD interfrequency cells

DRX cycle length (s)	$T_{\text{measure_inter}}$ (s) (DRX cycles) (normal requirement)	$T_{\text{measure_inter}}$ (s) (DRX cycles) (reduced requirement)
≤ 0.08	Non DRX Requirements in clause 8.1.2.3.2.1 are applicable	Non DRX Requirements in clause 8.1.2.3.2.1 are applicable
0.128	When configuration 2 non DRX Requirements in clause 8.1.2.3.2.1 are applicable, Otherwise Note $(5 \cdot K_n \cdot N_{\text{freq},n})$	When configuration 2 non DRX Requirements in clause 8.1.2.3.2.1 are applicable, Otherwise Note $(5 \cdot K_r \cdot N_{\text{freq},r})$
$0.128 < \text{DRX-cycle} \leq 2.56$	Note $(5 \cdot K_n \cdot N_{\text{freq},n})$	Note $(5 \cdot K_r \cdot N_{\text{freq},r})$
Note: Time depends upon the DRX cycle in use		

Table 8.1.2.3.2.2-3: Requirement to measure TDD inter-frequency cells when eDRX_CONN cycle is used

eDRX_CONN cycle length (s)	$T_{\text{measure_inter}}$ (s) (eDRX_CONN cycles) (normal requirement)	$T_{\text{measure_inter}}$ (s) (eDRX_CONN cycles) (reduced requirement)
$2.56 < \text{eDRX_CONN cycle} \leq 10.24$	Note $(5 \cdot K_n \cdot N_{\text{freq},n})$	Note $(5 \cdot K_r \cdot N_{\text{freq},r})$
Note: Time depends upon the eDRX_CONN cycle in use		

Table 8.1.2.3.2.2-4: Requirement to measure TDD inter-frequency cells when non-uniform gap pattern nonUniform1 – nonUniform4 is used

DRX_CONN cycle length (s)	$T_{\text{measure_inter}}$ (DRX cycles)			
	$T_{\text{burst}} = 1280 \text{ ms}$	$T_{\text{burst}} = 2560 \text{ ms}$	$T_{\text{burst}} = 5120 \text{ ms}$	$T_{\text{burst}} = 10240 \text{ ms}$
DRX-cycle ≤ 2.56	Note $(5 \cdot N_{\text{freq}} \cdot \text{ceil}(T_{\text{burst}}/480))$	Note $(5 \cdot N_{\text{freq}} \cdot \text{ceil}(T_{\text{burst}}/480))$	Note $(5 \cdot N_{\text{freq}} \cdot \text{ceil}(T_{\text{burst}}/480))$	Note $(5 \cdot N_{\text{freq}} \cdot \text{ceil}(T_{\text{burst}}/480))$
Note: Time depends upon the DRX cycle in use				

The RSRP measurement accuracy for all measured cells shall be as specified in the sub-clauses 9.1.3.1 and 9.1.3.2, the RSRQ measurement accuracy for all measured cells shall be as specified in the sub-clauses 9.1.6.1 and 9.1.6.2, and the RS-SINR measurement accuracy for all measured cells shall be as specified in the sub-clauses 9.1.17.3.1 and 9.1.17.3.2.

For category 1bis UE, when DRX or eDRX_CONN is in use, the UE shall be capable of performing RSRP and RSRQ measurements of at least 4 inter-frequency cells per TDD inter-frequency for up to 3 TDD inter-frequencies and the UE physical layer shall be capable of reporting RSRP and RSRQ measurements to higher layers with the measurement period $T_{\text{measure_inter}}$, either measurement gaps are scheduled or the UE supports capability of conducting such measurements without gaps. When DRX is in use, $T_{\text{measure_inter}}$ is as defined in Table 8.1.2.3.2.2-5, and when eDRX_CONN is in use, $T_{\text{measure_inter}}$ is as defined in Table 8.1.2.3.2.2-6.

Table 8.1.2.3.2.2-5: Requirement to measure TDD interfrequency cells (category 1bis UE)

DRX cycle length (s)	$T_{\text{measure_inter}}$ (s) (DRX cycles) (normal requirement)	$T_{\text{measure_inter}}$ (s) (DRX cycles) (reduced requirement)
≤ 0.08	Non DRX Requirements in clause 8.1.2.3.2.1 are applicable	Non DRX Requirements in clause 8.1.2.3.2.1 are applicable
0.128	When configuration 2 non DRX Requirements in clause 8.1.2.3.2.1 are applicable, Otherwise Note ($10 \cdot K_n \cdot N_{\text{freq},n}$)	When configuration 2 non DRX Requirements in clause 8.1.2.3.2.1 are applicable, Otherwise Note ($10 \cdot K_r \cdot N_{\text{freq},r}$)
$0.128 < \text{DRX-cycle} \leq 2.56$	Note ($10 \cdot K_n \cdot N_{\text{freq},n}$)	Note ($10 \cdot K_r \cdot N_{\text{freq},r}$)
Note: Time depends upon the DRX cycle in use		

Table 8.1.2.3.2.2-6: Requirement to measure TDD inter-frequency cells when eDRX_CONN cycle is used (category 1bis UE)

eDRX_CONN cycle length (s)	$T_{\text{measure_inter}}$ (s) (eDRX_CONN cycles) (normal requirement)	$T_{\text{measure_inter}}$ (s) (eDRX_CONN cycles) (reduced requirement)
$2.56 < \text{eDRX_CONN cycle} \leq 10.24$	Note ($10 \cdot K_n \cdot N_{\text{freq},n}$)	Note ($5 \cdot K_r \cdot N_{\text{freq},r}$)
Note: Time depends upon the eDRX_CONN cycle in use		

The RSRP measurement accuracy for all measured cells shall be as specified in the sub-clauses 9.1.3.3 and 9.1.3.4 and the RSRQ measurement accuracy for all measured cells shall be as specified in the sub-clauses 9.1.6.5 and 9.1.6.6.

8.1.2.3.2.2.1 Measurement Reporting Requirements

8.1.2.3.2.2.1.1 Periodic Reporting

Reported RSRP, RSRQ, and RS-SINR measurements contained in periodically triggered measurement reports shall meet the requirements in sections 9.1.3.1, 9.1.3.2, 9.1.6.1, 9.1.6.2, 9.1.17.3.1 and 9.1.17.3.2, respectively.

8.1.2.3.2.2.1.2 Event-triggered Periodic Reporting

Reported RSRP, RSRQ, and RS-SINR measurements contained in event triggered periodic measurement reports shall meet the requirements in clause 9.1.3.1, 9.1.3.2, 9.1.6.1, 9.1.6.2, 9.1.17.3.1 and 9.1.17.3.2, respectively.

The first report in event triggered periodic measurement reporting shall meet the requirements specified in clause 8.1.2.3.2.2.1.3.

8.1.2.3.2.2.1.3 Event Triggered Reporting

Reported RSRP, RSRQ, and RS-SINR measurements contained in event triggered measurement reports shall meet the requirements in clause 9.1.3.1, 9.1.3.2, 9.1.6.1, 9.1.6.2, 9.1.17.3.1 and 9.1.17.3.2, respectively.

The UE shall not send any event triggered measurement reports, as long as no reporting criteria are fulfilled.

The measurement reporting delay is defined as the time between an event that will trigger a measurement report and the point when the UE starts to transmit the measurement report over the air interface. This requirement assumes that the measurement report is not delayed by other RRC signalling on the DCCH. This measurement reporting delay excludes a delay uncertainty resulted when inserting the measurement report to the TTI of the uplink DCCH. The delay uncertainty is: $2 \times \text{TTI}_{\text{DCCH}}$ where TTI_{DCCH} is the duration of subframe or slot or subslot when the measurement report is transmitted on the PUSCH with subframe or slot or subslot duration. This measurement reporting delay excludes a delay which caused by no UL resources for UE to send the measurement report.

The event triggered measurement reporting delay, measured without L3 filtering shall be less than $T_{\text{Identify_Inter}}$ defined in Clause 8.1.2.3.2.2. When L3 filtering is used or IDC autonomous denial is configured or the UE is performing reception and/or transmission for ProSe Direct Discovery and/or ProSe Direct Communication, or the UE is configured to perform SRS carrier based switching, an additional delay can be expected.

If a cell which has been detectable at least for the time period $T_{\text{Identify_Inter}}$ in clause 8.1.2.3.2.2 and then triggers the measurement report as per TS 36.331 [2], the event triggered measurement reporting delay shall be less than $T_{\text{measure_inter}}$ in clause 8.1.2.3.2.2 provided the timing to that cell has not changed more than ± 50 Ts while measurement gap has not been available and the L3 filter has not been used. When L3 filtering is used or IDC autonomous denial is configured or the UE is performing reception and/or transmission for ProSe Direct Discovery and/or ProSe Direct Communication, or the UE is configured to perform SRS carrier based switching, an additional delay can be expected.

8.1.2.3.3 E-UTRAN TDD – FDD inter frequency measurements

8.1.2.3.3.1 E-UTRAN TDD – FDD inter frequency measurements when no DRX is used

The requirements in this clause shall apply to UE supporting FDD and TDD.

The requirements in clause 8.1.2.3.1.1 also apply for this section.

8.1.2.3.3.2 E-UTRAN TDD – FDD inter frequency measurements when DRX is used

The requirements in this clause shall apply to UE supporting FDD and TDD.

When DRX or eDRX_CONN cycle is used, the requirements in clause 8.1.2.3.1.2 shall also apply for this section.

8.1.2.3.4 E-UTRAN FDD – TDD inter frequency measurements

8.1.2.3.4.1 E-UTRAN FDD – TDD inter frequency measurements when no DRX is used

The requirements in this clause shall apply to UE supporting FDD and TDD.

The requirements in clause 8.1.2.3.2.1 also apply for this section.

8.1.2.3.4.2 E-UTRAN FDD – TDD inter frequency measurements when DRX is used

The requirements in this clause shall apply to UE supporting FDD and TDD.

When DRX or eDRX_CONN cycle is used, the requirements in clause 8.1.2.3.2.2 shall also apply for this section.

8.1.2.3.5 E-UTRAN FDD-FDD inter frequency measurements with autonomous gaps

8.1.2.3.5.1 Identification of a new CGI of E-UTRA FDD cell with autonomous gaps

No explicit neighbour list is provided to the UE for identifying a new CGI of E-UTRA cell. The UE shall identify and report the CGI when requested by the network for the purpose of 'reportCGI'. The UE may make autonomous gaps in both downlink reception and uplink transmission for receiving MIB and SIB1 message according to clause 5.5.3.1 of TS 36.331 [2]. Note that a UE is not required to use autonomous gap if si-RequestForHO is set to false. If autonomous gaps are used for measurement with the purpose of 'reportCGI', regardless of whether DRX or eDRX_CONN is used or not, or whether SCell(s) are configured or not, the UE shall be able to identify a new CGI of E-UTRA cell within:

$$T_{\text{identify_CGI,inter}} = T_{\text{basic_identify_CGI,inter}} \quad ms$$

Where

$T_{\text{basic_identify_CGI,inter}} = 150$ ms. This is the time period used in the above equation where the maximum allowed time for the UE to identify a new CGI of E-UTRA cell is defined, provided that the E-UTRA cell has been already identified by the UE.

A cell shall be considered identifiable following conditions are fulfilled:

- RSRP related side conditions given in Clause 9.1 are fulfilled for a corresponding Band,
- SCH_RP_{dBm} and $SCH\ \hat{E}s/Iot$ according to Annex B.2.3 for a corresponding Band.

The MIB of an E-UTRA cell whose CGI is identified shall be considered decodable by the UE provided the PBCH demodulation requirements are met according to [5].

The requirement for identifying a new CGI of an E-UTRA cell within $T_{\text{basic_identify_CGI,inter}}$ is applicable when no DRX is used as well as when any of the DRX or eDRX_CONN cycles specified in TS 36.331 [2] is used.

Within the time, $T_{\text{identify_CGI,intra}}$ *ms*, over which the UE identifies the new CGI of E-UTRA cell, the UE shall transmit at least 60 ACK/NACKs on PCell or each of activated SCell(s), provided that:

- there is continuous DL data allocation,
- no DRX and no eDRX_CONN cycle is used,
- no measurement gaps are configured,
- only one code word is transmitted in each subframe,
- no MBSFN subframes are configured in the PCell or each of activated SCell(s).

Note : ACK requirements for CGI reading were derived assuming *ShortTTI-r15* is not configured. When *ShortTTI-r15* is configured is used, a greater number of transmitted ACK/NACK is expected.

For the UE capable of SRS carrier based switching when configured to perform SRS carrier based switching for SRS transmission and/or RACH transmission via one or more SCells without PUSCH (NOTE: The requirement on the number of ACK/NACKs transmitted during SRS carrier based switching does not need to be tested):

- the requirements defined in this section shall be met provided during :
 - the SRS carrier based switching does not cause any interruption on the PCell or on any activated SCell during and
 - DL subframe #0 and DL subframe #5 per radio frame of the target E-UTRA are available at the UE.
- otherwise the time to acquire the new CGI of the E-UTRA cell may be extended or the UE may not be able to transmit the required number of ACK/NACKs on PCell or each of the activated SCell(s).

8.1.2.3.5.2 ECGI Reporting Delay

The ECGI reporting delay occurs due to the delay uncertainty when inserting the ECGI measurement report to the TTI of the uplink DCCH. The delay uncertainty is twice the TTI of the uplink DCCH. When the measurement report is transmitted on the PUSCH with subframe or slot or subslot duration, the delay uncertainty is twice the subframe or slot or subslot of the uplink DCCH. In case DRX is used, the ECGI reporting may be delayed until the next DRX cycle. In case eDRX_CONN is used, the ECGI reporting may be delayed until the next eDRX_CONN cycle. If IDC autonomous denial is configured, an additional delay can be expected.

8.1.2.3.6 E-UTRAN TDD-FDD inter frequency measurements using autonomous gaps

The requirements in this clause shall apply to UE supporting FDD and TDD.

8.1.2.3.6.1 Identification of a new CGI of E-UTRA FDD cell with autonomous gaps

No explicit neighbour list is provided to the UE for identifying a new CGI of E-UTRA cell. The UE shall identify and report the CGI when requested by the network for the purpose of 'reportCGI'. The UE may make autonomous gaps in both downlink reception and uplink transmission for receiving MIB and SIB1 message according to clause 5.5.3.1 of TS 36.331 [2]. Note that a UE is not required to use autonomous gap if si-RequestForHO is set to false. If autonomous gaps are used for measurement with the purpose of 'reportCGI', regardless of whether DRX or eDRX_CONN is used or not, or whether SCell(s) are configured or not, the UE shall be able to identify a new CGI of E-UTRA cell within:

$$T_{\text{identify_CGI,inter}} = T_{\text{basic_identify_CGI,inter}} \quad \textit{ms}$$

Where

$T_{\text{basic_identify_CGI,inter}} = 150$ ms. This is the time period used in the above equation where the maximum allowed time for the UE to identify a new CGI of E-UTRA cell is defined, provided that the E-UTRA cell has been already identified by the UE.

A cell shall be considered identifiable following conditions are fulfilled:

- RSRP related side conditions given in Clause 9.1 are fulfilled for a corresponding Band,
- $SCH_RP|_{dBm}$ and $SCH\ \hat{E}s/Iot$ according to Annex B.2.4 for a corresponding Band.

The MIB of an E-UTRA cell whose CGI is identified shall be considered decodable by the UE provided the PBCH demodulation requirements are met according to [5].

The requirement for identifying a new CGI of an E-UTRA cell within $T_{basic_identify_CGI,inter}$ is applicable when no DRX is used as well as when any of the DRX or eDRX_CONN cycles specified in TS 36.331 [2] is used.

Within the time, $T_{identify_CGI,inter}$ ms, over which the UE identifies the new CGI of E-UTRA cell, the UE shall be able to transmit at least the number of ACK/NACKs stated in Table 8.1.2.3.6.1-1 on PCell or each of activated SCell(s), provided that:

- there is continuous DL data allocation,
- no DRX and no eDRX_CONN cycle is used,
- no measurement gaps are configured,
- only one code word is transmitted in each subframe,
- no MBSFN subframes are configured in the PCell or each of activated SCell(s).

Table 8.1.2.3.6.1-1: Requirement on minimum number of ACK/NACKs to transmit during $T_{basic_identify_CGI,inter}$

TDD UL/DL configuration for serving cell	Minimum number of transmitted ACK/NACKs
0 (Note 1)	18
1	30
Note 1: When a UE is configured with <i>EIMTA-MainConfigServCell</i> via RRC signalling [2] only this requirement shall apply. Note 2: The requirement for other TDD UL/DL configuration is not specified.	

Note : ACK requirements for CGI reading were derived assuming 1ms TTI duration for both UL and DL. When shorter TTI is used, a greater number of transmitted ACK/NACK is expected.

For the UE capable of SRS carrier based switching when configured to perform SRS carrier based switching for SRS transmission and/or RACH transmission via one or more SCells without PUSCH (NOTE: The requirement on the number of ACK/NACKs transmitted during SRS carrier based switching does not need to be tested):

- the requirements defined in this section shall be met provided during :
 - the SRS carrier based switching does not cause any interruption on the PCell or on any activated SCell during and
 - DL subframe #0 and DL subframe #5 per radio frame of the target E-UTRA are available at the UE.
- otherwise the time to acquire the new CGI of the E-UTRA cell may be extended or the UE may not be able to transmit at least the number of ACK/NACKs as specified in Table 8.1.2.3.6.1-1 on PCell or each of the activated SCell(s).

8.1.2.3.6.2 ECGI Reporting Delay

The ECGI reporting delay occurs due to the delay uncertainty when inserting the ECGI measurement report to the TTI of the uplink DCCH. The delay uncertainty is twice the TTI of the uplink DCCH. When the measurement report is transmitted on the PUSCH with subframe or slot or subslot duration, the delay uncertainty is twice the subframe or slot or subslot of the uplink DCCH. In case DRX is used, the ECGI reporting may be delayed until the next DRX cycle. In case eDRX_CONN is used, the ECGI reporting may be delayed until the next eDRX_CONN cycle. If IDC autonomous denial is configured, an additional delay can be expected.

8.1.2.3.7 E-UTRAN TDD-TDD inter frequency measurements with autonomous gaps

8.1.2.3.7.1 Identification of a new CGI of E-UTRA TDD cell with autonomous gaps

No explicit neighbour list is provided to the UE for identifying a new CGI of E-UTRA cell. The UE shall identify and report the CGI when requested by the network for the purpose of ‘reportCGI’. The UE may make autonomous gaps in both downlink reception and uplink transmission for receiving MIB and SIB1 message according to clause 5.5.3.1 of TS 36.331 [2]. Note that a UE is not required to use autonomous gap if si-RequestForHO is set to false. If autonomous gaps are used for measurement with the purpose of ‘reportCGI’, regardless of whether DRX or eDRX_CONN is used or not, or whether SCell(s) are configured or not, the UE shall be able to identify a new CGI of E-UTRA cell within:

$$T_{\text{identify_CGI,inter}} = T_{\text{basic_identify_CGI,inter}} \text{ ms}$$

Where

$T_{\text{basic_identify_CGI,inter}} = 150$ ms. This is the time period used in the above equation where the maximum allowed time for the UE to identify a new CGI of E-UTRA cell is defined, provided that the E-UTRA cell has been already identified by the UE.

A cell shall be considered identifiable following conditions are fulfilled:

- RSRP related side conditions given in Clause 9.1 are fulfilled for a corresponding Band,
- SCH_RP and SCH Ês/Iot according to Annex B.2.4 for a corresponding Band.

The MIB of an E-UTRA cell whose CGI is identified shall be considered decodable by the UE provided the PBCH demodulation requirements are met according to [5].

The requirement for identifying a new CGI of an E-UTRA cell within $T_{\text{basic_identify_CGI,inter}}$ is applicable when no DRX is used as well as when any of the DRX or eDRX_CONN cycles specified in TS 36.331 [2] is used.

Within the time, $T_{\text{identify_CGI,inter}}$ ms, over which the UE identifies the new CGI of E-UTRA cell, the UE shall be able to transmit at least the number of ACK/NACKs stated in Table 8.1.2.3.7.1-1 on PCell or each of activated SCell(s), provided that:

- there is continuous DL data allocation,
- no DRX and no eDRX_CONN cycle is used,
- no measurement gaps are configured,
- only one code word is transmitted in each subframe,
- no MBSFN subframes are configured in the PCell or each of activated SCell(s).

Table 8.1.2.3.7.1-1: Requirement on minimum number of ACK/NACKs to transmit during $T_{\text{basic_identify_CGI,inter}}$

TDD UL/DL configuration for serving cell	Minimum number of transmitted ACK/NACKs
0 (Note 1)	18
1	30
Note 1: When a UE is configured with <i>EIMTA-MainConfigServCell</i> via RRC signalling [2] only this requirement shall apply cell. Note 2: The requirement for other TDD UL/DL configuration is not specified.	

Note : ACK requirements for CGI reading were derived assuming 1ms TTI duration for both UL and DL. When shorter TTI is used, a greater number of transmitted ACK/NACK is expected.

For the UE capable of SRS carrier based switching when configured to perform SRS carrier based switching for SRS transmission and/or RACH transmission via one or more SCells without PUSCH (NOTE: The requirement on the number of ACK/NACKs transmitted during SRS carrier based switching does not need to be tested):

- the requirements defined in this section shall be met provided during :
 - the SRS carrier based switching does not cause any interruption on the PCell or on any activated SCell during and
 - DL subframe #0 and DL subframe #5 per radio frame of the target E-UTRA are available at the UE.
- otherwise the time to acquire the new CGI of the E-UTRA cell may be extended or the UE may not be able to transmit at least the number of ACK/NACKs as specified in Table 8.1.2.3.7.1-1 on PCell or each of the activated SCell(s).

8.1.2.3.7.2 ECGI Reporting Delay

The ECGI reporting delay occurs due to the delay uncertainty when inserting the ECGI measurement report to the TTI of the uplink DCCH. The delay uncertainty is twice the TTI of the uplink DCCH. When the measurement report is transmitted on the PUSCH with subframe or slot or subslot duration, the delay uncertainty is twice the subframe or slot or subslot of the uplink DCCH. In case DRX is used, the ECGI reporting may be delayed until the next DRX cycle. In case eDRX_CONN is used, the ECGI reporting may be delayed until the next eDRX_CONN cycle. If IDC autonomous denial is configured, an additional delay can be expected.

8.1.2.3.8 E-UTRAN FDD-TDD inter frequency measurements using autonomous gaps

The requirements in this clause shall apply to UE supporting FDD and TDD.

8.1.2.3.8.1 Identification of a new CGI of E-UTRA TDD cell with autonomous gaps

No explicit neighbour list is provided to the UE for identifying a new CGI of E-UTRA cell. The UE shall identify and report the CGI when requested by the network for the purpose of 'reportCGI'. The UE may make autonomous gaps in both downlink reception and uplink transmission for receiving MIB and SIB1 message according to clause 5.5.3.1 of TS 36.331 [2]. Note that a UE is not required to use autonomous gap if si-RequestForHO is set to false. If autonomous gaps are used for measurement with the purpose of 'reportCGI', regardless of whether DRX or eDRX_CONN is used or not, or whether SCell(s) are configured or not, the UE shall be able to identify a new CGI of E-UTRA cell within:

$$T_{\text{identify_CGI,inter}} = T_{\text{basic_identify_CGI,inter}} \quad \text{ms}$$

Where

$T_{\text{basic_identify_CGI,inter}} = 150$ ms. This is the time period used in the above equation where the maximum allowed time for the UE to identify a new CGI of E-UTRA cell is defined, provided that the E-UTRA cell has been already identified by the UE.

A cell shall be considered identifiable following conditions are fulfilled:

- RSRP related side conditions given in Clause 9.1 are fulfilled for a corresponding Band,
- SCH_RP and SCH \hat{E} s/Iot according to Annex B.2.4 for a corresponding Band.

The MIB of an E-UTRA cell whose CGI is identified shall be considered decodable by the UE provided the PBCH demodulation requirements are met according to [5].

The requirement for identifying a new CGI of an E-UTRA cell within $T_{\text{basic_identify_CGI,inter}}$ is applicable when no DRX is used as well as when any of the DRX or eDRX_CONN cycles specified in TS 36.331 [2] is used.

Within the time, $T_{\text{identify_CGI,inter}}$ ms, over which the UE identifies the new CGI of E-UTRA cell, the UE shall have more than 60 ACK/NACKs transmitted on PCell or each of activated SCell(s), provided that:

- there is continuous DL data allocation,
- no DRX and no eDRX_CONN cycle is used,
- no measurement gaps are configured,
- only one code word is transmitted in each subframe,
- no MBSFN subframes are configured in the PCell or each of activated SCell(s).

Note : ACK requirements for CGI reading were derived assuming 1ms TTI duration for both UL and DL. When shorter TTI is used, a greater number of transmitted ACK/NACK is expected

For the UE capable of SRS carrier based switching when configured to perform SRS carrier based switching for SRS transmission and/or RACH transmission via one or more SCells without PUSCH (NOTE: The requirement on the number of ACK/NACKs transmitted during SRS carrier based switching does not need to be tested):

- the requirements defined in this section shall be met provided during :
 - the SRS carrier based switching does not cause any interruption on the PCell or on any activated SCell during and
 - DL subframe #0 and DL subframe #5 per radio frame of the target E-UTRA are available at the UE.
- otherwise the time to acquire the new CGI of the E-UTRA cell may be extended or the UE may not be able to transmit the required number of ACK/NACKs on PCell or each of the activated SCell(s).

8.1.2.3.8.2 ECGI Reporting Delay

The ECGI reporting delay occurs due to the delay uncertainty when inserting the ECGI measurement report to the TTI of the uplink DCCH. The delay uncertainty is twice the TTI of the uplink DCCH. When the measurement report is transmitted on the PUSCH with subframe or slot or subslot duration, the delay uncertainty is twice the subframe or slot or subslot of the uplink DCCH. In case DRX is used, the ECGI reporting may be delayed until the next DRX cycle. In case eDRX_CONN is used, the ECGI reporting may be delayed until the next eDRX_CONN cycle. If IDC autonomous denial is configured, an additional delay can be expected.

8.1.2.3.9 E-UTRAN FDD – FDD inter frequency measurements with FeMBMS/Unicast mixed cells

Requirements in this section apply for UE configured to perform inter-frequency measurements on a carrier with one or more FeMBMS/Unicast mixed cells and which are capable of receiving unicast from the FeMBMS/Unicast mixed cell and are capable of receiving at least one of *SystemInformationBlockType15* or *fembms-MixedCarrier-r14* indication and are provided with the information that one or more FeMBMS/Unicast mixed cells are present on the inter-frequency to be measured.

The minimum number of cells and the minimum number of inter-frequencies that the UE shall be able to measure on include also FeMBMS/Unicast mixed cells and the inter-frequencies with and without such cells.

8.1.2.3.9.1 E-UTRAN FDD – FDD inter frequency measurements with FeMBMS/unicast mixed cells when no DRX is used

When measurement gaps other than nonUniform1 – nonUniform4 are scheduled, or the UE supports capability of conducting such measurements without gaps, the UE shall be able to identify a new FDD inter-frequency within $T_{\text{Identify_Inter}}$ according to the following expression:

$$T_{\text{Identify_Inter}} = T_{\text{Basic_Identify_Inter}} \cdot \frac{480}{T_{\text{Inter1}}} \cdot N_{\text{freq},n} \cdot K_n + 240 \cdot N_{\text{freq},n} \cdot K_n \quad \text{ms (normal performance) and}$$

$$T_{\text{Identify_Inter}} = T_{\text{Basic_Identify_Inter}} \cdot \frac{480}{T_{\text{Inter1}}} \cdot N_{\text{freq},r} \cdot K_r + 240 \cdot N_{\text{freq},r} \cdot K_r \quad \text{ms (reduced performance)}$$

Where:

$T_{\text{Basic_Identify_Inter}} = 480$ ms. It is the time period used in the inter frequency equation where the maximum allowed time for the UE to identify a new FDD inter-frequency cell is defined.

$N_{\text{freq},n}$, $N_{\text{freq},r}$, K_n and K_r are defined in clause 8.1.2.1.1 and T_{Inter1} is defined in clause 8.1.2.1

When measurement gaps nonUniform1 – nonUniform4 are scheduled, the UE shall be able to identify a new FDD inter-frequency within $T_{\text{Identify_Inter}}$ according to the following expressions:

$$T_{\text{Identify_Inter}} = 8 \cdot T_{\text{burst}} \cdot N_{\text{freq}} + \frac{1}{2} T_{\text{burst}} \cdot N_{\text{freq}} \quad \text{ms}$$

If the UE requires measurement gaps to identify and measure inter-frequency and/or inter-RAT cells and the UE supports perServingCellMeasurementGap-r14 and is configured with per per-CC, or the UE supports parallel measurements, the UE shall be able to identify a new FDD inter-frequency within $T_{\text{Identify_Inter_perCC}}$ according to the following expression:

$$T_{\text{Identify_Inter_perCC}} = T_{\text{Basic_Identify_Inter}} \cdot \frac{480}{T_{\text{Inter1}}} \cdot N_{\text{freq},n,\text{effective}} \cdot K_n + 240 \cdot N_{\text{freq},n} \quad \text{ms (normal performance) and}$$

$$T_{\text{Identify_Inter_perCC}} = T_{\text{Basic_Identify_Inter}} \cdot \frac{480}{T_{\text{Inter1}}} \cdot N_{\text{freq},r,\text{effective}} \cdot K_r + 240 \cdot N_{\text{freq},r} \quad \text{ms (reduced performance)}$$

where:

$T_{\text{Basic_Identify_Inter}} = 480$ ms. It is the time period used in the inter frequency equation where the maximum allowed time for the UE to identify a new FDD inter-frequency cell is defined.

If the UE supports perServingCellMeasurementGap-r14 and is configured with per-CC gap, or the UE supports parallel measurements, $N_{\text{freq},n} = N_{\text{freq},n,\text{effective}}$ shall be used in section 8.1.2.3.9 when deriving the UE requirements. $N_{\text{freq},n,\text{effective}}$ and $N_{\text{freq},r,\text{effective}}$ are defined as effective number of layers to be monitored by the UE for normal performance group and reduced performance group. They are reported by the UE. $N_{\text{freq},n,\text{effective}}$ should be equal or less than $N_{\text{freq},n}$ defined in clause 8.1.2.1.1. and $N_{\text{freq},r,\text{effective}}$ should be equal or less than $N_{\text{freq},r}$ defined in clause 8.1.2.1.1. K_n and K_r are defined in clause 8.1.2.1.1 and T_{Inter1} is defined in clause 8.1.2.1. For UE other than category 1bis UE, a cell shall be considered detectable provided following conditions are fulfilled:

- RSRP_{dBm} and RSRP \hat{E} s/Iot according to Annex B.2.3 for a corresponding Band,
- other RSRP related side conditions given in Sections 9.1.3.1 and 9.1.3.2 are fulfilled for a corresponding Band,
- RSRQ related side conditions given in Sections 9.1.6.1 and 9.1.6.2 are fulfilled for a corresponding Band,
- RS-SINR related side conditions given in Sections 9.1.17.3.1 and 9.1.17.3.2 are fulfilled for a corresponding Band,
- SCH_RP_{dBm} and SCH \hat{E} s/Iot according to Annex B.2.3 for a corresponding Band.

For category 1bis UE, a cell shall be considered detectable provided following conditions are fulfilled:

- RSRP_{dBm} and RSRP \hat{E} s/Iot according to Annex B.2.3 for a corresponding Band,
- other RSRP related side conditions given in Sections 9.1.3.3 and 9.1.3.4 are fulfilled for a corresponding Band,
- RSRQ related side conditions given in Sections 9.1.6.5 and 9.1.6.6 are fulfilled for a corresponding Band,
- SCH_RP_{dBm} and SCH \hat{E} s/Iot according to Annex B.2.3 for a corresponding Band.

When measurement gaps are scheduled for FDD inter frequency measurements, or the UE supports capability of conducting such measurements without gaps, the UE physical layer shall be capable of reporting RSRP, RSRQ, and RS-SINR measurements to higher layers with measurement accuracy as specified in sub-clauses 9.1.3.1, 9.1.3.2, 9.1.6.1, 9.1.6.2, 9.1.17.3.1 and 9.1.17.3.2, respectively, with measurement period given by table 8.1.2.3.9.1-1.

Table 8.1.2.3.9.1-1: Measurement period and measurement bandwidth

Configuration	Physical Layer Measurement period: T _{Measurement_Period_Inter_FDD} [ms] (normal performance)	Physical Layer Measurement period: T _{Measurement_Period_Inter_FDD} [ms] (reduced performance)	Measurement bandwidth [RB]
0	720 x K _n x N _{freq,n}	720 x K _r x N _{freq,r}	6
1 (Note 1)	480 x K _n x N _{freq,n}	480 x K _r x N _{freq,r}	50
2 (Note 2)	1.5 · T _{burst} x N _{freq}	1.5 · T _{burst} x N _{freq}	6
3 (Note 3)	T _{burst} x N _{freq}	T _{burst} x N _{freq}	50

Note 1: This configuration is optional
 Note 2: This configuration is for when nonUniform1 – nonUniform4 are configured
 Note 3: This configuration is optional and when nonUniform1 – nonUniform4 are configured

The UE shall be capable of performing RSRP, RSRQ, and RS-SINR measurements of at least 4 inter-frequency cells per FDD inter-frequency for up to 3 FDD inter-frequencies or 8 FDD interfrequencies if the UE supports Increased UE carrier monitoring E-UTRA and the UE physical layer shall be capable of reporting RSRP, RSRQ, and RS-SINR measurements to higher layers with the measurement period defined in Table 8.1.2.3.9.1-1.

For category 1bis UE, when measurement gaps are scheduled for FDD inter frequency measurements, or the UE supports capability of conducting such measurements without gaps, the UE physical layer shall be capable of reporting RSRP and RSRQ measurements to higher layers with measurement accuracy as specified in sub-clauses 9.1.3.3, 9.1.3.4, 9.1.6.5 and 9.1.6.6, respectively, with measurement period given by table 8.1.2.3.9.1-2.

Table 8.1.2.3.9.1-2: Measurement period and measurement bandwidth (category 1bis UE)

Configuration	Physical Layer Measurement period: $T_{\text{Measurement_Period_Inter_FDD}}$ [ms] (normal performance)	Physical Layer Measurement period: $T_{\text{Measurement_Period_Inter_FDD}}$ [ms] (reduced performance)	Measurement bandwidth [RB]
0	$1440 \times K_n \times N_{\text{freq},n}$	$1440 \times K_r \times N_{\text{freq},r}$	6
1 (Note)	$960 \times K_n \times N_{\text{freq},n}$	$960 \times K_r \times N_{\text{freq},r}$	50
Note: This configuration is optional			

The category 1bis UE shall be capable of performing RSRP and RSRQ measurements of at least 4 inter-frequency cells per FDD inter-frequency for up to 3 FDD inter-frequencies or 8 FDD interfrequencies if the UE supports Increased UE carrier monitoring E-UTRA and the UE physical layer shall be capable of reporting RSRP and RSRQ measurements to higher layers with the measurement period defined in Table 8.1.2.3.9.1-2.

8.1.2.3.9.1.1 Measurement Reporting Requirements

8.1.2.3.9.1.1.1 Periodic Reporting

Reported RSRP, RSRQ, and RS-SINR measurements contained in periodically triggered measurement reports shall meet the requirements in sections 9.1.3.1, 9.1.3.2, 9.1.6.1, 9.1.6.2, 9.1.17.3.1 and 9.1.17.3.2, respectively.

8.1.2.3.9.1.1.2 Event-triggered Periodic Reporting

Reported RSRP, RSRQ, and RS-SINR measurements contained in event triggered periodic measurement reports shall meet the requirements in sections 9.1.3.1, 9.1.3.2, 9.1.6.1, 9.1.6.2, 9.1.17.3.1 and 9.1.17.3.2, respectively.

The first report in event triggered periodic measurement reporting shall meet the requirements specified in clause 8.1.2.3.9.1.1.3.

8.1.2.3.9.1.1.3 Event Triggered Reporting

Reported RSRP, RSRQ, and RS-SINR measurements contained in event triggered measurement reports shall meet the requirements in sections 9.1.3.1, 9.1.3.2, 9.1.6.1, 9.1.6.2, 9.1.17.3.1 and 9.1.17.3.2, respectively.

The UE shall not send any event triggered measurement reports, as long as no reporting criteria are fulfilled.

The measurement reporting delay is defined as the time between an event that will trigger a measurement report and the point when the UE starts to transmit the measurement report over the air interface. This requirement assumes that the measurement report is not delayed by other RRC signalling on the DCCH. This measurement reporting delay excludes a delay uncertainty resulted when inserting the measurement report to the TTI of the uplink DCCH. The delay uncertainty is: $2 \times TTI_{\text{DCCH}}$. This measurement reporting delay excludes a delay which caused by no UL resources for UE to send the measurement report.

The event triggered measurement reporting delay, measured without L3 filtering shall be less than $T_{\text{identify_inter}} \text{ OR } T_{\text{identify_inter-perCC}}$ when per-CC based measurement gap configured defined in clause 8.1.2.3.9.1. When L3 filtering is used or IDC autonomous denial is configured or the UE is performing reception and/or transmission for ProSe Direct Discovery and/or ProSe Direct Communication, or the UE is configured to perform SRS carrier based switching, an additional delay can be expected.

If a cell which has been detectable at least for the time period $T_{\text{identify_inter}}$ or $T_{\text{identify_inter-perCC}}$ when per-CC based measurement gap configured defined in clause 8.1.2.3.9.1 and then triggers the measurement report as per TS 36.331 [2], the event triggered measurement reporting delay shall be less than $T_{\text{Measurement_Period_Inter_FDD}}$ defined in clause 8.1.2.3.9.1 provided the timing to that cell has not changed more than $\pm 50 T_s$ while measurement gap has not been available and the L3 filter has not been used. When L3 filtering is used or IDC autonomous denial is configured or the UE is performing reception and/or transmission for ProSe Direct Discovery and/or ProSe Direct Communication, or the UE is configured to perform SRS carrier based switching, an additional delay can be expected.

8.1.2.3.9.2 E-UTRAN FDD – FDD inter frequency measurements with FeMBMS/Unicast mixed cells when DRX is used

When DRX or eDRX_CONN is in use, either measurement gaps are scheduled or the UE supports capability of conducting such measurements without gaps, the UE shall be able to identify a new detectable E-UTRAN FDD inter frequency cell within $T_{\text{identify_inter}}$ or $T_{\text{identify_inter-perCC}}$ when per-CC based measurement gap configured. When DRX is in use, $T_{\text{identify_inter}}$ is as defined in Table 8.1.2.3.9.2-1, and when eDRX_CONN is in use, $T_{\text{identify_inter}}$ is as defined in Table 8.1.2.3.9.2-1A for GP0 and GP1. If UE is configured with nonUniform1 – nonUniform4 $T_{\text{identify_inter}}$ is as defined in Table 8.1.2.3.9.2-1B.

Table 8.1.2.3.9.2-1: Requirement to identify a newly detectable FDD interfrequency cell

DRX cycle length (s)	$T_{\text{identify_inter}}$ (s) (DRX cycles), normal performance		$T_{\text{identify_inter}}$ (s) (DRX cycles), reduced performance	
	Gap period = 40 ms	Gap period = 80 ms	Gap period = 40 ms	Gap period = 80 ms
≤ 0.16	Non DRX Requirements in clause 8.1.2.3.9.1 are applicable	Non DRX Requirements in clause 8.1.2.3.9.1 are applicable	Non DRX Requirements in clause 8.1.2.3.9.1 are applicable	Non DRX Requirements in clause 8.1.2.3.9.1 are applicable
0.256	$5.12 * K_n * N_{\text{freq},n}$ ($20 * K_n * N_{\text{freq},n}$)	$7.68 * K_n * N_{\text{freq},n}$ ($30 * K_n * N_{\text{freq},n}$)	$5.12 * K_r * N_{\text{freq},r}$ ($20 * K_r * N_{\text{freq},r}$)	$7.68 * K_r * N_{\text{freq},r}$ ($30 * K_r * N_{\text{freq},r}$)
0.32	$6.4 * K_n * N_{\text{freq},n}$ ($20 * K_n * N_{\text{freq},n}$)	$7.68 * K_n * N_{\text{freq},n}$ ($24 * K_n * N_{\text{freq},n}$)	$6.4 * K_r * N_{\text{freq},r}$ ($20 * K_r * N_{\text{freq},r}$)	$7.68 * K_r * N_{\text{freq},r}$ ($24 * K_r * N_{\text{freq},r}$)
$0.32 < \text{DRX-cycle} \leq 2.56$	Note ($20 * K_n * N_{\text{freq},n}$)	Note ($20 * K_n * N_{\text{freq},n}$)	Note ($20 * K_r * N_{\text{freq},r}$)	Note ($20 * K_r * N_{\text{freq},r}$)
Note: Time depends upon the DRX cycle in use				

Table 8.1.2.3.9.2-1A: Requirement to identify a newly detectable FDD inter-frequency cell when eDRX_CONN cycle is used

eDRX_CONN cycle length (s)	$T_{\text{identify_inter}}$ (s) (eDRX_CONN cycles), normal performance		$T_{\text{identify_inter}}$ (s) (eDRX_CONN cycles), reduced performance	
	Gap period = 40 ms	Gap period = 80 ms	Gap period = 40 ms	Gap period = 80 ms
$2.56 < \text{eDRX_CONN cycle} \leq 10.24$	Note ($20 * K_n * N_{\text{freq},n}$)	Note ($20 * K_n * N_{\text{freq},n}$)	Note ($20 * K_r * N_{\text{freq},r}$)	Note ($20 * K_r * N_{\text{freq},r}$)
Note: Time depends upon the eDRX_CONN cycle in use				

Table 8.1.2.3.9.2-1B: Requirement to identify a newly detectable FDD inter-frequency cell when non-uniform gap pattern nonUniform1 – nonUniform4 is used

DRX_CONN cycle length (s)	$T_{\text{identify_inter}}$			
	$T_{\text{burst}} = 1280 \text{ ms}$	$T_{\text{burst}} = 2560 \text{ ms}$	$T_{\text{burst}} = 5120 \text{ ms}$	$T_{\text{burst}} = 10240 \text{ ms}$
≤ 0.16	Non DRX Requirements in clause 8.1.2.3.9.1 are applicable	Non DRX Requirements in clause 8.1.2.3.9.1 are applicable	Non DRX Requirements in clause 8.1.2.3.9.1 are applicable	Non DRX Requirements in clause 8.1.2.3.9.1 are applicable
$0.16 < \text{DRX-cycle} < 2.56$	$20 * N_{\text{freq}} * (T_{\text{burst}}/480)$	$20 * N_{\text{freq}} * (T_{\text{burst}}/480)$	$20 * N_{\text{freq}} * (T_{\text{burst}}/480)$	$20 * N_{\text{freq}} * (T_{\text{burst}}/480)$

For UE other than category 1bis UE, a cell shall be considered detectable provided following conditions are fulfilled:

- $RSRP_{dBm}$ and $RSRP \hat{E}s/Iot$ according to Annex B.2.3 for a corresponding Band,
- other RSRP related side conditions given in Clause 9.1.3.1 and 9.1.3.2 are fulfilled for a corresponding Band,
- RSRQ related side conditions given in Sections 9.1.6.1 and 9.1.6.2 are fulfilled for a corresponding Band,
- RS-SINR related side conditions given in Sections 9.1.17.3.1 and 9.1.17.3.2 are fulfilled for a corresponding Band,
- SCH_RP_{dBm} $SCH \hat{E}s/Iot$ according to Annex B.2.3 for a corresponding Band.

For category 1bis UE, a cell shall be considered detectable provided following conditions are fulfilled:

- $RSRP_{dBm}$ and $RSRP \hat{E}s/Iot$ according to Annex B.2.3 for a corresponding Band,
- other RSRP related side conditions given in Clause 9.1.3.3 and 9.1.3.4 are fulfilled for a corresponding Band,
- RSRQ related side conditions given in Sections 9.1.6.5 and 9.1.6.6 are fulfilled for a corresponding Band,
- SCH_RP_{dBm} $SCH \hat{E}s/Iot$ according to Annex B.2.3 for a corresponding Band.

When DRX or eDRX_CONN is in use, the UE shall be capable of performing RSRP, RSRQ, and RS-SINR measurements of at least 4 inter-frequency cells per FDD inter-frequency and the UE physical layer shall be capable of reporting RSRP, RSRQ, and RS-SINR measurements to higher layers with the measurement period $T_{measure_inter}$, either measurement gaps are scheduled or the UE supports capability of conducting such measurements without gaps. When DRX is used, $T_{measure_inter}$ is as defined in Table 8.1.2.3.9.2-2, and when eDRX_CONN is in use, $T_{measure_inter}$ is as defined in Table 8.1.2.3.9.2-3 for GP0 and GP1. If UE is configured with nonUniform1 – nonUniform4 $T_{identify_inter}$ is as defined in Table 8.1.2.3.9.2-4.

Table 8.1.2.3.9.2-2: Requirement to measure FDD interfrequency cells

DRX cycle length (s)	$T_{measure_inter}$ (s) (DRX cycles) (normal performance)	$T_{measure_inter}$ (s) (DRX cycles) (reduced performance)
≤ 0.08	Non DRX Requirements in clause 8.1.2.3.9.1 are applicable	Non DRX Requirements in clause 8.1.2.3.9.1 are applicable
0.128	Non DRX Requirements in clause 8.1.2.3.9.1 are applicable	Non DRX Requirements in clause 8.1.2.3.9.1 are applicable
$0.128 < DRX_cycle \leq 2.56$	Note ($5 * K_n * N_{freq,n}$)	Note ($5 * K_r * N_{freq,r}$)
Note: Time depends upon the DRX cycle in use		

Table 8.1.2.3.9.2-3: Requirement to measure FDD inter-frequency cells when eDRX_CONN cycle is used

eDRX_CONN cycle length (s)	$T_{measure_inter}$ (s) (eDRX_CONN cycles) (normal performance)	$T_{measure_inter}$ (s) (eDRX_CONN cycles) (reduced performance)
$2.56 < eDRX_CONN \text{ cycle} \leq 10.24$	Note ($5 * K_n * N_{freq,n}$)	Note ($5 * K_r * N_{freq,r}$)
Note: Time depends upon the eDRX_CONN cycle in use		

Table 8.1.2.3.9.2-4: Requirement to measure FDD inter-frequency cells when non-uniform gap pattern nonUniform1 – nonUniform4 is used

DRX_CONN cycle length (s)	$T_{measure_inter}$			
	$T_{burst} = 1280 \text{ ms}$	$T_{burst} = 2560 \text{ ms}$	$T_{burst} = 5120 \text{ ms}$	$T_{burst} = 10240 \text{ ms}$

DRX-cycle ≤2.56	$5 \cdot N_{\text{freq}} \cdot (T_{\text{burst}}/480)$	$5 \cdot N_{\text{freq}} \cdot (T_{\text{burst}}/480)$	$5 \cdot N_{\text{freq}} \cdot (T_{\text{burst}}/480)$	$5 \cdot N_{\text{freq}} \cdot (T_{\text{burst}}/480)$
--------------------	--	--	--	--

The RSRP measurement accuracy for all measured cells shall be as specified in the sub-clauses 9.1.3.1 and 9.1.3.2, the RSRQ measurement accuracy for all measured cells shall be as specified in the sub-clauses 9.1.6.1 and 9.1.6.2, and the RS-SINR measurement accuracy for all measured cells shall be as specified in the sub-clauses 9.1.17.3.1 and 9.1.17.3.2.

For category 1bis UE, when DRX or eDRX_CONN is in use, the UE shall be capable of performing RSRP and RSRQ measurements of at least 4 inter-frequency cells per FDD inter-frequency and the UE physical layer shall be capable of reporting RSRP and RSRQ measurements to higher layers with the measurement period $T_{\text{measure_inter}}$, either measurement gaps are scheduled or the UE supports capability of conducting such measurements without gaps. When DRX is used, $T_{\text{measure_inter}}$ is as defined in Table 8.1.2.3.9.2-5, and when eDRX_CONN is in use, $T_{\text{measure_inter}}$ is as defined in Table 8.1.2.3.9.2-6.

Table 8.1.2.3.9.2-5: Requirement to measure FDD interfrequency cells (category 1bis UE)

DRX cycle length (s)	$T_{\text{measure_inter}}$ (s) (DRX cycles) (normal performance)	$T_{\text{measure_inter}}$ (s) (DRX cycles) (reduced performance)
≤0.08	Non DRX Requirements in clause 8.1.2.3.9.1 are applicable	Non DRX Requirements in clause 8.1.2.3.9.1 are applicable
1.28	Non DRX Requirements in clause 8.1.2.3.9.1 are applicable	Non DRX Requirements in clause 8.1.2.3.9.1 are applicable
$1.28 < \text{DRX-cycle} \leq 2.56$	Note ($10 \cdot K_n \cdot N_{\text{freq},n}$)	Note ($10 \cdot K_r \cdot N_{\text{freq},r}$)
Note: Time depends upon the DRX cycle in use		

Table 8.1.2.3.9.2-6: Requirement to measure FDD inter-frequency cells when eDRX_CONN cycle is used (category 1bis UE)

eDRX_CONN cycle length (s)	$T_{\text{measure_inter}}$ (s) (eDRX_CONN cycles) (normal performance)	$T_{\text{measure_inter}}$ (s) (eDRX_CONN cycles) (reduced performance)
$2.56 < \text{eDRX_CONN cycle} \leq 10.24$	Note ($10 \cdot K_n \cdot N_{\text{freq},n}$)	Note ($5 \cdot K_r \cdot N_{\text{freq},r}$)
Note: Time depends upon the eDRX_CONN cycle in use		

The RSRP measurement accuracy for all measured cells shall be as specified in the sub-clauses 9.1.3.3 and 9.1.3.4 and the RSRQ measurement accuracy for all measured cells shall be as specified in the sub-clauses 9.1.6.5 and 9.1.6.6.

8.1.2.3.9.2.1 Measurement Reporting Requirements

8.1.2.3.9.2.1.1 Periodic Reporting

Reported RSRP, RSRQ, and RS-SINR measurements contained in periodically triggered measurement reports shall meet the requirements in sections 9.1.3.1, 9.1.3.2, 9.1.6.1, 9.1.6.2, 9.1.17.3.1 and 9.1.17.3.2, respectively.

8.1.2.3.9.2.1.2 Event-triggered Periodic Reporting

Reported RSRP, RSRQ, and RS-SINR measurements contained in event triggered periodic measurement reports shall meet the requirements in sections 9.1.3.1, 9.1.3.2, 9.1.6.1, 9.1.6.2, 9.1.17.3.1 and 9.1.17.3.2, respectively.

The first report in event triggered periodic measurement reporting shall meet the requirements specified in clause 8.1.2.3.9.2.1.3.

8.1.2.3.9.2.1.3 Event Triggered Reporting

Reported RSRP, RSRQ, and RS-SINR measurements contained in event triggered measurement reports shall meet the requirements in sections 9.1.3.1, 9.1.3.2, 9.1.6.1, 9.1.6.2, 9.1.17.3.1 and 9.1.17.3.2, respectively.

The UE shall not send any event triggered measurement reports, as long as no reporting criteria are fulfilled.

The measurement reporting delay is defined as the time between an event that will trigger a measurement report and the point when the UE starts to transmit the measurement report over the air interface. This requirement assumes that the measurement report is not delayed by other RRC signalling on the DCCH. This measurement reporting delay excludes a delay uncertainty resulted when inserting the measurement report to the TTI of the uplink DCCH. The delay uncertainty is: $2 \times TTI_{DCCH}$. This measurement reporting delay excludes a delay which caused by no UL resources for UE to send the measurement report.

The event triggered measurement reporting delay, measured without L3 filtering shall be less than $T_{identify_inter}$ defined in clause 8.1.2.3.9.2. When L3 filtering is used or IDC autonomous denial is configured or the UE is performing reception and/or transmission for ProSe Direct Discovery and/or ProSe Direct Communication, or the UE is configured to perform SRS carrier based switching, an additional delay can be expected.

If a cell which has been detectable at least for the time period $T_{identify_inter}$ defined in clause 8.1.2.3.9.2 and then triggers the measurement report as per TS 36.331 [2], the event triggered measurement reporting delay shall be less than $T_{measure_inter}$ defined in clause 8.1.2.3.9.2 provided the timing to that cell has not changed more than $\pm 50 T_s$ while measurement gap has not been available and the L3 filter has not been used. When L3 filtering is used or IDC autonomous denial is configured or the UE is performing reception and/or transmission for ProSe Direct Discovery and/or ProSe Direct Communication, or the UE is configured to perform SRS carrier based switching, an additional delay can be expected.

8.1.2.3.10 E-UTRAN TDD – FDD inter frequency measurements with FeMBMS/Unicast mixed cells

Requirements in this section apply for UE configured to perform inter-frequency measurements on a carrier with one or more FeMBMS/Unicast mixed cells and which are capable of receiving unicast from the FeMBMS/Unicast mixed cell and are capable of receiving at least one of *SystemInformationBlockType15* or *fembms-MixedCarrier-r14* indication and are provided with the information that one or more FeMBMS/Unicast mixed cells are present on the FDD inter-frequency to be measured.

8.1.2.3.10.1 E-UTRAN TDD – FDD inter frequency measurements with FeMBMS/Unicast mixed cells when no DRX is used

The requirements in clause 8.1.2.3.9.1 also apply for this section, where the minimum number of cells and the minimum number of inter-frequencies that the UE shall be able to measure on include also FeMBMS/Unicast mixed cells and the inter-frequencies with and without such cells.

8.1.2.3.10.2 E-UTRAN TDD – FDD inter frequency measurements with FeMBMS/Unicast mixed cells when DRX is used

When DRX or eDRX_CONN cycle is used, the requirements in clause 8.1.2.3.9.2 shall also apply for this section, where the minimum number of cells and the minimum number of inter-frequencies that the UE shall be able to measure on include also FeMBMS/Unicast mixed cells and the inter-frequencies with and without such cells.

8.1.2.4 Inter RAT measurements

The requirements in this section shall also apply, when the UE is configured to perform SRS carrier based switching and using measurement gaps.

8.1.2.4.1 E-UTRAN FDD – UTRAN FDD measurements

8.1.2.4.1.1 E-UTRAN FDD – UTRAN FDD measurements when no DRX is used

8.1.2.4.1.1.1 Identification of a new UTRA FDD cell

When explicit neighbour list is provided and no DRX is used, either measurement gaps are scheduled or the UE supports capability of conducting such measurements without gaps, the UE shall be able to identify a new detectable cell belonging to the monitored set within

$$T_{identify_UTRA_FDD} = T_{basic_identify_UTRA_FDD} \cdot \frac{480}{T_{inter1}} \cdot K_n \cdot N_{freq,n} \text{ ms (normal performance),}$$

and

$$T_{\text{identify_UTRA_FDD}} = T_{\text{basic_identify_UTRA_FDD}} \cdot \frac{480}{T_{\text{inter1}}} \cdot K_r \cdot N_{\text{freq},r} \quad \text{ms (reduced performance)}$$

A cell shall be considered detectable when

- CPICH Ec/Io \geq -20 dB,
- SCH_Ec/Io \geq -17 dB for at least one channel tap and SCH_Ec/Ior is equally divided between primary synchronisation code and secondary synchronisation code. When L3 filtering is used an additional delay can be expected.

8.1.2.4.1.1.1a Enhanced UTRA FDD cell identification requirements

When explicit neighbour list is provided and no DRX is used or when DRX cycle length \leq 40 ms, either measurement gaps are scheduled or the UE supports capability of conducting such measurements without gaps, the UE shall be able to identify a new detectable cell belonging to the monitored set within $T_{\text{identify_enhanced_UTRA_FDD}}$:

$$T_{\text{identify_enhanced_UTRA_FDD}} = (T_{\text{basic_identify_enhanced_UTRA_FDD}} \cdot \frac{480}{T_{\text{inter1}}} + 480) K_n N_{\text{freq},n} \quad \text{ms (normal performance)}$$

and

$$T_{\text{identify_enhanced_UTRA_FDD}} = (T_{\text{basic_identify_enhanced_UTRA_FDD}} \cdot \frac{480}{T_{\text{inter1}}} + 480) K_r N_{\text{freq},r} \quad \text{ms (reduced performance)}$$

A cell shall be considered detectable when:

- CPICH Ec/Io \geq -15 dB,
- SCH_Ec/Io \geq -15 dB for at least one channel tap and SCH_Ec/Ior is equally divided between primary synchronisation code and secondary synchronisation code. When L3 filtering is used an additional delay can be expected.

8.1.2.4.1.1.2 UE UTRA FDD CPICH measurement capability

When measurement gaps are scheduled for UTRA FDD inter RAT measurements, or the UE supports capability of conducting such measurements without gaps, the UE physical layer shall be capable of reporting measurements to higher layers with measurement accuracy as specified in Clause 9.2 with measurement period given by

$$T_{\text{measurement_UTRA_FDD}} = \text{Max} \left\{ T_{\text{Measurement_Period_UTRA_FDD}}, T_{\text{basic_measurement_UTRA_FDD}} \cdot \frac{480}{T_{\text{inter1}}} \cdot K_n \cdot N_{\text{freq},n} \right\} \text{ms (normal performance),}$$

and

$$T_{\text{measurement_UTRA_FDD}} = \text{Max} \left\{ T_{\text{Measurement_Period_UTRA_FDD}}, T_{\text{basic_measurement_UTRA_FDD}} \cdot \frac{480}{T_{\text{inter1}}} \cdot K_r \cdot N_{\text{freq},r} \right\} \text{ms (reduced performance)}$$

The UE shall be capable of performing UTRA FDD CPICH measurements for $X_{\text{basic_measurement_UTRA_FDD}}$ inter-frequency cells per FDD frequency and the UE physical layer shall be capable of reporting measurements to higher layers with the measurement period of $T_{\text{Measurement_UTRA_FDD}}$.

$$X_{\text{basic_measurement_UTRA_FDD}} = 6$$

$T_{\text{Measurement_Period_UTRA_FDD}} = 480$ ms. The period used for calculating the measurement period $T_{\text{measurement_UTRA_FDD}}$ for UTRA FDD CPICH measurements.

$T_{\text{basic_identify_UTRA_FDD}} = 300$ ms. This is the time period used in the inter RAT equation in clause 8.1.2.4.1.1.1 where the maximum allowed time for the UE to identify a new UTRA FDD cell is defined.

$T_{\text{basic_identify_enhanced_UTRA_FDD}} = 60$ ms. This is the time period used in the inter RAT equation in clause 8.1.2.4.1.1.1a where the maximum allowed time for the UE to identify a new UTRA FDD cell is defined.

$T_{\text{basic_measurement_UTRA_FDD}} = 50$ ms. This is the time period used in the equation for defining the measurement period for inter RAT CPICH measurements.

$N_{\text{freq, n}}$, $N_{\text{freq, r}}$, K_n and K_r are defined in clause 8.1.2.1.1 and T_{inter1} is defined in clause 8.1.2.1

8.1.2.4.1.1.3 Periodic Reporting

Reported measurements in periodically triggered measurement reports shall meet the requirements in clause 9.

8.1.2.4.1.1.4 Event Triggered Reporting

Reported measurements in event triggered measurement reports shall meet the requirements in clause 9.

The UE shall not send any event triggered measurement reports, as long as the reporting criteria is not fulfilled.

The measurement reporting delay is defined as the time between any event that will trigger a measurement report until the UE starts to transmit the measurement report over the Uu interface. This requirement assumes that the measurement report is not delayed by other RRC signalling on the DCCH. This measurement reporting delay excludes a delay uncertainty resulted when inserting the measurement report to the TTI of the uplink DCCH. The delay uncertainty is twice the TTI of the uplink DCCH. When the measurement report is transmitted on the PUSCH with subframe or slot or subslot duration, the delay uncertainty is twice the subframe or slot or subslot of the uplink DCCH. This measurement reporting delay excludes a delay which caused by no UL resources for UE to send the measurement report.

The event triggered measurement reporting delay, measured without L3 filtering shall be less than $T_{\text{identify, UTRA_FDD}}$ defined in Clause 8.1.2.4.1.1.1 for the minimum requirements or $T_{\text{identify, enhanced_UTRA_FDD}}$ defined in Clause 8.1.2.4.1.1.1a for the enhanced requirements When L3 filtering is used or IDC autonomous denial or the UE is performing reception and/or transmission for ProSe Direct Discovery and/or ProSe Direct Communication, or the UE is configured to perform SRS carrier based switching, an additional delay can be expected.

If a cell which has been detectable at least for the time period $T_{\text{identify, UTRA_FDD}}$ defined in clause 8.1.2.4.1.1.1 for the minimum requirements or $T_{\text{identify, enhanced_UTRA_FDD}}$ defined in Clause 8.1.2.4.1.1.1a for the enhanced requirements and then triggers the measurement report as per TS 36.331 [2], the event triggered measurement reporting delay shall be less than $T_{\text{measurement_UTRA_FDD}}$ defined in clause 8.1.2.4.1.1.2 provided the timing to that cell has not changed more than ± 32 chips while measurement gap has not been available and the L3 filter has not been used. When L3 filtering is used or IDC autonomous denial is configured or the UE is performing reception and/or transmission for ProSe Direct Discovery and/or ProSe Direct Communication, or the UE is configured to perform SRS carrier based switching, an additional delay can be expected.

8.1.2.4.1.1.5 Event-triggered Periodic Reporting

Reported measurements contained in event triggered periodic measurement reports shall meet the requirements in clause 9.

The first report in event triggered periodic measurement reporting shall meet the requirements specified in clause 8.1.2.4.1.1.4.

8.1.2.4.1.2 E-UTRAN FDD – UTRAN FDD measurements when DRX is used

When explicit neighbour list is provided and DRX or eDRX_CONN is used, either measurement gaps are scheduled or the UE supports capability of conducting such measurements without gaps, the UE shall be able to identify a new detectable cell belonging to the neighbour cell list within $T_{\text{identify,UTRA_FDD}}$. When DRX is used, $T_{\text{identify,UTRA_FDD}}$ is as defined in table 8.1.2.4.1.2-1, and when eDRX_CONN is used, $T_{\text{identify,UTRA_FDD}}$ is as defined in table 8.1.2.4.1.2-1A.

Table 8.1.2.4.1.2-1: Requirement to identify a newly detectable UTRA FDD cell

DRX cycle length (s)	$T_{\text{identify_UTRA_FDD}}$ (s) (DRX cycles) normal requirement		$T_{\text{identify_UTRA_FDD}}$ (s) (DRX cycles) reduced requirement	
		Gap period = 40 ms	Gap period = 80 ms	Gap period = 40 ms

≤0.04	Non DRX Requirements in clause 8.1.2.4.1.1 are applicable	Non DRX Requirements in clause 8.1.2.4.1.1 are applicable	Non DRX Requirements in clause 8.1.2.4.1.1 are applicable	Non DRX Requirements in clause 8.1.2.4.1.1 are applicable
0.064	$2.56 \cdot K_n \cdot N_{\text{freq},n}$ ($40 \cdot N_{\text{freq},n}$)	$4.8 \cdot K_n \cdot N_{\text{freq},n}$ ($75 \cdot K_n \cdot N_{\text{freq},n}$)	$2.56 \cdot K_r \cdot N_{\text{freq},r}$ ($40 \cdot K_r \cdot N_{\text{freq},r}$)	$4.8 \cdot K_r \cdot N_{\text{freq},r}$ ($75 \cdot K_r \cdot N_{\text{freq},r}$)
0.08	$3.2 \cdot K_n \cdot N_{\text{freq},n}$ ($40 \cdot K_n \cdot N_{\text{freq},n}$)	$4.8 \cdot K_n \cdot N_{\text{freq},n}$ ($60 \cdot K_n \cdot N_{\text{freq},n}$)	$3.2 \cdot K_r \cdot N_{\text{freq},r}$ ($40 \cdot K_r \cdot N_{\text{freq},r}$)	$4.8 \cdot K_r \cdot N_{\text{freq},r}$ ($60 \cdot K_r \cdot N_{\text{freq},r}$)
0.128	$3.2 \cdot K_n \cdot N_{\text{freq},n}$ ($25 \cdot K_n \cdot N_{\text{freq},n}$)	$4.8 \cdot K_n \cdot N_{\text{freq},n}$ ($37.5 \cdot K_n \cdot N_{\text{freq},n}$)	$3.2 \cdot K_r \cdot N_{\text{freq},r}$ ($25 \cdot K_r \cdot N_{\text{freq},r}$)	$4.8 \cdot K_r \cdot N_{\text{freq},r}$ ($37.5 \cdot K_r \cdot N_{\text{freq},r}$)
0.16	$3.2 \cdot K_n \cdot N_{\text{freq},n}$ ($20 \cdot K_n \cdot N_{\text{freq},n}$)	$4.8 \cdot K_n \cdot N_{\text{freq},n}$ ($30 \cdot K_n \cdot N_{\text{freq},n}$)	$3.2 \cdot K_r \cdot N_{\text{freq},r}$ ($20 \cdot K_r \cdot N_{\text{freq},r}$)	$4.8 \cdot K_r \cdot N_{\text{freq},r}$ ($30 \cdot K_r \cdot N_{\text{freq},r}$)
0.16 < DRX-cycle ≤ 2.56	Note ($20 \cdot K_n \cdot N_{\text{freq},n}$)	Note ($20 \cdot K_n \cdot N_{\text{freq},n}$)	Note ($20 \cdot K_r \cdot N_{\text{freq},r}$)	Note ($20 \cdot K_r \cdot N_{\text{freq},r}$)
Note: Time depends upon the DRX cycle in use				

Table 8.1.2.4.1.2-1A: Requirement to identify a newly detectable UTRA FDD cell when eDRX_CONN cycle is used

eDRX_CONN cycle length (s)	T _{identify_UTRA_FDD} (s) (eDRX_CONN cycles) normal requirement		T _{identify_UTRA_FDD} (s) (eDRX_CONN cycles) reduced requirement	
	Gap period = 40 ms	Gap period = 80 ms	Gap period = 40 ms	Gap period = 80 ms
2.56 < eDRX_CONN cycle ≤ 10.24	Note ($20 \cdot K_n \cdot N_{\text{freq},n}$)	Note ($20 \cdot K_n \cdot N_{\text{freq},n}$)	Note ($20 \cdot K_r \cdot N_{\text{freq},r}$)	Note ($20 \cdot K_r \cdot N_{\text{freq},r}$)
Note: Time depends upon the eDRX_CONN cycle in use				

A cell shall be considered detectable provided following conditions are fulfilled: A cell shall be considered detectable when

- CPICH Ec/Io ≥ -20 dB,
- SCH_Ec/Io ≥ -17 dB for at least one channel tap and SCH_Ec/Ior is equally divided between primary synchronisation code and secondary synchronisation code. When L3 filtering is used an additional delay can be expected.

When DRX or eDRX_CONN is used, the UE shall be capable of performing RSCP and Ec/Io measurements of at least 6 UTRA cells per UTRA FDD carrier for up to 3 UTRA FDD carriers and the UE physical layer shall be capable of reporting RSCP and Ec/Io measurements to higher layers within the measurement period T_{measure_UTRA_FDD}, either measurement gaps are scheduled or the UE supports capability of conducting such measurements without gaps. UE supporting Increased UE carrier monitoring UTRA shall be capable of performing RSCP and Ec/Io measurements of at least 6 UTRA cells per UTRA FDD carrier for up to 6 UTRA FDD carriers with maximum of 80 cells consisting of at most 32 cells per frequency layer in the neighbour cell list. When DRX is used, T_{measure_UTRA_FDD} is defined in Table 8.1.2.3.1.2-2, and when eDRX_CONN cycle is used, T_{measure_UTRA_FDD} is defined in Table 8.1.2.3.1.2-3.

Table 8.1.2.4.1.2-2: Requirement to measure UTRA FDD cells

DRX cycle length (s)	T _{measure_UTRA_FDD} (s) (DRX cycles) normal requirement		T _{measure_UTRA_FDD} (s) (DRX cycles) normal requirement	
	Gap period = 40 ms	Gap period = 80 ms	Gap period = 40 ms	Gap period = 80 ms
≤0.04	Non DRX Requirements in clause 8.1.2.4.1.1 are applicable	Non DRX Requirements in clause 8.1.2.4.1.1 are applicable	Non DRX Requirements in clause 8.1.2.4.1.1 are applicable	Non DRX Requirements in clause 8.1.2.4.1.1 are applicable

0.064	$0.48 * K_n * N_{freq,n}$ ($7.5 * K_n * N_{freq,n}$)	$0.8 * K_n * N_{freq,n}$ ($12.5 * K_n * N_{freq,n}$)	$0.48 * K_r * N_{freq,r}$ ($7.5 * K_r * N_{freq,r}$)	$0.8 * K_r * N_{freq,r}$ ($12.5 * K_r * N_{freq,r}$)
0.08	$0.48 * K_n * N_{freq,n}$ ($6 * K_n * N_{freq,n}$)	$0.8 * K_n * N_{freq,n}$ ($10 * N_{freq,n}$)	$0.48 * K_r * N_{freq,r}$ ($6 * K_r * N_{freq,r}$)	$0.8 * K_r * N_{freq,r}$ ($10 * K_r * N_{freq,r}$)
0.128	$0.64 * K_n * N_{freq,n}$ ($5 * K_n * N_{freq,n}$)	$0.8 * K_n * N_{freq,n}$ ($6.25 * N_{freq,n}$)	$0.64 * K_r * N_{freq,r}$ ($5 * K_r * N_{freq,r}$)	$0.8 * K_r * N_{freq,r}$ ($6.25 * N_{freq,r}$)
0.128 < DRX-cycle ≤ 2.56	Note ($5 * K_n * N_{freq,n}$)	Note ($5 * K_n * N_{freq,n}$)	Note ($5 * K_r * N_{freq,r}$)	Note ($5 * K_r * N_{freq,r}$)
Note: Time depends upon the DRX cycle in use				

Table 8.1.2.4.1.2-3: Requirement to measure UTRA FDD cells when eDRX_CONN cycle is used

eDRX_CONN cycle length (s)	T _{measure_UTRA_FDD} (s) (eDRX_CONN cycles) normal requirement		T _{measure_UTRA_FDD} (s) (eDRX_CONN cycles) normal requirement	
	Gap period = 40 ms	Gap period = 80 ms	Gap period = 40 ms	Gap period = 80 ms
2.56 < eDRX_CONN cycle ≤ 10.24	Note ($5 * K_n * N_{freq,n}$)	Note ($5 * K_n * N_{freq,n}$)	Note ($5 * K_r * N_{freq,r}$)	Note ($5 * K_r * N_{freq,r}$)
Note: Time depends upon the eDRX_CONN cycle in use				

The measurement accuracy for all measured cells shall be as specified in the sub-clause 9.1.

8.1.2.4.1.2.1 Periodic Reporting

Reported measurements in periodically triggered measurement reports shall meet the requirements in clause 9.

8.1.2.4.1.2.2 Event Triggered Reporting

Reported measurements in event triggered measurement reports shall meet the requirements in clause 9.

The UE shall not send any event triggered measurement reports, as long as the reporting criteria is not fulfilled.

The measurement reporting delay is defined as the time between any event that will trigger a measurement report until the UE starts to transmit the measurement report over the Uu interface. This requirement assumes that the measurement report is not delayed by other RRC signalling on the DCCH. This measurement reporting delay excludes a delay uncertainty resulted when inserting the measurement report to the TTI of the uplink DCCH. The delay uncertainty is twice the TTI of the uplink DCCH. When the measurement report is transmitted on the PUSCH with subframe or slot or subslot duration, the delay uncertainty is twice the subframe or slot or subslot of the uplink DCCH. This measurement reporting delay excludes a delay which caused by no UL resources for UE to send the measurement report.

The event triggered measurement reporting delay, measured without L3 filtering shall be less than T_{identify,UTRA_FDD} defined in Clause 8.1.2.4.1.2. When L3 filtering is used or IDC autonomous denial is configured or the UE is performing reception and/or transmission for ProSe Direct Discovery and/or ProSe Direct Communication, or the UE is configured to perform SRS carrier based switching, an additional delay can be expected.

If a cell which has been detectable at least for the time period T_{identify,UTRA_FDD} defined in clause 8.1.2.4.1.2 and then triggers the measurement report as per TS 36.331 [2], the event triggered measurement reporting delay shall be less than T_{measurement_UTRA_FDD} defined in clause 8.1.2.4.1.2 provided the timing to that cell has not changed more than ± 32 chips while measurement gap has not been available and the L3 filter has not been used. When L3 filtering is used or IDC autonomous denial is configured or the UE is performing reception and/or transmission for ProSe Direct Discovery and/or ProSe Direct Communication, or the UE is configured to perform SRS carrier based switching, an additional delay can be expected.

8.1.2.4.1.2.3 Event-triggered Periodic Reporting

Reported measurements contained in event triggered periodic measurement reports shall meet the requirements in clause 9.

The first report in event triggered periodic measurement reporting shall meet the requirements specified in clause 8.1.2.4.1.2.2.

8.1.2.4.2 E-UTRAN TDD – UTRAN FDD measurements

The requirements in clause 8.1.2.4.1 also apply for this section.

8.1.2.4.2.1 E-UTRAN TDD – UTRAN FDD measurements when no DRX is used

8.1.2.4.2.2 E-UTRAN TDD – UTRAN FDD measurements when DRX is used

8.1.2.4.3 E-UTRAN TDD – UTRAN TDD measurements

8.1.2.4.3.1 E-UTRAN TDD – UTRAN TDD measurements when no DRX is used

8.1.2.4.3.1.1 Identification of a new UTRA TDD cell

When explicit neighbour list is provided and no DRX is used, either measurement gaps are scheduled or the UE supports capability of conducting such measurements without gaps, the UE shall be able to identify a new detectable cell belonging to the monitored set within

$$T_{\text{identify, UTRA_TDD}} = \text{Max} \left\{ 5000, T_{\text{basic_identify_UTRA_TDD}} \cdot \frac{480}{T_{\text{inter1}}} \cdot K_n \cdot N_{\text{freq},n} \right\} \text{ms} \text{ (normal performance),}$$

and

$$T_{\text{identify, UTRA_TDD}} = \text{Max} \left\{ 5000, T_{\text{basic_identify_UTRA_TDD}} \cdot \frac{480}{T_{\text{inter1}}} \cdot K_r \cdot N_{\text{freq},r} \right\} \text{ms} \text{ (reduced performance)}$$

A cell shall be considered detectable when

- P-CCPCH Ec/Io \geq -8 dB,
- DwPCH_Ec/Io \geq -5 dB.

When L3 filtering is used an additional delay can be expected.

8.1.2.4.3.1.1a Enhanced UTRA TDD cell identification requirements

When explicit neighbour list is provided and no DRX is used or when DRX cycle length \leq 40 ms, either measurement gaps are scheduled or the UE supports capability of conducting such measurements without gaps, the UE shall be able to identify a new detectable cell belonging to the monitored set within $T_{\text{identify, enhanced_UTRA_TDD}}$:

$$T_{\text{identify, enhanced_UTRA_TDD}} = (T_{\text{basic_identify_enhanced_UTRA_TDD}} \cdot \frac{480}{T_{\text{inter1}}} + 480) \cdot K_n \cdot N_{\text{freq},n} \text{ ms} \text{ (normal performance),}$$

and

$$T_{\text{identify, enhanced_UTRA_TDD}} = (T_{\text{basic_identify_enhanced_UTRA_TDD}} \cdot \frac{480}{T_{\text{inter1}}} + 480) \cdot K_r \cdot N_{\text{freq},r} \text{ ms} \text{ (reduced performance)}$$

A cell shall be considered detectable when:

- P-CCPCH_Ec/Io \geq -6 dB,
- DwPCH_Ec/Io \geq -1 dB

When L3 filtering is used an additional delay can be expected.

8.1.2.4.3.1.2 UE UTRA TDD P-CCPCH RSCP measurement capability

When measurement gaps are scheduled for UTRA TDD inter RAT measurements, or the UE supports capability of conducting such measurements without gaps, the UE physical layer shall be capable of reporting measurements to higher layers with measurement accuracy as specified in Clause 9.3 with measurement period given by

$$T_{\text{measurement_UTRA_TDD}} = \text{Max} \left\{ T_{\text{Measurement_Period_UTRA_TDD}}, T_{\text{basic_measurement_UTRA_TDD}} \cdot \frac{480}{T_{\text{inter1}}} \cdot K_n \cdot N_{\text{freq},n} \right\} \text{ms} \text{ (normal performance)}$$

$$T_{\text{measurement_UTRA_TDD}} = \text{Max} \left\{ T_{\text{Measurement_Period_UTRA_TDD}} \cdot T_{\text{basic_measurement_UTRA_TDD}} \cdot \frac{480}{T_{\text{inter1}}} \cdot K_r \cdot N_{\text{freq},r} \right\} \text{ms (reduced performance)}$$

The UE shall be capable of performing UTRA TDD P-CCPCH RSCP measurements for $X_{\text{basic_measurementUTRA_TDD}}$ inter-frequency cells per TDD frequency of the monitored set, and the UE physical layer shall be capable of reporting measurements to higher layers with the measurement period of $T_{\text{Measurement_UTRA_TDD}}$.

$$X_{\text{basic_measurementUTRA_TDD}} = 6$$

$T_{\text{Measurement_Period_UTRA_TDD}} = 480$ ms is the period used for calculating the measurement period $T_{\text{measurement_UTRA_TDD}}$ for UTRA TDD P-CCPCH RSCP measurements.

$T_{\text{basic_identify_UTRA_TDD}} = 800$ ms is the time period used in the inter RAT equation in clause 8.1.2.4.3.1.1 where the maximum allowed time for the UE to identify a new UTRA TDD cell is defined.

$T_{\text{basic_identify_enhanced_UTRA_TDD}} = 80$ ms is the time period used in the inter RAT equation in clause 8.1.2.4.3.1.1a where the maximum allowed time for the UE to identify a new UTRA TDD cell is defined.

$T_{\text{basic_measurement_UTRA_TDD}} = 50$ ms is the time period used in the equation for defining the measurement period for inter RAT P-CCPCH RSCP measurements.

$N_{\text{freq},n}$, $N_{\text{freq},r}$, K_n and K_r are defined in clause 8.1.2.1.1 and T_{inter1} is defined in clause 8.1.2.1

8.1.2.4.3.1.3 Periodic Reporting

Reported measurements in periodically triggered measurement reports shall meet the requirements in clause 9.

8.1.2.4.3.1.4 Event Triggered Reporting

Reported measurements in event triggered measurement reports shall meet the requirements in clause 9.

The UE shall not send any event triggered measurement reports, as long as the reporting criteria is not fulfilled.

The measurement reporting delay is defined as the time between any event that will trigger a measurement report until the UE starts to transmit the measurement report over the Uu interface. This requirement assumes that the measurement report is not delayed by other RRC signalling on the DCCH. When the measurement report is transmitted on the PUSCH with subframe or slot or subslot duration, the delay uncertainty is twice the subframe or slot or subslot of the uplink DCCH. This measurement reporting delay excludes a delay uncertainty resulted when inserting the measurement report to the TTI of the uplink DCCH. The delay uncertainty is twice the TTI of the uplink DCCH. This measurement reporting delay excludes a delay which caused by no UL resources for UE to send the measurement report.

The event triggered measurement reporting delay, measured without L3 filtering shall be less than $T_{\text{identify, UTRA_TDD}}$ defined in Clause 8.1.2.4.3.1.1 for the minimum requirements or $T_{\text{identify, enhanced_UTRA_TDD}}$ defined in Clause 8.1.2.4.3.1.1a for the enhanced requirements. When L3 filtering is used or IDC autonomous denial is configured or the UE is performing reception and/or transmission for ProSe Direct Discovery and/or ProSe Direct Communication, or the UE is configured to perform SRS carrier based switching, an additional delay can be expected.

If a cell which has been detectable at least for the time period $T_{\text{identify, UTRA_TDD}}$ defined in clause 8.1.2.4.3.1.1 for the minimum requirements and then triggers the measurement report as per TS 36.331 [2], the event triggered measurement reporting delay shall be less than $T_{\text{measurement_UTRA_TDD}}$ defined in clause 8.1.2.4.3.1.2 provided the timing to that cell has not changed more than ± 10 chips while measurement gap has not been available and the L3 filter has not been used. When L3 filtering is used or IDC autonomous denial is configured or the UE is performing reception and/or transmission for ProSe Direct Discovery and/or ProSe Direct Communication, or the UE is configured to perform SRS carrier based switching, an additional delay can be expected.

8.1.2.4.3.1.5 Event-triggered Periodic Reporting

Reported measurements contained in event triggered periodic measurement reports shall meet the requirements in clause 9.

The first report in event triggered periodic measurement reporting shall meet the requirements specified in clause 8.1.2.4.3.1.4.

8.1.2.4.3.2 E-UTRAN TDD – UTRAN TDD measurements when DRX is used

When explicit neighbour list is provided and DRX or eDRX_CONN is used, either measurement gaps are scheduled or the UE supports capability of conducting such measurements without gaps, the UE shall be able to identify a new detectable cell belonging to the neighbour cell list within $T_{\text{identify,UTRA_TDD}}$. When DRX is used, $T_{\text{identify,UTRA_TDD}}$ is as defined in table 8.1.2.4.3.2-1, and when eDRX_CONN is used, $T_{\text{identify,UTRA_TDD}}$ is as defined in table 8.1.2.4.3.2-1A.

Table 8.1.2.4.3.2-1: Requirement to identify a newly detectable UTRA TDD cell

DRX cycle length (s)	$T_{\text{identify_UTRA_TDD}}$ (s) (DRX cycles) (normal requirement)		$T_{\text{identify_UTRA_TDD}}$ (s) (DRX cycles) (reduced requirement)	
	Gap period = 40 ms	Gap period = 80 ms	Gap period = 40 ms	Gap period = 80 ms
≤ 0.32	Non DRX Requirements in clause 8.1.2.4.3.1 are applicable	Non DRX Requirements in clause 8.1.2.4.3.1 are applicable	Non DRX Requirements in clause 8.1.2.4.3.1 are applicable	Non DRX Requirements in clause 8.1.2.4.3.1 are applicable
$0.32 < \text{DRX-cycle} \leq 0.512$	Note ($20 \cdot K_n \cdot N_{\text{freq},n}$)	Note ($25 \cdot K_n \cdot N_{\text{freq},n}$)	Note ($20 \cdot K_r \cdot N_{\text{freq},r}$)	Note ($25 \cdot K_r \cdot N_{\text{freq},r}$)
$0.512 < \text{DRX-cycle} \leq 2.56$	Note ($20 \cdot K_n \cdot N_{\text{freq},n}$)	Note ($20 \cdot K_n \cdot N_{\text{freq},n}$)	Note ($20 \cdot K_r \cdot N_{\text{freq},r}$)	Note ($20 \cdot K_r \cdot N_{\text{freq},r}$)
Note: Time depends upon the DRX cycle in use				

Table 8.1.2.4.3.2-1A: Requirement to identify a newly detectable UTRA TDD cell when eDRX_CONN cycle is used

eDRX_CONN cycle length (s)	$T_{\text{identify_UTRA_TDD}}$ (s) (eDRX_CONN cycles) (normal requirement)		$T_{\text{identify_UTRA_TDD}}$ (s) (eDRX_CONN cycles) (reduced requirement)	
	Gap period = 40 ms	Gap period = 80 ms	Gap period = 40 ms	Gap period = 80 ms
$2.56 < \text{eDRX_CONN cycle} \leq 10.24$	Note ($20 \cdot K_n \cdot N_{\text{freq},n}$)	Note ($20 \cdot K_n \cdot N_{\text{freq},n}$)	Note ($20 \cdot K_r \cdot N_{\text{freq},r}$)	Note ($20 \cdot K_r \cdot N_{\text{freq},r}$)
Note: Time depends upon the eDRX_CONN cycle in use				

A cell shall be considered detectable provided following conditions are fulfilled: A cell shall be considered detectable when

- $P\text{-CCPCH } E_c/I_0 \geq -8 \text{ dB}$,
- $DwPCH } E_c/I_0 \geq -5 \text{ dB}$.

When L3 filtering is used an additional delay can be expected.

When DRX or eDRX_CONN is in use, the UE shall be capable of performing UTRA TDD P-CCPCH RSCP measurements of at least 6 UTRA cells per UTRA TDD carrier for up to 3 UTRA TDD carriers and the UE physical layer shall be capable of reporting measurements to higher layers with the measurement period $T_{\text{measure_UTRA_TDD}}$, either measurement gaps are scheduled or the UE supports capability of conducting such measurements without gaps. UE supporting Increased UE carrier monitoring UTRA shall be capable of performing UTRA TDD P-CCPCH RSCP measurements of at least 6 UTRA cells per UTRA TDD carrier for up to 7 UTRA TDD carriers with maximum of 80 cells consisting of at most 32 cells per frequency layer in the neighbour cell list. When DRX is used, $T_{\text{measure_UTRA_TDD}}$ is as defined in Table 8.1.2.4.3.2-2, and when eDRX_CONN is used, $T_{\text{measure_UTRA_TDD}}$ is as defined in Table 8.1.2.4.3.2-3.

Table 8.1.2.4.3.2-2: Requirement to measure UTRA TDD cells

DRX cycle length (s)	$T_{\text{measure_UTRA_TDD}}$ (s) (DRX cycles) (normal requirement)		$T_{\text{measure_UTRA_TDD}}$ (s) (DRX cycles) (reduced requirement)	
	Gap period = 40 ms	Gap period = 80 ms	Gap period = 40 ms	Gap period = 80 ms
≤ 0.04	Non DRX Requirements in clause 8.1.2.4.3.1 are applicable	Non DRX Requirements in clause 8.1.2.4.3.1 are applicable	Non DRX Requirements in clause 8.1.2.4.3.1 are applicable	Non DRX Requirements in clause 8.1.2.4.3.1 are applicable

0.064	$0.48 \cdot K_n \cdot N_{\text{freq},n}$ ($7.5 \cdot K_n \cdot N_{\text{freq},n}$)	$0.8 \cdot K_n \cdot N_{\text{freq},n}$ ($12.5 \cdot K_n \cdot N_{\text{freq},n}$)	$0.48 \cdot K_r \cdot N_{\text{freq},r}$ ($7.5 \cdot K_r \cdot N_{\text{freq},r}$)	$0.8 \cdot K_r \cdot N_{\text{freq},r}$ ($12.5 \cdot K_r \cdot N_{\text{freq},r}$)
0.08	$0.48 \cdot K_n \cdot N_{\text{freq},n}$ ($6 \cdot K_n \cdot N_{\text{freq},n}$)	$0.8 \cdot K_n \cdot N_{\text{freq},n}$ ($10 \cdot K_n \cdot N_{\text{freq},n}$)	$0.48 \cdot K_r \cdot N_{\text{freq},r}$ ($6 \cdot K_r \cdot N_{\text{freq},r}$)	$0.8 \cdot K_r \cdot N_{\text{freq},r}$ ($10 \cdot K_r \cdot N_{\text{freq},r}$)
0.128	$0.64 \cdot K_n \cdot N_{\text{freq},n}$ ($5 \cdot K_n \cdot N_{\text{freq},n}$)	$0.8 \cdot K_n \cdot N_{\text{freq},n}$ ($6.25 \cdot K_n \cdot N_{\text{freq},n}$)	$0.64 \cdot K_r \cdot N_{\text{freq},r}$ ($5 \cdot K_r \cdot N_{\text{freq},r}$)	$0.8 \cdot K_r \cdot N_{\text{freq},r}$ ($6.25 \cdot K_r \cdot N_{\text{freq},r}$)
0. 128 < DRX- cycle ≤ 2.56	Note ($5 \cdot K_n$ $\cdot N_{\text{freq},n}$)	Note ($5 \cdot K_n$ $\cdot N_{\text{freq},n}$)	Note ($5 \cdot K_r$ $\cdot N_{\text{freq},r}$)	Note ($5 \cdot K_r$ $\cdot N_{\text{freq},r}$)
Note: Time depends upon the DRX cycle in use				

Table 8.1.2.4.3.2-3: Requirement to measure UTRA TDD cells when eDRX_CONN cycle is used

eDRX_CONN cycle length (s)	$T_{\text{measure_UTRA_TDD}}$ (s) (eDRX_CONN cycles) (normal requirement)		$T_{\text{measure_UTRA_TDD}}$ (s) (eDRX_CONN cycles) (reduced requirement)	
	Gap period = 40 ms	Gap period = 80 ms	Gap period = 40 ms	Gap period = 80 ms
$2.56 < \text{eDRX_CONN}$ $\text{cycles} \leq 10.24$	Note ($5 \cdot K_n$ $\cdot N_{\text{freq},n}$)	Note ($5 \cdot K_n$ $\cdot N_{\text{freq},n}$)	Note ($5 \cdot K_r$ $\cdot N_{\text{freq},r}$)	Note ($5 \cdot K_r$ $\cdot N_{\text{freq},r}$)
Note: Time depends upon the eDRX_CONN cycle in use				

The measurement accuracy for all measured cells shall be as specified in the sub-clause 9.1.

8.1.2.4.3.2.1 Periodic Reporting

Reported measurements in periodically triggered measurement reports shall meet the requirements in clause 9.

8.1.2.4.3.2.2 Event Triggered Reporting

Reported measurements in event triggered measurement reports shall meet the requirements in clause 9.

The UE shall not send any event triggered measurement reports, as long as the reporting criteria is not fulfilled.

The measurement reporting delay is defined as the time between any event that will trigger a measurement report until the UE starts to transmit the measurement report over the Uu interface. This requirement assumes that the measurement report is not delayed by other RRC signalling on the DCCH. This measurement reporting delay excludes a delay uncertainty resulted when inserting the measurement report to the TTI of the uplink DCCH. The delay uncertainty is twice the TTI of the uplink DCCH. When the measurement report is transmitted on the PUSCH with subframe or slot or subslot duration, the delay uncertainty is twice the subframe or slot or subslot of the uplink DCCH. This measurement reporting delay excludes a delay which caused by no UL resources for UE to send the measurement report.

The event triggered measurement reporting delay, measured without L3 filtering shall be less than $T_{\text{identify, UTRA_TDD}}$ defined in Clause 8.1.2.4.3.2 When L3 filtering is used or IDC autonomous denial is configured or the UE is performing reception and/or transmission for ProSe Direct Discovery and/or ProSe Direct Communication, or the UE is configured to perform SRS carrier based switching, an additional delay can be expected.

If a cell which has been detectable at least for the time period $T_{\text{identify, UTRA_TDD}}$ defined in clause 8.1.2.4.3.2 and then triggers the measurement report as per TS 36.331 [2], the event triggered measurement reporting delay shall be less than $T_{\text{measurement_UTRA_TDD}}$ defined in clause 8.1.2.4.3.2 provided the timing to that cell has not changed more than ± 10 chips while measurement gap has not been available and the L3 filter has not been used. When L3 filtering is used or IDC autonomous denial is configured or the UE is performing reception and/or transmission for ProSe Direct Discovery and/or ProSe Direct Communication, or the UE is configured to perform SRS carrier based switching, an additional delay can be expected.

8.1.2.4.3.2.3 Event-triggered Periodic Reporting

Reported measurements contained in event triggered periodic measurement reports shall meet the requirements in clause 9.

The first report in event triggered periodic measurement reporting shall meet the requirements specified in clause 8.1.2.4.3.2.2.

8.1.2.4.4 E-UTRAN FDD – UTRAN TDD measurements

The requirements in clause 8.1.2.4.3 also apply for this section.

8.1.2.4.5 E-UTRAN FDD – GSM measurements

8.1.2.4.5.1 E-UTRAN FDD – GSM measurements when no DRX is used

The requirements in this clause apply only to UE supporting E-UTRAN FDD and GSM.

Measurements on GSM cells can be requested with BSIC verified.

In RRC_CONNECTED state when a supported measurement gap pattern sequence according to Table 8.1.2.1-1 is configured by E-UTRAN, or the UE supports capability of conducting such measurements without gaps, the UE shall continuously measure GSM cells, search for new GSM cells given in the monitored set and re-confirm the BSIC for already detected cells.

8.1.2.4.5.1.1 GSM carrier RSSI

This measurement shall be based on measurement gaps allocated for GSM carrier RSSI measurement as described in clause 8.1.2.1. A UE supporting GSM measurements shall measure minimum number of 10 GSM carrier RSSI measurement samples ($N_{\text{GSM carrier RSSI}}$) per measurement gap. In RRC_CONNECTED state the measurement period, $T_{\text{Measurement Period, GSM}}$, for the GSM carrier RSSI measurement is $K_n * N_{\text{freq},n} * 480$ ms. The parameters $N_{\text{freq},n}$ and K_n are defined in clause 8.1.2.1.1.

The UE shall meet the measurement accuracy requirements stated for RXLEV in [8], when the given measurement time allows the UE to take at least 3 GSM carrier RSSI samples per GSM carrier in the monitored set during the measurement period.

In case the UE is not able to acquire the required number of samples per GSM carrier during one measurement period, the UE shall measure as many GSM carriers as possible during that measurement period using at least 3 samples per GSM carrier. The GSM carriers that were not measured during that measurement period shall be measured in the following measurement periods.

8.1.2.4.5.1.2 BSIC verification

Measurements on a GSM cell can be requested with BSIC verified. The UE shall be able to report the GSM cells with BSIC verified for those cells where the verification of BSIC has been successful.

The procedure for BSIC verification on a GSM cell can be divided into the following two tasks:

- **Initial BSIC identification:** Includes searching for the BSIC and decoding the BSIC for the first time when there is no knowledge about the relative timing between the E-UTRAN FDD and GSM cells. The UE shall trigger the initial BSIC identification within the available measurement gap pattern sequence. The requirements for BSIC re-confirmation can be found in clause 8.1.2.4.5.1.2.1.
- **BSIC re-confirmation:** Tracking and decoding the BSIC of a GSM cell after initial BSIC identification is performed. The UE shall trigger the BSIC re-confirmation within the available measurement gap pattern. The requirements for BSIC re-confirmation can be found in clause 8.1.2.4.5.1.2.2.

If the network requests measurements on a GSM cell the UE shall behave as follows:

- The UE shall perform GSM carrier RSSI measurements according to clause 8.1.2.4.5.1 when a measurement gap pattern sequence is activated, or the UE supports capability of conducting such measurements without gaps.

The UE shall perform measurement reporting as defined in TS 36.331 [2].

- The UE shall perform BSIC identification. The UE shall use the most recently available GSM carrier RSSI measurement results for arranging GSM cells in signal strength order for performing BSIC identification.
- The UE shall perform BSIC re-confirmation on all the GSM cells that have been successfully identified.
- The UE shall perform all configured event evaluation for event-triggered reporting after the BSIC has been verified for a GSM cell. The UE shall use the most recently available GSM carrier RSSI measurement results in event evaluation and event-triggered reporting.

- Event-triggered and periodic reports shall be triggered according to TS 36.331 [2].

The BSIC of a GSM cell is considered to be “verified” if the UE has decoded the SCH of the BCCH carrier and identified the BSIC at least one time (initial BSIC identification). Once a GSM cell has been identified the BSIC shall be re-confirmed at least once every $8 \cdot T_{\text{re-confirm,GSM}}$ seconds. Otherwise the BSIC of the GSM cell is considered as “non-verified”. If a measurement gap pattern sequence is deactivated by the network after BSIC has been identified or verified, the UE shall consider the BSIC as non-verified.

$T_{\text{identify,GSM}}$ indicates the maximum time allowed for the UE to decode the unknown BSIC of the GSM cell in one GSM BCCH carrier in the initial BSIC identification procedure.

$T_{\text{re-confirm,GSM}}$ indicates the maximum time allowed for the re-confirmation of the BSIC of one GSM cell in the BSIC re-confirmation procedure.

The UE shall be able to decode a BSIC within a measurement gap when the time difference between the middle of the received GSM synchronisation burst at the UE and the middle of the effective measurement gap is within the limits specified in table 8.1.2.4.5.1.2-1.

Table 8.1.2.4.5.1.2-1: The gap length and maximum time difference for BSIC verification

Gap length [ms]	Maximum time difference [μs]
6	± 2350 μs

The UE shall be able to perform BSIC verification at levels down to the reference sensitivity level or reference interference levels as specified in [9].

8.1.2.4.5.1.2.1 Initial BSIC identification

This measurement shall be based on the measurement gaps used for Initial BSIC identification as described in clause 8.1.2.4.5.1.2.

The UE shall continuously attempt to decode the BSIC of SCH on the BCCH carrier of the 8 strongest BCCH carriers of the GSM cells indicated in the Inter-RAT cell info list. The UE shall give priority for BSIC decoding attempts in decreasing signal strength order to BCCH carriers with unknown BSIC. The strongest BCCH carrier is defined as the BCCH carrier having the highest measured GSM carrier RSSI value.

If the BSIC of the GSM BCCH carrier has been successfully decoded the UE shall immediately continue BSIC identification with the next GSM BCCH carrier, in signal strength order, with unknown BSIC. The GSM cell for which the BSIC has been successfully identified shall be moved to the BSIC re-confirmation procedure.

If the UE has not successfully decoded the BSIC of the GSM BCCH carrier within $T_{\text{identify,GSM}}$ ms, the UE shall abort the BSIC identification attempts for that GSM BCCH carrier. The UE shall continue to try to perform BSIC identification of the next GSM BCCH carrier in signal strength order. The GSM BCCH carrier for which the BSIC identification failed shall not be re-considered for BSIC identification until BSIC identification attempts have been made for all the rest of the 8 strongest GSM BCCH carriers in the monitored set with unknown BSIC.

$T_{\text{identify,GSM}}$ values are given for a set of reference gap patterns in table 8.1.2.4.5.1.2.1-1. The requirements in the table represent the time required to guarantee at least two attempts to decode the BSIC for one GSM BCCH carrier. If inter-frequency RSTD measurements are configured and the UE requires measurement gaps for performing such measurements, then $T_{\text{identify,GSM}}$ shall be based on the 80ms gap configuration.

Table 8.1.2.4.5.1.2.1-1

$\text{ceil}(N_{\text{freq},n} \cdot K_n - M_{\text{gsm}})$	$T_{\text{identify,gsm}}(\text{ms})$		$T_{\text{reconfirm,gsm}}(\text{ms})$	
	40ms gap configuration (ID 0)	80ms gap configuration (ID 1)	40ms gap configuration (ID 0)	80ms gap configuration (ID 1)
0	2160	5280	1920	5040
1	5280	21760	5040	17280
2	5280	31680	5040	29280
3	19440	No requirement	13320	No requirement

4	31680	No requirement	29280	No requirement
5	31680	No requirement	29280	No requirement

8.1.2.4.5.1.2.2 BSIC re-confirmation

The UE shall maintain the timing information of up to 8 identified GSM cells. Initial timing information is obtained from the initial BSIC identification. The timing information shall be updated every time the BSIC is decoded.

For each measurement gap used for GSM BSIC reconfirmation as described in clause 8.1.2.4.5.1.2, the UE shall attempt to decode the BSIC falling within the measurement gap according to table 8.1.2.4.5.1.2.1-1. If more than one BSIC can be decoded within the same measurement gap, priority shall be given to the least recently decoded BSIC. If inter-frequency RSTD measurements are configured and the UE requires measurement gaps for performing such measurements, then $T_{re-confirm,GSM}$ shall be based on the 80ms gap configuration.

If the UE fails to decode the BSIC after two successive attempts or if the UE has not been able to re-confirm the BSIC for a GSM cell within $T_{re-confirm,GSM}$ seconds, the UE shall abort the BSIC re-confirmation attempts for that GSM cell. The GSM cell shall be treated as a new GSM cell with unidentified BSIC and the GSM cell shall be moved to the initial BSIC identification procedure, see clause 8.1.2.4.5.1.2.1.

8.1.2.4.5.1.2a Enhanced BSIC verification

In addition to the BSIC verification requirements in clause 8.1.2.4.5.1.2, when the UE receives the GSM cell at levels down to 10 dB + the reference sensitivity level or reference interference levels as specified in [9] the BSIC identification requirement in table 8.1.2.4.5.1.2a-1 applies. The BSIC verification requirements in table 8.1.2.4.5.1.2a-1 shall apply when no DRX is used or when DRX cycle length ≤ 40 ms.

Table 8.1.2.4.5.1.2a-1

	$T_{enhanced_identify,gsm}(ms)$		$T_{enhanced_reconfirm,gsm}(ms)$	
	40ms gap configuration (ID 0)	40ms gap configuration when interfrequency RSTD measurement is also configured and the UE requires measurement gaps for performing such measurements	40ms gap configuration (ID 0)	40ms gap configuration when interfrequency RSTD measurement is also configured and the UE requires measurement gaps for performing such measurements
$\text{ceil}(N_{req,n} * K_n - M_{gsm})$	1320	2160	1080	1920

8.1.2.4.5.1.3 Periodic Reporting

Reported measurements in periodically triggered measurement reports shall meet the requirements in clause 9.

8.1.2.4.5.1.4 Event Triggered Reporting

Reported measurements in event triggered measurement reports shall meet the requirements in clause 9.

The UE shall not send any event triggered measurement reports, as long as no reporting criteria are fulfilled.

The measurement reporting delay is defined as the time between an event that will trigger a measurement report and the point when the UE starts to transmit the measurement report over the air interface. This requirement assumes that that the measurement report is not delayed by other RRC signalling on the DCCH.

The event triggered reporting delay requirement is valid when the UE for each GSM carrier in the monitored set can take the required number of samples during the measurement period $T_{Measurement\ Period, GSM}$ (see clause 8.1.2.4.5.1).

The event triggered measurement reporting delay for a GSM cell with verified BSIC, measured without L3 filtering shall be less than $2 \cdot T_{\text{Measurement Period, GSM}}$, where $T_{\text{Measurement Period, GSM}}$ is defined in clause 8.1.2.4.5.1. When L3 filtering is used or IDC autonomous denial is configured or the UE is performing reception and/or transmission for ProSe Direct Discovery and/or ProSe Direct Communication, or the UE is configured to perform SRS carrier based switching, an additional delay can be expected.

8.1.2.4.5.1.5 Event-triggered Periodic Reporting

Reported measurements contained in event triggered periodic measurement reports shall meet the requirements in clause 9.

The first report in event triggered periodic measurement reporting shall meet the requirements specified in clause 8.1.2.4.5.1.4.

8.1.2.4.5.2 E-UTRAN FDD – GSM measurements when DRX is used

The requirements in this clause apply only to UE supporting E-UTRAN FDD and GSM.

Measurements on GSM cells can be requested with BSIC verified.

In RRC_CONNECTED state when a supported measurement gap pattern sequence according to Table 8.1.2.1-1 is configured by E-UTRAN, or the UE supports capability of conducting such measurements without gaps, the UE shall continuously measure GSM cells, search for new GSM cells given in the monitored set and re-confirm the BSIC for already detected cells. During DRX or eDRX_CONN periods the UE may use other periods of time outside the specified measurement gap patterns. The UE is not required to make measurements of GSM cells during DRX or eDRX_CONN periods if a measurement gap pattern has not been configured, unless the UE supports capability of conducting such measurements without gaps.

8.1.2.4.5.2.1 GSM carrier RSSI

This measurement shall be based on measurement gaps allocated for GSM carrier RSSI measurement as described in clause 8.1.2.1. A UE supporting GSM measurements shall measure minimum number of 10 GSM carrier RSSI measurement samples ($N_{\text{GSM carrier RSSI}}$) per DRX or eDRX_CONN cycle. When DRX is used in RRC_CONNECTED state, the measurement period, $T_{\text{Measurement Period, GSM}}$, for the GSM carrier RSSI measurement is shown in table 8.1.2.4.5.2.1-1. When eDRX_CONN is used in RRC_CONNECTED state, the measurement period, $T_{\text{Measurement Period, GSM}}$, for the GSM carrier RSSI measurement is shown in table 8.1.2.4.5.2.1-2. The parameters $N_{\text{freq},n}$ and K_n are defined in clause 8.1.2.1.1.

Table 8.1.2.4.5.2.1-1: GSM measurement period for large DRX

DRX cycle length (s)	$T_{\text{measure, GSM}}$ (s) (DRX cycles)
≤ 0.064	Non DRX Requirements are applicable
$0.064 < \text{DRX-cycle} \leq 0.08$	Note ($6 \cdot K_n \cdot N_{\text{freq},n}$)
$0.08 < \text{DRX-cycle} \leq 2.56$	Note ($5 \cdot K_n \cdot N_{\text{freq},n}$)
Note: Time depends upon the DRX cycle in use	

Table 8.1.2.4.5.2.1-2: GSM measurement period for large DRX when eDRX_CONN cycle is used

eDRX_CONN cycle length (s)	$T_{\text{measure, GSM}}$ (s) (eDRX_CONN cycles)
$2.56 < \text{eDRX_CONN cycle} \leq 10.24$	Note ($5 \cdot K_n \cdot N_{\text{freq},n}$)
Note: Time depends upon the eDRX_CONN cycle in use	

The UE shall meet the measurement accuracy requirements stated for RXLEV in [8], when the given measurement time allows the UE to take at least 3 GSM carrier RSSI samples per GSM carrier in the monitored set during the measurement period.

In case the UE is not able to acquire the required number of samples per GSM carrier during one measurement period, the UE shall measure as many GSM carriers as possible during that measurement period using at least 3 samples per GSM carrier. The GSM carriers that were not measured during that measurement period shall be measured in the following measurement periods.

8.1.2.4.5.2.2 BSIC verification

Measurements on a GSM cell can be requested with BSIC verified. The UE shall be able to report the GSM cells with BSIC verified for those cells where the verification of BSIC has been successful.

The procedure for BSIC verification on a GSM cell can be divided into the following two tasks:

- **Initial BSIC identification:** Includes searching for the BSIC and decoding the BSIC for the first time when there is no knowledge about the relative timing between the E-UTRAN FDD and GSM cells.
- **BSIC re-confirmation:** Tracking and decoding the BSIC of a GSM cell after initial BSIC identification is performed. The UE shall trigger the BSIC re-confirmation within the available measurement gap pattern

If the network requests measurements on a GSM cell, the UE shall behave as follows:

- The UE shall perform GSM carrier RSSI measurements according to clause 8.1.2.4.5.2.1 when a measurement gap pattern sequence is activated, or the UE supports capability of conducting such measurements without gaps.

The UE shall perform measurement reporting as defined in TS 36.331 [2].

- The UE shall perform BSIC identification. The UE shall use the most recently available GSM carrier RSSI measurement results for arranging GSM cells in signal strength order for performing BSIC identification.
- The UE shall perform BSIC re-confirmation on all the GSM cells that have been successfully identified.
- The UE shall perform all configured event evaluation for event-triggered reporting after the BSIC has been verified for a GSM cell. The UE shall use the most recently available GSM carrier RSSI measurement results in event evaluation and event-triggered reporting.
- Event-triggered and periodic reports shall be triggered according to TS 36.331 [2].

The BSIC of a GSM cell is considered to be “verified” if the UE has decoded the SCH of the BCCH carrier and identified the BSIC at least one time (initial BSIC identification). Once a GSM cell has been identified the BSIC shall be re-confirmed at least once every 30 seconds. Otherwise the BSIC of the GSM cell is considered as "non-verified".

The UE shall be able to perform BSIC verification at levels down to the reference sensitivity level or reference interference levels as specified in [9].

8.1.2.4.5.2.2.1 Initial BSIC identification

This measurement shall be made on GSM cells that are requested with BSIC verified.

For DRX cycle length ≤ 40 ms, the initial GSM BSIC identification requirements corresponding to the non DRX requirements as specified in clause 8.1.2.4.5.1.2.1 shall apply.

For DRX cycle length > 40 ms and any eDRX_CONN cycle, the UE shall make at least one attempt every $K_n \cdot N_{\text{freq},n} \cdot 30$ s to decode the BSIC of SCH on the BCCH carrier of the 8 strongest BCCH carriers of the GSM cells indicated in the Inter-RAT cell info list. If the UE has not successfully decoded the BSIC of the GSM BCCH carrier within $K_n \cdot N_{\text{freq},n} \cdot 60$ s, the UE shall abort the BSIC identification attempts for that GSM BCCH carrier. The UE shall give priority for BSIC decoding attempts in decreasing signal strength order to BCCH carriers with unknown BSIC. The strongest BCCH carrier is defined as the BCCH carrier having the highest measured GSM carrier RSSI value. The parameters $N_{\text{freq},n}$ and K_n are defined in clause 8.1.2.1.1.

If the BSIC of the GSM BCCH carrier has been successfully decoded the UE shall continue BSIC identification with the next GSM BCCH carrier, in signal strength order, with unknown BSIC. The GSM cell for which the BSIC has been successfully identified shall be moved to the BSIC re-confirmation procedure.

8.1.2.4.5.2.2.2 BSIC re-confirmation

The UE shall maintain the timing information of up to 8 identified GSM cells. Initial timing information is obtained from the initial BSIC identification. The timing information shall be updated every time the BSIC is decoded.

For DRX cycle length ≤ 40 ms, the GSM BSIC re-conformation requirements corresponding to the non DRX requirements as specified in clause 8.1.2.4.5.1.2.2 shall apply.

For DRX cycle length > 40 ms and any eDRX_CONN cycle, at least every $K_n \cdot N_{\text{freq},n} \cdot 30$ seconds, the UE shall attempt to decode the BSIC of each identified GSM cell. If the UE fails to decode the BSIC after two successive attempts or if the UE has not been able to re-confirm the BSIC for a GSM cell within $K_n \cdot N_{\text{freq},n} \cdot 60$ seconds, the UE shall abort the BSIC re-conformation attempts for that GSM cell. The GSM cell shall be treated as a new GSM cell with unidentified BSIC and the GSM cell shall be moved to the initial BSIC identification procedure, see clause 8.1.2.4.5.2.2.1. The parameters $N_{\text{freq},n}$ and k_n are defined in clause 8.1.2.1.1.

8.1.2.4.5.2.3 Periodic Reporting

Reported measurements in periodically triggered measurement reports shall meet the requirements in clause 9.

8.1.2.4.5.2.4 Event Triggered Reporting

Reported measurements in event triggered measurement reports shall meet the requirements in clause 9.

The UE shall not send any event triggered measurement reports, as long as no reporting criteria are fulfilled.

The measurement reporting delay is defined as the time between an event that will trigger a measurement report and the point when the UE starts to transmit the measurement report over the air interface. This requirement assumes that the measurement report is not delayed by other RRC signalling on the DCCH.

The event triggered reporting delay requirement is valid when the UE for each GSM carrier in the monitored set can take the required number of samples during the measurement period $T_{\text{Measurement Period, GSM}}$ (see clause 8.1.2.4.5.2.1).

The event triggered measurement reporting delay for a GSM cell with verified BSIC, measured without L3 filtering shall be less than $2 \cdot T_{\text{Measurement Period, GSM}}$, where $T_{\text{Measurement Period, GSM}}$ is defined in clause 8.1.2.4.5.2.1. When L3 filtering is used or IDC autonomous denial is configured or the UE is performing reception and/or transmission for ProSe Direct Discovery and/or ProSe Direct Communication, or the UE is configured to perform SRS carrier based switching, an additional delay can be expected.

8.1.2.4.5.2.5 Event-triggered Periodic Reporting

Reported measurements contained in event triggered periodic measurement reports shall meet the requirements in clause 9.

The first report in event triggered periodic measurement reporting shall meet the requirements specified in clause 8.1.2.4.5.2.4.

8.1.2.4.6 E-UTRAN TDD – GSM measurements

The requirements in clause 8.1.2.4.5 also apply for this section.

8.1.2.4.7 E-UTRAN FDD – UTRAN FDD measurements for SON

8.1.2.4.7.1 Identification of a new UTRA FDD cell for SON

No explicit neighbour list is provided to the UE for identifying a UTRA cell for SON. The UE shall identify and report only the strongest cell when requested by the network for the purpose of SON.

8.1.2.4.7.1.1 Requirements when no DRX is used

When no DRX is used, either measurement gaps are scheduled or the UE supports capability of conducting such measurements without gaps, the UE shall be able to identify a new cell within:

$$T_{\text{identify, UTRA_FDD}} = T_{\text{basic_identify_UTRA_FDD}} \cdot \frac{480}{T_{\text{inter1}}} \cdot K_n N_{\text{freq},n} \quad \text{ms (normal performance)}$$

and

$$T_{\text{identify, UTRA_FDD}} = T_{\text{basic_identify_UTRA_FDD}} \cdot \frac{480}{T_{\text{inter1}}} \cdot K_r N_{\text{freq},r} \quad \text{ms (reduced performance)}$$

$T_{\text{basic_identify_UTRA_FDD}} = 300$ ms. This is the time period used in the above equation where the maximum allowed time for the UE to identify a new UTRA FDD cell is defined.

A cell shall be considered identifiable following conditions are fulfilled:

- CPICH Ec/Io ≥ -20 dB,
- SCH_Ec/Io ≥ -17 dB for at least one channel tap and SCH_Ec/Ior is equally divided between primary synchronisation code and secondary synchronisation code. When L3 filtering is used an additional delay can be expected.

If the UE is unable to identify the UTRA cell for SON within $8 \cdot T_{\text{identify, UTRA_FDD}}$ ms, the UE may stop searching UTRA cells for SON.

8.1.2.4.7.1.2 Requirements when DRX is used

When DRX or eDRX_CONN is used, either measurement gaps are scheduled or the UE supports capability of conducting such measurements without gaps, the UE shall be able to identify a new cell within $T_{\text{identify, UTRA_FDD}}$. When DRX is used, $T_{\text{identify, UTRA_FDD}}$ is as defined in table 8.1.2.4.7.1.2-1, and when eDRX_CONN is used, $T_{\text{identify, UTRA_FDD}}$ is as defined in table 8.1.2.4.7.1.2-2.

Table 8.1.2.4.7.1.2-1: Requirement to identify a new UTRA FDD cell for SON

DRX cycle length (s)	$T_{\text{identify, UTRA_FDD}}$ (s) (DRX cycles) (normal requirement)		$T_{\text{identify, UTRA_FDD}}$ (s) (DRX cycles) (reduced requirement)	
	Gap period = 40 ms	Gap period = 80 ms	Gap period = 40 ms	Gap period = 80 ms
≤ 0.04	Non DRX Requirements in clause 8.1.2.4.7.1.1 are applicable	Non DRX Requirements in clause 8.1.2.4.7.1.1 are applicable	Non DRX Requirements in clause 8.1.2.4.7.1.1 are applicable	Non DRX Requirements in clause 8.1.2.4.7.1.1 are applicable
$0.04 < \text{DRX cycle} \leq 0.08$	Note ($45 \cdot K_n \cdot N_{\text{freq,n}}$)	Note ($95 \cdot K_n \cdot N_{\text{freq,n}}$)	Note ($45 \cdot K_r \cdot N_{\text{freq,r}}$)	Note ($95 \cdot K_r \cdot N_{\text{freq,r}}$)
0.128	$3.84 \cdot K_n \cdot N_{\text{freq,n}}$ ($30 \cdot K_n \cdot N_{\text{freq,n}}$)	$8.0 \cdot K_n \cdot N_{\text{freq,n}}$ ($62.5 \cdot K_n \cdot N_{\text{freq,n}}$)	$3.84 \cdot K_r \cdot N_{\text{freq,r}}$ ($30 \cdot K_r \cdot N_{\text{freq,r}}$)	$8.0 \cdot K_r \cdot N_{\text{freq,r}}$ ($62.5 \cdot K_r \cdot N_{\text{freq,r}}$)
0.16	$4.0 \cdot K_n \cdot N_{\text{freq,n}}$ ($25 \cdot K_n \cdot N_{\text{freq,n}}$)	$8.0 \cdot K_n \cdot N_{\text{freq,n}}$ ($50 \cdot K_n \cdot N_{\text{freq,n}}$)	$4.0 \cdot K_r \cdot N_{\text{freq,r}}$ ($25 \cdot K_r \cdot N_{\text{freq,r}}$)	$8.0 \cdot K_r \cdot N_{\text{freq,r}}$ ($50 \cdot K_r \cdot N_{\text{freq,r}}$)
0.256	$6.4 \cdot K_n \cdot N_{\text{freq,n}}$ ($25 \cdot K_n \cdot N_{\text{freq,n}}$)	$8.96 \cdot K_n \cdot N_{\text{freq,n}}$ ($35 \cdot K_n \cdot N_{\text{freq,n}}$)	$6.4 \cdot K_r \cdot N_{\text{freq,r}}$ ($25 \cdot K_r \cdot N_{\text{freq,r}}$)	$8.96 \cdot K_r \cdot N_{\text{freq,r}}$ ($35 \cdot K_r \cdot N_{\text{freq,r}}$)
0.32	$8 \cdot K_n \cdot N_{\text{freq,n}}$ ($25 \cdot K_n \cdot N_{\text{freq,n}}$)	$8.96 \cdot K_n \cdot N_{\text{freq,n}}$ ($28 \cdot K_n \cdot N_{\text{freq,n}}$)	$8 \cdot K_r \cdot N_{\text{freq,r}}$ ($25 \cdot K_r \cdot N_{\text{freq,r}}$)	$8.96 \cdot K_r \cdot N_{\text{freq,r}}$ ($28 \cdot K_r \cdot N_{\text{freq,r}}$)
$0.32 < \text{DRX cycle} \leq 2.56$	Note ($25 \cdot K_n \cdot N_{\text{freq,n}}$)	Note ($25 \cdot K_n \cdot N_{\text{freq,n}}$)	Note ($25 \cdot K_r \cdot N_{\text{freq,r}}$)	Note ($25 \cdot K_r \cdot N_{\text{freq,r}}$)
Note: Time depends upon the DRX cycle in use				

Table 8.1.2.4.7.1.2-2: Requirement to identify a new UTRA FDD cell for SON when eDRX_CONN cycle is used

eDRX_CONN cycle length (s)	$T_{\text{identify, UTRA_FDD}}$ (s) (eDRX_CONN cycles) (normal requirement)		$T_{\text{identify, UTRA_FDD}}$ (s) (eDRX_CONN cycles) (reduced requirement)	
	Gap period = 40 ms	Gap period = 80 ms	Gap period = 40 ms	Gap period = 80 ms
$2.56 < \text{eDRX_CONN cycle} \leq 10.24$	Note ($25 \cdot K_n \cdot N_{\text{freq,n}}$)	Note ($25 \cdot K_n \cdot N_{\text{freq,n}}$)	Note ($25 \cdot K_r \cdot N_{\text{freq,r}}$)	Note ($25 \cdot K_r \cdot N_{\text{freq,r}}$)
Note: Time depends upon the eDRX_CONN cycle in use				

A cell shall be considered identifiable provided following conditions are fulfilled:

- CPICH Ec/Io ≥ -20 dB,
- SCH_Ec/Io ≥ -17 dB for at least one channel tap and SCH_Ec/Ior is equally divided between primary synchronisation code and secondary synchronisation code. When L3 filtering is used an additional delay can be expected.

If the UE is unable to identify the UTRA cell for SON within $8 \cdot T_{\text{identify, UTRA_FDD}}$ seconds, the UE may stop searching UTRA cells for SON; when DRX is used $T_{\text{identify, UTRA_FDD}}$ is defined in table 8.1.2.4.7.1.2-1, and when eDRX_CONN is used $T_{\text{identify, UTRA_FDD}}$ is defined in table 8.1.2.4.7.1.2-2.

8.1.2.4.7.1.3 Reporting Delay

The UE shall not report the physical cell identity of an identifiable cell for SON as long as the reporting criteria are not fulfilled.

The reporting delay is defined as the time between the identification of the strongest cell for SON until the UE starts to transmit its physical cell identity over the Uu interface. This requirement assumes that the reporting of the physical cell identity is not delayed by other RRC signalling on the DCCH. This reporting delay excludes a delay uncertainty resulted when inserting the physical cell identity of the strongest cell for SON to the TTI of the uplink DCCH. The delay uncertainty is twice the TTI of the uplink DCCH. When the measurement report is transmitted on the PUSCH with subframe or slot or subslot duration, the delay uncertainty is twice the subframe or slot or subslot of the uplink DCCH. This reporting delay excludes any delay caused by unavailability of UL resources for UE sending the physical cell identity of the strongest cell for SON.

The reporting delay of the physical cell identity of the strongest cell for SON without L3 filtering shall be less than $T_{\text{identify, UTRA_FDD}}$ defined in clause 8.1.2.4.7.1.1 and in clause 8.1.2.4.7.1.2 for non DRX and DRX or eDRX_CONN cases respectively. When L3 filtering is used or IDC autonomous denial is configured, or the UE is configured to perform SRS carrier based switching, an additional delay can be expected.

8.1.2.4.8 E-UTRAN TDD – UTRAN FDD measurements for SON

The requirements in clause 8.1.2.4.7 also apply for this section.

8.1.2.4.9 E-UTRAN FDD – cdma2000 1xRTT measurements

UE shall perform cdma2000 1xRTT measurements according to the procedure defined in [15] on the cdma2000 1xRTT neighbor cells indicated by the serving eNode B. If measurement gaps are required, the UE shall perform cdma2000 1xRTT measurements only during the measurement gaps configured by the serving eNode B.

8.1.2.4.9.1A E-UTRAN FDD – cdma2000 1xRTT measurements when no DRX is used

When measurement gaps are scheduled for CDMA2000 1xRTT inter RAT measurements, or the UE supports capability of conducting such measurements without gaps, the UE physical layer shall be capable of reporting CDMA2000 1xRTT Pilot Strength measurements to higher layers with measurement accuracy as specified in Clause 9.5, corresponding to a 90% measurement success rate, with measurement period given by

$$T_{\text{measurement_CDMA2000_1x}} = T_{\text{basic_measurement_CDMA2000_k}} \cdot N_{\text{freq,n}} \cdot K_n \cdot S_{\text{gap}}$$

where $T_{\text{basic_measurement_CDMA2000_1x}} = 100$ ms and the measurement gap specific scale factor S_{gap} is based on the measurement gap pattern in use as defined in Table 8.1.2.4.9.1-1. If inter-frequency RSTD measurements are configured and the UE requires measurement gaps for performing such measurements, then S_{gap} shall be based to the Gap Pattern Id 1.

Table 8.1.2.4.9.1-1: Gap Pattern Specific Scale Factor

Gap Pattern Id	S_{gap}
0	32/3
1	64/3

8.1.2.4.9.1 Periodic Reporting

Reported measurements in periodically triggered measurement reports shall meet the requirements in clause 9.

The measurement reporting delay of each periodic report is defined as the time between the end of the last measurement period and the moment when the UE starts to transmit the measurement report over the Uu interface. This delay shall be less than T_{71m} defined in [15] for each periodic report. This measurement reporting delay excludes a delay which is caused by the unavailability of the uplink resources for the UE to send the measurement report.

8.1.2.4.10 E-UTRAN TDD – cdma2000 1xRTT measurements

The requirements in clause 8.1.2.4.9 also apply for this section.

8.1.2.4.11 E-UTRAN FDD – HRPD measurements

UE shall perform HRPD measurements according to the procedure defined in [11] on the HRPD neighbor cells indicated by the serving eNode B. If measurement gaps are required, the UE shall perform HRPD measurements only during the measurement gaps configured by the serving eNode B.

8.1.2.4.12 E-UTRAN TDD – HRPD measurements

The requirements in clause 8.1.2.4.11 also apply for this section.

8.1.2.4.13 E-UTRAN TDD – UTRAN TDD measurements for SON

8.1.2.4.13.1 Identification of a new UTRA TDD cell for SON

No explicit neighbour list is provided to the UE for identifying a UTRA TDD cell for SON. The UE shall identify and report only the strongest cell when requested by the network for the purpose of SON.

8.1.2.4.13.1.1 Requirements when no DRX is used

When no DRX is used, either measurement gaps are scheduled or the UE supports capability of conducting such measurements without gaps, the UE shall be able to identify a new cell within:

$$T_{\text{identify, UTRA_TDD}} = T_{\text{basic_identify_UTRA_TDD}} \cdot \frac{480}{T_{\text{interl}}} \cdot K_n \cdot N_{\text{freq},n} \text{ ms (normal performance)}$$

and

$$T_{\text{identify, UTRA_TDD}} = T_{\text{basic_identify_UTRA_TDD}} \cdot \frac{480}{T_{\text{interl}}} \cdot K_r \cdot N_{\text{freq},r} \text{ ms (reduced performance)}$$

$T_{\text{basic_identify_UTRA_TDD}} = 800$ ms. This is the time period used in the above equation where the maximum allowed time for the UE to identify a new UTRA TDD cell is defined.

A cell shall be considered identifiable following conditions are fulfilled:

- P-CCPCH $E_c/I_o \geq -8$ dB,
- DwPCH $E_c/I_o \geq -5$ dB.

When L3 filtering is used an additional delay can be expected.

If the UE is unable to identify the UTRA TDD cell for SON within $8 \cdot T_{\text{identify, UTRA_TDD}}$ ms, the UE may stop searching UTRA TDD cells for SON.

8.1.2.4.13.1.2 Requirements when DRX is used

When DRX or eDRX_CONN is used, either measurement gaps are scheduled or the UE supports capability of conducting such measurements without gaps, the UE shall be able to identify a new cell within $T_{\text{identify, UTRA_TDD}}$. When DRX is used, $T_{\text{identify, UTRA_TDD}}$ is as defined in table 8.1.2.4.13.1.2-1, and when eDRX_CONN is used, $T_{\text{identify, UTRA_TDD}}$ is as defined in table 8.1.2.4.13.1.2-2.

Table 8.1.2.4.13.1.2-1: Requirement to identify a new UTRA TDD cell for SON

DRX cycle length (s)	T _{identify, UTRA_TDD} (s) (DRX cycles)		T _{identify, UTRA_TDD} (s) (DRX cycles)	T _{identify, UTRA_TDD} (s) (DRX cycles)
	Gap period = 40 ms	Gap period = 80 ms	Gap period = 40 ms	Gap period = 80 ms
≤0.16	Non DRX Requirements in clause 8.1.2.4.3.1 are applicable	Non DRX Requirements in clause 8.1.2.4.3.1 are applicable	Non DRX Requirements in clause 8.1.2.4.3.1 are applicable	Non DRX Requirements in clause 8.1.2.4.3.1 are applicable
0.16 < DRX cycle ≤ 0.256	Note (25 * K _n * N _{freq,n})	Note (50 * K _n * N _{freq,n})	Note (25 * K _r * N _{freq,r})	Note (50 * K _r * N _{freq,r})
0.256 < DRX cycle ≤ 0.32	Note (25 * K _n * N _{freq,n})	Note (45 * K _n * N _{freq,n})	Note (25 * K _r * N _{freq,r})	Note (45 * K _r * N _{freq,r})

0.32<DRX cycles≤2.56	Note (25*K _n * N _{freq,n})	Note (25*K _n * N _{freq,n})	Note (25*K _r * N _{freq,r})	Note (25*K _r * N _{freq,r})
Note: Time depends upon the DRX cycle in use				

Table 8.1.2.4.13.1.2-2: Requirement to identify a new UTRA TDD cell for SON when eDRX_CONN cycle is used

eDRX_CONN cycle length (s)	T _{identify, UTRA_TDD} (s) (eDRX_CONN cycles)		T _{identify, UTRA_TDD} (s) (eDRX_CONN cycles)	
	Gap period = 40 ms	Gap period = 80 ms	Gap period = 40 ms	Gap period = 80 ms
2.56<eDRX_CONN cycle≤10.24	Note (25*K _n * N _{freq,n})	Note (25*K _n * N _{freq,n})	Note (25*K _r * N _{freq,r})	Note (25*K _r * N _{freq,r})
Note: Time depends upon the eDRX_CONN cycle in use				

A cell shall be considered identifiable provided following conditions are fulfilled:

- P-CCPCH Ec/Io ≥ -8 dB,
- DwPCH_Ec/Io ≥ -5 dB.

When L3 filtering is used an additional delay can be expected.

If the UE is unable to identify the UTRA TDD cell for SON within 8*T_{identify, UTRA_TDD} seconds, the UE may stop searching UTRA TDD cells for SON; when DRX is used T_{identify, UTRA_TDD} is defined in table 8.1.2.4.13.1.2-1, and when eDRX_CONN is used T_{identify, UTRA_TDD} is defined in table 8.1.2.4.13.1.2-2.

8.1.2.4.13.1.3 Reporting Delay

The UE shall not report the physical cell identity of an identifiable cell for SON as long as the reporting criteria are not fulfilled.

The reporting delay is defined as the time between the identification of the strongest cell for SON until the UE starts to transmit its physical cell identity over the Uu interface. This requirement assumes that the reporting of the physical cell identity is not delayed by other RRC signalling on the DCCH. This reporting delay excludes a delay uncertainty resulted when inserting the physical cell identity of the strongest cell for SON to the TTI of the uplink DCCH. The delay uncertainty is twice the TTI of the uplink DCCH. When the measurement report is transmitted on the PUSCH with subframe or slot or subslot duration, the delay uncertainty is twice the subframe or slot or subslot of the uplink DCCH. This reporting delay excludes any delay caused by unavailability of UL resources for UE sending the physical cell identity of the strongest cell for SON.

The reporting delay of the physical cell identity of the strongest cell for SON without L3 filtering shall be less than T_{identify, UTRA_TDD} defined in clause 8.1.2.4.13.1.1 and in clause 8.1.2.4.13.1.2 for non DRX and DRX and eDRX_CONN cases respectively. When L3 filtering is used or IDC autonomous denial is configured, or the UE is configured to perform SRS carrier based switching, an additional delay can be expected.

8.1.2.4.14 E-UTRAN FDD – UTRAN TDD measurements for SON

The requirements in clause 8.1.2.4.13 also apply for this section.

8.1.2.4.15 E-UTRAN FDD – cdma2000 1xRTT measurements for SON ANR

8.1.2.4.15.1 Identification of a new cdma2000 1xRTT cell for SON ANR

No explicit neighbour list is provided to the UE for identifying a cdma2000 1xRTT cell for SON ANR. The UE shall identify and report only the strongest cell when requested by the network for the purpose of SON ANR.

8.1.2.4.15.1.1 Requirement when no DRX is used

When measurement gaps are scheduled for CDMA2000 1xRTT inter RAT measurements, or the UE supports capability of conducting such measurements without gaps, the UE physical layer shall be capable of reporting CDMA2000 1xRTT

Pilot Strength measurements to higher layers with measurement accuracy as specified in Clause 9.5, corresponding to a 90% measurement success rate, with measurement period given by

$$T_{\text{measurement_CDMA2000_1x}} = T_{\text{basic_measurement_CDMA2000_k}} \cdot N_{\text{freq,n}} \cdot K_n \cdot S_{\text{gap}}$$

where $T_{\text{basic_measurement_CDMA2000_1x}} = 100$ ms and the measurement gap specific scale factor S_{gap} is based on the measurement gap pattern in use as defined in Table 8.1.2.4.15.1.1-1. If inter-frequency RSTD measurements are configured and the UE requires measurement gaps for performing such measurements, then S_{gap} shall be based to the Gap Pattern Id 1.

Table 8.1.2.4.15.1.1-1: Gap Pattern Specific Scale Factor

Gap Pattern Id	S_{gap}
0	32/3
1	64/3

If the UE is unable to identify the CDMA2000 1xRTT cell for SON ANR, the UE may stop searching CDMA2000 1xRTT cells for SON ANR. The time after which the UE may stop searching is up to UE implementation.

8.1.2.4.15.1.2 Reporting Delay

The UE shall not report the physical cell identity of an identifiable cell for SON ANR as long as the reporting criteria are not fulfilled.

The reporting delay is defined as the time between the identification of the strongest cell for SON ANR until the UE starts to transmit its physical cell identity over the Uu interface. This delay shall be less than T_{71m} defined in [15]. This measurement reporting delay excludes a delay which is caused by the unavailability of the uplink resources for the UE to send the measurement report.

8.1.2.4.16 E-UTRAN TDD – cdma2000 1xRTT measurements for SON ANR

The requirements in clause 8.1.2.4.15 also apply for this section.

8.1.2.4.17 E-UTRAN FDD-UTRAN FDD measurements with autonomous gaps

The requirements in this clause apply only to UE supporting E-UTRA FDD and UTRA FDD.

8.1.2.4.17.1 Identification of a new CGI of UTRA FDD cell with autonomous gaps

No explicit neighbour list is provided to the UE for identifying a new CGI of UTRA FDD cell. The UE shall identify and report the CGI when requested by the network for the purpose of ‘reportCGI’. The UE may make autonomous gaps in both downlink reception and uplink transmission for decoding SFN and receiving UTRAN MIB and SIB3 messages according to clause 5.5.3.1 of TS 36.331 [2]. Note that a UE is not required to use autonomous gap if si-RequestForHO is set to false. If autonomous gaps are used for measurement with the purpose of ‘reportCGI’, regardless of whether DRX or eDRX_CONN is used or not, the UE shall be able to identify a new CGI of UTRA FDD cell within:

$$T_{\text{identify_CGI_UTRAN_FDD}} = 630 + 40 \cdot \text{SIB3_REP} \text{ ms}$$

where SIB3_REP is the repetition period at which the UTRAN cell schedules SIB3 blocks in units of frames specified in TS 25.331 [7], provided that the UTRAN cell has been already identified by the UE.

This requirement is applicable for UTRA FDD target cell configurations where the information required to make the SI report can be determined from the MIB and SIB3 alone, and MIB and SIB3 are not segmented into multiple TTIs. Additionally, for the requirement to be applicable, the reception conditions shall be such that the system frame number of the target UTRA FDD cell, the MIB and SIB3 can each be successfully decoded in no more than four attempts.

According to the reception conditions:

A cell shall be considered identifiable following conditions are fulfilled:

- CPICH $E_c/I_o \geq -20$ dB,
- SCH $E_c/I_o \geq -17$ dB for at least one channel tap and SCH E_c/I_o is equally divided between primary synchronisation code and secondary synchronisation code. When L3 filtering is used an additional delay can be

expected. The system frame number, the MIB and SIB3 of the target cell shall be considered decodable provided the BCH demodulation requirements are met according to [29].

The requirement for identifying a new CGI of an UTRA FDD cell within $T_{\text{identify_CGI_UTRAN_FDD}}$ is applicable when no DRX is used as well as when any of the DRX or eDRX_CONN cycles specified in TS 36.331 [2] is used.

The UE capable of SRS carrier based switching when configured to perform SRS transmission and/or PRACH transmission over one or more SCells without PUSCH shall meet the requirements defined in Section 8.1.2.4.17.1 provided the following condition is met:

- all MIB/SIB3/SCH specified in Section 8.1.2.4.17.1 are available for CGI reading at the UE in the measured cell.

Otherwise the time to acquire the new CGI of the UTRA FDD cell may be extended.

8.1.2.4.17.2 CGI Reporting Delay

The CGI reporting delay occurs due to the delay uncertainty when inserting the CGI measurement report to the TTI of the uplink DCCH. The delay uncertainty is twice the TTI of the uplink DCCH. When the measurement report is transmitted on the PUSCH with subframe or slot or subslot duration, the delay uncertainty is twice the subframe or slot or subslot of the uplink DCCH. In case DRX is used, the CGI reporting may be delayed until the next DRX cycle. In case eDRX is used, the CGI reporting may be delayed until the next eDRX_CONN cycle. If IDC autonomous denial is configured, an additional delay can be expected.

8.1.2.4.18 E-UTRAN TDD-UTRAN FDD measurements with autonomous gaps

The requirements in this clause apply only to UE supporting E-UTRA TDD and UTRA FDD.

8.1.2.4.18.1 Identification of a new CGI of UTRA FDD cell with autonomous gaps

The requirements in clause 8.1.2.4.17.1 also apply for this section.

8.1.2.4.18.2 CGI Reporting Delay

The requirements in clause 8.1.2.4.17.2 also apply for this section.

8.1.2.4.19 E-UTRAN FDD – WLAN measurements

8.1.2.4.19.1 Introduction

The requirements in this section shall apply for a UE capable of E-UTRA FDD and LTE-WLAN Aggregation [2].

8.1.2.4.19.2 Requirements

8.1.2.4.19.2.1 E-UTRAN FDD – WLAN measurements when no DRX is used

In the RRC_CONNECTED state when no DRX is used the measurement period for WLAN RSSI shall be $T_{\text{WLAN_RSSI}}$ as defined in table 8.1.2.4.19.2.1-1.

The value of $T_{\text{WLAN_RSSI}}$ depends upon whether the WLAN RSSI measurement is performed on the serving access point (AP) or on a neighbour AP and in case of the neighbour AP whether the neighbour AP is known or unknown to the UE:

- Measurement of known single neighbor AP is time-sensitive and is performed on the AP for which information about the operating channel is known to the UE; and
- Measurement of unknown neighbor AP is not time-sensitive and is performed on the AP for which information about the operating channel is not known to the UE.

The UE shall be capable of performing WLAN RSSI measurements for certain minimum number of APs during $T_{\text{WLAN_RSSI}}$ as defined in table 8.1.2.4.19.2.1-1 provided that the beacon frame of the measured AP is available at the UE at least once every 102.4 ms. The UE physical layer shall be capable of reporting WLAN RSSI measurements to higher layers with the measurement period of $T_{\text{WLAN_RSSI}}$.

Table 8.1.2.4.19.2.1-1: WLAN RSSI measurement period

WLAN RSSI measurement configuration		$T_{\text{WLAN_RSSI}}$ [seconds]
Type of Measurement	Minimum number of APs measured during $T_{\text{WLAN_RSSI}}$	

Measurement of serving AP	1	0.5
Measurement of known neighbor AP on a single channel	1	5
Measurement of multiple unknown neighbor APs	3	30

The WLAN RSSI measurement accuracy for all measured access points shall be fulfilled according to the accuracy as specified in the sub-clause 9.7.1.

8.1.2.4.19.2.2 E-UTRAN FDD – WLAN measurements when DRX is used

In the RRC_CONNECTED state when DRX is used the measurement period for WLAN RSSI shall be T_{RSSI_DRX} as defined in table 8.1.2.4.19.2.2-1.

The value of $T_{WLAN_RSSI_DRX}$ depends upon whether the WLAN RSSI measurement is performed on the serving access point (AP) or on a neighbour AP and in case of the neighbour AP whether the neighbour AP is known or unknown to the UE:

- Measurement of known single neighbor AP is time-sensitive and is performed on the AP for which information about the operating channel is known to the UE; and
- Measurement of unknown neighbor AP is not time-sensitive and is performed on the AP for which information about the operating channel is not known to the UE

The UE shall be capable of performing WLAN RSSI measurements for certain minimum number of APs during $T_{WLAN_RSSI_DRX}$ as defined in table 8.1.2.4.19.2.2-1 provided that the beacon frame of the measured AP is available at the UE at least once every 102.4 ms. The UE physical layer shall be capable of reporting WLAN RSSI measurements to higher layers with the measurement period of $T_{WLAN_RSSI_DRX}$.

Table 8.1.2.4.19.2.2-1: Requirement to measure WLAN RSSI in DRX

WLAN RSSI measurement configuration		DRX cycle length (s)	$T_{WLAN_RSSI_DRX}$ (s)
Type of Measurement	Minimum number of APs measured during T_{WLAN_RSSI}		
Measurement of serving AP	1	$0.002 \leq DRX\text{-cycle} \leq 0.320$	MAX (0.5, $5 \cdot L_{DRX}$)
Measurement of one known neighbor AP on a single channel	1	$0.002 \leq DRX\text{-cycle} \leq 0.320$	MAX (5, $25 \cdot L_{DRX}$)
		$0.320 < DRX\text{-cycle} \leq 2.56$	MAX (5, $20 \cdot L_{DRX}$)
Measurement of 3 unknown neighbor APs	3	$0.002 \leq DRX\text{-cycle} \leq 0.320$	MAX (30, $150 \cdot L_{DRX}$)
		$0.320 < DRX\text{-cycle} \leq 2.56$	MAX (30, $120 \cdot L_{DRX}$)
Note 1: L_{DRX} is the length of DRX cycle in second(s)			

The WLAN RSSI measurement accuracy for all measured access points shall be fulfilled according to the accuracy as specified in the sub-clause 9.7.1.

8.1.2.4.19.2.3 Periodic Reporting

Reported measurements in periodically triggered measurement reports shall meet the requirements in clause 9.7.1.

8.1.2.4.19.2.4 Event Triggered Reporting

Reported measurements in event triggered measurement reports shall meet the requirements in clause 9.7.1.

The UE shall not send any event triggered measurement reports, as long as the reporting criteria is not fulfilled.

The measurement reporting delay is defined as the time between any event that will trigger a measurement report until the UE starts to transmit the measurement report over the Uu interface. This requirement assumes that the measurement report is not delayed by other RRC signalling on the DCCH. This measurement reporting delay excludes a delay uncertainty resulted when inserting the measurement report to the TTI of the uplink DCCH. The delay uncertainty is twice the TTI of the uplink DCCH. When the measurement report is transmitted on the PUSCH with subframe or slot or

subslot duration, the delay uncertainty is twice the subframe or slot or subslot of the uplink DCCH. This measurement reporting delay excludes a delay which caused by no UL resources for UE to send the measurement report.

The event triggered measurement reporting delay, measured without L3 filtering shall be less than T_{WLAN_RSSI} when no DRX is used as defined in section 8.1.2.4.19.2.1 and $T_{WLAN_RSSI_DRX}$ when DRX is used as defined in section 8.1.2.4.19.2.2. When L3 filtering is used or IDC autonomous denial or the UE is performing reception and/or transmission for ProSe Direct Discovery and/or ProSe Direct Communication, or the UE is configured to perform SRS carrier based switching, an additional delay can be expected.

8.1.2.4.19.2.5 Event-triggered Periodic Reporting

Reported measurements contained in event triggered periodic measurement reports shall meet the requirements in clause 9.7.1.

The first report in event triggered periodic measurement reporting shall meet the requirements specified in clause 8.1.2.4.19.2.3.

8.1.2.4.20 E-UTRAN TDD – WLAN measurements

The requirements in this section shall apply for a UE capable of E-UTRA TDD and LTE-WLAN Aggregation [2].

The requirements in clause 8.1.2.4.19 also apply for this section.

8.1.2.4.21 E-UTRAN FDD – NR measurements

Requirements in this clause shall apply for NR capable UE when not configured with EN-DC.

The UE shall be able to identify new inter-RAT E-UTRAN FDD – NR cells and perform SS-RSRP, SS-RSRQ, and SS-SINR measurements of identified inter-RAT cells if carrier frequency information is provided by the PCell, even if no explicit neighbour list with physical layer cell identities is provided.

8.1.2.4.21.1 E-UTRAN FDD – NR measurements

8.1.2.4.21.1.1 Identification of a new NR cell

When measurement gaps are scheduled, the UE shall be able to identify a new detectable cell within $T_{\text{identify_irat_without_index}}$ if UE is not indicated to report SSB based RRM measurement result with the associated SSB index (*reportQuantityRsinIndexes* or *maxNrofRSIndexesToReport* is not configured). Otherwise, UE shall be able to identify a new detectable inter-RAT cell within $T_{\text{identify_irat_with_index}}$. The UE shall be able to identify a new detectable inter-RAT SS block of an already detected cell within $T_{\text{identify_irat_without_index}}$.

$$T_{\text{identify_irat_without_index}} = (T_{\text{PSS/SSS_sync_irat}} + T_{\text{SSB_measurement_period_irat}}) \text{ ms}$$

$$T_{\text{identify_irat_with_index}} = (T_{\text{PSS/SSS_sync_irat}} + T_{\text{SSB_measurement_period_irat}} + T_{\text{SSB_time_index_irat}}) \text{ ms}$$

Where:

$T_{\text{PSS/SSS_sync_irat}}$: it is the time period used in PSS/SSS detection given in table 8.1.2.4.21.1.1-1 and table 8.1.2.4.21.1.1-2.

$T_{\text{SSB_time_index_irat}}$: it is the time period used to acquire the index of the SSB being measured given in table 8.1.2.4.21.1.1-3 and table 8.1.2.4.21.1.1-4.

$T_{\text{SSB_measurement_period_irat}}$: equal to a measurement period of SSB based measurement given in table 8.1.2.4.21.1.1-5 and table 8.1.2.4.21.1.1-6.

$M_{\text{pss/sss_sync_irat}}$: For a UE supporting FR2 power class 1, $M_{\text{pss/sss_sync_irat}} = 64$ samples. For a UE supporting FR2 power class 2 (vehicle mounted), $M_{\text{pss/sss_sync_irat}} = 40$ samples. For a UE supporting FR2 power class 3 (handheld), $M_{\text{pss/sss_sync_irat}} = 40$ samples. For a UE supporting FR2 power class 4, $M_{\text{pss/sss_sync_irat}} = 40$ samples.

$M_{\text{SSB_index_irat}}$: For a UE supporting FR2 power class 1, $M_{\text{SSB_index_irat}} = 40$ samples. For a UE supporting FR2 power class 2 (vehicle mounted), $M_{\text{SSB_index_irat}} = 24$ samples. For a UE supporting FR2 power class 3 (handheld), $M_{\text{SSB_index_irat}} = 24$ samples. For a UE supporting FR2 power class 4, $M_{\text{SSB_index_irat}} = 24$ samples.

$M_{\text{meas_period_irat}}$: For a UE supporting FR2 power class 1, $M_{\text{meas_period_irat}} = 64$ samples. For a UE supporting FR2 power class 2 (vehicle mounted), $M_{\text{meas_period_irat}} = 40$ samples. For a UE supporting FR2 power class 3 (handheld), $M_{\text{meas_period_irat}} = 40$ samples. For a UE supporting FR2 power class 4, $M_{\text{meas_period_irat}} = 40$ samples.

N_{freq} is defined in clause 8.1.2.1.1

For per-FR measurement gap capable UE as specified in 38.306 [49], when FR2 NR measurement object(s) is configured,

- UE can perform such measurements without gap, and
- UE fulfils the requirements for FR2 measurement objects based on effective MGRP = 20 ms.

Table 8.1.2.4.21.1.1-1: Time period for PSS/SSS detection (Frequency range FR1)

Condition ^{NOTE1,2}	$T_{\text{PSS/SSS_sync_irat}}$
No DRX	$\text{Max}(600\text{ms}, 8 \times \text{Max}(\text{MGRP}, \text{SMTC period})) \times N_{\text{freq}}$
DRX cycle \leq 320ms	$\text{Max}(600\text{ms}, \text{Ceil}(8 \times 1.5) \times \text{Max}(\text{MGRP}, \text{SMTC period}, \text{DRX cycle})) \times N_{\text{freq}}$
DRX cycle $>$ 320ms	$8 \times \text{DRX cycle} \times N_{\text{freq}}$
NOTE 1: DRX or non DRX requirements apply according to the conditions described in section 3.6.1 of TS 38.133 [50].	

Table 8.1.2.4.21.1.1-2: Time period for PSS/SSS detection (Frequency range FR2)

Condition ^{NOTE1,2}	$T_{\text{PSS/SSS_sync_irat}}$
No DRX	$\text{Max}(600\text{ms}, M_{\text{pss/sss_sync_irat}} \times \text{Max}(\text{MGRP}, \text{SMTC period})) \times N_{\text{freq}}$
DRX cycle \leq 320ms	$\text{Max}(600\text{ms}, (1.5 \times M_{\text{pss/sss_sync_irat}}) \times \text{Max}(\text{MGRP}, \text{SMTC period}, \text{DRX cycle})) \times N_{\text{freq}}$
DRX cycle $>$ 320ms	$M_{\text{pss/sss_sync_irat}} \times \text{DRX cycle} \times N_{\text{freq}}$
NOTE 1: DRX or non DRX requirements apply according to the conditions described in section 5.	

Table 8.1.2.4.21.1.1-3: Time period for time index detection (Frequency range FR1)

Condition ^{NOTE1,2}	$T_{\text{SSB_time_index_irat}}$
No DRX	$\text{Max}(120\text{ms}, 3 \times \text{Max}(\text{MGRP}, \text{SMTC period})) \times N_{\text{freq}}$
DRX cycle \leq 320ms	$\text{Max}(120\text{ms}, \text{Ceil}(3 \times 1.5) \times \text{Max}(\text{MGRP}, \text{SMTC period}, \text{DRX cycle})) \times N_{\text{freq}}$
DRX cycle $>$ 320ms	$3 \times \text{DRX cycle} \times N_{\text{freq}}$
NOTE 1: DRX or non DRX requirements apply according to the conditions described in section 5.	

Table 8.1.2.4.21.1.1-4: Time period for time index detection (Frequency range FR2)

Condition ^{NOTE1,2}	$T_{\text{SSB_time_index_irat}}$
No DRX	$\text{Max}(200\text{ms}, M_{\text{SSB_index_irat}} \times \text{Max}(\text{MGRP}, \text{SMTC period})) \times N_{\text{freq}}$
DRX cycle \leq 320ms	$\text{Max}(200\text{ms}, (1.5 \times M_{\text{SSB_index_irat}}) \times \text{Max}(\text{MGRP}, \text{SMTC period}, \text{DRX cycle})) \times N_{\text{freq}}$
DRX cycle $>$ 320ms	$M_{\text{SSB_index_irat}} \times \text{DRX cycle} \times N_{\text{freq}}$
NOTE 1: DRX or non DRX requirements apply according to the conditions described in section 5.	

In the requirements, an NR cell is considered detectable when:

- NR SS-RSRP related conditions in the accuracy requirements in Section 9.11.1 are fulfilled for a corresponding Band, together with the corresponding side conditions in Annex B.2.3 of TS 38.133 [50],
- NR SS-RSRQ related conditions in the accuracy requirements in Section 9.11.2 are fulfilled for a corresponding Band, together with the corresponding side conditions in Annex B.2.3 of TS 38.133 [50],
- NR SS-SINR related conditions in the accuracy requirements in Section 9.11.3 are fulfilled for a corresponding Band, together with the corresponding side conditions in Annex B.2.3 of TS 38.133 [50].

When measurement gaps are scheduled for NR measurements the UE physical layer shall be capable of reporting NR SS-RSRP, SS-RSRQ and SS-SINR measurements to higher layers with measurement accuracy as specified in clause 9.11, with measurement period as shown in table 8.1.2.4.21.1.1-5 and 8.1.2.4.21.1.1-6:

Table 8.1.2.4.21.1.1-5: Measurement period for inter-RAT measurements (Frequency range FR1)

Condition ^{NOTE1,2}	T _{SSB_measurement_period_irat}
No DRX	$\text{Max}(200\text{ms}, 8 \times \text{Max}(\text{MGRP}, \text{SMTC period})) \times N_{\text{freq}}$
DRX cycle \leq 320ms	$\text{Max}(200\text{ms}, \text{Ceil}(8 \times 1.5) \times \text{Max}(\text{MGRP}, \text{SMTC period}, \text{DRX cycle})) \times N_{\text{freq}}$
DRX cycle $>$ 320ms	$8 \times \text{DRX cycle} \times N_{\text{freq}}$
NOTE 1: DRX or non DRX requirements apply according to the conditions described in section 5	

Table 8.1.2.4.21.1.1-6: Measurement period for inter-RAT measurements (Frequency range FR2)

Condition ^{NOTE1,2}	T _{SSB_measurement_period_irat}
No DRX	$\text{Max}(400\text{ms}, M_{\text{meas_period_irat}} \times \text{Max}(\text{MGRP}, \text{SMTC period})) \times N_{\text{freq}}$
DRX cycle \leq 320ms	$\text{Max}(400\text{ms}, (1.5 \times M_{\text{meas_period_irat}}) \times \text{Max}(\text{MGRP}, \text{SMTC period}, \text{DRX cycle})) \times N_{\text{freq}}$
DRX cycle $>$ 320ms	$M_{\text{meas_period_irat}} \times \text{DRX cycle} \times N_{\text{freq}}$
NOTE 1: DRX or non DRX requirements apply according to the conditions described in section 5.	

The UE shall be capable of performing NR SS-RSRP, SS-RSRQ and SS-SINR for up to 7 NR carrier frequencies.

For each RAT E-UTRAN FDD-NR layer on FR1 or FR2, the UE shall be capable of monitoring at least 4 cells.

For each RAT E-UTRAN FDD-NR layer on FR1, during each layer 1 measurement period, the UE shall be capable of monitoring at least 7 SSBs with different SSB index and/or PCI on the RAT E-UTRAN FDD-NR layer.

For each RAT E-UTRAN FDD-NR layer on FR2, during each layer 1 measurement period, the UE shall be capable of monitoring at least 10 SSBs with different SSB index and/or PCI on the RAT E-UTRAN FDD-NR layer. The UE shall be capable of monitoring at least one SSB per cell.

The NR SS-RSRP measurement accuracy for all measured NR cells shall be as specified in clause 9.11.1. The NR SS-RSRQ measurement accuracy for all measured NR cells shall be as specified in clause 9.11.2. The NR SS-SINR measurement accuracy for all measured NR cells shall be as specified in clause 9.11.3.

NOTE: When inter-frequency RSTD measurements are configured and the UE requires measurement gaps for performing such measurements, gap pattern 0 is assumed and requirements in this clause are derived assuming MGRP=80ms is used.

8.1.2.4.21.1.2 Periodic Reporting

Reported measurements in periodically triggered measurement reports shall meet the requirements in clause 9.

8.1.2.4.21.1.3 Event Triggered Reporting

Reported measurements in event triggered measurement reports shall meet the requirements in clause 9.

The UE shall not send any event triggered measurement reports, as long as the reporting criteria are not fulfilled.

The measurement reporting delay is defined as the time between any event that will trigger a measurement report until the UE starts to transmit the measurement report over the Uu interface. This requirement assumes that the measurement report is not delayed by other RRC signalling on the DCCH. This measurement reporting delay excludes a delay uncertainty resulted when inserting the measurement report to the TTI of the uplink DCCH. The delay uncertainty is twice the TTI of the uplink DCCH. This measurement reporting delay excludes a delay which caused by no UL resources for UE to send the measurement report.

The event triggered measurement reporting delay, measured without L3 filtering shall be less than $T_{\text{identify_irat_without_index}}$ or $T_{\text{identify_irat_with_index}}$ defined in Clause 8.1.2.4.21.1.1 for the minimum requirements. When L3 filtering is used or IDC autonomous denial or the UE is performing reception and/or transmission for ProSe Direct Discovery and/or ProSe Direct Communication, or the UE is configured to perform SRS carrier based switching, an additional delay can be expected.

If an NR cell which has been detectable at least for the time period $T_{\text{identify_irat_without_index}}$ or $T_{\text{identify_irat_with_index}}$ defined in clause 8.1.2.4.21.1.1 for the minimum requirements and then triggers the measurement report as per TS 36.331 [2], the event triggered measurement reporting delay shall be less than $T_{\text{SSB_measurement_period_irat}}$ defined in clause 8.1.2.4.21.1.1 provided the timing to that cell has not changed more than $\pm 3200 T_c$ while measurement gap has not been available and the L3 filter has not been used. When L3 filtering is used or IDC autonomous denial is configured or the UE is performing reception and/or transmission for ProSe Direct Discovery and/or ProSe Direct Communication, or the UE is configured to perform SRS carrier based switching, an additional delay can be expected.

8.1.2.4.21.1.4 Event-triggered Periodic Reporting

Reported measurements contained in event triggered periodic measurement reports shall meet the requirements in clause 9.

The first report in event triggered periodic measurement reporting shall meet the requirements specified in clause 8.1.2.4.21.1.3.

8.1.2.4.21.2 Void

8.1.2.4.22 E-UTRAN TDD – NR measurements

Requirements in this clause shall apply for NR capable UE when not configured with EN-DC.

The requirements in clause 8.1.2.4.21 also apply for this section.

8.1.2.4.23 Void

8.1.2.4.24 Void

8.1.2.4.25 E-UTRAN FDD – NR SFTD Measurements

8.1.2.4.25.1 Introduction

This clause contains requirements for a UE supporting E-UTRAN FDD – NR dual connectivity and is applicable in RRC_CONNECTED state and conditioned on that no NR PSCell is configured. The UE shall perform inter-RAT SFTD measurement and report SFTD result with/without SS-RSRP after the network requests with *reportSFTD-Meas* set to neighbour cells. The overall delay includes RRC procedure delay to be defined in clause 11.2 in TS 36.331 [2] and SFTD measurement reporting delay in clause 8.1.2.4.25.3.

8.1.2.4.25.2 SFTD Measurement delay

The requirements on SFTD measurement delay defined in this section are applicable under the side condition $\hat{E}_s/\hat{I}_{ot} \geq -3$ dB for the NR cell. Depending on configuration, the SFTD measurement may be carried out with or without the support of configured measurement gaps. In the current release, indication on whether to carry out the SFTD measurement with or without measurement gaps is implicit and depending on whether measurement gaps are configured.

The UE shall be able to detect, identify and measure SFTD of up to 3 of the strongest NR cells on the carrier frequency provided in the SFTD measurement configuration. Further depending on the SFTD measurement configuration, the UE shall additionally report SS-RSRP for the one or more NR cells. The UE may or may not be configured with *cellsForWhichToReportSFTD*. The UE does not expect *cellsForWhichToReportSFTD* to change during an ongoing SFTD measurement.

When no measurement gaps are provided, the UE shall be capable of finding the NR cell regardless of its SSB position in the SMTC period. The SFTD measurement shall be conducted with sustained connection to the E-UTRA PCell and activated SCell(s), however, the UE may be allowed to cause a certain amount of interruptions for reconfiguration of the radio receiver, as specified in clause 7.35.

When measurement gaps are provided, the UE shall be capable of finding the NR cell under the additional condition that the SSB at least occasionally falls within the measurement gap.

When no MCG DRX is used, the UE shall be capable of determining SFTD within a physical layer measurement period of $T_{\text{measure_SFTD1}}$ as follows:

- For SFTD measurements without measurement gaps, and without additional SS-RSRP reporting:
 - For NR carrier in FR1: $T_{\text{measure_SFTD1}} = 14$ SMTC periods
 - For NR carrier in FR2: $T_{\text{measure_SFTD1}} = 112$ SMTC periods
- For SFTD measurements in measurement gaps, and without additional SS-RSRP reporting:
 - For NR carrier in FR1: $T_{\text{measure_SFTD1}} = N_{\text{freq}} \times 8 \times \text{Max}(\text{MGRP}, \text{SMTC period})$
 - For NR carrier in FR2: $T_{\text{measure_SFTD1}} = N_{\text{freq}} \times 64 \times \text{Max}(\text{MGRP}, \text{SMTC period})$
- For SFTD measurements without measurement gaps, and with additional SS-RSRP reporting:
 - For NR carrier in FR1: $T_{\text{measure_SFTD1}} = 19$ SMTC periods
 - For NR carrier in FR2: $T_{\text{measure_SFTD1}} = 152$ SMTC periods
- For SFTD measurements in measurement gaps, and with additional SS-RSRP reporting:
 - For NR carrier in FR1: $T_{\text{measure_SFTD1}} = N_{\text{freq}} \times 13 \times \text{Max}(\text{MGRP}, \text{SMTC period})$
 - For NR carrier in FR2: $T_{\text{measure_SFTD1}} = N_{\text{freq}} \times 104 \times \text{Max}(\text{MGRP}, \text{SMTC period})$

where N_{freq} is the number of carriers monitored in measurement gaps.

When MCG DRX is used, the same $T_{\text{measure_SFTD1}}$ as for non-DRX applies, but the reporting delay depends on the DRX cycle length in use.

In case an NR PSCell is added, the UE shall terminate the inter-RAT SFTD measurement.

In case PCell is changed due to handover, the UE shall terminate the inter-RAT SFTD measurement.

The measurement accuracy for the SFTD measurement shall fulfill the requirement in clause 9.1.27. The measurement accuracy for additionally reported NR SS-RSRP shall fulfil the requirement in clause 9.11.1.

8.1.2.4.25.3 SFTD Measurement reporting delay

The SFTD measurement reporting delay is defined as the time between a command that will trigger an SFTD measurement report and the point when the UE starts to transmit the measurement report over the air interface. This requirement assumes that the measurement report is not delayed by other RRC signalling on the DCCH. This measurement reporting delay excludes a delay uncertainty resulted when inserting the measurement report to the TTI of the uplink DCCH. The delay uncertainty is: $2 \times \text{TTI}_{\text{DCCH}}$. This measurement reporting delay excludes any delay caused by no UL resources for UE to send the measurement report. When the UE is configured to perform SRS carrier-based switching, an additional delay can be expected.

The SFTD measurement reporting delay shall be less than $T_{\text{measure_SFTD1}}$ defined in clause 8.1.2.4.25.2.

8.1.2.4.26 E-UTRAN TDD – NR SFTD Measurements

8.1.2.4.26.1 Introduction

This clause contains requirements for a UE supporting E-UTRAN TDD – NR dual connectivity and is applicable in RRC_CONNECTED state and conditioned on that no NR PSCell is configured.

When no measurement gap is provided, the UE is not required to perform SFTD measurement during the UL subframes of an E-UTRAN serving cell which is on the same TDD band with the NR target cell.

When no measurement gap is provided, the UE is not required to perform SFTD measurement during the UL subframes of a TDD E-UTRAN serving cell which is on the different band with the NR target cell when UE doesn't support *simultaneousRxTxInterBandENDC* in this band combination.

The requirements in clause 8.1.2.4.25 also apply for this section.

8.1.2.5 E-UTRAN OTDOA Intra-Frequency RSTD Measurements

All intra-frequency RSTD measurement requirements specified in Sections 8.1.2.5.1 and 8.1.2.5.2 shall apply without DRX as well as for any DRX and eDRX_CONN cycles specified in TS 36.331 [2].

When using CRS, in addition to PRS, is enabled in the OTDOA assistance data, it is up to UE implementation whether to use or not the CRS for RSTD measurements, but in either case the RSTD measurements reported by the UE shall meet the requirements specified in this section.

If network-based CRS interference mitigation is enabled in a cell for which the UE performs RSTD measurements, the UE capable of supporting network-based CRS interference mitigation shall perform RSTD measurements and meet all the requirements in this section, provided the CRS are available within at least the PRS bandwidth in the subframes with PRS during all positioning occasions within the RSTD measurement period.

8.1.2.5.1 E-UTRAN FDD Intra-Frequency OTDOA Measurements

When the physical layer cell identities of neighbour cells together with the OTDOA assistance data are provided, the UE shall be able to detect and measure intra-frequency RSTD, specified in TS 36.214 [4], for at least $n=16$ cells, including the reference cell, on the same carrier frequency f_1 as that of the reference cell within

$T_{\text{RSTD IntraFreqFDD, E-UTRAN}}$ ms as given below (see also Figure 8.1.2.5.1-1):

$$T_{\text{RSTD IntraFreqFDD, E-UTRAN}} = T_{\text{PRS}} \cdot (M - 1) + \Delta \quad \text{ms} \quad ,$$

where

$T_{\text{RSTD IntraFreqFDD, E-UTRAN}}$ is the total time for detecting and measuring at least n cells,

T_{PRS} is the cell-specific positioning subframe configuration period as defined in TS 36.211 [16],

M is the number of PRS positioning occasions as defined in Table 8.1.2.5.1-1, where each PRS positioning occasion comprises of N_{PRS} ($1 \leq N_{\text{PRS}} \leq 6$) consecutive downlink positioning subframes defined in TS 36.211 [16], and

$\Delta = 160 \cdot \left\lceil \frac{n}{M} \right\rceil$ ms is the measurement time for a single PRS positioning occasion which includes the sampling time

and the processing time.

Table 8.1.2.5.1-1: Number of PRS positioning occasions within $T_{\text{RSTD IntraFreqFDD, E-UTRAN}}$

Positioning subframe configuration period T_{PRS}	Number of PRS positioning occasions M	
	f_1 ^{Note1}	f_1 and f_2 ^{Note2}
160 ms	16	32
>160 ms	8	16

Note 1: When only intra-frequency RSTD measurements are performed over cells belonging to the serving FDD carrier frequency f_1 .
Note 2: When intra-frequency RSTD and inter-frequency RSTD measurements are performed over cells belonging to the serving FDD carrier frequency f_1 and one inter-frequency carrier frequency f_2 , respectively.

The UE physical layer shall be capable of reporting RSTD for the reference cell and all the neighbor cells i out of at least $(n-1)$ neighbor cells within $T_{\text{RSTD IntraFreqFDD, E-UTRAN}}$ provided:

$(\text{PRS } \hat{E}_s / \text{Iot})_{\text{ref}} \geq -6$ dB for all Frequency Bands for the reference cell,

$(\text{PRS } \hat{E}_s / \text{Iot})_i \geq -13$ dB for all Frequency Bands for neighbour cell i ,

$(\text{PRS } \hat{E}_s / \text{Iot})_{\text{ref}}$ and $(\text{PRS } \hat{E}_s / \text{Iot})_i$ conditions apply for all subframes of at least $L = \frac{M}{2}$ PRS positioning

occasions,

PRP 1,2_{dBm} according to Annex B.2.5 for a corresponding Band

$PRS \hat{E}_s / I_{ot}$ is defined as the ratio of the average received energy per PRS RE during the useful part of the symbol to the average received power spectral density of the total noise and interference for this RE, where the ratio is measured over all REs which carry PRS.

The time $T_{RSTD \text{ IntraFreqFDD, E-UTRAN}}$ starts from the first subframe of the PRS positioning occasion closest in time after both the OTDOA-RequestLocationInformation message and the OTDOA assistance data in the OTDOA-ProvideAssistanceData message as specified in TS 36.355 [24], are delivered to the physical layer of the UE as illustrated in Figure 8.1.2.5.1-1.

The RSTD measurement accuracy for all measured neighbor cells i shall be fulfilled according to the accuracy as specified in the sub-clause 9.1.10.1.

If the intra-frequency handover occurs while intra-frequency RSTD measurements are being performed then the UE shall complete the ongoing OTDOA measurement session. The UE shall also meet the intra-frequency OTDOA measurement and accuracy requirements. However in this case the RSTD measurement period ($T_{RSTD \text{ IntraFreqFDD, E-UTRAN, HO}}$) shall be according to the following expression:

$$T_{RSTD \text{ IntraFreqFDD, E-UTRAN, HO}} = T_{RSTD \text{ IntraFreqFDD, E-UTRAN}} + K \times T_{PRS} + T_{HO} \quad ms,$$

where:

K is the number of times the intra-frequency handover occurs during $T_{RSTD \text{ IntraFreqFDD, E-UTRAN, HO}}$.

T_{HO} is the time during which the intra-frequency RSTD measurement may not be possible due to intra-frequency handover; it can be up to 45 ms.

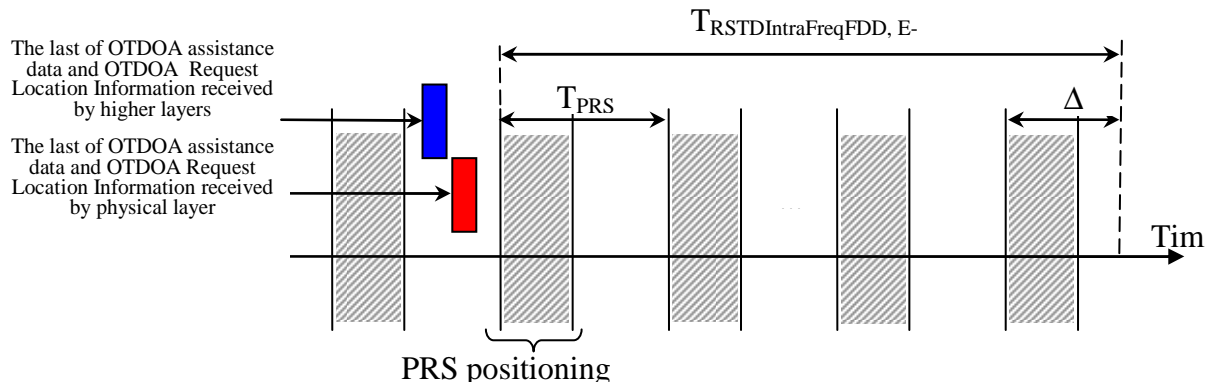

Figure 8.1.2.5.1-1. Illustration of the RSTD reporting time requirement in an FDD system.

Furthermore, due to the intra-frequency handover the UE shall meet the RSTD measurement accuracy for a PRS bandwidth which is not larger than the minimum channel bandwidth of all the PCells during the RSTD measurement period.

8.1.2.5.1.1 RSTD Measurement Reporting Delay

This requirement assumes that the measurement report is not delayed by other LPP signalling on the DCCH. This measurement reporting delay excludes a delay uncertainty resulted when inserting the measurement report to the TTI of the uplink DCCH. The delay uncertainty is: $2 \times TTI_{DCCH}$ where TTI_{DCCH} is the duration of subframe or slot or subslot when the measurement report is transmitted on the PUSCH with subframe or slot or subslot duration. This measurement reporting delay excludes any delay caused by no UL resources for UE to send the measurement report. When the UE is configured to perform SRS carrier based switching, an additional delay can be expected.

8.1.2.5.2 E-UTRAN TDD Intra-Frequency OTDOA Measurements

When the physical layer cell identities of neighbour cells together with the OTDOA assistance data are provided, the UE shall be able to detect and measure intra-frequency RSTD, specified in TS 36.214 [4], for at least $n=16$ cells,

including the reference cell, on the same carrier frequency f_1 as that of the reference cell within

$T_{\text{RSTD IntraFreqIDD,E-UTRAN}}$ ms as given below:

$$T_{\text{RSTD IntraFreqIDD,E-UTRAN}} = T_{\text{PRS}} \cdot (M - 1) + \Delta \quad \text{ms} \quad ,$$

where

$T_{\text{RSTD IntraFreqIDD,E-UTRAN}}$ is the total time for detecting and measuring at least n cells,

T_{PRS} is the cell-specific positioning subframe configuration period as defined in TS 36.211 [16],

M is the number of PRS positioning occasions as defined in Table 8.1.2.5.2-1, where a PRS positioning occasion is as defined in Clause 8.1.2.5.1, and

$\Delta = 160 \cdot \left\lceil \frac{n}{M} \right\rceil$ ms is the measurement time for a single PRS positioning occasion which includes the sampling time and the processing time.

Table 8.1.2.5.2-1: Number of PRS positioning occasions within $T_{\text{RSTD IntraFreqIDD,E-UTRAN}}$

Positioning subframe configuration period T_{PRS}	Number of PRS positioning occasions M	
	f_1 ^{Note1}	f_1 and f_2 ^{Note2}
160 ms	16	32
>160 ms	8	16

Note 1: When only intra-frequency RSTD measurements are performed over cells belonging to the serving TDD carrier frequency f_1 .
Note 2: When intra-frequency RSTD and inter-frequency RSTD measurements are performed over cells belonging to the serving TDD carrier frequency f_1 and one inter-frequency carrier frequency f_2 respectively.

The UE physical layer shall be capable of reporting RSTD for the reference cell and all the neighbor cells i out of at least $(n-1)$ neighbor cells within $T_{\text{RSTD IntraFreqIDD,E-UTRAN}}$ provided:

$(\text{PRS } \hat{E}_s / \text{Iot})_{\text{ref}} \geq -6$ dB for all Frequency Bands for the reference cell,

$(\text{PRS } \hat{E}_s / \text{Iot})_i \geq -13$ dB for all Frequency Bands for neighbour cell i ,

$(\text{PRS } \hat{E}_s / \text{Iot})_{\text{ref}}$ and $(\text{PRS } \hat{E}_s / \text{Iot})_i$ conditions apply for all subframes of at least $L = \frac{M}{2}$ PRS positioning

occasions,

PRP 1,2_{dBm} according to Annex B.2.5 for a corresponding Band

$\text{PRS } \hat{E}_s / \text{Iot}$ is as defined in Clause 8.1.2.5.1.

The time $T_{\text{RSTD IntraFreqIDD,E-UTRAN}}$ starts from the first subframe of the PRS positioning occasion closest in time after both the OTDOA-RequestLocationInformation message and the OTDOA assistance data in the OTDOA-ProvideAssistanceData message as specified in TS 36.355 [24], are delivered to the physical layer of the UE.

The RSTD measurement accuracy for all measured neighbor cells i shall be fulfilled according to the accuracy as specified in the sub-clause 9.1.10.1.

If the intra-frequency handover occurs while intra-frequency RSTD measurements are being performed then the UE shall complete the ongoing OTDOA measurement session. The UE shall also meet the intra-frequency OTDOA measurement and accuracy requirements. However in this case the RSTD measurement period (

$T_{\text{RSTD IntraFreqIDD,E-UTRAN,HO}}$) shall be according to the following expression:

$$T_{\text{RSTD IntraFreqIDD,E-UTRAN,HO}} = T_{\text{RSTD IntraFreqIDD,E-UTRAN}} + K \times T_{\text{PRS}} + T_{\text{HO}} \quad \text{ms} \quad ,$$

where:

K is the number of times the intra-frequency handover occurs during $T_{\text{RSTD IntraFreqTDD,E-UTRAN,HO}}$,

T_{HO} is the time during which the intra-frequency RSTD measurement may not be possible due to intra-frequency handover; it can be up to 45 ms.

Furthermore, due to the intra-frequency handover the UE shall meet the RSTD measurement accuracy for a PRS bandwidth which is not larger than the minimum channel bandwidth of all the PCells during the RSTD measurement period.

The intra-frequency requirements in this clause (8.1.2.5.2) shall apply for all TDD special subframe configurations specified in TS 36.211 [16] and for the TDD uplink-downlink configurations as specified in Table 8.1.2.5.2-2.

Table 8.1.2.5.2-2: TDD uplink-downlink subframe configurations applicable for TDD intra-frequency requirements

PRS Transmission Bandwidth [RB]	Applicable TDD uplink-downlink configurations
6, 15	1, 2, 3, 4 and 5
25, 50, 75, 100	0, 1, 2, 3, 4, 5 and 6
Note: Uplink-downlink configurations are specified in Table 4.2-2 in TS 36.211 [16].	

8.1.2.5.2.1 RSTD Measurement Reporting Delay

This requirement assumes that the measurement report is not delayed by other LPP signalling on the DCCH. This measurement reporting delay excludes a delay uncertainty resulted when inserting the measurement report to the TTI of the uplink DCCH. The delay uncertainty is: $2 \times T_{\text{TI}_{\text{DCCH}}}$ where $T_{\text{TI}_{\text{DCCH}}}$ is the duration of subframe or slot or subslot when the measurement report is transmitted on the PUSCH with subframe or slot or subslot duration. This measurement reporting delay excludes any delay caused by no UL resources for UE to send the measurement report. When the UE is configured to perform SRS carrier based switching, an additional delay can be expected.

8.1.2.5.3 E-UTRAN FDD Intra-Frequency OTDOA Measurements for UE Category 1bis

When the physical layer cell identities of neighbour cells together with the OTDOA assistance data are provided, the UE shall be able to detect and measure intra-frequency RSTD, specified in TS 36.214 [4], for at least $n=16$ cells, including the reference cell, on the same carrier frequency f_1 as that of the reference cell within

$T_{\text{RSTD IntraFreqFDD,E-UTRAN}}$ ms as given below (see also Figure 8.1.2.5.3-1):

$$T_{\text{RSTD IntraFreqFDD,E-UTRAN}} = T_{\text{PRS}} \cdot (M - 1) + \Delta \quad \text{ms},$$

where

$T_{\text{RSTD IntraFreqFDD,E-UTRAN}}$ is the total time for detecting and measuring at least n cells,

T_{PRS} is the cell-specific positioning subframe configuration period as defined in TS 36.211 [16],

M is the number of PRS positioning occasions as defined in Table 8.1.2.5.3-1, where a PRS positioning occasion is as defined in Clause 8.1.2.5.1, and

$\Delta = 160 \cdot \left\lceil \frac{n}{M} \right\rceil$ ms is the measurement time for a single PRS positioning occasion which includes the sampling time and the processing time.

Table 8.1.2.5.3-1: Number of PRS positioning occasions within $T_{\text{RSTD IntraFreqFDD,E-UTRAN}}$

Positioning subframe configuration period T_{PRS}	Number of PRS positioning occasions M	
	f_1 ^{Note1}	f_1 and f_2 ^{Note2}
160 ms	32	64
>160 ms	16	32

Note 1: When only intra-frequency RSTD measurements are performed over cells belonging to the serving FDD carrier frequency f1.
 Note 2: When intra-frequency RSTD and inter-frequency RSTD measurements are performed over cells belonging to the serving FDD carrier frequency f1 and one inter-frequency carrier frequency f2, respectively.

The UE physical layer shall be capable of reporting RSTD for the reference cell and all the neighbor cells i out of at least $(n-1)$ neighbor cells within $T_{RSTD\ IntraFreqFDD, E-UTRAN}$ provided:

$$\left(PRS \hat{E}_s / Iot \right)_{ref} \geq -6 \text{ dB for all Frequency Bands for the reference cell,}$$

$$\left(PRS \hat{E}_s / Iot \right)_i \geq -13 \text{ dB for all Frequency Bands for neighbour cell } i,$$

$\left(PRS \hat{E}_s / Iot \right)_{ref}$ and $\left(PRS \hat{E}_s / Iot \right)_i$ conditions apply for all subframes of at least $L = \frac{M}{2}$ PRS positioning occasions,

PRP $1,2_{dBm}$ according to Annex B.2.5 for a corresponding Band

$PRS \hat{E}_s / Iot$ is as defined in Clause 8.1.2.5.1.

The time $T_{RSTD\ IntraFreqFDD, E-UTRAN}$ starts from the first subframe of the PRS positioning occasion closest in time after both the OTDOA-RequestLocationInformation message and the OTDOA assistance data in the OTDOA-ProvideAssistanceData message as specified in TS 36.355 [24], are delivered to the physical layer of the UE as illustrated in Figure 8.1.2.5.3-1.

The RSTD measurement accuracy for all measured neighbor cells i shall be fulfilled according to the accuracy as specified in the sub-clause 9.1.10.5.

If the intra-frequency handover occurs while intra-frequency RSTD measurements are being performed then the UE shall complete the ongoing OTDOA measurement session. The UE shall also meet the intra-frequency OTDOA measurement and accuracy requirements. However in this case the RSTD measurement period ($T_{RSTD\ IntraFreqFDD, E-UTRAN, HO}$) shall be according to the following expression:

$$T_{RSTD\ IntraFreqFDD, E-UTRAN, HO} = T_{RSTD\ IntraFreqFDD, E-UTRAN} + K \times T_{PRS} + T_{HO} \quad ms ,$$

where:

K is the number of times the intra-frequency handover occurs during $T_{RSTD\ IntraFreqFDD, E-UTRAN, HO}$.

T_{HO} is the time during which the intra-frequency RSTD measurement may not be possible due to intra-frequency handover; it can be up to 45 ms.

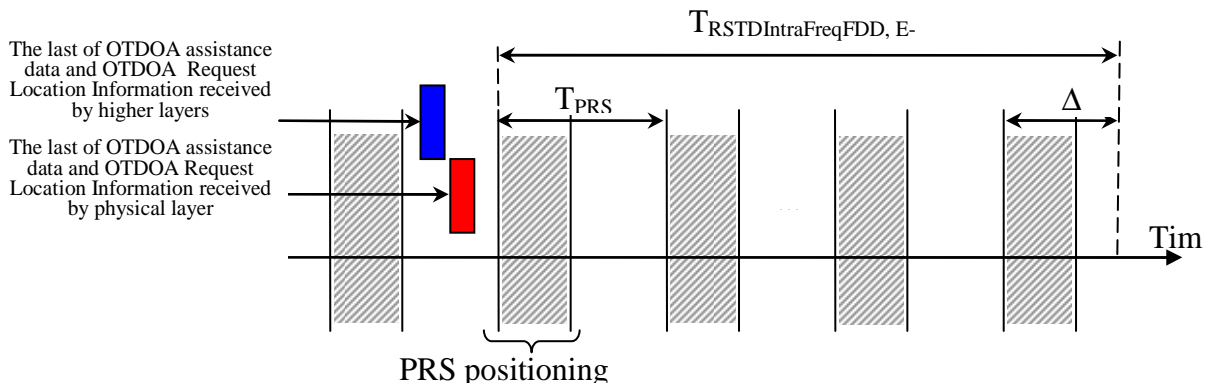

Figure 8.1.2.5.3-1. Illustration of the RSTD reporting time requirement in an FDD system.

Furthermore, due to the intra-frequency handover the UE shall meet the RSTD measurement accuracy for a PRS bandwidth which is not larger than the minimum channel bandwidth of all the PCells during the RSTD measurement period.

8.1.2.5.3.1 RSTD Measurement Reporting Delay

This requirement assumes that the measurement report is not delayed by other LPP signalling on the DCCH. This measurement reporting delay excludes a delay uncertainty resulted when inserting the measurement report to the TTI of the uplink DCCH. The delay uncertainty is: $2 \times TTI_{DCCH}$. This measurement reporting delay excludes any delay caused by no UL resources for UE to send the measurement report. When the UE is configured to perform SRS carrier based switching, an additional delay can be expected.

8.1.2.5.4 E-UTRAN TDD Intra-Frequency OTDOA Measurements for UE Category 1bis

When the physical layer cell identities of neighbour cells together with the OTDOA assistance data are provided, the UE shall be able to detect and measure intra-frequency RSTD, specified in TS 36.214 [4], for at least $n=16$ cells, including the reference cell, on the same carrier frequency f_1 as that of the reference cell within

$T_{RSTD \text{ IntraFreqTDD,E-UTRAN}}$ ms as given below:

$$T_{RSTD \text{ IntraFreqTDD,E-UTRAN}} = T_{PRS} \cdot (M - 1) + \Delta \quad ms,$$

where

$T_{RSTD \text{ IntraFreqTDD,E-UTRAN}}$ is the total time for detecting and measuring at least n cells,

T_{PRS} is the cell-specific positioning subframe configuration period as defined in TS 36.211 [16],

M is the number of PRS positioning occasions as defined in Table 8.1.2.5.4-1, where a PRS positioning occasion is as defined in Clause 8.1.2.5.1, and

$\Delta = 160 \cdot \left\lceil \frac{n}{M} \right\rceil$ ms is the measurement time for a single PRS positioning occasion which includes the sampling time and the processing time.

Table 8.1.2.5.4-1: Number of PRS positioning occasions within $T_{RSTD \text{ IntraFreqTDD,E-UTRAN}}$

Positioning subframe configuration period T_{PRS}	Number of PRS positioning occasions M	
	f_1 ^{Note1}	f_1 and f_2 ^{Note2}
160 ms	32	64
>160 ms	16	32
Note 1: When only intra-frequency RSTD measurements are performed over cells belonging to the serving TDD carrier frequency f_1 .		
Note 2: When intra-frequency RSTD and inter-frequency RSTD measurements are performed over cells belonging to the serving TDD carrier frequency f_1 and one inter-frequency carrier frequency f_2 respectively.		

The UE physical layer shall be capable of reporting RSTD for the reference cell and all the neighbor cells i out of at least $(n-1)$ neighbor cells within $T_{RSTD \text{ IntraFreqTDD,E-UTRAN}}$ provided:

$$\left(PRS \hat{E}_s / Iot \right)_{ref} \geq -6 \text{ dB for all Frequency Bands for the reference cell,}$$

$$\left(PRS \hat{E}_s / Iot \right)_i \geq -13 \text{ dB for all Frequency Bands for neighbour cell } i,$$

$\left(PRS \hat{E}_s / Iot \right)_{ref}$ and $\left(PRS \hat{E}_s / Iot \right)_i$ conditions apply for all subframes of at least $L = \frac{M}{2}$ PRS positioning occasions,

PRP 1,2_{dBm} according to Annex B.2.5 for a corresponding Band

$PRS \hat{E}_s / I_{ot}$ is as defined in Clause 8.1.2.5.1.

The time $T_{RSTD \text{ IntraFreqTDD,E-UTRAN}}$ starts from the first subframe of the PRS positioning occasion closest in time after both the OTDOA-RequestLocationInformation message and the OTDOA assistance data in the OTDOA-ProvideAssistanceData message as specified in TS 36.355 [24], are delivered to the physical layer of the UE.

The RSTD measurement accuracy for all measured neighbor cells i shall be fulfilled according to the accuracy as specified in the sub-clause 9.1.10.5.

If the intra-frequency handover occurs while intra-frequency RSTD measurements are being performed then the UE shall complete the ongoing OTDOA measurement session. The UE shall also meet the intra-frequency OTDOA measurement and accuracy requirements. However in this case the RSTD measurement period (

$T_{RSTD \text{ IntraFreqTDD,E-UTRAN,HO}}$) shall be according to the following expression:

$$T_{RSTD \text{ IntraFreqTDD,E-UTRAN,HO}} = T_{RSTD \text{ IntraFreqTDD,E-UTRAN}} + K \times T_{PRS} + T_{HO} \quad \text{ms},$$

where:

K is the number of times the intra-frequency handover occurs during $T_{RSTD \text{ IntraFreqTDD,E-UTRAN,HO}}$,

T_{HO} is the time during which the intra-frequency RSTD measurement may not be possible due to intra-frequency handover; it can be up to 45 ms.

Furthermore, due to the intra-frequency handover the UE shall meet the RSTD measurement accuracy for a PRS bandwidth which is not larger than the minimum channel bandwidth of all the PCells during the RSTD measurement period.

The intra-frequency requirements in this clause (8.1.2.5.4) shall apply for all TDD special subframe configurations specified in TS 36.211 [16] and for the TDD uplink-downlink configurations as specified in Table 8.1.2.5.4-2.

Table 8.1.2.5.4-2: TDD uplink-downlink subframe configurations applicable for TDD intra-frequency requirements

PRS Transmission Bandwidth [RB]	Applicable TDD uplink-downlink configurations
6, 15	1, 2, 3, 4 and 5
25, 50, 75, 100	0, 1, 2, 3, 4, 5 and 6
Note:	Uplink-downlink configurations are specified in Table 4.2-2 in TS 36.211 [16].

8.1.2.5.4.1 RSTD Measurement Reporting Delay

This requirement assumes that the measurement report is not delayed by other LPP signalling on the DCCH. This measurement reporting delay excludes a delay uncertainty resulted when inserting the measurement report to the TTI of the uplink DCCH. The delay uncertainty is: $2 \times TTI_{DCCH}$. This measurement reporting delay excludes any delay caused by no UL resources for UE to send the measurement report. When the UE is configured to perform SRS carrier based switching, an additional delay can be expected.

8.1.2.6.5 Void

8.1.2.6.6 Void

8.1.2.6.7 Void

8.1.2.6.8 Void

8.1.2.6 E-UTRAN Inter-Frequency OTDOA Measurements

All inter-frequency RSTD measurement requirements specified in Sections 8.1.2.6.1-8.1.2.6.4 shall apply, provided that

- the UE is capable of inter-frequency RSTD measurements for OTDOA [24], and
- either the measurement gap pattern ID # 0 specified in Clause 8.1.2.1 is used or the UE supports capability of conducting inter-frequency measurements without gaps.

All inter-frequency RSTD measurement requirements specified in Sections 8.1.2.6.1-8.1.2.6.4 shall apply without DRX as well as for any DRX or eDRX_CONN cycles specified in TS 36.331 [2].

The UE capable of SRS carrier based switching when configured to perform SRS transmission and/or RACH transmission over one or more SCells without PUSCH shall meet the requirements defined in Section 8.1.2.6 provided the following condition is met:

- all positioning subframes indicated in the OTDOA assistance data and specified in Section 9.1.10 are available for RSTD measurements at the UE in the measured and reference cells.

The requirements in this section shall also apply, when the UE is configured to perform SRS carrier based switching and using measurement gaps.

When using CRS, in addition to PRS, is enabled in the OTDOA assistance data, it is up to UE implementation whether to use or not the CRS for RSTD measurements, but in either case the RSTD measurements reported by the UE shall meet the requirements specified in this section.

If network-based CRS interference mitigation is enabled in a cell for which the UE performs RSTD measurements, the UE capable of supporting network-based CRS interference mitigation shall perform RSTD measurements and meet all the requirements in this section, provided the CRS are available within at least the PRS bandwidth in the subframes with PRS during all positioning occasions within the RSTD measurement period.

8.1.2.6.1 E-UTRAN FDD-FDD Inter-Frequency OTDOA Measurements

When the physical layer cell identities of neighbour cells together with the OTDOA assistance data are provided, the UE shall be able to detect and measure inter-frequency RSTD, specified in TS 36.214 [4], for at least $n=16$ cells, including the reference cell, within $k * T_{\text{RSTD InterFreqFDD, E-UTRAN}}$ ms as given below:

$$T_{\text{RSTD InterFreqFDD, E-UTRAN}} = T_{\text{PRS}} \cdot (M - 1) + \Delta \quad \text{ms} \quad ,$$

where

$k = 2$ if the UE is configured with inter-RAT measurement on one or more NR carriers, $k = 1$ otherwise,

$T_{\text{RSTD InterFreqFDD, E-UTRAN}}$ is the total time for detecting and measuring at least n cells,

T_{PRS} is the the largest value of the cell-specific positioning subframe configuration period, defined in TS 36.211 [16], among the measured n cells including the reference cell,

M is the number of PRS positioning occasions as defined in Table 8.1.2.6.1-1, where a PRS positioning occasion is as defined in clause 8.1.2.5.1,

$\Delta = 160 \cdot \left\lceil \frac{n}{M} \right\rceil$ ms is the measurement time for a single PRS positioning occasion which includes the sampling time and the processing time, and

the n cells are distributed on up to two carrier frequencies including a serving carrier frequency and one inter-frequency carrier.

Table 8.1.2.6.1-1: Number of PRS positioning occasions within $T_{\text{RSTD InterFreqFDD, E-UTRAN}}$

Positioning subframe configuration period T_{PRS}	Number of PRS positioning occasions M	
	f2 <small>Note1</small>	f1 and f2 <small>Note2</small>
160 ms	16	32
>160 ms	8	16

Note 1: When inter-frequency RSTD measurements are performed over the reference cell and neighbour cells, which belong to the FDD inter-frequency carrier frequency f2.
 Note 2: When inter-frequency RSTD measurements are performed over the reference cell and the neighbour cells, which belong to the serving FDD carrier frequency f1 and the FDD inter-frequency carrier frequency f2 respectively.

The UE physical layer shall be capable of reporting RSTD for the reference cell and all the neighbor cells i out of at least $(n-1)$ neighbor cells within $T_{\text{RSTD InterFreqFDD,E-UTRAN}}$ provided:

$$\left(\text{PRS } \hat{E}_s / \text{Iot} \right)_{ref} \geq -6 \text{ dB for all Frequency Bands for the reference cell,}$$

$$\left(\text{PRS } \hat{E}_s / \text{Iot} \right)_i \geq -13 \text{ dB for all Frequency Bands for neighbour cell } i,$$

$$\left(\text{PRS } \hat{E}_s / \text{Iot} \right)_{ref} \text{ and } \left(\text{PRS } \hat{E}_s / \text{Iot} \right)_i \text{ conditions apply for all subframes of at least } L = \frac{M}{2} \text{ PRS positioning}$$

occasions,

PRP 1,2_{dBm} according to Annex B.2.6 for a corresponding Band

$\text{PRS } \hat{E}_s / \text{Iot}$ is as defined in Clause 8.1.2.5.1.

The time $T_{\text{RSTD InterFreqFDD,E-UTRAN}}$ starts from the first subframe of the PRS positioning occasion closest in time after both the OTDOA-RequestLocationInformation message and the OTDOA assistance data in the OTDOA-ProvideAssistanceData message as specified in TS 36.355 [24], are delivered to the physical layer of the UE.

If the inter-frequency handover occurs while inter-frequency RSTD measurements are being performed, and the inter-frequency carrier on which RSTD is measured becomes the new serving carrier frequency after the inter-frequency handover, the UE shall complete the ongoing OTDOA measurement session. The UE shall also meet the inter-frequency OTDOA measurement and accuracy requirements. However in this case the RSTD measurement period ($T_{\text{RSTD InterFreqFDD,E-UTRAN,HO}}$) shall be according to the following expression:

$$T_{\text{RSTD InterFreqFDD,E-UTRAN,HO}} = T_{\text{RSTD InterFreqFDD,E-UTRAN}} + K \times T_{\text{PRS}} + T_{\text{HO}} \quad \text{ms},$$

where:

K is the number of times the inter-frequency handover occurs during $T_{\text{RSTD InterFreqFDD,E-UTRAN,HO}}$,

T_{HO} is the time during which the inter-frequency RSTD measurement may not be possible due to inter-frequency handover; it can be up to 45 ms.

The RSTD measurement accuracy for all measured neighbor cells i shall be fulfilled according to the accuracy as specified in the sub-clause 9.1.10.2.

Furthermore, due to the inter-frequency handover the UE shall meet the RSTD measurement accuracy for a PRS bandwidth which is not larger than the minimum channel bandwidth of those PCells on whose carriers RSTD measurement is performed during the RSTD measurement period.

8.1.2.6.1.1 RSTD Measurement Reporting Delay

This requirement assumes that the measurement report is not delayed by other LPP signalling on the DCCH. This measurement reporting delay excludes a delay uncertainty resulted when inserting the measurement report to the TTI of the uplink DCCH. The delay uncertainty is: $2 \times T_{\text{TTI DCCH}}$ where $T_{\text{TTI DCCH}}$ is the duration of subframe or slot or subslot when the measurement report is transmitted on the PUSCH with subframe or slot or subslot duration. This measurement reporting delay excludes any delay caused by no UL resources for UE to send the measurement report. When the UE is configured to perform SRS carrier based switching, an additional delay can be expected.

8.1.2.6.2 E-UTRAN TDD-FDD Inter-Frequency OTDOA Measurements

When the physical layer cell identities of neighbour cells together with the OTDOA assistance data are provided, the UE shall be able to detect and measure inter-frequency RSTD, specified in TS 36.214 [4], for at least $n=16$ cells,

including the reference cell, within $k * T_{\text{RSTD InterFreqTDDFDD,E-UTRAN}}$ ms as given below:

$$T_{\text{RSTD InterFreqTDDFDD,E-UTRAN}} = T_{\text{PRS}} \cdot (M - 1) + \Delta \quad \text{ms}$$

where

$k = 2$ if the UE is configured with inter-RAT measurement on one or more NR carriers, $k = 1$ otherwise,

$T_{\text{RSTD InterFreqTDDFDD,E-UTRAN}}$ is the total time for detecting and measuring at least n cells,

T_{PRS} is the largest value of the cell-specific positioning subframe configuration period, defined in TS 36.211 [16], among the measured n cells including the reference cell,

M is the number of PRS positioning occasions as defined in Table 8.1.2.6.2-1, where a PRS positioning occasion is as defined in clause 8.1.2.5.1,

$\Delta = 160 \cdot \left\lceil \frac{n}{M} \right\rceil$ ms is the measurement time for a single PRS positioning occasion which includes the sampling time and the processing time, and

the n cells are distributed on up to two carrier frequencies including a serving carrier frequency and one inter-frequency carrier.

Table 8.1.2.6.2-1: Number of PRS positioning occasions within $T_{\text{RSTD InterFreqTDDFDD,E-UTRAN}}$

Positioning subframe configuration period T_{PRS}	Number of PRS positioning occasions M	
	f2 ^{Note1}	f1 and f2 ^{Note2}
160 ms	16	32
>160 ms	8	16
NOTE 1: When inter-frequency RSTD measurements are performed over the reference cell and neighbour cells, which belong to the FDD inter-frequency carrier frequency f2.		
NOTE 2: When inter-frequency RSTD measurements are performed over the reference cell and the neighbour cells, which belong to the serving TDD carrier frequency f1 and the FDD inter-frequency carrier frequency f2 respectively.		

The UE physical layer shall be capable of reporting RSTD for the reference cell and all the neighbor cells i out of at least $(n-1)$ neighbor cells within $T_{\text{RSTD InterFreqTDDFDD,E-UTRAN}}$, provided:

$$\left(\text{PRS } \hat{E}_s / \text{Iot} \right)_{\text{ref}} \geq -6 \text{ dB for all Frequency Bands for the reference cell,}$$

$$\left(\text{PRS } \hat{E}_s / \text{Iot} \right)_i \geq -13 \text{ dB for all Frequency Bands for neighbour cell } i,$$

$\left(\text{PRS } \hat{E}_s / \text{Iot} \right)_{\text{ref}}$ and $\left(\text{PRS } \hat{E}_s / \text{Iot} \right)_i$ conditions apply for all subframes of at least $L = \frac{M}{2}$ PRS positioning occasions,

PRP 1,2_{dBm} according to Annex B.2.6 for a corresponding Band,

$\text{PRS } \hat{E}_s / \text{Iot}$ is as defined in Clause 8.1.2.5.1.

The time $T_{\text{RSTD InterFreqTDDFDD,E-UTRAN}}$ starts from the first subframe of the PRS positioning occasion closest in time after both the OTDOA-RequestLocationInformation message and the OTDOA assistance data in the OTDOA-ProvideAssistanceData message as specified in TS 36.355 [24], are delivered to the physical layer of the UE.

If the inter-frequency handover occurs while inter-frequency RSTD measurements are being performed, and the inter-frequency carrier on which RSTD is measured becomes the new serving carrier frequency after the inter-frequency handover, the UE shall complete the ongoing OTDOA measurement session. The UE shall also meet the inter-frequency OTDOA measurement and accuracy requirements. However in this case the RSTD measurement period ($T_{\text{RSTD InterFreqIDDFDD,E-UTRAN,HO}}$) shall be according to the following expression:

$$T_{\text{RSTD InterFreqIDDFDD,E-UTRAN,HO}} = T_{\text{RSTD InterFreqIDDFDD,E-UTRAN}} + K \times T_{\text{PRS}} + T_{\text{HO}} \quad \text{ms}$$

where:

K is the number of times the inter-frequency handover occurs during $T_{\text{RSTD InterFreqIDDFDD,E-UTRAN,HO}}$,

T_{HO} is the time during which the inter-frequency RSTD measurement may not be possible due to inter-frequency handover; it can be up to 45 ms.

The RSTD measurement accuracy for all measured neighbor cells i shall be fulfilled according to the accuracy as specified in the sub-clause 9.1.10.2.

Furthermore, due to the inter-frequency handover the UE shall meet the RSTD measurement accuracy for a PRS bandwidth which is not larger than the minimum channel bandwidth of those PCells on whose carriers RSTD measurement is performed during the RSTD measurement period.

The inter-frequency requirements in this clause (8.1.2.6.2) shall apply for all TDD special subframe configurations specified in TS 36.211 [16] and for the TDD uplink-downlink configurations as specified in Table 8.1.2.6.2-2.

Table 8.1.2.6.2-2: TDD uplink-downlink subframe configurations applicable for TDD-FDD inter-frequency requirements

PRS Transmission Bandwidth [RB]	Applicable TDD uplink-downlink configurations
6, 15	1, 2, 3, 4 and 5
25, 50, 75, 100	0, 1, 2, 3, 4, 5 and 6
NOTE: Uplink-downlink configurations are specified in Table 4.2-2 in TS 36.211 [16].	

8.1.2.6.2.1 RSTD Measurement Reporting Delay

This requirement assumes that the measurement report is not delayed by other LPP signalling on the DCCH. This measurement reporting delay excludes a delay uncertainty resulted when inserting the measurement report to the TTI of the uplink DCCH. The delay uncertainty is: $2 \times T_{\text{TI}_{\text{DCCH}}}$ where $T_{\text{TI}_{\text{DCCH}}}$ is the duration of subframe or slot or subslot when the measurement report is transmitted on the PUSCH with subframe or slot or subslot duration. This measurement reporting delay excludes any delay caused by no UL resources for UE to send the measurement report. When the UE is configured to perform SRS carrier based switching, an additional delay can be expected.

8.1.2.6.3 E-UTRAN TDD-TDD Inter-Frequency OTDOA Measurements

When the physical layer cell identities of neighbour cells together with the OTDOA assistance data are provided, the UE shall be able to detect and measure inter-frequency RSTD, specified in TS 36.214 [4], for at least $n=16$ cells, including the reference cell, within $k * T_{\text{RSTD InterFreqTDD,E-UTRAN}}$ ms as given below:

$$T_{\text{RSTD InterFreqTDD,E-UTRAN}} = T_{\text{PRS}} \cdot (M - 1) + \Delta \quad \text{ms}$$

where

$k = 2$ if the UE is configured with inter-RAT measurement on one or more NR carriers, $k = 1$ otherwise,

$T_{\text{RSTD InterFreqTDD,E-UTRAN}}$ is the total time for detecting and measuring at least n cells,

T_{PRS} is the largest value of the cell-specific positioning subframe configuration period, defined in TS 36.211 [16], among the measured n cells including the reference cell,

M is the number of PRS positioning occasions as defined in Table 8.1.2.6.1-1, where a PRS positioning occasion is as defined in clause 8.1.2.5.1,

$\Delta = 160 \cdot \left\lceil \frac{n}{M} \right\rceil$ ms is the measurement time for a single PRS positioning occasion which includes the sampling time and the processing time, and

the n cells are distributed on up to two carrier frequencies including a serving carrier frequency and one inter-frequency carrier.

Table 8.1.2.6.3-1: Number of PRS positioning occasions within $T_{\text{RSTD InterFreqTDD, E-UTRAN}}$

Positioning subframe configuration period T_{PRS}	Number of PRS positioning occasions M	
	f2 ^{Note1}	f1 and f2 ^{Note2}
160 ms	16	32
>160 ms	8	16

Note 1: When inter-frequency RSTD measurements are performed over the reference cell and neighbour cells, which belong to the TDD inter-frequency carrier frequency f2.
Note 2: When inter-frequency RSTD measurements are performed over the reference cell and the neighbour cells, which belong to the serving TDD carrier frequency f1 and the TDD inter-frequency carrier frequency f2 respectively.

The inter-frequency requirements in this clause (8.1.2.6.3) shall apply for all TDD special subframe configurations specified in TS 36.211 [16] and for the TDD uplink-downlink configurations as specified in Table 8.1.2.6.3-2.

Table 8.1.2.6.3-2: TDD uplink-downlink subframe configurations applicable for inter-frequency requirements

PRS Transmission Bandwidth [RB]	Applicable TDD uplink-downlink configurations
6, 15	3, 4 and 5
25	1, 2, 3, 4, 5 and 6
50, 75, 100	0, 1, 2, 3, 4, 5 and 6

Note 1: Uplink-downlink configurations are specified in Table 4.2-2 in TS 36.211 [16].
Note 2: For UEs capable of performing inter-frequency measurements without measurement gaps, TDD uplink-downlink subframe configurations as specified in Table 8.1.2.5.2-2 shall apply.

The UE physical layer shall be capable of reporting RSTD for the reference cell and all the neighbor cells i out of at least $(n-1)$ neighbor cells within $T_{\text{RSTD InterFreqTDD, E-UTRAN}}$ provided:

$(\text{PRS } \hat{E}_s / \text{Iot})_{\text{ref}} \geq -6$ dB for all Frequency Bands for the reference cell,

$(\text{PRS } \hat{E}_s / \text{Iot})_i \geq -13$ dB for all Frequency Bands for neighbour cell i ,

$(\text{PRS } \hat{E}_s / \text{Iot})_{\text{ref}}$ and $(\text{PRS } \hat{E}_s / \text{Iot})_i$ conditions apply for all subframes of at least $L = \frac{M}{2}$ PRS positioning

occasions,

PRP 1,2_{dBm} according to Annex B.2.6 for a corresponding Band

$\text{PRS } \hat{E}_s / \text{Iot}$ is as defined in Clause 8.1.2.5.1.

The time $T_{\text{RSTD InterFreqTDD, E-UTRAN}}$ starts from the first subframe of the PRS positioning occasion closest in time after both the OTDOA-RequestLocationInformation message and the OTDOA assistance data in the OTDOA-ProvideAssistanceData message as specified in TS 36.355 [24], are delivered to the physical layer of the UE.

If the inter-frequency handover occurs while inter-frequency RSTD measurements are being performed, and the inter-frequency carrier on which RSTD is measured becomes the new serving carrier frequency after the inter-frequency

handover, the UE shall complete the ongoing OTDOA measurement session. The UE shall also meet the inter-frequency OTDOA measurement and accuracy requirements. However in this case the RSTD measurement period ($T_{\text{RSTDInterFreqIDD,E-UTRAN,HO}}$) shall be according to the following expression:

$$T_{\text{RSTDInterFreqIDD,E-UTRAN,HO}} = T_{\text{RSTDInterFreqIDD,E-UTRAN}} + K \times T_{\text{PRS}} + T_{\text{HO}} \quad \text{ms},$$

where:

K is the number of times the inter-frequency handover occurs during $T_{\text{RSTDInterFreqIDD,E-UTRAN,HO}}$,

T_{HO} is the time during which the inter-frequency RSTD measurement may not be possible due to inter-frequency handover; it can be up to 45 ms.

The RSTD measurement accuracy for all measured neighbor cells i shall be fulfilled according to the accuracy as specified in the sub-clause 9.1.10.2.

Furthermore, due to the inter-frequency handover the UE shall meet the RSTD measurement accuracy for a PRS bandwidth which is not larger than the minimum channel bandwidth of those PCells on whose carriers RSTD measurement is performed during the RSTD measurement period.

8.1.2.6.3.1 RSTD Measurement Reporting Delay

This requirement assumes that the measurement report is not delayed by other LPP signalling on the DCCH. This measurement reporting delay excludes a delay uncertainty resulted when inserting the measurement report to the TTI of the uplink DCCH. The delay uncertainty is: $2 \times T_{\text{TI}_{\text{DCCH}}}$ where $T_{\text{TI}_{\text{DCCH}}}$ is the duration of subframe or slot or subslot when the measurement report is transmitted on the PUSCH with subframe or slot or subslot duration. This measurement reporting delay excludes any delay caused by no UL resources for UE to send the measurement report. When the UE is configured to perform SRS carrier based switching, an additional delay can be expected.

8.1.2.6.4 E-UTRAN FDD-TDD Inter-Frequency OTDOA Measurements

When the physical layer cell identities of neighbour cells together with the OTDOA assistance data are provided, the UE shall be able to detect and measure inter-frequency RSTD, specified in TS 36.214 [4], for at least $n=16$ cells, including the reference cell, within $k * T_{\text{RSTD InterFreqFDDTDD,E-UTRAN}}$ ms as given below:

$$T_{\text{RSTDInterFreqFDDTDD,E-UTRAN}} = T_{\text{PRS}} \cdot (M - 1) + \Delta \quad \text{ms},$$

where

$k = 2$ if the UE is configured with inter-RAT measurement on one or more NR carriers, $k = 1$ otherwise,

$T_{\text{RSTD InterFreqFDDTDD,E-UTRAN}}$ is the total time for detecting and measuring at least n cells,

T_{PRS} is the largest value of the cell-specific positioning subframe configuration period, defined in TS 36.211 [16], among the measured n cells including the reference cell,

M is the number of PRS positioning occasions as defined in Table 8.1.2.6.4-1, where a PRS positioning occasion is as defined in clause 8.1.2.5.1,

$\Delta = 160 \cdot \left\lceil \frac{n}{M} \right\rceil$ ms is the measurement time for a single PRS positioning occasion which includes the sampling time and the processing time, and

the n cells are distributed on up to two carrier frequencies including a serving carrier frequency and one inter-frequency carrier.

Table 8.1.2.6.4-1: Number of PRS positioning occasions within $T_{\text{RSTD InterFreqFDDTDD,E-UTRAN}}$

	Number of PRS positioning occasions M
--	---

Positioning subframe configuration period T_{PRS}	$f2$ ^{Note1}	$f1$ and $f2$ ^{Note2}
160 ms	16	32
>160 ms	8	16
Note 1: When inter-frequency RSTD measurements are performed over the reference cell and neighbour cells, which belong to the TDD inter-frequency carrier frequency $f2$. Note 2: When inter-frequency RSTD measurements are performed over the reference cell and the neighbour cells, which belong to the serving FDD carrier frequency $f1$ and the TDD inter-frequency carrier frequency $f2$ respectively.		

The UE physical layer shall be capable of reporting RSTD for the reference cell and all the neighbor cells i out of at least $(n-1)$ neighbor cells within $T_{\text{RSTD InterFreqFDDTDD,E-UTRAN}}$, provided:

$$\left(\text{PRS } \hat{E}_s / \text{Iot} \right)_{\text{ref}} \geq -6 \text{ dB for all Frequency Bands for the reference cell,}$$

$$\left(\text{PRS } \hat{E}_s / \text{Iot} \right)_i \geq -13 \text{ dB for all Frequency Bands for neighbour cell } i,$$

$\left(\text{PRS } \hat{E}_s / \text{Iot} \right)_{\text{ref}}$ and $\left(\text{PRS } \hat{E}_s / \text{Iot} \right)_i$ conditions apply for all subframes of at least $L = \frac{M}{2}$ PRS positioning occasions,

PRP $1,2|_{\text{dBm}}$ according to Annex B.2.6 for a corresponding Band

$\text{PRS } \hat{E}_s / \text{Iot}$ is as defined in Clause 8.1.2.5.1.

The time $T_{\text{RSTD InterFreqFDDTDD,E-UTRAN}}$ starts from the first subframe of the PRS positioning occasion closest in time after both the OTDOA-RequestLocationInformation message and the OTDOA assistance data in the OTDOA-ProvideAssistanceData message as specified in TS 36.355 [24], are delivered to the physical layer of the UE.

If the inter-frequency handover occurs while inter-frequency RSTD measurements are being performed, and the inter-frequency carrier on which RSTD is measured becomes the new serving carrier frequency after the inter-frequency handover, the UE shall complete the ongoing OTDOA measurement session. The UE shall also meet the inter-frequency OTDOA measurement and accuracy requirements. However in this case the RSTD measurement period ($T_{\text{RSTD InterFreqFDDTDD,E-UTRAN,HO}}$) shall be according to the following expression:

$$T_{\text{RSTD InterFreqFDDTDD,E-UTRAN,HO}} = T_{\text{RSTD InterFreqFDDTDD,E-UTRAN}} + K \times T_{\text{PRS}} + T_{\text{HO}} \quad \text{ms},$$

where:

K is the number of times the inter-frequency handover occurs during $T_{\text{RSTD InterFreqFDDTDD,E-UTRAN,HO}}$,

T_{HO} is the time during which the inter-frequency RSTD measurement may not be possible due to inter-frequency handover; it can be up to 45 ms.

The RSTD measurement accuracy for all measured neighbor cells i shall be fulfilled according to the accuracy as specified in the sub-clause 9.1.10.2.

Furthermore, due to the inter-frequency handover the UE shall meet the RSTD measurement accuracy for a PRS bandwidth which is not larger than the minimum channel bandwidth of those PCells on whose carriers RSTD measurement is performed during the RSTD measurement period.

The inter-frequency requirements in this clause (8.1.2.6.4) shall apply for all TDD special subframe configurations specified in TS 36.211 [16] and for the TDD uplink-downlink configurations as specified in Table 8.1.2.6.4-2.

Table 8.1.2.6.4-2: TDD uplink-downlink subframe configurations applicable for inter-frequency requirements

PRS Transmission Bandwidth [RB]	Applicable TDD uplink-downlink configurations
6, 15	3, 4 and 5
25	1, 2, 3, 4, 5 and 6
50, 75, 100	0, 1, 2, 3, 4, 5 and 6
Note 1:	Uplink-downlink configurations are specified in Table 4.2-2 in TS 36.211 [16].
Note2:	For UEs capable of performing inter-frequency measurements without measurement gaps, TDD uplink-downlink subframe configurations as specified in Table 8.1.2.5.2-2 shall apply.

8.1.2.6.4.1 RSTD Measurement Reporting Delay

This requirement assumes that the measurement report is not delayed by other LPP signalling on the DCCH. This measurement reporting delay excludes a delay uncertainty resulted when inserting the measurement report to the TTI of the uplink DCCH. The delay uncertainty is: $2 \times TTI_{DCCH}$ where TTI_{DCCH} is the duration of subframe or slot or subslot when the measurement report is transmitted on the PUSCH with subframe or slot or subslot duration. This measurement reporting delay excludes any delay caused by no UL resources for UE to send the measurement report. When the UE is configured to perform SRS carrier based switching, an additional delay can be expected.

8.1.2.6.5 E-UTRAN FDD-FDD Inter-Frequency OTDOA Measurements for UE Category 1bis

When the physical layer cell identities of neighbour cells together with the OTDOA assistance data are provided, the UE shall be able to detect and measure inter-frequency RSTD, specified in TS 36.214 [4], for at least $n=16$ cells, including the reference cell, within $T_{RSTD\ InterFreqFDD,E-UTRAN}$ ms as given below:

$$T_{RSTD\ InterFreqFDD,E-UTRAN} = T_{PRS} \cdot (M - 1) + \Delta \quad ms \quad ,$$

where

$T_{RSTD\ InterFreqFDD,E-UTRAN}$ is the total time for detecting and measuring at least n cells,

T_{PRS} is the the largest value of the cell-specific positioning subframe configuration period, defined in TS 36.211 [16], among the measured n cells including the reference cell,

M is the number of PRS positioning occasions as defined in Table 8.1.2.6.5-1, where a PRS positioning occasion is as defined in clause 8.1.2.5.1,

$\Delta = 160 \cdot \left\lceil \frac{n}{M} \right\rceil$ ms is the measurement time for a single PRS positioning occasion which includes the sampling time and the processing time, and

the n cells are distributed on up to two carrier frequencies including a serving carrier frequency and one inter-frequency carrier.

Table 8.1.2.6.5-1: Number of PRS positioning occasions within $T_{RSTD\ InterFreqFDD,E-UTRAN}$

Positioning subframe configuration period T_{PRS}	Number of PRS positioning occasions M	
	$f2$ ^{Note1}	$f1$ and $f2$ ^{Note2}
160 ms	32	64
>160 ms	16	32
Note 1:	When inter-frequency RSTD measurements are performed over the reference cell and neighbour cells, which belong to the FDD inter-frequency carrier frequency $f2$.	
Note 2:	When inter-frequency RSTD measurements are performed over the reference cell and the neighbour cells, which belong to the serving FDD carrier frequency $f1$ and the FDD inter-frequency carrier frequency $f2$ respectively.	

The UE physical layer shall be capable of reporting RSTD for the reference cell and all the neighbor cells i out of at least $(n-1)$ neighbor cells within $T_{\text{RSTD InterFreqFDD,E-UTRAN}}$ provided:

$$\left(\text{PRS } \hat{E}_s / \text{Iot} \right)_{\text{ref}} \geq -6 \text{ dB for all Frequency Bands for the reference cell,}$$

$$\left(\text{PRS } \hat{E}_s / \text{Iot} \right)_i \geq -13 \text{ dB for all Frequency Bands for neighbour cell } i,$$

$$\left(\text{PRS } \hat{E}_s / \text{Iot} \right)_{\text{ref}} \text{ and } \left(\text{PRS } \hat{E}_s / \text{Iot} \right)_i \text{ conditions apply for all subframes of at least } L = \frac{M}{2} \text{ PRS positioning occasions,}$$

PRP $1,2|_{\text{dBm}}$ according to Annex B.2.6 for a corresponding Band

$\text{PRS } \hat{E}_s / \text{Iot}$ is as defined in Clause 8.1.2.5.1.

The time $T_{\text{RSTD InterFreqFDD,E-UTRAN}}$ starts from the first subframe of the PRS positioning occasion closest in time after both the OTDOA-RequestLocationInformation message and the OTDOA assistance data in the OTDOA-ProvideAssistanceData message as specified in TS 36.355 [24], are delivered to the physical layer of the UE.

If the inter-frequency handover occurs while inter-frequency RSTD measurements are being performed, and the inter-frequency carrier on which RSTD is measured becomes the new serving carrier frequency after the inter-frequency handover, the UE shall complete the ongoing OTDOA measurement session. The UE shall also meet the inter-frequency OTDOA measurement and accuracy requirements. However in this case the RSTD measurement period ($T_{\text{RSTD InterFreqFDD,E-UTRAN,HO}}$) shall be according to the following expression:

$$T_{\text{RSTD InterFreqFDD,E-UTRAN,HO}} = T_{\text{RSTD InterFreqFDD,E-UTRAN}} + K \times T_{\text{PRS}} + T_{\text{HO}} \quad \text{ms},$$

where:

K is the number of times the inter-frequency handover occurs during $T_{\text{RSTD InterFreqFDD,E-UTRAN,HO}}$.

T_{HO} is the time during which the inter-frequency RSTD measurement may not be possible due to inter-frequency handover; it can be up to 45 ms.

The RSTD measurement accuracy for all measured neighbor cells i shall be fulfilled according to the accuracy as specified in the sub-clause 9.1.10.6.

Furthermore, due to the inter-frequency handover the UE shall meet the RSTD measurement accuracy for a PRS bandwidth which is not larger than the minimum channel bandwidth of those PCells on whose carriers RSTD measurement is performed during the RSTD measurement period.

8.1.2.6.5.1 RSTD Measurement Reporting Delay

This requirement assumes that the measurement report is not delayed by other LPP signalling on the DCCH. This measurement reporting delay excludes a delay uncertainty resulted when inserting the measurement report to the TTI of the uplink DCCH. The delay uncertainty is: $2 \times \text{TTI}_{\text{DCCH}}$. This measurement reporting delay excludes any delay caused by no UL resources for UE to send the measurement report. When the UE is configured to perform SRS carrier based switching, an additional delay can be expected.

8.1.2.6.6 E-UTRAN TDD-FDD Inter-Frequency OTDOA Measurements for UE Category 1bis

When the physical layer cell identities of neighbour cells together with the OTDOA assistance data are provided, the UE shall be able to detect and measure inter-frequency RSTD, specified in TS 36.214 [4], for at least $n=16$ cells,

including the reference cell, within $T_{\text{RSTD InterFreqTDDFDD,E-UTRAN}}$ ms as given below:

$$T_{\text{RSTD InterFreqTDDFDD,E-UTRAN}} = T_{\text{PRS}} \cdot (M - 1) + \Delta \quad \text{ms},$$

where

$T_{\text{RSTD InterFreqTDDFDD,E-UTRAN}}$ is the total time for detecting and measuring at least n cells,

T_{PRS} is the largest value of the cell-specific positioning subframe configuration period, defined in TS 36.211 [16], among the measured n cells including the reference cell,

M is the number of PRS positioning occasions as defined in Table 8.1.2.6.6-1, where a PRS positioning occasion is as defined in clause 8.1.2.5.1,

$\Delta = 160 \cdot \left\lceil \frac{n}{M} \right\rceil$ ms is the measurement time for a single PRS positioning occasion which includes the sampling time and the processing time, and

the n cells are distributed on up to two carrier frequencies including a serving carrier frequency and one inter-frequency carrier.

Table 8.1.2.6.6-1: Number of PRS positioning occasions within $T_{\text{RSTD InterFreqTDDFDD,E-UTRAN}}$

Positioning subframe configuration period T_{PRS}	Number of PRS positioning occasions M	
	f2 ^{Note1}	f1 and f2 ^{Note2}
160 ms	32	64
>160 ms	16	32
NOTE 1: When inter-frequency RSTD measurements are performed over the reference cell and neighbour cells, which belong to the FDD inter-frequency carrier frequency f2.		
NOTE 2: When inter-frequency RSTD measurements are performed over the reference cell and the neighbour cells, which belong to the serving TDD carrier frequency f1 and the FDD inter-frequency carrier frequency f2 respectively.		

The UE physical layer shall be capable of reporting RSTD for the reference cell and all the neighbor cells i out of at least $(n-1)$ neighbor cells within $T_{\text{RSTD InterFreqTDDFDD,E-UTRAN}}$, provided:

$(\text{PRS } \hat{E}_s / \text{Iot})_{\text{ref}} \geq -6$ dB for all Frequency Bands for the reference cell,

$(\text{PRS } \hat{E}_s / \text{Iot})_i \geq -13$ dB for all Frequency Bands for neighbour cell i ,

$(\text{PRS } \hat{E}_s / \text{Iot})_{\text{ref}}$ and $(\text{PRS } \hat{E}_s / \text{Iot})_i$ conditions apply for all subframes of at least $L = \frac{M}{2}$ PRS positioning occasions,

PRP 1,2_{dBm} according to Annex B.2.6 for a corresponding Band,

$\text{PRS } \hat{E}_s / \text{Iot}$ is as defined in Clause 8.1.2.5.1.

The time $T_{\text{RSTD InterFreqTDDFDD,E-UTRAN}}$ starts from the first subframe of the PRS positioning occasion closest in time after both the OTDOA-RequestLocationInformation message and the OTDOA assistance data in the OTDOA-ProvideAssistanceData message as specified in TS 36.355 [24], are delivered to the physical layer of the UE.

If the inter-frequency handover occurs while inter-frequency RSTD measurements are being performed, and the inter-frequency carrier on which RSTD is measured becomes the new serving carrier frequency after the inter-frequency handover, the UE shall complete the ongoing OTDOA measurement session. The UE shall also meet the inter-frequency OTDOA measurement and accuracy requirements. However in this case the RSTD measurement period ($T_{\text{RSTD InterFreqTDDFDD,E-UTRAN,HO}}$) shall be according to the following expression:

$$T_{\text{RSTD InterFreqTDDFDD,E-UTRAN,HO}} = T_{\text{RSTD InterFreqTDDFDD,E-UTRAN}} + K \times T_{\text{PRS}} + T_{\text{HO}} \quad \text{ms}$$

where:

K is the number of times the inter-frequency handover occurs during $T_{\text{RSTD InterFreqIDD,FDD,E-UTRAN,HO}}$,

T_{HO} is the time during which the inter-frequency RSTD measurement may not be possible due to inter-frequency handover; it can be up to 45 ms.

The RSTD measurement accuracy for all measured neighbor cells i shall be fulfilled according to the accuracy as specified in the sub-clause 9.1.10.6.

Furthermore, due to the inter-frequency handover the UE shall meet the RSTD measurement accuracy for a PRS bandwidth which is not larger than the minimum channel bandwidth of those PCells on whose carriers RSTD measurement is performed during the RSTD measurement period.

The inter-frequency requirements in this clause (8.1.2.6.6) shall apply for all TDD special subframe configurations specified in TS 36.211 [16] and for the TDD uplink-downlink configurations as specified in Table 8.1.2.6.6-2.

Table 8.1.2.6.6-2: TDD uplink-downlink subframe configurations applicable for TDD-FDD inter-frequency requirements

PRS Transmission Bandwidth [RB]	Applicable TDD uplink-downlink configurations
6, 15	1, 2, 3, 4 and 5
25, 50, 75, 100	0, 1, 2, 3, 4, 5 and 6
NOTE: Uplink-downlink configurations are specified in Table 4.2-2 in TS 36.211 [16].	

8.1.2.6.6.1 RSTD Measurement Reporting Delay

This requirement assumes that the measurement report is not delayed by other LPP signalling on the DCCH. This measurement reporting delay excludes a delay uncertainty resulted when inserting the measurement report to the TTI of the uplink DCCH. The delay uncertainty is: $2 \times TTI_{\text{DCCH}}$. This measurement reporting delay excludes any delay caused by no UL resources for UE to send the measurement report. When the UE is configured to perform SRS carrier based switching, an additional delay can be expected.

8.1.2.6.7 E-UTRAN TDD-TDD Inter-Frequency OTDOA Measurements for UE Category 1bis

When the physical layer cell identities of neighbour cells together with the OTDOA assistance data are provided, the UE shall be able to detect and measure inter-frequency RSTD, specified in TS 36.214 [4], for at least $n=16$ cells, including the reference cell, within $T_{\text{RSTD InterFreqIDD,E-UTRAN}}$ ms as given below:

$$T_{\text{RSTD InterFreqIDD,E-UTRAN}} = T_{\text{PRS}} \cdot (M - 1) + \Delta \quad \text{ms} \quad ,$$

where

$T_{\text{RSTD InterFreqIDD,E-UTRAN}}$ is the total time for detecting and measuring at least n cells,

T_{PRS} is the largest value of the cell-specific positioning subframe configuration period, defined in TS 36.211 [16], among the measured n cells including the reference cell,

M is the number of PRS positioning occasions as defined in Table 8.1.2.6.7-1, where a PRS positioning occasion is as defined in clause 8.1.2.5.1,

$\Delta = 160 \cdot \left\lceil \frac{n}{M} \right\rceil$ ms is the measurement time for a single PRS positioning occasion which includes the sampling time and the processing time, and

the n cells are distributed on up to two carrier frequencies including a serving carrier frequency and one inter-frequency carrier.

Table 8.1.2.6.7-1: Number of PRS positioning occasions within $T_{\text{RSTD InterFreqTDD, E-UTRAN}}$

Positioning subframe configuration period T_{PRS}	Number of PRS positioning occasions M	
	$f2$ ^{Note1}	$f1$ and $f2$ ^{Note2}
160 ms	32	6]
>160 ms	16	32
Note 1: When inter-frequency RSTD measurements are performed over the reference cell and neighbour cells, which belong to the TDD inter-frequency carrier frequency $f2$. Note 2: When inter-frequency RSTD measurements are performed over the reference cell and the neighbour cells, which belong to the serving TDD carrier frequency $f1$ and the TDD inter-frequency carrier frequency $f2$ respectively.		

The inter-frequency requirements in this clause (8.1.2.6.7) shall apply for all TDD special subframe configurations specified in TS 36.211 [16] and for the TDD uplink-downlink configurations as specified in Table 8.1.2.6.7-2.

Table 8.1.2.6.7-2: TDD uplink-downlink subframe configurations applicable for inter-frequency requirements

PRS Transmission Bandwidth [RB]	Applicable TDD uplink-downlink configurations
6, 15	3, 4 and 5
25	1, 2, 3, 4, 5 and 6
50, 75, 100	0, 1, 2, 3, 4, 5 and 6
Note 1: Uplink-downlink configurations are specified in Table 4.2-2 in TS 36.211 [16]. Note2: For UEs capable of performing inter-frequency measurements without measurement gaps, TDD uplink-downlink subframe configurations as specified in Table 8.1.2.5.2-2 shall apply.	

The UE physical layer shall be capable of reporting RSTD for the reference cell and all the neighbor cells i out of at least $(n-1)$ neighbor cells within $T_{\text{RSTD InterFreqTDD, E-UTRAN}}$ provided:

$$\left(\text{PRS } \hat{E}_s / \text{Iot} \right)_{\text{ref}} \geq -6 \text{ dB for all Frequency Bands for the reference cell,}$$

$$\left(\text{PRS } \hat{E}_s / \text{Iot} \right)_i \geq -13 \text{ dB for all Frequency Bands for neighbour cell } i,$$

$$\left(\text{PRS } \hat{E}_s / \text{Iot} \right)_{\text{ref}} \text{ and } \left(\text{PRS } \hat{E}_s / \text{Iot} \right)_i \text{ conditions apply for all subframes of at least } L = \frac{M}{2} \text{ PRS positioning occasions,}$$

PRP 1,2_{dBm} according to Annex B.2.6 for a corresponding Band

$\text{PRS } \hat{E}_s / \text{Iot}$ is as defined in Clause 8.1.2.5.1.

The time $T_{\text{RSTD InterFreqTDD, E-UTRAN}}$ starts from the first subframe of the PRS positioning occasion closest in time after both the OTDOA-RequestLocationInformation message and the OTDOA assistance data in the OTDOA-ProvideAssistanceData message as specified in TS 36.355 [24], are delivered to the physical layer of the UE.

If the inter-frequency handover occurs while inter-frequency RSTD measurements are being performed, and the inter-frequency carrier on which RSTD is measured becomes the new serving carrier frequency after the inter-frequency handover, the UE shall complete the ongoing OTDOA measurement session. The UE shall also meet the inter-frequency OTDOA measurement and accuracy requirements. However in this case the RSTD measurement period ($T_{\text{RSTD InterFreqTDD, E-UTRAN, HO}}$) shall be according to the following expression:

$$T_{\text{RSTD InterFreqTDD, E-UTRAN, HO}} = T_{\text{RSTD InterFreqTDD, E-UTRAN}} + K \times T_{\text{PRS}} + T_{\text{HO}} \quad \text{ms},$$

where:

K is the number of times the inter-frequency handover occurs during $T_{\text{RSTD InterFreqTDD, E-UTRAN, HO}}$,

T_{HO} is the time during which the inter-frequency RSTD measurement may not be possible due to inter-frequency handover; it can be up to 45 ms.

The RSTD measurement accuracy for all measured neighbor cells i shall be fulfilled according to the accuracy as specified in the sub-clause 9.1.10.6.

Furthermore, due to the inter-frequency handover the UE shall meet the RSTD measurement accuracy for a PRS bandwidth which is not larger than the minimum channel bandwidth of those PCells on whose carriers RSTD measurement is performed during the RSTD measurement period.

8.1.2.6.7.1 RSTD Measurement Reporting Delay

This requirement assumes that the measurement report is not delayed by other LPP signalling on the DCCH. This measurement reporting delay excludes a delay uncertainty resulted when inserting the measurement report to the TTI of the uplink DCCH. The delay uncertainty is: $2 \times TTI_{DCCH}$. This measurement reporting delay excludes any delay caused by no UL resources for UE to send the measurement report. When the UE is configured to perform SRS carrier based switching, an additional delay can be expected.

8.1.2.6.8 E-UTRAN FDD-TDD Inter-Frequency OTDOA Measurements for UE Category 1bis

When the physical layer cell identities of neighbour cells together with the OTDOA assistance data are provided, the UE shall be able to detect and measure inter-frequency RSTD, specified in TS 36.214 [4], for at least $n=16$ cells, including the reference cell, within $T_{RSTD\text{InterFreqFDDTDD,E-UTRAN}}$ ms as given below:

$$T_{RSTD\text{InterFreqFDDTDD,E-UTRAN}} = T_{PRS} \cdot (M - 1) + \Delta \quad \text{ms} ,$$

where

$T_{RSTD\text{InterFreqFDDTDD,E-UTRAN}}$ is the total time for detecting and measuring at least n cells,

T_{PRS} is the largest value of the cell-specific positioning subframe configuration period, defined in TS 36.211 [16], among the measured n cells including the reference cell,

M is the number of PRS positioning occasions as defined in Table 8.1.2.6.8-1, where a PRS positioning occasion is as defined in clause 8.1.2.5.1,

$\Delta = 160 \cdot \left\lceil \frac{n}{M} \right\rceil$ ms is the measurement time for a single PRS positioning occasion which includes the sampling time and the processing time, and

the n cells are distributed on up to two carrier frequencies including a serving carrier frequency and one inter-frequency carrier.

Table 8.1.2.6.8-1: Number of PRS positioning occasions within $T_{RSTD\text{InterFreqFDDTDD,E-UTRAN}}$

Positioning subframe configuration period T_{PRS}	Number of PRS positioning occasions M	
	f2 <small>Note1</small>	f1 and f2 <small>Note2</small>
160 ms	32	64
>160 ms	16	32
Note 1:	When inter-frequency RSTD measurements are performed over the reference cell and neighbour cells, which belong to the TDD inter-frequency carrier frequency f2.	
Note 2:	When inter-frequency RSTD measurements are performed over the reference cell and the neighbour cells, which belong to the serving FDD carrier frequency f1 and the TDD inter-frequency carrier frequency f2 respectively.	

The UE physical layer shall be capable of reporting RSTD for the reference cell and all the neighbor cells i out of at least $(n-1)$ neighbor cells within $T_{RSTD\text{InterFreqFDDTDD,E-UTRAN}}$, provided:

$(\text{PRS } \hat{E}_s / \text{Iot})_{ref} \geq -6$ dB for all Frequency Bands for the reference cell,

$(\text{PRS } \hat{E}_s / \text{Iot})_i \geq -13$ dB for all Frequency Bands for neighbour cell i ,

$(\text{PRS } \hat{E}_s / \text{Iot})_{ref}$ and $(\text{PRS } \hat{E}_s / \text{Iot})_i$ conditions apply for all subframes of at least $L = \frac{M}{2}$ PRS positioning occasions,

PRP 1,2_{dBm} according to Annex B.2.6 for a corresponding Band

$\text{PRS } \hat{E}_s / \text{Iot}$ is as defined in Clause 8.1.2.5.1.

The time $T_{\text{RSTDInterFreqFDDTDD,E-UTRAN}}$ starts from the first subframe of the PRS positioning occasion closest in time after both the OTDOA-RequestLocationInformation message and the OTDOA assistance data in the OTDOA-ProvideAssistanceData message as specified in TS 36.355 [24], are delivered to the physical layer of the UE.

If the inter-frequency handover occurs while inter-frequency RSTD measurements are being performed, and the inter-frequency carrier on which RSTD is measured becomes the new serving carrier frequency after the inter-frequency handover, the UE shall complete the ongoing OTDOA measurement session. The UE shall also meet the inter-frequency OTDOA measurement and accuracy requirements. However in this case the RSTD measurement period ($T_{\text{RSTDInterFreqDDTDD,E-UTRAN,HO}}$) shall be according to the following expression:

$$T_{\text{RSTDInterFreqDDTDD,E-UTRAN,HO}} = T_{\text{RSTDInterFreqFDDTDD,E-UTRAN}} + K \times T_{\text{PRS}} + T_{\text{HO}} \quad \text{ms},$$

where:

K is the number of times the inter-frequency handover occurs during $T_{\text{RSTDInterFreqDDTDD,E-UTRAN,HO}}$,

T_{HO} is the time during which the inter-frequency RSTD measurement may not be possible due to inter-frequency handover; it can be up to 45 ms.

The RSTD measurement accuracy for all measured neighbor cells i shall be fulfilled according to the accuracy as specified in the sub-clause 9.1.10.6.

Furthermore, due to the inter-frequency handover the UE shall meet the RSTD measurement accuracy for a PRS bandwidth which is not larger than the minimum channel bandwidth of those PCells on whose carriers RSTD measurement is performed during the RSTD measurement period.

The inter-frequency requirements in this clause (8.1.2.6.8) shall apply for all TDD special subframe configurations specified in TS 36.211 [16] and for the TDD uplink-downlink configurations as specified in Table 8.1.2.6.8-2.

Table 8.1.2.6.8-2: TDD uplink-downlink subframe configurations applicable for inter-frequency requirements

PRS Transmission Bandwidth [RB]	Applicable TDD uplink-downlink configurations
6, 15	3, 4 and 5
25	1, 2, 3, 4, 5 and 6
50, 75, 100	0, 1, 2, 3, 4, 5 and 6
Note 1:	Uplink-downlink configurations are specified in Table 4.2-2 in TS 36.211 [16].
Note 2:	For UEs capable of performing inter-frequency measurements without measurement gaps, TDD uplink-downlink subframe configurations as specified in Table 8.1.2.5.2-2 shall apply.

8.1.2.6.8.1 RSTD Measurement Reporting Delay

This requirement assumes that the measurement report is not delayed by other LPP signalling on the DCCH. This measurement reporting delay excludes a delay uncertainty resulted when inserting the measurement report to the TTI of the uplink DCCH. The delay uncertainty is: $2 \times \text{TTI}_{\text{DCCH}}$. This measurement reporting delay excludes any delay caused

by no UL resources for UE to send the measurement report. When the UE is configured to perform SRS carrier based switching, an additional delay can be expected.

8.1.2.7 E-UTRAN E-CID Measurements

8.1.2.7.1 E-UTRAN FDD UE Rx-Tx Time Difference Measurements

When no DRX is used the physical layer measurement period of the UE Rx-Tx time difference measurement shall be 200 ms.

When DRX is used in RRC_CONNECTED state the physical layer measurement period ($T_{\text{measure_FDD_UE_Rx_Tx1}}$) of the UE Rx-Tx time difference measurement shall be as specified in table 8.1.2.7.1-1. When eDRX_CONN is used in RRC_CONNECTED state, the physical layer measurement period ($T_{\text{measure_FDD_UE_Rx_Tx1}}$) of the UE Rx-Tx time difference measurement shall be as specified in table 8.1.2.7.1-2.

Table 8.1.2.7.1-1: FDD UE Rx-Tx time difference measurement requirement when DRX is used

DRX cycle length (s)	$T_{\text{measure_FDD_UE_Rx_Tx1}}$ (s) (DRX cycles)
≤ 0.04	0.2 (Note1)
$0.04 < \text{DRX-cycle} \leq 2.56$	Note2 (5)
Note1: Number of DRX cycle depends upon the DRX cycle in use Note2: Time depends upon the DRX cycle in use	

Table 8.1.2.7.1-2: FDD UE Rx-Tx time difference measurement requirement when eDRX_CONN is used

eDRX_CONN cycle length (s)	$T_{\text{measure_FDD_UE_Rx_Tx1}}$ (s) (eDRX_CONN cycles)
$2.56 < \text{eDRX_CONN cycle} \leq 10.24$	Note (5)
Note: Time depends upon the eDRX_CONN cycle in use	

If the UE is performing UE Rx-Tx time difference measurement while the PCell is changed due to the handover then the UE shall restart the Rx-Tx measurement on the new cell. In this case the UE shall also meet the UE Rx-Tx time difference measurement and accuracy requirements. However the physical layer measurement period of the UE Rx-Tx measurement shall not exceed $T_{\text{measure_FDD_UE_Rx_Tx3}}$ as defined in the following expression:

$$T_{\text{measure_FDD_UE_Rx_Tx3}} = (K+1) * (T_{\text{measure_FDD_UE_Rx_Tx1}}) + K * T_{\text{PCell_change_handover}}$$

Where:

K is the number of times the PCell is changed over the measurement period ($T_{\text{measure_FDD_UE_Rx_Tx3}}$),

$T_{\text{PCell_change_handover}}$ is the time necessary to change the PCell due to handover; it can be up to 45 ms.

If the UE supporting E-UTRA carrier aggregation when configured with the secondary component carrier(s) is performing UE Rx-Tx time difference measurement while the PCell is changed regardless whether the primary component carrier is changed or not then the UE shall restart the Rx-Tx measurement on the new PCell. In this case the UE shall also meet the UE Rx-Tx time difference measurement and accuracy requirements corresponding to the new PCell. However the physical layer measurement period of the UE Rx-Tx measurement shall not exceed $T_{\text{measure_FDD_UE_Rx_Tx2}}$ as defined in the following expression:

$$T_{\text{measure_FDD_UE_Rx_Tx2}} = (N+1) * (T_{\text{measure_FDD_UE_Rx_Tx1}}) + N * T_{\text{PCell_change_CA}}$$

Where:

N is the number of times the PCell is changed over the measurement period ($T_{\text{measure_FDD_UE_Rx_Tx2}}$),

$T_{\text{PCell_change_CA}}$ is the time necessary to change the PCell; it can be up to 25 ms.

If IDC autonomous denial is configured then the UE shall also meet the requirements, provided not more than 30 IDC autonomous denial subframes are configured over an IDC autonomous denial validity period of at least 200 ms.

The UE capable of SRS carrier based switching, when configured to perform SRS carrier based switching for SRS transmission and/or RACH transmission over one or more SCells without PUSCH, shall perform UE Rx-Tx time difference measurement and meet the requirements defined in Section 8.1.2.7.1 provided the following condition is met:

- at least one downlink subframe and one uplink subframe per radio frame are available for doing UE Rx-Tx time difference measurement at the UE in the PCell.

The measurement accuracy for the UE Rx-Tx time difference measurement when DRX or eDRX_CONN is used as well as when no DRX is used shall be as specified in the sub-clause 9.1.9.

8.1.2.7.1.1 UE Rx-Tx Measurement Reporting Delay

This requirement assumes that the measurement report is not delayed by other RRC or LPP signalling on the DCCH. This measurement reporting delay excludes a delay uncertainty resulted when inserting the measurement report to the TTI of the uplink DCCH. The delay uncertainty is: $2 \times TTI_{DCCH}$ where TTI_{DCCH} is the duration of subframe or slot or subslot when the measurement report is transmitted on the PUSCH with subframe or slot or subslot duration. This measurement reporting delay excludes any delay caused by no UL resources for UE to send the measurement report. When the UE is configured to perform SRS carrier based switching, an additional delay can be expected.

Reported measurements contained in periodically triggered measurement reports shall meet the requirements in sub-clause 9.1.9.

8.1.2.7.2 E-UTRAN TDD UE Rx-Tx Time Difference Measurements

When no DRX is used the physical layer measurement period of the UE Rx-Tx time difference measurement shall be 200 ms.

When DRX is used in RRC_CONNECTED state the physical layer measurement period ($T_{\text{measure_TDD_UE_Rx_Tx1}}$) of the UE Rx-Tx time difference measurement shall be as specified in table 8.1.2.7.2-1. When eDRX_CONN is used in RRC_CONNECTED state the physical layer measurement period ($T_{\text{measure_TDD_UE_Rx_Tx1}}$) of the UE Rx-Tx time difference measurement shall be as specified in table 8.1.2.7.2-2.

Table 8.1.2.7.2-1: TDD UE Rx-Tx time difference measurement requirement when DRX is used

DRX cycle length (s)	$T_{\text{measure_TDD_UE_Rx_Tx1}}$ (s) (DRX cycles)
≤ 0.04	0.2 (Note1)
$0.04 < \text{DRX-cycle} \leq 2.56$	Note2 (5)
Note1: Number of DRX cycle depends upon the DRX cycle in use Note2: Time depends upon the DRX cycle in use	

Table 8.1.2.7.2-2: TDD UE Rx-Tx time difference measurement requirement when eDRX_CONN is used

eDRX_CONN cycle length (s)	$T_{\text{measure_TDD_UE_Rx_Tx1}}$ (s) (eDRX_CONN cycles)
$2.56 < \text{eDRX_CONN cycle} \leq 10.24$	Note (5)
Note: Time depends upon the eDRX_CONN cycle in use	

If the UE is performing UE Rx-Tx time difference measurement while the PCell is changed due to the handover then the UE shall restart the Rx-Tx measurement on the new cell. In this case the UE shall also meet the UE Rx-Tx time difference measurement and accuracy requirements. However the physical layer measurement period of the UE Rx-Tx measurement shall not exceed $T_{\text{measure_TDD_UE_Rx_Tx3}}$ as defined in the following expression:

$$T_{\text{measure_TDD_UE_Rx_Tx3}} = (K+1) * (T_{\text{measure_TDD_UE_Rx_Tx1}}) + K * T_{\text{PCell_change_handover}}$$

Where:

K is the number of times the PCell is changed over the measurement period ($T_{\text{measure_TDD_UE_Rx_Tx3}}$),

$T_{\text{PCell_change_handover}}$ is the time necessary to change the PCell due to handover; it can be up to 45 ms.

If the UE supporting E-UTRA carrier aggregation when configured with the secondary component carrier(s) is performing UE Rx-Tx time difference measurement while the PCell is changed regardless whether the primary component carrier is changed or not then the UE shall restart the Rx-Tx measurement on the new PCell. In this case the

UE shall also meet the UE Rx-Tx time difference measurement and accuracy requirements corresponding to the new PCell. However the physical layer measurement period of the UE Rx-Tx measurement shall not exceed $T_{\text{measure_TDD_UE_Rx_Tx2}}$ as defined in the following expression:

$$T_{\text{measure_TDD_UE_Rx_Tx2}} = (N+1) * (T_{\text{measure_TDD_UE_Rx_Tx1}}) + N * T_{\text{PCell_change_CA}}$$

Where:

N is the number of times the PCell is changed over the measurement period ($T_{\text{measure_TDD_UE_Rx_Tx2}}$),

$T_{\text{PCell_change_CA}}$ is the time necessary to change the PCell; it can be up to 25 ms.

If IDC autonomous denial is configured then the UE shall also meet the requirements, provided not more than 30 IDC autonomous denial subframes are configured over an IDC autonomous denial validity period of at least 200 ms.

The measurement accuracy for the UE Rx-Tx time difference measurement when DRX or eDRX_CONN is used as well as when no DRX is used shall be as specified in the sub-clause 9.1.9.

For UE, which does not support simultaneous reception and transmission for inter-band TDD CA specified in TS 36.331 [2], and is compliant to the requirements for inter-band CA with uplink in one E-UTRA band and without simultaneous Rx/Tx specified in TS 36.101 [5], the UE Rx-Tx time difference measurement requirements in Section 8.1.2.7.2 shall apply also with different TDD UL/DL subframe configurations and/or different special subframe configurations used in CCs of different bands, under the following additional conditions:

- UE is not simultaneously scheduled in UL and DL on the different CCs, and
- At least one downlink and one uplink subframes per radio frame are available for the UE Rx-Tx time difference measurement in the measured cell.

The UE capable of SRS carrier based switching, when configured to perform SRS carrier based switching for SRS transmission and/or RACH transmission over one or more SCells without PUSCH, shall perform UE Rx-Tx time difference measurement and meet the requirements defined in Section 8.1.2.7.2 provided the following condition is met:

- at least one downlink subframe and one uplink subframe per radio frame are available for doing UE Rx-Tx time difference measurement at the UE in the PCell.

8.1.2.7.2.1 UE Rx-Tx Measurement Reporting Delay

This requirement assumes that the measurement report is not delayed by other RRC or LPP signalling on the DCCH. This measurement reporting delay excludes a delay uncertainty resulted when inserting the measurement report to the TTI of the uplink DCCH. The delay uncertainty is: $2 \times TTI_{\text{DCCH}}$ where TTI_{DCCH} is the duration of subframe or slot or subslot when the measurement report is transmitted on the PUSCH with subframe or slot or subslot duration. This measurement reporting delay excludes any delay caused by no UL resources for UE to send the measurement report. When the UE is configured to perform SRS carrier based switching, an additional delay can be expected.

Reported measurements contained in periodically triggered measurement reports shall meet the requirements in sub-clause 9.1.9.

8.1.2.7.3 E-UTRAN FDD Intra-frequency E-CID RSRP and RSRQ Measurements

8.1.2.7.3.1 Introduction

The requirements in section 8.1.2.7.3 shall apply provided the UE has received ECID-RequestLocationInformation message from E-SMLC via LPP requesting the UE to report E-CID E-UTRAN FDD intra-frequency RSRP and RSRQ measurements [24].

The UE capable of SRS carrier based switching, when configured to perform SRS carrier based switching for SRS transmission and/or RACH transmission over one or more SCells without PUSCH, shall perform UE Rx-Tx time difference measurement and meet the requirements defined in Section 8.1.2.7.3 provided the following condition is met:

- at least one downlink subframe and one uplink subframe per radio frame are available for doing UE Rx-Tx time difference measurement at the UE in the PCell.

8.1.2.7.3.2 Measurement Requirements

The requirements in section 8.1.2.2.1 and section 8.1.2.8.1 also apply for this section except the measurement reporting requirements. The measurement reporting requirements for E-CID RSRP and RSRQ are defined in section 8.1.2.7.3.3.

8.1.2.7.3.3 Measurement Reporting Delay

This requirement assumes that the measurement report is not delayed by other LPP signalling on the DCCH. This measurement reporting delay excludes a delay uncertainty resulted when inserting the measurement report to the TTI of the uplink DCCH. The delay uncertainty is: $2 \times TTI_{DCCH}$ where TTI_{DCCH} is the duration of subframe or slot or subslot when the measurement report is transmitted on the PUSCH with subframe or slot or subslot duration. This measurement reporting delay excludes any delay caused by no UL resources for UE to send the measurement report.

Reported RSRP and RSRQ measurements contained in periodically triggered measurement reports shall meet the requirements in section 9.1.2 and 9.1.5 respectively.

8.1.2.7.4 E-UTRAN TDD Intra-frequency E-CID RSRP and RSRQ Measurements

8.1.2.7.4.1 Introduction

The requirements in section 8.1.2.7.4 shall apply provided the UE has received ECID-RequestLocationInformation message from E-SMLC via LPP requesting the UE to report E-CID E-UTRAN TDD intra-frequency RSRP and RSRQ measurements [24].

The UE capable of SRS carrier based switching, when configured to perform SRS carrier based switching for SRS transmission and/or RACH transmission over one or more SCells without PUSCH, shall perform UE Rx-Tx time difference measurement and meet the requirements defined in Section 8.1.2.7.4 provided the following condition is met:

- at least one downlink subframe and one uplink subframe per radio frame are available for doing UE Rx-Tx time difference measurement at the UE in the PCell.

8.1.2.7.4.2 Measurement Requirements

The requirements in section 8.1.2.2.2 and section 8.1.2.8.2 also apply for this section except the measurement reporting requirements. The measurement reporting requirements for E-CID RSRP and RSRQ are defined in section 8.1.2.7.4.3.

8.1.2.7.4.3 Measurement Reporting Delay

This requirement assumes that the measurement report is not delayed by other LPP signalling on the DCCH. This measurement reporting delay excludes a delay uncertainty resulted when inserting the measurement report to the TTI of the uplink DCCH. The delay uncertainty is: $2 \times TTI_{DCCH}$ where TTI_{DCCH} is the duration of subframe or slot or subslot when the measurement report is transmitted on the PUSCH with subframe or slot or subslot duration. This measurement reporting delay excludes any delay caused by no UL resources for UE to send the measurement report. When the UE is configured to perform SRS carrier based switching, an additional delay can be expected.

Reported RSRP and RSRQ measurements contained in periodically triggered measurement reports shall meet the requirements in section 9.1.2 and 9.1.5 respectively.

8.1.2.8 E-UTRAN intra-frequency measurements under time domain measurement resource restriction

The requirements in sections 8.1.2.8.1 and 8.1.2.8.2 shall apply for cells for which time domain measurement resource restriction patterns for performing E-UTRAN FDD intra-frequency measurements and E-UTRAN TDD intra-frequency measurements, respectively, are configured by higher layers (TS 36.331 [2]), provided that also the following additional conditions are fulfilled:

The time domain measurement resource restriction pattern configured for the measured cell indicates at least one subframe per radio frame for performing the intra-frequency measurements, and

Four symbols containing CRS are available in all subframes indicated by the time domain measurement resource restriction pattern.

For cells which are not configured for measurements in the subframes indicated by the time-domain measurement resource restriction pattern, the corresponding requirements specified in Clause 8.1.2.2 apply.

8.1.2.8.1 E-UTRAN FDD intra-frequency measurements

8.1.2.8.1.1 E-UTRAN intra-frequency measurements when no DRX is used

When no DRX is in use the UE shall be able to identify a new detectable FDD intra-frequency cell within

$$T_{\text{identify_intra_eICIC}} = T_{\text{basic_identify_E-UTRA_FDD_eICIC, intra}} \cdot \frac{T_{\text{Measurement_Period_eICIC, Intra}}}{T_{\text{Intra}}} \text{ ms}$$

where

$T_{\text{basic_identify_E-UTRA_FDD_eICIC, intra}}$ is 1000 ms.

T_{Intra} is the minimum time available for intra-frequency measurements, during the measurement period with an arbitrarily chosen timing. The time is assumed to be available for performing intra-frequency measurements whenever the receiver is guaranteed to be active on the intra-frequency carrier.

A cell shall be considered detectable when

- RSRP related side conditions given in Sections 9.1.2.3 and 9.1.2.4 and RSRQ related side conditions given in Clause 9.1.5.2 are fulfilled for a corresponding Band,
- SCH_RP and SCH_Ês/Iot according to Annex B.2.8 for a corresponding Band.

Identification of a cell shall include detection of the cell and additionally performing a single measurement with measurement period of $T_{\text{Measurement_Period_eICIC, Intra}}$. If higher layer filtering is used, an additional cell identification delay can be expected.

In the RRC_CONNECTED state the measurement period for intra-frequency measurements is 200 ms. When no measurement gaps are activated, the UE shall be capable of performing RSRP and RSRQ measurements for 8 identified intra-frequency cells, including also the cells which are not measured in the subframes indicated by the time-domain measurement resource restriction pattern, and the UE physical layer shall be capable of reporting measurements to higher layers with the measurement period of 200 ms. When measurement gaps are activated the UE shall be capable of performing measurements for at least $Y_{\text{measurement_intra_eICIC}}$ cells, where $Y_{\text{measurement_intra_eICIC}}$ is defined in the following equation. If the UE has identified more than $Y_{\text{measurement_intra_eICIC}}$ cells, the UE shall perform measurements of at least 8 identified intra-frequency cells but the reporting rate of RSRP and RSRQ measurements of cells from UE physical layer to higher layers may be decreased.

$$Y_{\text{measurement_intra_eICIC}} = \text{Floor} \left\{ X_{\text{basic_measurement_FDD_eICIC}} \cdot \frac{T_{\text{Intra}}}{T_{\text{Measurement_Period_eICIC, Intra}}} \right\} \text{ cells}$$

where

$X_{\text{basic_measurement_FDD_eICIC}} = 8$ (cells)

$T_{\text{Measurement_Period_eICIC, Intra}} = 200$ ms is the measurement period for intra-frequency RSRP and RSRQ measurements.

The RSRP and RSRQ measurement accuracy for the measured cells configured with a time-domain measurement resource restriction pattern for RRM intra-frequency measurements shall be as specified in the sub-clauses 9.1.2.3, 9.1.2.4, and 9.1.5.2, respectively.

8.1.2.8.1.1.1 Measurement Reporting Requirements

8.1.2.8.1.1.1.1 Periodic Reporting

Reported RSRP and RSRQ measurements contained in periodically triggered measurement reports shall meet the requirements in sections 9.1.2.3, 9.1.2.4, and 9.1.5.2, respectively.

8.1.2.8.1.1.1.2 Event-triggered Periodic Reporting

Reported RSRP and RSRQ measurements contained in event triggered periodic measurement reports shall meet the requirements in sections 9.1.2.3, 9.1.2.4, and 9.1.5.2, respectively.

The first report in event triggered periodic reporting shall meet the requirements specified in clause 8.1.2.8.1.1.1.3.

8.1.2.8.1.1.3 Event Triggered Reporting

Reported RSRP and RSRQ measurements contained in event triggered measurement reports shall meet the requirements in sections 9.1.2.3, 9.1.2.4, and 9.1.5.2, respectively.

The UE shall not send any event triggered measurement reports, as long as no reporting criteria are fulfilled.

The measurement reporting delay is defined as the time between an event that will trigger a measurement report and the point when the UE starts to transmit the measurement report over the air interface. This requirement assumes that the measurement report is not delayed by other RRC signalling on the DCCH. This measurement reporting delay excludes a delay uncertainty resulted when inserting the measurement report to the TTI of the uplink DCCH. The delay uncertainty is: $2 \times TTI_{DCCH}$ where TTI_{DCCH} is the duration of subframe or slot or subslot when the measurement report is transmitted on the PUSCH with subframe or slot or subslot duration. This measurement reporting delay excludes a delay which caused by no UL resources for UE to send the measurement report.

The event triggered measurement reporting delay, measured without L3 filtering shall be less than $T_{identify_intra_eICIC}$ defined in Clause 8.1.2.8.1.1. When L3 filtering is used or IDC autonomous denial is configured an additional delay can be expected.

If a cell which has been detectable at least for the time period $T_{identify_intra_eICIC}$ defined in clause 8.1.2.8.1.1 becomes undetectable for a period ≤ 5 seconds and then the cell becomes detectable again and triggers an event, the event triggered measurement reporting delay shall be less than $T_{Measurement_Period_eICIC, Intra}$ provided the timing to that cell has not changed more than $\pm 50 T_s$ and the L3 filter has not been used. When L3 filtering is used or IDC autonomous denial is configured, an additional delay can be expected.

8.1.2.8.1.2 E-UTRAN intra-frequency measurements when DRX is used

When DRX is in use the UE shall be able to identify a new detectable FDD intra frequency cell within $T_{identify_intra_eICIC}$ as shown in table 8.1.2.8.1.2-1.

Table 8.1.2.8.1.2-1: Requirement to identify a newly detectable FDD intra-frequency cell

DRX cycle length (s)	$T_{identify_intra_eICIC}$ (DRX cycles)
≤ 0.04	1 (Note1)
$0.04 < DRX\text{-}cycle \leq 0.08$	Note2 (52)
0.128	4.22 (33)
$0.128 < DRX\text{-}cycle \leq 2.56$	Note2 (28)
Note1:	Number of DRX cycle depends upon the DRX cycle in use
Note2:	Time depends upon the DRX cycle in use

A cell shall be considered detectable when

- RSRP related side conditions given in Sections 9.1.2.3 and 9.1.2.4 and RSRQ related side conditions given in Clause 9.1.5.2 are fulfilled for a corresponding Band,
- SCH_RP and $SCH\ \hat{E}s/Iot$ according to Annex B.2.8 for a corresponding Band.

In the RRC_CONNECTED state the measurement period for intra-frequency measurements is $T_{measure_intra_eICIC}$ as shown in table 8.1.2.8.1.2-2. The UE shall be capable of performing RSRP and RSRQ measurements for 8 identified intra-frequency cells, including also the cells which are not measured in the subframes indicated by the time-domain measurement resource restriction pattern, and the UE physical layer shall be capable of reporting measurements to higher layers with the measurement period of $T_{measure_intra_eICIC}$.

Table 8.1.2.8.1.2-2: Requirement to measure FDD intra-frequency cells

DRX cycle length (s)	$T_{measure_intra_eICIC}$ (DRX cycles)
≤ 0.04	0.2 (Note1)

0.04<DRX-cycle≤0.16	Note2 (7)
0.16<DRX-cycle≤2.56	Note2 (5)
Note1:	Number of DRX cycle depends upon the DRX cycle in use
Note2:	Time depends upon the DRX cycle in use

The RSRP and RSRQ measurement accuracy for the measured cells configured with a time-domain measurement resource restriction pattern for RRM intra-frequency measurements shall be as specified in the sub-clauses 9.1.2.3, 9.1.2.4, and 9.1.5.2, respectively.

8.1.2.8.1.2.1 Measurement Reporting Requirements

8.1.2.8.1.2.1.1 Periodic Reporting

Reported RSRP and RSRQ measurements contained in periodically triggered measurement reports shall meet the requirements in sections 9.1.2.3, 9.1.2.4, and 9.1.5.2, respectively.

8.1.2.8.1.2.1.2 Event-triggered Periodic Reporting

Reported RSRP and RSRQ measurements contained in event triggered periodic measurement reports shall meet the requirements in sections 9.1.2.3, 9.1.2.4, and 9.1.5.2, respectively.

The first report in event triggered periodic measurement reporting shall meet the requirements specified in clause 8.1.2.8.1.2.1.3.

8.1.2.8.1.2.1.3 Event Triggered Reporting

Reported RSRP and RSRQ measurements contained in event triggered measurement reports shall meet the requirements in sections 9.1.2.3, 9.1.2.4, and 9.1.5.2, respectively.

The UE shall not send any event triggered measurement reports, as long as no reporting criteria are fulfilled.

The measurement reporting delay is defined as the time between an event that will trigger a measurement report and the point when the UE starts to transmit the measurement report over the air interface. This requirement assumes that the measurement report is not delayed by other RRC signalling on the DCCH. This measurement reporting delay excludes a delay uncertainty resulted when inserting the measurement report to the TTI of the uplink DCCH. The delay uncertainty is: $2 \times TTI_{DCCH}$ where TTI_{DCCH} is the duration of subframe or slot or subslot when the measurement report is transmitted on the PUSCH with subframe or slot or subslot duration. This measurement reporting delay excludes a delay which caused by no UL resources for UE to send the measurement report.

The event triggered measurement reporting delay, measured without L3 filtering shall be less than $T_{identify_intra_eICIC}$ defined in Clause 8.1.2.8.1.2. When L3 filtering is used or IDC autonomous denial is configured an additional delay can be expected.

If a cell which has been detectable at least for the time period $T_{identify_intra_eICIC}$ defined in clause 8.1.2.8.1.2 becomes undetectable for a period ≤ 5 seconds and then the cell becomes detectable again and triggers an event, the event triggered measurement reporting delay shall be less than $T_{measure_intra_eICIC}$ provided the timing to that cell has not changed more than $\pm 50 T_s$ and the L3 filter has not been used. When L3 filtering is used or IDC autonomous denial is configured, an additional delay can be expected.

8.1.2.8.2 E-UTRAN TDD intra-frequency measurements

8.1.2.8.2.1 E-UTRAN intra-frequency measurements when no DRX is used

When no DRX is in use the UE shall be able to identify a new detectable TDD intra-frequency cell within

$$T_{identify_intra_eICIC} = T_{basic_identify_E-UTRA_TDD_eICIC,intra} \cdot \frac{T_{Measurement_Period_eICIC,Intra}}{T_{Intra}} \quad ms$$

where

$T_{\text{basic_identify_E-UTRA_TDD_eICIC, intra}}$ is 1000 ms.

T_{Intra} is the minimum time available for intra-frequency measurements, during the measurement period with an arbitrarily chosen timing. The time is assumed to be available for performing intra-frequency measurements whenever the receiver is guaranteed to be active on the intra-frequency carrier.

A cell shall be considered detectable when

- RSRP related side conditions given in Sections 9.1.2.3 and 9.1.2.4 and RSRQ related side conditions given in Clause 9.1.5.2 are fulfilled for a corresponding Band,
- SCH_RP and $SCH\ \hat{E}s/Iot$ according to Annex B.2.8 for a corresponding Band.

Identification of a cell shall include detection of the cell and additionally performing a single measurement with measurement period of $T_{\text{Measurement_Period_eICIC, Intra}}$. If higher layer filtering is used, an additional cell identification delay can be expected.

In the RRC_CONNECTED state the measurement period for intra-frequency measurements is 200 ms. When no measurement gaps are activated, the UE shall be capable of performing RSRP and RSRQ measurements for 8 identified intra-frequency cells, including also the cells which are not measured in the subframes indicated by the time-domain measurement resource restriction pattern, and the UE physical layer shall be capable of reporting measurements to higher layers with the measurement period of 200 ms. When measurement gaps are activated the UE shall be capable of performing measurements for at least $Y_{\text{measurement_intra_eICIC}}$ cells, where $Y_{\text{measurement_intra_eICIC}}$ is defined in the following equation. If the UE has identified more than $Y_{\text{measurement_intra_eICIC}}$ cells, the UE shall perform measurements of at least 8 identified intra-frequency cells but the reporting rate of RSRP and RSRQ measurements of cells from UE physical layer to higher layers may be decreased.

$$Y_{\text{measurement_intra_eICIC}} = \text{Floor} \left\{ X_{\text{basic_measurement_TDD_eICIC}} \frac{T_{\text{Intra}}}{T_{\text{Measurement_Period_eICIC, Intra}}} \right\} \text{ cells}$$

where

$$X_{\text{basic_measurement_TDD_eICIC}} = 8 \text{ (cells)}$$

$T_{\text{Measurement_Period_eICIC, Intra}} = 200$ ms is the measurement period for intra-frequency RSRP and RSRQ measurements.

The RSRP and RSRQ measurement accuracy for the measured cells configured with a time-domain measurement resource restriction pattern for RRM intra-frequency measurements shall be as specified in the sub-clauses 9.1.2.3, 9.1.2.4, and 9.1.5.2, respectively.

8.1.2.8.2.1.1 Measurement Reporting Requirements

8.1.2.8.2.1.1.1 Periodic Reporting

Reported RSRP and RSRQ measurements contained in periodically triggered measurement reports shall meet the requirements in sections 9.1.2.3, 9.1.2.4, and 9.1.5.2, respectively.

8.1.2.8.2.1.1.2 Event-triggered Periodic Reporting

Reported RSRP and RSRQ measurements contained in event triggered periodic measurement reports shall meet the requirements in sections 9.1.2.3, 9.1.2.4, and 9.1.5.2, respectively.

The first report in event triggered periodic measurement reporting shall meet the requirements specified in clause 8.1.2.8.2.1.1.3.

8.1.2.8.2.1.1.3 Event Triggered Reporting

Reported RSRP and RSRQ measurements contained in event triggered measurement reports shall meet the requirements in sections 9.1.2.3, 9.1.2.4, and 9.1.5.2, respectively.

The UE shall not send any event triggered measurement reports, as long as no reporting criteria are fulfilled.

The measurement reporting delay is defined as the time between an event that will trigger a measurement report and the point when the UE starts to transmit the measurement report over the air interface. This requirement assumes that the measurement report is not delayed by other RRC signalling on the DCCH. This measurement reporting delay excludes a delay uncertainty resulted when inserting the measurement report to the TTI of the uplink DCCH. The delay uncertainty is: $2 \times TTI_{DCCH}$ where TTI_{DCCH} is the duration of subframe or slot or subslot when the measurement report is transmitted on the PUSCH with subframe or slot or subslot duration. This measurement reporting delay excludes a delay which caused by no UL resources for UE to send the measurement report.

The event triggered measurement reporting delay, measured without L3 filtering shall be less than $T_{identify_intra_eICIC}$ defined in Clause 8.1.2.8.2.1. When L3 filtering is used or IDC autonomous denial is configured an additional delay can be expected.

If a cell which has been detectable at least for the time period $T_{identify_intra_eICIC}$ defined in clause 8.1.2.8.2.1 becomes undetectable for a period ≤ 5 seconds and then the cell becomes detectable again and triggers an event, the event triggered measurement reporting delay shall be less than $T_{Measurement_Period_eICIC, Intra}$ provided the timing to that cell has not changed more than $\pm 50 T_s$ and the L3 filter has not been used. When L3 filtering is used or IDC autonomous denial is configured, an additional delay can be expected.

8.1.2.8.2.2 E-UTRAN intra-frequency measurements when DRX is used

When DRX is in use the UE shall be able to identify a new detectable TDD intra frequency cell within $T_{identify_intra_eICIC}$ as shown in table 8.1.2.8.2.2-1.

Table 8.1.2.8.2.2-1: Requirement to identify a newly detectable TDD intra-frequency cell

DRX cycle length (s)	$T_{identify_intra_eICIC}$ (DRX cycles)
≤ 0.04	1 (Note1)
$0.04 < DRX\text{-}cycle \leq 0.08$	Note2 (52)
0.128	4.22 (33)
$0.128 < DRX\text{-}cycle \leq 2.56$	Note2 (28)
Note1: Number of DRX cycle depends upon the DRX cycle in use	
Note2: Time depends upon the DRX cycle in use	

A cell shall be considered detectable when

- RSRP related side conditions given in Sections 9.1.2.3 and 9.1.2.4 and RSRQ related side conditions given in Clause 9.1.5.2 are fulfilled for a corresponding Band,
- SCH_{RP} and SCH_{Es/Iot} according to Annex B.2.8 for a corresponding Band.

In the RRC_CONNECTED state the measurement period for intra frequency measurements is $T_{measure_intra_eICIC}$ as shown in table 8.1.2.8.2.2-2. The UE shall be capable of performing RSRP and RSRQ measurements for 8 identified intra-frequency cells, including also the cells which are not measured in the subframes indicated by the time-domain measurement resource restriction pattern, and the UE physical layer shall be capable of reporting measurements to higher layers with the measurement period of $T_{measure_intra_eICIC}$.

Table 8.1.2.8.2.2-2: Requirement to measure TDD intra-frequency cells

DRX cycle length (s)	$T_{measure_intra_eICIC}$ (DRX cycles)
≤ 0.04	0.2 (Note1)
$0.04 < DRX\text{-}cycle \leq 0.16$	Note2 (7)
$0.16 < DRX\text{-}cycle \leq 2.56$	Note2 (5)

Note1:	Number of DRX cycle depends upon the DRX cycle in use.
Note2:	Time depends upon the DRX cycle in use.

The RSRP and RSRQ measurement accuracy for the measured cells configured with a time-domain measurement resource restriction pattern for RRM intra-frequency measurements shall be as specified in the sub-clauses 9.1.2.3, 9.1.2.4, and 9.1.5.2, respectively.

8.1.2.8.2.2.1 Measurement Reporting Requirements

8.1.2.8.2.2.1.1 Periodic Reporting

Reported RSRP and RSRQ measurements contained in periodically triggered measurement reports shall meet the requirements in sections 9.1.2.3, 9.1.2.4, and 9.1.5.2, respectively.

8.1.2.8.2.2.1.2 Event-triggered Periodic Reporting

Reported RSRP and RSRQ measurements contained in event triggered periodic measurement reports shall meet the requirements in sections 9.1.2.3, 9.1.2.4, and 9.1.5.2, respectively.

The first report in event triggered periodic measurement reporting shall meet the requirements specified in clause 8.1.2.8.2.2.1.3.

8.1.2.8.2.2.1.3 Event Triggered Reporting

Reported RSRP and RSRQ measurements contained in event triggered measurement reports shall meet the requirements in sections 9.1.2.3, 9.1.2.4, and 9.1.5.2, respectively.

The UE shall not send any event triggered measurement reports, as long as no reporting criteria are fulfilled.

The measurement reporting delay is defined as the time between an event that will trigger a measurement report and the point when the UE starts to transmit the measurement report over the air interface. This requirement assumes that the measurement report is not delayed by other RRC signalling on the DCCH. This measurement reporting delay excludes a delay uncertainty resulted when inserting the measurement report to the TTI of the uplink DCCH. The delay uncertainty is: $2 \times TTI_{DCCH}$ where TTI_{DCCH} is the duration of subframe or slot or subslot when the measurement report is transmitted on the PUSCH with subframe or slot or subslot duration. This measurement reporting delay excludes a delay which caused by no UL resources for UE to send the measurement report.

The event triggered measurement reporting delay, measured without L3 filtering shall be less than $T_{identify_intra_eICIC}$ defined in Clause 8.1.2.8.2.2. When L3 filtering is used or IDC autonomous denial is configured an additional delay can be expected.

If a cell which has been detectable at least for the time period $T_{identify_intra_eICIC}$ defined in clause 8.1.2.8.2.2 becomes undetectable for a period ≤ 5 seconds and then the cell becomes detectable again and triggers an event, the event triggered measurement reporting delay shall be less than $T_{measure_intra_eICIC}$ provided the timing to that cell has not changed more than $\pm 50 T_s$ and the L3 filter has not been used. When L3 filtering is used or IDC autonomous denial is configured, an additional delay can be expected.

8.1.2.8.3 E-UTRAN FDD intra-frequency measurements with CRS assistance information

The requirements in clause 8.1.2.8.3 shall apply for the UEs supporting the PSS/SSS and common channel interference handling, and CRS interference handling features. Moreover, the core requirements shall be satisfied provided that the following additional conditions are fulfilled:

- The UE is provided with the CRS assistance information via higher layers (TS 36.331 [2]),
- The CRS assistance information is valid during the entire measurement period.

The requirements in this section shall also be met when the number of transmit antenna ports [16] of one or more cells whose CRS assistance information is provided [2] is different from the number of transmit antenna ports of the measured cell.

8.1.2.8.3.1 E-UTRAN intra-frequency measurements when no DRX is used

When no DRX is in use the UE shall be able to identify a new detectable FDD intra-frequency cell within:

$$T_{\text{identify_intra_FeICIC}} = T_{\text{basic_identify_E-UTRA_FDD_FeICIC, intra}} \cdot \frac{T_{\text{Measurement_Period_FeICIC, Intra}}}{T_{\text{Intra}}} \text{ ms}$$

where

$T_{\text{basic_identify_E-UTRA_FDD_FeICIC, intra}}$ is 1000 ms.

T_{Intra} is the minimum time available for intra-frequency measurements, during the measurement period with an arbitrarily chosen timing. The time is assumed to be available for performing intra-frequency measurements whenever the receiver is guaranteed to be active on the intra-frequency carrier.

A cell shall be considered detectable when:

- RSRP related side conditions given in Sections 9.1.2.5 and 9.1.2.6 and RSRQ related side conditions given in Section 9.1.5.3 are fulfilled for a corresponding Band,
- SCH_RP and $SCH \hat{E}s/Iot$ according to Annex B, clause B.2.9 for a corresponding Band (Notes 1, 2).

Note 1: Part of the Iot includes the interference from at least:

- the PCell , or
- PCell and one intra-frequency neighbouring cell indicated in the CRS assistance information, or
- One or two intra-frequency neighbouring cells indicated in the CRS assistance information.

CRS assistance information has been provided for the intra-frequency neighbouring cells that generate interference. UE may use the CRS assistance information to mitigate the interference.

Note 2: An intra-frequency cell is known if it has been meeting the relevant cell identification requirement during the last 5 seconds.

Identification of a cell shall include detection of the cell and additionally performing a single measurement with measurement period of $T_{\text{Measurement_Period_FeICIC, Intra}}$. If higher layer filtering is used, an additional cell identification delay can be expected.

In the RRC_CONNECTED state the measurement period for intra-frequency measurements is 200 ms. When no measurement gaps are activated, the UE shall be capable of performing RSRP and RSRQ measurements for 8 identified intra-frequency cells, including also the cells which are not measured in the subframes indicated by the time-domain measurement resource restriction pattern and the cells indicated in the CRS assistance information, and the UE physical layer shall be capable of reporting measurements to higher layers with the measurement period of 200 ms. When measurement gaps are activated the UE shall be capable of performing measurements for at least

$Y_{\text{measurement_intra_FeICIC}}$ cells , where $Y_{\text{measurement_intra_FeICIC}}$ is defined in the following equation. If the UE has identified more than $Y_{\text{measurement_intra_FeICIC}}$ cells, the UE shall perform measurements of at least 8 identified intra-frequency cells but the reporting rate of RSRP and RSRQ measurements of cells from UE physical layer to higher layers may be decreased.

$$Y_{\text{measurement_intra_FeICIC}} = \text{Floor} \left\{ X_{\text{basic_measurement_FDD_FeICIC}} \cdot \frac{T_{\text{Intra}}}{T_{\text{Measurement_Period_FeICIC, Intra}}} \right\} \text{ cells}$$

where

$X_{\text{basic_measurement_FDD_FeICIC}} = 8$ (cells).

$T_{\text{Measurement_Period_FeICIC, Intra}} = 200$ ms is the measurement period for intra-frequency RSRP and RSRQ measurements.

The RSRP and RSRQ measurement accuracy for the measured cells configured with a time-domain measurement resource restriction pattern for RRM intra-frequency measurements with CRS assistance information shall be as specified in the sub-clauses 9.1.2.5, 9.1.2.6, and 9.1.5.3, respectively.

8.1.2.8.3.1.1 Measurement Reporting Requirements

8.1.2.8.3.1.1.1 Periodic Reporting

Reported RSRP and RSRQ measurements contained in periodically triggered measurement reports shall meet the requirements in sections 9.1.2.5, 9.1.2.6, and 9.1.5.3, respectively.

8.1.2.8.3.1.1.2 Event-triggered Periodic Reporting

Reported RSRP and RSRQ measurements contained in event triggered periodic measurement reports shall meet the requirements in sections 9.1.2.5, 9.1.2.6, and 9.1.5.3, respectively.

The first report in event triggered periodic measurement reporting shall meet the requirements specified in clause 8.1.2.8.3.1.1.3.

8.1.2.8.3.1.1.3 Event Triggered Reporting

Reported RSRP and RSRQ measurements contained in event triggered measurement reports shall meet the requirements in sections 9.1.2.5, 9.1.2.6, and 9.1.5.3, respectively.

The UE shall not send any event triggered measurement reports, as long as no reporting criteria are fulfilled.

The measurement reporting delay is defined as the time between an event that will trigger a measurement report and the point when the UE starts to transmit the measurement report over the air interface. This requirement assumes that the measurement report is not delayed by other RRC signalling on the DCCH. This measurement reporting delay excludes a delay uncertainty resulted when inserting the measurement report to the TTI of the uplink DCCH. The delay uncertainty is: $2 \times TTI_{DCCH}$ where TTI_{DCCH} is the duration of subframe or slot or subslot when the measurement report is transmitted on the PUSCH with subframe or slot or subslot duration. This measurement reporting delay excludes a delay which caused by no UL resources for UE to send the measurement report.

The event triggered measurement reporting delay, measured without L3 filtering shall be less than $T_{identify_intra_FeICIC}$ defined in Clause 8.1.2.8.3.1. When L3 filtering is used or IDC autonomous denial is configured, an additional delay can be expected.

If a cell which has been detectable at least for the time period $T_{identify_intra_FeICIC}$ defined in clause 8.1.2.8.3.1 becomes undetectable for a period ≤ 5 seconds and then the cell becomes detectable again and triggers an event, the event triggered measurement reporting delay shall be less than $T_{Measurement_Period_FeICIC, Intra}$ provided the timing to that cell has not changed more than $\pm 50 T_s$ and the L3 filter has not been used. When L3 filtering is used or IDC autonomous denial is configured, an additional delay can be expected.

8.1.2.8.3.2 E-UTRAN intra-frequency measurements when DRX is used

When DRX is in use the UE shall be able to identify a new detectable FDD intra frequency cell within $T_{identify_intra_FeICIC}$ as shown in table 8.1.2.8.3.2-1.

Table 8.1.2.8.3.2-1: Requirement to identify a newly detectable FDD intra-frequency cell

DRX cycle length (s)	$T_{identify_intra_FeICIC}$ (s) (DRX cycles)
≤ 0.04	1 (Note 1)
$0.04 < DRX\text{-}cycle \leq 0.08$	Note 2 (52)
0.128	4.22 (33)
$0.128 < DRX\text{-}cycle \leq 2.56$	Note 2 (28)
NOTE 1: Number of DRX cycle depends upon the DRX cycle in use. NOTE 2: Time depends upon the DRX cycle in use.	

A cell shall be considered detectable when:

- RSRP related side conditions given in Sections 9.1.2.5 and 9.1.2.6 and RSRQ related side conditions given in Section 9.1.5.3 are fulfilled for a corresponding Band,

- SCH_{RP} and SCH_{Es/Iot} according to Annex B, clause B.2.9 for a corresponding Band (Notes 1, 2).

Note 1: Part of the Iot includes the interference from at least:

- the PCell, or
- PCell and one intra-frequency neighbouring cell indicated in the CRS assistance information, or
- One or two intra-frequency neighbouring cells indicated in the CRS assistance information.

CRS assistance information has been provided for the intra-frequency neighbouring cells that generate interference. UE may use the CRS assistance information to mitigate the interference.

Note 2: An intra-frequency cell is known if it has been meeting the relevant cell identification requirement during the last 5 seconds.

In the RRC_CONNECTED state the measurement period for intra-frequency measurements is $T_{\text{measure_intra_FeICIC}}$ as shown in table 8.1.2.8.3.2-2. The UE shall be capable of performing RSRP and RSRQ measurements for 8 identified intra-frequency cells, including also the cells which are not measured in the subframes indicated by the time-domain measurement resource restriction pattern and the cell indicated in CRS assistance information, and the UE physical layer shall be capable of reporting measurements to higher layers with the measurement period of $T_{\text{measure_intra_FeICIC}}$.

Table 8.1.2.8.3.2-2: Requirement to measure FDD intra-frequency cells

DRX cycle length (s)	$T_{\text{identify_intra_FeICIC}}$ (s) (DRX cycles)
≤ 0.04	0.2 (Note 1)
$0.04 < \text{DRX-cycle} \leq 0.16$	Note 2 (7)
$0.16 < \text{DRX-cycle} \leq 2.56$	Note 2 (5)
NOTE 1: Number of DRX cycle depends upon the DRX cycle in use. NOTE 2: Time depends upon the DRX cycle in use.	

The RSRP and RSRQ measurement accuracy for the measured cells configured with a time-domain measurement resource restriction pattern for RRM intra-frequency measurements shall be as specified in the sub-clauses 9.1.2.5, 9.1.2.6, and 9.1.5.3, respectively.

8.1.2.8.3.2.1 Measurement Reporting Requirements

8.1.2.8.3.2.1.1 Periodic Reporting

Reported RSRP and RSRQ measurements contained in periodically triggered measurement reports shall meet the requirements in sections 9.1.2.5, 9.1.2.6, and 9.1.5.3, respectively.

8.1.2.8.3.2.1.2 Event-triggered Periodic Reporting

Reported RSRP and RSRQ measurements contained in event triggered periodic measurement reports shall meet the requirements in sections 9.1.2.5, 9.1.2.6, and 9.1.5.3, respectively.

The first report in event triggered periodic measurement reporting shall meet the requirements specified in clause 8.1.2.8.3.2.1.3.

8.1.2.8.3.2.1.3 Event Triggered Reporting

Reported RSRP and RSRQ measurements contained in event triggered measurement reports shall meet the requirements in sections 9.1.2.5, 9.1.2.6, and 9.1.5.3, respectively.

The UE shall not send any event triggered measurement reports, as long as no reporting criteria are fulfilled.

The measurement reporting delay is defined as the time between an event that will trigger a measurement report and the point when the UE starts to transmit the measurement report over the air interface. This requirement assumes that the measurement report is not delayed by other RRC signalling on the DCCH. This measurement reporting delay excludes a delay uncertainty resulted when inserting the measurement report to the TTI of the uplink DCCH. The delay uncertainty is: $2 \times TTI_{\text{DCCH}}$ where TTI_{DCCH} is the duration of subframe or slot or subslot when the measurement report is transmitted on the PUSCH with subframe or slot or subslot duration. This measurement reporting delay excludes a delay which caused by no UL resources for UE to send the measurement report.

The event triggered measurement reporting delay, measured without L3 filtering shall be less than $T_{\text{identify_intra_FeICIC}}$ defined in clause 8.1.2.8.3.2. When L3 filtering is used or IDC autonomous denial is configured, an additional delay can be expected.

If a cell which has been detectable at least for the time period $T_{\text{identify_intra_FeICIC}}$ defined in clause 8.1.2.8.3.2 becomes undetectable for a period ≤ 5 seconds and then the cell becomes detectable again and triggers an event, the event triggered measurement reporting delay shall be less than $T_{\text{measure_intra_FeICIC}}$ provided the timing to that cell has not changed more than $\pm 50 T_s$ and the L3 filter has not been used. When L3 filtering is used or IDC autonomous denial is configured, an additional delay can be expected.

8.1.2.8.4 E-UTRAN TDD intra-frequency measurements with CRS assistance information

The requirements in clause 8.1.2.8.3 shall apply for the UEs supporting the PSS/SSS and common channel interference handling, and CRS interference handling features. Moreover, the core requirements shall be satisfied provided that the following additional conditions are fulfilled:

- The UE is provided with the CRS assistance information via higher layers (TS 36.331 [2]),
- The CRS assistance information is valid during the entire measurement period.

The requirements in this section shall also be met when the number of transmit antenna ports [16] of one or more cells whose CRS assistance information is provided [2] is different from the number of transmit antenna ports of the measured cell.

8.1.2.8.4.1 E-UTRAN intra-frequency measurements when no DRX is used

When no DRX is in use the UE shall be able to identify a new detectable TDD intra-frequency cell within

$$T_{\text{identify_intra_FeICIC}} = T_{\text{basic_identify_E-UTRA_TDD_FeICIC, intra}} \cdot \frac{T_{\text{Measurement_Period_FeICIC, Intra}}}{T_{\text{Intra}}} \quad \text{ms}$$

where

$T_{\text{basic_identify_E-UTRA_TDD_FeICIC, intra}}$ is 1000 ms.

T_{Intra} is the minimum time available for intra-frequency measurements, during the measurement period with an arbitrarily chosen timing. The time is assumed to be available for performing intra-frequency measurements whenever the receiver is guaranteed to be active on the intra-frequency carrier.

A cell shall be considered detectable when:

- RSRP related side conditions given in Sections 9.1.2.5 and 9.1.2.6 and RSRQ related side conditions given in Section 9.1.5.3 are fulfilled for a corresponding Band,
- SCH_RP and $SCH\ \hat{E}s/Iot$ according to Annex B.2.9 for a corresponding Band (Notes 1, 2).

Note 1: Part of the Iot includes the interference from at least:

- the PCell, or
- PCell and one intra-frequency neighbouring cell indicated in the CRS assistance information, or
- One or two intra-frequency neighbouring cells indicated in the CRS assistance information

CRS assistance information has been provided for the intra-frequency neighbouring cells that generate interference. UE may use the CRS assistance information to mitigate the interference.

Note 2: An intra-frequency cell is known if it has been meeting the relevant cell identification requirement during the last 5 seconds.

Identification of a cell shall include detection of the cell and additionally performing a single measurement with measurement period of $T_{\text{Measurement_Period_FeICIC, Intra}}$. If higher layer filtering is used, an additional cell identification delay can be expected.

In the RRC_CONNECTED state the measurement period for intra-frequency measurements is 200 ms. When no measurement gaps are activated, the UE shall be capable of performing RSRP and RSRQ measurements for 8 identified intra-frequency cells, including also the cells which are not measured in the subframes indicated by the time-domain measurement resource restriction pattern and the cells indicated in the CRS assistance information, and the UE physical layer shall be capable of reporting measurements to higher layers with the measurement period of 200 ms. When measurement gaps are activated the UE shall be capable of performing measurements for at least $Y_{\text{measurement_intra_FeICIC}}$ cells, where $Y_{\text{measurement_intra_FeICIC}}$ is defined in the following equation. If the UE has identified more than $Y_{\text{measurement_intra_FeICIC}}$ cells, the UE shall perform measurements of at least 8 identified intra-frequency cells but the reporting rate of RSRP and RSRQ measurements of cells from UE physical layer to higher layers may be decreased.

$$Y_{\text{measurement_intra_FeICIC}} = \text{Floor} \left\{ X_{\text{basic_measurement_TDD_FeICIC}} \cdot \frac{T_{\text{Intra}}}{T_{\text{Measurement_Period_FeICIC, Intra}}} \right\} \text{ cells}$$

where

$$X_{\text{basic_measurement_TDD_FeICIC}} = 8 \text{ (cells)}$$

$T_{\text{Measurement_Period_FeICIC, Intra}} = 200\text{ms}$ is the measurement period for intra-frequency RSRP and RSRQ measurements.

The RSRP and RSRQ measurement accuracy for the measured cells configured with a time-domain measurement resource restriction pattern for RRM intra-frequency measurements with CRS assistance information shall be as specified in the sub-clauses 9.1.2.5, 9.1.2.6, and 9.1.5.3, respectively.

8.1.2.8.4.1.1 Measurement Reporting Requirements

8.1.2.8.4.1.1.1 Periodic Reporting

Reported RSRP and RSRQ measurements contained in periodically triggered measurement reports shall meet the requirements in sections 9.1.2.5, 9.1.2.6, and 9.1.5.3, respectively.

8.1.2.8.4.1.1.2 Event-triggered Periodic Reporting

Reported RSRP and RSRQ measurements contained in event triggered periodic measurement reports shall meet the requirements in sections 9.1.2.5, 9.1.2.6, and 9.1.5.3, respectively.

The first report in event triggered periodic measurement reporting shall meet the requirements specified in clause 8.1.2.8.4.1.1.3.

8.1.2.8.4.1.1.3 Event Triggered Reporting

Reported RSRP and RSRQ measurements contained in event triggered measurement reports shall meet the requirements in sections 9.1.2.5, 9.1.2.6, and 9.1.5.3, respectively.

The UE shall not send any event triggered measurement reports, as long as no reporting criteria are fulfilled.

The measurement reporting delay is defined as the time between an event that will trigger a measurement report and the point when the UE starts to transmit the measurement report over the air interface. This requirement assumes that the measurement report is not delayed by other RRC signalling on the DCCH. This measurement reporting delay excludes a delay uncertainty resulted when inserting the measurement report to the TTI of the uplink DCCH. The delay uncertainty is: $2 \times TTI_{\text{DCCH}}$ where TTI_{DCCH} is the duration of subframe or slot or subslot when the measurement report is transmitted on the PUSCH with subframe or slot or subslot duration. This measurement reporting delay excludes a delay which caused by no UL resources for UE to send the measurement report.

The event triggered measurement reporting delay, measured without L3 filtering shall be less than $T_{\text{identify_intra_FeICIC}}$ defined in clause 8.1.2.8.4.1. When L3 filtering is used or IDC autonomous denial is configured, an additional delay can be expected.

If a cell which has been detectable at least for the time period $T_{\text{identify_intra_FeICIC}}$ defined in clause 8.1.2.8.4.1 becomes undetectable for a period ≤ 5 seconds and then the cell becomes detectable again and triggers an event, the event triggered measurement reporting delay shall be less than $T_{\text{Measurement_Period_FeICIC, Intra}}$ provided the timing to that cell

has not changed more than ± 50 Ts and the L3 filter has not been used. When L3 filtering is used or IDC autonomous denial is configured, an additional delay can be expected.

8.1.2.8.4.2 E-UTRAN intra-frequency measurements when DRX is used

When DRX is in use the UE shall be able to identify a new detectable TDD intra frequency cell within $T_{\text{identify_intra_FeICIC}}$ as shown in table 8.1.2.8.4.2-1.

Table 8.1.2.8.4.2-1: Requirement to identify a newly detectable TDD intra-frequency cell

DRX cycle length (s)	$T_{\text{identify_intra_FeICIC}}$ (s) (DRX cycles)
≤ 0.04	1 (Note 1)
$0.04 < \text{DRX-cycle} \leq 0.08$	Note 2 (52)
0.128	4.22 (33)
$0.128 < \text{DRX-cycle} \leq 2.56$	Note 2 (28)
NOTE 1: Number of DRX cycle depends upon the DRX cycle in use. NOTE 2: Time depends upon the DRX cycle in use.	

A cell shall be considered detectable when:

- RSRP related side conditions given in Sections 9.1.2.5 and 9.1.2.6 and RSRQ related side conditions given in Section 9.1.5.3 are fulfilled for a corresponding Band,
- SCH_{RP} and $SCH_{\hat{E}s/Iot}$ according to Annex B.2.9 for a corresponding Band (Notes 1, 2).

Note 1: Part of the Iot includes the interference from at least:

- the PCell, or
- PCell and one intra-frequency neighbouring cell indicated in the CRS assistance information, or
- One or two intra-frequency neighbouring cells indicated in the CRS assistance information.

CRS assistance information has been provided for the intra-frequency neighbouring cells that generate interference. UE may use the CRS assistance information to mitigate the interference.

Note 2: An intra-frequency cell is known if it has been meeting the relevant cell identification requirement during the last 5 seconds.

In the RRC_CONNECTED state the measurement period for intra frequency measurements is $T_{\text{measure_intra_FeICIC}}$ as shown in table 8.1.2.8.4.2-2. The UE shall be capable of performing RSRP and RSRQ measurements for 8 identified intra-frequency cells, including also the cells which are not measured in the subframes indicated by the time-domain measurement resource restriction pattern and the cell indicated in CRS assistance information, and the UE physical layer shall be capable of reporting measurements to higher layers with the measurement period of $T_{\text{measure_intra_FeICIC}}$.

Table 8.1.2.8.4.2-2: Requirement to measure TDD intra-frequency cells

DRX cycle length (s)	$T_{\text{identify_intra_FeICIC}}$ (s) (DRX cycles)
≤ 0.04	0.2 (Note 1)
$0.04 < \text{DRX-cycle} \leq 0.16$	Note 2 (7)
$0.16 < \text{DRX-cycle} \leq 2.56$	Note 2 (5)
NOTE 1: Number of DRX cycle depends upon the DRX cycle in use. NOTE 2: Time depends upon the DRX cycle in use.	

The RSRP and RSRQ measurement accuracy for the measured cells configured with a time-domain measurement resource restriction pattern for RRM intra-frequency measurements shall be as specified in the sub-clauses 9.1.2.5, 9.1.2.6, and 9.1.5.3, respectively.

8.1.2.8.4.2.1 Measurement Reporting Requirements

8.1.2.8.4.2.1.1 Periodic Reporting

Reported RSRP and RSRQ measurements contained in periodically triggered measurement reports shall meet the requirements in sections 9.1.2.5, 9.1.2.6, and 9.1.5.3, respectively.

8.1.2.8.4.2.1.2 Event-triggered Periodic Reporting

Reported RSRP and RSRQ measurements contained in event triggered periodic measurement reports shall meet the requirements in sections 9.1.2.5, 9.1.2.6, and 9.1.5.3, respectively.

The first report in event triggered periodic measurement reporting shall meet the requirements specified in clause 8.1.2.8.2.2.1.3.

8.1.2.8.4.2.1.3 Event Triggered Reporting

Reported RSRP and RSRQ measurements contained in event triggered measurement reports shall meet the requirements in sections 9.1.2.5, 9.1.2.6, and 9.1.5.3, respectively.

The UE shall not send any event triggered measurement reports, as long as no reporting criteria are fulfilled.

The measurement reporting delay is defined as the time between an event that will trigger a measurement report and the point when the UE starts to transmit the measurement report over the air interface. This requirement assumes that the measurement report is not delayed by other RRC signalling on the DCCH. This measurement reporting delay excludes a delay uncertainty resulted when inserting the measurement report to the TTI of the uplink DCCH. The delay uncertainty is: $2 \times TTI_{DCCH}$ where TTI_{DCCH} is the duration of subframe or slot or subslot when the measurement report is transmitted on the PUSCH with subframe or slot or subslot duration. This measurement reporting delay excludes a delay which caused by no UL resources for UE to send the measurement report.

The event triggered measurement reporting delay, measured without L3 filtering shall be less than $T_{identify_intra_FeICIC}$ defined in clause 8.1.2.8.4.2. When L3 filtering is used or IDC autonomous denial is configured, an additional delay can be expected.

If a cell which has been detectable at least for the time period $T_{identify_intra_FeICIC}$ defined in clause 8.1.2.8.4.2 becomes undetectable for a period ≤ 5 seconds and then the cell becomes detectable again and triggers an event, the event triggered measurement reporting delay shall be less than $T_{measure_intra_FeICIC}$ provided the timing to that cell has not changed more than $\pm 50 T_s$ and the L3 filter has not been used. When L3 filtering is used or IDC autonomous denial is configured, an additional delay can be expected.

8.1.2.9 E-UTRAN E-CID Measurements when Time Domain Measurement Resource Restriction Pattern is Configured

8.1.2.9.1 E-UTRAN FDD UE Rx-Tx Time Difference Measurements

The requirements in this clause apply for UE configured with a time-domain measurement resource restriction pattern for PCell measurements, provided that also the following additional conditions are fulfilled:

- The time domain measurement resource restriction pattern configured for the PCell (TS 36.331 [2]) indicates at least one subframe per radio frame for performing the PCell measurements, and
- Four symbols containing CRS are available in all subframes indicated by the time domain measurement resource restriction pattern.

When the UE is provided with a time-domain measurement resource restriction pattern for PCell measurements, the UE Rx-Tx time difference measurement shall meet the measurement requirements specified in Clause 8.1.2.7.1 and accuracy requirements specified in Clause 9.1.9.3, where the condition $\hat{E}_s/I_{ot} \geq -3\text{dB}$ in Table 9.1.9.3-1 corresponds to the CRS \hat{E}_s/I_{ot} in subframes indicated by the time-domain measurement resource restriction pattern for PCell measurements (TS 36.331 [2]).

NOTE: It is up to the UE implementation whether the UE Rx-Tx time difference measurement is performed in any subframe or in subframes indicated by the time-domain measurement resource restriction pattern.

8.1.2.9.2 E-UTRAN TDD UE Rx-Tx Time Difference Measurements

The requirements in this clause apply for UE configured with a time-domain measurement resource restriction pattern for PCell measurements, provided that also the following additional conditions are fulfilled:

- The time domain measurement resource restriction pattern configured for the PCell (TS 36.331 [2]) indicates at least one subframe per radio frame for performing the PCell measurements, and
- Four symbols containing CRS are available in all subframes indicated by the time domain measurement resource restriction pattern.

When the UE is provided with a time-domain measurement resource restriction pattern for PCell measurements, the UE Rx-Tx time difference measurement shall meet the measurement requirements specified in Clause 8.1.2.7.2 and accuracy requirements specified in Clause 9.1.9.3, where the condition $\hat{E}_s/I_{ot} \geq -3\text{dB}$ in Table 9.1.9.3-1 corresponds to the CRS \hat{E}_s/I_{ot} in subframes indicated by the time-domain measurement resource restriction pattern for PCell measurements (TS 36.331 [2]).

NOTE: It is up to the UE implementation whether the UE Rx-Tx time difference measurement is performed in any subframe or in subframes indicated by the time-domain measurement resource restriction pattern.

8.1.2.9.3 E-UTRAN FDD UE Rx-Tx Time Difference Measurements with CRS Assistance Information

For UE configured with a time-domain measurement resource restriction pattern for PCell measurements, the requirements in this section apply under the following conditions:

- The time domain measurement resource restriction pattern configured for the PCell (TS 36.331 [2]) indicates at least one subframe per radio frame for performing the PCell measurements, and
- Four symbols containing CRS are available in all subframes indicated by the time domain measurement resource restriction pattern, and
- The UE is provided with the CRS assistance information (TS 36.331 [2]) and the CRS assistance information is valid throughout the entire evaluation period.

When the UE is provided with a time-domain measurement resource restriction pattern for serving cell measurements, the UE Rx-Tx time difference measurement shall meet the measurement requirements specified in Section 8.1.2.7.1 and accuracy requirements specified in Section 9.1.9.4.

The requirements in this section shall also be met when the number of transmit antenna ports [16] of one or more cells whose CRS assistance information is provided [2] is different from the number of transmit antenna ports of the measured cell.

NOTE: It is up to the UE implementation whether the UE Rx-Tx time difference measurement is performed in any subframe or in subframes indicated by the time-domain measurement resource restriction pattern.

8.1.2.9.4 E-UTRAN TDD UE Rx-Tx Time Difference Measurements with CRS Assistance Information

For UE configured with a time-domain measurement resource restriction pattern for PCell measurements, the requirements in this section apply under the following conditions:

- The time domain measurement resource restriction pattern configured for the PCell (TS 36.331 [2]) indicates at least one subframe per radio frame for performing the PCell measurements, and
- Four symbols containing CRS are available in all subframes indicated by the time domain measurement resource restriction pattern, and
- The UE is provided with the CRS assistance information (TS 36.331 [2]) and the CRS assistance information is valid throughout the entire evaluation period.

When the UE is provided with a time-domain measurement resource restriction pattern for serving cell measurements, the UE Rx-Tx time difference measurement shall meet the measurement requirements specified in Section 8.1.2.7.2 and accuracy requirements specified in Section 9.1.9.4.

The requirements in this section shall also be met when the number of transmit antenna ports [16] of one or more cells whose CRS assistance information is provided [2] is different from the number of transmit antenna ports of the measured cell.

NOTE: It is up to the UE implementation whether the UE Rx-Tx time difference measurement is performed in any subframe or in subframes indicated by the time-domain measurement resource restriction pattern.

8.1.2.10 Void

8.2 Capabilities for Support of Event Triggering and Reporting Criteria

8.2.1 Introduction

This clause contains requirements on UE capabilities for support of event triggering and reporting criteria. As long as the measurement configuration does not exceed the requirements stated in clause 8.2.2, the UE shall meet the performance requirements defined in clause 9.

The UE can be requested to make measurements under different measurement identities defined in TS 36.331 [2]. Each measurement identity corresponds to either event based reporting, periodic reporting, logged measurement reporting [2] or no reporting. In case of event based reporting, each measurement identity is associated with an event. In case of periodic reporting, a measurement identity is associated with one periodic reporting criterion. In case of logged measurement reporting, a measurement identity is associated with one logged measurement reporting criterion. In case of no reporting, a measurement identity is associated with one no reporting criterion.

The purpose of this clause is to set some limits on the number of different event, periodic, logged measurement and no reporting criteria the UE may be requested to track in parallel.

8.2.2 Requirements

In this clause a reporting criterion corresponds to either one event (in the case of event based reporting), or one periodic reporting criterion (in case of periodic reporting), or one logged measurement reporting criterion (in case of logged measurement reporting), or one no reporting criterion (in case of no reporting). For event based reporting, each instance of event, with the same or different event identities, is counted as separate reporting criterion in table 8.2.2-1.

The UE shall be able to support in parallel per category up to E_{cat} reporting criteria according to table 8.2.2-1. For the measurement categories belonging to measurements on: E-UTRA intra-frequency cells, E-UTRA inter-frequency cells, and inter-RAT per supported RAT (i.e. without counting other categories that the UE shall always support in parallel), the UE need not support more than the total number of reporting criteria as follows:

- 26 reporting criteria in total if the UE is not configured with any SCell or PSCell carrier frequency,
- 35 reporting criteria in total if the UE is configured with one SCell carrier frequency,
- 44 reporting criteria in total if the UE is configured with two SCell carrier frequencies,
- 53 reporting criteria in total if the UE is configured with three SCell carrier frequencies,
- 62 reporting criteria in total if the UE is configured with four SCell carrier frequencies,
- 71 reporting criteria in total if the UE is configured with five SCell carrier frequencies,
- 80 reporting criteria in total if the UE is configured with six SCell carrier frequencies,
- 35 reporting criteria in total if the UE is configured with one PSCell carrier frequency, and
- 44 reporting criteria in total if the UE is configured with one PSCell carrier frequency and one SCell carrier frequency.

Editor's note: the total reporting criteria are to be verified when the UE capabilities related to frame structure 3 are decided.

A UE supporting increased number of carriers to monitor beyond 3 carriers shall be able to support up to 20 reporting criteria for inter-frequency measurement category according to table 8.2.2-1. Additionally such UE shall be able to

support in parallel per category up to E_{cat} reporting criteria according to table 8.2.2-1. For the measurement categories belonging to measurements on: E-UTRA intra-frequency cells, E-UTRA inter-frequency cells, and inter-RAT per supported RAT, the UE need not support more than the total number of reporting criteria as follows:

- 39 reporting criteria in total if the UE is not configured with any SCell carrier frequency,
- 48 reporting criteria in total if the UE is configured with one SCell carrier frequency,
- 57 reporting criteria in total if the UE is configured with two SCell carrier frequencies,
- 48 reporting criteria in total if the UE is configured with one PSCell carrier frequency,
- 57 reporting criteria in total if the UE is configured with one PSCell carrier frequency and one SCell carrier frequencies,
- 66 reporting criteria in total if the UE is configured with three SCell carrier frequencies, and
- 75 reporting criteria in total if the UE is configured with four SCell carrier frequencies.
- 84 reporting criteria in total if the UE is configured with five SCell carrier frequencies
- 93 reporting criteria in total if the UE is configured with six SCell carrier frequencies

Editor's note: the total reporting criteria are to be verified when the UE capabilities related to frame structure 3 are decided.

The UE, which is capable of supporting EN-DC operation with NR PSCell and one or more NR carrier frequencies, in total shall be able to support in parallel per category up to E_{cat} reporting criteria according to table 8.2.2-1 in this section and table 9.1.4.2-1 in TS 38.133 [50]. For the measurement categories belonging to measurements on: E-UTRA intra-frequency cells, E-UTRA inter-frequency cells, inter-RAT per supported RAT, and NR cells on serving and non-serving carrier frequencies (i.e. without counting other categories that the UE shall always support in parallel), the UE, when configured with EN-DC, needs not support more than the number of reporting criteria $E_{cat,EN-DC,NR} + E_{cat,EN-DC,E-UTRA}$ in total, where

$E_{cat,EN-DC,NR}$ is specified in section 9.1.4.2 in TS 38.133 [50], and

$E_{cat,EN-DC,E-UTRA}$ is the total number of reporting criteria configured by PCell, except NR PSCell and NR SCells carrier frequencies:

- 36 reporting criteria if the UE is not configured with any SCell, regardless of the number of NR SCell carrier frequencies if any,
- $36 + 9 \times k$ reporting criteria if the UE is configured with at least one SCell, regardless of the number of NR SCell carrier frequencies if any, where k is the number of configured SCells carrier frequencies.

The UE, which is capable of supporting and configured with NE-DC operation with PSCell and NR PCell and one or more NR carrier frequencies, in total shall be able to support in parallel per category up to E_{cat} reporting criteria according to table 8.2.2-1 in this section and table 9.1.4.2-1 in TS 38.133 [50]. For the measurement categories belonging to measurements on: E-UTRA intra-frequency cells and E-UTRA inter-frequency cells, inter-RAT per supported RAT, and NR cells on serving and non-serving carrier frequencies (i.e. without counting other categories that the UE shall always support in parallel), the UE, when configured with NE-DC, needs not support more than the number of reporting criteria $E_{cat,NE-DC,NR} + E_{cat,NE-DC,E-UTRA}$ in total, where

$E_{cat,NE-DC,NR}$ is specified in section 9.1.4.2 in TS 38.133 [50], and

$E_{cat,NE-DC,E-UTRA} = E_{cat,NE-DC,E-UTRA,inter-RAT} + E_{cat,NE-DC,E-UTRA,intra-RAT}$, where

$E_{cat,NE-DC,E-UTRA,inter-RAT}$ is specified in section 9.1.4.2 in TS 38.133 [50], and

$E_{cat,NE-DC,E-UTRA,intra-RAT}$ is the total number of E-UTRA reporting criteria, including PSCell and SCells carrier frequencies:

- 19 reporting criteria if the UE is not configured with any SCell, regardless of the number of NR SCell carrier frequencies if any .

- $10 + 9 \times k$ reporting criteria if the UE is configured with least one SCell, where k is the number of configured E-UTRA serving carrier frequencies, including PSCell and SCells carrier frequencies, regardless of the number of NR SCell carrier frequencies if any.

Table 8.2.2-1: Requirements for reporting criteria per measurement category

Measurement category	E_{cat}	Note
Intra-frequency ^{Note 1, 5, 6}	10	Events for any one or a combination of intra-frequency RSRP, RSRQ, and RS-SINR ^{Note4} for E-UTRA intra-frequency cells
Intra-frequency UE Rx-Tx time difference ^{Note 5}	2	Intra-frequency UE Rx-Tx time difference measurements reported to E-UTRAN via RRC and to positioning server via LPP. Applies for UE supporting both LPP and UE Rx-Tx time difference measurement.
Intra-frequency RSTD ^{Note 2, 5, 6}	1	Intra-frequency RSTD measurement reporting for UE supporting OTDOA; 1 report capable of minimum 16 cell measurements for the intra-frequency
Intra-frequency RSRP and RSRQ measurements for E-CID ^{Note 5, 6}	1	Intra-frequency RSRP and RSRQ measurements for E-CID reported to E-SMLC via LPP [24]. One report capable of at least in total 9 intra-frequency RSRP and RSRQ measurements. Applicable to UE capable of reporting RSRP and RSRQ to E-SMLC via LPP.
Intra-frequency RSSI and channel occupancy measurements under operation with frame structure 3	1	One report capable of one UE RSSI and channel occupancy measurements per serving carrier frequency. Applicable for UE capable of performing and reporting UE RSSI and channel occupancy under operation with frame structure 3.
Inter-frequency ^{Note 5, 6}	10 / 28	Events for any one or a combination of inter-frequency RSRP, RSRQ, and RS-SINR ^{Note4} for E-UTRA inter-frequency cells (see note 3)
Inter-frequency RSTD ^{Note 2, 5, 6}	1	Inter-frequency RSTD measurement reporting for UE supporting OTDOA; 1 report capable of minimum 16 cell measurements for at least one inter-frequency. Only applicable as specified in Section 8.1.2.6.
Inter-frequency RSSI and channel occupancy measurements under operation with frame structure 3	1	One report capable of one UE RSSI and channel occupancy measurements for an inter-frequency. Applicable for UE capable of performing and reporting UE RSSI and channel occupancy under operation with frame structure 3.
Inter-RAT (GSM, cdma2000 1 x RTT and HRPD) Note 5	5	Only applicable for UE with this (inter-RAT) capability. This requirement ($E_{cat} = 5$) is per supported RAT.
Inter-RAT (UTRAN FDD, UTRAN TDD) Note 5	5 or 11	Only applicable for UE with this (inter-RAT) capability. This requirement ($E_{cat} = 5$ or 11) is per supported RAT. For UE which indicate support for Increased UE carrier monitoring UTRA $E_{cat} = 11$.
Inter-RAT NR carrier frequency ^{Note 5}	10	Events for NR cells on all inter-RAT NR carrier frequencies for UE capable of EN-DC operation. Only applicable for UE with this capability and measurements on any of the NR carrier frequencies other than the carrier frequency of the NR PSCell or NR SCell.
MBSFN measurements for MDT	1	MBSFN measurement reporting for UE supporting MBSFN measurements (MBSFN RSRP, MBSFN RSRQ, and MCH BLER) for MDT [2]; 1 report capable of minimum 1 MBSFN RSRP measurement [4], 1 MBSFN RSRQ measurement [4], and 1 MCH BLER measurement [4].

Note 1:	When the UE is configured with SCell, PSCell, PCell or NR PSCell carrier frequency, E_{cat} for Intra-frequency is applied per serving frequency.
Note 2:	When the UE is configured with one SCell carrier frequency, the UE shall be capable of supporting at least 2 reporting criteria for all RSTD measurements configured to be performed on PCell carrier frequency, SCell carrier frequency and inter-frequency carrier. When the UE is configured with two SCell carrier frequencies, the UE shall be capable of supporting at least 3 reporting criteria for all RSTD measurements configured to be performed on PCell carrier frequency, the two SCell carrier frequencies and inter-frequency carrier. These requirements apply when there is a single on-going LPP OTDOA location session.
Note 3:	Support of E_{cat} of 28 for Measurement category Inter-frequency is applied for a UE supporting increased number of carriers to monitor beyond 3.
Note 4:	For UEs supporting RS-SINR measurements
Note 5:	Applicable for UE configured with EN-DC operation mode.
Note 6:	Applicable for UE configured with NE-DC operation mode.

8.3 Measurements for E-UTRA carrier aggregation

8.3.1 Introduction

Requirements in this clause are applicable to UE supporting E-UTRA FDD, E-UTRA TDD and/or E-UTRA TDD-FDD carrier aggregation.

Non configured frequencies may be measured with measurement gaps or autonomous gaps according to the requirements in clause 8.1.2.3 (E-UTRAN inter frequency measurements and E-UTRAN inter frequency measurements with autonomous gaps).

For UE, which does not support simultaneous reception and transmission for inter-band TDD CA specified in TS 36.331, and is compliant to the requirements for inter-band CA with uplink in one E-UTRA band and without simultaneous Rx/Tx specified in TS 36.101, the inter-band CA requirements in Section 8.3 shall apply also with different TDD UL/DL subframe configurations and/or different special subframe configurations used in CCs of different bands, under the following additional conditions:

- UE is not simultaneously scheduled in UL and DL on the different CCs, and
- at least DL subframe #0 or DL subframe #5 are available for measurements in the measured cell.

The UE capable of SRS carrier based switching, when configured to perform SRS transmission and/or RACH transmission over one or more SCells without PUSCH shall meet the requirements defined in Section 8.3 provided the following condition is met:

- at least DL subframe #0 or DL subframe #5 per radio frame is available for measurements at the UE in the measured cell.

8.3.2 Measurements of the primary component carrier

Measurements of cells on the primary component carrier shall meet all applicable requirements (FDD or TDD) in clause 8.1.2.2 (E-UTRAN intra frequency measurements and E-UTRAN intra frequency measurements with autonomous gaps)

8.3.3 Measurements of a secondary component carrier

A Secondary component carrier may be activated, hibernated and deactivated by MAC-CE commands as specified in [17]. The applicable performance requirements depend on whether the SCell on the corresponding frequency is activated, dormant or deactivated.

8.3.3.1 Measurements of a secondary component carrier with active SCell

When the SCell is activated or dormant, measurement performance requirements for the frequency are those given in clause 8.1.2.2 (E-UTRAN intra frequency measurements and E-UTRAN intra frequency measurements with autonomous gaps). If common DRX is in use, then the requirements for that secondary component carrier are given by the applicable DRX requirements (FDD or TDD) in clause 8.1.2.2, otherwise the non DRX requirements are applicable. When *highSpeedEnhancedMeasFlag* is configured, the enhanced measurement requirements apply only to measurements of the primary component carrier and do not apply to measurements of a secondary component carrier

with active or dormant SCell. The applicable measurement accuracy requirements are in clause 9.1.11 (Carrier aggregation measurement accuracy)

8.3.3.2 Measurements of a secondary component carrier with deactivated SCell

This clause defines the measurement requirements of a secondary component carrier with deactivated SCell based on the parameter *measCycleSCell* defined in TS 36.331 [2].

8.3.3.2.1 E-UTRAN secondary component carrier measurements when no common DRX is used

When no DRX is in use the UE shall be able to identify a new detectable FDD or TDD cell on a secondary component carrier within $T_{\text{identify_scc}}$, according to the parameter *measCycleSCell* where $T_{\text{identify_scc}} = 20 \text{ measCycleSCell}$

A cell shall be considered detectable when

- RSRP related side conditions given in Clause 9.1 are fulfilled for a corresponding Band,
- RSRQ related side conditions given in Clause 9.1 are fulfilled for a corresponding Band,
- RS-SINR related side conditions given in Clause 9.1.17.2.1 are fulfilled for a corresponding Band,
- $SCH_RP|_{\text{dBm}}$ and $SCH \hat{E}_s/I_{ot}$ according to Annex B.2.7 for a corresponding Band.

The measurement period for deactivated scc measurements is $T_{\text{measure_scc}}$ according to the parameter *measCycleSCell* where $T_{\text{measure_scc}} = 5 \text{ measCycleSCell}$. The UE shall be capable of performing RSRP, RSRQ, and RS-SINR measurements for 8 identified cells on a secondary component carrier, and the UE physical layer shall be capable of reporting measurements to higher layers with the measurement period of $T_{\text{measure_scc}}$.

The measurement accuracy for all measured cells shall be as specified in the sub-clause 9.1.11 (Carrier aggregation measurement accuracy)

A UE may reconfigure the receiver bandwidth or turn on/off one of the RF chains when performing measurements on up to six SCCs with deactivated SCell. This may cause interruptions on PCell or activated SCell(s) or both that are specified in Section 7.8.

8.3.3.2.1.1 Measurement Reporting Requirements

8.3.3.2.1.1.1 Periodic Reporting

Reported RSRP, RSRQ, and RS-SINR measurements contained in periodically triggered measurement reports shall meet the applicable requirements in clause 9.

8.3.3.2.1.1.2 Event-triggered Periodic Reporting

Reported RSRP, RSRQ, and RS-SINR measurements contained in event triggered periodic measurement reports shall meet the applicable requirements in clause 9.

The first report in event triggered periodic measurement reporting shall meet the requirements specified in clause 8.3.3.2.1.1.3.

8.3.3.2.1.1.3 Event Triggered Reporting

Reported RSRP, RSRQ, and RS-SINR measurements contained in event triggered measurement reports shall meet the applicable requirements in clause 9.

The UE shall not send any event triggered measurement reports, as long as no reporting criteria are fulfilled.

The measurement reporting delay is defined as the time between an event that will trigger a measurement report and the point when the UE starts to transmit the measurement report over the air interface. This requirement assumes that the measurement report is not delayed by other RRC signalling on the DCCH. This measurement reporting delay excludes a delay uncertainty resulted when inserting the measurement report to the TTI of the uplink DCCH. The delay uncertainty is: $2 \times TTI_{\text{DCCH}}$ where TTI_{DCCH} is the duration of subframe or slot or subslot when the measurement report is transmitted

on the PUSCH with subframe or slot or subslot duration. This measurement reporting delay excludes a delay which is caused by no UL resources for UE to send the measurement report.

The event triggered measurement reporting delay, measured without L3 filtering shall be less than $T_{\text{identify_scc}}$ defined in Clause 8.3.3.2.1. When L3 filtering is used or IDC autonomous denial is configured, or the UE is configured to perform SRS carrier based switching, an additional delay can be expected.

If a cell which has been detectable at least for the time period $T_{\text{identify_scc}}$ defined in clause 8.3.3.2.1 becomes undetectable for a period ≤ 5 seconds and then the cell becomes detectable again and triggers an event, the event triggered measurement reporting delay shall be less than $T_{\text{measure_scc}}$ provided the timing to that cell has not changed more than $\pm 50 T_s$ and the L3 filter has not been used. When L3 filtering, or the UE is configured to perform SRS carrier based switching, is used an additional delay can be expected.

8.3.3.2.2 E-UTRAN secondary component carrier measurements when common DRX is used

When DRX is in use the UE shall be able to identify a new detectable FDD or TDD cell on a secondary component carrier within $T_{\text{identify_scc}}$, according to the parameter *measCycleSCell* where $T_{\text{identify_scc}} = \max(20 \text{ measCycleSCell}, T_{\text{identify_scc1}})$. $T_{\text{identify_scc1}}$ is given in table 8.3.3.2.2-1.

Table 8.3.3.2.2-1: Requirement for $T_{\text{identify_scc1}}$

DRX cycle length (s)	$T_{\text{identify_scc1}}$ (s) (DRX cycles)
≤ 0.04	0.8 (Note1)
$0.04 < \text{DRX-cycle} \leq 0.08$	Note2 (40)
0.128	3.2 (25)
$0.128 < \text{DRX-cycle} \leq 2.56$	Note2(20)
Note1: Number of DRX cycle depends upon the DRX cycle in use Note2: Time depends upon the DRX cycle in use	

A cell shall be considered detectable when

- RSRP related side conditions given in Clause 9.1 are fulfilled for a corresponding Band,
- RSRQ related side conditions given in Clause 9.1 are fulfilled for a corresponding Band,
- RS-SINR related side conditions given in Clause 9.1.17.2.1 are fulfilled for a corresponding Band,
- $SCH_RP|_{dBm}$ and $SCH \hat{E}s/Iot$ according to Annex B.2.7 for a corresponding Band.

The measurement period for deactivated scell measurements is $T_{\text{measure_scc}}$ according to the parameter *measCycleSCell* where $T_{\text{measure_scc}} = \max(5 \text{ measCycleSCell}, T_{\text{measure_scc1}})$. The UE shall be capable of performing RSRP, RSRQ, and RS-SINR measurements for 8 identified cells on a secondary component carrier, and the UE physical layer shall be capable of reporting measurements to higher layers with the measurement period of $T_{\text{measure_scc}}$. $T_{\text{measure_scc1}}$ is given in table 8.3.3.2.2-2

Table 8.3.3.2.2-2: Requirement for $T_{\text{measure_scc1}}$

DRX cycle length (s)	$T_{\text{measure_scc1}}$ (s) (DRX cycles)
≤ 0.04	0.2 (Note1)
$0.04 < \text{DRX-cycle} \leq 2.56$	Note2 (5)
Note1: Number of DRX cycle depends upon the DRX cycle in use Note2: Time depends upon the DRX cycle in use	

The measurement accuracy for all measured cells shall be as specified in the sub-clause 9.1.11 (Carrier aggregation measurement accuracy).

A UE may reconfigure receiver bandwidth taking into account the SCell activation/deactivation status, and when making measurements of cells on up to six SCCs with deactivated SCell. This may cause interruptions (packet drops) to a PCell or activated SCell(s) or both when the PCell and the SCell belong to the same frequency band. No interruptions while the On Duration timer is running shall be allowed when common DRX is used. The requirement considers only interruptions due to reconfiguration of the receiver bandwidth, and not due to other causes such as RF impairments or channel conditions.

8.3.3.2.2.1 Measurement Reporting Requirements

8.3.3.2.2.1.1 Periodic Reporting

Reported RSRP, RSRQ, and RS-SINR measurements contained in periodically triggered measurement reports shall meet the applicable requirements in clause 9.

8.3.3.2.2.1.2 Event-triggered Periodic Reporting

Reported RSRP, RSRQ, and RS-SINR measurements contained in event triggered periodic measurement reports shall meet the applicable requirements in clause 9.

The first report in event triggered periodic measurement reporting shall meet the requirements specified in clause 8.3.3.2.2.1.3.

8.3.3.2.2.1.3 Event Triggered Reporting

Reported RSRP, RSRQ, and RS-SINR measurements contained in event triggered measurement reports shall meet the applicable requirements in clause 9.

The UE shall not send any event triggered measurement reports, as long as no reporting criteria are fulfilled.

The measurement reporting delay is defined as the time between an event that will trigger a measurement report and the point when the UE starts to transmit the measurement report over the air interface. This requirement assumes that the measurement report is not delayed by other RRC signalling on the DCCH. This measurement reporting delay excludes a delay uncertainty resulted when inserting the measurement report to the TTI of the uplink DCCH. The delay uncertainty is: $2 \times TTI_{DCCH}$ where TTI_{DCCH} is the duration of subframe or slot or subslot when the measurement report is transmitted on the PUSCH with subframe or slot or subslot duration. This measurement reporting delay excludes a delay which is caused by no UL resources for UE to send the measurement report.

The event triggered measurement reporting delay, measured without L3 filtering shall be less than $T_{identify_scc}$ defined in Clause 8.3.3.2.2. When L3 filtering is used or IDC autonomous denial is configured, or the UE is configured to perform SRS carrier based switching, an additional delay can be expected.

If a cell which has been detectable at least for the time period $T_{identify_scc}$ defined in clause 8.3.3.2.2 becomes undetectable for a period ≤ 5 seconds and then the cell becomes detectable again and triggers an event, the event triggered measurement reporting delay shall be less than $T_{measure_scc}$ provided the timing to that cell has not changed more than $\pm 50 T_s$ and the L3 filter has not been used. When L3 filtering is used or the UE is configured to perform SRS carrier based switching, an additional delay can be expected.

8.3.3.3 Measurements on a secondary component carrier with FeMBMS/Unicast mixed cells and activated SCell

Requirements in this section apply for UE configured to operate on a secondary component carrier with activated SCell and one or more FeMBMS/Unicast mixed cells and capable of receiving at least one of *SystemInformationBlockType15* or *fembms-MixedCarrier-r14* indication and are provided with the information that one or more FeMBMS/Unicast mixed cells are present on the secondary component carrier to be measured.

The UE shall meet the requirements in Section 8.3.3.1, when performing measurements on a secondary component carrier with an active SCell and at least one FeMBMS/Unicast mixed cell which may or may not be the active SCell. The minimum number of cells that the UE shall be able to measure on includes also FeMBMS/Unicast mixed cells.

8.3.3.4 Measurements on a secondary component carrier with FeMBMS/Unicast mixed cells and deactivated SCell

Requirements in this section apply for UE configured to operate on a secondary component carrier with deactivated SCell and one or more FeMBMS/Unicast mixed cells and which are capable of receiving at least one of *SystemInformationBlockType15* or *fembms-MixedCarrier-r14* indication and are provided with the information that one or more FeMBMS/Unicast mixed cells are present on the secondary component carrier to be measured.

The UE shall meet the requirements in Section 8.3.3.2, when performing measurements on a secondary component carrier with a deactivated SCell and at least one FeMBMS/Unicast mixed cell which may or may not be the deactivated SCell. The minimum number of cells that the UE shall be able to measure on includes also FeMBMS/Unicast mixed cells.

8.4 OTDOA RSTD Measurements for E-UTRAN carrier aggregation

8.4.1 Introduction

This clause contains RSTD measurement requirements on UE capabilities for support of E-UTRA carrier aggregation. Requirements in this clause are applicable to all carrier aggregation capable UE which have been configured with one or two downlink SCell(s). Non-configured frequencies may be measured with measurement gaps according to the requirements in clause 8.1.2.6, i.e., E-UTRAN inter-frequency RSTD measurement period applies. Requirements in this clause are applicable for E-UTRA FDD, E-UTRA TDD and E-UTRA TDD-FDD carrier aggregation.

For UE, which does not support simultaneous reception and transmission for inter-band TDD CA specified in TS 36.331 [2], and is compliant to the requirements for inter-band CA with uplink in one E-UTRA band and without simultaneous Rx/Tx specified in TS 36.101 [5], RSTD requirements in Section 8.4 shall apply also with different TDD UL/DL subframe configurations and/or different special subframe configurations used in CCs of different bands, under the following additional conditions:

- all positioning subframes indicated in the OTDOA assistance data and specified in Section 9.1.10 are available for RSTD measurements in the measured and reference cells; and
- UE is not simultaneously scheduled in UL and DL on the different CCs.

The UE capable of SRS carrier based switching when configured to perform SRS transmission and/or RACH transmission over one or more SCells without PUSCH shall meet the requirements defined in Section 8.4 provided the following condition is met:

all positioning subframes indicated in the OTDOA assistance data and specified in Section 9.1.10 are available for RSTD measurements at the UE in the measured and reference cells.

If network-based CRS interference mitigation is enabled in a cell for which the UE performs RSTD measurements, the UE capable of supporting network-based CRS interference mitigation shall perform RSTD measurements and meet all the requirements in this section, provided the CRS are available within at least the PRS bandwidth in the subframes with PRS, with $N1=0$ and $N2=0$ subframes before and after the indicated PRS subframes respectively, during all positioning occasions within the RSTD measurement period.

8.4.2 Measurements on the primary component carrier

The RSTD measurements on cells belonging to the primary component carrier shall meet all applicable requirements (FDD or TDD) specified in clause 8.1.2.5, i.e., E-UTRAN intra-frequency RSTD measurement period applies.

The RSTD measurement accuracy for all the measurements on the primary component carrier shall be fulfilled according to the accuracy as specified in the sub-clause 9.1.12.

If the PCell is changed, regardless whether the primary component carrier is changed or not while the RSTD measurements are being performed on cells belonging to the primary component carrier, then the UE shall complete the ongoing OTDOA measurement session. In case of change of the primary component carrier, the requirements shall apply only if the primary component carrier is swapped with any of the currently configured secondary component carrier(s). The UE shall also meet the OTDOA measurement and accuracy requirements for the primary component

carrier. However in this case the total RSTD measurement period ($T_{\text{RSTD,E-UTRAN,PCell_change}}$) shall be according to the following expression:

$$T_{\text{RSTD,E-UTRAN,PCell_change}} = T_{\text{RSTD,E-UTRAN}} + K \times T_{\text{PRS}} + T_{\text{PCell_change}} \quad \text{ms},$$

where:

K is the number of times the PCell is changed during $T_{\text{RSTD,E-UTRAN,PCell_change}}$,

T_{PRS} is defined in clause 8.1.2.5,

$T_{\text{PCell_change}}$ is the time during which the RSTD measurement may not be possible due to PCell change; it can be up to 25 ms,

$T_{\text{RSTD,E-UTRAN}}$ corresponds to the E-UTRAN intra-frequency RSTD measurement period as specified in clause 8.1.2.5.

Furthermore, due to the PCell changing the UE shall meet the RSTD measurement accuracy for a PRS bandwidth which is not larger than the minimum channel bandwidth of those PCell/SCell(s) on whose carriers RSTD measurement is performed during the RSTD measurement period.

8.4.3 Measurements on a secondary component carrier

The RSTD measurements when all cells are on a configured secondary component carrier shall meet all applicable requirements (FDD or TDD) specified in clause 8.1.2.5, i.e., E-UTRAN intra-frequency RSTD measurement period applies, regardless of whether the Scell on the corresponding frequency is activated or deactivated by the MAC-CE commands as specified in [17].

The RSTD measurement accuracy for all the measurements on the secondary component carrier shall be fulfilled according to the accuracy as specified in the sub-clause 9.1.12.

A UE may reconfigure receiver bandwidth taking into account the SCell activation/deactivation status, RACH transmission over SCell without PUSCH if capable of SRS carrier based switching, and when making RSTD measurements on cells belonging to SCC with deactivated SCell. This may cause interruptions (packet drops) to a PCell when the PCell and the SCell belong to the adjacent or non-adjacent component carriers in the same frequency band or to different frequency bands. In this case, the UE shall follow the interruption requirements specified in Section 7.10. No interruption to the PCell shall be allowed during the PRS positioning occasion on the PCell.

If the PCell is changed, regardless whether the primary component carrier is changed or not while the RSTD measurements are being performed on cells belonging to the secondary component carrier, then the UE shall complete the ongoing OTDOA measurement session. In case of change of the primary component carrier, the requirements shall apply only if the primary component carrier is swapped with any of the currently configured secondary component carrier(s). The UE shall also meet the OTDOA measurement and accuracy requirements for the secondary component carrier. However in this case the total RSTD measurement period ($T_{\text{RSTD,E-UTRAN,PCell_change}}$) shall be according to the following expression:

$$T_{\text{RSTD,E-UTRAN,PCell_change}} = T_{\text{RSTD,E-UTRAN}} + K \times T_{\text{PRS}} + T_{\text{PCell_change}} \quad \text{ms},$$

where:

K is the number of times the PCell is changed during $T_{\text{RSTD,E-UTRAN,PCell_change}}$,

T_{PRS} is defined in clause 8.1.2.5,

$T_{\text{PCell_change}}$ is the time during which the RSTD measurement may not be possible due to PCell change; it can be up to 25 ms,

$T_{\text{RSTD,E-UTRAN}}$ corresponds to the E-UTRAN intra-frequency RSTD measurement period as specified in clause 8.1.2.5.

Furthermore, due to the PCell changing the UE shall meet the RSTD measurement accuracy for a PRS bandwidth which is not larger than the minimum channel bandwidth of those PCell/SCell(s) on whose carriers RSTD measurement is performed during the RSTD measurement period.

8.4.4 Measurements on both primary component carrier and a secondary component carrier

The RSTD measurements of cells on both primary component carrier and a configured secondary component carrier shall meet all applicable requirements (FDD-FDD, TDD-TDD, TDD-FDD or FDD-TDD inter-Frequency OTDOA) specified in clause 8.1.2.6, i.e., E-UTRAN inter-frequency RSTD measurement period applies regardless of whether the SCell on the corresponding frequency is activated or deactivated by the MAC-CE commands as specified in [17], with the following exceptions

- the number of PRS positioning occasions is as specified in Table 8.4.4-1 shall apply, and
- TDD uplink-downlink subframes configurations as specified in Clause 8.1.2.5.2, Table 8.1.2.5.2-2 shall apply.

Table 8.4.4-1: Number of PRS positioning occasions within measurement period

Positioning subframe configuration period T_{PRS}	Number of PRS positioning occasions M
160 ms	32
>160 ms	16

The RSTD measurement accuracy for all the measurements on both primary component carrier and the secondary component carrier shall be fulfilled according to the accuracy as specified in the sub-clause 9.1.12.

A UE may reconfigure its receiver bandwidth taking into account the SCell activation/deactivation status, RACH transmission over SCell without PUSCH if capable of SRS carrier based switching, and when performing RSTD measurements on cells belonging to at least SCC with deactivated SCell. This may cause interruptions (packet drops) on a PCell when the PCell and the SCell belong to the adjacent or non-adjacent component carriers in the same frequency band or to different frequency bands. In this case, the UE shall follow the interruption requirements specified in Section 7.10. No interruption to the PCell shall be allowed during the PRS positioning occasion on the PCell.

If the PCell is changed regardless whether the primary component carrier is changed or not while the RSTD measurements are being performed on cells belonging to both the primary component carrier and the secondary component carrier then the UE shall complete the ongoing OTDOA measurement session. In case of change of the primary component carrier, the requirements shall apply only if the primary component carrier is swapped with any of the currently configured secondary component carrier(s). The UE shall also meet the OTDOA measurement and accuracy requirements for the primary and secondary component carrier. However in this case the total RSTD measurement period ($T_{\text{RSTD,E-UTRAN,PCell_change}}$) shall be according to the following expression:

$$T_{\text{RSTD,E-UTRAN,PCell_change}} = T_{\text{RSTD,E-UTRAN}} + K \times T_{\text{PRS}} + T_{\text{PCell_change}} \quad \text{ms},$$

where:

K is the number of times the PCell is changed during $T_{\text{RSTD,E-UTRAN,PCell_change}}$,

T_{PRS} is defined in clause 8.1.2.6,

$T_{\text{PCell_change}}$ is the time during which the RSTD measurement may not be possible due to PCell change; it can be up to 25 ms,

$T_{\text{RSTD,E-UTRAN}}$ corresponds to the E-UTRAN inter-frequency RSTD measurement period as specified in clause 8.1.2.6 with the exception that the number of PRS positioning occasions is as specified in Table 8.4.4-1.

Furthermore, due to the PCell changing the UE shall meet the RSTD measurement accuracy for a PRS bandwidth which is not larger than the minimum channel bandwidth of those PCell/SCell(s) on whose carriers RSTD measurement is performed during the RSTD measurement period.

8.4.5 Measurements on different secondary component carriers

The RSTD measurements of cells on a configured secondary component carrier and another configured secondary component carrier shall meet all applicable requirements (FDD-FDD, TDD-TDD, TDD-FDD or FDD-TDD inter-Frequency OTDOA) specified in clause 8.1.2.6, i.e., E-UTRAN inter-frequency RSTD measurement period applies regardless of whether the SCell on the corresponding frequency is activated or deactivated by the MAC-CE commands as specified in [17], with the following exceptions

- the number of PRS positioning occasions is as specified in Table 8.4.4-1 shall apply, and
- TDD uplink-downlink subframes configurations as specified in Clause 8.1.2.5.2, Table 8.1.2.5.2-2 shall apply.

Table 8.4.4-1: Number of PRS positioning occasions within measurement period

Positioning subframe configuration period T_{PRS}	Number of PRS positioning occasions M
160 ms	32
>160 ms	16

The RSTD measurement accuracy for all the measurements on the secondary component carriers shall be fulfilled according to the accuracy as specified in the sub-clause 9.1.12.

A UE may reconfigure its receiver bandwidth taking into account the SCell activation/deactivation status, RACH transmission over SCell without PUSCH if capable of SRS carrier based switching, and when performing RSTD measurements on cells belonging to at least SCC with deactivated SCell. This may cause interruptions (packet drops) on a PCell when the PCell and the SCell belong to the adjacent or non-adjacent component carriers in the same frequency band or to different frequency bands. In this case, the UE shall follow the interruption requirements specified in Section 7.10. No interruption to the PCell shall be allowed during the PRS positioning occasion on the PCell. No interruption to the SCells shall be allowed during the PRS positioning occasion on the SCells.

If the PCell is changed regardless whether the primary component carrier is changed or not while the RSTD measurements are being performed on cells belonging to the secondary component carriers then the UE shall complete the ongoing OTDOA measurement session. In case of change of the primary component carrier, the requirements shall apply only if the primary component carrier is swapped with any of the currently configured secondary component carrier(s). The UE shall also meet the OTDOA measurement and accuracy requirements for the secondary component carriers. However in this case the total RSTD measurement period ($T_{\text{RSTD,E-UTRAN,PCell_change}}$) shall be according to the following expression:

$$T_{\text{RSTD,E-UTRAN,PCell_change}} = T_{\text{RSTD,E-UTRAN}} + K \times T_{\text{PRS}} + T_{\text{PCell_change}} \quad \text{ms},$$

where:

K is the number of times the PCell is changed during $T_{\text{RSTD,E-UTRAN,PCell_change}}$,

T_{PRS} is defined in clause 8.1.2.6,

$T_{\text{PCell_change}}$ is the time during which the RSTD measurement may not be possible due to PCell change; it can be up to 25 ms,

$T_{\text{RSTD,E-UTRAN}}$ corresponds to the E-UTRAN inter-frequency RSTD measurement period as specified in clause 8.1.2.6 with the exception that the number of PRS positioning occasions is as specified in Table 8.4.4-1.

Furthermore, due to the PCell changing the UE shall meet the RSTD measurement accuracy for a PRS bandwidth which is not larger than the minimum channel bandwidth of those PCell/SCell(s) on whose carriers RSTD measurement is performed during the RSTD measurement period.

8.5 Measurements for UE category 0

8.5.1 Introduction

The UE category 0 applicability of the requirements in subclause 8.5 is defined in Section 3.6.1.

This clause contains requirements on the UE regarding measurement reporting in RRC_CONNECTED state. The requirements are specified for E-UTRA intra frequency measurements. These measurements may be used by the E-UTRAN, e.g. for handover decisions. The measurement quantities are defined in [4], the measurement model is defined in [22] and measurement accuracies are specified in clause 9. Control of measurement reporting is specified in TS 36.331 [2].

When the UE is provided with IDC solution, the UE shall also perform RRM measurements and meet the corresponding requirements in clause 8.

8.5.2 Requirements

8.5.2.1 E-UTRAN intra frequency measurements

The UE shall be able to identify new intra-frequency cells and perform RSRP measurements of identified intra-frequency cells without an explicit intra-frequency neighbour cell list containing physical layer cell identities. During the RRC_CONNECTED state the UE shall continuously measure identified intra frequency cells and additionally search for and identify new intra frequency cells.

8.5.2.1.1 E-UTRAN FDD intra frequency measurements

8.5.2.1.1.1 E-UTRAN intra frequency measurements when no DRX is used

When no DRX is in use the UE shall be able to identify a new detectable FDD intra frequency cell within

$$T_{\text{identify_intra_UE cat 0}} = T_{\text{basic_identify_E-UTRA_FDD_UE cat 0}} \cdot \frac{T_{\text{Measurement_Period_UE cat 0, Intra}}}{T_{\text{Intra}}} \quad \text{ms}$$

where

$T_{\text{basic_identify_E-UTRA_FDD_UE cat 0, intra}}$ is 1000 ms

A cell shall be considered detectable when

- RSRP related side conditions given in Sections 9.1.13.1 and 9.1.13.2 and RSRQ related side conditions given in Clause 9.1.13.3 are fulfilled for a corresponding Band,
- SCH_{RP} and SCH_{Es/Iot} according to Annex B.2.1 for a corresponding Band.

For category 1bis UE, a cell shall be considered detectable when

- RSRP related side conditions given in Sections 9.1.2.7 and 9.1.2.8 and RSRQ related side conditions given in Clause 9.1.5.5 are fulfilled for a corresponding Band,
- SCH_{RP} and SCH_{Es/Iot} according to Annex B.2.1 for a corresponding Band.

T_{Intra} : This is the minimum time that is available for intra frequency measurements, during the measurement period with an arbitrarily chosen timing. Time is assumed to be available for performing intra frequency measurements whenever the receiver is guaranteed to be active on the intra frequency carrier.

Identification of a cell shall include detection of the cell and additionally performing a single measurement with measurement period of $T_{\text{Measurement_Period_UE cat 0 Intra}}$. If higher layer filtering is used, an additional cell identification delay can be expected.

In the RRC_CONNECTED state the measurement period for intra frequency measurements is 400 ms. When no measurement gaps are activated, the low complexity UE shall be capable of performing RSRP and RSRQ measurements for 8 identified-intra-frequency cells, and the UE physical layer shall be capable of reporting measurements to higher layers with the measurement period of 400 ms. When measurement gaps are activated the UE shall be capable of performing measurements for at least $Y_{\text{measurement intra_UE cat 0}}$ cells, where $Y_{\text{measurement intra_UE cat 0}}$ is defined in the following

equation. If the UE has identified more than $Y_{\text{measurement_intra_UE cat 0}}$ cells, the UE shall perform measurements of at least 8 identified intra-frequency cells but the reporting rate of RSRP and RSRQ measurements of cells from UE physical layer to higher layers may be decreased.

$$Y_{\text{measurement_intra_UE cat 0}} = \text{Floor} \left\{ X_{\text{basic_measurement_FDD_UE cat 0}} \cdot \frac{T_{\text{Intra}}}{T_{\text{Measurement_Period_UE cat 0, Intra}}} \right\}$$

cells where

$$X_{\text{basic_measurement_FDD_UE cat 0}} = 8 \text{ (cells)}$$

$T_{\text{Measurement_Period_UE cat 0, Intra}} = 400$ ms. The measurement period for Intra frequency RSRP and RSRQ measurements.

The RSRP measurement accuracy for all measured cells shall be as specified in the sub-clauses 9.1.13.1 and 9.1.13.2, and the RSRQ measurement accuracy for all measured cells shall be as specified in the sub-clause 9.1.13.3. For category 1bis UE, the RSRP measurement accuracy for all measured cells shall be as specified in the sub-clauses 9.1.2.7 and 9.1.2.8, and the RSRQ measurement accuracy for all measured cells shall be as specified in the sub-clause 9.1.5.5.

8.5.2.1.1.1.1 Measurement Reporting Requirements

8.5.2.1.1.1.1.1 Periodic Reporting

Reported RSRP and RSRQ measurements contained in periodically triggered measurement reports shall meet the requirements in sections 9.1.13.1, 9.1.13.2 and 9.1.13.3, respectively.

8.5.2.1.1.1.1.2 Event-triggered Periodic Reporting

Reported RSRP and RSRQ measurements contained in event triggered periodic measurement reports shall meet the requirements in sections 9.1.13.1, 9.1.13.2 and 9.1.13.3, respectively.

The first report in event triggered periodic measurement reporting shall meet the requirements specified in clause 8.5.2.1.1.1.1.3.

8.5.2.1.1.1.1.3 Event Triggered Reporting

Reported RSRP and RSRQ measurements contained in event triggered measurement reports shall meet the requirements in sections 9.1.13.1, 9.1.13.2 and 9.1.13.3, respectively.

The UE shall not send any event triggered measurement reports, as long as no reporting criteria are fulfilled.

The measurement reporting delay is defined as the time between an event that will trigger a measurement report and the point when the UE starts to transmit the measurement report over the air interface. This requirement assumes that the measurement report is not delayed by other RRC signalling on the DCCH. This measurement reporting delay excludes a delay uncertainty resulted when inserting the measurement report to the TTI of the uplink DCCH. The delay uncertainty is: $2 \times TTI_{\text{DCCH}}$. This measurement reporting delay excludes a delay which caused by no UL resources for UE to send the measurement report.

The event triggered measurement reporting delay, measured without L3 filtering shall be less than $T_{\text{identify_intra_UE cat 0}}$ defined in Clause 8.5.2.1.1.1. When L3 filtering is used or IDC autonomous denial is configured an additional delay can be expected.

If a cell which has been detectable at least for the time period $T_{\text{identify_intra_UE cat 0}}$ defined in clause 8.5.2.1.1.1 becomes undetectable for a period ≤ 5 seconds and then the cell becomes detectable again and triggers an event, the event triggered measurement reporting delay shall be less than $T_{\text{Measurement_Period_UE cat 0, Intra}}$ provided the timing to that cell has not changed more than $\pm 50 T_s$ and the L3 filter has not been used. When L3 filtering is used or IDC autonomous denial is configured, an additional delay can be expected.

8.5.2.1.1.2 E-UTRAN intra frequency measurements when DRX is used

When DRX is in use the UE shall be able to identify a new detectable FDD intra frequency cell within $T_{\text{identify_intra_UE cat 0}}$ as shown in table 8.5.2.1.1.2-1. When eDRX_CONN is in use the UE shall be able to identify a new detectable FDD intra-frequency cell within $T_{\text{identify_intra_UE cat 0}}$ as shown in table 8.5.2.1.1.2-1A.

Table 8.5.2.1.1.2-1: Requirement to identify a newly detectable FDD intrafrequency cell

DRX cycle length (s)	$T_{\text{identify_intra_UE cat 0}}$ (s) (DRX cycles)
≤ 0.04	1 (Note1)
$0.04 < \text{DRX-cycle} \leq 0.08$	Note2 (40)
0.128	3.2 (25)
$0.128 < \text{DRX-cycle} \leq 2.56$	Note2(20)
Note1: Number of DRX cycle depends upon the DRX cycle in use Note2: Time depends upon the DRX cycle in use	

Table 8.5.2.1.1.2-1A: Requirement to identify a newly detectable FDD intra-frequency cell when eDRX_CONN cycle is used

eDRX_CONN cycle length (s)	$T_{\text{identify_intra_UE cat 0}}$ (eDRX_CONN cycles)
$2.56 < \text{eDRX_CONN cycle} \leq 10.24$	Note(20)
Note: Time depends upon the eDRX_CONN cycle in use	

A cell shall be considered detectable when

- RSRP related side conditions given in Sections 9.1.13.1 and 9.1.13.2 and RSRQ related side conditions given in Clause 9.1.13.3 are fulfilled for a corresponding Band,
- SCH_RP and SCH \hat{E}_s/lot according to Annex B.2.1 for a corresponding Band

For category 1bis UE, a cell shall be considered detectable when

- RSRP related side conditions given in Sections 9.1.2.7 and 9.1.2.8 and RSRQ related side conditions given in Clause 9.1.5.5 are fulfilled for a corresponding Band,
- SCH_RP and SCH \hat{E}_s/lot according to Annex B.2.1 for a corresponding Band.

In the RRC_CONNECTED state the measurement period for intra frequency measurements is $T_{\text{measure_intra_UE cat 0}}$. When DRX is used, $T_{\text{measure_intra_UE cat 0}}$ is as defined in table 8.5.2.1.1.2-2, when eDRX_CONN is used, $T_{\text{measure_intra_UE cat 0}}$ is as defined in table 8.5.2.1.1.2-3. The UE shall be capable of performing RSRP and RSRQ measurements for 8 identified-intra-frequency cells, and the UE physical layer shall be capable of reporting measurements to higher layers with the measurement period of $T_{\text{measure_intra_UE cat 0}}$.

Table 8.5.2.1.1.2-2: Requirement to measure FDD intrafrequency cells

DRX cycle length (s)	$T_{\text{measure_intra_UE cat 0}}$ (s) (DRX cycles)
≤ 0.08	0.4 (Note1)
$0.08 < \text{DRX-cycle} \leq 2.56$	Note2 (5)
Note1: Number of DRX cycle depends upon the DRX cycle in use Note2: Time depends upon the DRX cycle in use	

Table 8.5.2.1.1.2-3: Requirement to measure FDD intra-frequency cells when eDRX_CONN cycle is used

eDRX_CONN cycle length (s)	$T_{\text{measure_intra_UE cat 0}}$ (eDRX_CONN cycles)
$2.56 < \text{eDRX_CONN cycle} \leq 10.24$	Note (5)
Note: Time depends upon the eDRX_CONN cycle in use	

The RSRP measurement accuracy for all measured cells shall be as specified in the sub-clauses 9.1.13.1 and 9.1.13.2, and the RSRQ measurement accuracy for all measured cells shall be as specified in the sub-clause 9.1.13.3.

For category 1bis UE, the RSRP measurement accuracy for all measured cells shall be as specified in the sub-clauses 9.1.2.7 and 9.1.2.8, and the RSRQ measurement accuracy for all measured cells shall be as specified in the sub-clause 9.1.5.5.

8.5.2.1.1.2.1 Measurement Reporting Requirements

8.5.2.1.1.2.1.1 Periodic Reporting

Reported RSRP and RSRQ measurements contained in periodically triggered measurement reports shall meet the requirements in sections 9.1.13.1, 9.1.13.2 and 9.1.13.3, respectively.

8.5.2.1.1.2.1.2 Event-triggered Periodic Reporting

Reported RSRP and RSRQ measurements contained in event triggered periodic measurement reports shall meet the requirements in sections 9.1.13.1, 9.1.13.2 and 9.1.13.3, respectively.

The first report in event triggered periodic measurement reporting shall meet the requirements specified in clause 8.5.2.1.1.2.1.3.

8.5.2.1.1.2.1.3 Event Triggered Reporting

Reported RSRP and RSRQ measurements contained in event triggered measurement reports shall meet the requirements in sections 9.1.13.1, 9.1.13.2 and 9.1.13.3, respectively.

The UE shall not send any event triggered measurement reports, as long as no reporting criteria are fulfilled.

The measurement reporting delay is defined as the time between an event that will trigger a measurement report and the point when the UE starts to transmit the measurement report over the air interface. This requirement assumes that the measurement report is not delayed by other RRC signalling on the DCCH. This measurement reporting delay excludes a delay uncertainty resulted when inserting the measurement report to the TTI of the uplink DCCH. The delay uncertainty is: $2 \times TTI_{DCCH}$. This measurement reporting delay excludes a delay which caused by no UL resources for UE to send the measurement report.

The event triggered measurement reporting delay, measured without L3 filtering shall be less than $T_{\text{identify_intra_UE cat 0}}$ defined in Clause 8.5.2.1.1.2. When L3 filtering is used or IDC autonomous denial is configured an additional delay can be expected.

If a cell which has been detectable at least for the time period $T_{\text{identify_intra_UE cat 0}}$ defined in clause 8.5.2.1.1.2 becomes undetectable for a period ≤ 5 seconds and then the cell becomes detectable again and triggers an event, the event triggered measurement reporting delay shall be less than $T_{\text{measure_intra_UE cat 0}}$ provided the timing to that cell has not changed more than ± 50 Ts and the L3 filter has not been used. When L3 filtering is used or IDC autonomous denial is configured, an additional delay can be expected.

8.5.2.1.2 E-UTRAN intra frequency measurements for HD-FDD

8.5.2.1.2.1 E-UTRAN intra frequency measurements when no DRX is used

The requirements in this section are applicable for the UE which supports half duplex operation on one or more supported frequency bands [2].

The requirements defined in clause 8.5.2.1.1.1 also apply for this section provided the following conditions are met:

- at least downlink subframe # 0 or downlink subframe # 5 per radio frame of an intra-frequency cell to be identified by the UE is available at the UE over $T_{\text{identify_intra_UE cat 0}}$;
- at least one downlink subframe per radio frame of measured cell is available at the UE for RSRP and RSRQ measurements assuming measured cell is identified cell over $T_{\text{measure_intra_UE cat 0}}$.

8.5.2.1.2.2 E-UTRAN intra frequency measurements when DRX is used

When DRX is in use the UE shall be able to identify a new detectable FDD intra frequency cell within $T_{\text{identify_intra_UE cat 0}}$ as shown in table 8.5.2.1.2.2-1. When eDRX_CONN is in use the UE shall be able to identify a new detectable FDD intra-frequency cell within $T_{\text{identify_intra_UE cat 0}}$ as shown in table 8.5.2.1.2.2-1A.

Table 8.5.2.1.2.2-1: Requirement to identify a newly detectable HD-FDD intrafrequency cell

DRX cycle length (s)	$T_{\text{identify_intra_UE cat 0}}$ (s) (DRX cycles)
≤ 0.04	1 (Note1)
$0.04 < \text{DRX-cycle} \leq 0.08$	Note2 (50)
0.128	3.2 (32)
$0.128 < \text{DRX-cycle} \leq 2.56$	Note2(25)
Note1: Number of DRX cycle depends upon the DRX cycle in use Note2: Time depends upon the DRX cycle in use	

Table 8.5.2.1.2.2-1A: Requirement to identify a newly detectable HD-FDD intra-frequency cell when eDRX_CONN cycle is used

eDRX_CONN cycle length (s)	$T_{\text{identify_intra_UE cat 0}}$ (eDRX_CONN cycles)
$2.56 < \text{eDRX_CONN cycles} \leq 10.24$	Note (25)
Note: Time depends upon the eDRX_CONN cycle in use	

A cell shall be considered detectable when

- RSRP related side conditions given in Sections 9.1.13.1 and 9.1.13.2 and RSRQ related side conditions given in Clause 9.1.13.3 are fulfilled for a corresponding Band,
- SCH_RP and SCH \hat{E}_s/I_{ot} according to Annex B.2.1 for a corresponding Band

When DRX is in use, in the RRC_CONNECTED state the measurement period for intra frequency measurements is $T_{\text{measure_intra_UE cat 0}}$ as shown in table 8.5.2.1.2.2-2. When eDRX_CONN is in use in the RRC_CONNECTED state, the measurement period for intra-frequency measurements is $T_{\text{measure_intra_UE cat 0}}$ as shown in table 8.5.2.1.2.2-3. The UE shall be capable of performing RSRP and RSRQ measurements for 8 identified-intra-frequency cells, and the UE physical layer shall be capable of reporting measurements to higher layers with the measurement period of $T_{\text{measure_intra_UE cat 0}}$.

Table 8.5.2.1.2.2-2: Requirement to measure HD-FDD intrafrequency cells

DRX cycle length (s)	$T_{\text{measure_intra_UE cat 0}}$ (s) (DRX cycles)
≤ 0.04	0.4 (Note1)
$0.04 < \text{DRX-cycle} \leq 0.16$	Note2 (7)
$0.16 < \text{DRX-cycle} \leq 2.56$	Note2(5)
Note1: Number of DRX cycle depends upon the DRX cycle in use Note2: Time depends upon the DRX cycle in use	

Table 8.5.2.1.2.2-3: Requirement to measure HD-FDD intra-frequency cells when eDRX_CONN cycle is used

eDRX_CONN cycle length (s)	$T_{\text{measure_intra_UE cat 0}}$ (eDRX_CONN cycles)
$2.56 < \text{eDRX_CONN cycle} \leq 10.24$	Note (5)
Note: Time depends upon the eDRX_CONN cycle in use	

The RSRP measurement accuracy for all measured cells shall be as specified in the sub-clauses 9.1.13.1 and 9.1.13.2, and the RSRQ measurement accuracy for all measured cells shall be as specified in the sub-clause 9.1.13.3.

8.5.2.1.1.2.1 Measurement Reporting Requirements

8.5.2.1.1.2.1.1 Periodic Reporting

Reported RSRP and RSRQ measurements contained in periodically triggered measurement reports shall meet the requirements in sections 9.1.13.1, 9.1.13.2 and 9.1.13.3, respectively.

8.5.2.1.1.2.1.2 Event-triggered Periodic Reporting

Reported RSRP and RSRQ measurements contained in event triggered periodic measurement reports shall meet the requirements in sections 9.1.13.1, 9.1.13.2 and 9.1.13.3, respectively.

The first report in event triggered periodic measurement reporting shall meet the requirements specified in clause 8.5.2.1.1.2.1.3.

8.5.2.1.1.2.1.3 Event Triggered Reporting

Reported RSRP and RSRQ measurements contained in event triggered measurement reports shall meet the requirements in sections 9.1.13.1, 9.1.13.2 and 9.1.13.3, respectively.

The UE shall not send any event triggered measurement reports, as long as no reporting criteria are fulfilled.

The measurement reporting delay is defined as the time between an event that will trigger a measurement report and the point when the UE starts to transmit the measurement report over the air interface. This requirement assumes that the measurement report is not delayed by other RRC signalling on the DCCH. This measurement reporting delay excludes a delay uncertainty resulted when inserting the measurement report to the TTI of the uplink DCCH. The delay uncertainty is: $2 \times TTI_{DCCH}$. This measurement reporting delay excludes a delay which caused by no UL resources for UE to send the measurement report.

The event triggered measurement reporting delay, measured without L3 filtering shall be less than $T_{\text{identify_intra_UE cat 0}}$ defined in Clause 8.5.2.1.1.2 When L3 filtering is used or IDC autonomous denial is configured an additional delay can be expected.

If a cell which has been detectable at least for the time period $T_{\text{identify_intra_UE cat 0}}$ defined in clause 8.5.2.1.1.2 becomes undetectable for a period ≤ 5 seconds and then the cell becomes detectable again and triggers an event, the event triggered measurement reporting delay shall be less than $T_{\text{measure_intra_UE cat 0}}$ provided the timing to that cell has not changed more than $\pm 50 T_s$ and the L3 filter has not been used. When L3 filtering is used or IDC autonomous denial is configured, an additional delay can be expected.

8.5.2.1.3 E-UTRAN TDD intra frequency measurements

8.5.2.1.3.1 E-UTRAN intra frequency measurements when no DRX is used

When no DRX is in use the UE shall be able to identify a new detectable TDD intra frequency cell within

$$T_{\text{identify_intra_UEcat 0}} = T_{\text{basic_identify_E-UTRA_TDD_UEcat 0, intra}} \cdot \frac{T_{\text{Measurement Period_UEcat 0, Intra}}}{T_{\text{Intra}}} \quad \text{ms}$$

where

$T_{\text{basic_identify_E-UTRA_TDD_UE cat 0, intra}}$ is 1000 ms

A cell shall be considered detectable when

- RSRP related side conditions given in Sections 9.1.13.1 and 9.1.13.2 and RSRQ related side conditions given in Clause 9.1.13.3 are fulfilled for a corresponding Band,
- SCH_RP and $SCH \hat{E}s/Iot$ according to Annex B.2.1 for a corresponding Band

For category 1bis UE, a cell shall be considered detectable when

- RSRP related side conditions given in Sections 9.1.2.7 and 9.1.2.8 and RSRQ related side conditions given in Clause 9.1.5.5 are fulfilled for a corresponding Band,
- SCH_RP and $SCH \hat{E}s/Iot$ according to Annex B.2.1 for a corresponding Band.

T_{Intra} : This is the minimum time that is available for intra frequency measurements, during the measurement period with an arbitrarily chosen timing. Time is assumed to be available for performing intra frequency measurements whenever the receiver is guaranteed to be active on the intra frequency carrier.

Identification of a cell shall include detection of the cell and additionally performing a single measurement with measurement period of $T_{\text{Measurement_Period_UE cat 0 Intra}}$. If higher layer filtering is used, an additional cell identification delay can be expected.

In the RRC_CONNECTED state the measurement period for intra frequency measurements is 400 ms. When no measurement gaps are activated, the UE shall be capable of performing RSRP and RSRQ measurements for 8 identified-intra-frequency cells, and the UE physical layer shall be capable of reporting measurements to higher layers with the measurement period of 400 ms. When measurement gaps are activated the UE shall be capable of performing measurements for at least $Y_{\text{measurement intra_UE cat 0}}$ cells, where $Y_{\text{measurement intra_UE cat 0}}$ is defined in the following equation. If the UE has identified more than $Y_{\text{measurement intra_UE cat 0}}$ cells, the UE shall perform measurements of at least 8 identified intra-frequency cells but the reporting rate of RSRP and RSRQ measurements of cells from UE physical layer to higher layers may be decreased.

$$Y_{\text{measurement intra_UE cat 0}} = \text{Floor} \left\{ X_{\text{basic measurement TDD_UE cat 0}} \cdot \frac{T_{\text{Intra}}}{T_{\text{Measurement_Period_UE cat 0, Intra}}} \right\}$$

cells where

$$X_{\text{basic measurement TDD_UE cat 0}} = 8 \text{ (cells)}$$

$T_{\text{Measurement_Period intra_UE cat 0}} = 400$ ms. The measurement period for Intra frequency RSRP and RSRQ measurements.

The RSRP measurement accuracy for all measured cells shall be as specified in the sub-clauses 9.1.13.1 and 9.1.13.2, and the RSRQ measurement accuracy for all measured cells shall be as specified in the sub-clause 9.1.13.3.

For category 1bis UE, the RSRP measurement accuracy for all measured cells shall be as specified in the sub-clauses 9.1.2.7 and 9.1.2.8, and the RSRQ measurement accuracy for all measured cells shall be as specified in the sub-clause 9.1.5.5.

8.5.2.1.3.1.1 Measurement Reporting Requirements

8.5.2.1.3.1.1.1 Periodic Reporting

Reported RSRP and RSRQ measurements contained in periodically triggered measurement reports shall meet the requirements in sections 9.1.13.1, 9.1.13.2 and 9.1.13.3, respectively.

8.5.2.1.3.1.1.2 Event-triggered Periodic Reporting

Reported RSRP and RSRQ measurements contained in event triggered periodic measurement reports shall meet the requirements in sections 9.1.13.1, 9.1.13.2 and 9.1.13.3, respectively.

The first report in event triggered periodic measurement reporting shall meet the requirements specified in clause 8.5.2.1.3.1.1.3.

8.5.2.1.3.1.1.3 Event Triggered Reporting

Reported RSRP and RSRQ measurements contained in event triggered measurement reports shall meet the requirements in sections 9.1.13.1, 9.1.13.2 and 9.1.13.3, respectively.

The UE shall not send any event triggered measurement reports, as long as no reporting criteria are fulfilled.

The measurement reporting delay is defined as the time between an event that will trigger a measurement report and the point when the UE starts to transmit the measurement report over the air interface. This requirement assumes that the measurement report is not delayed by other RRC signalling on the DCCH. This measurement reporting delay excludes a delay uncertainty resulted when inserting the measurement report to the TTI of the uplink DCCH. The delay uncertainty is: $2 \times TTI_{\text{DCCH}}$. This measurement reporting delay excludes a delay which caused by no UL resources for UE to send the measurement report.

The event triggered measurement reporting delay, measured without L3 filtering shall be less than $T_{\text{identify_intra_UE cat 0}}$ defined in Clause 8.5.2.1.3.1. When L3 filtering is used or IDC autonomous denial is configured an additional delay can be expected.

If a cell which has been detectable at least for the time period $T_{\text{identify_intra_UE cat 0}}$ defined in clause 8.5.2.1.3.1 becomes undetectable for a period ≤ 5 seconds and then the cell becomes detectable again and triggers an event, the event triggered measurement reporting delay shall be less than $T_{\text{Measurement_Period Intra_UE cat 0}}$ provided the timing to that cell has not changed more than $\pm 50 T_s$ and the L3 filter has not been used. When L3 filtering is used or IDC autonomous denial is configured, an additional delay can be expected.

8.5.2.1.3.2 E-UTRAN intra frequency measurements when DRX is used

When DRX is in use the UE shall be able to identify a new detectable TDD intra frequency cell within $T_{\text{identify_intra_UE cat 0}}$ as shown in table 8.5.2.1.3.2-1. When eDRX_CONN is in use the UE shall be able to identify a new detectable TDD intra-frequency cell within $T_{\text{identify_intra_UE cat 0}}$ as defined in table 8.5.2.1.3.2-1A.

Table 8.5.2.1.3.2-1: Requirement to identify a newly detectable TDD intrafrequency cell

DRX cycle length (s)	$T_{\text{identify_intra_UE cat 0}}$ (s) (DRX cycles)
≤ 0.04	1 (Note1)
$0.04 < \text{DRX-cycle} \leq 0.08$	Note2 (40)
0.128	3.2 (25)
$0.128 < \text{DRX-cycle} \leq 2.56$	Note2(20)
Note1: Number of DRX cycle depends upon the DRX cycle in use Note2: Time depends upon the DRX cycle in use	

Table 8.5.2.1.3.2-1A: Requirement to identify a newly detectable TDD intra-frequency cell when eDRX_CONN cycle is used

eDRX_CONN cycle length (s)	$T_{\text{identify_intra_UE cat 0}}$ (s) (eDRX_CONN cycles)
$2.56 < \text{eDRX_CONN cycles} \leq 10.24$	Note (20)
Note: Time depends upon the eDRX_CONN cycle in use	

A cell shall be considered detectable when

- RSRP related side conditions given in Clause 9.1.13.1 and 9.1.13.2 and RSRQ related side conditions given in Clause 9.1.13.3 are fulfilled for a corresponding Band,
- SCH_RP and SCH \hat{E}_s/Iot according to Annex B.2.1 for a corresponding Band

For category 1bis UE, a cell shall be considered detectable when

- RSRP related side conditions given in Sections 9.1.2.7 and 9.1.2.8 and RSRQ related side conditions given in Clause 9.1.5.5 are fulfilled for a corresponding Band,
- SCH_RP and SCH \hat{E}_s/Iot according to Annex B.2.1 for a corresponding Band.

When DRX is in use in the RRC_CONNECTED state the measurement period for intra frequency measurements is $T_{\text{measure_intra_UE cat 0}}$ as shown in table 8.5.2.1.3.2-2. When eDRX_CONN in the RRC_CONNECTED state is in use, the measurement period for intra-frequency measurements is $T_{\text{measure_intra_UE cat 0}}$ as defined in table 8.5.2.1.3.2-3. The UE shall be capable of performing RSRP and RSRQ measurements for 8 identified intra-frequency cells and the UE physical layer shall be capable of reporting measurements to higher layers with the measurement period of $T_{\text{measure_intra_UE cat 0}}$.

Table 8.5.2.1.3.2-2: Requirement to measure TDD intra frequency cells

DRX cycle length (s)	$T_{\text{measure_intra_UE cat 0}}$ (s) (DRX cycles)
≤ 0.08	0.4 (Note1)

0.08<DRX-cycle≤2.56	Note2 (5)
<p>Note1: Number of DRX cycle depends upon the DRX cycle in use.</p> <p>Note2: Time depends upon the DRX cycle in use.</p>	

Table 8.5.2.1.3.2-3: Requirement to measure TDD intra-frequency cells when eDRX_CONN cycle is used

eDRX_CONN cycle length (s)	$T_{\text{measure_intra_UE cat 0}} (s)$ (eDRX_CONN cycles)
2.56<eDRX_CONN cycle≤10.24	Note (5)
Note: Time depends upon the eDRX_CONN cycle in use.	

The RSRP measurement accuracy for all measured cells shall be as specified in the sub-clauses 9.1.13.1 and 9.1.13.2, and the RSRQ measurement accuracy for all measured cells shall be as specified in the sub-clause 9.1.13.3.

For category 1bis UE, the RSRP measurement accuracy for all measured cells shall be as specified in the sub-clauses 9.1.2.7 and 9.1.2.8, and the RSRQ measurement accuracy for all measured cells shall be as specified in the sub-clause 9.1.5.5.

8.5.2.1.3.2.1 Measurement Reporting Requirements

8.5.2.1.3.2.1.1 Periodic Reporting

Reported RSRP and RSRQ measurements contained in periodically triggered measurement reports shall meet the requirements in sections 9.1.13.1, 9.1.13.2 and 9.1.13.3, respectively.

8.5.2.1.3.2.1.2 Event-triggered Periodic Reporting

Reported RSRP and RSRQ measurements contained in event triggered periodic measurement reports shall meet the requirements in sections 9.1.13.1, 9.1.13.2 and 9.1.13.3, respectively.

The first report in event triggered periodic measurement reporting shall meet the requirements specified in clause 8.5.2.1.3.2.1.3.

8.5.2.1.3.2.1.3 Event Triggered Reporting

Reported RSRP and RSRQ measurements contained in event triggered measurement reports shall meet the requirements in sections 9.1.13.1, 9.1.13.2 and 9.1.13.3, respectively.

The UE shall not send any event triggered measurement reports, as long as no reporting criteria are fulfilled.

The measurement reporting delay is defined as the time between an event that will trigger a measurement report and the point when the UE starts to transmit the measurement report over the air interface. This requirement assumes that the measurement report is not delayed by other RRC signalling on the DCCH. This measurement reporting delay excludes a delay uncertainty resulted when inserting the measurement report to the TTI of the uplink DCCH. The delay uncertainty is: $2 \times TTI_{DCCH}$. This measurement reporting delay excludes a delay which caused by no UL resources for UE to send the measurement report.

The event triggered measurement reporting delay, measured without L3 filtering shall be less than $T_{\text{identify_intra_UE cat 0}}$ defined in Clause 8.5.2.1.3.2. When L3 filtering is used or IDC autonomous denial is configured an additional delay can be expected.

If a cell which has been detectable at least for the time period $T_{\text{identify_intra_UE cat 0}}$ defined in clause 8.5.2.1.3.2 becomes undetectable for a period ≤ 5 seconds and then the cell becomes detectable again and triggers an event, the event triggered measurement reporting delay shall be less than $T_{\text{measure_intra_UE cat 0}}$ provided the timing to that cell has not changed more than $\pm 50 T_s$ and the L3 filter has not been used. When L3 filtering is used or IDC autonomous denial is configured, an additional delay can be expected.

8.5.2.1.4 E-UTRAN FDD intra frequency measurements with autonomous gaps for UE category 0

The requirements defined in this subclause 8.5.2.1.4 apply provided the following condition is met:

- Tx diversity or transmission using multiple antennas are supported in the target cell to be detected.

8.5.2.1.4.1 Identification of a new CGI of E-UTRA cell with autonomous gaps

No explicit neighbour list is provided to the UE for identifying a new CGI of E-UTRA cell. The UE shall identify and report the CGI when requested by the network for the purpose 'reportCGI'. The UE may make autonomous gaps in downlink reception and uplink transmission for receiving MIB and SIB1 message according to clause 5.5.3.1 of TS 36.331 [2]. Note that a UE is not required to use autonomous gap if si-RequestForHO is set to false. If autonomous gaps are used for measurement with the purpose of 'reportCGI', regardless of whether DRX or eDRX_CONN is used or not, or whether SCell(s) are configured or not, the UE shall be able to identify a new CGI of E-UTRA cell within:

$$T_{\text{identify_CGI_LC-UE,intra}} = T_{\text{basic_identify_CGI_LC-UE,intra}} \quad ms$$

Where

$T_{\text{basic_identify_CGI_LC-UE,intra}} = 190$ ms. This is the time period used in the above equation where the maximum allowed time for the UE to identify a new CGI of an E-UTRA cell is defined, provided that the E-UTRA cell has been already identified by the UE.

A cell shall be considered identifiable following conditions are fulfilled:

- RSRP related side conditions given in Clause 9.1 are fulfilled for a corresponding Band,
- SCH_RP and SCH Ês/Iot according to Annex B.2.2 for a corresponding Band

The MIB of an E-UTRA cell whose CGI is identified shall be considered decodable by the UE provided the PBCH demodulation requirements are met according to [5].

The requirement for identifying a new CGI of an E-UTRA cell within $T_{\text{basic_identify_CGI_LC-UE,intra}}$ is applicable when no DRX is used as well as when any of the DRX or eDRX_CONN cycles specified in TS 36.331 [2] is used.

Within the time, $T_{\text{identify_CGI_LCUE,intra}}$ ms, over which the UE identifies the new CGI of E-UTRA cell, the UE shall transmit at least 92 ACK/NACKs on PCell provided that:

- there is continuous DL data allocation,
- no DRX and no eDRX_CONN cycle is used,
- no measurement gaps are configured,
- only one code word is transmitted in each subframe,
- no MBSFN subframes are configured in the PCell or each of activated SCell(s).

8.5.2.1.4.2 ECGI Reporting Delay

The ECGI reporting delay occurs due to the delay uncertainty when inserting the ECGI measurement report to the TTI of the uplink DCCH. The delay uncertainty is twice the TTI of the uplink DCCH. In case DRX is used, the ECGI reporting may be delayed until the next DRX cycle. In case eDRX_CONN is used, the ECGI reporting may be delayed until the next eDRX_CONN cycle. If IDC autonomous denial is configured, an additional delay can be expected.

8.5.2.1.5 E-UTRAN intra frequency measurements with autonomous gaps for HD-FDD UE category 0

The requirements in this section are applicable for the UE which supports half duplex FDD operation on one or more supported frequency bands [2].

The requirements defined in this subclause 8.5.2.1.5 apply provided the following condition is met:

- Tx diversity or transmission using multiple antennas are supported in the target cell to be detected.

8.5.2.1.5.1 Identification of a new CGI of E-UTRA cell with autonomous gaps

All the CGI requirements with the exception of requirement on the number of ACK/NACK transmission on PCell defined in clause 8.5.2.1.4.1 also apply for this section.

For the UE supporting half duplex FDD operation there is no requirement in terms of number of ACK/NACK transmission on PCell.

8.5.2.1.5.2 ECGI Reporting Delay

The ECGI reporting delay defined in clause 8.5.2.1.4.2 also apply for this section.

8.5.2.1.6 E-UTRAN TDD intra frequency measurements with autonomous gaps for UE category 0

The requirements defined in this subclause 8.5.2.1.6 apply provided the following condition is met:

- Tx diversity or transmission using multiple antennas are supported in the target cell to be detected.

8.5.2.1.6.1 Identification of a new CGI of E-UTRA cell with autonomous gaps

No explicit neighbour list is provided to the UE for identifying a new CGI of E-UTRA cell. The UE shall identify and report the CGI when requested by the network for the purpose 'reportCGI'. The UE may make autonomous gaps in downlink reception and uplink transmission for receiving MIB and SIB1 messages according to clause 5.5.3.1 of TS 36.331 [2]. Note that a UE is not required to use autonomous gap if si-RequestForHO is set to false. If autonomous gaps are used for measurement with the purpose of 'reportCGI', regardless of whether DRX or eDRX_CONN is used or not, or whether SCell(s) are configured or not, the UE shall be able to identify a new CGI of E-UTRA cell within:

$$T_{\text{identify_CGI_LC-UE,intra}} = T_{\text{basic_identify_CGI_LC-UE,intra}} \quad ms$$

Where

$T_{\text{basic_identify_CGI_LC-UE, intra}} = 190$ ms. This is the time period used in the above equation where the maximum allowed time for the UE to identify a new CGI of an E-UTRA cell is defined, provided that the E-UTRA cell has been already identified by the UE.

A cell shall be considered identifiable when the following conditions are fulfilled:

- RSRP related side conditions given in Clause 9.1 are fulfilled for a corresponding Band,
- SCH_RP and SCH \hat{E} s/Iot according to Annex B.2.2 for a corresponding Band

The MIB of an E-UTRA cell whose CGI is identified shall be considered decodable by the UE provided the PBCH demodulation requirements are met according to [5].

The requirement for identifying a new CGI of an E-UTRA cell within $T_{\text{basic_identify_CGI_LC-UE, intra}}$ is applicable when no DRX is used as well as when any of the DRX or eDRX_CONN cycles specified in TS 36.331 [2] is used.

Within the time, $T_{\text{identify_CGI_LCUE,intra}}$ ms, over which the UE identifies the new CGI of E-UTRA cell, the UE shall be able to transmit at least the number of ACK/NACKs stated in Table 8.5.2.1.6.1-1 on PCell provided that:

- there is continuous DL data allocation,
- no DRX and no eDRX_CONN cycle is used,
- no measurement gaps are configured,
- only one code word is transmitted in each subframe,
- no MBSFN subframes are configured in the PCell or each of activated SCell(s).

Table 8.5.2.1.6.1-1: Requirement on minimum number of ACK/NACKs to transmit during $T_{\text{basic_identify_CGI_LC-UE, intra-}}$

UL/DL configuration	Minimum number of transmitted ACK/NACKs
0	30
1	54
2	68
3	56
4	61
5	66
6	46

8.5.2.1.6.2 ECGI Reporting Delay

The ECGI reporting delay occurs due to the delay uncertainty when inserting the ECGI measurement report to the TTI of the uplink DCCH. The delay uncertainty is twice the TTI of the uplink DCCH. In case DRX is used, the ECGI reporting may be delayed until the next DRX cycle. In case eDRX_CONN is used, the ECGI reporting may be delayed until the next eDRX_CONN cycle. If IDC autonomous denial is configured, an additional delay can be expected.

8.6 Discovery signal measurements

8.6.1 Introduction

This clause contains requirements on the UE for measurement reporting in RRC_CONNECTED state when discovery signal [16] is configured. The requirements are specified for E-UTRA CRS based discovery signal measurements and CSI-RS based discovery signal measurements. These measurements may be used by the E-UTRAN, e.g. for handover decisions. The measurement quantities are defined in [4], the measurement model is defined in [22] and measurement accuracy requirements are specified in clause 9. Control of measurement reporting is specified in TS 36.331 [2].

The requirements in Section 9 are applicable for a UE performing measurements according to Section 8.6.

8.6.2 Requirements for CRS based discovery signal measurements

8.6.2.1 E-UTRAN intra frequency measurements

The UE shall be able to identify new intra-frequency cells and perform measurements of identified intra-frequency cells without an explicit intra-frequency neighbour cell list containing physical layer cell identities. During the RRC_CONNECTED state the UE shall continuously measure identified intra frequency cells and additionally search for and identify new intra frequency cells.

The UE capable of SRS carrier based switching when configured to perform SRS transmission and/or PRACH transmission over one or more SCells without PUSCH shall meet the requirements defined in Section 8.6.2.1 provided the following condition is met:

- minimum number of configured discovery signal occasions containing CRS based discovery signal as specified in section 8.6.2.1 are available for measurements at the UE in the measurement cell.

8.6.2.1.1 E-UTRAN FDD intra frequency measurements

8.6.2.1.1.1 E-UTRAN FDD intra frequency measurements when no DRX is used

When no DRX is in use the UE shall be able to identify a new detectable FDD intra frequency cell within $T_{\text{identify_intra_SCE}}$,

$$T_{\text{identify_intra_SCE}} = 12 * T_{\text{DMTC_periodicity}} + T_{\text{Measurement_Period_intra_FDD_CRS}}$$

A cell shall be considered detectable when

- RSRP related side conditions given in Sections 9.1.14.2 and RSRQ related side conditions given in Clause 9.1.14.4 are fulfilled for a corresponding Band,
- SCH_RP and SCH_Ês/Iot according to Annex B.2.10 for a corresponding Band

$T_{\text{DMTC_periodicity}}$ is the discovery signal measurement timing configuration periodicity of higher layer.

$T_{\text{Measurement_Period_intra_FDD_CRS}}$ is the intra-frequency period for measurements as shown in table 8.6.2.1.1.1-1

Identification of a cell shall include detection of the cell and additionally performing a single measurement with measurement period of $T_{\text{Measurement_Period_intra_FDD_CRS}}$ when no DRX is used. If higher layer filtering is used, an additional cell identification delay can be expected.

In the RRC_CONNECTED state the measurement period for intra frequency measurements is $T_{\text{Measurement_Period_intra_FDD_CRS}}$ as shown in table 8.6.2.1.1.1-1, when no DRX is in use. The UE shall be capable of performing RSRP and RSRQ measurements for 3 identified intra-frequency cells, and the UE physical layer shall be capable of reporting measurements to higher layers with the measurement period of $T_{\text{Measurement_Period_intra_FDD_CRS}}$

Table 8.6.2.1.1.1-1: Requirement to measure FDD intra frequency cell

Measurement bandwidth [RB]	Discovery signal occasion duration (<i>ds-OccasionDuration</i>) [ms]	$T_{\text{Measurement_Period_intra_FDD_CRS}}$ [ms]
≥ 6	≥ 1	$5 * T_{\text{DMTC_periodicity}}$
≥ 25	≥ 1	$3 * T_{\text{DMTC_periodicity}}$

The RSRP measurement accuracy for all measured cells shall be as specified in the sub-clauses 9.1.14.2, and the RSRQ measurement accuracy for all measured cells shall be as specified in the sub-clause 9.1.14.4.

8.6.2.1.1.1.1 Measurement Reporting Requirements

8.6.2.1.1.1.1.1 Periodic Reporting

Reported RSRP and RSRQ measurements contained in periodically triggered measurement reports shall meet the requirements in sections 9.1.14.2 and 9.1.14.4 respectively.

8.6.2.1.1.1.1.2 Event-triggered Periodic Reporting

Reported RSRP and RSRQ measurements contained in event triggered periodic measurement reports shall meet the requirements in sections 9.1.14.2 and 9.1.14.4 respectively.

The first report in event triggered periodic measurement reporting shall meet the requirements specified in clause 8.6.2.1.1.1.1.3.

8.6.2.1.1.1.1.3 Event Triggered Reporting

Reported RSRP and RSRQ measurements contained in event triggered measurement reports shall meet the requirements in sections 9.1.14.2 and 9.1.14.4 respectively.

The UE shall not send any event triggered measurement reports, as long as no reporting criteria are fulfilled.

The measurement reporting delay is defined as the time between an event that will trigger a measurement report and the point when the UE starts to transmit the measurement report over the air interface. This requirement assumes that the measurement report is not delayed by other RRC signalling on the DCCH. This measurement reporting delay excludes a delay uncertainty resulted when inserting the measurement report to the TTI of the uplink DCCH. The delay uncertainty is: $2 \times T_{\text{TTI_DCCH}}$ where $T_{\text{TTI_DCCH}}$ is the duration of subframe or slot or subslot when the measurement report is transmitted on the PUSCH with subframe or slot or subslot duration. This measurement reporting delay excludes a delay which caused by no UL resources for UE to send the measurement report.

The event triggered measurement reporting delay, measured without L3 filtering shall be less than $T_{\text{Identify_intra_SCE}}$ defined in Clause 8.6.2.1.1.1. When L3 filtering is used or IDC autonomous denial is configured or the UE is configured to perform SRS carrier based switching, an additional delay can be expected.

If a cell which has been detectable at least for the time period $T_{\text{Identify_intra_SCE}}$ defined in clause 8.6.2.1.1.1 becomes undetectable for a period ≤ 5 seconds and then the cell becomes detectable again and triggers an event, the event triggered measurement reporting delay shall be less than $T_{\text{Measurement_Period_intra_FDD_CRS}}$ provided the timing to that cell has not changed more than $\pm 50 T_s$ and the L3 filter has not been used. When L3 filtering is used or IDC autonomous denial is configured, or the UE is configured to perform SRS carrier based switching, an additional delay can be expected.

8.6.2.1.1.2 E-UTRAN FDD intra frequency measurements when DRX is used

When DRX is in use the UE shall be able to identify a new detectable FDD intra frequency cell within $T_{\text{identify_intra_SCE_DRX}}$.

$$T_{\text{identify_intra_SCE_DRX}} = 16 * \text{Max} \{ T_{\text{DMTC_periodicity}}, \text{DRX cycle length} \} + T_{\text{Measurement_Period_intra_FDD_CRS_DRX}}$$

A cell shall be considered detectable when

- RSRP related side conditions given in Sections 9.1.14.2 and RSRQ related side conditions given in Clause 9.1.14.4 are fulfilled for a corresponding Band,
- SCH_RP and SCH \hat{E}_s/I_{ot} according to Annex B.2.10 for a corresponding Band

$T_{\text{DMTC_periodicity}}$ is the discovery signal measurement timing configuration periodicity of higher layer.

$T_{\text{Measurement_Period_intra_FDD_CRS_DRX}}$ is the intra-frequency period for measurements as shown in table 8.6.2.1.1.2-1

Identification of a cell shall include detection of the cell and additionally performing a single measurement with measurement period of $T_{\text{Measurement_Period_intra_FDD_CRS_DRX}}$ when DRX is used. If higher layer filtering is used, an additional cell identification delay can be expected.

In the RRC_CONNECTED state the measurement period for intra frequency measurements is $T_{\text{Measurement_Period_intra_FDD_CRS_DRX}}$ as shown in table 8.6.2.1.1.2-1, when DRX is in use. The UE shall be capable of performing RSRP and RSRQ measurements for 3 identified intra-frequency cells, and the UE physical layer shall be capable of reporting measurements to higher layers with the measurement period of $T_{\text{Measurement_Period_intra_FDD_CRS_DRX}}$.

Table 8.6.2.1.1.2-1: Requirement to measure FDD intra frequency cell

Measurement bandwidth [RB]	Discovery signal occasion duration (<i>ds-OccasionDuration</i>) [ms]	$T_{\text{Measurement_Period_intra_FDD_CRS_DRX}}$ [ms]
≥ 6	≥ 1	$5 * \text{Max} \{ T_{\text{DMTC_periodicity}}, \text{DRX cycle length} \}$
≥ 25	≥ 1	$3 * \text{Max} \{ T_{\text{DMTC_periodicity}}, \text{DRX cycle length} \}$

The RSRP measurement accuracy for all measured cells shall be as specified in the sub-clauses 9.1.14.2, and the RSRQ measurement accuracy for all measured cells shall be as specified in the sub-clause 9.1.14.4.

8.6.2.1.1.2.1 Measurement Reporting Requirements

8.6.2.1.1.2.1.1 Periodic Reporting

Reported RSRP and RSRQ measurements contained in periodically triggered measurement reports shall meet the requirements in sections 9.1.14.2 and 9.1.14.4 respectively.

8.6.2.1.1.2.1.2 Event-triggered Periodic Reporting

Reported RSRP and RSRQ measurements contained in event triggered periodic measurement reports shall meet the requirements in sections 9.1.14.2 and 9.1.14.4 respectively.

The first report in event triggered periodic measurement reporting shall meet the requirements specified in clause 8.6.2.1.1.2.1.3.

8.6.2.1.1.2.1.3 Event Triggered Reporting

Reported RSRP and RSRQ measurements contained in event triggered measurement reports shall meet the requirements in sections 9.1.14.2 and 9.1.14.4 respectively.

The UE shall not send any event triggered measurement reports, as long as no reporting criteria are fulfilled.

The measurement reporting delay is defined as the time between an event that will trigger a measurement report and the point when the UE starts to transmit the measurement report over the air interface. This requirement assumes that that the measurement report is not delayed by other RRC signalling on the DCCH. This measurement reporting delay excludes a delay uncertainty resulted when inserting the measurement report to the TTI of the uplink DCCH. The delay

uncertainty is: $2 \times T_{TI_{DCCH}}$ where $T_{TI_{DCCH}}$ is the duration of subframe or slot or subslot when the measurement report is transmitted on the PUSCH with subframe or slot or subslot duration. This measurement reporting delay excludes a delay which caused by no UL resources for UE to send the measurement report.

The event triggered measurement reporting delay, measured without L3 filtering shall be less than $T_{identify_intra_SCE_DRX}$ defined in Clause 8.6.2.1.1.2. When L3 filtering is used or IDC autonomous denial is configured, or the UE is configured to perform SRS carrier based switching, an additional delay can be expected.

If a cell which has been detectable at least for the time period $T_{identify_intra_SCE_DRX}$ defined in clause 8.6.2.1.1.2 becomes undetectable for a period ≤ 5 seconds and then the cell becomes detectable again and triggers an event, the event triggered measurement reporting delay shall be less than $T_{Measurement_Period_intra_FDD_CRS_DRX}$ provided the timing to that cell has not changed more than $\pm 50 T_s$ and the L3 filter has not been used. When L3 filtering is used or IDC autonomous denial is configured, or the UE is configured to perform SRS carrier based switching, an additional delay can be expected.

8.6.2.1.2 E-UTRAN TDD intra frequency measurements

8.6.2.1.2.1 E-UTRAN TDD intra frequency measurements when no DRX is used

When no DRX is in use the UE shall be able to identify a new detectable TDD intra frequency cell within $T_{identify_intra_SCE}$,

$$T_{identify_intra_SCE} = 12 * T_{DMTC_periodicity} + T_{Measurement_Period_intra_TDD_CRS}$$

A cell shall be considered detectable when

- RSRP related side conditions given in Sections 9.1.14.2 and RSRQ related side conditions given in Clause 9.1.14.4 are fulfilled for a corresponding Band,
- SCH_{RP} and SCH_{Ês}/Iot according to Annex B.2.10 for a corresponding Band

$T_{DMTC_periodicity}$ is the discovery signal measurement timing configuration periodicity of higher layer.

$T_{Measurement_Period_intra_TDD_CRS}$ is the intra-frequency period for measurements

Identification of a cell shall include detection of the cell and additionally performing a single measurement with measurement period of $T_{Measurement_Period_intra_TDD_CRS}$ when no DRX is used. If higher layer filtering is used, an additional cell identification delay can be expected.

In the RRC_CONNECTED state the measurement period for intra frequency measurements is $T_{Measurement_Period_intra_TDD_CRS}$ as shown in table 8.6.2.1.2.1-1, when no DRX is in use. The UE shall be capable of performing RSRP and RSRQ measurements for 3 identified intra-frequency cells, and the UE physical layer shall be capable of reporting measurements to higher layers with the measurement period of $T_{Measurement_Period_intra_TDD_CRS}$

Table 8.6.2.1.2.1-1: Requirement to measure TDD intra frequency cell

Measurement bandwidth[RB]	Discovery signal occasion duration (<i>ds-OccasionDuration</i>) [ms]	$T_{Measurement_Period_intra_TDD_CRS}$ [ms]
≥ 6	≥ 2	$5 * T_{DMTC_periodicity}$
≥ 25	≥ 2	$3 * T_{DMTC_periodicity}$

The RSRP measurement accuracy for all measured cells shall be as specified in the sub-clauses 9.1.14.2, and RSRQ measurement accuracy for all measured cells shall be as specified in the sub-clause 9.1.14.4.

8.6.2.1.2.1.1 Measurement Reporting Requirements

8.6.2.1.2.1.1.1 Periodic Reporting

Reported RSRP and RSRQ measurements contained in periodically triggered measurement reports shall meet the requirements in sections 9.1.14.2 and 9.1.14.4 respectively.

8.6.2.1.2.1.1.2 Event-triggered Periodic Reporting

Reported RSRP and RSRQ measurements contained in event triggered periodic measurement reports shall meet the requirements in sections 9.1.14.2 and 9.1.14.4 respectively.

The first report in event triggered periodic measurement reporting shall meet the requirements specified in clause 8.6.2.1.2.1.1.3.

8.6.2.1.2.1.1.3 Event Triggered Reporting

Reported RSRP and RSRQ measurements contained in event triggered measurement reports shall meet the requirements in sections 9.1.14.2 and 9.1.14.4 respectively.

The UE shall not send any event triggered measurement reports, as long as no reporting criteria are fulfilled.

The measurement reporting delay is defined as the time between an event that will trigger a measurement report and the point when the UE starts to transmit the measurement report over the air interface. This requirement assumes that the measurement report is not delayed by other RRC signalling on the DCCH. This measurement reporting delay excludes a delay uncertainty resulted when inserting the measurement report to the TTI of the uplink DCCH. The delay uncertainty is: $2 \times TTI_{DCCH}$ where TTI_{DCCH} is the duration of subframe or slot or subslot when the measurement report is transmitted on the PUSCH with subframe or slot or subslot duration. This measurement reporting delay excludes a delay which caused by no UL resources for UE to send the measurement report.

The event triggered measurement reporting delay, measured without L3 filtering shall be less than $T_{identify_intra_SCE}$ defined in Clause 8.6.2.1.2.1. When L3 filtering is used or IDC autonomous denial is configured, or the UE is configured to perform SRS carrier based switching, an additional delay can be expected.

If a cell which has been detectable at least for the time period $T_{identify_intra_SCE}$ defined in clause 8.6.2.1.2.1 becomes undetectable for a period ≤ 5 seconds and then the cell becomes detectable again and triggers an event, the event triggered measurement reporting delay shall be less than $T_{Measurement_Period_intra_TDD_CRS}$ provided the timing to that cell has not changed more than $\pm 50 T_s$ and the L3 filter has not been used. When L3 filtering is used or IDC autonomous denial is configured, or the UE is configured to perform SRS carrier based switching, an additional delay can be expected.

8.6.2.1.2.2 E-UTRAN TDD intra frequency measurements when DRX is used

When DRX is in use the UE shall be able to identify a new detectable TDD intra frequency cell within $T_{identify_intra_SCE_DRX}$.

$$T_{identify_intra_SCE_DRX} = 16 * \max \{ T_{DMTC_periodicity}, DRX \text{ cycle length} \} + T_{Measurement_Period_intra_TDD_CRS_DRX}$$

A cell shall be considered detectable when

- RSRP related side conditions given in Sections 9.1.14.2 and RSRQ related side conditions given in Clause 9.1.14.4 are fulfilled for a corresponding Band,
- SCH_{RP} and SCH_{Ês/Iot} according to Annex B.2.10 for a corresponding Band

$T_{DMTC_periodicity}$ is the discovery signal measurement timing configuration periodicity of higher layer.

Identification of a cell shall include detection of the cell and additionally performing a single measurement with measurement period of $T_{Measurement_Period_intra_TDD_CRS_DRX}$ when DRX is used. If higher layer filtering is used, an additional cell identification delay can be expected.

In the RRC_CONNECTED state the measurement period for intra frequency measurements is $T_{Measurement_Period_intra_TDD_CRS_DRX}$ as shown in table 8.6.2.1.2.2-1, when DRX is in use. The UE shall be capable of performing RSRP and RSRQ measurements for 3 identified intra-frequency cells, and the UE physical layer shall be capable of reporting measurements to higher layers with the measurement period of $T_{Measurement_Period_intra_TDD_CRS_DRX}$

Table 8.6.2.1.2.2-1: Requirement to measure TDD intra frequency cell

Measurement bandwidth[RB]	Discovery signal occasion duration (<i>ds-OccasionDuration</i>) [ms]	$T_{Measurement_Period_intra_TDD_CRS_DRX}$ [ms]
≥ 6	≥ 2	$5 * \max\{ T_{DMTC_periodicity}, DRX \text{ cycle length} \}$

≥ 25	≥ 2	$3 * \text{Max}\{ T_{\text{DMTC_periodicity}}, \text{DRX cycle length} \}$
-----------	----------	---

The RSRP measurement accuracy for all measured cells shall be as specified in the sub-clauses 9.1.14.2, and the RSRQ measurement accuracy for all measured cells shall be as specified in the sub-clause 9.1.14.4.

8.6.2.1.2.2.1 Measurement Reporting Requirements

8.6.2.1.2.2.1.1 Periodic Reporting

Reported RSRP and RSRQ measurements contained in periodically triggered measurement reports shall meet the requirements in sections 9.1.14.2 and 9.1.14.4 respectively.

8.6.2.1.2.2.1.2 Event-triggered Periodic Reporting

Reported RSRP and RSRQ measurements contained in event triggered periodic measurement reports shall meet the requirements in sections 9.1.14.2 and 9.1.14.4 respectively.

The first report in event triggered periodic measurement reporting shall meet the requirements specified in clause 8.6.2.1.2.2.1.3.

8.6.2.1.2.2.1.3 Event Triggered Reporting

Reported RSRP and RSRQ measurements contained in event triggered measurement reports shall meet the requirements in sections 9.1.14.2 and 9.1.14.4 respectively.

The UE shall not send any event triggered measurement reports, as long as no reporting criteria are fulfilled.

The measurement reporting delay is defined as the time between an event that will trigger a measurement report and the point when the UE starts to transmit the measurement report over the air interface. This requirement assumes that the measurement report is not delayed by other RRC signalling on the DCCH. This measurement reporting delay excludes a delay uncertainty resulted when inserting the measurement report to the TTI of the uplink DCCH. The delay uncertainty is: $2 \times TTI_{\text{DCCH}}$ where TTI_{DCCH} is the duration of subframe or slot or subslot when the measurement report is transmitted on the PUSCH with subframe or slot or subslot duration. This measurement reporting delay excludes a delay which caused by no UL resources for UE to send the measurement report. When L3 filtering is used or IDC autonomous denial is configured an additional delay can be expected.

The event triggered measurement reporting delay, measured without L3 filtering shall be less than $T_{\text{identify_intra_SCE_DRX}}$ defined in Clause 8.6.2.1.2.2. When L3 filtering is used or IDC autonomous denial is configured, or the UE is configured to perform SRS carrier based switching, an additional delay can be expected.

If a cell which has been detectable at least for the time period $T_{\text{identify_intra_SCE_DRX}}$ defined in clause 8.6.2.1.2.2 becomes undetectable for a period ≤ 5 seconds and then the cell becomes detectable again and triggers an event, the event triggered measurement reporting delay shall be less than $T_{\text{Measurement_Period_intra_TDD_CRS_DRX}}$ provided the timing to that cell has not changed more than $\pm 50 T_s$ and the L3 filter has not been used. When L3 filtering is used or IDC autonomous denial is configured, or the UE is configured to perform SRS carrier based switching, an additional delay can be expected.

8.6.2.2 E-UTRAN inter frequency measurements

The UE shall be able to identify new inter-frequency cells and perform RSRP and RSRQ measurements of identified inter-frequency cells if carrier frequency information is provided by the PCell, even if no explicit neighbour list with physical layer cell identities is provided. The discovery signal occasion and the measurement gap should be aligned, provided that also the following additional conditions are fulfilled:

Entire discovery signal occasion should be contained in the measurement gap.

The subframe contained discovery signal for the measurement is not overlapped with the first 0.5ms period and the last 0.5ms period in every gap.

The UE capable of SRS carrier based switching when configured to perform SRS transmission and/or PRACH transmission over one or more SCells without PUSCH shall meet the requirements defined in Section 8.6.2.2 provided the following condition is met:

- minimum number of configured discovery signal occasions containing CRS based discovery signal as specified in section 8.6.2.2 are available for measurements at the UE in the measurement cell.

8.6.2.2.1 E-UTRAN FDD – FDD inter-frequency measurements

8.6.2.2.1.1 E-UTRAN FDD – FDD inter frequency measurements when no DRX is used

When measurement gaps are scheduled, or the UE supports capability of conducting such measurements without gaps, the UE shall be able to identify a new FDD inter-frequency within $T_{\text{Identify_Inter_SCE}}$ according to the following expression:

$$T_{\text{Identify_Inter_SCE}} = 13 * \text{Max} \{ T_{\text{DMTC_periodicity}}, \text{MGRP} \} * N_{\text{freq}} + T_{\text{Measurement_Period_inter_FDD_CRS}}$$

A cell shall be considered detectable provided following conditions are fulfilled:

- RSRP related side conditions given in Clause 9.1.14.2 and RSRQ related side conditions given in Sections 9.1.14.4 are fulfilled,
- $\text{SCH_RP}_{|\text{dBm}} \text{SCH } \hat{E}_s / \text{Tot}$ according to Annex B.2.11 for a corresponding Band,

$T_{\text{DMTC_periodicity}}$ is the discovery signal measurement timing configuration periodicity of higher layer.

$T_{\text{Measurement_Period_intra_FDD_CRS}}$ is the inter-frequency period for measurements as shown in table 8.6.2.2.1.1-1. N_{freq} is defined in clause 8.1.2.1.1.

When measurement gaps are scheduled for FDD inter frequency measurements, or the UE supports capability of conducting such measurements without gaps, the UE physical layer shall be capable of reporting RSRP and RSRQ measurements to higher layers with measurement accuracy as specified in sub-clauses 9.1.14.2 and 9.1.14.4, respectively, with measurement period given by table 8.6.2.2.1.1-1.

The UE shall be capable of performing RSRP and RSRQ measurements of at least 3 identified inter-frequency cells per FDD inter-frequency for up to 3 FDD inter-frequencies and the UE physical layer shall be capable of reporting RSRP and RSRQ measurements to higher layers with the measurement period defined in table 8.6.2.2.1.1-1 when no DRX is in use, either measurement gaps are scheduled or the UE supports capability of conducting such measurements without gaps.

Table 8.6.2.2.1.1-1: Requirement to measure FDD inter frequency cell

Measurement bandwidth[RB]	Discovery signal occasion duration (<i>ds-OccasionDuration</i>) [ms]	$T_{\text{Measurement_Period_inter_FDD_CRS}}$ [ms]
≥ 6	≥ 1	$5 * \text{Max} \{ T_{\text{DMTC_periodicity}}, \text{MGRP} \} * N_{\text{freq}}$
≥ 25	≥ 1	$3 * \text{Max} \{ T_{\text{DMTC_periodicity}}, \text{MGRP} \} * N_{\text{freq}}$

The RSRP measurement accuracy for all measured cells shall be as specified in the sub-clauses 9.1.14.2, and the RSRQ measurement accuracy for all measured cells shall be as specified in the sub-clause 9.1.14.4.

8.6.2.2.1.1.1 Measurement Reporting Requirements

8.6.2.2.1.1.1.1 Periodic Reporting

Reported RSRP and RSRQ measurements contained in periodically triggered measurement reports shall meet the requirements in sections 9.1.14.2 and 9.1.14.4, respectively.

8.6.2.2.1.1.1.2 Event-triggered Periodic Reporting

Reported RSRP and RSRQ measurements contained in event triggered periodic measurement reports shall meet the requirements in sections 9.1.14.2, and 9.1.14.4, respectively.

The first report in event triggered periodic measurement reporting shall meet the requirements specified in clause 8.6.2.2.1.1.1.3.

8.6.2.2.1.1.3 Event Triggered Reporting

Reported RSRP and RSRQ measurements contained in event triggered measurement reports shall meet the requirements in sections 9.1.14.2 and 9.1.14.4, respectively.

The UE shall not send any event triggered measurement reports, as long as no reporting criteria are fulfilled.

The measurement reporting delay is defined as the time between an event that will trigger a measurement report and the point when the UE starts to transmit the measurement report over the air interface. This requirement assumes that the measurement report is not delayed by other RRC signalling on the DCCH. This measurement reporting delay excludes a delay uncertainty resulted when inserting the measurement report to the TTI of the uplink DCCH. The delay uncertainty is: $2 \times TTI_{DCCH}$ where TTI_{DCCH} is the duration of subframe or slot or subslot when the measurement report is transmitted on the PUSCH with subframe or slot or subslot duration. This measurement reporting delay excludes a delay which caused by no UL resources for UE to send the measurement report.

The event triggered measurement reporting delay, measured without L3 filtering shall be less than $T_{Identify_Inter_SCE}$ defined in Clause 8.6.2.2.1.1. When L3 filtering is used or IDC autonomous denial is configured, or the UE is configured to perform SRS carrier based switching, an additional delay can be expected.

If a cell which has been detectable at least for the time period $T_{Identify_Inter_SCE}$ defined in clause 8.6.2.2.1.1 and then triggers the measurement report as per TS 36.331 [2], the event triggered measurement reporting delay shall be less than $T_{Measurement_Period_inter_FDD_CRS}$ provided the timing to that cell has not changed more than $\pm 50 T_s$ while measurement gap has not been available and the L3 filter has not been used. When L3 filtering is used or IDC autonomous denial is configured, or the UE is configured to perform SRS carrier based switching, an additional delay can be expected.

8.6.2.2.1.2 E-UTRAN FDD – FDD inter frequency measurements when DRX is used

When DRX is in use, either measurement gaps are scheduled or the UE supports capability of conducting such measurements without gaps, the UE shall be able to identify a new detectable E-UTRAN FDD inter frequency cell within $T_{Identify_inter_SCE_DRX}$.

$$T_{Identify_inter_SCE_DRX} = 17 * \text{Max} \{ T_{DMTC_periodicity}, \text{DRX cycle length, MGRP} \} * N_{freq} + T_{Measurement_Period_inter_FDD_CRS_DRX}$$

A cell shall be considered detectable when

- RSRP related side conditions given in Sections 9.1.14.2 and RSRQ related side conditions given in Clause 9.1.14.4 are fulfilled for a corresponding Band,
- SCH_RP and SCH \hat{E}_s/I_{ot} according to Annex B.2.11 for a corresponding Band

$T_{DMTC_periodicity}$ is the discovery signal measurement timing configuration periodicity of higher layer.

$T_{Measurement_Period_inter_FDD_CRS_DRX}$ is the inter-frequency period for measurements as shown in Table 8.6.2.2.1.2-1. N_{freq} is defined in clause 8.1.2.1.1.

Identification of a cell shall include detection of the cell and additionally performing a single measurement with measurement period of $T_{Measurement_Period_inter_FDD_CRS_DRX}$ when DRX is used. If higher layer filtering is used, an additional cell identification delay can be expected.

The UE shall be capable of performing RSRP and RSRQ measurements of at least 3 identified inter-frequency cells per FDD inter-frequency for up to 3 FDD inter-frequencies and the UE physical layer shall be capable of reporting RSRP and RSRQ measurements to higher layers with the measurement period defined in table 8.6.2.2.1.2-1 when DRX is in use, either measurement gaps are scheduled or the UE supports capability of conducting such measurements without gaps.

Table 8.6.2.2.1.2-1: Requirement to measure FDD interfrequency cell

Measurement bandwidth[RB]	Discovery signal occasion duration (<i>ds-OccasionDuration</i>) [ms]	$T_{Measurement_Period_inter_FDD_CRS_DRX}$ [ms]
≥ 6	≥ 1	$5 * \text{Max}\{ T_{DMTC_periodicity}, \text{DRX cycle length, MGRP} \} * N_{freq}$
≥ 25	≥ 1	$3 * \text{Max}\{ T_{DMTC_periodicity}, \text{DRX cycle length, MGRP} \} * N_{freq}$

The RSRP measurement accuracy for all measured cells shall be as specified in the sub-clauses 9.1.14.2, and the RSRQ measurement accuracy for all measured cells shall be as specified in the sub-clause 9.1.14.4.

8.6.2.2.1.2.1 Measurement Reporting Requirements

8.6.2.2.1.2.1.1 Periodic Reporting

Reported RSRP and RSRQ measurements contained in periodically triggered measurement reports shall meet the requirements in sections 9.1.14.2, and 9.1.14.4 respectively.

8.6.2.2.1.2.1.2 Event-triggered Periodic Reporting

Reported RSRP and RSRQ measurements contained in event triggered periodic measurement reports shall meet the requirements in sections 9.1.14.2 and 9.1.14.4 respectively.

The first report in event triggered periodic measurement reporting shall meet the requirements specified in clause 8.6.2.2.1.2.1.3.

8.6.2.2.1.2.1.3 Event Triggered Reporting

Reported RSRP and RSRQ measurements contained in event triggered measurement reports shall meet the requirements in sections 9.1.14.2, and 9.1.14.4 respectively.

The UE shall not send any event triggered measurement reports, as long as no reporting criteria are fulfilled.

The measurement reporting delay is defined as the time between an event that will trigger a measurement report and the point when the UE starts to transmit the measurement report over the air interface. This requirement assumes that the measurement report is not delayed by other RRC signalling on the DCCH. This measurement reporting delay excludes a delay uncertainty resulted when inserting the measurement report to the TTI of the uplink DCCH. The delay uncertainty is: $2 \times TTI_{DCCH}$ where TTI_{DCCH} is the duration of subframe or slot or subslot when the measurement report is transmitted on the PUSCH with subframe or slot or subslot duration. This measurement reporting delay excludes a delay which caused by no UL resources for UE to send the measurement report.

The event triggered measurement reporting delay, measured without L3 filtering shall be less than $T_{\text{identify_inter_SCE_DRX}}$ defined in Clause 8.6.2.2.1.2. When L3 filtering is used or IDC autonomous denial is configured, or the UE is configured to perform SRS carrier based switching, an additional delay can be expected.

If a cell which has been detectable at least for the time period $T_{\text{identify_inter_SCE_DRX}}$ defined in clause 8.6.2.2.1.2 becomes undetectable for a period ≤ 5 seconds and then the cell becomes detectable again and triggers an event, the event triggered measurement reporting delay shall be less than $T_{\text{Measurement_Period_inter_FDD_CRS_DRX}}$ provided the timing to that cell has not changed more than ± 50 Ts and the L3 filter has not been used. When L3 filtering is used or IDC autonomous denial is configured, or the UE is configured to perform SRS carrier based switching, an additional delay can be expected.

8.6.2.2.2 E-UTRAN TDD – TDD inter frequency measurements

8.6.2.2.2.1 E-UTRAN TDD – TDD inter frequency measurements when no DRX is used

When measurement gaps are scheduled, or the UE supports capability of conducting such measurements without gaps, the UE shall be able to identify a new TDD inter-frequency within $T_{\text{Identify_Inter_SCE}}$ according to the following expression:

$$T_{\text{Identify_inter_SCE}} = 13 * \text{Max} \{ T_{\text{DMTC_periodicity}}, \text{MGRP} \} * N_{\text{freq}} + T_{\text{Measurement_Period_inter_TDD_CRS}}$$

A cell shall be considered detectable provided following conditions are fulfilled:

- RSRP related side conditions given in Clause 9.1.14.2 and RSRQ related side conditions given in Sections 9.1.14.4 are fulfilled,
- $SCH_RP|_{dBm}$ and $SCH \hat{E}s/Iot$ according to Annex B.2.11 for a corresponding Band

$T_{\text{DMTC_periodicity}}$ is the discovery signal measurement timing configuration periodicity of higher layer.

$T_{\text{Measurement_Period_inter_TDD_CRS}}$ is the inter-frequency period for measurements as shown in Table 8.6.2.2.2.1-1. N_{freq} is defined in clause 8.1.2.1.1.

When measurement gaps are scheduled for TDD inter frequency measurements, or the UE supports capability of conducting such measurements without gaps, the UE physical layer shall be capable of reporting RSRP and RSRQ measurements to higher layers with measurement accuracy as specified in sub-clauses 9.1.14.2, and 9.1.14.4, respectively, with measurement period $T_{\text{Measurement_Period_inter_TDD_CRS}}$ given by table 8.6.2.2.2.1-1:

Table 8.6.2.2.2.1-1: Requirement to measure TDD interfrequency cell

Measurement bandwidth[RB]	Discovery signal occasion duration (<i>ds-OccasionDuration</i>) [ms]	$T_{\text{Measurement_Period_inter_TDD_CRS}}$ [ms]
≥ 6	≥ 2	$5 * \text{Max}\{ T_{\text{DMTC_periodicity}}, \text{MGRP}\} * N_{\text{freq}}$
≥ 25	≥ 2	$3 * \text{Max}\{ T_{\text{DMTC_periodicity}}, \text{MGRP}\} * N_{\text{freq}}$

The UE shall be capable of performing RSRP and RSRQ measurements of at least 3 identified inter-frequency cells per TDD inter-frequency for up to 3TDD inter-frequencies and the UE physical layer shall be capable of reporting RSRP and RSRQ measurements to higher layers with the measurement period defined in table 8.6.2.2.2.1-1 when no DRX is in use, either measurement gaps are scheduled or the UE supports capability of conducting such measurements without gaps.

8.6.2.2.2.1.1 Measurement Reporting Requirements

8.6.2.2.2.1.1.1 Periodic Reporting

Reported RSRP and RSRQ measurements contained in periodically triggered measurement reports shall meet the requirements in sections 9.1.14.2, and 9.1.14.4, respectively.

8.6.2.2.2.1.1.2 Event-triggered Periodic Reporting

Reported RSRP and RSRQ measurements contained in event triggered periodic measurement reports shall meet the requirements in sections 9.1.14.2, and 9.1.14.4, respectively.

The first report in event triggered periodic measurement reporting shall meet the requirements specified in clause 8.6.2.2.2.1.1.3.

8.6.2.2.2.1.1.3 Event Triggered Reporting

Reported RSRP and RSRQ measurements contained in event triggered measurement reports shall meet the requirements in sections 9.1.14.2, and 9.1.14.4, respectively.

The UE shall not send any event triggered measurement reports, as long as no reporting criteria are fulfilled.

The measurement reporting delay is defined as the time between an event that will trigger a measurement report and the point when the UE starts to transmit the measurement report over the air interface. This requirement assumes that that the measurement report is not delayed by other RRC signalling on the DCCH. This measurement reporting delay excludes a delay uncertainty resulted when inserting the measurement report to the TTI of the uplink DCCH. The delay uncertainty is: $2 \times TTI_{\text{DCCH}}$ where TTI_{DCCH} is the duration of subframe or slot or subslot when the measurement report is transmitted on the PUSCH with subframe or slot or subslot duration. This measurement reporting delay excludes a delay which caused by no UL resources for UE to send the measurement report.

The event triggered measurement reporting delay, measured without L3 filtering shall be less than $T_{\text{Identify_Inter}}$ defined in clause 8.6.2.2.2.1. When L3 filtering is used or IDC autonomous denial is configured, or the UE is configured to perform SRS carrier based switching, an additional delay can be expected.

If a cell which has been detectable at least for the time period $T_{\text{Identify_Inter_SCE}}$ defined in clause 8.6.2.2.2.1 and then triggers the measurement report as per TS 36.331 [2], the event triggered measurement reporting delay shall be less than $T_{\text{Measurement_Period_inter_TDD_CRS}}$ defined in clause 8.6.2.2.2.1 provided the timing to that cell has not changed more than ± 50 Ts while measurementgap has not been available and the L3 filter has not been used. When L3 filtering is used or IDC autonomous denial is configured, or the UE is configured to perform SRS carrier based switching, an additional delay can be expected.

8.6.2.2.2.2 E-UTRAN TDD – TDD inter frequency measurements when DRX is used

When DRX is in use, either measurement gaps are scheduled or the UE supports capability of conducting such measurements without gaps, the UE shall be able to identify a new detectable E-UTRAN TDD inter frequency cell within $T_{\text{identify_inter_SCE_DRX}}$

$$T_{\text{identify_inter_SCE_DRX}} = 17 * \text{Max} \{ T_{\text{DMTC_periodicity}}, \text{DRX cycle length, MGRP} \} * N_{\text{freq}} + T_{\text{Measurement_Period_inter_TDD_CRS_DRX}}$$

A cell shall be considered detectable when

- RSRP related side conditions given in Clause 9.1.14.2 and RSRQ related side conditions given in Sections 9.1.14.4 are fulfilled,
- $\text{SCH_RP}_{\text{dBm}}$ and SCH_Es/Iot according to Annex B.2.11 for a corresponding Band

$T_{\text{DMTC_periodicity}}$ is the discovery signal measurement timing configuration periodicity of higher layer.

$T_{\text{Measurement_Period_inter_TDD_CRS_DRX}}$ is the inter-frequency period for measurements as shown in Table 8.6.2.2.2.2-1. N_{freq} is defined in clause 8.1.2.1.1.

Identification of a cell shall include detection of the cell and additionally performing a single measurement with measurement period of $T_{\text{Measurement_Period_intra_TDD_CRS_DRX}}$ when DRX is used. If higher layer filtering is used, an additional cell identification delay can be expected.

The UE shall be capable of performing RSRP and RSRQ measurements of at least 3 identified inter-frequency cells per TDD inter-frequency for up to 3 TDD inter-frequencies and the UE physical layer shall be capable of reporting RSRP and RSRQ measurements to higher layers with the measurement period defined in table 8.6.2.2.2.2-1 when DRX is in use, either measurement gaps are scheduled or the UE supports capability of conducting such measurements without gaps.

Table 8.6.2.2.2.2-1: Requirement to measure TDD interfrequency cell

Measurement bandwidth[RB]	Discovery signal occasion duration (<i>ds-OccasionDuration</i>) [ms]	$T_{\text{Measurement_Period_inter_TDD_CRS_DRX}}$ [ms]
≥ 6	≥ 2	$5 * \text{Max}\{ T_{\text{DMTC_periodicity}}, \text{DRX cycle length, MGRP} \} * N_{\text{freq}}$
≥ 25	≥ 2	$3 * \text{Max}\{ T_{\text{DMTC_periodicity}}, \text{DRX cycle length, MGRP} \} * N_{\text{freq}}$

The RSRP measurement accuracy for all measured cells shall be as specified in the sub-clauses 9.1.14.2, and the RSRQ measurement accuracy for all measured cells shall be as specified in the sub-clause 9.1.14.4.

8.6.2.2.2.2.1 Measurement Reporting Requirements

8.6.2.2.2.2.1.1 Periodic Reporting

Reported RSRP and RSRQ measurements contained in periodically triggered measurement reports shall meet the requirements in sections 9.1.14.2, and 9.1.14.4, respectively.

8.6.2.2.2.2.1.2 Event-triggered Periodic Reporting

Reported RSRP and RSRQ measurements contained in event triggered periodic measurement reports shall meet the requirements in sections 9.1.14.2, and 9.1.14.4, respectively.

The first report in event triggered periodic measurement reporting shall meet the requirements specified in clause 8.6.2.2.2.2.1.3.

8.6.2.2.2.2.1.3 Event Triggered Reporting

Reported RSRP and RSRQ measurements contained in event triggered measurement reports shall meet the requirements in sections 9.1.14.2, and 9.1.14.4, respectively.

The UE shall not send any event triggered measurement reports, as long as no reporting criteria are fulfilled.

The measurement reporting delay is defined as the time between an event that will trigger a measurement report and the point when the UE starts to transmit the measurement report over the air interface. This requirement assumes that that

the measurement report is not delayed by other RRC signalling on the DCCH. This measurement reporting delay excludes a delay uncertainty resulted when inserting the measurement report to the TTI of the uplink DCCH. The delay uncertainty is: $2 \times TTI_{DCCH}$ where TTI_{DCCH} is the duration of subframe or slot or subslot when the measurement report is transmitted on the PUSCH with subframe or slot or subslot duration. This measurement reporting delay excludes a delay which caused by no UL resources for UE to send the measurement report.

The event triggered measurement reporting delay, measured without L3 filtering shall be less than $T_{Identify_Inter}$ defined in clause 8.6.2.2.2. When L3 filtering is used or IDC autonomous denial is configured, or the UE is configured to perform SRS carrier based switching, an additional delay can be expected.

If a cell which has been detectable at least for the time period $T_{Identify_inter_SCE_DRX}$ defined in clause 8.6.2.2.2 and then triggers the measurement report as per TS 36.331 [2], the event triggered measurement reporting delay shall be less than $T_{Measurement_Period_inter_TDD_CRS_DRX}$ defined in clause 8.6.2.2.2 provided the timing to that cell has not changed more than $\pm 50 T_s$ while measurementgap has not been available and the L3 filter has not been used. When L3 filtering is used or IDC autonomous denial is configured, or the UE is configured to perform SRS carrier based switching, an additional delay can be expected.

8.6.2.2.3 E-UTRAN TDD – FDD inter frequency measurements

8.6.2.2.3.1 E-UTRAN TDD – FDD inter frequency measurements when no DRX is used

The requirements in this clause shall apply to UE supporting FDD and TDD.

The requirements in clause 8.6.2.2.1.1 also apply for this section.

8.6.2.2.3.2 E-UTRAN TDD – FDD inter frequency measurements when DRX is used

The requirements in this clause shall apply to UE supporting FDD and TDD.

The requirements in clause 8.6.2.2.1.2 also apply for this section.

8.6.2.2.4 E-UTRAN FDD – TDD inter frequency measurements

8.6.2.2.4.1 E-UTRAN FDD – TDD inter frequency measurements when no DRX is used

The requirements in this clause shall apply to UE supporting FDD and TDD.

The requirements in clause 8.6.2.2.2.1 also apply for this section.

8.6.2.2.4.2 E-UTRAN FDD – TDD inter frequency measurements when DRX is used

The requirements in this clause shall apply to UE supporting FDD and TDD.

The requirements in clause 8.6.2.2.2.2 also apply for this section.

8.6.3 Requirements for CSI-RS based discovery signal measurements

8.6.3.1 E-UTRAN intra frequency measurements

The UE shall be able to identify new intra-frequency TPs and perform CSI-RSRP measurements of intra-frequency TPs with an explicit intra-frequency TP list containing physical layer cell identities. During the RRC_CONNECTED state the UE shall continuously measure identified intra frequency TPs and additionally search for and identify new intra frequency TPs.

The UE capable of SRS carrier based switching when configured to perform SRS transmission and/or RACH transmission over one or more SCells without PUSCH shall meet the requirements defined in Section 8.6.3.1 provided the following condition is met:

- minimum number of configured discovery signal occasions containing CSI-RS based discovery signal as specified in section 8.6.3.1 is available for measurements at the UE in the measurement cell.

8.6.3.1.1 E-UTRAN FDD intra frequency measurements

8.6.3.1.1.1 E-UTRAN FDD intra frequency measurements when no DRX is used

When no DRX is in use the UE shall be able to identify a new detectable FDD intra frequency TP within $T_{\text{identify_intra_TP_SCE}}$,

$$T_{\text{identify_intra_TP_SCE}} = T_{\text{identify_intra_SCE}} + T_{\text{Measurement_Period_intra_FDD_CSI-RS}}$$

A TP shall be considered detectable when

- CSI-RSRP related side conditions given in Sections 9.1.14.3 are fulfilled for a corresponding Band,
- SCH_{RP} and SCH Ês/Iot according to Annex B.2.10 for a corresponding Band

$T_{\text{identify_intra_SCE}}$ is the intra-frequency period for cell identification in section 8.6.2.1.1.1. $T_{\text{Measurement_Period_intra_FDD_CSI-RS}}$ is the intra-frequency period for TP measurement as shown in table 8.6.3.1.1.1-1.

Identification of a TP shall include identification of the cell and additionally performing a single measurement with measurement period of $T_{\text{Measurement_Period_intra_FDD_CSI-RS}}$ when no DRX is used. If higher layer filtering is used, an additional TP identification delay can be expected.

In the RRC_CONNECTED state the measurement period for intra frequency measurements is $T_{\text{Measurement_Period_intra_FDD_CSI-RS}}$ as shown in table 8.6.3.1.1.1-1, when no DRX is in use. The UE shall be capable of performing CSI-RSRP measurements for 3 identified intra-frequency TPs, and the UE physical layer shall be capable of reporting measurements to higher layers with the measurement period of $T_{\text{Measurement_Period_intra_FDD_CSI-RS}}$

Table 8.6.3.1.1.1-1: Requirement to measure FDD intra frequency TP

Measurement bandwidth [RB]	Discovery signal occasion duration (<i>ds-OccasionDuration</i>) [ms]	$T_{\text{Measurement_Period_intra_FDD_CSI-RS}}$ [ms]
≥ 6	≥ 1	5* $T_{\text{DMTC_periodicity}}$
≥ 25	≥ 1	3* $T_{\text{DMTC_periodicity}}$

$T_{\text{DMTC_periodicity}}$ is the discovery signal measurement timing configuration periodicity of higher layer.

The CSI-RSRP measurement accuracy for all measured TPs shall be as specified in the sub-clauses 9.1.14.3.

8.6.3.1.1.1.1 Measurement Reporting Requirements

8.6.3.1.1.1.1.1 Periodic Reporting

Reported CSI-RSRP measurements contained in periodically triggered measurement reports shall meet the requirements in sections 9.1.14.3.

8.6.3.1.1.1.1.2 Event-triggered Periodic Reporting

Reported CSI-RSRP measurements contained in event triggered periodic measurement reports shall meet the requirements in sections 9.1.14.3.

The first report in event triggered periodic measurement reporting shall meet the requirements specified in clause 8.6.3.1.1.1.1.3.

8.6.3.1.1.1.1.3 Event Triggered Reporting

Reported CSI-RSRP measurements contained in event triggered measurement reports shall meet the requirements in sections 9.1.14.3.

The UE shall not send any event triggered measurement reports, as long as no reporting criteria are fulfilled.

The measurement reporting delay is defined as the time between an event that will trigger a measurement report and the point when the UE starts to transmit the measurement report over the air interface. This requirement assumes that the measurement report is not delayed by other RRC signalling on the DCCH. This measurement reporting delay excludes a delay uncertainty resulted when inserting the measurement report to the TTI of the uplink DCCH. The delay uncertainty is: $2 \times TTI_{\text{DCCH}}$ where TTI_{DCCH} is the duration of subframe or slot or subslot when the measurement report is

transmitted on the PUSCH with subframe or slot or subslot duration. This measurement reporting delay excludes a delay which caused by no UL resources for UE to send the measurement report.

The event triggered measurement reporting delay, measured without L3 filtering shall be less than $T_{\text{identify_intra_TP_SCE}}$ defined in Clause 8.6.3.1.1.1. When L3 filtering is used or IDC autonomous denial is configured, or the UE is configured to perform SRS carrier based switching, an additional delay can be expected.

If a TP which has been detectable at least for the time period $T_{\text{identify_intra_TP_SCE}}$ defined in clause 8.6.3.1.1.1 becomes undetectable for a period ≤ 5 seconds and then the TP becomes detectable again and triggers an event, the event triggered measurement reporting delay shall be less than $T_{\text{Measurement_Period_intra_FDD_CSI-RS}}$ provided the timing to that TP has not changed more than $\pm 50 T_s$ and the L3 filter has not been used. When L3 filtering is used or IDC autonomous denial is configured, or the UE is configured to perform SRS carrier based switching, an additional delay can be expected.

8.6.3.1.1.2 E-UTRAN FDD intra frequency measurements when DRX is used

When DRX is in use the UE shall be able to identify a new detectable FDD intra frequency TP within

$T_{\text{identify_intra_TP_SCE_DRX}}$.

$$T_{\text{identify_intra_TP_SCE_DRX}} = T_{\text{identify_intra_SCE_DRX}} + T_{\text{Measurement_Period_intra_FDD_CSI-RS_DRX}}$$

A TP shall be considered detectable when

- CSI-RSRP related side conditions given in Sections 9.1.14.3 are fulfilled for a corresponding Band,
- SCH_{RP} and SCH_{Es}/I_{ot} according to Annex B.2.10 for a corresponding Band

$T_{\text{identify_intra_SCE_DRX}}$ is the intra-frequency period for cell identification in section 8.6.2.1.1.2. $T_{\text{Measurement_Period_intra_FDD_CSI-RS_DRX}}$ is the intra-frequency period for TP measurement as shown in table 8.6.3.1.1.2-1.

Identification of a TP shall include identification of the cell and additionally performing a single measurement with measurement period of $T_{\text{Measurement_Period_intra_FDD_CSI-RS_DRX}}$ when DRX is used. If higher layer filtering is used, an additional TP identification delay can be expected.

In the RRC_CONNECTED state the measurement period for intra frequency measurements is $T_{\text{Measurement_Period_intra_FDD_CSI-RS_DRX}}$ as shown in table 8.6.3.1.1.2-1, when DRX is in use. The UE shall be capable of performing CSI-RSRP measurements for 3 identified intra-frequency TPs, and the UE physical layer shall be capable of reporting measurements to higher layers with the measurement period of $T_{\text{Measurement_Period_intra_FDD_CSI-RS_DRX}}$.

Table 8.6.3.1.1.2-1: Requirement to measure FDD intra frequency TP

Measurement bandwidth [RB]	Discovery signal occasion duration (<i>ds-OccasionDuration</i>) [ms]	$T_{\text{Measurement_Period_intra_FDD_CSI-RS_DRX}}$ [ms]
≥ 6	≥ 1	$5 * \text{Max}\{T_{\text{DMTC_periodicity}}, \text{DRX cycle length}\}$
≥ 25	≥ 1	$3 * \text{Max}\{T_{\text{DMTC_periodicity}}, \text{DRX cycle length}\}$

$T_{\text{DMTC_periodicity}}$ is the discovery signal measurement timing configuration periodicity of higher layer.

The CSI-RSRP measurement accuracy for all measured TPs shall be as specified in the sub-clauses 9.1.14.3.

8.6.3.1.1.2.1 Measurement Reporting Requirements

8.6.3.1.1.2.1.1 Periodic Reporting

Reported CSI-RSRP measurements contained in periodically triggered measurement reports shall meet the requirements in sections 9.1.14.3.

8.6.3.1.1.2.1.2 Event-triggered Periodic Reporting

Reported CSI-RSRP measurements contained in event triggered periodic measurement reports shall meet the requirements in sections 9.1.14.3.

The first report in event triggered periodic measurement reporting shall meet the requirements specified in clause 8.6.3.1.1.2.1.3.

8.6.3.1.1.2.1.3 Event Triggered Reporting

Reported CSI-RSRP measurements contained in event triggered measurement reports shall meet the requirements in sections 9.1.14.3.

The UE shall not send any event triggered measurement reports, as long as no reporting criteria are fulfilled.

The measurement reporting delay is defined as the time between an event that will trigger a measurement report and the point when the UE starts to transmit the measurement report over the air interface. This requirement assumes that the measurement report is not delayed by other RRC signalling on the DCCH. This measurement reporting delay excludes a delay uncertainty resulted when inserting the measurement report to the TTI of the uplink DCCH. The delay uncertainty is: $2 \times TTI_{DCCH}$ where TTI_{DCCH} is the duration of subframe or slot or subslot when the measurement report is transmitted on the PUSCH with subframe or slot or subslot duration. This measurement reporting delay excludes a delay which caused by no UL resources for UE to send the measurement report.

The event triggered measurement reporting delay, measured without L3 filtering shall be less than $T_{identify_intra_TP_SCE_DRX}$ defined in Clause 8.6.3.1.1.2. When L3 filtering is used or IDC autonomous denial is configured, or the UE is configured to perform SRS carrier based switching, an additional delay can be expected.

If a TP which has been detectable at least for the time period $T_{identify_intra_TP_SCE_DRX}$ defined in clause 8.6.3.1.1.2 becomes undetectable for a period ≤ 5 seconds and then the TP becomes detectable again and triggers an event, the event triggered measurement reporting delay shall be less than $T_{Measurement_Period_intra_FDD_CSI-RS_DRX}$ provided the timing to that TP has not changed more than $\pm 50 T_s$ and the L3 filter has not been used. When L3 filtering is used or IDC autonomous denial is configured, or the UE is configured to perform SRS carrier based switching, an additional delay can be expected.

8.6.3.1.2 E-UTRAN TDD intra frequency measurements

8.6.3.1.2.1 E-UTRAN TDD intra frequency measurements when no DRX is used

When no DRX is in use the UE shall be able to identify a new detectable TDD intra frequency TP within $T_{identify_intra_TP_SCE}$,

$$T_{identify_intra_TP_SCE} = T_{identify_intra_SCE} + T_{Measurement_Period_intra_TDD_CSI-RS}$$

A TP shall be considered detectable when

- CSI-RSRP related side conditions given in Sections 9.1.14.3 are fulfilled for a corresponding Band,
- SCH_RP and $SCH\ \hat{E}s/Iot$ according to Annex B.2.10 for a corresponding Band

$T_{identify_intra_SCE}$ is the intra-frequency period for cell identification in section 8.6.2.1.2.1. $T_{Measurement_Period_intra_TDD_CSI-RS}$ is the intra-frequency period for TP measurement as shown in table 8.6.3.1.2.1-1.

Identification of a TP shall include identification of the cell and additionally performing a single measurement with measurement period of $T_{Measurement_Period_intra_TDD_CSI-RS}$ when no DRX is used. If higher layer filtering is used, an additional TP identification delay can be expected.

In the RRC_CONNECTED state the measurement period for intra frequency measurements is $T_{Measurement_Period_intra_TDD_CSI-RS}$ as shown in table 8.6.3.1.2.1-1, when no DRX is in use. The UE shall be capable of performing measurements for 3 identified intra-frequency TPs, and the UE physical layer shall be capable of reporting measurements to higher layers with the measurement period of $T_{Measurement_Period_intra_TDD_CSI-RS}$

Table 8.6.3.1.2.1-1: Requirement to measure TDD intra frequency TP

Measurement bandwidth [RB]	Discovery signal occasion duration (<i>ds-OccasionDuration</i>) [ms]	$T_{Measurement_Period_intra_TDD_CSI-RS}$ [ms]
≥ 6	≥ 2	$5 * T_{DMTC_periodicity}$
≥ 25	≥ 2	$3 * T_{DMTC_periodicity}$

$T_{DMTC_periodicity}$ is the discovery signal measurement timing configuration periodicity of higher layer.

The CSI-RSRP measurement accuracy for all measured TPs shall be as specified in the sub-clauses 9.1.14.3.

8.6.3.1.2.1.1 Measurement Reporting Requirements

8.6.3.1.2.1.1.1 Periodic Reporting

Reported CSI-RSRP measurements contained in periodically triggered measurement reports shall meet the requirements in sections 9.1.14.3.

8.6.3.1.2.1.1.2 Event-triggered Periodic Reporting

Reported CSI-RSRP measurements contained in event triggered periodic measurement reports shall meet the requirements in sections 9.1.14.3.

The first report in event triggered periodic measurement reporting shall meet the requirements specified in clause 8.6.3.1.2.1.1.3.

8.6.3.1.2.1.1.3 Event Triggered Reporting

Reported CSI-RSRP measurements contained in event triggered measurement reports shall meet the requirements in sections 9.1.14.3.

The UE shall not send any event triggered measurement reports, as long as no reporting criteria are fulfilled.

The measurement reporting delay is defined as the time between an event that will trigger a measurement report and the point when the UE starts to transmit the measurement report over the air interface. This requirement assumes that the measurement report is not delayed by other RRC signalling on the DCCH. This measurement reporting delay excludes a delay uncertainty resulted when inserting the measurement report to the TTI of the uplink DCCH. The delay uncertainty is: $2 \times TTI_{DCCH}$ where TTI_{DCCH} is the duration of subframe or slot or subslot when the measurement report is transmitted on the PUSCH with subframe or slot or subslot duration. This measurement reporting delay excludes a delay which caused by no UL resources for UE to send the measurement report. When L3 filtering is used or IDC autonomous denial is configured or the UE is configured to perform SRS carrier based switching, an additional delay can be expected.

The event triggered measurement reporting delay, measured without L3 filtering shall be less than $T_{\text{identify_intra_TP_SCE}}$ defined in Clause 8.6.3.1.2.1. When L3 filtering is used or IDC autonomous denial is configured, or the UE is configured to perform SRS carrier based switching, an additional delay can be expected.

If a TP which has been detectable at least for the time period $T_{\text{identify_intra_TP_SCE}}$ defined in clause 8.6.3.1.2.1 becomes undetectable for a period ≤ 5 seconds and then the TP becomes detectable again and triggers an event, the event triggered measurement reporting delay shall be less than $T_{\text{Measurement_Period_intra_TDD_CSI-RS}}$ provided the timing to that TP has not changed more than $\pm 50 T_s$ and the L3 filter has not been used. When L3 filtering is used or IDC autonomous denial is configured, or the UE is configured to perform SRS carrier based switching, an additional delay can be expected.

8.6.3.1.2.2 E-UTRAN TDD intra frequency measurements when DRX is used

When DRX is in use the UE shall be able to identify a new detectable TDD intra frequency TP within $T_{\text{identify_intra_TP_SCE_DRX}}$.

$$T_{\text{identify_intra_TP_SCE_DRX}} = T_{\text{identify_intra_SCE_DRX}} + T_{\text{Measurement_Period_intra_TDD_CSI-RS_DRX}}$$

A TP shall be considered detectable when

- CSI-RSRP related side conditions given in Sections 9.1.14.3 are fulfilled for a corresponding Band,
- SCH_RP and $SCH \hat{E}_s/Iot$ according to Annex B.2.10 for a corresponding Band

$T_{\text{identify_intra_SCE_DRX}}$ is the intra-frequency period for cell identification as shown in section 8.6.2.1.2.2.

$T_{\text{Measurement_Period_intra_TDD_CSI-RS_DRX}}$ is the intra-frequency period for TP measurement as shown in table 8.6.3.1.2.2-1.

Identification of a TP shall include identification of the cell and additionally performing a single measurement with measurement period of $T_{\text{Measurement_Period_intra_TDD_CSI-RS_DRX}}$ when DRX is used. If higher layer filtering is used, an additional TP identification delay can be expected.

In the RRC_CONNECTED state the measurement period for intra frequency measurements is $T_{\text{Measurement_Period_intra_TDD_CSI-RS_DRX}}$ as shown in table 8.6.3.1.2.2-1, when DRX is in use. The UE shall be capable of performing CSI-

RSRP measurements for 3 identified intra-frequency TPs, and the UE physical layer shall be capable of reporting measurements to higher layers with the measurement period of $T_{\text{Measurement_Period_intra_TDD_CSI-RS_DRX}}$

Table 8.6.3.1.2.2-1: Requirement to measure TDD intrafrequency TP

Measurement bandwidth [RB]	Discovery signal occasion duration (<i>ds-OccasionDuration</i>) [ms]	$T_{\text{Measurement_Period_intra_TDD_CSI-RS_DRX}}$ [ms]
≥ 6	≥ 2	$5 * \text{Max}\{T_{\text{DMTC_periodicity}}, \text{DRX cycle length}\}$
≥ 25	≥ 2	$3 * \text{Max}\{T_{\text{DMTC_periodicity}}, \text{DRX cycle length}\}$

$T_{\text{DMTC_periodicity}}$ is the discovery signal measurement timing configuration periodicity of higher layer.

The CSI-RSRP measurement accuracy for all measured TPs shall be as specified in the sub-clauses 9.1.14.3.

8.6.3.1.2.2.1 Measurement Reporting Requirements

8.6.3.1.2.2.1.1 Periodic Reporting

Reported CSI-RSRP measurements contained in periodically triggered measurement reports shall meet the requirements in sections 9.1.14.3.

8.6.3.1.2.2.1.2 Event-triggered Periodic Reporting

Reported CSI-RSRP measurements contained in event triggered periodic measurement reports shall meet the requirements in sections 9.1.14.3.

The first report in event triggered periodic measurement reporting shall meet the requirements specified in clause 8.6.3.1.2.2.1.3.

8.6.3.1.2.2.1.3 Event Triggered Reporting

Reported CSI-RSRP measurements contained in event triggered measurement reports shall meet the requirements in sections 9.1.14.3.

The UE shall not send any event triggered measurement reports, as long as no reporting criteria are fulfilled.

The measurement reporting delay is defined as the time between an event that will trigger a measurement report and the point when the UE starts to transmit the measurement report over the air interface. This requirement assumes that that the measurement report is not delayed by other RRC signalling on the DCCH. This measurement reporting delay excludes a delay uncertainty resulted when inserting the measurement report to the TTI of the uplink DCCH. The delay uncertainty is: $2 \times TTI_{\text{DCCH}}$ where TTI_{DCCH} is the duration of subframe or slot or subslot when the measurement report is transmitted on the PUSCH with subframe or slot or subslot duration. This measurement reporting delay excludes a delay which caused by no UL resources for UE to send the measurement report.

The event triggered measurement reporting delay, measured without L3 filtering shall be less than $T_{\text{identify_intra_TP_SCE_DRX}}$ defined in Clause 8.6.3.1.2.2. When L3 filtering is used or IDC autonomous denial is configured, or the UE is configured to perform SRS carrier based switching, an additional delay can be expected.

If a TP which has been detectable at least for the time period $T_{\text{identify_intra_TP_SCE_DRX}}$ defined in clause 8.6.3.1.2.2 becomes undetectable for a period ≤ 5 seconds and then the TP becomes detectable again and triggers an event, the event triggered measurement reporting delay shall be less than $T_{\text{Measurement_Period_intra_TDD_CSI-RS_DRX}}$ provided the timing to that TP has not changed more than $\pm 50 T_s$ and the L3 filter has not been used. When L3 filtering is used or IDC autonomous denial is configured, or the UE is configured to perform SRS carrier based switching, an additional delay can be expected.

8.6.3.2 E-UTRAN inter frequency measurements

The UE shall be able to identify new inter-frequency TPs and perform CSI-RSRP measurements of inter-frequency TP with an explicit inter-frequency TP list containing physical layer cell identities. The discovery signal occasion and the measurement gap should be aligned, provided that also the following additional conditions are fulfilled:

Entire discovery signal occasion should be contained in the measurement gap.

The subframe contained discovery signal for the measurement is not overlapped with the first 0.5ms period and the last 0.5ms period in every gap.

The UE capable of SRS carrier based switching when configured to perform SRS transmission and/or RACH transmission over one or more SCells without PUSCH shall meet the requirements defined in Section 8.6.3.2 provided the following condition is met:

- minimum number of configured discovery signal occasions containing CSI-RS based discovery signal as specified in section 8.6.3.2 is available for measurements at the UE in the measurement cell.

8.6.3.2.1 E-UTRAN FDD – FDD inter frequency measurements

8.6.3.2.1.1 E-UTRAN FDD – FDD inter frequency measurements when no DRX is used

When measurement gaps are scheduled, or the UE supports capability of conducting such measurements without gaps, the UE shall be able to identify a new FDD inter-frequency TP within $T_{\text{identify_inter_TP_SCE}}$ according to the following expression:

$$T_{\text{identify_inter_TP_SCE}} = T_{\text{identify_Inter_SCE}} + T_{\text{Measurement_Period_inter_FDD_CSI-RS}}$$

A TP shall be considered detectable when

- CSI-RSRP related side conditions given in Sections 9.1.14.3 are fulfilled for a corresponding Band,
- SCH_{RP} and SCH_{Ês}/Iot according to Annex B.2.11 for a corresponding Band

$T_{\text{identify_inter_SCE}}$ is the inter-frequency period for cell identification as shown in section 8.6.2.2.1.1. N_{freq} is defined in clause 8.1.2.1.1. $T_{\text{Measurement_Period_inter_FDD_CSI-RS}}$ is the inter-frequency period for TP measurement as shown in table 8.6.3.2.1.1-1.

When measurement gaps are scheduled for FDD inter frequency measurements, or the UE supports capability of conducting such measurements without gaps, the UE physical layer shall be capable of reporting CSI-RSRP measurements to higher layers with measurement accuracy as specified in sub-clauses 9.1.14.3, with measurement period given by table 8.6.3.2.1.1-1.

The UE shall be capable of performing CSI-RSRP measurements of at least 3 identified inter-frequency TPs per FDD inter-frequency for up to 3 FDD inter-frequencies and the UE physical layer shall be capable of reporting CSI-RSRP measurements to higher layers with the measurement period defined in table 8.6.3.2.1.1-1 when no DRX is in use, either measurement gaps are scheduled or the UE supports capability of conducting such measurements without gaps.

Table 8.6.3.2.1.1-1: Requirement to measure FDD inter frequency TP

Measurement bandwidth [RB]	Discovery signal occasion duration (<i>ds-OccasionDuration</i>) [ms]	$T_{\text{Measurement_Period_inter_FDD_CSI-RS}}$ [ms]
≥ 6	≥ 1	$5 * \text{Max}\{T_{\text{DMTC_periodicity}}, \text{MGRP}\} * N_{\text{freq}}$
≥ 25	≥ 1	$3 * \text{Max}\{T_{\text{DMTC_periodicity}}, \text{MGRP}\} * N_{\text{freq}}$

$T_{\text{DMTC_periodicity}}$ is the discovery signal measurement timing configuration periodicity of higher layer.

The CSI-RSRP measurement accuracy for all measured TPs shall be as specified in the sub-clauses 9.1.14.3.

8.6.3.2.1.1.1 Measurement Reporting Requirements

8.6.3.2.1.1.1.1 Periodic Reporting

Reported CSI-RSRP measurements contained in periodically triggered measurement reports shall meet the requirements in sections 9.1.14.3.

8.6.3.2.1.1.1.2 Event-triggered Periodic Reporting

Reported CSI-RSRP measurements contained in event triggered periodic measurement reports shall meet the requirements in sections 9.1.14.3.

The first report in event triggered periodic measurement reporting shall meet the requirements specified in clause 8.6.3.2.1.1.1.3.

8.6.3.2.1.1.3 Event Triggered Reporting

Reported CSI-RSRP measurements contained in event triggered measurement reports shall meet the requirements in sections 9.1.14.3.

The UE shall not send any event triggered measurement reports, as long as no reporting criteria are fulfilled.

The measurement reporting delay is defined as the time between an event that will trigger a measurement report and the point when the UE starts to transmit the measurement report over the air interface. This requirement assumes that the measurement report is not delayed by other RRC signalling on the DCCH. This measurement reporting delay excludes a delay uncertainty resulted when inserting the measurement report to the TTI of the uplink DCCH. The delay uncertainty is: $2 \times TTI_{DCCH}$ where TTI_{DCCH} is the duration of subframe or slot or subslot when the measurement report is transmitted on the PUSCH with subframe or slot or subslot duration. This measurement reporting delay excludes a delay which caused by no UL resources for UE to send the measurement report.

The event triggered measurement reporting delay, measured without L3 filtering shall be less than $T_{identify_inter_TP_SCE}$ defined in Clause 8.6.3.2.1.1. When L3 filtering is used or IDC autonomous denial is configured, or the UE is configured to perform SRS carrier based switching, an additional delay can be expected.

If a TP which has been detectable at least for the time period $T_{identify_inter_TP_SCE}$ defined in clause 8.6.3.2.1.1 becomes undetectable for a period ≤ 5 seconds and then the TP becomes detectable again and triggers an event, the event triggered measurement reporting delay shall be less than $T_{Measurement_Period_inter_FDD_CSI-RS}$ provided the timing to that TP has not changed more than $\pm 50 T_s$ and the L3 filter has not been used. When L3 filtering is used or IDC autonomous denial is configured, or the UE is configured to perform SRS carrier based switching, an additional delay can be expected.

8.6.3.2.1.2 E-UTRAN FDD – FDD inter frequency measurements when DRX is used

When DRX is in use, either measurement gaps are scheduled or the UE supports capability of conducting such measurements without gaps, the UE shall be able to identify a new detectable E-UTRAN FDD inter frequency TP within $T_{identify_inter_TP_SCE_DRX}$ according to the following expression:

$$T_{identify_inter_TP_SCE_DRX} = T_{identify_inter_SCE_DRX} + T_{Measurement_Period_inter_FDD_CSI-RS_DRX}$$

A TP shall be considered detectable when

- CSI-RSRP related side conditions given in Sections 9.1.14.3 are fulfilled for a corresponding Band,
- SCH_RP and $SCH \hat{E}s/Iot$ according to Annex B.2.11 for a corresponding Band

$T_{identify_inter_SCE_DRX}$ is the inter-frequency period for cell identification as shown in section 8.6.2.2.1.2. N_{freq} is defined in clause 8.1.2.1.1. $T_{Measurement_Period_inter_FDD_CSI-RS_DRX}$ is the inter-frequency period for TP measurement as shown in table 8.6.3.2.1.2-1.

When measurement gaps are scheduled for FDD inter frequency measurements, or the UE supports capability of conducting such measurements without gaps, the UE physical layer shall be capable of reporting CSI-RSRP measurements to higher layers with measurement accuracy as specified in sub-clauses 9.1.14.3, with measurement period given by table 8.6.3.2.1.2-1.

The UE shall be capable of performing CSI-RSRP measurements of at least 3 identified inter-frequency TPs per FDD inter-frequency for up to 3 FDD inter-frequencies and the UE physical layer shall be capable of reporting CSI-RSRP measurements to higher layers with the measurement period defined in table 8.6.3.2.1.2-1 when DRX is in use, either measurement gaps are scheduled or the UE supports capability of conducting such measurements without gaps.

Table 8.6.3.2.1.2-1: Requirement to measure FDD inter frequency TP

Measurement bandwidth [RB]	Discovery signal occasion duration (<i>ds-OccasionDuration</i>) [ms]	$T_{Measurement_Period_inter_FDD_CSI-RS_DRX}$ [ms]
≥ 6	≥ 1	$5 \cdot \text{Max}\{T_{DMTC_periodicity}, \text{DRX cycle length, MGRP}\} \cdot N_{freq}$
≥ 25	≥ 1	$3 \cdot \text{Max}\{T_{DMTC_periodicity}, \text{DRX cycle length, MGRP}\} \cdot N_{freq}$

$T_{DMTC_periodicity}$ is the discovery signal measurement timing configuration periodicity of higher layer.

The CSI-RSRP measurement accuracy for all measured TPs shall be as specified in the sub-clauses 9.1.14.3.

8.6.3.2.1.2.1 Measurement Reporting Requirements

8.6.3.2.1.2.1.1 Periodic Reporting

Reported CSI-RSRP measurements contained in periodically triggered measurement reports shall meet the requirements in sections 9.1.14.3 respectively.

8.6.3.2.1.2.1.2 Event-triggered Periodic Reporting

Reported CSI-RSRP measurements contained in event triggered periodic measurement reports shall meet the requirements in sections 9.1.14.3.

The first report in event triggered periodic measurement reporting shall meet the requirements specified in clause 8.6.3.2.1.2.1.3.

8.6.3.2.1.2.1.3 Event Triggered Reporting

Reported CSI-RSRP measurements contained in event triggered measurement reports shall meet the requirements in sections 9.1.14.3.

The UE shall not send any event triggered measurement reports, as long as no reporting criteria are fulfilled.

The measurement reporting delay is defined as the time between an event that will trigger a measurement report and the point when the UE starts to transmit the measurement report over the air interface. This requirement assumes that the measurement report is not delayed by other RRC signalling on the DCCH. This measurement reporting delay excludes a delay uncertainty resulted when inserting the measurement report to the TTI of the uplink DCCH. The delay uncertainty is: $2 \times TTI_{DCCH}$ where TTI_{DCCH} is the duration of subframe or slot or subslot when the measurement report is transmitted on the PUSCH with subframe or slot or subslot duration. This measurement reporting delay excludes a delay which caused by no UL resources for UE to send the measurement report. When L3 filtering is used or IDC autonomous denial is configured, or the UE is configured to perform SRS carrier based switching, an additional delay can be expected.

The event triggered measurement reporting delay, measured without L3 filtering shall be less than $T_{identify_inter_TP_SCE_DRX}$ defined in clause 8.6.3.2.1.2. When L3 filtering is used or IDC autonomous denial is configured, or the UE is configured to perform SRS carrier based switching, an additional delay can be expected.

If a TP which has been detectable at least for the time period $T_{identify_inter_TP_SCE_DRX}$ defined in clause 8.6.3.2.1.2 and then triggers the measurement report as per TS 36.331 [2], the event triggered measurement reporting delay shall be less than $T_{Measurement_Period_inter_FDD_CSI-RS_DRX}$ provided the timing to that TP has not changed more than $\pm 50 T_s$ while measurement gap has not been available and the L3 filter has not been used. When L3 filtering is used or IDC autonomous denial is configured, or the UE is configured to perform SRS carrier based switching, an additional delay can be expected.

8.6.3.2.2 E-UTRAN TDD – TDD inter frequency measurements

8.6.3.2.2.1 E-UTRAN TDD – TDD inter frequency measurements when no DRX is used

When measurement gaps are scheduled, or the UE supports capability of conducting such measurements without gaps, the UE shall be able to identify a new TDD inter-frequency TP within $T_{identify_inter_TP_SCE}$ according to the following expression:

$$T_{identify_inter_TP_SCE} = T_{identify_inter_SCE} + T_{Measurement_Period_inter_TDD_CSI-RS}$$

A TP shall be considered detectable when

- CSI-RSRP related side conditions given in Sections 9.1.14.3 are fulfilled for a corresponding Band,
- SCH_RP and $SCH \hat{E}_s/Iot$ according to Annex B.2.11 for a corresponding Band

$T_{identify_inter_SCE}$ is the inter-frequency period for cell identification as shown in section 8.6.2.2.1. N_{freq} is defined in clause 8.1.2.1.1. $T_{Measurement_Period_inter_TDD_CSI-RS}$ is the inter-frequency period for TP measurement as shown in table 8.6.3.2.2.1-1.

When measurement gaps are scheduled for TDD inter frequency measurements, or the UE supports capability of conducting such measurements without gaps, the UE physical layer shall be capable of reporting RSRP measurements

to higher layers with measurement accuracy as specified in sub-clauses 9.1.14.3, with measurement period given by table 8.6.3.2.2.1-1.

The UE shall be capable of performing CSI-RSRP measurements of at least 3 identified inter-frequency TP per TDD inter-frequency for up to 3TDD inter-frequencies and the UE physical layer shall be capable of reporting CSI-RSRP measurements to higher layers with the measurement period defined in table 8.6.3.2.2.1-1 when no DRX is in use, either measurement gaps are scheduled or the UE supports capability of conducting such measurements without gaps.

Table 8.6.3.2.2.1-1: Requirement to measure TDD inter frequency TP

Measurement bandwidth [RB]	Discovery signal occasion duration (<i>ds-OccasionDuration</i>) [ms]	$T_{\text{Measurement_Period_inter_TDD_CSI-RS}}$ [ms]
≥ 6	≥ 2	$5 * \text{Max}\{T_{\text{DMTC_periodicity}}, \text{MGRP}\} * N_{\text{freq}}$
≥ 25	≥ 2	$3 * \text{Max}\{T_{\text{DMTC_periodicity}}, \text{MGRP}\} * N_{\text{freq}}$

$T_{\text{DMTC_periodicity}}$ is the discovery signal measurement timing configuration periodicity of higher layer.

The CSI-RSRP measurement accuracy for all measured TPs shall be as specified in the sub-clauses 9.1.14.3.

8.6.3.2.2.1.1 Measurement Reporting Requirements

8.6.3.2.2.1.1.1 Periodic Reporting

Reported CSI-RSRP measurements contained in periodically triggered measurement reports shall meet the requirements in sections 9.1.14.3.

8.6.3.2.2.1.1.2 Event-triggered Periodic Reporting

Reported CSI-RSRP measurements contained in event triggered periodic measurement reports shall meet the requirements in sections 9.1.14.3.

The first report in event triggered periodic measurement reporting shall meet the requirements specified in clause 8.6.3.2.2.1.1.3.

8.6.3.2.2.1.1.3 Event Triggered Reporting

Reported CSI-RSRP measurements contained in event triggered measurement reports shall meet the requirements in sections 9.1.14.3.

The UE shall not send any event triggered measurement reports, as long as no reporting criteria are fulfilled.

The measurement reporting delay is defined as the time between an event that will trigger a measurement report and the point when the UE starts to transmit the measurement report over the air interface. This requirement assumes that the measurement report is not delayed by other RRC signalling on the DCCH. This measurement reporting delay excludes a delay uncertainty resulted when inserting the measurement report to the TTI of the uplink DCCH. The delay uncertainty is: $2 \times T_{\text{TTI}_{\text{DCCH}}}$ where $T_{\text{TTI}_{\text{DCCH}}}$ is the duration of subframe or slot or subslot when the measurement report is transmitted on the PUSCH with subframe or slot or subslot duration. This measurement reporting delay excludes a delay which caused by no UL resources for UE to send the measurement report. When L3 filtering is used or IDC autonomous denial is configured, or the UE is configured to perform SRS carrier based switching, an additional delay can be expected.

The event triggered measurement reporting delay, measured without L3 filtering shall be less than $T_{\text{identify_inter_TP_SCE}}$ defined in clause 8.6.3.2.2.1. When L3 filtering is used or IDC autonomous denial is configured, or the UE is configured to perform SRS carrier based switching, an additional delay can be expected.

If a TP which has been detectable at least for the time period $T_{\text{identify_inter_TP_SCE}}$ defined in clause 8.6.3.2.2.1 and then triggers the measurement report as per TS 36.331 [2], the event triggered measurement reporting delay shall be less than $T_{\text{Measurement_Period_inter_TDD_CSI-RS}}$ provided the timing to that TP has not changed more than $\pm 50 T_s$ while measurementgap has not been available and the L3 filter has not been used. When L3 filtering is used or IDC autonomous denial is configured, or the UE is configured to perform SRS carrier based switching, an additional delay can be expected.

8.6.3.2.2.2 E-UTRAN CSI-RS based TDD – TDD inter frequency measurements when DRX is used

When DRX is in use, either measurement gaps are scheduled or the UE supports capability of conducting such measurements without gaps, the UE shall be able to identify a new detectable E-UTRAN TDD inter frequency TP within $T_{\text{identify_inter_TP_SCE_DRX}}$ according to the following expression:

$$T_{\text{identify_inter_TP_SCE_DRX}} = T_{\text{identify_inter_SCE_DRX}} + T_{\text{Measurement_Period_inter_TDD_CSI-RS_DRX}}$$

A TP shall be considered detectable when

- RSRP related side conditions given in Sections 9.1.14.3 are fulfilled for a corresponding Band,
- SCH_{RP} and SCH \hat{E}_s/lot according to Annex B.2.11 for a corresponding Band

$T_{\text{identify_inter_SCE_DRX}}$ is the inter-frequency period for cell identification as shown in section 8.6.2.2.2.2. N_{freq} is defined in clause 8.1.2.1.1. $T_{\text{Measurement_Period_inter_TDD_CSI-RS_DRX}}$ is the inter-frequency period for TP measurement as shown in table 8.6.3.2.2.2-1.

When measurement gaps are scheduled for TDD inter frequency measurements, or the UE supports capability of conducting such measurements without gaps, the UE physical layer shall be capable of reporting CSI-RSRP measurements to higher layers with measurement accuracy as specified in sub-clauses 9.1.14.3, with measurement period given by table 8.6.3.2.2.2-1.

The UE shall be capable of performing CSI-RSRP measurements of at least 3 identified inter-frequency TPs per TDD inter-frequency for up to 3 TDD inter-frequencies and the UE physical layer shall be capable of reporting CSI-RSRP measurements to higher layers with the measurement period defined in table 8.6.3.2.2.2-1 when DRX is in use, either measurement gaps are scheduled or the UE supports capability of conducting such measurements without gaps.

Table 8.6.3.2.2.2-1: Requirement to measure TDD inter frequency TP

Measurement bandwidth [RB]	Discovery signal occasion duration (<i>ds-OccasionDuration</i>) [ms]	$T_{\text{Measurement_Period_inter_TDD_CSI-RS_DRX}}$ [ms]
≥ 6	≥ 2	$5 * \text{Max}\{T_{\text{DMTC_periodicity}}, \text{DRX cycle length, MGRP}\} * N_{\text{freq}}$
≥ 25	≥ 2	$3 * \text{Max}\{T_{\text{DMTC_periodicity}}, \text{DRX cycle length, MGRP}\} * N_{\text{freq}}$

$T_{\text{DMTC_periodicity}}$ is the discovery signal measurement timing configuration periodicity of higher layer.

The CSI-RSRP measurement accuracy for all measured TPs shall be as specified in the sub-clauses 9.1.14.3.

8.6.3.2.2.2.1 Measurement Reporting Requirements

8.6.3.2.2.2.1.1 Periodic Reporting

Reported CSI-RSRP measurements contained in periodically triggered measurement reports shall meet the requirements in sections 9.1.14.3.

8.6.3.2.2.2.1.2 Event-triggered Periodic Reporting

Reported CSI-RSRP measurements contained in event triggered periodic measurement reports shall meet the requirements in sections 9.1.14.3.

The first report in event triggered periodic measurement reporting shall meet the requirements specified in clause 8.6.3.2.2.2.1.3.

8.6.3.2.2.2.1.3 Event Triggered Reporting

Reported CSI-RSRP measurements contained in event triggered measurement reports shall meet the requirements in sections 9.1.14.3.

The UE shall not send any event triggered measurement reports, as long as no reporting criteria are fulfilled.

The measurement reporting delay is defined as the time between an event that will trigger a measurement report and the point when the UE starts to transmit the measurement report over the air interface. This requirement assumes that that

the measurement report is not delayed by other RRC signalling on the DCCH. This measurement reporting delay excludes a delay uncertainty resulted when inserting the measurement report to the TTI of the uplink DCCH. The delay uncertainty is: $2 \times TTI_{DCCH}$ where TTI_{DCCH} is the duration of subframe or slot or subslot when the measurement report is transmitted on the PUSCH with subframe or slot or subslot duration. This measurement reporting delay excludes a delay which caused by no UL resources for UE to send the measurement report. When L3 filtering is used or IDC autonomous denial is configured, or the UE is configured to perform SRS carrier based switching, an additional delay can be expected.

The event triggered measurement reporting delay, measured without L3 filtering shall be less than $T_{identify_inter_TP_SCE_DRX}$ defined in Clause 8.6.3.2.2.2. When L3 filtering is used or IDC autonomous denial is configured, or the UE is configured to perform SRS carrier based switching, an additional delay can be expected.

If a TP which has been detectable at least for the time period $T_{identify_inter_TP_SCE_DRX}$ in clause 8.6.3.2.2.2 and then triggers the measurement report as per TS 36.331 [2], the event triggered measurement reporting delay shall be less than $T_{Measurement_Period_inter_TDD_CSI_RS_DRX}$ provided the timing to that TP has not changed more than ± 50 Ts while measurement gap has not been available and the L3 filter has not been used. When L3 filtering is used or IDC autonomous denial is configured, or the UE is configured to perform SRS carrier based switching, an additional delay can be expected.

8.6.3.2.3 E-UTRAN TDD – FDD inter frequency measurements

8.6.3.2.3.1 E-UTRAN TDD – FDD inter frequency measurements when no DRX is used

The requirements in this clause shall apply to UE supporting FDD and TDD.

The requirements in clause 8.6.3.2.1.1 also apply for this section.

8.6.3.2.3.2 E-UTRAN TDD – FDD inter frequency measurements when DRX is used

The requirements in this clause shall apply to UE supporting FDD and TDD.

The requirements in clause 8.6.3.2.1.2 also apply for this section.

8.6.3.2.4 E-UTRAN FDD – TDD inter frequency measurements

8.6.3.2.4.1 E-UTRAN FDD – TDD inter frequency measurements when no DRX is used

The requirements in this clause shall apply to UE supporting FDD and TDD.

The requirements in clause 8.6.3.2.2.1 also apply for this section.

8.6.3.2.4.2 E-UTRAN FDD – TDD inter frequency measurements when DRX is used

The requirements in this clause shall apply to UE supporting FDD and TDD.

The requirements in clause 8.6.3.2.2.2 also apply for this section.

8.7 Discovery signal measurements for E-UTRA carrier aggregation

8.7.1 Introduction

Requirements in this clause are applicable to UE supporting E-UTRA FDD, E-UTRA TDD and/or E-UTRA TDD-FDD carrier aggregation.

Non configured frequencies may be measured with measurement gaps according to the requirements in clause 8.6.2.2 and clause 8.6.3.2 (E-UTRAN CRS based inter frequency measurements and E-UTRAN CSI-RS based inter frequency measurements).

8.7.2 Requirements for CRS based discovery signal measurements for E-UTRA carrier aggregation

8.7.2.1 Measurements of the primary component carrier

CRS based measurements of cells on the primary component carrier shall meet all applicable requirements (FDD or TDD) in clause 8.6.2.1.

8.7.2.2 Measurements of a secondary component carrier

A Secondary component carrier may be activated and deactivated by MAC-CE commands as specified in [17]. The applicable performance requirements depend on whether the SCell on the corresponding frequency is activated or deactivated.

8.7.2.3 Measurements of a secondary component carrier with active SCell

When the SCell is activated, measurement performance requirements for the frequency are those given in clause 8.6.2.1. If common DRX is in use, then the requirements for that secondary component carrier are given by the applicable DRX requirements (FDD or TDD) in clause 8.6.2.1, otherwise the non DRX requirements are applicable. The applicable measurement accuracy requirements are in clause 9.1.15.

8.7.2.4 Measurements of a secondary component carrier with deactivated SCell

This clause defines the measurement requirements of a secondary component carrier with deactivated SCell based on the parameter *measCycleSCell* defined in TS 36.331 [2].

8.7.2.4.1 E-UTRAN secondary component carrier measurements when no common DRX is used

When no DRX is in use the UE shall be able to identify a new detectable FDD or TDD cell on a secondary component carrier within $T_{\text{identify_scc_SCE}}$, according to the parameter *measCycleSCell* where $T_{\text{identify_scc_CRS}} = 13 * \text{measCycleSCell} + T_{\text{measure_scc_CRS}}$

A cell shall be considered detectable when

- RSRP related side condition given in Clause 9.1.15 are fulfilled for a corresponding Band,
- $SCH_RP|_{\text{dBm}}$ and $SCH \hat{E}s/I_{ot}$ according to Annex B.2.10 for a corresponding Band

The measurement period for deactivated scc measurements is $T_{\text{measure_scc_CRS}}$ according to the parameter *measCycleSCell* shown in Tables 8.7.2.4.1-1 and 8.7.2.4.1-2.

The UE capable of SRS carrier based switching when configured to perform SRS transmission and/or PRACH transmission over one or more SCells without PUSCH shall meet the requirements defined in Section 8.7.2.4.1 provided the following condition is met:

- minimum number of configured discovery signal occasions containing CRS based discovery signal as specified in section 8.7.2.4.1 are available for measurements at the UE in the measurement cell.

Table 8.7.2.4.1-1: Requirement to measure intra frequency cell on FDD SCC with deactivated SCell

Measurement bandwidth[RB]	Discovery signal occasion duration (<i>ds-OccasionDuration</i>) [ms]	$T_{\text{measure_scc_CRS}}$ [ms]
≥ 6	≥ 1	$5 * \text{measCycleSCell}$
≥ 25	≥ 1	$3 * \text{measCycleSCell}$

Table 8.7.2.4.1-2: Requirement to measure intra frequency cell on TDD SCC with deactivated SCell

Measurement bandwidth [RB]	Discovery signal occasion duration (<i>ds-OccasionDuration</i>) [ms]	$T_{\text{measure_scc_CRS}}$ [ms]
≥ 6	≥ 2	$5 * \text{measCycleSCell}$
≥ 25	≥ 2	$3 * \text{measCycleSCell}$

The UE shall be capable of performing RSRP and RSRQ measurements for 3 identified cells on a secondary component carrier, and the UE physical layer shall be capable of reporting measurements to higher layers with the measurement period of $T_{\text{measure_scc_CRS}}$.

The measurement accuracy for all measured cells shall be as specified in the sub-clause 9.1.15.

A UE may reconfigure the receiver bandwidth or turn on/off one of the RF chains when performing measurements on up to six SCCs with deactivated SCell. This may cause interruptions on PCell or activated SCell(s) or both that are specified in Section 7.8.

8.7.2.4.1.1 Measurement Reporting Requirements

8.7.2.4.1.1.1 Periodic Reporting

Reported measurements contained in periodically triggered measurement reports shall meet the requirements in clause 9.

8.7.2.4.1.1.2 Event-triggered Periodic Reporting

Reported measurements contained in event triggered periodic measurement reports shall meet the requirements in clause 9.

The first report in event triggered periodic CRS based measurement reporting shall meet the requirements specified in clause 8.7.2.4.1.1.3.

8.7.2.4.1.1.3 Event Triggered Reporting

Reported measurements contained in event triggered measurement reports shall meet the requirements in clause 9.

The UE shall not send any event triggered measurement reports, as long as no reporting criteria are fulfilled.

The measurement reporting delay is defined as the time between an event that will trigger a measurement report and the point when the UE starts to transmit the measurement report over the air interface. This requirement assumes that the measurement report is not delayed by other RRC signalling on the DCCH. This measurement reporting delay excludes a delay uncertainty resulted when inserting the measurement report to the TTI of the uplink DCCH. The delay uncertainty is: $2 \times TTI_{\text{DCCH}}$ where TTI_{DCCH} is the duration of subframe or slot or subslot when the measurement report is transmitted on the PUSCH with subframe or slot or subslot duration. This measurement reporting delay excludes a delay which is caused by no UL resources for UE to send the measurement report.

The event triggered measurement reporting delay, measured without L3 filtering shall be less than $T_{\text{identify_scc_CRS}}$ defined in Clause 8.7.2.4.1. When L3 filtering is used or IDC autonomous denial is configured, or the UE is configured to perform SRS carrier based switching, an additional delay can be expected.

If a cell which has been detectable at least for the time period $T_{\text{identify_scc_SCE}}$ defined in clause 8.7.2.4.1 becomes undetectable for a period ≤ 5 seconds and then the cell becomes detectable again and triggers an event, the event triggered measurement reporting delay shall be less than $T_{\text{measure_scc_CRS}}$ provided the timing to that cell has not changed more than ± 50 Ts and the L3 filter has not been used. When L3 filtering is used, or the UE is configured to perform SRS carrier based switching, an additional delay can be expected.

8.7.2.4.2 E-UTRAN secondary component carrier measurements when common DRX is used

When DRX is in use the UE shall be able to identify a new detectable FDD or TDD cell on a secondary component carrier within $T_{\text{identify_scc}}$, according to the parameter *measCycleSCell* where $T_{\text{identify_scc_SCE_DRX}} = 17 * \text{Max}(\text{measCycleSCell}, \text{DRX cycle length}) + T_{\text{measure_scc_CRS_DRX}}$.

A cell shall be considered detectable when

- RSRP related side condition given in Clause 9.1.15 are fulfilled for a corresponding Band,
- $SCH_RP|_{\text{dBm}}$ and $SCH \hat{E}_s/I_{\text{ot}}$ according to Annex B.2.10 for a corresponding Band

The measurement period for deactivated scell measurements is $T_{\text{measure_sc_CRS_DRX}}$ according to the parameter *measCycleSCell* shown in Tables 8.7.2.4.2-1 and 8.7.2.4.2-2.

The UE capable of SRS carrier based switching when configured to perform SRS transmission and/or PRACH transmission over one or more SCells without PUSCH shall meet the requirements defined in Section 8.7.2.4.2 provided the following condition is met:

- minimum number of configured discovery signal occasions containing CRS based discovery signal as specified in section 8.7.2.4.2 are available for measurements at the UE in the measurement cell.

Table 8.7.2.4.2-1: Requirement to measure intrafrequency cell on FDD SCC with deactivated SCell

Measurement bandwidth[RB]	Discovery signal occasion duration (<i>ds-OccasionDuration</i>) [ms]	$T_{\text{measure_sc_CRS_DRX}}$ [ms]
≥ 6	≥ 1	5* <i>Max{ measCycleSCell, DRX cycle length }</i>
≥ 25	≥ 1	3* <i>Max{ measCycleSCell, DRX cycle length }</i>

Table 8.7.2.4.2-2: Requirement to measure intrafrequency cell on TDD SCC with deactivated SCell

Measurement bandwidth[RB]	Discovery signal occasion duration (<i>ds-OccasionDuration</i>) [ms]	$T_{\text{measure_sc_CRS_DRX}}$ [ms]
≥ 6	≥ 2	5* <i>Max{ measCycleSCell, DRX cycle length }</i>
≥ 25	≥ 2	3* <i>Max{ measCycleSCell, DRX cycle length }</i>

The UE shall be capable of performing RSRP and RSRQ measurements for 3 identified cells on a secondary component carrier, and the UE physical layer shall be capable of reporting measurements to higher layers with the measurement period of $T_{\text{measure_sc_CRS_DRX}}$.

The measurement accuracy for all measured cells shall be as specified in the sub-clause 9.1.15.

A UE may reconfigure receiver bandwidth taking into account the SCell activation/deactivation status, and when making measurements of cells on up to six SCCs with deactivated SCell. This may cause interruptions (packet drops) to a PCell or activated SCell(s) or both when the PCell and the SCell belong to the same frequency band. No interruptions while the On Duration timer is running shall be allowed when common DRX is used. The requirement considers only interruptions due to reconfiguration of the receiver bandwidth, and not due to other causes such as RF impairments or channel conditions.

8.7.2.4.2.1 Measurement Reporting Requirements

8.7.2.4.2.1.1 Periodic Reporting

Reported measurements contained in periodically triggered measurement reports shall meet the requirements in clause 9.

8.7.2.4.2.1.2 Event-triggered Periodic Reporting

Reported measurements contained in event triggered periodic measurement reports shall meet the requirements in clause 9.

The first report in event triggered periodic measurement reporting shall meet the requirements specified in clause 8.7.2.4.2.1.3.

8.7.2.4.2.1.3 Event Triggered Reporting

Reported measurements contained in event triggered measurement reports shall meet the requirements in clause 9.

The UE shall not send any event triggered CRS based measurement reports, as long as no reporting criteria are fulfilled.

The measurement reporting delay is defined as the time between an event that will trigger a measurement report and the point when the UE starts to transmit the measurement report over the air interface. This requirement assumes that the measurement report is not delayed by other RRC signalling on the DCCH. This measurement reporting delay excludes a

delay uncertainty resulted when inserting the measurement report to the TTI of the uplink DCCH. The delay uncertainty is: $2 \times TTI_{DCCH}$ where TTI_{DCCH} is the duration of subframe or slot or subslot when the measurement report is transmitted on the PUSCH with subframe or slot or subslot duration. This measurement reporting delay excludes a delay which is caused by no UL resources for UE to send the measurement report.

The event triggered measurement reporting delay, measured without L3 filtering shall be less than $T_{identify_scc_CRS}$ defined in Clause 8.7.2.4.2. When L3 filtering is used or IDC autonomous denial is configured, or the UE is configured to perform SRS carrier based switching, an additional delay can be expected.

If a cell which has been detectable at least for the time period $T_{identify_scc_SCE_DRX}$ defined in clause 8.7.2.4.2 becomes undetectable for a period ≤ 5 seconds and then the cell becomes detectable again and triggers an event, the event triggered measurement reporting delay shall be less than $T_{measure_scc_CRS_DRX}$ provided the timing to that cell has not changed more than $\pm 50 T_s$ and the L3 filter has not been used. When L3 filtering is used, or the UE is configured to perform SRS carrier based switching, an additional delay can be expected.

8.7.3 Requirements for CSI-RS based discovery signal measurements for E-UTRA carrier aggregation

8.7.3.1 Measurements of the primary component carrier

Measurements of cells on the primary component carrier shall meet all applicable requirements (FDD or TDD) in clause 8.6.3.1.

8.7.3.2 Measurements of a secondary component carrier

A Secondary component carrier may be activated and deactivated by MAC-CE commands as specified in [17]. The applicable performance requirements depend on whether the SCell on the corresponding frequency is activated or deactivated.

8.7.3.3 Measurements of a secondary component carrier with active SCell

When the SCell is activated, measurement performance requirements for the frequency are those given in clause 8.6.3.1. If common DRX is in use, then the requirements for that secondary component carrier are given by the applicable DRX requirements (FDD or TDD) in clause 8.6.3.1, otherwise the non DRX requirements are applicable. The applicable measurement accuracy requirements are in clause 9.1.15.

8.7.3.4 Measurements of a secondary component carrier with deactivated SCell

This clause defines the measurement requirements of a secondary component carrier with deactivated SCell based on the parameter *measCycleSCell* defined in TS 36.331 [2].

8.7.3.4.1 E-UTRAN secondary component carrier measurements when no common DRX is used

When no DRX is in use the UE shall be able to identify a new detectable FDD or TDD TP on a secondary component carrier within $T_{identify_scc_TP_SCE}$, according to the parameter *measCycleSCell*, where $T_{identify_scc_TP_SCE} = T_{identify_scc_SCE} + T_{measure_scc_CSI-RS}$,

A cell shall be considered detectable when

- CSI-RSRP related side condition given in Clause 9.1.15 are fulfilled for a corresponding Band,
- $SCH_RP|_{dBm}$ and $SCH \hat{E}_s/I_{ot}$ according to Annex B.2.10 for a corresponding Band

$T_{identify_scc_SCE}$ is the intra-frequency period for cell identification in section 8.7.2.4.1. $T_{measure_scc_CSI-RS}$ is the intra-frequency period for TP measurement in table 8.7.3.4.1-1.

The measurement period for deactivated scell measurements is $T_{measure_scc_CSI-RS}$ according to the parameter *measCycleSCell* as shown in tables 8.7.3.4.1-1 and 8.7.3.4.1-2.

The UE capable of SRS carrier based switching when configured to perform SRS transmission and/or RACH transmission over one or more SCells without PUSCH shall meet the requirements defined in Section 8.7.3.4.1 provided the following condition is met:

- minimum number of configured discovery signal occasions containing CSI-RS based discovery signal as specified in section 8.7.3.4.1 is available for measurements at the UE in the measurement cell.

Table 8.7.3.4.1-1: Requirement to measure intra frequency TP on FDD SCC with deactivated SCell

Measurement bandwidth [RB]	Discovery signal occasion duration (<i>ds-OccasionDuration</i>) [ms]	$T_{\text{measure_scc_CSI-RS}}$ [ms]
≥ 6	≥ 1	5* <i>measCycleSCell</i>
≥ 25	≥ 1	3* <i>measCycleSCell</i>

Table 8.7.3.4.1-2: Requirement to measure intra frequency TP on TDD SCC with deactivated SCell

Measurement bandwidth [RB]	Discovery signal occasion duration (<i>ds-OccasionDuration</i>) [ms]	$T_{\text{measure_scc_CSI-RS}}$ [ms]
≥ 6	≥ 2	5* <i>measCycleSCell</i>
≥ 25	≥ 2	3* <i>measCycleSCell</i>

The UE shall be capable of performing RSRP measurements for 3 identified TPs on a secondary component carrier, and the UE physical layer shall be capable of reporting measurements to higher layers with the measurement period of $T_{\text{measure_scc_CSI-RS}}$.

The measurement accuracy for all measured TPs shall be as specified in the sub-clause 9.1.15.

A UE may reconfigure the receiver bandwidth or turn on/off one of the RF chains when performing measurements on up to six SCCs with deactivated SCell. This may cause interruptions on PCell or activated SCell(s) or both that are specified in Section 7.8.

8.7.3.4.1.1 Measurement Reporting Requirements

8.7.3.4.1.1.1 Periodic Reporting

Reported measurements contained in periodically triggered measurement reports shall meet the requirements in clause 9.

8.7.3.4.1.1.2 Event-triggered Periodic Reporting

Reported measurements contained in event triggered periodic measurement reports shall meet the requirements in clause 9.

The first report in event triggered periodic measurement reporting shall meet the requirements specified in clause 8.7.3.4.1.1.3.

8.7.3.4.1.1.3 Event Triggered Reporting

Reported measurements contained in event triggered measurement reports shall meet the requirements in clause 9.

The UE shall not send any event triggered measurement reports, as long as no reporting criteria are fulfilled.

The measurement reporting delay is defined as the time between an event that will trigger a measurement report and the point when the UE starts to transmit the measurement report over the air interface. This requirement assumes that the measurement report is not delayed by other RRC signalling on the DCCH. This measurement reporting delay excludes a delay uncertainty resulted when inserting the measurement report to the TTI of the uplink DCCH. The delay uncertainty is: $2 \times TTI_{\text{DCCH}}$ where TTI_{DCCH} is the duration of subframe or slot or subslot when the measurement report is transmitted on the PUSCH with subframe or slot or subslot duration. This measurement reporting delay excludes a delay which is caused by no UL resources for UE to send the measurement report.

The event triggered measurement reporting delay, measured without L3 filtering shall be less than $T_{\text{identify_scc_TP_SCE}}$ defined in Clause 8.7.3.4.1. When L3 filtering is used or IDC autonomous denial is configured, or the UE is configured to perform SRS carrier based switching, an additional delay can be expected.

If a TP which has been detectable at least for the time period $T_{\text{identify_scc_TP_SCE}}$ defined in clause 8.7.3.4.1 becomes undetectable for a period ≤ 5 seconds and then the TP becomes detectable again and triggers an event, the event triggered measurement reporting delay shall be less than $T_{\text{measure_scc_CSI-RS}}$ provided the timing to that TP has not changed more than $\pm 50 T_s$ and the L3 filter has not been used. When L3 filtering is used, or the UE is configured to perform SRS carrier based switching, an additional delay can be expected.

8.7.3.4.2 E-UTRAN secondary component carrier measurements when common DRX is used

When DRX is in use the UE shall be able to identify a new detectable FDD or TDD TP on a secondary component carrier within $T_{\text{identify_scc_TP_SCE_DRX}}$, according to the parameter *measCycleSCell*, where $T_{\text{identify_scc_TP_SCE_DRX}} = T_{\text{identify_scc_SCE_DRX}} + T_{\text{measure_scc_CSI-RS_DRX}}$,

A cell shall be considered detectable when

- CSI-RSRP related side condition given in Clause 9.1.15 are fulfilled for a corresponding Band,
- $SCH_RP|_{\text{dBm}}$ and $SCH\ \hat{E}s/Iot$ according to Annex B.2.10 for a corresponding Band

$T_{\text{identify_scc_SCE_DRX}}$ is the intra-frequency period for cell identification in section 8.7.2.4.2. $T_{\text{measure_scc_CSI-RS_DRX}}$ is the intra-frequency period for TP measurement in table 8.7.3.4.2-1.

The measurement period for deactivated scc measurements is $T_{\text{measure_scc_CSI-RS_DRX}}$ according to the parameter *measCycleSCell* as shown in tables 8.7.3.4.2-1 and 8.7.3.4.2-2.

The UE capable of SRS carrier based switching when configured to perform SRS transmission and/or RACH transmission over one or more SCells without PUSCH shall meet the requirements defined in Section 8.7.3.4.2 provided the following condition is met:

- minimum number of configured discovery signal occasions containing CSI-RS based discovery signal as specified in section 8.7.3.4.2 is available for measurements at the UE in the measurement cell.

Table 8.7.3.4.2-1: Requirement to measure intrafrequency TP on FDD SCC with deactivated SCell

Measurement bandwidth [RB]	Discovery signal occasion duration (<i>ds-OccasionDuration</i>) [ms]	$T_{\text{measure_scc_CSI-RS_DRX}}$ [ms]
≥ 6	≥ 1	$5 * \max \{ \text{measCycleSCell}, \text{DRX cycle length} \}$
≥ 25	≥ 1	$3 * \max \{ \text{measCycleSCell}, \text{DRX cycle length} \}$

Table 8.7.3.4.2-2: Requirement to measure intrafrequency TP on TDD SCC with deactivated SCell

Measurement bandwidth [RB]	Discovery signal occasion duration (<i>ds-OccasionDuration</i>) [ms]	$T_{\text{measure_scc_CSI-RS_DRX}}$ [ms]
≥ 6	≥ 2	$5 * \max \{ \text{measCycleSCell}, \text{DRX cycle length} \}$
≥ 25	≥ 2	$3 * \max \{ \text{measCycleSCell}, \text{DRX cycle length} \}$

The UE shall be capable of performing CSI-RSRP measurements for 3 identified TPs on a secondary component carrier, and the UE physical layer shall be capable of reporting measurements to higher layers with the measurement period of $T_{\text{measure_scc_CSI-RS_DRX}}$.

The measurement accuracy for all measured TPs shall be as specified in the sub-clause 9.1.15.

A UE may reconfigure receiver bandwidth taking into account the SCell activation/deactivation status, and when making measurements of TPs on up to six SCCs with deactivated SCell. This may cause interruptions (packet drops) to a PCell or activated SCell(s) or both when the PCell and the SCell belong to the same frequency band. No interruptions while the On Duration timer is running shall be allowed when common DRX is used. The requirement considers only interruptions due to reconfiguration of the receiver bandwidth, and not due to other causes such as RF impairments or channel conditions.

8.7.3.4.2.1 Measurement Reporting Requirements

8.7.3.4.2.1.1 Periodic Reporting

Reported measurements contained in periodically triggered measurement reports shall meet the requirements in clause 9.

8.7.3.4.2.1.2 Event-triggered Periodic Reporting

Reported measurements contained in event triggered periodic measurement reports shall meet the requirements in clause 9.

The first report in event triggered periodic measurement reporting shall meet the requirements specified in clause 8.7.3.4.2.1.3.

8.7.3.4.2.1.3 Event Triggered Reporting

Reported measurements contained in event triggered measurement reports shall meet the requirements in clause 9.

The UE shall not send any event triggered measurement reports, as long as no reporting criteria are fulfilled.

The measurement reporting delay is defined as the time between an event that will trigger a measurement report and the point when the UE starts to transmit the measurement report over the air interface. This requirement assumes that the measurement report is not delayed by other RRC signalling on the DCCH. This measurement reporting delay excludes a delay uncertainty resulted when inserting the measurement report to the TTI of the uplink DCCH. The delay uncertainty is: $2 \times TTI_{DCCH}$ where TTI_{DCCH} is the duration of subframe or slot or subslot when the measurement report is transmitted on the PUSCH with subframe or slot or subslot duration. This measurement reporting delay excludes a delay which is caused by no UL resources for UE to send the measurement report.

The event triggered measurement reporting delay, measured without L3 filtering shall be less than $T_{identify_scc_TP_SCE_DRX}$ defined in Clause 8.7.3.4.2. When L3 filtering is used or IDC autonomous denial is configured, or the UE is configured to perform SRS carrier based switching, an additional delay can be expected.

If a TP which has been detectable at least for the time period $T_{identify_scc_TP_SCE_DRX}$ defined in clause 8.7.3.4.2 becomes undetectable for a period ≤ 5 seconds and then the TP becomes detectable again and triggers an event, the event triggered measurement reporting delay shall be less than $T_{measure_scc_CSI-RS_DRX}$ provided the timing to that TP has not changed more than $\pm 50 T_s$ and the L3 filter has not been used. When L3 filtering is used, or the UE is configured to perform SRS carrier based switching, an additional delay can be expected.

8.8 Measurements for E-UTRA dual connectivity

8.8.1 Introduction

This clause contains requirements for UE supporting E-UTRA dual connectivity. Requirements in this clause are applicable to UEs which have been configured with one SCell in either MCG or SCG and one PCell for inter-band dual connectivity. Requirements in this clause are applicable to E-UTRA FDD, E-UTRA TDD and E-UTRA TDD-FDD dual connectivity.

The UE capable of SRS carrier based switching when configured to perform SRS transmission and/or RACH transmission over one or more SCells without PUSCH shall meet the requirements defined in Section 8.8 provided the following condition is met:

- at least DL subframe #0 or DL subframe #5 per radio frame is available for measurements at the UE in the measurement cell.

8.8.2 Intra-frequency measurements requirements on PCell

PCell intra-frequency measurements shall meet all applicable requirements in clause 8.1.2.2. If MCG DRX is in use, then the PCell intra-frequency requirements for when DRX is in use in clause 8.1.2.2 shall apply and shall depend on the MCG DRX cycle. Otherwise, the requirements for when DRX is not in use shall apply. The applicable measurement accuracy requirements are in clause 9.1.

8.8.3 Intra-frequency measurements requirements on PSCell

PSCell starts with activated state upon configuration and cannot be deactivated. PSCell intra-frequency measurements shall meet all applicable requirements in clause 8.1.2.2. If SCG DRX is in use, then the PSCell intra-frequency requirements for when DRX is in use in clause 8.1.2.2 shall apply and shall depend on the SCG DRX cycle. Otherwise, the requirements for when DRX is not in use shall apply. The applicable measurement accuracy requirements are in clause 9.1.

8.8.4 Inter-frequency and inter-RAT measurement requirements

Inter-frequency measurements shall meet all applicable requirements in clause 8.1.2.3. If MCG DRX is in use, then the inter-frequency requirements for when DRX is in use in clause 8.1.2.3 shall apply and shall depend on the MCG DRX cycle. Otherwise, the requirements for when DRX is not in use shall apply. The applicable measurement accuracy requirements are in clause 9.1.

Inter-RAT measurements shall meet all applicable requirements in clause 8.1.2.4. If MCG DRX is in use, then the inter-RAT requirements for when DRX is in use in clause 8.1.2.4 shall apply and shall depend on the MCG DRX cycle. Otherwise, the requirements for when DRX is not in use shall apply. The applicable measurement accuracy requirements are in clause 9.2, 9.3, 9.4 and 9.5.

8.8.5 Intra-frequency measurements with autonomous gaps

8.8.5.1 Identification of a new CGI of E-UTRA cell with autonomous gaps

No explicit neighbour list is provided to the UE for identifying a new CGI of E-UTRA cell. The UE shall identify and report the CGI when requested by the network for the purpose 'reportCGI'. The UE may make autonomous gaps in both MCG and SCG in downlink reception and uplink transmission for receiving MIB and SIB1 messages according to clause 5.5.3.1 of TS 36.331 [2]. Note that a UE is not required to use autonomous gap if si-RequestForHO is set to false. If autonomous gaps are used for measurement with the purpose of 'reportCGI', regardless of whether DRX is used or whether the SCell is configured, the UE shall be able to identify a new CGI of E-UTRA cell within:

$$T_{\text{identify_CGI, intra}} = T_{\text{basic_identify_CGI, intra}} \text{ ms}$$

where

$T_{\text{basic_identify_CGI, intra}} = 150$ ms. This is the time period used in the above equation where the maximum allowed time for the UE to identify a new CGI of an E-UTRA cell is defined, provided that the E-UTRA cell has been already identified by the UE.

A cell shall be considered identifiable following conditions are fulfilled:

- RSRP related side conditions given in Clause 9.1 are fulfilled for a corresponding Band,
- SCH_{RP} and SCH_{Es/Iot} according to Annex B.2.2 for a corresponding Band

The MIB of an E-UTRA cell whose CGI is identified shall be considered decodable by the UE provided that the PBCH demodulation requirements in [5] are met.

The requirement for identifying a new CGI of an E-UTRA cell within $T_{\text{basic_identify_CGI, intra}}$ is applicable when no DRX is used as well as when any of the DRX cycles specified in TS 36.331 [2] is used.

Within the time $T_{\text{identify_CGI, intra}}$ ms, over which the UE identifies the CGI of a new E-UTRA cell, the UE shall transmit at least a minimum number of ACK/NACKs on cells in MCG and SCG, respectively, as specified in Table 8.8.5.1-1. The requirement depends on duplex mode, dual connectivity mode of operation, and whether a cell belongs to MCG or SCG, and is further conditioned on:

- there is continuous DL data allocation,
- no DRX cycle is used,
- no measurement gaps are configured,
- only one code word is transmitted in each subframe,

- no MBSFN subframes are configured.

Table 8.8.5.1-1: Requirement on minimum number of ACK/NACKs to transmit during $T_{\text{identify_CGI, intra-}}$

Serving cell configuration	Minimum number of transmitted ACK/NACKs			
	Synchronous operation		Asynchronous operation	
	MCG	SCG	MCG	SCG
FDD	60		60	49
TDD UL/DL configuration 0	18		N/A	N/A
TDD UL/DL configuration 1	35		N/A	N/A
TDD UL/DL configuration 2	43		N/A	N/A
TDD UL/DL configuration 3	36		N/A	N/A
TDD UL/DL configuration 4	39		N/A	N/A
TDD UL/DL configuration 5	42		N/A	N/A
TDD UL/DL configuration 6	30		N/A	N/A

8.8.5.2 ECGI reporting delay

The ECGI reporting delay occurs due to the delay uncertainty when inserting the ECGI measurement report to the TTI of the uplink DCCH. The delay uncertainty is twice the TTI of the uplink DCCH. In case DRX is used, the ECGI reporting may be delayed until the next DRX cycle. If IDC autonomous denial is configured, an additional delay can be expected.

8.8.6 Inter-frequency measurements with autonomous gaps

8.8.6.1 Identification of a new CGI of E-UTRA cell with autonomous gaps

No explicit neighbour list is provided to the UE for identifying a new CGI of E-UTRA cell. The UE shall identify and report the CGI when requested by the network for the purpose 'reportCGI'. The UE may make autonomous gaps in both MCG and SCG in downlink reception and uplink transmission for receiving MIB and SIB1 messages according to clause 5.5.3.1 of TS 36.331 [2]. Note that a UE is not required to use autonomous gap if si-RequestForHO is set to false. If autonomous gaps are used for measurement with the purpose of 'reportCGI', regardless of whether DRX is used or whether the SCell is configured, the UE shall be able to identify a new CGI of E-UTRA cell within:

$$T_{\text{identify_CGI,inter}} = T_{\text{basic_identify_CGI,inter}} \text{ ms}$$

where

$T_{\text{basic_identify_CGI,inter}} = 150$ ms. This is the time period used in the above equation where the maximum allowed time for the UE to identify a new CGI of an E-UTRA cell is defined, provided that the E-UTRA cell has been already identified by the UE.

A cell shall be considered identifiable following conditions are fulfilled:

- RSRP related side conditions given in Clause 9.1 are fulfilled for a corresponding Band,
- SCH_{RP} and SCH_{Es/Iot} according to Annex B.2.2 for a corresponding Band

The MIB of an E-UTRA cell whose CGI is identified shall be considered decodable by the UE provided that the PBCH demodulation requirements in [5] are met.

The requirement for identifying a new CGI of an E-UTRA cell within $T_{\text{basic_identify_CGI,inter}}$ is applicable when no DRX is used as well as when any of the DRX cycles specified in TS 36.331 [2] is used.

Within the time $T_{\text{identify_CGI,inter}}$ ms, over which the UE identifies the CGI of a new E-UTRA cell, the UE shall transmit at least a minimum number of ACK/NACKs on cells in MCG and SCG, respectively, as specified in Table 8.8.6.1-1. The requirement depends on duplex mode, dual connectivity mode of operation, and whether a cell belongs to MCG or SCG, and is further conditioned on:

- there is continuous DL data allocation,
- no DRX cycle is used,
- no measurement gaps are configured,
- only one code word is transmitted in each subframe,
- no MBSFN subframes are configured.

Table 8.8.6.1-1: Requirement on minimum number of ACK/NACKs to transmit during $T_{\text{identify_CGI, inter-}}$

Serving cell configuration	Minimum number of transmitted ACK/NACKs			
	Synchronous operation		Asynchronous operation	
	MCG	SCG	MCG	SCG
FDD	60		60	49
TDD UL/DL configuration 0	18		N/A	N/A
TDD UL/DL configuration 1	30		N/A	N/A

8.8.6.2 ECGI reporting delay

The ECGI reporting delay occurs due to the delay uncertainty when inserting the ECGI measurement report to the TTI of the uplink DCCH. The delay uncertainty is twice the TTI of the uplink DCCH. In case DRX is used, the ECGI reporting may be delayed until the next DRX cycle. If IDC autonomous denial is configured, an additional delay can be expected.

8.8.7 SSTD Measurements

8.8.7.1 Introduction

This clause contains SSTD measurement requirements on UE capabilities for support of E-UTRA dual connectivity.

8.8.7.2 SSTD Measurement requirements

When no DRX is used the physical layer measurement period of the SSTD measurement shall be $T_{\text{measure_SSTD1}} = 200$ ms.

When either MCG DRX or SCG DRX is used, or both MCG DRX and SCG DRX are used in RRC_CONNECTED state the physical layer measurement period ($T_{\text{measure_SSTD1}}$) of the SSTD measurement shall be as specified in table 8.8.7.2-1.

Table 8.8.7.2-1: SSTD measurement requirement when DRX is used

DRX cycle length (s)	$T_{\text{measure_SSTD1}}$ (s) (DRX cycles)
≤ 0.04	0.2 (Note1)
$0.04 < \text{DRX-cycle} \leq 2.56$	Note2 (5)
Note1: Number of DRX cycle depends upon the DRX cycle in use Note2: Time depends upon the DRX cycle in use Note3: DRX cycle length in this table refers to the DRX cycle length configured on the CG in which DRX is used. When DRX is used in both MCG and SCG, DRX cycle length in this table refers to the longer DRX cycle length between MCG DRX and SCG DRX.	

If PCell is changed without changing PCC, and/or if PSCell is changed without changing a frequency of PSCell or if both PCell and PSCell are change by swapping the PCC with the frequency of PSCell while the UE is performing SSTD measurements, then the UE shall also meet the SSTD measurement and accuracy requirements corresponding to the new PCell and/or PSCell. However in this case the UE shall restart the SSTD measurement. In this case the total physical layer measurement period of the SSTD measurement shall not exceed $T_{\text{measure_SSTD2}}$ as defined in the following expression:

$$T_{\text{measure_SSTD2}} = (N+M+1) \cdot (T_{\text{measure_SSTD1}}) + N \cdot T_{\text{PCell_change_DC}} + M \cdot T_{\text{PSCell_change_DC}}$$

Where:

N is the number of times the PCell is changed over the measurement period ($T_{\text{measure_SSTD2}}$),

M is the number of times the PSCell is changed over the measurement period ($T_{\text{measure_SSTD2}}$),

$T_{\text{PCell_change_DC}}$ is the time necessary to change the PCell; it can be up to 25 ms,

$T_{\text{PSCell_change_DC}}$ is the time necessary to change the PSCell; it can be up to 25 ms.

The measurement accuracy for the SSTD measurement when DRX is used as well as when no DRX is used shall be as specified in the sub-clause 9.1.20.

8.8.7.3 SSTD Measurement Reporting Delay

This requirement assumes that the measurement report is not delayed by other RRC signalling on the DCCH. This measurement reporting delay excludes a delay uncertainty resulted when inserting the measurement report to the TTI of the uplink DCCH. The delay uncertainty is: $2 \times TTI_{\text{DCCH}}$. This measurement reporting delay excludes any delay caused by no UL resources for UE to send the measurement report. When the UE is configured to perform SRS carrier based switching, an additional delay can be expected.

Reported measurements contained in periodically triggered measurement reports shall meet the requirements in sub-clause 9.1.20.

8.8.8 Intra-frequency measurements requirements on SCell

SCell intra-frequency measurements shall meet all applicable requirements in clause 8.3.3. In case where the SCell belongs to MCG, the term “common DRX” in clause 8.3.3 shall be deemed to be replaced with “MCG DRX”. In case where the SCell belongs to SCG, the term “common DRX” and PCell in clause 8.3.3 shall be replaced with “SCG DRX” and PSCell, respectively.

8.9 MBSFN Measurements

8.9.1 Introduction

The requirements specified in Section 8.9 apply for MBSFN measurements (MBSFN RSRP, MBSFN RSRQ, and MCH BLER defined in [4]), which are performed in RRC_CONNECTED and logged for MDT by UEs which are MBMS-capable and also indicate their MBSFN measurement logging capability [2].

UE shall measure MBSFN RSRP, MBSFN RSRQ and MCH BLER only in subframes and on carriers where UE is decoding PMCH. The requirements are specified for any carrier where PMCH is received by UE. The requirements specified in this section apply for any carrier frequency with configured MBSFN subframes with PMCH, which may be the same as or different from any serving unicast carrier.

The UE receiving PMCH on any non-serving carrier and performing MBSFN measurements shall not cause interruptions on any serving carrier in unicast subframes and in the subframes with non-MBSFN multicast transmissions such as system information.

The requirements in section 8.9 shall also apply, when the UE is configured to perform SRS carrier based switching.

The requirements in Section 8.9 apply for 15 kHz subcarrier spacing configured in MBSFN subframes. The same requirements apply also for 1.25 kHz and 7.5 kHz subcarrier spacing, provided that $\text{MBSFN RSRP|dBm}/(\text{L kHz}) = \text{MBSFN RSRP|dBm}/15\text{kHz} + 10 \cdot \log_{10}(\text{L}/15)$, where L is 1.25 kHz or 7.5 kHz.

8.9.2 MBSFN RSRP Measurements

The UE physical layer shall be capable of performing the MBSFN RSRP measurement [4] within the MBSFN RSRP measurement period and report the measurement, while meeting the MBSFN RSRP measurement accuracy requirements specified in section 9.8.2.

The MBSFN RSRP measurement period is defined as the maximum between 640ms and the period during which the UE decodes [5, Section 10] 5 subframes containing PMCH transmissions.

The MBSFN RSRP measurement period is the same for UE using any DRX cycle, any eDRX_CONN cycle, or no DRX.

8.9.3 MBSFN RSRQ Measurements

The UE physical layer shall be capable of performing the MBSFN RSRQ measurement [4] within the MBSFN RSRP measurement period and report the measurement, while meeting the MBSFN RSRQ measurement accuracy requirements specified in section 9.8.3.

The MBSFN RSRQ measurement period is defined as the maximum between 640ms and the period during which the UE decodes [5, Section 10] 5 subframes containing PMCH transmissions.

The MBSFN RSRQ measurement period is the same for UE using any DRX cycle, any eDRX_CONN cycle, and no DRX.

8.9.4 MCH BLER Measurements

The UE physical layer shall be capable of performing and reporting the MCH BLER measurement [4] to higher layers within the MCH BLER measurement period. The MCH BLER measurement reporting is according to section 9.8.4.

The MCH BLER measurement period is equal to the MBSFN logging interval configured by higher layers [2].

8.10 Proximity-based Services

8.10.1 Introduction

This section contains the requirements for the UE capable of ProSe Direct Communication and/or ProSe Direct Discovery in RRC_CONNECTED state.

8.10.2 Requirements

When a UE in RRC_CONNECTED state is performing transmissions and/or reception for ProSe Direct Discovery and/or ProSe Direct Communication, the UE shall meet all the requirements specified in Section 8.

Note: The UE may need to interrupt ProSe operation in order to meet the measurement requirements of Section 8.

8.10.2.1 Initiation/Cease of SLSS transmissions with ProSe Direct Discovery

The requirements in this subclause are applicable to a UE capable of ProSe Direct Discovery and SLSS transmission and reception.

The requirements apply when the conditions for SLSS transmissions specified in [2] are met; *networkControlledSyncTx* is not configured; and *syncTxThreshIC* is included in *SystemInformationBlockType19*. The UE shall be capable of measuring the RSRP of the cell used to transmit ProSe Direct Discovery announcements and evaluate to initiate/cease SLSS transmissions within $T_{\text{evaluate,SLSS}}$ where,

- $T_{\text{evaluate,SLSS}} = 0.4$ seconds when UE is not configured with DRX, or,
- $T_{\text{evaluate,SLSS}} =$ as specified in Table 8.10.2.1-1 when UE is configured with DRX.

Table 8.10.2.1-1: $T_{\text{evaluate,SLSS}}$ with ProSe Direct Discovery

DRX cycle length [s]	$T_{\text{evaluate,SLSS}}$ [s] (number of DRX cycles)
≤ 0.04	0.4 (Note 1)
$0.04 < \text{DRX-cycle} \leq 2.56$	Note 2 (6)
Note1:	Number of DRX cycles depends upon the DRX cycle in use
Note2:	Time depends upon the DRX cycles in use

If higher layer filtering is configured, an additional delay in evaluation to initiate/cease SLSS transmissions can be expected.

For the cell used to transmit ProSe Direct Discovery announcements:

- RSRP related side conditions given in Sections 9.1.2.1 and 9.1.2.2 and RSRQ related side conditions given in Clause 9.1.5.1 for a corresponding Band are fulfilled,
- SCH_RP and $SCH\ \hat{E}s/Iot$ according to Annex B.2.1 for a corresponding Band are fulfilled.

8.10.2.2 Initiation/Cease of SLSS transmissions with ProSe Direct Communication

The requirements in this subclause are applicable to a UE capable of ProSe Direct Communication.

The requirements apply when the conditions for SLSS transmissions specified in [2] are met; *networkControlledSyncTx* is not configured; and *syncTxThreshIC* is included in *SystemInformationBlockType18*. The UE shall be capable of measuring the RSRP of the cell used to transmit ProSe Direct Communication to evaluate to initiate/cease SLSS transmissions within $T_{evaluate,SLSS}$

where,

- $T_{evaluate,SLSS} = 0.4$ seconds when UE is not configured with DRX.
- $T_{evaluate,SLSS} =$ as specified in Table 8.10.2.2-1 when UE is configured with DRX.

Table 8.10.2.2-1: $T_{evaluate,SLSS}$ with ProSe Direct Communication

DRX cycle length [s]	$T_{evaluate,SLSS}$ [s] (number of DRX cycles)
≤ 0.04	0.4 (Note 1)
$0.04 < DRX\text{-}cycle \leq 2.56$	Note 2 (6)
Note1:	Number of DRX cycles depends upon the DRX cycle in use
Note2:	Time depends upon the DRX cycles in use

If higher layer filtering is configured, an additional delay in evaluation to initiate/cease SLSS transmissions can be expected.

For the cell used to transmit ProSe Direct Communication:

- RSRP related side conditions given in Sections 9.1.2.1 and 9.1.2.2 and RSRQ related side conditions given in Clause 9.1.5.1 for a corresponding Band are fulfilled,
- SCH_RP and $SCH\ \hat{E}s/Iot$ according to Annex B.2.1 for a corresponding Band are fulfilled.

8.11 Discovery Signal Measurements under Operation with Frame Structure 3

8.11.1 Introduction

This section contains requirements on the UE for measurement reporting in RRC_CONNECTED state when discovery signal [16] is configured. The requirements are specified for E-UTRA CRS based discovery signal measurements and CSI-RS based discovery signal measurements.

The requirements in Section 8.11.2 shall apply for CRS based discovery signal measurements comprising RSRP and RSRQ measurements [4]. The requirements in Section 8.11.3 shall apply for CSI-RS based discovery signal measurements comprising CSI-RSRP measurements [4]. The requirements in Section 8.11.4 shall apply for UE RSSI measurements [4]. The requirements in Section 8.11.5 shall apply for UE channel occupancy measurements [2].

The measurement quantities are defined in [4], the measurement model is defined in [22] and measurement accuracy requirements are specified in Section 9. Control of measurement reporting is specified in TS 36.331 [2].

The requirements in Section 8.11 shall apply for carrier with E-UTRA operation following the frame structure type 3 [16].

The requirements in Section 9 are applicable for a UE performing measurements according to Section 8.11.

8.11.2 CRS based discovery signal measurements

8.11.2.1 E-UTRAN intra-frequency measurements

NOTE: The requirements in this section are applicable only for measurements on SCC following the frame structure type 3 [16].

The UE shall be able to identify new intra-frequency FS3 cells and perform measurements of identified intra-frequency cells without an explicit intra-frequency neighbour cell list containing physical layer cell identities. During the RRC_CONNECTED state the UE shall continuously measure identified intra-frequency cells and additionally search for and identify new intra-frequency cells.

8.11.2.1.1 Requirements

8.11.2.1.1.1 Requirements when no DRX is used

When no DRX is in use the UE shall be able to identify a new detectable FS3 intra-frequency cell within the cell identification time $T_{\text{identify_intra_FS3}}$, where the identification time of a cell shall include detection of the cell and additionally performing a single measurement with measurement period of $T_{\text{measure_intra_FS3_CRS}}$, where:

$T_{\text{identify_intra_FS3}}$ is the intra-frequency cell identification period as specified in Table 8.11.2.1.1.1-1,

$T_{\text{measure_intra_FS3_CRS}}$ is the intra-frequency period for measurements as shown in Table 8.11.2.1.1.1-2,

$T_{\text{DMTC_periodicity}}$ is the discovery signal measurement timing configuration periodicity of higher layer,

L is the number of configured discovery signal occasions which are not available during $T_{\text{identify_intra_FS3}}$ for cell identification at the UE due to the absence of the necessary radio signals from the cell or due to the corresponding downlink subframe being configured as an uplink subframe,

M is the number of configured discovery signal occasions which are not available during $T_{\text{measure_intra_FS3_CRS}}$ for the measurements at the UE due to the absence of the necessary radio signals from the cell or due to the corresponding downlink subframe being configured as an uplink subframe.

Table 8.11.2.1.1.1-1: Intra-frequency cell identification requirement under operation with frame structure 3

SCH $\tilde{E}s/\text{lot}$	CRS measurement bandwidth [RB] Note2	CRS $\tilde{E}s/\text{lot}$	$T_{\text{identify_intra_FS3}}$ [ms]
$0 \leq \text{SCH } \tilde{E}s/\text{lot}$	<25	$-6 \leq \text{CRS } \tilde{E}s/\text{lot}$	$(6+L) * k1*k2 * T_{\text{DMTC_periodicity}}$
$-6 \leq \text{SCH } \tilde{E}s/\text{lot} < 0$	<25		$(24+L) * k1*k2 * T_{\text{DMTC_periodicity}}$
$0 \leq \text{SCH } \tilde{E}s/\text{lot}$	≥ 25	$0 \leq \text{CRS } \tilde{E}s/\text{lot}$	$(2+L) * k1*k2 * T_{\text{DMTC_periodicity}}$
$-6 \leq \text{SCH } \tilde{E}s/\text{lot} < 0$	≥ 25		$(8+L) * k1*k2 * T_{\text{DMTC_periodicity}}$

NOTE 1: Discovery signal occasion duration (*ds-OccasionDuration*) is 1 ms.
NOTE 2: The requirements for measurement bandwidth ≥ 25 RB are optional.
NOTE 3: $k1=2$ when the measurement gaps configured for inter-frequency measurements in DMTC occasions or for inter-frequency RSSI measurements in RMTC occasions on a carrier with frame structure 3 overlap with some but not all DMTC occasions of the measured cell; otherwise, $k1=1$, e.g., when measurement gaps configured for inter-frequency measurements on a carrier with frame structure 3 do not overlap with DMTC occasions of the measured cell or when the UE does not require the measurement gaps for the inter-frequency measurements. The requirements apply, provided that the inter-frequency measurement gap pattern does not overlap with all DMTC occasions of the measured cell.

$$k2 = \max \left(2, \left\lceil \frac{N_{\text{FS3_SCC}}}{2} \right\rceil \right) \text{ when DMTC occasions in the measured cell not overlapping}$$

with the inter-frequency measurement gaps overlap with DMTC occasions of $N_{\text{FS3_SCC}}$ ($N_{\text{FS3_SCC}} > 0$) SCells on other FS3 carriers; otherwise, $k2=1$, e.g., when $N_{\text{FS3_SCC}}$ is 0.
NOTE 4: The requirements apply, provided that L is such that the intra-frequency cell identification period $T_{\text{identify_intra_FS3}}$ does not exceed $72*k1*k2 * T_{\text{DMTC_periodicity}}$.

A cell shall be considered detectable when the following conditions are met during the discovery signal occasions which are available during $T_{\text{identify_intra_FS3}}$:

- RSRP related side conditions given in Section 9.1.18.2 are fulfilled for a corresponding Band,
- RSRQ related side conditions given in Section 9.1.18.3 are fulfilled for a corresponding Band,
- SCH_{RP} is according to Annex B.2.12 for a corresponding Band and SCH Ês/lot is according to Table 8.11.2.1.1.1-1.

If higher layer filtering is used, an additional cell identification delay can be expected.

In the RRC_CONNECTED state the measurement period for intra-frequency measurements is $T_{\text{measure_intra_FS3_CRS}}$ as shown in Table 8.11.2.1.1.1-2, when no DRX is in use. The UE shall be capable of performing RSRP and RSRQ measurements for 3 identified intra-frequency cells, and the UE physical layer shall be capable of reporting measurements to higher layers within the measurement period of $T_{\text{measure_intra_FS3_CRS}}$.

Table 8.11.2.1.1.1-2: Intra-frequency measurement requirements under operation with frame structure 3

SCH Ês/lot	CRS measurement bandwidth [RB] ^{Note2}	CRS Ês/lot	$T_{\text{measure_intra_FS3_CRS}}$ [ms]
$0 \leq \text{SCH Ês/lot}$	<25	$-6 \leq \text{CRS Ês/lot}$	$(5+M) * k1*k2 * T_{\text{DMTC_periodicity}}$
$-6 \leq \text{SCH Ês/lot} < 0$	<25		$(20+M) * k1*k2 * T_{\text{DMTC_periodicity}}$
$0 \leq \text{SCH Ês/lot}$	≥ 25	$0 \leq \text{CRS Ês/lot}$	$(1+M) * k1*k2 * T_{\text{DMTC_periodicity}}$
$-6 \leq \text{SCH Ês/lot} < 0$	≥ 25		$(4+M) * k1*k2 * T_{\text{DMTC_periodicity}}$

NOTE 1: Discovery signal occasion duration (*ds-OccasionDuration*) is 1 ms.
 NOTE 2: The requirements for measurement bandwidth ≥ 25 RB are optional.
 NOTE 3: $k1=2$ when the measurement gaps configured for inter-frequency measurements in DMTC occasions or for inter-frequency RSSI measurements in RMTTC occasions on a carrier with frame structure 3 overlap with some but not all DMTC occasions of the measured cell; otherwise, $k1=1$, e.g., when measurement gaps configured for inter-frequency measurements on a carrier with frame structure 3 do not overlap with DMTC occasions of the measured cell or when the UE does not require the measurement gaps for the inter-frequency measurements. The requirements apply, provided that the inter-frequency measurement gap pattern does not overlap with all DMTC occasions of the measured cell.

$$k2 = \max \left(2, \left\lceil \frac{N_{\text{FS3_SCC}}}{2} \right\rceil \right)$$

when DMTC occasions in the measured cell not overlapping with the inter-frequency measurement gaps overlap with DMTC occasions of $N_{\text{FS3_SCC}}$ ($N_{\text{FS3_SCC}} > 0$) SCells on other FS3 carriers; otherwise, $k2=1$, e.g., when $N_{\text{FS3_SCC}}$ is 0.
 NOTE 4: The requirements apply, provided that M is such that the intra-frequency measurement period $T_{\text{measure_intra_FS3_CRS}}$ does not exceed $60 * k1 * k2 * T_{\text{DMTC_periodicity}}$.

The RSRP measurement accuracy for all measured cells shall be as specified in Section 9.1.18.2, and the RSRQ measurement accuracy for all measured cells shall be as specified in Section 9.1.18.3.

8.11.2.1.1.1.1 Measurement Reporting Requirements

8.11.2.1.1.1.1.1 Periodic Reporting

Reported RSRP and RSRQ measurements contained in periodically triggered measurement reports shall meet the requirements in Sections 9.1.18.2 and 9.1.18.3, respectively.

8.11.2.1.1.1.1.2 Event-triggered Periodic Reporting

Reported RSRP and RSRQ measurements contained in event triggered periodic measurement reports shall meet the requirements in Sections 9.1.18.2 and 9.1.18.3, respectively.

The first report in event triggered periodic measurement reporting shall meet the requirements specified in Section 8.11.2.1.1.1.1.3.

8.11.2.1.1.1.3 Event Triggered Reporting

Reported RSRP and RSRQ measurements contained in event triggered measurement reports shall meet the requirements in Sections 9.1.18.2 and 9.1.18.3, respectively.

The UE shall not send any event triggered measurement reports, as long as no reporting criteria are fulfilled.

The measurement reporting delay is defined as the time between an event that will trigger a measurement report and the point when the UE starts to transmit the measurement report over the air interface. This requirement assumes that the measurement report is not delayed by other RRC signalling on the DCCH. This measurement reporting delay excludes a delay uncertainty resulted when inserting the measurement report to the TTI of the uplink DCCH. The delay uncertainty is: $2 \times TTI_{DCCH}$. This measurement reporting delay excludes a delay which caused by no UL resources for UE to send the measurement report or by the LBT procedure performed by the UE in order to determine that the channel is clear for performing uplink transmission.

The event triggered measurement reporting delay, measured without L3 filtering shall be less than $T_{identify_intra_FS3}$ defined in Section 8.11.2.1.1.1. When L3 filtering is used or IDC autonomous denial is configured or LBT is performed by the UE on the carrier used for the measurement reporting an additional delay can be expected.

If a cell which has been detectable at least for the time period $T_{identify_intra_FS3}$ defined in Section 8.11.2.1.1.1 becomes undetectable for a period ≤ 8 seconds and then the cell becomes detectable again and triggers an event, the event triggered measurement reporting delay shall be less than $T_{identify_intra_FS3_CRS}$ provided the timing to that cell has not changed more than $\pm 50 T_s$ and the L3 filter has not been used. When L3 filtering is used or IDC autonomous denial is configured or LBT is performed by the UE on the carrier used for the measurement reporting, an additional delay can be expected.

8.11.2.1.1.2 Requirements when DRX is used

When DRX is in use the UE shall be able to identify a new detectable FS3 intra-frequency cell within the cell identification time $T_{identify_intra_FS3_DRX}$, where the cell identification time of a cell shall include detection of the cell and additionally performing a single measurement with measurement period of $T_{measure_intra_FS3_CRS_DRX}$, where:.

$T_{identify_intra_FS3_DRX}$ is the intra-frequency period for cell identification as shown in Table 8.11.2.1.1.2-1,

$T_{measure_intra_FS3_CRS_DRX}$ is the intra-frequency period for measurements as shown in Table 8.11.2.1.1.2-2,

$T_{DMTC_periodicity}$ is the discovery signal measurement timing configuration periodicity of higher layer,

L is the number of configured discovery signal occasions during ON DURATION and which are not available during $T_{identify_intra_FS3_DRX}$ for cell identification at the UE due to the absence of the necessary radio signals from the cell or due to the corresponding downlink subframe being configured as an uplink subframe,

M is the number of configured discovery signal occasions during ON DURATION and which are not available during $T_{measure_intra_FS3_CRS_DRX}$ for the measurements at the UE due to the absence of the necessary radio signals from the cell or due to the corresponding downlink subframe being configured as an uplink subframe.

Table 8.11.2.1.1.2-1: Intra-frequency cell identification requirements under operation with frame structure 3

SCH $\hat{E}s/lot$	CRS measurement bandwidth [RB] <small>Note2</small>	CRS $\hat{E}s/lot$	$T_{identify_intra_FS3_DRX}$ [ms]
$0 \leq SCH \hat{E}s/lot$	<25	$-6 \leq CRS \hat{E}s/lot$	$(6+L)^* k1*k2*Max\{T_{DMTC_periodicity}, DRX\ cycle\ length\}$
$-6 \leq SCH \hat{E}s/lot < 0$	<25		$(24+L)^* k1*k2*Max\{T_{DMTC_periodicity}, DRX\ cycle\ length\}$
$0 \leq SCH \hat{E}s/lot$	≥ 25	$0 \leq CRS \hat{E}s/lot$	$(2+L)^* k1*k2*Max\{T_{DMTC_periodicity}, DRX\ cycle\ length\}$
$-6 \leq SCH \hat{E}s/lot < 0$	≥ 25		$(8+L)^* k1*k2*Max\{T_{DMTC_periodicity}, DRX\ cycle\ length\}$
NOTE 1: Discovery signal occasion duration (<i>ds-OccasionDuration</i>) is 1 ms.			

NOTE 2: The requirements for measurement bandwidth ≥ 25 RB are optional.

NOTE 3: $k_1=2$ when the measurement gaps configured for inter-frequency measurements in DMTC occasions or for inter-frequency RSSI measurements in RMTC occasions on a carrier with frame structure 3 overlap with some but not all DMTC occasions of the measured cell during ON DURATION; otherwise, $k_1=1$, e.g., when measurement gaps configured for inter-frequency measurements on a carrier with frame structure 3 do not overlap with DMTC occasions of the measured cell during ON DURATION or when the UE does not require the measurement gaps for the inter-frequency measurements. The requirements apply, provided that the inter-frequency measurement gap pattern does not overlap with all DMTC occasions of the measured cell.

$$k_2 = \max \left(2, \left\lceil \frac{N_{FS3_SCC}}{2} \right\rceil \right)$$

when DMTC occasions in the measured cell not overlapping with the inter-frequency measurement gaps measurement gaps overlap with DMTC occasions of N_{FS3_SCC} ($N_{FS3_SCC} > 0$) SCells during ON DURATION on other FS3 carriers; otherwise, $k_2=1$, e.g., when N_{FS3_SCC} is 0.

NOTE 4: The requirements apply, provided that L is such that the intra-frequency cell identification period $T_{identify_intra_FS3_DRX}$ does not exceed $72 * k_1 * k_2 * \text{Max}\{T_{DMTC_periodicity}, \text{DRX cycle length}\}$.

A cell shall be considered detectable when the following conditions are met during the discovery signal occasions which are available during $T_{identify_intra_FS3_DRX}$:

- RSRP related side conditions given in Section 9.1.18.2 are fulfilled for a corresponding Band,
- RSRQ related side conditions given in Section 9.1.18.3 are fulfilled for a corresponding Band,
- SCH_{RP} is according to Annex B.2.12 for a corresponding Band and SCH Ês/lot is according to Table 8.11.2.1.1.2-1.

If higher layer filtering is used, an additional cell identification delay can be expected.

In the RRC_CONNECTED state the measurement period for intra-frequency measurements is $T_{measure_intra_FS3_CRS_DRX}$ as shown in Table 8.11.2.1.1.2-2, when DRX is in use. The UE shall be capable of performing RSRP and RSRQ measurements for 3 identified intra-frequency cells, and the UE physical layer shall be capable of reporting measurements to higher layers within the measurement period of $T_{measure_intra_FS3_CRS_DRX}$.

Table 8.11.2.1.1.2-2: Intra-frequency measurement requirements under operation with frame structure 3

SCH Ês/lot	CRS measurement bandwidth [RB] Note2	CRS Ês/lot	$T_{measure_intra_FS3_CRS_DRX}$ [ms]
$0 \leq \text{SCH Ês/lot}$	< 25	$-6 \leq \text{CRS Ês/lot}$	$(5+M)^* k_1 * k_2 * \text{Max}\{T_{DMTC_periodicity}, \text{DRX cycle length}\}$
$-6 \leq \text{SCH Ês/lot} < 0$	< 25		$(20+M)^* k_1 * k_2 * \text{Max}\{T_{DMTC_periodicity}, \text{DRX cycle length}\}$
$0 \leq \text{SCH Ês/lot}$	≥ 25	$0 \leq \text{CRS Ês/lot}$	$(1+M)^* k_1 * k_2 * \text{Max}\{T_{DMTC_periodicity}, \text{DRX cycle length}\}$
$-6 \leq \text{SCH Ês/lot} < 0$	≥ 25		$(4+M)^* k_1 * k_2 * \text{Max}\{T_{DMTC_periodicity}, \text{DRX cycle length}\}$
NOTE 1: Discovery signal occasion duration (<i>ds-OccasionDuration</i>) is 1 ms.			
NOTE 2: The requirements for measurement bandwidth ≥ 25 RB are optional.			
NOTE 3: $k_1=2$ when the measurement gaps configured for inter-frequency measurements in DMTC occasions or for inter-frequency RSSI measurements in RMTC occasions on a carrier with frame structure 3 overlap with some but not all DMTC occasions of the measured cell during ON DURATION; otherwise, $k_1=1$, e.g., when measurement gaps configured for inter-frequency measurements on a carrier with frame structure 3 do not overlap with DMTC occasions of the measured cell during ON DURATION or when the UE does not require the measurement gaps for the inter-frequency measurements. The requirements apply, provided			

that the inter-frequency measurement gap pattern does not overlap with all DMTC occasions of the measured cell.

$$k_2 = \max \left(2, \left\lceil \frac{N_{FS3_SCC}}{2} \right\rceil \right) \text{ when DMTC occasions in the measured cell not overlapping}$$

with the inter-frequency measurement gaps measurement gaps overlap with DMTC occasions of N_{FS3_SCC} ($N_{FS3_SCC} > 0$) SCells during ON DURATION on other FS3 carriers; otherwise, $k_2 = 1$, e.g., when N_{FS3_SCC} is 0.

NOTE 4: The requirements apply, provided that M is such that the intra-frequency measurement period $T_{\text{measure_intra_FS3_CRS_DRX}}$ does not exceed $60 * k_1 * k_2 * \text{Max}\{T_{\text{DMTC_periodicity}}, \text{DRX cycle length}\}$.

The RSRP measurement accuracy for all measured cells shall be as specified in Section 9.1.18.2, and the RSRQ measurement accuracy for all measured cells shall be as specified in Section 9.1.18.3.

8.11.2.1.1.2.1 Measurement Reporting Requirements

8.11.2.1.1.2.1.1 Periodic Reporting

Reported RSRP and RSRQ measurements contained in periodically triggered measurement reports shall meet the requirements in Sections 9.1.18.2 and 9.1.18.3, respectively.

8.11.2.1.1.2.1.2 Event-triggered Periodic Reporting

Reported RSRP and RSRQ measurements contained in event triggered periodic measurement reports shall meet the requirements in Sections 9.1.18.2 and 9.1.18.3, respectively.

The first report in event triggered periodic measurement reporting shall meet the requirements specified in Section 8.11.2.1.1.2.1.3.

8.11.2.1.1.2.1.3 Event Triggered Reporting

Reported RSRP and RSRQ measurements contained in event triggered measurement reports shall meet the requirements in Sections 9.1.18.2 and 9.1.18.3, respectively.

The UE shall not send any event triggered measurement reports, as long as no reporting criteria are fulfilled.

The measurement reporting delay is defined as the time between an event that will trigger a measurement report and the point when the UE starts to transmit the measurement report over the air interface. This requirement assumes that the measurement report is not delayed by other RRC signalling on the DCCH. This measurement reporting delay excludes a delay uncertainty resulted when inserting the measurement report to the TTI of the uplink DCCH. The delay uncertainty is: $2 \times TTI_{\text{DCCH}}$. This measurement reporting delay excludes a delay which caused by no UL resources for UE to send the measurement report or by the LBT procedure performed by the UE in order to determine that the channel is clear for performing uplink transmission.

The event triggered measurement reporting delay, measured without L3 filtering shall be less than $T_{\text{identify_intra_FS3_DRX}}$ defined in Section 8.11.2.1.1.2. When L3 filtering is used or IDC autonomous denial is configured or LBT is performed by the UE on the carrier used for the measurement reporting an additional delay can be expected.

If a cell which has been detectable at least for the time period $T_{\text{identify_intra_FS3_DRX}}$ defined in Section 8.11.2.1.1.2 becomes undetectable for a period ≤ 8 seconds and then the cell becomes detectable again and triggers an event, the event triggered measurement reporting delay shall be less than $T_{\text{identify_intra_FS3_CRS_DRX}}$ provided the timing to that cell has not changed more than $\pm 50 T_s$ and the L3 filter has not been used. When L3 filtering is used or IDC autonomous denial is configured or LBT is performed by the UE on the carrier used for the measurement reporting, an additional delay can be expected.

8.11.2.2 E-UTRAN inter-frequency measurements

The UE shall be able to identify new inter-frequency cells and perform RSRP and RSRQ measurements of identified inter-frequency cells if carrier frequency information is provided by the PCell, even if no explicit neighbour list with physical layer cell identities is provided. The discovery signal occasion and the measurement gap should be aligned, provided that also the following additional conditions are fulfilled:

Entire discovery signal occasion should be contained in the measurement gap.

The subframe contained discovery signal for the measurement is not overlapped with the first 0.5 ms period and the last 0.5 ms period in every gap.

8.11.2.2.1 E-UTRAN FDD-FS3 inter-frequency measurements

8.11.2.2.1.1 E-UTRAN FDD – FS3 inter-frequency measurements when no DRX is used

When measurement gaps are scheduled or the UE supports capability of conducting such measurements without gaps, the UE shall be able to identify a new detectable FS3 inter-frequency cell within the cell identification time $T_{\text{identify_inter_FS3}}$, which shall include detection of the cell and additionally performing a single measurement within the measurement period of $T_{\text{measure_inter_FS3_CRS}}$ when no DRX is used, where:

$T_{\text{identify_inter_FS3}}$ is the inter-frequency period for cell identification as shown in Table 8.11.2.2.1.1-1,

$T_{\text{measure_inter_FS3_CRS}}$ is the inter-frequency period for measurements as shown in Table 8.11.2.2.1.1-2,

$T_{\text{DMTC_periodicity}}$ is the discovery signal measurement timing configuration periodicity of higher layer,

N_{freq} is defined in Section 8.1.2.1.1,

N is the number of carriers operating under FS3 and which are subject to the channel assessment prior to transmissions,

L is the number of configured discovery signal occasions which are not available during the time for cell identification at the UE during measurement gaps due to the absence of the necessary radio signals from the measured cell,

M is the number of configured discovery signal occasions which are not available during $T_{\text{measure_inter_FS3_CRS}}$ for the measurements at the UE during measurement gaps due to the absence of the necessary radio signals from the measured cell.

If higher layer filtering is used, an additional cell identification delay can be expected.

The requirements in this section apply, provided that L and M are such that: the inter-frequency cell identification period $T_{\text{identify_inter_FS3}}$ does not exceed $75 * N_{\text{freq}} * \text{Max}\{T_{\text{DMTC_periodicity}}, \text{MGRP}\}$, and the inter-frequency period $T_{\text{measure_inter_FS3_CRS}}$ for measurements does not exceed $60 * N_{\text{freq}} * \text{Max}\{T_{\text{DMTC_periodicity}}, \text{MGRP}\}$.

Table 8.11.2.2.1.1-1: Inter-frequency cell identification requirements under operation with frame structure 3

SCH \hat{E} s/lot	CRS measurement bandwidth ^{Note2} [RB]	CRS \hat{E} s/lot	$T_{\text{identify_inter_FS3}}$ [ms]
$0 \leq \text{SCH } \hat{E}\text{s/lot}$	<25	$-6 \leq \text{CRS } \hat{E}\text{s/lot}$	$(7 * N_{\text{freq}} + L * N) * \text{Max}\{T_{\text{DMTC_periodicity}}, \text{MGRP}\}$
$-6 \leq \text{SCH } \hat{E}\text{s/lot} < 0$	<25		$(25 * N_{\text{freq}} + L * N) * \text{Max}\{T_{\text{DMTC_periodicity}}, \text{MGRP}\}$
$0 \leq \text{SCH } \hat{E}\text{s/lot}$	≥ 25	$0 \leq \text{CRS } \hat{E}\text{s/lot}$	$(3 * N_{\text{freq}} + L * N) * \text{Max}\{T_{\text{DMTC_periodicity}}, \text{MGRP}\}$
$-6 \leq \text{SCH } \hat{E}\text{s/lot} < 0$	≥ 25		$(9 * N_{\text{freq}} + L * N) * \text{Max}\{T_{\text{DMTC_periodicity}}, \text{MGRP}\}$

NOTE 1: Discovery signal occasion duration (*ds-OccasionDuration*) is 1 ms.
NOTE 2: The requirements for measurement bandwidth ≥ 25 RB are optional.

Table 8.11.2.2.1.1-2: Inter-frequency measurement requirements under operation with frame structure 3

SCH \hat{E} s/lot	CRS measurement bandwidth ^{Note2} [RB]	CRS \hat{E} s/lot	$T_{\text{measure_inter_FS3_CRS}}$ [ms]
$0 \leq \text{SCH } \hat{E}\text{s/lot}$	<25	$-6 \leq \text{CRS } \hat{E}\text{s/lot}$	$(5 * N_{\text{freq}} + M * N) * \text{Max}\{T_{\text{DMTC_periodicity}}, \text{MGRP}\}$
$-6 \leq \text{SCH } \hat{E}\text{s/lot} < 0$	<25		$(20 * N_{\text{freq}} + M * N) * \text{Max}\{T_{\text{DMTC_periodicity}}, \text{MGRP}\}$
$0 \leq \text{SCH } \hat{E}\text{s/lot}$	≥ 25	$0 \leq \text{CRS } \hat{E}\text{s/lot}$	$(1 * N_{\text{freq}} + M * N) * \text{Max}\{T_{\text{DMTC_periodicity}}, \text{MGRP}\}$
$-6 \leq \text{SCH } \hat{E}\text{s/lot} < 0$	≥ 25		$(4 * N_{\text{freq}} + M * N) * \text{Max}\{T_{\text{DMTC_periodicity}}, \text{MGRP}\}$

NOTE 1: Discovery signal occasion duration (*ds-OccasionDuration*) is 1 ms.
NOTE 2: The requirements for measurement bandwidth ≥ 25 RB are optional.

A cell shall be considered detectable when the following conditions are met during the discovery signal occasions which are available during $T_{\text{identify_inter_FS3}}$:

- RSRP related side conditions given in Section 9.1.18.2 are fulfilled for a corresponding Band,
- RSRQ related side conditions given in Section 9.1.18.3 are fulfilled for a corresponding Band,
- $SCH_RP|_{dBm}$ is according to Annex B.2.13.1 for a corresponding Band,
- $SCH\ \hat{E}s/Iot$ is according to Table 8.11.2.2.1.1-1.

When measurement gaps are scheduled for FS3 inter-frequency measurements or the UE supports capability of conducting such measurements without gaps, the UE physical layer shall be capable of reporting RSRP and RSRQ measurements to higher layers with measurement accuracy as specified in Sections 9.1.18.2 and 9.1.18.3, respectively, with measurement period given by table 8.11.2.2.1.1-2.

The UE shall be capable of performing RSRP and RSRQ measurements of at least 3 identified inter-frequency cells per FS3 inter-frequency for up to 3 FS3 inter-frequencies and the UE physical layer shall be capable of reporting RSRP and RSRQ measurements to higher layers with the measurement period defined in table 8.11.2.2.1.1-2 when no DRX is in use, either measurement gaps are scheduled or the UE supports capability of conducting such measurements without gaps.

The RSRP measurement accuracy for all measured cells shall be as specified in Section 9.1.18.2, and the RSRQ measurement accuracy for all measured cells shall be as specified in Section 9.1.18.3.

8.11.2.2.1.1 Measurement Reporting Requirements

8.11.2.2.1.1.1 Periodic Reporting

Reported RSRP and RSRQ measurements contained in periodically triggered measurement reports shall meet the requirements in sections 9.1.18.2 and 9.1.18.3, respectively.

8.11.2.2.1.1.2 Event-triggered Periodic Reporting

Reported RSRP and RSRQ measurements contained in event triggered periodic measurement reports shall meet the requirements in sections 9.1.18.2, and 9.1.18.3, respectively.

The first report in event triggered periodic measurement reporting shall meet the requirements specified in Section 8.11.2.2.1.1.3.

8.11.2.2.1.1.3 Event Triggered Reporting

Reported RSRP and RSRQ measurements contained in event triggered measurement reports shall meet the requirements in sections 9.1.18.2 and 9.1.18.3, respectively.

The UE shall not send any event triggered measurement reports, as long as no reporting criteria are fulfilled.

The measurement reporting delay is defined as the time between an event that will trigger a measurement report and the point when the UE starts to transmit the measurement report over the air interface. This requirement assumes that the measurement report is not delayed by other RRC signalling on the DCCH. This measurement reporting delay excludes a delay uncertainty resulted when inserting the measurement report to the TTI of the uplink DCCH. The delay uncertainty is: $2 \times TTI_{DCCH}$. This measurement reporting delay excludes a delay which caused by no UL resources for UE to send the measurement report or by the LBT procedure performed by the UE in order to determine that the channel is clear for performing uplink transmission.

The event triggered measurement reporting delay, measured without L3 filtering shall be less than $T_{\text{identify_inter_FS3}}$ defined in Section 8.11.2.2.1.1. When L3 filtering is used or IDC autonomous denial is configured or LBT is performed by the UE on the carrier used for the measurement reporting an additional delay can be expected.

If a cell which has been detectable at least for the time period $T_{\text{identify_inter_FS3}}$ defined in Section 8.11.2.2.1.1 and then triggers the measurement report as per TS 36.331 [2], the event triggered measurement reporting delay shall be less than $T_{\text{measure_inter_FS3_CRS}}$ provided the timing to that cell has not changed more than ± 50 Ts while measurement gap has not been available and the L3 filter has not been used. When L3 filtering is used or IDC autonomous denial is configured or LBT is performed by the UE on the carrier used for the measurement reporting, an additional delay can be expected.

8.11.2.2.1.2 E-UTRAN FDD – FS3 inter-frequency measurements when DRX is used

When measurement gaps are scheduled or the UE supports capability of conducting such measurements without gaps, the UE shall be able to identify a new detectable FS3 inter-frequency cell within the cell identification time $T_{\text{identify_inter_FS3_DRX}}$, which shall include detection of the cell and additionally performing a single measurement within the measurement period of $T_{\text{measure_inter_FS3_CRS_DRX}}$ when DRX is used, where:

$T_{\text{identify_inter_FS3_DRX}}$ is the inter-frequency period for measurements as shown in Table 8.11.2.2.1.2-1,

$T_{\text{measure_inter_FS3_CRS_DRX}}$ is the inter-frequency period for measurements as shown in Table 8.11.2.2.1.2-2,

$T_{\text{DMTC_periodicity}}$ is the discovery signal measurement timing configuration periodicity of higher layer,

N_{freq} is defined in Section 8.1.2.1.1,

N is the number of carriers operating under FS3 and which are subject to the channel assessment prior to transmissions,

L is the number of configured discovery signal occasions which are not available during the time for cell identification at the UE during measurement gaps due to the absence of the necessary radio signals from the measured cell,

M is the number of configured discovery signal occasions which are not available during $T_{\text{measure_inter_FS3_CRS_DRX}}$ for the measurements at the UE during measurement gaps due to the absence of the necessary radio signals from the measured cell.

The requirements in this section apply, provided that L and M are such that: the inter-frequency cell identification period $T_{\text{identify_inter_FS3_DRX}}$ does not exceed $75 * N_{\text{freq}} * \text{Max}\{T_{\text{DMTC_periodicity}}, \text{MGRP}, \text{DRX cycle length}\}$, and the inter-frequency period $T_{\text{measure_inter_FS3_CRS_DRX}}$ for measurements does not exceed $60 * N_{\text{freq}} * \text{Max}\{T_{\text{DMTC_periodicity}}, \text{MGRP}, \text{DRX cycle length}\}$.

If higher layer filtering is used, an additional cell identification delay can be expected.

Table 8.11.2.2.1.2-1: Inter-frequency cell identification requirements under operation with frame structure 3

SCH $\hat{E}s/\text{lot}$	CRS measurement bandwidth ^{Note2} [RB]	CRS $\hat{E}s/\text{lot}$	$T_{\text{identify_inter_FS3_DRX}}$ [ms]
$0 \leq \text{SCH } \hat{E}s/\text{lot}$	<25	$-6 \leq \text{CRS } \hat{E}s/\text{lot}$	$(7 * N_{\text{freq}} + L * N) * \text{Max}\{T_{\text{DMTC_periodicity}}, \text{MGRP}, \text{DRX cycle length}\}$
$-6 \leq \text{SCH } \hat{E}s/\text{lot} < 0$	<25		$(25 * N_{\text{freq}} + L * N) * \text{Max}\{T_{\text{DMTC_periodicity}}, \text{MGRP}, \text{DRX cycle length}\}$
$0 \leq \text{SCH } \hat{E}s/\text{lot}$	≥ 25	$0 \leq \text{CRS } \hat{E}s/\text{lot}$	$(3 * N_{\text{freq}} + L * N) * \text{Max}\{T_{\text{DMTC_periodicity}}, \text{MGRP}, \text{DRX cycle length}\}$
$-6 \leq \text{SCH } \hat{E}s/\text{lot} < 0$	≥ 25		$(9 * N_{\text{freq}} + L * N) * \text{Max}\{T_{\text{DMTC_periodicity}}, \text{MGRP}, \text{DRX cycle length}\}$
NOTE 1: Discovery signal occasion duration (<i>ds-OccasionDuration</i>) is 1 ms.			
NOTE 2: The requirements for measurement bandwidth ≥ 25 RB are optional.			

Table 8.11.2.2.1.2-2: Inter-frequency measurement requirements under operation with frame structure 3

SCH $\hat{E}s/\text{lot}$	CRS measurement bandwidth ^{Note2} [RB]	CRS $\hat{E}s/\text{lot}$	$T_{\text{measure_inter_FS3_CRS_DRX}}$ [ms]
$0 \leq \text{SCH } \hat{E}s/\text{lot}$	<25	$-6 \leq \text{CRS } \hat{E}s/\text{lot}$	$(5 * N_{\text{freq}} + M * N) * \text{Max}\{T_{\text{DMTC_periodicity}}, \text{MGRP}, \text{DRX cycle length}\}$
$-6 \leq \text{SCH } \hat{E}s/\text{lot} < 0$	<25		$(20 * N_{\text{freq}} + M * N) * \text{Max}\{T_{\text{DMTC_periodicity}}, \text{MGRP}, \text{DRX cycle length}\}$
$0 \leq \text{SCH } \hat{E}s/\text{lot}$	≥ 25	$0 \leq \text{CRS } \hat{E}s/\text{lot}$	$(1 * N_{\text{freq}} + M * N) * \text{Max}\{T_{\text{DMTC_periodicity}}, \text{MGRP}, \text{DRX cycle length}\}$
$-6 \leq \text{SCH } \hat{E}s/\text{lot} < 0$	≥ 25		$(4 * N_{\text{freq}} + M * N) * \text{Max}\{T_{\text{DMTC_periodicity}}, \text{MGRP}, \text{DRX cycle length}\}$

NOTE 1: Discovery signal occasion duration (*ds-OccasionDuration*) is 1 ms.

NOTE 2: The requirements for measurement bandwidth ≥ 25 RB are optional.

A cell shall be considered detectable when the following conditions are met during the discovery signal occasions which are available during $T_{\text{identify_inter_FS3_DRX}}$:

- RSRP related side conditions given in Section 9.1.18.2 are fulfilled for a corresponding Band,
- RSRQ related side conditions given in Section 9.1.18.3 are fulfilled for a corresponding Band,
- $SCH_RP|_{\text{dBm}}$ is according to Annex B.2.13.1 for a corresponding Band,
- $SCH\ \hat{E}_s/I_{ot}$ is according to Table 8.11.2.2.1.2-1.

The UE shall be capable of performing RSRP and RSRQ measurements of at least 3 identified inter-frequency cells per FS3 inter-frequency for up to 3 FS3 inter-frequencies and the UE physical layer shall be capable of reporting RSRP and RSRQ measurements to higher layers with the measurement period defined in table 8.11.2.2.1.2-2 when DRX is in use, either measurement gaps are scheduled or the UE supports capability of conducting such measurements without gaps.

The RSRP measurement accuracy for all measured cells shall be as specified in Section 9.1.18.2, and the RSRQ measurement accuracy for all measured cells shall be as specified in Section 9.1.18.3.

8.11.2.2.1.2.1 Measurement Reporting Requirements

8.11.2.2.1.2.1.1 Periodic Reporting

Reported RSRP and RSRQ measurements contained in periodically triggered measurement reports shall meet the requirements in sections 9.1.18.2 and 9.1.18.3, respectively.

8.11.2.2.1.2.1.2 Event-triggered Periodic Reporting

Reported RSRP and RSRQ measurements contained in event triggered periodic measurement reports shall meet the requirements in sections 9.1.18.2 and 9.1.18.3, respectively.

The first report in event triggered periodic measurement reporting shall meet the requirements specified in Section 8.11.2.2.1.2.1.3.

8.11.2.2.1.2.1.3 Event Triggered Reporting

Reported RSRP and RSRQ measurements contained in event triggered measurement reports shall meet the requirements in sections 9.1.18.2, and 9.1.18.3, respectively.

The UE shall not send any event triggered measurement reports, as long as no reporting criteria are fulfilled.

The measurement reporting delay is defined as the time between an event that will trigger a measurement report and the point when the UE starts to transmit the measurement report over the air interface. This requirement assumes that the measurement report is not delayed by other RRC signalling on the DCCH. This measurement reporting delay excludes a delay uncertainty resulted when inserting the measurement report to the TTI of the uplink DCCH. The delay uncertainty is: $2 \times TTI_{\text{DCCH}}$. This measurement reporting delay excludes a delay which caused by no UL resources for UE to send the measurement report or by the LBT procedure performed by the UE in order to determine that the channel is clear for performing uplink transmission.

The event triggered measurement reporting delay, measured without L3 filtering shall be less than $T_{\text{identify_inter_FS3_DRX}}$ defined in Section 8.11.2.2.1.2. When L3 filtering is used or IDC autonomous denial is configured or LBT is performed by the UE on the carrier used for the measurement reporting an additional delay can be expected.

If a cell which has been detectable at least for the time period $T_{\text{identify_inter_FS3_DRX}}$ defined in Section 8.11.2.2.1.2 becomes undetectable for a period ≤ 8 seconds and then the cell becomes detectable again and triggers an event, the event triggered measurement reporting delay shall be less than $T_{\text{identify_inter_FS3_CRS_DRX}}$ provided the timing to that cell has not changed more than ± 50 Ts and the L3 filter has not been used. When L3 filtering is used or IDC autonomous denial is configured or LBT is performed by the UE on the carrier used for the measurement reporting, an additional delay can be expected.

8.11.2.2.2 E-UTRAN TDD – FS3 inter-frequency measurements

8.11.2.2.2.1 E-UTRAN TDD – FS3 inter-frequency measurements when no DRX is used

The requirements in this section for UE configured with TDD PCell and no DRX are the same as the requirements in Section 8.11.2.2.1.1.

8.11.2.2.2.2 E-UTRAN TDD – FS3 inter-frequency measurements when DRX is used

The requirements in this section for UE configured with TDD PCell and DRX are the same as the requirements in Section 8.11.2.2.1.2.

8.11.3 CSI-RS based discovery signal measurements

8.11.3.1 E-UTRAN intra-frequency measurements

The UE shall be able to identify new intra-frequency FS3 TPs and perform CSI-RSRP measurements of intra-frequency TPs with an explicit intra-frequency TP list containing physical layer cell identities. During the RRC_CONNECTED state the UE shall continuously measure identified intra-frequency TPs and additionally search for and identify new intra-frequency TPs.

8.11.3.1.1 Requirements

8.11.3.1.1.1 Requirements when no DRX is used

When no DRX is in use the UE shall be able to identify a new detectable FS3 intra-frequency TP within the identification period $T_{\text{identify_intra_TP_FS3}}$, where identification of a TP shall include cell identification and additionally performing a single measurement on the TP.

$$T_{\text{identify_intra_TP_FS3}} = T_{\text{identify_intra_FS3}} + T_{\text{measure_intra_FS3_CSI-RS}},$$

where

$T_{\text{identify_intra_FS3}}$ is the intra-frequency period for cell identification in Section 8.11.2.1.1.1,

$T_{\text{measure_intra_FS3_CSI-RS}}$ is the intra-frequency period for TP measurement as shown in Table 8.11.3.1.1.1-1,

$T_{\text{DMTC_periodicity}}$ is the discovery signal measurement timing configuration periodicity of higher layer,

M is the number of configured discovery signal occasions which are not available during $T_{\text{measure_intra_FS3_CSI-RS}}$ for the measurements at the UE due to the absence of the necessary radio signals from the TP or due to the corresponding downlink subframe being configured as an uplink subframe.

During $T_{\text{identify_intra_TP_FS3}}$ over multiple discovery signal occasions, the UE may assume the following:

- in all the discovery signal occasions, which are available at the UE, the corresponding necessary cell-specific discovery signals are always available from the same set of TPs in the measured cell, and
- in all the discovery signal occasions, which are not available at the UE, the corresponding necessary cell-specific discovery signals are not available from any TP within the same measured cell.

A TP shall be considered detectable when the following conditions are met during the discovery signal occasions which are available during $T_{\text{identify_intra_TP_FS3}}$:

- CSI-RSRP related side conditions given in Section 9.1.18.4 are fulfilled for a corresponding Band,
- SCH_RP is according to Annex B.2.12 for a corresponding Band and SCH \hat{E}_s/I_{ot} is according to Section 8.11.2.1.1.1.

Identification of a TP shall include identification of the cell and additionally performing a single measurement on the TP within the measurement period of $T_{\text{measure_intra_FS3_CSI-RS}}$ when no DRX is used. If higher layer filtering is used, an additional TP identification delay can be expected.

In the RRC_CONNECTED state the measurement period for intra-frequency measurements is $T_{\text{measure_intra_FS3_CSI-RS}}$ as shown in table 8.11.3.1.1.1-1, when no DRX is in use. The UE shall be capable of performing CSI-RSRP measurements

for 3 identified intra-frequency TPs, and the UE physical layer shall be capable of reporting measurements to higher layers with the measurement period of $T_{\text{measure_intra_FS3_CSI-RS}}$

Table 8.11.3.1.1.1-1: Intra-frequency TP measurement requirements under operation with frame structure 3

SCH \dot{E} s/lot	CRS measurement bandwidth [RB] ^{Note2}	CSI-RS \dot{E} s/lot	$T_{\text{measure_intra_FS3_CSI-RS}}$ [ms]
$0 \leq \text{SCH } \dot{E}\text{s/lot}$	<25	$0 \leq \text{CSI-RS } \dot{E}\text{s/lot}$	$(5+M) \cdot k_1 \cdot k_2 \cdot T_{\text{DMTC_periodicity}}$
$-6 \leq \text{SCH } \dot{E}\text{s/lot} < 0$	<25		$(20+M) \cdot k_1 \cdot k_2 \cdot T_{\text{DMTC_periodicity}}$
$0 \leq \text{SCH } \dot{E}\text{s/lot}$	≥ 25	$0 \leq \text{CSI-RS } \dot{E}\text{s/lot}$	$(1+M) \cdot k_1 \cdot k_2 \cdot T_{\text{DMTC_periodicity}}$
$-6 \leq \text{SCH } \dot{E}\text{s/lot} < 0$	≥ 25		$(4+M) \cdot k_1 \cdot k_2 \cdot T_{\text{DMTC_periodicity}}$

NOTE 1: Discovery signal occasion duration (*ds-OccasionDuration*) is 1 ms.
NOTE 2: The requirements for measurement bandwidth ≥ 25 RB are optional.
NOTE 3: $k_1=2$ when the measurement gaps configured for inter-frequency measurements in DMTC occasions or for inter-frequency RSSI measurements in RMTC occasions on a carrier with frame structure 3 overlap with some but not all DMTC occasions of the measured TP; otherwise, $k_1=1$, e.g., when measurement gaps configured for inter-frequency measurements on a carrier with frame structure 3 do not overlap with DMTC occasions of the measured TP or when the UE does not require the measurement gaps for the inter-frequency measurements. The requirements apply, provided that the inter-frequency measurement gap pattern does not overlap with all DMTC occasions of the measured cell.

$$k_2 = \max \left(2, \left\lceil \frac{N_{\text{FS3_SCC}}}{2} \right\rceil \right)$$

when DMTC occasions in the measured TP not overlapping with the inter-frequency measurement gaps measurement gaps overlap with DMTC occasions of $N_{\text{FS3_SCC}}$ ($N_{\text{FS3_SCC}} > 0$) SCCells on other FS3 carriers; otherwise, $k_2=1$, e.g., when $N_{\text{FS3_SCC}}$ is 0.

NOTE 4: The requirements apply, provided that M is such that the intra-frequency period for TP measurement $T_{\text{measure_intra_FS3_CSI-RS}}$ does not exceed $60 \cdot k_1 \cdot k_2 \cdot T_{\text{DMTC_periodicity}}$.

The CSI-RSRP measurement accuracy for all measured TPs shall be as specified in Section 9.1.18.4.

8.11.3.1.1.1.1 Measurement Reporting Requirements

8.11.3.1.1.1.1.1 Periodic Reporting

Reported CSI-RSRP measurements contained in periodically triggered measurement reports shall meet the requirements in Section 9.1.18.4.

8.11.3.1.1.1.1.2 Event-triggered Periodic Reporting

Reported CSI-RSRP measurements contained in event triggered periodic measurement reports shall meet the requirements in Section 9.1.18.4.

The first report in event triggered periodic measurement reporting shall meet the requirements specified in Section 8.11.3.1.1.1.1.3.

8.11.3.1.1.1.1.3 Event Triggered Reporting

Reported CSI-RSRP measurements contained in event triggered measurement reports shall meet the requirements in Section 9.1.18.4.

The UE shall not send any event triggered measurement reports, as long as no reporting criteria are fulfilled.

The measurement reporting delay is defined as the time between an event that will trigger a measurement report and the point when the UE starts to transmit the measurement report over the air interface. This requirement assumes that the measurement report is not delayed by other RRC signalling on the DCCH. This measurement reporting delay excludes a delay uncertainty resulted when inserting the measurement report to the TTI of the uplink DCCH. The delay uncertainty is: $2 \times TTI_{\text{DCCH}}$. This measurement reporting delay excludes a delay which caused by no UL resources for UE to send the measurement report or by the LBT procedure performed by the UE in order to determine that the channel is clear for performing uplink transmission.

The event triggered measurement reporting delay, measured without L3 filtering shall be less than $T_{\text{identify_intra_TP_FS3}}$ defined in Section 8.11.3.1.1.1. When L3 filtering is used or IDC autonomous denial is configured or LBT is performed by the UE on the carrier used for the measurement reporting an additional delay can be expected.

If a TP which has been detectable at least for the time period $T_{\text{identify_intra_TP_FS3}}$ defined in Section 8.11.3.1.1.1 becomes undetectable for a period ≤ 8 seconds and then the TP becomes detectable again and triggers an event, the event triggered measurement reporting delay shall be less than $T_{\text{identify_intra_FS3_CSI-RS}}$ provided the timing to that TP has not changed more than ± 50 Ts and the L3 filter has not been used. When L3 filtering is used or IDC autonomous denial is configured or LBT is performed by the UE on the carrier used for the measurement reporting, an additional delay can be expected.

8.11.3.1.1.2 Requirements when DRX is used

When DRX is in use the UE shall be able to identify a new detectable FS3 intra-frequency TP within the identification period $T_{\text{identify_intra_TP_FS3_DRX}}$, where identification of a TP shall include cell identification and additionally performing a single measurement on the TP.

$$T_{\text{identify_intra_TP_FS3_DRX}} = T_{\text{identify_intra_FS3_DRX}} + T_{\text{measure_intra_FS3_CSI-RS_DRX}},$$

where:

$T_{\text{identify_intra_FS3_DRX}}$ is the intra-frequency period for cell identification in Section 8.11.2.1.1.2.

$T_{\text{measure_intra_FS3_CSI-RS_DRX}}$ is the intra-frequency period for TP measurement as shown in Table 8.11.3.1.1.2-1, where

$T_{\text{DMTC_periodicity}}$ is the discovery signal measurement timing configuration periodicity of higher layer,

M is the number of configured discovery signal occasions during ON DURATION and which are not available during $T_{\text{measure_intra_FS3_CSI-RS_DRX}}$ for the measurements at the UE due to the absence of the necessary radio signals from the TP or due to the corresponding downlink subframe being configured as an uplink subframe.

During $T_{\text{identify_intra_TP_FS3_DRX}}$ over multiple discovery signal occasions, the UE may assume the following:

- in all the discovery signal occasions, which are available at the UE, the corresponding necessary cell-specific discovery signals are always available from the same set of TPs in the measured cell, and
- in all the discovery signal occasions, which are not available at the UE, the corresponding necessary cell-specific discovery signals are not available from any TP within the same measured cell.

A TP shall be considered detectable when the following conditions are met during the discovery signal occasions which are available during $T_{\text{identify_intra_TP_FS3_DRX}}$:

- CSI-RSRP related side conditions given in Section 9.1.18.4 are fulfilled for a corresponding Band,
- SCH_RP is according to Annex B.2.12 for a corresponding Band and $SCH \hat{E}s/lot$ is according to Section 8.11.2.1.1.2.

Identification of a TP shall include identification of the cell and additionally performing a single measurement on the TP within measurement period of $T_{\text{measure_intra_FS3_CSI-RS_DRX}}$ when DRX is used. If higher layer filtering is used, an additional TP identification delay can be expected.

In the RRC_CONNECTED state the measurement period for intra frequency measurements is $T_{\text{measure_intra_FS3_CSI-RS_DRX}}$ as shown in Table 8.11.3.1.1.2-1, when DRX is in use. The UE shall be capable of performing CSI-RSRP measurements for 3 identified intra-frequency TPs, and the UE physical layer shall be capable of reporting measurements to higher layers with the measurement period of $T_{\text{measure_intra_FS3_CSI-RS_DRX}}$.

Table 8.11.3.1.1.2-1: Intra-frequency TP measurement requirements under operation with frame structure 3

SCH $\hat{E}s/lot$	CRS measurement bandwidth [RB] ^{Note2}	CSI-RS $\hat{E}s/lot$	$T_{\text{measure_intra_FS3_CSI-RS_DRX}}$ [ms]
$0 \leq SCH \hat{E}s/lot$	<25	$0 \leq CSI-RS \hat{E}s/lot$	$(5+M) * k1 * k2 * \text{Max}\{T_{\text{DMTC_periodicity}}, \text{DRX cycle length}\}$
$-6 \leq SCH \hat{E}s/lot < 0$	<25		$(20+M) * k1 * k2 * \text{Max}\{T_{\text{DMTC_periodicity}}, \text{DRX cycle length}\}$

$0 \leq \text{SCH } \dot{E}s/\text{lot}$	≥ 25	$0 \leq \text{CSI-RS } \dot{E}s/\text{lot}$	$(1+M) * k_1 * k_2 * \text{Max}\{T_{\text{DMTC_periodicity}}, \text{DRX cycle length}\}$
$-6 \leq \text{SCH } \dot{E}s/\text{lot} < 0$	≥ 25		$(4+M) * k_1 * k_2 * \text{Max}\{T_{\text{DMTC_periodicity}}, \text{DRX cycle length}\}$

NOTE 1: Discovery signal occasion duration (*ds-OccasionDuration*) is 1 ms.
NOTE 2: The requirements for measurement bandwidth ≥ 25 RB are optional.
NOTE 3: $k_1=2$ when the measurement gaps configured for inter-frequency measurements in DMTC occasions or for inter-frequency RSSI measurements in RMTC occasions on a carrier with frame structure 3 overlap with some but not all DMTC occasions of the measured TP during ON DURATION; otherwise, $k_1=1$, e.g., when measurement gaps configured for inter-frequency measurements on a carrier with frame structure 3 do not overlap with DMTC occasions of the measured TP during ON DURATION or when the UE does not require the measurement gaps for the inter-frequency measurements. The requirements apply, provided that the inter-frequency measurement gap pattern does not overlap with all DMTC occasions of the measured cell.

$$k_2 = \max\left(2, \left\lceil \frac{N_{\text{FS3_SCC}}}{2} \right\rceil\right)$$

when DMTC occasions in the measured TP not overlapping with the inter-frequency measurement gaps overlap with DMTC occasions of $N_{\text{FS3_SCC}}$ ($N_{\text{FS3_SCC}} > 0$) SCells during ON DURATION on other FS3 carriers; otherwise, $k_2=1$, e.g., when $N_{\text{FS3_SCC}}=0$.

NOTE 4: The requirements apply, provided that M is such that the intra-frequency period for TP measurement $T_{\text{measure_intra_FS3_CSI-RS_DRX}}$ does not exceed $60 * k_1 * k_2 * \text{Max}\{T_{\text{DMTC_periodicity}}, \text{DRX cycle length}\}$.

The CSI-RSRP measurement accuracy for all measured TPs shall be as specified in Section 9.1.18.4.

8.11.3.1.1.2.1 Measurement Reporting Requirements

8.11.3.1.1.2.1.1 Periodic Reporting

Reported CSI-RSRP measurements contained in periodically triggered measurement reports shall meet the requirements in Section 9.1.18.4.

8.11.3.1.1.2.1.2 Event-triggered Periodic Reporting

Reported CSI-RSRP measurements contained in event triggered periodic measurement reports shall meet the requirements in Section 9.1.18.4.

The first report in event triggered periodic measurement reporting shall meet the requirements specified in Section 8.11.3.1.1.2.1.3.

8.11.3.1.1.2.1.3 Event Triggered Reporting

Reported CSI-RSRP measurements contained in event triggered measurement reports shall meet the requirements in Section 9.1.18.4.

The UE shall not send any event triggered measurement reports, as long as no reporting criteria are fulfilled.

The measurement reporting delay is defined as the time between an event that will trigger a measurement report and the point when the UE starts to transmit the measurement report over the air interface. This requirement assumes that the measurement report is not delayed by other RRC signalling on the DCCH. This measurement reporting delay excludes a delay uncertainty resulted when inserting the measurement report to the TTI of the uplink DCCH. The delay uncertainty is: $2 \times TTI_{\text{DCCH}}$. This measurement reporting delay excludes a delay which caused by no UL resources for UE to send the measurement report or by the LBT procedure performed by the UE in order to determine that the channel is clear for performing uplink transmission.

The event triggered measurement reporting delay, measured without L3 filtering shall be less than $T_{\text{identify_intra_TP_FS3_DRX}}$ defined in Section 8.11.3.1.1.2. When L3 filtering is used or IDC autonomous denial is configured or LBT is performed by the UE on the carrier used for the measurement reporting an additional delay can be expected.

If a TP which has been detectable at least for the time period $T_{\text{identify_intra_TP_FS3_DRX}}$ defined in Section 8.11.3.1.1.2 becomes undetectable for a period ≤ 8 seconds and then the TP becomes detectable again and triggers an event, the event triggered measurement reporting delay shall be less than $T_{\text{identify_intra_FS3_CSI-RS_DRX}}$ provided the timing to that TP has not changed more than ± 50 Ts and the L3 filter has not been used. When L3 filtering is used or IDC autonomous denial is configured or LBT is performed by the UE on the carrier used for the measurement reporting, an additional delay can be expected.

8.11.3.2 E-UTRAN inter-frequency measurements

The UE shall be able to identify new inter-frequency TPs and perform CSI-RSRP measurements of the identified inter-frequency TPs with an explicit inter-frequency TP list containing physical layer cell identities. The discovery signal occasion and the measurement gap should be aligned, provided that also the following additional conditions are fulfilled:

Entire discovery signal occasion should be contained in the measurement gap.

The subframe contained discovery signal for the measurement is not overlapped with the first 0.5 ms period and the last 0.5 ms period in every gap.

8.11.3.2.1 E-UTRAN FDD – FS3 inter-frequency measurements

8.11.3.2.1.1 E-UTRAN FDD – FS3 inter-frequency measurements when no DRX is used

When measurement gaps are scheduled or the UE supports capability of conducting such measurements without gaps, the UE shall be able to identify a new detectable FS3 inter-frequency TP within the TP identification time $T_{\text{identify_inter_TP_FS3}}$ according to the following expression:

$$T_{\text{identify_inter_TP_FS3}} = T_{\text{identify_inter_FS3}} + T_{\text{measure_inter_FS3_CSI-RS}}$$

where

$T_{\text{identify_inter_FS3}}$ is the inter-frequency period for cell identification in Section 8.11.2.2.1.1,

$T_{\text{measure_inter_FS3_CSI-RS}}$ is the inter-frequency period for TP measurement as shown in Table 8.11.3.2.1.1-1,

$T_{\text{DMTC_periodicity}}$ is the discovery signal measurement timing configuration periodicity of higher layer,

N_{freq} is defined in section 8.1.2.1.1,

N is the number of carriers operating under FS3 and which are subject to the channel assessment prior to transmissions,

M is the number of configured discovery signal occasions which are not available during $T_{\text{measure_inter_FS3_CSI-RS}}$ for the measurements at the UE during measurement gaps due to the absence of the necessary radio signals from the measured TP.

The requirements in this section apply, provided that M is such that: the inter-frequency period $T_{\text{measure_inter_FS3_CSI-RS}}$ for TP measurements does not exceed $60 * N_{\text{freq}} * \text{Max}\{T_{\text{DMTC_periodicity}}, \text{MGRP}\}$.

During $T_{\text{identify_inter_TP_FS3}}$ over multiple discovery signal occasions, the UE may assume the following:

- in all the discovery signal occasions, which are available at the UE, the corresponding necessary cell-specific discovery signals are always available from the same set of TPs in the measured cell, and
- in all the discovery signal occasions, which are not available at the UE, the corresponding necessary cell-specific discovery signals are not available from any TP within the same measured cell.

A TP shall be considered detectable when the following conditions are met during the discovery signal occasions which are available during $T_{\text{identify_inter_TP_FS3}}$:

- CSI-RSRP related side conditions given in Section 9.1.18.4 are fulfilled for a corresponding Band,
- SCH_RP is according to Annex B.2.13.2 for a corresponding Band,
- SCH \hat{E}_s/I_{ot} is according to Table 8.11.2.2.1.1-1.

When measurement gaps are scheduled for FS3 inter-frequency measurements or the UE supports capability of conducting such measurements without gaps, the UE physical layer shall be capable of reporting CSI-RSRP measurements to higher layers with measurement accuracy as specified in section 9.1.18.4, with measurement period given by table 8.11.3.2.1.1-1.

The UE shall be capable of performing CSI-RSRP measurements of at least 3 identified inter-frequency TPs per FS3 inter-frequency for up to 3 FS3 inter-frequencies and the UE physical layer shall be capable of reporting CSI-RSRP

measurements to higher layers with the measurement period defined in table 8.11.3.2.1.1-1 when no DRX is in use, either measurement gaps are scheduled or the UE supports capability of conducting such measurements without gaps.

Table 8.11.3.2.1.1-1: Requirements to measure FS3 inter-frequency TP

SCH \hat{E} s/lot	CSI-RS measurement bandwidth ^{Note2} [RB]	CSI-RS \hat{E} s/lot	$T_{\text{measure_inter_FS3_CSI-RS}}$ [ms]
$0 \leq \text{SCH } \hat{E}\text{s/lot}$	<25	$0 \leq \text{CSI-RS } \hat{E}\text{s/lot}$	$(5 \cdot N_{\text{freq}} + M \cdot N) \cdot \text{Max}\{T_{\text{DMTC_periodicity}}, \text{MGRP}\}$
$-6 \leq \text{SCH } \hat{E}\text{s/lot} < 0$	<25		$(20 \cdot N_{\text{freq}} + M \cdot N) \cdot \text{Max}\{T_{\text{DMTC_periodicity}}, \text{MGRP}\}$
$0 \leq \text{SCH } \hat{E}\text{s/lot}$	≥ 25	$0 \leq \text{CSI-RS } \hat{E}\text{s/lot}$	$(1 \cdot N_{\text{freq}} + M \cdot N) \cdot \text{Max}\{T_{\text{DMTC_periodicity}}, \text{MGRP}\}$
$-6 \leq \text{SCH } \hat{E}\text{s/lot} < 0$	≥ 25		$(4 \cdot N_{\text{freq}} + M \cdot N) \cdot \text{Max}\{T_{\text{DMTC_periodicity}}, \text{MGRP}\}$
NOTE 1: Discovery signal occasion duration (<i>ds-OccasionDuration</i>) is 1 ms.			
NOTE 2: The requirements for measurement bandwidth ≥ 25 RB are optional.			

The CSI-RSRP measurement accuracy for all measured TPs shall be as specified in section 9.1.18.4.

8.11.3.2.1.1.1 Measurement Reporting Requirements

8.11.3.2.1.1.1.1 Periodic Reporting

Reported CSI-RSRP measurements contained in periodically triggered measurement reports shall meet the requirements in section 9.1.18.4.

8.11.3.2.1.1.1.2 Event-triggered Periodic Reporting

Reported CSI-RSRP measurements contained in event triggered periodic measurement reports shall meet the requirements in section 9.1.18.4.

The first report in event triggered periodic measurement reporting shall meet the requirements specified in section 8.11.3.2.1.1.1.3.

8.11.3.2.1.1.1.3 Event Triggered Reporting

Reported CSI-RSRP measurements contained in event triggered measurement reports shall meet the requirements in section 9.1.18.4.

The UE shall not send any event triggered measurement reports, as long as no reporting criteria are fulfilled.

The measurement reporting delay is defined as the time between an event that will trigger a measurement report and the point when the UE starts to transmit the measurement report over the air interface. This requirement assumes that the measurement report is not delayed by other RRC signalling on the DCCH. This measurement reporting delay excludes a delay uncertainty resulted when inserting the measurement report to the TTI of the uplink DCCH. The delay uncertainty is: $2 \times T_{\text{TI}_{\text{DCCH}}}$. This measurement reporting delay excludes a delay which caused by no UL resources for UE to send the measurement report or by the LBT procedure performed by the UE in order to determine that the channel is clear for performing uplink transmission.

The event triggered measurement reporting delay, measured without L3 filtering shall be less than $T_{\text{identify_inter_TP_FS3}}$ defined in Section 8.11.3.2.1.1. When L3 filtering is used or IDC autonomous denial is configured or LBT is performed by the UE on the carrier used for the measurement reporting an additional delay can be expected.

If a TP which has been detectable at least for the time period $T_{\text{identify_inter_TP_FS3}}$ defined in Section 8.11.3.2.1.1 becomes undetectable for a period ≤ 8 seconds and then the TP becomes detectable again and triggers an event, the event triggered measurement reporting delay shall be less than $T_{\text{identify_inter_FS3_CSI-RS}}$ provided the timing to that TP has not changed more than $\pm 50 T_s$ and the L3 filter has not been used. When L3 filtering is used or IDC autonomous denial is configured or LBT is performed by the UE on the carrier used for the measurement reporting, an additional delay can be expected.

8.11.3.2.1.2 E-UTRAN FDD – FS3 inter-frequency measurements when DRX is used

When DRX is in use, either measurement gaps are scheduled or the UE supports capability of conducting such measurements without gaps, the UE shall be able to identify a new detectable FS3 inter-frequency TP within $T_{\text{identify_inter_TP_FS3_DRX}}$ according to the following expression:

$$T_{\text{identify_inter_TP_FS3_DRX}} = T_{\text{identify_inter_FS3_DRX}} + T_{\text{measure_inter_FS3_CSI-RS_DRX}}$$

where

$T_{\text{identify_inter_FS3_DRX}}$ is the inter-frequency period for cell identification in Section 8.11.2.2.1.2,

$T_{\text{measure_inter_FS3_CSI-RS_DRX}}$ is the inter-frequency period for TP measurement as shown in Table 8.11.3.2.1.2-1,

$T_{\text{DMTC_periodicity}}$ is the discovery signal measurement timing configuration periodicity of higher layer,

N_{freq} is defined in section 8.1.2.1.1,

N is the number of carriers operating under FS3 and which are subject to the channel assessment prior to transmissions,

M is the number of configured discovery signal occasions which are not available during $T_{\text{measure_inter_FS3_CSI-RS_DRX}}$ for the measurements at the UE during measurement gaps due to the absence of the necessary radio signals from the measured cell.

The requirements in this section apply, provided that M is such that: the inter-frequency period $T_{\text{measure_inter_FS3_CSI-RS_DRX}}$ for TP measurements does not exceed $60 * N_{\text{freq}} * \text{Max}\{T_{\text{DMTC_periodicity}}, \text{MGRP}, \text{DRX cycle length}\}$.

During $T_{\text{identify_inter_TP_FS3_DRX}}$ over multiple discovery signal occasions, the UE may assume the following:

- in all the discovery signal occasions, which are available at the UE, the corresponding necessary cell-specific discovery signals are always available from the same set of TPs in the measured cell, and
- in all the discovery signal occasions, which are not available at the UE, the corresponding necessary cell-specific discovery signals are not available from any TP within the same measured cell.

A TP shall be considered detectable when the following conditions are met during the discovery signal occasions which are available during $T_{\text{identify_inter_TP_FS3_DRX}}$:

- CSI-RSRP related side conditions given in Sections 9.1.18.4 are fulfilled for a corresponding Band,
- SCH_{RP} is according to Annex B.2.13.2 for a corresponding Band,
- SCH Ês/lot is according to Table 8.11.2.2.1.2-1.

When measurement gaps are scheduled for FS3 inter-frequency measurements or the UE supports capability of conducting such measurements without gaps, the UE physical layer shall be capable of reporting CSI-RSRP measurements to higher layers with measurement accuracy as specified in section 9.1.18.4, with measurement period given by table 8.11.3.2.1.2-1.

The UE shall be capable of performing CSI-RSRP measurements of at least 3 identified inter-frequency TPs per FS3 inter-frequency for up to 3 FS3 inter-frequencies and the UE physical layer shall be capable of reporting CSI-RSRP measurements to higher layers with the measurement period defined in table 8.11.3.2.1.2-1 when DRX is in use, either measurement gaps are scheduled or the UE supports capability of conducting such measurements without gaps.

Table 8.11.3.2.1.2-1: Requirements to measure FS3 inter-frequency TP

SCH Ês/lot	CSI-RS measurement bandwidth ^{Note2} [RB]	CSI-RS Ês/lot	$T_{\text{measure_inter_FS3_CSI-RS_DRX}}$ [ms]
$0 \leq \text{SCH Ês/lot}$	<25	$0 \leq \text{CSI-RS Ês/lot}$	$(5 * N_{\text{freq}} + M * N) * \text{Max}\{T_{\text{DMTC_periodicity}}, \text{MGRP}, \text{DRX cycle length}\}$
$-6 \leq \text{SCH Ês/lot} < 0$	<25		$(20 * N_{\text{freq}} + M * N) * \text{Max}\{T_{\text{DMTC_periodicity}}, \text{MGRP}, \text{DRX cycle length}\}$
$0 \leq \text{SCH Ês/lot}$	≥ 25	$0 \leq \text{CSI-RS Ês/lot}$	$(1 * N_{\text{freq}} + M * N) * \text{Max}\{T_{\text{DMTC_periodicity}}, \text{MGRP}, \text{DRX cycle length}\}$
$-6 \leq \text{SCH Ês/lot} < 0$	≥ 25		$(4 * N_{\text{freq}} + M * N) * \text{Max}\{T_{\text{DMTC_periodicity}}, \text{MGRP}, \text{DRX cycle length}\}$

NOTE 1: Discovery signal occasion duration (*ds-OccasionDuration*) is 1 ms.

NOTE 2: The requirements for measurement bandwidth ≥ 25 RB are optional.

The CSI-RSRP measurement accuracy for all measured TPs shall be as specified in section 9.1.18.4.

8.11.3.2.1.2.1 Measurement Reporting Requirements

8.11.3.2.1.2.1.1 Periodic Reporting

Reported CSI-RSRP measurements contained in periodically triggered measurement reports shall meet the requirements in section 9.1.18.4.

8.11.3.2.1.2.1.2 Event-triggered Periodic Reporting

Reported CSI-RSRP measurements contained in event triggered periodic measurement reports shall meet the requirements in section 9.1.18.4.

The first report in event triggered periodic measurement reporting shall meet the requirements specified in section 8.11.3.2.1.2.1.3.

8.11.3.2.1.2.1.3 Event Triggered Reporting

Reported CSI-RSRP measurements contained in event triggered measurement reports shall meet the requirements in section 9.1.18.4.

The UE shall not send any event triggered measurement reports, as long as no reporting criteria are fulfilled.

The measurement reporting delay is defined as the time between an event that will trigger a measurement report and the point when the UE starts to transmit the measurement report over the air interface. This requirement assumes that the measurement report is not delayed by other RRC signalling on the DCCH. This measurement reporting delay excludes a delay uncertainty resulted when inserting the measurement report to the TTI of the uplink DCCH. The delay uncertainty is: $2 \times TTI_{DCCH}$. This measurement reporting delay excludes a delay which caused by no UL resources for UE to send the measurement report. When L3 filtering is used or IDC autonomous denial is configured an additional delay can be expected or by the LBT procedure performed by the UE in order to determine that the channel is clear for performing uplink transmission.

The event triggered measurement reporting delay, measured without L3 filtering shall be less than $T_{identify_inter_TP_FS3_DRX}$ defined in section 8.11.3.2.1.2. When L3 filtering is used or IDC autonomous denial is configured or LBT is performed by the UE on the carrier used for the measurement reporting an additional delay can be expected.

If a TP which has been detectable at least for the time period $T_{identify_inter_TP_SCE_DRX}$ defined in clause 8.11.3.2.1.2 and then triggers the measurement report as per TS 36.331 [2], the event triggered measurement reporting delay shall be less than $T_{measure_inter_FS3_CSI-RS_DRX}$ provided the timing to that TP has not changed more than $\pm 50 T_s$ while measurement gap has not been available and the L3 filter has not been used. When L3 filtering is used or IDC autonomous denial is configured or LBT is performed by the UE on the carrier used for the measurement reporting, an additional delay can be expected.

8.11.3.2.2 E-UTRAN TDD – FS3 inter-frequency measurements

8.11.3.2.2.1 E-UTRAN TDD – FS3 inter-frequency measurements when no DRX is used

The requirements in this section for UE configured with TDD PCell and no DRX are the same as the requirements in Section 8.11.3.2.1.1.

8.11.3.2.2.2 E-UTRAN TDD – FS3 inter-frequency measurements when DRX is used

The requirements in this section for UE configured with TDD PCell and DRX are the same as the requirements in Section 8.11.3.2.1.2.

8.11.4 RSSI measurements

8.11.4.1 E-UTRAN intra-frequency measurements

NOTE: The requirements in this section are applicable only for measurements on SCC following the frame structure type 3 [16].

The UE physical layer shall be capable of performing the RSSI measurements [4] on one or more serving carriers operating under frame structure type 3 [16], if the carrier(s) are indicated by higher layers [2], and reporting the RSSI

measurements to higher layers. The UE physical layer shall provide to higher layers a single RSSI sample for each OFDM symbol within each configured RSSI measurement duration [2] occurring with a configured RSSI measurement timing configuration periodicity [2]. The RSSI measurement period corresponds to $\max(\text{reportInterval}, \text{rmtc-Period})$ when no DRX is used and $\max(\text{reportInterval}, \text{rmtc-Period}, \text{DRX cycle length})$ when DRX is used, where reportInterval and rmtc-Period [2] are configured for the RSSI measurement by higher layers.

The RSSI measurement performed and reported according to this section shall meet the RSSI measurement accuracy requirement in Section 9.1.18.5.2.

8.11.4.2 E-UTRAN inter-frequency measurements

The UE physical layer shall be capable of performing the RSSI measurements [4] on one or more inter-frequency carriers operating under frame structure type 3 [16], if the carrier(s) are indicated by higher layers [2], and reporting the RSSI measurements to higher layers. The UE physical layer shall provide to higher layers a single RSSI sample for each OFDM symbol within each configured RSSI measurement duration [2] occurring with a configured RSSI measurement timing configuration periodicity [2]. The RSSI measurement period corresponds to $\max(\text{reportInterval}, \text{rmtc-Period} * N_{\text{freq}}, \text{MGRP} * N_{\text{freq}})$ when no DRX is used and $\max(\text{reportInterval}, N_{\text{freq}} * \max(\text{rmtc-Period}, \text{MGRP}, \text{DRX cycle length}))$ when DRX is used, where reportInterval and rmtc-Period [2] are configured for the RSSI measurement by higher layers, and N_{freq} is defined in clause 8.1.2.1.1.

If the UE requires measurement gaps to perform inter-frequency measurements, a single measurement gap pattern is used for all concurrent inter-frequency measurements, including inter-frequency RSSI measurements. The RSSI measurement duration and the measurement gap should be aligned, and the following additional condition should be fulfilled:

Entire RSSI measurement duration should be contained in the measurement gap.

UE is not required to perform RSSI measurement on symbols overlapped with the first 0.5 ms period and the last 0.5 ms period in every gap

The RSSI measurement performed and reported according to this section shall meet the RSSI measurement accuracy requirement in Section 9.1.18.5.3.

8.11.5 Channel occupancy measurements

8.11.5.1 E-UTRAN intra-frequency channel occupancy measurements

NOTE: The requirements in this section are applicable only for measurements on SCC following the frame structure type 3 [16].

The UE shall be capable of estimating the channel occupancy on one or more serving carrier frequencies indicated by higher layers [2], based on RSSI samples provided by the physical layer. The channel occupancy measurement period corresponds to $\max(\text{reportInterval}, \text{rmtc-Period})$ when no DRX is used and $\max(\text{reportInterval}, \text{rmtc-Period}, \text{DRX cycle length})$ when DRX is used, where reportInterval and rmtc-Period [2] are configured for the channel occupancy measurement by higher layers.

The channel occupancy measurement performed and reported according to this section shall meet the channel occupancy measurement accuracy requirements in Section 9.1.18.6.1.

8.11.5.2 E-UTRAN inter-frequency channel occupancy measurements

The UE shall be capable of estimating the channel occupancy on one or more carrier frequencies indicated by higher layers [2], based on RSSI samples provided by the physical layer. The channel occupancy measurement period corresponds to $\max(\text{reportInterval}, \text{rmtc-Period} * N_{\text{freq}}, \text{MGRP} * N_{\text{freq}})$ when no DRX is used and $\max(\text{reportInterval}, N_{\text{freq}} * \max(\text{rmtc-Period}, \text{MGRP}, \text{DRX cycle length}))$ when DRX is used, where reportInterval and rmtc-Period [2] are configured for the channel occupancy measurement by higher layers, and N_{freq} is defined in clause 8.1.2.1.1.

If the UE requires measurement gaps to perform inter-frequency measurements, a single measurement gap pattern is used for all concurrent inter-frequency measurements, including inter-frequency channel occupancy measurements.

The channel occupancy measurement performed and reported according to this section shall meet the channel occupancy measurement accuracy requirements in Section 9.1.18.6.2.

8.12 Discovery Signal Measurements for E-UTRA Carrier Aggregation under Operation with Frame Structure 3

8.12.1 Introduction

This section contains requirements on UE capabilities for support of E-UTRA carrier aggregation under operation with frame structure 3.

Non configured frequencies may be measured with measurement gaps according to the requirements in Section 8.11.2.2 and Section 8.11.3.2.

The requirements in Section 8.12 shall apply for SCC with E-UTRA operation following the frame structure type 3 [16].

8.12.2 CRS based discovery signal measurements for E-UTRA carrier aggregation

8.12.2.1 Introduction

The requirements in Section 8.12.2 shall apply for CRS based discovery signal measurements comprising RSRP and RSRQ measurements [4].

8.12.2.2 Measurements of a secondary component carrier

A secondary component carrier may be activated and deactivated by MAC-CE commands as specified in [17]. The applicable performance requirements depend on whether the SCell on the corresponding frequency is activated or deactivated.

8.12.2.3 Measurements of a secondary component carrier with active SCell

When the SCell is activated, measurement performance requirements for the frequency are those given in Section 8.11.2.1. If common DRX is in use, then the requirements for that secondary component carrier are given by the DRX requirements in Section 8.11.2.1.1.2, otherwise the non-DRX requirements are applicable. The applicable measurement accuracy requirements are in Section 9.1.19.

8.12.2.4 Measurements of a secondary component carrier with deactivated SCell

This section defines the measurement requirements of a secondary component carrier with deactivated SCell based on the parameter *measCycleSCell* defined in TS 36.331 [2].

8.12.2.4.1 E-UTRAN secondary component carrier measurements when no common DRX is used

When no DRX is in use the UE shall be able to identify a new detectable cell on a secondary component carrier within the cell identification time $T_{\text{identify_SCC_FS3}}$, where the cell identification of a cell shall include detection of the cell and additionally performing a single measurement with measurement period of $T_{\text{measure_SCC_FS3_CRS}}$.

$T_{\text{identify_SCC_FS3}}$ is the time period for cell identification as specified in Table 8.12.2.4.1-1,

$T_{\text{measure_SCC_FS3_CRS}}$ is the time period for measurements as shown in Table 8.12.2.4.1-2,

$T_{\text{DMTC_periodicity}}$ is the discovery signal measurement timing configuration periodicity of higher layer,

L is the number of configured discovery signal occasions which are not available during $T_{\text{identify_SCC_FS3}}$ for cell identification at the UE due to the absence of the necessary radio signals from the cell,

M is the number of configured discovery signal occasions which are not available during $T_{\text{measure_SCC_FS3_CRS}}$ for the measurements at the UE due to the absence of the necessary radio signals from the cell.

Table 8.12.2.4.1-1: Cell identification with deactivated SCell on SCC under operation with frame structure 3

SCH $\hat{E}s/lot$	CRS measurement bandwidth [RB] Note2	CRS $\hat{E}s/lot$	$T_{identify_SCC_FS3}$ [ms]
$0 \leq SCH \hat{E}s/lot$	<25	$-6 \leq CRS \hat{E}s/lot$	$(7+L)*k1*k2*measCycleSCell$
$-6 \leq SCH \hat{E}s/lot < 0$	<25		$(25+L)*k1*k2*measCycleSCell$
$0 \leq SCH \hat{E}s/lot$	≥ 25	$0 \leq CRS \hat{E}s/lot$	$(3+L)*k1*k2*measCycleSCell$
$-6 \leq SCH \hat{E}s/lot < 0$	≥ 25		$(9+L)*k1*k2*measCycleSCell$

Note 1: Discovery signal occasion duration (*ds-OccasionDuration*) is 1 ms.

Note 2: The requirements for measurement bandwidth ≥ 25 RB are optional.

Note 3: $k1=2$ when the measurement gaps configured for inter-frequency measurements in DMTC occasions or for inter-frequency RSSI measurements in RMTC occasions on a carrier with frame structure 3 overlap with some but not all DMTC occasions of the measured cell; otherwise, $k1=1$, e.g., when measurement gaps configured for inter-frequency measurements on a carrier with frame structure 3 do not overlap with DMTC occasions of the measured cell or when the UE does not require the measurement gaps for the inter-frequency measurements. The requirements apply, provided that the inter-frequency measurement gap pattern does not overlap with all DMTC occasions of the measured cell.

$$k2 = \max\left(2, \left\lceil \frac{N_{FS3_SCC}}{2} \right\rceil\right)$$

when DMTC occasions in the measured cell not overlapping with the inter-frequency measurement gaps overlap with DMTC occasions of N_{FS3_SCC} ($N_{FS3_SCC} > 0$) SCells on other FS3 carriers; otherwise, $k2=1$, e.g., when $N_{FS3_SCC}=0$.

Note 4: The requirements apply, provided that L is such that the cell identification period $T_{identify_SCC_FS3}$ does not exceed $75*k1*k2*measCycleSCell$.

A cell shall be considered detectable when the following conditions are met during the discovery signal occasions which are available during $T_{identify_SCC_FS3}$:

- RSRP related side condition given in Section 9.1.19 are fulfilled for a corresponding Band,
- $SCH_RP|_{dBm}$ is according to Annex B.2.12 for a corresponding Band and $SCH \hat{E}s/lot$ is according to Table 8.12.2.4.1-1.

The measurement period for deactivated SCell measurements is $T_{measure_SCC_FS3_CRS}$ according to the parameter *measCycleSCell* shown in Table 8.12.2.4.1-1.

Table 8.12.2.4.1-2: Measurement requirements on SCC with deactivated SCell under operation with frame structure 3 with deactivated SCell

SCH $\hat{E}s/lot$	CRS measurement bandwidth [RB] Note2	CRS $\hat{E}s/lot$	$T_{measure_SCC_FS3_CRS}$ [ms]
$0 \leq SCH \hat{E}s/lot$	<25	$-6 \leq CRS \hat{E}s/lot$	$(5+M)*k1*k2*measCycleSCell$
$-6 \leq SCH \hat{E}s/lot < 0$	<25		$(20+M)*k1*k2*measCycleSCell$
$0 \leq SCH \hat{E}s/lot$	≥ 25	$0 \leq CRS \hat{E}s/lot$	$(1+M)*k1*k2*measCycleSCell$
$-6 \leq SCH \hat{E}s/lot < 0$	≥ 25		$(4+M)*k1*k2*measCycleSCell$

Note 1: Discovery signal occasion duration (*ds-OccasionDuration*) is 1 ms.

Note 2: The requirements for measurement bandwidth ≥ 25 RB are optional.

Note 3: $k1=2$ when the measurement gaps configured for inter-frequency measurements in DMTC occasions or for inter-frequency RSSI measurements in RMTC occasions on a carrier with frame structure 3 overlap with some but not all DMTC occasions of the measured cell; otherwise, $k1=1$, e.g., when measurement gaps configured for inter-frequency measurements on a carrier with frame structure 3 do not overlap with DMTC occasions of the measured cell or when the UE does not require the measurement gaps for the inter-frequency measurements. The requirements apply, provided that the inter-frequency measurement gap pattern does not overlap with all DMTC occasions of the measured cell.

$$k_2 = \max\left(2, \left\lceil \frac{N_{FS3_SCC}}{2} \right\rceil\right)$$

when DMTC occasions in the measured cell not overlapping with the inter-frequency measurement gaps overlap with DMTC occasions of N_{FS3_SCC} ($N_{FS3_SCC} > 0$) SCells on other FS3 carriers; otherwise, $k_2=1$, e.g., when $N_{FS3_SCC}=0$.

Note 4: The requirements apply, provided that M is such that the time period $T_{measure_SCC_FS3_CRS}$ for measurements does not exceed $60 \cdot k_1 \cdot k_2 \cdot measCycleSCell$.

The UE shall be capable of performing RSRP and RSRQ measurements for 3 identified cells on a secondary component carrier, and the UE physical layer shall be capable of reporting measurements to higher layers within the measurement period of $T_{measure_SCC_FS3_CRS}$.

The measurement accuracy for all measured cells shall be as specified in Section 9.1.19.

A UE may reconfigure the receiver bandwidth or turn on/off one of the RF chains when performing measurements on one SCC with deactivated SCell. This may cause interruptions on PCell that are specified in Section 7.8.

8.12.2.4.1.1 Measurement Reporting Requirements

8.12.2.4.1.1.1 Periodic Reporting

Reported measurements contained in periodically triggered measurement reports shall meet the requirements in Section 9.

8.12.2.4.1.1.2 Event-triggered Periodic Reporting

Reported measurements contained in event triggered periodic measurement reports shall meet the requirements in Section 9.

The first report in event triggered periodic CRS based measurement reporting shall meet the requirements specified in Section 8.12.2.4.1.1.3.

8.12.2.4.1.1.3 Event Triggered Reporting

Reported measurements contained in event triggered measurement reports shall meet the requirements in Section 9.

The UE shall not send any event triggered measurement reports, as long as no reporting criteria are fulfilled.

The measurement reporting delay is defined as the time between an event that will trigger a measurement report and the point when the UE starts to transmit the measurement report over the air interface. This requirement assumes that the measurement report is not delayed by other RRC signalling on the DCCH. This measurement reporting delay excludes a delay uncertainty resulted when inserting the measurement report to the TTI of the uplink DCCH. The delay uncertainty is: $2 \times TTI_{DCCH}$. This measurement reporting delay excludes a delay which is caused by no UL resources for UE to send the measurement report or by the LBT procedure performed by the UE in order to determine that the channel is clear for performing uplink transmission.

The event triggered measurement reporting delay, measured without L3 filtering shall be less than $T_{identify_SCC_FS3}$ defined in Section 8.12.2.4.1. When L3 filtering is used or IDC autonomous denial is configured or LBT is performed by the UE on the carrier used for the measurement reporting an additional delay can be expected.

If a cell which has been detectable at least for the time period $T_{identify_SCC_FS3}$ defined in Section 8.12.2.4.1 becomes undetectable for a period ≤ 8 seconds and then the cell becomes detectable again and triggers an event, the event triggered measurement reporting delay shall be less than $T_{identify_SCC_FS3_CRS}$ provided the timing to that cell has not changed more than $\pm 50 T_s$ and the L3 filter has not been used. When L3 filtering is used or LBT is performed by the UE on the carrier used for the measurement reporting an additional delay can be expected.

8.12.2.4.2 E-UTRAN secondary component carrier measurements when common DRX is used

When DRX is in use the UE shall be able to identify a new detectable FS3 cell on a secondary component carrier within the cell identification time $T_{identify_SCC_FS3_DRX}$, according to the parameter $measCycleSCell$, where the cell identification time of a cell shall include detection of the cell and additionally performing a single measurement with measurement period of $T_{measure_SCC_FS3_CRS_DRX}$.

$T_{\text{identify_SCC_FS3_DRX}}$ is the time period for cell identification as shown in Table 8.12.2.4.2-1,

$T_{\text{measure_SCC_FS3_CRS_DRX}}$ is the time period for measurements as shown in Table 8.12.2.4.2-2,

$T_{\text{DMTC_periodicity}}$ is the discovery signal measurement timing configuration periodicity of higher layer,

L is the number of configured discovery signal occasions during ON DURATION and which are not available during $T_{\text{identify_SCC_FS3_DRX}}$ for cell identification at the UE due to the absence of the necessary radio signals from the cell,

M is the number of configured discovery signal occasions during ON DURATION and which are not available during $T_{\text{measure_SCC_FS3_CRS_DRX}}$ for the measurements at the UE due to the absence of the necessary radio signals from the cell.

Table 8.12.2.4.2-1: Cell identification on SCC with deactivated SCell under operation with frame structure 3

SCH \hat{E} s/lot	CRS measurement bandwidth [RB] Note2	CRS \hat{E} s/lot	$T_{\text{identify_SCC_FS3_DRX}}$ [ms]
$0 \leq \text{SCH } \hat{E}\text{s/lot}$	<25	$-6 \leq \text{CRS } \hat{E}\text{s/lot}$	$(7+L) * k1 * k2 * \text{Max}\{\text{measCycleSCell}, \text{DRX cycle length}\}$
$-6 \leq \text{SCH } \hat{E}\text{s/lot} < 0$	<25		$(25+L) * k1 * k2 * \text{Max}\{\text{measCycleSCell}, \text{DRX cycle length}\}$
$0 \leq \text{SCH } \hat{E}\text{s/lot}$	≥ 25	$0 \leq \text{CRS } \hat{E}\text{s/lot}$	$(3+L) * k1 * k2 * \text{Max}\{\text{measCycleSCell}, \text{DRX cycle length}\}$
$-6 \leq \text{SCH } \hat{E}\text{s/lot} < 0$	≥ 25		$(9+L) * k1 * k2 * \text{Max}\{\text{measCycleSCell}, \text{DRX cycle length}\}$
Note 1: Discovery signal occasion duration (<i>ds-OccasionDuration</i>) is 1 ms. Note 2: The requirements for measurement bandwidth ≥ 25 RB are optional. Note 3: $k1=2$ when the measurement gaps configured for inter-frequency measurements in DMTC occasions or for inter-frequency RSSI measurements in RMTC occasions on a carrier with frame structure 3 overlap with some but not all DMTC occasions of the measured cell during ON DURATION; otherwise, $k1=1$, e.g., when measurement gaps configured for inter-frequency measurements on a carrier with frame structure 3 do not overlap with DMTC occasions of the measured cell during ON DURATION or when the UE does not require the measurement gaps for the inter-frequency measurements. The requirements apply, provided that the inter-frequency measurement gap pattern does not overlap with all DMTC occasions of the measured cell. $k2 = \max\left(2, \left\lceil \frac{N_{\text{FS3_SCC}}}{2} \right\rceil\right)$ when DMTC occasions in the measured cell not overlapping with the inter-frequency measurement gaps overlap with DMTC occasions of $N_{\text{FS3_SCC}}$ ($N_{\text{FS3_SCC}} > 0$) SCells during ON DURATION on other FS3 carriers; otherwise, $k2=1$, e.g., when $N_{\text{FS3_SCC}}=0$. Note 4: The requirements apply, provided that L is such that the cell identification period $T_{\text{identify_SCC_FS3_DRX}}$ does not exceed $75 * k1 * k2 * \text{Max}\{\text{measCycleSCell}, \text{DRX cycle length}\}$.			

A cell shall be considered detectable when the following conditions are met during the discovery signal occasions which are available during $T_{\text{identify_SCC_FS3_DRX}}$:

- RSRP related side condition given in Section 9.1.19 are fulfilled for a corresponding Band,
- $\text{SCH_RP}_{\text{dBm}}$ is according to Annex B.2.12 for a corresponding Band and SCH \hat{E} s/lot is according to Table 8.12.2.4.2-1.

The measurement period for deactivated scell measurements is $T_{\text{measure_SCC_FS3_CRS_DRX}}$ according to the parameter *measCycleSCell* shown in Table 8.12.2.4.2-2.

Table 8.12.2.4.2-2: Measurement requirements on SCC with deactivated SCell under operation with frame structure 3

SCH \hat{E} s/lot	CRS measurement bandwidth [RB] Note2	CRS \hat{E} s/lot	$T_{\text{measure_SCC_FS3_CRS_DRX}}$ [ms]

$0 \leq \text{SCH } \hat{E}s/\text{lot}$	<25	$-6 \leq \text{CRS } \hat{E}s/\text{lot}$	$(5+M) * k1 * k2 * \text{Max}\{\text{measCycleSCell}, \text{DRX cycle length}\}$
$-6 \leq \text{SCH } \hat{E}s/\text{lot} < 0$	<25		$(20+M) * k1 * k2 * \text{Max}\{\text{measCycleSCell}, \text{DRX cycle length}\}$
$0 \leq \text{SCH } \hat{E}s/\text{lot}$	≥ 25	$0 \leq \text{CRS } \hat{E}s/\text{lot}$	$(1+M) * k1 * k2 * \text{Max}\{\text{measCycleSCell}, \text{DRX cycle length}\}$
$-6 \leq \text{SCH } \hat{E}s/\text{lot} < 0$	≥ 25		$(4+M) * k1 * k2 * \text{Max}\{\text{measCycleSCell}, \text{DRX cycle length}\}$
<p>Note 1: Discovery signal occasion duration (<i>ds-OccasionDuration</i>) is 1 ms.</p> <p>Note 2: The requirements for measurement bandwidth ≥ 25 RB are optional.</p> <p>Note 3: $k1=2$ when the measurement gaps configured for inter-frequency measurements in DMTC occasions or for inter-frequency RSSI measurements in RMTC occasions on a carrier with frame structure 3 overlap with some but not all DMTC occasions of the measured cell during ON DURATION; otherwise, $k1=1$, e.g., when measurement gaps configured for inter-frequency measurements on a carrier with frame structure 3 do not overlap with DMTC occasions of the measured cell during ON DURATION or when the UE does not require the measurement gaps for the inter-frequency measurements. The requirements apply, provided that the inter-frequency measurement gap pattern does not overlap with all DMTC occasions of the measured cell.</p> $k2 = \max\left(2, \left\lceil \frac{N_{FS3_SCC}}{2} \right\rceil\right)$ <p>when DMTC occasions in the measured cell not overlapping with the inter-frequency measurement gaps overlap with DMTC occasions of N_{FS3_SCC} ($N_{FS3_SCC} > 0$) SCells during ON DURATION on other FS3 carriers; otherwise, $k2=1$, e.g., when $N_{FS3_SCC}=0$.</p> <p>Note 4: The requirements apply, provided that M is such that the time period $T_{\text{measure_SCC_FS3_CRS_DRX}}$ for measurements does not exceed $60 * k1 * k2 * \text{Max}\{\text{measCycleSCell}, \text{DRX cycle length}\}$.</p>			

The UE shall be capable of performing RSRP and RSRQ measurements for 3 identified cells on a secondary component carrier, and the UE physical layer shall be capable of reporting measurements to higher layers with the measurement period of $T_{\text{measure_SCC_FS3_CRS_DRX}}$.

The measurement accuracy for all measured cells shall be as specified in Section 9.1.19.

A UE may reconfigure receiver bandwidth taking into account the SCell activation/deactivation status, and when making measurements of cells on one SCC with deactivated SCell. This may cause interruptions (packet drops) to a PCell. No interruptions while the On Duration timer is running shall be allowed when common DRX is used. The requirement considers only interruptions due to reconfiguration of the receiver bandwidth, and not due to other causes such as RF impairments or channel conditions.

8.12.2.4.2.1 Measurement Reporting Requirements

8.12.2.4.2.1.1 Periodic Reporting

Reported measurements contained in periodically triggered measurement reports shall meet the requirements in Section 9.

8.12.2.4.2.1.2 Event-triggered Periodic Reporting

Reported measurements contained in event triggered periodic measurement reports shall meet the requirements in Section 9.

The first report in event triggered periodic measurement reporting shall meet the requirements specified in Section 8.12.2.4.2.1.3.

8.12.2.4.2.1.3 Event Triggered Reporting

Reported measurements contained in event triggered measurement reports shall meet the requirements in Section 9.

The UE shall not send any event triggered CRS based measurement reports, as long as no reporting criteria are fulfilled.

The measurement reporting delay is defined as the time between an event that will trigger a measurement report and the point when the UE starts to transmit the measurement report over the air interface. This requirement assumes that the measurement report is not delayed by other RRC signalling on the DCCH. This measurement reporting delay excludes a delay uncertainty resulted when inserting the measurement report to the TTI of the uplink DCCH. The delay uncertainty is: $2 \times TTI_{\text{DCCH}}$. This measurement reporting delay excludes a delay which is caused by no UL resources for UE to send

the measurement report or by the LBT procedure performed by the UE in order to determine that the channel is clear for performing uplink transmission.

The event triggered measurement reporting delay, measured without L3 filtering shall be less than $T_{\text{identify_SCC_FS3}}$ defined in Section 8.12.2.4.2. When L3 filtering is used or IDC autonomous denial is configured or LBT is performed by the UE on the carrier used for the measurement reporting an additional delay can be expected.

If a cell which has been detectable at least for the time period $T_{\text{identify_SCC_FS3_DRX}}$ defined in Section 8.12.2.4.2 becomes undetectable for a period ≤ 8 seconds and then the cell becomes detectable again and triggers an event, the event triggered measurement reporting delay shall be less than $T_{\text{identify_SCC_FS3_CRS_DRX}}$ provided the timing to that cell has not changed more than $\pm 50 T_s$ and the L3 filter has not been used. When L3 filtering is used or LBT is performed by the UE on the carrier used for the measurement reporting an additional delay can be expected.

8.12.3 Requirements for CSI-RS based discovery signal measurements for E-UTRA carrier aggregation

8.12.3.1 Introduction

The requirements in Section 8.12.3 shall apply for CSI-RS based discovery signal measurements comprising CSI-RSRP measurements [4].

8.12.3.2 Measurements of a secondary component carrier

A Secondary component carrier may be activated and deactivated by MAC-CE commands as specified in [17]. The applicable performance requirements depend on whether the SCell on the corresponding frequency is activated or deactivated.

8.12.3.3 Measurements of a secondary component carrier with active SCell

When the SCell is activated, measurement performance requirements for the frequency are those given in Section 8.11.3.1. If common DRX is in use, then the requirements for that secondary component carrier are given by the DRX requirements in Section 8.11.3.1.1.2, otherwise the non DRX requirements are applicable. The applicable measurement accuracy requirements are in Section 9.1.19.

8.12.3.4 Measurements of a secondary component carrier with deactivated SCell

This section defines the measurement requirements of a secondary component carrier with deactivated SCell based on the parameter *measCycleSCell* defined in TS 36.331 [2].

8.12.3.4.1 E-UTRAN secondary component carrier measurements when no common DRX is used

When no DRX is in use the UE shall be able to identify a new detectable FS3 TP on a secondary component carrier within the cell identification time $T_{\text{identify_SCC_TP_FS3}}$, where the identification of a TP shall include cell identification and a single measurement on the TP within the measurement period $T_{\text{measure_SCC_FS3_CSI-RS}}$.

$$T_{\text{identify_SCC_TP_FS3}} = T_{\text{identify_SCC_FS3}} + T_{\text{measure_SCC_FS3_CSI-RS}},$$

where:

$T_{\text{identify_SCC_FS3}}$ is the time period for cell identification in Section 8.12.2.4.1,

$T_{\text{measure_SCC_FS3_CSI-RS}}$ is the time period for TP measurement in Table 8.12.3.4.1-1,

M is the number of configured discovery signal occasions which are not available for the measurements at the UE during $T_{\text{measure_SCC_FS3_CSI-RS}}$ due to the absence of the necessary radio signals from the cell.

During $T_{\text{identify_SCC_TP_FS3}}$ over multiple discovery signal occasions, the UE may assume the following:

- in all the discovery signal occasions, which are available at the UE, the corresponding necessary cell-specific discovery signals are always available from the same set of TPs in the measured cell, and
- in all the discovery signal occasions, which are not available at the UE, the corresponding necessary cell-specific discovery signals are not available from any TP within the same measured cell.

Table 8.12.3.4.1-1: Measurement requirements for a TP on SCC with deactivated SCell under operation with frame structure 3

SCH $\hat{E}s/lot$	CSI-RS measurement bandwidth [RB] ^{Note2}	CSI-RS $\hat{E}s/lot$	$T_{\text{measure_SCC_FS3_CSI-RS}}$ [ms]
$0 \leq \text{SCH } \hat{E}s/lot$	<25	$0 \leq \text{CSI-RS } \hat{E}s/lot$	$(5+M) * k1*k2 * \text{measCycleSCell}$
$-6 \leq \text{SCH } \hat{E}s/lot < 0$	<25		$(20+M) * k1*k2 * \text{measCycleSCell}$
$0 \leq \text{SCH } \hat{E}s/lot$	≥ 25	$0 \leq \text{CSI-RS } \hat{E}s/lot$	$(1+M) * k1*k2 * \text{measCycleSCell}$
$-6 \leq \text{SCH } \hat{E}s/lot < 0$	≥ 25		$(4+M) * k1*k2 * \text{measCycleSCell}$

Note 1: Discovery signal occasion duration (*ds-OccasionDuration*) is 1 ms.

Note 2: The requirements for measurement bandwidth ≥ 25 RB are optional.

Note 3: $k1=2$ when the measurement gaps configured for inter-frequency measurements in DMTC occasions or for inter-frequency RSSI measurements in RMTC occasions on a carrier with frame structure 3 overlap with some but not all DMTC occasions of the measured TP; otherwise, $k1=1$, e.g., when measurement gaps configured for inter-frequency measurements on a carrier with frame structure 3 do not overlap with DMTC occasions of the measured TP or when the UE does not require the measurement gaps for the inter-frequency measurements. The requirements apply, provided that the inter-frequency measurement gap pattern does not overlap with all DMTC occasions of the measured cell.

$$k2 = \max \left(2, \left\lceil \frac{N_{FS3_SCC}}{2} \right\rceil \right)$$

when DMTC occasions in the measured TP not overlapping with the inter-frequency measurement gaps overlap with DMTC occasions of N_{FS3_SCC} ($N_{FS3_SCC} > 0$) SCells on other FS3 carriers; otherwise, $k2=1$, e.g., when $N_{FS3_SCC}=0$.

Note 4: The requirements apply, provided that M is such that the time period $T_{\text{measure_SCC_FS3_CSI-RS}}$ for TP measurement does not exceed $60 * k1 * k2 * \text{measCycleSCell}$.

A TP shall be considered detectable when the following conditions are met during the discovery signal occasions which are available during $T_{\text{identify_SCC_TP_FS3}}$:

- CSI-RSRP related side condition given in Section 9.1.19 are fulfilled for a corresponding Band,
- $\text{SCH_RP}|_{\text{dBm}}$ is according to Annex B.2.12 for a corresponding Band and SCH $\hat{E}s/lot$ is according to Table 8.12.2.4.1-1.

The UE shall be capable of performing RSRP measurements for 3 identified TPs on a secondary component carrier, and the UE physical layer shall be capable of reporting measurements to higher layers with the measurement period of $T_{\text{measure_SCC_FS3_CSI-RS}}$.

The measurement accuracy for all measured TPs shall be as specified in Section 9.1.19.

A UE may reconfigure the receiver bandwidth or turn on/off one of the RF chains when performing measurements on one SCC with deactivated SCell. This may cause interruptions on PCell that are specified in Section 7.8.

8.12.3.4.1.1 Measurement Reporting Requirements

8.12.3.4.1.1.1 Periodic Reporting

Reported measurements contained in periodically triggered measurement reports shall meet the requirements in Section 9.

8.12.3.4.1.1.2 Event-triggered Periodic Reporting

Reported measurements contained in event triggered periodic measurement reports shall meet the requirements in Section 9.

The first report in event triggered periodic measurement reporting shall meet the requirements specified in Section 8.12.3.4.1.1.3.

8.12.3.4.1.1.3 Event Triggered Reporting

Reported measurements contained in event triggered measurement reports shall meet the requirements in Section 9.

The UE shall not send any event triggered measurement reports, as long as no reporting criteria are fulfilled.

The measurement reporting delay is defined as the time between an event that will trigger a measurement report and the point when the UE starts to transmit the measurement report over the air interface. This requirement assumes that the measurement report is not delayed by other RRC signalling on the DCCH. This measurement reporting delay excludes a delay uncertainty resulted when inserting the measurement report to the TTI of the uplink DCCH. The delay uncertainty is: $2 \times TTI_{DCCH}$. This measurement reporting delay excludes a delay which is caused by no UL resources for UE to send the measurement report or by the LBT procedure performed by the UE in order to determine that the channel is clear for performing uplink transmission.

The event triggered measurement reporting delay, measured without L3 filtering shall be less than $T_{identify_SCC_TP_FS3}$ defined in Section 8.12.3.4.1. When L3 filtering is used or IDC autonomous denial is configured or LBT is performed by the UE on the carrier used for the measurement reporting an additional delay can be expected.

If a TP which has been detectable at least for the time period $T_{identify_SCC_TP_FS3}$ defined in Section 8.12.3.4.1 becomes undetectable for a period ≤ 8 seconds and then the TP becomes detectable again and triggers an event, the event triggered measurement reporting delay shall be less than $T_{identify_SCC_FS3_CSI-RS}$ provided the timing to that TP has not changed more than ± 50 Ts and the L3 filter has not been used. When L3 filtering is used or LBT is performed by the UE on the carrier used for the measurement reporting an additional delay can be expected.

8.12.3.4.2 E-UTRAN secondary component carrier measurements when common DRX is used

When DRX is in use the UE shall be able to identify a new detectable FS3 TP on a secondary component carrier within $T_{identify_SCC_TP_FS3_DRX}$, according to the parameter *measCycleSCell*, where the identification of a TP shall include cell identification and a single measurement on the TP within the measurement period $T_{measure_SCC_FS3_CSI-RS_DRX}$.

$$T_{identify_SCC_TP_FS3_DRX} = T_{identify_SCC_FS3_DRX} + T_{measure_SCC_FS3_CSI-RS_DRX},$$

where:

$T_{identify_SCC_FS3_DRX}$ is the time period for cell identification in Section 8.12.2.4.2,

$T_{measure_SCC_FS3_CSI-RS_DRX}$ is the time period for TP measurement in Table 8.12.3.4.2-1,

M is the number of configured discovery signal occasions during ON DURATION and which are not available during $T_{measure_SCC_FS3_CSI-RS_DRX}$ for the measurements at the UE due to the absence of the necessary radio signals from the cell.

During $T_{identify_SCC_TP_FS3_DRX}$ over multiple discovery signal occasions, the UE may assume the following:

- in all the discovery signal occasions, which are available at the UE, the corresponding necessary cell-specific discovery signals are always available from the same set of TPs in the measured cell, and
- in all the discovery signal occasions, which are not available at the UE, the corresponding necessary cell-specific discovery signals are not available from any TP within the same measured cell.

Table 8.12.3.4.2-1: Measurement requirements for a TP on SCC with deactivated SCell under operation with frame structure 3

SCH $\hat{E}s/lot$	CSI-RS measurement bandwidth [RB] ^{Note2}	CSI-RS $\hat{E}s/lot$	$T_{measure_SCC_FS3_CSI-RS_DRX}$ [ms]
$0 \leq SCH \hat{E}s/lot$	<25	$0 \leq CSI-RS \hat{E}s/lot$	$(5+M) * k1*k2*Max\{measCycleSCell, DRX\ cycle\ length\}$
$-6 \leq SCH \hat{E}s/lot < 0$	<25		$(20+M) * k1*k2*Max\{measCycleSCell, DRX\ cycle\ length\}$
$0 \leq SCH \hat{E}s/lot$	≥ 25	$0 \leq CSI-RS \hat{E}s/lot$	$(1+M) * k1*k2*Max\{measCycleSCell, DRX\ cycle\ length\}$
$-6 \leq SCH \hat{E}s/lot < 0$	≥ 25		$(4+M) * k1*k2*Max\{measCycleSCell, DRX\ cycle\ length\}$

Note 1: Discovery signal occasion duration (*ds-OccasionDuration*) is 1 ms.

Note 2: The requirements for measurement bandwidth ≥ 25 RB are optional.

Note 3: $k1=2$ when the measurement gaps configured for inter-frequency measurements in DMTC occasions or for inter-frequency RSSI measurements in RMTC occasions on a carrier with frame structure 3 overlap with some but not all DMTC occasions of the measured TP during ON DURATION; otherwise, $k1=1$, e.g., when measurement gaps configured for inter-frequency measurements on a carrier with frame structure 3 do not

overlap with DMTC occasions of the measured TP during ON DURATION or when the UE does not require the measurement gaps for the inter-frequency measurements. The requirements apply, provided that the inter-frequency measurement gap pattern does not overlap with all DMTC occasions of the measured cell.

$$k_2 = \max \left(2, \left\lceil \frac{N_{FS3_SCC}}{2} \right\rceil \right) \text{ when DMTC occasions in the measured TP not overlapping with the inter-}$$

frequency measurement gaps overlap with DMTC occasions of N_{FS3_SCC} ($N_{FS3_SCC} > 0$) SCells during ON DURATION on other FS3 carriers; otherwise, $k_2 = 1$, e.g., when $N_{FS3_SCC} = 0$.

Note 4: The requirements apply, provided that M is such that the time period $T_{\text{measure_SCC_FS3_CSI-RS_DRX}}$ for TP measurement does not exceed $60 * k_1 * k_2 * \text{Max}\{\text{measCycleSCell}, \text{DRX cycle length}\}$.

A TP shall be considered detectable when the following conditions are met during the discovery signal occasions which are available during $T_{\text{identify_SCC_TP_FS3_DRX}}$:

- CSI-RSRP related side condition given in Section 9.1.19 are fulfilled for a corresponding Band,
- $SCH_RP|_{\text{dBm}}$ is according to Annex B.2.12 for a corresponding Band and $SCH \hat{E}_s / \text{Tot}$ is according to Table 8.12.2.4.2-1.

The UE shall be capable of performing CSI-RSRP measurements for 3 identified TPs on a secondary component carrier, and the UE physical layer shall be capable of reporting measurements to higher layers with the measurement period of $T_{\text{measure_SCC_FS3_CSI-RS_DRX}}$.

The measurement accuracy for all measured TPs shall be as specified in Section 9.1.19.

A UE may reconfigure receiver bandwidth taking into account the SCell activation/deactivation status, and when making measurements of TPs on one SCC with deactivated SCell. This may cause interruptions (packet drops) to a PCell. No interruptions while the On Duration timer is running shall be allowed when common DRX is used. The requirement considers only interruptions due to reconfiguration of the receiver bandwidth, and not due to other causes such as RF impairments or channel conditions.

8.12.3.4.2.1 Measurement Reporting Requirements

8.12.3.4.2.1.1 Periodic Reporting

Reported measurements contained in periodically triggered measurement reports shall meet the requirements in Section 9.

8.12.3.4.2.1.2 Event-triggered Periodic Reporting

Reported measurements contained in event triggered periodic measurement reports shall meet the requirements in Section 9.

The first report in event triggered periodic measurement reporting shall meet the requirements specified in Section 8.12.3.4.2.1.3.

8.12.3.4.2.1.3 Event Triggered Reporting

Reported measurements contained in event triggered measurement reports shall meet the requirements in Section 9.

The UE shall not send any event triggered measurement reports, as long as no reporting criteria are fulfilled.

The measurement reporting delay is defined as the time between an event that will trigger a measurement report and the point when the UE starts to transmit the measurement report over the air interface. This requirement assumes that the measurement report is not delayed by other RRC signalling on the DCCH. This measurement reporting delay excludes a delay uncertainty resulted when inserting the measurement report to the TTI of the uplink DCCH. The delay uncertainty is: $2 \times TTI_{\text{DCCH}}$. This measurement reporting delay excludes a delay which is caused by no UL resources for UE to send the measurement report or by the LBT procedure performed by the UE in order to determine that the channel is clear for performing uplink transmission.

The event triggered measurement reporting delay, measured without L3 filtering shall be less than $T_{\text{identify_SCC_TP_FS3_DRX}}$ defined in Section 8.12.3.4.2. When L3 filtering is used or IDC autonomous denial is configured or LBT is performed by the UE on the carrier used for the measurement reporting an additional delay can be expected.

If a TP which has been detectable at least for the time period $T_{\text{identify_SCC_TP_FS3_DRX}}$ defined in Section 8.12.3.4.2 becomes undetectable for a period ≤ 8 seconds and then the TP becomes detectable again and triggers an event, the event triggered measurement reporting delay shall be less than $T_{\text{identify_SCC_FS3_CSI-RS_DRX}}$ provided the timing to that TP has not changed more than $\pm 50 T_s$ and the L3 filter has not been used. When L3 filtering is used or LBT is performed by the UE on the carrier used for the measurement reporting an additional delay can be expected.

8.13 Measurements for UE Category M1

8.13.1 Introduction

The UE category M1 applicability of the requirements in subclause 8.13 is defined in Section 3.6.

This clause contains requirements on the UE regarding measurement reporting in RRC_CONNECTED state. The requirements are specified for E-UTRA intra frequency measurements. These measurements may be used by the E-UTRAN, e.g. for handover decisions. The measurement quantities are defined in TS 36.214 [4], the measurement model is defined in TS 36.302 [22] and measurement accuracies are specified in clause 9. Control of measurement reporting is specified in TS 36.331 [2].

The UE shall meet the requirements in Section 8.13, provided:

- the UE does not require measurement gaps for the corresponding measurements, or
- the UE requires measurement gaps for the corresponding measurements and is configured with the measurement gap pattern Id 0 or 1 and is not configured with any measurement gap pattern from Table 8.1.2.1-3.

If the UE requires measurement gaps for the corresponding measurements and is configured with the measurement gap pattern from Table 8.1.2.1-3, the UE is not required to perform any RRM measurements that requires gaps during the RSTD measurement period and the requirement in Section 8.13 shall not apply during the RSTD measurement period.

When the UE is provided with IDC solution, the UE shall also perform RRM measurements and meet the corresponding requirements in clause 8.

8.13.2 Requirements for UE category M1 with CE mode A

The UE category M1 applicability of the requirements in subclause 8.13.2 is defined in Section 3.6. The requirements defined in clause 8.13.2 apply provided the following conditions are met:

- UE is configured with measurement gap pattern ID#0 or ID#1 defined in Table 8.1.2.1-1.

Alternatively, the UE shall meet the requirements in subclause 8.13.2 defined for gap pattern ID#0 without using any measurement gaps provided:

- UE indicates it does not need gaps with the capability `intraFreq-CE-NeedForGaps-r13` [2, TS 36.331] for the frequency band of the serving cell, or
- UE is not configured with any reporting configuration that requires measurement on any intra-frequency neighbour cell.

8.13.2.1 E-UTRAN intra frequency measurements by UE category M1 with CE mode A

The UE shall be able to identify new intra-frequency cells and perform RSRP and RSRQ measurements of identified intra-frequency cells without an explicit intra-frequency neighbour cell list containing physical layer cell identities. During the RRC_CONNECTED state the UE shall continuously measure identified intra frequency cells and additionally search for and identify new intra frequency cells.

8.13.2.1.1 E-UTRAN FDD intra frequency measurements

8.13.2.1.1.1 E-UTRAN intra frequency measurements when no DRX is used

When no DRX is in use the UE shall be able to identify and measure a new detectable FDD intra frequency cell according to requirements in Table 8.13.2.1.1.1-1 when $SCH \hat{E}_s/I_{ot} \geq -6$ dB, provided

- $G=1$, or

- $r_{\max} * G < 80\text{ms}$, or
- UE is receiving PDSCH.

Otherwise, requirements in Table 8.13.2.1.1.1-3 apply, where r_{\max} and G are given by higher layer parameter $mPDCCH\text{-}NumRepetition$ and $mPDCCH\text{-}startSF\text{-}UESS$ respectively as defined in TS 36.213 [3].

Table 8.13.2.1.1.1-1: Requirement on cell identification delay and measurement delay for FDD intrafrequency cell

Gap pattern ID	Cell identification delay ($T_{\text{identify_intra_UE cat M1}}$)	Measurement delay ($T_{\text{measure_intra_UE cat M1}}$)
0	$1.44 * K_{\text{intra_M1_NC}} * K_{\text{RSTD_M1_NC}}$ seconds	$480 * K_{\text{intra_M1_NC}} * K_{\text{RSTD_M1_NC}}$ ms
1	$2.88 * K_{\text{intra_M1_NC}} * K_{\text{RSTD_M1_NC}}$ seconds	$960 * K_{\text{intra_M1_NC}} * K_{\text{RSTD_M1_NC}}$ ms

$K_{\text{intra_M1_NC}} = 100 / X$ where X is signalled by the RRC parameter $measGapSharingScheme$ [2] and is defined as in Table 8.13.2.1.1.1-2 when $highSpeedMeasGapCE\text{-}ModeA$ [2] is not configured, and in Table 8.13.2.1.1.1-2A when $highSpeedMeasGapCE\text{-}ModeA$ [2] is configured. N_{freq} is total number of inter-frequency layers to be monitored as defined in 8.1.2.1.1. When inter frequency measurement is not configured, $K_{\text{intra_M1_NC}}=1$ regardless whether or how parameter $measGapSharingScheme$ [2] is configured.

Table 8.13.2.1.1.1-2: Value of parameter X for CEModeA

$measGapSharingScheme$	Value of X (%)
'00'	$\frac{100}{N_{\text{freq}} + 1}$
'01'	40
'10'	50
'11'	60

Table 8.13.2.1.1.1-2A: Value of parameter X for CEModeA for UE configured with $highSpeedMeasGapCE\text{-}ModeA$

$measGapSharingScheme$	Value of X (%)
'00'	$\frac{100}{N_{\text{freq}} + 1}$
'01'	50
'10'	80
'11'	90

Table 8.13.2.1.1.1-3: Requirement on cell identification delay and measurement delay for FDD intrafrequency cell with MPDCCH scaling

Gap pattern ID	Cell identification delay ($T_{\text{identify_intra_UE cat M1}}$)	Measurement delay ($T_{\text{measure_intra_UE cat M1}}$)
0	$\text{Max}(20 * r_{\max} * G / 1000, 1.44) * K_{\text{intra_M1_NC}} * K_{\text{RSTD_M1_NC}}$ seconds	$\text{Max}(5 * r_{\max} * G, 480) * K_{\text{intra_M1_NC}} * K_{\text{RSTD_M1_NC}}$ ms
1	$\text{Max}(20 * r_{\max} * G / 1000, 2.88) * K_{\text{intra_M1_NC}} * K_{\text{RSTD_M1_NC}}$ seconds	$\text{Max}(5 * r_{\max} * G, 960) * K_{\text{intra_M1_NC}} * K_{\text{RSTD_M1_NC}}$ ms

$$K_{\text{RSTD_M1_NC}} = \frac{1}{1 - \max\left(\frac{40}{T_{\text{PRS}}}, \frac{N_{\text{PRS}}}{T_{\text{PRS}}}\right)}$$

$K_{\text{RSTD_M1_NC}}$ is applicable provided following conditions are met:

- $T_{\text{PRS}} > 40 \text{ ms}$

$$T_{PRS} > N_{PRS}$$

- PRS bandwidth is less than the bandwidth of the cell used for RSTD measurement in which case gaps are required

where

- T_{PRS} is the cell-specific positioning subframe configuration period as defined in TS 36.211 [16],
- N_{PRS} is the number of consecutive downlink positioning subframes in a positioning occasion defined in TS 36.211

Otherwise $K_{RSTD_MI_NC} = 1$.

A cell shall be considered detectable when

- RSRP related side conditions given in Sections 9.1.21.1 and 9.1.21.2 are fulfilled for a corresponding Band,
- RSRQ related side conditions given in Clause 9.1.21.6 are fulfilled for a corresponding Band,
- SCH_RP and $SCH\ \hat{E}s/Iot$ according to Annex Table B.2.14-1 for a corresponding Band.

Identification of a cell shall include detection of the cell and additionally performing a single measurement with measurement period of $T_{measure_intra_UE\ cat\ M1}$. If higher layer filtering is used, an additional cell identification delay can be expected.

In the RRC_CONNECTED state the measurement period for intra frequency measurements is according to Table 8.13.2.1.1.1-1. When measurement gaps are activated the UE shall be capable of performing measurements for at least 6 cells. If the UE has identified more than 6 cells, the UE shall perform measurements but the reporting rate of RSRP and RSRQ measurement of cells from UE physical layer to higher layers may be decreased.

The RSRP measurement accuracy for all measured cells shall be as specified in the sub-clauses 9.1.21.1 and 9.1.21.2.

The RSRQ measurement accuracy for all measured cells shall be as specified in the sub-clauses 9.1.21.6.

8.13.2.1.1.1 Measurement Reporting Requirements

8.13.2.1.1.1.1 Periodic Reporting

Reported RSRP and RSRQ measurement contained in periodically triggered measurement reports shall meet the requirements in sections 9.1.21.1, 9.1.21.2 and 9.1.21.6.

8.13.2.1.1.1.1.2 Event-triggered Periodic Reporting

Reported RSRP and RSRQ measurement contained in event triggered periodic measurement reports shall meet the requirements in sections 9.1.21.1, 9.1.21.2 and 9.1.21.6.

The first report in event triggered periodic measurement reporting shall meet the requirements specified in clause 8.13.2.1.1.1.1.3.

8.13.2.1.1.1.1.3 Event Triggered Reporting

Reported RSRP and RSRQ measurement contained in event triggered measurement reports shall meet the requirements in sections 9.1.21.1, 9.1.21.2 and 9.1.21.6.

The UE shall not send any event triggered measurement reports, as long as no reporting criteria are fulfilled.

The measurement reporting delay is defined as the time between an event that will trigger a measurement report and the point when the UE starts to transmit the measurement report over the air interface. This requirement assumes that the measurement report is not delayed by other RRC signalling on the DCCH. This measurement reporting delay excludes a delay uncertainty resulted when inserting the measurement report to the TTI of the uplink DCCH. The delay uncertainty is: $2 \times TTI_{DCCH}$. This measurement reporting delay excludes a delay which caused by no UL resources for UE to send the measurement report.

The event triggered measurement reporting delay, measured without L3 filtering shall be less than $T_{\text{identify_intra_UE cat M1_NC}}$ defined in Clause 8.13.2.1.1.1. When L3 filtering is used or IDC autonomous denial is configured an additional delay can be expected.

If a cell which has been detectable at least for the time period $T_{\text{identify_intra_UE cat M1_NC}}$ defined in clause 8.13.2.1.1.1 becomes undetectable for a period ≤ 5 seconds and then the cell becomes detectable again and triggers an event, the event triggered measurement reporting delay shall be less than $T_{\text{Measurement_Period_UE cat M1, Intra}}$ provided the timing to that cell has not changed more than $\pm 50 T_s$ and the L3 filter has not been used. When L3 filtering is used or IDC autonomous denial is configured, an additional delay can be expected.

8.13.2.1.1.2 E-UTRAN intra frequency measurements when DRX is used

When DRX is in use the UE shall be able to identify a new detectable FDD intra frequency cell within $T_{\text{identify_intra_UE cat M1_NC}}$ as shown in table 8.13.2.1.1.2-1.

When eDRX_CONN is in use the UE shall be able to identify a new detectable FDD intra frequency cell within $T_{\text{identify_intra_UE cat M1_NC}}$ as shown in table 8.13.2.1.1.2-1A.

Table 8.13.2.1.1.2-1: Requirement to identify a newly detectable FDD intrafrequency cell

Gap pattern ID	DRX cycle length (s)	$T_{\text{identify_intra_UE cat M1_NC}}$ (s) (DRX cycles)
0	≤ 0.04	$1.44 * K_{\text{intra_M1_NC}} * K_{\text{RSTD_M1_NC}}$ (Note 1)
	$0.04 < \text{DRX-cycle} \leq 0.08$	Note 2 ($40 * K_{\text{intra_M1_NC}} * K_{\text{RSTD_M1_NC}}$)
	0.128	$3.2 * K_{\text{intra_M1_NC}} * K_{\text{RSTD_M1_NC}}$ ($25 * K_{\text{intra_M1_NC}} * K_{\text{RSTD_M1_NC}}$)
	$0.128 < \text{DRX-cycle} \leq 2.56$	Note 2 ($20 * K_{\text{intra_M1_NC}} * K_{\text{RSTD_M1_NC}}$)
1	< 0.128	$2.88 * K_{\text{intra_M1_NC}} * K_{\text{RSTD_M1_NC}}$ (Note 1)
	0.128	$3.2 * K_{\text{intra_M1_NC}} * K_{\text{RSTD_M1_NC}}$ ($25 * K_{\text{intra_M1_NC}} * K_{\text{RSTD_M1_NC}}$)
	$0.128 < \text{DRX-cycle} \leq 2.56$	Note 2 ($20 * K_{\text{intra_M1_NC}} * K_{\text{RSTD_M1_NC}}$)
Note 1: Number of DRX cycle depends upon the DRX cycle in use		
Note 2: Time depends upon the DRX cycle in use		

Table 8.13.2.1.1.2-1A: Requirement to identify a newly detectable FDD intrafrequency cell when eDRX_CONN cycle is used

eDRX_CONN cycle length (s)	$T_{\text{identify_intra_UE cat M1_NC}}$ (s) (eDRX_CONN cycles)
$2.56 < \text{eDRX_CONN cycle} \leq 10.24$	Note ($20 * K_{\text{intra_M1_NC}} * K_{\text{RSTD_M1_NC}}$)
Note: Time depends upon the eDRX_CONN cycle in use	

A cell shall be considered detectable when

- RSRP related side conditions given in Sections 9.1.21.1 and 9.1.21.2 are fulfilled for a corresponding Band,
- RSRQ related side conditions given in Clause 9.1.21.6 are fulfilled for a corresponding Band,
- SCH_RP and SCH \hat{E}_s/Iot according to Annex B.2.14-1 for a corresponding Band

In the RRC_CONNECTED state the measurement period for intra frequency measurements is $T_{\text{measure_intra_UE cat M1}}$. When DRX is used, $T_{\text{measure_intra_UE cat M1_NC}}$ is as specified in table 8.13.2.1.1.2-2. When eDRX_CONN is used, $T_{\text{measure_intra_UE cat M1_NC}}$ is as specified in table 8.13.2.1.1.2-3. The UE shall be capable of performing RSRP and RSRQ measurements for 6 identified-intra-frequency cells, and the UE physical layer shall be capable of reporting measurements to higher layers with the measurement period of $T_{\text{measure_intra_UE cat M1}}$.

Table 8.13.2.1.1.2-2: Requirement to measure FDD intrafrequency cells

Gap pattern ID	DRX cycle length (s)	$T_{\text{measure_intra_UE cat M1_NC}}$ (s) (DRX cycles)
0	< 0.128	$0.48 * K_{\text{intra_M1_NC}} * K_{\text{RSTD_M1_NC}}$ (Note 1)
	$0.128 \leq \text{DRX-cycle} \leq 2.56$	Note 2 ($5 * K_{\text{intra_M1_NC}} * K_{\text{RSTD_M1_NC}}$)
1	< 0.256	$0.960 * K_{\text{intra_M1_NC}} * K_{\text{RSTD_M1_NC}}$ (Note 1)
	$0.256 \leq \text{DRX-cycle} \leq 2.56$	Note 2 ($* K_{\text{intra_M1_NC}} * K_{\text{RSTD_M1_NC}}$)
Note 1: Number of DRX cycle depends upon the DRX cycle in use		
Note 2: Time depends upon the DRX cycle in use		

Table 8.13.2.1.1.2-3: Requirement to measure FDD intrafrequency cells when eDRX_CONN cycle is used

eDRX_CONN cycle length (s)	$T_{\text{measure_intra_UE cat M1_NC}}$ (s) (eDRX_CONN cycles)
$2.56 < \text{eDRX_CONN cycle} \leq 10.24$	Note ($5 * K_{\text{intra_M1_NC}} * K_{\text{RSTD_M1_NC}}$)
Note: Time depends upon the eDRX_CONN cycle in use	

The RSRP measurement accuracy for all measured cells shall be as specified in the sub-clauses 9.1.21.1 and 9.1.21.2.

The RSRQ measurement accuracy for all measured cells shall be as specified in the sub-clauses 9.1.21.6.

The requirements in this subclause apply regardless of MPDCCH monitoring configuration.

8.13.2.1.1.2.1 Measurement Reporting Requirements

8.13.2.1.1.2.1.1 Periodic Reporting

Reported RSRP and RSRQ measurement contained in periodically triggered measurement reports shall meet the requirements in sections 9.1.21.1, 9.1.21.2 and 9.1.21.6.

8.13.2.1.1.2.1.2 Event-triggered Periodic Reporting

Reported RSRP and RSRQ measurement contained in event triggered periodic measurement reports shall meet the requirements in sections 9.1.21.1, 9.1.21.2 and 9.1.21.6.

The first report in event triggered periodic measurement reporting shall meet the requirements specified in clause 8.13.2.1.1.2.1.3.

8.13.2.1.1.2.1.3 Event Triggered Reporting

Reported RSRP and RSRQ measurement contained in event triggered measurement reports shall meet the requirements in sections 9.1.21.1, 9.1.21.2 and 9.1.21.6.

The UE shall not send any event triggered measurement reports, as long as no reporting criteria are fulfilled.

The measurement reporting delay is defined as the time between an event that will trigger a measurement report and the point when the UE starts to transmit the measurement report over the air interface. This requirement assumes that the measurement report is not delayed by other RRC signalling on the DCCH. This measurement reporting delay excludes a delay uncertainty resulted when inserting the measurement report to the TTI of the uplink DCCH. The delay uncertainty is: $2 \times T_{\text{TI_DCCH}}$. This measurement reporting delay excludes a delay which caused by no UL resources for UE to send the measurement report.

The event triggered measurement reporting delay, measured without L3 filtering shall be less than $T_{\text{identify_intra_UE cat M1}}$ defined in Clause 8.13.2.1.1.2. When L3 filtering is used or IDC autonomous denial is configured an additional delay can be expected.

If a cell which has been detectable at least for the time period $T_{\text{identify_intra_UE cat M1_NC}}$ defined in clause 8.13.2.1.1.2 becomes undetectable for a period ≤ 5 seconds and then the cell becomes detectable again and triggers an event, the event triggered measurement reporting delay shall be less than $T_{\text{measure_intra_UE cat M1_NC}}$ provided the timing to that cell has not changed more than $\pm 50 T_s$ and the L3 filter has not been used. When L3 filtering is used or IDC autonomous denial is configured, an additional delay can be expected.

8.13.2.1.2 E-UTRAN intra frequency measurements for HD-FDD

8.13.2.1.2.1 E-UTRAN intra frequency measurements when no DRX is used

The requirements in this section are applicable for the UE which supports half duplex operation on one or more supported frequency bands [2].

The requirements defined in clause 8.13.2.1.1.1 also apply for this section provided the following conditions are met:

- at least downlink subframe # 0 or downlink subframe # 5 per radio frame of an intra-frequency cell to be identified by the UE is available at the UE over $T_{\text{identify_intra_UE cat M1}}$;

- at least one downlink subframe per radio frame of measured cell is available at the UE for RSRP measurement assuming measured cell is identified cell over $T_{\text{measure_intra_UE cat M1}}$.
- RSRP related side conditions given in Sections 9.1.2.1 and 9.1.2.2 are fulfilled for a corresponding Band,
- RSRQ related side conditions given in Clause 9.1.21.6 are fulfilled for a corresponding Band,
- SCH_{RP} and SCH_{ES/Iot} according to Annex Table B.2.14-2 for a corresponding Band

8.13.2.1.2.2 E-UTRAN intra frequency measurements when DRX is used

The requirements in this section are applicable for the UE which supports half duplex operation on one or more supported frequency bands [2].

When DRX is in use the UE shall be able to identify a new detectable HD-FDD intra frequency cell within $T_{\text{identify_intra_UE cat M1_NC}}$ as shown in table 8.13.2.1.2.2-1.

When eDRX_CONN is in use, the UE shall be able to identify a new detectable FDD intra frequency cell within $T_{\text{identify_intra_UE cat M1_NC}}$ as shown in table 8.13.2.1.2.2-1A.

Table 8.13.2.1.2.2-1: Requirement to identify a newly detectable HD-FDD intrafrequency cell

Gap pattern ID	DRX cycle length (s)	$T_{\text{identify_intra_UE cat M1_NC}}$ (s) (DRX cycles)
0	≤ 0.04	$1.44 * K_{\text{intra_M1_NC}} * K_{\text{RSTD_M1_NC}}$ (Note 1)
	$0.04 < \text{DRX-cycle} \leq 0.08$	Note 2 ($40 * K_{\text{intra_M1_NC}} * K_{\text{RSTD_M1_NC}}$)
	0.128	$3.2 * K_{\text{intra_M1_NC}} * K_{\text{RSTD_M1_NC}}$ ($32 * K_{\text{intra_M1_NC}} * K_{\text{RSTD_M1_NC}}$)
	$0.128 < \text{DRX-cycle} \leq 2.56$	Note 2 ($25 * K_{\text{intra_M1_NC}} * K_{\text{RSTD_M1_NC}}$)
1	≤ 0.08	$2.88 * K_{\text{intra_M1_NC}} * K_{\text{RSTD_M1_NC}}$ (Note 1)
	0.128	$3.2 * K_{\text{intra_M1_NC}} * K_{\text{RSTD_M1_NC}}$ ($32 * K_{\text{intra_M1_NC}} * K_{\text{RSTD_M1_NC}}$)
	$0.128 < \text{DRX-cycle} \leq 2.56$	Note 2 ($25 * K_{\text{intra_M1_NC}} * K_{\text{RSTD_M1_NC}}$)
Note 1: Number of DRX cycle depends upon the DRX cycle in use		
Note 2: Time depends upon the DRX cycle in use		

Table 8.13.2.1.2.2-1A: Requirement to identify a newly detectable HD-FDD intrafrequency cell when eDRX_CONN cycle is used

eDRX_CONN cycle length (s)	$T_{\text{identify_intra_UE cat M1_NC}}$ (s) (eDRX_CONN cycles)
$2.56 < \text{eDRX_CONN cycle} \leq 10.24$	Note ($25 * K_{\text{intra_M1_NC}} * K_{\text{RSTD_M1_NC}}$)
Note: Time depends upon the eDRX_CONN cycle in use	

A cell shall be considered detectable when

- RSRP related side conditions given in Sections 9.1.21.1 and 9.1.21.2 are fulfilled for a corresponding Band,
- RSRQ related side conditions given in Clause 9.1.21.6 are fulfilled for a corresponding Band,
- SCH_{RP} and SCH_{ES/Iot} according to Annex Table B.2.14-2 for a corresponding Band

In the RRC_CONNECTED state the measurement period for intra frequency measurements is $T_{\text{measure_intra_UE cat M1}}$.

When DRX is used, $T_{\text{measure_intra_UE cat M1_NC}}$ is as specified in table 8.13.2.1.2.2-2. When eDRX_CONN is used, $T_{\text{measure_intra_UE cat M1_NC}}$ is as specified in table 8.13.2.1.2.2-3. The UE shall be capable of performing RSRP and RSRQ measurements for 6 identified-intra-frequency cells, and the UE physical layer shall be capable of reporting measurements to higher layers with the measurement period of $T_{\text{measure_intra_UE cat M1}}$.

Table 8.13.2.1.2.2-2: Requirement to measure HD-FDD intrafrequency cells

Gap pattern ID	DRX cycle length (s)	$T_{\text{measure_intra_UE cat M1_NC}}$ (s) (DRX cycles)
0	< 0.08	$0.48 * K_{\text{intra_M1_NC}} * K_{\text{RSTD_M1_NC}}$ (Note 1)
	$0.08 \leq \text{DRX-cycle} \leq 0.16$	Note 2 ($7 * K_{\text{intra_M1_NC}} * K_{\text{RSTD_M1_NC}}$)
	$0.16 < \text{DRX-cycle} \leq 2.56$	Note 2 ($5 * K_{\text{intra_M1_NC}} * K_{\text{RSTD_M1_NC}}$)
1	< 0.16	$0.96 * K_{\text{intra_M1_NC}} * K_{\text{RSTD_M1_NC}}$ (Note 1)
	DRX-cycle=0.16	$1.12 * K_{\text{intra_M1_NC}} * K_{\text{RSTD_M1_NC}}$ ($7 * K_{\text{intra_M1_NC}} * K_{\text{RSTD_M1_NC}}$)
	$0.16 < \text{DRX-cycle} \leq 2.56$	Note 2 ($5 * K_{\text{intra_M1_NC}} * K_{\text{RSTD_M1_NC}}$)
Note 1: Number of DRX cycle depends upon the DRX cycle in use		
Note 2: Time depends upon the DRX cycle in use		

Table 8.13.2.1.2.2-3: Requirement to measure HD-FDD intrafrequency cells when eDRX_CONN cycle is used

eDRX_CONN cycle length (s)	$T_{\text{measure_intra_UE cat M1_NC}}$ (s) (eDRX_CONN cycles)
$2.56 < \text{eDRX_CONN cycle} \leq 10.24$	Note (5 * $K_{\text{intra_M1_NC}}$ * $K_{\text{RSTD_M1_NC}}$)
Note: Time depends upon the eDRX_CONN cycle in use	

The RSRP measurement accuracy for all measured cells shall be as specified in the sub-clauses 9.1.21.1 and 9.1.21.2.

The RSRQ measurement accuracy for all measured cells shall be as specified in the sub-clauses 9.1.21.6.

The requirements in this subclause apply regardless of MPDCCH monitoring configuration.

8.13.2.1.2.2.1 Measurement Reporting Requirements

8.13.2.1.2.2.1.1 Periodic Reporting

Reported RSRP and RSRQ measurement contained in periodically triggered measurement reports shall meet the requirements in sections 9.1.21.1, 9.1.21.2 and 9.1.21.6.

8.13.2.1.2.2.1.2 Event-triggered Periodic Reporting

Reported RSRP and RSRQ measurement contained in event triggered periodic measurement reports shall meet the requirements in sections 9.1.21.1, 9.1.21.2, and 9.1.21.6.

The first report in event triggered periodic measurement reporting shall meet the requirements specified in clause 8.13.2.1.2.2.1.3.

8.13.2.1.2.2.1.3 Event Triggered Reporting

Reported RSRP and RSRQ measurement contained in event triggered measurement reports shall meet the requirements in sections 9.1.21.1, 9.1.21.2 and 9.1.21.6.

The UE shall not send any event triggered measurement reports, as long as no reporting criteria are fulfilled.

The measurement reporting delay is defined as the time between an event that will trigger a measurement report and the point when the UE starts to transmit the measurement report over the air interface. This requirement assumes that the measurement report is not delayed by other RRC signalling on the DCCH. This measurement reporting delay excludes a delay uncertainty resulted when inserting the measurement report to the TTI of the uplink DCCH. The delay uncertainty is: $2 \times T_{\text{TTI}_{\text{DCCH}}}$. This measurement reporting delay excludes a delay which caused by no UL resources for UE to send the measurement report.

The event triggered measurement reporting delay, measured without L3 filtering shall be less than $T_{\text{identify_intra_UE cat M1_NC}}$ defined in Clause 8.13.2.1.2.2 When L3 filtering is used or IDC autonomous denial is configured an additional delay can be expected.

If a cell which has been detectable at least for the time period $T_{\text{identify_intra_UE cat M1_NC}}$ defined in clause 8.13.2.1.2.2 becomes undetectable for a period ≤ 5 seconds and then the cell becomes detectable again and triggers an event, the event triggered measurement reporting delay shall be less than $T_{\text{measure_intra_UE cat M1_NC}}$ provided the timing to that cell has not changed more than $\pm 50 T_s$ and the L3 filter has not been used. When L3 filtering is used or IDC autonomous denial is configured, an additional delay can be expected.

8.13.2.1.3 E-UTRAN TDD intra frequency measurements

8.13.2.1.3.1 E-UTRAN intra frequency measurements when no DRX is used

When no DRX is in use, the UE shall be able to identify and measure a new detectable TDD intra frequency cell according to requirements in Table 8.13.2.1.3.1-1 when $\text{SCH } \hat{E}_s / I_{\text{ot}} \geq -6$ dB, provided

- $G=1$, or
- $r_{\text{max}} * G < 80\text{ms}$, or
- UE is receiving PDSCH.

Otherwise, requirements in Table 8.13.2.1.3.1-3 apply, where r_{\max} and G are given by higher layer parameter $mPDCCH\text{-}NumRepetition$ and $mPDCCH\text{-}startSF\text{-}UESS$ respectively as defined in TS 36.213 [3].

Table 8.13.2.1.3.1-1: Requirement on cell identification delay and measurement delay for TDD intrafrequency cell

Gap pattern ID	Cell identification delay ($T_{\text{identify_intra_UE cat M1}}$)	Measurement delay ($T_{\text{measure_intra_UE cat M1}}$)
0	$1.44 * K_{\text{intra_M1_NC}} * K_{\text{RSTD_M1_NC}}$ seconds	$480 * K_{\text{intra_M1_NC}} * K_{\text{RSTD_M1_NC}}$ ms
1	$2.88 * K_{\text{intra_M1_NC}} * K_{\text{RSTD_M1_NC}}$ seconds	$960 * K_{\text{intra_M1_NC}} * K_{\text{RSTD_M1_NC}}$ ms

$K_{\text{intra_M1_NC}} = 100 / X$ where X is signalled by the RRC parameter $measGapSharingScheme$ [2] and is defined as in Table 8.13.2.1.3.1-2 when $highSpeedMeasGapCE\text{-}ModeA$ [2] is not configured, and in Table 8.13.2.1.3.1-2A when $highSpeedMeasGapCE\text{-}ModeA$ [2] is configured. N_{freq} is total number of inter-frequency layers to be monitored as defined in 8.1.2.1.1. When inter frequency measurement is not configured, $K_{\text{intra_M1_NC}}=1$ regardless whether or how parameter $measGapSharingScheme$ [2] is configured.

Table 8.13.2.1.3.1-2: Value of parameter X for CEModeA

$measGapSharingScheme$	Value of X (%)
'00'	$\frac{100}{N_{\text{freq}} + 1}$
'01'	40
'10'	50
'11'	60

Table 8.13.2.1.3.1-2A: Value of parameter X for CEModeA for UE configured with $highSpeedMeasGapCE\text{-}ModeA$

$measGapSharingScheme$	Value of X (%)
'00'	$\frac{100}{N_{\text{freq}} + 1}$
'01'	50
'10'	80
'11'	90

Table 8.13.2.1.3.1-3: Requirement on cell identification delay and measurement delay for TDD intrafrequency cell with MPDCCH scaling

Gap pattern ID	Cell identification delay ($T_{\text{identify_intra_UE cat M1}}$)	Measurement delay ($T_{\text{measure_intra_UE cat M1}}$)
0	$\text{Max}(20 * r_{\max} * G / 1000, 1.44) * K_{\text{intra_M1_NC}} * K_{\text{RSTD_M1_NC}}$ seconds	$\text{Max}(5 * r_{\max} * G, 480) * K_{\text{intra_M1_NC}} * K_{\text{RSTD_M1_NC}}$ ms
1	$\text{Max}(20 * r_{\max} * G / 1000, 2.88) * K_{\text{intra_M1_NC}} * K_{\text{RSTD_M1_NC}}$ seconds	$\text{Max}(5 * r_{\max} * G, 960) * K_{\text{intra_M1_NC}} * K_{\text{RSTD_M1_NC}}$ ms

$$K_{\text{RSTD_M1_NC}} = \frac{1}{1 - \max\left(\frac{40}{T_{\text{PRS}}}, \frac{N_{\text{PRS}}}{T_{\text{PRS}}}\right)}$$

$K_{\text{RSTD_M1_NC}}$ is applicable provided following conditions are met:

- $T_{\text{PRS}} > 40$ ms
- $T_{\text{PRS}} > N_{\text{PRS}}$
- PRS bandwidth is less than the bandwidth of the cell used for RSTD measurement in which case gaps are required

where

- T_{PRS} is the cell-specific positioning subframe configuration period as defined in TS 36.211 [16],
- N_{PRS} is the number of consecutive downlink positioning subframes in a positioning occasion defined in TS 36.211

Otherwise $K_{RSTD_M1_NC} = 1$.

A cell shall be considered detectable when

- RSRP related side conditions given in Sections 9.1.21.1 and 9.1.21.2 are fulfilled for a corresponding Band,
- RSRQ related side conditions given in Clause 9.1.21.6 are fulfilled for a corresponding Band,
- SCH_RP and $SCH\ \hat{E}s/lot$ according to Annex Table B.2.14-1 for a corresponding Band.

Identification of a cell shall include detection of the cell and additionally performing a single measurement with measurement period of $T_{measure_intra_UE\ cat\ M1}$. If higher layer filtering is used, an additional cell identification delay can be expected.

In the RRC_CONNECTED state the measurement period for intra frequency measurements is according to Table 8.13.2.1.3.1-1. When measurement gaps are activated the UE shall be capable of performing measurements for at least 6 cells. If the UE has identified more than 6 cells, the UE shall perform measurements but the reporting rate of RSRP and RSRQ measurements of cells from UE physical layer to higher layers may be decreased.

The RSRP measurement accuracy for all measured cells shall be as specified in the sub-clauses 9.1.21.1 and 9.1.21.2.

The RSRQ measurement accuracy for all measured cells shall be as specified in the sub-clauses 9.1.21.6.

8.13.2.1.3.1.1 Measurement Reporting Requirements

8.13.2.1.3.1.1.1 Periodic Reporting

Reported RSRP and RSRQ measurement contained in periodically triggered measurement reports shall meet the requirements in sections 9.1.21.1, 9.1.21.2 and 9.1.21.6.

8.13.2.1.3.1.1.2 Event-triggered Periodic Reporting

Reported RSRP and RSRQ measurement contained in event triggered periodic measurement reports shall meet the requirements in sections 9.1.21.1, 9.1.21.2 and 9.1.21.6.

The first report in event triggered periodic measurement reporting shall meet the requirements specified in clause 8.13.2.1.3.1.1.3.

8.13.2.1.3.1.1.3 Event Triggered Reporting

Reported RSRP and RSRQ measurement contained in event triggered measurement reports shall meet the requirements in sections 9.1.21.1, 9.1.21.2 and 9.1.21.6.

The UE shall not send any event triggered measurement reports, as long as no reporting criteria are fulfilled.

The measurement reporting delay is defined as the time between an event that will trigger a measurement report and the point when the UE starts to transmit the measurement report over the air interface. This requirement assumes that the measurement report is not delayed by other RRC signalling on the DCCH. This measurement reporting delay excludes a delay uncertainty resulted when inserting the measurement report to the TTI of the uplink DCCH. The delay uncertainty is: $2 \times TTI_{DCCH}$. This measurement reporting delay excludes a delay which caused by no UL resources for UE to send the measurement report.

The event triggered measurement reporting delay, measured without L3 filtering shall be less than $T_{identify\ intra_UE\ cat\ M1_NC}$ defined in Clause 8.13.2.1.3.1. When L3 filtering is used or IDC autonomous denial is configured an additional delay can be expected.

If a cell which has been detectable at least for the time period $T_{identify_intra_UE\ cat\ M1_NC}$ defined in clause 8.13.2.1.3.1 becomes undetectable for a period ≤ 5 seconds and then the cell becomes detectable again and triggers an event, the

event triggered measurement reporting delay shall be less than $T_{\text{Measurement_Period Intra_UE cat M1_NC}}$ provided the timing to that cell has not changed more than $\pm 50 T_s$ and the L3 filter has not been used. When L3 filtering is used or IDC autonomous denial is configured, an additional delay can be expected.

8.13.2.1.3.2 E-UTRAN intra frequency measurements when DRX is used

When DRX is in use the UE shall be able to identify a new detectable TDD intra frequency cell within $T_{\text{identify_intra_UE cat M1}}$ as shown in table 8.13.2.1.3.2-1.

When eDRX_CONN is in use the UE shall be able to identify a new detectable TDD intra frequency cell within $T_{\text{identify_intra_UE cat M1_NC}}$ as shown in table 8.13.2.1.3.2-1A.

Table 8.13.2.1.3.2-1: Requirement to identify a newly detectable TDD intrafrequency cell

Gap pattern ID	DRX cycle length (s)	$T_{\text{identify_intra_UE cat M1_NC}}$ (s) (DRX cycles)
0	≤ 0.04	$1.44 * K_{\text{intra_M1_NC}} * K_{\text{RSTD_M1_NC}}$ (Note 1)
	$0.04 < \text{DRX-cycle} \leq 0.08$	Note 2 ($40 * K_{\text{intra_M1_NC}} * K_{\text{RSTD_M1_NC}}$)
	0.128	$3.2 * K_{\text{intra_M1_NC}} * K_{\text{RSTD_M1_NC}}$ ($25 * K_{\text{intra_M1_NC}} * K_{\text{RSTD_M1_NC}}$)
	$0.128 < \text{DRX-cycle} \leq 2.56$	Note 2 ($20 * K_{\text{intra_M1_NC}} * K_{\text{RSTD_M1_NC}}$)
1	< 0.128	$2.88 * K_{\text{intra_M1_NC}} * K_{\text{RSTD_M1_NC}}$ (Note 1)
	0.128	$3.2 * K_{\text{intra_M1_NC}} * K_{\text{RSTD_M1_NC}}$ ($25 * K_{\text{intra_M1_NC}} * K_{\text{RSTD_M1_NC}}$)
	$0.128 < \text{DRX-cycle} \leq 2.56$	Note 2 ($20 * K_{\text{intra_M1_NC}} * K_{\text{RSTD_M1_NC}}$)
	Note 1: Number of DRX cycle depends upon the DRX cycle in use Note 2: Time depends upon the DRX cycle in use	

Table 8.13.2.1.3.2-1A: Requirement to identify a newly detectable TDD intrafrequency cell when eDRX_CONN cycle is used

eDRX_CONN cycle length (s)	$T_{\text{identify_intra_UE cat M1_NC}}$ (s) (eDRX_CONN cycles)
$2.56 < \text{eDRX_CONN cycle} \leq 10.24$	Note ($20 * K_{\text{intra_M1_NC}} * K_{\text{RSTD_M1_NC}}$)
Note:	Time depends upon the eDRX_CONN cycle in use

A cell shall be considered detectable when

- RSRP related side conditions given in Clause 9.1.21.1 and 9.1.21.2 are fulfilled for a corresponding Band,
- RSRQ related side conditions given in Clause 9.1.21.6 are fulfilled for a corresponding Band,
- SCH_RP and SCH Ês/Iot according to Annex Table B.2.14-1 for a corresponding Band

In the RRC_CONNECTED state the measurement period for intra frequency measurements is $T_{\text{measure_intra_UE cat M1}}$. When DRX is used, $T_{\text{measure_intra_UE cat M1_NC}}$ is as specified in table 8.13.2.1.3.2-2. When eDRX_CONN is used, $T_{\text{measure_intra_UE cat M1_NC}}$ is as specified in table 8.13.2.1.3.2-3. The UE shall be capable of performing RSRP and RSRQ measurements for 6 identified intra-frequency cells and the UE physical layer shall be capable of reporting measurements to higher layers with the measurement period of $T_{\text{measure_intra_UE cat M1}}$.

Table 8.13.2.1.3.2-2: Requirement to measure TDD intra frequency cells

Gap pattern ID	DRX cycle length (s)	$T_{\text{measure_intra_UE cat M1_NC}}$ (s) (DRX cycles)
0	< 0.128	$0.48 * K_{\text{intra_M1_NC}} * K_{\text{RSTD_M1_NC}}$ (Note 1)
	$0.128 \leq \text{DRX-cycle} \leq 2.56$	Note 2 ($5 * K_{\text{intra_M1_NC}} * K_{\text{RSTD_M1_NC}}$)
1	< 0.256	$0.96 * K_{\text{intra_M1_NC}} * K_{\text{RSTD_M1_NC}}$ (Note 1)
	$0.256 \leq \text{DRX-cycle} \leq 2.56$	Note 2 ($5 * K_{\text{intra_M1_NC}} * K_{\text{RSTD_M1_NC}}$)
Note 1: Number of DRX cycle depends upon the DRX cycle in use Note 2: Time depends upon the DRX cycle in use		

Table 8.13.2.1.3.2-3: Requirement to measure TDD intra frequency cells when eDRX_CONN cycle is used

eDRX_CONN cycle length (s)	$T_{\text{measure_intra_UE cat M1_NC}}$ (s) (eDRX_CONN cycles)
$2.56 < \text{eDRX_CONN cycle} \leq 10.24$	Note ($5 * K_{\text{intra_M1_NC}} * K_{\text{RSTD_M1_NC}}$)
Note:	Time depends upon the eDRX_CONN cycle in use.

The RSRP measurement accuracy for all measured cells shall be as specified in the sub-clauses 9.1.21.1 and 9.1.21.2.

The RSRQ measurement accuracy for all measured cells shall be as specified in the sub-clauses 9.1.21.6.

The requirements in this subclause apply regardless of MPDCCH monitoring configuration.

8.13.2.1.3.2.1 Measurement Reporting Requirements

8.13.2.1.3.2.1.1 Periodic Reporting

Reported RSRP and RSRQ measurement contained in periodically triggered measurement reports shall meet the requirements in sections 9.1.21.1, 9.1.21.2 and 9.1.21.6.

8.13.2.1.3.2.1.2 Event-triggered Periodic Reporting

Reported RSRP and RSRQ measurement contained in event triggered periodic measurement reports shall meet the requirements in sections 9.1.21.1, 9.1.21.2 and 9.1.21.6.

The first report in event triggered periodic measurement reporting shall meet the requirements specified in clause 8.13.2.1.3.2.1.3.

8.13.2.1.3.2.1.3 Event Triggered Reporting

Reported RSRP and RSRQ measurement contained in event triggered measurement reports shall meet the requirements in sections 9.1.21.1, 9.1.21.2 and 9.1.21.6.

The UE shall not send any event triggered measurement reports, as long as no reporting criteria are fulfilled.

The measurement reporting delay is defined as the time between an event that will trigger a measurement report and the point when the UE starts to transmit the measurement report over the air interface. This requirement assumes that the measurement report is not delayed by other RRC signalling on the DCCH. This measurement reporting delay excludes a delay uncertainty resulted when inserting the measurement report to the TTI of the uplink DCCH. The delay uncertainty is: $2 \times TTI_{DCCH}$. This measurement reporting delay excludes a delay which caused by no UL resources for UE to send the measurement report.

The event triggered measurement reporting delay, measured without L3 filtering shall be less than $T_{\text{identify_intra_UE cat M1_NC}}$ defined in Clause 8.13.2.1.3.2. When L3 filtering is used or IDC autonomous denial is configured an additional delay can be expected.

If a cell which has been detectable at least for the time period $T_{\text{identify_intra_UE cat M1_NC}}$ defined in clause 8.13.2.1.3.2 becomes undetectable for a period ≤ 5 seconds and then the cell becomes detectable again and triggers an event, the event triggered measurement reporting delay shall be less than $T_{\text{measure_intra_UE cat M1_NC}}$ provided the timing to that cell has not changed more than $\pm 50 T_s$ and the L3 filter has not been used. When L3 filtering is used or IDC autonomous denial is configured, an additional delay can be expected.

8.13.2.2 Void

8.13.2.3 E-UTRAN OTDOA Intra-Frequency RSTD Measurements for Cat-M1 UE in CEModeA

All intra-frequency RSTD measurement requirements specified in Sections 8.13.2.3 shall apply without DRX as well as for any DRX and eDRX_CONN cycles specified in TS 36.331 [2]. All the measurement requirements specified in Sections 8.13.2.3 shall apply provided that the UE is configured:

- with the single PRS configuration for the reference cell and all the neighbour cells and
- with either the measurement gap pattern ID #0 specified in Clause 8.1.2.1 or any applicable measurement gap pattern specified in Table 8.1.2.1-3 for cat M1 RSTD measurements if the PRS bandwidth is less than the bandwidth of the cell used for the RSTD measurement in which case gaps are required

If CRS muting is enabled in a cell for which the UE performs RSTD measurements, the UE capable of supporting CRS muting [31] shall perform RSTD measurements and meet all the requirements in this section, provided the CRS are available within at least the PRS bandwidth in the subframes with PRS during all positioning occasions within the RSTD measurement period.

8.13.2.3.1 E-UTRAN FDD Intra-Frequency OTDOA Measurements

When the physical layer cell identities of neighbour cells together with the OTDOA assistance data are provided, the UE shall be able to detect and measure intra-frequency RSTD, specified in TS 36.214 [4], for at least $n=16$ cells, including the reference cell, on the same carrier frequency f_1 as that of the reference cell within $T_{\text{RSTDIntraFreqFDD,Cat}_M}$ ms as given below (see also Figure 8.13.2.3.1-1):

$$T_{\text{RSTDIntraFreqFDD,Cat}_M} = T_{\text{PRS}} \cdot (M - 1) + \Delta + T_{\text{MIB}} \text{ ms},$$

where

$T_{\text{RSTDIntraFreqFDD,Cat}_M}$ is the total time for detecting and measuring at least n cells,

T_{PRS} is the cell-specific positioning subframe configuration period as defined in TS 36.355 [24] for UE not configured with measurement gaps for intra-frequency RSTD. For UE configured with measurement gaps for intra-frequency RSTD measurements, $T_{\text{PRS}} = \max(T_{\text{PRS}}, \text{MGRP})$, where MGRP is the Measurement Gap Repetition Period as defined in section 8.1.2.1.

M is the number of PRS positioning occasions as defined in Table 8.13.2.3.1-1, where downlink positioning subframes defined in TS 36.211 [16], and

$\Delta = T_{\text{PRS}} \cdot \left\lceil \frac{n}{M} \right\rceil$ ms is the measurement time for a single PRS positioning occasion which includes the sampling time and the processing time,

N_{PRS} is the cell-specific number of PRS subframes within a PRS occasion as defined in TS 36.355[24],

$N_{\text{actual_PRS}}$ is the number of PRS subframes within a PRS occasion available at the UE; $N_{\text{actual_PRS}} = N_{\text{PRS}}$ when the measurement gaps are not required for the intra-frequency RSTD measurements; for UE configured with measurement gaps for intra-frequency RSTD measurements $N_{\text{actual_PRS}}$ is the number of PRS subframes which can be measured by UE within MGL, where $N_{\text{actual_PRS}} = (\text{MGL} - 2)$ if $\text{MGRP} \geq N_{\text{PRS}} > (\text{MGL} - 2)$, $N_{\text{actual_PRS}} = (\text{MGL} - 2) \cdot \left\lfloor \frac{N_{\text{PRS}}}{\text{MGRP}} \right\rfloor$ if $N_{\text{PRS}} > \text{MGRP}$, and $N_{\text{actual_PRS}} = N_{\text{PRS}}$ if $N_{\text{PRS}} \leq (\text{MGL} - 2)$.

$N_{\text{PRS_total}}$ is the minimum number of PRS subframes per cell measurement as specified in Section 9.1.21.20.

$T_{\text{PRS}} \cdot N_{\text{PRS}}$, $N_{\text{actual_PRS}}$ and $N_{\text{PRS_total}}$ are the parameters of the same cell, for which $T_{\text{PRS}} \cdot \left\lceil \frac{N_{\text{PRS_total}}}{N_{\text{actual_PRS}}} \right\rceil$ is the largest among all the measured cells.

T_{MIB} is the time required for acquiring the MIB information of the target cell. $T_{\text{MIB}} = 0$ if the SFN of at least one cell in OTDOA assistance data is known to the UE.

Editor's note: Requirements have assumed that `prsOccGroupLength` is not configured in the measurement period.

Table 8.13.2.3.1-1: Number of PRS positioning occasions within $T_{\text{RSTDInterFreqFDD,Cat}_M}$

Positioning subframe configuration period T_{PRS}	Number of PRS positioning occasions M	
	f_1 ^{Note1}	f_1 and f_2 ^{Note2}
160 ms	$16 \cdot \left\lceil \frac{N_{\text{PRS_Total}}}{N_{\text{actual_PRS}}} \right\rceil$	$32 \cdot \left\lceil \frac{N_{\text{PRS_Total}}}{N_{\text{actual_PRS}}} \right\rceil$

>160 ms	$8 \cdot \left\lceil \frac{N_{PRS_Total}}{N_{actual_PRS}} \right\rceil$	$16 \cdot \left\lceil \frac{N_{PRS_Total}}{N_{actual_PRS}} \right\rceil$
<p>Note 1: When only intra-frequency RSTD measurements are performed over cells belonging to the serving FDD carrier frequency f1.</p> <p>Note 2: When intra-frequency RSTD and inter-frequency RSTD measurements are performed over cells belonging to the serving FDD carrier frequency f1 and one inter-frequency carrier frequency f2, respectively.</p>		

The UE physical layer shall be capable of reporting RSTD for the reference cell and all the neighbor cells i out of at least $(n-1)$ neighbor cells within $T_{RSTDIntraFreqFDD,Cat_M}$ provided:

$$\left(PRS \hat{E}_s / Iot \right)_{ref} \geq -6 \text{ dB for all Frequency Bands for the reference cell,}$$

$$\left(PRS \hat{E}_s / Iot \right)_i \geq -13 \text{ dB for all Frequency Bands for neighbour cell } i,$$

$$\left(PRS \hat{E}_s / Iot \right)_{ref} \text{ and } \left(PRS \hat{E}_s / Iot \right)_i \text{ conditions apply for all subframes of at least } L = \frac{M}{2} \text{ PRS positioning occasions,}$$

PRP 1,2_{dBm} according to Annex B.2.22 for a corresponding Band

$PRS \hat{E}_s / Iot$ is defined as the ratio of the average received energy per PRS RE during the useful part of the symbol to the average received power spectral density of the total noise and interference for this RE, where the ratio is measured over all REs which carry PRS.

The time $T_{RSTDIntraFreqFDD,Cat_M}$ starts from the first subframe of the PRS positioning occasion closest in time after both the OTDOA-RequestLocationInformation message and the OTDOA assistance data in the OTDOA-ProvideAssistanceData message as specified in TS 36.355 [24], are delivered to the physical layer of the UE as illustrated in Figure 8.13.2.3.1-1.

The RSTD measurement accuracy for all measured neighbor cells i shall be fulfilled according to the accuracy as specified in the sub-clause 9.1.21.20.

If the intra-frequency handover occurs while intra-frequency RSTD measurements are being performed then the UE shall complete the ongoing OTDOA measurement session. The UE shall also meet the intra-frequency OTDOA measurement and accuracy requirements. However in this case the RSTD measurement period (

$T_{RSTDIntraFreqFDD,Cat_M,HO}$) shall be according to the following expression:

$$T_{RSTDIntraFreqFDD,Cat_M,HO} = T_{RSTDIntraFreqFDD,Cat_M} + K \times T_{PRS} + T_{HO} \quad ms,$$

where:

K is the number of times the intra-frequency handover occurs during $T_{RSTDIntraFreqFDD,Cat_M,HO}$.

T_{HO} is the time during which the intra-frequency RSTD measurement may not be possible due to intra-frequency handover.

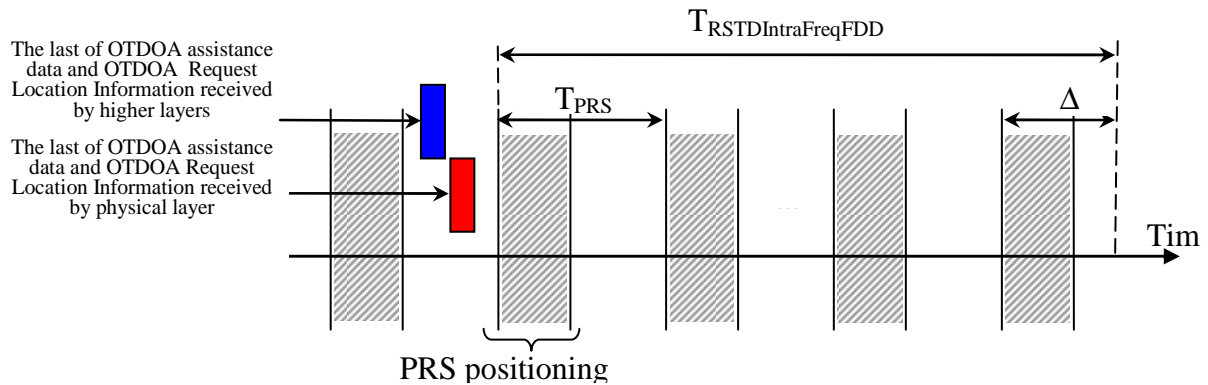

Figure 8.13.2.3.1-1: Illustration of the RSTD reporting time requirement in an FDD system.

Furthermore, due to the intra-frequency handover the UE shall meet the RSTD measurement accuracy for a PRS bandwidth which is not larger than the minimum channel bandwidth of all the PCells during the RSTD measurement period.

8.13.2.3.1.1 RSTD Measurement Reporting Delay

Reported measurement contained in event triggered measurement reports shall meet the requirements in sections 9.1.21.20.

The UE shall not send any measurement reports, as long as no reporting criteria are fulfilled.

The measurement reporting delay is defined as the time between the point when UE receive both the OTDOA-RequestLocationInformation message and the OTDOA assistance data in the OTDOA-ProvideAssistanceData message as specified in TS 36.355 [24], and the point when the UE starts to transmit the measurement report over the air interface. This requirement assumes that the measurement report is not delayed by other RRC signalling on the DCCH. This measurement reporting delay excludes a delay uncertainty resulted when inserting the measurement report to the TTI of the uplink DCCH. The delay uncertainty is: $N_{rep} \times TTI_{DCCH}$, where N_{rep} [21] is the maximum number of PUSCH repetitions configured for the UE, otherwise uncertainty is defined as $2 \times TTI_{DCCH}$. This measurement reporting delay excludes a delay which caused by no UL resources for UE to send the measurement report.

The measurement reporting delay shall be less than $T_{RSTDIntraFreqFDD, Cat_M}$ defined in Clause 8.13.2.3.1.

8.13.2.3.2 E-UTRAN TDD Intra-Frequency OTDOA Measurements

When the physical layer cell identities of neighbour cells together with the OTDOA assistance data are provided, the UE shall be able to detect and measure intra-frequency RSTD, specified in TS 36.214 [4], for at least $n=16$ cells, including the reference cell, on the same carrier frequency f_1 as that of the reference cell within $T_{RSTDIntraFreqTDD, Cat_M}$ ms as given below:

$$T_{RSTDIntraFreqTDD, Cat_M} = T_{PRS} \cdot (M - 1) + \Delta + T_{MIB},$$

where

$T_{RSTDIntraFreqTDD, Cat_M}$ is the total time for detecting and measuring at least n cells,

T_{PRS} is the cell-specific positioning subframe configuration period as defined in TS 36.355 [24] for UE not configured with measurement gaps for intra-frequency RSTD. For UE configured with measurement gaps for intra-frequency RSTD measurements, $T_{PRS} = \max(T_{PRS}, MGRP)$, where MGRP is the Measurement Gap Repetition Period as defined in section 8.1.2.1.

M is the number of PRS positioning occasions as defined in Table 8.13.2.3.1-1, where downlink positioning subframes defined in TS 36.211 [16], and

$\Delta = T_{PRS} \cdot \left\lceil \frac{n}{M} \right\rceil$ ms is the measurement time for a single PRS positioning occasion which includes the sampling time and the processing time,

N_{PRS} is the cell-specific number of PRS subframes within a PRS occasion as defined in TS 36.355 [24],

N_{actual_PRS} is the number of PRS subframes within a PRS occasion available at the UE; $N_{actual_PRS} = N_{PRS}$ when the measurement gaps are not required for the intra-frequency RSTD measurements; for UE configured with measurement gaps for intra-frequency RSTD measurements N_{actual_PRS} is the number of PRS subframes which can be measured by UE within MGL, where $N_{actual_PRS} = (MGL-2)$ if $MGRP \geq N_{PRS} > (MGL-2)$,
 $N_{actual_PRS} = (MGL - 2) \cdot \left\lfloor \frac{N_{PRS}}{MGRP} \right\rfloor$ if $N_{PRS} > MGRP$, and $N_{actual_PRS} = N_{PRS}$ if $N_{PRS} \leq (MGL-2)$.

N_{PRS_total} is the minimum number of PRS subframes per cell measurement as specified in Section 9.1.21.20.

$T_{PRS} N_{PRS}$, N_{actual_PRS} and N_{PRS_total} are the parameters of the same cell, for which $T_{PRS} \cdot \left\lceil \frac{N_{PRS_total}}{N_{actual_PRS}} \right\rceil$ is the largest among all the measured cells.

T_{MIB} is the time required for acquiring the MIB information of the target cell. $T_{MIB} = 0$ if the SFN of at least one cell in OTDOA assistance data is known to the UE.

Table 8.13.2.3.1-1: Number of PRS positioning occasions within $T_{RSTDIntraFreqIDD,Cat_M}$

Positioning subframe configuration period T_{PRS}	Number of PRS positioning occasions M	
	f1 ^{Note1}	f1 and f2 ^{Note2}
160 ms	$16 \cdot \left\lceil \frac{N_{PRS_Total}}{N_{actual_PRS}} \right\rceil$	$32 \cdot \left\lceil \frac{N_{PRS_Total}}{N_{actual_PRS}} \right\rceil$
>160 ms	$8 \cdot \left\lceil \frac{N_{PRS_Total}}{N_{actual_PRS}} \right\rceil$	$16 \cdot \left\lceil \frac{N_{PRS_Total}}{N_{actual_PRS}} \right\rceil$
Note 1: When only intra-frequency RSTD measurements are performed over cells belonging to the serving FDD carrier frequency f1. Note 2: When intra-frequency RSTD and inter-frequency RSTD measurements are performed over cells belonging to the serving FDD carrier frequency f1 and one inter-frequency carrier frequency f2, respectively.		

The UE physical layer shall be capable of reporting RSTD for the reference cell and all the neighbor cells i out of at least $(n-1)$ neighbor cells within $T_{RSTDIntraFreqIDD,Cat_M}$ provided:

$$\left(\text{PRS } \hat{E}_s / \text{Iot} \right)_{ref} \geq -6 \text{ dB for all Frequency Bands for the reference cell,}$$

$$\left(\text{PRS } \hat{E}_s / \text{Iot} \right)_i \geq -13 \text{ dB for all Frequency Bands for neighbour cell } i,$$

$$\left(\text{PRS } \hat{E}_s / \text{Iot} \right)_{ref} \text{ and } \left(\text{PRS } \hat{E}_s / \text{Iot} \right)_i \text{ conditions apply for all subframes of at least } L = \frac{M}{2} \text{ PRS positioning occasions,}$$

PRP 1,2_{dBm} according to Annex B.2.22 for a corresponding Band

PRSE_s / I_{ot} is defined as the ratio of the average received energy per PRS RE during the useful part of the symbol to the average received power spectral density of the total noise and interference for this RE, where the ratio is measured over all REs which carry PRS.

The time $T_{\text{RSTD IntraFreqIDD,Cat}_M}$ starts from the first subframe of the PRS positioning occasion closest in time after both the OTDOA-RequestLocationInformation message and the OTDOA assistance data in the OTDOA-ProvideAssistanceData message as specified in TS 36.355 [24], are delivered to the physical layer of the UE.

The RSTD measurement accuracy for all measured neighbor cells i shall be fulfilled according to the accuracy as specified in the sub-clause 9.1.21.20.

If the intra-frequency handover occurs while intra-frequency RSTD measurements are being performed then the UE shall complete the ongoing OTDOA measurement session. The UE shall also meet the intra-frequency OTDOA measurement and accuracy requirements. However in this case the RSTD measurement period ($T_{\text{RSTD IntraFreqIDD,Cat}_M,HO}$) shall be according to the following expression:

$T_{\text{RSTD IntraFreqIDD,Cat}_M,HO}$ shall be according to the following expression:

$$T_{\text{RSTD IntraFreqIDD,Cat}_M,HO} = T_{\text{RSTD IntraFreqIDD,Cat}_M} + K \times T_{\text{PRS}} + T_{\text{HO}} \quad \text{ms},$$

where:

K is the number of times the intra-frequency handover occurs during $T_{\text{RSTD IntraFreqIDD,Cat}_M,HO}$,

T_{HO} is the time during which the intra-frequency RSTD measurement may not be possible due to intra-frequency handover.

Furthermore, due to the intra-frequency handover the UE shall meet the RSTD measurement accuracy for a PRS bandwidth which is not larger than the minimum channel bandwidth of all the PCells during the RSTD measurement period.

The intra-frequency requirements in this clause (8.13.2.3.2) shall apply for all TDD special subframe configurations specified in TS 36.211 [16] and for the TDD uplink-downlink configurations as specified in Table 8.13.2.3.2-2.

Table 8.13.2.3.2-2: TDD uplink-downlink subframe configurations applicable for TDD intra-frequency requirements

PRS Transmission Bandwidth [RB]	Applicable TDD uplink-downlink configurations
6	1, 2, 3, 4 and 5
Note:	Uplink-downlink configurations are specified in Table 4.2-2 in TS 36.211 [16].

8.13.2.3.2.1 RSTD Measurement Reporting Delay

Reported measurement contained in event triggered measurement reports shall meet the requirements in sections 9.1.21.20.

The UE shall not send any measurement reports, as long as no reporting criteria are fulfilled.

The measurement reporting delay is defined as the time between the point when UE receive both the OTDOA-RequestLocationInformation message and the OTDOA assistance data in the OTDOA-ProvideAssistanceData message as specified in TS 36.355 [24], and the point when the UE starts to transmit the measurement report over the air interface. This requirement assumes that the measurement report is not delayed by other RRC signalling on the DCCH. This measurement reporting delay excludes a delay uncertainty resulted when inserting the measurement report to the TTI of the uplink DCCH. The delay uncertainty is: $N_{rep} \times TTI_{DCCH}$, where N_{rep} [21] is the maximum number of PUSCH repetitions configured for the UE, otherwise uncertainty is defined as $2 \times TTI_{DCCH}$. This measurement reporting delay excludes a delay which caused by no UL resources for UE to send the measurement report.

The measurement reporting delay shall be less than $T_{\text{RSTD IntraFreqIDD,Cat}_M}$ defined in Clause 8.13.2.3.2.

8.13.2.3.3 E-UTRAN HD-FDD Intra-Frequency OTDOA Measurements

The requirements in this section are applicable for the UE which supports half duplex operation on one or more supported frequency bands [2].

The requirements defined in clause 8.13.2.3.1 also apply for this section except the reporting delay requirement provided the following conditions are met:

- all positioning subframes indicated in the OTDOA assistance data and specified in Section 9.1.21.20 are available for RSTD measurements in the measured and reference cells.

8.13.2.3.3.1 RSTD Measurement Reporting Delay

Reported measurement contained in event triggered measurement reports shall meet the requirements in sections 9.1.21.20.

The UE shall not send any measurement reports, as long as no reporting criteria are fulfilled.

The measurement reporting delay is defined as the time between the point when UE receive both the OTDOA-RequestLocationInformation message and the OTDOA assistance data in the OTDOA-ProvideAssistanceData message as specified in TS 36.355 [24], and the point when the UE starts to transmit the measurement report over the air interface. This requirement assumes that the measurement report is not delayed by other RRC signalling on the DCCH. This measurement reporting delay excludes a delay uncertainty resulted when inserting the measurement report to the TTI of the uplink DCCH. The delay uncertainty is: $N_{rep} \times TTI_{DCCH}$, where N_{rep} [21] is the maximum number of PUSCH repetitions configured for the UE, otherwise uncertainty is defined as $2 \times TTI_{DCCH}$. This measurement reporting delay excludes a delay which caused by no UL resources for UE to send the measurement report.

The measurement reporting delay shall be less than measurement period defined in Clause 8.13.2.3.3.

8.13.2.4 E-UTRAN OTDOA Inter-Frequency RSTD Measurements for Cat-M1 UE in CEModeA

All inter-frequency RSTD measurement requirements specified in Sections 8.13.2.4 shall apply, provided that

- the UE is capable of inter-frequency RSTD measurements for OTDOA [24], and
- either the measurement gap pattern ID # 0 specified in Table 8.1.2.1-1 or any applicable measurement gap pattern specified in Table 8.1.2.1-3 is used or the UE supports capability of conducting inter-frequency measurements without gaps.

All inter-frequency RSTD measurement requirements specified in Sections 8.13.2.4 shall apply without DRX as well as for any DRX and eDRX_CONN cycles specified in TS 36.331 [2].

All positioning subframes indicated in the OTDOA assistance data and specified in sub-clause 9.1.21.17 are available for RSTD measurements in the measured and reference cell.

All the measurement requirements specified in Sections 8.13.2.4 shall apply provided that the UE is configured with the single PRS configuration for the reference cell and all the neighbour cells.

If CRS muting is enabled in a cell for which the UE performs RSTD measurements, the UE capable of supporting CRS muting [31] shall perform RSTD measurements and meet all the requirements in this section, provided the CRS are available within at least the PRS bandwidth in the subframes with PRS during all positioning occasions within the RSTD measurement period.

8.13.2.4.1 E-UTRAN FDD Inter-Frequency OTDOA Measurements

When the physical layer cell identities of neighbour cells together with the OTDOA assistance data are provided, the UE shall be able to detect and measure inter-frequency RSTD, specified in TS 36.214 [4], for at least $n=16$ cells, including the reference cell, on the same carrier frequency f_1 as that of the reference cell within $T_{RSTDInterFreqFDD,Cat_M}$ ms as given below (see also Figure 8.13.2.3.1-1):

$$T_{RSTDInterFreqFDD,Cat_M} = T_{PRS} \cdot (M - 1) + \Delta + T_{MIB} \text{ ms,}$$

where

$T_{\text{RSTDInterFreqFDD,Cat}_M}$ is the total time for detecting and measuring at least n cells,

T_{PRS} is the cell-specific positioning subframe configuration period as defined in TS 36.355 [24]; if $T_{\text{PRS}} < \text{MGRP}$, T_{PRS} equals to MGRP; MGRP is the Measurement Gap Repetition Period as defined in section 8.1.2.1,

M is the number of PRS positioning occasions as defined in Table 8.13.2.4.1-1, where downlink positioning subframes defined in TS 36.211 [16], and

$\Delta = T_{\text{PRS}} \cdot \left\lceil \frac{n}{M} \right\rceil$ ms is the measurement time for a single PRS positioning occasion which includes the sampling time and the processing time,

N_{PRS} is the cell-specific number of PRS subframes within a PRS occasion as defined in TS 36.355[24];

$N_{\text{actual_PRS}}$ is the number of PRS subframes within a PRS occasion that can be measured by UE within MGL; if $\text{MGRP} > N_{\text{PRS}} > (\text{MGL} - 2\text{ms})$, $N_{\text{actual_PRS}} = (\text{MGL} - 2\text{ms})$; if $N_{\text{PRS}} > \text{MGRP}$, $N_{\text{actual_PRS}} = (\text{MGL} - 2) \cdot \left\lfloor \frac{N_{\text{PRS}}}{\text{MGRP}} \right\rfloor$; $N_{\text{actual_PRS}} = N_{\text{PRS}}$ if $N_{\text{PRS}} \leq (\text{MGL} - 2)$;

$N_{\text{PRS_total}}$ is the minimum number of PRS subframes per cell measurement as specified in Section 9.1.21.17.

T_{PRS} , N_{PRS} , $N_{\text{actual_PRS}}$ and $N_{\text{PRS_total}}$ are the parameters of the same cell, for which $T_{\text{PRS}} \cdot \left\lceil \frac{N_{\text{PRS_total}}}{N_{\text{actual_PRS}}} \right\rceil$ is the largest among all the measured cells.

T_{MIB} is the time required for acquiring the MIB information of the target cell. $T_{\text{MIB}} = 0$ if the SFN of at least one cell in OTDOA assistance data is known to the UE.

Table 8.13.2.4.1-1: Number of PRS positioning occasions within $T_{\text{RSTDInterFreqFDD,Cat}_M}$

Positioning subframe configuration period T_{PRS}	Number of PRS positioning occasions M	
	f2 ^{Note1}	f1 and f2 ^{Note2}
160 ms	$16 \cdot \left\lceil \frac{N_{\text{PRS_Total}}}{N_{\text{actual_PRS}}} \right\rceil$	$32 \cdot \left\lceil \frac{N_{\text{PRS_Total}}}{N_{\text{actual_PRS}}} \right\rceil$
>160 ms	$8 \cdot \left\lceil \frac{N_{\text{PRS_Total}}}{N_{\text{actual_PRS}}} \right\rceil$	$16 \cdot \left\lceil \frac{N_{\text{PRS_Total}}}{N_{\text{actual_PRS}}} \right\rceil$
Note 1: When inter-frequency RSTD measurements are performed over the reference cell and neighbour cells, which belong to the FDD inter-frequency carrier frequency f2. Note 2: When inter-frequency RSTD measurements are performed over the reference cell and the neighbour cells, which belong to the serving FDD carrier frequency f1 and the FDD inter-frequency carrier frequency f2 respectively.		

The UE physical layer shall be capable of reporting RSTD for the reference cell and all the neighbor cells i out of at least $(n-1)$ neighbor cells within $T_{\text{RSTDInterFreqFDD,Cat}_M}$ provided:

$$\left(\text{PRS } \hat{E}_s / \text{Iot} \right)_{\text{ref}} \geq -6 \text{ dB for all Frequency Bands for the reference cell,}$$

$$\left(\text{PRS } \hat{E}_s / \text{Iot} \right)_i \geq -13 \text{ dB for all Frequency Bands for neighbour cell } i,$$

$(\text{PRS } \hat{E}_s / \text{Iot})_{ref}$ and $(\text{PRS } \hat{E}_s / \text{Iot})_i$ conditions apply for all subframes of at least $L = \frac{M}{2}$ PRS positioning occasions,

PRP 1,2_{dBm} according to Annex B.2.20 for a corresponding Band

$\text{PRS } \hat{E}_s / \text{Iot}$ is defined as the ratio of the average received energy per PRS RE during the useful part of the symbol to the average received power spectral density of the total noise and interference for this RE, where the ratio is measured over all REs which carry PRS.

The time $T_{\text{RSTD InterFreqFDD, Cat_M}}$ starts from the first subframe of the PRS positioning occasion closest in time after both the OTDOA-RequestLocationInformation message and the OTDOA assistance data in the OTDOA-ProvideAssistanceData message as specified in TS 36.355 [24], are delivered to the physical layer of the UE.

The RSTD measurement accuracy for all measured neighbor cells i shall be fulfilled according to the accuracy as specified in the sub-clause 9.1.21.17.

If the inter-frequency handover occurs while inter-frequency RSTD measurements are being performed then the UE shall complete the ongoing OTDOA measurement session. The UE shall also meet the inter-frequency OTDOA measurement and accuracy requirements. However in this case the RSTD measurement period ($T_{\text{RSTD InterFreqFDD, Cat_M, HO}}$) shall be according to the following expression:

$$T_{\text{RSTD InterFreqFDD, Cat_M, HO}} = T_{\text{RSTD InterFreqFDD, Cat_M}} + K \times T_{\text{PRS}} + T_{\text{HO}} \quad \text{ms},$$

where:

K is the number of times the inter-frequency handover occurs during $T_{\text{RSTD InterFreqFDD, Cat_M, HO}}$.

T_{HO} is the time during which the inter-frequency RSTD measurement may not be possible due to inter-frequency handover.

Furthermore, due to the inter-frequency handover the UE shall meet the RSTD measurement accuracy for a PRS bandwidth which is not larger than the minimum channel bandwidth of all the PCells during the RSTD measurement period.

8.13.2.4.1.1 RSTD Measurement Reporting Delay

Reported measurement contained in event triggered measurement reports shall meet the requirements in sections 9.1.21.17.

The UE shall not send any measurement reports, as long as no reporting criteria are fulfilled.

The measurement reporting delay is defined as the time between the point when UE receive both the OTDOA-RequestLocationInformation message and the OTDOA assistance data in the OTDOA-ProvideAssistanceData message as specified in TS 36.355 [24], and the point when the UE starts to transmit the measurement report over the air interface. This requirement assumes that the measurement report is not delayed by other RRC signalling on the DCCH. This measurement reporting delay excludes a delay uncertainty resulted when inserting the measurement report to the TTI of the uplink DCCH. The delay uncertainty is: $N_{rep} \times \text{TTI}_{\text{DCCH}}$, where N_{rep} [21] is the maximum number of PUSCH repetitions configured for the UE, otherwise uncertainty is defined as $2 \times \text{TTI}_{\text{DCCH}}$. This measurement reporting delay excludes a delay which caused by no UL resources for UE to send the measurement report.

The measurement reporting delay shall be less than $T_{\text{RSTD InterFreqFDD, Cat_M}}$ defined in Clause 8.13.2.4.1.

8.13.2.4.2 E-UTRAN TDD Inter-Frequency OTDOA Measurements

When the physical layer cell identities of neighbour cells together with the OTDOA assistance data are provided, the UE shall be able to detect and measure inter-frequency RSTD, specified in TS 36.214 [4], for at least $n=16$ cells, including the reference cell, on the same carrier frequency f_1 as that of the reference cell within $T_{\text{RSTD InterFreqTDD, Cat_M}}$ ms as given below:

$$T_{\text{RSTDInterFreqIDD,Cat}_M} = T_{\text{PRS}} \cdot (M - 1) + \Delta + T_{\text{MIB}} \text{ ms} ,$$

where

$T_{\text{RSTDInterFreqIDD,Cat}_M}$ is the total time for detecting and measuring at least n cells,

T_{PRS} is the cell-specific positioning subframe configuration period as defined in TS 36.355 [24]; if $T_{\text{PRS}} < \text{MGRP}$, T_{PRS} equals to MGRP; MGRP is the Measurement Gap Repetition Period as defined in section 8.1.2.1,

M is the number of PRS positioning occasions as defined in Table 8.13.2.4.2-1, where downlink positioning subframes defined in TS 36.211 [16], and

$\Delta = T_{\text{PRS}} \cdot \left\lceil \frac{n}{M} \right\rceil$ ms is the measurement time for a single PRS positioning occasion which includes the sampling time and the processing time,

N_{PRS} is the cell-specific number of PRS subframes within a PRS occasion as defined in TS 36.355[24];

$N_{\text{actual_PRS}}$ is the number of PRS subframes within a PRS occasion that can be measured by UE within MGL; if $\text{MGRP} \geq N_{\text{PRS}} > (\text{MGL} - 2\text{ms})$, $N_{\text{actual_PRS}} = (\text{MGL} - 2\text{ms})$; if $N_{\text{PRS}} > \text{MGRP}$, $N_{\text{actual_PRS}} = (\text{MGL} - 2) \cdot \left\lfloor \frac{N_{\text{PRS}}}{\text{MGRP}} \right\rfloor$; $N_{\text{actual_PRS}} = N_{\text{PRS}}$ if $N_{\text{PRS}} \leq (\text{MGL} - 2)$;

$N_{\text{PRS_total}}$ is the minimum number of PRS subframes per cell measurement as specified in Section 9.1.21.17.

T_{PRS} , N_{PRS} , $N_{\text{actual_PRS}}$ and $N_{\text{PRS_total}}$ are the parameters of the same cell, for which $T_{\text{PRS}} \cdot \left\lceil \frac{N_{\text{PRS_total}}}{N_{\text{actual_PRS}}} \right\rceil$ is the largest among all the measured cells.

T_{MIB} is the time required for acquiring the MIB information of the target cell. $T_{\text{MIB}} = 0$ if the SFN of at least one cell in OTDOA assistance data is known to the UE.

Table 8.13.2.4.2-1: Number of PRS positioning occasions within $T_{\text{RSTDInterFreqIDD,Cat}_M}$

Positioning subframe configuration period T_{PRS}	Number of PRS positioning occasions M	
	f21 ^{Note1}	f1 and f2 ^{Note2}
160 ms	$16 \cdot \left\lceil \frac{N_{\text{PRS_Total}}}{N_{\text{actual_PRS}}} \right\rceil$	$32 \cdot \left\lceil \frac{N_{\text{PRS_Total}}}{N_{\text{actual_PRS}}} \right\rceil$
>160 ms	$8 \cdot \left\lceil \frac{N_{\text{PRS_Total}}}{N_{\text{actual_PRS}}} \right\rceil$	$16 \cdot \left\lceil \frac{N_{\text{PRS_Total}}}{N_{\text{actual_PRS}}} \right\rceil$
Note 1:	When inter-frequency RSTD measurements are performed over the reference cell and neighbour cells, which belong to the TDD inter-frequency carrier frequency f2.	
Note 2:	When inter-frequency RSTD measurements are performed over the reference cell and the neighbour cells, which belong to the serving TDD carrier frequency f1 and the TDD inter-frequency carrier frequency f2 respectively.	

The UE physical layer shall be capable of reporting RSTD for the reference cell and all the neighbor cells i out of at least $(n-1)$ neighbor cells within $T_{\text{RSTDInterFreqIDD,Cat}_M}$ provided:

$(\text{PRS } \hat{E}_s / \text{Iot})_{ref} \geq -6$ dB for all Frequency Bands for the reference cell,

$(\text{PRS } \hat{E}_s / \text{Iot})_i \geq -13$ dB for all Frequency Bands for neighbour cell i ,

$(\text{PRS } \hat{E}_s / \text{Iot})_{ref}$ and $(\text{PRS } \hat{E}_s / \text{Iot})_i$ conditions apply for all subframes of at least $L = \frac{M}{2}$ PRS positioning occasions,

PRP 1,2_{dBm} according to Annex B.2.20 for a corresponding Band

$\text{PRS } \hat{E}_s / \text{Iot}$ is defined as the ratio of the average received energy per PRS RE during the useful part of the symbol to the average received power spectral density of the total noise and interference for this RE, where the ratio is measured over all REs which carry PRS.

The time $T_{\text{RSTD InterFreqIDD,Cat}_M}$ starts from the first subframe of the PRS positioning occasion closest in time after both the OTDOA-RequestLocationInformation message and the OTDOA assistance data in the OTDOA-ProvideAssistanceData message as specified in TS 36.355 [24], are delivered to the physical layer of the UE.

The RSTD measurement accuracy for all measured neighbor cells i shall be fulfilled according to the accuracy as specified in the sub-clause 9.1.21.17.

If the inter-frequency handover occurs while inter-frequency RSTD measurements are being performed then the UE shall complete the ongoing OTDOA measurement session. The UE shall also meet the inter-frequency OTDOA measurement and accuracy requirements. However in this case the RSTD measurement period (

$T_{\text{RSTD InterFreqIDD,Cat}_M,HO}$) shall be according to the following expression:

$$T_{\text{RSTD InterFreqIDD,Cat}_M,HO} = T_{\text{RSTD InterFreqIDD,Cat}_M} + K \times T_{\text{PRS}} + T_{\text{HO}} \quad \text{ms},$$

where:

K is the number of times the inter-frequency handover occurs during $T_{\text{RSTD InterFreqIDD,Cat}_M,HO}$,

T_{HO} is the time during which the inter-frequency RSTD measurement may not be possible due to inter-frequency handover.

Furthermore, due to the inter-frequency handover the UE shall meet the RSTD measurement accuracy for a PRS bandwidth which is not larger than the minimum channel bandwidth of all the PCells during the RSTD measurement period.

The inter-frequency requirements in this clause (8.13.2.4.2) shall apply for all TDD special subframe configurations specified in TS 36.211 [16] and for the TDD uplink-downlink configurations as specified in Table 8.13.2.4.2-2.

Table 8.13.2.4.2-2: TDD uplink-downlink subframe configurations applicable for TDD inter-frequency requirements

PRS Transmission Bandwidth [RB]	Applicable TDD uplink-downlink configurations
6	1, 2, 3, 4 and 5
Note: Uplink-downlink configurations are specified in Table 4.2-2 in TS 36.211 [16].	

8.13.2.4.2.1 RSTD Measurement Reporting Delay

Reported measurement contained in event triggered measurement reports shall meet the requirements in sections 9.1.21.17.

The UE shall not send any measurement reports, as long as no reporting criteria are fulfilled.

The measurement reporting delay is defined as the time between the point when UE receive both the OTDOA-RequestLocationInformation message and the OTDOA assistance data in the OTDOA-ProvideAssistanceData message

as specified in TS 36.355 [24], and the point when the UE starts to transmit the measurement report over the air interface. This requirement assumes that the measurement report is not delayed by other RRC signalling on the DCCH. This measurement reporting delay excludes a delay uncertainty resulted when inserting the measurement report to the TTI of the uplink DCCH. The delay uncertainty is: $N_{rep} \times TTI_{DCCH}$, where N_{rep} [21] is the maximum number of PUSCH repetitions configured for the UE, otherwise uncertainty is defined as $2 \times TTI_{DCCH}$. This measurement reporting delay excludes a delay which caused by no UL resources for UE to send the measurement report.

The measurement reporting delay shall be less than $T_{RSTDInterFreqTDD,Cat_M}$ defined in Clause 8.13.2.4.2.

8.13.2.4.3 E-UTRAN HD-FDD Inter-Frequency OTDOA Measurements

The requirements in this section are applicable for the UE which supports half duplex operation on one or more supported frequency bands [2].

The requirements defined in clause 8.13.2.4.1 also apply for this section except reporting delay requirement provided the following conditions are met:

- all positioning subframes indicated in the OTDOA assistance data and specified in Section 9.1.21.17 are available for RSTD measurements in the measured and reference cells.

8.13.2.4.3.1 RSTD Measurement Reporting Delay

Reported measurement contained in event triggered measurement reports shall meet the requirements in sections 9.1.21.17.

The UE shall not send any measurement reports, as long as no reporting criteria are fulfilled.

The measurement reporting delay is defined as the time between the point when UE receive both the OTDOA-RequestLocationInformation message and the OTDOA assistance data in the OTDOA-ProvideAssistanceData message as specified in TS 36.355 [24], and the point when the UE starts to transmit the measurement report over the air interface. This requirement assumes that the measurement report is not delayed by other RRC signalling on the DCCH. This measurement reporting delay excludes a delay uncertainty resulted when inserting the measurement report to the TTI of the uplink DCCH. The delay uncertainty is: $N_{rep} \times TTI_{DCCH}$, where N_{rep} [21] is the maximum number of PUSCH repetitions configured for the UE, otherwise uncertainty is defined as $2 \times TTI_{DCCH}$. This measurement reporting delay excludes a delay which caused by no UL resources for UE to send the measurement report.

The measurement reporting delay shall be less than measurement period as defined in Clause 8.13.2.4.3.

8.13.2.5 E-UTRAN E-CID Measurements Requirements for UE category M1 with CE mode A

8.13.2.5.1 Intra-frequency FDD E-CID RSRP and RSRQ Measurements for Cat-M1 UE in CEModeA

8.13.2.5.1.1 Introduction

The requirements in section 8.13.2.5.1 shall apply provided the UE has received ECID-RequestLocationInformation message from E-SMLC via LPP requesting the UE to report E-CID E-UTRAN FDD intra-frequency RSRP and RSRQ measurements [24].

8.13.2.5.1.2 Measurement Requirements

The requirements in section 8.13.2.1.1 also apply for this section except the measurement reporting requirements. The measurement reporting requirements for E-CID RSRP and RSRQ are defined in section 8.13.2.5.1.3.

8.13.2.5.1.3 Measurement Reporting Delay

This requirement assumes that that the measurement report is not delayed by other LPP signalling on the DCCH. This measurement reporting delay excludes a delay uncertainty resulted when inserting the measurement report to the TTI of the uplink DCCH. The delay uncertainty is: $2 \times TTI_{DCCH}$. This measurement reporting delay excludes any delay caused by no UL resources for UE to send the measurement report.

Reported RSRP and RSRQ measurements contained in periodically triggered measurement reports shall meet the requirements in section 9.1.21.1, 9.1.21.2 and 9.1.21.6.

8.13.2.5.2 Intra-frequency HD-FDD E-CID RSRP and RSRQ Measurements for Cat-M1 UE in CEModeA

8.13.2.5.2.1 Introduction

The requirements in section 8.13.2.5.2 shall apply provided the UE has received ECID-RequestLocationInformation message from E-SMLC via LPP requesting the UE to report E-CID E-UTRAN HD-FDD intra-frequency RSRP and RSRQ measurements [24].

8.13.2.5.2.2 Measurement Requirements

The requirements in section 8.13.2.1.2 also apply for this section except the measurement reporting requirements. The measurement reporting requirements for E-CID RSRP and RSRQ are defined in section 8.13.2.5.2.3.

8.13.2.5.2.3 Measurement Reporting Delay

This requirement assumes that that the measurement report is not delayed by other LPP signalling on the DCCH. This measurement reporting delay excludes a delay uncertainty resulted when inserting the measurement report to the TTI of the uplink DCCH. The delay uncertainty is: $2 \times TTI_{DCCH}$. This measurement reporting delay excludes any delay caused by no UL resources for UE to send the measurement report.

Reported RSRP and RSRQ measurements contained in periodically triggered measurement reports shall meet the requirements in section 9.1.21.1, 9.1.21.2 and 9.1.21.6.

8.13.2.5.3 Intra-frequency TDD E-CID RSRP and RSRQ Measurements for Cat-M1 UE in CEModeA

8.13.2.5.3.1 Introduction

The requirements in section 8.13.2.5.3 shall apply provided the UE has received ECID-RequestLocationInformation message from E-SMLC via LPP requesting the UE to report E-CID E-UTRAN TDD intra-frequency RSRP and RSRQ measurements [24].

8.13.2.5.3.2 Measurement Requirements

The requirements in section 8.13.2.1.3 also apply for this section except the measurement reporting requirements. The measurement reporting requirements for E-CID RSRP and RSRQ are defined in section 8.13.2.5.3.3.

8.13.2.5.3.3 Measurement Reporting Delay

This requirement assumes that that the measurement report is not delayed by other LPP signalling on the DCCH. This measurement reporting delay excludes a delay uncertainty resulted when inserting the measurement report to the TTI of the uplink DCCH. The delay uncertainty is: $2 \times TTI_{DCCH}$. This measurement reporting delay excludes any delay caused by no UL resources for UE to send the measurement report.

Reported RSRP and RSRQ measurements contained in periodically triggered measurement reports shall meet the requirements in section 9.1.21.1, 9.1.21.2 and 9.1.21.6.

8.13.2.5.4 Inter-frequency FDD E-CID RSRP and RSRQ Measurements for Cat-M1 UE in CEModeA

8.13.2.5.4.1 Introduction

The requirements in section 8.13.2.5.4 shall apply provided the UE has received ECID-RequestLocationInformation message from E-SMLC via LPP requesting the UE to report E-CID E-UTRAN FDD inter-frequency RSRP and RSRQ measurements [24].

8.13.2.5.4.2 Measurement Requirements

The requirements in section 8.13.2.6.1 also apply for this section except the measurement reporting requirements. The measurement reporting requirements for E-CID RSRP and RSRQ are defined in section 8.13.2.5.4.3.

8.13.2.5.4.3 Measurement Reporting Delay

This requirement assumes that that the measurement report is not delayed by other LPP signalling on the DCCH. This measurement reporting delay excludes a delay uncertainty resulted when inserting the measurement report to the TTI of

the uplink DCCH. The delay uncertainty is: $2 \times TTI_{DCCH}$. This measurement reporting delay excludes any delay caused by no UL resources for UE to send the measurement report.

Reported RSRP and RSRQ measurements contained in periodically triggered measurement reports shall meet the requirements in section 9.1.21.9, 9.1.21.10, 9.1.21.13 and 9.1.21.14.

8.13.2.5.5 Inter-frequency HD-FDD E-CID RSRP and RSRQ Measurements for Cat-M1 UE in CEModeA

8.13.2.5.5.1 Introduction

The requirements in section 8.13.2.5.5 shall apply provided the UE has received ECID-RequestLocationInformation message from E-SMLC via LPP requesting the UE to report E-CID E-UTRAN HD-FDD inter-frequency RSRP and RSRQ measurements [24].

8.13.2.5.5.2 Measurement Requirements

The requirements in section 8.13.2.6.2 also apply for this section except the measurement reporting requirements. The measurement reporting requirements for E-CID RSRP and RSRQ are defined in section 8.13.2.5.5.3.

8.13.2.5.5.3 Measurement Reporting Delay

This requirement assumes that that the measurement report is not delayed by other LPP signalling on the DCCH. This measurement reporting delay excludes a delay uncertainty resulted when inserting the measurement report to the TTI of the uplink DCCH. The delay uncertainty is: $2 \times TTI_{DCCH}$. This measurement reporting delay excludes any delay caused by no UL resources for UE to send the measurement report.

Reported RSRP and RSRQ measurements contained in periodically triggered measurement reports shall meet the requirements in section 9.1.21.9, 9.1.21.10, 9.1.21.13 and 9.1.21.14.

8.13.2.5.6 Inter-frequency TDD E-CID RSRP and RSRQ Measurements for Cat-M1 UE in CEModeA

8.13.2.5.6.1 Introduction

The requirements in section 8.13.2.5.6 shall apply provided the UE has received ECID-RequestLocationInformation message from E-SMLC via LPP requesting the UE to report E-CID E-UTRAN TDD inter-frequency RSRP and RSRQ measurements [24].

8.13.2.5.6.2 Measurement Requirements

The requirements in section 8.13.2.6.3 also apply for this section except the measurement reporting requirements. The measurement reporting requirements for E-CID RSRP and RSRQ are defined in section 8.13.2.5.6.3.

8.13.2.5.6.3 Measurement Reporting Delay

This requirement assumes that that the measurement report is not delayed by other LPP signalling on the DCCH. This measurement reporting delay excludes a delay uncertainty resulted when inserting the measurement report to the TTI of the uplink DCCH. The delay uncertainty is: $2 \times TTI_{DCCH}$. This measurement reporting delay excludes any delay caused by no UL resources for UE to send the measurement report.

Reported RSRP and RSRQ measurements contained in periodically triggered measurement reports shall meet the requirements in section 9.1.21.9, 9.1.21.10, 9.1.21.13 and 9.1.21.14.

8.13.2.5.7 E-UTRAN FDD UE Rx-Tx Time Difference Measurements for UE category M1 in CEModeA

When no DRX is used the physical layer measurement period of the UE Rx-Tx time difference measurement shall be 480 ms.

When DRX is used in RRC_CONNECTED state the physical layer measurement period ($T_{\text{measure_FDD_UE_Rx_Tx1}}$) of the UE Rx-Tx time difference measurement shall be as specified in table 8.13.2.5.7-1.

Table 8.13.2.5.7-1: FDD UE Rx-Tx time difference measurement requirement when DRX is used

DRX cycle length (s)	$T_{\text{measure_FDD_UE_Rx_Tx1}}$ (s) (DRX cycles)
----------------------	---

< 0.128	0.48 (Note1)
$0.128 \leq \text{DRX-cycle} \leq 2.56$	Note2 (5)
Note1:	Number of DRX cycle depends upon the DRX cycle in use
Note2:	Time depends upon the DRX cycle in use

If the UE is performing UE Rx-Tx time difference measurement while the PCell is changed due to the handover then the UE shall restart the Rx-Tx measurement on the new cell. In this case the UE shall also meet the UE Rx-Tx time difference measurement and accuracy requirements. However the physical layer measurement period of the UE Rx-Tx measurement shall not exceed $T_{\text{measure_FDD_UE_Rx_Tx3}}$ as defined in the following expression:

$$T_{\text{measure_FDD_UE_Rx_Tx3}} = (K+1) * (T_{\text{measure_FDD_UE_Rx_Tx1}}) + K * T_{\text{PCell_change_handover}}$$

Where:

K is the number of times the PCell is changed over the measurement period ($T_{\text{measure_FDD_UE_Rx_Tx3}}$),

$T_{\text{PCell_change_handover}}$ is the time necessary to change the PCell due to handover.

The measurement accuracy for the UE Rx-Tx time difference measurement when DRX is used as well as when no DRX is used shall be as specified in the sub-clause 9.1.21.19.

If CRS muting is enabled in a cell for which the UE performs UE Rx-Tx time difference measurement, the UE capable of supporting CRS muting [31] shall perform the UE Rx-Tx time difference measurements and meet all the requirements in this section, provided the CRS are available within UE bandwidth in the serving cell during the UE Rx-Tx time difference measurement period.

8.13.2.5.7.1 UE Rx-Tx Measurement Reporting Delay

Reported measurement contained in event triggered measurement reports shall meet the requirements in sections 9.1.21.21.

The UE shall not send any measurement reports, as long as no reporting criteria are fulfilled.

The measurement reporting delay is defined as the time between the point when UE receive ECID-RequestLocationInformation message and the point when the UE starts to transmit the measurement report over the air interface. This requirement assumes that the measurement report is not delayed by other RRC signalling on the DCCH. This measurement reporting delay excludes a delay uncertainty resulted when inserting the measurement report to the TTI of the uplink DCCH. The delay uncertainty is: $\text{pusch-maxNumRepetitionCEmodeA} \times \text{TTI}_{\text{DCCH}}$, where $\text{pusch-maxNumRepetitionCEmodeA}$ [2] is the maximum number of PUSCH repetitions configured for the UE in CE Mode A provided that $\text{pusch-maxNumRepetitionCEmodeA} > 1$, otherwise uncertainty is defined as $2 \times \text{TTI}_{\text{DCCH}}$. This measurement reporting delay excludes a delay which caused by no UL resources for UE to send the measurement report.

The measurement reporting delay shall be less than the physical layer measurement period defined in Clause 8.13.2.5.7.

8.13.2.5.8 E-UTRAN TDD UE Rx-Tx Time Difference Measurements for UE category M1 in CEModeA

When no DRX is used the physical layer measurement period of the UE Rx-Tx time difference measurement shall be 480 ms.

When DRX is used in RRC_CONNECTED state the physical layer measurement period ($T_{\text{measure_TDD_UE_Rx_Tx1}}$) of the UE Rx-Tx time difference measurement shall be as specified in table 8.13.2.5.8-1.

Table 8.13.2.5.8-1: TDD UE Rx-Tx time difference measurement requirement when DRX is used

DRX cycle length (s)	$T_{\text{measure_TDD_UE_Rx_Tx1}}$ (s) (DRX cycles)
< 0.128	0.48 (Note1)
$0.128 \leq \text{DRX-cycle} \leq 2.56$	Note2 (5)
Note1:	Number of DRX cycle depends upon the DRX cycle in use
Note2:	Time depends upon the DRX cycle in use

If the UE is performing UE Rx-Tx time difference measurement while the PCell is changed due to the handover then the UE shall restart the Rx-Tx measurement on the new cell. In this case the UE shall also meet the UE Rx-Tx time

difference measurement and accuracy requirements. However the physical layer measurement period of the UE Rx-Tx measurement shall not exceed $T_{\text{measure_TDD_UE_Rx_Tx3}}$ as defined in the following expression:

$$T_{\text{measure_TDD_UE_Rx_Tx3}} = (K+1) \cdot (T_{\text{measure_TDD_UE_Rx_Tx1}}) + K \cdot T_{\text{PCell_change_handover}}$$

Where:

K is the number of times the PCell is changed over the measurement period ($T_{\text{measure_TDD_UE_Rx_Tx3}}$),

$T_{\text{PCell_change_handover}}$ is the time necessary to change the PCell due to handover.

The measurement accuracy for the UE Rx-Tx time difference measurement when DRX is used as well as when no DRX is used shall be as specified in the sub-clause 9.1.21.19.

If CRS muting is enabled in a cell for which the UE performs UE Rx-Tx time difference measurement, the UE capable of supporting CRS muting [31] shall perform the UE Rx-Tx time difference measurements and meet all the requirements in this section, provided the CRS are available within UE bandwidth in the serving cell during the UE Rx-Tx time difference measurement period.

8.13.2.5.8.1 UE Rx-Tx Measurement Reporting Delay

Reported measurement contained in event triggered measurement reports shall meet the requirements in sections 9.1.21.21.

The UE shall not send any measurement reports, as long as no reporting criteria are fulfilled.

The measurement reporting delay is defined as the time between the point when UE receive ECID-RequestLocationInformation message and the point when the UE starts to transmit the measurement report over the air interface. This requirement assumes that the measurement report is not delayed by other RRC signalling on the DCCH. This measurement reporting delay excludes a delay uncertainty resulted when inserting the measurement report to the TTI of the uplink DCCH. The delay uncertainty is: $\text{pusch-maxNumRepetitionCEmodeA} \times \text{TTI}_{\text{DCCH}}$, where $\text{pusch-maxNumRepetitionCEmodeA}$ [2] is the maximum number of PUSCH repetitions configured for the UE in CE Mode A provided that $\text{pusch-maxNumRepetitionCEmodeA} > 1$, otherwise uncertainty is defined as $2 \times \text{TTI}_{\text{DCCH}}$. This measurement reporting delay excludes a delay which caused by no UL resources for UE to send the measurement report.

The measurement reporting delay shall be less than the physical layer measurement period defined in Clause 8.13.2.5.8.

8.13.2.5.9 E-UTRAN HD-FDD UE Rx-Tx Time Difference Measurements for UE category M1 in CEModeA

The requirements in this section are applicable for the UE which supports half duplex operation on one or more supported frequency bands.

The requirements defined in clause 8.13.2.5.7 also apply for this section except the measurement reporting requirements provided the following conditions are met:

- At least one downlink and one uplink subframes per radio frame are available for the UE Rx-Tx time difference measurement in the measured cell.
- at least downlink subframe # 0 or downlink subframe # 5 per radio frame of an intra-frequency cell to be identified by the UE is available at the UE;
- SCH_RP and SCH_Es/Iot according to Annex Table B.2.14-2 for a corresponding Band

8.13.2.5.9.1 UE Rx-Tx Measurement Reporting Delay

Reported measurement contained in event triggered measurement reports shall meet the requirements in sections 9.1.21.19.

The UE shall not send any measurement reports, as long as no reporting criteria are fulfilled.

The measurement reporting delay is defined as the time between the point when UE receive ECID-RequestLocationInformation message and the point when the UE starts to transmit the measurement report over the air interface. This requirement assumes that the measurement report is not delayed by other RRC signalling on the DCCH. This measurement reporting delay excludes a delay uncertainty resulted when inserting the measurement report to the

TTI of the uplink DCCH. The delay uncertainty is: $pusch-maxNumRepetitionCEmodeA \times TTI_{DCCH}$, where $pusch-maxNumRepetitionCEmodeA$ [2] is the maximum number of PUSCH repetitions configured for the UE in CE Mode A provided that $pusch-maxNumRepetitionCEmodeA > 1$, otherwise uncertainty is defined as $2 \times TTI_{DCCH}$. This measurement reporting delay excludes a delay which caused by no UL resources for UE to send the measurement report.

The measurement reporting delay shall be less than the physical layer measurement period defined in Clause 8.13.2.5.9.

8.13.2.6 E-UTRAN inter frequency measurements by UE category M1 with CE mode A

The UE shall be able to identify new inter-frequency cells and perform RSRP and RSRQ measurements of identified inter-frequency cells if carrier frequency information is provided by the PCell, even if no explicit neighbour list with physical layer cell identities is provided. During the RRC_CONNECTED state the UE shall continuously measure identified inter frequency cells and additionally search for and identify new inter frequency cells.

8.13.2.6.1 E-UTRAN FDD - FDD inter frequency measurements

8.13.2.6.1.1 E-UTRAN FDD - FDD inter frequency measurements when no DRX is used

When no DRX is in use the UE shall be able to identify and measure a new detectable FDD inter-frequency cell according to requirements in Table 8.13.2.6.1.1-1 when $SCH \hat{E}_s / I_{ot} \geq -6$ dB, provided

- $G=1$, or
- $r_{max} * G < 80$ ms, or
- UE is receiving PDSCH.

Otherwise, requirements in Table 8.13.2.6.1.1-3 apply, where r_{max} and G are given by higher layer parameter $mPDCCH-NumRepetition$ and $mPDCCH-startSF-UESS$ respectively as defined in TS 36.213 [3].

Table 8.13.2.6.1.1-1: Requirement on cell identification delay and measurement delay for FDD interfrequency cell

Gap pattern ID	Cell identification delay ($T_{identify_inter_UE\ cat\ M1_NC}$)	Measurement delay ($T_{measure_inter_UE\ cat\ M1_NC_NC}$)
0	$1.44 * K_{inter_M1_NC} * KRSTD_M1_NC$ seconds	$480 * K_{inter_M1_NC} * KRSTD_M1_NC$ ms
1	$2.88 * K_{inter_M1_NC}$ seconds	$960 * K_{inter_M1_NC}$ ms

$$K_{inter_M1_NC} = \frac{N_{freq} * 100}{(100 - X)}$$

where X is signalled by the RRC parameter $measGapSharingScheme$ [2] and is defined as in Table 8.13.2.6.1.1-2 when $highSpeedMeasGapCE-ModeA$ [2] is not configured, and in Table 8.13.2.6.1.1-2A when $highSpeedMeasGapCE-ModeA$ [2] is configured. N_{freq} is total number of inter-frequency layers to be monitored as defined in 8.1.2.1.1.

Table 8.13.2.6.1.1-2: Value of parameter X for CEModeA

$measGapSharingScheme$	Value of X (%)
'00'	$\frac{100}{N_{freq} + 1}$
'01'	40
'10'	50
'11'	60

Table 8.13.2.6.1.1-2A: Value of parameter X for CEModeA for UE configured with $highSpeedMeasGapCE-ModeA$

$measGapSharingScheme$	Value of X (%)
'00'	$\frac{100}{N_{freq} + 1}$

'01'	50
'10'	80
'11'	90

Table 8.13.2.6.1.1-3: Requirement on cell identification delay and measurement delay for FDD interfrequency cell with MPDCCH scaling

Gap pattern ID	Cell identification delay ($T_{\text{identify_inter_UE cat M1}}$)	Measurement delay ($T_{\text{measure_inter_UE cat M1}}$)
0	$\text{Max}(20 * r_{\text{max}} * G / 1000, 1.44) * K_{\text{inter_M1_NC}} * K_{\text{RSTD_M1_NC}}$ seconds	$\text{Max}(5 * r_{\text{max}} * G, 480) * K_{\text{inter_M1_NC}} * K_{\text{RSTD_M1_NC}}$ ms
1	$\text{Max}(20 * r_{\text{max}} * G / 1000, 2.88) * K_{\text{inter_M1_NC}} * K_{\text{RSTD_M1_NC}}$ seconds	$\text{Max}(5 * r_{\text{max}} * G, 960) * K_{\text{inter_M1_NC}} * K_{\text{RSTD_M1_NC}}$ ms

$$K_{\text{RSTD_M1_NC}} = \frac{1}{1 - \max\left(\frac{40}{T_{\text{PRS}}}, \frac{N_{\text{PRS}}}{T_{\text{PRS}}}\right)}$$

$K_{\text{RSTD_M1_NC}}$ is applicable provided following conditions are met:

- $T_{\text{PRS}} > 40$ ms
- $T_{\text{PRS}} > N_{\text{PRS}}$

where

- T_{PRS} is the cell-specific positioning subframe configuration period as defined in TS 36.211 [16],
- N_{PRS} is the number of consecutive downlink positioning subframes in a positioning occasion defined in TS 36.211

Otherwise $K_{\text{RSTD_M1_NC}} = 1$.

A cell shall be considered detectable when

- RSRP related side conditions given in Sections 9.1.21.9 and 9.1.22.10 are fulfilled for a corresponding Band,
- RSRQ related side conditions given in Clause 9.1.21.13 and 9.1.21.14 are fulfilled for a corresponding Band,
- SCH_{RP} and SCH_{Ês}/Iot according to Annex Table B.2.14-1 for a corresponding Band.

Identification of a cell shall include detection of the cell and additionally performing a single measurement with measurement period of $T_{\text{measure_inter_UE cat M1_NC}}$. If higher layer filtering is used, an additional cell identification delay can be expected.

In the RRC_CONNECTED state the measurement period for inter frequency measurements is according to Table 8.13.2.6.1.1-1. When measurement gaps are scheduled for FDD inter frequency measurements, or the UE supports capability of conducting such measurements without gaps, the UE physical layer shall be capable of reporting RSRP and RSRQ measurements to higher layers with measurement accuracy as specified in sub-clauses 9.1.21.9, 9.1.21.10, 9.1.21.13 and 9.1.21.14.

The UE shall be capable of performing RSRP and RSRQ measurements of at least 4 inter-frequency cells per FDD inter-frequency for up to 2 FDD inter-frequencies and the UE physical layer shall be capable of reporting RSRP and RSRQ measurements to higher layers with the measurement period defined in Table 8.13.2.6.1.1-1.

8.13.2.6.1.1.1 Measurement Reporting Requirements

8.13.2.6.1.1.1.1 Periodic Reporting

Reported RSRP and RSRQ measurement contained in periodically triggered measurement reports shall meet the requirements in sections 9.1.21.9, 9.1.21.10, 9.1.21.13 and 9.1.21.14.

8.13.2.6.1.1.1.2 Event-triggered Periodic Reporting

Reported RSRP and RSRQ measurement contained in event triggered periodic measurement reports shall meet the requirements in sections 9.1.21.9, 9.1.21.10, 9.1.21.13 and 9.1.21.14.

The first report in event triggered periodic measurement reporting shall meet the requirements specified in clause 8.13.2.6.1.1.1.3.

8.13.2.6.1.1.1.3 Event Triggered Reporting

Reported RSRP and RSRQ measurement contained in event triggered measurement reports shall meet the requirements in sections 9.1.21.9, 9.1.21.10, 9.1.21.13 and 9.1.21.14.

The UE shall not send any event triggered measurement reports, as long as no reporting criteria are fulfilled.

The measurement reporting delay is defined as the time between an event that will trigger a measurement report and the point when the UE starts to transmit the measurement report over the air interface. This requirement assumes that the measurement report is not delayed by other RRC signalling on the DCCH. This measurement reporting delay excludes a delay uncertainty resulted when inserting the measurement report to the TTI of the uplink DCCH. The delay uncertainty is: $2 \times TTI_{DCCH}$. This measurement reporting delay excludes a delay which caused by no UL resources for UE to send the measurement report.

The event triggered measurement reporting delay, measured without L3 filtering shall be less than $T_{identify_inter_UE\ cat\ M1_NC}$ defined in Clause 8.13.2.6.1.1. When L3 filtering is used or IDC autonomous denial is configured an additional delay can be expected.

If a cell which has been detectable at least for the time period $T_{identify_inter_UE\ cat\ M1_NC}$ defined in clause 8.13.2.6.1.1 becomes undetectable for a period ≤ 5 seconds and then the cell becomes detectable again and triggers an event, the event triggered measurement reporting delay shall be less than $T_{Measurement_Period_UE\ cat\ M1_NC, Inter}$ provided the timing to that cell has not changed more than $\pm 50 T_s$ and the L3 filter has not been used. When L3 filtering is used or IDC autonomous denial is configured, an additional delay can be expected.

8.13.2.6.1.2 E-UTRAN inter frequency measurements when DRX is used

When DRX is in use and when measurement gaps are scheduled, or the UE supports capability of conducting such measurements without gaps, the UE shall be able to identify a new detectable FDD inter-frequency cell within $T_{identify_inter_UE\ cat\ M1_NC}$ as shown in table 8.13.2.6.1.2-1.

When eDRX_CONN is in use and when measurement gaps are scheduled, or the UE supports capability of conducting such measurements without gaps, the UE shall be able to identify a new detectable FDD inter-frequency cell within $T_{identify_inter_UE\ cat\ M1_NC}$ as shown in table 8.13.2.6.1.2-1A.

Table 8.13.2.6.1.2-1: Requirement to identify a newly detectable FDD interfrequency cell

Gap pattern ID	DRX cycle length (s)	$T_{identify_inter_UE\ cat\ M1_NC}$ (s) (DRX cycles)
0	≤ 0.04	$1.44 * K_{inter_M1} * KRSTD_{M1_NC}$ (Note 1)
	$0.04 < DRX\text{-}cycle \leq 0.08$	Note 2 ($40 * K_{inter_M1} * KRSTD_{M1_NC}$)
	0.128	$3.2 * K_{inter_M1} * KRSTD_{M1_NC}$ ($25 * K_{inter_M1} * KRSTD_{M1_NC}$)
	$0.128 < DRX\text{-}cycle \leq 2.56$	Note 2 ($20 * K_{inter_M1} * KRSTD_{M1_NC}$)
1	< 0.128	$2.88 * K_{inter_M1} * KRSTD_{M1_NC}$ (Note 1)
	0.128	$3.2 * K_{inter_M1} * KRSTD_{M1_NC}$ ($25 * K_{inter_M1} * KRSTD_{M1_NC}$)
	$0.128 < DRX\text{-}cycle \leq 2.56$	Note 2 ($20 * K_{inter_M1} * KRSTD_{M1_NC}$)
Note 1: Number of DRX cycle depends upon the DRX cycle in use		
Note 2: Time depends upon the DRX cycle in use		

Table 8.13.2.6.1.2-1A: Requirement to identify a newly detectable FDD interfrequency cell when eDRX_CONN cycle is used

eDRX_CONN cycle length (s)	$T_{\text{identify_inter_UE cat M1_NC}}$ (s) (eDRX_CONN cycles)
$2.56 < \text{eDRX_CONN cycle} \leq 10.24$	Note ($20 * K_{\text{inter_M1}} * K_{\text{RSTD_M1_NC}}$)
Note: Time depends upon the eDRX_CONN cycle in use	

A cell shall be considered detectable when

- RSRP related side conditions given in Sections 9.1.21.9 and 9.1.21.10 are fulfilled for a corresponding Band,
- RSRQ related side conditions given in Clause 9.1.21.13 and 9.21.14 are fulfilled for a corresponding Band,
- SCH_RP and SCH_Ês/Iot according to Annex B.2.14-1 for a corresponding Band

When DRX or eDRX_CONN is in use, the UE shall be capable of performing RSRP and RSRQ measurements of at least 4 inter-frequency cells per FDD inter-frequency and the UE physical layer shall be capable of reporting RSRP and RSRQ to higher layers with the measurement period $T_{\text{measure_inter_UE cat M1_NC}}$, either measurement gaps are scheduled or the UE supports capability of conducting such measurements without gaps. When DRX is used, $T_{\text{measure_inter_UE cat M1_NC}}$ is as defined in Table 8.13.2.6.1.2-2, and when eDRX_CONN is in use, $T_{\text{measure_inter_UE cat M1_NC}}$ is as defined in Table 8.13.2.6.1.2-3.

Table 8.13.2.6.1.2-2: Requirement to measure FDD interfrequency cells

Gap pattern ID	DRX cycle length (s)	$T_{\text{measure_inter_UE cat M1_NC}}$ (s) (DRX cycles)
0	< 0.128	$0.48 * K_{\text{inter_M1 cat M1_NC}} * K_{\text{RSTD_M1_NC}}$ (Note 1)
	$0.128 \leq \text{DRX-cycle} \leq 2.56$	Note 2 ($5 * K_{\text{inter_M1}} * K_{\text{RSTD_M1_NC}}$)
1	< 0.256	$0.960 * K_{\text{inter_M1 cat M1_NC}} * K_{\text{RSTD_M1_NC}}$ (Note 1)
	$0.256 \leq \text{DRX-cycle} \leq 2.56$	Note 2 ($5 * K_{\text{inter_M1}} * K_{\text{RSTD_M1_NC}}$)
Note 1: Number of DRX cycle depends upon the DRX cycle in use		
Note 2: Time depends upon the DRX cycle in use		

Table 8.13.2.6.1.2-3: Requirement to measure FDD interfrequency cells when eDRX_CONN cycle is used

eDRX_CONN cycle length (s)	$T_{\text{measure_inter_UE cat M1_NC}}$ (s) (eDRX_CONN cycles)
$2.56 < \text{eDRX_CONN cycle} \leq 10.24$	Note ($5 * K_{\text{inter_M1}} * K_{\text{RSTD_M1_NC}}$)
Note: Time depends upon the eDRX_CONN cycle in use	

The RSRP measurement accuracy for all measured cells shall be as specified in the sub-clauses 9.1.21.9 and 9.1.21.10.

The RSRQ measurement accuracy for all measured cells shall be as specified in the sub-clauses 9.1.21.13 and 9.1.21.14.

The requirements in this subclause apply regardless of MPDCCH monitoring configuration.

8.13.2.6.1.2.1 Measurement Reporting Requirements

8.13.2.6.1.2.1.1 Periodic Reporting

Reported RSRP and RSRQ measurement contained in periodically triggered measurement reports shall meet the requirements in sections 9.1.21.9, 9.1.21.10, 9.1.21.13 and 9.1.21.14.

8.13.2.6.1.2.1.2 Event-triggered Periodic Reporting

Reported RSRP and RSRQ measurement contained in event triggered periodic measurement reports shall meet the requirements in sections 9.1.21.9, 9.1.21.10, 9.1.21.13 and 9.1.21.14.

The first report in event triggered periodic measurement reporting shall meet the requirements specified in clause 8.13.2.6.1.2.1.3.

8.13.2.6.1.2.1.3 Event Triggered Reporting

Reported RSRP and RSRQ measurement contained in event triggered measurement reports shall meet the requirements in sections 9.1.21.9, 9.1.21.10, 9.1.21.13 and 9.1.21.14.

The UE shall not send any event triggered measurement reports, as long as no reporting criteria are fulfilled.

The measurement reporting delay is defined as the time between an event that will trigger a measurement report and the point when the UE starts to transmit the measurement report over the air interface. This requirement assumes that the measurement report is not delayed by other RRC signalling on the DCCH. This measurement reporting delay excludes a delay uncertainty resulted when inserting the measurement report to the TTI of the uplink DCCH. The delay uncertainty is: $2 \times TTI_{DCCH}$. This measurement reporting delay excludes a delay which caused by no UL resources for UE to send the measurement report.

The event triggered measurement reporting delay, measured without L3 filtering shall be less than $T_{identify_inter_UE\ cat\ M1_NC}$ defined in Clause 8.13.2.6.1.2 When L3 filtering is used or IDC autonomous denial is configured an additional delay can be expected.

If a cell which has been detectable at least for the time period $T_{identify_inter_UE\ cat\ M1_NC}$ defined in clause 8.13.2.6.1.2 becomes undetectable for a period ≤ 5 seconds and then the cell becomes detectable again and triggers an event, the event triggered measurement reporting delay shall be less than $T_{measure_inter_UE\ cat\ M1_NC}$ provided the timing to that cell has not changed more than $\pm 50 T_s$ and the L3 filter has not been used. When L3 filtering is used or IDC autonomous denial is configured, an additional delay can be expected.

8.13.2.6.2 E-UTRAN inter-frequency measurements for HD-FDD

8.13.2.6.2.1 E-UTRAN inter-frequency measurements when no DRX is used

The requirements in this section are applicable for the UE which supports half duplex operation on one or more supported frequency bands [2].

The requirements defined in clause 8.13.2.6.1.1 also apply for this section provided the following conditions are met:

- at least downlink subframe # 0 or downlink subframe # 5 per radio frame of an inter-frequency cell to be identified by the UE is available at the UE over $T_{identify_inter_UE\ cat\ M1_NC}$;
- at least one downlink subframe per radio frame of measured cell is available at the UE for RSRP measurement assuming measured cell is identified cell over $T_{measure_inter_UE\ cat\ M1_NC}$.
- RSRP related side conditions given in Sections 9.1.21.9 and 9.1.21.10 are fulfilled for a corresponding Band,
- RSRQ related side conditions given in Clause 9.1.21.13 and 9.1.21.14 are fulfilled for a corresponding Band,
- SCH_{RP} and SCH_{Es}/I_{ot} according to Annex Table B.2.14-2 for a corresponding Band

8.13.2.6.2.2 E-UTRAN inter frequency measurements when DRX is used

The requirements in this section are applicable for the UE which supports half duplex operation on one or more supported frequency bands [2].

When DRX is in use and when measurement gaps are scheduled, or the UE supports capability of conducting such measurements without gaps, the UE shall be able to identify a new detectable FDD inter-frequency cell within $T_{identify_inter_UE\ cat\ M1_NC}$ as shown in table 8.13.2.6.2.2-1.

When eDRX_{CONN} is in use and when measurement gaps are scheduled, or the UE supports capability of conducting such measurements without gaps, the UE shall be able to identify a new detectable FDD inter-frequency cell within $T_{identify_inter_UE\ cat\ M1_NC}$ as shown in table 8.13.2.6.2.2-1A.

Table 8.13.2.6.2.2-1: Requirement to identify a newly detectable HD-FDD interfrequency cell

Gap pattern ID	DRX cycle length (s)	$T_{identify_inter_UE\ cat\ M1_NC}$ (s) (DRX cycles)
0	≤ 0.04	$1.44 * K_{inter_M1} * K_{RSTD_M1_NC}$ (Note1)
	$0.04 < DRX\text{-}cycle \leq 0.08$	Note 2 ($40 * K_{inter_M1} * K_{RSTD_M1_NC}$)
	0.128	$3.2 * K_{inter_M1} * K_{RSTD_M1_NC}$ ($32 * K_{inter_M1} * K_{RSTD_M1_NC}$)
	$0.128 < DRX\text{-}cycle \leq 2.56$	Note 2 ($25 * K_{inter_M1} * K_{RSTD_M1_NC}$)
1	≤ 0.08	$2.88 * K_{inter_M1} * K_{RSTD_M1_NC}$ (Note1)

	0.128	$3.2 * K_{inter_M1} * KRSTD_M1_NC$ ($32 * K_{inter_M1} * KRSTD_M1_NC$)
	$0.128 < DRX_cycle \leq 2.56$	Note 2 ($25 * K_{inter_M1} * KRSTD_M1_NC$)
Note 1:	Number of DRX cycle depends upon the DRX cycle in use	
Note 2:	Time depends upon the DRX cycle in use	

Table 8.13.2.6.2.2-1A: Requirement to identify a newly detectable HD-FDD interfrequency cell when eDRX_CONN cycle is used

eDRX_CONN cycle length (s)	$T_{identify_inter_UE\ cat\ M1_NC}$ (s) (eDRX_CONN cycles)
$2.56 < eDRX_CONN\ cycle \leq 10.24$	Note ($25 * K_{inter_M1} * KRSTD_M1_NC$)
Note:	Time depends upon the eDRX_CONN cycle in use

A cell shall be considered detectable when

- RSRP related side conditions given in Sections 9.1.21.9 and 9.1.21.10 are fulfilled for a corresponding Band,
- RSRQ related side conditions given in Clause 9.1.21.13 and 9.1.21.14 are fulfilled for a corresponding Band,
- SCH_RP and SCH_Ês/Iot according to Annex Table B.2.14-2 for a corresponding Band

When DRX or eDRX_CONN is in use, the UE shall be capable of performing RSRP and RSRQ measurements of at least 4 inter-frequency cells per FDD inter-frequency and the UE physical layer shall be capable of reporting RSRP and RSRQ to higher layers with the measurement period $T_{measure_inter_UE\ cat\ M1_NC}$, either measurement gaps are scheduled or the UE supports capability of conducting such measurements without gaps. When DRX is used, $T_{measure_inter_UE\ cat\ M1_NC}$ is as defined in Table 8.13.2.6.2.2-2, and when eDRX_CONN is in use, $T_{measure_inter_UE\ cat\ M1_NC}$ is as defined in Table 8.13.2.6.2.2-3.

Table 8.13.2.6.2.2-2: Requirement to measure HD-FDD interfrequency cells

Gap pattern ID	DRX cycle length (s)	$T_{measure_inter_UE\ cat\ M1_NC}$ (s) (DRX cycles)
0	<0.08	$0.48 * K_{inter_M1} * KRSTD_M1_NC$ (Note 1)
	$0.08 \leq DRX_cycle \leq 0.16$	Note 2 ($7 * K_{inter_M1} * KRSTD_M1_NC$)
	$0.16 < DRX_cycle \leq 2.56$	Note 2 ($5 * K_{inter_M1} * KRSTD_M1_NC$)
1	<0.16	$0.96 * K_{inter_M1} * KRSTD_M1_NC$ (Note 1)
	DRX-cycle=0.16	$1.12 * K_{inter_M1} * KRSTD_M1_NC$ ($7 * K_{inter_M1} * KRSTD_M1_NC$)
	$0.16 < DRX_cycle \leq 2.56$	Note 2 ($5 * K_{inter_M1} * KRSTD_M1_NC$)
Note 1:	Number of DRX cycle depends upon the DRX cycle in use	
Note 2:	Time depends upon the DRX cycle in use	

Table 8.13.2.6.2.2-3: Requirement to measure HD-FDD interfrequency cells when eDRX_CONN cycle is used

eDRX_CONN cycle length (s)	$T_{measure_inter_UE\ cat\ M1_NC}$ (s) (eDRX_CONN cycles)
$2.56 < eDRX_CONN\ cycle \leq 10.24$	Note ($5 * K_{inter_M1} * KRSTD_M1_NC$)
Note:	Time depends upon the eDRX_CONN cycle in use

The RSRP measurement accuracy for all measured cells shall be as specified in the sub-clauses 9.1.21.10 and 9.1.21.11.

The RSRQ measurement accuracy for all measured cells shall be as specified in the sub-clauses 9.1.21.13 and 9.1.21.14.

The requirements in this subclause apply regardless of MPDCCH monitoring configuration.

8.13.2.6.2.2.1 Measurement Reporting Requirements

8.13.2.6.2.2.1.1 Periodic Reporting

Reported RSRP and RSRQ measurement contained in periodically triggered measurement reports shall meet the requirements in sections 9.1.21.9, 9.1.21.10, 9.1.21.13 and 9.1.21.14.

8.13.2.6.2.2.1.2 Event-triggered Periodic Reporting

Reported RSRP and RSRQ measurement contained in event triggered periodic measurement reports shall meet the requirements in sections 9.1.21.9, 9.1.21.10, 9.1.21.13 and 9.1.21.14.

The first report in event triggered periodic measurement reporting shall meet the requirements specified in clause 8.13.2.6.2.2.1.3.

8.13.2.6.2.2.1.3 Event Triggered Reporting

Reported RSRP and RSRQ measurement contained in event triggered measurement reports shall meet the requirements in sections 9.1.21.9, 9.1.21.10, 9.1.21.13 and 9.1.21.14.

The UE shall not send any event triggered measurement reports, as long as no reporting criteria are fulfilled.

The measurement reporting delay is defined as the time between an event that will trigger a measurement report and the point when the UE starts to transmit the measurement report over the air interface. This requirement assumes that the measurement report is not delayed by other RRC signalling on the DCCH. This measurement reporting delay excludes a delay uncertainty resulted when inserting the measurement report to the TTI of the uplink DCCH. The delay uncertainty is: $2 \times TTI_{DCCH}$. This measurement reporting delay excludes a delay which caused by no UL resources for UE to send the measurement report.

The event triggered measurement reporting delay, measured without L3 filtering shall be less than $T_{identify_inter_UE\ cat\ M1_NC}$ defined in Clause 8.13.2.6.2.2 When L3 filtering is used or IDC autonomous denial is configured an additional delay can be expected.

If a cell which has been detectable at least for the time period $T_{identify_inter_UE\ cat\ M1_NC}$ defined in clause 8.13.2.6.2.2 becomes undetectable for a period ≤ 5 seconds and then the cell becomes detectable again and triggers an event, the event triggered measurement reporting delay shall be less than $T_{measure_inter_UE\ cat\ M1_NC}$ provided the timing to that cell has not changed more than $\pm 50 T_s$ and the L3 filter has not been used. When L3 filtering is used or IDC autonomous denial is configured, an additional delay can be expected.

8.13.2.6.3 E-UTRAN TDD inter frequency measurements

8.13.2.6.3.1 E-UTRAN inter frequency measurements when no DRX is used

When no DRX is in use and when measurement gaps are scheduled, or the UE supports capability of conducting such measurements without gaps, the UE shall be able to identify and measure a new detectable TDD inter frequency cell according to requirements in Table 8.13.2.6.3.1-1 when $SCH\ \hat{E}_s/I_{ot} \geq -6$ dB, provided

- $G=1$, or
- $r_{max} * G < 80$ ms, or
- UE is receiving PDSCH.

Otherwise, requirements in Table 8.13.2.6.3.1-3 apply, where r_{max} and G are given by higher layer parameter *mPDCCH-NumRepetition* and *mPDCCH-startSF-U ESS* respectively as defined in TS 36.213 [3].

Table 8.13.2.6.3.1-1: Requirement on cell identification delay and measurement delay for TDD interfrequency cell

Gap pattern ID	Cell identification delay ($T_{identify_inter_UE\ cat\ M1_NC}$)	Measurement delay ($T_{measure_inter_UE\ cat\ M1_NC}$)
0	$1.44 * K_{inter_M1_NC} * K_{RSTD_M1_NC}$ seconds	$480 * K_{inter_M1_NC} * K_{RSTD_M1_NC}$ ms
1	$2.88 * K_{inter_M1_NC} * K_{RSTD_M1_NC}$ seconds	$960 * K_{inter_M1_NC} * K_{RSTD_M1_NC}$ ms

$$K_{inter_M1_NC} = \frac{N_{freq} * 100}{(100 - X)}$$

where X is signalled by the RRC parameter *measGapSharingScheme* [2] and is defined as in Table 8.13.2.6.3.1-2 when *highSpeedMeasGapCE-ModeA* [2] is not configured, and in Table 8.13.2.6.3.1-2A when *highSpeedMeasGapCE-ModeA* [2] is configured. N_{freq} is total number of inter-frequency layers to be monitored as defined in 8.1.2.1.1.

Table 8.13.2.6.3.1-2: Value of parameter X for CEModeA

<i>measGapSharingScheme</i>	Value of X (%)
'00'	$\frac{100}{N_{\text{freq}} + 1}$
'01'	40
'10'	50
'11'	60

Table 8.13.2.6.3.1-2A: Value of parameter X for CEModeA for UE configured with *highSpeedMeasGapCE-ModeA*

<i>measGapSharingScheme</i>	Value of X (%)
'00'	$\frac{100}{N_{\text{freq}} + 1}$
'01'	50
'10'	80
'11'	90

Table 8.13.2.6.3.1-3: Requirement on cell identification delay and measurement delay for TDD interfrequency cell with MPDCCH scaling

Gap pattern ID	Cell identification delay ($T_{\text{identify_inter_UE cat M1}}$)	Measurement delay ($T_{\text{measure_inter_UE cat M1}}$)
0	$\text{Max}(20 * r_{\text{max}} * G / 1000, 1.44) * K_{\text{inter_M1_NC}} * K_{\text{RSTD_M1_NC}}$ seconds	$\text{Max}(5 * r_{\text{max}} * G, 480) * K_{\text{inter_M1_NC}} * K_{\text{RSTD_M1_NC}}$ ms
1	$\text{Max}(20 * r_{\text{max}} * G / 1000, 2.88) * K_{\text{inter_M1_NC}} * K_{\text{RSTD_M1_NC}}$ seconds	$\text{Max}(5 * r_{\text{max}} * G, 960) * K_{\text{inter_M1_NC}} * K_{\text{RSTD_M1_NC}}$ ms

$$K_{\text{RSTD_M1_NC}} = \frac{1}{1 - \max\left(\frac{40}{T_{\text{PRS}}}, \frac{N_{\text{PRS}}}{T_{\text{PRS}}}\right)}$$

$K_{\text{RSTD_M1_NC}}$ is applicable provided following conditions are met:

- $T_{\text{PRS}} > 40$ ms
- $T_{\text{PRS}} > N_{\text{PRS}}$

where

- T_{PRS} is the cell-specific positioning subframe configuration period as defined in TS 36.211 [16],
- N_{PRS} is the number of consecutive downlink positioning subframes in a positioning occasion defined in TS 36.211

Otherwise $K_{\text{RSTD_M1_NC}} = 1$.

A cell shall be considered detectable when

- RSRP related side conditions given in Sections 9.1.21.9 and 9.1.21.10 are fulfilled for a corresponding Band,
- RSRQ related side conditions given in Clause 9.1.21.13 and 9.1.21.14 are fulfilled for a corresponding Band,
- SCH_{RP} and SCH_{Ês}/I_{ot} according to Annex Table B.2.14-1 for a corresponding Band.

When measurement gaps are scheduled for TDD inter frequency measurements, or the UE supports capability of conducting such measurements without gaps, the UE physical layer shall be capable of reporting RSRP and RSRQ to higher layers with measurement accuracy as specified in sub-clauses 9.1.21.9, 9.1.21.10, 9.1.21.13 and 9.1.21.14 with measurement period ($T_{\text{measure_inter_UE cat M1_NC}}$) given by table 8.13.2.6.3.1-1:

The UE shall be capable of performing RSRP and RSRQ measurements of at least 4 inter-frequency cells per TDD inter-frequency and the UE physical layer shall be capable of reporting RSRP and RSRQ measurements to higher layers with the measurement period $T_{\text{measure_inter_UE cat M1_NC}}$.

8.13.2.6.3.1.1 Measurement Reporting Requirements

8.13.2.6.3.1.1.1 Periodic Reporting

Reported RSRP and RSRQ measurement contained in periodically triggered measurement reports shall meet the requirements in sections 9.1.21.9, 9.1.21.10, 9.1.21.13 and 9.1.21.14.

8.13.2.6.3.1.1.2 Event-triggered Periodic Reporting

Reported RSRP and RSRQ measurement contained in event triggered periodic measurement reports shall meet the requirements in sections 9.1.21.9, 9.1.21.10, 9.1.21.13 and 9.1.21.14.

The first report in event triggered periodic measurement reporting shall meet the requirements specified in clause 8.13.2.6.3.1.1.3.

8.13.2.6.3.1.1.3 Event Triggered Reporting

Reported RSRP and RSRQ measurement contained in event triggered measurement reports shall meet the requirements in sections 9.1.21.9, 9.1.21.10, 9.1.21.13 and 9.1.21.14.

The UE shall not send any event triggered measurement reports, as long as no reporting criteria are fulfilled.

The measurement reporting delay is defined as the time between an event that will trigger a measurement report and the point when the UE starts to transmit the measurement report over the air interface. This requirement assumes that the measurement report is not delayed by other RRC signalling on the DCCH. This measurement reporting delay excludes a delay uncertainty resulted when inserting the measurement report to the TTI of the uplink DCCH. The delay uncertainty is: $2 \times TTI_{\text{DCCH}}$. This measurement reporting delay excludes a delay which caused by no UL resources for UE to send the measurement report.

The event triggered measurement reporting delay, measured without L3 filtering shall be less than $T_{\text{identify_inter_UE cat M1_NC}}$ defined in Clause 8.13.2.6.3.1. When L3 filtering is used or IDC autonomous denial is configured an additional delay can be expected.

If a cell which has been detectable at least for the time period $T_{\text{identify_inter_UE cat M1_NC}}$ defined in clause 8.13.2.6.3.1 becomes undetectable for a period ≤ 5 seconds and then the cell becomes detectable again and triggers an event, the event triggered measurement reporting delay shall be less than $T_{\text{Measurement_Period Inter_UE cat M1_NC}}$ provided the timing to that cell has not changed more than $\pm 50 T_s$ and the L3 filter has not been used. When L3 filtering is used or IDC autonomous denial is configured, an additional delay can be expected.

8.13.2.6.3.2 E-UTRAN inter frequency measurements when DRX is used

When DRX is in use and when DRX or eDRX_CONN is in use, either measurement gaps are scheduled or the UE supports capability of conducting such measurements without gaps, the UE shall be able to identify a new detectable TDD inter frequency cell within $T_{\text{identify_inter_UE cat M1}}$ as shown in table 8.13.2.6.3.2-1.

When eDRX_CONN is in use the UE shall be able to identify a new detectable TDD inter frequency cell within $T_{\text{identify_inter_UE cat M1_NC}}$ as shown in table 8.13.2.6.3.2-1A.

Table 8.13.2.6.3.2-1: Requirement to identify a newly detectable TDD interfrequency cell

Gap pattern ID	DRX cycle length (s)	$T_{\text{identify_inter_UE cat M1_NC}}$ (s) (DRX cycles)
0	≤ 0.04	$1.44 * K_{\text{inter_M1}} * K_{\text{RSTD_M1_NC}}$ (Note 1)
	$0.04 < \text{DRX-cycle} \leq 0.08$	Note 2 ($40 * K_{\text{inter_M1}} * K_{\text{RSTD_M1_NC}}$)
	0.128	$3.2 * K_{\text{inter_M1}} * K_{\text{RSTD_M1_NC}}$ ($25 * K_{\text{inter_M1}} * K_{\text{RSTD_M1_NC}}$)
	$0.128 < \text{DRX-cycle} \leq 2.56$	Note 2 ($20 * K_{\text{inter_M1}} * K_{\text{RSTD_M1_NC}}$)
1	< 0.128	$2.88 * K_{\text{inter_M1}} * K_{\text{RSTD_M1_NC}}$ (Note 1)
	0.128	$3.2 * K_{\text{inter_M1}} * K_{\text{RSTD_M1_NC}}$ ($25 * K_{\text{inter_M1}} * K_{\text{RSTD_M1_NC}}$)

	$0.128 < \text{DRX-cycle} \leq 2.56$	Note 2 ($20 * K_{\text{inter_M1}} * K_{\text{RSTD_M1_NC}}$)
Note 1:	Number of DRX cycle depends upon the DRX cycle in use	
Note 2:	Time depends upon the DRX cycle in use	

Table 8.13.2.6.3.2-1A: Requirement to identify a newly detectable TDD interfrequency cell when eDRX_CONN cycle is used

eDRX_CONN cycle length (s)	$T_{\text{identify_inter_UE cat M1_NC}}$ (s) (eDRX_CONN cycles)
$2.56 < \text{eDRX_CONN cycle} \leq 10.24$	Note ($20 * K_{\text{inter_M1}} * K_{\text{RSTD_M1_NC}}$)
Note:	Time depends upon the eDRX_CONN cycle in use

A cell shall be considered detectable when

- RSRP related side conditions given in Clause 9.1.21.9 and 9.1.21.10 are fulfilled for a corresponding Band,
- RSRQ related side conditions given in Clause 9.1.21.13 and 9.1.21.14 are fulfilled for a corresponding Band,
- SCH_RP and SCH_Ês/Iot according to Annex Table B.2.14-1 for a corresponding Band

When DRX or eDRX_CONN is in use, the UE shall be capable of performing RSRP and RSRQ measurements of at least 4 inter-frequency cells per TDD inter-frequency for up to 3 TDD inter-frequencies and the UE physical layer shall be capable of reporting RSRP and RSRQ measurements to higher layers with the measurement period $T_{\text{measure_inter_UE cat M1_NC}}$, either measurement gaps are scheduled or the UE supports capability of conducting such measurements without gaps. When DRX is in use, $T_{\text{measure_inter_UE cat M1_NC}}$ is as defined in Table 8.13.2.6.3.2-2, and when eDRX_CONN is in use, $T_{\text{measure_inter_UE cat M1_NC}}$ is as defined in Table 8.13.2.6.3.2-3.

Table 8.13.2.6.3.2-2: Requirement to measure TDD inter frequency cells

Gap pattern ID	DRX cycle length (s)	$T_{\text{measure_inter_UE cat M1_NC}}$ (s) (DRX cycles)
0	< 0.128	$0.48 * K_{\text{inter_M1}} * K_{\text{RSTD_M1_NC}}$ (Note 1)
	$0.128 \leq \text{DRX-cycle} \leq 2.56$	Note 2 ($5 * K_{\text{inter_M1}} * K_{\text{RSTD_M1_NC}}$)
1	< 0.256	$0.96 * K_{\text{inter_M1}} * K_{\text{RSTD_M1_NC}}$ (Note 1)
	$0.256 \leq \text{DRX-cycle} \leq 2.56$	Note 2 ($5 * K_{\text{inter_M1}} * K_{\text{RSTD_M1_NC}}$)
Note 1:	Number of DRX cycle depends upon the DRX cycle in use	
Note 2:	Time depends upon the DRX cycle in use	

Table 8.13.2.6.3.2-3: Requirement to measure TDD inter frequency cells when eDRX_CONN cycle is used

eDRX_CONN cycle length (s)	$T_{\text{measure_inter_UE cat M1_NC}}$ (s) (eDRX_CONN cycles)
$2.56 < \text{eDRX_CONN cycle} \leq 10.24$	Note ($5 * K_{\text{inter_M1}} * K_{\text{RSTD_M1_NC}}$)
Note:	Time depends upon the eDRX_CONN cycle in use.

The RSRP measurement accuracy for all measured cells shall be as specified in the sub-clauses 9.1.21.9 and 9.1.21.10.

The RSRQ measurement accuracy for all measured cells shall be as specified in the sub-clauses 9.1.21.13 and 9.1.21.14.

The requirements in this subclause apply regardless of MPDCCH monitoring configuration.

8.13.2.6.3.2.1 Measurement Reporting Requirements

8.13.2.6.3.2.1.1 Periodic Reporting

Reported RSRP and RSRQ measurement contained in periodically triggered measurement reports shall meet the requirements in sections 9.1.21.9, 9.1.21.10, 9.1.21.13 and 9.1.21.14.

8.13.2.6.3.2.1.2 Event-triggered Periodic Reporting

Reported RSRP and RSRQ measurement contained in event triggered periodic measurement reports shall meet the requirements in sections 9.1.21.9, 9.1.21.10, 9.1.21.13 and 9.1.21.14.

The first report in event triggered periodic measurement reporting shall meet the requirements specified in clause 8.13.2.6.3.2.1.3.

8.13.2.6.3.2.1.3 Event Triggered Reporting

Reported RSRP and RSRQ measurement contained in event triggered measurement reports shall meet the requirements in sections 9.1.21.9, 9.1.21.10, 9.1.21.13 and 9.1.21.14.

The UE shall not send any event triggered measurement reports, as long as no reporting criteria are fulfilled.

The measurement reporting delay is defined as the time between an event that will trigger a measurement report and the point when the UE starts to transmit the measurement report over the air interface. This requirement assumes that the measurement report is not delayed by other RRC signalling on the DCCH. This measurement reporting delay excludes a delay uncertainty resulted when inserting the measurement report to the TTI of the uplink DCCH. The delay uncertainty is: $2 \times TTI_{DCCH}$. This measurement reporting delay excludes a delay which caused by no UL resources for UE to send the measurement report.

The event triggered measurement reporting delay, measured without L3 filtering shall be less than $T_{identify_inter_UE\ cat\ M1_NC}$ defined in Clause 8.13.2.6.3.2. When L3 filtering is used or IDC autonomous denial is configured an additional delay can be expected.

If a cell which has been detectable at least for the time period $T_{identify_inter_UE\ cat\ M1_NC}$ defined in clause 8.13.2.6.3.2 becomes undetectable for a period ≤ 5 seconds and then the cell becomes detectable again and triggers an event, the event triggered measurement reporting delay shall be less than $T_{measure_inter_UE\ cat\ M1_NC}$ provided the timing to that cell has not changed more than $\pm 50 T_s$ and the L3 filter has not been used. When L3 filtering is used or IDC autonomous denial is configured, an additional delay can be expected.

8.13.2.7 Maximum allowed layers for multiple monitoring for UE category M1 with CE mode A

The UE UE category M1 configured with CE mode A shall be capable of monitoring at least:

- Depending on UE capability, 2 FDD E-UTRA inter-frequency carriers, and
- Depending on UE capability, 2 TDD E-UTRA carriers.

In addition to the requirements defined above, the UE shall be capable of monitoring a total of at least 5 carrier frequency layers, which include one serving carrier frequency and any of the above defined combination of E-UTRA FDD inter-frequency and E-UTRA TDD inter-frequency layers.

8.13.3 Requirements for UE category M1 with CE mode B

The UE category M1 applicability of the requirements in subclause 8.13.3 is defined in Section 3.6. The requirements defined in clause 8.13.3 apply provided the following conditions are met:

- UE is configured with measurement gap pattern ID#0 or ID#1 defined in Table 8.1.2.1-1.

Alternatively, the UE shall meet the requirements in subclause 8.13.3 defined for gap pattern ID#0 without using any measurement gaps provided:

- UE indicates it does not need gaps with the capability `intraFreq-CE-NeedForGaps-r13` [2, TS36.331] for the frequency band of the serving cell, or
- UE is not configured with any reporting configuration that requires measurement on any intra-frequency neighbour cell.

8.13.3.1 E-UTRAN intra frequency measurements by UE category M1 with CE mode B

The UE shall be able to identify new intra-frequency cells and perform RSRP and RSRQ measurements of identified intra-frequency cells without an explicit intra-frequency neighbour cell list containing physical layer cell identities. During the RRC_CONNECTED state the UE shall continuously measure identified intra frequency cells and additionally search for and identify new intra frequency cells.

8.13.3.1.1 E-UTRAN FDD intra frequency measurements

8.13.3.1.1.1 E-UTRAN intra frequency measurements when no DRX is used

When no DRX is in use the UE shall be able to identify and measure a new detectable FDD intra frequency cell according to requirements in Table 8.13.3.1.1.1-1 provided that additional conditions table 8.13.3.1.1.1-1 is met, and

- $G=1$, or
- $r_{\max} * G < 800\text{ms}$, or
- UE is receiving PDSCH.

Otherwise, requirements in Table 8.13.3.1.1.1-4 apply, where r_{\max} and G are given by higher layer parameter *mPDCCH-NumRepetition* and *mPDCCH-startSF-U ESS* respectively as defined in TS 36.213 [3].

Table 8.13.3.1.1.1-1: Requirement on cell identification delay and measurement delay for FDD intrafrequency cell

Neighbouring cell SCH Es/lot: Q2 [dB]	Gap pattern ID	Cell identification delay ($T_{\text{identify_intra_UE cat M1}}$)	Measurement delay ($T_{\text{measure_intra_UE cat M1}}$)
$-15 \leq Q2 < -6$	0	$320.8 * K_{\text{intra_M1_EC}} * K_{\text{RSTD_M1_EC}} S$	$800 * K_{\text{intra_M1_EC}} * K_{\text{RSTD_M1_EC}} \text{ms}$
	1	$321.6 * K_{\text{intra_M1_EC}} * K_{\text{RSTD_M1_EC}} S$	$1600 * K_{\text{intra_M1_EC}} * K_{\text{RSTD_M1_EC}} \text{ms}$
$Q2 \geq -6$	0	$21.8 * K_{\text{intra_M1_EC}} * K_{\text{RSTD_M1_EC}} S$	$800 * K_{\text{intra_M1_EC}} * K_{\text{RSTD_M1_EC}} \text{ms}$
	1	$22.6 * K_{\text{intra_M1_EC}} * K_{\text{RSTD_M1_EC}} S$	$1600 * K_{\text{intra_M1_EC}} * K_{\text{RSTD_M1_EC}} \text{ms}$

Table 8.13.3.1.1.1-2: Void

$K_{\text{intra_M1_EC}} = 100 / X$ where X is signalled by the RRC parameter *measGapSharingScheme* [2] and is defined as in Table 8.13.3.1.1.1-3. N_{freq} is total number of inter-frequency layers to be monitored as defined in 8.1.2.1.1. When inter frequency measurement is not configured, $K_{\text{intra_M1_EC}}=1$ regardless whether or how parameter *measGapSharingScheme* [2] is configured.

Table 8.13.3.1.1.1-3: Value of parameter X for CEModeB

<i>measGapSharingScheme</i>	Value of X (%)
'00'	$\frac{100}{N_{\text{freq}} + 1}$
'01'	50
'10'	75
'11'	87.5

Table 8.13.3.1.1.1-4: Requirement on cell identification delay and measurement delay for FDD intrafrequency cell

Neighbouring cell SCH Es/lot: Q2 [dB]	Gap pattern ID	Cell identification delay ($T_{\text{identify_intra_UE cat M1}}$)	Measurement delay ($T_{\text{measure_intra_UE cat M1}}$)
$-15 \leq Q2 < -6$	0	$\text{Max}(400 * r_{\max} * G / 1000, 320.8) * K_{\text{intra_M1_EC}} * K_{\text{RSTD_M1_EC}} S$	$\text{Max}(5 * r_{\max} * G, 800) * K_{\text{intra_M1_EC}} * K_{\text{RSTD_M1_EC}} \text{ms}$
	1	$\text{Max}(400 * r_{\max} * G / 1000, 321.6) * K_{\text{intra_M1_EC}} * K_{\text{RSTD_M1_EC}} S$	$\text{Max}(5 * r_{\max} * G, 1600) * K_{\text{intra_M1_EC}} * K_{\text{RSTD_M1_EC}} \text{ms}$
$Q2 \geq -6$	0	$\text{Max}(20 * r_{\max} * G / 1000, 21.8) * K_{\text{intra_M1_EC}} * K_{\text{RSTD_M1_EC}} S$	$\text{Max}(5 * r_{\max} * G, 800) * K_{\text{intra_M1_EC}} * K_{\text{RSTD_M1_EC}} \text{ms}$
	1	$\text{Max}(20 * r_{\max} * G / 1000, 22.6) * K_{\text{intra_M1_EC}} * K_{\text{RSTD_M1_EC}} S$	$\text{Max}(5 * r_{\max} * G, 1600) * K_{\text{intra_M1_EC}} * K_{\text{RSTD_M1_EC}} \text{ms}$

$$K_{\text{RSTD_MI_EC}} = \frac{1}{1 - \max\left(\frac{40}{T_{\text{PRS}}}, \frac{N_{\text{PRS}}}{T_{\text{PRS}}}\right)}$$

$K_{\text{RSTD_MI_NC}}$ is applicable provided following conditions are met:

- $T_{\text{PRS}} > 40$ ms
- $T_{\text{PRS}} > N_{\text{PRS}}$
- PRS bandwidth is less than the bandwidth of the cell used for RSTD measurement in which case gaps are required

where

- T_{PRS} is the cell-specific positioning subframe configuration period as defined in TS 36.211 [16],
- N_{PRS} is the number of consecutive downlink positioning subframes in a positioning occasion defined in TS 36.211

Otherwise $K_{\text{RSTD_MI_EC}} = 1$.

A cell shall be considered detectable when

- RSRP related side conditions given in Sections 9.1.21.3 and 9.1.21.4 are fulfilled for a corresponding Band,
- RSRQ related side conditions given in Clause 9.1.21.7 are fulfilled for a corresponding Band,
- SCH_RP and $SCH\ \hat{E}s/lot$ according to Annex Table B.2.14-3 for a corresponding Band.

Identification of a cell shall include detection of the cell and additionally performing a single measurement with measurement period of $T_{\text{measure_intra_UE cat M1_EC}}$. If higher layer filtering is used, an additional cell identification delay can be expected.

In the RRC_CONNECTED state the measurement period for intra frequency measurements is according to Table 8.13.3.1.1.1-1. When measurement gaps are activated the UE shall be capable of performing measurements for at least 6 cells. If the UE has identified more than 6 cells, the UE shall perform measurements but the reporting rate of RSRP and RSRQ measurements of cells from UE physical layer to higher layers may be decreased.

The RSRP measurement accuracy for all measured cells shall be as specified in the sub-clauses 9.1.21.3, 9.1.21.4 and 9.1.21.7.

The RSRQ measurement accuracy for all measured cells shall be as specified in the sub-clauses 9.1.21.7.

8.13.3.1.1.1 Measurement Reporting Requirements

8.13.3.1.1.1.1 Periodic Reporting

Reported RSRP and RSRQ measurement contained in periodically triggered measurement reports shall meet the requirements in sections 9.1.21.3, 9.1.21.4 and 9.1.21.7.

8.13.3.1.1.1.2 Event-triggered Periodic Reporting

Reported RSRP and RSRQ measurement contained in event triggered periodic measurement reports shall meet the requirements in sections 9.1.21.3, 9.1.21.4 and 9.1.21.7.

The first report in event triggered periodic measurement reporting shall meet the requirements specified in clause 8.13.3.1.1.1.3.

8.13.3.1.1.1.3 Event Triggered Reporting

Reported RSRP and RSRQ measurement contained in event triggered measurement reports shall meet the requirements in sections 9.1.21.3, 9.1.21.4 and 9.1.21.7.

The UE shall not send any event triggered measurement reports, as long as no reporting criteria are fulfilled.

The measurement reporting delay is defined as the time between an event that will trigger a measurement report and the point when the UE starts to transmit the measurement report over the air interface. This requirement assumes that the measurement report is not delayed by other RRC signalling on the DCCH. This measurement reporting delay excludes a delay uncertainty resulted when inserting the measurement report to the TTI of the uplink DCCH. The delay uncertainty is: $pusch-maxNumRepetitionCEmodeB \times TTI_{DCCH}$, where $pusch-maxNumRepetitionCEmodeB$ [2] is the maximum number of PUSCH repetitions configured for the UE in CE Mode B provided that $pusch-maxNumRepetitionCEmodeB > 1$, otherwise uncertainty is defined as $2 \times TTI_{DCCH}$. This measurement reporting delay excludes a delay which caused by no UL resources for UE to send the measurement report.

The event triggered measurement reporting delay, measured without L3 filtering shall be less than $T_{identify_intra_UE\ cat\ M1_EC}$ defined in Clause 8.13.3.1.1.1. When L3 filtering is used or IDC autonomous denial is configured an additional delay can be expected.

If a cell which has been detectable at least for the time period $T_{identify_intra_UE\ cat\ M1_EC}$ defined in clause 8.13.3.1.1.1 becomes undetectable for a period ≤ 5 seconds and then the cell becomes detectable again and triggers an event, the event triggered measurement reporting delay shall be less than $T_{Measurement_Period_UE\ cat\ M1_EC, Intra}$ provided the timing to that cell has not changed more than $\pm 50 T_s$ and the L3 filter has not been used. When L3 filtering is used or IDC autonomous denial is configured, an additional delay can be expected.

8.13.3.1.1.2 E-UTRAN intra frequency measurements when DRX is used

When DRX is in use the UE shall be able to identify a new detectable FDD intra frequency cell within $T_{identify_intra_UE\ cat\ M1_EC}$ as shown in table 8.13.3.1.1.2-1 provided that additional conditions Table 8.13.3.1.1.2-1 is met.

When eDRX_CONN is in use the UE shall be able to identify a new detectable FDD intra frequency cell within $T_{identify_intra_UE\ cat\ M1_EC}$ as shown in table 8.13.3.1.1.2-1B.

Table 8.13.3.1.1.2-1: Requirement to identify a newly detectable FDD intrafrequency cell

Neighbouring cell SCH \hat{E} s/lot: Q2 [dB]	Gap pattern ID	DRX cycle length (s)	$T_{identify_intra_UE\ cat\ M1}$ (s) (DRX cycles)
-15 ≤ Q2 < -6	0	≤ 0.64	$320.8 * K_{intra_M1_EC} * KRSTD_M1_EC$ (Note1)
		0.64 < DRX-cycle ≤ 2.56	Note2 ($400 * K_{intra_M1_EC} * KRSTD_M1_EC$)
	1	DRX-cycle ≤ 0.640	$321.6 * K_{intra_M1_EC} * KRSTD_M1_EC$ (Note1)
		0.64 < DRX-cycle ≤ 2.56	Note2 ($400 * K_{intra_M1_EC} * KRSTD_M1_EC$)
Q2 ≥ -6	0	≤ 0.64	$21.8 * K_{intra_M1_EC} * KRSTD_M1_EC$ (Note1)
		0.64 < DRX-cycle ≤ 2.56	Note2 ($24 * K_{intra_M1_EC} * KRSTD_M1_EC$)
	1	DRX-cycle ≤ 0.640	$22.6 * K_{intra_M1_EC} * KRSTD_M1_EC$ (Note1)
		0.64 < DRX-cycle ≤ 2.56	Note2 ($24 * K_{intra_M1_EC} * KRSTD_M1_EC$)
Note1: Number of DRX cycle depends upon the DRX cycle in use			
Note2: Time depends upon the DRX cycle in use			

Table 8.13.3.1.1.2-1A: Void

Table 8.13.3.1.1.2-1B: Requirement to identify a newly detectable FDD intrafrequency cell when eDRX_CONN is used

eDRX_CONN cycle length (s)	$T_{identify_intra_UE\ cat\ M1_EC}$ (s) (eDRX_CONN cycles)
----------------------------	---

$2.56 < eDRX_CONN \text{ cycle} \leq 10.24$	Note ($400 * K_{intra_M1_EC} * KRSTD_M1_EC$)
NOTE: Time depends upon the eDRX_CONN cycle in use	

A cell shall be considered detectable when

- RSRP related side conditions given in Sections 9.1.21.3 and 9.1.21.4 are fulfilled for a corresponding Band,
- RSRQ related side conditions given in Clause 9.1.21.7 are fulfilled for a corresponding Band,
- SCH_RP and SCH $\hat{E}s/Iot$ according to Annex Table B.2.14-3 for a corresponding Band

In the RRC_CONNECTED state the measurement period for intra frequency measurements is $T_{measure_intra_UE \text{ cat } M1_EC}$. When DRX is used, $T_{measure_intra_UE \text{ cat } M1_EC}$ is as specified in table 8.13.3.1.1.2-2 provided that additional conditions table 8.13.3.1.1.2-2 is met. When eDRX_CONN is used, $T_{measure_intra_UE \text{ cat } M1_EC}$ is as specified in table 8.13.3.1.1.2-4. The UE shall be capable of performing RSRP and RSRQ measurements for 6 identified-intra-frequency cells, and the UE physical layer shall be capable of reporting measurements to higher layers with the measurement period of $T_{measure_intra_UE \text{ cat } M1_EC}$.

Table 8.13.3.1.1.2-2: Requirement to measure FDD intrafrequency cells

Target cell SCH $\hat{E}s/Iot$: Q2 [dB]	Gap pattern ID	DRX cycle length (s)	$T_{measure_intra_UE \text{ cat } M1}$ (s) (DRX cycles)
Q2 \geq -15	0	≤ 0.16	$0.8 * K_{intra_M1_EC} * KRSTD_M1_EC$ (Note1)
		$0.16 < DRX\text{-cycle} \leq 2.56$	Note2($5 * K_{intra_M1_EC} * KRSTD_M1_EC$)
	1	≤ 0.32	$1.6 * K_{intra_M1_EC} * KRSTD_M1_EC$ (Note1)
		$0.32 < DRX\text{-cycle} \leq 2.56$	Note2($5 * K_{intra_M1_EC} * KRSTD_M1_EC$)
Note1: Number of DRX cycle depends upon the DRX cycle in use			
Note2: Time depends upon the DRX cycle in use			

Table 8.13.3.1.1.2-3: Void

Table 8.13.3.1.1.2-4: Requirement to measure FDD intrafrequency cells when eDRX_CONN cycle is used

eDRX_CONN cycle length (s)	$T_{measure_intra_UE \text{ cat } M1_EC}$ (s) (eDRX_CONN cycles)
$2.56 < eDRX_CONN \text{ cycle} \leq 10.24$	Note ($5 * K_{intra_M1_EC} * KRSTD_M1_EC$)
NOTE: Time depends upon the eDRX_CONN cycle in use	

The RSRP measurement accuracy for all measured cells shall be as specified in the sub-clauses 9.1.21.3 and 9.1.21.4.

The RSRQ measurement accuracy for all measured cells shall be as specified in the sub-clauses 9.1.21.7.

The requirements in this subclause apply regardless of MPDCCH monitoring configuration.

8.13.3.1.1.2.1 Measurement Reporting Requirements

8.13.3.1.1.2.1.1 Periodic Reporting

Reported RSRP and RSRQ measurement contained in periodically triggered measurement reports shall meet the requirements in sections 9.1.21.3, 9.1.21.4 and 9.1.21.7.

8.13.3.1.1.2.1.2 Event-triggered Periodic Reporting

Reported RSRP and RSRQ measurement contained in event triggered periodic measurement reports shall meet the requirements in sections 9.1.21.3, 9.1.21.4 and 9.1.21.7.

The first report in event triggered periodic measurement reporting shall meet the requirements specified in clause 8.13.3.1.1.2.1.3.

8.13.3.1.1.2.1.3 Event Triggered Reporting

Reported RSRP and RSRQ measurement contained in event triggered measurement reports shall meet the requirements in sections 9.1.21.3, 9.1.21.4 and 9.1.21.7.

The UE shall not send any event triggered measurement reports, as long as no reporting criteria are fulfilled.

The measurement reporting delay is defined as the time between an event that will trigger a measurement report and the point when the UE starts to transmit the measurement report over the air interface. This requirement assumes that the measurement report is not delayed by other RRC signalling on the DCCH. This measurement reporting delay excludes a delay uncertainty resulted when inserting the measurement report to the TTI of the uplink DCCH. The delay uncertainty is: $pusch-maxNumRepetitionCEmodeB \times TTI_{DCCH}$, where $pusch-maxNumRepetitionCEmodeB$ [2] is the maximum number of PUSCH repetitions configured for the UE in CE Mode B provided that $pusch-maxNumRepetitionCEmodeB > 1$, otherwise uncertainty is defined as $2 \times TTI_{DCCH}$. This measurement reporting delay excludes a delay which caused by no UL resources for UE to send the measurement report.

The event triggered measurement reporting delay, measured without L3 filtering shall be less than $T_{identify_intra_UE\ cat\ M1_EC}$ defined in Clause 8.13.3.1.1.2. When L3 filtering is used or IDC autonomous denial is configured an additional delay can be expected.

If a cell which has been detectable at least for the time period $T_{identify_intra_UE\ cat\ M1_EC}$ defined in clause 8.13.3.1.1.2 becomes undetectable for a period ≤ 5 seconds and then the cell becomes detectable again and triggers an event, the event triggered measurement reporting delay shall be less than $T_{measure_intra_UE\ cat\ M1_EC}$ provided the timing to that cell has not changed more than $\pm 50 T_s$ and the L3 filter has not been used. When L3 filtering is used or IDC autonomous denial is configured, an additional delay can be expected.

8.13.3.1.2 E-UTRAN intra frequency measurements for HD-FDD

8.13.3.1.2.1 E-UTRAN intra frequency measurements when no DRX is used

The requirements in this section are applicable for the UE which supports half duplex operation on one or more supported frequency bands [2].

The requirements defined in clause 8.13.3.1.1.1 also apply for this section provided the following conditions are met:

- at least downlink subframe # 0 and downlink subframe # 5 per radio frame of an intra-frequency cell to be identified by the UE is available at the UE over $T_{identify_intra_UE\ cat\ M1_EC}$;
- at least two consecutive downlink subframe per radio frame of measured cell is available at the UE for RSRP measurements assuming measured cell is identified cell over $T_{measure_intra_UE\ cat\ M1_EC}$.
- RSRP related side conditions given in Sections 9.1.21.3 and 9.1.21.4 are fulfilled for a corresponding Band,
- RSRQ related side conditions given in Clause 9.1.21.7 are fulfilled for a corresponding Band,
- SCH_RP and $SCH\ \hat{E}s/lot$ according to Annex Table B.2.14-4

8.13.3.1.2.2 E-UTRAN intra frequency measurements when DRX is used

The requirements in this section are applicable for the UE which supports half duplex operation on one or more supported frequency bands [2].

When DRX is in use the UE shall be able to identify a new detectable HD-FDD intra frequency cell within $T_{identify_intra_UE\ cat\ M1_EC}$ as shown in table 8.13.3.1.2.2-1 provided that additional conditions table 8.13.3.1.2.2-1 is met.

When eDRX_CONN is in use, the UE shall be able to identify a new detectable FDD intra frequency cell within $T_{identify_intra_UE\ cat\ M1_EC}$ as shown in table 8.13.3.1.2.2-1B.

Table 8.13.3.1.2.2-1: Requirement to identify a newly detectable HD-FDD intrafrequency cell

Neighbouring cell SCH $\hat{E}s/lot$: Q2 [dB]	Gap pattern ID	DRX cycle length (s)	$T_{identify_intra_UE\ cat\ M1}$ (s) (DRX cycles)
-15 ≤ Q2 < -6	0	≤0.64	$320.8 * K_{intra_M1} * K_{RSTD_M1_EC}$ (Note1)
		0.64 < DRX-cycles ≤ 2.56	Note2 ($400 * K_{intra_M1} * K_{RSTD_M1_EC}$)
	1	DRX-cycle ≤ 0.640	$321.6 * K_{intra_M1} * K_{RSTD_M1_EC}$ (Note1)
		0.64 < DRX-cycle ≤ 2.56	Note2 ($400 * K_{intra_M1} * K_{RSTD_M1_EC}$)

Q2>=6	0	≤0.64	$21.8 * K_{intra_M1} * K_{RSTD_M1_EC}$ (Note1)
		0.64 < DRX-cycle ≤ 2.56	Note2 ($24 * K_{intra_M1} * K_{RSTD_M1_EC}$)
	1	DRX-cycle ≤ 0.640	$22.6 * K_{intra_M1} * K_{RSTD_M1_EC}$ (Note1)
		0.64 < DRX-cycle ≤ 2.56	Note2 ($24 * K_{intra_M1} * K_{RSTD_M1_EC}$)
Note1: Number of DRX cycle depends upon the DRX cycle in use			
Note2: Time depends upon the DRX cycle in use			

Table 8.13.3.1.2.2-1A: Void

Table 8.13.3.1.2.2-1B: Requirement to identify a newly detectable HD-FDD intrafrequency cell when eDRX_CONN cycle is used

eDRX_CONN cycle length (s)	T _{identify_intra_UE cat M1_EC} (s) (eDRX_CONN cycles)
2.56 < eDRX_CONN cycle ≤ 10.24	Note ($400 * K_{intra_M1_EC} * K_{RSTD_M1_EC}$)
NOTE: Time depends upon the eDRX_CONN cycle in use	

A cell shall be considered detectable when

- RSRP related side conditions given in Sections 9.1.21.3 and 9.1.21.4 are fulfilled for a corresponding Band,
- RSRQ related side conditions given in Clause 9.1.21.7 are fulfilled for a corresponding Band,
- SCH_RP and SCH_Ês/Iot according to Annex Table B.2.14-4 for a corresponding Band

In the RRC_CONNECTED state the measurement period for intra frequency measurements is T_{measure_intra_UE cat M1_EC}. When DRX is used, T_{measure_intra_UE cat M1_EC} is as specified in table 8.13.3.1.2.2-2 provided that additional conditions Table 8.13.3.1.2.2-2 is met. When eDRX_CONN cycle is used, T_{measure_intra_UE cat M1_EC} is as specified in table 8.13.3.1.2.2-4. The UE shall be capable of performing RSRP and RSRQ measurements for 6 identified-intra-frequency cells, and the UE physical layer shall be capable of reporting measurements to higher layers with the measurement period of T_{measure_intra_UE cat M1_EC}.

Table 8.13.3.1.2.2-2: Requirement to measure HD-FDD intrafrequency cells

Neighbouring cell SCH_Ês/Iot: Q2 [dB]	Gap pattern ID	DRX cycle length (s)	T _{measure_intra_UE cat M1} (s) (DRX cycles)
Q2>=15	0	<0.128	$0.8 * K_{intra_EC} * K_{RSTD_M1_EC}$ (Note1)
		0.128 ≤ DRX-cycle ≤ 0.16	Note2 ($7 * K_{intra_EC} * K_{RSTD_M1_EC}$)
		0.16 < DRX-cycle ≤ 2.56	Note2 ($5 * K_{intra_EC} * K_{RSTD_M1_EC}$)
	1	≤0.32	$1.6 * K_{intra_EC} * K_{RSTD_M1_EC}$ (Note1)
		0.32 < DRX-cycle ≤ 2.56	Note2 ($5 * K_{intra_EC} * K_{RSTD_M1_EC}$)
Note1: Number of DRX cycle depends upon the DRX cycle in use			
Note2: Time depends upon the DRX cycle in use			

Table 8.13.3.1.2.2-3: Void

Table 8.13.3.1.2.2-4: Requirement to measure HD-FDD intrafrequency cells when eDRX_CONN cycle is used

eDRX_CONN cycle length (s)	T _{measure_intra_UE cat M1_EC} (s) (eDRX_CONN cycles)
2.56 < eDRX_CONN cycle ≤ 10.24	NOTE ($5 * K_{intra_M1_EC} * K_{RSTD_M1_EC}$)
NOTE: Time depends upon the eDRX_CONN cycle in use	

The RSRP measurement accuracy for all measured cells shall be as specified in the sub-clauses 9.1.21.3 and 9.1.21.4.

The RSRQ measurement accuracy for all measured cells shall be as specified in the sub-clauses 9.1.21.7.

The requirements in this subclause apply regardless of MPDCCH monitoring configuration.

8.13.3.1.2.2.1 Measurement Reporting Requirements

8.13.3.1.2.2.1.1 Periodic Reporting

Reported RSRP and RSRQ measurement contained in periodically triggered measurement reports shall meet the requirements in sections 9.1.21.3, 9.1.21.4 and 9.1.21.7.

8.13.3.1.2.2.1.2 Event-triggered Periodic Reporting

Reported RSRP and RSRQ measurement contained in event triggered periodic measurement reports shall meet the requirements in sections 9.1.21.3, 9.1.21.4 and 9.1.21.7.

The first report in event triggered periodic measurement reporting shall meet the requirements specified in clause 8.13.3.1.2.2.1.3.

8.13.3.1.2.2.1.3 Event Triggered Reporting

Reported RSRP and RSRQ measurements contained in event triggered measurement reports shall meet the requirements in sections 9.1.21.3, 9.1.21.4 and 9.1.21.7.

The UE shall not send any event triggered measurement reports, as long as no reporting criteria are fulfilled.

The measurement reporting delay is defined as the time between an event that will trigger a measurement report and the point when the UE starts to transmit the measurement report over the air interface. This requirement assumes that the measurement report is not delayed by other RRC signalling on the DCCH. This measurement reporting delay excludes a delay uncertainty resulted when inserting the measurement report to the TTI of the uplink DCCH. The delay uncertainty is: $pusch-maxNumRepetitionCEmodeB \times TTI_{DCCH}$, where $pusch-maxNumRepetitionCEmodeB$ [2] is the maximum number of PUSCH repetitions configured for the UE in CE Mode B provided that $pusch-maxNumRepetitionCEmodeB > 1$, otherwise uncertainty is defined as $2 \times TTI_{DCCH}$. This measurement reporting delay excludes a delay which caused by no UL resources for UE to send the measurement report.

The event triggered measurement reporting delay, measured without L3 filtering shall be less than $T_{identify_intra_UE\ cat\ M1_EC}$ defined in Clause 8.13.3.1.2.2 When L3 filtering is used or IDC autonomous denial is configured an additional delay can be expected.

If a cell which has been detectable at least for the time period $T_{identify_intra_UE\ cat\ M1_EC}$ defined in clause 8.13.3.1.2.2 becomes undetectable for a period ≤ 5 seconds and then the cell becomes detectable again and triggers an event, the event triggered measurement reporting delay shall be less than $T_{measure_intra_UE\ cat\ M1_EC}$ provided the timing to that cell has not changed more than $\pm 50 T_s$ and the L3 filter has not been used. When L3 filtering is used or IDC autonomous denial is configured, an additional delay can be expected.

8.13.3.1.3 E-UTRAN TDD intra frequency measurements

8.13.3.1.3.1 E-UTRAN intra frequency measurements when no DRX is used

When no DRX is in use the UE shall be able to identify and measure a new detectable TDD intra frequency cell according to requirements in Table 8.13.3.1.3.1-1 provided that additional conditions Table 8.13.3.1.3.1-2 is met, and

- $G=1$, or
- $r_{max} * G < 800ms$, or
- UE is receiving PDSCH.

Otherwise, requirements in Table 8.13.3.1.3.1-4 apply, where r_{max} and G are given by higher layer parameter $mPDCCH-NumRepetition$ and $mPDCCH-startSF-U ESS$ respectively as defined in TS 36.213 [3].

Table 8.13.3.1.3.1-1: Requirement on cell identification delay and measurement delay for TDD intrafrequency cell

Neighbouring cell SCH \bar{E} s/lot: Q2 [dB]	Gap pattern ID	Cell identification delay ($T_{\text{identify_intra_UE cat M1}}$) for neighbouring cell SCH \bar{E} s/lot (Q): $-15 \leq Q2 < -6$	Measurement delay ($T_{\text{measure_intra_UE cat M1}}$)
$-15 \leq Q2 < -6$	0	$320.8 * K_{\text{intra_M1_EC}} * K_{\text{RSTD_M1_EC}} S$	$800 * K_{\text{intra_M1_EC}} * K_{\text{RSTD_M1_EC}} \text{ms}^{\text{Note1}}$ $1600 * K_{\text{intra_M1_EC}} * K_{\text{RSTD_M1_EC}} \text{ms}^{\text{Note2}}$
	1	$321.6 * K_{\text{intra_M1_EC}} * K_{\text{RSTD_M1_EC}} S$	$1600 * K_{\text{intra_M1_EC}} * K_{\text{RSTD_M1_EC}} \text{ms}^{\text{Note1}}$ $3200 * K_{\text{intra_M1_EC}} \text{ms}^{\text{Note2}}$
$Q2 \geq -6$	0	$21.8 * K_{\text{intra_M1_EC}} * K_{\text{RSTD_M1_EC}} S$	$800 * K_{\text{intra_M1_EC}} * K_{\text{RSTD_M1_EC}} \text{ms}^{\text{Note1}}$ $1600 * K_{\text{intra_M1_EC}} * K_{\text{RSTD_M1_EC}} \text{ms}^{\text{Note2}}$
	1	$22.6 * K_{\text{intra_M1_EC}} * K_{\text{RSTD_M1_EC}} S$	$1600 * K_{\text{intra_M1_EC}} * K_{\text{RSTD_M1_EC}} \text{ms}^{\text{Note1}}$ $3200 * K_{\text{intra_M1_EC}} * K_{\text{RSTD_M1_EC}} \text{ms}^{\text{Note2}}$
Note1: Under TDD UL/DL configuration other than 0. Note2: Under TDD UL/DL configuration 0.			

$K_{\text{intra_M1_EC}} = 100 / X$ where X is signalled by the RRC parameter *measGapSharingScheme* [2] and is defined as in Table 8.13.3.1.3.1-3. N_{freq} is total number of inter-frequency layers to be monitored as defined in 8.1.2.1.1. When inter frequency measurement is not configured, $K_{\text{intra_M1_EC}}=1$ regardless whether or how parameter *measGapSharingScheme* [2] is configured.

Table 8.13.3.1.3.1-2: Void

Table 8.13.3.1.3.1-3: Value of parameter X for CEModeB

<i>measGapSharingScheme</i>	Value of X (%)
'00'	$\frac{100}{N_{\text{freq}} + 1}$
'01'	50
'10'	75
'11'	87.5

Table 8.13.3.1.3.1-4: Requirement on cell identification delay and measurement delay for TDD intrafrequency cell

Neighbouring cell SCH \bar{E} s/lot: Q2 [dB]	Gap pattern ID	Cell identification delay ($T_{\text{identify_intra_UE cat M1}}$)	Measurement delay ($T_{\text{measure_intra_UE cat M1}}$)
$-15 \leq Q2 < -6$	0	$\text{Max}(400 * r_{\text{max}} * G / 1000, 320.8) * K_{\text{intra_M1_EC}} * K_{\text{RSTD_M1_EC}} S$	$\text{Max}(5 * r_{\text{max}} * G, 800) * K_{\text{intra_M1_EC}} * K_{\text{RSTD_M1_EC}} \text{ms}^{\text{Note1}}$ $\text{Max}(5 * r_{\text{max}} * G, 1600) * K_{\text{intra_M1_EC}} * K_{\text{RSTD_M1_EC}} \text{ms}^{\text{Note2}}$
	1	$\text{Max}(400 * r_{\text{max}} * G / 1000, 321.6) * K_{\text{intra_M1_EC}} * K_{\text{RSTD_M1_EC}} S$	$\text{Max}(5 * r_{\text{max}} * G, 1600) * K_{\text{intra_M1_EC}} * K_{\text{RSTD_M1_EC}} \text{ms}^{\text{Note1}}$ $\text{Max}(5 * r_{\text{max}} * G, 3200) * K_{\text{intra_M1_EC}} * K_{\text{RSTD_M1_EC}} \text{ms}^{\text{Note2}}$
$Q2 \geq -6$	0	$\text{Max}(20 * r_{\text{max}} * G / 1000, 21.8) * K_{\text{intra_M1_EC}} * K_{\text{RSTD_M1_EC}} S$	$\text{Max}(5 * r_{\text{max}} * G, 800) * K_{\text{intra_M1_EC}} * K_{\text{RSTD_M1_EC}} \text{ms}^{\text{Note1}}$

			$\text{Max}(5 * r_{\text{max}} * G, 1600) * K_{\text{intra_M1_EC}} * K_{\text{RSTD_M1_EC}} \text{ ms}^{\text{Note2}}$
	1	$\text{Max}(20 * r_{\text{max}} * G / 1000, 22.6) * K_{\text{intra_M1_EC}} * K_{\text{RSTD_M1_EC}} \text{ s}$	$\text{Max}(5 * r_{\text{max}} * G, 1600) * K_{\text{intra_M1_EC}} * K_{\text{RSTD_M1_EC}} \text{ ms}^{\text{Note1}}$
			$\text{Max}(5 * r_{\text{max}} * G, 3200) * K_{\text{intra_M1_EC}} * K_{\text{RSTD_M1_EC}} \text{ ms}^{\text{Note2}}$
Note1: Under TDD UL/DL configuration other than 0. Note2: Under TDD UL/DL configuration 0.			

$$K_{\text{RSTD_M1_EC}} = \frac{1}{1 - \max\left(\frac{40}{T_{\text{PRS}}}, \frac{N_{\text{PRS}}}{T_{\text{PRS}}}\right)}$$

$K_{\text{RSTD_M1_NC}}$ is applicable provided following conditions are met:

- $T_{\text{PRS}} > 40 \text{ ms}$
- $T_{\text{PRS}} > N_{\text{PRS}}$
- PRS bandwidth is less than the bandwidth of the cell used for RSTD measurement in which case gaps are required

where

- T_{PRS} is the cell-specific positioning subframe configuration period as defined in TS 36.211 [16],
- N_{PRS} is the number of consecutive downlink positioning subframes in a positioning occasion defined in TS 36.211

Otherwise $K_{\text{RSTD_M1_EC}} = 1$.

A cell shall be considered detectable when

- RSRP related side conditions given in Sections 9.1.21.3 and 9.1.21.4 are fulfilled for a corresponding Band,
- RSRQ related side conditions given in Clause 9.1.21.7 are fulfilled for a corresponding Band,
- SCH_RP and $SCH\ \hat{E}s/\text{lot}$ according to Annex Table B.2.14-3 for a corresponding Band.

Identification of a cell shall include detection of the cell and additionally performing a single measurement with measurement period of $T_{\text{measure_intra_UE cat M1_EC}}$. If higher layer filtering is used, an additional cell identification delay can be expected.

In the RRC_CONNECTED state the measurement period for intra frequency measurements is according to Table 8.13.3.1.3.1-1. When measurement gaps are activated the UE shall be capable of performing measurements for at least 6 cells. If the UE has identified more than 6 cells, the UE shall perform measurements but the reporting rate of RSRP and RSRQ measurements of cells from UE physical layer to higher layers may be decreased.

The RSRP measurement accuracy for all measured cells shall be as specified in the sub-clauses 9.1.21.3 and 9.1.21.4.

The RSRQ measurement accuracy for all measured cells shall be as specified in the sub-clauses 9.1.21.7.

8.13.3.1.3.1.1 Measurement Reporting Requirements

8.13.3.1.3.1.1.1 Periodic Reporting

Reported RSRP and RSRQ measurement contained in periodically triggered measurement reports shall meet the requirements in sections 9.1.21.3, 9.1.21.4 and 9.1.21.7.

8.13.3.1.3.1.1.2 Event-triggered Periodic Reporting

Reported RSRP and RSRQ measurement contained in event triggered periodic measurement reports shall meet the requirements in sections 9.1.21.3, 9.1.21.4 and 9.1.21.7.

The first report in event triggered periodic measurement reporting shall meet the requirements specified in clause 8.13.3.1.3.1.1.3.

8.13.3.1.3.1.1.3 Event Triggered Reporting

Reported RSRP measurement contained in event triggered measurement reports shall meet the requirements in sections 9.1.21.3, 9.1.21.4 and 9.1.21.7.

The UE shall not send any event triggered measurement reports, as long as no reporting criteria are fulfilled.

The measurement reporting delay is defined as the time between an event that will trigger a measurement report and the point when the UE starts to transmit the measurement report over the air interface. This requirement assumes that the measurement report is not delayed by other RRC signalling on the DCCH. This measurement reporting delay excludes a delay uncertainty resulted when inserting the measurement report to the TTI of the uplink DCCH. The delay uncertainty is: $pusch-maxNumRepetitionCEmodeB \times TTI_{DCCH}$, where $pusch-maxNumRepetitionCEmodeB$ [2] is the maximum number of PUSCH repetitions configured for the UE in CE Mode B provided that $pusch-maxNumRepetitionCEmodeB > 1$, otherwise uncertainty is defined as $2 \times TTI_{DCCH}$. This measurement reporting delay excludes a delay which caused by no UL resources for UE to send the measurement report.

The event triggered measurement reporting delay, measured without L3 filtering shall be less than $T_{identify_intra_UE\ cat\ M1_EC}$ defined in Clause 8.13.3.1.3.1. When L3 filtering is used or IDC autonomous denial is configured an additional delay can be expected.

If a cell which has been detectable at least for the time period $T_{identify_intra_UE\ cat\ M1_EC}$ defined in clause 8.13.3.1.3.1 becomes undetectable for a period ≤ 5 seconds and then the cell becomes detectable again and triggers an event, the event triggered measurement reporting delay shall be less than $T_{Measurement_Period\ Intra_UE\ cat\ M1_EC}$ provided the timing to that cell has not changed more than $\pm 50 T_s$ and the L3 filter has not been used. When L3 filtering is used or IDC autonomous denial is configured, an additional delay can be expected.

8.13.3.1.3.2 E-UTRAN intra frequency measurements when DRX is used

When DRX is in use the UE shall be able to identify a new detectable TDD intra frequency cell within $T_{identify_intra_UE\ cat\ M1_EC}$ as shown in table 8.13.3.1.3.2-1 provided that additional conditions table 8.13.3.1.3.2-1 is met.

When eDRX_CONN is in use the UE shall be able to identify a new detectable TDD intra frequency cell within $T_{identify_intra_UE\ cat\ M1_EC}$ as shown in table 8.13.3.1.3.2-1B.

Table 8.13.3.1.3.2-1: Requirement to identify a newly detectable TDD intrafrequency cell

Neighbouring cell SCH \bar{E} s/lot: Q2 [dB]	Gap pattern ID	DRX cycle length (s)	$T_{identify_intra_UE\ cat\ M1}$ (s) (DRX cycles)
$-15 \leq Q2 < -6$	0	≤ 0.64	$320.8 * K_{intra_M1_EC} * K_{RSTD_M1_EC}$ (Note1)
		$0.64 < DRX-cycle \leq 2.56$	Note2 ($400 * K_{intra_M1_EC} * K_{RSTD_M1_EC}$)
	1	$DRX-cycle \leq 0.640$	$321.6 * K_{intra_M1_EC} * K_{RSTD_M1_EC}$ (Note1)
		$0.64 < DRX-cycle \leq 2.56$	Note2 ($400 * K_{intra_M1_EC} * K_{RSTD_M1_EC}$)
$Q2 \geq -6$	0	≤ 0.64	$21.8 * K_{intra_M1_EC} * K_{RSTD_M1_EC}$ (Note1)
		$0.64 < DRX-cycle \leq 2.56$	Note2 ($24 * K_{intra_M1_EC} * K_{RSTD_M1_EC}$)
	1	$DRX-cycle \leq 0.640$	$22.6 * K_{intra_M1_EC} * K_{RSTD_M1_EC}$ (Note1)
		$0.64 < DRX-cycle \leq 2.56$	Note2 ($24 * K_{intra_M1_EC} * K_{RSTD_M1_EC}$)
Note1: Number of DRX cycle depends upon the DRX cycle in use			
Note2: Time depends upon the DRX cycle in use			

Table 8.13.3.1.3.2-1A: Void

Table 8.13.3.1.3.2-1B: Requirement to identify a newly detectable TDD intrafrequency cell when eDRX_CONN cycle is used

eDRX_CONN cycle length (s)	T _{Identify_intra_UE cat M1_EC} (s) (eDRX_CONN cycles)
2.56 < eDRX_CONN cycle ≤ 10.24	Note (400 * K _{intra_M1_EC} * K _{RSTD_M1_EC})
NOTE: Time depends upon the eDRX_CONN cycle in use	

A cell shall be considered detectable when

- RSRP related side conditions given in Clause 9.1.21.3 and 9.1.21.4 are fulfilled for a corresponding Band,
- RSRQ related side conditions given in Clause 9.1.21.7 are fulfilled for a corresponding Band,
- SCH_{RP} and SCH_{Es/lot} according to Annex Table B.2.14-3 for a corresponding Band

In the RRC_CONNECTED state the measurement period for intra frequency measurements is T_{measure_intra_UE cat M1_EC}. When DRX is used, T_{measure_intra_UE cat M1_EC} is as shown in table 8.13.3.1.3.2-2 provided that additional conditions Table 8.13.3.1.3.2-2 is met. When eDRX_CONN is used, T_{measure_intra_UE cat M1_EC} is as shown in table 8.13.3.1.3.2-4. The UE shall be capable of performing RSRP and RSRQ measurement for 6 identified intra-frequency cells and the UE physical layer shall be capable of reporting measurements to higher layers with the measurement period of T_{measure_intra_UE cat M1_EC}.

Table 8.13.3.1.3.2-2: Requirement to measure TDD intra frequency cells

Neighbouring cell SCH _{Es/lot} : Q2 [dB]	TDD Uplink-downlink configuration	Gap pattern ID	DRX cycle length (s)	T _{measure_intra_UE cat M1} (s) (DRX cycles)
Q2 ≥ 15	Other than 0	0	≤ 0.16	0.8 * K _{intra_M1_EC} * K _{RSTD_M1_EC} (Note1)
			0.16 < DRX-cycle ≤ 2.56	Note2 (5 * K _{intra_M1_EC} * K _{RSTD_M1_EC})
		1	≤ 0.32	1.6 * K _{intra_M1_EC} * K _{RSTD_M1_EC} (Note1)
			0.32 < DRX-cycle ≤ 2.56	Note2 (5 * K _{intra_M1_EC} * K _{RSTD_M1_EC})
	0	0	≤ 0.32	1.6 * K _{intra_M1_EC} * K _{RSTD_M1_EC} (Note1)
			0.32 < DRX-cycle ≤ 2.56	Note2 (5 * K _{intra_M1_EC} * K _{RSTD_M1_EC})
		1	≤ 0.64	3.2 * K _{intra_M1_EC} * K _{RSTD_M1_EC} (Note1)
			0.64 < DRX-cycle ≤ 2.56	Note2 (5 * K _{intra_M1_EC} * K _{RSTD_M1_EC})
Note 1: Number of DRX cycle depends upon the DRX cycle in use.				
Note 2: Time depends upon the DRX cycle in use.				

Table 8.13.3.1.3.2-3: Void

Table 8.13.3.1.3.2-4: Requirement to measure TDD intra frequency cells when eDRX_CONN cycle is used

eDRX_CONN cycle length (s)	T _{measure_intra_UE cat M1_EC} (s) (eDRX_CONN cycles)
2.56 < eDRX_CONN cycle ≤ 10.24	Note (5 * K _{intra_M1_EC} * K _{RSTD_M1_EC})
NOTE: Time depends upon the eDRX_CONN cycle in use.	

The RSRP measurement accuracy for all measured cells shall be as specified in the sub-clauses 9.1.21.3 and 9.1.21.4.

The RSRQ measurement accuracy for all measured cells shall be as specified in the sub-clauses 9.1.21.7.

The requirements in this subclause apply regardless of MPDCCH monitoring configuration.

8.13.3.1.3.2.1 Measurement Reporting Requirements

8.13.3.1.3.2.1.1 Periodic Reporting

Reported RSRP and RSRQ measurement contained in periodically triggered measurement reports shall meet the requirements in sections 9.1.21.3, 9.1.21.4 and 9.1.21.7.

8.13.3.1.3.2.1.2 Event-triggered Periodic Reporting

Reported RSRP and RSRQ measurement contained in event triggered periodic measurement reports shall meet the requirements in sections 9.1.21.3, 9.1.21.4 and 9.1.21.7.

The first report in event triggered periodic measurement reporting shall meet the requirements specified in clause 8.13.3.1.3.2.1.3.

8.13.3.1.3.2.1.3 Event Triggered Reporting

Reported RSRP and RSRQ measurement contained in event triggered measurement reports shall meet the requirements in sections 9.1.21.3, 9.1.21.4 and 9.1.21.7.

The UE shall not send any event triggered measurement reports, as long as no reporting criteria are fulfilled.

The measurement reporting delay is defined as the time between an event that will trigger a measurement report and the point when the UE starts to transmit the measurement report over the air interface. This requirement assumes that the measurement report is not delayed by other RRC signalling on the DCCH. This measurement reporting delay excludes a delay uncertainty resulted when inserting the measurement report to the TTI of the uplink DCCH. The delay uncertainty is: $pusch-maxNumRepetitionCEmodeB \times TTI_{DCCH}$, where $pusch-maxNumRepetitionCEmodeB$ [2] is the maximum number of PUSCH repetitions configured for the UE in CE Mode B provided that $pusch-maxNumRepetitionCEmodeB > 1$, otherwise uncertainty is defined as $2 \times TTI_{DCCH}$. This measurement reporting delay excludes a delay which caused by no UL resources for UE to send the measurement report.

The event triggered measurement reporting delay, measured without L3 filtering shall be less than $T_{identify_intra_UE\ cat\ M1_EC}$ defined in Clause 8.13.3.1.3.2. When L3 filtering is used or IDC autonomous denial is configured an additional delay can be expected.

If a cell which has been detectable at least for the time period $T_{identify_intra_UE\ cat\ M1_EC}$ defined in clause 8.13.3.1.3.2 becomes undetectable for a period ≤ 5 seconds and then the cell becomes detectable again and triggers an event, the event triggered measurement reporting delay shall be less than $T_{measure_intra_UE\ cat\ M1_EC}$ provided the timing to that cell has not changed more than $\pm 50 T_s$ and the L3 filter has not been used. When L3 filtering is used or IDC autonomous denial is configured, an additional delay can be expected.

8.13.3.1.4 E-UTRAN FDD intra frequency measurements with autonomous gaps for UE category M1 with CE mode B

The requirements defined in this subclause 8.13.3.1.4 apply provided the following condition is met:

- Tx diversity or transmission using multiple antennas are supported in the target cell to be detected.
- Repetitions of MIB/SIB1-BR are supported in the target cell to be detected.

8.13.3.1.4.1 Identification of a new CGI of E-UTRA cell with autonomous gaps

No explicit neighbour list is provided to the UE for identifying a new CGI of E-UTRA cell. The UE shall identify and report the CGI when requested by the network for the purpose 'reportCGI'. The UE may make autonomous gaps in downlink reception and uplink transmission for receiving MIB and SIB1-BR message according to clause 5.5.3.1 of TS 36.331 [2]. Note that a UE is not required to use autonomous gap if `si-RequestForHO` is set to false. If autonomous gaps are used for measurement with the purpose of 'reportCGI', regardless of whether DRX or eDRX_CONN is used or not, or whether SCell(s) are configured or not, the UE shall be able to identify a new CGI of E-UTRA cell within:

$$T_{identify_CGI_CatM1,intra} = T_{basic_identify_CGI_CatM1,intra} \quad ms$$

Where

$T_{\text{basic_identify_CGI_Cat M1, intra}}$ is the time period used in the above equation where the maximum allowed time for the UE to identify a new CGI of an E-UTRA cell is defined, provided that the E-UTRA cell has been already identified by the UE.

- For UE not supporting cross-TTI MIB/SIB-BR decoding, $T_{\text{basic_identify_CGI_Cat M1, intra}} = 5120$ ms.
- For UE supporting cross-TTI MIB/SIB1-BR decoding, $T_{\text{basic_identify_CGI_Cat M1, intra}} = 3200$ ms provided that the target E-UTRA cell does not change the MIB payload information except the system frame number across MIB TTI and does not change the SIB1-BR information across SIB1-BR TTI. Otherwise $T_{\text{basic_identify_CGI_Cat M1, intra}} = 5120$ ms.

A cell shall be considered identifiable following conditions are fulfilled:

- RSRP related side conditions given in Clause 9.1 are fulfilled for a corresponding Band,
- SCH_RP and $\text{SCH } \hat{E}_s/\text{lot}$ according to Annex B.2.14 for a corresponding Band

The MIB of an E-UTRA cell whose CGI is identified shall be considered decodable by the UE provided the PBCH demodulation requirements are met according to [5].

The requirement for identifying a new CGI of an E-UTRA cell within $T_{\text{basic_identify_CGI_Cat M1, intra}}$ is applicable when no DRX is used as well as when any of DRX and eDRX_CONN cycles specified in TS 36.331 [2] is used.

Within the time, $T_{\text{identify_CGI_Cat M1, intra}}$ ms, over which the UE identifies the new CGI of E-UTRA cell, the PBCH repetition and SIB1-BR repetition level in the target cell shall be as specified in Table 8.13.3.1.4.1-1.

Table 8.13.3.1.4.1-1: Conditions in target cell during $T_{\text{basic_identify_CGI_Cat M1, intra}}$

Target cell			
\hat{E}_s/lot [dB]	PBCH repetition	SIB1-BR repetition level	SIB1-BR TBS
≥ -15	Configured as specified in TS 36.211 [16]	16	208

8.13.3.1.4.2 ECGI Reporting Delay

The ECGI reporting delay occurs due to the delay uncertainty when inserting the ECGI measurement report to the TTI of the uplink DCCH. The delay uncertainty is twice the TTI of the uplink DCCH. In case DRX is used, the ECGI reporting may be delayed until the next DRX cycle. In case eDRX_CONN is used, the ECGI reporting may be delayed until the next eDRX_CONN cycle. If IDC autonomous denial is configured, an additional delay can be expected.

8.13.3.1.5 E-UTRAN intra frequency measurements with autonomous gaps for HD-FDD UE category M1 with CE mode B

The requirements in this section are applicable for the UE which supports half duplex FDD operation on one or more supported frequency bands [2].

The requirements defined in this subclause 8.13.3.1.5 apply provided the following condition is met:

- Tx diversity or transmission using multiple antennas are supported in the target cell to be detected.
- Repetitions of MIB/SIB1-BR are supported in the target cell to be detected.

8.13.3.1.5.1 Identification of a new CGI of E-UTRA cell with autonomous gaps

The CGI requirements defined in clause 8.13.3.1.4.1 also apply for this section.

8.13.3.1.5.2 ECGI Reporting Delay

The ECGI reporting delay defined in clause 8.13.3.1.5.2 also apply for this section

8.13.3.1.6 E-UTRAN TDD intra frequency measurements with autonomous gaps for UE category M1 with CE mode B

The requirements defined in this subclause 8.13.3.1.6 apply provided the following condition is met:

- Tx diversity or transmission using multiple antennas are supported in the target cell to be detected.

- Repetitions of MIB/SIB1-BR are supported in the target cell to be detected.

8.13.3.1.6.1 Identification of a new CGI of E-UTRA cell with autonomous gaps

No explicit neighbour list is provided to the UE for identifying a new CGI of E-UTRA cell. The UE shall identify and report the CGI when requested by the network for the purpose 'reportCGI'. The UE may make autonomous gaps in downlink reception and uplink transmission for receiving MIB and SIB1-BR messages according to clause 5.5.3.1 of TS 36.331 [2]. Note that a UE is not required to use autonomous gap if si-RequestForHO is set to false. If autonomous gaps are used for measurement with the purpose of 'reportCGI', regardless of whether DRX or eDRX_CONN is used or not, or whether SCell(s) are configured or not, the UE shall be able to identify a new CGI of E-UTRA cell within:

$$T_{\text{identify_CGI_CatM1,intra}} = T_{\text{basic_identify_CGI_CatM1,intra}} \quad \text{ms}$$

Where

$T_{\text{basic_identify_CGI_Cat M1, intra}}$ is the time period used in the above equation where the maximum allowed time for the UE to identify a new CGI of an E-UTRA cell is defined, provided that the E-UTRA cell has been already identified by the UE.

- For UE not supporting cross-TTI MIB/SIB-BR decoding, $T_{\text{basic_identify_CGI_Cat M1, intra}} = 5120$ ms.
- For UE supporting cross-TTI MIB/SIB1-BR decoding, $T_{\text{basic_identify_CGI_Cat M1, intra}} = 3200$ ms, provided that the target E-UTRA cell does not change the MIB payload information except the system frame number across MIB TTI and does not change the SIB1-BR information across SIB1-BR TTI. Otherwise $T_{\text{basic_identify_CGI_Cat M1, intra}} = 5120$ ms.

A cell shall be considered identifiable when the following conditions are fulfilled:

- RSRP related side conditions given in Clause 9.1 are fulfilled for a corresponding Band,
- SCH_{RP} and SCH_{Es}/lot according to Annex B.2.14 for a corresponding Band

The MIB of an E-UTRA cell whose CGI is identified shall be considered decodable by the UE provided the PBCH demodulation requirements are met according to [5].

The requirement for identifying a new CGI of an E-UTRA cell within $T_{\text{basic_identify_CGI_Cat M1, intra}}$ is applicable when no DRX is used as well as when any of the DRX or eDRX_CONN cycles specified in TS 36.331 [2] is used.

Within the time, $T_{\text{identify_CGI_Cat M1, intra}}$ ms, over which the UE identifies the new CGI of E-UTRA cell, the PBCH repetition and SIB1-BR repetition level in the target cell shall be as specified Table 8.13.3.1.6.1-2.

Table 8.13.3.1.6.1-1: Conditions in target cell during $T_{\text{basic_identify_CGI_Cat M1, intra}}$

Target cell			
Es/lot [dB]	PBCH repetition level	SIB1-BR repetition level	SIB1-BR TBS
≥ -15	Configured with repetition, as specified in TS 36.211 [16]	16	208

8.13.3.1.6.2 ECGI Reporting Delay

The ECGI reporting delay occurs due to the delay uncertainty when inserting the ECGI measurement report to the TTI of the uplink DCCH. The delay uncertainty is twice the TTI of the uplink DCCH. In case DRX is used, the ECGI reporting may be delayed until the next DRX cycle. In case eDRX_CONN is used, the ECGI reporting may be delayed until the next eDRX_CONN cycle. If IDC autonomous denial is configured, an additional delay can be expected.

8.13.3.2 Void

8.13.3.3 E-UTRAN OTDOA Intra-Frequency RSTD Measurements for Cat-M1 UE in CEModeB

All intra-frequency RSTD measurement requirements specified in Sections 8.13.3.3 shall apply without DRX as well as for any DRX and eDRX_CONN cycles specified in TS 36.331 [2].

All the measurement requirements specified in Sections 8.13.3.3 shall apply provided that the UE is configured:

- with the single PRS configuration for the reference cell and all the neighbour cells and
- with either the measurement gap pattern ID #0 specified in Clause 8.1.2.1 or any applicable measurement gap pattern specified in Table 8.1.2.1-3 for cat M1 RSTD measurements if the PRS bandwidth is less than the bandwidth of the cell used for the RSTD measurement in which case gaps are required.

If CRS muting is enabled in a cell for which the UE performs RSTD measurements, the UE capable of supporting CRS muting [31] shall perform RSTD measurements and meet all the requirements in this section, provided the CRS are available within at least the PRS bandwidth in the subframes with PRS during all positioning occasions within the RSTD measurement period.

8.13.3.3.1 E-UTRAN FDD Intra-Frequency OTDOA Measurements

When the physical layer cell identities of neighbour cells together with the OTDOA assistance data are provided, the UE shall be able to detect and measure intra-frequency RSTD, specified in TS 36.214 [4], for at least $n=16$ cells, including the reference cell, on the same carrier frequency f_1 as that of the reference cell within $T_{\text{RSTDIntraFreqFDD,Cat}_M}$ ms as given below (see also Figure 8.13.3.3.1-1):

$$T_{\text{RSTDIntraFreqFDD,Cat}_M} = T_{\text{PRS}} \cdot (M - 1) + \Delta + T_{\text{MIB}} \text{ ms,}$$

where

$T_{\text{RSTDIntraFreqFDD,Cat}_M}$ is the total time for detecting and measuring at least n cells,

T_{PRS} is the cell-specific positioning subframe configuration period as defined in TS 36.355 [24] for UE not configured with measurement gaps for intra-frequency RSTD. For UE configured with measurement gaps for intra-frequency RSTD measurements, $T_{\text{PRS}} = \max(T_{\text{PRS}}, \text{MGRP})$, where MGRP is the Measurement Gap Repetition Period as defined in section 8.1.2.1.

M is the number of PRS positioning occasions as defined in Table 8.13.3.3.1-1, where downlink positioning subframes defined in TS 36.211 [16], and

$\Delta = T_{\text{PRS}} \cdot \left\lceil \frac{n}{M} \right\rceil$ ms is the measurement time for a single PRS positioning occasion which includes the sampling time and the processing time,

N_{PRS} is the cell-specific number of PRS subframes within a PRS occasion as defined in TS 36.355[24];

$N_{\text{actual_PRS}}$ is the number of PRS subframes within a PRS occasion available at the UE; $N_{\text{actual_PRS}} = N_{\text{PRS}}$ when the measurement gaps are not required for the intra-frequency RSTD measurements; for UE configured with measurement gaps for intra-frequency RSTD measurements $N_{\text{actual_PRS}}$ is the number of PRS subframes which can be measured by UE within MGL, where $N_{\text{actual_PRS}} = (MGL-2)$ if $\text{MGRP} \geq N_{\text{PRS}} > (MGL-2)$, $N_{\text{actual_PRS}} = (MGL - 2) \cdot \left\lfloor \frac{N_{\text{PRS}}}{\text{MGRP}} \right\rfloor$ if $N_{\text{PRS}} > \text{MGRP}$, and $N_{\text{actual_PRS}} = N_{\text{PRS}}$ if $N_{\text{PRS}} \leq (MGL-2)$.

$N_{\text{PRS_total}}$ is the minimum number of PRS subframes per cell measurement as specified in Section 9.1.21.21.

T_{PRS} , N_{PRS} , $N_{\text{actual_PRS}}$ and $N_{\text{PRS_total}}$ are the parameters of the same cell, for which $T_{\text{PRS}} \cdot \left\lceil \frac{N_{\text{PRS_total}}}{N_{\text{actual_PRS}}} \right\rceil$ is the largest among all the measured cells.

T_{MIB} is the time required for acquiring the MIB information of the target cell. $T_{\text{MIB}} = 0$ if the SFN of at least one cell in OTDOA assistance data is known to the UE.

Table 8.13.3.3.1-1: Number of PRS positioning occasions within $T_{\text{RSTDIntraFreqFDD,Cat}_M}$

Positioning subframe configuration period T_{PRS}	Number of PRS positioning occasions M	
	f1 ^{Note1}	f1 and f2 ^{Note2}
160 ms	$16 \cdot \left\lceil \frac{N_{\text{PRS_Total}}}{N_{\text{actual_PRS}}} \right\rceil$	$32 \cdot \left\lceil \frac{N_{\text{PRS_Total}}}{N_{\text{actual_PRS}}} \right\rceil$
>160 ms	$8 \cdot \left\lceil \frac{N_{\text{PRS_Total}}}{N_{\text{actual_PRS}}} \right\rceil$	$16 \cdot \left\lceil \frac{N_{\text{PRS_Total}}}{N_{\text{actual_PRS}}} \right\rceil$

Note 1: When only intra-frequency RSTD measurements are performed over cells belonging to the serving FDD carrier frequency f1.
Note 2: When intra-frequency RSTD and inter-frequency RSTD measurements are performed over cells belonging to the serving FDD carrier frequency f1 and one inter-frequency carrier frequency f2, respectively.

The UE physical layer shall be capable of reporting RSTD for the reference cell and all the neighbor cells i out of at least $(n-1)$ neighbor cells within $T_{\text{RSTDIntraFreqFDD,Cat}_M}$ provided:

$$\left(\text{PRS } \hat{E}_s / \text{Iot} \right)_{\text{ref}} \geq -15 \text{ dB for all Frequency Bands for the reference cell,}$$

$$\left(\text{PRS } \hat{E}_s / \text{Iot} \right)_i \geq -15 \text{ dB for all Frequency Bands for neighbour cell } i,$$

$$\left(\text{PRS } \hat{E}_s / \text{Iot} \right)_{\text{ref}} \text{ and } \left(\text{PRS } \hat{E}_s / \text{Iot} \right)_i \text{ conditions apply for all subframes of at least } L = \frac{M}{2} \text{ PRS positioning}$$

occasions,

PRP 1,2_{dBm} according to Annex B.2.22 for a corresponding Band

$\text{PRS } \hat{E}_s / \text{Iot}$ is defined as the ratio of the average received energy per PRS RE during the useful part of the symbol to the average received power spectral density of the total noise and interference for this RE, where the ratio is measured over all REs which carry PRS.

The time $T_{\text{RSTDIntraFreqFDD,Cat}_M}$ starts from the first subframe of the PRS positioning occasion closest in time after both the OTDOA-RequestLocationInformation message and the OTDOA assistance data in the OTDOA-ProvideAssistanceData message as specified in TS 36.355 [24], are delivered to the physical layer of the UE as illustrated in Figure 8.13.3.3.1-1.

The RSTD measurement accuracy for all measured neighbor cells i shall be fulfilled according to the accuracy as specified in the sub-clause 9.1.21.21.

If the intra-frequency handover occurs while intra-frequency RSTD measurements are being performed then the UE shall complete the ongoing OTDOA measurement session. The UE shall also meet the intra-frequency OTDOA measurement and accuracy requirements. However in this case the RSTD measurement period ($T_{\text{RSTDIntraFreqFDD,Cat}_M,\text{HO}}$) shall be according to the following expression:

$$T_{\text{RSTDIntraFreqFDD,Cat}_M,\text{HO}} = T_{\text{RSTDIntraFreqFDD,Cat}_M} + K \times T_{\text{PRS}} + T_{\text{HO}} \quad \text{ms},$$

where:

K is the number of times the intra-frequency handover occurs during $T_{\text{RSTDIntraFreqFDD,Cat}_M,\text{HO}}$.

T_{HO} is the time during which the intra-frequency RSTD measurement may not be possible due to intra-frequency handover.

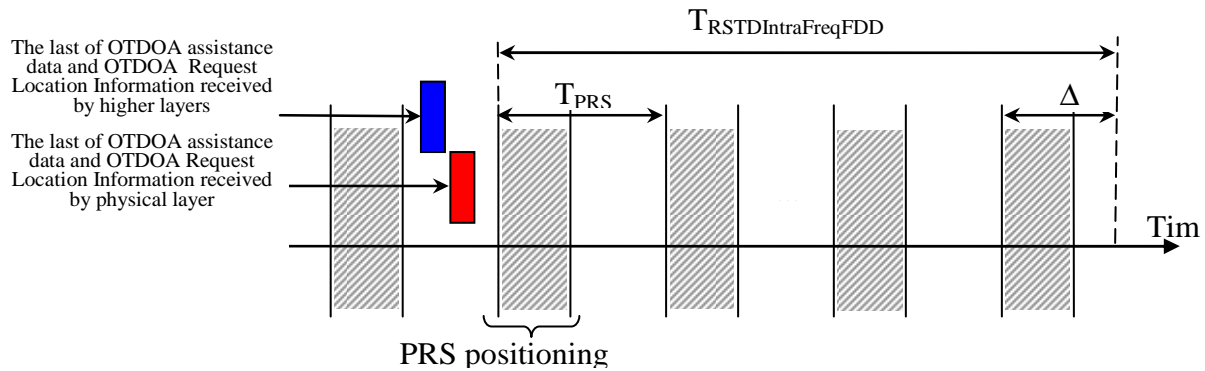

Figure 8.13.3.3.1-1: Illustration of the RSTD reporting time requirement in an FDD system.

Furthermore, due to the intra-frequency handover the UE shall meet the RSTD measurement accuracy for a PRS bandwidth which is not larger than the minimum channel bandwidth of all the PCells during the RSTD measurement period.

8.13.3.3.1.1 RSTD Measurement Reporting Delay

Reported measurement contained in event triggered measurement reports shall meet the requirements in sections 9.1.21.21.

The UE shall not send any measurement reports, as long as no reporting criteria are fulfilled.

The measurement reporting delay is defined as the time between the point when UE receive both the OTDOA-RequestLocationInformation message and the OTDOA assistance data in the OTDOA-ProvideAssistanceData message as specified in TS 36.355 [24], and the point when the UE starts to transmit the measurement report over the air interface. This requirement assumes that the measurement report is not delayed by other RRC signalling on the DCCH. This measurement reporting delay excludes a delay uncertainty resulted when inserting the measurement report to the TTI of the uplink DCCH. The delay uncertainty is: $N_{rep} \times TTI_{DCCH}$, where N_{rep} [21] is the maximum number of PUSCH repetitions configured for the UE, otherwise uncertainty is defined as $2 \times TTI_{DCCH}$. This measurement reporting delay excludes a delay which caused by no UL resources for UE to send the measurement report.

The measurement reporting delay shall be less than $T_{RSTDIntraFreqFDD,Cat_M}$ defined in Clause 8.13.3.3.1.

8.13.3.3.2 E-UTRAN TDD Intra-Frequency OTDOA Measurements

When the physical layer cell identities of neighbour cells together with the OTDOA assistance data are provided, the UE shall be able to detect and measure intra-frequency RSTD, specified in TS 36.214 [4], for at least $n=16$ cells, including the reference cell, on the same carrier frequency f_1 as that of the reference cell within $T_{RSTDIntraFreqIDD,Cat_M}$ ms as given below:

$$T_{RSTDIntraFreqIDD,Cat_M} = T_{PRS} \cdot (M - 1) + \Delta + T_{MIB} ,$$

where

$T_{RSTDIntraFreqIDD,Cat_M}$ is the total time for detecting and measuring at least n cells,

T_{PRS} is the cell-specific positioning subframe configuration period as defined in TS 36.355 [24] for UE not configured with measurement gaps for intra-frequency RSTD. For UE configured with measurement gaps for intra-frequency RSTD measurements, $T_{PRS} = \max(T_{PRS}, MGRP)$, where MGRP is the Measurement Gap Repetition Period as defined in section 8.1.2.1.

M is the number of PRS positioning occasions as defined in Table 8.13.3.3.1-1, where downlink positioning subframes defined in TS 36.211 [16], and

$\Delta = T_{PRS} \cdot \left\lceil \frac{n}{M} \right\rceil$ ms is the measurement time for a single PRS positioning occasion which includes the sampling time and the processing time,

N_{PRS} is the cell-specific number of PRS subframes within a PRS occasion as defined in TS 36.355[24];

N_{actual_PRS} is the number of PRS subframes within a PRS occasion available at the UE; $N_{actual_PRS} = N_{PRS}$ when the measurement gaps are not required for the intra-frequency RSTD measurements; for UE configured with measurement gaps for intra-frequency RSTD measurements N_{actual_PRS} is the number of PRS subframes which can be measured by UE within MGL, where $N_{actual_PRS} = (MGL-2)$ if $MGRP \geq N_{PRS} > (MGL-2)$, $N_{actual_PRS} = (MGL - 2) \cdot \left\lceil \frac{N_{PRS}}{MGRP} \right\rceil$ if $N_{PRS} > MGRP$, and $N_{actual_PRS} = N_{PRS}$ if $N_{PRS} \leq (MGL-2)$.

N_{PRS_total} is the minimum number of PRS subframes per cell measurement as specified in Section 9.1.21.21.

$T_{PRS} N_{PRS}$, N_{actual_PRS} and N_{PRS_total} are the parameters of the same cell, for which $T_{PRS} \cdot \left\lceil \frac{N_{PRS_total}}{N_{actual_PRS}} \right\rceil$ is the largest among all the measured cells.

T_{MIB} is the time required for acquiring the MIB information of the target cell. $T_{MIB} = 0$ if the SFN of at least one cell in OTDOA assistance data is known to the UE.

Table 8.13.3.3.1-1: Number of PRS positioning occasions within $T_{RSTD\ IntraFreq\ IDD, Cat_M}$

Positioning subframe configuration period T_{PRS}	Number of PRS positioning occasions M	
	f1 <small>Note1</small>	f1 and f2 <small>Note2</small>
160 ms	$16 \cdot \left\lceil \frac{N_{PRS_Total}}{N_{actual_PRS}} \right\rceil$	$32 \cdot \left\lceil \frac{N_{PRS_Total}}{N_{actual_PRS}} \right\rceil$
>160 ms	$8 \cdot \left\lceil \frac{N_{PRS_Total}}{N_{actual_PRS}} \right\rceil$	$16 \cdot \left\lceil \frac{N_{PRS_Total}}{N_{actual_PRS}} \right\rceil$
Note 1: When only intra-frequency RSTD measurements are performed over cells belonging to the serving FDD carrier frequency f1. Note 2: When intra-frequency RSTD and inter-frequency RSTD measurements are performed over cells belonging to the serving FDD carrier frequency f1 and one inter-frequency carrier frequency f2, respectively.		

The UE physical layer shall be capable of reporting RSTD for the reference cell and all the neighbor cells i out of at least $(n-1)$ neighbor cells within $T_{RSTD\ IntraFreq\ IDD, Cat_M}$ provided:

$$\left(PRS \hat{E}_s / Iot \right)_{ref} \geq -15 \text{ dB for all Frequency Bands for the reference cell,}$$

$$\left(PRS \hat{E}_s / Iot \right)_i \geq -15 \text{ dB for all Frequency Bands for neighbour cell } i,$$

$\left(PRS \hat{E}_s / Iot \right)_{ref}$ and $\left(PRS \hat{E}_s / Iot \right)_i$ conditions apply for all subframes of at least $L = \frac{M}{2}$ PRS positioning occasions,

PRP 1,2_{dBm} according to Annex B.2.22 for a corresponding Band

$\text{PRS } \hat{E}_s / I_{ot}$ is defined as the ratio of the average received energy per PRS RE during the useful part of the symbol to the average received power spectral density of the total noise and interference for this RE, where the ratio is measured over all REs which carry PRS.

The time $T_{\text{RSTDIntraFreqIDD,Cat_M}}$ starts from the first subframe of the PRS positioning occasion closest in time after both the OTDOA-RequestLocationInformation message and the OTDOA assistance data in the OTDOA-ProvideAssistanceData message as specified in TS 36.355 [24], are delivered to the physical layer of the UE.

The RSTD measurement accuracy for all measured neighbor cells i shall be fulfilled according to the accuracy as specified in the sub-clause 9.1.21.21.

If the intra-frequency handover occurs while intra-frequency RSTD measurements are being performed then the UE shall complete the ongoing OTDOA measurement session. The UE shall also meet the intra-frequency OTDOA measurement and accuracy requirements. However in this case the RSTD measurement period ($T_{\text{RSTDIntraFreqIDD,Cat_M,HO}}$) shall be according to the following expression:

$$T_{\text{RSTDIntraFreqIDD,Cat_M,HO}} = T_{\text{RSTDIntraFreqIDD,Cat_M}} + K \times T_{\text{PRS}} + T_{\text{HO}} \quad \text{ms},$$

where:

K is the number of times the intra-frequency handover occurs during $T_{\text{RSTDIntraFreqIDD,Cat_M,HO}}$,

T_{HO} is the time during which the intra-frequency RSTD measurement may not be possible due to intra-frequency handover.

Furthermore, due to the intra-frequency handover the UE shall meet the RSTD measurement accuracy for a PRS bandwidth which is not larger than the minimum channel bandwidth of all the PCells during the RSTD measurement period.

The intra-frequency requirements in this clause (8.13.3.3.2) shall apply for all TDD special subframe configurations specified in TS 36.211 [16] and for the TDD uplink-downlink configurations as specified in Table 8.13.3.3.2-2.

Table 8.13.3.3.2-2: TDD uplink-downlink subframe configurations applicable for TDD intra-frequency requirements

PRS Transmission Bandwidth [RB]	Applicable TDD uplink-downlink configurations
6	1, 2, 3, 4 and 5
Note: Uplink-downlink configurations are specified in Table 4.2-2 in TS 36.211 [16].	

8.13.3.3.2.1 RSTD Measurement Reporting Delay

Reported measurement contained in event triggered measurement reports shall meet the requirements in sections 9.1.21.21.

The UE shall not send any measurement reports, as long as no reporting criteria are fulfilled.

The measurement reporting delay is defined as the time between the point when UE receive both the OTDOA-RequestLocationInformation message and the OTDOA assistance data in the OTDOA-ProvideAssistanceData message as specified in TS 36.355 [24], and the point when the UE starts to transmit the measurement report over the air interface. This requirement assumes that the measurement report is not delayed by other RRC signalling on the DCCH. This measurement reporting delay excludes a delay uncertainty resulted when inserting the measurement report to the TTI of the uplink DCCH. The delay uncertainty is: $N_{rep} \times TTI_{\text{DCCH}}$, where N_{rep} [21] is the maximum number of PUSCH repetitions configured for the UE, otherwise uncertainty is defined as $2 \times TTI_{\text{DCCH}}$. This measurement reporting delay excludes a delay which caused by no UL resources for UE to send the measurement report.

The measurement reporting delay shall be less than $T_{\text{RSTDIntraFreqIDD,Cat_M}}$ defined in Clause 8.13.3.3.2.

8.13.3.3.3 E-UTRAN HD-FDD Intra-Frequency OTDOA Measurements

The requirements in this section are applicable for the UE which supports half duplex operation on one or more supported frequency bands [2].

The requirements defined in clause 8.13.3.3.1 also apply for this section except the reporting delay requirement provided the following conditions are met:

- all positioning subframes indicated in the OTDOA assistance data and specified in Section 9.1.21.21 are available for RSTD measurements in the measured and reference cells.

8.13.3.3.3.1 RSTD Measurement Reporting Delay

Reported measurement contained in event triggered measurement reports shall meet the requirements in sections 9.1.21.21.

The UE shall not send any measurement reports, as long as no reporting criteria are fulfilled.

The measurement reporting delay is defined as the time between the point when UE receive both the OTDOA-RequestLocationInformation message and the OTDOA assistance data in the OTDOA-ProvideAssistanceData message as specified in TS 36.355 [24], and the point when the UE starts to transmit the measurement report over the air interface. This requirement assumes that the measurement report is not delayed by other RRC signalling on the DCCH. This measurement reporting delay excludes a delay uncertainty resulted when inserting the measurement report to the TTI of the uplink DCCH. The delay uncertainty is: $N_{rep} \times TTI_{DCCH}$, where N_{rep} [21] is the maximum number of PUSCH repetitions configured for the UE, otherwise uncertainty is defined as $2 \times TTI_{DCCH}$. This measurement reporting delay excludes a delay which caused by no UL resources for UE to send the measurement report.

The measurement reporting delay shall be less than measurement period defined in Clause 8.13.3.3.3.

8.13.3.4 E-UTRAN E-CID Measurements Requirements for UE category M1 with CE mode B

8.13.3.4.1 Intra-frequency E-CID FDD RSRP and RSRQ Measurements for Cat-M1 UE in CEModeB

8.13.3.4.1.1 Introduction

The requirements in section 8.13.3.4.1 shall apply provided the UE has received ECID-RequestLocationInformation message from E-SMLC via LPP requesting the UE to report E-CID E-UTRAN FDD intra-frequency RSRP and RSRQ measurements [24].

8.13.3.4.1.2 Measurement Requirements

The requirements in section 8.13.3.1.1 also apply for this section except the measurement reporting requirements. The measurement reporting requirements for E-CID RSRP and RSRQ are defined in section 8.13.3.4.1.3.

8.13.3.4.1.3 Measurement Reporting Delay

This requirement assumes that that the measurement report is not delayed by other LPP signalling on the DCCH. This measurement reporting delay excludes a delay uncertainty resulted when inserting the measurement report to the TTI of the uplink DCCH. The delay uncertainty is: $2 \times TTI_{DCCH}$. The delay uncertainty is: $pusch-maxNumRepetitionCEmodeB \times TTI_{DCCH}$, where $pusch-maxNumRepetitionCEmodeB$ [2] is the maximum number of PUSCH repetitions configured for the UE in CE Mode B provided that $pusch-maxNumRepetitionCEmodeB > 1$, otherwise uncertainty is defined as $2 \times TTI_{DCCH}$. This measurement reporting delay excludes any delay caused by no UL resources for UE to send the measurement report.

Reported RSRP and RSRQ measurements contained in periodically triggered measurement reports shall meet the requirements in section 9.1.21.3, 9.1.21.4 and 9.1.21.7.

8.13.3.4.2 Intra-frequency HD-FDD E-CID RSRP and RSRQ Measurements for Cat-M1 UE in CEModeB

8.13.3.4.2.1 Introduction

The requirements in section 8.13.3.4.2 shall apply provided the UE has received ECID-RequestLocationInformation message from E-SMLC via LPP requesting the UE to report E-CID E-UTRAN HD-FDD intra-frequency RSRP and RSRQ measurements [24].

8.13.3.4.2.2 Measurement Requirements

The requirements in section 8.13.3.4.2 also apply for this section except the measurement reporting requirements. The measurement reporting requirements for E-CID RSRP and RSRQ are defined in section 8.13.3.4.2.3.

8.13.3.4.2.3 Measurement Reporting Delay

This requirement assumes that that the measurement report is not delayed by other LPP signalling on the DCCH. This measurement reporting delay excludes a delay uncertainty resulted when inserting the measurement report to the TTI of the uplink DCCH. The delay uncertainty is: $2 \times TTI_{DCCH}$. The delay uncertainty is: $pusch-maxNumRepetitionCEmodeB \times TTI_{DCCH}$, where $pusch-maxNumRepetitionCEmodeB$ [2] is the maximum number of PUSCH repetitions configured for the UE in CE Mode B provided that $pusch-maxNumRepetitionCEmodeB > 1$, otherwise uncertainty is defined as $2 \times TTI_{DCCH}$. This measurement reporting delay excludes any delay caused by no UL resources for UE to send the measurement report.

Reported RSRP and RSRQ measurements contained in periodically triggered measurement reports shall meet the requirements in section 9.1.21.3, 9.1.21.4 and 9.1.21.7.

8.13.3.4.3 Intra-frequency TDD E-CID RSRP and RSRQ Measurements for Cat-M1 UE in CEModeB

8.13.3.4.3.1 Introduction

The requirements in section 8.13.3.4.3 shall apply provided the UE has received ECID-RequestLocationInformation message from E-SMLC via LPP requesting the UE to report E-CID E-UTRAN TDD intra-frequency RSRP and RSRQ measurements [24].

8.13.3.4.3.2 Measurement Requirements

The requirements in section 8.13.3.4.3 also apply for this section except the measurement reporting requirements. The measurement reporting requirements for E-CID RSRP and RSRQ are defined in section 8.13.3.4.3.3.

8.13.3.4.3.3 Measurement Reporting Delay

This requirement assumes that that the measurement report is not delayed by other LPP signalling on the DCCH. This measurement reporting delay excludes a delay uncertainty resulted when inserting the measurement report to the TTI of the uplink DCCH. The delay uncertainty is: $pusch-maxNumRepetitionCEmodeB \times TTI_{DCCH}$, where $pusch-maxNumRepetitionCEmodeB$ [2] is the maximum number of PUSCH repetitions configured for the UE in CE Mode B provided that $pusch-maxNumRepetitionCEmodeB > 1$, otherwise uncertainty is defined as $2 \times TTI_{DCCH}$. The delay uncertainty is: $2 \times TTI_{DCCH}$. This measurement reporting delay excludes any delay caused by no UL resources for UE to send the measurement report.

Reported RSRP and RSRQ measurements contained in periodically triggered measurement reports shall meet the requirements in section 9.1.21.3, 9.1.21.4 and 9.1.21.7.

8.13.3.4.4 Inter-frequency E-CID FDD RSRP and RSRQ Measurements for Cat-M1 UE in CEModeB

8.13.3.4.4.1 Introduction

The requirements in section 8.13.3.4.4 shall apply provided the UE has received ECID-RequestLocationInformation message from E-SMLC via LPP requesting the UE to report E-CID E-UTRAN FDD inter-frequency RSRP and RSRQ measurements [24].

8.13.3.4.4.2 Measurement Requirements

The requirements in section 8.13.3.5.1 also apply for this section except the measurement reporting requirements. The measurement reporting requirements for E-CID RSRP and RSRQ are defined in section 8.13.3.4.4.3.

8.13.3.4.4.3 Measurement Reporting Delay

This requirement assumes that that the measurement report is not delayed by other LPP signalling on the DCCH. This measurement reporting delay excludes a delay uncertainty resulted when inserting the measurement report to the TTI of the uplink DCCH. The delay uncertainty is: $2 \times TTI_{DCCH}$. The delay uncertainty is: $pusch-maxNumRepetitionCEmodeB \times TTI_{DCCH}$, where *pusch-maxNumRepetitionCEmodeB* [2] is the maximum number of PUSCH repetitions configured for the UE in CE Mode B provided that *pusch-maxNumRepetitionCEmodeB* > 1, otherwise uncertainty is defined as $2 \times TTI_{DCCH}$. This measurement reporting delay excludes any delay caused by no UL resources for UE to send the measurement report.

Reported RSRP and RSRQ measurements contained in periodically triggered measurement reports shall meet the requirements in section 9.1.21.11, 9.1.21.12, 9.1.21.15 and 9.1.21.16.

8.13.3.4.5 Inter-frequency HD-FDD E-CID RSRP and RSRQ Measurements for Cat-M1 UE in CEModeB

8.13.3.4.5.1 Introduction

The requirements in section 8.13.3.4.5 shall apply provided the UE has received ECID-RequestLocationInformation message from E-SMLC via LPP requesting the UE to report E-CID E-UTRAN HD-FDD inter-frequency RSRP and RSRQ measurements [24].

8.13.3.4.5.2 Measurement Requirements

The requirements in section 8.13.3.5.2 also apply for this section except the measurement reporting requirements. The measurement reporting requirements for E-CID RSRP and RSRQ are defined in section 8.13.3.4.5.3.

8.13.3.4.5.3 Measurement Reporting Delay

This requirement assumes that that the measurement report is not delayed by other LPP signalling on the DCCH. This measurement reporting delay excludes a delay uncertainty resulted when inserting the measurement report to the TTI of the uplink DCCH. The delay uncertainty is: $2 \times TTI_{DCCH}$. The delay uncertainty is: $pusch-maxNumRepetitionCEmodeB \times TTI_{DCCH}$, where *pusch-maxNumRepetitionCEmodeB* [2] is the maximum number of PUSCH repetitions configured for the UE in CE Mode B provided that *pusch-maxNumRepetitionCEmodeB* > 1, otherwise uncertainty is defined as $2 \times TTI_{DCCH}$. This measurement reporting delay excludes any delay caused by no UL resources for UE to send the measurement report.

Reported RSRP and RSRQ measurements contained in periodically triggered measurement reports shall meet the requirements in section 9.1.21.11, 9.1.21.12, 9.1.21.15 and 9.1.21.16.

8.13.3.4.6 Inter-frequency TDD E-CID RSRP and RSRQ Measurements for Cat-M1 UE in CEModeB

8.13.3.4.6.1 Introduction

The requirements in section 8.13.3.4.6 shall apply provided the UE has received ECID-RequestLocationInformation message from E-SMLC via LPP requesting the UE to report E-CID E-UTRAN TDD inter-frequency RSRP and RSRQ measurements [24].

8.13.3.4.6.2 Measurement Requirements

The requirements in section 8.13.3.5.3 also apply for this section except the measurement reporting requirements. The measurement reporting requirements for E-CID RSRP and RSRQ are defined in section 8.13.3.4.6.3.

8.13.3.4.6.3 Measurement Reporting Delay

This requirement assumes that that the measurement report is not delayed by other LPP signalling on the DCCH. This measurement reporting delay excludes a delay uncertainty resulted when inserting the measurement report to the TTI of the uplink DCCH. The delay uncertainty is: $pusch-maxNumRepetitionCEmodeB \times TTI_{DCCH}$, where *pusch-maxNumRepetitionCEmodeB* [2] is the maximum number of PUSCH repetitions configured for the UE in CE Mode B

provided that $pusch-maxNumRepetitionCEmodeB > 1$, otherwise uncertainty is defined as $2 \times TTI_{DCCH}$. The delay uncertainty is: $2 \times TTI_{DCCH}$. This measurement reporting delay excludes any delay caused by no UL resources for UE to send the measurement report.

Reported RSRP and RSRQ measurements contained in periodically triggered measurement reports shall meet the requirements in section 9.1.21.11, 9.1.21.12, 9.1.21.15 and 9.1.21.16.

8.13.3.5 E-UTRAN inter frequency measurements by UE category M1 with CE Mode B

The UE shall be able to identify new inter-frequency cells and perform RSRP and RSRQ measurements of identified inter-frequency cells if carrier frequency information is provided by the PCell, even if no explicit neighbour list with physical layer cell identities is provided. During the RRC_CONNECTED state the UE shall continuously measure identified inter frequency cells and additionally search for and identify new inter frequency cells.

8.13.3.5.1 E-UTRAN FDD - FDD inter frequency measurements

8.13.3.5.1.1 E-UTRAN FDD - FDD inter frequency measurements when no DRX is used

When no DRX is in use and when measurement gaps are scheduled, or the UE supports capability of conducting such measurements without gaps, the UE shall be able to identify and measure a new detectable FDD inter-frequency cell according to requirements in Table 8.13.3.5.1.1-1 when additional condition in Table 8.13.3.5.1.1-1 is met, and

- $G=1$, or
- $r_{max} * G < 800\text{ms}$, or
- UE is receiving PDSCH.

Otherwise, requirements in Table 8.13.3.5.1.1-3 apply, where r_{max} and G are given by higher layer parameter $mPDCCH-NumRepetition$ and $mPDCCH-startSF-UeSS$ respectively as defined in TS 36.213 [3].

Table 8.13.3.5.1.1-1: Requirement on cell identification delay and measurement delay for FDD interfrequency cell

Neighbouring cell SCH Es/lot: Q2 [dB]	Gap pattern ID	Cell identification delay ($T_{\text{Identify_intra_UE cat M1}}$)	Measurement delay ($T_{\text{measure_intra_UE cat M1}}$)
$-15 \leq Q2 < -6$	0	$320.8 * K_{\text{inter_M1_EC}} * K_{\text{RSTD_M1_EC}} \text{ s}$	$800 * K_{\text{inter_M1_EC}} * K_{\text{RSTD_M1_EC}} \text{ ms}$
	1	$321.6 * K_{\text{inter_M1}} \text{ s}$	$1600 * K_{\text{inter_M1}} \text{ ms}$
$Q2 \geq -6$	0	$21.8 * K_{\text{inter_M1_EC}} * K_{\text{RSTD_M1_EC}} \text{ s}$	$800 * K_{\text{inter_M1_EC}} * K_{\text{RSTD_M1_EC}} \text{ ms}$
	1	$22.6 * K_{\text{inter_M1_EC}} \text{ s}$	$1600 * K_{\text{inter_M1_EC}} \text{ ms}$

$$K_{\text{inter_M1_EC}} = \frac{N_{\text{freq}} * 100}{(100 - X)}$$

where X is signalled by the RRC parameter $measGapSharingScheme$ [2] and is defined as in Table 8.13.3.5.1.1-2.

N_{freq} is total number of inter-frequency layers to be monitored as defined in 8.1.2.1.1.

Table 8.13.3.5.1.1-2: Value of parameter X for CEModeB

$measGapSharingScheme$	Value of X (%)
'00'	$\frac{100}{N_{\text{freq}} + 1}$
'01'	50
'10'	75
'11'	87.5

Table 8.13.3.5.1.1-3: Requirement on cell identification delay and measurement delay for FDD interfrequency cell

Neighbouring cell SCH Ês/lot: Q2 [dB]	Gap pattern ID	Cell identification delay ($T_{\text{identify_inter_UE cat M1}}$)	Measurement delay ($T_{\text{measure_inter_UE cat M1}}$)
$-15 \leq Q2 < -6$	0	$\text{Max}(400 * r_{\text{max}} * G / 1000, 320.8) * K_{\text{inter_M1_EC}} * K_{\text{RSTD_M1_EC S}}$	$\text{Max}(5 * r_{\text{max}} * G, 800) * K_{\text{inter_M1_EC}} * K_{\text{RSTD_M1_EC ms}}$
	1	$\text{Max}(400 * r_{\text{max}} * G / 1000, 321.6) * K_{\text{inter_M1_EC}} * K_{\text{RSTD_M1_EC S}}$	$\text{Max}(5 * r_{\text{max}} * G, 1600) * K_{\text{inter_M1_EC}} * K_{\text{RSTD_M1_EC ms}}$
$Q2 \geq -6$	0	$\text{Max}(20 * r_{\text{max}} * G / 1000, 21.8) * K_{\text{inter_M1_EC}} * K_{\text{RSTD_M1_EC S}}$	$\text{Max}(5 * r_{\text{max}} * G, 800) * K_{\text{inter_M1_EC}} * K_{\text{RSTD_M1_EC ms}}$
	1	$\text{Max}(20 * r_{\text{max}} * G / 1000, 22.6) * K_{\text{inter_M1_EC}} * K_{\text{RSTD_M1_EC S}}$	$\text{Max}(5 * r_{\text{max}} * G, 1600) * K_{\text{inter_M1_EC}} * K_{\text{RSTD_M1_EC ms}}$

$$K_{\text{RSTD_M1_EC}} = \frac{1}{1 - \max\left(\frac{40}{T_{\text{PRS}}}, \frac{N_{\text{PRS}}}{T_{\text{PRS}}}\right)}$$

$K_{\text{RSTD_M1_NC}}$ is applicable provided following conditions are met:

- $T_{\text{PRS}} > 40$ ms
- $T_{\text{PRS}} > N_{\text{PRS}}$

where

- T_{PRS} is the cell-specific positioning subframe configuration period as defined in TS 36.211 [16],
- N_{PRS} is the number of consecutive downlink positioning subframes in a positioning occasion defined in TS 36.211

Otherwise $K_{\text{RSTD_M1_EC}} = 1$.

A cell shall be considered detectable when

- RSRP related side conditions given in Sections 9.1.21.11 and 9.1.21.12 are fulfilled for a corresponding Band,
- RSRQ related side conditions given in Clause 9.1.21.15 and 9.1.21.16 are fulfilled for a corresponding Band,
- SCH_{RP} and SCH Ês/lot according to Annex Table B.2.18-1 for a corresponding Band.

Identification of a cell shall include detection of the cell and additionally performing a single measurement with measurement period of $T_{\text{measure_inter_UE cat M1_EC}}$. If higher layer filtering is used, an additional cell identification delay can be expected.

In the RRC_CONNECTED state the measurement period for inter frequency measurements is according to Table 8.13.3.5.1.1-1. When measurement gaps are scheduled for FDD inter frequency measurements, or the UE supports capability of conducting such measurements without gaps, the UE physical layer shall be capable of reporting RSRP and RSRQ measurements to higher layers with measurement accuracy as specified in sub-clauses 9.1.21.11, 9.1.21.12, 9.1.21.15 and 9.1.21.16.

The UE shall be capable of performing RSRP and RSRQ measurements of at least 4 inter-frequency cells per FDD inter-frequency for up to 3 FDD inter-frequencies and the UE physical layer shall be capable of reporting RSRP and RSRQ measurements to higher layers with the measurement period defined in Table 8.13.3.5.1.1-1.

8.13.3.5.1.1.1 Measurement Reporting Requirements

8.13.3.5.1.1.1.1 Periodic Reporting

Reported RSRP and RSRQ measurement contained in periodically triggered measurement reports shall meet the requirements in sections 9.1.21.11, 9.1.21.12, 9.1.21.15 and 9.1.21.16.

8.13.3.5.1.1.1.2 Event-triggered Periodic Reporting

Reported RSRP and RSRQ measurement contained in event triggered periodic measurement reports shall meet the requirements in sections 9.1.21.11, 9.1.21.12, 9.1.21.15 and 9.1.21.16.

The first report in event triggered periodic measurement reporting shall meet the requirements specified in clause 8.13.3.5.1.1.1.3.

8.13.3.5.1.1.1.3 Event Triggered Reporting

Reported RSRP and RSRQ measurement contained in event triggered measurement reports shall meet the requirements in sections 9.1.21.11, 9.1.21.12, 9.1.21.15 and 9.1.21.16.

The UE shall not send any event triggered measurement reports, as long as no reporting criteria are fulfilled.

The measurement reporting delay is defined as the time between an event that will trigger a measurement report and the point when the UE starts to transmit the measurement report over the air interface. This requirement assumes that the measurement report is not delayed by other RRC signalling on the DCCH. This measurement reporting delay excludes a delay uncertainty resulted when inserting the measurement report to the TTI of the uplink DCCH. The delay uncertainty is: $pusch-maxNumRepetitionCEmodeB \times TTI_{DCCH}$, where $pusch-maxNumRepetitionCEmodeB$ [2] is the maximum number of PUSCH repetitions configured for the UE in CE Mode B provided that $pusch-maxNumRepetitionCEmodeB > 1$, otherwise uncertainty is defined as $2 \times TTI_{DCCH}$. This measurement reporting delay excludes a delay which caused by no UL resources for UE to send the measurement report.

The event triggered measurement reporting delay, measured without L3 filtering shall be less than $T_{identify_inter_UE\ cat\ M1_EC}$ defined in Clause 8.13.3.5.1.1. When L3 filtering is used or IDC autonomous denial is configured an additional delay can be expected.

If a cell which has been detectable at least for the time period $T_{identify_inter_UE\ cat\ M1_EC}$ defined in clause 8.13.3.5.1.1 becomes undetectable for a period ≤ 5 seconds and then the cell becomes detectable again and triggers an event, the event triggered measurement reporting delay shall be less than $T_{Measurement_Period_UE\ cat\ M1_EC, Inter}$ provided the timing to that cell has not changed more than $\pm 50 T_s$ and the L3 filter has not been used. When L3 filtering is used or IDC autonomous denial is configured, an additional delay can be expected.

8.13.3.5.1.2 E-UTRAN inter frequency measurements when DRX is used

When DRX is in use and when measurement gaps are scheduled, or the UE supports capability of conducting such measurements without gaps, the UE shall be able to identify a new detectable FDD inter-frequency cell within $T_{identify_inter_UE\ cat\ M1_EC}$ as shown in table 8.13.3.5.1.2-1.

When eDRX_CONN is in use and when measurement gaps are scheduled, or the UE supports capability of conducting such measurements without gaps, the UE shall be able to identify a new detectable FDD inter-frequency cell within $T_{identify_inter_UE\ cat\ M1_EC}$ as shown in table 8.13.3.5.1.2-1.

Table 8.13.3.5.1.2-1: Requirement to identify a newly detectable FDD interfrequency cell

Neighbouring cell SCH \bar{E} s/lot: Q2 [dB]	Gap pattern ID	DRX cycle length (s)	$T_{identify_intra_UE\ cat\ M1}$ (s) (DRX cycles)
$-15 \leq Q2 < -6$	0	≤ 0.64	$320.8 * K_{inter_M1} * K_{RSTD_M1_EC}$ (Note1)
		$0.64 < DRX-cycle \leq 2.56$	Note2($400 * K_{inter_M1} * K_{RSTD_M1_EC}$)
	1	$DRX-cycle \leq 0.640$	$321.6 * K_{inter_M1} * K_{RSTD_M1_EC}$ (Note1)
		$0.64 < DRX-cycle \leq 2.56$	Note2($400 * K_{inter_M1} * K_{RSTD_M1_EC}$)
$Q2 \geq -6$	0	≤ 0.64	$21.8 * K_{inter_M1} * K_{RSTD_M1_EC}$ (Note1)
		$0.64 < DRX-cycle \leq 2.56$	Note2($24 * K_{inter_M1} * K_{RSTD_M1_EC}$)
	1	$DRX-cycle \leq 0.640$	$22.6 * K_{inter_M1} * K_{RSTD_M1_EC}$ (Note1)
		$0.64 < DRX-cycle \leq 2.56$	Note2($24 * K_{inter_M1} * K_{RSTD_M1_EC}$)
Note1: Number of DRX cycle depends upon the DRX cycle in use			
Note2: Time depends upon the DRX cycle in use			

Table 8.13.3.5.1.2-1B: Requirement to identify a newly detectable FDD interfrequency cell when eDRX_CONN is used

eDRX_CONN cycle length (s)	T _{identify_inter_UE cat M1_EC} (s) (eDRX_CONN cycles)
2.56 < eDRX_CONN cycle ≤ 10.24	Note (400 * K _{inter_M1} * K _{RSTD_M1_EC})
Note:	Time depends upon the eDRX_CONN cycle in use

A cell shall be considered detectable when

- RSRP related side conditions given in Sections 9.1.21.11 and 9.1.21.12 are fulfilled for a corresponding Band,
- RSRQ related side conditions given in Clause 9.1.21.15 and 9.1.21.16 are fulfilled for a corresponding Band,
- SCH_{RP} and SCH_{ES}/lot according to Annex B.2.18-1 for a corresponding Band

When DRX or eDRX_CONN is in use, the UE shall be capable of performing RSRP and RSRQ measurements of at least 4 inter-frequency cells per FDD inter-frequency and the UE physical layer shall be capable of reporting RSRP and RSRQ to higher layers with the measurement period T_{measure_inter_UE cat M1_EC}, either measurement gaps are scheduled or the UE supports capability of conducting such measurements without gaps. When DRX is used, T_{measure_inter_UE cat M1_EC} is as defined in Table 8.13.3.5.1.2-2, and when eDRX_CONN is in use, T_{measure_inter_UE cat M1_EC} is as defined in Table 8.13.3.5.1.2-2.

Table 8.13.3.5.1.2-2: Requirement to measure FDD interfrequency cells

Target cell SCH _{ES} /lot: Q2 [dB]	Gap pattern ID	DRX cycle length (s)	T _{measure_intra_UE cat M1} (s) (DRX cycles)
Q2 ≥ -15	0	≤ 0.16	0.8 * K _{inter_M1} * K _{RSTD_M1_EC} (Note1)
		0.16 < DRX-cycle ≤ 2.56	Note2(5 * K _{inter_M1} * K _{RSTD_M1_EC})
	1	≤ 0.32	1.6 * K _{inter_M1} * K _{RSTD_M1_EC} (Note1)
		0.32 < DRX-cycle ≤ 2.56	Note2(5 * K _{inter_M1} * K _{RSTD_M1_EC})
Note 1:	Number of DRX cycle depends upon the DRX cycle in use		
Note 2:	Time depends upon the DRX cycle in use		

Table 8.13.3.5.1.2-3: Requirement to measure FDD interfrequency cells when eDRX_CONN cycle is used

eDRX_CONN cycle length (s)	T _{measure_inter_UE cat M1_EC} (s) (eDRX_CONN cycles)
2.56 < eDRX_CONN cycle ≤ 10.24	Note (5 * K _{inter_M1} * K _{RSTD_M1_EC})
Note:	Time depends upon the eDRX_CONN cycle in use

The RSRP measurement accuracy for all measured cells shall be as specified in the sub-clauses 9.1.21.11 and 9.1.21.12.

The RSRQ measurement accuracy for all measured cells shall be as specified in the sub-clauses 9.1.21.15 and 9.1.21.16.

The requirements in this subclause apply regardless of MPDCCH monitoring configuration.

8.13.3.5.1.2.1 Measurement Reporting Requirements

8.13.3.5.1.2.1.1 Periodic Reporting

Reported RSRP and RSRQ measurement contained in periodically triggered measurement reports shall meet the requirements in sections 9.1.21.11, 9.1.21.12, 9.1.21.15 and 9.1.21.16.

8.13.3.5.1.2.1.2 Event-triggered Periodic Reporting

Reported RSRP and RSRQ measurement contained in event triggered periodic measurement reports shall meet the requirements in sections 9.1.21.11, 9.1.21.12, 9.1.21.15 and 9.1.21.16.

The first report in event triggered periodic measurement reporting shall meet the requirements specified in clause 8.13.3.5.1.2.1.3.

8.13.3.5.1.2.1.3 Event Triggered Reporting

Reported RSRP and RSRQ measurement contained in event triggered measurement reports shall meet the requirements in sections 9.1.21.11, 9.1.21.12, 9.1.21.15 and 9.1.21.16.

The UE shall not send any event triggered measurement reports, as long as no reporting criteria are fulfilled.

The measurement reporting delay is defined as the time between an event that will trigger a measurement report and the point when the UE starts to transmit the measurement report over the air interface. This requirement assumes that the measurement report is not delayed by other RRC signalling on the DCCH. This measurement reporting delay excludes a delay uncertainty resulted when inserting the measurement report to the TTI of the uplink DCCH. The delay uncertainty is: $pusch-maxNumRepetitionCEmodeB \times TTI_{DCCH}$, where $pusch-maxNumRepetitionCEmodeB$ [2] is the maximum number of PUSCH repetitions configured for the UE in CE Mode B provided that $pusch-maxNumRepetitionCEmodeB > 1$, otherwise uncertainty is defined as $2 \times TTI_{DCCH}$. This measurement reporting delay excludes a delay which caused by no UL resources for UE to send the measurement report.

The event triggered measurement reporting delay, measured without L3 filtering shall be less than $T_{identify_inter_UE\ cat\ M1_EC}$ defined in Clause 8.13.3.5.1.2 When L3 filtering is used or IDC autonomous denial is configured an additional delay can be expected.

If a cell which has been detectable at least for the time period $T_{identify_inter_UE\ cat\ M1_EC}$ defined in clause 8.13.3.5.1.2 becomes undetectable for a period ≤ 5 seconds and then the cell becomes detectable again and triggers an event, the event triggered measurement reporting delay shall be less than $T_{measure_inter_UE\ cat\ M1_EC}$ provided the timing to that cell has not changed more than $\pm 50 T_s$ and the L3 filter has not been used. When L3 filtering is used or IDC autonomous denial is configured, an additional delay can be expected.

8.13.3.5.2 E-UTRAN inter-frequency measurements for HD-FDD

8.13.3.5.2.1 E-UTRAN inter-frequency measurements when no DRX is used

The requirements in this section are applicable for the UE which supports half duplex operation on one or more supported frequency bands [2].

The requirements defined in clause 8.13.3.5.1.1 also apply for this section provided the following conditions are met:

- RSRP related side conditions given in Sections 9.1.21.11 and 9.1.21.12 are fulfilled for a corresponding Band,
- RSRQ related side conditions given in Clause 9.1.21.15 and 9.1.21.16 are fulfilled for a corresponding Band,
- SCH_RP and $SCH\ \hat{E}s/lot$ according to Annex Table B.2.18-2 for a corresponding Band

8.13.3.5.2.2 E-UTRAN inter frequency measurements when DRX is used

The requirements in this section are applicable for the UE which supports half duplex operation on one or more supported frequency bands [2].

When DRX is in use and when measurement gaps are scheduled, or the UE supports capability of conducting such measurements without gaps, the UE shall be able to identify a new detectable FDD inter-frequency cell within $T_{identify_inter_UE\ cat\ M1_EC}$ as shown in table 8.13.3.5.2.2-1.

When eDRX_CONN is in use and when measurement gaps are scheduled, or the UE supports capability of conducting such measurements without gaps, the UE shall be able to identify a new detectable FDD inter-frequency cell within $T_{identify_inter_UE\ cat\ M1_EC}$ as shown in table 8.13.3.5.2.2-1.

Table 8.13.3.5.2.2-1: Requirement to identify a newly detectable HD-FDD interfrequency cell

Neighbouring cell $SCH\ \hat{E}s/lot$: Q2 [dB]	Gap pattern ID	DRX cycle length (s)	$T_{identify_intra_UE\ cat\ M1}$ (s) (DRX cycles)
-15 ≤ Q2 < -6	0	≤ 0.64	$320.8 * K_{inter_M1} * K_{RSTD_M1_EC}$ (Note1)
		0.64 < DRX-cycle ≤ 2.56	Note2(400 * $K_{inter_M1} * K_{RSTD_M1_EC}$)
	1	DRX-cycle ≤ 0.640	$321.6 * K_{inter_M1} * K_{RSTD_M1_EC}$ (Note1)
		0.64 < DRX-cycle ≤ 2.56	Note2(400 * $K_{inter_M1} * K_{RSTD_M1_EC}$)

Q2>=6	0	≤0.64	21.8 * K _{inter_M1} * K _{RSTD_M1_EC} (Note1)
		0.64 < DRX-cycle ≤ 2.56	Note2(24 * K _{inter_M1} * K _{RSTD_M1_EC})
	1	DRX-cycle ≤ 0.640	22.6 * K _{inter_M1} * K _{RSTD_M1_EC} (Note1)
		0.64 < DRX-cycle ≤ 2.56	Note2(24 * K _{inter_M1} * K _{RSTD_M1_EC})
Note 1: Number of DRX cycle depends upon the DRX cycle in use			
Note 2: Time depends upon the DRX cycle in use			

Table 8.13.3.5.2-1B: Requirement to identify a newly detectable HD-FDD interfrequency cell when eDRX_CONN cycle is used

eDRX_CONN cycle length (s)	T _{identify_inter_UE cat M1_EC} (s) (eDRX_CONN cycles)
2.56 < eDRX_CONN cycle ≤ 10.24	Note (400 * K _{inter_M1} * K _{RSTD_M1_EC})
Note: Time depends upon the eDRX_CONN cycle in use	

A cell shall be considered detectable when

- RSRP related side conditions given in Sections 9.1.21.11 and 9.1.21.12 are fulfilled for a corresponding Band,
- RSRQ related side conditions given in Clause 9.1.21.15 and 9.1.21.16 are fulfilled for a corresponding Band,
- SCH_{RP} and SCH_{Es/lot} according to Annex Table B.2.18-2 for a corresponding Band

When DRX or eDRX_CONN is in use, the UE shall be capable of performing RSRP and RSRQ measurements of at least 4 inter-frequency cells per FDD inter-frequency and the UE physical layer shall be capable of reporting RSRP and RSRQ to higher layers with the measurement period T_{measure_inter_UE cat M1_EC}, either measurement gaps are scheduled or the UE supports capability of conducting such measurements without gaps. When DRX is used, T_{measure_inter_UE cat M1_EC} is as defined in Table 8.13.3.5.2.2-2, and when eDRX_CONN is in use, T_{measure_inter_UE cat M1_EC} is as defined in Table 8.13.3.5.2.2-2.

Table 8.13.3.5.2.2-2: Requirement to measure HD-FDD interfrequency cells

Neighbouring cell SCH _{Es/lot} : Q2 [dB]	Gap pattern ID	DRX cycle length (s)	T _{measure_intra_UE cat M1} (s) (DRX cycles)
Q2>=15	0	<0.128	0.8 * K _{inter_M1} * K _{RSTD_M1_EC} (Note1)
		0.128 ≤ DRX-cycle ≤ 0.16	Note2 (7 * K _{inter_M1} * K _{RSTD_M1_EC})
		0.16 < DRX-cycle ≤ 2.56	Note2(5 * K _{inter_M1} * K _{RSTD_M1_EC})
	1	≤0.32	1.6 * K _{inter_M1} * K _{RSTD_M1_EC} (Note1)
		0.32 < DRX-cycle ≤ 2.56	Note2(5 * K _{inter_M1} * K _{RSTD_M1_EC})
Note 1: Number of DRX cycle depends upon the DRX cycle in use			
Note 2: Time depends upon the DRX cycle in use			

Table 8.13.3.5.2.2-3: Requirement to measure HD-FDD interfrequency cells when eDRX_CONN cycle is used

eDRX_CONN cycle length (s)	T _{measure_inter_UE cat M1_EC} (s) (eDRX_CONN cycles)
2.56 < eDRX_CONN cycle ≤ 10.24	Note (5 * K _{inter_M1} * K _{RSTD_M1_EC})
Note: Time depends upon the eDRX_CONN cycle in use	

The RSRP measurement accuracy for all measured cells shall be as specified in the sub-clauses 9.1.21.11 and 9.1.21.12.

The RSRQ measurement accuracy for all measured cells shall be as specified in the sub-clauses 9.1.21.15 and 9.1.21.16.

The requirements in this subclause apply regardless of MPDCCH monitoring configuration.

8.13.3.5.2.2.1 Measurement Reporting Requirements

8.13.3.5.2.2.1.1 Periodic Reporting

Reported RSRP and RSRQ measurement contained in periodically triggered measurement reports shall meet the requirements in sections 9.1.21.11, 9.1.21.12, 9.1.21.15 and 9.1.21.16.

8.13.3.5.2.2.1.2 Event-triggered Periodic Reporting

Reported RSRP and RSRQ measurement contained in event triggered periodic measurement reports shall meet the requirements in sections 9.1.21.11, 9.1.21.12, 9.1.21.15 and 9.1.21.16.

The first report in event triggered periodic measurement reporting shall meet the requirements specified in clause 8.13.3.5.2.2.1.3.

8.13.3.5.2.2.1.3 Event Triggered Reporting

Reported RSRP and RSRQ measurement contained in event triggered measurement reports shall meet the requirements in sections 9.1.21.11, 9.1.21.12, 9.1.21.15 and 9.1.21.16.

The UE shall not send any event triggered measurement reports, as long as no reporting criteria are fulfilled.

The measurement reporting delay is defined as the time between an event that will trigger a measurement report and the point when the UE starts to transmit the measurement report over the air interface. This requirement assumes that the measurement report is not delayed by other RRC signalling on the DCCH. This measurement reporting delay excludes a delay uncertainty resulted when inserting the measurement report to the TTI of the uplink DCCH. The delay uncertainty is: $pusch-maxNumRepetitionCEmodeB \times TTI_{DCCH}$, where $pusch-maxNumRepetitionCEmodeB$ [2] is the maximum number of PUSCH repetitions configured for the UE in CE Mode B provided that $pusch-maxNumRepetitionCEmodeB > 1$, otherwise uncertainty is defined as $2 \times TTI_{DCCH}$. This measurement reporting delay excludes a delay which caused by no UL resources for UE to send the measurement report.

The event triggered measurement reporting delay, measured without L3 filtering shall be less than $T_{identify_inter_UE\ cat\ M1_EC}$ defined in Clause 8.13.3.5.2.2 When L3 filtering is used or IDC autonomous denial is configured an additional delay can be expected.

If a cell which has been detectable at least for the time period $T_{identify_inter_UE\ cat\ M1_EC}$ defined in clause 8.13.3.5.2.2 becomes undetectable for a period ≤ 5 seconds and then the cell becomes detectable again and triggers an event, the event triggered measurement reporting delay shall be less than $T_{measure_inter_UE\ cat\ M1_EC}$ provided the timing to that cell has not changed more than $\pm 50 T_s$ and the L3 filter has not been used. When L3 filtering is used or IDC autonomous denial is configured, an additional delay can be expected.

8.13.3.5.3 E-UTRAN TDD inter frequency measurements

8.13.3.5.3.1 E-UTRAN inter frequency measurements when no DRX is used

When no DRX is in use and when measurement gaps are scheduled, or the UE supports capability of conducting such measurements without gaps, the UE shall be able to identify and measure a new detectable TDD inter frequency cell according to requirements in Table 8.13.3.5.3.1-1 when additional condition in Table 8.13.3.5.3.1-1 is met, and

- $G=1$, or
- $r_{max} * G < 800ms$, or
- UE is receiving PDSCH.

Otherwise, requirements in Table 8.13.3.5.3.1-3 apply, where r_{max} and G are given by higher layer parameter $mPDCCH-NumRepetition$ and $mPDCCH-startSF-U ESS$ respectively as defined in TS 36.213 [3].

Table 8.13.3.5.3.1-1: Requirement on cell identification delay and measurement delay for TDD interfrequency cell

Neighbouring cell SCH Es/lot: Q2 [dB]	Gap pattern ID	Cell identification delay ($T_{identify_intra_UE\ cat\ M1}$) for neighbouring cell SCH Es/lot (Q): $-15 \leq Q2 < -6$ [dB]	Measurement delay ($T_{measure_intra_UE\ cat\ M1}$)
---------------------------------------	----------------	--	---

-15 ≤ Q2 < -6	0	320.8 * K _{inter_M1_EC} * KRSTD_M1_EC S	800 * K _{inter_M1_EC} * KRSTD_M1_EC ms ^{Note1} 1600 * K _{inter_M1_EC} * KRSTD_M1_EC ms ^{Note2}
	1	321.6 * K _{inter_M1_EC} S	1600 * K _{inter_M1_EC} ms ^{Note1} 3200 * K _{inter_M1_EC} ms ^{Note2}
Q2 ≥ -6	0	21.8 * K _{inter_M1_EC} * KRSTD_M1_EC S	800 * K _{inter_M1_EC} * KRSTD_M1_EC ms ^{Note1} 1600 * K _{inter_M1_EC} * KRSTD_M1_EC ms ^{Note2}
	1	22.6 * K _{inter_M1_EC} S	1600 * K _{inter_M1_EC} ms ^{Note1} 3200 * K _{inter_M1_EC} ms ^{Note2}
Note 1: Under TDD UL/DL configuration other than 0. Note 2: Under TDD UL/DL configuration 0.			

$$K_{inter_M1_EC} = \frac{N_{freq} * 100}{(100 - X)}$$

where X is signalled by the RRC parameter *measGapSharingScheme* and is defined as in Table 8.13.3.5.3.1-2. N_{freq} is total number of inter-frequency layers to be monitored as defined in 8.1.2.1.1.

Table 8.13.3.5.3.1-2: Value of parameter X for CEModeB

<i>measGapSharingScheme</i>	Value of X (%)
'00'	$\frac{100}{N_{freq} + 1}$
'01'	50
'10'	75
'11'	87.5

Table 8.13.3.5.3.1-3: Requirement on cell identification delay and measurement delay for TDD interfrequency cell

Neighbouring cell SCH Es/lot: Q2 [dB]	Gap pattern ID	Cell identification delay (T _{identify_inter_UE cat M1})	Measurement delay (T _{measure_inter_UE cat M1})
-15 ≤ Q2 < -6	0	Max(400 * r _{max} * G / 1000, 320.8) * K _{inter_M1_EC} * KRSTD_M1_EC S	Max(5 * r _{max} * G, 800) * K _{inter_M1_EC} * KRSTD_M1_EC ms ^{Note1} Max(5 * r _{max} * G, 1600) * K _{inter_M1_EC} * KRSTD_M1_EC ms ^{Note2}
	1	Max(400 * r _{max} * G / 1000, 321.6) * K _{inter_M1_EC} * KRSTD_M1_EC S	Max(5 * r _{max} * G, 1600) * K _{inter_M1_EC} * KRSTD_M1_EC ms ^{Note1} Max(5 * r _{max} * G, 3200) * K _{inter_M1_EC} * KRSTD_M1_EC ms ^{Note2}
Q2 ≥ -6	0	Max(20 * r _{max} * G / 1000, 21.8) * K _{inter_M1_EC} * KRSTD_M1_EC S	Max(5 * r _{max} * G, 800) * K _{inter_M1_EC} * KRSTD_M1_EC ms ^{Note1} Max(5 * r _{max} * G, 1600) * K _{inter_M1_EC} * KRSTD_M1_EC ms ^{Note2}
	1	Max(20 * r _{max} * G / 1000, 22.6) * K _{inter_M1_EC} * KRSTD_M1_EC S	Max(5 * r _{max} * G, 1600) * K _{inter_M1_EC} * KRSTD_M1_EC ms ^{Note1} Max(5 * r _{max} * G, 3200) * K _{inter_M1_EC} * KRSTD_M1_EC ms ^{Note2}
Note1: Under TDD UL/DL configuration other than 0. Note2: Under TDD UL/DL configuration 0.			

$$K_{\text{RSTD_M1_EC}} = \frac{1}{1 - \max\left(\frac{40}{T_{\text{PRS}}}, \frac{N_{\text{PRS}}}{T_{\text{PRS}}}\right)}$$

$K_{\text{RSTD_M1_NC}}$ is applicable provided following conditions are met:

- $T_{\text{PRS}} > 40$ ms
- $T_{\text{PRS}} > N_{\text{PRS}}$

where

- T_{PRS} is the cell-specific positioning subframe configuration period as defined in TS 36.211 [16],
- N_{PRS} is the number of consecutive downlink positioning subframes in a positioning occasion defined in TS 36.211

Otherwise $K_{\text{RSTD_M1_EC}} = 1$.

A cell shall be considered detectable when

- RSRP related side conditions given in Sections 9.1.21.11 and 9.1.21.12 are fulfilled for a corresponding Band,
- RSRQ related side conditions given in Clause 9.1.21.15 and 9.1.21.16 are fulfilled for a corresponding Band,
- SCH_RP and $SCH\ \hat{E}s/lot$ according to Annex Table B.2.16-1 for a corresponding Band.

When measurement gaps are scheduled for TDD inter frequency measurements, or the UE supports capability of conducting such measurements without gaps, the UE physical layer shall be capable of reporting RSRP and RSRQ to higher layers with measurement accuracy as specified in sub-clauses 9.1.21.11, 9.1.21.12, 9.1.21.15 and 9.1.21.16 with measurement period ($T_{\text{measure_inter_UE cat M1_EC}}$) given by table 8.13.3.5.3.1-1:

The UE shall be capable of performing RSRP and RSRQ measurements of at least 4 inter-frequency cells per TDD inter-frequency and the UE physical layer shall be capable of reporting RSRP and RSRQ measurements to higher layers with the measurement period $T_{\text{measure_inter_UE cat M1_EC}}$.

8.13.3.5.3.1.1 Measurement Reporting Requirements

8.13.3.5.3.1.1.1 Periodic Reporting

Reported RSRP and RSRQ measurement contained in periodically triggered measurement reports shall meet the requirements in sections 9.1.21.11, 9.1.21.12, 9.1.21.15 and 9.1.21.16.

8.13.3.5.3.1.1.2 Event-triggered Periodic Reporting

Reported RSRP and RSRQ measurement contained in event triggered periodic measurement reports shall meet the requirements in sections 9.1.21.11, 9.1.21.12, 9.1.21.15 and 9.1.21.16.

The first report in event triggered periodic measurement reporting shall meet the requirements specified in clause 8.13.3.5.3.1.1.3.

8.13.3.5.3.1.1.3 Event Triggered Reporting

Reported RSRP and RSRQ measurement contained in event triggered measurement reports shall meet the requirements in sections 9.1.21.11, 9.1.21.12, 9.1.21.15 and 9.1.21.16.

The UE shall not send any event triggered measurement reports, as long as no reporting criteria are fulfilled.

The measurement reporting delay is defined as the time between an event that will trigger a measurement report and the point when the UE starts to transmit the measurement report over the air interface. This requirement assumes that the measurement report is not delayed by other RRC signalling on the DCCH. This measurement reporting delay excludes a delay uncertainty resulted when inserting the measurement report to the TTI of the uplink DCCH. The delay

uncertainty is: $pusch-maxNumRepetitionCEmodeB \times TTI_{DCCH}$, where $pusch-maxNumRepetitionCEmodeB$ [2] is the maximum number of PUSCH repetitions configured for the UE in CE Mode B provided that $pusch-maxNumRepetitionCEmodeB > 1$, otherwise uncertainty is defined as $2 \times TTI_{DCCH}$. This measurement reporting delay excludes a delay which caused by no UL resources for UE to send the measurement report.

The event triggered measurement reporting delay, measured without L3 filtering shall be less than $T_{identify_inter_UE\ cat\ M1_EC}$ defined in Clause 8.13.3.5.3.1. When L3 filtering is used or IDC autonomous denial is configured an additional delay can be expected.

If a cell which has been detectable at least for the time period $T_{identify_inter_UE\ cat\ M1_EC}$ defined in clause 8.13.3.5.3.1 becomes undetectable for a period ≤ 5 seconds and then the cell becomes detectable again and triggers an event, the event triggered measurement reporting delay shall be less than $T_{Measurement_Period\ Inter_UE\ cat\ M1_EC}$ provided the timing to that cell has not changed more than $\pm 50 T_s$ and the L3 filter has not been used. When L3 filtering is used or IDC autonomous denial is configured, an additional delay can be expected.

8.13.3.5.3.2 E-UTRAN inter frequency measurements when DRX is used

When DRX is in use and when DRX or eDRX_CONN is in use, either measurement gaps are scheduled or the UE supports capability of conducting such measurements without gaps, the UE shall be able to identify a new detectable TDD inter frequency cell within $T_{identify_inter_UE\ cat\ M1}$ as shown in table 8.13.3.5.3.2-1.

When eDRX_CONN is in use the UE shall be able to identify a new detectable TDD inter frequency cell within $T_{identify_inter_UE\ cat\ M1_EC}$ as shown in table 8.13.3.5.3.2-1.

Table 8.13.3.5.3.2-1: Requirement to identify a newly detectable TDD interfrequency cell

Neighbouring cell SCH $\hat{E}s/lot$: Q2 [dB]	Gap pattern ID	DRX cycle length (s)	$T_{identify_intra_UE\ cat\ M1}$ (s) (DRX cycles)
$-15 \leq Q2 < -6$	0	≤ 0.64	$320.8 * K_{inter_M1} * K_{RSTD_M1_EC}$ (Note1)
		$0.64 < DRX-cycle \leq 2.56$	Note2($400 * K_{inter_M1} * K_{RSTD_M1_EC}$)
	1	$DRX-cycle \leq 0.640$	$321.6 * K_{inter_M1}$ (Note1)
		$0.64 < DRX-cycle \leq 2.56$	Note2($400 * K_{inter_M1}$)
$Q2 \geq -6$	0	≤ 0.64	$21.8 * K_{inter_M1} * K_{RSTD_M1_EC}$ (Note1)
		$0.64 < DRX-cycle \leq 2.56$	Note2($24 * K_{inter_M1} * K_{RSTD_M1_EC}$)
	1	$DRX-cycle \leq 0.640$	$22.6 * K_{inter_M1}$ (Note1)
		$0.64 < DRX-cycle \leq 2.56$	Note2($24 * K_{inter_M1}$)
Note 1: Number of DRX cycle depends upon the DRX cycle in use			
Note 2: Time depends upon the DRX cycle in use			

Table 8.13.3.5.3.2-1A: Requirement to identify a newly detectable TDD interfrequency cell when eDRX_CONN cycle is used

eDRX_CONN cycle length (s)	$T_{identify_inter_UE\ cat\ M1_EC}$ (s) (eDRX_CONN cycles)
$2.56 < eDRX_CONN\ cycle \leq 10.24$	Note ($400 * K_{inter_M1} * K_{RSTD_M1_EC}$)
Note: Time depends upon the eDRX_CONN cycle in use	

A cell shall be considered detectable when

- RSRP related side conditions given in Clause 9.1.21.11 and 9.1.21.12 are fulfilled for a corresponding Band,
- RSRQ related side conditions given in Clause 9.1.21.15 and 9.1.21.16 are fulfilled for a corresponding Band,
- SCH_{RP} and SCH $\hat{E}s/lot$ according to Annex Table B.2.16-1 for a corresponding Band

When DRX or eDRX_CONN is in use, the UE shall be capable of performing RSRP and RSRQ measurements of at least 4 inter-frequency cells per TDD inter-frequency for up to 3 TDD inter-frequencies and the UE physical layer shall be capable of reporting RSRP and RSRQ measurements to higher layers with the measurement period $T_{measure_inter_UE\ cat\ M1_EC}$, either measurement gaps are scheduled or the UE supports capability of conducting such measurements without

gaps. When DRX is in use, $T_{\text{measure_inter_UE cat M1_EC}}$ is as defined in Table 8.13.3.5.3.2-2, and when eDRX_CONN is in use, $T_{\text{measure_inter_UE cat M1_EC}}$ is as defined in Table 8.13.3.5.3.2-2.

Table 8.13.3.5.3.2-2: Requirement to measure TDD inter frequency cells

Neighbouring cell SCH Es/lot: Q2 [dB]	TDD Uplink-downlink configuration	Gap pattern ID	DRX cycle length (s)	$T_{\text{measure_intra_UE cat M1}} (s)$ (DRX cycles)
Q2 ≥ -15	Other than 0	0	≤ 0.16	$0.8 * K_{\text{inter_M1}} * K_{\text{RSTD_M1_EC}}$ (Note1)
			$0.16 < \text{DRX-cycle} \leq 2.56$	Note2($5 * K_{\text{inter_M1}} * K_{\text{RSTD_M1_EC}}$)
		1	≤ 0.32	$1.6 * K_{\text{inter_M1}}$ (Note1)
			$0.32 < \text{DRX-cycle} \leq 2.56$	Note2($5 * K_{\text{inter_M1}}$)
	0	0	≤ 0.32	$1.6 * K_{\text{inter_M1}} * K_{\text{RSTD_M1_EC}}$ (Note1)
			$0.32 < \text{DRX-cycle} \leq 2.56$	Note2($5 * K_{\text{inter_M1}} * K_{\text{RSTD_M1_EC}}$)
		1	≤ 0.64	$3.2 * K_{\text{inter_M1}}$ (Note1)
			$0.64 < \text{DRX-cycle} \leq 2.56$	Note2($5 * K_{\text{inter_M1}}$)
Note 1: Number of DRX cycle depends upon the DRX cycle in use.				
Note 2: Time depends upon the DRX cycle in use.				

Table 8.13.3.5.3.2-3: Requirement to measure TDD inter frequency cells when eDRX_CONN cycle is used

eDRX_CONN cycle length (s)	$T_{\text{measure_inter_UE cat M1_EC}} (s)$ (eDRX_CONN cycles)
$2.56 < \text{eDRX_CONN cycle} \leq 10.24$	Note ($5 * K_{\text{inter_M1}} * K_{\text{RSTD_M1_EC}}$)
Note: Time depends upon the eDRX_CONN cycle in use.	

The RSRP measurement accuracy for all measured cells shall be as specified in the sub-clauses 9.1.21.11 and 9.1.21.12.

The RSRQ measurement accuracy for all measured cells shall be as specified in the sub-clauses 9.1.21.15 and 9.1.21.16.

The requirements in this subclause apply regardless of MPDCCH monitoring configuration.

8.13.3.5.3.2.1 Measurement Reporting Requirements

8.13.3.5.3.2.1.1 Periodic Reporting

Reported RSRP and RSRQ measurement contained in periodically triggered measurement reports shall meet the requirements in sections 9.1.21.11, 9.1.21.12, 9.1.21.15 and 9.1.21.16.

8.13.3.5.3.2.1.2 Event-triggered Periodic Reporting

Reported RSRP and RSRQ measurement contained in event triggered periodic measurement reports shall meet the requirements in sections 9.1.21.11, 9.1.21.12, 9.1.21.15 and 9.1.21.16.

The first report in event triggered periodic measurement reporting shall meet the requirements specified in clause 8.13.3.5.3.2.1.3.

8.13.3.5.3.2.1.3 Event Triggered Reporting

Reported RSRP and RSRQ measurement contained in event triggered measurement reports shall meet the requirements in sections 9.1.21.11, 9.1.21.12, 9.1.21.15 and 9.1.21.16.

The UE shall not send any event triggered measurement reports, as long as no reporting criteria are fulfilled.

The measurement reporting delay is defined as the time between an event that will trigger a measurement report and the point when the UE starts to transmit the measurement report over the air interface. This requirement assumes that the measurement report is not delayed by other RRC signalling on the DCCH. This measurement reporting delay excludes a delay uncertainty resulted when inserting the measurement report to the TTI of the uplink DCCH. The delay

uncertainty is: $pusch-maxNumRepetitionCEmodeB \times TTI_{DCCH}$, where $pusch-maxNumRepetitionCEmodeB$ [2] is the maximum number of PUSCH repetitions configured for the UE in CE Mode B provided that $pusch-maxNumRepetitionCEmodeB > 1$, otherwise uncertainty is defined as $2 \times TTI_{DCCH}$. This measurement reporting delay excludes a delay which caused by no UL resources for UE to send the measurement report.

The event triggered measurement reporting delay, measured without L3 filtering shall be less than $T_{identify_inter_UE\ cat\ M1_EC}$ defined in Clause 8.13.3.5.3.2. When L3 filtering is used or IDC autonomous denial is configured an additional delay can be expected.

If a cell which has been detectable at least for the time period $T_{identify_inter_UE\ cat\ M1_EC}$ defined in clause 8.13.3.5.3.2 becomes undetectable for a period ≤ 5 seconds and then the cell becomes detectable again and triggers an event, the event triggered measurement reporting delay shall be less than $T_{measure_inter_UE\ cat\ M1_EC}$ provided the timing to that cell has not changed more than $\pm 50 T_s$ and the L3 filter has not been used. When L3 filtering is used or IDC autonomous denial is configured, an additional delay can be expected.

8.13.3.6 Maximum allowed layers for multiple monitoring for UE category M1 with CE mode B

The UE UE category M1 configured with CE mode B shall be capable of monitoring at least:

- Depending on UE capability, 2 FDD E-UTRA inter-frequency carriers, and
- Depending on UE capability, 2 TDD E-UTRA carriers.

In addition to the requirements defined above, the UE shall be capable of monitoring a total of at least 5 carrier frequency layers, which include one serving carrier frequency and any of the above defined combination of E-UTRA FDD inter-frequency and E-UTRA TDD inter-frequency layers.

8.13.3.7 E-UTRAN OTDOA Inter-Frequency RSTD Measurements for Cat-M1 UE in CEModeB

All inter-frequency RSTD measurement requirements specified in Sections 8.13.3.7 shall apply, provided that

- the UE is capable of inter-frequency RSTD measurements for OTDOA [24], and
- either the measurement gap pattern ID # 0 specified in Table 8.1.2.1-1 or any applicable measurement gap pattern specified in Table 8.1.2.1-3 is used or the UE supports capability of conducting inter-frequency measurements without gaps.

All inter-frequency RSTD measurement requirements specified in Sections 8.13.3.7 shall apply without DRX as well as for any DRX and eDRX_CONN cycles specified in TS 36.331 [2].

All positioning subframes indicated in the OTDOA assistance data and specified in sub-clause 9.1.21.18 are available for RSTD measurements in the measured and reference cell.

All the measurement requirements specified in Sections 8.13.3.7 shall apply provided that the UE is configured with the single PRS configuration for the reference cell and all the neighbour cells.

If CRS muting is enabled in a cell for which the UE performs RSTD measurements, the UE capable of supporting CRS muting [31] shall perform RSTD measurements and meet all the requirements in this section, provided the CRS are available within at least the PRS bandwidth in the subframes with PRS during all positioning occasions within the RSTD measurement period.

8.13.3.7.1 E-UTRAN FDD Inter-Frequency OTDOA Measurements

When the physical layer cell identities of neighbour cells together with the OTDOA assistance data are provided, the UE shall be able to detect and measure inter-frequency RSTD, specified in TS 36.214 [4], for at least $n=16$ cells, including the reference cell, on the same carrier frequency f_1 as that of the reference cell within $T_{RSTDInterFreqFDD,Cat_M}$ ms as given below (see also Figure 8.13.2.3.1-1):

$$T_{RSTDInterFreqFDD,Cat_M} = T_{PRS} \cdot (M - 1) + \Delta + T_{MIB} \text{ ms},$$

where

$T_{RSTDInterFreqFDD,Cat_M}$ is the total time for detecting and measuring at least n cells,

T_{PRS} is the cell-specific positioning subframe configuration period as defined in TS 36.355 [24]; if $T_{PRS} < MGRP$, T_{PRS} equals to MGRP; MGRP is the Measurement Gap Repetition Period as defined in section 8.1.2.1,

M is the number of PRS positioning occasions as defined in Table 8.13.3.7.1-1, where downlink positioning subframes defined in TS 36.211 [16], and

$\Delta = T_{PRS} \cdot \left\lceil \frac{n}{M} \right\rceil$ ms is the measurement time for a single PRS positioning occasion which includes the sampling time and the processing time,

N_{PRS} is the cell-specific number of PRS subframes within a PRS occasion as defined in TS 36.355[24];

N_{actual_PRS} is the number of PRS subframes within a PRS occasion that can be measured by UE within MGL; if $MGRP >= N_{PRS} > (MGL-2ms)$, $N_{actual_PRS} = (MGL-2ms)$; if $N_{PRS} > MGRP$, $N_{actual_PRS} = (MGL - 2) \cdot \left\lceil \frac{N_{PRS}}{MGRP} \right\rceil$; $N_{actual_PRS} = N_{PRS}$ if $N_{PRS} \leq (MGL-2)$;

N_{PRS_total} is the minimum number of PRS subframes per cell measurement as specified in Section 9.1.21.18.

T_{PRS} , N_{PRS} , N_{actual_PRS} and N_{PRS_total} are the parameters of the same cell, for which $T_{PRS} \cdot \left\lceil \frac{N_{PRS_total}}{N_{actual_PRS}} \right\rceil$ is the largest among all the measured cells.

T_{MIB} is the time required for acquiring the MIB information of the target cell. $T_{MIB} = 0$ if the SFN of at least one cell in OTDOA assistance data is known to the UE.

Table 8.13.3.7.1-1: Number of PRS positioning occasions within $T_{RSTDInterFreqFDD,Cat_M}$

Positioning subframe configuration period T_{PRS}	Number of PRS positioning occasions M	
	f2 ^{Note1}	f1 and f2 ^{Note2}
160 ms	$16 \cdot \left\lceil \frac{N_{PRS_Total}}{N_{actual_PRS}} \right\rceil$	$32 \cdot \left\lceil \frac{N_{PRS_Total}}{N_{actual_PRS}} \right\rceil$
>160 ms	$8 \cdot \left\lceil \frac{N_{PRS_Total}}{N_{actual_PRS}} \right\rceil$	$16 \cdot \left\lceil \frac{N_{PRS_Total}}{N_{actual_PRS}} \right\rceil$
Note 1: When inter-frequency RSTD measurements are performed over the reference cell and neighbour cells, which belong to the FDD inter-frequency carrier frequency f2. Note 2: When inter-frequency RSTD measurements are performed over the reference cell and the neighbour cells, which belong to the serving FDD carrier frequency f1 and the FDD inter-frequency carrier frequency f2 respectively.		

The UE physical layer shall be capable of reporting RSTD for the reference cell and all the neighbor cells i out of at least $(n-1)$ neighbor cells within $T_{RSTDInterFreqFDD,Cat_M}$ provided:

$$\left(PRS \hat{E}_s / Iot \right)_{ref} \geq -15 \text{ dB for all Frequency Bands for the reference cell,}$$

$$\left(PRS \hat{E}_s / Iot \right)_i \geq -15 \text{ dB for all Frequency Bands for neighbour cell } i,$$

$(\text{PRS } \hat{E}_s / \text{Iot})_{ref}$ and $(\text{PRS } \hat{E}_s / \text{Iot})_i$ conditions apply for all subframes of at least $L = \frac{M}{2}$ PRS positioning occasions,

PRP 1,2_{dBm} according to Annex B.2.20 for a corresponding Band

$\text{PRS } \hat{E}_s / \text{Iot}$ is defined as the ratio of the average received energy per PRS RE during the useful part of the symbol to the average received power spectral density of the total noise and interference for this RE, where the ratio is measured over all REs which carry PRS.

The time $T_{\text{RSTDInterFreqHDD,Cat}_M}$ starts from the first subframe of the PRS positioning occasion closest in time after both the OTDOA-RequestLocationInformation message and the OTDOA assistance data in the OTDOA-ProvideAssistanceData message as specified in TS 36.355 [24], are delivered to the physical layer of the UE.

The RSTD measurement accuracy for all measured neighbor cells i shall be fulfilled according to the accuracy as specified in the sub-clause 9.1.21.18.

If the inter-frequency handover occurs while inter-frequency RSTD measurements are being performed then the UE shall complete the ongoing OTDOA measurement session. The UE shall also meet the inter-frequency OTDOA measurement and accuracy requirements. However in this case the RSTD measurement period ($T_{\text{RSTDInterFreqHDD,Cat}_M,\text{HO}}$) shall be according to the following expression:

$$T_{\text{RSTDInterFreqHDD,Cat}_M,\text{HO}} = T_{\text{RSTDInterFreqHDD,Cat}_M} + K \times T_{\text{PRS}} + T_{\text{HO}} \quad \text{ms},$$

where:

K is the number of times the inter-frequency handover occurs during $T_{\text{RSTDInterFreqHDD,Cat}_M,\text{HO}}$.

T_{HO} is the time during which the inter-frequency RSTD measurement may not be possible due to inter-frequency handover.

Furthermore, due to the inter-frequency handover the UE shall meet the RSTD measurement accuracy for a PRS bandwidth which is not larger than the minimum channel bandwidth of all the PCells during the RSTD measurement period.

8.13.3.7.1.1 RSTD Measurement Reporting Delay

Reported measurement contained in event triggered measurement reports shall meet the requirements in sections 9.1.21.18.

The UE shall not send any measurement reports, as long as no reporting criteria are fulfilled.

The measurement reporting delay is defined as the time between the point when UE receive both the OTDOA-RequestLocationInformation message and the OTDOA assistance data in the OTDOA-ProvideAssistanceData message as specified in TS 36.355 [24], and the point when the UE starts to transmit the measurement report over the air interface. This requirement assumes that the measurement report is not delayed by other RRC signalling on the DCCH. This measurement reporting delay excludes a delay uncertainty resulted when inserting the measurement report to the TTI of the uplink DCCH. The delay uncertainty is: $N_{rep} \times \text{TTI}_{\text{DCCH}}$, where N_{rep} [21] is the maximum number of PUSCH repetitions configured for the UE, otherwise uncertainty is defined as $2 \times \text{TTI}_{\text{DCCH}}$. This measurement reporting delay excludes a delay which caused by no UL resources for UE to send the measurement report.

The measurement reporting delay shall be less than $T_{\text{RSTDInterFreqHDD,Cat}_M}$ defined in Clause 8.13.3.7.1.

8.13.3.7.2 E-UTRAN TDD Inter-Frequency OTDOA Measurements

When the physical layer cell identities of neighbour cells together with the OTDOA assistance data are provided, the UE shall be able to detect and measure inter-frequency RSTD, specified in TS 36.214 [4], for at least $n=16$ cells, including the reference cell, on the same carrier frequency f_1 as that of the reference cell within $T_{\text{RSTDInterFreqTDD,Cat}_M}$ ms as given below:

$$T_{\text{RSTDInterFreqIDD,Cat}_M} = T_{\text{PRS}} \cdot (M - 1) + \Delta + T_{\text{MIB}} \text{ ms},$$

where

$T_{\text{RSTDInterFreqIDD,Cat}_M}$ is the total time for detecting and measuring at least n cells,

T_{PRS} is the cell-specific positioning subframe configuration period as defined in TS 36.355 [24]; if $T_{\text{PRS}} < \text{MGRP}$, T_{PRS} equals to MGRP; MGRP is the Measurement Gap Repetition Period as defined in section 8.1.2.1,

M is the number of PRS positioning occasions as defined in Table 8.13.3.7.2-1, where downlink positioning subframes defined in TS 36.211 [16], and

$\Delta = T_{\text{PRS}} \cdot \left\lceil \frac{n}{M} \right\rceil$ ms is the measurement time for a single PRS positioning occasion which includes the sampling time and the processing time,

N_{PRS} is the cell-specific number of PRS subframes within a PRS occasion as defined in TS 36.355[24];

$N_{\text{actual_PRS}}$ is the number of PRS subframes within a PRS occasion that can be measured by UE within MGL; if $\text{MGRP} \geq N_{\text{PRS}} > (\text{MGL} - 2\text{ms})$, $N_{\text{actual_PRS}} = (\text{MGL} - 2\text{ms})$; if $N_{\text{PRS}} > \text{MGRP}$, $N_{\text{actual_PRS}} = (\text{MGL} - 2) \cdot \left\lceil \frac{N_{\text{PRS}}}{\text{MGRP}} \right\rceil$; $N_{\text{actual_PRS}} = N_{\text{PRS}}$ if $N_{\text{PRS}} \leq (\text{MGL} - 2)$;

$N_{\text{PRS_total}}$ is the minimum number of PRS subframes per cell measurement as specified in Section 9.1.21.18.

T_{PRS} , N_{PRS} , $N_{\text{actual_PRS}}$ and $N_{\text{PRS_total}}$ are the parameters of the same cell, for which $T_{\text{PRS}} \cdot \left\lceil \frac{N_{\text{PRS_total}}}{N_{\text{actual_PRS}}} \right\rceil$ is the largest among all the measured cells.

T_{MIB} is the time required for acquiring the MIB information of the target cell. $T_{\text{MIB}} = 0$ if the SFN of at least one cell in OTDOA assistance data is known to the UE.

Table 8.13.3.7.2-1: Number of PRS positioning occasions within $T_{\text{RSTDInterFreqIDD,Cat}_M}$

Positioning subframe configuration period T_{PRS}	Number of PRS positioning occasions M	
	f2 ^{Note1}	f1 and f2 ^{Note2}
160 ms	$16 \cdot \left\lceil \frac{N_{\text{PRS_Total}}}{N_{\text{actual_PRS}}} \right\rceil$	$32 \cdot \left\lceil \frac{N_{\text{PRS_Total}}}{N_{\text{actual_PRS}}} \right\rceil$
>160 ms	$8 \cdot \left\lceil \frac{N_{\text{PRS_Total}}}{N_{\text{actual_PRS}}} \right\rceil$	$16 \cdot \left\lceil \frac{N_{\text{PRS_Total}}}{N_{\text{actual_PRS}}} \right\rceil$
<p>Note 1: When inter-frequency RSTD measurements are performed over the reference cell and neighbour cells, which belong to the TDD inter-frequency carrier frequency f2.</p> <p>Note 2: When inter-frequency RSTD measurements are performed over the reference cell and the neighbour cells, which belong to the serving TDD carrier frequency f1 and the TDD inter-frequency carrier frequency f2 respectively.</p>		

The UE physical layer shall be capable of reporting RSTD for the reference cell and all the neighbor cells i out of at least $(n-1)$ neighbor cells within $T_{\text{RSTDInterFreqIDD,Cat}_M}$ provided:

$(\text{PRS } \hat{E}_s / \text{Iot})_{ref} \geq -15 \text{ dB}$ for all Frequency Bands for the reference cell,

$(\text{PRS } \hat{E}_s / \text{Iot})_i \geq -15 \text{ dB}$ for all Frequency Bands for neighbour cell i ,

$(\text{PRS } \hat{E}_s / \text{Iot})_{ref}$ and $(\text{PRS } \hat{E}_s / \text{Iot})_i$ conditions apply for all subframes of at least $L = \frac{M}{2}$ PRS positioning occasions,

PRP 1,2_{dBm} according to Annex B.2.20 for a corresponding Band

$\text{PRS } \hat{E}_s / \text{Iot}$ is defined as the ratio of the average received energy per PRS RE during the useful part of the symbol to the average received power spectral density of the total noise and interference for this RE, where the ratio is measured over all REs which carry PRS.

The time $T_{\text{RSTDInterFreqIDD,Cat_M}}$ starts from the first subframe of the PRS positioning occasion closest in time after both the OTDOA-RequestLocationInformation message and the OTDOA assistance data in the OTDOA-ProvideAssistanceData message as specified in TS 36.355 [24], are delivered to the physical layer of the UE.

The RSTD measurement accuracy for all measured neighbor cells i shall be fulfilled according to the accuracy as specified in the sub-clause 9.1.21.18.

If the inter-frequency handover occurs while inter-frequency RSTD measurements are being performed then the UE shall complete the ongoing OTDOA measurement session. The UE shall also meet the inter-frequency OTDOA measurement and accuracy requirements. However in this case the RSTD measurement period ($T_{\text{RSTDInterFreqIDD,Cat_M,HO}}$) shall be according to the following expression:

$$T_{\text{RSTDInterFreqIDD,Cat_M,HO}} = T_{\text{RSTDInterFreqIDD,Cat_M}} + K \times T_{\text{PRS}} + T_{\text{HO}} \quad \text{ms},$$

where:

K is the number of times the inter-frequency handover occurs during $T_{\text{RSTDInterFreqIDD,Cat_M,HO}}$.

T_{HO} is the time during which the inter-frequency RSTD measurement may not be possible due to inter-frequency handover.

Furthermore, due to the inter-frequency handover the UE shall meet the RSTD measurement accuracy for a PRS bandwidth which is not larger than the minimum channel bandwidth of all the PCells during the RSTD measurement period.

The inter-frequency requirements in this clause (8.13.3.7.2) shall apply for all TDD special subframe configurations specified in TS 36.211 [16] and for the TDD uplink-downlink configurations as specified in Table 8.13.3.7.2-2.

Table 8.13.3.7.2-2: TDD uplink-downlink subframe configurations applicable for TDD inter-frequency requirements

PRS Transmission Bandwidth [RB]	Applicable TDD uplink-downlink configurations
6	1, 2, 3, 4 and 5
Note:	Uplink-downlink configurations are specified in Table 4.2-2 in TS 36.211 [16].

8.13.3.7.2.1 RSTD Measurement Reporting Delay

Reported measurement contained in event triggered measurement reports shall meet the requirements in sections 9.1.21.18.

The UE shall not send any measurement reports, as long as no reporting criteria are fulfilled.

The measurement reporting delay is defined as the time between the point when UE receive both the OTDOA-RequestLocationInformation message and the OTDOA assistance data in the OTDOA-ProvideAssistanceData message

as specified in TS 36.355 [24], and the point when the UE starts to transmit the measurement report over the air interface. This requirement assumes that the measurement report is not delayed by other RRC signalling on the DCCH. This measurement reporting delay excludes a delay uncertainty resulted when inserting the measurement report to the TTI of the uplink DCCH. The delay uncertainty is: $N_{rep} \times TTI_{DCCH}$, where N_{rep} [21] is the maximum number of PUSCH repetitions configured for the UE, otherwise uncertainty is defined as $2 \times TTI_{DCCH}$. This measurement reporting delay excludes a delay which caused by no UL resources for UE to send the measurement report.

The measurement reporting delay shall be less than $T_{RSTDInterFreqTDD,Cat_M}$ defined in Clause 8.13.3.7.2.

8.13.3.7.3 E-UTRAN HD-FDD Inter-Frequency OTDOA Measurements

The requirements in this section are applicable for the UE which supports half duplex operation on one or more supported frequency bands [2].

The requirements defined in clause 8.13.3.7.1 also apply for this section except reporting delay requirement provided the following conditions are met:

- all positioning subframes indicated in the OTDOA assistance data and specified in Section 9.1.21.18 are available for RSTD measurements in the measured and reference cells.

8.13.3.7.3.1 RSTD Measurement Reporting Delay

Reported measurement contained in event triggered measurement reports shall meet the requirements in sections 9.1.21.18.

The UE shall not send any measurement reports, as long as no reporting criteria are fulfilled.

The measurement reporting delay is defined as the time between the point when UE receive both the OTDOA-RequestLocationInformation message and the OTDOA assistance data in the OTDOA-ProvideAssistanceData message as specified in TS 36.355 [24], and the point when the UE starts to transmit the measurement report over the air interface. This requirement assumes that the measurement report is not delayed by other RRC signalling on the DCCH. This measurement reporting delay excludes a delay uncertainty resulted when inserting the measurement report to the TTI of the uplink DCCH. The delay uncertainty is: $N_{rep} \times TTI_{DCCH}$, where N_{rep} [21] is the maximum number of PUSCH repetitions configured for the UE, otherwise uncertainty is defined as $2 \times TTI_{DCCH}$. This measurement reporting delay excludes a delay which caused by no UL resources for UE to send the measurement report.

The measurement reporting delay shall be less than measurement period as defined in Clause 8.13.3.7.3.

8.14 Measurements for UE category NB1

8.14.1 Introduction

This clause contains requirements on the UE category NB1 regarding measurement in RRC_CONNECTED state. The requirements are specified for NB-IoT intra frequency measurements for serving NB-IoT cell. These measurements may be used by the NB-IoT for uplink power control. The measurement quantities are defined in [4], the measurement model is defined in [22] and measurement accuracies are specified in clause 9. During the RRC_CONNECTED state the UE shall continuously measure serving NB-IoT cell.

The UE shall meet all applicable requirements specified in clause 8.14 under the following conditions:

- at least 1 DL subframe per radio frame of serving NB-IoT cell is available at the UE during measurement period.

8.14.2 NB-IoT intra frequency measurements under normal coverage

8.14.2.1 NB-IoT intra frequency measurements when no DRX is used

In the RRC_CONNECTED state the measurement period for intra frequency measurements is 800ms, unless the UE is capable of NSSS-based RRM measurements and *nss-NumOccDiffPrecoders* value *n1* [2] is indicated by higher layers, by which the measurement period is [1600] ms. The NRSRP measurement accuracy shall be as specified in the sub-clauses 9.1.22.1.

8.14.2.2 NB-IoT intra frequency measurements when DRX is used

When DRX is used in the RRC_CONNECTED state the measurement period for intra frequency measurements is $T_{\text{measure_intra}}$ as shown in table 8.14.2.2-1.

Table 8.14.2.2-1: Requirement for intrafrequency measurement

DRX cycle length (s)	$T_{\text{measure_intra}}$ (s) (DRX cycles)
$0.256 < \text{DRX-cycle} \leq 10.24$	Note1 (5)
Note1: Time depends upon the DRX cycle in use	

The NRSRP measurement accuracy shall be as specified in the sub-clauses 9.1.22.1

8.14.3 NB-IoT intra frequency measurements under enhanced coverage

8.14.3.1 NB-IoT intra frequency measurements when no DRX is used

In the RRC_CONNECTED state the measurement period for intra frequency measurements is 1600ms. The NRSRP measurement accuracy shall be as specified in the sub-clauses 9.1.22.1.

8.14.3.2 NB-IoT intra frequency measurements when DRX is used

When DRX is used in the RRC_CONNECTED state the measurement period for intra frequency measurements is $T_{\text{measure_intra}}$ as shown in table 8.14.3.2-1.

Table 8.14.3.2-1: Requirement for intrafrequency measurement

DRX cycle length (s)	$T_{\text{measure_intra}}$ (s) (DRX cycles)
$0.256 < \text{DRX-cycle} \leq 10.24$	Note1 (5)
Note1: Time depends upon the DRX cycle in use	

The NRSRP measurement accuracy shall be as specified in the sub-clauses 9.1.22.1.

8.15 Void

8.16 Measurements for UE Category M2

8.16.1 Introduction

The UE category M2 applicability of the requirements in subclause 8.16 is defined in Section 3.6.

This clause contains requirements on the UE regarding measurement reporting in RRC_CONNECTED state. The requirements are specified for E-UTRA intra frequency measurements. These measurements may be used by the E-UTRAN, e.g. for handover decisions. The measurement quantities are defined in TS 36.214 [4], the measurement model is defined in TS 36.302 [22] and measurement accuracies are specified in clause 9. Control of measurement reporting is specified in TS 36.331 [2].

The UE shall meet the requirements in Section 8.16, provided:

- the UE does not require measurement gaps for the corresponding measurements, or
- the UE requires measurement gaps for the corresponding measurements and is configured with the measurement gap pattern Id 0 or 1 and is not configured with any measurement gap pattern from Table 8.1.2.1-3.

If the UE requires measurement gaps for the corresponding measurements and is configured with the measurement gap pattern from Table 8.1.2.1-3, the UE is not required to perform any RRM measurements that requires gaps during the RSTD measurement period and the requirement in Section 8.16 shall not apply during the RSTD measurement period.

When the UE is provided with IDC solution, the UE shall also perform RRM measurements and meet the corresponding requirements in clause 8.

8.16.2 Requirements for UE category M2 with CE mode A

8.16.2.1 E-UTRAN FDD UE Rx-Tx Time Difference Measurements for UE category M2 in CEModeA

When no DRX is used the physical layer measurement period of the UE Rx-Tx time difference measurement shall be 480 ms.

When DRX is used in RRC_CONNECTED state the physical layer measurement period ($T_{\text{measure_FDD_UE_Rx_Tx1}}$) of the UE Rx-Tx time difference measurement shall be as specified in table 8.16.2.1-1.

Table 8.16.2.1-1: FDD UE Rx-Tx time difference measurement requirement when DRX is used

DRX cycle length (s)	$T_{\text{measure_FDD_UE_Rx_Tx1}}$ (s) (DRX cycles)
< 0.128	0.48 (Note1)
$0.128 \leq \text{DRX-cycle} \leq 2.56$	Note2 (5)
Note 1: Number of DRX cycle depends upon the DRX cycle in use	
Note 2: Time depends upon the DRX cycle in use	

If the UE is performing UE Rx-Tx time difference measurement while the PCell is changed due to the handover then the UE shall restart the Rx-Tx measurement on the new cell. In this case the UE shall also meet the UE Rx-Tx time difference measurement and accuracy requirements. However the physical layer measurement period of the UE Rx-Tx measurement shall not exceed $T_{\text{measure_FDD_UE_Rx_Tx3}}$ as defined in the following expression:

$$T_{\text{measure_FDD_UE_Rx_Tx3}} = (K+1) * (T_{\text{measure_FDD_UE_Rx_Tx1}}) + K * T_{\text{PCell_change_handover}}$$

Where:

K is the number of times the PCell is changed over the measurement period ($T_{\text{measure_FDD_UE_Rx_Tx3}}$),

$T_{\text{PCell_change_handover}}$ is the time necessary to change the PCell due to handover.

The measurement accuracy for the UE Rx-Tx time difference measurement when DRX or eDRX_CONN is used as well as when no DRX is used shall be as specified in the sub-clause 9.1.25.3.

If CRS muting is enabled in a cell for which the UE performs UE Rx-Tx time difference measurement, the UE capable of supporting CRS muting [31] shall perform the UE Rx-Tx time difference measurements and meet all the requirements in this section, provided the CRS are available within UE bandwidth in the serving cell during the UE Rx-Tx time difference measurement period.

8.16.2.1.1 UE Rx-Tx Measurement Reporting Delay

Reported measurement contained in event triggered measurement reports shall meet the requirements in sections 9.1.25.5.

The UE shall not send any measurement reports, as long as no reporting criteria are fulfilled.

The measurement reporting delay is defined as the time between the point when UE receive ECID-RequestLocationInformation message and the point when the UE starts to transmit the measurement report over the air interface. This requirement assumes that the measurement report is not delayed by other RRC signalling on the DCCH. This measurement reporting delay excludes a delay uncertainty resulted when inserting the measurement report to the TTI of the uplink DCCH. The delay uncertainty is: $\text{pusch-maxNumRepetitionCEmodeA} \times \text{TTI}_{\text{DCCH}}$, where $\text{pusch-maxNumRepetitionCEmodeA}$ [2] is the maximum number of PUSCH repetitions configured for the UE in CE Mode A provided that $\text{pusch-maxNumRepetitionCEmodeA} > 1$, otherwise uncertainty is defined as $2 \times \text{TTI}_{\text{DCCH}}$. This measurement reporting delay excludes a delay which caused by no UL resources for UE to send the measurement report.

The measurement reporting delay shall be less than the physical layer measurement period defined in Clause 8.16.2.1.

8.16.2.2 E-UTRAN TDD UE Rx-Tx Time Difference Measurements for UE category M2 in CEModeA

When no DRX is used the physical layer measurement period of the UE Rx-Tx time difference measurement shall be 480 ms.

When DRX is used in RRC_CONNECTED state the physical layer measurement period ($T_{\text{measure_TDD_UE_Rx_Tx1}}$) of the UE Rx-Tx time difference measurement shall be as specified in table 8.16.2.2-1.

Table 8.16.2.2-1: TDD UE Rx-Tx time difference measurement requirement when DRX is used

DRX cycle length (s)	$T_{\text{measure_TDD_UE_Rx_Tx1}}$ (s) (DRX cycles)
< 0.128	0.48 (Note1)
$0.128 \leq \text{DRX-cycle} \leq 2.56$	Note2 (5)
Note 1: Number of DRX cycle depends upon the DRX cycle in use	
Note 2: Time depends upon the DRX cycle in use	

If the UE is performing UE Rx-Tx time difference measurement while the PCell is changed due to the handover then the UE shall restart the Rx-Tx measurement on the new cell. In this case the UE shall also meet the UE Rx-Tx time difference measurement and accuracy requirements. However the physical layer measurement period of the UE Rx-Tx measurement shall not exceed $T_{\text{measure_TDD_UE_Rx_Tx3}}$ as defined in the following expression:

$$T_{\text{measure_TDD_UE_Rx_Tx3}} = (K+1) \cdot (T_{\text{measure_TDD_UE_Rx_Tx1}}) + K \cdot T_{\text{PCell_change_handover}}$$

Where:

K is the number of times the PCell is changed over the measurement period ($T_{\text{measure_TDD_UE_Rx_Tx3}}$),

$T_{\text{PCell_change_handover}}$ is the time necessary to change the PCell due to handover.

The measurement accuracy for the UE Rx-Tx time difference measurement when DRX or eDRX_CONN is used as well as when no DRX is used shall be as specified in the sub-clause 9.1.25.3.

If CRS muting is enabled in a cell for which the UE performs UE Rx-Tx time difference measurement, the UE capable of supporting CRS muting [31] shall perform the UE Rx-Tx time difference measurements and meet all the requirements in this section, provided the CRS are available within UE bandwidth in the serving cell during the UE Rx-Tx time difference measurement period.

8.16.2.2.1 UE Rx-Tx Measurement Reporting Delay

Reported measurement contained in event triggered measurement reports shall meet the requirements in sections 9.1.25.5.

The UE shall not send any measurement reports, as long as no reporting criteria are fulfilled.

The measurement reporting delay is defined as the time between the point when UE receive ECID-RequestLocationInformation message and the point when the UE starts to transmit the measurement report over the air interface. This requirement assumes that the measurement report is not delayed by other RRC signalling on the DCCH. This measurement reporting delay excludes a delay uncertainty resulted when inserting the measurement report to the TTI of the uplink DCCH. The delay uncertainty is: $\text{pusch-maxNumRepetitionCEmodeA} \times \text{TTI}_{\text{DCCH}}$, where $\text{pusch-maxNumRepetitionCEmodeA}$ [2] is the maximum number of PUSCH repetitions configured for the UE in CE Mode A provided that $\text{pusch-maxNumRepetitionCEmodeA} > 1$, otherwise uncertainty is defined as $2 \times \text{TTI}_{\text{DCCH}}$. This measurement reporting delay excludes a delay which caused by no UL resources for UE to send the measurement report.

The measurement reporting delay shall be less than the physical layer measurement period defined in Clause 8.16.2.2.

8.16.2.2a E-UTRAN HD-FDD UE Rx-Tx Time Difference Measurements for UE category M2 in CEModeA

The requirements in this section are applicable for the UE which supports half duplex operation on one or more supported frequency bands.

The requirements defined in clause 8.16.2.1 also apply for this section except the measurement reporting requirements provided the following conditions are met:

- At least one downlink and one uplink subframes per radio frame are available for the UE Rx-Tx time difference measurement in the measured cell.
- at least downlink subframe # 0 or downlink subframe # 5 per radio frame of an intra-frequency cell to be identified by the UE is available at the UE;

- SCH_{RP} and SCH_{Es/Iot} according to Annex Table B.2.14-2 for a corresponding Band

If CRS muting is enabled in a cell for which the UE performs UE Rx-Tx time difference measurement, the UE capable of supporting CRS muting [31] shall perform the UE Rx-Tx time difference measurements and meet all the requirements in this section, provided the CRS are available within UE bandwidth in the serving cell during the UE Rx-Tx time difference measurement period.

8.16.2.2a.1 UE Rx-Tx Measurement Reporting Delay

Reported measurement contained in event triggered measurement reports shall meet the requirements in sections 9.1.25.5.

The UE shall not send any measurement reports, as long as no reporting criteria are fulfilled.

The measurement reporting delay is defined as the time between the point when UE receive ECID-RequestLocationInformation message and the point when the UE starts to transmit the measurement report over the air interface. This requirement assumes that the measurement report is not delayed by other RRC signalling on the DCCH. This measurement reporting delay excludes a delay uncertainty resulted when inserting the measurement report to the TTI of the uplink DCCH. The delay uncertainty is: $pusch-maxNumRepetitionCEmodeA \times TTI_{DCCH}$, where $pusch-maxNumRepetitionCEmodeA$ [2] is the maximum number of PUSCH repetitions configured for the UE in CE Mode A provided that $pusch-maxNumRepetitionCEmodeA > 1$, otherwise uncertainty is defined as $2 \times TTI_{DCCH}$. This measurement reporting delay excludes a delay which caused by no UL resources for UE to send the measurement report.

The measurement reporting delay shall be less than the physical layer measurement period defined in Clause 8.16.2.2a.

8.16.2.3 E-UTRAN OTDOA Intra-Frequency RSTD Measurements for Cat-M2 UE in CEModeA

All intra-frequency RSTD measurement requirements specified in Sections 8.16.2.3 shall apply without DRX as well as for any DRX and eDRX_CONN cycles specified in TS 36.331 [2].

All the measurement requirements specified in Sections 8.16.2.3 shall apply provided that the UE is configured:

- with the single PRS configuration for the reference cell and all the neighbour cells and
- with either the measurement gap pattern ID #0 specified in Clause 8.1.2.1 or any applicable measurement gap pattern specified in Table 8.1.2.1-3 for cat M2 RSTD measurements if the PRS bandwidth is less than the bandwidth of the cell used for the RSTD measurement in which case gaps are required.

If CRS muting is enabled in a cell for which the UE performs RSTD measurements, the UE capable of supporting CRS muting [31] shall perform RSTD measurements and meet all the requirements in this section, provided the CRS are available within at least the PRS bandwidth in the subframes with PRS during all positioning occasions within the RSTD measurement period.

8.16.2.3.1 E-UTRAN FDD Intra-Frequency OTDOA Measurements

When the physical layer cell identities of neighbour cells together with the OTDOA assistance data are provided, the UE shall be able to detect and measure intra-frequency RSTD, specified in TS 36.214 [4], for at least $n=16$ cells, including the reference cell, on the same carrier frequency f_1 as that of the reference cell within $T_{RSTDIntraFreqFDD,Cat_M}$ ms as given below (see also Figure 8.16.2.3.1-1):

$$T_{RSTDIntraFreqFDD,Cat_M} = T_{PRS} \cdot (M - 1) + \Delta + T_{MIB} \text{ ms},$$

where

$T_{RSTDIntraFreqFDD,Cat_M}$ is the total time for detecting and measuring at least n cells,

T_{PRS} is the cell-specific positioning subframe configuration period as defined in TS 36.355 [24] for UE not configured with measurement gaps for intra-frequency RSTD. For UE configured with measurement gaps for

intra-frequency RSTD measurements, $T_{PRS} = \max(T_{PRS}, MGRP)$, where MGRP is the Measurement Gap Repetition Period as defined in section 8.1.2.1.

M is the number of PRS positioning occasions as defined in Table 8.16.2.3.1-1, where downlink positioning subframes defined in TS 36.211 [16], and

$\Delta = T_{PRS} \cdot \left\lceil \frac{n}{M} \right\rceil$ ms is the measurement time for a single PRS positioning occasion which includes the sampling time and the processing time,

N_{PRS} is the cell-specific number of PRS subframes within a PRS occasion as defined in TS 36.355 [24],

N_{actual_PRS} is the number of PRS subframes within a PRS occasion available at the UE; $N_{actual_PRS} = N_{PRS}$ when the measurement gaps are not required for the intra-frequency RSTD measurements; for UE configured with measurement gaps for intra-frequency RSTD measurements N_{actual_PRS} is the number of PRS subframes which can be measured by UE within MGL, where $N_{actual_PRS} = (MGL-2)$ if $MGRP \geq N_{PRS} > (MGL-2)$, $N_{actual_PRS} = (MGL - 2) \cdot \left\lceil \frac{N_{PRS}}{MGRP} \right\rceil$ if $N_{PRS} > MGRP$, and $N_{actual_PRS} = N_{PRS}$ if $N_{PRS} \leq (MGL-2)$.

N_{PRS_total} is the minimum number of PRS subframes per cell measurement as specified in Section 9.1.25.4.

$T_{PRS} N_{PRS}$, N_{actual_PRS} and N_{PRS_total} are the parameters of the same cell, for which $T_{PRS} \cdot \left\lceil \frac{N_{PRS_total}}{N_{actual_PRS}} \right\rceil$ is the largest among all the measured cells.

T_{MIB} is the time required for acquiring the MIB information of the target cell. $T_{MIB} = 0$ if the SFN of at least one cell in OTDOA assistance data is known to the UE.

Table 8.16.2.3.1-1: Number of PRS positioning occasions within $T_{RSTD\text{IntraFreqFDD,Cat}_M}$

Positioning subframe configuration period T_{PRS}	Number of PRS positioning occasions M	
	f1 ^{Note1}	f1 and f2 ^{Note2}
160 ms	$16 \cdot \left\lceil \frac{N_{PRS_Total}}{N_{actual_PRS}} \right\rceil$	$32 \cdot \left\lceil \frac{N_{PRS_Total}}{N_{actual_PRS}} \right\rceil$
>160 ms	$8 \cdot \left\lceil \frac{N_{PRS_Total}}{N_{actual_PRS}} \right\rceil$	$16 \cdot \left\lceil \frac{N_{PRS_Total}}{N_{actual_PRS}} \right\rceil$
Note 1: When only intra-frequency RSTD measurements are performed over cells belonging to the serving FDD carrier frequency f1. Note 2: When intra-frequency RSTD and inter-frequency RSTD measurements are performed over cells belonging to the serving FDD carrier frequency f1 and one inter-frequency carrier frequency f2, respectively.		

The UE physical layer shall be capable of reporting RSTD for the reference cell and all the neighbor cells i out of at least $(n-1)$ neighbor cells within $T_{RSTD\text{IntraFreqFDD,Cat}_M}$ provided:

$$\left(\text{PRS } \hat{E}_s / \text{Iot} \right)_{ref} \geq -6 \text{ dB for all Frequency Bands for the reference cell,}$$

$$\left(\text{PRS } \hat{E}_s / \text{Iot} \right)_i \geq -13 \text{ dB for all Frequency Bands for neighbour cell } i,$$

$(\text{PRS } \hat{E}_s / I_{ot})_{ref}$ and $(\text{PRS } \hat{E}_s / I_{ot})_i$ conditions apply for all subframes of at least $L = \frac{n}{2}$ PRS positioning occasions,

PRP 1,2_{dBm} according to Annex B.2.23 for a corresponding Band

$\text{PRS } \hat{E}_s / I_{ot}$ is defined as the ratio of the average received energy per PRS RE during the useful part of the symbol to the average received power spectral density of the total noise and interference for this RE, where the ratio is measured over all REs which carry PRS.

The time $T_{\text{RSTDIntraFreqFDD,Cat}_M}$ starts from the first subframe of the PRS positioning occasion closest in time after both the OTDOA-RequestLocationInformation message and the OTDOA assistance data in the OTDOA-ProvideAssistanceData message as specified in TS 36.355 [24], are delivered to the physical layer of the UE as illustrated in Figure 8.16.2.3.1-1.

The RSTD measurement accuracy for all measured neighbor cells i shall be fulfilled according to the accuracy as specified in the sub-clause 9.1.25.4.

If the intra-frequency handover occurs while intra-frequency RSTD measurements are being performed then the UE shall complete the ongoing OTDOA measurement session. The UE shall also meet the intra-frequency OTDOA measurement and accuracy requirements. However in this case the RSTD measurement period ($T_{\text{RSTDIntraFreqFDD,Cat}_M,\text{HO}}$) shall be according to the following expression:

$$T_{\text{RSTDIntraFreqFDD,Cat}_M,\text{HO}} = T_{\text{RSTDIntraFreqFDD,Cat}_M} + K \times T_{\text{PRS}} + T_{\text{HO}} \quad \text{ms},$$

where:

K is the number of times the intra-frequency handover occurs during $T_{\text{RSTDIntraFreqFDD,Cat}_M,\text{HO}}$.

T_{HO} is the time during which the intra-frequency RSTD measurement may not be possible due to intra-frequency handover.

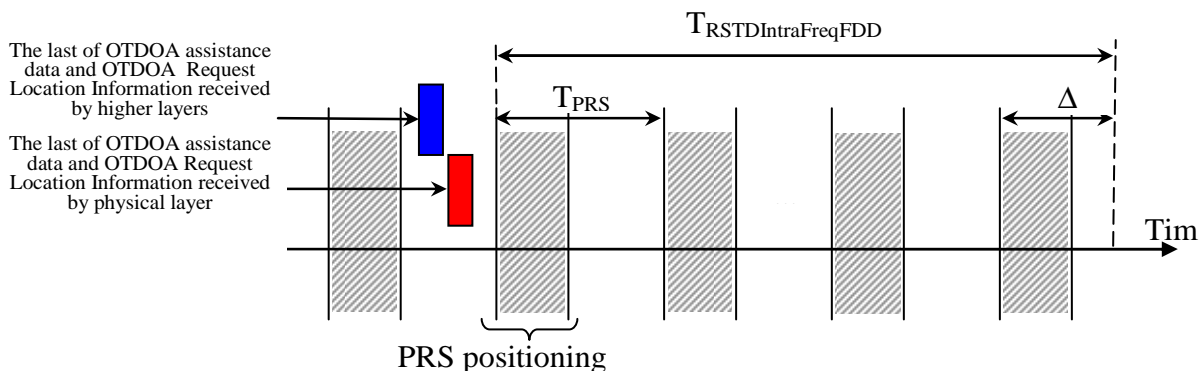

Figure 8.16.2.3.1-1: Illustration of the RSTD reporting time requirement in an FDD system.

Furthermore, due to the intra-frequency handover the UE shall meet the RSTD measurement accuracy for a PRS bandwidth which is not larger than the minimum channel bandwidth of all the PCells during the RSTD measurement period.

8.16.2.3.1.1 RSTD Measurement Reporting Delay

Reported measurement contained in event triggered measurement reports shall meet the requirements in sections 9.1.25.4.

The UE shall not send any measurement reports, as long as no reporting criteria are fulfilled.

The measurement reporting delay is defined as the time between the point when UE receive both the OTDOA-RequestLocationInformation message and the OTDOA assistance data in the OTDOA-ProvideAssistanceData message

as specified in TS 36.355 [24], and the point when the UE starts to transmit the measurement report over the air interface. This requirement assumes that the measurement report is not delayed by other RRC signalling on the DCCH. This measurement reporting delay excludes a delay uncertainty resulted when inserting the measurement report to the TTI of the uplink DCCH. The delay uncertainty is: $N_{rep} \times TTI_{DCCH}$, where N_{rep} [21] is the maximum number of PUSCH repetitions configured for the UE, otherwise uncertainty is defined as $2 \times TTI_{DCCH}$. This measurement reporting delay excludes a delay which caused by no UL resources for UE to send the measurement report.

The measurement reporting delay shall be less than $T_{RSTDIntraFreqIDD,Cat_M}$ defined in Clause 8.16.2.3.1.

8.16.2.3.2 E-UTRAN TDD Intra-Frequency OTDOA Measurements

When the physical layer cell identities of neighbour cells together with the OTDOA assistance data are provided, the UE shall be able to detect and measure intra-frequency RSTD, specified in TS 36.214 [4], for at least $n=16$ cells, including the reference cell, on the same carrier frequency f_1 as that of the reference cell within $T_{RSTDIntraFreqIDD,Cat_M}$ ms as given below:

$$T_{RSTDIntraFreqIDD,Cat_M} = T_{PRS} \cdot (M - 1) + \Delta + T_{MIB},$$

where

$T_{RSTDIntraFreqIDD,Cat_M}$ is the total time for detecting and measuring at least n cells,

T_{PRS} is the cell-specific positioning subframe configuration period as defined in TS 36.355 [24] for UE not configured with measurement gaps for intra-frequency RSTD. For UE configured with measurement gaps for intra-frequency RSTD measurements, $T_{PRS} = \max(T_{PRS}, MGRP)$, where MGRP is the Measurement Gap Repetition Period as defined in section 8.1.2.1.

M is the number of PRS positioning occasions as defined in Table 8.16.2.3.1-1, where downlink positioning subframes defined in TS 36.211 [16], and

$\Delta = T_{PRS} \cdot \left\lceil \frac{n}{M} \right\rceil$ ms is the measurement time for a single PRS positioning occasion which includes the sampling time and the processing time,

N_{PRS} is the cell-specific number of PRS subframes within a PRS occasion as defined in TS 36.355 [24],

N_{PRS_total} is the minimum number of PRS subframes per cell measurement as specified in Section 9.1.25.4.

N_{actual_PRS} is the number of PRS subframes within a PRS occasion available at the UE; $N_{actual_PRS} = N_{PRS}$ when the measurement gaps are not required for the intra-frequency RSTD measurements; for UE configured with measurement gaps for intra-frequency RSTD measurements N_{actual_PRS} is the number of PRS subframes which can be measured by UE within MGL, where $N_{actual_PRS} = (MGL-2)$ if $MGRP \geq N_{PRS} > (MGL-2)$, $N_{actual_PRS} = (MGL - 2) \cdot \left\lfloor \frac{N_{PRS}}{MGRP} \right\rfloor$ if $N_{PRS} > MGRP$, and $N_{actual_PRS} = N_{PRS}$ if $N_{PRS} \leq (MGL-2)$.

$T_{PRS} \cdot N_{PRS}$, N_{actual_PRS} and N_{PRS_total} are the parameters of the same cell, for which $T_{PRS} \cdot \left\lceil \frac{N_{PRS_total}}{N_{actual_PRS}} \right\rceil$ is the largest among all the measured cells.

T_{MIB} is the time required for acquiring the MIB information of the target cell. $T_{MIB} = 0$ if the SFN of at least one cell in OTDOA assistance data is known to the UE.

Table 8.16.2.3.1-1: Number of PRS positioning occasions within $T_{\text{RSTDIntraFreqIDD,Cat}_M}$

Positioning subframe configuration period T_{PRS}	Number of PRS positioning occasions M	
	f1 ^{Note1}	f1 and f2 ^{Note2}
160 ms	$16 \cdot \left\lceil \frac{N_{\text{PRS_Total}}}{N_{\text{actual_PRS}}} \right\rceil$	$32 \cdot \left\lceil \frac{N_{\text{PRS_Total}}}{N_{\text{actual_PRS}}} \right\rceil$
>160 ms	$8 \cdot \left\lceil \frac{N_{\text{PRS_Total}}}{N_{\text{actual_PRS}}} \right\rceil$	$16 \cdot \left\lceil \frac{N_{\text{PRS_Total}}}{N_{\text{actual_PRS}}} \right\rceil$
Note 1:	When only intra-frequency RSTD measurements are performed over cells belonging to the serving FDD carrier frequency f1.	
Note 2:	When intra-frequency RSTD and inter-frequency RSTD measurements are performed over cells belonging to the serving FDD carrier frequency f1 and one inter-frequency carrier frequency f2, respectively.	

The UE physical layer shall be capable of reporting RSTD for the reference cell and all the neighbor cells i out of at least $(n-1)$ neighbor cells within $T_{\text{RSTDIntraFreqIDD,Cat}_M}$ provided:

$$\left(\text{PRS } \hat{E}_s / \text{Iot} \right)_{\text{ref}} \geq -6 \text{ dB for all Frequency Bands for the reference cell,}$$

$$\left(\text{PRS } \hat{E}_s / \text{Iot} \right)_i \geq -13 \text{ dB for all Frequency Bands for neighbour cell } i,$$

$$\left(\text{PRS } \hat{E}_s / \text{Iot} \right)_{\text{ref}} \text{ and } \left(\text{PRS } \hat{E}_s / \text{Iot} \right)_i \text{ conditions apply for all subframes of at least } L = \frac{n}{2} \text{ PRS positioning occasions,}$$

PRP 1,2_{dBm} according to Annex B.2.23 for a corresponding Band

$\text{PRS } \hat{E}_s / \text{Iot}$ is defined as the ratio of the average received energy per PRS RE during the useful part of the symbol to the average received power spectral density of the total noise and interference for this RE, where the ratio is measured over all REs which carry PRS.

The time $T_{\text{RSTDIntraFreqIDD,Cat}_M}$ starts from the first subframe of the PRS positioning occasion closest in time after both the OTDOA-RequestLocationInformation message and the OTDOA assistance data in the OTDOA-ProvideAssistanceData message as specified in TS 36.355 [24], are delivered to the physical layer of the UE.

The RSTD measurement accuracy for all measured neighbor cells i shall be fulfilled according to the accuracy as specified in the sub-clause 9.1.25.4.

If the intra-frequency handover occurs while intra-frequency RSTD measurements are being performed then the UE shall complete the ongoing OTDOA measurement session. The UE shall also meet the intra-frequency OTDOA measurement and accuracy requirements. However in this case the RSTD measurement period ($T_{\text{RSTDIntraFreqIDD,Cat}_M,\text{HO}}$) shall be according to the following expression:

$$T_{\text{RSTDIntraFreqIDD,Cat}_M,\text{HO}} = T_{\text{RSTDIntraFreqIDD,Cat}_M} + K \times T_{\text{PRS}} + T_{\text{HO}} \quad \text{ms},$$

where:

K is the number of times the intra-frequency handover occurs during $T_{\text{RSTDIntraFreqIDD,Cat}_M,\text{HO}}$.

T_{HO} is the time during which the intra-frequency RSTD measurement may not be possible due to intra-frequency handover.

Furthermore, due to the intra-frequency handover the UE shall meet the RSTD measurement accuracy for a PRS bandwidth which is not larger than the minimum channel bandwidth of all the PCells during the RSTD measurement period.

The intra-frequency requirements in this clause (8.16.2.3.2) shall apply for all TDD special subframe configurations specified in TS 36.211 [16] and for the TDD uplink-downlink configurations as specified in Table 8.16.2.3.2-2.

Table 8.16.2.3.2-2: TDD uplink-downlink subframe configurations applicable for TDD intra-frequency requirements

PRS Transmission Bandwidth [RB]	Applicable TDD uplink-downlink configurations
6,	1, 2, 3, 4 and 5
25	0, 1, 2, 3, 4, 5 and 6
Note:	Uplink-downlink configurations are specified in Table 4.2-2 in TS 36.211 [16].

8.16.2.3.2.1 RSTD Measurement Reporting Delay

Reported measurement contained in event triggered measurement reports shall meet the requirements in sections 9.1.25.4.

The UE shall not send any measurement reports, as long as no reporting criteria are fulfilled.

The measurement reporting delay is defined as the time between the point when UE receive both the OTDOA-RequestLocationInformation message and the OTDOA assistance data in the OTDOA-ProvideAssistanceData message as specified in TS 36.355 [24], and the point when the UE starts to transmit the measurement report over the air interface. This requirement assumes that the measurement report is not delayed by other RRC signalling on the DCCH. This measurement reporting delay excludes a delay uncertainty resulted when inserting the measurement report to the TTI of the uplink DCCH. The delay uncertainty is: $N_{rep} \times TTI_{DCCH}$, where N_{rep} [21] is the maximum number of PUSCH repetitions configured for the UE, otherwise uncertainty is defined as $2 \times TTI_{DCCH}$. This measurement reporting delay excludes a delay which caused by no UL resources for UE to send the measurement report.

The measurement reporting delay shall be less than $T_{RSTD, IntraFreq, TDD, Cat_M}$ defined in Clause 8.16.2.3.2.

8.16.2.3.3 E-UTRAN HD-FDD Intra-Frequency OTDOA Measurements

The requirements in this section are applicable for the UE which supports half duplex operation on one or more supported frequency bands [2].

The requirements defined in clause 8.16.2.3.1 also apply for this section except the reporting delay requirement provided the following conditions are met:

- all positioning subframes indicated in the OTDOA assistance data and specified in Section 9.1.25.4 are available for RSTD measurements in the measured and reference cells.

8.16.2.3.3.1 RSTD Measurement Reporting Delay

Reported measurement contained in event triggered measurement reports shall meet the requirements in sections 9.1.25.4.

The UE shall not send any measurement reports, as long as no reporting criteria are fulfilled.

The measurement reporting delay is defined as the time between the point when UE receive both the OTDOA-RequestLocationInformation message and the OTDOA assistance data in the OTDOA-ProvideAssistanceData message as specified in TS 36.355 [24], and the point when the UE starts to transmit the measurement report over the air interface. This requirement assumes that the measurement report is not delayed by other RRC signalling on the DCCH. This measurement reporting delay excludes a delay uncertainty resulted when inserting the measurement report to the TTI of the uplink DCCH. The delay uncertainty is: $N_{rep} \times TTI_{DCCH}$, where N_{rep} [21] is the maximum number of PUSCH repetitions configured for the UE, otherwise uncertainty is defined as $2 \times TTI_{DCCH}$. This measurement reporting delay excludes a delay which caused by no UL resources for UE to send the measurement report.

The measurement reporting delay shall be less than measurement period defined in Clause 8.16.2.3.3.

8.16.2.4 E-UTRAN OTDOA Inter-Frequency RSTD Measurements for Cat-M2 UE in CEModeA

All inter-frequency RSTD measurement requirements specified in Sections 8.16.2.4 shall apply, provided that

- the UE is capable of inter-frequency RSTD measurements for OTDOA [24], and
- either the measurement gap pattern ID # 0 specified in Table 8.1.2.1-1 or any applicable measurement gap pattern specified in Table 8.1.2.1-3 is used or the UE supports capability of conducting inter-frequency measurements without gaps.

All inter-frequency RSTD measurement requirements specified in Sections 8.16.2.4 shall apply without DRX as well as for any DRX and eDRX_CONN cycles specified in TS 36.331 [2].

All positioning subframes indicated in the OTDOA assistance data and specified in sub-clause 9.1.25.1 are available for RSTD measurements in the measured and reference cell.

All the measurement requirements specified in Sections 8.16.2.4 shall apply provided that the UE is configured with the single PRS configuration for the reference cell and all the neighbour cells.

If CRS muting is enabled in a cell for which the UE performs RSTD measurements, the UE capable of supporting CRS muting [31] shall perform RSTD measurements and meet all the requirements in this section, provided the CRS are available within at least the PRS bandwidth in the subframes with PRS during all positioning occasions within the RSTD measurement period.

8.16.2.4.1 E-UTRAN FDD Inter-Frequency OTDOA Measurements

When the physical layer cell identities of neighbour cells together with the OTDOA assistance data are provided, the UE shall be able to detect and measure inter-frequency RSTD, specified in TS 36.214 [4], for at least $n=16$ cells, including the reference cell, on the same carrier frequency f_1 as that of the reference cell within $T_{\text{RSTDInterFreqFDD,Cat}_M}$ ms as given below:

$$T_{\text{RSTDInterFreqFDD,Cat}_M} = T_{\text{PRS}} \cdot (M - 1) + \Delta + T_{\text{MIB}} \text{ ms},$$

where

$T_{\text{RSTDInterFreqFDD,Cat}_M}$ is the total time for detecting and measuring at least n cells,

T_{PRS} is the cell-specific positioning subframe configuration period as defined in TS 36.355 [24]; if $T_{\text{PRS}} < \text{MGRP}$, T_{PRS} equals to MGRP; MGRP is the Measurement Gap Repetition Period as defined in section 8.1.2.1,

M is the number of PRS positioning occasions as defined in Table 8.16.2.4.1-1, where downlink positioning subframes defined in TS 36.211 [16], and

$\Delta = T_{\text{PRS}} \cdot \left\lceil \frac{n}{M} \right\rceil$ ms is the measurement time for a single PRS positioning occasion which includes the sampling time and the processing time,

N_{PRS} is the cell-specific number of PRS subframes within a PRS occasion as defined in TS 36.355 [24];

$N_{\text{actual_PRS}}$ is the number of PRS subframes within a PRS occasion that can be measured by UE within MGL; if

$$\text{MGRP} \geq N_{\text{PRS}} > (\text{MGL} - 2\text{ms}), N_{\text{actual_PRS}} = (\text{MGL} - 2\text{ms}); \text{ if } N_{\text{PRS}} > \text{MGRP}, N_{\text{actual_PRS}} = (\text{MGL} - 2) \cdot \left\lfloor \frac{N_{\text{PRS}}}{\text{MGRP}} \right\rfloor; N_{\text{actual_PRS}} = N_{\text{PRS}} \text{ if } N_{\text{PRS}} \leq (\text{MGL} - 2);$$

$N_{\text{PRS_total}}$ is the minimum number of PRS subframes per cell measurement as specified in Section 9.1.25.3.

T_{PRS} , N_{PRS} , N_{actual_PRS} and N_{PRS_total} are the parameters of the same cell, for which $T_{PRS} \cdot \left\lceil \frac{N_{PRS_total}}{N_{actual_PRS}} \right\rceil$ is the largest among all the measured cells.

T_{MIB} is the time required for acquiring the MIB information of the target cell. $T_{MIB} = 0$ if the SFN of at least one cell in OTDOA assistance data is known to the UE.

Table 8.16.2.4.1-1: Number of PRS positioning occasions within $T_{RSTDInterFreqHDD,Cat_M}$

Positioning subframe configuration period T_{PRS}	Number of PRS positioning occasions M	
	f2 ^{Note1}	f1 and f2 ^{Note2}
160 ms	$16 \cdot \left\lceil \frac{N_{PRS_Total}}{N_{actual_PRS}} \right\rceil$	$32 \cdot \left\lceil \frac{N_{PRS_Total}}{N_{actual_PRS}} \right\rceil$
>160 ms	$8 \cdot \left\lceil \frac{N_{PRS_Total}}{N_{actual_PRS}} \right\rceil$	$16 \cdot \left\lceil \frac{N_{PRS_Total}}{N_{actual_PRS}} \right\rceil$
Note 1: When inter-frequency RSTD measurements are performed over the reference cell and neighbour cells, which belong to the FDD inter-frequency carrier frequency f2. Note 2: When inter-frequency RSTD measurements are performed over the reference cell and the neighbour cells, which belong to the serving FDD carrier frequency f1 and the FDD inter-frequency carrier frequency f2 respectively.		

The UE physical layer shall be capable of reporting RSTD for the reference cell and all the neighbor cells i out of at least $(n-1)$ neighbor cells within $T_{RSTDInterFreqHDD,Cat_M}$ provided:

$$\left(\text{PRS } \hat{E}_s / \text{Iot} \right)_{ref} \geq -6 \text{ dB for all Frequency Bands for the reference cell,}$$

$$\left(\text{PRS } \hat{E}_s / \text{Iot} \right)_i \geq -13 \text{ dB for all Frequency Bands for neighbour cell } i,$$

$$\left(\text{PRS } \hat{E}_s / \text{Iot} \right)_{ref} \text{ and } \left(\text{PRS } \hat{E}_s / \text{Iot} \right)_i \text{ conditions apply for all subframes of at least } L = \frac{M}{2} \text{ PRS positioning occasions,}$$

PRP 1,2_{dBm} according to Annex B.2.21 for a corresponding Band

$\text{PRS } \hat{E}_s / \text{Iot}$ is defined as the ratio of the average received energy per PRS RE during the useful part of the symbol to the average received power spectral density of the total noise and interference for this RE, where the ratio is measured over all REs which carry PRS.

The time $T_{RSTDInterFreqHDD,Cat_M}$ starts from the first subframe of the PRS positioning occasion closest in time after both the OTDOA-RequestLocationInformation message and the OTDOA assistance data in the OTDOA-ProvideAssistanceData message as specified in TS 36.355 [24], are delivered to the physical layer of the UE.

The RSTD measurement accuracy for all measured neighbor cells i shall be fulfilled according to the accuracy as specified in the sub-clause 9.1.25.1.

If the inter-frequency handover occurs while inter-frequency RSTD measurements are being performed then the UE shall complete the ongoing OTDOA measurement session. The UE shall also meet the inter-frequency OTDOA measurement and accuracy requirements. However in this case the RSTD measurement period ($T_{RSTDInterFreqHDD,Cat_M,HO}$) shall be according to the following expression:

$$T_{RSTDInterFreqHDD,Cat_M,HO} = T_{RSTDInterFreqHDD,Cat_M} + K \times T_{PRS} + T_{HO} \quad ms,$$

where:

K is the number of times the inter-frequency handover occurs during $T_{\text{RSTDInterFreqTDD,Cat}_M,\text{HO}}$.

T_{HO} is the time during which the inter-frequency RSTD measurement may not be possible due to inter-frequency handover.

Furthermore, due to the inter-frequency handover the UE shall meet the RSTD measurement accuracy for a PRS bandwidth which is not larger than the minimum channel bandwidth of all the PCells during the RSTD measurement period.

8.16.2.4.1.1 RSTD Measurement Reporting Delay

Reported measurement contained in event triggered measurement reports shall meet the requirements in sections 9.1.25.1.

The UE shall not send any measurement reports, as long as no reporting criteria are fulfilled.

The measurement reporting delay is defined as the time between the point when UE receive both the OTDOA-RequestLocationInformation message and the OTDOA assistance data in the OTDOA-ProvideAssistanceData message as specified in TS 36.355 [24], and the point when the UE starts to transmit the measurement report over the air interface. This requirement assumes that the measurement report is not delayed by other RRC signalling on the DCCH. This measurement reporting delay excludes a delay uncertainty resulted when inserting the measurement report to the TTI of the uplink DCCH. The delay uncertainty is: $N_{\text{rep}} \times \text{TTI}_{\text{DCCH}}$, where N_{rep} [21] is the maximum number of PUSCH repetitions configured for the UE, otherwise uncertainty is defined as $2 \times \text{TTI}_{\text{DCCH}}$. This measurement reporting delay excludes a delay which caused by no UL resources for UE to send the measurement report.

The measurement reporting delay shall be less than $T_{\text{RSTDInterFreqTDD,Cat}_M}$ defined in Clause 8.16.2.4.1.

8.16.2.4.2 E-UTRAN TDD Inter-Frequency OTDOA Measurements

When the physical layer cell identities of neighbour cells together with the OTDOA assistance data are provided, the UE shall be able to detect and measure inter-frequency RSTD, specified in TS 36.214 [4], for at least $n=16$ cells, including the reference cell, on the same carrier frequency f_1 as that of the reference cell within $T_{\text{RSTDInterFreqTDD,Cat}_M}$ ms as given below:

$$T_{\text{RSTDInterFreqTDD,Cat}_M} = T_{\text{PRS}} \cdot (M - 1) + \Delta + T_{\text{MIB}} \quad \text{ms},$$

where

$T_{\text{RSTDInterFreqTDD,Cat}_M}$ is the total time for detecting and measuring at least n cells,

T_{PRS} is the cell-specific positioning subframe configuration period as defined in TS 36.355 [24]; if $T_{\text{PRS}} < \text{MGRP}$, T_{PRS} equals to MGRP; MGRP is the Measurement Gap Repetition Period as defined in section 8.1.2.1,

M is the number of PRS positioning occasions as defined in Table 8.16.2.4.2-1, where downlink positioning subframes defined in TS 36.211 [16], and

$\Delta = T_{\text{PRS}} \cdot \left\lceil \frac{n}{M} \right\rceil$ ms is the measurement time for a single PRS positioning occasion which includes the sampling time and the processing time,

N_{PRS} is the cell-specific number of PRS subframes within a PRS occasion as defined in TS 36.355[24];

$N_{\text{actual_PRS}}$ is the number of PRS subframes within a PRS occasion that can be measured by UE within MGL; if $N_{\text{PRS}} > (\text{MGL} - 2\text{ms})$, $N_{\text{actual_PRS}} = (\text{MGL} - 2\text{ms})$; if $N_{\text{PRS}} \leq (\text{MGL} - 2\text{ms})$, $N_{\text{actual_PRS}} = N_{\text{PRS}}$ if $N_{\text{PRS}} \leq (\text{MGL} - 2)$; otherwise, $N_{\text{actual_PRS}} = (\text{MGL} - 2) \cdot \left\lfloor \frac{N_{\text{PRS}}}{\text{MGRP}} \right\rfloor$;

$N_{\text{PRS_total}}$ is the minimum number of PRS subframes per cell measurement as specified in Section 9.1.25.3.

T_{PRS} , N_{PRS} , $N_{\text{actual_PRS}}$ and $N_{\text{PRS_total}}$ are the parameters of the same cell, for which $T_{\text{PRS}} \cdot \left\lfloor \frac{N_{\text{PRS_total}}}{N_{\text{actual_PRS}}} \right\rfloor$ is the largest among all the measured cells.

T_{MIB} is the time required for acquiring the MIB information of the target cell. $T_{\text{MIB}} = 0$ if the SFN of at least one cell in OTDOA assistance data is known to the UE.

Table 8.16.2.4.2-1: Number of PRS positioning occasions within $T_{\text{RSTDInterFreqTDD,Cat_M}}$

Positioning subframe configuration period T_{PRS}	Number of PRS positioning occasions M	
	f2 ^{Note1}	f1 and f2 ^{Note2}
160 ms	$16 \cdot \left\lfloor \frac{N_{\text{PRS_Total}}}{N_{\text{actual_PRS}}} \right\rfloor$	$32 \cdot \left\lfloor \frac{N_{\text{PRS_Total}}}{N_{\text{actual_PRS}}} \right\rfloor$
>160 ms	$8 \cdot \left\lfloor \frac{N_{\text{PRS_Total}}}{N_{\text{actual_PRS}}} \right\rfloor$	$16 \cdot \left\lfloor \frac{N_{\text{PRS_Total}}}{N_{\text{actual_PRS}}} \right\rfloor$
Note 1: When inter-frequency RSTD measurements are performed over the reference cell and neighbour cells, which belong to the TDD inter-frequency carrier frequency f2. Note 2: When inter-frequency RSTD measurements are performed over the reference cell and the neighbour cells, which belong to the serving TDD carrier frequency f1 and the TDD inter-frequency carrier frequency f2 respectively.		

The UE physical layer shall be capable of reporting RSTD for the reference cell and all the neighbor cells i out of at least $(n-1)$ neighbor cells within $T_{\text{RSTDInterFreqTDD,Cat_M}}$ provided:

$$\left(\text{PRS } \hat{E}_s / \text{Iot} \right)_{\text{ref}} \geq -6 \text{ dB for all Frequency Bands for the reference cell,}$$

$$\left(\text{PRS } \hat{E}_s / \text{Iot} \right)_i \geq -13 \text{ dB for all Frequency Bands for neighbour cell } i,$$

$$\left(\text{PRS } \hat{E}_s / \text{Iot} \right)_{\text{ref}} \text{ and } \left(\text{PRS } \hat{E}_s / \text{Iot} \right)_i \text{ conditions apply for all subframes of at least } L = \frac{M}{2} \text{ PRS positioning occasions,}$$

PRP 1,2_{dBm} according to Annex B.2.21 for a corresponding Band

$\text{PRS } \hat{E}_s / \text{Iot}$ is defined as the ratio of the average received energy per PRS RE during the useful part of the symbol to the average received power spectral density of the total noise and interference for this RE, where the ratio is measured over all REs which carry PRS.

The time $T_{\text{RSTDInterFreqTDD,Cat_M}}$ starts from the first subframe of the PRS positioning occasion closest in time after both the OTDOA-RequestLocationInformation message and the OTDOA assistance data in the OTDOA-ProvideAssistanceData message as specified in TS 36.355 [24], are delivered to the physical layer of the UE.

The RSTD measurement accuracy for all measured neighbor cells i shall be fulfilled according to the accuracy as specified in the sub-clause 9.1.25.1.

If the inter-frequency handover occurs while inter-frequency RSTD measurements are being performed then the UE shall complete the ongoing OTDOA measurement session. The UE shall also meet the inter-frequency OTDOA measurement and accuracy requirements. However in this case the RSTD measurement period ($T_{\text{RSTDInterFreqTDD,Cat}_M,\text{HO}}$) shall be according to the following expression:

$T_{\text{RSTDInterFreqTDD,Cat}_M,\text{HO}}$ shall be according to the following expression:

$$T_{\text{RSTDInterFreqTDD,Cat}_M,\text{HO}} = T_{\text{RSTDInterFreqIDD,Cat}_M} + K \times T_{\text{PRS}} + T_{\text{HO}} \quad \text{ms},$$

where:

K is the number of times the inter-frequency handover occurs during $T_{\text{RSTDInterFreqTDD,Cat}_M,\text{HO}}$.

T_{HO} is the time during which the inter-frequency RSTD measurement may not be possible due to inter-frequency handover.

Furthermore, due to the inter-frequency handover the UE shall meet the RSTD measurement accuracy for a PRS bandwidth which is not larger than the minimum channel bandwidth of all the PCells during the RSTD measurement period.

The inter-frequency requirements in this clause (8.16.2.4.2) shall apply for all TDD special subframe configurations specified in TS 36.211 [16] and for the TDD uplink-downlink configurations as specified in Table 8.16.2.4.2-2.

Table 8.16.2.4.2-2: TDD uplink-downlink subframe configurations applicable for TDD inter-frequency requirements

PRS Transmission Bandwidth [RB]	Applicable TDD uplink-downlink configurations
6	1, 2, 3, 4 and 5
24	0, 1, 2, 3, 4, 5 and 6
Note:	Uplink-downlink configurations are specified in Table 4.2-2 in TS 36.211 [16].

8.16.2.4.2.1 RSTD Measurement Reporting Delay

Reported measurement contained in event triggered measurement reports shall meet the requirements in sections 9.1.25.1.

The UE shall not send any measurement reports, as long as no reporting criteria are fulfilled.

The measurement reporting delay is defined as the time between the point when UE receive both the OTDOA-RequestLocationInformation message and the OTDOA assistance data in the OTDOA-ProvideAssistanceData message as specified in TS 36.355 [24], and the point when the UE starts to transmit the measurement report over the air interface. This requirement assumes that the measurement report is not delayed by other RRC signalling on the DCCH. This measurement reporting delay excludes a delay uncertainty resulted when inserting the measurement report to the TTI of the uplink DCCH. The delay uncertainty is: $N_{\text{rep}} \times \text{TTI}_{\text{DCCH}}$, where N_{rep} [21] is the maximum number of PUSCH repetitions configured for the UE, otherwise uncertainty is defined as $2 \times \text{TTI}_{\text{DCCH}}$. This measurement reporting delay excludes a delay which caused by no UL resources for UE to send the measurement report.

The measurement reporting delay shall be less than $T_{\text{RSTDInterFreqTDD,Cat}_M}$ defined in Clause 8.16.2.4.2.

8.16.2.4.3 E-UTRAN HD-FDD Inter-Frequency OTDOA Measurements

The requirements in this section are applicable for the UE which supports half duplex operation on one or more supported frequency bands [2].

The requirements defined in clause 8.16.2.4.1 also apply for this section except reporting delay requirement provided the following conditions are met:

- all positioning subframes indicated in the OTDOA assistance data and specified in Section 9.1.25.1 are available for RSTD measurements in the measured and reference cells.

8.16.2.4.3.1 RSTD Measurement Reporting Delay

Reported measurement contained in event triggered measurement reports shall meet the requirements in sections 9.1.25.1.

The UE shall not send any measurement reports, as long as no reporting criteria are fulfilled.

The measurement reporting delay is defined as the time between the point when UE receive both the OTDOA-RequestLocationInformation message and the OTDOA assistance data in the OTDOA-ProvideAssistanceData message as specified in TS 36.355 [24], and the point when the UE starts to transmit the measurement report over the air interface. This requirement assumes that the measurement report is not delayed by other RRC signalling on the DCCH. This measurement reporting delay excludes a delay uncertainty resulted when inserting the measurement report to the TTI of the uplink DCCH. The delay uncertainty is: $N_{rep} \times TTI_{DCCH}$, where N_{rep} [21] is the maximum number of PUSCH repetitions configured for the UE, otherwise uncertainty is defined as $2 \times TTI_{DCCH}$. This measurement reporting delay excludes a delay which caused by no UL resources for UE to send the measurement report.

The measurement reporting delay shall be less than measurement period as defined in Clause 8.16.2.4.3.

8.16.3 Requirements for UE category M2 with CE mode B

8.16.3.1 E-UTRAN OTDOA Intra-Frequency RSTD Measurements for Cat-M2 UE in CEModeB

All intra-frequency RSTD measurement requirements specified in Sections 8.16.3.1 shall apply without DRX as well as for any DRX and eDRX_CONN cycles specified in TS 36.331 [2].

All the measurement requirements specified in Sections 8.16.3.1 shall apply provided that the UE is configured:

- with the single PRS configuration for the reference cell and all the neighbour cells and
- with either the measurement gap pattern ID #0 specified in Clause 8.1.2.1 or any applicable measurement gap pattern specified in Table 8.1.2.1-3 for cat M2 RSTD measurements if the PRS bandwidth is less than the bandwidth of the cell used for the RSTD measurement in which case gaps are required.

If CRS muting is enabled in a cell for which the UE performs RSTD measurements, the UE capable of supporting CRS muting [31] shall perform RSTD measurements and meet all the requirements in this section, provided the CRS are available within at least the PRS bandwidth in the subframes with PRS during all positioning occasions within the RSTD measurement period.

8.16.3.1.1 E-UTRAN FDD Intra-Frequency OTDOA Measurements

When the physical layer cell identities of neighbour cells together with the OTDOA assistance data are provided, the UE shall be able to detect and measure intra-frequency RSTD, specified in TS 36.214 [4], for at least $n=16$ cells, including the reference cell, on the same carrier frequency f_1 as that of the reference cell within $T_{RSTDIntraFreqFDD,Cat_M}$ ms as given below (see also Figure 8.16.3.1.1-1):

$$T_{RSTDIntraFreqFDD,Cat_M} = T_{PRS} \cdot (M - 1) + \Delta + T_{MIB} \text{ ms,}$$

where

$T_{RSTDIntraFreqFDD,Cat_M}$ is the total time for detecting and measuring at least n cells,

T_{PRS} is the cell-specific positioning subframe configuration period as defined in TS 36.355 [24] for UE not configured with measurement gaps for intra-frequency RSTD. For UE configured with measurement gaps for intra-frequency RSTD measurements, $T_{PRS} = \max(T_{PRS}, MGRP)$, where MGRP is the Measurement Gap Repetition Period as defined in section 8.1.2.1.

M is the number of PRS positioning occasions as defined in Table 8.16.3.1.1-1, where downlink positioning subframes defined in TS 36.211 [16], and

$\Delta = T_{PRS} \cdot \left\lceil \frac{n}{M} \right\rceil$ ms is the measurement time for a single PRS positioning occasion which includes the sampling time and the processing time,

N_{PRS} is the cell-specific number of PRS subframes within a PRS occasion as defined in TS 36.355 [24],

N_{actual_PRS} is the number of PRS subframes within a PRS occasion available at the UE; $N_{actual_PRS} = N_{PRS}$ when the measurement gaps are not required for the intra-frequency RSTD measurements; for UE configured with measurement gaps for intra-frequency RSTD measurements N_{actual_PRS} is the number of PRS subframes which can be measured by UE within MGL, where $N_{actual_PRS} = (MGL-2)$ if $MGRP \geq N_{PRS} > (MGL-2)$, $N_{actual_PRS} = (MGL - 2) \cdot \left\lceil \frac{N_{PRS}}{MGRP} \right\rceil$ if $N_{PRS} > MGRP$, and $N_{actual_PRS} = N_{PRS}$ if $N_{PRS} \leq (MGL-2)$.

N_{PRS_total} is the minimum number of PRS subframes per cell measurement as specified in Section 9.1.25.5.

$T_{PRS} N_{PRS}$, N_{actual_PRS} and N_{PRS_total} are the parameters of the same cell, for which $T_{PRS} \cdot \left\lceil \frac{N_{PRS_total}}{N_{actual_PRS}} \right\rceil$ is the largest among all the measured cells.

T_{MIB} is the time required for acquiring the MIB information of the target cell. $T_{MIB} = 0$ if the SFN of at least one cell in OTDOA assistance data is known to the UE.

Table 8.16.3.1.1-1: Number of PRS positioning occasions within $T_{RSTD\text{IntraFreqFDD,Cat}_M}$

Positioning subframe configuration period T_{PRS}	Number of PRS positioning occasions M	
	f1 ^{Note1}	f1 and f2 ^{Note2}
160 ms	$16 \cdot \left\lceil \frac{N_{PRS_Total}}{N_{actual_PRS}} \right\rceil$	$32 \cdot \left\lceil \frac{N_{PRS_Total}}{N_{actual_PRS}} \right\rceil$
>160 ms	$8 \cdot \left\lceil \frac{N_{PRS_Total}}{N_{actual_PRS}} \right\rceil$	$16 \cdot \left\lceil \frac{N_{PRS_Total}}{N_{actual_PRS}} \right\rceil$
Note 1: When only intra-frequency RSTD measurements are performed over cells belonging to the serving FDD carrier frequency f1. Note 2: When intra-frequency RSTD and inter-frequency RSTD measurements are performed over cells belonging to the serving FDD carrier frequency f1 and one inter-frequency carrier frequency f2, respectively.		

The UE physical layer shall be capable of reporting RSTD for the reference cell and all the neighbor cells i out of at least $(n-1)$ neighbor cells within $T_{RSTD\text{IntraFreqFDD,Cat}_M}$ provided:

$$\left(\text{PRS } \hat{E}_s / \text{Iot} \right)_{ref} \geq -15 \text{ dB for all Frequency Bands for the reference cell,}$$

$$\left(\text{PRS } \hat{E}_s / \text{Iot} \right)_i \geq -15 \text{ dB for all Frequency Bands for neighbour cell } i,$$

$\left(\text{PRS } \hat{E}_s / \text{Iot} \right)_{ref}$ and $\left(\text{PRS } \hat{E}_s / \text{Iot} \right)_i$ conditions apply for all subframes of at least $L = \frac{n}{2}$ PRS positioning occasions,

PRP 1,2_{dBm} according to Annex B.2.23 for a corresponding Band

$PRS \hat{E}_s / I_{ot}$ is defined as the ratio of the average received energy per PRS RE during the useful part of the symbol to the average received power spectral density of the total noise and interference for this RE, where the ratio is measured over all REs which carry PRS.

The time $T_{RSTDIntraFreqFDD,Cat_M}$ starts from the first subframe of the PRS positioning occasion closest in time after both the OTDOA-RequestLocationInformation message and the OTDOA assistance data in the OTDOA-ProvideAssistanceData message as specified in TS 36.355 [24], are delivered to the physical layer of the UE as illustrated in Figure 8.16.3.1.1-1.

The RSTD measurement accuracy for all measured neighbor cells i shall be fulfilled according to the accuracy as specified in the sub-clause 9.1.25.5.

If the intra-frequency handover occurs while intra-frequency RSTD measurements are being performed then the UE shall complete the ongoing OTDOA measurement session. The UE shall also meet the intra-frequency OTDOA measurement and accuracy requirements. However in this case the RSTD measurement period ($T_{RSTDIntraFreqFDD,Cat_M,HO}$) shall be according to the following expression:

$$T_{RSTDIntraFreqFDD,Cat_M,HO} = T_{RSTDIntraFreqFDD,Cat_M} + K \times T_{PRS} + T_{HO} \quad ms,$$

where:

K is the number of times the intra-frequency handover occurs during $T_{RSTDIntraFreqFDD,Cat_M,HO}$.

T_{HO} is the time during which the intra-frequency RSTD measurement may not be possible due to intra-frequency handover.

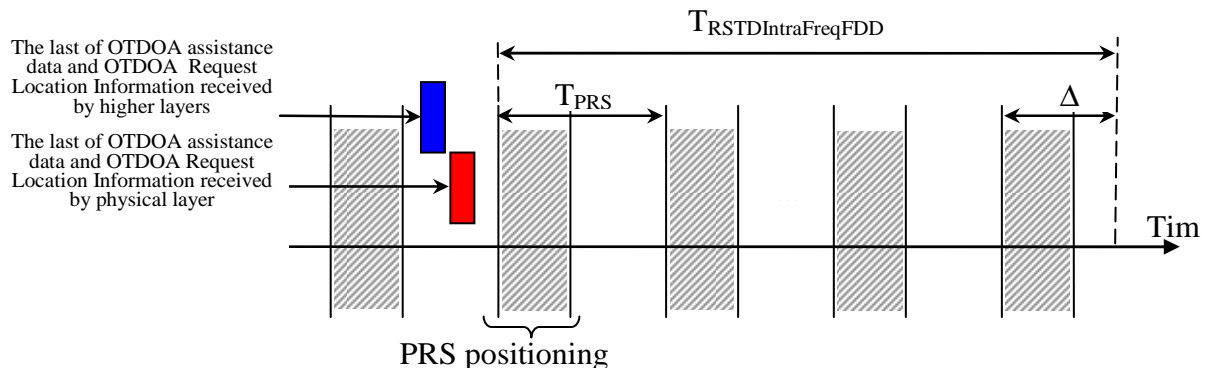

Figure 8.16.3.1.1-1: Illustration of the RSTD reporting time requirement in an FDD system.

Furthermore, due to the intra-frequency handover the UE shall meet the RSTD measurement accuracy for a PRS bandwidth which is not larger than the minimum channel bandwidth of all the PCells during the RSTD measurement period.

8.16.3.1.1.1 RSTD Measurement Reporting Delay

Reported measurement contained in event triggered measurement reports shall meet the requirements in sections 9.1.25.5.

The UE shall not send any measurement reports, as long as no reporting criteria are fulfilled.

The measurement reporting delay is defined as the time between the point when UE receive both the OTDOA-RequestLocationInformation message and the OTDOA assistance data in the OTDOA-ProvideAssistanceData message as specified in TS 36.355 [24], and the point when the UE starts to transmit the measurement report over the air interface. This requirement assumes that the measurement report is not delayed by other RRC signalling on the DCCH. This measurement reporting delay excludes a delay uncertainty resulted when inserting the measurement report to the TTI of the uplink DCCH. The delay uncertainty is: $N_{rep} \times TTI_{DCCH}$, where N_{rep} [21] is the maximum number of PUSCH repetitions configured for the UE, otherwise uncertainty is defined as $2 \times TTI_{DCCH}$. This measurement reporting delay excludes a delay which caused by no UL resources for UE to send the measurement report.

The measurement reporting delay shall be less than $T_{\text{RSTDIntraFreqIDD,Cat}_M}$ defined in Clause 8.16.3.1.1.

8.16.3.1.2 E-UTRAN TDD Intra-Frequency OTDOA Measurements

When the physical layer cell identities of neighbour cells together with the OTDOA assistance data are provided, the UE shall be able to detect and measure intra-frequency RSTD, specified in TS 36.214 [4], for at least $n=16$ cells, including the reference cell, on the same carrier frequency f_1 as that of the reference cell within $T_{\text{RSTDIntraFreqIDD,Cat}_M}$ ms as given below:

$$T_{\text{RSTDIntraFreqIDD,Cat}_M} = T_{\text{PRS}} \cdot (M - 1) + \Delta + T_{\text{MIB}},$$

where

$T_{\text{RSTDIntraFreqIDD,Cat}_M}$ is the total time for detecting and measuring at least n cells,

T_{PRS} is the cell-specific positioning subframe configuration period as defined in TS 36.355 [24] for UE not configured with measurement gaps for intra-frequency RSTD. For UE configured with measurement gaps for intra-frequency RSTD measurements, $T_{\text{PRS}} = \max(T_{\text{PRS}}, \text{MGRP})$, where MGRP is the Measurement Gap Repetition Period as defined in section 8.1.2.1.

M is the number of PRS positioning occasions as defined in Table 8.16.3.1.1-1, where downlink positioning subframes defined in TS 36.211 [16], and

$\Delta = T_{\text{PRS}} \cdot \left\lceil \frac{n}{M} \right\rceil$ ms is the measurement time for a single PRS positioning occasion which includes the sampling time and the processing time,

N_{PRS} is the cell-specific number of PRS subframes within a PRS occasion as defined in TS 36.355[24],

$N_{\text{actual_PRS}}$ is the number of PRS subframes within a PRS occasion available at the UE; $N_{\text{actual_PRS}} = N_{\text{PRS}}$ when the measurement gaps are not required for the intra-frequency RSTD measurements; for UE configured with measurement gaps for intra-frequency RSTD measurements $N_{\text{actual_PRS}}$ is the number of PRS subframes which can be measured by UE within MGL, where $N_{\text{actual_PRS}} = (\text{MGL}-2)$ if $\text{MGRP} \geq N_{\text{PRS}} > (\text{MGL}-2)$, $N_{\text{actual_PRS}} = (\text{MGL} - 2) \cdot \left\lfloor \frac{N_{\text{PRS}}}{\text{MGRP}} \right\rfloor$ if $N_{\text{PRS}} > \text{MGRP}$, and $N_{\text{actual_PRS}} = N_{\text{PRS}}$ if $N_{\text{PRS}} \leq (\text{MGL}-2)$.

$N_{\text{PRS_total}}$ is the minimum number of PRS subframes per cell measurement as specified in Section 9.1.25.5.

T_{PRS} , N_{PRS} , $N_{\text{actual_PRS}}$ and $N_{\text{PRS_total}}$ are the parameters of the same cell, for which $T_{\text{PRS}} \cdot \left\lceil \frac{N_{\text{PRS_total}}}{N_{\text{actual_PRS}}} \right\rceil$ is the largest among all the measured cells.

T_{MIB} is the time required for acquiring the MIB information of the target cell. $T_{\text{MIB}} = 0$ if the SFN of at least one cell in OTDOA assistance data is known to the UE.

Table 8.16.3.1.2-1: Number of PRS positioning occasions within $T_{\text{RSTDIntraFreqIDD,Cat}_M}$

Positioning subframe configuration period T_{PRS}	Number of PRS positioning occasions M	
	f_1 ^{Note1}	f_1 and f_2 ^{Note2}

160 ms	$16 \cdot \left\lceil \frac{N_{PRS_Total}}{N_{actual_PRS}} \right\rceil$	$32 \cdot \left\lceil \frac{N_{PRS_Total}}{N_{actual_PRS}} \right\rceil$
>160 ms	$8 \cdot \left\lceil \frac{N_{PRS_Total}}{N_{actual_PRS}} \right\rceil$	$16 \cdot \left\lceil \frac{N_{PRS_Total}}{N_{actual_PRS}} \right\rceil$
<p>Note 1: When only intra-frequency RSTD measurements are performed over cells belonging to the serving FDD carrier frequency f1.</p> <p>Note 2: When intra-frequency RSTD and inter-frequency RSTD measurements are performed over cells belonging to the serving FDD carrier frequency f1 and one inter-frequency carrier frequency f2, respectively.</p>		

The UE physical layer shall be capable of reporting RSTD for the reference cell and all the neighbor cells i out of at least $(n-1)$ neighbor cells within $T_{RSTDIntraFreqTDD,Cat_M}$ provided:

$$\left(\text{PRS } \hat{E}_s / \text{Iot} \right)_{ref} \geq -15 \text{ dB for all Frequency Bands for the reference cell,}$$

$$\left(\text{PRS } \hat{E}_s / \text{Iot} \right)_i \geq -15 \text{ dB for all Frequency Bands for neighbour cell } i,$$

$$\left(\text{PRS } \hat{E}_s / \text{Iot} \right)_{ref} \text{ and } \left(\text{PRS } \hat{E}_s / \text{Iot} \right)_i \text{ conditions apply for all subframes of at least } L = \frac{n}{2} \text{ PRS positioning occasions,}$$

PRP 1,2_{dBm} according to Annex B.2.23 for a corresponding Band

$\text{PRS } \hat{E}_s / \text{Iot}$ is defined as the ratio of the average received energy per PRS RE during the useful part of the symbol to the average received power spectral density of the total noise and interference for this RE, where the ratio is measured over all REs which carry PRS.

The time $T_{RSTDIntraFreqTDD,Cat_M}$ starts from the first subframe of the PRS positioning occasion closest in time after both the OTDOA-RequestLocationInformation message and the OTDOA assistance data in the OTDOA-ProvideAssistanceData message as specified in TS 36.355 [24], are delivered to the physical layer of the UE.

The RSTD measurement accuracy for all measured neighbor cells i shall be fulfilled according to the accuracy as specified in the sub-clause 9.1.25.5.

If the intra-frequency handover occurs while intra-frequency RSTD measurements are being performed then the UE shall complete the ongoing OTDOA measurement session. The UE shall also meet the intra-frequency OTDOA measurement and accuracy requirements. However in this case the RSTD measurement period (

$T_{RSTDIntraFreqTDD,Cat_M,HO}$) shall be according to the following expression:

$$T_{RSTDIntraFreqTDD,Cat_M,HO} = T_{RSTDIntraFreqTDD,Cat_M} + K \times T_{PRS} + T_{HO} \quad \text{ms,}$$

where:

K is the number of times the intra-frequency handover occurs during $T_{RSTDIntraFreqTDD,Cat_M,HO}$.

T_{HO} is the time during which the intra-frequency RSTD measurement may not be possible due to intra-frequency handover.

Furthermore, due to the intra-frequency handover the UE shall meet the RSTD measurement accuracy for a PRS bandwidth which is not larger than the minimum channel bandwidth of all the PCells during the RSTD measurement period.

The intra-frequency requirements in this clause (8.16.3.1.2) shall apply for all TDD special subframe configurations specified in TS 36.211 [16] and for the TDD uplink-downlink configurations as specified in Table 8.16.3.1.2-2.

Table 8.16.3.1.2-2: TDD uplink-downlink subframe configurations applicable for TDD intra-frequency requirements

PRS Transmission Bandwidth [RB]	Applicable TDD uplink-downlink configurations
6	1, 2, 3, 4 and 5
25	0, 1, 2, 3, 4, 5 and 6
Note:	Uplink-downlink configurations are specified in Table 4.2-2 in TS 36.211 [16].

8.16.3.1.2.1 RSTD Measurement Reporting Delay

Reported measurement contained in event triggered measurement reports shall meet the requirements in sections 9.1.25.5.

The UE shall not send any measurement reports, as long as no reporting criteria are fulfilled.

The measurement reporting delay is defined as the time between the point when UE receive both the OTDOA-RequestLocationInformation message and the OTDOA assistance data in the OTDOA-ProvideAssistanceData message as specified in TS 36.355 [24], and the point when the UE starts to transmit the measurement report over the air interface. This requirement assumes that the measurement report is not delayed by other RRC signalling on the DCCH. This measurement reporting delay excludes a delay uncertainty resulted when inserting the measurement report to the TTI of the uplink DCCH. The delay uncertainty is: $N_{rep} \times TTI_{DCCH}$, where N_{rep} [21] is the maximum number of PUSCH repetitions configured for the UE, otherwise uncertainty is defined as $2 \times TTI_{DCCH}$. This measurement reporting delay excludes a delay which caused by no UL resources for UE to send the measurement report.

The measurement reporting delay shall be less than $T_{RSTDIntraFreqTDD,Cat_M}$ defined in Clause 8.16.3.1.2.

8.16.3.1.3 E-UTRAN HD-FDD Intra-Frequency OTDOA Measurements

The requirements in this section are applicable for the UE which supports half duplex operation on one or more supported frequency bands [2].

The requirements defined in clause 8.16.3.1.1 also apply for this section except the reporting delay requirement provided the following conditions are met:

- all positioning subframes indicated in the OTDOA assistance data and specified in Section 9.1.25.5 are available for RSTD measurements in the measured and reference cells.

8.16.3.1.3.1 RSTD Measurement Reporting Delay

Reported measurement contained in event triggered measurement reports shall meet the requirements in sections 9.1.25.5.

The UE shall not send any measurement reports, as long as no reporting criteria are fulfilled.

The measurement reporting delay is defined as the time between the point when UE receive both the OTDOA-RequestLocationInformation message and the OTDOA assistance data in the OTDOA-ProvideAssistanceData message as specified in TS 36.355 [24], and the point when the UE starts to transmit the measurement report over the air interface. This requirement assumes that the measurement report is not delayed by other RRC signalling on the DCCH. This measurement reporting delay excludes a delay uncertainty resulted when inserting the measurement report to the TTI of the uplink DCCH. The delay uncertainty is: $N_{rep} \times TTI_{DCCH}$, where N_{rep} [21] is the maximum number of PUSCH repetitions configured for the UE, otherwise uncertainty is defined as $2 \times TTI_{DCCH}$. This measurement reporting delay excludes a delay which caused by no UL resources for UE to send the measurement report.

The measurement reporting delay shall be less than measurement period defined in Clause 8.16.3.1.3.

8.16.3.2 E-UTRAN OTDOA Inter-Frequency RSTD Measurements for Cat-M2 UE in CEModeB

All inter-frequency RSTD measurement requirements specified in Sections 8.16.3.2 shall apply, provided that

- the UE is capable of inter-frequency RSTD measurements for OTDOA [24], and

- either the measurement gap pattern ID # 0 specified in Table 8.1.2.1-1 or any applicable measurement gap pattern specified in Table 8.1.2.1-3 is used or the UE supports capability of conducting inter-frequency measurements without gaps.

All inter-frequency RSTD measurement requirements specified in Sections 8.16.3.2 shall apply without DRX as well as for any DRX and eDRX_CONN cycles specified in TS 36.331 [2].

All positioning subframes indicated in the OTDOA assistance data and specified in sub-clause 9.1.25.2 are available for RSTD measurements in the measured and reference cell.

All the measurement requirements specified in Sections 8.16.3.2 shall apply provided that the UE is configured with the single PRS configuration for the reference cell and all the neighbour cells.

If CRS muting is enabled in a cell for which the UE performs RSTD measurements, the UE capable of supporting CRS muting [31] shall perform RSTD measurements and meet all the requirements in this section, provided the CRS are available within at least the PRS bandwidth in the subframes with PRS during all positioning occasions within the RSTD measurement period.

8.16.3.2.1 E-UTRAN FDD Inter-Frequency OTDOA Measurements

When the physical layer cell identities of neighbour cells together with the OTDOA assistance data are provided, the UE shall be able to detect and measure inter-frequency RSTD, specified in TS 36.214 [4], for at least $n=16$ cells, including the reference cell, on the same carrier frequency f_1 as that of the reference cell within $T_{\text{RSTDInterFreqFDD,Cat}_M}$ ms as given below:

$$T_{\text{RSTDInterFreqFDD,Cat}_M} = T_{\text{PRS}} \cdot (M - 1) + \Delta + T_{\text{MIB}} \text{ ms},$$

where

$T_{\text{RSTDInterFreqFDD,Cat}_M}$ is the total time for detecting and measuring at least n cells,

T_{PRS} is the cell-specific positioning subframe configuration period as defined in TS 36.355 [24]; if $T_{\text{PRS}} < \text{MGRP}$, T_{PRS} equals to MGRP; MGRP is the Measurement Gap Repetition Period as defined in section 8.1.2.1,

M is the number of PRS positioning occasions as defined in Table 8.16.3.2.1-1, where downlink positioning subframes defined in TS 36.211 [16], and

$\Delta = T_{\text{PRS}} \cdot \left\lceil \frac{n}{M} \right\rceil$ ms is the measurement time for a single PRS positioning occasion which includes the sampling time and the processing time,

N_{PRS} is the cell-specific number of PRS subframes within a PRS occasion as defined in TS 36.355 [24];

$N_{\text{actual_PRS}}$ is the number of PRS subframes within a PRS occasion that can be measured by UE within MGL; if $\text{MGRP} > (N_{\text{PRS}} \cdot (MGL - 2) \text{ms})$, $N_{\text{actual_PRS}} = (MGL - 2) \cdot \left\lfloor \frac{N_{\text{PRS}}}{\text{MGRP}} \right\rfloor$; if $N_{\text{PRS}} > \text{MGRP}$, $N_{\text{actual_PRS}} = N_{\text{PRS}}$ if $N_{\text{PRS}} \leq (MGL - 2)$;

$N_{\text{PRS_total}}$ is the minimum number of PRS subframes per cell measurement as specified in Section 9.1.25.2.

T_{PRS} , N_{PRS} , $N_{\text{actual_PRS}}$ and $N_{\text{PRS_total}}$ are the parameters of the same cell, for which $T_{\text{PRS}} \cdot \left\lceil \frac{N_{\text{PRS_total}}}{N_{\text{actual_PRS}}} \right\rceil$ is the largest among all the measured cells.

T_{MIB} is the time required for acquiring the MIB information of the target cell. $T_{MIB} = 0$ if the SFN of at least one cell in OTDOA assistance data is known to the UE.

Table 8.16.3.2.1-1: Number of PRS positioning occasions within $T_{RSTDInterFreqFDD,Cat_M}$

Positioning subframe configuration period T_{PRS}	Number of PRS positioning occasions M	
	f2 ^{Note1}	f1 and f2 ^{Note2}
160 ms	$16 \cdot \left\lceil \frac{N_{PRS_Total}}{N_{actual_PRS}} \right\rceil$	$32 \cdot \left\lceil \frac{N_{PRS_Total}}{N_{actual_PRS}} \right\rceil$
>160 ms	$8 \cdot \left\lceil \frac{N_{PRS_Total}}{N_{actual_PRS}} \right\rceil$	$16 \cdot \left\lceil \frac{N_{PRS_Total}}{N_{actual_PRS}} \right\rceil$
Note 1: When inter-frequency RSTD measurements are performed over the reference cell and neighbour cells, which belong to the FDD inter-frequency carrier frequency f2. Note 2: When inter-frequency RSTD measurements are performed over the reference cell and the neighbour cells, which belong to the serving FDD carrier frequency f1 and the FDD inter-frequency carrier frequency f2 respectively.		

The UE physical layer shall be capable of reporting RSTD for the reference cell and all the neighbor cells i out of at least $(n-1)$ neighbor cells within $T_{RSTDInterFreqFDD,Cat_M}$ provided:

$$\left(\text{PRS } \hat{E}_s / \text{Iot} \right)_{ref} \geq -15 \text{ dB for all Frequency Bands for the reference cell,}$$

$$\left(\text{PRS } \hat{E}_s / \text{Iot} \right)_i \geq -15 \text{ dB for all Frequency Bands for neighbour cell } i,$$

$$\left(\text{PRS } \hat{E}_s / \text{Iot} \right)_{ref} \text{ and } \left(\text{PRS } \hat{E}_s / \text{Iot} \right)_i \text{ conditions apply for all subframes of at least } L = \frac{M}{2} \text{ PRS positioning occasions,}$$

PRP 1,2_{dBm} according to Annex B.2.21 for a corresponding Band

$\text{PRS } \hat{E}_s / \text{Iot}$ is defined as the ratio of the average received energy per PRS RE during the useful part of the symbol to the average received power spectral density of the total noise and interference for this RE, where the ratio is measured over all REs which carry PRS.

The time $T_{RSTDInterFreqFDD,Cat_M}$ starts from the first subframe of the PRS positioning occasion closest in time after both the OTDOA-RequestLocationInformation message and the OTDOA assistance data in the OTDOA-ProvideAssistanceData message as specified in TS 36.355 [24], are delivered to the physical layer of the UE.

The RSTD measurement accuracy for all measured neighbor cells i shall be fulfilled according to the accuracy as specified in the sub-clause 9.1.25.2.

If the inter-frequency handover occurs while inter-frequency RSTD measurements are being performed then the UE shall complete the ongoing OTDOA measurement session. The UE shall also meet the inter-frequency OTDOA measurement and accuracy requirements. However in this case the RSTD measurement period (

$T_{RSTDInterFreqFDD,Cat_M,HO}$) shall be according to the following expression:

$$T_{RSTDInterFreqFDD,Cat_M,HO} = T_{RSTDInterFreqFDD,Cat_M} + K \times T_{PRS} + T_{HO} \quad \text{ms,}$$

where:

K is the number of times the inter-frequency handover occurs during $T_{RSTDInterFreqFDD,Cat_M,HO}$.

T_{HO} is the time during which the inter-frequency RSTD measurement may not be possible due to inter-frequency handover.

Furthermore, due to the inter-frequency handover the UE shall meet the RSTD measurement accuracy for a PRS bandwidth which is not larger than the minimum channel bandwidth of all the PCells during the RSTD measurement period.

8.16.3.2.1.1 RSTD Measurement Reporting Delay

Reported measurement contained in event triggered measurement reports shall meet the requirements in sections 9.1.25.2.

The UE shall not send any measurement reports, as long as no reporting criteria are fulfilled.

The measurement reporting delay is defined as the time between the point when UE receive both the OTDOA-RequestLocationInformation message and the OTDOA assistance data in the OTDOA-ProvideAssistanceData message as specified in TS 36.355 [24], and the point when the UE starts to transmit the measurement report over the air interface. This requirement assumes that the measurement report is not delayed by other RRC signalling on the DCCH. This measurement reporting delay excludes a delay uncertainty resulted when inserting the measurement report to the TTI of the uplink DCCH. The delay uncertainty is: $N_{rep} \times TTI_{DCCH}$, where N_{rep} [21] is the maximum number of PUSCH repetitions configured for the UE, otherwise uncertainty is defined as $2 \times TTI_{DCCH}$. This measurement reporting delay excludes a delay which caused by no UL resources for UE to send the measurement report.

The measurement reporting delay shall be less than $T_{RSTDInterFreqIDD,Cat_M}$ defined in Clause 8.16.3.2.1.

8.16.3.2.2 E-UTRAN TDD Inter-Frequency OTDOA Measurements

When the physical layer cell identities of neighbour cells together with the OTDOA assistance data are provided, the UE shall be able to detect and measure inter-frequency RSTD, specified in TS 36.214 [4], for at least $n=16$ cells, including the reference cell, on the same carrier frequency f_1 as that of the reference cell within $T_{RSTDInterFreqIDD,Cat_M}$ ms as given below:

$$T_{RSTDInterFreqIDD,Cat_M} = T_{PRS} \cdot (M - 1) + \Delta + T_{MIB} \quad \text{ms ,}$$

where

$T_{RSTDInterFreqIDD,Cat_M}$ is the total time for detecting and measuring at least n cells,

T_{PRS} is the cell-specific positioning subframe configuration period as defined in TS 36.355 [24] ; if $T_{PRS} < MGRP$, T_{PRS} equals to MGRP; MGRP is the Measurement Gap Repetition Period as defined in section 8.1.2.1,

M is the number of PRS positioning occasions as defined in Table 8.16.3.2.2-1, where downlink positioning subframes defined in TS 36.211 [16], and

$\Delta = T_{PRS} \cdot \left\lceil \frac{n}{M} \right\rceil$ ms is the measurement time for a single PRS positioning occasion which includes the sampling time and the processing time,

N_{PRS} is the cell-specific number of PRS subframes within a PRS occasion as defined in TS 36.355[24];

N_{actual_PRS} is the number of PRS subframes within a PRS occasion that can be measured by UE within MGL; if

$$MGRP \geq N_{PRS} > (MGL - 2\text{ms}), N_{actual_PRS} = (MGL - 2\text{ms}); \text{ if } N_{PRS} > MGRP, N_{actual_PRS} = (MGL - 2) \cdot \left\lfloor \frac{N_{PRS}}{MGRP} \right\rfloor; N_{actual_PRS} = N_{PRS} \text{ if } N_{PRS} \leq (MGL - 2);$$

N_{PRS_total} is the minimum number of PRS subframes per cell measurement as specified in Section 9.1.25.2.

T_{PRS} , N_{PRS} , N_{actual_PRS} and N_{PRS_total} are the parameters of the same cell, for which $T_{PRS} \cdot \left\lceil \frac{N_{PRS_total}}{N_{actual_PRS}} \right\rceil$ is the largest among all the measured cells.

T_{MIB} is the time required for acquiring the MIB information of the target cell. $T_{MIB} = 0$ if the SFN of at least one cell in OTDOA assistance data is known to the UE.

Table 8.16.3.2.2-1: Number of PRS positioning occasions within $T_{RSTDInterFreqTDD,Cat_M}$

Positioning subframe configuration period T_{PRS}	Number of PRS positioning occasions M	
	f2 ^{Note1}	f1 and f2 ^{Note2}
160 ms	$16 \cdot \left\lceil \frac{N_{PRS_Total}}{N_{actual_PRS}} \right\rceil$	$32 \cdot \left\lceil \frac{N_{PRS_Total}}{N_{actual_PRS}} \right\rceil$
>160 ms	$8 \cdot \left\lceil \frac{N_{PRS_Total}}{N_{actual_PRS}} \right\rceil$	$16 \cdot \left\lceil \frac{N_{PRS_Total}}{N_{actual_PRS}} \right\rceil$
Note 1: When inter-frequency RSTD measurements are performed over the reference cell and neighbour cells, which belong to the TDD inter-frequency carrier frequency f2. Note 2: When inter-frequency RSTD measurements are performed over the reference cell and the neighbour cells, which belong to the serving TDD carrier frequency f1 and the TDD inter-frequency carrier frequency f2 respectively.		

The UE physical layer shall be capable of reporting RSTD for the reference cell and all the neighbor cells i out of at least $(n-1)$ neighbor cells within $T_{RSTDInterFreqTDD,Cat_M}$ provided:

$$\left(\text{PRS } \hat{E}_s / \text{Iot} \right)_{ref} \geq -15 \text{ dB for all Frequency Bands for the reference cell,}$$

$$\left(\text{PRS } \hat{E}_s / \text{Iot} \right)_i \geq -15 \text{ dB for all Frequency Bands for neighbour cell } i,$$

$\left(\text{PRS } \hat{E}_s / \text{Iot} \right)_{ref}$ and $\left(\text{PRS } \hat{E}_s / \text{Iot} \right)_i$ conditions apply for all subframes of at least $L = \frac{M}{2}$ PRS positioning occasions,

PRP 1,2_{dBm} according to Annex B.2.21 for a corresponding Band

$\text{PRS } \hat{E}_s / \text{Iot}$ is defined as the ratio of the average received energy per PRS RE during the useful part of the symbol to the average received power spectral density of the total noise and interference for this RE, where the ratio is measured over all REs which carry PRS.

The time $T_{RSTDInterFreqTDD,Cat_M}$ starts from the first subframe of the PRS positioning occasion closest in time after both the OTDOA-RequestLocationInformation message and the OTDOA assistance data in the OTDOA-ProvideAssistanceData message as specified in TS 36.355 [24], are delivered to the physical layer of the UE.

The RSTD measurement accuracy for all measured neighbor cells i shall be fulfilled according to the accuracy as specified in the sub-clause 9.1.25.2.

If the inter-frequency handover occurs while inter-frequency RSTD measurements are being performed then the UE shall complete the ongoing OTDOA measurement session. The UE shall also meet the inter-frequency OTDOA measurement and accuracy requirements. However in this case the RSTD measurement period ($T_{RSTDInterFreqTDD,Cat_M,HO}$) shall be according to the following expression:

$T_{RSTDInterFreqTDD,Cat_M,HO}$ shall be according to the following expression:

$$T_{\text{RSTDInterFreqIDD,Cat_M,HO}} = T_{\text{RSTDInterFreqIDD,Cat_M}} + K \times T_{\text{PRS}} + T_{\text{HO}} \quad \text{ms},$$

where:

K is the number of times the inter-frequency handover occurs during $T_{\text{RSTDInterFreqIDD,Cat_M,HO}}$.

T_{HO} is the time during which the inter-frequency RSTD measurement may not be possible due to inter-frequency handover.

Furthermore, due to the inter-frequency handover the UE shall meet the RSTD measurement accuracy for a PRS bandwidth which is not larger than the minimum channel bandwidth of all the PCells during the RSTD measurement period.

The inter-frequency requirements in this clause (8.16.3.2.2) shall apply for all TDD special subframe configurations specified in TS 36.211 [16] and for the TDD uplink-downlink configurations as specified in Table 8.16.3.2.2-2.

Table 8.16.3.2.2-2: TDD uplink-downlink subframe configurations applicable for TDD inter-frequency requirements

PRS Transmission Bandwidth [RB]	Applicable TDD uplink-downlink configurations
6	1, 2, 3, 4 and 5
24	0, 1, 2, 3, 4, 5 and 6
Note:	Uplink-downlink configurations are specified in Table 4.2-2 in TS 36.211 [16].

8.16.3.2.2.1 RSTD Measurement Reporting Delay

Reported measurement contained in event triggered measurement reports shall meet the requirements in sections 9.1.25.2.

The UE shall not send any measurement reports, as long as no reporting criteria are fulfilled.

The measurement reporting delay is defined as the time between the point when UE receive both the OTDOA-RequestLocationInformation message and the OTDOA assistance data in the OTDOA-ProvideAssistanceData message as specified in TS 36.355 [24], and the point when the UE starts to transmit the measurement report over the air interface. This requirement assumes that the measurement report is not delayed by other RRC signalling on the DCCH. This measurement reporting delay excludes a delay uncertainty resulted when inserting the measurement report to the TTI of the uplink DCCH. The delay uncertainty is: $N_{rep} \times TTI_{\text{DCCH}}$, where N_{rep} [21] is the maximum number of PUSCH repetitions configured for the UE, otherwise uncertainty is defined as $2 \times TTI_{\text{DCCH}}$. This measurement reporting delay excludes a delay which caused by no UL resources for UE to send the measurement report.

The measurement reporting delay shall be less than $T_{\text{RSTDInterFreqIDD,Cat_M}}$ defined in Clause 8.16.3.2.2.

8.16.3.2.3 E-UTRAN HD-FDD Inter-Frequency OTDOA Measurements

The requirements in this section are applicable for the UE which supports half duplex operation on one or more supported frequency bands [2].

The requirements defined in clause 8.16.3.2.1 also apply for this section except reporting delay requirement provided the following conditions are met:

- all positioning subframes indicated in the OTDOA assistance data and specified in Section 9.1.25.2 are available for RSTD measurements in the measured and reference cells.

8.16.3.2.3.1 RSTD Measurement Reporting Delay

Reported measurement contained in event triggered measurement reports shall meet the requirements in sections 9.1.25.2.

The UE shall not send any measurement reports, as long as no reporting criteria are fulfilled.

The measurement reporting delay is defined as the time between the point when UE receive both the OTDOA-RequestLocationInformation message and the OTDOA assistance data in the OTDOA-ProvideAssistanceData message as specified in TS 36.355 [24], and the point when the UE starts to transmit the measurement report over the air interface. This requirement assumes that the measurement report is not delayed by other RRC signalling on the DCCH. This measurement reporting delay excludes a delay uncertainty resulted when inserting the measurement report to the TTI of the uplink DCCH. The delay uncertainty is: $N_{rep} \times TTI_{DCCH}$, where N_{rep} [21] is the maximum number of PUSCH repetitions configured for the UE, otherwise uncertainty is defined as $2 \times TTI_{DCCH}$. This measurement reporting delay excludes a delay which caused by no UL resources for UE to send the measurement report.

The measurement reporting delay shall be less than measurement period as defined in Clause 8.16.3.2.3.

8.17 Measurements for E-UTRA – NR Dual Connectivity

8.17.1 Introduction

This clause contains requirements for UE supporting dual connectivity with E-UTRA PCell and NR PSCell.

Requirements in this clause are applicable to UEs which have been configured with EN-DC. Requirements in this clause are applicable to both E-UTRA FDD and E-UTRA TDD PCell in combination with an NR PSCell.

8.17.1.1 Measurement Gap Sharing

For UE configured with per-UE measurement gap, measurement gap sharing shall be applied when UE requires measurement gaps to identify and measure cells on NR intra-frequency carriers or when SMTC configured for NR intra-frequency measurement are fully overlapping with per-UE measurement gaps, and when UE is configured to identify and measure cells on E-UTRA gap-needed inter-frequency carriers, NR inter-frequency carriers, inter-RAT UTRAN carriers and/or inter-RAT GSM carriers.

For UE configured with per-FR1 measurement gap, measurement gap sharing shall be applied when UE requires measurement gaps to identify and measure cells on NR FR1 intra-frequency carriers or when SMTC configured for NR FR1 intra-frequency measurement are fully overlapping with per-FR1 measurement gaps, and when UE is configured to identify and measure cells on E-UTRA gap-needed inter-frequency carriers, NR inter-frequency carriers, inter-RAT UTRAN carriers and/or inter-RAT GSM carriers.

In this clause, NR intra-frequency or NR inter-frequency measurement is defined respective to NR serving carriers as specified in clauses 9.2 and 9.3 of TS 38.133 [50], which is also inter-RAT measurement respective to E-UTRA serving carriers.

When network signals “01”, “10” or “11” with RRC parameter *measGapSharingScheme* [2] and the value of X is defined as in Table 8.17.1.1-1, and $Kinter = 1 / (100 - X) * 100$.

When network signals “00” indicating equal splitting gap sharing, X is not applied.

The RRC parameter *MeasGapSharingScheme* shall be applied to the calculation of carrier specific scaling factor as specified in clause 9.1.5.2.1 of TS 38.133 [50]

Table 8.17.1.1-1: Value of parameter X for EN-DC measurement gap sharing

<i>measGapSharingScheme</i>	Value of X (%)
'00'	Equal splitting
'01'	25
'10'	50
'11'	75
Note:	It is left to UE implementation to determine which measurement gap sharing scheme in the table to be applied, when <i>MeasGapSharingScheme</i> is absent and there is no stored value in the field.

8.17.1A Intrafrequency Measurements

PCC intra-frequency measurements shall meet all applicable requirements in clause 8.1.2.2. If MCG DRX is in use, then the PCell intra-frequency requirements for when DRX is in use in clause 8.1.2.2 shall apply and shall depend on

the MCG DRX cycle. Otherwise, the requirements for when DRX is not in use shall apply. The applicable measurement accuracy requirements are in clause 9.1.

SCC intra-frequency measurements shall meet all applicable requirements in clause 8.3.3. If MCG DRX is in use, then the PCell intra-frequency requirements for when DRX is in use in clause 8.1.2.2 shall apply and shall depend on the MCG DRX cycle. Otherwise, the requirements for when DRX is not in use shall apply. The applicable measurement accuracy requirements are in clause 9.1.

8.17.2 SFTD Measurements

8.17.2.1 Introduction

This clause contains SFTD measurement requirements on UE capabilities for support of EN-DC in RRC_CONNECTED state. The overall delay includes RRC procedure delay to be defined in clause 11.2 in TS 36.331 [2], and SFTD measurement reporting delay in clause 8.17.2.3.

8.17.2.2 SFTD Measurement requirements

When no DRX is used in either of PCell and PSCell, the physical layer measurement period of the SFTD measurement shall be $T_{\text{measure_SFTD1}} = \max(200, 5 \times \text{SMTC period})$ ms.

When DRX is used in either of the E-UTRA PCell or the NR PSCell, or in both PCell and PSCell, the physical layer measurement period ($T_{\text{measure_SFTD1}}$) of the SFTD measurement shall be as specified in table 8.17.2.2-1.

Table 8.17.2.2-1: SFTD measurement requirement when DRX is used

DRX cycle length (s) ^{Note 3}	$T_{\text{measure_SFTD1}}$ (s)
≤ 0.04	$\max(0.2, 5 \times \text{SMTC period})$ (Note 1)
$0.04 < \text{DRX cycle} \leq 0.32$	$8 \times \max(\text{DRX cycle}, \text{SMTC period})$
$0.32 < \text{DRX cycle} \leq 10.24$	$5 \times \text{DRX cycle}$
Note 1:	Number of DRX cycles depends upon the DRX cycle in use
Note 2:	(Void)
Note 3:	DRX cycle length in this table refers to the DRX cycle length configured for PCell or PSCell. When DRX is used in both PCell and PSCell, DRX cycle length in this table refers to the longer of the DRX cycle lengths for PCell and PSCell.

If PSCell is changed without changing carrier frequency of PSCell, while the UE is performing SFTD measurements, the UE shall still meet SFTD measurement and accuracy requirements for the new PSCell. In this case the UE shall restart the SFTD measurement, and the total physical layer measurement period shall not exceed $T_{\text{measure_SFTD2}}$ as defined by the following expression:

$$T_{\text{measure_SFTD2}} = (M+1) \cdot (T_{\text{measure_SFTD1}}) + M \cdot T_{\text{PSCell_change_ENDC}}$$

where:

M is the number of times the NR PSCell is changed over the measurement period ($T_{\text{measure_SFTD2}}$), and

$T_{\text{PSCell_change_ENDC}}$ is the time necessary to change the PSCell; it can be up to 25 ms.

If PCell is changed, or if PSCell is changed with different carrier frequency from PSCell, the UE shall terminate SFTD measurements.

The measurement accuracy for the SFTD measurement when DRX is used as well as when no DRX is used shall be as specified in the sub-clause 9.1.27.

8.17.2.3 SFTD Measurement Reporting Delay

The SFTD measurement reporting delay is defined as the time between a command that will trigger an SFTD measurement report and the point when the UE starts to transmit the measurement report over the air interface. This requirement assumes that the measurement report is not delayed by other RRC signalling on the DCCH. This measurement reporting delay excludes a delay uncertainty resulted when inserting the measurement report to the TTI of the uplink DCCH. The delay uncertainty is: $2 \times \text{TTI}_{\text{DCCH}}$. This measurement reporting delay excludes any delay caused

by no UL resources for UE to send the measurement report. When the UE is configured to perform SRS carrier-based switching, an additional delay can be expected.

The SFTD measurement reporting delay shall be less than measurement period defined in clause 8.17.2.2.

8.17.3 E-UTRA Inter-frequency Measurements when Configured with E-UTRA-NR Dual Connectivity Operation

8.17.3.1 Introduction

The E-UTRAN inter frequency measurement requirements defined in section 8.17.3 shall apply when the UE capable of EN-DC is operating in EN-DC mode. The requirements in section 8.17.3 are applicable for gap pattern id # 0, 1, 2, 3, 4, 6, 7, 8, 10 as defined specified in Table 8.1.2.1-1.

When per-UE measurement gap is configured, the scaling factor $CSSF_{E-UTRA, NSA}$ used in the E-UTRAN inter frequency measurement requirements for the UE configured with EN-DC mode is determined according to $CSSF_{within_gap,i}$ as specified in clause 9.1.5.2.1 of TS 38.133 [50]. When per-FR gap is configured, the scaling factor $CSSF_{E-UTRA, NSA}$ shall exclude the frequencies not on the corresponding frequency range. When the UE is not configured with EN-DC mode then the E-UTRAN inter frequency measurement requirements defined in section 8.1.2.3 shall apply.

8.17.3.2 E-UTRAN FDD inter frequency measurements

8.17.3.2.1 E-UTRAN FDD inter frequency measurements when no DRX is used

8.17.3.2.1.1 Introduction

The requirements in this section shall apply for E-UTRAN FDD-FDD inter frequency measurements and for E-UTRAN TDD-FDD inter frequency measurements when the UE is operating in EN-DC mode.

8.17.3.2.1.2 Requirements

When measurement gaps are scheduled, or the UE supports capability of conducting such measurements without gaps, then the UE shall be able to identify a new FDD inter-frequency within $T_{Identify_Inter}$ according to the following expression:

$$T_{Identify_Inter} = T_{Basic_Identify_Inter} \cdot \frac{480}{T_{inter1}} \cdot CSSF_{E-UTRA, NSA} \quad ms$$

Where:

$T_{Basic_Identify_Inter} = 480$ ms. It is the time period used in the inter frequency equation where the maximum allowed time for the UE to identify a new FDD inter-frequency cell is defined.

T_{inter1} is defined in clause 8.1.2.1.

A cell shall be considered detectable provided following conditions are fulfilled:

- $RSRP_{dBm}$ and $RSRP \hat{E}s/Iot$ according to Annex B.2.3 for a corresponding Band,
- other RSRP related side conditions given in Sections 9.1.3.1 and 9.1.3.2 are fulfilled for a corresponding Band,
- RSRQ related side conditions given in Sections 9.1.6.1 and 9.1.6.2 are fulfilled for a corresponding Band,
- RS-SINR related side conditions given in Sections 9.1.17.3.1 and 9.1.17.3.2 are fulfilled for a corresponding Band₂
- SCH_RP_{dBm} and $SCH \hat{E}s/Iot$ according to Annex B.2.3 for a corresponding Band.

When measurement gaps are scheduled for FDD inter frequency measurements, or the UE supports capability of conducting such measurements without gaps, the UE physical layer shall be capable of reporting RSRP, RSRQ, and RS-SINR measurements to higher layers with measurement accuracy as specified in sub-clauses 9.1.3.1, 9.1.3.2, 9.1.6.1, 9.1.6.2, 9.1.17.3.1 and 9.1.17.3.2, respectively, with measurement period given by table 8.17.3.2.1.2-1.

Table 8.17.3.2.1.2-1: Measurement period and measurement bandwidth

Configuration	Physical Layer Measurement period: $T_{\text{Measurement_Period_Inter_FDD}}$ [ms]	Measurement bandwidth [RB]
0	480 x $\text{CSSF}_{\text{E-UTRA, NSA}}$	6
1 (Note 1)	240 x $\text{CSSF}_{\text{E-UTRA, NSA}}$	50
Note 1: This configuration is optional		

The UE shall be capable of performing RSRP, RSRQ, and RS-SINR measurements of at least 4 inter-frequency cells per FDD inter-frequency for up to 6 FDD inter-frequencies and the UE physical layer shall be capable of reporting RSRP, RSRQ, and RS-SINR measurements to higher layers with the measurement period defined in Table 8.17.3.2.2-1.

8.17.3.2.1.3 Measurement Reporting Requirements

8.17.3.2.1.3.1 Periodic Reporting

Reported RSRP, RSRQ and RS-SINR measurements contained in periodically triggered measurement reports shall meet the requirements in sections 9.1.3.1, 9.1.3.2, 9.1.6.1, 9.1.6.2, 9.1.17.3.1 and 9.1.17.3.2, respectively.

8.17.3.2.1.3.2 Event-triggered Periodic Reporting

Reported RSRP, RSRQ and RS-SINR measurements contained in event triggered periodic measurement reports shall meet the requirements in sections 9.1.3.1, 9.1.3.2, 9.1.6.1, 9.1.6.2, 9.1.17.3.1 and 9.1.17.3.2, respectively.

The first report in event triggered periodic measurement reporting shall meet the requirements specified in clause 8.17.3.2.1.3.3.

8.17.3.2.1.3.3 Event Triggered Reporting

Reported RSRP, RSRQ, and RS-SINR measurements contained in event triggered measurement reports shall meet the requirements in sections 9.1.3.1, 9.1.3.2, 9.1.6.1, 9.1.6.2, 9.1.17.3.1 and 9.1.17.3.2, respectively.

The UE shall not send any event triggered measurement reports as long as no reporting criteria are fulfilled.

The measurement reporting delay is defined as the time between an event that will trigger a measurement report and the point when the UE starts to transmit the measurement report over the air interface. This requirement assumes that the measurement report is not delayed by other RRC signalling on the DCCH. This measurement reporting delay excludes a delay uncertainty resulted when inserting the measurement report to the TTI of the uplink DCCH. The delay uncertainty is: $2 \times TTI_{\text{DCCH}}$. This measurement reporting delay excludes a delay which caused by no UL resources for UE to send the measurement report.

The event triggered measurement reporting delay, measured without L3 filtering shall be less than $T_{\text{Identify_Inter}}$ defined in clause 8.17.3.2.1 When L3 filtering is used or IDC autonomous denial is configured or the UE is performing reception and/or transmission for ProSe Direct Discovery and/or ProSe Direct Communication, or the UE is configured to perform SRS carrier based switching, an additional delay can be expected.

If a cell which has been detectable at least for the time period, $T_{\text{Identify_Inter}}$ defined in clause 8.17.3.2.1 and then triggers the measurement report as per TS 36.331 [2], the event triggered measurement reporting delay shall be less than $T_{\text{Measurement_Period_Inter_FDD}}$ defined in clause 8.17.3.2.1 provided the timing to that cell has not changed more than ± 50 Ts while measurement gap has not been available and the L3 filter has not been used. When L3 filtering is used or IDC autonomous denial is configured or the UE is performing reception and/or transmission for ProSe Direct Discovery and/or ProSe Direct Communication, or the UE is configured to perform SRS carrier based switching, an additional delay can be expected.

8.17.3.2.2 E-UTRAN FDD inter frequency measurements when DRX is used

8.17.3.2.2.1 Introduction

The requirements in this section shall apply for E-UTRAN FDD-FDD inter frequency measurements and for E-UTRAN TDD-FDD inter frequency measurements when the UE is operating in EN-DC mode.

8.17.3.2.2.2 Requirements

When DRX or eDRX_CONN is in use, either measurement gaps are scheduled or the UE supports capability of conducting such measurements without gaps, the UE shall be able to identify a new detectable E-UTRAN FDD inter

frequency cell within $T_{\text{Identify_Inter}}$. When DRX is in use, $T_{\text{Identify_inter}}$ is as defined in Table 8.17.3.2.2.2-1, and when eDRX_CONN is in use, $T_{\text{Identify_Inter}}$ is as defined in Table 8.17.3.2.2.2-1A. When MCG DRX is in use the applicable DRX cycle is the MCG DRX cycle.

Table 8.17.3.2.2.2-1: Requirement to identify a newly detectable FDD interfrequency cell

DRX cycle length (s)	$T_{\text{Identify_inter}}$ (s) (DRX cycles)	
	Gap period = 40 ms, 20 ms	Gap period = 80 ms
≤ 0.16	Non DRX Requirements in clause 8.17.3.1 are applicable	Non DRX Requirements in clause 8.17.3.1 are applicable
0.256	5.12* CSSF _{E-UTRA, NSA} (20* CSSF _{E-UTRA, NSA})	7.68* CSSF _{E-UTRA, NSA} (30* CSSF _{E-UTRA, NSA})
0.32	6.4* CSSF _{E-UTRA, NSA} (20* CSSF _{E-UTRA, NSA})	7.68* CSSF _{E-UTRA, NSA} (24* CSSF _{E-UTRA, NSA})
$0.32 < \text{DRXcycle} \leq 2.56$	Note (20* CSSF _{E-UTRA, NSA})	Note (20* CSSF _{E-UTRA, NSA})
Note: Time depends upon the DRX cycle in use		

Table 8.17.3.2.2.2-1A: Requirement to identify a newly detectable FDD inter-frequency cell when eDRX_CONN cycle is used

eDRX_CONN cycle length (s)	$T_{\text{Identify_inter}}$ (s) (eDRX_CONN cycles)	
	Gap period = 40 ms, 20 ms	Gap period = 80 ms
$2.56 < \text{eDRX_CONN cycle} \leq 10.24$	Note (20* CSSF _{E-UTRA, NSA})	Note (20* CSSF _{E-UTRA, NSA})
Note: Time depends upon the eDRX_CONN cycle in use		

A cell shall be considered detectable provided following conditions are fulfilled:

- RSRP_{dBm} and RSRP \hat{E} s/Iot according to Annex B.2.3 for a corresponding Band,
- other RSRP related side conditions given in Clause 9.1.3.1 and 9.1.3.2 are fulfilled for a corresponding Band,
- RSRQ related side conditions given in Sections 9.1.6.1 and 9.1.6.2 are fulfilled for a corresponding Band,
- RS-SINR related side conditions given in Sections 9.1.17.3.1 and 9.1.17.3.2 are fulfilled for a corresponding Band₂,
- SCH_RP_{dBm} SCH \hat{E} s/Iot according to Annex B.2.3 for a corresponding Band.

When DRX or eDRX_CONN is in use, the UE shall be capable of performing RSRP, RSRQ, and RS-SINR measurements of at least 4 inter-frequency cells per FDD inter-frequency and the UE physical layer shall be capable of reporting RSRP, RSRQ, and RS-SINR measurements to higher layers with the measurement period $T_{\text{measure_inter}}$, either measurement gaps are scheduled or the UE supports capability of conducting such measurements without gaps. When DRX is used, $T_{\text{measure_inter}}$ is as defined in Table 8.17.3.2.2.2-2, and when eDRX_CONN is in use, $T_{\text{measure_inter}}$ is as defined in Table 8.17.3.2.2.2-3. When MCG DRX is in use the applicable DRX cycle is the MCG DRX cycle.

Table 8.17.3.2.2.2-2: Requirement to measure FDD interfrequency cells

DRX cycle length (s)	$T_{\text{measure_inter}}$ (s) (DRX cycles)
≤ 0.08	Non DRX Requirements in clause 8.17.3.1 are applicable
$0.08 < \text{DRX-cycle} \leq 2.56$	Note (5* CSSF _{E-UTRA, NSA})
Note: Time depends upon the DRX cycle in use	

Table 8.17.3.2.2.2-3: Requirement to measure FDD inter-frequency cells when eDRX_CONN cycle is used

eDRX_CONN cycle length (s)	$T_{\text{measure_inter}}$ (s) (eDRX_CONN cycles)
$2.56 < \text{eDRX_CONN cycle} \leq 10.24$	Note (5* CSSF _{E-UTRA, NSA})
Note: Time depends upon the eDRX_CONN cycle in use	

The RSRP measurement accuracy for all measured cells shall be as specified in the sub-clauses 9.1.3.1 and 9.1.3.2, the RSRQ measurement accuracy for all measured cells shall be as specified in the sub-clauses 9.1.6.1 and 9.1.6.2, and the RS-SINR measurement accuracy for all measured cells shall be as specified in the sub-clauses 9.1.17.3.1 and 9.1.17.3.2.

8.17.3.3.2.3 Measurement Reporting Requirements

8.17.3.3.2.3.1 Periodic Reporting

Reported RSRP, RSRQ, and RS-SINR measurements contained in periodically triggered measurement reports shall meet the requirements in sections 9.1.3.1, 9.1.3.2, 9.1.6.1, 9.1.6.2, 9.1.17.3.1 and 9.1.17.3.2, respectively.

8.17.3.3.2.3.2 Event-triggered Periodic Reporting

Reported RSRP, RSRQ, and RS-SINR measurements contained in event triggered periodic measurement reports shall meet the requirements in sections 9.1.3.1, 9.1.3.2, 9.1.6.1, 9.1.6.2, 9.1.17.3.1 and 9.1.17.3.2, respectively.

The first report in event triggered periodic measurement reporting shall meet the requirements specified in clause 8.17.3.3.2.3.3.

8.17.3.3.2.3.3 Event Triggered Reporting

Reported RSRP, RSRQ, and RS-SINR measurements contained in event triggered measurement reports shall meet the requirements in sections 9.1.3.1, 9.1.3.2, 9.1.6.1, 9.1.6.2, 9.1.17.3.1 and 9.1.17.3.2, respectively.

The UE shall not send any event triggered measurement reports, as long as no reporting criteria are fulfilled.

The measurement reporting delay is defined as the time between an event that will trigger a measurement report and the point when the UE starts to transmit the measurement report over the air interface. This requirement assumes that the measurement report is not delayed by other RRC signalling on the DCCH. This measurement reporting delay excludes a delay uncertainty resulted when inserting the measurement report to the TTI of the uplink DCCH. The delay uncertainty is: $2 \times TTI_{DCCH}$. This measurement reporting delay excludes a delay which caused by no UL resources for UE to send the measurement report.

The event triggered measurement reporting delay, measured without L3 filtering shall be less than $T_{\text{identify_inter}}$ defined in clause 8.17.3.2.2. When L3 filtering is used or IDC autonomous denial is configured or the UE is performing reception and/or transmission for ProSe Direct Discovery and/or ProSe Direct Communication, or the UE is configured to perform SRS carrier based switching, an additional delay can be expected.

If a cell which has been detectable at least for the time period $T_{\text{Identify_Inter}}$ defined in clause 8.17.3.2.2 and then triggers the measurement report as per TS 36.331 [2], the event triggered measurement reporting delay shall be less than $T_{\text{Measure_Inter}}$ defined in clause 8.17.3.2.2 provided the timing to that cell has not changed more than $\pm 50 T_s$ while measurement gap has not been available and the L3 filter has not been used. When L3 filtering is used or IDC autonomous denial is configured or the UE is performing reception and/or transmission for ProSe Direct Discovery and/or ProSe Direct Communication, or the UE is configured to perform SRS carrier based switching, an additional delay can be expected.

8.17.3.3 E-UTRAN TDD inter frequency measurements

8.17.3.3.1 E-UTRAN TDD inter frequency measurements when no DRX is used

8.17.3.3.1.1 Introduction

The requirements in this section shall apply for E-UTRAN TDD-TDD inter frequency measurements and for E-UTRAN FDD-TDD inter frequency measurements when the UE is operating in EN-DCmode.

8.17.3.3.1.2 Requirements

When measurement gaps are scheduled, or the UE supports capability of conducting such measurements without gaps, then the UE shall be able to identify a new TDD inter-frequency within $T_{\text{Identify_Inter}}$ according to the following expression:

$$T_{\text{Identify_Inter}} = T_{\text{Basic_Identify_Inter}} \cdot \frac{480}{T_{\text{inter1}}} \cdot \text{CSSF}_{\text{E-UTRA,NSA}} \quad \text{ms}$$

Where:

$T_{\text{Basic_Identify_Inter}} = 480$ ms. It is the time period used in the inter frequency equation where the maximum allowed time for the UE to identify a new TDD inter-frequency cell is defined.

T_{inter1} is defined in clause 8.1.2.1.

A cell shall be considered detectable provided following conditions are fulfilled:

- RSRP_{dBm} and $\text{RSRP } \hat{E}_s/\text{Iot}$ according to Annex B.2.3 for a corresponding Band,
- other RSRP related side conditions given in Sections 9.1.3.1 and 9.1.3.2 are fulfilled for a corresponding Band,
- RSRQ related side conditions given in Sections 9.1.6.1 and 9.1.6.2 are fulfilled for a corresponding Band,
- RS-SINR related side conditions given in Sections 9.1.17.3.1 and 9.1.17.3.2 are fulfilled for a corresponding Band_{*x*}
- $\text{SCH_RP}_{\text{dBm}}$ and $\text{SCH } \hat{E}_s/\text{Iot}$ according to Annex B.2.3 for a corresponding Band.

When measurement gaps are scheduled for TDD inter frequency measurements, or the UE supports capability of conducting such measurements without gaps, the UE physical layer shall be capable of reporting RSRP, RSRQ, and RS-SINR measurements to higher layers with measurement accuracy as specified in sub-clauses 9.1.3.1, 9.1.3.2, 9.1.6.1, 9.1.6.2, 9.1.17.3.1 and 9.1.17.3.2, respectively, with measurement period given by table 8.17.3.3.1.2-1.

Table 8.17.3.3.1.2-1: $T_{\text{Measurement_Period_TDD_Inter}}$ for different configurations

Configuratio n	Measurement bandwidth [RB]	Number of UL/DL sub- frames per half frame (5 ms)		DwPTS		$T_{\text{Measurement_Period_TDD_Inter}}$ [ms]
		DL	UL	Normal CP	Extended CP	
0	6	2	2	$19760T_s$	$20480 \cdot T_s$	$480 \times \text{CSSF}_{\text{E-UTRA, NSA}}$
1 (Note 1)	50	2	2	$19760T_s$	$20480 \cdot T_s$	$240 \times \text{CSSF}_{\text{E-UTRA, NSA}}$
2	6	1	3	$19760T_s$	$20480 \cdot T_s$	$720 \times \text{CSSF}_{\text{E-UTRA, NSA}}$
3 (Note 1)	50	1	3	$19760T_s$	$20480 \cdot T_s$	$480 \times \text{CSSF}_{\text{E-UTRA, NSA}}$
Note 1: This configuration is optional						
Note 2: T_s is defined in TS 36.211 [16]						

The UE shall be capable of performing RSRP, RSRQ, and RS-SINR measurements of at least 4 inter-frequency cells per TDD inter-frequency for up to 6 TDD inter-frequencies and the UE physical layer shall be capable of reporting RSRP, RSRQ, and RS-SINR measurements to higher layers with the measurement period defined in Table 8.17.3.3.1.2-1.

8.17.3.3.1.3 Measurement Reporting Requirements

8.17.3.3.1.3.1 Periodic Reporting

Reported RSRP, RSRQ and RS-SINR measurements contained in periodically triggered measurement reports shall meet the requirements in sections 9.1.3.1, 9.1.3.2, 9.1.6.1, 9.1.6.2, 9.1.17.3.1 and 9.1.17.3.2, respectively.

8.17.3.3.1.3.2 Event-triggered Periodic Reporting

Reported RSRP, RSRQ and RS-SINR measurements contained in event triggered periodic measurement reports shall meet the requirements in sections 9.1.3.1, 9.1.3.2, 9.1.6.1, 9.1.6.2, 9.1.17.3.1 and 9.1.17.3.2, respectively.

The first report in event triggered periodic measurement reporting shall meet the requirements specified in clause 8.17.3.3.1.3.3.

8.17.3.3.1.3.3 Event Triggered Reporting

Reported RSRP, RSRQ, and RS-SINR measurements contained in event triggered measurement reports shall meet the requirements in sections 9.1.3.1, 9.1.3.2, 9.1.6.1, 9.1.6.2, 9.1.17.3.1 and 9.1.17.3.2, respectively.

The UE shall not send any event triggered measurement reports as long as no reporting criteria are fulfilled.

The measurement reporting delay is defined as the time between an event that will trigger a measurement report and the point when the UE starts to transmit the measurement report over the air interface. This requirement assumes that the measurement report is not delayed by other RRC signalling on the DCCH. This measurement reporting delay excludes a delay uncertainty resulted when inserting the measurement report to the TTI of the uplink DCCH. The delay uncertainty is: $2 \times TTI_{DCCH}$. This measurement reporting delay excludes a delay which caused by no UL resources for UE to send the measurement report.

The event triggered measurement reporting delay, measured without L3 filtering shall be less than $T_{Identify_Inter}$ defined in clause 8.17.3.3.1. When L3 filtering is used or IDC autonomous denial is configured or the UE is performing reception and/or transmission for ProSe Direct Discovery and/or ProSe Direct Communication, or the UE is configured to perform SRS carrier based switching, an additional delay can be expected.

If a cell which has been detectable at least for the time period, $T_{Identify_Inter}$ defined in clause 8.17.3.3.1 and then triggers the measurement report as per TS 36.331 [2], the event triggered measurement reporting delay shall be less than $T_{Measurement_Period_Inter_TDD}$ defined in clause 8.17.3.3.1 provided the timing to that cell has not changed more than ± 50 Ts while measurement gap has not been available and the L3 filter has not been used. When L3 filtering is used or IDC autonomous denial is configured or the UE is performing reception and/or transmission for ProSe Direct Discovery and/or ProSe Direct Communication, or the UE is configured to perform SRS carrier based switching, an additional delay can be expected.

8.17.3.3.2 E-UTRAN TDD inter frequency measurements when DRX is used

8.17.3.3.2.1 Introduction

The requirements in this section shall apply for E-UTRAN TDD-TDD inter frequency measurements and for E-UTRAN FDD-TDD inter frequency measurements when the UE is operating in EN-DCmode. If the UE is not yet configured with the EN-DC operation then the UE shall meet the E-UTRAN TDD-TDD inter frequency measurement requirements and E-UTRAN FDD-TDD inter frequency measurement requirements defined in section 8.1.2.3.2 and 8.1.2.3.4 respectively.

8.17.3.3.2.2 Requirements

When DRX or eDRX_CONN is in use, either measurement gaps are scheduled or the UE supports capability of conducting such measurements without gaps, the UE shall be able to identify a new detectable E-UTRAN TDD inter frequency cell within $T_{Identify_Inter}$. When DRX is in use, $T_{identify_inter}$ is as defined in Table 8.17.3.3.2.2-1, and when eDRX_CONN is in use, $T_{Identify_Inter}$ is as defined in Table 8.17.3.3.2.2-1A. When MCG DRX is in use the applicable DRX cycle is the MCG DRX cycle.

Table 8.17.3.3.2.2-1: Requirement to identify a newly detectable TDD interfrequency cell

DRX cycle length (s)	$T_{Identify_Inter}$ (s) (DRX cycles)	
	Gap period = 40 ms, 20 ms	Gap period = 80 ms
≤ 0.16	Non DRX Requirements in clause 8.17.3.1 are applicable	Non DRX Requirements in clause 8.17.3.1 are applicable
0.256	$5.12 \times CSSF_{E-UTRA, NSA}$ ($20 \times CSSF_{E-UTRA, NSA}$)	$7.68 \times CSSF_{E-UTRA, NSA}$ ($30 \times CSSF_{E-UTRA, NSA}$)
0.32	$6.4 \times CSSF_{E-UTRA, NSA}$ ($20 \times CSSF_{E-UTRA, NSA}$)	$7.68 \times CSSF_{E-UTRA, NSA}$ ($24 \times CSSF_{E-UTRA, NSA}$)
$0.32 < DRX_{cycle} \leq 2.56$	Note ($20 \times CSSF_{E-UTRA, NSA}$)	Note ($20 \times CSSF_{E-UTRA, NSA}$)
Note: Time depends upon the DRX cycle in use		

Table 8.17.3.3.2.2-1A: Requirement to identify a newly detectable TDD inter-frequency cell when eDRX_CONN cycle is used

eDRX_CONN cycle length (s)	$T_{Identify_Inter}$ (s) (eDRX_CONN cycles)	
	Gap period = 40 ms, 20 ms	Gap period = 80 ms
$2.56 < eDRX_CONN\ cycle \leq 10.24$	Note ($20 \times CSSF_{E-UTRA, NSA}$)	Note ($20 \times CSSF_{E-UTRA, NSA}$)
Note: Time depends upon the eDRX_CONN cycle in use		

A cell shall be considered detectable provided following conditions are fulfilled:

- $RSRP_{dBm}$ and $RSRP \hat{E}s/Tot$ according to Annex B.2.3 for a corresponding Band,
- other RSRP related side conditions given in Clause 9.1.3.1 and 9.1.3.2 are fulfilled for a corresponding Band,
- RSRQ related side conditions given in Sections 9.1.6.1 and 9.1.6.2 are fulfilled for a corresponding Band,
- RS-SINR related side conditions given in Sections 9.1.17.3.1 and 9.1.17.3.2 are fulfilled for a corresponding Band,
- SCH_RP_{dBm} $SCH \hat{E}s/Tot$ according to Annex B.2.3 for a corresponding Band.

When DRX or eDRX_CONN is in use, the UE shall be capable of performing RSRP, RSRQ, and RS-SINR measurements of at least 4 inter-frequency cells per TDD inter-frequency and the UE physical layer shall be capable of reporting RSRP, RSRQ, and RS-SINR measurements to higher layers with the measurement period $T_{measure_inter}$, either measurement gaps are scheduled or the UE supports capability of conducting such measurements without gaps. When DRX is used, $T_{measure_inter}$ is as defined in Table 8.17.3.3.2.2-2, and when eDRX_CONN is in use, $T_{measure_inter}$ is as defined in Table 8.17.3.3.2.2-3. When MCG DRX is in use the applicable DRX cycle is the MCG DRX cycle.

Table 8.17.3.3.2.2-2: Requirement to measure TDD interfrequency cells

DRX cycle length (s)	$T_{measure_inter}$ (s) (DRX cycles)
≤ 0.08	Non DRX Requirements in clause 8.17.3.1 are applicable
$0.08 < DRX\text{-}cycle \leq 2.56$	Note ($5 * CSSF_{E-UTRA, NSA}$)
Note: Time depends upon the DRX cycle in use	

Table 8.17.3.3.2.2-3: Requirement to measure TDD inter-frequency cells when eDRX_CONN cycle is used

eDRX_CONN cycle length (s)	$T_{measure_inter}$ (s) (eDRX_CONN cycles)
$2.56 < eDRX_CONN\text{ cycle} \leq 10.24$	Note ($5 * CSSF_{E-UTRA, NSA}$)
Note: Time depends upon the eDRX_CONN cycle in use	

The RSRP measurement accuracy for all measured cells shall be as specified in the sub-clauses 9.1.3.1 and 9.1.3.2, the RSRQ measurement accuracy for all measured cells shall be as specified in the sub-clauses 9.1.6.1 and 9.1.6.2, and the RS-SINR measurement accuracy for all measured cells shall be as specified in the sub-clauses 9.1.17.3.1 and 9.1.17.3.2.

8.17.3.3.2.3 Measurement Reporting Requirements

8.17.3.3.2.3.1 Periodic Reporting

Reported RSRP, RSRQ, and RS-SINR measurements contained in periodically triggered measurement reports shall meet the requirements in sections 9.1.3.1, 9.1.3.2, 9.1.6.1, 9.1.6.2, 9.1.17.3.1 and 9.1.17.3.2, respectively.

8.17.3.3.2.3.2 Event-triggered Periodic Reporting

Reported RSRP, RSRQ, and RS-SINR measurements contained in event triggered periodic measurement reports shall meet the requirements in sections 9.1.3.1, 9.1.3.2, 9.1.6.1, 9.1.6.2, 9.1.17.3.1 and 9.1.17.3.2, respectively.

The first report in event triggered periodic measurement reporting shall meet the requirements specified in clause 8.17.3.3.2.3.3.

8.17.3.3.2.3.3 Event Triggered Reporting

Reported RSRP, RSRQ, and RS-SINR measurements contained in event triggered measurement reports shall meet the requirements in sections 9.1.3.1, 9.1.3.2, 9.1.6.1, 9.1.6.2, 9.1.17.3.1 and 9.1.17.3.2, respectively.

The UE shall not send any event triggered measurement reports as long as no reporting criteria are fulfilled.

The measurement reporting delay is defined as the time between an event that will trigger a measurement report and the point when the UE starts to transmit the measurement report over the air interface. This requirement assumes that the measurement report is not delayed by other RRC signalling on the DCCH. This measurement reporting delay excludes a delay uncertainty resulted when inserting the measurement report to the TTI of the uplink DCCH. The delay uncertainty is: $2 \times TTI_{DCCH}$. This measurement reporting delay excludes a delay which caused by no UL resources for UE to send the measurement report.

The event triggered measurement reporting delay, measured without L3 filtering shall be less than $T_{\text{identify_inter}}$ defined in clause 8.17.3.3.2.3. When L3 filtering is used or IDC autonomous denial is configured or the UE is performing reception and/or transmission for ProSe Direct Discovery and/or ProSe Direct Communication, or the UE is configured to perform SRS carrier based switching, an additional delay can be expected.

If a cell which has been detectable at least for the time period $T_{\text{Identify_Inter}}$ defined in clause 8.17.3.3.2.3 and then triggers the measurement report as per TS 36.331 [2], the event triggered measurement reporting delay shall be less than $T_{\text{Measure_Inter}}$ defined in clause 8.17.3.3.2.3 provided the timing to that cell has not changed more than ± 50 Ts while measurement gap has not been available and the L3 filter has not been used. When L3 filtering is used or IDC autonomous denial is configured or the UE is performing reception and/or transmission for ProSe Direct Discovery and/or ProSe Direct Communication, or the UE is configured to perform SRS carrier based switching, an additional delay can be expected.

8.17.4 E-UTRA Inter-RAT NR Measurements when Configured with E-UTRA-NR Dual Connectivity Operation

8.17.4.1 E-UTRAN FDD – NR measurements when configured with E-UTRA-NR Dual connectivity

Requirements in this clause apply for the NR capable UE configured with inter-RAT measurement on NR. For UE supporting EN-DC operation, the requirements in this clause shall apply when NR PSCell is configured. When the UE is not configured with E-UTRA-NR dual connectivity mode then the E-UTRAN FDD - NR measurement requirements defined in section 8.1.2.4.21 shall apply. When the E-UTRAN FDD-NR measurement object configured by E-UTRA PCell is on an NR serving frequency carrier, then the NR intra-frequency measurements requirements defined in clause 9.2 of TS 38.133 [50] shall apply.

The UE shall be able to identify new inter-RAT NR cells and perform SS-RSRP, SS-RSRQ, and SS-SINR measurements of identified inter-RAT NR cells if carrier frequency information is provided by the PCell, even if no explicit neighbour list with physical layer cell identities is provided.

An NR cell is considered detectable when:

- NR SS-RSRP related conditions in the accuracy requirements in clause 9.11.1 are fulfilled for a corresponding Band, together with the corresponding side conditions in Annex B.2.3 of TS 38.133 [50],
- NR SS-RSRQ related conditions in the accuracy requirements in clause 9.11.2 are fulfilled for a corresponding Band, together with the corresponding side conditions in Annex B.2.3 of TS 38.133 [50],
- NR SS-SINR related conditions in the accuracy requirements in clause 9.11.3 are fulfilled for a corresponding Band, together with the corresponding side conditions in Annex B.2.3 of TS 38.133 [50].

The NR SS-RSRP measurement accuracy for all measured NR cells shall be as specified in clause 9.11.1, the NR SS-RSRQ measurement accuracy for all measured NR cells shall be as specified in clause 9.11.2, and NR SS-SINR measurement accuracy for all measured NR cells shall be as specified in clause 9.11.3.

8.17.4.1.1 NR Inter-RAT cell identification

When measurement gaps are provided, or the UE supports capability of conducting such measurements without gaps, the UE shall be able to identify a new detectable inter-RAT NR cell within $T_{\text{identify_NR_without_index}}$ if UE is not indicated to report SSB based RRM measurement result with the associated SSB index (*reportQuantityRsIndexes* or *maxNrofRSIndexesToReport* is not configured). Otherwise UE shall be able to identify a new detectable inter-RAT NR cell within $T_{\text{identify_NR_with_index}}$. The UE shall be able to identify a new detectable inter-RAT NR SS block of an already detected cell within $T_{\text{identify_inter_without_index}}$.

$$T_{\text{identify_NR_without_index}} = (T_{\text{PSS/SSS_sync_NR}} + T_{\text{SSB_measurement_period_NR}}) \text{ ms}$$

$$T_{\text{identify_NR_with_index}} = (T_{\text{PSS/SSS_sync_NR}} + T_{\text{SSB_measurement_period_NR}} + T_{\text{SSB_time_index_NR}}) \text{ ms}$$

Where:

$T_{\text{PSS/SSS_sync_NR}}$: it is the time period used in PSS/SSS detection given in table 8.17.4.1.1-1 and table 8.17.4.1.1-2.

$T_{\text{SSB_time_index_NR}}$: it is the time period used to acquire the index of the SSB being measured given in table 8.17.4.1.1-3 and table 8.17.4.1.1-4.

$T_{SSB_measurement_period_NR}$: equal to a measurement period of SSB based measurement given in table 8.17.4.1.2-1 and table 8.17.4.1.2-2.

M_{pss/sss_sync_NR} : For a UE supporting FR2 power class 1, $M_{pss/sss_sync_NR}=64$ samples. For a UE supporting FR2 power class 2 (vehicle mounted), $M_{pss/sss_sync_NR}=40$ samples. For a UE supporting FR2 power class 3 (handheld), $M_{pss/sss_sync_NR}=40$ samples. For a UE supporting FR2 power class 4, $M_{pss/sss_sync_NR}=40$ samples.

$M_{SSB_index_NR}$: For a UE supporting FR2 power class 1, $M_{SSB_index_NR}=40$ samples. For a UE supporting FR2 power class 2 (vehicle mounted), $M_{pss/sss_sync_NR}=24$ samples. For a UE supporting FR2 power class 3 (handheld), $M_{SSB_index_NR}=24$ samples. For a UE supporting FR2 power class 4, $M_{meas_period_NR}=24$ samples.

$M_{meas_period_NR}$: For a UE supporting FR2 power class 1, $M_{meas_period_NR}=64$ samples. For a UE supporting FR2 power class 2 (vehicle mounted), $M_{pss/sss_sync_NR}=40$ samples. For a UE supporting FR2 power class 3 (handheld), $M_{meas_period_NR}=40$ samples. For a UE supporting FR2 power class 4, $M_{meas_period_NR}=40$ samples.

$CSSF_{NR,EN-DC}$: it is a carrier specific scaling factor and is determined according to $CSSF_{within_gap,i}$ defined in clause 9.1.5.2.1 of TS 38.133 [50] for measurement conducted within measurement gaps in EN-DC mode.

Table 8.17.4.1.1-1: Time period for PSS/SSS detection (Frequency range FR1)

Condition ^{NOTE1,2}	T_{PSS/SSS_sync_NR}
No DRX	$\text{Max}(600\text{ms}, 8 \times \text{Max}(\text{MGRP}, \text{SMTC period})) \times CSSF_{NR,EN-DC}$
DRX cycle $\leq 320\text{ms}$	$\text{Max}(600\text{ms}, \text{Ceil}(8 \times 1.5) \times \text{Max}(\text{MGRP}, \text{SMTC period}, \text{DRX cycle})) \times CSSF_{NR,EN-DC}$
DRX cycle $> 320\text{ms}$	$8 \times \text{DRX cycle} \times CSSF_{NR,EN-DC}$
NOTE 1: DRX or non DRX requirements apply according to the conditions described in clause 3.6.1 of TS 38.133 [50].	
NOTE 2: In EN-DC operation, the parameters, timers and scheduling requests referred to in clause 3.6.1 of TS 38.133 [50] are for the secondary cell group. The DRX cycle is the DRX cycle of the secondary cell group.	

Table 8.17.4.1.1-2: Time period for PSS/SSS detection (Frequency range FR2)

Condition ^{NOTE1,2}	T_{PSS/SSS_sync_NR}
No DRX	$\text{Max}(600\text{ms}, M_{pss/sss_sync_NR} \times \text{Max}(\text{MGRP}, \text{SMTC period})) \times CSSF_{NR,EN-DC}$
DRX cycle $\leq 320\text{ms}$	$\text{Max}(600\text{ms}, (1.5 \times M_{pss/sss_sync_NR}) \times \text{Max}(\text{MGRP}, \text{SMTC period}, \text{DRX cycle})) \times CSSF_{NR,EN-DC}$
DRX cycle $> 320\text{ms}$	$M_{pss/sss_sync_NR} \times \text{DRX cycle} \times CSSF_{NR,EN-DC}$
NOTE 1: DRX or non DRX requirements apply according to the conditions described in clause 3.6.1 of TS 38.133 [50].	
NOTE 2: In EN-DC operation, the parameters, timers and scheduling requests referred to in clause 3.6.1 of TS 38.133 [50] are for the secondary cell group. The DRX cycle is the DRX cycle of the secondary cell group.	

Table 8.17.4.1.1-3: Time period for time index detection (Frequency range FR1)

Condition ^{NOTE1,2}	$T_{SSB_time_index_NR}$
No DRX	$\text{Max}(120\text{ms}, 3 \times \text{Max}(\text{MGRP}, \text{SMTC period})) \times CSSF_{NR,EN-DC}$
DRX cycle $\leq 320\text{ms}$	$\text{Max}(120\text{ms}, \text{Ceil}(3 \times 1.5) \times \text{Max}(\text{MGRP}, \text{SMTC period}, \text{DRX cycle})) \times CSSF_{NR,EN-DC}$
DRX cycle $> 320\text{ms}$	$3 \times \text{DRX cycle} \times CSSF_{NR,EN-DC}$
NOTE 1: DRX or non DRX requirements apply according to the conditions described in clause 3.6.1 of TS 38.133 [50].	
NOTE 2: In EN-DC operation, the parameters, timers and scheduling requests referred to in clause 3.6.1 of TS 38.133 [50] are for the secondary cell group. The DRX cycle is the DRX cycle of the secondary cell group.	

Table 8.17.4.1.1-4: Time period for time index detection (Frequency range FR2)

Condition ^{NOTE1,2}	$T_{SSB_time_index_NR}$
------------------------------	----------------------------

No DRX	$\text{Max}(200\text{ms}, M_{\text{SSB_index_NR}} \times \text{Max}(\text{MGRP}, \text{SMTC period})) \times \text{CSSF}_{\text{NR,EN-DC}}$
DRX cycle $\leq 320\text{ms}$	$\text{Max}(200\text{ms}, (1.5 \times M_{\text{SSB_index_NR}}) \times \text{Max}(\text{MGRP}, \text{SMTC period}, \text{DRX cycle})) \times \text{CSSF}_{\text{NR,EN-DC}}$
DRX cycle $> 320\text{ms}$	$M_{\text{SSB_index_NR}} \times \text{DRX cycle} \times \text{CSSF}_{\text{NR,EN-DC}}$
NOTE 1: DRX or non DRX requirements apply according to the conditions described in clause 3.6.1 of TS 38.133 [50].	
NOTE 2: In EN-DC operation, the parameters, timers and scheduling requests referred to in clause 3.6.1 of TS 38.133 [50] are for the secondary cell group. The DRX cycle is the DRX cycle of the secondary cell group.	

When SCG DRX is in use the applicable DRX cycle is the SCG DRX cycle.

8.17.4.1.2 NR Inter-RAT measurement

When measurement gaps are provided for inter frequency measurements, or the UE supports capability of conducting such measurements without gaps, the UE physical layer shall be capable of reporting NR SS-RSRP, NR SS-RSRQ and NR SS-SINR measurements to higher layers with measurement accuracy as specified in sub-clauses 9.11.1, 9.11.2 and 9.11.3, respectively, with a measurement period given by:

Table 8.17.4.1.2-1: Measurement period for NR inter-RAT measurements with gaps (Frequency range FR1)

Condition ^{NOTE1,2}	T _{SSB_measurement_period_NR}
No DRX	$\text{Max}(200\text{ms}, 8 \times \text{Max}(\text{MGRP}, \text{SMTC period})) \times \text{CSSF}_{\text{NR,EN-DC}}$
DRX cycle $\leq 320\text{ms}$	$\text{Max}(200\text{ms}, \text{Ceil}(8 \times 1.5) \times \text{Max}(\text{MGRP}, \text{SMTC period}, \text{DRX cycle})) \times \text{CSSF}_{\text{NR,EN-DC}}$
DRX cycle $> 320\text{ms}$	$8 \times \text{DRX cycle} \times \text{CSSF}_{\text{NR,EN-DC}}$
NOTE 1: DRX or non DRX requirements apply according to the conditions described in clause 3.6.1 of TS 38.133 [50].	
NOTE 2: In EN-DC operation, the parameters, timers and scheduling requests referred to in clause 3.6.1 of TS 38.133 [50] are for the secondary cell group. The DRX cycle is the DRX cycle of the secondary cell group.	

Table 8.17.4.1.2: Measurement period for NR inter-RAT measurements with gaps (Frequency range FR2)

Condition ^{NOTE1,2}	T _{SSB_measurement_period_NR}
No DRX	$\text{Max}(400\text{ms}, M_{\text{meas_period_NR}} \times \text{Max}(\text{MGRP}, \text{SMTC period})) \times \text{CSSF}_{\text{NR,EN-DC}}$
DRX cycle $\leq 320\text{ms}$	$\text{Max}(400\text{ms}, (1.5 \times M_{\text{meas_period_NR}}) \times \text{Max}(\text{MGRP}, \text{SMTC period}, \text{DRX cycle})) \times \text{CSSF}_{\text{NR,EN-DC}}$
DRX cycle $> 320\text{ms}$	$M_{\text{meas_period_NR}} \times \text{DRX cycle} \times \text{CSSF}_{\text{NR,EN-DC}}$
NOTE 1: DRX or non DRX requirements apply according to the conditions described in clause 3.6.1 of TS 38.133 [50].	
NOTE 2: In EN-DC operation, the parameters, timers and scheduling requests referred to in clause 3.6.1 of TS 38.133 [50] are for the secondary cell group. The DRX cycle is the DRX cycle of the secondary cell group.	

When SCG DRX is in use the applicable DRX cycle is the SCG DRX cycle.

8.17.4.1.3 NR Inter-RAT measurement reporting

8.17.4.1.3.1 Periodic Reporting

Reported NR SS-RSRP, NR SS-RSRQ and NR SS-SINR measurements contained in periodically triggered measurement reports shall meet the requirements in clauses 9.11.1, 9.11.2 and 9.11.3, respectively.

8.17.4.1.3.2 Event-triggered Periodic Reporting

Reported NR SS-RSRP, NR SS-RSRQ and NR SS-SINR measurements contained in event triggered periodic measurement reports shall meet the requirements in clauses 9.11.1, 9.11.2 and 9.11.3, respectively.

The first report in event triggered periodic measurement reporting shall meet the requirements specified in clause 8.17.4.1.3.3.

8.17.4.1.3.3 Event-triggered Reporting

Reported NR SS-RSRP, NR SS-RSRQ and NR SS-SINR measurements contained in event triggered measurement reports shall meet the requirements in clauses 9.11.1, 9.11.2 and 9.11.3, respectively.

The UE shall not send any event triggered measurement reports, as long as no reporting criteria are fulfilled.

The measurement reporting delay is defined as the time between an event that will trigger a measurement report and the point when the UE starts to transmit the measurement report over the air interface. This requirement assumes that the measurement report is not delayed by other RRC signalling on the DCCH. This measurement reporting delay excludes a delay uncertainty resulted when inserting the measurement report to the TTI of the uplink DCCH. The delay uncertainty is: $2 \times TTI_{DCCH}$. This measurement reporting delay excludes a delay which caused by no UL resources for UE to send the measurement report.

The event triggered measurement reporting delay, measured without L3 filtering shall be within $T_{identify_NR_without_index}$ if UE is not indicated to report SSB based RRM measurement result with the associated SSB index. Otherwise UE shall be able to identify a new detectable NR cell within $T_{identify_NR_with_index}$. Both $T_{identify_inter_without_index}$ and $T_{identify_inter_with_index}$ are defined in clause 8.17.4.1.1. When L3 filtering is used an additional delay can be expected.

If an NR cell which has been detectable at least for the time period $T_{identify_NR_without_index}$ or $T_{identify_NR_with_index}$ defined in clause 8.17.4.1.1 and then triggers the measurement report as per TS 38.331 [38], the event triggered measurement reporting delay shall be less than $T_{SSB_measurement_period_NR}$ defined in clause 8.17.4.1.2 provided the timing to that cell has not changed more than $\pm 3200 T_c$ while measurement gap has not been available and the L3 filter has not been used. When L3 filtering is used an additional delay can be expected.

8.17.4.2 E-UTRAN TDD – NR measurements when configured with E-UTRA-NR Dual connectivity

The requirements in clause 8.17.4.1 also apply for this section.

8.17.5 E-UTRAN FDD – UTRAN FDD measurements when Configured with E-UTRA-NR Dual Connectivity

8.17.5.1 Introduction

The requirements in this clause apply only to UE supporting E-UTRAN FDD and UTRA FDD. The E-UTRAN FDD - UTRAN FDD measurement requirements defined in section 8.17.5 shall apply when the UE capable of E-UTRA-NR dual connectivity is operating in E-UTRA-NR dual connectivity mode. The requirements in section 8.17.5 are applicable for gap pattern id # 0 and #1 as specified in Table 8.1.2.1-1.

The scaling factor $CSSF_{UTRA_NSA}$ used in the UTRA FDD measurement requirements in section 8.17.5 for the UE configured with E-UTRA-NR dual connectivity mode is determined according to $CSSF_{within_gap,i}$ as specified in clause 9.1.5.2.1 of TS 38.133 [50]. When the UE is not configured with E-UTRA-NR dual connectivity mode then the E-UTRAN FDD-UTRAN FDD measurement requirements defined in section 8.1.2.4.1 shall apply.

8.17.5.2 E-UTRAN FDD – UTRAN FDD measurements when no DRX is used

8.17.5.2.1 Identification of a new UTRA FDD cell

When explicit neighbour list is provided and no DRX is used, either measurement gaps are scheduled or the UE supports capability of conducting such measurements without gaps, the UE shall be able to identify a new detectable cell belonging to the monitored set within

$$T_{identify_UTRA_FDD} = T_{basic_identify_UTRA_FDD} \cdot \frac{480}{T_{inter1}} \cdot CSSF_{UTRA,NSA} \quad ms$$

A cell shall be considered detectable when

- CPICH $E_c/I_0 \geq -20$ dB,
- SCH $E_c/I_0 \geq -17$ dB for at least one channel tap and SCH E_c/I_0 is equally divided between primary synchronisation code and secondary synchronisation code. When L3 filtering is used an additional delay can be expected.

8.17.5.2.2 Enhanced UTRA FDD cell identification requirements

When explicit neighbour list is provided and no DRX is used or when DRX cycle length ≤ 40 ms, either measurement gaps are scheduled or the UE supports capability of conducting such measurements without gaps, the UE shall be able to identify a new detectable cell belonging to the monitored set within $T_{\text{identify, enhanced_UTRA_FDD}}$:

$$T_{\text{identify, enhanced_UTRA_FDD}} = (T_{\text{basic_identify_enhanced_UTRA_FDD}} \cdot \frac{480}{T_{\text{inter1}}} + 480) \cdot \text{CSSF}_{\text{UTRA, NSA}} \quad \text{ms}$$

A cell shall be considered detectable when:

- CPICH $E_c/I_0 \geq -15$ dB,
- SCH $E_c/I_0 \geq -15$ dB for at least one channel tap and SCH E_c/I_0 is equally divided between primary synchronisation code and secondary synchronisation code. When L3 filtering is used an additional delay can be expected.

8.17.5.2.3 UE UTRA FDD CPICH measurement capability

When measurement gaps are scheduled for UTRA FDD inter RAT measurements, or the UE supports capability of conducting such measurements without gaps, the UE physical layer shall be capable of reporting measurements to higher layers with measurement accuracy as specified in Clause 9.2 with measurement period given by:

$$T_{\text{measurement_UTRA_FDD}} = \text{Max} \left\{ T_{\text{Measurement_Period_UTRA_FDD}}, T_{\text{basic_measurement_UTRA_FDD}} \cdot \frac{480}{T_{\text{inter1}}} \cdot \text{CSSF}_{\text{UTRA, NSA}} \right\} \quad \text{ms}$$

The UE shall be capable of performing UTRA FDD CPICH measurements for $X_{\text{basic_measurement_UTRA_FDD}}$ inter-frequency cells per FDD frequency and the UE physical layer shall be capable of reporting measurements to higher layers with the measurement period of $T_{\text{Measurement_UTRA_FDD}}$.

$$X_{\text{basic_measurement_UTRA_FDD}} = 6$$

$T_{\text{Measurement_Period_UTRA_FDD}} = 480$ ms. The period used for calculating the measurement period $T_{\text{measurement_UTRA_FDD}}$ for UTRA FDD CPICH measurements.

$T_{\text{basic_identify_UTRA_FDD}} = 300$ ms. This is the time period used in the inter RAT equation in clause 8.17.5.2.1 where the maximum allowed time for the UE to identify a new UTRA FDD cell is defined.

$T_{\text{basic_identify_enhanced_UTRA_FDD}} = 60$ ms. This is the time period used in the inter RAT equation in clause 8.17.5.2.2 where the maximum allowed time for the UE to identify a new UTRA FDD cell is defined.

$T_{\text{basic_measurement_UTRA_FDD}} = 50$ ms. This is the time period used in the equation for defining the measurement period for inter RAT CPICH measurements.

8.17.5.2.4 Periodic Reporting

Reported measurements in periodically triggered measurement reports shall meet the requirements in clause 9.

8.17.5.2.5 Event Triggered Reporting

Reported measurements in event triggered measurement reports shall meet the requirements in clause 9.

The UE shall not send any event triggered measurement reports, as long as the reporting criteria is not fulfilled.

The measurement reporting delay is defined as the time between any event that will trigger a measurement report until the UE starts to transmit the measurement report over the Uu interface. This requirement assumes that the measurement report is not delayed by other RRC signalling on the DCCH. This measurement reporting delay excludes a delay

uncertainty resulted when inserting the measurement report to the TTI of the uplink DCCH. The delay uncertainty is twice the TTI of the uplink DCCH. When the measurement report is transmitted on the PUSCH with subframe or slot or subslot duration, the delay uncertainty is twice the subframe or slot or subslot of the uplink DCCH. This measurement reporting delay excludes a delay which caused by no UL resources for UE to send the measurement report.

The event triggered measurement reporting delay, measured without L3 filtering shall be less than $T_{\text{identify, UTRA_FDD}}$ defined in Clause 8.17.5.2.1 for the minimum requirements or $T_{\text{identify, enhanced_UTRA_FDD}}$ defined in Clause 8.17.5.2.2 for the enhanced requirements When L3 filtering is used or IDC autonomous denial or the UE is performing reception and/or transmission for ProSe Direct Discovery and/or ProSe Direct Communication, or the UE is configured to perform SRS carrier based switching, an additional delay can be expected.

If a cell which has been detectable at least for the time period $T_{\text{identify, UTRA_FDD}}$ defined in clause 8.17.5.2.1 for the minimum requirements or $T_{\text{identify, enhanced_UTRA_FDD}}$ defined in Clause 8.17.5.2.2 for the enhanced requirements and then triggers the measurement report as per TS 36.331 [2], the event triggered measurement reporting delay shall be less than $T_{\text{measurement_UTRA_FDD}}$ defined in clause 8.17.5.2.3 provided the timing to that cell has not changed more than ± 32 chips while measurement gap has not been available and the L3 filter has not been used. When L3 filtering is used or IDC autonomous denial is configured or the UE is performing reception and/or transmission for ProSe Direct Discovery and/or ProSe Direct Communication, or the UE is configured to perform SRS carrier based switching, an additional delay can be expected.

8.17.5.2.6 Event-triggered Periodic Reporting

Reported measurements contained in event triggered periodic measurement reports shall meet the requirements in clause 9.

The first report in event triggered periodic measurement reporting shall meet the requirements specified in clause 8.17.5.2.5.

8.17.5.3 E-UTRAN FDD – UTRAN FDD measurements when DRX is used

When explicit neighbour list is provided and DRX or eDRX_CONN is used, either measurement gaps are scheduled or the UE supports capability of conducting such measurements without gaps, the UE shall be able to identify a new detectable cell belonging to the neighbour cell list within $T_{\text{identify,UTRA_FDD}}$. When DRX is used, $T_{\text{identify,UTRA_FDD}}$ is as defined in table 8.17.5.3-1, and when eDRX_CONN is used, $T_{\text{identify,UTRA_FDD}}$ is as defined in table 8.17.5.3-2. When MCG DRX is in use the applicable DRX cycle is the MCG DRX cycle.

Table 8.17.5.3-1: Requirement to identify a newly detectable UTRA FDD cell

DRX cycle length (s)	$T_{\text{identify_UTRA_FDD}}$ (s) (DRX cycles)	
	Gap ID # 0	Gap ID # 1
≤ 0.04	Non DRX Requirements in clause 8.17.5.2 are applicable	Non DRX Requirements in clause 8.17.5.2 are applicable
0.064	$2.56 \cdot \text{CSSF}_{\text{UTRA,NSA}}$ ($40 \cdot \text{CSSF}_{\text{UTRA,NSA}}$)	$4.8 \cdot \text{CSSF}_{\text{UTRA,NSA}}$ ($75 \cdot \text{CSSF}_{\text{UTRA,NSA}}$)
0.08	$3.2 \cdot \text{CSSF}_{\text{UTRA,NSA}}$ ($40 \cdot \text{CSSF}_{\text{UTRA,NSA}}$)	$4.8 \cdot \text{CSSF}_{\text{UTRA,NSA}}$ ($60 \cdot \text{CSSF}_{\text{UTRA,NSA}}$)
0.128	$3.2 \cdot \text{CSSF}_{\text{UTRA,NSA}}$ ($25 \cdot \text{CSSF}_{\text{UTRA,NSA}}$)	$4.8 \cdot \text{CSSF}_{\text{UTRA,NSA}}$ ($37.5 \cdot \text{CSSF}_{\text{UTRA,NSA}}$)
0.16	$3.2 \cdot \text{CSSF}_{\text{UTRA,NSA}}$ ($20 \cdot \text{CSSF}_{\text{UTRA,NSA}}$)	$4.8 \cdot \text{CSSF}_{\text{UTRA,NSA}}$ ($30 \cdot \text{CSSF}_{\text{UTRA,NSA}}$)
$0.16 < \text{DRX-cycle} \leq 2.56$	Note ($20 \cdot \text{CSSF}_{\text{UTRA,NSA}}$)	Note ($20 \cdot \text{CSSF}_{\text{UTRA,NSA}}$)
Note: Time depends upon the DRX cycle in use		

Table 8.17.5.3-2: Requirement to identify a newly detectable UTRA FDD cell when eDRX_CONN cycle is used

eDRX_CONN cycle length (s)	$T_{\text{identify_UTRA_FDD}}$ (s) (eDRX_CONN cycles)	
	Gap ID # 0	Gap ID # 1
$2.56 < \text{eDRX_CONN cycle} \leq 10.24$	Note ($20 \cdot \text{CSSF}_{\text{UTRA,NSA}}$)	Note ($20 \cdot \text{CSSF}_{\text{UTRA,NSA}}$)
Note: Time depends upon the eDRX_CONN cycle in use		

A cell shall be considered detectable provided following conditions are fulfilled: A cell shall be considered detectable when

- CPICH $E_c/I_o \geq -20$ dB,
- SCH $E_c/I_o \geq -17$ dB for at least one channel tap and SCH E_c/I_o is equally divided between primary synchronisation code and secondary synchronisation code. When L3 filtering is used an additional delay can be expected.

When DRX or eDRX_CONN is used, the UE shall be capable of performing RSCP and E_c/I_o measurements of at least 6 UTRA cells per UTRA FDD carrier for up to 3 UTRA FDD carriers and the UE physical layer shall be capable of reporting RSCP and E_c/I_o measurements to higher layers within the measurement period $T_{\text{measure_UTRA_FDD}}$, either measurement gaps are scheduled or the UE supports capability of conducting such measurements without gaps. UE supporting Increased UE carrier monitoring UTRA shall be capable of performing RSCP and E_c/I_o measurements of at least 6 UTRA cells per UTRA FDD carrier for up to 6 UTRA FDD carriers with maximum of 80 cells consisting of at most 32 cells per frequency layer in the neighbour cell list. When DRX is used, $T_{\text{measure_UTRA_FDD}}$ is defined in Table 8.1.2.3.1.2-3, and when eDRX_CONN cycle is used, $T_{\text{measure_UTRA_FDD}}$ is defined in Table 8.1.2.3.1.2-4. When MCG DRX is in use the applicable DRX cycle is the MCG DRX cycle.

Table 8.17.5.3-3: Requirement to measure UTRA FDD cells

DRX cycle length (s)	$T_{\text{measure_UTRA_FDD}}$ (s) (DRX cycles)	
	Gap ID # 0	Gap ID # 1
≤ 0.04	Non DRX Requirements in clause 8.17.5.2 are applicable	Non DRX Requirements in clause 8.17.5.2 are applicable
0.064	$0.48 \cdot \text{CSSF}_{\text{UTRA,NSA}}$ ($7.5 \cdot \text{CSSF}_{\text{UTRA,NSA}}$)	$0.8 \cdot \text{CSSF}_{\text{UTRA,NSA}}$ ($12.5 \cdot \text{CSSF}_{\text{UTRA,NSA}}$)
0.08	$0.48 \cdot \text{CSSF}_{\text{UTRA,NSA}}$ ($6 \cdot \text{CSSF}_{\text{UTRA,NSA}}$)	$0.8 \cdot \text{CSSF}_{\text{UTRA,NSA}}$ ($10 \cdot \text{CSSF}_{\text{UTRA,NSA}}$)
0.128	$0.64 \cdot \text{CSSF}_{\text{UTRA,NSA}}$ ($5 \cdot \text{CSSF}_{\text{UTRA,NSA}}$)	$0.8 \cdot \text{CSSF}_{\text{UTRA,NSA}}$ ($6.25 \cdot \text{CSSF}_{\text{UTRA,NSA}}$)
$0.128 < \text{DRX-cycle} \leq 2.56$	Note ($5 \cdot \text{CSSF}_{\text{UTRA,NSA}}$)	Note ($5 \cdot \text{CSSF}_{\text{UTRA,NSA}}$)
Note: Time depends upon the DRX cycle in use		

Table 8.17.5.3-4: Requirement to measure UTRA FDD cells when eDRX_CONN cycle is used

eDRX_CONN cycle length (s)	$T_{\text{measure_UTRA_FDD}}$ (s) (eDRX_CONN cycles)	
	Gap ID # 0	Gap ID # 1
$2.56 < \text{eDRX_CONN cycle} \leq 10.24$	Note ($5 \cdot \text{CSSF}_{\text{UTRA,NSA}}$)	Note ($5 \cdot \text{CSSF}_{\text{UTRA,NSA}}$)
Note: Time depends upon the eDRX_CONN cycle in use		

The measurement accuracy for all measured cells shall be as specified in the sub-clause 9.1.

8.17.5.3.1 Periodic Reporting

Reported measurements in periodically triggered measurement reports shall meet the requirements in clause 9.

8.17.5.3.2 Event Triggered Reporting

Reported measurements in event triggered measurement reports shall meet the requirements in clause 9.

The UE shall not send any event triggered measurement reports, as long as the reporting criteria is not fulfilled.

The measurement reporting delay is defined as the time between any event that will trigger a measurement report until the UE starts to transmit the measurement report over the Uu interface. This requirement assumes that the measurement report is not delayed by other RRC signalling on the DCCH. This measurement reporting delay excludes a delay uncertainty resulted when inserting the measurement report to the TTI of the uplink DCCH. The delay uncertainty is twice the TTI of the uplink DCCH. When the measurement report is transmitted on the PUSCH with subframe or slot or subslot duration, the delay uncertainty is twice the subframe or slot or subslot of the uplink DCCH. This measurement reporting delay excludes a delay which caused by no UL resources for UE to send the measurement report.

The event triggered measurement reporting delay, measured without L3 filtering shall be less than $T_{\text{identify,UTRA_FDD}}$ defined in Clause 8.17.5.3. When L3 filtering is used or IDC autonomous denial is configured or the UE is performing reception and/or transmission for ProSe Direct Discovery and/or ProSe Direct Communication, or the UE is configured to perform SRS carrier based switching, an additional delay can be expected.

If a cell which has been detectable at least for the time period $T_{\text{identify_UTRA_FDD}}$ defined in clause 8.17.5.3 and then triggers the measurement report as per TS 36.331 [2], the event triggered measurement reporting delay shall be less than $T_{\text{measurement_UTRA_FDD}}$ defined in clause 8.17.5.3 provided the timing to that cell has not changed more than ± 32 chips while measurement gap has not been available and the L3 filter has not been used. When L3 filtering is used or IDC autonomous denial is configured or the UE is performing reception and/or transmission for ProSe Direct Discovery and/or ProSe Direct Communication, or the UE is configured to perform SRS carrier based switching, an additional delay can be expected.

8.17.5.3.3 Event-triggered Periodic Reporting

Reported measurements contained in event triggered periodic measurement reports shall meet the requirements in clause 9.

The first report in event triggered periodic measurement reporting shall meet the requirements specified in clause 8.17.5.3.2.

8.17.6 E-UTRAN TDD – UTRAN FDD measurements when Configured with E-UTRA-NR Dual Connectivity

The requirements in clause 8.17.5 also apply for this section when the UE is operating in E-UTRA-NR dual connectivity mode. Otherwise when the UE is not configured with E-UTRA-NR dual connectivity mode then the E-UTRAN FDD-UTRAN FDD measurement requirements defined in section 8.1.2.4.2 shall apply.

8.17.7 E-UTRAN FDD – UTRAN FDD measurements for SON when Configured with E-UTRA-NR Dual Connectivity

8.17.7.1 Introduction

The requirements in this clause apply only to UE supporting E-UTRAN FDD and UTRA FDD. The E-UTRAN FDD - UTRAN FDD measurement requirements for SON defined in section 8.17.7 shall apply when the UE capable of E-UTRA-NR dual connectivity is operating in E-UTRA-NR dual connectivity mode. The requirements in section 8.17.7 are applicable for gap pattern id # 0 and #1 as specified in Table 8.1.2.1-1.

The scaling factor $CSSF_{\text{UTRA,NSA}}$ used in the UTRA FDD measurement requirements for SON in section 8.17.7 for the UE configured with E-UTRA-NR dual connectivity mode is determined according to $CSSF_{\text{within_gap},i}$ as specified in clause 9.1.5.2.1 of TS 38.133 [50]. When the UE is not configured with E-UTRA-NR dual connectivity mode then the E-UTRAN FDD-UTRAN FDD measurement requirements defined in section 8.1.2.4.7 shall apply.

8.17.7.2 Identification of a new UTRA FDD cell for SON

No explicit neighbour list is provided to the UE for identifying a UTRA cell for SON. The UE shall identify and report only the strongest cell when requested by the network for the purpose of SON.

8.17.7.2.1 Requirements when no DRX is used

When no DRX is used, either measurement gaps are scheduled or the UE supports capability of conducting such measurements without gaps, the UE shall be able to identify a new cell within:

$$T_{\text{identify_UTRA_FDD}} = T_{\text{basic_identify_UTRA_FDD}} \cdot \frac{480}{T_{\text{inter1}}} \cdot CSSF_{\text{UTRA,NSA}} \quad \text{ms}$$

$T_{\text{basic_identify_UTRA_FDD}} = 300$ ms. This is the time period used in the above equation where the maximum allowed time for the UE to identify a new UTRA FDD cell is defined.

A cell shall be considered identifiable following conditions are fulfilled:

- CPICH $E_c/I_o \geq -20$ dB,
- SCH $E_c/I_o \geq -17$ dB for at least one channel tap and SCH E_c/I_o is equally divided between primary synchronisation code and secondary synchronisation code. When L3 filtering is used an additional delay can be expected.

If the UE is unable to identify the UTRA cell for SON within $8 \cdot T_{\text{identify, UTRA_FDD}}$ ms, the UE may stop searching UTRA cells for SON.

8.17.7.2.2 Requirements when DRX is used

When DRX or eDRX_CONN is used, either measurement gaps are scheduled or the UE supports capability of conducting such measurements without gaps, the UE shall be able to identify a new cell within $T_{\text{identify, UTRA_FDD}}$. When DRX is used, $T_{\text{identify, UTRA_FDD}}$ is as defined in table 8.17.7.2.2-1, and when eDRX_CONN is used, $T_{\text{identify, UTRA_FDD}}$ is as defined in table 8.17.7.2.2-2. When MCG DRX is in use the applicable DRX cycle is the MCG DRX cycle.

Table 8.17.7.2.2-1: Requirement to identify a new UTRA FDD cell for SON

DRX cycle length (s)	$T_{\text{identify, UTRA_FDD}}$ (s) (DRX cycles)	
	Gap ID # 0	Gap ID # 1
≤ 0.04	Non DRX Requirements in clause 8.17.7.2.1 are applicable	Non DRX Requirements in clause 8.17.7.2.1 are applicable
$0.04 < \text{DRX cycle} \leq 0.08$	Note ($45 \cdot \text{CSSF}_{\text{UTRA,NSA}}$)	Note ($95 \cdot \text{CSSF}_{\text{UTRA,NSA}}$)
0.128	$3.84 \cdot \text{CSSF}_{\text{UTRA,NSA}}$ ($30 \cdot \text{CSSF}_{\text{UTRA,NSA}}$)	$8.0 \cdot \text{CSSF}_{\text{UTRA,NSA}}$ ($62.5 \cdot \text{CSSF}_{\text{UTRA,NSA}}$)
0.16	$4.0 \cdot \text{CSSF}_{\text{UTRA,NSA}}$ ($25 \cdot \text{CSSF}_{\text{UTRA,NSA}}$)	$8.0 \cdot \text{NCSSF}_{\text{UTRA,NSA}}$ ($50 \cdot \text{CSSF}_{\text{UTRA,NSA}}$)
0.256	$6.4 \cdot \text{CSSF}_{\text{UTRA,NSA}}$ ($25 \cdot \text{CSSF}_{\text{UTRA,NSA}}$)	$8.96 \cdot \text{CSSF}_{\text{UTRA,NSA}}$ ($35 \cdot \text{CSSF}_{\text{UTRA,NSA}}$)
0.32	$8 \cdot \text{CSSF}_{\text{UTRA,NSA}}$ ($25 \cdot \text{CSSF}_{\text{UTRA,NSA}}$)	$8.96 \cdot \text{CSSF}_{\text{UTRA,NSA}}$ ($28 \cdot \text{CSSF}_{\text{UTRA,NSA}}$)
$0.32 < \text{DRX cycle} \leq 2.56$	Note ($25 \cdot \text{CSSF}_{\text{UTRA,NSA}}$)	Note ($25 \cdot \text{CSSF}_{\text{UTRA,NSA}}$)
Note: Time depends upon the DRX cycle in use		

Table 8.17.7.2.2-2: Requirement to identify a new UTRA FDD cell for SON when eDRX_CONN cycle is used

eDRX_CONN cycle length (s)	$T_{\text{identify, UTRA_FDD}}$ (s) (eDRX_CONN cycles)	
	Gap ID # 0	Gap ID # 1
$2.56 < \text{eDRX_CONN cycle} \leq 10.24$	Note ($25 \cdot \text{CSSF}_{\text{UTRA,NSA}}$)	Note ($25 \cdot \text{CSSF}_{\text{UTRA,NSA}}$)
Note: Time depends upon the eDRX_CONN cycle in use		

A cell shall be considered identifiable provided following conditions are fulfilled:

- CPICH $E_c/I_o \geq -20$ dB,
- SCH $E_c/I_o \geq -17$ dB for at least one channel tap and SCH E_c/I_o is equally divided between primary synchronisation code and secondary synchronisation code. When L3 filtering is used an additional delay can be expected.

If the UE is unable to identify the UTRA cell for SON within $8 \cdot T_{\text{identify, UTRA_FDD}}$ seconds, the UE may stop searching UTRA cells for SON; when DRX is used $T_{\text{identify, UTRA_FDD}}$ is defined in table 8.17.7.2.2-1, and when eDRX_CONN is used $T_{\text{identify, UTRA_FDD}}$ is defined in table 8.17.7.2.2-2.

8.17.7.2.3 Reporting Delay

The UE shall not report the physical cell identity of an identifiable cell for SON as long as the reporting criteria are not fulfilled.

The reporting delay is defined as the time between the identification of the strongest cell for SON until the UE starts to transmit its physical cell identity over the Uu interface. This requirement assumes that the reporting of the physical cell identity is not delayed by other RRC signalling on the DCCH. This reporting delay excludes a delay uncertainty resulted when inserting the physical cell identity of the strongest cell for SON to the TTI of the uplink DCCH. The delay uncertainty is twice the TTI of the uplink DCCH. When the measurement report is transmitted on the PUSCH with subframe or slot or subslot duration, the delay uncertainty is twice the subframe or slot or subslot of the uplink DCCH. This reporting delay excludes any delay caused by unavailability of UL resources for UE sending the physical cell identity of the strongest cell for SON.

The reporting delay of the physical cell identity of the strongest cell for SON without L3 filtering shall be less than $T_{\text{identify, UTRA_FDD}}$ defined in clause 8.17.7.2.1 and in clause 8.17.7.2.2 for non DRX and DRX or eDRX_CONN cases respectively. When L3 filtering is used or IDC autonomous denial is configured, or the UE is configured to perform SRS carrier based switching, an additional delay can be expected.

8.17.8 E-UTRAN TDD – UTRAN FDD measurements for SON when Configured with E-UTRA-NR Dual Connectivity

The requirements in clause 8.17.7 also apply for this section when the UE is operating in E-UTRA-NR dual connectivity mode. Otherwise when the UE is not configured with E-UTRA-NR dual connectivity mode then the E-UTRAN TDD-UTRAN FDD measurement requirements for SON defined in section 8.1.2.4.8 shall apply.

8.17.9 E-UTRAN TDD – UTRAN TDD measurements when Configured with E-UTRA-NR Dual Connectivity

8.17.9.1 Introduction

The requirements in this clause apply only to UE supporting E-UTRAN TDD and UTRA FDD. The E-UTRAN TDD - UTRAN TDD measurement requirements defined in section 8.17.9 shall apply when the UE capable of E-UTRA-NR dual connectivity is operating in E-UTRA-NR dual connectivity mode. The requirements in section 8.17.9 are applicable for gap pattern id # 0 and #1 as specified in Table 8.1.2.1-1.

The scaling factor $CSSF_{\text{UTRA, NSA}}$ used in the UTRA TDD measurement requirements in section 8.17.9 for the UE configured with E-UTRA-NR dual connectivity mode is determined according to $CSSF_{\text{within_gap}, i}$ as specified in clause 9.1.5.2.1 of TS 38.133 [50]. When the UE is not configured with E-UTRA-NR dual connectivity mode then the E-UTRAN TDD-UTRAN TDD measurement requirements defined in section 8.1.2.4.3 shall apply.

8.17.9.2 E-UTRAN FDD – UTRAN TDD measurements when no DRX is used

8.17.9.2.1 Identification of a new UTRA FDD cell

When explicit neighbour list is provided and no DRX is used, either measurement gaps are scheduled or the UE supports capability of conducting such measurements without gaps, the UE shall be able to identify a new detectable cell belonging to the monitored set within

$$T_{\text{identify, UTRA_TDD}} = \text{Max} \left\{ 5000, T_{\text{basic identify UTRA_TDD}} \cdot \frac{480}{T_{\text{inter1}}} \cdot CSSF_{\text{UTRA, NSA}} \right\} \text{ms}$$

A cell shall be considered detectable when

- $P\text{-CCPCH } E_c/I_0 \geq -8 \text{ dB}$,
- $DwPCH_E_c/I_0 \geq -5 \text{ dB}$.

When L3 filtering is used an additional delay can be expected.

8.17.9.2.2 Enhanced UTRA TDD cell identification requirements

When explicit neighbour list is provided and no DRX is used or when DRX cycle length $\leq 40 \text{ ms}$, either measurement gaps are scheduled or the UE supports capability of conducting such measurements without gaps, the UE shall be able to identify a new detectable cell belonging to the monitored set within $T_{\text{identify, enhanced_UTRA_TDD}}$:

$$T_{\text{identify, enhanced_UTRA_TDD}} = (T_{\text{basic_identify_enhanced_UTRA_TDD}} \cdot \frac{480}{T_{\text{inter1}}} + 480) \cdot CSSF_{\text{UTRA, NSA}} \text{ms}$$

A cell shall be considered detectable when:

- $P\text{-CCPCH_}E_c/I_0 \geq -6 \text{ dB}$,
- $DwPCH_E_c/I_0 \geq -1 \text{ dB}$

When L3 filtering is used an additional delay can be expected.

8.17.9.2.3 UE UTRA TDD P-CCPCH RSCP measurement capability

When measurement gaps are scheduled for UTRA TDD inter RAT measurements, or the UE supports capability of conducting such measurements without gaps, the UE physical layer shall be capable of reporting measurements to higher layers with measurement accuracy as specified in Clause 9.3 with measurement period given by

$$T_{\text{measurement_UTRA_TDD}} = \text{Max} \left\{ T_{\text{Measurement_Period_UTRA_TDD}}, T_{\text{basic_measurement_UTRA_TDD}} \cdot \frac{480}{T_{\text{inter1}}} \cdot \text{CSSF}_{\text{UTRA,NSA}} \right\} \text{ms}$$

The UE shall be capable of performing UTRA TDD P-CCPCH RSCP measurements for $X_{\text{basic_measurementUTRA_TDD}}$ inter-frequency cells per TDD frequency of the monitored set, and the UE physical layer shall be capable of reporting measurements to higher layers with the measurement period of $T_{\text{Measurement_UTRA_TDD}}$.

$$X_{\text{basic_measurementUTRA_TDD}} = 6$$

$T_{\text{Measurement_Period_UTRA_TDD}} = 480$ ms is the period used for calculating the measurement period $T_{\text{measurement_UTRA_TDD}}$ for UTRA TDD P-CCPCH RSCP measurements.

$T_{\text{basic_identify_UTRA_TDD}} = 800$ ms is the time period used in the inter RAT equation in clause 8.17.9.2.1 where the maximum allowed time for the UE to identify a new UTRA TDD cell is defined.

$T_{\text{basic_identify_enhanced_UTRA_TDD}} = 80$ ms is the time period used in the inter RAT equation in clause 8.17.9.2.2 where the maximum allowed time for the UE to identify a new UTRA TDD cell is defined.

$T_{\text{basic_measurement_UTRA_TDD}} = 50$ ms is the time period used in the equation for defining the measurement period for inter RAT P-CCPCH RSCP measurements.

8.17.9.2.4 Periodic Reporting

Reported measurements in periodically triggered measurement reports shall meet the requirements in clause 9.

8.17.9.2.5 Event Triggered Reporting

Reported measurements in event triggered measurement reports shall meet the requirements in clause 9.

The UE shall not send any event triggered measurement reports, as long as the reporting criteria is not fulfilled.

The measurement reporting delay is defined as the time between any event that will trigger a measurement report until the UE starts to transmit the measurement report over the Uu interface. This requirement assumes that the measurement report is not delayed by other RRC signalling on the DCCH. When the measurement report is transmitted on the PUSCH with subframe or slot or subslot duration, the delay uncertainty is twice the subframe or slot or subslot of the uplink DCCH. This measurement reporting delay excludes a delay uncertainty resulted when inserting the measurement report to the TTI of the uplink DCCH. The delay uncertainty is twice the TTI of the uplink DCCH. This measurement reporting delay excludes a delay which caused by no UL resources for UE to send the measurement report.

The event triggered measurement reporting delay, measured without L3 filtering shall be less than $T_{\text{identify, UTRA_TDD}}$ defined in Clause 8.17.9.2.1 for the minimum requirements or $T_{\text{identify, enhanced_UTRA_TDD}}$ defined in Clause 8.17.9.2.2 for the enhanced requirements. When L3 filtering is used or IDC autonomous denial is configured or the UE is performing reception and/or transmission for ProSe Direct Discovery and/or ProSe Direct Communication, or the UE is configured to perform SRS carrier based switching, an additional delay can be expected.

If a cell which has been detectable at least for the time period $T_{\text{identify, UTRA_TDD}}$ defined in clause 8.17.9.2.1 for the minimum requirements and then triggers the measurement report as per TS 36.331 [2], the event triggered measurement reporting delay shall be less than $T_{\text{measurement_UTRA_TDD}}$ defined in clause 8.17.9.2.3 provided the timing to that cell has not changed more than ± 10 chips while measurement gap has not been available and the L3 filter has not been used. When L3 filtering is used or IDC autonomous denial is configured or the UE is performing reception and/or transmission for ProSe Direct Discovery and/or ProSe Direct Communication, or the UE is configured to perform SRS carrier based switching, an additional delay can be expected.

8.17.9.2.6 Event-triggered Periodic Reporting

Reported measurements contained in event triggered periodic measurement reports shall meet the requirements in clause 9.

The first report in event triggered periodic measurement reporting shall meet the requirements specified in clause 8.17.9.2.5.

8.17.9.3 E-UTRAN TDD – UTRAN TDD measurements when DRX is used

When explicit neighbour list is provided and DRX or eDRX_CONN is used, either measurement gaps are scheduled or the UE supports capability of conducting such measurements without gaps, the UE shall be able to identify a new detectable cell belonging to the neighbour cell list within $T_{\text{identify_UTRA_TDD}}$. When DRX is used, $T_{\text{identify_UTRA_TDD}}$ is as defined in table 8.17.9.3-1, and when eDRX_CONN is used, $T_{\text{identify_UTRA_TDD}}$ is as defined in table 8.17.9.3-2. When MCG DRX is in use the applicable DRX cycle is the MCG DRX cycle.

Table 8.17.9.3-1: Requirement to identify a newly detectable UTRA TDD cell

DRX cycle length (s)	$T_{\text{identify_UTRA_TDD}}$ (s) (DRX cycles)	
	Gap ID # 0	Gap ID # 1
≤ 0.32	Non DRX Requirements in clause 8.1.2.4.3.1 are applicable	Non DRX Requirements in clause 8.1.2.4.3.1 are applicable
$0.32 < \text{DRX-cycle} \leq 0.512$	Note ($20 \cdot \text{CSSF}_{\text{UTRA,NSA}}$)	Note ($25 \cdot \text{CSSF}_{\text{UTRA,NSA}}$)
$0.512 < \text{DRX-cycle} \leq 2.56$	Note ($20 \cdot \text{CSSF}_{\text{UTRA,NSA}}$)	Note ($20 \cdot \text{CSSF}_{\text{UTRA,NSA}}$)
Note:	Time depends upon the DRX cycle in use	

Table 8.17.9.3-2: Requirement to identify a newly detectable UTRA TDD cell when eDRX_CONN cycle is used

eDRX_CONN cycle length (s)	$T_{\text{identify_UTRA_TDD}}$ (s) (eDRX_CONN cycles)	
	Gap ID # 0	Gap ID # 1
$2.56 < \text{eDRX_CONN cycle} \leq 10.24$	Note ($20 \cdot \text{CSSF}_{\text{UTRA,NSA}}$)	Note ($20 \cdot \text{CSSF}_{\text{UTRA,NSA}}$)
Note:	Time depends upon the eDRX_CONN cycle in use	

A cell shall be considered detectable provided following conditions are fulfilled: A cell shall be considered detectable when

- P-CCPCH $E_c/I_o \geq -8$ dB,
- DwPCH $E_c/I_o \geq -5$ dB.

When L3 filtering is used an additional delay can be expected.

When DRX or eDRX_CONN is in use, the UE shall be capable of performing UTRA TDD P-CCPCH RSCP measurements of at least 6 UTRA cells per UTRA TDD carrier for up to 3 UTRA TDD carriers and the UE physical layer shall be capable of reporting measurements to higher layers with the measurement period $T_{\text{measure_UTRA_TDD}}$, either measurement gaps are scheduled or the UE supports capability of conducting such measurements without gaps. UE supporting Increased UE carrier monitoring UTRA shall be capable of performing UTRA TDD P-CCPCH RSCP measurements of at least 6 UTRA cells per UTRA TDD carrier for up to 7 UTRA TDD carriers with maximum of 80 cells consisting of at most 32 cells per frequency layer in the neighbour cell list. When DRX is used, $T_{\text{measure_UTRA_TDD}}$ is as defined in Table 8.17.9.3-3, and when eDRX_CONN is used, $T_{\text{measure_UTRA_TDD}}$ is as defined in Table 8.17.9.3-4. When MCG DRX is in use the applicable DRX cycle is the MCG DRX cycle.

Table 8.17.9.3-3: Requirement to measure UTRA TDD cells

DRX cycle length (s)	$T_{\text{measure_UTRA_TDD}}$ (s) (DRX cycles)	
	Gap ID # 0	Gap ID # 1
≤ 0.04	Non DRX Requirements in clause 8.1.2.4.3.1 are applicable	Non DRX Requirements in clause 8.1.2.4.3.1 are applicable
0.064	$0.48 \cdot \text{CSSF}_{\text{UTRA,NSA}}$ ($7.5 \cdot \text{CSSF}_{\text{UTRA,NSA}}$)	$0.8 \cdot \text{CSSF}_{\text{UTRA,NSA}}$ ($12.5 \cdot \text{CSSF}_{\text{UTRA,NSA}}$)
0.08	$0.48 \cdot \text{CSSF}_{\text{UTRA,NSA}}$ ($6 \cdot \text{CSSF}_{\text{UTRA,NSA}}$)	$0.8 \cdot \text{CSSF}_{\text{UTRA,NSA}}$ ($10 \cdot \text{CSSF}_{\text{UTRA,NSA}}$)
0.128	$0.64 \cdot \text{CSSF}_{\text{UTRA,NSA}}$ ($5 \cdot \text{CSSF}_{\text{UTRA,NSA}}$)	$0.8 \cdot \text{CSSF}_{\text{UTRA,NSA}}$ ($6.25 \cdot \text{CSSF}_{\text{UTRA,NSA}}$)
$0.128 < \text{DRX-cycle} \leq 2.56$	Note ($5 \cdot \text{CSSF}_{\text{UTRA,NSA}}$)	Note ($5 \cdot \text{CSSF}_{\text{UTRA,NSA}}$)
Note:	Time depends upon the DRX cycle in use	

Table 8.17.9.3-4: Requirement to measure UTRA TDD cells when eDRX_CONN cycle is used

eDRX_CONN cycle length (s)	T _{measure_UTRA_TDD} (s) (eDRX_CONN cycles)	
	Gap ID # 0	Gap ID # 1
2.56 < eDRX_CONN cycles ≤ 10.24	Note (5*CSSF _{UTRA,NSA})	Note (5*CSSF _{UTRA,NSA})
Note: Time depends upon the eDRX_CONN cycle in use		

The measurement accuracy for all measured cells shall be as specified in the sub-clause 9.1.

8.17.9.3.1 Periodic Reporting

Reported measurements in periodically triggered measurement reports shall meet the requirements in clause 9.

8.17.9.3.2 Event Triggered Reporting

Reported measurements in event triggered measurement reports shall meet the requirements in clause 9.

The UE shall not send any event triggered measurement reports, as long as the reporting criteria is not fulfilled.

The measurement reporting delay is defined as the time between any event that will trigger a measurement report until the UE starts to transmit the measurement report over the Uu interface. This requirement assumes that the measurement report is not delayed by other RRC signalling on the DCCH. This measurement reporting delay excludes a delay uncertainty resulted when inserting the measurement report to the TTI of the uplink DCCH. The delay uncertainty is twice the TTI of the uplink DCCH. When the measurement report is transmitted on the PUSCH with subframe or slot or subslot duration, the delay uncertainty is twice the subframe or slot or subslot of the uplink DCCH. This measurement reporting delay excludes a delay which caused by no UL resources for UE to send the measurement report.

The event triggered measurement reporting delay, measured without L3 filtering shall be less than T_{identify, UTRA_TDD} defined in Clause 8.17.9.3. When L3 filtering is used or IDC autonomous denial is configured or the UE is performing reception and/or transmission for ProSe Direct Discovery and/or ProSe Direct Communication, or the UE is configured to perform SRS carrier based switching, an additional delay can be expected.

If a cell which has been detectable at least for the time period T_{identify, UTRA_TDD} defined in clause 8.17.9.3 and then triggers the measurement report as per TS 36.331 [2], the event triggered measurement reporting delay shall be less than T_{measurement_UTRA_TDD} defined in clause 8.17.9.3 provided the timing to that cell has not changed more than ± 10 chips while measurement gap has not been available and the L3 filter has not been used. When L3 filtering is used or IDC autonomous denial is configured or the UE is performing reception and/or transmission for ProSe Direct Discovery and/or ProSe Direct Communication, or the UE is configured to perform SRS carrier based switching, an additional delay can be expected.

8.17.9.3.3 Event-triggered Periodic Reporting

Reported measurements contained in event triggered periodic measurement reports shall meet the requirements in clause 9.

The first report in event triggered periodic measurement reporting shall meet the requirements specified in clause 8.17.9.3.2.

8.17.10 E-UTRAN FDD – UTRAN TDD measurements when Configured with E-UTRA-NR Dual Connectivity

The requirements in clause 8.17.9 also apply for this section when the UE is operating in E-UTRA-NR dual connectivity mode. Otherwise when the UE is not configured with E-UTRA-NR dual connectivity mode then the E-UTRAN FDD-UTRAN TDD measurement requirements defined in section 8.1.2.4.4 shall apply.

8.17.11 E-UTRAN TDD – UTRAN TDD measurements for SON when Configured with E-UTRA-NR Dual Connectivity

8.17.11.1 Introduction

The requirements in this clause apply only to UE supporting E-UTRAN TDD and UTRA TDD. The E-UTRAN TDD - UTRAN TDD measurement requirements for SON defined in section 8.17.11 shall apply when the UE capable of E-

UTRA-NR dual connectivity is operating in E-UTRA-NR dual connectivity mode. The requirements in section 8.17.11 are applicable for gap pattern id # 0 and #1 as specified in Table 8.1.2.1-1.

The scaling factor $CSSF_{UTRA,NSA}$ used in the UTRA TDD measurement requirements for SON in section 8.17.11 for the UE configured with E-UTRA-NR dual connectivity mode is determined according to $CSSF_{within_gap,i}$ as specified in clause 9.1.5.2.1 of TS 38.133 [50]. When the UE is not configured with E-UTRA-NR dual connectivity mode then the E-UTRAN TDD-UTRAN TDD measurement requirements defined in section 8.1.2.4.13 shall apply.

8.17.11.2 Identification of a new UTRA TDD cell for SON

No explicit neighbour list is provided to the UE for identifying a UTRA cell for SON. The UE shall identify and report only the strongest cell when requested by the network for the purpose of SON.

8.17.11.2.1 Requirements when no DRX is used

When no DRX is used, either measurement gaps are scheduled or the UE supports capability of conducting such measurements without gaps, the UE shall be able to identify a new cell within:

$$T_{\text{identify_UTRA_TDD}} = T_{\text{basic_identify_UTRA_TDD}} \cdot \frac{480}{T_{\text{inter1}}} \cdot CSSF_{UTRA,NSA} \quad ms$$

$T_{\text{basic_identify_UTRA_TDD}} = 800$ ms. This is the time period used in the above equation where the maximum allowed time for the UE to identify a new UTRA TDD cell is defined.

A cell shall be considered identifiable following conditions are fulfilled:

- P-CCPCH $E_c/I_0 \geq -8$ dB,
- DwPCH $E_c/I_0 \geq -5$ dB.

When L3 filtering is used an additional delay can be expected.

If the UE is unable to identify the UTRA TDD cell for SON within $8 \cdot T_{\text{identify_UTRA_TDD}}$ ms, the UE may stop searching UTRA TDD cells for SON.

8.17.11.2.2 Requirements when DRX is used

When DRX or eDRX_CONN is used, either measurement gaps are scheduled or the UE supports capability of conducting such measurements without gaps, the UE shall be able to identify a new cell within $T_{\text{identify_UTRA_TDD}}$. When DRX is used, $T_{\text{identify_UTRA_TDD}}$ is as defined in table 8.17.11.2.2-1, and when eDRX_CONN is used, $T_{\text{identify_UTRA_TDD}}$ is as defined in table 8.17.11.2.2-2. When MCG DRX is in use the applicable DRX cycle is the MCG DRX cycle.

Table 8.17.11.2.2-1: Requirement to identify a new UTRA TDD cell for SON

DRX cycle length (s)	$T_{\text{identify_UTRA_TDD}}$ (s) (DRX cycles)	
	Gap Id # 0	Gap Id # 1
≤ 0.16	Non DRX Requirements in clause 8.1.2.4.3.1 are applicable	Non DRX Requirements in clause 8.1.2.4.3.1 are applicable
$0.16 < \text{DRX cycle} \leq 0.256$	Note ($25 \cdot CSSF_{UTRA,NSA}$)	Note ($50 \cdot CSSF_{UTRA,NSA}$)
$0.256 < \text{DRX cycle} \leq 0.32$	Note ($25 \cdot CSSF_{UTRA,NSA}$)	Note ($45 \cdot CSSF_{UTRA,NSA}$)
$0.32 < \text{DRX cycle} \leq 2.56$	Note ($25 \cdot CSSF_{UTRA,NSA}$)	Note ($25 \cdot CSSF_{UTRA,NSA}$)
Note: Time depends upon the DRX cycle in use		

Table 8.17.11.2.2-2: Requirement to identify a new UTRA TDD cell for SON when eDRX_CONN cycle is used

eDRX_CONN cycle length (s)	$T_{\text{identify_UTRA_TDD}}$ (s) (eDRX_CONN cycles)	
	Gap Id # 0	Gap Id # 1
$2.56 < \text{eDRX_CONN cycle} \leq 10.24$	Note ($25 \cdot CSSF_{UTRA,NSA}$)	Note ($25 \cdot CSSF_{UTRA,NSA}$)
Note: Time depends upon the eDRX_CONN cycle in use		

A cell shall be considered identifiable provided following conditions are fulfilled:

- P-CCPCH $E_c/I_0 \geq -8$ dB,

- $DwPCH_{Ec/Io} \geq -5$ dB.

When L3 filtering is used an additional delay can be expected.

If the UE is unable to identify the UTRA TDD cell for SON within $8 \cdot T_{\text{identify, UTRA_TDD}}$ seconds, the UE may stop searching UTRA TDD cells for SON; when DRX is used $T_{\text{identify, UTRA_TDD}}$ is defined in table 8.17.11.2.2-1, and when eDRX_CONN is used $T_{\text{identify, UTRA_TDD}}$ is defined in table 8.17.11.2.2-2.

8.17.11.2.3 Reporting Delay

The UE shall not report the physical cell identity of an identifiable cell for SON as long as the reporting criteria are not fulfilled.

The reporting delay is defined as the time between the identification of the strongest cell for SON until the UE starts to transmit its physical cell identity over the Uu interface. This requirement assumes that the reporting of the physical cell identity is not delayed by other RRC signalling on the DCCH. This reporting delay excludes a delay uncertainty resulted when inserting the physical cell identity of the strongest cell for SON to the TTI of the uplink DCCH. The delay uncertainty is twice the TTI of the uplink DCCH. When the measurement report is transmitted on the PUSCH with subframe or slot or subslot duration, the delay uncertainty is twice the subframe or slot or subslot of the uplink DCCH. This reporting delay excludes any delay caused by unavailability of UL resources for UE sending the physical cell identity of the strongest cell for SON.

The reporting delay of the physical cell identity of the strongest cell for SON without L3 filtering shall be less than $T_{\text{identify, UTRA_TDD}}$ defined in clause 8.17.11.2.1 and in clause 8.17.11.2.2 for non DRX and DRX and eDRX_CONN cases respectively. When L3 filtering is used or IDC autonomous denial is configured, or the UE is configured to perform SRS carrier based switching, an additional delay can be expected.

8.17.12 E-UTRAN FDD – UTRAN TDD measurements for SON when Configured with E-UTRA-NR Dual Connectivity

The requirements in clause 8.17.11 also apply for this section when the UE is operating in E-UTRA-NR dual connectivity mode. Otherwise when the UE is not configured with E-UTRA-NR dual connectivity mode then the E-UTRAN FDD-UTRAN FDD measurement requirements for SON defined in section 8.1.2.4.14 shall apply.

8.17.13 E-UTRAN FDD – GSM measurements when Configured with E-UTRA-NR Dual Connectivity

8.17.13.1 Introduction

The requirements in this clause apply only to UE supporting E-UTRAN FDD and GSM. The E-UTRAN FDD - GSM measurement requirements defined in section 8.17.13 shall apply when the UE capable of E-UTRA-NR dual connectivity is operating in E-UTRA-NR dual connectivity mode. The requirements in section 8.17.13 are applicable for gap pattern id # 0 and #1 as specified in Table 8.1.2.1-1.

The scaling factor $CSSF_{\text{GSM, NSA}}$ used in the GSM measurement requirements in section 8.17.13 for the UE configured with E-UTRA-NR dual connectivity mode is determined according to $CSSF_{\text{within_gap, i}}$ as specified in clause 9.1.5.2.1 of TS 38.133 [50]. When the UE is not configured with E-UTRA-NR dual connectivity mode then the E-UTRAN FDD-GSM measurement requirements defined in section 8.1.2.4.5 shall apply.

8.17.13.2 E-UTRAN FDD – GSM measurements when no DRX is used

Measurements on GSM cells can be requested with BSIC verified. In RRC_CONNECTED state when a supported measurement gap pattern id # 0 or # 1 according to Table 8.1.2.1-1 is configured by E-UTRAN, or the UE supports capability of conducting such measurements without gaps, the UE shall continuously measure GSM cells, search for new GSM cells given in the monitored set and re-confirm the BSIC for already detected cells.

8.17.13.2.1 GSM carrier RSSI

This measurement shall be based on measurement gaps allocated for GSM carrier RSSI measurement as described in clause 8.1.2.1. A UE supporting GSM measurements shall measure minimum number of 10 GSM carrier RSSI measurement samples ($N_{\text{GSM carrier RSSI}}$) per measurement gap. In RRC_CONNECTED state the measurement period, $T_{\text{Measurement Period, GSM}}$, for the GSM carrier RSSI measurement is $CSSF_{\text{GSM, NSA}} \cdot 480$ ms.

The UE shall meet the measurement accuracy requirements stated for RXLEV in TS 45.008 [8], when the given measurement time allows the UE to take at least 3 GSM carrier RSSI samples per GSM carrier in the monitored set during the measurement period.

In case the UE is not able to acquire the required number of samples per GSM carrier during one measurement period, the UE shall measure as many GSM carriers as possible during that measurement period using at least 3 samples per GSM carrier. The GSM carriers that were not measured during that measurement period shall be measured in the following measurement periods.

8.17.13.2.2 BSIC verification

Measurements on a GSM cell can be requested with BSIC verified. The UE shall be able to report the GSM cells with BSIC verified for those cells where the verification of BSIC has been successful.

The procedure for BSIC verification on a GSM cell can be divided into the following two tasks:

- **Initial BSIC identification:** Includes searching for the BSIC and decoding the BSIC for the first time when there is no knowledge about the relative timing between the E-UTRAN FDD and GSM cells. The UE shall trigger the initial BSIC identification within the available measurement gap pattern sequence. The requirements for BSIC re-confirmation can be found in clause 8.17.13.2.2.1.
- **BSIC re-confirmation:** Tracking and decoding the BSIC of a GSM cell after initial BSIC identification is performed. The UE shall trigger the BSIC re-confirmation within the available measurement gap pattern. The requirements for BSIC re-confirmation can be found in clause 8.17.13.2.2.2.

If the network requests measurements on a GSM cell the UE shall behave as follows:

- The UE shall perform GSM carrier RSSI measurements according to clause 8.17.13.2 when a measurement gap pattern sequence is activated, or the UE supports capability of conducting such measurements without gaps.

The UE shall perform measurement reporting as defined in TS 36.331 [2].

- The UE shall perform BSIC identification. The UE shall use the most recently available GSM carrier RSSI measurement results for arranging GSM cells in signal strength order for performing BSIC identification.
- The UE shall perform BSIC re-confirmation on all the GSM cells that have been successfully identified.
- The UE shall perform all configured event evaluation for event-triggered reporting after the BSIC has been verified for a GSM cell. The UE shall use the most recently available GSM carrier RSSI measurement results in event evaluation and event-triggered reporting.
- Event-triggered and periodic reports shall be triggered according to TS 36.331 [2].

The BSIC of a GSM cell is considered to be “verified” if the UE has decoded the SCH of the BCCH carrier and identified the BSIC at least one time (initial BSIC identification). Once a GSM cell has been identified the BSIC shall be re-confirmed at least once every $8 \cdot T_{\text{re-confirm,GSM}}$ seconds. Otherwise the BSIC of the GSM cell is considered as “non-verified”. If a measurement gap pattern sequence is deactivated by the network after BSIC has been identified or verified, the UE shall consider the BSIC as non-verified.

$T_{\text{identify,GSM}}$ indicates the maximum time allowed for the UE to decode the unknown BSIC of the GSM cell in one GSM BCCH carrier in the initial BSIC identification procedure.

$T_{\text{re-confirm,GSM}}$ indicates the maximum time allowed for the re-confirmation of the BSIC of one GSM cell in the BSIC re-confirmation procedure.

The UE shall be able to decode a BSIC within a measurement gap when the time difference between the middle of the received GSM synchronisation burst at the UE and the middle of the effective measurement gap is within the limits specified in table 8.17.13.2.2-1.

Table 8.17.13.2.2-1: The gap length and maximum time difference for BSIC verification

Gap length [ms]	Maximum time difference [μs]
6	± 2350 μs

The UE shall be able to perform BSIC verification at levels down to the reference sensitivity level or reference interference levels as specified in TS 45.005 [9].

8.17.13.2.2.1 Initial BSIC identification

This measurement shall be based on the measurement gaps used for Initial BSIC identification as described in clause 8.17.13.2.2.

The UE shall continuously attempt to decode the BSIC of SCH on the BCCH carrier of the 8 strongest BCCH carriers of the GSM cells indicated in the Inter-RAT cell info list. The UE shall give priority for BSIC decoding attempts in decreasing signal strength order to BCCH carriers with unknown BSIC. The strongest BCCH carrier is defined as the BCCH carrier having the highest measured GSM carrier RSSI value.

If the BSIC of the GSM BCCH carrier has been successfully decoded the UE shall immediately continue BSIC identification with the next GSM BCCH carrier, in signal strength order, with unknown BSIC. The GSM cell for which the BSIC has been successfully identified shall be moved to the BSIC re-confirmation procedure.

If the UE has not successfully decoded the BSIC of the GSM BCCH carrier within $T_{\text{identify,GSM}}$ ms, the UE shall abort the BSIC identification attempts for that GSM BCCH carrier. The UE shall continue to try to perform BSIC identification of the next GSM BCCH carrier in signal strength order. The GSM BCCH carrier for which the BSIC identification failed shall not be re-considered for BSIC identification until BSIC identification attempts have been made for all the rest of the 8 strongest GSM BCCH carriers in the monitored set with unknown BSIC.

$T_{\text{identify,GSM}}$ values are given for a set of reference gap patterns in table 8.17.13.2.2.1-1. The requirements in the table represent the time required to guarantee at least two attempts to decode the BSIC for one GSM BCCH carrier. If inter-frequency RSTD measurements are configured and the UE requires measurement gaps for performing such measurements, then $T_{\text{identify,GSM}}$ shall be based on the 80ms gap configuration.

Table 8.17.13.2.2.1-1

ceil(CSSF _{GSM} , NSA * K _n – M _{gsm})	T _{identify,gsm} (ms)		T _{reconfirm,gsm} (ms)	
	40ms gap configuration (ID 0)	80ms gap configuration (ID 1)	40ms gap configuration (ID 0)	80ms gap configuration (ID 1)
0	2160	5280	1920	5040
1	5280	21760	5040	17280
2	5280	31680	5040	29280
3	19440	No requirement	13320	No requirement
4	31680	No requirement	29280	No requirement
5	31680	No requirement	29280	No requirement

8.17.13.2.2.2 BSIC re-confirmation

The UE shall maintain the timing information of up to 8 identified GSM cells. Initial timing information is obtained from the initial BSIC identification. The timing information shall be updated every time the BSIC is decoded.

For each measurement gap used for GSM BSIC reconfirmation as described in clause 8.17.13.2.2, the UE shall attempt to decode the BSIC falling within the measurement gap according to table 8.17.13.2.2.1-1. If more than one BSIC can be decoded within the same measurement gap, priority shall be given to the least recently decoded BSIC. If inter-frequency RSTD measurements are configured and the UE requires measurement gaps for performing such measurements, then $T_{\text{re-confirm,GSM}}$ shall be based on the 80ms gap configuration.

If the UE fails to decode the BSIC after two successive attempts or if the UE has not been able to re-confirm the BSIC for a GSM cell within $T_{\text{re-confirm,GSM}}$ seconds, the UE shall abort the BSIC re-confirmation attempts for that GSM cell. The GSM cell shall be treated as a new GSM cell with unidentified BSIC and the GSM cell shall be moved to the initial BSIC identification procedure, see clause 8.17.13.2.2.1.

8.17.13.2.3 Enhanced BSIC verification

In addition to the BSIC verification requirements in clause 8.17.13.2.2, when the UE receives the GSM cell at levels down to 10 dB + the reference sensitivity level or reference interference levels as specified in TS 45.005 [9] the BSIC

identification requirement in table 8.17.13.2.3-1 applies. The BSIC verification requirements in table 8.17.13.2.3-1 shall apply when no DRX is used or when DRX cycle length ≤ 40 ms.

Table 8.17.13.2.3-1

$\text{ceil}(\text{CSSF}_{\text{GSM}}, \text{NSA} \cdot \text{K}_n - \text{M}_{\text{gsm}})$	$T_{\text{enhanced_identify,gsm}}(\text{ms})$		$T_{\text{enhanced_reconfirm,gsm}}(\text{ms})$	
	40ms gap configuration (ID 0)	40ms gap configuration when interfrequency RSTD measurement is also configured and the UE requires measurement gaps for performing such measurements	40ms gap configuration (ID 0)	40ms gap configuration when interfrequency RSTD measurement is also configured and the UE requires measurement gaps for performing such measurements
0	1320	2160	1080	1920

8.17.13.2.4 Periodic Reporting

Reported measurements in periodically triggered measurement reports shall meet the requirements in clause 9.

8.17.13.2.5 Event Triggered Reporting

Reported measurements in event triggered measurement reports shall meet the requirements in clause 9.

The UE shall not send any event triggered measurement reports, as long as no reporting criteria are fulfilled.

The measurement reporting delay is defined as the time between an event that will trigger a measurement report and the point when the UE starts to transmit the measurement report over the air interface. This requirement assumes that the measurement report is not delayed by other RRC signalling on the DCCH.

The event triggered reporting delay requirement is valid when the UE for each GSM carrier in the monitored set can take the required number of samples during the measurement period $T_{\text{Measurement Period, GSM}}$ (see clause 8.17.13.2).

The event triggered measurement reporting delay for a GSM cell with verified BSIC, measured without L3 filtering shall be less than $2 \cdot T_{\text{Measurement Period, GSM}}$, where $T_{\text{Measurement Period, GSM}}$ is defined in clause 8.17.13.2. When L3 filtering is used or IDC autonomous denial is configured or the UE is performing reception and/or transmission for ProSe Direct Discovery and/or ProSe Direct Communication, or the UE is configured to perform SRS carrier based switching, an additional delay can be expected.

8.17.13.2.6 Event-triggered Periodic Reporting

Reported measurements contained in event triggered periodic measurement reports shall meet the requirements in clause 9.

The first report in event triggered periodic measurement reporting shall meet the requirements specified in clause 8.17.13.2.5.

8.17.13.3 E-UTRAN FDD – GSM measurements when DRX is used

Measurements on GSM cells can be requested with BSIC verified. In RRC_CONNECTED state when a supported measurement gap pattern id # 0 or # 1 according to Table 8.1.2.1-1 is configured by E-UTRAN, or the UE supports capability of conducting such measurements without gaps, the UE shall continuously measure GSM cells, search for new GSM cells given in the monitored set and re-confirm the BSIC for already detected cells. During DRX or eDRX_CONN periods the UE may use other periods of time outside the specified measurement gap patterns. The UE is not required to make measurements of GSM cells during DRX or eDRX_CONN periods if a measurement gap pattern has not been configured, unless the UE supports capability of conducting such measurements without gaps.

8.17.13.3.1 GSM carrier RSSI

This measurement shall be based on measurement gaps allocated for GSM carrier RSSI measurement as described in clause 8.1.2.1. A UE supporting GSM measurements shall measure minimum number of 10 GSM carrier RSSI measurement samples ($N_{\text{GSM carrier RSSI}}$) per DRX or eDRX_CONN cycle. When DRX is used in RRC_CONNECTED state, the measurement period, $T_{\text{Measurement Period, GSM}}$, for the GSM carrier RSSI measurement is shown in table 8.17.13.3.1-1. When eDRX_CONN is used in RRC_CONNECTED state, the measurement period, $T_{\text{Measurement Period, GSM}}$, for the GSM carrier RSSI measurement is shown in table 8.17.13.3.1-2. When MCG DRX is in use the applicable DRX cycle is the MCG DRX cycle.

Table 8.17.13.3.1-1: GSM measurement period for large DRX

DRX cycle length (s)	$T_{\text{measure,GSM}}$ (s) (DRX cycles)
≤ 0.064	Non DRX Requirements are applicable
$0.064 < \text{DRX-cycle} \leq 0.08$	Note (6*CSSF _{GSM, NSA})
$0.08 < \text{DRX-cycle} \leq 2.56$	Note (5*CSSF _{GSM, NSA})
Note:	Time depends upon the DRX cycle in use

Table 8.17.13.3.1-2: GSM measurement period for large DRX when eDRX_CONN cycle is used

eDRX_CONN cycle length (s)	$T_{\text{measure,GSM}}$ (s) (eDRX_CONN cycles)
$2.56 < \text{eDRX_CONN cycle} \leq 10.24$	Note (5*CSSF _{GSM, NSA})
Note:	Time depends upon the eDRX_CONN cycle in use

The UE shall meet the measurement accuracy requirements stated for RXLEV in TS 45.008 [8], when the given measurement time allows the UE to take at least 3 GSM carrier RSSI samples per GSM carrier in the monitored set during the measurement period.

In case the UE is not able to acquire the required number of samples per GSM carrier during one measurement period, the UE shall measure as many GSM carriers as possible during that measurement period using at least 3 samples per GSM carrier. The GSM carriers that were not measured during that measurement period shall be measured in the following measurement periods.

8.17.13.3.2 BSIC verification

Measurements on a GSM cell can be requested with BSIC verified. The UE shall be able to report the GSM cells with BSIC verified for those cells where the verification of BSIC has been successful.

The procedure for BSIC verification on a GSM cell can be divided into the following two tasks:

- **Initial BSIC identification:** Includes searching for the BSIC and decoding the BSIC for the first time when there is no knowledge about the relative timing between the E-UTRAN FDD and GSM cells.
- **BSIC re-confirmation:** Tracking and decoding the BSIC of a GSM cell after initial BSIC identification is performed. The UE shall trigger the BSIC re-confirmation within the available measurement gap pattern

If the network requests measurements on a GSM cell, the UE shall behave as follows:

- The UE shall perform GSM carrier RSSI measurements according to clause 8.17.13.3.1 when a measurement gap pattern sequence is activated, or the UE supports capability of conducting such measurements without gaps.

The UE shall perform measurement reporting as defined in TS 36.331 [2].

- The UE shall perform BSIC identification. The UE shall use the most recently available GSM carrier RSSI measurement results for arranging GSM cells in signal strength order for performing BSIC identification.
- The UE shall perform BSIC re-confirmation on all the GSM cells that have been successfully identified.
- The UE shall perform all configured event evaluation for event-triggered reporting after the BSIC has been verified for a GSM cell. The UE shall use the most recently available GSM carrier RSSI measurement results in event evaluation and event-triggered reporting.
- Event-triggered and periodic reports shall be triggered according to TS 36.331 [2].

The BSIC of a GSM cell is considered to be "verified" if the UE has decoded the SCH of the BCCH carrier and identified the BSIC at least one time (initial BSIC identification). Once a GSM cell has been identified the BSIC shall be re-confirmed at least once every 30 seconds. Otherwise the BSIC of the GSM cell is considered as "non-verified".

The UE shall be able to perform BSIC verification at levels down to the reference sensitivity level or reference interference levels as specified in TS 45.005 [9].

8.17.13.3.2.1 Initial BSIC identification

This measurement shall be made on GSM cells that are requested with BSIC verified.

For DRX cycle length ≤ 40 ms, the initial GSM BSIC identification requirements corresponding to the non DRX requirements as specified in clause 8.17.13.2.2.1 shall apply.

For DRX cycle length > 40 ms and any eDRX_CONN cycle, the UE shall make at least one attempt every $CSSF_{GSM, NSA} * 30$ s to decode the BSIC of SCH on the BCCH carrier of the 8 strongest BCCH carriers of the GSM cells indicated in the Inter-RAT cell info list. If the UE has not successfully decoded the BSIC of the GSM BCCH carrier within $CSSF_{GSM, NSA} * 60$ s, the UE shall abort the BSIC identification attempts for that GSM BCCH carrier. The UE shall give priority for BSIC decoding attempts in decreasing signal strength order to BCCH carriers with unknown BSIC. The strongest BCCH carrier is defined as the BCCH carrier having the highest measured GSM carrier RSSI value.

If the BSIC of the GSM BCCH carrier has been successfully decoded the UE shall continue BSIC identification with the next GSM BCCH carrier, in signal strength order, with unknown BSIC. The GSM cell for which the BSIC has been successfully identified shall be moved to the BSIC re-confirmation procedure.

8.17.13.3.2 BSIC re-confirmation

The UE shall maintain the timing information of up to 8 identified GSM cells. Initial timing information is obtained from the initial BSIC identification. The timing information shall be updated every time the BSIC is decoded.

For DRX cycle length ≤ 40 ms, the GSM BSIC re-confirmation requirements corresponding to the non DRX requirements as specified in clause 8.17.13.2.2.2 shall apply.

For DRX cycle length > 40 ms and any eDRX_CONN cycle, at least every $CSSF_{GSM, NSA} * 30$ seconds, the UE shall attempt to decode the BSIC of each identified GSM cell. If the UE fails to decode the BSIC after two successive attempts or if the UE has not been able to re-confirm the BSIC for a GSM cell within $CSSF_{GSM, NSA} * 60$ seconds, the UE shall abort the BSIC re-confirmation attempts for that GSM cell. The GSM cell shall be treated as a new GSM cell with unidentified BSIC and the GSM cell shall be moved to the initial BSIC identification procedure, see clause 8.17.13.3.2.1.

8.17.13.3.3 Periodic Reporting

Reported measurements in periodically triggered measurement reports shall meet the requirements in clause 9.

8.17.13.3.4 Event Triggered Reporting

Reported measurements in event triggered measurement reports shall meet the requirements in clause 9.

The UE shall not send any event triggered measurement reports, as long as no reporting criteria are fulfilled.

The measurement reporting delay is defined as the time between an event that will trigger a measurement report and the point when the UE starts to transmit the measurement report over the air interface. This requirement assumes that the measurement report is not delayed by other RRC signalling on the DCCH.

The event triggered reporting delay requirement is valid when the UE for each GSM carrier in the monitored set can take the required number of samples during the measurement period $T_{\text{Measurement Period, GSM}}$ (see clause 8.17.13.3.1).

The event triggered measurement reporting delay for a GSM cell with verified BSIC, measured without L3 filtering shall be less than $2 * T_{\text{Measurement Period, GSM}}$, where $T_{\text{Measurement Period, GSM}}$ is defined in clause 8.17.13.3.1. When L3 filtering is used or IDC autonomous denial is configured or the UE is performing reception and/or transmission for ProSe Direct Discovery and/or ProSe Direct Communication, or the UE is configured to perform SRS carrier based switching, an additional delay can be expected.

8.17.13.3.5 Event-triggered Periodic Reporting

Reported measurements contained in event triggered periodic measurement reports shall meet the requirements in clause 9.

The first report in event triggered periodic measurement reporting shall meet the requirements specified in clause 8.17.13.3.4.

8.17.14 E-UTRAN TDD – GSM measurements when Configured with E-UTRA-NR Dual Connectivity

The requirements in clause 8.17.13 also apply for this section when the UE is operating in E-UTRA-NR dual connectivity mode. Otherwise when the UE is not configured with E-UTRA-NR dual connectivity mode then the E-UTRAN FDD-GSM measurement requirements defined in section 8.1.2.4.6 shall apply.

8.17.15 E-UTRAN Inter-Frequency RSTD measurements when configured with E-UTRA-NR Dual Connectivity

All inter-frequency RSTD measurement requirements specified in Sections 8.17.15.1-8.17.15.4 shall apply without DRX as well as for any DRX or eDRX_CONN cycles specified in TS 36.331 [2].

The applicability of the requirements in clause 8.17.15 is same as defined in 8.1.2.6.

8.17.15.1 E-UTRAN FDD-FDD Inter-Frequency RSTD measurements when configured with E-UTRA-NR Dual Connectivity

The requirements for inter-frequency RSTD measurements in clause 8.1.2.6.1 shall apply, except that the number of PRS positioning occasions within measurement period of $T_{\text{RSTD InterFreqFDD, EN-DC}}$ is as specified in Table 8.17.15.1-1:

Table 8.17.15.1-1: Number of PRS positioning occasions within $T_{\text{RSTD InterFreqFDD, EN-DC}}$

Positioning subframe configuration period T_{PRS}	Number of PRS positioning occasions M	
	$f2$ ^{Note1}	$f1$ and $f2$ ^{Note2}
160 ms	$16 \times \text{CSSF}_{\text{interFreq}}$	$32 \times \text{CSSF}_{\text{interFreq}}$
>160 ms	$8 \times \text{CSSF}_{\text{interFreq}}$	$16 \times \text{CSSF}_{\text{interFreq}}$
NOTE 1: When inter-frequency RSTD measurements are performed over the reference cell and neighbour cells, which belong to the FDD inter-frequency carrier frequency $f2$.		
NOTE 2: When inter-frequency RSTD measurements are performed over the reference cell and the neighbour cells, which belong to the serving FDD carrier frequency $f1$ and the FDD inter-frequency carrier frequency $f2$ respectively.		

Where:

M is the number of PRS positioning occasions as defined in Table 8.17.15.1-1, where a PRS positioning occasion is as defined in clause 8.1.2.5.1,

$\text{CSSF}_{\text{interFreq}}$ is the carrier-specific scaling factor for the inter-frequency RSTD measurements and is determined according to $\text{CSSF}_{\text{within_gap},i}$ defined in TS 38.133 [50] clause 9.1.5.2.

8.17.15.1.1 RSTD measurement Reporting Delay

The requirements in clause 8.1.2.6.1.1 shall apply.

8.17.15.2 E-UTRAN TDD-FDD Inter-Frequency RSTD measurements when configured with E-UTRA-NR Dual Connectivity

The requirements for inter-frequency RSTD measurements in clause 8.1.2.6.2 shall apply, except that the number of PRS positioning occasions within measurement period of $T_{\text{RSTD InterFreqTDDFDD, EN-DC}}$ is as specified in Table 8.17.15.2-1:

Table 8.17.15.2-1: Number of PRS positioning occasions within $T_{\text{RSTD InterFreqTDDFDD, EN-DC}}$

Positioning subframe configuration period T_{PRS}	Number of PRS positioning occasions M	
	$f2$ ^{Note1}	$f1$ and $f2$ ^{Note2}
160 ms	$16 \times \text{CSSF}_{\text{interFreq}}$	$32 \times \text{CSSF}_{\text{interFreq}}$
>160 ms	$8 \times \text{CSSF}_{\text{interFreq}}$	$16 \times \text{CSSF}_{\text{interFreq}}$

NOTE 1: When inter-frequency RSTD measurements are performed over the reference cell and neighbour cells, which belong to the FDD inter-frequency carrier frequency f2.
 NOTE 2: When inter-frequency RSTD measurements are performed over the reference cell and the neighbour cells, which belong to the serving TDD carrier frequency f1 and the FDD inter-frequency carrier frequency f2 respectively.

Where:

M is the number of PRS positioning occasions as defined in Table 8.17.15.2-1, where a PRS positioning occasion is as defined in clause 8.1.2.5.1,

$CSSF_{interFreq}$ is the carrier-specific scaling factor for the inter-frequency RSTD measurements and is determined according to $CSSF_{within_gap,i}$ defined in TS 38.133 [50] clause 9.1.5.2.

8.17.15.2.1 RSTD measurement Reporting Delay

The requirements in clause 8.17.15.1.1 also apply for this section.

8.17.15.3 E-UTRAN TDD-TDD Inter-Frequency RSTD measurements when configured with E-UTRA-NR Dual Connectivity

The requirements for inter-frequency RSTD measurements in clause 8.1.2.6.3 shall apply, except that the number of PRS positioning occasions within measurement period of $T_{RSTD\ InterFreqTDD, EN-DC}$ is as specified in Table 8.17.15.3-1:

Table 8.17.15.3-1: Number of PRS positioning occasions within $T_{RSTD\ InterFreqTDD, EN-DC}$

Positioning subframe configuration period T_{PRS}	Number of PRS positioning occasions M	
	f2 <small>Note1</small>	f1 and f2 <small>Note2</small>
160 ms	$16 \times CSSF_{interFreq}$	$32 \times CSSF_{interFreq}$
>160 ms	$8 \times CSSF_{interFreq}$	$16 \times CSSF_{interFreq}$
NOTE 1: When inter-frequency RSTD measurements are performed over the reference cell and neighbour cells, which belong to the TDD inter-frequency carrier frequency f2. NOTE 2: When inter-frequency RSTD measurements are performed over the reference cell and the neighbour cells, which belong to the serving TDD carrier frequency f1 and the TDD inter-frequency carrier frequency f2 respectively.		

Where:

M is the number of PRS positioning occasions as defined in Table 8.17.15.3-1, where a PRS positioning occasion is as defined in clause 8.1.2.5.1,

$CSSF_{interFreq}$ is the carrier-specific scaling factor for the inter-frequency RSTD measurements and is determined according to $CSSF_{within_gap,i}$ defined in TS 38.133 [50] clause 9.1.5.2,

8.17.15.3.1 RSTD measurement Reporting Delay

The requirements in clause 8.17.15.1.1 also apply for this section.

8.17.15.4 E-UTRAN FDD-TDD Inter-Frequency RSTD measurements when configured with E-UTRA-NR Dual Connectivity

The requirements for inter-frequency RSTD measurements in clause 8.1.2.6.4 shall apply, except that the number of PRS positioning occasions within measurement period of $T_{RSTD\ InterFreqFDDTDD, EN-DC}$ is as specified in Table 8.17.15.4-1:

Table 8.17.15.4-1: Number of PRS positioning occasions within $T_{RSTD\ InterFreqFDDTDD, EN-DC}$

Positioning subframe configuration period T_{PRS}	Number of PRS positioning occasions M	
	f2 <small>Note1</small>	f1 and f2 <small>Note2</small>
160 ms	$16 \times CSSF_{interFreq}$	$32 \times CSSF_{interFreq}$
>160 ms	$8 \times CSSF_{interFreq}$	$16 \times CSSF_{interFreq}$

NOTE 1: When inter-frequency RSTD measurements are performed over the reference cell and neighbour cells, which belong to the TDD inter-frequency carrier frequency f_2 .

NOTE 2: When inter-frequency RSTD measurements are performed over the reference cell and the neighbour cells, which belong to the serving FDD carrier frequency f_1 and the TDD inter-frequency carrier frequency f_2 respectively.

Where:

M is the number of PRS positioning occasions as defined in Table 8.17.15.4-1, where a PRS positioning occasion is as defined in clause 8.1.2.5.1,

$CSSF_{\text{interFreq}}$ is the carrier-specific scaling factor for the inter-frequency RSTD measurements and is determined according to $CSSF_{\text{within_gap},i}$ defined in TS 38.133 [50] clause 9.1.5.2,

8.17.15.4.1 RSTD measurement Reporting Delay

The requirements in clause 8.17.15.1.1 also apply for this section.

8.18 Measurements for non-BL/CE UE

8.18.1 Introduction

The non-BL/CE UE applicability of the requirements in subclause 8.18 is defined in Section 3.6. The requirements defined in Section 8.18 do not apply when the UE is of category 1bis.

8.18.2 Requirements for non-BL/CE UE with CE Mode B

8.18.2.1 E-UTRAN intra frequency measurements

8.18.2.1.1 E-UTRAN FDD intra frequency measurements with autonomous gaps for non-BL/CE with CE Mode B

The requirements defined in this subclause 8.18.2.1.4 apply provided the following condition is met:

- Tx diversity or transmission using multiple antennas are supported in the target cell to be detected.
- Repetitions of MIB/SIB1-BR are supported in the target cell to be detected.

8.18.2.1.1.1 Identification of a new CGI of E-UTRA cell with autonomous gaps

No explicit neighbour list is provided to the UE for identifying a new CGI of E-UTRA cell. The UE shall identify and report the CGI when requested by the network for the purpose 'reportCGI'. The UE may make autonomous gaps in downlink reception and uplink transmission for receiving MIB and SIB1-BR message according to clause 5.5.3.1 of TS 36.331 [2]. Note that a UE is not required to use autonomous gap if $si\text{-RequestForHO}$ is set to false. If autonomous gaps are used for measurement with the purpose of 'reportCGI', regardless of whether DRX or eDRX_CONN is used or not, or whether SCell(s) are configured or not, the UE shall be able to identify a new CGI of E-UTRA cell within:

$$T_{\text{identify_CGI_non-BL/CE, intra}} = T_{\text{basic_identify_CGI_non-BL/CE, intra}} \quad ms$$

Where

$T_{\text{basic_identify_CGI_non-BL/CE, intra}} = 2640$ ms. This is the time period used in the above equation where the maximum allowed time for the UE to identify a new CGI of an E-UTRA cell is defined, provided that the E-UTRA cell has been already identified by the UE.

A cell shall be considered identifiable following conditions are fulfilled:

- RSRP related side conditions given in Clause 9.1 are fulfilled for a corresponding Band,
- SCH_RP and $SCH\ \hat{E}s/Iot$ according to Annex B.2.14 for a corresponding Band

The MIB of an E-UTRA cell whose CGI is identified shall be considered decodable by the UE provided the PBCH demodulation requirements are met according to [5].

The requirement for identifying a new CGI of an E-UTRA cell within $T_{\text{basic_identify_CGI_non-BL/CE, intra}}$ is applicable when no DRX is used as well as when any of DRX and eDRX_CONN cycles specified in TS 36.331 [2] is used.

Within the time, $T_{\text{identify_CGI_non-BL/CE, intra}}$ ms, over which the UE identifies the new CGI of E-UTRA cell, the PBCH repetition and SIB1-BR repetition level in the target cell shall be as specified in Table 8.18.2.1.1.1-1.

Table 8.18.2.1.1-1: Conditions in target cell during $T_{\text{basic_identify_CGI_non-BL/CE, intra}}$

Target cell			
\hat{E}_s/lot [dB]	PBCH repetition	SIB1-BR repetition level	SIB1-BR TBS [bits]
≥ -15	Configured as specified in TS 36.211 [16]	16	208

8.18.2.1.1.2 ECGI Reporting Delay

The ECGI reporting delay occurs due to the delay uncertainty when inserting the ECGI measurement report to the TTI of the uplink DCCH. The delay uncertainty is twice the TTI of the uplink DCCH. In case DRX is used, the ECGI reporting may be delayed until the next DRX cycle. In case eDRX_CONN is used, the ECGI reporting may be delayed until the next eDRX_CONN cycle. If IDC autonomous denial is configured, an additional delay can be expected.

8.18.2.1.2 E-UTRAN intra frequency measurements with autonomous gaps for HD-FDD non-BL/CE with CE Mode B

The requirements in this section are applicable for the UE which supports half duplex FDD operation on one or more supported frequency bands [2].

The requirements defined in this subclause 8.13.3.1.5 apply provided the following condition is met:

- Tx diversity or transmission using multiple antennas are supported in the target cell to be detected.
- Repetitions of MIB/SIB1-BR are supported in the target cell to be detected.

8.18.2.1.2.1 Identification of a new CGI of E-UTRA cell with autonomous gaps

The CGI requirements defined in clause 8.18.2.1.1.1 also apply for this section.

8.18.2.1.2.2 ECGI Reporting Delay

The ECGI reporting delay defined in clause 8.18.2.1.1.2 also apply for this section

8.18.2.1.3 E-UTRAN TDD intra frequency measurements with autonomous gaps for non-BL/CE with CE Mode B

The requirements defined in this subclause 8.18.2.1.3 apply provided the following condition is met:

- Tx diversity or transmission using multiple antennas are supported in the target cell to be detected.
- Repetitions of MIB/SIB1-BR are supported in the target cell to be detected.

8.18.2.1.3.1 Identification of a new CGI of E-UTRA cell with autonomous gaps

No explicit neighbour list is provided to the UE for identifying a new CGI of E-UTRA cell. The UE shall identify and report the CGI when requested by the network for the purpose 'reportCGI'. The UE may make autonomous gaps in downlink reception and uplink transmission for receiving MIB and SIB1-BR messages according to clause 5.5.3.1 of TS 36.331 [2]. Note that a UE is not required to use autonomous gap if si-RequestForHO is set to false. If autonomous gaps are used for measurement with the purpose of 'reportCGI', regardless of whether DRX or eDRX_CONN is used or not, or whether SCell(s) are configured or not, the UE shall be able to identify a new CGI of E-UTRA cell within:

$$T_{\text{identify_CGI_non-BL/CE, intra}} = T_{\text{basic_identify_CGI_non-BL/CE, intra}} \quad \text{ms}$$

Where

$T_{\text{basic_identify_CGI_non-BL/CE, intra}} = 2640$ ms. This is the time period used in the above equation where the maximum allowed time for the UE to identify a new CGI of an E-UTRA cell is defined, provided that the E-UTRA cell has been already identified by the UE.

A cell shall be considered identifiable when the following conditions are fulfilled:

- RSRP related side conditions given in Clause 9.1 are fulfilled for a corresponding Band,
- SCH_{RP} and SCH \hat{E}_s/lot according to Annex B.2.14 for a corresponding Band

The MIB of an E-UTRA cell whose CGI is identified shall be considered decodable by the UE provided the PBCH demodulation requirements are met according to [5].

The requirement for identifying a new CGI of an E-UTRA cell within $T_{\text{basic_identify_CGI_non-BL/CE, intra}}$ is applicable when no DRX is used as well as when any of the DRX or eDRX_CONN cycles specified in TS 36.331 [2] is used.

Within the time, $T_{\text{identify_CGI_non-BL/CE, intra}}$ *ms*, over which the UE identifies the new CGI of E-UTRA cell, the PBCH repetition and SIB1-BR repetition level in the target cell shall be as specified Table 8.18.2.1.3.1-1.

Table 8.18.2.1.3.1-1: Conditions in target cell during $T_{\text{basic_identify_CGI_non-BL/CE, intra}}$

Target cell			
\hat{E}_s/lot [dB]	PBCH repetition level	SIB1-BR repetition level	SIB1-BR TBS [bits]
≥ -15	Configured with repetition, as specified in TS 36.211 [16]	16	208

8.18.2.1.3.2 ECGI Reporting Delay

The ECGI reporting delay occurs due to the delay uncertainty when inserting the ECGI measurement report to the TTI of the uplink DCCH. The delay uncertainty is twice the TTI of the uplink DCCH. In case DRX is used, the ECGI reporting may be delayed until the next DRX cycle. In case eDRX_CONN is used, the ECGI reporting may be delayed until the next eDRX_CONN cycle. If IDC autonomous denial is configured, an additional delay can be expected.

8.19 Measurements for NR – E-UTRA Dual Connectivity

8.19.1 Introduction

This clause contains requirements for UE supporting dual connectivity with NR PCell and E-UTRA PSCell.

Requirements in this clause are applicable to UEs which have been configured with NE-DC. Requirements in this clause are applicable to both E-UTRA FDD and E-UTRA TDD PSCell in combination with an NR PCell.

The application of measurement gap sharing and calculation of carrier specific scaling factor are the same as defined in clause 8.17.1.1 and 8.17.1.2, except that

- The term PCell and PSCell shall be deemed to be swapped, and
- UE is not expected to be configured to identify and measure cells on any of: inter-RAT NR, UTRAN, and GSM carriers.

8.19.2 Intra-frequency Measurements

PSCC intra-frequency measurements shall meet all applicable requirements in clause 8.1.2.2. If SCG DRX is in use, then the PCell intra-frequency requirements for when DRX is in use in clause 8.1.2.2 shall apply and shall depend on the SCG DRX cycle. Otherwise, the requirements for when DRX is not in use shall apply. The applicable measurement accuracy requirements are in clause 9.1.

SCC intra-frequency measurements shall meet all applicable requirements in clause 8.3.3. If SCG DRX is in use, then the PCell intra-frequency requirements for when DRX is in use in clause 8.1.2.2 shall apply and shall depend on the SCG DRX cycle. Otherwise, the requirements for when DRX is not in use shall apply. The applicable measurement accuracy requirements are in clause 9.1.

8.19.3 Inter-frequency Measurements

The E-UTRAN inter-frequency measurement requirements defined in section 8.19.3 shall apply when the UE capable of NE-DC is operating in NE-DC mode. The requirements in section 8.17.3 are applicable for gap pattern id # 0, 1, 2, 3, 4, 6, 7, 8, 10 as specified in Table 8.1.2.1-1.

The same requirements defined in clause 8.17.3 shall apply, except that

- The term EN-DC shall be deemed to be replaced with NE-DC, and
- The MCG DRX shall be deemed to be replaced with SCG DRX.

8.19.4 Void

8.19.5 Intra-frequency E-CID Measurements

The requirements in this clause shall apply provided the UE has received ECID-RequestLocationInformation message from LMF via LPP requesting the UE to report E-CID UE Rx-Tx Time Difference Measurements and/or E-CID E-UTRAN intra-frequency RSRP and RSRQ measurements [59].

PSCC intra-frequency E-CID measurements shall meet E-UTRAN E-CID intra-frequency measurements requirements in clauses 8.1.2.7.3 and 8.1.2.7.4. If SCG DRX is in use, then the PCell intra-frequency requirements for when DRX is in use in clauses 8.1.2.7.3 and 8.1.2.7.4 shall apply and shall depend on the SCG DRX cycle. Otherwise, the requirements for when DRX is not in use shall apply. The applicable measurement accuracy requirements are in clause 9.1.

SCC intra-frequency E-CID measurements shall meet all applicable requirements in clause 8.3.3. If SCG DRX is in use, then the PCell intra-frequency requirements for when DRX is in use in clause 8.1.2.2 shall apply and shall depend on the SCG DRX cycle. Otherwise, the requirements for when DRX is not in use shall apply. The applicable measurement accuracy requirements are in clause 9.1.

9 Measurements performance requirements for UE

One of the key services provided by the physical layer is the measurements used to trigger or perform a multitude of functions. Both the UE and the E-UTRAN are required to perform measurements. The physical layer measurement model and a complete list of measurements are specified in [25] and [22] respectively. The physical layer measurements are described and defined in [4]. In this clause for each measurement the relevant requirements on the measurement period, reporting range, granularity and performance in terms of accuracy are specified.

Since the UE reference sensitivity requirements are different depending on supported band, this is noted in each case with definition of the range I_0 for each frequency band. Definitions of each frequency bands can be found in [5].

Except for requirements in sections 9.1.2A, 9.1.3A, 9.1.5A and 9.1.6A, the accuracy requirements in this clause are applicable for AWGN radio propagation conditions and assume independent interference (noise) at each receiver antenna port.

9.1 E-UTRAN measurements

9.1.1 Introduction

The requirements in this clause are applicable for a UE:

- in state RRC_CONNECTED
- performing measurements with appropriate measurement gaps as defined in Clause 8.1.2.1.
- that is synchronised to the cell that is measured.

The reported measurement result after layer 1 filtering shall be an estimate of the average value of the measured quantity over the measurement period. The reference point for the measurement result after layer 1 filtering is referred to as point B in the measurement model described in [25].

The accuracy requirements in this clause are valid for the reported measurement result after layer 1 filtering. The accuracy requirements are verified from the measurement report at point D in the measurement model having the higher layer filtering disabled.

In the requirements of Section 9 for the UE capable of CA and the UEs configured with up to six downlink SCell(s), the applicable exceptions for side conditions are specified in Annex B, Sections B.4.2 and B.4.3, respectively.

9.1.2 Intra-frequency RSRP Accuracy Requirements

9.1.2.1 Absolute RSRP Accuracy

Unless otherwise specified, the requirements for absolute accuracy of RSRP in this clause apply to a cell on the same frequency as that of the serving cell.

The accuracy requirements in Table 9.1.2.1-1 are valid under the following conditions:

Cell specific reference signals are transmitted either from one, two or four antenna ports.

Conditions defined in 36.101 Clause 7.3 for reference sensitivity are fulfilled.

RSRP_{dBm} according to Annex B.3.1 for a corresponding Band

Table 9.1.2.1-1: RSRP Intra frequency absolute accuracy

Accuracy		Conditions				
Normal condition	Extreme condition	Ês/lot	I _o ^{Note 1} range			
			E-UTRA operating band groups ^{Note 3}	Minimum I _o		Maximum I _o
dB	dB	dB		dBm/15kHz ^{Note 2}	dBm/BW _{Channel}	dBm/BW _{Channel}
±4.5	±9	≥-6 dB	FDD_A, TDD_A	-121	N/A	-70
			FDD_B1, FDD_B2	-120.5	N/A	-70
			FDD_C, TDD_C	-120	N/A	-70
			FDD_D	-119.5	N/A	-70
			FDD_E, TDD_E	-119	N/A	-70
			FDD_F	-118.5	N/A	-70
			FDD_G	-118	N/A	-70
			FDD_H, FDD_N	-117.5	N/A	-70
±8	±11	≥-6 dB	FDD_A, TDD_A, FDD_B1, FDD_B2, FDD_C, TDD_C, FDD_D, FDD_E, TDD_E, FDD_F, FDD_G, FDD_H, FDD_N	N/A	-70	-50

NOTE 1: I_o is assumed to have constant EPRE across the bandwidth.
 NOTE 2: The condition level is increased by Δ>0, when applicable, as described in Sections B.4.2 and B.4.3.
 NOTE 3: E-UTRA operating band groups are as defined in Section 3.5.

9.1.2.2 Relative Accuracy of RSRP

The relative accuracy of RSRP is defined as the RSRP measured from one cell compared to the RSRP measured from another cell on the same frequency.

The accuracy requirements in Table 9.1.2.2-1 are valid under the following conditions:

Cell specific reference signals are transmitted either from one, two or four antenna ports.

Conditions defined in 36.101 Clause 7.3 for reference sensitivity are fulfilled.

RSRP_{1,2}_{dBm} according to Annex B.3.8 for a corresponding Band.

Table 9.1.2.2-1: RSRP Intra frequency relative accuracy

Accuracy		Conditions	
		I _o ^{Note 1} range	

Normal condition	Extreme condition	$\hat{E}s/lot$ ^{Note 2}	E-UTRA operating band groups ^{Note 5}	Minimum l_o	Maximum l_o
dB	dB	dB		dBm/15kHz ^{Note 4}	dBm/BW _{Channel}
±2	±3	≥-3 dB	FDD_A, TDD_A	-121	-50
			FDD_B1, FDD_B2	-120.5	-50
			FDD_C, TDD_C	-120	-50
			FDD_D	-119.5	-50
			FDD_E, TDD_E	-119	-50
			FDD_F	-118.5	-50
			FDD_G	-118	-50
			FDD_H	-117.5	-50
			FDD_N	-114.5	-50
±3	±3	≥-6 dB	Note 3	Note 3	Note 3

NOTE 1: l_o is assumed to have constant EPRE across the bandwidth.
 NOTE 2: The parameter $\hat{E}s/lot$ is the minimum $\hat{E}s/lot$ of the pair of cells to which the requirement applies.
 NOTE 3: The same bands and the same l_o conditions for each band apply for this requirement as for the corresponding highest accuracy requirement.
 NOTE 4: The condition level is increased by $\Delta > 0$, when applicable, as described in Sections B.4.2 and B.4.3.
 NOTE 5: E-UTRA operating band groups are as defined in Section 3.5.

9.1.2.3 Absolute RSRP Accuracy under Time Domain Measurement Resource Restriction

The requirements for absolute accuracy of RSRP in this clause shall apply to a cell on the same frequency as that of the serving cell when a time domain measurement resource restriction pattern for performing RSRP measurements on this cell is configured by higher layers (TS 36.331 [2]).

The accuracy requirements in Table 9.1.2.3-1 are valid under the following conditions:

Cell specific reference signals in the measured cell are transmitted either from one, two or four antenna ports,

Conditions defined in 36.101 Clause 7.3 for reference sensitivity are fulfilled,

RSRP_{dBm} according to Annex B.3.9 for a corresponding Band,

The time domain measurement resource restriction pattern configured for the measured cell indicates at least one subframe per radio frame for performing the RSRP measurement,

Four symbols containing CRS are available in all subframes indicated by the time domain measurement resource restriction pattern.

Table 9.1.2.3-1: RSRP Intra frequency absolute accuracy under time domain measurement resource restriction

Accuracy		Conditions				
Normal condition	Extreme condition	$\hat{E}s/lot$	l_o ^{Note 2} range			
			E-UTRA operating band groups ^{Note 4}	Minimum l_o		Maximum l_o
dB	dB	dB		dBm/ 15kHz ^{Note 1, 3}	dBm/BW _{Channel}	dBm/BW _{Channel}
±4.5	±9	≥-4 dB	FDD_A, TDD_A	-121	N/A	-70
			FDD_B1, FDD_B2	-120.5	N/A	-70
			FDD_C, TDD_C	-120	N/A	-70
			FDD_D	-119.5	N/A	-70
			FDD_E, TDD_E	-119	N/A	-70
			FDD_F	-118.5	N/A	-70
			FDD_G	-118	N/A	-70
			FDD_H	-117.5	N/A	-70
			FDD_N	-114.5	N/A	-70
±8	±11	≥-4 dB	FDD_A, TDD_A, FDD_B1, FDD_B2, FDD_C, TDD_C, FDD_D, FDD_E, TDD_E, FDD_F, FDD_G, FDD_H, FDD_N	N/A	-70	-50

NOTE 1: This minimum I_0 condition is expressed as the average I_0 per RE over all REs in that symbol.
 NOTE 2: I_0 is defined in subframes indicated by the time domain measurement resource restriction pattern configured for performing RSRP measurements of this cell. The I_0 range defined by the minimum and the maximum I_0 levels applies to CRS and non-CRS symbols. I_0 may be different in different symbols within a subframe.
 NOTE 3: The condition level is increased by $\Delta > 0$, when applicable, as described in Sections B.4.2 and B.4.3.
 NOTE 4: E-UTRA operating band groups are as defined in Section 3.5.

For time domain measurements restriction under colliding CRS with ABS configured in non-MBSFN subframes, requirements in Section 9.1.2.1 apply.

9.1.2.4 Relative Accuracy of RSRP under Time Domain Measurement Resource Restriction

The requirements for relative accuracy of RSRP in this clause shall apply to a cell on the same frequency as that of the serving cell when a time domain measurement resource restriction pattern for performing RSRP measurements for this cell is configured by higher layers (TS 36.331 [2]).

The accuracy requirements in Table 9.1.2.4-1 are valid under the following conditions:

Cell specific reference signals in the measured cell are transmitted either from one, two or four antenna ports,

Conditions defined in 36.101 Clause 7.3 for reference sensitivity are fulfilled,

$RSRP_{1,2|dBm}$ according to Annex B.3.10 for a corresponding Band,

The time domain measurement resource restriction pattern configured for the measured cell indicates at least one subframe per radio frame for performing the RSRP measurement,

Four symbols containing CRS are available in all subframes indicated by the time domain measurement resource restriction pattern.

Table 9.1.2.4-1: RSRP Intra frequency relative accuracy under time domain measurement resource restriction

Accuracy		Conditions			
Normal condition	Extreme condition	$\hat{E}s/I_0$ ^{Note 2}	I_0 ^{Note 3} range		
			E-UTRA operating band groups ^{Note 6}	Minimum I_0	Maximum I_0
dB	dB	dB		dBm/ 15kHz ^{Note 1, 5}	dBm/BW _{Channel}
±2	±3	≥-2 dB	FDD_A, TDD_A	-121	-50
			FDD_B1, FDD_B2	-120.5	-50
			FDD_C, TDD_C	-120	-50
			FDD_D	-119.5	-50
			FDD_E, TDD_E	-119	-50
			FDD_F	-118.5	-50
			FDD_G	-118	-50
			FDD_H	-117.5	-50
			FDD_N	-114.5	-50
±3	±3	≥-4 dB	Note 4	Note 4	Note 4

NOTE 1: This minimum I_0 condition is expressed as the average I_0 per RE over all REs in that symbol.
 NOTE 2: The parameter $\hat{E}s/I_0$ is the minimum $\hat{E}s/I_0$ of the pair of cells to which the requirement applies.
 NOTE 3: I_0 is defined in subframes indicated by the time domain measurement resource restriction pattern configured for performing RSRP measurements of this cell. The I_0 range defined by the minimum and the maximum I_0 levels applies to CRS and non-CRS symbols. I_0 may be different in different symbols within a subframe.
 NOTE 4: The same bands and the same I_0 conditions for each band apply for this requirement as for the corresponding highest accuracy requirement.
 NOTE 5: The condition level is increased by $\Delta > 0$, when applicable, as described in Sections B.4.2 and B.4.3.
 NOTE 6: E-UTRA operating band groups are as defined in Section 3.5.

For time domain measurements restriction under colliding CRS with ABS configured in non-MBSFN subframes, requirements in Section 9.1.2.2 apply.

9.1.2.5 Absolute RSRP Accuracy under Time Domain Measurement Resource Restriction with CRS assistance information

The requirements for absolute accuracy of RSRP in this clause shall apply to a cell on the same frequency as that of the serving cell when a time domain measurement resource restriction pattern for performing RSRP measurements on this cell is configured by higher layers (TS 36.331 [2]) and the CRS assistance information is provided. The requirements apply for UEs supporting CRS interference handling.

The accuracy requirements in Table 9.1.2.5-1 are valid under the following conditions:

Cell specific reference signals in the measured cell are transmitted either from one, two or four antenna ports,

Conditions defined in 36.101 Section 7.3 for reference sensitivity are fulfilled,

RSRP_{dBm} according to Annex B.3.11 for a corresponding Band,

The time domain measurement resource restriction pattern configured for the measured cell indicates at least one subframe per radio frame for performing the RSRP measurement,

Four symbols containing CRS are available in all subframes indicated by the time domain measurement resource restriction pattern,

The UE is provided with the CRS assistance information (TS 36.331 [2]) and the CRS assistance information is valid throughout the entire evaluation period.

The requirements in this section shall also be met when the number of transmit antenna ports [16] of one or more cells whose CRS assistance information is provided [2] is different from the number of transmit antenna ports of the measured cell.

Table 9.1.2.5-1: RSRP Intra frequency absolute accuracy under Time Domain Measurement Resource Restriction with CRS assistance information

Accuracy		Conditions				
Normal condition	Extreme condition	Ês/lot	I _o ^{Note 2} range			
			E-UTRA operating band groups ^{Note 4}	Minimum I _o		Maximum I _o
dB	dB	dB		dBm/15kHz ^{Note 1,3}	dBm/BW _{Channel}	dBm/BW _{Channel}
±4.5	±9	≥-9.46	FDD_A, TDD_A	-121	N/A	-70
			FDD_B1, FDD_B2	-120.5	N/A	-70
			FDD_C, TDD_C	-120	N/A	-70
			FDD_D	-119.5	N/A	-70
			FDD_E, TDD_E	-119	N/A	-70
			FDD_F	-118.5	N/A	-70
			FDD_G	-118	N/A	-70
			FDD_H	-117.5	N/A	-70
			FDD_N	-114.5	N/A	-70
±8	±11	≥-9.46	FDD_A, TDD_A, FDD_B1, FDD_B2, FDD_C, TDD_C, FDD_D, FDD_E, TDD_E, FDD_F, FDD_G, FDD_H, FDD_N	N/A	-70	-50

NOTE 1: This I_o condition is expressed as the average I_o per RE over all REs in an OFDM symbol.
 NOTE 2: I_o is defined in subframes indicated by the time domain measurement resource restriction pattern configured for performing RSRP measurements of this cell. The specified I_o range applies to CRS and non-CRS symbols. I_o may be different in different symbols within a subframe.
 NOTE 3: The condition level is increased by Δ>0, when applicable, as described in Sections B.4.2 and B.4.3.
 NOTE 4: E-UTRA operating band groups are as defined in Section 3.5.

9.1.2.6 Relative Accuracy of RSRP under Time Domain Measurement Resource Restriction with CRS assistance information

The requirements for relative accuracy of RSRP in this clause shall apply to a cell on the same frequency as that of the serving cell when a time domain measurement resource restriction pattern for performing RSRP measurements for this

cell is configured by higher layers (TS 36.331 [2]) and the CRS assistance information is provided. The requirements apply for UEs supporting CRS interference handling.

The accuracy requirements in Table 9.1.2.6-1 are valid under the following conditions:

Cell specific reference signals in the measured cell are transmitted either from one, two or four antenna ports,

Conditions defined in 36.101 Section 7.3 for reference sensitivity are fulfilled,

RSRP_{1,2}_{dBm} according to Annex B.3.12 for a corresponding Band,

The time domain measurement resource restriction pattern configured for the measured cell indicates at least one subframe per radio frame for performing the RSRP measurement,

Four symbols containing CRS are available in all subframes indicated by the time domain measurement resource restriction pattern,

The UE is provided with the CRS assistance information (TS 36.331 [2]) and the CRS assistance information is valid throughout the entire evaluation period.

The requirements in this section shall also be met also when the number of transmit antenna ports [16] of one or more cells whose CRS assistance information is provided [2] is different from the number of transmit antenna ports of the measured cell.

Table 9.1.2.6-1: RSRP Intra frequency relative accuracy under Time Domain Measurement Resource Restriction with CRS assistance information

Accuracy		Conditions			
Normal condition	Extreme condition	Es/lot ^{Note 2, 6}	Io ^{Note 3} range		
			E-UTRA operating band groups ^{Note 7}	Minimum Io	Maximum Io
dB	dB	dB	dBm/15kHz ^{Note 1, 5}	dBm/BW _{Channel}	
±2	±3	≥-6.96	FDD_A, TDD_A	-121	-50
			FDD_B1, FDD_B2	-120.5	-50
			FDD_C, TDD_C	-120	-50
			FDD_D	-119.5	-50
			FDD_E, TDD_E	-119	-50
			FDD_F	-118.5	-50
			FDD_G	-118	-50
			FDD_H	-117.5	-50
FDD_N	-114.5	-50			
±3	±3	≥-9.46	Note 4	Note 4	Note 4

NOTE 1: This Io condition is expressed as the average Io per RE over all REs in an OFDM symbol.
 NOTE 2: The parameter Es/lot is the minimum Es/lot of the pair of cells to which the requirement applies.
 NOTE 3: Io is defined in subframes indicated by the time domain measurement resource restriction pattern configured for performing RSRP measurements of this cell. The specified Io range applies to CRS and non-CRS symbols. Io may be different in different symbols within a subframe.
 NOTE 4: The same bands and the same Io conditions for each band apply for this requirement as for the corresponding highest accuracy requirement.
 NOTE 5: The condition level is increased by Δ>0, when applicable, as described in Sections B.4.2 and B.4.3.
 NOTE 6: The gap between the Es/lot level in table 9.1.2.6-1 and 9.1.2.4-1 is due to the interference from either PCell or at least one neighbour cell indicated within the CRS assistance information.
 NOTE 7: E-UTRA operating band groups are as defined in Section 3.5.

9.1.2.7 Absolute RSRP Accuracy for UE Category 1bis

Unless otherwise specified, the requirements for absolute accuracy of RSRP in this clause apply to a cell on the same frequency as that of the serving cell.

The accuracy requirements in Table 9.1.2.7-1 are valid under the following conditions:

Cell specific reference signals are transmitted either from one, two or four antenna ports.

Conditions defined in 36.101 Clause 7.3 for reference sensitivity are fulfilled.

RSRP_{dBm} according to Annex B.3.1 for a corresponding Band

Table 9.1.2.7-1: RSRP Intra frequency absolute accuracy for UE category 1bis

Accuracy		Conditions				
Normal condition	Extreme condition	Ês/lot	I _o ^{Note 1} range			
			E-UTRA operating band groups ^{Note 3}	Minimum I _o		Maximum I _o
dB	dB	dB		dBm/15kHz ^{Note 2}	dBm/BW _{Channel}	dBm/BW _{Channel}
±5.5	±10	≥-6 dB	FDD_A, TDD_A	-121	N/A	-70
			FDD_B1	-120.5	N/A	-70
			FDD_C, TDD_C	-120	N/A	-70
			FDD_D	-119.5	N/A	-70
			FDD_E, TDD_E	-119	N/A	-70
			FDD_F	-118.5	N/A	-70
			FDD_G	-118	N/A	-70
			FDD_H	-117.5	N/A	-70
			FDD_N	-114.5	N/A	-70
±9	±12	≥-6 dB	FDD_A, TDD_A, FDD_B1, FDD_C, TDD_C, FDD_D, FDD_E, TDD_E, FDD_F, FDD_G, FDD_H, FDD_N	N/A	-70	-50

NOTE 1: I_o is assumed to have constant EPRE across the bandwidth.
 NOTE 2: The condition level is increased by Δ>0, when applicable, as described in Sections B.4.2 and B.4.3.
 NOTE 3: E-UTRA operating band groups are as defined in Section 3.5.

9.1.2.8 Relative Accuracy of RSRP for UE Category 1bis

The relative accuracy of RSRP is defined as the RSRP measured from one cell compared to the RSRP measured from another cell on the same frequency.

The accuracy requirements in Table 9.1.2.8-1 are valid under the following conditions:

Cell specific reference signals are transmitted either from one, two or four antenna ports.

Conditions defined in 36.101 Clause 7.3 for reference sensitivity are fulfilled.

RSRP_{1,2}_{dBm} according to Annex B.3.8 for a corresponding Band.

Table 9.1.2.8-1: RSRP Intra frequency relative accuracy for UE category 1bis

Accuracy		Conditions			
Normal condition	Extreme condition	Ês/lot ^{Note 2}	I _o ^{Note 1} range		
			E-UTRA operating band groups ^{Note 5}	Minimum I _o	Maximum I _o
dB	dB	dB		dBm/15kHz ^{Note 4}	dBm/BW _{Channel}
±3	±4	≥-3 dB	FDD_A, TDD_A	-121	-50
			FDD_B1	-120.5	-50
			FDD_C, TDD_C	-120	-50
			FDD_D	-119.5	-50
			FDD_E, TDD_E	-119	-50
			FDD_F	-118.5	-50
			FDD_G	-118	-50
			FDD_H	-117.5	-50
			FDD_N	-114.5	-50
±4	±4	≥-6 dB	Note 3	Note 3	Note 3

NOTE 1: I_o is assumed to have constant EPRE across the bandwidth.
 NOTE 2: The parameter Ês/lot is the minimum Ês/lot of the pair of cells to which the requirement applies.
 NOTE 3: The same bands and the same I_o conditions for each band apply for this requirement as for the corresponding highest accuracy requirement.
 NOTE 4: The condition level is increased by Δ>0, when applicable, as described in Sections B.4.2 and B.4.3.
 NOTE 5: E-UTRA operating band groups are as defined in Section 3.5.

9.1.2A Intra-frequency RSRP Accuracy Requirements in High Doppler Conditions

The accuracy requirements in this clause are applicable for EVA300 and EVA600 propagation conditions and assume independent interference (noise) at each receiver antenna port. The accuracy requirements in this clause are also applicable for EVA875 and HST875 propagation conditions when *highSpeedEnhancedMeasFlag* is configured and assume independent interference (noise) at each receiver antenna port.

9.1.2A.1 Absolute RSRP Accuracy in high Doppler conditions

The requirements for absolute accuracy of RSRP in this clause apply to a cell on the same frequency as that of the serving cell.

The accuracy requirements in Table 9.1.2A.1-1 are valid under the following conditions:

Cell specific reference signals are transmitted either from one, two or four antenna ports.

Conditions defined in 36.101 Clause 7.3 for reference sensitivity are fulfilled.

RSRP_{dBm} according to Annex B.3.1 for a corresponding Band

Table 9.1.2A1-1: RSRP Intra frequency absolute accuracy

Accuracy		Conditions				
Normal condition	Extreme condition	Ês/lot	I _o ^{Note 1} range			
			E-UTRA operating band groups ^{Note 3}	Minimum I _o		Maximum I _o
dB	dB	dB		dBm/15kHz ^{Note 2}	dBm/BW _{Channel}	dBm/BW _{Channel}
±6	±10.5	≥-6 dB	FDD_A, TDD_A	-121	N/A	-70
			FDD_B1, FDD_B2	-120.5	N/A	-70
			FDD_C, TDD_C	-120	N/A	-70
			FDD_D	-119.5	N/A	-70
			FDD_E, TDD_E	-119	N/A	-70
			FDD_F	-118.5	N/A	-70
			FDD_G	-118	N/A	-70
			FDD_H, TDD_H	-117.5	N/A	-70
			FDD_N	-114.5	N/A	-70
±9.5	±12.5	≥-6 dB	FDD_A, TDD_A, FDD_B1, FDD_C, TDD_C, FDD_D, FDD_E, TDD_E, FDD_F, FDD_G, FDD_H, FDD_N	N/A	-70	-50

NOTE 1: I_o is assumed to have constant EPRE across the bandwidth.
 NOTE 2: The condition level is increased by Δ>0, when applicable, as described in Sections B.4.2 and B.4.3.
 NOTE 3: E-UTRA operating band groups are as defined in Section 3.5.

9.1.2A.2 Relative Accuracy of RSRP in high Doppler conditions

The relative accuracy of RSRP is defined as the RSRP measured from one cell compared to the RSRP measured from another cell on the same frequency.

The accuracy requirements in Table 9.1.2A.2-1 are valid under the following conditions:

Cell specific reference signals are transmitted either from one, two or four antenna ports.

Conditions defined in 36.101 Clause 7.3 for reference sensitivity are fulfilled.

RSRP_{1,2}_{dBm} according to Annex B.3.8 for a corresponding Band.

Table 9.1.2A.2-1: RSRP Intra frequency relative accuracy

Accuracy		Conditions	
		I _o ^{Note 1} range	

Normal condition	Extreme condition	$\hat{E}s/lot$ ^{Note 2}	E-UTRA operating band groups ^{Note 5}	Minimum Io	Maximum Io
dB	dB	dB		dBm/15kHz ^{Note 4}	dBm/BW _{Channel}
±3.3	±4.3	≥-3 dB	FDD_A, TDD_A	-121	-50
			FDD_B1, FDD_B2	-120.5	-50
			FDD_C, TDD_C	-120	-50
			FDD_D	-119.5	-50
			FDD_E, TDD_E	-119	-50
			FDD_F	-118.5	-50
			FDD_G	-118	-50
			FDD_H	-117.5	-50
			FDD_N	-114.5	-50
±4.3	±4.3	≥-6 dB	Note 3	Note 3	Note 3

NOTE 1: Io is assumed to have constant EPRE across the bandwidth.
 NOTE 2: The parameter $\hat{E}s/lot$ is the minimum $\hat{E}s/lot$ of the pair of cells to which the requirement applies.
 NOTE 3: The same bands and the same Io conditions for each band apply for this requirement as for the corresponding highest accuracy requirement.
 NOTE 4: The condition level is increased by $\Delta > 0$, when applicable, as described in Sections B.4.2 and B.4.3.
 NOTE 5: E-UTRA operating band groups are as defined in Section 3.5.

9.1.2B Intra-frequency RSRP Accuracy requirements for CA Idle Mode Measurements

9.1.2B.1 Introduction

The requirements in this clause are applicable for a UE:

- in state RRC_IDLE
- that is synchronised to the cell that is measured.

The requirements are for absolute accuracy of RSRP.

9.1.2B.2 Intra-frequency Absolute RSRP Accuracy for CA Idle Mode Measurements

Unless otherwise specified, the requirements for absolute accuracy of RSRP in this clause apply to the Idle mode serving cell.

The accuracy requirements in Table 9.1.2B.2-1 are valid under the following conditions:

Cell specific reference signals are transmitted either from one, two or four antenna ports.

Conditions defined in TS 36.101 [5] Clause 7.3 for reference sensitivity are fulfilled.

RSRP[dBm] according to Annex B.1.1 for a corresponding Band

Table 9.1.2B.2-1: RSRP Intra frequency absolute accuracy

Accuracy		Conditions				
Normal condition	Extreme condition	$\hat{E}s/lot$	E-UTRA operating band groups ^{Note 3}	Io ^{Note 1} range		Maximum Io
				Minimum Io		
dB	dB	dB		dBm/15kHz ^{Note 2}	dBm/BW _{Channel}	dBm/BW _{Channel}
±6	±10.5	≥-4 dB	FDD_A, TDD_A	-121	N/A	-70
			FDD_B1, FDD_B2	-120.5	N/A	-70
			FDD_C, TDD_C	-120	N/A	-70
			FDD_D	-119.5	N/A	-70
			FDD_E, TDD_E	-119	N/A	-70
			FDD_F	-118.5	N/A	-70
			FDD_G	-118	N/A	-70
			FDD_H	-117.5	N/A	-70
			FDD_N	-114.5	N/A	-70

±9.5	±12.5	≥-4 dB	FDD_A, TDD_A, FDD_B1, FDD_B2, FDD_C, TDD_C, FDD_D, FDD_E, TDD_E, FDD_F, FDD_G, FDD_H, FDD_N	N/A	-70	-50
NOTE 1: I_0 is assumed to have constant EPRE across the bandwidth. NOTE 2: The condition level is increased by $\Delta > 0$, when applicable, as described in Sections B.4.2 and B.4.3. NOTE 3: E-UTRA operating band groups are as defined in Section 3.5.						

9.1.3 Inter-frequency RSRP Accuracy Requirements

9.1.3.1 Absolute RSRP Accuracy

The requirements for absolute accuracy of RSRP in this clause apply to a cell that has different carrier frequency from the serving cell.

The accuracy requirements in Table 9.1.3.1-1 are valid under the following conditions:

Cell specific reference signals are transmitted either from one, two or four antenna ports.

Conditions defined in 36.101 Clause 7.3 for reference sensitivity are fulfilled.

RSRP_{dBm} according to Annex B.3.3 for a corresponding Band

Table 9.1.3.1-1: RSRP Inter frequency absolute accuracy

Accuracy		Conditions				
Normal condition	Extreme condition	\hat{E}_s/lot	I_0 ^{Note 1} range			
			E-UTRA operating band groups ^{Note 3}	Minimum I_0		Maximum I_0
dB	dB	dB		dBm/15kHz ^{Note 2}	dBm/BW _{Channel}	dBm/BW _{Channel}
±4.5	±9	≥-6 dB	FDD_A, TDD_A	-121	N/A	-70
			FDD_B1, FDD_B2	-120.5	N/A	-70
			FDD_C, TDD_C	-120	N/A	-70
			FDD_D	-119.5	N/A	-70
			FDD_E, TDD_E	-119	N/A	-70
			FDD_F	-118.5	N/A	-70
			FDD_G	-118	N/A	-70
			FDD_H	-117.5	N/A	-70
			FDD_N	-114.5	N/A	-70
±8	±11	≥-6 dB	FDD_A, TDD_A, FDD_B1, FDD_B2, FDD_C, TDD_C, FDD_D, FDD_E, TDD_E, FDD_F, FDD_G, FDD_H, FDD_N	N/A	-70	-50
NOTE 1: I_0 is assumed to have constant EPRE across the bandwidth. NOTE 2: The condition level is increased by $\Delta > 0$, when applicable, as described in Sections B.4.2 and B.4.3. NOTE 3: E-UTRA operating band groups are as defined in Section 3.5.						

9.1.3.2 Relative Accuracy of RSRP

The relative accuracy of RSRP in inter frequency case is defined as the RSRP measured from one cell compared to the RSRP measured from another cell on a different frequency.

The accuracy requirements in Table 9.1.3.2-1 are valid under the following conditions:

Cell specific reference signals are transmitted either from one, two or four antenna ports.

Conditions defined in 36.101 Clause 7.3 for reference sensitivity are fulfilled.

RSRP_{1,2}_{dBm} according to Annex B.3.4 for a corresponding Band

$$\left| RSRP 1 \Big|_{dBm} - RSRP 2 \Big|_{dBm} \right| \leq 27 \text{ dB}$$

| Channel 1_{Io} -Channel 2_{Io} | ≤ 20 dB

Table 9.1.3.2-1: RSRP Inter frequency relative accuracy

Accuracy		Conditions			
Normal condition	Extreme condition	$\hat{E}s/lot$ ^{Note 2}	Io ^{Note 1} range		
			E-UTRA operating band groups ^{Note 4}	Minimum Io	Maximum Io
dB	dB	dB	dBm/15kHz ^{Note 3}	dBm/BW _{Channel}	
±4.5	±6	≥-6 dB	FDD_A, TDD_A	-121	-50
			FDD_B1, FDD_B2	-120.5	-50
			FDD_C, TDD_C	-120	-50
			FDD_D	-119.5	-50
			FDD_E, TDD_E	-119	-50
			FDD_F	-118.5	-50
			FDD_G	-118	-50
			FDD_H	-117.5	-50
			FDD_N	-114.5	-50

NOTE 1: Io is assumed to have constant EPRE across the bandwidth.
 NOTE 2: The parameter $\hat{E}s/lot$ is the minimum $\hat{E}s/lot$ of the pair of cells to which the requirement applies.
 NOTE 3: The condition level is increased by $\Delta > 0$, when applicable, as described in Sections B.4.2 and B.4.3.
 NOTE 4: E-UTRA operating band groups are as defined in Section 3.5.

9.1.3.3 Absolute RSRP Accuracy for UE Category 1bis

The requirements for absolute accuracy of RSRP in this clause apply to a cell that has different carrier frequency from the serving cell.

The accuracy requirements in Table 9.1.3.3-1 are valid under the following conditions:

Cell specific reference signals are transmitted either from one, two or four antenna ports.

Conditions defined in 36.101 Clause 7.3 for reference sensitivity are fulfilled.

RSRP[dBm] according to Annex B.3.3 for a corresponding Band

Table 9.1.3.3-1: RSRP Inter frequency absolute accuracy for UE category 1bis

Accuracy		Conditions				
Normal condition	Extreme condition	$\hat{E}s/lot$	Io ^{Note 1} range			
			E-UTRA operating band groups ^{Note 3}	Minimum Io	Maximum Io	
dB	dB	dB	dBm/15kHz ^{Note 2}	dBm/BW _{Channel}	dBm/BW _{Channel}	
±5.5	±10	≥-6 dB	FDD_A, TDD_A	-121	N/A	-70
			FDD_B1	-120.5	N/A	-70
			FDD_C, TDD_C	-120	N/A	-70
			FDD_D	-119.5	N/A	-70
			FDD_E, TDD_E	-119	N/A	-70
			FDD_F	-118.5	N/A	-70
			FDD_G	-118	N/A	-70
			FDD_H	-117.5	N/A	-70
			FDD_N	-114.5	N/A	-70
±9	±12	≥-6 dB	FDD_A, TDD_A, FDD_B1, FDD_C, TDD_C, FDD_D, FDD_E, TDD_E, FDD_F, FDD_G, FDD_H, FDD_N	N/A	-70	-50

NOTE 1: Io is assumed to have constant EPRE across the bandwidth.
 NOTE 2: The condition level is increased by $\Delta > 0$, when applicable, as described in Sections B.4.2 and B.4.3.
 NOTE 3: E-UTRA operating band groups are as defined in Section 3.5.

9.1.3.4 Relative Accuracy of RSRP for UE Category 1bis

The relative accuracy of RSRP in inter frequency case is defined as the RSRP measured from one cell compared to the RSRP measured from another cell on a different frequency.

The accuracy requirements in Table 9.1.3.4-1 are valid under the following conditions:

Cell specific reference signals are transmitted either from one, two or four antenna ports.

Conditions defined in 36.101 Clause 7.3 for reference sensitivity are fulfilled.

RSRP_{1,2}_{dBm} according to Annex B.3.4 for a corresponding Band

$$|RSRP 1|_{dBm} - RSRP 2|_{dBm} | \leq 27 dB$$

$$|Channel 1_{Io} - Channel 2_{Io} | \leq 20 dB$$

Table 9.1.3.4-1: RSRP Inter frequency relative accuracy for UE category 1bis

Accuracy		Conditions			
Normal condition	Extreme condition	Ês/Iot ^{Note 2}	I _o ^{Note 1} range		
			E-UTRA operating band groups ^{Note 4}	Minimum I _o	Maximum I _o
dB	dB	dB	dBm/15kHz ^{Note 3}	dBm/BW _{Channel}	
±5.5	±7	≥-6 dB	FDD_A, TDD_A	-121	-50
			FDD_B1	-120.5	-50
			FDD_C, TDD_C	-120	-50
			FDD_D	-119.5	-50
			FDD_E, TDD_E	-119	-50
			FDD_F	-118.5	-50
			FDD_G	-118	-50
			FDD_H	-117.5	-50
			FDD_N	-114.5	-50

NOTE 1: I_o is assumed to have constant EPRE across the bandwidth.
 NOTE 2: The parameter Ês/Iot is the minimum Ês/Iot of the pair of cells to which the requirement applies.
 NOTE 3: The condition level is increased by Δ>0, when applicable, as described in Sections B.4.2 and B.4.3.
 NOTE 4: E-UTRA operating band groups are as defined in Section 3.5.

9.1.3A Inter-frequency RSRP Accuracy Requirements in High Doppler Conditions

The accuracy requirements in this clause are applicable for [EVA300 and EVA600] propagation conditions and assume independent interference (noise) at each receiver antenna port.

9.1.3A.1 Absolute RSRP Accuracy in high Doppler conditions

The requirements for absolute accuracy of RSRP in this clause apply to a cell that has different carrier frequency from the serving cell.

The accuracy requirements in Table 9.1.3A.1-1 are valid under the following conditions:

Cell specific reference signals are transmitted either from one, two or four antenna ports.

Conditions defined in 36.101 Clause 7.3 for reference sensitivity are fulfilled.

RSRP_{dBm} according to Annex B.3.3 for a corresponding Band

Table 9.1.3A.1-1: RSRP Inter frequency absolute accuracy

Accuracy		Conditions		
Normal condition	Extreme condition	Ês/Iot	I _o ^{Note 1} range	
			E-UTRA operating band groups ^{Note 3}	Minimum I _o

dB	dB	dB		dBm/15kHz ^{Note 2}	dBm/BW _{Channel}	dBm/BW _{Channel}
±6	±10.5	≥-6 dB	FDD_A, TDD_A	-121	N/A	-70
			FDD_B1, FDD_B2	-120.5	N/A	-70
			FDD_C, TDD_C	-120	N/A	-70
			FDD_D	-119.5	N/A	-70
			FDD_E, TDD_E	-119	N/A	-70
			FDD_F	-118.5	N/A	-70
			FDD_G	-118	N/A	-70
			FDD_H	-117.5	N/A	-70
			FDD_N	-114.5	N/A	-70
±9.5	±12.5	≥-6 dB	FDD_A, TDD_A, FDD_B1, FDD_C, TDD_C, FDD_D, FDD_E, TDD_E, FDD_F, FDD_G, FDD_H, FDD_N	N/A	-70	-50

NOTE 1: I_o is assumed to have constant EPRE across the bandwidth.

NOTE 2: The condition level is increased by Δ>0, when applicable, as described in Sections B.4.2 and B.4.3.

NOTE 3: E-UTRA operating band groups are as defined in Section 3.5.

9.1.3A.2 Relative Accuracy of RSRP in high Doppler conditions

The relative accuracy of RSRP in inter frequency case is defined as the RSRP measured from one cell compared to the RSRP measured from another cell on a different frequency.

The accuracy requirements in Table 9.1.3A.2-1 are valid under the following conditions:

Cell specific reference signals are transmitted either from one, two or four antenna ports.

Conditions defined in 36.101 Clause 7.3 for reference sensitivity are fulfilled.

RSRP_{1,2|dBm} according to Annex B.3.4 for a corresponding Band

$$|RSRP 1|_{dBm} - RSRP 2|_{dBm} | \leq 27 dB$$

$$|Channel 1_Io - Channel 2_Io | \leq 20 dB$$

Table 9.1.3A.2-1: RSRP Inter frequency relative accuracy

Accuracy		Conditions			
Normal condition	Extreme condition	Ês/lot ^{Note 2}	I _o ^{Note 1} range		
			E-UTRA operating band groups ^{Note 4}	Minimum I _o	Maximum I _o
dB	dB	dB	dBm/15kHz ^{Note 3}	dBm/BW _{Channel}	dBm/BW _{Channel}
±5.8	±7.3	≥-6 dB	FDD_A, TDD_A	-121	-50
			FDD_B1, FDD_B2	-120.5	-50
			FDD_C, TDD_C	-120	-50
			FDD_D	-119.5	-50
			FDD_E, TDD_E	-119	-50
			FDD_F	-118.5	-50
			FDD_G	-118	-50
			FDD_H	-117.5	-50
			FDD_N	-114.5	-50

NOTE 1: I_o is assumed to have constant EPRE across the bandwidth.

NOTE 2: The parameter Ês/lot is the minimum Ês/lot of the pair of cells to which the requirement applies.

NOTE 3: The condition level is increased by Δ>0, when applicable, as described in Sections B.4.2 and B.4.3.

NOTE 4: E-UTRA operating band groups are as defined in Section 3.5.

9.1.3B Inter-frequency RSRP Accuracy requirements for CA Idle Mode Measurements

9.1.3B.1 Introduction

The requirements in this clause are applicable for a UE:

- in state RRC_IDLE
- that is synchronised to the cell that is measured.

The requirements are for absolute accuracy of RSRP for overlapping and non-overlapping carriers.

9.1.3B.2 Inter-frequency Absolute RSRP Accuracy for Overlapping Carrier

The requirements for absolute accuracy of RSRP of an overlapping carrier when $S_{rxlev} \leq S_{nonIntraSearchP}$ or $S_{qual} \leq S_{nonIntraSearchQ}$, in this clause, apply to a cell that has different carrier frequency from the serving cell.

The accuracy requirements in Table 9.1.3B.2-1 are valid under the following conditions:

Cell specific reference signals are transmitted either from one, two or four antenna ports.

Conditions defined in TS 36.101 [5] Clause 7.3 for reference sensitivity are fulfilled.

RSRP[dBm] according to Annex B.1.2 for a corresponding Band

Table 9.1.3B.2-1: RSRP Inter frequency absolute accuracy for overlapping carrier

Accuracy		Conditions				
Normal condition	Extreme condition	Es/lot	Io ^{Note 1} range			
			E-UTRA operating band groups ^{Note 3}	Minimum Io		Maximum Io
dB	dB	dB		dBm/15kHz ^{Note 2}	dBm/BW _{Channel}	dBm/BW _{Channel}
±6	±10.5	≥-4 dB	FDD_A, TDD_A	-121	N/A	-70
			FDD_B1, FDD_B2	-120.5	N/A	-70
			FDD_C, TDD_C	-120	N/A	-70
			FDD_D	-119.5	N/A	-70
			FDD_E, TDD_E	-119	N/A	-70
			FDD_F	-118.5	N/A	-70
			FDD_G	-118	N/A	-70
			FDD_H	-117.5	N/A	-70
			FDD_N	-114.5	N/A	-70
±9.5	±12.5	≥-4 dB	FDD_A, TDD_A, FDD_B1, FDD_B2, FDD_C, TDD_C, FDD_D, FDD_E, TDD_E, FDD_F, FDD_G, FDD_H, FDD_N	N/A	-70	-50

NOTE 1: Io is assumed to have constant EPRE across the bandwidth.
 NOTE 2: The condition level is increased by Δ>0, when applicable, as described in Sections B.4.2 and B.4.3.
 NOTE 3: E-UTRA operating band groups are as defined in Section 3.5.

9.1.3B.3 Inter-frequency Absolute RSRP Accuracy for Overlapping and Non-overlapping Carrier

The requirements for absolute accuracy of RSRP of an overlapping carrier when $S_{rxlev} > S_{nonIntraSearchP}$ and $S_{qual} > S_{nonIntraSearchQ}$, and a non-overlapping carrier in this clause, apply to a cell that has different carrier frequency from the serving cell.

The accuracy requirements in Table 9.1.3B.3-1 are valid under the following conditions:

Cell specific reference signals are transmitted either from one, two or four antenna ports.

Conditions defined in TS 36.101 [5] Clause 7.3 for reference sensitivity are fulfilled.

RSRP[dBm according to Annex B.1.2 for a corresponding Band

Table 9.1.3B.3-1: RSRP Inter frequency absolute accuracy for overlapping and non-overlapping carrier

Accuracy		Conditions				
Normal condition	Extreme condition	Ês/lot	Io ^{Note 1} range			
			E-UTRA operating band groups ^{Note 3}	Minimum Io		Maximum Io
dB	dB	dB		dBm/15kHz ^{Note 2}	dBm/BW _{Channel}	dBm/BW _{Channel}
±7	±11.5	≥-4 dB	FDD_A, TDD_A	-121	N/A	-70
			FDD_B1, FDD_B2	-120.5	N/A	-70
			FDD_C, TDD_C	-120	N/A	-70
			FDD_D	-119.5	N/A	-70
			FDD_E, TDD_E	-119	N/A	-70
			FDD_F	-118.5	N/A	-70
			FDD_G	-118	N/A	-70
			FDD_H	-117.5	N/A	-70
			FDD_N	-114.5	N/A	-70
±10.5	±13.5	≥-4 dB	FDD_A, TDD_A, FDD_B1, FDD_B2, FDD_C, TDD_C, FDD_D, FDD_E, TDD_E, FDD_F, FDD_G, FDD_H, FDD_N	N/A	-70	-50

NOTE 1: Io is assumed to have constant EPRE across the bandwidth.
 NOTE 2: The condition level is increased by Δ>0, when applicable, as described in Sections B.4.2 and B.4.3.
 NOTE 3: E-UTRA operating band groups are as defined in Section 3.5.

9.1.4 RSRP Measurement Report Mapping

The reporting range of RSRP is defined from -156 dBm to -44 dBm with 1 dB resolution.

The mapping of measured quantity is defined in Table 9.1.4-1. The range in the signalling may be larger than the guaranteed accuracy range.

Table 9.1.4-1: RSRP measurement report mapping

Reported value	Measured quantity value	Unit
RSRP_-17	RSRP < -156	dBm
RSRP_-16	-156 ≤ RSRP < -155	dBm
...
RSRP_-03	-143 ≤ RSRP < -142	dBm
RSRP_-02	-142 ≤ RSRP < -141	dBm
RSRP_-01	-141 ≤ RSRP < -140	dBm
RSRP_00	RSRP < -140	dBm
RSRP_01	-140 ≤ RSRP < -139	dBm
RSRP_02	-139 ≤ RSRP < -138	dBm
...
RSRP_95	-46 ≤ RSRP < -45	dBm
RSRP_96	-45 ≤ RSRP < -44	dBm
RSRP_97	-44 ≤ RSRP	dBm

9.1.5 Intra-frequency RSRQ Accuracy Requirements

9.1.5.1 Absolute RSRQ Accuracy

The requirements for absolute accuracy of RSRQ in this clause apply to a cell on the same frequency as that of the serving cell.

The accuracy requirements in Table 9.1.5.1-1 are valid under the following conditions:

Cell specific reference signals are transmitted either from one, two or four antenna ports.

Conditions defined in 36.101 Clause 7.3 for reference sensitivity are fulfilled.

RSRP_{dBm} according to Annex B.3.1 for a corresponding Band

Table 9.1.5.1-1: RSRQ Intra frequency absolute accuracy

Accuracy		Conditions			
Normal condition	Extreme condition	Ês/lot	I _o ^{Note 1} range		
			E-UTRA operating band groups ^{Note 4}	Minimum I _o	Maximum I _o
dB	dB	dB		dBm/15kHz ^{Note 3}	dBm/BW _{Channel}
±2.5	±4	≥-3 dB	FDD_A, TDD_A	-121	-50
			FDD_B1, FDD_B2	-120.5	-50
			FDD_C, TDD_C	-120	-50
			FDD_D	-119.5	-50
			FDD_E, TDD_E	-119	-50
			FDD_F	-118.5	-50
			FDD_G	-118	-50
			FDD_H	-117.5	-50
			FDD_N	-114.5	-50
±3.5	±4	≥-6 dB	Note 2	Note 2	Note 2

NOTE 1: I_o is assumed to have constant EPRE across the bandwidth.
 NOTE 2: The same bands and the same I_o conditions for each band apply for this requirement as for the corresponding highest accuracy requirement.
 NOTE 3: The condition level is increased by Δ>0, when applicable, as described in Sections B.4.2 and B.4.3.
 NOTE 4: E-UTRA operating band groups are as defined in Section 3.5.

9.1.5.2 Absolute RSRQ Accuracy under Time Domain Measurement Resource Restriction

The requirements for absolute accuracy of RSRQ in this clause shall apply to a cell on the same frequency as that of the serving cell when a time domain measurement resource restriction pattern for performing RSRQ measurements of this cell is configured by higher layers (TS 36.331 [2]).

The accuracy requirements in Table 9.1.5.2-1 are valid under the following conditions:

Cell specific reference signals in the measured cell are transmitted either from one, two or four antenna ports,

Conditions defined in 36.101 Clause 7.3 for reference sensitivity are fulfilled,

RSRP_{dBm} according to Annex B.3.9 for a corresponding Band,

The time domain measurement resource restriction pattern configured for the measured cell indicates at least one subframe per radio frame for performing the RSRQ measurement,

The RSRQ measurement is not performed in any subframe other than those indicated by the time domain measurement resource restriction pattern configured for the measured cell,

Four symbols containing CRS are available in all subframes indicated by the time domain measurement resource restriction pattern.

Table 9.1.5.2-1: RSRQ Intra frequency absolute accuracy under time domain measurement resource restriction

Accuracy		Conditions			
Normal condition	Extreme condition	Ês/lot	I _o ^{Note 2} range		
			E-UTRA operating band groups ^{Note 5}	Minimum I _o	Maximum I _o
dB	dB	dB		dBm/15kHz ^{Note 1, 4}	dBm/BW _{Channel}
±2.5	±4	≥-2 dB	FDD_A, TDD_A	-121	-50
			FDD_B1, FDD_B2	-120.5	-50
			FDD_C, TDD_C	-120	-50

			FDD_D	-119.5	-50
			FDD_E, TDD_E	-119	-50
			FDD_F	-118.5	-50
			FDD_G	-118	-50
			FDD_H	-117.5	-50
			FDD_N	-114.5	-50
±3.5	±4	≥-4 dB	Note 3	Note 3	Note 3
<p>NOTE 1: This minimum l_o condition is expressed as the average l_o per RE over all REs in that symbol.</p> <p>NOTE 2: l_o is defined in subframes indicated by the time domain measurement resource restriction pattern configured for performing RSRQ measurements of this cell. The l_o range defined by the minimum and the maximum l_o levels applies to CRS and non-CRS symbols. l_o may be different in different symbols within a subframe.</p> <p>NOTE 3: The same bands and the same l_o conditions for each band apply for this requirement as for the corresponding highest accuracy requirement.</p> <p>NOTE 4: The condition level is increased by $\Delta > 0$, when applicable, as described in Sections B.4.2 and B.4.3.</p> <p>NOTE 5: E-UTRA operating band groups are as defined in Section 3.5.</p>					

For time domain measurements restriction under colliding CRS with ABS configured in non-MBSFN subframes, requirements in Section 9.1.5.1 apply.

9.1.5.3 Absolute RSRQ Accuracy under Time Domain Measurement Resource Restriction with CRS assistance information

The requirements for absolute accuracy of RSRQ in this section shall apply to a cell on the same frequency as that of the serving cell when a time domain measurement resource restriction pattern for performing RSRQ measurements of this cell is configured by higher layers (TS 36.331 [2]) and the CRS assistance information is provided. The requirements apply for UEs supporting CRS interference handling.

The accuracy requirements in Table 9.1.5.3-1 are valid under the following conditions:

Cell specific reference signals in the measured cell are transmitted either from one, two or four antenna ports,

Conditions defined in 36.101 Section 7.3 for reference sensitivity are fulfilled,

$RSRP_{dBm}$ according to Annex B.3.11 for a corresponding Band,

The time domain measurement resource restriction pattern configured for the measured cell indicates at least one subframe per radio frame for performing the RSRQ measurement,

The RSRQ measurement is not performed in any subframe other than those indicated by the time domain measurement resource restriction pattern configured for the measured cell,

Four symbols containing CRS are available in all subframes indicated by the time domain measurement resource restriction pattern,

The UE is provided with the CRS assistance information (TS 36.331 [2]) and the CRS assistance information is valid throughout the entire evaluation period.

The requirements in this section shall also be met when the number of transmit antenna ports [16] of one or more cells whose CRS assistance information is provided [2] is different from the number of transmit antenna ports of the measured cell.

Table 9.1.5.3-1: RSRQ Intra frequency absolute accuracy under Time Domain Measurement Resource Restriction with CRS assistance information

Accuracy		Conditions			
Normal condition	Extreme condition	$\hat{E}s/l_o$ ^{Note 5}	l_o ^{Note 2} range		
			E-UTRA operating band groups ^{Note 6}	Minimum l_o	Maximum l_o
dB	dB	dB	dBm/15kHz ^{Note 1, 4}	dBm/BW _{Channel}	
±2.5	±4	≥-6.96	FDD_A, TDD_A	-121	-50
			FDD_B1, FDD_B2	-120.5	-50
			FDD_C, TDD_C	-120	-50
			FDD_D	-119.5	-50
			FDD_E, TDD_E	-119	-50

			FDD_F	-118.5	-50
			FDD_G	-118	-50
			FDD_H	-117.5	-50
			FDD_N	-114.5	-50
±3.5	±4	≥-9.46	Note 3	Note 3	Note 3
<p>NOTE 1: This l_o condition is expressed as the average l_o per RE over all REs in that symbol.</p> <p>NOTE 2: l_o is defined in subframes indicated by the time domain measurement resource restriction pattern configured for performing RSRQ measurements of this cell. The specified l_o range applies to CRS and non-CRS symbols. l_o may be different in different symbols within a subframe.</p> <p>NOTE 3: The same bands and the same l_o conditions for each band apply for this requirement as for the corresponding highest accuracy requirement.</p> <p>NOTE 4: The condition level is increased by $\Delta > 0$, when applicable, as described in Sections B.4.2 and B.4.3.</p> <p>NOTE 5: The gap between the E_s/l_{ot} level in table 9.1.5.3-1 and 9.1.5.2-1 is due to the interference from either PCell or at least one neighbour cell indicated within the CRS assistance information.</p> <p>NOTE 6: E-UTRA operating band groups are as defined in Section 3.5.</p>					

9.1.5.4 Absolute WB-RSRQ Accuracy

The requirements in this section shall apply when the measurement configuration message received by the UE contains *widebandRSRQ-Meas* parameter in TS 36.331 [2]. The WB-RSRQ accuracy figures in Table 9.1.5.4-1 are relative to the value that would be obtained by using the *AllowedMeasBandwidth* in TS 36.331 [2].

The accuracy requirements in Table 9.1.5.4-1 are valid under the following conditions:

The value of the parameter, *AllowedMeasBandwidth* in TS 36.331 [2], is 50 resource blocks or larger

Cell specific reference signals are transmitted either from one, two or four antenna ports.

Conditions defined in TS 36.101 [5] Clause 7.3 for reference sensitivity are fulfilled.

RSRP[dBm] according to Annex B.3.1 for a corresponding Band.

Table 9.1.5.4-1: WB-RSRQ Intra frequency absolute accuracy

Accuracy		Conditions				
Normal condition	Extreme condition	\hat{E}_s/l_{ot} Note 3	$l_{o1}-l_{o2}$ Note 2	l_o range ^{Note 1}		
				E-UTRA operating band groups ^{Note 6}	Minimum l_o ^{Note 5}	Maximum l_o
dB	dB	dB	dB		dBm/15kHz	dBm/BW _{Channel}
±2.5	±4	≥-3 dB	0 ≤ $l_{o1}-l_{o2}$	FDD_A, TDD_A	-121	-50
				FDD_B1, FDD_B2	-120.5	-50
				FDD_C, TDD_C	-120	-50
				FDD_D	-119.5	-50
				FDD_E, TDD_E	-119	-50
				FDD_F	-118.5	-50
				FDD_G	-118	-50
				FDD_H	-117.5	-50
				FDD_N	-114.5	-50
±3.5	±4	≥-6 dB		Note 4	Note 4	Note 4

NOTE 1: l_o is the average across all the resource blocks within the *AllowedMeasBandwidth* in TS 36.331 [2].

NOTE 2: l_{o1} is the l_o level in the resource blocks other than central 6 resource blocks within the *AllowedMeasBandwidth* in TS 36.331 [2] and l_{o2} is the l_o level in central 6 resource blocks. The l_{o1} and l_{o2} have the same range as defined for l_o .

NOTE 3: l_{ot} is the received power spectrum density of total interference and noise for all the resource blocks, other than central 6 resource blocks.

NOTE 4: The same bands and the same l_o conditions for each band apply for this requirement as for the corresponding highest accuracy requirement.

NOTE 5: The condition level is increased by $\Delta > 0$, when applicable, as described in Sections B.4.2 and B.4.3.

NOTE 6: E-UTRA operating band groups are as defined in Section 3.5.

9.1.5.5 Absolute RSRQ Accuracy for UE Category 1bis

The requirements for absolute accuracy of RSRQ in this clause apply to a cell on the same frequency as that of the serving cell.

The accuracy requirements in Table 9.1.5.5-1 are valid under the following conditions:

Cell specific reference signals are transmitted either from one, two or four antenna ports.

Conditions defined in 36.101 Clause 7.3 for reference sensitivity are fulfilled.

RSRP|dBm according to Annex B.3.1 for a corresponding Band

Table 9.1.5.5-1: RSRQ Intra frequency absolute accuracy for UE category 1bis

Accuracy		Conditions			
Normal condition	Extreme condition	Ês/lot	I _o ^{Note 1} range		
			E-UTRA operating band groups ^{Note 4}	Minimum I _o	Maximum I _o
dB	dB	dB	dBm/15kHz ^{Note 3}	dBm/BW _{Channel}	
±3.5	±5	≥-3 dB	FDD_A, TDD_A	-121	-50
			FDD_B1	-120.5	-50
			FDD_C, TDD_C	-120	-50
			FDD_D	-119.5	-50
			FDD_E, TDD_E	-119	-50
			FDD_F	-118.5	-50
			FDD_G	-118	-50
			FDD_H	-117.5	-50
FDD_N	-114.5	-50			
±4.5	±5	≥-6 dB	Note 2	Note 2	Note 2

NOTE 1: I_o is assumed to have constant EPRE across the bandwidth.
 NOTE 2: The same bands and the same I_o conditions for each band apply for this requirement as for the corresponding highest accuracy requirement.
 NOTE 3: The condition level is increased by Δ>0, when applicable, as described in Sections B.4.2 and B.4.3.
 NOTE 4: E-UTRA operating band groups are as defined in Section 3.5.

9.1.5A Intra-frequency RSRQ Accuracy Requirements in High Doppler Conditions

The accuracy requirements in this clause are applicable for EVA300 and EVA600 propagation conditions and assume independent interference (noise) at each receiver antenna port. The accuracy requirements in this clause are also applicable for EVA875 and HST875 propagation conditions when *highSpeedEnhancedMeasFlag* is configured and assume independent interference (noise) at each receiver antenna port.

9.1.5A.1 Absolute RSRQ Accuracy in high Doppler conditions

The requirements for absolute accuracy of RSRQ in this clause apply to a cell on the same frequency as that of the serving cell.

The accuracy requirements in Table 9.1.5A.1-1 are valid under the following conditions:

Cell specific reference signals are transmitted either from one, two or four antenna ports.

Conditions defined in 36.101 Clause 7.3 for reference sensitivity are fulfilled.

RSRP|dBm according to Annex B.3.1 for a corresponding Band

Table 9.1.5A.1-1: RSRQ Intra frequency absolute accuracy

Accuracy		Conditions			
Normal condition	Extreme condition	Ês/lot	I _o ^{Note 1} range		
			E-UTRA operating band groups ^{Note 4}	Minimum I _o	Maximum I _o
dB	dB	dB	dBm/15kHz ^{Note 3}	dBm/BW _{Channel}	
±4	±5.5	≥-3 dB	FDD_A, TDD_A	-121	-50
			FDD_B1, FDD_B2	-120.5	-50
			FDD_C, TDD_C	-120	-50
			FDD_D	-119.5	-50
			FDD_E, TDD_E	-119	-50

			FDD_F	-118.5	-50
			FDD_G	-118	-50
			FDD_H	-117.5	-50
			FDD_N	-114.5	-50
±5	±5.5	≥-6 dB	Note 2	Note 2	Note 2
<p>NOTE 1: I_0 is assumed to have constant EPRE across the bandwidth.</p> <p>NOTE 2: The same bands and the same I_0 conditions for each band apply for this requirement as for the corresponding highest accuracy requirement.</p> <p>NOTE 3: The condition level is increased by $\Delta > 0$, when applicable, as described in Sections B.4.2 and B.4.3.</p> <p>NOTE 4: E-UTRA operating band groups are as defined in Section 3.5.</p>					

9.1.5B Intra-frequency RSRQ Accuracy requirements for CA Idle Mode Measurements

9.1.5B.1 Introduction

The requirements in this clause are applicable for a UE:

- in state RRC_IDLE
- that is synchronised to the cell that is measured.

The requirements are for absolute accuracy of RSRQ.

9.1.5B.2 Intra-frequency Absolute RSRQ Accuracy for CA Idle Mode Measurements

Unless otherwise specified, the requirements for absolute accuracy of RSRQ in this clause apply to the Idle mode serving cell.

The accuracy requirements in Table 9.1.5B.2-1 are valid under the following conditions:

Cell specific reference signals are transmitted either from one, two or four antenna ports.

Conditions defined in TS 36.101 [5] Clause 7.3 for reference sensitivity are fulfilled.

RSRP_{dBm} according to Annex B.1.1 for a corresponding Band

Table 9.1.5B.2-1: RSRQ Intra frequency absolute accuracy

Accuracy		Conditions			
Normal condition	Extreme condition	\hat{E}_s/lot	I_0 ^{Note 1} range		
			E-UTRA operating band groups ^{Note 4}	Minimum I_0	Maximum I_0
dB	dB	dB		dBm/15kHz ^{Note 3}	dBm/BW _{Channel}
±4	±5.5	≥-3 dB	FDD_A, TDD_A	-121	-50
			FDD_B1, FDD_B2	-120.5	-50
			FDD_C, TDD_C	-120	-50
			FDD_D	-119.5	-50
			FDD_E, TDD_E	-119	-50
			FDD_F	-118.5	-50
			FDD_G	-118	-50
			FDD_H	-117.5	-50
			FDD_N	-114.5	-50
±5	±5.5	≥-6 dB	Note 2	Note 2	Note 2
<p>NOTE 1: I_0 is assumed to have constant EPRE across the bandwidth.</p> <p>NOTE 2: The same bands and the same I_0 conditions for each band apply for this requirement as for the corresponding highest accuracy requirement.</p> <p>NOTE 3: The condition level is increased by $\Delta > 0$, when applicable, as described in Sections B.4.2 and B.4.3.</p> <p>NOTE 4: E-UTRA operating band groups are as defined in Section 3.5.</p>					

9.1.6 Inter-frequency RSRQ Accuracy Requirements

9.1.6.1 Absolute RSRQ Accuracy

The requirements for absolute accuracy of RSRQ in this clause apply to a cell that has different carrier frequency from the serving cell.

The accuracy requirements in Table 9.1.6.1-1 are valid under the following conditions:

Cell specific reference signals are transmitted either from one, two or four antenna ports.

Conditions defined in 36.101 Clause 7.3 for reference sensitivity are fulfilled.

RSRP_{dBm} according to Annex B.3.3 for a corresponding Band

Table 9.1.6.1-1: RSRQ Inter frequency absolute accuracy

Accuracy		Conditions			
Normal condition	Extreme condition	Ês/lot	I _o ^{Note 1} range		
			E-UTRA operating band groups ^{Note 4}	Minimum I _o	Maximum I _o
dB	dB	dB	dBm/15kHz ^{Note 3}	dBm/BW _{Channel}	
±2.5	±4	≥-3 dB	FDD_A, TDD_A	-121	-50
			FDD_B1, FDD_B2	-120.5	-50
			FDD_C, TDD_C	-120	-50
			FDD_D	-119.5	-50
			FDD_E, TDD_E	-119	-50
			FDD_F	-118.5	-50
			FDD_G	-118	-50
			FDD_H	-117.5	-50
			FDD_N	-114.5	-50
±3.5	±4	≥-6 dB	Note 2	Note 2	Note 2

NOTE 1: I_o is assumed to have constant EPRE across the bandwidth.
NOTE 2: The same bands and the same I_o conditions for each band apply for this requirement as for the corresponding highest accuracy requirement.
NOTE 3: The condition level is increased by Δ>0, when applicable, as described in Sections B.4.2 and B.4.3.
NOTE 4: E-UTRA operating band groups are as defined in Section 3.5.

9.1.6.2 Relative Accuracy of RSRQ

The relative accuracy of RSRQ in inter frequency case is defined as the RSRQ measured from one cell compared to the RSRQ measured from another cell on a different frequency.

The accuracy requirements in Table 9.1.6.2-1 are valid under the following conditions:

Cell specific reference signals are transmitted either from one, two or four antenna ports.

Conditions defined in 36.101 Clause 7.3 for reference sensitivity are fulfilled.

RSRP_{1,2}_{dBm} according to Annex B.3.4 for a corresponding Band

$$|RSRP 1|_{dBm} - RSRP 2|_{dBm}| \leq 27 \text{ dB}$$

$$|Channel 1_{I_o} - Channel 2_{I_o}| \leq 20 \text{ dB}$$

Table 9.1.6.2-1: RSRQ Inter frequency relative accuracy

Accuracy		Conditions			
Normal condition	Extreme condition	Ês/lot ^{Note 2}	I _o ^{Note 1} range		
			E-UTRA operating band groups ^{Note 5}	Minimum I _o	Maximum I _o
dB	dB	dB	dBm/15kHz ^{Note 4}	dBm/BW _{Channel}	
±3	±4	≥-3 dB	FDD_A, TDD_A	-121	-50
			FDD_B1, FDD_B2	-120.5	-50

			FDD_C, TDD_C	-120	-50
			FDD_D	-119.5	-50
			FDD_E, TDD_E	-119	-50
			FDD_F	-118.5	-50
			FDD_G	-118	-50
			FDD_H	-117.5	-50
			FDD_N	-114.5	-50
±4	±4	≥-6 dB	Note 3	Note 3	Note 3
<p>NOTE 1: I_0 is assumed to have constant EPRE across the bandwidth.</p> <p>NOTE 2: The parameter \hat{E}_s/I_{ot} is the minimum \hat{E}_s/I_{ot} of the pair of cells to which the requirement applies.</p> <p>NOTE 3: The same bands and the same I_0 conditions for each band apply for this requirement as for the corresponding highest accuracy requirement.</p> <p>NOTE 4: The condition level is increased by $\Delta > 0$, when applicable, as described in Sections B.4.2 and B.4.3.</p> <p>NOTE 5: E-UTRA operating band groups are as defined in Section 3.5.</p>					

9.1.6.3 Absolute WB-RSRQ Accuracy

The requirements in this section shall apply when the measurement configuration message received by the UE contains *widebandRSRQ-Meas* parameter in TS 36.331 [2]. The WB-RSRQ accuracy figures in Table 9.1.6.3-1 are relative to the value that would be obtained by using the *AllowedMeasBandwidth* in TS 36.331 [2].

The accuracy requirements in Table 9.1.6.3-1 are valid under the following conditions:

The value of the parameter, *AllowedMeasBandwidth* in TS 36.331 [2], is 50 resource blocks or larger

Cell specific reference signals are transmitted either from one, two or four antenna ports.

Conditions defined in TS 36.101 [5] Clause 7.3 for reference sensitivity are fulfilled.

RSRP[dBm] according to Annex B.3.1 for a corresponding Band.

Table 9.1.6.3-1: WB-RSRQ Inter frequency absolute accuracy

Accuracy		Conditions				
Normal condition	Extreme condition	\hat{E}_s/I_{ot} Note 3	$I_{o1}-I_{o2}$ Note 2	I_0 range ^{Note 1}		
				E-UTRA operating band groups ^{Note 6}	Minimum I_0 Note 5	Maximum I_0
dB	dB	dB	dB		dBm/15kHz	dBm/BW _{Channel}
±2.5	±4	≥-3 dB	0 ≤ $I_{o1}-I_{o2}$	FDD_A, TDD_A	-121	-50
				FDD_B1, FDD_B2	-120.5	-50
				FDD_C, TDD_C	-120	-50
				FDD_D	-119.5	-50
				FDD_E, TDD_E	-119	-50
				FDD_F	-118.5	-50
				FDD_G	-118	-50
				FDD_H	-117.5	-50
				FDD_N	-114.5	-50
±3.5	±4	≥-6 dB		Note 4	Note 4	Note 4

NOTE 1: I_0 is the average across all the resource blocks within the *AllowedMeasBandwidth* in TS 36.331 [2].

NOTE 2: I_{o1} is the I_0 level in the resource blocks other than central 6 resource blocks within the *AllowedMeasBandwidth* in TS 36.331 [2] and I_{o2} is the I_0 level in central 6 resource blocks. The I_{o1} and I_{o2} have the same range as defined for I_0 .

NOTE 3: I_{ot} is the received power spectrum density of total interference and noise for all the resource blocks, other than central 6 resource blocks.

NOTE 4: The same bands and the same I_0 conditions for each band apply for this requirement as for the corresponding highest accuracy requirement.

NOTE 5: The condition level is increased by $\Delta > 0$, when applicable, as described in Sections B.4.2 and B.4.3.

NOTE 6: E-UTRA operating band groups are as defined in Section 3.5.

9.1.6.4 Relative WB-RSRQ Accuracy

The requirements in this section shall apply when the measurement configuration message received by the UE contains *widebandRSRQ-Meas* parameter in TS 36.331 [2]. The WB-RSRQ accuracy figures in Table 9.1.6.4-1 are relative to the value that would be obtained by using the *AllowedMeasBandwidth* in TS 36.331 [2].

The accuracy requirements in Table 9.1.6.4-1 are valid under the following conditions:

The value of the parameter, *AllowedMeasBandwidth* in TS 36.331 [2], is 50 resource blocks or larger for the measured cells from different frequencies

Cell specific reference signals are transmitted either from one, two or four antenna ports.

Conditions defined in TS 36.101 [5] Clause 7.3 for reference sensitivity are fulfilled.

RSRP_{1,2}_{dBm} according to Annex B.3.4 for a corresponding Band

$$\left| RSRP1_{dBm} - RSRP2_{dBm} \right| \leq 27 dB$$

$$| \text{Channel 1}_{Io} - \text{Channel 2}_{Io} | \leq 20 \text{ dB}$$

Table 9.1.6.4-1: WB-RSRQ Inter frequency relative accuracy

Accuracy		Conditions				
Normal condition	Extreme condition	Ês/lot Note 3	Io1-Io2 Note 2	Io range Note 1		
				E-UTRA operating band groups Note 6	Minimum Io Note 5	Maximum Io
dB	dB	dB	dB		dBm/15kHz	dBm/BW _{Channel}
±3	±4	≥-3 dB	0 ≤ Io1 - Io2	FDD_A, TDD_A	-121	-50
				FDD_B1, FDD_B2	-120.5	-50
				FDD_C, TDD_C	-120	-50
				FDD_D	-119.5	-50
				FDD_E, TDD_E	-119	-50
				FDD_F	-118.5	-50
				FDD_G	-118	-50
				FDD_H	-117.5	-50
FDD_N	-114.5	-50				
±4	±4	≥-6 dB		Note 4	Note 4	Note 4

NOTE 1: Io is the average across all the resource blocks within the *AllowedMeasBandwidth* in TS 36.331 [2].

NOTE 2: Io1 is the Io level in the resource blocks other than central 6 resource blocks within the *AllowedMeasBandwidth* in TS 36.331 [2] and Io2 is the Io level in central 6 resource blocks. The Io1 and Io2 have the same range as defined for Io.

NOTE 3: lot is the received power spectrum density of total interference and noise for all the resource blocks, other than central 6 resource blocks. The parameter Ês/lot is the minimum Ês/lot of the pair of cells to which the requirement applies

NOTE 4: The same bands and the same Io conditions for each band apply for this requirement as for the corresponding highest accuracy requirement.

NOTE 5: The condition level is increased by Δ>0, when applicable, as described in Sections B.4.2 and B.4.3.

NOTE 6: E-UTRA operating band groups are as defined in Section 3.5.

9.1.6.5 Absolute RSRQ Accuracy for UE Category 1bis

The requirements for absolute accuracy of RSRQ in this clause apply to a cell that has different carrier frequency from the serving cell.

The accuracy requirements in Table 9.1.6.5-1 are valid under the following conditions:

Cell specific reference signals are transmitted either from one, two or four antenna ports.

Conditions defined in 36.101 Clause 7.3 for reference sensitivity are fulfilled.

RSRP_{dBm} according to Annex B.3.3 for a corresponding Band

Table 9.1.6.5-1: RSRQ Inter frequency absolute accuracy for UE category 1bis

Accuracy		Conditions			
Normal condition	Extreme condition	Ês/lot	Io Note 1 range		
			E-UTRA operating band groups Note 4	Minimum Io	Maximum Io
dB	dB	dB		dBm/15kHz Note 3	dBm/BW _{Channel}
			FDD_A, TDD_A	-121	-50

±3.5	±5	≥-3 dB	FDD_B1	-120.5	-50
			FDD_C, TDD_C	-120	-50
			FDD_D	-119.5	-50
			FDD_E, TDD_E	-119	-50
			FDD_F	-118.5	-50
			FDD_G	-118	-50
			FDD_H	-117.5	-50
			FDD_N	-114.5	-50
±4.5	±5	≥-6 dB	Note 2	Note 2	Note 2
<p>NOTE 1: I_o is assumed to have constant EPRE across the bandwidth.</p> <p>NOTE 2: The same bands and the same I_o conditions for each band apply for this requirement as for the corresponding highest accuracy requirement.</p> <p>NOTE 3: The condition level is increased by Δ>0, when applicable, as described in Sections B.4.2 and B.4.3.</p> <p>NOTE 4: E-UTRA operating band groups are as defined in Section 3.5.</p>					

9.1.6.6 Relative Accuracy of RSRQ for UE Category 1bis

The relative accuracy of RSRQ in inter frequency case is defined as the RSRQ measured from one cell compared to the RSRQ measured from another cell on a different frequency.

The accuracy requirements in Table 9.1.6.6-1 are valid under the following conditions:

Cell specific reference signals are transmitted either from one, two or four antenna ports.

Conditions defined in 36.101 Clause 7.3 for reference sensitivity are fulfilled.

RSRP_{1,2}_{dBm} according to Annex B.3.4 for a corresponding Band

$$|RSRP 1|_{dBm} - RSRP 2|_{dBm} | \leq 27 dB$$

$$|Channel 1_{Io} - Channel 2_{Io} | \leq 20 dB$$

Table 9.1.6.6-1: RSRQ Inter frequency relative accuracy for UE category 1bis

Accuracy		Conditions			
Normal condition	Extreme condition	Ês/lot ^{Note 2}	I _o ^{Note 1} range		
			E-UTRA operating band groups ^{Note 5}	Minimum I _o	Maximum I _o
dB	dB	dB	dBm/15kHz ^{Note 4}	dBm/BW _{Channel}	
±4	±5	≥-3 dB	FDD_A, TDD_A	-121	-50
			FDD_B1	-120.5	-50
			FDD_C, TDD_C	-120	-50
			FDD_D	-119.5	-50
			FDD_E, TDD_E	-119	-50
			FDD_F	-118.5	-50
			FDD_G	-118	-50
			FDD_H	-117.5	-50
			FDD_N	-114.5	-50
±5	±5	≥-6 dB	Note 3	Note 3	Note 3
<p>NOTE 1: I_o is assumed to have constant EPRE across the bandwidth.</p> <p>NOTE 2: The parameter Ês/lot is the minimum Ês/lot of the pair of cells to which the requirement applies.</p> <p>NOTE 3: The same bands and the same I_o conditions for each band apply for this requirement as for the corresponding highest accuracy requirement.</p> <p>NOTE 4: The condition level is increased by Δ>0, when applicable, as described in Sections B.4.2 and B.4.3.</p> <p>NOTE 5: E-UTRA operating band groups are as defined in Section 3.5.</p>					

9.1.6A Inter-frequency RSRQ Accuracy Requirements in High Doppler Conditions

The accuracy requirements in this clause are applicable for EVA300 and EVA600 propagation conditions and assume independent interference (noise) at each receiver antenna port.

9.1.6A.1 Absolute RSRQ Accuracy in high Doppler conditions

The requirements for absolute accuracy of RSRQ in this clause apply to a cell that has different carrier frequency from the serving cell.

The accuracy requirements in Table 9.1.6A.1-1 are valid under the following conditions:

Cell specific reference signals are transmitted either from one, two or four antenna ports.

Conditions defined in 36.101 Clause 7.3 for reference sensitivity are fulfilled.

RSRP_{dBm} according to Annex B.3.3 for a corresponding Band

Table 9.1.6A.1-1: RSRQ Inter frequency absolute accuracy

Accuracy		Conditions			
Normal condition	Extreme condition	Ês/lot	I _o ^{Note 1} range		
			E-UTRA operating band groups ^{Note 4}	Minimum I _o	Maximum I _o
dB	dB	dB	dBm/15kHz ^{Note 3}	dBm/BW _{Channel}	
±4	±5.5	≥-3 dB	FDD_A, TDD_A	-121	-50
			FDD_B1, FDD_B2	-120.5	-50
			FDD_C, TDD_C	-120	-50
			FDD_D	-119.5	-50
			FDD_E, TDD_E	-119	-50
			FDD_F	-118.5	-50
			FDD_G	-118	-50
			FDD_H	-117.5	-50
			FDD_N	-114.5	-50
±5	±5.5	≥-6 dB	Note 2	Note 2	Note 2

NOTE 1: I_o is assumed to have constant EPRE across the bandwidth.
 NOTE 2: The same bands and the same I_o conditions for each band apply for this requirement as for the corresponding highest accuracy requirement.
 NOTE 3: The condition level is increased by Δ>0, when applicable, as described in Sections B.4.2 and B.4.3.
 NOTE 4: E-UTRA operating band groups are as defined in Section 3.5.

9.1.6A.2 Relative Accuracy of RSRQ in high Doppler conditions

The relative accuracy of RSRQ in inter frequency case is defined as the RSRQ measured from one cell compared to the RSRQ measured from another cell on a different frequency.

The accuracy requirements in Table 9.1.6A.2-1 are valid under the following conditions:

Cell specific reference signals are transmitted either from one, two or four antenna ports.

Conditions defined in 36.101 Clause 7.3 for reference sensitivity are fulfilled.

RSRP_{1,2}_{dBm} according to Annex B.3.4 for a corresponding Band

$$|RSRP\ 1|_{dBm} - RSRP\ 2|_{dBm} | \leq 27\ dB$$

$$|Channel\ 1_I_o - Channel\ 2_I_o | \leq 20\ dB$$

Table 9.1.6A.2-1: RSRQ Inter frequency relative accuracy

Accuracy		Conditions			
Normal condition	Extreme condition	Ês/lot ^{Note 2}	I _o ^{Note 1} range		
			E-UTRA operating band groups ^{Note 5}	Minimum I _o	Maximum I _o
dB	dB	dB	dBm/15kHz ^{Note 4}	dBm/BW _{Channel}	
±3.5	±5.0	≥-3 dB	FDD_A, TDD_A	-121	-50
			FDD_B1, FDD_B2	-120.5	-50
			FDD_C, TDD_C	-120	-50
			FDD_D	-119.5	-50

			FDD_E, TDD_E	-119	-50
			FDD_F	-118.5	-50
			FDD_G	-118	-50
			FDD_H	-117.5	-50
			FDD_N	-114.5	-50
±4.5	±5.0	≥-6 dB	Note 3	Note 3	Note 3
<p>NOTE 1: I_0 is assumed to have constant EPRE across the bandwidth.</p> <p>NOTE 2: The parameter \hat{E}_s/I_0 is the minimum \hat{E}_s/I_0 of the pair of cells to which the requirement applies.</p> <p>NOTE 3: The same bands and the same I_0 conditions for each band apply for this requirement as for the corresponding highest accuracy requirement.</p> <p>NOTE 4: The condition level is increased by $\Delta > 0$, when applicable, as described in Sections B.4.2 and B.4.3.</p> <p>NOTE 5: E-UTRA operating band groups are as defined in Section 3.5.</p>					

9.1.6B Inter-frequency absolute RSRQ Accuracy requirements for CA Idle Mode Measurements

9.1.6B.1 Introduction

The requirements in this clause are applicable for a UE:

- in state RRC_IDLE
- that is synchronised to the cell that is measured.

The requirements are for absolute accuracy of RSRQ for overlapping and non-overlapping carriers.

9.1.6B.2 Inter-frequency Absolute RSRQ Accuracy for Overlapping Carrier

The requirements for absolute accuracy of RSRQ for an overlapping carrier when $S_{rxlev} \leq S_{nonIntraSearchP}$ or $S_{qual} \leq S_{nonIntraSearchQ}$ in this clause, apply to a cell that has different carrier frequency from the serving cell.

The accuracy requirements in Table 9.1.6B.2-1 are valid under the following conditions:

Cell specific reference signals are transmitted either from one, two or four antenna ports.

Conditions defined in TS 36.101 [5] Clause 7.3 for reference sensitivity are fulfilled.

RSRP[dBm] according to Annex B.1.2 for a corresponding Band

Table 9.1.6B.2-1: RSRQ Inter frequency absolute accuracy for overlapping carrier

Accuracy		Conditions			
Normal condition	Extreme condition	\hat{E}_s/I_0	I_0 ^{Note 1} range		
			E-UTRA operating band groups ^{Note 4}	Minimum I_0	Maximum I_0
dB	dB	dB		dBm/15kHz ^{Note 3}	dBm/BW _{Channel}
±4	±5.5	≥-3 dB	FDD_A, TDD_A	-121	-50
			FDD_B1, FDD_B2	-120.5	-50
			FDD_C, TDD_C	-120	-50
			FDD_D	-119.5	-50
			FDD_E, TDD_E	-119	-50
			FDD_F	-118.5	-50
			FDD_G	-118	-50
			FDD_H	-117.5	-50
			FDD_N	-114.5	-50
±5	±5.5	≥-6 dB	Note 2	Note 2	Note 2
<p>NOTE 1: I_0 is assumed to have constant EPRE across the bandwidth.</p> <p>NOTE 2: The same bands and the same I_0 conditions for each band apply for this requirement as for the corresponding highest accuracy requirement.</p> <p>NOTE 3: The condition level is increased by $\Delta > 0$, when applicable, as described in Sections B.4.2 and B.4.3.</p> <p>NOTE 4: E-UTRA operating band groups are as defined in Section 3.5.</p>					

9.1.6B.3 Inter-frequency absolute RSRQ Accuracy for Overlapping and Non-overlapping Carrier

The requirements for absolute accuracy of RSRQ for and overlapping carrier when $S_{rxlev} > S_{nonIntraSearchP}$ and $S_{qual} > S_{nonIntraSearchQ}$ and a non-overlapping carrier in this clause apply to a cell that has different carrier frequency from the serving cell.

The accuracy requirements in Table 9.1.6B.3-1 are valid under the following conditions:

Cell specific reference signals are transmitted either from one, two or four antenna ports.

Conditions defined in TS 36.101 [5] Clause 7.3 for reference sensitivity are fulfilled.

RSRP[dBm] according to Annex B.1.2 for a corresponding Band

Table 9.1.6B.3-1: RSRQ Inter frequency absolute accuracy for overlapping and non-overlapping carrier

Accuracy		Conditions			
Normal condition	Extreme condition	$\hat{E}s/lot$	I_o ^{Note 1} range		
			E-UTRA operating band groups ^{Note 4}	Minimum I_o	Maximum I_o
dB	dB	dB		dBm/15kHz ^{Note 3}	dBm/BW _{Channel}
±5	±6.5	≥-3 dB	FDD_A, TDD_A	-121	-50
			FDD_B1, FDD_B2	-120.5	-50
			FDD_C, TDD_C	-120	-50
			FDD_D	-119.5	-50
			FDD_E, TDD_E	-119	-50
			FDD_F	-118.5	-50
			FDD_G	-118	-50
			FDD_H	-117.5	-50
			FDD_N	-114.5	-50
±6	±6.5	≥-6 dB	Note 2	Note 2	Note 2

NOTE 1: I_o is assumed to have constant EPRE across the bandwidth.
 NOTE 2: The same bands and the same I_o conditions for each band apply for this requirement as for the corresponding highest accuracy requirement.
 NOTE 3: The condition level is increased by $\Delta > 0$, when applicable, as described in Sections B.4.2 and B.4.3.
 NOTE 4: E-UTRA operating band groups are as defined in Section 3.5.

9.1.7 RSRQ Measurement Report Mapping

The reporting range of RSRQ is defined from -34 dB to 2.5 dB with 0.5 dB resolution.

The mapping of measured quantity is defined in table 9.1.7-1. The range in the signalling may be larger than the guaranteed accuracy range.

Table 9.1.7-1: RSRQ measurement report mapping

Reported value	Measured quantity value	Unit
RSRQ_-30	$RSRQ < -34$	dB
RSRQ_-29	$-34 \leq RSRQ < -33.5$	dB
...
RSRQ_-02	$-20.5 \leq RSRQ < -20$	dB
RSRQ_-01	$-20 \leq RSRQ < -19.5$	dB
RSRQ_00	$RSRQ < -19.5$	dB
RSRQ_01	$-19.5 \leq RSRQ < -19$	dB
RSRQ_02	$-19 \leq RSRQ < -18.5$	dB
...
RSRQ_32	$-4 \leq RSRQ < -3.5$	dB
RSRQ_33	$-3.5 \leq RSRQ < -3$	dB
RSRQ_34	$-3 \leq RSRQ$	dB
RSRQ_35	$-3 \leq RSRQ < -2.5$	dB
RSRQ_36	$-2.5 \leq RSRQ < -2$	dB
...

RSRQ_45	$2 \leq \text{RSRQ} < 2.5$	dB
RSRQ_46	$2.5 \leq \text{RSRQ}$	dB

Note: The ranges from RSRQ_-30 to RSRQ_-01 and from RSRQ_35 to RSRQ_46 apply for the UE who can support extended RSRQ range in [31].

9.1.8 Power Headroom

The requirements in this clause shall apply for power headroom Type 1 and for power headroom Type 2, which are specified in clause 5.1.1.2 in [3].

For a UE not configured with a secondary cell, the power headroom provides the serving eNB with information about the differences between the UE configured maximum output power (P_{CMAX}) defined in TS 36.101 [5] and the estimated power for UL-SCH transmission of the serving cell [3]. In this case the UE shall meet requirements for power headroom Type 1.

For a UE configured with a secondary cell, the power headroom provides the serving eNB with information about the differences between the UE configured maximum output power ($P_{\text{CMAX},c}$) defined in TS 36.101[5] and the estimated power for UL-SCH transmission per activated serving cell c , or the estimated power for simultaneous PUSCH and PUCCH transmission on PCell [3]. In this case the UE shall meet requirements for both power headroom Type 1 and Type 2.

9.1.8.1 Period

The reported power headroom shall be estimated over 1 subframe or 1 slot or subslot in use by the UE for the uplink.

When *extendedPHR* is not configured [17], the Type 1 power headroom shall be estimated for the primary serving cell as defined in clause 5.1.1.2 in TS 36.213 [3].

When *extendedPHR* is configured [17], the Type 1 and Type 2 power headroom shall be estimated for each activated serving cell with configured uplink as defined in clause 5.1.1.2 in TS 36.213 [3].

9.1.8.2 Reporting Delay

The power headroom reporting delay is defined as the time between the beginning of the power headroom reference period and the time when the UE starts transmitting the power headroom over the radio interface. The reporting delay of the power headroom shall be 0 ms, which is applicable for all configured triggering mechanisms for power headroom reporting.

9.1.8.3 Void

9.1.8.4 Report Mapping

The power headroom reporting range is from -23 ...+40 dB. Table 9.1.8.4-1 defines the report mapping.

Table 9.1.8.4-1: Power headroom report mapping

Reported value	Measured quantity value (dB)
POWER_HEADROOM_0	$-23 \leq \text{PH} < -22$
POWER_HEADROOM_1	$-22 \leq \text{PH} < -21$
POWER_HEADROOM_2	$-21 \leq \text{PH} < -20$
POWER_HEADROOM_3	$-20 \leq \text{PH} < -19$
POWER_HEADROOM_4	$-19 \leq \text{PH} < -18$
POWER_HEADROOM_5	$-18 \leq \text{PH} < -17$
...	...
POWER_HEADROOM_57	$34 \leq \text{PH} < 35$
POWER_HEADROOM_58	$35 \leq \text{PH} < 36$
POWER_HEADROOM_59	$36 \leq \text{PH} < 37$
POWER_HEADROOM_60	$37 \leq \text{PH} < 38$
POWER_HEADROOM_61	$38 \leq \text{PH} < 39$
POWER_HEADROOM_62	$39 \leq \text{PH} < 40$
POWER_HEADROOM_63	$\text{PH} \geq 40$

9.1.9 UE Rx – Tx time difference

9.1.9.1 Measurement Requirement

The UE RX-TX time difference is measured from the PCell.

The accuracy requirements in Table 9.1.9.1-1 are valid under the following conditions:

Cell specific reference signals are transmitted either from one, two or four antenna ports.

Conditions defined in 36.101 Clause 7.3 for reference sensitivity are fulfilled.

No changes to the uplink transmission timing are applied during the measurement period.

RSRP_{dBm} according to Annex B.3.5 for a corresponding Band

Table 9.1.9.1-1: UE Rx – Tx time difference measurement accuracy

Accuracy	Conditions				
	Ês/lot	Downlink transmission bandwidth of PCell	I _o ^{Note 1} range		
E-UTRA operating band groups ^{Note 6}			Minimum I _o	Maximum I _o	
T _s ^{Note 2}	dB	MHz		dBm/15kHz ^{Note 5}	dBm/BW _{Channel}
±20	≥-3 dB	≥1.4 MHz	FDD_A ^{Note 7} , TDD_A	-121	-50
			FDD_B1, FDD_B2	-120.5	-50
			FDD_C, TDD_C	-120	-50
			FDD_D	-119.5	-50
			FDD_E, TDD_E	-119	-50
			FDD_F	-118.5	-50
			FDD_G ^{Note 4}	-118	-50
			FDD_H	-117.5	-50
			FDD_N	-114.5	-50
±14	≥-3 dB	≥ 3 MHz	Note 3	Note 3	Note 3
±10	≥-3 dB	≥ 5 MHz	Note 3	Note 3	Note 3
±7	≥-3 dB	≥10 MHz	Note 3	Note 3	Note 3

NOTE 1: When in dBm/15kHz, the minimum I_o condition is expressed as the average I_o per RE over all REs in that symbol. I_o may be different in different symbols within a subframe.

NOTE 2: T_s is the basic timing unit defined in TS 36.211.

NOTE 3: The same bands and the same I_o conditions for each band apply for this requirement as for the corresponding requirement with downlink bandwidth ≥1.4 MHz.

NOTE 4: Except Band 29.

NOTE 5: The condition level is increased by Δ>0, when applicable, as described in Sections B.4.2 and B.4.3.

NOTE 6: E-UTRA operating band groups are as defined in Section 3.5.

NOTE 7: Except Band 32, Band 75, Band 76.

9.1.9.2 Measurement Report mapping

The reporting range of E-UTRAN FDD UE Rx-Tx time difference is defined from 0 to 20472T_s with 2T_s resolution for UE Rx-Tx time difference less than 4096T_s and 8T_s for UE Rx-Tx time difference equal to or greater than 4096T_s.

The mapping of measured quantity is defined in Table 9.1.9.2-1.

Table 9.1.9.2-1: UE Rx-Tx time difference measurement report mapping

Reported value	Measured quantity value	Unit
RX-TX_TIME_DIFFERENCE_0000	T _{UE Rx-Tx} < 2	T _s
RX-TX_TIME_DIFFERENCE_0001	2 ≤ T _{UE Rx-Tx} < 4	T _s
RX-TX_TIME_DIFFERENCE_0002	4 ≤ T _{UE Rx-Tx} < 6	T _s
...
RX-TX_TIME_DIFFERENCE_2046	4092 ≤ T _{UE Rx-Tx} < 4094	T _s
RX-TX_TIME_DIFFERENCE_2047	4094 ≤ T _{UE Rx-Tx} < 4096	T _s
RX-TX_TIME_DIFFERENCE_2048	4096 ≤ T _{UE Rx-Tx} < 4104	T _s
RX-TX_TIME_DIFFERENCE_2049	4104 ≤ T _{UE Rx-Tx} < 4112	T _s

...
RX-TX_TIME_DIFFERENCE_4093	$20456 \leq T_{UE\ Rx-Tx} < 20464$	T_s
RX-TX_TIME_DIFFERENCE_4094	$20464 \leq T_{UE\ Rx-Tx} < 20472$	T_s
RX-TX_TIME_DIFFERENCE_4095	$20472 \leq T_{UE\ Rx-Tx}$	T_s

The reporting range of E-UTRAN TDD UE Rx-Tx time difference is defined from 624 to $21096T_s$ with $2T_s$ resolution for UE Rx-Tx time difference less than $4720T_s$ and $8T_s$ for UE Rx-Tx time difference equal to or greater than $4720T_s$.

The mapping of measured quantity is defined in Table 9.1.9.2-2.

Table 9.1.9.2-2: EUTRAN TDD UE Rx-Tx time difference measurement report mapping

Reported value	Measured quantity value	Unit
RX-TX_TIME_DIFFERENCE_TDD_0000	$T_{UE\ Rx-Tx} < 626$	T_s
RX-TX_TIME_DIFFERENCE_TDD_0001	$626 \leq T_{UE\ Rx-Tx} < 628$	T_s
RX-TX_TIME_DIFFERENCE_TDD_0002	$628 \leq T_{UE\ Rx-Tx} < 630$	T_s
...
RX-TX_TIME_DIFFERENCE_TDD_2046	$4716 \leq T_{UE\ Rx-Tx} < 4718$	T_s
RX-TX_TIME_DIFFERENCE_TDD_2047	$4718 \leq T_{UE\ Rx-Tx} < 4720$	T_s
RX-TX_TIME_DIFFERENCE_TDD_2048	$4720 \leq T_{UE\ Rx-Tx} < 4728$	T_s
RX-TX_TIME_DIFFERENCE_TDD_2049	$4728 \leq T_{UE\ Rx-Tx} < 4736$	T_s
...
RX-TX_TIME_DIFFERENCE_TDD_4093	$21080 \leq T_{UE\ Rx-Tx} < 21088$	T_s
RX-TX_TIME_DIFFERENCE_TDD_4094	$21088 \leq T_{UE\ Rx-Tx} < 21096$	T_s
RX-TX_TIME_DIFFERENCE_TDD_4095	$21096 \leq T_{UE\ Rx-Tx}$	T_s

9.1.9.3 Measurement Requirement under Time Domain Measurement Resource Restriction

The requirements in this section apply for UE configured with a time-domain measurement resource restriction pattern for PCell measurements. The UE Rx-Tx time difference is measured from the Pcell.

The accuracy requirements in Table 9.1.9.3-1 are valid under the following conditions:

- Cell specific reference signals are transmitted either from one, two or four antenna ports,
- Conditions defined in 36.101 Clause 7.3 for reference sensitivity are fulfilled,
- No changes to the uplink transmission timing are applied during the measurement period,

RSRP_{dBm} according to Annex B.3.5 for a corresponding Band,

- The time domain measurement resource restriction pattern configured for the PCell indicates at least one subframe per radio frame for performing the PCell measurements [2],
- Four symbols containing CRS are available in all subframes indicated by the time domain measurement resource restriction pattern.

Table 9.1.9.3-1: UE Rx–Tx time difference measurement accuracy under time domain measurement resource restriction

Accuracy	Conditions				
	Ês/lot ^{Note 6}	Downlink transmission bandwidth of PCell	I _o ^{Note 1, 5} range		
			E-UTRA operating band groups ^{Note 8}	Minimum I _o	Maximum I _o
T _s ^{Note 2}	dB	MHz		dBm/15kHz ^{Note 7}	dBm/BW _{Channel}
±20	≥-3 dB	≤ 3 MHz	FDD_A ^{Note 9} , TDD_A	-121	-50
			FDD_B1, FDD_B2	-120.5	-50
			FDD_C, TDD_C	-120	-50
			FDD_D	-119.5	-50
			FDD_E, TDD_E	-119	-50
			FDD_F	-118.5	-50

			FDD_G ^{Note 4}	-118	-50
			FDD_H	-117.5	-50
			FDD_N	-114.5	-50
±10	≥-3 dB	≥ 5 MHz	Note 3	Note 3	Note 3
<p>NOTE 1: When in dBm/15kHz, the minimum I_o condition is expressed as the average I_o per RE over all REs in that symbol. I_o may be different in different symbols within a subframe.</p> <p>NOTE 2: T_s is the basic timing unit defined in TS 36.211.</p> <p>NOTE 3: The same bands and the same I_o conditions for each band apply for this requirement as for the corresponding requirement with downlink bandwidth ≤ 3 MHz.</p> <p>NOTE 4: Except Band 29.</p> <p>NOTE 5: I_o is defined for the subframes indicated by the time-domain measurement resource restriction pattern for serving cell measurements. The specified I_o range applies to CRS and non-CRS symbols. I_o may be different in different symbols within a subframe.</p> <p>NOTE 6: CRS \hat{E}_s/I_{ot} is in subframes indicated for PCell measurements by the time-domain measurement resource restriction pattern.</p> <p>NOTE 7: The condition level is increased by $\Delta > 0$, when applicable, as described in Sections B.4.2 and B.4.3.</p> <p>NOTE 8: E-UTRA operating band groups are as defined in Section 3.5.</p> <p>NOTE 9: Except Band 32, Band 75, Band 76.</p>					

NOTE: It is up to the UE implementation whether the UE Rx-Tx time difference measurement is performed in any subframe or in subframes indicated by the time-domain measurement resource restriction pattern.

9.1.9.4 Measurement Requirement when Time Domain Measurement Resource Restriction Pattern is Configured with CRS Assistance Information

The UE Rx-Tx time difference measurement is performed for the PCell.

For UE configured with a time-domain measurement resource restriction pattern for PCell measurements, the accuracy requirements in Table 9.1.9.4-1 apply provided that the following conditions are met for the PCell:

- PCell cell specific reference signals are transmitted from one, two or four antenna ports,
- Conditions defined in 36.101 Section 7.3 for reference sensitivity are fulfilled,
- No changes to the uplink transmission timing are applied during the measurement period,
- $RSRP_{dBm}$ according to Annex B.3.13 for a corresponding Band,
- The time domain measurement resource restriction pattern configured for the measured cell indicates at least one subframe per radio frame for performing the RSRP measurement,
- Four symbols containing CRS are available in all subframes indicated by the time domain measurement resource restriction pattern, and
- The UE is provided via PCell with the CRS assistance information (TS 36.331 [2]) and the CRS assistance information is valid throughout the entire evaluation period.

The requirements in this section shall also be met when the number of transmit antenna ports [16] of one or more cells whose CRS assistance information is provided [2] is different from the number of transmit antenna ports of the measured cell.

When the CRS assistance information is provided, the transmission bandwidth [30] in all intra-frequency cells in the CRS assistance information [2] is the same or larger than the transmission bandwidth of the PCell for which measurement is performed.

Table 9.1.9.4-1: UE Rx–Tx time difference measurement accuracy

Accuracy	Conditions				
	CRS \hat{E}_s/I_{ot} ^{Note 6}	Downlink transmission bandwidth of PCell	I_o range ^{Note 5}		
			E-UTRA operating band groups ^{Note 8}	Minimum I_o ^{Note 1, 7}	Maximum I_o
T_s ^{Note 2}	dB	MHz		dBm/15kHz ^{Note 7}	dBm/BW _{Channel}
±20	≥-7.76	≤ 3 MHz	FDD_A ^{Note 9} , TDD_A	-121	-50
			FDD_B1, FDD_B2	-120.5	-50

			FDD_C, TDD_C	-120	-50
			FDD_D	-119.5	-50
			FDD_E, TDD_E	-119	-50
			FDD_F	-118.5	-50
			FDD_G ^{Note 4}	-118	-50
			FDD_H	-117.5	-50
			FDD_N	-114.5	-50
±10	≥-7.76	≥ 5 MHz	Note 3	Note 3	Note 3
<p>NOTE 1: This l_o condition is expressed as the average l_o per RE over all REs in an OFDM symbol.</p> <p>NOTE 2: T_s is the basic timing unit defined in TS 36.211.</p> <p>NOTE 3: The same bands and the same l_o conditions for each band apply for this requirement as for the corresponding requirement with downlink bandwidth ≤ 3 MHz.</p> <p>NOTE 4: Except Band 29.</p> <p>NOTE 5: l_o is defined in subframes indicated for PCell measurements by the time domain measurement resource restriction pattern. The specified l_o range applies to CRS and non-CRS symbols. l_o may be different in different symbols within a subframe.</p> <p>NOTE 6: CRS \hat{E}_s/l_o is in subframes indicated for PCell measurements by the time-domain measurement resource restriction pattern.</p> <p>NOTE 7: The condition level is increased by $\Delta > 0$, when applicable, as described in Sections B.4.2 and B.4.3.</p> <p>NOTE 8: E-UTRA operating band groups are as defined in Section 3.5.</p> <p>NOTE 9: Except Band 32, Band 75, Band 76.</p>					

NOTE: It is up to the UE implementation whether the UE Rx-Tx time difference measurement is performed in any subframe or in subframes indicated by the time-domain measurement resource restriction pattern.

9.1.10 Reference Signal Time Difference (RSTD)

NOTE: This measurement is used for UE positioning purposes.

9.1.10.1 Intra-Frequency Accuracy Requirement

The accuracy requirements in Table 9.1.10.1-1 are valid under the following conditions:

Conditions defined in 36.101 Clause 7.3 for reference sensitivity are fulfilled.

PRP $1,2_{dBm}$ according to Annex B.3.6 for a corresponding Band

There are no measurement gaps overlapping with the PRS subframes of the measured serving cell.

The parameter expectedRSTDUncertainty signalled over LPP by E-SMLC as defined in TS 36.355 [24] is less than 5 μs .

If using CRS, in addition to PRS, is enabled in the OTDOA assistance data, the CRS measurement bandwidth is not smaller than the minimum PRS bandwidth.

Table 9.1.10.1-1: RSTD measurement accuracy

Accuracy	Conditions					
	PRS \hat{E}_s/l_o	Minimum PRS bandwidth, which is minimum of serving cell channel bandwidth and the PRS bandwidths of the reference cell and the measured neighbour cell i ^{Note 5}	Minimum number of available measurement subframes among the reference cell and the measured neighbour cell i	l_o ^{Note 7} range		
				E-UTRA operating band groups ^{Note 8}	Minimum l_o ^{Note 1}	Maximum l_o

T_s ^{Note 2}	dB	RB			dBm/15kHz ^{Note 6}	dBm/BW _{Channel} _i
±15	(PRS \hat{E}_s/I_{ot}) _{ref} ≥ -6dB and (PRS \hat{E}_s/I_{ot}) _i ≥ -13dB	≥ 6	6	FDD_A, TDD_A	-121	-50
				FDD_B1, FDD_B2	-120.5	-50
				FDD_C, TDD_C	-120	-50
				FDD_D	-119.5	-50
				FDD_E, TDD_E	-119	-50
				FDD_F	-118.5	-50
				FDD_G	-118	-50
				FDD_H	-117.5	-50
				FDD_N	-114.5	-50
±10	(PRS \hat{E}_s/I_{ot}) _{ref} ≥ -6dB and (PRS \hat{E}_s/I_{ot}) _i ≥ -13dB	≥ 15	6	Note 4	Note 4	Note 4
±6	(PRS \hat{E}_s/I_{ot}) _{ref} ≥ -6dB and (PRS \hat{E}_s/I_{ot}) _i ≥ -13dB	≥ 25	≥ 2	Note 4	Note 4	Note 4
±5	(PRS \hat{E}_s/I_{ot}) _{ref} ≥ -6dB and (PRS \hat{E}_s/I_{ot}) _i ≥ -13dB	≥ 50	≥ 1	Note 4	Note 4	Note 4
±4	(PRS \hat{E}_s/I_{ot}) _{ref} ≥ -6dB and (PRS \hat{E}_s/I_{ot}) _i ≥ -13dB	≥ 75	≥ 1	Note 4	Note 4	Note 4

NOTE 1: This minimum I_{ot} condition is expressed as the average I_{ot} per RE over all REs in an OFDM symbol.
 NOTE 2: T_s is the basic timing unit defined in TS 36.211 [16].
 NOTE 3: PRS bandwidth is as indicated in *prs-Bandwidth* in the OTDOA assistance data defined in [24].
 NOTE 4: The same bands and the same I_{ot} conditions for each band apply for this requirement as for the corresponding requirement with the PRS bandwidth ≥ 6 RB.
 NOTE 5: The serving cell, the reference cell, and the measured neighbour cell i are on the same carrier frequency.
 NOTE 6: The condition level is increased by $\Delta > 0$, when applicable, as described in Sections B.4.2 and B.4.3.
 NOTE 7: The I_{ot} is defined in PRS positioning subframes. The same I_{ot} range applies to PRS and non-PRS symbols. I_{ot} levels are different in PRS and non-PRS symbols within the same subframe.
 NOTE 8: E-UTRA operating band groups are as defined in Section 3.5.

9.1.10.2 Inter-Frequency Accuracy Requirement

The accuracy requirements in Table 9.1.10.2-1 are valid under the following conditions:

Conditions defined in 36.101 Clause 7.3 for reference sensitivity are fulfilled.

PRP $1,2_{dBm}$ according to Annex B.3.7 for a corresponding Band

There are no measurement gaps overlapping with the PRS subframes in cells belonging to the serving carrier frequency.

The parameter expected RSTD Uncertainty signalled over LPP by E-SMLC as defined in TS 36.355 [24] is less than 5 μs .

If using CRS, in addition to PRS, is enabled in the OTDOA assistance data, the CRS measurement bandwidth is not smaller than the minimum PRS bandwidth.

Table 9.1.10.2-1: RSTD measurement accuracy

Accuracy	Conditions					
	PRS \hat{E}_s/I_{ot}	Minimum PRS bandwidth which is minimum of serving cell channel bandwidth ^{Note}	Minimum number of available measurement subframes among the reference cell and the	I_{ot} ^{Note 6} range		
				E-UTRA operating band groups ^{Note 8}	Minimum I_{ot} ^{Note 1}	Maximum I_{ot}

T_s ^{Note 2}	dB	⁷ and the PRS bandwidths of the reference cell and the measured neighbour cell i	measured neighbour cell i		dBm/15kHz ^{Note 5}	dBm/BW _{Chan} nel
± 21	$(PRS \hat{E}_s/lot)_{ref} \geq -6\text{dB}$ and $(PRS \hat{E}_s/lot)_i \geq -13\text{dB}$	≥ 6	⁴ NOTE 9	FDD_A, TDD_A	-121	-50
				FDD_B1, FDD_B2	-120.5	-50
				FDD_C, TDD_C	-120	-50
				FDD_D	-119.5	-50
				FDD_E, TDD_E	-119	-50
				FDD_F	-118.5	-50
				FDD_G	-118	-50
				FDD_H	-117.5	-50
				FDD_N	-114.5	-50
± 16	$(PRS \hat{E}_s/lot)_{ref} \geq -6\text{dB}$ and $(PRS \hat{E}_s/lot)_i \geq -13\text{dB}$	≥ 15	⁴ NOTE 9	Note 4	Note 4	Note 4
± 10	$(PRS \hat{E}_s/lot)_{ref} \geq -6\text{dB}$ and $(PRS \hat{E}_s/lot)_i \geq -13\text{dB}$	≥ 25	≥ 2 ^{NOTE 9}	Note 4	Note 4	Note 4
± 9	$(PRS \hat{E}_s/lot)_{ref} \geq -6\text{dB}$ and $(PRS \hat{E}_s/lot)_i \geq -13\text{dB}$	≥ 50	≥ 1	Note 4	Note 4	Note 4
± 8	$(PRS \hat{E}_s/lot)_{ref} \geq -6\text{dB}$ and $(PRS \hat{E}_s/lot)_i \geq -13\text{dB}$	≥ 75	≥ 1	Note 4	Note 4	Note 4

NOTE 1: This minimum I_0 condition is expressed as the average I_0 per RE over all REs in an OFDM symbol.
 NOTE 2: T_s is the basic timing unit defined in TS 36.211 [16].
 NOTE 3: PRS bandwidth is as indicated in *prs-Bandwidth* in the OTDOA assistance data defined in [24].
 NOTE 4: The same bands and the same I_0 conditions for each band apply for this requirement as for the corresponding requirement with the PRS bandwidth ≥ 6 RB.
 NOTE 5: The condition level is increased by $\Delta > 0$, when applicable, as described in Sections B.4.2 and B.4.3.
 NOTE 6: The I_0 is defined in PRS positioning subframes. The same I_0 range applies to PRS and non-PRS symbols. I_0 levels are different in PRS and non-PRS symbols within the same subframe.
 NOTE 7: If a CA capable UE is configured with one or two SCell(s), the serving cell channel bandwidth is the minimum of the serving cell channel bandwidths in the component carriers involved in the RSTD measurement. If any of the serving cells is not involved in this RSTD measurement for CA, the channel bandwidth of that serving cell is not included in the determination of the minimum PRS bandwidth.
 NOTE 8: E-UTRA operating band groups are as defined in Section 3.5.
 NOTE 9: Requirement is not applicable if gap pattern with ID=2 or ID=3 is in use.

9.1.10.3 RSTD Measurement Report Mapping

The reporting range of RSTD is defined from $-15391T_s$ to $15391T_s$ with $1T_s$ resolution for absolute value of RSTD less or equal to $4096T_s$ and $5T_s$ for absolute value of RSTD greater than $4096T_s$.

The mapping of measured quantity is defined in Table 9.1.10.3-1.

Table 9.1.10.3-1: RSTD report mapping

Reported Value	Measured Quantity Value	Unit
RSTD_0000	$-15391 > \text{RSTD}$	T_s
RSTD_0001	$-15391 \leq \text{RSTD} < -15386$	T_s
...
RSTD_2258	$-4106 \leq \text{RSTD} < -4101$	T_s
RSTD_2259	$-4101 \leq \text{RSTD} < -4096$	T_s
RSTD_2260	$-4096 \leq \text{RSTD} < -4095$	T_s
RSTD_2261	$-4095 \leq \text{RSTD} < -4094$	T_s
...
RSTD_6353	$-3 \leq \text{RSTD} < -2$	T_s

RSTD_6354	$-2 \leq \text{RSTD} < -1$	T_s
RSTD_6355	$-1 \leq \text{RSTD} \leq 0$	T_s
RSTD_6356	$0 < \text{RSTD} \leq 1$	T_s
RSTD_6357	$1 < \text{RSTD} \leq 2$	T_s
RSTD_6358	$2 < \text{RSTD} \leq 3$	T_s
...
RSTD_10450	$4094 < \text{RSTD} \leq 4095$	T_s
RSTD_10451	$4095 < \text{RSTD} \leq 4096$	T_s
RSTD_10452	$4096 < \text{RSTD} \leq 4101$	T_s
RSTD_10453	$4101 < \text{RSTD} \leq 4106$	T_s
...
RSTD_12709	$15381 < \text{RSTD} \leq 15386$	T_s
RSTD_12710	$15386 < \text{RSTD} \leq 15391$	T_s
RSTD_12711	$15391 < \text{RSTD}$	T_s

9.1.10.4 Higher-Resolution RSTD Measurement Report Mapping

The reporting range of higher-resolution RSTD is defined from $-15391 T_s$ to $15391 T_s$ with $0.5 T_s$ resolution.

The UE shall report a reference quantity based on Table 9.1.10.3-1 and a relative quantity Δ_{RSTL} defined in Table 9.1.10.4-1, so that the difference between the measured RSTD quantity and the lower bound of the corresponding range from Table 9.1.10.3-1 is between Δ_{RSTL} and $\Delta_{RSTL} + \text{resolutionStep}$.

RSTD_delta_0 or RSTD_delta_1 specified in Table 9.1.10.4-1 can be reported together with any value from Table 9.1.10.3-1 in the range from RSTD_2260 to RSTD_10451. In this case, *resolutionStep* is 0.5.

Any relative quantity value from Table 9.1.10.4-1, except RSTD_delta_1, can be reported together with any value from Table 9.1.10.3-1 in the range from RSTD_0000 to RSTD_2259 or in the range from RSTD_10452 to RSTD_12711. In this case, *resolutionStep* is 1.0.

Table 9.1.10.4-1: Relative quantity mapping for higher-resolution RSTD measurement reporting

Reported Relative Quantity Value	Measured Relative Quantity Value, Δ_{RSTL}	Unit
RSTD_delta_0	0	T_s
RSTD_delta_1	0.5	T_s
RSTD_delta_2	1.0	T_s
RSTD_delta_3	2.0	T_s
RSTD_delta_4	3.0	T_s
RSTD_delta_5	4.0	T_s

9.1.10.5 Intra-Frequency Accuracy Requirement for UE Category 1bis

The accuracy requirements in Table 9.1.10.5-1 are valid under the following conditions:

Conditions defined in 36.101 Clause 7.3 for reference sensitivity are fulfilled.

PRP $1,2_{\text{dBm}}$ according to Annex B.3.6 for a corresponding Band

There are no measurement gaps overlapping with the PRS subframes of the measured serving cell.

The parameter expectedRSTDUncertainty signalled over LPP by E-SMLC as defined in TS 36.355 [24] is less than $5 \mu\text{s}$.

Table 9.1.10.5-1: RSTD measurement accuracy

Accuracy	Conditions					
	PRS $\hat{\epsilon}_s/\text{lot}$	Minimum PRS bandwidth, which is minimum of	Minimum number of available measurement subframes	Io ^{Note 7} range		
				E-UTRA operating band groups ^{Note 8}	Minimum Io ^{Note 1}	Maximum Io

		serving cell channel bandwidth and the PRS bandwidths of the reference cell and the measured neighbour cell <i>i</i> ^{Note 5}	among the reference cell and the measured neighbour cell <i>i</i>			
T_s ^{Note 2}	dB	RB			dBm/15kHz ^{Note 6}	dBm/BW _{Channel} _{<i>i</i>}
±15	(PRS \hat{E}_s/lot) _{ref} ≥ -6dB and (PRS \hat{E}_s/lot) _{<i>i</i>} ≥ -13dB	≥ 6	6	FDD_A, TDD_A	-121	-50
				FDD_B1	-120.5	-50
				FDD_C, TDD_C	-120	-50
				FDD_D	-119.5	-50
				FDD_E, TDD_E	-119	-50
				FDD_F	-118.5	-50
				FDD_G	-118	-50
				FDD_H	-117.5	-50
FDD_N	-114.5	-50				
±10	(PRS \hat{E}_s/lot) _{ref} ≥ -6dB and (PRS \hat{E}_s/lot) _{<i>i</i>} ≥ -13dB	≥ 15	6	Note 4	Note 4	Note 4
±6	(PRS \hat{E}_s/lot) _{ref} ≥ -6dB and (PRS \hat{E}_s/lot) _{<i>i</i>} ≥ -13dB	≥ 25	≥ 2	Note 4	Note 4	Note 4
±5	(PRS \hat{E}_s/lot) _{ref} ≥ -6dB and (PRS \hat{E}_s/lot) _{<i>i</i>} ≥ -13dB	≥ 50	≥ 1	Note 4	Note 4	Note 4
±4	(PRS \hat{E}_s/lot) _{ref} ≥ -6dB and (PRS \hat{E}_s/lot) _{<i>i</i>} ≥ -13dB	≥ 75	≥ 1	Note 4	Note 4	Note 4

NOTE 1: This minimum I_0 condition is expressed as the average I_0 per RE over all REs in an OFDM symbol.
 NOTE 2: T_s is the basic timing unit defined in TS 36.211 [16].
 NOTE 3: PRS bandwidth is as indicated in *prs-Bandwidth* in the OTDOA assistance data defined in [24].
 NOTE 4: The same bands and the same I_0 conditions for each band apply for this requirement as for the corresponding requirement with the PRS bandwidth ≥ 6 RB.
 NOTE 5: The serving cell, the reference cell, and the measured neighbour cell *i* are on the same carrier frequency.
 NOTE 6: The I_0 is defined in PRS positioning subframes. The same I_0 range applies to PRS and non-PRS symbols. I_0 levels are different in PRS and non-PRS symbols within the same subframe.
 NOTE 7: E-UTRA operating band groups are as defined in Section 3.5.

9.1.10.6 Inter-Frequency Accuracy Requirement for UE Category 1bis

The accuracy requirements in Table 9.1.10.6-1 are valid under the following conditions:

Conditions defined in 36.101 Clause 7.3 for reference sensitivity are fulfilled.

PRP 1,2_{dBm} according to Annex B.3.7 for a corresponding Band

There are no measurement gaps overlapping with the PRS subframes in cells belonging to the serving carrier frequency.

The parameter expectedRSTDUncertainty signalled over LPP by E-SMLC as defined in TS 36.355 [24] is less than 5 μs.

Table 9.1.10.6-1: RSTD measurement accuracy

Accuracy	Conditions
----------	------------

	PRS \hat{E}_s/lot	Minimum PRS bandwidth which is minimum of serving cell channel bandwidth ^{Note 7} and the PRS bandwidths of the reference cell and the measured neighbour cell i	Minimum number of available measurement subframes among the reference cell and the neighbour cell i	Io ^{Note 6} range		
				E-UTRA operating band groups ^{Note 8}	Minimum Io ^{Note 1}	Maximum Io
Ts ^{Note 2}	dB	RB		dBm/15kHz ^{Note 5}	dBm/BW _{Chan} ^{nel}	
±21	(PRS \hat{E}_s/lot) _{ref} ≥ -6dB and (PRS \hat{E}_s/lot) _i ≥ -13dB	≥ 6	4	FDD_A, TDD_A	-121	-50
				FDD_B1	-120.5	-50
				FDD_C, TDD_C	-120	-50
				FDD_D	-119.5	-50
				FDD_E, TDD_E	-119	-50
				FDD_F	-118.5	-50
				FDD_G	-118	-50
				FDD_H	-117.5	-50
			FDD_N	-114.5	-50	
±16	(PRS \hat{E}_s/lot) _{ref} ≥ -6dB and (PRS \hat{E}_s/lot) _i ≥ -13dB	≥ 15	4	Note 4	Note 4	Note 4
±10	(PRS \hat{E}_s/lot) _{ref} ≥ -6dB and (PRS \hat{E}_s/lot) _i ≥ -13dB	≥ 25	≥ 2	Note 4	Note 4	Note 4
±9	(PRS \hat{E}_s/lot) _{ref} ≥ -6dB and (PRS \hat{E}_s/lot) _i ≥ -13dB	≥ 50	≥ 1	Note 4	Note 4	Note 4
±8	(PRS \hat{E}_s/lot) _{ref} ≥ -6dB and (PRS \hat{E}_s/lot) _i ≥ -13dB	≥ 75	≥ 1	Note 4	Note 4	Note 4

NOTE 1: This minimum Io condition is expressed as the average Io per RE over all REs in an OFDM symbol.
 NOTE 2: Ts is the basic timing unit defined in TS 36.211 [16].
 NOTE 3: PRS bandwidth is as indicated in *prs-Bandwidth* in the OTDOA assistance data defined in [24].
 NOTE 4: The same bands and the same Io conditions for each band apply for this requirement as for the corresponding requirement with the PRS bandwidth ≥ 6 RB.
 NOTE 5: The Io is defined in PRS positioning subframes. The same Io range applies to PRS and non-PRS symbols. Io levels are different in PRS and non-PRS symbols within the same subframe.
 NOTE 6: E-UTRA operating band groups are as defined in Section 3.5.

9.1.11 Carrier aggregation measurement accuracy

This clause contains requirements on UE capabilities for support of E-UTRA FDD, TDD and TDD-FDD carrier aggregation. Requirements in this clause are applicable to all carrier aggregation capable UEs which have been configured with up to six downlink SCell(s). Note: This clause covers measurement accuracy requirements for frequencies corresponding to those used for the PCell and SCell(s); measurements of any other frequency are considered to be inter-frequency measurements covered by the accuracy requirements in clause 9.1.3 for inter-frequency RSRP, clause 9.1.6 for inter-frequency RSRQ, and clause 9.1.17.3 for inter-frequency RS-SINR.

The requirements in this clause apply for bandwidths defined in the bandwidth combination set for the CA configurations supported by the UE [5].

9.1.11.1 Primary component carrier accuracy requirement

RSRP measurements of cells on the primary component carrier shall meet the intra-frequency absolute accuracy requirements in section 9.1.2.1.

RSRQ measurements of cells on the primary component carrier shall meet the intra-frequency absolute accuracy requirements in section 9.1.5.1.

RS-SINR measurements of cells on the primary component carrier shall meet the intra-frequency absolute accuracy requirements in section 9.1.17.2.1.

Comparisons between RSRP of cells on the primary component carrier shall also meet the intra-frequency relative accuracy requirements in sections 9.1.2.2.

9.1.11.2 Secondary component carrier accuracy requirement

RSRP measurements of cells on any of the secondary component carrier(s) shall meet the intra-frequency absolute accuracy requirements in section 9.1.2.1.

RSRQ measurements of cells on any of the secondary component carrier(s) shall meet the intra-frequency absolute accuracy requirements in section 9.1.5.1.

RS-SINR measurements of cells on any of the secondary component carrier(s) shall meet the intra-frequency absolute accuracy requirements in section 9.1.17.2.1.

Comparisons between RSRP of cells on the same secondary component carrier shall meet the intra-frequency relative accuracy requirements in sections 9.1.2.2

9.1.11.3 Primary and secondary component carrier relative accuracy requirement

When measurements of cells on the primary component carrier are compared with measurements of cells on any of the secondary component carrier(s), the applicable relative accuracy requirements are:

RSRP inter-frequency accuracy requirements in section 9.1.3.2,

RSRQ inter-frequency accuracy requirements in section 9.1.6.2,

RS-SINR inter-frequency accuracy requirements in section 9.1.17.3.2.

9.1.11.4 Secondary component carrier relative accuracy requirement

When measurements of cells on any of the secondary component carrier(s) are compared with measurements of cells on the other secondary component carrier, the applicable relative accuracy requirements are:

RSRP inter-frequency accuracy requirements in section 9.1.3.2,

RSRQ inter-frequency accuracy requirements in section 9.1.6.2,

RS-SINR inter-frequency accuracy requirements in section 9.1.17.3.2.

9.1.12 Reference Signal Time Difference (RSTD) Measurement Accuracy Requirements for Carrier Aggregation

This clause contains requirements for E-UTRA FDD, TDD and TDD-FDD carrier aggregation. This clause contains RSTD measurement accuracy requirements for a UE configured with one or two downlink SCell(s). The UE may operate in one of the E-UTRA carrier aggregations listed in clause 8.3.1. The requirements in this clause shall apply regardless whether the configured downlink secondary cell is activated or deactivated by the MAC-CE command [17]. The requirements apply for bandwidths defined in the bandwidth combination set for the CA configurations supported by the UE [5].

The RSTD measurements, which are obtained when both the reference cell and neighbouring cell belong to the primary component carrier, shall meet the intra-frequency RSTD accuracy requirements defined in clause 9.1.10.1.

The RSTD measurements, which are obtained when both the reference cell and neighbouring cell belong to the same secondary component carrier, shall meet the intra-frequency RSTD accuracy requirements defined in clause 9.1.10.1.

The RSTD measurements, which are obtained when the reference cell and neighbouring cell do not belong to the same carrier, shall meet the inter-frequency RSTD accuracy requirements defined in clause 9.1.10.2.

9.1.13 Measurement accuracy for UE category 0

9.1.13.1 Intra-frequency Absolute RSRP Accuracy for UE category 0

The requirements for absolute accuracy of RSRP in this clause apply to a cell on the same frequency as that of the serving cell for UE category 0.

The accuracy requirements in Table 9.1.13.1-1 are valid under the following conditions:

Cell specific reference signals are transmitted either from one, two or four antenna ports.

Conditions defined in 36.101 Clause 7.3 for reference sensitivity are fulfilled.

RSRP_{dBm} according to Annex B.3.27 for a corresponding Band

At least 1 DL subframe per radio frame of measured cell is available at the UE for RSRP measurement assuming measured cell is identified cell.

Table 9.1.13.1-1: RSRP Intra frequency absolute accuracy for UE category 0

Accuracy		Conditions				
Normal condition	Extreme condition	Ês/lot	I _o ^{Note 1} range			
			E-UTRA operating band groups ^{Note 3}	Minimum I _o		Maximum I _o
dB	dB	dB		dBm/15kHz ^{Note 2}	dBm/BW _{Channel}	dBm/BW _{Channel}
±7	±10	≥-6 dB	FDD-0_A, TDD-0_A	-121	N/A	-70
			FDD-0_B	-120.5	N/A	-70
			FDD-0_C, TDD-0_C	-120	N/A	-70
			FDD-0_D	-119.5	N/A	-70
			FDD-0_E, TDD-0_E	-119	N/A	-70
			FDD-0_F	-118.5	N/A	-70
			FDD-0_G	-118	N/A	-70
			FDD-0_H	-117.5	N/A	-70
			FDD-0_N	-114.5	N/A	-70
±9	±12	≥-6 dB	FDD-0_A, TDD-0_A, FDD-0_B, FDD-0_C, TDD-0_C, FDD-0_D, FDD-0_E, TDD-0_E, FDD-0_F, FDD-0_G, FDD-0_H, FDD-0_N	N/A	-70	-50

NOTE 1: I_o is assumed to have constant EPRE across the bandwidth.
NOTE 2: The condition level is increased by Δ>0, when applicable, as described in Sections B.4.2 and B.4.3.
NOTE 3: E-UTRA operating band groups are as defined in Section 3.5.

9.1.13.2 Intra-frequency Relative Accuracy of RSRP for UE category 0

The relative accuracy of RSRP is defined as the RSRP measured from one cell compared to the RSRP measured from another cell on the same frequency for category 0 UE.

The accuracy requirements in Table 9.1.13.2-1 are valid under the following conditions:

Cell specific reference signals are transmitted either from one, two or four antenna ports.

Conditions defined in 36.101 Clause 7.3 for reference sensitivity are fulfilled.

RSRP_{1,2}_{dBm} according to Annex B.3.28 for a corresponding Band.

At least 1 DL subframe per radio frame of measured cell is available at the UE for RSRP measurement assuming measured cell is identified cell.

Table 9.1.13.2-1: RSRP Intra frequency relative accuracy for UE category 0

Accuracy		Conditions		
Normal condition	Extreme condition	Ês/lot ^{Note 2}	I _o ^{Note 1} range	
			E-UTRA operating band groups ^{Note 5}	Minimum I _o

dB	dB	dB		dBm/15kHz ^{Note 4}	dBm/BW _{Channel}
±3	±4	≥-3 dB	FDD-0_A, TDD-0_A	-121	-50
			FDD-0_B	-120.5	-50
			FDD-0_C, TDD-0_C	-120	-50
			FDD-0_D	-119.5	-50
			FDD-0_E, TDD-0_E	-119	-50
			FDD-0_F	-118.5	-50
			FDD-0_G	-118	-50
			FDD-0_H	-117.5	-50
			FDD-0_N	-114.5	-50
±4	±4	≥-6 dB	Note 3	Note 3	Note 3

NOTE 1: I_0 is assumed to have constant EPRE across the bandwidth.
 NOTE 2: The parameter \hat{E}_s/I_0 is the minimum \hat{E}_s/I_0 of the pair of cells to which the requirement applies.
 NOTE 3: The same bands and the same I_0 conditions for each band apply for this requirement as for the corresponding highest accuracy requirement.
 NOTE 4: The condition level is increased by $\Delta > 0$, when applicable, as described in Sections B.4.2 and B.4.3.
 NOTE 5: E-UTRA operating band groups are as defined in Section 3.5.

9.1.13.3 Intra-frequency Absolute RSRQ Accuracy for UE category 0

The requirements for absolute accuracy of RSRQ in this clause apply to a cell on the same frequency as that of the serving cell for category 0 UE.

The accuracy requirements in Table 9.1.13.3-1 are valid under the following conditions:

Cell specific reference signals are transmitted either from one, two or four antenna ports.

Conditions defined in 36.101 Clause 7.3 for reference sensitivity are fulfilled.

RSRP[dBm] according to Annex B.3.27 for a corresponding Band

At least 1 DL subframe per radio frame of measured cell is available at the UE for RSRQ measurement assuming measured cell is identified cell.

Table 9.1.13.3-1: RSRQ Intra frequency absolute accuracy for UE category 0

Accuracy		Conditions			
Normal condition	Extreme condition	\hat{E}_s/I_0	I_0 ^{Note 1} range		
			E-UTRA operating band groups ^{Note 4}	Minimum I_0	Maximum I_0
dB	dB	dB	dBm/15kHz ^{Note 3}	dBm/BW _{Channel}	
±3.5	±5	≥-3 dB	FDD-0_A, TDD-0_A	-121	-50
			FDD-0_B	-120.5	-50
			FDD-0_C, TDD-0_C	-120	-50
			FDD-0_D	-119.5	-50
			FDD-0_E, TDD-0_E	-119	-50
			FDD-0_F	-118.5	-50
			FDD-0_G	-118	-50
			FDD-0_H	-117.5	-50
			FDD-0_N	-114.5	-50
±4.5	±5	≥-6 dB	Note 2	Note 2	Note 2

NOTE 1: I_0 is assumed to have constant EPRE across the bandwidth.
 NOTE 2: The same bands and the same I_0 conditions for each band apply for this requirement as for the corresponding highest accuracy requirement.
 NOTE 3: The condition level is increased by $\Delta > 0$, when applicable, as described in Sections B.4.2 and B.4.3.
 NOTE 4: E-UTRA operating band groups are as defined in Section 3.5.

9.1.14 Accuracy requirements for Discovery Signal Measurements

9.1.14.1 Introduction

Discovery signal measurements are performed when higher layers indicate measurements based on discovery signals according to DMTC configuration [2]. The discovery measurement accuracy requirements are defined for the following physical layer measurements performed in discovery signal occasions [16],

RSRP measured in subframes of the configured discovery signal occasions as specified in [4],

CSI-RSRP measurements specified in [4],

RSRQ measured in subframes of the configured discovery signal occasions as specified in [4].

9.1.14.2 RSRP measurements in discovery signal occasions

Intra-frequency absolute RSRP measurement accuracy requirements in discovery signal occasions are the same as specified in Section 9.1.2.1.

Intra-frequency relative RSRP measurement accuracy requirements in discovery signal occasions are the same as specified in Section 9.1.2.2.

Inter-frequency absolute RSRP measurement accuracy requirements in discovery signal occasions are the same as specified in Section 9.1.3.1.

Inter-frequency relative RSRP measurement accuracy requirements in discovery signal occasions are the same as specified in Section 9.1.3.2.

Measurement report mapping for RSRP measurements in discovery signal occasions are the same as specified in Section 9.1.4.

9.1.14.3 CSI-RSRP measurements in discovery signal occasions

9.1.14.3.1 Intra-frequency CSI-RSRP measurements

9.1.14.3.1.1 Absolute CSI-RSRP measurement requirements

In this clause, absolute CSI-RSRP measurement accuracy requirements in discovery signal occasions apply to a cell or TP on the same frequency as that of the serving cell.

The accuracy requirements in Table 9.1.14.3.1.1-1 are valid under the following conditions:

CSI reference signals in discovery signal occasions are transmitted on one antenna port only from each TP,

Conditions defined in 36.101 Clause 7.3 for reference sensitivity are fulfilled.

CSI-RSRP is specified in Annex B.3.14 for a corresponding Band.

Table 9.1.14.3.1.1-1: Intra-frequency absolute CSI-RSRP measurement accuracy

Accuracy		Conditions				
Normal condition	Extreme condition	CSI \hat{E}_s/lot	I_0 ^{Note 1} range			
			E-UTRA operating band groups ^{Note 3}	Minimum I_0		Maximum I_0
dB	dB	dB		$\text{dBm}/15\text{kHz}$ ^{Note 2}	$\text{dBm}/\text{BW}_{\text{Channel}}$	$\text{dBm}/\text{BW}_{\text{Channel}}$
± 4.5	± 9	≥ 0 dB	FDD_A, TDD_A	-121	N/A	-70
			FDD_B1, FDD_B2	-120.5	N/A	-70
			FDD_C, TDD_C	-120	N/A	-70
			FDD_D	-119.5	N/A	-70
			FDD_E, TDD_E	-119	N/A	-70
			FDD_F	-118.5	N/A	-70
			FDD_G	-118	N/A	-70
			FDD_H	-117.5	N/A	-70
			FDD_N	-114.5	N/A	-70

±8	±11	≥0 dB	FDD_A, TDD_A, FDD_B1, FDD_B2, FDD_C, TDD_C, FDD_D, FDD_E, TDD_E, FDD_F, FDD_G, FDD_H, FDD_N	N/A	-70	-50
NOTE 1: I _o is assumed to have constant EPRE across the bandwidth. NOTE 2: The condition level is increased by Δ>0, when applicable, as described in Sections B.4.2 and B.4.3. NOTE 3: E-UTRA operating band groups are as defined in Section 3.5.						

9.1.14.3.1.2 Relative CSI-RSRP measurement requirements

In this section, the relative CSI-RSRP measurement is defined as the CSI-RSRP measured from one cell or TP compared to the CSI-RSRP measured on the same frequency from another cell or from another TP. If two TPs are compared, they may belong to the same or different cells.

The accuracy requirements in Table 9.1.14.3.1.2-1 are valid under the following conditions:

CSI reference signals in discovery signal occasions are transmitted on one antenna port only from each TP.

Conditions defined in 36.101 Clause 7.3 for reference sensitivity are fulfilled.

CSI-RSRP is specified in Annex B.3.15 for a corresponding Band.

Table 9.1.14.3.1.2-1: Intra-frequency relative CSI-RSRP measurement accuracy

Accuracy		Conditions			
Normal condition	Extreme condition	CSI Ês/lot ^{Note 2}	I _o ^{Note 1} range		
			E-UTRA operating band groups ^{Note 5}	Minimum I _o	Maximum I _o
dB	dB	dB		dBm/15kHz ^{Note 4}	dBm/BW _{Channel}
±2	±3	≥0 dB	FDD_A, TDD_A	-121	-50
			FDD_B1, FDD_B2	-120.5	-50
			FDD_C, TDD_C	-120	-50
			FDD_D	-119.5	-50
			FDD_E, TDD_E	-119	-50
			FDD_F	-118.5	-50
			FDD_G	-118	-50
			FDD_H	-117.5	-50
FDD_N	-114.5	-50			
NOTE 1: I _o is assumed to have constant EPRE across the bandwidth. NOTE 2: The parameter CSI Ês/lot is the minimum CSI Ês/lot of the pair of cells or TPs to which the requirement applies. NOTE 3: Void NOTE 4: The condition level is increased by Δ>0, when applicable, as described in Sections B.4.2 and B.4.3. NOTE 5: E-UTRA operating band groups are as defined in Section 3.5.					

9.1.14.3.2 Inter-frequency CSI-RSRP measurements

9.1.14.3.2.1 Absolute CSI-RSRP measurement requirements

In this clause, absolute CSI-RSRP measurement accuracy requirements for discovery signal measurements apply to a cell or TP on a different carrier frequency from that of the serving cell.

The accuracy requirements in Table 9.1.14.3.2.1-1 are valid under the following conditions:

CSI reference signals in discovery signal occasions are transmitted on one antenna port only from each TP.

Conditions defined in 36.101 Clause 7.3 for reference sensitivity are fulfilled.

CSI-RSRP is specified in Annex B.3.16 for a corresponding Band.

Table 9.1.14.3.2.1-1: Inter-frequency absolute CSI-RSRP measurement accuracy

Accuracy		Conditions	
		CSI	I _o ^{Note 1} range

Normal condition	Extreme condition	Es/lot	E-UTRA operating band groups ^{Note 3}	Minimum Io		Maximum Io
				dBm/15kHz ^{Note 2}	dBm/BW _{Channel}	dBm/BW _{Channel}
dB	dB	dB				
±4.5	±9	≥0 dB	FDD_A, TDD_A	-121	N/A	-70
			FDD_B1, FDD_B2	-120.5	N/A	-70
			FDD_C, TDD_C	-120	N/A	-70
			FDD_D	-119.5	N/A	-70
			FDD_E, TDD_E	-119	N/A	-70
			FDD_F	-118.5	N/A	-70
			FDD_G	-118	N/A	-70
			FDD_H	-117.5	N/A	-70
			FDD_N	-114.5	N/A	-70
±8	±11	≥0 dB	FDD_A, TDD_A, FDD_B1, FDD_B2, FDD_C, TDD_C, FDD_D, FDD_E, TDD_E, FDD_F, FDD_G, FDD_H, FDD_N	N/A	-70	-50

NOTE 1: Io is assumed to have constant EPRE across the bandwidth.
 NOTE 2: The condition level is increased by Δ>0, when applicable, as described in Sections B.4.2 and B.4.3.
 NOTE 3: E-UTRA operating band groups are as defined in Section 3.5.

9.1.14.3.2.2 Relative CSI-RSRP measurement requirements

In this section, the relative CSI-RSRP measurement is defined as the CSI-RSRP measured from one cell or TP compared to the CSI-RSRP measured on a different frequency from another cell or from another TP.

The accuracy requirements in Table 9.1.14.3.2.2-1 are valid under the following conditions:

CSI reference signals in discovery signal occasions are transmitted on one antenna port only from each TP.

Conditions defined in 36.101 Clause 7.3 for reference sensitivity are fulfilled.

CSI-RSRP is specified in Annex B.3.17 for a corresponding Band.

$$|CSI_RSRP 1|_{dBm} - CSI_RSRP 2|_{dBm} | \leq 27 dB$$

$$|Channel 1_{Io} - Channel 2_{Io} | \leq 20 dB$$

Table 9.1.14.3.2.2-1: Inter-frequency relative CSI-RSRP measurement accuracy

Accuracy		Conditions			
Normal condition	Extreme condition	CSI Es/lot ^{Note 2}	Io ^{Note 1} range		
			E-UTRA operating band groups ^{Note 4}	Minimum Io	Maximum Io
dB	dB	dB	dBm/15kHz ^{Note 3}	dBm/BW _{Channel}	
±4.5	±6	≥0 dB	FDD_A, TDD_A	-121	-50
			FDD_B1, FDD_B2	-120.5	-50
			FDD_C, TDD_C	-120	-50
			FDD_D	-119.5	-50
			FDD_E, TDD_E	-119	-50
			FDD_F	-118.5	-50
			FDD_G	-118	-50
			FDD_H	-117.5	-50
			FDD_N	-114.5	-50

NOTE 1: Io is assumed to have constant EPRE across the bandwidth.
 NOTE 2: The parameter CSI Es/lot is the minimum CSI Es/lot of the pair of cells or TPs to which the requirement applies.
 NOTE 3: The condition level is increased by Δ>0, when applicable, as described in Sections B.4.2 and B.4.3.
 NOTE 4: E-UTRA operating band groups are as defined in Section 3.5.

9.1.14.3.3 CSI-RSRP measurement report mapping

The reporting range of CSI-RSRP is defined from -140 dBm to -44 dBm with 1 dB resolution.

The mapping of measured quantity is defined in Table 9.1.14.3.3-1. The range in the signalling may be larger than the guaranteed accuracy range.

Table 9.1.14.3.3-1: CSI-RSRP measurement report mapping

Reported value	Measured quantity value	Unit
CSI_RSRP_00	CSI_RSRP < -140	dBm
CSI_RSRP_01	-140 ≤ CSI_RSRP < -139	dBm
CSI_RSRP_02	-139 ≤ CSI_RSRP < -138	dBm
...
CSI_RSRP_95	-46 ≤ CSI_RSRP < -45	dBm
CSI_RSRP_96	-45 ≤ CSI_RSRP < -44	dBm
CSI_RSRP_97	-44 ≤ CSI_RSRP	dBm

9.1.14.4 RSRQ measurements in discovery signal occasions

Intra-frequency absolute RSRQ measurement accuracy requirements in discovery signal occasions are the same as specified in Section 9.1.5.1.

Inter-frequency absolute RSRQ measurement accuracy requirements in discovery signal occasions are the same as specified in Section 9.1.6.1.

Inter-frequency relative RSRQ measurement accuracy requirements in discovery signal occasions are the same as specified in Section 9.1.6.2.

Measurement report mapping for RSRQ measurements in discovery signal occasions are the same as specified in Section 9.1.7.

9.1.15 Discovery signal measurements accuracy for E-UTRAN carrier aggregation

This clause contains requirements on UE capabilities for support of E-UTRA FDD, TDD and TDD-FDD carrier aggregation when discovery signal [16] is configured. Requirements in this clause are applicable to all carrier aggregation capable UEs which have been configured with up to six downlink SCell(s). Note : This clause covers measurement accuracy requirements for frequencies corresponding to those used for the PCell and SCell(s). Measurements of any other frequency are considered to be inter-frequency measurements covered by the accuracy requirements in clause 9.1.14.

The requirements in this clause apply for bandwidths defined in the bandwidth combination set for the CA configurations supported by the UE [5].

9.1.15.1 Requirements for CRS based discovery signal measurements accuracy for E-UTRAN carrier aggregation

9.1.15.1.1 Primary component carrier accuracy requirement

RSRP and RSRQ measurements of cells on the primary component carrier shall meet the intrafrequency absolute accuracy requirements in sections 9.1.14.2 and 9.1.14.4. Comparisons between RSRP of cells on the primary component carrier shall also meet the intra-frequency relative accuracy requirements in sections 9.1.14.2.

9.1.15.1.2 Secondary component carrier accuracy requirement

RSRP and RSRQ measurements of cells on any of the secondary component carrier(s) shall meet the intrafrequency absolute accuracy requirements in sections 9.1.14.2 and 9.1.14.4. Comparisons between RSRP of cells on the same secondary component carrier shall meet the intra-frequency relative accuracy requirements in sections 9.1.14.2.

9.1.15.1.3 Primary and secondary component carrier relative accuracy requirement

When measurements of cells on the primary component carrier are compared with measurements of cells on any of the secondary component carrier(s), the applicable relative accuracy requirements are the RSRP and RSRQ inter-frequency accuracy requirements in sections 9.1.14.2 and 9.1.14.4.

9.1.15.1.4 Secondary component carrier relative accuracy requirement

When measurements of cells on any of the secondary component carrier(s) are compared with measurements of cells on the other secondary component carrier, the applicable relative accuracy requirements are the RSRP and RSRQ inter-frequency accuracy requirements in sections 9.1.14.2 and 9.1.14.4.

9.1.15.2 Requirements for CSI-RS based discovery signal measurements accuracy for E-UTRAN carrier aggregation

9.1.15.2.1 Primary component carrier accuracy requirement

RSRP measurements of cells on the primary component carrier shall meet the intrafrequency absolute accuracy requirements in sections 9.1.14.3.1.1. Comparisons between RSRP of cells on the primary component carrier shall also meet the intra-frequency relative accuracy requirements in sections 9.1.14.3.1.2.

9.1.15.2.2 Secondary component carrier accuracy requirement

RSRP measurements of cells on any of the secondary component carrier(s) shall meet the intrafrequency absolute accuracy requirements in sections 9.1.14.3.1.1. Comparisons between RSRP of cells on the same secondary component carrier shall meet the intra-frequency relative accuracy requirements in sections 9.1.14.3.1.2.

9.1.15.2.3 Primary and secondary component carrier relative accuracy requirement

When measurements of cells on the primary component carrier are compared with measurements of cells on any of the secondary component carrier(s), the applicable relative accuracy requirements are the RSRP inter-frequency accuracy requirements in sections 9.1.14.3.2.2.

9.1.15.2.4 Secondary component carrier relative accuracy requirement

When measurements of cells on any of the secondary component carrier(s) are compared with measurements of cells on the other secondary component carrier, the applicable relative accuracy requirements are the RSRP inter-frequency accuracy requirements in sections 9.1.14.3.2.2.

9.1.16 Accuracy requirements for RSRQ measurement on all OFDM symbols

This clause contains requirements for RSRQ measurement when measurement configuration message received by the UE contains *measRSRQ-OnAllSymbols-r12* parameter in TS 36.331 [2].

Intra-frequency absolute RSRQ measurement accuracy requirements when measured on all OFDM symbols are the same as specified in Section 9.1.5.1.

Inter-frequency absolute RSRQ measurement accuracy requirements when measured on all OFDM symbols are the same as specified in Section 9.1.6.1.

Inter-frequency relative RSRQ measurement accuracy requirements when measured on all OFDM symbols are the same as specified in Section 9.1.6.2.

NOTE: The minimum I_0 condition in Table 9.1.5.1-1, Table 9.1.6.1-1 and Table 9.1.6.2-1 is expressed as the average I_0 per RE over all REs in that symbol.

NOTE: The I_0 range defined by the minimum and the maximum I_0 levels in Table 9.1.5.1-1, Table 9.1.6.1-1 and Table 9.1.6.2-1 applies to CRS and non-CRS symbols. I_0 may be different in different symbols within a subframe.

NOTE: I_{ot} in Table 9.1.5.1-1, Table 9.1.6.1-1 and Table 9.1.6.2-1 is the received power spectrum density of total interference and noise averaged over CRS REs.

Intra-frequency absolute WB-RSRQ measurement accuracy requirements when measured on all OFDM symbols are the same as specified in Section 9.1.5.4.

Inter-frequency absolute WB-RSRQ measurement accuracy requirements when measured on all OFDM symbols are the same as specified in Section 9.1.6.3.

Inter-frequency relative WB-RSRQ measurement accuracy requirements when measured on all OFDM symbols are the same as specified in Section 9.1.6.4.

NOTE: The minimum I_o condition in Table 9.1.5.4-1, Table 9.1.6.3-1 and Table 9.1.6.4-1 is expressed as the average I_o per RE over all REs in that symbol across all the resource blocks within the *AllowedMeasBandwidth* in TS 36.331 [2].

NOTE: The I_{o1} , I_{o2} and I_o range defined by the minimum and the maximum I_o levels in Table 9.1.5.4-1, Table 9.1.6.3-1 and Table 9.1.6.4-1 applies to CRS and non-CRS symbols. I_{o1} , I_{o2} and I_o may be different in different symbols within a subframe.

NOTE: I_{ot} in Table 9.1.5.4-1, Table 9.1.6.3-1 and Table 9.1.6.4-1 is the received power spectrum density of total interference and noise averaged over CRS REs.

9.1.17 RS-SINR Measurements

9.1.17.1 Measurement Report Mapping

The reporting range of RS-SINR measurement is defined from -23 dB to 40 dB with 0.5 dB resolution.

The mapping of the measured quantity is defined in table 9.1.17.1 -1. The range in the signalling may be larger than the guaranteed accuracy range.

Table 9.1.17.1-1: RS-SINR measurement report mapping

Reported Value	Measured Quantity Value	Unit
RS-SINR_000	RS-SINR < -23	dB
RS-SINR_001	$-23 \leq \text{RS-SINR} < -22.5$	dB
...
RS-SINR_126	$39.5 \leq \text{RS-SINR} < 40$	dB
RS-SINR_127	$40 \leq \text{RS-SINR}$	dB

9.1.17.2 Intra-frequency RS-SINR Measurement Accuracy Requirements

9.1.17.2.1 Absolute RS-SINR Measurement Accuracy Requirements

The requirements for absolute accuracy of intra-frequency RS-SINR in this clause apply to a cell on the same frequency as that of the serving cell.

The accuracy requirements in Table 9.1.17.2.1-1 are valid under the following conditions:

Cell specific reference signals are transmitted either from one, two or four antenna ports.

Conditions defined in 36.101 Clause 7.3 for reference sensitivity are fulfilled.

RSRP[dBm] according to Annex B.3.18 for a corresponding Band.

Table 9.1.17.2.1-1: Intra-frequency RS-SINR absolute accuracy

Accuracy		Conditions			
Normal condition	Extreme condition	$\hat{E}s/lot$	I_o ^{Note 1} range		
			E-UTRA operating band groups ^{Note 4}	Minimum I_o	Maximum I_o
dB	dB	dB	dBm/15kHz ^{Note 3}	dBm/BW _{Channel}	
±3.0	±4	≥-3 dB ^{Note 5}	FDD_A, TDD_A	-121	-50
			FDD_B1, FDD_B2	-120.5	-50
			FDD_C, TDD_C	-120	-50
			FDD_D	-119.5	-50
			FDD_E, TDD_E	-119	-50
			FDD_F	-118.5	-50
			FDD_G	-118	-50
			FDD_H	-117.5	-50
			FDD_N	-114.5	-50

±3.5	±4	≥-6 dB	Note 2	Note 2	Note 2
NOTE 1: I_0 is assumed to have constant EPRE across the bandwidth.					
NOTE 2: The same bands and the same I_0 conditions for each band apply for this requirement as for the corresponding highest accuracy requirement.					
NOTE 3: The condition level is increased by $\Delta > 0$, when applicable, as described in Sections B.4.2 and B.4.3.					
NOTE 4: E-UTRA operating band groups are as defined in Section 3.5.					
NOTE 5: The requirements apply for $\hat{E}_s/\text{lot} \leq 25$ dB.					

9.1.17.3 Inter-frequency RS-SINR Measurement Accuracy Requirements

9.1.17.3.1 Absolute RS-SINR Measurement Accuracy Requirements

The requirements for absolute accuracy of inter-frequency RS-SINR in this clause apply to a cell that has different carrier frequency from the serving cell.

The accuracy requirements in Table 9.1.17.3-1 are valid under the following conditions:

Cell specific reference signals are transmitted either from one, two or four antenna ports.

Conditions defined in 36.101 Clause 7.3 for reference sensitivity are fulfilled.

RSRP_{dBm} according to Annex B.3.19 for a corresponding Band.

Table 9.1.17.3.1-1: Inter-frequency RS-SINR absolute accuracy

Accuracy		Conditions			
Normal condition	Extreme condition	\hat{E}_s/lot	I_0 ^{Note 1} range		
			E-UTRA operating band groups ^{Note 4}	Minimum I_0	Maximum I_0
dB	dB	dB	dBm/15kHz ^{Note 3}	dBm/BW _{Channel}	
±3.0	±4	≥-3 dB ^{Note 5}	FDD_A, TDD_A	-121	-50
			FDD_B1, FDD_B2	-120.5	-50
			FDD_C, TDD_C	-120	-50
			FDD_D	-119.5	-50
			FDD_E, TDD_E	-119	-50
			FDD_F	-118.5	-50
			FDD_G	-118	-50
			FDD_H	-117.5	-50
		FDD_N	-114.5	-50	
±3.5	±4	≥-6 dB	Note 2	Note 2	Note 2

NOTE 1: I_0 is assumed to have constant EPRE across the bandwidth.
NOTE 2: The same bands and the same I_0 conditions for each band apply for this requirement as for the corresponding highest accuracy requirement.
NOTE 3: The condition level is increased by $\Delta > 0$, when applicable, as described in Sections B.4.2 and B.4.3.
NOTE 4: E-UTRA operating band groups are as defined in Section 3.5.
NOTE 5: The requirements apply for $\hat{E}_s/\text{lot} \leq 25$ dB.

9.1.17.3.2 Relative RS-SINR Measurement Accuracy Requirements

The relative accuracy of inter-frequency RS-SINR in this clause is defined as the RS-SINR measured from one cell compared to the RS-SINR measured from another cell on a different frequency.

The accuracy requirements in Table 9.1.17.3.2-1 are valid under the following conditions:

Cell specific reference signals are transmitted either from one, two or four antenna ports.

Conditions defined in 36.101 Clause 7.3 for reference sensitivity are fulfilled.

RSRP_{1,2}_{dBm} according to Annex B.3.20 for a corresponding Band.

$$\left| RSRP 1 \Big|_{dBm} - RSRP 2 \Big|_{dBm} \right| \leq 27 \text{ dB}$$

| Channel 1_{Io} - Channel 2_{Io} | ≤ 20 dB

Table 9.1.17.3.2-1: Inter-frequency RS-SINR relative accuracy

Accuracy		Conditions			
Normal condition	Extreme condition	Ês/lot ^{Note 2}	Io ^{Note 1} range		
			E-UTRA operating band groups ^{Note 5}	Minimum Io	Maximum Io
dB	dB	dB		dBm/15kHz ^{Note 4}	dBm/BW _{Channel}
±3.5	±4	≥-3 dB ^{Note 6}	FDD_A, TDD_A	-121	-50
			FDD_B1, FDD_B2	-120.5	-50
			FDD_C, TDD_C	-120	-50
			FDD_D	-119.5	-50
			FDD_E, TDD_E	-119	-50
			FDD_F	-118.5	-50
			FDD_G	-118	-50
			FDD_H	-117.5	-50
FDD_N	-114.5	-50			
±4.0	±4	≥-6 dB	Note 3	Note 3	Note 3

NOTE 1: Io is assumed to have constant EPRE across the bandwidth.
 NOTE 2: The parameter Ês/lot is the minimum Ês/lot of the pair of cells to which the requirement applies.
 NOTE 3: The same bands and the same Io conditions for each band apply for this requirement as for the corresponding highest accuracy requirement.
 NOTE 4: The condition level is increased by Δ>0, when applicable, as described in Sections B.4.2 and B.4.3.
 NOTE 5: E-UTRA operating band groups are as defined in Section 3.5.
 NOTE 6: The requirements apply for Ês/lot ≤ 25 dB.

9.1.18 Accuracy Requirements for Measurements under Operation with Frame Structure 3

9.1.18.1 Introduction

The accuracy requirements in this section are defined for the following physical layer measurements: RSRP, RSRQ, CSI-RSRP, and RSSI, where the measurements are performed on cells of E-UTRA carriers during the configured DMTC occasion [2] under operation with frame structure 3 [16].

9.1.18.2 RSRP measurements

9.1.18.2.1 RSRP measurement report mapping

The measurement report mapping for RSRP measurements is as defined in Section 9.1.4.

9.1.18.2.2 Inter-frequency absolute RSRP measurement accuracy requirements

The requirements for absolute accuracy of RSRP in this clause apply to a cell that has a different carrier frequency from the serving cell.

The accuracy requirements in Table 9.1.18.2.2-1 are valid under the following conditions:

Cell specific reference signals are transmitted either from one, two or four antenna ports.

Conditions defined in 36.101 Clause 7.3 for reference sensitivity are fulfilled.

RSRP|dBm according to Annex B.3.23.1 for a corresponding Band.

The discovery signal occasion does not contain any MBSFN subframe and contains at least four CRS symbols over two adjacent slots.

Table 9.1.18.2.2-1: RSRP inter-frequency absolute accuracy

Accuracy		Conditions		
Normal condition	Extreme condition	Ês/lot	Io ^{Note 1} range	
			E-UTRA operating band groups ^{Note 3}	Minimum Io

dB	dB	dB		dBm/15kHz ^{Note 2}	dBm/BW _{Channel}	dBm/BW _{Channel}
±4.5	±9	≥-6 dB	FS3_G	-118	N/A	-70
±8	±11	≥-6 dB	FS3_G	N/A	-70	-50

NOTE 1: I_0 is assumed to have constant EPRE across the bandwidth.
 NOTE 2: The condition level is increased by $\Delta > 0$, when applicable, as described in Sections B.4.2 and B.4.3.
 NOTE 3: E-UTRA operating band groups are as defined in Section 3.5.

9.1.18.2.3 Inter-frequency relative RSRP measurement accuracy requirements

The relative accuracy of inter-frequency RSRP measurement is defined as the RSRP measured from one cell compared to the RSRP measured from another cell on a different frequency.

The accuracy requirements in Table 9.1.18.2.3-1 are valid under the following conditions:

Cell specific reference signals are transmitted either from one, two or four antenna ports.

Conditions defined in 36.101 Clause 7.3 for reference sensitivity are fulfilled.

RSRP_{1,2}_{dBm} according to Annex B.3.4 for a corresponding Band

$$|RSRP 1|_{dBm} - RSRP 2|_{dBm} | \leq 27 dB$$

$$|Channel 1_{I_0} - Channel 2_{I_0} | \leq 20 dB$$

The discovery signal occasion does not contain any MBSFN subframe and contains at least four CRS symbols over two adjacent slots.

Table 9.1.18.2.3-1: RSRP inter-frequency relative accuracy

Accuracy		Conditions			
Normal condition	Extreme condition	$\hat{E}s/I_0$ ^{Note 2}	I_0 ^{Note 1} range		
			E-UTRA operating band groups ^{Note 4}	Minimum I_0	Maximum I_0
dB	dB	dB	dBm/15kHz ^{Note 3}	dBm/BW _{Channel}	
±4.5	±6	≥-6 dB	FS3_G	-118	-50

NOTE 1: I_0 is assumed to have constant EPRE across the bandwidth.
 NOTE 2: The parameter $\hat{E}s/I_0$ is the minimum $\hat{E}s/I_0$ of the pair of cells to which the requirement applies.
 NOTE 3: The condition level is increased by $\Delta > 0$, when applicable, as described in Sections B.4.2 and B.4.3.
 NOTE 4: E-UTRA operating band groups are as defined in Section 3.5.

9.1.18.2.4 Intra-frequency absolute RSRP measurement accuracy requirements

NOTE: These requirements are applicable only for CA under operation with frame structure 3 [16].

The requirements for absolute accuracy of RSRP in this clause apply to a cell on a serving carrier frequency.

The accuracy requirements in Table 9.1.18.2.4-1 are valid under the following conditions:

Cell specific reference signals are transmitted either from one, two or four antenna ports.

Conditions defined in 36.101 Clause 7.3 for reference sensitivity are fulfilled.

RSRP_{dBm} according to Annex B.3.21.1 for a corresponding Band.

The discovery signal occasion does not contain any MBSFN subframe and contains at least four CRS symbols over two adjacent slots.

Table 9.1.18.2.4-1: RSRP intra frequency absolute accuracy

Accuracy		Conditions		
Normal condition	Extreme condition	$\hat{E}s/I_0$	I_0 ^{Note 1} range	
			E-UTRA operating band groups ^{Note 3}	Minimum I_0

dB	dB	dB		dBm/15kHz Note 2	dBm/BW _{Channel}	dBm/BW _{Channel}
±4.5	±9	≥-6 dB	FS3_G	-118	N/A	-70
±8	±11	≥-6 dB	FS3_G	N/A	-70	-50

NOTE 1: I_0 is assumed to have constant EPRE across the bandwidth.
NOTE 2: The condition level is increased by $\Delta > 0$, when applicable, as described in Sections B.4.2 and B.4.3.
NOTE 3: E-UTRA operating band groups are as defined in Section 3.5.

9.1.18.2.5 Intra-frequency relative RSRP measurement accuracy requirements

NOTE: These requirements are applicable only for CA under operation with frame structure 3 [16].

The relative accuracy of RSRP is defined as the RSRP measured from one cell compared to the RSRP measured from another cell on the same carrier frequency.

The accuracy requirements in Table 9.1.18.2.5-1 are valid under the following conditions:

Cell specific reference signals are transmitted either from one, two or four antenna ports.

Conditions defined in 36.101 Clause 7.3 for reference sensitivity are fulfilled.

RSRP_{1,2}_{dBm} according to Annex B.3.22.1 for a corresponding Band.

The discovery signal occasion does not contain any MBSFN subframe and contains at least four CRS symbols over two adjacent slots.

Table 9.1.18.2.5-1: RSRP intra frequency relative accuracy

Accuracy		Conditions			
Normal condition	Extreme condition	\hat{E}_s/I_{ot} Note 2	I_0 Note 1 range		
			E-UTRA operating band groups Note 5	Minimum I_0	Maximum I_0
dB	dB	dB	dBm/15kHz Note 4	dBm/BW _{Channel}	
±2	±3	≥-3 dB	FS3_G	-118	-50
±3	±3	≥-6 dB	Note 3	Note 3	Note 3

NOTE 1: I_0 is assumed to have constant EPRE across the bandwidth.
NOTE 2: The parameter \hat{E}_s/I_{ot} is the minimum \hat{E}_s/I_{ot} of the pair of cells to which the requirement applies.
NOTE 3: The same bands and the same I_0 conditions for each band apply for this requirement as for the corresponding highest accuracy requirement.
NOTE 4: The condition level is increased by $\Delta > 0$, when applicable, as described in Sections B.4.2 and B.4.3.
NOTE 5: E-UTRA operating band groups are as defined in Section 3.5.

9.1.18.3 RSRQ measurements

9.1.18.3.1 RSRQ measurement report mapping

The measurement report mapping for RSRQ measurements is as defined in Section 9.1.7.

9.1.18.3.2 Inter-frequency absolute RSRQ measurement accuracy requirements

The requirements for absolute accuracy of RSRQ in this clause apply to a cell that has different carrier frequency from the serving cell.

The accuracy requirements in Table 9.1.18.3.2-1 are valid under the following conditions:

Cell specific reference signals are transmitted either from one, two or four antenna ports.

Conditions defined in 36.101 Clause 7.3 for reference sensitivity are fulfilled.

RSRP_{dBm} according to Annex B.3.23.2 for a corresponding Band.

The discovery signal occasion does not contain any MBSFN subframe and contains at least four CRS symbols over two adjacent slots.

Table 9.1.18.3.2-1: RSRQ inter-frequency absolute accuracy

Accuracy		Conditions			
Normal condition	Extreme condition	$\hat{E}s/lot$	Io ^{Note 1} range		
			E-UTRA operating band groups ^{Note 4}	Minimum Io	Maximum Io
dB	dB	dB		dBm/15kHz ^{Note 3}	dBm/BW _{Channel}
±2.5	±4	≥-3 dB	FS3_G	-118	-50
±3.5	±4	≥-6 dB	Note 2	Note 2	Note 2
NOTE 1: Io is assumed to have constant EPRE across the bandwidth. NOTE 2: The same bands and the same Io conditions for each band apply for this requirement as for the corresponding highest accuracy requirement. NOTE 3: The condition level is increased by $\Delta > 0$, when applicable, as described in Sections B.4.2 and B.4.3. NOTE 4: E-UTRA operating band groups are as defined in Section 3.5.					

9.1.18.3.3 Inter-frequency relative RSRQ measurement accuracy requirements

The relative accuracy of RSRQ in inter frequency case is defined as the RSRQ measured from one cell compared to the RSRQ measured from another cell on a different frequency.

The accuracy requirements in Table 9.1.18.3.3-1 are valid under the following conditions:

Cell specific reference signals are transmitted either from one, two or four antenna ports.

Conditions defined in 36.101 Clause 7.3 for reference sensitivity are fulfilled.

$RSRP_{1,2|dBm}$ according to Annex B.3.24.2 for a corresponding Band.

$$\left| RSRP_{1|dBm} - RSRP_{2|dBm} \right| \leq 27 \text{ dB}$$

$$\left| \text{Channel 1}_Io - \text{Channel 2}_Io \right| \leq 20 \text{ dB}$$

The discovery signal occasion does not contain any MBSFN subframe and contains at least four CRS symbols over two adjacent slots.

Table 9.1.18.3.3-1: RSRQ inter-frequency relative accuracy

Accuracy		Conditions			
Normal condition	Extreme condition	$\hat{E}s/lot$ ^{Note 2}	Io ^{Note 1} range		
			E-UTRA operating band groups ^{Note 5}	Minimum Io	Maximum Io
dB	dB	dB		dBm/15kHz ^{Note 4}	dBm/BW _{Channel}
±3	±4	≥-3 dB	FS3_G	-118	-50
±4	±4	≥-6 dB	Note 3	Note 3	Note 3
NOTE 1: Io is assumed to have constant EPRE across the bandwidth. NOTE 2: The parameter $\hat{E}s/lot$ is the minimum $\hat{E}s/lot$ of the pair of cells to which the requirement applies. NOTE 3: The same bands and the same Io conditions for each band apply for this requirement as for the corresponding highest accuracy requirement. NOTE 4: The condition level is increased by $\Delta > 0$, when applicable, as described in Sections B.4.2 and B.4.3. NOTE 5: E-UTRA operating band groups are as defined in Section 3.5.					

9.1.18.3.4 Intra-frequency absolute RSRQ measurement accuracy requirements

NOTE: These requirements are applicable only for CA under operation with frame structure 3 [16].

The requirements for absolute accuracy of RSRQ in this clause apply to a cell on a serving carrier frequency.

The accuracy requirements in Table 9.1.18.3.4-1 are valid under the following conditions:

Cell specific reference signals are transmitted either from one, two or four antenna ports.

Conditions defined in 36.101 Clause 7.3 for reference sensitivity are fulfilled.

$RSRP|dBm$ according to Annex B.3.21.2 for a corresponding Band.

The discovery signal occasion does not contain any MBSFN subframe and contains at least four CRS symbols over two adjacent slots.

Table 9.1.18.3.4-1: RSRQ intra frequency absolute accuracy

Accuracy		Conditions			
Normal condition	Extreme condition	\hat{E}_s/lot	I_o ^{Note 1} range		
			E-UTRA operating band groups ^{Note 4}	Minimum I_o	Maximum I_o
dB	dB	dB		dBm/15kHz ^{Note 3}	dBm/BW _{Channel}
± 2.5	± 4	≥ -3 dB	FS3_G	-118	-50
± 3.5	± 4	≥ -6 dB	Note 2	Note 2	Note 2

NOTE 1: I_o is assumed to have constant EPRE across the bandwidth.
NOTE 2: The same bands and the same I_o conditions for each band apply for this requirement as for the corresponding highest accuracy requirement.
NOTE 3: The condition level is increased by $\Delta > 0$, when applicable, as described in Sections B.4.2 and B.4.3.
NOTE 4: E-UTRA operating band groups are as defined in Section 3.5.

9.1.18.4 CSI-RSRP measurements

9.1.18.4.1 CSI-RSRP measurement report mapping

The measurement report mapping for CSI-RSRP measurements is as defined in Section 9.1.14.3.3.

9.1.18.4.2 Inter-frequency absolute CSI-RSRP measurement accuracy requirements

In this clause, absolute CSI-RSRP measurement accuracy requirements for discovery signal measurements apply to a cell or TP operating under frame structure 3 [3] on a different carrier frequency from that of the serving cell.

The accuracy requirements in Table 9.1.18.4.2-1 are valid under the following conditions:

CSI reference signals in discovery signal occasions are transmitted on one antenna port only from each TP.

Conditions defined in 36.101 Clause 7.3 for reference sensitivity are fulfilled.

CSI-RSRP is as specified in Annex B.3.23.3 for a corresponding Band.

The discovery signal occasion does not contain any MBSFN subframe and contains at least two CSI REs per resource block within the measured bandwidth in two adjacent slots.

Table 9.1.18.4.2-1: Inter-frequency absolute CSI-RSRP measurement accuracy

Accuracy		Conditions			
Normal condition	Extreme condition	CSI \hat{E}_s/lot	I_o ^{Note 1} range		
			E-UTRA operating band groups ^{Note 3}	Minimum I_o	
dB	dB	dB		dBm/15kHz ^{Note 2}	dBm/BW _{Channel}
± 4.5	± 9	≥ 0 dB	FS3_G	-118	N/A
± 8	± 11	≥ 0 dB	FS3_G	N/A	-70

NOTE 1: I_o is assumed to have constant EPRE across the bandwidth.
NOTE 2: The condition level is increased by $\Delta > 0$, when applicable, as described in Sections B.4.2 and B.4.3.
NOTE 3: E-UTRA operating band groups are as defined in Section 3.5.

9.1.18.4.3 Inter-frequency relative CSI-RSRP measurement accuracy requirements

In this section, the relative CSI-RSRP measurement is defined as the CSI-RSRP measured from one cell or TP compared to the CSI-RSRP measured on a different frequency from another cell or from another TP, where at least one measured cell or TP is operating under frame structure 3 [3].

The accuracy requirements in Table 9.1.18.4.3-1 are valid under the following conditions:

CSI reference signals in discovery signal occasions are transmitted on one antenna port only from each TP.

Conditions defined in 36.101 Clause 7.3 for reference sensitivity are fulfilled.

CSI-RSRP is as specified in Annex B.3.24.3 for a corresponding Band.

$$\left| CSI_RSRP 1 \Big|_{dBm} - CSI_RSRP 2 \Big|_{dBm} \right| \leq 27 \text{ dB}$$

$$| \text{Channel 1}_{Io} - \text{Channel 2}_{Io} | \leq 20 \text{ dB}$$

The discovery signal occasion does not contain any MBSFN subframe and contains at least two CSI REs per resource block within the measured bandwidth in two adjacent slots.

Table 9.1.18.4.3-1: Inter-frequency relative CSI-RSRP measurement accuracy

Accuracy		Conditions			
Normal condition	Extreme condition	CSI Ês/lot ^{Note 2}	Io ^{Note 1} range		
			E-UTRA operating band groups ^{Note 4}	Minimum Io	Maximum Io
dB	dB	dB	dBm/15kHz ^{Note 3}	dBm/BW _{Channel}	
±4.5	±6	≥0 dB	FS3_G	-118	-50
NOTE 1: Io is assumed to have constant EPRE across the bandwidth.					
NOTE 2: The parameter CSI Ês/lot is the minimum CSI Ês/lot of the pair of cells or TPs to which the requirement applies.					
NOTE 3: The condition level is increased by Δ>0, when applicable, as described in Sections B.4.2 and B.4.3.					
NOTE 4: E-UTRA operating band groups are as defined in Section 3.5.					

9.1.18.4.4 Intra-frequency absolute CSI-RSRP measurement accuracy requirements

NOTE: These requirements are applicable only for CA under operation with frame structure 3 [16].

In this clause, absolute CSI-RSRP measurement accuracy requirements in discovery signal occasions apply to a cell or TP on a serving carrier frequency operating under frame structure 3 [3].

The accuracy requirements in Table 9.1.18.4.4-1 are valid under the following conditions:

CSI reference signals in discovery signal occasions are transmitted on one antenna port only from each TP,

Conditions defined in 36.101 Clause 7.3 for reference sensitivity are fulfilled.

CSI-RSRP is as specified in Annex B.3.21.3 for a corresponding Band.

The discovery signal occasion does not contain any MBSFN subframe and contains at least two CSI REs per resource block within the measured bandwidth in two adjacent slots of the same subframe or different subframes.

Table 9.1.18.4.4-1: Intra-frequency absolute CSI-RSRP measurement accuracy

Accuracy		Conditions				
Normal condition	Extreme condition	CSI Ês/lot	Io ^{Note 1} range			
			E-UTRA operating band groups ^{Note 3}	Minimum Io		Maximum Io
dB	dB	dB	dBm/15kHz ^{Note 2}	dBm/BW _{Channel}	dBm/BW _{Channel}	
±4.5	±9	≥0 dB	FS3_G	-118	N/A	-70
±8	±11	≥0 dB	FS3_G	N/A	-70	-50
NOTE 1: Io is assumed to have constant EPRE across the bandwidth.						
NOTE 2: The condition level is increased by Δ>0, when applicable, as described in Sections B.4.2 and B.4.3.						
NOTE 3: E-UTRA operating band groups are as defined in Section 3.5.						

9.1.18.4.5 Intra-frequency relative CSI-RSRP measurement accuracy requirements

NOTE: These requirements are applicable only for CA under operation with frame structure 3 [16].

In this section, the relative CSI-RSRP measurement is defined as the CSI-RSRP measured from one cell or TP compared to the CSI-RSRP measured on the same frequency from another cell or from another TP operating under frame structure 3 [16]. If two TPs are compared, they may belong to the same or different cells.

The accuracy requirements in Table 9.1.18.4.5-1 are valid under the following conditions:

CSI reference signals in discovery signal occasions are transmitted on one antenna port only from each TP.

Conditions defined in 36.101 Clause 7.3 for reference sensitivity are fulfilled.

CSI-RSRP is as specified in Annex B.3.22.3 for a corresponding Band.

The discovery signal occasion does not contain any MBSFN subframe and contains at least two CSI REs per resource block within the measured bandwidth in two adjacent slots of the same subframe or different subframes.

Table 9.1.18.4.5-1: Intra-frequency relative CSI-RSRP measurement accuracy

Accuracy		Conditions			
Normal condition	Extreme condition	CSI \hat{E}_s/lot ^{Note 2}	I_0 ^{Note 1} range		
			E-UTRA operating band groups ^{Note 5}	Minimum I_0	Maximum I_0
dB	dB	dB	dBm/15kHz ^{Note 4}	dBm/BW _{Channel}	
±2	±3	≥ 0 dB	FS3_G	-118	-50
±3	±3	≥ 0 dB	Note 3	Note 3	Note 3

NOTE 1: I_0 is assumed to have constant EPRE across the bandwidth.
 NOTE 2: The parameter CSI \hat{E}_s/lot is the minimum CSI \hat{E}_s/lot of the pair of cells or TPs to which the requirement applies.
 NOTE 3: The same bands and the same I_0 conditions for each band apply for this requirement as for the corresponding highest accuracy requirement.
 NOTE 4: The condition level is increased by $\Delta > 0$, when applicable, as described in Sections B.4.2 and B.4.3.
 NOTE 5: E-UTRA operating band groups are as defined in Section 3.5.

9.1.18.5 RSSI measurements

9.1.18.5.1 RSSI measurement report mapping

The reporting range of RSSI measurement is defined from -100 dBm to -25 dBm with 1 dBm resolution.

The mapping of the measured quantity is defined in table 9.1.18.5.1-1. The range in the signalling may be larger than the guaranteed accuracy range.

Table 9.1.18.5.1-1: RSSI measurement report mapping

Reported value	Measured quantity value	Unit
RSSI_00	RSSI < -100	dBm
RSSI_01	-100 ≤ RSSI < -99	dBm
RSSI_02	-99 ≤ RSSI < -98	dBm
...
RSSI_74	-27 ≤ RSSI < -26	dBm
RSSI_75	-26 ≤ RSSI < -25	dBm
RSSI_76	-25 ≤ RSSI	dBm

9.1.18.5.2 Intra-frequency absolute RSSI measurement accuracy requirements

NOTE: These requirements are applicable only for CA under operation with frame structure 3 [16].

The intra-frequency RSSI requirements are specified in Table 9.1.18.5.2-1. The requirements apply for any configured RSSI *measDuration* [2], provided that:

- All symbols during each RSSI measurement duration are available for RSSI sampling within the same reporting interval.

Table 9.1.18.5.2-1: Intra-frequency RSSI accuracy

Accuracy		Conditions		
Normal condition	Extreme condition	I_0 ^{Note 1} range		
		E-UTRA operating band groups ^{Note 4}	Minimum I_0	Maximum I_0
dB	dB		dBm/15kHz ^{Note 3}	dBm/BW _{Channel}
±3.5	±6.5	FS3_G	-118	-50

±5.5	±8.5	Note 2	Note 2	Note 2
NOTE 1: I_0 is assumed to have constant EPRE across the bandwidth.				
NOTE 2: The same bands and the same I_0 conditions for each band apply for this requirement as for the corresponding highest accuracy requirement.				
NOTE 3: The condition level is increased by $\Delta > 0$, when applicable, as described in Sections B.4.2 and B.4.3.				
NOTE 4: E-UTRA operating band groups are as defined in Section 3.5.				

The RSSI measurement bandwidth assumed in defining the accuracy requirements in Table 9.1.18.5.2-1 is 6 RB. UE may measure according to *AllowedMeasBandwidth*. UE which measures with a bandwidth other than 6RB shall scale the measured RSSI to report a nominal RSSI equivalent to 6RB measurement.

9.1.18.5.3 Inter-frequency absolute RSSI measurement accuracy requirements

The inter-frequency RSSI requirements are the same as specified in Section 9.1.18.5.2.

9.1.18.6 Channel occupancy measurements

9.1.18.6.1 Intra-frequency channel occupancy measurement accuracy requirements

NOTE: These requirements are applicable only for CA under operation with frame structure 3 [16].

The UE shall be able to correctly evaluate the intra-frequency channel occupancy configured according to 36.331 [2], provided that the following conditions are met:

- All symbols during each RSSI measurement duration are available for RSSI sampling within the same reporting interval,
- RSSI at the UE receiver meets the following condition with respect to the configured *channelOccupancyThreshold* [2]:

RSSI at the UE receiver is below $channelOccupancyThreshold - \Delta_{RSSI}$, or

RSSI at the UE receiver is above $channelOccupancyThreshold + \Delta_{RSSI}$,

where Δ_{RSSI} is the applicable RSSI measurement accuracy value from the RSSI measurement accuracy requirements specified in Section 9.1.18.5.2.

The UE expects that *channelOccupancyThreshold* [2] is configured assuming RSSI measurement bandwidth of 6 RB.

9.1.18.6.2 Inter-frequency channel occupancy measurement accuracy requirements

The UE shall be able to correctly evaluate the inter-frequency channel occupancy configured according to 36.331 [2], provided that the following conditions are met:

- All symbols during each RSSI measurement duration are available for RSSI sampling within the same reporting interval,
- RSSI at the UE receiver meets the following condition with respect to the configured *channelOccupancyThreshold* [2]:

RSSI at the UE receiver is below $channelOccupancyThreshold - \Delta_{RSSI}$, or

RSSI at the UE receiver is above $channelOccupancyThreshold + \Delta_{RSSI}$,

where Δ_{RSSI} is the applicable RSSI measurement accuracy value from the RSSI measurement accuracy requirements specified in Section 9.1.18.5.3.

The UE expects that *channelOccupancyThreshold* [2] is configured assuming RSSI measurement bandwidth of 6 RB.

9.1.19 Accuracy Requirements for Carrier Aggregation for Measurements under Operation with Frame Structure 3

9.1.19.1 Introduction

The accuracy requirements in this section are defined for the following physical layer measurements: RSRP, RSRQ, CSI-RSRP, and RSSI, where the measurements are performed on cells of E-UTRA carriers during the configured DMTC occasion [2] under operation with frame structure 3 [16].

9.1.19.2 Accuracy requirements for measurements on SCC

The requirements in this section are for the measurements on cells of E-UTRA carriers operated under frame structure 3 on one SCC.

Absolute RSRP measurements of cells on SCC shall meet the intra-frequency absolute accuracy requirements in Section 9.1.18.2.4.

Comparisons between RSRP measurements of cells on the same SCC shall meet the intra-frequency relative accuracy requirements in Section 9.1.18.2.5.

Absolute RSRQ measurements of cells on SCC shall meet the intra-frequency absolute accuracy requirements in Section 9.1.18.3.4.

CSI-RSRP measurements of cells on SCC shall meet the intra-frequency absolute accuracy requirements in Section 9.1.18.4.4.

Comparisons between CSI-RSRP measurements of cells on the same SCC shall meet the intra-frequency relative accuracy requirements in Section 9.1.18.4.5.

RSSI measurements on SCC shall meet the intra-frequency absolute accuracy requirements in Section 9.1.18.5.3.

9.1.19.3 Relative accuracy requirements for measurements on different SCCs

The requirements in this section are for the measurements on cells of E-UTRA carriers operated under frame structure 3 on two different SCCs.

When RSRP measurements of cells on any of the SCC are compared with RSRP measurements of cells on the other SCC, the applicable relative accuracy requirements are the inter-frequency relative RSRP measurement accuracy requirements in Section 9.1.18.2.3.

When RSRQ measurements of cells on any of the SCC are compared with RSRQ measurements of cells on the other SCC, the applicable relative accuracy requirements are the inter-frequency relative RSRQ measurement accuracy requirements in Section 9.1.18.3.3.

When CSI-RSRP measurements of cells on any of the SCC are compared with CSI-RSRP measurements of cells on the other SCC, the applicable relative accuracy requirements are the inter-frequency relative CSI-RSRP measurement accuracy requirements in Section 9.1.18.4.3.

9.1.19.4 Relative accuracy requirements for measurements on SCC and PCC

The requirements in this section are for the measurements on cells of an E-UTRA carrier operated under frame structure 3 on SCC and cells on an E-UTRA carrier operated under frame structure 1 or 2 on PCC.

When RSRP measurements of cells on any of the SCC are compared with RSRP measurements of cells on the PCC, the applicable relative accuracy requirements are the inter-frequency relative RSRP measurement accuracy requirements in Section 9.1.18.2.3.

When RSRQ measurements of cells on any of the SCC are compared with RSRQ measurements of cells on the PCC, the applicable relative accuracy requirements are the inter-frequency relative RSRQ measurement accuracy requirements in Section 9.1.18.3.3.

When CSI-RSRP measurements of cells on any of the SCC are compared with CSI-RSRP measurements of cells on the PCC, the applicable relative accuracy requirements are the inter-frequency relative CSI-RSRP measurement accuracy requirements in Section 9.1.18.4.3.

9.1.20 SFN and Subframe Time Difference (SSTD)

9.1.20.1 SSTD Accuracy Requirement

The SFN and subframe time difference (SSTD) is measured between MeNB and SeNB.

The accuracy requirements in Table 9.1.20.1-1 are valid under the following conditions:

Cell specific reference signals are transmitted either from one, two or four antenna ports.

Conditions defined in 36.101 Clause 7.3 for reference sensitivity are fulfilled.

No changes to the uplink transmission timing are applied during the measurement period.

RSRP_{dBm} according to Annex B.3.5 for a corresponding Band

Table 9.1.20.1-1: SFN and subframe time difference measurement accuracy

Accuracy	Conditions				
	Ês/lot	MIN(PCell downlink transmission Bandwidth, PSCell downlink transmission Bandwidth)	I _o ^{Note 1} range		
E-UTRA operating band groups ^{Note 6}			Minimum I _o	Maximum I _o	
T _s ^{Note 2}	dB	MHz		dBm/15kHz ^{Note 5}	dBm/BW _{Channel}
±52	≥-3 dB	≥1.4 MHz	FDD_A ^{Note 7} , TDD_A	-121	-50
			FDD_C, TDD_C	-120	-50
			FDD_D	-119.5	-50
			FDD_E, TDD_E	-119	-50
			FDD_F	-118.5	-50
			FDD_G ^{Note 4}	-118	-50
			FDD_H FDD_N	-117.5 -114.5	-50 -50
±40	≥-3 dB	≥ 3 MHz	Note 3	Note 3	Note 3

NOTE 1: When in dBm/15kHz, the minimum I_o condition is expressed as the average I_o per RE over all REs in that symbol. I_o may be different in different symbols within a subframe.

NOTE 2: T_s is the basic timing unit defined in TS 36.211.

NOTE 3: The same bands and the same I_o conditions for each band apply for this requirement as for the corresponding requirement with downlink bandwidth ≥1.4 MHz.

NOTE 4: Except Band 29.

NOTE 5: The condition level is increased by Δ>0, when applicable, as described in Sections B.4.2 and B.4.3.

NOTE 6: E-UTRA operating band groups are as defined in Section 3.5.

NOTE 7: Except Band 32, Band 75, Band 76.

9.1.20.2 SSTD Measurement Report Mapping

SFN and subframe timing difference (SSTD) measurement report comprises 3 elements:

SFN offset between MeNB and SeNB (ΔX)

Reporting range of ΔX is between frame number # 0 to frame number # 1023 as defined in TS 36.331 [2].

Frame boundary offset between MeNB and SeNB (ΔY)

Reporting range of ΔY is between subframe number #-5 and subframe number# 4 as defined in TS 36.331 [2].

Subframe boundary offset between MeNB and SeNB (ΔZ)

The reporting range of value of ΔZ is between -1320T_s and +1320T_s with the reporting granularity of 10T_s in the intervals [-1320T_s, -700T_s] and [700T_s, 1320T_s].

The mapping of measured Subframe boundary offset (ΔZ) is defined in Table 9.1.20.2-1.

Table 9.1.20.2-1: SSTD report mapping

Reported Value	Measured Quantity Value	Unit
SUBFRAME_BOUNDARY_OFFSET_00	$\Delta Z \leq -1320$	T_s
SUBFRAME_BOUNDARY_OFFSET_01	$-1320 < \Delta Z \leq -1310$	T_s
SUBFRAME_BOUNDARY_OFFSET_02	$-1310 < \Delta Z \leq -1300$	T_s
...
SUBFRAME_BOUNDARY_OFFSET_62	$-710 < \Delta Z \leq -700$	T_s
SUBFRAME_BOUNDARY_OFFSET_63	$-700 < \Delta Z \leq 0$	T_s
SUBFRAME_BOUNDARY_OFFSET_64	$0 < \Delta Z \leq 700$	T_s
SUBFRAME_BOUNDARY_OFFSET_65	$700 < \Delta Z \leq 710$	T_s
...
SUBFRAME_BOUNDARY_OFFSET_125	$1300 < \Delta Z \leq 1310$	T_s
SUBFRAME_BOUNDARY_OFFSET_126	$1310 < \Delta Z \leq 1320$	T_s
SUBFRAME_BOUNDARY_OFFSET_127	$1320 < \Delta Z$	T_s

9.1.21 Measurement accuracy for UE category M1

The requirements in this clause are applicable for UE category M1. The requirements in clause 9.1.21.1, 9.1.21.2, 9.1.21.6, 9.1.21.9, 9.1.21.10, 9.1.21.13 and 9.1.21.14 are also applicable for ETU220 propagation condition when *highSpeedMeasGapCE-ModeA* is configured.

9.1.21.1 Intra-frequency Absolute RSRP Accuracy for UE category M1 with CE mode A

The requirements for absolute accuracy of RSRP in this clause apply to a cell on the same frequency as that of the serving cell for UE category M1.

The accuracy requirements in Table 9.1.21.1-1 and Table 9.1.21.1-2 are valid under the following conditions:

Cell specific reference signals are transmitted either from one, two or four antenna ports.

Conditions defined in 36.101 Clause 7.3 for reference sensitivity are fulfilled.

RSRP[dBm] according to Annex B.3.1 for a corresponding Band

At least 1 DL subframe per radio frame of measured cell is available at the UE for RSRP measurement assuming measured cell is identified cell.

Table 9.1.21.1-1: RSRP Intra frequency absolute accuracy for UE category M1 with CE mode A for FDD and TDD

Accuracy		Conditions				
Normal condition	Extreme condition	Es/lot	Io ^{Note 1} range			
			E-UTRA operating band groups ^{Note 3}	Minimum Io		Maximum Io
dB	dB	dB		dBm/15kHz ^{Note 2}	dBm/BW _{Channel}	dBm/BW _{Channel}
±7	±10	≥-6 dB	FDD-M1_A, TDD-M1_A	-121	N/A	-70
			FDD-M1_B	-120.5	N/A	-70
			FDD-M1_D	-119.5	N/A	-70
			FDD-M1_E, TDD-M1_E	-119	N/A	-70
			FDD-M1_F	-118.5	N/A	-70
			FDD-M1_G	-118	N/A	-70
			FDD-M1_N	-114.5	N/A	-70
±9	±12	≥-6 dB	FDD-M1_A, TDD-M1_A, FDD-M1_D, FDD-M1_E, TDD-M1_E, FDD-M1_F, FDD-M1_G, FDD-M1_N	N/A	-70	-50

NOTE 1: Io is assumed to have constant EPRE across the bandwidth.

NOTE 2: The condition level is increased by Δ>0, when applicable, as described in Sections B.4.2 and B.4.3.

NOTE 3: E-UTRA operating band groups are as defined in Section 3.5.

Table 9.1.21.1-2: RSRP Intra frequency absolute accuracy for UE category M1 with CE mode A for HD-FDD

Accuracy		Conditions				
Normal condition	Extreme condition	Ês/lot	I _o ^{Note 1} range			
			E-UTRA operating band groups ^{Note 3}	Minimum I _o	Maximum I _o	
dB	dB	dB		dBm/15kHz ^{Note 2}	dBm/BW _{Channel}	dBm/BW _{Channel}
±7	±10	≥-6 dB	FDD-M1_A	-121	N/A	-70
			FDD-M1_B	-120.5	N/A	-70
			FDD-M1_D	-119.5	N/A	-70
			FDD-M1_E	-119	N/A	-70
			FDD-M1_F	-118.5	N/A	-70
			FDD-M1_G	-118	N/A	-70
			FDD-M1_N	-114.5	N/A	-70
±9	±12	≥-6 dB	FDD-M1_A, FDD-M1_D, FDD-M1_E, FDD-M1_F, FDD-M1_G, FDD-M1_N	N/A	-70	-50

NOTE 1: I_o is assumed to have constant EPRE across the bandwidth.
 NOTE 2: The condition level is increased by Δ>0, when applicable, as described in Sections B.4.2 and B.4.3.
 NOTE 3: E-UTRA operating band groups are as defined in Section 3.5.

9.1.21.2 Intra-frequency Relative Accuracy of RSRP for UE category M1 with CE mode A

The relative accuracy of RSRP is defined as the RSRP measured from one cell compared to the RSRP measured from another cell on the same frequency for category M1 UE.

The accuracy requirements in Table 9.1. 21.2-1 and Table 9.1. 21.2-2 are valid under the following conditions:

Cell specific reference signals are transmitted either from one, two or four antenna ports.

Conditions defined in 36.101 Clause 7.3 for reference sensitivity are fulfilled.

RSRP_{1,2}_{dBm} according to Annex B.3.8 for a corresponding Band.

At least 1 DL subframe per radio frame of measured cell is available at the UE for RSRP measurement assuming measured cell is identified cell.

Table 9.1.21.2-1: RSRP Intra frequency relative accuracy for UE category M1 with CE mode A for FDD and TDD

Accuracy		Conditions			
Normal condition	Extreme condition	Ês/lot ^{Note 2}	I _o ^{Note 1} range		
			E-UTRA operating band groups ^{Note 5}	Minimum I _o	Maximum I _o
dB	dB	dB		dBm/15kHz ^{Note 4}	dBm/BW _{Channel}
±3	±4	≥-3 dB	FDD-M1_A, TDD-M1_A	-121	-50
			FDD-M1_B	-120.5	-50
			FDD-M1_D	-119.5	-50
			FDD-M1_E, TDD-M1_E	-119	-50
			FDD-M1_F	-118.5	-50
			FDD-M1_G	-118	-50
			FDD-M1_N	-114.5	-50
±4	±4	≥-6 dB	Note 3	Note 3	Note 3

NOTE 1: I_o is assumed to have constant EPRE across the bandwidth.
 NOTE 2: The parameter Ês/lot is the minimum Ês/lot of the pair of cells to which the requirement applies.
 NOTE 3: The same bands and the same I_o conditions for each band apply for this requirement as for the corresponding highest accuracy requirement.
 NOTE 4: The condition level is increased by Δ>0, when applicable, as described in Sections B.4.2 and B.4.3.
 NOTE 5: E-UTRA operating band groups are as defined in Section 3.5.

Table 9.1.21.2-2: RSRP Intra frequency relative accuracy for UE category M1 with CE mode A for HD-FDD

Accuracy		Conditions			
Normal condition	Extreme condition	$\hat{E}s/lot$ ^{Note 2}	Io ^{Note 1} range		
			E-UTRA operating band groups ^{Note 5}	Minimum Io	Maximum Io
dB	dB	dB		dBm/15kHz ^{Note 4}	dBm/BW _{Channel}
±3	±4	≥-3 dB	FDD-M1_A	-121	-50
			FDD-M1_B	-120.5	-50
			FDD-M1_D	-119.5	-50
			FDD-M1_E	-119	-50
			FDD-M1_F	-118.5	-50
			FDD-M1_G	-118	-50
			FDD-M1_N	-114.5	-50
±4	±4	≥-6 dB	Note 3	Note 3	Note 3

NOTE 1: Io is assumed to have constant EPRE across the bandwidth.
 NOTE 2: The parameter $\hat{E}s/lot$ is the minimum $\hat{E}s/lot$ of the pair of cells to which the requirement applies.
 NOTE 3: The same bands and the same Io conditions for each band apply for this requirement as for the corresponding highest accuracy requirement.
 NOTE 4: The condition level is increased by $\Delta > 0$, when applicable, as described in Sections B.4.2 and B.4.3.
 NOTE 5: E-UTRA operating band groups are as defined in Section 3.5.

9.1.21.3 Intra-frequency Absolute RSRP Accuracy for UE category M1 with CE mode B

The requirements for absolute accuracy of RSRP in this clause apply to a cell on the same frequency as that of the serving cell for UE category M1.

The accuracy requirements in Table 9.1.21.3-1 and Table 9.1.21.3-2 are valid under the following conditions:

Cell specific reference signals are transmitted either from one, two or four antenna ports.

Conditions defined in 36.101 Clause 7.3 for reference sensitivity are fulfilled.

RSRP[dBm] according to Annex B.3.1 for a corresponding Band

At least 1 DL subframe per radio frame of measured cell is available at the UE for RSRP measurement assuming measured cell is identified cell.

Table 9.1.21.3-1: RSRP Intra frequency absolute accuracy for UE category M1 with CE mode B for FDD and TDD

Accuracy		Conditions				
Normal condition	Extreme condition	$\hat{E}s/lot$	Io ^{Note 1} range			
			E-UTRA operating band groups ^{Note 3}	Minimum Io		Maximum Io
dB	dB	dB		dBm/15kHz ^{Note 2}	dBm/BW _{Channel}	dBm/BW _{Channel}
±8	±11	15 ≤ $\hat{E}s/lot$ ≤ -12 dB	FDD-M1_A, TDD-M1_A	-121	N/A	-70
			FDD-M1_B	-120.5	N/A	-70
			FDD-M1_D	-119.5	N/A	-70
			FDD-M1_E, TDD-M1_E	-119	N/A	-70
±7	±10	≥-12 dB	FDD-M1_F	-118.5	N/A	-70
			FDD-M1_G	-118	N/A	-70
			FDD-M1_N	-114.5	N/A	-70
±10	±13	15 ≤ $\hat{E}s/lot$ ≤ -12 dB	FDD-M1_A, TDD-M1_A, FDD-M1_B, FDD-M1_D, FDD-M1_E, TDD-M1_E, FDD-M1_F, FDD-M1_G, FDD-M1_N	N/A	-70	-50
±9	±12	≥-12 dB				

NOTE 1: Io is assumed to have constant EPRE across the bandwidth.
 NOTE 2: The condition level is increased by $\Delta > 0$, when applicable, as described in Sections B.4.2 and B.4.3.
 NOTE 3: E-UTRA operating band groups are as defined in Section 3.5.

Table 9.1.21.3-2: RSRP Intra frequency absolute accuracy for UE category M1 with CE mode B for HD-FDD

Accuracy		Conditions				
Normal condition	Extreme condition	Ês/lot	I _o ^{Note 1} range			
			E-UTRA operating band groups ^{Note 3}	Minimum I _o		Maximum I _o
dB	dB	dB		dBm/15kHz ^{Note 2}	dBm/BW _{Channel}	dBm/BW _{Channel}
±8	±11	15 ≤ Ês/lot ≤ -12 dB	FDD-M1_A	-121	N/A	-70
			FDD-M1_B	-120.5	N/A	-70
			FDD-M1_D	-119.5	N/A	-70
			FDD-M1_E	-119	N/A	-70
±7	±10	≥ -12 dB	FDD-M1_F	-118.5	N/A	-70
			FDD-M1_G	-118	N/A	-70
			FDD-M1_N	-114.5	N/A	-70
±10	±13	15 ≤ Ês/lot ≤ -12 dB	FDD-M1_A, FDD-M1_B, FDD-M1_D, FDD-M1_E, FDD-M1_F, FDD-M1_G, FDD-M1_N	N/A	-70	-50
±9	±12	≥ -12 dB				

NOTE 1: I_o is assumed to have constant EPRE across the bandwidth.
 NOTE 2: The condition level is increased by Δ > 0, when applicable, as described in Sections B.4.2 and B.4.3.
 NOTE 3: E-UTRA operating band groups are as defined in Section 3.5.

9.1.21.4 Intra-frequency Relative Accuracy of RSRP for UE category M1 with CE mode B

The relative accuracy of RSRP is defined as the RSRP measured from one cell compared to the RSRP measured from another cell on the same frequency for category M1 UE.

The accuracy requirements in Table 9.1.21.4-1 and Table 9.1.21.4-2 are valid under the following conditions:

Cell specific reference signals are transmitted either from one, two or four antenna ports.

Conditions defined in 36.101 Clause 7.3 for reference sensitivity are fulfilled.

RSRP_{1,2}_{dBm} according to Annex B.3.8 for a corresponding Band.

At least 1 DL subframe per radio frame of measured cell is available at the UE for RSRP measurement assuming measured cell is identified cell.

Table 9.1.21.4-1: RSRP Intra frequency relative accuracy for UE category M1 with CE mode B for FDD and TDD

Accuracy		Conditions			
Normal condition	Extreme condition	Ês/lot ^{Note 2}	I _o ^{Note 1} range		
			E-UTRA operating band groups ^{Note 5}	Minimum I _o	Maximum I _o
dB	dB	dB		dBm/15kHz ^{Note 4}	dBm/BW _{Channel}
±4	±4	≥ -12 dB	FDD-M1_A, TDD-M1_A	-121	-50
			FDD-M1_B	-120.5	-50
			FDD-M1_D	-119.5	-50
			FDD-M1_E, TDD-M1_E	-119	-50
			FDD-M1_F	-118.5	-50
			FDD-M1_G	-118	-50
±5	±5	15 ≤ Ês/lot ≤ -12 dB	Note 3	Note 3	Note 3

NOTE 1: I_o is assumed to have constant EPRE across the bandwidth.
 NOTE 2: The parameter Ês/lot is the minimum Ês/lot of the pair of cells to which the requirement applies.

NOTE 3: The same bands and the same I_o conditions for each band apply for this requirement as for the corresponding highest accuracy requirement.
 NOTE 4: The condition level is increased by $\Delta > 0$, when applicable, as described in Sections B.4.2 and B.4.3.
 NOTE 5: E-UTRA operating band groups are as defined in Section 3.5.

Table 9.1.21.4-2: RSRP Intra frequency relative accuracy for UE category M1 with CE mode B for HD-FDD

Accuracy		Conditions			
Normal condition	Extreme condition	$\hat{E}s/lot$ ^{Note 2}	I_o ^{Note 1} range		
			E-UTRA operating band groups ^{Note 5}	Minimum I_o	Maximum I_o
dB	dB	dB		dBm/15kHz ^{Note 4}	dBm/BW _{Channel}
±4	±4	≥-12 dB	FDD-M1_A	-121	-50
			FDD-M1_B	-120.5	-50
			FDD-M1_D	-119.5	-50
			FDD-M1_E	-119	-50
			FDD-M1_F	-118.5	-50
			FDD-M1_G	-118	-50
			FDD-M1_N	-114.5	-50
±5	±5	$15 \leq \hat{E}s/lot \leq -12$ dB	Note 3	Note 3	Note 3

NOTE 1: I_o is assumed to have constant EPRE across the bandwidth.
 NOTE 2: The parameter $\hat{E}s/lot$ is the minimum $\hat{E}s/lot$ of the pair of cells to which the requirement applies.
 NOTE 3: The same bands and the same I_o conditions for each band apply for this requirement as for the corresponding highest accuracy requirement.
 NOTE 4: The condition level is increased by $\Delta > 0$, when applicable, as described in Sections B.4.2 and B.4.3.
 NOTE 5: E-UTRA operating band groups are as defined in Section 3.5.

9.1.21.5 RSRP Measurement Report Mapping

The reporting range of RSRP is the same as defined in section 9.1.4.

9.1.21.6 Intra-frequency Absolute Accuracy of RSRQ for UE category M1 with CE mode A

The requirements for absolute accuracy of RSRQ in this clause apply to a cell on the same frequency as that of the serving cell.

The accuracy requirements in Tables 9.1.21.6-1 and 9.1.21.6-2 are valid under the following conditions:

Cell specific reference signals are transmitted either from one, two or four antenna ports.

Conditions defined in 36.101 Clause 7.3 for reference sensitivity are fulfilled.

RSRP[dBm] according to Annex B.3.1 for a corresponding Band

Table 9.1.21.6-1: RSRQ Intra frequency absolute accuracy UE category M1 with CE mode A for FDD and TDD

Accuracy		Conditions			
Normal condition	Extreme condition	$\hat{E}s/lot$	I_o ^{Note 1} range		
			E-UTRA operating band groups ^{Note 4}	Minimum I_o	Maximum I_o
dB	dB	dB		dBm/15kHz ^{Note 3}	dBm/BW _{Channel}
±4	±5.5	≥-3 dB	FDD-M1_A, TDD-M1_A	-121	-50
			FDD-M1_B	-120.5	-50
			FDD-M1_D	-119.5	-50
			FDD-M1_E, TDD-M1_E	-119	-50
			FDD-M1_F	-118.5	-50
			FDD-M1_G	-118	-50

			FDD-M1_N	-114.5	-50
±5	±5.5	≥-6 dB	Note 2	Note 2	Note 2
NOTE 1: I_0 is assumed to have constant EPRE across the bandwidth.					
NOTE 2: The same bands and the same I_0 conditions for each band apply for this requirement as for the corresponding highest accuracy requirement.					
NOTE 3: The condition level is increased by $\Delta > 0$, when applicable, as described in Sections B.4.2 and B.4.3.					
NOTE 4: E-UTRA operating band groups are as defined in Section 3.5.					

Table 9.1.21.6-2: RSRQ Intra frequency absolute accuracy UE category M1 with CE mode A for HD-FDD

Accuracy		Conditions			
Normal condition	Extreme condition	$\hat{E}s/lot$	I_0 ^{Note 1} range		
			E-UTRA operating band groups ^{Note 4}	Minimum I_0	Maximum I_0
dB	dB	dB		dBm/15kHz ^{Note 3}	dBm/BW _{Channel}
±4	±5.5	≥-3 dB	FDD-M1_A	-121	-50
			FDD-M1_B	-120.5	-50
			FDD-M1_D	-119.5	-50
			FDD-M1_E	-119	-50
			FDD-M1_F	-118.5	-50
			FDD-M1_G	-118	-50
±5	±5.5	≥-6 dB	Note 2	Note 2	Note 2
NOTE 1: I_0 is assumed to have constant EPRE across the bandwidth.					
NOTE 2: The same bands and the same I_0 conditions for each band apply for this requirement as for the corresponding highest accuracy requirement.					
NOTE 3: The condition level is increased by $\Delta > 0$, when applicable, as described in Sections B.4.2 and B.4.3.					
NOTE 4: E-UTRA operating band groups are as defined in Section 3.5.					

9.1.21.7 Intra-frequency Absolute Accuracy of RSRQ for UE category M1 with CE mode B

The requirements for absolute accuracy of RSRQ in this clause apply to a cell on the same frequency as that of the serving cell.

The accuracy requirements in Tables 9.1.21.7-1 and 9.1.21.7-2 are valid under the following conditions:

Cell specific reference signals are transmitted either from one, two or four antenna ports.

Conditions defined in 36.101 Clause 7.3 for reference sensitivity are fulfilled.

RSRP[dBm] according to Annex B.3.1 for a corresponding Band

Table 9.1.21.7-1: RSRQ Intra frequency absolute accuracy UE category M1 with CE mode B for FDD and TDD

Accuracy		Conditions			
Normal condition	Extreme condition	$\hat{E}s/lot$	I_0 ^{Note 1} range		
			E-UTRA operating band groups ^{Note 4}	Minimum I_0	Maximum I_0
dB	dB	dB		dBm/15kHz ^{Note 3}	dBm/BW _{Channel}
±5	±6.5	≥-12 dB	FDD-M1_A, TDD-M1_A	-121	-50
			FDD-M1_B	-120.5	-50
			FDD-M1_D	-119.5	-50
			FDD-M1_E, TDD-M1_E	-119	-50
			FDD-M1_F	-118.5	-50
			FDD-M1_G	-118	-50
±6	±6.5	$15 \leq \hat{E}s/lot \leq -12$ dB	Note 2	Note 2	Note 2
NOTE 1: I_0 is assumed to have constant EPRE across the bandwidth.					
NOTE 2: The same bands and the same I_0 conditions for each band apply for this requirement as for the corresponding highest accuracy requirement.					
NOTE 3: The condition level is increased by $\Delta > 0$, when applicable, as described in Sections B.4.2 and B.4.3.					
NOTE 4: E-UTRA operating band groups are as defined in Section 3.5.					

NOTE 1: I_0 is assumed to have constant EPRE across the bandwidth.
 NOTE 2: The same bands and the same I_0 conditions for each band apply for this requirement as for the corresponding highest accuracy requirement.
 NOTE 3: The condition level is increased by $\Delta > 0$, when applicable, as described in Sections B.4.2 and B.4.3.
 NOTE 4: E-UTRA operating band groups are as defined in Section 3.5.

Table 9.1.21.7-2: RSRQ Intra frequency absolute accuracy UE category M1 with CE mode B for HD-FDD

Accuracy		Conditions			
Normal condition	Extreme condition	\hat{E}_s/lot	I_0 ^{Note 1} range		
			E-UTRA operating band groups ^{Note 4}	Minimum I_0	Maximum I_0
dB	dB	dB		dBm/15kHz ^{Note 3}	dBm/BW _{Channel}
±5	±6.5	≥-12 dB	FDD-M1_A	-121	-50
			FDD-M1_B	-120.5	-50
			FDD-M1_D	-119.5	-50
			FDD-M1_E	-119	-50
			FDD-M1_F	-118.5	-50
			FDD-M1_G	-118	-50
			FDD-M1_N	-114.5	-50
±6	±6.5	15 ≤ \hat{E}_s/lot ≤ -12 dB	Note 2	Note 2	Note 2

NOTE 1: I_0 is assumed to have constant EPRE across the bandwidth.
 NOTE 2: The same bands and the same I_0 conditions for each band apply for this requirement as for the corresponding highest accuracy requirement.
 NOTE 3: The condition level is increased by $\Delta > 0$, when applicable, as described in Sections B.4.2 and B.4.3.
 NOTE 4: E-UTRA operating band groups are as defined in Section 3.5.

9.1.21.8 RSRQ Measurement Report Mapping

The reporting range of RSRQ is the same as defined in section 9.1.7.

9.1.21.9 Inter-frequency Absolute RSRP Accuracy for UE category M1 with CE mode A

The requirements for absolute accuracy of RSRP in this clause apply to a cell on another frequency than that of the serving cell for UE category M1.

The accuracy requirements in Table 9.1.21.9-1 and Table 9.1.21.9-2 are valid under the following conditions:

Cell specific reference signals are transmitted either from one, two or four antenna ports.

Conditions defined in 36.101 Clause 7.3 for reference sensitivity are fulfilled.

RSRP [dBm] according to Annex B.3.1 for a corresponding Band

At least 1 DL subframe per radio frame of measured cell is available at the UE for RSRP measurement assuming measured cell is identified cell.

Table 9.1.21.9-1: RSRP Inter frequency absolute accuracy for UE category M1 with CE mode A for FDD and TDD

Accuracy		Conditions				
Normal condition	Extreme condition	\hat{E}_s/lot	I_0 ^{Note 1} range			
			E-UTRA operating band groups ^{Note 3}	Minimum I_0	Maximum I_0	
dB	dB	dB	dBm/15kHz ^{Note 2}	dBm/BW _{Channel}	dBm/BW _{Channel}	
±5	±6.5	≥-6 dB	FDD-M1_A, TDD-M1_A	-121	N/A	-70
			FDD-M1_B	-120.5	N/A	-70
			FDD-M1_D	-119.5	N/A	-70
			FDD-M1_E, TDD-M1_E	-119	N/A	-70

			FDD-M1_F	-118.5	N/A	-70
			FDD-M1_G	-118	N/A	-70
			FDD-M1_N	-114.5	N/A	-70
±6	±6.5	≥-6 dB	FDD-M1_A, TDD-M1_A, FDD-M1_D, FDD-M1_E, TDD-M1_E, FDD-M1_F, FDD-M1_G, FDD-M1_N	N/A	-70	-50

NOTE 1: I_0 is assumed to have constant EPRE across the bandwidth.
 NOTE 2: The condition level is increased by $\Delta > 0$, when applicable, as described in Sections B.4.2 and B.4.3.
 NOTE 3: E-UTRA operating band groups are as defined in Section 3.5.

Table 9.1.21.9-2: RSRP Inter frequency absolute accuracy for UE category M1 with CE mode A for HD-FDD

Accuracy		Conditions				
Normal condition	Extreme condition	\hat{E}_s/I_{ot}	I_0 ^{Note 1} range			
			E-UTRA operating band groups ^{Note 3}	Minimum I_0		Maximum I_0
dB	dB	dB		dBm/15kHz ^{Note 2}	dBm/BW _{Channel}	dBm/BW _{Channel}
±7	±10	≥-6 dB	FDD-M1_A	-121	N/A	-70
			FDD-M1_B	-120.5	N/A	-70
			FDD-M1_D	-119.5	N/A	-70
			FDD-M1_E	-119	N/A	-70
			FDD-M1_F	-118.5	N/A	-70
			FDD-M1_G	-118	N/A	-70
			FDD-M1_N	-114.5	N/A	-70
±9	±12	≥-6 dB	FDD-M1_A, FDD-M1_D, FDD-M1_E, FDD-M1_F, FDD-M1_G, FDD-M1_N	N/A	-70	-50

NOTE 1: I_0 is assumed to have constant EPRE across the bandwidth.
 NOTE 2: The condition level is increased by $\Delta > 0$, when applicable, as described in Sections B.4.2 and B.4.3.
 NOTE 3: E-UTRA operating band groups are as defined in Section 3.5.

9.1.21.10 Inter-frequency Relative Accuracy of RSRP for UE category M1 with CE mode A

The relative accuracy of RSRP is defined as the RSRP measured from one cell compared to the RSRP measured from another cell on another frequency for category M1 UE.

The accuracy requirements in Table 9.1.21.10-1 and Table 9.1.21.10-2 are valid under the following conditions:

Cell specific reference signals are transmitted either from one, two or four antenna ports.

Conditions defined in 36.101 Clause 7.3 for reference sensitivity are fulfilled.

RSRP_{1,2}_{dBm} according to Annex B.3.8 for a corresponding Band.

At least 1 DL subframe per radio frame of measured cell is available at the UE for RSRP measurement assuming measured cell is identified cell.

Table 9.1.21.10-1: RSRP Inter frequency relative accuracy for UE category M1 with CE mode A for FDD and TDD

Accuracy		Conditions			
Normal condition	Extreme condition	\hat{E}_s/I_{ot} ^{Note 2}	I_0 ^{Note 1} range		
			E-UTRA operating band groups ^{Note 5}	Minimum I_0	Maximum I_0
dB	dB	dB	dBm/15kHz ^{Note 4}	dBm/BW _{Channel}	
±7	±8	≥-3 dB	FDD-M1_A, TDD-M1_A	-121	-50
			FDD-M1_B	-120.5	-50
			FDD-M1_D	-119.5	-50
			FDD-M1_E, TDD-M1_E	-119	-50

			FDD-M1_F	-118.5	-50
			FDD-M1_G	-118	-50
			FDD-M1_N	-114.5	-50
±8	±8	≥-6 dB	Note 3	Note 3	Note 3
<p>NOTE 1: I_0 is assumed to have constant EPRE across the bandwidth.</p> <p>NOTE 2: The parameter \hat{E}_s/I_{ot} is the minimum \hat{E}_s/I_{ot} of the pair of cells to which the requirement applies.</p> <p>NOTE 3: The same bands and the same I_0 conditions for each band apply for this requirement as for the corresponding highest accuracy requirement.</p> <p>NOTE 4: The condition level is increased by $\Delta > 0$, when applicable, as described in Sections B.4.2 and B.4.3.</p> <p>NOTE 5: E-UTRA operating band groups are as defined in Section 3.5.</p>					

Table 9.1.21.10-2: RSRP Inter frequency relative accuracy for UE category M1 with CE mode A for HD-FDD

Accuracy		Conditions			
Normal condition	Extreme condition	\hat{E}_s/I_{ot} ^{Note 2}	I_0 ^{Note 1} range		
			E-UTRA operating band groups ^{Note 5}	Minimum I_0	Maximum I_0
dB	dB	dB		dBm/15kHz ^{Note 4}	dBm/BW _{Channel}
±7	±8	≥-3 dB	FDD-M1_A	-121	-50
			FDD-M1_B	-120.5	-50
			FDD-M1_D	-119.5	-50
			FDD-M1_E	-119	-50
			FDD-M1_F	-118.5	-50
			FDD-M1_G	-118	-50
			FDD-M1_N	-114.5	-50
±8	±8	≥-6 dB	Note 3	Note 3	Note 3
<p>NOTE 1: I_0 is assumed to have constant EPRE across the bandwidth.</p> <p>NOTE 2: The parameter \hat{E}_s/I_{ot} is the minimum \hat{E}_s/I_{ot} of the pair of cells to which the requirement applies.</p> <p>NOTE 3: The same bands and the same I_0 conditions for each band apply for this requirement as for the corresponding highest accuracy requirement.</p> <p>NOTE 4: The condition level is increased by $\Delta > 0$, when applicable, as described in Sections B.4.2 and B.4.3.</p> <p>NOTE 5: E-UTRA operating band groups are as defined in Section 3.5.</p>					

9.1.21.11 Inter-frequency Absolute RSRP Accuracy for UE category M1 with CE mode B

The requirements for absolute accuracy of RSRP in this clause apply to a cell on another frequency than that of the serving cell for UE category M1.

The accuracy requirements in Table 9.1.21.11-1 and Table 9.1.21.11-2 are valid under the following conditions:

Cell specific reference signals are transmitted either from one, two or four antenna ports.

Conditions defined in 36.101 Clause 7.3 for reference sensitivity are fulfilled.

RSRP|dBm according to Annex B.3.1 for a corresponding Band

At least 1 DL subframe per radio frame of measured cell is available at the UE for RSRP measurement assuming measured cell is identified cell.

Table 9.1.21.11-1: RSRP Inter frequency absolute accuracy for UE category M1 with CE mode B for FDD and TDD

Accuracy		Conditions				
Normal condition	Extreme condition	\hat{E}_s/I_{ot}	I_0 ^{Note 1} range			
			E-UTRA operating band groups ^{Note 3}	Minimum I_0		Maximum I_0
dB	dB	dB		dBm/15kHz ^{Note 2}	dBm/BW _{Channel}	
±8	±11	- 15 ≤ \hat{E}_s/I_{ot} ≤ -12 dB	FDD-M1_A, TDD-M1_A	-121	N/A	-70
			FDD-M1_B	-120.5	N/A	-70
			FDD-M1_D	-119.5	N/A	-70

±7	±10	≥-12 dB	FDD-M1_E, TDD-M1_E	-119	N/A	-70
			FDD-M1_F	-118.5	N/A	-70
			FDD-M1_G	-118	N/A	-70
			FDD-M1_N	-114.5	N/A	-70
±10	±13	15 ≤ Ês/lot ≤ -12 dB	FDD-M1_A, TDD-M1_A, FDD-M1_D, FDD-M1_E, TDD-M1_E, FDD-M1_F, FDD-M1_G, FDD-M1_N	N/A	-70	-50
±9	±12	≥-12 dB				

NOTE 1: I_o is assumed to have constant EPRE across the bandwidth.
 NOTE 2: The condition level is increased by Δ>0, when applicable, as described in Sections B.4.2 and B.4.3.
 NOTE 3: E-UTRA operating band groups are as defined in Section 3.5.

Table 9.1.21.11-2: RSRP Inter frequency absolute accuracy for UE category M1 with CE mode B for HD-FDD

Accuracy		Conditions				
Normal condition	Extreme condition	Ês/lot	I _o ^{Note 1} range			
			E-UTRA operating band groups ^{Note 3}	Minimum I _o		Maximum I _o
dB	dB	dB		dBm/15kHz ^{Note 2}	dBm/BW _{Channel}	dBm/BW _{Channel}
±8	±11	15 ≤ Ês/lot ≤ -12 dB	FDD-M1_A	-121	N/A	-70
			FDD-M1_B	-120.5	N/A	-70
			FDD-M1_D	-119.5	N/A	-70
			FDD-M1_E	-119	N/A	-70
			FDD-M1_F	-118.5	N/A	-70
			FDD-M1_G	-118	N/A	-70
±7	±10	≥-12 dB	FDD-M1_N	-114.5	N/A	-70
±10	±13	15 ≤ Ês/lot ≤ -12 dB	FDD-M1_A, FDD-M1_D, FDD-M1_E, FDD-M1_F, FDD-M1_G, FDD-M1_N	N/A	-70	-50
±9	±12	≥-12 dB				

NOTE 1: I_o is assumed to have constant EPRE across the bandwidth.
 NOTE 2: The condition level is increased by Δ>0, when applicable, as described in Sections B.4.2 and B.4.3.
 NOTE 3: E-UTRA operating band groups are as defined in Section 3.5.

9.1.21.12 Inter-frequency Relative Accuracy of RSRP for UE category M1 with CE mode B

The relative accuracy of RSRP is defined as the RSRP measured from one cell compared to the RSRP measured from another cell on another frequency for category M1 UE.

The accuracy requirements in Table 9.1.21.12-1 and Table 9.1.21.12-2 are valid under the following conditions:

Cell specific reference signals are transmitted either from one, two or four antenna ports.

Conditions defined in 36.101 Clause 7.3 for reference sensitivity are fulfilled.

RSRP_{1,2}_{dBm} according to Annex B.3.8 for a corresponding Band.

At least 1 DL subframe per radio frame of measured cell is available at the UE for RSRP measurement assuming measured cell is identified cell.

Table 9.1.21.12-1: RSRP Inter frequency relative accuracy for UE category M1 with CE mode B for FDD and TDD

Accuracy		Conditions			
Normal condition	Extreme condition	Ês/lot ^{Note 2}	I _o ^{Note 1} range		
			E-UTRA operating band groups ^{Note 5}	Minimum I _o	Maximum I _o
dB	dB	dB		dBm/15kHz ^{Note 4}	dBm/BW _{Channel}
±7	±10	≥-12 dB	FDD-M1_A, TDD-M1_A	-121	-50
			FDD-M1_B	-120.5	-50

			FDD-M1_D	-119.5	-50
			FDD-M1_E, TDD-M1_E	-119	-50
			FDD-M1_F	-118.5	-50
			FDD-M1_G	-118	-50
			FDD-M1_N	-114.5	-50
±8	±11	$15 \leq \hat{E}_s/\text{lot} \leq -12$ dB	Note 3	Note 3	Note 3

NOTE 1: I_o is assumed to have constant EPRE across the bandwidth.
 NOTE 2: The parameter \hat{E}_s/lot is the minimum \hat{E}_s/lot of the pair of cells to which the requirement applies.
 NOTE 3: The same bands and the same I_o conditions for each band apply for this requirement as for the corresponding highest accuracy requirement.
 NOTE 4: The condition level is increased by $\Delta > 0$, when applicable, as described in Sections B.4.2 and B.4.3.
 NOTE 5: E-UTRA operating band groups are as defined in Section 3.5.

Table 9.1.21.12-2: RSRP Inter frequency relative accuracy for UE category M1 with CE mode B for HD-FDD

Accuracy		Conditions			
Normal condition	Extreme condition	\hat{E}_s/lot Note 2	I_o Note 1 range		
			E-UTRA operating band groups Note 5	Minimum I_o	Maximum I_o
dB	dB	dB		dBm/15kHz Note 4	dBm/BW _{Channel}
±7	±10	≥-12 dB	FDD-M1_A	-121	-50
			FDD-M1_B	-120.5	-50
			FDD-M1_D	-119.5	-50
			FDD-M1_E	-119	-50
			FDD-M1_F	-118.5	-50
			FDD-M1_G	-118	-50
			FDD-M1_N	-114.5	-50
±8	±11	$15 \leq \hat{E}_s/\text{lot} \leq -12$ dB	Note 3	Note 3	Note 3

NOTE 1: I_o is assumed to have constant EPRE across the bandwidth.
 NOTE 2: The parameter \hat{E}_s/lot is the minimum \hat{E}_s/lot of the pair of cells to which the requirement applies.
 NOTE 3: The same bands and the same I_o conditions for each band apply for this requirement as for the corresponding highest accuracy requirement.
 NOTE 4: The condition level is increased by $\Delta > 0$, when applicable, as described in Sections B.4.2 and B.4.3.
 NOTE 5: E-UTRA operating band groups are as defined in Section 3.5.

9.1.21.13 Inter-frequency Absolute Accuracy of RSRQ for UE category M1 in CE mode A

The requirements for absolute accuracy of RSRQ in this clause apply to a cell that has different carrier frequency from the serving cell.

The accuracy requirements in Tables 9.1.21.13-1 and 9.1.21.13-2 are valid under the following conditions:

Cell specific reference signals are transmitted either from one, two or four antenna ports.

Conditions defined in 36.101 Clause 7.3 for reference sensitivity are fulfilled.

RSRP|dBm according to Annex B.3.3 for a corresponding Band

Table 9.1.21.13-1: RSRQ Inter frequency absolute accuracy UE category M1 with CE mode A for FDD and TDD

Accuracy		Conditions			
Normal condition	Extreme condition	\hat{E}_s/lot	I_o Note 1 range		
			E-UTRA operating band groups Note 4	Minimum I_o	Maximum I_o
dB	dB	dB		dBm/15kHz Note 3	dBm/BW _{Channel}
±4	±5.5	≥-3 dB	FDD-M1_A, TDD-M1_A	-121	-50
			FDD-M1_B	-120.5	-50

			FDD-M1_D	-119.5	-50
			FDD-M1_E, TDD-M1_E	-119	-50
			FDD-M1_F	-118.5	-50
			FDD-M1_G	-118	-50
			FDD-M1_N	-114.5	-50
±5	±5.5	≥-6 dB	Note 2	Note 2	Note 2
<p>NOTE 1: I_0 is assumed to have constant EPRE across the bandwidth.</p> <p>NOTE 2: The same bands and the same I_0 conditions for each band apply for this requirement as for the corresponding highest accuracy requirement.</p> <p>NOTE 3: The condition level is increased by $\Delta > 0$, when applicable, as described in Sections B.4.2 and B.4.3.</p> <p>NOTE 4: E-UTRA operating band groups are as defined in Section 3.5.</p>					

Table 9.1.21.13-2: RSRQ Inter frequency absolute accuracy UE category M1 with CE mode A for HD-FDD

Accuracy		Conditions			
Normal condition	Extreme condition	$\hat{E}s/lot$	I_0 ^{Note 1} range		
			E-UTRA operating band groups ^{Note 4}	Minimum I_0	Maximum I_0
dB	dB	dB	dBm/15kHz ^{Note 3}	dBm/BW _{Channel}	
±4	±5.5	≥-3 dB	FDD-M1_A, TDD-M1_A	-121	-50
			FDD-M1_B	-120.5	-50
			FDD-M1_D	-119.5	-50
			FDD-M1_E, TDD-M1_E	-119	-50
			FDD-M1_F	-118.5	-50
			FDD-M1_G	-118	-50
±5	±5.5	≥-6 dB	Note 2	Note 2	Note 2
<p>NOTE 1: I_0 is assumed to have constant EPRE across the bandwidth.</p> <p>NOTE 2: The same bands and the same I_0 conditions for each band apply for this requirement as for the corresponding highest accuracy requirement.</p> <p>NOTE 3: The condition level is increased by $\Delta > 0$, when applicable, as described in Sections B.4.2 and B.4.3.</p> <p>NOTE 4: E-UTRA operating band groups are as defined in Section 3.5.</p>					

9.1.21.14 Inter-frequency Relative Accuracy of RSRQ for UE category M1 in CE mode A

The relative accuracy of RSRQ in inter frequency case is defined as the RSRQ measured from one cell compared to the RSRQ measured from another cell on a different frequency.

The accuracy requirements in Tables 9.1.21.14-1 and 9.1.21.14-2 are valid under the following conditions:

Cell specific reference signals are transmitted either from one, two or four antenna ports.

Conditions defined in 36.101 Clause 7.3 for reference sensitivity are fulfilled.

$RSRP_{1,2|dBm}$ according to Annex B.3.4 for a corresponding Band

$$|RSRP_{1|dBm} - RSRP_{2|dBm}| \leq 27 \text{ dB}$$

$$|Channel\ 1_{I_0} - Channel\ 2_{I_0}| \leq 20 \text{ dB}$$

Table 9.1.21.14-1: RSRQ Inter frequency relative accuracy UE category M1 with CE mode A for FDD and TDD

Accuracy		Conditions			
Normal condition	Extreme condition	$\hat{E}s/lot$ ^{Note 2}	I_0 ^{Note 1} range		
			E-UTRA operating band groups ^{Note 5}	Minimum I_0	Maximum I_0
dB	dB	dB	dBm/15kHz ^{Note 4}	dBm/BW _{Channel}	
±4.5	±5.5	≥-3 dB	FDD-M1_A, TDD-M1_A	-121	-50
			FDD-M1_B	-120.5	-50
			FDD-M1_D	-119.5	-50

			FDD-M1_E, TDD-M1_E	-119	-50
			FDD-M1_F	-118.5	-50
			FDD-M1_G	-118	-50
			FDD-M1_N	-114.5	-50
±5.5	±5.5	≥-6 dB	Note 3	Note 3	Note 3
<p>NOTE 1: I_0 is assumed to have constant EPRE across the bandwidth.</p> <p>NOTE 2: The parameter \hat{E}_s/I_0 is the minimum \hat{E}_s/I_0 of the pair of cells to which the requirement applies.</p> <p>NOTE 3: The same bands and the same I_0 conditions for each band apply for this requirement as for the corresponding highest accuracy requirement.</p> <p>NOTE 4: The condition level is increased by $\Delta > 0$, when applicable, as described in Sections B.4.2 and B.4.3.</p> <p>NOTE 5: E-UTRA operating band groups are as defined in Section 3.5.</p>					

Table 9.1.21.14-2: RSRQ Inter frequency relative accuracy UE category M1 with CE mode A for HD-FDD

Accuracy		Conditions			
Normal condition	Extreme condition	\hat{E}_s/I_0 ^{Note 2}	I_0 ^{Note 1} range		
			E-UTRA operating band groups ^{Note 5}	Minimum I_0	Maximum I_0
dB	dB	dB		dBm/15kHz ^{Note 4}	dBm/BW _{Channel}
±4.5	±5.5	≥-3 dB	FDD-M1_A	-121	-50
			FDD-M1_B	-120.5	-50
			FDD-M1_D	-119.5	-50
			FDD-M1_E	-119	-50
			FDD-M1_F	-118.5	-50
			FDD-M1_G	-118	-50
±5.5	±5.5	≥-6 dB	Note 3	Note 3	Note 3
<p>NOTE 1: I_0 is assumed to have constant EPRE across the bandwidth.</p> <p>NOTE 2: The parameter \hat{E}_s/I_0 is the minimum \hat{E}_s/I_0 of the pair of cells to which the requirement applies.</p> <p>NOTE 3: The same bands and the same I_0 conditions for each band apply for this requirement as for the corresponding highest accuracy requirement.</p> <p>NOTE 4: The condition level is increased by $\Delta > 0$, when applicable, as described in Sections B.4.2 and B.4.3.</p> <p>NOTE 5: E-UTRA operating band groups are as defined in Section 3.5.</p>					

9.1.21.15 Inter-frequency Absolute Accuracy of RSRQ for UE category M1 in CE mode B

The requirements for absolute accuracy of RSRQ in this clause apply to a cell that has different carrier frequency from the serving cell.

The accuracy requirements in Tables 9.1.21.15-1 and 9.1.21.15-2 are valid under the following conditions:

Cell specific reference signals are transmitted either from one, two or four antenna ports.

Conditions defined in 36.101 Clause 7.3 for reference sensitivity are fulfilled.

RSRP|dBm according to Annex B.3.3 for a corresponding Band

Table 9.1.21.15-1: RSRQ Inter frequency absolute accuracy UE category M1 with CE mode B for FDD and TDD

Accuracy		Conditions			
Normal condition	Extreme condition	\hat{E}_s/I_0	I_0 ^{Note 1} range		
			E-UTRA operating band groups ^{Note 4}	Minimum I_0	Maximum I_0
dB	dB	dB		dBm/15kHz ^{Note 3}	dBm/BW _{Channel}
±5	±6.5	≥-12 dB	FDD-M1_A, TDD-M1_A	-121	-50
			FDD-M1_B	-120.5	-50
			FDD-M1_D	-119.5	-50
			FDD-M1_E, TDD-M1_E	-119	-50
			FDD-M1_F	-118.5	-50
			FDD-M1_G	-118	-50

			FDD-M1_N	-114.5	-50
±6	±6.5	15 ≤ Ês/lot ≤ -12 dB	Note 2	Note 2	Note 2
NOTE 1: I _o is assumed to have constant EPRE across the bandwidth. NOTE 2: The same bands and the same I _o conditions for each band apply for this requirement as for the corresponding highest accuracy requirement. NOTE 3: The condition level is increased by Δ>0, when applicable, as described in Sections B.4.2 and B.4.3. NOTE 4: E-UTRA operating band groups are as defined in Section 3.5.					

Table 9.1.21.15-2: RSRQ Inter frequency absolute accuracy UE category M1 with CE mode B for HD-FDD

Accuracy		Conditions			
Normal condition	Extreme condition	Ês/lot	I _o ^{Note 1} range		
			E-UTRA operating band groups ^{Note 4}	Minimum I _o	Maximum I _o
dB	dB	dB		dBm/15kHz ^{Note 3}	dBm/BW _{Channel}
±5	±6.5	≥-12 dB	FDD-M1_A, TDD-M1_A	-121	-50
			FDD-M1_B	-120.5	-50
			FDD-M1_D	-119.5	-50
			FDD-M1_E, TDD-M1_E	-119	-50
			FDD-M1_F	-118.5	-50
			FDD-M1_G	-118	-50
			FDD-M1_N	-114.5	-50
±6	±6.5	15 ≤ Ês/lot ≤ -12 dB	Note 2	Note 2	Note 2
NOTE 1: I _o is assumed to have constant EPRE across the bandwidth. NOTE 2: The same bands and the same I _o conditions for each band apply for this requirement as for the corresponding highest accuracy requirement. NOTE 3: The condition level is increased by Δ>0, when applicable, as described in Sections B.4.2 and B.4.3. NOTE 4: E-UTRA operating band groups are as defined in Section 3.5.					

9.1.21.16 Inter-frequency Relative Accuracy of RSRQ for UE category M1 in CE mode B

The relative accuracy of RSRQ in inter frequency case is defined as the RSRQ measured from one cell compared to the RSRQ measured from another cell on a different frequency.

The accuracy requirements in Tables 9.1.21.16-1 and 9.1.21.16-2 are valid under the following conditions:

Cell specific reference signals are transmitted either from one, two or four antenna ports.

Conditions defined in 36.101 Clause 7.3 for reference sensitivity are fulfilled.

RSRP_{1,2}_{dBm} according to Annex B.3.4 for a corresponding Band

$$|RSRP_{1,dBm} - RSRP_{2,dBm}| \leq 27 \text{ dB}$$

$$|Channel\ 1_I_o - Channel\ 2_I_o| \leq 20 \text{ dB}$$

Table 9.1.21.16-1: RSRQ Inter frequency relative accuracy UE category M1 with CE mode B for FDD and TDD

Accuracy		Conditions			
Normal condition	Extreme condition	Ês/lot ^{Note 2}	I _o ^{Note 1} range		
			E-UTRA operating band groups ^{Note 5}	Minimum I _o	Maximum I _o
dB	dB	dB		dBm/15kHz ^{Note 4}	dBm/BW _{Channel}
±5.5	±6.5	≥-12 dB	FDD-M1_A, TDD-M1_A	-121	-50
			FDD-M1_B	-120.5	-50
			FDD-M1_D	-119.5	-50

			FDD-M1_E, TDD-M1_E	-119	-50
			FDD-M1_F	-118.5	-50
			FDD-M1_G	-118	-50
			FDD-M1_N	-114.5	-50
±6.5	±6.5	$15 \leq \hat{E}_s/\text{lot} \leq -12$ dB	Note 3	Note 3	Note 3
<p>NOTE 1: I_0 is assumed to have constant EPRE across the bandwidth. NOTE 2: The parameter \hat{E}_s/lot is the minimum \hat{E}_s/lot of the pair of cells to which the requirement applies. NOTE 3: The same bands and the same I_0 conditions for each band apply for this requirement as for the corresponding highest accuracy requirement. NOTE 4: The condition level is increased by $\Delta > 0$, when applicable, as described in Sections B.4.2 and B.4.3. NOTE 5: E-UTRA operating band groups are as defined in Section 3.5.</p>					

Table 9.1.21.16-2: RSRQ Inter frequency relative accuracy UE category M1 with CE mode B for HD-FDD

Accuracy		Conditions			
Normal condition	Extreme condition	\hat{E}_s/lot ^{Note 2}	I_0 ^{Note 1} range		
			E-UTRA operating band groups ^{Note 5}	Minimum I_0	Maximum I_0
dB	dB	dB		dBm/15kHz ^{Note 4}	dBm/BW _{Channel}
±5.5	±6.5	≥-12 dB	FDD-M1_A	-121	-50
			FDD-M1_B	-120.5	-50
			FDD-M1_D	-119.5	-50
			FDD-M1_E	-119	-50
			FDD-M1_F	-118.5	-50
			FDD-M1_G	-118	-50
			FDD-M1_N	-114.5	-50
±6.5	±6.5	$15 \leq \hat{E}_s/\text{lot} \leq -12$ dB	Note 3	Note 3	Note 3
<p>NOTE 1: I_0 is assumed to have constant EPRE across the bandwidth. NOTE 2: The parameter \hat{E}_s/lot is the minimum \hat{E}_s/lot of the pair of cells to which the requirement applies. NOTE 3: The same bands and the same I_0 conditions for each band apply for this requirement as for the corresponding highest accuracy requirement. NOTE 4: The condition level is increased by $\Delta > 0$, when applicable, as described in Sections B.4.2 and B.4.3. NOTE 5: E-UTRA operating band groups are as defined in Section 3.5.</p>					

9.1.21.17 Inter-Frequency RSTD Accuracy Requirement for UE category M1 in CE mode A

The accuracy requirements in Table 9.1.21.17-1 are valid under the following conditions:

Conditions defined in 36.101 Clause 7.3 for reference sensitivity are fulfilled.

PRP $1,2_{\text{dBm}}$ according to Annex B.3.31 for a corresponding Band

There are no measurement gaps overlapping with the PRS subframes of the measured serving cell.

The parameter expectedRSTDUncertainty signalled over LPP by E-SMLC as defined in TS 36.355 [24] is less than 5 μs.

Table 9.1.21.17-1: RSTD measurement accuracy for CE Mode A

Accuracy	PRS \hat{E}_s/lot	Minimum PRS bandwidth, which is minimum of serving cell channel bandwidth and the PRS bandwidths of the reference	Minimum number of available measurement subframes among the reference cell and the measured neighbour cell i	The number of consecutive downlink subframes N_{PRS} among the reference cell and the measured neighbour cell i	Conditions		
					I_0 ^{Note 4} range		
					E-UTRA operating band groups ^{Note 5}	Minimum I_0 ^{Note 1}	Maximum I_0

		cell and the measured neighbour cell <i>i</i>		as defined in [24]			
Ts ^{Note 2}	dB	RB				dBm/15kHz	dBm/BW _{Channel}
±21	(PRS \hat{E}_s/lot) _{ref} ≥ -6dB and (PRS \hat{E}_s/lot) _i ≥ -13dB	≥ 6	≥ 12	≥ 4	FDD-M1_A, TDD-M1_A	-121	-50
					FDD-M1_B	-120.5	-50
					FDD-M1_C, TDD-M1_C	-120	-50
					FDD-M1_D	-119.5	-50
					FDD-M1_E, TDD-M1_E	-119	-50
					FDD-M1_F	-118.5	-50
					FDD-M1_G	-118	-50
					FDD-M1_H	-117.5	-50
					FDD-M1_N	-114.5	-50

NOTE 1: This minimum I_o condition is expressed as the average I_o per RE over all REs in an OFDM symbol.
 NOTE 2: Ts is the basic timing unit defined in TS 36.211 [16].
 NOTE 3: PRS bandwidth is as indicated in *prs-Bandwidth* in the OTDOA assistance data defined in [24].
 NOTE 4: The I_o is defined in PRS positioning subframes. The same I_o range applies to PRS and non-PRS symbols. I_o levels are different in PRS and non-PRS symbols within the same subframe.
 NOTE 5: E-UTRA operating band groups are as defined in Section 3.5.

9.1.21.18 Inter-Frequency RSTD Accuracy Requirement for UE category M1 in CE mode B

The accuracy requirements in Table 9.1.21.18-1 are valid under the following conditions:

Conditions defined in 36.101 Clause 7.3 for reference sensitivity are fulfilled.

PRP 1,2_{dBm} according to Annex B.3.31 for a corresponding Band

There are no measurement gaps overlapping with the PRS subframes of the measured serving cell.

The parameter expectedRSTDUncertainty signalled over LPP by E-SMLC as defined in TS 36.355 [24] is less than 5 μs.

Table 9.1.21.18-1: RSTD measurement accuracy for CEModeB

Accuracy	PRS \hat{E}_s/lot	Minimum PRS bandwidth, which is minimum of serving cell channel bandwidth and the PRS bandwidths of the reference cell and the measured neighbour cell <i>i</i>	Minimum number of available measurement subframes among the reference cell and the measured neighbour cell <i>i</i>	The number of consecutive downlink subframes N _{PRS} among the reference cell and the measured neighbour cell <i>i</i> as defined in [24]	Conditions		
					E-UTRA operating band groups ^{Note 5}	Minimum I_o ^{Note 1}	Maximum I_o
Ts ^{Note 2}	dB	RB			dBm/15kHz	dBm/BW _{Channel}	
[±21]		≥ 6	≥ 30	≥ 4	FDD-M1_A,	-121	-50

(PRS \hat{E}_s/lot) _{ref} $\geq -15\text{dB}$ and (PRS \hat{E}_s/lot) _i $\geq -15\text{dB}$				TDD-M1_A		
				FDD-M1_B	-120.5	-50
				FDD-M1_C, TDD-M1_C	-120	-50
				FDD-M1_D	-119.5	-50
				FDD-M1_E, TDD-M1_E	-119	-50
				FDD-M1_F	-118.5	-50
				FDD-M1_G	-118	-50
				FDD-M1_H	-117.5	-50
				FDD-M1_N	-114.5	-50
NOTE 1: This minimum l_0 condition is expressed as the average l_0 per RE over all REs in an OFDM symbol. NOTE 2: T_s is the basic timing unit defined in TS 36.211 [16]. NOTE 3: PRS bandwidth is as indicated in <i>prs-Bandwidth</i> in the OTDOA assistance data defined in [24]. NOTE 4: The l_0 is defined in PRS positioning subframes. The same l_0 range applies to PRS and non-PRS symbols. l_0 levels are different in PRS and non-PRS symbols within the same subframe. NOTE 5: E-UTRA operating band groups are as defined in Section 3.5.						

9.1.21.19 UE RX-TX time difference Accuracy Requirement for Cat-M1

The UE RX-TX time difference is measured from the PCell.

The accuracy requirements in Table 9.1.21.19-1 are valid under the following conditions:

Conditions defined in 36.101 Clause 7.3 for reference sensitivity are fulfilled.

No changes to the uplink transmission timing are applied during the measurement period.

$RSRP|_{dBm}$ according to Annex B.2.14 for a corresponding Band

Table 9.1.21.19-1: UE Rx – Tx time difference measurement accuracy for CEModeA

Accuracy	Conditions				
	\hat{E}_s/lot	Downlink transmission bandwidth of PCell	l_0 ^{Note 1} range		
			E-UTRA operating band groups ^{Note 3}	Minimum l_0	Maximum l_0
T_s ^{Note 2}	dB	RB		dBm/15kHz	dBm/BW _{Channel}
±20	≥ -3 dB	≥ 6	FDD-M1_A, TDD-M1_A	-121	-50
			FDD-M1_B	-120.5	-50
			FDD-M1_C, TDD-M1_C	-120	-50
			FDD-M1_D	-119.5	-50
			FDD-M1_E, TDD-M1_E	-119	-50
			FDD-M1_F	-118.5	-50
			FDD-M1_G	-118	-50
			FDD-M1_H	-117.5	-50
			FDD-M1_N	-114.5	-50
NOTE 1: When in dBm/15kHz, the minimum l_0 condition is expressed as the average l_0 per RE over all REs in that symbol. l_0 may be different in different symbols within a subframe. NOTE 2: T_s is the basic timing unit defined in TS 36.211. NOTE 3: E-UTRA operating band groups are as defined in Section 3.5.					

9.1.21.20 Intra-Frequency RSTD Accuracy Requirement for UE category M1 in CE mode A

The accuracy requirements in Table 9.1.21.20-1 are valid under the following conditions:

Conditions defined in 36.101 Clause 7.3 for reference sensitivity are fulfilled.

PRP $1,2_{dBm}$ according to Annex B.3.33 for a corresponding Band

For a UE that does not need a measurement gap for intra-frequency RSTD measurement, there are no measurement gaps overlapping with the PRS subframes of the measured serving cell and PRS are available within the UE measurement bandwidth in all PRS subframes

For a UE that needs a measurement gap for intra-frequency RSTD measurement, the measurement gaps are configured to contain PRS subframes

The parameter *expectedRSTDUncertainty* signalled over LPP by E-SMLC as defined in TS 36.355 [24] is less than 5 μ s.

Table 9.1.21.20-1: RSTD measurement accuracy for CEModeA

Accuracy	Conditions						
	PRS $\hat{\epsilon}_{s/lot}$	Minimum PRS bandwidth, which is minimum of serving cell channel bandwidth and the PRS bandwidths of the reference cell and the measured neighbour cell <i>i</i> <small>Note 4</small>	Minimum number of available measurement subframes among the reference cell and the measured neighbour cell <i>i</i>	The number of consecutive downlink subframes N_{PRS} among the reference cell and the measured neighbour cell <i>i</i> as defined in [24]	Io <small>Note 5</small> range		
					E-UTRA operating band groups <small>Note 6</small>	Minimum Io <small>Note 1</small>	Maximum Io
T_s <small>Note 2</small>	dB	RB			dBm/15kHz	dBm/BW _{Channel}	
± 15 <small>Note 7</small>	(PRS $\hat{\epsilon}_{s/lot})_{ref} \geq -6dB$ and (PRS $\hat{\epsilon}_{s/lot})_i \geq -13dB$	≥ 6	≥ 12	≥ 6	FDD-M1_A, TDD-M1_A	-121	-50
					FDD-M1_B	-120.5	-50
					FDD-M1_C, TDD-M1_C	-120	-50
					FDD-M1_D	-119.5	-50
					FDD-M1_E, TDD-M1_E	-119	-50
					FDD-M1_F	-118.5	-50
					FDD-M1_G	-118	-50
					FDD-M1_H	-117.5	-50
					FDD-M1_N	-114.5	-50
± 15 <small>Note 8</small>	(PRS $\hat{\epsilon}_{s/lot})_{ref} \geq -6dB$ and	≥ 6	≥ 12	≥ 4	FDD-M1_A, TDD-M1_A	-121	-50
					FDD-M1_B	-120.5	-50

	(PRS \hat{E}_s/lot); $\geq -13\text{dB}$			FDD-M1_C, TDD-M1_C	-120	-50
				FDD-M1_D	-119.5	-50
				FDD-M1_E, TDD-M1_E	-119	-50
				FDD-M1_F	-118.5	-50
				FDD-M1_G	-118	-50
				FDD-M1_H	-117.5	-50
				FDD-M1_N	-114.5	-50
<p>NOTE 1: This minimum I_0 condition is expressed as the average I_0 per RE over all REs in an OFDM symbol.</p> <p>NOTE 2: T_s is the basic timing unit defined in TS 36.211 [16].</p> <p>NOTE 3: PRS bandwidth is as indicated in <i>prs-Bandwidth</i> in the OTDOA assistance data defined in [24].</p> <p>NOTE 4: The serving cell, the reference cell, and the measured neighbour cell i are on the same carrier frequency.</p> <p>NOTE 5: The I_0 is defined in PRS positioning subframes. The same I_0 range applies to PRS and non-PRS symbols. I_0 levels are different in PRS and non-PRS symbols within the same subframe.</p> <p>NOTE 6: E-UTRA operating band groups are as defined in Section 3.5.</p> <p>NOTE 7: The requirement applies when PRS are available within the UE measurement bandwidth in all PRS subframes and measurement gaps are not required.</p> <p>NOTE 8: The requirement applies when measurement gaps are required.</p>						

9.1.21.21 Intra-Frequency RSTD Accuracy Requirement for UE category M1 in CE mode B

The accuracy requirements in Table 9.1.21.21-1 are valid under the following conditions:

Conditions defined in 36.101 Clause 7.3 for reference sensitivity are fulfilled.

PRP 1,2_{dBm} according to Annex B.3.33 for a corresponding Band

For a UE that does not need a measurement gap for intra-frequency RSTD measurement, there are no measurement gaps overlapping with the PRS subframes of the measured serving cell and PRS are available within the UE measurement bandwidth in all PRS subframes

For a UE that needs a measurement gap for intra-frequency RSTD measurement, the measurement gaps are configured to contain PRS subframes

The parameter *expectedRSTDUncertainty* signalled over LPP by E-SMLC as defined in TS 36.355 [24] is less than 5 μs .

Table 9.1.21.21-1: RSTD measurement accuracy for CEModeB

Accuracy	Conditions						
	PRS \hat{E}_s/lot	Minimum PRS bandwidth, which is minimum of serving cell channel bandwidth and the PRS bandwidths of the reference cell and the measured neighbour cell i <small>Note 4</small>	Minimum number of available measurement subframes among the reference cell and the measured neighbour cell i	The number of consecutive downlink subframes N_{PRS} among the reference cell and the measured neighbour cell i as defined in [24]	I_0 <small>Note 5</small> range		
E-UTRA operating band groups <small>Note 6</small>					Minimum I_0 <small>Note 1</small>	Maximum I_0	
T_s <small>Note 2</small>	dB	RB			dBm/15kHz	dBm/BW _{Channel}	

±15 ^{Note7}	(PRS $\hat{E}_s/lot)_{ref} \geq -6\text{dB}$ and (PRS $\hat{E}_s/lot)_i \geq -13\text{dB}$)	≥ 6	≥ 30	≥ 6	FDD-M1_A, TDD-M1_A	-121	-50
					FDD-M1_B	-120.5	-50
					FDD-M1_C, TDD-M1_C	-120	-50
					FDD-M1_D	-119.5	-50
					FDD-M1_E, TDD-M1_E	-119	-50
					FDD-M1_F	-118.5	-50
					FDD-M1_G	-118	-50
					FDD-M1_H	-117.5	-50
					FDD-M1_N	-114.5	-50
±15 ^{Note8}	(PRS $\hat{E}_s/lot)_{ref} \geq -6\text{dB}$ and (PRS $\hat{E}_s/lot)_i \geq -13\text{dB}$)	≥ 6	≥ 30	≥ 4	FDD-M1_A, TDD-M1_A	-121	-50
					FDD-M1_B	-120.5	-50
					FDD-M1_C, TDD-M1_C	-120	-50
					FDD-M1_D	-119.5	-50
					FDD-M1_E, TDD-M1_E	-119	-50
					FDD-M1_F	-118.5	-50
					FDD-M1_G	-118	-50
					FDD-M1_H	-117.5	-50
					FDD-M1_N	-114.5	-50
<p>NOTE 1: This minimum l_0 condition is expressed as the average l_0 per RE over all REs in an OFDM symbol.</p> <p>NOTE 2: T_s is the basic timing unit defined in TS 36.211 [16].</p> <p>NOTE 3: PRS bandwidth is as indicated in <i>prs-Bandwidth</i> in the OTDOA assistance data defined in [24].</p> <p>NOTE 4: The serving cell, the reference cell, and the measured neighbour cell i are on the same carrier frequency.</p> <p>NOTE 5: The l_0 is defined in PRS positioning subframes. The same l_0 range applies to PRS and non-PRS symbols. l_0 levels are different in PRS and non-PRS symbols within the same subframe.</p> <p>NOTE 6: E-UTRA operating band groups are as defined in Section 3.5.</p> <p>NOTE 7: The requirement applies when PRS are available within the UE measurement bandwidth in all PRS subframes and measurement gaps are not required.</p> <p>NOTE 8: The requirement applies when measurement gaps are required.</p>							

9.1.22 Measurement accuracy for UE Category NB1

9.1.22.1 Intra-frequency Absolute NRSRP Accuracy for UE Category NB1

The requirements for absolute accuracy of NRSRP in this clause apply to a cell on the same frequency as that of the serving cell for UE Category NB1 for stand-alone, guard-band and in-band deployments. For a UE capable of NSSS-

based RRM measurement, provided that *nss-NumOccDiffPrecoders* value *n1* has been indicated by higher layers, the accuracy requirement as specified in Table 9.1.22.1-2 shall apply. Otherwise, the accuracy requirement as specified in Table 9.1.22.1-1 shall apply.

The accuracy requirements in Table 9.1.22.1-1 and Table 9.1.22.1-2 are valid under the following conditions:

Narrowband reference signals are transmitted either from one or two ports.

Conditions defined in Clause 7.3 of TS 36.101 [5] for reference sensitivity are fulfilled.

NRSRP[dBm] according to Annex B.3.25 for a corresponding Band

At least 1 DL subframe per radio frame of measured cell is available at the UE for NRSRP measurement assuming measured cell is identified cell.

Table 9.1.22.1-1: NRSRP Intra frequency absolute accuracy for UE Category NB1

Accuracy		Conditions				
Normal condition	Extreme condition	\hat{E}_s/lot	E-UTRA operating band groups ^{Note 2}	I_o ^{Note 1} range		
				Minimum I_o		Maximum I_o
dB	dB	dB		dBm/15kHz	dBm/BW _{Channel}	dBm/BW _{Channel}
±6	±9	≥-6 dB	NFDD_G, NTDD_G	-122.9	N/A	-70
±8	±11	≥-6 dB	NFDD_G, NTDD_G	N/A	-70	-50
±10.3	±13.3	$15 \leq \hat{E}_s/\text{lot} \leq -6$ dB	NFDD_G, NTDD_G	-122.9	N/A	-70
±12.3	±15.3	$15 \leq \hat{E}_s/\text{lot} \leq -6$ dB	NFDD_G, NTDD_G	N/A	-70	-50

NOTE 1: I_o is assumed to have constant EPRE across the bandwidth.
NOTE 2: E-UTRA operating band groups are as defined in Section 3.5.

Table 9.1.22.1-2: NRSRP Intra frequency absolute accuracy for UE Category NB1 under NSSS-based measurement

Accuracy		Conditions				
Normal condition	Extreme condition	\hat{E}_s/lot	E-UTRA operating band groups ^{Note 2}	I_o ^{Note 1} range		
				Minimum I_o		Maximum I_o
dB	dB	dB		dBm/15kHz	dBm/BW _{Channel}	dBm/BW _{Channel}
±4	±7	≥-6 dB	NFDD_G, NTDD_G	-122.9	N/A	-70
±6	±9	≥-6 dB	NFDD_G, NTDD_G	N/A	-70	-50
±6	±9	$15 \leq \hat{E}_s/\text{lot} \leq -6$ dB	NFDD_G, NTDD_G	-122.9	N/A	-70
±8	±11	$15 \leq \hat{E}_s/\text{lot} \leq -6$ dB	NFDD_G, NTDD_G	N/A	-70	-50

NOTE 1: I_o is assumed to have constant EPRE across the bandwidth.
NOTE 2: E-UTRA operating band groups are as defined in Section 3.5.

9.1.22.2 Void

9.1.22.3 Intra-frequency Absolute NRSRQ Accuracy for UE Category NB1

The requirements for absolute accuracy of NRSRQ in this clause apply to a cell on the same frequency as that of the serving cell for NB-IoT UE for stand-alone, guard-band and in-band deployments. For a UE capable of NSSS-based RRM measurement, provided that *nss-NumOccDiffPrecoders* value *n1* has been indicated by higher layers, the accuracy requirement as specified in Table 9.1.22.3-2 shall apply. Otherwise, the accuracy requirement as specified in Table 9.1.22.3-1 shall apply.

The accuracy requirements in Table 9.1.22.3-1 and Table 9.1.22.3-2 are valid under the following conditions:

Narrowband reference signals are transmitted either from one or two antenna ports.

Conditions defined in Clause 7.3 of TS 36.101 [5] for reference sensitivity are fulfilled.

NRSRP[dBm according to Annex B.3.25 for a corresponding Band

At least 1 DL subframe per radio frame of measured cell is available at the UE for NRSRQ measurement assuming measured cell is identified cell.

Table 9.1.22.3-1: NRSRQ Intra frequency absolute accuracy for UE Category NB1

Accuracy		Conditions			
Normal condition	Extreme condition	Ês/lot	I _o ^{Note 1} range		
			E-UTRA operating band groups Note 3	Minimum I _o	Maximum I _o
dB	dB	dB		dBm/15kHz	dBm/BW _{Channel}
±5.2	±8.2	≥-3 dB	NFDD_G, NTDD_G	-122.9	-50
±7.2	±10.2	≥-6 dB	Note 2	Note 2	Note 2
±9.5	±12.5	-15 ≤ Ês/lot ≤ -6 dB	NFDD_G, NTDD_G	-122.9	-50
±11.5	±14.5	-15 ≤ Ês/lot ≤ -6 dB	Note 2	Note 2	Note 2

NOTE 1: I_o is assumed to have constant EPRE across the bandwidth.
 NOTE 2: The same bands and the same I_o conditions for each band apply for this requirement as for the corresponding highest accuracy requirement.
 NOTE 3: E-UTRA operating band groups are as defined in Section 3.5.

Table 9.1.22.3-2: NRSRQ Intra frequency absolute accuracy for UE Category NB1 under NSSS-based measurement

Accuracy		Conditions				
Normal condition	Extreme condition	Ês/lot	I _o ^{Note 1} range			
			E-UTRA operating band groups Note 2	Minimum I _o		Maximum I _o
dB	dB	dB		dBm/15kHz	dBm/BW _{Channel}	dBm/BW _{Channel}
±3.2	±6.2	≥-6 dB	NFDD_G, NTDD_G	-122.9	N/A	-70
±5.2	±8.2	≥-6 dB	NFDD_G, NTDD_G	N/A	-70	-50
±5.2	±8.2	15 ≤ Ês/lot ≤ -6 dB	NFDD_G, NTDD_G	-122.9	N/A	-70
±7.2	±10.2	15 ≤ Ês/lot ≤ -6 dB	NFDD_G, NTDD_G	N/A	-70	-50

NOTE 1: I_o is assumed to have constant EPRE across the bandwidth.
 NOTE 2: E-UTRA operating band groups are as defined in Section 3.5.

9.1.22.4 Void

9.1.22.5 Inter-frequency Absolute NRSRP Accuracy for UE Category NB1

The requirements for absolute accuracy of NRSRP in this clause apply to a cell that has different carrier frequency from the serving cell. For a UE capable of NSSS-based RRM measurement, provided that *nss-NumOccDiffPrecoders* value *n* has been indicated by higher layers, the accuracy requirement as specified in Table 9.1.22.5-2 shall apply. Otherwise, the accuracy requirement as specified in Table 9.1.22.5-1 shall apply.

The accuracy requirements in Table 9.1.22.5-1 and Table 9.1.22.5-2 are valid under the following conditions:

Narrowband reference signals are transmitted either from one or two antenna ports.

Conditions defined in Clause 7.3 of TS 36.101 [5] for reference sensitivity are fulfilled.

NRSRP[dBm according to Annex B.3.26 for a corresponding Band

At least 1 DL subframe per radio frame of measured cell is available at the UE for NRSRP measurement assuming measured cell is identified cell.

Table 9.1.22.5-1: NRSRP Inter frequency absolute accuracy for UE Category NB1

Accuracy		Conditions				
Normal condition	Extreme condition	Ês/lot	Io ^{Note 1} range			
			E-UTRA operating band groups ^{Note 2}	Minimum Io		Maximum Io
dB	dB	dB		dBm/15kHz	dBm/BW _{Channel}	dBm/BW _{Channel}
±6	±9	≥-6 dB	NFDD_G, NTDD_G	-122.9	N/A	-70
±8	±11	≥-6 dB	NFDD_G, NTDD_G	N/A	-70	-50
±10.3	±13.3	15 ≤ Ês/lot ≤ -6 dB	NFDD_G, NTDD_G	-122.9	N/A	-70
±12.3	±15.3	15 ≤ Ês/lot ≤ -6 dB	NFDD_G, NTDD_G	N/A	-70	-50

NOTE 1: Io is assumed to have constant EPRE across the bandwidth.
 NOTE 2: E-UTRA operating band groups are as defined in Section 3.5.

Table 9.1.22.5-2: NRSRP Inter frequency absolute accuracy for UE Category NB1 under NSSS-based measurement

Accuracy		Conditions				
Normal condition	Extreme condition	Ês/lot	Io ^{Note 1} range			
			E-UTRA operating band groups ^{Note 2}	Minimum Io		Maximum Io
dB	dB	dB		dBm/15kHz	dBm/BW _{Channel}	dBm/BW _{Channel}
±4	±7	≥-6 dB	NFDD_G, NTDD_G	-122.9	N/A	-70
±6	±9	≥-6 dB	NFDD_G, NTDD_G	N/A	-70	-50
±6	±9	15 ≤ Ês/lot ≤ -6 dB	NFDD_G, NTDD_G	-122.9	N/A	-70
±8	±11	15 ≤ Ês/lot ≤ -6 dB	NFDD_G, NTDD_G	N/A	-70	-50

NOTE 1: Io is assumed to have constant EPRE across the bandwidth.
 NOTE 2: E-UTRA operating band groups are as defined in Section 3.5.

9.1.22.6 Void

9.1.22.7 Inter-frequency Absolute NRSRQ Accuracy for UE Category NB1

The requirements for absolute accuracy of NRSRQ in this clause apply to a cell that has different carrier frequency from the serving cell. For a UE capable of NSSS-based RRM measurement, provided that *nss-NumOccDiffPrecoders* value *n1* has been indicated by higher layers, the accuracy requirement as specified in Table 9.1.22.7-2 shall apply. Otherwise, the accuracy requirement as specified in Table 9.1.22.7-1 shall apply.

The accuracy requirements in Table 9.1.22.7-1 and Table 9.1.22.7-2 are valid under the following conditions:

Narrowband reference signals are transmitted either from one or two antenna ports.

Conditions defined in Clause 7.3 of TS 36.101 [5] for reference sensitivity are fulfilled.

NRSRP|dBm according to Annex B.3.26 for a corresponding Band

At least 1 DL subframe per radio frame of measured cell is available at the UE for NRSRQ measurement assuming measured cell is identified cell.

Table 9.1.22.7-1: NRSRQ Inter frequency absolute accuracy for UE Category NB1

Accuracy		Conditions	
		Ês/lot	Io ^{Note 1} range

Normal condition	Extreme condition		E-UTRA operating band groups Note 3	Minimum l_o	Maximum l_o
dB	dB	dB		dBm/15kHz	dBm/BW _{Channel}
±5.2	±8.2	≥-3 dB	NFDD_G, NTDD_G	-122.9	-50
±7.2	±10.2	≥-6 dB	Note 2	Note 2	Note 2
±9.5	±12.5	-15 ≤ \hat{E}_s/lot ≤ -6 dB	NFDD_G, NTDD_G	-122.9	-50
±11.5	±14.5	-15 ≤ \hat{E}_s/lot ≤ -6 dB	Note 2	Note 2	Note 2

NOTE 1: l_o is assumed to have constant EPRE across the bandwidth.
NOTE 2: The same bands and the same l_o conditions for each band apply for this requirement as for the corresponding highest accuracy requirement.
NOTE 3: E-UTRA operating band groups are as defined in Section 3.5.

Table 9.1.22.7-2: NRSRQ Inter frequency absolute accuracy for UE Category NB1 under NSSS-based measurement

Accuracy		Conditions				
Normal condition	Extreme condition	\hat{E}_s/lot	l_o Note 1 range			
			E-UTRA operating band groups Note 2	Minimum l_o		Maximum l_o
dB	dB	dB		dBm/15kHz	dBm/BW _{Channel}	dBm/BW _{Channel}
±3.2	±6.2	≥-6 dB	NFDD_G, NTDD_G	-122.9	N/A	-70
±5.2	±8.2]	≥-6 dB	NFDD_G, NTDD_G	N/A	-70	-50
±5.2	±8.2	15 ≤ \hat{E}_s/lot ≤ -6 dB	NFDD_G, NTDD_G	-122.9	N/A	-70
±7.2	±10.2	15 ≤ \hat{E}_s/lot ≤ -6 dB	NFDD_G, NTDD_G	N/A	-70	-50

NOTE 1: l_o is assumed to have constant EPRE across the bandwidth.
NOTE 2: E-UTRA operating band groups are as defined in Section 3.5.

9.1.22.8 Void

9.1.22.9 NRSRP Measurement Report Mapping

The reporting range of NRSRP is defined from -156 dBm to -44 dBm with 1 dB resolution.

The mapping of measured quantity is defined in Table 9.1.22.9-1. The range in the signalling may be larger than the guaranteed accuracy range.

Table 9.1.22.9-1: NRSRP measurement report mapping

Reported value	Measured quantity value	Unit
NRSRP_00	NRSRP < -156	dBm
NRSRP_01	-156 ≤ NRSRP < -155	dBm
NRSRP_02	-155 ≤ NRSRP < -154	dBm
...
NRSRP_111	-46 ≤ NRSRP < -45	dBm
NRSRP_112	-45 ≤ NRSRP < -44	dBm
NRSRP_113	-44 ≤ NRSRP	dBm

9.1.22.10 Intra-Frequency RSTD Accuracy Requirement for NB1 for normal coverage

The accuracy requirements in Table 9.1.22.10-1 are valid under the following conditions:

Conditions defined in 36.101 Clause 7.3 for reference sensitivity are fulfilled.

NPRP 1,2]_{dBm} according to Annex B.3.29 for a corresponding Band

There are no measurement gaps overlapping with the NPRS subframes of the measured serving cell.

The parameter expectedRSTDUncertainty signalled over LPP by E-SMLC as defined in TS 36.355 [24] is less than 5 μs.

UE is configured via LPP with nprsInfo-Type2 as specified in TS 36.355 [24] for any cell whose NPRS RE overlaps with the NPRS RE of any other cell in the OTDOA assistance data on the same frequency.

Table 9.1.22.10-1: Intra RSTD measurement accuracy for normal coverage

Accuracy	Conditions					
	NPRS $\hat{E}s/lot$	UE NPRS measurement bandwidth on the reference cell and the measured neighbour cell i ^{Note 3}	Minimum number of available measurement subframes among the reference cell and the measured neighbour cell i , N_{NPRS_total} ^{Note 6}	Io ^{Note 7} range		
				E-UTRA operating band groups ^{Note 7}	Minimum Io ^{Note 1}	Maximum Io
T_s ^{Note 2}	dB	RB			dBm/15kHz	dBm/BW _{Channel}
±20	(NPRS $\hat{E}s/lot$) _{ref} ≥ -6dB and (NPRS $\hat{E}s/lot$) _i ≥ -13dB	1	320	NFDD_G, NTDD_G	-118	-70

NOTE 1: This minimum Io condition is expressed as the average Io per RE over all REs in an OFDM symbol.
 NOTE 2: T_s is the basic timing unit defined in TS 36.211 [16].
 NOTE 3: The serving cell, the reference cell, and the measured neighbour cell i are on the same carrier frequency.
 NOTE 4: The Io is defined in NPRS positioning subframes. The same Io range applies to NPRS and non-NPRS symbols. Io levels are different in NPRS and non-NPRS symbols within the same subframe.
 NOTE 5: E-UTRA operating band groups are as defined in Section 3.5.
 NOTE 6: N_{NPRS_total} can be in one or more NPRS positioning occasions.

9.1.22.11 Inter-Frequency RSTD Accuracy Requirement for NB1 for normal coverage

The accuracy requirements in Table 9.1.22.11-1 are valid under the following conditions:

Conditions defined in 36.101 Clause 7.3 for reference sensitivity are fulfilled.

NPRP 1,2|_{dBm} according to Annex B.3.29 for a corresponding Band

There are no measurement gaps overlapping with the NPRS subframes of the measured serving cell.

The parameter expectedRSTDUncertainty signalled over LPP by E-SMLC as defined in TS 36.355 [24] is less than 5 μs.

UE is configured via LPP with nprsInfo-Type2 as specified in TS 36.355 [24] for any cell whose NPRS RE overlaps with the NPRS RE of any other cell in the OTDOA assistance data on the same frequency.

Table 9.1.22.11-1: Inter RSTD measurement accuracy for normal coverage

Accuracy	Conditions					
	NPRS $\hat{E}s/lot$	UE NPRS measurement bandwidth on the reference cell and the measured neighbour cell i ^{Note 3}	Minimum number of available measurement subframes among the reference cell and the measured neighbour cell i , N_{NPRS_total} ^{Note 6}	Io ^{Note 7} range		
				E-UTRA operating band groups ^{Note 7}	Minimum Io ^{Note 1}	Maximum Io

Ts <small>Note 2</small>	dB	RB			dBm/15kHz	dBm/BW _{Channel} <small>i</small>
±28	(NPRS \hat{E}_s/lot) _{ref} ≥ -6dB and (NPRS \hat{E}_s/lot) _i ≥ -13dB	1	320	NFDD_G, NTDD_G	-118	-70

NOTE 1: This minimum l_o condition is expressed as the average l_o per RE over all REs in an OFDM symbol.
 NOTE 2: Ts is the basic timing unit defined in TS 36.211 [16].
 NOTE 3: The serving cell, the reference cell, and the measured neighbour cell *i* are on the same carrier frequency.
 NOTE 4: The l_o is defined in NPRS positioning subframes. The same l_o range applies to NPRS and non-NPRS symbols. l_o levels are different in NPRS and non-NPRS symbols within the same subframe.
 NOTE 5: E-UTRA operating band groups are as defined in Section 3.5.
 NOTE 6: $N_{\text{NPRS}_{total}}$ can be in one or more NPRS positioning occasions.

9.1.22.12 Intra-Frequency RSTD Accuracy Requirement for NB1 for enhanced coverage

The accuracy requirements in Table 9.1.22.12-1 are valid under the following conditions:

Conditions defined in 36.101 Clause 7.3 for reference sensitivity are fulfilled.

NPRP 1,2_{dBm} according to Annex B.3.29 for a corresponding Band

There are no measurement gaps overlapping with the NPRS subframes of the measured serving cell.

The parameter expectedRSTDUncertainty signalled over LPP by E-SMLC as defined in TS 36.355 [24] is less than 5 μs.

UE is configured via LPP with nprsInfo-Type2 as specified in TS 36.355 [24] for any cell whose NPRS RE overlaps with the NPRS RE of any other cell in the OTDOA assistance data on the same frequency.

Table 9.1.22.12-1: RSTD measurement accuracy for enhanced coverage

Accuracy	Conditions					
	NPRS \hat{E}_s/lot	UE NPRS measurement bandwidth on the reference cell and the measured neighbour cell <i>i</i> <small>Note 3</small>	Minimum number of available measurement subframes among the reference cell and the measured neighbour cell <i>i</i> , $N_{\text{NPRS}_{total}}$ <small>Note 6</small>	l_o <small>Note 7</small> range		
				E-UTRA operating band groups <small>Note 7</small>	Minimum l_o <small>Note 1</small>	Maximum l_o
Ts <small>Note 2</small>	dB	RB			dBm/15kHz	dBm/BW _{Channel} <small>i</small>
±32	(NPRS \hat{E}_s/lot) _{ref} ≥ -15dB and (NPRS \hat{E}_s/lot) _i ≥ -15dB	1	320	NFDD_G, NTDD_G	-118	-70

NOTE 1: This minimum l_o condition is expressed as the average l_o per RE over all REs in an OFDM symbol.
 NOTE 2: Ts is the basic timing unit defined in TS 36.211 [16].
 NOTE 3: The serving cell, the reference cell, and the measured neighbour cell *i* are on the same carrier frequency.
 NOTE 4: The l_o is defined in NPRS positioning subframes. The same l_o range applies to NPRS and non-NPRS symbols. l_o levels are different in NPRS and non-NPRS symbols within the same subframe.
 NOTE 5: E-UTRA operating band groups are as defined in Section 3.5.

NOTE 6: N_{NPRS_total} can be in one or more NPRS positioning occasions.

9.1.22.13 Inter-Frequency RSTD Accuracy Requirement for NB1 for enhanced coverage

The accuracy requirements in Table 9.1.22.13-1 are valid under the following conditions:

Conditions defined in 36.101 Clause 7.3 for reference sensitivity are fulfilled.

NPRP $1,2_{dBm}$ according to Annex B.3.29 for a corresponding Band

There are no measurement gaps overlapping with the NPRS subframes of the measured serving cell.

The parameter expectedRSTDUncertainty signalled over LPP by E-SMLC as defined in TS 36.355 [24] is less than 5 μs .

UE is configured via LPP with nprsInfo-Type2 as specified in TS 36.355 [24] for any cell whose NPRS RE overlaps with the NPRS RE of any other cell in the OTDOA assistance data on the same frequency.

Table 9.1.22.13-1: RSTD measurement accuracy for enhanced coverage

Accuracy	Conditions					
	NPRS \hat{E}_s/lot	UE NPRS measurement bandwidth on the reference cell and the measured neighbour cell i ^{Note 3}	Minimum number of available measurement subframes among the reference cell and the measured neighbour cell i , N_{NPRS_total} ^{Note 6}	Io ^{Note 7} range		
				E-UTRA operating band groups ^{Note 7}	Minimum Io ^{Note 1}	Maximum Io
T_s ^{Note 2}	dB	RB			dBm/15kHz	dBm/BW _{Channel}
± 40	$(NPRS \hat{E}_s/lot)_{ref} \geq -15dB$ and $(NPRS \hat{E}_s/lot)_i \geq -15dB$	1	320	NFDD_G, NTDD_G	-118	-70

NOTE 1: This minimum Io condition is expressed as the average Io per RE over all REs in an OFDM symbol.
 NOTE 2: T_s is the basic timing unit defined in TS 36.211 [16].
 NOTE 3: The serving cell, the reference cell, and the measured neighbour cell i are on the same carrier frequency.
 NOTE 4: The Io is defined in NPRS positioning subframes. The same Io range applies to NPRS and non-NPRS symbols. Io levels are different in NPRS and non-NPRS symbols within the same subframe.
 NOTE 5: E-UTRA operating band groups are as defined in Section 3.5.
 NOTE 6: N_{NPRS_total} can be in one or more NPRS positioning occasions.

9.1.22.14 NRSRQ Measurement Report Mapping

The reporting range of NRSRQ is defined from -34 dB to 2.5 dB with 0.5 dB resolution.

The mapping of measured quantity is defined in table 9.1.22.14-1. The range in the signalling may be larger than the guaranteed accuracy range.

Table 9.1.22.14-1: NRSRQ measurement report mapping

Reported value	Measured quantity value	Unit
NRSRQ_-30	$NRSRQ < -34$	dB
NRSRQ_-29	$-34 \leq NRSRQ < -33.5$	dB
...

NRSRQ_-02	$-20.5 \leq \text{NRSRQ} < -20$	dB
NRSRQ_-01	$-20 \leq \text{NRSRQ} < -19.5$	dB
NRSRQ_00	$\text{NRSRQ} < -19.5$	dB
NRSRQ_01	$-19.5 \leq \text{NRSRQ} < -19$	dB
NRSRQ_02	$-19 \leq \text{NRSRQ} < -18.5$	dB
...
NRSRQ_32	$-4 \leq \text{NRSRQ} < -3.5$	dB
NRSRQ_33	$-3.5 \leq \text{NRSRQ} < -3$	dB
NRSRQ_34	$-3 \leq \text{NRSRQ}$	dB
NRSRQ_35	$-3 \leq \text{NRSRQ} < -2.5$	dB
NRSRQ_36	$-2.5 \leq \text{NRSRQ} < -2$	dB
...
NRSRQ_45	$2 \leq \text{NRSRQ} < 2.5$	dB
NRSRQ_46	$2.5 \leq \text{NRSRQ}$	dB

9.1.22.15 MSG3-based Measurement Report Mapping for UE Category NB1

Table 9.1.22.15-1: Downlink channel quality measurement report mapping of CQI-NPDCCH-NB when the DL channel quality reporting is supported [7]

Reported value	NPDCCH repetition level
noMeasurement	No measurement reporting
candidateRep-A	1
candidateRep-B	2
candidateRep-C	4
candidateRep-D	8
candidateRep-E	16
candidateRep-F	32
candidateRep-G	64
candidateRep-H	128
candidateRep-I	256
candidateRep-J	512
candidateRep-K	1024
candidateRep-L	2048

The NPDCCH repetition level for CQI-NPDCCH-Short-NB is chosen with regard to the signalled parameter R_{\max} , the maximum number of repetitions for NPDCCH common search space for random access response (npdcch-NumRepetitions-RA) in SystemInformationBlockType2-NB. The report mapping is defined in Table 9.1.22.15-2.

Table 9.1.22.15-2: Downlink channel quality measurement report mapping of CQI-NPDCCH-Short-NB when the DL channel quality reporting is supported [7]

Reported value	NPDCCH repetition level
noMeasurements	No measurement reporting
candidateRep-1	$R_{\max}/8$ (NOTE 1)
candidateRep-2	R_{\max} (NOTE 3)
candidateRep-3	$4 \times R_{\max}$ (NOTE 2)
NOTE 1: When R_{\max} is less than 8, set candidateRep-1 to 1.	
NOTE 2: When R_{\max} is more than 512, set candidateRep-3 to 2048.	
NOTE 3: When R_{\max} is 1, set candidateRep-2 to 2.	

9.1.22.16 Downlink Channel Quality Measurement Accuracy for UE Category NB1

The requirements for accuracy of downlink channel quality reporting in this clause apply only to the serving cell on the anchor carrier for UE Category NB1.

The accuracy requirements in Table 9.1.22.16-1 are valid under the following conditions:

- Cell specific reference signals are transmitted either from one or two ports.
- Conditions defined in TS 36.101 [5] Clause 7.3 for reference sensitivity are fulfilled.

- NRSRP[dBm according to Annex B.3.25 for a corresponding Band.

Table 9.1.22.16-1: Downlink channel quality reporting accuracy for UE Category NB1

NPDCCH Repetition	Pm-Dsg (%)	Conditions				
		\hat{E}_s/lot	I_0 ^{NOTE 1} range			
			E-UTRA operating band groups ^{NOTE 2}	Minimum I_0		Maximum I_0
		dB		dBm/15kHz	dBm/BW _{Channel}	dBm/BW _{Channel}
R ^{NOTE 1}	≤1	≥ -6 dB	NFDD_G	-122.9	N/A	-70
R/4 ^{NOTE 1}	>1	≥ -6 dB	NFDD_G	-122.9	N/A	-70
R ^{NOTE 1}	≤1	-15 ≤ \hat{E}_s/lot ≤ -6 dB	NFDD_G	- 122.9	N/A	-70
R/8 ^{NOTE 1}	>1	-15 ≤ \hat{E}_s/lot ≤ -6 dB	NFDD_G	- 122.9	N/A	-70

NOTE 1: R is the reported NPDCCH repetition level that UE has reported in CQI-NPDCCH-NB or CQI-NPDCCH-Short-NB.
NOTE 2: I_0 is assumed to have constant EPRE across the bandwidth.
NOTE 3: E-UTRA operating band groups are as defined in Section 3.5.

9.1.23 Power Headroom for UE Category NB1

The requirements in this clause shall apply for power headroom for UE Category NB1 as defined in [31].

The power headroom provides the serving eNB with information about the differences between the UE configured maximum output power (P_{CMAX}), defined in TS 36.101 [5] and the estimated power for UL-NSCH transmission of the serving cell [3].

Table 9.1.23 -1: The applicability of power headroom report mapping requirements for different power class UE

Power class	Power headroom report mapping
PC3 and PC5	As defined in section 9.1.23.3
PC6	As defined in section 9.1.23.4

9.1.23.1 Period

The reported power headroom shall be estimated over 1 slot of NPUSCH transmissions.

9.1.23.2 Reporting Delay

The power headroom reporting delay is defined as the time between the beginning of the power headroom reference period and the time when the UE starts transmitting the power headroom over the radio interface. The reporting delay of the power headroom shall be 0 ms, which is applicable for all configured triggering mechanisms for power headroom reporting.

9.1.23.3 Report Mapping for UE Category NB1

The power headroom reporting range is from -54 dB to +11 dB (or +19 dB if enhanced PHR is used) for UE category NB1 when the enhanced coverage level 0 is selected during the random access procedure [17]. The report mapping is defined in Table 9.1.23.3-1 for UEs not supporting enhanced PHR, and in Table 9.1.23.3-1A for UEs supporting enhanced PHR [31].

Table 9.1.23.3-1: Power headroom report mapping for UE category NB1 UEs not supporting enhanced PHR [31] when the enhanced coverage level 0 is selected during random access procedure [17]

Reported value	Measured quantity value (dB)
----------------	------------------------------

POWER_HEADROOM_0	$-54 \leq \text{PH} < 5$
POWER_HEADROOM_1	$5 \leq \text{PH} < 8$
POWER_HEADROOM_2	$8 \leq \text{PH} < 11$
POWER_HEADROOM_3	$\text{PH} \geq 11$

Table 9.1.23.3-1A: Power headroom report mapping for UE category NB1 UEs supporting enhanced PHR [31] when the enhanced coverage level 0 is selected during random access procedure [17]

Reported value	Measured quantity value (dB)
POWER_HEADROOM_0	$-54 \leq \text{PH} < -37$
POWER_HEADROOM_1	$-37 \leq \text{PH} < -33$
POWER_HEADROOM_2	$-33 \leq \text{PH} < -29$
POWER_HEADROOM_3	$-29 \leq \text{PH} < -25$
POWER_HEADROOM_4	$-25 \leq \text{PH} < -21$
POWER_HEADROOM_5	$-21 \leq \text{PH} < -17$
POWER_HEADROOM_6	$-17 \leq \text{PH} < -13$
POWER_HEADROOM_7	$-13 \leq \text{PH} < -9$
POWER_HEADROOM_8	$-9 \leq \text{PH} < -5$
POWER_HEADROOM_9	$-5 \leq \text{PH} < -1$
POWER_HEADROOM_10	$-1 \leq \text{PH} < 3$
POWER_HEADROOM_11	$3 \leq \text{PH} < 7$
POWER_HEADROOM_12	$7 \leq \text{PH} < 11$
POWER_HEADROOM_13	$11 \leq \text{PH} < 15$
POWER_HEADROOM_14	$15 \leq \text{PH} < 19$
POWER_HEADROOM_15	$\text{PH} \geq 19$

The power headroom reporting range is from -54 dB to +6 dB (or +11 dB if enhanced PHR is used) for UE category NB1 when enhanced coverage level other than 0 is selected during the random access procedure [17]. The report mapping is defined in Table 9.1.23.3-2 for the UEs not supporting enhanced PHR, and in Table 9.1.23.3-2A for UEs supporting enhanced PHR [31].

Table 9.1.23.3-2: Power headroom report mapping for UE category NB1 UEs not supporting enhanced PHR [31] when the enhanced coverage level other than 0 is selected during random access procedure [17]

Reported value	Measured quantity value (dB)
POWER_HEADROOM_0	$-54 \leq \text{PH} < -10$
POWER_HEADROOM_1	$-10 \leq \text{PH} < -2$
POWER_HEADROOM_2	$-2 \leq \text{PH} < 6$
POWER_HEADROOM_3	$\text{PH} \geq 6$

Table 9.1.23.3-2A: Power headroom report mapping for UE category NB1 supporting enhanced PHR [31] when the enhanced coverage level other than 0 is selected during random access procedure [17]

Reported value	Measured quantity value (dB)
POWER_HEADROOM_0	$-54 \leq \text{PH} < -45$
POWER_HEADROOM_1	$-45 \leq \text{PH} < -41$
POWER_HEADROOM_2	$-41 \leq \text{PH} < -37$
POWER_HEADROOM_3	$-37 \leq \text{PH} < -33$
POWER_HEADROOM_4	$-33 \leq \text{PH} < -29$
POWER_HEADROOM_5	$-29 \leq \text{PH} < 25$
POWER_HEADROOM_6	$-25 \leq \text{PH} < -21$
POWER_HEADROOM_7	$-21 \leq \text{PH} < -17$
POWER_HEADROOM_8	$-17 \leq \text{PH} < -13$
POWER_HEADROOM_9	$-13 \leq \text{PH} < -9$
POWER_HEADROOM_10	$-9 \leq \text{PH} < -5$
POWER_HEADROOM_11	$-5 \leq \text{PH} < -1$
POWER_HEADROOM_12	$-1 \leq \text{PH} < 3$
POWER_HEADROOM_13	$3 \leq \text{PH} < 7$
POWER_HEADROOM_14	$7 \leq \text{PH} < 11$

POWER_HEADROOM_15	PH \geq 11
-------------------	--------------

9.1.23.3.1 Void

9.1.23.3.2 Void

9.1.23.4 Report Mapping for UE Category NB1 for UE Power Class 6

The power headroom reporting range is -54 dB ... +11 dB for UE category NB1 when the enhanced coverage level 0 is selected during the random access procedure [17] for UE power class 6 [5]. The report mapping is defined in Table 9.1.23.4-1 for the UEs not supporting enhanced PHR, and in Table 9.1.23.4-1A for UEs supporting enhanced PHR [31].

Table 9.1.23.4-1: Power headroom report mapping for UE category NB1 UEs not supporting enhanced PHR when the enhanced coverage level 0 is selected during random access procedure [17] for UE PC6

Reported value	Measured quantity value (dB)
POWER_HEADROOM_0	$-54 \leq \text{PH} < 5$
POWER_HEADROOM_1	$5 \leq \text{PH} < 8$
POWER_HEADROOM_2	$8 \leq \text{PH} < 11$
POWER_HEADROOM_3	PH \geq 11

Table 9.1.23.4-1A: Power headroom report mapping for UE category NB1 for UE PC6 and supporting enhanced PHR [31] when the enhanced coverage level 0 is selected during random access procedure [17] for UE PC6

Reported value	Measured quantity value (dB)
POWER_HEADROOM_0	$-54 \leq \text{PH} < -45$
POWER_HEADROOM_1	$-45 \leq \text{PH} < -41$
POWER_HEADROOM_2	$-41 \leq \text{PH} < -37$
POWER_HEADROOM_3	$-37 \leq \text{PH} < -33$
POWER_HEADROOM_4	$-33 \leq \text{PH} < -29$
POWER_HEADROOM_5	$-29 \leq \text{PH} < -25$
POWER_HEADROOM_6	$-25 \leq \text{PH} < -21$
POWER_HEADROOM_7	$-21 \leq \text{PH} < -17$
POWER_HEADROOM_8	$-17 \leq \text{PH} < -13$
POWER_HEADROOM_9	$-13 \leq \text{PH} < -9$
POWER_HEADROOM_10	$-9 \leq \text{PH} < -5$
POWER_HEADROOM_11	$-5 \leq \text{PH} < -1$
POWER_HEADROOM_12	$-1 \leq \text{PH} < 3$
POWER_HEADROOM_13	$3 \leq \text{PH} < 7$
POWER_HEADROOM_14	$7 \leq \text{PH} < 11$
POWER_HEADROOM_15	PH \geq 11

The power headroom reporting range is from [-54] dB ...0 dB for UE category NB1 when the enhanced coverage level other than 0 is selected during the random access procedure [17] for UE power class of 6 [5]. The report mapping is defined in Table 9.1.23.4-2.

Table 9.1.23.4-2: Power headroom report mapping for UE category NB1 when the enhanced coverage level other than 0 is selected during random access procedure [17] for UE PC6

Reported value	Measured quantity value (dB)
POWER_HEADROOM_0	$-54 \leq \text{PH} < -20$
POWER_HEADROOM_1	$-20 \leq \text{PH} < -10$
POWER_HEADROOM_2	$-10 \leq \text{PH} < 0$
POWER_HEADROOM_3	PH \geq 0

9.1.24 Void

9.1.25 Measurement accuracy for UE category M2

9.1.25.1 Inter-Frequency RSTD Accuracy Requirement for UE category M2 in CE mode A

The accuracy requirements in Table 9.1.25.1-1 are valid under the following conditions:

Conditions defined in 36.101 Clause 7.3 for reference sensitivity are fulfilled.

PRP $1,2_{dBm}$ according to Annex B.3.32 for a corresponding Band

There are no measurement gaps overlapping with the PRS subframes of the measured serving cell.

The parameter expectedRSTDUncertainty signalled over LPP by E-SMLC as defined in TS 36.355 [24] is less than 5 μs .

Table 9.1.25.1-1: RSTD measurement accuracy for CE Mode A

Accuracy	Conditions						
	PRS \hat{E}_s/lot	Minimum PRS bandwidth, which is minimum of serving cell channel bandwidth and the PRS bandwidths of the reference cell and the measured neighbour cell i	Minimum number of available measurement subframes among the reference cell and the measured neighbour cell i	The number of consecutive downlink subframes N_{PRS} among the reference cell and the measured neighbour cell i as defined in [24]	Io ^{Note 5} range		
					E-UTRA operating band groups ^{Note 6}	Minimum Io ^{Note 1}	Maximum Io
T_s ^{Note 2}	dB	RB			dBm/15kHz	dBm/BW _{Channel}	
± 21	(PRS \hat{E}_s/lot) _{ref} $\geq -6dB$ and (PRS \hat{E}_s/lot) _i $\geq -13dB$	≥ 6	≥ 12	≥ 4	FDD-M1_A, TDD-M1_A	-121	-50
					FDD-M1_B	-120.5	-50
					FDD-M1_C, TDD-M1_C	-120	-50
					FDD-M1_D	-119.5	-50
					FDD-M1_E, TDD-M1_E	-119	-50
					FDD-M1_F	-118.5	-50
					FDD-M1_G	-118	-50
					FDD-M1_H	-117.5	-50
					FDD-M1_N	-114.5	-50
± 10	(PRS \hat{E}_s/lot) _{ref} $\geq -6dB$ and (PRS \hat{E}_s/lot) _i $\geq -13dB$	≥ 24	≥ 4	≥ 2	Note 4	Note 4	Note 4

NOTE 1: This minimum Io condition is expressed as the average Io per RE over all REs in an OFDM symbol.
 NOTE 2: T_s is the basic timing unit defined in TS 36.211 [16].
 NOTE 3: PRS bandwidth is as indicated in *prs-Bandwidth* in the OTDOA assistance data defined in [24].
 NOTE 4: The same bands and the same Io conditions for each band apply for this requirement as for the corresponding requirement with the PRS bandwidth ≥ 6 RB.
 NOTE 5: The Io is defined in PRS positioning subframes. The same Io range applies to PRS and non-PRS symbols. Io levels are different in PRS and non-PRS symbols within the same subframe.
 NOTE 6: E-UTRA operating band groups are as defined in Section 3.5.

9.1.25.2 Inter-Frequency RSTD Accuracy Requirement for UE category M2 in CE mode B

The accuracy requirements in Table 9.1.25.2-1 are valid under the following conditions:

Conditions defined in 36.101 Clause 7.3 for reference sensitivity are fulfilled.

PRP $1,2_{dBm}$ according to Annex B.3.32 for a corresponding Band

There are no measurement gaps overlapping with the PRS subframes of the measured serving cell.

The parameter expectedRSTDUncertainty signalled over LPP by E-SMLC as defined in TS 36.355 [24] is less than 5 μs .

Table 9.1.25.2-1: RSTD measurement accuracy for CE Mode B

Accuracy	Conditions						
	PRS \hat{E}_s/lot	Minimum PRS bandwidth, which is minimum of serving cell channel bandwidth and the PRS bandwidths of the reference cell and the measured neighbour cell i	Minimum number of available measurement subframes among the reference cell and the measured neighbour cell i	The number of consecutive downlink subframes N_{PRS} among the reference cell and the measured neighbour cell i as defined in [24]	Io ^{Note 5} range		
Ts ^{Note 2}	dB	RB			E-UTRA operating band groups ^{Note 6}	Minimum Io ^{Note 1}	Maximum Io
						dBm/15kHz	dBm/BW _{Channel}
± 21	(PRS \hat{E}_s/lot) _{ref} $\geq -15dB$ and (PRS \hat{E}_s/lot) _i $\geq -15dB$	≥ 6	≥ 30	≥ 4	FDD-M1_A, TDD-M1_A	-121	-50
					FDD-M1_B	-120.5	-50
					FDD-M1_C, TDD-M1_C	-120	-50
					FDD-M1_D	-119.5	-50
					FDD-M1_E, TDD-M1_E	-119	-50
					FDD-M1_F	-118.5	-50
					FDD-M1_G	-118	-50
					FDD-M1_H	-117.5	-50
					FDD-M1_N	-114.5	-50
± 10	(PRS \hat{E}_s/lot) _{ref} $\geq -15dB$ and (PRS \hat{E}_s/lot) _i $\geq -15dB$	≥ 24	≥ 8	≥ 4	Note 4	Note 4	Note 4

NOTE 1: This minimum Io condition is expressed as the average Io per RE over all REs in an OFDM symbol.
 NOTE 2: Ts is the basic timing unit defined in TS 36.211 [16].
 NOTE 3: PRS bandwidth is as indicated in *prs-Bandwidth* in the OTDOA assistance data defined in [24].
 NOTE 4: The same bands and the same Io conditions for each band apply for this requirement as for the corresponding requirement with the PRS bandwidth ≥ 6 RB.
 NOTE 5: The Io is defined in PRS positioning subframes. The same Io range applies to PRS and non-PRS symbols. Io levels are different in PRS and non-PRS symbols within the same subframe.
 NOTE 6: E-UTRA operating band groups are as defined in Section 3.5.

9.1.25.3 UE RX-TX time difference Accuracy Requirement for Cat-M2

The UE RX-TX time difference is measured from the PCell.

The accuracy requirements in Table 9.1.25.3-1 are valid under the following conditions:

Conditions defined in 36.101 Clause 7.3 for reference sensitivity are fulfilled.

No changes to the uplink transmission timing are applied during the measurement period.

RSRP_{dBm} according to Annex B.2.14 for a corresponding Band

Table 9.1.25.3-1: UE Rx – Tx time difference measurement accuracy for CEModeA

Accuracy	Conditions				
	Ês/lot	Downlink transmission bandwidth of PCell	I _o ^{Note 1} range		
			E-UTRA operating band groups ^{Note 4}	Minimum I _o	Maximum I _o
T _s ^{Note 2}	dB	RB		dBm/15kHz	dBm/BW _{Channel}
±20	≥-3 dB	≥ 6	FDD-M1_A, TDD-M1_A	-121	-50
			FDD-M1_B	-120.5	-50
			FDD-M1_C, TDD-M1_C	-120	-50
			FDD-M1_D	-119.5	-50
			FDD-M1_E, TDD-M1_E	-119	-50
			FDD-M1_F	-118.5	-50
			FDD-M1_G	-118	-50
			FDD-M1_H	-117.5	-50
			FDD-M1_N	-114.5	-50
±10	≥-3 dB	≥ 24	Note 3	Note 3	Note 3

NOTE 1: When in dBm/15kHz, the minimum I_o condition is expressed as the average I_o per RE over all REs in that symbol. I_o may be different in different symbols within a subframe.
 NOTE 2: T_s is the basic timing unit defined in TS 36.211.
 NOTE 3: The same bands and the same I_o conditions for each band apply for this requirement as for the corresponding requirement with downlink bandwidth ≥1.4 MHz.
 NOTE 4: E-UTRA operating band groups are as defined in Section 3.5.

9.1.25.4 Intra-Frequency RSTD Accuracy Requirement for UE category M2 in CE mode A

The accuracy requirements in Table 9.1.25.4-1 are valid under the following conditions:

Conditions defined in 36.101 Clause 7.3 for reference sensitivity are fulfilled.

PRP 1,2_{dBm} according to Annex B.3.34 for a corresponding Band

For a UE that does not need a measurement gap for intra-frequency RSTD measurement, there are no measurement gaps overlapping with the PRS subframes of the measured serving cell and PRS are available within the UE measurement bandwidth in all PRS subframes

For a UE that needs a measurement gap for intra-frequency RSTD measurement, the measurement gaps are configured to contain PRS subframes

The parameter *expectedRSTDUncertainty* signalled over LPP by E-SMLC as defined in TS 36.355 [24] is less than 5 µs.

Table 9.1.25.4-1: RSTD measurement accuracy for CEModeA

Accuracy	Conditions						
	PRS Ês/lot	Minimum PRS bandwidth, which is minimum of serving cell channel bandwidth and the PRS bandwidths of the reference	Minimum number of available measurement subframes among the reference cell and the measured neighbour cell <i>i</i>	The number of consecutive downlink subframes N _{PRS} among the reference cell and the measured neighbour cell <i>i</i> as defined in [24]	I _o ^{Note 6} range		
					E-UTRA operating band groups ^{Note 7}	Minimum I _o ^{Note 1}	Maximum I _o

		cell and the measured neighbour cell i ^{Note 5}					
T_s ^{Note 2}	dB	RB				dBm/15kHz	dBm/BW _{Channel}
± 15 ^{Note 8}	(PRS \hat{E}_s/lot) _{ref} ≥ -6 dB and (PRS \hat{E}_s/lot) _i ≥ -13 dB	≥ 6	≥ 12	≥ 6	FDD-M1_A, TDD-M1_A	-121	-50
					FDD-M1_B	-120.5	-50
					FDD-M1_C, TDD-M1_C	-120	-50
					FDD-M1_D	-119.5	-50
					FDD-M1_E, TDD-M1_E	-119	-50
					FDD-M1_F	-118.5	-50
					FDD-M1_G	-118	-50
					FDD-M1_H, FDD-M1_N	-117.5, -114.5	-50, -50
± 15 ^{Note 9}	(PRS \hat{E}_s/lot) _{ref} ≥ -6 dB and (PRS \hat{E}_s/lot) _i ≥ -13 dB	≥ 6	≥ 12	≥ 4	FDD-M1_A, TDD-M1_A	-121	-50
					FDD-M1_B	-120.5	-50
					FDD-M1_C, TDD-M1_C	-120	-50
					FDD-M1_D	-119.5	-50
					FDD-M1_E, TDD-M1_E	-119	-50
					FDD-M1_F	-118.5	-50
					FDD-M1_G	-118	-50
					FDD-M1_H, FDD-M1_N	-117.5, -114.5	-50, -50
± 6	(PRS \hat{E}_s/lot) _{ref} ≥ -6 dB and (PRS \hat{E}_s/lot) _i ≥ -13 dB	≥ 24	≥ 4	≥ 2	Note 4	Note 4	Note 4
<p>NOTE 1: This minimum l_o condition is expressed as the average l_o per RE over all REs in an OFDM symbol.</p> <p>NOTE 2: T_s is the basic timing unit defined in TS 36.211 [16].</p> <p>NOTE 3: PRS bandwidth is as indicated in <i>prs-Bandwidth</i> in the OTDOA assistance data defined in [24].</p> <p>NOTE 4: The same bands and the same l_o conditions for each band apply for this requirement as for the corresponding requirement with the PRS bandwidth ≥ 6 RB.</p> <p>NOTE 5: The serving cell, the reference cell, and the measured neighbour cell i are on the same carrier frequency.</p> <p>NOTE 6: The l_o is defined in PRS positioning subframes. The same l_o range applies to PRS and non-PRS symbols. l_o levels are different in PRS and non-PRS symbols within the same subframe.</p> <p>NOTE 7: E-UTRA operating band groups are as defined in Section 3.5.</p> <p>NOTE 8: The requirement applies when PRS are available within the UE measurement bandwidth in all PRS subframes and measurement gaps are not required.</p> <p>NOTE 9: The requirement applies when measurement gaps are required.</p>							

9.1.25.5 Intra-Frequency RSTD Accuracy Requirement for UE category M2 in CE mode B

The accuracy requirements in Table 9.1.25.5-1 are valid under the following conditions:

Conditions defined in 36.101 Clause 7.3 for reference sensitivity are fulfilled.

PRP $1,2_{dBm}$ according to Annex B.3.34 for a corresponding Band

For a UE that does not need a measurement gap for intra-frequency RSTD measurement, there are no measurement gaps overlapping with the PRS subframes of the measured serving cell and PRS are available within the UE measurement bandwidth in all PRS subframes

For a UE that needs a measurement gap for intra-frequency RSTD measurement, the measurement gaps are configured to contain PRS subframes

The parameter *expectedRSTDUncertainty* signalled over LPP by E-SMLC as defined in TS 36.355 [24] is less than 5 μ s.

Table 9.1.25.5-1: RSTD measurement accuracy for CEModeB

Accuracy	PRs \hat{E}_s/lot	Minimum PRS bandwidth, which is minimum of serving cell channel bandwidth and the PRS bandwidths of the reference cell and the measured neighbour cell i ^{Note 5}	Minimum number of available measurement subframes among the reference cell and the measured neighbour cell i	The number of consecutive downlink subframes N_{PRS} among the reference cell and the measured neighbour cell i as defined in [24]	Conditions		
					Io ^{Note 6} range		
T_s ^{Note 2}	dB	RB			E-UTRA operating band groups ^{Note 7}	Minimum Io ^{Note 1}	Maximum Io
						dBm/15kHz	dBm/BW _{Channel}
± 15 ^{Note 8}	(PRs \hat{E}_s/lot) _{ref} ≥ -15 dB and (PRs \hat{E}_s/lot) _i ≥ -15 dB	≥ 6	≥ 30	≥ 6	FDD-M1_A, TDD-M1_A	-121	-50
					FDD-M1_B	-120.5	-50
					FDD-M1_C, TDD-M1_C	-120	-50
					FDD-M1_D	-119.5	-50
					FDD-M1_E, TDD-M1_E	-119	-50
					FDD-M1_F	-118.5	-50
					FDD-M1_G	-118	-50
					FDD-M1_H	-117.5	-50
± 15 ^{Note 9}	(PRs \hat{E}_s/lot) _{ref} ≥ -15 dB and (PRs \hat{E}_s/lot) _i ≥ -15 dB	≥ 6	≥ 30	≥ 4	FDD-M1_A, TDD-M1_A	-121	-50
					FDD-M1_B	-120.5	-50
					FDD-M1_C, TDD-M1_C	-120	-50
					FDD-M1_D	-119.5	-50
					FDD-M1_E, TDD-M1_E	-119	-50
					FDD-M1_F	-118.5	-50
					FDD-M1_G	-118	-50
					FDD-M1_H	-117.5	-50
± 6	(PRs \hat{E}_s/lot) _{ref} ≥ -15 dB and (PRs \hat{E}_s/lot) _i ≥ -15 dB	≥ 24	≥ 8	≥ 4	Note 4	Note 4	Note 4

NOTE 1: This minimum Io condition is expressed as the average Io per RE over all REs in an OFDM symbol.
 NOTE 2: Ts is the basic timing unit defined in TS 36.211 [16].
 NOTE 3: PRS bandwidth is as indicated in *prs-Bandwidth* in the OTDOA assistance data defined in [24].
 NOTE 4: The same bands and the same Io conditions for each band apply for this requirement as for the corresponding requirement with the PRS bandwidth ≥ 6 RB.
 NOTE 5: The serving cell, the reference cell, and the measured neighbour cell i are on the same carrier frequency.
 NOTE 6: The Io is defined in PRS positioning subframes. The same Io range applies to PRS and non-PRS symbols. Io levels are different in PRS and non-PRS symbols within the same subframe.
 NOTE 7: E-UTRA operating band groups are as defined in Section 3.5.
 NOTE 8: The requirement applies when PRS are available within the UE measurement bandwidth in all PRS subframes and measurement gaps are not required.
 NOTE 9: The requirement applies when measurement gaps are required.

9.1.26 Measurement Accuracy for non-BL CE UE

The requirements defined in Section 9.1.26 do not apply when the UE is of category 1bis.

9.1.26.1 Intra-frequency Absolute Accuracy of RSRP for non-BL CE UE in CE mode A

The requirements for absolute accuracy of RSRP in this clause apply to a cell on the same frequency as that of the serving cell for non-BL CE UE.

The accuracy requirements in Table 9.1.26.1-1 and Table 9.1.26.1-2 are valid under the following conditions:

Cell specific reference signals are transmitted either from one, two or four antenna ports.

Conditions defined in 36.101 Clause 7.3 for reference sensitivity are fulfilled.

RSRP[dBm] according to Annex B.3.1 for a corresponding Band

At least 1 DL subframe per radio frame of measured cell is available at the UE for RSRP measurement assuming measured cell is identified cell.

Table 9.1.26.1-1: RSRP Intra frequency absolute accuracy for non-BL CE UE with CE mode A for FDD and TDD

Accuracy		Conditions				
Normal condition	Extreme condition	\hat{E}_s/lot	I_o ^{Note 1} range			
			E-UTRA operating band groups ^{Note 3}	Minimum I_o		Maximum I_o
dB	dB	dB		dBm/15kHz ^{Note 2}	dBm/BW _{Channel}	dBm/BW _{Channel}
±5.5	±8.5	≥-6 dB	FDD-M1_A, TDD-M1_A	-121	N/A	-70
			FDD-M1_D	-119.5	N/A	-70
			FDD-M1_E, TDD-M1_E	-119	N/A	-70
			FDD-M1_F	-118.5	N/A	-70
			FDD-M1_G	-118	N/A	-70
			FDD-M1_N	-114.5	N/A	-70
±8	±11	≥-6 dB	FDD-M1_A, TDD-M1_A, FDD-M1_D, FDD-M1_E, TDD-M1_E, FDD-M1_F, FDD-M1_G, FDD-M1_N	N/A	-70	-50

NOTE 1: I_o is assumed to have constant EPRE across the bandwidth.
NOTE 2: The condition level is increased by $\Delta > 0$, when applicable, as described in Sections B.4.2 and B.4.3.
NOTE 3: E-UTRA operating band groups are as defined in Section 3.5.

Table 9.1.26.1-2: RSRP Intra frequency absolute accuracy for non-BL DE UE with CE mode A for HD-FDD

Accuracy		Conditions				
Normal condition	Extreme condition	\hat{E}_s/lot	I_o ^{Note 1} range			
			E-UTRA operating band groups ^{Note 3}	Minimum I_o		Maximum I_o
dB	dB	dB		dBm/15kHz ^{Note 2}	dBm/BW _{Channel}	dBm/BW _{Channel}
±5.5	±8.5	≥-6 dB	FDD-M1_A	-121	N/A	-70
			FDD-M1_D	-119.5	N/A	-70
			FDD-M1_E	-119	N/A	-70
			FDD-M1_F	-118.5	N/A	-70
			FDD-M1_G	-118	N/A	-70
			FDD-M1_N	-114.5	N/A	-70
±8	±11	≥-6 dB	FDD-M1_A, FDD-M1_D, FDD-M1_E, FDD-M1_F, FDD-M1_G, FDD-M1_N	N/A	-70	-50

NOTE 1: I_o is assumed to have constant EPRE across the bandwidth.
NOTE 2: The condition level is increased by $\Delta > 0$, when applicable, as described in Sections B.4.2 and B.4.3.
NOTE 3: E-UTRA operating band groups are as defined in Section 3.5.

9.1.26.2 Intra-frequency Relative Accuracy of RSRP for non-BL CE UE in CE mode A

The same requirement as for UE category M1 in Clause 9.1.21.2 applies.

9.1.26.3 Intra-frequency Absolute Accuracy of RSRP for non-BL CE UE in CE mode B

The requirements for absolute accuracy of RSRP in this clause apply to a cell on the same frequency as that of the serving cell for non-BL CE UE.

The accuracy requirements in Table 9.1.26.3-1 and Table 9.1.26.3-2 are valid under the following conditions:

Cell specific reference signals are transmitted either from one, two or four antenna ports.

Conditions defined in 36.101 Clause 7.3 for reference sensitivity are fulfilled.

RSRP|dBm according to Annex B.3.1 for a corresponding Band

At least 1 DL subframe per radio frame of measured cell is available at the UE for RSRP measurement assuming measured cell is identified cell.

Table 9.1.26.3-1: RSRP Intra frequency absolute accuracy for non-BL CE UE with CE mode B for FDD and TDD

Accuracy		Conditions				
Normal condition	Extreme condition	Ês/lot	I _o ^{Note 1} range			
			E-UTRA operating band groups ^{Note 3}	Minimum I _o		Maximum I _o
dB	dB	dB		dBm/15kHz ^{Note 2}	dBm/BW _{Channel}	dBm/BW _{Channel}
±8	±11	15 ≤ Ês/lot ≤ -12 dB	FDD-M1_A, TDD-M1_A	-121	N/A	-70
			FDD-M1_D	-119.5	N/A	-70
			FDD-M1_E, TDD-M1_E	-119	N/A	-70
±6	±9	≥ -12 dB	FDD-M1_F	-118.5	N/A	-70
			FDD-M1_G	-118	N/A	-70
			FDD-M1_N	-114.5	N/A	-70
±10	±13	15 ≤ Ês/lot ≤ -12 dB	FDD-M1_A, TDD-M1_A, FDD-M1_D, FDD-M1_E, TDD-M1_E, FDD-M1_F, FDD-M1_G, FDD-M1_N	N/A	-70	-50
±8	±11	≥ -12 dB				

NOTE 1: I_o is assumed to have constant EPRE across the bandwidth.
 NOTE 2: The condition level is increased by Δ>0, when applicable, as described in Sections B.4.2 and B.4.3.
 NOTE 3: E-UTRA operating band groups are as defined in Section 3.5.

Table 9.1.26.3-2: RSRP Intra frequency absolute accuracy for non-BL CE UE with CE mode B for HD-FDD

Accuracy		Conditions				
Normal condition	Extreme condition	Ês/lot	I _o ^{Note 1} range			
			E-UTRA operating band groups ^{Note 3}	Minimum I _o		Maximum I _o
dB	dB	dB		dBm/15kHz ^{Note 2}	dBm/BW _{Channel}	dBm/BW _{Channel}
±8	±11	15 ≤ Ês/lot ≤ -12 dB	FDD-M1_A	-121	N/A	-70
			FDD-M1_D	-119.5	N/A	-70
			FDD-M1_E	-119	N/A	-70
±6	±9	≥ -12 dB	FDD-M1_F	-118.5	N/A	-70
			FDD-M1_G	-118	N/A	-70
			FDD-M1_N	-114.5	N/A	-70
±10	±13	15 ≤ Ês/lot ≤ -12 dB	FDD-M1_A, FDD-M1_D, FDD-M1_E, FDD-M1_F, FDD-M1_G, FDD-M1_N	N/A	-70	-50
±8	±11	≥ -12 dB				

NOTE 1: I_o is assumed to have constant EPRE across the bandwidth.
 NOTE 2: The condition level is increased by Δ>0, when applicable, as described in Sections B.4.2 and B.4.3.
 NOTE 3: E-UTRA operating band groups are as defined in Section 3.5.

9.1.26.4 Intra-frequency Relative Accuracy of RSRP for non-BL CE UE in CE mode B

The relative accuracy of RSRP is defined as the RSRP measured from one cell compared to the RSRP measured from another cell on the same frequency for the non-BL CE UE.

The accuracy requirements in Table 9.1.26.4-1 and Table 9.1.26.4-2 are valid under the following conditions:

Cell specific reference signals are transmitted either from one, two or four antenna ports.

Conditions defined in 36.101 Clause 7.3 for reference sensitivity are fulfilled.

RSRP_{1,2}_{dBm} according to Annex B.3.8 for a corresponding Band.

At least 1 DL subframe per radio frame of measured cell is available at the UE for RSRP measurement assuming measured cell is identified cell.

Table 9.1.26.4-1: RSRP Intra frequency relative accuracy for non-BL CE UE with CE mode B for FDD and TDD

Accuracy		Conditions			
Normal condition	Extreme condition	$\hat{E}s/lot$ ^{Note 2}	Io ^{Note 1} range		
			E-UTRA operating band groups ^{Note 5}	Minimum Io	Maximum Io
dB	dB	dB		dBm/15kHz ^{Note 4}	dBm/BW _{Channel}
±3	±3	≥-12 dB	FDD-M1_A, TDD-M1_A	-121	-50
			FDD-M1_D	-119.5	-50
			FDD-M1_E, TDD-M1_E	-119	-50
			FDD-M1_F	-118.5	-50
			FDD-M1_G	-118	-50
			FDD-M1_N	-114.5	-50
±5	±5	$15 \leq \hat{E}s/lot < -12$ dB	Note 3	Note 3	Note 3

NOTE 1: Io is assumed to have constant EPRE across the bandwidth.
NOTE 2: The parameter $\hat{E}s/lot$ is the minimum $\hat{E}s/lot$ of the pair of cells to which the requirement applies.
NOTE 3: The same bands and the same Io conditions for each band apply for this requirement as for the corresponding highest accuracy requirement.
NOTE 4: The condition level is increased by $\Delta > 0$, when applicable, as described in Sections B.4.2 and B.4.3.
NOTE 5: E-UTRA operating band groups are as defined in Section 3.5.

Table 9.1.26.4-2: RSRP Intra frequency relative accuracy for non-BL CE UE with CE mode B for HD-FDD

Accuracy		Conditions			
Normal condition	Extreme condition	$\hat{E}s/lot$ ^{Note 2}	Io ^{Note 1} range		
			E-UTRA operating band groups ^{Note 5}	Minimum Io	Maximum Io
dB	dB	dB		dBm/15kHz ^{Note 4}	dBm/BW _{Channel}
±3	±3	≥-12 dB	FDD-M1_A	-121	-50
			FDD-M1_D	-119.5	-50
			FDD-M1_E	-119	-50
			FDD-M1_F	-118.5	-50
			FDD-M1_G	-118	-50
			FDD-M1_N	-114.5	-50
±5	±5	$15 \leq \hat{E}s/lot < -12$ dB	Note 3	Note 3	Note 3

NOTE 1: Io is assumed to have constant EPRE across the bandwidth.
NOTE 2: The parameter $\hat{E}s/lot$ is the minimum $\hat{E}s/lot$ of the pair of cells to which the requirement applies.
NOTE 3: The same bands and the same Io conditions for each band apply for this requirement as for the corresponding highest accuracy requirement.
NOTE 4: The condition level is increased by $\Delta > 0$, when applicable, as described in Sections B.4.2 and B.4.3.
NOTE 5: E-UTRA operating band groups are as defined in Section 3.5.

9.1.26.5 RSRP Measurement Report Mapping

The same RSRP reporting range as for UE category M1 in Clause 9.1.21.5 applies.

9.1.26.6 Intra-frequency Absolute Accuracy of RSRQ for non-BL CE UE in CE mode A

The same requirement as for UE category M1 in Clause 9.1.21.6 applies.

9.1.26.7 Intra-frequency Absolute Accuracy of RSRQ for non-BL CE UE in CE mode B

The requirements for absolute accuracy of RSRQ in this clause apply to a cell on the same frequency as that of the serving cell for the non-BL CE UE.

The accuracy requirements in Tables 9.1.26.7-1 and 9.1.26.7-2 are valid under the following conditions:

Cell specific reference signals are transmitted either from one, two or four antenna ports.

Conditions defined in 36.101 Clause 7.3 for reference sensitivity are fulfilled.

RSRP|dBm according to Annex B.3.1 for a corresponding Band

Table 9.1.26.7-1: RSRQ Intra frequency absolute accuracy for non-BL CE UE with CE mode B for FDD and TDD

Accuracy		Conditions			
Normal condition	Extreme condition	Ês/lot	I _o ^{Note 1} range		
			E-UTRA operating band groups ^{Note 4}	Minimum I _o	Maximum I _o
dB	dB	dB	dBm/15kHz ^{Note 3}	dBm/BW _{Channel}	
±4	±5.5	≥-12 dB	FDD-M1_A, TDD-M1_A	-121	-50
			FDD-M1_D	-119.5	-50
			FDD-M1_E, TDD-M1_E	-119	-50
			FDD-M1_F	-118.5	-50
			FDD-M1_G	-118	-50
			FDD-M1_N	-114.5	-50
±6	±6.5	15 ≤ Ês/lot ≤ -12 dB	Note 2	Note 2	Note 2

NOTE 1: I_o is assumed to have constant EPRE across the bandwidth.
 NOTE 2: The same bands and the same I_o conditions for each band apply for this requirement as for the corresponding highest accuracy requirement.
 NOTE 3: The condition level is increased by Δ>0, when applicable, as described in Sections B.4.2 and B.4.3.
 NOTE 4: E-UTRA operating band groups are as defined in Section 3.5.

Table 9.1.26.7-2: RSRQ Intra frequency absolute accuracy for non-BL CE UE with CE mode B for HD-FDD

Accuracy		Conditions			
Normal condition	Extreme condition	Ês/lot	I _o ^{Note 1} range		
			E-UTRA operating band groups ^{Note 4}	Minimum I _o	Maximum I _o
dB	dB	dB	dBm/15kHz ^{Note 3}	dBm/BW _{Channel}	
[±4]	±5.5	≥-12 dB	FDD-M1_A	-121	-50
			FDD-M1_D	-119.5	-50
			FDD-M1_E	-119	-50
			FDD-M1_F	-118.5	-50
			FDD-M1_G	-118	-50
			FDD-M1_N	-114.5	-50
±6	±6.5	15 ≤ Ês/lot ≤ -12 dB	Note 2	Note 2	Note 2

NOTE 1: I_o is assumed to have constant EPRE across the bandwidth.

NOTE 2: The same bands and the same I_0 conditions for each band apply for this requirement as for the corresponding highest accuracy requirement.
 NOTE 3: The condition level is increased by $\Delta > 0$, when applicable, as described in Sections B.4.2 and B.4.3.
 NOTE 4: E-UTRA operating band groups are as defined in Section 3.5.

9.1.26.8 RSRQ Measurement Report Mapping

The same RSRQ reporting range as for UE category M1 in Clause 9.1.21.8 applies.

9.1.26.9 Inter-frequency Absolute Accuracy of RSRP for non-BL CE UE in CE mode A

The requirements for absolute accuracy of RSRP in this clause apply to a cell on another frequency than that of the serving cell for non-BL CE UE.

The accuracy requirements in Table 9.1.26.9-1 and Table 9.1.26.9-2 are valid under the following conditions:

Cell specific reference signals are transmitted either from one, two or four antenna ports.

Conditions defined in 36.101 Clause 7.3 for reference sensitivity are fulfilled.

RSRP[dBm] according to Annex B.3.1 for a corresponding Band

At least 1 DL subframe per radio frame of measured cell is available at the UE for RSRP measurement assuming measured cell is identified cell.

Table 9.1.26.9-1: RSRP Inter frequency absolute accuracy for non-BL CE UE with CE mode A for FDD and TDD

Accuracy		Conditions				
Normal condition	Extreme condition	\hat{E}_s/I_{ot}	I_0 ^{Note 1} range			
			E-UTRA operating band groups ^{Note 3}	Minimum I_0		Maximum I_0
dB	dB	dB		dBm/15kHz ^{Note 2}	dBm/BW _{Channel}	dBm/BW _{Channel}
±5.5	±8.5	≥-6 dB	FDD-M1_A, TDD-M1_A	-121	N/A	-70
			FDD-M1_D	-119.5	N/A	-70
			FDD-M1_E, TDD-M1_E	-119	N/A	-70
			FDD-M1_F	-118.5	N/A	-70
			FDD-M1_G	-118	N/A	-70
			FDD-M1_N	-114.5	N/A	-70
±8	±11	≥-6 dB	FDD-M1_A, TDD-M1_A, FDD-M1_D, FDD-M1_E, TDD-M1_E, FDD-M1_F, FDD-M1_G, FDD-M1_N	N/A	-70	-50

NOTE 1: I_0 is assumed to have constant EPRE across the bandwidth.
 NOTE 2: The condition level is increased by $\Delta > 0$, when applicable, as described in Sections B.4.2 and B.4.3.
 NOTE 3: E-UTRA operating band groups are as defined in Section 3.5.

Table 9.1.26.9-2: RSRP Inter frequency absolute accuracy for non-BL CE UE with CE mode A for HD-FDD

Accuracy		Conditions				
Normal condition	Extreme condition	\hat{E}_s/I_{ot}	I_0 ^{Note 1} range			
			E-UTRA operating band groups ^{Note 3}	Minimum I_0		Maximum I_0
dB	dB	dB		dBm/15kHz ^{Note 2}	dBm/BW _{Channel}	dBm/BW _{Channel}
±5.5	±8.5	≥-6 dB	FDD-M1_A	-121	N/A	-70
			FDD-M1_D	-119.5	N/A	-70
			FDD-M1_E	-119	N/A	-70
			FDD-M1_F	-118.5	N/A	-70
			FDD-M1_G	-118	N/A	-70
			FDD-M1_N	-114.5	N/A	-70

±8	±11	≥-6 dB	FDD-M1_A, FDD-M1_D, FDD-M1_E, FDD-M1_F, FDD-M1_G, FDD-M1_N	N/A	-70	-50
----	-----	--------	--	-----	-----	-----

NOTE 1: I_0 is assumed to have constant EPRE across the bandwidth.
 NOTE 2: The condition level is increased by $\Delta > 0$, when applicable, as described in Sections B.4.2 and B.4.3.
 NOTE 3: E-UTRA operating band groups are as defined in Section 3.5.

9.1.26.10 Inter-frequency Relative Accuracy of RSRP for non-BL CE UE in CE mode A

The relative accuracy of RSRP is defined as the RSRP measured from one cell compared to the RSRP measured from another cell on another frequency for the non-BL CE UE.

The accuracy requirements in Table 9.1.26.10-1 and Table 9.1.26.10-2 are valid under the following conditions:

Cell specific reference signals are transmitted either from one, two or four antenna ports.

Conditions defined in 36.101 Clause 7.3 for reference sensitivity are fulfilled.

$RSRP_{1,2}|_{dBm}$ according to Annex B.3.8 for a corresponding Band.

At least 1 DL subframe per radio frame of measured cell is available at the UE for RSRP measurement assuming measured cell is identified cell.

Table 9.1.26.10-1: RSRP Inter frequency relative accuracy for non-BL CE UE with CE mode A for FDD and TDD

Accuracy		Conditions			
Normal condition	Extreme condition	$\hat{E}s/I_0$ ^{Note 2}	I_0 ^{Note 1} range		
			E-UTRA operating band groups ^{Note 5}	Minimum I_0	Maximum I_0
dB	dB	dB	dBm/15kHz ^{Note 4}	dBm/BW _{Channel}	
±5.5	±6.5	≥-3 dB	FDD-M1_A, TDD-M1_A	-121	-50
			FDD-M1_D	-119.5	-50
			FDD-M1_E, TDD-M1_E	-119	-50
			FDD-M1_F	-118.5	-50
			FDD-M1_G	-118	-50
			FDD-M1_N	-114.5	-50
±6.5	±6.5	≥-6 dB	Note 3	Note 3	Note 3

NOTE 1: I_0 is assumed to have constant EPRE across the bandwidth.
 NOTE 2: The parameter $\hat{E}s/I_0$ is the minimum $\hat{E}s/I_0$ of the pair of cells to which the requirement applies.
 NOTE 3: The same bands and the same I_0 conditions for each band apply for this requirement as for the corresponding highest accuracy requirement.
 NOTE 4: The condition level is increased by $\Delta > 0$, when applicable, as described in Sections B.4.2 and B.4.3.
 NOTE 5: E-UTRA operating band groups are as defined in Section 3.5.

Table 9.1.26.10-2: RSRP Inter frequency relative accuracy for non-BL CE UE with CE mode A for HD-FDD

Accuracy		Conditions			
Normal condition	Extreme condition	$\hat{E}s/I_0$ ^{Note 2}	I_0 ^{Note 1} range		
			E-UTRA operating band groups ^{Note 5}	Minimum I_0	Maximum I_0
dB	dB	dB	dBm/15kHz ^{Note 4}	dBm/BW _{Channel}	
±5.5	±6.5	≥-3 dB	FDD-M1_A	-121	-50
			FDD-M1_D	-119.5	-50
			FDD-M1_E	-119	-50
			FDD-M1_F	-118.5	-50
			FDD-M1_G	-118	-50
			FDD-M1_N	-114.5	-50
±6.5	±6.5	≥-6 dB	Note 3	Note 3	Note 3

NOTE 1: I_0 is assumed to have constant EPRE across the bandwidth.
 NOTE 2: The parameter $\hat{E}s/I_0$ is the minimum $\hat{E}s/I_0$ of the pair of cells to which the requirement applies.
 NOTE 3: The same bands and the same I_0 conditions for each band apply for this requirement as for the corresponding highest accuracy requirement.

NOTE 4: The condition level is increased by $\Delta > 0$, when applicable, as described in Sections B.4.2 and B.4.3.
 NOTE 5: E-UTRA operating band groups are as defined in Section 3.5.

9.1.26.11 Inter-frequency Absolute Accuracy of RSRP for non-BL CE UE in CE mode B

The requirements for absolute accuracy of RSRP in this clause apply to a cell on another frequency than that of the serving cell for the non-BL UE.

The accuracy requirements in Table 9.1.26.11-1 and Table 9.1.26.11-2 are valid under the following conditions:

Cell specific reference signals are transmitted either from one, two or four antenna ports.

Conditions defined in 36.101 Clause 7.3 for reference sensitivity are fulfilled.

RSRP[dBm] according to Annex B.3.1 for a corresponding Band

At least 1 DL subframe per radio frame of measured cell is available at the UE for RSRP measurement assuming measured cell is identified cell.

Table 9.1.26.11-1: RSRP Inter frequency absolute accuracy for non-BL CE UE with CE mode B for FDD and TDD

Accuracy		Conditions				
Normal condition	Extreme condition	\hat{E}_s/lot	I_o ^{Note 1} range			
			E-UTRA operating band groups ^{Note 3}	Minimum I_o		Maximum I_o
dB	dB	dB		dBm/15kHz ^{Note 2}	dBm/BW _{Channel}	dBm/BW _{Channel}
±8	±11	- 15 ≤ \hat{E}_s/lot ≤ -12 dB	FDD-M1_A, TDD-M1_A	-121	N/A	-70
			FDD-M1_D	-119.5	N/A	-70
			FDD-M1_E, TDD-M1_E	-119	N/A	-70
±6	±9	≥ -12 dB	FDD-M1_F	-118.5	N/A	-70
			FDD-M1_G	-118	N/A	-70
			FDD-M1_N	-114.5	N/A	-70
±10	±13	- 15 ≤ \hat{E}_s/lot ≤ -12 dB	FDD-M1_A, TDD-M1_A, FDD-M1_D, FDD-M1_E, TDD-M1_E, FDD-M1_F, FDD-M1_G, FDD-M1_N	N/A	-70	-50
±8	±11	≥ -12 dB				

NOTE 1: I_o is assumed to have constant EPRE across the bandwidth.
 NOTE 2: The condition level is increased by $\Delta > 0$, when applicable, as described in Sections B.4.2 and B.4.3.
 NOTE 3: E-UTRA operating band groups are as defined in Section 3.5.

Table 9.1.26.11-2: RSRP Inter frequency absolute accuracy for non-BL CE UE with CE mode B for HD-FDD

Accuracy		Conditions				
Normal condition	Extreme condition	\hat{E}_s/lot	I_o ^{Note 1} range			
			E-UTRA operating band groups ^{Note 3}	Minimum I_o		Maximum I_o
dB	dB	dB		dBm/15kHz ^{Note 2}	dBm/BW _{Channel}	dBm/BW _{Channel}
±8	±11	- 15 ≤ \hat{E}_s/lot ≤ -12 dB	FDD-M1_A	-121	N/A	-70
			FDD-M1_D	-119.5	N/A	-70
			FDD-M1_E	-119	N/A	-70
±6	±9	≥ -12 dB	FDD-M1_F	-118.5	N/A	-70
			FDD-M1_G	-118	N/A	-70
			FDD-M1_N	-114.5	N/A	-70
±10	±13	- 15 ≤ \hat{E}_s/lot ≤ -12 dB	FDD-M1_A, FDD-M1_D, FDD-M1_E, FDD-M1_F, FDD-M1_G, FDD-M1_N	N/A	-70	-50
±8	±11	≥ -12 dB				

NOTE 1: I_o is assumed to have constant EPRE across the bandwidth.
 NOTE 2: The condition level is increased by $\Delta > 0$, when applicable, as described in Sections B.4.2 and B.4.3.

NOTE 3: E-UTRA operating band groups are as defined in Section 3.5.

9.1.26.12 Inter-frequency Relative Accuracy of RSRP for non-BL CE UE in CE mode B

The relative accuracy of RSRP is defined as the RSRP measured from one cell compared to the RSRP measured from another cell on another frequency.

The accuracy requirements in Table 9.1.26.12-1 and Table 9.1.26.12-2 are valid under the following conditions:

Cell specific reference signals are transmitted either from one, two or four antenna ports.

Conditions defined in 36.101 Clause 7.3 for reference sensitivity are fulfilled.

RSRP_{1,2}_{dBm} according to Annex B.3.8 for a corresponding Band.

At least 1 DL subframe per radio frame of measured cell is available at the UE for RSRP measurement assuming measured cell is identified cell.

Table 9.1.26.12-1: RSRP Inter frequency relative accuracy for non-BL CE UE with CE mode B for FDD and TDD

Accuracy		Conditions			
Normal condition	Extreme condition	Ês/lot ^{Note 2}	I _o ^{Note 1} range		
			E-UTRA operating band groups ^{Note 5}	Minimum I _o	Maximum I _o
dB	dB	dB	dBm/15kHz ^{Note 4}	dBm/BW _{Channel}	
±6	±9	≥-12 dB	FDD-M1_A, TDD-M1_A	-121	-50
			FDD-M1_D	-119.5	-50
			FDD-M1_E, TDD-M1_E	-119	-50
			FDD-M1_F	-118.5	-50
			FDD-M1_G	-118	-50
			FDD-M1_N	-114.5	-50
±8	±11	15 ≤ Ês/lot ≤ -12 dB	Note 3	Note 3	Note 3

NOTE 1: I_o is assumed to have constant EPRE across the bandwidth.
 NOTE 2: The parameter Ês/lot is the minimum Ês/lot of the pair of cells to which the requirement applies.
 NOTE 3: The same bands and the same I_o conditions for each band apply for this requirement as for the corresponding highest accuracy requirement.
 NOTE 4: The condition level is increased by Δ>0, when applicable, as described in Sections B.4.2 and B.4.3.
 NOTE 5: E-UTRA operating band groups are as defined in Section 3.5.

Table 9.1.26.12-2: RSRP Inter frequency relative accuracy for non-BL CE UE with CE mode B for HD-FDD

Accuracy		Conditions			
Normal condition	Extreme condition	Ês/lot ^{Note 2}	I _o ^{Note 1} range		
			E-UTRA operating band groups ^{Note 5}	Minimum I _o	Maximum I _o
dB	dB	dB	dBm/15kHz ^{Note 4}	dBm/BW _{Channel}	
±6	±9	≥-12 dB	FDD-M1_A	-121	-50
			FDD-M1_D	-119.5	-50
			FDD-M1_E	-119	-50
			FDD-M1_F	-118.5	-50
			FDD-M1_G	-118	-50
			FDD-M1_N	-114.5	-50
±8	±11	15 ≤ Ês/lot ≤ -12 dB	Note 3	Note 3	Note 3

NOTE 1: I_o is assumed to have constant EPRE across the bandwidth.
 NOTE 2: The parameter Ês/lot is the minimum Ês/lot of the pair of cells to which the requirement applies.
 NOTE 3: The same bands and the same I_o conditions for each band apply for this requirement as for the corresponding highest accuracy requirement.
 NOTE 4: The condition level is increased by Δ>0, when applicable, as described in Sections B.4.2 and B.4.3.

NOTE 5: E-UTRA operating band groups are as defined in Section 3.5.

9.1.26.13 Inter-frequency Absolute Accuracy of RSRQ for non-BL CE UE in CE mode A

The same requirement as for UE category M1 in Clause 9.1.21.13 applies.

9.1.26.14 Inter-frequency Relative Accuracy of RSRQ for non-BL CE UE in CE mode A

The same requirement as for UE category M1 in Clause 9.1.21.14 applies.

9.1.26.15 Inter-frequency Absolute Accuracy of RSRQ for non-BL CE UE in CE mode B

The requirements for absolute accuracy of RSRQ in this clause apply to a cell that has different carrier frequency from the serving cell for the non-BL CE UE.

The accuracy requirements in Tables 9.1.26.15-1 and 9.1.26.15-2 are valid under the following conditions:

Cell specific reference signals are transmitted either from one, two or four antenna ports.

Conditions defined in 36.101 Clause 7.3 for reference sensitivity are fulfilled.

RSRP[dBm] according to Annex B.3.3 for a corresponding Band

Table 9.1.26.15-1: RSRQ Inter frequency absolute accuracy for non-BL CE UE with CE mode B for FDD and TDD

Accuracy		Conditions			
Normal condition	Extreme condition	Ês/lot	Io ^{Note 1} range		
			E-UTRA operating band groups ^{Note 4}	Minimum Io	Maximum Io
dB	dB	dB		dBm/15kHz ^{Note 3}	dBm/BW _{Channel}
±4	±5.5	≥-12 dB	FDD-M1_A, TDD-M1_A	-121	-50
			FDD-M1_D	-119.5	-50
			FDD-M1_E, TDD-M1_E	-119	-50
			FDD-M1_F	-118.5	-50
			FDD-M1_G	-118	-50
			FDD-M1_N	-114.5	-50
±6	±6.5	15 ≤ Ês/lot ≤ -12 dB	Note 2	Note 2	Note 2

NOTE 1: Io is assumed to have constant EPRE across the bandwidth.
 NOTE 2: The same bands and the same Io conditions for each band apply for this requirement as for the corresponding highest accuracy requirement.
 NOTE 3: The condition level is increased by Δ>0, when applicable, as described in Sections B.4.2 and B.4.3.
 NOTE 4: E-UTRA operating band groups are as defined in Section 3.5.

Table 9.1.26.15-2: RSRQ Inter frequency absolute accuracy for non-BL CE UE with CE mode B for HD-FDD

Accuracy		Conditions			
Normal condition	Extreme condition	Ês/lot	Io ^{Note 1} range		
			E-UTRA operating band groups ^{Note 4}	Minimum Io	Maximum Io
dB	dB	dB		dBm/15kHz ^{Note 3}	dBm/BW _{Channel}
±4	±5.5	≥-12 dB	FDD-M1_A, TDD-M1_A	-121	-50
			FDD-M1_D	-119.5	-50
			FDD-M1_E, TDD-M1_E	-119	-50
			FDD-M1_F	-118.5	-50
			FDD-M1_G	-118	-50
			FDD-M1_N	-114.5	-50

±6	±6.5	$15 \leq \hat{E}_s/\text{lot} \leq -12$ dB	Note 2	Note 2	Note 2
<p>NOTE 1: I_0 is assumed to have constant EPRE across the bandwidth.</p> <p>NOTE 2: The same bands and the same I_0 conditions for each band apply for this requirement as for the corresponding highest accuracy requirement.</p> <p>NOTE 3: The condition level is increased by $\Delta > 0$, when applicable, as described in Sections B.4.2 and B.4.3.</p> <p>NOTE 4: E-UTRA operating band groups are as defined in Section 3.5.</p>					

9.1.26.16 Inter-frequency Relative Accuracy of RSRQ for non-BL CE UE in CE mode B

The relative accuracy of RSRQ in inter frequency case is defined as the RSRQ measured from one cell compared to the RSRQ measured from another cell on a different frequency.

The accuracy requirements in Tables 9.1.26.16-1 and 9.1.26.16-2 are valid under the following conditions:

Cell specific reference signals are transmitted either from one, two or four antenna ports.

Conditions defined in 36.101 Clause 7.3 for reference sensitivity are fulfilled.

$RSRP_{1,2|dBm}$ according to Annex B.3.4 for a corresponding Band

$$|RSRP_{1|dBm} - RSRP_{2|dBm}| \leq 27 \text{ dB}$$

$$|Channel\ 1_{I_0} - Channel\ 2_{I_0}| \leq 20 \text{ dB}$$

Table 9.1.26.16-1: RSRQ Inter frequency relative accuracy for non-BL CE UE with CE mode B for FDD and TDD

Accuracy		Conditions			
Normal condition	Extreme condition	\hat{E}_s/lot ^{Note 2}	I_0 ^{Note 1} range		
			E-UTRA operating band groups ^{Note 5}	Minimum I_0	Maximum I_0
dB	dB	dB	dBm/15kHz ^{Note 4}	dBm/BW _{Channel}	
±4.5	±5.5	≥-12 dB	FDD-M1_A, TDD-M1_A	-121	-50
			FDD-M1_D	-119.5	-50
			FDD-M1_E, TDD-M1_E	-119	-50
			FDD-M1_F	-118.5	-50
			FDD-M1_G	-118	-50
			FDD-M1_N	-114.5	-50
±6.5	±6.5	$15 \leq \hat{E}_s/\text{lot} \leq -12$ dB	Note 3	Note 3	Note 3
<p>NOTE 1: I_0 is assumed to have constant EPRE across the bandwidth.</p> <p>NOTE 2: The parameter \hat{E}_s/lot is the minimum \hat{E}_s/lot of the pair of cells to which the requirement applies.</p> <p>NOTE 3: The same bands and the same I_0 conditions for each band apply for this requirement as for the corresponding highest accuracy requirement.</p> <p>NOTE 4: The condition level is increased by $\Delta > 0$, when applicable, as described in Sections B.4.2 and B.4.3.</p> <p>NOTE 5: E-UTRA operating band groups are as defined in Section 3.5.</p>					

Table 9.1.26.16-2: RSRQ Inter frequency relative accuracy for non-BL CE UE with CE mode B for HD-FDD

Accuracy		Conditions			
Normal condition	Extreme condition	\hat{E}_s/lot ^{Note 2}	I_0 ^{Note 1} range		
			E-UTRA operating band groups ^{Note 5}	Minimum I_0	Maximum I_0
dB	dB	dB	dBm/15kHz ^{Note 4}	dBm/BW _{Channel}	
±4.5	±5.5	≥-12 dB	FDD-M1_A	-121	-50
			FDD-M1_D	-119.5	-50
			FDD-M1_E	-119	-50
			FDD-M1_F	-118.5	-50
			FDD-M1_G	-118	-50

			FDD-M1_N	-114.5	-50
±6.5	±6.5	$15 \leq \hat{E}_s/\text{lot} \leq -12$ dB	Note 3	Note 3	Note 3
<p>NOTE 1: I_0 is assumed to have constant EPRE across the bandwidth.</p> <p>NOTE 2: The parameter \hat{E}_s/lot is the minimum \hat{E}_s/lot of the pair of cells to which the requirement applies.</p> <p>NOTE 3: The same bands and the same I_0 conditions for each band apply for this requirement as for the corresponding highest accuracy requirement.</p> <p>NOTE 4: The condition level is increased by $\Delta > 0$, when applicable, as described in Sections B.4.2 and B.4.3.</p> <p>NOTE 5: E-UTRA operating band groups are as defined in Section 3.5.</p>					

9.1.27 SFN and frame Timing Difference (SFTD)

9.1.27.1 SFTD Accuracy Requirement

The SFN and frame timing difference (SFTD) is measured between PCell and NR PSCell under EN-DC, or between PCell and NR cell for inter-RAT SFTD. The inter-RAT SFTD measurement can only be configured for E-UTRA - NR band combinations that are supported by the UE.

The accuracy requirements in Table 9.1.27.1-4 are applicable under the following conditions:

For PCell SFN and frame timing measurement:

- Cell specific reference signals are transmitted either from one, two or four antenna ports.
- Conditions defined in TS 36.101 [5] clause 7.3 for reference sensitivity are fulfilled.
- No changes to the uplink transmission timing are applied during the measurement period.
- $RSRP|_{dBm}$ according to Annex B.3.5 for a corresponding Band.
- I_0 range defined in Table 9.1.27.1-1.

Table 9.1.27.1-1: PCell I_0 range conditions for SFTD measurement accuracy

Parameter	I_0 ^{Note 1} range		
	E-UTRA operating band groups ^{Note 4, 5}	Minimum I_0 dBm/15kHz ^{Note 2, 3}	Maximum I_0 dBm/BW _{Channel}
Conditions	FDD_A, TDD_A	-121	-50
	FDD_C, TDD_C	-120	-50
	FDD_D	-119.5	-50
	FDD_E, TDD_E	-119	-50
	FDD_F	-118.5	-50
	FDD_G	-118	-50
	FDD_H	-117.5	-50
	FDD_N	-114.5	-50

NOTE 1: When in dBm/15kHz, the minimum I_0 condition is expressed as the average I_0 per RE over all REs in that symbol. I_0 may be different in different symbols within a subframe.

NOTE 2: The condition level is increased by $\Delta > 0$, when applicable, as described in clause B.4.2 and B.4.3.

NOTE 3: The condition level is increased by MSD as defined in clause 7.3B in TS 38.101-3 [54], if applicable depending on E-UTRA – NR band combination.

NOTE 4: E-UTRA operating band groups are as defined in clause 3.5.

NOTE 5: Only E-UTRA bands within EN-DC band combinations as specified in clause 5.5B in TS 38.101-3 [54] are applicable.

For NR PSCell, or NR cell SFN and frame timing measurement in FR1:

- Conditions defined in TS 38.101-1 [18] clause 7.3 for reference sensitivity are fulfilled.
- I_0 range defined in Table 9.1.27.1-2.

Table 9.1.27.1-2: NR PSCell, or NR cell I_0 range conditions for SFTD measurement accuracy in FR1

Parameter	I_0 ^{Note 1} range		
	NR operating band groups ^{Note 4, 5}	Minimum I_0 ^{Note 2, 3}	Maximum I_0

		dBm/ SCS _{SSB}		dBm/BW _{Channel}
		SCS _{SSB} = 15 kHz	SCS _{SSB} = 30 kHz	
Conditions	NR_FDD_FR1_A, NR_TDD_FR1_A	-121	-118	-50
	NR_FDD_FR1_B	-120.5	-117.5	-50
	NR_TDD_FR1_C	-120	-117	-50
	NR_FDD_FR1_D, NR_TDD_FR1_D	-119.5	-116.5	-50
	NR_FDD_FR1_E, NR_TDD_FR1_E	-119	-116	-50
	NR_FDD_FR1_G	-118	-115	-50
	NR_FDD_FR1_H	-117.5	-114.5	-50
NOTE 1: I _o is assumed to have constant EPRE across the bandwidth.				
NOTE 2: The condition level is increased by ΔR _{IB,c} as defined in clause 7.3B in TS 38.101-3 [54], depending on E-UTRA – NR band combination.				
NOTE 3: The condition level is increased by MSD as defined in clause 7.3B in TS 38.101-3 [54], if applicable depending on E-UTRA – NR band combination.				
NOTE 4: NR operating band groups are as defined in clause 3.5.				
NOTE 5: Only NR bands within EN-DC band combinations as specified in clause 5.5B in TS 38.101-3 [54] are applicable.				

For NR PSCell, or NR cell SFN and frame timing measurement in FR2:

- Conditions defined in TS 38.101-2 [19] clause 7.3 for reference sensitivity are fulfilled.
- I_o range defined in Table 9.1.27.1-3.
- The measured signals are in the directions covered by the percentile EIS spherical coverage of the UE, defined in TS 38.101-2 [19] clause 7.3.4.

Table 9.1.27.1-3: NR PSCell, or NR cell I_o range conditions for SFTD measurement accuracy in FR2

Parameter	I _o ^{Note 1} range		
	Minimum I _o ^{Note 2, 3}		Maximum I _o
	dBm/ SCS _{SSB}		dBm/BW _{Channel}
	SCS _{SSB} = 15 kHz	SCS _{SSB} = 30 kHz	
Conditions	Same value as SSB_RP in Table B.2.4.1-2, according to UE Power class, operating band and angle of arrival	Same value as SSB_RP in Table B.2.4.1-2, according to UE Power class, operating band and angle of arrival	50
NOTE 1: I _o is assumed to have constant EPRE across the bandwidth and specified at the Reference point.			
NOTE 2: Values based on Refsens and EIS spherical coverage as defined in TS 38.101-2 [19] clauses 7.3.2 and 7.3.4. Applicable side condition selected depending on angle of arrival.			
NOTE 3: In the test cases, the SSB Ês/lot and related parameters may need to be adjusted to ensure Ês/lot at UE baseband is above the value defined in this table.			

Table 9.1.27.1-4: SFTD measurement accuracy

Accuracy	Conditions	
	Ês/lot	Frequency range
T_s ^{Note 1}	≥ -3 dB	
40		FR1
40		FR2
NOTE 1: T _s is the basic timing unit defined in TS 36.211 [16].		
NOTE 2: The parameter Ês/lot is the minimum Ês/lot of the pair of cells to which the requirement applies.		

9.2 UTRAN FDD Measurements

The requirements in this clause are applicable for a UE:

- in state RRC_CONNECTED

- performing measurements according to clause 8.1.2.4 with appropriate measurement gaps
- that is synchronised to the cell that is measured.

The reported measurement result after layer 1 filtering shall be an estimate of the average value of the measured quantity over the measurement period. The reference point for the measurement result after layer 1 filtering is referred to as point B in the measurement model described in TS 25.302 [6].

The accuracy requirements in this clause are valid for the reported measurement result after layer 1 filtering. The accuracy requirements are verified from the measurement report at point D in the measurement model having the layer 3 filtering disabled.

9.2.1 UTRAN FDD CPICH RSCP

NOTE: This measurement is for handover between E-UTRAN and UTRAN FDD and for SON.

The requirements in this clause are valid for terminals supporting this capability.

The measurement period for RRC_CONNECTED state is specified in clauses 8.1.2.4.1 and 8.1.2.4.2.

In RRC_CONNECTED state the accuracy requirements shall meet the absolute accuracy requirements in table 9.2.1-1, under the following conditions:

- CPICH Ec/Io condition for a detectable cell is as specified in clauses 8.1.2.4.1, 8.1.2.4.2, 8.1.2.4.7, 8.1.2.4.8;
- SCH_Ec/Io condition for a detectable cell is as specified in clauses 8.1.2.4.1, 8.1.2.4.2, 8.1.2.4.7, 8.1.2.4.8.

Table 9.2.1-1: UTRAN FDD CPICH_RSCP absolute accuracy

Accuracy		Conditions		
Normal condition	Extreme condition	Io range		
		UTRA operating bands	Minimum Io	Maximum Io
dB	dB		dBm/3.84 MHz	dBm/3.84 MHz
±6	±9	Band I, IV, VI, X XI, XIX and XXI	-94	-70
		Band IX	-93	-70
		Band II, V and VII	-92	-70
		Band III, VIII, XII, XIII, XIV, XX and XXII	-91	-70
		Band XXV, XXVI ^{Note 1}	-90.5	-70
±8	±11	Note 2	-70	-50
NOTE 1: For Band XXVI, the condition has the minimum Io of -92 dBm/3.84 MHz when the carrier frequency of the assigned UTRA channel is within 869-894 MHz for the UE which supports both Band V and Band XXVI operating frequencies.				
NOTE 2: The same bands apply for this requirement as for the corresponding highest accuracy requirement.				

If the UE, in RRC_CONNECTED state, needs measurement gaps to perform UTRAN FDD measurements, the relevant UTRAN FDD measurement procedure and measurement gap pattern stated in clause 8.1.2.4 shall apply.

The reporting range and mapping specified for FDD CPICH RSCP in TS 25.133 [18] shall apply.

9.2.2 Void

9.2.3 UTRAN FDD CPICH Ec/No

NOTE: This measurement is for handover between E-UTRAN and UTRAN FDD and for SON.

The requirements in this clause are valid for terminals supporting this capability.

The measurement period for RRC_CONNECTED state is specified in clauses 8.1.2.4.1 and 8.1.2.4.2.

In RRC_CONNECTED state the accuracy requirements shall be the same as the inter-frequency measurement accuracy requirements for FDD CPICH Ec/No in TS 25.133 [18].

If the UE, in RRC_CONNECTED state, needs measurement gaps to perform UTRAN FDD measurements, the UTRAN FDD measurement procedure and measurement gap pattern stated in clause 8.1.2.4.1 shall apply.

The reporting range and mapping specified for FDD CPICH Ec/No in TS 25.133 [18] shall apply.

9.3 UTRAN TDD Measurements

The requirements in this clause are applicable for a UE:

- in state RRC_CONNECTED
- performing measurements according to clause 8.1.2.4 with appropriate measurement gaps
- that is synchronised to the cell that is measured.

The reported measurement result after layer 1 filtering shall be an estimate of the average value of the measured quantity over the measurement period. The reference point for the measurement result after layer 1 filtering is referred to as point B in the measurement model described in TS 25.302 [6].

The accuracy requirements in this clause are valid for the reported measurement result after layer 1 filtering. The accuracy requirements are verified from the measurement report at point D in the measurement model having the layer 3 filtering disabled.

9.3.1 UTRAN TDD P-CCPCH RSCP

NOTE: This measurement is for handover between E-UTRAN and UTRAN TDD and for SON.

The requirements in this clause are valid for terminals supporting this capability.

The measurement period for RRC_CONNECTED state is specified in clauses 8.1.2.4.3 and 8.1.2.4.4.

In RRC_CONNECTED state the accuracy requirements shall be the same as the inter-frequency measurement accuracy requirements for TDD P-CCPCH in TS 25.123 [19].

If the UE, in RRC_CONNECTED state, needs measurement gaps to perform UTRAN TDD measurements, the relevant UTRAN TDD measurement procedure and measurement gap pattern stated in clause 8.1.2.4 shall apply.

The reporting range and mapping specified for TDD P-CCPCH RSCP in TS 25.123 [19] shall apply.

9.3.2 Void

9.3.3 Void

9.4 GSM Measurements

The requirements in this clause are applicable for a UE:

- in state RRC_CONNECTED
- performing measurements according to clause 8.1.2.4.5 with appropriate measurement gaps
- that is synchronised to the cell that is measured.

The reported measurement result after layer 1 filtering shall be an estimate of the average value of the measured quantity over the measurement period. The reference point for the measurement result after layer 1 filtering is referred to as point B in the measurement model described in TS 25.302 [6].

The accuracy requirements in this clause are valid for the reported measurement result after layer 1 filtering. The accuracy requirements are verified from the measurement report at point D in the measurement model having the layer 3 filtering disabled.

9.4.1 GSM carrier RSSI

NOTE: This measurement is for handover between E-UTRAN and GSM.

The requirements in this clause are valid for terminals supporting this capability.

The measurement period for RRC_CONNECTED state is specified in clause 8.1.2.4.5.

In RRC_CONNECTED state the measurement accuracy requirements for RXLEV in TS 45.008 [8] shall apply.

If the UE, in RRC_CONNECTED state, needs measurement gaps to perform GSM measurements, the GSM measurement procedure and measurement gap pattern stated in clause 8.1.2.4.5 shall apply.

The reporting range and mapping specified for RXLEV in TS 45.008 [8] shall apply.

9.5 CDMA2000 1x RTT Measurements

The requirements in this clause are applicable for a UE:

- in RRC_CONNECTED state.
- synchronised to the cell that is measured.

9.5.1 CDMA2000 1x RTT Pilot Strength

NOTE: This measurement is for handover between E-UTRAN and cdma2000 1 x RTT.

The requirements in this clause are valid for terminals supporting this capability.

CDMA2000 1xRTT Pilot Strength defined in sub-clause 5.1.10 of [4] shall meet the performance requirement defined in sub-clause 3.2.4 of [14] on the cdma2000 1xRTT neighbour cells indicated by the serving eNode B.

9.6 $P_{\text{CMAX},c}$

For a UE configured with a secondary cell, the UE is required to report the UE configured maximum output power ($P_{\text{CMAX},c}$) together with the power headroom. This clause defines the requirements for the $P_{\text{CMAX},c}$ reporting.

9.6.1 Report Mapping

The $P_{\text{CMAX},c}$ reporting range is defined from -29dBm to 33 dBm with 1 dB resolution. Table 9.6.1-1 defines the reporting mapping.

Table 9.6.1-1 Mapping of $P_{\text{CMAX},c}$

Reported value	Measured quantity value	Unit
PCMAX_C_00	$P_{\text{CMAX},c} < -29$	dBm
PCMAX_C_01	$-29 \leq P_{\text{CMAX},c} < -28$	dBm
PCMAX_C_02	$-28 \leq P_{\text{CMAX},c} < -27$	dBm
...
PCMAX_C_61	$31 \leq P_{\text{CMAX},c} < 32$	dBm
PCMAX_C_62	$32 \leq P_{\text{CMAX},c} < 33$	dBm
PCMAX_C_63	$33 \leq P_{\text{CMAX},c}$	dBm

9.6.2 Estimation Period

When *extendedPHR* is configured and UE is required to include $P_{\text{CMAX},c}$ in Extended PHR MAC control element as defined in subclause 5.4.6 in [17], the UE shall calculate the $P_{\text{CMAX},c}$ per activated serving cell *c* for UL-SCH transmission according to subclause 6.2.5A of TS 36.101 [5] over 1 subframe.

9.6.3 Reporting Delay

The $P_{\text{CMAX},c}$ reporting delay is defined as the time between the beginning of the $P_{\text{CMAX},c}$ reference period and the time when the UE starts transmitting $P_{\text{CMAX},c}$ over the radio interface. The reporting delay of the $P_{\text{CMAX},c}$ shall be 0 ms, which is applicable for all configured triggering mechanisms for $P_{\text{CMAX},c}$ reporting.

9.7 IEEE802.11 Measurements

The requirements in this clause are applicable for a UE:

- in RRC_CONNECTED state.
- synchronised to the IEEE 802.11 access point that is measured.

9.7.1 WLAN RSSI

NOTE: This measurement is for access network selection and traffic steering between E-UTRAN and WLAN.

The requirements in this clause are valid for terminals supporting this capability.

WLAN RSSI defined in sub-clause 5.1.16 of [4] shall meet the performance requirement defined in [32].

9.7.2 WLAN RSSI Measurement Report Mapping

This sub-clause 9.7.2 doesn't apply to LPP *WLAN-MeasurementInformation*. The WLAN RSSI measurement report mapping is defined in [32] for LPP *WLAN-MeasurementInformation*.

The reporting range of WLAN RSSI is defined from -100 dBm to 40 dBm with 1 dB resolution.

The mapping of measured quantity is defined in Table 9.7.2-1. The range in the signalling may be larger than the guaranteed accuracy range.

Table 9.7.2-1: WLAN RSSI measurement report mapping

Reported value	Measured quantity value	Unit
WLAN_RSSI_00	WLAN RSSI < -100	dBm
WLAN_RSSI_01	-100 ≤ WLAN RSSI < -99	dBm
WLAN_RSSI_02	-99 ≤ WLAN RSSI < -98	dBm
...
WLAN_RSSI_139	38 ≤ WLAN RSSI < 39	dBm
WLAN_RSSI_140	39 ≤ WLAN RSSI < 40	dBm
WLAN_RSSI_141	40 ≤ WLAN RSSI	dBm

9.8 MBSFN Measurements

9.8.1 Introduction

MBSFN measurements include MBSFN RSRP, MBSFN RSRQ, and MCH BLER, which are defined in [4]. The measurements are used for MDT.

The requirements in Section 9.8 apply for 15 kHz subcarrier spacing configured in MBSFN subframes. The same requirements apply also for 1.25 kHz and 7.5 kHz subcarrier spacing, provided that $\text{MBSFN RSRP}[\text{dBm}/(\text{L}) \text{ kHz}] = \text{MBSFN RSRP}[\text{dBm}/15\text{kHz}] + 10 \cdot \log_{10}(\text{L}/15)$, where L is 1.25 kHz or 7.5 kHz.

9.8.2 MBSFN RSRP

9.8.2.1 Absolute MBSFN RSRP measurement accuracy requirements

The requirements for absolute accuracy of MBSFN RSRP in this clause apply to any carrier, which may be the same as or different from any serving unicast carrier, where PMCH is received while meeting performance requirements in Section 10 of [5].

The accuracy requirements in Table 9.8.2.1-1 are valid under the following conditions:

MBSFN RS are transmitted from antenna port 4 in the MBSFN subframes where PMCH is received.

Conditions defined in 36.101 Clause 7.3 for reference sensitivity are fulfilled.

MBSFN RSRP[dBm/15kHz is the same as RSRP[dBm/15kHz specified in Annex B.3.1 for each corresponding Band.

Table 9.8.2.1-1: Absolute MBSFN RSRP measurement accuracy

Accuracy		Conditions				
Normal condition	Extreme condition	Ês/lot	I _o ^{Note 1} range			
			E-UTRA operating band groups ^{Note 3}	Minimum I _o		Maximum I _o
dB	dB	dB		dBm/15kHz ^{Note 2}	dBm/BW _{Channel}	dBm/BW _{Channel}
±4.5	±9	≥-6 dB	FDD_A, TDD_A	-121	N/A	-70
			FDD_B1, FDD_B2	-120.5	N/A	-70
			FDD_C, TDD_C	-120	N/A	-70
			FDD_D	-119.5	N/A	-70
			FDD_E, TDD_E	-119	N/A	-70
			FDD_F	-118.5	N/A	-70
			FDD_G	-118	N/A	-70
			FDD_H	-117.5	N/A	-70
			FDD_N	-114.5	N/A	-70
±8	±11	≥-6 dB	FDD_A, TDD_A, FDD_B1, FDD_B2, FDD_C, TDD_C, FDD_D, FDD_E, TDD_E, FDD_F, FDD_G, FDD_H, FDD_N	N/A	-70	-50

NOTE 1: I_o is assumed to have constant EPRE across the bandwidth.
 NOTE 2: The condition level is increased by Δ>0, when applicable, as described in Sections B.4.2 and B.4.3.
 NOTE 3: E-UTRA operating band groups are as defined in Section 3.5.

9.8.2.2 MBSFN RSRP measurement report mapping

The reporting range of MBSFN RSRP is defined from -140 dBm to -44 dBm with 1 dB resolution, for 15kHz subcarrier spacing.

The mapping of measured quantity is defined in Table 9.8.2.2-1. The range in the signalling may be larger than the guaranteed accuracy range.

Table 9.8.2.2-1: MBSFN RSRP measurement report mapping

Reported value	Measured quantity value	Unit
MBSFN_RSRP_00	MBSFN_RSRP < -140	dBm / 15 kHz
MBSFN_RSRP_01	-140 ≤ MBSFN_RSRP < -139	dBm / 15 kHz
MBSFN_RSRP_02	-139 ≤ MBSFN_RSRP < -138	dBm / 15 kHz
...
MBSFN_RSRP_95	-46 ≤ MBSFN_RSRP < -45	dBm / 15 kHz
MBSFN_RSRP_96	-45 ≤ MBSFN_RSRP < -44	dBm / 15 kHz
MBSFN_RSRP_97	-44 ≤ MBSFN_RSRP	dBm / 15 kHz

9.8.2.3 MBSFN RSRP measurement report mapping for 7.5 kHz subcarrier spacing

The reporting range of MBSFN RSRP is defined from -143 dBm to -47 dBm with 1 dB resolution, for 7.5 kHz subcarrier spacing.

The mapping of measured quantity is defined in Table 9.8.2.3-1. The range in the signalling may be larger than the guaranteed accuracy range.

Table 9.8.2.3-1: MBSFN RSRP measurement report mapping

Reported value	Measured quantity value	Unit
MBSFN_RSRP_00	MBSFN_RSRP < -143	dBm / 7.5 kHz
MBSFN_RSRP_01	-143 ≤ MBSFN_RSRP < -142	dBm / 7.5 kHz
MBSFN_RSRP_02	-142 ≤ MBSFN_RSRP < -141	dBm / 7.5 kHz
...	...	dBm / 7.5 kHz

MBSFN_RSRP_95	$-49 \leq \text{MBSFN_RSRP} < -48$	dBm / 7.5 kHz
MBSFN_RSRP_96	$-48 \leq \text{MBSFN_RSRP} < -47$	dBm / 7.5 kHz
MBSFN_RSRP_97	$-47 \leq \text{MBSFN_RSRP}$	dBm / 7.5 kHz

9.8.2.4 MBSFN RSRP measurement report mapping for 1.25 kHz subcarrier spacing

The reporting range of MBSFN RSRP is defined from -151 dBm to -55 dBm with 1 dB resolution, for 1.25 kHz subcarrier spacing.

The mapping of measured quantity is defined in Table 9.8.2.4-1. The range in the signalling may be larger than the guaranteed accuracy range.

Table 9.8.2.4-1: MBSFN RSRP measurement report mapping

Reported value	Measured quantity value	Unit
MBSFN_RSRP_00	$\text{MBSFN_RSRP} < -151$	dBm / 1.25 kHz
MBSFN_RSRP_01	$-151 \leq \text{MBSFN_RSRP} < -150$	dBm / 1.25 kHz
MBSFN_RSRP_02	$-150 \leq \text{MBSFN_RSRP} < -149$	dBm / 1.25 kHz
...	...	dBm / 1.25 kHz
MBSFN_RSRP_95	$-57 \leq \text{MBSFN_RSRP} < -56$	dBm / 1.25 kHz
MBSFN_RSRP_96	$-56 \leq \text{MBSFN_RSRP} < -55$	dBm / 1.25 kHz
MBSFN_RSRP_97	$-55 \leq \text{MBSFN_RSRP}$	dBm / 1.25 kHz

9.8.3 MBSFN RSRQ

9.8.3.1 Absolute MBSFN RSRQ measurement accuracy requirements

The requirements for absolute accuracy of MBSFN RSRQ in this clause apply to any carrier, which may be the same as or different from a serving unicast carrier, where PMCH is received while meeting performance requirements in Section 10 of [5].

The accuracy requirements in Table 9.8.3.1-1 are valid under the following conditions:

MBSFN RS are transmitted from antenna port 4 in the MBSFN subframes where PMCH is received.

Conditions defined in 36.101 Clause 7.3 for reference sensitivity are fulfilled.

MBSFN RSRP[dBm/15kHz] is the same as RSRP[dBm/15kHz] specified in Annex B.3.1 for each corresponding Band.

Table 9.8.3.1-1: Absolute MBSFN RSRQ measurement accuracy

Accuracy		Conditions			
Normal condition	Extreme condition	Ês/lot	I _o ^{Note 1} range		
			E-UTRA operating band groups ^{Note 4}	Minimum I _o	Maximum I _o
dB	dB	dB	dBm/15kHz ^{Note 3}	dBm/BW _{Channel}	
±2.5	±4	≥-3 dB	FDD_A, TDD_A	-121	-50
			FDD_B1, FDD_B2	-120.5	-50
			FDD_C, TDD_C	-120	-50
			FDD_D	-119.5	-50
			FDD_E, TDD_E	-119	-50
			FDD_F	-118.5	-50
			FDD_G	-118	-50
			FDD_H	-117.5	-50
			FDD_N	-114.5	-50
±3.5	±4	≥-6 dB	Note 2	Note 2	Note 2

NOTE 1: I_o is assumed to have constant EPRE across the bandwidth.
 NOTE 2: The same bands and the same I_o conditions for each band apply for this requirement as for the corresponding highest accuracy requirement.
 NOTE 3: The condition level is increased by Δ>0, when applicable, as described in Sections B.4.2 and B.4.3.
 NOTE 4: E-UTRA operating band groups are as defined in Section 3.5.

9.8.3.2 MBSFN RSRQ measurement report mapping

The reporting range of MBSFN RSRQ is defined from -23 dB to -8 dB with 0.5 dB resolution, for 15 kHz subcarrier spacing.

The mapping of measured quantity is defined in Table 9.8.3.2-1. The range in the signalling may be larger than the guaranteed accuracy range.

Table 9.8.3.2-1: MBSFN RSRQ measurement report mapping

Reported value	Measured quantity value	Unit
MBSFN_RSRQ_00	MBSFN_RSRQ < -23	dB / 15 kHz
MBSFN_RSRQ_01	-23 ≤ MBSFN_RSRQ < -22.5	dB / 15 kHz
MBSFN_RSRQ_02	-22.5 ≤ MBSFN_RSRQ < -22	dB / 15 kHz
...
MBSFN_RSRQ_30	-8.5 ≤ MBSFN_RSRQ < -8	dB / 15 kHz
MBSFN_RSRQ_31	-8 ≤ MBSFN_RSRQ	dB / 15 kHz

9.8.3.3 MBSFN RSRQ measurement report mapping for 7.5 kHz subcarrier spacing

The reporting range of MBSFN RSRQ is defined from -26 dB to -8 dB with 0.4 dB resolution, for 7.5 kHz subcarrier spacing.

The mapping of measured quantity is defined in Table 9.8.3.3-1. The range in the signalling may be larger than the guaranteed accuracy range.

Table 9.8.3.3-1: MBSFN RSRQ measurement report mapping

Reported value	Measured quantity value	Unit
MBSFN_RSRQ_00	MBSFN_RSRQ < -26.0	dB
MBSFN_RSRQ_01	-26.0 ≤ MBSFN_RSRQ < -25.4	dB
MBSFN_RSRQ_02	-25.4 ≤ MBSFN_RSRQ < -24.8	dB
...
MBSFN_RSRQ_30	-8.6 ≤ MBSFN_RSRQ < -8	dB
MBSFN_RSRQ_31	-8 ≤ MBSFN_RSRQ	dB

9.8.3.4 MBSFN RSRQ measurement report mapping for 1.25 kHz subcarrier spacing

The reporting range of MBSFN RSRQ is defined from -32 dB to -14 dB with 0.4 dB resolution, for 1.25 kHz subcarrier spacing.

The mapping of measured quantity is defined in Table 9.8.3.4-1. The range in the signalling may be larger than the guaranteed accuracy range.

Table 9.8.3.4-1: MBSFN RSRQ measurement report mapping

Reported value	Measured quantity value	Unit
MBSFN_RSRQ_00	MBSFN_RSRQ < -32	dB
MBSFN_RSRQ_01	-32 ≤ MBSFN_RSRQ < -31.4	dB
MBSFN_RSRQ_02	-31.4 ≤ MBSFN_RSRQ < -30.8	dB
...
MBSFN_RSRQ_30	-14.6 ≤ MBSFN_RSRQ < -14	dB
MBSFN_RSRQ_31	-14 ≤ MBSFN_RSRQ	dB

9.8.4 MCH BLER

MCH BLER shall be measured as defined in [4].

9.8.4.1 Measurement report mapping for MCH BLER

The UE shall report MCH BLER together with the corresponding total number of MCH blocks, which were received by the UE during the MCH BLER measurement period and used for calculating the reported MCH BLER.

The reporting range of MCH BLER is defined from 0.1% to 50% with uniform quantization in log domain.

The mapping of measured quantity is defined in Table 9.8.4.1-1. The range in the signalling may be larger than the range specified in the table below.

Table 9.8.4.1-1: MCH BLER measurement report mapping

Reported value	Measured quantity value	Unit
MCH BLER_00	MCH BLER < 0.1	%
MCH BLER_01	0.1 ≤ MCH BLER < 0.123	%
MCH BLER_02	0.123 ≤ MCH BLER < 0.151	%
MCH BLER_03	0.151 ≤ MCH BLER < 0.186	%
MCH BLER_04	0.186 ≤ MCH BLER < 0.229	%
MCH BLER_05	0.229 ≤ MCH BLER < 0.282	%
MCH BLER_06	0.282 ≤ MCH BLER < 0.347	%
MCH BLER_07	0.347 ≤ MCH BLER < 0.426	%
MCH BLER_08	0.426 ≤ MCH BLER < 0.525	%
MCH BLER_09	0.525 ≤ MCH BLER < 0.645	%
MCH BLER_10	0.645 ≤ MCH BLER < 0.794	%
MCH BLER_11	0.794 ≤ MCH BLER < 0.976	%
MCH BLER_12	0.976 ≤ MCH BLER < 1.201	%
MCH BLER_13	1.201 ≤ MCH BLER < 1.478	%
MCH BLER_14	1.478 ≤ MCH BLER < 1.818	%
MCH BLER_15	1.818 ≤ MCH BLER < 2.236	%
MCH BLER_16	2.236 ≤ MCH BLER < 2.751	%
MCH BLER_17	2.751 ≤ MCH BLER < 3.384	%
MCH BLER_18	3.384 ≤ MCH BLER < 4.163	%
MCH BLER_19	4.163 ≤ MCH BLER < 5.121	%
MCH BLER_20	5.121 ≤ MCH BLER < 6.300	%
MCH BLER_21	6.300 ≤ MCH BLER < 7.750	%
MCH BLER_22	7.750 ≤ MCH BLER < 9.533	%
MCH BLER_23	9.533 ≤ MCH BLER < 11.728	%
MCH BLER_24	11.728 ≤ MCH BLER < 14.427	%
MCH BLER_25	14.427 ≤ MCH BLER < 17.478	%
MCH BLER_26	17.478 ≤ MCH BLER < 21.833	%
MCH BLER_27	21.833 ≤ MCH BLER < 26.858	%
MCH BLER_28	26.858 ≤ MCH BLER < 33.040	%
MCH BLER_29	33.040 ≤ MCH BLER < 40.645	%
MCH BLER_30	40.645 ≤ MCH BLER < 50	%
MCH BLER_31	50 ≤ MCH BLER	%

9.8.4.2 Measurement report mapping for MCH Block Number

The reporting range of the total number of received MCH blocks during the measurement period is defined from 0 to 65152. The total number of received MCH blocks is quantized to two values n and m with the mappings defined in Table 9.8.4.2-1 and Table 9.8.4.2-2, respectively.

The range in the signalling may be larger than the range specified in the table below.

N_R in Table 9.8.4.2-1 and Table 9.8.4.2-2 represents the total number of received MCH blocks. $f(N_R)$ is a function of N_R

with the definition that $f(N_R) = \frac{N_R - (2^n - 1) \times 2^8}{2^n}$, from where the quantized total number of MCH blocks is found as $(2^n - 1) \times 2^8 + m \times 2^n$.

Table 9.8.4.2-1: Number of received MCH blocks mapping to n

Reported value, n	Number of received MCH blocks
MCH_NR_N_00	$0 \leq N_R < 256$
MCH_NR_N_01	$256 \leq N_R < 768$
MCH_NR_N_02	$768 \leq N_R < 1792$

MCH_NR_N_03	$1792 \leq N_R < 3840$
MCH_NR_N_04	$3840 \leq N_R < 7936$
MCH_NR_N_05	$7936 \leq N_R < 16128$
MCH_NR_N_06	$16128 \leq N_R < 32512$
MCH_NR_N_07	$32512 \leq N_R$

Table 9.8.4.2-2: Number of received MCH blocks mapping to m

Reported value, m	f(N _R)
MCH_NR_M_00	$0 \leq f(N_R) < 1$
MCH_NR_M_01	$1 \leq f(N_R) < 2$
MCH_NR_M_02	$2 \leq f(N_R) < 3$
...	...
MCH_NR_M_253	$253 \leq f(N_R) < 254$
MCH_NR_M_254	$254 \leq f(N_R) < 255$
MCH_NR_M_255	$255 \leq f(N_R)$

9.9 ProSe Measurements

9.9.1 Introduction

The requirements in this section are applicable for a UE capable of ProSe Direct Communication and/or ProSe Direct Discovery.

The reported measurement result after layer 1 filtering shall be an estimate of the average value of the measured quantity over the measurement period. The reference point for the measurement result after layer 1 filtering is referred to as point B in the measurement model described in [25].

The accuracy requirements in this clause are:

- applicable for AWGN radio propagation conditions,
- assume independent interference (noise) at each receiver antenna port.
- valid for the reported measurement result after layer 1 filtering,
- are verified from the measurement report at point D in the measurement model having the higher layer filtering disabled.

9.9.2 Intra-Frequency S-RSRP Measurement Accuracy Requirements

9.9.2.1 Absolute S-RSRP Accuracy

The requirements for absolute accuracy of S-RSRP in this clause apply to a ProSe synchronization source on the same frequency as that of the own ProSe UE performing the measurement.

The accuracy requirements in Table 9.9.2.1-1 are valid under the following conditions:

- Demodulation reference signals are transmitted from one port.
- Conditions defined in 36.101 Clause 7.3D for reference sensitivity are fulfilled.
- S-RSRP[dBm according to Annex B.5.1 for a corresponding Band are fulfilled.

Table 9.9.2.1-1: Intra-frequency S-RSRP absolute accuracy for UE capable of ProSe Direct Communication and/or ProSe Direct Discovery

Accuracy		Conditions		
Normal condition	Extreme condition	Ês/Iot Note 4	I _o Note 1 range	
			E-UTRA ProSe operating band groups Note 3	Minimum I _o

dB	dB	dB		dBm/15kHz Note 2	dBm/BW _{Channel}	dBm/BW _{Channel}
±4.5	±9	≥-6 dB	FDD_A	-121	N/A	-70
			FDD_D	-119.5	N/A	-70
			FDD_E, TDD_E	-119	N/A	-70
			FDD_F	-118.5	N/A	-70
			FDD_G	-118	N/A	-70
			FDD_N	-114.5	N/A	-70
±8	±11	≥-6 dB	FDD_A, FDD_D, FDD_E, TDD_E, FDD_F, FDD_G, FDD_N	N/A	-70	-50

NOTE 1: I_0 is assumed to have constant EPRE across the bandwidth.
 NOTE 2: The condition level is increased by $\Delta > 0$, when applicable, as described in Sections B.4.2 and B.4.3.
 NOTE 3: E-UTRA ProSe operating band groups are as defined in Section 3.5 for the corresponding E-UTRA operating bands.
 NOTE 4: \hat{E}_s/lot for a SyncRef UE is the minimum of the \hat{E}_s/lot of PSSS/PSBCH and the \hat{E}_s/lot of SSSS

9.9.2.2 Relative Accuracy of S-RSRP

The relative accuracy of S-RSRP is defined as the S-RSRP measured from one ProSe synchronization source compared to the S-RSRP measured from another ProSe synchronization source on the same frequency.

The accuracy requirements in Table 9.9.2.2-1 are valid under the following conditions:

- Demodulation reference signals are transmitted from one port.
- Conditions defined in 36.101 Clause 7.3D for reference sensitivity are fulfilled.
- $S\text{-RSRP}_{1,2}|_{\text{dBm}}$ according to Annex B.5.2 for a corresponding Band.

Table 9.9.2.2-1: S-RSRP Intra frequency relative accuracy for UE capable of ProSe direct communication and/or ProSe Direct Discovery

Accuracy		Conditions			
Normal condition	Extreme condition	\hat{E}_s/lot ^{Note 2, 6}	I_0 ^{Note 1} range		
			E-UTRA ProSe operating band groups ^{Note 5}	Minimum I_0	Maximum I_0
dB	dB	dB		dBm/15kHz ^{Note 4}	dBm/BW _{Channel}
±2	±3	≥-3 dB	FDD_A	-121	-50
			FDD_D	-119.5	-50
			FDD_E, TDD_E	-119	-50
			FDD_F	-118.5	-50
			FDD_G	-118	-50
			FDD_N	-114.5	-50
±3	±3	≥-6 dB	Note 3	Note 3	Note 3

NOTE 1: I_0 is assumed to have constant EPRE across the bandwidth.
 NOTE 2: The parameter \hat{E}_s/lot is the minimum \hat{E}_s/lot of the pair of SyncRef UEs to which the requirement applies.
 NOTE 3: The same bands and the same I_0 conditions for each band apply for this requirement as for the corresponding highest accuracy requirement.
 NOTE 4: The condition level is increased by $\Delta > 0$, when applicable, as described in Sections B.4.2 and B.4.3.
 NOTE 5: E-UTRA ProSe operating band groups are as defined in Section 3.5 for the corresponding E-UTRA operating bands.
 NOTE 6: \hat{E}_s/lot for a SyncRef UE is the minimum of the \hat{E}_s/lot of PSSS/PSBCH and the \hat{E}_s/lot of SSSS

9.9.3 Intra-Frequency SD-RSRP Measurement Accuracy Requirements

The requirements in this clause are applicable for a remote ProSe UE:

- in state RRC_IDLE or RRC_CONNECTED if the frequency used for ProSe is the serving frequency, or
- is out of coverage on the frequency used for ProSe, and

- that is synchronised to the ProSe relay UE that is measured.

9.9.3.1 Absolute SD-RSRP Accuracy

The requirements for absolute accuracy of SD-RSRP in this clause apply to a ProSe UE performing SD-RSRP measurements on the same frequency as used by the ProSe relay UE transmitting the relay Discovery message.

The accuracy requirements in Table 9.9.3.1-1 are valid under the following conditions:

- Demodulation reference signals are transmitted from one port.
- Conditions defined in 36.101 Clause 7.3D for reference sensitivity are fulfilled.
- SD-RSRP[dBm] according to Annex B.5.4 for a corresponding Band are fulfilled.
- *numReTx* is configured as 3 for the relay Discovery transmissions. For *numReTx* < 3, the minimum \hat{E}_s/N_{oc} at which the accuracy requirements are fulfilled is expected to be higher than as specified for *numReTx*=3.

Table 9.9.3.1-1: Intra-frequency SD-RSRP absolute accuracy for remote UE [2] capable of ProSe Direct Communication and ProSe Direct Discovery and configured by upper layers for relay operation.

Accuracy		Conditions				
Normal condition	Extreme condition	\hat{E}_s/N_{oc} Note 4	I_o Note 1 range			
			E-UTRA ProSe operating band groups Note 3	Minimum I_o		Maximum I_o
dB	dB	dB		dBm/15kHz Note 2	dBm/BW _{Channel}	dBm/BW _{Channel}
±4.5	±9	≥-1.5 dB	FDD_D	-119.5	N/A	-70
			FDD_E	-119	N/A	-70
			FDD_F	-118.5	N/A	-70
			FDD_G	-118	N/A	-70
			FDD_N	-114.5	N/A	-70
±8	±11	≥-1.5 dB	FDD_D, FDD_E, FDD_F, FDD_G, FDD_N	N/A	-70	-50

NOTE 1: I_o is assumed to have constant EPRE across the bandwidth.
 NOTE 2: The condition level is increased by $\Delta > 0$, when applicable, as described in Sections B.4.2 and B.4.3.
 NOTE 3: E-UTRA ProSe operating band groups are as defined in Section 3.5 for the corresponding E-UTRA operating bands.
 NOTE 4: When *numReTx* is configured as 3 for the relay Discovery transmissions. For *numReTx* < 3, the minimum \hat{E}_s/N_{oc} at which the accuracy requirements are fulfilled is expected to be higher than as specified for *numReTx*=3.
 NOTE 5: Layer 1 filtering for SD-RSRP is performed using PSDCH (re)transmissions within a discovery period.

9.9.3.2 Relative Accuracy of SD-RSRP

The relative accuracy of SD-RSRP in this clause apply to a ProSe UE performing SD-RSRP measurements on the same frequency as used by the ProSe relay UE transmitting the relay Discovery message.

The accuracy requirements in Table 9.9.3.2-1 are valid under the following conditions:

- Demodulation reference signals are transmitted from one port.
- Conditions defined in 36.101 Clause 7.3D for reference sensitivity are fulfilled.
- SD-RSRP[dBm] according to Annex B.5.5 for a corresponding Band are fulfilled.
- *numReTx* is configured as 3 for the relay Discovery transmissions. For *numReTx* < 3, the minimum \hat{E}_s/N_{oc} at which the accuracy requirements are fulfilled is expected to be higher than as specified for *numReTx*=3.

Table 9.9.3.2-1: Intra-frequency SD-RSRP relative accuracy for remote UE [2] capable of ProSe Direct Communication and ProSe Direct Discovery and configured by upper layers for relay operation.

Accuracy		Conditions			
Normal condition	Extreme condition	$\hat{E}s/N_{oc}$ ^{Note 6}	I_o ^{Note 1} range		
			E-UTRA ProSe operating band groups ^{Note 5}	Minimum I_o	Maximum I_o
dB	dB	dB		dBm/15kHz ^{Note 4}	dBm/BW _{Channel}
±2	±3	≥-1.5 dB	FDD_D	-119.5	-50
			FDD_E	-119	-50
			FDD_F	-118.5	-50
			FDD_G	-118	-50
			FDD_N	-114.5	-50
±3	±3	≥-1.5 dB	Note 3	Note 3	Note 3

NOTE 1: I_o is assumed to have constant EPRE across the bandwidth.
NOTE 2: The parameter $\hat{E}s/N_{oc}$ is the minimum $\hat{E}s/N_{oc}$ of the pair of ProSe Relay UEs to which the requirement applies.
NOTE 3: The same bands and the same I_o conditions for each band apply for this requirement as for the corresponding highest accuracy requirement.
NOTE 4: The condition level is increased by $\Delta > 0$, when applicable, as described in Sections B.4.2 and B.4.3.
NOTE 5: E-UTRA ProSe operating band groups are as defined in Section 3.5 for the corresponding E-UTRA operating bands.
NOTE 6: When $numReTx$ is configured as 3 for the relay Discovery transmissions. For $numReTx < 3$, the minimum $\hat{E}s/N_{oc}$ at which the accuracy requirements are fulfilled is expected to be higher than as specified for $numReTx=3$.
NOTE 7: Layer 1 filtering for SD-RSRP is performed using PSDCH (re)transmissions within a discovery period.

9.10 V2X Measurements

9.10.1 Introduction

The requirements in this section are applicable for a UE capable of V2X sidelink communication.

The reported measurement result after layer 1 filtering shall be an estimate of the average value of the measured quantity over the measurement period. The reference point for the measurement result after layer 1 filtering is referred to as point B in the measurement model described in [25].

The accuracy requirements in this clause are:

- applicable for AWGN radio propagation conditions,
- assume independent interference (noise) at each receiver antenna port.
- valid for the reported measurement result after layer 1 filtering,
- are verified from the measurement report at point D in the measurement model having the higher layer filtering disabled.

9.10.2 Intra-Frequency S-RSRP Measurement Accuracy Requirements

9.10.2.1 Absolute S-RSRP Accuracy

The requirements for absolute accuracy of S-RSRP in this clause apply to a V2X synchronization source on the same frequency as that of the own V2X UE performing the measurement.

The accuracy requirements in Table 9.10.2.1-1 are valid under the following conditions:

- Demodulation reference signals are transmitted from one port.
- Conditions defined in 36.101 Clause 7.3.1G for reference sensitivity are fulfilled.
- S-RSRP[dBm] according to Annex B.6.2 for a corresponding Band are fulfilled.

Table 9.10.2.1-1: Intra-frequency S-RSRP absolute accuracy for UE capable of V2X sidelink communication

Accuracy		Conditions				
Normal condition	Extreme condition	$\hat{E}s/lot$ Note 4	Io Note 1 range			
			E-UTRA V2X operating band groups Note 3	Minimum Io		Maximum Io
dB	dB	dB		dBm/15kHz Note 2	dBm/BW _{Channel}	dBm/BW _{Channel}
±4.5	±9	≥-6 dB	TDD_G	-118	N/A	-70
±8	±11	≥-6 dB	TDD_G	N/A	-70	-50

NOTE 1: Io is assumed to have constant EPRE across the bandwidth.
NOTE 2: The condition level is increased by $\Delta > 0$, when applicable, as described in Sections B.4.2 and B.4.3.
NOTE 3: E-UTRA V2X operating band groups are as defined in Section 3.5 for the corresponding E-UTRA operating bands.
NOTE 4: $\hat{E}s/lot$ for a SyncRef UE is the minimum of the $\hat{E}s/lot$ of PSSS/PSBCH and the $\hat{E}s/lot$ of SSSS

9.10.2.2 Relative Accuracy of S-RSRP

The relative accuracy of S-RSRP is defined as the S-RSRP measured from one V2X synchronization source compared to the S-RSRP measured from another V2X synchronization source on the same frequency.

The accuracy requirements in Table 9.10.2.2-1 are valid under the following conditions:

- Demodulation reference signals are transmitted from one port.
- Conditions defined in 36.101 Clause 7.3.1G for reference sensitivity are fulfilled.
- $S\text{-RSRP}_{1,2|dBm}$ according to Annex B.6.3 for a corresponding Band.

Table 9.10.2.2-1: S-RSRP Intra frequency relative accuracy for UE capable of V2X sidelink communication

Accuracy		Conditions			
Normal condition	Extreme condition	$\hat{E}s/lot$ Note 2, 6	Io Note 1 range		
			E-UTRA V2X operating band groups Note 5	Minimum Io	Maximum Io
dB	dB	dB		dBm/15kHz Note 4	dBm/BW _{Channel}
±2	±3	≥-3 dB	TDD_G	-118	-50
±3	±3	≥-6 dB	Note 3	Note 3	Note 3

NOTE 1: Io is assumed to have constant EPRE across the bandwidth.
NOTE 2: The parameter $\hat{E}s/lot$ is the minimum $\hat{E}s/lot$ of the pair of SyncRef UEs to which the requirement applies.
NOTE 3: The same bands and the same Io conditions for each band apply for this requirement as for the corresponding highest accuracy requirement.
NOTE 4: The condition level is increased by $\Delta > 0$, when applicable, as described in Sections B.4.2 and B.4.3.
NOTE 5: E-UTRA V2X operating band groups are as defined in Section 3.5 for the corresponding E-UTRA operating bands.
NOTE 6: $\hat{E}s/lot$ for a SyncRef UE is the minimum of the $\hat{E}s/lot$ of PSSS/PSBCH and the $\hat{E}s/lot$ of SSSS

9.10.3 PSSCH-RSRP Measurement Accuracy Requirements

9.10.3.1 Intra-frequency Absolute PSSCH-RSRP Accuracy

The requirements for absolute accuracy of PSSCH-RSRP in this clause apply to a UE performing PSSCH-RSRP measurements on the same frequency as used by operating V2X sidelink communication.

The accuracy requirements in this clause are:

- applicable for AWGN radio propagation conditions,
- assume independent interference (noise) at each receiver antenna port.

The accuracy requirements in Table 9.10.3.1-1 are valid under the following conditions:

- Demodulation reference signals are transmitted from one port.
- Conditions defined in 36.101 Clause 7.3.1G for reference sensitivity are fulfilled.
- PSSCH-RSRP[dBm] according to Annex B.6.5 for a corresponding Band are fulfilled.

Table 9.10.3.1-1: Intra-frequency PSSCH-RSRP absolute accuracy for UE capable of V2X sidelink communication

Accuracy		Conditions				
Normal condition	Extreme condition	\hat{E}_s/lot Note 4	I_0 Note 1 range			
			E-UTRA V2X operating band groups Note 3	Minimum I_0		Maximum I_0
dB	dB	dB		dBm/15kHz Note 2	dBm/BW _{Channel}	dBm/BW _{Channel}
±5	±9.5	≥0	TDD_G	-118	N/A	-70
±8.5	±11.5	≥0	TDD_G	N/A	-70	-50

NOTE 1: I_0 is assumed to have constant EPRE across the bandwidth.
 NOTE 2: The condition level is increased by $\Delta > 0$, when applicable, as described in Sections B.4.2 and B.4.3.
 NOTE 3: E-UTRA V2X operating band groups are as defined in Section 3.5 for the corresponding E-UTRA operating bands.
 NOTE 4: The parameter \hat{E}_s/lot is the \hat{E}_s/lot of PSSCH-DMRS.

9.10.4 S-RSSI Measurement Accuracy Requirements

9.10.4.1 Intra-frequency absolute S-RSSI measurement accuracy requirements

The intra-frequency S-RSSI requirements are specified in Table 9.10.4.1-1. The requirements apply for measurement period of 1subframe (1ms) and for any configured measurement bandwidth larger than 5RBs (0.9MHz), provided that:

- All symbols during each RSSI measurement duration are available for RSSI sampling within the same measurement interval.

Table 9.10.4.1-1: Intra-frequency S-RSSI absolute accuracy

Accuracy		Conditions		
Normal condition	Extreme condition	E-UTRA V2X operating band groups Note 4	Minimum I_0	Maximum I_0
			dBm/15kHz Note 3	dBm/BW _{Channel}
dB	dB			
±2.5	±5.5	TDD_G	-118	-50
±4.5	±7.5	Note 2	Note 2	Note 2

NOTE 1: I_0 is assumed to have constant EPRE across the bandwidth.
 NOTE 2: The same bands and the same I_0 conditions for each band apply for this requirement as for the corresponding highest accuracy requirement.
 NOTE 3: The condition level is increased by $\Delta > 0$, when applicable, as described in Sections B.4.2 and B.4.3.
 NOTE 4: E-UTRA V2X operating band groups are as defined in Section 3.5.

9.10.4.2 Intra-frequency relative S-RSSI measurement accuracy requirements

The relative accuracy of S-RSSI is defined as the RSRP measured on one configured measurement bandwidth compared to the S-RSSI measured on another configured measurement bandwidth. The intra-frequency S-RSSI relative requirements are specified in Table 9.10.4.2-1. The requirements apply for measurement period of 100subframe (1s), for any configured measurement bandwidth larger than 5RBs (0.9MHz), and for sampling interval of 20ms, 50ms and 100ms, provided that:

- All symbols during each RSSI measurement duration are available for RSSI sampling within the same measurement interval.

Table 9.10.4.2-1: Intra-frequency S-RSSI relative accuracy

Accuracy		Conditions		
Normal condition	Extreme condition	E-UTRA V2X operating band groups ^{Note 4}	Minimum I_0	Maximum I_0
±2.5	±5.5	TDD_G	-118	-50
±4.5	±7.5	Note 2	Note 2	Note 2
NOTE 1: I_0 is assumed to have constant EPRE across the bandwidth.				
NOTE 2: The same bands and the same I_0 conditions for each band apply for this requirement as for the corresponding highest accuracy requirement.				
NOTE 3: The condition level is increased by $\Delta > 0$, when applicable, as described in Sections B.4.2 and B.4.3.				
NOTE 4: E-UTRA V2X operating band groups are as defined in Section 3.5.				

9.11 NR Measurements

The requirements in this clause are applicable for a UE:

- in RRC_CONNECTED state
- performing inter-RAT E-UTRAN FDD – NR or E-UTRAN TDD – NR measurements with appropriate measurement gaps according to Section 8
- that is synchronised to the cell that is measured.

The reported measurement result after layer 1 filtering shall be an estimate of the average value of the measured quantity over the measurement period. The reference point for the measurement result after layer 1 filtering is referred to as point B in the measurement model described in TS 25.302 [6].

The accuracy requirements in this clause are valid for the reported measurement result after layer 1 filtering. The accuracy requirements are verified from the measurement report at point D in the measurement model having the layer 3 filtering disabled.

9.11.1 NR SS-RSRP Measurements

The accuracy requirements of NR SS-RSRP measurements in FR1 and the corresponding side conditions shall be the same as the inter-frequency SS-RSRP Absolute Accuracy Requirements in TS 38.133 [50] subclause 10.1.4.1. The accuracy requirements of NR SS-RSRP measurements in FR2 and the corresponding side conditions shall be the same as the inter-frequency SS-RSRP Absolute Accuracy Requirements in TS 38.133 [50] subclause 10.1.5.1.

The measurement period of NR SS-RSRP measurements in RRC_CONNECTED state is specified in Sections 8.1.2.4.21 for UE with FDD PCell not configured with E-UTRA-NR Dual Connectivity operation. The measurement period of NR SS-RSRP measurements in RRC_CONNECTED state is specified in Sections 8.1.2.4.22 for UE with TDD PCell not configured with E-UTRA-NR Dual Connectivity operation. For for UE with FDD PCell configured with E-UTRA-NR Dual Connectivity operation, the measurement period of NR SS-RSRP measurements in RRC_CONNECTED state is specified in Sections 8.17.4.1. For for UE with TDD PCell configured with E-UTRA-NR Dual Connectivity operation, the measurement period of NR SS-RSRP measurements in RRC_CONNECTED state is specified in Sections 8.17.4.2.

The reporting range and mapping specified for SS-RSRP measurements in TS 38.133 [50] subclause 10.1.6 shall apply.

9.11.2 NR SS-RSRQ Measurements

The accuracy requirements of NR SS-RSRQ measurements in FR1 and the corresponding side conditions shall be the same as the inter-frequency SS-RSRQ Absolute Accuracy Requirements in TS 38.133 [50] subclause 10.1.9.1. The accuracy requirements of NR SS-RSRQ measurements in FR2 and the corresponding side conditions shall be the same as the inter-frequency SS-RSRQ Absolute Accuracy Requirements in TS 38.133 [50] subclause 10.1.10.1.

The measurement period of NR SS-RSRQ measurements in RRC_CONNECTED state is specified in Sections 8.1.2.4.21 for UE with FDD PCell not configured with E-UTRA-NR Dual Connectivity operation. The measurement period of NR SS-RSRQ measurements in RRC_CONNECTED state is specified in Sections 8.1.2.4.22 for UE with TDD PCell not configured with E-UTRA-NR Dual Connectivity operation. For for UE with FDD PCell configured with E-UTRA-NR Dual Connectivity operation, the measurement period of NR SS-RSRQ measurements in RRC_CONNECTED state is specified in Sections 8.17.4.1. For for UE with TDD PCell configured with E-UTRA-NR Dual Connectivity operation, the measurement period of NR SS-RSRQ measurements in RRC_CONNECTED state is specified in Sections 8.17.4.2.

The reporting range and mapping specified for SS-RSRQ measurements in TS 38.133 [50] subclause 10.1.11 shall apply.

9.11.3 NR SS-SINR Measurements

The accuracy requirements of NR SS-SINR measurements in FR1 and the corresponding side conditions shall be the same as the inter-frequency SS-SINR Absolute Accuracy Requirements in TS 38.133 [50] subclause 10.1.14.1. The accuracy requirements of NR SS-SINR measurements in FR2 and the corresponding side conditions shall be the same as the inter-frequency SS-SINR Absolute Accuracy Requirements in TS 38.133 [50] subclause 10.1.15.1.

The measurement period of NR SS-SINR measurements in RRC_CONNECTED state is specified in Sections 8.1.2.4.21 for UE with FDD PCell not configured with E-UTRA-NR Dual Connectivity operation. The measurement period of NR SS-SINR measurements in RRC_CONNECTED state is specified in Sections 8.1.2.4.22 for UE with TDD PCell not configured with E-UTRA-NR Dual Connectivity operation. For for UE with FDD PCell configured with E-UTRA-NR Dual Connectivity operation, the measurement period of NR SS-SINR measurements in RRC_CONNECTED state is specified in Sections 8.17.4.1. For for UE with TDD PCell configured with E-UTRA-NR Dual Connectivity operation, the measurement period of NR SS-SINR measurements in RRC_CONNECTED state is specified in Sections 8.17.4.2.

The reporting range and mapping specified for SS-SINR measurements in TS 38.133 [50] subclause 10.1.16 shall apply.

10 Measurements Performance Requirements for E-UTRAN

10.1 Received Interference Power

The measurement period shall be 100 ms.

10.1.1 Absolute accuracy requirement

Table 10.1.1-1: Received Interference Power absolute accuracy

Parameter	Unit	Accuracy [dB]	Conditions
			lob [dBm/180 kHz]
lob	dBm/180 kHz	± 4	-117 ... -96

10.1.2 Relative accuracy requirement

The relative accuracy is defined as the Received Interference Power measured at one frequency compared to the Received Interference Power measured from the same frequency at a different time.

Table 10.1.2-1: Received Interference Power relative accuracy

Parameter	Unit	Accuracy [dB]	Conditions
			lob [dBm/180 kHz]
lob	dBm/180 kHz	± 0.5	-117 ... -96 AND for changes $\leq \pm 9.0$ dB

10.1.3 Received Interference Power measurement report mapping

The reporting range for *Received Interference Power (RIP)* is from -126 ... -75 dBm.

In table 10.2.3-1 the mapping of measured quantity is defined. The range in the signalling may be larger than the guaranteed accuracy range.

Table 10.1.3-1: Received Interference Power measurement reporting range

Reported value	Measured quantity value	Unit
RTWP_LEV_000	$RIP < -126.0$	dBm
RTWP_LEV_001	$-126.0 \leq RIP < -125.9$	dBm
RTWP_LEV_002	$-125.9 \leq RIP < -125.8$	dBm
...
RTWP_LEV_509	$-75.2 \leq RIP < -75.1$	dBm
RTWP_LEV_510	$-75.1 \leq RIP < -75.0$	dBm
RTWP_LEV_511	$-75.0 \leq RIP$	dBm

10.2 Angle of Arrival (AOA)

10.2.1 Range/mapping

The reporting range for AOA measurement is from 0 to 360 degree, with resolution of 0.5 degree.

The mapping of the measured quantity is defined in table 10.2.1-1.

Table 10.2.1-1: AOA measurement report mapping

Reported value	Measured quantity value	Unit
AOA_ANGLE_000	$0 \leq AOA_ANGLE < 0.5$	degree
AOA_ANGLE_001	$0.5 \leq AOA_ANGLE < 1$	degree
AOA_ANGLE_002	$1 \leq AOA_ANGLE < 1.5$	degree
...
AOA_ANGLE_717	$358.5 \leq AOA_ANGLE < 359$	degree
AOA_ANGLE_718	$359 \leq AOA_ANGLE < 359.5$	degree
AOA_ANGLE_719	$359.5 \leq AOA_ANGLE < 360$	degree

10.3 Timing Advance (T_{ADV})

10.3.1 Report mapping

The reporting range of T_{ADV} is defined from 0 to $49232T_s$ with $2T_s$ resolution for timing advance less or equal to $4096T_s$ and $8T_s$ for timing advance greater than $4096T_s$.

The mapping of measured quantity is defined in Table 10.3.1-1.

Table 10.3.1-1: T_{ADV} measurement report mapping

Reported value	Measured quantity value	Unit
TIME_ADVANCE_00	$T_{ADV} < 2$	T_s
TIME_ADVANCE_01	$2 \leq T_{ADV} < 4$	T_s
TIME_ADVANCE_02	$4 \leq T_{ADV} < 6$	T_s
...
TIME_ADVANCE_2046	$4092 \leq T_{ADV} < 4094$	T_s
TIME_ADVANCE_2047	$4094 \leq T_{ADV} < 4096$	T_s
TIME_ADVANCE_2048	$4096 \leq T_{ADV} < 4104$	T_s
TIME_ADVANCE_2049	$4104 \leq T_{ADV} < 4112$	T_s
...
TIME_ADVANCE_7688	$49216 \leq T_{ADV} < 49224$	T_s
TIME_ADVANCE_7689	$49224 \leq T_{ADV} < 49232$	T_s
TIME_ADVANCE_7690	$49232 \leq T_{ADV}$	T_s

NOTE: For report mapping of type2 T_{ADV} for TDD, the T_{ADV} equal to (eNB Rx – Tx time difference) + 624 T_s .

11 ProSe Requirements in Any Cell Selection state

11.1 Introduction

This section contains the requirements for the UE capable of ProSe Direct Communication and/or ProSe Direct Discovery when the UE is out of coverage on the carrier used for ProSe operation, as defined in [1]. The ProSe requirements shall apply provided that the sidelink used by the UE for ProSe Direct Communication and/or ProSe Direct Discovery is on the carrier that is preconfigured in the ProSe UE for out-of-coverage operation. The requirements apply when the UE is:

- in any cell selection state, or,
- out of coverage on the ProSe carrier and is associated with a serving cell on a non-ProSe carrier.

Note: Any cell selection state refers to a UE that is out of network coverage and is not associated with a serving cell on any carrier [1].

11.2 UE Transmit Timing for ProSe in Any Cell Selection State

11.2.1 Introduction

This clause contains requirements on the UE capable of ProSe Direct Communication and/or ProSe Direct Discovery regarding transmit timing if the UE is out of coverage on the carrier used for ProSe operation.

11.2.2 ProSe UE transmission timing

The requirements in this subclause are applicable when the reference timing used for deriving ProSe transmission is from another ProSe UE transmitting sidelink synchronization signals.

The sidelink transmissions takes place $(N_{TA,SL} + N_{TA,offset}) \cdot T_s$ before the reception of the first detected path (in time) of the corresponding timing reference frame from the UE, with $N_{TA,offset} = 0$ and $N_{TA,SL} = 0$ [16]. The transmission timing error for sidelink transmissions shall be less than or equal to $\pm T_e$ where the timing error limit value T_e is specified in Table 11.2.2-1.

Table 11.2.2-1: T_e Timing Error Limit

Sidelink Bandwidth (MHz)	T_e
≥ 1.4	$24 \cdot T_s$
Note:	T_s is the basic timing unit defined in TS 36.211

11.3 Initiation/Cease of SLSS Transmissions

11.3.1 Introduction

The requirements in this subclause apply when the conditions for SLSS transmissions specified in [2] are met and if *syncTxThreshOoC* is included in the preconfigured ProSe parameters.

11.3.2 Requirements

The UE shall be capable of measuring the S-RSRP of the selected SyncRef UE used to derive transmission timing for ProSe Direct Communication and/or ProSe Direct Discovery and evaluate it to initiate/cease SLSS transmissions within $T_{evaluate,SLSS} = 0.8$ seconds.

If higher layer filtering for S-RSRP measurements is pre-configured, an additional delay in evaluation to initiate/cease SLSS transmissions can be expected.

For the selected SyncRef UE [2] used to derive transmission timing for ProSe Direct Communication and/or ProSe Direct Discovery:

- S-RSRP related side conditions given in Section 11.5 for a corresponding Band are fulfilled,
- ProSe SCH_{RP} and SCH_{Ês/Iot} according to Annex B.5.1 for a corresponding Band are fulfilled.

11.4 Measurements for ProSe in Any Cell Selection State

11.4.1 Introduction

This clause contains requirements for E-UTRA cell identification for the UE capable of ProSe Direct Communication and/or ProSe Direct Discovery if the UE is out of coverage on the carrier used for ProSe operation.

The UE can be preconfigured with ProSe resources for out of coverage ProSe operation.

The requirements in this section are applicable for the ProSe if the UE is out of coverage on the carrier used for ProSe operation using the preconfigured ProSe resources. The ProSe UE shall:

- continuously search for any detectable E-UTRA cell on the downlink carrier frequency associated with the preconfigured ProSe carrier frequency for out of coverage ProSe operation, and
- if in any cell selection state, then search cells also on other carriers and perform cell selection according to the procedure specified in section 4.1.

11.4.2 Requirements

11.4.2.1 E-UTRA FDD

The requirements in this subclause are applicable when the preconfigured ProSe carrier is FDD (parameter *tdd-ConfigSL* is configured as *none*).

The UE capable of ProSe Direct Communication and/or ProSe Direct Discovery immediately upon being out of coverage on the ProSe carrier shall search for any detectable cell on the carrier preconfigured with ProSe resources.

The UE shall be able to identify a newly detectable E-UTRA FDD cell on the downlink carrier frequency associated with the preconfigured with ProSe carrier frequency:

- within $T_{\text{basic_identify_OoC_ProSe Tx_ON}}$ if the UE is performing ProSe transmissions on the sidelink, or
- within $T_{\text{basic_identify_OoC_ProSe Tx_OFF}}$ if the UE is not performing ProSe transmissions on the sidelink.

where,

$T_{\text{basic_identify_OoC_ProSe Tx_ON}} = 6.4$ seconds, and

$T_{\text{basic_identify_OoC_ProSe Tx_OFF}} = 32$ seconds.

An E-UTRA cell is considered detectable provided it meets the intra-frequency cell identification conditions specified in section 8.1.2.2.

11.4.2.2 E-UTRA TDD

The requirements in this subclause are applicable when the preconfigured ProSe carrier is configured as TDD.

The UE capable of ProSe Direct Discovery immediately upon being out of coverage on the ProSe carrier shall search for any detectable cell on the carrier preconfigured with ProSe resources.

The UE shall be able to identify a newly detectable E-UTRA TDD cell on TDD carrier frequency preconfigured for ProSe operation:

- within $T_{\text{basic_identify_OoC_ProSe Tx_ON}}$ if the UE is performing ProSe transmissions on the sidelink, or
- within $T_{\text{basic_identify_OoC_ProSe Tx_OFF}}$ if the UE is not performing ProSe transmissions on the sidelink.

where,

$T_{\text{basic_identify_OoC_ProSe Tx_ON}} = 6.4$ seconds, and

$T_{\text{basic_identify_OoC_ProSe Tx_OFF}} = 32$ seconds.

An E-UTRA cell is considered detectable provided it meets the intra-frequency cell identification conditions specified in section 8.1.2.2.

The UE shall be allowed to interrupt ProSe Direct Discovery operation in order to meet the requirements in this subclause.

11.5 Selection / Reselection of ProSe Synchronization Reference

11.5.1 Introduction

This clause contains requirements for the measurements performed by the UE capable of ProSe Direct Communication and/or ProSe Direct Discovery if the UE is out of coverage on the carrier used for ProSe operation.

11.5.2 Selection/Reselection to intra-frequency SyncRef UE

11.5.2.1 Introduction

This clause contains requirements for the measurement for the ProSe synchronization on the UE capable of ProSe Direct Communication and/or ProSe Direct Discovery if the UE is out of coverage on the carrier used for ProSe operation.

11.5.2.2 Requirements

The UE shall be able to identify newly detectable SyncRef UE within $T_{\text{detect,SyncRef UE}}$ seconds if SyncRef UE meets the selection / reselection criterion defined in TS 36.331 [2].

ProSe synchronization source, SyncRef UE, is defined as a ProSe synchronization source which is capable to transmit ProSe synchronization signals.

A SyncRef UE is considered to be detectable when

- S-RSRP related side conditions given in Section 9.9.2 are fulfilled for a corresponding Band,
- ProSe SCH_{RP} and SCH_{Es/Iot} are fulfilled according to Annex B.5.3 for a corresponding Band.

$T_{\text{detect,SyncRef UE}}$ is defined as 20 seconds at SCH_{Es/Iot} ≥ -4 dB, provided that the ProSe UE is allowed to drop a maximum of 2% of its ProSe Direct Communication and ProSe Direct Discovery transmissions at the physical layer for the purpose of SyncRef UE selection / reselection.

The UE capable of ProSe Direct Communication and/or ProSe Direct Discovery shall be capable of performing S-RSRP measurements for 6 identified ProSe synchronization sources with the measurement period of 400 ms. It is assumed that the ProSe synchronization sources do not drop or delay more than one SLSS transmission within the measurement period. Otherwise, the measurement period may be extended.

11.6 Void

11.7 Selection / Reselection of ProSe relay UE

11.7.1 Introduction

This section contains the requirements related to selection and reselection of ProSe relay UE when the remote UE is out of coverage on the frequency used for ProSe Direct Communication.

The requirements apply for the selection and reselection of candidate relay UEs that are transmitting relay discovery signals within the discovery resource pool as configured for the remote UE, and follow a synchronization source that either the same or is synchronized to the one use by remote UE.

11.7.2 Selection / Reselection of intra-frequency ProSe relay UE

For a remote UE configured by upper layer for relay operation, the remote UE shall search for candidate relay UEs for selection and/or reselection every discovery period.

If the remote UE has a selected sidelink relay UE, then the remote UE shall measure the SD-RSRP of the selected relay once in every four discovery periods and evaluate if it meets the relay selection criterion as defined in [TS 36.331, 5.10.11.4].

The remote UE shall measure SD-RSRP of the candidate relay UEs every $T_{\text{measure, ProSe_Relay_Intra}}$ for intra-frequency relay UEs that are detected and measured according to the measurement rules.

For an intra-frequency relay UEs that are detected, but that has not been selected or reselected to, the remote UE shall be capable of evaluating that the intra-frequency relay UE has met selection or reselection criterion defined in [2, 5.10.11.4] within $T_{\text{evaluate, ProSe_Relay_Intra}}$ as specified in table 11.7.2-1.

The minimum requirements are required to meet when the selected and candidate relay UEs are transmitting relay discovery message every discovery period.

Table 11.7.2-1: $T_{\text{measure, ProSe_Relay_Intra}}$ and $T_{\text{evaluate, ProSe_Relay_intra}}$

Discovery Period [s]	$T_{\text{measure, ProSe_Relay_Intra}}$ [s] (number of discovery periods)	$T_{\text{evaluate, ProSe_Relay_intra}}$ [s] (number of discovery periods)
$0.04 \leq \text{Discovery period} \leq 10.24$	Note 1 (4)	Note 1 (16)
NOTE 1: Time depends upon the configured Discovery period.		

12 V2V Sidelink Communication Requirements for V2V Operation on Dedicated V2V Carrier

12.1 Introduction

This section contains the requirements for the UE capable of V2V sidelink communication under the following conditions:

- no cell operates on the carrier used for the V2V sidelink communication and
- no configuration related to V2V communication is received by the UE from the serving cell.

12.2 Transmit Timing

This clause contains requirements regarding transmit timing for the UE capable of V2V sidelink communication under the following additional condition:

- the UE is pre-configured with parameters for enabling the UE to acquire timing synchronization.

12.2.1 GNSS as timing reference

The requirements in this subclause are applicable when the reference timing used by the UE for V2V communication is derived from GNSS signals.

The sidelink transmissions takes place $(N_{\text{TA, SL}} + N_{\text{TA offset}}) \cdot T_s$ before the subframe starting boundary derived from subclause 5.10.14 of TS 36.331 [2], where $N_{\text{TA offset}} = 0$ and $N_{\text{TA, SL}} = 0$. The transmission timing error for sidelink transmissions shall be less than or equal to $\pm T_e$ where the timing error limit value T_e is specified as $12 \cdot T_s$ and T_s is the basic timing unit defined in TS 36.211.

12.3 Interruption

This clause contains interruption requirements for the UE capable of V2V sidelink communication under the following additional conditions:

- the UE is pre-configured with parameters for enabling the UE to acquire timing synchronization
- the UE has dedicated transmitter chain and dedicated receiver chain for the V2V operation
- the UE performs independent concurrent E-UTRAN operation in an E-UTRA band and stand-alone V2V sidelink operation.

The UE shall not cause any interruption on the serving cell when receiving or transmitting V2V sidelink communication signals.

12.4 Reliability of GNSS signal

This clause contains requirements regarding reliability of GNSS signal for the UE capable of V2V sidelink communication under the following additional condition:

- the UE is pre-configured with parameters for enabling the UE to acquire the GNSS synchronization.

If UE considers GNSS is a reliable synchronization reference, the UE shall meet timing accuracy requirement as specified in 12.2 and frequency accuracy requirement as specified in 6.5.1G of TS36.101.

13 V2X Requirements

13.1 Introduction

This section contains the requirements for the UE capable of V2X sidelink communication when the UE is out of coverage on the carrier used for V2X sidelink operation, as defined in [1]. The requirements apply when the UE is:

- in any cell selection state, or,
- out of coverage on the V2X sidelink carrier and is associated with a serving cell on a non-V2X sidelink carrier.

Note: Any cell selection state refers to a UE that is out of network coverage and is not associated with a serving cell on any carrier [1].

Note: When a UE in RRC_CONNECTED state is performing transmissions and/or reception for V2X sidelink communication, the UE shall meet all the requirements specified in Section 8 assuming that UE has a dedicated RX/TX chain for V2X sidelink communication. Otherwise, the UE may interrupt the V2X sidelink communication in order to meet the measurement requirements specified in Section 8.

13.2 UE Transmit Timing

13.2.1 Introduction

This clause contains requirements of transmission timing for V2X sidelink communication when:

- GNSS is used as the synchronization reference source;
- Serving cell/PCell is used as the synchronization reference source;
- SyncRef UE is used as the synchronization reference source.

13.2.2 GNSS as synchronization reference source

The requirements in this subclause are applicable when the reference timing used by the UE for V2X sidelink communication is derived from GNSS.

The sidelink transmissions takes place $(N_{TA, SL} + N_{TA, offset}) \cdot T_s$ before the subframe starting boundary as defined in Clause 5.10.14 of TS 36.331 [2], where $N_{TA, offset} = 0$ and $N_{TA, SL} = 0$.

The transmission timing error requirements for sidelink transmissions in Section 12.2 as specified for V2V Sidelink Communication shall apply.

13.2.3 Serving cell/PCell as synchronization reference source

The requirements in this subclause are applicable when the reference timing used for Sidelink transmissions is the serving cell (RRC_IDLE) or PCell (RRC_CONNECTED) on a non-V2X sidelink carrier.

The sidelink transmissions takes place $(N_{TA, SL} + N_{TA, offset}) \cdot T_s$ before the reception of the first detected path (in time) of the corresponding downlink frame from the reference cell, where $N_{TA, offset} = 0$ and $N_{TA, SL} = 0$.

The requirements in Section 7.1 as specified for PRACH transmissions shall apply.

13.2.4 SyncRef UE as synchronization reference source

The requirements in this subclause are applicable when the reference timing used for deriving sidelink transmission is from SyncRef UE transmitting sidelink synchronization signals.

The sidelink transmissions takes place $(N_{TA, SL} + N_{TA, offset}) \cdot T_s$ before the reception of the first detected path (in time) of the corresponding timing reference frame from the SyncRef UE, where $N_{TA, offset} = 0$ and $N_{TA, SL} = 0$.

The requirements in Section 11.2 as specified for ProSe in Any Cell Selection State shall apply.

13.3 Initiation/Cease of SLSS Transmissions

13.3.1 Introduction

The requirements in this subclause are applicable to the UE capable of V2X sidelink communication when:

- GNSS is used as the synchronization reference source;
- Serving cell / PCell is used as the synchronization reference source;
- SyncRef UE is used as the synchronization reference source.

13.3.1.1 Initiation/Cease of SLSS transmissions with Serving cell / PCell as synchronization reference source

The requirements apply when the Serving cell / PCell is used as synchronization reference source and when the UE is

- out of coverage on the V2X sidelink carrier and in-coverage with a serving cell on a non-V2X sidelink carrier,

and when the conditions for SLSS transmissions specified in [2] are met; *networkControlledSyncTx* is not configured; and *syncTxThreshIC* is included in *SystemInformationBlockType21*. The UE shall be capable of measuring the RSRP of the cell used as synchronization reference source to evaluate to initiate/cease SLSS transmissions within $T_{evaluate, SLSS}$

where,

- $T_{evaluate, SLSS} = 0.4$ seconds when UE is not configured with DRX.
- $T_{evaluate, SLSS} =$ as specified in Table 13.3.1.1-1 when UE is configured with DRX.

Table 13.3.1.1-1: $T_{evaluate, SLSS}$ with V2X sidelink communication

DRX cycle length [s]	$T_{evaluate, SLSS}$ [s] (number of DRX cycles)
≤ 0.04	0.4 (Note 1)
$0.04 < \text{DRX-cycle} \leq 2.56$	Note 2 (6)

Note1:	Number of DRX cycles depends upon the DRX cycle in use
Note2:	Time depends upon the DRX cycles in use

If higher layer filtering is configured, an additional delay in evaluation to initiate/cease SLSS transmissions can be expected.

For the cell as synchronization reference source:

- RSRP related side conditions given in Sections 9.1.2.1 and 9.1.2.2 and RSRQ related side conditions given in Clause 9.1.5.1 for a corresponding Band are fulfilled,
- SCH_{RP} and SCH \hat{E}_s/I_{ot} according to Annex B.2.1 for a corresponding Band are fulfilled.

13.3.1.2 Initiation/Cease of SLSS transmissions with GNSS as synchronization reference source

The requirements apply when GNSS is used as synchronization reference source and when the UE is

- out of coverage on the V2X sidelink carrier and in-coverage with a serving cell on a non-V2X sidelink carrier,

and when the conditions for SLSS transmissions specified in [2] are met; *networkControlledSyncTx* is not configured; and *syncTxThreshIC* is included in *SystemInformationBlockType21*.

The requirements in Section 13.3.1.1 shall apply.

13.3.1.3 Initiation/Cease of SLSS transmissions with SyncRef UE as synchronization reference source

The requirements apply when SyncRef UE is used as synchronization reference source and when the UE is

- in any cell selection state, or
- out of coverage on the V2X sidelink carrier and is associated with a serving cell on a non-V2X sidelink carrier,

and when the conditions for SLSS transmissions specified in [2] are met and when SyncRef UE is used as synchronization reference source and if *syncTxThreshOoC* is included in the preconfigured V2X parameters.

The UE shall be capable of measuring the S-RSRP of the selected SyncRef UE used as synchronization reference source and evaluate it to initiate/cease SLSS transmissions within $T_{evaluate,SLSS} = 0.64$ seconds.

If higher layer filtering for S-RSRP measurements is pre-configured, an additional delay in evaluation to initiate/cease SLSS transmissions can be expected.

For the selected SyncRef UE [2] used to derive transmission timing for V2X sidelink communication:

- S-RSRP related side conditions given in Section 13.4 for a corresponding Band are fulfilled,
- V2X SCH_{RP} and SCH \hat{E}_s/I_{ot} according to Annex B.6.4 for a corresponding Band are fulfilled.

13.4 Selection / Reselection of V2X Synchronization Reference Source

The requirements defined in section 13.4 do not apply to the UEs that do not support transmission and reception of SLSS.

A V2X SyncRef UE is considered to be detectable when

- S-RSRP related side conditions given in Section 9.10.2 are fulfilled for a corresponding Band,
- V2X SCH_{RP} and SCH \hat{E}_s/I_{ot} according to Annex B.6.4 for a corresponding Band are fulfilled.

When GNSS synchronization reference source is configured as the highest priority and

- UE is synchronized to GNSS directly,
 - UE shall not drop any V2X SLSS and data transmission for the purpose of selection/reselection to the SyncRef UE.
- UE is synchronized to a SyncRef UE that is synchronized to GNSS directly or in-directly,
 - UE shall not drop any V2X data transmission for the purpose of selection/reselection to the SyncRef UE. The UE shall be able to identify newly detectable intra-frequency V2X SyncRef UE within $T_{\text{detect,SyncRef UE_V2X}}$ seconds if the V2X SyncRef UE meets the selection / reselection criterion defined in TS 36.331 [2]. $T_{\text{detect,SyncRef UE_V2X}}$ is defined as 1.6 seconds at SCH Es/Iot ≥ 0 dB, provided that the UE is allowed to drop a maximum of 30% of its SLSS transmissions during $T_{\text{detect,SyncRef UE_V2X}}$ for the purpose of selection / reselection to the SyncRef UE.
- in other case
 - The UE shall be able to identify newly detectable intra-frequency V2X SyncRef UE within $T_{\text{detect,SyncRef UE_V2X}}$ seconds if the SyncRef UE meets the selection / reselection criterion defined in TS 36.331 [2]. $T_{\text{detect,SyncRef UE_V2X}}$ is defined as 8 seconds at SCH Es/Iot ≥ 0 dB, provided that the UE is allowed to drop a maximum of 6% of its V2X data and SLSS transmissions during $T_{\text{detect,SyncRef UE_V2X}}$ for the purpose of selection / reselection to the SyncRef UE. UE is allowed to drop up to 2 subframes of its V2X data reception per PSBCH monitoring occasion and overall drop rate shall not exceed 0.3% of its V2X data reception during $T_{\text{detect,SyncRef UE_V2X}}$ for the purpose of selection / reselection to the SyncRef UE.

When serving cell/PCell synchronization reference source is configured as the highest priority,

- UE shall be able to identify newly detectable intra-frequency V2X SyncRef UE within $T_{\text{detect,SyncRef UE_V2X}}$ seconds if the SyncRef UE meets the selection / reselection criterion defined in TS 36.331 [2]. $T_{\text{detect,SyncRef UE_V2X}}$ is defined as 8 seconds at SCH Es/Iot ≥ 0 dB, provided that the V2X UE is allowed to drop a maximum of 6% of its V2X data and SLSS transmissions for the purpose of selection / reselection to the SyncRef UE. UE is allowed to drop up to 2 subframes of its V2X data reception per PSBCH monitoring occasion and overall drop rate shall not exceed 0.3% of its V2X data reception during $T_{\text{detect,SyncRef UE_V2X}}$ for the purpose of selection / reselection to the SyncRef UE.

UE shall be capable of performing S-RSRP measurements for 3 identified intra-frequency V2X SyncRef UE with the measurement period of 320 ms. It is assumed that the V2X SyncRef UE do not drop or delay any SLSS transmission within the measurement period. Otherwise, the measurement period may be extended.

When UE is synchronized to GNSS directly, before selection / reselection of the new synchronization reference source UE shall evaluate the GNSS synchronization source reliability for at least 20 seconds before changing the synchronization reference from GNSS to another synchronization reference source. UE shall be always synchronized to GNSS directly during the evaluation of GNSS synchronization source reliability.

13.5 Autonomous Resource Selection/Reselection measurements

13.5.1 Introduction

This section contains the requirements related to autonomous resource selection/reselection of the UE capable of V2X sidelink communication.

13.5.2 PSSCH-RSRP measurements

The UE physical layer shall be capable of performing the PSSCH-RSRP measurements [4] on the carrier operating V2X sidelink communication for determining the subset of resources to be excluded in PSSCH resource selection in sidelink transmission mode 4. The PSSCH-RSRP measurement period corresponds to one sub-frame and the measurement shall meet the PSSCH-RSRP measurement accuracy requirement in Section 9.10.

13.5.3 S-RSSI measurements

The UE physical layer shall be capable of performing the S-RSSI measurements [4] on the carrier operating V2X sidelink communication for determining the subset of resources to be excluded in PSSCH resource selection in sidelink

transmission mode 4. The S-RSSI measurement period corresponds to 1 second and the filtered measurement shall meet the S-RSSI measurement accuracy requirement in Section 9.10.

13.6 Congestion Control measurements

The UE shall be capable of estimating the channel busy ratio for one or more transmission pools indicated by higher layers [2], based on S-RSSI measurements provided by the physical layer.

When no sidelink transmissions occur, the UE physical layer shall perform a single-shot S-RSSI measurement for each sub-channel included in all the subframes configured as transmission pools.

The S-RSSI measurement performed according to this section shall meet the S-RSSI measurement accuracy requirements defined in Section 9.10.4.

The UE shall perform channel busy ratio (CBR) measurement based on S-RSSI measurements as described in TS 36.214 [4].

13.7 Interruption

13.7.1 Interruptions to WAN due to V2X Sidelink Communication

This sub-clause contains the requirements related to the interruptions on the serving cell(s) due to V2X sidelink communication.

A UE capable of V2X sidelink communication may indicate its interest (initiation or termination) in V2X sidelink communication to the connected eNodeB using IE *SidelinkUEInformation* [2].

The UE is allowed an interruption of up to 1 subframe on the serving cell(s) during the RRC reconfiguration procedure that includes the V2X sidelink communication configuration message *sl-V2X-ConfigDedicated* [2] (setup and release). This interruption is for both uplink and downlink of the serving cell(s).

13.7.2 V2X Sidelink Communication Dropping due to synchronization reference source change

This sub-clause contains the requirements related to the interruptions on the V2X sidelink communication due to synchronization source change.

UE is allowed to drop V2X sidelink signal transmission or reception for up to 1 subframe when synchronization reference source is changed:

- from GNSS
 - to Serving cell/PCell;
 - to SyncRef UE that is not synchronized to GNSS directly or in-directly;
- from SyncRef UE that is synchronized to GNSS directly or in-directly
 - to Serving cell/PCell;
 - to SyncRef UE that is not synchronized to GNSS directly or in-directly;
- from Serving cell/PCell
 - to GNSS
 - to SyncRef UE that is synchronized to GNSS directly or in-directly;
- from SyncRef UE that is not synchronized to GNSS directly or in-directly
 - to GNSS;
 - to SyncRef UE that is synchronized to GNSS directly or in-directly;

UE is allowed to interruption any V2X sidelink signals including PSSCH, PSCCH, PSBCH and SLSS signals.

13.7.3 Interruptions to WAN due to V2X Carrier Aggregation

This sub-clause contains the requirements related to the interruptions on the serving cell/PCell due to V2X component carrier addition/release.

When any number of component carriers is added or released for V2X carrier aggregation using the same *RRCCONNECTIONRECONFIGURATION* message as defined in TS 36.331 [2], the UE capable of V2X sidelink communication is allowed an interruption of up to 2 subframes to WAN. This interruption is for both uplink and downlink of serving cell/PCell.

Upon receiving V2X carrier addition/release command by using the *RRCCONNECTIONRECONFIGURATION* message that includes *sl-V2X-ConfigDedicated* in WAN subframe n , the interruption to WAN shall not occur before in WAN subframe $n+5$ and no later than in WAN subframe $n + 21+N$, where N is the number of component carrier added/released.

13.8 Reliability of GNSS signal

This clause contains requirements regarding reliability of GNSS signal for the UE capable of V2X sidelink communication under the following additional condition:

- The UE is configured or pre-configured with parameters for enabling the UE to acquire the GNSS synchronization.

If UE considers GNSS is a reliable synchronization reference, the UE shall meet timing accuracy requirement as specified in 12.2 and frequency accuracy requirement as specified in 6.5.1G of TS36.101. Otherwise, the UE shall be capable to select another synchronization reference source.

13.9 Component Carrier Addition and Release Delay for V2X Sidelink Carrier Aggregation

The requirements in this subclause are applicable to UE configured in sidelink transmission mode 3.

Upon receiving V2X carrier addition/release command by using the *RRCCONNECTIONRECONFIGURATION* message that includes *sl-V2X-ConfigDedicated* in WAN subframe n , UE shall accomplish the V2X component carrier addition/release no later than the end of WAN subframe $n + 21+N$, where N is the number of component carrier added/released.

NOTE: For UE configured in sidelink transmission mode 4, the delay is up to UE implementation.

13.10 Selection / Reselection of V2X Synchronization Reference Source for V2X Carrier Aggregation

Requirements in this clause are applicable to UE supporting V2X sidelink carrier aggregation.

When the UE is synchronized to a SyncRef UE in a carrier and required only to search other SyncRef UEs in the synchronized carrier, the UE shall be able to identify a newly detectable V2X SyncRef UE within $T_{\text{detect,SyncRef UE}_V2X}$ if the SyncRef UE meets the selection/reselection criterion defined in TS 36.331 [2]. UE shall be capable of performing S-RSRP measurements for 3 identified V2X SyncRef UE with the measurement period of 320 ms.

When the synchronization reference source for V2X sidelink carrier aggregation is lost and has to search SyncRef UE on the aggregated carriers which are configured as synchronization carrier, the UE shall be able to identify a newly detectable V2X SyncRef UE within $N \times T_{\text{detect,SyncRef UE}_V2X}$ if the SyncRef UE meets the selection/reselection criterion defined in TS 36.331 [2]. UE shall be capable of performing S-RSRP measurements for 3 identified V2X SyncRef UE per carrier with the measurement period of $N \times 320$ ms.

It is assumed that the identified V2X SyncRef UE does not drop or delay any SLSS transmission within the measurement period. Otherwise, the measurement period may be extended.

When GNSS synchronization reference source is configured as the highest priority and

- UE is synchronized to a SyncRef UE that is synchronized to GNSS directly or in-directly,

- The value of $T_{\text{detect,SyncRef UE_V2X}}$ is as 1.6 seconds at SCH Es/Iot ≥ 0 dB, provided that the UE is allowed to drop a maximum of 30% of its SLSS transmissions on each carrier operating V2X sidelink communication during $T_{\text{detect,SyncRef UE_V2X}}$ for the purpose of selection / reselection to the SyncRef UE.
- in other case
 - The value of $T_{\text{detect,SyncRef UE_V2X}}$ is as 8 seconds at SCH Es/Iot ≥ 0 dB, provided that the UE is allowed to drop a maximum of 6% of its SLSS transmissions on each carrier operating V2X sidelink communication during $T_{\text{detect,SyncRef UE_V2X}}$ for the purpose of selection / reselection to the SyncRef UE.
 - UE is allowed to drop up to 2 subframes of its V2X data reception on each carrier operating V2X sidelink communication per PSBCH monitoring occasion and overall drop rate shall not exceed 0.3% of its V2X data reception during $T_{\text{detect,SyncRef UE_V2X}}$ for the purpose of selection / reselection to the SyncRef UE.

When serving cell/PCell synchronization reference source is configured as the highest priority,

- The value of $T_{\text{detect,SyncRef UE_V2X}}$ is as 8 seconds at SCH Es/Iot ≥ 0 dB, provided that the UE is allowed to drop a maximum of 6% of its SLSS transmissions on each carrier operating V2X sidelink communication during $T_{\text{detect,SyncRef UE_V2X}}$ for the purpose of selection / reselection to the SyncRef UE.
- UE is allowed to drop up to 2 subframes of its V2X data reception on each carrier operating V2X sidelink communication per PSBCH monitoring occasion and overall drop rate shall not exceed 0.3% of its V2X data reception during $T_{\text{detect,SyncRef UE_V2X}}$ for the purpose of selection / reselection to the SyncRef UE.

N is the number of aggregated carriers configured as synchronization carrier.

Annex A (normative): Test Cases

A.1 Purpose of annex

This Annex specifies test specific parameters for some of the functional requirements in sections 4 to 9. The tests provide additional information to how the requirements should be interpreted for the purpose of conformance testing. The tests in this Annex are described such that one functional requirement may be tested in one or several test and one test may verify several requirements. Some requirements may lack a test.

The conformance tests are specified in TS 36.521-3 [23]. Statistical interpretation of the requirements is described in Annex A.2.

A.2 Requirement classification for statistical testing

Requirements in this specification are either expressed as absolute requirements with a single value stating the requirement, or expressed as a success rate. There are no provisions for the statistical variations that will occur when the parameter is tested.

Annex A outlines the tests in more detail and lists the test parameters needed. The test will result in an outcome of a test variable value for the device under test (DUT) inside or outside the test limit. Overall, the probability of a "good" DUT being inside the test limit(s) and the probability of a "bad" DUT being outside the test limit(s) should be as high as possible. For this reason, when selecting the test variable and the test limit(s), the statistical nature of the test is accounted for.

The statistical nature depends on the type of requirement. Some have large statistical variations, while others are not statistical in nature at all. When testing a parameter with a statistical nature, a confidence level is set. This establishes the probability that a DUT passing the test actually meets the requirements and determines how many times a test has to be repeated and what the pass and fail criteria are. Those aspects are not covered by TS 36.133. The details of the tests on how many times to run it and how to establish confidence in the tests are described in TS 36.521-3 [23]. This Annex establishes the variable to be used in the test and whether it can be viewed as statistical in nature or not.

A.2.1 Types of requirements in TS 36.133

A.2.1.1 Time and delay requirements on UE higher layer actions

A very large part of the RRM requirements are delay requirements:

- In E-UTRAN RRC_IDLE state mobility (clause A.4) there is cell re-selection delay.
- In E-UTRAN RRC_CONNECTED state mobility (clauses A.5 and A.8) there is handover delay, cell search delay and measurement reporting delay.
- In RRC Connection Control (clause A.6) there is RRC re-establishment delay.

All have in common that the UE is required to perform an action observable in higher layers (e.g. camp on the correct cell) within a certain time after a specific event (e.g. when a new strong pilot or reference signal appears). The delay time is statistical in nature for several reasons, among others that several of the measurements are performed by the UE in a fading radio environment.

The variations make a strict limit unsuitable for a test. Instead there is a condition set for a correct action by the UE, e.g. that the UE shall camp on the correct cell within X seconds. Then the rate of correct events is observed during repeated tests and a limit is set on the rate of correct events, usually 90% correct events are required. How the limit is applied in the test depends on the confidence required, further detailed are in TS 36.521-3 [23].

A.2.1.2 Measurements of power levels, relative powers and time

A very large number of requirements are on measurements that the UE performs:

- In E-UTRAN RRC_CONNECTED state mobility (clause A.5) there are measurement reports.
- In Measurement Performance Requirements (clause A.9) there are requirements for all type of measurements.

The accuracy requirements on measurements are expressed in this specification as a fixed limit (e.g. +/-X dB), but the measurement error will have a distribution that is not easily confined in fixed limits. Assuming a Gaussian distribution of the error, the limits will have to be set at $\pm 3.29\sigma$ if the probability of failing a "good DUT" in a single test is to be kept at 0.1%. It is more reasonable to set the limit tighter and test the DUT by counting the rate of measurements that are within the limits, in a way similar to the requirements on delay.

A.2.1.3 Implementation requirements

A few requirements are strict actions the UE should take or capabilities the UE should have, without any allowance for deviations. These requirements are absolute and should be tested as such. Examples are:

- "Event triggered report rate" in E-UTRAN RRC_CONNECTED state mobility (clauses A.5 and A.8)
- "Correct behaviour at time-out" in RRC connection control (clause A.6)

A.2.1.4 Physical layer timing requirements

There are requirements on Timing and Signaling Characteristics (clauses A.7). There are both absolute and relative limits on timing accuracy depending upon the type of requirement. Examples are:

- Initial Transmit Timing (clause A.7.1) has an absolute limit on timing accuracy.
- Timing Advance (clause A.7.2) has a relative limit on timing accuracy.

A.3 RRM test configurations

A.3.1 Reference Measurement Channels

A.3.1.1 PDSCH

A.3.1.1.1 FDD

Table A.3.1.1.1-1: PDSCH Reference Measurement Channels for FDD

Parameter	Unit	Value								
		R.2 FDD		R.5 FDD	R.7 FDD	R.0 FDD	R.1 FDD	R.3 FDD	R.4 FDD	R.6 FDD
Reference channel										
Channel bandwidth	MHz	1.4	3	5	5	10	10	10	20	20
Number of transmitter antennas		1		1	1	1	2	1	1	1
Allocated resource blocks (Note 4)		2		11	11	24	24	24	24	24
Allocated subframes per Radio Frame		10		10	10	10	10	10	10	10
Modulation		QPS K		QPS K	QPS K	QPS K	QPS K	QPS K	QPS K	QPS K
Target Coding Rate		1/3		1/3	1/3	1/3	1/3	1/3	1/3	1/3
Information Bit Payload										
For Sub-Frames 4, 9	Bits	120		968	968	2088	2088	2088	2088	2088
For Sub-Frame 5	Bits	104		776	776	2088	1736	2088	2088	2088
For Sub-Frame 0	Bits	32		616	616	1736	1736	1736	1736	1736
For Sub-Frame 1, 2, 3, 6, 7, 8	Bits	0		0	968	0	0	2088	0	2088
Number of Code Blocks per Sub-Frame (Note 5)										
For Sub-Frames 4, 9		1		1	1	1	1	1	1	1
For Sub-Frame 5		1		1	1	1	1	1	1	1
For Sub-Frame 0		1		1	1	1	1	1	1	1
For Sub-Frame 1, 2, 3, 6, 7, 8		0		0	1	0	0	1	0	1
Binary Channel Bits Per Sub-Frame										
For Sub-Frames 4, 9	Bits	456		2772	2772	6624	6336	6624	6624	6624
For Sub-Frame 5	Bits	360		2484	2484	6336	6048	6336	6336	6336
For Sub-Frame 0	Bits	176		1932	1932	5784	5520	5784	5784	5784

For Sub-Frame 1, 2, 3, 6, 7, 8	Bits	0		0	2772	0	0	6624	0	6624
Max. Throughput averaged over 1 frame	kbps	37.6		332.8	913.6	800	765	2053	800	2053
Note 1:	2 symbols allocated to PDCCH for 10 MHz channel BW. 4 symbols allocated to PDCCH for 1.4 MHz channel BW. 3 OFDM symbols allocated to PDCCH for 5 MHz channel BW.									
Note 2:	Reference signal, synchronization signals and PBCH allocated as defined in 3GPP TS 36.211 [16].									
Note 3:	If necessary the information bit payload size can be adjusted to facilitate the test implementation. The payload sizes are defined in 3GPP TS 36.213 [3].									
Note 4:	Allocation is located in the middle of bandwidth.									
Note 5:	If more than one Code Block is present, an additional CRC sequence of L = 24 Bits is attached to each Code Block (otherwise L = 0 Bit)									
Note 6:	PDSCH allocation applies only to subframes not configured as PRS subframes.									

Table A.3.1.1.1-2: PDSCH Reference Measurement Channels for FDD with slot duration TTI

	Unit	R.8 FDD
Bandwidth	MHz	10
Number of transmit antennas		1
Allocated resource blocks(Note 4)		24
Allocated subframes per Radio Frame		10
Modulation		QPSK
Target coding rate		1/3
Information Bit Payload		
For Sub-Frame 4, 9		
Slot index 0	Bits	872
Slot index 1	Bits	1224
For Sub-Frame 5		
Slot index 0	Bits	872
Slot index 1	Bits	1224
For Sub-Frame 0		
Slot index 0	Bits	872
Slot index 1	Bits	1032
For Sub-Frame 1, 2, 3, 6, 7, 8		
Slot index 0	Bits	0
Slot index 1	Bits	0
Number of Code Blocks per slot (Note 5)		
For Sub-Frame 4, 9		
Slot index 0		1
Slot index 1		1
For Sub-Frame 5		
Slot index 0		1
Slot index 1		1
For Sub-Frame 0		
Slot index 0		1
Slot index 1		1
For Sub-Frame 1, 2, 3, 6, 7, 8		
Slot index 0		0
Slot index 1		0
Binary Channel Bits per slot		
For Sub-Frame 4, 9	Bits	
Slot index 0	Bits	2784
Slot index 1	Bits	3840
For Sub-Frame 5	Bits	
Slot index 0	Bits	2496
Slot index 1	Bits	3840
For Sub-Frame 0	Bits	
Slot index 0	Bits	2496
Slot index 1	Bits	3288
For Sub-Frame 1, 2, 3, 6, 7, 8	Bits	
Slot index 0	Bits	0
Slot index 1	Bits	0
Max. Throughput averaged over 1 frame	kbps	819.2
Note 1:	2 symbols allocated to PDCCH for 10 MHz channel BW. 4 symbols allocated to PDCCH for 1.4 MHz channel BW. 3 OFDM symbols allocated to PDCCH for 5 MHz channel BW.	

Note 2:	Reference signal, synchronization signals and PBCH allocated as defined in 3GPP TS 36.211 [16].
Note 3:	If necessary the information bit payload size can be adjusted to facilitate the test implementation. The payload sizes are defined in 3GPP TS 36.213 [3].
Note 4:	Allocation is located in the middle of bandwidth.
Note 5:	If more than one Code Block is present, an additional CRC sequence of L = 24 Bits is attached to each Code Block (otherwise L = 0 Bit)
Note 6:	PDSCH allocation applies only to subframes not configured as PRS subframes.
Note 7:	Note SPDCCH is transmitted outside allocated resource blocks

Table A.3.1.1.1-3: PDSCH Reference Measurement Channels for FDD with subslot duration TTI

	Unit	R.9 FDD
Bandwidth	MHz	10
Number of transmit antennas		1
Allocated resource blocks(Note 4)		24
Allocated subframes per Radio Frame		10
Modulation		QPSK
Target coding rate		1/3
Information Bit Payload		
For Sub-Frame 4, 9		
Subslot index 1	Bits	504
Subslot index 2	Bits	344
Subslot index 3	Bits	344
Subslot index 4	Bits	344
Subslot index 5	Bits	504
For Sub-Frame 5		
Subslot index 1	Bits	504
Subslot index 2	Bits	288
Subslot index 3	Bits	344
Subslot index 4	Bits	344
Subslot index 5	Bits	504
For Sub-Frame 0		
Subslot index 1	Bits	504
Subslot index 2	Bits	288
Subslot index 3	Bits	224
Subslot index 4	Bits	288
Subslot index 5		504
For Sub-Frame 1, 2, 3, 6, 7, 8		
Subslot index 1	Bits	0
Subslot index 2	Bits	0
Subslot index 3	Bits	0
Subslot index 4	Bits	0
Subslot index 5	Bits	0
Number of Code Blocks per Sub-Frame(Note 5)		
For Sub-Frame 4, 9		
Subslot index 1		1
Subslot index 2		1
Subslot index 3		1
Subslot index 4		1
Subslot index 5		1
For Sub-Frame 5		
Subslot index 1		1
Subslot index 2		1
Subslot index 3		1
Subslot index 4		1
Subslot index 5		1
For Sub-Frame 0		
Subslot index 1		1
Subslot index 2		1
Subslot index 3		1
Subslot index 4		1
Subslot index 5		1
For Sub-Frame 1, 2, 3, 6, 7, 8		
Subslot index 1		0

Subslot index 2		0
Subslot index 3		0
Subslot index 4		0
Subslot index 5		0
Binary Channel Bits per subslot		
For Sub-Frame 4, 9	Bits	
Subslot index 1	Bits	1632
Subslot index 2	Bits	1152
Subslot index 3	Bits	1056
Subslot index 4	Bits	1152
Subslot index 5	Bits	1632
For Sub-Frame 5	Bits	
Subslot index 1	Bits	1632
Subslot index 2	Bits	864
Subslot index 3	Bits	1056
Subslot index 4	Bits	1152
Subslot index 5	Bits	1632
For Sub-Frame 0	Bits	
Subslot index 1	Bits	1632
Subslot index 2	Bits	864
Subslot index 3	Bits	792
Subslot index 4	Bits	864
Subslot index 5	Bits	1632
For Sub-Frame 1, 2, 3, 6, 7, 8	Bits	
Subslot index 1	Bits	0
Subslot index 2	Bits	0
Subslot index 3	Bits	0
Subslot index 4	Bits	0
Subslot index 5	Bits	0
Max. Throughput averaged over 1 frame	kbps	787.2
<p>Note 1: 2 symbols allocated to PDCCH for 10 MHz channel BW. 4 symbols allocated to PDCCH for 1.4 MHz channel BW. 3 OFDM symbols allocated to PDCCH for 5 MHz channel BW.</p> <p>Note 2: Reference signal, synchronization signals and PBCH allocated as defined in 3GPP TS 36.211 [16].</p> <p>Note 3: If necessary the information bit payload size can be adjusted to facilitate the test implementation. The payload sizes are defined in 3GPP TS 36.213 [3].</p> <p>Note 4: Allocation is located in the middle of bandwidth.</p> <p>Note 5: If more than one Code Block is present, an additional CRC sequence of L = 24 Bits is attached to each Code Block (otherwise L = 0 Bit)</p> <p>Note 6: PDSCH allocation applies only to subframes not configured as PRS subframes.</p> <p>Note 7: Note SPDCCH is transmitted outside allocated resource blocks</p>		

A.3.1.1.2 TDD

Table A.3.1.1.2-1: PDSCH Reference Measurement Channels for TDD UL/DL configuration1

Parameter	Unit	Value					
		R.2 TDD		R.4 TDD	R.0 TDD	R.1 TDD	R.3 TDD
Reference channel							
Channel bandwidth	MHz	1.4	3	5	10	10	20
Number of transmitter antennas		1		1	1	2	1
Allocated resource blocks (Note 4)		2		11	24	24	24
Uplink-Downlink Configuration (Note 5)		1		1	1	1	1
Special Subframe Configuration (Note 6)		6		6	6	6	6
Allocated subframes per Radio Frame		6		6	6	6	6
Modulation		QPSK		QPSK	QPSK	QPSK	QPSK
Target Coding Rate		1/3		1/3	1/3	1/3	1/3
Information Bit Payload							
For Sub-Frames 4,9	Bits	120		968	2088	2088	2088
For Sub-Frame 5	Bits	104		968	2088	2088	2088
For Sub-Frame 0	Bits	56		616	2088	1736	2088
For Sub-Frame 1, 6 (DwPTS)	Bits	56		552	1032	1032	1032
Number of Code Blocks per Sub-Frame (Note 7)		1		1	1	1	1

For Sub-Frames 4,9		1		1	1	1	1
For Sub-Frame 5		1		1	1	1	1
For Sub-Frame 0		1		1	1	1	1
For Sub-Frame 1, 6 (DwPTS)		1		1	1	1	1
Binary Channel Bits Per Sub-Frame							
For Sub-Frames 4,9	Bits	456		2772	6624	6336	6624
For Sub-Frame 5	Bits	408		2628	6480	6192	6480
For Sub-Frame 0	Bits	224		2076	5928	5664	5928
For Sub-Frame 1, 6 (DwPTS)	Bits	272		1616	3696	3504	3696
Max. Throughput averaged over 1 frame	Mbps	0.051		0.462	1.041	1.006	1.0416
		2		4	6	4	
<p>Note 1: 2 symbols allocated to PDCCH for 10 MHz channel BW. 3 OFDM symbols allocated to PDCCH for 5MHz channel BW. 4 symbols allocated to PDCCH for 1.4 MHz channel BW. For special subframe (1 & 6) only 2 OFDM symbols are allocated to PDCCH for all bandwidths.</p> <p>Note 2: Reference signal, synchronization signals and PBCH allocated as defined in TS 36.211 [16].</p> <p>Note 3: If necessary the information bit payload size can be adjusted to facilitate the test implementation. The payload sizes are defined in TS 36.213 [3].</p> <p>Note 4: Allocation is located in the middle of bandwidth.</p> <p>Note 5: As per Table 4.2-2 in TS 36.211 [16]</p> <p>Note 6: As per Table 4.2-1 in TS 36.211 [16]</p> <p>Note 7: If more than one Code Block is present, an additional CRC sequence of L = 24 Bits is attached to each Code Block (otherwise L = 0 Bit)</p> <p>Note 8: PDSCH allocation applies only to subframes not configured as PRS subframes.</p>							

Table A.3.1.1.2-2: PDSCH Reference Measurement Channels for TDD UL/DL configuration0

Parameter	Unit	Value					
Reference channel					R.5 TDD		
Channel bandwidth	MHz	1.4	3	5	10	10	20
Number of transmitter antennas					1		
Allocated resource blocks (Note 4)					24		
Uplink-Downlink Configuration (Note 5)					0		
Special Subframe Configuration (Note 6)					6		
Allocated subframes per Radio Frame					4		
Modulation					QPSK		
Target Coding Rate					1/3		
Information Bit Payload							
For Sub-Frames 4,9	Bits				N/A		
For Sub-Frame 5	Bits				2088		
For Sub-Frame 0	Bits				2088		
For Sub-Frame 1, 6 (DwPTS)	Bits				1032		
Number of Code Blocks per Sub-Frame (Note 7)					1		
For Sub-Frames 4,9					N/A		
For Sub-Frame 5					1		
For Sub-Frame 0					1		
For Sub-Frame 1, 6 (DwPTS)					1		
Binary Channel Bits Per Sub-Frame							
For Sub-Frames 4,9	Bits				N/A		
For Sub-Frame 5	Bits				6480		
For Sub-Frame 0	Bits				5928		
For Sub-Frame 1, 6 (DwPTS)	Bits				3696		
Max. Throughput averaged over 1 frame	Mbps				0.624		
<p>Note 1: 2 symbols allocated to PDCCH for 10 MHz channel BW. 3 OFDM symbols allocated to PDCCH for 5MHz channel BW. 4 symbols allocated to PDCCH for 1.4 MHz channel BW. For special subframe (1 & 6) only 2 OFDM symbols are allocated to PDCCH for all bandwidths.</p> <p>Note 2: Reference signal, synchronization signals and PBCH allocated as defined in TS 36.211 [16].</p> <p>Note 3: If necessary the information bit payload size can be adjusted to facilitate the test implementation. The payload sizes are defined in TS 36.213 [3].</p> <p>Note 4: Allocation is located in the middle of bandwidth.</p> <p>Note 5: As per Table 4.2-2 in TS 36.211 [16]</p> <p>Note 6: As per Table 4.2-1 in TS 36.211 [16]</p> <p>Note 7: If more than one Code Block is present, an additional CRC sequence of L = 24 Bits is attached to each Code Block (otherwise L = 0 Bit)</p> <p>Note 8: PDSCH allocation applies only to subframes not configured as PRS subframes.</p>							

Table A.3.1.1.2-3: PDSCH Reference Measurement Channels for TDD slot duration TTI

	Unit	R.6 TDD
Bandwidth	MHz	10
Number of transmit antennas		1
Allocated resource blocks(Note 4)		24
Uplink-Downlink Configuration (Note 5)		1
Special Subframe Configuration (Note 6)		6
Allocated subframes per Radio Frame		6
Modulation		QPSK
Target coding rate		1/3
Information Bit Payload		
For Sub-Frame 4, 9		
Slot index 0	Bits	872
Slot index 1	Bits	1224
For Sub-Frame 5		
Slot index 0	Bits	872
Slot index 1	Bits	1224
For Sub-Frame 0		
Slot index 0	Bits	872
Slot index 1	Bits	1032
For Sub-Frame 1, 6 (DwPTS)		(1032)
Slot index 0	Bits	872
Slot index 1	Bits	N/A
Number of Code Blocks per Sub-Frame		
For Sub-Frame 4, 9		
Slot index 0		1
Slot index 1		1
For Sub-Frame 5		
Slot index 0		1
Slot index 1		1
For Sub-Frame 0		
Slot index 0		1
Slot index 1		1
For Sub-Frame 1, 6 (DwPTS)		
Slot index 0		1
Slot index 1		N/A
Binary Channel Bits per slot		
For Sub-Frame 4, 9	Bits	
Slot index 0	Bits	2784
Slot index 1	Bits	3840
For Sub-Frame 5	Bits	
Slot index 0	Bits	2784
Slot index 1	Bits	3696
For Sub-Frame 0	Bits	
Slot index 0	Bits	2640
Slot index 1	Bits	3288
For Sub-Frame 1, 6 (DwPTS)	Bits	
Slot index 0	Bits	2640
Slot index 1	Bits	N/A
Max. Throughput averaged over 1 frame	kbps	999.6
Note 1:	2 symbols allocated to PDCCH for 10 MHz channel BW. 3 OFDM symbols allocated to PDCCH for 5MHz channel BW. 4 symbols allocated to PDCCH for 1.4 MHz channel BW. For special subframe (1 & 6) only 2 OFDM symbols are allocated to PDCCH for all bandwidths.	
Note 2:	Reference signal, synchronization signals and PBCH allocated as defined in TS 36.211 [16].	
Note 3:	If necessary the information bit payload size can be adjusted to facilitate the test implementation. The payload sizes are defined in TS 36.213 [3].	
Note 4:	Allocation is located in the middle of bandwidth.	
Note 5:	As per Table 4.2-2 in TS 36.211 [16]	
Note 6:	As per Table 4.2-1 in TS 36.211 [16]	
Note 7:	If more than one Code Block is present, an additional CRC sequence of L = 24 Bits is attached to each Code Block (otherwise L = 0 Bit)	

Note 8: PDSCH allocation applies only to subframes not configured as PRS subframes.
Note 9: SPDCCH is transmitted outside allocated resource blocks

A.3.1.1.3 FDD for UE category 0

Table A.3.1.1.3-1: PDSCH Reference Measurement Channels for FDD

Parameter	Unit	Value		
		R.13 FDD	R.14 FDD	R.15 FDD
Reference channel		R.13 FDD	R.14 FDD	R.15 FDD
Channel bandwidth	MHz	10	10	10
Number of transmitter antennas		1	2	2
Allocated resource blocks (Note 4)		24	24	24
Allocated subframes per Radio Frame		10	10	10
Modulation		QPSK	QPSK	QPSK
Target Coding Rate		1/10	1/10	1/10
Information Bit Payload				
For Sub-Frames 4, 9	Bits	648	648	648
For Sub-Frame 5	Bits	648	648	648
For Sub-Frame 0	Bits	648	648	648
For Sub-Frame 1, 2, 3, 6, 7, 8	Bits	0	0	648
Number of Code Blocks per Sub-Frame (Note 5)				
For Sub-Frames 4, 9		1	1	1
For Sub-Frame 5		1	1	1
For Sub-Frame 0		1	1	1
For Sub-Frame 1, 2, 3, 6, 7, 8		0	0	1
Binary Channel Bits Per Sub-Frame				
For Sub-Frames 4, 9	Bits	6624	6336	6636
For Sub-Frame 5	Bits	6336	6048	6408
For Sub-Frame 0	Bits	5784	5520	5520
For Sub-Frame 1, 2, 3, 6, 7, 8	Bits	0	0	6636
Max. Throughput averaged over 1 frame	kbps	259.2	259.2	648
Note 1:	2 symbols allocated to PDCCH for 10 MHz channel BW. 4 symbols allocated to PDCCH for 1.4 MHz channel BW. 3 OFDM symbols allocated to PDCCH for 5 MHz channel BW.			
Note 2:	Reference signal, synchronization signals and PBCH allocated as defined in 3GPP TS 36.211 [16].			
Note 3:	If necessary the information bit payload size can be adjusted to facilitate the test implementation. The payload sizes are defined in 3GPP TS 36.213 [3].			
Note 4:	Allocation is located in the middle of bandwidth.			
Note 5:	If more than one Code Block is present, an additional CRC sequence of L = 24 Bits is attached to each Code Block (otherwise L = 0 Bit)			
Note 6:	PDSCH allocation applies only to subframes not configured as PRS subframes.			

A.3.1.1.4 HD-FDD for UE category 0

Table A.3.1.1.4-1: PDSCH Reference Measurement Channels for HD-FDD

Parameter	Unit	Value	
		R.1 HD-FDD	R.2 HD-FDD
Reference channel		R.1 HD-FDD	R.2 HD-FDD
Channel bandwidth	MHz	10	10
Number of transmitter antennas		1	2
Allocated resource blocks (Note 4)		24	24
Allocated subframes per Radio Frame		10	10
Modulation		QPSK	QPSK
Target Coding Rate		1/10	1/10
Information Bit Payload			
For Sub-Frames 4, 9,	Bits	0	0
For Sub-Frame 5 (Note 7)	Bits	424	424
For Sub-Frame 0 (Note 7)	Bits	648	648
For Sub-Frame 1, 2, 3, 6, 7, 8	Bits	0	0
Number of Code Blocks per Sub-Frame (Note 5)			
For Sub-Frames 4, 9		0	0
For Sub-Frame 5		1	1
For Sub-Frame 0		1	1

For Sub-Frame 1, 2, 3, 6, 7, 8		0	0
Binary Channel Bits Per Sub-Frame			
For Sub-Frames 4, 9	Bits	0	0
For Sub-Frame 5	Bits	6336	6048
For Sub-Frame 0	Bits	5784	5520
For Sub-Frame 1, 2, 3, 6, 7, 8	Bits	0	0
Max. Throughput averaged over 1 frame	kbps	-	-
Note 1:	2 symbols allocated to PDCCH for 10 MHz channel BW. 4 symbols allocated to PDCCH for 1.4 MHz channel BW. 3 OFDM symbols allocated to PDCCH for 5 MHz channel BW.		
Note 2:	Reference signal, synchronization signals and PBCH allocated as defined in 3GPP TS 36.211 [16].		
Note 3:	If necessary the information bit payload size can be adjusted to facilitate the test implementation. The payload sizes are defined in 3GPP TS 36.213 [3].		
Note 4:	Allocation is located in the middle of bandwidth.		
Note 5:	If more than one Code Block is present, an additional CRC sequence of L = 24 Bits is attached to each Code Block (otherwise L = 0 Bit)		
Note 6:	PDSCH allocation applies only to subframes not configured as PRS subframes.		
Note 7:	Sub-frame 0 or sub-frame 5 is randomly scheduled in downlink.		

A.3.1.1.5 TDD for UE category 0

Table A.3.1.1.5-1: PDSCH Reference Measurement Channels for TDD UL/DL configuration1

Parameter	Unit	Value	
		R.12 TDD	R.13 TDD
Reference channel		R.12 TDD	R.13 TDD
Channel bandwidth	MHz	10	10
Number of transmitter antennas		1	2
Allocated resource blocks (Note 4)		24	24
Uplink-Downlink Configuration (Note 5)		1	1
Special Subframe Configuration (Note 6)		6	6
Allocated subframes per Radio Frame		6	6
Modulation		QPSK	QPSK
Target Coding Rate		1/10	1/10
Information Bit Payload			
For Sub-Frames 4,9	Bits	648	648
For Sub-Frame 5	Bits	648	648
For Sub-Frame 0	Bits	648	648
For Sub-Frame 1, 6 (DwPTS)	Bits	488	488
Number of Code Blocks per Sub-Frame (Note 7)		1	1
For Sub-Frames 4,9		1	1
For Sub-Frame 5		1	1
For Sub-Frame 0		1	1
For Sub-Frame 1, 6 (DwPTS)		1	1
Binary Channel Bits Per Sub-Frame			
For Sub-Frames 4,9	Bits	6624	6336
For Sub-Frame 5	Bits	6580	6192
For Sub-Frame 0	Bits	5928	5664
For Sub-Frame 1, 6 (DwPTS)	Bits	3696	3408
Max. Throughput averaged over 1 frame	Mbps	0.3552	0.3552
Note 1:	2 symbols allocated to PDCCH for 10 MHz channel BW. 3 OFDM symbols allocated to PDCCH for 5MHz channel BW. 4 symbols allocated to PDCCH for 1.4 MHz channel BW. For special subframe (1 & 6) only 2 OFDM symbols are allocated to PDCCH for all bandwidths.		
Note 2:	Reference signal, synchronization signals and PBCH allocated as defined in TS 36.211 [16].		
Note 3:	If necessary the information bit payload size can be adjusted to facilitate the test implementation. The payload sizes are defined in TS 36.213 [3].		
Note 4:	Allocation is located in the middle of bandwidth.		
Note 5:	As per Table 4.2-2 in TS 36.211 [16]		
Note 6:	As per Table 4.2-1 in TS 36.211 [16]		
Note 7:	If more than one Code Block is present, an additional CRC sequence of L = 24 Bits is attached to each Code Block (otherwise L = 0 Bit)		
Note 8:	PDSCH allocation applies only to subframes not configured as PRS subframes.		

A.3.1.1.6 Frame Structure 3

Table A.3.1.1.6-1: PDSCH Reference Measurement Channels for FS 3

Parameter	Unit	Value			
		R.0 FS3	R.1 FS3		
Reference channel					
Channel bandwidth	MHz			20	20
Number of transmitter antennas				1	1
Allocated resource blocks (Note 4)				24	24
Allocated subframes per Radio Frame				10	10
Modulation				QPSK	QPSK
Target Coding Rate				1/3	1/3
Information Bit Payload					
For Sub-Frames 4, 9	Bits			2088	2088
For Sub-Frame 5	Bits			2088	2088
For Sub-Frame 0	Bits			2088	2088
For Sub-Frame 1, 2, 3, 6, 7, 8	Bits			2088	(Note 7)
Number of Code Blocks per Sub-Frame (Note 5)					
For Sub-Frames 4, 9				1	1
For Sub-Frame 5				1	1
For Sub-Frame 0				1	1
For Sub-Frame 1, 2, 3, 6, 7, 8				1	1
Binary Channel Bits Per Sub-Frame					
For Sub-Frames 4, 9	Bits			6624	6624
For Sub-Frame 5	Bits			6336	6336
For Sub-Frame 0	Bits			6336	6336
For Sub-Frame 1, 2, 3, 6, 7, 8	Bits			6624	0
Max. Throughput averaged over 1 frame	kbps			2088	2088
Note 1:	2 symbols allocated to PDCCH for 20 MHz channel BW.				
Note 2:	Reference signal, synchronization signals allocated as defined in 3GPP TS 36.211 [16].				
Note 3:	If necessary the information bit payload size can be adjusted to facilitate the test implementation. The payload sizes are defined in 3GPP TS 36.213 [3].				
Note 4:	Allocation is located in the middle of bandwidth.				
Note 5:	If more than one Code Block is present, an additional CRC sequence of L = 24 Bits is attached to each Code Block (otherwise L = 0 Bit)				
Note 6:	PDSCH allocation applies only to subframes not configured as PRS subframes.				
Note 7:	PDSCH allocation applies only to subframes where there is no DRS transmission				
Note 8:	PDSCH is not transmitted in subframes where it is determined that transmission should not occur according to the listen before talk (LBT model).				
Note 9:	Max throughput averaged over 1 frame does not account for missed PDSCH transmission due to LBT or DRS transmission				

A.3.1.2 PCFICH/PDCCH/PHICH

A.3.1.2.1 FDD

Table A.3.1.2.1-1: PCFICH/PDCCH/PHICH Reference Channel for FDD

Parameter	Unit	Value								
		R.8 FDD	R.14 FDD	R.11 FDD	R.12 FDD	R.10 FDD	R.13 FDD	R.6 FDD	R.7 FDD	R.9 FDD
Reference channel										
Channel bandwidth	MHz	1.4	1.4	5	5	20	20	10	10	10
Number of transmitter antennas		1	1	1	2	1	2	1	2	2
Control region OFDM symbols ^{Note1}	symbols	4	3	3	3	2	2	2	2	3
Aggregation level	CCE	2 (Note 6)	2 (Note 6)	8	8	8	8	8	8	8
DCI Format		Note 3	Note 3	Note 3	Note 3	Note 3	Note 3	Note 3	Note 3	Note 3
Cell ID		Note 4	Note 4	Note 4	Note 4	Note 4	Note 4	Note 4	Note 4	Note 4
Payload (without CRC)	Bits	Note 5	Note 5	Note 5	Note 5	Note 5	Note 5	Note 5	Note 5	Note 5
		Note 1: The control region consists of PCFICH, PHICH and PDCCH. Note 2: DCI formats are defined in TS 36.212. Note 3: DCI format shall depend upon the test configuration.								

		Note 4: Cell ID shall depend upon the test configuration. Note 5: Payload size shall depend upon the test configuration. Note 6: For PDCCH using SI/RA/P-RNTI, Aggregation level 4 is used.
--	--	---

A.3.1.2.2 TDD

Table A.3.1.2.2-1: PCFICH/PDCCH/PHICH Reference Channel for TDD

Parameter	Unit	Value								
		R.8 TDD	R.14 TDD	R.11 TDD	R.12 TDD	R.10 TDD	R.13 TDD	R.6 TDD	R.7 TDD	R.9 TDD
Reference channel										
Channel bandwidth	MHz	1.4	1.4	5	5	20	20	10	10	10
Number of transmitter antennas		1	1	1	2	1	2	1	2	2
Control region OFDM symbols ^{Note1}	symbols	4 (Note 6)	3 (Note 6)	3	3	2	2	2	2	3
Aggregation level	CCE	2 (Note 7)	2 (Note 7)	8	8	8	8	8	8	8
DCI Format		Note 3	Note 3	Note 3	Note 3	Note 3	Note 3	Note 3	Note 3	Note 3
Cell ID		Note 4	Note 4	Note 4	Note 4	Note 4	Note 4	Note 4	Note 4	Note 4
Payload (without CRC)	Bits	Note 5	Note 5	Note 5	Note 5	Note 5	Note 5	Note 5	Note 5	Note 5

Note 1: The control region consists of PCFICH, PHICH and PDCCH.
 Note 2: DCI formats are defined in TS 36.212.
 Note 3: DCI format shall depend upon the test configuration.
 Note 4: Cell ID shall depend upon the test configuration.
 Note 5: Payload size shall depend upon the test configuration.
 Note 6: Only 2 OFDM symbols for special subframes 1 and 6.
 Note 7: For PDCCH using SI/RA/P-RNTI, Aggregation level 4 is used.

A.3.1.2.3 HD-FDD for UE category 0

Table A.3.1.2.3-1: PCFICH/PDCCH/PHICH Reference Channel for HD-FDD

Parameter	Unit	Value		
		R.3 HD-FDD	R.4 HD-FDD	R.5 HD-FDD
Reference channel				
Channel bandwidth	MHz	10	10	10
Number of transmitter antennas		1	2	2
Control region OFDM symbols ^{Note1}	symbols	2	2	3
Aggregation level	CCE	8	8	8
DCI Format		Note 3	Note 3	Note 3
Cell ID		Note 4	Note 4	Note 4
Payload (without CRC)	Bits	Note 5	Note 5	Note 5

Note 1: The control region consists of PCFICH, PHICH and PDCCH.
 Note 2: DCI formats are defined in TS 36.212.
 Note 3: DCI format shall depend upon the test configuration.
 Note 4: Cell ID shall depend upon the test configuration.
 Note 5: Payload size shall depend upon the test configuration.
 Note 6: For PDCCH using SI/RA/P-RNTI, Aggregation level 4 is used.
 Note 7: Sub-frame 0 or sub-frame 5 is randomly scheduled in downlink.

A.3.1.2.4 FS 3

Table A.3.1.2.4-1: PCFICH/PDCCH/PHICH Reference Channel for FS 3

Parameter	Unit	Value			
					R.0 FS3
Reference channel					
Channel bandwidth	MHz	10	10	10	20
Number of transmitter antennas					1
Control region OFDM symbols ^{Note1}	symbols				2
Aggregation level	CCE				8
DCI Format					Note 3
Cell ID					Note 4
Payload (without PDC)	Bits				Note 5

Note 1:	The control region consists of PCFICH, PHICH and PDCCH.
Note 2:	DCI formats are defined in TS 36.212.
Note 3:	DCI format shall depend upon the test configuration.
Note 4:	Cell ID shall depend upon the test configuration.
Note 5:	Payload size shall depend upon the test configuration.
Note 6:	For PDCCH using SI/RA/P-RNTI, Aggregation level 4 is used.
Note 7:	PCFICH/PDCCH/PHICH allocation applies only to subframes where there is no DRS transmission
Note 8:	PCFICH/PDCCH/PHICH are not transmitted in subframes where it is determined that transmission should not occur according to the listen before talk (LBT model).

A.3.1.3 MPDCCH Reference Channels for Cat-M1 UEs

MPDCCH reference measurement channels in this section can be used in tests for Cat-M2 UEs.

A.3.1.3.1 FDD in CEModeA

Table A.3.1.3.1-1: MPDCCH Reference Channel for Cat-M1 FDD UEs in CEModeA

Parameter	Unit	Value			
		R.16 FDD	R.17 FDD	R.24 FDD	R.25 FDD
MPDCCH Reference channel	-	R.16 FDD	R.17 FDD	R.24 FDD	R.25 FDD
Carrier bandwidth	MHz	10	10	5	5
Number of transmitter antennas	-	1	2	1	2
DCI Format	-	6-1A	6-1A	6-1A	6-1A
Transmission Type	-	Distributed	Distributed	Distributed	Distributed
Number of PRB pairs per M-PDCCH set	-	4	4	4	4
Aggregation level	ECCE	16	16	16	16
Maximum number of repetitions	-	8	8	8	8
Frequency hopping	-	ON	ON	ON	ON
Number of narrowbands	-	2	2	2	2
MPDCCH Narrowband	-	7 th	7 th	4 th	4 th
Frequency HoppingOffset	narrowbands	7	7	3	3
MPDCCH start subframe	subframes	1	1	1	1
MPDCCH start symbol	symbols	2	2	2	2
Frequency hopping interval	subframes	4	4	4	4
Payload (without CRC)	Bits	Note 1	Note 1	Note 1	Note 1
Cell ID	-	Note 2	Note 2	Note 2	Note 2
Note 1: Payload size shall depend upon the test configuration.					
Note 2: Cell ID shall depend upon the test configuration.					

A.3.1.3.2 HD-FDD in CEModeA

Table A.3.1.3.2-1: MPDCCH Reference Channel for Cat-M1 HD-FDD UEs in CEModeA

Parameter	Unit	Value			
		R.6 HD-FDD	R.7 HD-FDD	R.14 HD-FDD	R.15 HD-FDD
MPDCCH Reference channel	-	R.6 HD-FDD	R.7 HD-FDD	R.14 HD-FDD	R.15 HD-FDD
Carrier bandwidth	MHz	10	10	5	5
Number of transmitter antennas	-	1	2	1	2
DCI Format	-	6-1A	6-1A	6-1A	6-1A
Transmission Type	-	Distributed	Distributed	Distributed	Distributed
Number of PRB pairs per M-PDCCH set	-	4	4	4	4
Aggregation level	ECCE	16	16	16	16
Maximum number of repetitions	-	8	8	8	8
Frequency hopping	-	ON	ON	ON	ON
Number of narrowbands	-	2	2	2	2
MPDCCH Narrowband	-	7 th	7 th	4 th	4 th
Frequency HoppingOffset	narrowbands	7	7	3	3
MPDCCH start subframe	subframes	1	1	1	1
MPDCCH start symbol	symbols	2	2	2	2
Frequency hopping interval	subframes	4	4	4	4

Payload (without CRC)	Bits	Note 1	Note 1	Note 1	Note 1
Cell ID	-	Note 2	Note 2	Note 2	Note 2
Note 1: Payload size shall depend upon the test configuration.					
Note 2: Cell ID shall depend upon the test configuration.					

A.3.1.3.3 TDD in CEModeA

Table A.3.1.3.3-1: MPDCCH Reference Channel for Cat-M1 TDD UEs in CEModeA

Parameter	Unit	Value	
		R.14 TDD	R.15 TDD
MPDCCH Reference channel	-	R.14 TDD	R.15 TDD
Carrier bandwidth	MHz	10	10
Number of transmitter antennas	-	1	2
DCI Format	-	6-1A	6-1A
Transmission Type	-	Distributed	Distributed
Number of PRB pairs per M-PDCCH set	-	4	4
Aggregation level	ECCE	16	16
Maximum number of repetitions	-	8	8
Frequency hopping	-	ON	ON
Number of narrowbands	-	2	2
MPDCCH Narrowband	-	7 th	7 th
Frequency HoppingOffset	narrowbands	7	7
MPDCCH start subframe	subframes	1	1
MPDCCH start symbol	symbols	2	2
Frequency hopping interval	subframes	10	10
Payload (without CRC)	Bits	Note 1	Note 1
Cell ID	-	Note 2	Note 2
Note 1: Payload size shall depend upon the test configuration.			
Note 2: Cell ID shall depend upon the test configuration.			

A.3.1.3.4 FDD in CEModeB

Table A.3.1.3.4-1: MPDCCH Reference Channel for Cat-M1 FDD UEs in CEModeB

Parameter	Unit	Value			
		R.18 FDD	R.19 FDD	R.26 FDD	R.27 FDD
MPDCCH Reference channel	-	R.18 FDD	R.19 FDD	R.26 FDD	R.27 FDD
Carrier bandwidth	MHz	10	10	5	5
Number of transmitter antennas	-	1	2	1	2
DCI Format	-	6-1B	6-1B	6-1B	6-1B
Transmission Type	-	Distributed	Distributed	Distributed	Distributed
Number of PRB pairs per M-PDCCH set	-	6	6	6	6
Aggregation level	ECCE	24	24	24	24
Maximum number of repetitions	-	128	128	128	128
Frequency hopping	-	ON	ON	ON	ON
Number of narrowbands	-	2	2	2	2
MPDCCH Narrowband	-	7 th	7 th	4 th	4 th
Frequency HoppingOffset	narrowbands	7	7	3	3
MPDCCH start subframe	subframes	1	1	1	1
MPDCCH start symbol	symbols	2	2	2	2
Frequency hopping interval	subframes	8	8	8	8
Payload (without CRC)	Bits	18	18	17	17
Cell ID	-	Note 1	Note 1	Note 1	Note 1
Note 1: Cell ID shall depend upon the test configuration.					

A.3.1.3.5 HD-FDD in CEModeB

Table A.3.1.3.5-1: MPDCCH Reference Channel for Cat-M1 HD-FDD UEs in CEModeB

Parameter	Unit	Value
-----------	------	-------

MPDCCH Reference channel	-	R.8 HD-FDD	R.9 HD-FDD	R.16 HD-FDD	R.17 HD-FDD
Carrier bandwidth	MHz	10	10	5	5
Number of transmitter antennas	-	1	2	1	2
DCI Format	-	6-1B	6-1B	6-1B	6-1B
Transmission Type	-	Distributed	Distributed	Distributed	Distributed
Number of PRB pairs per M-PDCCH set	-	6	6	6	6
Aggregation level	ECCE	24	24	24	24
Maximum number of repetitions	-	128	128	128	128
Frequency hopping	-	ON	ON	ON	ON
Number of narrowbands	-	2	2	2	2
MPDCCH Narrowband	-	7 th	7 th	4 th	4 th
Frequency HoppingOffset	narrowbands	7	7	3	3
MPDCCH start subframe	subframes	1	1	1	1
MPDCCH start symbol	symbols	2	2	2	2
Frequency hopping interval	subframes	8	8	8	8
Payload (without CRC)	Bits	18	18	17	17
Cell ID	-	Note 1	Note 1	Note 1	Note 1
Note 1: Cell ID shall depend upon the test configuration.					

A.3.1.3.6 TDD in CEModeB

Table A.3.1.3.6-1: MPDCCH Reference Channel for Cat-M1 TDD UEs in CEModeB

Parameter	Unit	Value	
MPDCCH Reference channel	-	R.16 TDD	R.17 TDD
Carrier bandwidth	MHz	10	10
Number of transmitter antennas	-	1	2
DCI Format	-	6-1B	6-1B
Transmission Type	-	Distributed	Distributed
Number of PRB pairs per M-PDCCH set	-	6	6
Aggregation level	ECCE	24	24
Maximum number of repetitions	-	128	128
Frequency hopping	-	ON	ON
Number of narrowbands	-	2	2
MPDCCH Narrowband	-	7 th	7 th
Frequency HoppingOffset	narrowbands	7	7
MPDCCH start subframe	subframes	1	1
MPDCCH start symbol	symbols	2	2
Frequency hopping interval	subframes	20	20
Payload (without CRC)	Bits	18	18
Cell ID	-	Note 1	Note 1
Note 1: Cell ID shall depend upon the test configuration.			

A.3.1.4 PDSCH Reference Channel for Cat-M1 UEs

A.3.1.4.1 FDD in CEModeA

Table A.3.1.4.1-1: PDSCH Reference Channel for Cat-M1 FDD in CEModeA

Parameter	Unit	Value					
PDSCH Reference channel		R.20 FDD	R.21 FDD	R.28 FDD	R.29 FDD	R.32 FDD	R.33 FDD
Carrier bandwidth	MHz	10	10	5	5	10	10
Number of transmitter antennas		1	2	1	2	1	2
Allocated resource blocks ^{Note1}	PRBs	2	2	2	2	2	2

Allocated subframes per Radio Frame	subframes	10	10	10	10	10	10
Modulation		QPSK	QPSK	QPSK	QPSK	QPSK	QPSK
Target coding rate		1/3	1/3	1/3	1/3	1/3	1/3
Information Bit Payload							
Sub-Frames 0 ~ 9	Bits	32	32	32	32	32	32
Number of Code Blocks per Sub-Frame							
Sub-Frames 0 ~ 9		1	1	1	1	1	1
Maximum number of repetitions		16	16	16	16	1	1
Frequency hopping		ON	ON	ON	ON	ON	ON
Number of narrowbands for frequency hopping	narrowbands	2	2	2	2	2	2
PDSCH Narrowband		2 nd	2 nd	2 nd	2 nd	2 nd	2 nd
Frequency HoppingOffset	narrowbands	7	7	3	3	7	7
PDSCH start symbol	symbols	2	2	2	2	2	2
Frequency hopping interval	subframes	4	4	4	4	4	4
Cell ID		Note 2	Note 2	Note 2	Note 2	Note 2	Note 2
Note 1: Allocation is located in the middle of narrowband.							
Note 2: Cell ID shall depend upon the test configuration.							

A.3.1.4.2 HD-FDD in CEModeA

Table A.3.1.4.2-1: PDSCH Reference Channel for Cat-M1 HD-FDD in CEModeA

Parameter	Unit	Value					
		R.10 HD-FDD	R.11 HD-FDD	R.18 HD-FDD	R.19 HD-FDD	R.24 HD-FDD	R.25 HD-FDD
PDSCH Reference channel							
Carrier bandwidth	MHz	10	10	5	5	10	10
Number of transmitter antennas		1	2	1	2	1	2
Allocated resource blocks ^{Note1}	PRBs	2	2	2	2	2	2
Allocated subframes per Radio Frame	subframes	10	10	10	10	10	10
Modulation		QPSK	QPSK	QPSK	QPSK	QPSK	QPSK
Target coding rate		1/3	1/3	1/3	1/3	1/3	1/3
Information Bit Payload							
Sub-Frames 0 ~ 9	Bits	32	32	32	32	32	32
Number of Code Blocks per Sub-Frame							
Sub-Frames 0 ~ 9		1	1	1	1	1	1
Maximum number of repetitions		16	16	16	16	1	1
Frequency hopping		ON	ON	ON	ON	ON	ON
Number of narrowbands for frequency hopping	narrowbands	2	2	2	2	2	2
PDSCH Narrowband		1 st	1 st	1 st	1 st	1 st	1 st
Frequency HoppingOffset	narrowbands	7	7	3	3	7	7
PDSCH start symbol	symbols	2	2	2	2	2	2
Frequency hopping interval	subframes	4	4	4	4	4	4
Cell ID		Note 2	Note 2	Note 2	Note 2	Note 2	Note 2
Note 1: Allocation is located in the middle of narrowband.							
Note 2: Cell ID shall depend upon the test configuration.							

A.3.1.4.3 TDD in CEModeA

Table A.3.1.4.3-1: PDSCH Reference Channel for Cat-M1 TDD in CEModeA

Parameter	Unit	Value
-----------	------	-------

PDSCH Reference channel		R.16 TDD	R.17 TDD
Carrier bandwidth	MHz	10	10
Number of transmitter antennas		1	2
Allocated resource blocks ^{Note1}	PRBs	2	2
Allocated subframes per Radio Frame		4	4
TDD Uplink-Downlink Configuration		0	0
TDD Special Subframe Configuration		6	6
Modulation		QPSK	QPSK
Target coding rate		1/3	1/3
Information Bit Payload			
All Sub-Frames except 1, 6 (TDD)	Bits	32	32
All Sub-Frames except 1, 6 (TDD DwPTS)	-	0	0
Number of Code Blocks per Sub-Frame		1	1
All Sub-Frames except 1, 6 (TDD)		1	1
All Sub-Frames except 1, 6 (TDD DwPTS)		0	0
Maximum number of repetitions		16	16
Frequency hopping		ON	ON
Number of narrowbands for frequency hopping		2	2
PDSCH Narrowband		2 nd	2 nd
Frequency HoppingOffset	narrowbands	7	7
PDSCH start symbol	symbols	2	2
Frequency hopping interval	subframes	10	10
Cell ID		Note 2	Note 2
Note 1: Allocation is located in the middle of narrowband.			
Note 2: Cell ID shall depend upon the test configuration.			

A.3.1.4.4 FDD in CEModeB

Table A.3.1.4.4-1: PDSCH Reference Channel for Cat-M1 FDD in CEModeB

Parameter	Unit	Value			
		R.22 FDD	R.23 FDD	R.30 FDD	R.31 FDD
PDSCH Reference channel					
Carrier bandwidth	MHz	10	10	5	5
Number of transmitter antennas		1	2	1	2
Allocated resource blocks ^{Note1}		2	2	2	2
Allocated subframes per Radio Frame	-	10	10	10	10
Modulation	-	QPSK	QPSK	QPSK	QPSK
Target coding rate	-	1/3	1/3	1/3	1/3
Information Bit Payload					
Sub-Frames 0 ~ 9	Bits	32	32	32	32
Number of Code Blocks per Sub-Frame					
Sub-Frames 0 ~ 9	-	1	1	1	1
Maximum number of repetitions	-	192	192	192	192
Frequency hopping	-	ON	ON	ON	ON
Number of narrowbands for frequency hopping	narrowbands	2	2	2	2
PDSCH Narrowband	-	2 nd	2 nd	2 nd	2 nd
Frequency HoppingOffset	narrowbands	7	7	3	3
PDSCH start symbol	symbols	2	2	2	2
Frequency hopping interval	subframes	8	8	8	8
Cell ID		Note 2	Note 2	Note 2	Note 2
Note 1: Allocation is located in the middle of narrowband.					
Note 2: Cell ID shall depend upon the test configuration.					

A.3.1.4.5 HD-FDD in CEModeB

Table A.3.1.4.5-1: PDSCH Reference Channel for Cat-M1 HD-FDD in CEModeB

Parameter	Unit	Value			
		R.12 HD-FDD	R.13 HD-FDD	R.20 HD-FDD	R.21 HD-FDD
PDSCH Reference channel		R.12 HD-FDD	R.13 HD-FDD	R.20 HD-FDD	R.21 HD-FDD
Carrier bandwidth	MHz	10	10	5	5
Number of transmitter antennas		1	2	1	2
Allocated resource blocks ^{Note1}	PRBs	2	2	2	2
Allocated subframes per Radio Frame	subframes	10	10	10	10
Modulation		QPSK	QPSK	QPSK	QPSK
Target coding rate		1/3	1/3	1/3	1/3
Information Bit Payload					
Sub-Frames 0 ~ 9	Bits	32	32	32	32
Number of Code Blocks per Sub-Frame					
Sub-Frames 0 ~ 9		1	1	1	1
Maximum number of repetitions		192	192	192	192
Frequency hopping		ON	ON	ON	ON
Number of narrowbands for frequency hopping	narrowbands	2	2	2	2
PDSCH Narrowband		1 st	1 st	1 st	1 st
Frequency HoppingOffset	narrowbands	7	7	3	3
PDSCH start symbol	symbols	2	2	2	2
Frequency hopping interval	subframes	8	8	8	8
Cell ID		Note 2	Note 2	Note 2	Note 2
Note 1: Allocation is located in the middle of narrowband.					
Note 2: Cell ID shall depend upon the test configuration.					

A.3.1.4.6 TDD in CEModeB

Table A.3.1.4.6-1: PDSCH Reference Channel for Cat-M1 TDD in CEModeB

Parameter	Unit	Value	
		R.18 TDD	R.19 TDD
PDSCH Reference channel		R.18 TDD	R.19 TDD
Carrier bandwidth	MHz	10	10
Number of transmitter antennas		1	2
Allocated resource blocks ^{Note1}	PRBs	2	2
Allocated subframes per Radio Frame		4	4
TDD Uplink-Downlink Configuration		0	0
TDD Special Subframe Configuration		6	6
Modulation		QPSK	QPSK
Target coding rate		1/3	1/3
Information Bit Payload			
All Sub-Frames except 1, 6 (TDD)	Bits	32	32
All Sub-Frames except 1, 6 (TDD DwPTS)	-	0	0
Number of Code Blocks per Sub-Frame		1	1
All Sub-Frames except 1, 6 (TDD)		1	1
All Sub-Frames except 1, 6 (TDD DwPTS)		0	0
Maximum number of repetitions		192	192
Frequency hopping		ON	ON
Number of narrowbands for frequency hopping		2	2
PDSCH Narrowband		2 nd	2 nd
Frequency HoppingOffset	narrowbands	7	7
PDSCH start symbol	symbols	2	2
Frequency hopping interval	subframes	20	20
Cell ID		Note 2	Note 2
Note 1: Allocation is located in the middle of narrowband.			

Note 2: Cell ID shall depend upon the test configuration.

A.3.1.5 NPDSCH Reference Channel for UE category NB1

A.3.1.5.1 HD-FDD in-band operation

Table A.3.1.5.1-1: NPDSCH Reference Channel for UE category NB1 for in-band operation

Parameter	Unit	Value			
		R.14 HD-FDD	R.15 HD-FDD	R.16 HD-FDD	R.17 HD-FDD
NPDSCH Reference channel	-	R.14 HD-FDD	R.15 HD-FDD	R.16 HD-FDD	R.17 HD-FDD
LTE Carrier bandwidth	MHz	10	10	5	5
Allocated resource blocks	PRB	1	1	1	1
Number of transmitter antennas	-	1	2	1	2
Allocated subframes per Radio Frame	subframes	Note 1	Note 1	Note 1	Note 1
Modulation		QPSK	QPSK	QPSK	QPSK
Target coding rate		1/3	1/3	1/3	1/3
Information Bit Payload					
For Sub-Frame 1, 2, 3, 6, 7, 8	Bits	40 Note 2	40 Note 2	40 Note 2	40 Note 2
For Sub-Frame 4, 9	Bits	Note 3	Note 3	Note 3	Note 3
For Sub-Frame 0, 5	Bits	0	0	0	0
Number of Code Blocks per Sub-Frame					
For Sub-Frame 1, 2, 3, 6, 7, 8		1 Note 4	1 Note 4	1 Note 4	1 Note 4
For Sub-Frame 4, 9		Note 5	Note 5	Note 5	Note 5
For Sub-Frame 0, 5		0	0	0	0
Maximum number of repetitions	-	Note 6	Note 6	Note 6	Note 6
NPDCCH start symbol	symbols	3	3	3	3
Cell ID	-	Note 7	Note 7	Note 7	Note 7
Note 1: Shall depend upon the NPDSCH scheduling. Note 2: Only apply for subframes scheduled with NPDSCH. Note 3: 40 for subframes scheduled with NPDSCH when $n_f \bmod 2 \neq 0$. Otherwise 0. Note 4: Only apply for subframes scheduled with NPDSCH. Note 5: 1 for subframes scheduled with NPDSCH when $n_f \bmod 2 \neq 0$. Otherwise 0. Note 6: Maximum number of repetitions shall depend upon the test configuration. Note 7: Cell ID shall depend upon the test configuration.					

A.3.1.5.2 Void

A.3.1.5.3 HD-FDD standalone operation

Table A.3.1.5.3-1: NPDSCH Reference Channel for UE category NB1 for standalone operation

Parameter	Unit	Value	
		R.18 HD-FDD	R.19 HD-FDD
NPDSCH Reference channel	-	R.18 HD-FDD	R.19 HD-FDD
Channel bandwidth	KHz	200	200
Number of transmitter antennas	-	1	2
Allocated subframes per Radio Frame	subframes	Note 1	Note 1
Modulation		QPSK	QPSK
Target coding rate		1/3	1/3
Information Bit Payload			
For Sub-Frame 1, 2, 3, 6, 7, 8	Bits	72 Note 2	72 Note 2
For Sub-Frame 4, 9	Bits	Note 3	Note 3
For Sub-Frame 0, 5	Bits	0	0
Number of Code Blocks per Sub-Frame			
For Sub-Frame 1, 2, 3, 6, 7, 8		1 Note 4	1 Note 4
For Sub-Frame 4, 9		Note 5	Note 5
For Sub-Frame 0, 5		0	0
Maximum number of repetitions	-	Note 6	Note 6
Cell ID	-	Note 7	Note 7

Note 1:	Shall depend upon the NPDSCH scheduling
Note 2:	Only apply for subframes scheduled with NPDSCH.
Note 3:	72 for subframes scheduled with NPDSCH when $n_f \bmod 2 \neq 0$. Otherwise 0.
Note 4:	only apply for subframes scheduled with NPDSCH..
Note 5:	1 for subframes scheduled with NPDSCH when $n_f \bmod 2 \neq 0$. Otherwise 0.
Note 6:	Maximum number of repetitions shall depend upon the test configuration.
Note 7:	Cell ID shall depend upon the test configuration.

A.3.1.5.4 Void

A.3.1.5.5 HD-FDD guard band operation

Table A.3.1.5.5-1: NPDSCH Reference Channel for UE category NB1 for guard band operation

Parameter	Unit	Value			
		R.22 HD-FDD	R.23 HD-FDD	R.32 HD-FDD	R.33 HD-FDD
NPDSCH Reference channel	-	R.22 HD-FDD	R.23 HD-FDD	R.32 HD-FDD	R.33 HD-FDD
LTE Carrier bandwidth	MHz	10	10	5	5
Allocated resource blocks for NB-IoT	PRB	1	1	1	1
Number of transmitter antennas	-	1	2	1	2
Allocated subframes per Radio Frame	subframes	Note 1	Note 1	Note 1	Note 1
Modulation		QPSK	QPSK	QPSK	QPSK
Target coding rate		1/3	1/3	1/3	1/3
Information Bit Payload					
For Sub-Frame 1, 2, 3, 6, 7, 8	Bits	72 Note 2	72 Note 2	72 Note 2	72 Note 2
For Sub-Frame 4, 9	Bits	Note 3	Note 3	Note 3	Note 3
For Sub-Frame 0, 5	Bits	0	0	0	0
Number of Code Blocks per Sub-Frame					
For Sub-Frame 1, 2, 3, 6, 7, 8		1 Note 4	1 Note 4	1 Note 4	1 Note 4
For Sub-Frame 4, 9		Note 5	Note 5	Note 5	Note 5
For Sub-Frame 0, 5		0	0	0	0
Maximum number of repetitions	-	Note 6	Note 6	Note 6	Note 6
Cell ID	-	Note 7	Note 7	Note 7	Note 7
Note 1: Shall depend upon the NPDSCH scheduling. Note 2: Only apply for subframes scheduled with NPDSCH. Note 3: 72 for subframes scheduled with NPDSCH when $n_f \bmod 2 \neq 0$. Otherwise 0. Note 4: Only apply for subframes scheduled with NPDSCH. Note 5: 1 for subframes scheduled with NPDSCH when $n_f \bmod 2 \neq 0$. Otherwise 0. Note 6: Maximum number of repetitions shall depend upon the test configuration. Note 7: Cell ID shall depend upon the test configuration.					

A.3.1.5.6 Void

A.3.1.5.7 TDD in-band operation

Table A.3.1.5.7-1: NPDSCH Reference Channel for UE category NB1 for in-band operation

Parameter	Unit	Value	
		R.14 NB-TDD	R.15 NB-TDD
NPDSCH Reference channel	-	R.14 NB-TDD	R.15 NB-TDD
LTE Carrier bandwidth	MHz	10	10
Allocated resource blocks	PRB	1	1
Number of transmitter antennas	-	1	2
Allocated subframes per Radio Frame	subframes	Note 1	Note 1
Modulation		QPSK	QPSK
Target coding rate		1/3	1/3
Information Bit Payload			
For Sub-Frame 4	Bits	40 Note 2	40 Note 2
For Sub-Frame 0, 5, 9	Bits	0	0
For Sub-Frame 1, 6 (DwPTS)	Bits	16 or 40 Note 6	16 or 40 Note 6
Number of Code Blocks per Sub-Frame			

For Sub-Frame 4		1 Note 2	1 Note 2
For Sub-Frame 0, 5, 9		0	0
For Sub-Frame 1, 6 (DwPTS)		1	1
Maximum number of repetitions	-	Note 3	Note 3
NPDCCH start symbol	symbols	3	3
Cell ID	-	Note 4	Note 4
<p>Note 1: Shall depend upon the NPDSCH scheduling.</p> <p>Note 2: Only apply for subframes scheduled with NPDSCH.</p> <p>Note 3: Maximum number of repetitions shall depend upon the test configuration.</p> <p>Note 4: Cell ID shall depend upon the test configuration.</p> <p>Note 5: SIB1-NB is transmitted in subframe 0 in odd radio frames.</p> <p>Note 6: Set 40 when NPDSCH is transmitted with repetition. Set 16 when NPDSCH is transmitted without repetition.</p>			

A.3.1.5.8 TDD standalone operation

Table A.3.1.5.8-1: NPDSCH Reference Channel for UE category NB1 for standalone operation

Parameter	Unit	Value	
		R.18 NB-TDD	R.19 NB-TDD
NPDSCH Reference channel	-	R.18 NB-TDD	R.19 NB-TDD
Channel bandwidth	KHz	200	200
Number of transmitter antennas	-	1	2
Allocated subframes per Radio Frame	subframes	Note 1	Note 1
Modulation		QPSK	QPSK
Target coding rate		1/3	1/3
Information Bit Payload			
For Sub-Frame 4	Bits	72 Note 2	72 Note 2
For Sub-Frame 0, 5, 9	Bits	0	0
For Sub-Frame 1, 6 (DwPTS)	Bits	40 or 72 Note 6	40 or 72 Note 6
Number of Code Blocks per Sub-Frame			
For Sub-Frame 4		1 Note 2	1 Note 2
For Sub-Frame 0, 5, 9		0	0
For Sub-Frame 1, 6 (DwPTS)		1	1
Maximum number of repetitions	-	Note 3	Note 3
Cell ID	-	Note 4	Note 4
<p>Note 1: Shall depend upon the NPDSCH scheduling.</p> <p>Note 2: Only apply for subframes scheduled with NPDSCH.</p> <p>Note 3: Maximum number of repetitions shall depend upon the test configuration.</p> <p>Note 4: Cell ID shall depend upon the test configuration.</p> <p>Note 5: SIB1-NB is transmitted in subframe 0 in odd radio frames.</p> <p>Note 6: Set 72 when NPDSCH is transmitted with repetition. Set 40 when NPDSCH is transmitted without repetition.</p>			

A.3.1.5.9 TDD guard band operation

Table A.3.1.5.9-1: NPDSCH Reference Channel for UE category NB1 for guard band operation

Parameter	Unit	Value	
		R.22 NB-TDD	R.23 NB-TDD
NPDSCH Reference channel	-	R.22 NB-TDD	R.23 NB-TDD
LTE Carrier bandwidth	MHz	10	10
Allocated resource blocks for NB-IoT	PRB	1	1
Number of transmitter antennas	-	1	2
Allocated subframes per Radio Frame	subframes	Note 1	Note 1
Modulation		QPSK	QPSK
Target coding rate		1/3	1/3
Information Bit Payload			
For Sub-Frame 4	Bits	72 Note 2	72 Note 2
For Sub-Frame 0, 5, 9	Bits	0	0
For Sub-Frame 1, 6 (DwPTS)	Bits	40 or 72 Note 6	40 or 72 Note 6
Number of Code Blocks per Sub-Frame			
For Sub-Frame 4		1 Note 2	1 Note 2
For Sub-Frame 0, 5, 9		0	0
For Sub-Frame 1, 6 (DwPTS)		1	1

Maximum number of repetitions	-	Note 3	Note 3
Cell ID	-	Note 4	Note 4
<p>Note 1: Shall depend upon the NPDSCH scheduling.</p> <p>Note 2: Only apply for subframes scheduled with NPDSCH.</p> <p>Note 3: Maximum number of repetitions shall depend upon the test configuration.</p> <p>Note 4: Cell ID shall depend upon the test configuration.</p> <p>Note 5: SIB1-NB is transmitted in subframe 0 in odd radio frames.</p> <p>Note 6: Set 72 when NPDSCH is transmitted with repetition. Set 40 when NPDSCH is transmitted without repetition.</p>			

A.3.1.6 NPDCCH Reference Channel for UE category NB1

A.3.1.6.1 In-band operation

Table A.3.1.6.1-1: NPDCCH Reference Channel for UE category NB1 for in-band operation in 10MHz LTE system

Parameter	Unit	Value			
		R.26 HD-FDD R.26 NB-TDD	R.27 HD-FDD R.27 NB-TDD	R.28 HD-FDD R.28 NB-TDD	R.29 HD-FDD R.29 NB-TDD
NPDCCH Reference channel	-				
LTE Carrier bandwidth	MHz	10	10	10	10
Allocated resource blocks ^{Note1}	PRB	1	1	1	1
Number of transmitter antennas	-	1	2	1	2
DCI Format	-	N1	N1	N0	N0
Aggregation level	NCCE	2	2	2	2
Maximum number of repetitions	-	Note 2	Note 2	Note 2	Note 2
NPDCCH start symbol	symbols	3	3	3	3
Payload (without CRC)	Bits	Note 3	Note 3	Note 3	Note 3
Cell ID	-	Note 4	Note 4	Note 4	Note 4
<p>Note 1: Allocation is located in the middle of narrowband.</p> <p>Note 2: Maximum number of repetitions shall depend upon the test configuration.</p> <p>Note 3: Payload size shall depend upon the test configuration.</p> <p>Note 4: Cell ID shall depend upon the test configuration.</p>					

Table A.3.1.6.1-2: NPDCCH Reference Channel for UE category NB1 for in-band operation in 5MHz LTE system

Parameter	Unit	Value			
		R.38 HD-FDD	R.39 HD-FDD	R.40 HD-FDD	R.41 HD-FDD
NPDCCH Reference channel	-				
LTE Carrier bandwidth	MHz	5	5	5	5
Allocated resource blocks ^{Note1}	PRB	1	1	1	1
Number of transmitter antennas	-	1	2	1	2
DCI Format	-	N1	N1	N0	N0
Aggregation level	NCCE	2	2	2	2
Maximum number of repetitions	-	Note 2	Note 2	Note 2	Note 2
NPDCCH start symbol	symbols	3	3	3	3
Payload (without CRC)	Bits	Note 3	Note 3	Note 3	Note 3
Cell ID	-	Note 4	Note 4	Note 4	Note 4
<p>Note 1: Allocation is located in the middle of narrowband.</p> <p>Note 2: Maximum number of repetitions shall depend upon the test configuration.</p> <p>Note 3: Payload size shall depend upon the test configuration.</p> <p>Note 4: Cell ID shall depend upon the test configuration.</p>					

A.3.1.6.2 Void

A.3.1.6.3 Standalone operation

Table A.3.1.6.3-1: NPDCCH Reference Channel for UE category NB1 for standalone operation

Parameter	Unit	Value			
		R.30 HD-FDD R.30 NB-TDD	R.31 HD-FDD R.31 NB-TDD	R.32 HD-FDD R.32 NB-TDD	R.33 HD-FDD R.33 NB-TDD
NPDCCH Reference channel	-				
Channel bandwidth	KHz	200	200	200	200
Number of transmitter antennas	-	1	2	1	2

DCI Format	-	N1	N1	N0	N0
Aggregation level	NCCE	2	2	2	2
Maximum number of repetitions	-	Note 2	Note 2	Note 2	Note 2
Payload (without CRC)	Bits	Note 3	Note 3	Note 3	Note 3
Cell ID	-	Note 4	Note 4	Note 4	Note 4
<p>Note 1: Allocation is located in the middle of narrowband.</p> <p>Note 2: Maximum number of repetitions shall depend upon the test configuration.</p> <p>Note 3: Payload size shall depend upon the test configuration.</p> <p>Note 4: Cell ID shall depend upon the test configuration.</p>					

A.3.1.6.4 Void

A.3.1.6.5 Guard band operation

Table A.3.1.6.5-1: NPDCCH Reference Channel for UE category NB1 for guard band operation in 10MHz LTE system

Parameter	Unit	Value			
NPDCCH Reference channel	-	R.34 HD-FDD R.34 NB-TDD	R.35 HD-FDD R.35 NB-TDD	R.36 HD-FDD R.36 NB-TDD	R.37 HD-FDD R.37 NB-TDD
LTE Carrier bandwidth	MHz	10	10	10	10
Allocated resource blocks for NB- IoT ^{Note1}	PRB	1	1	1	1
Number of transmitter antennas	-	1	2	1	2
DCI Format	-	N1	N1	N0	N0
Aggregation level	NCCE	2	2	2	2
Maximum number of repetitions	-	Note 2	Note 2	Note 2	Note 2
Payload (without CRC)	Bits	Note 3	Note 3	Note 3	Note 3
Cell ID	-	Note 4	Note 4	Note 4	Note 4
<p>Note 1: Allocation is located in the middle of narrowband.</p> <p>Note 2: Maximum number of repetitions shall depend upon the test configuration.</p> <p>Note 3: Payload size shall depend upon the test configuration.</p> <p>Note 4: Cell ID shall depend upon the test configuration.</p>					

Table A.3.1.6.5-2: NPDCCH Reference Channel for UE category NB1 for guard band operation in 5MHz LTE system

Parameter	Unit	Value			
NPDCCH Reference channel	-	R.42 HD-FDD	R.43 HD-FDD	R.44 HD-FDD	R.45 HD-FDD
LTE Carrier bandwidth	MHz	5	5	5	5
Allocated resource blocks for NB- IoT ^{Note1}	PRB	1	1	1	1
Number of transmitter antennas	-	1	2	1	2
DCI Format	-	N1	N1	N0	N0
Aggregation level	NCCE	2	2	2	2
Maximum number of repetitions	-	Note 2	Note 2	Note 2	Note 2
Payload (without CRC)	Bits	Note 3	Note 3	Note 3	Note 3
Cell ID	-	Note 4	Note 4	Note 4	Note 4
<p>Note 1: Allocation is located in the middle of narrowband.</p> <p>Note 2: Maximum number of repetitions shall depend upon the test configuration.</p> <p>Note 3: Payload size shall depend upon the test configuration.</p> <p>Note 4: Cell ID shall depend upon the test configuration.</p>					

A.3.1.6.6 Void

A.3.2 OFDMA Channel Noise Generator (OCNG)

A.3.2.1 OCNG Patterns for FDD

The following OCNG patterns are used for modelling allocations to virtual UEs (which are not under test) and/or allocations used for MBSFN. The OCNG pattern for each sub frame specifies the allocations that shall be filled with OCNG, and furthermore, the relative power level of each such allocation.

In each test case the OCNG is expressed by parameters OCNG_RA and OCNG_RB which together with a relative power level (γ) specifies the PDSCH EPRE-to-RS EPRE ratios in OFDM symbols without and with reference symbols, respectively. The relative power, which is used for modelling boosting per virtual UE allocation, is expressed by:

$$\gamma_i = PDSCH_RA/OCNG_RA = PDSCH_RB/OCNG_RB$$

where γ_i denotes the relative power level of the i :th virtual UE. The parameter settings of OCNG_RA, OCNG_RB, and the set of relative power levels γ are chosen such that when also taking allocations to the UE under test into account, as given by a PDSCH reference channel, a constant transmitted power spectral density that is constant on an OFDM symbol basis is targeted.

Moreover the OCNG pattern is accompanied by a PCFICH/PDCCH/PHICH reference channel which specifies the control region. The number of PDCCH OFDM symbols in the non-MBSFN subframes is the same as specified in the RMC used in the test. The number of PDCCH OFDM symbols in the MBSFN subframe is the maximal allowed according to TS 36.213 [16]. For any aggregation and PHICH allocation, the PDCCH and any unused PHICH groups are padded with resource element groups with a power level given by PDCCH_RA/RB and PHICH_RA/RB as specified in the test case such that a total power spectral density in the control region that is constant on an OFDM symbol basis is targeted.

For subframes configured as PRS subframes the PDSCH allocation defined in the OCNG pattern does not apply.

For subframes configured as ABS subframes the PDSCH and PMCH allocation defined in the OCNG pattern does not apply.

The system information is scheduled in the allocations reserved for the OCNG patterns, in the subframes not configured for MBSFN. For this purpose the number of the RB-s allocated with PDSCH defined in the OCNG pattern can be reduced as necessary.

A.3.2.1.1 OCNG FDD pattern 1: outer resource blocks allocation in 10 MHz

Table A.3.2.1.1-1: OP.1 FDD: OCNG FDD Pattern 1

Allocation n_{PRB}	Relative power level γ_{PRB} [dB]				PDSCH Data	PMCH Data
	Subframe					
	0	5	4,9	1-3, 6-8		
0 – 12	0	0	0	N/A	Note 1	N/A
37 – 49	0	0	0	N/A		
0-49	N/A	N/A	N/A	Note 4	N/A	Note 2
<p>Note 1: These physical resource blocks are assigned to an arbitrary number of virtual UEs with one PDSCH per virtual UE; the data transmitted over the OCNG PDSCHs shall be uncorrelated pseudo random data, which is QPSK modulated. The parameter γ_{PRB} is used to scale the power of PDSCH.</p> <p>Note 2: Each physical resource block (PRB) is assigned to MBSFN transmission. The data in each PRB shall be uncorrelated with data in other PRBs over the period of any measurement. The MBSFN data shall be QPSK modulated. PMCH symbols shall not contain cell-specific Reference Signals. PMCH subframes shall contain cell-specific Reference Signals only in the first symbol of the first time slot. The parameter γ_{PRB} is used to scale the power of PMCH.</p> <p>Note 3: If two or more transmit antennas with CRS are used in the test, the PDSCH part of OCNG shall be transmitted to the virtual users by all the transmit antennas with CRS and according to the antenna transmission mode 2. The parameter γ_{PRB} applies to each antenna port separately, so the transmit power of the PDSCH part of OCNG is equal between all the transmit antennas with CRS used in the test. The antenna transmission modes are specified in clause 7.1 in TS 36.213.</p> <p>Note 4: 0dB for 1 transmit antenna with CRS, +3dB for 2 transmit antennas with CRS</p> <p>Note 5: If SPDCCH is to be transmitted on a physical resource block (PRB), this takes priority over OCNG transmission</p> <p>N/A: Not Applicable</p>						

A.3.2.1.2 OCNG FDD pattern 2: full bandwidth allocation in 10 MHz

Table A.3.2.1.2-1: OP.2 FDD: OCNG FDD Pattern 2

Allocation n_{PRB}	Relative power level γ_{PRB} [dB]				PDSCH Data	PMCH Data
	Subframe					
	0	5	4, 9	1 – 3, 6 – 8		
0 – 49	0	0	0	N/A	Note 1	N/A
0 – 49	N/A	N/A	N/A	Note 4	N/A	Note 2
<p>Note 1: These physical resource blocks are assigned to an arbitrary number of virtual UEs with one PDSCH per virtual UE; the data transmitted over the OCNG PDSCHs shall be uncorrelated pseudo random data, which is QPSK modulated. The parameter γ_{PRB} is used to scale the power of PDSCH.</p> <p>Note 2: Each physical resource block (PRB) is assigned to MBSFN transmission. The data in each PRB shall be uncorrelated with data in other PRBs over the period of any measurement. The MBSFN data shall be QPSK modulated. PMCH subframes shall contain cell-specific Reference Signals only in the first symbol of the first time slot. The parameter γ_{PRB} is used to scale the power of PMCH.</p> <p>Note 3: If two or more transmit antennas with CRS are used in the test, the PDSCH part of OCNG shall be transmitted to the virtual users by all the transmit antennas with CRS and according to the antenna transmission mode 2. The parameter γ_{PRB} applies to each antenna port separately, so the transmit power of the PDSCH part of OCNG is equal between all the transmit antennas with CRS used in the test. The antenna transmission modes are specified in clause 7.1 in TS 36.213.</p> <p>Note 4: 0dB for 1 transmit antenna with CRS, +3dB for 2 transmit antennas with CRS</p> <p>N/A: Not Applicable</p>						

A.3.2.1.3 OCNG FDD pattern 3: outer resource blocks allocation in 1.4 MHz

Table A.3.2.1.3-1: OP.3 FDD: OCNG FDD Pattern 3

Allocation n_{PRB}	Relative power level γ_{PRB} [dB]				PDSCH Data	PMCH Data
	Subframe					
	0	5	4,9	1-3, 6-8		
0 – 1	0	0	0	N/A	Note 1	N/A
4 – 5	0	0	0	N/A		
0 – 5	N/A	N/A	N/A	Note 4	N/A	Note 2
<p>Note 1: These physical resource blocks are assigned to an arbitrary number of virtual UEs with one PDSCH per virtual UE; the data transmitted over the OCNG PDSCHs shall be uncorrelated pseudo random data, which is QPSK modulated. The parameter γ_{PRB} is used to scale the power of PDSCH.</p> <p>Note 2: Each physical resource block (PRB) is assigned to MBSFN transmission. The data in each PRB shall be uncorrelated with data in other PRBs over the period of any measurement. The MBSFN data shall be QPSK modulated. PMCH symbols shall not contain cell-specific Reference Signals. PMCH subframes shall contain cell-specific Reference Signals only in the first symbol of the first time slot. The parameter γ_{PRB} is used to scale the power of PMCH.</p> <p>Note 3: If two or more transmit antennas with CRS are used in the test, the PDSCH part of OCNG shall be transmitted to the virtual users by all the transmit antennas with CRS and according to the antenna transmission mode 2. The parameter γ_{PRB} applies to each antenna port separately, so the transmit power of the PDSCH part of OCNG is equal between all the transmit antennas with CRS used in the test. The antenna transmission modes are specified in clause 7.1 in TS 36.213.</p> <p>Note 4: 0dB for 1 transmit antenna with CRS, +3dB for 2 transmit antennas with CRS</p>						

N/A: Not Applicable

A.3.2.1.4 OCNG FDD pattern 4: full bandwidth allocation in 1.4 MHz

Table A.3.2.1.4-1: OP.4 FDD: OCNG FDD Pattern 4

Allocation n_{PRB}	Relative power level γ_{PRB} [dB]				PDSCH Data	PMCH Data
	Subframe					
	0	5	4, 9	1 – 3, 6 – 8		
0 – 5	0	0	0	N/A	Note 1	N/A
0 – 5	N/A	N/A	N/A	Note 4	N/A	Note 2

Note 1: These physical resource blocks are assigned to an arbitrary number of virtual UEs with one PDSCH per virtual UE; the data transmitted over the OCNG PDSCHs shall be uncorrelated pseudo random data, which is QPSK modulated. The parameter γ_{PRB} is used to scale the power of PDSCH.

Note 2: Each physical resource block (PRB) is assigned to MBSFN transmission. The data in each PRB shall be uncorrelated with data in other PRBs over the period of any measurement. The MBSFN data shall be QPSK modulated. PMCH subframes shall contain cell-specific Reference Signals only in the first symbol of the first time slot. The parameter γ_{PRB} is used to scale the power of PMCH.

Note 3: If two or more transmit antennas with CRS are used in the test, the PDSCH part of OCNG shall be transmitted to the virtual users by all the transmit antennas with CRS and according to the antenna transmission mode 2. The parameter γ_{PRB} applies to each antenna port separately, so the transmit power of the PDSCH part of OCNG is equal between all the transmit antennas with CRS used in the test. The antenna transmission modes are specified in clause 7.1 in TS 36.213.

Note 4: 0dB for 1 transmit antenna with CRS, +3dB for 2 transmit antennas with CRS

N/A: Not Applicable

A.3.2.1.5 OCNG FDD pattern 5: outer resource blocks allocation in 10 MHz (without MBSFN)

Table A.3.2.1.5-1: OP.5 FDD: OCNG FDD Pattern 5

Allocation n_{PRB}	Relative power level γ_{PRB} [dB]				PDSCH Data
	Subframe (Note 1)				
	0	5	4,9	1-3, 6-8	
0 – 12	0	0	0	N/A	Note 2
37 – 49	0	0	0	N/A	
0 – 49	N/A	N/A	N/A	0	

Note 1: The allocation of any PDSCH with or without SIB1 applies only to the subframes not configured as PRS subframes.

Note 2: These physical resource blocks are assigned to an arbitrary number of virtual UEs with one PDSCH per virtual UE; the data transmitted over the OCNG PDSCHs shall be uncorrelated pseudo random data, which is QPSK modulated. The parameter γ_{PRB} is used to scale the power of PDSCH.

Note 3: If two or more transmit antennas with CRS are used in the test, the PDSCH part of OCNG shall be transmitted to the virtual users by all the transmit antennas with CRS and according to the antenna transmission mode 2. The parameter γ_{PRB} applies to each antenna port separately, so the transmit power of the PDSCH part of OCNG is equal between all the

transmit antennas with CRS used in the test. The antenna transmission modes are specified in clause 7.1 in TS 36.213.
N/A: Not Applicable

A.3.2.1.6 OCNG FDD pattern 6: full bandwidth allocation in 10 MHz (without MBSFN)

Table A.3.2.1.6-1: OP.6 FDD: OCNG FDD Pattern 6

Allocation n_{PRB}	Relative power level γ_{PRB} [dB]				PDSCH Data
	Subframe (Note 1)				
	0	5	4, 9	1 – 3, 6 – 8	
0 – 49	0	0	0	0	Note 2
<p>Note 1: The allocation of any PDSCH with or without SIB1 applies only to the subframes not configured as PRS subframes.</p> <p>Note 2: These physical resource blocks are assigned to an arbitrary number of virtual UEs with one PDSCH per virtual UE; the data transmitted over the OCNG PDSCHs shall be uncorrelated pseudo random data, which is QPSK modulated. The parameter γ_{PRB} is used to scale the power of PDSCH.</p> <p>Note 3: If two or more transmit antennas with CRS are used in the test, the PDSCH part of OCNG shall be transmitted to the virtual users by all the transmit antennas with CRS and according to the antenna transmission mode 2. The parameter γ_{PRB} applies to each antenna port separately, so the transmit power of the PDSCH part of OCNG is equal between all the transmit antennas with CRS used in the test. The antenna transmission modes are specified in clause 7.1 in TS 36.213.</p> <p>N/A: Not Applicable</p>					

A.3.2.1.7 OCNG FDD pattern 7: full bandwidth allocation in 1.4 MHz (without MBSFN)

Table A.3.2.1.7-1: OP.7 FDD: OCNG FDD Pattern 7

Allocation n_{PRB}	Relative power level γ_{PRB} [dB]				PDSCH Data
	Subframe (Note 1)				
	0	5	4, 9	1 – 3, 6 – 8	
0 – 5	0	0	0	0	Note 2
<p>Note 1: The allocation of any PDSCH with or without SIB1 applies only to the subframes not configured as PRS subframes.</p> <p>Note 2: These physical resource blocks are assigned to an arbitrary number of virtual UEs with one PDSCH per virtual UE; the data transmitted over the OCNG PDSCHs shall be uncorrelated pseudo random data, which is QPSK modulated. The parameter γ_{PRB} is used to scale the power of PDSCH.</p> <p>Note 3: If two or more transmit antennas with CRS are used in the test, the PDSCH part of OCNG shall be transmitted to the virtual users by all the transmit antennas with CRS and according to the antenna transmission mode 2. The parameter γ_{PRB} applies to each antenna port separately, so the transmit power of the PDSCH part of OCNG is equal between all the transmit antennas with CRS used in the test. The antenna transmission modes are specified in clause 7.1 in TS 36.213.</p> <p>N/A: Not Applicable</p>					

A.3.2.1.8 OCNG FDD pattern 8: outer resource blocks allocation in 10 MHz for MBSFN ABS

Table A.3.2.1.8-1: OP.8 FDD: OCNG FDD Pattern 8

Allocation n_{PRB}	Relative power level γ_{PRB} [dB]				PDSCH Data
	Subframe (Note 1)				
	0	5	4,9	(1-3, 6-8) ^{Note4}	
0 – 12	0	0	0	N/A	Note 2
37 – 49	0	0	0	N/A	
0 – 49	N/A	N/A	N/A	0	
Note 1:	PDSCH allocation does not apply to subframes configured as PRS subframes.				
Note 2:	These physical resource blocks are assigned to an arbitrary number of virtual UEs with one PDSCH per virtual UE; the data transmitted over the OCNG PDSCHs shall be uncorrelated pseudo random data, which is QPSK modulated. The parameter γ_{PRB} is used to scale the power of PDSCH.				
Note 3:	If two or more transmit antennas with CRS are used in the test, the PDSCH part of OCNG shall be transmitted to the virtual users by all the transmit antennas with CRS and according to the antenna transmission mode 2. The parameter γ_{PRB} applies to each antenna port separately, so the transmit power of the PDSCH part of OCNG is equal between all the transmit antennas with CRS used in the test. The antenna transmission modes are specified in clause 7.1 in TS 36.213.				
Note 4:	The subframe(s) configured as MBSFN ABS in a test shall not contain any PMCH data and shall contain CRS only in the first symbol of the first time slot. The subframe(s) configured as MBSFN ABS depend upon the MBSFN ABS pattern used in the test.				
N/A:	Not Applicable				

A.3.2.1.9 OCNG FDD pattern 9: full bandwidth allocation in 10 MHz for MBSFN ABS

Table A.3.2.1.9-1: OP.9 FDD: OCNG FDD Pattern 9

Allocation n_{PRB}	Relative power level γ_{PRB} [dB]				PDSCH Data
	Subframe (Note 1)				
	0	5	4, 9	(1-3, 6-8) ^{Note4}	
0 – 49	0	0	0	0	Note 2
Note 1:	PDSCH allocation applies only to subframes not configured as PRS subframes.				
Note 2:	These physical resource blocks are assigned to an arbitrary number of virtual UEs with one PDSCH per virtual UE; the data transmitted over the OCNG PDSCHs shall be uncorrelated pseudo random data, which is QPSK modulated. The parameter γ_{PRB} is used to scale the power of PDSCH.				
Note 3:	If two or more transmit antennas with CRS are used in the test, the PDSCH part of OCNG shall be transmitted to the virtual users by all the transmit antennas with CRS and according to the antenna transmission mode 2. The parameter γ_{PRB} applies to each antenna port separately, so the transmit power of the PDSCH part of OCNG is equal between all the transmit antennas with CRS used in the test. The antenna transmission modes are specified in clause 7.1 in TS 36.213.				
Note 4:	The subframe(s) configured as MBSFN ABS in a test shall not contain any PMCH data and shall contain CRS only in the first symbol of the first time slot. The subframe(s) configured as MBSFN ABS depend upon the MBSFN ABS pattern used in the test.				
N/A:	Not Applicable				

A.3.2.1.10 OCNG FDD pattern 10: outer resource blocks allocation in 10 MHz with user data in every subframe (without MBSFN)

Table A.3.2.1.10-1: OP.10 FDD: OCNG FDD Pattern 10

Allocation n_{PRB}	Relative power level γ_{PRB} [dB]				PDSCH Data
	Subframe (Note 1)				
	0	5	4, 9	1 - 3, 6 - 8	
0 - 12	0	0	0	0	Note 2
37 - 49	0	0	0	0	
Note 1:	The allocation of any PDSCH with or without SIB1 applies only to the subframes not configured as PRS subframes.				
Note 2:	These physical resource blocks are assigned to an arbitrary number of virtual UEs with one PDSCH per virtual UE; the data transmitted over the OCNG PDSCHs shall be uncorrelated pseudo random data, which is QPSK modulated. The parameter γ_{PRB} is used to scale the power of PDSCH.				
Note 3:	If two or more transmit antennas with CRS are used in the test, the PDSCH part of OCNG shall be transmitted to the virtual users by all the transmit antennas with CRS and according to the antenna transmission mode 2. The parameter γ_{PRB} applies to each antenna port separately, so the transmit power of the PDSCH part of OCNG is equal between all the transmit antennas with CRS used in the test. The antenna transmission modes are specified in section 7.1 in 3GPP TS 36.213.				
N/A:	Not Applicable				

A.3.2.1.11 OCNG FDD pattern 11: outer resource blocks allocation in 20 MHz

Table A.3.2.1.11-1: OP.11 FDD: OCNG FDD Pattern 11

Allocation n_{PRB}	Relative power level γ_{PRB} [dB]				PDSCH Data	PMCH Data
	Subframe					
	0	5	4,9	1-3, 6-8		
0 – 37	0	0	0	N/A	Note 1	N/A
62 – 99	0	0	0	N/A		
0-99	N/A	N/A	N/A	Note 4	N/A	Note 2
Note 1:	These physical resource blocks are assigned to an arbitrary number of virtual UEs with one PDSCH per virtual UE; the data transmitted over the OCNG PDSCHs shall be uncorrelated pseudo random data, which is QPSK modulated. The parameter γ_{PRB} is used to scale the power of PDSCH.					
Note 2:	Each physical resource block (PRB) is assigned to MBSFN transmission. The data in each PRB shall be uncorrelated with data in other PRBs over the period of any measurement. The MBSFN data shall be QPSK modulated. PMCH symbols shall not contain cell-specific Reference Signals. PMCH subframes shall contain cell-specific Reference Signals only in the first symbol of the first time slot. The parameter γ_{PRB} is used to scale the power of PMCH.					
Note 3:	If two or more transmit antennas with CRS are used in the test, the PDSCH part of OCNG shall be transmitted to the virtual users by all the transmit antennas with CRS and according to the antenna transmission mode 2. The parameter γ_{PRB} applies to each antenna port separately, so the transmit power of the PDSCH part of OCNG is equal between all the transmit antennas with CRS used in the test. The antenna transmission modes are specified in section 7.1 in 3GPP TS 36.213.					
Note 4:	0dB for 1 transmit antenna with CRS, +3dB for 2 transmit antennas with CRS					
N/A:	Not Applicable					

A.3.2.1.12 OCNG FDD pattern 12: full bandwidth allocation in 20 MHz

Table A.3.2.1.12-1: OP.12 FDD: OCNG FDD Pattern 12

Allocation n_{PRB}	Relative power level γ_{PRB} [dB]				PDSCH Data	PMCH Data
	Subframe					
	0	5	4, 9	1 – 3, 6 – 8		
0 – 99	0	0	0	N/A	Note 1	N/A
0 – 99	N/A	N/A	N/A	Note 4	N/A	Note 2
<p>Note 1: These physical resource blocks are assigned to an arbitrary number of virtual UEs with one PDSCH per virtual UE; the data transmitted over the OCNG PDSCHs shall be uncorrelated pseudo random data, which is QPSK modulated. The parameter γ_{PRB} is used to scale the power of PDSCH.</p> <p>Note 2: Each physical resource block (PRB) is assigned to MBSFN transmission. The data in each PRB shall be uncorrelated with data in other PRBs over the period of any measurement. The MBSFN data shall be QPSK modulated. PMCH subframes shall contain cell-specific Reference Signals only in the first symbol of the first time slot. The parameter γ_{PRB} is used to scale the power of PMCH.</p> <p>Note 3: If two or more transmit antennas with CRS are used in the test, the PDSCH part of OCNG shall be transmitted to the virtual users by all the transmit antennas with CRS and according to the antenna transmission mode 2. The parameter γ_{PRB} applies to each antenna port separately, so the transmit power of the PDSCH part of OCNG is equal between all the transmit antennas with CRS used in the test. The antenna transmission modes are specified in section 7.1 in 3GPP TS 36.213.</p> <p>Note 4: 0dB for 1 transmit antenna with CRS, +3dB for 2 transmit antennas with CRS</p> <p>N/A: Not Applicable</p>						

A.3.2.1.13 OCNG FDD pattern 13: outer resource blocks allocation in 20 MHz (without MBSFN)

Table A.3.2.1.13-1: OP.13 FDD: OCNG FDD Pattern 13

Allocation n_{PRB}	Relative power level γ_{PRB} [dB]				PDSCH Data
	Subframe (Note 1)				
	0	5	4,9	1-3, 6-8	
0 – 37	0	0	0	N/A	Note 2
62 – 99	0	0	0	N/A	
0 – 99	N/A	N/A	N/A	0	
<p>Note 1: The allocation of any PDSCH with or without SIB1 applies only to the subframes not configured as PRS subframes.</p> <p>Note 2: These physical resource blocks are assigned to an arbitrary number of virtual UEs with one PDSCH per virtual UE; the data transmitted over the OCNG PDSCHs shall be uncorrelated pseudo random data, which is QPSK modulated. The parameter γ_{PRB} is used to scale the power of PDSCH.</p> <p>Note 3: If two or more transmit antennas with CRS are used in the test, the PDSCH part of OCNG shall be transmitted to the virtual users by all the transmit antennas with CRS and according to the antenna transmission mode 2. The parameter γ_{PRB} applies to each antenna port separately, so the transmit power of the PDSCH part of OCNG is equal between all the transmit antennas with CRS used in the test. The antenna transmission modes are specified in section 7.1 in 3GPP TS 36.213.</p> <p>N/A: Not Applicable</p>					

A.3.2.1.14 OCNG FDD pattern 14: full bandwidth allocation in 20 MHz (without MBSFN)

Table A.3.2.1.14-1: OP.14 FDD: OCNG FDD Pattern 14

Allocation n_{PRB}	Relative power level γ_{PRB} [dB]				PDSCH Data
	Subframe (Note 1)				
	0	5	4, 9	1 – 3, 6 – 8	
0 – 99	0	0	0	0	Note 2
<p>Note 1: The allocation of any PDSCH with or without SIB1 applies only to the subframes not configured as PRS subframes.</p> <p>Note 2: These physical resource blocks are assigned to an arbitrary number of virtual UEs with one PDSCH per virtual UE; the data transmitted over the OCNG PDSCHs shall be uncorrelated pseudo random data, which is QPSK modulated. The parameter γ_{PRB} is used to scale the power of PDSCH.</p> <p>Note 3: If two or more transmit antennas with CRS are used in the test, the PDSCH part of OCNG shall be transmitted to the virtual users by all the transmit antennas with CRS and according to the antenna transmission mode 2. The parameter γ_{PRB} applies to each antenna port separately, so the transmit power of the PDSCH part of OCNG is equal between all the transmit antennas with CRS used in the test. The antenna transmission modes are specified in section 7.1 in 3GPP TS 36.213.</p> <p>N/A: Not Applicable</p>					

A.3.2.1.15 OCNG FDD pattern 15: outer resource blocks allocation in 5 MHz

Table A.3.2.1.15-1: OP.15 FDD: OCNG FDD Pattern 15

Allocation n_{PRB}	Relative power level γ_{PRB} [dB]				PDSCH Data	PMCH Data
	Subframe					
	0	5	4,9	1-3, 6-8		
0 – 6	0	0	0	N/A	Note 1	N/A
18 – 24	0	0	0	N/A		
0-24	N/A	N/A	N/A	Note 4	N/A	Note 2
<p>Note 1: These physical resource blocks are assigned to an arbitrary number of virtual UEs with one PDSCH per virtual UE; the data transmitted over the OCNG PDSCHs shall be uncorrelated pseudo random data, which is QPSK modulated. The parameter γ_{PRB} is used to scale the power of PDSCH.</p> <p>Note 2: Each physical resource block (PRB) is assigned to MBSFN transmission. The data in each PRB shall be uncorrelated with data in other PRBs over the period of any measurement. The MBSFN data shall be QPSK modulated. PMCH symbols shall not contain cell-specific Reference Signals. PMCH subframes shall contain cell-specific Reference Signals only in the first symbol of the first time slot. The parameter γ_{PRB} is used to scale the power of PMCH.</p> <p>Note 3: If two or more transmit antennas with CRS are used in the test, the PDSCH part of OCNG shall be transmitted to the virtual users by all the transmit antennas with CRS and according to the antenna transmission mode 2. The parameter γ_{PRB} applies to each antenna port separately, so the transmit power of the PDSCH part of OCNG is equal between all the transmit antennas with CRS used in the test. The antenna transmission modes are specified in section 7.1 in 3GPP TS 36.213.</p> <p>Note 4: 0dB for 1 transmit antenna with CRS, +3dB for 2 transmit antennas with CRS</p> <p>N/A: Not Applicable</p>						

A.3.2.1.16 OCNG FDD pattern 16: full bandwidth allocation in 5 MHz

Table A.3.2.1.16-1: OP.16 FDD: OCNG FDD Pattern 16

Allocation n_{PRB}	Relative power level γ_{PRB} [dB]				PDSCH Data	PMCH Data
	Subframe					
	0	5	4, 9	1 - 3, 6 - 8		
0 - 24	0	0	0	N/A	Note 1	N/A
0 - 24	N/A	N/A	N/A	Note 4	N/A	Note 2
<p>Note 1: These physical resource blocks are assigned to an arbitrary number of virtual UEs with one PDSCH per virtual UE; the data transmitted over the OCNG PDSCHs shall be uncorrelated pseudo random data, which is QPSK modulated. The parameter γ_{PRB} is used to scale the power of PDSCH.</p> <p>Note 2: Each physical resource block (PRB) is assigned to MBSFN transmission. The data in each PRB shall be uncorrelated with data in other PRBs over the period of any measurement. The MBSFN data shall be QPSK modulated. PMCH subframes shall contain cell-specific Reference Signals only in the first symbol of the first time slot. The parameter γ_{PRB} is used to scale the power of PMCH.</p> <p>Note 3: If two or more transmit antennas with CRS are used in the test, the PDSCH part of OCNG shall be transmitted to the virtual users by all the transmit antennas with CRS and according to the antenna transmission mode 2. The parameter γ_{PRB} applies to each antenna port separately, so the transmit power of the PDSCH part of OCNG is equal between all the transmit antennas with CRS used in the test. The antenna transmission modes are specified in section 7.1 in 3GPP TS 36.213.</p> <p>Note 4: 0dB for 1 transmit antenna with CRS, +3dB for 2 transmit antennas with CRS</p> <p>N/A: Not Applicable</p>						

A.3.2.1.17 OCNG FDD pattern 17: outer resource blocks allocation in 20 MHz with user data in every subframe (without MBSFN)

Table A.3.2.1.17-1: OP.17 FDD: OCNG FDD Pattern 17

Allocation n_{PRB}	Relative power level γ_{PRB} [dB]				PDSCH Data
	Subframe (Note 1)				
	0	5	4, 9	1 - 3, 6 - 8	
0 - 37	0	0	0	0	Note 2
62 - 99	0	0	0	0	
<p>Note 1: The allocation of any PDSCH with or without SIB1 applies only to the subframes not configured as PRS subframes.</p> <p>Note 2: These physical resource blocks are assigned to an arbitrary number of virtual UEs with one PDSCH per virtual UE; the data transmitted over the OCNG PDSCHs shall be uncorrelated pseudo random data, which is QPSK modulated. The parameter γ_{PRB} is used to scale the power of PDSCH.</p> <p>Note 3: If two or more transmit antennas with CRS are used in the test, the PDSCH part of OCNG shall be transmitted to the virtual users by all the transmit antennas with CRS and according to the antenna transmission mode 2. The parameter γ_{PRB} applies to each antenna port separately, so the transmit power of the PDSCH part of OCNG is equal between all the transmit antennas with CRS used in the test. The antenna transmission modes are specified in section 7.1 in 3GPP TS 36.213.</p> <p>N/A: Not Applicable.</p>					

A.3.2.1.18 OCNG FDD pattern 18: outer resource blocks allocation in 5 MHz (without MBSFN)

Table A.3.2.1.18-1: OP.18 FDD: OCNG FDD Pattern 18

Allocation n_{PRB}	Relative power level γ_{PRB} [dB]		PDSCH Data
	Subframe (Note 1)		

	0	5	4,9	1-3, 6-8	
0 – 6	0	0	0	N/A	Note 2
18 – 24	0	0	0	N/A	
0 – 24	N/A	N/A	N/A	0	
Note 1:	The allocation of any PDSCH with or without SIB1 applies only to the subframes not configured as PRS subframes.				
Note 2:	These physical resource blocks are assigned to an arbitrary number of virtual UEs with one PDSCH per virtual UE; the data transmitted over the OCNG PDSCHs shall be uncorrelated pseudo random data, which is QPSK modulated. The parameter γ_{PRB} is used to scale the power of PDSCH.				
Note 3:	If two or more transmit antennas with CRS are used in the test, the PDSCH part of OCNG shall be transmitted to the virtual users by all the transmit antennas with CRS and according to the antenna transmission mode 2. The parameter γ_{PRB} applies to each antenna port separately, so the transmit power of the PDSCH part of OCNG is equal between all the transmit antennas with CRS used in the test. The antenna transmission modes are specified in section 7.1 in 3GPP TS 36.213.				
N/A:	Not Applicable				

A.3.2.1.19 OCNG FDD pattern 19: full bandwidth allocation in 5 MHz (without MBSFN)

Table A.3.2.1.19-1: OP.19 FDD: OCNG FDD Pattern 19

Allocation n_{PRB}	Relative power level γ_{PRB} [dB]				PDSCH Data
	Subframe (Note 1)				
	0	5	4, 9	1 – 3, 6 – 8	
0 – 24	0	0	0	0	Note 2
Note 1:	The allocation of any PDSCH with or without SIB1 applies only to the subframes not configured as PRS subframes.				
Note 2:	These physical resource blocks are assigned to an arbitrary number of virtual UEs with one PDSCH per virtual UE; the data transmitted over the OCNG PDSCHs shall be uncorrelated pseudo random data, which is QPSK modulated. The parameter γ_{PRB} is used to scale the power of PDSCH.				
Note 3:	If two or more transmit antennas with CRS are used in the test, the PDSCH part of OCNG shall be transmitted to the virtual users by all the transmit antennas with CRS and according to the antenna transmission mode 2. The parameter γ_{PRB} applies to each antenna port separately, so the transmit power of the PDSCH part of OCNG is equal between all the transmit antennas with CRS used in the test. The antenna transmission modes are specified in section 7.1 in 3GPP TS 36.213.				
N/A:	Not Applicable				

A.3.2.1.20 OCNG FDD pattern 20: outer resource blocks allocation in 5 MHz with user data in every subframe (without MBSFN)

Table A.3.2.1.20-1: OP.20 FDD: OCNG FDD Pattern 20

Allocation n_{PRB}	Relative power level γ_{PRB} [dB]				PDSCH Data
	Subframe (Note 1)				
	0	5	4, 9	1 - 3, 6 - 8	
0 - 6	0	0	0	0	Note 2
18 - 24	0	0	0	0	
Note 1:	The allocation of any PDSCH with or without SIB1 applies only to the subframes not configured as PRS subframes.				

Note 2:	These physical resource blocks are assigned to an arbitrary number of virtual UEs with one PDSCH per virtual UE; the data transmitted over the OCNG PDSCHs shall be uncorrelated pseudo random data, which is QPSK modulated. The parameter γ_{PRB} is used to scale the power of PDSCH.
Note 3:	If two or more transmit antennas with CRS are used in the test, the PDSCH part of OCNG shall be transmitted to the virtual users by all the transmit antennas with CRS and according to the antenna transmission mode 2. The parameter γ_{PRB} applies to each antenna port separately, so the transmit power of the PDSCH part of OCNG is equal between all the transmit antennas with CRS used in the test. The antenna transmission modes are specified in section 7.1 in 3GPP TS 36.213.
N/A:	Not Applicable.

A.3.2.1.21 OCNG FDD pattern 21: Generic resource blocks allocation (without MBSFN)

Table A.3.2.1.21-1: OP.21 FDD: OCNG FDD Pattern 21

OCNG Pattern Name	Bandwidth (MHz)	Allocation n_{PRB}	Relative power level γ_{PRB} [dB]				PDSCH Data
			Subframe ^{Note 5}				
			0	5	4, 9	1 – 3, 6 – 8	
OP.21 FDD	10	0 – 49 ^{Note 1,2}	0	0	0	0	Note 3
<p>Note 1: The OCNG pattern is used only for a serving cell of the UE under test.</p> <p>Note 2: The OCNG allocation applied to all downlink physical resource blocks (PRBs) except the REs that are allocated for the PDSCH for the UE under test.</p> <p>Note 3: OCNG PRBs are assigned to an arbitrary number of virtual UEs with one PDSCH per virtual UE; the data transmitted over the OCNG PDSCHs shall be uncorrelated pseudo random data, which is QPSK modulated. The parameter γ_{PRB} is used to scale the power of PDSCH.</p> <p>Note 4: If two or more transmit antennas with CRS are used in the test, the PDSCH part of OCNG shall be transmitted to the virtual users by all the transmit antennas with CRS and according to the antenna transmission mode 2. The parameter γ_{PRB} applies to each antenna port separately, so the transmit power of the PDSCH part of OCNG is equal between all the transmit antennas with CRS used in the test. The antenna transmission modes are specified in clause 7.1 in TS 36.213.</p> <p>Note 5: The allocation of any PDSCH with or without SIB1 applies only to the subframes not configured as PRS subframes.</p>							

A.3.2.1.22 OCNG FDD pattern 22: Generic resource blocks allocation in 5MHz (without MBSFN)

Table A.3.2.1.22-1: OP.22 FDD: OCNG FDD Pattern 22

OCNG Pattern Name	Bandwidth (MHz)	Allocation n_{PRB}	Relative power level γ_{PRB} [dB]				PDSCH Data
			Subframe				
			0	5	4, 9	1 – 3, 6 – 8	
OP.22 FDD	5	0 – 24 ^{Note 1,2}	0	0	0	0	Note 3
<p>Note 1: The OCNG pattern is used only for a serving cell of the UE under test.</p> <p>Note 2: The OCNG allocation applied to all downlink physical resource blocks (PRBs) except the REs that are allocated for the PDSCH for the UE under test.</p> <p>Note 3: OCNG PRBs are assigned to an arbitrary number of virtual UEs with one PDSCH per virtual UE; the data transmitted over the OCNG PDSCHs shall be uncorrelated pseudo random data, which is QPSK modulated. The parameter γ_{PRB} is used to scale the power of PDSCH.</p> <p>Note 4: If two or more transmit antennas with CRS are used in the test, the PDSCH part of OCNG shall be transmitted to the virtual users by all the transmit antennas with CRS and according to the antenna transmission mode 2. The parameter γ_{PRB} applies to each antenna port separately, so the transmit power of the PDSCH part of OCNG is equal between all the transmit antennas with CRS used in the test. The antenna transmission modes are specified in clause 7.1 in TS 36.213.</p>							

A.3.2.2 OCNG Patterns for TDD

The following OCNG patterns are used for modelling allocations to virtual UEs (which are not under test). The OCNG pattern for each sub frame specifies the allocations that shall be filled with OCNG, and furthermore, the relative power level of each such allocation.

In each test case the OCNG is expressed by parameters OCNG_RA and OCNG_RB which together with a relative power level (γ) specifies the PDSCH EPRE-to-RS EPRE ratios in OFDM symbols without and with reference symbols, respectively. The relative power, which is used for modelling boosting per virtual UE allocation, is expressed by:

$$\gamma_i = PDSCH_RA / OCNG_RA = PDSCH_RB / OCNG_RB$$

where γ_i denotes the relative power level of the i :th virtual UE. The parameter settings of OCNG_RA, OCNG_RB, and the set of relative power levels γ are chosen such that when also taking allocations to the UE under test into account, as given by a PDSCH reference channel, a transmitted power spectral density that is constant on an OFDM symbol basis is targeted.

Moreover the OCNG pattern is accompanied by a PCFICH/PDCCH/PHICH reference channel which specifies the control region. The number of PDCCH OFDM symbols in the non-MBSFN subframes is the same as specified in the RMC used in the test. The number of PDCCH OFDM symbols in the MBSFN subframe is the maximal allowed according to TS 36.213 [16]. For any aggregation and PHICH allocation, the PDCCH and any unused PHICH groups are padded with resource element groups with a power level given by PDCCH_RA/RB and PHICH_RA/RB as specified in the test case such that a total power spectral density in the control region that is constant on an OFDM symbol basis is targeted.

For subframes configured as PRS subframes the PDSCH allocation defined in the OCNG pattern does not apply.

For subframes configured as ABS subframes the PDSCH and PMCH allocation defined in the OCNG pattern does not apply.

The system information is scheduled in the allocations reserved for the OCNG patterns, in the subframes not configured for MBSFN. For this purpose the number of the RB-s allocated with PDSCH defined in the OCNG pattern can be reduced as necessary.

A.3.2.2.1 OCNG TDD pattern 1: outer resource blocks allocation in 10 MHz

Table A.3.2.2.1-1: OP.1 TDD: OCNG TDD Pattern 1 for 5ms downlink-to-uplink switch-point periodicity

Allocation n_{PRB}	Relative power level γ_{PRB} [dB]				PDSCH Data
	Subframe (Note 1)				
	0	5	3, 4, 8, 9 and 6 (as normal subframe) Note 3	1 and 6 (as special subframe) Note 3	
0 – 12	0	0	0	Table A.3.2.2.1-2	Note 2
37 – 49	0	0	0		
<p>Note 1: The allocation of any PDSCH with or without SIB1 applies only to the subframes not configured as PRS subframes.</p> <p>Note 2: These physical resource blocks are assigned to an arbitrary number of virtual UEs with one PDSCH per virtual UE; the data transmitted over the OCNG PDSCHs shall be uncorrelated pseudo random data, which is QPSK modulated. The parameter γ_{PRB} is used to scale the power of PDSCH.</p> <p>Note 3: Subframes available for DL transmission depends on the Uplink-Downlink configuration defined in Table 4.2-2 in TS 36.211 [16].</p> <p>Note 4: If two or more transmit antennas with CRS are used in the test, the OCNG shall be transmitted to the virtual users by all the transmit antennas with CRS and according to the antenna transmission mode 2. The parameter γ_{PRB} applies to each antenna port separately, so the transmit power is equal between all the transmit antennas with CRS used in the test. The antenna transmission modes are specified in clause 7.1 in TS 36.213.</p>					

Note 5: If SPDCCH is to be transmitted on a physical resource block (PRB), this takes priority over OCNB transmission

Table A.3.2.2.1-2: OP.1 TDD: OCNB TDD Pattern 1 for special subframe configuration with 5ms downlink-to-uplink switch-point periodicity

Allocation n_{PRB}	Relative power level γ_{PRB} [dB]																	
	Special subframe configuration																	
	0		1		2		3		4		5		6		7		8	
	Control region OFDM symbols																	
	1	2	1	2	1	2	1	2	1	2	1	2	1	2	1	2	1	2
0 – 12	0	0	0	0	0	0	0	0	0	0	0	0	0	0	0	0	0	0
37 – 49	0	0	0	0	0	0	0	0	0	0	0	0	0	0	0	0	0	0

Note 1: Special subframe configurations are defined in Table 4.2-1 in TS 36.211 [16].

A.3.2.2.2 OCNB TDD pattern 2: full bandwidth allocation in 10 MHz

Table A.3.2.2.2-1: OP.2 TDD: OCNB TDD Pattern 2 for 5ms downlink-to-uplink switch-point periodicity

Allocation n_{PRB}	Relative power level γ_{PRB} [dB]				PDSCH Data
	Subframe (Note 1)				
	0	5	3, 4, 8, 9 and 6 (as normal subframe) ^{Note 3}	1 and 6 (as special subframe) ^{Note 3}	
0 – 49	0	0	0	0	Note 2

Note 1: The allocation of any PDSCH with or without SIB1 applies only to the subframes not configured as PRS subframes.

Note 2: These physical resource blocks are assigned to an arbitrary number of virtual UEs with one PDSCH per virtual UE; the data transmitted over the OCNB PDSCHs shall be uncorrelated pseudo random data, which is QPSK modulated. The parameter γ_{PRB} is used to scale the power of PDSCH.

Note 3: Subframes available for DL transmission depends on the Uplink-Downlink configuration in Table 4.2-2 in TS 36.211 [16].

Note 4: If two or more transmit antennas with CRS are used in the test, the OCNB shall be transmitted to the virtual users by all the transmit antennas with CRS and according to the antenna transmission mode 2. The parameter γ_{PRB} applies to each antenna port separately, so the transmit power is equal between all the transmit antennas with CRS used in the test. The antenna transmission modes are specified in clause 7.1 in TS 36.213.

A.3.2.2.3 OCNB TDD pattern 3: outer resource blocks allocation in 1.4 MHz

Table A.3.2.2.3-1: OP.3 TDD: OCNB TDD Pattern 3 for 5 ms downlink-to-uplink switch-point periodicity

Allocation n_{PRB}	Relative power level γ_{PRB} [dB]		PDSCH Data
	Subframe (Note 1)		

	0	5	3, 4, 8, 9 and 6 (as normal subframe) <small>Note 3</small>	1 and 6 (as special subframe) <small>Note 3</small>	
0 – 1	0	0	0	0	Note 2
4 – 5	0	0	0	0	
<p>Note 1: The allocation of any PDSCH with or without SIB1 applies only to the subframes not configured as PRS subframes.</p> <p>Note 2: These physical resource blocks are assigned to an arbitrary number of virtual UEs with one PDSCH per virtual UE; the data transmitted over the OCNG PDSCHs shall be uncorrelated pseudo random data, which is QPSK modulated. The parameter γ_{PRB} is used to scale the power of PDSCH.</p> <p>Note 3: Subframes available for DL transmission depends on the Uplink-Downlink configuration defined in Table 4.2-2 in TS 36.211 [16].</p> <p>Note 4: If two or more transmit antennas with CRS are used in the test, the OCNG shall be transmitted to the virtual users by all the transmit antennas with CRS and according to the antenna transmission mode 2. The parameter γ_{PRB} applies to each antenna port separately, so the transmit power is equal between all the transmit antennas with CRS used in the test. The antenna transmission modes are specified in clause 7.1 in TS 36.213.</p>					

A.3.2.2.4 OCNG TDD pattern 4: full bandwidth allocation in 1.4 MHz

Table A.3.2.2.4-1: OP.4 TDD: OCNG TDD Pattern 4 for 5 ms downlink-to-uplink switch-point periodicity

Allocation n_{PRB}	Relative power level γ_{PRB} [dB]				PDSCH Data
	Subframe (Note 1)				
	0	5	3, 4, 8, 9 and 6 (as normal subframe) <small>Note 3</small>	1 and 6 (as special subframe) <small>Note 3</small>	
0 – 5	0	0	0	0	Note 2
<p>Note 1: The allocation of any PDSCH with or without SIB1 applies only to the subframes not configured as PRS subframes.</p> <p>Note 2: These physical resource blocks are assigned to an arbitrary number of virtual UEs with one PDSCH per virtual UE; the data transmitted over the OCNG PDSCHs shall be uncorrelated pseudo random data, which is QPSK modulated. The parameter γ_{PRB} is used to scale the power of PDSCH.</p> <p>Note 3: Subframes available for DL transmission depends on the Uplink-Downlink configuration in Table 4.2-2 in TS 36.211 [16].</p> <p>Note 4: If two or more transmit antennas with CRS are used in the test, the OCNG shall be transmitted to the virtual users by all the transmit antennas with CRS and according to the antenna transmission mode 2. The parameter γ_{PRB} applies to each antenna port separately, so the transmit power is equal between all the transmit antennas with CRS used in the test. The antenna transmission modes are specified in clause 7.1 in TS 36.213.</p>					

A.3.2.2.5 OCNG TDD pattern 5: outer resource blocks allocation in 10 MHz for MBSFN ABS

Table A.3.2.2.5-1: OP.5 TDD: OCNG TDD Pattern 5 for 5ms downlink-to-uplink switch-point periodicity

Allocation n_{PRB}	Relative power level γ_{PRB} [dB]				PDSCH Data
	Subframe (Note 1)				
	0	5	3, 4, 8, 9 and 6 (as normal subframe) <small>Note 3</small>	1 and 6 (as special subframe) <small>Note 3</small>	

0 – 12	0	0	0	Table A.3.2.2.5-2	Note 2
37 – 49	0	0	0		
<p>Note 1: PDSCH allocation does not apply to subframes configured as PRS subframes.</p> <p>Note 2: These physical resource blocks are assigned to an arbitrary number of virtual UEs with one PDSCH per virtual UE; the data transmitted over the OCNG PDSCHs shall be uncorrelated pseudo random data, which is QPSK modulated. The parameter γ_{PRB} is used to scale the power of PDSCH.</p> <p>Note 3: Subframes available for DL transmission depends on the Uplink-Downlink configuration defined in Table 4.2-2 in TS 36.211 [16]. Any of the subframes 3, 4, 8 and 9 configured as MBSFN ABS in a test shall not contain any PMCH data and shall contain CRS only in the first symbol of the first time slot. The subframe(s) configured as MBSFN ABS depend upon the MBSFN ABS pattern used in the test.</p> <p>Note 4: If two or more transmit antennas with CRS are used in the test, the OCNG shall be transmitted to the virtual users by all the transmit antennas with CRS and according to the antenna transmission mode 2. The parameter γ_{PRB} applies to each antenna port separately, so the transmit power is equal between all the transmit antennas with CRS used in the test. The antenna transmission modes are specified in clause 7.1 in TS 36.213.</p>					

Table A.3.2.2.5-2: OP.5 TDD: OCNB TDD Pattern 5 for special subframe configuration with 5ms downlink-to-uplink switch-point periodicity

Allocation n_{PRB}	Relative power level γ_{PRB} [dB]																	
	Special subframe configuration																	
	0		1		2		3		4		5		6		7		8	
	Control region OFDM symbols																	
	1	2	1	2	1	2	1	2	1	2	1	2	1	2	1	2	1	2
0 – 12	0		0		0		0		0		0		0		0		0	
37 – 49	0		0		0		0		0		0		0		0		0	

Note 1: Special subframe configurations are defined in Table 4.2-1 in TS 36.211 [16].

A.3.2.2.6 OCNB TDD pattern 6: full bandwidth allocation in 10 MHz for MBSFN ABS

Table A.3.2.2.6-1: OP.6 TDD: OCNB TDD Pattern 6 for 5ms downlink-to-uplink switch-point periodicity

Allocation n_{PRB}	Relative power level γ_{PRB} [dB]				PDSCH Data
	Subframe (Note 1)				
	0	5	3, 4, 8, 9 and 6 (as normal subframe) ^{Note 3}	1 and 6 (as special subframe) ^{Note 3}	
0 – 49	0	0	0	0	Note 2

Note 1: PDSCH allocation does not apply to subframes configured as PRS subframes.
 Note 2: These physical resource blocks are assigned to an arbitrary number of virtual UEs with one PDSCH per virtual UE; the data transmitted over the OCNB PDSCHs shall be uncorrelated pseudo random data, which is QPSK modulated. The parameter γ_{PRB} is used to scale the power of PDSCH.
 Note 3: Subframes available for DL transmission depends on the Uplink-Downlink configuration in Table 4.2-2 in TS 36.211 [16]. Any of the subframes 3, 4, 8 and 9 configured as MBSFN ABS in a test shall not contain any PMCH data and shall contain CRS only in the first symbol of the first time slot. The subframe(s) configured as MBSFN ABS depend upon the MBSFN ABS pattern used in the test.
 Note 4: If two or more transmit antennas with CRS are used in the test, the OCNB shall be transmitted to the virtual users by all the transmit antennas with CRS and according to the antenna transmission mode 2. The parameter γ_{PRB} applies to each antenna port separately, so the transmit power is equal between all the transmit antennas with CRS used in the test. The antenna transmission modes are specified in clause 7.1 in TS 36.213.

A.3.2.2.7 OCNB TDD pattern 7: outer resource blocks allocation in 20 MHz

Table A.3.2.2.7-1: OP.7 TDD: OCNB TDD Pattern 7 for 5ms downlink-to-uplink switch-point periodicity

Allocation n_{PRB}	Relative power level γ_{PRB} [dB]				PDSCH Data
	Subframe (Note 1)				
	0	5	3, 4, 8, 9 and 6 (as normal subframe) ^{Note 3}	1 and 6 (as special subframe) ^{Note 3}	
0 – 37	0	0	0	Table A.3.2.2.7-2	Note 2
62 – 99	0	0	0		

Note 1:	The allocation of any PDSCH with or without SIB1 applies only to the subframes not configured as PRS subframes.
Note 2:	These physical resource blocks are assigned to an arbitrary number of virtual UEs with one PDSCH per virtual UE; the data transmitted over the OCNB PDSCHs shall be uncorrelated pseudo random data, which is QPSK modulated. The parameter γ_{PRB} is used to scale the power of PDSCH.
Note 3:	Subframes available for DL transmission depends on the Uplink-Downlink configuration defined in Table 4.2-2 in 3GPP TS 36.211 [16].
Note 4:	If two or more transmit antennas with CRS are used in the test, the OCNB shall be transmitted to the virtual users by all the transmit antennas with CRS and according to the antenna transmission mode 2. The parameter γ_{PRB} applies to each antenna port separately, so the transmit power is equal between all the transmit antennas with CRS used in the test. The antenna transmission modes are specified in section 7.1 in 3GPP TS 36.213.

Table A.3.2.2.7-2: OP.7 TDD: OCNB TDD Pattern 7 for special subframe configuration with 5ms downlink-to-uplink switch-point periodicity

Allocation n_{PRB}	CP length	Relative power level γ_{PRB} [dB]																	
		Special subframe configuration																	
		0		1		2		3		4		5		6		7		8	
Control region OFDM symbols																			
		1	2	1	2	1	2	1	2	1	2	1	2	1	2	1	2	1	2
0 – 37	N	0	0	0	0	0	0	0	0	0	0	0	0	0	0	0	0	0	0
62 – 99	N	0	0	0	0	0	0	0	0	0	0	0	0	0	0	0	0	0	0

Note 1: Special subframe configurations are defined in Table 4.2-1 in TS 36.211 [16].

A.3.2.2.8 OCNB TDD pattern 8: full bandwidth allocation in 20 MHz

Table A.3.2.2.8-1: OP.8 TDD: OCNB TDD Pattern 8 for 5ms downlink-to-uplink switch-point periodicity

Allocation n_{PRB}	Relative power level γ_{PRB} [dB]				PDSCH Data
	Subframe (Note 1)				
	0	5	3, 4, 8, 9 and 6 (as normal subframe) ^{Note 3}	1 and 6 (as special subframe) ^{Note 3}	
0 – 99	0	0	0	0	Note 2

Note 1:	The allocation of any PDSCH with or without SIB1 applies only to the subframes not configured as PRS subframes
Note 2:	These physical resource blocks are assigned to an arbitrary number of virtual UEs with one PDSCH per virtual UE; the data transmitted over the OCNB PDSCHs shall be uncorrelated pseudo random data, which is QPSK modulated. The parameter γ_{PRB} is used to scale the power of PDSCH.
Note 3:	Subframes available for DL transmission depends on the Uplink-Downlink configuration in Table 4.2-2 in 3GPP TS 36.211 [16].
Note 4:	If two or more transmit antennas with CRS are used in the test, the OCNB shall be transmitted to the virtual users by all the transmit antennas with CRS and according to the antenna transmission mode 2. The parameter γ_{PRB} applies to each antenna port separately, so the transmit power is equal between all the transmit antennas with CRS used in the test. The antenna transmission modes are specified in section 7.1 in 3GPP TS 36.213.

A.3.2.2.9 OCNB TDD pattern 9: outer resource blocks allocation in 5 MHz

Table A.3.2.2.9-1: OP.9 TDD: OCNB TDD Pattern 9 for 5ms downlink-to-uplink switch-point periodicity

Allocation n_{PRB}	Relative power level γ_{PRB} [dB]	PDSCH Data
	Subframe (Note 1)	

	0	5	3, 4, 8, 9 and 6 (as normal subframe) ^{Note 3}	1 and 6 (as special subframe) ^{Note 3}	
0 – 6	0	0	0	Table A.3.2.2.9-2	Note 2
18 – 24	0	0	0		
<p>Note 1: The allocation of any PDSCH with or without SIB1 applies only to the subframes not configured as PRS subframes.</p> <p>Note 2: These physical resource blocks are assigned to an arbitrary number of virtual UEs with one PDSCH per virtual UE; the data transmitted over the OCNB PDSCHs shall be uncorrelated pseudo random data, which is QPSK modulated. The parameter γ_{PRB} is used to scale the power of PDSCH.</p> <p>Note 3: Subframes available for DL transmission depends on the Uplink-Downlink configuration defined in Table 4.2-2 in 3GPP TS 36.211 [16].</p> <p>Note 4: If two or more transmit antennas with CRS are used in the test, the OCNB shall be transmitted to the virtual users by all the transmit antennas with CRS and according to the antenna transmission mode 2. The parameter γ_{PRB} applies to each antenna port separately, so the transmit power is equal between all the transmit antennas with CRS used in the test. The antenna transmission modes are specified in section 7.1 in 3GPP TS 36.213.</p>					

Table A.3.2.2.9-2: OP.9 TDD: OCNB TDD Pattern 9 for special subframe configuration with 5ms downlink-to-uplink switch-point periodicity

Allocation n_{PRB}	CP length	Relative power level γ_{PRB} [dB]																	
		Special subframe configuration																	
		0		1		2		3		4		5		6		7		8	
		Control region OFDM symbols																	
		1	2	1	2	1	2	1	2	1	2	1	2	1	2	1	2	1	2
0 – 6	N	0	0	0	0	0	0	0	0	0	0	0	0	0	0	0	0	0	0
18 – 24	N	0	0	0	0	0	0	0	0	0	0	0	0	0	0	0	0	0	0

Note 1: Special subframe configurations are defined in Table 4.2-1 in TS 36.211 [16].

A.3.2.2.10 OCNB TDD pattern 10: full bandwidth allocation in 5 MHz

Table A.3.2.2.10-1: OP.10 TDD: OCNB TDD Pattern 10 for 5ms downlink-to-uplink switch-point periodicity

Allocation n_{PRB}	Relative power level γ_{PRB} [dB]				PDSCH Data
	Subframe (Note 1)				
	0	5	3, 4, 8, 9 and 6 (as normal subframe) ^{Note 3}	1 and 6 (as special subframe) ^{Note 3}	
0 – 24	0	0	0	0	Note 2
<p>Note 1: The allocation of any PDSCH with or without SIB1 applies only to the subframes not configured as PRS subframes.</p> <p>Note 2: These physical resource blocks are assigned to an arbitrary number of virtual UEs with one PDSCH per virtual UE; the data transmitted over the OCNB PDSCHs shall be uncorrelated pseudo random data, which is QPSK modulated. The parameter γ_{PRB} is used to scale the power of PDSCH.</p> <p>Note 3: Subframes available for DL transmission depends on the Uplink-Downlink configuration in Table 4.2-2 in 3GPP TS 36.211 [16].</p> <p>Note 4: If two or more transmit antennas with CRS are used in the test, the OCNB shall be transmitted to the virtual users by all the transmit antennas with CRS and according to the antenna transmission mode 2. The parameter γ_{PRB} applies to each antenna port separately, so the</p>					

transmit power is equal between all the transmit antennas with CRS used in the test. The antenna transmission modes are specified in section 7.1 in 3GPP TS 36.213.

A.3.2.2.11 OCNG TDD pattern 11: Generic resource blocks allocation (without MBSFN)

Table A.3.2.2.11-1: OP.11 TDD: OCNG TDD Pattern 11

OCNG Pattern Name	Bandwidth (MHz)	Allocation n_{PRB}	Relative power level γ_{PRB} [dB]				PDSCH Data
			Subframe ^{Note 6}				
			0	5	3, 4, 8, 9 and 6 (as normal subframe) ^{Note 5}	1 and 6 (as special subframe) ^{Note 5}	
OP.11 TDD	10	0 – 49 ^{Note 1,2}	0	0	0	0	Note 3
<p>Note 1: The OCNG pattern is used only for a serving cell of the UE under test.</p> <p>Note 2: The OCNG allocation applied to all downlink physical resource blocks (PRBs) except the REs that are allocated for the PDSCH for the UE under test.</p> <p>Note 3: OCNG PRBs are assigned to an arbitrary number of virtual UEs with one PDSCH per virtual UE; the data transmitted over the OCNG PDSCHs shall be uncorrelated pseudo random data, which is QPSK modulated. The parameter γ_{PRB} is used to scale the power of PDSCH.</p> <p>Note 4: If two or more transmit antennas with CRS are used in the test, the PDSCH part of OCNG shall be transmitted to the virtual users by all the transmit antennas with CRS and according to the antenna transmission mode 2. The parameter γ_{PRB} applies to each antenna port separately, so the transmit power of the PDSCH part of OCNG is equal between all the transmit antennas with CRS used in the test. The antenna transmission modes are specified in clause 7.1 in TS 36.213.</p> <p>Note 5: Subframes available for DL transmission depends on the Uplink-Downlink configuration in Table 4.2-2 in TS 36.211 [16].</p> <p>Note 6: The allocation of any PDSCH with or without SIB1 applies only to the subframes not configured as PRS subframes.</p>							

A.3.2.3 OCNG Patterns for Narrowband IoT

The following Narrowband OCNG patterns (NOCNG) are used for modelling allocations to UEs not under test in a Narrowband IoT cell. Depending on scenario, allocations may be for UEs of category NB1only, or for UEs of category NB1 as well as of other categories. The former is applicable to guard-band and stand-alone deployments of Narrowband IoT, whereas the latter is applicable to in-band deployment. In order to allow different power levels for the LTE cell and the Narrowband IoT cell, a distinction is made between OCNG and NOCNG where the latter is used for category NB1 UEs and the former is used for other UE categories.

OCNG in the LTE cell is expressed by parameters OCNG_RA and OCNG_RB which together with a relative power level (γ) specifies the PDSCH-to-RS EPRE ratio in OFDM symbols with and without LTE cell-specific reference symbols, respectively. The relative power, which is used for modelling boosting per virtual LTE UE allocation, is expressed by:

$$\gamma_i = PDSCH_{RA} / OCNG_{RA} = PDSCH_{RB} / OCNG_{RB}$$

where γ_i denotes the relative power level of the i :th virtual LTE UE.

Moreover in each test case NOCNG is expressed by parameters NOCNG_RA and NOCNG_RB which together with a relative power level (γ) specifies the <channel>-to-RS EPRE ratio in OFDM symbols with and without Narrowband reference symbols (NB-RS), respectively. The relative power, which is used for modelling boosting per virtual UE category NB1 allocation, is expressed by:

$$\gamma_k = \langle channel \rangle_k_{RA} / NOCNG_{RA} = \langle channel \rangle_k_{RB} / NOCNG_{RB}$$

where γ_k denotes the relative power level of the k :th virtual NB-IoT UE, and channel may be either of NPDCCH and NPDSCH.

The parameter settings of OCNG_RA, OCNG_RB, NOCNG_RA, NOCNG_RB and the set of relative power levels γ are chosen such that when also taking allocations to the UE category NB1 under test into account, as given by a NPDCCH and NPDSCH reference channels, a transmitted power spectral density that is constant on an OFDM symbol basis is targeted.

A.3.2.3.1 Narrowband IoT OCNG FDD pattern 1: In-band NB-IoT in 10 MHz EUTRAN cell

Table A.3.2.3.1-1: NOP.1 FDD: OCNG FDD Pattern 1

Allocation n_{PRB}	Relative power level γ_{PRB} [dB]			PDSCH Data	NPDCCH and NPDSCH Data
	Subframe				
	0, 4	5, 9	1-3, 6-8		
$0 - (nCell[1]RB - 1)$ (Note 5)	0	0	0	Note 1	N/A
$nCell[1]RB$ (Note 5)	0 (Note 3)	0 (Note 3)	N/A	N/A	Note 2
	N/A	N/A	0	Note 1	N/A
$(nCell[1]RB + 1) - (nCell[...]RB - 1)$ (Note 5)	0	0	0	Note 1	N/A
$nCell[...]RB$ (Note 5)	0 (Note 3)	0 (Note 3)	N/A	N/A	Note 2
	N/A	N/A	0	Note 1	N/A
$(nCell[...]RB + 1) - (nCell[N]RB - 1)$ (Note 5)	0	0	0	Note 1	N/A
$nCell[N]RB$ (Note 5)	0 (Note 3)	0 (Note 3)	N/A	N/A	Note 2
	N/A	N/A	0	Note 1	N/A
$(nCell[N]RB + 1) - 49$ (Note 5)	0	0	0	Note 1	N/A

Note 1: These physical resource blocks are assigned to an arbitrary number of virtual UEs with one PDSCH per virtual UE; the data transmitted over the OCNG PDSCHs shall be uncorrelated QPSK modulated pseudo random data. The parameter γ_{PRB} is used to scale the power of PDSCH.
If two or more transmit antennas with CRS are used in the test, the PDSCH part of OCNG shall be transmitted to the virtual users by all the transmit antennas with CRS and according to the antenna transmission mode 2. The parameter γ_{PRB} applies to each antenna port separately, so the transmit power of the PDSCH part of OCNG is equal between all the transmit antennas with CRS used in the test. The antenna transmission modes are specified in clause 7.1 in TS 36.213.

Note 2: This physical resource block is assigned to a virtual UE for transmission of NPDCCH or NPDSCH; the data transmitted over the NOCNG NPDCCH or NPDSCH shall be uncorrelated QPSK modulated pseudo random data. The parameter γ_{PRB} is used to scale the power of NPDCCH and NPDSCH.
If two transmit antennas with NBRS are used in the test, the NPDCCH and NPDSCH parts of NOCNG shall be transmitted to the virtual users by both transmit antennas with NBRS and according to the antenna transmission mode 2. The parameter γ_{PRB} applies to each antenna port separately, so the transmit power of the NPDCCH and NPDSCH parts of NOCNG is equal between both the transmit antennas with NBRS used in the test. The antenna transmission modes are specified in clause 7.1 in TS 36.213.

Note 3: Value of γ_{PRB} is applicable to PRBs not used for transmission of NPSS, NSSS, and NPBCH in anchor cells.

Note 4: SI transmissions, and NPDCCH and NPDSCH for the UE under test, have precedence over OCNG and NOCNG.

Note 5: $nCell[k]RB$ is the index of the RB used for allocation of the NB-IoT cell k with $k = \{1, \dots, N\}$ with N the total number of the NB-IoT cells belonging to the same LTE donor cell as specified in the individual tests.

N/A: Not Applicable

A.3.2.3.2 Narrowband IoT OCNG FDD pattern 2: guard band NB-IoT in 10 MHz EUTRAN cell

Table A.3.2.3.2-1: NOP.2 FDD: OCNG FDD Pattern 2

Allocation n_{PRB}	Relative power level γ_{PRB} [dB]			PDSCH Data	NPDCCH and NPDSCH Data
	Subframe				
	0, 4	5, 9	1-3, 6-8		
0-49	0	0	0	Note 1	N/A
50	0 (Note 3)	0 (Note 3)	0	N/A	Note 2
<p>Note 1: These physical resource blocks are assigned to an arbitrary number of virtual UEs with one PDSCH per virtual UE; the data transmitted over the OCNG PDSCHs shall be uncorrelated QPSK modulated pseudo random data. The parameter γ_{PRB} is used to scale the power of PDSCH.</p> <p>If two or more transmit antennas with CRS are used in the test, the PDSCH part of OCNG shall be transmitted to the virtual users by all the transmit antennas with CRS and according to the antenna transmission mode 2. The parameter γ_{PRB} applies to each antenna port separately, so the transmit power of the PDSCH part of OCNG is equal between all the transmit antennas with CRS used in the test. The antenna transmission modes are specified in clause 7.1 in TS 36.213.</p> <p>Note 2: This physical resource block is assigned to a virtual UE for transmission of NPDCCH or NPDSCH; the data transmitted over the NOCNG NPDCCH or NPDSCH shall be uncorrelated QPSK modulated pseudo random data. The parameter γ_{PRB} is used to scale the power of NPDCCH and NPDSCH.</p> <p>If two transmit antennas with NBRS are used in the test, the NPDCCH and NPDSCH parts of NOCNG shall be transmitted to the virtual users by both transmit antennas with NBRS and according to the antenna transmission mode 2. The parameter γ_{PRB} applies to each antenna port separately, so the transmit power of the NPDCCH and NPDSCH parts of NOCNG is equal between both the transmit antennas with NBRS used in the test. The antenna transmission modes are specified in clause 7.1 in TS 36.213.</p> <p>Note 3: Value of γ_{PRB} is applicable to PRBs not used for transmission of NPSS, NSSS and NPBCH in anchor cell ($n_{PRB} = 50$).</p> <p>Note 4: SI transmissions, and NPDCCH and NPDSCH for the UE under test, have precedence over OCNG and NOCNG.</p> <p>N/A: Not Applicable</p>					

A.3.2.3.3 Narrowband IoT OCNG FDD pattern 3: standalone NB-IoT

Table A.3.2.3.3-1: NOP.3 FDD: OCNG FDD Pattern 3

Allocation n_{PRB}	Relative power level γ_{PRB} [dB]			NPDCCH and NPDSCH Data
	Subframe			
	0, 4	5, 9	1-3, 6-8	
0	0 (Note 2)	0 (Note 2)	0	Note 1
<p>Note 1: This physical resource block is assigned to a virtual UE for transmission of NPDCCH or NPDSCH; the data transmitted over the NOCNG NPDCCH or NPDSCH shall be uncorrelated QPSK modulated pseudo random data. The parameter γ_{PRB} is used to scale the power of NPDCCH and NPDSCH.</p> <p>If two transmit antennas with NBRS are used in the test, the NPDCCH and NPDSCH parts of NOCNG shall be transmitted to the virtual users by both transmit antennas with NBRS and according to the antenna transmission mode 2. The parameter γ_{PRB} applies to each antenna port separately, so the transmit power of the NPDCCH and NPDSCH parts of NOCNG is equal between both the transmit antennas with NBRS used in the test. The antenna transmission modes are specified in clause 7.1 in TS 36.213.</p> <p>Note 2: Value of γ_{PRB} is applicable to PRBs not used for transmission of NPSS, NSSS and NPBCH in anchor cell ($n_{PRB} = 0$).</p>				

Note 3: SI transmissions, and NPDCCH and NPDSCH for the UE under test, have precedence over NOCNG.

A.3.2.3.4 Narrowband IoT OCNG FDD pattern 4: In-band NB-IoT in 5 MHz EUTRAN cell

Table A.3.2.3.4-1: NOP.4 FDD: OCNG FDD Pattern 4

Allocation n_{PRB}	Relative power level γ_{PRB} [dB]			PDSCH Data	NPDCCH and NPDSCH Data
	Subframe				
	0, 4	5, 9	1-3, 6-8		
$0 - (nCell[1]RB - 1)$ (Note 5)	0	0	0	Note 1	N/A
$nCell[1]RB$ (Note 5)	0 (Note 3)	0 (Note 3)	N/A	N/A	Note 2
	N/A	N/A	0	Note 1	N/A
$(nCell[1]RB + 1) - (nCell[...]RB - 1)$ (Note 5)	0	0	0	Note 1	N/A
$nCell[...]RB$ (Note 5)	0 (Note 3)	0 (Note 3)	N/A	N/A	Note 2
	N/A	N/A	0	Note 1	N/A
$(nCell[...]RB + 1) - (nCell[N]RB - 1)$ (Note 5)	0	0	0	Note 1	N/A
$nCell[N]RB$ (Note 5)	0 (Note 3)	0 (Note 3)	N/A	N/A	Note 2
	N/A	N/A	0	Note 1	N/A
$(nCell[N]RB + 1) - 24$ (Note 5)	0	0	0	Note 1	N/A
<p>Note 1: These physical resource blocks are assigned to an arbitrary number of virtual UEs with one PDSCH per virtual UE; the data transmitted over the OCNG PDSCHs shall be uncorrelated QPSK modulated pseudo random data. The parameter γ_{PRB} is used to scale the power of PDSCH. If two or more transmit antennas with CRS are used in the test, the PDSCH part of OCNG shall be transmitted to the virtual users by all the transmit antennas with CRS and according to the antenna transmission mode 2. The parameter γ_{PRB} applies to each antenna port separately, so the transmit power of the PDSCH part of OCNG is equal between all the transmit antennas with CRS used in the test. The antenna transmission modes are specified in clause 7.1 in TS 36.213.</p> <p>Note 2: This physical resource block is assigned to a virtual UE for transmission of NPDCCH or NPDSCH; the data transmitted over the NOCNG NPDCCH or NPDSCH shall be uncorrelated QPSK modulated pseudo random data. The parameter γ_{PRB} is used to scale the power of NPDCCH and NPDSCH. If two transmit antennas with NBRS are used in the test, the NPDCCH and NPDSCH parts of NOCNG shall be transmitted to the virtual users by both transmit antennas with NBRS and according to the antenna transmission mode 2. The parameter γ_{PRB} applies to each antenna port separately, so the transmit power of the NPDCCH and NPDSCH parts of NOCNG is equal between both the transmit antennas with NBRS used in the test. The antenna transmission modes are specified in clause 7.1 in TS 36.213.</p> <p>Note 3: Value of γ_{PRB} is applicable to PRBs not used for transmission of NPSS, NSSS, and NPBCH in anchor cells.</p> <p>Note 4: SI transmissions, and NPDCCH and NPDSCH for the UE under test, have precedence over OCNG and NOCNG.</p> <p>Note 5: $nCell[k]RB$ is the index of the RB used for allocation of the NB-IoT cell k with $k = \{1, \dots, N\}$ with N the total number of the NB-IoT cells belonging to the same LTE donor cell as specified in the individual tests.</p> <p>N/A: Not Applicable</p>					

A.3.2.3.5 Narrowband IoT OCNG FDD pattern 5: guard band NB-IoT in 5 MHz EUTRAN cell

Table A.3.2.3.5-1: NOP.5 FDD: OCNG FDD Pattern 5

Allocation n_{PRB}	Relative power level γ_{PRB} [dB]			PDSCH Data	NPDCCH and NPDSCH Data
	Subframe				
	0, 4	5, 9	1-3, 6-8		
0 – 24	0	0	0	Note 1	N/A
25	0 (Note 3)	0 (Note 3)	0	N/A	Note 2
<p>Note 1: These physical resource blocks are assigned to an arbitrary number of virtual UEs with one PDSCH per virtual UE; the data transmitted over the OCNG PDSCHs shall be uncorrelated QPSK modulated pseudo random data. The parameter γ_{PRB} is used to scale the power of PDSCH. If two or more transmit antennas with CRS are used in the test, the PDSCH part of OCNG shall be transmitted to the virtual users by all the transmit antennas with CRS and according to the antenna transmission mode 2. The parameter γ_{PRB} applies to each antenna port separately, so the transmit power of the PDSCH part of OCNG is equal between all the transmit antennas with CRS used in the test. The antenna transmission modes are specified in clause 7.1 in TS 36.213.</p> <p>Note 2: This physical resource block is assigned to a virtual UE for transmission of NPDCCH or NPDSCH; the data transmitted over the NOCNG NPDCCH or NPDSCH shall be uncorrelated QPSK modulated pseudo random data. The parameter γ_{PRB} is used to scale the power of NPDCCH and NPDSCH. If two transmit antennas with NBRS are used in the test, the NPDCCH and NPDSCH parts of NOCNG shall be transmitted to the virtual users by both transmit antennas with NBRS and according to the antenna transmission mode 2. The parameter γ_{PRB} applies to each antenna port separately, so the transmit power of the NPDCCH and NPDSCH parts of NOCNG is equal between both the transmit antennas with NBRS used in the test. The antenna transmission modes are specified in clause 7.1 in TS 36.213.</p> <p>Note 3: Value of γ_{PRB} is applicable to PRBs not used for transmission of NPSS, NSSS and NPBCH in anchor cell ($n_{PRB} = 25$).</p> <p>Note 4: SI transmissions, and NPDCCH and NPDSCH for the UE under test, have precedence over OCNG and NOCNG.</p> <p>N/A: Not Applicable</p>					

A.3.2.3.6 Narrowband IoT OCNG TDD pattern 1: In-band NB-IoT in 10 MHz EUTRAN cell

Table A.3.2.3.6-1: NOP.1 TDD: OCNG TDD Pattern 1 for uplink-downlink configurations 1 and 2

Allocation n_{PRB}	Relative power level γ_{PRB} [dB]			PDSCH Data	NPDCCH and NPDSCH Data
	Subframe				
	0, 5, 9	1, 6 ^{Note 7}	3, 4, 8 ^{Note 4}		
$0 - (nCell[1]RB - 1)$ (Note 5)	0	0	0	Note 1	N/A
$nCell[1]RB$ (Note 5)	0 (Note 3)	0	N/A	N/A	Note 2
	N/A	N/A	0	Note 1	N/A
$(nCell[1]RB + 1) -$ $(nCell[...]RB - 1)$ (Note 5)	0	0	0	Note 1	N/A
$nCell[...]RB$	0 (Note 3)	0	N/A	N/A	Note 2

(Note 5)	N/A	N/A	0	Note 1	N/A
$(nCell[...]/RB + 1) - (nCell[...]/RB - 1)$ (Note 5)	0	0	0	Note 1	N/A
$nCell[...]/RB$ (Note 5)	0 (Note 3)	0	N/A	N/A	Note 2
	N/A	N/A	0	Note 1	N/A
$(nCell[...]/RB + 1) - 49$ (Note 5)	0	0	0	Note 1	N/A
<p>Note 1: These physical resource blocks are assigned to an arbitrary number of virtual UEs with one PDSCH per virtual UE; the data transmitted over the OCNG PDSCHs shall be uncorrelated QPSK modulated pseudo random data. The parameter γ_{PRB} is used to scale the power of PDSCH. If two or more transmit antennas with CRS are used in the test, the PDSCH part of OCNG shall be transmitted to the virtual users by all the transmit antennas with CRS and according to the antenna transmission mode 2. The parameter γ_{PRB} applies to each antenna port separately, so the transmit power of the PDSCH part of OCNG is equal between all the transmit antennas with CRS used in the test. The antenna transmission modes are specified in clause 7.1 in TS 36.213.</p> <p>Note 2: This physical resource block is assigned to a virtual UE for transmission of NPDCCH or NPDSCH; the data transmitted over the NOCNG NPDCCH or NPDSCH shall be uncorrelated QPSK modulated pseudo random data. The parameter γ_{PRB} is used to scale the power of NPDCCH and NPDSCH. If two transmit antennas with NBRS are used in the test, the NPDCCH and NPDSCH parts of NOCNG shall be transmitted to the virtual users by both transmit antennas with NBRS and according to the antenna transmission mode 2. The parameter γ_{PRB} applies to each antenna port separately, so the transmit power of the NPDCCH and NPDSCH parts of NOCNG is equal between both the transmit antennas with NBRS used in the test. The antenna transmission modes are specified in clause 7.1 in TS 36.213.</p> <p>Note 3: Value of γ_{PRB} is applicable to PRBs not used for transmission of NPSS, NSSS, and NPBCH in anchor cells.</p> <p>Note 4: Subframes available for DL transmission depends on the Uplink-Downlink configuration in Table 4.2-2 in TS 36.211 [16].</p> <p>Note 5: $nCell[k]/RB$ is the index of the RB used for allocation of the NB-IoT cell k with $k = \{1, \dots, N\}$ with N the total number of the NB-IoT cells belonging to the same E-UTRA donor cell as specified in the individual tests.</p> <p>Note 6: SI transmissions, and NPDCCH and NPDSCH for the UE under test, have precedence over OCNG and NOCNG.</p> <p>Note 7: Whether NPDSCH transmissions are carried out in DwPTS depends on the special subframe configuration in use.</p> <p>N/A: Not Applicable</p>					

A.3.2.3.7 Narrowband IoT OCNG TDD pattern 2: guard band NB-IoT in 10 MHz EUTRAN cell

Table A.3.2.3.7-1: NOP.2 TDD: OCNG TDD Pattern 2 for uplink-downlink configurations 1 and 2

Allocation n_{PRB}	Relative power level γ_{PRB} [dB]			PDSCH Data	NPDCCH and NPDSCH Data
	Subframe				
	0, 5, 9	1, 6 ^{Note 6}	3, 4, 8 ^{Note 4}		
0-49	0	0	0	Note 1	N/A
50	0 (Note 3)	0	0	N/A	Note 2
<p>Note 1: These physical resource blocks are assigned to an arbitrary number of virtual UEs with one PDSCH per virtual UE; the data transmitted over the OCNG PDSCHs shall be uncorrelated QPSK modulated pseudo random data. The parameter γ_{PRB} is used to scale the power of PDSCH. If two or more transmit antennas with CRS are used in the test, the PDSCH part of OCNG shall be transmitted to the virtual users by all the transmit antennas with CRS and according</p>					

	to the antenna transmission mode 2. The parameter γ_{PRB} applies to each antenna port separately, so the transmit power of the PDSCH part of OCNG is equal between all the transmit antennas with CRS used in the test. The antenna transmission modes are specified in clause 7.1 in TS 36.213.
Note 2:	This physical resource block is assigned to a virtual UE for transmission of NPDCCH or NPDSCH; the data transmitted over the NOCNG NPDCCH or NPDSCH shall be uncorrelated QPSK modulated pseudo random data. The parameter γ_{PRB} is used to scale the power of NPDCCH and NPDSCH. If two transmit antennas with NBRS are used in the test, the NPDCCH and NPDSCH parts of NOCNG shall be transmitted to the virtual users by both transmit antennas with NBRS and according to the antenna transmission mode 2. The parameter γ_{PRB} applies to each antenna port separately, so the transmit power of the NPDCCH and NPDSCH parts of NOCNG is equal between both the transmit antennas with NBRS used in the test. The antenna transmission modes are specified in clause 7.1 in TS 36.213.
Note 3:	Value of γ_{PRB} is applicable to PRBs not used for transmission of NPSS, NSSS and NPBCH in anchor cell ($n_{PRB} = 50$).
Note 4:	Subframes available for DL transmission depends on the Uplink-Downlink configuration in Table 4.2-2 in TS 36.211 [16].
Note 5:	SI transmissions, and NPDCCH and NPDSCH for the UE under test, have precedence over OCNG and NOCNG.
Note 6:	Whether NPDSCH transmissions are carried out in DwPTS depends on the special subframe configuration in use.
N/A:	Not Applicable

A.3.2.3.8 Narrowband IoT OCNG TDD pattern 3: standalone NB-IoT

Table A.3.2.3.8-1: NOP.3 TDD: OCNG TDD Pattern 3 for uplink-downlink configurations 1 and 2

Allocation n_{PRB}	Relative power level γ_{PRB} [dB]			NPDCCH and NPDSCH Data
	Subframe			
	0, 5, 9	1, 6 ^{Note 5}	3, 4, 8 ^{Note 3}	
0	0 (Note 2)	0	0	Note 1
Note 1:	This physical resource block is assigned to a virtual UE for transmission of NPDCCH or NPDSCH; the data transmitted over the NOCNG NPDCCH or NPDSCH shall be uncorrelated QPSK modulated pseudo random data. The parameter γ_{PRB} is used to scale the power of NPDCCH and NPDSCH. If two transmit antennas with NBRS are used in the test, the NPDCCH and NPDSCH parts of NOCNG shall be transmitted to the virtual users by both transmit antennas with NBRS and according to the antenna transmission mode 2. The parameter γ_{PRB} applies to each antenna port separately, so the transmit power of the NPDCCH and NPDSCH parts of NOCNG is equal between both the transmit antennas with NBRS used in the test. The antenna transmission modes are specified in clause 7.1 in TS 36.213.			
Note 2:	Value of γ_{PRB} is applicable to PRBs not used for transmission of NPSS, NSSS and NPBCH in anchor cell ($n_{PRB} = 0$).			
Note 3:	Subframes available for DL transmission depends on the Uplink-Downlink configuration in Table 4.2-2 in TS 36.211 [16].			
Note 4:	SI transmissions, and NPDCCH and NPDSCH for the UE under test, have precedence over NOCNG.			
Note 5:	Whether NPDSCH transmissions are carried out in DwPTS depends on the special subframe configuration in use.			

A.3.2.4 OCNG Patterns for V2X sidelink

The following V2X sidelink OCNG patterns (VOCNG) are used for modelling allocations to virtual V2X UEs (which are not under test). The OCNG pattern for each subframe specifies the allocations that shall be filled with OCNG, and furthermore, the relative power level of each such allocation.

In each test case VOCNG is expressed by parameters VOCNG_RA and VOCNG_RB which together with a relative power level (γ) specifies the PSSCH EPRE-to-RS EPRE ratios in OFDM symbols without and with reference symbols, respectively. The relative power, which is used for modelling boosting per virtual V2X UE allocation, is expressed by:

$$\gamma_i = PSSCH_i_RA/VOCNG_RA = PSSCH_i_RB/VOCNG_RB,$$

where γ_i denotes the relative power level of the i :th virtual V2X UE. The parameter settings of VOCNG_RA, VOCNG_RB, and the set of relative power levels γ are chosen such that when also taking allocations to the UE under test into account, as given by a PSSCH reference channel.

Moreover the VOCNG pattern is accompanied by a PSCCH reference channel which specifies the control region. The number of PSCCH OFDM symbols in all subframes is the same as specified in the RMC used in the test.

A.3.2.4.1 V2X sidelink OCNG TDD pattern 1: outer resource blocks allocation in 10 MHz

Table A.3.2.4.1-1: VOP.1 HD: OCNG TDD Pattern 1

Allocation n_{PRB}	Relative power level γ_{PRB} [dB]		PSCCH and PSSCH Data
	Subframe ^{Note 2}		
	0 - 19		
0 – 4	18		Note 1
10–25	18		
Note 1: These physical resource blocks are assigned to an arbitrary number of virtual UEs with one PSSCH per virtual UE; the data transmitted over the OCNG PSSCHs shall be uncorrelated pseudo random data, which is QPSK modulated. The parameter γ_{PRB} is used to scale the power of PSSCH. Note 2: Value of γ_{PRB} is applicable to subframes not used for V2X sidelink transmissions.			

A.3.2.4.2 V2X sidelink OCNG TDD pattern 2: outer resource blocks allocation in 10 MHz

Table A.3.2.4.2-1: VOP.2 HD: OCNG TDD Pattern 2

Allocation n_{PRB}	Relative power level γ_{PRB} [dB]		PSCCH and PSSCH Data
	Subframe ^{Note 2}		
	0 - 19		
0 – 4	18		Note 1
10-14	18		
15 –19	8.1		
20–25	18		
Note 1: These physical resource blocks are assigned to an arbitrary number of virtual UEs with one PSSCH per virtual UE; the data transmitted over the OCNG PSSCHs shall be uncorrelated pseudo random data, which is QPSK modulated. The parameter γ_{PRB} is used to scale the power of PSSCH. Note 2: Value of γ_{PRB} is applicable to subframes not used for V2X sidelink transmissions.			

A.3.3 Reference DRX Configurations

Table A.3.3-1: Reference DRX Configurations

Parameter	Value		Comments
	DRX_S	DRX_L	
Reference configuration	DRX_S	DRX_L	As defined in 4.8.2.1.5 in TS 36.508
onDurationTimer	psf2	psf6	
drx-InactivityTimer	psf100	psf1920	
drx-RetransmissionTimer	psf16	psf16	
longDRX-CycleStartOffset	sf40, 0	sf1280, 0	
shortDRX	disabled	disabled	
Note:	For further information see clause 6.3.2 in TS 36.331.		

A.3.4 ABS Transmission Configurations

A.3.4.1 Non-MBSFN ABS Transmission Configurations

A.3.4.1.1 Non-MBSFN ABS Transmission, 1x2 antenna with PBCH

Table A.3.4.1.1-1: Transmission configuration with non-MBSFN ABS, 1x2 with PBCH

Physical Channels and Signals	Parameters	EPRE, [dB]	
		Non-ABS	ABS
PBCH	PBCH_RA	0	0
	PBCH_RB	0	0
PSS	PSS_RA	0	0
SSS	SSS_RA	0	0
PCFICH	PCFICH_RB	0	0 ^{Note 1}
PHICH	PHICH_RA	0	-Inf
	PHICH_RB	0	-Inf
PDCCH	PDCCH_RA	0	0 ^{Note 1}
	PDCCH_RB	0	0 ^{Note 1}
PDSCH	PDSCH_RA	0	0 ^{Note 1}
	PDSCH_RB	0	0 ^{Note 1}
OCNG	OCNG_RA	0	-Inf
	OCNG_RB	0	-Inf
NOTE 1: Only used for SIB1, otherwise EPRE is -Inf			
NOTE 2: 1x2 antenna configuration is assumed			

A.3.4.1.2 Non-MBSFN ABS Transmission, 2x2 antenna without PBCH

Table A.3.4.1.2-1: Transmission configuration #1 with non-MBSFN ABS, 2x2 without PBCH

Physical Channels and Signals	Parameters	EPRE, [dB]	
		Non-ABS	ABS
PBCH	PBCH_RA	-3	-Inf
	PBCH_RB	-3	-Inf
PSS	PSS_RA	-3	-3
SSS	SSS_RA	-3	-3
PCFICH	PCFICH_RB	1	-Inf
PHICH	PHICH_RA	-3	-Inf
	PHICH_RB	-3	-Inf
PDCCH	PDCCH_RA	1	-Inf
	PDCCH_RB	1	-Inf
PDSCH	PDSCH_RA	-3	-Inf
	PDSCH_RB	-3	-Inf
OCNG	OCNG_RA	-3	-Inf
	OCNG_RB	-3	-Inf
NOTE: 2x2 antenna configuration is assumed			

Table A.3.4.1.2-2: Transmission configuration #2 with non-MBSFN ABS, 2x2 without PBCH

Physical Channels and Signals	Parameters	EPRE, [dB]	
		Non-ABS	ABS
PBCH	PBCH_RA	-3	-Inf
	PBCH_RB	-3	-Inf
PSS	PSS_RA	-3	-3
SSS	SSS_RA	-3	-3
PCFICH	PCFICH_RB	1	-Inf
PHICH	PHICH_RA	-3	-Inf
	PHICH_RB	-3	-Inf
PDCCH	PDCCH_RA	-3	-Inf
	PDCCH_RB	-3	-Inf
PDSCH	PDSCH_RA	-3	-Inf
	PDSCH_RB	-3	-Inf
OCNG	OCNG_RA	-3	-Inf
	OCNG_RB	-3	-Inf
NOTE: 2x2 antenna configuration is assumed			

A.3.4.2 MBSFN ABS Transmission Configurations

A.3.4.2.1 MBSFN ABS Transmission, 1x2 antenna

Table A.3.4.2.1-1: Transmission configuration with MBSFN ABS, 1x2

Physical Channels and Signals	Parameters	EPRE, [dB]	
		Non-ABS	ABS
PBCH	PBCH_RA	0	N/A
	PBCH_RB	0	N/A
PSS	PSS_RA	0	N/A
SSS	SSS_RA	0	N/A
PCFICH	PCFICH_RB	0	-Inf
PHICH	PHICH_RA	0	-Inf
	PHICH_RB	0	-Inf
PDCCH	PDCCH_RA	0	-Inf
	PDCCH_RB	0	-Inf
PDSCH	PDSCH_RA	0	-Inf
	PDSCH_RB	0	-Inf
PMCH	PMCH_RA	0	-Inf
	PMCH_RB	0	-Inf
OCNG	OCNG_RA	0	-Inf
	OCNG_RB	0	-Inf
NOTE: 1x2 antenna configuration is assumed			

A.3.4.2.2 MBSFN ABS Transmission, 2x2 antenna

Table A.3.4.2.2-1: Transmission configuration #1 with MBSFN ABS, 2x2

Physical Channels and Signals	Parameters	EPRE, [dB]	
		Non-ABS	ABS
PBCH	PBCH_RA	-3	N/A
	PBCH_RB	-3	N/A
PSS	PSS_RA	-3	N/A
SSS	SSS_RA	-3	N/A
PCFICH	PCFICH_RB	1	-Inf
PHICH	PHICH_RA	-3	-Inf
	PHICH_RB	-3	-Inf
PDCCH	PDCCH_RA	1	-Inf
	PDCCH_RB	1	-Inf
PDSCH	PDSCH_RA	-3	-Inf

	PDSCH_RB	-3	-Inf
PMCH	PMCH_RA	-3	-Inf
	PMCH_RB	-3	-Inf
OCNG	OCNG_RA	-3	-Inf
	OCNG_RB	-3	-Inf
NOTE: 2x2 antenna configuration is assumed			

Table A.3.4.2.2-2: Transmission configuration # 2 with MBSFN ABS, 2x2

Physical Channels and Signals	Parameters	EPRE, [dB]	
		Non-ABS	ABS
PBCH	PBCH_RA	-3	N/A
	PBCH_RB	-3	N/A
PSS	PSS_RA	-3	N/A
SSS	SSS_RA	-3	N/A
PCFICH	PCFICH_RB	1	-Inf
PHICH	PHICH_RA	-3	-Inf
	PHICH_RB	-3	-Inf
PDCCH	PDCCH_RA	-3	-Inf
	PDCCH_RB	-3	-Inf
PDSCH	PDSCH_RA	-3	-Inf
	PDSCH_RB	-3	-Inf
PMCH	PMCH_RA	-3	-Inf
	PMCH_RB	-3	-Inf
OCNG	OCNG_RA	-3	-Inf
	OCNG_RB	-3	-Inf
NOTE: 2x2 antenna configuration is assumed			

A.3.5 Impact of Reference Sensitivity Degradation with Carrier Aggregation on Test Cases

A.3.5.1 Impact of Reference Sensitivity Degradation due to Insertion Loss

For a UE supporting inter-band carrier aggregation configuration with uplink in one E-UTRA band, if there is a relaxation of receiver sensitivity $\Delta R_{IB,c} > 0$ dB as defined in TS 36.101 [5], 7.3.1-1A, there is no adjustment of test parameters in the tests specified in TS 36.133 when $\Delta R_{IB,c} \leq 1$ dB.

A.3.6 Carrier Aggregation Test Cases with Different Channel Bandwidth Combinations

A.3.6.1 Introduction

In Annex A carrier aggregation test cases may be defined with different channel bandwidth combinations to verify the same RRM requirement.

If multiple carrier aggregation test cases with different channel bandwidth combinations are defined to verify the same RRM requirement that is channel bandwidth independent, then the UE needs to be tested only with one bandwidth combination out of the bandwidth combination sets supported by that UE.

A.3.7 Test Cases with Different Channel Bandwidths

A.3.7.1 Introduction

This clause defines a principle which is applicable to test cases verifying RRM requirements for single carrier operation.

A.3.7.2 Principle of testing

Test cases defined for 5MHz channel bandwidth that reference this clause are applicable to UEs that support only bands within band group FDD_N.

A.3.8 Antenna Configuration

Unless otherwise specified, E-UTRA FDD or E-UTRA TDD cells in all RRM Test cases in AWGN propagation condition are configured with Antenna Configuration 1x2.

A.3.8.1 Antenna connection for 4 Rx capable UEs

A.3.8.1.1 Introduction

All tests in sections A.4 to A.9 are specified for UEs supporting either category 0 (1RX) or 2RX. In this section, the antenna connection method for applying 2RX tests to UEs supporting 4RX antenna ports is specified. No tests are currently specified in section A.4-A.9 which are applicable only to 4RX antenna ports, so 4RX capable UEs are always tested by reusing tests which were originally specified for 2RX UEs.

A.3.8.1.2 Principle of testing

A.3.8.1.2.1 Single carrier tests

For 4RX capable UEs supporting at least one 2RX band, all single carrier tests specified in section A.4 to A.8 shall be tested on any band where 2RX is supported with the antenna connection specified in A.3.8.1.2.3. For single carrier tests specified in section A.9, all tests shall be tested with the antenna connection specified in A.3.8.1.2.3 for bands where 2RX is supported, and the antenna connection specified in A.3.8.1.2.4 for bands where 4RX is supported.

For 4RX capable UEs which do not support any 2RX band, all tests specified in sections A.4 to A.9 shall be tested using the antenna connection specified in section A.3.8.1.2.4. For radio link monitoring tests, the SNR levels are modified according to table A.3.8.1.2.1-1 and table A.3.8.1.2.1-2.

Table A.3.8.1.2.1-1 Modified parameters for RLM out of sync testing with 4 RX antenna connection

Test case	SNR during T3 (dB)			
	Test 1	Test 2	Test 3	Test 4
A.7.3.1	-17	-17	-15	-15.7
A.7.3.3	-16.6	-16.7	-14.8	-15.4
A.7.3.5	-15.7	-17	N/A	N/A
A.7.3.7	-15.4	-16.6	N/A	N/A
A.7.3.9 (cell 1)	Note 1	N/A	N/A	N/A
A.7.3.10 (cell 1)	Note 1	N/A	N/A	N/A
A.7.3.13 (cell 1)	Note 1	N/A	N/A	N/A
A.7.3.14 (cell 1)	Note 1	N/A	N/A	N/A
A.7.3.17 (cell 1)	Note 1	N/A	N/A	N/A
A.7.3.18 (cell 1)	Note 1	N/A	N/A	N/A
A.7.3.23	-15.7	N/A	N/A	N/A

Note 1: For 4Rx capable UEs without any 2Rx supported RF bands, this test can be skipped.

Table A.3.8.1.2.1-2 Modified parameters for RLM in sync single carrier testing with 4 RX antenna connection

Test case	SNR during T3 (dB)		SNR during T4 (dB)	
	Test 1	Test 2	Test 1	Test 2
A.7.3.2	-14	-15.7	-9.9	-10.8
A.7.3.4	-14.8	-15.4	-9.9	-10.8
A.7.3.6	-17	N/A	-12.2	N/A
A.7.3.8	-16.6	N/A	-12.6	N/A
A.7.3.11 (cell 1)	Note 1	N/A	Note 1	N/A
A.7.3.12 (cell 1)	Note 1	N/A	Note 1	N/A
A.7.3.15 (cell 1)	Note 1	N/A	Note 1	N/A
A.7.3.16 (cell 1)	Note 1	N/A	Note 1	N/A
A.7.3.19 (cell 1)	Note 1	N/A	Note 1	N/A

A.7.3.20 (cell 1)	Note 1	N/A	Note 1	N/A
A.7.3.21 (cell 1)	Note 1	N/A	Note 1	N/A
A.7.3.22 (cell 1)	Note 1	N/A	Note 1	N/A
A.7.3.24	-15.7	N/A	-10.8	N/A
A.7.3.25	-15.7	N/A	-10.8	N/A
Note 1: For 4Rx capable UEs without any 2Rx supported RF bands, this test can be skipped.				

A.3.8.1.2.2 Carrier aggregation and Dual connectivity tests

All carrier aggregation and dual connectivity tests are performed using the antenna connection in section A.3.8.1.2.3 for the PCell antenna connection if the PCell is on a band where 2RX is supported or the antenna connection in A.3.8.1.2.4 for the PCell antenna connection if the PCell is on a band where 4RX is supported.

All carrier aggregation and dual connectivity tests are performed using the antenna connection in section A.3.8.1.2.3 for the SCell or PSCell antenna connection if an SCell or PSCell is on band where 2RX is supported or the testing procedure in A.3.8.1.2.4 for the SCell or PSCell antenna connection if an SCell or PSCell is on a band where 4RX is supported.

For dual connectivity radio link monitoring tests with the PSCell on a band where 4RX is supported, the PSCell SNR levels are modified according to table A.3.8.1.2.2 -1 and table A.3.8.1.2.2 -2.

Table A.3.8.1.2.1-1 Modified parameters for dual connectivity RLM out of sync testing with 4 RX antenna connection

Test case	SNR during T3 (dB)
A.7.3.38 (cell 2)	-15.7 (5MHz) -15.7 (10MHz) -16.3 (20 MHz)
A.7.3.39 (cell 2)	-15.7 (5MHz) -15.7 (10MHz) -16.3 (20 MHz)
A.7.3.40 (cell 2)	-15.4 (5MHz) -15.4 (10MHz) -16.1 (20MHz)

Table A.3.8.1.2.1-1 Modified parameters for RLM out of sync testing with 4 RX antenna connection

Test case	SNR during T3 (dB)	SNR during T4 (dB)
A.7.3.41 (cell 2)	-15.7 (5 Mhz) -17.0 (10 Mhz) -17.0 (20 Mhz)	-10.8 (5MHz) -12.2 (10MHz) -12.2 (20 MHz)
A.7.3.42 (cell 2)	-15.7 (5 Mhz) -17.0 (10 Mhz) -17.0 (20 Mhz)	-10.8 (5MHz) -12.2 (10MHz) -12.2 (20 MHz)
A.7.3.43 (cell 2)	-16.6 (5MHz) -16.6 (10 MHz) -16.6 (20 MHz)	-12.6 (5MHz) -12.6 (10 MHz) -12.6 (20 MHz)

A.3.8.1.2.3 Antenna connection for bands where 2RX is supported

For bands where 2RX is supported, it is left to the UE declaration and AP configuration to decide which 2 of the 4 Rx ports are connected with data source from system simulator. The remaining 2 Rx ports shall be connected with zero input. No test parameters or requirements are modified.

A.3.8.1.2.4 Antenna connection for bands where 4RX is supported

For bands where 4RX is supported, all 4 Rx are connected with data source from system simulator. The system simulator shall provide independent noise and fading (low correlation) for each antenna port. Except for the modifications to radio link monitoring thresholds described in sections A.3.8.1.2.1 and A.3.8.1.2.2, no test parameters or requirements are modified.

A.3.8.2 Antenna connection for 8 Rx capable UEs

A.3.8.2.1 Introduction

In this clause, the antenna connection method for applying 2RX tests or 4RX tests to UEs supporting 8RX antenna ports is specified. No tests are currently specified in clause A.4-A.9 which are applicable only to 8RX antenna ports, so 8RX capable UEs are always tested by reusing tests which were originally specified for 2RX UEs or 4Rx UEs.

A.3.8.2.2 Principle of testing

A.3.8.2.2.1 Single carrier tests

For 8RX capable UEs supporting at least one 2RX band, all single carrier tests specified in clause A.4 to A.8 shall be tested on any band where 2RX is supported with the antenna connection specified in A.3.8.2.2.3. For single carrier tests specified in clause A.9, all tests shall be tested with the antenna connection specified in A.3.8.2.2.3 for bands where 2RX is supported, and the antenna connection specified in A.3.8.2.2.5 for bands where 8RX is supported.

For 8RX capable UEs supporting at least one 4RX band but without supporting any 2RX band, all single carrier tests specified in clause A.4 to A.8 shall be tested on any band where 4RX is supported with the antenna connection specified in A.3.8.2.2.4. For single carrier tests specified in clause A.9, all tests shall be tested with the antenna connection specified in A.3.8.2.2.4 for bands where 4RX is supported, and the antenna connection specified in A.3.8.2.2.8 for bands where 8RX is supported. For radio link monitoring tests, the SNR levels are modified according to table A.3.8.1.2.1-1 and table A.3.8.1.2.1-2.

For 8RX capable UEs which do not support any 2RX or 4RX band, all tests specified in clauses A.4 to A.9 shall be tested using the antenna connection specified in clause A.3.8.1.2.5. For radio link monitoring tests, the SNR levels are modified according to table A.3.8.1.2.1-1 and table A.3.8.1.2.1-2.

A.3.8.2.2.2 Carrier aggregation and Dual connectivity tests

All carrier aggregation and dual connectivity tests are performed using the antenna connection in clause A.3.8.2.2.3 for the PCell antenna connection if the PCell is on a band where 2RX is supported or the antenna connection in A.3.8.2.2.4 for the PCell antenna connection if the PCell is on a band where 4RX is supported but without supporting any 2RX band or the antenna connection in A.3.8.2.2.5 for the PCell antenna connection if the PCell is on a band where 8RX is supported.

All carrier aggregation and dual connectivity tests are performed using the antenna connection in clause A.3.8.2.2.3 for the SCell or PSCell antenna connection if an SCell or PSCell is on band where 2RX is supported or the testing procedure in A.3.8.2.2.4 for the SCell or PSCell antenna connection if an SCell or PSCell is on a band where 4RX is supported but without supporting any 2RX band or the testing procedure in A.3.8.2.2.5 for the SCell or PSCell antenna connection if an SCell or PSCell is on a band where 8RX is supported.

For dual connectivity radio link monitoring tests with the PSCell on a band where 8RX is supported, the PSCell SNR levels are modified according to table A.3.8.1.2.2 -1 and table A.3.8.1.2.2 -2.

A.3.8.2.2.3 Antenna connection for bands where 2RX is supported

For bands where 2RX is supported, it is left to the UE declaration and AP configuration to decide which 2 of the 8 Rx ports are connected with data source from system simulator. The remaining 6 Rx ports shall be connected with zero input. No test parameters or requirements are modified.

A.3.8.2.2.4 Antenna connection for bands where 4RX is supported

For bands where 4RX is supported, it is left to the UE declaration and AP configuration to decide which 4 of the 8 Rx ports are connected with data source from system simulator. The remaining 4 Rx ports shall be connected with zero input. Except for the modifications to radio link monitoring thresholds described in clauses A.3.8.1.2.1 and A.3.8.1.2.2, no test parameters or requirements are modified.

A.3.8.2.2.5 Antenna connection for bands where 8RX is supported

For bands where 8RX is supported, all 8 Rx are connected with data source from system simulator. The system simulator shall provide independent noise and fading (low correlation) for each antenna port. Except for the modifications to radio link monitoring thresholds described in clauses A.3.8.1.2.1 and A.3.8.1.2.2, no test parameters or requirements are modified.

A.3.9 Carrier Aggregation Test Cases with Different Duplex Modes

A.3.9.1 Introduction

This clause defines a principle which is applicable to test cases verifying RRM requirements for carrier aggregation.

A.3.9.2 Principle of testing

In Annex A carrier aggregation test cases may be defined for different duplex modes or combination of duplex modes (E-UTRA FDD, E-UTRA TDD and E-UTRA TDD-FDD) to verify the same RRM requirement.

If multiple carrier aggregation test cases are defined for different duplex modes (E-UTRA FDD or E-UTRA TDD) or for combination of duplex modes (E-UTRA TDD-FDD) to verify the same RRM requirement which is independent of the duplex mode and is identical for different duplex modes or combination of duplex modes, then from UE the performance point of view the test coverage can be considered fulfilled by executing only the corresponding test case(s) with one of the duplex modes supported by the UE.

A.3.10 Carrier Aggregation Test Cases with Different CA Configurations

A.3.10.1 Introduction

This clause defines a principle which is applicable to test cases verifying RRM requirements for carrier aggregation.

A.3.10.2 Principle of testing

In Annex A carrier aggregation test cases may be defined for two CCs as well as for more than two CCs to verify the same RRM requirement.

If multiple carrier aggregation test cases are defined for two CCs as well as for more than two CCs to verify the same RRM requirement, then from the UE performance point of view the test coverage can be considered fulfilled by executing only the test cases with the maximum number of CCs supported by the UE.

Editor's note: whether it is sufficient to test for any one of the band combinations supported by the UE is FFS.

A.3.11 Test Cases for Synchronous and Asynchronous Dual Connectivity

A.3.11.1 Introduction

This clause defines a principle which is applicable to test cases verifying RRM requirements for dual connectivity (DC) operation in synchronous and asynchronous scenarios.

A.3.11.2 Principle of Testing

In Annex A test cases may be defined in both synchronous DC and asynchronous DC scenarios to verify the same RRM requirement.

If test cases are defined in both synchronous and asynchronous DC scenarios to verify the same RRM requirement then the UE capable of both synchronous and asynchronous DC operations needs to be tested with one of the tests in either synchronous or asynchronous DC scenarios.

A.3.12 Proximity-based Services

A.3.12.1 Introduction

This clause also defines the principle and the reference configurations that are applicable to test cases verifying RRM core requirements for ProSe Direct Discovery and ProSe Direct Communication.

A.3.12.2 Reference DRX configurations for ProSe tests

Table A.3.12.2-1: Reference DRX Configurations

Parameter	Value
Reference configuration	DRX_P1
onDurationTimer	psf1
drx-InactivityTimer	psf1
drx-RetransmissionTimer	psf1
longDRX-CycleStartOffset	sf320, 0
shortDRX	Disabled
Note:	For further information see clause 6.3.2 in TS 36.331.

A.3.12.3 Test Cases with Different Channel Bandwidths

A.3.12.3.1 Introduction

This clause defines a principle which is applicable to test cases verifying ProSe RRM requirements with different channel bandwidths.

A.3.12.3.2 Principle of testing

Some ProSe test cases are defined for different channel bandwidths to verify the same RRM requirement.

If test cases with different channel bandwidth are defined to verify the same RRM requirement then the UE is required to pass the test cases only with one of the channel bandwidths.

A.3.12.4 Reference resource pool configurations for ProSe Direct Discovery

Table A.3.12.4-1: ProSe Direct Discovery configuration for E-UTRA FDD (Configuration #1)

Information Element			Value
<i>discRxPool</i>	<i>cp-Len</i>		Normal
	<i>discPeriod</i>		rf32
	<i>numRetx</i>		0
	<i>numRepetition</i>		1
	<i>tf-ResourceConfig</i>	<i>prb-Num</i>	12
		<i>prb-Start</i>	0
		<i>prb-End</i>	23
		<i>offsetIndicator</i>	160
		<i>subframeBitmap</i>	11000000 00000000 00000000 00000000 00000000
	<i>txParameters</i>		not present
	<i>rxParameters</i>		not present
<i>discTxPoolCommon/ discTxPoolDedicated</i>	<i>cp-Len</i>		Normal
	<i>discPeriod</i>		rf32
	<i>numRetx</i>		0
	<i>numRepetition</i>		1
	<i>tf-ResourceConfig</i>	<i>prb-Num</i>	2
		<i>prb-Start</i>	3
		<i>prb-End</i>	5
		<i>offsetIndicator</i>	160
		<i>subframeBitmap</i>	10000000 00000000 00000000 00000000 00000000
	<i>txParameters</i>	<i>txParametersGeneral</i>	<i>alpha</i> <i>p0</i>
			al0 31

		<i>ue-SelectedResourceConfig</i>	<i>poolSelection</i>	random
			<i>txProbability</i>	p100
	<i>rxParameters</i>			not present
<i>discTxPowerInfo</i>	<i>discMaxTxPower</i>			23
<i>SL-SyncConfig</i>	<i>syncCP-Len</i>			Normal
	<i>syncOffsetIndicator</i>			35 (155 mod 40)
	<i>sIssid</i>			30
	<i>txParameters</i>	<i>txParametersGeneral</i>	<i>alpha</i>	al0
			<i>p0</i>	31
		<i>syncTxThreshIC</i>		0 (-infinity)
	<i>rxParamsNCell</i>			not present
<i>discInterFreqList</i>				not present

Table A.3.12.4-2: ProSe Direct Discovery configuration for E-UTRA FDD (Configuration #2)

Information Element				Value
<i>discRxPool</i>	<i>cp-Len</i>			Normal
	<i>discPeriod</i>			rf32
	<i>numRetx</i>			0
	<i>numRepetition</i>			1
	<i>tf-ResourceConfig</i>	<i>prb-Num</i>		12
		<i>prb-Start</i>		0
		<i>prb-End</i>		23
		<i>offsetIndicator</i>		160
		<i>subframeBitmap</i>		11000000 00000000 00000000 00000000 00000000
	<i>txParameters</i>			not present
	<i>rxParameters</i>	<i>tdd-Config</i>		not present
		<i>syncConfigIndex</i>		0
<i>discTxPoolCommon/ discTxPoolDedicated</i>				not present
<i>discTxPowerInfo</i>	<i>discMaxTxPower</i>			23
<i>SL-SyncConfig</i>	<i>syncCP-Len</i>			Normal
	<i>syncOffsetIndicator</i>			20 (140 mod 40)
	<i>sIssid</i>			30
	<i>txParameters</i>			not present
	<i>rxParamsNCell</i>	<i>physCellId</i>		1
		<i>discSyncWindow</i>		w1
<i>discInterFreqLis</i>				not present

Table A.3.12.4-3: ProSe Direct Discovery configuration for E-UTRA TDD Config 0 (Configuration #3)

Information Element				Value
<i>discRxPool</i>	<i>cp-Len</i>			Normal
	<i>discPeriod</i>			rf32
	<i>numRetx</i>			0
	<i>numRepetition</i>			1
	<i>tf-ResourceConfig</i>	<i>prb-Num</i>		12
		<i>prb-Start</i>		0
		<i>prb-End</i>		23
		<i>offsetIndicator</i>		163
		<i>subframeBitmap</i>		11000000 00000000 00000000 00000000 00000000 00
	<i>txParameters</i>			not present

	<i>rxParameters</i>			not present
<i>discTxPoolCommon/ discTxPoolDedicated</i>	<i>cp-Len</i>			Normal
	<i>discPeriod</i>			rf32
	<i>numRetx</i>			0
	<i>numRepetition</i>			1
	<i>tf-ResourceConfig</i>	<i>prb-Num</i>		2
		<i>prb-Start</i>		3
		<i>prb-End</i>		5
		<i>offsetIndicator</i>		163
		<i>subframeBitmap</i>		10000000 00000000 00000000 00000000 00000000 00
	<i>txParameters</i>	<i>txParametersGeneral</i>	<i>alpha</i>	al0
			<i>p0</i>	31
		<i>ue- SelectedResourceConfig</i>	<i>poolSelection</i>	random
			<i>txProbability</i>	p100
	<i>rxParameters</i>			not present
<i>discTxPowerInfo</i>	<i>discMaxTxPower</i>			23
<i>SL-SyncConfig</i>	<i>syncCP-Len</i>			Normal
	<i>syncOffsetIndicator</i>			38 (158 mod 40)
	<i>slsid</i>			30
	<i>txParameters</i>	<i>txParametersGeneral</i>	<i>alpha</i>	al0
			<i>p0</i>	31
		<i>syncTxThreshIC</i>		0 (-infinity)
	<i>rxParamsNCell</i>			not present
<i>discInterFreqList</i>				not present

Table A.3.12.4-4: ProSe Direct Discovery configuration for E-UTRA FDD for PS discovery (Configuration #4)

Information Element				Value
<i>discConfig</i>				not present
<i>discInterFreqList</i>				not present
<i>discConfig-v1310</i>				not present
<i>discConfigPS</i>	<i>discRxPoolPS</i>	<i>cp-Len</i>		Normal
		<i>discPeriod-v1310</i>		rf4
		<i>numRetx</i>		0
		<i>numRepetition</i>		1
		<i>tf-ResourceConfig</i>	<i>prb-Num</i>	12
			<i>prb-Start</i>	0
			<i>prb-End</i>	23
			<i>offsetIndicator</i>	20
			<i>subframeBitmap</i>	11000000 00000000 00000000 00000000 00000000
		<i>txParameters</i>		not present
		<i>rxParameters</i>	<i>tdd-Config</i>	not present
			<i>syncConfigIndex</i>	0
	<i>discTxPoolPS- Common/ discTxPoolPS- Dedicated</i>			not present
<i>discConfigRelay</i>	<i>relayUE-Config</i>	<i>threshHigh</i>		not present
		<i>threshLow</i>		not present
		<i>hystMax</i>		not present
		<i>hystMin</i>		not present
	<i>remoteUE-Config</i>	<i>threshHigh</i>		0

				(-130dBm)
		<i>hystMax</i>		dB0
		<i>reselectionInfoC</i>	<i>q-RxLevMin</i>	(-94dBm)
			<i>filterCoefficient</i>	fc0
			<i>minHyst</i>	dB3

Table A.3.12.4-5: ProSe Direct Discovery configuration for E-UTRA FDD for inter-frequency discovery (Configuration #5)

Information Element			Value
<i>discConfig</i>			not present
<i>discInterFreqList</i>	<i>carrierFreq</i>		Note 1
	<i>plmn-IdentityList</i>		not present
<i>discConfig-v1310</i>			
<i>discInterFreqList-v1310</i>			
<i>discResourcesNonPS</i>	<i>discRxResourcesInterFreq</i>	<i>cp-Len</i>	Normal
		<i>discPeriod</i>	rf32
		<i>numRetx</i>	0
		<i>numRepetition</i>	1
		<i>tf-ResourceConfig</i>	
		<i>prb-Num</i>	12
		<i>prb-Start</i>	0
		<i>prb-End</i>	23
		<i>offsetIndicator</i>	160
		<i>subframeBitmap</i>	11000000 00000000 00000000 00000000 00000000
		<i>txParameters</i>	not present
		<i>rxParameters</i>	not present
		<i>rxParamsAddNeighFreq</i>	
		<i>physCellId</i>	Note 1
	<i>discTxResourcesInterFreq</i>	<i>discTxPoolCommon</i>	
		<i>cp-Len</i>	Normal
		<i>discPeriod</i>	rf32
		<i>numRetx</i>	0
		<i>numRepetition</i>	1
		<i>tf-ResourceConfig</i>	
		<i>prb-Num</i>	2
		<i>prb-Start</i>	3
		<i>prb-End</i>	5
		<i>offsetIndicator</i>	160
		<i>subframeBitmap</i>	10000000 00000000 00000000 00000000 00000000
		<i>txParameters</i>	
		<i>txParametersGeneral</i>	
		<i>alpha</i>	al0
		<i>p0</i>	31
		<i>ue-SelectedResourceConfig</i>	
		<i>poolSelection</i>	
		<i>txProbability</i>	p100
		<i>rxParameters</i>	not present
		<i>rxParamsAddNeighFreq</i>	not present
		<i>txParamsAddNeighFreq</i>	
		<i>physCellId</i>	Note 1
		<i>p-Max</i>	23
		<i>tdd-Config</i>	not present
		<i>tdd-Config-v1130</i>	not present
		<i>freqInfo</i>	
		<i>ul-CarrierFreq</i>	Note 1

		<i>ul-Bandwidth</i>	n25
		<i>additionalSpectrumEmission</i>	NS_01
		<i>referenceSignalPower</i>	Note 2
		<i>syncConfigIndex</i>	not present
<i>discResourcesPS</i>			not present
<i>discConfigOther</i>	<i>txPowerInfo</i>	<i>discMaxTxPower</i>	23
	<i>refCarrierCommon</i>		not present
	<i>discSyncConfig</i>		not present
	<i>discCellSelectionInfo</i>	<i>q-RxLevMin</i>	-70 (-140dBm)
		<i>q-RxLevMinOffset</i>	not present
		<i>q-Hyst</i>	dB0
		<i>q-RxLevMinReselection</i>	-70 (-140dBm)
		<i>t-ReselectionEUTRA</i>	0
<i>gapRequestsAllowedCommon</i>			True
<i>discConfigRelay</i>			not present
<i>discConfigPS</i>			not present
NOTE 1: As specified in the test.			
NOTE 2: As configured by the test system.			

A.3.12.5 Reference resource pool configurations for ProSe Direct Communication

Table A.3.12.5-1: ProSe Direct Communication configuration for E-UTRA FDD (Configuration #1)

Information Element				Value (5MHz)	Value (10MHz)
<i>commRxPool</i>	<i>sc-CP-Len</i>			Normal	
	<i>sc-Period</i>			sf40	
	<i>sc-TF-ResourceConfig</i>	<i>prb-Num</i>		12	25
		<i>prb-Start</i>		0	0
		<i>prb-End</i>		23	49
		<i>offsetIndicator</i>		0	
		<i>subframeBitmap</i>		00011000 00000000 00000000 00000000 00000000	
	<i>data-CP-Len</i>			Normal	
	<i>dataHoppingConfig</i>	<i>hoppingParameter</i>		0	
		<i>numSubbands</i>		ns1	
		<i>rb-Offset</i>		0	
	<i>ue-SelectedResourceConfig</i>	<i>data-TF-ResourceConfig</i>	<i>prb-Num</i>	12	25
			<i>prb-Start</i>	0	0
			<i>prb-End</i>	23	49
			<i>offsetIndicator</i>	0	
		<i>subframeBitmap</i>		00000000 11111111 11111111 11111111 11111111	
		<i>trpt-Subset-r12</i>		001	
	<i>rxParametersNCell</i>			not present	
	<i>txParameters</i>			not present	
<i>commTxPoolNormalCommon/ commTxPoolNormalDedicated</i>	<i>sc-CP-Len</i>			Normal	
	<i>sc-Period</i>			sf40	
	<i>sc-TF-ResourceConfig</i>	<i>prb-Num</i>		12	25
		<i>prb-Start</i>		0	0
		<i>prb-End</i>		24	49
		<i>offsetIndicator</i>		0	
		<i>subframeBitmap</i>		00011000	

				00000000 00000000 00000000 00000000
	<i>data-CP-Len</i>			Normal
	<i>dataHoppingConfig</i>	<i>hoppingParameter</i>		0
		<i>numSubbands</i>		ns1
		<i>rb-Offset</i>		0
	<i>ue-SelectedResourceConfig</i>	<i>data-TF-ResourceConfig</i>	<i>prb-Num</i>	12 25
			<i>prb-Start</i>	0 0
			<i>prb-End</i>	23 49
			<i>offsetIndicator</i>	0
			<i>subframeBitmap</i>	00000000 11111111 11111111 11111111 11111111
		<i>trpt-Subset-r12</i>		001
	<i>rxParametersNCell</i>			not present
	<i>txParameters</i>	<i>sc-TxParameters</i>	<i>alpha</i>	al0
			<i>p0</i>	31
		<i>dataTxParameters</i>	<i>alpha</i>	al0
			<i>p0</i>	31
<i>SL-SyncConfig</i>	<i>syncCP-Len</i>			Normal
	<i>syncOffsetIndicator</i>			2
	<i>slssid</i>			30
	<i>txParameters</i>	<i>txParametersGeneral</i>	<i>alpha</i>	al0
			<i>p0</i>	31
		<i>syncTxThreshIC</i>		0 (-infinity)
	<i>rxParamsNCell</i>			not present

Table A.3.12.5-2: ProSe Direct Communication pre-configuration for E-UTRAN FDD for out-of-network coverage operation (Configuration #2)

Information Element			Value (5MHz)	Value (10MHz)
<i>preconfigSync</i>	<i>syncCP-Len-r12</i>		Normal	
	<i>syncOffsetIndicator1</i>		2	
	<i>syncOffsetIndicator2</i>		1	
	<i>syncTxParameters</i>		31	
	<i>syncTxThreshOoC</i>		0 (-110dBm / 15kHz)	
	<i>filterCoefficient</i>		fc0	
	<i>syncRefMinHyst</i>		dB0	
	<i>syncRefDiffHyst</i>		dB0	
<i>preconfigComm</i>	<i>sc-CP-Len</i>		Normal	
	<i>sc-Period</i>		sf40	
	<i>sc-TF-ResourceConfig</i>	<i>prb-Num</i>	12	25
		<i>prb-Start</i>	0	0
		<i>prb-End</i>	23	49
		<i>offsetIndicator</i>	0	
		<i>subframeBitmap</i>	00011000 00000000 00000000 00000000 00000000	
	<i>data-CP-Len</i>		Normal	
	<i>dataHoppingConfig</i>	<i>hoppingParameter</i>	0	
		<i>numSubbands</i>	ns1	
		<i>rb-Offset</i>	0	
	<i>ue-SelectedResourceConfig</i>	<i>data-TF-ResourceConfig</i>	<i>prb-Num</i>	12 25
			<i>prb-Start</i>	0 0

			<i>prb-End</i>	23	49
			<i>offsetIndicator</i>	0	
			<i>subframeBitmap</i>	00000000 11111111 11111111 11111111 11111111	
		<i>trpt-Subset-r12</i>		001	

A.3.12.6 Reference Measurement Channels for ProSe Direct Discovery

A.3.12.6.1 FDD

Table A.3.12.6-1: PSDCH Reference Measurement Channels for FDD

Parameter	Unit	Value
Reference channel		D.1 FDD
Channel bandwidth	MHz	5
Allocated resource blocks		2
Subcarriers per resource block		12
Allocated subframes per Discovery period		1
DFT-OFDM Symbols per subframe (see note)		11
Modulation		QPSK
Information Bit Payload		232
Transport block CRC	Bits	24
Maximum number of HARQ transmissions		1
Binary Channel Bits (see note)	Bits	528
NOTE1: PSDCH transmissions are rate-matched for 12 DFT-OFDM symbols per subframe, and the last symbol shall be punctured as per TS 36.211.		

A.3.12.7 Reference measurement channels for ProSe Direct Communication

A.3.12.7.1 FDD

Table A.3.12.7-1: PSCCH Reference Measurement Channels for FDD

Parameter		Unit	Value	
Reference channel			CC.1 FDD	CC.2 FDD
Channel bandwidth		MHz	5	10
Allocated resource blocks			1	1
Subcarriers per resource block			12	12
DFT-OFDM Symbols per subframe (see Note 1)			11	11
Modulation			QPSK	QPSK
Information Bit Payload		Bits	41	43
Information bits	Frequency hopping flag		0	
	RB assignment		Set as per PSSCH RB allocation specific in the test	
	Time resource pattern (<i>l_{TRP}</i>)		0 (Note 2)	
	Modulation and coding scheme		Set as the PSSCH MCS specified in the test	
	Timing advance indication		0	
	Group destination ID		As set by higher layers	
Transport block CRC		Bits	16	16
Maximum number of HARQ transmissions			2	2
Binary Channel Bits (see Note 1)		Bits	264	264
NOTE1: PSCCH transmissions are rate-matched for 12 DFT-OFDM symbols per subframe, and the last symbol shall be punctured as per TS 36.211.				
NOTE 2: For <i>N_{TRP}</i> = 8 (FDD) and <i>trpt-Subset</i> = 001, <i>l_{TRP}</i> = 0 corresponds to a time repetition pattern of (1,0,0,0,0,0,0,0) as per TS 36.213.				

Table A.3.12.7-1: PSSCH Reference Measurement Channels for FDD

Parameter	Unit	Value	
		CD.1 FDD	CD.2 FDD
Reference channel		CD.1 FDD	CD.2 FDD
Channel bandwidth	MHz	5	10
Allocated resource blocks		2	3
Subcarriers per resource block		12	12
DFT-OFDM Symbols per subframe (see Note 1)		11	11
Modulation		QPSK	QPSK
Target Code Rate		1/3	1/3
Information Bit Payload		176	256
Transport block CRC	Bits	24	24
Maximum number of HARQ transmissions		3	3
Binary Channel Bits (see note)	Bits	528	1056
NOTE1: PSDCH transmissions are rate-matched for 12 DFT-OFDM symbols per subframe, and the last symbol shall be punctured as per TS 36.211.			

A.3.12.8 ProSe Receive Traffic Generator

This clause defines the configuration for active Sidelink UEs used to generate receive traffic in ProSe RRM tests.

A.3.12.8.1 ProSe Direct Communication Receive Traffic Generator for FDD

Table A.3.12.8.1-1: Active Sidelink UE configuration for ProSe Direct Communication

Configuration			PCP.1.FDD
Channel BW		MHz	5 or 10
Number of Active Sidelink UEs per sc-period			5 MHz: 12 10 MHz: 16
Active Sidelink UEs	PSCCH RMC (defined in A.3.12.7)		5 MHz: CC.1 FDD 10 MHz: CC.2 FDD
	PSCCH resource allocation		5MHz: [2i:2i], for Sidelink UE i=0,...,11 10MHz:[3i:3i], for Sidelink UE i = 0, ..., 15
	PSSCH RMC (defined in A.3.12.7)		5 MHz: CD.1 FDD 10 MHz: CD.2 FDD
	PSSCH resource allocation		Non-overlapping RBs 5MHz: [2i:2i+1], for Sidelink UE i = 0, ..., 11 10MHz:[3i:3i+2], for Sidelink UE i = 0, ..., 15
	RSRP	dBm/15kHz	-98

A.3.12.8.2 ProSe Direct Discovery Receive Traffic Generator for FDD

Table A.3.12.8.2-1: Active Sidelink UE configuration for ProSe Direct Discovery

Configuration			PDP.1.FDD	PDP.2.FDD
Channel BW		MHz	5	
Number of Active Sidelink UEs per Discovery subframe			12	
Active Sidelink UEs	Sidelink UE Transmissions		PSDCH (RMC D.1 FDD)	PSDCH (RMC D.1 FDD) + SLSS on synchronization subframe
	Resource allocation		Non overlapping RBs in a subframe	
	RSRP	dBm/15kHz	-95	

A.3.13 Time Offset between Cells

A.3.13.1 Introduction

In Annex A in some test cases a parameter called, ‘time offset between cells’ is used. The meaning of this parameter is defined in this clause.

A.3.13.2 Definition

Unless explicitly stated otherwise, the time offset between cells for a pair of cells is defined as the difference between radio frame start timings of the pair of cells.

A.3.14 Carrier Aggregation under operation with Frame Structure 3 Test Cases with Different Duplex Modes

A.3.14.1 Introduction

This clause defines a principle which is applicable to test cases verifying RRM requirements for carrier aggregation with at least one Scell under operation with Frame Structure 3.

A.3.14.2 Principle of testing

In Annex A, tests for carrier aggregation with at least one Scell under operation with frame structure 3 are specified with both an FDD and a TDD Pcell to verify the same RRM requirement. If both types of tests are relevant to a UE considering supported CA bands, the test coverage can be considered fulfilled by executing either the tests with FDD PCell or the tests with TDD PCell and the UE is not required to pass both tests.

A.3.15 Dual connectivity test cases with different combination of duplex mode

A.3.15.1 Introduction

This clause defines a principle which is applicable to test cases verifying RRM requirements for dual connectivity (DC) operation with different combination of duplex modes.

A.3.15.2 Principle of testing

If multiple dual connectivity test cases are defined for different combination of duplex modes (E-UTRA FDD-FDD, E-UTRA TDD-TDD and E-UTRA TDD-FDD) to verify the same RRM requirement which is independent of the combination of duplex modes and is identical for different combination of duplex modes, then from UE the performance point of view the test coverage can be considered fulfilled by executing only the corresponding test case(s) with one of the combination of duplex modes supported by the UE.

A.3.16 Reference PRACH Configurations

Table A.3.16-1: PRACH configuration parameters

Parameter	Value			Comments
	PRACH_2CE	PRACH_3CE	PRACH_4CE	
Reference configuration	PRACH_2CE	PRACH_3CE	PRACH_4CE	
Rsrp-ThresholdsPRACH	{-99} dBm	{-107, -99} dBm	{-107, -99, -92} dBm	As defined in TS36.331
CE level 0:	Configured	Configured	Configured	Up to 4 CE levels, each corresponding to a PRACH configuration
Prach Configuration Index:	4	4	4	See TS 36.211 section 5.7.1
numRepetitionPerPreambleAttempt:	1	1	1	Number of PRACH repetitions per attempt for each CE level, See TS 36.211

prach-HoppingConfig:	off	off	off	Coverage level specific frequency hopping configuration for PRACH
CE level 1:	Configured	Configured	Configured	Up to 4 CE levels, each corresponding to a PRACH configuration
Prach Configuration Index:	4	4	4	see TS 36.211 section 5.7.1
numRepetitionPerPreambleAttempt:	128	64	32	Number of PRACH repetitions per attempt for each CE level, See TS 36.211
prach-HoppingConfig:	off	off	off	Coverage level specific frequency hopping configuration for PRACH
CE level 2:	Not Configured	Configured	Configured	Up to 4 CE levels, each corresponding to a PRACH configuration
Prach Configuration Index:	-	4	4	see TS 36.211 section 5.7.1
numRepetitionPerPreambleAttempt:	-	128	64	Number of PRACH repetitions per attempt for each CE level, See TS 36.211
prach-HoppingConfig:	-	off	off	Coverage level specific frequency hopping configuration for PRACH
CE level 3:	Not Configured	Not Configured	Configured	Up to 4 CE levels, each corresponding to a PRACH configuration
Prach Configuration Index:	-	-	4	see TS 36.211 section 5.7.1
numRepetitionPerPreambleAttempt:	-	-	128	Number of PRACH repetitions per attempt for each CE level, See TS 36.211
prach-HoppingConfig:	-	-	off	Coverage level specific frequency hopping configuration for PRACH

A.3.17 Listen before talk model

A.3.17.1 Introduction

In some RRM test cases for FS3, a listen before talk (LBT) model is specified. The intention of the LBT model is to emulate using test equipment the behaviour of an FS3 eNB which performs channel measurement to check that the channel is clear prior to performing downlink transmission.

A.3.17.2 Definition

Prior to each DMTC window, the test equipment shall determine whether to transmit a discovery reference signal (DRS) during the DMTC window with probability $P=0.75$. In many cases the test requirement depends on the number of configured discovery signal occasions which are not available during the test, so the test equipment shall track how many DRS are not transmitted during the test period. If the test equipment determines that it shall transmit a DRS, then the timing of the DRS transmission within the DMTC window is randomly selected from the set of possible DRS transmission signal timings, such that there is an equal probability of any valid DRS timing.

For non DRS downlink transmission bursts, if transmission occurred in the previous subframe, transmission is muted for a duration of one subframe. Additionally, if the start time of the candidate transmission burst is within 8 subframes of the start of the DMTC window, transmission is not performed. Otherwise

The length of the transmission burst in subframes is defined as N . The burst transmission format is determined according to the steps below:

1. Select N randomly from a given set of the number of subframes $S_1=\{1,3,5,8\}$ with equal probability as the total length of burst transmission format.
2. A uniform random variable from 0 to 1 is generated. If the random variable is less than $P=0.75$, a burst of N fully occupied subframes is transmitted. Otherwise, the burst transmission is muted and the muting duration is the same as the number N of subframes for determined burst format.

A.3.18 Reference NPRACH Configurations

Table A.3.18-1 and A.3.18-2 define the reference NB-IoT PRACH configurations for a NB-IoT RRM test case where the UE is required to transmit NPRACH during the testing procedure, but the testing purpose of the RRM test case does not include testing NPRACH performance.

Table A.3.18-1: NPRACH.R-1: HD-FDD Reference NPRACH Configuration

Field	Value			Comment
Parameters not per NPRACH coverage level				
rsrp-ThresholdsPrach	{rsrp1, rsrp2}			The values of NPRACH RSRP thresholds for will be set according the requirement of individual test cases
nprach-CP-Length	us66dot7			NPRACH format 0
Parameters per NPRACH coverage Level				
CE Level	Level 0	Level 1	Level 2	Valid values as defined in TS 36.331 [2]
nprach-Periodicity	ms40	ms40	ms40	{ms40, ms80, ms160, ms240, ms320, ms640, ms1280, ms2560}
nprach-StartTime	ms8	ms8	ms8	{ms8, ms16, ms32, ms64, ms128, ms256, ms512, ms1024}
nprach-SubcarrierOffset	n0	n0	n0	{n0, n12, n24, n36, n2, n18, n34}
nprach-NumSubcarriers	n12	n12	n12	{n12, n24, n36, n48}
nprach-SubcarrierMSG3-RangeStart	{one}	{one}	{one}	{zero, oneThird, twoThird, one}
maxNumPreambleAttemptCE	n3	n5	n7	{n3, n4, n5, n6, n7, n8, n10}
numRepetitionsPerPreambleAttempt	n1	n8	n32	{n1, n2, n4, n8, n16, n32, n64, n128}
npdcch-NumRepetitions-RA	r1	r8	r32	{r1, r2, r4, r8, r16, r32, r64, r128, r256, r512, r1024, r2048}
npdcch-StartSF-CSS-RA	v8	v2	v2	{v1dot5, v2, v4, v8, v16, v32, v48, v64}
npdcch-Offset-RA	zero	zero	zero	{zero, oneEighth, oneFourth, threeEighth}
nprach-NumCBRA-StartSubcarriers	n8	n8	n8	{n8, n10, n11, n12, n20, n22, n23, n24, n32, n34, n35, n36, n40, n44, n48}
Note 1: See Clause 6.7.3.2 in TS 36.331 [2] for further information on the parameters in this table.				

Table A.3.18-2: NPRACH.R-2: TDD Reference NPRACH Configuration

Field	Value			Comment
Parameters not per NPRACH coverage level				
rsrp-ThresholdsPrach	{rsrp1, rsrp2}			The values of NPRACH RSRP thresholds for will be set according the requirement of individual test cases
nprach-PreambleFormat	fmt-0			See TS 36.211 [16] section 10.1.6
Parameters per NPRACH coverage Level				
CE Level	Level 0	Level 1	Level 2	Valid values as defined in TS 36.331 [2]

nprach-Periodicity	ms80	ms80	ms80	{ms80, ms160, ms320, ms640, ms1280, ms2560, ms5120, ms10240}
nprach-StartTime	ms10	ms10	ms10	{ms10, ms20, ms40, ms80, ms160, ms320, ms640, ms1280, ms2560, ms5120}
nprach-SubcarrierOffset	n0	n0	n0	{n0, n12, n24, n36, n2, n18, n34}
nprach-NumSubcarriers	n12	n12	n12	{n12, n24, n36, n48}
nprach-SubcarrierMSG3-RangeStart	{one}	{one}	{one}	{zero, oneThird, twoThird, one}
maxNumPreambleAttemptCE	n3	n5	n7	{n3, n4, n5, n6, n7, n8, n10}
numRepetitionsPerPreambleAttempt	n1	n8	n32	{n1, n2, n4, n8, n16, n32, n64, n128, n256, n512, n1024}
npdcch-NumRepetitions-RA	r1	r8	r32	{r1, r2, r4, r8, r16, r32, r64, r128, r256, r512, r1024, r2048}
npdcch-StartSF-CSS-RA	v8	v4	v4	{v4, v8, v16, v32, v48, v64, v96, v128}
npdcch-Offset-RA	zero	zero	zero	{zero, oneEighth, oneFourth, threeEighth}
nprach-NumCBRA-StartSubcarriers	n8	n8	n8	{n8, n10, n11, n12, n20, n22, n23, n24, n32, n34, n35, n36, n40, n44, n48}
Note 1: See Clause 6.7.3.2 in TS 36.331 [2] for further information on the parameters in this table.				

A.3.19 Dual connectivity test cases with different bandwidth combinations

A.3.19.1 Introduction

This clause defines a principle which is applicable to test cases verifying RRM requirements for dual connectivity (DC) operation with different bandwidth combinations.

A.3.19.2 Principle of testing

If multiple dual connectivity test cases with different channel bandwidth combinations are defined to verify the same RRM requirement that is channel bandwidth independent, then the UE needs to be tested only with one bandwidth combination out of the bandwidth combination sets supported by that UE.

A.3.20 Category M1 UE Test Cases

A.3.20.1 Introduction

This clause defines a principle which is applicable to test cases verifying RRM requirements for Category M1 UE in both CEModeA and CEModeB.

A.3.20.2 Principle of Cat-M1 UE Testing

In Annex A Cat-M1 UE test cases may be defined for both CEModeA and CEModeB to verify the same type of RRM requirement.

If test cases are defined in both CEModeA and CEModeB in order to verify the same type of RRM requirement then the UE capable of CEModeB needs to be tested for the corresponding test(s) defined in CEModeA and/or in CEModeB according to the applicability rules defined in Table A.3.20.2-1.

The UE which is not capable of CEModeB shall be tested for all CEModeA test cases defined in Annex A.

In test cases defined for CEModeB, test equipment shall transmit PBCH with 5 repetitions as specified in section 6.6.4 of TS 36.211 [16].

Table A.3.20.2-1: Test case applicability rules for category M1 UE in CEModeA and CEModeB

Type of Test Cases	Coverage mode(s) Applicable for Testing	
	CEModeA	CEModeB
A.4 E-UTRAN RRC IDLE State: Intra-frequency Cell Re-Selection Tests for Category M1 UE	X	X
A.4 E-UTRAN RRC IDLE State: Inter-frequency Cell Re-Selection Tests for Category M1 UE	X	X
A.5 E-UTRAN RRC CONNECTED Mode Mobility: E-UTRAN Intra-frequency with SFN acquisition Handover Tests for Category M1 UE	X	
A.5 E-UTRAN RRC CONNECTED Mode Mobility: E-UTRAN Inter-frequency with SFN acquisition Handover Tests for Category M1 UE	X	
A.5 E-UTRAN RRC CONNECTED Mode Mobility: E-UTRAN Intra-frequency without SFN acquisition Handover Tests for Category M1 UE		X
A.5 E-UTRAN RRC CONNECTED Mode Mobility: E-UTRAN Inter-frequency without SFN acquisition Handover Tests for Category M1 UE		X
A.5 RRC Connection Control: E-UTRAN Intra-frequency RRC Re-Establishment Tests for Category M1 UE		X
A.5 RRC Connection Control: E-UTRAN Inter-frequency RRC Re-Establishment Tests for Category M1 UE		X
A.6 E-UTRAN Contention Based Random Access Tests for Cat-M1 UE		X
A.7 Timing and Signalling Characteristics: E-UTRAN UE Transmit Timing Accuracy Tests for Category M1 UE		X
A.7 Timing and Signalling Characteristics: E-UTRAN Timing Advance Adjustment Accuracy Tests for Cat-M1 UE		X
A.7.3 Radio Link Monitoring: E-UTRAN Radio Link Monitoring Tests for Category M1 UE	X	
A.7.3 Radio Link Monitoring: E-UTRAN Radio Link Monitoring Tests for for Early In-sync and Early Out-of-sync for Category M1 UE		X
A.8 Measurements Procedures: E-UTRAN Intra-frequency Event Triggered Reporting under Fading Propagation Conditions Tests for Category M1 UE	X	X
A.8 Measurements Procedures: E-UTRAN Intra-frequency Serving Cell Event Triggered Reporting under Fading Propagation Conditions Tests for Category M1 UE without Gaps	X	N/A
A.8 Measurements Procedures: E-UTRAN Intra-frequency Identification of a New CGI of E-UTRA cell using Autonomous Gaps Tests for Category M1 UE	N/A	X
A.8 Measurements Procedures: E-UTRAN Inter-frequency Event Triggered Reporting under Fading Propagation Conditions Tests for Category M1 UE	X	X
A.8.12 Measurements Procedures: E-UTRAN Intra-frequency RSTD measurement reporting delay tests for Category M1 UE	X	X
A.8.13 Measurements Procedures: E-UTRAN Inter-frequency RSTD measurement reporting delay tests for Category M1 UE	X	X
A.9 Measurement Performance Requirements: RSRP Intra-Frequency Measurement Accuracy Tests for Category M1 UE	X	X
A.9.7 Measurement Performance Requirements: E-UTRAN UE Rx-Tx Time Difference Measurement Accuracy Tests for Category M1 UE	X	N/A
A.9.8 Measurement Performance Requirements: E-UTRAN Intra-frequency RSTD Measurement Accuracy Tests for Category M1 UE	X	X
A.9.8 Measurement Performance Requirements: E-UTRAN Inter-frequency RSTD Measurement Accuracy Tests for Category M1 UE	X	X

A.3.20.3 Principle of Cat-M1 UE testing for inter-frequency RSTD measurement period requirements with measurement gaps

For the Cat-M1 UE, capable of supporting measurement gaps specified in Table 8.1.2.1-3 and requiring gaps for inter-frequency RSTD measurements, and which can be configured with applicable measurement gaps specified in Table 8.1.2.1-1 or Table 8.1.2.1-3, in order to verify inter-frequency RSTD measurement period with measurement gaps, it is

sufficient to verify the RSTD measurement period requirements only under the applicable measurement gaps specified in Table 8.1.2.1-3, for each of the CEModeA and CEModeB.

A.3.21 V2V Sidelink Communication on Dedicated V2V Carrier

A.3.21.1 Introduction

This clause also defines the principle and the reference configurations that are applicable to test cases verifying RRM core requirements for V2V sidelink communication on dedicated V2V carrier.

A.3.21.2 Reference resource pool configurations for V2V Sidelink Communication

Table A.3.21.2-1: Pre-configuration for V2V Sidelink Communication

Derivation Path: TS 36.331 [3] clause 9.3.2, SL-V2X-Preconfiguration			
Information Element	Value/remark	Comment	Condition
SL-V2X-PreconfigCommPool-r14 ::= SEQUENCE {			
sl-OffsetIndicator-r14	0	Indicates the offset of the first subframe of a resource pool within a SFN cycle. If absent, the resource pool starts from first subframe of SFN=0.	
sl-Subframe-r14 included in SL-PreconfigV2X-TxPoolList	10000000000000000000 10000000000000000000 10000000000000000000 10000000000000000000 10000000000000000000	Indicates the bitmap of the TX resource pool, which is defined by repeating the bitmap within a SFN cycle (see TS 36.213 [23])	
sl-Subframe-r14 included in SL-PreconfigV2X-RxPoolList	11111111111111111111 11111111111111111111 11111111111111111111 11111111111111111111 11111111111111111111	Indicates the bitmap of the RX resource pool, which is defined by repeating the bitmap within a SFN cycle (see TS 36.213 [23])	
adjacencyPSCCH-PSSCH-r14	True	Adjacent: TURE Non-adjacent: FALSE	
sizeSubchannel-r14	5	Minimum bandwidth of subchannel for adjacent transmission	
startRB-Subchannel-r14	0	Indicates the lowest RB index of the subchannel with the lowest index.	
startRB-PSCCH-Pool-r14	0	Indicates the lowest RB index of the PSCCH pool	
}			

A.3.21.3 Reference measurement channels for V2V Sidelink Communication

Table A.3.21.3-1: PSCCH Reference Measurement Channels

Parameter	Unit	Value
Reference channel		CC.1
Channel bandwidth	MHz	10
Allocated PSCCH resource blocks		2
DFT-OFDM symbols per subframe (see Note 1)		9
Modulation		QPSK
Information Bit Payload (without CRC)	Bits	32
Information Bit	SCI Format	1
	Priority	As set by higher layers
	Resource reservation	0
	Modulation and coding scheme	Set as the PSSCH MCS specified in the test
	Retransmission index	Note 4
	Time gap between initial transmission and retransmission	

	Frequency resource location of the initial transmission and retransmission		Initial transmission: Set as per PSSCH RB allocation specific in the test Retransmission: Note 4
	Reserved bits		Set all these bits to 0
	Transport block CRC	Bits	16
	Binary Channel Bits (see Note 3)	Bits	432
Note 1:	PSSCH transmissions are rate-matched for 10 DFT-OFDM symbols per subframe, and the last symbol shall be punctured as per TS 36.211.		
Note 2:	SF_{gap} is the value indicated by "Time gap between initial transmission and retransmission" field in the configured sidelink grant, and $SF_{gap} = 0$ means no retransmission of the associated TB as per TS 36.213.		
Note 3:	Binary channel bits calculated under assumption of 9 DFT-OFDM symbols per subframe.		
Note 4:	UE is allowed to autonomously select the un-used or redundant bits/code-points in SCI format 1		

Table A.3.21.3-2: PSSCH Reference Measurement Channels

Parameter	Unit	Value
Reference channel		CD.1
Sidelink transmission mode		4
Channel bandwidth	MHz	10
Allocated PSSCH resource blocks		3
DFT-OFDM symbols per subframe (see Note 1)		9
Modulation		QPSK
Target Code Rate		1/3
Information Bit Payload (Transport block size)	Bits	208
Transport block CRC	Bits	24
Number of PSSCH HARQ retransmissions		0
Binary Channel Bits (see Note 2)	Bits	648
Note 1:	PSSCH transmissions are rate-matched for 10 DFT-OFDM symbols per subframe, and the last symbol shall be punctured as per TS 36.211.	
Note 2:	Binary channel bits calculated under assumption of 9 DFT-OFDM symbols per subframe.	

A.3.22 Category 1bis UE Test Cases

A.3.22.1 Introduction

This clause defines a principle which is applicable to test cases verifying RRM requirements for Category 1bis UE.

A.3.22.2 Principle of Category 1bis UE Testing

In Annex A, tests in table A.3.22.2-1 defined for Category ≥ 1 UE with 2 Rx antenna are applicable to Category 1bis UE with 1 Rx antenna. Unless otherwise specified, same test configurations are used except for propagation channel change to 1x1 or 2x1 according to number of Tx antennas. For RSRP and RSRQ measurement accuracy test, corresponding measurement accuracy requirement for Category 1bis UE is specified in the table. For band dependent RRM tests defined in section A.9, only subset of bands that are defined for Cat.1bis UE are applicable.

Table A.3.22.2-1: Test cases applicable to category 1bis UE

Test category	Test case	Test case name
Cell re-selection tests	A.4.2.20	E-UTRAN FDD – FDD Intra frequency case for UE Category 1bis
	A.4.2.21	E-UTRAN TDD – TDD Intra frequency case for UE Category 1bis
	A.4.2.31	E-UTRAN FDD – FDD Inter frequency case for UE Category 1bis
	A.4.2.32	E-UTRAN FDD – TDD Inter frequency case for UE Category 1bis
	A.4.2.33	E-UTRAN TDD – FDD Inter frequency case for UE Category 1bis
	A.4.2.34	E-UTRAN TDD – TDD: Inter frequency case for UE Category 1bis
Handover tests	A.5.1.19	E-UTRAN FDD - FDD Intra frequency handover for UE Category 1bis
	A.5.1.20	E-UTRAN TDD - TDD Intra frequency handover for UE Category 1bis

	A.5.1.3	E-UTRAN FDD – FDD Inter frequency handover
	A.5.1.4	E-UTRAN TDD – TDD Inter frequency handover
	A.5.1.5	E-UTRAN FDD – FDD Inter frequency handover: unknown target cell
	A.5.1.6	E-UTRAN TDD – TDD Inter frequency handover; unknown Target Cell
	A.5.1.7	E-UTRAN FDD – TDD Inter frequency handover
	A.5.1.8	E-UTRAN TDD – FDD Inter frequency handover
RRC re-establishment tests	A.6.1.1	E-UTRAN FDD Intra-frequency RRC Re-establishment
	A.6.1.2	E-UTRAN FDD Inter-frequency RRC Re-establishment
	A.6.1.3	E-UTRAN TDD Intra-frequency RRC Re-establishment
	A.6.1.4	E-UTRAN TDD Inter-frequency RRC Re-establishment
Random access tests	A.6.2.1	E-UTRAN FDD – Contention Based Random Access Test
	A.6.2.2	E-UTRAN FDD – Non-Contention Based Random Access Test
	A.6.2.3	E-UTRAN TDD – Contention Based Random Access Test
	A.6.2.4	E-UTRAN TDD – Non-Contention Based Random Access Test
RRC connection release with redirection tests	A.6.3.1	Redirection from E-UTRAN FDD to UTRAN FDD
	A.6.3.2	Redirection from E-UTRAN TDD to UTRAN FDD
	A.6.3.3	Redirection from E-UTRAN FDD to GERAN when System Information is provided
	A.6.3.4	Redirection from E-UTRAN TDD to GERAN when System Information is provided
	A.6.3.5	E-UTRA TDD RRC connection release redirection to UTRA TDD
	A.6.3.6	E-UTRA FDD RRC connection release redirection to UTRA TDD
	A.6.3.7	E-UTRA TDD RRC connection release redirection to UTRA TDD without SI provided
	A.6.3.8	E-UTRA FDD RRC connection release redirection to UTRA TDD without SI provided
	A.6.3.9	Redirection from E-UTRAN FDD to UTRAN FDD without System Information
	A.6.3.10	Redirection from E-UTRAN FDD to GERAN when System Information is not provided
	A.6.3.11	Redirection from E-UTRAN TDD to GERAN when System Information is not provided
	A.6.3.12	E-UTRAN TDD RRC connection release redirection to UTRAN FDD without SI provided
UE transmit timing tests	A.7.1.1	E-UTRAN FDD – UE Transmit Timing Accuracy Tests
	A.7.1.2	E-UTRAN TDD - UE Transmit Timing Accuracy Tests
UE timing advance tests	A.7.2.1	E-UTRAN FDD – UE Timing Advance Adjustment Accuracy Test
	A.7.2.2	E-UTRAN TDD – UE Timing Advance Adjustment Accuracy Test
Radio link monitoring tests	A.7.3.26	E-UTRAN FD-FDD Radio Link Monitoring Test for Out-of-sync for UE Category 0
	A.7.3.27	E-UTRAN FD-FDD Radio Link Monitoring Test for In-sync for UE Category 0
	A.7.3.28	E-UTRAN FD-FDD Radio Link Monitoring Test for Out-of-sync in DRX for UE category 0
	A.7.3.29	E-UTRAN FD-FDD Radio Link Monitoring Test for In-sync in DRX for UE Category 0
	A.7.3.34	E-UTRAN TDD Radio Link Monitoring Test for Out-of-sync for UE Category 0
	A.7.3.35	E-UTRAN TDD Radio Link Monitoring Test for In-sync for UE category 0
	A.7.3.36	E-UTRAN TDD Radio Link Monitoring Test for Out-of-sync in DRX for UE category 0
A.7.3.37	E-UTRAN TDD Radio Link Monitoring Test for In-sync in DRX for UE category 0	
Event-triggered reporting	A.8.1.11	E-UTRAN FDD-FDD intra-frequency event triggered reporting under fading propagation conditions in asynchronous cells for UE category 0
	A.8.1.12	E-UTRAN FDD-FDD intra-frequency event triggered reporting under fading propagation conditions in synchronous cells for UE category 0
	A.8.1.13	E-UTRAN FDD-FDD intra-frequency event triggered reporting under fading propagation conditions in synchronous cells with DRX for UE category 0
	A.8.2.12	E-UTRAN TDD-TDD intra-frequency event triggered reporting under fading propagation conditions in synchronous cells
	A.8.2.13	E-UTRAN TDD-TDD intra-frequency event triggered reporting under fading propagation conditions in synchronous cells with DRX
	A.8.3.1	E-UTRAN FDD-FDD Inter-frequency event triggered reporting under fading propagation conditions in asynchronous cells

	A.8.3.2	E-UTRAN FDD-FDD Inter-frequency event triggered reporting when DRX is used under fading propagation conditions in asynchronous cells
	A.8.3.3	E-UTRAN FDD-FDD inter-frequency event triggered reporting under AWGN propagation conditions in asynchronous cells with DRX when L3 filtering is used
	A.8.4.1	E-UTRAN TDD-TDD Inter-frequency event triggered reporting under fading propagation conditions in synchronous cells
	A.8.4.2	E-UTRAN TDD-TDD Inter-frequency event triggered reporting when DRX is used under fading propagation conditions in synchronous cells
	A.8.4.3	E-UTRAN TDD-TDD inter-frequency event triggered reporting under AWGN propagation conditions in synchronous cells with DRX when L3 filtering is used
	A.8.4.6	E-UTRAN TDD-TDD Inter-frequency event triggered reporting for TDD UL/DL configuration 0
CGI reading tests	A.8.1.19	E-UTRAN FDD-FDD Intra-frequency identification of a new CGI of E-UTRA cell using autonomous gaps for UE category 0
	A.8.1.20	E-UTRAN FDD - FDD Intra-frequency identification of a new CGI of E-UTRA cell using autonomous gaps with DRX for UE category 0
	A.8.2.7	E-UTRAN TDD Intra-frequency identification of a new CGI of E-UTRA cell using autonomous gaps
	A.8.2.8	E-UTRAN TDD Intra-frequency identification of a new CGI of E-UTRA cell using autonomous gaps with DRX
RSTD measurement reporting delay test	A.8.12.1	E-UTRAN FDD intra-frequency RSTD measurement reporting delay test case
	A.8.12.2	E-UTRAN TDD intra-frequency RSTD measurement reporting delay test case
	A.8.13.1	E-UTRAN FDD-FDD inter-frequency RSTD measurement reporting delay test case with the reference cell on the serving carrier frequency
	A.8.13.2	E-UTRAN TDD-TDD inter-frequency RSTD measurement reporting delay test case with the reference cell on the serving carrier frequency
RSRP measurement accuracy tests	A.9.1.1	FDD Intra frequency case Measurement accuracy requirement in 9.1.2.7 and 9.1.2.8
	A.9.1.2	TDD Intra frequency case Measurement accuracy requirement in 9.1.2.7 and 9.1.2.8
	A.9.1.3	FDD—FDD Inter frequency case Measurement accuracy requirement in 9.1.3.3 and 9.1.3.4
	A.9.1.4	TDD—TDD Inter frequency case Measurement accuracy requirement in 9.1.3.3 and 9.1.3.4
	A.9.1.5	FDD—TDD Inter frequency case Measurement accuracy requirement in 9.1.3.3 and 9.1.3.4
RSRQ measurement accuracy tests	A.9.2.1	FDD Intra frequency case Measurement accuracy requirement in 9.1.5.5
	A.9.2.2	TDD Intra frequency case Measurement accuracy requirement in 9.1.5.5
	A.9.2.3	FDD—FDD Inter frequency case Measurement accuracy requirement in 9.1.6.5 and 9.1.6.6
	A.9.2.4	TDD—TDD Inter frequency case Measurement accuracy requirement in 9.1.6.5 and 9.1.6.6
	A.9.2.4A	FDD—TDD Inter frequency case Measurement accuracy requirement in 9.1.6.5 and 9.1.6.6
UE Rx-Tx time difference measurement accuracy tests	A.9.7.1	E-UTRAN FDD UE Rx – Tx time difference case
	A.9.7.2	E-UTRA TDD
RSTD measurement accuracy tests	A.9.8.1	E-UTRAN FDD RSTD intra frequency case Measurement accuracy requirement in 9.1.10.5
	A.9.8.2	E-UTRAN TDD RSTD intra frequency case Measurement accuracy requirement in 9.1.10.5
	A.9.8.3	E-UTRAN FDD-FDD RSTD inter frequency case Measurement accuracy requirement in 9.1.10.6
	A.9.8.4	E-UTRAN TDD-TDD RSTD inter frequency case Measurement accuracy requirement in 9.1.10.5

A.3.23 Category NB2 UE Test Cases

A.3.23.1 Introduction

This clause defines a principle which is applicable to test cases verifying RRM requirements for Category NB2 UE in both normal and enhanced coverage.

A.3.23.2 Principle of Category NB2 UE Testing

In Annex A, test cases in table A.3.23.2-1 defined for Category NB1 UE are applicable to Category NB2 UE.

Table A.3.23.2-1: Test cases applicable to Category NB2 UE

Test category	Section	Test case
Cell re-selection	A.4.2.18	HD – FDD Intra frequency case for UE Category NB1 In-Band mode in normal coverage
	A.4.2.19	HD – FDD Intra frequency case for UE Category NB1 In-Band mode in enhanced coverage
	A.4.2.24	HD – FDD Inter frequency case for UE Category NB1 In-Band mode in enhanced coverage
	A.4.2.35	TDD - TDD Intra frequency case for UE Category NB1 In-Band mode in normal coverage
	A.4.2.36	TDD – TDD Intra frequency case for UE Category NB1 In-Band mode in enhanced coverage
	A.4.2.37	TDD – TDD Inter frequency case for UE Category NB1 In-Band mode in enhanced coverage
Idle RSTD measurement	A.4.7.1	HD – FDD Intra frequency case for UE Category NB1 standalone mode in enhanced coverage
	A.4.7.2	HD – FDD Inter frequency case for UE Category NB1 standalone mode in enhanced coverage
	A.4.7.3	TDD Intra frequency case for UE Category NB1 standalone mode in enhanced coverage
	A.4.7.4	TDD Inter frequency case for UE Category NB1 standalone mode in enhanced coverage
RRC re-establishment	A.6.1.15	HD-FDD Intra-frequency RRC Re-establishment for UE category NB1 in In-Band mode under enhancednormal coverage
	A.6.1.16	HD-FDD Inter-frequency RRC Re-establishment for UE category NB1 in In-Band mode under normalenhanced coverage
	A.6.1.23	TDD Inter-frequency RRC Re-establishment for UE category NB1 in In-Band mode under normal coverage
	A.6.1.24	TDD - TDD Intra-frequency RRC Re-establishment for UE category NB1 in In-Band mode under enhanced coverage
Random access	A.6.2.16	HD-FDD Random Access Test for UE category NB1 in In-band Mode under Normal Coverage
	A.6.2.17	HD-FDD Contention Based Random Access Test for UE category NB1s in In-band Mode in Enhanced Coverage
	A.6.2.18	HD-FDD Contention Based Random Access on Non-anchor Carrier Test for UE category NB1 UEs In-band mode in Enhanced Coverage
	A.6.2.19	TDD Contention Based Random Access Test for UE category NB1 UEs In-band mode in normal coverage
	A.6.2.20	TDD Contention Based Random Access Test for UE category NB1 UEs In-band mode in enhanced coverage
	A.6.2.21	TDD Contention Based Random Access on Non-anchor Carrier Test for UE category NB1 UEs In-band mode in Enhanced Coverage
UE transmit timing	A.7.1.17	E-UTRAN HD-FDD – UE Transmit Timing Accuracy Tests for Category NB1 UE In-Band mode under normal coverage
	A.7.1.18	E-UTRAN HD-FDD – UE Transmit Timing Accuracy Tests for Category NB1 UE In-band mode under enhanced coverage
	A.7.1.27	TDD – UE Transmit Timing Accuracy Tests for Category NB1 UE In-Band mode under normal coverage
	A.7.1.28	TDD – UE Transmit Timing Accuracy Tests for Category NB1 UE In-band mode under enhanced coverage
UE timing advance	A.7.2.9	HD-FDD UE Timing Advance Adjustment Accuracy Test for UE Category NB1 in Standalone Mode under Enhance Coverage
	A.7.2.15	TDD – TDD UE Timing Advance Adjustment Accuracy Test for UE Category NB1 in Standalone Mode under Enhanced Coverage

Radio link monitoring	A.7.3.60	HD-FDD Radio Link Monitoring Test for Out-of-sync in DRX for UE category NB1 In-band mode in normal coverage
	A.7.3.61	HD-FDD Radio Link Monitoring Test for Out-of-sync in DRX for UE category NB1 In-band mode in enhanced coverage
	A.7.3.62	HD-FDD Radio Link Monitoring Test for In-sync with DRX for UE Category NB1 In-Band mode in Enhanced Coverage
	A.7.3.63	HD-FDD Radio Link Monitoring Test for In-sync with DRX for UE Category NB1 In-Band mode in Normal Coverage
	A.7.3.64	HD-FDD Radio Link Monitoring Test for In-sync without DRX for UE Category NB1 In-Band mode in Normal Coverage
	A.7.3.65	HD-FDD Radio Link Monitoring Test for In-sync without DRX for UE Category NB1 In-Band mode in Enhanced Coverage
	A.7.3.66	HD-FDD Radio Link Monitoring Test for Out-of-sync without DRX for UE category NB1 in Standalone Mode in Normal Coverage
	A.7.3.67	HD-FDD Radio Link Monitoring Test for Out-of-sync without DRX for UE category NB1 in Guardband Mode under Enhanced Coverage
	A.7.3.88	TDD Radio Link Monitoring Test for Out-of-sync in DRX for UE category NB1 In-band mode in normal coverage
	A.7.3.89	TDD Radio Link Monitoring Test for Out-of-sync in DRX for UE category NB1 In-band mode in enhanced coverage
	A.7.3.90	TDD Radio Link Monitoring Test for In-sync with DRX for UE Category NB1 In-Band mode in Normal Coverage
	A.7.3.91	TDD Radio Link Monitoring Test for In-sync with DRX for UE Category NB1 In-Band mode in Enhanced Coverage
	A.7.3.92	TDD Radio Link Monitoring Test for In-sync without DRX for UE Category NB1 In-Band mode in Normal Coverage
	A.7.3.93	TDD Radio Link Monitoring Test for In-sync without DRX for UE Category NB1 In-Band mode in Enhanced Coverage
	A.7.3.94	TDD Radio Link Monitoring Test for Out-of-sync without DRX for UE Category NB1 Standalone mode in Normal Coverage
A.7.3.95	TDD Radio Link Monitoring Test for Out-of-sync without DRX for UE Category NB1 guard band mode in Enhanced Coverage	
RSTD measurement accuracy	A.9.8.16	HD – FDD Intra frequency case for UE Category NB1 inband mode in normal coverage
	A.9.8.17	HD – FDD Inter frequency case for UE Category NB1 inband mode in normal coverage
	A.9.8.18	HD – FDD Intra frequency case for UE Category NB1 inband mode in enhanced coverage
	A.9.8.19	HD – FDD Inter frequency case for UE Category NB1 inband mode in enhanced coverage
	A.9.8.32	TDD Intra frequency case for UE Category NB1 inband mode in normal coverage
	A.9.8.33	TDD Inter frequency case for UE Category NB1 inband mode in normal coverage
	A.9.8.34	TDD Intra frequency case for UE Category NB1 inband mode in enhanced coverage
A.9.8.35	TDD Inter frequency case for UE Category NB1 inband mode in enhanced coverage	
Channel quality reporting accuracy	A.9.14.1	E-UTRAN HD-FDD Downlink channel quality reporting accuracy for UE Category NB1 Standalone mode under normal coverage
	A.9.14.2	E-UTRAN HD-FDD Downlink channel quality reporting accuracy for UE Category NB1 Standalone mode under enhanced coverage

A.3.24 V2X sidelink communication

A.3.24.1 Introduction

This clause also defines the principle and the reference configurations that are applicable to test cases verifying RRM core requirements for V2X sidelink communication.

A.3.24.2 Reference resource pool configurations for V2X Sidelink Communication

Table A.3.24.2-1: Pre-configuration for V2X Sidelink Communication (Configuration #1)

Derivation Path: TS 36.331 [3] clause 9.3.2, SL-V2X-Preconfiguration			
Information Element	Value/remark	Comment	Condition
SL-V2X-PreconfigCommPool-r14 ::= SEQUENCE {			
sl-OffsetIndicator-r14	0	Indicates the offset of the first subframe of a resource pool within a SFN cycle. If absent, the resource pool starts from first subframe of SFN=0.	
sl-Subframe-r14 included in SL-PreconfigV2X-TxPoolList	11111111111111111111 11111111111111111111 11111111111111111111 11111111111111111111 11111111111111111111	Indicates the bitmap of the TX resource pool, which is defined by repeating the bitmap within a SFN cycle (see TS 36.213 [23])	
sl-Subframe-r14 included in SL-PreconfigV2X-RxPoolList	11111111111111111111 11111111111111111111 11111111111111111111 11111111111111111111 11111111111111111111	Indicates the bitmap of the RX resource pool, which is defined by repeating the bitmap within a SFN cycle (see TS 36.213 [23])	
adjacencyPSCCH-PSSCH-r14	True	Adjacent: TURE Non-adjacent: FALSE	
sizeSubchannel-r14	5	Minimum bandwidth of subchannel for adjacent transmission	
startRB-Subchannel-r14	0	Indicates the lowest RB index of the subchannel with the lowest index.	
startRB-PSCCH-Pool-r14	0	Indicates the lowest RB index of the PSCCH pool	
}			

Table A.3.24.2-2: V2X sidelink Communication configuration for E-UTRAN (Configuration #2)

Derivation Path: 36.331 clause 6.3.8				
Information Element	Value (10MHz)	Comment		
SL-V2X-InterFreqUE-Config-r14 ::= SEQUENCE {				
physCellIdList-r14				Not present
typeTxSync-r14		<i>Set according to the specific test configuration</i>		ENUMERATED {gnss, enb, ue}
v2x-SyncConfig-r14				Not present
v2x-CommRxPool-r14	SL-CommResourcePoolV2X -r14 SEQUENCE {			RxPool A monitoring UE can receive on the resources of this pool when a transmitting UE uses the Tx Pool Normal or Tx Pool Exceptional
	sl-OffsetIndicator-r14	0		small-r12 Indicates the offset of the first subframe of a resource pool within a SFN cycle. If absent, the resource pool starts from first subframe of SFN=0.
	sl-Subframe-r14	11111111 11111111 1111		bs20-r14 for FDD Indicates the bitmap of the TX resource pool,

				which is defined by repeating the bitmap within a SFN cycle (see TS 36.213 [23])
		adjacencyPSCCH-PSSCH-r14	TRUE	BOOLEAN Adjacent: TURE Non-adjacent: FALSE
		sizeSubchannel-r14	50	ENUMERATED {n50} Minimum bandwidth of subchannel for adjacent transmission
		numSubchannel-r14	1	ENUMERATED {n1} Number of subchannel for adjacent transmission
		startRB-Subchannel-r14	0	Indicates the lowest RB index of the subchannel with the lowest index.
		startRB-PSCCH-Pool-r14	0	Indicates the lowest RB index of the PSCCH pool
		}		
	v2x-CommTxPoolNormal-r14	SL-CommResourcePoolV2X -r14 SEQUENCE {		Tx Pool Normal
		sl-OffsetIndicator-r14	0	small-r12
		sl-Subframe-r14	11111111 11111111 0000	bs20-r14
		adjacencyPSCCH-PSSCH-r14	TRUE	BOOLEAN
		sizeSubchannel-r14	50	ENUMERATED {n50}
		numSubchannel-r14	1	ENUMERATED {n1}
		startRB-Subchannel-r14	0	
		startRB-PSCCH-Pool-r14	0	
		dataTxParameters-r14 SEQUENCE {		
		alpha-r12	a0	Sidelink power control: a0 corresponds to 0
		p0-r12	31	INTEGER (-126..31), unit dBm
		}		
		}		
	v2x-CommTxPoolExceptional-r14	SL-CommResourcePoolV2X -r14 SEQUENCE {		Tx Pool Exceptional
		sl-OffsetIndicator-r14	0	small-r12
		sl-Subframe-r14	00000000 00000000 1111	bs20-r14
		adjacencyPSCCH-PSSCH-r14	TRUE	BOOLEAN
		sizeSubchannel-r14	50	ENUMERATED {n50}
		numSubchannel-r14	1	ENUMERATED {n1}
		startRB-Subchannel-r14	0	
		startRB-PSCCH-Pool-r14	0	
		dataTxParameters-r14 SEQUENCE {		
		alpha-r12	a0	Sidelink power control: a0 corresponds to 0
		p0-r12	31	INTEGER (-126..31), unit dBm
		}		
		}		
	p2x-CommTxPoolNormal-r14			Not present
	v2x-ResourceSelectionConfig-r14	SL-CommTxPoolSensingConfig-r14 ::= SEQUENCE {		

		pssch-TxConfigList-r14 ::= SEQUENCE {	SL-PSSCH-TxConfig-r14	
		typeTxSync-r14	Set according to the specific test configuration	ENUMERATED {gnss, enb, ue}
		thresUE-Speed-r14	kmph200	
		parametersAboveThres-r14 SEQUENCE {		
		minMCS-PSSCH-r14	0	
		maxMCS-PSSCH-r14	15	
		minSubChannel-NumberPSSCH-r14	1	
		maxSubchannel-NumberPSSCH-r14	1	
		allowedRetxNumberPSSCH-r14	Both	
		maxTxPower-r14	Not present	
		}		
		parametersBelowThres-r14 SEQUENCE {		
		minMCS-PSSCH-r14	4	
		maxMCS-PSSCH-r14	25	
		minSubChannel-NumberPSSCH-r14	1	
		maxSubchannel-NumberPSSCH-r14	1	
		allowedRetxNumberPSSCH-r14	n1	
		maxTxPower-r14	Not present	
		}		
		thresPSSCH-RSRP-List-r14 SEQUENCE (SIZE (64)) OF SL-ThresPSSCH-RSRP-r14 {		
		SL-ThresPSSCH-RSRP-r14[n]	1	For n=1,2,...,64, where n denotes the index for the threshold used for sensing based UE autonomous resource selection
		}		
		restrictResourceReservationPeriod-r14	{v1}	BIT STRING (SIZE (10))
		probResourceKeep-r14	v0	
		}		
	zoneConfig-r14			Not present
	}			

A.3.24.3 Reference measurement channels for V2X Sidelink Communication

Table A.3.24.3-1: PSCCH Reference Measurement Channels

Parameter		Unit	Value
Reference channel			CC.1A HD
Channel bandwidth		MHz	10
Allocated PSCCH resource blocks			2
DFT-OFDM symbols per subframe (see Note 1)			9
Modulation			QPSK
Information Bit Payload (without CRC)		Bits	32
Information Bit	SCI Format		1
	Priority		As set by higher layers
	Resource reservation		0

	Modulation and coding scheme		Set as the PSSCH MCS specified in the test
	Retransmission index		Note 4
	Time gap between initial transmission and retransmission		0 (Note 3)
	Frequency resource location of the initial transmission and retransmission		Initial transmission: Set as per PSSCH RB allocation specific in the test Retransmission: Note 4
	Reserved bits		Set all these bits to 0
	Transport block CRC	Bits	16
	Binary Channel Bits (see Note 2)	Bits	432
Note 1:	PSSCH transmissions are rate-matched for 10 DFT-OFDM symbols per subframe, and the last symbol shall be punctured as per TS 36.211.		
Note 2:	Binary channel bits calculated under assumption of 9 DFT-OFDM symbols per subframe.		
Note 3:	SF_{gap} is the value indicated by "Time gap between initial transmission and retransmission" field in the configured sidelink grant, and $SF_{gap} = 0$ means no retransmission of the associated TB as per TS 36.213.		
Note 4:	UE is allowed to autonomously select the un-used or redundant bits/code-points in SCI format 1		

Table A.3.24.3-2: PSSCH Reference Measurement Channels

Parameter	Unit	Value
Reference channel		CD.1A HD
Sidelink transmission mode		4
Channel bandwidth	MHz	10
Allocated PSSCH resource blocks		48
DFT-OFDM symbols per subframe (see Note 1)		9
Modulation		QPSK
Target Code Rate		1/3
Information Bit Payload (Transport block size)	Bits	3496
Transport block CRC	Bits	24
Number of PSSCH HARQ retransmissions		0
Binary Channel Bits (see Note 2)	Bits	10368
Note 1:	PSSCH transmissions are rate-matched for 10 DFT-OFDM symbols per subframe, and the last symbol shall be punctured as per TS 36.211.	
Note 2:	Binary channel bits calculated under assumption of 9 DFT-OFDM symbols per subframe.	

Table A.3.24.3-3: PSSCH Reference Measurement Channels

Parameter	Unit	Value
Reference channel		CD.1B HD
Sidelink transmission mode		4
Channel bandwidth	MHz	10
Allocated PSSCH resource blocks		3
DFT-OFDM symbols per subframe (see Note 1)		9
Modulation		QPSK
Target Code Rate		1/3
Information Bit Payload (Transport block size)	Bits	208
Transport block CRC	Bits	24
Number of PSSCH HARQ retransmissions		0
Binary Channel Bits (see Note 2)	Bits	648
Note 1:	PSSCH transmissions are rate-matched for 10 DFT-OFDM symbols per subframe, and the last symbol shall be punctured as per TS 36.211.	
Note 2:	Binary channel bits calculated under assumption of 9 DFT-OFDM symbols per subframe.	

A.3.25 Category M2 UE Test Cases

A.3.25.1 Introduction

This clause defines a principle which is applicable to test cases verifying RRM requirements for Category M2 UE in both CEModeA and CEModeB.

A.3.25.2 Principle of Cat-M2 UE Testing

In Annex A Cat-M2 UE test cases may be defined for both CEModeA and CEModeB to verify the same type of RRM requirement.

If test cases are defined in both CEModeA and CEModeB in order to verify the same type of RRM requirement then the UE capable of CEModeB needs to be tested for the corresponding test(s) defined in CEModeA and/or in CEModeB according to the applicability rules defined in Table A.3.25.2-1.

The UE which is not capable of CEModeB shall be tested for all CEModeA test cases defined in Annex A.

Table A.3.25.2-1: Test case applicability rules for category M2 UE in CEModeA and CEModeB

Type of Test Cases	Coverage mode(s) Applicable for Testing	
	CEModeA	CEModeB
A.4 E-UTRAN RRC IDLE State: Intra-frequency Cell Re-Selection Tests for Category M1 UE	X	X
A.4 E-UTRAN RRC IDLE State: Inter-frequency Cell Re-Selection Tests for Category M1 UE	X	X
A.5 E-UTRAN RRC CONNECTED Mode Mobility: E-UTRAN Intra-frequency with SFN acquisition Handover Tests for Category M1 UE	X	
A.5 E-UTRAN RRC CONNECTED Mode Mobility: E-UTRAN Inter-frequency with SFN acquisition Handover Tests for Category M1 UE	X	
A.5 E-UTRAN RRC CONNECTED Mode Mobility: E-UTRAN Intra-frequency without SFN acquisition Handover Tests for Category M1 UE		X
A.5 E-UTRAN RRC CONNECTED Mode Mobility: E-UTRAN Inter-frequency without SFN acquisition Handover Tests for Category M1 UE		X
A.5 RRC Connection Control: E-UTRAN Intra-frequency RRC Re-Establishment Tests for Category M1 UE		X
A.5 RRC Connection Control: E-UTRAN Inter-frequency RRC Re-Establishment Tests for Category M1 UE		X
A.6 E-UTRAN Contention Based Random Access Tests for Cat-M1 UE		X
A.7 Timing and Signalling Characteristics: E-UTRAN UE Transmit Timing Accuracy Tests for Category M2 UE		X
A.7 Timing and Signalling Characteristics: E-UTRAN Timing Advance Adjustment Accuracy Tests for Cat-M1 UE		X
A.7.3 Radio Link Monitoring: E-UTRAN Radio Link Monitoring Tests for Category M1 UE	X	
A.7.3 Radio Link Monitoring: E-UTRAN Radio Link Monitoring Tests for for Early In-sync and Early Out-of-sync for Category M1 UE		X
A.8 Measurements Procedures: E-UTRAN Intra-frequency Event Triggered Reporting under Fading Propagation Conditions Tests for Category M1 UE	X	X
A.8 Measurements Procedures: E-UTRAN Inter-frequency Event Triggered Reporting under Fading Propagation Conditions Tests for Category M1 UE	X	X
A.8 Measurements Procedures: E-UTRAN Intra-frequency Serving Cell Event Triggered Reporting under Fading Propagation Conditions Tests for Category M1 UE without Gaps	X	N/A
A.8 Measurements Procedures: E-UTRAN Intra-frequency Identification of a New CGI of E-UTRA cell using Autonomous Gaps Tests for Category M1 UE	N/A	X
A.8.12 Measurements Procedures: E-UTRAN Intra-frequency RSTD measurement reporting delay tests for Category M2 UE	X	X
A.8.13 Measurements Procedures: E-UTRAN Inter-frequency RSTD measurement reporting delay tests for Category M2 UE	X	X

A.9 Measurement Performance Requirements: RSRP Intra-Frequency Measurement Accuracy Tests for Category M2 UE	X	X
A.9.7 Measurement Performance Requirements: E-UTRAN UE Rx-Tx Time Difference Measurement Accuracy Tests for Category M2 UE	X	N/A
A.9.8 Measurement Performance Requirements: E-UTRAN Intra-frequency RSTD Measurement Accuracy Tests for Category M2 UE	X	X
A.9.8 Measurement Performance Requirements: E-UTRAN Inter-frequency RSTD Measurement Accuracy Tests for Category M2 UE	X	X

A.3.25.3 Principle of Cat-M2 UE testing for inter-frequency RSTD measurement period requirements with measurement gaps

For the Cat-M2 UE configured with 1.4 MHz UE RF bandwidth, capable of supporting measurement gaps specified in Table 8.1.2.1-3 and requiring gaps for inter-frequency RSTD measurements, and which can be configured with applicable measurement gaps specified in Table 8.1.2.1-1 or Table 8.1.2.1-3, in order to verify inter-frequency RSTD measurement period with measurement gaps it is sufficient to verify the requirement only under the applicable measurement gaps specified in Table 8.1.2.1-3, for each of the CEModeA and CEModeB.

For the Cat-M2 UE in CEModeB configured with 5 MHz UE RF bandwidth, capable of supporting measurement gaps specified in Table 8.1.2.1-3 and requiring gaps for inter-frequency RSTD measurements, and which can be configured with applicable measurement gaps specified in Table 8.1.2.1-1 or Table 8.1.2.1-3, in order to verify inter-frequency RSTD measurement period with measurement gaps it is sufficient to verify the requirement only under the applicable measurement gaps specified in Table 8.1.2.1-3.

A.3.26 sTTI and processing time reduction test cases with different sTTI/processing time reduction scheme

A.3.26.1 Introduction

This clause defines a principle which is applicable to RRM performance requirement test cases with different TTI duration and processing time for a UE configured with *ShortTTI-r15* or *ShortProcessingTime=TRUE*.

A.3.26.2 Principle of testing

If multiple test cases defined for different TTI duration and processing time are applicable to a UE configured with *ShortTTI-r15* or *ShortProcessingTime=TRUE* to verify the timing advance adjustment delay, from the UE performance point of view the test coverage can be considered fulfilled by executing only the test case with the shortest TTI duration and processing time among all the TTI duration and processing time supported by the UE. For a UE capable of *ShortTTI-r15* and *dl-STTI-Length-r15=subslot* configuration and *ProcessingTimelineSet-r15=set1*, coverage is fulfilled by executing only the test with configured *ShortTTI-r15*, *dl-STTI-Length-r15= subslot*, and *proc-Timeline-r15=nplus4set1*, and for a UE capable of *ShortTTI-r15* and *dl-STTI-Length-r15=subslot* configuration and *ProcessingTimelineSet-r15=set2*, coverage is fulfilled by executing only the test with configured *ShortTTI-r15*, *dl-STTI-Length-r15= subslot*, and *proc-Timeline-r15=nplus6set2*.

A.3.27 LTE INACTIVE Cell Re-selection Test Cases

A.3.27.1 Introduction

This clause defines a principle which is applicable to test cases verifying RRM requirements for INACTIVE mode cell-reselection under connectivity to 5GC.

A.3.27.2 Principle of INACTIVE cell re-selection Testing

For a UE supporting RRC_INACTIVE state, the requirements in Section 4A are considered fulfilled if the UE passes the cell-reselection test cases defined in Section A.4 for RRC_IDLE state.

A.4 E-UTRAN RRC_IDLE state

A.4.2 Cell Re-Selection

A.4.2.1 E-UTRAN FDD – FDD Intra frequency case

A.4.2.1.1 Test Purpose and Environment

This test is to verify the requirement for the FDD-FDD intra frequency cell reselection requirements specified in clause 4.2.2.3.

The test scenario comprises of 1 E-UTRA FDD carrier and 2 cells as given in tables A.4.2.1.1-1 and A.4.2.1.1-2. The test consists of three successive time periods, with time duration of T1, T2 and T3 respectively. Only Cell 1 is already identified by the UE prior to the start of the test, i.e. Cell 2 is not identified by the UE prior to the start of the test. Cell 1 and Cell 2 belong to different tracking areas. Furthermore, UE has not registered with network for the tracking area containing Cell 2.

Table A.4.2.1.1-1: General test parameters for FDD intra frequency cell reselection test case

Parameter		Unit	Value	Comment
Initial condition	Active cell		Cell1	
	Neighbour cells		Cell2	
T2 end condition	Active cell		Cell2	
	Neighbour cells		Cell1	
Final condition	Visited cell		Cell1	
E-UTRA RF Channel Number			1	Only one FDD carrier frequency is used.
Channel Bandwidth (BW _{channel})		MHz	10	
Time offset between cells			3 ms	Asynchronous cells
Access Barring Information		-	Not Sent	No additional delays in random access procedure.
PRACH configuration			4	As specified in table 5.7.1-2 in TS 36.211
DRX cycle length		s	1.28	The value shall be used for all cells in the test.
T1		s	>7	During T1, Cell 2 shall be powered off, and during the off time the physical cell identity shall be changed, The intention is to ensure that Cell 2 has not been detected by the UE prior to the start of period T2
T2		s	40	T2 need to be defined so that cell re-selection reaction time is taken into account.
T3		s	15	T3 need to be defined so that cell re-selection reaction time is taken into account.

Table A.4.2.1.1-2: Cell specific test parameters for FDD intra frequency cell reselection test case in AWGN

Parameter	Unit	Cell 1			Cell 2		
		T1	T2	T3	T1	T2	T3
E-UTRA RF Channel Number		1			1		
BW _{channel}	MHz	10			10		
OCNG Patterns defined in A.3.2.1.2 (OP.2 FDD)		OP.2 FDD			OP.2 FDD		
PBCH_RA	dB	0			0		
PBCH_RB							
PSS_RA							
SSS_RA							
PCFICH_RB							
PHICH_RA							
PHICH_RB							
PDCCH_RA							
PDCCH_RB							
PDSCH_RA							
PDSCH_RB							
OCNG_RA ^{Note 1}							
OCNG_RB ^{Note 1}							
Qrxlevmin	dBm	-140	-140	-140	-140	-140	-140
Pcompensation	dB	0	0	0	0	0	0
Qhyst _s	dB	0	0	0	0	0	0
Qoffset _{s, n}	dB	0	0	0	0	0	0
Cell_selection_and_reselection_quality_measurement		RSRP			RSRP		
\hat{E}_s/I_{ot}	dB	16	-3.11	2.79	-infinity	2.79	-3.11
N_{oc} ^{Note2}	dBm/15 kHz	-98					
\hat{E}_s/N_{oc}	dB	16	13	16	-infinity	16	13
RSRP ^{Note3}	dBm/15 kHz	-82	-85	-82	-infinity	-82	-85
Treselection	s	0	0	0	0	0	0
Sintrasearch	dB	Not sent			Not sent		
Propagation Condition		AWGN					
<p>Note 1: OCNG shall be used such that both cells are fully allocated and a constant total transmitted power spectral density is achieved for all OFDM symbols.</p> <p>Note 2: Interference from other cells and noise sources not specified in the test is assumed to be constant over subcarriers and time and shall be modelled as AWGN of appropriate power for N_{oc} to be fulfilled.</p> <p>Note 3: RSRP levels have been derived from other parameters for information purposes. They are not settable parameters themselves.</p>							

A.4.2.1.2 Test Requirements

The cell reselection delay to a newly detectable cell is defined as the time from the beginning of time period T2, to the moment when the UE camps on Cell 2, and starts to send preambles on the PRACH for sending the RRC CONNECTION REQUEST message to perform a Tracking Area Update procedure on Cell 2.

The cell re-selection delay to a newly detectable cell shall be less than 34 s.

The cell reselection delay to an already detected cell is defined as the time from the beginning of time period T3, to the moment when the UE camps on Cell 1, and starts to send preambles on the PRACH for sending the RRC CONNECTION REQUEST message to perform a Tracking Area Update procedure on Cell 1.

The cell re-selection delay to an already detected cell shall be less than 8 s.

The rate of correct cell reselections observed during repeated tests shall be at least 90%.

NOTE: The cell re-selection delay to a newly detectable cell can be expressed as: $T_{\text{detect,EUTRAN_Intra}} + T_{\text{SI}}$, and to an already detected cell can be expressed as: $T_{\text{evaluateFDD,intra}} + T_{\text{SI}}$,

Where:

$T_{\text{detect,EUTRAN_Intra}}$ See Table 4.2.2.3-1 in clause 4.2.2.3

$T_{\text{evaluateFDD,intra}}$ See Table 4.2.2.3-1 in clause 4.2.2.3

T_{SI} Maximum repetition period of relevant system info blocks that needs to be received by the UE to camp on a cell; 1280 ms is assumed in this test case.

This gives a total of 33.28 s, allow 34 s for the cell re-selection delay to a newly detectable cell and 7.68 s, allow 8 s for the cell re-selection delay to an already detected cell in the test case.

A.4.2.2 E-UTRAN TDD – TDD Intra frequency case

A.4.2.2.1 Test Purpose and Environment

This test is to verify the requirement for the TDD-TDD intra frequency cell reselection requirements specified in clause 4.2.2.3.

The test scenario comprises of 1 E-UTRA TDD carrier and 2 cells as given in tables A.4.2.2.1-1 and A.4.2.2.1-2. The test consists of three successive time periods, with time duration of T1, T2, and T3 respectively. Only cell 1 is already identified by the UE prior to the start of the test. Cell 1 and cell 2 belong to different tracking areas. Furthermore, UE has not registered with network for the tracking area containing cell 2.

Table A.4.2.2.1-1: General test parameters for TDD intra frequency cell re-selection test case

Parameter		Unit	Value	Comment
Initial condition	Active cell		Cell1	
	Neighbour cells		Cell2	
T2 end condition	Active cell		Cell2	
	Neighbour cells		Cell1	
Final condition	Visited cell		Cell1	
E-UTRA RF Channel Number			1	Only one TDD carrier frequency is used.
Channel Bandwidth (BW_{channel})		MHZ	10	
Time offset between cells		μs	3	Synchronous cells
Access Barring Information		-	Not Sent	No additional delays in random access procedure.
Special subframe configuration			6	As specified in table 4.2-1 in TS 36.211
Uplink-downlink configuration			1	As specified in table 4.2-2 in TS 36.211
PRACH configuration index			53	As specified in table 5.7.1-3 in TS 36.211
DRX cycle length		s	1.28	The value shall be used for all cells in the test.
T1		s	>7	During T1, Cell 2 shall be powered off, and during the off time the physical cell identity shall be changed, The intention is to ensure that Cell 2 has not been detected by the UE prior to the start of period T2
T2		s	40	T2 need to be defined so that cell re-selection reaction time is taken into account.
T3		s	15	T3 need to be defined so that cell re-selection reaction time is taken into account.

Table A.4.2.2.1-2: Cell specific test parameters for TDD intra frequency cell re-selection test case in AWGN

Parameter	Unit	Cell 1			Cell 2		
		T1	T2	T3	T1	T2	T3
E-UTRA RF Channel Number		1			1		

BW _{channel}	MHz	10			10		
OCNG Pattern defined in A.3.2.2.2 (OP.2 TDD)		OP.2 TDD			OP.2 TDD		
PBCH_RA	dB	0			0		
PBCH_RB							
PSS_RA							
SSS_RA							
PCFICH_RB							
PHICH_RA							
PHICH_RB							
PDCCH_RA							
PDCCH_RB							
PDSCH_RA							
PDSCH_RB							
OCNG_RA ^{Note 1}							
OCNG_RB ^{Note 1}							
Q _{rxlevmin}	dBm	-140			-140		
P _{compensation}	dB	0			0		
Q _{hyst_s}	dB	0			0		
Q _{offset_{s, n}}	dB	0			0		
Cell_selection_and_reselection_quality_measurement		RSRP			RSRP		
\hat{E}_s/I_{ot}	dB	16	-3.11	2.79	-infinity	2.79	-3.11
N_{oc} ^{Note2}	dBm/15 kHz	-98					
\hat{E}_s/N_{oc}	dB	16	13	16	-infinity	16	13
RSRP ^{Note3}	dBm/15 kHz	-82	-85	-82	-infinity	-82	-85
T _{reselection}	s	0	0	0	0	0	0
S _{intrasearch}	dB	Not sent			Not sent		
Propagation Condition		AWGN					
<p>Note 1: OCNG shall be used such that both cells are fully allocated and a constant total transmitted power spectral density is achieved for all OFDM symbols.</p> <p>Note 2: Interference from other cells and noise sources not specified in the test is assumed to be constant over subcarriers and time and shall be modelled as AWGN of appropriate power for N_{oc} to be fulfilled.</p> <p>Note 3: RSRP levels have been derived from other parameters for information purposes. They are not settable parameters themselves.</p>							

A.4.2.2.2 Test Requirements

The cell reselection delay to a newly detectable cell is defined as the time from the beginning of time period T2, to the moment when the UE camps on Cell 2, and starts to send preambles on the PRACH for sending the RRC CONNECTION REQUEST message to perform a Tracking Area Update procedure on Cell 2.

The cell re-selection delay to a newly detectable cell shall be less than 34 s.

The cell reselection delay to an already detected cell is defined as the time from the beginning of time period T3, to the moment when the UE camps on cell 1, and starts to send preambles on the PRACH for sending the RRC CONNECTION REQUEST message to perform a Tracking Area Update procedure on cell 1.

The cell re-selection delay shall be less than 8 s.

The rate of correct cell reselections observed during repeated tests shall be at least 90%.

NOTE: The cell re-selection delay to a newly detectable cell can be expressed as: $T_{\text{detect, E-UTRAN_intra}} + T_{\text{SI-EUTRA}}$, and to an already detected cell can be expressed as: $T_{\text{evaluate, E-UTRAN_intra}} + T_{\text{SI-EUTRA}}$,

Where:

$T_{\text{detect,EUTRAN_Intra}}$ See Table 4.2.2.3-1 in clause 4.2.2.3

$T_{\text{evaluate,E-UTRAN_intra}}$ See Table 4.2.2.3-1 in clause 4.2.2.3

$T_{\text{SI-EUTRA}}$ Maximum repetition period of relevant system info blocks that needs to be received by the UE to camp on a cell; 1280 ms is assumed in this test case.

This gives a total of 33.28 s, allow 34 s for the cell re-selection delay to a newly detectable cell and 7.68 s, allow 8 s for the cell re-selection delay to an already detected cell in the test case.

A.4.2.3 E-UTRAN FDD – FDD Inter frequency case

A.4.2.3.1 Test Purpose and Environment

This test is to verify the requirement for the FDD-FDD inter-frequency cell reselection requirements specified in clause 4.2.2.4.

The test scenario comprises of 2 E-UTRA FDD cells on 2 different carriers as given in tables A.4.2.3.1-1 and A.4.2.3.1-2. The test consists of three successive time periods, with time duration of T1, T2 and T3 respectively. Both cell 1 and cell 2 are already identified by the UE prior to the start of the test. Cell 1 and cell 2 belong to different tracking areas and cell 2 is of higher priority than cell 1. Furthermore, UE has not registered with network for the tracking area containing cell 2.

Table A.4.2.3.1-1: General test parameters for FDD-FDD inter frequency cell re-selection test case

Parameter		Unit	Value	Comment
Initial condition	Active cell		Cell2	UE shall be forced to cell 2 in the initialisation phase, so that reselection to cell 1 occurs during the first T1 phase
T1 end condition	Active cell		Cell1	UE shall perform reselection to cell 1 during T1
	Neighbour cell		Cell2	
Final condition	Active cell		Cell2	UE shall perform reselection to cell 2 during T3
E-UTRA RF Channel Number			1, 2	Two FDD carrier frequencies are used.
Time offset between cells			3 ms	Asynchronous cells
PRACH configuration			4	As specified in table 5.7.1-2 in TS 36.211
Access Barring Information		-	Not Sent	No additional delays in random access procedure.
DRX cycle length		s	1.28	The value shall be used for all cells in the test.
T1		s	15	T1 need to be defined so that cell re-selection reaction time is taken into account.
T2		s	>7	During T2, cell 2 shall be powered off, and during the off time the physical cell identity shall be changed, The intention is to ensure that cell 2 has not been detected by the UE prior to the start of period T3.
T3		s	75	T3 need to be defined so that cell re-selection reaction time is taken into account.

Table A.4.2.3.1-2: Cell specific test parameters for FDD-FDD inter-frequency cell reselection test case in AWGN

Parameter	Unit	Cell 1			Cell 2		
		T1	T2	T3	T1	T2	T3
E-UTRA RF Channel number		1			2		
BW_{channel}	MHz	10			10		
OCNG Patterns defined in A.3.2.1.2 (OP.2 FDD)		OP.2 FDD			OP.2 FDD		
PBCH_RA	dB						
PBCH_RB	dB						
PSS_RA	dB						
SSS_RA	dB						
PCFICH_RB	dB						

PHICH_RA	dB	0			0		
PHICH_RB	dB						
PDCCH_RA	dB						
PDCCH_RB	dB						
PDSCH_RA	dB						
PDSCH_RB	dB						
OCNG_RA ^{Note 1}	dB						
OCNG_RB ^{Note 1}	dB						
Qrxlevmin	dBm	-140			-140		
N_{oc} ^{Note 2}	dBm/15 kHz	-98					
RSRP ^{Note 3}	dBm/15 KHz	-84	-84	-84	-102	-infinity	-86
\hat{E}_s/I_{ot}	dB	14	14	14	-4	-infinity	12
\hat{E}_s/N_{oc}	dB	14	14	14	-4	-infinity	12
Treselection ^{EUTRAN}	s	0			0		
Snonintrasearch	dB	50			Not sent		
Thresh _{x, high}	dB	48			48		
Thresh _{-serving, low}	dB	44			44		
Thresh _{x, low}	dB	50			50		
Propagation Condition		AWGN					
Note 1: OCNG shall be used such that both cells are fully allocated and a constant total transmitted power spectral density is achieved for all OFDM symbols.							
Note 2: Interference from other cells and noise sources not specified in the test is assumed to be constant over subcarriers and time and shall be modelled as AWGN of appropriate power for N_{oc} to be fulfilled.							
Note 3: RSRP levels have been derived from other parameters for information purposes. They are not settable parameters themselves.							

A.4.2.3.2 Test Requirements

The cell reselection delay to higher priority is defined as the time from the beginning of time period T3, to the moment when the UE camps on cell 2, and starts to send preambles on the PRACH for sending the RRC CONNECTION REQUEST message to perform a Tracking Area Update procedure on Cell 2.

The cell re-selection delay to higher priority shall be less than 68 s.

The cell reselection delay to lower priority is defined as the time from the beginning of time period T1, to the moment when the UE camps on cell 1, and starts to send preambles on the PRACH for sending the RRC CONNECTION REQUEST message to perform a Tracking Area Update procedure on cell 1.

The cell re-selection delay to lower priority shall be less than 8 s.

The rate of correct cell reselections observed during repeated tests shall be at least 90%.

NOTE: The cell re-selection delay to higher priority cell can be expressed as: $T_{\text{higher_priority_search}} + T_{\text{evaluateFDD,inter}} + T_{\text{SI}}$, and to lower priority cell can be expressed as: $T_{\text{evaluateFDD,inter}} + T_{\text{SI}}$,

Where:

$T_{\text{higher_priority_search}}$ See clause 4.2.2

$T_{\text{evaluateFDD,inter}}$ See Table 4.2.2.4-1 in clause 4.2.2.4

T_{SI} Maximum repetition period of relevant system info blocks that needs to be received by the UE to camp on a cell; 1280 ms is assumed in this test case.

This gives a total of 67.68 s for higher priority cell search and 7.68 s for lower priority cell search, allow 68 s for higher priority cell and 8 s for lower priority cell in the test case.

A.4.2.4 E-UTRAN FDD – TDD Inter frequency case

A.4.2.4.1 Test Purpose and Environment

This test is to verify the requirement for the FDD-TDD inter-frequency cell reselection requirements specified in clause 4.2.2.4.

The test scenario comprises of 1 E-UTRA FDD cell and 1 E-UTRA TDD cell as given in tables A.4.2.4.1-1 and A.4.2.4.1-2. The test consists of three successive time periods, with time duration of T1, T2 and T3 respectively. Both cell 1 and cell 2 are already identified by the UE prior to the start of the test. Cell 1 and cell 2 belong to different tracking areas and cell 2 is of higher priority than cell 1. Furthermore, UE has not registered with network for the tracking area containing cell 2.

Table A.4.2.4.1-1: General test parameters for FDD-TDD inter frequency cell re-selection test case

Parameter		Unit	Value	Comment
Initial condition	Active cell		Cell2	UE shall be forced to cell 2 in the initialisation phase, so that reselection to cell 1 occurs during the first T1 phase
T1 end condition	Active cell		Cell1	UE shall perform reselection to cell 1 during T1
	Neighbour cell		Cell2	
Final condition	Active cell		Cell2	UE shall perform reselection to cell 2 during T3
Cell 1 E-UTRA RF Channel Number			1	One FDD carrier frequency is used. And Cell 1 is on RF channel number 1.
Cell 2 E-UTRA RF Channel Number			2	One TDD carrier frequencies is used. And Cell 2 is on RF channel number 2.
Time offset between cells			3 ms	Asynchronous cells
E-UTRA FDD PRACH configuration			4	As specified in table 5.7.1-2 in TS 36.211
E-UTRA TDD PRACH configuration			53	As specified in table 5.7.1-3 in TS 36.211
Special subframe configuration			6	As specified in table 4.2-1 in TS 36.211
Uplink-downlink configuration			1	As specified in table 4.2-2 in TS 36.211
E-UTRA FDD Access Barring Information		-	Not Sent	No additional delays in random access procedure.
E-UTRA TDD Access Barring Information		-	Not Sent	No additional delays in random access procedure.
DRX cycle length		s	1.28	The value shall be used for all cells in the test.
T1		s	15	T1 need to be defined so that cell re-selection reaction time is taken into account.
T2		s	>7	During T2, cell 2 shall be powered off, and during the off time the physical cell identity shall be changed, The intention is to ensure that cell 2 has not been detected by the UE prior to the start of period T3.
T3		s	75	T3 need to be defined so that cell re-selection reaction time is taken into account.

Table A.4.2.4.1-2: Cell specific test parameters for FDD-TDD inter-frequency cell reselection test case in AWGN

Parameter	Unit	Cell 1			Cell 2		
		T1	T2	T3	T1	T2	T3
E-UTRA RF Channel number		1			2		
BW _{channel}	MHz	10			10		
OCNG Patterns defined in A.3.2.1.2 (OP.2 FDD) and A.3.2.2.2 (OP.2 TDD)		OP.2 FDD			OP.2 TDD		
PBCH_RA	dB						
PBCH_RB	dB						
PSS_RA	dB						
SSS_RA	dB						

PCFICH_RB	dB	0			0		
PHICH_RA	dB						
PHICH_RB	dB						
PDCCH_RA	dB						
PDCCH_RB	dB						
PDSCH_RA	dB						
PDSCH_RB	dB						
OCNG_RA ^{Note 1}	dB						
OCNG_RB ^{Note 1}	dB						
Qrxlevmin	dBm	-140			-140		
N_{oc} ^{Note 2}	dBm/15 kHz	-98					
RSRP ^{Note 3}	dBm/15 KHz	-84	-84	-84	-102	-infinity	-86
\hat{E}_s/I_{ot}	dB	14	14	14	-4	-infinity	12
\hat{E}_s/N_{oc}	dB	14	14	14	-4	-infinity	12
Treselection ^{EUTRAN}	s	0			0		
Snonintrasearch	dB	50			Not sent		
Thresh _{x, high}	dB	48			48		
Thresh _{serv, low}	dB	44			44		
Thresh _{x, low}	dB	50			50		
Propagation Condition		AWGN					
Note 1:	OCNG shall be used such that both cells are fully allocated and a constant total transmitted power spectral density is achieved for all OFDM symbols.						
Note 2:	Interference from other cells and noise sources not specified in the test is assumed to be constant over subcarriers and time and shall be modelled as AWGN of appropriate power for N_{oc} to be fulfilled.						
Note 3:	RSRP levels have been derived from other parameters for information purposes. They are not settable parameters themselves.						

A.4.2.4.2 Test Requirements

The cell reselection delay to higher priority is defined as the time from the beginning of time period T3, to the moment when the UE camps on cell 2, and starts to send preambles on the PRACH for sending the RRC CONNECTION REQUEST message to perform a Tracking Area Update procedure on cell 2.

The cell re-selection delay to higher priority shall be less than 68 s.

The cell reselection delay to lower priority is defined as the time from the beginning of time period T1, to the moment when the UE camps on cell 1, and starts to send preambles on the PRACH for sending the RRC CONNECTION REQUEST message to perform a Tracking Area Update procedure on cell 1.

The cell re-selection delay to lower priority shall be less than 8 s.

The rate of correct cell reselections observed during repeated tests shall be at least 90%.

NOTE: The cell re-selection delay to higher priority cell can be expressed as: $T_{\text{higher_priority_search}} + T_{\text{evaluate,E-UTRAN_inter}} + T_{\text{SI-EUTRA}}$, and to lower priority cell can be expressed as: $T_{\text{evaluate,E-UTRAN_inter}} + T_{\text{SI-EUTRA}}$,

Where:

$T_{\text{higher_priority_search}}$ See clause 4.2.2

$T_{\text{evaluate,E-UTRAN_inter}}$ See Table 4.2.2.4-1 in clause 4.2.2.4

$T_{\text{SI-EUTRA}}$ Maximum repetition period of relevant system info blocks that needs to be received by the UE to camp on a cell; 1280 ms is assumed in this test case.

This gives a total of 67.68 s for higher priority cell search and 7.68 s for lower priority cell search, allow 68 s for higher priority cell and 8 s for lower priority cell in the test case.

A.4.2.5 E-UTRAN TDD – FDD Inter frequency case

A.4.2.5.1 Test Purpose and Environment

This test is to verify the requirement for the TDD-FDD inter-frequency cell reselection requirements specified in clause 4.2.2.4.

The test scenario comprises of 1 E-UTRA TDD cell and 1 E-UTRA FDD cell as given in tables A.4.2.5.1-1 and A.4.2.5.1-2. The test consists of three successive time periods, with time duration of T1, T2 and T3 respectively. Both cell 1 and cell 2 are already identified by the UE prior to the start of the test. Cell 1 and cell 2 belong to different tracking areas and cell 2 is of higher priority than cell 1. Furthermore, UE has not registered with network for the tracking area containing cell 2.

Table A.4.2.5.1-1: General test parameters for TDD-FDD inter frequency cell re-selection test case

Parameter		Unit	Value	Comment
Initial condition	Active cell		Cell2	UE shall be forced to cell 2 in the initialisation phase, so that reselection to cell 1 occurs during the first T1 phase
T1 end condition	Active cell		Cell1	UE shall perform reselection to cell 1 during T1
	Neighbour cell		Cell2	
Final condition	Active cell		Cell2	UE shall perform reselection to cell 2 during T3
Cell 1 E-UTRA RF Channel Number			1	One TDD carrier frequency is used. And Cell 1 is on RF channel number 1.
Cell 2 E-UTRA RF Channel Number			2	One FDD carrier frequencies is used. And Cell 2 is on RF channel number 2.
Time offset between cells			3 ms	Asynchronous cells
E-UTRA TDD PRACH configuration			53	As specified in table 5.7.1-3 in TS 36.211
Special subframe configuration			6	As specified in table 4.2-1 in TS 36.211
Uplink-downlink configuration			1	As specified in table 4.2-2 in TS 36.211
E-UTRA FDD PRACH configuration			4	As specified in table 5.7.1-2 in TS 36.211
E-UTRA FDD Access Barring Information		-	Not Sent	No additional delays in random access procedure.
E-UTRA TDD Access Barring Information		-	Not Sent	No additional delays in random access procedure.
DRX cycle length		s	1.28	The value shall be used for all cells in the test.
T1		s	15	T1 need to be defined so that cell re-selection reaction time is taken into account.
T2		s	>7	During T2, cell 2 shall be powered off, and during the off time the physical cell identity shall be changed, The intention is to ensure that cell 2 has not been detected by the UE prior to the start of period T3.
T3		s	75	T3 need to be defined so that cell re-selection reaction time is taken into account.

Table A.4.2.5.1-2: Cell specific test parameters for TDD-FDD inter-frequency cell reselection test case in AWGN

Parameter	Unit	Cell 1			Cell 2		
		T1	T2	T3	T1	T2	T3
E-UTRA RF Channel number		1			2		
BW _{channel}	MHz	10			10		
OCNG Patterns defined in A.3.2.1.2 (OP.2 FDD) and A.3.2.2.2 (OP.2 TDD)		OP.2 TDD			OP.2 FDD		
PBCH_RA	dB						
PBCH_RB	dB						
PSS_RA	dB						
SSS_RA	dB						

PCFICH_RB	dB	0			0		
PHICH_RA	dB						
PHICH_RB	dB						
PDCCH_RA	dB						
PDCCH_RB	dB						
PDSCH_RA	dB						
PDSCH_RB	dB						
OCNG_RA ^{Note 1}	dB						
OCNG_RB ^{Note 1}	dB						
Qrxlevmin	dBm	-140			-140		
N_{oc} ^{Note 2}	dBm/15 kHz	-98					
RSRP ^{Note 3}	dBm/15 KHz	-84	-84	-84	-102	-infinity	-86
\hat{E}_s/I_{ot}	dB	14	14	14	-4	-infinity	12
\hat{E}_s/N_{oc}	dB	14	14	14	-4	-infinity	12
Treselection ^{EUTRAN}	s	0			0		
Snonintrasearch	dB	50			Not sent		
Thresh _{x, high}	dB	48			48		
Thresh _{serv, low}	dB	44			44		
Thresh _{x, low}	dB	50			50		
Propagation Condition		AWGN					
Note 1:	OCNG shall be used such that both cells are fully allocated and a constant total transmitted power spectral density is achieved for all OFDM symbols.						
Note 2:	Interference from other cells and noise sources not specified in the test is assumed to be constant over subcarriers and time and shall be modelled as AWGN of appropriate power for N_{oc} to be fulfilled.						
Note 3:	RSRP levels have been derived from other parameters for information purposes. They are not settable parameters themselves.						

A.4.2.5.2 Test Requirements

The cell reselection delay to higher priority is defined as the time from the beginning of time period T3, to the moment when the UE camps on cell 2, and starts to send preambles on the PRACH for sending the RRC CONNECTION REQUEST message to perform a Tracking Area Update procedure on cell 2.

The cell re-selection delay to higher priority shall be less than 68 s.

The cell reselection delay to lower priority is defined as the time from the beginning of time period T1, to the moment when the UE camps on cell 1, and starts to send preambles on the PRACH for sending the RRC CONNECTION REQUEST message to perform a Tracking Area Update procedure on cell 1.

The cell re-selection delay to lower priority shall be less than 8 s.

The rate of correct cell reselections observed during repeated tests shall be at least 90%.

NOTE: The cell re-selection delay to higher priority cell can be expressed as: $T_{\text{higher_priority_search}} + T_{\text{evaluate,E-UTRAN_inter}} + T_{\text{SI-EUTRA}}$, and to lower priority cell can be expressed as: $T_{\text{evaluate,E-UTRAN_inter}} + T_{\text{SI-EUTRA}}$,

Where:

$T_{\text{higher_priority_search}}$ See clause 4.2.2

$T_{\text{evaluate,E-UTRAN_inter}}$ See Table 4.2.2.4-1 in clause 4.2.2.4

$T_{\text{SI-EUTRA}}$ Maximum repetition period of relevant system info blocks that needs to be received by the UE to camp on a cell; 1280 ms is assumed in this test case.

This gives a total of 67.68 s for higher priority cell search and 7.68 s for lower priority cell search, allow 68 s for higher priority cell and 8 s for lower priority cell in the test case.

A.4.2.6 E-UTRAN TDD – TDD: Inter frequency case

A.4.2.6.1 Test Purpose and Environment

This test is to verify the requirement for the TDD-TDD inter-frequency cell reselection requirements specified in clause 4.2.2.4.

The test scenario comprises of 2 E-UTRA TDD cells on 2 different carriers as given in tables A.4.2.6.1-1 and A.4.2.6.1-2. The test consists of three successive time periods, with time duration of T1, T2, and T2 respectively. Both cell 1 and cell 2 are already identified by the UE prior to the start of the test. Cell 1 and cell 2 belong to different tracking areas and cell 2 is of higher priority than cell 1. Furthermore, UE has not registered with network for the tracking area containing cell 2.

Table A.4.2.6.1-1: General test parameters for TDD-TDD inter frequency cell reselection test case

Parameter		Unit	Value	Comment
Initial condition	Active cell		Cell2	UE shall be forced to cell 2 in the initialisation phase, so that reselection to cell 1 occurs during the first T1 phase
T1 end condition	Active cells		Cell1	UE shall perform reselection to cell 1 during T1
	Neighbour cell		Cell2	
Final condition	Active cell		Cell2	UE shall perform reselection to cell 2 during T3
E-UTRA RF Channel Number			1, 2	Two TDD carrier frequencies are used.
Time offset between cells			3 μ s	Synchronous cells
Access Barring Information		-	Not Sent	No additional delays in random access procedure.
Special subframe configuration			6	As specified in table 4.2-1 in TS 36.211
Uplink-downlink configuration			1	As specified in table 4.2-2 in TS 36.211
PRACH configuration index			53	As specified in table 5.7.1-3 in TS 36.211
DRX cycle length		s	1.28	The value shall be used for all cells in the test.
T1		s	15	T1 need to be defined so that cell re-selection reaction time is taken into account.
T2		s	>7	During T2, cell 2 shall be powered off, and during the off time the physical cell identity shall be changed, The intention is to ensure that cell 2 has not been detected by the UE prior to the start of period T3.
T3		s	75	T3 need to be defined so that cell re-selection reaction time is taken into account.

Table A.4.2.6.1-2: Cell specific test parameters for TDD-TDD inter-frequency cell reselection test case in AWGN

Parameter	Unit	Cell 1			Cell 2		
		T1	T2	T3	T1	T2	T3
E-UTRA RF Channel number		1			2		
BW _{channel}	MHz	10			10		
OCNG Pattern defined in A.3.2.2.2 (OP.2 TDD)		OP.2 TDD			OP.2 TDD		
PBCH_RA	dB	0			0		
PBCH_RB	dB						
PSS_RA	dB						
SSS_RA	dB						
PCFICH_RB	dB						
PHICH_RA	dB						
PHICH_RB	dB						
PDCCH_RA	dB						
PDCCH_RB	dB						
PDSCH_RA	dB						
PDSCH_RB	dB						
OCNG_RA ^{Note 1}	dB						

OCNG_RB ^{Note 1}	dB						
Qrxlevmin	dBm	-140			-140		
N_{oc} ^{Note 2}	dBm/15 kHz	-98					
RSRP ^{Note 3}	dBm/15 KHz	-84	-84	-84	-102	-infinity	-86
\hat{E}_s/I_{ot}	dB	14	14	14	-4	-infinity	12
\hat{E}_s/N_{oc}	dB	14	14	14	-4	-infinity	12
Treselection _{EUTRAN}	S	0			0		
Snonintrasearch	dB	50			Not sent		
Thresh _{x, high}	dB	48			48		
Thresh _{serv, low}	dB	44			44		
Thresh _{x, low}	dB	50			50		
Propagation Condition		AWGN					
Note 1:	OCNG shall be used such that both cells are fully allocated and a constant total transmitted power spectral density is achieved for all OFDM symbols.						
Note 2:	Interference from other cells and noise sources not specified in the test is assumed to be constant over subcarriers and time and shall be modelled as AWGN of appropriate power for N_{oc} to be fulfilled.						
Note 3:	RSRP levels have been derived from other parameters for information purposes. They are not settable parameters themselves.						

A.4.2.6.2 Test Requirements

The cell reselection delay to higher priority is defined as the time from the beginning of time period T3, to the moment when the UE camps on cell 2, and starts to send preambles on the PRACH for sending the RRC CONNECTION REQUEST message to perform a Tracking Area Update procedure on cell 2.

The cell re-selection delay to higher priority shall be less than 68 s.

The cell reselection delay to lower priority is defined as the time from the beginning of time period T1, to the moment when the UE camps on cell 1, and starts to send preambles on the PRACH for sending the RRC CONNECTION REQUEST message to perform a Tracking Area Update procedure on cell 1.

The cell re-selection delay to lower priority shall be less than 8 s.

The rate of correct cell reselections observed during repeated tests shall be at least 90%.

NOTE: The cell re-selection delay to higher priority cell can be expressed as: $T_{\text{higher_priority_search}} + T_{\text{evaluate,E-UTRAN_inter}} + T_{\text{SI-EUTRA}}$, and to lower priority cell can be expressed as: $T_{\text{evaluate,E-UTRAN_inter}} + T_{\text{SI-EUTRA}}$,

Where:

$T_{\text{higher_priority_search}}$ See clause 4.2.2

$T_{\text{evaluate,E-UTRAN_inter}}$ See Table 4.2.2.4-1 in clause 4.2.2.4

$T_{\text{SI-EUTRA}}$ Maximum repetition period of relevant system info blocks that needs to be received by the UE to camp on a cell; 1280 ms is assumed in this test case.

This gives a total of 67.68 s for higher priority cell search and 7.68 s for lower priority cell search, allow 68 s for higher priority cell and 8 s for lower priority cell in the test case.

A.4.2.7 E-UTRAN FDD – FDD Inter frequency case in the existence of non-allowed CSG cell

A.4.2.7.1 Test Purpose and Environment

This test is to verify the requirement for the FDD-FDD inter-frequency cell reselection requirements specified in clause 4.2.2.4 when there is the interference from non-allowed CSG cell and the layers have equal priority.

The test scenario comprises of 2 E-UTRA FDD cells on 2 different carriers and 1 non-allowed E-UTRA FDD CSG cell as given in tables A.4.2.7.1-1 and A.4.2.7.1-2. The test consists of three successive time periods, with time duration of T1, T2 and T3 respectively. Cell 1 is already identified by the UE prior to the start of the test. Cell 1 and cell 2 belong to different tracking areas and cell 3 is a non-allowed CSG cell. Furthermore, UE has not registered with network for the tracking area containing cell 2.

Table A.4.2.7.1-1: General test parameters for FDD-FDD inter frequency cell re-selection test case with non-allowed CSG cell

Parameter		Unit	Value	Comment
Initial condition	Active cell		Cell1	UE shall be forced to cell 1 in the initialisation phase
Final condition	Active cell		Cell2	UE shall perform reselection to cell 2 during T2
E-UTRA RF Channel Number			1, 2	Two FDD carrier frequencies are used.
Time offset between cells			3 ms	Asynchronous cells
PRACH configuration			4	As specified in table 5.7.1-2 in TS 36.211
Access Barring Information		-	Not Sent	No additional delays in random access procedure.
DRX cycle length		s	1.28	The value shall be used for all cells in the test.
T1		s	15	T1 need to be defined so that the non-allowed CSG cell is identified.
T2		s	40	T2 need to be defined so that cell re-selection reaction time is taken into account.
T3		s	15	T3 need to be defined so that whether cell re-selection would not occur is insured.

Table A.4.2.7.1-2: Cell specific test parameters for FDD-FDD inter frequency cell re-selection test case with non-allowed CSG cell

Parameter	Unit	Cell 1			Cell 2			Cell 3(Non-allowed CSG cell)		
		T1	T2	T3	T1	T2	T3	T1	T2	T3
E-UTRA RF Channel Number		1			2			1		
BW _{channel}	MHz	10			10			10		
OCNG Patterns defined in A.3.2.1.2 (OP.2 FDD)		OP.2 FDD			OP.2 FDD			OP.2 FDD		
PBCH_RA	dB	0			0			0		
PBCH_RB	dB									
PSS_RA	dB									
SSS_RA	dB									
PCFICH_RB	dB									
PHICH_RA	dB									
PHICH_RB	dB									
PDCCH_RA	dB									
PDCCH_RB	dB									
PDSCH_RA	dB									
PDSCH_RB	dB									
OCNG_RA ^{Note 1}	dB									
OCNG_RB ^{Note 1}	dB									
Qrxlevmin	dBm	-140			-140			-140		
Qqualmin	dB				-20					
N_{oc} ^{Note 2}	dBm/15 kHz				-98					
RSRP ^{Note 3}	dBm/15 kHz	-90	-90	-85	-	-85	-90	-90	-85	-60
RSRQ ^{Note 3}	dB	-14.1	-17.1	-35.8	Infinity			-14.1	-12.1	-10.8

\hat{E}_s/I_{ot}	dB	-0.64	-5.21	-25	- Infinity	13	8	-0.64	4.36	24.8
\hat{E}_s/N_{oc}	dB	8	8	13	- Infinity	13	8	8	13	38
Treselection	s	0			0			0		
Snonintrasearch	dB	-10			Not sent			Not sent		
Propagation Condition		AWGN								
Note 1:	OCNG shall be used such that both cells are fully allocated and a constant total transmitted power spectral density is achieved for all OFDM symbols.									
Note 2:	Interference from other cells and noise sources not specified in the test is assumed to be constant over subcarriers and time and shall be modelled as AWGN of appropriate power for N_{oc} to be fulfilled.									
Note 3:	RSRP and RSRQ levels have been derived from other parameters for information purposes. They are not settable parameters themselves.									

A.4.2.7.2 Test Requirements

The cell reselection delay to a newly detectable cell is defined as the time from the beginning of time period T2, to the moment when the UE camps on Cell 2, and starts to send preambles on the PRACH for sending the RRC CONNECTION REQUEST message to perform a Tracking Area Update procedure on Cell 2.

The cell re-selection delay to a newly detectable cell shall be less than 34 s.

The rate of correct cell reselections observed during repeated tests shall be at least 90%.

The probability of reselection from Cell 2 to Cell 1 during T3 observed during testing shall be less than 10%.

NOTE: The cell re-selection delay to a newly detectable cell can be expressed as: $T_{\text{detect,EUTRAN_Inter}} + T_{\text{SI}}$,

Where:

$T_{\text{detect,EUTRAN_Inter}}$ See Table 4.2.2.4-1 in clause 4.2.2.4

T_{SI} Maximum repetition period of relevant system info blocks that needs to be received by the UE to camp on a cell; 1280 ms is assumed in this test case.

This gives a total of 33.28 s, allow 34 s for the cell re-selection delay to a newly detectable cell in the test case.

A.4.2.8 E-UTRAN TDD – TDD Inter frequency case in the existence of non-allowed CSG cell

A.4.2.8.1 Test Purpose and Environment

This test is to verify the requirement for the TDD-TDD inter-frequency cell reselection requirements specified in clause 4.2.2.4 when there is the interference from non-allowed CSG cell and the layers have equal priority.

The test scenario comprises of 2 E-UTRA TDD cells on 2 different carriers and 1 non-allowed E-UTRA TDD CSG cell as given in tables A.4.2.8.1-1 and A.4.2.8.1-2. The test consists of three successive time periods, with time duration of T1, T2 and T3 respectively. Cell 1 is already identified by the UE prior to the start of the test. Cell 1 and cell 2 belong to different tracking areas and cell 3 is a non-allowed CSG cell. Furthermore, UE has not registered with network for the tracking area containing cell 2.

Table A.4.2.8.1-1: General test parameters for TDD-TDD inter frequency cell re-selection test case with non-allowed CSG cell

Parameter	Unit	Value	Comment
Initial condition	Active cell	Cell1	UE shall be forced to cell 1 in the initialisation phase
Final condition	Active cell	Cell2	UE shall perform reselection to cell 2 during T2
E-UTRA RF Channel Number		1, 2	Two TDD carrier frequencies are used.

Time offset between cells	μs	3	Synchronous cells
Uplink-downlink configuration		1	As specified in table 4.2-2 in TS 36.211
Special subframe configuration		6	As specified in table 4.2-1 in TS 36.211
PRACH configuration		53	As specified in table 5.7.1-3 in TS 36.211
Access Barring Information	-	Not Sent	No additional delays in random access procedure.
DRX cycle length	s	1.28	The value shall be used for all cells in the test.
T1	s	15	T1 need to be defined so that the non-allowed CSG cell is identified.
T2	s	40	T2 need to be defined so that cell re-selection reaction time is taken into account.
T3	s	15	T3 need to be defined so that whether cell re-selection would not occur is insured.

Table A.4.2.8.1-2: Cell specific test parameters for TDD-TDD inter frequency cell re-selection test case with non-allowed CSG cell

Parameter	Unit	Cell 1			Cell 2			Cell 3 (Non-allowed CSG cell)		
		T1	T2	T3	T1	T2	T3	T1	T2	T3
E-UTRA RF Channel Number		1			2			1		
BW_{channel}	MHz	10			10			10		
OCNG Pattern defined in A.3.2.2.2 (OP.2 TDD)		OP.2 TDD			OP.2 TDD			OP.2 TDD		
PBCH_RA	dB									
PBCH_RB	dB									
PSS_RA	dB									
SSS_RA	dB									
PCFICH_RB	dB									
PHICH_RA	dB									
PHICH_RB	dB	0			0			0		
PDCCH_RA	dB									
PDCCH_RB	dB									
PDSCH_RA	dB									
PDSCH_RB	dB									
OCNG_RA ^{Note 1}	dB									
OCNG_RB ^{Note 1}	dB									
Qrxlevmin	dBm	-140			-140			-140		
Qqualmin	dB				-20					
N_{oc} ^{Note 2}	dBm/ 15kHz				-98					
RSRP ^{Note 3}	dBm/ 15kHz	-90	-90	-85	-Infinity	-85	-90	-90	-85	-60
RSRQ ^{Note 3}	dB	-14.1	-17.1	-35.8				-14.1	-12.1	-10.8
\hat{E}_s/I_{ot}	dB	-0.64	-5.21	-25	-Infinity	13	8	-0.64	4.36	24.8
\hat{E}_s/N_{oc}	dB	8	8	13	-Infinity	13	8	8	13	38
Treselection	S	0			0			0		
Snonintrasearch	dB	-10			Not sent			Not sent		
Propagation Condition		AWGN								
<p>Note 1: OCNG shall be used such that both cells are fully allocated and a constant total transmitted power spectral density is achieved for all OFDM symbols.</p> <p>Note 2: Interference from other cells and noise sources not specified in the test is assumed to be constant over subcarriers and time and shall be modelled as AWGN of appropriate power for N_{oc} to be fulfilled.</p> <p>Note 3: RSRP and RSRQ levels have been derived from other parameters for information purposes. They are not settable parameters themselves.</p>										

A.4.2.8.2 Test Requirements

The cell reselection delay to a newly detectable cell is defined as the time from the beginning of time period T2, to the moment when the UE camps on Cell 2, and starts to send preambles on the PRACH for sending the RRC CONNECTION REQUEST message to perform a Tracking Area Update procedure on Cell 2.

The cell re-selection delay to a newly detectable cell shall be less than 34 s.

The rate of correct cell reselections observed during repeated tests shall be at least 90%.

The probability of reselection from Cell 2 to Cell 1 during T3 observed during testing shall be less than 10%.

NOTE: The cell re-selection delay to a newly detectable cell can be expressed as: $T_{\text{detect,EUTRAN_Inter}} + T_{\text{SI}}$,

Where:

$T_{\text{detect,EUTRAN_Inter}}$ See Table 4.2.2.4-1 in clause 4.2.2.4

T_{SI} Maximum repetition period of relevant system info blocks that needs to be received by the UE to camp on a cell; 1280 ms is assumed in this test case.

This gives a total of 33.28 s, allow 34 s for the cell re-selection delay to a newly detectable cell in the test case.

A.4.2.9 E-UTRAN FDD – FDD Intra frequency case for 5MHz bandwidth

A.4.2.9.1 Test Purpose and Environment

The purpose of this test case is the same as for the test defined in subclause A.4.2.1.1.

The parameters of this test are the same as defined in Subclause A.4.2.1.1 except that the values of the parameters in the Table A.4.2.9.1-1 will replace the values of the corresponding parameters in A.4.2.1.1-1, and the values of the parameters in the Table A.4.2.9.1-2 will replace the values of the corresponding parameters in A.4.2.1.1-2.

Table A.4.2.9.1-1: General test parameters for FDD intra frequency cell reselection test case for 5MHz bandwidth

Parameter	Unit	Value	Comment
Channel Bandwidth (BW_{channel})	MHz	5	
Note 1:	See Table A.4.2.1.1-1 for the other parameters.		
Note 2:	This is according to the principle defined in section A.3.7.2.		

Table A.4.2.9.1-2: Cell specific test parameters for FDD intra frequency cell reselection test case in AWGN for 5MHz

Parameter	Unit	Cell 1			Cell 2		
		T1	T2	T3	T1	T2	T3
BW_{channel}	MHz	5			5		
OCNG Patterns defined in A.3.2.1.16 (OP.16 FDD)		OP.16 FDD			OP.16 FDD		
Note 1:	OCNG shall be used such that both cells are fully allocated and a constant total transmitted power spectral density is achieved for all OFDM symbols.						
Note 2:	See Table A.4.2.1.1-2 for the other parameters.						

A.4.2.9.2 Test Requirements

The test requirements defined in section A.4.2.1.2 shall apply to this test case.

A.4.2.10 E-UTRAN FDD – FDD reselection using an increased number of carriers

A.4.2.10.1 Test Purpose and Environment

This test is to verify the requirement for the FDD-FDD inter-frequency cell reselection requirements for increased UE carrier monitoring specified in clause 4.2.2.4.

The test scenario comprises of indicating 8 E-UTRA FDD interfrequency cells on 8 different carriers in the neighbour list of cell 1 as given in tables A.4.2.10.1-1 and A.4.2.10.1-2. Each repetition of the test consists of five successive time periods, with time duration of T0, T1, T2, T3 and T4 respectively. In the initialisation phase and at the start of each repetition of T0, the test equipment provides signals for cell 1 (serving cell), and selects frequencies for cells 2, 3 and 4

which are chosen from the 8 interfrequency layers which are configured in the UE neighbour cell list as described in general and cell specific parameters. The neighbour lists of cells 2, 3 and 4 shall include the frequency of cell 1 in the normal performance group as well as the other frequencies configured to the UE in the test.

Cell 1, 2, 3 and 4 are identified by the UE during time phase T0. Cell 1, cell 2, cell 3 and cell 4 all belong to different tracking areas. Furthermore, UE has not registered with network for the tracking area containing cell 2, 3 or 4. Cells 1, 2, 3 and 4 all have equal absolute priority.

Table A.4.2.10.1-1: General test parameters for FDD-FDD inter frequency cell re-selection test case

Parameter		Unit	Value	Comment
T0	Active cell		Cell1	T0 is repeated on each repetition of the test. In T0 the test equipment selects frequencies for cell 2, 3, 4 and then time is allowed for the UE to identify the neighbour cells. See cell specific parameters for detailed settings.
T1 start condition	Active cell		Cell 1	
T1 end condition	Active cell		Cell 2	UE shall perform reselection to cell 2 during T1
	Neighbour cell		Cell 1, cell 3, cell 4	
T2 end condition	Active cell		Cell 3	UE shall perform reselection to cell 3 during T2
	Neighbour cell		Cell 1, cell 2, cell 4	
T3 end condition	Active cell		Cell 4	UE shall perform reselection to cell 4 during T3
	Neighbour cell		Cell 1, cell 2, cell 3	
T4 end condition	Active cell		Cell 1	UE shall perform reselection to cell 1 during T4
	Neighbour cell		Cell 2, cell 3, cell 4	
UE configured E-UTRA RF Channel Number			1, 2,3,4,5,6,7,8,9	Serving cell and eight xDD carrier frequencies are used in the UE neighbour cell list. Frequencies 5,6,7,8 and 9 are indicated to have reduced performance
Test equipment configuration			Cell 1 uses UTRA RF channel number 1 Cells 2,3,4 are randomly selected to use different frequencies selected from frequencies 2,3,4,5,6,7,8,9	
PRACH configuration			4	As specified in table 5.7.1-2 in TS 36.211 [16]
Access Barring Information		-	Not Sent	No additional delays in random access procedure.
DRX cycle length		s	1.28	The value shall be used for all cells in the test.
T0		s	(Test equipment frequency selection and configuration time) + 960	T0 is defined so that the Test equipment selects frequencies and configures the cells, then the UE cell detection time is taken into account.
T1		s	25	T1 need to be defined so that cell re-selection reaction time is taken into account.
T2		s	200	T2 need to be defined so that cell re-selection reaction time is taken into account
T3		s	200	T3 need to be defined so that cell re-selection reaction time is taken into account.
T4		s	25	T4 need to be defined so that cell re-selection reaction time is taken into account

Table A.4.2.10.1-2: Cell specific test parameters for FDD-FDD inter-frequency cell reselection test case in AWGN

Parameter	Unit	Cell 1					Cell 2					Cell 3					Cell 4				
		T0	T1	T2	T3	T4	T0	T1	T2	T3	T4	T0	T1	T2	T3	T4	T0	T1	T2	T3	T4
E-UTRA RF Channel number		1					Randomly selected from 2,3,4 such that cell 2 is in the normal performance group					Randomly selected from 5,6,7,8,9 such that cell 3 is in the reduced performance group					Randomly selected from 5,6,7,8,9 such that cell 4 is in the reduced performance group				
BW _{channel}	MHz	5MHz: N _{RB} = 25 10MHz: N _{RB} = 50					5MHz: N _{RB} = 25 10MHz: N _{RB} = 50					5MHz: N _{RB} = 25 10MHz: N _{RB} = 50					5MHz: N _{RB} = 25 10MHz: N _{RB} = 50				
OCNG patterns		OP.16 FDD (5MHz) OP.2 FDD (10MHz)					OP.16 FDD (5MHz) OP.2 FDD (10MHz)					OP.16 FDD (5MHz) OP.2 FDD (10MHz)					OP.16 FDD (5MHz) OP.2 FDD (10MHz)				
PBCH_RA	dB	0					0					0					0				
PBCH_RB	dB																				
PSS_RA	dB																				
SSS_RA	dB																				
PCFICH_RB	dB																				
PHICH_RA	dB																				
PHICH_RB	dB																				
PDCCH_RA	dB																				
PDCCH_RB	dB																				
PDSCH_RA	dB																				
PDSCH_RB	dB																				
OCNG_RA ^{Note 1}	dB																				
OCNG_RB ^{Note 1}	dB																				
Qrxlevmin	dBm	-140					-140					-140					-140				
N _{oc} ^{Note 2}	dBm/15 kHz	-98					-98					-98					-98				
\hat{E}_s/N_{oc}	dB	14	8	8	8	14	8	14	8	8	8	8	8	14	8	8	8	8	8	14	8
\hat{E}_s/I_{ot}	dB	14	8	8	8	14	8	14	8	8	8	8	8	14	8	8	8	8	8	14	8
RSRP ^{Note 3}	dBm/15 kHz	-84	-90	-90	-90	-84	-90	-84	-90	-90	-90	-90	-90	-84	-90	-90	-90	-90	-90	-84	-90
Treselection _{NEUTRAN}	s	0					0					0					0				
Snonintrasearch	dB	62					62					62					62				
Propagation Condition		AWGN					AWGN					AWGN					AWGN				
Antenna Configuration		1x2					1x2					1x2					1x2				
Timing offset to Cell 1		-					3ms					3ms					3ms				

Note 1: OCNG shall be used such that both cells are fully allocated and a constant total transmitted power spectral density is achieved for all OFDM symbols.
 Note 2: Interference from other cells and noise sources not specified in the test is assumed to be constant over subcarriers and time and shall be modelled as AWGN of appropriate power for to be fulfilled.
 Note 3: Es/Iot and RSRP levels have been derived from other parameters for information purposes. They are not settable parameters themselves.

A.4.2.10.2 Test Requirements

The cell reselection delay is defined as the time from the beginning of a relevant time period, to the moment when the UE camps on the target cell, and starts to send preambles on the PRACH for sending the RRC CONNECTION REQUEST message to perform a Tracking Area Update procedure on the target cell.

The reselection delays shall meet the requirements in table A.4.2.10.2-1.

Table A.4.2.10.2-1 : Reselection delay requirements

Time phase	Target cell	Requirement for reselection delay (seconds)
T1	Cell 2 (normal performance group)	20.5
T2	Cell 3 (reduced performance group)	193.3
T3	Cell 4 (reduced performance group)	193.3
T4	Cell 1 (normal performance group)	20.5

NOTE: The cell re-selection delay to a normal performance group cell can be expressed as: $K_{\text{carrier,normal}} * T_{\text{evaluate,E-UTRAN_Inter}} + T_{\text{SI}}$, and to a reduced performance group cell can be expressed as: $6 * K_{\text{carrier,reduced}} * T_{\text{evaluate,E-UTRAN_Inter}} + T_{\text{SI}}$

This gives a total of 20.48 s for normal performance group reselection and 193.28 s for reduced performance group reselection, allow 20.5 s for normal performance group and 193.3 s for reduced performance group in the test case. At least 90% of reselections to the reduced performance group shall be within the required time, and at least 90% of reselections to the normal performance group shall be within the required time, with a successful reselection counted if it is within the required time regardless of the carrier frequencies involved.

A.4.2.11 E-UTRAN TDD – TDD reselection using an increased number of carriers

A.4.2.11.1 Test Purpose and Environment

This test is to verify the requirement for the TDD-TDD inter-frequency cell reselection requirements for increased UE carrier monitoring specified in clause 4.2.2.4.

The test scenario comprises of indicating 8 E-UTRA TDD interfrequency cells on 8 different carriers in the neighbour list of cell 1 as given in tables A.4.2.11.1-1 and A.4.2.11.1-2. Each repetition of the test consists of five successive time periods, with time duration of T0, T1, T2, T3 and T4 respectively. In the initialisation phase and at the start of each repetition of T0, the test equipment provides signals for cell 1 (serving cell), and selects frequencies for cells 2, 3 and 4 which are chosen from the 8 interfrequency layers which are configured in the UE neighbour cell list as described in general and cell specific parameters. The neighbour lists of cells 2, 3 and 4 shall include the frequency of cell 1 in the normal performance group as well as the other frequencies configured to the UE in the test.

Cell 1, 2, 3 and 4 are identified by the UE during time phase T0. Cell 1, cell 2, cell 3 and cell 4 all belong to different tracking areas. Furthermore, UE has not registered with network for the tracking area containing cell 2, 3 or 4. Cells 1, 2, 3 and 4 all have equal absolute priority.

Table A.4.2.11.1-1: General test parameters for TDD-TDD inter frequency cell re-selection test case

Parameter	Unit	Value	Comment
T0	Active cell	Cell1	T0 is repeated on each repetition of the test. In T0 the test equipment selects frequencies for cell 2,3,4 and then time is allowed for the UE to identify the neighbour cells. See cell specific parameters for detailed settings.
T1 start condition	Active cell	Cell 1	
T1 end condition	Active cell	Cell 2	UE shall perform reselection to cell 2 during T1
	Neighbour cell	Cell 1, cell 3, cell 4	
T2 end condition	Active cell	Cell 3	UE shall perform reselection to cell 3 during T2
	Neighbour cell	Cell 1, cell 2, cell 4	
T3 end condition	Active cell	Cell4	UE shall perform reselection to cell 4 during T3

	Neighbour cell		Cell 1, cell 2, cell 3	
T4 end condition	Active cell		Cell1	UE shall perform reselection to cell 1 during T4
	Neighbour cell		Cell 2, cell 3, cell 4	
UE configured E-UTRA RF Channel Number			1, 2,3,4,5,6,7,8,9	Serving cell and eight xDD carrier frequencies are used in the UE neighbour cell list. Frequencies 5,6,7,8 and 9 are indicated to have reduced performance
Test equipment configuration			Cell 1 uses UTRA RF channel number 1 Cells 2,3,4 are randomly selected to use different frequencies selected from frequencies 2,3,4,5,6,7,8,9	
PRACH configuration			4	As specified in table 5.7.1-2 in TS 36.211 [16]
Access Barring Information	-		Not Sent	No additional delays in random access procedure.
DRX cycle length	s		1.28	The value shall be used for all cells in the test.
T0	s		(Test equipment frequency selection and configuration time) + 960	T0 is defined so that the Test equipment selects frequencies and configures the cells, then the UE cell detection time is taken into account.
T1	s		25	T1 need to be defined so that cell reselection reaction time is taken into account.
T2	s		200	T2 need to be defined so that cell reselection reaction time is taken into account
T3	s		200	T3 need to be defined so that cell reselection reaction time is taken into account.
T4	s		25	T4 need to be defined so that cell reselection reaction time is taken into account

Table A.4.2.11.1-2: Cell specific test parameters for TDD-TDD inter-frequency cell reselection test case in AWGN

Parameter	Unit	Cell 1					Cell 2					Cell 3					Cell 4				
		T0	T1	T2	T3	T4	T0	T1	T2	T3	T4	T0	T1	T2	T3	T4	T0	T1	T2	T3	T4
E-UTRA RF Channel number		1					Randomly selected from 2,3,4 such that cell 2 is in the normal performance group					Randomly selected from 5,6,7,8,9 such that cell 3 is in the reduced performance group					Randomly selected from 5,6,7,8,9 such that cell 4 is in the reduced performance group				
BW _{channel}	MHz	5MHz: N _{RB} = 25 10MHz: N _{RB} = 50					5MHz: N _{RB} = 25 10MHz: N _{RB} = 50					5MHz: N _{RB} = 25 10MHz: N _{RB} = 50					5MHz: N _{RB} = 25 10MHz: N _{RB} = 50				
OCNG Patterns		5MHz: OP.10 TDD 10MHz: OP.2 TDD					5MHz: OP.10 TDD 10MHz: OP.2 TDD					5MHz: OP.10 TDD 10MHz: OP.2 TDD					5MHz: OP.10 TDD 10MHz: OP.2 TDD				
PBCH_RA	dB	0					0					0					0				
PBCH_RB	dB																				
PSS_RA	dB																				
SSS_RA	dB																				
PCFICH_RB	dB																				
PHICH_RA	dB																				
PHICH_RB	dB																				
PDCCH_RA	dB																				
PDCCH_RB	dB																				
PDSCH_RA	dB																				
PDSCH_RB	dB																				
OCNG_RA ^{Note 1}	dB																				
OCNG_RB ^{Note 1}	dB																				
Qrxlevmin	dBm	-140					-140					-140					-140				
N _{oc} ^{Note 2}	dBm15 kHz	-98					-98					-98					-98				
\hat{E}_s/N_{oc}	dB	14	8	8	8	14	8	14	8	8	8	8	8	14	8	8	8	8	8	14	8
\hat{E}_s/I_{ot}	dB	14	8	8	8	14	8	14	8	8	8	8	8	14	8	8	8	8	8	14	8
RSRP ^{Note 3}	dBm/15 kHz	-84	-90	-90	-90	-84	-90	-84	-90	-90	-90	-90	-90	-84	-90	-90	-90	-90	-90	-84	-90
Treselection _{EU} TRAN	s	0					0					0					0				
Snonintrasearch	dB	62					62					62					62				
Propagation Condition		AWGN					AWGN					AWGN					AWGN				
Antenna Configuration		1x2					1x2					1x2					1x2				
Timing offset to Cell 1		-					3ms					3ms					3ms				

Note 1: OCNG shall be used such that both cells are fully allocated and a constant total transmitted power spectral density is achieved for all OFDM symbols.
 Note 2: Interference from other cells and noise sources not specified in the test is assumed to be constant over subcarriers and time and shall be modelled as AWGN of appropriate power for to be fulfilled.
 Note 3: Es/lot and RSRP levels have been derived from other parameters for information purposes. They are not settable parameters themselves.

A.4.2.11.2 Test Requirements

The cell reselection delay is defined as the time from the beginning of a relevant time period, to the moment when the UE camps on the target cell, and starts to send preambles on the PRACH for sending the RRC CONNECTION REQUEST message to perform a Tracking Area Update procedure on the target cell.

The reselection delays shall meet the requirements in table A.4.2.11.2-1

Table A.4.2.11.2-1 : Reselection delay requirements

Time phase	Target cell	Requirement for reselection delay (seconds)
T1	Cell 2 (normal performance group)	20.5
T2	Cell 3 (reduced performance group)	193.3
T3	Cell 4 (reduced performance group)	193.3
T4	Cell 1 (normal performance group)	20.5

NOTE: The cell re-selection delay to a normal performance group cell can be expressed as: $K_{\text{carrier,normal}} * T_{\text{evaluate,E-UTRAN_Inter}} + T_{\text{SI}}$, and to a reduced performance group cell can be expressed as: $6 * K_{\text{carrier,reduced}} * T_{\text{evaluate,E-UTRAN_Inter}} + T_{\text{SI}}$

This gives a total of 20.48 s for normal performance group reselection and 193.28 s for reduced performance group reselection, allow 20.5 s for normal performance group and 193.3 s for reduced performance group in the test case. At least 90% of reselections to the reduced performance group shall be within the required time, and at least 90% of reselections to the normal performance group shall be within the required time, with a successful reselection counted if it is within the required time regardless of the carrier frequencies involved.

A.4.2.12 E-UTRAN FDD – FDD Intra frequency case for Cat-M1 UE in normal coverage

A.4.2.12.1 Test Purpose and Environment

This test is to verify the requirement for the FDD-FDD intra frequency cell reselection requirements for category M1 UE in normal coverage specified in clause 4.2.2.3.

The test scenario comprises of 1 E-UTRA FDD carrier and 2 cells as given in tables A.4.2.12.1-1 and A.4.2.12.1-2. The test consists of three successive time periods, with time duration of T1, T2 and T3 respectively. Only Cell 1 is already identified by the UE prior to the start of the test, i.e. Cell 2 is not identified by the UE prior to the start of the test. Cell 1 and Cell 2 belong to different tracking areas. Furthermore, UE has not registered with network for the tracking area containing Cell 2.

Table A.4.2.12.1-1: General test parameters for FDD intra frequency cell reselection test case for Cat-M1 UE in normal coverage

Parameter	Unit	Value	Comment
Initial condition	Active cell	Cell1	
	Neighbour cells	Cell2	
T2 end condition	Active cell	Cell2	
	Neighbour cells	Cell1	
Final condition	Visited cell	Cell1	
E-UTRA RF Channel Number		1	Only one FDD carrier frequency is used.
Access Barring Information	-	Not Sent	No additional delays in random access procedure.
PRACH Configuration		PRACH_2CE	Refer to A.3.16
DRX cycle length	s	1.28	The value shall be used for all cells in the test.
T1	s	>7	During T1, Cell 2 shall be powered off, and during the off time the physical cell identity shall be changed, The intention is to ensure that Cell 2 has not been detected by the UE prior to the start of period T2

T2	s	40	T2 need to be defined so that cell re-selection reaction time is taken into account.
T3	s	15	T3 need to be defined so that cell re-selection reaction time is taken into account.

Table A.4.2.12.1-2: Cell specific test parameters for FDD intra frequency cell reselection test case for Cat-M1 UE in normal coverage

Parameter	Unit	Cell 1			Cell 2		
		T1	T2	T3	T1	T2	T3
E-UTRA RF Channel Number		1					
BW _{channel}	MHz	10					
OCNG Patterns		OP.6 FDD			OP.6 FDD		
PBCH_RA	dB	-3			-3		
PBCH_RB	dB						
PSS_RA	dB						
SSS_RA	dB						
MPDCCH_RA	dB						
MPDCCH_RB	dB						
PDSCH_RA	dB						
PDSCH_RB	dB						
OCNG_RA ^{Note 1}	dB						
OCNG_RB ^{Note 1}	dB						
Qrxlevmin	dBm	-140	-140	-140	-140	-140	-140
Pcompensation	dB	0	0	0	0	0	0
Qhyst _s	dB	0	0	0	0	0	0
Qoffset _{s, n}	dB	0	0	0	0	0	0
Cell_selection_and_reselection_quality_measurement		RSRP			RSRP		
N_{oc} ^{Note2}	dBm/15 kHz	-98					
\hat{E}_s / N_{oc}	dB	16	12	16	-infinity	16	12
\hat{E}_s / I_{ot}	dB	16	-4.11	3.73	-infinity	3.73	-4.11
RSRP ^{Note3}	dBm/15 kHz	-82	-86	-82	-infinity	-82	-86
Treselection	s	0	0	0	0	0	0
Sintrasearch	dB	Not sent			Not sent		
Propagation Condition		AWGN			AWGN		
Antenna Configuration		2x1			2x1		
Timing offset to Cell 1	ms	-			3		
<p>Note 1: OCNG shall be used such that both cells are fully allocated and a constant total transmitted power spectral density is achieved for all OFDM symbols.</p> <p>Note 2: Interference from other cells and noise sources not specified in the test is assumed to be constant over subcarriers and time and shall be modelled as AWGN of appropriate power for N_{oc} to be fulfilled.</p> <p>Note 3: RSRP levels have been derived from other parameters for information purposes. They are not settable parameters themselves.</p>							

A.4.2.12.2 Test Requirements

The cell reselection delay to a newly detectable cell is defined as the time from the beginning of time period T2, to the moment when the UE camps on Cell 2, and starts to send preambles on the PRACH for sending the RRC CONNECTION REQUEST message to perform a Tracking Area Update procedure on Cell 2.

The cell re-selection delay to a newly detectable cell shall be less than 34 s.

The cell reselection delay to an already detected cell is defined as the time from the beginning of time period T3, to the moment when the UE camps on Cell 1, and starts to send preambles on the PRACH for sending the RRC CONNECTION REQUEST message to perform a Tracking Area Update procedure on Cell 1.

The cell re-selection delay to an already detected cell shall be less than 8 s.

The rate of correct cell reselections observed during repeated tests shall be at least 90%.

NOTE: The cell re-selection delay to a newly detectable cell can be expressed as: $T_{detect,EUTRA_Intra} + T_{SI-EUTRA-M1-NC}$, and to an already detected cell can be expressed as: $T_{evaluate,EUTRA_Intra} + T_{SI-EUTRA-M1-NC}$.

Where:

$T_{\text{detect,EUTRAN_Intra}}$ See Table 4.2.2.3-1 in clause 4.2.2.3

$T_{\text{evaluate,EUTRAN_Intra}}$ See Table 4.2.2.3-1 in clause 4.2.2.3

$T_{\text{SI-EUTRA-M1-NC}}$ Maximum repetition period of relevant system info blocks that needs to be received by the UE to camp on a cell; 1280 ms is assumed in this test case.

This gives a total of 33.28 s, allow 34 s for the cell re-selection delay to a newly detectable cell and 7.68 s, allow 8 s for the cell re-selection delay to an already detected cell in the test case.

A.4.2.13 E-UTRAN HD – FDD Intra frequency case for Cat-M1 UE in normal coverage

A.4.2.13.1 Test Purpose and Environment

This test is to verify the requirement for the HD-FDD intra frequency cell reselection requirements for Cat-M1 UE specified in clause 4.2.2.3.

The test scenario comprises of 1 E-UTRA carrier and 2 cells as given in tables A.4.2.13.1-1 and A.4.2.13.1-2. The test consists of three successive time periods, with time duration of T1, T2 and T3 respectively. Only Cell 1 is already identified by the UE prior to the start of the test, i.e. Cell 2 is not identified by the UE prior to the start of the test. Cell 1 and Cell 2 belong to different tracking areas. Furthermore, UE has not registered with network for the tracking area containing Cell 2.

Table A.4.2.13.1-1: General test parameters for HD-FDD intra frequency cell reselection test case for Cat-M1 UE in normal coverage

Parameter		Unit	Value	Comment
Initial condition	Active cell		Cell1	
	Neighbour cells		Cell2	
T2 end condition	Active cell		Cell2	
	Neighbour cells		Cell1	
Final condition	Visited cell		Cell1	
E-UTRA RF Channel Number			1	Only one carrier frequency is used.
Access Barring Information		-	Not Sent	No additional delays in random access procedure.
PRACH Configuration			PRACH_2CE	Refer to A.3.16
DRX cycle length		s	1.28	The value shall be used for all cells in the test.
T1		s	>7	During T1, Cell 2 shall be powered off, and during the off time the physical cell identity shall be changed, The intention is to ensure that Cell 2 has not been detected by the UE prior to the start of period T2
T2		s	40	T2 need to be defined so that cell re-selection reaction time is taken into account.
T3		s	15	T3 need to be defined so that cell re-selection reaction time is taken into account.

Table A.4.2.13.1-2: Cell specific test parameters for HD-FDD intra frequency cell reselection test case for Cat-M1 UE in normal coverage

Parameter	Unit	Cell 1			Cell 2		
		T1	T2	T3	T1	T2	T3
E-UTRA RF Channel Number		1					
BW _{channel}	MHz	10					
OCNG Patterns		OP.6 FDD			OP.6 FDD		
PBCH_RA	dB	-3			-3		
PBCH_RB	dB						
PSS_RA	dB						
SSS_RA	dB						
MPDCCH_RA	dB						
MPDCCH_RB	dB						
PDSCH_RA	dB						
PDSCH_RB	dB						
OCNG_RA ^{Note 1}	dB						
OCNG_RB ^{Note 1}	dB						
Qrxlevmin	dBm	-140	-140	-140	-140	-140	-140
Pcompensation	dB	0	0	0	0	0	0
Qhyst _s	dB	0	0	0	0	0	0
Qoffset _{s, n}	dB	0	0	0	0	0	0
Cell_selection_and_reselection_quality_measurement		RSRP			RSRP		
N_{oc} ^{Note2}	dBm/15 kHz	-98					
\hat{E}_s / N_{oc}	dB	16	12	16	-infinity	16	12
\hat{E}_s / I_{ot}	dB	16	-4.11	3.73	-infinity	3.73	-4.11
RSRP ^{Note3}	dBm/15 kHz	-82	-86	-82	-infinity	-82	-86
Treselection	s	0	0	0	0	0	0
Sintrasearch	dB	Not sent			Not sent		
Propagation Condition		AWGN			AWGN		
Antenna Configuration		2x1			2x1		
Timing offset to Cell 1	ms	-			3		
<p>Note 1: OCNG shall be used such that both cells are fully allocated and a constant total transmitted power spectral density is achieved for all OFDM symbols.</p> <p>Note 2: Interference from other cells and noise sources not specified in the test is assumed to be constant over subcarriers and time and shall be modelled as AWGN of appropriate power for N_{oc} to be fulfilled.</p> <p>Note 3: RSRP levels have been derived from other parameters for information purposes. They are not settable parameters themselves.</p>							

A.4.2.13.2 Test Requirements

The cell reselection delay to a newly detectable cell is defined as the time from the beginning of time period T2, to the moment when the UE camps on Cell 2, and starts to send preambles on the PRACH for sending the RRC CONNECTION REQUEST message to perform a Tracking Area Update procedure on Cell 2.

The cell re-selection delay to a newly detectable cell shall be less than 34 s.

The cell reselection delay to an already detected cell is defined as the time from the beginning of time period T3, to the moment when the UE camps on Cell 1, and starts to send preambles on the PRACH for sending the RRC CONNECTION REQUEST message to perform a Tracking Area Update procedure on Cell 1.

The cell re-selection delay to an already detected cell shall be less than 8 s.

The rate of correct cell reselections observed during repeated tests shall be at least 90%.

NOTE: The cell re-selection delay to a newly detectable cell can be expressed as: $T_{detect,EUTRAN_Intra} + T_{SI-EUTRA-M1-NC}$, and to an already detected cell can be expressed as: $T_{evaluate,EUTRAN_Intra} + T_{SI-EUTRA-M1-NC}$.

Where:

$T_{\text{detect,EUTRAN_Intra}}$ See Table 4.2.2.3-1 in clause 4.2.2.3

$T_{\text{evaluate,EUTRAN_Intra}}$ See Table 4.2.2.3-1 in clause 4.2.2.3

$T_{\text{SI-EUTRA-M1-NC}}$ Maximum repetition period of relevant system info blocks that needs to be received by the UE to camp on a cell; 1280 ms is assumed in this test case.

This gives a total of 33.28 s, allow 34 s for the cell re-selection delay to a newly detectable cell and 7.68 s, allow 8 s for the cell re-selection delay to an already detected cell in the test case.

A.4.2.14 E-UTRAN TDD – TDD Intra frequency case for Cat-M1 UE in normal coverage

A.4.2.14.1 Test Purpose and Environment

This test is to verify the requirement for the TDD intra frequency cell reselection requirements for Cat-M1 UE specified in clause 4.2.2.3.

The test scenario comprises of 1 E-UTRA TDD carrier and 2 cells as given in tables A.4.2.14.1-1 and A.4.2.14.1-2. The test consists of three successive time periods, with time duration of T1, T2, and T3 respectively. Only cell 1 is already identified by the UE prior to the start of the test. Cell 1 and cell 2 belong to different tracking areas. Furthermore, UE has not registered with network for the tracking area containing cell 2.

Table A.4.2.14.1-1: General test parameters for TDD intra frequency cell re-selection test case for Cat-M1 UE

Parameter		Unit	Value	Comment
Initial condition	Active cell		Cell1	
	Neighbour cells		Cell2	
T2 end condition	Active cell		Cell2	
	Neighbour cells		Cell1	
Final condition	Visited cell		Cell1	
E-UTRA RF Channel Number			1	Only one TDD carrier frequency is used.
Access Barring Information		-	Not Sent	No additional delays in random access procedure.
Special subframe configuration			6	As specified in table 4.2-1 in TS 36.211
Uplink-downlink configuration			1	As specified in table 4.2-2 in TS 36.211
PRACH Configuration			PRACH_2CE	Refer to A.3.16
DRX cycle length		s	1.28	The value shall be used for all cells in the test.
T1		s	>7	During T1, Cell 2 shall be powered off, and during the off time the physical cell identity shall be changed, The intention is to ensure that Cell 2 has not been detected by the UE prior to the start of period T2
T2		s	40	T2 need to be defined so that cell re-selection reaction time is taken into account.
T3		s	15	T3 need to be defined so that cell re-selection reaction time is taken into account.

Table A.4.2.14.1-2: Cell specific test parameters for TDD intra frequency cell re-selection test case for Cat-M1 UE in AWGN in normal coverage

Parameter	Unit	Cell 1			Cell 2		
		T1	T2	T3	T1	T2	T3
E-UTRA RF Channel Number		1					
BW_{channel}	MHz	10					
OCNG Patterns		OP.2 TDD			OP.2 TDD		
PBCH_RA	dB	-3			-3		
PBCH_RB	dB						
PSS_RA	dB						

SSS_RA	dB						
MPDCCH_RA	dB						
MPDCCH_RB	dB						
PDSCH_RA	dB						
PDSCH_RB	dB						
OCNG_RA ^{Note 1}	dB						
OCNG_RB ^{Note 1}	dB						
Qrxlevmin	dBm	-140	-140	-140	-140	-140	-140
Pcompensation	dB	0	0	0	0	0	0
Qhysts	dB	0	0	0	0	0	0
Qoffset _{s, n}	dB	0	0	0	0	0	0
Cell_selection_and_reselection_quality_measurement		RSRP			RSRP		
N_{oc} ^{Note2}	dBm/15 kHz	-98					
\hat{E}_s/N_{oc}	dB	16	12	16	-infinity	16	12
\hat{E}_s/I_{ot}	dB	16	-4.11	3.73	-infinity	3.73	-4.11
RSRP ^{Note3}	dBm/15 kHz	-82	-86	-82	-infinity	-82	-86
Treselection	s	0	0	0	0	0	0
Sintrasearch	dB	Not sent			Not sent		
Propagation Condition		AWGN			AWGN		
Antenna Configuration		2x1			2x1		
Timing offset to Cell 1	μ s	-			3		
<p>Note 1: OCNG shall be used such that both cells are fully allocated and a constant total transmitted power spectral density is achieved for all OFDM symbols.</p> <p>Note 2: Interference from other cells and noise sources not specified in the test is assumed to be constant over subcarriers and time and shall be modelled as AWGN of appropriate power for N_{oc} to be fulfilled.</p> <p>Note 3: RSRP levels have been derived from other parameters for information purposes. They are not settable parameters themselves.</p>							

A.4.2.14.2 Test Requirements

The cell reselection delay to a newly detectable cell is defined as the time from the beginning of time period T2, to the moment when the UE camps on Cell 2, and starts to send preambles on the PRACH for sending the RRC CONNECTION REQUEST message to perform a Tracking Area Update procedure on Cell 2.

The cell re-selection delay to a newly detectable cell shall be less than 34 s.

The cell reselection delay to an already detected cell is defined as the time from the beginning of time period T3, to the moment when the UE camps on cell 1, and starts to send preambles on the PRACH for sending the RRC CONNECTION REQUEST message to perform a Tracking Area Update procedure on cell 1.

The cell re-selection delay shall be less than 8 s.

The rate of correct cell reselections observed during repeated tests shall be at least 90%.

NOTE: The cell re-selection delay to a newly detectable cell can be expressed as: $T_{\text{detect, E-UTRAN_Intra}} + T_{\text{SI-EUTRA-MI-NC}}$, and to an already detected cell can be expressed as: $T_{\text{evaluate, E-UTRAN_intra}} + T_{\text{SI-EUTRA-MI-NC}}$.

Where:

$T_{\text{detect, E-UTRAN_Intra}}$ See Table 4.2.2.3-1 in clause 4.2.2.3

$T_{\text{evaluate, E-UTRAN_intra}}$ See Table 4.2.2.3-1 in clause 4.2.2.3

$T_{\text{SI-EUTRA-MI-NC}}$ Maximum repetition period of relevant system info blocks that needs to be received by the UE to camp on a cell; 1280 ms is assumed in this test case.

This gives a total of 33.28 s, allow 34 s for the cell re-selection delay to a newly detectable cell and 7.68 s, allow 8 s for the cell re-selection delay to an already detected cell in the test case.

A.4.2.15 E-UTRAN FDD – FDD Intra frequency case for Cat-M1 UE in enhanced coverage

A.4.2.15.1 Test Purpose and Environment

This test is to verify the requirement for the FDD-FDD intra frequency cell reselection requirements for category M1 UE in enhanced coverage specified in clause 4.2.2.11.

The test scenario comprises of 1 E-UTRA FDD carrier and 2 cells as given in tables A.4.2.15.1-1 and A.4.2.15.1-2. The test consists of three successive time periods, with time duration of T1, T2 and T3 respectively. Only Cell 1 is already identified by the UE prior to the start of the test, i.e. Cell 2 is not identified by the UE prior to the start of the test. Cell 1 and Cell 2 belong to different tracking areas. Furthermore, UE has not registered with network for the tracking area containing Cell 2.

Table A.4.2.15.1-1: General test parameters for FDD intra frequency cell reselection test case for Cat-M1 UE in enhanced coverage

Parameter		Unit	Value	Comment
Initial condition	Active cell		Cell1	
	Neighbour cells		Cell2	
T2 end condition	Active cell		Cell2	
	Neighbour cells		Cell1	
Final condition	Visited cell		Cell1	
E-UTRA RF Channel Number			1	Only one FDD carrier frequency is used.
Access Barring Information		-	Not Sent	No additional delays in random access procedure.
PRACH Parameters			PRACH_4CE	Refer to A.3.16
DRX cycle length		s	0.64	The value shall be used for all cells in the test.
T1		s	>7	During T1, Cell 2 shall be powered off, and during the off time the physical cell identity shall be changed, The intention is to ensure that Cell 2 has not been detected by the UE prior to the start of period T2
T2		s	≤340	T2 need to be defined so that cell reselection reaction time is taken into account.
T3		s	20	T3 need to be defined so that cell reselection reaction time is taken into account.

Table A.4.2.15.1-2: Cell specific test parameters for FDD intra frequency cell reselection test case for Cat-M1 UE in enhanced coverage

Parameter	Unit	Cell 1			Cell 2		
		T1	T2	T3	T1	T2	T3
E-UTRA RF Channel Number		1					
BW _{channel}	MHz	10					
OCNG Patterns		OP.6 FDD			OP.6 FDD		
PBCH_RA	dB	-3			-3		
PBCH_RB	dB						
PSS_RA	dB						
SSS_RA	dB						
MPDCCH_RA	dB						
MPDCCH_PB	dB						
PDSCH_RA	dB						
PDSCH_RB	dB						
OCNG_RA ^{Note 1}	dB						
OCNG_RB ^{Note 1}	dB						
Qrxlevmin	dBm	-140	-140	-140	-140	-140	-140
Pcompensation	dB	0	0	0	0	0	0
Qhyst _s	dB	0	0	0	0	0	0
Qoffset _{s, n}	dB	0	0	0	0	0	0
Cell_selection_and_reselection_quality_measurement		RSRP			RSRP		
N_{oc} ^{Note2}	dBm/15 kHz	-98					
\hat{E}_s / N_{oc}	dB	-7	-12	-7	-infinity	-7	-12
\hat{E}_s / I_{ot}	dB	-7	-12.79	-7.27	-infinity	-7.27	-12.79
RSRP ^{Note3}	dBm/15 kHz	-105	-110	-105	-infinity	-105	-110
Treselection	s	0	0	0	0	0	0
Sintrasearch	dB	Not sent			Not sent		
Propagation Condition		AWGN			AWGN		
Antenna Configuration		2x1			2x1		
Timing offset to Cell 1	ms	-			3		
<p>Note 1: OCNG shall be used such that both cells are fully allocated and a constant total transmitted power spectral density is achieved for all OFDM symbols.</p> <p>Note 2: Interference from other cells and noise sources not specified in the test is assumed to be constant over subcarriers and time and shall be modelled as AWGN of appropriate power for N_{oc} to be fulfilled.</p> <p>Note 3: RSRP levels have been derived from other parameters for information purposes. They are not settable parameters themselves.</p>							

A.4.2.15.2 Test Requirements

The cell reselection delay to a newly detectable cell is defined as the time from the beginning of time period T2, to the moment when the UE camps on Cell 2, and starts to send preambles on the PRACH for sending the RRC CONNECTION REQUEST message to perform a Tracking Area Update procedure on Cell 2.

The cell re-selection delay to a newly detectable cell shall be less than 338 s.

The cell reselection delay to an already detected cell is defined as the time from the beginning of time period T3, to the moment when the UE camps on Cell 1, and starts to send preambles on the PRACH for sending the RRC CONNECTION REQUEST message to perform a Tracking Area Update procedure on Cell 1.

The cell re-selection delay to an already detected cell shall be less than 18 s.

The rate of correct cell reselections observed during repeated tests shall be at least 90%.

NOTE: The cell re-selection delay to a newly detectable cell can be expressed as: $T_{\text{detect,EUTRAN_Intra}} + T_{\text{SI}}$, and to an already detected cell can be expressed as: $T_{\text{evaluate,EUTRAN_Intra}} + T_{\text{SI}}$.

Where:

$T_{\text{detect,EUTRAN_Intra}}$ See Table 4.2.2.11-1 in clause 4.2.2.11

$T_{\text{evaluate,EUTRAN_Intra}}$ See Table 4.2.2.11-1 in clause 4.2.2.11

T_{SI} Maximum repetition period of relevant system info blocks that needs to be received by the UE to camp on a cell; 6400 ms is assumed in this test case.

This gives a total of 337.36 s, allow 338 s for the cell re-selection delay to a newly detectable cell and 17.36 s, allow 18 s for the cell re-selection delay to an already detected cell in the test case.

A.4.2.16 E-UTRAN HD – FDD Intra frequency case for Cat-M1 UE in enhanced coverage

A.4.2.16.1 Test Purpose and Environment

This test is to verify the requirement for the HD-FDD intra frequency cell reselection requirements for Cat-M1 UE specified in clause 4.2.2.11.

The test scenario comprises of 1 E-UTRA carrier and 2 cells as given in tables A.4.2.16.1-1 and A.4.2.16.1-2. The test consists of three successive time periods, with time duration of T1, T2 and T3 respectively. Only Cell 1 is already identified by the UE prior to the start of the test, i.e. Cell 2 is not identified by the UE prior to the start of the test. Cell 1 and Cell 2 belong to different tracking areas. Furthermore, UE has not registered with network for the tracking area containing Cell 2.

Table A.4.2.16.1-1: General test parameters for HD-FDD intra frequency cell reselection test case for Cat-M1 UE in enhanced coverage

Parameter		Unit	Value	Comment
Initial condition	Active cell		Cell1	
	Neighbour cells		Cell2	
T2 end condition	Active cell		Cell2	
	Neighbour cells		Cell1	
Final condition	Visited cell		Cell1	
E-UTRA RF Channel Number			1	Only one carrier frequency is used.
Access Barring Information		-	Not Sent	No additional delays in random access procedure.
PRACH Parameters			PRACH_4CE	Refer to A.3.16
DRX cycle length		s	0.64	The value shall be used for all cells in the test.
T1		s	>7	During T1, Cell 2 shall be powered off, and during the off time the physical cell identity shall be changed, The intention is to ensure that Cell 2 has not been detected by the UE prior to the start of period T2
T2		s	≤340	T2 need to be defined so that cell re-selection reaction time is taken into account.
T3		s	≤20	T3 need to be defined so that cell re-selection reaction time is taken into account.

Table A.4.2.16.1-2: Cell specific test parameters for HD-FDD intra frequency cell reselection test case for Cat-M1 UE in enhanced coverage

Parameter	Unit	Cell 1			Cell 2		
		T1	T2	T3	T1	T2	T3
E-UTRA RF Channel Number		1					
BW _{channel}	MHz	10					
OCNG Patterns		OP.6 FDD			OP.6 FDD		
PBCH_RA	dB	-3			-3		
PBCH_RB	dB						
PSS_RA	dB						
SSS_RA	dB						
MPDCCH_RA	dB						
MPDCCH_PB	dB						
PDSCH_RA	dB						
PDSCH_RB	dB						
OCNG_RA ^{Note 1}	dB						
OCNG_RB ^{Note 1}	dB						
Qrxlevmin	dBm	-140	-140	-140	-140	-140	-140
Pcompensation	dB	0	0	0	0	0	0
Qhyst _s	dB	0	0	0	0	0	0
Qoffset _{s, n}	dB	0	0	0	0	0	0
Cell_selection_and_reselection_quality_measurement		RSRP			RSRP		
N_{oc} ^{Note2}	dBm/15 kHz	-98					
\hat{E}_s / N_{oc}	dB	-7	-12	-7	-infinity	-7	-12
\hat{E}_s / I_{ot}	dB	-7	-12.79	-7.27	-infinity	-7.27	-12.79
RSRP ^{Note3}	dBm/15 kHz	-105	-110	-105	-infinity	-105	-110
Treselection	s	0	0	0	0	0	0
Sintrasearch	dB	Not sent			Not sent		
Propagation Condition		AWGN			AWGN		
Antenna Configuration		2x1			2x1		
Timing offset to Cell 1	ms	-			3		
<p>Note 1: OCNG shall be used such that both cells are fully allocated and a constant total transmitted power spectral density is achieved for all OFDM symbols.</p> <p>Note 2: Interference from other cells and noise sources not specified in the test is assumed to be constant over subcarriers and time and shall be modelled as AWGN of appropriate power for N_{oc} to be fulfilled.</p> <p>Note 3: RSRP levels have been derived from other parameters for information purposes. They are not settable parameters themselves.</p>							

A.4.2.16.2 Test Requirements

The cell reselection delay to a newly detectable cell is defined as the time from the beginning of time period T2, to the moment when the UE camps on Cell 2, and starts to send preambles on the PRACH for sending the RRC CONNECTION REQUEST message to perform a Tracking Area Update procedure on Cell 2.

The cell re-selection delay to a newly detectable cell shall be less than 338 s.

The cell reselection delay to an already detected cell is defined as the time from the beginning of time period T3, to the moment when the UE camps on Cell 1, and starts to send preambles on the PRACH for sending the RRC CONNECTION REQUEST message to perform a Tracking Area Update procedure on Cell 1.

The cell re-selection delay to an already detected cell shall be less than 18 s.

The rate of correct cell reselections observed during repeated tests shall be at least 90%.

NOTE: The cell re-selection delay to a newly detectable cell can be expressed as: $T_{\text{detect,EUTRAN_Intra}} + T_{\text{SI}}$, and to an already detected cell can be expressed as: $T_{\text{evaluate,EUTRAN_Intra}} + T_{\text{SI}}$.

Where:

$T_{\text{detect,EUTRAN_Intra}}$ See Table 4.2.2.11-1 in clause 4.2.2.11

$T_{\text{evaluate,EUTRAN_Intra}}$ See Table 4.2.2.11-1 in clause 4.2.2.11

T_{SI} Maximum repetition period of relevant system info blocks that needs to be received by the UE to camp on a cell; 6400 ms is assumed in this test case.

This gives a total of 337.36 s, allow 338 s for the cell re-selection delay to a newly detectable cell and 17.36 s, allow 18 s for the cell re-selection delay to an already detected cell in the test case.

A.4.2.17 E-UTRAN TDD – TDD Intra frequency case for Cat-M1 UE in enhanced coverage

A.4.2.17.1 Test Purpose and Environment

This test is to verify the requirement for the TDD intra frequency cell reselection requirements for Cat-M1 UE specified in clause 4.2.2.11.

The test scenario comprises of 1 E-UTRA TDD carrier and 2 cells as given in tables A.4.2.17.1-1 and A.4.2.17.1-2. The test consists of three successive time periods, with time duration of T1, T2, and T3 respectively. Only cell 1 is already identified by the UE prior to the start of the test. Cell 1 and cell 2 belong to different tracking areas. Furthermore, UE has not registered with network for the tracking area containing cell 2.

Table A.4.2.17.1-1: General test parameters for TDD intra frequency cell re-selection test case for Cat-M1 UE

Parameter		Unit	Value	Comment
Initial condition	Active cell		Cell1	
	Neighbour cells		Cell2	
T2 end condition	Active cell		Cell2	
	Neighbour cells		Cell1	
Final condition	Visited cell		Cell1	
E-UTRA RF Channel Number			1	Only one TDD carrier frequency is used.
Access Barring Information		-	Not Sent	No additional delays in random access procedure.
Special subframe configuration			6	As specified in table 4.2-1 in TS 36.211
Uplink-downlink configuration			1	As specified in table 4.2-2 in TS 36.211
PRACH Parameters			PRACH_4CE	Refer to A.3.16
DRX cycle length		s	0.64	The value shall be used for all cells in the test.
T1		s	>7	During T1, Cell 2 shall be powered off, and during the off time the physical cell identity shall be changed, The intention is to ensure that Cell 2 has not been detected by the UE prior to the start of period T2
T2		s	≤340	T2 need to be defined so that cell re-selection reaction time is taken into account.
T3		s	≤20	T3 need to be defined so that cell re-selection reaction time is taken into account.

Table A.4.2.17.1-2: Cell specific test parameters for TDD intra frequency cell re-selection test case for Cat-M1 UE in AWGN in enhanced coverage

Parameter	Unit	Cell 1			Cell 2		
		T1	T2	T3	T1	T2	T3
E-UTRA RF Channel Number		1					
BW_{channel}	MHz	10					
OCNG Patterns		OP.2 TDD			OP.2 TDD		
PBCH_RA	dB	-3			-3		
PBCH_RB	dB						
PSS_RA	dB						

SSS_RA	dB						
MPDCCH_RA	dB						
MPDCCH_PB	dB						
PDSCH_RA	dB						
PDSCH_RB	dB						
OCNG_RA ^{Note 1}	dB						
OCNG_RB ^{Note 1}	dB						
Qrxlevmin	dBm	-140	-140	-140	-140	-140	-140
Pcompensation	dB	0	0	0	0	0	0
Qhysts	dB	0	0	0	0	0	0
Qoffsets _{s, n}	dB	0	0	0	0	0	0
Cell_selection_and_reselection_quality_measurement		RSRP			RSRP		
N_{oc} ^{Note2}	dBm/15 kHz	-98					
\hat{E}_s/N_{oc}	dB	-7	-12	-7	-infinity	-7	-12
\hat{E}_s/I_{ot}	dB	-7	-12.79	-7.27	-infinity	-7.27	-12.79
RSRP ^{Note3}	dBm/15 kHz	-105	-110	-105	-infinity	-105	-110
Treselection	s	0	0	0	0	0	0
Sintrasearch	dB	Not sent			Not sent		
Propagation Condition		AWGN			AWGN		
Antenna Configuration		2x1			2x1		
Timing offset to Cell 1	μ s	-			3		
<p>Note 1: OCNG shall be used such that both cells are fully allocated and a constant total transmitted power spectral density is achieved for all OFDM symbols.</p> <p>Note 2: Interference from other cells and noise sources not specified in the test is assumed to be constant over subcarriers and time and shall be modelled as AWGN of appropriate power for N_{oc} to be fulfilled.</p> <p>Note 3: RSRP levels have been derived from other parameters for information purposes. They are not settable parameters themselves.</p>							

A.4.2.17.2 Test Requirements

The cell reselection delay to a newly detectable cell is defined as the time from the beginning of time period T2, to the moment when the UE camps on Cell 2, and starts to send preambles on the PRACH for sending the RRC CONNECTION REQUEST message to perform a Tracking Area Update procedure on Cell 2.

The cell re-selection delay to a newly detectable cell shall be less than 338 s.

The cell reselection delay to an already detected cell is defined as the time from the beginning of time period T3, to the moment when the UE camps on Cell 1, and starts to send preambles on the PRACH for sending the RRC CONNECTION REQUEST message to perform a Tracking Area Update procedure on Cell 1.

The cell re-selection delay to an already detected cell shall be less than 18 s.

The rate of correct cell reselections observed during repeated tests shall be at least 90%.

NOTE: The cell re-selection delay to a newly detectable cell can be expressed as: $T_{\text{detect,EUTRAN_Intra}} + T_{\text{SI}}$, and to an already detected cell can be expressed as: $T_{\text{evaluate,EUTRAN_Intra}} + T_{\text{SI}}$,

Where:

$T_{\text{detect,EUTRAN_Intra}}$ See Table 4.2.2.11-1 in clause 4.2.2.11

$T_{\text{evaluate,EUTRAN_Intra}}$ See Table 4.2.2.11-1 in clause 4.2.2.11

T_{SI} Maximum repetition period of relevant system info blocks that needs to be received by the UE to camp on a cell; 6400 ms is assumed in this test case.

This gives a total of 337.36 s, allow 338 s for the cell re-selection delay to a newly detectable cell and 17.36 s, allow 18 s for the cell re-selection delay to an already detected cell in the test case.

A.4.2.18 HD – FDD Intra frequency case for UE Category NB1 In-Band mode in normal coverage

A.4.2.18.1 Test Purpose and Environment

This test is to verify the requirement for the HD-FDD intra frequency cell reselection requirements for Cat-NB1 UE specified in clause 4.6.2.2.

The test scenario comprises of 1 E-UTRA carrier with two ecells of different cell ID and one NB-IoT carrier with 2 ncells of different physical cell ID, as given in tables A.4.2.18.1-1, A.4.2.18.1-2 and A.4.2.18.1-3. The test consists of three successive time periods, with time duration of T1, T2 and T3 respectively. Only nCell1 is already identified by the UE prior to the start of the test, i.e. nCell 2 is not identified. nCell 1 and nCell 2 belong to different tracking areas. Furthermore, UE has not registered with network for the tracking area containing nCell 2.

Table A.4.2.18.1-1: General test parameters for HD-FDD intra frequency cell reselection test case for Cat-NB1 UE in normal coverage

Parameter		Unit	Value	Comment
NB-IOT operational mode			In-band	
Initial condition	Active cell		nCell1	
	Neighbour cells		eCell1, eCell2, nCell2	
T2 end condition	Active cell		nCell2	
	Neighbour cells		eCell1, eCell2, nCell1	
Final condition	Visited cell		nCell1	
E-UTRA RF Channel Number			1	One carrier frequency is used for eCell1 and eCell2.
Access Barring Information		-	Not Sent	No additional delays in random access procedure.
NPRACH Configuration			NPRACH.R-1	Refer to A.3.18
DRX cycle length		s	1.28	The value shall be used for all cells in the test.
T1		s	>7	During T1, nCell2 shall be powered off, and during the off time the physical cell identity shall be changed. The intention is to ensure that nCell2 has not been detected by the UE prior to the start of period T2
T2		s	60	T2 is defined so that cell re-selection time is taken into account. Once the UE has reselected to nCell2 (within T2) T3 starts
T3		s	15	T3 is defined so that cell re-selection time is taken into account.

Table A.4.2.18.1-2: nCell 1, nCell 2 specific test parameters for HD-FDD intra frequency cell reselection test case for Cat-NB1 UE in normal coverage

Parameter	Unit	nCell 1			nCell 2		
		T1	T2	T3	T1	T2	T3
BW _{channel}	kHz	180			180		
PRB location within eCell	-	eCell 1 BW _{channel} 5MHz: 17 eCell 1 BW _{channel} 10MHz: 30			eCell 2 BW _{channel} 5MHz: 17 eCell 2 BW _{channel} 10MHz: 30		
NPBCH_RA	dB	-3			-3		
NPBCH_RB	dB						
NPSS_RA	dB						
NSSS_RA	dB						
NPDCCH_RA	dB						
NPDCCH_RB	dB						
NPDSCH_RA	dB						
NPDSCH_RB	dB						
NOCNG_RA ^{Note 1}	dB						
NOCNG_RB ^{Note 1}	dB						
Qrxlevmin	dBm	-140	-140	-140	-140	-140	-140
Pcompensation	dB	0	0	0	0	0	0

Qhysts	dB	0	0	0	0	0	0
Qoffsets,n	dB	0	0	0	0	0	0
Cell_selection_and_reselection_quality_measurement		NRSRP			NRSRP		
N_{oc}	dBm/15 kHz	Specified in Table A.4.2.18.1-3					
\hat{E}_s/N_{oc}	dB	17	13	17	-infinity	17	13
\hat{E}_s/I_{ot} Note2	dB	17	-4.09	3.79	-infinity	3.79	-4.09
NRSRP Note2	dBm/15 kHz	-81	-85	-81	-infinity	-81	-85
Treselection	s	0	0	0	0	0	0
Propagation Condition		AWGN			AWGN		
Antenna Configuration		2x1			2x1		
Timing offset to nCell 1	ms	-			3		
Note 1: NOCNG shall be used such that both cells are fully allocated and a constant total transmitted power spectral density is achieved for all OFDM symbols. Note 2: Es/Iot and NRSRP levels have been derived from other parameters for information purposes. They are not settable parameters themselves.							

Table A.4.2.18.1-3: eCell 1 and eCell2 specific test parameters for HD-FDD intra frequency cell reselection test case for Cat-NB1 UE in normal coverage

Parameter	Unit	eCell 1			eCell 2		
		T1	T2	T3	T1	T2	T3
BW _{channel}	MHz	5 or 10			5 or 10		
NOCNG Pattern defined in clause D.3	-	BW _{channel} 5MHz: NOP.4 FDD BW _{channel} 10MHz: NOP.1 FDD			BW _{channel} 5MHz: NOP.4 FDD BW _{channel} 10MHz: NOP.1 FDD		
PBCH_RA	dB	-3			-3		
PBCH_RB	dB						
PSS_RA	dB						
SSS_RA	dB						
PDCCH_RA	dB						
PDCCH_RB	dB						
PDSCH_RA	dB						
PDSCH_RB	dB						
OCNG_RA ^{Note 1}	dB						
OCNG_RB ^{Note 1}	dB						
Qrxlevmin	dBm	-140	-140	-140	-140	-140	-140
Pcompensation	dB	0	0	0	0	0	0
Qhysts	dB	0	0	0	0	0	0
Qoffsets,n	dB	0	0	0	0	0	0
N_{oc} Note2	dBm/15 kHz	-98			-98		
\hat{E}_s/N_{oc} Note2	dBm	3	3	3	3	3	3
Treselection	s	0	0	0	0	0	0
Propagation Condition		AWGN			AWGN		
Antenna Configuration		2x1			2x1		
Timing offset to eCell 1	ms	-			3		
Note 1: OCNG shall be used such that the Cell is fully allocated and a constant total transmitted power spectral density is achieved for all OFDM symbols. Note 2: Interference from other cells and noise sources not specified in the test is assumed to be constant over subcarriers and time and shall be modelled as AWGN of appropriate power N_{oc} . Note 3: Void							

A.4.2.18.2 Test Requirements

The cell reselection delay to a newly detectable cell is defined as the time from the beginning of time period T2, to the moment when the UE camps on nCell 2, and starts to send preambles on the PRACH for sending the RRC CONNECTION REQUEST message to perform a Tracking Area Update procedure on nCell 2.

The cell re-selection delay to a newly detectable cell shall be less than 59.32 s.

The cell reselection delay to an already detected cell is defined as the time from the beginning of time period T3, to the moment when the UE camps on nCell 1, and starts to send preambles on the PRACH for sending the RRC CONNECTION REQUEST message to perform a Tracking Area Update procedure on nCell 1.

The cell re-selection delay to an already detected cell shall be less than 14.82 s.

The rate of correct cell reselections observed during repeated tests shall be at least 90%.

NOTE: The cell re-selection delay to a newly detectable cell can be expressed as: $T_{\text{detect,NB_Intra_NB-IoT-NC}} + T_{\text{SI}}$, and to an already detected cell can be expressed as: $T_{\text{evaluate, NB_intra_NB-IoT-NC}} + T_{\text{SI}}$.

Where:

$T_{\text{detect,NB_Intra_NB-IoT-NC}}$ See Table 4.6.2.2-1 in clause 4.6.2.2

$T_{\text{evaluate, NB_intra_NB-IoT-NC}}$ See Table 4.6.2.2-1 in clause 4.6.2.2

T_{SI} Maximum repetition period of relevant system info blocks that needs to be received by the UE to camp on a cell; 8.32 s is assumed in this test case.

This gives a total of 59.32 s, allow 60 s for the cell re-selection delay to a newly detectable cell and 14.82 s, allow 15s for the cell re-selection delay to an already detected cell in the test case.

A.4.2.19 HD – FDD Intra frequency case for UE Category NB1 In-Band mode in enhanced coverage

A.4.2.19.1 Test Purpose and Environment

This test is to verify the requirement for the HD-FDD intra frequency cell reselection requirements for Cat-NB1 UE specified in clause 4.6.2.4.

The test scenario comprises of 1 E-UTRA carrier and a total of 4 cells as given in tables A.4.2.19.1-1, A.4.2.19.1-2 and A.4.2.19.1-3. The test consists of three successive time periods, with time duration of T1, T2 and T3 respectively. Only nCell1 is already identified by the UE prior to the start of the test, i.e. nCell 2 is not identified. nCell 1 and nCell 2 belong to different tracking areas. Furthermore, UE has not registered with network for the tracking area containing nCell 2.

Table A.4.2.19.1-1: General test parameters for HD-FDD intra frequency cell reselection test case for Cat-NB1 UE in enhanced coverage

Parameter	Unit	Value	Comment
NB-IOT operational mode		In-band	
Initial condition	Active cell	nCell1	
	Neighbour cells	eCell1, eCell2, nCell2	
T2 end condition	Active cell	nCell2	
	Neighbour cells	eCell1, eCell2, nCell1	
Final condition	Visited cell	nCell1	
E-UTRA RF Channel Number		1	One carrier frequency is used for eCell1 and eCell2.
Access Barring Information	-	Not Sent	No additional delays in random access procedure.
NPRACH Configuration		NPRACH.R-1	Refer to A.3.18
DRX cycle length	s	1.28	The value shall be used for all cells in the test.
T1	s	>7	During T1, nCell2 shall be powered off, and during the off time the physical cell identity shall be changed. The intention is to ensure that nCell2 has not been detected by the UE prior to the start of period T2
T2	s	67	T2 is defined so that cell re-selection time is taken into account. Once the UE has reselected to nCell2 (within T2) T3 starts

T3	s	22	T3 is defined so that cell re-selection time is taken into account.
----	---	----	---

Table A.4.2.19.1-2: nCell 1, nCell 2 specific test parameters for HD-FDD intra frequency cell reselection test case for Cat-NB1 UE in enhanced coverage

		nCell 1			nCell 2		
		T1	T2	T3	T1	T2	T3
BW _{channel}	kHz	180			180		
PRB location within eCell	-	eCell 1 BW _{channel} 5MHz: 17 eCell 1 BW _{channel} 10MHz: 30			eCell 2 BW _{channel} 5MHz: 17 eCell 2 BW _{channel} 10MHz: 30		
NPBCH_RA	dB	-3			-3		
NPBCH_RB	dB						
NPSS_RA	dB						
NSSS_RA	dB						
NPDCCH_RA	dB						
NPDCCH_RB	dB						
NPDSCH_RA	dB						
NPDSCH_RB	dB						
NOCNG_RA ^{Note 1}	dB						
NOCNG_RB ^{Note 1}	dB						
Qrxlevmin	dBm	-156	-156	-156	-156	-156	-156
Pcompensation	dB	0	0	0	0	0	0
Qhysts	dB	0	0	0	0	0	0
Qoffset _{s,n}	dB	0	0	0	0	0	0
Cell_selection_and_reselection_quality_measurement		NRSRP			NRSRP		
N _{oc}	dBm/15 kHz	Specified in Table A.4.2.19.1-3					
\hat{E}_s/N_{oc}	dB	-9	-9	-0.7	-infinity	-0.7	-9
\hat{E}_s/I_{ot} ^{Note2}	dB	-9	-11.67	-1.21	-infinity	-1.21	-11.67
NRSRP ^{Note2}	dBm/15 kHz	-107	-107	-98.7	-infinity	-98.7	-107
Treselection	s	0	0	0	0	0	0
Propagation Condition		AWGN			AWGN		
Antenna Configuration		2x1			2x1		
Timing offset to nCell 1	ms	-			3		
Note 1: NOCNG shall be used such that both cells are fully allocated and a constant total transmitted power spectral density is achieved for all OFDM symbols. Note 2: Es/Iot and NRSRP levels have been derived from other parameters for information purposes. They are not settable parameters themselves.							

Table A.4.2.19.1-3: eCell 1 and eCell2 specific test parameters for HD-FDD intra frequency cell reselection test case for Cat-NB1 UE in enhanced coverage

Parameter	Unit	eCell 1			eCell 2		
		T1	T2	T3	T1	T2	T3
BW _{channel}	MHz	5 or 10			5 or 10		
NOCNG Pattern	-	BW _{channel} 5MHz: NOP.4 FDD BW _{channel} 10MHz: NOP.1 FDD			BW _{channel} 5MHz: NOP.4 FDD BW _{channel} 10MHz: NOP.1 FDD		
PBCH_RA	dB	-3			-3		
PBCH_RB	dB						
PSS_RA	dB						
SSS_RA	dB						
PDCCH_RA	dB						
PDCCH_RB	dB						
PDSCH_RA	dB						
PDSCH_RB	dB						
OCNG_RA ^{Note 1}	dB						
OCNG_RB ^{Note 1}	dB						
Qrxlevmin	dBm	-140	-140	-140	-140	-140	-140
Pcompensation	dB	0	0	0	0	0	0

Qhyst _s	dB	0	0	0	0	0	0
Qoffset _{s,n}	dB	0	0	0	0	0	0
N_{oc} ^{Note2}	dBm/15 kHz	-98			-98		
\hat{E}_s / N_{oc} ^{Note2}	dBm	3	3	3	3	3	3
Treselection	s	0	0	0	0	0	0
Propagation Condition		AWGN			AWGN		
Antenna Configuration		2x1			2x1		
Timing offset to eCell 1	ms	-			3		
<p>Note 1: OCNG shall be used such that the Cell is fully allocated and a constant total transmitted power spectral density is achieved for all OFDM symbols.</p> <p>Note 2: Interference from other cells and noise sources not specified in the test is assumed to be constant over subcarriers and time and shall be modelled as AWGN of appropriate power N_{oc}.</p> <p>Note 3: Void</p>							

A.4.2.19.2 Test Requirements

The cell reselection delay to a newly detectable cell is defined as the time from the beginning of time period T2, to the moment when the UE camps on nCell 2, and starts to send preambles on the PRACH for sending the RRC CONNECTION REQUEST message to perform a Tracking Area Update procedure on nCell 2.

The cell re-selection delay to a newly detectable cell shall be less than 66.32 s.

The cell reselection delay to an already detected cell is defined as the time from the beginning of time period T3, to the moment when the UE camps on nCell 1, and starts to send preambles on the PRACH for sending the RRC CONNECTION REQUEST message to perform a Tracking Area Update procedure on nCell 1.

The cell re-selection delay to an already detected cell shall be less than 21.12 s.

The rate of correct cell reselections observed during repeated tests shall be at least 90%.

NOTE: The cell re-selection delay to a newly detectable cell can be expressed as: $T_{\text{detect,NB_Intra_NB-IoT-EC}} + T_{\text{SI}}$, and to an already detected cell can be expressed as: $T_{\text{evaluate, NB_intra_NB-IoT-EC}} + T_{\text{SI}}$,

Where:

$T_{\text{detect,NB_Intra_NB-IoT-EC}}$ See Table 4.6.2.4-1 in clause 4.6.2.4

$T_{\text{evaluate, NB_intra_NB-IoT-EC}}$ See Table 4.6.2.4-1 in clause 4.6.2.4

T_{SI} Maximum repetition period of relevant system info blocks that needs to be received by the UE to camp on a cell; 8.32s is assumed in this test case.

This gives a total of 66.32 s, allow 67 s for the cell re-selection delay to a newly detectable cell and 21.12s, allow 22s for the cell re-selection delay to an already detected cell in the test case.

A.4.2.20 E-UTRAN FDD – FDD Intra frequency case for UE Category 1bis

A.4.2.20.1 Test Purpose and Environment

This test is to verify the requirement for the FDD-FDD intra frequency cell reselection requirements for UE category 1bis specified in clause 4.2.2.3.

The test scenario comprises of 1 E-UTRA FDD carrier and 2 cells as given in tables A.4.2.20.1-1 and A.4.2.20.1-2. The test consists of three successive time periods, with time duration of T1, T2 and T3 respectively. Only Cell 1 is already identified by the UE prior to the start of the test, i.e. Cell 2 is not identified by the UE prior to the start of the test. Cell 1 and Cell 2 belong to different tracking areas. Furthermore, UE has not registered with network for the tracking area containing Cell 2.

Table A.4.2.20.1-1: General test parameters for FDD intra frequency cell reselection test case

Parameter	Unit	Value	Comment
-----------	------	-------	---------

Initial condition	Active cell		Cell1	
	Neighbour cells		Cell2	
T2 end condition	Active cell		Cell2	
	Neighbour cells		Cell1	
Final condition	Visited cell		Cell1	
E-UTRA RF Channel Number			1	Only one FDD carrier frequency is used.
Access Barring Information		-	Not Sent	No additional delays in random access procedure.
PRACH configuration			4	As specified in table 5.7.1-2 in TS 36.211
DRX cycle length		s	1.28	The value shall be used for all cells in the test.
T1		s	>7	During T1, Cell 2 shall be powered off, and during the off time the physical cell identity shall be changed, The intention is to ensure that Cell 2 has not been detected by the UE prior to the start of period T2
T2		s	40	T2 need to be defined so that cell re-selection reaction time is taken into account.
T3		s	15	T3 need to be defined so that cell re-selection reaction time is taken into account.

Table A.4.2.20.1-2: Cell specific test parameters for FDD intra frequency cell reselection test case in AWGN

Parameter	Unit	Cell 1			Cell 2		
		T1	T2	T3	T1	T2	T3
E-UTRA RF Channel Number		1			1		
BW _{channel}	MHz	10			10		
OCNG Patterns defined in A.3.2.1.2		OP.2 FDD			OP.2 FDD		
PBCH_RA	dB	0			0		
PBCH_RB							
PSS_RA							
SSS_RA							
PCFICH_RB							
PHICH_RA							
PHICH_RB							
PDCCH_RA							
PDCCH_RB							
PDSCH_RA							
PDSCH_RB							
OCNG_RA ^{Note 1}							
OCNG_RB ^{Note 1}							
Qrxlevmin	dBm	-140			-140		
Pcompensation	dB	0			0		
Qhyst _s	dB	0			0		
Qoffset _{s,n}	dB	0			0		
Cell selection and reselection quality measurement		RSRP			RSRP		
N_{oc} ^{Note2}	dBm/15 kHz	-98					
\hat{E}_s / N_{oc}	dB	17	13	17	-infinity	17	13
\hat{E}_s / I_{ot}	dB	17	-4.09	3.79	-infinity	3.79	-4.09
RSRP ^{Note3}	dBm/15 kHz	-81	-85	-81	-infinity	-81	-85
Treselection	s	0			0		
Sintrasearch	dB	Not sent			Not sent		
Propagation Condition		AWGN			AWGN		

Antenna Configuration		1x1	1x1
Timing offset to Cell 1 Asynchronous cells	ms	-	3
Note 1:	OCNG shall be used such that both cells are fully allocated and a constant total transmitted power spectral density is achieved for all OFDM symbols.		
Note 2:	Interference from other cells and noise sources not specified in the test is assumed to be constant over subcarriers and time and shall be modelled as AWGN of appropriate power for N_{oc} to be fulfilled.		
Note 3:	Es/lot and RSRP levels have been derived from other parameters for information purposes. They are not settable parameters themselves.		

A.4.2.20.2 Test Requirements

The cell reselection delay to a newly detectable cell is defined as the time from the beginning of time period T2, to the moment when the UE camps on Cell 2, and starts to send preambles on the PRACH for sending the RRC CONNECTION REQUEST message to perform a Tracking Area Update procedure on Cell 2.

The cell re-selection delay to a newly detectable cell shall be less than 34 s.

The cell reselection delay to an already detected cell is defined as the time from the beginning of time period T3, to the moment when the UE camps on Cell 1, and starts to send preambles on the PRACH for sending the RRC CONNECTION REQUEST message to perform a Tracking Area Update procedure on Cell 1.

The cell re-selection delay to an already detected cell shall be less than 8 s.

The rate of correct cell reselections observed during repeated tests shall be at least 90%.

NOTE: The cell re-selection delay to a newly detectable cell can be expressed as: $T_{\text{detect,EUTRAN_Intra}} + T_{\text{SI}}$, and to an already detected cell can be expressed as: $T_{\text{evaluateFDD,intra}} + T_{\text{SI}}$,

Where:

$T_{\text{detect,EUTRAN_Intra}}$ See Table 4.2.2.3-1 in clause 4.2.2.3

$T_{\text{evaluateFDD,intra}}$ See Table 4.2.2.3-1 in clause 4.2.2.3

T_{SI} Maximum repetition period of relevant system info blocks that needs to be received by the UE to camp on a cell; 1280 ms is assumed in this test case.

This gives a total of 33.28 s, allow 34 s for the cell re-selection delay to a newly detectable cell and 7.68 s, allow 8 s for the cell re-selection delay to an already detected cell in the test case.

A.4.2.21 E-UTRAN TDD – TDD Intra frequency case for UE Category 1bis

A.4.2.21.1 Test Purpose and Environment

This test is to verify the requirement for the TDD-TDD intra frequency cell reselection requirements for UE category 1bis specified in clause 4.2.2.3.

The test scenario comprises of 1 E-UTRA TDD carrier and 2 cells as given in tables A.4.2.21.1-1 and A.4.2.21.1-2. The test consists of three successive time periods, with time duration of T1, T2, and T3 respectively. Only cell 1 is already identified by the UE prior to the start of the test. Cell 1 and cell 2 belong to different tracking areas. Furthermore, UE has not registered with network for the tracking area containing cell 2.

Table A.4.2.21.1-1: General test parameters for TDD intra frequency cell re-selection test case

	Parameter	Unit	Value	Comment
Initial condition	Active cell		Cell1	
	Neighbour cells		Cell2	
T2 end condition	Active cell		Cell2	
	Neighbour cells		Cell1	
Final condition	Visited cell		Cell1	

E-UTRA RF Channel Number		1	Only one TDD carrier frequency is used.
Access Barring Information	-	Not Sent	No additional delays in random access procedure.
Special subframe configuration		6	As specified in table 4.2-1 in TS 36.211
Uplink-downlink configuration		1	As specified in table 4.2-2 in TS 36.211
PRACH configuration index		53	As specified in table 5.7.1-3 in TS 36.211
DRX cycle length	s	1.28	The value shall be used for all cells in the test.
T1	s	>7	During T1, Cell 2 shall be powered off, and during the off time the physical cell identity shall be changed, The intention is to ensure that Cell 2 has not been detected by the UE prior to the start of period T2
T2	s	40	T2 need to be defined so that cell re-selection reaction time is taken into account.
T3	s	15	T3 need to be defined so that cell re-selection reaction time is taken into account.

Table A.4.2.21.1-2: Cell specific test parameters for TDD intra frequency cell re-selection test case in AWGN

Parameter	Unit	Cell 1			Cell 2		
		T1	T2	T3	T1	T2	T3
E-UTRA RF Channel Number		1			1		
$BW_{channel}$	MHz	10			10		
OCNG Pattern defined in A.3.2.2.2		OP.2 TDD			OP.2 TDD		
PBCH_RA	dB	0			0		
PBCH_RB							
PSS_RA							
SSS_RA							
PCFICH_RB							
PHICH_RA							
PHICH_RB							
PDCCH_RA							
PDCCH_RB							
PDSCH_RA							
PDSCH_RB							
OCNG_RA ^{Note 1}							
OCNG_RB ^{Note 1}							
Qrxlevmin							
Pcompensation	dB	0			0		
Qhyst _s	dB	0			0		
Qoffset _{s, n}	dB	0			0		
Cell_selection_and_reselection_quality_measurement		RSRP			RSRP		
N_{oc} ^{Note2}	dBm/15 kHz	-98					
\hat{E}_s / N_{oc}	dB	17	13	17	-infinity	17	13
\hat{E}_s / I_{ot}	dB	17	-4.09	3.79	-infinity	3.79	-4.09
RSRP ^{Note3}	dBm/15 kHz	-81	-85	-81	-infinity	-81	-85
Treselection	s	0	0	0	0	0	0
Sintrasearch	dB	Not sent			Not sent		
Propagation Condition		AWGN			AWGN		
Antenna Configuration		1x1			1x1		
Timing offset to Cell 1 Synchronous cells	μs	-			3		

Note 1:	OCNG shall be used such that both cells are fully allocated and a constant total transmitted power spectral density is achieved for all OFDM symbols.
Note 2:	Interference from other cells and noise sources not specified in the test is assumed to be constant over subcarriers and time and shall be modelled as AWGN of appropriate power for N_{oc} to be fulfilled.
Note 3:	Es/Iot and RSRP levels have been derived from other parameters for information purposes. They are not settable parameters themselves.

A.4.2.21.2 Test Requirements

The cell reselection delay to a newly detectable cell is defined as the time from the beginning of time period T2, to the moment when the UE camps on Cell 2, and starts to send preambles on the PRACH for sending the RRC CONNECTION REQUEST message to perform a Tracking Area Update procedure on Cell 2.

The cell re-selection delay to a newly detectable cell shall be less than 34 s.

The cell reselection delay to an already detected cell is defined as the time from the beginning of time period T3, to the moment when the UE camps on cell 1, and starts to send preambles on the PRACH for sending the RRC CONNECTION REQUEST message to perform a Tracking Area Update procedure on cell 1.

The cell re-selection delay shall be less than 8 s.

The rate of correct cell reselections observed during repeated tests shall be at least 90%.

NOTE: The cell re-selection delay to a newly detectable cell can be expressed as: $T_{\text{detect,EUTRAN_Intra}} + T_{\text{SI-EUTRA}}$, and to an already detected cell can be expressed as: $T_{\text{evaluate, E-UTRAN_intra}} + T_{\text{SI-EUTRA}}$,

Where:

$T_{\text{detect,EUTRAN_Intra}}$ See Table 4.2.2.3-1 in clause 4.2.2.3

$T_{\text{evaluate,E-UTRAN_intra}}$ See Table 4.2.2.3-1 in clause 4.2.2.3

$T_{\text{SI-EUTRA}}$ Maximum repetition period of relevant system info blocks that needs to be received by the UE to camp on a cell; 1280 ms is assumed in this test case.

This gives a total of 33.28 s, allow 34 s for the cell re-selection delay to a newly detectable cell and 7.68 s, allow 8 s for the cell re-selection delay to an already detected cell in the test case.

A.4.2.22 E-UTRAN FDD – FDD Intra frequency case for UE configured with highSpeedEnhancedMeasFlag

A.4.2.22.1 Test Purpose and Environment

This test is to verify the requirement for the FDD-FDD intra frequency cell reselection requirements for UE configured with *highSpeedEnhancedMeasFlag* specified in clause 4.2.2.3.

The test scenario comprises of 1 E-UTRA FDD carrier and 2 cells as given in tables A.4.2.22.1-1 and A.4.2.22.1-2. The test consists of three successive time periods, with time duration of T1, T2 and T3 respectively.

highSpeedEnhancedMeasFlag is broadcasted to UE. Only Cell 1 is already identified by the UE prior to the start of the test, i.e., Cell 2 is not identified by the UE prior to the start of the test. Cell 1 and Cell 2 belong to different tracking areas. Furthermore, UE has not registered with network for the tracking area containing Cell 2.

Table A.4.2.22.1-1: General test parameters for E-UTRAN FDD – FDD Intra frequency case for UE configured with highSpeedEnhancedMeasFlag

	Parameter	Unit	Value	Comment
Initial condition	Active cell		Cell1	
	Neighbour cells		Cell2	
T2 end condition	Active cell		Cell2	
	Neighbour cells		Cell1	

Final condition	Visited cell		Cell1	
E-UTRA RF Channel Number			1	Only one FDD carrier frequency is used.
Access Barring Information	-		Not Sent	No additional delays in random access procedure.
PRACH configuration			4	As specified in table 5.7.1-2 in TS 36.211
DRX cycle length	s		1.28	The value shall be used for all cells in the test.
T1	s		>7	During T1, Cell 2 shall be powered off, and during the off time the physical cell identity shall be changed. The intention is to ensure that Cell 2 has not been detected by the UE prior to the start of period T2
T2	s		≤20	T2 need to be defined so that cell re-selection reaction time is taken into account.
T3	s		≤8	T3 need to be defined so that cell re-selection reaction time is taken into account.

Table A.4.2.22.1-2: Cell specific test parameters for E-UTRAN FDD – FDD Intra frequency case for UE configured with highSpeedEnhancedMeasFlag

Parameter	Unit	Cell 1			Cell 2		
		T1	T2	T3	T1	T2	T3
E-UTRA RF Channel Number		1			1		
$BW_{channel}$	MHz	5MHz: NRB,c = 25 10MHz: NRB,c = 50 20MHz: NRB,c = 100			5MHz: NRB,c = 25 10MHz: NRB,c = 50 20MHz: NRB,c = 100		
OCNG Patterns defined in A.3.2.1		5MHz: OP.16 FDD 10MHz: OP.2 FDD 20MHz: OP.12 FDD			5MHz: OP.16 FDD 10MHz: OP.2 FDD 20MHz: OP.12 FDD		
PBCH_RA	dB	-3			-3		
PBCH_RB							
PSS_RA							
SSS_RA							
PCFICH_RB							
PHICH_RA							
PHICH_RB							
PDCCH_RA							
PDCCH_RB							
PDSCH_RA							
PDSCH_RB							
OCNG_RA ^{Note 1}							
OCNG_RB ^{Note 1}							
$Q_{rxlevmin}$	dBm	-140			-140		
$P_{compensation}$	dB	0			0		
Q_{hyst_s}	dB	0			0		
$Q_{offset_{s,n}}$	dB	0			0		
Cell_selection_and_reselection_quality_measurement		RSRP			RSRP		
N_{oc} ^{Note2}	dBm/15 kHz	-98					
\hat{E}_s/N_{oc}	dB	16	13	16	-infinity	16	13
\hat{E}_s/I_{ot}	dB	16	-3.11	2.79	-infinity	2.79	-3.11
RSRP ^{Note3}	dBm/15 kHz	-82	-85	-82	-infinity	-82	-85
Treselection	s	0			0		
Sintrasearch	dB	Not sent			Not sent		
Propagation Condition		AWGN			AWGN 1750Hz ^{Note4}		
Antenna Configuration		2x2			2x2		
Timing offset to Cell 1 Synchronous cells	us	-			3		
Note 1:	OCNG shall be used such that both cells are fully allocated and a constant total transmitted power spectral density is achieved for all OFDM symbols.						
Note 2:	Interference from other cells and noise sources not specified in the test is assumed to be constant over subcarriers and time and shall be modelled as AWGN of appropriate power for N_{oc} to be fulfilled.						
Note 3:	Es/Iot and RSRP levels have been derived from other parameters for information purposes. They are not settable parameters themselves.						
Note 4:	The AWGN 1750Hz condition is a non fading propagation channel with one tap. Doppler shift is a constant 1750Hz.						

A.4.2.22.2 Test Requirements

The cell reselection delay to a newly detectable cell is defined as the time from the beginning of time period T2, to the moment when the UE camps on Cell 2, and starts to send preambles on the PRACH for sending the RRC CONNECTION REQUEST message to perform a Tracking Area Update procedure on Cell 2.

The cell re-selection delay to a newly detectable cell shall be less than 15 s.

The cell reselection delay to an already detected cell is defined as the time from the beginning of time period T3, to the moment when the UE camps on Cell 1, and starts to send preambles on the PRACH for sending the RRC CONNECTION REQUEST message to perform a Tracking Area Update procedure on Cell 1.

The cell re-selection delay to an already detected cell shall be less than 6 s.

The rate of correct cell reselections observed during repeated tests shall be at least 90%.

NOTE: The cell re-selection delay to a newly detectable cell can be expressed as: $T_{\text{detect,EUTRAN_Intra}} + T_{\text{SI}}$, and to an already detected cell can be expressed as: $T_{\text{evaluateFDD,intra}} + T_{\text{SI}}$,

Where:

$T_{\text{detect,EUTRAN_Intra}}$ See Table 4.2.2.3-3 in clause 4.2.2.3

$T_{\text{evaluateFDD,intra}}$ See Table 4.2.2.3-3 in clause 4.2.2.3

T_{SI} Maximum repetition period of relevant system info blocks that needs to be received by the UE to camp on a cell; 1280 ms is assumed in this test case.

This gives a total of 14.08 s, allow 15 s for the cell re-selection delay to a newly detectable cell and 5.12 s, allow 6 s for the cell re-selection delay to an already detected cell in the test case.

A.4.2.23 E-UTRAN TDD – TDD Intra frequency case for UE configured with highSpeedEnhancedMeasFlag

A.4.2.23.1 Test Purpose and Environment

This test is to verify the requirement for the TDD-TDD intra frequency cell reselection requirements for UE configured with *highSpeedEnhancedMeasFlag* specified in clause 4.2.2.3.

The test scenario comprises of 1 E-UTRA TDD carrier and 2 cells as given in tables A.4.2.23.1-1 and A.4.2.23.1-2. The test consists of three successive time periods, with time duration of T1, T2, and T3 respectively.

highSpeedEnhancedMeasFlag is broadcasted to UE. Only cell 1 is already identified by the UE prior to the start of the test. Cell 1 and cell 2 belong to different tracking areas. Furthermore, UE has not registered with network for the tracking area containing cell 2.

Table A.4.2.23.1-1: General test parameters for E-UTRAN TDD – TDD Intra frequency case for UE configured with highSpeedEnhancedMeasFlag

Parameter	Unit	Value	Comment
Initial condition	Active cell	Cell1	
	Neighbour cells	Cell2	
T2 end condition	Active cell	Cell2	
	Neighbour cells	Cell1	
Final condition	Visited cell	Cell1	
E-UTRA RF Channel Number		1	Only one TDD carrier frequency is used.
Access Barring Information	-	Not Sent	No additional delays in random access procedure.
Special subframe configuration		6	As specified in table 4.2-1 in TS 36.211
Uplink-downlink configuration		1	As specified in table 4.2-2 in TS 36.211
PRACH configuration index		53	As specified in table 5.7.1-3 in TS 36.211
DRX cycle length	s	1.28	The value shall be used for all cells in the test.
T1	s	>7	During T1, Cell 2 shall be powered off, and during the off time the physical cell identity shall be changed, The intention is to ensure that Cell 2 has not been detected by the UE prior to the start of period T2
T2	s	≤20	T2 need to be defined so that cell re-selection reaction time is taken into account.
T3	s	≤8	T3 need to be defined so that cell re-selection reaction time is taken into account.

Table A.4.2.23.1-2: Cell specific test parameters for E-UTRAN TDD – TDD Intra frequency case for UE configured with highSpeedEnhancedMeasFlag

Parameter	Unit	Cell 1			Cell 2		
		T1	T2	T3	T1	T2	T3
E-UTRA RF Channel Number		1			1		
$BW_{channel}$	MHz	5MHz: NRB,c = 25 10MHz: NRB,c = 50 20MHz: NRB,c = 100			5MHz: NRB,c = 25 10MHz: NRB,c = 50 20MHz: NRB,c = 100		
OCNG Pattern defined in A.3.2.2		5MHz: OP.10 TDD 10MHz: OP.2 TDD 20MHz: OP.8 FDD			5MHz: OP.10 TDD 10MHz: OP.2 TDD 20MHz: OP.8 FDD		
PBCH_RA	dB	-3			-3		
PBCH_RB							
PSS_RA							
SSS_RA							
PCFICH_RB							
PHICH_RA							
PHICH_RB							
PDCCH_RA							
PDCCH_RB							
PDSCH_RA							
PDSCH_RB							
OCNG_RA ^{Note 1}							
OCNG_RB ^{Note 1}							
Qrxlevmin	dBm	-140			-140		
Pcompensation	dB	0			0		
Qhyst _s	dB	0			0		
Qoffset _{s, n}	dB	0			0		
Cell_selection_and_reselection_quality_measurement		RSRP			RSRP		
N_{oc} ^{Note2}	dBm/15 kHz	-98					
\hat{E}_s / N_{oc}	dB	16	13	16	-infinity	16	13
\hat{E}_s / I_{ot}	dB	16	-3.11	2.79	-infinity	2.79	-3.11
RSRP ^{Note3}	dBm/15 kHz	-82	-85	-82	-infinity	-82	-85
Treselection	s	0			0		
Sintrasearch	dB	Not sent			Not sent		
Propagation Condition		AWGN			AWGN 1750Hz ^{Note4}		
Antenna Configuration		2x2			2x2		
Timing offset to Cell 1 Synchronous cells	us	-			3		
<p>Note 1: OCNG shall be used such that both cells are fully allocated and a constant total transmitted power spectral density is achieved for all OFDM symbols.</p> <p>Note 2: Interference from other cells and noise sources not specified in the test is assumed to be constant over subcarriers and time and shall be modelled as AWGN of appropriate power for N_{oc} to be fulfilled.</p> <p>Note 3: E_s/I_{ot} and RSRP levels have been derived from other parameters for information purposes. They are not settable parameters themselves.</p> <p>Note 4: The AWGN 1750Hz condition is a non fading propagation channel with one tap. Doppler shift is a constant 1750Hz.</p>							

A.4.2.23.2 Test Requirements

The cell reselection delay to a newly detectable cell is defined as the time from the beginning of time period T2, to the moment when the UE camps on Cell 2, and starts to send preambles on the PRACH for sending the RRC CONNECTION REQUEST message to perform a Tracking Area Update procedure on Cell 2.

The cell re-selection delay to a newly detectable cell shall be less than 15 s.

The cell reselection delay to an already detected cell is defined as the time from the beginning of time period T3, to the moment when the UE camps on cell 1, and starts to send preambles on the PRACH for sending the RRC CONNECTION REQUEST message to perform a Tracking Area Update procedure on cell 1.

The cell re-selection delay shall be less than 6 s.

The rate of correct cell reselections observed during repeated tests shall be at least 90%.

NOTE: The cell re-selection delay to a newly detectable cell can be expressed as: $T_{\text{detect,EUTRAN_Intra}} + T_{\text{SI-EUTRA}}$, and to an already detected cell can be expressed as: $T_{\text{evaluate,E-UTRAN_intra}} + T_{\text{SI-EUTRA}}$,

Where:

$T_{\text{detect,EUTRAN_Intra}}$ See Table 4.2.2.3-3 in clause 4.2.2.3

$T_{\text{evaluate,E-UTRAN_intra}}$ See Table 4.2.2.3-3 in clause 4.2.2.3

$T_{\text{SI-EUTRA}}$ Maximum repetition period of relevant system info blocks that needs to be received by the UE to camp on a cell; 1280 ms is assumed in this test case.

This gives a total of 14.08 s, allow 15 s for the cell re-selection delay to a newly detectable cell and 5.12 s, allow 6 s for the cell re-selection delay to an already detected cell in the test case.

A.4.2.24 HD – FDD Inter frequency case for UE Category NB1 In-Band mode in enhanced coverage

A.4.2.24.1 Test Purpose and Environment

This test is to verify the requirement for the HD-FDD inter frequency cell reselection requirements for Cat-NB1 UE specified in clause 4.6.2.6.

The test scenario comprises of 1 E-UTRA carrier and a total of 3 cells as given in tables A.4.2.24.1-1, A.4.2.24.1-2 and A.4.2.24.1-3. The test consists of three successive time periods, with time duration of T1, T2 and T3 respectively. Only nCell1 is already identified by the UE prior to the start of the test, i.e. nCell 2 is not identified. nCell 1 and nCell 2 belong to different tracking areas. Furthermore, UE has not registered with network for the tracking area containing nCell 2.

Table A.4.2.24.1-1: General test parameters for HD-FDD inter frequency cell reselection test case for Cat-NB1 UE in enhanced coverage

Parameter	Unit	Value	Comment
NB-IOT operational mode		In-band	
Initial condition	Active cell	nCell1	
	Neighbour cells	eCell1, nCell2	
T2 end condition	Active cell	nCell2	
	Neighbour cells	eCell1, nCell1	
Final condition	Visited cell	nCell1	
E-UTRA RF Channel Number		1	One carrier frequency is used for eCell.
Access Barring Information	-	Not Sent	No additional delays in random access procedure.
PRACH Configuration		1	Refer to A.3.16
DRX cycle length	s	1.28	The value shall be used for all cells in the test.
T1	s	>7	During T1, nCell2 shall be powered off, and during the off time the physical cell identity shall be changed. The intention is to ensure that nCell2 has not been detected by the UE prior to the start of period T2
T2	s	67	T2 is defined so that cell re-selection time is taken into account.
T3	s	22	T3 is defined so that cell re-selection time is taken into account.

Table A.4.2.24.1-2: nCell 1, nCell 2 specific test parameters for HD-FDD inter frequency cell reselection test case for Cat-NB1 UE in enhanced coverage

		nCell 1			nCell 2		
		T1	T2	T3	T1	T2	T3
BW _{channel}	kHz	180			180		
PRB location within eCell	-	eCell 1 BW _{channel} 5MHz: 17 eCell 1 BW _{channel} 10MHz: 30			eCell 1 BW _{channel} 5MHz: 22 eCell 1 BW _{channel} 10MHz: 35		
NPBCH_RA	dB	-3			-3		
NPBCH_RB	dB						
NPSS_RA	dB						
NSSS_RA	dB						
NPDCCH_RA	dB						
NPDCCH_RB	dB						
NPDSCH_RA	dB						
NPDSCH_RB	dB						
NOCNG_RA ^{Note 1}	dB						
NOCNG_RB ^{Note 1}	dB						
Qrxlevmin	dBm	-140			-140		
Pcompensation	dB	0			0		
Qhysts	dB	0			0		
Qoffsets _{s,n}	dB	0			0		
Cell_selection_and_reselection_quality_measurement		NRSRP			NRSRP		
N _{oc}	dBm/15 kHz	Specified in Table A.4.2.24.1-3					
\hat{E}_s/N_{oc}	dB	-12	-12	-2.7	-infinity	-2.7	-12
\hat{E}_s/I_{ot} ^{Note2}	dB	-12	-12	-2.7	-infinity	-2.7	-12
NRSRP ^{Note2}	dBm/15 kHz	-110	-110	-100.7	-infinity	-100.7	-110
Treselection	s	0			0		
Propagation Condition		AWGN			AWGN		
Antenna Configuration		2x1			2x1		
Timing offset to nCell 1	ms	0					
Note 1: NOCNG shall be used such that both cells are fully allocated and a constant total transmitted power spectral density is achieved for all OFDM symbols. Note 2: Es/Iot and NRSRP levels have been derived from other parameters for information purposes. They are not settable parameters themselves.							

Table A.4.2.24.1-3: eCell 1 specific test parameters for HD-FDD inter frequency cell reselection test case for Cat-NB1 UE in enhanced coverage

		eCell 1		
		T1	T2	T3
BW _{channel}	MHz	5 or 10		
OCNG Pattern	-	BW _{channel} 5MHz: NOP.4 FDD BW _{channel} 10MHz: NOP.1 FDD		
PBCH_RA	dB	-3		
PBCH_RB	dB			
PSS_RA	dB			
SSS_RA	dB			
PDCCH_RA	dB			
PDCCH_RB	dB			
PDSCH_RA	dB			
PDSCH_RB	dB			
OCNG_RA ^{Note 1}	dB			
OCNG_RB ^{Note 1}	dB			
Qrxlevmin	dBm	-140		
Pcompensation	dB	0		
Qhysts	dB	0		
Qoffsets _{s,n}	dB	0		
N _{oc}	dBm/15 kHz	-98		

\hat{E}_s / N_{oc}	dB	3	3	3
Treselection	s	0		
Propagation Condition		AWGN		
Antenna Configuration		2x1		
Note 1:	OCNG shall be used such that the eCell is fully allocated and a constant total transmitted power spectral density is achieved for all OFDM symbols.			
Note 2:	Interference from other cells and noise sources not specified in the test is assumed to be constant over subcarriers and time and shall be modelled as AWGN of appropriate power N_{oc} .			

A.4.2.24.2 Test Requirements

The cell reselection delay to a newly detectable cell is defined as the time from the beginning of time period T2, to the moment when the UE camps on nCell 2, and starts to send preambles on the PRACH for sending the RRC CONNECTION REQUEST message to perform a Tracking Area Update procedure on nCell 2.

The cell re-selection delay to a newly detectable cell shall be less than 66.32 s.

The cell reselection delay to an already detected cell is defined as the time from the beginning of time period T3, to the moment when the UE camps on nCell 1, and starts to send preambles on the PRACH for sending the RRC CONNECTION REQUEST message to perform a Tracking Area Update procedure on nCell 1.

The cell re-selection delay to an already detected cell shall be less than 21.12 s.

The rate of correct cell reselections observed during repeated tests shall be at least 90%.

NOTE: The cell re-selection delay to a newly detectable cell can be expressed as: $T_{\text{detect,NB_Inter_EC}} + T_{\text{SI}}$, and to an already detected cell can be expressed as: $T_{\text{evaluate, NB_Inter_EC}} + T_{\text{SI}}$,

Where:

$T_{\text{detect,NB_Inter_EC}}$ See Table 4.6.2.6-1 in clause 4.6.2.6

$T_{\text{evaluate, NB_Inter_EC}}$ See Table 4.6.2.6-1 in clause 4.6.2.6

T_{SI} Maximum repetition period of relevant system info blocks that needs to be received by the UE to camp on a cell; 8.32 s is assumed in this test case.

This gives a total of 66.32 s, allow 67 s for the cell re-selection delay to a newly detectable cell and 21.12 s, allow 22 s for the cell re-selection delay to an already detected cell in the test case.

A.4.2.25 E-UTRAN FDD – FDD Inter frequency case for Cat-M1 UE in normal coverage

A.4.2.25.1 Test Purpose and Environment

This test is to verify the requirement for the FDD-FDD inter frequency cell reselection requirements for category M1 UE in normal coverage specified in clause 4.7.2.1.3.

The test scenario comprises of 2 E-UTRA FDD cells on 2 different carriers as given in tables A.4.2.25.1-1 and A.4.2.25.1-2. The test consists of three successive time periods, with time duration of T1, T2 and T3 respectively. Both cell 1 and cell 2 are already identified by the UE prior to the start of the test. Cell 1 and cell 2 belong to different tracking areas and cell 2 is of higher priority than cell 1. Furthermore, UE has not registered with network for the tracking area containing cell 2.

Table A.4.2.25.1-1: General test parameters for FD-FDD inter frequency cell reselection test case for Cat-M1 UE in normal coverage

	Parameter	Unit	Value	Comment
Initial condition	Active cell		Cell2	UE shall be forced to cell 2 in the initialisation phase, so that reselection to cell 1 occurs during the first T1 phase
	Active cell		Cell1	UE shall perform reselection to cell 1 during T1

T1 end condition	Neighbour cell		Cell2	
Final condition	Active cell		Cell2	UE shall perform reselection to cell 2 during T3
E-UTRA RF Channel Number			1, 2	Two FDD carrier frequencies are used.
PRACH configuration			PRACH_2CE	See table in A.3.16
Access Barring Information	-		Not Sent	No additional delays in random access procedure.
DRX cycle length	s		1.28	The value shall be used for all cells in the test.
T1	s		15	T1 need to be defined so that cell re-selection reaction time is taken into account.
T2	s		>7	During T2, cell 2 shall be powered off, and during the off time the physical cell identity shall be changed, The intention is to ensure that cell 2 has not been detected by the UE prior to the start of period T3.
T3	s		75	T3 need to be defined so that cell re-selection reaction time is taken into account.

Table A.4.2.25.1-2: Cell specific test parameters for FD-FDD inter frequency cell reselection test case for Cat-M1 UE in normal coverage

Parameter	Unit	Cell 1			Cell 2		
		T1	T2	T3	T1	T2	T3
E-UTRA RF Channel number		1			2		
BW _{channel}	MHz	10			10		
OCNG Patterns defined in A.3.2.1.6		OP.6 FDD			OP.6 FDD		
PBCH_RA	dB	-3			-3		
PBCH_RB	dB						
PSS_RA	dB						
SSS_RA	dB						
MPDCCH_RA	dB						
MPDCCH_RB	dB						
PDSCH_RA	dB						
PDSCH_RB	dB						
OCNG_RA ^{Note 1}	dB						
OCNG_RB ^{Note 1}	dB						
Qrxlevmin	dBm	-140			-140		
N_{oc} ^{Note 2}	dBm/15 kHz	-98					
\hat{E}_s/N_{oc}	dB	14	14	14	-4	-infinity	12
\hat{E}_s/I_{ot}	dB	14	14	14	-4	-infinity	12
RSRP ^{Note 3}	dBm/15 KHz	-84	-84	-84	-102	-infinity	-86
Treselection _{EUTRAN}	s	0			0		
Snonintrasearch	dB	50			Not sent		
Thresh _{x, high}	dB	48			48		
Thresh _{servng, low}	dB	44			44		
Thresh _{x, low}	dB	50			50		
Propagation Condition		AWGN					
Antenna Configuration		2x1			2x1		
Timing offset to Cell 1	ms	-			3		
Note 1:	OCNG shall be used such that both cells are fully allocated and a constant total transmitted power spectral density is achieved for all OFDM symbols.						
Note 2:	Interference from other cells and noise sources not specified in the test is assumed to be constant over subcarriers and time and shall be modelled as AWGN of appropriate power for N_{oc} to be fulfilled.						
Note 3:	RSRP levels have been derived from other parameters for information purposes. They are not settable parameters themselves.						

A.4.2.25.2 Test Requirements

The cell reselection delay to higher priority is defined as the time from the beginning of time period T3, to the moment when the UE camps on cell 2, and starts to send preambles on the PRACH for sending the RRC CONNECTION REQUEST message to perform a Tracking Area Update procedure on Cell 2.

The cell re-selection delay to higher priority shall be less than 68 s.

The cell reselection delay to lower priority is defined as the time from the beginning of time period T1, to the moment when the UE camps on cell 1, and starts to send preambles on the PRACH for sending the RRC CONNECTION REQUEST message to perform a Tracking Area Update procedure on cell 1.

The cell re-selection delay to lower priority shall be less than 8 s.

The rate of correct cell reselections observed during repeated tests shall be at least 90%.

NOTE: The cell re-selection delay to higher priority cell can be expressed as: $T_{\text{higher_priority_search}} + T_{\text{evaluateFDD,inter}} + T_{\text{SI}}$, and to lower priority cell can be expressed as: $T_{\text{evaluateFDD,inter}} + T_{\text{SI}}$,

Where:

$T_{\text{higher_priority_search}}$ See clause 4.7.2.1.3

$T_{\text{evaluate, E-UTRAN_Inter_NC}}$ See Table 4.7.2.1.3-1 in clause 4.7.2.1.3

$T_{\text{SI-EUTRA-M1-NC}}$ Maximum repetition period of relevant system info blocks that needs to be received by the UE to camp on a cell; 1280 ms is assumed in this test case.

This gives a total of 67.68 s for higher priority cell search and 7.68 s for lower priority cell search, allow 68 s for higher priority cell and 8 s for lower priority cell in the test case.

A.4.2.26 E-UTRAN HD – FDD Inter frequency case for Cat-M1 UE in normal coverage

A.4.2.26.1 Test Purpose and Environment

This test is to verify the requirement for the HD-FDD inter frequency cell reselection requirements for category M1 UE in normal coverage specified in clause 4.7.2.1.3.

The test scenario comprises of 2 E-UTRA FDD cells on 2 different carriers as given in tables A.4.2.26.1-1 and A.4.2.26.1-2. The test consists of three successive time periods, with time duration of T1, T2 and T3 respectively. Both cell 1 and cell 2 are already identified by the UE prior to the start of the test. Cell 1 and cell 2 belong to different tracking areas and cell 2 is of higher priority than cell 1. Furthermore, UE has not registered with network for the tracking area containing cell 2.

Table A.4.2.26.1-1: General test parameters for HD-FDD inter frequency cell reselection test case for Cat-M1 UE in normal coverage

	Parameter	Unit	Value	Comment
Initial condition	Active cell		Cell2	UE shall be forced to cell 2 in the initialisation phase, so that reselection to cell 1 occurs during the first T1 phase
T1 end condition	Active cell		Cell1	UE shall perform reselection to cell 1 during T1
	Neighbour cell		Cell2	
Final condition	Active cell		Cell2	UE shall perform reselection to cell 2 during T3
E-UTRA RF Channel Number			1, 2	Two FDD carrier frequencies are used.
PRACH configuration			PRACH_2CE	See table in A.3.16
Access Barring Information		-	Not Sent	No additional delays in random access procedure.
DRX cycle length		s	1.28	The value shall be used for all cells in the test.
T1		s	15	T1 need to be defined so that cell re-selection reaction time is taken into account.

T2	s	>7	During T2, cell 2 shall be powered off, and during the off time the physical cell identity shall be changed, The intention is to ensure that cell 2 has not been detected by the UE prior to the start of period T3.
T3	s	75	T3 need to be defined so that cell re-selection reaction time is taken into account.

Table A.4.2.26.1-2: Cell specific test parameters for HD-FDD inter frequency cell reselection test case for Cat-M1 UE in normal coverage

Parameter	Unit	Cell 1			Cell 2		
		T1	T2	T3	T1	T2	T3
E-UTRA RF Channel number		1			2		
$BW_{channel}$	MHz	10			10		
OCNG Patterns defined in A.3.2.1.6		OP.6 FDD			OP.6 FDD		
PBCH_RA	dB	-3			-3		
PBCH_RB	dB						
PSS_RA	dB						
SSS_RA	dB						
MPDCCH_RA	dB						
MPDCCH_RB	dB						
PDSCH_RA	dB						
PDSCH_RB	dB						
OCNG_RA ^{Note 1}	dB						
OCNG_RB ^{Note 1}	dB						
Qrxlevmin	dBm	-140			-140		
N_{oc} ^{Note 2}	dBm/15 kHz	-98					
\hat{E}_s / N_{oc}	dB	14	14	14	-4	-infinity	12
\hat{E}_s / I_{ot}	dB	14	14	14	-4	-infinity	12
RSRP ^{Note 3}	dBm/15 KHz	-84	-84	-84	-102	-infinity	-86
Treselection _{EUTRAN}	s	0			0		
Snonintrasearch	dB	50			Not sent		
Thresh _{x, high}	dB	48			48		
Thresh _{serv, low}	dB	44			44		
Thresh _{x, low}	dB	50			50		
Propagation Condition		AWGN					
Antenna Configuration		2x1			2x1		
Timing offset to Cell 1	ms	-			3		
Note 1:	OCNG shall be used such that both cells are fully allocated and a constant total transmitted power spectral density is achieved for all OFDM symbols.						
Note 2:	Interference from other cells and noise sources not specified in the test is assumed to be constant over subcarriers and time and shall be modelled as AWGN of appropriate power for N_{oc} to be fulfilled.						
Note 3:	RSRP levels have been derived from other parameters for information purposes. They are not settable parameters themselves.						

A.4.2.26.2 Test Requirements

The cell reselection delay to higher priority is defined as the time from the beginning of time period T3, to the moment when the UE camps on cell 2, and starts to send preambles on the PRACH for sending the RRC CONNECTION REQUEST message to perform a Tracking Area Update procedure on Cell 2.

The cell re-selection delay to higher priority shall be less than 68 s.

The cell reselection delay to lower priority is defined as the time from the beginning of time period T1, to the moment when the UE camps on cell 1, and starts to send preambles on the PRACH for sending the RRC CONNECTION REQUEST message to perform a Tracking Area Update procedure on cell 1.

The cell re-selection delay to lower priority shall be less than 8 s.

The rate of correct cell reselections observed during repeated tests shall be at least 90%.

NOTE: The cell re-selection delay to higher priority cell can be expressed as: $T_{\text{higher_priority_search}} + T_{\text{evaluateFDD,inter}} + T_{\text{SI}}$, and to lower priority cell can be expressed as: $T_{\text{evaluateFDD,inter}} + T_{\text{SI}}$,

Where:

$T_{\text{higher_priority_search}}$ See clause 4.7.2.1.3

$T_{\text{evaluate, E-UTRAN_Inter_NC}}$ See Table 4.7.2.1.3-1 in clause 4.7.2.1.3

$T_{\text{SI-EUTRA-M1-NC}}$ Maximum repetition period of relevant system info blocks that needs to be received by the UE to camp on a cell; 1280 ms is assumed in this test case.

This gives a total of 67.68 s for higher priority cell search and 7.68 s for lower priority cell search, allow 68 s for higher priority cell and 8 s for lower priority cell in the test case.

A.4.2.27 E-UTRAN TDD – FDD Inter frequency case for Cat-M1 UE in normal coverage

A.4.2.27.1 Test Purpose and Environment

This test is to verify the requirement for the TDD-TDD inter frequency cell reselection requirements for category M1 UE in normal coverage specified in clause 4.7.2.1.3.

The test scenario comprises of 2 E-UTRA TDD cells on 2 different carriers as given in tables A.4.2.27.1-1 and A.4.2.27.1-2. The test consists of three successive time periods, with time duration of T1, T2 and T3 respectively. Both cell 1 and cell 2 are already identified by the UE prior to the start of the test. Cell 1 and cell 2 belong to different tracking areas and cell 2 is of higher priority than cell 1. Furthermore, UE has not registered with network for the tracking area containing cell 2.

Table A.4.2.27.1-1: General test parameters for TDD-TDD inter frequency cell reselection test case for Cat-M1 UE in normal coverage

	Parameter	Unit	Value	Comment
Initial condition	Active cell		Cell2	UE shall be forced to cell 2 in the initialisation phase, so that reselection to cell 1 occurs during the first T1 phase
T1 end condition	Active cell		Cell1	UE shall perform reselection to cell 1 during T1
	Neighbour cell		Cell2	
Final condition	Active cell		Cell2	UE shall perform reselection to cell 2 during T3
E-UTRA RF Channel Number			1, 2	Two FDD carrier frequencies are used.
PRACH configuration			PRACH_2CE	See table in A.3.16
Access Barring Information		-	Not Sent	No additional delays in random access procedure.
Special subframe configuration			6	As specified in table 4.2-1 in TS 36.211
Uplink-downlink configuration			1	As specified in table 4.2-1 in TS 36.211
DRX cycle length		s	1.28	The value shall be used for all cells in the test.
T1		s	15	T1 need to be defined so that cell re-selection reaction time is taken into account.
T2		s	>7	During T2, cell 2 shall be powered off, and during the off time the physical cell identity shall be changed, The intention is to ensure that cell 2 has not been detected by the UE prior to the start of period T3.
T3		s	75	T3 need to be defined so that cell re-selection reaction time is taken into account.

Table A.4.2.27.1-2: Cell specific test parameters for TDD-TDD inter frequency cell reselection test case for Cat-M1 UE in normal coverage

Parameter	Unit	Cell 1			Cell 2		
		T1	T2	T3	T1	T2	T3
E-UTRA RF Channel number		1			2		
BW _{channel}	MHz	10			10		
OCNG Patterns defined in A.3.2.1.2 (OP.2 FDD)		OP.2 TDD			OP.2 TDD		
PBCH_RA	dB	-3			-3		
PBCH_RB	dB						
PSS_RA	dB						
SSS_RA	dB						
MPDCCH_RA	dB						
MPDCCH_RB	dB						
PDSCH_RA	dB						
PDSCH_RB	dB						
OCNG_RA ^{Note 1}	dB						
OCNG_RB ^{Note 1}	dB						
Qrxlevmin	dBm	-140			-140		
N_{oc} ^{Note 2}	dBm/15 kHz	-98					
\hat{E}_s/N_{oc}	dB	14	14	14	-4	-infinity	12
\hat{E}_s/I_{ot}	dB	14	14	14	-4	-infinity	12
RSRP ^{Note 3}	dBm/15 KHz	-84	-84	-84	-102	-infinity	-86
Treselection _{EUTRAN}	s	0			0		
Snonintrasearch	dB	50			Not sent		
Thresh _{x, high}	dB	48			48		
Thresh _{serv, low}	dB	44			44		
Thresh _{x, low}	dB	50			50		
Propagation Condition		AWGN					
Antenna Configuration		2x1			2x1		
Timing offset to Cell 1	μs	-			3		
Note 1:	OCNG shall be used such that both cells are fully allocated and a constant total transmitted power spectral density is achieved for all OFDM symbols.						
Note 2:	Interference from other cells and noise sources not specified in the test is assumed to be constant over subcarriers and time and shall be modelled as AWGN of appropriate power for N_{oc} to be fulfilled.						
Note 3:	RSRP levels have been derived from other parameters for information purposes. They are not settable parameters themselves.						

A.4.2.27.2 Test Requirements

The cell reselection delay to higher priority is defined as the time from the beginning of time period T3, to the moment when the UE camps on cell 2, and starts to send preambles on the PRACH for sending the RRC CONNECTION REQUEST message to perform a Tracking Area Update procedure on Cell 2.

The cell re-selection delay to higher priority shall be less than 68 s.

The cell reselection delay to lower priority is defined as the time from the beginning of time period T1, to the moment when the UE camps on cell 1, and starts to send preambles on the PRACH for sending the RRC CONNECTION REQUEST message to perform a Tracking Area Update procedure on cell 1.

The cell re-selection delay to lower priority shall be less than 8 s.

The rate of correct cell reselections observed during repeated tests shall be at least 90%.

NOTE: The cell re-selection delay to higher priority cell can be expressed as: $T_{\text{higher_priority_search}} + T_{\text{evaluateFDD,inter}} + T_{\text{SI}}$, and to lower priority cell can be expressed as: $T_{\text{evaluateFDD,inter}} + T_{\text{SI}}$,

Where:

T_{higher_priority_search} See clause 4.7.2.1.3

T_{evaluate, E-UTRAN_Inter_NC} See Table 4.7.2.1.3-1 in clause 4.7.2.1.3

T_{SI-EUTRA-MI-NC} Maximum repetition period of relevant system info blocks that needs to be received by the UE to camp on a cell; 1280 ms is assumed in this test case.

This gives a total of 67.68 s for higher priority cell search and 7.68 s for lower priority cell search, allow 68 s for higher priority cell and 8 s for lower priority cell in the test case.

A.4.2.28 E-UTRAN FDD – FDD Inter frequency case for Cat-M1 UE in enhanced coverage

A.4.2.28.1 Test Purpose and Environment

This test is to verify the requirement for the FDD-FDD inter frequency cell reselection requirements for category M1 UE in enhanced coverage specified in clause 4.7.2.2.3.

The test scenario comprises of 2 E-UTRA FDD cells on 2 different carriers as given in tables A.4.2.28.1-1 and A.4.2.28.1-2. The test consists of three successive time periods, with time duration of T1, T2 and T3 respectively. Only Cell 1 is already identified by the UE prior to the start of the test, i.e. Cell 2 is not identified by the UE prior to the start of the test. Cell 1 and Cell 2 belong to different tracking areas. Furthermore, UE has not registered with network for the tracking area containing Cell 2.

Table A.4.2.28.1-1: General test parameters for FD-FDD inter frequency cell reselection test case for Cat-M1 UE in enhanced coverage

Parameter		Unit	Value	Comment
Initial condition	Active cell		Cell1	
	Neighbour cells		Cell2	
T2 end condition	Active cell		Cell2	
	Neighbour cells		Cell1	
Final condition	Visited cell		Cell1	
E-UTRA RF Channel Number			1, 2	Two FDD carrier frequencies are used.
Access Barring Information		-	Not Sent	No additional delays in random access procedure.
PRACH Parameters			PRACH_4CE	Refer to A.3.16
DRX cycle length		s	0.64	The value shall be used for all cells in the test.
T1		s	>7	During T1, Cell 2 shall be powered off, and during the off time the physical cell identity shall be changed, The intention is to ensure that Cell 2 has not been detected by the UE prior to the start of period T2
T2		s	≤340	T2 need to be defined so that cell re-selection reaction time is taken into account.
T3		s	20	T3 need to be defined so that cell re-selection reaction time is taken into account.

Table A.4.2.28.1-2: Cell specific test parameters for FD-FDD inter frequency cell reselection test case for Cat-M1 UE in enhanced coverage

Parameter	Unit	Cell 1			Cell 2		
		T1	T2	T3	T1	T2	T3
E-UTRA RF Channel number		1			2		
BW _{channel}	MHz	10 for 10 MHz cell BW: 5 for 5 MHz cell BW			10 for 10 MHz cell BW: 5 for 5 MHz cell BW		

OCNG Patterns defined in A.3.2.1.6		OP.6 FDD for 10 MHz cell BW: OP.19 FDD for 5 MHz cell BW			OP.6 FDD for 10 MHz cell BW: OP.19 FDD for 5 MHz cell BW		
PBCH_RA	dB	-3			-3		
PBCH_RB	dB						
PSS_RA	dB						
SSS_RA	dB						
MPDCCH_RA	dB						
MPDCCH_RB	dB						
PDSCH_RA	dB						
PDSCH_RB	dB						
OCNG_RA ^{Note 1}	dB						
OCNG_RB ^{Note 1}	dB						
Qrxlevmin	dBm	-140			-140		
N_{oc} ^{Note 2}	dBm/15 kHz	-98			-98		
\hat{E}_s/N_{oc}	dB	-5	-12	-5	-infinity	-5	-12
\hat{E}_s/I_{ot}	dB	-5	-12	-5	-infinity	-5	-12
RSRP ^{Note 3}	dBm/15 KHz	-103	-110	-103	-infinity	-103	-110
Treselection ^{EUTRAN}	s	0			0		
Snonintrasearch	dB	Not sent			Not sent		
Propagation Condition		AWGN			AWGN		
Antenna Configuration		2x1			2x1		
Timing offset to Cell 1	ms	-			3		
<p>Note 1: OCNG shall be used such that both cells are fully allocated and a constant total transmitted power spectral density is achieved for all OFDM symbols.</p> <p>Note 2: Interference from other cells and noise sources not specified in the test is assumed to be constant over subcarriers and time and shall be modelled as AWGN of appropriate power for N_{oc} to be fulfilled.</p> <p>Note 3: RSRP levels have been derived from other parameters for information purposes. They are not settable parameters themselves.</p>							

A.4.2.28.2 Test Requirements

The cell reselection delay to a newly detectable cell is defined as the time from the beginning of time period T2, to the moment when the UE camps on Cell 2, and starts to send preambles on the PRACH for sending the RRC CONNECTION REQUEST message to perform a Tracking Area Update procedure on Cell 2.

The cell re-selection delay to a newly detectable cell shall be less than 337 s.

The cell reselection delay to an already detected cell is defined as the time from the beginning of time period T3, to the moment when the UE camps on Cell 1, and starts to send preambles on the PRACH for sending the RRC CONNECTION REQUEST message to perform a Tracking Area Update procedure on Cell 1.

The cell re-selection delay to an already detected cell shall be less than 17 s.

The rate of correct cell reselections observed during repeated tests shall be at least 90%.

NOTE: The cell re-selection delay to a newly detectable cell can be expressed as: $T_{\text{detect,EUTRAN_Inter_EC}} + T_{\text{SI-EUTRA-MI-EC}}$, and to an already detected cell can be expressed as: $T_{\text{evaluate,EUTRAN_Inter_EC}} + T_{\text{SI-MI-EC}}$,

Where:

$T_{\text{detect,EUTRAN_Inter_EC}}$ See Table 4.7.2.2.3-1 in clause 4.7.2.2.3

$T_{\text{evaluate,EUTRAN_Inter_EC}}$ See Table 4.7.2.2.3-1 in clause 4.7.2.2.3

$T_{\text{SI-EUTRA-MI-EC}}$ Maximum repetition period of relevant system info blocks that needs to be received by the UE to camp on a cell; 6400 ms is assumed in this test case.

This gives a total of 336.64 s, allow 337 s for the cell re-selection delay to a newly detectable cell and 16.64 s, allow 17 s for the cell re-selection delay to an already detected cell in the test case.

A.4.2.29 E-UTRAN HD – FDD Inter frequency case for Cat-M1 UE in enhanced coverage

A.4.2.29.1 Test Purpose and Environment

This test is to verify the requirement for the HD-FDD inter frequency cell reselection requirements for category M1 UE in enhanced coverage specified in clause 4.7.2.2.3.

The test scenario comprises of 2 E-UTRA FDD cells on 2 different carriers as given in tables A.4.2.29.1-1 and A.4.2.29.1-2. The test consists of three successive time periods, with time duration of T1, T2 and T3 respectively. Only Cell 1 is already identified by the UE prior to the start of the test, i.e. Cell 2 is not identified by the UE prior to the start of the test. Cell 1 and Cell 2 belong to different tracking areas. Furthermore, UE has not registered with network for the tracking area containing Cell 2.

Table A.4.2.29.1-1: General test parameters for HD-FDD inter frequency cell reselection test case for Cat-M1 UE in enhanced coverage

Parameter		Unit	Value	Comment
Initial condition	Active cell		Cell1	
	Neighbour cells		Cell2	
T2 end condition	Active cell		Cell2	
	Neighbour cells		Cell1	
Final condition	Visited cell		Cell1	
E-UTRA RF Channel Number			1, 2	Two FDD carrier frequencies are used.
Access Barring Information		-	Not Sent	No additional delays in random access procedure.
PRACH Parameters			PRACH_4CE	Refer to A.3.16
DRX cycle length		s	0.64	The value shall be used for all cells in the test.
T1		s	>7	During T1, Cell 2 shall be powered off, and during the off time the physical cell identity shall be changed, The intention is to ensure that Cell 2 has not been detected by the UE prior to the start of period T2
T2		s	≤340	T2 need to be defined so that cell re-selection reaction time is taken into account.
T3		s	20	T3 need to be defined so that cell re-selection reaction time is taken into account.

Table A.4.2.29.1-2: Cell specific test parameters for HD-FDD inter frequency cell reselection test case for Cat-M1 UE in enhanced coverage

Parameter	Unit	Cell 1			Cell 2		
		T1	T2	T3	T1	T2	T3
E-UTRA RF Channel number		1			2		
BW _{channel}	MHz	10 for 10 MHz cell BW: 5 for 5 MHz cell BW			10 for 10 MHz cell BW: 5 for 5 MHz cell BW		
OCNG Patterns defined in A.3.2.1.6		OP.6 FDD for 10 MHz cell BW: OP.19 FDD for 5 MHz cell BW			OP.6 FDD for 10 MHz cell BW: OP.19 FDD for 5 MHz cell BW		
PBCH_RA	dB						
PBCH_RB	dB						
PSS_RA	dB						
SSS_RA	dB						
MPDCCH_RA	dB						

MPDCCH_RB	dB	-3			-3		
PDSCH_RA	dB						
PDSCH_RB	dB						
OCNG_RA ^{Note 1}	dB						
OCNG_RB ^{Note 1}	dB						
Qrxlevmin	dBm	-140			-140		
N_{oc} ^{Note 2}	dBm/15 kHz	-98			-98		
\hat{E}_s/N_{oc}	dB	-5	-12	-5	-infinity	-5	-12
\hat{E}_s/I_{ot}	dB	-5	-12	-5	-infinity	-5	-12
RSRP ^{Note 3}	dBm/15 KHz	-103	-110	-103	-infinity	-103	-110
Treselection ^{EUTRAN}	s	0			0		
Snonintrasearch	dB	Not sent			Not sent		
Propagation Condition		AWGN			AWGN		
Antenna Configuration		2x1			2x1		
Timing offset to Cell 1	ms	-			3		
<p>Note 1: OCNG shall be used such that both cells are fully allocated and a constant total transmitted power spectral density is achieved for all OFDM symbols.</p> <p>Note 2: Interference from other cells and noise sources not specified in the test is assumed to be constant over subcarriers and time and shall be modelled as AWGN of appropriate power for N_{oc} to be fulfilled.</p> <p>Note 3: RSRP levels have been derived from other parameters for information purposes. They are not settable parameters themselves.</p>							

A.4.2.29.2 Test Requirements

The cell reselection delay to a newly detectable cell is defined as the time from the beginning of time period T2, to the moment when the UE camps on Cell 2, and starts to send preambles on the PRACH for sending the RRC CONNECTION REQUEST message to perform a Tracking Area Update procedure on Cell 2.

The cell re-selection delay to a newly detectable cell shall be less than 337 s.

The cell reselection delay to an already detected cell is defined as the time from the beginning of time period T3, to the moment when the UE camps on Cell 1, and starts to send preambles on the PRACH for sending the RRC CONNECTION REQUEST message to perform a Tracking Area Update procedure on Cell 1.

The cell re-selection delay to an already detected cell shall be less than 17 s.

The rate of correct cell reselections observed during repeated tests shall be at least 90%.

NOTE: The cell re-selection delay to a newly detectable cell can be expressed as: $T_{\text{detect,EUTRAN_Inter_EC}} + T_{\text{SI-EUTRA-MI-EC}}$, and to an already detected cell can be expressed as: $T_{\text{evaluate,EUTRAN_Inter_EC}} + T_{\text{SI_MI_EC}}$,

Where:

$T_{\text{detect,EUTRAN_Inter_EC}}$ See Table 4.7.2.2.3-1 in clause 4.7.2.2.3

$T_{\text{evaluate,EUTRAN_Inter_EC}}$ See Table 4.7.2.2.3-1 in clause 4.7.2.2.3

$T_{\text{SI-EUTRA-MI-EC}}$ Maximum repetition period of relevant system info blocks that needs to be received by the UE to camp on a cell; 6400 ms is assumed in this test case.

This gives a total of 336.64 s, allow 337 s for the cell re-selection delay to a newly detectable cell and 16.64 s, allow 17 s for the cell re-selection delay to an already detected cell in the test case.

A.4.2.30 E-UTRAN TDD Inter frequency case for Cat-M1 UE in enhanced coverage

A.4.2.30.1 Test Purpose and Environment

This test is to verify the requirement for the TDD-TDD inter frequency cell reselection requirements for category M1 UE in enhanced coverage specified in clause 4.7.2.2.3.

The test scenario comprises of 2 E-UTRA TDD cells on 2 different carriers as given in tables A.4.2.30.1-1 and A.4.2.30.1-2. The test consists of three successive time periods, with time duration of T1, T2 and T3 respectively. Only Cell 1 is already identified by the UE prior to the start of the test, i.e. Cell 2 is not identified by the UE prior to the start of the test. Cell 1 and Cell 2 belong to different tracking areas. Furthermore, UE has not registered with network for the tracking area containing Cell 2.

Table A.4.2.30.1-1: General test parameters for TDD-TDD inter frequency cell reselection test case for Cat-M1 UE in enhanced coverage

Parameter		Unit	Value	Comment
Initial condition	Active cell		Cell1	
	Neighbour cells		Cell2	
T2 end condition	Active cell		Cell2	
	Neighbour cells		Cell1	
Final condition	Visited cell		Cell1	
E-UTRA RF Channel Number			1, 2	Two TDD carrier frequencies are used.
Access Barring Information		-	Not Sent	No additional delays in random access procedure.
Special subframe configuration			6	As specified in table 4.2-1 in TS 36.211
Uplink-downlink configuration			1	As specified in table 4.2-1 in TS 36.211
PRACH Parameters			PRACH_4CE	Refer to A.3.16
DRX cycle length		s	0.64	The value shall be used for all cells in the test.
T1		s	>7	During T1, Cell 2 shall be powered off, and during the off time the physical cell identity shall be changed, The intention is to ensure that Cell 2 has not been detected by the UE prior to the start of period T2
T2		s	≤340	T2 need to be defined so that cell re-selection reaction time is taken into account.
T3		s	20	T3 need to be defined so that cell re-selection reaction time is taken into account.

Table A.4.2.30.1-2: Cell specific test parameters for TDD-TDD inter frequency cell reselection test case for Cat-M1 UE in enhanced coverage

Parameter	Unit	Cell 1			Cell 2		
		T1	T2	T3	T1	T2	T3
E-UTRA RF Channel number		1			2		
BW _{channel}	MHz	10 for 10 MHz cell BW: 5 for 5 MHz cell BW			10 for 10 MHz cell BW: 5 for 5 MHz cell BW		
OCNG Patterns defined in A.3.2.1.6		OP.2 TDD for 10 MHz cell BW: OP.10 TDD for 5 MHz cell BW			OP.2 TDD for 10 MHz cell BW: OP.10 TDD for 5 MHz cell BW		
PBCH_RA	dB	-3			-3		
PBCH_RB	dB						
PSS_RA	dB						
SSS_RA	dB						
MPDCCH_RA	dB						
MPDCCH_RB	dB						
PDSCH_RA	dB						
PDSCH_RB	dB						
OCNG_RA ^{Note 1}	dB						
OCNG_RB ^{Note 1}	dB						
Qrxlevmin	dBm	-140			-140		
N_{oc} ^{Note 2}	dBm/15 kHz	-98			-98		
\hat{E}_s/N_{oc}	dB	-5	-12	-5	-infinity	-5	-12

\hat{E}_s/I_{ot}	dB	-5	-12	-5	-infinity	-5	-12
RSRP ^{Note 3}	dBm/15 KHz	-103	-110	-103	-infinity	-103	-110
Treselection _{EUTRAN}	s	0			0		
Snonintra search	dB	Not sent			Not sent		
Propagation Condition		AWGN			AWGN		
Antenna Configuration		2x1			2x1		
Timing offset to Cell 1	ms	-			3		
Note 1:	OCNG shall be used such that both cells are fully allocated and a constant total transmitted power spectral density is achieved for all OFDM symbols.						
Note 2:	Interference from other cells and noise sources not specified in the test is assumed to be constant over subcarriers and time and shall be modelled as AWGN of appropriate power for N_{oc} to be fulfilled.						
Note 3:	RSRP levels have been derived from other parameters for information purposes. They are not settable parameters themselves.						

A.4.2.30.2 Test Requirements

The cell reselection delay to a newly detectable cell is defined as the time from the beginning of time period T2, to the moment when the UE camps on Cell 2, and starts to send preambles on the PRACH for sending the RRC CONNECTION REQUEST message to perform a Tracking Area Update procedure on Cell 2.

The cell re-selection delay to a newly detectable cell shall be less than 337 s.

The cell reselection delay to an already detected cell is defined as the time from the beginning of time period T3, to the moment when the UE camps on Cell 1, and starts to send preambles on the PRACH for sending the RRC CONNECTION REQUEST message to perform a Tracking Area Update procedure on Cell 1.

The cell re-selection delay to an already detected cell shall be less than 17 s.

The rate of correct cell reselections observed during repeated tests shall be at least 90%.

NOTE: The cell re-selection delay to a newly detectable cell can be expressed as: $T_{\text{detect,EUTRAN_Inter_EC}} + T_{\text{SI-EUTRA-MI-EC}}$, and to an already detected cell can be expressed as: $T_{\text{evaluate,EUTRAN_Inter_EC}} + T_{\text{SI_MI_EC}}$,

Where:

$T_{\text{detect,EUTRAN_Inter_EC}}$ See Table 4.7.2.2.3-1 in clause 4.7.2.2.3

$T_{\text{evaluate,EUTRAN_Inter_EC}}$ See Table 4.7.2.2.3-1 in clause 4.7.2.2.3

$T_{\text{SI-EUTRA-MI-EC}}$ Maximum repetition period of relevant system info blocks that needs to be received by the UE to camp on a cell; 6400 ms is assumed in this test case.

This gives a total of 336.64 s, allow 337 s for the cell re-selection delay to a newly detectable cell and 16.64 s, allow 17 s for the cell re-selection delay to an already detected cell in the test case.

A.4.2.31 E-UTRAN FDD – FDD Inter frequency case for UE Category 1bis

A.4.2.31.1 Test Purpose and Environment

This test is to verify the requirement for the FDD-FDD inter-frequency cell reselection requirements for UE category 1bis specified in clause 4.2.2.4.

The test scenario comprises of 2 E-UTRA FDD cells on 2 different carriers as given in tables A.4.2.31.1-1 and A.4.2.31.1-2. The test consists of three successive time periods, with time duration of T1, T2 and T3 respectively. Both cell 1 and cell 2 are already identified by the UE prior to the start of the test. Cell 1 and cell 2 belong to different tracking areas and cell 2 is of higher priority than cell 1. Furthermore, UE has not registered with network for the tracking area containing cell 2.

Table A.4.2.31.1-1: General test parameters for FDD-FDD inter frequency cell re-selection test case for UE Category 1bis

Parameter	Unit	Value	Comment
-----------	------	-------	---------

Initial condition	Active cell		Cell2	UE shall be forced to cell 2 in the initialisation phase, so that reselection to cell 1 occurs during the first T1 phase
T1 end condition	Active cell		Cell1	UE shall perform reselection to cell 1 during T1
	Neighbour cell		Cell2	
Final condition	Active cell		Cell2	UE shall perform reselection to cell 2 during T3
E-UTRA RF Channel Number			1, 2	Two FDD carrier frequencies are used.
Time offset between cells			3 ms	Asynchronous cells
PRACH configuration			4	As specified in table 5.7.1-2 in TS 36.211
Access Barring Information	-		Not Sent	No additional delays in random access procedure.
DRX cycle length	s		1.28	The value shall be used for all cells in the test.
T1	s		15	T1 need to be defined so that cell re-selection reaction time is taken into account.
T2	s		>7	During T2, cell 2 shall be powered off, and during the off time the physical cell identity shall be changed, The intention is to ensure that cell 2 has not been detected by the UE prior to the start of period T3.
T3	s		75	T3 need to be defined so that cell re-selection reaction time is taken into account.

Table A.4.2.31.1-2: Cell specific test parameters for FDD-FDD inter-frequency cell reselection test case in AWGN for UE Category 1bis

Parameter	Unit	Cell 1			Cell 2		
		T1	T2	T3	T1	T2	T3
E-UTRA RF Channel number		1			2		
BW _{channel}	MHz	10			10		
OCNG Patterns defined in A.3.2.1.2 (OP.2 FDD)		OP.2 FDD			OP.2 FDD		
PBCH_RA	dB	0			0		
PBCH_RB	dB						
PSS_RA	dB						
SSS_RA	dB						
PCFICH_RB	dB						
PHICH_RA	dB						
PHICH_RB	dB						
PDCCH_RA	dB						
PDCCH_RB	dB						
PDSCH_RA	dB						
PDSCH_RB	dB						
OCNG_RA ^{Note 1}	dB						
OCNG_RB ^{Note 1}	dB						
Qrxlevmin	dBm						
N_{oc} ^{Note 2}	dBm/15 kHz	-98.5			-98.5		
RSRP ^{Note 3}	dBm/15 KHz	-83.5	-83.5	-83.5	-102.5	-infinity	-85.5
\hat{E}_s/I_{ot}	dB	15	15	15	-4	-infinity	13
\hat{E}_s/N_{oc}	dB	15	15	15	-4	-infinity	13
Treselection _{EUTRAN}	s	0			0		
Snonintrasearch	dB	50			Not sent		
Thresh _{x, high}	dB	48			48		
Thresh _{serv, low}	dB	44			44		
Thresh _{x, low}	dB	50			50		
Propagation Condition		AWGN			AWGN		
Antenna Configuration		1x1			1x1		

- Note 1: OCNG shall be used such that both cells are fully allocated and a constant total transmitted power spectral density is achieved for all OFDM symbols.
- Note 2: Interference from other cells and noise sources not specified in the test is assumed to be constant over subcarriers and time and shall be modelled as AWGN of appropriate power for N_{oc} to be fulfilled.
- Note 3: RSRP levels have been derived from other parameters for information purposes. They are not settable parameters themselves.

A.4.2.31.2 Test Requirements

The cell reselection delay to higher priority is defined as the time from the beginning of time period T3, to the moment when the UE camps on cell 2, and starts to send preambles on the PRACH for sending the RRC CONNECTION REQUEST message to perform a Tracking Area Update procedure on Cell 2.

The cell re-selection delay to higher priority shall be less than 68 s.

The cell reselection delay to lower priority is defined as the time from the beginning of time period T1, to the moment when the UE camps on cell 1, and starts to send preambles on the PRACH for sending the RRC CONNECTION REQUEST message to perform a Tracking Area Update procedure on cell 1.

The cell re-selection delay to lower priority shall be less than 8 s.

The rate of correct cell reselections observed during repeated tests shall be at least 90%.

NOTE: The cell re-selection delay to higher priority cell can be expressed as: $T_{\text{higher_priority_search}} + T_{\text{evaluateFDD,inter}} + T_{\text{SI}}$, and to lower priority cell can be expressed as: $T_{\text{evaluateFDD,inter}} + T_{\text{SI}}$,

Where:

$T_{\text{higher_priority_search}}$ See clause 4.2.2

$T_{\text{evaluateFDD,inter}}$ See Table 4.2.2.4-1 in clause 4.2.2.4

T_{SI} Maximum repetition period of relevant system info blocks that needs to be received by the UE to camp on a cell; 1280 ms is assumed in this test case.

This gives a total of 67.68 s for higher priority cell search and 7.68 s for lower priority cell search, allow 68 s for higher priority cell and 8 s for lower priority cell in the test case.

A.4.2.32 E-UTRAN FDD – TDD Inter frequency case for UE Category 1bis

A.4.2.32.1 Test Purpose and Environment

This test is to verify the requirement for the FDD-TDD inter-frequency cell reselection requirements for UE Category 1bis specified in clause 4.2.2.4.

The test scenario comprises of 1 E-UTRA FDD cell and 1 E-UTRA TDD cell as given in tables A.4.2.32.1-1 and A.4.2.32.1-2. The test consists of three successive time periods, with time duration of T1, T2 and T3 respectively. Both cell 1 and cell 2 are already identified by the UE prior to the start of the test. Cell 1 and cell 2 belong to different tracking areas and cell 2 is of higher priority than cell 1. Furthermore, UE has not registered with network for the tracking area containing cell 2.

Table A.4.2.32.1-1: General test parameters for FDD-TDD inter frequency cell re-selection test case for UE Category 1bis

	Parameter	Unit	Value	Comment
Initial condition	Active cell		Cell2	UE shall be forced to cell 2 in the initialisation phase, so that reselection to cell 1 occurs during the first T1 phase
T1 end condition	Active cell		Cell1	UE shall perform reselection to cell 1 during T1
	Neighbour cell		Cell2	
Final condition	Active cell		Cell2	UE shall perform reselection to cell 2 during T3

Cell 1 E-UTRA RF Channel Number		1	One FDD carrier frequency is used. And Cell 1 is on RF channel number 1.
Cell 2 E-UTRA RF Channel Number		2	One TDD carrier frequencies is used. And Cell 2 is on RF channel number 2.
Time offset between cells		3 ms	Asynchronous cells
E-UTRA FDD PRACH configuration		4	As specified in table 5.7.1-2 in TS 36.211
E-UTRA TDD PRACH configuration		53	As specified in table 5.7.1-3 in TS 36.211
Special subframe configuration		6	As specified in table 4.2-1 in TS 36.211
Uplink-downlink configuration		1	As specified in table 4.2-2 in TS 36.211
E-UTRA FDD Access Barring Information	-	Not Sent	No additional delays in random access procedure.
E-UTRA TDD Access Barring Information	-	Not Sent	No additional delays in random access procedure.
DRX cycle length	s	1.28	The value shall be used for all cells in the test.
T1	s	15	T1 need to be defined so that cell re-selection reaction time is taken into account.
T2	s	>7	During T2, cell 2 shall be powered off, and during the off time the physical cell identity shall be changed, The intention is to ensure that cell 2 has not been detected by the UE prior to the start of period T3.
T3	s	75	T3 need to be defined so that cell re-selection reaction time is taken into account.

Table A.4.2.32.1-2: Cell specific test parameters for FDD-TDD inter-frequency cell reselection test case in AWGN for UE Category 1bis

Parameter	Unit	Cell 1			Cell 2		
		T1	T2	T3	T1	T2	T3
E-UTRA RF Channel number		1			2		
$BW_{channel}$	MHz	10			10		
OCNG Patterns defined in A.3.2.1.2 (OP.2 FDD) and A.3.2.2.2 (OP.2 TDD)		OP.2 FDD			OP.2 TDD		
PBCH_RA	dB	0			0		
PBCH_RB	dB						
PSS_RA	dB						
SSS_RA	dB						
PCFICH_RB	dB						
PHICH_RA	dB						
PHICH_RB	dB						
PDCCH_RA	dB						
PDCCH_RB	dB						
PDSCH_RA	dB						
PDSCH_RB	dB						
OCNG_RA ^{Note 1}	dB						
OCNG_RB ^{Note 1}	dB						
$Q_{rxlevmin}$	dBm	-140			-140		
N_{oc} ^{Note 2}	dBm/15 kHz	-98.5			-98.5		
RSRP ^{Note 3}	dBm/15 KHz	-83.5	-83.5	-83.5	-102.5	-infinity	-85.5
\hat{E}_s/I_{ot}	dB	15	15	15	-4	-infinity	13
\hat{E}_s/N_{oc}	dB	15	15	15	-4	-infinity	13
Treselection _{EUTRAN}	s	0			0		
Snonintrasearch	dB	50			Not sent		
Thresh _{x, high}	dB	48			48		
Thresh _{servng, low}	dB	44			44		
Thresh _{x, low}	dB	50			50		
Propagation Condition		AWGN			AWGN		
Antenna Configuration		1x1			1x1		

- Note 1: OCNG shall be used such that both cells are fully allocated and a constant total transmitted power spectral density is achieved for all OFDM symbols.
- Note 2: Interference from other cells and noise sources not specified in the test is assumed to be constant over subcarriers and time and shall be modelled as AWGN of appropriate power for N_{oc} to be fulfilled.
- Note 3: RSRP levels have been derived from other parameters for information purposes. They are not settable parameters themselves.

A.4.2.32.2 Test Requirements

The cell reselection delay to higher priority is defined as the time from the beginning of time period T3, to the moment when the UE camps on cell 2, and starts to send preambles on the PRACH for sending the RRC CONNECTION REQUEST message to perform a Tracking Area Update procedure on cell 2.

The cell re-selection delay to higher priority shall be less than 68 s.

The cell reselection delay to lower priority is defined as the time from the beginning of time period T1, to the moment when the UE camps on cell 1, and starts to send preambles on the PRACH for sending the RRC CONNECTION REQUEST message to perform a Tracking Area Update procedure on cell 1.

The cell re-selection delay to lower priority shall be less than 8 s.

The rate of correct cell reselections observed during repeated tests shall be at least 90%.

NOTE: The cell re-selection delay to higher priority cell can be expressed as: $T_{\text{higher_priority_search}} + T_{\text{evaluate,E-UTRAN_inter}} + T_{\text{SI-EUTRA}}$, and to lower priority cell can be expressed as: $T_{\text{evaluate,E-UTRAN_inter}} + T_{\text{SI-EUTRA}}$,

Where:

$T_{\text{higher_priority_search}}$ See clause 4.2.2

$T_{\text{evaluate,E-UTRAN_inter}}$ See Table 4.2.2.4-1 in clause 4.2.2.4

$T_{\text{SI-EUTRA}}$ Maximum repetition period of relevant system info blocks that needs to be received by the UE to camp on a cell; 1280 ms is assumed in this test case.

This gives a total of 67.68 s for higher priority cell search and 7.68 s for lower priority cell search, allow 68 s for higher priority cell and 8 s for lower priority cell in the test case.

A.4.2.33 E-UTRAN TDD – FDD Inter frequency case for UE Category 1bis

A.4.2.33.1 Test Purpose and Environment

This test is to verify the requirement for the TDD-FDD inter-frequency cell reselection requirements for UE Category 1bis specified in clause 4.2.2.4.

The test scenario comprises of 1 E-UTRA TDD cell and 1 E-UTRA FDD cell as given in tables A.4.2.33.1-1 and A.4.2.33.1-2. The test consists of three successive time periods, with time duration of T1, T2 and T3 respectively. Both cell 1 and cell 2 are already identified by the UE prior to the start of the test. Cell 1 and cell 2 belong to different tracking areas and cell 2 is of higher priority than cell 1. Furthermore, UE has not registered with network for the tracking area containing cell 2.

Table A.4.2.33.1-1: General test parameters for TDD-FDD inter frequency cell re-selection test case for UE Category 1bis

	Parameter	Unit	Value	Comment
Initial condition	Active cell		Cell2	UE shall be forced to cell 2 in the initialisation phase, so that reselection to cell 1 occurs during the first T1 phase
T1 end condition	Active cell		Cell1	UE shall perform reselection to cell 1 during T1
	Neighbour cell		Cell2	
Final condition	Active cell		Cell2	UE shall perform reselection to cell 2 during T3

Cell 1 E-UTRA RF Channel Number		1	One TDD carrier frequency is used. And Cell 1 is on RF channel number 1.
Cell 2 E-UTRA RF Channel Number		2	One FDD carrier frequencies is used. And Cell 2 is on RF channel number 2.
Time offset between cells		3 ms	Asynchronous cells
E-UTRA TDD PRACH configuration		53	As specified in table 5.7.1-3 in TS 36.211
Special subframe configuration		6	As specified in table 4.2-1 in TS 36.211
Uplink-downlink configuration		1	As specified in table 4.2-2 in TS 36.211
E-UTRA FDD PRACH configuration		4	As specified in table 5.7.1-2 in TS 36.211
E-UTRA FDD Access Barring Information	-	Not Sent	No additional delays in random access procedure.
E-UTRA TDD Access Barring Information	-	Not Sent	No additional delays in random access procedure.
DRX cycle length	s	1.28	The value shall be used for all cells in the test.
T1	s	15	T1 need to be defined so that cell re-selection reaction time is taken into account.
T2	s	>7	During T2, cell 2 shall be powered off, and during the off time the physical cell identity shall be changed, The intention is to ensure that cell 2 has not been detected by the UE prior to the start of period T3.
T3	s	75	T3 need to be defined so that cell re-selection reaction time is taken into account.

Table A.4.2.33.1-2: Cell specific test parameters for TDD-FDD inter-frequency cell reselection test case in AWGN for UE Category 1bis

Parameter	Unit	Cell 1			Cell 2		
		T1	T2	T3	T1	T2	T3
E-UTRA RF Channel number		1			2		
$BW_{channel}$	MHz	10			10		
OCNG Patterns defined in A.3.2.1.2 (OP.2 FDD) and A.3.2.2.2 (OP.2 TDD)		OP.2 TDD			OP.2 FDD		
PBCH_RA	dB	0			0		
PBCH_RB	dB						
PSS_RA	dB						
SSS_RA	dB						
PCFICH_RB	dB						
PHICH_RA	dB						
PHICH_RB	dB						
PDCCH_RA	dB						
PDCCH_RB	dB						
PDSCH_RA	dB						
PDSCH_RB	dB						
OCNG_RA ^{Note 1}	dB						
OCNG_RB ^{Note 1}	dB						
$Q_{rxlevmin}$	dBm						
N_{oc} ^{Note 2}	dBm/15 kHz	-98.5			-98.5		
RSRP ^{Note 3}	dBm/15 KHz	-83.5	-83.5	-83.5	-102.5	-infinity	-85.5
\hat{E}_s/I_{ot}	dB	15	15	15	-4	-infinity	13
\hat{E}_s/N_{oc}	dB	15	15	15	-4	-infinity	13
Treselection _{EUTRAN}	s	0			0		
Snonintrasearch	dB	50			Not sent		
Thresh _{x, high}	dB	48			48		
Thresh _{serv, low}	dB	44			44		
Thresh _{x, low}	dB	50			50		
Propagation Condition		AWGN			AWGN		
Antenna Configuration		1x1			1x1		

- Note 1: OCNG shall be used such that both cells are fully allocated and a constant total transmitted power spectral density is achieved for all OFDM symbols.
- Note 2: Interference from other cells and noise sources not specified in the test is assumed to be constant over subcarriers and time and shall be modelled as AWGN of appropriate power for N_{oc} to be fulfilled.
- Note 3: RSRP levels have been derived from other parameters for information purposes. They are not settable parameters themselves.

A.4.2.33.2 Test Requirements

The cell reselection delay to higher priority is defined as the time from the beginning of time period T3, to the moment when the UE camps on cell 2, and starts to send preambles on the PRACH for sending the RRC CONNECTION REQUEST message to perform a Tracking Area Update procedure on cell 2.

The cell re-selection delay to higher priority shall be less than 68 s.

The cell reselection delay to lower priority is defined as the time from the beginning of time period T1, to the moment when the UE camps on cell 1, and starts to send preambles on the PRACH for sending the RRC CONNECTION REQUEST message to perform a Tracking Area Update procedure on cell 1.

The cell re-selection delay to lower priority shall be less than 8 s.

The rate of correct cell reselections observed during repeated tests shall be at least 90%.

NOTE: The cell re-selection delay to higher priority cell can be expressed as: $T_{\text{higher_priority_search}} + T_{\text{evaluate,E-UTRAN_inter}} + T_{\text{SI-EUTRA}}$, and to lower priority cell can be expressed as: $T_{\text{evaluate,E-UTRAN_inter}} + T_{\text{SI-EUTRA}}$,

Where:

$T_{\text{higher_priority_search}}$ See clause 4.2.2

$T_{\text{evaluate,E-UTRAN_inter}}$ See Table 4.2.2.4-1 in clause 4.2.2.4

$T_{\text{SI-EUTRA}}$ Maximum repetition period of relevant system info blocks that needs to be received by the UE to camp on a cell; 1280 ms is assumed in this test case.

This gives a total of 67.68 s for higher priority cell search and 7.68 s for lower priority cell search, allow 68 s for higher priority cell and 8 s for lower priority cell in the test case.

A.4.2.34 E-UTRAN TDD – TDD: Inter frequency case for UE Category 1bis

A.4.2.34.1 Test Purpose and Environment

This test is to verify the requirement for the TDD-TDD inter-frequency cell reselection requirements for UE Category 1bis specified in clause 4.2.2.4.

The test scenario comprises of 2 E-UTRA TDD cells on 2 different carriers as given in tables A.4.2.34.1-1 and A.4.2.34.1-2. The test consists of three successive time periods, with time duration of T1, T2, and T2 respectively. Both cell 1 and cell 2 are already identified by the UE prior to the start of the test. Cell 1 and cell 2 belong to different tracking areas and cell 2 is of higher priority than cell 1. Furthermore, UE has not registered with network for the tracking area containing cell 2.

Table A.4.2.34.1-1: General test parameters for TDD-TDD inter frequency cell reselection test case for UE Category 1bis

	Parameter	Unit	Value	Comment
Initial condition	Active cell		Cell2	UE shall be forced to cell 2 in the initialisation phase, so that reselection to cell 1 occurs during the first T1 phase
T1 end condition	Active cells		Cell1	UE shall perform reselection to cell 1 during T1
	Neighbour cell		Cell2	
Final condition	Active cell		Cell2	UE shall perform reselection to cell 2 during T3

E-UTRA RF Channel Number		1, 2	Two TDD carrier frequencies are used.
Time offset between cells		3 μ s	Synchronous cells
Access Barring Information	-	Not Sent	No additional delays in random access procedure.
Special subframe configuration		6	As specified in table 4.2-1 in TS 36.211
Uplink-downlink configuration		1	As specified in table 4.2-2 in TS 36.211
PRACH configuration index		53	As specified in table 5.7.1-3 in TS 36.211
DRX cycle length	s	1.28	The value shall be used for all cells in the test.
T1	s	15	T1 need to be defined so that cell re-selection reaction time is taken into account.
T2	s	>7	During T2, cell 2 shall be powered off, and during the off time the physical cell identity shall be changed, The intention is to ensure that cell 2 has not been detected by the UE prior to the start of period T3.
T3	s	75	T3 need to be defined so that cell re-selection reaction time is taken into account.

Table A.4.2.34.1-2: Cell specific test parameters for TDD-TDD inter-frequency cell reselection test case in AWGN for UE Category 1bis

Parameter	Unit	Cell 1			Cell 2		
		T1	T2	T3	T1	T2	T3
E-UTRA RF Channel number		1			2		
$BW_{channel}$	MHz	10			10		
OCNG Pattern defined in A.3.2.2.2 (OP.2 TDD)		OP.2 TDD			OP.2 TDD		
PBCH_RA	dB	0			0		
PBCH_RB	dB						
PSS_RA	dB						
SSS_RA	dB						
PCFICH_RB	dB						
PHICH_RA	dB						
PHICH_RB	dB						
PDCCH_RA	dB						
PDCCH_RB	dB						
PDSCH_RA	dB						
PDSCH_RB	dB						
OCNG_RA ^{Note 1}	dB						
OCNG_RB ^{Note 1}	dB						
$Q_{rxlevmin}$	dBm	-140			-140		
N_{oc} ^{Note 2}	dBm/15 kHz	-98.5			-98.5		
RSRP ^{Note 3}	dBm/15 KHz	-83.5	-83.5	-83.5	-102.5	-infinity	-85.5
\hat{E}_s/I_{ot}	dB	15	15	15	-4	-infinity	13
\hat{E}_s/N_{oc}	dB	15	15	15	-4	-infinity	13
Treselection _{EUTRAN}	S	0			0		
Snonintrasearch	dB	50			Not sent		
Thresh _{x, high}	dB	48			48		
Thresh _{servicing, low}	dB	44			44		
Thresh _{x, low}	dB	50			50		
Propagation Condition		AWGN			AWGN		
Antenna Configuration		1x1			1x1		
Note 1:	OCNG shall be used such that both cells are fully allocated and a constant total transmitted power spectral density is achieved for all OFDM symbols.						
Note 2:	Interference from other cells and noise sources not specified in the test is assumed to be constant over subcarriers and time and shall be modelled as AWGN of appropriate power for N_{oc} to be fulfilled.						
Note 3:	RSRP levels have been derived from other parameters for information purposes. They are not settable parameters themselves.						

A.4.2.34.2 Test Requirements

The cell reselection delay to higher priority is defined as the time from the beginning of time period T3, to the moment when the UE camps on cell 2, and starts to send preambles on the PRACH for sending the RRC CONNECTION REQUEST message to perform a Tracking Area Update procedure on cell 2.

The cell re-selection delay to higher priority shall be less than 68 s.

The cell reselection delay to lower priority is defined as the time from the beginning of time period T1, to the moment when the UE camps on cell 1, and starts to send preambles on the PRACH for sending the RRC CONNECTION REQUEST message to perform a Tracking Area Update procedure on cell 1.

The cell re-selection delay to lower priority shall be less than 8 s.

The rate of correct cell reselections observed during repeated tests shall be at least 90%.

NOTE: The cell re-selection delay to higher priority cell can be expressed as: $T_{\text{higher_priority_search}} + T_{\text{evaluate,E-UTRAN_inter}} + T_{\text{SI-EUTRA}}$, and to lower priority cell can be expressed as: $T_{\text{evaluate,E-UTRAN_inter}} + T_{\text{SI-EUTRA}}$,

Where:

$T_{\text{higher_priority_search}}$ See clause 4.2.2

$T_{\text{evaluate,E-UTRAN_inter}}$ See Table 4.2.2.4-1 in clause 4.2.2.4

$T_{\text{SI-EUTRA}}$ Maximum repetition period of relevant system info blocks that needs to be received by the UE to camp on a cell; 1280 ms is assumed in this test case.

This gives a total of 67.68 s for higher priority cell search and 7.68 s for lower priority cell search, allow 68 s for higher priority cell and 8 s for lower priority cell in the test case.

A.4.2.35 E-UTRAN TDD - TDD Intra frequency case for UE Category NB1 In-Band mode in normal coverage

A.4.2.35.1 Test Purpose and Environment

This test is to verify the requirement for the TDD intra frequency cell reselection requirements for Cat-NB1 UE specified in clause 4.6.2.2.

The test scenario comprises of 1 E-UTRA carrier with two ecells of different cell ID and one NB-IoT carrier with 2 ncells of different physical cell ID, as given in tables A.4.2.35.1-1, A.4.2.35.1-2 and A.4.2.35.1-3. The test consists of three successive time periods, with time duration of T1, T2 and T3 respectively. Only nCell1 is already identified by the UE prior to the start of the test, i.e. nCell 2 is not identified. nCell 1 and nCell 2 belong to different tracking areas. Furthermore, UE has not registered with network for the tracking area containing nCell 2.

Table A.4.2.35.1-1: General test parameters for TDD intra frequency cell reselection test case for Cat-NB1 UE in normal coverage

Parameter		Unit	Value	Comment
NB-IOT operational mode			In-band	
Initial condition	Active cell		nCell1	
	Neighbour cells		eCell1, eCell2, nCell2	
T2 end condition	Active cell		nCell2	
	Neighbour cells		eCell1, eCell2, nCell1	
Final condition	Visited cell		nCell1	
E-UTRA RF Channel Number			1	One carrier frequency is used for eCell1 and eCell2.
Access Barring Information		-	Not Sent	No additional delays in random access procedure.
Special subframe configuration			6	As specified in table 4.2-1 in TS 36.211 [16]
Uplink-downlink configuration			1	As specified in table 4.2-2 in TS 36.211 [16]

NPRACH Configuration		NPRACH.R-2	As specified in A.3.18
DRX cycle length	s	1.28	The value shall be used for all cells in the test.
T1	s	>7	During T1, nCell2 shall be powered off, and during the off time the physical cell identity shall be changed. The intention is to ensure that nCell2 has not been detected by the UE prior to the start of period T2
T2	s	60	T2 is defined so that cell re-selection time is taken into account. Once the UE has reselected to nCell2 (within T2) T3 starts
T3	s	15	T3 is defined so that cell re-selection time is taken into account.

Table A.4.2.35.1-2: nCell 1, nCell 2 specific test parameters for TDD intra frequency cell reselection test case for Cat-NB1 UE in normal coverage

Parameter	Unit	nCell 1			nCell 2		
		T1	T2	T3	T1	T2	T3
BW _{channel}	kHz	180			180		
PRB location within eCell	-	eCell 1 BW _{channel} 10MHz: 30			eCell 2 BW _{channel} 10MHz: 30		
NPBCH_RA	dB	-3			-3		
NPBCH_RB	dB						
NPSS_RA	dB						
NSSS_RA	dB						
NPDCCH_RA	dB						
NPDCCH_RB	dB						
NPDSCH_RA	dB						
NPDSCH_RB	dB						
NOCNG_RA ^{Note 1}	dB						
NOCNG_RB ^{Note 1}	dB						
Qrxlevmin	dBm	-140	-140	-140	-140	-140	-140
Pcompensation	dB	0	0	0	0	0	0
Qhysts	dB	0	0	0	0	0	0
Qoffsets _{s,n}	dB	0	0	0	0	0	0
Cell_selection_and_reselection_quality_measurement		NRSRP			NRSRP		
N _{oc}	dBm/15 kHz	Specified in Table A.4.2.35.1-3					
\hat{E}_s / N_{oc}	dB	17	13	17	-infinity	17	13
\hat{E}_s / I_{ot} ^{Note2}	dB	17	-4.09	3.79	-infinity	3.79	-4.09
NRSRP ^{Note2}	dBm/15 kHz	-81	-85	-81	-infinity	-81	-85
Treselection	s	0	0	0	0	0	0
Propagation Condition		AWGN			AWGN		
Antenna Configuration		2x1			2x1		
Timing offset to nCell 1	μs	-			3		
Note 1: NOCNG shall be used such that both cells are fully allocated and a constant total transmitted power spectral density is achieved for all OFDM symbols. Note 2: Es/Iot and NRSRP levels have been derived from other parameters for information purposes. They are not settable parameters themselves.							

Table A.4.2.35.1-3: eCell 1 and eCell2 specific test parameters for TDD intra frequency cell reselection test case for Cat-NB1 UE in normal coverage

Parameter	Unit	eCell 1			eCell 2		
		T1	T2	T3	T1	T2	T3
BW _{channel}	MHz	10			10		
NOCNG Pattern defined in clause D.3	-	BW _{channel} 10MHz: NOP.1 TDD			BW _{channel} 10MHz: NOP.1 TDD		
PBCH_RA	dB	-3			-3		
PBCH_RB	dB						
PSS_RA	dB						

SSS_RA	dB						
PDCCH_RA	dB						
PDCCH_RB	dB						
PDSCH_RA	dB						
PDSCH_RB	dB						
OCNG_RA ^{Note 1}	dB						
OCNG_RB ^{Note 1}	dB						
Qrxlevmin	dBm	-140	-140	-140	-140	-140	-140
Pcompensation	dB	0	0	0	0	0	0
Qhysts	dB	0	0	0	0	0	0
Qoffsets _{s, n}	dB	0	0	0	0	0	0
N_{oc} ^{Note2}	dBm/15 kHz	-98			-98		
\hat{E}_s / N_{oc} ^{Note2}	dBm	3	3	3	3	3	3
Treselection	s	0	0	0	0	0	0
Propagation Condition		AWGN			AWGN		
Antenna Configuration		2x1			2x1		
Timing offset to eCell 1	μ s	-			3		
<p>Note 1: OCNG shall be used such that the Cell is fully allocated and a constant total transmitted power spectral density is achieved for all OFDM symbols.</p> <p>Note 2: Interference from other cells and noise sources not specified in the test is assumed to be constant over subcarriers and time and shall be modelled as AWGN of appropriate power N_{oc}.</p>							

A.4.2.35.2 Test Requirements

The cell reselection delay to a newly detectable cell is defined as the time from the beginning of time period T2, to the moment when the UE camps on nCell 2, and starts to send preambles on the PRACH for sending the RRC CONNECTION REQUEST message to perform a Tracking Area Update procedure on nCell 2.

The cell re-selection delay to a newly detectable cell shall be less than 59.32 s.

The cell reselection delay to an already detected cell is defined as the time from the beginning of time period T3, to the moment when the UE camps on nCell 1, and starts to send preambles on the PRACH for sending the RRC CONNECTION REQUEST message to perform a Tracking Area Update procedure on nCell 1.

The cell re-selection delay to an already detected cell shall be less than 14.82 s.

The rate of correct cell reselections observed during repeated tests shall be at least 90%.

NOTE: The cell re-selection delay to a newly detectable cell can be expressed as: $T_{\text{detect, NB_Intra_NB-IoT-NC}} + T_{\text{SI}}$, and to an already detected cell can be expressed as: $T_{\text{evaluate, NB_intra_NB-IoT-NC}} + T_{\text{SI}}$,

Where:

$T_{\text{detect, NB_Intra_NB-IoT-NC}}$ See Table 4.6.2.2-1 in clause 4.6.2.2

$T_{\text{evaluate, NB_intra_NB-IoT-NC}}$ See Table 4.6.2.2-1 in clause 4.6.2.2

T_{SI} Maximum repetition period of relevant system info blocks that needs to be received by the UE to camp on a cell; 8.32 s is assumed in this test case.

This gives a total of 59.32 s, allow 60 s for the cell re-selection delay to a newly detectable cell and 14.82 s, allow 15 s for the cell re-selection delay to an already detected cell in the test case.

A.4.2.36 E-UTRAN TDD – TDD Intra frequency case for UE Category NB1 In-Band mode in enhanced coverage

A.4.2.36.1 Test Purpose and Environment

This test is to verify the requirement for the TDD intra frequency cell reselection requirements for Cat-NB1 UE specified in clause 4.6.2.4.

The test scenario comprises of 1 E-UTRA carrier and a total of 4 cells as given in tables A.4.2.36.1-1, A.4.2.36.1-2 and A.4.2.36.1-3. The test consists of three successive time periods, with time duration of T1, T2 and T3 respectively. Only nCell1 is already identified by the UE prior to the start of the test, i.e. nCell 2 is not identified. nCell 1 and nCell 2 belong to different tracking areas. Furthermore, UE has not registered with network for the tracking area containing nCell 2.

Table A.4.2.36.1-1: General test parameters for TDD intra frequency cell reselection test case for Cat-NB1 UE in enhanced coverage

Parameter		Unit	Value	Comment
NB-IOT operational mode			In-band	
Initial condition	Active cell		nCell1	
	Neighbour cells		eCell1, eCell2, nCell2	
T2 end condition	Active cell		nCell2	
	Neighbour cells		eCell1, eCell2, nCell1	
Final condition	Visited cell		nCell1	
E-UTRA RF Channel Number			1	One carrier frequency is used for eCell1 and eCell2.
Access Barring Information		-	Not Sent	No additional delays in random access procedure.
Special subframe configuration			6	As specified in table 4.2-1 in TS 36.211 [16]
Uplink-downlink configuration			1	As specified in table 4.2-2 in TS 36.211 [16]
NPRACH Configuration			NPRACH.R-2	Refer to A.3.18
DRX cycle length		s	1.28	The value shall be used for all cells in the test.
T1		s	>7	During T1, nCell2 shall be powered off, and during the off time the physical cell identity shall be changed. The intention is to ensure that nCell2 has not been detected by the UE prior to the start of period T2
T2		s	67	T2 is defined so that cell re-selection time is taken into account. Once the UE has reselected to nCell2 (within T2) T3 starts
T3		s	22	T3 is defined so that cell re-selection time is taken into account.

Table A.4.2.36.1-2: nCell 1, nCell 2 specific test parameters for TDD intra frequency cell reselection test case for Cat-NB1 UE in enhanced coverage

		nCell 1			nCell 2		
		T1	T2	T3	T1	T2	T3
BW _{channel}	kHz	180			180		
PRB location within eCell	-	eCell 1 BW _{channel} 10MHz: 30			eCell 2 BW _{channel} 10MHz: 30		
NPBCH_RA	dB	-3			-3		
NPBCH_RB	dB						
NPSS_RA	dB						
NSSS_RA	dB						
NPDCCH_RA	dB						
NPDCCH_RB	dB						
NPDSCH_RA	dB						
NPDSCH_RB	dB						
NOCNG_RA ^{Note 1}	dB						
NOCNG_RB ^{Note 1}	dB						
Qrxlevmin	dBm	-156	-156	-156	-156	-156	-156
Pcompensation	dB	0	0	0	0	0	0
Qhysts	dB	0	0	0	0	0	0
Qoffsets _{s, n}	dB	0	0	0	0	0	0
Cell_selection_and_reselection_quality_measurement		NRSRP			NRSRP		
	dBm/15 kHz	Specified in Table A.4.2.36.1-3					

	dB	-9	-9	-0.7	-infinity	-0.7	-9
Note2	dB	-9	-11.67	-1.21	-infinity	-1.21	-11.67
NRSRP Note2	dBm/15 kHz	-107	-107	-98.7	-infinity	-98.7	-107
Treselection	s	0	0	0	0	0	0
Propagation Condition		AWGN			AWGN		
Antenna Configuration		2x1			2x1		
Timing offset to nCell 1	ms	-			3		
Note 1: NOCNG shall be used such that both cells are fully allocated and a constant total transmitted power spectral density is achieved for all OFDM symbols. Note 2: Es/lot and NRSRP levels have been derived from other parameters for information purposes. They are not settable parameters themselves.							

Table A.4.2.36.1-3: eCell 1 and eCell2 specific test parameters for TDD intra frequency cell reselection test case for Cat-NB1 UE in enhanced coverage

Parameter	Unit	eCell 1			eCell 2		
		T1	T2	T3	T1	T2	T3
BW _{channel}	MHz	10			10		
NOCNG Pattern	-	BW _{channel} 10MHz: NOP.1 TDD			BW _{channel} 10MHz: NOP.1 TDD		
PBCH_RA	dB	-3			-3		
PBCH_RB	dB						
PSS_RA	dB						
SSS_RA	dB						
PDCCH_RA	dB						
PDCCH_RB	dB						
PDSCH_RA	dB						
PDSCH_RB	dB						
OCNG_RA ^{Note 1}	dB						
OCNG_RB ^{Note 1}	dB						
Qrxlevmin	dBm	-140	-140	-140	-140	-140	-140
Pcompensation	dB	0	0	0	0	0	0
Qhyst _s	dB	0	0	0	0	0	0
Qoffset _{s, n}	dB	0	0	0	0	0	0
Note2	dBm/15 kHz	-98			-98		
Note2	dBm	3	3	3	3	3	3
Treselection	s	0	0	0	0	0	0
Propagation Condition		AWGN			AWGN		
Antenna Configuration		2x1			2x1		
Timing offset to eCell 1	ms	-			3		
Note 1: OCNG shall be used such that the Cell is fully allocated and a constant total transmitted power spectral density is achieved for all OFDM symbols. Note 2: Interference from other cells and noise sources not specified in the test is assumed to be constant over subcarriers and time and shall be modelled as AWGN of appropriate power .							

A.4.2.36.2 Test Requirements

The cell reselection delay to a newly detectable cell is defined as the time from the beginning of time period T2, to the moment when the UE camps on nCell 2, and starts to send preambles on the PRACH for sending the RRC CONNECTION REQUEST message to perform a Tracking Area Update procedure on nCell 2.

The cell re-selection delay to a newly detectable cell shall be less than 66.32 s.

The cell reselection delay to an already detected cell is defined as the time from the beginning of time period T3, to the moment when the UE camps on nCell 1, and starts to send preambles on the PRACH for sending the RRC CONNECTION REQUEST message to perform a Tracking Area Update procedure on nCell 1.

The cell re-selection delay to an already detected cell shall be less than 21.12 s.

The rate of correct cell reselections observed during repeated tests shall be at least 90%.

NOTE: The cell re-selection delay to a newly detectable cell can be expressed as: $T_{\text{detect, NB_intra_NB-IoT-EC}} + T_{\text{SI}}$, and to an already detected cell can be expressed as: $T_{\text{evaluate, NB_intra_NB-IoT-EC}} + T_{\text{SI}}$.

Where:

$T_{\text{detect,NB_Intra_NB-IoT-EC}}$ See Table 4.6.2.4-1 in clause 4.6.2.4

$T_{\text{evaluate, NB_intra_NB-IoT-EC}}$ See Table 4.6.2.4-1 in clause 4.6.2.4

T_{SI} Maximum repetition period of relevant system info blocks that needs to be received by the UE to camp on a cell; 8.32s is assumed in this test case.

This gives a total of 66.32 s, allow 67 s for the cell re-selection delay to a newly detectable cell and 21.12s, allow 22s for the cell re-selection delay to an already detected cell in the test case.

A.4.2.37 E-UTRAN TDD – TDD Inter frequency case for UE Category NB1 In-Band mode in enhanced coverage

A.4.2.37.1 Test Purpose and Environment

This test is to verify the requirement for the TDD inter frequency cell reselection requirements for Cat-NB1 UE specified in clause 4.6.2.6.

The test scenario comprises of 1 E-UTRA carrier and a total of 3 cells as given in tables A.4.2.37.1-1, A.4.2.37.1-2 and A.4.2.37.1-3. The test consists of three successive time periods, with time duration of T1, T2 and T3 respectively. Only nCell1 is already identified by the UE prior to the start of the test, i.e. nCell 2 is not identified. nCell 1 and nCell 2 belong to different tracking areas. Furthermore, UE has not registered with network for the tracking area containing nCell 2.

Table A.4.2.37.1-1: General test parameters for TDD inter frequency cell reselection test case for Cat-NB1 UE in enhanced coverage

Parameter		Unit	Value	Comment
NB-IOT operational mode			In-band	
Initial condition	Active cell		nCell1	
	Neighbour cells		eCell1, nCell2	
T2 end condition	Active cell		nCell2	
	Neighbour cells		eCell1, nCell1	
Final condition	Visited cell		nCell1	
E-UTRA RF Channel Number			1	One carrier frequency is used for eCell.
Access Barring Information		-	Not Sent	No additional delays in random access procedure.
Special subframe configuration			6	As specified in table 4.2-1 in TS 36.211 [16]
Uplink-downlink configuration			1	As specified in table 4.2-2 in TS 36.211 [16]
NPRACH Configuration			NPRACH.R-2	Refer to A.3.18
DRX cycle length		s	1.28	The value shall be used for all cells in the test.
T1		s	>7	During T1, nCell2 shall be powered off, and during the off time the physical cell identity shall be changed. The intention is to ensure that nCell2 has not been detected by the UE prior to the start of period T2
T2		s	67	T2 is defined so that cell re-selection time is taken into account.
T3		s	22	T3 is defined so that cell re-selection time is taken into account.

Table A.4.2.37.1-2: nCell 1, nCell 2 specific test parameters for TDD inter frequency cell reselection test case for Cat-NB1 UE in enhanced coverage

		nCell 1			nCell 2		
		T1	T2	T3	T1	T2	T3
BW_{channel}	kHz	180			180		

PRB location within eCell	-	eCell 1 BW _{channel} 10MHz: 30			eCell 1 BW _{channel} 10MHz: 35		
NPBCH_RA	dB	-3			-3		
NPBCH_RB	dB						
NPSS_RA	dB						
NSSS_RA	dB						
NPDCCH_RA	dB						
NPDCCH_RB	dB						
NPDSCH_RA	dB						
NPDSCH_RB	dB						
NOCNG_RA ^{Note 1}	dB						
NOCNG_RB ^{Note 1}	dB						
Qrxlevmin	dBm	-140			-140		
Pcompensation	dB	0			0		
Qhysts	dB	0			0		
Qoffsets _{s,n}	dB	0			0		
Cell_selection_and_reselection_quality_measurement		NRSRP			NRSRP		
	dBm/15 kHz	Specified in Table A.4.2.37.1-3					
	dB	-12	-12	-2.7	-infinity	-2.7	-12
Note2	dB	-12	-12	-2.7	-infinity	-2.7	-12
NRSRP ^{Note2}	dBm/15 kHz	-110	-110	-100.7	-infinity	-100.7	-110
Treselection	s	0			0		
Propagation Condition		AWGN			AWGN		
Antenna Configuration		2x1			2x1		
Timing offset to nCell 1	ms	0					
<p>Note 1: NOCNG shall be used such that both cells are fully allocated and a constant total transmitted power spectral density is achieved for all OFDM symbols.</p> <p>Note 2: Es/lot and NRSRP levels have been derived from other parameters for information purposes. They are not settable parameters themselves.</p>							

Table A.4.2.37.1-3: eCell 1 specific test parameters for TDD inter frequency cell reselection test case for Cat-NB1 UE in enhanced coverage

		eCell 1		
		T1	T2	T3
BW _{channel}	MHz	10		
OCNG Pattern	-	BW _{channel} 10MHz: NOP.1 TDD		
PBCH_RA	dB	-3		
PBCH_RB	dB			
PSS_RA	dB			
SSS_RA	dB			
PDCCH_RA	dB			
PDCCH_RB	dB			
PDSCH_RA	dB			
PDSCH_RB	dB			
OCNG_RA ^{Note 1}	dB			
OCNG_RB ^{Note 1}	dB			
Qrxlevmin	dBm	-140		
Pcompensation	dB	0		
Qhysts	dB	0		
Qoffsets _{s,n}	dB	0		
	dBm/15 kHz	-98		
	dB	3	3	3
Treselection	s	0		
Propagation Condition		AWGN		
Antenna Configuration		2x1		
<p>Note 1: OCNG shall be used such that the eCell is fully allocated and a constant total transmitted power spectral density is achieved for all OFDM symbols.</p> <p>Note 2: Interference from other cells and noise sources not specified in the test is assumed to be constant over subcarriers and time and shall be modelled as AWGN of appropriate power .</p>				

A.4.2.37.2 Test Requirements

The cell reselection delay to a newly detectable cell is defined as the time from the beginning of time period T2, to the moment when the UE camps on nCell 2, and starts to send preambles on the PRACH for sending the RRC CONNECTION REQUEST message to perform a Tracking Area Update procedure on nCell 2.

The cell re-selection delay to a newly detectable cell shall be less than 66.32 s.

The cell reselection delay to an already detected cell is defined as the time from the beginning of time period T3, to the moment when the UE camps on nCell 1, and starts to send preambles on the PRACH for sending the RRC CONNECTION REQUEST message to perform a Tracking Area Update procedure on nCell 1.

The cell re-selection delay to an already detected cell shall be less than 21.12 s.

The rate of correct cell reselections observed during repeated tests shall be at least 90%.

NOTE: The cell re-selection delay to a newly detectable cell can be expressed as: $T_{\text{detect, NB_Inter_EC}} + T_{\text{SI}}$, and to an already detected cell can be expressed as: $T_{\text{evaluate, NB_Inter_EC}} + T_{\text{SI}}$,

Where:

$T_{\text{detect, NB_Inter_EC}}$ See Table 4.6.2.6-1 in clause 4.6.2.6

$T_{\text{evaluate, NB_Inter_EC}}$ See Table 4.6.2.6-1 in clause 4.6.2.6

T_{SI} Maximum repetition period of relevant system info blocks that needs to be received by the UE to camp on a cell; 8.32 s is assumed in this test case.

This gives a total of 66.32 s, allow 67 s for the cell re-selection delay to a newly detectable cell and 21.12 s, allow 22 s for the cell re-selection delay to an already detected cell in the test case.

A.4.2.38 HD – FDD Intra frequency case for UE Category NB1 In-Band mode in normal coverage with serving cell RRM measurement relaxation

A.4.2.38.1 Test Purpose and Environment

This test is to verify the requirement for the HD-FDD intra frequency cell reselection requirements for Cat-NB1 UE specified in clause 4.6.2.1A when UE is configured to monitor WUS according to Table A.4.2.38.1-1 and under the serving cell RRM measurement relaxation according to the subclause 4.6.2.1A and under the intra-frequency neighbor cell measurement relaxation according to the subclause 4.6.2.2.

The test scenario comprises of 1 E-UTRA carrier with two eCells of different cell ID and one NB-IoT carrier with 2 nCells of different physical cell ID, as given in tables A.4.2.38.1-1, A.4.2.38.1-2 and A.4.2.38.1-3. The test consists of two successive time periods, with time duration of T1 and T2, respectively. Only nCell1 is already identified by the UE prior to the start of the test, i.e. nCell 2 is not identified. nCell 1 and nCell 2 belong to different tracking areas. Furthermore, UE has not registered with network for the tracking area containing nCell 2.

Table A.4.2.38.1-1: General test parameters for HD-FDD intra frequency cell reselection test case for Cat-NB1 UE in normal coverage

Parameter	Unit	Value	Comment
NB-IOT operational mode		In-band	
Initial condition	Active cell	nCell1	
	Neighbour cells	eCell1, eCell2, nCell2	
T2 end condition	Active cell	nCell2	
	Neighbour cells	eCell1, eCell2, nCell1	
Final condition	Visited cell	nCell1	
E-UTRA RF Channel Number		1	One carrier frequency is used for eCell1 and eCell2.
Access Barring Information	-	Not Sent	No additional delays in random access procedure.

NPRACH Configuration		NPRACH.R-1		Refer to A.3.18
S _{SearchDeltaP}	dB	6		Threshold for relaxed monitoring criterion as specified in 5.2.4.12.1 in [1]
R _{max}		[128]		
maxDurationFactor		[one4th]		WUS config. W _{max} = 32 (=1/4*R _{max})
numPOs		[n1]		WUS config. Single PO mapped to each WUS occasion
timeOffsetDRX		[ms40]		WUS config. Gap between the end of WUS duration to the associated PO
numDRX-CycleRelaxed		[4]		Serving cell RRM measurement is relaxed by
DRX cycle length	s	1.28		The value shall be used for all cells in the test.
T1	s	>[30]		During T1, nCell2 shall be powered off, and during the off time the physical cell identity shall be changed. The intention is to ensure that nCell2 has not been detected by the UE prior to the start of period T2
T2	s	[70]		T2 is defined so that cell re-selection time is taken into account.

Table A.4.2.38.1-2: nCell 1, nCell 2 specific test parameters for HD-FDD intra frequency cell reselection test case for Cat-NB1 UE in normal coverage

Parameter	Unit	nCell 1		nCell 2	
		T1	T2	T1	T2
BW _{channel}	kHz	180		180	
PRB location within eCell	-	eCell 1 BW _{channel} 5MHz: 18 eCell 1 BW _{channel} 10MHz: 30		eCell 2 BW _{channel} 5MHz: 18 eCell 2 BW _{channel} 10MHz: 30	
NPBCH_RA	dB	-3		-3	
NPBCH_RB	dB				
NPSS_RA	dB				
NSSS_RA	dB				
NPDCCH_RA	dB				
NPDCCH_RB	dB				
NPDSCH_RA	dB				
NPDSCH_RB	dB				
NOCNG_RA ^{Note 1}	dB				
NOCNG_RB ^{Note 1}	dB				
Q _{rxlevmin}	dBm	-140	-140	-140	-140
P _{compensation}	dB	0	0	0	0
Q _{hysts}	dB	0	0	0	0
Q _{offsets,n}	dB	0	0	0	0
Cell_selection_and_reselection_quality_measurement		NRSRP		NRSRP	
N _{oc}	dBm/15 kHz	Specified in Table A.4.2.18.1-3			
\hat{E}_s / N_{oc}	dB	17	7	-infinity	11
\hat{E}_s / I_{ot} ^{Note2}	dB	17	4.33	-infinity	3.21
NRSRP ^{Note2}	dBm/15 kHz	-81	91	-infinity	87
T _{reselection}	s	0	0	0	0
Propagation Condition		AWGN		AWGN	
Antenna Configuration		2x1		2x1	
Timing offset to nCell 1	ms	-		3	
<p>Note 1: NOCNG shall be used such that both cells are fully allocated and a constant total transmitted power spectral density is achieved for all OFDM symbols.</p> <p>Note 2: Es/Iot and NRSRP levels have been derived from other parameters for information purposes. They are not settable parameters themselves.</p>					

Table A.4.2.38.1-3: eCell 1 and eCell2 specific test parameters for HD-FDD intra frequency cell reselection test case for Cat-NB1 UE in normal coverage

Parameter	Unit	eCell 1		eCell 2	
		T1	T2	T1	T2
$BW_{channel}$	MHz	5 or 10		5 or 10	
NOCNG Pattern defined in clause D.3	-	$BW_{channel}$ 5MHz: NOP.4 FDD $BW_{channel}$ 10MHz: NOP.1 FDD		$BW_{channel}$ 5MHz: NOP.4 FDD $BW_{channel}$ 10MHz: NOP.1 FDD	
PBCH_RA	dB	-3		-3	
PBCH_RB	dB				
PSS_RA	dB				
SSS_RA	dB				
PDCCH_RA	dB				
PDCCH_RB	dB				
PDSCH_RA	dB				
PDSCH_RB	dB				
OCNG_RA ^{Note 1}	dB				
OCNG_RB ^{Note 1}	dB				
Qrxlevmin	dBm	-140	-140	-140	-140
Pcompensation	dB	0	0	0	0
Qhyst _s	dB	0	0	0	0
Qoffset _{s, n}	dB	0	0	0	0
N_{oc} ^{Note2}	dBm/15 kHz	-98		-98	
\hat{E}_s / N_{oc} ^{Note2}	dBm	3	3	3	3
Treselection	s	0	0	0	0
Propagation Condition		AWGN		AWGN	
Antenna Configuration		2x1		2x1	
Timing offset to eCell 1	ms	-		3	
Note 1:	OCNG shall be used such that the Cell is fully allocated and a constant total transmitted power spectral density is achieved for all OFDM symbols.				
Note 2:	Interference from other cells and noise sources not specified in the test is assumed to be constant over subcarriers and time and shall be modelled as AWGN of appropriate power N_{oc} .				
Note 3:	Void				

A.4.2.38.2 Test Requirements

Before the beginning of T2, UE is under relaxed monitoring where the serving cell measurement is performed every 5.12 s and the infra-frequency measurement for the neighbor cells is relaxed according to subclause 5.2.4.12.0 in TS 36.304 [1].

The cell reselection delay to a newly detectable cell is defined as the time from the beginning of time period T2, to the moment when the UE camps on nCell 2, and starts to send preambles on the PRACH for sending the RRC CONNECTION REQUEST message to perform a Tracking Area Update procedure on nCell 2.

The cell re-selection delay to a newly detectable cell shall be less than [69.56] s.

The cell reselection delay to an already detected cell is defined as the time from the beginning of time period T2, to the moment when the UE camps on nCell 2, and starts to send preambles on the PRACH for sending the RRC CONNECTION REQUEST message to perform a Tracking Area Update procedure on nCell 2.

The rate of correct cell reselections observed during repeated tests shall be at least 90%.

NOTE: The cell re-selection delay to a newly detectable cell can be expressed as: $T_{evaluate, serv_NB-NC} + T_{detect, NB_Intra_NB-IoT-NC} + T_{SI}$.

Where:

$T_{detect, NB_Intra_NB-IoT-NC}$ See Table 4.6.2.2-1 in clause 4.6.2.2, based on the configured DRX cycle

$T_{evaluate, serv_NB-NC}$ See Table 4.6.2.2-1 in clause 4.6.2.2, based on the effective DRX cycle after relaxation; [10.24] s is assumed in this test case.

T_{SI} Maximum repetition period of relevant system info blocks that needs to be received by the UE to camp on a cell; 8.32 s is assumed in this test case.

This gives a total of [69.56] s, allow [70] s for the cell re-selection delay to a newly detectable in the test case.

A.4.3 E-UTRAN to UTRAN Cell Re-Selection

A.4.3.1 E-UTRAN FDD – UTRAN FDD:

A.4.3.1.1 EUTRA FDD-UTRA FDD cell reselection: UTRA FDD is of higher priority

A.4.3.1.1.1 Test Purpose and Environment

This test is to verify the requirement for the E-UTRA FDD- UTRA FDD inter-RAT cell reselection requirements specified in clause 4.2.2.5 when the UTRA cell is of higher priority.

The test scenario comprises of one E-UTRA FDD and one UTRA FDD cells as given in tables A.4.3.1.1.1-1, A.4.3.1.1.1-2 and A.4.3.1.1.1-3. The test consists of three successive time periods, with time duration of T1, T2 and T3 respectively. E-UTRA cell 1 is already identified by the UE prior to the start of the test. Cell 2 is of higher priority than cell 1.

Table A.4.3.1.1.1-1: General test parameters for E-UTRA FDD- higher priority UTRA FDD inter RAT cell re-selection test case

Parameter		Unit	Value	Comment
Initial condition	Active cell		Cell 1	UE is on cell 1 in the initialisation phase, so that reselection to cell 2 occurs during T2
T2 end condition	Active cell		Cell 2	UE shall perform reselection to cell 2 during T2
	Neighbour cell		Cell 1	
T3 end condition	Active cell		Cell 1	UE shall perform reselection to cell 1 during T3
	Neighbour cell		Cell 2	
E-UTRA PRACH configuration			4	As specified in table 5.7.1-2 in TS 36.211
E_UTRA Access Barring Information		-	Not Sent	No additional delays in random access procedure.
DRX cycle length		s	1.28	The value shall be used for all cells in the test.
T1		s	>20	During T1, cell 2 shall be powered off, and during the off time the primary scrambling code shall be changed. The intention is to ensure that cell 2 has not been detected by the UE prior to the start of period T2.
T2		s	85	T2 needs to be defined so that cell re-selection reaction time is taken into account.
T3		s	25	T3 need to be defined so that cell re-selection reaction time is taken into account.

Table A.4.3.1.1.1-2: Cell specific test parameters for cell 1(E-UTRA)

Parameter	Unit	Cell 1		
		T1	T2	T3
E-UTRA RF Channel number		1		
BW _{channel}	MHz	10		
OCNG Patterns defined in A.3.2.1.2 (OP.2 FDD)		OP.2 FDD		
PBCH_RA	dB	0		
PBCH_RB	dB			
PSS_RA	dB			
SSS_RA	dB			
PCFICH_RB	dB			
PHICH_RA	dB			
PHICH_RB	dB			

PDCCH_RA	dB			
PDCCH_RB	dB			
PDSCH_RA	dB			
PDSCH_RB	dB			
OCNG_RA ^{Note 1}	dB			
OCNG_RB ^{Note 1}	dB			
Qqualmin for UTRA neighbour cell	dB	-20		
Qrxlevmin for UTRA neighbour cell	dBm	-115		
Qrxlevmin	dBm	-140		
N_{oc}	dBm/15 kHz	-98		
RSRP	dBm/15 KHz	-84	-84	-84
\hat{E}_s/I_{ot}	dB	14	14	14
\hat{E}_s/N_{oc}	dB	14	14	14
Treselection _{EUTRAN}	S	0		
Snointrasearch	dB	50		
Thresh _{x, high} (Note 2)	dB	40		
Propagation Condition		AWGN		
Note 1: OCNG shall be used such that both cells are fully allocated and a constant total transmitted power spectral density is achieved for all OFDM symbols.				
Note 2: This refers to the value of Thresh _{x, high} which is included in E-UTRA system information, and is a threshold for the UTRA target cell				

Table A.4.3.1.1.1-3: Cell specific test parameters for cell 2(UTRA)

Parameter	Unit	Cell 2 (UTRA)		
		T1	T2	T3
UTRA RF Channel Number		Channel 2		
CPICH_Ec/Ior	dB	-10		
PCCPCH_Ec/Ior	dB	-12		
SCH_Ec/Ior	dB	-12		
PICH_Ec/Ior	dB	-15		
OCNS_Ec/Ior	dB	-0.941		
\hat{I}_{or}/I_{oc}	dB	-Infinity	11	-5
I_{oc}	dBm/3,84 MHz	-70		
CPICH_Ec/Io	dB	-Infinity	-10.33	-16.19
CPICH_RSCP	dBm	-Infinity	-69	-85
Propagation Condition		AWGN		
Qqualmin	dB	-20		
Qrxlevmin	dBm	-115		
QrxlevminEUTRA	dBm	-140		
UE_TXPWR_MAX_RACH	dBm	21		
Treselection	s	0		
Sprioritysearch1	dB	62		
Sprioritysearch2	dB	0		
Thresh _{serv, low}	dB	36		
Thresh _{x, low} (Note 1)	dB	50		
Note 1: This refers to the value of Thresh _{x, low} which is included in UTRA system information, and is a threshold for the E-UTRA target cell				

A.4.3.1.1.2 Test Requirements

The cell reselection delay to higher priority is defined as the time from the beginning of time period T2, to the moment when the UE camps on cell 2, and starts to send preambles on the PRACH for sending the RRC CONNECTION REQUEST message on cell 2.

The cell re-selection delay to higher priority shall be less than 81 s.

The rate of correct cell reselections observed during repeated tests shall be at least 90%.

NOTE: The cell re-selection delay to higher priority cell can be expressed as: $T_{\text{higher_priority_search}} + T_{\text{evaluateUTRA_FDD}} + T_{\text{SI-UTRA}}$

Where:

$T_{\text{higher_priority_search}}$	See clause 4.2.2; 60s is assumed in this test case
$T_{\text{evaluateUTRA-FDD}}$	See Table 4.2.2.5.1-1
$T_{\text{SI-UTRA}}$	Maximum repetition period of relevant system info blocks that needs to be received by the UE to camp on a cell; 1280 ms is assumed in this test case.

This gives a total of 80.48 s for higher priority cell search, allow 81 s for higher priority cell reselection in the test case.

A.4.3.1.2 EUTRA FDD-UTRA FDD cell reselection: UTRA FDD is of lower priority

A.4.3.1.2.1 Test Purpose and Environment

This test is to verify the requirement for the EUTRA FDD- UTRA FDD inter-RAT cell reselection requirements specified in clause 4.2.2.5.1 when the UTRA cell is of lower priority.

The test scenario comprises of one UTRA FDD and one E-UTRA FDD cells as given in tables A.4.3.1.2.1-1, A.4.3.1.2.1-2 and A.4.3.1.2.1-3. The test consists of two successive time periods, with time duration of T1 and T2 respectively. Both E-UTRA cell 1 and UTRA cell 2 are already identified by the UE prior to the start of the test. Cell 2 is of lower priority than cell 1.

Table A.4.3.1.2.1-1: General test parameters for EUTRA FDD- lower priority UTRA FDD inter RAT cell re-selection test case

Parameter		Unit	Value	Comment
Initial condition	Active cell		Cell1	E-UTRAN cell
T1 end condition	Active cells		Cell1	UE shall perform reselection to cell 1 during T1 for subsequent iterations of the test
	Neighbour cell		Cell2	
T2 end condition	Active cell		Cell2	UE shall perform reselection to cell 2 during T2
	Neighbour cell		Cell1	
E-UTRA PRACH configuration			4	As specified in table 5.7.1-2 in TS 36.211
E_UTRA Access Barring Information		-	Not Sent	No additional delays in random access procedure.
DRX cycle length		s	1.28	The value shall be used for all cells in the test.
T1		s	85	T1 need to be defined so that cell re-selection reaction time is taken into account.
T2		s	25	T2 need to be defined so that cell re-selection reaction time is taken into account.

Table A.4.3.1.2.1-2: Cell specific test parameters for cell 1 (E-UTRA)

Parameter	Unit	Cell 1	
		T1	T2
E-UTRA RF Channel number		1	
BW_{channel}	MHz	10	
OCNG Patterns defined in A.3.2.1.2 (OP.2 FDD)		OP.2 FDD	
PBCH_RA	dB		
PBCH_RB	dB		
PSS_RA	dB		
SSS_RA	dB		
PCFICH_RB	dB		

PHICH_RA	dB	0	
PHICH_RB	dB		
PDCCH_RA	dB		
PDCCH_RB	dB		
PDSCH_RA	dB		
PDSCH_RB	dB		
OCNG_RA ^{Note 1}	dB		
OCNG_RB ^{Note 1}	dB		
Qqualmin for UTRA neighbour cell	dB	-20	
Qrxlevmin for UTRA neighbour cell	dBm	-115	
Qrxlevmin	dBm	-140	
N_{oc}	dBm/15 kHz	-98	
RSRP	dBm/15 KHz	-86	-102
\hat{E}_s/I_{ot}	dB	12	-4
\hat{E}_s/N_{oc}	dB	12	-4
Treselection ^{EUTRAN}	s	0	
Snonintrasearch	dB	Not sent	
Thresh _{servng, low}	dB	44	
Thresh _{x, low} (Note 2)	dB	42	
Propagation Condition		AWGN	
<p>Note 1: OCNG shall be used such that both cells are fully allocated and a constant total transmitted power spectral density is achieved for all OFDM symbols.</p> <p>Note 2: This refers to the value of Thresh_{x, low} which is included in E-UTRA system information, and is a threshold for the UTRA target cell</p>			

Table A.4.3.1.2.1-3: Cell specific test parameters for cell 2 (UTRA)

Parameter	Unit	Cell 2 (UTRA)	
		T1	T2
UTRA RF Channel Number		Channel 2	
CPICH_Ec/lor	dB	-10	
PCCPCH_Ec/lor	dB	-12	
SCH_Ec/lor	dB	-12	
PICH_Ec/lor	dB	-15	
OCNS_Ec/lor	dB	-0.941	
\hat{I}_{or}/I_{oc}	dB	13	13
I_{oc}	dBm/3,84 MHz	-70	
CPICH_Ec/lo	dB	-10.21	-10.21
CPICH_RSCP	dBm	-67	-67
Propagation Condition		AWGN	
Qqualmin	dB	-20	
Qrxlevmin	dBm	-115	
QrxlevminEUTRA	dBm	-140	
UE_TXPWR_MAX_RACH	dBm	21	
Treselection	s	0	
Sprioritysearch1	dB	42	
Sprioritysearch2	dB	0	
Thresh _{x, high} (Note 1)	dB	48	
<p>Note 1: This refers to the value of Thresh_{x, high} which is included in UTRA system information, and is a threshold for the E-UTRA target cell</p>			

A.4.3.1.2.2 Test Requirements

The cell reselection delay to lower priority is defined as the time from the beginning of time period T2, to the moment when the UE camps on cell 2, and starts to send preambles on the PRACH for sending the RRC CONNECTION REQUEST message on cell 2.

The cell re-selection delay to lower priority shall be less than 21 s.

The rate of correct cell reselections observed during repeated tests shall be at least 90%.

NOTE: The cell re-selection delay to lower priority cell can be expressed as: $T_{\text{evaluateUTRA_FDD}} + T_{\text{SI-UTRA}}$

Where:

$T_{\text{evaluateUTRA-FDD}}$ See Table 4.2.2.5.1-1

$T_{\text{SI-UTRA}}$ Maximum repetition period of relevant system info blocks that needs to be received by the UE to camp on a cell; 1280 ms is assumed in this test case.

This gives a total of 20.48 s for lower priority cell reselection, allow 21 s.

A.4.3.1.3 EUTRA FDD-UTRA FDD cell reselection in fading propagation conditions: UTRA FDD is of lower priority

A.4.3.1.3.1 Test Purpose and Environment

This test is to verify the requirement for the EUTRA FDD- UTRA FDD inter-RAT cell reselection requirements specified in clause 4.2.2.5.1 when the UTRA cell is of lower priority, and to verify the robustness of the UE measurement filtering in a fading environment. The E-UTRA cell is in fading propagation conditions and the UTRA cell is in AWGN propagation conditions.

The test scenario comprises of one UTRA FDD and one E-UTRA FDD cells as given in tables A.4.3.1.3.1-1, A.4.3.1.3.1-2 and A.4.3.1.3.1-3. The test consists of four successive time periods, with time duration of T1 T2, T3 and T4 respectively. Both E-UTRA cell 1 and UTRA cell 2 are already identified by the UE prior to the start of the test. Cell 2 is of lower priority than cell 1.

Table A.4.3.1.3.1-1: General test parameters for EUTRA FDD- lower priority UTRA FDD inter RAT cell re-selection test case

Parameter		Unit	Value	Comment
Initial condition	Active cell		Cell1	E-UTRAN cell
T1 end condition	Active cells		Cell1	UE shall perform reselection to cell 1 during T1 for subsequent iterations of the test
	Neighbour cell		Cell2	
T3 end condition	Active cell		Cell2	UE shall perform reselection to cell 2 during T3
	Neighbour cell		Cell1	
E-UTRA PRACH configuration			4	As specified in table 5.7.1-2 in TS 36.211
E_UTRA Access Barring Information		-	Not Sent	No additional delays in random access procedure.
DRX cycle length		s	1.28	The value shall be used for all cells in the test.
T1		s	<85	T1 need to be defined so that cell re-selection reaction time is taken into account. T1 is terminated when the UE starts to send preambles to cell 1
T2		s	64	The start of T2 is defined as the time when the UE starts to send PRACH preambles to cell 1
T3		s	<25	T3 need to be defined so that cell re-selection reaction time is taken into account. T3 is terminated when the UE starts to send preambles to cell 2
T4		s	64	The start of T4 is defined as the time when the UE starts to send PRACH preambles to cell 2

Table A.4.3.1.3.1-2: Cell specific test parameters for cell 1 (E-UTRA)

Parameter	Unit	Cell 1			
		T1	T2	T3	T4
E-UTRA RF Channel number		1			
BW _{channel}	MHz	10			
Correlation Matrix and Antenna Configuration		1x2 Low			
OCNG Patterns defined in A.3.2.1.2 (OP.2 FDD)		OP.2 FDD			
PSS_RA	dB	0			
SSS_RA	dB	0			
PCFICH_RB	dB	0			
PHICH_RA	dB	0			
PHICH_RB	dB	0			
PDCCH_RA	dB	0			
PDCCH_RB	dB	0			
PDSCH_RA	dB	0			
PDSCH_RB	dB	0			
OCNG_RA ^{Note 1}	dB	0			
OCNG_RB ^{Note 1}	dB	0			
Qqualmin for UTRA neighbour cell	dB	-20			
Qrxlevmin for UTRA neighbour cell	dBm	-115			
Qrxlevmin	dBm	-140			
N_{oc}	dBm/15 kHz	-104			
RSRP	dBm/15 KHz	-82	-82	-107	-107
\hat{E}_s/I_{ot}	dB	22	22	-3	-3
\hat{E}_s/N_{oc}	dB	22	22	-3	-3
Treselection _{EUTRAN}	s	0			
Snonintrasearch	dB	Not sent			
Thresh _{serv, low}	dB	44			
Thresh _{x, low} (Note 2)	dB	42			
Propagation Condition		ETU70			
Note 1: OCNG shall be used such that both cells are fully allocated and a constant total transmitted power spectral density is achieved for all OFDM symbols.					
Note 2: This refers to the value of Thresh _{x, low} which is included in E-UTRA system information, and is a threshold for the UTRA target cell.					

Table A.4.3.1.3.1-3: Cell specific test parameters for cell 2 (UTRA)

Parameter	Unit	Cell 2 (UTRA)			
		T1	T2	T3	T4
UTRA RF Channel Number		Channel 2			
CPICH_Ec/lor	dB	-10			
PCCPCH_Ec/lor	dB	-12			
SCH_Ec/lor	dB	-12			
PICH_Ec/lor	dB	-15			
OCNS_Ec/lor	dB	-0.941			
\hat{I}_{or}/I_{oc}	dB	13	13	13	13
I_{oc}	dBm/3,84 MHz	-70			
CPICH_Ec/lo	dB	-10.21	-10.21	-10.21	-10.21
CPICH_RSCP	dBm	-67	-67	-67	-67
Propagation Condition		AWGN			
Qqualmin	dB	-20			
Qrxlevmin	dBm	-115			
QrxlevminEUTRA	dBm	-140			
UE_TXPWR_MAX_RACH	dBm	21			

Treselection	s	0
Sprioritysearch1	dB	42
Sprioritysearch2	dB	0
Thresh _{x, high} (Note 1)	dB	44
Note 1 : This refers to the value of Thresh _{x, high} which is included in UTRA system information, and is a threshold for the E-UTRA target cell		

A.4.3.1.3.2 Test Requirements

The probability of reselection from cell 1 to cell 2 during T2 observed during testing shall be less than 10%

The probability of reselection from cell 2 to cell 1 during T4 observed during testing shall be less than 10%

The cell reselection delay to lower priority is defined as the time from the beginning of time period T3, to the moment when the UE camps on cell 2, and starts to send preambles on the PRACH for sending the RRC CONNECTION REQUEST message on cell 2. In order to evaluate reselection delay, the system simulator first needs to verify that the UE is camped on cell 1 at the start of T3

The cell re-selection delay to lower priority shall be less than 21 s.

The rate of correct cell reselections observed during repeated tests shall be at least 90%.

NOTE: The cell re-selection delay to lower priority cell can be expressed as: $T_{\text{evaluateUTRA_FDD}} + T_{\text{SI-UTRA}}$

Where:

$T_{\text{evaluateUTRA-FDD}}$ See Table 4.2.2.5.1-1

$T_{\text{SI-UTRA}}$ Maximum repetition period of relevant system info blocks that needs to be received by the UE to camp on a cell; 1280 ms is assumed in this test case.

This gives a total of 20.48 s for lower priority cell reselection, allow 21 s.

A.4.3.1.4 EUTRA FDD-UTRA FDD cell reselection: UTRA FDD is of lower priority for 5MHz bandwidth

A.4.3.1.4.1 Test Purpose and Environment

The purpose of this test case is the same as for the test defined in subclause A.4.3.1.2.1

The parameters of this test are the same as defined in Subclause A.4.3.1.2.1 except that the values of the parameters in the Table A.4.3.1.4.1-2 will replace the values of the corresponding parameters in A.4.3.1.2.1-2.

This is according to the principle defined in section A.3.7.2.

Table A.4.3.1.4.1-2: Cell specific test parameters for cell 1 (E-UTRA) for 5MHz bandwidth

Parameter	Unit	Cell 1	
		T1	T2
BW _{channel}	MHz	5	
OCNG Patterns defined in A.3.2.1.16 (OP.16 FDD)		OP.16 FDD	
Note 1: See Table A.4.3.1.2.1-2 for the other parameters.			

A.4.3.1.4.2 Test Requirements

The test requirements defined in section A.4.3.1.2.1 shall apply to this test case.

A.4.3.1.5 Idle mode FDD to UTRA FDD interRAT reselection

A.4.3.1.5.1 Test Purpose and Environment

This test is to verify the requirement for the E-UTRA FDD-UTRA FDD inter-RAT cell reselection requirements for increased UE carrier monitoring specified in clause 4.2.2.4.

The test scenario comprises of indicating 8 UTRA FDD interfrequency cells on 6 different carriers in the neighbour list of cell 1 as given in table A.4.3.1.5-1 and cells 2 and 3 as given in table A.4.3.1.5-2. Each repetition of the test consists of five successive time periods, with time duration of T0, T1, T2, T3 and T4 respectively. In the initialisation phase and at the start of each repetition of T0, the test equipment provides signals for cell 1 (serving cell), and selects frequencies for cells 2 and 3 which are chosen from the 6 inter-RAT layers which are configured in the UE neighbour cell list as described in general and cell specific parameters. The neighbour lists of cells 2 and 3 shall include the frequency of cell 1 in the normal performance group and shall exclude the other frequencies configured to the UE in the test.

Cell 1, 2 and 3 are identified by the UE during time period T0. Cell 1, cell 2 and cell 3 all belong to different tracking areas. Furthermore, UE has not registered with network for the tracking area containing cell 2 or 3. Cells 2 and 3 all have lower absolute priority than cell 1.

Table A.4.3.1.5-1: General test parameters for E-UTRAN FDD- UTRAN FDD inter frequency cell re-selection test case

Parameter		Unit	Value	Comment
T0	Active cell		Cell 1	T0 is repeated on each repetition of the test. In T0 the test equipment selects frequencies for cell 2 and 3, and then time is allowed for the UE to identify the neighbour cells. See cell specific parameters for detailed settings.
T1 start condition	Active cell		Cell 1	
T1 end condition	Active cell		Cell 2	UE shall perform reselection to cell 2 during T1
	Neighbour cell		Cell 1, cell 3	
T2 end condition	Active cell		Cell 1	UE shall perform reselection to cell 1 during T2
	Neighbour cell		Cell 2, cell 3	
T3 end condition	Active cell		Cell 3	UE shall perform reselection to cell 3 during T3
	Neighbour cell		Cell 1, cell 2	
T4 end condition	Active cell		Cell 1	UE shall perform reselection to cell 1 during T4
	Neighbour cell		Cell 2, cell 3	
UE configured E-UTRA RF Channel Number			1	Serving cell and six UTRA FDD carrier frequencies are used in the UE neighbour cell list. Frequencies 5,6 and 7 are indicated to have reduced performance
UE configured UTRA RF Channel Number			2,3,4,5,6,7	
Test equipment configuration			Cell 1 uses E-UTRA RF channel number 1 Cells 2,3,4 are randomly selected to use different frequencies selected from frequencies 2,3,4,5,6,7	
PRACH configuration			4	As specified in table 5.7.1-2 in TS 36.211
Access Barring Information		-	Not Sent	No additional delays in random access procedure.
DRX cycle length		s	1.28	The value shall be used for all cells in the test.
T0		s	(test equipment frequency selection and configuration time) + 960	Initialisation time need to be defined so that cell detection time is taken into account.

T1	s	60	T1 need to be defined so that cell re-selection reaction time is taken into account.
T2	s	25	T2 need to be defined so that cell re-selection reaction time is taken into account
T3	s	350	T3 need to be defined so that cell re-selection reaction time is taken into account.
T4	s	25	T4 need to be defined so that cell re-selection reaction time is taken into account

Table A.4.3.1.5-2: Cell specific test parameters for E-UTRAN FDD- UTRAN FDD inter-RAT cell reselection test case in AWGN cell 1 (E-UTRAN)

Parameter	Unit	Cell 1				
		T0	T1	T2	T3	T4
E-UTRA RF Channel number		1				
BW _{channel}	MHz	5MHz: N _{RB} = 25 10MHz: N _{RB} = 50				
Io	dBm/4.5MHz(25RB) dBm/9Mhz(50RB)	-59.06 -56.05	-71.77 -68.76	-59.06 -56.05	-71.77 -68.76	-59.06 -56.05
PDSCH parameters: DL Reference Measurement Channel		OP.16 FDD (5MHz) OP.2 FDD (10MHz)				
PBCH RA	dB	0				
PBCH RB	dB					
PSS RA	dB					
SSS RA	dB					
PCFICH RB	dB					
PHICH RA	dB					
PHICH RB	dB					
PDCCH RA	dB					
PDCCH RB	dB					
PDSCH RA	dB					
PDSCH RB	dB					
OCNG_RA ^{Note 1}	dB					
OCNG_RB ^{Note 1}	dB					
Qrxlevmin	dBm					
N _{oc} ^{Note 2}	dBm	-98				
RSRP ^{Note 3}	dBm	-84	-102	-84	-102	-84
\hat{E}_s / I_{ot}	dB	14	-4	14	-4	14
\hat{E}_s / N_{oc}	dB	14	-4	14	-4	1
Treselection _{EUTRAN}	s	0				
Snonintrasearch	dB	62				
Thresh _{serv, low}	dB	44				
Thresh _{x, low} (Note 4)	dB	40				
Propagation Condition		AWGN				
Note 1: OCNG shall be used such that the cell is fully allocated and a constant total transmitted power spectral density is achieved for all OFDM symbols. Note 2: Interference from other cells and noise sources not specified in the test is assumed to be constant over subcarriers and						

time and shall be modelled as AWGN of appropriate power for to be fulfilled.

Note 3: RSRP levels have been derived from other parameters for information purposes. They are not settable parameters themselves.

Note 4: This refers to the value of $Thresh_{x, low}$ which is included in E-UTRA system information, and is a threshold for the UTRA target cell

Table A.4.3.1.5-3: Cell specific test parameters for cells 2 and 3 (UTRA)

Parameter	Unit	Cell 2					Cell 3				
		T0	T1	T2	T3	T4	T0	T1	T2	T3	T4
UTRA RF Channel Number		Randomly selected from 1, 2, 3 such that cell 2 is in the normal performance group					Randomly selected from 4, 5, 6 such that cell 3 is in the reduced performance group				
CPICH_Ec/lor	dB	-10					-10				
PCCPCH_Ec/lor	dB	-12					-12				
SCH_Ec/lor	dB	-12					-12				
PICH_Ec/lor	dB	-15					-15				
OCNS_Ec/lor	dB	-0.941					0.941				
\hat{I}_{or}/I_{oc}	dB	+11	+11	+11	-5	+11	+11	-5	+11	+11	+11
I_{oc}	dBm/3,84 MHz	-70					-70				
CPICH_Ec/lo	dB	-10.3 3	-10.3 3	-10.3 3	-16.1 91	-10.3 3	-10.3 3	-16.1 9	-10.3 3	-10.3 3	-10.3 3
CPICH_RSCP	dBm	-69	-69	-69	-85	-69	-69	-85	-69	-69	-69
Propagation Condition		AWGN					AWGN				
Qqualmin	dB	-20					-20				
Qrxlevmin	dBm	-115					-115				
QrxlevminEUTRA	dBm	-140					-140				
UE_TXPWR_MAX_RACH	dBm	21					21				
Treselection	s	0					0				
Sprioritysearch1	dB	40					40				
Sprioritysearch2	dB	0					0				
Thresh _{x,high} (Note 1)	dB	50					50				
Note 1: This refers to the value of $Thresh_{x, high}$ which is included in UTRA system information, and is a threshold for the E-UTRA target cell											

A.4.3.1.5.2 Test Requirements

The cell reselection delay is defined as the time from the beginning of a relevant time period, to the moment when the UE camps on the target cell, and starts to send preambles on the PRACH for sending the RRC CONNECTION REQUEST message to perform a Tracking Area Update procedure on the target cell.

The reselection delays shall meet the requirements in table A.4.3.1.5.2-1

Table A.4.3.1.5.2-1

Time phase	Target cell	Requirement for reselection delay (seconds)
T0	Cell 1	
T1	Cell 2 (normal performance group)	59
T2	Cell 1 (normal performance group)	21
T3	Cell 3 (reduced performance group)	347
T4	Cell 1 (normal performance group)	21

NOTE: The cell re-selection delay to a normal performance group cell can be expressed as: $(N_{UTRA_carrier,normal}) * T_{evaluateUTRA_FDD} + T_{SI-UTRA}$ and to a reduced performance group cell can be expressed as: $6 * N_{UTRA_carrier,reduced} * T_{evaluateUTRA_FDD} + T_{SI-UTRA}$.

Where:

$T_{\text{evaluateUTRA-FDD}}$ See Table 4.2.2.5.1-1
 $T_{\text{SI-UTRA}}$ Maximum repetition period of relevant system info blocks that needs to be received by the UE to camp on a cell; 1280 ms is assumed in this test case.

This gives a total of 58.88 s for normal performance group reselection, allow 21 s, and gives a total of 346.88 s for reduced performance group reselection, allow 347 s for reduced performance group in the test case. For reselections back to cell 1 since only one frequency is configured, the requirement is $T_{\text{evaluate,E-UTRAN}} + T_{\text{SI}} = 20.48$ s, allow 21 s.

A.4.3.2 E-UTRAN FDD – UTRAN TDD:

A.4.3.2.1 Test Purpose and Environment

A.4.3.2.1.1 Void

A.4.3.2.1.2 1.28Mcps TDD option

This test is to verify the requirement for the E-UTRA FDD to UTRA TDD inter-RAT cell reselection requirements specified in clause 4.2.2.5.2 when the UTRA cell is of lower priority.

This test scenario comprised of 1 E-UTRA FDD serving cell (Cell 1), and 1 UTRA TDD cell (Cell 2) to be re-selected. Test parameters are given in table A.4.3.2.1.2-1, A.4.3.2.1.2-2, and A.4.3.2.1.2-3. The test consists of two successive time periods, with time duration of T1 and T2 respectively. Cell 2 is of lower priority than cell 1.

The ranking of the cells shall be made according to the cell reselection criteria specified in TS36.304.

Table A.4.3.2.1.2-1: General test parameters for E-UTRA FDD to UTRA (1.28 Mcps TDD OPTION) Cell Re-selection

Parameter		Unit	Value	Comment
Initial condition	Active cell		Cell1	E-UTRAN cell
T1 end condition	Active cell		Cell1	UE shall perform reselection to cell 1 during T1 for subsequent iterations of the test
	Neighbour cell		Cell2	1.28 Mcps TDD OPTION cell
T2 end condition	Active cell		Cell2	UE shall perform reselection to cell 2 during T2
	Neighbour cell		Cell1	E-UTRA FDD cell
CP length of cell 1			normal	
E-UTRA PRACH configuration			4	As specified in table 5.7.1-2 in TS 36.211
Time offset between cells			3 ms	Asynchronous cells
Access Barring Information		-	Not sent	No additional delays in random access procedure.
Treselection		s	0	
DRX cycle length		s	1,28	
HCS			Not used	
T1		s	85	T1 need to be defined so that cell re-selection reaction time is taken into account.
T2		s	25	

Table A.4.3.2.1.2-2: Cell specific test parameters for cell re-selection E-UTRA FDD to UTRA TDD test case (cell 1)

Parameter	Unit	Cell 1	
		T1	T2
E-UTRA RF Channel Number		1	
BW_{channel}	MHz	10	
PBCH_RA	dB	0	0
PBCH_RB	dB		
PSS_RA	dB		
SSS_RA	dB		

PCFICH_RB	dB		
PHICH_RA	dB		
PHICH_RB	dB		
PDCCH_RA	dB		
PDCCH_RB	dB		
PDSCH_RA	dB		
PDSCH_RB	dB		
OCNG_RA ^{Note1}	dB		
OCNG_RB ^{Note1}	dB		
Qrxlevmin	dBm/15kHz	-140	-140
N_{oc}	dBm/15kHz	-98	
RSRP	dBm/15kHz	-87	-101
\hat{E}_s/I_{ot}	dB	11	-3
S _{nonintra} search	dB	Not sent	
Thresh _{serv} ,low	dB	46 (-94dBm)	
Thresh _x ,low (Note2)	dB	24 (-79dBm)	
Propagation Condition		AWGN	
Note 1: OCNG shall be used such that cell is fully allocated and a constant total transmitted power spectral density is achieved for all OFDM symbols.			
Note2: This refers to the value of Thresh _x ,low which is included in E-UTRA system information, and is a threshold for the UTRA TDD target cell			

Table A.4.3.2.1.2-3: Cell specific test parameters for cell re-selection E-UTRA FDD to UTRA TDD test case (cell 2)

Parameter	Unit	Cell 2 (UTRA)			
		0		DwPTS	
Timeslot Number		T1	T2	T1	T2
UTRA RF Channel Number (Note1)		Channel 2			
PCCPCH_Ec/I _{or}	dB	-3	-3	0	0
DwPCH_Ec/I _{or}	dB			0	0
OCNS_Ec/I _{or}	dB	-3	-3		
\hat{I}_{or}/I_{oc}	dB	11	11	11	11
I_{oc}	dBm/1.28 MHz	-80			
PCCPCH RSCP	dBm	-72	-72	n.a.	n.a.
Propagation Condition		AWGN			
Qrxlevmin	dBm	-103			
Qoffset _{1s,n}	dB	C1, C2: 0			
Qhyst _{1s}	dB	0			
Thresh _x ,high (Note2)	dB	46 (-94dBm)			
Note1: In the case of multi-frequency cell, the UTRA RF Channel Number is the primary frequency's channel number.					
Note2: This refers to the value of Thresh _x ,high which is included in UTRA system information, and is a threshold for the E-UTRA target cell					

A.4.3.2.1.3 Void

A.4.3.2.2 Test Requirements

A.4.3.2.2.1 1.28Mcps TDD option

The cell reselection delay to lower priority is defined as the time from the beginning of time period T2, to the moment when the UE camps on cell 2, and starts to send the SYNCH-UL sequence in the UpPTS for sending the RRC CONNECTION REQUEST message on cell 2.

The cell re-selection delay to lower priority shall be less than 21 s.

The rate of correct cell reselections observed during repeated tests shall be at least 90%.

NOTE: The cell re-selection delay to lower priority cell can be expressed as: $T_{\text{evaluateUTRA_TDD}} + T_{\text{SI-UTRA}}$

Where:

$T_{\text{evaluateUTRA_TDD}}$ 19.2s, See table table 4.2.2.5.2-1

$T_{\text{SI-UTRA}}$ Maximum repetition period of relevant system info blocks that needs to be received by the UE to camp on a cell; 1280 ms is assumed in this test case.

This gives a total of 20.48 s, allow 21 s for lower priority cell reselection in the test case.

A.4.3.2.2.3 Void

A.4.3.2A E-UTRA FDD to UTRA TDD cell re-selection for IncMon

A.4.3.2A.1 Test Purpose and Environment

This test is to verify the requirement for the E-UTRA FDD to UTRA TDD inter-RAT cell reselection requirements for increased UE carrier monitoring specified in clause 4.2.2.4. UTRA TDD cells are of lower priority than E-UTRA serving cell.

The test scenario comprises of indicating 7 UTRA TDD inter-RAT cells on 7 different carriers in the neighbour list of cell 1 as given in tables A.4.3.2A.1-1, A.4.3.2A.1-2 and A.4.3.2A.1-3. Each repetition of the test consists of five successive time periods, with time duration of T0, T1, T2, T3, and T4 respectively. In the initialisation phase and at the start of each repetition of T0, the test equipment provides signals for cell 1 (E-UTRA serving cell), and selects frequencies for cells 2 and 3 which are chosen from the 7 inter-RAT layers which are configured in the UE neighbour cell list as described in general and cell specific parameters. The neighbour lists of cells 2 and 3 shall include the frequency of cell 1 in the normal performance group and shall exclude the other UTRA TDD frequencies configured to the UE in the test.

Cell 1, 2 and 3 are identified by the UE during time phase T0. Cell 1, cell 2 and cell 3 belong to different tracking areas. Furthermore, UE has not registered with network for the tracking area containing cell 2 or 3.

Table A.4.3.2A.1-1: General test parameters for E-UTRA FDD to UTRA TDD inter-RAT cell re-selection test case

Parameter		Unit	Value	Comment
T0	Active cell		Cell1	T0 is repeated on each repetition of the test. In T0 the test equipment selects frequencies for cell 2, 3 and then time is allowed for the UE to identify the neighbour cells. See cell specific parameters for detailed settings.
T1 start condition	Active cell		Cell 1	
T1 end condition	Active cell		Cell2	UE shall perform reselection to cell 2 during T1
	Neighbour cell		Cell1	
T2 end condition	Active cell		Cell1	UE shall perform reselection to cell 1 during T2
T3 end condition	Active cell		Cell3	UE shall perform reselection to cell 3 during T3
	Neighbour cell		Cell1	
T4 end condition	Active cell		Cell1	UE shall perform reselection to cell 1 in T4 so that next repetition of test can start from T0
UE configured UTRA RF Channel Number			1, 2, 3, 4, 5, 6, 7	Seven UTRA TDD carrier frequencies are used in the UE neighbour cell list. Frequencies 4, 5, 6, and 7 are indicated to have reduced performance
Test equipment configuration			Cell 1, 2, 3	Cell 1 uses E-UTRA RF channel number 1 Cells 2 is randomly selected to use different frequencies selected from UTRA frequencies 1, 2, 3. Cells 3 is randomly selected to use different frequencies selected from UTRA frequencies 4, 5, 6, 7.
CP length of cell 1			normal	

PRACH configuration		4	As specified in table 5.7.1-2 in TS 36.211 [16]
Access Barring Information	-	Not Sent	No additional delays in random access procedure.
$T_{\text{reselection}}$	s	0	
HCS		Not used	
DRX cycle length	s	1.28	The value shall be used for all cells in the test.
T0	s	(Test equipment frequency selection and configuration time) + 960	T0 is defined so that the Test equipment selects frequencies and configures the cells, then the UE cell detection time is taken into account.
T1	s	60	T1 need to be defined so that cell re-selection reaction time is taken into account.
T2	s	25	T2 need to be defined so that cell re-selection reaction time is taken into account
T3	s	500	T3 need to be defined so that cell re-selection reaction time is taken into account.
T4	s	25	T4 need to be defined so that cell re-selection reaction time is taken into account

Table A.4.3.2A.1-2: E-UTRA Cell specific test parameters for E-UTRA FDD to UTRA TDD inter-RAT cell reselection test case in AWGN

Parameter	Unit	Cell 1				
		T0	T1	T2	T3	T4
E-UTRA RF Channel number		1				
BW_{channel}	MHz	5MHz: $N_{RB} = 25$ 10MHz: $N_{RB} = 50$				
OCNG Patterns		5MHz: OP.16 FDD 10MHz: OP.2 FDD				
PBCH_RA	dB	0				
PBCH_RB	dB					
PSS_RA	dB					
SSS_RA	dB					
PCFICH_RB	dB					
PHICH_RA	dB					
PHICH_RB	dB					
PDCCH_RA	dB					
PDCCH_RB	dB					
PDSCH_RA	dB					
PDSCH_RB	dB					
OCNG_RA ^{NOTE 1}	dB					
OCNG_RB ^{NOTE 1}	dB					
N_{oc} ^{NOTE 2}	dBm/15kHz					
\hat{E}_s / N_{oc}	dB	11	-3	11	-3	11
\hat{E}_s / I_{ot} ^{NOTE 3}	dB	11	-3	11	-3	11
RSRP ^{NOTE 3}	dBm/15kHz	-87	-101	-87	-101	-87
$Q_{rxlevmin}$	dBm/15kHz	-140				
$S_{nonintrasearch}$	dB	Not sent				
Thresh _{serv, low}	dB	46 (-94dBm)				
Thresh _{x, low} ^{NOTE 4}	dB	24 (-79dBm)				
Propagation Condition		AWGN				
Antenna Configuration		1x2				
<p>NOTE 1: OCNG shall be used such that both cells are fully allocated and a constant total transmitted power spectral density is achieved for all OFDM symbols.</p> <p>NOTE 2: Interference from other cells and noise sources not specified in the test is assumed to be constant over subcarriers and time and shall be modelled as AWGN of appropriate power for to be fulfilled.</p> <p>NOTE 3: E_s/I_{ot} and RSRP levels have been derived from other parameters for information purposes. They are not settable parameters themselves.</p>						

NOTE 4: This refers to the value of $Thresh_{x, low}$ which is included in E-UTRA system information, and is a threshold for the UTRA TDD target cell.

Table A.4.3.2A.1-3: UTRA TDD Cell specific test parameters for E-UTRA FDD to UTRA TDD inter-RAT cell reselection test case in AWGN

Parameter	Unit	Cell 2 (UTRA TDD)									
		0					DwPTS				
Timeslot Number		T0	T1	T2	T3	T4	T0	T1	T2	T3	T4
UTRA RF Channel Number <small>NOTE 1</small>		Randomly selected from 1, 2, 3 such that cell 2 is in the normal performance group									
PCCPCH_Ec/lor	dB	-3									
DwPCH_Ec/lor	dB						0				
OCNS_Ec/lor	dB	-3									
I_{oc}	dBm/ 1.28 MHz	-80									
\hat{I}_{or}/I_{oc}	dB	-3	11	-3	-3	-3	-3	11	-3	-3	-3
PCCPCH RSCP	dBm	-86	-72	-86	-86	-86	n.a.				
Propagation Condition		AWGN									
$Q_{rxlevmin}$	dBm	-103									
$Q_{offset1_{s,n}}$	dB	C1, C2: 0									
Q_{hyst1_s}	dB	0									
$S_{prioritysearch1}$	dB	24 (-79dBm)									
$S_{prioritysearch2}$	dB	0									
$Thresh_{x, high}$ <small>NOTE 2</small>	dB	46 (-94dBm)									
$S_{searchE-UTRA}$	dB	Not send									
Time offset to cell1	ms	3									
NOTE 1: In the case of multi-frequency cell, the UTRA RF Channel Number is the primary frequency's channel number.											
NOTE 2: This refers to the value of $Thresh_{x, high}$ which is included in UTRA system information, and is a threshold for the E-UTRA target cell											

Table A.4.3.2A.1-4:

Parameter	Unit	Cell 3 (UTRA TDD)									
		0					DwPTS				
Timeslot Number		T0	T1	T2	T3	T4	T0	T1	T2	T3	T4
UTRA RF Channel Number <small>NOTE 1</small>		Randomly selected from 4, 5, 6, 7 such that cell 3 is in the reduced performance group									
PCCPCH_Ec/lor	dB	-3									
DwPCH_Ec/lor	dB						0				
OCNS_Ec/lor	dB	-3									
I_{oc}	dBm/ 1.28 MHz	-80									
\hat{I}_{or}/I_{oc}	dB	-3	-3	-3	11	-3	-3	-3	-3	11	-3
PCCPCH RSCP	dBm	-86	-86	-86	-72	-86	n.a.				
Propagation Condition		AWGN									
$Q_{rxlevmin}$	dBm	-103									
$Q_{offset1_{s,n}}$	dB	C1, C2: 0									
Q_{hyst1_s}	dB	0									
$S_{prioritysearch1}$	dB	24 (-79dBm)									
$S_{prioritysearch2}$	dB	0									
$Thresh_{x, high}$ <small>NOTE 2</small>	dB	46 (-94dBm)									
$S_{searchE-UTRA}$	dB	Not send									
Time offset to cell1	ms	3									
Time offset to cell2	µs	3									

NOTE 1: In the case of multi-frequency cell, the UTRA RF Channel Number is the primary frequency's channel number.

NOTE 2: This refers to the value of $\text{Thresh}_{x, \text{high}}$ which is included in UTRA system information, and is a threshold for the E-UTRA target cell

A.4.3.2A.2 Test Requirements

The cell reselection delay is defined as the time from the beginning of a relevant time period, to the moment when the UE camps on the target cell, and starts to send the SYNCH-UL sequence in the UpPTS on cell 2, 3 for sending the RRC CONNECTION REQUEST message to perform a Tracking Area Update procedure on the target cell.

The reselection delays shall meet the requirements in table A.4.3.2A.2-1

Table A.4.3.2A.2-1: Test requirements for E-UTRA FDD to UTRA TDD inter-RAT cell reselection

Time phase	Target cell	Requirement for reselection delay (seconds)
T1	Cell 2 (normal performance group)	58.9
T3	Cell 3 (reduced performance group)	462.1

The rate of correct cell reselections observed during repeated tests shall be at least 90%, with a successful reselection counted if it is within the required time regardless of the carrier frequencies involved. At least 90% of reselections to the reduced performance group shall be within the required time, and at least 90% of reselections to the normal performance group shall be within the required time.

NOTE: The cell re-selection delay to a normal performance group cell can be expressed as: $N_{\text{UTRA_carrier_TDD,normal}} * T_{\text{evaluateUTRA_TDD}} + T_{\text{SI_UTRA}}$, and to a reduced performance group cell can be expressed as: $6 * N_{\text{UTRA_carrier_TDD,reduced}} * T_{\text{evaluateUTRA_TDD}} + T_{\text{SI_UTRA}}$,

Where:

$T_{\text{evaluateUTRA_TDD}}$ 19.2s, See Table 4.2.2.5.2-1

$T_{\text{SI_UTRA}}$ Maximum repetition period of relevant system info blocks that needs to be received by the UE to camp on a cell; 1280 ms is assumed in this test case.

This gives a total of $3 * 19.2 + 1.28 = 58.88$ s for normal performance group reselection and $6 * 4 * 19.2 + 1.28 = 462.08$ s for reduced performance group reselection, allow 58.9s for normal performance group and 462.1s for reduced performance group in the test case.

Since only one E-UTRA frequency is configured and signal level of UTRA cell is lower than threshold of $S_{\text{prioritysearch}}$, the UE shall select back to cell 1 (E-UTRA cell) within $K_{\text{carrier}} * T_{\text{evaluateEUTRA}} + T_{\text{SI}} = 19.2 + 1.28 = 20.48$ s.

A.4.3.3 E-UTRAN TDD – UTRAN FDD:

A.4.3.3.1 Test Purpose and Environment

This test is to verify the requirement for the EUTRA TDD- UTRA FDD inter-RAT cell reselection requirements specified in clause 4.2.2.5.1 when the UTRA cell is of lower priority.

The test scenario comprises of one UTRA FDD and one E-UTRA TDD cells as given in tables A.4.3.3.1-1, A.4.3.3.1-2 and A.4.3.3.1-3. The test consists of two successive time periods, with time duration of T1 and T2 respectively. Both E-UTRA cell 1 and UTRA cell 2 are already identified by the UE prior to the start of the test. Cell 2 is of lower priority than cell 1.

Table A.4.3.3.1-1: General test parameters for EUTRA TDD- lower priority UTRA FDD inter RAT cell reselection test case

	Parameter	Unit	Value	Comment
Initial condition	Active cell		Cell1	E-UTRAN cell
T1 end condition	Active cells		Cell1	UE shall perform reselection to cell 1 during T1 for subsequent iterations of the test

	Neighbour cell		Cell2	
T2 end condition	Active cell		Cell2	UE shall perform reselection to cell 2 during T2
	Neighbour cell		Cell1	
E-UTRA PRACH configuration			53	As specified in table 5.7.1-3 in TS 36.211
Uplink-downlink configuration of cell 1			1	As specified in table 4.2.2 in TS 36.211
Special subframe configuration of cell 1			6	As specified in table 4.2.1 in TS 36.211
E_UTRA Access Barring Information		-	Not Sent	No additional delays in random access procedure.
DRX cycle length		s	1.28	The value shall be used for all cells in the test.
T1		s	85	T1 need to be defined so that cell re-selection reaction time is taken into account.
T2		s	25	T2 need to be defined so that cell re-selection reaction time is taken into account.

Table A.4.3.3.1-2: Cell specific test parameters for cell 1(E-UTRA)

Parameter	Unit	Cell 1	
		T1	T2
E-UTRA RF Channel number		1	
$BW_{channel}$	MHz	10	
OCNG Patterns defined in A.3.2.2.2 (OP.2 TDD)		OP.2 TDD	
PBCH_RA	dB	0	
PBCH_RB	dB		
PSS_RA	dB		
SSS_RA	dB		
PCFICH_RB	dB		
PHICH_RA	dB		
PHICH_RB	dB		
PDCCH_RA	dB		
PDCCH_RB	dB		
PDSCH_RA	dB		
PDSCH_RB	dB		
OCNG_RA ^{NOTE 1}	dB		
OCNG_RB ^{NOTE 1}	dB		
Qqualmin for UTRA neighbour cell	dB		
Qrxlevmin for UTRA neighbour cell	dBm	-115	
Qrxlevmin	dBm	-140	
N_{oc}	dBm/15 kHz	-98	
RSRP	dBm/15 KHz	-86	-102
\hat{E}_s / I_{ot}	dB	12	-4
\hat{E}_s / N_{oc}	dB	12	-4
Treselection ^{EUTRAN}	s	0	
Snoninrasearch	dB	Not sent	
Thresh _{servng, low}	dB	44	
Thresh _{x, low} (NOTE 2)	dB	42	
Propagation Condition		AWGN	
NOTE 1: OCNG shall be used such that both cells are fully allocated and a constant total transmitted power spectral density is achieved for all OFDM symbols.			
NOTE 2: This refers to the value of Thresh _{x, low} which is included in E-UTRA system information, and is a threshold for the UTRA target cell			

Table A.4.3.3.1-3: Cell specific test parameters for cell 2 (UTRA)

Parameter	Unit	Cell 2 (UTRA)	
		T1	T2
UTRA RF Channel Number		Channel 2	
CPICH_Ec/lor	dB	-10	
PCCPCH_Ec/lor	dB	-12	
SCH_Ec/lor	dB	-12	
PICH_Ec/lor	dB	-15	
OCNS_Ec/lor	dB	-0.941	
\hat{I}_{or}/I_{oc}	dB	13	13
I_{oc}	dBm/3,84 MHz	-70	
CPICH_Ec/lo	dB	-10.21	-10.21
CPICH_RSCP	dBm	-67	-67
Propagation Condition		AWGN	
Qqualmin	dB	-20	
Qrxlevmin	dBm	-115	
QrxlevminEUTRA	dBm	-140	
UE_TXPWR_MAX_RACH	dBm	21	
Treselection	s	0	
Sprioritysearch1	dB	42	
Sprioritysearch2	dB	0	
Thresh _{x, high} (NOTE 1)	dB	48	
NOTE 1 : This refers to the value of Thresh _{x, high} which is included in UTRA system information, and is a threshold for the E-UTRA target cell			

A.4.3.3.2 Test Requirements

The cell reselection delay to lower priority is defined as the time from the beginning of time period T2, to the moment when the UE camps on cell 2, and starts to send preambles on the PRACH for sending the RRC CONNECTION REQUEST message on cell 2.

The cell re-selection delay to lower priority shall be less than 21 s.

The rate of correct cell reselections observed during repeated tests shall be at least 90%.

NOTE: The cell re-selection delay to lower priority cell can be expressed as: $T_{\text{evaluateUTRA_FDD}} + T_{\text{SI-UTRA}}$

Where:

$T_{\text{evaluateUTRA-FDD}}$ See Table 4.2.2.5.1-1

$T_{\text{SI-UTRA}}$ Maximum repetition period of relevant system info blocks that needs to be received by the UE to camp on a cell; 1280 ms is assumed in this test case.

This gives a total of 20.48 s for lower priority cell reselection, allow 21 s.

A.4.3.3A Idle mode TDD to UTRA FDD interRAT reselection

A.4.3.3A.1 Test Purpose and Environment

This test is to verify the requirement for the E-UTRA TDD-UTRA FDD inter-RAT cell reselection requirements for increased UE carrier monitoring specified in clause 4.2.2.4.

The test scenario comprises of indicating 8 UTRA FDD interfrequency cells on 6 different carriers in the neighbour list of cell 1 as given in table A.4.3.3A.1-2 and table A.4.3.3A.1-3 and cells 2 and 3 as given in table A.4.3.3A.1-4. Each repetition of the test consists of five successive time periods, with time duration of T0, T1, T2, T3 and T4 respectively. In the initialisation phase and at the start of each repetition of T0, the test equipment provides signals for cell 1 (serving cell), and selects frequencies for cells 2 and 3 which are chosen from the 6 inter-RAT layers which are configured in the UE neighbour cell list as described in general and cell specific parameters. The neighbour lists of cells 2 and 3 shall

include the frequency of cell 1 in the normal performance group and shall exclude the other frequencies configured to the UE in the test.

Cell 1, 2 and 3 4 are identified by the UE during time period T0. Cell 1, cell 2 and cell 3 belong to different tracking areas. Furthermore, UE has not registered with network for the tracking area containing cell 2 or 3. Cells 1, 2 and 3 4 all have lower absolute priority than cell 1.

Table A.4.3.3A.1-1: General test parameters for E-UTRAN TDD- UTRAN FDD inter frequency cell re-selection test case

Parameter		Unit	Value	Comment
T0	Active cell		Cell 1	T0 is repeated on each repetition of the test. In T0 the test equipment selects frequencies for cell 2, 3 and then time is allowed for the UE to identify the neighbour cells. See cell specific parameters for detailed settings.
T1 start condition	Active cell		Cell 1	
T1 end condition	Active cell		Cell 2	UE shall perform reselection to cell 2 during T1
	Neighbour cell		Cell 1, cell 3	
T2 end condition	Active cell		Cell 1	UE shall perform reselection to cell 1 during T2
	Neighbour cell		Cell 2, cell 3	
T3 end condition	Active cell		Cell 3	UE shall perform reselection to cell 3 during T3
	Neighbour cell		Cell 1, cell 2	
T4 end condition	Active cell		Cell 1	UE shall perform reselection to cell 1 during T4
	Neighbour cell		Cell 2, cell 3	
UE configured E-UTRA RF Channel Number			1	Serving cell and six UTRA FDD carrier frequencies are used in the UE neighbour cell list. Frequencies 5,6 and 7 are indicated to have reduced performance
UE configured UTRA RF Channel Number			2,3,4,5,6,7	
Test equipment configuration			Cell 1 uses E-UTRA RF channel number 1 Cells 2,3,4 are randomly selected to use different frequencies selected from frequencies 2,3,4,5,6,7	
PRACH configuration			4	As specified in table 5.7.1-2 in TS 36.211
Access Barring Information		-	Not Sent	No additional delays in random access procedure.
DRX cycle length		s	1.28	The value shall be used for all cells in the test.
T0		s	(test equipment frequency selection and configuration time) + 960	Initialisation time need to be defined so that cell detection time is taken into account.
T1		s	60	T1 need to be defined so that cell reselection reaction time is taken into account.
T2		s	25	T2 need to be defined so that cell reselection reaction time is taken into account

T3	s	350	T3 need to be defined so that cell re-selection reaction time is taken into account.
T4	s	25	T4 need to be defined so that cell re-selection reaction time is taken into account

Table A.4.3.3A.1-2: General test parameters for EUTRA TDD- UTRA FDD inter RAT cell re-selection test case

Parameter	Unit	Value	Comment
Uplink-downlink configuration of cell 1		1	As specified in table 4.2.2 in TS 36.211
Special subframe configuration of cell 1		6	As specified in table 4.2.1 in TS 36.211

Table A.4.3.3A.1-3: Cell specific test parameters for E-UTRAN TDD- UTRAN FDD inter-RAT cell reselection test case in AWGN cell 1 (E-UTRAN)

Parameter	Unit	Cell 1				
		T0	T1	T2	T3	T4
E-UTRA RF Channel number		1				
BW _{channel}	MHz	5MHz: N _{RB} = 25 10MHz: N _{RB} = 50				
l _o	dBm/4.5MHz(25RB) dBm/9Mhz(50RB)	-59.06 -56.05	-71.77 -68.76	-59.06 -56.05	-71.77 -68.76	-59.06 -56.05
PDSCH parameters: DL Reference Measurement Channel		OP.10 TDD(5MHz) OP.2 TDD (10MHz)				
PBCH RA	dB	0				
PBCH RB	dB					
PSS RA	dB					
SSS RA	dB					
PCFICH RB	dB					
PHICH RA	dB					
PHICH RB	dB					
PDCCH RA	dB					
PDCCH RB	dB					
PDSCH RA	dB					
PDSCH RB	dB					
OCNG_RA ^{Note 1}	dB					
OCNG_RB ^{Note 1}	dB					
Qrxlevmin	dBm	-140				
N _{oc} ^{Note 2}	dBm	-98				
RSRP ^{Note 3}	dBm	-84	-102	-84	-102	-84
\hat{E}_s / I_{ot}	dB	14	-4	14	-4	14
\hat{E}_s / N_{oc}	dB	14	-4	14	-4	14
Treselection _{EUTRAN}	s	0				
Snonintrasearch	dB	62				
Thresh _{serv, low}	dB	44				
Thresh _{x, low} (Note 4)	dB	40				
Propagation Condition		AWGN				
Note 1: OCNG shall be used such that the cell is fully allocated and a constant total transmitted power spectral density is achieved for all OFDM symbols.						

Note 2: Interference from other cells and noise sources not specified in the test is assumed to be constant over subcarriers and time and shall be modelled as AWGN of appropriate power for to be fulfilled.

Note 3: RSRP levels have been derived from other parameters for information purposes. They are not settable parameters themselves.

Note 4: This refers to the value of $Thresh_{x, low}$ which is included in E-UTRA system information, and is a threshold for the UTRA target cell.

Table A.4.3.3A.1-4: Cell specific test parameters for cells 2 and 3 (UTRA)

Parameter	Unit	Cell 2					Cell 3				
		T0	T1	T2	T3	T4	T0	T1	T2	T3	T4
UTRA RF Channel Number		Randomly selected from 1, 2, 3 such that cell 2 is in the normal performance group					Randomly selected from 4, 5, 6 such that cell 3 is in the reduced performance group				
CPICH_Ec/Ior	dB	-10					-10				
PCCPCH_Ec/Ior	dB	-12					-12				
SCH_Ec/Ior	dB	-12					-12				
PICH_Ec/Ior	dB	-15					-15				
OCNS_Ec/Ior	dB	-0.941					0.941				
\hat{I}_{or} / I_{oc}	dB	+11	+11	+11	-5	+11	+11	-5	+11	+11	+11
I_{oc}	dBm/3,84 MHz	-70					-70				
CPICH_Ec/Io	dB	-10.3 3	-10.3 3	-10.3 3	-16.1 9	-10.3 3	-10.3 3	-16.1 9	-10.3 6	-10.3 3	-10.3 3
CPICH_RSCP	dBm	-69	-69	-69	-85	-69	-69	-85	-69	-69	-69
Propagation Condition		AWGN					AWGN				
Qqualmin	dB	-20					-20				
Qrxlevmin	dBm	-115					-115				
QrxlevminEUTRA	dBm	-140					-140				
UE_TXPWR_MAX_RACH	dBm	21					21				
Treselection	s	0					0				
Sprioritysearch1	dB	40					40				
Sprioritysearch2	dB	0					0				
Thresh _{x,high} (Note 1)	dB	50					50				
Note 1: This refers to the value of $Thresh_{x, high}$ which is included in UTRA system information, and is a threshold for the E-UTRA target cell											

A.4.3.3A.2 Test Requirements

The cell reselection delay is defined as the time from the beginning of a relevant time period, to the moment when the UE camps on the target cell, and starts to send preambles on the PRACH for sending the RRC CONNECTION REQUEST message to perform a Tracking Area Update procedure on the target cell.

The reselection delays shall meet the requirements in table A.4.3.1.5-1

Table A.4.3.3A.2-1

Time phase	Target cell	Requirement for reselection delay (seconds)
T0	Cell 1	
T1	Cell 2 (normal performance group)	59
T2	Cell 1 (normal performance group)	21
T3	Cell 3 (reduced performance group)	347
T4	Cell 1 (normal performance group)	21

NOTE: The cell re-selection delay to a normal performance group cell can be expressed as: $(N_{UTRA_carrier,normal}) * T_{evaluateUTRA_FDD} + T_{SI-UTRA}$ and to a reduced performance group cell can be expressed as: $6 * N_{UTRA_carrier,reduced} * T_{evaluateUTRA_FDD} + T_{SI-UTRA}$.

Where:

$T_{\text{evaluateUTRA-FDD}}$	See Table 4.2.2.5.1-1
$T_{\text{SI-UTRA}}$	Maximum repetition period of relevant system info blocks that needs to be received by the UE to camp on a cell; 1280 ms is assumed in this test case.

This gives a total of 58.88 s for normal performance group reselection, allow 59 s, and gives a total of 346.88 s for reduced performance group reselection, allow 347 s for reduced performance group in the test case. For reselections back to cell 1 since only one frequency is configured, the requirement is $T_{\text{evaluate,E-UTRAN}} + T_{\text{SI}} = 20.48$ s, allow 21 s.

A.4.3.4 E-UTRAN TDD – UTRAN TDD:

A.4.3.4.1 E-UTRA to UTRA TDD cell re-selection: UTRA is of higher priority

A.4.3.4.1.1 Test Purpose and Environment

A.4.3.4.1.1.1 Void

A.4.3.4.1.1.2 1.28 Mcps TDD option

This test is to verify the requirement for the E-UTRA TDD to UTRA TDD inter-RAT cell re-selection requirements specified in clause 4.2.2.5 when the UTRA cell is of higher priority.

This test scenario comprised of 1 E-UTRA TDD serving cell, and 1 UTRA TDD cell to be re-selected. Test parameters are given in table A.4.3.4.1.1.2-1, A.4.3.4.1.1.2-2, and A.4.3.4.1.1.2-3. The test consists of three successive time periods, with time duration of T1, T2 and T3 respectively. E-UTRA cell 1 is already identified by the UE prior to the start of the test. Cell 2 is of higher priority than cell 1.

The ranking of the cells shall be made according to the cell reselection criteria specified in TS36.304.

Table A.4.3.4.1.1.2-1: General test parameters for E-UTRAN to UTRAN (1.28 Mcps TDD OPTION) Cell Re-selection

Parameter		Unit	Value	Comment
Initial condition	Active cell		Cell 1	UE is on cell 1 in the initialisation phase, so that reselection to cell 2 occurs during T2
T2 end condition	Active cell		Cell 2	UE shall perform reselection to cell 2 during T2
	Neighbour cell		Cell 1	
T3 end condition	Active cell		Cell 1	UE shall perform reselection to cell 1 during T3
	Neighbour cell		Cell 2	
Uplink-downlink configuration of cell 1			1	As specified in table 4.2.2 in TS 36.211
Special subframe configuration of cell 1			6	As specified in table 4.2.1 in TS 36.211
PRACH configuration of cell 1			53	As specified in table 4.7.1-3 in TS 36.211
CP length of cell 1			Normal	
Time offset between cells			3 ms	Asynchronous cells
Access Barring Information		-	Not sent	No additional delays in random access procedure.
$T_{\text{reselection}}$		s	0	
DRX cycle length		s	1,28	
HCS			Not used	
T1		s	>20	During T1, cell 2 shall be powered off, and during the off time the primary scrambling code shall be changed, The intention is to ensure that cell 2 has not been detected by the UE prior to the start of period T2.
T2		s	85	T2 needs to be defined so that cell re-selection reaction time is taken into account.
T3		s	25	T3 needs to be defined so that cell re-selection reaction time is taken into account.

Table A.4.3.4.1.1.2-2: Cell specific test parameters for cell re-selection E-UTRA TDD to UTRA TDD test case (cell 1)

Parameter	Unit	Cell 1		
		T1	T2	T3
E-UTRA RF Channel Number		1		
$BW_{channel}$	MHz	10		
PBCH_RA	dB	0	0	0
PBCH_RB	dB			
PSS_RA	dB			
SSS_RA	dB			
PCFICH_RB	dB			
PHICH_RA	dB			
PHICH_RB	dB			
PDCCH_RA	dB			
PDCCH_RB	dB			
PDSCH_RA	dB			
PDSCH_RB	dB			
OCNG_RA ^{NOTE 1}	dB			
OCNG_RB ^{NOTE 1}	dB			
$Q_{rxlevmin}$	dBm/15kHz			
N_{oc}	dBm/15kHz	-98		
RSRP	dBm/15kHz	-87	-87	-87
\hat{E}_s / I_{ot}	dB	11	11	11
Thresh _{x, high} (NOTE 2)	dB	24(-79dBm)		
$S_{nonintrasearch}$	dB	46		
Propagation Condition		AWGN		
NOTE 1: OCNG shall be used such that cell is fully allocated and a constant total transmitted power spectral density is achieved for all OFDM symbols.				
NOTE 2: This refers to the value of Thresh _{x, high} which is included in E-UTRA system information, and is a threshold for the UTRA target cell				

Table A.4.3.4.1.1.2-3: Cell specific test parameters for cell re-selection E-UTRA TDD to UTRA TDD test case (cell 2)

Parameter	Unit	Cell 2 (UTRA)					
		0			DwPTS		
Timeslot Number		T1	T2	T3	T1	T2	T3
UTRA RF Channel Number (NOTE 1)		Channel 2					
PCCPCH_Ec/lor	dB	-3	-3	-3			
DwPCH_Ec/lor	dB				0	0	0
OCNS_Ec/lor	dB	-3	-3	-3			
\hat{I}_{or} / I_{oc}	dB	-inf	11	-3	-inf	11	-3
I_{oc}	dBm/1.28 MHz	-80					
PCCPCH RSCP	dBm	-inf	-72	-86	n.a.		
Propagation Condition		AWGN					
$Q_{rxlevmin}$	dBm	-103					
$Q_{offset1s,n}$	dB	C1, C2: 0					
Q_{hyst1s}	dB	0					
$S_{nonintrasearch}$	dB	Not sent					
Thresh _{serv, low}	dB	24 (-79dBm)					
Thresh _{x, low} (NOTE 2)	dB	46 (-94dBm)					
NOTE 1: In the case of multi-frequency cell, the UTRA RF Channel Number is the primary frequency's channel number.							
NOTE 2: This refers to the value of Thresh _{x, low} which is included in UTRA system information, and is a threshold for the E-UTRA target cell							

- A.4.3.4.1.1.3 Void
- A.4.3.4.1.2 Test Requirements
- A.4.3.4.1.2.1 Void
- A.4.3.4.1.2.2 1.28 Mcps TDD option

The cell reselection delay to higher priority is defined as the time from the beginning of time period T2, to the moment when the UE camps on cell 2, and starts to send the SYNCH-UL sequence in the UpPTS for sending the RRC CONNECTION REQUEST message on cell 2.

The cell re-selection delay to higher priority shall be less than 81 s.

The rate of correct cell reselections observed during repeated tests shall be at least 90%.

NOTE: The cell re-selection delay to higher priority cell can be expressed as: $T_{\text{higher_priority_search}} + T_{\text{evaluateUTRA_TDD}} + T_{\text{SL_UTRA}}$,

Where:

$T_{\text{higher_priority_search}}$ 60s, See clause 4.2.2

$T_{\text{evaluateUTRA_TDD}}$ 19.2s, See Table 4.2.2.5.2-1

$T_{\text{SL_UTRA}}$ Maximum repetition period of relevant system info blocks that needs to be received by the UE to camp on a cell; 1280 ms is assumed in this test case.

This gives a total of 80.48 s, allow 81 s for higher priority cell reselection in the test case.

- A.4.3.4.1.2.3 Void
- A.4.3.4.2 E-UTRA to UTRA TDD cell re-selection: UTRA is of lower priority
- A.4.3.4.2.1 Test Purpose and Environment
- A.4.3.4.2.1.1 Void
- A.4.3.4.2.1.2 1.28 Mcps TDD option

This test is to verify the requirement for the E-UTRA TDD to UTRA TDD inter-RAT cell re-selection requirements specified in clause 4.2.2.5 when the UTRA cell is of lower priority.

This test scenario comprised of 1 E-UTRA TDD serving cell (Cell 1), and 1 UTRA TDD cell (Cell 2) to be re-selected. Test parameters are given in table A.4.3.4.2.1.2-1, A.4.3.4.2.1.2-2, and A.4.3.4.2.1.2-3. The test consists of two successive time periods, with time duration of T1 and T2 respectively. Cell 2 is of lower priority than cell 1.

The ranking of the cells shall be made according to the cell reselection criteria specified in TS36.304.

Table A.4.3.4.2.1.2-1: General test parameters for E-UTRAN to UTRAN (1.28 Mcps TDD OPTION) Cell Re-selection

Parameter		Unit	Value	Comment
Initial condition	Active cell		Cell 1	E-UTRAN cell
T1 end condition	Active cell		Cell1	UE shall perform reselection to cell 1 during T1 for subsequent iterations of the test
	Neighbour cell		Cell2	1.28 Mcps TDD OPTION cell
T2 end condition	Active cell		Cell2	UE shall perform reselection to cell 2 during T2
	Neighbour cell		Cell1	E-UTRA TDD cell
Uplink-downlink configuration of cell 1			1	As specified in table 4.2.2 in TS 36.211
Special subframe configuration of cell 1			6	As specified in table 4.2.1 in TS 36.211
PRACH configuration of cell 1			53	As specified in table 4.7.1-3 in TS 36.211
CP length of cell 1			Normal	
Time offset between cells			3 ms	Asynchronous cells

Access Barring Information	-	Not sent	No additional delays in random access procedure.
Treselection	s	0	
DRX cycle length	s	1,28	
HCS		Not used	
T1	s	85	
T2	s	25	

Table A.4.3.4.2.1.2-2: Cell specific test parameters for cell re-selection E-UTRA TDD to UTRA TDD test case (cell 1)

Parameter	Unit	Cell 1	
		T1	T2
E-UTRA RF Channel Number		1	
$BW_{channel}$	MHz	10	
PBCH_RA	dB	0	0
PBCH_RB	dB		
PSS_RA	dB		
SSS_RA	dB		
PCFICH_RB	dB		
PHICH_RA	dB		
PHICH_RB	dB		
PDCCH_RA	dB		
PDCCH_RB	dB		
PDSCH_RA	dB		
PDSCH_RB	dB		
OCNG_RA ^{Note1}	dB		
OCNG_RB ^{Note1}	dB		
Qrxlevmin	dBm/15kHz		
N_{oc}	dBm/15kHz	-98	
RSRP	dBm/15kHz	-87	-101
\hat{E}_s/I_{ot}	dB	11	-3
$S_{nonintra}$	dB	Not sent	
Thresh _{serv,low}	dB	46 (-94dBm)	
Thresh _{x,low} (Note2)	dB	24 (-79dBm)	
Propagation Condition		AWGN	
Note1: OCNG shall be used such that cell is fully allocated and a constant total transmitted power spectral density is achieved for all OFDM symbols. Note2: This refers to the value of Thresh _{x,low} which is included in E-UTRA system information, and is a threshold for the UTRA target cell			

Table A.4.3.4.2.1.2-3: Cell specific test parameters for cell re-selection E-UTRA TDD to UTRA TDD test case (cell 2)

Parameter	Unit	Cell 2 (UTRA)			
		0		DwPTS	
Timeslot Number		T1	T2	T1	T2
UTRA RF Channel Number (Note1)		Channel 2			
PCCPCH_Ec/Ior	dB	-3	-3		
DwPCH_Ec/Ior	dB			0	0
OCNS_Ec/Ior	dB	-3	-3		
\hat{I}_{or}/I_{oc}	dB	11	11	11	11
I_{oc}	dBm/1.28 MHz	-80			
PCCPCH RSCP	dBm	-72	-72	n.a.	n.a.
Propagation Condition		AWGN			

Qrxlevmin	dBm	-103
Qoffset1 _{s,n}	dB	C1, C2: 0
Qhyst1 _s	dB	0
Thresh _{x,high} (Note2)	dB	46 (-94dBm)
Note1:	In the case of multi-frequency cell, the UTRA RF Channel Number is the primary frequency's channel number.	
Note2:	This refers to the value of Thresh _{x,high} which is included in UTRA system information, and is a threshold for the E-UTRA target cell	

A.4.3.4.2.1.3 Void

A.4.3.4.2.2 Test Requirements

A.4.3.4.2.2.1 Void

A.4.3.4.2.2.2 1.28 Mpcs TDD option

The cell reselection delay to lower priority is defined as the time from the beginning of time period T2, to the moment when the UE camps on cell 2, and starts to send the SYNCH-UL sequence in the UpPTS for sending the RRC CONNECTION REQUEST message on cell 2.

The cell re-selection delay to lower priority shall be less than 21 s.

The rate of correct cell reselections observed during repeated tests shall be at least 90%.

NOTE: The cell re-selection delay to lower priority cell can be expressed as: $T_{\text{evaluateUTRA_TDD}} + T_{\text{SL_UTRA}}$,

Where:

$T_{\text{evaluateUTRA_TDD}}$ 19.2s, See Table 4.2.2.5.2-1

$T_{\text{SL_UTRA}}$ Maximum repetition period of relevant system info blocks that needs to be received by the UE to camp on a cell; 1280 ms is assumed in this test case.

This gives a total of 20.48 s, allow 21 s for lower priority cell reselection in the test case.

A.4.3.4.2.2.3 Void

A.4.3.4.3 EUTRA TDD-UTRA TDD cell reselection in fading propagation conditions: UTRA TDD is of lower priority

A.4.3.4.3.1 Test Purpose and Environment

This test is to verify the requirement for the EUTRA TDD- UTRA TDD inter-RAT cell reselection requirements specified in clause 4.2.2.5.2 when the UTRA cell is of lower priority, and to verify the robustness of the UE measurement filtering in a fading environment. The E-UTRA cell is in fading propagation conditions and the UTRA cell is in AWGN propagation conditions.

The test scenario comprises of one UTRA TDD and one E-UTRA TDD cells as given in tables A.4.3.4.3.1-1, A.4.3.4.3.1-2 and A.4.3.4.3.1-3. The test consists of four successive time periods, with time duration of T1 T2, T3 and T4 respectively. Both E-UTRA cell 1 and UTRA cell 2 are already identified by the UE prior to the start of the test. Cell 2 is of lower priority than cell 1.

Table A.4.3.4.3.1-1: General test parameters for EUTRA TDD- lower priority UTRA TDD inter RAT cell re-selection test case

	Parameter	Unit	Value	Comment
Initial condition	Active cell		Cell1	E-UTRAN cell
T1 end condition	Active cells		Cell1	UE shall perform reselection to cell 1 during T1 for subsequent iterations of the test
	Neighbour cell		Cell2	
	Active cell		Cell2	UE shall perform reselection to cell 2 during T3

T3 end condition	Neighbour cell		Cell1	
E-UTRA PRACH configuration			53	As specified in table 5.7.1-3 in TS 36.211
Uplink-downlink configuration of cell 1			1	As specified in table 4.2.2 in TS 36.211
Special subframe configuration of cell 1			6	As specified in table 4.2.1 in TS 36.211
E_UTRA Access Barring Information	-		Not Sent	No additional delays in random access procedure.
DRX cycle length	s		1.28	The value shall be used for all cells in the test.
T1	s		<85	T1 need to be defined so that cell re-selection reaction time is taken into account. T1 is terminated when the UE starts to send preambles to cell 1
T2	s		64	The start of T2 is defined as the time when the UE starts to send PRACH preambles to cell 1
T3	s		<25	T3 need to be defined so that cell re-selection reaction time is taken into account. T3 is terminated when the UE starts to send PRACH preambles to cell 2
T4	s		64	The start of T4 is defined as the time when the UE starts to send PRACH preambles to cell 2

Table A.4.3.4.3.1-2: Cell specific test parameters for cell 1 (E-UTRA)

Parameter	Unit	Cell 1			
		T1	T2	T3	T4
E-UTRA RF Channel number		1			
BW _{channel}	MHz	10			
Correlation Matrix and Antenna Configuration		1x2 Low			
OCNG Patterns defined in A.3.2.2.2 (OP.2 TDD)		OP.2 TDD			
PSS_RA	dB	0			
SSS_RA	dB				
PCFICH_RB	dB				
PHICH_RA	dB				
PHICH_RB	dB				
PDCCH_RA	dB				
PDCCH_RB	dB				
PDSCH_RA	dB				
PDSCH_RB	dB				
OCNG_RA ^{Note 1}	dB				
OCNG_RB ^{Note 1}	dB				
Qrxlevmin for UTRA neighbour cell	dBm				
Qrxlevmin	dBm	-140			
N _{oc}	dBm/15 kHz	-104			
RSRP	dBm/15 KHz	-82	-82	-107	-107
\hat{E}_s/I_{ot}	dB	22	22	-3	-3
\hat{E}_s/N_{oc}	dB	22	22	-3	-3
Treselection _{EUTRAN}	s	0			
Snonintrasearch	dB	Not sent			
Thresh _{serv,low}	dB	44			
Thresh _{x,low} ^(Note 2)	dB	24			
Propagation Condition		ETU70			
Note 1: OCNG shall be used such that both cells are fully allocated and a constant total transmitted power spectral density is achieved for all OFDM symbols.					
Note 2: This refers to the value of Thresh _{x,low} which is included in E-UTRA system information, and is a threshold for the UTRA target cell.					

Table A.4.3.4.3.1-3: Cell specific test parameters for cell 2 (UTRA)

Parameter	Unit	Cell 2 (UTRA)							
		0				DwPTS			
Timeslot Number		T1	T2	T3	T4	T1	T2	T3	T4
UTRA RF Channel Number ^(Note1)		Channel 2							
PCCPCH_Ec/lor	dB	-3							
DwPCH_Ec/lor	dB					0			
OCNS_Ec/lor	dB	-3							
\hat{I}_{or}/I_{oc}	dB	13	13	13	13	13	13	13	13
I_{oc}	dBm/1.28 MHz	-80							
PCCPCH RSCP	dBm	-70	-70	-70	-70	n.a.	n.a.	n.a.	n.a.
Propagation Condition		AWGN							
Qrxlevmin	dBm	-103							
Qrxlevmin _{EUTRA}	dBm	-140							
UE_TXPWR_MAX_RACH	dBm	21							
Treselection	s	0							
Thresh _{x, high} ^(Note2)	dB	44							
Note1:	In the case of multi-frequency cell, the UTRA RF Channel Number is the primary frequency's channel number.								
Note2:	This refers to the value of Thresh _{x, high} which is included in UTRA system information, and is a threshold for the E-UTRA target cell								

A.4.3.4.3.2 Test Requirements

The probability of reselection from cell 1 to cell 2 during T2 observed during testing shall be less than 10%

The probability of reselection from cell 2 to cell 1 during T4 observed during testing shall be less than 10%

The cell reselection delay to lower priority is defined as the time from the beginning of time period T3, to the moment when the UE camps on cell 2, and starts to send the SYNCH-UL sequene in the UpPTS for sending the RRC CONNECTION REQUEST message on cell 2. In order to evaluate reselection delay, the system simulator first needs to verify that the UE is camped on cell 1 at the start of T3

The cell re-selection delay to lower priority shall be less than 21 s.

The rate of correct cell reselections observed during repeated tests shall be at least 90%.

NOTE: The cell re-selection delay to lower priority cell can be expressed as: $T_{\text{evaluateUTRA_TDD}} + T_{\text{SI-UTRA}}$

Where:

$T_{\text{evaluateUTRA_TDD}}$ 19.2s, See Table 4.2.2.5.2-1

$T_{\text{SI-UTRA}}$ Maximum repetition period of relevant system info blocks that needs to be received by the UE to camp on a cell; 1280 ms is assumed in this test case.

This gives a total of 20.48 s for lower priority cell reselection, allow 21 s.

A.4.3.4.4 E-UTRA TDD to UTRA TDD cell re-selection for IncMon

A.4.3.4.4.1 Test Purpose and Environment

This test is to verify the requirement for the E-UTRA TDD to UTRA TDD inter-RAT cell reselection requirements for increased UE carrier monitoring specified in clause 4.2.2.4. UTRA TDD cells are of lower priority than E-UTRA serving cell.

The test scenario comprises of indicating 7 UTRA TDD inter-RAT cells on 7 different carriers in the neighbour list of cell 1 as given in tables A.4.3.4.4.1-1, A.4.3.4.4.1-2 and A.4.3.4.4.1-3. Each repetition of the test consists of five successive time periods, with time duration of T0, T1, T2, T3, and T4 respectively. In the initialisation phase and at the start of each repetition of T0, the test equipment provides signals for cell 1 (E-UTRA serving cell), and selects frequencies for cells 2 and 3 which are chosen from the 7 inter-RAT layers which are configured in the UE neighbour cell list as described in general and cell specific parameters. The neighbour lists of cells 2 and 3 shall include the

frequency of cell 1 in the normal performance group and shall exclude the other UTRA TDD frequencies configured to the UE in the test.

Cell 1, 2, and 3 are identified by the UE during time phase T0. Cell 1, cell 2, and cell 3 belong to different tracking areas. Furthermore, UE has not registered with network for the tracking area containing cell 2 or 3.

Table A.4.3.4.4.1-1: General test parameters for E-UTRA TDD to UTRA TDD inter-RAT cell re-selection test case

Parameter		Unit	Value	Comment
T0	Active cell		Cell1	T0 is repeated on each repetition of the test. In T0 the test equipment selects frequencies for cell 2, 3 and then time is allowed for the UE to identify the neighbour cells. See cell specific parameters for detailed settings.
T1 start condition	Active cell		Cell 1	
T1 end condition	Active cell		Cell2	UE shall perform reselection to cell 2 during T1
	Neighbour cell		Cell1	
T2 end condition	Active cell		Cell1	UE shall perform reselection to cell 1 during T2
T3 end condition	Active cell		Cell3	UE shall perform reselection to cell 3 during T3
	Neighbour cell		Cell1	
T4 end condition	Active cell		Cell1	UE shall perform reselection to cell 1 in T4 so that next repetition of test can start from T0
UE configured UTRA RF Channel Number			1, 2, 3, 4, 5, 6, 7	Seven UTRA TDD carrier frequencies are used in the UE neighbour cell list. Frequencies 4, 5, 6, and 7 are indicated to have reduced performance
Test equipment configuration			Cell 1, 2, 3	Cell 1 uses E-UTRA RF channel number 1 Cells 2 is randomly selected to use different frequencies selected from UTRA frequencies 1, 2, 3. Cells 3 is randomly selected to use different frequencies selected from UTRA frequencies 4, 5, 6, 7.
Uplink-downlink configuration of cell 1			1	As specified in table 4.2.2 in TS 36.211 [16]
Special subframe configuration of cell 1			6	As specified in table 4.2.1 in TS 36.211 [16]
CP length of cell 1			normal	
PRACH configuration			53	As specified in table 5.7.1-3 in TS 36.211 [16]
Access Barring Information		-	Not Sent	No additional delays in random access procedure.
T _{reselection}		s	0	
HCS			Not used	
DRX cycle length		s	1.28	The value shall be used for all cells in the test.
T0		s	(Test equipment frequency selection and configuration time) + 960	T0 is defined so that the Test equipment selects frequencies and configures the cells, then the UE cell detection time is taken into account.
T1		s	60	T1 need to be defined so that cell re-selection reaction time is taken into account.
T2		s	25	T2 need to be defined so that cell re-selection reaction time is taken into account
T3		s	500	T3 need to be defined so that cell re-selection reaction time is taken into account.
T4		s	25	T4 need to be defined so that cell re-selection reaction time is taken into account

Table A.4.3.4.4.1-2: E-UTRA Cell specific test parameters for E-UTRA TDD to UTRA TDD inter-RAT cell reselection test case in AWGN

Parameter	Unit	Cell 1				
		T0	T1	T2	T3	T4

E-UTRA RF Channel number		1				
BW _{channel}	MHz	5MHz: N _{RB} = 25 10MHz: N _{RB} = 50				
OCNG Patterns		5MHz: OP.10 TDD 10MHz: OP.2 TDD				
PBCH_RA	dB	0				
PBCH_RB	dB					
PSS_RA	dB					
SSS_RA	dB					
PCFICH_RB	dB					
PHICH_RA	dB					
PHICH_RB	dB					
PDCCH_RA	dB					
PDCCH_RB	dB					
PDSCH_RA	dB					
PDSCH_RB	dB					
OCNG_RA <small>Note 1</small>	dB					
OCNG_RB <small>Note 1</small>	dB					
N_{oc} <small>Note 2</small>	dBm/15kHz	-98				
\hat{E}_s/N_{oc}	dB	11	-3	11	-3	11
\hat{E}_s/I_{ot} <small>Note 3</small>	dB	11	-3	11	-3	11
RSRP <small>Note 3</small>	dBm/15kHz	-87	-101	-87	-101	-87
Q _{rxlevmin}	dBm/15kHz	-140				
S _{noninrasearch}	dB	Not sent				
Thresh _{servng, low}	dB	46 (-94dBm)				
Thresh _{x, low} <small>Note 4</small>	dB	24 (-79dBm)				
Propagation Condition		AWGN				
Antenna Configuration		1x2				
<p>Note 1: OCNG shall be used such that both cells are fully allocated and a constant total transmitted power spectral density is achieved for all OFDM symbols.</p> <p>Note 2: Interference from other cells and noise sources not specified in the test is assumed to be constant over subcarriers and time and shall be modelled as AWGN of appropriate power for to be fulfilled.</p> <p>Note 3: E_s/I_{ot} and RSRP levels have been derived from other parameters for information purposes. They are not settable parameters themselves.</p> <p>Note 4: This refers to the value of Thresh_{x, low} which is included in E-UTRA system information, and is a threshold for the UTRA TDD target cell.</p>						

Table A.4.3.4.4.1-3: UTRA TDD Cell specific test parameters for E-UTRA TDD to UTRA TDD inter-RAT cell reselection test case in AWGN

Parameter	Unit	Cell 2 (UTRA TDD)									
		0					DwPTS				
Timeslot Number		T0	T1	T2	T3	T4	T0	T1	T2	T3	T4
UTRA RF Channel Number <small>Note1</small>		Randomly selected from 1, 2, 3 such that cell 2 is in the normal performance group									
PCCPCH_Ec/lor	dB	-3									
DwPCH_Ec/lor	dB						0				
OCNS_Ec/lor	dB	-3									
I_{oc}	dBm/ 1.28 MHz	-80									
\hat{I}_{or}/I_{oc}	dB	-3	11	-3	-3	-3	-3	11	-3	-3	-3
PCCPCH RSCP	dBm	-86	-72	-86	-86	-86	n.a.				
Propagation Condition		AWGN									
Q _{rxlevmin}	dBm	-103									
Qoffset1 _{s,n}	dB	C1, C2: 0									
Qhyst1 _s	dB	0									
S _{prioritysearch1}	dB	24 (-79dBm)									

$S_{\text{prioritysearch2}}$	dB	0
$\text{Thresh}_{x, \text{low}}$ ^{Note2}	dB	46 (-94dBm)
$S_{\text{searchE-UTRA}}$	dB	Not send
Time offset to cell1	ms	3
Note1:	In the case of multi-frequency cell, the UTRA RF Channel Number is the primary frequency's channel number.	
Note2:	This refers to the value of $\text{Thresh}_{x, \text{low}}$ which is included in UTRA system information, and is a threshold for the E-UTRA target cell	

Table A.4.3.4.4.1-4:

Parameter	Unit	Cell 3 (UTRA TDD)									
		0					DwPTS				
Timeslot Number		T0	T1	T2	T3	T4	T0	T1	T2	T3	T4
UTRA RF Channel Number ^{Note1}		Randomly selected from 4, 5, 6, 7 such that cell 3 is in the reduced performance group									
PCCPCH_Ec/Ior	dB	-3									
DwPCH_Ec/Ior	dB						0				
OCNS_Ec/Ior	dB	-3									
I_{oc}	dBm/ 1.28 MHz	-80									
\hat{I}_{or} / I_{oc}	dB	-3	-3	-3	11	-3	-3	-3	-3	11	-3
PCCPCH RSCP	dBm	-86	-86	-86	-72	-86	n.a.				
Propagation Condition		AWGN									
$Q_{rxlevmin}$	dBm	-103									
$Q_{offset1s,n}$	dB	C1, C2: 0									
Q_{hyst1s}	dB	0									
$S_{\text{prioritysearch1}}$	dB	24 (-79dBm)									
$S_{\text{prioritysearch2}}$	dB	0									
$\text{Thresh}_{x, \text{high}}$ ^{Note2}	dB	46 (-94dBm)									
$S_{\text{searchE-UTRA}}$	dB	Not send									
Time offset to cell1	ms	3									
Time offset to cell2	μs	3									
Note1:	In the case of multi-frequency cell, the UTRA RF Channel Number is the primary frequency's channel number.										
Note2:	This refers to the value of $\text{Thresh}_{x, \text{high}}$ which is included in UTRA system information, and is a threshold for the E-UTRA target cell										

A.4.3.4.4.2 Test Requirements

The cell reselection delay is defined as the time from the beginning of a relevant time period, to the moment when the UE camps on the target cell, and starts to send the SYNCH-UL sequence in the UpPTS on cell 2, 3 for sending the RRC CONNECTION REQUEST message to perform a Tracking Area Update procedure on the target cell.

The reselection delays shall meet the requirements in table A.4.3.4.4.2-1

Table A.4.3.4.4.2-1: Test requirements for E-UTRA TDD to UTRA TDD inter-RAT cell reselection

Time phase	Target cell	Requirement for reselection delay (seconds)
T1	Cell 2 (normal performance group)	58.9
T3	Cell 3 (reduced performance group)	462.1

The rate of correct cell reselections observed during repeated tests shall be at least 90%, with a successful reselection counted if it is within the required time regardless of the carrier frequencies involved. At least 90% of reselections to the reduced performance group shall be within the required time, and at least 90% of reselections to the normal performance group shall be within the required time.

NOTE: The cell re-selection delay to a normal performance group cell can be expressed as: $N_{\text{UTRA_carrier_TDD,normal}} * T_{\text{evaluateUTRA_TDD}} + T_{\text{SI_UTRA}}$, and to a reduced performance group cell can be expressed as: $6 * N_{\text{UTRA_carrier_TDD,reduced}} * T_{\text{evaluateUTRA_TDD}} + T_{\text{SI_UTRA}}$,

Where:

$T_{\text{evaluateUTRA_TDD}}$ 19.2s, See Table 4.2.2.5.2-1

$T_{\text{SI_UTRA}}$ Maximum repetition period of relevant system info blocks that needs to be received by the UE to camp on a cell; 1280 ms is assumed in this test case.

This gives a total of $3 * 19.2 + 1.28 = 58.88$ s for normal performance group reselection and $6 * 4 * 19.2 + 1.28 = 462.08$ s for reduced performance group reselection, allow 58.9s for normal performance group and 462.1s for reduced performance group in the test case.

Since only one E-UTRA frequency is configured and signal level of UTRA cell is lower than threshold of $S_{\text{prioritysearch}}$, the UE shall select back to cell 1 (E-UTRA cell) within $K_{\text{carrier}} * T_{\text{evaluateEUTRA}} + T_{\text{SI}} = 19.2 + 1.28 = 20.48$ s, allow 21s.

A.4.4 E-UTRAN to GSM Cell Re-Selection

A.4.4.1 E-UTRAN FDD – GSM:

A.4.4.1.1 Test Purpose and Environment

This test is to verify the requirement for the E-UTRAN FDD to GSM cell re-selection delay reported in clause 4.2.2.5.

This scenario implies the presence of 1 E-UTRAN serving cell, and 1 GSM cell to be re-selected. The UE is requested to monitor neighbouring cells on 1 E-UTRA carrier and 12 GSM cells. Test parameters are given in Table, A.4.4.1-1, A.4.4.1-2, A.4.4.1-3. E-UTRA FDD cell (Cell 1) and GSM cell (cell 2) shall belong to different Location Areas. The test comprises two successive time periods, T1 and T2. During initialization before the start of the test, the UE is camped on cell 1. By the end of T1, the UE has identified BSIC on the GSM BCCH carrier of cell 2 but the signal levels do not meet the reselection criterion during T1. At the start of T2, the signal levels change such that cell 2 satisfies reselection criterion. The GSM layer is configured at a lower priority than the serving E-UTRA FDD layer.

Table A.4.4.1-1: General test parameters for E-UTRA FDD GSM cell re-selection test case

Parameter		Unit	Value	Comment
Initial condition	Active cell		Cell1	UE shall be forced to cell 1 in the initialisation phase and shall be able to detect and monitor the 4 strongest GSM BCCH carriers in T1 . Cell 1 is an E-UTRA FDD cell.
Final condition	Neighbour cell		Cell2	UE shall perform reselection to cell 2 during T2. Cell 2 is a GSM cell.
E-UTRA RF Channel Number			1	1 E-UTRA FDD carrier frequency
GSM ARFCN			1	12 GSM BCCH carriers are used
PRACH configuration			4	As specified in table 5.7.1-2 in TS 36.211
Access Barring Information		-	Not Sent	No additional delays in random access procedure.
CP length of cell 1			Normal	
DRX cycle length		s	1.28	The value shall be used for all cells in the test.
T1		s	35	T1 need to be defined so that cell re-selection reaction time is taken into account.
T2		s	35	T2 need to be defined so that the higher layer search periodicity and cell re-selection reaction time are taken into account.
Propagation channel			AWGN	

Table A.4.4.1-2: Cell-specific test parameters for Cell 1 – E-UTRA FDD cell

Parameter	Unit	Cell 1	
		T1	T2
E-UTRA RF Channel number		1	
BW _{channel}	MHz	10	

OCNG Patterns defined in A.3.2.1.2 (OP.2 FDD)		OP.2 FDD	
PBCH_RA	dB	0	
PBCH_RB	dB		
PSS_RA	dB		
SSS_RA	dB		
PCFICH_RB	dB		
PHICH_RA	dB		
PHICH_RB	dB		
PDCCH_RA	dB		
PDCCH_RB	dB		
PDSCH_RA	dB		
PDSCH_RB	dB		
OCNG_RA ^{Note 1}	dB		
OCNG_RB ^{Note 1}	dB		
Qrxlevmin	dBm		
N_{oc}	dBm/15 kHz	-98	
RSRP	dBm/15 KHz	-89	-102
\hat{E}_s / I_{ot}	dB	9	-4
\hat{E}_s / N_{oc}	dB	9	-4
TreselectionEUTRAN	s	0	
Snonintrasearch	dB	Not sent	
Thresh _{serv, low}	dB	44	
Thresh _{x, low} (Note 2)	dB	24	
<p>Note 1: OCNG shall be used such that both cells are fully allocated and a constant total transmitted power spectral density is achieved for all OFDM symbols.</p> <p>Note 2: This refers to Thresh_{x, low} which is included in E-UTRA system information, and is a threshold for GSM target cell.</p>			

Table A.4.4.1-3: Cell-specific test parameters for Cell 2 – GSM cell

Parameter	Unit	Cell 2 (GSM)	
		T1	T2
Absolute RF Channel Number		ARFCN 1	
RXLEV	dBm	-90	-75
RXLEV_ACCESS_MIN	dBm	-105	
MS_TXPWR_MAX_CCH	dBm	24	

A.4.4.1.2 Test Requirements

The cell re-selection delay is defined as the time from the beginning of time period T2, to the moment when the UE camps on Cell 2, and starts to send the RR Channel Request message for location update to Cell 2.

The cell re-selection delay shall be less than $26\text{ s} + T_{BCCH}$, where T_{BCCH} is the maximum time allowed to read BCCH data from GSM cell [8].

The rate of correct cell reselections observed during repeated tests shall be at least 90%.

NOTE: The cell re-selection delay can be expressed as: $4 * T_{measureGSM} + T_{BCCH}$, where:

$T_{measureGSM}$ See Table 4.2.2.5.3-1 in clause 4.2.2.5.3.

T_{BCCH} Maximum time allowed to read BCCH data from GSM cell [8].
According to [8], the maximum time allowed to read the BCCH data, when being synchronized to a BCCH carrier, is 1.9 s.

This gives a total of $25.6\text{ s} + T_{BCCH}$, allow $26\text{ s} + T_{BCCH}$ in the test case.

A.4.4.2 E-UTRAN TDD – GSM:

A.4.4.2.1 Test Purpose and Environment

This test is to verify the requirement for the E-UTRAN TDD to GSM cell re-selection delay reported in clause 4.2.2.5.

This scenario implies the presence of 1 E-UTRAN serving cell, and 1 GSM cell to be re-selected. The UE is requested to monitor neighbouring cells on 1 E-UTRA carrier and 12 GSM cells. Test parameters are given in Table, A.4.4.2-1, A.4.4.2-2, A.4.4.2-3. E-UTRA TDD cell (Cell 1) and GSM cell (cell 2) shall belong to different Location Areas. The test comprises two successive time periods, T1 and T2. During initialization before the start of the test, the UE is camped on cell 1. By the end of T1, the UE has identified BSIC on the GSM BCCH carrier of cell 2 but the signal levels do not meet the reselection criterion during T1. At the start of T2, the signal levels change such that cell 2 satisfies reselection criterion. The GSM layer is configured at a lower priority than the serving E-UTRA TDD layer.

Table A.4.4.2-1: General test parameters for E-UTRA TDD GSM cell re-selection test case

Parameter		Unit	Value	Comment
Initial condition	Active cell		Cell1	UE shall be forced to cell 1 in the initialisation phase and shall be able to detect and monitor the 4 strongest GSM BCCH carriers in T1. Cell 1 is an E-UTRA TDD cell.
Final condition	Neighbour cell		Cell2	UE shall perform reselection to cell 2 during T2. Cell 2 is a GSM cell.
E-UTRA RF Channel Number			1	1 E-UTRA TDD carrier frequency
GSM ARFCN			1	12 GSM BCCH carriers are used
Uplink-downlink configuration of cell 1			1	As specified in table 4.2.2 in TS 36.211
Special subframe configuration for cell 1			6	As specified in table 4.2.1 in TS 36.211
PRACH configuration for cell 1			53	As specified in table 5.7.1-3 in TS 36.211
CP length of cell 1			Normal	
Access Barring Information		-	Not Sent	No additional delays in random access procedure.
DRX cycle length		s	1.28	The value shall be used for all cells in the test.
T1		s	35	T1 need to be defined so that cell re-selection reaction time is taken into account.
T2		s	35	T2 need to be defined so that the higher layer search periodicity and cell re-selection reaction time are taken into account.
Propagation channel			AWGN	

Table A.4.4.2-2: Cell-specific test parameters for Cell 1 – E-UTRA TDD cell

Parameter	Unit	Cell 1	
		T1	T2
E-UTRA RF Channel number		1	
BW _{channel}	MHz	10	
OCNG Patterns defined in A.3.2.2.2 (OP.2 TDD)		OP.2 TDD	
PBCH_RA	dB	0	
PBCH_RB	dB		
PSS_RA	dB		
SSS_RA	dB		
PCFICH_RB	dB		
PHICH_RA	dB		
PHICH_RB	dB		
PDCCH_RA	dB		
PDCCH_RB	dB		
PDSCH_RA	dB		
PDSCH_RB	dB		
OCNG_RA ^{Note 1}	dB		
OCNG_RB ^{Note 1}	dB		
Qrxlevmin	dBm		

N_{oc}	dBm/15 kHz	-98	
RSRP	dBm/15 KHz	-89	-102
\hat{E}_s/I_{ot}	dB	9	-4
\hat{E}_s/N_{oc}	dB	9	-4
$T_{reselectionEUTRAN}$	s	0	
$S_{noninrasearch}$	dB	Not sent	
$Thresh_{serving, low}$	dB	44	
$Thresh_{x, low}$ (Note 2)	dB	24	
Note 1: OCNG shall be used such that both cells are fully allocated and a constant total transmitted power spectral density is achieved for all OFDM symbols.			
Note 2: This refers to $Thresh_{x, low}$ which is included in E-UTRA system information, and is a threshold for GSM target cell.			

Table A.4.4.2-3: Cell-specific test parameters for Cell 2 – GSM cell

Parameter	Unit	Cell 2 (GSM)	
		T1	T2
Absolute RF Channel Number		ARFCN 1	
RXLEV	dBm	-90	-75
RXLEV_ACCESS_MIN	dBm	-105	
MS_TXPWR_MAX_CCH	dBm	24	

A.4.4.2.2 Test Requirements

The cell re-selection delay is defined as the time from the beginning of time period T2, to the moment when the UE camps on Cell 2, and starts to send the RR Channel Request message for location update to Cell 2.

The cell re-selection delay shall be less than $26\text{ s} + T_{BCCH}$, where T_{BCCH} is the maximum time allowed to read BCCH data from GSM cell [8].

The rate of correct cell reselections observed during repeated tests shall be at least 90%.

NOTE: The cell re-selection delay can be expressed as: $4 * T_{measureGSM} + T_{BCCH}$, where:

$T_{measureGSM}$ See Table 4.2.2.5.3-1 in clause 4.2.2.5.3.

T_{BCCH} Maximum time allowed to read BCCH data from GSM cell [8].
According to [8], the maximum time allowed to read the BCCH data, when being synchronized to a BCCH carrier, is 1.9 s.

This gives a total of $25.6\text{ s} + T_{BCCH}$, allow $26\text{ s} + T_{BCCH}$ in the test case.

A.4.5 E-UTRAN to HRPD Cell Re-Selection

A.4.5.1 E-UTRAN FDD – HRPD

A.4.5.1.1 E-UTRAN FDD – HRPD Cell Reselection: HRPD is of Lower Priority

A.4.5.1.1.1 Test Purpose and Environment

This test is to verify the requirement for the E-UTRAN FDD- HRPD inter-RAT cell reselection requirements specified in clause 4.2.2.5.4 when the HRPD cell is of lower priority.

The test scenario comprises of one HRPD and one E-UTRAN FDD cells as given in tables A.4.5.1.1.1-1, A.4.5.1.1.1-2 and A.4.5.1.1.1-3.

The test consists of two successive time periods, with time duration of T1 and T2 respectively. Both E-UTRAN FDD cell 1 and HRPD cell 2 are already identified by the UE prior to the start of the test. At T1 the UE is camped on to cell 1. Cell 2 is of lower priority than cell 1. Cell 1 and cell 2 shall belong to different tracking areas.

Table A.4.5.1.1.1-1: General Test Parameters for E-UTRAN FDD - lower priority HRPD Cell Re-selection

	Parameter	Unit	Value	Comment
Initial condition	Active cell		Cell 1	E-UTRAN FDD cell
	Neighbour cell		Cell 2	HRPD cell
Final condition	Active cell		Cell 2	HRPD cell is selecting during T2
DRX cycle length		s	1.28	
E-UTRA FDD RF Channel Number			1	Only one FDD carrier frequency is used.
E-UTRA FDD Channel Bandwidth ($BW_{channel}$)		MHz	10	
HRPD RF Channel Number			1	Only one HRPD carrier frequency is used.
E-UTRA FDD PRACH configuration			4	As specified in table 5.7.1-2 in TS 36.211
E_UTRA FDD Access Barring Information		-	Not Sent	No additional delays in random access procedure.
T1		s	30	
T2		s	30	

Table A.4.5.1.1.1-2: Cell Specific Test Parameters for E-UTRAN FDD (Cell # 1)

Parameter	Unit	Cell 1	
		T1	T2
E-UTRA RF Channel number		1	
BW_{channel}	MHz	10	
OCNG Patterns defined in A.3.2.1.2 (OP.2 FDD)		OP.2 FDD	
PBCH_RA	dB	0	
PBCH_RB	dB		
PSS_RA	dB		
SSS_RA	dB		
PCFICH_RB	dB		
PHICH_RA	dB		
PHICH_RB	dB		
PDCCH_RA	dB		
PDCCH_RB	dB		
PDSCH_RA	dB		
PDSCH_RB	dB		
OCNG_RA ^{Note 1}	dB		
OCNG_RB ^{Note 1}	dB		
N_{oc}	dBm/15 kHz		
RSRP	dBm/15 KHz	-89	-102
\hat{E}_s/I_{ot}	dB	9	-4
\hat{E}_s/N_{oc}	dB	9	-4
Treselection _{EUTRAN}	S	0	
Snonintrasearch	dB	Not sent	
cellReselectionPriority	-	1	
Qrxlevmin	dBm	-140	
Qrxlevminoffset	dB	0	
Pcompensation	dB	0	
$S_{\text{ServingCell}}$	dB	51	38
Thresh _{serv, low}	dB	44	
Propagation Condition		AWGN	
Note 1: OCNG shall be used such that both cells are fully allocated and a constant total transmitted power spectral density is achieved for all OFDM symbols.			

Table A.4.5.1.1.1-3: Cell Specific Test Parameters for HRPD (cell # 2)

Parameter	Unit	Cell 2	
		T1	T2
HRPD RF Channel Number			1
$\frac{\text{Control } E_b}{N_t}$ (38.4 kbps)	dB	21	
$\frac{\text{Control } E_b}{N_t}$ (76.8 kbps)	dB	18	
\hat{I}_{or} / I_{oc}	dB	0	0
I_{oc}	dBm/ 1.2288 MHz	-55	
CDMA2000 HRPD Pilot Strength	dB	-3	-3
Propagation Condition		AWGN	
$S_{\text{nonServingCell},x}$		-6	
Treselection	s	0	
hrpd-CellReselectionPriority	-	0	
Thresh _{x, low}		-14	

A.4.5.1.1.2 Test Requirements

The cell reselection delay to lower priority is defined as the time from the beginning of time period T2, to the moment when the UE camps on cell 2 and starts to send access probe preambles on the Access Channel on cell 2.

The cell re-selection delay to the lower priority cell 2 shall be less than 21 s.

The rate of correct cell reselections observed during repeated tests shall be at least 90%.

NOTE: The cell re-selection delay to lower priority cell can be expressed as: $T_{\text{evaluateHRPD}} + T_{\text{SI-HRPD}}$

Where:

$T_{\text{evaluateHRPD}}$ See Table 4.2.2.5.4-1

$T_{\text{SI-HRPD}}$ Maximum repetition period of relevant system information blocks that need to be received by the UE to camp on cell 2; 1704 ms is assumed in this test case.

This gives a total of 20.904 s for the lower priority cell reselection, allow 21 s in the test case.

A.4.5.2 E-UTRAN TDD – HRPD

A.4.5.2.1 E-UTRAN TDD – HRPD Cell Reselection: HRPD is of Lower Priority

A.4.5.2.1.1 Test Purpose and Environment

This test is to verify the requirement for the E-UTRAN TDD- HRPD inter-RAT cell reselection requirements specified in clause 4.2.2.5.4 when the HRPD cell is of lower priority.

The test scenario comprises of one HRPD and one E-UTRAN TDD cells as given in tables A.4.5.2.1.1-1, A.4.5.2.1.1-2 and A.4.5.2.1.1-3.

The test consists of two successive time periods, with time duration of T1 and T2 respectively. Both E-UTRAN TDD cell 1 and HRPD cell 2 are already identified by the UE prior to the start of the test. At T1 the UE is camped on to cell 1. Cell 2 is of lower priority than cell 1. Cell 1 and cell 2 shall belong to different tracking areas.

Table A.4.5.2.1.1-1: General Test Parameters for E-UTRAN TDD - lower priority HRPD Cell Reselection

Parameter	Unit	Value	Comment
Initial condition	Active cell	Cell 1	E-UTRAN TDD cell
	Neighbour cell	Cell 2	HRPD cell
Final condition	Active cell	Cell 2	HRPD cell is selecting during T2
Uplink-downlink configuration of cell 1		1	As specified in table 4.2.2 in TS 36.211

Special subframe configuration of cell 1		6	As specified in table 4.2.1 in TS 36.211
CP length of cell 1		Normal	
DRX cycle length	s	1.28	
E-UTRA TDD RF Channel Number		1	Only one TDD carrier frequency is used.
E-UTRA TDD Channel Bandwidth (BWchannel)	MHz	10	
HRPD RF Channel Number		1	Only one HRPD carrier frequency is used.
E-UTRA TDD PRACH configuration of cell 1		53	As specified in table 4.7.1-3 in TS 36.211
E_UTRA TDD Access Barring Information	-	Not Sent	No additional delays in random access procedure.
T1	s	30	
T2	s	30	

Table A.4.5.2.1.1-2: Cell Specific Test Parameters for E-UTRAN TDD (Cell # 1)

Parameter	Unit	Cell 1	
		T1	T2
E-UTRA RF Channel number		1	
$BW_{channel}$	MHz	10	
OCNG Patterns defined in A.3.2.2.2 (OP.2 TDD)		OP.2 TDD	
PBCH_RA	dB	0	
PBCH_RB	dB		
PSS_RA	dB		
SSS_RA	dB		
PCFICH_RB	dB		
PHICH_RA	dB		
PHICH_RB	dB		
PDCCH_RA	dB		
PDCCH_RB	dB		
PDSCH_RA	dB		
PDSCH_RB	dB		
OCNG_RA ^{Note 1}	dB		
OCNG_RB ^{Note 1}	dB		
N_{oc}	dBm/15 kHz		
RSRP	dBm/15 KHz	-89	-102
\hat{E}_s/I_{ot}	dB	9	-4
\hat{E}_s/N_{oc}	dB	9	-4
Treselection _{EUTRAN}	S	0	
Snonintrasearch	dB	Not sent	
cellReselectionPriority	-	1	
Qrxlevmin	dBm	-140	
Qrxlevminoffset	dB	0	
Pcompensation	dB	0	
S _{ServingCell}	dB	51	38
Thresh _{serv, low}	dB	44	
Propagation Condition		AWGN	
Note 1: OCNG shall be used such that both cells are fully allocated and a constant total transmitted power spectral density is achieved for all OFDM symbols.			

Table A.4.5.2.1.1-3: Cell Specific Test Parameters for HRPD (cell # 2)

Parameter	Unit	Cell 2	
		T1	T2
HRPD RF Channel Number			1
$\frac{\text{Control } E_b}{N_t}$ (38.4 kbps)	dB	21	
$\frac{\text{Control } E_b}{N_t}$ (76.8 kbps)	dB	18	
\hat{I}_{or} / I_{oc}	dB	0	0
I_{oc}	dBm/ 1.2288 MHz	-55	
CDMA2000 HRPD Pilot Strength	dB	-3	-3
Propagation Condition		AWGN	
$S_{\text{nonServingCell},x}$		-6	
Treselection	s	0	
hrpd-CellReselectionPriority	-	0	
Thresh _{x, low}		-14	

A.4.5.2.1.2 Test Requirements

The cell reselection delay to lower priority is defined as the time from the beginning of time period T2, to the moment when the UE camps on cell 2 and starts to send access probe preambles on the Access Channel on cell 2.

The cell re-selection delay to the lower priority cell 2 shall be less than 21 s.

The rate of correct cell reselections observed during repeated tests shall be at least 90%.

NOTE: The cell re-selection delay to lower priority cell can be expressed as: $T_{\text{evaluateHRPD}} + T_{\text{SI-HRPD}}$

Where:

$T_{\text{evaluateHRPD}}$ See Table 4.2.2.5.4-1

$T_{\text{SI-HRPD}}$ Maximum repetition period of relevant system information blocks that need to be received by the UE to camp on cell 2; 1704 ms is assumed in this test case.

This gives a total of 20.904 s for the lower priority cell reselection, allow 21 s in the test case.

A.4.6 E-UTRAN to cdma2000 1X Cell Re-Selection

A.4.6.1 E-UTRAN FDD – cdma2000 1X

A.4.6.1.1 E-UTRAN FDD – cdma2000 1X Cell Reselection: cdma2000 1X is of Lower Priority

A.4.6.1.1.1 Test Purpose and Environment

This test is to verify the requirement for the E-UTRAN FDD- cdma2000 1X inter-RAT cell reselection requirements specified in clause 4.2.2.5.5 when the cdma2000 1X cell is of lower priority.

The test scenario comprises of one cdma2000 1X and one E-UTRAN FDD cells as given in tables A.4.6.1.1.1-1, A.4.6.1.1.1-2 and A.4.6.1.1.1-3.

The test consists of two successive time periods, with time duration of T1 and T2 respectively. Both E-UTRAN FDD cell 1 and cdma2000 1X cell 2 are already identified by the UE prior to the start of the test. At T1 the UE is camped on to cell 1. Cell 2 is of lower priority than cell 1. Cell 1 and cell 2 shall belong to different tracking areas.

Table A.4.6.1.1.1-1: General Test Parameters for E-UTRAN FDD - lower priority cdma2000 1X Cell Re-selection

Parameter	Unit	Value	Comment
Initial condition	Active cell	Cell 1	E-UTRAN FDD cell

	Neighbour cell		Cell 2	cdma2000 1X cell
Final condition	Active cell		Cell 2	cdma2000 1X cell is selecting during T2
DRX cycle length		s	1.28	
E-UTRA FDD RF Channel Number			1	Only one FDD carrier frequency is used.
E-UTRA FDD Channel Bandwidth ($BW_{channel}$)		MHz	10	
cdma2000 1X RF Channel Number			1	Only one cdma2000 1X carrier frequency is used.
E-UTRA FDD PRACH configuration			4	As specified in table 5.7.1-2 in TS 36.211
E_UTRA FDD Access Barring Information		-	Not Sent	No additional delays in random access procedure.
T1		s	30	
T2		s	30	

Table A.4.6.1.1-2: Cell Specific Test Parameters for E-UTRAN FDD (Cell # 1)

Parameter	Unit	Cell 1	
		T1	T2
E-UTRA RF Channel number		1	
BW _{channel}	MHz	10	
OCNG Patterns defined in A.3.2.1.2 (OP.2 FDD)		OP.2 FDD	
PBCH_RA	dB	0	
PBCH_RB	dB		
PSS_RA	dB		
SSS_RA	dB		
PCFICH_RB	dB		
PHICH_RA	dB		
PHICH_RB	dB		
PDCCH_RA	dB		
PDCCH_RB	dB		
PDSCH_RA	dB		
PDSCH_RB	dB		
OCNG_RA ^{Note 1}	dB		
OCNG_RB ^{Note 1}	dB		
N_{oc} ^{Note 2}	dBm/15 kHz		
RSRP ^{Note 3}	dBm/15 KHz	-89	-102
\hat{E}_s/I_{ot}	dB	9	-4
\hat{E}_s/N_{oc}	dB	9	-4
Treselection _{EUTRAN}	S	0	
Snonintrasearch	dB	Not sent	
cellReselectionPriority	-	1	
Qrxlevmin	dBm	-140	
Qrxlevminoffset	dB	0	
Pcompensation	dB	0	
S _{ServingCell}	dB	51	38
Thresh _{servin, low}	dB	44	
Propagation Condition		AWGN	
<p>Note 1: OCNG shall be used such that both cells are fully allocated and a constant total transmitted power spectral density is achieved for all OFDM symbols.</p> <p>Note 2: Interference from other cells and noise sources not specified in the test is assumed to be constant over subcarriers and time and shall be modelled as AWGN of appropriate power for N_{oc} to be fulfilled.</p> <p>Note 3: RSRP levels have been derived from other parameters for information purposes. They are not settable parameters themselves.</p>			

Table A.4.6.1.1-3: Cell Specific Test Parameters for cdma2000 1X (cell # 2)

Parameter	Unit	Cell 2	
		T1	T2
cdma2000 1X RF Channel Number		1	
$\frac{\text{Pilot } E_c}{I_{or}}$	dB	-7	
$\frac{\text{Sync } E_c}{I_{or}}$	dB	-16	
$\frac{\text{Paging } E_c}{I_{or}}$ (4.8 kbps)	dB	-12	
\hat{I}_{or} / I_{oc}	dB	0	0
I_{oc}	dBm/ 1.2288 MHz	-55	
CDMA2000 1xRTT Pilot Strength	dB	-10	-10
Propagation Condition		AWGN	
$S_{nonServingCell,x}$		-20	
Treselection	s	0	
oneXRTT-CellReselectionPriority	-	0	
Thresh _{x, low}		-28	

A.4.6.1.1.2 Test Requirements

The cell reselection delay to lower priority is defined as the time from the beginning of time period T2, to the moment when the UE camps on cell 2 and starts to send access probe preambles on the Access Channel on cell 2.

The cell re-selection delay to the lower priority cell 2 shall be less than 21 s.

The rate of correct cell reselections observed during repeated tests shall be at least 90%.

NOTE: The cell re-selection delay to lower priority cell can be expressed as: $T_{\text{evaluatecdma2000 1X}} + T_{\text{SI-cdma2000 1X}}$

Where:

$T_{\text{evaluatecdma2000 1X}}$ See Table 4.2.2.5.5-1

$T_{\text{SI-cdma2000 1X}}$ Maximum repetition period of relevant system information blocks that need to be received by the UE to camp on cell 2; 1280 ms is assumed in this test case.

This gives a total of 20.48 s for the lower priority cell reselection, allow 21 s in the test case.

A.4.6.2 E-UTRAN TDD – cdma2000 1X

A.4.6.2.1 E-UTRAN TDD –cdma2000 1X Cell Reselection: cdma2000 1X is of Lower Priority

A.4.6.2.1.1 Test Purpose and Environment

This test is to verify the requirement for the E-UTRAN TDD- cdma2000 1X inter-RAT cell reselection requirements specified in clause 4.2.2.5.5 when the cdma2000 1X cell is of lower priority.

The test scenario comprises of one cdma2000 1X and one E-UTRAN TDD cells as given in tables A.4.6.2.1.1-1, A.4.6.2.1.1-2 and A.4.6.2.1.1-3.

The test consists of two successive time periods, with time duration of T1 and T2 respectively. Both E-UTRAN TDD cell 1 and cdma2000 1X cell 2 are already identified by the UE prior to the start of the test. At T1 the UE is camped on to cell 1. Cell 2 is of lower priority than cell 1. Cell 1 and cell 2 shall belong to different tracking areas.

Table A.4.6.2.1.1-1: General Test Parameters for E-UTRAN TDD - lower priority cdma2000 1X Cell Reselection

	Parameter	Unit	Value	Comment
Initial condition	Active cell		Cell 1	E-UTRAN TDD cell
	Neighbour cell		Cell 2	cdma2000 1X cell

Final condition	Active cell		Cell 2	cdma2000 1X cell is selecting during T2
DRX cycle length		s	1.28	
E-UTRA TDD RF Channel Number			1	Only one TDD carrier frequency is used.
E-UTRA TDD Channel Bandwidth (BW_{channel})		MHz	10	
cdma2000 1X RF Channel Number			1	Only one cdma2000 1X carrier frequency is used.
E-UTRA TDD PRACH configuration			53	As specified in table 5.7.1-3 in TS 36.211
Uplink-downlink configuration of cell 1			1	As specified in table 4.2.2 in TS 36.211
Special subframe configuration of cell 1			6	As specified in table 4.2.1 in TS 36.211
E_UTRA TDD Access Barring Information		-	Not Sent	No additional delays in random access procedure.
T1		s	30	
T2		s	30	

Table A.4.6.2.1.1-2: Cell Specific Test Parameters for E-UTRAN TDD (Cell # 1)

Parameter	Unit	Cell 1	
		T1	T2
E-UTRA RF Channel number		1	
BW_{channel}	MHz	10	
OCNG Patterns defined in A.3.2.2.2 (OP.2 TDD)		OP.2 TDD	
PBCH_RA	dB	0	
PBCH_RB	dB		
PSS_RA	dB		
SSS_RA	dB		
PCFICH_RB	dB		
PHICH_RA	dB		
PHICH_RB	dB		
PDCCH_RA	dB		
PDCCH_RB	dB		
PDSCH_RA	dB		
PDSCH_RB	dB		
OCNG_RA ^{Note 1}	dB		
OCNG_RB ^{Note 1}	dB		
N_{oc} ^{Note 2}	dBm/15 kHz		
RSRP ^{Note 3}	dBm/15 KHz	-89	-102
\hat{E}_s/I_{ot}	dB	9	-4
\hat{E}_s/N_{oc}	dB	9	-4
Treselection _{EUTRAN}	S	0	
Snonintrasearch	dB	Not sent	
cellReselectionPriority	-	1	
Qrxlevmin	dBm	-140	
Qrxlevminoffset	dB	0	
Pcompensation	dB	0	
$S_{\text{ServingCell}}$	dB	51	38
Thresh _{serv, low}	dB	44	
Propagation Condition		AWGN	
Note 1:	CNG shall be used such that both cells are fully allocated and a constant total transmitted power spectral density is achieved for all OFDM symbols.		
Note 2:	Interference from other cells and noise sources not specified in the test is assumed to be constant over subcarriers and time and shall be modelled as AWGN of appropriate power for N_{oc} to be fulfilled.		
Note 3:	SRP levels have been derived from other parameters for information purposes. They are not settable parameters themselves.		

Table A.4.6.2.1.1-3: Cell Specific Test Parameters for cdma2000 1X (cell # 2)

Parameter	Unit	Cell 2	
		T1	T2
cdma2000 1X RF Channel Number		1	
$\frac{\text{Pilot } E_c}{I_{or}}$	dB	-7	
$\frac{\text{Sync } E_c}{I_{or}}$	dB	-16	
$\frac{\text{Paging } E_c}{I_{or}}$ (4.8 kbps)	dB	-12	
\hat{I}_{or} / I_{oc}	dB	0	0
I_{oc}	dBm/ 1.2288 MHz	-55	
CDMA2000 1xRTT Pilot Strength	dB	-10	-10
Propagation Condition		AWGN	
$S_{nonServingCell,x}$		-20	
Treselection	s	0	
oneXRTT-CellReselectionPriority	-	0	
Thresh _{x, low}		-28	

A.4.6.2.1.2 Test Requirements

The cell reselection delay to lower priority is defined as the time from the beginning of time period T2, to the moment when the UE camps on cell 2 and starts to send access probe preambles on the Access Channel on cell 2.

The cell re-selection delay to the lower priority cell 2 shall be less than 21 s.

The rate of correct cell reselections observed during repeated tests shall be at least 90%.

NOTE: The cell re-selection delay to lower priority cell can be expressed as: $T_{\text{evaluatecdma2000 1X}} + T_{\text{SI-cdma2000 1X}}$

Where:

$T_{\text{evaluatecdma2000 1X}}$ See Table 4.2.2.5.5-1

$T_{\text{SI-cdma2000 1X}}$ Maximum repetition period of relevant system information blocks that need to be received by the UE to camp on cell 2; 1280 ms is assumed in this test case.

This gives a total of 20.48 s for the lower priority cell reselection, allow 21 s in the test case.

A.4.7 Idle State Positioning Measurement for UE category NB1

A.4.7.1 HD – FDD Intra frequency case for UE Category NB1 standalone mode in enhanced coverage

A.4.7.1.1 Test Purpose and Environment

The purpose of the test is to verify that the intra frequency RSTD measurement period for HD-FDD category NB1 UE meets the delay requirements specified in Clause 4.8.2.

In the test there are three synchronous cells: nCell 1, nCell 2 and nCell 3. nCell 1 is the reference cell. nCell 2 and nCell 3 are the neighbour cells. All cells are on the same RF channel.

The test consists of six consecutive time intervals, with duration of T1, T2, T3, T4, T5, and T6. nCell 1 is active throughout T1, T2, T3, T4, T5, and T6, whilst nCell 2 and nCell 3 are activated only in the beginning of T2. nCell 2 is active until the end of T5, and nCell 3 is active until the end of T4. nCell 1 transmits NPRS in T2 and T4, while nCell 2 transmits NPRS in T3 and T5, and nCell 3 transmits NPRS only in T2 and T4. Note: The information on when NPRS is muted is conveyed to the UE using PRS muting information.

Prior to the start of the time duration T1, the UE shall be fully synchronized to nCell1.

At the start of the time duration T1, the OTDOA assistance data and *OTDOA-RequestLocationInformation* as defined in TS 36.355 [24], shall be provided to the UE. The duration of T1 is sufficiently long to deliver the OTDOA assistance data and *OTDOA-RequestLocationInformation* to the UE and is independent of the delay requirements specified in Clause 4.8.2.

After OTDOA assistance data and *OTDOA-RequestLocationInformation* have been successfully received, the UE is provided with a RRC connection release command. The RRC connection release command shall be received by the UE in the last TTI of interval T1. The UE shall enter RRC_IDLE state within ΔT seconds after the receipt of the RRC connection release, where $\Delta T = 10$ s is the maximum delay for NB-IOT UE to perform RRC connection release as define in TS36.331 [2].

The test parameters are given in Tables A.4.7.1.1-1 A.4.7.1.1-2 and A.4.7.1.1-3.

Table A.4.7.1.1-1: General test parameters

Parameter	Unit	Value	Comment
NB-IoT operational mode		Standalone	
Reference cell		nCell 1	Reference cell is the cell in the OTDOA assistance data with respect to which the RSTD measurement is defined, as specified in TS 36.214 [4] and TS 36.355 [24]. The reference cell is the PCell in this test case.
Neighbor cells		nCell 2 and nCell 3	Cell 2 and Cell 3 appear at random places in the neighbour cell list in the OTDOA assistance data, but Cell 2 always appears in the first half of the list, whilst Cell 3 appears in the second half of the list.
nprsID		(nprsID of Cell 1 – nprsID of Cell 2)mod6=1 and (nprsID of Cell 1 – nprsID of Cell 3)mod6=2	As defined in TS36.366 [24]
nprs-period	ms	1280	As defined in TS36.355 [24]
nprs-startSF		sf0	Subframe offset of the NPRS positioning occasion as defined in TS36.355 [24]
Number of consecutive downlink positioning subframes nprs-NumSF		320	As defined in TS36.355 [24]
NPRS muting info		nCell 1: '11110000' nCell 2: '00001111' nCell 3: '11110000'	Correponds to nprs-MutingInfoB defined in TS 36.355 [24]
PartA Configuration		N/A	NPRS is configured based on PartB but not PartA.
CP length		Normal	
NPRACH Configuration		NPRACH.R-1	Refer to A.3.18
DRX cycle length		1.28	The value shall be used for all cells in the test.
Radio frame receive time offset between the cells at the UE antenna connector	μ s	nCell 2 to nCell 1: 1 nCell 3 to nCell 1: -1	PRS are transmitted from synchronous cells
Expected RSTD	μ s	nCell 2: 3 nCell 3: 3 Other neighbour cells: randomly between -3 and 3	The expected RSTD is what is expected at the receiver. The corresponding parameter in the OTDOA assistance data specified in TS 36.355 [24] is the expectedRSTD indicator
Expected RSTD uncertainty for all neighbour cells	μ s	5	The corresponding parameter in the OTDOA assistance data specified in TS 36.355 [24] is the expectedRSTD-Uncertainty index

Number of cells provided in OTDOA assistance data		16	Including the reference cell
T2	s	5.12	The length of the time interval that follows immediately after time interval T1
T3	s	5.12	The length of the time interval that follows immediately after time interval T2
T4	s	5.12	The length of the time interval that follows immediately after time interval T3
T5	s	5.12	The length of the time interval that follows immediately after time interval T4
T6	s	≥ 57	The length of the time interval that follows immediately after time interval T5

Table A.4.7.1.1-2: Cell-specific test parameters during T1 and T6

Parameter	Unit	nCell 1	nCell 2	nCell 3
NB-IoT RF Channel Number		1	1	1
NB-IoT Channel Bandwidth (BW _{channel})	kHz	200	200	200
OCNG Pattern ^{Note 1}		NOP.3 FDD	N/A	N/A
NPDSCH parameters ^{Note 2}		R.18 HD-FDD	N/A	N/A
NPDCCH parameters ^{Note 2}		R.30 HD-FDD	N/A	N/A
NPBCH_RA	dB	0	N/A	N/A
NPBCH_RB				
NPSS_RA				
NSSS_RA				
NPDCCH_RA				
NPDCCH_RB				
NPDSCH_RA				
NPDSCH_RB				
OCNG_RA ^{Note 1}				
OCNG_RB ^{Note 1}				
N_{oc} ^{Note 3}	dBm/15 kHz	-98		
$NPRS \hat{E}_s / N_{oc}$	dB	-Infinity	-Infinity	-Infinity
\hat{E}_s / N_{oc}	dB	-2	-Infinity	-Infinity
Propagation Condition		AWGN		
Antenna Configuration		1x1		
Timing offset to nCell 1	μs	N/A	1	-1
<p>Note 1: OCNG shall be used such that the cell is fully allocated and a constant total transmitted power spectral density is achieved for all OFDM symbols. The OCNG pattern is chosen during the test according to the presence of a DL reference measurement channel.</p> <p>Note 2: The NPDSCH and NPDCCH reference measurement channels are used in the test only when a downlink transmission dedicated to the UE under test is required.</p> <p>Note 3: Interference from other cells and noise sources not specified in the test are assumed to be constant over subcarriers and time and shall be modelled as AWGN of appropriate power for N_{oc} to be fulfilled.</p>				

Table A.4.7.1.1-3: Cell-specific test parameters from T2 to T5

Parameter	Unit	nCell 1		nCell 2		nCell 3		
		T2 and T4	T3 and T5	T2 and T4	T3 and T5	T2 and T4	T3 and T5	
$BW_{channel}$	kHz	200		200		200		
NB-IoT RF Channel Number		1		1		1		
OCNG patterns		NOP.3 FDD		N/A	NOP.3 FDD	NOP.3 FDD	N/A	
NPBCH_RA	dB	0		0		0		N/A
NPBCH_RB								
NPSS_RA								
NSSS_RA								
NPDCCH_RA								
NPDCCH_RB								
NPDSCH_RA								
NPDSCH_RB								
OCNG_RA ^{Note 1}								
OCNG_RB ^{Note 1}								
NPRS_RA	dB	-3	N/A	N/A	0	0	N/A	
N_{oc} ^{Note 3}	dBm/15 kHz	-98	-95	-98	-95	-98	-95	
$NPRS \hat{E}_s/N_{oc}$	dB	-15	-Infinity	-Infinity	-15	-15	-Infinity	
$NPRS \hat{E}_s/I_{ot}$ ^{Note 4}	dB	-15	-Infinity	-Infinity	-15	-15	-Infinity	
I_o ^{Note 4}	dBm/180kHz	-87.14	-87.12	-87.14	-87.12	-87.14	-87.12	
NPRP ^{Note 4}	dBm/15 kHz	-113	-Infinity	-Infinity	-110	-113	-Infinity	
NRSRP ^{Note 4}	dBm/15 kHz	-110	-107	-113	-110	-113	-Infinity	
\hat{E}_s/N_{oc} ^{Note 4}	dB	-12	-12	-15	-15	-15	-Infinity	
Propagation Condition		AWGN						
Antenna Configuration		1x1						
Timing offset to nCell 1	μ s	N/A		1		-1		
Note 1:	OCNG shall be used such that active cells (all, except Cell 3 in T3) are fully allocated and a constant total transmitted power spectral density is achieved for all OFDM symbols other than those in the subframes with transmitted NPRS.							
Note 3:	Interference from other cells and noise sources not specified in the test are assumed to be constant over subcarriers and time and shall be modelled as AWGN of appropriate power for N_{oc} to be fulfilled.							
Note 4:	If NPRS_RA is not "N/A", \hat{E}_s/N_{oc} , $NPRS \hat{E}_s/I_{ot}$, I_o , NRSRP and NPRP levels have been derived from other parameters and are given for information purpose. If NPRS_RA is "N/A", I_o and NRSRP levels have been derived from other parameters and are given for information purpose. These are not settable test parameters. Interference conditions shall be applied to all PRS symbols of DL positioning subframes.							

A.4.7.1.2 Test Requirements

The RSTD measurement time fulfils the requirements specified in Clause 4.8.2.

The UE shall perform and report the RSTD measurements for nCell 2 and nCell 3 with respect to the reference cell in the OTDOA assistance data, nCell 1, within $T_{RSTD_intra_NB-IoT-EC} + T_{RandomAccess_NB-IoT-EC} = 67.16$ s starting from the

beginning of time interval T4, to the moment when the UE starts to send preambles on the PRACH for sending the positioning measurement report message to nCell1.

The RSTD measurement time $T_{\text{RSTD_intra_NB-IoT-EC}}$ in the test is derived according to section 4.8.2. This gives the total RSTD measurement time of 11.52s for Cell 2 and Cell 3 with respect to the reference Cell 1

The random access to an already detected cell $T_{\text{RandomAccess_NB-IoT-EC}}$ can be expressed as: $T_{\text{evaluate, NB_intra_NB-IoT-EC}} + T_{\text{SI}} + T_{\text{PRACH_NB-IoT}}$,

Where:

$T_{\text{evaluate, NB_intra_NB-IoT-EC}}$ See Table 4.6.2.4-1 in clause 4.6.2.4

$T_{\text{SI}} = 41560$ ms; it is the time required for receiving all the relevant system information as defined in TS 36.331 for the target NB-IoT FDD cell.

$T_{\text{PRACH_NB-IoT}} = 1280$ ms; it is the additional delay caused by the random access procedure.

This gives $T_{\text{RandomAccess_NB-IoT-EC}} = 55.64$ s for the random access delay to an already detected cell in the test case.

The rate of the correct events for each neighbour cell observed during repeated tests shall be at least 90%, where the reported RSTD measurement for each correct event shall be within the RSTD reporting range specified in Clause 9.1.10.3, i.e., between RSTD_0000 and RSTD_12711.

A.4.7.2 HD – FDD Inter frequency case for UE Category NB1 standalone mode in enhanced coverage

A.4.7.2.1 Test Purpose and Environment

The purpose of the test is to verify that the RSTD measurement period for HD-FDD category NB1 UE meets the delay requirements specified in Clause 4.8.4.

In the test there are three synchronous cells: nCell 1, nCell 2 and nCell 3. nCell 1 is the reference cell. nCell 2 and nCell 3 are the neighbour cells.

The test consists of six consecutive time intervals, with duration of T1, T2, T3, T4, T5, and T6. nCell 1 is active throughout T1, T2, T3, T4, T5, and T6, whilst nCell 2 and nCell 3 are activated only in the beginning of T2. nCell 2 is active until the end of T5, and nCell 3 is active until the end of T4. nCell 1 transmits NPRS in T2 and T4, while nCell 2 transmits NPRS in T3 and T5, and nCell 3 transmits NPRS only in T2 and T4. Note: The information on when NPRS is muted is conveyed to the UE using PRS muting information.

Prior to the start of the time duration T1, the UE shall be fully synchronized to nCell1

At the start of the time duration T1, the OTDOA assistance data and *OTDOA-RequestLocationInformation* as defined in TS 36.355 [24], shall be provided to the UE. The duration of T1 is sufficiently long to deliver the OTDOA assistance data and *OTDOA-RequestLocationInformation* to the UE and is independent of the delay requirements specified in Clause 4.8.2.

After OTDOA assistance data and *OTDOA-RequestLocationInformation* have been successfully received, the UE is provided with a RRC connection release command. The RRC connection release command shall be received by the UE in the last TTI of interval T1. The UE shall enter RRC_IDLE state within ΔT seconds after the receipt of the RRC connection release, where $\Delta T = 10$ s is the maximum delay for NB-IOT UE to perform RRC connection release as define in TS36.331 [2].

The test parameters are given in Tables A.4.7.2.1-1 A.4.7.2.1-2 and A.4.7.2.1-3.

Table A.4.7.2.1-1: General test parameters

Parameter	Unit	Value	Comment
NB-IoT operational mode		Standalone	

Reference cell		nCell 1	Reference cell is the cell in the OTDOA assistance data with respect to which the RSTD measurement is defined, as specified in TS 36.214 [4] and TS 36.355 [24]. The reference cell is the PCell in this test case.
Neighbor cells		nCell 2 and nCell 3	Cell 2 and Cell 3 appear at random places in the neighbour cell list in the OTDOA assistance data, but Cell 2 always appears in the first half of the list, whilst Cell 3 appears in the second half of the list.
nprsID		(nprsID of Cell 1 – nprsID of Cell 2)mod6=1 and (nprsID of Cell 1 – nprsID of Cell 3)mod6=2	As defined in TS36.366 [24]
nprs-period	ms	640	As defined in TS36.355 [24]
nprs-startSF		sf0	Subframe offset of the NPRS positioning occasion as defined in TS36.355 [24]
Number of consecutive downlink positioning subframes nprs-NumSF		320	As defined in TS36.355 [24]
nprs-SubframeOffset		0	As defined in TS36.355 [24]
NPRS muting info		Cell 1: '1111111100000000' Cell 2: '0000000011111111' Cell 3: '1111111100000000'	Correponds to nprs-MutingInfoB defined in TS 36.355 [24]
PartA Configuration		N/A	NPRS is configured based on PartB but not PartA.
CP length		Normal	
NPRACH Configuration		NPRACH.R-1	Refer to A.3.18
DRX		1.28	DRX parameters are further specified in Table A.8.12.1.1-3
Radio frame receive time offset between the cells at the UE antenna connector	μs	nCell 2 to nCell 1: 1 nCell 3 to nCell 1: -1	PRS are transmitted from synchronous cells
Expected RSTD	μs	Cell 2: -2 Cell 3: 2 Other neighbour cells: randomly between -3 and 3	The expected RSTD is what is expected at the receiver. The corresponding parameter in the OTDOA assistance data specified in TS 36.355 [24] is the expectedRSTD indicator
Expected RSTD uncertainty for all neighbour cells	μs	5	The corresponding parameter in the OTDOA assistance data specified in TS 36.355 [24] is the expectedRSTD-Uncertainty index
Number of cells provided in OTDOA assistance data		16	Including the reference cell
T2	s	5.12	The length of the time interval that follows immediately after time interval T1
T3	s	5.12	The length of the time interval that follows immediately after time interval T2
T4	s	5.12	The length of the time interval that follows immediately after time interval T3
T5	s	5.12	The length of the time interval that follows immediately after time interval T4

T6	s	≥ 57	The length of the time interval that follows immediately after time interval T5
----	---	-----------	---

Table A.4.7.2.1-2: Cell-specific test parameters during T1 and T6

Parameter	Unit	nCell 1	nCell 2	nCell 3
NB-IoT RF Channel Number		1	2	2
NB-IoT Channel Bandwidth (BW_{channel})	KHz	200	200	200
OCNG Pattern ^{Note 1}		NOP.3 FDD	N/A	N/A
NPDSCH parameters ^{Note 2}		R.18 HD-FDD	N/A	N/A
NPDCCH parameters ^{Note 2}		R.30 HD-FDD	N/A	N/A
NPBCH_RA	dB	0	N/A	N/A
NPBCH_RB				
NPSS_RA				
NSSS_RA				
NPDCCH_RA				
NPDCCH_RB				
NPDSCH_RA				
NPDSCH_RB				
OCNG_RA ^{Note 1}				
OCNG_RB ^{Note 1}				
N_{oc} ^{Note 3}	dBm/ 15 kHz	-98		
$NPRS \hat{E}_s / N_{oc}$	dB	-Infinity	-Infinity	-Infinity
\hat{E}_s / N_{oc}	dB	-2	-Infinity	-Infinity
Propagation Condition		AWGN		
Antenna Configuration		1x1		
Timing offset to nCell 1	μs	N/A	1	-1
<p>Note 1: OCNG shall be used such that the cell is fully allocated and a constant total transmitted power spectral density is achieved for all OFDM symbols. The OCNG pattern is chosen during the test according to the presence of a DL reference measurement channel.</p> <p>Note 2: The NPDSCH and NPDCCH reference measurement channels are used in the test only when a downlink transmission dedicated to the UE under test is required.</p> <p>Note 3: Interference from other cells and noise sources not specified in the test are assumed to be constant over subcarriers and time and shall be modelled as AWGN of appropriate power for N_{oc} to be fulfilled.</p>				

Table A.4.7.2.1-3: Cell-specific test parameters from T2 to T5

Parameter	Unit	nCell 1		nCell 2		nCell 3	
		T2 and T4	T3 and T5	T2 and T4	T3 and T5	T2 and T4	T3 and T5
BW_{channel}	kHz	200		200		200	
NB-IoT RF Channel Number		1		2		2	
NPDSCH parameters ^{Note 2}		R.18 HD-FDD		N/A		N/A	
NPDCCH parameters ^{Note 2}		R.30 HD-FDD		N/A		N/A	

OCNG patterns		NOP.3 FDD		N/A	NOP.3 FDD	NOP.3 FDD	N/A	
NPBCH_RA	dB	0		0		0		N/A
NPBCH_RB								
NPSS_RA								
NSSS_RA								
NPDCCH_RA								
NPDCCH_RB								
NPDSCH_RA								
NPDSCH_RB								
OCNG_RA ^{Note 1}								
OCNG_RB ^{Note 1}								
NPRS_RA								
N_{oc} ^{Note 3}	dBm/ 15 kHz	-98	-98	-98	-95	-98	-95	
$NPRS \hat{E}_s/N_{oc}$	dB	-15	-Infinity	-Infinity	-15	-15	-Infinity	
$NPRS \hat{E}_s/I_{ot}$ ^{Note 4}	dB	-15	-Infinity	-Infinity	-15	-15	-Infinity	
I_o ^{Note 4}	dBm/ 180kHz	-87.17	-87.20	-87.17	-87.15	-87.17	-87.15	
NPRP ^{Note 4}	dBm/ 15 kHz	-113	-Infinity	-Infinity	-110	-113	-Infinity	
NRSRP ^{Note 4}	dBm/ 15 kHz	-110	-110	-113	-110	-113	-Infinity	
\hat{E}_s/N_{oc} ^{Note 4}	dB	-12	-12	-15	-15	-15	-Infinity	
Propagation Condition		AWGN						
Antenna Configuration		1x1						
Timing offset to nCell 1	μ s	N/A		1		-1		
Note 1:	OCNG shall be used such that active cells (all, except Cell 3 in T3) are fully allocated and a constant total transmitted power spectral density is achieved for all OFDM symbols other than those in the subframes with transmitted NPRS.							
Note 3:	Interference from other cells and noise sources not specified in the test are assumed to be constant over subcarriers and time and shall be modelled as AWGN of appropriate power for N_{oc} to be fulfilled.							
Note 4:	If NPRS_RA is not "N/A", \hat{E}_s/N_{oc} , $NPRS \hat{E}_s/I_{ot}$, I_o , NRSRP and NPRP levels have been derived from other parameters and are given for information purpose. If NPRS_RA is "N/A", I_o and NRSRP levels have been derived from other parameters and are given for information purpose. These are not settable test parameters. Interference conditions shall be applied to all PRS symbols of DL positioning subframes.							

A.4.7.4.2 Test Requirements

The RSTD measurement time fulfils the requirements specified in Clause 4.8.4.

The UE shall perform and report the RSTD measurements for nCell 2 and nCell 3 with respect to the reference cell in the OTDOA assistance data, nCell 1, within $T_{RSTD_inter_NB-IoT-EC} + T_{RandomAccess_NB-IoT-EC} = 67.16$ s starting from the beginning of time interval T4, to the moment when the UE starts to send preambles on the PRACH for sending the positioning measurement report message to nCell1.

The RSTD measurement time $T_{RSTD_inter_NB-IoT-EC}$ in the test is derived according to section 4.8.4. This gives the total RSTD measurement time of 11.52 s for Cell 2 and Cell 3 with respect to the reference Cell 1.

The random access to an already detected cell $T_{RandomAccess_NB-IoT-EC}$ can be expressed as: $T_{evaluate, NB_inter_NB-IoT-EC} + T_{SI} + T_{PRACH_NB-IoT}$,

Where:

$T_{\text{evaluate, NB_inter_NB-IoT-EC}}$ See Table 4.6.2.4-1 in clause 4.6.2.4

$T_{\text{SI}} = 41560$ ms; it is the time required for receiving all the relevant system information as defined in TS 36.331 for the target NB-IoT FDD cell.

$T_{\text{PRACH_NB-IoT}} = 1280$ ms; it is the additional delay caused by the random access procedure.

This gives $T_{\text{RandomAccess_NB-IoT}} = 55.64$ s for the random access delay to an already detected cell in the test case.

The rate of the correct events for each neighbour cell observed during repeated tests shall be at least 90%, where the reported RSTD measurement for each correct event shall be within the RSTD reporting range specified in Clause 9.1.10.3, i.e., between RSTD_0000 and RSTD_12711.

A.4.7.3 TDD Intra frequency case for UE Category NB1 standalone mode in enhanced coverage

A.4.7.3.1 Test Purpose and Environment

The purpose of the test is to verify that the intra frequency RSTD measurement period for TDD category NB1 UE meets the delay requirements specified in Clause 4.8.2. In the test there are three synchronous cells: nCell 1, nCell 2 and nCell 3. nCell 1 is the reference cell. nCell 2 and nCell 3 are the neighbour cells. All cells are on the same RF channel.

The test consists of six consecutive time intervals, with duration of T1, T2, T3, T4, T5, and T6. nCell 1 is active throughout T1, T2, T3, T4, T5, and T6, whilst nCell 2 and nCell 3 are activated only in the beginning of T2. nCell 2 is active until the end of T5, and nCell 3 is active until the end of T4. nCell 1 transmits NPRS in T2 and T4, while nCell 2 transmits NPRS in T3 and T5, and nCell 3 transmits NPRS only in T2 and T4. Note: The information on when NPRS is muted is conveyed to the UE using PRS muting information.

Prior to the start of the time duration T1, the UE shall be fully synchronized to nCell1.

At the start of the time duration T1, the OTDOA assistance data and *OTDOA-RequestLocationInformation* as defined in TS 36.355 [24], shall be provided to the UE. The duration of T1 is sufficiently long to deliver the OTDOA assistance data and *OTDOA-RequestLocationInformation* to the UE and is independent of the delay requirements specified in Clause 4.8.2.

After OTDOA assistance data and *OTDOA-RequestLocationInformation* have been successfully received, the UE is provided with an RRC connection release command. The RRC connection release command shall be received by the UE in the last TTI of interval T1. The UE shall enter RRC_IDLE state within ΔT seconds after the receipt of the RRC connection release, where $\Delta T = 10$ s is the maximum delay for NB-IOT UE to perform RRC connection release as defined in TS 36.331 [2].

The test parameters are given in Tables A.4.7.3.1-1 A.4.7.3.1-2 and A.4.7.3.1-3.

Table A.4.7.3.1-1: General test parameters

Parameter	Unit	Value	Comment
NB-IoT operational mode		Standalone	
Reference cell		nCell 1	Reference cell is the cell in the OTDOA assistance data with respect to which the RSTD measurement is defined, as specified in TS 36.214 [4] and TS 36.355 [24]. The reference cell is the PCell in this test case.
Neighbor cells		nCell 2 and nCell 3	Cell 2 and Cell 3 appear at random places in the neighbour cell list in the OTDOA assistance data, but Cell 2 always appears in the first half of the list, whilst Cell 3 appears in the second half of the list.

nprsID		(nprsID of Cell 1 – nprsID of Cell 2)mod6=1 and (nprsID of Cell 1 – nprsID of Cell 3)mod6=2	As defined in TS 36.355 [24]
nprs-period	ms	1280	As defined in TS 36.355 [24]
nprs-startSF		sf0	Subframe offset of the NPRS positioning occasion as defined in TS 36.355 [24]
Number of consecutive downlink positioning subframes nprs-NumSF		640	As defined in TS 36.355 [24]
NPRS muting info		nCell 1: '11110000' nCell 2: '00001111' nCell 3: '11110000'	Corresponds to nprs-MutingInfoB defined in TS 36.355 [24]
PartA Configuration		N/A	NPRS is configured based on PartB but not PartA.
CP length		Normal	
NPRACH Configuration		NPRACH.R-2	Specified in A.3.18
DRX cycle length		1.28	The value shall be used for all cells in the test.
Radio frame receive time offset between the cells at the UE antenna connector	µs	nCell 2 to nCell 1: 1 nCell 3 to nCell 1: -1	PRS are transmitted from synchronous cells
Expected RSTD	µs	nCell 2: 3 nCell 3: 3 Other neighbour cells: randomly between -3 and 3	The expected RSTD is what is expected at the receiver. The corresponding parameter in the OTDOA assistance data specified in TS 36.355 [24] is the expectedRSTD indicator
Expected RSTD uncertainty for all neighbour cells	µs	5	The corresponding parameter in the OTDOA assistance data specified in TS 36.355 [24] is the expectedRSTD-Uncertainty index
Number of cells provided in OTDOA assistance data		16	Including the reference cell
Special subframe configuration		6	As specified in table 4.2-1 in TS 36.211 [16]
Uplink-downlink configuration		2	As specified in table 4.2-2 in TS 36.211 [16]
T2	s	5.12	The length of the time interval that follows immediately after time interval T1
T3	s	5.12	The length of the time interval that follows immediately after time interval T2
T4	s	5.12	The length of the time interval that follows immediately after time interval T3
T5	s	[5.12]	The length of the time interval that follows immediately after time interval T4
T6	s	≥ 58.2	The length of the time interval that follows immediately after time interval T5

Table A.4.7.3.1-2: Cell-specific test parameters during T1 and T6

Parameter	Unit	nCell 1	nCell 2	nCell 3
NB-IoT RF Channel Number		1	1	1
NB-IoT Channel Bandwidth (BW _{channel})	kHz	200	200	200
OCNG Pattern ^{Note 1}		NOP.3 TDD	N/A	N/A

NPDSCH parameters ^{Note 2}		R.18 NB-TDD	N/A	N/A
NPDCCH parameters ^{Note 2}		R.30 NB-TDD	N/A	N/A
NPBCH_RA	dB	0	N/A	N/A
NPBCH_RB				
NPSS_RA				
NSSS_RA				
NPDCCH_RA				
NPDCCH_RB				
NPDSCH_RA				
NPDSCH_RB				
OCNG_RA ^{Note 1}				
OCNG_RB ^{Note 1}				
N_{oc} ^{Note 3}	dBm/ 15 kHz	-98		
$NPRS \hat{E}_s/N_{oc}$	dB	-Infinity	-Infinity	-Infinity
\hat{E}_s/N_{oc}	dB	-2	-Infinity	-Infinity
Propagation Condition		AWGN		
Antenna Configuration		1x1		
Timing offset to nCell 1	μ s	N/A	1	-1
<p>Note 1: OCNG shall be used such that the cell is fully allocated and a constant total transmitted power spectral density is achieved for all OFDM symbols. The OCNG pattern is chosen during the test according to the presence of a DL reference measurement channel.</p> <p>Note 2: The NPDSCH and NPDCCH reference measurement channels are used in the test only when a downlink transmission dedicated to the UE under test is required.</p> <p>Note 3: Interference from other cells and noise sources not specified in the test are assumed to be constant over subcarriers and time and shall be modelled as AWGN of appropriate power for N_{oc} to be fulfilled.</p>				

Table A.4.7.3.1-3: Cell-specific test parameters from T2 to T5

Parameter	Unit	nCell 1		nCell 2		nCell 3	
		T2 and T4	T3 and T5	T2 and T4	T3 and T5	T2 and T4	T3 and T5
$BW_{channel}$	kHz	200		200		200	
NB-IoT RF Channel Number		1		1		1	
OCNG patterns		NOP.3 TDD		N/A	NOP.3 TDD	NOP.3 TDD	N/A
NPBCH_RA	dB	0		0	0	0	N/A
NPBCH_RB							
NPSS_RA							
NSSS_RA							
NPDCCH_RA							
NPDCCH_RB							
NPDSCH_RA							
NPDSCH_RB							
OCNG_RA ^{Note 1}							
OCNG_RB ^{Note 1}							
NPRS_RA	dB	-3	N/A	N/A	0	0	N/A
N_{oc} ^{Note 3}	dBm/ 15 kHz	-98	-95	-98	-95	-98	-95
$NPRS \hat{E}_s/N_{oc}$	dB	-15	-Infinity	-Infinity	-15	-15	-Infinity

NPRS \hat{E}_s/I_{ot} Note 4	dB	-15	-Infinity	-Infinity	-15	-15	-Infinity
I_o Note 4	dBm/ 180kHz	-87.14	-87.12	-87.14	-87.12	-87.14	-87.12
NPRP Note 4	dBm/ 15 kHz	-113	-Infinity	-Infinity	-110	-113	-Infinity
NRSRP Note 4	dBm/ 15 kHz	-110	-107	-113	-110	-113	-Infinity
\hat{E}_s/N_{oc} Note 4	dB	-12	-12	-15	-15	-15	-Infinity
Propagation Condition		AWGN					
Antenna Configuration		1x1					
Timing offset to nCell 1	μ s	N/A		1	-1		
Note 1:	OCNG shall be used such that active cells (all, except Cell 3 in T3) are fully allocated and a constant total transmitted power spectral density is achieved for all OFDM symbols other than those in the subframes with transmitted NPRS.						
Note 3:	Interference from other cells and noise sources not specified in the test are assumed to be constant over subcarriers and time and shall be modelled as AWGN of appropriate power for N_{oc} to be fulfilled.						
Note 4:	If NPRS_RA is not "N/A", \hat{E}_s/N_{oc} , NPRS \hat{E}_s/I_{ot} , I_o , NRSRP and NPRP levels have been derived from other parameters and are given for information purpose. If NPRS_RA is "N/A", I_o and NRSRP levels have been derived from other parameters and are given for information purpose. These are not settable test parameters. Interference conditions shall be applied to all PRS symbols of DL positioning subframes.						

A.4.7.3.2 Test Requirements

The RSTD measurement time fulfils the requirements specified in Clause 4.8.2.

The UE shall perform and report the RSTD measurements for nCell 2 and nCell 3 with respect to the reference cell in the OTDOA assistance data, nCell 1, within $T_{RSTD_intra_NB-IoT-EC} + T_{RandomAccess_NB-IoT-EC} = 68.44$ s starting from the beginning of time interval T4, to the moment when the UE starts to send preambles on the PRACH for sending the positioning measurement report message to nCell 1.

The RSTD measurement time $T_{RSTD_intra_NB-IoT-EC}$ in the test is derived according to section 4.8.2. This gives the total RSTD measurement time of 11.52 s for nCell 2 and nCell 3 with respect to the reference nCell 1.

The random access to an already detected cell $T_{RandomAccess_NB-IoT-EC}$ can be expressed as: $T_{evaluate, NB_intra_NB-IoT-EC} + T_{SI} + T_{PRACH_NB-IoT}$,

Where:

$T_{evaluate, NB_intra_NB-IoT-EC}$ See Table 4.6.2.4-1 in clause 4.6.2.4

$T_{SI} = 41560$ ms; it is the time required for receiving all the relevant system information as defined in TS 36.331 for the target NB-IoT TDD cell.

$T_{PRACH_NB-IoT} = 2560$ ms; it is the additional delay caused by the random access procedure.

This gives $T_{RandomAccess_NB-IoT-EC} = 56.92$ s for the random access delay to an already detected cell in the test case.

The rate of the correct events for each neighbour cell observed during repeated tests shall be at least 90%, where the reported RSTD measurement for each correct event shall be within the RSTD reporting range specified in Clause 9.1.10.3, i.e., between RSTD_0000 and RSTD_12711.

A.4.7.4 TDD Inter frequency case for UE Category NB1 standalone mode in enhanced coverage

A.4.7.4.1 Test Purpose and Environment

The purpose of the test is to verify that the RSTD measurement period for TDD category NB1 UE meets the delay requirements specified in Clause 4.8.4. In the test there are three synchronous cells: nCell 1, nCell 2 and nCell 3. nCell 1 is the reference cell. nCell 2 and nCell 3 are the neighbour cells.

The test consists of six consecutive time intervals, with durations of T1, T2, T3, T4, T5, and T6. nCell 1 is active throughout T1, T2, T3, T4, T5, and T6, whilst nCell 2 and nCell 3 are activated only in the beginning of T2. nCell 2 is active until the end of T5, and nCell 3 is active until the end of T4. nCell 1 transmits NPRS in T2 and T4, while nCell 2 transmits NPRS in T3 and T5, and nCell 3 transmits NPRS only in T2 and T4. Note: The information on when NPRS is muted is conveyed to the UE using PRS muting information.

Prior to the start of the time duration T1, the UE shall be fully synchronized to nCell 1.

At the start of the time duration T1, the OTDOA assistance data and *OTDOA-RequestLocationInformation* as defined in TS 36.355 [24], shall be provided to the UE. The duration of T1 is sufficiently long to deliver the OTDOA assistance data and *OTDOA-RequestLocationInformation* to the UE and is independent of the delay requirements specified in Clause 4.8.2.

After OTDOA assistance data and *OTDOA-RequestLocationInformation* have been successfully received, the UE is provided with a RRC connection release command. The RRC connection release command shall be received by the UE in the last TTI of interval T1. The UE shall enter RRC_IDLE state within ΔT seconds after the receipt of the RRC connection release, where $\Delta T = 10$ s is the maximum delay for NB-IOT UE to perform RRC connection release as defined in TS 36.331 [2].

The test parameters are given in Tables A.4.7.4.1-1 A.4.7.4.1-2 and A.4.7.4.1-3.

Table A.4.7.4.1-1: General test parameters

Parameter	Unit	Value	Comment
NB-IoT operational mode		Standalone	
Reference cell		nCell 1	Reference cell is the cell in the OTDOA assistance data with respect to which the RSTD measurement is defined, as specified in TS 36.214 [4] and TS 36.355 [24]. The reference cell is the PCell in this test case.
Neighbor cells		nCell 2 and nCell 3	Cell 2 and Cell 3 appear at random places in the neighbour cell list in the OTDOA assistance data, but Cell 2 always appears in the first half of the list, whilst Cell 3 appears in the second half of the list.
nprsID		(nprsID of Cell 1 – nprsID of Cell 2)mod6=1 and (nprsID of Cell 1 – nprsID of Cell 3)mod6=2	As defined in TS 36.355 [24]
nprs-period	ms	1280	As defined in TS 36.355 [24]
nprs-startSF		sf0	Subframe offset of the NPRS positioning occasion as defined in TS 36.355 [24]
Number of consecutive downlink positioning subframes nprs-NumSF		640	As defined in TS 36.355 [24]
nprs-SubframeOffset		0	As defined in TS 36.355 [24]
NPRS muting info		Cell 1: '1111111100000000' Cell 2: '0000000011111111' Cell 3: '1111111100000000'	Corresponds to nprs-MutingInfoB defined in TS 36.355 [24]

PartA Configuration		N/A	NPRS is configured based on PartB but not PartA.
CP length		Normal	
NPRACH Configuration		NPRACH.R-2	Refer to A.3.18
DRX		1.28	DRX parameters are further specified in Table A.8.12.1.1-3
Radio frame receive time offset between the cells at the UE antenna connector	µs	nCell 2 to nCell 1: 1 nCell 3 to nCell 1: -1	PRS are transmitted from synchronous cells
Expected RSTD	µs	Cell 2: -2 Cell 3: 2 Other neighbour cells: randomly between -3 and 3	The expected RSTD is what is expected at the receiver. The corresponding parameter in the OTDOA assistance data specified in TS 36.355 [24] is the expectedRSTD indicator
Expected RSTD uncertainty for all neighbour cells	µs	5	The corresponding parameter in the OTDOA assistance data specified in TS 36.355 [24] is the expectedRSTD-Uncertainty index
Number of cells provided in OTDOA assistance data		16	Including the reference cell
Special subframe configuration		6	As specified in table 4.2-1 in TS 36.211 [16]
Uplink-downlink configuration		2	As specified in table 4.2-2 in TS 36.211 [16]
T2	s	5.12	The length of the time interval that follows immediately after time interval T1
T3	s	5.12	The length of the time interval that follows immediately after time interval T2
T4	s	10.24	The length of the time interval that follows immediately after time interval T3
T5	s	10.24	The length of the time interval that follows immediately after time interval T4
T6	s	≥ 58.2	The length of the time interval that follows immediately after time interval T5

Table A.4.7.4.1-2: Cell-specific test parameters during T1 and T6

Parameter	Unit	nCell 1	nCell 2	nCell 3
NB-IoT RF Channel Number		1	2	2
NB-IoT Channel Bandwidth ($BW_{channel}$)	KHz	200	200	200
OCNG Pattern ^{Note 1}		NOP.3 TDD	N/A	N/A
NPDSCH parameters ^{Note 2}		R.18 NB-TDD	N/A	N/A
NPDCCH parameters ^{Note 2}		R.30 NB-TDD	N/A	N/A
NPBCH_RA	dB	0	N/A	N/A
NPBCH_RB				
NPSS_RA				
NSSS_RA				
NPDCCH_RA				
NPDCCH_RB				
NPDSCH_RA				
NPDSCH_RB				
OCNG_RA ^{Note 1}				
OCNG_RB ^{Note 1}				

N_{oc} <small>Note 3</small>	dBm/ 15 kHz	-98		
$NPRS \hat{E}_s/N_{oc}$	dB	-Infinity	-Infinity	-Infinity
\hat{E}_s/N_{oc}	dB	-2	-Infinity	-Infinity
Propagation Condition		AWGN		
Antenna Configuration		1x1		
Timing offset to nCell 1	μ s	N/A	1	-1
<p>Note 1: OCNG shall be used such that the cell is fully allocated and a constant total transmitted power spectral density is achieved for all OFDM symbols. The OCNG pattern is chosen during the test according to the presence of a DL reference measurement channel.</p> <p>Note 2: The NPDSCH and NPDCCH reference measurement channels are used in the test only when a downlink transmission dedicated to the UE under test is required.</p> <p>Note 3: Interference from other cells and noise sources not specified in the test are assumed to be constant over subcarriers and time and shall be modelled as AWGN of appropriate power for N_{oc} to be fulfilled.</p>				

Table A.4.7.4.1-3: Cell-specific test parameters from T2 to T5

Parameter	Unit	nCell 1		nCell 2		nCell 3		
		T2 and T4	T3 and T5	T2 and T4	T3 and T5	T2 and T4	T3 and T5	
$BW_{channel}$	kHz	200		200		200		
NB-IoT RF Channel Number		1		2		2		
NPDSCH parameters <small>Note 2</small>		R.18 NB-TDD		N/A		N/A		
NPDCCH parameters <small>Note 2</small>		R.30 NB-TDD		N/A		N/A		
OCNG patterns		NOP.3 TDD		N/A	NOP.3 TDD	NOP.3 TDD	N/A	
NPBCH_RA	dB	0		0		0		N/A
NPBCH_RB								
NPSS_RA								
NSSS_RA								
NPDCCH_RA								
NPDCCH_RB								
NPDSCH_RA								
NPDSCH_RB								
OCNG_RA <small>Note 1</small>								
OCNG_RB <small>Note 1</small>								
NPRS_RA	dB	-3	N/A	N/A	0	0	N/A	
N_{oc} <small>Note 3</small>	dBm/ 15 kHz	-98	-98	-98	-95	-98	-95	
$NPRS \hat{E}_s/N_{oc}$	dB	-15	-Infinity	-Infinity	-15	-15	-Infinity	
$NPRS \hat{E}_s/I_{ot}$ <small>Note 4</small>	dB	-15	-Infinity	-Infinity	-15	-15	-Infinity	
I_o <small>Note 4</small>	dBm/ 180kHz	-87.17	-87.20	-87.17	-87.15	-87.17	-87.15	
NPRP <small>Note 4</small>	dBm/ 15 kHz	-113	-Infinity	-Infinity	-110	-113	-Infinity	
NRSRP <small>Note 4</small>	dBm/ 15 kHz	-110	-110	-113	-110	-113	-Infinity	
\hat{E}_s/N_{oc} <small>Note 4</small>	dB	-12	-12	-15	-15	-15	-Infinity	
Propagation Condition		AWGN						

Antenna Configuration		1x1		
Timing offset to nCell 1	μs	N/A	1	-1
Note 1:	OCNG shall be used such that active cells (all, except Cell 3 in T3) are fully allocated and a constant total transmitted power spectral density is achieved for all OFDM symbols other than those in the subframes with transmitted NPRS.			
Note 3:	Interference from other cells and noise sources not specified in the test are assumed to be constant over subcarriers and time and shall be modelled as AWGN of appropriate power for N_{oc} to be fulfilled.			
Note 4:	If NPRS_RA is not "N/A", \hat{E}_s/N_{oc} , NPRS \hat{E}_s/I_{ot} , I_o , NRSRP and NPRP levels have been derived from other parameters and are given for information purpose. If NPRS_RA is "N/A", I_o and NRSRP levels have been derived from other parameters and are given for information purpose. These are not settable test parameters. Interference conditions shall be applied to all PRS symbols of DL positioning subframes.			

A.4.7.4.2 Test Requirements

The RSTD measurement time fulfils the requirements specified in Clause 4.8.4.

The UE shall perform and report the RSTD measurements for nCell 2 and nCell 3 with respect to the reference cell in the OTDOA assistance data, nCell 1, within $T_{RSTD_inter_NB-IoT-EC} + T_{RandomAccess_NB-IoT-EC} = 78.68$ s starting from the beginning of time interval T4, to the moment when the UE starts to send preambles on the PRACH for sending the positioning measurement report message to nCell 1.

The RSTD measurement time $T_{RSTD_inter_NB-IoT-EC}$ in the test is derived according to section 4.8.4. This gives the total RSTD measurement time of 21.76 s for nCell 2 and nCell 3 with respect to the reference nCell 1.

The random access to an already detected cell $T_{RandomAccess_NB-IoT-EC}$ can be expressed as: $T_{evaluate, NB_inter_NB-IoT-EC} + T_{SI} + T_{PRACH_NB-IoT}$,

Where:

$T_{evaluate, NB_inter_NB-IoT-EC}$ See Table 4.6.2.4-1 in clause 4.6.2.4

$T_{SI} = 41560$ ms; it is the time required for receiving all the relevant system information as defined in TS 36.331 for the target NB-IoT TDD cell.

$T_{PRACH_NB-IoT} = 2560$ ms; it is the additional delay caused by the random access procedure.

This gives $T_{RandomAccess_NB-IoT} = 56.92$ s for the random access delay to an already detected cell in the test case.

The rate of the correct events for each neighbour cell observed during repeated tests shall be at least 90%, where the reported RSTD measurement for each correct event shall be within the RSTD reporting range specified in Clause 9.1.10.3, i.e., between RSTD_0000 and RSTD_12711.

A.5 E-UTRAN RRC CONNECTED Mode Mobility

A.5.1 E-UTRAN Handover

A.5.1.1 E-UTRAN FDD - FDD Intra frequency handover

A.5.1.1.1 Test Purpose and Environment

This test is to verify the requirement for the FDD-FDD intra frequency handover requirements specified in clause 5.1.2.1.

The test scenario comprises of 1 E-UTRA FDD carrier and 2 cells as given in tables A.5.1.1.1-1 and A.5.1.1.1-2. The test consists of three successive time periods, with time durations of T1, T2 and T3 respectively. At the start of time duration T1, the UE may not have any timing information of cell 2.

E-UTRAN shall send a RRC message implying handover to cell 2. The RRC message implying handover shall be sent to the UE during period T2, after the UE has reported Event A3. T3 is defined as the end of the last TTI containing the RRC message implying handover.

Table A.5.1.1.1-1: General test parameters for E-UTRAN FDD-FDD intra frequency handover test case

Parameter		Unit	Value	Comment
PDSCH parameters			DL Reference Measurement Channel R.0 FDD	As specified in clause A.3.1.1.1
PCFICH/PDCCH/PHICH parameters			DL Reference Measurement Channel R.6 FDD	As specified in clause A.3.1.2.1
Initial conditions	Active cell		Cell 1	
	Neighbouring cell		Cell 2	
Final condition	Active cell		Cell 2	
E-UTRA RF Channel Number			1	Only one FDD carrier frequency is used.
Channel Bandwidth ($BW_{channel}$)		MHz	10	
A3-Offset		dB	0	
Hysteresis		dB	0	
Time To Trigger		s	0	
Filter coefficient			0	L3 filtering is not used
DRX				OFF
CP length			Normal	
Access Barring Information		-	Not Sent	No additional delays in random access procedure.
PRACH configuration			4	As specified in table 5.7.1-2 in TS 36.211
Time offset between cells			3 ms	Asynchronous cells
T1		s	5	
T2		s	≤ 5	
T3		s	1	

Table A.5.1.1.1-2: Cell specific test parameters for E-UTRAN FDD-FDD intra frequency handover test case

Parameter	Unit	Cell 1			Cell 2		
		T1	T2	T3	T1	T2	T3
E-UTRA RF Channel Number		1			1		
$BW_{channel}$	MHz	10			10		
OCNG Patterns defined in A.3.2.1.1 (OP.1 FDD) and in A.3.2.1.2 (OP.2 FDD)		OP.1 FDD	OP.1 FDD	OP.2 FDD	OP.2 FDD	OP.2 FDD	OP.1 FDD
PBCH_RA	dB	0			0		
PBCH_RB	dB						
PSS_RA	dB						
SSS_RA	dB						
PCFICH_RB	dB						
PHICH_RA	dB						
PHICH_RB	dB						
PDCCH_RA	dB						
PDCCH_RB	dB						
PDSCH_RA	dB						
PDSCH_RB	dB						
OCNG_RA ^{Note 1}	dB						
OCNG_RB ^{Note 1}	dB						
\hat{E}_s/I_{ot}	dB						
N_{oc} ^{Note 2}	dBm/15 KHz	-98					
\hat{E}_s/N_{oc}	dB	8	8	8	- Infinity	11	11
RSRP ^{Note 3}	dBm/15 KHz	-90	-90	-90	- Infinity	-87	-87
Propagation Condition		AWGN					
<p>Note 1: OCNG shall be used such that both cells are fully allocated and a constant total transmitted power spectral density is achieved for all OFDM symbols.</p> <p>Note 2: Interference from other cells and noise sources not specified in the test is assumed to be constant over subcarriers and time and shall be modelled as AWGN of appropriate power for N_{oc} to be fulfilled.</p> <p>Note 3: RSRP levels have been derived from other parameters for information purposes. They are not settable parameters themselves.</p>							

A.5.1.1.2 Test Requirements

The UE shall start to transmit the PRACH to Cell 2 less than 50 ms from the beginning of time period T3.

The rate of correct handovers observed during repeated tests shall be at least 90%.

NOTE: The handover delay can be expressed as: RRC procedure delay + $T_{interrupt}$, where:

RRC procedure delay = 15 ms and is specified in clause 11.2 in TS 36.331 [2].

$T_{interrupt}$ = 35 ms in the test; $T_{interrupt}$ is defined in clause 5.1.2.1.2.1.

This gives a total of 50 ms.

A.5.1.2 E-UTRAN TDD - TDD Intra frequency handover

A.5.1.2.1 Test Purpose and Environment

This test is to verify the requirement for the TDD-TDD intra frequency handover requirements specified in clause 5.2.2.4.

The test scenario comprises of 1 E-UTRA TDD carrier and 2 cells as given in tables A.5.1.2.1-1 and A.5.1.2.1-2. The test consists of three successive time periods, with time durations of T1, T2 and T3 respectively. At the start of time duration T1, the UE may not have any timing information of cell 2.

E-UTRAN shall send a RRC message implying handover to cell 2. The RRC message implying handover shall be sent to the UE during period T2, after the UE has reported Event A3. T3 is defined as the end of the last TTI containing the RRC message implying handover.

Table A.5.1.2.1-1: General test parameters for E-UTRAN TDD-TDD Intra frequency handover test case

Parameter		Unit	Value	Comment
PDSCH parameters			DL Reference Measurement Channel R.0 TDD	As specified in clause A.3.1.1.2
PCFICH/PDCCHPHICH parameters			DL Reference Measurement Channel R.6 TDD	As specified in clause A.3.1.2.2
Initial conditions	Active cell		Cell 1	
	Neighbouring cell		Cell 2	
Final condition	Active cell		Cell 2	
E-UTRA RF Channel Number			1	Only one TDD carrier frequency is used.
Channel Bandwidth ($BW_{channel}$)		MHz	10	
A3-Offset		dB	0	
Hysteresis		dB	0	
Time To Trigger		s	0	
Filter coefficient			0	L3 filtering is not used
DRX				OFF
CP length			Normal	
Access Barring Information		-	Not Sent	No additional delays in random access procedure.
Special subframe configuration			6	As specified in table 4.2-1 in TS 36.211
Uplink-downlink configuration			1	As specified in table 4.2-2 in TS 36.211
PRACH configuration index			53	As specified in table 5.7.1-3 in TS 36.211
Time offset between cells			3 μ s	Synchronous cells
T1		s	5	
T2		s	≤ 5	
T3		s	1	

Table A.5.1.2.1-2: Cell specific test parameters for E-UTRAN TDD-TDD Intra frequency handover test case

Parameter	Unit	Cell 1			Cell 2		
		T1	T2	T3	T1	T2	T3
E-UTRA RF Channel Number		1			1		
BW _{channel}	MHz	10			10		
OCNG Patterns defined in A.3.2.2.1 (OP.1 TDD) and in A.3.2.2.2 (OP.2 TDD)		OP.1 TDD	OP.1 TDD	OP.2 TDD	OP.2 TDD	OP.2 TDD	OP.1 TDD
PBCH_RA	dB	0			0		
PBCH_RB	dB						
PSS_RA	dB						
SSS_RA	dB						
PCFICH_RB	dB						
PHICH_RA	dB						
PHICH_RB	dB						
PDCCH_RA	dB						
PDCCH_RB	dB						
PDSCH_RA	dB						
PDSCH_RB	dB						
OCNG_RA ^{Note 1}	dB						
OCNG_RB ^{Note 1}	dB						
\hat{E}_s/I_{ot}	dB	8	-3.3	-3.3	-Infinity	2.36	2.36
N_{oc} ^{Note 2}	dBm/15 KHz	-98					
\hat{E}_s/N_{oc}	dB	8	8	8	-Infinity	11	11
RSRP ^{Note 3}	dBm/15 KHz	-90	-90	-90	-Infinity	-87	-87
Propagation Condition		AWGN					
<p>Note 1: OCNG shall be used such that both cells are fully allocated and a constant total transmitted power spectral density is achieved for all OFDM symbols.</p> <p>Note 2: Interference from other cells and noise sources not specified in the test is assumed to be constant over subcarriers and time and shall be modelled as AWGN of appropriate power for N_{oc} to be fulfilled.</p> <p>Note 3: RSRP levels have been derived from other parameters for information purposes. They are not settable parameters themselves.</p>							

A.5.1.2.2 Test Requirements

The UE shall start to transmit the PRACH to Cell 2 less than 50 ms from the beginning of time period T3.

The rate of correct handovers observed during repeated tests shall be at least 90%.

NOTE: The handover delay can be expressed as: RRC procedure delay + $T_{interrupt}$, where:

RRC procedure delay = 15 ms and is specified in clause 11.2 in TS 36.331 [2].

$T_{interrupt}$ = 35 ms in the test; $T_{interrupt}$ is defined in clause 5.2.2.4.2.1.

This gives a total of 50 ms.

A.5.1.3 E-UTRAN FDD – FDD Inter frequency handover

A.5.1.3.1 Test Purpose and Environment

This test is to verify the requirement for the FDD-FDD inter-frequency handover requirements specified in clause 5.1.2.1.

The test scenario comprises of two E-UTRA FDD carriers and one cell on each carrier as given in tables A.5.1.3.1-1 and A.5.1.3.1-2. PDCCHs indicating new transmissions shall be sent continuously to ensure that the UE would not enter the DRX state. The test consists of three successive time periods, with time durations of T1, T2 and T3 respectively. At

the start of time duration T1, the UE does not have any timing information of cell 2. Starting T2, cell 2 becomes detectable and the UE is expected to detect and send a measurement report. Gap pattern configuration with id #0 as specified in Table 8.1.2.1-1 is configured before T2 begins to enable inter-frequency monitoring.

A RRC message implying handover shall be sent to the UE during period T2, after the UE has reported Event A3. The start of T3 is the instant when the last TTI containing the RRC message implying handover is sent to the UE.

Table A.5.1.3.1-1: General test parameters for E-UTRAN FDD-FDD Inter frequency handover test case

Parameter		Unit	Value	Comment
PDSCH parameters			DL Reference Measurement Channel R.0 FDD	As specified in clause A.3.1.1.1
PCFICH/PDCCH/PHICH parameters			DL Reference Measurement Channel R.6 FDD	As specified in clause A.3.1.2.1
Initial conditions	Active cell		Cell 1	Cell 1 is on RF channel number 1
	Neighbouring cell		Cell 2	Cell 2 is on RF channel number 2
Final condition	Active cell		Cell 2	
E-UTRA RF channel number			1, 2	Two FDD carriers are used
Channel Bandwidth ($BW_{channel}$)		MHz	10	
A3-Offset		dB	-4	
Hysteresis		dB	0	
TimeToTrigger		s	0	
Filter coefficient			0	L3 filtering is not used
DRX			DRX_L	As specified in clause A.3.3
PRACH configuration			4	As specified in table 5.7.1-2 in TS 36.211
Access Barring Information		-	Not sent	No additional delays in random access procedure
Time offset between cells			3 ms	Asynchronous cells
Gap pattern configuration Id			0	As specified in Table 8.1.2.1-1 started before T2 starts
T1		s	5	
T2		s	≤5	
T3		s	1	

Table A.5.1.3.1-2: Cell specific test parameters for E-UTRAN FDD-FDD Inter frequency handover test case

Parameter	Unit	Cell 1			Cell 2		
		T1	T2	T3	T1	T2	T3
E-UTRA RF Channel number		1			2		
BW _{channel}	MHz	10			10		
OCNG Patterns defined in A.3.2.1.1 (OP.1 FDD) and in A.3.2.1.2 (OP.2 FDD)		OP.1 FDD	OP.1 FDD	OP.2 FDD	OP.2 FDD	OP.2 FDD	OP.1 FDD
PBCH_RA	dB	0			0		
PBCH_RB	dB						
PSS_RA	dB						
SSS_RA	dB						
PCFICH_RB	dB						
PHICH_RA	dB						
PHICH_RB	dB						
PDCCH_RA	dB						
PDCCH_RB	dB						
PDSCH_RA	dB						
PDSCH_RB	dB						
OCNG_RA ^{Note 1}	dB						
OCNG_RB ^{Note 1}	dB						
\hat{E}_s / I_{ot}	dB	4	4	4	-Infinity	7	7
N_{oc} ^{Note 2}	dBm/15 kHz	-98					
\hat{E}_s / N_{oc}	dB	4	4	4	-Infinity	7	7
RSRP ^{Note 3}	dBm/15 KHz	-94	-94	-94	-Infinity	-91	-91
Propagation Condition		AWGN					
Note 1:	OCNG shall be used such that both cells are fully allocated and a constant total transmitted power spectral density is achieved for all OFDM symbols.						
Note 2:	Interference from other cells and noise sources not specified in the test is assumed to be constant over subcarriers and time and shall be modelled as AWGN of appropriate power for N_{oc} to be fulfilled.						
Note 3:	RSRP levels have been derived from other parameters for information purposes. They are not settable parameters themselves.						

A.5.1.3.2 Test Requirements

The UE shall start to transmit the PRACH to Cell 2 less than 50 ms from the beginning of time period T3.

The rate of correct handovers observed during repeated tests shall be at least 90%.

NOTE: The handover delay can be expressed as: RRC procedure delay + $T_{interrupt}$, where:

RRC procedure delay = 15 ms and is specified in clause 11.2 in TS 36.331 [2].

$T_{interrupt}$ = 35 ms in the test; $T_{interrupt}$ is defined in clause 5.1.2.1.2.1.

This gives a total of 50 ms.

A.5.1.4 E-UTRAN TDD – TDD Inter frequency handover

A.5.1.4.1 Test Purpose and Environment

This test is to verify the requirement for the TDD-TDD inter frequency handover requirements specified in clause 5.2.2.4.

The test scenario comprises of two E-UTRA TDD carriers and one cell on each carrier as given in tables Table A.5.1.4.1-1 and Table A.5.1.4.1-2. PDCCHs indicating new transmissions shall be sent continuously to ensure that the

UE would not enter the DRX state. The test consists of three successive time periods, with time durations of T1, T2 and T3 respectively. At the start of time duration T1, the UE may not have any timing information of cell 2.

E-UTRAN shall send a RRC message implying handover to cell 2. The RRC message implying handover shall be sent to the UE during period T2, after the UE has reported Event A3.

Table A.5.1.4.1-1: General test parameters for E-UTRAN TDD-TDD Inter frequency handover test case

Parameter		Unit	Value	Comment
PDSCH parameters			DL Reference Measurement Channel R.0 TDD	As specified in clause A.3.1.1.2
PCFICH/PDCCH/PHICH parameters			DL Reference Measurement Channel R.6 TDD	As specified in clause A.3.1.2.2
Gap Pattern Id			1	As specified in TS 36.133 clause 8.1.2.1.
Initial conditions	Active cell		Cell 1	
	Neighbour cell		Cell 2	
Final conditions	Active cell		Cell 2	
E-UTRA RF channel number			1, 2	Two TDD carriers are used
Channel Bandwidth (BW_{channel})		MHz	10	
A3-Offset		dB	-4	
Hysteresis		dB	0	
Time to Trigger		ms	0	
Filter coefficient			0	
DRX			DRX_L	As specified in clause A.3.3
CP length			Normal	
Access Barring Information		-	Not Sent	No additional delays in random access procedure.
Special subframe configuration			6	As specified in table 4.2-1 in TS 36.211
Uplink-downlink configuration			1	As specified in table 4.2-2 in TS 36.211
PRACH configuration			53	As specified in table 5.7.1-3 in TS 36.211
Time offset between cells			3 μ s	Synchronous cells
T1		s	5	
T2		s	≤ 5	
T3		s	1	

Table A.5.1.4.1-2: Cell specific test parameters for E-UTRAN TDD-TDD Inter frequency handover test case

Parameter	Unit	Cell 1			Cell 2		
		T1	T2	T3	T1	T2	T3
E-UTRA RF Channel number		1			2		
BW _{channel}	MHz	10			10		
OCNG Patterns defined in A.3.2.1.1 (OP.1 FDD) and in A.3.2.1.2 (OP.2 FDD)		OP.1 FDD	OP.1 FDD	OP.2 FDD	OP.2 FDD	OP.2 FDD	OP.1 FDD
PBCH_RA	dB	0			0		
PBCH_RB	dB						
PSS_RA	dB						
SSS_RA	dB						
PCFICH_RB	dB						
PHICH_RA	dB						
PHICH_RB	dB						
PDCCH_RA	dB						
PDCCH_RB	dB						
PDSCH_RA	dB						
PDSCH_RB	dB						
OCNG_RA ^{Note 1}	dB						
OCNG_RB ^{Note 1}	dB						
\hat{E}_s/I_{oc}	dB	4	4	4	-Infinity	7	7
N_{oc} ^{Note 2}	dBm/15 kHz	-98					
\hat{E}_s/N_{oc}	dB	4	4	4	-Infinity	7	7
RSRP ^{Note 3}	dBm/15 KHz	-94	-94	-94	-infinity	-91	-91
Propagation Condition		AWGN					
Note 1:	OCNG shall be used such that both cells are fully allocated and a constant total transmitted power spectral density is achieved for all OFDM symbols.						
Note 2:	Interference from other cells and noise sources not specified in the test is assumed to be constant over subcarriers and time and shall be modelled as AWGN of appropriate power for N_{oc} to be fulfilled.						
Note 3:	RSRP levels have been derived from other parameters for information purposes. They are not settable parameters themselves.						

A.5.1.4.2 Test Requirements

The UE shall start to transmit the PRACH to Cell 2 less than 50 ms from the beginning of time period T3.

The rate of correct handovers observed during repeated tests shall be at least 90%.

NOTE: The handover delay can be expressed as: RRC procedure delay + $T_{interrupt}$, where:

RRC procedure delay = 15 ms and is specified in clause 11.2 in TS 36.331 [2].

$T_{interrupt}$ = 35 ms in the test; $T_{interrupt}$ is defined in clause 5.2.2.4.2.1.

This gives a total of 50 ms.

A.5.1.5 E-UTRAN FDD – FDD Inter frequency handover: unknown target cell

A.5.1.5.1 Test Purpose and Environment

This test is to verify the FDD-FDD inter-frequency handover requirements for the case when the target cell is unknown as specified in clause 5.1.2.1.

The test scenario comprises of two E-UTRA FDD carriers and one cell on each carrier as given in tables A.5.1.5.1-1 and A.5.1.5.1-2. No gap patterns are configured in the test case. The test consists of two successive time periods, with time durations of T1 and T2 respectively. At the start of time duration T1, the UE does not have any timing information of cell 2. Starting T2, cell 2 becomes detectable and the UE is expected to detect and start to transmit the PRACH to Cell 2.

A RRC message implying handover shall be sent to the UE during period T1. The start of T2 is the instant when the last TTI containing the RRC message implying handover is sent to the UE.

Table A.5.1.5.1-1: General test parameters for the E-UTRAN FDD-FDD Inter frequency handover test case when the target cell is unknown

Parameter		Unit	Value	Comment
PDSCH parameters			DL Reference Measurement Channel R.0 FDD	As specified in clause A.3.1.1.1
PCFICH/PDCCH/PHICH parameters			DL Reference Measurement Channel R.6 FDD	As specified in clause A.3.1.2.1
Initial conditions	Active cell		Cell 1	Cell 1 is on RF channel number 1
	Neighbouring cell		Cell 2	Cell 2 is on RF channel number 2
Final condition	Active cell		Cell 2	
E-UTRA RF channel number			1, 2	Two FDD carriers are used
Channel Bandwidth ($BW_{channel}$)		MHz	10	
DRX			OFF	Non-DRX test
PRACH configuration			4	As specified in table 5.7.1-2 in TS 36.211
Access Barring Information		-	Not sent	No additional delays in random access procedure
Time offset between cells			3 ms	Asynchronous cells
T1		s	≤ 5	
T2		s	1	

Table A.5.1.5.1-2: Cell specific test parameters for the E-UTRAN FDD-FDD Inter frequency handover test case when the target cell is unknown

Parameter	Unit	Cell 1		Cell 2	
		T1	T2	T1	T2
E-UTRA RF Channel number		1		2	
BW _{channel}	MHz	10		10	
OCNG Patterns defined in A.3.2.1.1 (OP.1 FDD) and in A.3.2.1.2 (OP.2 FDD)		OP.1 FDD	OP.2 FDD	OP.2 FDD	OP.1 FDD
PBCH_RA	dB	0		0	
PBCH_RB	dB				
PSS_RA	dB				
SSS_RA	dB				
PCFICH_RB	dB				
PHICH_RA	dB				
PHICH_RB	dB				
PDCCH_RA	dB				
PDCCH_RB	dB				
PDSCH_RA	dB				
PDSCH_RB	dB				
OCNG_RA ^{Note 1}	dB				
OCNG_RB ^{Note 1}	dB				
\hat{E}_s / I_{ot}	dB				
N_{oc} ^{Note 2}	dBm/15 kHz	-98			
\hat{E}_s / N_{oc}	dB	4	4	-Infinity	7
RSRP ^{Note 3}	dBm/15 KHz	-94	-94	-Infinity	-91
Propagation Condition		AWGN			
Note 1:	OCNG shall be used such that both cells are fully allocated and a constant total transmitted power spectral density is achieved for all OFDM symbols.				
Note 2:	Interference from other cells and noise sources not specified in the test is assumed to be constant over subcarriers and time and shall be modelled as AWGN of appropriate power for N_{oc} to be fulfilled.				
Note 3:	RSRP levels have been derived from other parameters for information purposes. They are not settable parameters themselves.				

A.5.1.5.2 Test Requirements

The UE shall start to transmit the PRACH to Cell 2 less than 130 ms from the beginning of time period T2.

The rate of correct handovers observed during repeated tests shall be at least 90%.

NOTE: The handover delay can be expressed as: RRC procedure delay + $T_{interrupt}$, where:

RRC procedure delay = 15 ms, which is specified in clause 11.2 in TS 36.331 [2].

$T_{interrupt}$ = 115 ms in the test. See clause 5.1.2.1.2.1.

This gives a total of 130 ms.

A.5.1.6 E-UTRAN TDD – TDD Inter frequency handover; unknown Target Cell

A.5.1.6.1 Test Purpose and Environment

This test is to verify the TDD-TDD inter-frequency handover requirements for the case when the target cell is unknown as specified in clause 5.2.2.4.

The test scenario comprises of two E-UTRA TDD carriers and one cell on each carrier as given in tables A.5.1.6.1-1 and A.5.1.6.1-2. No gap patterns are configured in the test case. The test consists of two successive time periods, with time durations of T1, T2 respectively. At the start of time duration T1, the UE does not have any timing information of cell 2. Starting T2, cell 2 becomes detectable and the UE receives a RRC handover command from the network. The start of T2 is the instant when the last TTI containing the RRC message implying handover is sent to the UE.

Table A.5.1.6.1-1: General test parameters for the E-UTRAN TDD-TDD Inter-Frequency handover test case when the target cell is unknown

Parameter		Unit	Value	Comment
PDSCH parameters			DL Reference Measurement Channel R.0 TDD	As specified in clause A.3.1.1.2
PCFICH/PDCCH/PHICH parameters			DL Reference Measurement Channel R.6 TDD	As specified in clause A.3.1.2.2
Initial conditions	Active cell		Cell 1	Cell 1 is on RF channel number 1
	Neighbouring cell		Cell 2	Cell 2 is on RF channel number 2
Final condition	Active cell		Cell 2	
E-UTRA RF channel number			1, 2	Two TDD carriers
DRX			OFF	Non-DRX test
Access Barring Information		-	Not sent	No additional delays in random access procedure
Special subframe configuration			6	As specified in table 4.2-1 in TS 36.211
Uplink-downlink configuration			1	As specified in table 4.2-2 in TS 36.211
PRACH configuration			53	As specified in table 5.7.1-3 in TS 36.211
Time offset between cells			3 μ s	Synchronous cells
Gap pattern configuration			-	No gap pattern configured
T1		s	≤ 5	
T2		s	1	

Table A.5.1.6.1-2: Cell specific test parameters for the E-UTRAN TDD-TDD Inter frequency handover test case when the target cell is unknown

Parameter	Unit	Cell 1		Cell 2	
		T1	T2	T1	T2
E-UTRA RF Channel Number		1		2	
$BW_{channel}$	MHz	10		10	
OCNG Patterns defined in A.3.2.2.1 (OP.1 TDD) and in A.3.2.2.2 (OP.2 TDD)		OP.1 TDD	OP.2 TDD	OP.2 TDD	OP.1 TDD
PBCH_RA	dB	0		0	
PBCH_RB	dB				
PSS_RA	dB				
SSS_RA	dB				
PCFICH_RB	dB				
PHICH_RA	dB				
PHICH_RB	dB				
PDCCH_RA	dB				
PDCCH_RB	dB				
PDSCH_RA	dB				
PDSCH_RB	dB				
OCNG_RA ^{Note 1}	dB				
OCNG_RB ^{Note 1}	dB				
N_{oc} ^{Note 3}	dBm/15 kHz	-98			
RSRP ^{Note 4}	dBm/15 kHz	-94	-94	-Infinity	-93
\hat{E}_s/I_{ot}	dB	4	4	-Infinity	5
SCH_RP ^{Note 4}	dBm/15 kHz	-94	-94	-Infinity	-93
\hat{E}_s/N_{oc}	dB	4	4	-Infinity	5
Propagation Condition		AWGN			
<p>Note 1: OCNG shall be used such that both cells are fully allocated and a constant total transmitted power spectral density is achieved for all OFDM symbols.</p> <p>Note 2: The resources for uplink transmission are assigned to the UE prior to the start of time period T2.</p> <p>Note 3: Interference from other cells and noise sources not specified in the test is assumed to be constant over subcarriers and time and shall be modelled as AWGN of appropriate power for N_{oc} to be fulfilled.</p> <p>Note 4: RSRP and SCH_RP levels have been derived from other parameters for information purposes. They are not settable parameters themselves.</p>					

A.5.1.6.2 Test Requirements

The UE shall start to transmit the PRACH to Cell 2 less than 130 ms from the beginning of time period T2.

The rate of correct handovers observed during repeated tests shall be at least 90%.

NOTE: The handover delay can be expressed as: RRC procedure delay + $T_{interrupt}$, where:

RRC procedure delay = 15 ms, which is specified in clause 11.2 in TS 36.331 [2].

$T_{interrupt}$ = 115 ms in the test. See clause 5.2.2.4.2.1.

This gives a total of 130 ms.

A.5.1.7 E-UTRAN FDD – TDD Inter frequency handover

A.5.1.7.1 Test Purpose and Environment

This test is to verify the requirement for the FDD-TDD inter frequency handover requirements specified in clause 5.2.2.2.

The test scenario comprises of one E-UTRA FDD cell and one E-UTRA TDD cell as given in tables Table A.5.1.7.1-1 , Table A.5.1.7.1-2 and Table A.5.1.7.1-3. PDCCHs indicating new transmissions shall be sent continuously to ensure that the UE would not enter the DRX state. The test consists of three successive time periods, with time durations of T1, T2 and T3 respectively. At the start of time duration T1, the UE does not have any timing information of cell 2.

E-UTRAN shall send a RRC message implying handover to cell 2. The RRC message implying handover shall be sent to the UE during period T2, after the UE has reported Event A3.

Table A.5.1.7.1-1: General test parameters for E-UTRAN FDD-TDD Inter frequency handover test case

Parameter		Unit	Value	Comment
Cell 1 PDSCH parameters			DL Reference Measurement Channel R.0 FDD	As specified in clause A.3.1.1.1
Cell 1 PCFICH/PDCCH/PHICH parameters			DL Reference Measurement Channel R.6 FDD	As specified in clause A.3.1.2.1
Cell 2 PDSCH parameters			DL Reference Measurement Channel R.0 TDD	As specified in clause A.3.1.1.2
Cell 2 PCFICH/PDCCH/PHICH parameters			DL Reference Measurement Channel R.6 TDD	As specified in clause A.3.1.2.2
Gap Pattern Id			0	As specified in TS 36.133 clause 8.1.2.1.
Initial conditions	Active cell		Cell 1	
	Neighbour cell		Cell 2	
Final conditions	Active cell		Cell 2	
Cell 1 E-UTRA RF channel number			1	One FDD carrier is used
Cell 2 E-UTRA RF channel number			2	One TDD carrier is used
Channel Bandwidth (BW _{channel})		MHz	10	
A3-Offset		dB	-4	
Hysteresis		dB	0	
Time to Trigger		ms	0	
Filter coefficient			0	
DRX			DRX_L	As specified in clause A.3.3
CP length			Normal	
E-UTRA TDD Access Barring Information		-	Not Sent	No additional delays in random access procedure.
Special subframe configuration			6	As specified in table 4.2-1 in TS 36.211. Applicable to cell 2.
Uplink-downlink configuration			1	As specified in table 4.2-2 in TS 36.211. Applicable to cell 2
E-UTRA TDD PRACH configuration			53	As specified in table 5.7.1-3 in TS 36.211
Time offset between cells			3 ms	Asynchronous cells
T1		s	5	
T2		s	≤5	
T3		s	1	

Table A.5.1.7.1-2: Cell specific test parameters for E-UTRAN FDD (cell #1) in E-UTRAN FDD-TDD Inter frequency handover test case

Parameter	Unit	Cell 1		
		T1	T2	T3
E-UTRA RF Channel number		1		
BW _{channel}	MHz	10		
OCNG Patterns defined in A.3.2.1.1 (OP.1 FDD) and in A.3.2.1.2 (OP.2 FDD)		OP.1 FDD	OP.1 FDD	OP.2 FDD
PBCH_RA	dB	0		
PBCH_RB	dB			
PSS_RA	dB			
SSS_RA	dB			
PCFICH_RB	dB			
PHICH_RA	dB			
PHICH_RB	dB			

PDCCH_RA	dB			
PDCCH_RB	dB			
PDSCH_RA	dB			
PDSCH_RB	dB			
OCNG_RA ^{Note 1}	dB			
OCNG_RB ^{Note 1}	dB			
\hat{E}_s / I_{ot}	dB	4	4	4
N_{oc} ^{Note 2}	dBm/15 kHz	-98		
\hat{E}_s / N_{oc}	dB	4	4	4
RSRP ^{Note 3}	dBm/15 KHz	-94	-94	-94
Propagation Condition	AWGN			
<p>Note 1: OCNG shall be used such that both cells are fully allocated and a constant total transmitted power spectral density is achieved for all OFDM symbols.</p> <p>Note 2: Interference from other cells and noise sources not specified in the test is assumed to be constant over subcarriers and time and shall be modelled as AWGN of appropriate power for N_{oc} to be fulfilled.</p> <p>Note 3: RSRP levels have been derived from other parameters for information purposes. They are not settable parameter themselves.</p>				

Table A.5.1.7.1-3: Cell specific test parameters for E-UTRAN TDD (cell #2) in E-UTRAN FDD-TDD Inter frequency handover test case

Parameter	Unit	Cell 2		
		T1	T2	T3
E-UTRA RF Channel number		2		
BW _{channel}	MHz	10		
OCNG Patterns defined in A.3.2.2.1 (OP.1 TDD) and in A.3.2.2.2 (OP.2 TDD)		OP.2 TDD	OP.2 TDD	OP.1 TDD
PBCH_RA	dB	0		
PBCH_RB	dB			
PSS_RA	dB			
SSS_RA	dB			
PCFICH_RB	dB			
PHICH_RA	dB			
PHICH_RB	dB			
PDCCH_RA	dB			
PDCCH_RB	dB			
PDSCH_RA	dB			
PDSCH_RB	dB			
OCNG_RA ^{Note 1}	dB			
OCNG_RB ^{Note 1}	dB			
\hat{E}_s / I_{ot}	dB			
N_{oc} ^{Note 2}	dBm/15 kHz	-98		
\hat{E}_s / N_{oc}	dB	-Infinity	7	7
RSRP ^{Note 3}	dBm/15 KHz	-Infinity	-91	-91
Propagation Condition	AWGN			
<p>Note 1: OCNG shall be used such that both cells are fully allocated and a constant total transmitted power spectral density is achieved for all OFDM symbols.</p> <p>Note 2: Interference from other cells and noise sources not specified in the test is assumed to be constant over subcarriers and time and shall be modelled as AWGN of appropriate power for N_{oc} to be fulfilled.</p> <p>Note 3: RSRP levels have been derived from other parameters for information purposes. They are not settable parameter themselves.</p>				

A.5.1.7.2 Test Requirements

The UE shall start to transmit the PRACH to Cell 2 less than 50 ms from the beginning of time period T3.

The rate of correct handovers observed during repeated tests shall be at least 90%.

NOTE: The handover delay can be expressed as: RRC procedure delay + $T_{\text{interrupt}}$, where:

RRC procedure delay = 15 ms and is specified in clause 11.2 in TS 36.331 [2].

$T_{\text{interrupt}}$ = 35 ms in the test; $T_{\text{interrupt}}$ is defined in clause 5.2.2.4.2.1.

This gives a total of 50 ms.

A.5.1.8 E-UTRAN TDD – FDD Inter frequency handover

A.5.1.8.1 Test Purpose and Environment

This test is to verify the requirement for the TDD-FDD inter-frequency handover requirements specified in clause 5.2.2.3.

The test scenario comprises of one E-UTRA TDD cell and one E-UTRA FDD cell as given in tables Table A.5.1.8.1-1, Table A.5.1.8.1-2 and Table A.5.1.8.1-3. PDCCHs indicating new transmissions should be sent continuously to ensure that the UE would not enter the DRX state. The test consists of three successive time periods, with time durations of T1, T2 and T3 respectively. At the start of time duration T1, the UE does not have any timing information of cell 2. Starting T2, cell 2 becomes detectable and the UE is expected to detect and send a measurement report. Gap pattern configuration with id #0 as specified in Table 8.1.2.1-1 is configured before T2 begins to enable inter-frequency monitoring.

A RRC message implying handover shall be sent to the UE during period T2, after the UE has reported Event A3. The start of T3 is the instant when the last TTI containing the RRC message implying handover is sent to the UE.

Table A.5.1.8.1-1: General test parameters for E-UTRAN TDD-FDD Inter frequency handover test case

Parameter		Unit	Value	Comment
Cell 1 PDSCH parameters			DL Reference Measurement Channel R.0 TDD	As specified in clause A.3.1.1.2
Cell 1 PCFICH/PDCCH/PHICH parameters			DL Reference Measurement Channel R.6 TDD	As specified in clause A.3.1.2.2
Cell 2 PDSCH parameters			DL Reference Measurement Channel R.0 FDD	As specified in clause A.3.1.1.1
Cell 2 PCFICH/PDCCH/PHICH parameters			DL Reference Measurement Channel R.6 FDD	As specified in clause A.3.1.2.1
Initial conditions	Active cell		Cell 1	Cell 1 is on RF channel number 1
	Neighbouring cell		Cell 2	Cell 2 is on RF channel number 2
Final condition	Active cell		Cell 2	
Cell 1 E-UTRA RF channel number			1	One TDD carrier is used
Cell 2 E-UTRA RF channel number			2	One FDD carrier is used
Channel Bandwidth (BW_{channel})		MHz	10	
A3-Offset		dB	-4	
Hysteresis		dB	0	
TimeToTrigger		s	0	
Filter coefficient			0	L3 filtering is not used
DRX			DRX_L	As specified in clause A.3.3
E-UTRA FDD PRACH configuration			4	As specified in table 5.7.1-2 in TS 36.211
E-UTRA FDD Access Barring Information		-	Not sent	No additional delays in random access procedure
Time offset between cells			3 ms	Asynchronous cells
Gap pattern configuration Id			0	As specified in Table 8.1.2.1-1 started before T2 starts
T1		s	5	
T2		s	≤ 5	
T3		s	1	

Table A.5.1.8.1-2: Cell specific test parameters for E-UTRAN TDD (cell #1) in E-UTRAN TDD-FDD Inter frequency handover test case

Parameter	Unit	Cell 1		
		T1	T2	T3
E-UTRA RF Channel number		1		
BW _{channel}	MHz	10		
OCNG Patterns defined in A.3.2.2.1 (OP.1 TDD) and in A.3.2.2.2 (OP.2 TDD)		OP.1 TDD	OP.1 TDD	OP.2 TDD
PBCH_RA	dB	0		
PBCH_RB				
PSS_RA				
SSS_RA				
PCFICH_RB				
PHICH_RA				
PHICH_RB				
PDCCH_RA				
PDCCH_RB				
PDSCH_RA				
PDSCH_RB				
OCNG_RA ^{Note 1}				
OCNG_RB ^{Note 1}				
\hat{E}_s / I_{ot}				
N_{oc} ^{Note 2}	dBm/15 kHz	-98		
\hat{E}_s / N_{oc}	dB	4	4	4
RSRP ^{Note 3}	dBm/15 KHz	-94	-94	-94
Propagation Condition	AWGN			
<p>Note 1: OCNG shall be used such that both cells are fully allocated and a constant total transmitted power spectral density is achieved for all OFDM symbols.</p> <p>Note 2: Interference from other cells and noise sources not specified in the test is assumed to be constant over subcarriers and time and shall be modelled as AWGN of appropriate power for N_{oc} to be fulfilled.</p> <p>Note 3: RSRP levels have been derived from other parameters for information purposes. They are not settable parameter themselves.</p>				

Table A.5.1.8.1-3: Cell specific test parameters for E-UTRAN FDD (cell #2) in E-UTRAN TDD-FDD Inter frequency handover test case

Parameter	Unit	Cell 2		
		T1	T2	T3
E-UTRA RF Channel number		2		
BW _{channel}	MHz	10		
OCNG Patterns defined in A.3.2.1.1 (OP.1 FDD) and in A.3.2.1.2 (OP.2 FDD)		OP.2 FDD	OP.2 FDD	OP.1 FDD
PBCH_RA	dB	0		
PBCH_RB				
PSS_RA				
SSS_RA				
PCFICH_RB				
PHICH_RA				
PHICH_RB				
PDCCH_RA				
PDCCH_RB				
PDSCH_RA				
PDSCH_RB				
OCNG_RA ^{Note 1}				
OCNG_RB ^{Note 1}				
\hat{E}_s / I_{ot}				

N_{oc} <small>Note 2</small>	dBm/15 kHz	-98		
\hat{E}_s / N_{oc}	dB	-Infinity	7	7
RSRP <small>Note 3</small>	dBm/15 KHz	-Infinity	-91	-91
Propagation Condition	AWGN			
<p>Note 1: OCNG shall be used such that both cells are fully allocated and a constant total transmitted power spectral density is achieved for all OFDM symbols.</p> <p>Note 2: Interference from other cells and noise sources not specified in the test is assumed to be constant over subcarriers and time and shall be modelled as AWGN of appropriate power for N_{oc} to be fulfilled.</p> <p>Note 3: RSRP levels have been derived from other parameters for information purposes. They are not settable parameter themselves.</p>				

A.5.1.8.2 Test Requirements

The UE shall start to transmit the PRACH to Cell 2 less than 50 ms from the beginning of time period T3.

The rate of correct handovers observed during repeated tests shall be at least 90%.

NOTE: The handover delay can be expressed as: RRC procedure delay + $T_{interrupt}$, where:

RRC procedure delay = 15 ms and is specified in clause 11.2 in TS 36.331 [2].

$T_{interrupt}$ = 35 ms in the test; $T_{interrupt}$ is defined in clause 5.1.2.1.2.1.

This gives a total of 50 ms.

A.5.1.9 E-UTRAN FDD - FDD Intra frequency handover for 5MHz bandwidth

A.5.1.9.1 Test Purpose and Environment

The purpose of this test case is the same as for the test defined in subclause A.5.1.1. The test parameters are the same except those described in the following section. The listed parameter values in Tables A.5.1.9.1-1 and A.5.1.9.1-2 will replace the values of corresponding parameters in Tables A.5.1.1.1-1 and A.5.1.1.1-2.

Table A.5.1.9.1-1: General test parameters for E-UTRAN FDD-FDD intra frequency handover test case, 5MHz

Parameter	Unit	Value	Comment
PDSCH parameters		DL Reference Measurement Channel R.5 FDD	As specified in clause A.3.1.1.1
PCFICH/PDCCH/PHICH parameters		DL Reference Measurement Channel R.11 FDD	As specified in clause A.3.1.2.1
Channel Bandwidth ($BW_{channel}$)	MHz	5	
Note 1: See Table A.5.1.1.1-1 for other general test parameters.			
Note 2: This test is performed according to the principle defined in section A.3.7.2			

Table A.5.1.9.1-2: Cell specific test parameters for E-UTRAN FDD-FDD intra frequency handover test case, 5MHz

Parameter	Unit	Cell 1			Cell 2		
		T1	T2	T3	T1	T2	T3
$BW_{channel}$	MHz	5			5		
OCNG Patterns defined in A.3.2.1.15 (OP.15 FDD) and in A.3.2.1.16 (OP.16 FDD)		OP.15 FDD	OP.15 FDD	OP.16 FDD	OP.16 FDD	OP.16 FDD	OP.15 FDD
Note 1: See Table A.5.1.1.1-2 for other cell-specific test parameters.							

A.5.1.9.2 Test Requirements

The requirements defined in section A.5.1.1.2 shall apply to this test case.

A.5.1.10 E-UTRAN FDD - FDD Intra frequency handover for UE category 0

A.5.1.10.1 Test Purpose and Environment

This test is to verify the requirement for the FDD-FDD intra frequency handover requirements specified in clause 5.1.2.1.

The test scenario comprises of 1 E-UTRA FDD carrier and 2 cells as given in tables A.5.1.10.1-1 and A.5.1.10.1-2. The test consists of three successive time periods, with time durations of T1, T2 and T3 respectively. At the start of time duration T1, the UE may not have any timing information of cell 2.

E-UTRAN shall send a RRC message implying handover to cell 2. The RRC message implying handover shall be sent to the UE during period T2, after the UE has reported Event A3. T3 is defined as the end of the last TTI containing the RRC message implying handover.

Table A.5.1.10.1-1: General test parameters for E-UTRAN FDD-FDD intra frequency handover test case

Parameter		Unit	Value	Comment
PDSCH parameters			DL Reference Measurement Channel R.13 FDD	As specified in clause A.3.1.1.3
PCFICH/PDCCH/PHICH parameters			DL Reference Measurement Channel R.6 FDD	As specified in clause A.3.1.2.1
Initial conditions	Active cell		Cell 1	
	Neighbouring cell		Cell 2	
Final condition	Active cell		Cell 2	
E-UTRA RF Channel Number			1	Only one FDD carrier frequency is used.
Channel Bandwidth ($BW_{channel}$)		MHz	10	
A3-Offset		dB	0	
Hysteresis		dB	0	
Time To Trigger		s	0	
Filter coefficient			0	L3 filtering is not used
DRX				OFF
CP length			Normal	
Access Barring Information		-	Not Sent	No additional delays in random access procedure.
PRACH configuration			4	As specified in table 5.7.1-2 in TS 36.211
Time offset between cells			3 ms	Asynchronous cells
T1		s	5	
T2		s	≤5	
T3		s	1	

Table A.5.1.10.1-2: Cell specific test parameters for E-UTRAN FDD-FDD intra frequency handover test case

Parameter	Unit	Cell 1			Cell 2		
		T1	T2	T3	T1	T2	T3
E-UTRA RF Channel Number		1			1		
$BW_{channel}$	MHz	10			10		
OCNG Patterns defined in A.3.2.1.1 (OP.1 FDD) and in A.3.2.1.2 (OP.2 FDD)		OP.1 FDD	OP.1 FDD	OP.2 FDD	OP.2 FDD	OP.2 FDD	OP.1 FDD
PBCH_RA	dB						
PBCH_RB	dB						
PSS_RA	dB						
SSS_RA	dB						
PCFICH_RB	dB						

PHICH_RA	dB	0			0		
PHICH_RB	dB						
PDCCH_RA	dB						
PDCCH_RB	dB						
PDSCH_RA	dB						
PDSCH_RB	dB						
OCNG_RA ^{Note 1}	dB						
OCNG_RB ^{Note 1}	dB						
\hat{E}_s/I_{ot}	dB	8	-3.3	-3.3	-Infinity	2.36	2.36
N_{oc} ^{Note 2}	dBm/15 KHz	-98					
\hat{E}_s/N_{oc}	dB	8	8	8	-Infinity	11	11
RSRP ^{Note 3}	dBm/15 KHz	-90	-90	-90	-Infinity	-87	-87
Propagation Condition		AWGN					
<p>Note 1: OCNG shall be used such that both cells are fully allocated and a constant total transmitted power spectral density is achieved for all OFDM symbols.</p> <p>Note 2: Interference from other cells and noise sources not specified in the test is assumed to be constant over subcarriers and time and shall be modelled as AWGN of appropriate power for N_{oc} to be fulfilled.</p> <p>Note 3: RSRP levels have been derived from other parameters for information purposes. They are not settable parameters themselves.</p>							

A.5.1.10.2 Test Requirements

The UE shall start to transmit the PRACH to Cell 2 less than 50 ms from the beginning of time period T3.

The rate of correct handovers observed during repeated tests shall be at least 90%.

NOTE: The handover delay can be expressed as: RRC procedure delay + $T_{interrupt}$, where:

RRC procedure delay = 15 ms and is specified in clause 11.2 in TS 36.331 [2].

$T_{interrupt}$ = 35 ms in the test; $T_{interrupt}$ is defined in clause 5.1.2.1.2.1.

This gives a total of 50 ms.

A.5.1.11 E-UTRAN HD - FDD Intra frequency handover for UE category 0

A.5.1.11.1 Test Purpose and Environment

This test is to verify the requirement for the HD-FDD intra frequency handover requirements specified in clause 5.2.2.5.

The test scenario comprises of 1 E-UTRA FDD carrier and 2 cells as given in tables A.5.1.11.1-1 and A.5.1.11.1-2. The test consists of three successive time periods, with time durations of T1, T2 and T3 respectively. At the start of time duration T1, the UE may not have any timing information of cell 2.

E-UTRAN shall send a RRC message implying handover to cell 2. The RRC message implying handover shall be sent to the UE during period T2, after the UE has reported Event A3. T3 is defined as the end of the last TTI containing the RRC message implying handover.

Table A.5.1.11.1-1: General test parameters for E-UTRAN HD-FDD intra frequency handover test case

Parameter		Unit	Value	Comment
PDSCH parameters			DL Reference Measurement Channel R.1 HD-FDD	As specified in clause A.3.1.1.4
PCFICH/PDCCH/PHICH parameters			DL Reference Measurement Channel R.3 HD-FDD	As specified in clause A.3.1.2.3
Initial conditions	Active cell		Cell 1	
	Neighbouring cell		Cell 2	
Final condition	Active cell		Cell 2	
E-UTRA RF Channel Number			1	Only one FDD carrier frequency is used.
Channel Bandwidth ($BW_{channel}$)		MHz	10	
A3-Offset		dB	0	

Hysteresis	dB	0	
Time To Trigger	s	0	
Filter coefficient		0	L3 filtering is not used
DRX			OFF
CP length		Normal	
Access Barring Information	-	Not Sent	No additional delays in random access procedure.
PRACH configuration		4	As specified in table 5.7.1-2 in TS 36.211
Time offset between cells		3 ms	Asynchronous cells
T1	s	5	
T2	s	≤5	
T3	s	1	

Table A.5.1.11.1-2: Cell specific test parameters for E-UTRAN FDD-FDD intra frequency handover test case

Parameter	Unit	Cell 1			Cell 2		
		T1	T2	T3	T1	T2	T3
E-UTRA RF Channel Number		1			1		
$BW_{channel}$	MHz	10			10		
OCNG Patterns defined in A.3.2.1.1 (OP.1 FDD) and in A.3.2.1.2 (OP.2 FDD)		OP.1 FDD	OP.1 FDD	OP.2 FDD	OP.2 FDD	OP.2 FDD	OP.1 FDD
PBCH_RA	dB	0			0		
PBCH_RB	dB						
PSS_RA	dB						
SSS_RA	dB						
PCFICH_RB	dB						
PHICH_RA	dB						
PHICH_RB	dB						
PDCCH_RA	dB						
PDCCH_RB	dB						
PDSCH_RA	dB						
PDSCH_RB	dB						
OCNG_RA ^{Note 1}	dB						
OCNG_RB ^{Note 1}	dB						
\hat{E}_s/I_{α}	dB	8	-3.3	-3.3	-Infinity	2.36	2.36
N_{oc} ^{Note 2}	dBm/15 KHz	-98					
\hat{E}_s/N_{oc}	dB	8	8	8	-Infinity	11	11
RSRP ^{Note 3}	dBm/15 KHz	-90	-90	-90	-Infinity	-87	-87
Propagation Condition		AWGN					
<p>Note 1: OCNG shall be used such that both cells are fully allocated and a constant total transmitted power spectral density is achieved for all OFDM symbols.</p> <p>Note 2: Interference from other cells and noise sources not specified in the test is assumed to be constant over subcarriers and time and shall be modelled as AWGN of appropriate power for N_{oc} to be fulfilled.</p> <p>Note 3: RSRP levels have been derived from other parameters for information purposes. They are not settable parameters themselves.</p>							

A.5.1.11.2 Test Requirements

The UE shall start to transmit the PRACH to Cell 2 less than 50 ms from the beginning of time period T3.

The rate of correct handovers observed during repeated tests shall be at least 90%.

NOTE: The handover delay can be expressed as: RRC procedure delay + $T_{interrupt}$, where:

RRC procedure delay = 15 ms and is specified in clause 11.2 in TS 36.331 [2].

$T_{\text{interrupt}} = 35$ ms in the test; $T_{\text{interrupt}}$ is defined in clause 5.2.2.5.2.1.

This gives a total of 50 ms.

A.5.1.12 E-UTRAN TDD - TDD Intra frequency handover for UE category 0

A.5.1.12.1 Test Purpose and Environment

This test is to verify the requirement for the TDD-TDD intra frequency handover requirements specified in clause 5.2.2.4.

The test scenario comprises of 1 E-UTRA TDD carrier and 2 cells as given in tables A.5.1.12.1-1 and A.5.1.12.1-2. The test consists of three successive time periods, with time durations of T1, T2 and T3 respectively. At the start of time duration T1, the UE may not have any timing information of cell 2.

E-UTRAN shall send a RRC message implying handover to cell 2. The RRC message implying handover shall be sent to the UE during period T2, after the UE has reported Event A3. T3 is defined as the end of the last TTI containing the RRC message implying handover.

Table A.5.1.12.1-1: General test parameters for E-UTRAN TDD-TDD Intra frequency handover test case

Parameter		Unit	Value	Comment
PDSCH parameters			DL Reference Measurement Channel R.12 TDD	As specified in clause A.3.1.1.5
PCFICH/PDCCHPHICH parameters			DL Reference Measurement Channel R.6 TDD	As specified in clause A.3.1.2.2
Initial conditions	Active cell		Cell 1	
	Neighbouring cell		Cell 2	
Final condition	Active cell		Cell 2	
E-UTRA RF Channel Number			1	Only one TDD carrier frequency is used.
Channel Bandwidth (BW_{channel})		MHz	10	
A3-Offset		dB	0	
Hysteresis		dB	0	
Time To Trigger		s	0	
Filter coefficient			0	L3 filtering is not used
DRX				OFF
CP length			Normal	
Access Barring Information		-	Not Sent	No additional delays in random access procedure.
Special subframe configuration			6	As specified in table 4.2-1 in TS 36.211
Uplink-downlink configuration			1	As specified in table 4.2-2 in TS 36.211
PRACH configuration index			53	As specified in table 5.7.1-3 in TS 36.211
Time offset between cells			3 μ s	Synchronous cells
T1		s	5	
T2		s	≤ 5	
T3		s	1	

Table A.5.1.12.1-2: Cell specific test parameters for E-UTRAN TDD-TDD Intra frequency handover test case

Parameter	Unit	Cell 1			Cell 2		
		T1	T2	T3	T1	T2	T3
E-UTRA RF Channel Number		1			1		
BW_{channel}	MHz	10			10		
OCNG Patterns defined in A.3.2.2.1 (OP.1 TDD) and in A.3.2.2.2 (OP.2 TDD)		OP.1 TDD	OP.1 TDD	OP.2 TDD	OP.2 TDD	OP.2 TDD	OP.1 TDD
PBCH_RA	dB						

PBCH_RB	dB						
PSS_RA	dB						
SSS_RA	dB						
PCFICH_RB	dB						
PHICH_RA	dB						
PHICH_RB	dB						
PDCCH_RA	dB	0			0		
PDCCH_RB	dB						
PDSCH_RA	dB						
PDSCH_RB	dB						
OCNG_RA ^{Note 1}	dB						
OCNG_RB ^{Note 1}	dB						
\hat{E}_s / I_{ot}	dB	8	-3.3	-3.3	-Infinity	2.36	2.36
N_{oc} ^{Note 2}	dBm/15 KHz	-98					
\hat{E}_s / N_{oc}	dB	8	8	8	-Infinity	11	11
RSRP ^{Note 3}	dBm/15 KHz	-90	-90	-90	-Infinity	-87	-87
Propagation Condition		AWGN					
Note 1:	OCNG shall be used such that both cells are fully allocated and a constant total transmitted power spectral density is achieved for all OFDM symbols.						
Note 2:	Interference from other cells and noise sources not specified in the test is assumed to be constant over subcarriers and time and shall be modelled as AWGN of appropriate power for N_{oc} to be fulfilled.						
Note 3:	RSRP levels have been derived from other parameters for information purposes. They are not settable parameters themselves.						

A.5.1.12.2 Test Requirements

The UE shall start to transmit the PRACH to Cell 2 less than 50 ms from the beginning of time period T3.

The rate of correct handovers observed during repeated tests shall be at least 90%.

NOTE: The handover delay can be expressed as: RRC procedure delay + $T_{interrupt}$, where:

RRC procedure delay = 15 ms and is specified in clause 11.2 in TS 36.331 [2].

$T_{interrupt}$ = 35 ms in the test; $T_{interrupt}$ is defined in clause 5.2.2.4.2.1.

This gives a total of 50 ms.

A.5.1.13 E-UTRAN FDD-FDD Intra frequency handover for Cat-M1 UEs in CEModeA

A.5.1.13.1 Test Purpose and Environment

This test is to verify the requirement for the FDD-FDD intra frequency handover requirements specified in clause 5.5.2.1.

The test scenario comprises of one E-UTRA FDD carrier and two cells as given in tables A.5.1.13.1-1 and A.5.1.13.1-2. The test consists of three successive time periods, with time durations of T1, T2 and T3 respectively. At the start of time duration T1, the UE may not have any timing information of Cell 2.

E-UTRAN shall send a RRC message implying handover to Cell 2. The RRC message implying handover shall be sent to the UE during period T2, after the UE has reported Event A3. T3 is defined as the end of the last TTI containing the RRC message implying handover.

During the test, UE is configured with measurement gap for cell search, because the narrowband of the PDSCH Reference Measurement Channel does not overlap with the centre 6 PRBs of the carrier bandwidth.

Table A.5.1.13.1-1: General test parameters for E-UTRAN FDD-FDD intra frequency handover for Cat-M1 UEs in CEModeA test case

Parameter	Unit	Value	Comment
Initial conditions	Active cell	Cell 1	

	Neighbouring cell		Cell 2	
Final condition	Active cell		Cell 2	
E-UTRA RF Channel Number			1	Only one FDD carrier frequency is used.
A3-Offset	dB		0	
Hysteresis	dB		0	
Time To Trigger	s		0	
Filter coefficient			0	L3 filtering is not used
DRX				OFF
CP length			Normal	
Access Barring Information	-		Not Sent	No additional delays in random access procedure.
PRACH configuration			PRACH_4CE	As specified in A.3.16
PRACH initial CE level			0	Specified in the handover message
T1	s		5	
T2	s		≤5	
T3	s		1	
Gap pattern ID			1	

Table A.5.1.13.1-2: Cell specific test parameters for E-UTRAN FDD-FDD intra frequency handover for Cat-M1 UEs in CEModeA test case

Parameter	Unit	Cell 1			Cell 2				
		T1	T2	T3	T1	T2	T3		
E-UTRA RF Channel Number		1							
BW _{channel}	MHz	10							
PDSCH Reference Channel in clause A.3.1.4.1		R.21 FDD	R.21 FDD	-	-	-	R.21 FDD		
MPDCCH Reference Channel in clause A.3.1.3.1		R.17 FDD			R.17 FDD				
PCFICH/PDCCH/PHICH Reference Channel in clause A.3.1.2.1		R.7 FDD			R.7 FDD				
OCNG Patterns in clause A.3.2.1		OP.21 FDD	OP.21 FDD	OP.6 FDD	OP.6 FDD	OP.6 FDD	OP.21 FDD		
PBCH_RA	dB								
PBCH_RB	dB								
PSS_RA	dB								
SSS_RA	dB								
PCFICH_RB	dB								
PHICH_RA	dB								
PHICH_RB	dB								
PDCCH_RA	dB							-3	-3
PDCCH_RB	dB								
MPDCCH_RA	dB								
MPDCCH_RB	dB								
PDSCH_RA	dB								
PDSCH_RB	dB								
OCNG_RA ^{Note 1}	dB								
OCNG_RB ^{Note 1}	dB								
N_{oc} ^{Note 2}	dBm/15 KHz	-98							
\hat{E}_s / N_{oc}	dB	8	8	8	-Infinity	12	12		
\hat{E}_s / I_{ot} ^{Note 3}	dB	8	-4.27	-4.27	-Infinity	3.36	3.36		
RSRP ^{Note 3}	dBm/15 KHz	-90	-90	-90	-Infinity	-86	-86		
I_0 ^{Note 3}	dBm/9MHz	-61.58	- 56.57	- 56.57	Specified in columns for Cell 1				
Propagation Condition		AWGN			AWGN				
Antenna Configuration		2x1			2x1				

Timing offset to Cell 1 Asynchronous cells	ms	-	3
Note 1:	OCNG shall be used such that both cells are fully allocated and a constant total transmitted power spectral density is achieved for all OFDM symbols.		
Note 2:	Interference from other cells and noise sources not specified in the test is assumed to be constant over subcarriers and time and shall be modelled as AWGN of appropriate power for N_{oc} to be fulfilled.		
Note 3:	Es/lot, RSRP and Io level has been derived from other parameters for information purpose. They are not settable parameters themselves.		

A.5.1.13.2 Test Requirements

The UE shall finish the transmission of all repetitions of the PRACH to Cell 2 less than 170 ms from the beginning of time period T3.

The rate of correct handovers observed during repeated tests shall be at least 90%.

NOTE: The handover delay can be expressed as: RRC procedure delay + $T_{interrupt}$, where:

RRC procedure delay = 15 ms and is specified in clause 11.2 in TS 36.331 [2].

$T_{interrupt}$ = 120 + 35 ms in the test; $T_{interrupt}$ is defined in clause 5.5.2.1.2.

This gives a total of 170 ms.

A.5.1.14 E-UTRAN HD-FDD Intra frequency handover for Cat-M1 UEs in CEModeA

A.5.1.14.1 Test Purpose and Environment

This test is to verify the requirement for the HD-FDD intra frequency handover requirements specified in clause 5.5.2.2.

The test scenario comprises of 1 E-UTRA FDD carrier and 2 cells as given in tables A.5.1.14.1-1 and A.5.1.14.1-2. The test consists of three successive time periods, with time durations of T1, T2 and T3 respectively. At the start of time duration T1, the UE may not have any timing information of Cell 2.

E-UTRAN shall send a RRC message implying handover to Cell 2. The RRC message implying handover shall be sent to the UE during period T2, after the UE has reported Event A3. T3 is defined as the end of the last TTI containing the RRC message implying handover.

During the test, UE is configured with measurement gap for cell search, because the narrowband of the PDSCH Reference Measurement Channel does not overlap with the centre 6 PRBs of the carrier bandwidth.

Table A.5.1.14.1-1: General test parameters for E-UTRAN HD-FDD intra frequency handover for Cat-M1 UEs in CEModeA test case

Parameter	Unit	Value	Comment
Initial conditions	Active cell	Cell 1	
	Neighbouring cell	Cell 2	
Final condition	Active cell	Cell 2	
E-UTRA RF Channel Number		1	Only one FDD carrier frequency is used.
A3-Offset	dB	0	
Hysteresis	dB	0	
Time To Trigger	s	0	
Filter coefficient		0	L3 filtering is not used
DRX			OFF
CP length		Normal	
Access Barring Information	-	Not Sent	No additional delays in random access procedure.
PRACH configuration		PRACH_4CE	As specified in A.3.16
PRACH initial CE level		0	Specified in the handover message
T1	s	5	
T2	s	≤5	

T3	s	1	
Gap pattern ID		1	

Table A.5.1.14.1-2: Cell specific test parameters for E-UTRAN HD-FDD intra frequency handover for Cat-M1 UEs in CEModeA test case

Parameter	Unit	Cell 1			Cell 2				
		T1	T2	T3	T1	T2	T3		
E-UTRA RF Channel Number		1							
BW _{channel}	MHz	10							
PDSCH Reference Channel in clause A.3.1.4.2		R.11 HD-FDD	R.11 HD-FDD	-	-	-	R.11 HD-FDD		
MPDCCH Reference Channel in clause A.3.1.3.2		R.7 HD-FDD			R.7 HD-FDD				
PCFICH/PDCCH/PHICH Reference Channel in clause A.3.1.2.3		R.4 HD-FDD			R.4 HD-FDD				
OCNG Patterns in clause A.3.2.1		OP.21 FDD	OP.21 FDD	OP.6 FDD	OP.6 FDD	OP.6 FDD	OP.21 FDD		
PBCH_RA	dB								
PBCH_RB	dB								
PSS_RA	dB								
SSS_RA	dB								
PCFICH_RB	dB								
PHICH_RA	dB								
PHICH_RB	dB								
PDCCH_RA	dB							-3	-3
PDCCH_RB	dB							-3	-3
MPDCCH_RA	dB								
MPDCCH_RB	dB								
PDSCH_RA	dB								
PDSCH_RB	dB								
OCNG_RA ^{Note 1}	dB								
OCNG_RB ^{Note 1}	dB								
N_{oc} ^{Note 2}	dBm/15 KHz	-98							
\hat{E}_s / N_{oc} ^{Note 3}	dB	8	8	8	-Infinity	12	12		
\hat{E}_s / I_{ot}	dB	8	-4.27	-4.27	-Infinity	3.36	3.36		
RSRP ^{Note 3}	dBm/15 KHz	-90	-90	-90	-Infinity	-86	-86		
I_o ^{Note 3}	dBm/9MHz	-61.58	- 56.57	- 56.57	Specified in columns for Cell 1				
Propagation Condition		AWGN			AWGN				
Antenna Configuration		2x1			2x1				
Timing offset to Cell 1 Asynchronous cells	ms	-			3				
<p>Note 1: OCNG shall be used such that both cells are fully allocated and a constant total transmitted power spectral density is achieved for all OFDM symbols.</p> <p>Note 2: Interference from other cells and noise sources not specified in the test is assumed to be constant over subcarriers and time and shall be modelled as AWGN of appropriate power for N_{oc} to be fulfilled.</p> <p>Note 3: E_s/I_{ot}, RSRP and I_o level has been derived from other parameters for information purpose. They are not settable parameters themselves</p>									

A.5.1.14.2 Test Requirements

The UE shall finish the transmission of all the repetitions of the PRACH to Cell 2 less than 170 ms from the beginning of time period T3.

The rate of correct handovers observed during repeated tests shall be at least 90%.

NOTE: The handover delay can be expressed as: RRC procedure delay + $T_{\text{interrupt}}$, where:

RRC procedure delay = 15 ms and is specified in clause 11.2 in TS 36.331 [2].

$T_{\text{interrupt}} = 120 + 35$ ms in the test; $T_{\text{interrupt}}$ is defined in clause 5.5.2.1.2.

This gives a total of 170 ms.

A.5.1.15 E-UTRAN TDD Intra frequency handover for Cat-M1 UEs in CEModeA

A.5.1.15.1 Test Purpose and Environment

This test is to verify the requirement for the TDD intra frequency handover requirements specified in clause 5.5.2.3.

The test scenario comprises of 1 E-UTRA TDD carrier and 2 cells as given in tables A.5.1.15.1-1 and A.5.1.15.1-2. The test consists of three successive time periods, with time durations of T1, T2 and T3 respectively. At the start of time duration T1, the UE may not have any timing information of Cell 2.

E-UTRAN shall send a RRC message implying handover to Cell 2. The RRC message implying handover shall be sent to the UE during period T2, after the UE has reported Event A3. T3 is defined as the end of the last TTI containing the RRC message implying handover.

During the test, UE is configured with measurement gap for cell search, because the narrowband of the PDSCH Reference Measurement Channel does not overlap with the centre 6 PRBs of the carrier bandwidth.

Table A.5.1.15.1-1: General test parameters for E-UTRAN TDD Intra frequency handover for Cat-M1 UEs in CEModeA test case

Parameter		Unit	Value	Comment
Initial conditions	Active cell		Cell 1	
	Neighbouring cell		Cell 2	
Final condition	Active cell		Cell 2	
E-UTRA RF Channel Number			1	Only one TDD carrier frequency is used.
A3-Offset		dB	0	
Hysteresis		dB	0	
Time To Trigger		s	0	
Filter coefficient			0	L3 filtering is not used
DRX				OFF
CP length			Normal	
Access Barring Information		-	Not Sent	No additional delays in random access procedure.
Special subframe configuration			6	As specified in table 4.2-1 in TS 36.211
Uplink-downlink configuration			1	As specified in table 4.2-2 in TS 36.211
PRACH configuration index			PRACH_4CE	As specified in A.3.16
PRACH initial CE level			0	Specified in the handover message
T1		s	5	
T2		s	≤5	
T3		s	1	
Gap pattern ID			1	

Table A.5.1.15.1-2: Cell specific test parameters for E-UTRAN TDD Intra frequency handover for Cat-M1 UEs in CEModeA test case

Parameter	Unit	Cell 1			Cell 2		
		T1	T2	T3	T1	T2	T3
E-UTRA RF Channel Number		1					
BW_{channel}	MHz	10					

PDSCH Reference Channel in clause A.3.1.4.3		R.17 TDD	R.17 TDD	-	-	-	R.17 TDD
MPDCCH Reference Channel in clause A.3.1.3.3		R.15 TDD			R.15 TDD		
PCFICH/PDCCH/PHICH Reference Channel in clause A.3.1.2.2		R.7 TDD			R.7 TDD		
OCNG Patterns in clause A.3.2.2		OP.11 TDD	OP.11 TDD	OP.2 TDD	OP.2 TDD	OP.2 TDD	OP.11 TDD
PBCH_RA	dB	-3			-3		
PBCH_RB	dB						
PSS_RA	dB						
SSS_RA	dB						
PCFICH_RB	dB						
PHICH_RA	dB						
PHICH_RB	dB						
PDCCH_RA	dB						
PDCCH_RB	dB						
MPDCCH_RA	dB						
MPDCCH_RB	dB						
PDSCH_RA	dB						
PDSCH_RB	dB						
OCNG_RA ^{Note 1}	dB						
OCNG_RB ^{Note 1}	dB						
N_{oc} ^{Note 2}	dBm/15 KHz	-98					
\hat{E}_s / N_{oc}	dB	8	8	8	-Infinity	12	12
\hat{E}_s / I_{ot} ^{Note 3}	dB	8	-4.27	-4.27	-Infinity	3.36	3.36
RSRP ^{Note 3}	dBm/15 KHz	-90	-90	-90	-Infinity	-86	-86
I_o ^{Note 3}	dBm/9MHz	-61.58	-56.57	-56.57	Specified in columns for Cell 1		
Propagation Condition		AWGN			AWGN		
Antenna Configuration		2x1			2x1		
Timing offset to Cell 1 Synchronous cells	μ s	-			3		
<p>Note 1: OCNG shall be used such that both cells are fully allocated and a constant total transmitted power spectral density is achieved for all OFDM symbols.</p> <p>Note 2: Interference from other cells and noise sources not specified in the test is assumed to be constant over subcarriers and time and shall be modelled as AWGN of appropriate power for N_{oc} to be fulfilled.</p> <p>Note 3: E_s/I_{ot}, RSRP and I_o level has been derived from other parameters for information purpose. They are not settable parameters themselves</p>							

A.5.1.15.2 Test Requirements

The UE shall finish the transmission of all the repetitions of the PRACH to Cell 2 less than 170 ms from the beginning of time period T3.

The rate of correct handovers observed during repeated tests shall be at least 90%.

NOTE: The handover delay can be expressed as: RRC procedure delay + $T_{interrupt}$, where:

RRC procedure delay = 15 ms and is specified in clause 11.2 in TS 36.331 [2].

$T_{interrupt}$ = 120 + 35 ms in the test; $T_{interrupt}$ is defined in clause 5.5.2.3.2.

This gives a total of 170 ms.

A.5.1.16 E-UTRAN FDD-FDD Intra frequency handover for Cat-M1 UEs in CEModeB

A.5.1.16.1 Test Purpose and Environment

This test is to verify the requirement for the FDD-FDD intra frequency handover requirements specified in clause 5.6.2.1.

The test scenario comprises of one E-UTRA FDD carrier and two cells as given in tables A.5.1.16.1-1 and A.5.1.16.1-2. The test consists of three successive time periods, with time durations of T1, T2 and T3 respectively. At the start of time duration T1, the UE may not have any timing information of Cell 2.

During period T2, the UE should report Event A3, and afterwards E-UTRAN shall send a RRC message to the UE implying handover to Cell 2. T3 is defined as the end of the last TTI containing the RRC message from UE implying handover.

During the test, the UE is configured with measurement gap for cell search, because the narrowband of the PDSCH Reference Measurement Channel does not overlap with the centre 6 PRBs of the carrier bandwidth.

Table A.5.1.16.1-1: General test parameters for E-UTRAN FDD-FDD intra frequency handover for Cat-M1 UEs in CEModeB test case

Parameter		Unit	Value	Comment
Initial conditions	Active cell		Cell 1	
	Neighbouring cell		Cell 2	
Final condition	Active cell		Cell 2	
E-UTRA RF Channel Number			1	Only one FDD carrier frequency is used.
A3-Offset		dB	0	
Hysteresis		dB	0	
Time To Trigger		s	0	
Filter coefficient			0	L3 filtering is not used
DRX				OFF
CP length			Normal	
Access Barring Information		-	Not Sent	No additional delays in random access procedure.
PRACH configuration			PRACH_4CE	As specified in A.3.16
PRACH initial CE level			0	Specified in handover message
T1		s	5	
T2		s	≤5	
T3		s	5	
Gap pattern ID			1	

Table A.5.1.16.1-2: Cell specific test parameters for E-UTRAN FDD-FDD intra frequency handover for Cat-M1 UEs in CEModeB test case

Parameter	Unit	Cell 1			Cell 2		
		T1	T2	T3	T1	T2	T3
E-UTRA RF Channel Number		1					
BW _{channel}	MHz	10					
PDSCH Reference Channel in A.3.1.4.4		R.23 FDD	R.23 FDD	-	-	-	R.23 FDD
MPDCCH Reference Channel in A.3.1.3.4		R.19 FDD			R.19 FDD		
PCFICH/PDCCH/PHICH Reference Channel in clause A.3.1.2.1		R.7 FDD			R.7 FDD		
OCNG Patterns in clause A.3.2.1		OP.21 FDD	OP.21 FDD	OP.6 FDD	OP.6 FDD	OP.6 FDD	OP.21 FDD
PBCH_RA	dB	-3			-3		
PBCH_RB	dB						
PSS_RA	dB						
SSS_RA	dB						

PCFICH_RB	dB						
PHICH_RA	dB						
PHICH_RB	dB						
PDCCH_RA	dB						
PDCCH_RB	dB						
MPDCCH_RA	dB						
MPDCCH_RB	dB						
PDSCH_RA	dB						
PDSCH_RB	dB						
OCNG_RA ^{Note 1}	dB						
OCNG_RB ^{Note 1}	dB						
N_{oc} ^{Note 2}	dBm/15 KHz				-98		
\hat{E}_s / N_{oc}	dB	-12	-12	-12	-Infinity	-7	-7
\hat{E}_s / I_{ot} ^{Note 3}	dB	-12	-12.79	-12.79	-Infinity	-7.27	-7.27
RSRP ^{Note 3}	dBm/15 KHz	-110	-110	-110	-Infinity	-105	-105
I_o ^{Note 3}	dBm/9MHz	-69.95	-69.21	-69.21	Specified in columns for Cell 1		
Propagation Condition		AWGN			AWGN		
Antenna Configuration		2x1			2x1		
Timing offset to Cell 1 Asynchronous cells	ms	-			3		
Note 1: OCNG shall be used such that both cells are fully allocated and a constant total transmitted power spectral density is achieved for all OFDM symbols.							
Note 2: Interference from other cells and noise sources not specified in the test is assumed to be constant over subcarriers and time and shall be modelled as AWGN of appropriate power for N_{oc} to be fulfilled.							
Note 3: E_s/I_{ot} , RSRP and I_o level has been derived from other parameters for information purpose. They are not settable parameters themselves.							

A.5.1.16.2 Test Requirements

The UE shall finish transmission of all repetitions of the PRACH to Cell 2 less than 2610ms from the beginning of time period T3.

The rate of correct handovers observed during repeated tests shall be at least 90%.

NOTE: The handover delay can be expressed as: RRC procedure delay + $T_{interrupt}$, where:

RRC procedure delay = 15 ms and is specified in clause 11.2 in TS 36.331 [2].

$T_{interrupt} = 2560\text{ms} + 35\text{ms} = 2595\text{ms}$ is defined in clause 5.6.2.1.2.

This gives a total of 2610ms.

A.5.1.17 E-UTRAN HD-FDD Intra frequency handover for Cat-M1 UEs in CEModeB

A.5.1.17.1 Test Purpose and Environment

This test is to verify the requirement for the HD-FDD intra frequency handover requirements specified in clause 5.6.2.2.

The test scenario comprises of one E-UTRA FDD carrier and two cells as given in tables A.5.1.17.1-1 and A.5.1.17.1-2. The test consists of three successive time periods, with time durations of T1, T2 and T3 respectively. At the start of time duration T1, the UE may not have any timing information of Cell 2.

During period T2, the UE should report Event A3, and afterwards E-UTRAN shall send a RRC message to the UE implying handover to Cell 2. During T3 is defined as the end of the last TTI containing the RRC message from UE implying handover.

During the test, UE is configured with measurement gap for cell search, because the narrowband of the PDSCH Reference Measurement Channel does not overlap with the centre 6 PRBs of the carrier bandwidth.

Table A.5.1.17.1-1: General test parameters for E-UTRAN HD-FDD intra frequency handover for Cat-M1 UEs in CEModeB test case

Parameter		Unit	Value	Comment
Initial conditions	Active cell		Cell 1	
	Neighbouring cell		Cell 2	
Final condition	Active cell		Cell 2	
A3-Offset		dB	0	
Hysteresis		dB	0	
Time To Trigger		s	0	
Filter coefficient			0	L3 filtering is not used
DRX				OFF
CP length			Normal	
Access Barring Information		-	Not Sent	No additional delays in random access procedure.
PRACH configuration			PRACH_4CE	As specified in clause A.3.16
PRACH initial CE level			0	Specified in handover message
T1		s	5	
T2		s	≤5	
T3		s	5	
Gap pattern ID			1	

Table A.5.1.17.1-2: Cell specific test parameters for E-UTRAN HD-FDD intra frequency handover for Cat-M1 UEs in CEModeA test case

Parameter	Unit	Cell 1			Cell 2								
		T1	T2	T3	T1	T2	T3						
E-UTRA RF Channel Number		1											
$BW_{channel}$	MHz	10											
PDSCH Reference Channel in clause A.3.1.4.5		R.13 HD-FDD	R.13 HD-FDD	-	-	-	R.13 HD-FDD						
MPDCCH Reference Channel in clause A.3.1.3.5		R.9 HD-FDD			R.9 HD-FDD								
PCFICH/PDCCH/PHICH Reference Channel in clause A.3.1.2.3		R.4 HD-FDD			R.4 HD-FDD								
OCNG Patterns in clause A.3.2.1		OP.21 FDD	OP.21 FDD	OP.6 FDD	OP.6 FDD	OP.6 FDD	OP.21 FDD						
PBCH_RA	dB												
PBCH_RB	dB												
PSS_RA	dB												
SSS_RA	dB												
PCFICH_RB	dB												
PHICH_RA	dB												
PHICH_RB	dB												
PDCCH_RA	dB							-3			-3		
PDCCH_RB	dB												
MPDCCH_RA	dB												
MPDCCH_RB	dB												
PDSCH_RA	dB												
PDSCH_RB	dB												
OCNG_RA ^{Note 1}	dB												
OCNG_RB ^{Note 1}	dB												
N_{oc} ^{Note 2}	dBm/15 KHz							-98					
\hat{E}_s / N_{oc} ^{Note 3}	dB	-12	-12	-12	-Infinity	-7	-7						
\hat{E}_s / I_{ot}	dB	-12	-12.79	-12.79	-Infinity	-7.27	-7.27						
RSRP ^{Note 3}	dBm/15 KHz	-110	-110	-110	-Infinity	-105	-105						
I_o ^{Note 3}	dBm/9MHz	-69.95	-69.21	-69.21	Specified in columns for Cell 1								

Propagation Condition		AWGN	AWGN
Antenna Configuration		2x1	2x1
Timing offset to Cell 1 Asynchronous cells	ms	-	3
Note 1:	OCNG shall be used such that both cells are fully allocated and a constant total transmitted power spectral density is achieved for all OFDM symbols.		
Note 2:	Interference from other cells and noise sources not specified in the test is assumed to be constant over subcarriers and time and shall be modelled as AWGN of appropriate power for N_{oc} to be fulfilled.		
Note 3:	Es/lot, RSRP and Io level has been derived from other parameters for information purpose. They are not settable parameters themselves.		

A.5.1.17.2 Test Requirements

The UE shall finish the transmission of all repetitions of the PRACH to Cell 2 less than 2610 ms from the beginning of time period T3.

The rate of correct handovers observed during repeated tests shall be at least 90%.

NOTE: The handover delay can be expressed as: RRC procedure delay + $T_{interrupt}$, where:

RRC procedure delay = 15 ms and is specified in clause 11.2 in TS 36.331 [2].

$T_{interrupt} = 2560\text{ms} + 35\text{ms} = 2595\text{ms}$ is defined in clause 5.6.2.1.2.

This gives a total of 2610ms.

A.5.1.18 E-UTRAN TDD Intra frequency handover for Cat-M1 UEs in CEModeB

A.5.1.18.1 Test Purpose and Environment

This test is to verify the requirement for the TDD-TDD intra frequency handover requirements specified in clause 5.6.2.3.

The test scenario comprises of one E-UTRA TDD carrier and two cells as given in tables A.5.1.18.1-1 and A.5.1.18.1-2. The test consists of three successive time periods, with time durations of T1, T2 and T3 respectively. At the start of time duration T1, the UE may not have any timing information of Cell 2.

During period T2, the UE should report Event A3, and afterwards E-UTRAN shall send a RRC message to the UE implying handover to Cell 2. During T3 is defined as the end of the last TTI containing the RRC message from UE implying handover.

During the test, the UE is configured with measurement gap for cell search, because the narrowband of the PDSCH Reference Measurement Channel does not overlap with the centre 6 PRBs of the carrier bandwidth.

Table A.5.1.18.1-1: General test parameters for E-UTRAN TDD Intra frequency handover for Cat-M1 UEs in CEModeB test case

Parameter	Unit	Value	Comment
Initial conditions	Active cell	Cell 1	
	Neighbouring cell	Cell 2	
Final condition	Active cell	Cell 2	
A3-Offset	dB	0	
Hysteresis	dB	0	
Time To Trigger	s	0	
Filter coefficient		0	L3 filtering is not used
DRX			OFF
CP length		Normal	
Access Barring Information	-	Not Sent	No additional delays in random access procedure.
Special subframe configuration		6	As specified in table 4.2-1 in TS 36.211
Uplink-downlink configuration		1	As specified in table 4.2-2 in TS 36.211

PRACH configuration		PRACH_4CE	As specified in clause A.3.16
PRACH initial CE level		0	Specified in handover message
T1	s	5	
T2	s	≤5	
T3	s	5	
Gap pattern ID		1	

Table A.5.1.18.1-2: Cell specific test parameters for E-UTRAN TDD Intra frequency handover test case

Parameter	Unit	Cell 1			Cell 2		
		T1	T2	T3	T1	T2	T3
E-UTRA RF Channel Number		1			1		
$BW_{channel}$	MHz	10			10		
PDSCH Reference Channel in clause A.3.1.4.6		R.19 TDD	R.19 TDD	-	-	-	R.19 TDD
MPDCCH Reference Channel in clause A.3.1.3.6		R.17 TDD			R.17 TDD		
PCFICH/PDCCH/PHICH Reference Channel in clause A.3.1.2.2		R.7 TDD			R.7 TDD		
OCNG Patterns in clause A.3.2.2		OP.11 TDD	OP.11 TDD	OP.2 TDD	OP.2 TDD	OP.2 TDD	OP.11 TDD
PBCH_RA	dB	-3			-3		
PBCH_RB	dB						
PSS_RA	dB						
SSS_RA	dB						
PCFICH_RB	dB						
PHICH_RA	dB						
PHICH_RB	dB						
PDCCH_RA	dB						
PDCCH_RB	dB						
MPDCCH_RA	dB						
MPDCCH_RB	dB						
PDSCH_RA	dB						
PDSCH_RB	dB						
OCNG_RA ^{Note 1}	dB						
OCNG_RB ^{Note 1}	dB						
N_{oc} ^{Note 2}	dBm/15 KHz	-98					
\hat{E}_s / N_{oc}	dB	-12	-12	-12	-Infinity	-7	-7
\hat{E}_s / I_{ot} ^{Note 3}	dB	-12	-12.79	-12.79	-Infinity	-7.27	-7.27
RSRP ^{Note 3}	dBm/15 KHz	-110	-110	-110	-Infinity	-105	-105
I_o ^{Note 3}	dBm/9MHz	-69.95	-69.21	-69.21	Specified in columns for Cell 1		
Propagation Condition		AWGN			AWGN		
Antenna Configuration		2x1			2x1		
Timing offset to Cell 1 Synchronous cells	μs	-			3		
<p>Note 1: OCNG shall be used such that both cells are fully allocated and a constant total transmitted power spectral density is achieved for all OFDM symbols.</p> <p>Note 2: Interference from other cells and noise sources not specified in the test is assumed to be constant over subcarriers and time and shall be modelled as AWGN of appropriate power for N_{oc} to be fulfilled.</p> <p>Note 3: E_s/I_{ot}, RSRP and I_o level has been derived from other parameters for information purpose. They are not settable parameters themselves.</p>							

A.5.1.18.2 Test Requirements

The UE shall finish the transmission of all repetitions of the PRACH to Cell 2 less than 2610 ms from the beginning of time period T3.

The rate of correct handovers observed during repeated tests shall be at least 90%.

NOTE: The handover delay can be expressed as: RRC procedure delay + $T_{\text{interrupt}}$, where:

RRC procedure delay = 15 ms and is specified in clause 11.2 in TS 36.331 [2].

$T_{\text{interrupt}} = 2560\text{ms} + 35\text{ms} = 2595\text{ms}$ is defined in clause 5.6.2.1.2.

This gives a total of 2610 ms.

A.5.1.19 E-UTRAN FDD - FDD Intra frequency handover for UE Category 1bis

A.5.1.19.1 Test Purpose and Environment

This test is to verify the requirement for the FDD-FDD intra frequency handover requirements for UE category 1bis specified in clause 5.1.2.1.

The test scenario comprises of 1 E-UTRA FDD carrier and 2 cells as given in tables A.5.1.19.1-1 and A.5.1.19.1-2. The test consists of three successive time periods, with time durations of T1, T2 and T3 respectively. At the start of time duration T1, the UE may not have any timing information of cell 2.

E-UTRAN shall send a RRC message implying handover to cell 2. The RRC message implying handover shall be sent to the UE during period T2, after the UE has reported Event A3. T3 is defined as the end of the last TTI containing the RRC message implying handover.

Table A.5.1.19.1-1: General test parameters for E-UTRAN FDD-FDD intra frequency handover test case

Parameter		Unit	Value	Comment
Initial conditions	Active cell		Cell 1	
	Neighbouring cell		Cell 2	
Final condition	Active cell		Cell 2	
E-UTRA RF Channel Number			1	Only one FDD carrier frequency is used.
A3-Offset		dB	0	
Hysteresis		dB	0	
Time To Trigger		s	0	
Filter coefficient			0	L3 filtering is not used
DRX				OFF
CP length			Normal	
Access Barring Information		-	Not Sent	No additional delays in random access procedure.
PRACH configuration			4	As specified in table 5.7.1-2 in TS 36.211
T1		s	5	
T2		s	≤ 5	
T3		s	1	

Table A.5.1.19.1-2: Cell specific test parameters for E-UTRAN FDD-FDD intra frequency handover test case

Parameter	Unit	Cell 1			Cell 2		
		T1	T2	T3	T1	T2	T3
E-UTRA RF Channel Number		1			1		
$BW_{channel}$	MHz	10			10		
PDSCH Reference Measurement Channel in clause A.3.1.1.1		R.0 FDD	R.0 FDD	-	-	-	R.0 FDD
PCFICH/PDCCH/PHICH Reference Channel in clause A.3.1.2.1		R.6 FDD			R.6 FDD		
OCNG Patterns defined in A.3.2.1.1 and in A.3.2.1.2		OP.1 FDD	OP.1 FDD	OP.2 FDD	OP.2 FDD	OP.2 FDD	OP.1 FDD
PBCH_RA	dB	0			0		
PBCH_RB	dB						
PSS_RA	dB						
SSS_RA	dB						
PCFICH_RB	dB						
PHICH_RA	dB						
PHICH_RB	dB						
PDCCH_RA	dB						
PDCCH_RB	dB						
PDSCH_RA	dB						
PDSCH_RB	dB						
OCNG_RA ^{Note 1}	dB						
OCNG_RB ^{Note 1}	dB						
N_{oc} ^{Note 2}	dBm/15 KHz						
\hat{E}_s / N_{oc}	dB	8	8	8	- Infinity	12	12
\hat{E}_s / I_{ot}	dB	8	-4.27	-4.27	-Infinity	3.36	3.36
RSRP ^{Note 3}	dBm/15 KHz	-90	-90	-90	- Infinity	-86	-86
I_o ^{Note 3}	dBm/9MHz	-61.58	- 56.57	- 56.57	Specified in columns for Cell 1		
Propagation Condition		AWGN			AWGN		
Antenna Configuration		1x1			1x1		
Timing offset to Cell 1 Asynchronous cells	ms	-			3		
<p>Note 1: OCNG shall be used such that both cells are fully allocated and a constant total transmitted power spectral density is achieved for all OFDM symbols.</p> <p>Note 2: Interference from other cells and noise sources not specified in the test is assumed to be constant over subcarriers and time and shall be modelled as AWGN of appropriate power for N_{oc} to be fulfilled.</p> <p>Note 3: E_s/I_{ot}, RSRP and I_o levels have been derived from other parameters for information purposes. They are not settable parameters themselves.</p>							

A.5.1.19.2 Test Requirements

The UE shall start to transmit the PRACH to Cell 2 less than 50 ms from the beginning of time period T3.

The rate of correct handovers observed during repeated tests shall be at least 90%.

NOTE: The handover delay can be expressed as: RRC procedure delay + $T_{interrupt}$, where:

RRC procedure delay = 15 ms and is specified in clause 11.2 in TS 36.331 [2].

$T_{interrupt}$ = 35 ms in the test; $T_{interrupt}$ is defined in clause 5.1.2.1.2.

This gives a total of 50 ms.

A.5.1.20 E-UTRAN TDD - TDD Intra frequency handover for UE Category 1bis

A.5.1.20.1 Test Purpose and Environment

This test is to verify the requirement for the TDD-TDD intra frequency handover requirements for UE category 1bis specified in clause 5.2.2.4.

The test scenario comprises of 1 E-UTRA TDD carrier and 2 cells as given in tables A.5.1.20.1-1 and A.5.1.20.1-2. The test consists of three successive time periods, with time durations of T1, T2 and T3 respectively. At the start of time duration T1, the UE may not have any timing information of cell 2.

E-UTRAN shall send a RRC message implying handover to cell 2. The RRC message implying handover shall be sent to the UE during period T2, after the UE has reported Event A3. T3 is defined as the end of the last TTI containing the RRC message implying handover.

Table A.5.1.20.1-1: General test parameters for E-UTRAN TDD-TDD Intra frequency handover test case

Parameter		Unit	Value	Comment
Initial conditions	Active cell		Cell 1	
	Neighbouring cell		Cell 2	
Final condition	Active cell		Cell 2	
E-UTRA RF Channel Number			1	Only one TDD carrier frequency is used.
A3-Offset		dB	0	
Hysteresis		dB	0	
Time To Trigger		s	0	
Filter coefficient			0	L3 filtering is not used
DRX				OFF
CP length			Normal	
Access Barring Information		-	Not Sent	No additional delays in random access procedure.
Special subframe configuration			6	As specified in table 4.2-1 in TS 36.211
Uplink-downlink configuration			1	As specified in table 4.2-2 in TS 36.211
PRACH configuration index			53	As specified in table 5.7.1-3 in TS 36.211
T1		s	5	
T2		s	≤5	
T3		s	1	

Table A.5.1.20.1-2: Cell specific test parameters for E-UTRAN TDD-TDD Intra frequency handover test case

Parameter	Unit	Cell 1			Cell 2		
		T1	T2	T3	T1	T2	T3
E-UTRA RF Channel Number		1			1		
$BW_{channel}$	MHz	10			10		
PDSCH Reference Measurement Channel in clause A.3.1.1.2		R.0 TDD	R.0 TDD	-	-	-	R.0 TDD
PCFICH/PDCCH/PHICH Reference Channel in clause A.3.1.2.2		R.6 TDD			R.6 TDD		
OCNG Patterns defined in A.3.2.2.1 and in A.3.2.2.2		OP.1 TDD	OP.1 TDD	OP.2 TDD	OP.2 TDD	OP.2 TDD	OP.1 TDD
PBCH_RA	dB	0			0		
PBCH_RB	dB						
PSS_RA	dB						
SSS_RA	dB						
PCFICH_RB	dB						
PHICH_RA	dB						
PHICH_RB	dB						
PDCCH_RA	dB						
PDCCH_RB	dB						
PDSCH_RA	dB						
PDSCH_RB	dB						
OCNG_RA ^{Note 1}	dB						
OCNG_RB ^{Note 1}	dB						
N_{oc} ^{Note 2}	dBm/15 KHz						
\hat{E}_s / N_{oc}	dB	8	8	8	- Infinity	12	12
\hat{E}_s / I_{ot}	dB	8	-4.27	-4.27	-Infinity	3.36	3.36
RSRP ^{Note 3}	dBm/15 KHz	-90	-90	-90	- Infinity	-86	-86
I_o ^{Note 3}	dBm/9MHz	-61.58	- 56.57	- 56.57	Specified in columns for Cell 1		
Propagation Condition		AWGN			AWGN		
Antenna Configuration		1x1			1x1		
Timing offset to Cell 1 Asynchronous cells	μ s	-			3		
<p>Note 1: OCNG shall be used such that both cells are fully allocated and a constant total transmitted power spectral density is achieved for all OFDM symbols.</p> <p>Note 2: Interference from other cells and noise sources not specified in the test is assumed to be constant over subcarriers and time and shall be modelled as AWGN of appropriate power for N_{oc} to be fulfilled.</p> <p>Note 3: E_s/I_{ot}, RSRP and I_o levels have been derived from other parameters for information purposes. They are not settable parameters themselves.</p>							

A.5.1.20.2 Test Requirements

The UE shall start to transmit the PRACH to Cell 2 less than 50 ms from the beginning of time period T3.

The rate of correct handovers observed during repeated tests shall be at least 90%.

NOTE: The handover delay can be expressed as: RRC procedure delay + $T_{interrupt}$, where:

RRC procedure delay = 15 ms and is specified in clause 11.2 in TS 36.331 [2].

$T_{interrupt}$ = 35 ms in the test; $T_{interrupt}$ is defined in clause 5.2.2.4.2.

This gives a total of 50 ms.

A.5.1.21 E-UTRAN FDD - FDD Intra frequency RACH-less handover

A.5.1.21.1 Test Purpose and Environment

This test is to verify the requirement for the FDD-FDD intra frequency RACH-less handover requirements specified in clause 5.1.2.1.

The test scenario comprises of 1 E-UTRA FDD carrier and 2 cells as given in tables A.5.1.21.1-1 and A.5.1.21.1-2. The test consists of three successive time periods, with time durations of T1, T2 and T3 respectively. At the start of time duration T1, the UE may not have any timing information of cell 2.

E-UTRAN shall send a RRC message implying RACH-less handover to cell 2. The RRC message implying handover shall be sent to the UE during period T2, after the UE has reported Event A3, and the PUSCH transmission in the cell2 is configured in the RRC message from cell1. T3 is defined as the end of the last TTI containing the RRC message implying handover.

Table A.5.1.21.1-1: General test parameters for E-UTRAN FDD-FDD intra frequency RACH-less handover test case

Parameter		Unit	Value	Comment
PDSCH parameters			DL Reference Measurement Channel R.0 FDD	As specified in clause A.3.1.1.1
PCFICH/PDCCH/PHICH parameters			DL Reference Measurement Channel R.6 FDD	As specified in clause A.3.1.2.1
Initial conditions	Active cell		Cell 1	
	Neighbouring cell		Cell 2	
Final condition	Active cell		Cell 2	
E-UTRA RF Channel Number			1	Only one FDD carrier frequency is used.
Channel Bandwidth ($BW_{channel}$)		MHz	10	
A3-Offset		dB	0	
Hysteresis		dB	0	
Time To Trigger		s	0	
Filter coefficient			0	L3 filtering is not used
ul-SchedInterval-r14			sf10	As specified in section 6.3.4 in TS 36.331
ul-StartSubframe-r14			0	As specified in section 6.3.4 in TS 36.331
DRX				OFF
CP length			Normal	
Time offset between cells			3 ms	Asynchronous cells
T1		s	5	
T2		s	≤ 5	
T3		s	1	

Table A.5.1.21.1-2: Cell specific test parameters for E-UTRAN FDD-FDD intra frequency RACH-less handover test case

Parameter	Unit	Cell 1			Cell 2		
		T1	T2	T3	T1	T2	T3
E-UTRA RF Channel Number		1			1		
BW _{channel}	MHz	10			10		
OCNG Patterns defined in A.3.2.1.1 (OP.1 FDD) and in A.3.2.1.2 (OP.2 FDD)		OP.1 FDD	OP.1 FDD	OP.2 FDD	OP.2 FDD	OP.2 FDD	OP.1 FDD
PBCH_RA	dB	0			0		
PBCH_RB	dB						
PSS_RA	dB						
SSS_RA	dB						
PCFICH_RB	dB						
PHICH_RA	dB						
PHICH_RB	dB						
PDCCH_RA	dB						
PDCCH_RB	dB						
PDSCH_RA	dB						
PDSCH_RB	dB						
OCNG_RA ^{Note 1}	dB						
OCNG_RB ^{Note 1}	dB						
\hat{E}_s / I_{ot}	dB	8	-3.3	-3.3	-Infinity	2.36	2.36
N_{oc} ^{Note 2}	dBm/15 KHz	-98					
\hat{E}_s / N_{oc}	dB	8	8	8	- Infinity	11	11
RSRP ^{Note 3}	dBm/15 KHz	-90	-90	-90	- Infinity	-87	-87
Propagation Condition		AWGN					
<p>Note 1: OCNG shall be used such that both cells are fully allocated and a constant total transmitted power spectral density is achieved for all OFDM symbols.</p> <p>Note 2: Interference from other cells and noise sources not specified in the test is assumed to be constant over subcarriers and time and shall be modelled as AWGN of appropriate power for N_{oc} to be fulfilled.</p> <p>Note 3: RSRP levels have been derived from other parameters for information purposes. They are not settable parameters themselves.</p>							

A.5.1.21.2 Test Requirements

The UE shall start to transmit the PUSCH to Cell 2 less than 45 ms from the beginning of time period T3.

The rate of correct handovers observed during repeated tests shall be at least 90%.

NOTE: The handover delay can be expressed as: RRC procedure delay + $T_{interrupt}$, where:

RRC procedure delay = 15 ms and is specified in clause 11.2 in TS 36.331 [2].

$T_{interrupt}$ = 30 ms in the test; $T_{interrupt}$ is defined in clause 5.1.2.1.2.2.

This gives a total of 45 ms.

A.5.1.22 E-UTRAN TDD - TDD Intra frequency RACH-less handover

A.5.1.22.1 Test Purpose and Environment

This test is to verify the requirement for the TDD-TDD intra frequency RACH-less handover requirements specified in clause 5.2.2.4.

The test scenario comprises of 1 E-UTRA TDD carrier and 2 cells as given in tables A.5.1.22.1-1 and A.5.1.22.1-2. The test consists of three successive time periods, with time durations of T1, T2 and T3 respectively. At the start of time duration T1, the UE may not have any timing information of cell 2.

E-UTRAN shall send a RRC message implying RACH-less handover to cell 2. The RRC message implying handover shall be sent to the UE during period T2, after the UE has reported Event A3, and the PUSCH transmission in the cell2 is configured in the RRC message from cell1. T3 is defined as the end of the last TTI containing the RRC message implying handover.

Table A.5.1.22.1-1: General test parameters for E-UTRAN TDD-TDD Intra frequency RACH-less handover test case

Parameter		Unit	Value	Comment
PDSCH parameters			DL Reference Measurement Channel R.0 TDD	As specified in clause A.3.1.1.2
PCFICH/PDCCHPHICH parameters			DL Reference Measurement Channel R.6 TDD	As specified in clause A.3.1.2.2
Initial conditions	Active cell		Cell 1	
	Neighbouring cell		Cell 2	
Final condition	Active cell		Cell 2	
E-UTRA RF Channel Number			1	Only one TDD carrier frequency is used.
Channel Bandwidth ($BW_{channel}$)		MHz	10	
A3-Offset		dB	0	
Hysteresis		dB	0	
Time To Trigger		s	0	
Filter coefficient			0	L3 filtering is not used
ul-SchedInterval-r14			sf10	As specified in section 6.3.4 in TS 36.331
ul-StartSubframe-r14			2	As specified in section 6.3.4 in TS 36.331
DRX				OFF
CP length			Normal	
Special subframe configuration			6	As specified in table 4.2-1 in TS 36.211
Uplink-downlink configuration			1	As specified in table 4.2-2 in TS 36.211
Time offset between cells			3 μ s	Synchronous cells
T1		s	5	
T2		s	≤ 5	
T3		s	1	

Table A.5.1.22.1-2: Cell specific test parameters for E-UTRAN TDD-TDD Intra frequency RACH-less handover test case

Parameter	Unit	Cell 1			Cell 2		
		T1	T2	T3	T1	T2	T3
E-UTRA RF Channel Number		1			1		
BW _{channel}	MHz	10			10		
OCNG Patterns defined in A.3.2.2.1 (OP.1 TDD) and in A.3.2.2.2 (OP.2 TDD)		OP.1 TDD	OP.1 TDD	OP.2 TDD	OP.2 TDD	OP.2 TDD	OP.1 TDD
PBCH_RA	dB	0			0		
PBCH_RB	dB						
PSS_RA	dB						
SSS_RA	dB						
PCFICH_RB	dB						
PHICH_RA	dB						
PHICH_RB	dB						
PDCCH_RA	dB						
PDCCH_RB	dB						
PDSCH_RA	dB						
PDSCH_RB	dB						
OCNG_RA ^{Note 1}	dB						
OCNG_RB ^{Note 1}	dB						
\hat{E}_s / I_{ot}	dB	8	-3.3	-3.3	-Infinity	2.36	2.36
N_{oc} ^{Note 2}	dBm/15 KHz	-98					
\hat{E}_s / N_{oc}	dB	8	8	8	-Infinity	11	11
RSRP ^{Note 3}	dBm/15 KHz	-90	-90	-90	-Infinity	-87	-87
Propagation Condition		AWGN					
<p>Note 1: OCNG shall be used such that both cells are fully allocated and a constant total transmitted power spectral density is achieved for all OFDM symbols.</p> <p>Note 2: Interference from other cells and noise sources not specified in the test is assumed to be constant over subcarriers and time and shall be modelled as AWGN of appropriate power for N_{oc} to be fulfilled.</p> <p>Note 3: RSRP levels have been derived from other parameters for information purposes. They are not settable parameters themselves.</p>							

A.5.1.22.2 Test Requirements

The UE shall start to transmit the PUSCH to Cell 2 less than 45 ms from the beginning of time period T3.

The rate of correct handovers observed during repeated tests shall be at least 90%.

NOTE: The handover delay can be expressed as: RRC procedure delay + $T_{interrupt}$, where:

RRC procedure delay = 15 ms and is specified in clause 11.2 in TS 36.331 [2].

$T_{interrupt}$ = 30 ms in the test; $T_{interrupt}$ is defined in clause 5.2.2.4.2.

This gives a total of 45 ms.

A.5.1.23 E-UTRAN FDD – FDD Inter frequency RACH-less handover

A.5.1.23.1 Test Purpose and Environment

This test is to verify the requirement for the FDD-FDD inter-frequency RACH-less handover requirements specified in clause 5.1.2.1.

The test scenario comprises of two E-UTRA FDD carriers and one cell on each carrier as given in tables A.5.1.23.1-1 and A.5.1.23.1-2. PDCCHs indicating new transmissions shall be sent continuously to ensure that the UE would not enter the DRX state. The test consists of three successive time periods, with time durations of T1, T2 and T3

respectively. At the start of time duration T1, the UE does not have any timing information of cell 2. Starting T2, cell 2 becomes detectable and the UE is expected to detect and send a measurement report. Gap pattern configuration with id #0 as specified in Table 8.1.2.1-1 is configured before T2 begins to enable inter-frequency monitoring.

A RRC message implying RACH-less handover shall be sent to the UE during period T2, after the UE has reported Event A3, and the PUSCH transmission in the cell2 is configured in the RRC message from cell1. The start of T3 is the instant when the last TTI containing the RRC message implying handover is sent to the UE.

Table A.5.1.23.1-1: General test parameters for E-UTRAN FDD-FDD Inter frequency RACH-less handover test case

Parameter		Unit	Value	Comment
PDSCH parameters			DL Reference Measurement Channel R.0 FDD	As specified in clause A.3.1.1.1
PCFICH/PDCCH/PHICH parameters			DL Reference Measurement Channel R.6 FDD	As specified in clause A.3.1.2.1
Initial conditions	Active cell		Cell 1	Cell 1 is on RF channel number 1
	Neighbouring cell		Cell 2	Cell 2 is on RF channel number 2
Final condition	Active cell		Cell 2	
E-UTRA RF channel number			1, 2	Two FDD carriers are used
Channel Bandwidth ($BW_{channel}$)		MHz	10	
A3-Offset		dB	-4	
Hysteresis		dB	0	
TimeToTrigger		s	0	
Filter coefficient			0	L3 filtering is not used
ul-SchedInterval-r14			sf10	As specified in section 6.3.4 in TS 36.331
ul-StartSubframe-r14			0	As specified in section 6.3.4 in TS 36.331
DRX			DRX_L	As specified in clause A.3.3
Time offset between cells			3 ms	Asynchronous cells
Gap pattern configuration Id			0	As specified in Table 8.1.2.1-1 started before T2 starts
T1		s	5	
T2		s	≤5	
T3		s	1	

Table A.5.1.23.1-2: Cell specific test parameters for E-UTRAN FDD-FDD Inter frequency RACH-less handover test case

Parameter	Unit	Cell 1			Cell 2		
		T1	T2	T3	T1	T2	T3
E-UTRA RF Channel number		1			2		
BW _{channel}	MHz	10			10		
OCNG Patterns defined in A.3.2.1.1 (OP.1 FDD) and in A.3.2.1.2 (OP.2 FDD)		OP.1 FDD	OP.1 FDD	OP.2 FDD	OP.2 FDD	OP.2 FDD	OP.1 FDD
PBCH_RA	dB	0			0		
PBCH_RB	dB						
PSS_RA	dB						
SSS_RA	dB						
PCFICH_RB	dB						
PHICH_RA	dB						
PHICH_RB	dB						
PDCCH_RA	dB						
PDCCH_RB	dB						
PDSCH_RA	dB						
PDSCH_RB	dB						
OCNG_RA ^{Note 1}	dB						
OCNG_RB ^{Note 1}	dB						
\hat{E}_s / I_{ot}	dB	4	4	4	-Infinity	7	7
N_{oc} ^{Note 2}	dBm/15 kHz	-98					
\hat{E}_s / N_{oc}	dB	4	4	4	-Infinity	7	7
RSRP ^{Note 3}	dBm/15 KHz	-94	-94	-94	-Infinity	-91	-91
Propagation Condition		AWGN					
<p>Note 1: OCNG shall be used such that both cells are fully allocated and a constant total transmitted power spectral density is achieved for all OFDM symbols.</p> <p>Note 2: Interference from other cells and noise sources not specified in the test is assumed to be constant over subcarriers and time and shall be modelled as AWGN of appropriate power for N_{oc} to be fulfilled.</p> <p>Note 3: RSRP levels have been derived from other parameters for information purposes. They are not settable parameters themselves.</p>							

A.5.1.23.2 Test Requirements

The UE shall start to transmit the PUSCH to Cell 2 less than 45 ms from the beginning of time period T3.

The rate of correct handovers observed during repeated tests shall be at least 90%.

NOTE: The handover delay can be expressed as: RRC procedure delay + $T_{interrupt}$, where:

RRC procedure delay = 15 ms and is specified in clause 11.2 in TS 36.331 [2].

$T_{interrupt}$ = 30 ms in the test; $T_{interrupt}$ is defined in clause 5.1.2.1.2.

This gives a total of 45 ms.

A.5.1.24 E-UTRAN TDD – TDD Inter frequency RACH-less handover

A.5.1.24.1 Test Purpose and Environment

This test is to verify the requirement for the TDD-TDD inter frequency RACH-less handover requirements specified in clause 5.2.2.4.

The test scenario comprises of two E-UTRA TDD carriers and one cell on each carrier as given in tables Table A.5.1.24.1-1 and Table A.5.1.24.1-2. PDCCHs indicating new transmissions shall be sent continuously to ensure that the UE would not enter the DRX state. The test consists of three successive time periods, with time durations of T1, T2 and T3 respectively. At the start of time duration T1, the UE may not have any timing information of cell 2.

E-UTRAN shall send a RRC message implying RACH-less handover to cell 2. The RRC message implying handover shall be sent to the UE during period T2, after the UE has reported Event A3, and the PUSCH transmission in the cell2 is configured in the RRC message from cell1.

Table A.5.1.24.1-1: General test parameters for E-UTRAN TDD-TDD Inter frequency RACH-less handover test case

Parameter		Unit	Value	Comment
PDSCH parameters			DL Reference Measurement Channel R.0 TDD	As specified in clause A.3.1.1.2
PCFICH/PDCCH/PHICH parameters			DL Reference Measurement Channel R.6 TDD	As specified in clause A.3.1.2.2
Gap Pattern Id			1	As specified in TS 36.133 clause 8.1.2.1.
Initial conditions	Active cell		Cell 1	
	Neighbour cell		Cell 2	
Final conditions	Active cell		Cell 2	
E-UTRA RF channel number			1, 2	Two TDD carriers are used
Channel Bandwidth ($BW_{channel}$)		MHz	10	
A3-Offset		dB	-4	
Hysteresis		dB	0	
Time to Trigger		ms	0	
Filter coefficient			0	
ul-SchedInterval-r14			sf10	As specified in section 6.3.4 in TS 36.331
ul-StartSubframe-r14			2	As specified in section 6.3.4 in TS 36.331
DRX			DRX_L	As specified in clause A.3.3
CP length			Normal	
Special subframe configuration			6	As specified in table 4.2-1 in TS 36.211
Uplink-downlink configuration			1	As specified in table 4.2-2 in TS 36.211
Time offset between cells			3 μ s	Synchronous cells
T1		s	5	
T2		s	≤ 5	
T3		s	1	

Table A.5.1.24.1-2: Cell specific test parameters for E-UTRAN TDD-TDD Inter frequency RACH-less handover test case

Parameter	Unit	Cell 1			Cell 2		
		T1	T2	T3	T1	T2	T3
E-UTRA RF Channel number		1			2		
BW _{channel}	MHz	10			10		
OCNG Patterns defined in A.3.2.1.1 (OP.1 FDD) and in A.3.2.1.2 (OP.2 FDD)		OP.1 FDD	OP.1 FDD	OP.2 FDD	OP.2 FDD	OP.2 FDD	OP.1 FDD
PBCH_RA	dB	0			0		
PBCH_RB	dB						
PSS_RA	dB						
SSS_RA	dB						
PCFICH_RB	dB						
PHICH_RA	dB						
PHICH_RB	dB						
PDCCH_RA	dB						
PDCCH_RB	dB						
PDSCH_RA	dB						
PDSCH_RB	dB						
OCNG_RA ^{Note 1}	dB						
OCNG_RB ^{Note 1}	dB						
\hat{E}_s / I_{oc}	dB	4	4	4	-Infinity	7	7
N_{oc} ^{Note 2}	dBm/15 kHz	-98					
\hat{E}_s / N_{oc}	dB	4	4	4	-Infinity	7	7
RSRP ^{Note 3}	dBm/15 KHz	-94	-94	-94	-infinity	-91	-91
Propagation Condition		AWGN					
<p>Note 1: OCNG shall be used such that both cells are fully allocated and a constant total transmitted power spectral density is achieved for all OFDM symbols.</p> <p>Note 2: Interference from other cells and noise sources not specified in the test is assumed to be constant over subcarriers and time and shall be modelled as AWGN of appropriate power for N_{oc} to be fulfilled.</p> <p>Note 3: RSRP levels have been derived from other parameters for information purposes. They are not settable parameters themselves.</p>							

A.5.1.24.2 Test Requirements

The UE shall start to transmit the PUSCH to Cell 2 less than 45 ms from the beginning of time period T3.

The rate of correct handovers observed during repeated tests shall be at least 90%.

NOTE: The handover delay can be expressed as: RRC procedure delay + $T_{interrupt}$, where:

RRC procedure delay = 15 ms and is specified in clause 11.2 in TS 36.331 [2].

$T_{interrupt}$ = 30 ms in the test; $T_{interrupt}$ is defined in clause 5.2.2.4.2.

This gives a total of 45 ms.

A.5.1.25 E-UTRAN FDD - FDD Intra frequency make-before-break handover

A.5.1.25.1 Test Purpose and Environment

This test is to verify the requirement for the FDD-FDD intra frequency make-before-break handover requirements specified in clause 5.1.2.1.

The test scenario comprises of 1 E-UTRA FDD carrier and 2 cells as given in tables A.5.1.25.1-1 and A.5.1.25.1-2. The test consists of three successive time periods, with time durations of T1, T2 and T3 respectively. At the start of time duration T1, the UE may not have any timing information of cell 2.

E-UTRAN shall send a RRC message implying make-before-break handover to cell 2. The RRC message implying make-before-break handover shall be sent to the UE during period T2, after the UE has reported Event A3. T3 is defined as the end of the last TTI containing the RRC message implying make-before-break handover.

Table A.5.1.25.1-1: General test parameters for E-UTRAN FDD-FDD intra frequency make-before-break handover test case

Parameter		Unit	Value	Comment
PDSCH parameters			DL Reference Measurement Channel R.0 FDD	As specified in clause A.3.1.1.1
PCFICH/PDCCH/PHICH parameters			DL Reference Measurement Channel R.6 FDD	As specified in clause A.3.1.2.1
Initial conditions	Active cell		Cell 1	
	Neighbouring cell		Cell 2	
Final condition	Active cell		Cell 2	
E-UTRA RF Channel Number			1	Only one FDD carrier frequency is used.
Channel Bandwidth ($BW_{channel}$)		MHz	10	
A3-Offset		dB	0	
Hysteresis		dB	0	
Time To Trigger		s	0	
Filter coefficient			0	L3 filtering is not used
DRX				OFF
CP length			Normal	
Access Barring Information		-	Not Sent	No additional delays in random access procedure.
PRACH configuration			4	As specified in table 5.7.1-2 in TS 36.211
Time offset between cells			3 ms	Asynchronous cells
T1		s	5	
T2		s	≤5	
T3		s	1	

Table A.5.1.25.1-2: Cell specific test parameters for E-UTRAN FDD-FDD intra frequency make-before-break handover test case

Parameter	Unit	Cell 1			Cell 2		
		T1	T2	T3	T1	T2	T3
E-UTRA RF Channel Number		1			1		
BW _{channel}	MHz	10			10		
OCNG Patterns defined in A.3.2.1.1 (OP.1 FDD) and in A.3.2.1.2 (OP.2 FDD)		OP.1 FDD	OP.1 FDD	OP.1 FDD	OP.2 FDD	OP.2 FDD	OP.1 FDD
PBCH_RA	dB	0			0		
PBCH_RB	dB						
PSS_RA	dB						
SSS_RA	dB						
PCFICH_RB	dB						
PHICH_RA	dB						
PHICH_RB	dB						
PDCCH_RA	dB						
PDCCH_RB	dB						
PDSCH_RA	dB						
PDSCH_RB	dB						
OCNG_RA ^{Note 1}	dB						
OCNG_RB ^{Note 1}	dB						
\hat{E}_s / I_{ot}	dB	8	-3.3	-3.3	-Infinity	2.36	2.36
N_{oc} ^{Note 2}	dBm/15 KHz	-98					
\hat{E}_s / N_{oc}	dB	8	8	8	- Infinity	11	11
RSRP ^{Note 3}	dBm/15 KHz	-90	-90	-90	- Infinity	-87	-87
Propagation Condition		AWGN					
<p>Note 1: OCNG shall be used such that both cells are fully allocated and a constant total transmitted power spectral density is achieved for all OFDM symbols.</p> <p>Note 2: Interference from other cells and noise sources not specified in the test is assumed to be constant over subcarriers and time and shall be modelled as AWGN of appropriate power for N_{oc} to be fulfilled.</p> <p>Note 3: RSRP levels have been derived from other parameters for information purposes. They are not settable parameters themselves.</p>							

A.5.1.25.2 Test Requirements

The UE shall start to transmit the PRACH to Cell 2 less than 50 ms from the beginning of time period T3.

The rate of correct handovers observed during repeated tests shall be at least 90%.

NOTE: The make-before-break handover delay can be expressed as: RRC procedure delay + $T_{interrupt}$, where:

RRC procedure delay = 15 ms and is specified in clause 11.2 in TS 36.331 [2].

$T_{interrupt}$ = 35 ms in the test; $T_{interrupt}$ is defined in clause 5.1.2.1.2.3.

This gives a total of 50 ms.

The UE shall be scheduled on Cell 1 continuously throughout the test. From the start of T3 until the UE start to transmit the PRACH, at most 5 of all expected ACK/NACKs can be not transmitted by the UE.

Both the rate of correct handovers and the number of not transmitted ACK/NACKs have to be fulfilled simultaneously.

A.5.1.26 E-UTRAN TDD - TDD Intra frequency make-before-break handover

A.5.1.26.1 Test Purpose and Environment

This test is to verify the requirement for the TDD-TDD intra frequency make-before-break handover requirements specified in clause 5.2.2.4.

The test scenario comprises of 1 E-UTRA TDD carrier and 2 cells as given in tables A.5.1.26.1-1 and A.5.1.26.1-2. The test consists of three successive time periods, with time durations of T1, T2 and T3 respectively. At the start of time duration T1, the UE may not have any timing information of cell 2.

E-UTRAN shall send a RRC message implying make-before-break handover to cell 2. The RRC message implying make-before-break handover shall be sent to the UE during period T2, after the UE has reported Event A3. T3 is defined as the end of the last TTI containing the RRC message implying make-before-break handover.

Table A.5.1.26.1-1: General test parameters for E-UTRAN TDD-TDD Intra frequency make-before-break handover test case

Parameter		Unit	Value	Comment
PDSCH parameters			DL Reference Measurement Channel R.0 TDD	As specified in clause A.3.1.1.2
PCFICH/PDCCHPHICH parameters			DL Reference Measurement Channel R.6 TDD	As specified in clause A.3.1.2.2
Initial conditions	Active cell		Cell 1	
	Neighbouring cell		Cell 2	
Final condition	Active cell		Cell 2	
E-UTRA RF Channel Number			1	Only one TDD carrier frequency is used.
Channel Bandwidth (BW_{channel})		MHz	10	
A3-Offset		dB	0	
Hysteresis		dB	0	
Time To Trigger		s	0	
Filter coefficient			0	L3 filtering is not used
DRX				OFF
CP length			Normal	
Access Barring Information		-	Not Sent	No additional delays in random access procedure.
Special subframe configuration			6	As specified in table 4.2-1 in TS 36.211
Uplink-downlink configuration			1	As specified in table 4.2-2 in TS 36.211
PRACH configuration index			53	As specified in table 5.7.1-3 in TS 36.211
Time offset between cells			3 μ s	Synchronous cells
T1		s	5	
T2		s	≤ 5	
T3		s	1	

Table A.5.1.26.1-2: Cell specific test parameters for E-UTRAN TDD-TDD Intra frequency make-before-break handover test case

Parameter	Unit	Cell 1			Cell 2		
		T1	T2	T3	T1	T2	T3
E-UTRA RF Channel Number		1			1		
BW _{channel}	MHz	10			10		
OCNG Patterns defined in A.3.2.2.1 (OP.1 TDD) and in A.3.2.2.2 (OP.2 TDD)		OP.1 TDD	OP.1 TDD	OP.1 TDD	OP.2 TDD	OP.2 TDD	OP.1 TDD
PBCH_RA	dB	0			0		
PBCH_RB	dB						
PSS_RA	dB						
SSS_RA	dB						
PCFICH_RB	dB						
PHICH_RA	dB						
PHICH_RB	dB						
PDCCH_RA	dB						
PDCCH_RB	dB						
PDSCH_RA	dB						
PDSCH_RB	dB						
OCNG_RA ^{Note 1}	dB						
OCNG_RB ^{Note 1}	dB						
\hat{E}_s / I_{ot}	dB						
N_{oc} ^{Note 2}	dBm/15 KHz	-98					
\hat{E}_s / N_{oc}	dB	8	8	8	-Infinity	11	11
RSRP ^{Note 3}	dBm/15 KHz	-90	-90	-90	-Infinity	-87	-87
Propagation Condition		AWGN					
<p>Note 1: OCNG shall be used such that both cells are fully allocated and a constant total transmitted power spectral density is achieved for all OFDM symbols.</p> <p>Note 2: Interference from other cells and noise sources not specified in the test is assumed to be constant over subcarriers and time and shall be modelled as AWGN of appropriate power for N_{oc} to be fulfilled.</p> <p>Note 3: RSRP levels have been derived from other parameters for information purposes. They are not settable parameters themselves.</p>							

A.5.1.26.2 Test Requirements

The UE shall start to transmit the PRACH to Cell 2 less than 50 ms from the beginning of time period T3.

The rate of correct make-before-break handovers observed during repeated tests shall be at least 90%.

NOTE: The make-before-break handover delay can be expressed as: RRC procedure delay + $T_{interrupt}$, where:

RRC procedure delay = 15 ms and is specified in clause 11.2 in TS 36.331 [2].

$T_{interrupt}$ = 35 ms in the test; $T_{interrupt}$ is defined in clause 5.2.2.4.2.3.

This gives a total of 50 ms.

The UE shall be scheduled on Cell 1 continuously throughout the test. From the start of T3 until the UE start to transmit the PRACH, at most 3 of all expected ACK/NACKs can be not transmitted by the UE.

Both the rate of correct handovers and the number of not transmitted ACK/NACKs have to be fulfilled simultaneously.

A.5.1.27 E-UTRAN FDD inter frequency handover for Cat-M1 UEs in CEModeA

A.5.1.27.1 Test Purpose and Environment

This test is to verify the requirement for the FDD inter frequency handover requirements specified in clause 5.5.2.1.

The test scenario comprises of two E-UTRA FDD carriers and one cell in each carrier as given in tables A.5.1.27.1-1 and A.5.1.27.1-2. The test consists of three successive time periods, with time durations of T1, T2 and T3 respectively. At the start of time duration T1, the UE may not have any timing information of Cell 2.

Starting T2, cell 2 becomes detectable and the UE is expected to detect and send a measurement report. The RRC message implying handover to Cell 2 shall be sent to the UE during period T2, after the UE has reported Event A3. The *field sameSFN-Indication* is not included in the handover command. The start of T3 is the instant when the last TTI containing the RRC message implying handover is sent to the UE.

During the test, UE is configured with measurement gap to enable inter-frequency monitoring.

Table A.5.1.27.1-1: General test parameters for E-UTRAN FDD inter frequency handover for Cat-M1 UEs in CEModeA test case

Parameter		Unit	Value	Comment
Initial conditions	Active cell		Cell 1	Cell 1 is on RF channel number 1
	Neighbouring cell		Cell 2	Cell 2 is on RF channel number 2
Final condition	Active cell		Cell 2	
E-UTRA RF Channel Number			1, 2	Two FDD carriers are used.
A3-Offset		dB	0	
Hysteresis		dB	0	
Time To Trigger		s	0	
Filter coefficient			0	L3 filtering is not used
DRX				OFF
CP length			Normal	
Access Barring Information		-	Not Sent	No additional delays in random access procedure.
PRACH configuration			PRACH_4CE	As specified in A.3.16
PRACH initial CE level			0	Specified in the handover message
T1		s	5	
T2		s	≤5	
T3		s	1	
Gap pattern ID			1	

Table A.5.1.27.1-2: Cell specific test parameters for E-UTRAN FDD inter frequency handover for Cat-M1 UEs in CEModeA test case

Parameter	Unit	Cell 1			Cell 2		
		T1	T2	T3	T1	T2	T3
E-UTRA RF Channel Number		1			2		
BW _{channel}	MHz	10			10		
PDSCH Reference Channel in clause A.3.1.4.1		R.21 FDD	R.21 FDD	-	-	-	R.21 FDD
MPDCCH Reference Channel in clause A.3.1.3.1		R.17 FDD			R.17 FDD		
PCFICH/PDCCH/PHICH Reference Channel in clause A.3.1.2.1		R.7 FDD			R.7 FDD		
OCNG Patterns in clause A.3.2.1		OP.21 FDD	OP.21 FDD	OP.6 FDD	OP.6 FDD	OP.6 FDD	OP.21 FDD
PBCH_RA	dB	-3			-3		
PBCH_RB	dB						
PSS_RA	dB						
SSS_RA	dB						

PCFICH_RB	dB						
PHICH_RA	dB						
PHICH_RB	dB						
PDCCH_RA	dB						
PDCCH_RB	dB						
MPDCCH_RA	dB						
MPDCCH_RB	dB						
PDSCH_RA	dB						
PDSCH_RB	dB						
OCNG_RA ^{Note 1}	dB						
OCNG_RB ^{Note 1}	dB						
N_{oc} ^{Note 2}	dBm/15 KHz	-98			-98		
\hat{E}_s / N_{oc}	dB	-3	-3	-3	-Infinity	4	4
\hat{E}_s / I_{ot} ^{Note 3}	dB	-3	-3	-3	-Infinity	4	4
RSRP ^{Note 3}	dBm/15 KHz	-101	-101	-101	-Infinity	-94	-94
I_o ^{Note 3}	dBm/9MHz	-68.45	-68.45	-68.45	-Infinity	-64.76	-64.76
Propagation Condition		AWGN			AWGN		
Antenna Configuration		2x1			2x1		
Timing offset to Cell 1 Asynchronous cells	ms	-			3		
Note 1: OCNG shall be used such that both cells are fully allocated and a constant total transmitted power spectral density is achieved for all OFDM symbols.							
Note 2: Interference from other cells and noise sources not specified in the test is assumed to be constant over subcarriers and time and shall be modelled as AWGN of appropriate power for N_{oc} to be fulfilled.							
Note 3: E_s/I_{ot} , RSRP and I_o level has been derived from other parameters for information purpose. They are not settable parameters themselves.							

A.5.1.27.2 Test Requirements

The UE shall finish the transmission of all repetitions of the PRACH to Cell 2 less than 170 ms from the beginning of time period T3.

The rate of correct handovers observed during repeated tests shall be at least 90%.

NOTE: The handover delay can be expressed as: RRC procedure delay + $T_{interrupt}$, where:

RRC procedure delay = 15 ms and is specified in clause 11.2 in TS 36.331 [2].

$T_{interrupt} = 120 + 35$ ms in the test; $T_{interrupt}$ is defined in clause 5.5.2.1.2.

This gives a total of 170 ms.

A.5.1.28 E-UTRAN HD-FDD inter frequency handover for Cat-M1 UEs in CEModeA

A.5.1.28.1 Test Purpose and Environment

This test is to verify the requirement for the HD-FDD inter frequency handover requirements specified in clause 5.5.2.2.

The test scenario comprises of two E-UTRA FDD carriers and one cell in each carrier as given in tables A.5.1.28.1-1 and A.5.1.28.1-2. The test consists of three successive time periods, with time durations of T1, T2 and T3 respectively. At the start of time duration T1, the UE may not have any timing information of Cell 2.

Starting T2, cell 2 becomes detectable and the UE is expected to detect and send a measurement report. The RRC message implying handover to Cell 2 shall be sent to the UE during period T2, after the UE has reported Event A3. The *field sameSFN-Indication* is not included in the handover command. The start of T3 is the instant when the last TTI containing the RRC message implying handover is sent to the UE.

During the test, UE is configured with measurement gap to enable inter-frequency monitoring.

Table A.5.1.28.1-1: General test parameters for E-UTRAN HD-FDD inter frequency handover for Cat-M1 UEs in CEModeA test case

Parameter		Unit	Value	Comment
Initial conditions	Active cell		Cell 1	Cell 1 is on RF channel number 1
	Neighbouring cell		Cell 2	Cell 2 is on RF channel number 2
Final condition	Active cell		Cell 2	
E-UTRA RF Channel Number			1, 2	Two FDD carriers are used.
A3-Offset		dB	0	
Hysteresis		dB	0	
Time To Trigger		s	0	
Filter coefficient			0	L3 filtering is not used
DRX				OFF
CP length			Normal	
Access Barring Information		-	Not Sent	No additional delays in random access procedure.
PRACH configuration			PRACH_4CE	As specified in A.3.16
PRACH initial CE level			0	Specified in the handover message
T1		s	5	
T2		s	≤5	
T3		s	1	
Gap pattern ID			1	

Table A.5.1.28.1-2: Cell specific test parameters for E-UTRAN HD-FDD inter frequency handover for Cat-M1 UEs in CEModeA test case

Parameter	Unit	Cell 1			Cell 2							
		T1	T2	T3	T1	T2	T3					
E-UTRA RF Channel Number		1			2							
BW _{channel}	MHz	10			10							
PDSCH Reference Channel in clause A.3.1.4.1		R.11 HD-FDD	R.11 HD-FDD	-	-	-	R.11 HD-FDD					
MPDCCH Reference Channel in clause A.3.1.3.1		R.7 HD-FDD			R.7 HD-FDD							
PCFICH/PDCCH/PHICH Reference Channel in clause A.3.1.2.1		R.4 HD-FDD			R.4 HD-FDD							
OCNG Patterns in clause A.3.2.1		OP.21 FDD	OP.21 FDD	OP.6 FDD	OP.6 FDD	OP.6 FDD	OP.21 FDD					
PBCH_RA	dB											
PBCH_RB	dB											
PSS_RA	dB											
SSS_RA	dB											
PCFICH_RB	dB											
PHICH_RA	dB											
PHICH_RB	dB											
PDCCH_RA	dB							-3	-3	-3	-3	-3
PDCCH_RB	dB							-3	-3	-3	-3	-3
MPDCCH_RA	dB							-3	-3	-3	-3	-3
MPDCCH_RB	dB							-3	-3	-3	-3	-3
PDSCH_RA	dB							-3	-3	-3	-3	-3
PDSCH_RB	dB							-3	-3	-3	-3	-3
OCNG_RA ^{Note 1}	dB							-3	-3	-3	-3	-3
OCNG_RB ^{Note 1}	dB	-3	-3	-3	-3	-3						
N_{oc} ^{Note 2}	dBm/15 KHz	-98			-98							
\hat{E}_s / N_{oc}	dB	-3	-3	-3	-Infinity	4	4					
\hat{E}_s / I_{ot} ^{Note 3}	dB	-3	-3	-3	-Infinity	4	4					
RSRP ^{Note 3}	dBm/15 KHz	-101	-101	-101	-Infinity	-94	-94					

I_0 ^{Note 3}	dBm/9MHz	-68.45	-68.45	-68.45	-Infinity	-64.76	-64.76
Propagation Condition		AWGN			AWGN		
Antenna Configuration		2x1			2x1		
Timing offset to Cell 1 Asynchronous cells	ms	-			3		
Note 1:	OCNG shall be used such that both cells are fully allocated and a constant total transmitted power spectral density is achieved for all OFDM symbols.						
Note 2:	Interference from other cells and noise sources not specified in the test is assumed to be constant over subcarriers and time and shall be modelled as AWGN of appropriate power for N_{oc} to be fulfilled.						
Note 3:	Es/lot, RSRP and I_0 level has been derived from other parameters for information purpose. They are not settable parameters themselves.						

A.5.1.28.2 Test Requirements

The UE shall finish the transmission of all repetitions of the PRACH to Cell 2 less than 170 ms from the beginning of time period T3.

The rate of correct handovers observed during repeated tests shall be at least 90%.

NOTE: The handover delay can be expressed as: RRC procedure delay + $T_{interrupt}$, where:

RRC procedure delay = 15 ms and is specified in clause 11.2 in TS 36.331 [2].

$T_{interrupt} = 120 + 35$ ms in the test; $T_{interrupt}$ is defined in clause 5.5.2.1.2.

This gives a total of 170 ms.

A.5.1.29 E-UTRAN TDD inter frequency handover for Cat-M1 UEs in CEModeA

A.5.1.29.1 Test Purpose and Environment

This test is to verify the requirement for the TDD inter frequency handover requirements specified in clause 5.5.2.3.

The test scenario comprises of two E-UTRA TDD carriers and one cell in each carrier as given in tables A.5.1.29.1-1 and A.5.1.29.1-2. The test consists of three successive time periods, with time durations of T1, T2 and T3 respectively. At the start of time duration T1, the UE may not have any timing information of Cell 2.

Starting T2, cell 2 becomes detectable and the UE is expected to detect and send a measurement report. The RRC message implying handover to Cell 2 shall be sent to the UE during period T2, after the UE has reported Event A3. The *field sameSFN-Indication* is not included in the handover command. The start of T3 is the instant when the last TTI containing the RRC message implying handover is sent to the UE.

During the test, UE is configured with measurement gap to enable inter-frequency monitoring.

Table A.5.1.29.1-1: General test parameters for E-UTRAN TDD inter frequency handover for Cat-M1 UEs in CEModeA test case

Parameter		Unit	Value	Comment
Initial conditions	Active cell		Cell 1	Cell 1 is on RF channel number 1
	Neighbouring cell		Cell 2	Cell 2 is on RF channel number 2
Final condition	Active cell		Cell 2	
E-UTRA RF Channel Number			1, 2	Two TDD carriers are used.
A3-Offset		dB	0	
Hysteresis		dB	0	
Time To Trigger		s	0	
Filter coefficient			0	L3 filtering is not used
DRX				OFF
CP length			Normal	
Access Barring Information		-	Not Sent	No additional delays in random access procedure.
Special subframe configuration			6	As specified in table 4.2-1 in TS 36.211

Uplink-downlink configuration		1	As specified in table 4.2-2 in TS 36.211
PRACH configuration		PRACH_4CE	As specified in A.3.16
PRACH initial CE level		0	Specified in the handover message
T1	s	5	
T2	s	≤5	
T3	s	1	
Gap pattern ID		1	

Table A.5.1.29.1-2: Cell specific test parameters for E-UTRAN TDD inter frequency handover for Cat-M1 UEs in CEModeA test case

Parameter	Unit	Cell 1			Cell 2							
		T1	T2	T3	T1	T2	T3					
E-UTRA RF Channel Number		1			2							
BW _{channel}	MHz	10			10							
PDSCH Reference Channel in clause A.3.1.4.1		R.17 TDD	R.17 TDD	-	-	-	R.17 TDD					
MPDCCH Reference Channel in clause A.3.1.3.1		R.15 TDD			R.15 TDD							
PCFICH/PDCCH/PHICH Reference Channel in clause A.3.1.2.1		R.7 TDD			R.7 TDD							
OCNG Patterns in clause A.3.2.1		OP.11 TDD	OP.11 TDD	OP.2 TDD	OP.2 TDD	OP.2 TDD	OP.11 TDD					
PBCH_RA	dB											
PBCH_RB	dB											
PSS_RA	dB											
SSS_RA	dB											
PCFICH_RB	dB											
PHICH_RA	dB											
PHICH_RB	dB											
PDCCH_RA	dB							-3	-3	-3	-3	-3
PDCCH_RB	dB											
MPDCCH_RA	dB											
MPDCCH_RB	dB											
PDSCH_RA	dB											
PDSCH_RB	dB											
OCNG_RA ^{Note 1}	dB											
OCNG_RB ^{Note 1}	dB											
N_{oc} ^{Note 2}	dBm/15 KHz	-98			-98							
\hat{E}_s / N_{oc}	dB	-3	-3	-3	-Infinity	4	4					
\hat{E}_s / I_{ot} ^{Note 3}	dB	-3	-3	-3	-Infinity	4	4					
RSRP ^{Note 3}	dBm/15 KHz	-101	-101	-101	-Infinity	-94	-94					
I_o ^{Note 3}	dBm/9MHz	-68.45	-68.45	-68.45	-Infinity	-64.76	-64.76					
Propagation Condition		AWGN			AWGN							
Antenna Configuration		2x1			2x1							
Timing offset to Cell 1 Synchronous cells	us	-			3							
<p>Note 1: OCNG shall be used such that both cells are fully allocated and a constant total transmitted power spectral density is achieved for all OFDM symbols.</p> <p>Note 2: Interference from other cells and noise sources not specified in the test is assumed to be constant over subcarriers and time and shall be modelled as AWGN of appropriate power for N_{oc} to be fulfilled.</p> <p>Note 3: E_s/I_{ot}, RSRP and I_o level has been derived from other parameters for information purpose. They are not settable parameters themselves.</p>												

A.5.1.29.2 Test Requirements

The UE shall finish the transmission of all repetitions of the PRACH to Cell 2 less than 170 ms from the beginning of time period T3.

The rate of correct handovers observed during repeated tests shall be at least 90%.

NOTE: The handover delay can be expressed as: RRC procedure delay + $T_{\text{interrupt}}$, where:

RRC procedure delay = 15 ms and is specified in clause 11.2 in TS 36.331 [2].

$T_{\text{interrupt}} = 120 + 35$ ms in the test; $T_{\text{interrupt}}$ is defined in clause 5.5.2.1.2.

This gives a total of 170 ms.

A.5.1.30 E-UTRAN FDD inter frequency handover for Cat-M1 UEs in CEModeB

A.5.1.30.1 Test Purpose and Environment

This test is to verify the requirement for the FDD inter frequency handover requirements specified in clause 5.5.3.1.

The test scenario comprises of two E-UTRA FDD carriers and one cell in each carrier as given in tables A.5.1.30.1-1 and A.5.1.30.1-2. The test consists of three successive time periods, with time durations of T1, T2 and T3 respectively. At the start of time duration T1, the UE may not have any timing information of Cell 2.

Starting T2, cell 2 becomes detectable and the UE is expected to detect and send a measurement report. The RRC message implying handover to Cell 2 shall be sent to the UE during period T2, after the UE has reported Event A3. The *field sameSFN-Indication* is not included in the handover command. The start of T3 is the instant when the last TTI containing the RRC message implying handover is sent to the UE.

During the test, UE is configured with measurement gap to enable inter-frequency monitoring.

Table A.5.1.30.1-1: General test parameters for E-UTRAN FDD inter frequency handover for Cat-M1 UEs in CEModeB test case

Parameter		Unit	Value	Comment
Initial conditions	Active cell		Cell 1	Cell 1 is on RF channel number 1
	Neighbouring cell		Cell 2	Cell 2 is on RF channel number 2
Final condition	Active cell		Cell 2	
E-UTRA RF Channel Number			1, 2	Two FDD carriers are used.
A3-Offset		dB	0	
Hysteresis		dB	0	
Time To Trigger		s	0	
Filter coefficient			0	L3 filtering is not used
DRX				OFF
CP length			Normal	
Access Barring Information		-	Not Sent	No additional delays in random access procedure.
PRACH configuration			PRACH_4CE	As specified in A.3.16
PRACH initial CE level			0	Specified in the handover message
T1		s	5	
T2		s	≤5	
T3		s	1	
Gap pattern ID			1	

Table A.5.1.30.1-2: Cell specific test parameters for E-UTRAN FDD inter frequency handover for Cat-M1 UEs in CEModeB test case

Parameter	Unit	Cell 1			Cell 2		
		T1	T2	T3	T1	T2	T3
E-UTRA RF Channel Number		1			2		
BW _{channel}	MHz	10			10		

PDSCH Reference Channel in clause A.3.1.4		R.23 FDD	R.23 FDD	-	-	-	R.21 FDD
MPDCCH Reference Channel in clause A.3.1.3		R.19 FDD			R.17 FDD		
PCFICH/PDCCH/PHICH Reference Channel in clause A.3.1.2.1		R.7 FDD			R.7 FDD		
OCNG Patterns in clause A.3.2.1		OP.21 FDD	OP.21 FDD	OP.6 FDD	OP.6 FDD	OP.6 FDD	OP.21 FDD
PBCH_RA	dB	-3			-3		
PBCH_RB	dB						
PSS_RA	dB						
SSS_RA	dB						
PCFICH_RB	dB						
PHICH_RA	dB						
PHICH_RB	dB						
PDCCH_RA	dB						
PDCCH_RB	dB						
MPDCCH_RA	dB						
MPDCCH_RB	dB						
PDSCH_RA	dB						
PDSCH_RB	dB						
OCNG_RA ^{Note 1}	dB						
OCNG_RB ^{Note 1}	dB						
N_{oc} ^{Note 2}	dBm/15 KHz	-98			-98		
\hat{E}_s / N_{oc}	dB	-12	-12	-12	-Infinity	-4	-4
\hat{E}_s / I_{ot} ^{Note 3}	dB	-12	-12	-12	-Infinity	-4	-4
RSRP ^{Note 3}	dBm/15 KHz	-110	-110	-110	-Infinity	-102	-102
I_o ^{Note 3}	dBm/9MHz	-69.95	-69.95	-69.95	-Infinity	-68.76	-68.76
Propagation Condition		AWGN			AWGN		
Antenna Configuration		2x1			2x1		
Timing offset to Cell 1 Asynchronous cells	ms	-			3		
<p>Note 1: OCNG shall be used such that both cells are fully allocated and a constant total transmitted power spectral density is achieved for all OFDM symbols.</p> <p>Note 2: Interference from other cells and noise sources not specified in the test is assumed to be constant over subcarriers and time and shall be modelled as AWGN of appropriate power for N_{oc} to be fulfilled.</p> <p>Note 3: E_s/I_{ot}, RSRP and I_o level has been derived from other parameters for information purpose. They are not settable parameters themselves.</p>							

A.5.1.30.2 Test Requirements

The UE shall finish the transmission of all repetitions of the PRACH to Cell 2 less than 2610 ms from the beginning of time period T3.

The rate of correct handovers observed during repeated tests shall be at least 90%.

NOTE: The handover delay can be expressed as: RRC procedure delay + $T_{interrupt}$, where:

RRC procedure delay = 15 ms and is specified in clause 11.2 in TS 36.331 [2].

$T_{interrupt}$ = 2560 + 35 ms in the test; $T_{interrupt}$ is defined in clause 5.5.2.1.2.

This gives a total of 2610 ms.

A.5.1.31 E-UTRAN HD-FDD inter frequency handover for Cat-M1 UEs in CEModeB

A.5.1.31.1 Test Purpose and Environment

This test is to verify the requirement for the HD-FDD inter frequency handover requirements specified in clause 5.5.3.2.

The test scenario comprises of two E-UTRA FDD carriers and one cell in each carrier as given in tables A.5.1.31.1-1 and A.5.1.31.1-2. The test consists of three successive time periods, with time durations of T1, T2 and T3 respectively. At the start of time duration T1, the UE may not have any timing information of Cell 2.

Starting T2, cell 2 becomes detectable and the UE is expected to detect and send a measurement report. The RRC message implying handover to Cell 2 shall be sent to the UE during period T2, after the UE has reported Event A3. The *field sameSFN-Indication* is not included in the handover command. The start of T3 is the instant when the last TTI containing the RRC message implying handover is sent to the UE.

During the test, UE is configured with measurement gap to enable inter-frequency monitoring.

Table A.5.1.31.1-1: General test parameters for E-UTRAN HD-FDD inter frequency handover for Cat-M1 UEs in CEModeB test case

Parameter		Unit	Value	Comment
Initial conditions	Active cell		Cell 1	Cell 1 is on RF channel number 1
	Neighbouring cell		Cell 2	Cell 2 is on RF channel number 2
Final condition	Active cell		Cell 2	
E-UTRA RF Channel Number			1, 2	Two FDD carriers are used.
A3-Offset		dB	0	
Hysteresis		dB	0	
Time To Trigger		s	0	
Filter coefficient			0	L3 filtering is not used
DRX				OFF
CP length			Normal	
Access Barring Information		-	Not Sent	No additional delays in random access procedure.
PRACH configuration			PRACH_4CE	As specified in A.3.16
PRACH initial CE level			0	Specified in the handover message
T1		s	5	
T2		s	≤5	
T3		s	1	
Gap pattern ID			1	

Table A.5.1.31.1-2: Cell specific test parameters for E-UTRAN HD-FDD inter frequency handover for Cat-M1 UEs in CEModeB test case

Parameter	Unit	Cell 1			Cell 2		
		T1	T2	T3	T1	T2	T3
E-UTRA RF Channel Number		1			2		
BW _{channel}	MHz	10			10		
PDSCH Reference Channel in clause A.3.1.4		R.13 HD-FDD	R.13 HD-FDD	-	-	-	R.11 HD-FDD
MPDCCH Reference Channel in clause A.3.1.3		R.9 HD-FDD			R.7 HD-FDD		
PCFICH/PDCCH/PHICH Reference Channel in clause A.3.1.2.1		R.4 HD-FDD			R.4 HD-FDD		
OCNG Patterns in clause A.3.2.1		OP.21 FDD	OP.21 FDD	OP.6 FDD	OP.6 FDD	OP.6 FDD	OP.21 FDD
PBCH_RA	dB	-3			-3		
PBCH_RB	dB						
PSS_RA	dB						
SSS_RA	dB						

PCFICH_RB	dB						
PHICH_RA	dB						
PHICH_RB	dB						
PDCCH_RA	dB						
PDCCH_RB	dB						
MPDCCH_RA	dB						
MPDCCH_RB	dB						
PDSCH_RA	dB						
PDSCH_RB	dB						
OCNG_RA ^{Note 1}	dB						
OCNG_RB ^{Note 1}	dB						
N_{oc} ^{Note 2}	dBm/15 KHz	-98			-98		
\hat{E}_s / N_{oc}	dB	-12	-12	-12	-Infinity	-4	-4
\hat{E}_s / I_{ot} ^{Note 3}	dB	-12	-12	-12	-Infinity	-4	-4
RSRP ^{Note 3}	dBm/15 KHz	-110	-110	-110	-Infinity	-102	-102
I_o ^{Note 3}	dBm/9MHz	-69.95	-69.95	-69.95	-Infinity	-68.76	-68.76
Propagation Condition		AWGN			AWGN		
Antenna Configuration		2x1			2x1		
Timing offset to Cell 1 Asynchronous cells	ms	-			3		
Note 1: OCNG shall be used such that both cells are fully allocated and a constant total transmitted power spectral density is achieved for all OFDM symbols.							
Note 2: Interference from other cells and noise sources not specified in the test is assumed to be constant over subcarriers and time and shall be modelled as AWGN of appropriate power for N_{oc} to be fulfilled.							
Note 3: E_s/I_{ot} , RSRP and I_o level has been derived from other parameters for information purpose. They are not settable parameters themselves.							

A.5.1.31.2 Test Requirements

The UE shall finish the transmission of all repetitions of the PRACH to Cell 2 less than 2610 ms from the beginning of time period T3.

The rate of correct handovers observed during repeated tests shall be at least 90%.

NOTE: The handover delay can be expressed as: RRC procedure delay + $T_{interrupt}$, where:

RRC procedure delay = 15 ms and is specified in clause 11.2 in TS 36.331 [2].

$T_{interrupt} = 2560 + 35$ ms in the test; $T_{interrupt}$ is defined in clause 5.5.2.1.2.

This gives a total of 2610 ms.

A.5.1.32 E-UTRAN TDD inter frequency handover for Cat-M1 UEs in CEModeB

A.5.1.32.1 Test Purpose and Environment

This test is to verify the requirement for the TDD inter frequency handover requirements specified in clause 5.5.3.3.

The test scenario comprises of two E-UTRA TDD carriers and one cell in each carrier as given in tables A.5.1.32.1-1 and A.5.1.32.1-2. The test consists of three successive time periods, with time durations of T1, T2 and T3 respectively. At the start of time duration T1, the UE may not have any timing information of Cell 2.

Starting T2, cell 2 becomes detectable and the UE is expected to detect and send a measurement report. The RRC message implying handover to Cell 2 shall be sent to the UE during period T2, after the UE has reported Event A3. The *field sameSFN-Indication* is not included in the handover command. The start of T3 is the instant when the last TTI containing the RRC message implying handover is sent to the UE.

During the test, UE is configured with measurement gap to enable inter-frequency monitoring.

Table A.5.1.32.1-1: General test parameters for E-UTRAN TDD inter frequency handover for Cat-M1 UEs in CEModeB test case

Parameter		Unit	Value	Comment
Initial conditions	Active cell		Cell 1	Cell 1 is on RF channel number 1
	Neighbouring cell		Cell 2	Cell 2 is on RF channel number 2
Final condition	Active cell		Cell 2	
E-UTRA RF Channel Number			1, 2	Two TDD carriers are used.
A3-Offset		dB	0	
Hysteresis		dB	0	
Time To Trigger		s	0	
Filter coefficient			0	L3 filtering is not used
DRX				OFF
CP length			Normal	
Access Barring Information		-	Not Sent	No additional delays in random access procedure.
Special subframe configuration			6	As specified in table 4.2-1 in TS 36.211
Uplink-downlink configuration			1	As specified in table 4.2-2 in TS 36.211
PRACH configuration			PRACH_4CE	As specified in A.3.16
PRACH initial CE level			0	Specified in the handover message
T1		s	5	
T2		s	≤5	
T3		s	1	
Gap pattern ID			1	

Table A.5.1.32.1-2: Cell specific test parameters for E-UTRAN TDD inter frequency handover for Cat-M1 UEs in CEModeB test case

Parameter	Unit	Cell 1			Cell 2		
		T1	T2	T3	T1	T2	T3
E-UTRA RF Channel Number		1			2		
BW _{channel}	MHz	10			10		
PDSCH Reference Channel in clause A.3.1.4.1		R.19 TDD	R.19 TDD	-	-	-	R.17 TDD
MPDCCH Reference Channel in clause A.3.1.3.1		R.17 TDD			R.15 TDD		
PCFICH/PDCCH/PHICH Reference Channel in clause A.3.1.2.1		R.7 TDD			R.7 TDD		
OCNG Patterns in clause A.3.2.1		OP.11 TDD	OP.11 TDD	OP.2 TDD	OP.2 TDD	OP.2 TDD	OP.11 TDD
PBCH_RA	dB						
PBCH_RB	dB						
PSS_RA	dB						
SSS_RA	dB						
PCFICH_RB	dB						
PHICH_RA	dB						
PHICH_RB	dB						
PDCCH_RA	dB						
PDCCH_RB	dB						
MPDCCH_RA	dB						
MPDCCH_RB	dB						
PDSCH_RA	dB						
PDSCH_RB	dB						
OCNG_RA ^{Note 1}	dB						
OCNG_RB ^{Note 1}	dB						
N_{oc} ^{Note 2}	dBm/15 KHz	-98			-98		
\hat{E}_s / N_{oc}	dB	-12	-12	-12	-Infinity	-4	-4

\hat{E}_s/I_{ot} <small>Note 3</small>	dB	-12	-12	-12	-Infinity	-4	-4
RSRP <small>Note 3</small>	dBm/15 KHz	-110	-110	-110	-Infinity	-102	-102
I_o <small>Note 3</small>	dBm/9MHz	-69.95	-69.95	-69.95	-Infinity	-68.76	-68.76
Propagation Condition		AWGN			AWGN		
Antenna Configuration		2x1			2x1		
Timing offset to Cell 1 Synchronous cells	us	-			3		
Note 1:	OCNG shall be used such that both cells are fully allocated and a constant total transmitted power spectral density is achieved for all OFDM symbols.						
Note 2:	Interference from other cells and noise sources not specified in the test is assumed to be constant over subcarriers and time and shall be modelled as AWGN of appropriate power for N_{oc} to be fulfilled.						
Note 3:	Es/Iot, RSRP and Io level has been derived from other parameters for information purpose. They are not settable parameters themselves.						

A.5.1.32.2 Test Requirements

The UE shall finish the transmission of all repetitions of the PRACH to Cell 2 less than 2610 ms from the beginning of time period T3.

The rate of correct handovers observed during repeated tests shall be at least 90%.

NOTE: The handover delay can be expressed as: RRC procedure delay + $T_{interrupt}$, where:

RRC procedure delay = 15 ms and is specified in clause 11.2 in TS 36.331 [2].

$T_{interrupt}$ = 2560 + 35 ms in the test; $T_{interrupt}$ is defined in clause 5.5.2.1.2.

This gives a total of 2610 ms.

A.5.1.33 E-UTRAN FDD-FDD Intra frequency handover for Cat-M1 UEs in CEModeA without SFN acquisition

A.5.1.33.1 Test Purpose and Environment

This test is to verify the requirement for the FDD-FDD intra frequency handover requirements without SFN acquisition specified in clause 5.5.2.1.

The test scenario comprises of one E-UTRA FDD carrier and two cells as given in tables A.5.1.33.1-1 and A.5.1.33.1-2. The test consists of three successive time periods, with time durations of T1, T2 and T3 respectively. At the start of time duration T1, the UE may not have any timing information of Cell 2.

E-UTRAN shall send a RRC message implying handover to Cell 2. The RRC message implying handover shall be sent to the UE during period T2, after the UE has reported Event A3. The field sameSFN-Indication and mib-RepetitionStatus are included in the handover command. T3 is defined as the end of the last TTI containing the RRC message implying handover.

During the test, UE is configured with measurement gap for cell search, because the narrowband of the PDSCH Reference Measurement Channel does not overlap with the centre 6 PRBs of the carrier bandwidth.

Table A.5.1.33.1-1: General test parameters for E-UTRAN FDD-FDD intra frequency handover for Cat-M1 UEs in CEModeA without SFN acquisition test case

Parameter	Unit	Value	Comment
Initial conditions		Cell 1	
		Cell 2	
Final condition		Cell 2	
E-UTRA RF Channel Number		1	Only one FDD carrier frequency is used.
A3-Offset	dB	0	
Hysteresis	dB	0	
Time To Trigger	s	0	

Filter coefficient		0	L3 filtering is not used
DRX			OFF
CP length		Normal	
Access Barring Information	-	Not Sent	No additional delays in random access procedure.
PRACH configuration		PRACH_4CE	As specified in A.3.16
PRACH initial CE level		0	Specified in the handover message
T1	s	5	
T2	s	≤5	
T3	s	1	
Gap pattern ID		1	

Table A.5.1.33.1-2: Cell specific test parameters for E-UTRAN FDD-FDD intra frequency handover for Cat-M1 UEs in CEModeA without SFN acquisition test case

Parameter	Unit	Cell 1			Cell 2		
		T1	T2	T3	T1	T2	T3
E-UTRA RF Channel Number		1					
$BW_{channel}$	MHz	10					
PDSCH Reference Channel in clause A.3.1.4.1		R.21 FDD	R.21 FDD	-	-	-	R.21 FDD
MPDCCH Reference Channel in clause A.3.1.3.1		R.17 FDD			R.17 FDD		
PCFICH/PDCCH/PHICH Reference Channel in clause A.3.1.2.1		R.7 FDD			R.7 FDD		
OCNG Patterns in clause A.3.2.1		OP.21 FDD	OP.21 FDD	OP.6 FDD	OP.6 FDD	OP.6 FDD	OP.21 FDD
PBCH_RA	dB	-3			-3		
PBCH_RB	dB						
PSS_RA	dB						
SSS_RA	dB						
PCFICH_RB	dB						
PHICH_RA	dB						
PHICH_RB	dB						
PDCCH_RA	dB						
PDCCH_RB	dB						
MPDCCH_RA	dB						
MPDCCH_RB	dB						
PDSCH_RA	dB						
PDSCH_RB	dB						
OCNG_RA ^{Note 1}	dB						
OCNG_RB ^{Note 1}	dB						
N_{oc} ^{Note 2}	dBm/15 KHz	-98					
\hat{E}_s / N_{oc}	dB	8	8	8	-Infinity	12	12
\hat{E}_s / I_{ot} ^{Note 3}	dB	8	-4.27	-4.27	-Infinity	3.36	3.36
RSRP ^{Note 3}	dBm/15 KHz	-90	-90	-90	-Infinity	-86	-86
I_o ^{Note 3}	dBm/9MHz	-61.58	- 56.57	- 56.57	Specified in columns for Cell 1		
Propagation Condition		AWGN			AWGN		
Antenna Configuration		2x1			2x1		
Timing offset to Cell 1 Synchronous cells	us	-			3		

Note 1:	OCNG shall be used such that both cells are fully allocated and a constant total transmitted power spectral density is achieved for all OFDM symbols.
Note 2:	Interference from other cells and noise sources not specified in the test is assumed to be constant over subcarriers and time and shall be modelled as AWGN of appropriate power for N_{oc} to be fulfilled.
Note 3:	E_s/lot , RSRP and I_o level has been derived from other parameters for information purpose. They are not settable parameters themselves.

A.5.1.13.2 Test Requirements

The UE shall finish the transmission of all repetitions of the PRACH to Cell 2 less than 50 ms from the beginning of time period T3.

The rate of correct handovers observed during repeated tests shall be at least 90%.

NOTE: The handover delay can be expressed as: RRC procedure delay + $T_{interrupt}$, where:

RRC procedure delay = 15 ms and is specified in clause 11.2 in TS 36.331 [2].

$T_{interrupt}$ = 35 ms in the test; $T_{interrupt}$ is defined in clause 5.5.2.1.2.

This gives a total of 50 ms.

A.5.1.34 E-UTRAN HD-FDD Intra frequency handover for Cat-M1 UEs in CEModeA without SFN acquisition

A.5.1.34.1 Test Purpose and Environment

This test is to verify the requirement for the HD-FDD intra frequency handover requirements without SFN acquisition specified in clause 5.5.2.2.

The test scenario comprises of 1 E-UTRA FDD carrier and 2 cells as given in tables A.5.1.34.1-1 and A.5.1.34.1-2. The test consists of three successive time periods, with time durations of T1, T2 and T3 respectively. At the start of time duration T1, the UE may not have any timing information of Cell 2.

E-UTRAN shall send a RRC message implying handover to Cell 2. The RRC message implying handover shall be sent to the UE during period T2, after the UE has reported Event A3. The field sameSFN-Indication and mib-RepetitionStatus are included in the handover command. T3 is defined as the end of the last TTI containing the RRC message implying handover.

During the test, UE is configured with measurement gap for cell search, because the narrowband of the PDSCH Reference Measurement Channel does not overlap with the centre 6 PRBs of the carrier bandwidth.

Table A.5.1.34.1-1: General test parameters for E-UTRAN HD-FDD intra frequency handover for Cat-M1 UEs in CEModeA without SFN acquisition test case

Parameter		Unit	Value	Comment
Initial conditions	Active cell		Cell 1	
	Neighbouring cell		Cell 2	
Final condition	Active cell		Cell 2	
E-UTRA RF Channel Number			1	Only one FDD carrier frequency is used.
A3-Offset		dB	0	
Hysteresis		dB	0	
Time To Trigger		s	0	
Filter coefficient			0	L3 filtering is not used
DRX				OFF
CP length			Normal	
Access Barring Information		-	Not Sent	No additional delays in random access procedure.
PRACH configuration			PRACH_4CE	As specified in A.3.16
PRACH initial CE level			0	Specified in the handover message
T1		s	5	
T2		s	≤5	

T3	s	1	
Gap pattern ID		1	

Table A.5.1.34.1-2: Cell specific test parameters for E-UTRAN HD-FDD intra frequency handover for Cat-M1 UEs in CEModeA without SFN acquisition test case

Parameter	Unit	Cell 1			Cell 2				
		T1	T2	T3	T1	T2	T3		
E-UTRA RF Channel Number		1							
BW _{channel}	MHz	10							
PDSCH Reference Channel in clause A.3.1.4.2		R.11 HD-FDD	R.11 HD-FDD	-	-	-	R.11 HD-FDD		
MPDCCH Reference Channel in clause A.3.1.3.2		R.7 HD-FDD			R.7 HD-FDD				
PCFICH/PDCCH/PHICH Reference Channel in clause A.3.1.2.3		R.4 HD-FDD			R.4 HD-FDD				
OCNG Patterns in clause A.3.2.1		OP.21 FDD	OP.21 FDD	OP.6 FDD	OP.6 FDD	OP.6 FDD	OP.21 FDD		
PBCH_RA	dB								
PBCH_RB	dB								
PSS_RA	dB								
SSS_RA	dB								
PCFICH_RB	dB								
PHICH_RA	dB								
PHICH_RB	dB								
PDCCH_RA	dB							-3	-3
PDCCH_RB	dB								
MPDCCH_RA	dB								
MPDCCH_RB	dB								
PDSCH_RA	dB								
PDSCH_RB	dB								
OCNG_RA ^{Note 1}	dB								
OCNG_RB ^{Note 1}	dB								
N_{oc} ^{Note 2}	dBm/15 KHz	-98							
\hat{E}_s / N_{oc} ^{Note 3}	dB	8	8	8	-Infinity	12	12		
\hat{E}_s / I_{ot}	dB	8	-4.27	-4.27	-Infinity	3.36	3.36		
RSRP ^{Note 3}	dBm/15 KHz	-90	-90	-90	-Infinity	-86	-86		
I_o ^{Note 3}	dBm/9MHz	-61.58	- 56.57	- 56.57	Specified in columns for Cell 1				
Propagation Condition		AWGN			AWGN				
Antenna Configuration		2x1			2x1				
Timing offset to Cell 1 Synchronous cells	us	-			3				
<p>Note 1: OCNG shall be used such that both cells are fully allocated and a constant total transmitted power spectral density is achieved for all OFDM symbols.</p> <p>Note 2: Interference from other cells and noise sources not specified in the test is assumed to be constant over subcarriers and time and shall be modelled as AWGN of appropriate power for N_{oc} to be fulfilled.</p> <p>Note 3: E_s/I_{ot}, RSRP and I_o level has been derived from other parameters for information purpose. They are not settable parameters themselves</p>									

A.5.1.34.2 Test Requirements

The UE shall finish the transmission of all the repetitions of the PRACH to Cell 2 less than 50 ms from the beginning of time period T3.

The rate of correct handovers observed during repeated tests shall be at least 90%.

NOTE: The handover delay can be expressed as: RRC procedure delay + $T_{\text{interrupt}}$, where:

RRC procedure delay = 15 ms and is specified in clause 11.2 in TS 36.331 [2].

$T_{\text{interrupt}}$ = 35 ms in the test; $T_{\text{interrupt}}$ is defined in clause 5.5.2.1.2.

This gives a total of 50 ms.

A.5.1.35 E-UTRAN TDD Intra frequency handover for Cat-M1 UEs in CEModeA without SFN acquisition

A.5.1.35.1 Test Purpose and Environment

This test is to verify the requirement for the TDD intra frequency handover requirements without SFN acquisition specified in clause 5.5.2.3.

The test scenario comprises of 1 E-UTRA TDD carrier and 2 cells as given in tables A.5.1.35.1-1 and A.5.1.35.1-2. The test consists of three successive time periods, with time durations of T1, T2 and T3 respectively. At the start of time duration T1, the UE may not have any timing information of Cell 2.

E-UTRAN shall send a RRC message implying handover to Cell 2. The RRC message implying handover shall be sent to the UE during period T2, after the UE has reported Event A3. The field sameSFN-Indication and mib-RepetitionStatus are included in the handover command. T3 is defined as the end of the last TTI containing the RRC message implying handover.

During the test, UE is configured with measurement gap for cell search, because the narrowband of the PDSCH Reference Measurement Channel does not overlap with the centre 6 PRBs of the carrier bandwidth.

Table A.5.1.35.1-1: General test parameters for E-UTRAN TDD Intra frequency handover for Cat-M1 UEs in CEModeA without SFN acquisition test case

Parameter		Unit	Value	Comment
Initial conditions	Active cell		Cell 1	
	Neighbouring cell		Cell 2	
Final condition	Active cell		Cell 2	
E-UTRA RF Channel Number			1	Only one TDD carrier frequency is used.
A3-Offset		dB	0	
Hysteresis		dB	0	
Time To Trigger		s	0	
Filter coefficient			0	L3 filtering is not used
DRX				OFF
CP length			Normal	
Access Barring Information		-	Not Sent	No additional delays in random access procedure.
Special subframe configuration			6	As specified in table 4.2-1 in TS 36.211
Uplink-downlink configuration			1	As specified in table 4.2-2 in TS 36.211
PRACH configuration index			PRACH_4CE	As specified in A.3.16
PRACH initial CE level			0	Specified in the handover message
T1		s	5	
T2		s	≤5	
T3		s	1	
Gap pattern ID			1	

Table A.5.1.35.1-2: Cell specific test parameters for E-UTRAN TDD Intra frequency handover for Cat-M1 UEs in CEModeA without SFN acquisition test case

Parameter	Unit	Cell 1			Cell 2		
		T1	T2	T3	T1	T2	T3
E-UTRA RF Channel Number		1					
BW _{channel}	MHz	10					

PDSCH Reference Channel in clause A.3.1.4.3		R.17 TDD	R.17 TDD	-	-	-	R.17 TDD
MPDCCH Reference Channel in clause A.3.1.3.3		R.15 TDD			R.15 TDD		
PCFICH/PDCCH/PHICH Reference Channel in clause A.3.1.2.2		R.7 TDD			R.7 TDD		
OCNG Patterns in clause A.3.2.2		OP.11 TDD	OP.11 TDD	OP.2 TDD	OP.2 TDD	OP.2 TDD	OP.11 TDD
PBCH_RA	dB	-3			-3		
PBCH_RB	dB						
PSS_RA	dB						
SSS_RA	dB						
PCFICH_RB	dB						
PHICH_RA	dB						
PHICH_RB	dB						
PDCCH_RA	dB						
PDCCH_RB	dB						
MPDCCH_RA	dB						
MPDCCH_RB	dB						
PDSCH_RA	dB						
PDSCH_RB	dB						
OCNG_RA ^{Note 1}	dB						
OCNG_RB ^{Note 1}	dB						
N_{oc} ^{Note 2}	dBm/15 KHz	-98					
\hat{E}_s / N_{oc}	dB	8	8	8	-Infinity	12	12
\hat{E}_s / I_{ot} ^{Note 3}	dB	8	-4.27	-4.27	-Infinity	3.36	3.36
RSRP ^{Note 3}	dBm/15 KHz	-90	-90	-90	-Infinity	-86	-86
I_o ^{Note 3}	dBm/9MHz	-61.58	-56.57	-56.57	Specified in columns for Cell 1		
Propagation Condition		AWGN			AWGN		
Antenna Configuration		2x1			2x1		
Timing offset to Cell 1 Synchronous cells	μ s	-			3		
<p>Note 1: OCNG shall be used such that both cells are fully allocated and a constant total transmitted power spectral density is achieved for all OFDM symbols.</p> <p>Note 2: Interference from other cells and noise sources not specified in the test is assumed to be constant over subcarriers and time and shall be modelled as AWGN of appropriate power for N_{oc} to be fulfilled.</p> <p>Note 3: E_s/I_{ot}, RSRP and I_o level has been derived from other parameters for information purpose. They are not settable parameters themselves</p>							

A.5.1.35.2 Test Requirements

The UE shall finish the transmission of all the repetitions of the PRACH to Cell 2 less than 50 ms from the beginning of time period T3.

The rate of correct handovers observed during repeated tests shall be at least 90%.

NOTE: The handover delay can be expressed as: RRC procedure delay + $T_{interrupt}$, where:

RRC procedure delay = 15 ms and is specified in clause 11.2 in TS 36.331 [2].

$T_{interrupt}$ = 35 ms in the test; $T_{interrupt}$ is defined in clause 5.5.2.1.2.

This gives a total of 50 ms.

A.5.1.36 E-UTRAN FDD-FDD Intra frequency handover for Cat-M1 UEs in CEModeB without SFN acquisition

A.5.1.36.1 Test Purpose and Environment

This test is to verify the requirement for the FDD-FDD intra frequency handover requirements without SFN acquisition specified in clause 5.5.3.1.

The test scenario comprises of one E-UTRA FDD carrier and two cells as given in tables A.5.1.36.1-1 and A.5.1.36.1-2. The test consists of three successive time periods, with time durations of T1, T2 and T3 respectively. At the start of time duration T1, the UE may not have any timing information of Cell 2.

During period T2, the UE should report Event A3, and afterwards E-UTRAN shall send a RRC message to the UE implying handover to Cell 2. The field sameSFN-Indication and mib-RepetitionStatus are included in the handover command. T3 is defined as the end of the last TTI containing the RRC message from UE implying handover.

During the test, the UE is configured with measurement gap for cell search, because the narrowband of the PDSCH Reference Measurement Channel does not overlap with the centre 6 PRBs of the carrier bandwidth.

Table A.5.1.36.1-1: General test parameters for E-UTRAN FDD-FDD intra frequency handover for Cat-M1 UEs in CEModeB without SFN acquisition test case

Parameter	Unit	Value	Comment
Initial conditions	Active cell	Cell 1	
	Neighbouring cell	Cell 2	
Final condition	Active cell	Cell 2	
E-UTRA RF Channel Number		1	Only one FDD carrier frequency is used.
A3-Offset	dB	0	
Hysteresis	dB	0	
Time To Trigger	s	0	
Filter coefficient		0	L3 filtering is not used
DRX			OFF
CP length		Normal	
Access Barring Information	-	Not Sent	No additional delays in random access procedure.
PRACH configuration		PRACH_4CE	As specified in A.3.16
PRACH initial CE level		0	Specified in handover message
T1	s	5	
T2	s	≤5	
T3	s	5	
Gap pattern ID		1	

Table A.5.1.36.1-2: Cell specific test parameters for E-UTRAN FDD-FDD intra frequency handover for Cat-M1 UEs in CEModeB without SFN acquisition test case

Parameter	Unit	Cell 1			Cell 2		
		T1	T2	T3	T1	T2	T3
E-UTRA RF Channel Number		1					
BW _{channel}	MHz	10					
PDSCH Reference Channel in A.3.1.4.4		R.23 FDD	R.23 FDD	-	-	-	R.23 FDD
MPDCCH Reference Channel in A.3.1.3.4		R.19 FDD			R.19 FDD		
PCFICH/PDCCH/PHICH Reference Channel in clause A.3.1.2.1		R.7 FDD			R.7 FDD		
OCNG Patterns in clause A.3.2.1		OP.21 FDD	OP.21 FDD	OP.6 FDD	OP.6 FDD	OP.6 FDD	OP.21 FDD
PBCH_RA	dB	-3			-3		
PBCH_RB	dB						
PSS_RA	dB						
SSS_RA	dB						

PCFICH_RB	dB						
PHICH_RA	dB						
PHICH_RB	dB						
PDCCH_RA	dB						
PDCCH_RB	dB						
MPDCCH_RA	dB						
MPDCCH_RB	dB						
PDSCH_RA	dB						
PDSCH_RB	dB						
OCNG_RA ^{Note 1}	dB						
OCNG_RB ^{Note 1}	dB						
N_{oc} ^{Note 2}	dBm/15 KHz				-98		
\hat{E}_s / N_{oc}	dB	-12	-12	-12	-Infinity	-7	-7
\hat{E}_s / I_{ot} ^{Note 3}	dB	-12	-12.79	-12.79	-Infinity	-7.27	-7.27
RSRP ^{Note 3}	dBm/15 KHz	-110	-110	-110	-Infinity	-105	-105
I_o ^{Note 3}	dBm/9MHz	-69.95	-69.21	-69.21	Specified in columns for Cell 1		
Propagation Condition		AWGN			AWGN		
Antenna Configuration		2x1			2x1		
Timing offset to Cell 1 Synchronous cells	us	-			3		
Note 1: OCNG shall be used such that both cells are fully allocated and a constant total transmitted power spectral density is achieved for all OFDM symbols.							
Note 2: Interference from other cells and noise sources not specified in the test is assumed to be constant over subcarriers and time and shall be modelled as AWGN of appropriate power for N_{oc} to be fulfilled.							
Note 3: E_s/I_{ot} , RSRP and I_o level has been derived from other parameters for information purpose. They are not settable parameters themselves.							

A.5.1.36.2 Test Requirements

The UE shall finish transmission of all repetitions of the PRACH to Cell 2 less than 50ms from the beginning of time period T3.

The rate of correct handovers observed during repeated tests shall be at least 90%.

NOTE: The handover delay can be expressed as: RRC procedure delay + $T_{interrupt}$, where:

RRC procedure delay = 15 ms and is specified in clause 11.2 in TS 36.331 [2].

$T_{interrupt}$ = 35ms is defined in clause 5.6.2.1.2.

This gives a total of 50ms.

A.5.1.37 E-UTRAN HD-FDD Intra frequency handover for Cat-M1 UEs in CEModeB without SFN acquisition

A.5.1.37.1 Test Purpose and Environment

This test is to verify the requirement for the HD-FDD intra frequency handover requirements without SFN acquisition specified in clause 5.5.3.2.

The test scenario comprises of one E-UTRA FDD carrier and two cells as given in tables A.5.1.37.1-1 and A.5.1.37.1-2. The test consists of three successive time periods, with time durations of T1, T2 and T3 respectively. At the start of time duration T1, the UE may not have any timing information of Cell 2.

During period T2, the UE should report Event A3, and afterwards E-UTRAN shall send a RRC message to the UE implying handover to Cell 2. The field sameSFN-Indication and mib-RepetitionStatus are included in the handover command. During T3 is defined as the end of the last TTI containing the RRC message from UE implying handover.

During the test, UE is configured with measurement gap for cell search, because the narrowband of the PDSCH Reference Measurement Channel does not overlap with the centre 6 PRBs of the carrier bandwidth.

Table A.5.1.37.1-1: General test parameters for E-UTRAN HD-FDD intra frequency handover for Cat-M1 UEs in CEModeB without SFN acquisition test case

Parameter		Unit	Value	Comment
Initial conditions	Active cell		Cell 1	
	Neighbouring cell		Cell 2	
Final condition	Active cell		Cell 2	
A3-Offset		dB	0	
Hysteresis		dB	0	
Time To Trigger		s	0	
Filter coefficient			0	L3 filtering is not used
DRX				OFF
CP length			Normal	
Access Barring Information		-	Not Sent	No additional delays in random access procedure.
PRACH configuration			PRACH_4CE	As specified in clause A.3.16
PRACH initial CE level			0	Specified in handover message
T1		s	5	
T2		s	≤5	
T3		s	5	
Gap pattern ID			1	

Table A.5.1.37.1-2: Cell specific test parameters for E-UTRAN HD-FDD intra frequency handover for Cat-M1 UEs in CEModeB without SFN acquisition test case

Parameter	Unit	Cell 1			Cell 2				
		T1	T2	T3	T1	T2	T3		
E-UTRA RF Channel Number		1							
BW _{channel}	MHz	10							
PDSCH Reference Channel in clause A.3.1.4.5		R.13 HD-FDD	R.13 HD-FDD	-	-	-	R.13 HD-FDD		
MPDCCH Reference Channel in clause A.3.1.3.5		R.9 HD-FDD			R.9 HD-FDD				
PCFICH/PDCCH/PHICH Reference Channel in clause A.3.1.2.3		R.4 HD-FDD			R.4 HD-FDD				
OCNG Patterns in clause A.3.2.1		OP.21 FDD	OP.21 FDD	OP.6 FDD	OP.6 FDD	OP.6 FDD	OP.21 FDD		
PBCH_RA	dB								
PBCH_RB	dB								
PSS_RA	dB								
SSS_RA	dB								
PCFICH_RB	dB								
PHICH_RA	dB								
PHICH_RB	dB								
PDCCH_RA	dB							-3	-3
PDCCH_RB	dB								
MPDCCH_RA	dB								
MPDCCH_RB	dB								
PDSCH_RA	dB								
PDSCH_RB	dB								
OCNG_RA ^{Note 1}	dB								
OCNG_RB ^{Note 1}	dB								
N_{oc} ^{Note 2}	dBm/15 KHz							-98	
\hat{E}_s / N_{oc} ^{Note 3}	dB	-12	-12	-12	-Infinity	-7	-7		
\hat{E}_s / I_{ot}	dB	-12	-12.79	-12.79	-Infinity	-7.27	-7.27		

RSRP ^{Note 3}	dBm/15 KHz	-110	-110	-110	-Infinity	-105	-105
I ₀ ^{Note 3}	dBm/9MHz	-69.95	-69.21	-69.21	Specified in columns for Cell 1		
Propagation Condition		AWGN			AWGN		
Antenna Configuration		2x1			2x1		
Timing offset to Cell 1 Synchronous cells	us	-			3		
Note 1:	OCNG shall be used such that both cells are fully allocated and a constant total transmitted power spectral density is achieved for all OFDM symbols.						
Note 2:	Interference from other cells and noise sources not specified in the test is assumed to be constant over subcarriers and time and shall be modelled as AWGN of appropriate power for N_{oc} to be fulfilled.						
Note 3:	Es/lot, RSRP and I ₀ level has been derived from other parameters for information purpose. They are not settable parameters themselves.						

A.5.1.37.2 Test Requirements

The UE shall finish the transmission of all repetitions of the PRACH to Cell 2 less than 50 ms from the beginning of time period T3.

The rate of correct handovers observed during repeated tests shall be at least 90%.

NOTE: The handover delay can be expressed as: RRC procedure delay + T_{interrupt}, where:

RRC procedure delay = 15 ms and is specified in clause 11.2 in TS 36.331 [2].

T_{interrupt} = 35ms is defined in clause 5.6.2.1.2.

This gives a total of 50ms.

A.5.1.38 E-UTRAN TDD Intra frequency handover for Cat-M1 UEs in CEModeB without SFN acquisition

A.5.1.38.1 Test Purpose and Environment

This test is to verify the requirement for the TDD-TDD intra frequency handover requirements without SFN acquisition specified in clause 5.5.3.3.

The test scenario comprises of one E-UTRA TDD carrier and two cells as given in tables A.5.1.38.1-1 and A.5.1.38.1-2. The test consists of three successive time periods, with time durations of T1, T2 and T3 respectively. At the start of time duration T1, the UE may not have any timing information of Cell 2.

During period T2, the UE should report Event A3, and afterwards E-UTRAN shall send a RRC message to the UE implying handover to Cell 2. The field sameSFN-Indication and mib-RepetitionStatus are included in the handover command. During T3 is defined as the end of the last TTI containing the RRC message from UE implying handover.

During the test, the UE is configured with measurement gap for cell search, because the narrowband of the PDSCH Reference Measurement Channel does not overlap with the centre 6 PRBs of the carrier bandwidth.

Table A.5.1.38.1-1: General test parameters for E-UTRAN TDD Intra frequency handover for Cat-M1 UEs in CEModeB without SFN acquisition test case

Parameter		Unit	Value	Comment
Initial conditions	Active cell		Cell 1	
	Neighbouring cell		Cell 2	
Final condition	Active cell		Cell 2	
A3-Offset		dB	0	
Hysteresis		dB	0	
Time To Trigger		s	0	
Filter coefficient			0	L3 filtering is not used
DRX				OFF
CP length			Normal	
Access Barring Information		-	Not Sent	No additional delays in random access procedure.

Special subframe configuration		6	As specified in table 4.2-1 in TS 36.211
Uplink-downlink configuration		1	As specified in table 4.2-2 in TS 36.211
PRACH configuration		PRACH_4CE	As specified in clause A.3.16
PRACH initial CE level		0	Specified in handover message
T1	s	5	
T2	s	≤5	
T3	s	5	
Gap pattern ID		1	

Table A.5.1.38.1-2: Cell specific test parameters for E-UTRAN TDD Intra frequency handover for Cat-M1 UEs in CEModeB without SFN acquisition test case

Parameter	Unit	Cell 1			Cell 2				
		T1	T2	T3	T1	T2	T3		
E-UTRA RF Channel Number		1			1				
BW _{channel}	MHz	10			10				
PDSCH Reference Channel in clause A.3.1.4.6		R.19 TDD	R.19 TDD	-	-	-	R.19 TDD		
MPDCCH Reference Channel in clause A.3.1.3.6		R.17 TDD			R.17 TDD				
PCFICH/PDCCH/PHICH Reference Channel in clause A.3.1.2.2		R.7 TDD			R.7 TDD				
OCNG Patterns in clause A.3.2.2		OP.11 TDD	OP.11 TDD	OP.2 TDD	OP.2 TDD	OP.2 TDD	OP.11 TDD		
PBCH_RA	dB								
PBCH_RB	dB								
PSS_RA	dB								
SSS_RA	dB								
PCFICH_RB	dB								
PHICH_RA	dB								
PHICH_RB	dB								
PDCCH_RA	dB							-3	-3
PDCCH_RB	dB							-3	-3
MPDCCH_RA	dB							-3	-3
MPDCCH_RB	dB							-3	-3
PDSCH_RA	dB							-3	-3
PDSCH_RB	dB							-3	-3
OCNG_RA ^{Note 1}	dB							-3	-3
OCNG_RB ^{Note 1}	dB	-3	-3						
N_{oc} ^{Note 2}	dBm/15 KHz	-98							
\hat{E}_s / N_{oc}	dB	-12	-12	-12	-Infinity	-7	-7		
\hat{E}_s / I_{ot} ^{Note 3}	dB	-12	-12.79	-12.79	-Infinity	-7.27	-7.27		
RSRP ^{Note 3}	dBm/15 KHz	-110	-110	-110	-Infinity	-105	-105		
I_o ^{Note 3}	dBm/9MHz	-69.95	-69.21	-69.21	Specified in columns for Cell 1				
Propagation Condition		AWGN			AWGN				
Antenna Configuration		2x1			2x1				
Timing offset to Cell 1 Synchronous cells	μs	-			3				
<p>Note 1: OCNG shall be used such that both cells are fully allocated and a constant total transmitted power spectral density is achieved for all OFDM symbols.</p> <p>Note 2: Interference from other cells and noise sources not specified in the test is assumed to be constant over subcarriers and time and shall be modelled as AWGN of appropriate power for N_{oc} to be fulfilled.</p> <p>Note 3: E_s/I_{ot}, RSRP and I_o level has been derived from other parameters for information purpose. They are not settable parameters themselves.</p>									

A.5.1.38.2 Test Requirements

The UE shall finish the transmission of all repetitions of the PRACH to Cell 2 less than 50 ms from the beginning of time period T3.

The rate of correct handovers observed during repeated tests shall be at least 90%.

NOTE: The handover delay can be expressed as: RRC procedure delay + $T_{\text{interrupt}}$, where:

RRC procedure delay = 15 ms and is specified in clause 11.2 in TS 36.331 [2].

$T_{\text{interrupt}} = 35\text{ms}$ is defined in clause 5.6.2.1.2.

This gives a total of 50 ms.

A.5.1.39 E-UTRAN FDD - FDD Intra frequency handover with direct SCell activation

A.5.1.39.1 Test Purpose and Environment

This test is to verify the requirement for the FDD-FDD intra frequency handover with direct SCell activation requirements specified in subclause 7.7.19.

The test scenario comprises of two E-UTRA FDD carriers and 2 cells as given in tables A.5.1.39.1-1 and A.5.1.39.1-2. The test consists of three successive time periods, with time durations of T1, T2, and T3 respectively.

At the start of time duration T1, the UE is in connected mode with PCell and SCell1 (cell 2) is in activated state and UE is reporting CQI for both PCell and SCell1.

Time period T2 starts when UE receives a handover command that also activates SCell1 (Cell2). This is done using an *RRConnectionReconfiguration* message with parameter *sCellState* set to *activated* for the SCell1 (Cell 2). The message is sent from the test equipment to the UE and is received in a subframe # denoted *m* at the UE antenna connector. The UE shall accomplish the activation of the SCell no later than subframe ($m + N_{\text{direct}}$).

Time period T3 starts at ($m + N_{\text{direct}}$), at which point UE shall be reporting a valid CQI for both PCell and SCell1.

Table A.5.1.39.1-1: General test parameters for E-UTRAN FDD-FDD intra-frequency handover with direct SCell activation test case

Parameter	Unit	Value	Comment
PDSCH parameters		DL Reference Measurement Channel R.0 FDD	As specified in clause A.3.1.1.1
PCFICH/PDCCH/PHICH parameters		DL Reference Measurement Channel R.6 FDD	As specified in clause A.3.1.2.1
Initial conditions	PCell	Cell 1	Cell 1 is on RF channel number 1
	SCell1	Cell 2	Cell 2 is on RF channel number 2
Final condition	PCell	Cell 1	Cell 1 is on RF channel number 1
	SCell1	Cell 2	Cell 2 is on RF channel number 2
E-UTRA RF channel number		1, 2	Two FDD carriers are used
Channel Bandwidth (BW_{channel})	MHz	10	
CP length		Normal	
DRX		-	OFF
PRACH configuration		4	As specified in table 5.7.1-2 in TS 36.211 [16]
Access Barring Information	-	Not sent	No additional delays in random access procedure
Time offset between cells		-	Intra-cell handover, no offset
T1	s	1	
T2	ms	N_{direct}	
T3	s	1	

Table A.5.1.39.1-2: Cell specific test parameters for E-UTRAN FDD-FDD intra frequency handover with direct SCell activation test case

Parameter	Unit	Cell 1			Cell 2		
		T1	T2	T3	T1	T2	T3
E-UTRA RF Channel Number		1			2		
$BW_{channel}$	MHz	10			10		
OCNG Patterns defined in A.3.2.1.2 (OP.2 FDD)		OP.2 FDD	OP.2 FDD	OP.2 FDD	OP.2 FDD	OP.2 FDD	OP.2 FDD
PBCH_RA	dB	0			0		
PBCH_RB	dB						
PSS_RA	dB						
SSS_RA	dB						
PCFICH_RB	dB						
PHICH_RA	dB						
PHICH_RB	dB						
PDCCH_RA	dB						
PDCCH_RB	dB						
PDSCH_RA	dB						
PDSCH_RB	dB						
OCNG_RA ^{Note 1}	dB						
OCNG_RB ^{Note 1}	dB						
\hat{E}_s / I_{ot}	dB						
N_{oc} ^{Note 2}	dBm/15 KHz	-98					
\hat{E}_s / N_{oc}	dB	8	8	8	8	8	8
RSRP ^{Note 3}	dBm/15 KHz	-90	-90	-90	-90	-90	-90
Propagation Condition		AWGN					
<p>Note 1: OCNG shall be used such that both cells are fully allocated and a constant total transmitted power spectral density is achieved for all OFDM symbols.</p> <p>Note 2: Interference from other cells and noise sources not specified in the test is assumed to be constant over subcarriers and time and shall be modelled as AWGN of appropriate power for N_{oc} to be fulfilled.</p> <p>Note 3: RSRP levels have been derived from other parameters for information purposes. They are not settable parameters themselves.</p>							

A.5.1.39.2 Test Requirements

The UE shall be capable to transmit valid CSI report for the directly activated SCell1 no later than in subframe $m+N_{direct}$.

The rate of correct observed SCell1 direct activation delay during repeated tests shall be at least 90%.

NOTE: The SCell activation delay, N_{direct} , can be expressed as: $N_{direct} = T_{RRC_process} + T_{interrupt} + T_{IU} + T_2 + T_3 + T_{interrupt_window} + T_{time_direct}$, where:

$T_{RRC_Process}$ is the RRC procedure delay = 20 ms which is the RRC procedure delay defined for SCell addition in clause 11.2 of TS 36.331 [2],

$T_{interrupt}$ is the interruption time as defined in subclause 5.1.2.1.2,

T_2 is the delay for obtaining a valid TA command for the target PCell from the target PCell and the scheduling grant for sending valid CSI report in the target PCell. T_2 is up to [13] subframes,

T_3 is the delay for applying the received TA for uplink transmission in the target PCell, and greater than or equal to 6 subframes,

$T_{interrupt_window}$ is the interruption window which is 5ms for FDD and

T_{time_direct} is the direct SCell activation delay. If the SCell is known, then T_{time_direct} is 20 ms. If the SCell is unknown, then T_{time_direct} is 30 ms provided the SCell can be successfully detected on the first attempt.

This gives a total of $N_{direct} = 65 + T_{IU} + T_2 + T_3$ ms = 65 + 10 + 13 + 6 = 94 ms.

During T3 the UE shall send valid CSI reports for PCell and SCell1 with non-zero CQI index and continue to send CSI reports for PCell and SCell1 (Cell 2) with non-zero CQI index until the end of T3.

All of the above test requirements shall be fulfilled in order for the observed SCell1 direct activation delay to be counted as correct.

A.5.1.40 E-UTRAN TDD - TDD Intra frequency handover with direct SCell activation

A.5.1.40.1 Test Purpose and Environment

This test is to verify the requirement for the TDD-TDD intra frequency handover with direct SCell activation requirements specified in subclause 7.7.19.

The test scenario comprises of two E-UTRA TDD carriers and 2 cells as given in tables A.5.1.40.1-1 and A.5.1.40.1-2. The test consists of three successive time periods, with time durations of T1, T2, and T3 respectively.

At the start of time duration T1, the UE is in connected mode with PCell and SCell1 (cell 2) is in activated state and UE is reporting CQI for both PCell and SCell1.

Time period T2 starts when UE receives a handover command that also activates SCell1 (Cell2). This is done using an *RRConnectionReconfiguration* message with parameter *sCellState* set to *activated* for the SCell1 (Cell 2). The message is sent from the test equipment to the UE and is received in a subframe # denoted m at the UE antenna connector. The UE shall accomplish the activation of the SCell no later than subframe (m+ N_{direct}).

Time period T3 starts at (m+ N_{direct}), at which point UE shall be reporting a valid CQI for both PCell and SCell1.

Table A.5.1.40.1-1: General test parameters for E-UTRAN TDD-TDD Intra frequency handover test case

Parameter		Unit	Value	Comment
PDSCH parameters			DL Reference Measurement Channel R.0 TDD	As specified in clause A.3.1.1.2
PCFICH/PDCCHPHICH parameters			DL Reference Measurement Channel R.6 TDD	As specified in clause A.3.1.2.2
Initial conditions	PCell		Cell 1	Cell 1 is on RF channel number 1
	SCell1		Cell 2	Cell 2 is on RF channel number 2
Final condition	PCell		Cell 1	Cell 1 is on RF channel number 1
	SCell1		Cell 2	Cell 2 is on RF channel number 2
E-UTRA RF Channel Number			1,2	Two TDD carriers are used.
Channel Bandwidth ($BW_{channel}$)		MHz	10	
DRX			-	OFF
CP length			Normal	
Access Barring Information		-	Not Sent	No additional delays in random access procedure.
Special subframe configuration			6	As specified in table 4.2-1 in TS 36.211 [16]
Uplink-downlink configuration			1	As specified in table 4.2-2 in TS 36.211 [16]
PRACH configuration index			53	As specified in table 5.7.1-3 in TS 36.211 [16]
Time offset between cells			-	Intra-cell handover, no offset
T1		s	1	
T2		s	N_{direct}	
T3		s	1	

Table A.5.1.40.1-2: Cell specific test parameters for E-UTRAN TDD-TDD Intra frequency handover test case

Parameter	Unit	Cell 1			Cell 2		
		T1	T2	T3	T1	T2	T3
E-UTRA RF Channel Number		1			1		
BW _{channel}	MHz	10			10		
OCNG Patterns defined in A.3.2.2.1 (OP.1 TDD) and in A.3.2.2.2 (OP.2 TDD)		OP.2 TDD	OP.2 TDD	OP.2 TDD	OP.2 TDD	OP.2 TDD	OP.2 TDD
PBCH_RA	dB	0			0		
PBCH_RB	dB						
PSS_RA	dB						
SSS_RA	dB						
PCFICH_RB	dB						
PHICH_RA	dB						
PHICH_RB	dB						
PDCCH_RA	dB						
PDCCH_RB	dB						
PDSCH_RA	dB						
PDSCH_RB	dB						
OCNG_RA ^{Note 1}	dB						
OCNG_RB ^{Note 1}	dB						
\hat{E}_s / I_{ot}	dB	8	8	8	8	8	8
N_{oc} ^{Note 2}	dBm/15 KHz	-98					
\hat{E}_s / N_{oc}	dB	8	8	8	8	8	8
RSRP ^{Note 3}	dBm/15 KHz	-90	-90	-90	-90	-90	-90
Propagation Condition		AWGN					
<p>Note 1: OCNG shall be used such that both cells are fully allocated and a constant total transmitted power spectral density is achieved for all OFDM symbols.</p> <p>Note 2: Interference from other cells and noise sources not specified in the test is assumed to be constant over subcarriers and time and shall be modelled as AWGN of appropriate power for N_{oc} to be fulfilled.</p> <p>Note 3: RSRP levels have been derived from other parameters for information purposes. They are not settable parameters themselves.</p>							

A.5.1.40.2 Test Requirements

The UE shall be capable to transmit valid CSI report for the directly activated SCell1 no later than in subframe $m+N_{direct}$.

The rate of correct observed SCell1 direct activation delay during repeated tests shall be at least 90%.

NOTE: The SCell activation delay, N_{direct} , can be expressed as: $N_{direct} = T_{RRC_process} + T_{interrupt} + T_{IU} + T_2 + T_3 + T_{interrupt_window} + T_{time_direct}$, where:

$T_{RRC_process}$ is the RRC procedure delay = 20 ms which is the RRC procedure delay defined for SCell addition in clause 11.2 of TS 36.331 [2],

$T_{interrupt}$ is the interruption time as defined in subclause 5.1.2.1.2,

T_2 is the delay for obtaining a valid TA command for the target PCell from the target PCell and the scheduling grant for sending valid CSI report in the target PCell. T_2 is up to [13] subframes,

T_3 is the delay for applying the received TA for uplink transmission in the target PCell, and greater than or equal to 6 subframes,

$T_{interrupt_window}$ is the interruption window which is 7 ms for TDD and

T_{time_direct} is the direct SCell activation delay. If the SCell is known, then T_{time_direct} is 20 ms. If the SCell is unknown, then T_{time_direct} is 30 ms provided the SCell can be successfully detected on the first attempt.

This gives a total of $N_{direct} = 67 + T_{IU} + T_2 + T_3$ ms = 67 + 10 + 13 + 6 = 96 ms.

During T3 the UE shall send valid CSI reports for PCell and SCell1 with non-zero CQI index and continue to send CSI reports for PCell and SCell1 (Cell 2) with non-zero CQI index until the end of T3.

All of the above test requirements shall be fulfilled in order for the observed SCell1 direct activation delay to be counted as correct.

A.5.2 E-UTRAN Handover to other RATs

A.5.2.1 E-UTRAN FDD – UTRAN FDD Handover

A.5.2.1.1 Test Purpose and Environment

This test is to verify the requirement for the E-UTRAN FDD to UTRAN FDD handover requirements specified in clause 5.3.1.

The test parameters are given in Tables A.5.2.1.1-1, A.5.2.1.1-2 and A.5.2.1.1-3. The test consists of three successive time periods, with time durations of T1, T2 and T3 respectively. At the start of time duration T1, the UE does not have any timing information of Cell 2. Starting T2, Cell 2 becomes detectable and the UE is expected to detect and send a measurement report. Gap pattern configuration with id #0 as specified in Table 8.1.2.1-1 is configured before T2 begins to enable inter-RAT frequency monitoring.

A RRC message implying handover shall be sent to the UE during period T2, after the UE has reported Event B2. The start of T3 is the instant when the last TTI containing the RRC message implying handover is sent to the UE. The handover message shall contain cell 2 as the target cell.

Table A.5.2.1.1-1: General test parameters for E-UTRAN FDD to UTRAN FDD handover test case

Parameter		Unit	Value	Comment
PDSCH parameters			DL Reference Measurement Channel R.0 FDD	As specified in clause A.3.1.1.1
PCFICH/PDCCH/PHICH parameters			DL Reference Measurement Channel R.6 FDD	As specified in clause A.3.1.2.1
Initial conditions	Active cell		Cell 1	E-UTRAN cell
	Neighbouring cell		Cell 2	UTRAN cell
Final condition	Active cell		Cell 2	UTRAN cell
Channel Bandwidth ($BW_{channel}$)		MHz	10	
Gap Pattern Id			0	As specified in Table 8.1.2.1-1 started before T2 starts
E-UTRAN FDD measurement quantity			RSRP	
Inter-RAT (UTRAN FDD) measurement quantity			CPICH Ec/No	
b2-Threshold1		dBm	-90	Absolute E-UTRAN RSRP threshold for event B2
b2-Threshold2-UTRA		dB	-18	Absolute UTRAN CPICH Ec/Io threshold for event B2
Hysteresis		dB	0	
TimeToTrigger		s	0	
Filter coefficient			0	L3 filtering is not used
DRX			OFF	Non-DRX test
Access Barring Information		-	Not sent	No additional delays in random access procedure
E-UTRA RF Channel Number			1	One E-UTRA FDD carrier frequency is used.
E-UTRA Channel Bandwidth ($BW_{channel}$)		MHz	10	
UTRA RF Channel Number			1	One UTRA FDD carrier frequency is used.
Monitored UTRA FDD cell list size			12	UTRA cells on UTRA RF channel 1 provided in the cell before T2.
Post-verification period			False	
T1		s	5	

T2	s	≤ 5	
T3	s	1	

Table A.5.2.1.1-2: Cell specific test parameters for E-UTRAN FDD to UTRAN FDD handover test case (cell 1)

Parameter	Unit	Cell 1 (E-UTRA)		
		T1	T2	T3
E-UTRA RF Channel number		1		
$BW_{channel}$	MHz	10		
OCNG Patterns defined in A.3.2.1.1 (OP.1 FDD) and in A.3.2.1.2 (OP.2 FDD)		OP.1 FDD	OP.1 FDD	OP.2 FDD
PBCH_RA	dB	0		
PBCH_RB	dB			
PSS_RA	dB			
SSS_RA	dB			
PCFICH_RB	dB			
PHICH_RA	dB			
PHICH_RB	dB			
PDCCH_RA	dB			
PDCCH_RB	dB			
PDSCH_RA	dB			
PDSCH_RB	dB			
OCNG_RA ^{Note 1}	dB			
OCNG_RB ^{Note 1}	dB			
\hat{E}_s / I_{ot}	dB			
N_{oc}	dBm/15 kHz	-98		
\hat{E}_s / N_{oc}	dB	0	0	0
RSRP ^{Note 2}	dBm/15 KHz	-98	-98	-98
I_o ^{Note 2}	dBm/9 MHz	-67.21	-67.21	-67.21
Propagation Condition		AWGN		
Note 1: OCNG shall be used such that both cells are fully allocated and a constant total transmitted power spectral density is achieved for all OFDM symbols.				
Note 2: RSRP and I_o levels have been derived from other parameters for information purposes. They are not settable parameters themselves.				

Table A.5.2.1.1-3: Cell specific test parameters for E-UTRAN FDD to UTRAN FDD handover test case (cell 2)

Parameter	Unit	Cell 2 (UTRA)		
		T1	T2	T3
CPICH_Ec/lor	dB	-10		
PCCPCH_Ec/lor	dB	-12		
SCH_Ec/lor	dB	-12		
PICH_Ec/lor	dB	-15		
DCH_Ec/lor	dB	N/A	N/A	Note 1
OCNS_Ec/lor	dB	-0.941	0.941	Note 2
\hat{I}_{or} / I_{oc}	dB	-infinity	-1.8	-1.8
I_{oc}	dBm/3,84 MHz	-70	-70	-70
CPICH_Ec/lo	dB	-infinity	-14	-14
Propagation Condition		AWGN		
Note 1: The DPCH level is controlled by the power control loop				
Note 2: The power of the OCNS channel that is added shall make the total power from the cell to be equal to I_{or} .				

A.5.2.1.2 Test Requirements

The UE shall start to transmit the UL DPCH to Cell 2 less than 190 ms from the beginning of time period T3.

The rate of correct handovers observed during repeated tests shall be at least 90%.

NOTE: The handover delay can be expressed as: RRC procedure delay + $T_{\text{interrupt}}$, where:

RRC procedure delay = 50 ms, which is specified in clause 5.3.1.1.1.

$T_{\text{interrupt}}$ = 140 ms in the test; $T_{\text{interrupt}}$ is defined in clause 5.3.1.1.2.

This gives a total of 190 ms.

A.5.2.2 E-UTRAN TDD - UTRAN FDD Handover

A.5.2.2.1 Test Purpose and Environment

This test is to verify the E-UTRAN TDD – UTRAN FDD handover requirements specified in clause 5.3.1.

The test scenario comprises of one E-UTRAN TDD cell and one UTRAN FDD cell as given in the tables A.5.2.2.1-1, A.5.2.2.1-2 and A.5.2.2.1-3. The test consists of three successive time periods, with time duration of T1, T2 and T3 respectively. At start of time duration T1, the UE does not have any timing information of cell 2. Gap pattern configuration with id #0 as specified in Table 8.1.2.1-1 is configured before the start of T2 to enable the monitoring of UTRAN FDD. A neighbouring cell list, including the UTRAN cell (cell2), shall be sent to the UE before T2 starts. During the time T2 cell 2 becomes detectable and the UE is expected to detect and send the measurement report. A RRC message implying handover shall be sent to the UE during T2, after the UE has reported event B2. The start of T3 is the instant when the last TTI containing the RRC message implying handover is sent to the UE. The handover message shall contain cell 2 as the target cell.

Table A.5.2.2.1-1: General test parameters for E-UTRAN TDD-UTRAN FDD handover

Parameter		Unit	Value	Comment
PDSCH parameters (E-UTRAN TDD)			DL Reference Measurement Channel R.0 TDD	As specified in clause A.3.1.1.2
PCFICH/PDCCH/PHICH parameters (E-UTRAN TDD)			DL Reference Measurement Channel R.6 TDD	As specified in clause A.3.1.2.2
Initial conditions	Active cell		Cell 1	Cell 1 is on E-UTRA RF channel number 1.
	Neighbour cell		Cell 2	Cell 2 is on UTRA RF channel number 1.
Final conditions	Active cell		Cell 2	
Special subframe configuration			6	As specified in table 4.2-1 in TS 36.211. Applicable to cell 1.
Uplink-downlink configuration			1	As specified in table 4.2-2 in TS 36.211. Applicable to cell 1
E-UTRAN TDD measurement quantity			RSRP	
Inter-RAT (UTRA FDD) measurement quantity			CPICH Ec/Io	
b2-Threshold1		dBm	-90	Absolute E-UTRAN RSRP threshold for event B2
b2-Threshold2-UTRA		dB	-18	UTRAN FDD CPICH Ec/Io threshold for event B2
Hysteresis		dB	0	
DRX			OFF	No DRX configured.
Time to Trigger		ms	0	
Filter coefficient			0	
CP length			Normal	Applicable to cell 1
Gap pattern configuration Id			0	As specified in Table 8.1.2.1-1; to start before T2 starts
E-UTRA RF Channel Number			1	One E-UTRA TDD carrier frequency is used.
E-UTRA Channel Bandwidth (BW_{channel})		MHz	10	
UTRA RF Channel Number			1	One UTRA FDD carrier frequency is used.
Monitored UTRA FDD cell list size			12	UTRA cells on UTRA RF channel 1 provided in the cell list before T2.
Post-verification period			False	Post verification is not used.
T1		s	5	

T2	s	≤5	
T3	s	1	

Table A.5.2.2.1-2: Cell specific test parameters for E-UTRAN TDD (cell 1) for handover to UTRAN FDD (cell # 2)

Parameter	Unit	Cell 1 (E-UTRAN)		
		T1	T2	T3
E-UTRA RF Channel Number		1		
BW _{channel}	MHz	10		
OCNG Pattern defined in A.3.2.2.1 (OP.1 TDD) and in A.3.2.2.2 (OP.2 TDD)		OP.1 TDD		OP.2 TDD
PBCH_RA	dB	0		
PBCH_RB				
PSS_RA				
SSS_RA				
PCFICH_RB				
PHICH_RA				
PHICH_RB				
PDCCH_RA				
PDCCH_RB				
PDSCH_RA				
PDSCH_RB				
OCNG_RA ^{Note 1}				
OCNG_RB ^{Note 1}				
RSRP				
\hat{E}_s/I_{ot}	dB	0	0	0
\hat{E}_s/N_{oc}	dB	0	0	0
N_{oc}	dBm/15 kHz	-98		
I_o ^{Note 2}	dBm/9 MHz	-67.21	-67.21	-67.21
Propagation Condition		AWGN		
Note 1: OCNG shall be used such that the cell is fully allocated and a constant total transmitted power spectral density is achieved for all OFDM symbols. Note 2: RSRP and I_o levels have been derived from other parameters for information purposes. They are not settable parameters themselves.				

Table A.5.2.2.1-3: Cell specific test parameters for UTRAN FDD (cell # 2) for handover from E-UTRAN TDD cell (cell #1)

Parameter	Unit	Cell 1 (UTRA)		
		T1	T2	T3
CPICH_Ec/I _{or}	dB	-10		
PCCPCH_Ec/I _{or}	dB	-12		
SCH_Ec/I _{or}	dB	-12		
PICH_Ec/I _{or}	dB	-15		
DPCH_Ec/I _{or}	dB	N/A	N/A	Note 1
OCNS	dB	-0.941	-0.941	Note 2
\hat{I}_{or}/I_{oc}	dB	-infinity	-1.8	-1.8
I_{oc}	dBm/3.84 MHz	-70		
CPICH_Ec/I _o	dB	-infinity	-14	-14
Propagation Condition		AWGN		

Note 1: The DPCH level is controlled by the power control loop
 Note 2: The power of the OCNS channel that is added shall make the total power from the cell to be equal to I_{or} .

A.5.2.2.2 Test Requirements

The UE shall start to transmit the UL DPCH to Cell 2 less than 190 ms from the beginning of time period T3.

The rate of correct handovers observed during repeated tests shall be at least 90%.

NOTE: The handover delay can be expressed as: RRC procedure delay + $T_{interrupt}$, where:

RRC procedure delay = 50 ms, which is specified in clause 5.1.1.1.1.

$T_{interrupt}$ = 140 ms in the test; $T_{interrupt}$ is defined in clause 5.3.1.1.2.

This gives a total of 190 ms.

A.5.2.3 E-UTRAN FDD- GSM Handover

A.5.2.3.1 Test Purpose and Environment

This test is to verify the requirement for the E-UTRAN to GSM cell handover delay specified in clause 5.3.3.

The test parameters are given in Table A.5.2.3.1 -1, A.5.2.3.1 -2 and A.5.2.3.1 -3 below. In the measurement control information it is indicated to the UE that event-triggered reporting with Event B1 shall be used. The test consists of three successive time periods, with time duration of T1, T2 and T3 respectively. At the start of time duration T1, the UE may not have any timing information of cell 2.

The RRC message implying handover to cell 2 shall be sent to the UE during period T2, after the UE has reported Event B1. The start of T3 is defined as the end of last E-UTRAN TTI containing the RRC message implying handover.

The requirements are also applicable for a UE not requiring measurement gap, in which case no measurement gap pattern should be sent for the parameters specified in Table A.5.2.3.1-1.

Table A.5.2.3.1 -1: General test parameters for E-UTRAN FDD-GSM handover

Parameter		Unit	Value	Comment
PDSCH parameters			DL Reference Measurement Channel R.0 FDD	As specified in clause A.3.1.1.1
PCFICH/PDCCH/PHICH parameters			DL Reference Measurement Channel R.6 FDD	As specified in clause A.3.1.2.1
Gap Pattern Id			1	As specified in TS 36.133 section 8.1.2.1.
Initial conditions	Active cell		Cell 1	
	Neighbour cell		Cell 2	
Final conditions	Active cell		Cell 2	
Inter-RAT measurement quantity			GSM Carrier RSSI	
Threshold other system		dBm	-80	Absolute GSM carrier RSSI threshold for event B1.
Hysteresis		dB	0	
Time to Trigger		ms	0	
Filter coefficient			0	L3 filtering is not used
DRX				OFF
T1		s	20	
T2		s	7	
T3		s	1	

Table A. A.5.2.3.1 - 2: Cell Specific Parameters for Handover from E- UTRAN FDD to GSM cell case (cell 1)

Parameter	Unit	Cell 1	
		T1, T2	T3
BW _{channel}	MHz	10	

OCNG Patterns defined in A.3.2.1.1 (OP.1 FDD) and in A.3.2.1.2 (OP.2 FDD)		OP.1 FDD	OP.2 FDD
PBCH_RA	dB	0	
PBCH_RB	dB		
PSS_RA	dB		
SSS_RA	dB		
PCFICH_RB	dB		
PHICH_RA	dB		
PHICH_RB	dB		
PDCCH_RA	dB		
PDCCH_RB	dB		
PDSCH_RA	dB		
PDSCH_RB	dB		
OCNG_RA ^{Note1}	dB		
OCNG_RB ^{Note1}	dB		
\hat{E}_s / I_{ot}	dB	4	
N_{oc} ^{Note 2}	dBm/15 kHz	-98 (AWGN)	
\hat{E}_s / N_{oc}	dB	4	
RSRP ^{Note 3}	dBm/15kHz z	-94	
Propagation Condition		AWGN	
Note 1: OCNG shall be used such that cell 1 is fully allocated and a constant total transmitted power spectral density is achieved for all OFDM symbols. Note 2: Interference from other cells and noise sources not specified in the test is assumed to be constant over subcarriers and time and shall be modelled as AWGN of appropriate power for N_{oc} to be fulfilled. Note 3: RSRP levels have been derived from other parameters for information purposes. They are not settable parameters themselves.			

Table A.5.2.3.1 - 3: Cell Specific Parameters for Handover from E-UTRAN FDD to GSM cell case (cell 2)

Parameter	Unit	Cell 2 (GSM)	
		T1	T2, T3
Absolute RF Channel Number		ARFCN 1	
RXLEV	dBm	-85	-75

A.5.2.3.2 Test Requirements

The UE shall begin to send access bursts on the new DCCH of the target cell less than 100 ms from the beginning of time period T3.

The rate of correct handovers observed during repeated tests shall be at least 90%.

NOTE: The test requirement in this test case is expressed as:

$$T_{\text{Handover delay}} = 90 \text{ ms (Table 5.3.3.2.1-1)} + T_{\text{offset}} + T_{\text{UL}}$$

T_{offset} : Equal to 4.65 ms, GSM timing uncertainty between the time from when the UE is ready to transmit until the start of the next timeslot in GSM 26 multiframe structure

T_{UL} : Equal to 4.65 ms, the time the UE has to wait in case the next timeslot is an idle frame or a SACCH frame.

This gives a total of 99.3 ms, allow 100 ms in the test case.

A.5.2.4 E-UTRAN TDD - UTRAN TDD Handover

A.5.2.4.1 Test Purpose and Environment

A.5.2.4.1.1 Void

A.5.2.4.1.2 1.28 Mcps TDD option

This test is to verify the requirement for E-UTRAN TDD to UTRAN TDD handover requirements specified in clause 5.3.2.

The test scenario comprises of 1 E-UTRA TDD cell and 1 UTRA TDD cell as given in tables Table A.5.2.4.1.2-1, Table A.5.2.4.1.2-2, and Table A.5.2.4.1.2-3. Gap pattern configuration #0 as defined in table 8.1.2.1-1 is provided.

The test consists of three successive time periods, with time durations of T1, T2 and T3 respectively.

E-UTRAN shall send a RRC message implying handover to UE. The RRC message implying handover shall be sent to the UE during period T2, after the UE has reported Event B2. The end of the last TTI containing handover message is begin of T3 duration.

Table A.5.2.4.1.2-1: General test parameters for E-UTRA TDD to UTRA(1.28 Mcps TDD OPTION) handover test case

Parameter		Unit	Value	Comment
PDSCH parameters			DL Reference Measurement Channel R.0 TDD	As specified in clause A.3.1.1.2
PCFICH/PDCCH/PHICH parameters			DL Reference Measurement Channel R.6 TDD	As specified in clause A.3.1.2.2
Initial conditions	Active cell		Cell 1	E-UTRA TDD cell
	Neighbour cell		Cell 2	UTRA 1.28Mcps TDD Cell
Final conditions	Active cell		Cell 2	
Gap Pattern Id			0	As specified in TS 36.133 clause 8.1.2.1.
Uplink-downlink configuration of cell 1			1	As specified in table 4.2.2 in TS 36.211
Special subframe configuration of cell 1			6	As specified in table 4.2.1 in TS 36.211
CP length of cell 1			Normal	
Time offset between cells			3 ms	Asynchronous cells
Access Barring Information			Not Sent	No additional delays in random access procedure.
Assigned Sub-Channel Number			1	No additional delays in random access procedure due to ASC.
Hysteresis	dB		0	
Time To Trigger	s		0	
Filter coefficient			0	L3 filtering is not used
DRX			OFF	
Ofn	dB		0	
Thresh1	dBm		-93	E-UTRA event B2 threshold
Thresh2	dBm		-80	UTRA event B2 threshold
T1	s		5	
T2	s		≤10	
T3	s		1	

Table A.5.2.4.1.2-2: Cell specific test parameters for E-UTRA TDD to UTRA TDD handover test case (cell 1)

Parameter	Unit	Cell 1		
		T1	T2	T3
E-UTRA RF Channel Number		1		
BW _{channel}	MHz	10		

OCNG Pattern defined in A.3.2.2.1 (OP.1 TDD) and in A.3.2.1.2 (OP.2 TDD)		OP.1 TDD		OP.2 TDD
PBCH_RA	dB	0	0	0
PBCH_RB	dB			
PSS_RA	dB			
SSS_RA	dB			
PCFICH_RB	dB			
PHICH_RA	dB			
PHICH_RB	dB			
PDCCH_RA	dB			
PDCCH_RB	dB			
PDSCH_RA	dB			
PDSCH_RB	dB			
OCNG_RA ^{Note 1}	dB			
OCNG_RB ^{Note 1}	dB			
\hat{E}_s / I_{ot}	dB	13	-3	-3
\hat{E}_s / N_{oc}	dB	13	-3	-3
N_{oc}	dBm/15kHz	-98		
RSRP ^{Note 2}	dBm/15kHz	-85	-101	-101
SCH_RP ^{Note 2}	dBm/15 kHz	-85	-101	-101
I_o ^{Note 2}	dBm/9MHz	-57.01	-68.45	-68.45
Propagation Condition		AWGN		
<p>Note 1: OCNG shall be used such that cell is fully allocated and a constant total transmitted power spectral density is achieved for all OFDM symbols.</p> <p>Note 2: RSRP, SCH_RP and I_o levels have been derived from other parameters for information purposes. They are not settable parameters themselves</p>				

Table A.5.2.4.1.2-3: Cell specific test parameters for cell search E-UTRA to UTRA case (cell 2)

Parameter	Unit	Cell 2 (UTRA)					
Timeslot Number		0			DwPTS		
		T1	T2	T3	T1	T2	T3
UTRA RF Channel Number ^{Note 21}		Channel 2					
PCCPCH_Ec/Ior	dB	-3					
DwPCH_Ec/Ior	dB				0		
OCNS_Ec/Ior	dB	-3					
\hat{I}_{or} / I_{oc}	dB	-3	11	11	-3	11	11
I_{oc}	dBm/1.28 MHz	-80					
PCCPCH RSCP ^{Note 2}	dBm	-86	-72	-72	n.a.		
I_o ^{Note 2}	dBm/1.28 MHz	-78.24	-68.67	-68.67			
Propagation Condition		AWGN					
<p>Note 1: In the case of multi-frequency cell, the UTRA RF Channel Number is the primary frequency's channel number.</p> <p>Note 2: PCCPCH_RSCP and I_o levels have been derived from other parameters for information purposes. They are not settable parameters themselves.</p>							

A.5.2.4.1.3 Void

A.5.2.4.2 Test Requirements

A.5.2.4.2.1 Void

A.5.2.4.2.2 1.28 Mcps TDD option

The UE shall start to transmit the SYNCH-UL sequence in the UpPTS to Cell 2 less than 120 ms from the beginning of time period T3.

The rate of correct handovers observed during repeated tests shall be at least 90%.

NOTE: The handover delay can be expressed as: RRC procedure delay + $T_{\text{interrupt}}$, where:

RRC procedure delay = 50 ms, which is specified in clause 5.3.2.2.1.

$T_{\text{interrupt}}$ is defined in clause 5.3.2.2.2. $T_{\text{interrupt}} = 70$ ms in the test as following:

$$T_{\text{interrupt}} = T_{\text{offset}} + T_{\text{UL}} + 30 * F_{\text{SFN}} + 20 \text{ ms}$$

$$T_{\text{offset}} = 10 \text{ ms}; T_{\text{UL}} = 10 \text{ ms}; \text{ and } F_{\text{SFN}} = 1 \text{ for UE decoding SFN.}$$

This gives a total of 120 ms.

A.5.2.4.2.3 Void

A.5.2.5 E-UTRAN FDD – UTRAN TDD Handover

A.5.2.5.1 Test Purpose and Environment

A.5.2.5.1.1 Void

A.5.2.5.1.2 1.28 Mcps TDD option

This test is to verify the requirement for the E-UTRAN FDD to UTRAN TDD handover requirements specified in clause 5.3.2.

The test scenario comprises of two cells, E-UTRA TDD cell1 and UTRA TDD cell2. The test consists of three successive time periods, with time durations of T1, T2 and T3 respectively. At the start of time duration T1, the UE does not have any timing information of Cell 2. Starting T2, Cell 2 becomes detectable and the UE is expected to detect and send a measurement report. Gap pattern configuration with id #1 as specified in Table 8.1.2.1-1 is configured before T2 begins to enable inter-RAT frequency monitoring. The test parameters are given in Tables A.5.2.5.1-1, A.5.2.5.1-2 and A.5.2.5.1-3.

A RRC message implying handover shall be sent to the UE during period T2, after the UE has reported Event B2. The start of T3 is the instant when the last TTI containing the RRC message implying handover is sent to the UE. The handover message shall contain cell 2 as the target cell.

Table A.5.2.5.1.2-1: General test parameters for E-UTRA FDD to UTRA (1.28 Mcps TDD option) handover test case

Parameter		Unit	Value	Comment
PDSCH parameters			DL Reference Measurement Channel R.0 FDD	As specified in clause A.3.1.1.1
PCFICH/PDCCH/PHICH parameters			DL Reference Measurement Channel R.6 FDD	As specified in clause A.3.1.2.1
Initial conditions	Active cell		Cell 1	E-UTRA FDD cell
	Neighbour cell		Cell 2	UTRA 1.28Mcps TDD Cell
Final conditions	Active cell		Cell 2	
Gap Pattern Id			1	As specified in TS 36.133 clause 8.1.2.1.

E-UTRAN FDD measurement quantity		RSRP	
UTRAN TDD measurement quantity		RSCP	
CP length of cell 1		Normal	
Access Barring Information		Not Sent	No additional delays in random access procedure.
Assigned Sub-Channel Number		1	No additional delays in random access procedure due to ASC.
Hysteresis	dB	0	
Time To Trigger	s	0	
Filter coefficient		0	L3 filtering is not used
DRX		OFF	
Ofn	dB	0	
Thresh1	dBm	-93	Absolute E-UTRAN RSRP threshold for event B2
Thresh2	dBm	-80S	Absolute UTRAN RSCP threshold for event B2
T1	s	5	
T2	s	≤ 10	
T3	s	1	

Table A.5.2.5.1.2-2: Cell specific test parameters for E-UTRAN FDD to UTRAN (1.28 Mcps TDD option) handover test case (cell 1)

Parameter	Unit	Cell 1 (E-UTRA)		
		T1	T2	T3
E-UTRA RF Channel number		1		
BW _{channel}	MHz	10		
OCNG Patterns defined in A.3.2.1.1 (OP.1 FDD) and in A.3.2.1.2 (OP.2 FDD)		OP.1 FDD	OP.1 FDD	OP.2 FDD
PBCH_RA	dB	0		
PBCH_RB	dB			
PSS_RA	dB			
SSS_RA	dB			
PCFICH_RB	dB			
PHICH_RA	dB			
PHICH_RB	dB			
PDCCH_RA	dB			
PDCCH_RB	dB			
PDSCH_RA	dB			
PDSCH_RB	dB			
OCNG_RA ^{Note 1}	dB			
OCNG_RB ^{Note 1}	dB			
\hat{E}_s / N_{oc}	dB			
N_{oc}	dBm/15 kHz	-98		
\hat{E}_s / I_{ot}	dB	13	-3	-3
RSRP ^{Note 2}	dBm/15 KHz	-85	-101	-101
I _o ^{Note 2}	dBm/9MHz	-57.01	-68.45	-68.45
Propagation Condition		AWGN		
Note 1: OCNG shall be used such that both cells are fully allocated and a constant total transmitted power spectral density is achieved for all OFDM symbols. Note 2: RSRP and I _o levels have been derived from other parameters for information purposes. They are not settable parameters themselves				

Table A.5.2.5.1.2-3: Cell specific test parameters for E-UTRAN FDD to UTRAN (1.28 Mcps TDD option) handover test case (cell 2)

Parameter	Unit	Cell 2 (UTRA)
-----------	------	---------------

Timeslot Number		0			DwPTS		
		T1	T2	T3	T1	T2	T3
UTRA RF Channel Number <small>Note 21</small>		Channel 2					
PCCPCH_Ec/Ior	dB	-3					
DwPCH_Ec/Ior	dB				0		
OCNS_Ec/Ior	dB	-3					
\hat{I}_{or}/I_{oc}	dB	-3	11	11	-3	11	11
I_{oc}	dBm/1.28 MHz	-80					
PCCPCH_RSCP <small>Note 2</small>	dBm	-86	-72	-72	n.a.		
I_o <small>Note 2</small>	dBm/1.28 MHz	-78.24	-68.67	-68.67			
Propagation Condition		AWGN					
<p>Note 1: In the case of multi-frequency cell, the UTRA RF Channel Number is the primary frequency's channel number.</p> <p>Note 2: PCCPCH_RSCP and I_o levels have been derived from other parameters for information purposes. They are not settable parameters themselves.</p>							

A.5.2.5.1.3 Void

A.5.2.5.2 Test Requirements

A.5.2.5.2.1 Void

A.5.2.5.2.2 1.28 Mcps TDD option

The UE shall start to transmit the SYNCH-UL sequence in the UpPTS to Cell 2 less than 120 ms from the beginning of time period T3.

The rate of correct handovers observed during repeated tests shall be at least 90%.

NOTE: The handover delay can be expressed as: RRC procedure delay + $T_{\text{interrupt}}$, where:

RRC procedure delay = 50 ms, which is specified in clause 5.3.2.2.1.

$T_{\text{interrupt}}$ is defined in clause 5.3.2.2.2. $T_{\text{interrupt}} = 70$ ms in the test as following:

$$T_{\text{interrupt}1} = T_{\text{offset}} + T_{\text{UL}} + 30 * F_{\text{SFN}} + 20 \text{ ms}$$

$$T_{\text{offset}} = 10 \text{ ms}; T_{\text{UL}} = 10 \text{ ms}; \text{ and } F_{\text{SFN}} = 1 \text{ for UE decoding SFN.}$$

This gives a total of 120 ms.

A.5.2.5.2.3 Void

A.5.2.6 E-UTRAN TDD - GSM Handover

A.5.2.6.1 Test Purpose and Environment

This test is to verify the requirement for the E-UTRAN to GSM cell handover delay specified in clause 5.3.3.

The test parameters are given in Table A.5.2.6.1-1, A.5.2.6.1-2 and A.5.2.6.1-3 below. In the measurement control information it is indicated to the UE that event-triggered reporting with Event B1 shall be used. The test consists of three successive time periods, with time duration of T1, T2 and T3 respectively. At the start of time duration T1, the UE may not have any timing information of cell 2.

The RRC message implying handover to cell 2 shall be sent to the UE during period T2, after the UE has reported Event B1. The start of T3 is defined as the end of last E-UTRAN TTI containing the RRC message implying handover.

The requirements are also applicable for a UE not requiring measurement gap, in which case no measurement gap pattern should be sent for the parameters specified in Table A.5.2.6.1-1.

Table A.5.2.6.1-1: General test parameters for E-UTRAN TDD to GSM neighbours handover test case in AWGN propagation condition

Parameter		Unit	Value	Comment
PDSCH parameters			DL Reference Measurement Channel R.0 TDD	As specified in clause A.3.1.1.2
PCFICH/PDCCH/PHICH parameters			DL Reference Measurement Channel R.6 TDD	As specified in clause A.3.1.2.2
Gap Pattern Id			1	As specified in TS 36.133 clause 8.1.2.1.
Initial conditions	Active cell		Cell 1	
	Neighbour cell		Cell 2	
Final conditions	Active cell		Cell 2	
Uplink-downlink configuration of cell 1			1	As specified in table 4.2.2 in TS 36.211
Special subframe configuration of cell 1			6	As specified in table 4.2.1 in TS 36.211
CP length of cell 1			Normal	
Inter-RAT measurement quantity			GSM Carrier RSSI	
E-UTRA RF Channel Number			1	E-UTRA RF Channel Number
E-UTRA Channel Bandwidth ($BW_{channel}$)		MHz	10	E-UTRA Channel Bandwidth ($BW_{channel}$)
Threshold other system		dBm	-80	Absolute GSM carrier RSSI threshold for event B1.
Hysteresis		dB	0	
Time to Trigger		ms	0	
Filter coefficient			0	L3 filtering is not used
DRX			OFF	
T1		s	20	
T2		s	7	
T3		s	1	

Table A.5.2.6.1-2: Cell Specific Parameters for Handover E- UTRAN TDD to GSM handover test case

Parameter	Unit	Cell 1			
		T1, T2	T3		
E-UTRA RF Channel Number		1			
$BW_{channel}$	MHz	10			
OCNG Patterns defined in A.3.2.2.1 (OP.1 TDD) and in A.3.2.2.2 (OP.2 TDD)		OP.1 TDD	OP.2 TDD		
PBCH_RA	dB	0			
PBCH_RB	dB				
PSS_RA	dB				
SSS_RA	dB				
PCFICH_RB	dB				
PHICH_RA	dB				
PHICH_RB	dB				
PDCCH_RA	dB				
PDCCH_RB	dB				
PDSCH_RA	dB				
PDSCH_RB	dB				
OCNG_RA ^{Note1}	dB				
OCNG_RB ^{Note1}	dB				
\hat{E}_s / N_{oc}	dB			4	
N_{oc} ^{Note 2}	dBm/15 kHz			-98 (AWGN)	
\hat{E}_s / I_{ot}	dB			4	
RSRP ^{Note 3}	dBm/15kHz	-94			
Propagation Condition		AWGN			

NOTE 1: OCNB shall be used such that cell 1 is fully allocated and a constant total transmitted power spectral density is achieved for all OFDM symbols.

NOTE 2: Interference from other cells and noise sources not specified in the test is assumed to be constant over subcarriers and time and shall be modelled as AWGN of appropriate power for N_{oc} to be fulfilled.

NOTE 3: RSRP levels have been derived from other parameters for information purposes. They are not settable parameters themselves.

Table A.5.2.6.1-3: Cell Specific Parameters for Handover E-UTRAN to GSM cell case (cell 2)

Parameter	Unit	Cell 2 (GSM)	
		T1	T2, T3
Absolute RF Channel Number		ARFCN 1	
RXLEV	dBm	-85	-75

A.5.2.6.2 Test Requirements

The UE shall begin to send access bursts on the new DCCH of the target cell less than 100 ms from the beginning of time period T3.

The rate of correct handovers observed during repeated tests shall be at least 90%.

NOTE: The test requirement in this test case is expressed as:

$$T_{\text{Handover delay}} = 90 \text{ ms (Table 5.3.3.2.1-1)} + T_{\text{offset}} + T_{\text{UL}}$$

T_{offset} : Equal to 4.65 ms, GSM timing uncertainty between the time from when the UE is ready to transmit until the start of the next timeslot in GSM 26 multiframe structure

T_{UL} : Equal to 4.65 ms, the time the UE has to wait in case the next timeslot is an idle frame or a SACCH frame.

This gives a total of 99.3 ms, allow 100 ms in the test case.

A.5.2.7 E-UTRAN FDD – UTRAN FDD Handover; Unknown Target Cell

A.5.2.7.1 Test Purpose and Environment

This test is to verify the requirement for the E-UTRAN FDD to UTRAN FDD handover requirements for the case when the target cell is unknown as specified in clause 5.3.1.

The test parameters are given in Tables A.5.2.7.1-1, A.5.2.7.1-2 and A.5.2.7.1-3. The test consists of two successive time periods, with time durations of T1, T2. At the start of time duration T1, the UE does not have any timing information of Cell 2. Starting T2, cell 2 becomes detectable and the UE receives a RRC handover command from the network. The start of T2 is the instant when the last TTI containing the RRC message implying handover is sent to the UE. No Gap pattern configuration shall be used.

Table A.5.2.7.1-1: General test parameters for E-UTRAN FDD to UTRAN FDD handover test case

Parameter		Unit	Value	Comment
PDSCH parameters			DL Reference Measurement Channel R.0 FDD	As specified in clause A.3.1.1.1
PCFICH/PDCCH/PHICH parameters			DL Reference Measurement Channel R.6 FDD	As specified in clause A.3.1.2.1
Initial conditions	Active cell		Cell 1	E-UTRAN cell
	Neighbouring cell		Cell 2	UTRAN cell
Final condition	Active cell		Cell 2	UTRAN cell
Channel Bandwidth (BW_{channel})		MHz	10	
E-UTRAN FDD measurement quantity			RSRP	
Inter-RAT (UTRAN FDD) measurement quantity			CPICH E_c/N_0	
DRX			OFF	Non-DRX test

Access Barring Information	-	Not sent	No additional delays in random access procedure
E-UTRA RF Channel Number		1	One E-UTRA FDD carrier frequency is used.
E-UTRA Channel Bandwidth (BWchannel)	MHz	10	
UTRA RF Channel Number		1	One UTRA FDD carrier frequency is used.
Monitored UTRA FDD cell list size		12	UTRA cells on UTRA RF channel 1 provided in the cell before T2.
Post-verification period		False	
T1	s	≤5	
T2	s	1	

Table A.5.2.7.1-2: Cell specific test parameters for E-UTRAN FDD to UTRAN FDD handover test case (cell 1)

Parameter	Unit	Cell 1 (E-UTRA)	
		T1	T2
E-UTRA RF Channel number		1	
BW _{channel}	MHz	10	
OCNG Patterns defined in A.3.2.1.1 (OP.1 FDD) and in A.3.2.1.2 (OP.2 FDD)		OP.1 FDD	OP.2 FDD
PBCH_RA	dB	0	
PBCH_RB	dB		
PSS_RA	dB		
SSS_RA	dB		
PCFICH_RB	dB		
PHICH_RA	dB		
PHICH_RB	dB		
PDCCH_RA	dB		
PDCCH_RB	dB		
PDSCH_RA	dB		
PDSCH_RB	dB		
OCNG_RA ^{Note 1}	dB		
OCNG_RB ^{Note 1}	dB		
\hat{E}_s / I_{ot}	dB		
N_{oc} ^{Note 2}	dBm/15 kHz	-98	
\hat{E}_s / N_{oc}	dB	0	0
RSRP ^{Note 3}	dBm/15 KHz	-98	-98
Propagation Condition		AWGN	
<p>Note 1: OCNG shall be used such that both cells are fully allocated and a constant total transmitted power spectral density is achieved for all OFDM symbols.</p> <p>Note 2: Interference from other cells and noise sources not specified in the test is assumed to be constant over subcarriers and time and shall be modelled as AWGN of appropriate power for N_{oc} to be fulfilled.</p> <p>Note 3: RSRP levels have been derived from other parameters for information purposes. They are not settable parameters themselves.</p>			

Table A.5.2.7.1-3: Cell specific test parameters for E-UTRAN FDD to UTRAN FDD handover test case (cell 2)

Parameter	Unit	Cell 2 (UTRA)	
		T1	T2
CPICH_Ec/I _{or}	dB	-10	
PCCPCH_Ec/I _{or}	dB	-12	
SCH_Ec/I _{or}	dB	-12	
PICH_Ec/I _{or}	dB	-15	
DCH_Ec/I _{or}	dB	Note 1	
OCNS_Ec/I _{or}	dB	Note 2	
\hat{I}_{or} / I_{oc}	dB	-infinity	-1.8
I_{oc}	dBm/3,84 MHz	-70	-70
CPICH_Ec/I _o	dB	-infinity	-14
Propagation Condition		AWGN	
<p>Note 1: The DPCH level is controlled by the power control loop</p> <p>Note 2: The power of the OCNS channel that is added shall make the total power from the cell to be equal to I_{or}.</p>			

A.5.2.7.2 Test Requirements

The UE shall start to transmit the UL DPCCCH to Cell 2 less than 290 ms from the beginning of time period T2.

The rate of correct handovers observed during repeated tests shall be at least 90%.

NOTE: The handover delay can be expressed as: RRC procedure delay + $T_{interrupt}$, where:

RRC procedure delay is 50ms. See clause 5.3.1.1.1.

$T_{interrupt}$ is 240ms. See clause 5.3.1.1.2.

This gives a total of 290ms in the test case.

A.5.2.8 E-UTRAN FDD - GSM Handover; Unknown Target Cell

A.5.2.8.1 Test Purpose and Environment

This test is to verify the E-UTRAN FDD to GSM handover requirements for the case when the target GSM cell is unknown as specified in clause 5.3.3.

The test parameters are given in Table A.5.2.8.1-1, A.5.2.8.1-2 and A.5.2.8.1-3 below. The test consists of two successive time periods, with time duration of T1, T2 respectively. At the start of time duration T1, the UE will not have any timing information of cell 2. Starting T2, cell 2 becomes detectable and the UE receives a RRC handover command from the network. The start of T2 is the instant when the last TTI containing the RRC message implying handover is sent to the UE. No Gap pattern configuration shall be used.

Table A.5.2.8.1-1: General test parameters for E-UTRAN FDD to GSM handover test case; unknown target cell

Parameter		Unit	Value	Comment
PDSCH parameters			DL Reference Measurement Channel R.0 FDD	As specified in clause A.3.1.1.1
PCFICH/PDCCH/PHICH parameters			DL Reference Measurement Channel R.6 FDD	As specified in clause A.3.1.2.1
Gap Pattern Id			None	No measurement gaps shall be provided.
Initial conditions	Active cell		Cell 1	
	Neighbour cell		Cell 2	
Final conditions	Active cell		Cell 2	
DRX			OFF	No DRX configured
T1		s	7	
T2		s	1	

Table A.5.2.8.1 - 2: Cell specific parameters for cell # 1 in E-UTRAN FDD to GSM handover test case; unknown target cell

Parameter	Unit	Cell 1	
		T1	T2
BW _{channel}	MHz	10	
OCNG Patterns defined in A.3.2.1.1 (OP.1 FDD) and in A.3.2.1.2 (OP.2 FDD)		OP.1 FDD	OP.2 FDD
PBCH_RA	dB	0	
PBCH_RB	dB		
PSS_RA	dB		
SSS_RA	dB		
PCFICH_RB	dB		
PHICH_RA	dB		
PHICH_RB	dB		
PDCCH_RA	dB		
PDCCH_RB	dB		
PDSCH_RA	dB		
PDSCH_RB	dB		
OCNG_RA ^{Note1}	dB		
OCNG_RB ^{Note1}	dB		
\hat{E}_s/I_{ot}	dB		
N_{oc} ^{Note 2}	dBm/15 kHz	-98	
\hat{E}_s/N_{oc}	dB	4	
RSRP ^{Note 3}	dBm/15 kHz	-94	
Propagation Condition		AWGN	
Note 1: OCNG shall be used such that cell 1 is fully allocated and a constant total transmitted power spectral density is achieved for all OFDM symbols. Note 2: Interference from other cells and noise sources not specified in the test is assumed to be constant over subcarriers and time and shall be modelled as AWGN of appropriate power for N_{oc} to be fulfilled. Note 3: RSRP levels have been derived from other parameters for information purposes. They are not settable parameters themselves.			

Table A.5.2.8.1-3: Cell specific parameters for cell # 2 in E-UTRAN FDD to GSM handover test case; unknown target cell

Parameter	Unit	Cell 2 (GSM)	
		T1	T2
Absolute RF Channel Number		ARFCN 1	
RXLEV	dBm	-Infinity	-75

A.5.2.8.2 Test Requirements

The UE shall begin to send access bursts on the new DCCH of the target cell less than 200 ms from the beginning of time period T2.

The rate of correct handovers observed during repeated tests shall be at least 90%.

NOTE: The test requirement in this test case is expressed as:

$$T_{\text{Handover delay}} = 190 \text{ ms (Table 5.3.3.2.1-1)} + T_{\text{offset}} + T_{\text{UL}}$$

T_{offset}: Equal to 4.65 ms is the GSM timing uncertainty from the time when the UE is ready to transmit until the start of the next timeslot in GSM 26 multiframe structure

T_{UL} : Equal to 4.65 ms is the time the UE has to wait in case the next timeslot is an idle frame or a SACCH frame.

This gives a total of 199.3 ms, allow 200 ms in the test case.

A.5.2.9 E-UTRAN TDD - GSM Handover; Unknown Target Cell

A.5.2.9.1 Test Purpose and Environment

This test is to verify the E-UTRAN TDD to GSM handover requirements for the case when the target GSM cell is unknown as specified in clause 5.3.3.

The test parameters are given in Table A.5.2.9.1 -1, A.5.2.9.1 -2 and A.5.2.9.1 -3 below. The test consists of two successive time periods, with time duration of T1, T2 respectively. At the start of time duration T1, the UE will not have any timing information of cell 2. Starting T2, cell 2 becomes detectable and the UE receives a RRC handover command from the network. The start of T2 is the instant when the last TTI containing the RRC message implying handover is sent to the UE. No Gap pattern configuration shall be used.

Table A.5.2.9.1-1: General test parameters for E-UTRAN TDD to GSM handover test case; unknown target cell

Parameter		Unit	Value	Comment
PDSCH parameters			DL Reference Measurement Channel R.0 TDD	As specified in clause A.3.1.1.2
PCFICH/PDCCH/PHICH parameters			DL Reference Measurement Channel R.6 TDD	As specified in clause A.3.1.2.2
Gap Pattern Id			None	No measurement gaps shall be provided.
Initial conditions	Active cell		Cell 1	
	Neighbour cell		Cell 2	
Final conditions	Active cell		Cell 2	
DRX			OFF	No DRX configured
Special subframe configuration			6	As specified in table 4.2-1 in TS 36.211
Uplink-downlink configuration			1	As specified in table 4.2-2 in TS 36.211
T1		s	7	
T2		s	1	

Table A.5.2.9.1 - 2: Cell specific parameters for cell # 1 in E-UTRAN TDD to GSM handover test case; unknown target cell

Parameter	Unit	Cell 1	
		T1	T2
BW _{channel}	MHz	10	
OCNG Patterns defined in A.3.2.2.1 (OP.1 TDD) and in A.3.2.2.2 (OP.2 TDD)		OP.1 TDD	OP.2 TDD
PBCH_RA	dB	0	
PBCH_RB	dB		
PSS_RA	dB		
SSS_RA	dB		
PCFICH_RB	dB		
PHICH_RA	dB		
PHICH_RB	dB		
PDCCH_RA	dB		
PDCCH_RB	dB		
PDSCH_RA	dB		
PDSCH_RB	dB		
OCNG_RA ^{Note1}	dB		
OCNG_RB ^{Note1}	dB		
\hat{E}_s/I_{ot}	dB		
N_{oc} ^{Note 2}	dBm/15 kHz	-98	
\hat{E}_s/N_{oc}	dB	4	
RSRP ^{Note 3}	dBm/15 kHz	-94	
Propagation Condition		AWGN	
Note 1: OCNG shall be used such that cell 1 is fully allocated and a constant total transmitted power spectral density is achieved for all OFDM symbols. Note 2: Interference from other cells and noise sources not specified in the test is assumed to be constant over subcarriers and time and shall be modelled as AWGN of appropriate power for N_{oc} to be fulfilled. Note 3: RSRP levels have been derived from other parameters for information purposes. They are not settable parameters themselves.			

Table A.5.2.9.1 - 3: Cell specific parameters for cell # 2 in E-UTRAN TDD to GSM handover test case; unknown target cell

Parameter	Unit	Cell 2 (GSM)	
		T1	T2
Absolute RF Channel Number		ARFCN 1	
RXLEV	dBm	-Infinity	-75

A.5.2.9.2 Test Requirements

The UE shall begin to send access bursts on the new DCCH of the target cell less than 200 ms from the beginning of time period T2.

The rate of correct handovers observed during repeated tests shall be at least 90%.

NOTE: The test requirement in this test case is expressed as:

$$T_{\text{Handover delay}} = 190 \text{ ms (Table 5.3.3.2.1-1)} + T_{\text{offset}} + T_{\text{UL}}$$

T_{offset}: Equal to 4.65 ms is the GSM timing uncertainty from the time when the UE is ready to transmit until the start of the next timeslot in GSM 26 multiframe structure

T_{UL} : Equal to 4.65 ms is the time the UE has to wait in case the next timeslot is an idle frame or a SACCH frame.

This gives a total of 199.3 ms, allow 200 ms in the test case.

A.5.2.10 E-UTRAN TDD to UTRAN TDD handover: unknown target cell

A.5.2.10.1 Test Purpose and Environment

This test is to verify the requirement for E-UTRAN TDD to UTRAN TDD handover requirements specified in clause 5.3.2 when the target UTRAN TDD cell is unknown.

The test scenario comprises of 1 E-UTRAN TDD cell and 1 UTRAN TDD cell as given in tables A.5.2.10.1-1, A.5.2.10.1-2, and A.5.2.10.1-3. No gap pattern is configured in the test case.

The test consists of two successive time periods, with time durations of T1 and T2 respectively. During time duration T1, a RRC message implying handover to UTRA 1.28Mcps TDD cell shall be sent to the UE. The end of the last TTI containing handover message is the beginning of T2 duration.

Table A.5.2.10.1-1: General test parameters for E-UTRAN TDD to unknown UTRAN TDD cell handover test case

Parameter		Unit	Value	Comment
PDSCH parameters			DL Reference Measurement Channel R.0 TDD	As specified in clause A.3.1.1.2
PCFICH/PDCCH/PHICH parameters			DL Reference Measurement Channel R.6 TDD	As specified in clause A.3.1.2.2
Initial conditions	Active cell		Cell 1	E-UTRAN TDD cell
	Neighbour cell		Cell 2	UTRA 1.28Mcps TDD cell
Final conditions	Active cell		Cell 2	UTRA 1.28Mcps TDD cell
CP length of cell 1			Normal	
Uplink-downlink configuration of cell 1			1	As specified in table 4.2.2 in TS 36.211
Special subframe configuration of cell 1			6	As specified in table 4.2.1 in TS 36.211
Time offset between cells			3 ms	Asynchronous cells
Access Barring Information			Not Sent	No additional delays in random access procedure.
Assigned Sub-Channel Number			1	No additional delays in random access procedure due to ASC.
TimeToTrigger		s	0	
Filter coefficient			0	L3 filtering is not used
DRX			OFF	
T1		s	5	During T1, cell 2 shall be powered off, and during the off time the physical layer cell identity shall be changed.
T2		s	1	

Table A.5.2.10.1-2: Cell specific test parameters for E-UTRAN TDD to unknown UTRAN TDD cell handover test case (cell 1)

Parameter	Unit	Cell 1	
		T1	T2
E-UTRA RF Channel Number		1	
BWchannel	MHz	10	
OCNG Patterns defined in TS36.133 A.3.2.2.1 (OP.1 TDD) and in A.3.2.2.2 (OP.2 TDD)		OP.1 TDD	OP.2 TDD
PBCH_RA	dB	0	0
PBCH_RB	dB		

PSS_RA	dB		
SSS_RA	dB		
PCFICH_RB	dB		
PHICH_RA	dB		
PHICH_RB	dB		
PDCCH_RA	dB		
PDCCH_RB	dB		
PDSCH_RA	dB		
PDSCH_RB	dB		
OCNG_RANote 1	dB		
OCNG_RBNote 1	dB		
\hat{E}_s/I_{ot}	dB	3	3
\hat{E}_s/N_{oc}	dB	3	3
N_{oc}	dBm/15kHz	-98	
RSRP	dBm/15kHz	-95	-95
SCH_RP	dBm/15 kHz	-95	-95
Propagation Condition		AWGN	
Note 1:	OCNG shall be used such that cell is fully allocated and a constant total transmitted power spectral density is achieved for all OFDM symbols.		
Note 2:	RSRP and SCH_RP levels have been derived from other parameters for information purposes. They are not settable parameters themselves.		

Table A.5.2.10.1-3: Cell specific test parameters for E-UTRAN TDD to unknown UTRAN TDD cell test case (cell 2)

Parameter	Unit	Cell 2 (UTRA)			
		0		DwPTS	
Timeslot Number		T1	T2	T1	T2
UTRA RF Channel Number ^{Note1}		Channel 2			
PCCPCH_Ec/lor	dB	-3			
DwPCH_Ec/lor	dB			0	
OCNS_Ec/lor	dB	-3			
\hat{I}_{or}/I_{oc}	dB	-infinity	13	-infinity	13
I_{oc}	dBm/1.28 MHz	-80			
PCCPCH RSCP	dBm	-infinity	-70	n.a.	
Propagation Condition		AWGN			
Note1:	In the case of multi-frequency cell, the UTRA RF Channel Number is the primary frequency's channel number.				
Note2:	P-CCPCH RSCP levels have been derived from other parameters for information purposes. They are not settable parameters themselves.				

A.5.2.10.2 Test Requirements

The UE shall start to transmit the SYNCH-UL sequence in the UpPTS to Cell 2 less than 280 ms from the beginning of time period T2.

The rate of correct handovers observed during repeated tests shall be at least 90%.

NOTE: The handover delay can be expressed as: RRC procedure delay + Tinterrupt, where:

RRC procedure delay = 50 ms, which is specified in clause 5.3.2.2.1.

Tinterrupt is defined in clause 5.3.2.2.2. Tinterrupt = 230 ms in the test as following:

$$T_{interrupt1} = T_{offset} + T_{UL} + 30 * F_{SFN} + 180 \text{ ms}$$

$T_{\text{offset}} = 10$ ms; $T_{\text{UL}} = 10$ ms; and $F_{\text{SFN}} = 1$ for UE decoding SFN.

This gives a total of 280 ms.

A.5.2.10A E-UTRAN FDD – UTRAN FDD Multicarrier Handover with two target cells

A.5.2.10A.1 Test Purpose and Environment

This test is to verify the requirement for the E-UTRAN FDD to UTRAN FDD handover requirements specified in clause 5.3.1 in a 2 cell multicarrier configuration. It is applicable to UEs that support DC-HSDPA, DB-DC-HSDPA and which do not support 3C-HSDPA or 4C-HSDPA.

The test parameters are given in Tables A.5.2.10A.1-1, A.5.2.10A.1-2 and A.5.2.10A.1-3. The test consists of three successive time periods, with time durations of T1, T2 and T3 respectively. At the start of time duration T1, the UE does not have any timing information of Cell 2. Starting T2, Cell 2 and cell 3 become detectable and the UE is expected to detect and send a measurement report. Gap pattern configuration with id #0 as specified in Table 8.1.2.1-1 is configured before T2 begins to enable inter-RAT frequency monitoring.

A RRC message implying handover to cell 2 and cell 3 shall be sent to the UE during period T2, after the UE has reported Event B2. The start of T3 is the instant when the last TTI containing the RRC message implying handover is sent to the UE. The handover message shall contain cell 2 as the target Primary Serving HS-DSCH cell and cell 3 as the target Secondary Serving HS-DSCH cell.

Table A.5.2.10A.1-1: General test parameters for E-UTRAN FDD to UTRAN FDD handover test case

Parameter		Unit	Value	Comment
PDSCH parameters			DL Reference Measurement Channel R.0 FDD	As specified in clause A.3.1.1.1
PCFICH/PDCCH/PHICH parameters			DL Reference Measurement Channel R.6 FDD	As specified in clause A.3.1.2.1
Initial conditions	Active cell		Cell 1	E-UTRAN cell
	Neighbouring cell		Cell 2	UTRAN cell
Final condition	Active cell		Cell 2 and cell 3	UTRAN cell
Channel Bandwidth (BW_{channel})		MHz	10	
Gap Pattern Id			0	As specified in Table 8.1.2.1-1 started before T2 starts
E-UTRAN FDD measurement quantity			RSRP	
Inter-RAT (UTRAN FDD) measurement quantity			CPICH Ec/Io	
b2-Threshold1		dBm	-90	Absolute E-UTRAN RSRP threshold for event B2
b2-Threshold2-UTRA		dB	-18	Absolute UTRAN CPICH Ec/Io threshold for event B2
Hysteresis		dB	0	
TimeToTrigger		s	0	
Filter coefficient			0	L3 filtering is not used
DRX			OFF	Non-DRX test
Access Barring Information		-	Not sent	No additional delays in random access procedure
E-UTRA RF Channel Number			1	One E-UTRA FDD carrier frequency is used.
E-UTRA Channel Bandwidth (BW_{channel})		MHz	10	
UTRA RF Channel Number			1	One UTRA FDD carrier frequency is used.
Monitored UTRA FDD cell list size			12	UTRA cells on UTRA RF channel 1 provided in the cell before T2.
Post-verification period			False	
T1		s	5	
T2		s	≤ 5	
T3		s	1	

Table A.5.2.10A.1-2: Cell specific test parameters for E-UTRAN FDD to UTRAN FDD handover test case (cell 1)

Parameter	Unit	Cell 1 (E-UTRA)		
		T1	T2	T3
E-UTRA RF Channel number		1		
$BW_{channel}$	MHz	10		
OCNG Patterns defined in A.3.2.1.1 (OP.1 FDD) and in A.3.2.1.2 (OP.2 FDD)		OP.1 FDD	OP.1 FDD	OP.2 FDD
PBCH_RA	dB	0		
PBCH_RB	dB			
PSS_RA	dB			
SSS_RA	dB			
PCFICH_RB	dB			
PHICH_RA	dB			
PHICH_RB	dB			
PDCCH_RA	dB			
PDCCH_RB	dB			
PDSCH_RA	dB			
PDSCH_RB	dB			
OCNG_RA ^{Note 1}	dB			
OCNG_RB ^{Note 1}	dB			
\hat{E}_s / I_{ot}	dB	0	0	0
N_{oc}	dBm/15 kHz	-98		
\hat{E}_s / N_{oc}	dB	0	0	0
RSRP ^{Note 2}	dBm/15 KHz	-98	-98	-98
I_o ^{Note 2}	dBm/9 MHz	-67.21	-67.21	-67.21
Propagation Condition		AWGN		
Note 1: OCNG shall be used such that both cells are fully allocated and a constant total transmitted power spectral density is achieved for all OFDM symbols. Note 2: RSRP and I_o levels have been derived from other parameters for information purposes. They are not settable parameters themselves.				

Table A.5.2.10A.1-3: Cell specific test parameters for E-UTRAN FDD to UTRAN FDD multi carrier handover test case (cell 2 and cell 3)

		Cell 2			Cell 3		
		T1	T2	T3	T1	T2	T3
UTRA RF Channel Number		Channel 1			Channel 2		
Cell type		Primary Serving HS-DSCH Cell			Secondary Serving HS-DSCH Cell		
CPICH_Ec/Ior	dB	-10			-10		
PCCPCH_Ec/Ior	dB	-12			-12		
SCH_Ec/Ior	dB	-12			-12		
PICH_Ec/Ior	dB	-15			-15		
HS-SCCH_Ec/Ior	dB	-13			-13		
HS-DPDCH_Ec/Ior	dB	-10			-10		
DPCH_Ec/Ior	dB	Note 1			N/A		
OCNS		Note 2			-2.02		
\hat{I}_{or} / I_{oc}	dB	-Inf	-1.8	-1.8	-Inf	-1.8	-1.8
I_{oc}	dBm/3.84 MHz	-70					
Propagation Condition		AWGN			AWGN		
Note 1: The DPCH level is controlled by the power control loop Note 2: The power of the OCNS channel that is added shall make the total power from the cell to be equal to I_{or} Note 3: The UE shall be scheduled continuously with HS-DSCH data during T3 using both cell 2 and cell 3							

A.5.2.10A.2 Test Requirements

The UE shall start to transmit the UL DPCCCH to Cell 2 less than 210 ms from the beginning of time period T3.

The rate of correct handovers observed during repeated tests shall be at least 90%.

NOTE: The handover delay can be expressed as: RRC procedure delay + $T_{\text{interrupt}}$, where:

RRC procedure delay = 50 ms, which is specified in clause 5.3.1.1.1.

$T_{\text{interrupt}}$ = 160 ms in the test; $T_{\text{interrupt}}$ is defined in clause 5.3.1.1.2.

This gives a total of 210 ms.

A.5.2.10B E-UTRAN TDD – UTRAN FDD Multicarrier Handover with two target cells

A.5.2.10B.1 Test Purpose and Environment

This test is to verify the requirement for the E-UTRAN TDD to UTRAN FDD handover requirements specified in clause 5.3.1 in a 2 cell multicarrier configuration. It is applicable to UEs that support DC-HSDPA, DB-DC-HSDPA and which do not support 3C-HSDPA or 4C-HSDPA.

The test parameters are given in Tables A.5.2.10B.1-1, A.5.2.10B.1-2 and A.5.2.10B.1-3. The test consists of three successive time periods, with time durations of T1, T2 and T3 respectively. At the start of time duration T1, the UE does not have any timing information of Cell 2. Starting T2, Cell 2 and cell 3 become detectable and the UE is expected to detect and send a measurement report. Gap pattern configuration with id #0 as specified in Table 8.1.2.1-1 is configured before T2 begins to enable inter-RAT frequency monitoring.

A RRC message implying handover to cell 2 and cell 3 shall be sent to the UE during period T2, after the UE has reported Event B2. The start of T3 is the instant when the last TTI containing the RRC message implying handover is sent to the UE. The handover message shall contain cell 2 as the target Primary Serving HS-DSCH cell and cell 3 as the target Secondary Serving HS-DSCH cell.

Table A.5.2.10B.1-1: General test parameters for E-UTRAN TDD to UTRAN FDD handover test case

Parameter		Unit	Value	Comment
PDSCH parameters (E-UTRAN TDD)			DL Reference Measurement Channel R.0 TDD	As specified in clause A.3.1.1.2
PCFICH/PDCCH/PHICH parameters (E-UTRAN TDD)			DL Reference Measurement Channel R.6 TDD	As specified in clause A.3.1.2.2
Initial conditions	Active cell		Cell 1	Cell 1 is on E-UTRA RF channel number 1.
	Neighbour cell		Cell 2	Cell 2 is on UTRA RF channel number 1.
Final conditions	Active cell		Cell 2 and cell 3	
Special subframe configuration			6	As specified in table 4.2-1 in TS 36.211. Applicable to cell 1.
Uplink-downlink configuration			1	As specified in table 4.2-2 in TS 36.211. Applicable to cell 1
E-UTRAN TDD measurement quantity			RSRP	
Inter-RAT (UTRA FDD) measurement quantity			CPICH Ec/Io	
b2-Threshold1		dBm	-90	Absolute E-UTRAN RSRP threshold for event B2
b2-Threshold2-UTRA		dB	-18	UTRAN FDD CPICH Ec/Io threshold for event B2
Hysteresis		dB	0	
DRX			OFF	No DRX configured.
Time to Trigger		ms	0	
Filter coefficient			0	
CP length			Normal	Applicable to cell 1
Gap pattern configuration Id			0	As specified in Table 8.1.2.1-1; to start before T2 starts

E-UTRA RF Channel Number		1	One E-UTRA TDD carrier frequency is used.
E-UTRA Channel Bandwidth (BW _{channel})	MHz	10	
UTRA RF Channel Number		1	One UTRA FDD carrier frequency is used.
Monitored UTRA FDD cell list size		12	UTRA cells on UTRA RF channel 1 provided in the cell list before T2.
Post-verification period		False	Post verification is not used.
T1	s	5	
T2	s	≤5	
T3	s	1	

Table A.5.2.10B.1-2: Cell specific test parameters for E-UTRAN TDD to UTRAN FDD handover test case (cell 1)

Parameter	Unit	Cell 1 (E-UTRAN)		
		T1	T2	T3
E-UTRA RF Channel Number		1		
BW _{channel}	MHz	10		
OCNG Pattern defined in A.3.2.2.1 (OP.1 TDD) and in A.3.2.2.2 (OP.2 TDD)		OP.1 TDD		OP.2 TDD
PBCH_RA	dB	0		
PBCH_RB				
PSS_RA				
SSS_RA				
PCFICH_RB				
PHICH_RA				
PHICH_RB				
PDCCH_RA				
PDCCH_RB				
PDSCH_RA				
PDSCH_RB				
OCNG_RA ^{Note 1}				
OCNG_RB ^{Note 1}				
RSRP				
\hat{E}_s/I_{ot}	dB	0	0	0
\hat{E}_s/N_{oc}	dB	0	0	0
N_{oc}	dBm/15 kHz	-98		
I_o ^{Note 2}	dBm/9 MHz	-67.21	-67.21	-67.21
Propagation Condition		AWGN		
Note 1: OCNG shall be used such that the cell is fully allocated and a constant total transmitted power spectral density is achieved for all OFDM symbols. Note 2: RSRP and I_o levels have been derived from other parameters for information purposes. They are not settable parameters themselves.				

Table A.5.2.10B.1-3: Cell specific test parameters for E-UTRAN TDD to UTRAN FDD multi carrier handover test case (cell 2 and cell 3)

		Cell 2			Cell 3		
		T1	T2	T3	T1	T2	T3
UTRA RF Channel Number		Channel 1			Channel 2		
Cell type		Primary Serving HS-DSCH Cell			Secondary Serving HS-DSCH Cell		
CPICH_Ec/I _{or}	dB	-10			-10		
PCCPCH_Ec/I _{or}	dB	-12			-12		
SCH_Ec/I _{or}	dB	-12			-12		

PICH_Ec/lor	dB	-15			-15		
HS-SCCH_Ec/lor	dB	-13			-13		
HS-DPDCH_Ec/lor	dB	-10			-10		
DPCH_Ec/lor	dB	Note 1			N/A		
OCNS		Note 2			-2.02		
\hat{I}_{or}/I_{oc}	dB	-Inf	-1.8	-1.8	-Inf	-1.8	-1.8
I_{oc}	dBm/3.84 MHz	-70					
Propagation Condition		AWGN			AWGN		
Note 1: The DPCH level is controlled by the power control loop							
Note 2: The power of the OCNS channel that is added shall make the total power from the cell to be equal to I_{or}							
Note 3: The UE shall be scheduled continuously with HS-DSCH data during T3 using both cell 2 and cell 3							

A.5.2.10B.2 Test Requirements

The UE shall start to transmit the UL DPCCCH to Cell 2 less than 210 ms from the beginning of time period T3.

The rate of correct handovers observed during repeated tests shall be at least 90%.

NOTE: The handover delay can be expressed as: RRC procedure delay + $T_{interrupt}$, where:

RRC procedure delay = 50 ms, which is specified in clause 5.3.1.1.1.

$T_{interrupt}$ = 160 ms in the test; $T_{interrupt}$ is defined in clause 5.3.1.1.2.

This gives a total of 210 ms.

A.5.2.11 E-UTRAN FDD – UTRAN FDD Handover for 5MHz Bandwidth

A.5.2.11.1 Test Purpose and Environment

The purpose of this test case is the same as for the test defined in subclause A.5.2.1.1.

The parameters of this test are the same as defined in Subclause A.5.2.1.1 except that the values of the parameters in the Table A.5.2.11.1-1 will replace the values of the corresponding parameters in A.5.2.1.1-1, and the values of the parameters in the Table A.5.2.11.1-2 will replace the values of the corresponding parameters in A.5.2.1.1-2.

Table A.5.2.11.1-1: General test parameters for E-UTRAN FDD to UTRAN FDD handover test case for 5MHz bandwidth

Parameter	Unit	Value	Comment
PDSCH parameters		DL Reference Measurement Channel R.5 FDD	As specified in clause A.3.1.1.1
PCFICH/PDCCH/PHICH parameters		DL Reference Measurement Channel R.11 FDD	As specified in clause A.3.1.2.1
E-UTRA Channel Bandwidth (BW _{channel})	MHz	5	
Note 1: See Table A.5.2.1.1-1 for other general test parameters.			
Note 2: This test is according to the principle defined in section A.3.7.2.			

Table A.5.2.11.1-2: Cell specific test parameters for E-UTRAN FDD to UTRAN FDD handover test case (cell 1)

Parameter	Unit	Cell 1 (E-UTRA)		
		T1	T2	T3
BW _{channel}	MHz	5		
OCNG Patterns defined in A.3.2.1.15 (OP.15 FDD) and in A.3.2.1.16 (OP.16 FDD)		OP.15 FDD	OP.15 FDD	OP.16 FDD
I_o Note 2	dBm/4.5 MHz	-70.22	-70.22	-70.22

Note 1:	OCNG shall be used such that both cells are fully allocated and a constant total transmitted power spectral density is achieved for all OFDM symbols.
Note 2:	RSRP and I_0 levels have been derived from other parameters for information purposes. They are not settable parameters themselves.
Note 3:	See Table A.5.2.1.1-2 for other cell specific test parameters.

A.5.2.11.2 Test Requirements

The test requirements defined in section A.5.2.1.2 shall apply to this test case.

A.5.3 E-UTRAN Handover to Non-3GPP RATs

A.5.3.1 E-UTRAN FDD – HRPD Handover

A.5.3.1.1 Test Purpose and Environment

This test is to verify the requirement for the E-UTRAN FDD to HRPD handover requirements specified in clause 5.4.1.

The test parameters are given in Tables A.5.3.1.1-1, A.5.3.1.1-2 and A.5.3.1.1-3. The test consists of three successive time periods, with time durations of T1, T2 and T3 respectively. At the start of time duration T1, the UE does not have any timing information of Cell 2. Starting T2, Cell 2 becomes detectable and the UE is expected to detect and send a measurement report. Gap pattern configuration with id #0 as specified in Table 8.1.2.1-1 is configured before T2 begins to enable inter-RAT frequency monitoring.

A RRC message implying handover shall be sent to the UE during period T2, after the UE has reported Event B2. The start of T3 is the instant when the last TTI containing the RRC message implying handover is sent to the UE. The handover message shall contain cell 2 as the target cell.

Table A.5.3.1.1-1: General test parameters for E-UTRAN FDD to HRPD handover test case

Parameter		Unit	Value	Comment
PDSCH parameters			DL Reference Measurement Channel R.0 FDD	As specified in clause A.3.1.1.1
PCFICH/PDCCH/PHICH parameters			DL Reference Measurement Channel R.6 FDD	As specified in clause A.3.1.2.1
Initial conditions	Active cell		Cell 1	E-UTRAN FDD cell
	Neighbouring cell		Cell 2	HRPD cell
Final condition	Active cell		Cell 2	HRPD cell
Channel Bandwidth ($BW_{channel}$)		MHz	10	
Gap Pattern Id			0	As specified in Table 8.1.2.1-1 started before T2 starts
E-UTRAN FDD measurement quantity			RSRP	
Inter-RAT (HRPD) measurement quantity			CDMA2000 HRPD Pilot Strength	
b2-Threshold1		dBm	-90	Absolute E-UTRAN RSRP threshold for event B2
b2-Threshold2-CDMA2000		dB	-7	Absolute 'CDMA2000 HRPD Pilot Strength' threshold for event B2
Hysteresis		dB	0	
TimeToTrigger		s	0	
Filter coefficient			0	L3 filtering is not used
DRX			OFF	Non-DRX test
Access Barring Information		-	Not sent	No additional delays in random access procedure
E-UTRA RF Channel Number			1	One E-UTRA FDD carrier frequency is used.
E-UTRA Channel Bandwidth ($BW_{channel}$)		MHz	10	
HRPD RF Channel Number			1	One HRPD carrier frequency is used.
HRPD neighbour cell list size			8	HRPD cells on HRPD RF channel 1 provided in the cell list before T2.
cdma2000-SearchWindowSize			8 (60 PN chips)	Search window size as defined in clause 6.3.5 in TS 36.331

T1	s	5	
T2	s	≤ 10	
T3	s	1	

Table A.5.3.1.1-2: Cell specific test parameters for E-UTRAN FDD cell#1 for handover to HRPD cell # 2

Parameter	Unit	Cell 1 (E-UTRA)		
		T1	T2	T3
E-UTRA RF Channel number		1		
$BW_{channel}$	MHz	10		
OCNG Patterns defined in A.3.2.1.1 (OP.1 FDD) and in A.3.2.1.2 (OP.2 FDD)		OP.1 FDD		OP.2 FDD
PBCH_RA	dB	0		
PBCH_RB	dB			
PSS_RA	dB			
SSS_RA	dB			
PCFICH_RB	dB			
PHICH_RA	dB			
PHICH_RB	dB			
PDCCH_RA	dB			
PDCCH_RB	dB			
PDSCH_RA	dB			
PDSCH_RB	dB			
OCNG_RA ^{Note 1}	dB			
OCNG_RB ^{Note 1}	dB			
N_{oc} ^{Note 2}	dBm/15 kHz			
RSRP ^{Note 3}	dBm/15 KHz	-98	-98	-98
\hat{E}_s / N_{oc}	dB	0	0	0
\hat{E}_s / I_{ot}	dB	0	0	0
Propagation Condition		AWGN		
<p>Note 1: OCNG shall be used such that both cells are fully allocated and a constant total transmitted power spectral density is achieved for all OFDM symbols.</p> <p>Note 2: Interference from other cells and noise sources not specified in the test is assumed to be constant over subcarriers and time and shall be modelled as AWGN of appropriate power for N_{oc} to be fulfilled.</p> <p>Note 3: RSRP levels have been derived from other parameters for information purposes. They are not settable parameters themselves.</p>				

Table A.5.3.1.1-3: Cell specific test parameters for HRPD (cell # 2) for handover from E-UTRAN FDD cell (cell #1)

Parameter	Unit	Cell 2 (HRPD)		
		T1	T2	T3
$\frac{\text{Control } E_b}{N_t}$ (38.4 kbps)	dB	21		
$\frac{\text{Control } E_b}{N_t}$ (76.8 kbps)	dB	18		
\hat{I}_{or}/I_{oc}	dB	-infinity	0	0
I_{oc}	dBm/1.2288 MHz	-55		
CDMA2000 HRPD Pilot Strength	dB	-infinity	-3	-3
Propagation Condition		AWGN		

A.5.3.1.2 Test Requirements

The UE shall start transmission of the reverse control channel in HRPD to Cell 2 less than 127 ms from the beginning of time period T3.

The rate of correct handovers observed during repeated tests shall be at least 90%.

NOTE: The handover delay can be expressed as: RRC procedure delay + $T_{\text{interrupt}}$, where:

RRC procedure delay = 50 ms, which is specified in clause 5.4.1.1.1.

$T_{\text{interrupt}}$ = 76.66 ms in the test; $T_{\text{interrupt}}$ is defined in clause 5.4.1.1.2.

This gives a total of 126.66 ms, allow 127 ms in the test.

A.5.3.2 E-UTRAN FDD – cdma2000 1X Handover

A.5.3.2.1 Test Purpose and Environment

This test is to verify the requirement for the E-UTRAN FDD to cdma2000 1X handover requirements specified in clause 5.4.2.

The test parameters are given in Tables A.5.3.2.1-1, A.5.3.2.1-2 and A.5.3.2.1-3. The test consists of three successive time periods, with time durations of T1, T2 and T3 respectively. At the start of time duration T1, the UE does not have any timing information of Cell 2. Starting T2, Cell 2 becomes detectable and the UE is expected to detect and send a measurement report. Gap pattern configuration with id #0 as specified in Table 8.1.2.1-1 is configured before T2 begins to enable inter-RAT frequency monitoring.

A RRC message implying handover shall be sent to the UE during period T2, after the UE has reported Event B2. The start of T3 is the instant when the last TTI containing the RRC message implying handover is sent to the UE. The handover message shall contain cell 2 as the target cell.

Table A.5.3.2.1-1: General test parameters for E-UTRAN FDD to cdma2000 1X handover test case

Parameter	Unit	Value	Comment
PDSCH parameters		DL Reference Measurement Channel R.0 FDD	As specified in clause A.3.1.1.1
PCFICH/PDCCH/PHICH parameters		DL Reference Measurement Channel R.6 FDD	As specified in clause A.3.1.2.1
Initial conditions	Active cell	Cell 1	E-UTRAN FDD cell
	Neighbouring cell	Cell 2	cdma2000 1X cell
Final condition	Active cell	Cell 2	cdma2000 1X cell
Channel Bandwidth (BW_{channel})	MHz	10	
Gap Pattern Id		0	As specified in Table 8.1.2.1-1 started before T2 starts
E-UTRAN FDD measurement quantity		RSRP	

Inter-RAT (cdma2000 1X) measurement quantity		CDMA2000 1xRTT Pilot Strength	
b2-Threshold1	dBm	-90	Absolute E-UTRAN RSRP threshold for event B2
b2-Threshold2-CDMA2000	dB	-14	Absolute 'CDMA2000 1xRTT Pilot Strength' threshold for event B2
Hysteresis	dB	0	
TimeToTrigger	s	0	
Filter coefficient		0	L3 filtering is not used
DRX		OFF	Non-DRX test
Access Barring Information	-	Not sent	No additional delays in random access procedure
E-UTRA RF Channel Number		1	One E-UTRA FDD carrier frequency is used.
E-UTRA Channel Bandwidth (BWchannel)	MHz	10	
cdma2000 1X RF Channel Number		1	One HRPD carrier frequency is used.
cdma2000 1X neighbour cell list size		8	cdma2000 1X cells on cdma2000 1X RF channel 1 provided in the cell list before T2.
cdma2000-SearchWindowSize		8 (60 PN chips)	Search window size as defined in clause 6.3.5 in TS 36.331
T1	s	5	
T2	s	≤10	
T3	s	1	

Table A.5.3.2.1-2: Cell specific test parameters for E-UTRAN FDD cell#1 for handover to cdma2000 1X cell # 2

Parameter	Unit	Cell 1 (E-UTRA)		
		T1	T2	T3
E-UTRA RF Channel number		1		
$BW_{channel}$	MHz	10		
OCNG Patterns defined in A.3.2.1.1 (OP.1 FDD) and in A.3.2.1.2 (OP.2 FDD)		OP.1 FDD		OP.2 FDD
PBCH_RA	dB	0		
PBCH_RB	dB			
PSS_RA	dB			
SSS_RA	dB			
PCFICH_RB	dB			
PHICH_RA	dB			
PHICH_RB	dB			
PDCCH_RA	dB			
PDCCH_RB	dB			
PDSCH_RA	dB			
PDSCH_RB	dB			
OCNG_RA ^{Note 1}	dB			
OCNG_RB ^{Note 1}	dB			
N_{oc} ^{Note 2}	dBm/15 kHz			
RSRP ^{Note 3}	dBm/15 KHz	-98	-98	-98
\hat{E}_s / N_{oc}	dB	0	0	0
\hat{E}_s / I_{ot}	dB	0	0	0
Propagation Condition		AWGN		
<p>Note 1: OCNG shall be used such that both cells are fully allocated and a constant total transmitted power spectral density is achieved for all OFDM symbols.</p> <p>Note 2: Interference from other cells and noise sources not specified in the test is assumed to be constant over subcarriers and time and shall be modelled as AWGN of appropriate power for N_{oc} to be fulfilled.</p> <p>Note 3: RSRP levels have been derived from other parameters for information purposes. They are not settable parameters themselves.</p>				

Table A.5.3.2.1-3: Cell specific test parameters for cdma2000 1X (cell # 2) for handover from E-UTRAN FDD cell (cell #1)

Parameter	Unit	Cell 2 (cdma2000 1X)		
		T1	T2	T3
$\frac{\text{Pilot } E_c}{I_{or}}$	dB	-7		
$\frac{\text{Sync } E_c}{I_{or}}$	dB	-16		
$\frac{\text{Paging } E_c}{I_{or}}$ (4.8 kbps)	dB	-12		
\hat{I}_{or}/I_{oc}	dB	-infinity	0	0
I_{oc}	dBm/1.2288 MHz	-55		
CDMA2000 1xRTT Pilot Strength	dB	-infinity	-10	-10
Propagation Condition		AWGN		

A.5.3.2.2 Test Requirements

The UE shall start transmission of the reverse control channel in cdma2000 1X to Cell 2 less than 300 ms from the beginning of time period T3.

NOTE: The handover delay can be expressed as: RRC procedure delay + $T_{\text{interrupt}}$, where:

RRC procedure delay = 130 ms, which is specified in clause 5.4.2.1.1.

$T_{\text{interrupt}}$ = 170 ms in the test; $T_{\text{interrupt}}$ is defined in clause 5.4.2.1.2.

This gives a total of 300 ms.

A.5.3.3 E-UTRAN FDD – HRPD Handover; Unknown Target Cell

A.5.3.3.1 Test Purpose and Environment

This test is to verify the requirement for the E-UTRAN FDD to HRPD handover requirements for the case when the target HRPD cell is unknown as specified in clause 5.4.1.

The test parameters are given in Tables A.5.3.3.1-1, A.5.3.3.1-2 and A.5.3.3.1-3. The test consists of two successive time periods, with time durations of T1 and T2 respectively. At the start of time duration T1, the UE does not have any timing information of cell 2. During time period T1, message containing Information Element *systemTimeInfo* as defined in clause 6.3.1 of TS 36.331 [2] shall be sent by the System Simulator (SS). No gap patterns are configured in the test case. No HRPD neighbour cell list shall be provided to the UE.

A RRC message implying handover to the unknown HRPD cell shall be sent to the UE towards the end of the time period T1. The start of T2 is the instant when the last TTI containing the RRC message implying handover is sent to the UE. The handover message shall contain cell 2 as the target cell.

Table A.5.3.3.1-1: General test parameters for E-UTRAN FDD to HRPD handover test case; unknown target HRPD cell

Parameter	Unit	Value	Comment
PDSCH parameters		DL Reference Measurement Channel R.0 FDD	As specified in clause A.3.1.1.1
PCFICH/PDCCH/PHICH parameters		DL Reference Measurement Channel R.6 FDD	As specified in clause A.3.1.2.1
Initial conditions	Active cell	Cell 1	E-UTRAN FDD cell
	Neighbouring cell	Cell 2	HRPD cell
Final condition	Active cell	Cell 2	HRPD cell
Channel Bandwidth (BW_{channel})	MHz	10	
DRX		OFF	Non-DRX test
Access Barring Information	-	Not sent	No additional delays in random access procedure

E-UTRA RF Channel Number		1	One E-UTRA FDD carrier frequency is used.
E-UTRA Channel Bandwidth (BWchannel)	MHz	10	
HRPD RF Channel Number		1	One HRPD carrier frequency is used.
cdma2000-SearchWindowSize		8 (60 PN chips)	Search window size as defined in clause 6.3.5 in TS 36.331
T1	s	≤ 5	
T2	s	1	

Table A.5.3.3.1-2: Cell specific test parameters for E-UTRAN FDD cell#1 for handover to unknown HRPD cell # 2

Parameter	Unit	Cell 1 (E-UTRAN FDD)	
		T1	T2
E-UTRA RF Channel number		1	
$BW_{channel}$	MHz	10	
OCNG Patterns defined in A.3.2.1.1 (OP.1 FDD)		OP.1 FDD	
PBCH_RA	dB	0	
PBCH_RB	dB		
PSS_RA	dB		
SSS_RA	dB		
PCFICH_RB	dB		
PHICH_RA	dB		
PHICH_RB	dB		
PDCCH_RA	dB		
PDCCH_RB	dB		
PDSCH_RA	dB		
PDSCH_RB	dB		
OCNG_RA ^{Note 1}	dB		
OCNG_RB ^{Note 1}	dB		
N_{oc} ^{Note 2}	dBm/15 kHz		
RSRP ^{Note 3}	dBm/15 kHz	-98	-98
\hat{E}_s / N_{oc}	dB	0	0
\hat{E}_s / I_{ot}	dB	0	0
Propagation Condition		AWGN	
Note 1: OCNG shall be used such that both cells are fully allocated and a constant total transmitted power spectral density is achieved for all OFDM symbols. Note 2: Interference from other cells and noise sources not specified in the test is assumed to be constant over subcarriers and time and shall be modelled as AWGN of appropriate power for N_{oc} to be fulfilled. Note 3: RSRP levels have been derived from other parameters for information purposes. They are not settable parameters themselves.			

Table A.5.3.3.1-3: Cell specific test parameters for unknown HRPD (cell # 2) for handover from E-UTRAN FDD cell (cell #1)

Parameter	Unit	Cell 2 (HRPD)	
		T1	T2
$\frac{\text{Control } E_b}{N_t}$ (38.4 kbps)	dB	21	
$\frac{\text{Control } E_b}{N_t}$ (76.8 kbps)	dB	18	
\hat{I}_{or} / I_{oc}	dB	-infinity	0
I_{oc}	dBm/1.22 88 MHz	-55	
CDMA2000 HRPD Pilot Strength	dB	-infinity	-3
Propagation Condition		AWGN	

A.5.3.3.2 Test Requirements

The UE shall start transmission of the reverse control channel in HRPD to Cell 2 less than 127 ms from the beginning of time period T2.

The rate of correct handovers observed during repeated tests shall be at least 90%.

NOTE: The handover delay is expressed as: RRC procedure delay + $T_{\text{interrupt}}$, where:

$T_{\text{interrupt}}$ also includes time to detect HRPD cell; see clause 5.4.1.1.2

This gives a total of 126.66 ms, allow 127 ms in the test case.

A.5.3.4 E-UTRAN FDD – cdma2000 1X Handover; Unknown Target cell

A.5.3.4.1 Test Purpose and Environment

This test is to verify the requirement for the E-UTRAN FDD to cdma2000 1X handover requirements for the case when the target cdma2000 1X cell is unknown as specified in clause 5.4.2.

The test parameters are given in Tables A.5.3.4.1-1, A.5.3.4.1-2 and A.5.3.4.1-3. The test consists of two successive time periods, with time durations of T1 and T2 respectively. At the start of time duration T1, the UE does not have any timing information of cell 2. During time period T1, message containing Information Element *systemTimeInfo* as defined in clause 6.3.1 of TS 36.331 [2] shall be sent by the System Simulator (SS). No gap patterns are configured in the test case. No cdma2000 1X neighbour cell list shall be provided to the UE.

A RRC message implying handover to the unknown cdma2000 1X cell shall be sent to the UE towards the end of the time period T1. The start of T2 is the instant when the last TTI containing the RRC message implying handover is sent to the UE. The handover message shall contain cell 2 as the target cell.

Table A.5.3.2.1-1: General test parameters for E-UTRAN FDD to cdma2000 1X handover test case; unknown target cdma2000 1X cell

Parameter		Unit	Value	Comment
PDSCH parameters			DL Reference Measurement Channel R.0 FDD	As specified in clause A.3.1.1.1
PCFICH/PDCCH/PHICH parameters			DL Reference Measurement Channel R.6 FDD	As specified in clause A.3.1.2.1
Initial conditions	Active cell		Cell 1	E-UTRAN FDD cell
	Neighbouring cell		Cell 2	cdma2000 1X cell
Final condition	Active cell		Cell 2	cdma2000 1X cell
Channel Bandwidth (BW_{channel})		MHz	10	
DRX			OFF	Non-DRX test
Access Barring Information		-	Not sent	No additional delays in random access procedure
E-UTRA RF Channel Number			1	One E-UTRA FDD carrier frequency is used.
E-UTRA Channel Bandwidth (BW_{channel})		MHz	10	
cdma2000 1X RF Channel Number			1	One HRPD carrier frequency is used.
cdma2000-SearchWindowSize			8 (60 PN chips)	Search window size as defined in clause 6.3.5 in TS 36.331
T1		s	≤5	
T2		s	1	

Table A.5.3.2.1-2: Cell specific test parameters for E-UTRAN FDD cell#1 for handover to unknown cdma2000 1X cell # 2

Parameter	Unit	Cell 1 (E-UTRAN FDD)	
		T1	T2
E-UTRA RF Channel number		1	
BW_{channel}	MHz	10	
OCNG Patterns defined in A.3.2.1.1 (OP.1 FDD)		OP.1 FDD	
PBCH_RA	dB	0	
PBCH_RB	dB		
PSS_RA	dB		
SSS_RA	dB		
PCFICH_RB	dB		

PHICH_RA	dB		
PHICH_RB	dB		
PDCCH_RA	dB		
PDCCH_RB	dB		
PDSCH_RA	dB		
PDSCH_RB	dB		
OCNG_RA ^{Note 1}	dB		
OCNG_RB ^{Note 1}	dB		
N_{oc} ^{Note 2}	dBm/15 kHz	-98	
RSRP ^{Note 3}	dBm/15 kHz	-98	-98
\hat{E}_s / N_{oc}	dB	0	0
\hat{E}_s / I_{ot}	dB	0	0
Propagation Condition		AWGN	
<p>Note 1: OCNG shall be used such that both cells are fully allocated and a constant total transmitted power spectral density is achieved for all OFDM symbols.</p> <p>Note 2: Interference from other cells and noise sources not specified in the test is assumed to be constant over subcarriers and time and shall be modelled as AWGN of appropriate power for N_{oc} to be fulfilled.</p> <p>Note 3: RSRP levels have been derived from other parameters for information purposes. They are not settable parameters themselves.</p>			

Table A.5.3.2.1-3: Cell specific test parameters for unknown cdma2000 1X (cell # 2) for handover from E-UTRAN FDD cell (cell #1)

Parameter	Unit	Cell 2 (cdma2000 1X)	
		T1	T1
$\frac{\text{Pilot } E_c}{I_{or}}$	dB	-7	
$\frac{\text{Sync } E_c}{I_{or}}$	dB	-16	
$\frac{\text{Paging } E_c}{I_{or}}$ (4.8 kbps)	dB	-12	
\hat{I}_{or} / I_{oc}	dB	-infinity	0
I_{oc}	dBm/1.22 88 MHz	-55	
CDMA2000 1xRTT Pilot Strength	dB	-infinity	-10
Propagation Condition		AWGN	

A.5.3.4.2 Test Requirements

The UE shall start transmission of the reverse control channel in cdma2000 1X to Cell 2 less than 300 ms from the beginning of time period T2.

The rate of correct handovers observed during repeated tests shall be at least 90%.

NOTE: The handover delay is expressed as: RRC procedure delay + $T_{interrupt}$, where:

$T_{interrupt}$ also includes time to detect cdma2000 1X cell; see clause 5.4.2.1.2

This gives a total of 300 ms.

A.5.3.5 E-UTRAN TDD – HRPD Handover

A.5.3.5.1 Test Purpose and Environment

This test is to verify the requirement for the E-UTRAN TDD to HRPD handover requirements specified in clause 5.4.1.

The test parameters are given in Tables A.5.3.5.1-1, A.5.3.5.1-2 and A.5.3.5.1-3. The test consists of three successive time periods, with time durations of T1, T2 and T3 respectively. At the start of time duration T1, the UE does not have any timing information of Cell 2. Starting T2, Cell 2 becomes detectable and the UE is expected to detect and send a measurement report. Gap pattern configuration with id #0 as specified in Table 8.1.2.1-1 is configured before T2 begins to enable inter-RAT frequency monitoring.

A RRC message implying handover shall be sent to the UE during period T2, after the UE has reported Event B2. The start of T3 is the instant when the last TTI containing the RRC message implying handover is sent to the UE. The handover message shall contain cell 2 as the target cell.

Table A.5.3.5.1-1: General test parameters for E-UTRAN TDD to HRPD handover test case

Parameter		Unit	Value	Comment
PDSCH parameters			DL Reference Measurement Channel R.0 TDD	As specified in clause A.3.1.1.2
PCFICH/PDCCH/PHICH parameters			DL Reference Measurement Channel R.6 TDD	As specified in clause A.3.1.2.2
Initial conditions	Active cell		Cell 1	E-UTRAN TDD cell
	Neighbouring cell		Cell 2	HRPD cell
Final condition	Active cell		Cell 2	HRPD cell
Channel Bandwidth (BW _{channel})		MHz	10	
Gap Pattern Id			0	As specified in Table 8.1.2.1-1 started before T2 starts
E-UTRAN TDD measurement quantity			RSRP	
Inter-RAT (HRPD) measurement quantity			CDMA2000 HRPD Pilot Strength	
b2-Threshold1		dBm	-90	Absolute E-UTRAN RSRP threshold for event B2
b2-Threshold2-CDMA2000		dB	-7	Absolute 'CDMA2000 HRPD Pilot Strength' threshold for event B2
Hysteresis		dB	0	
TimeToTrigger		s	0	
Filter coefficient			0	L3 filtering is not used
DRX			OFF	Non-DRX test
Access Barring Information		-	Not sent	No additional delays in random access procedure
E-UTRA RF Channel Number			1	One E-UTRA TDD carrier frequency is used.
E-UTRA Channel Bandwidth (BW _{channel})		MHz	10	
Uplink-downlink configuration of cell 1			1	As specified in table 4.2.2 in TS 36.211
Special subframe configuration of cell 1			6	As specified in table 4.2.1 in TS 36.211
HRPD RF Channel Number			1	One HRPD carrier frequency is used.
HRPD neighbour cell list size			8	HRPD cells on HRPD RF channel 1 provided in the cell list before T2.
cdma2000-SearchWindowSize			8 (60 PN chips)	Search window size as defined in clause 6.3.5 in TS 36.331
T1		s	5	
T2		s	≤10	
T3		s	1	

Table A.5.3.5.1-2: Cell specific test parameters for E-UTRAN TDD cell#1 for handover to HRPD cell # 2

Parameter	Unit	Cell 1 (E-UTRA)		
		T1	T2	T3
E-UTRA RF Channel number		1		
BW _{channel}	MHz	10		
OCNG Patterns defined in TS36.133 A.3.2.2.1 (OP.1 TDD) and in A.3.2.2.2 (OP.2 TDD)		OP.1 TDD		OP.2 TDD

PBCH_RA	dB	0		
PBCH_RB	dB			
PSS_RA	dB			
SSS_RA	dB			
PCFICH_RB	dB			
PHICH_RA	dB			
PHICH_RB	dB			
PDCCH_RA	dB			
PDCCH_RB	dB			
PDSCH_RA	dB			
PDSCH_RB	dB			
OCNG_RA ^{Note 1}	dB			
OCNG_RB ^{Note 1}	dB			
N_{oc} ^{Note 2}	dBm/15 kHz			
RSRP ^{Note 3}	dBm/15 KHz	-98	-98	-98
\hat{E}_s / N_{oc}	dB	0	0	0
\hat{E}_s / I_{ot}	dB	0	0	0
Propagation Condition		AWGN		
Note 1: OCNG shall be used such that both cells are fully allocated and a constant total transmitted power spectral density is achieved for all OFDM symbols.				
Note 2: Interference from other cells and noise sources not specified in the test is assumed to be constant over subcarriers and time and shall be modelled as AWGN of appropriate power for N_{oc} to be fulfilled.				
Note 3: RSRP levels have been derived from other parameters for information purposes. They are not settable parameters themselves.				

Table A.5.3.5.1-3: Cell specific test parameters for HRPD (cell # 2) for handover from E-UTRAN TDD cell (cell #1)

Parameter	Unit	Cell 2 (HRPD)		
		T1	T2	T3
$\frac{\text{Control } E_b}{N_t}$ (38.4 kbps)	dB	21		
$\frac{\text{Control } E_b}{N_t}$ (76.8 kbps)	dB	18		
\hat{I}_{or} / I_{oc}	dB	-infinity	0	0
I_{oc}	dBm/1.2288 MHz	-55		
CDMA2000 HRPD Pilot Strength	dB	-infinity	-3	-3
Propagation Condition		AWGN		

A.5.3.5.2 Test Requirements

The UE shall start transmission of the reverse control channel in HRPD to Cell 2 less than 127 ms from the beginning of time period T3.

The rate of correct handovers observed during repeated tests shall be at least 90%.

NOTE: The handover delay can be expressed as: RRC procedure delay + $T_{\text{interrupt}}$, where:

RRC procedure delay = 50 ms, which is specified in clause 5.4.1.1.1.

$T_{\text{interrupt}}$ = 76.66 ms in the test; $T_{\text{interrupt}}$ is defined in clause 5.4.1.1.2.

This gives a total of 126.66 ms, allow 127 ms in the test.

A.5.3.6 E-UTRAN TDD – cdma2000 1X Handover

A.5.3.6.1 Test Purpose and Environment

This test is to verify the requirement for the E-UTRAN TDD to cdma2000 1X handover requirements specified in clause 5.4.2.

The test parameters are given in Tables A.5.3.6.1-1, A.5.3.6.1-2 and A.5.3.6.1-3. The test consists of three successive time periods, with time durations of T1, T2 and T3 respectively. At the start of time duration T1, the UE does not have any timing information of Cell 2. Starting T2, Cell 2 becomes detectable and the UE is expected to detect and send a measurement report. Gap pattern configuration with id #0 as specified in Table 8.1.2.1-1 is configured before T2 begins to enable inter-RAT frequency monitoring.

A RRC message implying handover shall be sent to the UE during period T2, after the UE has reported Event B2. The start of T3 is the instant when the last TTI containing the RRC message implying handover is sent to the UE. The handover message shall contain cell 2 as the target cell.

Table A.5.3.6.1-1: General test parameters for E-UTRAN TDD to cdma2000 1X handover test case

Parameter		Unit	Value	Comment
PDSCH parameters			DL Reference Measurement Channel R.0 TDD	As specified in clause A.3.1.1.2
PCFICH/PDCCH/PHICH parameters			DL Reference Measurement Channel R.6 TDD	As specified in clause A.3.1.2.2
Initial conditions	Active cell		Cell 1	E-UTRAN TDD cell
	Neighbouring cell		Cell 2	cdma2000 1X cell
Final condition	Active cell		Cell 2	cdma2000 1X cell
Channel Bandwidth (BW _{channel})		MHz	10	
Gap Pattern Id			0	As specified in Table 8.1.2.1-1 started before T2 starts
E-UTRAN TDD measurement quantity			RSRP	
Inter-RAT (cdma2000 1X) measurement quantity			CDMA2000 1xRTT Pilot Strength	
b2-Threshold1		dBm	-90	Absolute E-UTRAN RSRP threshold for event B2
b2-Threshold2-CDMA2000		dB	-14	Absolute 'CDMA2000 1xRTT Pilot Strength' threshold for event B2
Hysteresis		dB	0	
TimeToTrigger		S	0	
Filter coefficient			0	L3 filtering is not used
DRX			OFF	Non-DRX test
Access Barring Information		-	Not sent	No additional delays in random access procedure
E-UTRA RF Channel Number			1	One E-UTRA TDD carrier frequency is used.
E-UTRA Channel Bandwidth (BW _{channel})		MHz	10	
cdma2000 1X RF Channel Number			1	One cdma2000 1X carrier frequency is used.
cdma2000 1X neighbour cell list size			8	cdma2000 1X cells on cdma2000 1X RF channel 1 provided in the cell list before T2.
cdma2000-SearchWindowSize			8 (60 PN chips)	Search window size as defined in clause 6.3.5 in TS 36.331
T1		S	5	
T2		S	≤10	
T3		S	1	

Table A.5.3.6.1-2: Cell specific test parameters for E-UTRAN TDD cell#1 for handover to cdma2000 1X cell # 2

Parameter	Unit	Cell 1 (E-UTRA)		
		T1	T2	T3
E-UTRA RF Channel number		1		
$BW_{channel}$	MHz	10		
OCNG Patterns defined in A.3.2.2.1 (OP.1 TDD) and in A.3.2.2.2 (OP.2 TDD)		OP.1 TDD		OP.2 TDD
PBCH_RA	dB	0		
PBCH_RB				
PSS_RA				
SSS_RA				
PCFICH_RB				
PHICH_RA				
PHICH_RB				
PDCCH_RA				
PDCCH_RB				
PDSCH_RA				
PDSCH_RB				
OCNG_RA ^{Note 1}				
OCNG_RB ^{Note 1}				
N_{oc} ^{Note 2}				
RSRP ^{Note 3}	dBm/15 KHz	-98	-98	-98
\hat{E}_s / N_{oc}	dB	0	0	0
\hat{E}_s / I_{ot}	dB	0	0	0
Propagation Condition		AWGN		
<p>Note 1: OCNG shall be used such that both cells are fully allocated and a constant total transmitted power spectral density is achieved for all OFDM symbols.</p> <p>Note 2: Interference from other cells and noise sources not specified in the test is assumed to be constant over subcarriers and time and shall be modelled as AWGN of appropriate power for N_{oc} to be fulfilled.</p> <p>Note 3: RSRP levels have been derived from other parameters for information purposes. They are not settable parameters themselves.</p>				

Table A.5.3.6.1-3: Cell specific test parameters for cdma2000 1X (cell # 2) for handover from E-UTRAN TDD cell (cell #1)

Parameter	Unit	Cell 2 (cdma2000 1X)		
		T1	T2	T3
$\frac{Pilot E_c}{I_{or}}$	dB	-7		
$\frac{Sync E_c}{I_{or}}$	dB	-16		
$\frac{Paging E_c}{I_{or}}$ (4.8 kbps)	dB	-12		
\hat{I}_{or} / I_{oc}	dB	-infinity	0	0
I_{oc}	dBm/1.2288 MHz	-55		
CDMA2000 1xRTT Pilot Strength	dB	-infinity	-10	-10
Propagation Condition		AWGN		

A.5.3.6.2 Test Requirements

The UE shall start transmission of the reverse control channel in cdma2000 1X to Cell 2 less than 300 ms from the beginning of time period T3.

NOTE: The handover delay can be expressed as: RRC procedure delay + $T_{\text{interrupt}}$, where:

RRC procedure delay = 130 ms, which is specified in clause 5.4.2.1.1.

$T_{\text{interrupt}}$ = 170 ms in the test; $T_{\text{interrupt}}$ is defined in clause 5.4.2.1.2.

This gives a total of 300 ms.

A.6 RRC Connection Control

A.6.1 RRC Re-establishment

A.6.1.1 E-UTRAN FDD Intra-frequency RRC Re-establishment

A.6.1.1.1 Test Purpose and Environment

The purpose is to verify that the E-UTRA FDD intra-frequency RRC re-establishment delay is within the specified limits. These tests will verify the requirements in clause 6.1.2.

The test parameters are given in table A.6.1.1.1-1 and table A.6.1.1.1-2 below. The test consists of 3 successive time periods, with time duration of T1, T2 and T3 respectively. At the start of time period T2, cell 1, which is the active cell, is deactivated. The time period T3 starts after the occurrence of the radio link failure.

Table A.6.1.1.1-1: General test parameters for E-UTRAN FDD intra-frequency RRC Re-establishment test case

Parameter		Unit	Value	Comment
PDSCH parameters			DL Reference Measurement Channel R.0 FDD	As specified in clause A.3.1.1.1
PCFICH/PDCCH/PHICH parameters			DL Reference Measurement Channel R.6 FDD	As specified in clause A.3.1.2.1
Initial conditions	Active cell		Cell 1	
	Neighbouring cell		Cell 2	
Final condition	Active cell		Cell 2	
E-UTRA RF Channel Number			1	Only one FDD carrier frequency is used.
Channel Bandwidth (BW_{channel})		MHz	10	
N310		-	1	Maximum consecutive out-of-sync indications from lower layers
N311		-	1	Minimum consecutive in-sync indications from lower layers
T310		ms	0	Radio link failure timer; T310 is disabled
T311		ms	3000	RRC re-establishment timer
DRX			OFF	
CP length			Normal	
Access Barring Information		-	Not Sent	No additional delays in random access procedure.
PRACH configuration index			4	As specified in table 5.7.1-2 in TS 36.211
Time offset between cells		ms	3	Asynchronous cells
T1		s	5	
T2		ms	200	
T3		s	3	

Table A.6.1.1.1-2: Cell specific test parameters for E-UTRAN FDD intra-frequency RRC Re-establishment test case

Parameter	Unit	Cell 1			Cell 2		
		T1	T2	T3	T1	T2	T3
E-UTRA RF Channel Number		1			1		
BW _{channel}	MHz	10			10		
OCNG Patterns defined in A.3.2.1.1 (OP.1 FDD) and in A.3.2.1.2 (OP.2 FDD)		OP.1 FDD	OP.1 FDD	OP.2 FDD	OP.2 FDD	OP.2 FDD	OP.1 FDD
PBCH_RA	dB	0			0		
PBCH_RB	dB						
PSS_RA	dB						
SSS_RA	dB						
PCFICH_RB	dB						
PHICH_RA	dB						
PHICH_RB	dB						
PDCCH_RA	dB						
PDCCH_RB	dB						
PDSCH_RA	dB						
PDSCH_RB	dB						
OCNG_RA ^{Note 1}	dB						
OCNG_RB ^{Note 1}	dB						
\hat{E}_s / I_{ot}	dB						
N_{oc} ^{Note 2}	dBm/15 KHz	-98					
\hat{E}_s / N_{oc}	dB	7	-Infinity	-Infinity	4	4	4
RSRP ^{Note 3}	dBm/15 KHz	-91	-Infinity	-Infinity	-94	-94	-94
Propagation Condition		AWGN					
<p>Note 1: OCNG shall be used such that both cells are fully allocated and a constant total transmitted power spectral density is achieved for all OFDM symbols.</p> <p>Note 2: Interference from other cells and noise sources not specified in the test is assumed to be constant over subcarriers and time and shall be modelled as AWGN of appropriate power for N_{oc} to be fulfilled.</p> <p>Note 3: RSRP levels have been derived from other parameters for information purposes. They are not settable parameters themselves.</p>							

A.6.1.1.2 Test Requirements

The RRC re-establishment delay is defined as the time from the start of time period T3, to the moment when the UE starts to send PRACH preambles to cell 2 for sending the *RRCConnectionReestablishmentRequest* message to cell 2.

The RRC re-establishment delay to a known E-UTRA FDD intra frequency cell shall be less than 1.5 s.

The rate of correct RRC re-establishments observed during repeated tests shall be at least 90%.

NOTE: The RRC re-establishment delay in the test is derived from the following expression:

$$T_{\text{re-establish_delay}} = T_{\text{UL_grant}} + T_{\text{UE_re-establish_delay}}$$

Where:

$T_{\text{UL_grant}}$ = It is the time required to acquire and process uplink grant from the target cell. The PRACH reception at the system simulator is used as a trigger for the completion of the test; hence $T_{\text{UL_grant}}$ is not used.

$$T_{\text{UE_re-establish_delay}} = 50 \text{ ms} + N_{\text{freq}} * T_{\text{search}} + T_{\text{SI}} + T_{\text{PRACH}}$$

$$N_{\text{freq}} = 1$$

$$T_{\text{search}} = 100 \text{ ms}$$

$T_{SI} = 1280$ ms; it is the time required for receiving all the relevant system information as defined in TS 36.331 for the target E-UTRAN FDD cell.

$T_{PRACH} = 15$ ms; it is the additional delay caused by the random access procedure.

This gives a total of 1445 ms, allow 1.5 s in the test case.

A.6.1.2 E-UTRAN FDD Inter-frequency RRC Re-establishment

A.6.1.2.1 Test Purpose and Environment

The purpose is to verify that the E-UTRA FDD inter-frequency RRC re-establishment delay is within the specified limits. These tests will verify the requirements in clause 6.1.2.

The test parameters are given in table A.6.1.1.2-1 and table A.6.1.1.2-2 below. The test consists of 3 successive time periods, with time duration of T1, T2 and T3 respectively. At the start of time period T2, cell 1, which is the active cell, is deactivated. The time period T3 starts after the occurrence of radio link failure. At the start of time period T3, cell 2, which is the neighbour cell, is activated.

Table A.6.1.2.1-1: General test parameters for E-UTRAN FDD inter-frequency RRC Re-establishment test case

Parameter		Unit	Value	Comment
PDSCH parameters			DL Reference Measurement Channel R.0 FDD	As specified in clause A.3.1.1.1
PCFICH/PDCCH/PHICH parameters			DL Reference Measurement Channel R.6 FDD	As specified in clause A.3.1.2.1
Initial conditions	Active cell		Cell 1	
	Neighbouring cell		Cell 2	
Final condition	Active cell		Cell 2	
E-UTRA RF Channel Number (cell 1)			1	
E-UTRA RF Channel Number (cell 2)			2	
E-UTRA FDD inter-frequency carrier list size			1	2 E-UTRA FDD carrier frequencies in total: 1 intra-frequency and 1 inter-frequency
Channel Bandwidth ($BW_{channel}$)		MHz	10	
N310		-	1	Maximum consecutive out-of-sync indications from lower layers
N311		-	1	Minimum consecutive in-sync indications from lower layers
T310		ms	0	Radio link failure timer; T310 is disabled
T311		ms	5000	RRC re-establishment timer
DRX			OFF	
CP length			Normal	
Access Barring Information		-	Not Sent	No additional delays in random access procedure.
PRACH configuration index			4	As specified in table 5.7.1-2 in TS 36.211
Time offset between cells		ms	3	Asynchronous cells
T1		s	5	
T2		ms	200	
T3		s	5	

Table A.6.1.2.1-2: Cell specific test parameters for E-UTRAN FDD inter-frequency RRC Re-establishment test case

Parameter	Unit	Cell 1			Cell 2		
		T1	T2	T3	T1	T2	T3
E-UTRA RF Channel Number		1			2		
$BW_{channel}$	MHz	10			10		

OCNG Patterns defined in A.3.2.1.1 (OP.1 FDD) and in A.3.2.1.2 (OP.2 FDD)		OP.1 FDD	OP.1 FDD	OP.2 FDD	OP.2 FDD	OP.2 FDD	OP.1 FDD
PBCH_RA	dB						
PBCH_RB	dB						
PSS_RA	dB						
SSS_RA	dB						
PCFICH_RB	dB						
PHICH_RA	dB						
PHICH_RB	dB						
PDCCH_RA	dB	0		0			
PDCCH_RB	dB						
PDSCH_RA	dB						
PDSCH_RB	dB						
OCNG_RA ^{Note 1}	dB						
OCNG_RB ^{Note 1}	dB						
\hat{E}_s / I_{ot}	dB	4	-Infinity	-Infinity	-Infinity	-Infinity	7
N_{oc} ^{Note 2}	dBm/15 KHz	-98					
\hat{E}_s / N_{oc}	dB	4	-Infinity	-Infinity	-Infinity	-Infinity	7
RSRP ^{Note 3}	dBm/15 KHz	-94	-Infinity	-Infinity	-Infinity	-Infinity	-91
Propagation Condition		AWGN					
<p>Note 1: OCNG shall be used such that both cells are fully allocated and a constant total transmitted power spectral density is achieved for all OFDM symbols.</p> <p>Note 2: Interference from other cells and noise sources not specified in the test is assumed to be constant over subcarriers and time and shall be modelled as AWGN of appropriate power for N_{oc} to be fulfilled.</p> <p>Note 3: RSRP levels have been derived from other parameters for information purposes. They are not settable parameters themselves.</p>							

A.6.1.2.2 Test Requirements

The RRC re-establishment delay is defined as the time from the start of time period T3, to the moment when the UE starts to send PRACH preambles to cell 2 for sending the *RRConnectionReestablishmentRequest* message to cell 2.

The RRC re-establishment delay to an unknown E-UTRA FDD inter frequency cell shall be less than 3 s.

The rate of correct RRC re-establishments observed during repeated tests shall be at least 90%.

NOTE: The RRC re-establishment delay in the test is derived from the following expression:

$$T_{\text{re-establish_delay}} = T_{\text{UL_grant}} + T_{\text{UE_re-establish_delay}}$$

Where:

$T_{\text{UL_grant}}$ = It is the time required to acquire and process uplink grant from the target cell. The PRACH reception at the system simulator is used as a trigger for the completion of the test; hence $T_{\text{UL_grant}}$ is not used.

$$T_{\text{UE_re-establish_delay}} = 50 \text{ ms} + N_{\text{freq}} * T_{\text{search}} + T_{\text{SI}} + T_{\text{PRACH}}$$

$$N_{\text{freq}} = 2$$

$$T_{\text{search}} = 800 \text{ ms}$$

$T_{\text{SI}} = 1280 \text{ ms}$; it is the time required for receiving all the relevant system information as defined in TS 36.331 for the target E-UTRAN FDD cell.

$T_{\text{PRACH}} = 15 \text{ ms}$; it is the additional delay caused by the random access procedure.

This gives a total of 2945 ms, allow 3 s in the test case.

A.6.1.3 E-UTRAN TDD Intra-frequency RRC Re-establishment

A.6.1.3.1 Test Purpose and Environment

The purpose is to verify that the E-UTRA TDD intra-frequency RRC re-establishment delay is within the specified limits. These tests will verify the requirements in clause 6.1.2.

The test parameters are given in table A.6.1.3.1-1 and table A.6.1.3.1-2 below. The test consists of 3 successive time periods, with time duration of T1, T2 and T3 respectively. At the start of time period T2, cell 1, which is the active cell, is deactivated. The time period T3 starts after the occurrence of the radio link failure.

Table A.6.1.3.1-1: General test parameters for E-UTRAN TDD intra-frequency RRC Re-establishment test case

Parameter		Unit	Value	Comment
PDSCH parameters			DL Reference Measurement Channel R.0 TDD	As specified in clause A.3.1.1.2
PCFICH/PDCCH/PHICH parameters			DL Reference Measurement Channel R.6 TDD	As specified in clause A.3.1.2.2
Initial conditions	Active cell		Cell 1	
	Neighbouring cell		Cell 2	
Final condition	Active cell		Cell 2	
E-UTRA RF Channel Number			1	Only one TDD carrier frequency is used.
Channel Bandwidth (BW_{channel})		MHz	10	
N310		-	1	Maximum consecutive out-of-sync indications from lower layers
N311		-	1	Minimum consecutive in-sync indications from lower layers
T310		ms	0	Radio link failure timer; T310 is disabled
T311		ms	3000	RRC re-establishment timer
DRX			OFF	
CP length			Normal	
Access Barring Information		-	Not Sent	No additional delays in random access procedure.
Special subframe configuration			6	As specified in table 4.2-1 in TS 36.211
Uplink-downlink configuration			1	As specified in table 4.2-2 in TS 36.211
PRACH configuration index			53	As specified in table 5.7.1-3 in TS 36.211
Time offset between cells		μs	3	Synchronous cells
T1		s	5	
T2		ms	200	
T3		s	3	

Table A.6.1.3.1-2: Cell specific test parameters for E-UTRAN TDD intra-frequency RRC Re-establishment test case

Parameter	Unit	Cell 1			Cell 2		
		T1	T2	T3	T1	T2	T3
E-UTRA RF Channel Number		1			1		
BW_{channel}	MHz	10			10		
OCNG Patterns defined in A.3.2.2.1 (OP.1 TDD) and in A.3.2.2.2 (OP.2 TDD)		OP.1 TDD	OP.1 TDD	OP.2 TDD	OP.2 TDD	OP.2 TDD	OP.1 TDD
PBCH_RA	dB						
PBCH_RB	dB						
PSS_RA	dB						
SSS_RA	dB						
PCFICH_RB	dB						
PHICH_RA	dB						

PHICH_RB	dB	0			0		
PDCCH_RA	dB	0			0		
PDCCH_RB	dB	0			0		
PDSCH_RA	dB	0			0		
PDSCH_RB	dB	0			0		
OCNG_RA ^{Note 1}	dB	0			0		
OCNG_RB ^{Note 1}	dB	0			0		
\hat{E}_s / I_{ot}	dB	1.54	-Infinity	-Infinity	-3.79	4	4
N_{oc} ^{Note 2}	dBm/15 KHz	-98					
\hat{E}_s / N_{oc}	dB	7	-Infinity	-Infinity	4	4	4
RSRP ^{Note 3}	dBm/15 KHz	-91	-Infinity	-Infinity	-94	-94	-94
Propagation Condition		AWGN					
<p>Note 1: OCNG shall be used such that both cells are fully allocated and a constant total transmitted power spectral density is achieved for all OFDM symbols.</p> <p>Note 2: Interference from other cells and noise sources not specified in the test is assumed to be constant over subcarriers and time and shall be modelled as AWGN of appropriate power for N_{oc} to be fulfilled.</p> <p>Note 3: RSRP levels have been derived from other parameters for information purposes. They are not settable parameters themselves.</p>							

A.6.1.3.2 Test Requirements

The RRC re-establishment delay is defined as the time from the start of time period T3, to the moment when the UE starts to send PRACH preambles to cell 2 for sending the *RRCConnectionReestablishmentRequest* message to cell 2.

The RRC re-establishment delay to a known E-UTRA TDD intra frequency cell shall be less than 1.5 s.

The rate of correct RRC re-establishments observed during repeated tests shall be at least 90%.

NOTE: The RRC re-establishment delay in the test is derived from the following expression:

$$T_{\text{re-establish_delay}} = T_{\text{UL_grant}} + T_{\text{UE_re-establish_delay}}$$

Where:

$T_{\text{UL_grant}}$ = It is the time required to acquire and process uplink grant from the target cell. The PRACH reception at the system simulator is used as a trigger for the completion of the test; hence $T_{\text{UL_grant}}$ is not used.

$$T_{\text{UE_re-establish_delay}} = 50 \text{ ms} + N_{\text{freq}} * T_{\text{search}} + T_{\text{SI}} + T_{\text{PRACH}}$$

$$N_{\text{freq}} = 1$$

$$T_{\text{search}} = 100 \text{ ms}$$

$T_{\text{SI}} = 1280 \text{ ms}$; it is the time required for receiving all the relevant system information as defined in TS 36.331 for the target E-UTRAN TDD cell.

$T_{\text{PRACH}} = 15 \text{ ms}$; it is the additional delay caused by the random access procedure.

This gives a total of 1445 ms, allow 1.5 s in the test case.

A.6.1.4 E-UTRAN TDD Inter-frequency RRC Re-establishment

A.6.1.4.1 Test Purpose and Environment

The purpose is to verify that the E-UTRA TDD inter-frequency RRC re-establishment delay is within the specified limits. These tests will verify the requirements in clause 6.1.2.

The test parameters are given in table A.6.1.4.1-1 and table A.6.1.4.1-2 below. The test consists of 3 successive time periods, with time duration of T1, T2 and T3 respectively. At the start of time period T2, cell 1, which is the active cell, is deactivated. The time period T3 starts after the occurrence of radio link failure. At the start of time period T3, cell 2, which is the neighbour cell, is activated.

Table A.6.1.4.1-1: General test parameters for E-UTRAN TDD inter-frequency RRC Re-establishment test case

Parameter		Unit	Value	Comment
PDSCH parameters			DL Reference Measurement Channel R.0 TDD	As specified in clause A.3.1.1.2
PCFICH/PDCCH/PHICH parameters			DL Reference Measurement Channel R.6 TDD	As specified in clause A.3.1.2.2
Initial conditions	Active cell		Cell 1	
	Neighbouring cell		Cell 2	
Final condition	Active cell		Cell 2	
E-UTRA RF Channel Number (cell 1)			1	
E-UTRA RF Channel Number (cell 2)			2	
E-UTRA TDD inter-frequency carrier list size			1	2 E-UTRA TDD carrier frequencies in total: 1 intra-frequency and 1 inter-frequency
Channel Bandwidth ($BW_{channel}$)		MHz	10	
N310		-	1	Maximum consecutive out-of-sync indications from lower layers
N311		-	1	Minimum consecutive in-sync indications from lower layers
T310		ms	0	Radio link failure timer; T310 is disabled
T311		ms	5000	RRC re-establishment timer
DRX			OFF	
CP length			Normal	
Access Barring Information		-	Not Sent	No additional delays in random access procedure.
Special subframe configuration			6	As specified in table 4.2-1 in TS 36.211
Uplink-downlink configuration			1	As specified in table 4.2-2 in TS 36.211
PRACH configuration index			53	As specified in table 5.7.1-3 in TS 36.211
Time offset between cells		μ s	3	Synchronous cells
T1		s	5	
T2		ms	200	
T3		s	5	

Table A.6.1.4.1-2: Cell specific test parameters for E-UTRAN TDD inter-frequency RRC Re-establishment test case

Parameter	Unit	Cell 1			Cell 2		
		T1	T2	T3	T1	T2	T3
E-UTRA RF Channel Number		1			2		
$BW_{channel}$	MHz	10			10		
OCNG Patterns defined in A.3.2.2.1 (OP.1 TDD) and in A.3.2.2.2 (OP.2 TDD)		OP.1 TDD	OP.1 TDD	OP.2 TDD	OP.2 TDD	OP.2 TDD	OP.1 TDD
PBCH_RA	dB	0			0		
PBCH_RB	dB						
PSS_RA	dB						
SSS_RA	dB						
PCFICH_RB	dB						
PHICH_RA	dB						
PHICH_RB	dB						
PDCCH_RA	dB						
PDCCH_RB	dB						
PDSCH_RA	dB						
PDSCH_RB	dB						
OCNG_RA ^{Note 1}	dB						
OCNG_RB ^{Note 1}	dB						
\hat{E}_s / I_{ot}	dB						

N_{oc} <small>Note 2</small>	dBm/15 KHz	-98					
\hat{E}_s / N_{oc}	dB	4	-Infinity	-Infinity	-Infinity	-Infinity	7
RSRP <small>Note 3</small>	dBm/15 KHz	-94	-Infinity	-Infinity	-Infinity	-Infinity	-91
Propagation Condition		AWGN					
<p>Note 1: OCNG shall be used such that both cells are fully allocated and a constant total transmitted power spectral density is achieved for all OFDM symbols.</p> <p>Note 2: Interference from other cells and noise sources not specified in the test is assumed to be constant over subcarriers and time and shall be modelled as AWGN of appropriate power for N_{oc} to be fulfilled.</p> <p>Note 3: RSRP levels have been derived from other parameters for information purposes. They are not settable parameters themselves.</p>							

A.6.1.4.2 Test Requirements

The RRC re-establishment delay is defined as the time from the start of time period T3, to the moment when the UE starts to send PRACH preambles to cell 2 for sending the *RRCConnectionReestablishmentRequest* message to cell 2.

The RRC re-establishment delay to an unknown E-UTRA TDD inter frequency cell shall be less than 3 s.

The rate of correct RRC re-establishments observed during repeated tests shall be at least 90%.

NOTE: The RRC re-establishment delay in the test is derived from the following expression:

$$T_{\text{re-establish_delay}} = T_{\text{UL_grant}} + T_{\text{UE_re-establish_delay}}$$

Where:

$T_{\text{UL_grant}}$ = It is the time required to acquire and process uplink grant from the target cell. The PRACH reception at the system simulator is used as a trigger for the completion of the test; hence $T_{\text{UL_grant}}$ is not used.

$$T_{\text{UE_re-establish_delay}} = 50 \text{ ms} + N_{\text{freq}} * T_{\text{search}} + T_{\text{SI}} + T_{\text{PRACH}}$$

$$N_{\text{freq}} = 2$$

$$T_{\text{search}} = 800 \text{ ms}$$

$T_{\text{SI}} = 1280 \text{ ms}$; it is the time required for receiving all the relevant system information as defined in TS 36.331 for the target E-UTRAN TDD cell.

$T_{\text{PRACH}} = 15 \text{ ms}$; it is the additional delay caused by the random access procedure.

This gives a total of 2945 ms, allow 3 s in the test case.

A.6.1.5 E-UTRAN FDD Intra-frequency RRC Re-establishment for 5MHz bandwidth

A.6.1.5.1 Test Purpose and Environment

The purpose of this test case is the same as for the test defined in subclause A.6.1.1.1.

The parameters of this test are the same as defined in Subclause A.6.1.1.1 except that the values of the parameters in the Table A.6.1.5.1-1 will replace the values of the corresponding parameters in A.6.1.1.1-1, and the values of the parameters in the Table A.6.1.5.1-2 will replace the values of the corresponding parameters in A.6.1.1.1-2.

Table A.6.1.5.1-1: General test parameters for E-UTRAN FDD intra-frequency RRC Re-establishment test case for 5MHz bandwidth

Parameter	Unit	Value	Comment
PDSCH parameters		DL Reference Measurement Channel R.5 FDD	As specified in clause A.3.1.1.1
PCFICH/PDCCH/PHICH parameters		DL Reference Measurement Channel R.11 FDD	As specified in clause A.3.1.2.1
Channel Bandwidth (BW_{channel})	MHz	5	

Note 1: See Table A.6.1.1.1-1 for the other parameters.
 Note 2: This test is according to the principle defined in section A.3.7.2.

Table A.6.1.5.1-2: Cell specific test parameters for E-UTRAN FDD intra-frequency RRC Re-establishment test case for 5MHz bandwidth

Parameter	Unit	Cell 1			Cell 2		
		T1	T2	T3	T1	T2	T3
$BW_{channel}$	MHz	5			5		
OCNG Patterns defined in A.3.2.1.15 (OP.15 FDD) and A.3.2.1.16 (OP.16 FDD)		OP.15 FDD	OP.15 FDD	OP.16 FDD	OP.16 FDD	OP.16 FDD	OP.15 FDD
Note 1: OCNG shall be used such that both cells are fully allocated and a constant total transmitted power spectral density is achieved for all OFDM symbols.							
Note 2: See Table A.6.1.5.1-2 for the other parameters.							

A.6.1.5.2 Test Requirements

The test requirements defined in section A.6.1.1.2 shall apply to this test case.

A.6.1.6 E-UTRAN FD-FDD Intra-frequency RRC Re-establishment for UE category 0

A.6.1.6.1 Test Purpose and Environment

The purpose is to verify that the E-UTRA FDD intra-frequency RRC re-establishment delay is within the specified limits. These tests will verify the requirements in clause 6.1.2.

The test parameters are given in table A.6.1.6.1-1 and table A.6.1.6.1-2 below. The test consists of 3 successive time periods, with time duration of T1, T2 and T3 respectively. At the start of time period T2, cell 1, which is the active cell, is deactivated. The time period T3 starts after the occurrence of the radio link failure.

Table A.6.1.6.1-1: General test parameters for E-UTRAN FDD intra-frequency RRC Re-establishment test case

Parameter	Unit	Value	Comment
PDSCH parameters		DL Reference Measurement Channel R.13 FDD	As specified in clause A.3.1.1.3
PCFICH/PDCCH/PHICH parameters		DL Reference Measurement Channel R.6 FDD	As specified in clause A.3.1.2.1
Initial conditions	Active cell	Cell 1	
	Neighbouring cell	Cell 2	
Final condition	Active cell	Cell 2	
E-UTRA RF Channel Number		1	Only one FDD carrier frequency is used.
Channel Bandwidth ($BW_{channel}$)	MHz	10	
N310	-	1	Maximum consecutive out-of-sync indications from lower layers
N311	-	1	Minimum consecutive in-sync indications from lower layers
T310	ms	0	Radio link failure timer; T310 is disabled
T311	ms	3000	RRC re-establishment timer
DRX		OFF	
CP length		Normal	
Access Barring Information	-	Not Sent	No additional delays in random access procedure.
PRACH configuration index		4	As specified in table 5.7.1-2 in TS 36.211
Time offset between cells	ms	3	Asynchronous cells
T1	s	5	
T2	ms	200	

T3	s	3	
----	---	---	--

Table A.6.1.6.1-2: Cell specific test parameters for E-UTRAN FDD intra-frequency RRC Re-establishment test case

Parameter	Unit	Cell 1			Cell 2		
		T1	T2	T3	T1	T2	T3
E-UTRA RF Channel Number		1			1		
BW _{channel}	MHz	10			10		
OCNG Patterns defined in A.3.2.1.1 (OP.1 FDD) and in A.3.2.1.2 (OP.2 FDD)		OP.1 FDD	OP.1 FDD	OP.2 FDD	OP.2 FDD	OP.2 FDD	OP.1 FDD
PBCH_RA	dB	0			0		
PBCH_RB	dB						
PSS_RA	dB						
SSS_RA	dB						
PCFICH_RB	dB						
PHICH_RA	dB						
PHICH_RB	dB						
PDCCH_RA	dB						
PDCCH_RB	dB						
PDSCH_RA	dB						
PDSCH_RB	dB						
OCNG_RA ^{Note 1}	dB						
OCNG_RB ^{Note 1}	dB						
\hat{E}_s / I_{ot}	dB						
N_{oc} ^{Note 2}	dBm/15 KHz	-98					
\hat{E}_s / N_{oc}	dB	7	-Infinity	-Infinity	4	4	4
RSRP ^{Note 3}	dBm/15 KHz	-91	-Infinity	-Infinity	-94	-94	-94
Propagation Condition		AWGN					
Note 1: OCNG shall be used such that both cells are fully allocated and a constant total transmitted power spectral density is achieved for all OFDM symbols. Note 2: Interference from other cells and noise sources not specified in the test is assumed to be constant over subcarriers and time and shall be modelled as AWGN of appropriate power for N_{oc} to be fulfilled. Note 3: RSRP levels have been derived from other parameters for information purposes. They are not settable parameters themselves.							

A.6.1.6.2 Test Requirements

The RRC re-establishment delay is defined as the time from the start of time period T3, to the moment when the UE starts to send PRACH preambles to cell 2 for sending the *RRCConnectionReestablishmentRequest* message to cell 2.

The RRC re-establishment delay to a known E-UTRA FDD intra frequency cell shall be less than 1.5 s.

The rate of correct RRC re-establishments observed during repeated tests shall be at least 90%.

NOTE: The RRC re-establishment delay in the test is derived from the following expression:

$$T_{re-establish_delay} = T_{UL_grant} + T_{UE_re-establish_delay}$$

Where:

T_{UL_grant} = It is the time required to acquire and process uplink grant from the target cell. The PRACH reception at the system simulator is used as a trigger for the completion of the test; hence T_{UL_grant} is not used.

$$T_{UE_re-establish_delay} = 50 \text{ ms} + N_{freq} * T_{search} + T_{SI} + T_{PRACH}$$

$$N_{freq} = 1$$

$T_{\text{search}} = 100 \text{ ms}$

$T_{\text{SI}} = 1280 \text{ ms}$; it is the time required for receiving all the relevant system information as defined in TS 36.331 for the target E-UTRAN FDD cell.

$T_{\text{PRACH}} = 15 \text{ ms}$; it is the additional delay caused by the random access procedure.

This gives a total of 1445 ms, allow 1.5 s in the test case.

A.6.1.7 E-UTRAN HD-FDD Intra-frequency RRC Re-establishment for UE category 0

A.6.1.7.1 Test Purpose and Environment

The purpose is to verify that the E-UTRA FDD intra-frequency RRC re-establishment delay is within the specified limits. These tests will verify the requirements in clause 6.1.2.

The test parameters are given in table A.6.1.7.1-1 and table A.6.1.7.1-2 below. The test consists of 3 successive time periods, with time duration of T1, T2 and T3 respectively. At the start of time period T2, cell 1, which is the active cell, is deactivated. The time period T3 starts after the occurrence of the radio link failure.

Table A.6.1.7.1-1: General test parameters for E-UTRAN HD-FDD intra-frequency RRC Re-establishment test case

Parameter		Unit	Value	Comment
PDSCH parameters			DL Reference Measurement Channel R.1 HD-FDD	As specified in clause A.3.1.1.4
PCFICH/PDCCH/PHICH parameters			DL Reference Measurement Channel R.3 HD-FDD	As specified in clause A.3.1.2.3
Initial conditions	Active cell		Cell 1	
	Neighbouring cell		Cell 2	
Final condition	Active cell		Cell 2	
E-UTRA RF Channel Number			1	Only one FDD carrier frequency is used.
Channel Bandwidth (BW_{channel})		MHz	10	
N310		-	1	Maximum consecutive out-of-sync indications from lower layers
N311		-	1	Minimum consecutive in-sync indications from lower layers
T310		ms	0	Radio link failure timer; T310 is disabled
T311		ms	3000	RRC re-establishment timer
DRX			OFF	
CP length			Normal	
Access Barring Information		-	Not Sent	No additional delays in random access procedure.
PRACH configuration index			4	As specified in table 5.7.1-2 in TS 36.211
Time offset between cells		ms	3	Asynchronous cells
T1		s	5	
T2		ms	200	
T3		s	3	

Table A.6.1.7.1-2: Cell specific test parameters for E-UTRAN HD-FDD intra-frequency RRC Re-establishment test case

Parameter	Unit	Cell 1			Cell 2		
		T1	T2	T3	T1	T2	T3
E-UTRA RF Channel Number		1			1		
BW_{channel}	MHz	10			10		
OCNG Patterns defined in A.3.2.1.1 (OP.1 FDD) and in A.3.2.1.2 (OP.2 FDD)		OP.1 FDD	OP.1 FDD	OP.2 FDD	OP.2 FDD	OP.2 FDD	OP.1 FDD

PBCH_RA	dB						
PBCH_RB	dB						
PSS_RA	dB						
SSS_RA	dB						
PCFICH_RB	dB						
PHICH_RA	dB						
PHICH_RB	dB						
PDCCH_RA	dB	0			0		
PDCCH_RB	dB						
PDSCH_RA	dB						
PDSCH_RB	dB						
OCNG_RA ^{Note 1}	dB						
OCNG_RB ^{Note 1}	dB						
\hat{E}_s / I_{ot}	dB	1.54	-Infinity	-Infinity	-3.79	4	4
N_{oc} ^{Note 2}	dBm/15 KHz	-98					
\hat{E}_s / N_{oc}	dB	7	-Infinity	-Infinity	4	4	4
RSRP ^{Note 3}	dBm/15 KHz	-91	-Infinity	-Infinity	-94	-94	-94
Propagation Condition		AWGN					
Note 1:	OCNG shall be used such that both cells are fully allocated and a constant total transmitted power spectral density is achieved for all OFDM symbols.						
Note 2:	Interference from other cells and noise sources not specified in the test is assumed to be constant over subcarriers and time and shall be modelled as AWGN of appropriate power for N_{oc} to be fulfilled.						
Note 3:	RSRP levels have been derived from other parameters for information purposes. They are not settable parameters themselves.						

A.6.1.7.2 Test Requirements

The RRC re-establishment delay is defined as the time from the start of time period T3, to the moment when the UE starts to send PRACH preambles to cell 2 for sending the *RRConnectionReestablishmentRequest* message to cell 2.

The RRC re-establishment delay to a known E-UTRA FDD intra frequency cell shall be less than 1.5 s.

The rate of correct RRC re-establishments observed during repeated tests shall be at least 90%.

NOTE: The RRC re-establishment delay in the test is derived from the following expression:

$$T_{\text{re-establish_delay}} = T_{\text{UL_grant}} + T_{\text{UE_re-establish_delay}}$$

Where:

$T_{\text{UL_grant}}$ = It is the time required to acquire and process uplink grant from the target cell. The PRACH reception at the system simulator is used as a trigger for the completion of the test; hence $T_{\text{UL_grant}}$ is not used.

$$T_{\text{UE_re-establish_delay}} = 50 \text{ ms} + N_{\text{freq}} * T_{\text{search}} + T_{\text{SI}} + T_{\text{PRACH}}$$

$$N_{\text{freq}} = 1$$

$$T_{\text{search}} = 100 \text{ ms}$$

$T_{\text{SI}} = 1280 \text{ ms}$; it is the time required for receiving all the relevant system information as defined in TS 36.331 for the target E-UTRAN FDD cell.

$T_{\text{PRACH}} = 15 \text{ ms}$; it is the additional delay caused by the random access procedure.

This gives a total of 1445 ms, allow 1.5 s in the test case.

A.6.1.8 E-UTRAN TDD Intra-frequency RRC Re-establishment for UE category 0

A.6.1.8.1 Test Purpose and Environment

The purpose is to verify that the E-UTRA TDD intra-frequency RRC re-establishment delay is within the specified limits. These tests will verify the requirements in clause 6.1.2.

The test parameters are given in table A.6.1.8.1-1 and table A.6.1.8.1-2 below. The test consists of 3 successive time periods, with time duration of T1, T2 and T3 respectively. At the start of time period T2, cell 1, which is the active cell, is deactivated. The time period T3 starts after the occurrence of the radio link failure.

Table A.6.1.8.1-1: General test parameters for E-UTRAN TDD intra-frequency RRC Re-establishment test case

Parameter		Unit	Value	Comment
PDSCH parameters			DL Reference Measurement Channel R.12 TDD	As specified in clause A.3.1.1.5
PCFICH/PDCCH/PHICH parameters			DL Reference Measurement Channel R.6 TDD	As specified in clause A.3.1.2.2
Initial conditions	Active cell		Cell 1	
	Neighbouring cell		Cell 2	
Final condition	Active cell		Cell 2	
E-UTRA RF Channel Number			1	Only one TDD carrier frequency is used.
Channel Bandwidth (BW_{channel})		MHz	10	
N310		-	1	Maximum consecutive out-of-sync indications from lower layers
N311		-	1	Minimum consecutive in-sync indications from lower layers
T310		ms	0	Radio link failure timer; T310 is disabled
T311		ms	3000	RRC re-establishment timer
DRX			OFF	
CP length			Normal	
Access Barring Information		-	Not Sent	No additional delays in random access procedure.
Special subframe configuration			6	As specified in table 4.2-1 in TS 36.211
Uplink-downlink configuration			1	As specified in table 4.2-2 in TS 36.211
PRACH configuration index			53	As specified in table 5.7.1-3 in TS 36.211
Time offset between cells		μs	3	Synchronous cells
T1		s	5	
T2		ms	200	
T3		s	3	

Table A.6.1.8.1-2: Cell specific test parameters for E-UTRAN TDD intra-frequency RRC Re-establishment test case

Parameter	Unit	Cell 1			Cell 2		
		T1	T2	T3	T1	T2	T3
E-UTRA RF Channel Number		1			1		
BW_{channel}	MHz	10			10		
OCNG Patterns defined in A.3.2.2.1 (OP.1 TDD) and in A.3.2.2.2 (OP.2 TDD)		OP.1 TDD	OP.1 TDD	OP.2 TDD	OP.2 TDD	OP.2 TDD	OP.1 TDD
PBCH_RA	dB						
PBCH_RB	dB						
PSS_RA	dB						
SSS_RA	dB						
PCFICH_RB	dB						

PHICH_RA	dB	0			0		
PHICH_RB	dB						
PDCCH_RA	dB						
PDCCH_RB	dB						
PDSCH_RA	dB						
PDSCH_RB	dB						
OCNG_RA ^{Note 1}	dB						
OCNG_RB ^{Note 1}	dB						
\hat{E}_s / I_{ot}	dB	1.54	-Infinity	-Infinity	-3.79	4	4
N_{oc} ^{Note 2}	dBm/15 KHz	-98					
\hat{E}_s / N_{oc}	dB	7	-Infinity	-Infinity	4	4	4
RSRP ^{Note 3}	dBm/15 KHz	-91	-Infinity	-Infinity	-94	-94	-94
Propagation Condition		AWGN					
<p>Note 1: OCNG shall be used such that both cells are fully allocated and a constant total transmitted power spectral density is achieved for all OFDM symbols.</p> <p>Note 2: Interference from other cells and noise sources not specified in the test is assumed to be constant over subcarriers and time and shall be modelled as AWGN of appropriate power for N_{oc} to be fulfilled.</p> <p>Note 3: RSRP levels have been derived from other parameters for information purposes. They are not settable parameters themselves.</p>							

A.6.1.8.2 Test Requirements

The RRC re-establishment delay is defined as the time from the start of time period T3, to the moment when the UE starts to send PRACH preambles to cell 2 for sending the *RRConnectionReestablishmentRequest* message to cell 2.

The RRC re-establishment delay to a known E-UTRA TDD intra frequency cell shall be less than 1.5 s.

The rate of correct RRC re-establishments observed during repeated tests shall be at least 90%.

NOTE: The RRC re-establishment delay in the test is derived from the following expression:

$$T_{\text{re-establish_delay}} = T_{\text{UL_grant}} + T_{\text{UE_re-establish_delay}}$$

Where:

$T_{\text{UL_grant}}$ = It is the time required to acquire and process uplink grant from the target cell. The PRACH reception at the system simulator is used as a trigger for the completion of the test; hence $T_{\text{UL_grant}}$ is not used.

$$T_{\text{UE_re-establish_delay}} = 50 \text{ ms} + N_{\text{freq}} * T_{\text{search}} + T_{\text{SI}} + T_{\text{PRACH}}$$

$$N_{\text{freq}} = 1$$

$$T_{\text{search}} = 100 \text{ ms}$$

$T_{\text{SI}} = 1280 \text{ ms}$; it is the time required for receiving all the relevant system information as defined in TS 36.331 for the target E-UTRAN TDD cell.

$T_{\text{PRACH}} = 15 \text{ ms}$; it is the additional delay caused by the random access procedure.

This gives a total of 1445 ms, allow 1.5 s in the test case.

A.6.1.9 E-UTRAN FD-FDD Intra-frequency RRC Re-establishment for Cat-M1 UE in CEModeA

A.6.1.9.1 Test Purpose and Environment

The purpose is to verify that the E-UTRA FDD intra-frequency RRC re-establishment delay is within the specified limits. These tests will verify the requirements in clause 6.7.2.

The test parameters are given in table A.6.1.9.1-1 and table A.6.1.9.1-2 below. The test consists of 3 successive time periods, with time duration of T1, T2 and T3 respectively. At the start of time period T2, cell 1, which is the active cell, is deactivated. The time period T3 starts after the occurrence of the radio link failure.

Table A.6.1.9.1-1: General test parameters for E-UTRAN FDD intra-frequency RRC Re-establishment test case

Parameter		Unit	Value	Comment
Initial conditions	Active cell		Cell 1	
	Neighbouring cell		Cell 2	
Final condition	Active cell		Cell 2	
E-UTRA RF Channel Number			1	Only one FDD carrier frequency is used.
Channel Bandwidth ($BW_{channel}$)		MHz	10	
PRACH Configuration			PRACH_2CE	As specified in A.3.16
N310		-	1	Maximum consecutive out-of-sync indications from lower layers
N311		-	1	Minimum consecutive in-sync indications from lower layers
T310		ms	0	Radio link failure timer; T310 is disabled
T311		ms	3000	RRC re-establishment timer
DRX			OFF	
CP length			Normal	
Access Barring Information		-	Not Sent	No additional delays in random access procedure.
PRACH configuration index			4	As specified in table 5.7.1-2 in TS 36.211
Time offset between cells		ms	3	Asynchronous cells
T1		s	5	
T2		ms	400	
T3		s	3	

Table A.6.1.9.1-2: Cell specific test parameters for E-UTRAN FDD intra-frequency RRC Re-establishment test case

Parameter	Unit	Cell 1			Cell 2		
		T1	T2	T3	T1	T2	T3
E-UTRA RF Channel Number		1			1		
$BW_{channel}$	MHz	10			10		
PDSCH Reference Channel in clause A.3.1.4.1		R.21 FDD	R.21 FDD	-	-	-	R.21 FDD
MPDCCH Reference Channel in clause A.3.1.3.1		R.17 FDD			R.17 FDD		
OCNG Patterns in clause A.3.2.1		OP.21 FDD	OP.21 FDD	OP.6 FDD	OP.6 FDD	OP.6 FDD	OP.21 FDD
PBCH_RA	dB	-3			-3		
PBCH_RB	dB						
PSS_RA	dB						
SSS_RA	dB						
MPDCCH_RA	dB						
MPDCCH_RB	dB						
PDSCH_RA	dB						
PDSCH_RB	dB						
OCNG_RA ^{Note 1}	dB						
OCNG_RB ^{Note 1}	dB						
\hat{E}_s / I_{ot}	dB	1.54	-Infinity	-Infinity	-3.79	4	4
N_{oc} ^{Note 2}	dBm/15 KHz	-98					
\hat{E}_s / N_{oc}	dB	7	-Infinity	-Infinity	4	4	4
RSRP ^{Note 3}	dBm/15 KHz	-91	-Infinity	-Infinity	-94	-94	-94

Propagation Condition		AWGN	AWGN
Antenna Configuration		2x1	2x1
Note 1:	OCNG shall be used such that both cells are fully allocated and a constant total transmitted power spectral density is achieved for all OFDM symbols.		
Note 2:	Interference from other cells and noise sources not specified in the test is assumed to be constant over subcarriers and time and shall be modelled as AWGN of appropriate power for N_{oc} to be fulfilled.		
Note 3:	Es/lot and RSRP levels have been derived from other parameters for information purposes. They are not settable parameters themselves.		

A.6.1.9.2 Test Requirements

The RRC re-establishment delay is defined as the time from the start of time period T3, to the moment when the UE starts to send PRACH preambles to cell 2 for sending the *RRConnectionReestablishmentRequest* message to cell 2.

The RRC re-establishment delay to a known E-UTRA FDD intra frequency cell shall be less than 1.5 s.

The rate of correct RRC re-establishments observed during repeated tests shall be at least 90%.

NOTE: The RRC re-establishment delay in the test is derived from the following expression:

$$T_{\text{re-establish_delay}} = T_{\text{UL_grant}} + T_{\text{UE_re-establish_delay}}$$

Where:

$T_{\text{UL_grant}}$ = It is the time required to acquire and process uplink grant from the target cell. The PRACH reception at the system simulator is used as a trigger for the completion of the test; hence $T_{\text{UL_grant}}$ is not used.

$$T_{\text{UE_re-establish_delay}} = 50 \text{ ms} + N_{\text{freq}} * T_{\text{search}} + T_{\text{SI-EUTRA-M1-CEModeA}} + T_{\text{PRACH}}$$

$$N_{\text{freq}} = 1$$

$$T_{\text{search}} = 0 \text{ ms}$$

$T_{\text{SI-EUTRA-M1-CEModeA}} = 1280 \text{ ms}$; it is the time required for receiving all the relevant system information as defined in TS 36.331 for the target E-UTRAN FDD cell.

$T_{\text{PRACH}} = 15 \text{ ms}$; it is the additional delay caused by the random access procedure.

This gives a total of 1345 ms, allow 1.5 s in the test case.

A.6.1.10 E-UTRAN HD-FDD Intra-frequency RRC Re-establishment for Cat-M1 UE in CEModeA

A.6.1.10.1 Test Purpose and Environment

The purpose is to verify that the E-UTRA FDD intra-frequency RRC re-establishment delay is within the specified limits. These tests will verify the requirements in clause 6.7.2.

The test parameters are given in table A.6.1.10.1-1 and table A.6.1.10.1-2 below. The test consists of 3 successive time periods, with time duration of T1, T2 and T3 respectively. At the start of time period T2, cell 1, which is the active cell, is deactivated. The time period T3 starts after the occurrence of the radio link failure.

Table A.6.1.10.1-1: General test parameters for E-UTRAN HD-FDD intra-frequency RRC Re-establishment test case

Parameter	Unit	Value	Comment
Initial conditions		Cell 1	
		Cell 2	
Final condition		Cell 2	
E-UTRA RF Channel Number		1	Only one FDD carrier frequency is used.
Channel Bandwidth (BW_{channel})	MHz	10	
PRACH Configuration		PRACH_2CE	As specified in A.3.16

N310	-	1	Maximum consecutive out-of-sync indications from lower layers
N311	-	1	Minimum consecutive in-sync indications from lower layers
T310	ms	0	Radio link failure timer; T310 is disabled
T311	ms	3000	RRC re-establishment timer
DRX		OFF	
CP length		Normal	
Access Barring Information	-	Not Sent	No additional delays in random access procedure.
PRACH configuration index		4	As specified in table 5.7.1-2 in TS 36.211
Time offset between cells	ms	3	Asynchronous cells
T1	s	5	
T2	ms	400	
T3	s	3	

Table A.6.1.10.1-2: Cell specific test parameters for E-UTRAN HD-FDD intra-frequency RRC Re-establishment test case

Parameter	Unit	Cell 1			Cell 2		
		T1	T2	T3	T1	T2	T3
E-UTRA RF Channel Number		1			1		
$BW_{channel}$	MHz	10			10		
PDSCH Reference Channel in clause A.3.1.4.2		R.11 HD-FDD	R.11 HD-FDD	-	-	-	R.11 HD-FDD
MPDCCH Reference Channel in clause A.3.1.3.2		R.7 HD-FDD			R.7 HD-FDD		
OCNG Patterns in clause A.3.2.1		OP.21 FDD	OP.21 FDD	OP.6 FDD	OP.6 FDD	OP.6 FDD	OP.21 FDD
PBCH_RA	dB	-3			-3		
PBCH_RB	dB						
PSS_RA	dB						
SSS_RA	dB						
MPDCCH_RA	dB						
MPDCCH_RB	dB						
PDSCH_RA	dB						
PDSCH_RB	dB						
OCNG_RA ^{Note 1}	dB						
OCNG_RB ^{Note 1}	dB						
\hat{E}_s / I_{ot}	dB	1.54	-Infinity	-Infinity	-3.79	4	4
N_{oc} ^{Note 2}	dBm/15 KHz	-98					
\hat{E}_s / N_{oc}	dB	7	-Infinity	-Infinity	4	4	4
RSRP ^{Note 3}	dBm/15 KHz	-91	-Infinity	-Infinity	-94	-94	-94
Propagation Condition		AWGN			AWGN		
Antenna Configuration		2x1			2x1		
Note 1:	OCNG shall be used such that both cells are fully allocated and a constant total transmitted power spectral density is achieved for all OFDM symbols.						
Note 2:	Interference from other cells and noise sources not specified in the test is assumed to be constant over subcarriers and time and shall be modelled as AWGN of appropriate power for N_{oc} to be fulfilled.						
Note 3:	Es/lot and RSRP levels have been derived from other parameters for information purposes. They are not settable parameters themselves.						

A.6.1.10.2 Test Requirements

The RRC re-establishment delay is defined as the time from the start of time period T3, to the moment when the UE starts to send PRACH preambles to cell 2 for sending the *RRConnectionReestablishmentRequest* message to cell 2.

The RRC re-establishment delay to a known E-UTRA FDD intra frequency cell shall be less than 1.5 s.

The rate of correct RRC re-establishments observed during repeated tests shall be at least 90%.

NOTE: The RRC re-establishment delay in the test is derived from the following expression:

$$T_{\text{re-establish_delay}} = T_{\text{UL_grant}} + T_{\text{UE_re-establish_delay}}$$

Where:

$T_{\text{UL_grant}}$ = It is the time required to acquire and process uplink grant from the target cell. The PRACH reception at the system simulator is used as a trigger for the completion of the test; hence $T_{\text{UL_grant}}$ is not used.

$$T_{\text{UE_re-establish_delay}} = 50 \text{ ms} + N_{\text{freq}} * T_{\text{search}} + T_{\text{SI-EUTRA-M1-CEModeA}} + T_{\text{PRACH}}$$

$$N_{\text{freq}} = 1$$

$$T_{\text{search}} = 0 \text{ ms}$$

$T_{\text{SI-EUTRA-M1-CEModeA}} = 1280 \text{ ms}$; it is the time required for receiving all the relevant system information as defined in TS 36.331 for the target E-UTRAN FDD cell.

$T_{\text{PRACH}} = 15 \text{ ms}$; it is the additional delay caused by the random access procedure.

This gives a total of 1345 ms, allow 1.5 s in the test case.

A.6.1.11 E-UTRAN TDD Intra-frequency RRC Re-establishment for Cat-M1 UE in CEModeA

A.6.1.11.1 Test Purpose and Environment

The purpose is to verify that the E-UTRA TDD intra-frequency RRC re-establishment delay is within the specified limits. These tests will verify the requirements in clause 6.7.2.

The test parameters are given in table A.6.1.11.1-1 and table A.6.1.11.1-2 below. The test consists of 3 successive time periods, with time duration of T1, T2 and T3 respectively. At the start of time period T2, cell 1, which is the active cell, is deactivated. The time period T3 starts after the occurrence of the radio link failure.

Table A.6.1.11.1-1: General test parameters for E-UTRAN TDD intra-frequency RRC Re-establishment test case

Parameter		Unit	Value	Comment
Initial conditions	Active cell		Cell 1	
	Neighbouring cell		Cell 2	
Final condition	Active cell		Cell 2	
E-UTRA RF Channel Number			1	Only one TDD carrier frequency is used.
Channel Bandwidth (BW_{channel})		MHz	10	
PRACH Configuration			PRACH_2CE	As specified in A.3.16
N310		-	1	Maximum consecutive out-of-sync indications from lower layers
N311		-	1	Minimum consecutive in-sync indications from lower layers
T310		ms	0	Radio link failure timer; T310 is disabled
T311		ms	3000	RRC re-establishment timer
DRX			OFF	
CP length			Normal	
Access Barring Information		-	Not Sent	No additional delays in random access procedure.
Special subframe configuration			6	As specified in table 4.2-1 in TS 36.211
Uplink-downlink configuration			1	As specified in table 4.2-2 in TS 36.211
PRACH configuration index			53	As specified in table 5.7.1-3 in TS 36.211

Time offset between cells	μ s	3	Synchronous cells
T1	s	5	
T2	ms	400	
T3	s	3	

Table A.6.1.11.1-2: Cell specific test parameters for E-UTRAN TDD intra-frequency RRC Re-establishment test case

Parameter	Unit	Cell 1			Cell 2		
		T1	T2	T3	T1	T2	T3
E-UTRA RF Channel Number		1			1		
BW _{channel}	MHz	10			10		
PDSCH Reference Channel in clause A.3.1.4.3		R.17 TDD	R.17 TDD	-	-	-	R.17 TDD
MPDCCH Reference Channel in clause A.3.1.3.3		R.15 TDD			R.15 TDD		
OCNG Patterns in cluse A.3.2.2		OP.11 TDD	OP.11 TDD	OP.2 TDD	OP.2 TDD	OP.2 TDD	OP.11 TDD
PBCH_RA	dB	-3			-3		
PBCH_RB	dB						
PSS_RA	dB						
SSS_RA	dB						
MPDCCH_RA	dB						
MPDCCH_RB	dB						
PDSCH_RA	dB						
PDSCH_RB	dB						
OCNG_RA ^{Note 1}	dB						
OCNG_RB ^{Note 1}	dB						
\hat{E}_s/I_{ot}	dB	1.54	-Infinity	-Infinity	-3.79	4	4
N_{oc} ^{Note 2}	dBm/15 KHz	-98					
\hat{E}_s/N_{oc}	dB	7	-Infinity	-Infinity	4	4	4
RSRP ^{Note 3}	dBm/15 KHz	-91	-Infinity	-Infinity	-94	-94	-94
Propagation Condition		AWGN			AWGN		
Antenna Configuration		2x1			2x1		
<p>Note 1: OCNG shall be used such that both cells are fully allocated and a constant total transmitted power spectral density is achieved for all OFDM symbols.</p> <p>Note 2: Interference from other cells and noise sources not specified in the test is assumed to be constant over subcarriers and time and shall be modelled as AWGN of appropriate power for N_{oc} to be fulfilled.</p> <p>Note 3: E_s/I_{ot} and RSRP levels have been derived from other parameters for information purposes. They are not settable parameters themselves.</p>							

A.6.1.11.2 Test Requirements

The RRC re-establishment delay is defined as the time from the start of time period T3, to the moment when the UE starts to send PRACH preambles to cell 2 for sending the *RRCConnectionReestablishmentRequest* message to cell 2.

The RRC re-establishment delay to a known E-UTRA TDD intra frequency cell shall be less than 1.5 s.

The rate of correct RRC re-establishments observed during repeated tests shall be at least 90%.

NOTE: The RRC re-establishment delay in the test is derived from the following expression:

$$T_{\text{re-establish_delay}} = T_{\text{UL_grant}} + T_{\text{UE_re-establish_delay}}$$

Where:

$T_{\text{UL_grant}}$ = It is the time required to acquire and process uplink grant from the target cell. The PRACH reception at the system simulator is used as a trigger for the completion of the test; hence $T_{\text{UL_grant}}$ is not used.

$$T_{UE_re-establish_delay} = 50 \text{ ms} + N_{freq} * T_{search} + T_{SI-EUTRA-M1-CEModeA} + T_{PRACH}$$

$$N_{freq} = 1$$

$$T_{search} = 0 \text{ ms}$$

$T_{SI-EUTRA-M1-CEModeA} = 1280 \text{ ms}$; it is the time required for receiving all the relevant system information as defined in TS 36.331 for the target E-UTRAN TDD cell.

$T_{PRACH} = 15 \text{ ms}$; it is the additional delay caused by the random access procedure.

This gives a total of 1345 ms, allow 1.5 s in the test case.

A.6.1.12 E-UTRAN FD-FDD Intra-frequency RRC Re-establishment for Cat-M1 UE in CEModeB

A.6.1.12.1 Test Purpose and Environment

The purpose is to verify that the E-UTRA FDD intra-frequency RRC re-establishment delay is within the specified limits. These tests will verify the requirements in clause 6.7.2.

The test parameters are given in table A.6.1.12.1-1 and table A.6.1.12.1-2 below. The test consists of 4 successive time periods, with time duration of T1, T2, T3 and T4 respectively. During T1, both cell 1 and cell 2 are in CEModeB. At the start of time period T3, cell 1, which is the active cell, is deactivated. The time period T4 starts after the occurrence of the radio link failure.

Table A.6.1.12.1-1: General test parameters for E-UTRAN FDD intra-frequency RRC Re-establishment test case

Parameter		Unit	Value	Comment
Initial conditions	Active cell		Cell 1	
	Neighbouring cell		Cell 2	
Final condition	Active cell		Cell 2	
E-UTRA RF Channel Number			1	Only one FDD carrier frequency is used.
Channel Bandwidth ($BW_{channel}$)		MHz	10	
PRACH Configuration			PRACH_3CE	As specified in A.3.16
N310		-	1	Maximum consecutive out-of-sync indications from lower layers
N311		-	1	Minimum consecutive in-sync indications from lower layers
T310		ms	0	Radio link failure timer; T310 is disabled
T311		ms	3000	RRC re-establishment timer
DRX			OFF	
CP length			Normal	
Access Barring Information		-	Not Sent	No additional delays in random access procedure.
PRACH configuration index			4	As specified in table 5.7.1-2 in TS 36.211
Time offset between cells		ms	3	Asynchronous cells
T1		s	5	
T2		s	5	
T3		ms	4000	
T4		s	9	

Table A.6.1.12.1-2: Cell specific test parameters for E-UTRAN FDD intra-frequency RRC Re-establishment test case

Parameter	Unit	Cell 1				Cell 2			
		T1	T2	T3	T4	T1	T2	T3	T4
E-UTRA RF Channel Number		1				1			
$BW_{channel}$	MHz	10				10			

PDSCH Reference Channel in clause A.3.1.4.4		R.23 FDD	R.23 FDD	R.23 FDD	-	-	-	-	R.23 FDD
MPDCCH Reference Channel in clause A.3.1.3.4		R.19 FDD				R.19 FDD			
OCNG Patterns in clause A.3.2.1		OP.21 FDD	OP.21 FDD	OP.21 FDD	OP.6 FDD	OP.6 FDD	OP.6 FDD	OP.6 FDD	OP.21 FDD
PBCH_RA	dB	-3				-3			
PBCH_RB	dB								
PSS_RA	dB								
SSS_RA	dB								
MPDCCH_RA	dB								
MPDCCH_RB	dB								
PDSCH_RA	dB								
PDSCH_RB	dB								
OCNG_RA ^{Note 1}	dB								
OCNG_RB ^{Note 1}	dB								
\hat{E}_s/I_{ot}	dB	1.54	-15.27	-Infinity	-Infinity	-3.79	-12.14	-12	-12
N_{oc} ^{Note 2}	dBm/15 KHz	-98							
\hat{E}_s/N_{oc}	dB	7	-15	-Infinity	-Infinity	4	-12	-12	-12
RSRP ^{Note 3}	dBm/15 KHz	-91	-113	-Infinity	-Infinity	-94	-110	-110	-110
Propagation Condition		AWGN				AWGN			
Antenna Configuration		2x1				2x1			
<p>Note 1: OCNG shall be used such that both cells are fully allocated and a constant total transmitted power spectral density is achieved for all OFDM symbols.</p> <p>Note 2: Interference from other cells and noise sources not specified in the test is assumed to be constant over subcarriers and time and shall be modelled as AWGN of appropriate power for N_{oc} to be fulfilled.</p> <p>Note 3: E_s/I_{ot} and RSRP levels have been derived from other parameters for information purposes. They are not settable parameters themselves.</p>									

A.6.1.12.2 Test Requirements

The RRC re-establishment delay is defined as the time from the start of time period T4, to the moment when the UE starts to send PRACH preambles to cell 2 for sending the *RRCConnectionReestablishmentRequest* message to cell 2.

The RRC re-establishment delay to a known E-UTRA FDD intra frequency cell shall be less than 7 s.

The rate of correct RRC re-establishments observed during repeated tests shall be at least 90%.

NOTE: The RRC re-establishment delay in the test is derived from the following expression:

$$T_{\text{re-establish_delay}} = T_{\text{UL_grant}} + T_{\text{UE_re-establish_delay}}$$

Where:

$T_{\text{UL_grant}}$ = It is the time required to acquire and process uplink grant from the target cell. The PRACH reception at the system simulator is used as a trigger for the completion of the test; hence $T_{\text{UL_grant}}$ is not used.

$$T_{\text{UE_re-establish_delay}} = 50 \text{ ms} + N_{\text{freq}} * T_{\text{search}} + T_{\text{SI-EUTRA-MI-CEModeB}} + T_{\text{PRACH}}$$

$$N_{\text{freq}} = 1$$

$$T_{\text{search}} = 0 \text{ ms}$$

$T_{\text{SI-EUTRA-MI-CEModeB}} = 6400 \text{ ms}$; it is the time required for receiving all the relevant system information as defined in TS 36.331 for the target E-UTRAN FDD cell.

$T_{\text{PRACH}} = 15 \text{ ms}$; it is the additional delay caused by the random access procedure.

This gives a total of 6485 ms, allow 7 s in the test case.

A.6.1.13 E-UTRAN HD-FDD Intra-frequency RRC Re-establishment for Cat-M1 UE in CEModeB

A.6.1.13.1 Test Purpose and Environment

The purpose is to verify that the E-UTRA FDD intra-frequency RRC re-establishment delay is within the specified limits. These tests will verify the requirements in clause 6.7.2.

The test parameters are given in table A.6.1.13.1-1 and table A.6.1.13.1-2 below. The test consists of 4 successive time periods, with time duration of T1, T2, T3 and T4 respectively. During T1, both cell 1 and cell 2 are in CEModeB. At the start of time period T3, cell 1, which is the active cell, is deactivated. The time period T4 starts after the occurrence of the radio link failure.

Table A.6.1.13.1-1: General test parameters for E-UTRAN HD-FDD intra-frequency RRC Re-establishment test case

Parameter		Unit	Value	Comment
Initial conditions	Active cell		Cell 1	
	Neighbouring cell		Cell 2	
Final condition	Active cell		Cell 2	
E-UTRA RF Channel Number			1	Only one FDD carrier frequency is used.
Channel Bandwidth ($BW_{channel}$)		MHz	10	
PRACH Configuration			PRACH_3CE	As specified in A.3.16
N310		-	1	Maximum consecutive out-of-sync indications from lower layers
N311		-	1	Minimum consecutive in-sync indications from lower layers
T310		ms	0	Radio link failure timer; T310 is disabled
T311		ms	3000	RRC re-establishment timer
DRX			OFF	
CP length			Normal	
Access Barring Information		-	Not Sent	No additional delays in random access procedure.
PRACH configuration index			4	As specified in table 5.7.1-2 in TS 36.211
Time offset between cells		ms	3	Asynchronous cells
T1		s	5	
T2		s	5	
T3		ms	4000	
T4		s	9	

Table A.6.1.13.1-2: Cell specific test parameters for E-UTRAN HD-FDD intra-frequency RRC Re-establishment test case

Parameter	Unit	Cell 1				Cell 2			
		T1	T2	T3	T4	T1	T2	T3	T4
E-UTRA RF Channel Number		1				1			
$BW_{channel}$	MHz	10				10			
PDSCH Reference Channel in clause A.3.1.4.5		R.13 HD-FDD	R.13 HD-FDD	R.13 HD-FDD	-	-	-	-	R.13 HD-FDD
MPDCCH Reference Channel in clause A.3.1.3.5		R.9 HD-FDD				R.9 HD-FDD			
OCNG Patterns in clause A.3.2.		OP.21 FDD	OP.21 FDD	OP.21 FDD	OP.6 FDD	OP.6 FDD	OP.6 FDD	OP.6 FDD	OP.21 FDD
PBCH_RA	dB	-3				-3			
PBCH_RB	dB								
PSS_RA	dB								
SSS_RA	dB								
MPDCCH_RA	dB								
MPDCCH_RB	dB								

PDSCH_RA	dB								
PDSCH_RB	dB								
OCNG_RA ^{Note 1}	dB								
OCNG_RB ^{Note 1}	dB								
\hat{E}_s / I_{ot}	dB	1.54	-15.27	-	-	-3.79	-12.14	-12	-12
N_{oc} ^{Note 2}	dBm/15 KHz	-98							
\hat{E}_s / N_{oc}	dB	7	-15	-	-	4	-12	-12	-12
RSRP ^{Note 3}	dBm/15 KHz	-91	-113	-	-	-94	-110	-110	-110
Propagation Condition		AWGN				AWGN			
Antenna Configuration		2x1				2x1			
Note 1:	OCNG shall be used such that both cells are fully allocated and a constant total transmitted power spectral density is achieved for all OFDM symbols.								
Note 2:	Interference from other cells and noise sources not specified in the test is assumed to be constant over subcarriers and time and shall be modelled as AWGN of appropriate power for N_{oc} to be fulfilled.								
Note 3:	Es/lot and RSRP levels have been derived from other parameters for information purposes. They are not settable parameters themselves.								

A.6.1.13.2 Test Requirements

The RRC re-establishment delay is defined as the time from the start of time period T4, to the moment when the UE starts to send PRACH preambles to cell 2 for sending the *RRCConnectionReestablishmentRequest* message to cell 2.

The RRC re-establishment delay to a known E-UTRA FDD intra frequency cell shall be less than 7 s.

The rate of correct RRC re-establishments observed during repeated tests shall be at least 90%.

NOTE: The RRC re-establishment delay in the test is derived from the following expression:

$$T_{\text{re-establish_delay}} = T_{\text{UL_grant}} + T_{\text{UE_re-establish_delay}}$$

Where:

$T_{\text{UL_grant}}$ = It is the time required to acquire and process uplink grant from the target cell. The PRACH reception at the system simulator is used as a trigger for the completion of the test; hence $T_{\text{UL_grant}}$ is not used.

$$T_{\text{UE_re-establish_delay}} = 50 \text{ ms} + N_{\text{freq}} * T_{\text{search}} + T_{\text{SI-EUTRA-M1-CEModeB}} + T_{\text{PRACH}}$$

$$N_{\text{freq}} = 1$$

$$T_{\text{search}} = 0 \text{ ms}$$

$T_{\text{SI-EUTRA-M1-CEModeB}}$ = 6400 ms; it is the time required for receiving all the relevant system information as defined in TS 36.331 for the target E-UTRAN FDD cell.

T_{PRACH} = 15 ms; it is the additional delay caused by the random access procedure.

This gives a total of 6465 ms, allow 7 s in the test case.

A.6.1.14 E-UTRAN TDD Intra-frequency RRC Re-establishment for Cat-M1 UE in CEModeB

A.6.1.14.1 Test Purpose and Environment

The purpose is to verify that the E-UTRA TDD intra-frequency RRC re-establishment delay is within the specified limits. These tests will verify the requirements in clause 6.7.2.

The test parameters are given in table A.6.1.14.1-1 and table A.6.1.14.1-2 below. The test consists of 4 successive time periods, with time duration of T1, T2, T3 and T4 respectively. During T1, both cell 1 and cell 2 are in CEModeB. At the start of time period T3, cell 1, which is the active cell, is deactivated. The time period T4 starts after the occurrence of the radio link failure.

Table A.6.1.14.1-1: General test parameters for E-UTRAN TDD intra-frequency RRC Re-establishment test case

Parameter		Unit	Value	Comment
Initial conditions	Active cell		Cell 1	
	Neighbouring cell		Cell 2	
Final condition	Active cell		Cell 2	
E-UTRA RF Channel Number			1	Only one TDD carrier frequency is used.
Channel Bandwidth ($BW_{channel}$)		MHz	10	
PRACH Configuration			PRACH_3CE	As specified in A.3.16
N310		-	1	Maximum consecutive out-of-sync indications from lower layers
N311		-	1	Minimum consecutive in-sync indications from lower layers
T310		ms	0	Radio link failure timer; T310 is disabled
T311		ms	3000	RRC re-establishment timer
DRX			OFF	
CP length			Normal	
Access Barring Information		-	Not Sent	No additional delays in random access procedure.
Special subframe configuration			6	As specified in table 4.2-1 in TS 36.211
Uplink-downlink configuration			1	As specified in table 4.2-2 in TS 36.211
PRACH configuration index			53	As specified in table 5.7.1-3 in TS 36.211
Time offset between cells		μ s	3	Synchronous cells
T1		s	5	
T2		s	5	
T3		ms	4000	
T4		s	9	

Table A.6.1.14.1-2: Cell specific test parameters for E-UTRAN TDD intra-frequency RRC Re-establishment test case

Parameter	Unit	Cell 1				Cell 2			
		T1	T2	T3	T4	T1	T2	T3	T4
E-UTRA RF Channel Number		1				1			
$BW_{channel}$	MHz	10				10			
PDSCH Reference Channel in clause A.3.1.4.6		R.19 TDD	R.19 TDD	R.19 TDD	-	-	-	-	R.19 TDD
MPDCCH Reference Channel in clause A.3.1.3.6		R.17 TDD				R.17 TDD			
OCNG Patterns in clause A.3.2.2		OP.11 TDD	OP.11 TDD	OP.11 TDD	OP.2 TDD	OP.2 TDD	OP.2 TDD	OP.2T DD	OP.11 TDD
PBCH_RA	dB	0				0			
PBCH_RB	dB								
PSS_RA	dB								
SSS_RA	dB								
MPDCCH_RA	dB								
MPDCCH_RB	dB								
PDSCH_RA	dB								
PDSCH_RB	dB								
OCNG_RA ^{Note 1}	dB								
OCNG_RB ^{Note 1}	dB								
\hat{E}_s/I_{ot}	dB	1.54	-15.27	-Infinity	-Infinity	-3.79	-12.14	-12	-12
N_{oc} ^{Note 2}	dBm/15 KHz	-98							
\hat{E}_s/N_{oc}	dB	7	-15	-Infinity	-Infinity	4	-12	-12	-12

RSRP ^{Note 3}	dBm/15 KHz	-91	-113	-Infinity	-Infinity	-94	-110	-110	-110
Propagation Condition		AWGN				AWGN			
Antenna Configuration		2x1				2x1			
Note 1:	OCNG shall be used such that both cells are fully allocated and a constant total transmitted power spectral density is achieved for all OFDM symbols.								
Note 2:	Interference from other cells and noise sources not specified in the test is assumed to be constant over subcarriers and time and shall be modelled as AWGN of appropriate power for N_{oc} to be fulfilled.								
Note 3:	Es/lot and RSRP levels have been derived from other parameters for information purposes. They are not settable parameters themselves.								

A.6.1.14.2 Test Requirements

The RRC re-establishment delay is defined as the time from the start of time period T3, to the moment when the UE starts to send PRACH preambles to cell 2 for sending the *RRCConnectionReestablishmentRequest* message to cell 2.

The RRC re-establishment delay to a known E-UTRA TDD intra frequency cell shall be less than 7 s.

The rate of correct RRC re-establishments observed during repeated tests shall be at least 90%.

NOTE: The RRC re-establishment delay in the test is derived from the following expression:

$$T_{\text{re-establish_delay}} = T_{\text{UL_grant}} + T_{\text{UE_re-establish_delay}}$$

Where:

$T_{\text{UL_grant}}$ = It is the time required to acquire and process uplink grant from the target cell. The PRACH reception at the system simulator is used as a trigger for the completion of the test; hence $T_{\text{UL_grant}}$ is not used.

$$T_{\text{UE_re-establish_delay}} = 50 \text{ ms} + N_{\text{freq}} * T_{\text{search}} + T_{\text{SI-EUTRA-MI-CEModeB}} + T_{\text{PRACH}}$$

$$N_{\text{freq}} = 1$$

$$T_{\text{search}} = 0 \text{ ms}$$

$T_{\text{SI-EUTRA-MI-CEModeB}} = 6400 \text{ ms}$; it is the time required for receiving all the relevant system information as defined in TS 36.331 for the target E-UTRAN TDD cell.

$T_{\text{PRACH}} = 15 \text{ ms}$; it is the additional delay caused by the random access procedure.

This gives a total of 6465 ms, allow 7s in the test case.

A.6.1.15 HD-FDD Intra-frequency RRC Re-establishment for UE category NB1 in In-Band mode under enhanced coverage

A.6.1.15.1 Test Purpose and Environment

The purpose is to verify that the NB-IoT FDD intra-frequency RRC re-establishment delay is within the specified limits. These tests will verify the requirements for Cat-NB1 UE in clause 6.5.

The test parameters are given in table A.6.1.15.1-1 and table A.6.1.15.1-2 below. nCell1 and nCell2 are NB-IoT cells with different physical cell ID on the same frequency carrier. The test consists of 3 successive time periods, with time duration of T1, T2 and T3 respectively. At the start of time period T2, cell 1, which is the active cell, is deactivated. The time period T3 starts after the occurrence of the radio link failure.

Table A.6.1.15.1-1: General test parameters for HD-FDD Intra-frequency RRC Re-establishment for UE category NB1 in In-Band mode under enhanced coverage

Parameter		Unit	Value	Comment
NB-IOT operational mode			In-band	
Initial condition	Active cell		nCell1	
	Neighbour cells		eCell1, eCell2, nCell2	

Final condition	Active cell		nCell2	
E-UTRA RF Channel Number			1	One carrier frequency is used for eCell1 and eCell2.
Access Barring Information	-		Not Sent	No additional delays in random access procedure.
NPRACH Configuration			NPRACH.R-1	Refer to A.3.18
NPDCCH repetition level			16	NPDCCH R_{max}
N310	-		1	Maximum consecutive out-of-sync indications from lower layers
N311	-		1	Minimum consecutive in-sync indications from lower layers
T310	Ms		0	Radio link failure timer; T310 is disabled
T311-v13xy	Ms		60000	RRC re-establishment timer
DRX			OFF	
T1	S		5	
T2	Ms		400	
T3	S		60	

Table A.6.1.15.1-2: nCell 1, nCell 2 specific test parameters for HD-FDD Intra-frequency RRC Re-establishment for UE category NB1 in In-Band mode under enhanced coverage

Parameter	Unit	nCell 1			nCell 2		
		T1	T2	T3	T1	T2	T3
$BW_{channel}$	kHz	200			200		
PRB location within eCell	-	eCell1 $BW_{channel}$ 5MHz: 17 eCell1 $BW_{channel}$ 10MHz: 30			eCell1 $BW_{channel}$ 5MHz: 17 eCell1 $BW_{channel}$ 10MHz: 30		
NPDSCH parameters		eCell1 $BW_{channel}$ 5MHz: R.16 HD-FDD eCell1 $BW_{channel}$ 10MHz: R.14 HD-FDD			eCell1 $BW_{channel}$ 5MHz: R.16 HD-FDD eCell1 $BW_{channel}$ 10MHz: R.14 HD-FDD		
NPDCCH parameters		eCell1 $BW_{channel}$ 5MHz: R.38 HD-FDD eCell1 $BW_{channel}$ 10MHz: R.26 HD-FDD			eCell1 $BW_{channel}$ 5MHz: R.38 HD-FDD eCell1 $BW_{channel}$ 10MHz: R.26 HD-FDD		
NPBCH_RA	dB	0			0		
NPBCH_RB	dB						
NPSS_RA	dB						
NSSS_RA	dB						
NPDCCH_RA	dB						
NPDCCH_RB	dB						
NPDSCH_RA	dB						
NPDSCH_RB	dB						
NOCNG_RA ^{Note 1}	dB						
NOCNG_RB ^{Note 1}	dB						
N_{oc}	dBm/15 kHz	Specified in Table A.6.1.15.1-3					
\hat{E}_s/N_{oc}	dB	7	-Infinity	-Infinity	-Infinity	-12.6	-12.6
\hat{E}_s/I_{ot} ^{Note2}	dB	7	-Infinity	-Infinity	-Infinity	-12.6	-12.6
NRSRP ^{Note2}	dBm/15 kHz	-91	-Infinity	-Infinity	-Infinity	-110.6	-110.6
Propagation Condition		AWGN			AWGN		
Antenna Configuration		1x1			1x1		
Timing offset to nCell 1	ms	-			3		
Note 1: NOCNG shall be used such that both cells are fully allocated and a constant total transmitted power spectral density is achieved for all OFDM symbols. Note 2: E_s/I_{ot} and NRSRP levels have been derived from other parameters for information purposes. They are not settable parameters themselves.							

Table A.6.1.15.1-3: eCell 1 and eCell2 specific test parameters for HD-FDD Intra-frequency RRC Re-establishment for UE category NB1 in In-Band mode under enhanced coverage

Parameter	Unit	eCell 1			eCell 2		
		T1	T2	T3	T1	T2	T3

$BW_{channel}$	MHz	5 or 10			5 or 10		
NOCNG Patterns		$BW_{channel}$ 5MHz: NOP.4 FDD $BW_{channel}$ 10MHz: NOP.1 FDD			$BW_{channel}$ 5MHz: NOP.4 FDD $BW_{channel}$ 10MHz: NOP.1 FDD		
PBCH_RA	dB	0			0		
PBCH_RB	dB						
PSS_RA	dB						
SSS_RA	dB						
PDCCH_RA	dB						
PDCCH_RB	dB						
PCFICH_RB	dB						
OCNG_RA ^{Note 1}	dB						
OCNG_RB ^{Note 1}	dB						
Qrxlevmin	dBm	-140	-140	-140	-140	-140	-140
Pcompensation	dB	0	0	0	0	0	0
Qhyst _s	dB	0	0	0	0	0	0
Qoffset _{s, n}	dB	0	0	0	0	0	0
N_{oc} ^{Note2}	dBm/15 kHz	-98			-98		
\hat{E}_s / N_{oc}	dBm	-12.6	-12.6	-12.6	-12.6	-12.6	-12.6
Propagation Condition		AWGN			AWGN		
Antenna Configuration		1x1			1x1		
Timing offset to eCell 1	ms	-			3		
<p>Note 1: OCNG shall be used such that the eCell is fully allocated and a constant total transmitted power spectral density is achieved for all OFDM symbols.</p> <p>Note 2: Interference from other cells and noise sources not specified in the test is assumed to be constant over subcarriers and time and shall be modelled as AWGN of appropriate power N_{oc}.</p> <p>Note 3: E_s/lot and RSRP levels have been derived from other parameters for information purposes. They are not settable parameters themselves.</p>							

A.6.1.15.2 Test Requirements

The RRC re-establishment delay is defined as the time from the start of time period T3, to the moment when the UE starts to send NPRACH preambles to cell 2 for sending the *RRConnectionReestablishmentRequest* message to cell 2.

The RRC re-establishment delay to an unknown NB-IoT FDD intra frequency cell shall be less than 58 s.

The rate of correct RRC re-establishments observed during repeated tests shall be at least 90%.

NOTE: The RRC re-establishment delay in the test is derived from the following expression:

$$T_{\text{re-establish_delay}} = T_{\text{UL_grant}} + T_{\text{UE-re-establish_delay_NB-IoT}}$$

Where:

- $T_{\text{UL_grant}}$ = It is the time required to acquire and process uplink grant from the target cell. The NPRACH reception at the system simulator is used as a trigger for the completion of the test; hence $T_{\text{UL_grant}}$ is not used.
- $T_{\text{UE-re-establish_delay_NB-IoT}} = 100 \text{ ms} + N_{\text{NB-IoT-freq}} * T_{\text{search_NB-IoT}} + T_{\text{SI_NB-IoT}} + T_{\text{PRACH_NB-IoT}}$
- $N_{\text{NB-IoT-freq}} = 1$
- $T_{\text{search_NB-IoT}} = 14800 \text{ ms}$
- $T_{\text{SI_NB-IoT}} = 41560 \text{ ms}$; it is the time required for receiving all the relevant system information as defined in TS 36.331 for the target NB-IoT FDD cell.
- $T_{\text{PRACH_NB-IoT}} = 1280 \text{ ms}$; it is the additional delay caused by the random access procedure.

A.6.1.16 HD-FDD Inter-frequency RRC Re-establishment for UE category NB1 in In-Band mode under normal coverage

A.6.1.16.1 Test Purpose and Environment

The purpose is to verify that the NB-IoT FDD inter-frequency RRC re-establishment delay is within the specified limits. These tests will verify the requirements for Cat-NB1 UE in clause 6.5.

The test parameters are given in table A.6.1.16.1-1 and table A.6.1.16.1-2 below. nCell1 and nCell2 are NB-IoT cells on different frequency carriers. The test consists of 3 successive time periods, with time duration of T1, T2 and T3 respectively. At the start of time period T2, cell 1, which is the active cell, is deactivated. The time period T3 starts after the occurrence of the radio link failure. During T1, the UE shall be indicated with the carrier frequency of nCell 2 to ensure that the UE has the context of the carrier frequency of nCell 2.

Table A.6.1.16.1-1: General test parameters for HD-FDD Inter-frequency RRC Re-establishment for UE category NB1 in In-Band mode under normal coverage

Parameter	Unit	Value	Comment
NB-IOT operational mode		In-band	
Initial condition	Active cell	nCell1	
	Neighbour cells	eCell1, nCell2	
Final condition	Active cell	nCell2	
E-UTRA RF Channel Number		1	One carrier frequency is used for eCell.
Access Barring Information	-	Not Sent	No additional delays in random access procedure.
NPRACH Configuration		NPRACH.R-1	Refer to A.3.18
NPDCCH repetition level		16	NPDCCH R_{max}
N310	-	1	Maximum consecutive out-of-sync indications from lower layers
N311	-	1	Minimum consecutive in-sync indications from lower layers
T310	Ms	0	Radio link failure timer; T310 is disabled
T311	Ms	15000	RRC re-establishment timer
DRX		OFF	
T1	S	5	
T2	Ms	400	
T3	S	15	

Table A.6.1.16.1-2: nCell 1, nCell 2 specific test parameters for HD-FDD Inter-frequency RRC Re-establishment for UE category NB1 in In-Band mode under normal coverage

Parameter	Unit	nCell 1			nCell 2		
		T1	T2	T3	T1	T2	T3
BW _{channel}	kHz	200			200		
PRB location within eCell	-	eCell1 BW _{channel} 5MHz: 17 eCell1 BW _{channel} 10MHz: 30			eCell1 BW _{channel} 5MHz: 22 eCell1 BW _{channel} 10MHz: 35		
NPDSCH parameters		eCell1 BW _{channel} 5MHz: R.16 HD-FDD eCell1 BW _{channel} 10MHz: R.14 HD-FDD			eCell1 BW _{channel} 5MHz: R.16 HD-FDD eCell1 BW _{channel} 10MHz: R.14 HD-FDD		
NPDCCH parameters		eCell1 BW _{channel} 5MHz: R.38 HD-FDD eCell1 BW _{channel} 10MHz: R.26 HD-FDD			eCell1 BW _{channel} 5MHz: R.38 HD-FDD eCell1 BW _{channel} 10MHz: R.26 HD-FDD		
NPBCH_RA	dB	0			0		
NPBCH_RB	dB						
NPSS_RA	dB						
NSSS_RA	dB						
NPDCCH_RA	dB						
NPDCCH_RB	dB						
NPDSCH_RA	dB						
NPDSCH_RB	dB						

NOCNG_RA ^{Note 1}	dB						
NOCNG_RB ^{Note 1}	dB						
N_{oc}	dBm/15 kHz	Specified in Table A.6.1.16.1-3					
\hat{E}_s/N_{oc}	dB	7	-Infinity	-Infinity	-Infinity	4	4
\hat{E}_s/I_{ot} ^{Note2}	dB	7	-Infinity	-Infinity	-Infinity	4	4
NRSRP ^{Note2}	dBm/15 kHz	-91	-Infinity	-Infinity	-Infinity	-94	-94
Propagation Condition		AWGN			AWGN		
Antenna Configuration		1x1			1x1		
Timing offset to nCell 1	ms	-			3		
<p>Note 1: NOCNG shall be used such that both cells are fully allocated and a constant total transmitted power spectral density is achieved for all OFDM symbols.</p> <p>Note 2: Es/lot and NRSRP levels have been derived from other parameters for information purposes. They are not settable parameters themselves.</p>							

Table A.6.1.16.1-3: eCell 1 specific test parameters for HD-FDD Inter-frequency RRC Re-establishment for UE category NB1 in In-Band mode under normal coverage

Parameter	Unit	eCell 1		
		T1	T2	T3
BW _{channel}	MHz	5 or 10		
NOCNG Patterns		BW _{channel} 5MHz: NOP.4 FDD BW _{channel} 10MHz: NOP.1 FDD		
PBCH_RA	dB	0		
PBCH_RB	dB			
PSS_RA	dB			
SSS_RA	dB			
PCFICH_RB	dB			
PDCCH_RA	dB			
PDCCH_RB	dB			
OCNG_RA ^{Note 1}	dB			
OCNG_RB ^{Note 1}	dB			
N_{oc}	dBm/15 kHz			
\hat{E}_s/N_{oc}	dB	4	4	4
\hat{E}_s/I_{ot} ^{Note2}	dB	4	4	4
RSRP ^{Note2}	dBm/15 kHz	-94	-94	-94
Propagation Condition		AWGN		
Antenna Configuration		1x1		
<p>Note 1: OCNG shall be used such that the eCell is fully allocated and a constant total transmitted power spectral density is achieved for all OFDM symbols.</p> <p>Note 2: Interference from other cells and noise sources not specified in the test is assumed to be constant over subcarriers and time and shall be modelled as AWGN of appropriate power N_{oc}.</p> <p>Note 3: Es/lot and RSRP levels have been derived from other parameters for information purposes. They are not settable parameters themselves.</p>				

A.6.1.16.2 Test Requirements

The RRC re-establishment delay is defined as the time from the start of time period T3, to the moment when the UE starts to send NPRACH preambles to cell 2 for sending the *RRConnectionReestablishmentRequest* message to cell 2.

The RRC re-establishment delay to an unknown NB-IoT FDD inter frequency cell shall be less than 12 s.

The rate of correct RRC re-establishments observed during repeated tests shall be at least 90%.

NOTE: The RRC re-establishment delay in the test is derived from the following expression:

$$T_{\text{re-establish_delay}} = T_{\text{UL_grant}} + T_{\text{UE-re-establish_delay_NB-IoT}}$$

Where:

- $T_{\text{UL_grant}}$ = It is the time required to acquire and process uplink grant from the target cell. The NPRACH reception at the system simulator is used as a trigger for the completion of the test; hence $T_{\text{UL_grant}}$ is not used.
- $T_{\text{UE-re-establish_delay_NB-IoT}} = 100 \text{ ms} + N_{\text{NB-IoT-freq}} * T_{\text{search_NB-IoT}} + T_{\text{SL_NB-IoT}} + T_{\text{PRACH_NB-IoT}}$
- $N_{\text{NB-IoT-freq}} = 2$
- $T_{\text{search_NB-IoT}} = 1400 \text{ ms}$
- $T_{\text{SL_NB-IoT}} = 8320 \text{ ms}$; it is the time required for receiving all the relevant system information as defined in TS 36.331 for the target NB-IoT FDD cell.
- $T_{\text{PRACH_NB-IoT}} = 80 \text{ ms}$; it is the additional delay caused by the random access procedure.

A.6.1.17 E-UTRAN FD-FDD Inter-frequency RRC Re-establishment for Cat-M1 UE in CEModeA

A.6.1.17.1 Test Purpose and Environment

The purpose is to verify that the E-UTRA FDD inter-frequency RRC re-establishment delay is within the specified limits. These tests will verify the requirements in clause 6.7.2.

The test parameters are given in table A.6.1.17.1-1 and table A.6.1.17.2-2 below. The test consists of 3 successive time periods, with time duration of T1, T2 and T3 respectively. During T1, the UE shall be indicated with the carrier frequency of Cell 2 to ensure that the UE has the context of the carrier frequency of Cell 2. At the start of time period T2, cell 1, which is the active cell, is deactivated. The time period T3 starts after the occurrence of radio link failure. At the start of time period T3, cell 2, which is the neighbour cell, is activated.

Table A.6.1.17.1-1: General test parameters for E-UTRAN FDD inter-frequency RRC Re-establishment test case

Parameter		Unit	Value	Comment
Initial conditions	Active cell		Cell 1	
	Neighbouring cell		Cell 2	
Final condition	Active cell		Cell 2	
E-UTRA RF Channel Number (cell 1)			1	Only one FDD carrier frequency is used.
E-UTRA RF Channel Number (cell 2)			2	
E-UTRA FDD inter-frequency carrier list size			1	2 E-UTRA FDD carrier frequencies in total: 1 intra-frequency and 1 inter-frequency
Channel Bandwidth (BW_{channel})		MHz	10	
PRACH Configuration			PRACH_2CE	As specified in A.3.16
N310		-	1	Maximum consecutive out-of-sync indications from lower layers
N311		-	1	Minimum consecutive in-sync indications from lower layers
T310		ms	0	Radio link failure timer; T310 is disabled
T311		ms	3000	RRC re-establishment timer
DRX			OFF	
CP length			Normal	
Access Barring Information		-	Not Sent	No additional delays in random access procedure.
PRACH configuration index			4	As specified in table 5.7.1-2 in TS 36.211
T1		s	5	
T2		ms	400	
T3		s	3	

Table A.6.1.17.1-2: Cell specific test parameters for E-UTRAN FDD inter-frequency RRC Re-establishment test case

Parameter	Unit	Cell 1			Cell 2		
		T1	T2	T3	T1	T2	T3
E-UTRA RF Channel Number		1			2		
BW _{channel}	MHz	10			10		
PDSCH parameters (As specified in clause A.3.1.4.1)		DL Reference Measurement Channel R.21 FDD			DL Reference Measurement Channel R.21 FDD		
MPDCCH parameters (As specified in clause A.3.1.3.1)		DL Reference Measurement Channel R.17 FDD			DL Reference Measurement Channel R.17 FDD		
OCNG Patterns defined in A.3.2.1.21 (OP.21 FDD) and in A.3.2.1.6 (OP.6 FDD)		OP.21 FDD	OP.21 FDD	OP.6 FDD	OP.6 FDD	OP.6 FDD	OP.21 FDD
PBCH_RA	dB	-3			-3		
PBCH_RB	dB						
PSS_RA	dB						
SSS_RA	dB						
MPDCCH_RA	dB						
MPDCCH_RB	dB						
PDSCH_RA	dB						
PDSCH_RB	dB						
OCNG_RA ^{Note 1}	dB						
OCNG_RB ^{Note 1}	dB						
\hat{E}_s / I_{ot}	dB	4	-Infinity	-Infinity	-Infinity	-Infinity	7
N_{oc} ^{Note 2}	dBm/15 KHz	-98					
\hat{E}_s / N_{oc}	dB	4	-Infinity	-Infinity	-Infinity	-Infinity	7
RSRP ^{Note 3}	dBm/15 KHz	-94	-Infinity	-Infinity	-Infinity	-Infinity	-91
Propagation Condition		AWGN					
Antenna Configuration		2x1			2x1		
Timing offset to Cell 1 (Asynchronous cells)	ms	-			3		
<p>Note 1: OCNG shall be used such that both cells are fully allocated and a constant total transmitted power spectral density is achieved for all OFDM symbols.</p> <p>Note 2: Interference from other cells and noise sources not specified in the test is assumed to be constant over subcarriers and time and shall be modelled as AWGN of appropriate power for N_{oc} to be fulfilled.</p> <p>Note 3: RSRP levels have been derived from other parameters for information purposes. They are not settable parameters themselves.</p>							

A.6.1.17.2 Test Requirements

The RRC re-establishment delay is defined as the time from the start of time period T3, to the moment when the UE starts to send PRACH preambles to cell 2 for sending the *RRCConnectionReestablishmentRequest* message to cell 2.

The RRC re-establishment delay to a known E-UTRA FDD inter frequency cell shall be less than 3.5 s.

The rate of correct RRC re-establishments observed during repeated tests shall be at least 90%.

NOTE: The RRC re-establishment delay in the test is derived from the following expression:

$$T_{\text{re-establish_delay}} = T_{\text{UL_grant}} + T_{\text{UE_re-establish_delay}}$$

Where:

$T_{\text{UL_grant}}$ = It is the time required to acquire and process uplink grant from the target cell. The PRACH reception at the system simulator is used as a trigger for the completion of the test; hence $T_{\text{UL_grant}}$ is not used.

$$T_{\text{UE_re-establish_delay}} = 50 \text{ ms} + N_{\text{freq}} * T_{\text{search}} + T_{\text{SI-EUTRA-M1-CEModeA}} + T_{\text{PRACH}}$$

$$N_{\text{freq}} = 2$$

$$T_{\text{search}} = 1000 \text{ ms}$$

$T_{\text{SI-EUTRA-MI-CEModeA}} = 1280 \text{ ms}$; it is the time required for receiving all the relevant system information as defined in TS 36.331 for the target E-UTRAN FDD cell.

$T_{\text{PRACH}} = 15 \text{ ms}$; it is the additional delay caused by the random access procedure.

This gives a total of 3345 ms, allow 3.5 s in the test case.

A.6.1.18 E-UTRAN HD-FDD Inter-frequency RRC Re-establishment for Cat-M1 UE in CEModeA

A.6.1.18.1 Test Purpose and Environment

The purpose is to verify that the E-UTRA HD-FDD inter-frequency RRC re-establishment delay is within the specified limits. These tests will verify the requirements in clause 6.7.2.

The test parameters are given in table A.6.1.18.1-1 and table A.6.1.18.2-2 below. The test consists of 3 successive time periods, with time duration of T1, T2 and T3 respectively. During T1, the UE shall be indicated with the carrier frequency of Cell 2 to ensure that the UE has the context of the carrier frequency of Cell 2. At the start of time period T2, cell 1, which is the active cell, is deactivated. The time period T3 starts after the occurrence of radio link failure. At the start of time period T3, cell 2, which is the neighbour cell, is activated.

Table A.6.1.18.1-1: General test parameters for E-UTRAN HD-FDD inter-frequency RRC Re-establishment test case

Parameter		Unit	Value	Comment
Initial conditions	Active cell		Cell 1	
	Neighbouring cell		Cell 2	
Final condition	Active cell		Cell 2	
E-UTRA RF Channel Number (cell 1)			1	Only one FDD carrier frequency is used.
E-UTRA RF Channel Number (cell 2)			2	
E-UTRA FDD inter-frequency carrier list size			1	2 E-UTRA FDD carrier frequencies in total: 1 intra-frequency and 1 inter-frequency
Channel Bandwidth (BW_{channel})		MHz	10	
PRACH Configuration			PRACH_2CE	As specified in A.3.16
N310		-	1	Maximum consecutive out-of-sync indications from lower layers
N311		-	1	Minimum consecutive in-sync indications from lower layers
T310		ms	0	Radio link failure timer; T310 is disabled
T311		ms	3000	RRC re-establishment timer
DRX			OFF	
CP length			Normal	
Access Barring Information		-	Not Sent	No additional delays in random access procedure.
PRACH configuration index			4	As specified in table 5.7.1-2 in TS 36.211
Time offset between cells		ms	3	Asynchronous cells
T1		s	5	
T2		ms	400	
T3		s	3	

Table A.6.1.18.1-2: Cell specific test parameters for E-UTRAN HD-FDD inter-frequency RRC Re-establishment test case

Parameter	Unit	Cell 1			Cell 2		
		T1	T2	T3	T1	T2	T3
E-UTRA RF Channel Number		1			2		

BW _{channel}	MHz	10			10		
PDSCH parameters (As specified in clause A.3.1.4.2)		DL Reference Measurement Channel R.11 HD-FDD			DL Reference Measurement Channel R.11 HD-FDD		
MPDCCH parameters (As specified in clause A.3.1.3.2)		DL Reference Measurement Channel R.11 HD-FDD			DL Reference Measurement Channel R.11 HD-FDD		
OCNG Patterns defined in A.3.2.1.21 (OP.21 FDD) and in A.3.2.1.6 (OP.6 FDD)		OP.21 FDD	OP.21 FDD	OP.6 FDD	OP.6 FDD	OP.6 FDD	OP.21 FDD
PBCH_RA	dB	-3			-3		
PBCH_RB	dB						
PSS_RA	dB						
SSS_RA	dB						
MPDCCH_RA	dB						
MPDCCH_RB	dB						
PDSCH_RA	dB						
PDSCH_RB	dB						
OCNG_RA ^{Note 1}	dB						
OCNG_RB ^{Note 1}	dB						
\hat{E}_s / I_{ot}	dB	4	-Infinity	-Infinity	-Infinity	-Infinity	7
N_{oc} ^{Note 2}	dBm/15 KHz	-98					
\hat{E}_s / N_{oc}	dB	4	-Infinity	-Infinity	-Infinity	-Infinity	7
RSRP ^{Note 3}	dBm/15 KHz	-94	-Infinity	-Infinity	-Infinity	-Infinity	-91
Propagation Condition		AWGN					
Antenna Configuration		2x1			2x1		
Timing offset to Cell 1 (Asynchronous cells)	Ms	-			3		
<p>Note 1: OCNG shall be used such that both cells are fully allocated and a constant total transmitted power spectral density is achieved for all OFDM symbols.</p> <p>Note 2: Interference from other cells and noise sources not specified in the test is assumed to be constant over subcarriers and time and shall be modelled as AWGN of appropriate power for N_{oc} to be fulfilled.</p> <p>Note 3: RSRP levels have been derived from other parameters for information purposes. They are not settable parameters themselves.</p>							

A.6.1.18.2 Test Requirements

The RRC re-establishment delay is defined as the time from the start of time period T3, to the moment when the UE starts to send PRACH preambles to cell 2 for sending the *RRCConnectionReestablishmentRequest* message to cell 2.

The RRC re-establishment delay to a known E-UTRA FDD inter frequency cell shall be less than 3.5 s.

The rate of correct RRC re-establishments observed during repeated tests shall be at least 90%.

NOTE: The RRC re-establishment delay in the test is derived from the following expression:

$$T_{\text{re-establish_delay}} = T_{\text{UL_grant}} + T_{\text{UE_re-establish_delay}}$$

Where:

$T_{\text{UL_grant}}$ = It is the time required to acquire and process uplink grant from the target cell. The PRACH reception at the system simulator is used as a trigger for the completion of the test; hence $T_{\text{UL_grant}}$ is not used.

$$T_{\text{UE_re-establish_delay}} = 50 \text{ ms} + N_{\text{freq}} * T_{\text{search}} + T_{\text{SI-EUTRA-M1-CEModeA}} + T_{\text{PRACH}}$$

$$N_{\text{freq}} = 2$$

$$T_{\text{search}} = 1000 \text{ ms}$$

$T_{\text{SI-EUTRA-M1-CEModeA}} = 1280 \text{ ms}$; it is the time required for receiving all the relevant system information as defined in TS 36.331 for the target E-UTRAN FDD cell.

$T_{PRACH} = 15$ ms; it is the additional delay caused by the random access procedure.

This gives a total of 3345 ms, allow 3.5 s in the test case.

A.6.1.19 E-UTRAN TDD-TDD Inter-frequency RRC Re-establishment for Cat-M1 UE in CEModeA

A.6.1.19.1 Test Purpose and Environment

The purpose is to verify that the E-UTRA TDD inter-frequency RRC re-establishment delay is within the specified limits. These tests will verify the requirements in clause 6.7.2.

The test parameters are given in table A.6.1.19.1-1 and table A.6.1.19.2-2 below. The test consists of 3 successive time periods, with time duration of T1, T2 and T3 respectively. During T1, the UE shall be indicated with the carrier frequency of Cell 2 to ensure that the UE has the context of the carrier frequency of Cell 2. At the start of time period T2, cell 1, which is the active cell, is deactivated. The time period T3 starts after the occurrence of radio link failure. At the start of time period T3, cell 2, which is the neighbour cell, is activated.

Table A.6.1.19.1-1: General test parameters for E-UTRAN TDD inter-frequency RRC Re-establishment test case

Parameter		Unit	Value	Comment
Initial conditions	Active cell		Cell 1	
	Neighbouring cell		Cell 2	
Final condition	Active cell		Cell 2	
E-UTRA RF Channel Number (cell 1)			1	Only one FDD carrier frequency is used.
E-UTRA RF Channel Number (cell 2)			2	
E-UTRA TDD inter-frequency carrier list size			1	2 E-UTRA TDD carrier frequencies in total: 1 intra-frequency and 1 inter-frequency
Channel Bandwidth ($BW_{channel}$)		MHz	10	
PRACH Configuration			PRACH_2CE	As specified in A.3.16
N310		-	1	Maximum consecutive out-of-sync indications from lower layers
N311		-	1	Minimum consecutive in-sync indications from lower layers
T310		ms	0	Radio link failure timer; T310 is disabled
T311		ms	3000	RRC re-establishment timer
DRX			OFF	
CP length			Normal	
Access Barring Information		-	Not Sent	No additional delays in random access procedure.
Special subframe configuration			6	As specified in table 4.2-1 in TS 36.211
Uplink-downlink configuration			1	As specified in table 4.2-1 in TS 36.211
PRACH configuration index			4	As specified in table 5.7.1-2 in TS 36.211
T1		s	5	
T2		ms	400	
T3		s	3	

Table A.6.1.19.1-2: Cell specific test parameters for E-UTRAN TDD inter-frequency RRC Re-establishment test case

Parameter	Unit	Cell 1			Cell 2		
		T1	T2	T3	T1	T2	T3
E-UTRA RF Channel Number		1			2		
$BW_{channel}$	MHz	10			10		
PDSCH parameters (As specified in clause A.3.1.4.3)		DL Reference Measurement Channel R.17 TDD			DL Reference Measurement Channel R.17 TDD		

MPDCCH parameters (As specified in clause A.3.1.3.3)		DL Reference Measurement Channel R.15 TDD			DL Reference Measurement Channel R.15 TDD		
		OP.11 TDD	OP.11 TDD	OP.2 TDD	OP.2 TDD	OP.2 TDD	OP.11 TDD
OCNG Patterns defined in A.3.2.2.11 (OP.11 TDD) and in A.3.2.2.2 (OP.2 TDD)							
PBCH_RA	dB	-3			-3		
PBCH_RB	dB						
PSS_RA	dB						
SSS_RA	dB						
MPDCCH_RA	dB						
MPDCCH_RB	dB						
PDSCH_RA	dB						
PDSCH_RB	dB						
OCNG_RA ^{Note 1}	dB						
OCNG_RB ^{Note 1}	dB						
\hat{E}_s / I_{ot}	dB	4	-Infinity	-Infinity	-Infinity	-Infinity	7
N_{oc} ^{Note 2}	dBm/15 KHz	-98					
\hat{E}_s / N_{oc}	dB	4	-Infinity	-Infinity	-Infinity	-Infinity	7
RSRP ^{Note 3}	dBm/15 KHz	-94	-Infinity	-Infinity	-Infinity	-Infinity	-91
Propagation Condition		AWGN					
Antenna Configuration		2x1			2x1		
Timing offset to Cell 1 (Synchronous cells)	μ s	-			3		
<p>Note 1: OCNG shall be used such that both cells are fully allocated and a constant total transmitted power spectral density is achieved for all OFDM symbols.</p> <p>Note 2: Interference from other cells and noise sources not specified in the test is assumed to be constant over subcarriers and time and shall be modelled as AWGN of appropriate power for N_{oc} to be fulfilled.</p> <p>Note 3: RSRP levels have been derived from other parameters for information purposes. They are not settable parameters themselves.</p>							

A.6.1.19.2 Test Requirements

The RRC re-establishment delay is defined as the time from the start of time period T3, to the moment when the UE starts to send PRACH preambles to cell 2 for sending the *RRCConnectionReestablishmentRequest* message to cell 2.

The RRC re-establishment delay to a known E-UTRA FDD inter frequency cell shall be less than 3.5 s.

The rate of correct RRC re-establishments observed during repeated tests shall be at least 90%.

NOTE: The RRC re-establishment delay in the test is derived from the following expression:

$$T_{\text{re-establish_delay}} = T_{\text{UL_grant}} + T_{\text{UE_re-establish_delay}}$$

Where:

$T_{\text{UL_grant}}$ = It is the time required to acquire and process uplink grant from the target cell. The PRACH reception at the system simulator is used as a trigger for the completion of the test; hence $T_{\text{UL_grant}}$ is not used.

$$T_{\text{UE_re-establish_delay}} = 50 \text{ ms} + N_{\text{freq}} * T_{\text{search}} + T_{\text{SI-EUTRA-M1-CEModeA}} + T_{\text{PRACH}}$$

$$N_{\text{freq}} = 2$$

$$T_{\text{search}} = 1000 \text{ ms}$$

$T_{\text{SI-EUTRA-M1-CEModeA}} = 1280 \text{ ms}$; it is the time required for receiving all the relevant system information as defined in TS 36.331 for the target E-UTRAN FDD cell.

$T_{\text{PRACH}} = 15 \text{ ms}$; it is the additional delay caused by the random access procedure.

This gives a total of 3345 ms, allow 3.5 s in the test case.

A.6.1.20 E-UTRAN FD-FDD Inter-frequency RRC Re-establishment for Cat-M1 UE in CEModeB

A.6.1.20.1 Test Purpose and Environment

The purpose is to verify that the E-UTRA FDD inter-frequency RRC re-establishment delay is within the specified limits. These tests will verify the requirements in clause 6.7.2.

The test consists of 4 successive time periods, with time duration of T1, T2, T3 and T4 respectively. During T1, both cell 1 and cell 2 are in CEModeB, and UE shall be indicated with the carrier frequency of Cell 2 to ensure that the UE has the context of the carrier frequency of Cell 2. At the start of time period T3, cell 1, which is the active cell, is deactivated. The time period T4 starts after the occurrence of the radio link failure.

Table A.6.1.20.1-1: General test parameters for E-UTRAN FDD inter-frequency RRC Re-establishment test case

Parameter		Unit	Value	Comment
Initial conditions	Active cell		Cell 1	
	Neighbouring cell		Cell 2	
Final condition	Active cell		Cell 2	
E-UTRA RF Channel Number (cell 1)			1	
E-UTRA RF Channel Number (cell 2)			2	
E-UTRA FDD inter-frequency carrier list size			1	2 E-UTRA FDD carrier frequencies in total: 1 intra-frequency and 1 inter-frequency
PRACH Configuration			PRACH_3CE	As specified in A.3.16
N310		-	1	Maximum consecutive out-of-sync indications from lower layers
N311		-	1	Minimum consecutive in-sync indications from lower layers
T310		ms	0	Radio link failure timer; T310 is disabled
T311		ms	3000	RRC re-establishment timer
DRX			OFF	
CP length			Normal	
Access Barring Information		-	Not Sent	No additional delays in random access procedure.
PRACH configuration index			4	As specified in table 5.7.1-2 in TS 36.211
T1		s	5	
T2		s	5	
T3		s	4	
T4		s	9	

Table A.6.1.20.1-2: Cell specific test parameters for E-UTRAN FDD inter-frequency RRC Re-establishment test case

Parameter	Unit	Cell 1				Cell 2			
		T1	T2	T3	T4	T1	T2	T3	T4
E-UTRA RF Channel Number		1				2			
BW _{channel}	MHz	5 10				5 10			
PDSCH Reference Channel in clause A.3.1.4.4		5MHz: R.31 FDD 10MHz: R.23 FDD		-		-		5MHz: R.31 FDD 10MHz: R.23 FDD	
MPDCCH Reference Channel in clause A.3.1.3.4		R.19 FDD				R.19 FDD			
OCNG Patterns in clause A.3.2.1		5MHz: OP.22 FDD 10MHz: OP.21 FDD		5MHz: OP.19 FDD 10MHz: OP.6 FDD		5 MHz: OP.19 FDD 10MHz: OP.6 FDD		5 MHz: OP.22 FDD 10MHz: OP.21 FDD	
PBCH_RA	dB	-3				-3			
PBCH_RB	dB								

PSS_RA	dB								
SSS_RA	dB								
MPDCCH_RA	dB								
MPDCCH_RB	dB								
PDSCH_RA	dB								
PDSCH_RB	dB								
OCNG_RA ^{Note 1}	dB								
OCNG_RB ^{Note 1}	dB								
N_{oc} ^{Note 2}	dBm/15 KHz	-98				-98			
\hat{E}_s/N_{oc}	dB	7	-15	-Infinity	-Infinity	4	-12	-12	-12
\hat{E}_s/I_{ot}	dB	7	-15	-Infinity	-Infinity	4	-12	-12	-12
RSRP ^{Note 3}	dBm/15 KHz	-91	-113	-Infinity	-Infinity	-94	-110	-110	-110
Propagation Condition		AWGN				AWGN			
Antenna Configuration		2x1				2x1			
Timing offset to Cell 1 (Asynchronous cells)	ms	-				3			
<p>Note 1: OCNG shall be used such that both cells are fully allocated and a constant total transmitted power spectral density is achieved for all OFDM symbols.</p> <p>Note 2: Interference from other cells and noise sources not specified in the test is assumed to be constant over subcarriers and time and shall be modelled as AWGN of appropriate power for N_{oc} to be fulfilled.</p> <p>Note 3: E_s/I_{ot} and RSRP levels have been derived from other parameters for information purposes. They are not settable parameters themselves.</p>									

A.6.1.20.2 Test Requirements

The RRC re-establishment delay is defined as the time from the start of time period T4, to the moment when the UE starts to send PRACH preambles to cell 2 for sending the *RRCConnectionReestablishmentRequest* message to cell 2.

The RRC re-establishment delay to a known E-UTRA FDD inter frequency cell shall be less than 7 s.

The rate of correct RRC re-establishments observed during repeated tests shall be at least 90%.

NOTE: The RRC re-establishment delay in the test is derived from the following expression:

$$T_{\text{re-establish_delay}} = T_{\text{UL_grant}} + T_{\text{UE_re-establish_delay}}$$

Where:

$T_{\text{UL_grant}}$ = It is the time required to acquire and process uplink grant from the target cell. The PRACH reception at the system simulator is used as a trigger for the completion of the test; hence $T_{\text{UL_grant}}$ is not used.

$$T_{\text{UE_re-establish_delay}} = 50 \text{ ms} + N_{\text{freq}} * T_{\text{search}} + T_{\text{SI-EUTRA-M1-CEModeB}} + T_{\text{PRACH}}$$

$$N_{\text{freq}} = 2$$

$$T_{\text{search}} = 100 \text{ ms}$$

$T_{\text{SI-EUTRA-M1-CEModeB}} = 6400 \text{ ms}$; it is the time required for receiving all the relevant system information as defined in TS 36.331 for the target E-UTRAN FDD cell.

$T_{\text{PRACH}} = 15 \text{ ms}$; it is the additional delay caused by the random access procedure.

This gives a total of 6665 ms, allow 7 s in the test case.

A.6.1.21 E-UTRAN HD-FDD Inter-frequency RRC Re-establishment for Cat-M1 UE in CEModeB

A.6.1.21.1 Test Purpose and Environment

The purpose is to verify that the E-UTRA HD-FDD inter-frequency RRC re-establishment delay is within the specified limits. These tests will verify the requirements in clause 6.7.2.

The test consists of 4 successive time periods, with time duration of T1, T2, T3 and T4 respectively. During T1, both cell 1 and cell 2 are in CEModeB, and UE shall be indicated with the carrier frequency of Cell 2 to ensure that the UE has the context of the carrier frequency of Cell 2. At the start of time period T3, cell 1, which is the active cell, is deactivated. The time period T4 starts after the occurrence of the radio link failure.

Table A.6.1.21.1-1: General test parameters for E-UTRAN HD-FDD inter-frequency RRC Re-establishment test case

Parameter		Unit	Value	Comment
Initial conditions	Active cell		Cell 1	
	Neighbouring cell		Cell 2	
Final condition	Active cell		Cell 2	
E-UTRA RF Channel Number (cell 1)			1	Only one FDD carrier frequency is used.
E-UTRA RF Channel Number (cell 2)			2	
E-UTRA FDD inter-frequency carrier list size			1	2 E-UTRA FDD carrier frequencies in total: 1 intra-frequency and 1 inter-frequency
Channel Bandwidth ($BW_{channel}$)		MHz	10	
PRACH Configuration			PRACH_3CE	As specified in A.3.16
N310		-	1	Maximum consecutive out-of-sync indications from lower layers
N311		-	1	Minimum consecutive in-sync indications from lower layers
T310		ms	0	Radio link failure timer; T310 is disabled
T311		ms	3000	RRC re-establishment timer
DRX			OFF	
CP length			Normal	
Access Barring Information		-	Not Sent	No additional delays in random access procedure.
PRACH configuration index			4	As specified in table 5.7.1-2 in TS 36.211
T1		s	5	
T2		s	5	
T3		s	400	
T4		s	9	

Table A.6.1.21.1-2: Cell specific test parameters for E-UTRAN HD-FDD inter-frequency RRC Re-establishment test case

Parameter	Unit	Cell 1				Cell 2			
		T1	T2	T3	T4	T1	T2	T3	T4
E-UTRA RF Channel Number		1				1			
$BW_{channel}$	MHz	10				10			
PDSCH Reference Channel in clause A.3.1.4.4		R.13 HD-FDD			-	-			R.13 HD-FDD
MPDCCH Reference Channel in clause A.3.1.3.4		R.19 FDD				R.19 FDD			
OCNG Patterns in clause A.3.2.1		OP.21 FDD		OP.6 FDD	OP.6 FDD			OP.21 FDD	
PBCH_RA	dB	-3				-3			
PBCH_RB	dB								
PSS_RA	dB								
SSS_RA	dB								

MPDCCH_RA	dB								
MPDCCH_RB	dB								
PDSCH_RA	dB								
PDSCH_RB	dB								
OCNG_RA ^{Note 1}	dB								
OCNG_RB ^{Note 1}	dB								
\hat{E}_s/I_{ot}	dB	1.54	-15.27	-Infinity	-Infinity	-3.79	-12.14	-12	-12
N_{oc} ^{Note 2}	dBm/15 KHz	-98							
\hat{E}_s/N_{oc}	dB	7	-15	-Infinity	-Infinity	4	-12	-12	-12
RSRP ^{Note 3}	dBm/15 KHz	-91	-113	-Infinity	-Infinity	-94	-110	-110	-110
Propagation Condition		AWGN				AWGN			
Antenna Configuration		2x1				2x1			
Timing offset to Cell 1 (Asynchronous cells)	ms	-				3			
Note 1:	OCNG shall be used such that both cells are fully allocated and a constant total transmitted power spectral density is achieved for all OFDM symbols.								
Note 2:	Interference from other cells and noise sources not specified in the test is assumed to be constant over subcarriers and time and shall be modelled as AWGN of appropriate power for N_{oc} to be fulfilled.								
Note 3:	Es/Iot and RSRP levels have been derived from other parameters for information purposes. They are not settable parameters themselves.								

A.6.1.21.2 Test Requirements

The RRC re-establishment delay is defined as the time from the start of time period T4, to the moment when the UE starts to send PRACH preambles to cell 2 for sending the *RRCConnectionReestablishmentRequest* message to cell 2.

The RRC re-establishment delay to a known E-UTRA FDD inter frequency cell shall be less than 7 s.

The rate of correct RRC re-establishments observed during repeated tests shall be at least 90%.

NOTE: The RRC re-establishment delay in the test is derived from the following expression:

$$T_{\text{re-establish_delay}} = T_{\text{UL_grant}} + T_{\text{UE_re-establish_delay}}$$

Where:

$T_{\text{UL_grant}}$ = It is the time required to acquire and process uplink grant from the target cell. The PRACH reception at the system simulator is used as a trigger for the completion of the test; hence $T_{\text{UL_grant}}$ is not used.

$$T_{\text{UE_re-establish_delay}} = 50 \text{ ms} + N_{\text{freq}} * T_{\text{search}} + T_{\text{SI-EUTRA-M1-CEModeB}} + T_{\text{PRACH}}$$

$$N_{\text{freq}} = 2$$

$$T_{\text{search}} = 100 \text{ ms}$$

$T_{\text{SI-EUTRA-M1-CEModeB}} = 6400 \text{ ms}$; it is the time required for receiving all the relevant system information as defined in TS 36.331 for the target E-UTRAN FDD cell.

$T_{\text{PRACH}} = 15 \text{ ms}$; it is the additional delay caused by the random access procedure.

This gives a total of 6665 ms, allow 7 s in the test case.

A.6.1.22 E-UTRAN TDD Inter-frequency RRC Re-establishment for Cat-M1 UE in CEModeB

A.6.1.22.1 Test Purpose and Environment

The purpose is to verify that the E-UTRA TDD inter-frequency RRC re-establishment delay is within the specified limits. These tests will verify the requirements in clause 6.7.2.

The test consists of 4 successive time periods, with time duration of T1, T2, T3 and T4 respectively. During T1, both cell 1 and cell 2 are in CEModeB, and UE shall be indicated with the carrier frequency of Cell 2 to ensure that the UE has the context of the carrier frequency of Cell 2. At the start of time period T3, cell 1, which is the active cell, is deactivated. The time period T4 starts after the occurrence of the radio link failure.

Table A.6.1.22.1-1: General test parameters for E-UTRAN TDD inter-frequency RRC Re-establishment test case

Parameter		Unit	Value	Comment
Initial conditions	Active cell		Cell 1	
	Neighbouring cell		Cell 2	
Final condition	Active cell		Cell 2	
E-UTRA RF Channel Number (cell 1)			1	Only one FDD carrier frequency is used.
E-UTRA RF Channel Number (cell 2)			2	
E-UTRA FDD inter-frequency carrier list size			1	2 E-UTRA FDD carrier frequencies in total: 1 intra-frequency and 1 inter-frequency
Channel Bandwidth ($BW_{channel}$)		MHz	10	
PRACH Configuration			PRACH_3CE	As specified in A.3.16
N310		-	1	Maximum consecutive out-of-sync indications from lower layers
N311		-	1	Minimum consecutive in-sync indications from lower layers
T310		ms	0	Radio link failure timer; T310 is disabled
T311		ms	3000	RRC re-establishment timer
DRX			OFF	
CP length			Normal	
Access Barring Information		-	Not Sent	No additional delays in random access procedure.
Special subframe configuration			6	As specified in table 4.2-1 in TS 36.211
Uplink-downlink configuration			1	As specified in table 4.2-2 in TS 36.211
PRACH configuration index			53	As specified in table 5.7.1-3 in TS 36.211
T1		s	5	
T2		s	5	
T3		s	400	
T4		s	9	

Table A.6.1.22.1-2: Cell specific test parameters for E-UTRAN HD-FDD inter-frequency RRC Re-establishment test case

Parameter	Unit	Cell 1				Cell 2			
		T1	T2	T3	T4	T1	T2	T3	T4
E-UTRA RF Channel Number		1				1			
$BW_{channel}$	MHz	10				10			
PDSCH Reference Channel in clause A.3.1.4.4		R.19 TDD			-	-			R.19 TDD
MPDCCH Reference Channel in clause A.3.1.3.4		R.17 FDD				R.17 FDD			
OCNG Patterns in clause A.3.2.1		OP.11 TDD		OP.2 TDD	OP.2 FDD			OP.11 FDD	
PBCH_RA	dB	-3				-3			
PBCH_RB	dB								
PSS_RA	dB								
SSS_RA	dB								
MPDCCH_RA	dB								
MPDCCH_RB	dB								
PDSCH_RA	dB								
PDSCH_RB	dB								
OCNG_RA ^{Note 1}	dB								
OCNG_RB ^{Note 1}	dB								

\hat{E}_s/I_{ot}	dB	1.54	-15.27	-Infinity	-Infinity	-3.79	-12.14	-12	-12
N_{oc} Note 2	dBm/15 KHz	-98							
\hat{E}_s/N_{oc}	dB	7	-15	-Infinity	-Infinity	4	-12	-12	-12
RSRP Note 3	dBm/15 KHz	-91	-113	-Infinity	-Infinity	-94	-110	-110	-110
Propagation Condition		AWGN				AWGN			
Antenna Configuration		2x1				2x1			
Timing offset to Cell 1 (Synchronous cells)	μ s	-				3			
Note 1:	OCNG shall be used such that both cells are fully allocated and a constant total transmitted power spectral density is achieved for all OFDM symbols.								
Note 2:	Interference from other cells and noise sources not specified in the test is assumed to be constant over subcarriers and time and shall be modelled as AWGN of appropriate power for N_{oc} to be fulfilled.								
Note 3:	Es/Iot and RSRP levels have been derived from other parameters for information purposes. They are not settable parameters themselves.								

A.6.1.22.2 Test Requirements

The RRC re-establishment delay is defined as the time from the start of time period T4, to the moment when the UE starts to send PRACH preambles to cell 2 for sending the *RRCConnectionReestablishmentRequest* message to cell 2.

The RRC re-establishment delay to a known E-UTRA TDD inter frequency cell shall be less than 7 s.

The rate of correct RRC re-establishments observed during repeated tests shall be at least 90%.

NOTE: The RRC re-establishment delay in the test is derived from the following expression:

$$T_{\text{re-establish_delay}} = T_{\text{UL_grant}} + T_{\text{UE_re-establish_delay}}$$

Where:

$T_{\text{UL_grant}}$ = It is the time required to acquire and process uplink grant from the target cell. The PRACH reception at the system simulator is used as a trigger for the completion of the test; hence $T_{\text{UL_grant}}$ is not used.

$$T_{\text{UE_re-establish_delay}} = 50 \text{ ms} + N_{\text{freq}} * T_{\text{search}} + T_{\text{SI-EUTRA-M1-CEModeB}} + T_{\text{PRACH}}$$

$$N_{\text{freq}} = 2$$

$$T_{\text{search}} = 100 \text{ ms}$$

$T_{\text{SI-EUTRA-M1-CEModeB}} = 6400 \text{ ms}$; it is the time required for receiving all the relevant system information as defined in TS 36.331 for the target E-UTRAN TDD cell.

$T_{\text{PRACH}} = 15 \text{ ms}$; it is the additional delay caused by the random access procedure.

This gives a total of 6665 ms, allow 7 s in the test case.

A.6.1.23 E-UTRAN TDD Inter-frequency RRC Re-establishment for UE category NB1 in In-Band mode under normal coverage

A.6.1.23.1 Test Purpose and Environment

The purpose is to verify that the NB-IoT TDD inter-frequency RRC re-establishment delay is within the specified limits. These tests will verify the requirements for Cat-NB1 UE in clause 6.5.

The test parameters are given in table A.6.1.23.1-1 and table A.6.1.23.1-2 below. nCell1 and nCell2 are NB-IoT cells on different frequency carriers. The test consists of 3 successive time periods, with time duration of T1, T2 and T3 respectively. At the start of time period T2, cell 1, which is the active cell, is deactivated. The time period T3 starts after the occurrence of the radio link failure. During T1, the UE shall be indicated with the carrier frequency of nCell 2 to ensure that the UE has the context of the carrier frequency of nCell 2.

Table A.6.1.23.1-1: General test parameters for TDD Inter-frequency RRC Re-establishment for UE category NB1 in In-Band mode under normal coverage

Parameter		Unit	Value	Comment
NB-IOT operational mode			In-band	
Initial condition	Active cell		nCell1	
	Neighbour cells		eCell1, nCell2	
Final condition	Active cell		nCell2	
E-UTRA RF Channel Number			1	One carrier frequency is used for eCell.
Access Barring Information		-	Not Sent	No additional delays in random access procedure.
Special subframe configuration			6	As specified in table 4.2-1 in TS 36.211 [16]
Uplink-downlink configuration			1	As specified in table 4.2-2 in TS 36.211 [16]
NPRACH Configuration			NPRACH.R-2	As specified in A.3.18
NPDCCH repetition level			16	The value shall be used for all cells in the test.
N310		-	1	Maximum consecutive out-of-sync indications from lower layers
N311		-	1	Minimum consecutive in-sync indications from lower layers
T310		ms	0	Radio link failure timer; T310 is disabled
T311		ms	15000	RRC re-establishment timer
DRX			OFF	
T1		s	5	
T2		ms	400	
T3		s	15	

Table A.6.1.23.1-2: nCell 1, nCell 2 specific test parameters for TDD Inter-frequency RRC Re-establishment for UE category NB1 in In-Band mode under normal coverage

Parameter	Unit	nCell 1			nCell 2		
		T1	T2	T3	T1	T2	T3
$BW_{channel}$	kHz	200			200		
PRB location within eCell	-	eCell1 $BW_{channel}$ 10MHz: 30			eCell1 $BW_{channel}$ 10MHz: 35		
NPDSCH parameters		eCell1 $BW_{channel}$ 10MHz: R.14 NB-TDD			eCell1 $BW_{channel}$ 10MHz: R.14 NB-TDD		
NPDCCH parameters		eCell1 $BW_{channel}$ 10MHz: R.26 NB-TDD			eCell1 $BW_{channel}$ 10MHz: R.26 NB-TDD		
NPBCH_RA	dB	0			0		
NPBCH_RB	dB						
NPSS_RA	dB						
NSSS_RA	dB						
NPDCCH_RA	dB						
NPDCCH_RB	dB						
NPDSCH_RA	dB						
NPDSCH_RB	dB						
NOCNG_RA ^{Note 1}	dB						
NOCNG_RB ^{Note 1}	dB						
N_{oc}	dBm/15 kHz	Specified in Table A.6.1.23.1-3					
\hat{E}_s / N_{oc}	dB	7	-Infinity	-Infinity	-Infinity	4	4
\hat{E}_s / I_{ot} ^{Note2}	dB	7	-Infinity	-Infinity	-Infinity	4	4
NRSRP ^{Note2}	dBm/15 kHz	-91	-Infinity	-Infinity	-Infinity	-94	-94
Propagation Condition		AWGN			AWGN		
Antenna Configuration		1x1			1x1		
Timing offset to nCell 1	μs	-			3		

Note 1:	NOCNG shall be used such that both cells are fully allocated and a constant total transmitted power spectral density is achieved for all OFDM symbols.
Note 2:	Es/lot and NRSRP levels have been derived from other parameters for information purposes. They are not settable parameters themselves.

Table A.6.1.23.1-3: eCell 1 specific test parameters for TDD Inter-frequency RRC Re-establishment for UE category NB1 in In-Band mode under normal coverage

Parameter	Unit	eCell 1		
		T1	T2	T3
BW _{channel}	MHz	10		
NOCNG Patterns		BW _{channel} 10MHz: NOP.1 TDD		
PBCH_RA	dB	0		
PBCH_RB	dB			
PSS_RA	dB			
SSS_RA	dB			
PCFICH_RB	dB			
PDCCH_RA	dB			
PDCCH_RB	dB			
OCNG_RA ^{Note 1}	dB			
OCNG_RB ^{Note 1}	dB			
N_{oc}	dBm/15 kHz			
\hat{E}_s/N_{oc}	dB	4	4	4
\hat{E}_s/I_{ot} ^{Note2}	dB	4	4	4
RSRP ^{Note2}	dBm/15 kHz	-94	-94	-94
Propagation Condition		AWGN		
Antenna Configuration		1x1		
Note 1:	OCNG shall be used such that the eCell is fully allocated and a constant total transmitted power spectral density is achieved for all OFDM symbols.			
Note 2:	Interference from other cells and noise sources not specified in the test is assumed to be constant over subcarriers and time and shall be modelled as AWGN of appropriate power N_{oc} .			
Note 3:	Es/lot and RSRP levels have been derived from other parameters for information purposes. They are not settable parameters themselves.			

A.6.1.23.2 Test Requirements

The RRC re-establishment delay is defined as the time from the start of time period T3, to the moment when the UE starts to send NPRACH preambles to cell 2 for sending the *RRCConnectionReestablishmentRequest* message to cell 2.

The RRC re-establishment delay to an unknown NB-IoT TDD inter frequency cell shall be less than 12 s.

The rate of correct RRC re-establishments observed during repeated tests shall be at least 90%.

NOTE: The RRC re-establishment delay in the test is derived from the following expression:

$$T_{\text{re-establish_delay}} = T_{\text{UL_grant}} + T_{\text{UE-re-establish_delay_NB-IoT}}$$

Where:

- $T_{\text{UL_grant}}$ = It is the time required to acquire and process uplink grant from the target cell. The NPRACH reception at the system simulator is used as a trigger for the completion of the test; hence $T_{\text{UL_grant}}$ is not used.
- $T_{\text{UE-re-establish_delay_NB-IoT}} = 100 \text{ ms} + N_{\text{NB-IoT-freq}} * T_{\text{search_NB-IoT}} + T_{\text{SI_NB-IoT}} + T_{\text{RACH_NB-IoT}}$
- $N_{\text{NB-IoT-freq}} = 2$
- $T_{\text{search_NB-IoT}} = 1400 \text{ ms}$

- $T_{SL_NB-IoT} = 8320$ ms; it is the time required for receiving all the relevant system information as defined in TS 36.331 [2] for the target NB-IoT TDD cell.
- $T_{PRACH_NB-IoT} = 80$ ms; it is the additional delay caused by the random access procedure.

A.6.1.24 E-UTRAN TDD - TDD Intra-frequency RRC Re-establishment for UE category NB1 in In-Band mode under enhanced coverage

A.6.1.24.1 Test Purpose and Environment

The purpose is to verify that the NB-IoT TDD intra-frequency RRC re-establishment delay is within the specified limits. These tests will verify the requirements for Cat-NB1 UE in clause 6.5.

The test parameters are given in table A.6.1.24.1-1 and table A.6.1.24.1-2 below. nCell1 and nCell2 are NB-IoT cells with different physical cell ID on the same frequency carrier. The test consists of 3 successive time periods, with time duration of T1, T2 and T3 respectively. At the start of time period T2, cell 1, which is the active cell, is deactivated. The time period T3 starts after the occurrence of the radio link failure.

Table A.6.1.24.1-1: General test parameters for TDD Intra-frequency RRC Re-establishment for UE category NB1 in In-Band mode under enhanced coverage

Parameter		Unit	Value	Comment
NB-IOT operational mode			In-band	
Initial condition	Active cell		nCell1	
	Neighbour cells		eCell1, eCell2, nCell2	
Final condition	Active cell		nCell2	
E-UTRA RF Channel Number			1	One carrier frequency is used for eCell1 and eCell2.
Access Barring Information		-	Not Sent	No additional delays in random access procedure.
Special subframe configuration			6	As specified in table 4.2-1 in TS 36.211 [16]
Uplink-downlink configuration			1	As specified in table 4.2-2 in TS 36.211 [16]
NPRACH Configuration			NPRACH.R-2	As specified in A.3.18
NPDCCH repetition level			16	NPDCCH R_{max}
N310		-	1	Maximum consecutive out-of-sync indications from lower layers
N311		-	1	Minimum consecutive in-sync indications from lower layers
T310		Ms	0	Radio link failure timer; T310 is disabled
T311-v13xy		Ms	60000	RRC re-establishment timer
DRX			OFF	
T1		S	5	
T2		Ms	400	
T3		S	60	

Table A.6.1.24.1-2: nCell 1, nCell 2 specific test parameters for TDD Intra-frequency RRC Re-establishment for UE category NB1 in In-Band mode under enhanced coverage

Parameter	Unit	nCell 1			nCell 2		
		T1	T2	T3	T1	T2	T3
$BW_{channel}$	kHz	200			200		
PRB location within eCell	-	eCell1 $BW_{channel}$ 10MHz: 30			eCell1 $BW_{channel}$ 10MHz: 30		
NPDSCH parameters		eCell1 $BW_{channel}$ 10MHz: R.14 NB-TDD			eCell1 $BW_{channel}$ 10MHz: R.14 NB-TDD		
NPDCCH parameters		eCell1 $BW_{channel}$ 10MHz: R.26 NB-TDD			eCell1 $BW_{channel}$ 10MHz: R.26 NB-TDD		
NPBCH_RA	dB	0			0		
NPBCH_RB	dB						
NPSS_RA	dB						

NSSS_RA	dB						
NPDCCH_RA	dB						
NPDCCH_RB	dB						
NPDSCH_RA	dB						
NPDSCH_RB	dB						
NOCNG_RA ^{Note 1}	dB						
NOCNG_RB ^{Note 1}	dB						
N_{oc}	dBm/15 kHz	Specified in Table A.6.1.24.1-3					
\hat{E}_s / N_{oc}	dB	7	-Infinity	-Infinity	-Infinity	-12.6	-12.6
\hat{E}_s / I_{ot} ^{Note2}	dB	7	-Infinity	-Infinity	-Infinity	-12.6	-12.6
NRSRP ^{Note2}	dBm/15 kHz	-91	-Infinity	-Infinity	-Infinity	-110.6	-110.6
Propagation Condition		AWGN			AWGN		
Antenna Configuration		1x1			1x1		
Timing offset to nCell 1	ms	-			3		
<p>Note 1: NOCNG shall be used such that both cells are fully allocated and a constant total transmitted power spectral density is achieved for all OFDM symbols.</p> <p>Note 2: E_s/I_{ot} and NRSRP levels have been derived from other parameters for information purposes. They are not settable parameters themselves.</p>							

Table A.6.1.24.1-3: eCell 1 and eCell2 specific test parameters for TDD Intra-frequency RRC Re-establishment for UE category NB1 in In-Band mode under enhanced coverage

Parameter	Unit	eCell 1			eCell 2		
		T1	T2	T3	T1	T2	T3
BW _{channel}	MHz	10			10		
NOCNG Patterns		BW _{channel} 10MHz: NOP.1 TDD			BW _{channel} 10MHz: NOP.1 TDD		
PBCH_RA	dB	0			0		
PBCH_RB	dB						
PSS_RA	dB						
SSS_RA	dB						
PDCCH_RA	dB						
PDCCH_RB	dB						
PCFICH_RB	dB						
OCNG_RA ^{Note 1}	dB						
OCNG_RB ^{Note 1}	dB						
Qrxlevmin	dBm	-140	-140	-140	-140	-140	-140
Pcompensation	dB	0	0	0	0	0	0
Qhyst _s	dB	0	0	0	0	0	0
Qoffset _{s,n}	dB	0	0	0	0	0	0
^{Note2}	dBm/15 kHz	-98			-98		
	dBm	-12.6	-12.6	-12.6	-12.6	-12.6	-12.6
Propagation Condition		AWGN			AWGN		
Antenna Configuration		1x1			1x1		
Timing offset to eCell 1	ms	-			3		
<p>Note 1: OCNG shall be used such that the eCell is fully allocated and a constant total transmitted power spectral density is achieved for all OFDM symbols.</p> <p>Note 2: Interference from other cells and noise sources not specified in the test is assumed to be constant over subcarriers and time and shall be modelled as AWGN of appropriate power N_{oc}.</p> <p>Note 3: E_s/I_{ot} and RSRP levels have been derived from other parameters for information purposes. They are not settable parameters themselves.</p>							

A.6.1.24.2 Test Requirements

The RRC re-establishment delay is defined as the time from the start of time period T3, to the moment when the UE starts to send NPRACH preambles to cell 2 for sending the *RRConnectionReestablishmentRequest* message to cell 2.

The RRC re-establishment delay to an unknown NB-IoT TDD intra frequency cell shall be less than 60 s.

The rate of correct RRC re-establishments observed during repeated tests shall be at least 90%.

NOTE: The RRC re-establishment delay in the test is derived from the following expression:

$$T_{\text{re-establish_delay}} = T_{\text{UL_grant}} + T_{\text{UE-re-establish_delay_NB-IoT}}$$

Where:

- $T_{\text{UL_grant}}$ = It is the time required to acquire and process uplink grant from the target cell. The NPRACH reception at the system simulator is used as a trigger for the completion of the test; hence $T_{\text{UL_grant}}$ is not used.
- $T_{\text{UE-re-establish_delay_NB-IoT}} = 100 \text{ ms} + N_{\text{NB-IoT-freq}} * T_{\text{search_NB-IoT}} + T_{\text{SI_NB-IoT}} + T_{\text{PRACH_NB-IoT}}$
- $N_{\text{NB-IoT-freq}} = 1$
- $T_{\text{search_NB-IoT}} = 14800 \text{ ms}$
- $T_{\text{SI_NB-IoT}} = 41560 \text{ ms}$; it is the time required for receiving all the relevant system information as defined in TS 36.331 for the target NB-IoT TDD cell.
- $T_{\text{PRACH_NB-IoT}} = 2560 \text{ ms}$; it is the additional delay caused by the random access procedure.

A.6.2 Random Access

A.6.2.1 E-UTRAN FDD – Contention Based Random Access Test

A.6.2.1.1 Test Purpose and Environment

The purpose of this test is to verify that the behavior of the random access procedure is according to the requirements and that the PRACH power settings and timing are within specified limits. This test will verify the requirements in Clause 6.2.2 and Clause 7.1.2 in an AWGN model.

For this test a single cell is used. The test parameters are given in tables A.6.2.1.1-1 and A.6.2.1.1-2.

Table A.6.2.1.1-1: General test parameters for FDD contention based random access test

Parameter	Unit	Value	Comments	
E-UTRA RF Channel Number		1		
BW_{channel}	MHz	10		
OCNG Pattern ^{Note 1}		OP.1/2 FDD ^{Note 1}	As defined in A.3.2.1.1/2.	
PDSCH parameters ^{Note 4}		DL Reference Measurement Channel R.0 FDD ^{Note 4}	As defined in A.3.1.1.1.	
PCFICH/PDCCH/PHICH parameters		DL Reference Measurement Channel R.6 FDD	As defined in A.3.1.2.1.	
PBCH_RA	dB	0		
PBCH_RB	dB			
PSS_RA	dB			
SSS_RA	dB			
PCFICH_RB	dB			
PHICH_RA	dB			
PHICH_RB	dB			
PDCCH_RA	dB			
PDCCH_RB	dB			
PDSCH_RA	dB			
PDSCH_RB	dB			
OCNG_RA ^{Note 1}	dB			
OCNG_RB ^{Note 1}	dB			
$\hat{E}_s / I_{\text{ot}}$	dB		3	
N_{oc}	dBm/15 KHz		-98	
$\hat{E}_s / N_{\text{oc}}$	dB		3	
I_0 ^{Note 2}	dBm/9 MHz	-65.5		
RSRP ^{Note 3}	dBm/15 KHz	-95		

referenceSignalPower	dBm/15 KHz	-5	As defined in clause 6.3.2 in TS 36.331.
Configured UE transmitted power (P_{CMAX})	dBm	23	As defined in clause 6.2.5 in TS 36.101.
PRACH Configuration Index	-	4	As defined in table 5.7.1-2 in TS 36.211.
Backoff Parameter Index	-	2	As defined in table 7.2-1 in TS 36.321.
Propagation Condition	-	AWGN	
Note 1:	OCNG shall be used such that the cell is fully allocated and a constant total transmitted power spectral density is achieved for all OFDM symbols. The OCNG pattern is chosen during the test according to the presence of a DL reference measurement channel.		
Note 2:	Io level has been derived from other parameters for information purpose. It is not a settable parameter.		
Note 3:	RSRP level has been derived from other parameters for information purposes. It is not a settable parameter.		
Note 4:	The DL PDSCH reference measurement channel is used in the test only when a downlink transmission dedicated to the UE under test is required.		

Table A.6.2.1.1-2: RACH-Configuration parameters for FDD contention based random access test

Field	Value	Comment
powerRampingStep	dB2	
preambleInitialReceivedTargetPower	dBm-120	
preambleTransMax	n6	
ra-ResponseWindowSize	sf10	10 sub-frames
mac-ContentionResolutionTimer	sf48	48 sub-frames
maxHARQ-Msg3Tx	4	
Note: For further information see Clause 6.3.2 in TS 36.331.		

A.6.2.1.2 Test Requirements

Contention based random access is triggered by *not* explicitly assigning a random access preamble via dedicated signalling in the downlink.

A.6.2.1.2.1 Random Access Response Reception

To test the UE behavior specified in Subclause 6.2.2.1.1 the System Simulator shall transmit a Random Access Response containing a Random Access Preamble identifier corresponding to the transmitted Random Access Preamble after 5 preambles have been received by the System Simulator. In response to the first 4 preambles, the System Simulator shall transmit a Random Access Response *not* corresponding to the transmitted Random Access Preamble.

The UE may stop monitoring for Random Access Response(s) and shall transmit the msg3 if the Random Access Response contains a Random Access Preamble identifier corresponding to the transmitted Random Access Preamble.

The UE shall re-select a preamble and transmit with the calculated PRACH transmission power when the backoff time expires if all received Random Access Responses contain Random Access Preamble identifiers that do not match the transmitted Random Access Preamble.

In addition, the power applied to all preambles shall be in accordance with what is specified in Subclause 6.2.2. The power of the first preamble shall be -30 dBm. The power of the first preamble shall be -30 dBm with an accuracy specified in clause 6.3.5.1.1 of TS 36.101 [5]. The relative power applied to additional preambles shall have an accuracy specified in clause 6.3.5.2.1 of TS 36.101 [5].

The transmit timing of all PRACH transmissions shall be within the accuracy specified in Subclause 7.1.2.

A.6.2.1.2.2 No Random Access Response Reception

To test the UE behavior specified in subclause 6.2.2.1.2 the System Simulator shall transmit a Random Access Response containing a Random Access Preamble identifier corresponding to the transmitted Random Access Preamble after 5 preambles have been received by the System Simulator. The System Simulator shall *not* respond to the first 4 preambles.

The UE shall re-select a preamble and transmit with the calculated PRACH transmission power when the backoff time expires if no Random Access Response is received within the RA Response window.

In addition, the power applied to all preambles shall be in accordance with what is specified in Subclause 6.2.2. The power of the first preamble shall be -30 dBm with an accuracy specified in clause 6.3.5.1.1 of TS 36.101 [5]. The relative power applied to additional preambles shall have an accuracy specified in clause 6.3.5.2.1 of TS 36.101 [5].

The transmit timing of all PRACH transmissions shall be within the accuracy specified in Subclause 7.1.2.

A.6.2.1.2.3 Receiving a NACK on msg3

To test the UE behavior specified in subclause 6.2.2.1.3 the System Simulator shall NACK *all* UE msg3 following a successful Random Access Response.

The UE shall re-transmit the msg3 upon the reception of a NACK on msg3 until the maximum number of HARQ re-transmissions is reached.

A.6.2.1.2.4 Reception of an Incorrect Message over Temporary C-RNTI

To test the UE behavior specified in Subclause 6.2.2.1.5 the System Simulator shall send a message addressed to the temporary C-RNTI with a UE Contention Resolution Identity included in the MAC control element *not* matching the CCCH SDU transmitted in msg3 uplink message.

The UE shall re-select a preamble and transmit with the calculated PRACH transmission power when the backoff time expires unless the received message includes a UE Contention Resolution Identity MAC control element and the UE Contention Resolution Identity included in the MAC control element matches the CCCH SDU transmitted in the uplink message.

A.6.2.1.2.5 Reception of a Correct Message over Temporary C-RNTI

To test the UE behavior specified in Subclause 6.2.2.1.5 the System Simulator shall send a message addressed to the temporary C-RNTI with a UE Contention Resolution Identity included in the MAC control element matching the CCCH SDU transmitted in the msg3 uplink message.

The UE shall send ACK if the Contention Resolution is successful.

A.6.2.1.2.6 Contention Resolution Timer expiry

To test the UE behavior specified in Subclause 6.2.2.1.6 the System Simulator shall *not* send a response to a msg3.

The UE shall re-select a preamble and transmit with the calculated PRACH transmission power when the backoff time expires if the Contention Resolution Timer expires.

A.6.2.2 E-UTRAN FDD – Non-Contention Based Random Access Test

A.6.2.2.1 Test Purpose and Environment

The purpose of this test is to verify that the behavior of the random access procedure is according to the requirements and that the PRACH power settings and timing are within specified limits. This test will verify the requirements in Clause 6.2.2 and Clause 7.1.2 in an AWGN model.

For this test a single cell is used. The test parameters are given in tables A.6.2.2.1-1 and A.6.2.2.1-2.

Table A.6.2.2.1-1: General test parameters for FDD non-contention based random access test

Parameter	Unit	Value	Comments
E-UTRA RF Channel Number		1	
BW _{channel}	MHz	10	
OCNG Pattern		OP.1 FDD	As defined in A.3.2.1.1.
PDSCH parameters		DL Reference Measurement Channel R.0 FDD	As defined in A.3.1.1.1.
PCFICH/PDCCH/PHICH parameters		DL Reference Measurement Channel R.6 FDD	As defined in A.3.1.2.1.
PBCH_RA	dB		
PBCH_RB	dB		
PSS_RA	dB		

SSS_RA	dB		
PCFICH_RB	dB		
PHICH_RA	dB		
PHICH_RB	dB	0	
PDCCH_RA	dB		
PDCCH_RB	dB		
PDSCH_RA	dB		
PDSCH_RB	dB		
OCNG_RA ^{Note 1}	dB		
OCNG_RB ^{Note 1}	dB		
\hat{E}_s/I_{ot}	dB	3	
N_{oc}	dBm/15 KHz	-98	
\hat{E}_s/N_{oc}	dB	3	
I_o ^{Note 2}	dBm/9 MHz	-65.5	
RSRP ^{Note 3}	dBm/15 KHz	-95	
referenceSignalPower	dBm/15 KHz	-5	As defined in clause 6.3.2 in TS 36.331.
Configured UE transmitted power (P_{CMAX})	dBm	23	As defined in clause 6.2.5 in TS 36.101.
PRACH Configuration Index	-	4	As defined in table 5.7.1-2 in TS 36.211.
Backoff Parameter Index	-	2	As defined in table 7.2-1 in TS 36.321.
Propagation Condition	-	AWGN	
Note 1: OCNG shall be used such that the cell is fully allocated and a constant total transmitted power spectral density is achieved for all OFDM symbols.			
Note 2: I_o level has been derived from other parameters for information purpose. It is not a settable parameter.			
Note 3: RSRP level has been derived from other parameters for information purposes. It is not a settable parameter.			

Table A.6.2.2.1-2: RACH-Configuration parameters for FDD non-contention based random access test

Field	Value	Comment
powerRampingStep	dB2	
preambleInitialReceivedTargetPower	dBm-120	
preambleTransMax	n6	
ra-ResponseWindowSize	sf10	10 sub-frames
Note: For further information see Clause 6.3.2 in TS 36.331.		

A.6.2.2.2 Test Requirements

Non-Contention based random access is triggered by explicitly assigning a random access preamble via dedicated signalling in the downlink.

A.6.2.2.2.1 Random Access Response Reception

To test the UE behavior specified in Subclause 6.2.2.2.1 the System Simulator shall transmit a Random Access Response containing a Random Access Preamble identifier corresponding to the transmitted Random Access Preamble after 5 preambles have been received by the System Simulator. In response to the first 4 preambles, the System Simulator shall transmit a Random Access Response *not* corresponding to the transmitted Random Access Preamble.

The UE may stop monitoring for Random Access Response(s) if the Random Access Response contains a Random Access Preamble identifier corresponding to the transmitted Random Access Preamble.

The UE shall re-transmit the preamble with the calculated PRACH transmission power if all received Random Access Responses contain Random Access Preamble identifiers that do not match the transmitted Random Access Preamble.

In addition, the power applied to all preambles shall be in accordance with what is specified in Subclause 6.2.2. The power of the first preamble shall be -30 dBm with an accuracy specified in clause 6.3.5.1.1 of TS 36.101 [5]. The relative power applied to additional preambles shall have an accuracy specified in clause 6.3.5.2.1 of TS 36.101 [5].

The transmit timing of all PRACH transmissions shall be within the accuracy specified in Subclause 7.1.2.

A.6.2.2.2 No Random Access Response Reception

To test the UE behavior specified in subclause 6.2.2.2 the System Simulator shall transmit a Random Access Response containing a Random Access Preamble identifier corresponding to the transmitted Random Access Preamble after 5 preambles have been received by the System Simulator. The System Simulator shall *not* respond to the first 4 preambles.

The UE shall re-transmit the preamble with the calculated PRACH transmission power.

In addition, the power applied to all preambles shall be in accordance with what is specified in Subclause 6.2.2. The power of the first preamble shall be -30 dBm with an accuracy specified in clause 6.3.5.1.1 of TS 36.101 [5]. The relative power applied to additional preambles shall have an accuracy specified in clause 6.3.5.2.1 of TS 36.101 [5].

The transmit timing of all PRACH transmissions shall be within the accuracy specified in Subclause 7.1.2.

A.6.2.3 E-UTRAN TDD – Contention Based Random Access Test

A.6.2.3.1 Test Purpose and Environment

The purpose of this test is to verify that the behavior of the random access procedure is according to the requirements and that the PRACH power settings and timing are within specified limits. This test will verify the requirements in Clause 6.2.2 and Clause 7.1.2 in an AWGN model.

For this test a single cell is used. The test parameters are given in tables A.6.2.3.1-1 and A.6.2.3.1-2.

Table A.6.2.3.1-1: General test parameters for TDD contention based random access test

Parameter	Unit	Value	Comments
E-UTRA RF Channel Number	-	1	
BW_{channel}	MHz	10	
OCNG Pattern ^{Note 1}	-	OP.1/2 TDD ^{Note 1}	As defined in A.3.2.2.1/2.
PDSCH parameters ^{Note 4}	-	DL Reference Measurement Channel R.0 TDD ^{Note 4}	As defined in A.3.1.1.2.
PCFICH/PDCCH/PHICH parameters	-	DL Reference Measurement Channel R.6 TDD	As defined in A.3.1.2.2.
Special subframe configuration	-	6	As specified in table 4.2-1 in TS 36.211.
Uplink-downlink configuration	-	1	As specified in table 4.2-2 in TS 36.211.
PBCH_RA	dB	0	
PBCH_RB	dB		
PSS_RA	dB		
SSS_RA	dB		
PCFICH_RB	dB		
PHICH_RA	dB		
PHICH_RB	dB		
PDCCH_RA	dB		
PDCCH_RB	dB		
PDSCH_RA	dB		
PDSCH_RB	dB		
OCNG_RA ^{Note 1}	dB		
OCNG_RB ^{Note 1}	dB		
$\hat{E}_s / I_{\text{ot}}$	dB		3
N_{oc}	dBm/15 KHz	-98	
$\hat{E}_s / N_{\text{oc}}$	dB	3	
I_0 ^{Note 2}	dBm/9 MHz	-65.5	
RSRP ^{Note 3}	dBm/15 KHz	-95	

referenceSignalPower	dBm/15 KHz	-5	As defined in clause 6.3.2 in TS 36.331.
Configured UE transmitted power (P_{CMAX})	dBm	23	As defined in clause 6.2.5 in TS 36.101.
PRACH Configuration Index	-	53	As defined in table 5.7.1-3 in TS 36.211.
Backoff Parameter Index	-	2	As defined in table 7.2-1 in TS 36.321.
Propagation Condition	-	AWGN	
Note 1:	OCNG shall be used such that the cell is fully allocated and a constant total transmitted power spectral density is achieved for all OFDM symbols. The OCNG pattern is chosen during the test according to the presence of a DL reference measurement channel.		
Note 2:	Io level has been derived from other parameters for information purpose. It is not a settable parameter.		
Note 3:	RSRP level has been derived from other parameters for information purposes. It is not a settable parameter.		
Note 4:	The DL PDSCH reference measurement channel is used in the test only when a downlink transmission dedicated to the UE under test is required.		

Table A.6.2.3.1-2: RACH-Configuration parameters for TDD contention based random access test

Field	Value	Comment
numberOfRA-Preambles	n52	
sizeOfRA-PreamblesGroupA	n52	No group B.
powerRampingStep	dB2	
preambleInitialReceivedTargetPower	dBm-120	
preambleTransMax	n6	
ra-ResponseWindowSize	sf10	10 sub-frames
mac-ContentionResolutionTimer	sf48	48 sub-frames
maxHARQ-Msg3Tx	4	
Note:	For further information see Clause 6.3.2 in TS 36.331.	

A.6.2.3.2 Test Requirements

Contention based random access is triggered by *not* explicitly assigning a random access preamble via dedicated signalling in the downlink.

A.6.2.3.2.1 Random Access Response Reception

To test the UE behavior specified in Subclause 6.2.2.1.1 the System Simulator shall transmit a Random Access Response containing a Random Access Preamble identifier corresponding to the transmitted Random Access Preamble after 5 preambles have been received by the System Simulator. In response to the first 4 preambles, the System Simulator shall transmit a Random Access Response *not* corresponding to the transmitted Random Access Preamble.

The UE may stop monitoring for Random Access Response(s) and shall transmit the msg3 if the Random Access Response contains a Random Access Preamble identifier corresponding to the transmitted Random Access Preamble.

The UE shall re-select a preamble and transmit with the calculated PRACH transmission power when the backoff time expires if all received Random Access Responses contain Random Access Preamble identifiers that do not match the transmitted Random Access Preamble.

In addition, the power applied to all preambles shall be in accordance with what is specified in Subclause 6.2.2. The power of the first preamble shall be -22 dBm with an accuracy specified in clause 6.3.5.1.1 of TS 36.101 [5]. The relative power applied to additional preambles shall have an accuracy specified in clause 6.3.5.2.1 of TS 36.101 [5].

The transmit timing of all PRACH transmissions shall be within the accuracy specified in Subclause 7.1.2.

A.6.2.3.2.2 No Random Access Response reception

To test the UE behavior specified in Subclause 6.2.2.1.2 the System Simulator shall transmit a Random Access Response containing a Random Access Preamble identifier corresponding to the transmitted Random Access Preamble

after 5 preambles have been received by the System Simulator. The System Simulator shall *not* respond to the first 4 preambles.

The UE shall re-select a preamble and transmit with the calculated PRACH transmission power when the backoff time expires if no Random Access Response is received within the RA Response window.

In addition, the power applied to all preambles shall be in accordance with what is specified in Subclause 6.2.2. The power of the first preamble shall be -22 dBm with an accuracy specified in clause 6.3.5.1.1 of TS 36.101 [5]. The relative power applied to additional preambles shall have an accuracy specified in clause 6.3.5.2.1 of TS 36.101 [5].

The transmit timing of all PRACH transmissions shall be within the accuracy specified in Subclause 7.1.2.

A.6.2.3.2.3 Receiving a NACK on msg3

To test the UE behavior specified in Subclause 6.2.2.1.3 the System Simulator shall NACK *all* UE msg3 following a successful Random Access Response.

The UE shall re-transmit the msg3 upon the reception of a NACK on msg3 until the maximum number of HARQ re-transmissions is reached.

A.6.2.3.2.4 Reception of an Incorrect Message over Temporary C-RNTI

To test the UE behavior specified in Subclause 6.2.2.1.5 the System Simulator shall send a message addressed to the temporary C-RNTI with a UE Contention Resolution Identity included in the MAC control element *not* matching the CCCH SDU transmitted in msg3 uplink message.

The UE shall re-select a preamble and transmit with the calculated PRACH transmission power when the backoff time expires unless the received message includes a UE Contention Resolution Identity MAC control element and the UE Contention Resolution Identity included in the MAC control element matches the CCCH SDU transmitted in the uplink message.

A.6.2.3.2.5 Reception of a Correct Message over Temporary C-RNTI

To test the UE behavior specified in Subclause 6.2.2.1.5 the System Simulator shall send a message addressed to the temporary C-RNTI with a UE Contention Resolution Identity included in the MAC control element matching the CCCH SDU transmitted in the msg3 uplink message.

The UE shall send ACK if the Contention Resolution is successful.

A.6.2.3.2.6 Contention Resolution Timer expiry

To test the UE behavior specified in Subclause 6.2.2.1.6 the System Simulator shall *not* send a response to a msg3.

The UE shall re-select a preamble and transmit with the calculated PRACH transmission power when the backoff time expires if the Contention Resolution Timer expires.

A.6.2.4 E-UTRAN TDD – Non-Contention Based Random Access Test

A.6.2.4.1 Test Purpose and Environment

The purpose of this test is to verify that the behavior of the random access procedure is according to the requirements and that the PRACH power settings and timing are within specified limits. This test will verify the requirements in Clause 6.2.2 and Clause 7.1.2 in an AWGN model.

For this test a single cell is used. The test parameters are given in tables A.6.2.4.1-1 and A.6.2.4.1-2.

Table A.6.2.4.1-1: General test parameters for TDD non-contention based random access test

Parameter	Unit	Value	Comments
E-UTRA RF Channel Number	-	1	
BW _{channel}	MHz	10	
OCNG Pattern	-	OP.1 TDD	As defined in A.3.2.2.1.
PDSCH parameters	-	DL Reference Measurement Channel R.0 TDD	As defined in A.3.1.1.2.
PCFICH/PDCCH/PHICH parameters	-	DL Reference Measurement Channel R.6 TDD	As defined in A.3.1.2.2.

Special subframe configuration	-	6	As specified in table 4.2-1 in TS 36.211.
Uplink-downlink configuration	-	1	As specified in table 4.2-2 in TS 36.211.
PBCH_RA	dB	0	
PBCH_RB	dB		
PSS_RA	dB		
SSS_RA	dB		
PCFICH_RB	dB		
PHICH_RA	dB		
PHICH_RB	dB		
PDCCH_RA	dB		
PDCCH_RB	dB		
PDSCH_RA	dB		
PDSCH_RB	dB		
OCNG_RA ^{Note 1}	dB		
OCNG_RB ^{Note 1}	dB		
\hat{E}_s / I_{ot}	dB		3
N_{oc}	dBm/15 KHz	-98	
\hat{E}_s / N_{oc}	dB	3	
I_o ^{Note 2}	dBm/9 MHz	-65.5	
RSRP ^{Note 3}	dBm/15 KHz	-95	
referenceSignalPower	dBm/15 KHz	-5	As defined in clause 6.3.2 in TS 36.331.
Configured UE transmitted power (P_{CMAX})	dBm	23	As defined in clause 6.2.5 in TS 36.101.
PRACH Configuration Index	-	53	As defined in table 5.7.1-3 in TS 36.211.
Backoff Parameter Index	-	2	As defined in table 7.2-1 in TS 36.321.
Propagation Condition	-	AWGN	
<p>Note 1: OCNG shall be used such that the cell is fully allocated and a constant total transmitted power spectral density is achieved for all OFDM symbols.</p> <p>Note 2: I_o level has been derived from other parameters for information purpose. It is not a settable parameter.</p> <p>Note 3: RSRP level has been derived from other parameters for information purposes. It is not a settable parameter.</p>			

Table A.6.2.4.1-2: RACH-Configuration parameters for TDD non-contention based random access test

Field	Value	Comment
powerRampingStep	dB2	
preambleInitialReceivedTargetPower	dBm-120	
preambleTransMax	n6	
ra-ResponseWindowSize	sf10	10 sub-frames
Note: For further information see Clause 6.3.2 in TS 36.331.		

A.6.2.4.2 Test Requirements

Non-Contention based random access is triggered by explicitly assigning a random access preamble via dedicated signalling in the downlink.

A.6.2.4.2.1 Random Access Response Reception

To test the UE behavior specified in Subclause 6.2.2.2.1 the System Simulator shall transmit a Random Access Response containing a Random Access Preamble identifier corresponding to the transmitted Random Access Preamble after 5 preambles have been received by the System Simulator. In response to the first 4 preambles, the System Simulator shall transmit a Random Access Response *not* corresponding to the transmitted Random Access Preamble.

The UE may stop monitoring for Random Access Response(s) if the Random Access Response contains a Random Access Preamble identifier corresponding to the transmitted Random Access Preamble.

The UE shall re-transmit the preamble with the calculated PRACH transmission power if all received Random Access Responses contain Random Access Preamble identifiers that do not match the transmitted Random Access Preamble.

In addition, the power applied to all preambles shall be in accordance with what is specified in Subclause 6.2.2. The power of the first preamble shall be -22 dBm with an accuracy specified in clause 6.3.5.1.1 of TS 36.101 [5]. The relative power applied to additional preambles shall have an accuracy specified in clause 6.3.5.2.1 of TS 36.101 [5].

The transmit timing of all PRACH transmissions shall be within the accuracy specified in Subclause 7.1.2.

A.6.2.4.2.2 No Random Access Response Reception

To test the UE behavior specified in Subclause 6.2.2.2.2 the System Simulator shall transmit a Random Access Response containing a Random Access Preamble identifier corresponding to the transmitted Random Access Preamble after 5 preambles have been received by the System Simulator. The System Simulator shall *not* respond to the first 4 preambles.

The UE shall re-transmit the preamble with the calculated PRACH transmission power.

In addition, the power applied to all preambles shall be in accordance with what is specified in Subclause 6.2.2. The power of the first preamble shall be -22 dBm with an accuracy specified in clause 6.3.5.1.1 of TS 36.101 [5]. The relative power applied to additional preambles shall have an accuracy specified in clause 6.3.5.2.1 of TS 36.101 [5].

The transmit timing of all PRACH transmissions shall be within the accuracy specified in Subclause 7.1.2.

A.6.2.5 E-UTRAN FDD – Contention Based Random Access Test for 5MHz bandwidth

A.6.2.5.1 Test Purpose and Environment

The purpose of this test case is the same as for the test defined in subclause A.6.2.1.1.

The parameters of this test are the same as defined in Subclause A.6.2.1.1 except that the values of the parameters in the Table A.6.2.5.1-1 will replace the values of the corresponding parameters in A.6.2.1.1-1

Table A.6.2.5.1-1: General test parameters for FDD contention based random access test for 5MHz bandwidth

Parameter	Unit	Value	Comments
BW_{channel}	MHz	5	
OCNG Pattern ^{Note 1}		OP.15/16 FDD ^{Note 1}	As defined in A.3.2.1.15/16.
PDSCH parameters ^{Note 2}		DL Reference Measurement Channel R.5 FDD ^{Note 2}	As defined in A.3.1.1.1.
PCFICH/PDCCH/PHICH parameters		DL Reference Measurement Channel R.11 FDD	As defined in A.3.1.2.1.
I_0 ^{Note 2}	dBm/4.5 MHz	-68.5	
Note 1:	OCNG shall be used such that the cell is fully allocated and a constant total transmitted power spectral density is achieved for all OFDM symbols. The OCNG pattern is chosen during the test according to the presence of a DL reference measurement channel.		
Note 2:	The DL PDSCH reference measurement channel is used in the test only when a downlink transmission dedicated to the UE under test is required.		
Note 3:	See Table A.6.2.1.1-1 for the other parameters.		
Note 4:	This test is according to the principle defined in section A.3.7.2.		

A.6.2.5.2 Test Requirements

The test requirements defined in section A.6.2.1.2 shall apply to this test case.

A.6.2.6 E-UTRAN FDD – Non-contention Based Random Access Test for 5MHz bandwidth

A.6.2.6.1 Test Purpose and Environment

The purpose of this test case is the same as for the test defined in subclause A.6.2.2.1.

The parameters of this test are the same as defined in Subclause A.6.2.2.1 except that the values of the parameters in the Table A.6.2.6.1-1 will replace the values of the corresponding parameters in A.6.2.2.1-1

Table A.6.2.6.1-1: General test parameters for FDD non-contention based random access test for 5MHz bandwidth

Parameter	Unit	Value	Comments
BW _{channel}	MHz	5	
OCNG Pattern ^{Note 1}		OP.15 FDD ^{Note 1}	As defined in A.3.2.1.15.
PDSCH parameters ^{Note 2}		DL Reference Measurement Channel R.5 FDD ^{Note 2}	As defined in A.3.1.1.1.
PCFICH/PDCCH/PHICH parameters		DL Reference Measurement Channel R.11 FDD	As defined in A.3.1.2.1.
I _o ^{Note 2}	dBm/4.5 MHz	-68.5	
Note 1: OCNG shall be used such that the cell is fully allocated and a constant total transmitted power spectral density is achieved for all OFDM symbols. Note 2: I _o level has been derived from other parameters for information purpose. It is not a settable parameter Note 3: See Table A.6.2.2.1-1 for the other parameters. Note 4: This test is according to the principle defined in section A.3.7.2.			

A.6.2.6.2 Test Requirements

The test requirements defined in section A.6.2.2.2 shall apply to this test case.

A.6.2.7 E-UTRAN FDD – Non-Contention Based Random Access Test For SCell

A.6.2.7.1 Test Purpose and Environment

The purpose of this test is to verify that the behavior of the random access procedure, for the SCell, is according to the requirements and that the PRACH power settings and timing, for the SCell, are within specified limits. This test will verify the requirements in Clause 6.2.2 and Clause 7.1.2 in an AWGN model.

For this test two cells are used. Cell 1 is PCell and Cell 2 is SCell. PCell and SCell are different timing advance group. Cell 1 is in the primary Timing Advance Group (pTAG) and Cell 2 is in the secondary Timing Advance Group (sTAG). The purpose of the PCell is to allow the SCell to be configured and to handle the Random Access Response which takes place on PCell. The test parameters are given in tables A.6.2.7.1-1 and A.6.2.7.1-2.

Table A.6.2.7.1-1: General test parameters for FDD non-contention based random access test

Parameter	Unit	Cell 1	Cell 2	Comments
E-UTRA RF Channel Number		1	2	
BW _{channel}	MHz	10	10	
Active PCell		Cell 1		Primary cell of RF channel number 1.
Active SCell			Cell 2	Secondary cell of RF channel number 2.
TAG configuration		pTAG	sTAG	pTAG+sTAG configures Cell 1 and Cell 2 to separate TAGs
OCNG Pattern		OP.1 FDD	OP.1 FDD	As defined in A.3.2.1.11.

PDSCH parameters		DL Reference Measurement Channel R.0 FDD	DL Reference Measurement Channel R.0 FDD	As defined in A.3.1.1.1.
PCFICH/PDCCH/PHICH parameters		DL Reference Measurement Channel R.6 FDD	DL Reference Measurement Channel R.6 FDD	As defined in A.3.1.2.1.
PBCH_RA	dB	0	0	
PBCH_RB	dB			
PSS_RA	dB			
SSS_RA	dB			
PCFICH_RB	dB			
PHICH_RA	dB			
PHICH_RB	dB			
PDCCH_RA	dB			
PDCCH_RB	dB			
PDSCH_RA	dB			
PDSCH_RB	dB			
OCNG_RA ^{Note 1}	dB			
OCNG_RB ^{Note 1}	dB			
\hat{E}_s / I_{ot}	dB			3
N_{oc}	dBm/15 KHz	-98	-98	
\hat{E}_s / N_{oc}	dB	3	3	
I_o ^{Note 2}	dBm/9 MHz	-65.5	-65.5	
RSRP ^{Note 3}	dBm/15 KHz	-95	-95	
referenceSignalPower	dBm/15 KHz	-5	-5	As defined in clause 6.3.2 in TS 36.331.
Configured UE transmitted power ($P_{CMAX,c}$)	dBm	23	23	As defined in clause 6.2.5 in TS 36.101.
PRACH Configuration Index	-	4	4	As defined in table 5.7.1-2 in TS 36.211.
Backoff Parameter Index	-	2	2	As defined in table 7.2-1 in TS 36.321.
Propagation Condition	-	AWGN	AWGN	
Note 1: OCNG shall be used such that the cell is fully allocated and a constant total transmitted power spectral density is achieved for all OFDM symbols. Note 2: I_o level has been derived from other parameters for information purpose. It is not a settable parameter. Note 3: RSRP level has been derived from other parameters for information purposes. It is not a settable parameter.				

Table A.6.2.7.1-2: RACH-Configuration parameters for FDD non-contention based random access test

Field	Value	Comment
powerRampingStep	dB2	
preambleInitialReceivedTargetPower	dBm-120	
preambleTransMax	n6	
ra-ResponseWindowSize	sf10	10 sub-frames
Note: For further information see Clause 6.3.2 in TS 36.331.		

A.6.2.7.2 Test Requirements

Non-Contention based random access is triggered by explicitly assigning a random access preamble via dedicated signalling in the downlink.

A.6.2.7.2.1 Random Access Response Reception

To test the UE behavior specified in Subclause 6.2.2.2.1 the System Simulator shall transmit, on Cell 1, the PCell, a Random Access Response containing a Random Access Preamble identifier corresponding to the transmitted Random Access Preamble after 5 preambles have been received by the System Simulator, on Cell 2. In response to the first 4 preambles, the System Simulator shall transmit a Random Access Response *not* corresponding to the transmitted Random Access Preamble.

The UE may stop monitoring for Random Access Response(s) if the Random Access Response contains a Random Access Preamble identifier corresponding to the transmitted Random Access Preamble.

The UE shall re-transmit the preamble with the calculated PRACH transmission power if all received Random Access Responses contain Random Access Preamble identifiers that do not match the transmitted Random Access Preamble.

In addition, the power applied to all preambles shall be in accordance with what is specified in Subclause 6.2.2. The power of the first preamble shall be -30 dBm with an accuracy specified in clause 6.3.5.1.1 of TS 36.101 [5]. The relative power applied to additional preambles shall have an accuracy specified in clause 6.3.5.2.1 of TS 36.101 [5].

The transmit timing of all PRACH transmissions shall be within the accuracy specified in Subclause 7.1.2.

A.6.2.7.2.2 No Random Access Response Reception

To test the UE behavior specified in subclause 6.2.2.2.2 the System Simulator shall transmit, on Cell 1, the PCell, a Random Access Response containing a Random Access Preamble identifier corresponding to the transmitted Random Access Preamble after 5 preambles have been received by the System Simulator on Cell 2. The System Simulator shall *not* respond to the first 4 preambles.

The UE shall re-transmit the preamble with the calculated PRACH transmission power.

In addition, the power applied to all preambles shall be in accordance with what is specified in Subclause 6.2.2. The power of the first preamble shall be -30 dBm with an accuracy specified in clause 6.3.5.1.1 of TS 36.101 [5]. The relative power applied to additional preambles shall have an accuracy specified in clause 6.3.5.2.1 of TS 36.101 [5].

The transmit timing of all PRACH transmissions shall be within the accuracy specified in Subclause 7.1.2.

A.6.2.7.2.3 Stop Preamble transmission if maximum number of preamble transmission counter has been reached

To test the UE behavior specified in Subclause 6.2.2 the System Simulator shall transmit, in response to the first 6 preambles, a Random Access Response *not* corresponding to the transmitted Random Access Preamble on Cell 1, the PCell. The UE shall stop transmitting preambles after 6 preambles.

The UE shall re-transmit the preamble with the calculated PRACH transmission power.

In addition, the power applied to all preambles shall be in accordance with what is specified in Subclause 6.2.2. The power of the first preamble shall be -30 dBm with an accuracy specified in clause 6.3.5.1.1 of TS 36.101 [5]. The relative power applied to additional preambles shall have an accuracy specified in clause 6.3.5.2.1 of TS 36.101 [5].

The transmit timing of all PRACH transmissions shall be within the accuracy specified in Subclause 7.1.2.

A.6.2.8 E-UTRAN TDD – Non-Contention Based Random Access Test For SCell

A.6.2.8.1 Test Purpose and Environment

This test is applicable for UE supporting the optional capability of Multiple Timing Advance.

The purpose of this test is to verify that the behavior of the random access procedure, for the SCell, is according to the requirements and that the PRACH power settings and timing, for the SCell, are within specified limits. This test will verify the requirements in Clause 6.2.2 and Clause 7.1.2 in an AWGN model.

For this test two cells are used. Cell 1 is PCell and Cell 2 is SCell. PCell and SCell are different timing advance group. Cell 1 is in the primary Timing Advance Group (pTAG) and Cell 2 is in the secondary Timing Advance Group (sTAG). The purpose of the PCell is to allow the SCell to be configured and to handle the Random Access Response which takes place on PCell. The test parameters are given in tables A.6.2.8.1-1 and A.6.2.8.1-2.

Table A.6.2.8.1-1: General test parameters for TDD non-contention based random access test

Parameter	Unit	Cell 1	Cell 2	Comments
E-UTRA RF Channel Number	-	1	1	
BW_{channel}	MHz	10	10	
Active PCell		Cell 1		Primary cell of RF channel number 1.

Active SCell			Cell 2	Secondary cell of RF channel number 2.
TAG configuration		pTAG	sTAG	pTAG+sTAG configures Cell 1 and Cell 2 to separate TAGs
OCNG Pattern	-	OP.1 TDD	OP.1 TDD	As defined in A.3.2.2.1.
PDSCH parameters	-	DL Reference Measurement Channel R.0 TDD	DL Reference Measurement Channel R.0 TDD	As defined in A.3.1.1.2.
PCFICH/PDCCH/PHICH parameters	-	DL Reference Measurement Channel R.6 TDD	DL Reference Measurement Channel R.6 TDD	As defined in A.3.1.2.2.
Special subframe configuration	-	6	6	As specified in table 4.2-1 in TS 36.211.
Uplink-downlink configuration	-	1	1	As specified in table 4.2-2 in TS 36.211.
PBCH_RA	dB	0	0	
PBCH_RB	dB			
PSS_RA	dB			
SSS_RA	dB			
PCFICH_RB	dB			
PHICH_RA	dB			
PHICH_RB	dB			
PDCCH_RA	dB			
PDCCH_RB	dB			
PDSCH_RA	dB			
PDSCH_RB	dB			
OCNG_RA <small>Note 1</small>	dB			
OCNG_RB <small>Note 1</small>	dB			
\hat{E}_s / I_{ot}	dB			3
N_{oc}	dBm/15 KHz	-98	-98	
\hat{E}_s / N_{oc}	dB	3	3	
I_o <small>Note 2</small>	dBm/9 MHz	-65.5	-65.5	
RSRP <small>Note 3</small>	dBm/15 KHz	-95	-95	
referenceSignalPower	dBm/15 KHz	-5	-5	As defined in clause 6.3.2 in TS 36.331.
Configured UE transmitted power ($P_{CMAX,c}$)	dBm	23	23	As defined in clause 6.2.5 in TS 36.101.
PRACH Configuration Index	-	53	53	As defined in table 5.7.1-3 in TS 36.211.
Backoff Parameter Index	-	2	2	As defined in table 7.2-1 in TS 36.321.
Propagation Condition	-	AWGN	AWGN	
<p>Note 1: OCNG shall be used such that the cell is fully allocated and a constant total transmitted power spectral density is achieved for all OFDM symbols.</p> <p>Note 2: I_o level has been derived from other parameters for information purpose. It is not a settable parameter.</p> <p>Note 3: RSRP level has been derived from other parameters for information purposes. It is not a settable parameter.</p>				

Table A.6.2.8.1-2: RACH-Configuration parameters for TDD non-contention based random access test

Field	Value	Comment
powerRampingStep	dB2	
preambleInitialReceivedTargetPower	dBm-120	
preambleTransMax	n6	
ra-ResponseWindowSize	sf10	10 sub-frames
Note: For further information see Clause 6.3.2 in TS 36.331.		

A.6.2.8.2 Test Requirements

Non-Contention based random access is triggered by explicitly assigning a random access preamble via dedicated signalling in the downlink.

A.6.2.8.2.1 Random Access Response Reception

To test the UE behavior specified in Subclause 6.2.2.2.1 the System Simulator shall transmit, on Cell 1, the PCell, a Random Access Response containing a Random Access Preamble identifier corresponding to the transmitted Random Access Preamble after 5 preambles have been received by the System Simulator, on Cell 2. In response to the first 4 preambles, the System Simulator shall transmit a Random Access Response *not* corresponding to the transmitted Random Access Preamble.

The UE may stop monitoring for Random Access Response(s) if the Random Access Response contains a Random Access Preamble identifier corresponding to the transmitted Random Access Preamble.

The UE shall re-transmit the preamble with the calculated PRACH transmission power if all received Random Access Responses contain Random Access Preamble identifiers that do not match the transmitted Random Access Preamble.

In addition, the power applied to all preambles shall be in accordance with what is specified in Subclause 6.2.2. The power of the first preamble shall be -22 dBm with an accuracy specified in clause 6.3.5.1.1 of TS 36.101 [5]. The relative power applied to additional preambles shall have an accuracy specified in clause 6.3.5.2.1 of TS 36.101 [5].

The transmit timing of all PRACH transmissions shall be within the accuracy specified in Subclause 7.1.2.

A.6.2.8.2.2 No Random Access Response Reception

To test the UE behavior specified in Subclause 6.2.2.2.2 the System Simulator shall transmit, on Cell 1, the PCell, a Random Access Response containing a Random Access Preamble identifier corresponding to the transmitted Random Access Preamble after 5 preambles have been received by the System Simulator, on Cell 2. The System Simulator shall *not* respond to the first 4 preambles.

The UE shall re-transmit the preamble with the calculated PRACH transmission power.

In addition, the power applied to all preambles shall be in accordance with what is specified in Subclause 6.2.2. The power of the first preamble shall be -22 dBm with an accuracy specified in clause 6.3.5.1.1 of TS 36.101 [5]. The relative power applied to additional preambles shall have an accuracy specified in clause 6.3.5.2.1 of TS 36.101 [5].

The transmit timing of all PRACH transmissions shall be within the accuracy specified in Subclause 7.1.2.

A.6.2.8.2.3 Stop Preamble transmission if maximum number of preamble transmission counter has been reached

To test the UE behavior specified in Subclause 6.2.2 the System Simulator shall transmit, in response to the first 6 preambles, a Random Access Response *not* corresponding to the transmitted Random Access Preamble on Cell 1, the PCell. The UE shall stop transmitting preambles after 6 preambles.

The UE shall re-transmit the preamble with the calculated PRACH transmission power.

In addition, the power applied to all preambles shall be in accordance with what is specified in Subclause 6.2.2. The power of the first preamble shall be -22 dBm with an accuracy specified in clause 6.3.5.1.1 of TS 36.101 [5]. The relative power applied to additional preambles shall have an accuracy specified in clause 6.3.5.2.1 of TS 36.101 [5].

The transmit timing of all PRACH transmissions shall be within the accuracy specified in Subclause 7.1.2.

A.6.2.9 3DL/3UL TDD CA Non-Contention Based Random Access Test for 2 SCells

A.6.2.9.1 Test Purpose and Environment

This test is applicable for UE supporting the optional capability of Multiple Timing Advance.

The purpose of this test is to verify that the behavior of the random access procedure, for the two SCells, is according to the requirements and that the PRACH power settings and timing, for the SCell, are within specified limits. This test will verify the requirements in Clause 6.2.2 and Clause 7.1.2 in an AWGN model.

For this test three cells are used. Cell 1 is PCell, Cell 2 is SCell1 and Cell 3 is SCell2. Cell 1 and Cell 2/Cell 3 belong to different timing advance groups. Cell 1 is in the primary Timing Advance Group (pTAG). Cell 2 and Cell3 are in the same secondary Timing Advance Group (sTAG). The purpose of the Cell 1 is to allow Cell 2 and Cell 3 to be configured and to handle the Random Access Response which takes place on Cell 1. The test parameters are given in tables A.6.2.9.1-1 and A.6.2.9.1-2.

Table A.6.2.9.1-1: General test parameters for 3DL/3UL TDD CA non-contention based random access test

Parameter	Unit	Cell 1	Cell 2	Cell 3	Comments
E-UTRA RF Channel Number	-	1	2	3	
BW _{channel}	-	5MHz: N _{RB,c} = 25 10MHz: N _{RB,c} = 50 20MHz: N _{RB,c} = 100	5MHz: N _{RB,c} = 25 10MHz: N _{RB,c} = 50 20MHz: N _{RB,c} = 100	5MHz: N _{RB,c} = 25 10MHz: N _{RB,c} = 50 20MHz: N _{RB,c} = 100	
TAG configuration	-	pTAG	sTAG	sTAG	Cell 2 and Cell 3 are in the same sTAG
PDSCH parameters: DL Reference Measurement Channel	-	5MHz: R.4 TDD 10MHz: R.0 TDD 20MHz: R.3 TDD	5MHz: R.4 TDD 10MHz: R.0 TDD 20MHz: R.3 TDD	5MHz: R.4 TDD 10MHz: R.0 TDD 20MHz: R.3 TDD	As defined in A.3.1.1.2.
PCFICH/PDCCH/PHI CH parameters: DL Reference Measurement Channel	-	5MHz: R.11 TDD 10MHz: R.6 TDD 20MHz: R.10 TDD	5MHz: R.11 TDD 10MHz: R.6 TDD 20MHz: R.10 TDD	5MHz: R.11 TDD 10MHz: R.6 TDD 20MHz: R.10 TDD	As defined in A.3.1.2.2.
OCNG Patterns	-	5MHz: OP.9 TDD 10MHz: OP.1 TDD 20MHz: OP.7 TDD	5MHz: OP.9 TDD 10MHz: OP.1 TDD 20MHz: OP.7 TDD	5MHz: OP.9 TDD 10MHz: OP.1 TDD 20MHz: OP.7 TDD	As defined in A.3.2.2.
Special subframe configuration	-	6	6	6	As specified in table 4.2-1 in TS 36.211.
Uplink-downlink configuration	-	1	1	1	As specified in table 4.2-2 in TS 36.211.
PBCH_RA	dB				
PBCH_RB	dB				
PSS_RA	dB				
SSS_RA	dB				
PCFICH_RB	dB				
PHICH_RA	dB				
PHICH_RB	dB	0	0	0	
PDCCH_RA	dB				
PDCCH_RB	dB				
PDSCH_RA	dB				
PDSCH_RB	dB				
OCNG_RA ^{Note 1}	dB				
OCNG_RB ^{Note 1}	dB				
\hat{E}_s/I_{ot}	dB	3	3	3	
N_{oc}	dBm/15 KHz	-98	-98	-98	
\hat{E}_s/N_{oc}	dB	3	3	3	
I_o ^{Note 2}	dBm/BW _{channel}	-65.5+10log (N _{RB,c} /50)	-65.5+10log (N _{RB,c} /50)	-65.5+10log (N _{RB,c} /50)	
RSRP ^{Note 3}	dBm/15 KHz	-95	-95	-95	
referenceSignalPower	dBm/15 KHz	-5	-5	-5	As defined in clause 6.3.2 in TS 36.331.
Configured UE transmitted power ($P_{CMAX,c}$)	dBm	23	23	23	As defined in clause 6.2.5 in TS 36.101.

PRACH Configuration Index	-	53	53	53	As defined in table 5.7.1-3 in TS 36.211.
Backoff Parameter Index	-	2	2	2	As defined in table 7.2-1 in TS 36.321.
Propagation Condition	-	AWGN	AWGN	AWGN	
Antenna Configuration		1x2	1x2	1x2	
Timing offset to Cell 1	μs	-	0	0	
Time alignment error relative to cell 1 ^{Note 4}	μs	-	$\leq \text{TAE}$	$\leq \text{TAE}$	
Time alignment error relative to cell 2 ^{Note 4}	μs	-	-	$\leq \text{TAE}$	
Note 1:	OCNG shall be used such that the cell is fully allocated and a constant total transmitted power spectral density is achieved for all OFDM symbols.				
Note 2:	I _o level has been derived from other parameters for information purpose. It is not a settable parameter.				
Note 3:	RSRP level has been derived from other parameters for information purposes. It is not a settable parameter.				
Note 4:	The time alignment error (TAE) between two cells specified in TS36.104 [30] clause 6.5.3.1 (value depends upon the type of carrier aggregation).				
Note 5:	This test verifies the RRM requirement which is independent of channel bandwidth and is performed according to the principle defined in section A.3.6.1.				

Table A.6.2.9.1-2: RACH-Configuration parameters for cell2 and cell3 for 3DL/3UL TDD CA non-contention based random access test

Field	Value	Comment
powerRampingStep	dB2	
preambleInitialReceivedTargetPower	dBm-120	
preambleTransMax	n6	
ra-ResponseWindowSize	sf10	10 sub-frames
Note 1:	For further information see Clause 6.3.2 in TS 36.331.	

A.6.2.9.2 Test Requirements

Non-Contention based random access is triggered by explicitly assigning a random access preamble via dedicated signalling in the downlink.

A.6.2.9.2.1 Random Access Response Reception

A.6.2.9.2.1.1 Test Requirements for Cell 2

To test the UE behavior specified in Subclause 6.2.2.2.1 the System Simulator shall transmit, on cell 1 a Random Access Response containing a Random Access Preamble identifier corresponding to the transmitted Random Access Preamble after 5 preambles have been received by the System Simulator, on cell 2. In response to the first 4 preambles, the System Simulator shall transmit a Random Access Response *not* corresponding to the transmitted Random Access Preamble.

The UE may stop monitoring for Random Access Response(s) if the Random Access Response contains a Random Access Preamble identifier corresponding to the transmitted Random Access Preamble.

The UE shall re-transmit the preamble with the calculated PRACH transmission power if all received Random Access Responses contain Random Access Preamble identifiers that do not match the transmitted Random Access Preamble.

In addition, the power applied to all preambles shall be in accordance with what is specified in Subclause 6.2.2. The power of the first preamble shall be -22 dBm with an accuracy specified in clause 6.3.5.1.1 of TS 36.101 [5]. The relative power applied to additional preambles shall have an accuracy specified in clause 6.3.5.2.1 of TS 36.101 [5].

The transmit timing of all PRACH transmissions on cell 2 shall be within the accuracy specified in Subclause 7.1.2.

A.6.2.9.2.1.2 Test Requirements for Cell 3

To test the UE behavior specified in Subclause 6.2.2.2.1 the System Simulator shall transmit, on cell 1 a Random Access Response containing a Random Access Preamble identifier corresponding to the transmitted Random Access Preamble after 5 preambles have been received by the System Simulator, on cell 3. In response to the first 4 preambles, the System Simulator shall transmit a Random Access Response *not* corresponding to the transmitted Random Access Preamble.

The UE may stop monitoring for Random Access Response(s) if the Random Access Response contains a Random Access Preamble identifier corresponding to the transmitted Random Access Preamble.

The UE shall re-transmit the preamble with the calculated PRACH transmission power if all received Random Access Responses contain Random Access Preamble identifiers that do not match the transmitted Random Access Preamble.

In addition, the power applied to all preambles shall be in accordance with what is specified in Subclause 6.2.2. The power of the first preamble shall be -22 dBm with an accuracy specified in clause 6.3.5.1.1 of TS 36.101 [5]. The relative power applied to additional preambles shall have an accuracy specified in clause 6.3.5.2.1 of TS 36.101 [5].

The transmit timing of all PRACH transmissions on cell 3 shall be within the accuracy specified in Subclause 7.1.2.

A.6.2.9.2.2 No Random Access Response Reception

A.6.2.9.2.2.1 Test Requirements for Cell 2

To test the UE behavior specified in Subclause 6.2.2.2.2 the System Simulator shall transmit, on cell 1, a Random Access Response containing a Random Access Preamble identifier corresponding to the transmitted Random Access Preamble after 5 preambles have been received by the System Simulator, on cell 2. The System Simulator shall *not* respond to the first 4 preambles.

The UE shall re-transmit the preamble with the calculated PRACH transmission power on cell 2.

In addition, the power applied to all preambles shall be in accordance with what is specified in Subclause 6.2.2. The power of the first preamble shall be -22 dBm with an accuracy specified in clause 6.3.5.1.1 of TS 36.101 [5]. The relative power applied to additional preambles shall have an accuracy specified in clause 6.3.5.2.1 of TS 36.101 [5].

The transmit timing of all PRACH transmissions on cell 2 shall be within the accuracy specified in Subclause 7.1.2.

A.6.2.9.2.2.2 Test Requirements for Cell 3

To test the UE behavior specified in Subclause 6.2.2.2.2 the System Simulator shall transmit, on cell 1, a Random Access Response containing a Random Access Preamble identifier corresponding to the transmitted Random Access Preamble after 5 preambles have been received by the System Simulator, on cell 3. The System Simulator shall *not* respond to the first 4 preambles.

The UE shall re-transmit the preamble with the calculated PRACH transmission power on cell 3.

In addition, the power applied to all preambles shall be in accordance with what is specified in Subclause 6.2.2. The power of the first preamble shall be -22 dBm with an accuracy specified in clause 6.3.5.1.1 of TS 36.101 [5]. The relative power applied to additional preambles shall have an accuracy specified in clause 6.3.5.2.1 of TS 36.101 [5].

The transmit timing of all PRACH transmissions on cell 3 shall be within the accuracy specified in Subclause 7.1.2.

A.6.2.9.2.3 Stop Preamble transmission if maximum number of preamble transmission counter has been reached

A.6.2.9.2.3.1 Test Requirements for Cell 2

To test the UE behavior specified in Subclause 6.2.2 the System Simulator shall transmit, in response to the first 6 preambles, a Random Access Response *not* corresponding to the transmitted Random Access Preamble on cell 1. The UE shall stop transmitting preambles after 6 preambles.

The UE shall re-transmit the preamble with the calculated PRACH transmission power on cell 2.

In addition, the power applied to all preambles shall be in accordance with what is specified in Subclause 6.2.2. The power of the first preamble shall be -22 dBm with an accuracy specified in clause 6.3.5.1.1 of TS 36.101 [5]. The relative power applied to additional preambles shall have an accuracy specified in clause 6.3.5.2.1 of TS 36.101 [5].

The transmit timing of all PRACH transmissions on cell 2 shall be within the accuracy specified in Subclause 7.1.2.

A.6.2.9.2.3.2 Test Requirements for Cell 3

To test the UE behavior specified in Subclause 6.2.2 the System Simulator shall transmit, in response to the first 6 preambles, a Random Access Response *not* corresponding to the transmitted Random Access Preamble on cell 1. The UE shall stop transmitting preambles after 6 preambles.

The UE shall re-transmit the preamble with the calculated PRACH transmission power on cell 3.

In addition, the power applied to all preambles shall be in accordance with what is specified in Subclause 6.2.2. The power of the first preamble shall be -22 dBm with an accuracy specified in clause 6.3.5.1.1 of TS 36.101 [5]. The relative power applied to additional preambles shall have an accuracy specified in clause 6.3.5.2.1 of TS 36.101 [5].

The transmit timing of all PRACH transmissions on cell 3 shall be within the accuracy specified in Subclause 7.1.2.

A.6.2.10 E-UTRAN FDD Contention Based Random Access Test for Cat-M1 UEs in Normal Coverage

A.6.2.10.1 Test Purpose and Environment

The purpose of this test is to verify whether the behavior of the random access procedure of a Cat-M1 UE in Normal Coverage is according to the requirements, whether the PRACH power settings and timing are within specified limits, and whether the UE determines properly the enhanced coverage level based on the RSRP measurement and the configured criterion in RSRP-ThresholdsPrach [2]. This test will verify the requirements in Clause 6.2.2, Clause 6.2.3 and Clause 7.24.2 in an AWGN model.

For this test a single cell is used. The test parameters are given in tables A.6.2.10.1-1 and A.6.2.10.1-2.

Table A.6.2.10.1-1: General test parameters for FDD contention based random access test

Parameter	Unit	Value	Comments
E-UTRA RF Channel Number		1	
BW_{channel}	MHz	10	
OCNG Pattern ^{Note 1}		OP.21 FDD	As defined in A.3.2.1.21.
PDSCH parameters ^{Note 2}		R.20 FDD	As defined in A.3.1.4.1
MPDCCH parameters ^{Note 2}		R.16 FDD	As defined in A.3.1.3.1
PCFICH/PDCCH/PHICH parameters		DL Reference Measurement Channel R.6 FDD	As defined in A.3.1.2.1
PBCH_RA	dB	0	
PBCH_RB	dB		
PSS_RA	dB		
SSS_RA	dB		
PCFICH_RB	dB		
PHICH_RA	dB		
PHICH_RB	dB		
PDCCH_RA	dB		
PDCCH_RB	dB		
MPDCCH_RA	dB		
MPDCCH_RB	dB		
PDSCH_RA	dB		
PDSCH_RB	dB		
OCNG_RA ^{Note 1}	dB		
OCNG_RB ^{Note 1}	dB		
N_{oc}	dBm/15 KHz	-103	
\hat{E}_s / N_{oc}	dB	3	
\hat{E}_s / I_{ot} ^{Note 3}	dB	3	
RSRP ^{Note 3}	dBm/15 KHz	-100	

I_0 ^{Note 3}	dBm/9 MHz	-70.45	
Propagation Condition	-	AWGN	
Note 1:	OCNG shall be used such that the cell is fully allocated and a constant total transmitted power spectral density is achieved for all OFDM symbols. The OCNG pattern is chosen during the test according to the presence of a DL reference measurement channel.		
Note 2:	The PDSCH and MPDCCH reference measurement channels are used in the test only when a downlink transmission dedicated to the UE under test is required.		
Note 3:	E_s/lot , RSRP and I_0 level has been derived from other parameters for information purpose. They are not settable parameters themselves.		

Table A.6.2.10.1-2: RACH-Configuration parameters for FDD contention based random access test

Field	Value				Comment
Parameters not per CE Levels					
powerRampingStep	dB2				
preambleInitialReceivedTargetPower	dBm-120				
preambleTransMax	n6				
maxHARQ-Msg3Tx	4				
rar-HoppingConfig	Off				
Parameters per CE Levels					
CE Level	Level 0	Level 1	Level 2	Level 3	
ra-ResponseWindowSize (per CE)	sf20	sf80	sf180	sf320	
mac-ContentionResolutionTimer (per CE)	sf80	sf120	sf200	sf480	
PreambleMappingInfo {firstPreamble, lastPreamble}	{0, 9}	{10, 19}	{20, 29}	{30, 39}	
Note: For further information see Clause 6.3.2 in TS 36.331.					

Table A.6.2.10.1-3: PRACH-Configuration parameters for FDD contention based random access test

Field	Value				Comment
Parameters not per CE Levels					
rsrp-ThresholdsPrach	{24, 27, 33}				Corresponding to {-116, -113, -107} dBm as defined in Section 9.1.21.5
mpdcch-startSF-CSS-RA	v1				
referenceSignalPower	-5 dBm/15 KHz				As defined in clause 6.3.2 in TS 36.331.
maxHARQ-Msg3Tx	4				As defined in table 5.7.1-2 in TS 36.211
Backoff Parameter Index	2				As defined in table 7.2-1 in TS 36.321
Configured UE transmitted power (P_{CMAX})	Maximum value allowed by the applicable UE power class				As defined in clause 6.2.5 in TS 36.101
Parameters per PRACH CE Levels					
CE Level	Level 0	Level 1	Level 2	Level 3	
prach-ConfigIndex	4	4	4	4	As defined in table 5.7.1-2 in TS 36.211
prach-FreqOffset	0	0	0	0	
prach-StartingSubframe	sf2	sf4	sf16	sf64	
maxNumPreambleAttempt	n3	n5	n7	n10	
numRepetitionPerPreambleAttempt	n1	n4	n16	n64	
mpdcch-NarrowbandsToMonitor	2	2	2	2	
mpdcch-NumRepetition-RA	r8	r8	r128	r128	
prach-HoppingConfig	Off	Off	Off	Off	
Note 1: See Clause 6.3.2 in TS 36.331 for further information on the parameters in this table.					

A.6.2.10.2 Test Requirements

Contention based random access is triggered by *not* explicitly assigning a random access preamble via dedicated signalling in the downlink.

A.6.2.10.2.1 Random Access Response Reception

To test the UE behavior specified in Subclause 6.2.2, the System Simulator shall transmit a Random Access Response containing a Random Access Preamble identifier corresponding to the transmitted Random Access Preamble after 5 preamble transmission attempts (the preamble may be transmitted multiple times in each attempt) have been received by the System Simulator. In response to the first 4 preamble transmission attempts, the System Simulator shall transmit a Random Access Response *not* corresponding to the transmitted Random Access Preamble.

The UE may stop monitoring for Random Access Response(s) and shall transmit the msg3 if the Random Access Response contains a Random Access Preamble identifier corresponding to the transmitted Random Access Preamble.

The UE shall re-select a preamble and transmit with the calculated PRACH transmission power when the backoff time expires if all received Random Access Responses contain Random Access Preamble identifiers that do not match the transmitted Random Access Preamble.

In addition, the power applied to all preambles shall be in accordance with what is specified in Subclause 6.2.2. The power of the first preamble shall be -25 dBm with an accuracy specified in clause 6.3.5.1.1 of TS 36.101 [5]. The relative power applied to additional preambles shall have an accuracy specified in clause 6.3.5.2.1 of TS 36.101 [5].

The transmit timing of all PRACH transmissions shall be within the accuracy specified in Subclause 7.24.2.

A.6.2.10.2.2 No Random Access Response Reception

To test the UE behavior specified in subclause 6.2.2.1.2, the System Simulator shall transmit a Random Access Response containing a Random Access Preamble identifier corresponding to the transmitted Random Access Preamble after 5 preamble transmission attempts have been received by the System Simulator. The System Simulator shall *not* respond to the first 4 preamble transmission attempts.

The UE shall re-select a preamble and transmit with the calculated PRACH transmission power when the backoff time expires if no Random Access Response is received within the RA Response window.

In addition, the power applied to all preambles shall be in accordance with what is specified in Subclause 6.2.2. The power of the first preamble shall be -25 dBm with an accuracy specified in clause 6.3.5.1.1 of TS 36.101 [5]. The relative power applied to additional preambles shall have an accuracy specified in clause 6.3.5.2.1 of TS 36.101 [5].

The transmit timing of all PRACH transmissions shall be within the accuracy specified in Subclause 7.24.2.

A.6.2.10.2.3 Receiving a NACK on msg3

To test the UE behavior specified in subclause 6.2.2.1.3, the System Simulator shall NACK *all* UE msg3 following a successful Random Access Response.

The UE shall re-transmit the msg3 upon the reception of a NACK on msg3 until the maximum number of HARQ re-transmissions is reached.

A.6.2.10.2.4 Reception of an Incorrect Message over Temporary C-RNTI

To test the UE behavior specified in Subclause 6.2.2.1.5, the System Simulator shall send a message addressed to the temporary C-RNTI with a UE Contention Resolution Identity included in the MAC control element *not* matching the CCCH SDU transmitted in msg3 uplink message.

The UE shall re-select a preamble and transmit with the calculated PRACH transmission power when the backoff time expires unless the received message includes a UE Contention Resolution Identity MAC control element and the UE Contention Resolution Identity included in the MAC control element matches the CCCH SDU transmitted in the uplink message.

A.6.2.10.2.5 Reception of a Correct Message over Temporary C-RNTI

To test the UE behavior specified in Subclause 6.2.2.1.5, the System Simulator shall send a message addressed to the temporary C-RNTI with a UE Contention Resolution Identity included in the MAC control element matching the CCCH SDU transmitted in the msg3 uplink message.

The UE shall send ACK if the Contention Resolution is successful.

A.6.2.10.2.6 Contention Resolution Timer expiry

To test the UE behavior specified in Subclause 6.2.2.1.6, the System Simulator shall *not* send a response to a msg3.

The UE shall re-select a preamble and transmit with the calculated PRACH transmission power when the backoff time expires if the Contention Resolution Timer expires.

A.6.2.10.2.7 PRACH Resource Selection

The UE shall select PRACH resources and transmits or re- transmits PRACH preambles using the PRACH resources and PRACH configuration corresponding to the coverage enhancement level 0.

Note: The PRACH Resource Selection requirement is already assumed for testing the other PRACH requirements.

A.6.2.11 E-UTRAN HD-FDD Contention Based Random Access Test for Cat-M1 UEs in Normal Coverage

A.6.2.11.1 Test Purpose and Environment

The purpose of this test is to verify whether the behavior of the random access procedure of a Cat-M1 UE in Normal Coverage is according to the requirements, whether the PRACH power settings and timing are within specified limits, and whether the UE determines properly the enhanced coverage level based on the RSRP measurement and the configured criterion in RSRP-ThresholdsPrach [2]. This test will verify the requirements in Clause 6.2.2, Clause 6.2.3 and Clause 7.24.2 in an AWGN model.

For this test a single cell is used. The test parameters are given in tables A.6.2.11.1-1 and A.6.2.11.1-2.

Table A.6.2.11.1-1: General test parameters for HD-FDD contention based random access test

Parameter	Unit	Value	Comments
E-UTRA RF Channel Number		1	
BW_{channel}	MHz	10	
OCNG Pattern ^{Note 1}		OP.21 FDD	As defined in A.3.2.1.21.
PDSCH parameters ^{Note 2}		R.10 HD-FDD	As defined in A.3.1.4.2
MPDCCH parameters ^{Note 2}		R.6 HD-FDD	As defined in A.3.1.3.2
PCFICH/PDCCH/PHICH parameters		DL Reference Measurement Channel R.3 HD-FDD	As defined in A.3.1.2.3
PBCH_RA	dB	0	
PBCH_RB	dB		
PSS_RA	dB		
SSS_RA	dB		
PCFICH_RB	dB		
PHICH_RA	dB		
PHICH_RB	dB		
PDCCH_RA	dB		
PDCCH_RB	dB		
MPDCCH_RA	dB		
MPDCCH_RB	dB		
PDSCH_RA	dB		
PDSCH_RB	dB		
OCNG_RA ^{Note 1}	dB		
OCNG_RB ^{Note 1}	dB		

N_{oc}	dBm/15 KHz	-103	
\hat{E}_s/N_{oc}	dB	3	
\hat{E}_s/I_{ot} <small>Note 3</small>	dB	3	
RSRP <small>Note 3</small>	dBm/15 KHz	-100	
I_o <small>Note 3</small>	dBm/9 MHz	-70.45	
Propagation Condition	-	AWGN	
<p>Note 1: OCNG shall be used such that the cell is fully allocated and a constant total transmitted power spectral density is achieved for all OFDM symbols. The OCNG pattern is chosen during the test according to the presence of a DL reference measurement channel.</p> <p>Note 2: The PDSCH and MPDCCH reference measurement channels are used in the test only when a downlink transmission dedicated to the UE under test is required.</p> <p>Note 3: E_s/I_{ot}, RSRP and I_o level has been derived from other parameters for information purpose. They are not settable parameters themselves.</p>			

Table A.6.2.11.1-2: RACH-Configuration parameters for HD-FDD contention based random access test

Field	Value				Comment
Parameters not per CE Levels					
powerRampingStep	dB2				
preambleInitialReceivedTargetPower	dBm-120				
preambleTransMax	n6				
maxHARQ-Msg3Tx	4				
rar-HoppingConfig	Off				
Parameters per CE Levels					
CE Level	Level 0	Level 1	Level 2	Level 3	
ra-ResponseWindowSize (per CE)	sf20	sf80	sf180	sf320	
mac-ContentionResolutionTimer (per CE)	sf80	sf120	sf200	sf480	
PreambleMappingInfo {firstPreamble, lastPreamble}	{0, 9}	{10, 19}	{20, 29}	{30, 39}	
Note: For further information see Clause 6.3.2 in TS 36.331.					

Table A.6.2.11.1-3: PRACH-Configuration parameters for HD-FDD contention based random access test

Field	Value				Comment
Parameters not per CE Levels					
rsrp-ThresholdsPrach	{24, 27, 33}				Corresponding to {-116, -113, -107} dBm as defined in Section 9.1.21.5
mpdcch-startSF-CSS-RA	v1				
referenceSignalPower	-5 dBm/15 KHz				As defined in clause 6.3.2 in TS 36.331.
maxHARQ-Msg3Tx	4				As defined in table 5.7.1-2 in TS 36.211
Backoff Parameter Index	2				As defined in table 7.2-1 in TS 36.321
Configured UE transmitted power (P_{CMAX})	Maximum value allowed by the applicable UE power class				As defined in clause 6.2.5 in TS 36.101
Parameters per PRACH CE Levels					
CE Level	Level 0	Level 1	Level 2	Level 3	
prach-ConfigIndex	4	4	4	4	As defined in table 5.7.1-2 in TS 36.211
prach-FreqOffset	0	0	0	0	
prach-StartingSubframe	sf2	sf4	sf16	sf64	
maxNumPreambleAttempt	n3	n5	n7	n10	
numRepetitionPerPreambleAttempt	n1	n4	n16	n64	

mpdcch-NarrowbandsToMonitor	2	2	2	2	
mpdcch-NumRepetition-RA	r8	r8	r128	r128	
prach-HoppingConfig	Off	Off	Off	Off	
Note 1: See Clause 6.3.2 in TS 36.331 for further information on the parameters in this table.					

A.6.2.11.2 Test Requirements

Contention based random access is triggered by *not* explicitly assigning a random access preamble via dedicated signalling in the downlink.

A.6.2.11.2.1 Random Access Response Reception

To test the UE behavior specified in Subclause 6.2.2, the System Simulator shall transmit a Random Access Response containing a Random Access Preamble identifier corresponding to the transmitted Random Access Preamble after 5 preamble transmission attempts (the preamble may be transmitted multiple times in each attempt) have been received by the System Simulator. In response to the first 4 preamble transmission attempts, the System Simulator shall transmit a Random Access Response *not* corresponding to the transmitted Random Access Preamble.

The UE may stop monitoring for Random Access Response(s) and shall transmit the msg3 if the Random Access Response contains a Random Access Preamble identifier corresponding to the transmitted Random Access Preamble.

The UE shall re-select a preamble and transmit with the calculated PRACH transmission power when the backoff time expires if all received Random Access Responses contain Random Access Preamble identifiers that do not match the transmitted Random Access Preamble.

In addition, the power applied to all preambles shall be in accordance with what is specified in Subclause 6.2.2. The power of the first preamble shall be -25 dBm with an accuracy specified in clause 6.3.5.1.1 of TS 36.101 [5]. The relative power applied to additional preambles shall have an accuracy specified in clause 6.3.5.2.1 of TS 36.101 [5].

The transmit timing of all PRACH transmissions shall be within the accuracy specified in Subclause 7.24.2.

A.6.2.11.2.2 No Random Access Response Reception

To test the UE behavior specified in subclause 6.2.2.1.2, the System Simulator shall transmit a Random Access Response containing a Random Access Preamble identifier corresponding to the transmitted Random Access Preamble after 5 preamble transmission attempts have been received by the System Simulator. The System Simulator shall *not* respond to the first 4 preamble transmission attempts.

The UE shall re-select a preamble and transmit with the calculated PRACH transmission power when the backoff time expires if no Random Access Response is received within the RA Response window.

In addition, the power applied to all preambles shall be in accordance with what is specified in Subclause 6.2.2. The power of the first preamble shall be -25 dBm with an accuracy specified in clause 6.3.5.1.1 of TS 36.101 [5]. The relative power applied to additional preambles shall have an accuracy specified in clause 6.3.5.2.1 of TS 36.101 [5].

The transmit timing of all PRACH transmissions shall be within the accuracy specified in Subclause 7.24.2.

A.6.2.11.2.3 Receiving a NACK on msg3

To test the UE behavior specified in subclause 6.2.2.1.3, the System Simulator shall NACK *all* UE msg3 following a successful Random Access Response.

The UE shall re-transmit the msg3 upon the reception of a NACK on msg3 until the maximum number of HARQ re-transmissions is reached.

A.6.2.11.2.4 Reception of an Incorrect Message over Temporary C-RNTI

To test the UE behavior specified in Subclause 6.2.2.1.5, the System Simulator shall send a message addressed to the temporary C-RNTI with a UE Contention Resolution Identity included in the MAC control element *not* matching the CCCH SDU transmitted in msg3 uplink message.

The UE shall re-select a preamble and transmit with the calculated PRACH transmission power when the backoff time expires unless the received message includes a UE Contention Resolution Identity MAC control element and the UE

Contention Resolution Identity included in the MAC control element matches the CCCH SDU transmitted in the uplink message.

A.6.2.11.2.5 Reception of a Correct Message over Temporary C-RNTI

To test the UE behavior specified in Subclause 6.2.2.1.5, the System Simulator shall send a message addressed to the temporary C-RNTI with a UE Contention Resolution Identity included in the MAC control element matching the CCCH SDU transmitted in the msg3 uplink message.

The UE shall send ACK if the Contention Resolution is successful.

A.6.2.11.2.6 Contention Resolution Timer expiry

To test the UE behavior specified in Subclause 6.2.2.1.6, the System Simulator shall *not* send a response to a msg3.

The UE shall re-select a preamble and transmit with the calculated PRACH transmission power when the backoff time expires if the Contention Resolution Timer expires.

A.6.2.11.2.7 PRACH Resource Selection

The UE shall select PRACH resources and transmits or re- transmits PRACH preambles using the PRACH resources and PRACH configuration corresponding to the coverage enhancement level 0.

Note: The PRACH Resource Selection requirement is already assumed for testing the other PRACH requirements.

A.6.2.12 E-UTRAN TDD Contention Based Random Access Test for Cat-M1 UEs in Normal Coverage

A.6.2.12.1 Test Purpose and Environment

The purpose of this test is to verify whether the behavior of the random access procedure of a Cat-M1 UE in Normal Coverage is according to the requirements, whether the PRACH power settings and timing are within specified limits, and whether the UE determines properly the enhanced coverage level based on the RSRP measurement and the configured criterion in RSRP-ThresholdsPrach [2]. This test will verify the requirements in Clause 6.2.2, Clause 6.2.3 and Clause 7.24.2 in an AWGN model.

For this test a single cell is used. The test parameters are given in tables A.6.2.12.1-1 and A.6.2.12.1-2.

Table A.6.2.12.1-1: General test parameters for TDD contention based random access test

Parameter	Unit	Value	Comments
E-UTRA RF Channel Number		1	
BW _{channel}	MHz	10	
OCNG Pattern ^{Note 1}		OP.11 TDD	As defined in A.3.2.2.11.
PDSCH parameters ^{Note 2}		R.16 TDD	As defined in A.3.1.4.3
MPDCCH parameters ^{Note 2}		R.14 TDD	As defined in A.3.1.3.3
PCFICH/PDCCH/PHICH parameters		DL Reference Measurement Channel R.6 TDD	As defined in A.3.1.2.2
Special subframe configuration	-	6	As specified in table 4.2-1 in TS 36.211.
Uplink-downlink configuration	-	1	As specified in table 4.2-2 in TS 36.211.
PBCH_RA	dB		
PBCH_RB	dB		
PSS_RA	dB		
SSS_RA	dB		
PCFICH_RB	dB		
PHICH_RA	dB		

PHICH_RB	dB	0	
PDCCH_RA	dB		
PDCCH_RB	dB		
MPDCCH_RA	dB		
MPDCCH_RB	dB		
PDSCH_RA	dB		
PDSCH_RB	dB		
OCNG_RA ^{Note 1}	dB		
OCNG_RB ^{Note 1}	dB		
N_{oc}	dBm/15 KHz	-103	
\hat{E}_s/N_{oc}	dB	3	
\hat{E}_s/I_{ot} ^{Note 3}	dB	3	
RSRP ^{Note 3}	dBm/15 KHz	-100	
I_o ^{Note 3}	dBm/9 MHz	-70.45	
Propagation Condition	-	AWGN	
<p>Note 1: OCNG shall be used such that the cell is fully allocated and a constant total transmitted power spectral density is achieved for all OFDM symbols. The OCNG pattern is chosen during the test according to the presence of a DL reference measurement channel.</p> <p>Note 2: The PDSCH and MPDCCH reference measurement channels are used in the test only when a downlink transmission dedicated to the UE under test is required.</p> <p>Note 3: E_s/I_{ot}, RSRP and I_o level has been derived from other parameters for information purpose. They are not settable parameters themselves.</p>			

Table A.6.2.12.1-2: RACH-Configuration parameters for TDD contention based random access test

Field	Value				Comment
Parameters not per CE Levels					
numberOfRA-Preambles	n52				
sizeOfRA-PreamblesGroupA	n52				No group B.
powerRampingStep	dB2				
preambleInitialReceivedTargetPower	dBm-120				
preambleTransMax	n6				
maxHARQ-Msg3Tx	4				
rar-HoppingConfig	Off				
Parameters per CE Levels					
CE Level	Level 0	Level 1	Level 2	Level 3	
ra-ResponseWindowSize (per CE)	sf20	sf80	sf180	sf320	
mac-ContentionResolutionTimer (per CE)	sf80	sf120	sf200	sf480	
PreambleMappingInfo {firstPreamble, lastPreamble}	{0, 9}	{10, 19}	{20, 29}	{30, 39}	
Note 1: For further information see Clause 6.3.2 in TS 36.331.					

Table A.6.2.12.1-3: PRACH-Configuration parameters for TDD contention based random access test

Field	Value	Comment
Parameters not per CE Levels		
rsrp-ThresholdsPrach	{24, 31, 38}	Corresponding to {-116, -109, -102} dBm as defined in Section 9.1.21.5
mpdcch-startSF-CSS-RA	v1	
referenceSignalPower	-5 dBm/15 KHz	As defined in clause 6.3.2 in TS 36.331.
maxHARQ-Msg3Tx	4	As defined in table 5.7.1-2 in TS 36.211
Backoff Parameter Index	2	As defined in table 7.2-1 in TS 36.321
Configured UE transmitted power (P_{CMAX})	Maximum value allowed by the applicable UE power class	As defined in clause 6.2.5 in TS 36.101

Parameters per PRACH CE Levels					
CE Level	Level 0	Level 1	Level 2	Level 3	
prach-ConfigIndex	53	53	53	53	As defined in table 5.7.1-2 in TS 36.211
prach-FreqOffset	0	0	0	0	
prach-StartingSubframe	sf2	sf4	sf16	sf64	
maxNumPreambleAttempt	n3	n5	n7	n10	
numRepetitionPerPreambleAttempt	n1	n4	n16	n64	
mpdcch-NarrowbandsToMonitor	2	2	2	2	
mpdcch-NumRepetition-RA	r8	r8	r128	r128	
prach-HoppingConfig	Off	Off	Off	Off	
Note 1: See Clause 6.3.2 in TS 36.331 for further information on the parameters in this table.					

A.6.2.12.2 Test Requirements

Contention based random access is triggered by *not* explicitly assigning a random access preamble via dedicated signalling in the downlink.

A.6.2.12.2.1 Random Access Response Reception

To test the UE behavior specified in Subclause 6.2.2, the System Simulator shall transmit a Random Access Response containing a Random Access Preamble identifier corresponding to the transmitted Random Access Preamble after 5 preamble transmission attempts (the preamble may be transmitted multiple times in each attempt) have been received by the System Simulator. In response to the first 4 preamble transmission attempts, the System Simulator shall transmit a Random Access Response *not* corresponding to the transmitted Random Access Preamble.

The UE may stop monitoring for Random Access Response(s) and shall transmit the msg3 if the Random Access Response contains a Random Access Preamble identifier corresponding to the transmitted Random Access Preamble.

The UE shall re-select a preamble and transmit with the calculated PRACH transmission power when the backoff time expires if all received Random Access Responses contain Random Access Preamble identifiers that do not match the transmitted Random Access Preamble.

In addition, the power applied to all preambles shall be in accordance with what is specified in Subclause 6.2.2. The power of the first preamble shall be -30 dBm. The power of the first preamble shall be -30 dBm with an accuracy specified in clause 6.3.5.1.1 of TS 36.101 [5]. The relative power applied to additional preambles shall have an accuracy specified in clause 6.3.5.2.1 of TS 36.101 [5].

The transmit timing of all PRACH transmissions shall be within the accuracy specified in Subclause 7.24.2.

A.6.2.12.2.2 No Random Access Response Reception

To test the UE behavior specified in subclause 6.2.2.1.2, the System Simulator shall transmit a Random Access Response containing a Random Access Preamble identifier corresponding to the transmitted Random Access Preamble after 5 preamble transmission attempts have been received by the System Simulator. The System Simulator shall *not* respond to the first 4 preamble transmission attempts.

The UE shall re-select a preamble and transmit with the calculated PRACH transmission power when the backoff time expires if no Random Access Response is received within the RA Response window.

In addition, the power applied to all preambles shall be in accordance with what is specified in Subclause 6.2.2. The power of the first preamble shall be -30 dBm with an accuracy specified in clause 6.3.5.1.1 of TS 36.101 [5]. The relative power applied to additional preambles shall have an accuracy specified in clause 6.3.5.2.1 of TS 36.101 [5].

The transmit timing of all PRACH transmissions shall be within the accuracy specified in Subclause 7.24.2.

A.6.2.12.2.3 Receiving a NACK on msg3

To test the UE behavior specified in subclause 6.2.2.1.3, the System Simulator shall NACK *all* UE msg3 following a successful Random Access Response.

The UE shall re-transmit the msg3 upon the reception of a NACK on msg3 until the maximum number of HARQ re-transmissions is reached.

A.6.2.12.2.4 Reception of an Incorrect Message over Temporary C-RNTI

To test the UE behavior specified in Subclause 6.2.2.1.5, the System Simulator shall send a message addressed to the temporary C-RNTI with a UE Contention Resolution Identity included in the MAC control element *not* matching the CCCH SDU transmitted in msg3 uplink message.

The UE shall re-select a preamble and transmit with the calculated PRACH transmission power when the backoff time expires unless the received message includes a UE Contention Resolution Identity MAC control element and the UE Contention Resolution Identity included in the MAC control element matches the CCCH SDU transmitted in the uplink message.

A.6.2.12.2.5 Reception of a Correct Message over Temporary C-RNTI

To test the UE behavior specified in Subclause 6.2.2.1.5, the System Simulator shall send a message addressed to the temporary C-RNTI with a UE Contention Resolution Identity included in the MAC control element matching the CCCH SDU transmitted in the msg3 uplink message.

The UE shall send ACK if the Contention Resolution is successful.

A.6.2.12.2.6 Contention Resolution Timer expiry

To test the UE behavior specified in Subclause 6.2.2.1.6, the System Simulator shall *not* send a response to a msg3.

The UE shall re-select a preamble and transmit with the calculated PRACH transmission power when the backoff time expires if the Contention Resolution Timer expires.

A.6.2.12.2.7 PRACH Resource Selection

The UE shall select PRACH resources and transmits or re-transmits PRACH preambles using the PRACH resources and PRACH configuration corresponding to the coverage enhancement level 0.

Note: The PRACH Resource Selection requirement is already assumed for testing the other PRACH requirements.

A.6.2.13 E-UTRAN FDD Contention Based Random Access Test for Cat-M1 UEs in Enhanced Coverage

A.6.2.13.1 Test Purpose and Environment

The purpose of this test is to verify whether the behavior of the random access procedure of a Cat-M1 UE in Enhanced Coverage is according to the requirements, whether the PRACH power settings and timing are within specified limits, and whether the UE determines properly the enhanced coverage level based on the RSRP measurement and the configured criterion in RSRP-ThresholdsPrach [2]. This test will verify the requirements in Clause 7.24.2, Clause 6.2.3 and Clause 7.1.2 in an AWGN model.

For this test a single cell is used. The test parameters are given in tables A.6.2.13.1-1 and A.6.2.13.1-2.

Table A.6.2.13.1-1: General test parameters for FDD contention based random access test

Parameter	Unit	Value	Comments
E-UTRA RF Channel Number		1	
BW _{channel}	MHz	10	
OCNG Pattern ^{Note 1}		OP.21 FDD	As defined in A.3.2.1.21.
PDSCH parameters ^{Note 2}		R.22 FDD	As defined in A.3.1.4.4
MPDCCH parameters ^{Note 2}		R.18 FDD	As defined in A.3.1.3.4
PCFICH/PDCCH/PHICH parameters		DL Reference Measurement Channel R.6 FDD	As defined in A.3.1.2.1

PBCH_RA	dB	0		
PBCH_RB	dB			
PSS_RA	dB			
SSS_RA	dB			
PCFICH_RB	dB			
PHICH_RA	dB			
PHICH_RB	dB			
PDCCH_RA	dB			
PDCCH_RB	dB			
MPDCCH_RA	dB			
MPDCCH_RB	dB			
PDSCH_RA	dB			
PDSCH_RB	dB			
OCNG_RA ^{Note 1}	dB			
OCNG_RB ^{Note 1}	dB			
N_{oc}	dBm/15 KHz		-98	
\hat{E}_s / N_{oc}	dB		-12	
\hat{E}_s / I_{ot} ^{Note 3}	dB	-12		
RSRP ^{Note 3}	dBm/15 KHz	-110		
I_o ^{Note 3}	dBm/9 MHz	-70		
Propagation Condition	-	AWGN		
<p>Note 1: OCNG shall be used such that the cell is fully allocated and a constant total transmitted power spectral density is achieved for all OFDM symbols. The OCNG pattern is chosen during the test according to the presence of a DL reference measurement channel.</p> <p>Note 2: The PDSCH and MPDCCH reference measurement channels are used in the test only when a downlink transmission dedicated to the UE under test is required.</p> <p>Note 3: E_s/I_{ot}, RSRP and I_o level has been derived from other parameters for information purpose. They are not settable parameters themselves.</p>				

Table A.6.2.13.1-2: RACH-Configuration parameters for FDD contention based random access test

Field	Value				Comment
Parameters not per CE Levels					
powerRampingStep	dB2				
preambleInitialReceivedTargetPower	dBm-120				
preambleTransMax	n6				
maxHARQ-Msg3Tx	4				
rar-HoppingConfig	Off				
Parameters per CE Levels					
CE Level	Level 0	Level 1	Level 2	Level 3	
ra-ResponseWindowSize (per CE)	sf20	sf80	sf180	sf320	
mac-ContentionResolutionTimer (per CE)	sf80	sf120	sf200	sf480	
PreambleMappingInfo {firstPreamble, lastPreamble}	{0, 9}	{10,19}	{20,29}	{30,39}	
Note: For further information see Clause 6.3.2 in TS 36.331.					

Table A.6.2.13.1-3: PRACH-Configuration parameters for FDD contention based random access test

Field	Value		Comment
Parameters not per CE Levels			
rsrp-ThresholdsPrach	{23,37,47}		Corresponding to {-117, -103, -93} dBm as defined in Section 9.1.21.5
mpdcch-startSF-CSS-RA	v1		
referenceSignalPower	-5 dBm/15 KHz		As defined in clause 6.3.2 in TS 36.331.
maxHARQ-Msg3Tx	4		As defined in table 5.7.1-2 in TS 36.211

Backoff Parameter Index	2				As defined in table 7.2-1 in TS 36.321
Configured UE transmitted power (P_{CMAX})	Maximum value allowed by the applicable UE power class				As defined in clause 6.2.5 in TS 36.101
Parameters per PRACH CE Levels					
CE Level	Level 0	Level 1	Level 2	Level 3	
prach-ConfigIndex	4	4	4	4	As defined in table 5.7.1-2 in TS 36.211
prach-FreqOffset	0	0	0	0	
prach-StartingSubframe	sf2	sf4	sf16	sf64	
maxNumPreambleAttempt	n3	n5	n7	n10	
numRepetitionPerPreambleAttempt	n1	n4	n16	n64	
mpdcch-NarrowbandsToMonitor	2	2	2	2	
mpdcch-NumRepetition-RA	r8	r8	r128	r128	
prach-HoppingConfig	Off	Off	Off	Off	
Note 1: See Clause 6.3.2 in TS 36.331 for further information on the parameters in this table.					

A.6.2.13.2 Test Requirements

Contention based random access is triggered by *not* explicitly assigning a random access preamble via dedicated signalling in the downlink.

A.6.2.13.2.1 Random Access Response Reception

To test the UE behavior specified in Subclause 6.2.2, the System Simulator shall transmit a Random Access Response containing a Random Access Preamble identifier corresponding to the transmitted Random Access Preamble after 5 preamble transmission attempts (the preamble may be transmitted multiple times in each attempt) have been received by the System Simulator. In response to the first 4 preamble transmission attempts, the System Simulator shall transmit a Random Access Response *not* corresponding to the transmitted Random Access Preamble.

The UE may stop monitoring for Random Access Response(s) and shall transmit the msg3 if the Random Access Response contains a Random Access Preamble identifier corresponding to the transmitted Random Access Preamble.

The UE shall re-select a preamble and transmit with the calculated PRACH transmission power when the backoff time expires if all received Random Access Responses contain Random Access Preamble identifiers that do not match the transmitted Random Access Preamble.

In addition, the power applied to all preambles shall be in accordance with what is specified in Subclause 6.2.2. The power of the first preamble shall be -27 dBm. The power of the first preamble shall be -27 dBm with an accuracy specified in clause 6.3.5.1.1 of TS 36.101 [5]. The relative power applied to additional preambles shall have an accuracy specified in clause 6.3.5.2.1 of TS 36.101 [5].

The transmit timing of all PRACH transmissions shall be within the accuracy specified in Subclause 7.24.2.

A.6.2.13.2.2 No Random Access Response Reception

To test the UE behavior specified in subclause 6.2.2.1.2, the System Simulator shall transmit a Random Access Response containing a Random Access Preamble identifier corresponding to the transmitted Random Access Preamble after 5 preamble transmission attempts have been received by the System Simulator. The System Simulator shall *not* respond to the first 4 preamble transmission attempts.

The UE shall re-select a preamble and transmit with the calculated PRACH transmission power when the backoff time expires if no Random Access Response is received within the RA Response window.

In addition, the power applied to all preambles shall be in accordance with what is specified in Subclause 6.2.2. The power of the first preamble shall be -27 dBm with an accuracy specified in clause 6.3.5.1.1 of TS 36.101 [5]. The relative power applied to additional preambles shall have an accuracy specified in clause 6.3.5.2.1 of TS 36.101 [5].

The transmit timing of all PRACH transmissions shall be within the accuracy specified in Subclause 7.24.2.

A.6.2.13.2.3 Receiving a NACK on msg3

To test the UE behavior specified in subclause 6.2.2.1.3, the System Simulator shall NACK *all* UE msg3 following a successful Random Access Response.

The UE shall re-transmit the msg3 upon the reception of a NACK on msg3 until the maximum number of HARQ re-transmissions is reached.

A.6.2.13.2.4 Reception of an Incorrect Message over Temporary C-RNTI

To test the UE behavior specified in Subclause 6.2.2.1.5, the System Simulator shall send a message addressed to the temporary C-RNTI with a UE Contention Resolution Identity included in the MAC control element *not* matching the CCCH SDU transmitted in msg3 uplink message.

The UE shall re-select a preamble and transmit with the calculated PRACH transmission power when the backoff time expires unless the received message includes a UE Contention Resolution Identity MAC control element and the UE Contention Resolution Identity included in the MAC control element matches the CCCH SDU transmitted in the uplink message.

A.6.2.13.2.5 Reception of a Correct Message over Temporary C-RNTI

To test the UE behavior specified in Subclause 6.2.2.1.5, the System Simulator shall send a message addressed to the temporary C-RNTI with a UE Contention Resolution Identity included in the MAC control element matching the CCCH SDU transmitted in the msg3 uplink message.

The UE shall send ACK if the Contention Resolution is successful.

A.6.2.13.2.6 Contention Resolution Timer expiry

To test the UE behavior specified in Subclause 6.2.2.1.6, the System Simulator shall *not* send a response to a msg3.

The UE shall re-select a preamble and transmit with the calculated PRACH transmission power when the backoff time expires if the Contention Resolution Timer expires.

A.6.2.13.2.7 PRACH Resource Selection

The UE shall select PRACH resources and transmits or re-transmits PRACH preambles using the PRACH resources and PRACH configuration corresponding to the coverage enhancement level 2.

Note: The PRACH Resource Selection requirement is already assumed for testing the other PRACH requirements.

A.6.2.14 E-UTRAN HD-FDD Contention Based Random Access Test for Cat-M1 UEs in Enhanced Coverage

A.6.2.14.1 Test Purpose and Environment

The purpose of this test is to verify whether the behavior of the random access procedure of a Cat-M1 UE in Enhanced Coverage is according to the requirements, whether the PRACH power settings and timing are within specified limits, and whether the UE determines properly the enhanced coverage level based on the RSRP measurement and the configured criterion in RSRP-ThresholdsPrach [2]. This test will verify the requirements in Clause 6.2.2, Clause 6.2.3 and Clause 7.24.2 in an AWGN model.

For this test a single cell is used. The test parameters are given in tables A.6.2.14.1-1 and A.6.2.14.1-2.

Table A.6.2.14.1-1: General test parameters for HD-FDD contention based random access test

Parameter	Unit	Value	Comments
E-UTRA RF Channel Number		1	
BW _{channel}	MHz	10	
OCNG Pattern ^{Note 1}		OP.21 FDD	As defined in A.3.2.1.21.
PDSCH parameters ^{Note 2}		R.12 HD-FDD	As defined in A.3.1.4.5

MPDCCH parameters ^{Note 2}		R.8 HD-FDD	As defined in A.3.1.3.5
PCFICH/PDCCH/PHICH parameters		DL Reference Measurement Channel R.3 HD-FDD	As defined in A.3.1.2.3
PBCH_RA	dB	0	
PBCH_RB	dB		
PSS_RA	dB		
SSS_RA	dB		
PCFICH_RB	dB		
PHICH_RA	dB		
PHICH_RB	dB		
PDCCH_RA	dB		
PDCCH_RB	dB		
MPDCCH_RA	dB		
MPDCCH_RB	dB		
PDSCH_RA	dB		
PDSCH_RB	dB		
OCNG_RA ^{Note 1}	dB		
OCNG_RB ^{Note 1}	dB		
N_{oc}	dBm/15 KHz		-98
\hat{E}_s/N_{oc}	dB	-12	
\hat{E}_s/I_{ot} ^{Note 3}	dB	-12	
RSRP ^{Note 3}	dBm/15 KHz	-110	
I_o ^{Note 3}	dBm/9 MHz	-70	
Propagation Condition	-	AWGN	
<p>Note 1: OCNG shall be used such that the cell is fully allocated and a constant total transmitted power spectral density is achieved for all OFDM symbols. The OCNG pattern is chosen during the test according to the presence of a DL reference measurement channel.</p> <p>Note 2: The PDSCH and MPDCCH reference measurement channels are used in the test only when a downlink transmission dedicated to the UE under test is required.</p> <p>Note 3: E_s/I_{ot}, RSRP and I_o level has been derived from other parameters for information purpose. They are not settable parameters themselves.</p>			

Table A.6.2.14.1-2: RACH-Configuration parameters for HD-FDD contention based random access test

Field	Value				Comment
Parameters not per CE Levels					
powerRampingStep	dB2				
preambleInitialReceivedTargetPower	dBm-120				
preambleTransMax	n6				
maxHARQ-Msg3Tx	4				
rar-HoppingConfig	Off				
Parameters per CE Levels					
CE Level	Level 0	Level 1	Level 2	Level 3	
ra-ResponseWindowSize (per CE)	sf20	sf80	sf180	sf320	
mac-ContentionResolutionTimer (per CE)	sf80	sf120	sf200	sf480	
PreambleMappingInfo {firstPreamble, lastPreamble}	{0, 9}	{10,19}	{20,29}	{30,39}	
Note: For further information see Clause 6.3.2 in TS 36.331.					

Table A.6.2.14.1-3: PRACH-Configuration parameters for HD-FDD contention based random access test

Field	Value	Comment
Parameters not per CE Levels		

rsrp-ThresholdsPrach	{23,37,47}	Corresponding {-117, -103, -93} dBm as defined in Section 9.1.21.5			
mpdcch-startSF-CSS-RA	v1				
referenceSignalPower	-5 dBm/15 KHz	As defined in clause 6.3.2 in TS 36.331.			
maxHARQ-Msg3Tx	4	As defined in table 5.7.1-2 in TS 36.211			
Backoff Parameter Index	2	As defined in table 7.2-1 in TS 36.321			
Configured UE transmitted power (P_{CMAX})	Maximum value allowed by the applicable UE power class	As defined in clause 6.2.5 in TS 36.101			
Parameters per PRACH CE Levels					
CE Level	Level 0	Level 1	Level 2	Level 3	
prach-ConfigIndex	4	4	4	4	As defined in table 5.7.1-2 in TS 36.211
prach-FreqOffset	0	0	0	0	
prach-StartingSubframe	sf2	sf4	sf16	sf64	
maxNumPreambleAttempt	n3	n5	n7	n10	
numRepetitionPerPreambleAttempt	n1	n4	n16	n64	
mpdcch-NarrowbandsToMonitor	2	2	2	2	
mpdcch-NumRepetition-RA	r8	r8	r128	r128	
prach-HoppingConfig	Off	Off	Off	Off	
Note 1: See Clause 6.3.2 in TS 36.331 for further information on the parameters in this table.					

A.6.2.14.2 Test Requirements

Contention based random access is triggered by *not* explicitly assigning a random access preamble via dedicated signalling in the downlink.

A.6.2.14.2.1 Random Access Response Reception

To test the UE behavior specified in Subclause 6.2.2, the System Simulator shall transmit a Random Access Response containing a Random Access Preamble identifier corresponding to the transmitted Random Access Preamble after 5 preamble transmission attempts (the preamble may be transmitted multiple times in each attempt) have been received by the System Simulator. In response to the first 4 preamble transmission attempts, the System Simulator shall transmit a Random Access Response *not* corresponding to the transmitted Random Access Preamble.

The UE may stop monitoring for Random Access Response(s) and shall transmit the msg3 if the Random Access Response contains a Random Access Preamble identifier corresponding to the transmitted Random Access Preamble.

The UE shall re-select a preamble and transmit with the calculated PRACH transmission power when the backoff time expires if all received Random Access Responses contain Random Access Preamble identifiers that do not match the transmitted Random Access Preamble.

In addition, the power applied to all preambles shall be in accordance with what is specified in Subclause 6.2.2. The power of the first preamble shall be -27 dBm. The power of the first preamble shall be -27 dBm with an accuracy specified in clause 6.3.5.1.1 of TS 36.101 [5]. The relative power applied to additional preambles shall have an accuracy specified in clause 6.3.5.2.1 of TS 36.101 [5].

The transmit timing of all PRACH transmissions shall be within the accuracy specified in Subclause 7.24.2.

A.6.2.14.2.2 No Random Access Response Reception

To test the UE behavior specified in subclause 6.2.2.1.2, the System Simulator shall transmit a Random Access Response containing a Random Access Preamble identifier corresponding to the transmitted Random Access Preamble after 5 preamble transmission attempts have been received by the System Simulator. The System Simulator shall *not* respond to the first 4 preamble transmission attempts.

The UE shall re-select a preamble and transmit with the calculated PRACH transmission power when the backoff time expires if no Random Access Response is received within the RA Response window.

In addition, the power applied to all preambles shall be in accordance with what is specified in Subclause 6.2.2. The power of the first preamble shall be -27 dBm with an accuracy specified in clause 6.3.5.1.1 of TS 36.101 [5]. The relative power applied to additional preambles shall have an accuracy specified in clause 6.3.5.2.1 of TS 36.101 [5].

The transmit timing of all PRACH transmissions shall be within the accuracy specified in Subclause 7.24.2.

A.6.2.14.2.3 Receiving a NACK on msg3

To test the UE behavior specified in subclause 6.2.2.1.3, the System Simulator shall NACK *all* UE msg3 following a successful Random Access Response.

The UE shall re-transmit the msg3 upon the reception of a NACK on msg3 until the maximum number of HARQ re-transmissions is reached.

A.6.2.14.2.4 Reception of an Incorrect Message over Temporary C-RNTI

To test the UE behavior specified in Subclause 6.2.2.1.5, the System Simulator shall send a message addressed to the temporary C-RNTI with a UE Contention Resolution Identity included in the MAC control element *not* matching the CCCH SDU transmitted in msg3 uplink message.

The UE shall re-select a preamble and transmit with the calculated PRACH transmission power when the backoff time expires unless the received message includes a UE Contention Resolution Identity MAC control element and the UE Contention Resolution Identity included in the MAC control element matches the CCCH SDU transmitted in the uplink message.

A.6.2.14.2.5 Reception of a Correct Message over Temporary C-RNTI

To test the UE behavior specified in Subclause 6.2.2.1.5, the System Simulator shall send a message addressed to the temporary C-RNTI with a UE Contention Resolution Identity included in the MAC control element matching the CCCH SDU transmitted in the msg3 uplink message.

The UE shall send ACK if the Contention Resolution is successful.

A.6.2.14.2.6 Contention Resolution Timer expiry

To test the UE behavior specified in Subclause 6.2.2.1.6, the System Simulator shall *not* send a response to a msg3.

The UE shall re-select a preamble and transmit with the calculated PRACH transmission power when the backoff time expires if the Contention Resolution Timer expires.

A.6.2.14.2.7 PRACH Resource Selection

The UE shall select PRACH resources and transmits or re-transmits PRACH preambles using the PRACH resources and PRACH configuration corresponding to the coverage enhancement level 2.

Note: The PRACH Resource Selection requirement is already assumed for testing the other PRACH requirements.

A.6.2.15 E-UTRAN TDD Contention Based Random Access Test for Cat-M1 UEs in Enhanced Coverage

A.6.2.15.1 Test Purpose and Environment

The purpose of this test is to verify whether the behavior of the random access procedure of a Cat-M1 UE in Enhanced Coverage is according to the requirements, whether the PRACH power settings and timing are within specified limits, and whether the UE determines properly the enhanced coverage level based on the RSRP measurement and the configured criterion in RSRP-ThresholdsPrach [2]. This test will verify the requirements in Clause 6.2.2, Clause 6.2.3 and Clause 7.24.2 in an AWGN model.

For this test a single cell is used. The test parameters are given in tables A.6.2.15.1-1 and A.6.2.15.1-2.

Table A.6.2.15.1-1: General test parameters for TDD contention based random access test

Parameter	Unit	Value	Comments
E-UTRA RF Channel Number		1	

$BW_{channel}$	MHz	10	
OCNG Pattern ^{Note 1}		OP.11 TDD	As defined in A.3.2.2.11.
PDSCH parameters ^{Note 2}		R.18 TDD	As defined in A.3.1.4.6
MPDCCH parameters ^{Note 2}		R.16 TDD	As defined in A.3.1.3.6
PCFICH/PDCCH/PHICH parameters		DL Reference Measurement Channel R.6 TDD	As defined in A.3.1.2.2
Special subframe configuration	-	6	As specified in table 4.2-1 in TS 36.211.
Uplink-downlink configuration	-	1	As specified in table 4.2-2 in TS 36.211.
PBCH_RA	dB	0	
PBCH_RB	dB		
PSS_RA	dB		
SSS_RA	dB		
PCFICH_RB	dB		
PHICH_RA	dB		
PHICH_RB	dB		
PDCCH_RA	dB		
PDCCH_RB	dB		
MPDCCH_RA	dB		
MPDCCH_RB	dB		
PDSCH_RA	dB		
PDSCH_RB	dB		
OCNG_RA ^{Note 1}	dB		
OCNG_RB ^{Note 1}	dB		
N_{oc}	dBm/15 KHz	-98	
\hat{E}_s/N_{oc}	dB	-12	
\hat{E}_s/I_{ot} ^{Note 3}	dB	-12	
RSRP ^{Note 3}	dBm/15 KHz	-110	
I_o ^{Note 3}	dBm/9 MHz	-70	
Propagation Condition	-	AWGN	
<p>Note 1: OCNG shall be used such that the cell is fully allocated and a constant total transmitted power spectral density is achieved for all OFDM symbols. The OCNG pattern is chosen during the test according to the presence of a DL reference measurement channel.</p> <p>Note 2: The PDSCH and MPDCCH reference measurement channels are used in the test only when a downlink transmission dedicated to the UE under test is required.</p> <p>Note 3: E_s/I_{ot}, RSRP and I_o level has been derived from other parameters for information purpose. They are not settable parameters themselves.</p>			

Table A.6.2.15.1-2: RACH-Configuration parameters for TDD contention based random access test

Field	Value				Comment
Parameters not per CE Levels					
numberOfRA-Preambles	n52				
sizeOfRA-PreamblesGroupA	n52				No group B.
powerRampingStep	dB2				
preambleInitialReceivedTargetPower	dBm-120				
preambleTransMax	n6				
maxHARQ-Msg3Tx	4				
rar-HoppingConfig	Off				
Parameters per CE Levels					
CE Level	Level 0	Level 1	Level 2	Level 3	
ra-ResponseWindowSize (per CE)	sf20	sf80	sf180	sf320	
mac-ContentionResolutionTimer (per CE)	sf80	sf120	sf200	sf480	

PreambleMappingInfo {firstPreamble, lastPreamble}	{0, 9}	{10,19}	{20,29}	{30,39}	
Note: For further information see Clause 6.3.2 in TS 36.331.					

Table A.6.2.15.1-3: PRACH-Configuration parameters for TDD contention based random access test

Field	Value				Comment
Parameters not per CE Levels					
rsrp-ThresholdsPrach	{23,37,47}				Corresponding to {-117, -103, -93} dBm as defined in Section 9.1.21.5
mpdcch-startSF-CSS-RA	v1				
referenceSignalPower	-5 dBm/15 KHz				As defined in clause 6.3.2 in TS 36.331.
maxHARQ-Msg3Tx	4				As defined in table 5.7.1-2 in TS 36.211
Backoff Parameter Index	2				As defined in table 7.2-1 in TS 36.321
Configured UE transmitted power (P_{CMAX})	Maximum value allowed by the applicable UE power class				As defined in clause 6.2.5 in TS 36.101
Parameters per PRACH CE Levels					
CE Level	Level 0	Level 1	Level 2	Level 3	
prach-ConfigIndex	53	53	53	53	As defined in table 5.7.1-2 in TS 36.211
prach-FreqOffset	0	0	0	0	
prach-StartingSubframe	sf2	sf4	sf16	sf64	
maxNumPreambleAttempt	n3	n5	n7	n10	
numRepetitionPerPreambleAttempt	n1	n4	n16	n64	
mpdcch-NarrowbandsToMonitor	2	2	2	2	
mpdcch-NumRepetition-RA	r8	r8	r128	r128	
prach-HoppingConfig	Off	Off	Off	Off	
Note 1: See Clause 6.3.2 in TS 36.331 for further information on the parameters in this table.					

A.6.2.15.2 Test Requirements

Contention based random access is triggered by *not* explicitly assigning a random access preamble via dedicated signalling in the downlink.

A.6.2.15.2.1 Random Access Response Reception

To test the UE behavior specified in Subclause 6.2.2, the System Simulator shall transmit a Random Access Response containing a Random Access Preamble identifier corresponding to the transmitted Random Access Preamble after 5 preamble transmission attempts (the preamble may be transmitted multiple times in each attempt) have been received by the System Simulator. In response to the first 4 preamble transmission attempts, the System Simulator shall transmit a Random Access Response *not* corresponding to the transmitted Random Access Preamble.

The UE may stop monitoring for Random Access Response(s) and shall transmit the msg3 if the Random Access Response contains a Random Access Preamble identifier corresponding to the transmitted Random Access Preamble.

The UE shall re-select a preamble and transmit with the calculated PRACH transmission power when the backoff time expires if all received Random Access Responses contain Random Access Preamble identifiers that do not match the transmitted Random Access Preamble.

In addition, the power applied to all preambles shall be in accordance with what is specified in Subclause 6.2.2. The power of the first preamble shall be -27 dBm. The power of the first preamble shall be -27 dBm with an accuracy specified in clause 6.3.5.1.1 of TS 36.101 [5]. The relative power applied to additional preambles shall have an accuracy specified in clause 6.3.5.2.1 of TS 36.101 [5].

The transmit timing of all PRACH transmissions shall be within the accuracy specified in Subclause 7.24.2.

A.6.2.15.2.2 No Random Access Response Reception

To test the UE behavior specified in subclause 6.2.2.1.2, the System Simulator shall transmit a Random Access Response containing a Random Access Preamble identifier corresponding to the transmitted Random Access Preamble after 5 preamble transmission attempts have been received by the System Simulator. The System Simulator shall *not* respond to the first 4 preamble transmission attempts.

The UE shall re-select a preamble and transmit with the calculated PRACH transmission power when the backoff time expires if no Random Access Response is received within the RA Response window.

In addition, the power applied to all preambles shall be in accordance with what is specified in Subclause 6.2.2. The power of the first preamble shall be -27 dBm with an accuracy specified in clause 6.3.5.1.1 of TS 36.101 [5]. The relative power applied to additional preambles shall have an accuracy specified in clause 6.3.5.2.1 of TS 36.101 [5].

The transmit timing of all PRACH transmissions shall be within the accuracy specified in Subclause 7.24.2.

A.6.2.15.2.3 Receiving a NACK on msg3

To test the UE behavior specified in subclause 6.2.2.1.3, the System Simulator shall NACK *all* UE msg3 following a successful Random Access Response.

The UE shall re-transmit the msg3 upon the reception of a NACK on msg3 until the maximum number of HARQ re-transmissions is reached.

A.6.2.15.2.4 Reception of an Incorrect Message over Temporary C-RNTI

To test the UE behavior specified in Subclause 6.2.2.1.5, the System Simulator shall send a message addressed to the temporary C-RNTI with a UE Contention Resolution Identity included in the MAC control element *not* matching the CCCH SDU transmitted in msg3 uplink message.

The UE shall re-select a preamble and transmit with the calculated PRACH transmission power when the backoff time expires unless the received message includes a UE Contention Resolution Identity MAC control element and the UE Contention Resolution Identity included in the MAC control element matches the CCCH SDU transmitted in the uplink message.

A.6.2.15.2.5 Reception of a Correct Message over Temporary C-RNTI

To test the UE behavior specified in Subclause 6.2.2.1.5, the System Simulator shall send a message addressed to the temporary C-RNTI with a UE Contention Resolution Identity included in the MAC control element matching the CCCH SDU transmitted in the msg3 uplink message.

The UE shall send ACK if the Contention Resolution is successful.

A.6.2.15.2.6 Contention Resolution Timer expiry

To test the UE behavior specified in Subclause 6.2.2.1.6, the System Simulator shall *not* send a response to a msg3.

The UE shall re-select a preamble and transmit with the calculated PRACH transmission power when the backoff time expires if the Contention Resolution Timer expires.

A.6.2.15.2.7 PRACH Resource Selection

The UE shall select PRACH resources and transmits or re-transmits PRACH preambles using the PRACH resources and PRACH configuration corresponding to the coverage enhancement level 2.

Note: The PRACH Resource Selection requirement is already assumed for testing the other PRACH requirements.

A.6.2.16 Contention Based Random Access Test for UE category NB1 UEs In-band mode in normal coverage

A.6.2.16.1 Test Purpose and Environment

The purpose of this test is to verify whether the behavior of the random access procedure of a category NB1 UE in Normal Coverage is according to the requirements, whether the NPRACH power settings and timing are within

specified limits, and whether the UE determines properly the enhanced coverage level based on the NRSRP measurement and the configured criterion in NRSRP-ThresholdsPrach [2]. This test will verify the requirements in Clause 6.6.2, Clause 6.6.3 and Clause 7.20.2 in an AWGN model.

For this test a single NB-IoT cell and a single LTE cell are used. The test parameters are given in tables A.6.2.16.1-1, A.6.2.16.1-2 and A.6.2.16.1-4.

Table A.6.2.16.1-1: nCell specific test parameters for HD-FDD contention based random access test for UE category NB1 In-Band mode in Normal Coverage

Parameter	Unit	Value	Comments
NB-IOT operational mode		In-band	
BW_{channel}	kHz	200	
PRB location within eCell	-	eCell1 BW_{channel} 5MHz: 17 eCell1 BW_{channel} 10MHz: 30	
NPDSCH parameters ^{Note 2}		eCell1 BW_{channel} 5MHz: R.17 HD-FDD eCell1 BW_{channel} 10MHz: R.15 HD-FDD	As defined in A.3.1.5.1
NPDCCH parameters ^{Note 2}		eCell1 BW_{channel} 5MHz: R.39 HD-FDD eCell1 BW_{channel} 10MHz: R.27 HD-FDD	As defined in A.3.1.6.1
NPBCH_RA	dB	-3	
NPBCH_RB	dB		
NPSS_RA	dB		
NSSS_RA	dB		
NPDCCH_RA	dB		
NPDCCH_RB	dB		
NPDSCH_RA	dB		
NPDSCH_RB	dB		
NOCNG_RA ^{Note 1}	dB		
NOCNG_RB ^{Note 1}	dB		
DRX		OFF	
N_{oc}	dBm/15 kHz	Specified in Table A.6.2.16.1-2	
\hat{E}_s / N_{oc}	dB	3	
\hat{E}_s / I_{ot} ^{Note 3}	dB	3	
NRSRP ^{Note 3}	dBm/15 kHz	-95	
I_o ^{Note 3}	dBm/180 KHz	-82.45	
Propagation Condition	-	AWGN	
Antenna Configuration		2x1	
Note 1:	NOCNG shall be used such that the cell is fully allocated and a constant total transmitted power spectral density is achieved for all OFDM symbols. The OCNG pattern is chosen during the test according to the presence of a DL reference measurement channel.		
Note 2:	The NPDSCH and NPDCCH reference measurement channels are used in the test only when a downlink transmission dedicated to the UE under test is required.		
Note 3:	E_s/I_{ot} , NRSRP and I_o level has been derived from other parameters for information purpose. They are not settable parameters themselves.		

Table A.6.2.16.1-2: eCell specific test parameters for HD-FDD contention based random access test for UE category NB1 In-Band mode in Normal Coverage

Parameter	Unit	Value
-----------	------	-------

E-UTRA RF Channel Number		1
BW_{channel}	MHz	5 or 10
NOCNG Pattern ^{Note 1}	-	BW_{channel} 5MHz: NOP.4 FDD BW_{channel} 10MHz: NOP.1 FDD
PBCH_RA	dB	-3
PBCH_RB	dB	
PSS_RA	dB	
SSS_RA	dB	
PCFICH_RB	dB	
PHICH_RA	dB	
PHICH_RB	dB	
PDCCH_RA	dB	
PDCCH_RB	dB	
PDSCH_RA	dB	
PDSCH_RB	dB	
OCNG_RA ^{Note 1}	dB	
OCNG_RB ^{Note 1}	dB	
N_{oc}	dBm/15 kHz	-98
\hat{E}_s / N_{oc}	dB	3
Propagation Condition	-	AWGN
Antenna Configuration	-	2x1
Note 1: OCNG shall be used such that the eCell is fully allocated and a constant total transmitted power spectral density is achieved for all OFDM symbols.		

Table A.6.2.16.1-3: Void

Table A.6.2.16.1-4: NPRACH-Configuration parameters for HD-FDD contention based random access test for UE category NB1 In-Band mode in Normal Coverage

Field	Value			Comment
Parameters not per NPRACH resource				
RSRP-ThresholdsNPRACH-InfoList	{40, 55}			Corresponding to {-116, -101} dBm as defined in Section 9.1.22.9
nprach-CP-Length	us66dot7			
nrs-Power	-5 dBm/15 kHz			As defined in clause 6.7.3 in TS 36.331.
Backoff Parameter Index	1			As defined in table 7.2-2 in TS 36.321
Configured UE transmitted power (P_{CMAX})	23 dBm for power class 3, 20 dBm for power class 5, 14 dBm for power class 6			As defined in clause 6.2.5F in TS 36.101
powerRampingStep	dB2			
preambleInitialReceivedTarget Power	dBm-112			
preambleTransMax-CE	n6			
Parameters per NPRACH Resource				
NPRACH Resource	Level 0	Level 1	Level 2	
nprach-Periodicity	ms40	ms240	ms1280	
nprach-StartTime	ms8	ms64	ms512	
nprach-SubcarrierOffset	n0	n0	n0	
nprach-NumSubcarriers	n12	n12	n12	
nprach-SubcarrierMSG3-RangeStart	zero	zero	zero	
maxNumPreambleAttemptCE	n3	n6	n10	
numRepetitionsPerPreambleAttempt	n2	n8	n64	
npdcch-NumRepetitions-RA	r4	r16	r128	
npdcch-StartSF-CSS-RA	v1dot5	v1dot5	v1dot5	
npdcch-Offset-RA	zero	zero	Zero	

nprach-NumCBRA-StartSubcarriers	n8	n8	n8	
ra-ResponseWindowSize (per NPRACH Resource)	pp2	pp2	pp2	
mac-ContentionResolutionTimer (per NPRACH Resource)	pp8	pp8	pp8	
Note 1: See Clause 6.7.3 in TS 36.331 for further information on the parameters in this table.				

A.6.2.16.2 Test Requirements

Contention based random access is triggered by *not* explicitly assigning a random access preamble via dedicated signalling in the downlink.

A.6.2.16.2.1 Random Access Response Reception

To test the UE behavior specified in Subclause 6.6.2, the System Simulator shall transmit a Random Access Response containing a Random Access Preamble identifier corresponding to the transmitted Random Access Preamble after 3 preamble transmission attempts (the preamble may be transmitted multiple times in each attempt) have been received by the System Simulator. In response to the first 2 preamble transmission attempts, the System Simulator shall transmit a Random Access Response *not* corresponding to the transmitted Random Access Preamble.

The UE may stop monitoring for Random Access Response(s) and shall transmit the msg3 if the Random Access Response contains a Random Access Preamble identifier corresponding to the transmitted Random Access Preamble.

The UE shall re-select a preamble and transmit with the calculated NPRACH transmission power when the backoff time expires if all received Random Access Responses contain Random Access Preamble identifiers that do not match the transmitted Random Access Preamble.

In addition, the power applied to all preambles shall be in accordance with what is specified in Subclause 6.6.2. The power of the first preamble shall be -25 dBm with an accuracy specified in clause 6.3.5F.1.1 of TS 36.101 [5]. The relative power applied to additional preambles shall have an accuracy specified in clause 6.3.5F.2 of TS 36.101 [5].

The transmit timing of all NPRACH transmissions shall be within the accuracy specified in Subclause 7.20.2.

A.6.2.16.2.2 No Random Access Response Reception

To test the UE behavior specified in subclause 6.6.2.2, the System Simulator shall transmit a Random Access Response containing a Random Access Preamble identifier corresponding to the transmitted Random Access Preamble after 3 preamble transmission attempts have been received by the System Simulator. The System Simulator shall *not* respond to the first 2 preamble transmission attempts.

The UE shall re-select a preamble and transmit with the calculated NPRACH transmission power when the backoff time expires if no Random Access Response is received within the RA Response window.

In addition, the power applied to all preambles shall be in accordance with what is specified in Subclause 6.6.2. The power of the first preamble shall be -25 dBm with an accuracy specified in clause 6.3.5F.1.1 of TS 36.101 [5]. The relative power applied to additional preambles shall have an accuracy specified in clause 6.3.5F.2 of TS 36.101 [5].

The transmit timing of all NPRACH transmissions shall be within the accuracy specified in Subclause 7.20.2.

A.6.2.16.2.3 Receiving a NACK on msg3

To test the UE behavior specified in subclause 6.6.2.3, the System Simulator shall NACK *all* UE msg3 following a successful Random Access Response.

The UE shall re-transmit the msg3 upon the reception of a NACK on msg3 until the maximum number of re-transmissions defined by *maxNumPreambleAttemptCE* in the table A.6.2.16.1-4 is reached.

A.6.2.16.2.4 Reception of an Incorrect Message over Temporary C-RNTI

To test the UE behavior specified in Subclause 6.6.2.4, the System Simulator shall send a message addressed to the temporary C-RNTI with a UE Contention Resolution Identity included in the MAC control element *not* matching the CCCH SDU transmitted in msg3 uplink message.

The UE shall re-select a preamble and transmit with the calculated NPRACH transmission power when the backoff time expires unless the received message includes a UE Contention Resolution Identity MAC control element and the UE Contention Resolution Identity included in the MAC control element matches the CCCH SDU transmitted in the uplink message.

A.6.2.16.2.5 Reception of a Correct Message over Temporary C-RNTI

To test the UE behavior specified in Subclause 6.6.2.4, the System Simulator shall send a message addressed to the temporary C-RNTI with a UE Contention Resolution Identity included in the MAC control element matching the CCCH SDU transmitted in the msg3 uplink message.

The UE shall send ACK if the Contention Resolution is successful.

A.6.2.16.2.6 Contention Resolution Timer expiry

To test the UE behavior specified in Subclause 6.6.2.5, the System Simulator shall *not* send a response to a msg3.

The UE shall re-select a preamble and transmit with the calculated NPRACH transmission power when the backoff time expires if the Contention Resolution Timer expires.

A.6.2.16.2.7 NPRACH Resource Selection

The UE shall select NPRACH resources and transmits or re- transmits NPRACH preambles using the NPRACH resources and NPRACH configuration corresponding to the coverage enhancement level 0. The rate of correct coverage enhancement level selection during repeated tests shall be at least 90%.

Note: Correct coverage enhancement level selection is a prerequisite for testing the other NPRACH requirements.

A.6.2.17 Contention Based Random Access Test for UE category NB1 UEs In-band mode in Enhanced Coverage

A.6.2.17.1 Test Purpose and Environment

The purpose of this test is to verify whether the behavior of the random access procedure of a category NB1 UE in Enhanced Coverage is according to the requirements, whether the NPRACH power settings and timing are within specified limits, and whether the UE determines properly the enhanced coverage level based on the NRSRP measurement and the configured criterion in NRSRP-ThresholdsPrach [2]. This test will verify the requirements in Clause 6.6.2, Clause 6.6.3 and Clause 7.20.2 in an AWGN model.

For this test a single NB-IoT cell and a single LTE cell are used. The test parameters are given in tables A.6.2.17.1-1, A.6.2.17.1-2 and A.6.2.17.1-4.

Table A.6.2.17.1-1: nCell specific test parameters for HD-FDD contention based random access test for UE category NB1 In-Band mode in Enhanced Coverage

Parameter	Unit	Value	Comments
NB-IOT operational mode		In-band	
BW _{channel}	kHz	200	
PRB location within eCell	-	eCell1 BW _{channel} 5MHz: 17 eCell1 BW _{channel} 10MHz: 30	
NPDSCH parameters ^{Note 2}		eCell1 BW _{channel} 5MHz: R.17 HD-FDD eCell1 BW _{channel} 10MHz: R.15 HD-FDD	As defined in A.3.1.5.1
NPDCCH parameters ^{Note 2}		eCell1 BW _{channel} 5MHz: R.39 HD-FDD eCell1 BW _{channel} 10MHz: R.27 HD-FDD	As defined in A.3.1.6.1

NPBCH_RA	dB	-3	
NPBCH_RB	dB		
NPSS_RA	dB		
NSSS_RA	dB		
NPDCCH_RA	dB		
NPDCCH_RB	dB		
NPDSCH_RA	dB		
NPDSCH_RB	dB		
NOCNG_RA ^{Note 1}	dB		
NOCNG_RB ^{Note 1}	dB		
DRX			
N_{oc}	dBm/15 kHz	Specified in Table A.6.2.17.1-2	
\hat{E}_s / N_{oc}	dB	-12.5	
\hat{E}_s / I_{ot} ^{Note 3}	dB	-12.5	
NRSRP ^{Note 3}	dBm/15 kHz	-110.5	
I_o ^{Note 3}	dBm/180KH z	-86.97	
Propagation Condition	-	AWGN	
Antenna Configuration		2x1	
Note 1: NOCNG shall be used such that the cell is fully allocated and a constant total transmitted power spectral density is achieved for all OFDM symbols. The OCNG pattern is chosen during the test according to the presence of a DL reference measurement channel.			
Note 2: The NPDSCH and NPDCCH reference measurement channels are used in the test only when a downlink transmission dedicated to the UE under test is required.			
Note 3: Es/lot, NRSRP and Io level has been derived from other parameters for information purpose. They are not settable parameters themselves.			

Table A.6.2.17.1-2: eCell specific test parameters for HD-FDD contention based random access test for UE category NB1 In-Band mode in Enhanced Coverage

Parameter	Unit	Value
E-UTRA RF Channel Number		1
$BW_{channel}$	MHz	5 or 10
NOCNG Pattern ^{Note 1}	-	$BW_{channel}$ 5MHz: NOP.4 FDD $BW_{channel}$ 10MHz: NOP.1 FDD
PBCH_RA	dB	-3
PBCH_RB	dB	
PSS_RA	dB	
SSS_RA	dB	
PCFICH_RB	dB	
PHICH_RA	dB	
PHICH_RB	dB	
PDCCH_RA	dB	
PDCCH_RB	dB	
PDSCH_RA	dB	
PDSCH_RB	dB	
OCNG_RA ^{Note 1}	dB	
OCNG_RB ^{Note 1}	dB	
N_{oc}	dBm/15 kHz	
\hat{E}_s / N_{oc}	dB	3
Propagation Condition	-	AWGN
Antenna Configuration	-	2x1
Note 1: OCNG shall be used such that the cell is fully allocated and a constant total transmitted power spectral density is achieved for all OFDM symbols.		

Table A.6.2.17.1-3: Void

Table A.6.2.17.1-4: NPRACH-Configuration parameters for HD-FDD contention based random access test for UE category NB1 In-Band mode in Enhanced Coverage

Field	Value			Comment
Parameters not per NPRACH resource				
RSRP-ThresholdsNPRACH-InfoList	{35, 56}			Corresponding to {-121, -100} dBm as defined in Section 9.1.22.9
nprach-CP-Length	us266dot7			
nrs-Power	-5 dBm/15 kHz			As defined in clause 6.7.3 in TS 36.331.
Backoff Parameter Index	1			As defined in table 7.2-2 in TS 36.321
Configured UE transmitted power (P_{CMAX})	23 dBm for power class 3, 20 dBm for power class 5, 14 dBm for power class 6			As defined in clause 6.2.5F in TS 36.101
powerRampingStep	dB2			
preambleInitialReceivedTargetPower	dBm-120			
preambleTransMax-CE	n6			
Parameters per NPRACH Resource				
NPRACH Resource	Level 0	Level 1	Level 2	
nprach-Periodicity	ms40	ms240	ms1280	
nprach-StartTime	ms8	ms64	ms512	
nprach-SubcarrierOffset	n0	n0	n0	
nprach-NumSubcarriers	n12	n12	n12	
nprach-SubcarrierMSG3-RangeStart	zero	zero	zero	
maxNumPreambleAttemptCE	n3	n6	n10	
numRepetitionsPerPreambleAttempt	n2	n8	n64	
npdcch-NumRepetitions-RA	r4	r16	r128	
npdcch-StartSF-CSS-RA	v1dot5	v1dot5	v1dot5	
npdcch-Offset-RA	zero	zero	Zero	
nprach-NumCBRA-StartSubcarriers	n8	n8	n8	
ra-ResponseWindowSize (per NPRACH Resource)	pp2	pp2	pp2	
mac-ContentionResolutionTimer (per NPRACH Resource)	pp8	pp8	pp8	
Note 1: See Clause 6.7.3 in TS 36.331 for further information on the parameters in this table.				

A.6.2.17.2 Test Requirements

Contention based random access is triggered by *not* explicitly assigning a random access preamble via dedicated signalling in the downlink.

A.6.2.17.2.1 Random Access Response Reception

To test the UE behavior specified in Subclause 6.6.2, the System Simulator shall transmit a Random Access Response containing a Random Access Preamble identifier corresponding to the transmitted Random Access Preamble after 5 preamble transmission attempts (the preamble may be transmitted multiple times in each attempt) have been received by the System Simulator. In response to the first 4 preamble transmission attempts, the System Simulator shall transmit a Random Access Response *not* corresponding to the transmitted Random Access Preamble.

The UE may stop monitoring for Random Access Response(s) and shall transmit the msg3 if the Random Access Response contains a Random Access Preamble identifier corresponding to the transmitted Random Access Preamble.

The UE shall re-select a preamble and transmit with the calculated NPRACH transmission power when the backoff time expires if all received Random Access Responses contain Random Access Preamble identifiers that do not match the transmitted Random Access Preamble.

In addition, the power applied to all preambles shall be in accordance with what is specified in Subclause 6.6.2. The power of the first preamble shall be 23 dBm for power class 3, 20 dBm for power class 5 and 14 dBm for power class 6 with an accuracy specified in clause 6.3.5F.1.1 of TS 36.101 [5].

The transmit timing of all NPRACH transmissions shall be within the accuracy specified in Subclause 7.20.2.

A.6.2.17.2.2 No Random Access Response Reception

To test the UE behavior specified in subclause 6.6.2.2, the System Simulator shall transmit a Random Access Response containing a Random Access Preamble identifier corresponding to the transmitted Random Access Preamble after 5 preamble transmission attempts have been received by the System Simulator. The System Simulator shall *not* respond to the first 4 preamble transmission attempts.

The UE shall re-select a preamble and transmit with the calculated NPRACH transmission power when the backoff time expires if no Random Access Response is received within the RA Response window.

In addition, the power applied to all preambles shall be in accordance with what is specified in Subclause 6.2.2. The power of the first preamble shall be 23 dBm for power class 3, 20 dBm for power class 5 and 14 dBm for power class 6 with an accuracy specified in clause 6.3.5F.1.1 of TS 36.101 [5].

The transmit timing of all NPRACH transmissions shall be within the accuracy specified in Subclause 7.20.2.

A.6.2.17.2.3 Receiving a NACK on msg3

To test the UE behavior specified in subclause 6.6.2.3, the System Simulator shall NACK *all* UE msg3 following a successful Random Access Response.

The UE shall re-transmit the msg3 upon the reception of a NACK on msg3 until the maximum number of re-transmissions defined by *maxNumPreambleAttemptCE* in the table A.6.2.17.1-4 is reached.

A.6.2.17.2.4 Reception of an Incorrect Message over Temporary C-RNTI

To test the UE behavior specified in Subclause 6.6.2.4, the System Simulator shall send a message addressed to the temporary C-RNTI with a UE Contention Resolution Identity included in the MAC control element *not* matching the CCCH SDU transmitted in msg3 uplink message.

The UE shall re-select a preamble and transmit with the calculated NPRACH transmission power when the backoff time expires unless the received message includes a UE Contention Resolution Identity MAC control element and the UE Contention Resolution Identity included in the MAC control element matches the CCCH SDU transmitted in the uplink message.

A.6.2.17.2.5 Reception of a Correct Message over Temporary C-RNTI

To test the UE behavior specified in Subclause 6.6.2.4, the System Simulator shall send a message addressed to the temporary C-RNTI with a UE Contention Resolution Identity included in the MAC control element matching the CCCH SDU transmitted in the msg3 uplink message.

The UE shall send ACK if the Contention Resolution is successful.

A.6.2.17.2.6 Contention Resolution Timer expiry

To test the UE behavior specified in Subclause 6.6.2.5, the System Simulator shall *not* send a response to a msg3.

The UE shall re-select a preamble and transmit with the calculated NPRACH transmission power when the backoff time expires if the Contention Resolution Timer expires.

A.6.2.17.2.7 NPRACH Resource Selection

The UE shall select NPRACH resources and transmits or re-transmits NPRACH preambles using the NPRACH resources and NPRACH configuration corresponding to the coverage enhancement level 1. The rate of correct coverage enhancement level selection during repeated tests shall be at least 90%.

Note: Correct coverage enhancement level Sselection requirement is a prerequisite already assumed for testing the other NPRACH requirements.

A.6.2.18 Contention Based Random Access on Non-anchor Carrier Test for UE category NB1 UEs In-band mode in Enhanced Coverage

A.6.2.18.1 Test Purpose and Environment

The purpose of this test is to verify whether the behavior of the random access procedure of a category NB1 UE in Enhanced Coverage is according to the requirements, whether the NPRACH power settings and timing are within specified limits, and whether the UE determines properly the enhanced coverage level based on the NRSRP measurement and the configured criterion in NRSRP-ThresholdsPrach [2]. This test will verify the requirements in Clause 6.6.2, Clause 6.6.3 and Clause 7.20.2 in an AWGN model.

For this test a single NB-IoT cell and a single LTE cell are used. The test parameters are given in tables A.6.2.18.1-1, A.6.2.18.1-2 and A.6.2.18.1-3.

Table A.6.2.18.1-1: nCell specific test parameters for HD-FDD contention based random access on non-achor carrier test for UE category NB1 In-Band mode in Enhanced Coverage

Parameter	Unit	Value	Comments
NB-IOT operational mode		In-band	
$BW_{channel}$	kHz	200	
Anchor PRB location within eCell	-	eCell1 $BW_{channel}$ 5MHz: 17 eCell1 $BW_{channel}$ 10MHz: 30	
Non-anchor PRB location within eCell		eCell1 $BW_{channel}$ 5MHz: 18 eCell1 $BW_{channel}$ 10MHz: 31	
NPDSCH parameters ^{Note 2}		eCell1 $BW_{channel}$ 5MHz: R.17 HD-FDD eCell1 $BW_{channel}$ 10MHz: R.15 HD-FDD	As defined in A.3.1.5.1
NPDCCH parameters ^{Note 2}		eCell1 $BW_{channel}$ 5MHz: R.39 HD-FDD eCell1 $BW_{channel}$ 10MHz: R.27 HD-FDD	As defined in A.3.1.6.1
NPBCH_RA	dB	-3	
NPBCH_RB	dB		
NPSS_RA	dB		
NSSS_RA	dB		
NPDCCH_RA	dB		
NPDCCH_RB	dB		
NPDSCH_RA	dB		
NPDSCH_RB	dB		
NOCNG_RA ^{Note 1}	dB		
NOCNG_RB ^{Note 1}	dB		
DRX		OFF	
N_{oc}	dBm/15 kHz	Specified in Table A.6.2.18.1-2	
\hat{E}_s/N_{oc}	dB	-12.5	
\hat{E}_s/I_{ot} ^{Note 3}	dB	-12.5	
NRSRP ^{Note 3}	dBm/15 kHz	-110.5	
I_o ^{Note 3}	dBm/180 KHz	-86.97	
Propagation Condition	-	AWGN	
Antenna Configuration		2x1	

Note 1:	NOCNG shall be used such that the cell is fully allocated and a constant total transmitted power spectral density is achieved for all OFDM symbols. The OCNG pattern is chosen during the test according to the presence of a DL reference measurement channel.
Note 2:	The NPDSCH and NPDCCH reference measurement channels are used in the test only when a downlink transmission dedicated to the UE under test is required.
Note 3:	Es/lot, NRSRP and Io level has been derived from other parameters for information purpose. They are not settable parameters themselves.

Table A.6.2.18.1-2: eCell specific test parameters for HD-FDD contention based random access on non-anchor carrier test for UE category NB1 In-Band mode in Enhanced Coverage

Parameter	Unit	Value
E-UTRA RF Channel Number		1
BW _{channel}	MHz	5 or 10
NOCNG Pattern ^{Note 1}	-	BW _{channel} 5MHz: NOP.4 FDD BW _{channel} 10MHz: NOP.1 FDD
PBCH_RA	dB	-3
PBCH_RB	dB	
PSS_RA	dB	
SSS_RA	dB	
PCFICH_RB	dB	
PHICH_RA	dB	
PHICH_RB	dB	
PDCCH_RA	dB	
PDCCH_RB	dB	
PDSCH_RA	dB	
PDSCH_RB	dB	
OCNG_RA ^{Note 1}	dB	
OCNG_RB ^{Note 1}	dB	
N_{oc}	dBm/15 kHz	-98
\hat{E}_s / N_{oc}	dB	3
Propagation Condition	-	AWGN
Antenna Configuration	-	2x1
Note 1: OCNG shall be used such that the cell is fully allocated and a constant total transmitted power spectral density is achieved for all OFDM symbols.		

Table A.6.2.18.1-3: NPRACH-Configuration parameters for HD-FDD contention based random access on non-anchor carrier test for UE category NB1 In-Band mode in Enhanced Coverage

Field	Value			Comment
Parameters not per NPRACH resource				
RSRP-ThresholdsNPRACH-InfoList	{35, 56}			Corresponding to {-121, -100} dBm as defined in Section 9.1.22.9
nprach-CP-Length	us266dot7			
nrs-Power	-5 dBm/15 kHz			As defined in clause 6.7.3 in TS 36.331.
Backoff Parameter Index	1			As defined in table 7.2-2 in TS 36.321
Configured UE transmitted power (P_{CMAX})	23 dBm for power class 3, 20 dBm for power class 5, 14 dBm for power class 6			As defined in clause 6.2.5F in TS 36.101
powerRampingStep	dB2			
preambleInitialReceivedTarget Power	dBm-120			
preambleTransMax-CE	n6			
Parameters per NPRACH Resource				
NPRACH Resource	Level 0	Level 1	Level 2	
nprach-ProbabilityAnchor	zero	zero	zero	

nprach-NumCBRA-StartSubcarriers	n8	n8	n8	
nprach-Periodicity	ms40	ms240	ms1280	
nprach-StartTime	ms8	ms64	ms512	
nprach-SubcarrierOffset	n0	n0	n0	
nprach-NumSubcarriers	n12	n12	n12	
nprach-SubcarrierMSG3-RangeStart	zero	zero	zero	
maxNumPreambleAttemptCE	n3	n6	n10	
numRepetitionsPerPreambleAttempt	n2	n8	n64	
npdcch-NumRepetitions-RA	r4	r16	r128	
npdcch-StartSF-CSS-RA	v1dot5	v1dot5	v1dot5	
npdcch-Offset-RA	zero	zero	Zero	
ra-ResponseWindowSize (per NPRACH Resource)	pp2	pp2	pp2	
mac-ContentionResolutionTimer (per NPRACH Resource)	pp8	pp8	pp8	
Note 1: See Clause 6.7.3 in TS 36.331 for further information on the parameters in this table.				

A.6.2.18.2 Test Requirements

Contention based random access is triggered by *not* explicitly assigning a random access preamble via dedicated signalling in the downlink.

A.6.2.18.2.1 Random Access Response Reception

To test the UE behavior specified in Subclause 6.6.2, the System Simulator shall transmit a Random Access Response containing a Random Access Preamble identifier corresponding to the transmitted Random Access Preamble after 5 preamble transmission attempts (the preamble may be transmitted multiple times in each attempt) have been received by the System Simulator. In response to the first 4 preamble transmission attempts, the System Simulator shall transmit a Random Access Response *not* corresponding to the transmitted Random Access Preamble.

The UE may stop monitoring for Random Access Response(s) and shall transmit the msg3 if the Random Access Response contains a Random Access Preamble identifier corresponding to the transmitted Random Access Preamble.

The UE shall re-select a preamble and transmit with the calculated NPRACH transmission power when the backoff time expires if all received Random Access Responses contain Random Access Preamble identifiers that do not match the transmitted Random Access Preamble.

In addition, the power applied to all preambles shall be in accordance with what is specified in Subclause 6.6.2. The power of the first preamble shall be 23 dBm for power class 3, 20 dBm for power class 5 and 14 dBm for power class 6 with an accuracy specified in clause 6.3.5F.1.1 of TS 36.101 [5].

The transmit timing of all NPRACH transmissions shall be within the accuracy specified in Subclause 7.20.2.

A.6.2.18.2.2 No Random Access Response Reception

To test the UE behavior specified in subclause 6.6.2.2, the System Simulator shall transmit a Random Access Response containing a Random Access Preamble identifier corresponding to the transmitted Random Access Preamble after 5 preamble transmission attempts have been received by the System Simulator. The System Simulator shall *not* respond to the first 4 preamble transmission attempts.

The UE shall re-select a preamble and transmit with the calculated NPRACH transmission power when the backoff time expires if no Random Access Response is received within the RA Response window.

In addition, the power applied to all preambles shall be in accordance with what is specified in Subclause 6.6.2. The power of the first preamble shall be 23 dBm for power class 3, 20 dBm for power class 5 and 14 dBm for power class 6 with an accuracy specified in clause 6.3.5F.1.1 of TS 36.101 [5].

The transmit timing of all NPRACH transmissions shall be within the accuracy specified in Subclause 7.20.2.

A.6.2.18.2.3 Receiving a NACK on msg3

To test the UE behavior specified in subclause 6.6.2.3, the System Simulator shall NACK *all* UE msg3 following a successful Random Access Response.

The UE shall re-transmit the msg3 upon the reception of a NACK on msg3 until the maximum number of re-transmissions defined by *maxNumPreambleAttemptCE* in the table A.6.2.18.1-3 is reached.

A.6.2.18.2.4 Reception of an Incorrect Message over Temporary C-RNTI

To test the UE behavior specified in Subclause 6.6.2.4, the System Simulator shall send a message addressed to the temporary C-RNTI with a UE Contention Resolution Identity included in the MAC control element *not* matching the CCCH SDU transmitted in msg3 uplink message.

The UE shall re-select a preamble and transmit with the calculated NPRACH transmission power when the backoff time expires unless the received message includes a UE Contention Resolution Identity MAC control element and the UE Contention Resolution Identity included in the MAC control element matches the CCCH SDU transmitted in the uplink message.

A.6.2.18.2.5 Reception of a Correct Message over Temporary C-RNTI

To test the UE behavior specified in Subclause 6.6.2.4, the System Simulator shall send a message addressed to the temporary C-RNTI with a UE Contention Resolution Identity included in the MAC control element matching the CCCH SDU transmitted in the msg3 uplink message.

The UE shall send ACK if the Contention Resolution is successful.

A.6.2.18.2.6 Contention Resolution Timer expiry

To test the UE behavior specified in Subclause 6.6.2.5, the System Simulator shall *not* send a response to a msg3.

The UE shall re-select a preamble and transmit with the calculated NPRACH transmission power when the backoff time expires if the Contention Resolution Timer expires.

A.6.2.18.2.7 NPRACH Resource Selection

The UE shall select NPRACH resources in non-anchor carrier and transmits or re-transmits NPRACH preambles using the NPRACH resources and NPRACH configuration corresponding to the coverage enhancement level 1. The rate of correct coverage enhancement level selection during repeated tests shall be at least 90%.

Note: Correct coverage enhancement level selection is a prerequisite for testing the other NPRACH requirements.

A.6.2.19 TDD Contention Based Random Access Test for UE category NB1 UEs In-band mode in normal coverage

A.6.2.19.1 Test Purpose and Environment

The purpose of this test is to verify whether the behavior of the random access procedure of a category NB1 UE in Normal Coverage is according to the requirements, whether the NPRACH power settings and timing are within specified limits, and whether the UE determines properly the enhanced coverage level based on the NRSRP measurement and the configured criterion in NRSRP-ThresholdsPrach [2]. This test will verify the requirements in Clause 6.6.2, Clause 6.6.3 and Clause 7.20.2 in an AWGN model.

For this test a single NB-IoT cell and a single LTE cell are used. The test parameters are given in tables A.6.2.19.1-1, A.6.2.19.1-2 and A.6.2.19.1-3.

Table A.6.2.19.1-1: nCell specific test parameters for TDD contention based random access test for UE category NB1 In-Band mode in Normal Coverage

Parameter	Unit	Value	Comments
NB-IOT operational mode		In-band	
BW _{channel}	kHz	200	
PRB location within eCell	-	eCell1 BW _{channel} 10MHz: 30	

NPDSCH parameters ^{Note 2}		R.15 NB-TDD	Specified in section A.3.1.5.7
NPDCCH parameters ^{Note 2}		R.27 NB-TDD	Specified in section A.3.1.6.1
NPBCH_RA	dB	-3	
NPBCH_RB	dB		
NPSS_RA	dB		
NSSS_RA	dB		
NPDCCH_RA	dB		
NPDCCH_RB	dB		
NPDSCH_RA	dB		
NPDSCH_RB	dB		
NOCNG_RA ^{Note 1}	dB		
NOCNG_RB ^{Note 1}	dB		
DRX		OFF	
N_{oc}	dBm/15 kHz	Specified in Table A.6.2.19.1-2	
\hat{E}_s/N_{oc}	dB	3	
\hat{E}_s/I_{ot} ^{Note 3}	dB	3	
NRSRP ^{Note 3}	dBm/15 kHz	-95	
I_o ^{Note 3}	dBm/180 KHz	-82.45	
Propagation Condition	-	AWGN	
Antenna Configuration		2x1	
<p>Note 1: NOCNG shall be used such that the cell is fully allocated and a constant total transmitted power spectral density is achieved for all OFDM symbols. The OCNG pattern is chosen during the test according to the presence of a DL reference measurement channel.</p> <p>Note 2: The NPDSCH and NPDCCH reference measurement channels are used in the test only when a downlink transmission dedicated to the UE under test is required.</p> <p>Note 3: E_s/I_{ot}, NRSRP and I_o level has been derived from other parameters for information purpose. They are not settable parameters themselves.</p>			

Table A.6.2.19.1-2: eCell specific test parameters for TDD contention based random access test for UE category NB1 In-Band mode in Normal Coverage

Parameter	Unit	Value
E-UTRA RF Channel Number		1
$BW_{channel}$	MHz	10
NOCNG Pattern ^{Note 1}	-	NOP.1 TDD
PBCH_RA	dB	-3
PBCH_RB	dB	
PSS_RA	dB	
SSS_RA	dB	
PCFICH_RB	dB	
PHICH_RA	dB	
PHICH_RB	dB	
PDCCH_RA	dB	
PDCCH_RB	dB	
PDSCH_RA	dB	
PDSCH_RB	dB	
OCNG_RA ^{Note 1}	dB	
OCNG_RB ^{Note 1}	dB	
N_{oc}	dBm/15 kHz	
\hat{E}_s/N_{oc}	dB	3
Propagation Condition	-	AWGN
Antenna Configuration	-	2x1
<p>Note 1: OCNG shall be used such that the eCell is fully allocated and a constant total transmitted power spectral density is achieved for all OFDM symbols.</p>		

Table A.6.2.19.1-3: NPRACH-Configuration parameters for TDD contention based random access test for UE category NB1 In-Band mode in Normal Coverage

Field	Value			Comment
Parameters not per NPRACH resource				
RSRP-ThresholdsNPRACH-InfoList	{40, 55}			Corresponding to {-116, -101} dBm as defined in Section 9.1.22.9
nprach-PreambleFormat	fmt-0			See TS 36.211 section 10.1.6
nrs-Power	-5 dBm/15 kHz			As defined in clause 6.7.3 in TS 36.331.
Backoff Parameter Index	1			As defined in table 7.2-2 in TS 36.321
Configured UE transmitted power (P_{CMAX})	23 dBm for power class 3, 20 dBm for power class 5, 14 dBm for power class 6			As defined in clause 6.2.5F in TS 36.101
powerRampingStep	dB2			
preambleInitialReceivedTarget Power	dBm-112			
preambleTransMax-CE	n6			
Parameters per NPRACH Resource				
NPRACH Resource	Level 0	Level 1	Level 2	
nprach-Periodicity	ms80	ms640	ms5120	
nprach-StartTime	ms10	ms80	ms640	
nprach-SubcarrierOffset	n0	n0	n0	
nprach-NumSubcarriers	n12	n12	n12	
nprach-SubcarrierMSG3-RangeStart	zero	zero	zero	
maxNumPreambleAttemptCE	n3	n6	n10	
numRepetitionsPerPreambleAttempt	n2	n8	n64	
npdcch-NumRepetitions-RA	r4	r16	r128	
npdcch-StartSF-CSS-RA	v4	v4	v4	
npdcch-Offset-RA	zero	zero	Zero	
nprach-NumCBRA-StartSubcarriers	n8	n8	n8	
ra-ResponseWindowSize (per NPRACH Resource)	pp2	pp2	pp2	
mac-ContentionResolutionTimer (per NPRACH Resource)	pp8	pp8	pp8	
Note 1: See Clause 6.7.3 in TS 36.331 [2] for further information on the parameters in this table.				

A.6.2.19.2 Test Requirements

Contention based random access is triggered by *not* explicitly assigning a random access preamble via dedicated signalling in the downlink.

A.6.2.19.2.1 Random Access Response Reception

To test the UE behavior specified in Subclause 6.6.2, the System Simulator shall transmit a Random Access Response containing a Random Access Preamble identifier corresponding to the transmitted Random Access Preamble after 3 preamble transmission attempts (the preamble may be transmitted multiple times in each attempt) have been received by the System Simulator. In response to the first 2 preamble transmission attempts, the System Simulator shall transmit a Random Access Response *not* corresponding to the transmitted Random Access Preamble.

The UE may stop monitoring for Random Access Response(s) and shall transmit the msg3 if the Random Access Response contains a Random Access Preamble identifier corresponding to the transmitted Random Access Preamble.

The UE shall re-select a preamble and transmit with the calculated NPRACH transmission power when the backoff time expires if all received Random Access Responses contain Random Access Preamble identifiers that do not match the transmitted Random Access Preamble.

In addition, the power applied to all preambles shall be in accordance with what is specified in Subclause 6.6.2. The power of the first preamble shall be -25 dBm with an accuracy specified in clause 6.3.5F.1.1 of TS 36.101 [5]. The relative power applied to additional preambles shall have an accuracy specified in clause 6.3.5F.2 of TS 36.101 [5].

The transmit timing of all NPRACH transmissions shall be within the accuracy specified in Subclause 7.20.2.

A.6.2.19.2.2 No Random Access Response Reception

To test the UE behavior specified in subclause 6.6.2.2, the System Simulator shall transmit a Random Access Response containing a Random Access Preamble identifier corresponding to the transmitted Random Access Preamble after 3 preamble transmission attempts have been received by the System Simulator. The System Simulator shall *not* respond to the first 2 preamble transmission attempts.

The UE shall re-select a preamble and transmit with the calculated NPRACH transmission power when the backoff time expires if no Random Access Response is received within the RA Response window.

In addition, the power applied to all preambles shall be in accordance with what is specified in Subclause 6.6.2. The power of the first preamble shall be -25 dBm with an accuracy specified in clause 6.3.5F.1.1 of TS 36.101 [5]. The relative power applied to additional preambles shall have an accuracy specified in clause 6.3.5F.2 of TS 36.101 [5].

The transmit timing of all NPRACH transmissions shall be within the accuracy specified in Subclause 7.20.2.

A.6.2.19.2.3 Receiving a NACK on msg3

To test the UE behavior specified in subclause 6.6.2.3, the System Simulator shall NACK *all* UE msg3 following a successful Random Access Response.

The UE shall re-transmit the msg3 upon the reception of a NACK on msg3 until the maximum number of re-transmissions defined by *maxNumPreambleAttemptCE* in the table A.6.2.19.1-3 is reached.

A.6.2.19.2.4 Reception of an Incorrect Message over Temporary C-RNTI

To test the UE behavior specified in Subclause 6.6.2.4, the System Simulator shall send a message addressed to the temporary C-RNTI with a UE Contention Resolution Identity included in the MAC control element *not* matching the CCCH SDU transmitted in msg3 uplink message.

The UE shall re-select a preamble and transmit with the calculated NPRACH transmission power when the backoff time expires unless the received message includes a UE Contention Resolution Identity MAC control element and the UE Contention Resolution Identity included in the MAC control element matches the CCCH SDU transmitted in the uplink message.

A.6.2.19.2.5 Reception of a Correct Message over Temporary C-RNTI

To test the UE behavior specified in Subclause 6.6.2.4, the System Simulator shall send a message addressed to the temporary C-RNTI with a UE Contention Resolution Identity included in the MAC control element matching the CCCH SDU transmitted in the msg3 uplink message.

The UE shall send ACK if the Contention Resolution is successful.

A.6.2.19.2.6 Contention Resolution Timer expiry

To test the UE behavior specified in Subclause 6.6.2.5, the System Simulator shall *not* send a response to a msg3.

The UE shall re-select a preamble and transmit with the calculated NPRACH transmission power when the backoff time expires if the Contention Resolution Timer expires.

A.6.2.19.2.7 NPRACH Resource Selection

The UE shall select NPRACH resources and transmits or re-transmits NPRACH preambles using the NPRACH resources and NPRACH configuration corresponding to the coverage enhancement level 0. The rate of correct coverage enhancement level selection during repeated tests shall be at least 90%.

Note: Correct coverage enhancement level selection is a prerequisite for testing the other NPRACH requirements.

A.6.2.20 TDD Contention Based Random Access Test for UE category NB1 UEs In-band mode in enhanced coverage

A.6.2.20.1 Test Purpose and Environment

The purpose of this test is to verify whether the behavior of the random access procedure of a category NB1 UE in Enhanced coverage is according to the requirements, whether the NPRACH power settings and timing are within specified limits, and whether the UE determines properly the enhanced coverage level based on the NRSRP measurement and the configured criterion in NRSRP-ThresholdsPrach [2]. This test will verify the requirements in Clause 6.6.2, Clause 6.6.3 and Clause 7.20.2 in an AWGN model.

For this test a single NB-IoT cell and a single LTE cell are used. The test parameters are given in tables A.6.2.20.1-1, A.6.2.20.1-2 and A.6.2.20.1-3.

Table A.6.2.20.1-1: nCell specific test parameters for TDD contention based random access test for UE category NB1 In-Band mode in Enhanced coverage

Parameter	Unit	Value	Comments
NB-IOT operational mode		In-band	
$BW_{channel}$	kHz	200	
PRB location within eCell	-	eCell1 $BW_{channel}$ 10MHz: 30	
NPDSCH parameters ^{Note 2}		R.15 NB-TDD	Specified in section A.3.1.5.7
NPDCCH parameters ^{Note 2}		R.27 NB-TDD	Specified in section A.3.1.6.1
NPBCH_RA	dB	-3	
NPBCH_RB	dB		
NPSS_RA	dB		
NSSS_RA	dB		
NPDCCH_RA	dB		
NPDCCH_RB	dB		
NPDSCH_RA	dB		
NPDSCH_RB	dB		
NOCNG_RA ^{Note 1}	dB		
NOCNG_RB ^{Note 1}	dB		
DRX		OFF	
N_{oc}	dBm/15 kHz	Specified in Table A.6.2.20.1-2	
\hat{E}_s/N_{oc}	dB	-12.5	
\hat{E}_s/I_{ot} ^{Note 3}	dB	-12.5	
NRSRP ^{Note 3}	dBm/15 kHz	-110.5	
I_o ^{Note 3}	dBm/180 KHz	-86.97	
Propagation Condition	-	AWGN	
Antenna Configuration		2x1	
<p>Note 1: NOCNG shall be used such that the cell is fully allocated and a constant total transmitted power spectral density is achieved for all OFDM symbols. The OCNG pattern is chosen during the test according to the presence of a DL reference measurement channel.</p> <p>Note 2: The NPDSCH and NPDCCH reference measurement channels are used in the test only when a downlink transmission dedicated to the UE under test is required.</p> <p>Note 3: E_s/I_{ot}, NRSRP and I_o level has been derived from other parameters for information purpose. They are not settable parameters themselves.</p>			

Table A.6.2.20.1-2: eCell specific test parameters for TDD contention based random access test for UE category NB1 In-Band mode in Enhanced coverage

Parameter	Unit	Value
E-UTRA RF Channel Number		1

BW _{channel}	MHz	10
NOCNG Pattern ^{Note 1}	-	NOP.1 TDD
PBCH_RA	dB	-3
PBCH_RB	dB	
PSS_RA	dB	
SSS_RA	dB	
PCFICH_RB	dB	
PHICH_RA	dB	
PHICH_RB	dB	
PDCCH_RA	dB	
PDCCH_RB	dB	
PDSCH_RA	dB	
PDSCH_RB	dB	
OCNG_RA ^{Note 1}	dB	
OCNG_RB ^{Note 1}	dB	
N_{oc}	dBm/15 kHz	
\hat{E}_s / N_{oc}	dB	3
Propagation Condition	-	AWGN
Antenna Configuration	-	2x1
Note 1: OCNG shall be used such that the eCell is fully allocated and a constant total transmitted power spectral density is achieved for all OFDM symbols.		

Table A.6.2.20.1-3: NPRACH-Configuration parameters for TDD contention based random access test for UE category NB1 In-Band mode in Enhanced coverage

Field	Value			Comment
Parameters not per NPRACH resource				
RSRP-ThresholdsNPRACH-InfoList	{35, 56}			Corresponding to {-116, -101} dBm as defined in Section 9.1.22.9
nprach-PreambleFormat	fmt-0			See TS 36.211 section 10.1.6
nrs-Power	-5 dBm/15 kHz			As defined in clause 6.7.3 in TS 36.331.
Backoff Parameter Index	1			As defined in table 7.2-2 in TS 36.321
Configured UE transmitted power (P_{CMAX})	23 dBm for power class 3, 20 dBm for power class 5, 14 dBm for power class 6			As defined in clause 6.2.5F in TS 36.101
powerRampingStep	dB2			
preambleInitialReceivedTargetPower	dBm-120			
preambleTransMax-CE	n6			
Parameters per NPRACH Resource				
NPRACH Resource	Level 0	Level 1	Level 2	
nprach-Periodicity	ms80	ms640	ms5120	
nprach-StartTime	ms10	ms80	ms640	
nprach-SubcarrierOffset	n0	n0	n0	
nprach-NumSubcarriers	n12	n12	n12	
nprach-SubcarrierMSG3-RangeStart	zero	zero	zero	
maxNumPreambleAttemptCE	n3	n6	n10	
numRepetitionsPerPreambleAttempt	n2	n8	n64	
npdcch-NumRepetitions-RA	r4	r16	r128	
npdcch-StartSF-CSS-RA	v4	v4	v4	
npdcch-Offset-RA	zero	zero	Zero	
nprach-NumCBRA-StartSubcarriers	n8	n8	n8	
ra-ResponseWindowSize (per NPRACH Resource)	pp2	pp2	pp2	

mac-ContentionResolutionTimer (per NPRACH Resource)	pp8	pp8	pp8	
Note 1: See Clause 6.7.3 in TS 36.331 [2] for further information on the parameters in this table.				

A.6.2.20.2 Test Requirements

Contention based random access is triggered by *not* explicitly assigning a random access preamble via dedicated signalling in the downlink.

A.6.2.20.2.1 Random Access Response Reception

To test the UE behavior specified in Subclause 6.6.2, the System Simulator shall transmit a Random Access Response containing a Random Access Preamble identifier corresponding to the transmitted Random Access Preamble after 3 preamble transmission attempts (the preamble may be transmitted multiple times in each attempt) have been received by the System Simulator. In response to the first 2 preamble transmission attempts, the System Simulator shall transmit a Random Access Response *not* corresponding to the transmitted Random Access Preamble.

The UE may stop monitoring for Random Access Response(s) and shall transmit the msg3 if the Random Access Response contains a Random Access Preamble identifier corresponding to the transmitted Random Access Preamble.

The UE shall re-select a preamble and transmit with the calculated NPRACH transmission power when the backoff time expires if all received Random Access Responses contain Random Access Preamble identifiers that do not match the transmitted Random Access Preamble.

In addition, the power applied to all preambles shall be in accordance with what is specified in Subclause 6.6.2. The power of the first preamble shall be -25 dBm with an accuracy specified in clause 6.3.5F.1.1 of TS 36.101 [5]. The relative power applied to additional preambles shall have an accuracy specified in clause 6.3.5F.2 of TS 36.101 [5].

The transmit timing of all NPRACH transmissions shall be within the accuracy specified in Subclause 7.20.2.

A.6.2.20.2.2 No Random Access Response Reception

To test the UE behavior specified in subclause 6.6.2.2, the System Simulator shall transmit a Random Access Response containing a Random Access Preamble identifier corresponding to the transmitted Random Access Preamble after 5 preamble transmission attempts have been received by the System Simulator. The System Simulator shall *not* respond to the first 4 preamble transmission attempts.

The UE shall re-select a preamble and transmit with the calculated NPRACH transmission power when the backoff time expires if no Random Access Response is received within the RA Response window.

In addition, the power applied to all preambles shall be in accordance with what is specified in Subclause 6.2.2. The power of the first preamble shall be 23 dBm for power class 3, 20 dBm for power class 5 and 14 dBm for power class 6 with an accuracy specified in clause 6.3.5F.1.1 of TS 36.101 [5].

The transmit timing of all NPRACH transmissions shall be within the accuracy specified in Subclause 7.20.2.

A.6.2.20.2.3 Receiving a NACK on msg3

To test the UE behavior specified in subclause 6.6.2.3, the System Simulator shall NACK *all* UE msg3 following a successful Random Access Response.

The UE shall re-transmit the msg3 upon the reception of a NACK on msg3 until the maximum number of re-transmissions defined by *maxNumPreambleAttemptCE* in the table A.6.2.20.1-3 is reached.

A.6.2.20.2.4 Reception of an Incorrect Message over Temporary C-RNTI

To test the UE behavior specified in Subclause 6.6.2.4, the System Simulator shall send a message addressed to the temporary C-RNTI with a UE Contention Resolution Identity included in the MAC control element *not* matching the CCCH SDU transmitted in msg3 uplink message.

The UE shall re-select a preamble and transmit with the calculated NPRACH transmission power when the backoff time expires unless the received message includes a UE Contention Resolution Identity MAC control element and the UE

Contention Resolution Identity included in the MAC control element matches the CCCH SDU transmitted in the uplink message.

A.6.2.20.2.5 Reception of a Correct Message over Temporary C-RNTI

To test the UE behavior specified in Subclause 6.6.2.4, the System Simulator shall send a message addressed to the temporary C-RNTI with a UE Contention Resolution Identity included in the MAC control element matching the CCCH SDU transmitted in the msg3 uplink message.

The UE shall send ACK if the Contention Resolution is successful.

A.6.2.20.2.6 Contention Resolution Timer expiry

To test the UE behavior specified in Subclause 6.6.2.5, the System Simulator shall *not* send a response to a msg3.

The UE shall re-select a preamble and transmit with the calculated NPRACH transmission power when the backoff time expires if the Contention Resolution Timer expires.

A.6.2.20.2.7 NPRACH Resource Selection

The UE shall select NPRACH resources and transmits or re- transmits NPRACH preambles using the NPRACH resources and NPRACH configuration corresponding to the coverage enhancement level 1. The rate of correct coverage enhancement level selection during repeated tests shall be at least 90%.

Note: Correct coverage enhancement level Sselection requirement is a prerequisite already assumed for testing the other NPRACH requirements.

A.6.2.21 TDD Contention Based Random Access on Non-anchor Carrier Test for UE category NB1 UEs In-band mode in Enhanced Coverage

A.6.2.21.1 Test Purpose and Environment

The purpose of this test is to verify whether the behavior of the random access procedure of a category NB1 UE in Enhanced Coverage is according to the requirements, whether the NPRACH power settings and timing are within specified limits, and whether the UE determines properly the enhanced coverage level based on the NRSRP measurement and the configured criterion in NRSRP-ThresholdsPrach [2]. This test will verify the requirements in Clause 6.6.2, Clause 6.6.3 and Clause 7.20.2 in an AWGN model.

For this test a single NB-IoT cell and a single LTE cell are used. The test parameters are given in tables A.6.2.21.1-1, A.6.2.21.1-2 and A.6.2.21.1-3.

Table A.6.2.21.1-1: nCell specific test parameters for TDD contention based random access on non-anchor test for UE category NB1 In-Band mode in Enhanced Coverage

Parameter	Unit	Value	Comments
NB-IOT operational mode		In-band	
BW _{channel}	kHz	200	
PRB location within eCell	-	eCell1 BW _{channel} 10MHz: 30	
NPDSCH parameters ^{Note 2}		R.15 NB-TDD	Specified in section A.3.1.5.7
NPDCCH parameters ^{Note 2}		R.27 NB-TDD	Specified in section A.3.1.6.1
NPBCH_RA	dB	-3	
NPBCH_RB	dB		
NPSS_RA	dB		
NSSS_RA	dB		
NPDCCH_RA	dB		
NPDCCH_RB	dB		
NPDSCH_RA	dB		
NPDSCH_RB	dB		
NOCNG_RA ^{Note 1}	dB		
NOCNG_RB ^{Note 1}	dB		
DRX		OFF	

N_{oc}	dBm/15 kHz	Specified in Table A.6.2.21.1-2	
\hat{E}_s/N_{oc}	dB	-12.5	
\hat{E}_s/I_{ot} <small>Note 3</small>	dB	-12.5	
NRSRP <small>Note 3</small>	dBm/15 kHz	-110.5	
I_o <small>Note 3</small>	dBm/180 KHz	-86.97	
Propagation Condition	-	AWGN	
Antenna Configuration	-	2x1	
<p>Note 1: NOCNG shall be used such that the cell is fully allocated and a constant total transmitted power spectral density is achieved for all OFDM symbols. The OCNG pattern is chosen during the test according to the presence of a DL reference measurement channel.</p> <p>Note 2: The NPDSCH and NPDCCH reference measurement channels are used in the test only when a downlink transmission dedicated to the UE under test is required.</p> <p>Note 3: E_s/I_o, NRSRP and I_o level has been derived from other parameters for information purpose. They are not settable parameters themselves.</p>			

Table A.6.2.21.1-2: eCell specific test parameters for TDD contention based random access on non-anchor test for UE category NB1 In-Band mode in Enhanced Coverage

Parameter	Unit	Value
E-UTRA RF Channel Number		1
$BW_{channel}$	MHz	10
NOCNG Pattern <small>Note 1</small>	-	NOP.1 TDD
PBCH_RA	dB	-3
PBCH_RB	dB	
PSS_RA	dB	
SSS_RA	dB	
PCFICH_RB	dB	
PHICH_RA	dB	
PHICH_RB	dB	
PDCCH_RA	dB	
PDCCH_RB	dB	
PDSCH_RA	dB	
PDSCH_RB	dB	
OCNG_RA <small>Note 1</small>	dB	
OCNG_RB <small>Note 1</small>	dB	
N_{oc}	dBm/15 kHz	
\hat{E}_s/N_{oc}	dB	3
Propagation Condition	-	AWGN
Antenna Configuration	-	2x1
<p>Note 1: OCNG shall be used such that the eCell is fully allocated and a constant total transmitted power spectral density is achieved for all OFDM symbols.</p>		

Table A.6.2.21.1-3: NPRACH-Configuration parameters for TDD contention based random access on non-anchor test for UE category NB1 In-Band mode in Enhanced Coverage

Field	Value	Comment
Parameters not per NPRACH resource		
RSRP-ThresholdsNPRACH-InfoList	{35, 56}	Corresponding to {-116, -101} dBm as defined in Section 9.1.22.9
nprach-PreambleFormat	fmt-0	See TS 36.211 section 10.1.6
nrs-Power	-5 dBm/15 kHz	As defined in clause 6.7.3 in TS 36.331.

Backoff Parameter Index	1			As defined in table 7.2-2 in TS 36.321
Configured UE transmitted power (P_{CMAX})	23 dBm for power class 3, 20 dBm for power class 5, 14 dBm for power class 6			As defined in clause 6.2.5F in TS 36.101
powerRampingStep	dB2			
preambleInitialReceivedTarget Power	dBm-120			
preambleTransMax-CE	n6			
Parameters per NPRACH Resource				
NPRACH Resource	Level 0	Level 1	Level 2	
nprach-Periodicity	ms80	ms640	ms5120	
nprach-StartTime	ms10	ms80	ms640	
nprach-SubcarrierOffset	n0	n0	n0	
nprach-NumSubcarriers	n12	n12	n12	
nprach-SubcarrierMSG3-RangeStart	zero	zero	zero	
maxNumPreambleAttemptCE	n3	n6	n10	
numRepetitionsPerPreambleAttempt	n2	n8	n64	
npdcch-NumRepetitions-RA	r4	r16	r128	
npdcch-StartSF-CSS-RA	v4	v4	v4	
npdcch-Offset-RA	zero	zero	Zero	
nprach-NumCBRA-StartSubcarriers	n8	n8	n8	
ra-ResponseWindowSize (per NPRACH Resource)	pp2	pp2	pp2	
mac-ContentionResolutionTimer (per NPRACH Resource)	pp8	pp8	pp8	
Note 1: See Clause 6.7.3 in TS 36.331 [2] for further information on the parameters in this table.				

A.6.2.21.2 Test Requirements

Contention based random access is triggered by *not* explicitly assigning a random access preamble via dedicated signalling in the downlink.

A.6.2.21.2.1 Random Access Response Reception

To test the UE behavior specified in Subclause 6.6.2, the System Simulator shall transmit a Random Access Response containing a Random Access Preamble identifier corresponding to the transmitted Random Access Preamble after 5 preamble transmission attempts (the preamble may be transmitted multiple times in each attempt) have been received by the System Simulator. In response to the first 4 preamble transmission attempts, the System Simulator shall transmit a Random Access Response *not* corresponding to the transmitted Random Access Preamble.

The UE may stop monitoring for Random Access Response(s) and shall transmit the msg3 if the Random Access Response contains a Random Access Preamble identifier corresponding to the transmitted Random Access Preamble.

The UE shall re-select a preamble and transmit with the calculated NPRACH transmission power when the backoff time expires if all received Random Access Responses contain Random Access Preamble identifiers that do not match the transmitted Random Access Preamble.

In addition, the power applied to all preambles shall be in accordance with what is specified in Subclause 6.6.2. The power of the first preamble shall be 23 dBm for power class 3, 20 dBm for power class 5 and 14 dBm for power class 6 with an accuracy specified in clause 6.3.5F.1.1 of TS 36.101 [5].

The transmit timing of all NPRACH transmissions shall be within the accuracy specified in Subclause 7.20.2.

A.6.2.21.2.2 No Random Access Response Reception

To test the UE behavior specified in subclause 6.6.2.2, the System Simulator shall transmit a Random Access Response containing a Random Access Preamble identifier corresponding to the transmitted Random Access Preamble after 5 preamble transmission attempts have been received by the System Simulator. The System Simulator shall *not* respond to the first 4 preamble transmission attempts.

The UE shall re-select a preamble and transmit with the calculated NPRACH transmission power when the backoff time expires if no Random Access Response is received within the RA Response window.

In addition, the power applied to all preambles shall be in accordance with what is specified in Subclause 6.6.2. The power of the first preamble shall be 23 dBm for power class 3, 20 dBm for power class 5 and 14 dBm for power class 6 with an accuracy specified in clause 6.3.5F.1.1 of TS 36.101 [5].

The transmit timing of all NPRACH transmissions shall be within the accuracy specified in Subclause 7.20.2.

A.6.2.21.2.3 Receiving a NACK on msg3

To test the UE behavior specified in subclause 6.6.2.3, the System Simulator shall NACK *all* UE msg3 following a successful Random Access Response.

The UE shall re-transmit the msg3 upon the reception of a NACK on msg3 until the maximum number of re-transmissions defined by *maxNumPreambleAttemptCE* in the table A.6.2.21.1-3 is reached.

A.6.2.21.2.4 Reception of an Incorrect Message over Temporary C-RNTI

To test the UE behavior specified in Subclause 6.6.2.4, the System Simulator shall send a message addressed to the temporary C-RNTI with a UE Contention Resolution Identity included in the MAC control element *not* matching the CCCH SDU transmitted in msg3 uplink message.

The UE shall re-select a preamble and transmit with the calculated NPRACH transmission power when the backoff time expires unless the received message includes a UE Contention Resolution Identity MAC control element and the UE Contention Resolution Identity included in the MAC control element matches the CCCH SDU transmitted in the uplink message.

A.6.2.21.2.5 Reception of a Correct Message over Temporary C-RNTI

To test the UE behavior specified in Subclause 6.6.2.4, the System Simulator shall send a message addressed to the temporary C-RNTI with a UE Contention Resolution Identity included in the MAC control element matching the CCCH SDU transmitted in the msg3 uplink message.

The UE shall send ACK if the Contention Resolution is successful.

A.6.2.21.2.6 Contention Resolution Timer expiry

To test the UE behavior specified in Subclause 6.6.2.5, the System Simulator shall *not* send a response to a msg3.

The UE shall re-select a preamble and transmit with the calculated NPRACH transmission power when the backoff time expires if the Contention Resolution Timer expires.

A.6.2.21.2.7 NPRACH Resource Selection

The UE shall select NPRACH resources in non-anchor carrier and transmits or re-transmits NPRACH preambles using the NPRACH resources and NPRACH configuration corresponding to the coverage enhancement level 1. The rate of correct coverage enhancement level selection during repeated tests shall be at least 90%.

Note: Correct coverage enhancement level selection is a prerequisite for testing the other NPRACH requirements.

A.6.3 RRC Connection Release with Redirection

A.6.3.1 Redirection from E-UTRAN FDD to UTRAN FDD

A.6.3.1.1 Test Purpose and Environment

The purpose of this test is to verify that the UE makes correct performing the RRC connection release with redirection to the target UTRAN FDD cell. This test will partly verify the RRC connection release with redirection to UTRAN FDD cell requirements in clause 6.3.2.1.

The test parameters are given in Tables A.6.3.1.1-1, A.6.3.1.1-2 and A.6.3.1.1-3 below. The test consists of two successive time periods, with time duration of T1, and T2 respectively. The “*RRConnectionRelease*” message containing the relevant system information of Cell 2 shall be sent to the UE during period T1 and the start of T2 is the

instant when the last TTI containing the RRC message is sent to the UE. Prior to time duration T2, the UE shall not have any timing information of Cell 2. Cell 2 is powered up at the beginning of the T2.

Table A.6.3.1.1-1: General test parameters for RRC Connection Release with Redirection from E-UTRAN FDD to UTRAN FDD under AWGN propagation conditions

Parameter	Unit	Value	Comment
PDSCH parameters (E-UTRAN FDD)		DL Reference Measurement Channel R.0 FDD	As specified in clause A.3.1.1.1.
PCFICH/PDCCH/PHICH parameters (E-UTRAN FDD)		DL Reference Measurement Channel R.6 FDD	As specified in clause A.3.1.2.1.
Active cell		Cell 1	Cell 1 is on E-UTRA RF channel number 1.
Neighbour cell		Cell 2	Cell 2 is on UTRA RF channel number 1.
CP length		Normal	Applicable to cell 1
E-UTRA RF Channel Number		1	One E-UTRA FDD carrier frequency is used.
E-UTRA Channel Bandwidth ($BW_{channel}$)	MHz	10	
UTRA RF Channel Number		1	One UTRA FDD carrier frequency is used.
Inter-RAT (UTRA FDD) measurement quantity		CPICH Ec/Io	
Filter coefficient		0	L3 filtering is not used.
DRX		OFF	
UTRA FDD cell list size		16	UTRA cells on UTRA RF channel 1 provided in the "RRCConnectionRelease" message from the E-UTRAN
T1	s	≤5	
T2	s	1	

Table A.6.3.1.1-2: Cell specific test parameters for cell #1 E-UTRAN FDD to UTRAN FDD RRC release with redirection under AWGN propagation conditions

Parameter	Unit	Cell 1	
		T1	T2
E-UTRA RF Channel Number		1	
$BW_{channel}$	MHz	10	
OCNG Pattern defined in A.3.2.1.1 (OP.1 FDD)		OP.1 FDD	
PBCH_RA	dB	0	
PBCH_RB	dB		
PSS_RA	dB		
SSS_RA	dB		
PCFICH_RB	dB		
PHICH_RA	dB		
PHICH_RB	dB		
PDCCH_RA	dB		
PDCCH_RB	dB		
PDSCH_RA	dB		
PDSCH_RB	dB		
OCNG_RA ^{Note 1}	dB		
OCNG_RB ^{Note 1}	dB		
\hat{E}_s/I_{ot}	dB		
N_{oc} ^{Note 3}	dBm/15 kHz	-98	
\hat{E}_s/N_{oc}	dB	4	4
RSRP ^{Note 4}	dBm/15 kHz	-94	-94
SCH_RP	dBm/15 kHz	-94	-94
Propagation Condition		AWGN	

Note 1:	OCNG shall be used such that the cell is fully allocated and a constant total transmitted power spectral density is achieved for all OFDM symbols.
Note 2:	The resources for uplink transmission are assigned to the UE prior to the start of time period T2.
Note 3:	Interference from other cells and noise sources not specified in the test is assumed to be constant over subcarriers and time and shall be modelled as AWGN of appropriate power for N_{oc} to be fulfilled.
Note 4:	RSRP levels have been derived from other parameters for information purposes. They are not settable parameters themselves.

Table A.6.3.1.1-3: Cell specific test parameters for cell #2 E-UTRAN FDD to UTRAN FDD RRC release with redirection under AWGN propagation conditions

Parameter	Unit	Cell 2	
		T1	T1
UTRA RF Channel Number		1	
CPICH_Ec/Ior	dB	-10	
PCCPCH_Ec/Ior	dB	-12	
SCH_Ec/Ior	dB	-12	
PICH_Ec/Ior	dB	-15	
DPCH_Ec/Ior	dB	N/A	
OCNS		-0.941	
\hat{I}_{or}/I_{oc}	dB	$-\infty$	0.02
I_{oc}	dBm/3.84 MHz	-70	
CPICH_Ec/Io ^{Note 3}	dB	$-\infty$	-13
Propagation Condition		AWGN	
Note 1:	The DPCH level is controlled by the power control loop.		
Note 2:	The power of the OCNS channel that is added shall make the total power from the cell to be equal to I_{or} .		
Note 3:	This gives an SCH Ec/Io of -15dB		

A.6.3.1.2 Test Requirements

The UE shall start to transmit random access to Cell 2 less than 650 ms from the beginning of time period T2.

The rate of correct RRC connection release redirection to UTRAN FDD observed during repeated tests shall be at least 90%.

NOTE: The Re-establishment delay in this case can be expressed as

$$T_{\text{connection_release_redirect_UTRA FDD}} = T_{\text{RRC_procedure_delay}} + T_{\text{identify-UTRA FDD}} + T_{\text{SI-UTRA FDD}} + T_{\text{RA}}$$

where

$$T_{\text{RRC_procedure_delay}} = 110 \text{ ms}$$

$$T_{\text{identify-UTRA FDD}} = 500 \text{ ms}$$

$T_{\text{SI-UTRA FDD}}$ = the time required for acquiring all the relevant system information of the target UTRA FDD cell. This time depends upon whether the UE is provided with the relevant system information of the target UTRA FDD cell or not by the E-UTRAN before the RRC connection is released. 0 ms is assumed in this test case.

T_{RA} = The additional delay caused by the random access procedure. 40 ms is assumed in this test case.

This gives a total of 650 ms.

A.6.3.2 Redirection from E-UTRAN TDD to UTRAN FDD

A.6.3.2.1 Test Purpose and Environment

The purpose of this test is to verify that the UE makes correct performing the RRC connection release with redirection to the target UTRAN FDD cell. This test will partly verify the RRC connection release with redirection to UTRAN FDD cell requirements in clause 6.3.2.1.

The test parameters are given in Tables A.6.3.2.1-1, A.6.3.2.1-2 and A.6.3.2.1-3 below. The test consists of two successive time periods, with time duration of T1, and T2 respectively. The “*RRCConnectionRelease*” message containing the relevant system information of Cell 2 shall be sent to the UE during period T1 and the start of T2 is the instant when the last TTI containing the RRC message is sent to the UE. Prior to time duration T2, the UE shall not have any timing information of cell 2. Cell 2 is powered up at the beginning of the T2,

Table A.6.3.2.1-1: General test parameters for RRC Connection Release with Redirection from E-UTRAN TDD to UTRAN FDD under AWGN propagation conditions

Parameter	Unit	Value	Comment
PDSCH parameters (E-UTRAN TDD)		DL Reference Measurement Channel R.0 TDD	As specified in clause A.3.1.1.2.
PCFICH/PDCCH/PHICH parameters (E-UTRAN TDD)		DL Reference Measurement Channel R.6 TDD	As specified in clause A.3.1.2.2.
Active cell		Cell 1	Cell 1 is on E-UTRA RF channel number 1.
Neighbour cell		Cell 2	Cell 2 is on UTRA RF channel number 1.
CP length		Normal	Applicable to cell 1
E-UTRA RF Channel Number		1	One E-UTRA TDD carrier frequency is used.
E-UTRA Channel Bandwidth ($BW_{channel}$)	MHz	10	
Special subframe configuration		6	As specified in table 4.2-1 in TS 36.211
Uplink-downlink configuration		1	As specified in table 4.2-2 in TS 36.211
UTRA RF Channel Number		1	One UTRA FDD carrier frequency is used.
Inter-RAT (UTRA FDD) measurement quantity		CPICH Ec/Io	
Filter coefficient		0	L3 filtering is not used.
DRX		OFF	
UTRA FDD cell list size		16	UTRA cells on UTRA RF channel 1 provided in the “ <i>RRCConnectionRelease</i> ” message from the E-UTRAN
T1	s	≤5	
T2	s	1	

Table A.6.3.2.1-2: Cell specific test parameters for cell #1 E-UTRAN TDD to UTRAN FDD RRC release with redirection under AWGN propagation conditions

Parameter	Unit	Cell 1	
		T1	T2
E-UTRA RF Channel Number		1	
$BW_{channel}$	MHz	10	
OCNG Pattern defined in A.3.2.2.1 (OP.1 TDD)		OP.1 TDD	
PBCH_RA	dB	0	
PBCH_RB	dB		
PSS_RA	dB		
SSS_RA	dB		
PCFICH_RB	dB		
PHICH_RA	dB		
PHICH_RB	dB		
PDCCH_RA	dB		
PDCCH_RB	dB		
PDSCH_RA	dB		
PDSCH_RB	dB		
OCNG_RA ^{Note 1}	dB		
OCNG_RB ^{Note 1}	dB		

\hat{E}_s/I_{ot}	dB	4	4
N_{oc} Note 3	dBm/15 kHz	-98	
\hat{E}_s/N_{oc}	dB	4	4
RSRP Note 4	dBm/15 kHz	-94	-94
SCH_RP	dBm/15 kHz	-94	-94
Propagation Condition		AWGN	
<p>Note 1: OCNG shall be used such that the cell is fully allocated and a constant total transmitted power spectral density is achieved for all OFDM symbols.</p> <p>Note 2: The resources for uplink transmission are assigned to the UE prior to the start of time period T2.</p> <p>Note 3: Interference from other cells and noise sources not specified in the test is assumed to be constant over subcarriers and time and shall be modelled as AWGN of appropriate power for N_{oc} to be fulfilled.</p> <p>Note 4: RSRP levels have been derived from other parameters for information purposes. They are not settable parameters themselves.</p>			

Table A.6.3.2.1-3: Cell specific test parameters for cell #2 E-UTRAN TDD to UTRAN FDD RRC release with redirection under AWGN propagation conditions

Parameter	Unit	Cell 2	
		T1	T2
UTRA RF Channel Number		1	
CPICH_Ec/I _{or}	dB	-10	
PCCPCH_Ec/I _{or}	dB	-12	
SCH_Ec/I _{or}	dB	-12	
PICH_Ec/I _{or}	dB	-15	
DPCH_Ec/I _{or}	dB	N/A	
OCNS		-0.941	
\hat{I}_{or}/I_{oc}	dB	$-\infty$	0.02
I_{oc}	dBm/3.84 MHz	-70	
CPICH_Ec/I _o Note 3	dB	$-\infty$	-13
Propagation Condition		AWGN	
<p>Note 1: The DPCH level is controlled by the power control loop.</p> <p>Note 2: The power of the OCNS channel that is added shall make the total power from the cell to be equal to I_{or}.</p> <p>Note 3: This gives an SCH Ec/I_o of -15dB</p>			

A.6.3.2.2 Test Requirements

The UE shall start to transmit random access to Cell 2 less than 650 ms from the beginning of time period T2.

The rate of correct RRC connection release redirection to UTRA FDD observed during repeated tests shall be at least 90%.

NOTE: The Re-establishment delay in this case can be expressed as

$$T_{\text{connection_release_redirect_UTRA FDD}} = T_{\text{RRC_procedure_delay}} + T_{\text{identify-UTRA FDD}} + T_{\text{SI-UTRA FDD}} + T_{\text{RA}}$$

where

$$T_{\text{RRC_procedure_delay}} = 110 \text{ ms}$$

$$T_{\text{identify-UTRA FDD}} = 500 \text{ ms}$$

$T_{\text{SI-UTRA FDD}}$ = the time required for acquiring all the relevant system information of the target UTRA FDD cell.

This time depends upon whether the UE is provided with the relevant system information of the target UTRA FDD cell or not by the E-UTRAN before the RRC connection is released. 0 ms is assumed in this test case.

T_{RA} = The additional delay caused by the random access procedure. 40 ms is assumed in this test case.

This gives a total of 650 ms.

A.6.3.3 Redirection from E-UTRAN FDD to GERAN when System Information is provided

A.6.3.3.1 Test Purpose and Environment

The purpose of this test is to verify that the UE performs the RRC connection release with redirection from the E-UTRA FDD to the target GERAN cell within $T_{\text{connection_release_redirect_GERAN}}$. This test will partly verify the RRC connection release with redirection to GERAN requirements in clause 6.3.2.2.

The test parameters are given in Tables A.6.3.3.1-1, A.6.3.3.1-2 and A.6.3.3.1-3 below. No measurement gaps are configured. The test consists of two successive time periods, with time duration of T1, and T2 respectively. During time duration T1, the UE shall not have any timing information of cell 2. The start of T2 is the instant when the last TTI containing the RRC message, “*RRCConnectionRelease*”, is received by the UE from cell 1. The “*RRCConnectionRelease*” message shall contain all the relevant system information of cell 2.

Table A.6.3.3.1-1: General test parameters for RRC connection release with redirection from E-UTRAN FDD to GERAN in AWGN

Parameter	Unit	Value	Comment
PDSCH parameters (E-UTRAN FDD)		DL Reference Measurement Channel R.0 FDD	As specified in clause A.3.1.1.1.
PCFICH/PDCCH/PHICH parameters (E-UTRAN FDD)		DL Reference Measurement Channel R.6 FDD	As specified in clause A.3.1.2.1.
Active cell		Cell 1	Cell 1 is on E-UTRA RF channel number 1.
Neighbour cell		Cell 2	Cell 2 is on Absolute RF Channel Number 1 (GSM cell)
CP length		Normal	Applicable to cell 1
E-UTRA RF Channel Number		1	One E-UTRA FDD carrier frequency is used.
E-UTRA Channel Bandwidth (BW_{channel})	MHz	10	
DRX		OFF	
Monitored GSM cell list size		6 GSM neighbour including ARFCN 1	GSM cells are provided in the “ <i>RRCConnectionRelease</i> ” message.
T1	s	5	
T2	s	2	

Table A.6.3.3.1-2: Cell specific test parameters for E-UTRA FDD cell (cell #1) for RRC connection release with redirection from E-UTRAN FDD to GERAN in AWGN

Parameter	Unit	Cell 1	
		T1	T2
E-UTRA RF Channel Number		1	
BW_{channel}	MHz	10	
OCNG Pattern defined in A.3.2.1.1 (OP.1 FDD)		OP.1 FDD	
PBCH_RA	dB	0	
PBCH_RB	dB		
PSS_RA	dB		
SSS_RA	dB		
PCFICH_RB	dB		
PHICH_RA	dB		
PHICH_RB	dB		
PDCCH_RA	dB		
PDCCH_RB	dB		
PDSCH_RA	dB		
PDSCH_RB	dB		
OCNG_RANote 1	dB		
OCNG_RBNote 1	dB		
$\hat{E}_s / I_{\text{ot}}$	dB		
$\hat{E}_s / N_{\text{oc}}$	dB	4	4

N_{oc}	dBm/15 kHz	-98	
RSRP	dBm/15 kHz	-94	-94
SCH_RP	dBm/15 kHz	-94	-94
Propagation Condition		AWGN	
Note 1:	OCNG shall be used such that the cell is fully allocated and a constant total transmitted power spectral density is achieved for all OFDM symbols.		
Note 2:	Interference from other cells and noise sources not specified in the test is assumed to be constant over subcarriers and time and shall be modelled as AWGN of appropriate power for N_{oc} to be fulfilled.		
Note 3:	RSRP levels have been derived from other parameters for information purposes. They are not settable parameters themselves.		

Table A.6.3.3.1-3: Cell specific test parameters for GERAN cell (cell #2) for RRC connection release with redirection from E-UTRAN FDD to GERAN in AWGN

Parameter	Unit	Cell 2	
		T1	T2
Absolute RF Channel Number		ARFNC 1	
RXLEV	dBm	-Infinity	-75
GSM BSIC		N/A	Valid

A.6.3.3.2 Test Requirements

The UE shall begin to send access bursts on RACH of the target GERAN cell (cell #2) less than 1120 ms from the beginning of time period T2.

The rate of correct “RRC connection release with redirection to GERAN” observed during repeated tests shall be at least 90%.

NOTE: The test requirement in this test case is expressed as:

$$T_{\text{connection_release_redirect_GERAN}} = T_{\text{RRC_procedure_delay}} + T_{\text{identify-GERAN}} + T_{\text{SI-GERAN}} + T_{\text{RA}}$$

$T_{\text{RRC_procedure_delay}} = 110$ ms, which is the time for processing the received message “*RRCCConnectionRelease*”.

$T_{\text{identify-GERAN}} = 1000$ ms, which is the time for identifying the target GERAN cell.

$T_{\text{SI-GERAN}} = 0$; UE does not have to read the system information of the GERAN cell since all relevant SI is provided to the UE in the “*RRCCConnectionRelease*” message.

$T_{\text{RA}} = 10$ ms, which is about 2 GSM frames (2×4.65 ms) to account for the GSM timing uncertainty.

A.6.3.4 Redirection from E-UTRAN TDD to GERAN when System Information is provided

A.6.3.4.1 Test Purpose and Environment

The purpose of this test is to verify that the UE performs the RRC connection release with redirection from the E-UTRA TDD to the target GERAN cell within $T_{\text{connection_release_redirect_GERAN}}$. This test will partly verify the RRC connection release with redirection to GERAN requirements in clause 6.3.2.2.

The test parameters are given in Tables A.6.3.4.1-1, A.6.3.4.1-2 and A.6.3.4.1-3 below. No measurement gaps are configured. The test consists of two successive time periods, with time duration of T1, and T2 respectively. During time duration T1, the UE shall not have any timing information of cell 2. The start of T2 is the instant when the last TTI containing the RRC message, “*RRCCConnectionRelease*”, is received by the UE from cell 1. The “*RRCCConnectionRelease*” message shall contain all the relevant system information of cell 2.

Table A.6.3.4.1-1: General test parameters for RRC connection release with redirection from E-UTRAN TDD to GERAN in AWGN

Parameter	Unit	Value	Comment
-----------	------	-------	---------

PDSCH parameters (E-UTRAN TDD)		DL Reference Measurement Channel R.0 TDD	As specified in clause A.3.1.1.2.
PCFICH/PDCCH/PHICH parameters (E-UTRAN TDD)		DL Reference Measurement Channel R.6 TDD	As specified in clause A.3.1.2.2.
Active		Cell 1	Cell 1 is on E-UTRA RF channel number 1.
Neighbour cell		Cell 2	Cell 2 is on Absolute RF Channel Number 1 (GSM cell)
CP length		Normal	Applicable to cell 1
Special subframe configuration		6	As specified in table 4.2.1 in TS 36.211. The same configuration applies to all cells.
Uplink-downlink configuration		1	
E-UTRA RF Channel Number		1	One E-UTRA TDD carrier frequency is used.
E-UTRA Channel Bandwidth (BW _{channel})	MHz	10	
DRX		OFF	
Monitored GSM cell list size		6 GSM neighbour including ARFCN 1	GSM cells provided in the "RRCConnectionRelease" message.
T1	s	5	
T2	s	2	

Table A.6.3.4.1-2: Cell specific test parameters for E-UTRA TDD cell (cell #1) for RRC connection release with redirection from E-UTRAN TDD to GERAN in AWGN

Parameter	Unit	Cell 1	
		T1	T2
E-UTRA RF Channel Number		1	
BW _{channel}	MHz	10	
OCNG Pattern defined in A.3.2.2.1 (OP.1 TDD)		OP.1 TDD	
PBCH_RA	dB	0	
PBCH_RB	dB		
PSS_RA	dB		
SSS_RA	dB		
PCFICH_RB	dB		
PHICH_RA	dB		
PHICH_RB	dB		
PDCCH_RA	dB		
PDCCH_RB	dB		
PDSCH_RA	dB		
PDSCH_RB	dB		
OCNG_RA ^{Note 1}	dB		
OCNG_RB ^{Note 1}	dB		
\hat{E}_s / I_{ot}	dB		
\hat{E}_s / N_{oc}	dB	4	4
N_{oc}	dBm/15 kHz	-98	
RSRP	dBm/15 kHz	-94	-94
SCH_RP	dBm/15 kHz	-94	-94
Propagation Condition		AWGN	
Note 1: OCNG shall be used such that the cell is fully allocated and a constant total transmitted power spectral density is achieved for all OFDM symbols. Note 2: Interference from other cells and noise sources not specified in the test is assumed to be constant over subcarriers and time and shall be modelled as AWGN of appropriate power for N_{oc} to be fulfilled. Note 3: RSRP levels have been derived from other parameters for information purposes. They are not settable parameters themselves.			

Table A.6.3.4.1-3: Cell specific test parameters for GERAN cell (cell #2) for RRC connection release with redirection from E-UTRAN TDD to GERAN in AWGN

Parameter	Unit	Cell 2	
		T1	T2

Absolute RF Channel Number		ARFNC 1	
RXLEV	dBm	-Infinity	-75
GSM BSIC		N/A	Valid

A.6.3.4.2 Test Requirements

The UE shall begin to send access bursts on RACH of the target GERAN cell (cell #2) less than 1120 ms from the beginning of time period T2.

The rate of correct “RRC connection release with redirection to GERAN” observed during repeated tests shall be at least 90%.

NOTE: The test requirement in this test case is expressed as:

$$T_{\text{connection_release_redirect_GERAN}} = T_{\text{RRC_procedure_delay}} + T_{\text{identify_GERAN}} + T_{\text{SI_GERAN}} + T_{\text{RA}}$$

$T_{\text{RRC_procedure_delay}} = 110$ ms, which is the time for processing the received message “*RRCConnectionRelease*”.

$T_{\text{identify_GERAN}} = 1000$ ms, which is the time for identifying the target GERAN cell.

A.6.3.5 E-UTRA TDD RRC connection release redirection to UTRA TDD

A.6.3.5.1 Test Purpose and Environment

The purpose of this test is to verify that the UE performs the RRC connection release with redirection from the E-UTRA TDD to the target UTRA TDD cell within $T_{\text{connection_release_redirect_UTRA TDD}}$. This test will partly verify the RRC connection release with redirection to UTRA TDD requirements in clause 6.3.2.3.

The test parameters are given in table A.6.3.5.1-1, table A.6.3.5.1-2, and table A.6.3.5.1-3. No measurement gaps are configured. The test consists of two successive time periods, with time duration of T1, and T2 respectively. During time duration T1, the UE shall not have any timing information of cell 2. The “*RRCConnectionRelease*” message containing the relevant system information of Cell 2 shall be sent to the UE during period T1 and the start of T2 is the instant when the last TTI containing the RRC message, “*RRCConnectionRelease*”, is received by the UE from cell 1. The “*RRCConnectionRelease*” message shall contain all the relevant system information of Cell 2.

Table A.6.3.5.1-1: General test parameters for E-UTRA TDD RRC connection release redirection to UTRA TDD

Parameter	Unit	Value	Comment
PDSCH parameters (E-UTRAN TDD)		DL Reference Measurement Channel R.0 TDD	As specified in clause A.3.1.1.2.
PCFICH/PDCCH/PHICH parameters (E-UTRAN TDD)		DL Reference Measurement Channel R.6 TDD	As specified in clause A.3.1.2.2.
Active cell		Cell 1	Cell 1 is on E-UTRA RF channel number 1.
Neighbour cell		Cell 2	Cell 2 is on UTRA RF channel number 1.
Time offset between cells	ms	3	Asynchronous cells
E-UTRA RF Channel Number		1	One E-UTRA TDD carrier frequency is used.
E-UTRA Channel Bandwidth (BW_{channel})	MHz	10	
CP length		Normal	Applicable to cell 1
Special subframe configuration of cell 1		6	As specified in table 4.2.1 in TS 36.211
Uplink-downlink configuration of cell 1		1	As specified in table 4.2-2 in TS 36.211
UTRA RF Channel Number		1	One UTRA TDD carrier frequency is used.
UTRA RF Channel Number		1	One UTRA TDD carrier frequency is used.
Filter coefficient		0	L3 filtering is not used.
DRX		OFF	

Monitored UTRA TDD cell list size		16	UTRA cells on UTRA RF channel 1 provided in the "RRCConnectionRelease" message from the E-UTRAN
T1	s	5	
T2	s	1	

Table A.6.3.5.1-2: Cell specific test parameters for cell 1 in E-UTRA TDD RRC connection release redirection to UTRA TDD test

Parameter	Unit	Cell 1	
		T1	T2
E-UTRA RF Channel Number		1	
BW _{channel}	MHz	10	
OCNG Pattern defined in A.3.2.2.1 (OP.1 TDD)		OP.1 TDD	
PBCH_RA	dB	0	
PBCH_RB	dB		
PSS_RA	dB		
SSS_RA	dB		
PCFICH_RB	dB		
PHICH_RA	dB		
PHICH_RB	dB		
PDCCH_RA	dB		
PDCCH_RB	dB		
PDSCH_RA	dB		
PDSCH_RB	dB		
OCNG_RA ^{Note 1}	dB		
OCNG_RB ^{Note 1}	dB		
\hat{E}_s / I_{ot}	dB		
N_{oc} ^{Note 3}	dBm/15 kHz	-98	
\hat{E}_s / N_{oc}	dB	4	4
RSRP ^{Note 4}	dBm/15 kHz	-94	-94
SCH_RP	dBm/15 kHz	-94	-94
Propagation Condition		AWGN	
<p>Note 1: OCNG shall be used such that the cell is fully allocated and a constant total transmitted power spectral density is achieved for all OFDM symbols.</p> <p>Note 2: The resources for uplink transmission are assigned to the UE prior to the start of time period T2.</p> <p>Note 3: Interference from other cells and noise sources not specified in the test is assumed to be constant over subcarriers and time and shall be modelled as AWGN of appropriate power for N_{oc} to be fulfilled.</p> <p>Note 4: RSRP levels have been derived from other parameters for information purposes. They are not settable parameters themselves.</p>			

Table A.6.3.5.1-3: Cell specific test parameters for cell 2 in E-UTRA TDD RRC connection release redirection to UTRA TDD test

Parameter	Unit	Cell 2 (UTRA TDD)			
		0		DwPTS	
Timeslot Number		T1	T2	T1	T2
UTRA RF Channel Number ^{Note1}		Channel 1			
PCCPCH_Ec/I _{or}	dB	-4.77	-4.77		
DwPCH_Ec/I _{or}	dB			0	0
OCNS_Ec/I _{or} ^{Note2}	dB	-1.76	-1.76		
\hat{I}_{or} / I_{oc}	dB	-inf	8	-inf	8
I_{oc}	dBm/1.28 MHz	-80			
PCCPCH RSCP ^{Note3}	dBm	-inf	-76.77	n.a.	n.a.
PCCPCH_Ec/I _o ^{Note3}	dB	-inf	-5.41	n.a.	n.a.
DwPCH_Ec/I _o ^{Note3}	dB	n.a.	n.a.	-inf	-0.64

Propagation Condition		AWGN
Note 1:	In the case of multi-frequency cell, the UTRA RF Channel Number is the primary frequency's channel number.	
Note 2:	The power of the OCNS channel that is added shall make the total power from the cell to be equal to I_{or} .	
Note 3:	P-CCPCH RSRP, PCCPCH_Ec/I _o and DwPCH_Ec/I _o levels have been derived from other parameters for information purposes. They are not settable parameters themselves.	

A.6.3.5.2 Test Requirements

The UE shall start to transmit the SYNCH-UL sequence in the UpPTS to Cell 2 less than 650 ms from the beginning of time period T2.

The rate of correct RRC connection release redirection to UTRA TDD observed during repeated tests shall be at least 90%.

NOTE: The time delay can be expressed as: $T_{RRC_procedure_delay} + T_{identify-UTRA\ TDD} + T_{SI-UTRA\ TDD} + T_{RA}$, where:

$T_{RRC_procedure_delay} = 110$ ms, which is specified in clause 6.3.2.3.

$T_{identify-UTRA\ TDD} = 500$ ms; which is defined in clause 6.3.2.3.

$T_{SI-UTRA\ TDD} = 0$ ms, UE does not have to read the system information of the UTRAN TDD since all relevant SI is provided to the UE in the “*RRCConnectionRelease*” message.

$T_{RA} = 40$ ms. This is the additional delay caused by the random access procedure

It gives a total delay of 650 ms.

A.6.3.6 E-UTRA FDD RRC connection release redirection to UTRA TDD

A.6.3.6.1 Test Purpose and Environment

The purpose of this test is to verify that the UE performs the RRC connection release with redirection from the E-UTRA FDD to the target UTRA TDD cell within $T_{connection_release_redirect_UTRA\ TDD}$. This test will partly verify the RRC connection release with redirection to UTRA TDD requirements in clause 6.3.2.3.

The test parameters are given in table A.6.3.6.1-1, table A.6.3.6.1-2, and table A.6.3.6.1-3. No measurement gaps are configured. The test consists of two successive time periods, with time duration of T1, and T2 respectively. During time duration T1, the UE shall not have any timing information of cell 2. The “*RRCConnectionRelease*” message containing the relevant system information of Cell 2 shall be sent to the UE during period T1 and the start of T2 is the instant when the last TTI containing the RRC message, “*RRCConnectionRelease*”, is received by the UE from cell 1. The “*RRCConnectionRelease*” message shall contain all the relevant system information of Cell 2.

Table A.6.3.6.1-1: General test parameters for E-UTRA FDD RRC connection release redirection to UTRA TDD

Parameter	Unit	Value	Comment
PDSCH parameters (E-UTRAN FDD)		DL Reference Measurement Channel R.0 FDD	As specified in clause A.3.1.1.1.
PCFICH/PDCCH/PHICH parameters (E-UTRAN FDD)		DL Reference Measurement Channel R.6 FDD	As specified in clause A.3.1.2.1.
Active cell		Cell 1	Cell 1 is on E-UTRA RF channel number 1.
Neighbour cell		Cell 2	Cell 2 is on UTRA RF channel number 1.
CP length		Normal	Applicable to cell 1
Time offset between cells	ms	3	Asynchronous cells
E-UTRA RF Channel Number		1	One E-UTRA FDD carrier frequency is used.
E-UTRA Channel Bandwidth (BW _{channel})	MHz	10	
Filter coefficient		0	L3 filtering is not used.

DRX		OFF	
Monitored UTRA TDD cell list size		16	UTRA cells on UTRA RF channel 1 provided in the "RRCConnectionRelease" message from the E-UTRAN
T1	s	5	
T2	s	1	

Table A.6.3.6.1-2: Cell specific test parameters for cell 1 in E-UTRA FDD RRC connection release redirection to UTRA TDD test

Parameter	Unit	Cell 1	
		T1	T2
E-UTRA RF Channel Number		1	
BW _{channel}	MHz	10	
OCNG Patterns defined in A.3.2.1.1 (OP.1 FDD)		OP.1 FDD	
PBCH_RA	dB	0	
PBCH_RB	dB		
PSS_RA	dB		
SSS_RA	dB		
PCFICH_RB	dB		
PHICH_RA	dB		
PHICH_RB	dB		
PDCCH_RA	dB		
PDCCH_RB	dB		
PDSCH_RA	dB		
PDSCH_RB	dB		
OCNG_RA ^{Note 1}	dB		
OCNG_RB ^{Note 1}	dB		
\hat{E}_s/I_{ot}	dB		
N_{oc} ^{Note 3}	dBm/15 kHz	-98	
\hat{E}_s/N_{oc}	dB	4	4
RSRP ^{Note 4}	dBm/15 kHz	-94	-94
SCH_RP	dBm/15 kHz	-94	-94
Propagation Condition		AWGN	
<p>Note 1: OCNG shall be used such that both cells are fully allocated and a constant total transmitted power spectral density is achieved for all OFDM symbols.</p> <p>Note 2: The resources for uplink transmission are assigned to the UE prior to the start of time period T2.</p> <p>Note 3: Interference from other cells and noise sources not specified in the test is assumed to be constant over subcarriers and time and shall be modelled as AWGN of appropriate power for N_{oc} to be fulfilled.</p> <p>Note 4: RSRP levels have been derived from other parameters for information purposes. They are not settable parameters themselves.</p>			

Table A.6.3.6.1-3: Cell specific test parameters for cell 2 in E-UTRA FDD RRC connection release redirection to UTRA TDD test

Parameter	Unit	Cell 2 (UTRA TDD)			
		0		DwPTS	
Timeslot Number		T1	T2	T1	T2
UTRA RF Channel Number ^{Note1}		Channel 1			
PCCPCH_Ec/I _{or}	dB	-4.77	-4.77		
DwPCH_Ec/I _{or}	dB			0	0
OCNS_Ec/I _{or} ^{Note2}	dB	-1.76	-1.76		
\hat{I}_{or}/I_{oc}	dB	-inf	8	-inf	8
I_{oc}	dBm/1.28 MHz	-80			
PCCPCH RSCP ^{Note3}	dBm	-inf	-76.77	n.a.	n.a.
PCCPCH_Ec/I _o ^{Note3}	dB	-inf	-5.41	n.a.	n.a.

DwPCH_Ec/Io ^{Note3}	dB	n.a.	n.a.	-inf	-0.64
Propagation Condition		AWGN			
Note 1:	In the case of multi-frequency cell, the UTRA RF Channel Number is the primary frequency's channel number.				
Note 2:	The power of the OCNS channel that is added shall make the total power from the cell to be equal to I _{or} .				
Note 3:	P-CCPCH RSRP, PCCPCH_Ec/Io and DwPCH_Ec/Io levels have been derived from other parameters for information purposes. They are not settable parameters themselves.				

A.6.3.6.2 Test Requirements

The UE shall start to transmit the SYNCH-UL sequence in the UpPTS to Cell 2 less than 650 ms from the beginning of time period T2.

The rate of correct RRC connection release redirection to UTRA TDD observed during repeated tests shall be at least 90%.

NOTE: The time delay can be expressed as: $T_{\text{RRC_procedure_delay}} + T_{\text{identify-UTRA TDD}} + T_{\text{SI-UTRA TDD}} + T_{\text{RA}}$, where:

$T_{\text{RRC_procedure_delay}} = 110$ ms, which is specified in clause 6.3.2.3.

$T_{\text{identify-UTRA TDD}} = 500$ ms; which is defined in clause 6.3.2.3.

$T_{\text{SI-UTRA TDD}} = 0$ ms, UE does not have to read the system information of the UTRAN TDD since all relevant SI is provided to the UE in the "RRCConnectionRelease" message.

$T_{\text{RA}} = 40$ ms. This is the additional delay caused by the random access procedure.

This gives a total delay of 650 ms.

A.6.3.7 E-UTRA TDD RRC connection release redirection to UTRA TDD without SI provided

A.6.3.7.1 Test Purpose and Environment

The purpose of this test is to verify that the UE performs the RRC connection release with redirection from the E-UTRA TDD to the target UTRA TDD cell within $T_{\text{connection_release_redirect_UTRA TDD}}$. This test will partly verify the RRC connection release with redirection to UTRA TDD requirements in clause 6.3.2.3.

The test parameters are given in table A.6.3.7.1-1, table A.6.3.7.1-2, and table A.6.3.7.1-3. No measurement gaps are configured. The test consists of two successive time periods, with time duration of T1, and T2 respectively. During time duration T1, the UE shall not have any timing information of cell 2. The "RRCConnectionRelease" message not containing the relevant system information of Cell 2 shall be sent to the UE during period T1 and the start of T2 is the instant when the last TTI containing the RRC message, "RRCConnectionRelease", is received by the UE from Cell 1.

Table A.6.3.7.1-1: General test parameters for E-UTRA TDD RRC connection release redirection to UTRA TDD without SI provided

Parameter	Unit	Value	Comment
PDSCH parameters (E-UTRAN TDD)		DL Reference Measurement Channel R.0 TDD	As specified in clause A.3.1.1.2.
PCFICH/PDCCH/PHICH parameters (E-UTRAN TDD)		DL Reference Measurement Channel R.6 TDD	As specified in clause A.3.1.2.2.
Active cell		Cell 1	Cell 1 is on E-UTRA RF channel number 1.
Neighbour cell		Cell 2	Cell 2 is on UTRA RF channel number 1.
Time offset between cells	ms	3	Asynchronous cells
E-UTRA RF Channel Number		1	One E-UTRA TDD carrier frequency is used.
E-UTRA Channel Bandwidth (BW _{channel})	MHz	10	

CP length		Normal	Applicable to cell 1
Uplink-downlink configuration of cell 1		1	As specified in table 4.2.2 in TS 36.211
Special subframe configuration of cell 1		6	As specified in table 4.2.1 in TS 36.211
UTRA RF Channel Number		1	One UTRA TDD carrier frequency is used.
Filter coefficient		0	L3 filtering is not used.
DRX		OFF	
Monitored UTRA TDD cell list size		none	No explicit neighbour list is provided to the UE
T1	s	5	
T2	s	2	

Table A.6.3.7.1-2: Cell specific test parameters for cell 1 in E-UTRA TDD RRC connection release redirection to UTRA TDD test without SI provided

Parameter	Unit	Cell 1	
		T1	T2
E-UTRA RF Channel Number		1	
BW _{channel}	MHz	10	
OCNG Pattern defined in A.3.2.2.1 (OP.1 TDD)		OP.1 TDD	
PBCH_RA	dB	0	
PBCH_RB	dB		
PSS_RA	dB		
SSS_RA	dB		
PCFICH_RB	dB		
PHICH_RA	dB		
PHICH_RB	dB		
PDCCH_RA	dB		
PDCCH_RB	dB		
PDSCH_RA	dB		
PDSCH_RB	dB		
OCNG_RA ^{Note 1}	dB		
OCNG_RB ^{Note 1}	dB		
\hat{E}_s / I_{ot}	dB		
N_{oc} ^{Note 3}	dBm/15 kHz	-98	
\hat{E}_s / N_{oc}	dB	4	4
RSRP ^{Note 4}	dBm/15 kHz	-94	-94
SCH_RP	dBm/15 kHz	-94	-94
Propagation Condition		AWGN	
Note 1: OCNG shall be used such that both cells are fully allocated and a constant total transmitted power spectral density is achieved for all OFDM symbols. Note 2: The resources for uplink transmission are assigned to the UE prior to the start of time period T2. Note 3: Interference from other cells and noise sources not specified in the test is assumed to be constant over subcarriers and time and shall be modelled as AWGN of appropriate power for N_{oc} to be fulfilled. Note 4: RSRP levels have been derived from other parameters for information purposes. They are not settable parameters themselves.			

Table A.6.3.7.1-3: Cell specific test parameters for cell 2 in E-UTRA TDD RRC connection release redirection to UTRA TDD test without SI provided

Parameter	Unit	Cell 2 (UTRA TDD)			
		0		DwPTS	
Timeslot Number		T1	T2	T1	T2
UTRA RF Channel Number ^{Note1}		Channel 1			
PCCPCH_Ec/Ior	dB	-4.77	-4.77		
DwPCH_Ec/Ior	dB			0	0
OCNS_Ec/Ior ^{Note2}	dB	-1.76	-1.76		

\hat{I}_{or}/I_{oc}	dB	-inf	8	-inf	8
I_{oc}	dBm/1.28 MHz	-80			
PCCPCH RSCP ^{Note3}	dBm	-inf	-76.77	n.a.	n.a.
PCCPCH_Ec/Io ^{Note3}	dB	-inf	-5.41	n.a.	n.a.
DwPCH_Ec/Io ^{Note3}	dB	n.a.	n.a.	-inf	-0.64
Propagation Condition		AWGN			
Note 1:	In the case of multi-frequency cell, the UTRA RF Channel Number is the primary frequency's channel number.				
Note 2:	The power of the OCNS channel that is added shall make the total power from the cell to be equal to I_{or} .				
Note 3:	P-CCPCH RSRP, PCCPCH_Ec/Io and DwPCH_Ec/Io levels have been derived from other parameters for information purposes. They are not settable parameters themselves.				

A.6.3.7.2 Test Requirements

The UE shall start to transmit the SYNCH-UL sequence in the UpPTS to Cell 2 less than 1930 ms from the beginning of time period T2.

The rate of correct RRC connection release redirection to UTRA TDD observed during repeated tests shall be at least 90%.

NOTE: The time delay can be expressed as: $T_{RRC_procedure_delay} + T_{identify-UTRA\ TDD} + T_{SI-UTRA\ TDD} + T_{RA}$, where:

$T_{RRC_procedure_delay} = 110$ ms, which is specified in clause 6.3.2.3.

$T_{identify-UTRA\ TDD} = 500$ ms; which is defined in clause 6.3.2.3.

$T_{SI-UTRA\ TDD}$: Maximum repetition period of relevant system info blocks that need to be received by the UE during RRC connection release redirection to UTRA TDD cell. 1280 ms is assumed in this test case.

$T_{RA} = 40$ ms, this is the additional delay caused by the random access procedure.

This gives a total delay of 1930 ms.

A.6.3.8 E-UTRA FDD RRC connection release redirection to UTRA TDD without SI provided

A.6.3.8.1 Test Purpose and Environment

The purpose of this test is to verify that the UE performs the RRC connection release with redirection from the E-UTRA FDD to the target UTRA TDD cell within $T_{connection_release_redirect_UTRA\ TDD}$. This test will partly verify the RRC connection release with redirection to UTRA TDD requirements in clause 6.3.2.3.

The test parameters are given in table A.6.3.8.1-1, table A.6.3.8.1-2, and table A.6.3.8.1-3. No measurement gaps are configured. The test consists of two successive time periods, with time duration of T1, and T2 respectively. During time duration T1, the UE shall not have any timing information of cell 2. The “*RRCConnectionRelease*” message not containing the relevant system information of Cell 2 shall be sent to the UE during period T1 and the start of T2 is the instant when the last TTI containing the RRC message, “*RRCConnectionRelease*”, is received by the UE from Cell 1.

Table A.6.3.8.1-1: General test parameters for E-UTRA FDD RRC connection release redirection to UTRA TDD without SI provided

Parameter	Unit	Value	Comment
PDSCH parameters (E-UTRAN FDD)		DL Reference Measurement Channel R.0 FDD	As specified in clause A.3.1.1.1.
PCFICH/PDCCH/PHICH parameters (E-UTRAN FDD)		DL Reference Measurement Channel R.6 FDD	As specified in clause A.3.1.2.1.
Active cell		Cell 1	Cell 1 is on E-UTRA RF channel number 1.
Neighbour cell		Cell 2	Cell 2 is on UTRA RF channel number 1.

Time offset between cells	ms	3	Asynchronous cells
E-UTRA RF Channel Number		1	One E-UTRA TDD carrier frequency is used.
E-UTRA Channel Bandwidth (BW _{channel})	MHz	10	
CP length		Normal	Applicable to cell 1
UTRA RF Channel Number		1	One UTRA TDD carrier frequency is used.
Filter coefficient		0	L3 filtering is not used.
DRX		OFF	
Monitored UTRA TDD cell list size		none	No explicit neighbour list is provided to the UE
T1	S	5	
T2	S	2	

Table A.6.3.8.1-2: Cell specific test parameters for cell 1 in E-UTRA FDD RRC connection release redirection to UTRA TDD test without SI provided

Parameter	Unit	Cell 1	
		T1	T2
E-UTRA RF Channel Number		1	
BW _{channel}	MHz	10	
OCNG Patterns defined in A.3.2.1.1 (OP.1 FDD)		OP.1 FDD	
PBCH_RA	dB	0	
PBCH_RB	dB		
PSS_RA	dB		
SSS_RA	dB		
PCFICH_RB	dB		
PHICH_RA	dB		
PHICH_RB	dB		
PDCCH_RA	dB		
PDCCH_RB	dB		
PDSCH_RA	dB		
PDSCH_RB	dB		
OCNG_RA ^{Note 1}	dB		
OCNG_RB ^{Note 1}	dB		
\hat{E}_s/I_{ot}	dB		
N_{oc} ^{Note 3}	dBm/15 kHz	-98	
\hat{E}_s/N_{oc}	dB	4	4
RSRP ^{Note 4}	dBm/15 kHz	-94	-94
SCH_RP	dBm/15 kHz	-94	-94
Propagation Condition		AWGN	
Note 1: OCNG shall be used such that both cells are fully allocated and a constant total transmitted power spectral density is achieved for all OFDM symbols. Note 2: The resources for uplink transmission are assigned to the UE prior to the start of time period T2. Note 3: Interference from other cells and noise sources not specified in the test is assumed to be constant over subcarriers and time and shall be modelled as AWGN of appropriate power for N_{oc} to be fulfilled. Note 4: RSRP levels have been derived from other parameters for information purposes. They are not settable parameters themselves.			

Table A.6.3.8.1-3: Cell specific test parameters for cell 2 in E-UTRA FDD RRC connection release redirection to UTRA TDD test without SI provided

Parameter	Unit	Cell 2 (UTRA TDD)			
Timeslot Number		0		DwPTS	
		T1	T2	T1	T2
UTRA RF Channel Number ^{Note1}		Channel 1			
PCCPCH_Ec/Ior	dB	-4.77	-4.77		

DwPCH_Ec/I _{or}	dB			0	0
OCNS_Ec/I _{or} ^{Note2}	dB	-1.76	-1.76		
\hat{I}_{or}/I_{oc}	dB	-inf	8	-inf	8
I_{oc}	dBm/1.28 MHz	-80			
PCCPCH RSCP ^{Note3}	dBm	-inf	-76.77	n.a.	n.a.
PCCPCH_Ec/I _o ^{Note3}	dB	-inf	-5.41	n.a.	n.a.
DwPCH_Ec/I _o ^{Note3}	dB	n.a.	n.a.	-inf	-0.64
Propagation Condition		AWGN			
Note 1:	In the case of multi-frequency cell, the UTRA RF Channel Number is the primary frequency's channel number.				
Note 2:	The power of the OCNS channel that is added shall make the total power from the cell to be equal to I _{or} .				
Note 3:	P-CCPCH RSRP, PCCPCH_Ec/I _o and DwPCH_Ec/I _o levels have been derived from other parameters for information purposes. They are not settable parameters themselves.				

A.6.3.8.2 Test Requirements

The UE shall start to transmit the SYNCH-UL sequence in the UpPTS to Cell 2 less than 1930 ms from the beginning of time period T2.

The rate of correct RRC connection release redirection to UTRA TDD observed during repeated tests shall be at least 90%.

NOTE: The time delay can be expressed as: $T_{RRC_procedure_delay} + T_{identify-UTRA\ TDD} + T_{SI-UTRA\ TDD} + T_{RA}$, where:

$T_{RRC_procedure_delay} = 110$ ms, which is specified in clause 6.3.2.3.

$T_{identify-UTRA\ TDD} = 500$ ms; which is defined in clause 6.3.2.3.

$T_{SI-UTRA\ TDD}$: Maximum repetition period of relevant system info blocks that need to be received by the UE during RRC connection release redirection to UTRA TDD cell. 1280 ms is assumed in this test case.

$T_{RA} = 40$ ms, this is the additional delay caused by the random access procedure.

This gives a total delay of 1930 ms.

A.6.3.9 Redirection from E-UTRAN FDD to UTRAN FDD without System Information

A.6.3.9.1 Test Purpose and Environment

The purpose of this test is to verify that the UE makes correct performing the RRC connection release with redirection to the target UTRAN FDD cell. This test will partly verify the RRC connection release with redirection to UTRAN FDD cell requirements in clause 6.3.2.1.

The test parameters are given in Tables A.6.3.9.1-1, A.6.3.9.1-2 and A.6.3.9.1-3 below. The test consists of two successive time periods, with time duration of T1, and T2 respectively. The “*RRCConnectionRelease*” message not containing any system information of Cell 2 shall be sent to the UE during period T1. The start of T2 is the instant when the last TTI containing the RRC message is sent to the UE. Prior to time duration T2, the UE shall not have any timing information of Cell 2. Cell 2 is powered up at the beginning of the T2.

Table A.6.3.9.1-1: General test parameters for RRC Connection Release with Redirection from E-UTRAN FDD to UTRAN FDD under AWGN propagation conditions

Parameter	Unit	Value	Comment
PDSCH parameters (E-UTRAN FDD)		DL Reference Measurement Channel R.0 FDD	As specified in clause A.3.1.1.1.
PCFICH/PDCCH/PHICH parameters (E-UTRAN FDD)		DL Reference Measurement Channel R.6 FDD	As specified in clause A.3.1.2.1.
Active cell		Cell 1	Cell 1 is on E-UTRA RF channel number 1.
Neighbour cell		Cell 2	Cell 2 is on UTRA RF channel number 1.
CP length		Normal	Applicable to cell 1

E-UTRA RF Channel Number		1	One E-UTRA FDD carrier frequency is used.
E-UTRA Channel Bandwidth ($BW_{channel}$)	MHz	10	
UTRA RF Channel Number		1	One UTRA FDD carrier frequency is used.
Inter-RAT (UTRA FDD) measurement quantity		CPICH Ec/Io	
Filter coefficient		0	L3 filtering is not used.
DRX		OFF	
UTRA FDD cell list size		None	No explicit neighbour list is provided to the UE
T1	s	≤ 5	
T2	s	2	

Table A.6.3.9.1-2: Cell specific test parameters for cell #1 E-UTRAN FDD to UTRAN FDD RRC release with redirection under AWGN propagation conditions

Parameter	Unit	Cell 1	
		T1	T2
E-UTRA RF Channel Number		1	
$BW_{channel}$	MHz	10	
OCNG Pattern defined in A.3.2.1.1 (OP.1 FDD)		OP.1 FDD	
PBCH_RA	dB	0	
PBCH_RB	dB		
PSS_RA	dB		
SSS_RA	dB		
PCFICH_RB	dB		
PHICH_RA	dB		
PHICH_RB	dB		
PDCCH_RA	dB		
PDCCH_RB	dB		
PDSCH_RA	dB		
PDSCH_RB	dB		
OCNG_RA ^{Note 1}	dB		
OCNG_RB ^{Note 1}	dB		
\hat{E}_s/I_{ot}	dB		
N_{oc} ^{Note 3}	dBm/15 kHz	-98	
\hat{E}_s/N_{oc}	dB	4	4
RSRP ^{Note 4}	dBm/15 kHz	-94	-94
SCH_RP	dBm/15 kHz	-94	-94
Propagation Condition		AWGN	
Note 1: OCNG shall be used such that the cell is fully allocated and a constant total transmitted power spectral density is achieved for all OFDM symbols. Note 2: The resources for uplink transmission are assigned to the UE prior to the start of time period T2. Note 3: Interference from other cells and noise sources not specified in the test is assumed to be constant over subcarriers and time and shall be modelled as AWGN of appropriate power for N_{oc} to be fulfilled. Note 4: RSRP levels have been derived from other parameters for information purposes. They are not settable parameters themselves.			

Table A.6.3.9.1-3: Cell specific test parameters for cell #2 E-UTRAN FDD to UTRAN FDD RRC release with redirection under AWGN propagation conditions

Parameter	Unit	Cell 2	
		T1	T1
UTRA RF Channel Number		1	
CPICH_Ec/Ior	dB	-10	
PCCPCH_Ec/Ior	dB	-12	
SCH_Ec/Ior	dB	-12	
PICH_Ec/Ior	dB	-15	

DPCH_Ec/I _{or}	dB	N/A	
OCNS		-0.941	
\hat{I}_{or} / I_{oc}	dB	$-\infty$	0.02
I_{oc}	dBm/3.84 MHz	-70	
CPICH_Ec/I _o ^{Note 3}	dB	$-\infty$	-13
Propagation Condition		AWGN	
Note 1: The DPCH level is controlled by the power control loop.			
Note 2: The power of the OCNS channel that is added shall make the total power from the cell to be equal to I _{or} .			
Note 3: This gives an SCH Ec/I _o of -15dB			

A.6.3.9.2 Test Requirements

The UE shall start to send random access to the target UTRA FDD cell (Cell 2) less than 1930 ms from the beginning of time period T2.

The rate of correct “RRC connection release with redirection to UTRAN” observed during repeated tests shall be at least 90%.

NOTE: The test requirement in this case can be expressed as

$$T_{\text{connection_release_redirect_UTRA FDD}} = T_{\text{RRC_procedure_delay}} + T_{\text{identify-UTRA FDD}} + T_{\text{SI-UTRA FDD}} + T_{\text{RA}}$$

where

$$T_{\text{RRC_procedure_delay}} = 110 \text{ ms}$$

$$T_{\text{identify-UTRA FDD}} = 500 \text{ ms}$$

$T_{\text{SI-UTRA FDD}}$ = the time required for acquiring all the relevant system information of the target UTRA FDD cell. This time depends upon whether the UE is provided with the relevant system information of the target UTRA FDD cell or not by the E-UTRAN before the RRC connection is released. Since no SI is provided, 1280 ms is assumed in this test case.

T_{RA} = The additional delay caused by the random access procedure. 40 ms is assumed in this test case.

This gives a total of 1930 ms.

A.6.3.10 Redirection from E-UTRAN FDD to GERAN when System Information is not provided

A.6.3.10.1 Test Purpose and Environment

The purpose of this test is to verify that the UE performs the RRC connection release with redirection from the E-UTRA FDD to the target GERAN cell within $T_{\text{connection_release_redirect_GERAN}}$. This test will partly verify the RRC connection release with redirection to GERAN requirements in clause 6.3.2.2.

The test parameters are given in Tables A.6.3.10.1-1, A.6.3.10.1-2 and A.6.3.10.1-3 below. No measurement gaps are configured. The test consists of two successive time periods, with time duration of T1, and T2 respectively. During time duration T1, the UE shall not have any timing information of cell 2. The start of T2 is the instant when the last TTI containing the RRC message, “*RRCConnectionRelease*”, is received by the UE from cell 1. The “*RRCConnectionRelease*” message shall not contain any system information of cell 2.

Table A.6.3.10.1-1: General test parameters for RRC connection release with redirection from E-UTRAN FDD to GERAN in AWGN

Parameter	Unit	Value	Comment
PDSCH parameters (E-UTRAN FDD)		DL Reference Measurement Channel R.0 FDD	As specified in clause A.3.1.1.1.
PCFICH/PDCCH/PHICH parameters (E-UTRAN FDD)		DL Reference Measurement Channel R.6 FDD	As specified in clause A.3.1.2.1.
Active cell		Cell 1	Cell 1 is on E-UTRA RF channel number 1.

Neighbour cell		Cell 2	Cell 2 is on Absolute RF Channel Number 1 (GSM cell)
CP length		Normal	Applicable to cell 1
E-UTRA RF Channel Number		1	One E-UTRA FDD carrier frequency is used.
E-UTRA Channel Bandwidth (BW _{channel})	MHz	10	
DRX		OFF	
Monitored GSM cell list size		6 GSM neighbour including ARFCN 1	Only the list of GERAN carrier frequencies is provided in the "RRCConnectionRelease" message.
T1	s	≤5	
T2	s	4	

Table A.6.3.10.1-2: Cell specific test parameters for E-UTRA FDD cell (cell #1) for RRC connection release with redirection from E-UTRAN FDD to GERAN in AWGN

Parameter	Unit	Cell 1	
		T1	T2
E-UTRA RF Channel Number		1	
BW _{channel}	MHz	10	
OCNG Pattern defined in A.3.2.1.1 (OP.1 FDD)		OP.1 FDD	
PBCH_RA	dB	0	
PBCH_RB	dB		
PSS_RA	dB		
SSS_RA	dB		
PCFICH_RB	dB		
PHICH_RA	dB		
PHICH_RB	dB		
PDCCH_RA	dB		
PDCCH_RB	dB		
PDSCH_RA	dB		
PDSCH_RB	dB		
OCNG_RA ^{Note 1}	dB		
OCNG_RB ^{Note 1}	dB		
\hat{E}_s/I_{ot}	dB		
\hat{E}_s/N_{oc}	dB	4	4
N_{oc}	dBm/15 kHz	-98	
RSRP	dBm/15 kHz	-94	-94
SCH_RP	dBm/15 kHz	-94	-94
Propagation Condition		AWGN	
Note 1:	OCNG shall be used such that the cell is fully allocated and a constant total transmitted power spectral density is achieved for all OFDM symbols.		
Note 2:	Interference from other cells and noise sources not specified in the test is assumed to be constant over subcarriers and time and shall be modelled as AWGN of appropriate power for N_{oc} to be fulfilled.		
Note 3:	RSRP levels have been derived from other parameters for information purposes. They are not settable parameters themselves.		

Table A.6.3.10.1-3: Cell specific test parameters for GERAN cell (cell #2) for RRC connection release with redirection from E-UTRAN FDD to GERAN in AWGN

Parameter	Unit	Cell 2	
		T1	T2
Absolute RF Channel Number		ARFNC 1	
RXLEV	dBm	-Infinity	-75
GSM BSIC		N/A	Valid

A.6.3.10.2 Test Requirements

The UE shall begin to send access bursts on RACH of the target GERAN cell (cell #2) less than 3020 ms from the beginning of time period T2.

The rate of correct “RRC connection release with redirection to GERAN” observed during repeated tests shall be at least 90%.

NOTE: The test requirement in this test case is expressed as:

$$T_{\text{connection_release_redirect_GERAN}} = T_{\text{RRC_procedure_delay}} + T_{\text{identify-GERAN}} + T_{\text{SI-GERAN}} + T_{\text{RA}}$$

$T_{\text{RRC_procedure_delay}} = 110$ ms, which is the time for processing the received message “*RRCCONNECTIONRELEASE*”.

$T_{\text{identify-GERAN}} = 1000$ ms, which is the time for identifying the target GERAN cell.

$T_{\text{SI-GERAN}} = 1900$ ms, which is the maximum time allowed to read BCCH data from the target GERAN cell.

$T_{\text{RA}} = 10$ ms, which is about 2 GSM frames (2×4.65 ms) to account for the GSM timing uncertainty.

A.6.3.11 Redirection from E-UTRAN TDD to GERAN when System Information is not provided

A.6.3.11.1 Test Purpose and Environment

The purpose of this test is to verify that the UE performs the RRC connection release with redirection from the E-UTRA TDD to the target GERAN cell within $T_{\text{connection_release_redirect_GERAN}}$. This test will partly verify the RRC connection release with redirection to GERAN requirements in clause 6.3.2.2.

The test parameters are given in Tables A.6.3.11.1-1, A.6.3.11.1-2 and A.6.3.11.1-3 below. No measurement gaps are configured. The test consists of two successive time periods, with time duration of T1, and T2 respectively. During time duration T1, the UE shall not have any timing information of cell 2. The start of T2 is the instant when the last TTI containing the RRC message, “*RRCCONNECTIONRELEASE*”, is received by the UE from cell 1. The “*RRCCONNECTIONRELEASE*” message shall not contain any system information of cell 2.

Table A.6.3.11.1-1: General test parameters for RRC connection release with redirection from E-UTRAN TDD to GERAN in AWGN

Parameter	Unit	Value	Comment
PDSCH parameters (E-UTRAN TDD)		DL Reference Measurement Channel R.0 TDD	As specified in clause A.3.1.1.2.
PCFICH/PDCCH/PHICH parameters (E-UTRAN TDD)		DL Reference Measurement Channel R.6 TDD	As specified in clause A.3.1.2.2.
Active		Cell 1	Cell 1 is on E-UTRA RF channel number 1.
Neighbour cell		Cell 2	Cell 2 is on Absolute RF Channel Number 1 (GSM cell)
CP length		Normal	Applicable to cell 1
Special subframe configuration		6	As specified in table 4.2.1 in TS 36.211. The same configuration applies to all cells.
Uplink-downlink configuration		1	
E-UTRA RF Channel Number		1	One E-UTRA TDD carrier frequency is used.
E-UTRA Channel Bandwidth (BW_{channel})	MHz	10	
DRX		OFF	
Monitored GSM cell list size		6 GSM neighbour including ARFCN 1	Only the list of GERAN carrier frequencies is provided in the “ <i>RRCCONNECTIONRELEASE</i> ” message.
T1	s	≤5	
T2	s	4	

Table A.6.3.11.1-2: Cell specific test parameters for E-UTRA TDD cell (cell #1) for RRC connection release with redirection from E-UTRAN TDD to GERAN in AWGN

Parameter	Unit	Cell 1
-----------	------	--------

		T1	T2
E-UTRA RF Channel Number		1	
BW _{channel}	MHz	10	
OCNG Pattern defined in A.3.2.2.1 (OP.1 TDD)		OP.1 TDD	
PBCH_RA	dB	0	
PBCH_RB	dB		
PSS_RA	dB		
SSS_RA	dB		
PCFICH_RB	dB		
PHICH_RA	dB		
PHICH_RB	dB		
PDCCH_RA	dB		
PDCCH_RB	dB		
PDSCH_RA	dB		
PDSCH_RB	dB		
OCNG_RA ^{Note 1}	dB		
OCNG_RB ^{Note 1}	dB		
\hat{E}_s/I_{ot}	dB	4	4
\hat{E}_s/N_{oc}	dB	4	4
N_{oc}	dBm/15 kHz	-98	
RSRP	dBm/15 kHz	-94	-94
SCH_RP	dBm/15 kHz	-94	-94
Propagation Condition		AWGN	
Note 1: OCNG shall be used such that the cell is fully allocated and a constant total transmitted power spectral density is achieved for all OFDM symbols. Note 2: Interference from other cells and noise sources not specified in the test is assumed to be constant over subcarriers and time and shall be modelled as AWGN of appropriate power for N_{oc} to be fulfilled. Note 3: RSRP levels have been derived from other parameters for information purposes. They are not settable parameters themselves.			

Table A.6.3.11.1-3: Cell specific test parameters for GERAN cell (cell #2) for RRC connection release with redirection from E-UTRAN TDD to GERAN in AWGN

Parameter	Unit	Cell 2	
		T1	T2
Absolute RF Channel Number		ARFNC 1	
RXLEV	dBm	-Infinity	-75
GSM BSIC		N/A	Valid

A.6.3.11.2 Test Requirements

The UE shall begin to send access bursts on RACH of the target GERAN cell (cell #2) less than 3020 ms from the beginning of time period T2.

The rate of correct “RRC connection release with redirection to GERAN” observed during repeated tests shall be at least 90%.

NOTE: The test requirement in this test case is expressed as:

$$T_{\text{connection_release_redirect_GERAN}} = T_{\text{RRC_procedure_delay}} + T_{\text{identify-GERAN}} + T_{\text{SI-GERAN}} + T_{\text{RA}}$$

$T_{\text{RRC_procedure_delay}} = 110$ ms, which is the time for processing the received message “*RRCConnectionRelease*”.

$T_{\text{identify-GERAN}} = 1000$ ms, which is the time for identifying the target GERAN cell.

$T_{\text{SI-GERAN}} = 1900$ ms, which is the maximum time allowed to read BCCH data from the target GERAN cell.

$T_{\text{RA}} = 10$ ms, which is about 2 GSM frames (2×4.65 ms) to account for the GSM timing uncertainty.

A.6.3.12 E-UTRAN TDD RRC connection release redirection to UTRAN FDD without SI provided

A.6.3.12.1 Test Purpose and Environment

The purpose of this test is to verify that the UE performs the RRC connection release with redirection from the E-UTRAN TDD to the target UTRAN FDD cell within $T_{\text{connection_release_redirect_UTRAN FDD}}$. This test will partly verify the RRC connection release with redirection to UTRAN FDD requirements in clause 6.3.2.1.

The test parameters are given in table A.6.3.12.1-1, table A.6.3.12.1-2, and table A.6.3.12.1-3. The test consists of two successive time periods, with time duration of T1, and T2 respectively. During time duration T1, the UE shall not have any timing information of cell 2. The “*RRCConnectionRelease*” message not containing any system information of Cell 2 shall be sent to the UE during period T1. The start of T2 is the instant when the last TTI containing the RRC message, “*RRCConnectionRelease*”, is received by the UE from Cell 1.

Table A.6.3.12.1-1: General test parameters for E-UTRAN TDD RRC connection release redirection to UTRAN FDD without SI provided

Parameter	Unit	Value	Comment
PDSCH parameters (E-UTRAN TDD)		DL Reference Measurement Channel R.0 TDD	As specified in clause A.3.1.1.2.
PCFICH/PDCCH/PHICH parameters (E-UTRAN TDD)		DL Reference Measurement Channel R.6 TDD	As specified in clause A.3.1.2.2.
Active cell		Cell 1	Cell 1 is on E-UTRAN RF channel number 1.
Neighbour cell		Cell 2	Cell 2 is on UTRAN RF channel number 1.
E-UTRAN RF Channel Number		1	One E-UTRAN TDD carrier frequency is used.
E-UTRAN Channel Bandwidth (BW_{channel})	MHz	10	
Uplink-downlink configuration of cell 1		1	As specified in table 4.2.2 in TS 36.211
Special subframe configuration of cell 1		6	As specified in table 4.2.1 in TS 36.211
CP length		Normal	Applicable to cell 1
UTRAN RF Channel Number		1	One UTRAN TDD carrier frequency is used.
Filter coefficient		0	L3 filtering is not used.
DRX		OFF	
Monitored UTRAN FDD cell list size		None	No explicit neighbour list is provided to the UE
T1	s	≤ 5	
T2	s	2	

Table A.6.3.12.1-2: Cell specific test parameters for cell 1 in E-UTRAN TDD RRC connection release redirection to UTRAN FDD test without SI provided

Parameter	Unit	Cell 1	
		T1	T2
E-UTRAN RF Channel Number		1	
BW_{channel}	MHz	10	
OCNG Pattern defined in A.3.2.2.1 (OP.1 TDD)		OP.1 TDD	
PBCH_RA	dB	0	
PBCH_RB	dB		
PSS_RA	dB		
SSS_RA	dB		
PCFICH_RB	dB		
PHICH_RA	dB		
PHICH_RB	dB		

PDCCH_RA	dB		
PDCCH_RB	dB		
PDSCH_RA	dB		
PDSCH_RB	dB		
OCNG_RA ^{Note 1}	dB		
OCNG_RB ^{Note 1}	dB		
\hat{E}_s/I_{ot}	dB	4	4
N_{oc} ^{Note 3}	dBm/15 kHz	-98	
\hat{E}_s/N_{oc}	dB	4	4
RSRP ^{Note 4}	dBm/15 kHz	-94	-94
SCH_RP	dBm/15 kHz	-94	-94
Propagation Condition		AWGN	
<p>Note 1: OCNG shall be used such that the cell is fully allocated and a constant total transmitted power spectral density is achieved for all OFDM symbols.</p> <p>Note 2: The resources for uplink transmission are assigned to the UE prior to the start of time period T2.</p> <p>Note 3: Interference from other cells and noise sources not specified in the test is assumed to be constant over subcarriers and time and shall be modelled as AWGN of appropriate power for N_{oc} to be fulfilled.</p> <p>Note 4: RSRP levels have been derived from other parameters for information purposes. They are not settable parameters themselves.</p>			

Table A.6.3.12.1-3: Cell specific test parameters for cell 2 in E-UTRAN TDD RRC connection release redirection to UTRAN FDD test without SI provided

Parameter	Unit	Cell 2	
		T1	T1
UTRAN RF Channel Number		1	
CPICH_Ec/I _{or}	dB	-10	
PCCPCH_Ec/I _{or}	dB	-12	
SCH_Ec/I _{or}	dB	-12	
PICH_Ec/I _{or}	dB	-15	
DPCH_Ec/I _{or}	dB	N/A	
OCNS		-0.941	
\hat{I}_{or}/I_{oc}	dB	-∞	0.02
I_{oc}	dBm/3.84 MHz	-70	
CPICH_Ec/I _o ^{Note 3}	dB	-∞	-13
Propagation Condition		AWGN	
<p>Note 1: The DPCH level is controlled by the power control loop.</p> <p>Note 2: The power of the OCNS channel that is added shall make the total power from the cell to be equal to I_{or}.</p> <p>Note 3: This gives an SCH Ec/I_o of -15dB</p>			

A.6.3.12.2 Test Requirements

The UE shall start to send random access to the target UTRAN FDD cell (Cell 2) less than 1930 ms from the beginning of time period T2.

The rate of correct RRC connection release redirection to UTRAN FDD observed during repeated tests shall be at least 90%.

NOTE: The time delay can be expressed as: $T_{RRC_procedure_delay} + T_{identify-UTRAN\ FDD} + T_{SI-UTRAN\ FDD} + T_{RA}$, where:

$T_{RRC_procedure_delay} = 110$ ms, which is specified in clause 6.3.2.1.

$T_{identify-UTRAN\ FDD} = 500$ ms; which is defined in clause 6.3.2.1.

$T_{SI-UTRAN\ FDD}$: Maximum repetition period of relevant system info blocks that need to be received by the UE during RRC connection release redirection to UTRAN FDD cell. 1280 ms is assumed in this test case.

$T_{RA} = 40\text{ms}$, this is the additional delay caused by the random access procedure.

This gives a total delay of 1930 ms.

A.7 Timing and Signalling Characteristics

A.7.1 UE Transmit Timing

A.7.1.1 E-UTRAN FDD – UE Transmit Timing Accuracy Tests

A.7.1.1.1 Test Purpose and Environment

The purpose of this test is to verify that the UE is capable of following the frame timing change of the connected eNode B and that the UE initial transmit timing accuracy, maximum amount of timing change in one adjustment, minimum and maximum adjustment rate are within the specified limits. This test will verify the requirements in clause 7.1.2.

For this test a single cell is used. Table A.7.1.1.1-1 defines the strength of the transmitted signals and the propagation condition. The transmit timing is verified by the UE transmitting SRS using the configuration defined in Table A.7.1.1.1-2.

Table A.7.1.1.1-1: Test Parameters for UE Transmit Timing Accuracy Tests for E-UTRAN FDD

Parameter	Unit	Value			
		Test 1	Test 2	Test 3	Test 4
E-UTRA RF Channel Number		1	1	1	1
Channel Bandwidth (BW_{channel})	MHz	10	10	1.4	10
DRX cycle	ms	N/A	80 ^{Note5}	N/A	640 ^{Note5}
PDCCH/PCFICH/PHICH Reference measurement channel ^{Note1}		R.6 FDD	R.6 FDD	R.8 FDD	R.6 FDD
OCNG Pattern ^{Note2}		OP.2 FDD	OP.2 FDD	OP.4 FDD	OP.2 FDD
PBCH_RA	dB	0	0	0	0
PBCH_RB					
PSS_RA					
SSS_RA					
PCFICH_RB					
PHICH_RA					
PHICH_RB					
PDCCH_RA					
PDCCH_RB					
OCNG_RA ^{Note3}					
OCNG_RB ^{Note3}					
N_{oc}	dBm/15 kHz	-98	-98	-98	-98
\hat{E}_s/I_{ot}	dB	3	3	3	3
\hat{E}_s/N_{oc}	dB	3	3	3	3
I_o ^{Note4}	dBm/9 MHz	-65.5	-65.5	N/A	-65.5
	dBm/1.08 MHz	N/A	N/A	-74.7	N/A
Propagation condition	-	AWGN	AWGN	AWGN	AWGN
<p>Note 1: For the reference measurement channels, see clause A.3.1.</p> <p>Note 2: For the OCNG pattern, see clause A.3.2.</p> <p>Note 3: OCNG shall be used such that both cells are fully allocated and a constant total transmitted power spectral density is achieved for all OFDM symbols.</p> <p>Note 4: I_o level has been derived from other parameters for information purpose. It is not a settable parameter.</p> <p>Note 5: DRX related parameters are defined in Table A.7.1.1.1-3.</p>					

Table A.7.1.1.1-2: Sounding Reference Symbol Configuration to be used in UE Transmit Timing Accuracy Tests for E-UTRAN FDD

Field	Value				Comment
	Test 1	Test 2	Test 3	Test 4	
srsBandwidthConfiguration	bw5	bw5	bw7	bw5	
srsSubframeConfiguration	sc1	sc3	sc1	sc3	
ackNackSrsSimultaneousTransmission	FALSE	FALSE	FALSE	FALSE	
srsMaxUpPTS	N/A	N/A	N/A	N/A	Not applicable for FDD
srsBandwidth	0	0	0	0	No hopping
srsHoppingBandwidth	hbw0	hbw0	hbw0	hbw0	
frequencyDomainPosition	0	0	0	0	
duration	TRUE	TRUE	TRUE	TRUE	Indefinite duration
Srs-ConfigurationIndex	0	77	0	317	SRS periodicity of 2ms, 80 ms and 320ms for Test 1, 2 and 4, respectively.
transmissionComb	0	0	0	0	
cyclicShift	cs0	cs0	cs0	cs0	No cyclic shift
SRS-AntennaPort	an1				Number of antenna ports used for SRS transmission

Note: For further information see clause 6.3.2 in TS 36.331.

Table A.7.1.1.1-3: drx-Configuration to be used in UE Transmit Timing Accuracy Test 2 and Test 4 for E-UTRAN FDD

Field	Value		Comment
	Test 2	Test 4	
onDurationTimer	psf1	psf1	
drx-InactivityTimer	psf1	psf1	
drx-RetransmissionTimer	psf1	psf1	
longDRX-CycleStartOffset	sf80	sf640	
shortDRX	disable	disable	

Note: For further information see clause 6.3.2 in TS 36.331.

A.7.1.1.2 Test Requirements

For parameters specified in Tables A.7.1.1.1-1 and A.7.1.1.1-2, the initial transmit timing accuracy, the maximum amount of timing change in one adjustment, the minimum and the maximum adjustment rate shall be within the limits defined in clause 7.1.2.

The following sequence of events shall be used to verify that the requirements are met.

For the 10MHz channel bandwidth, the test sequence shall be carried out in RRC_CONNECTED for both non-DRX (for Test1) and DRX with a cycle length of 80 ms or a cycle length of 640 ms (Tests 2 and 4, respectively):

- After a connection is set up with the cell, the test system shall verify that the UE transmit timing offset is within $N_{TA} \times T_S \pm 12 \times T_S$ with respect to the first detected path (in time) of the corresponding downlink frame of cell 1.
- The test system adjusts the downlink transmit timing for the cell by $+64 \times T_S$ (for Test 1 and Test 2) or $+32 \times T_S$ (for Test 4) compared to that in (a).
- The test system shall verify that for Test 1 the adjustment step size and the adjustment rate shall be according to the requirements in clause 7.1.2 until the UE transmit timing offset is within $N_{TA} \times T_S \pm 12 \times T_S$ with respect to the first detected path (in time) of the corresponding downlink frame of cell 1. Skip this step for Test 2 and Test 4.
- The test system shall verify that the UE transmit timing offset stays within $N_{TA} \times T_S \pm 12 \times T_S$ with respect to the first detected path (in time) of the corresponding downlink frame of cell 1. For test 2 and test 4 the UE transmit

timing offset shall be verified for the first transmission in the DRX cycle immediately after DL timing adjustment.

For the 1.4MHz channel bandwidth, the test sequence shall be carried out in RRC_CONNECTED for non-DRX (Test 3):

- a) After a connection is set up with the cell, the test system shall verify that the UE transmit timing offset is within $N_{TA} \times T_S \pm 24 \times T_S$ with respect to the first detected path (in time) of the corresponding downlink frame of cell 1.
- b) The test system adjusts the downlink transmit timing for the cell by $+128 \times T_S$ (approximately $+4\mu s$) compared to that in (a).
- c) The test system shall verify that the adjustment step size and the adjustment rate shall be according to the requirements in clause 7.1.2 until the UE transmit timing offset is within $N_{TA} \times T_S \pm 24 \times T_S$ with respect to the first detected path (in time) of the corresponding downlink frame of cell 1.
- d) The test system shall verify that the UE transmit timing offset stays within $N_{TA} \times T_S \pm 24 \times T_S$ with respect to the first detected path (in time) of the corresponding downlink frame of cell 1.

A.7.1.2 E-UTRAN TDD - UE Transmit Timing Accuracy Tests

A.7.1.2.1 Test Purpose and Environment

The purpose of this test is to verify that the UE is capable of following the frame timing change of the connected eNode B and that the UE initial transmit timing accuracy, maximum amount of timing change in one adjustment, minimum and maximum adjustment rate are within the specified limits. This test will verify the requirements in clause 7.1.2.

For this test a single cell is used. Table A.7.1.2.1-1 defines the strength of the transmitted signals and the propagation condition. The transmit timing is verified by the UE transmitting SRS using the configuration defined in Table A.7.1.2.1-2.

Table A.7.1.2.1-1: Test Parameters for UE Transmit Timing Accuracy Tests for E-UTRAN TDD

Parameter	Unit	Value				
		Test 1	Test 2	Test 3	Test 4	
E-UTRA RF Channel Number		1	1	1	1	
Channel Bandwidth ($BW_{channel}$)	MHz	10	10	1.4	10	
Special subframe configuration ^{Note1}		6	6	6	6	
Uplink-downlink configuration ^{Note2}		1	1	1	1	
DRX cycle	ms	N/A	80 ^{Note7}	N/A	640 ^{Note7}	
PDCCH/PCFICH/PHICH Reference measurement channel ^{Note3}		R.6 TDD	R.6 TDD	R.8 TDD	R.6 TDD	
OCNG Pattern ^{Note4}		OP.2 TDD	OP.2 TDD	OP.4 TDD	OP.2 TDD	
PBCH_RA	dB	0	0	0	0	
PBCH_RB						
PSS_RA						
SSS_RA						
PCFICH_RB						
PHICH_RA						
PHICH_RB		0	0	0	0	
PDCCH_RA						
PDCCH_RB						
OCNG_RA ^{Note5}						
OCNG_RB ^{Note5}						
N_{oc}		dBm/15 kHz	-98	-98	-98	-98
\hat{E}_s/I_{ot}		dB	3	3	3	3
\hat{E}_s/N_{oc}	dB	3	3	3	3	
I_o ^{Note6}	dBm/9 MHz	-65.5	-65.5	N/A	-65.5	

	dBm/1.08 MHz	N/A	N/A	-74.7	N/A
Propagation condition	-	AWGN	AWGN	AWGN	AWGN
Note 1: For the special subframe configuration see table 4.2-1 in TS 36.211. Note 2: For the uplink-downlink configuration see table 4.2-2 in TS 36.211. Note 3: For the reference measurement channels, see clause A.3.1. Note 4: For the OCNG pattern, see clause A.3.2. Note 5: OCNG shall be used such that both cells are fully allocated and a constant total transmitted power spectral density is achieved for all OFDM symbols. Note 6: lo level has been derived from other parameters for information purpose. It is not a settable parameter. Note 7: DRX related parameters are defined in Table A.7.1.2.1-3.					

Table A.7.1.2.1-2: Sounding Reference Symbol Configuration to be used in UE Transmit Timing Accuracy Tests for E-UTRAN TDD

Field	Value				Comment
	Test 1	Test 2	Test 3	Test 4	
srsBandwidthConfiguration	bw5	bw5	bw7	bw5	
srsSubframeConfiguration	sc3	sc3	sc3	sc3	Once every 5 subframes
ackNackSrsSimultaneousTransmission	FALSE	FALSE	FALSE	FALSE	
srsMaxUpPTS	FALSE	FALSE	FALSE	FALSE	
srsBandwidth	0	0	0	0	No hopping
srsHoppingBandwidth	hbw0	hbw0	hbw0	hbw0	
frequencyDomainPosition	0	0	0	0	
duration	TRUE	TRUE	TRUE	TRUE	Indefinite duration
Srs-ConfigurationIndex	15	85	15	325	SRS periodicity of 10, 80, 10 and 320 ms for Test 1, 2, 3 and 4 respectively.
transmissionComb	0	0	0	0	
cyclicShift	cs0	cs0	cs0	cs0	No cyclic shift
SRS-AntennaPort	an1				Number of antenna ports used for SRS transmission
Note: For further information see clause 6.3.2 in TS 36.331.					

Table A.7.1.2.1-3: DRX Configuration to be used in UE Transmit Timing Accuracy Test 2 and Test 4 for E-UTRAN TDD

Field	Value		Comment
	Test 2	Test 4	
onDurationTimer	psf1	psf1	
drx-InactivityTimer	psf1	psf1	
drx-RetransmissionTimer	psf1	psf1	
longDRX-CycleStartOffset	sf80	Sf640	
shortDRX	disable	disable	
Note: For further information see clause 6.3.2 in TS 36.331.			

A.7.1.2.2 Test Requirements

For parameters specified in Tables A.7.1.2.1-1 and A.7.1.2.1-2, the initial transmit timing accuracy, the maximum amount of timing change in one adjustment, the minimum and the maximum adjustment rate shall be within the limits defined in clause 7.1.2.

The following sequence of events shall be used to verify that the requirements are met.

For the 10MHz channel bandwidth, the test sequence shall be carried out in RRC_CONNECTED for both non-DRX (for Test1) and DRX with a cycle length of 80 ms or a cycle length of 640 ms (Tests 2 and 4, respectively):

- a) After a connection is set up with the cell, the test system shall verify that the UE transmit timing offset is within $(N_{TA} + 624) \times T_S \pm 12 \times T_S$ with respect to the first detected path (in time) of the corresponding downlink frame of cell 1.
- b) The test system adjusts the downlink transmit timing for the cell by $+64 \times T_S$ (for Test 1 and Test 2) or $+32 \times T_S$ (for Test 4) compared to that in (a).
- c) The test system shall verify that for test 1 the adjustment step size and the adjustment rate shall be according to the requirements in clause 7.1.2 until the UE transmit timing offset is within $(N_{TA} + 624) \times T_S \pm 12 \times T_S$ with respect to the first detected path (in time) of the corresponding downlink frame of cell 1. Skip this step for test 2 and test 4.
- d) The test system shall verify that the UE transmit timing offset stays within $(N_{TA} + 624) \times T_S \pm 12 \times T_S$ with respect to the first detected path (in time) of the corresponding downlink frame of cell 1. For test 2 and test 4 the UE transmit timing offset shall be verified for the first transmission in the DRX cycle immediately after DL timing adjustment.

For the 1.4MHz channel bandwidth, the test sequence shall be carried out in RRC_CONNECTED for non-DRX (Test 3):

- a) After a connection is set up with the cell, the test system shall verify that the UE transmit timing offset is within $(N_{TA} + 624) \times T_S \pm 24 \times T_S$ with respect to the first detected path (in time) of the corresponding downlink frame of cell 1.
- b) The test system adjusts the downlink transmit timing for the cell by $+128 \times T_S$ (approximately $+4\mu s$) compared to that in (a).
- c) The test system shall verify that the adjustment step size and the adjustment rate shall be according to the requirements in clause 7.1.2 until the UE transmit timing offset is within $(N_{TA} + 624) \times T_S \pm 24 \times T_S$ with respect to the first detected path (in time) of the corresponding downlink frame of cell 1.
- d) The test system shall verify that the UE transmit timing offset stays within $(N_{TA} + 624) \times T_S \pm 24 \times T_S$ with respect to the first detected path (in time) of the corresponding downlink frame of cell 1.

A.7.1.3 E-UTRAN FDD – UE Transmit Timing Accuracy Tests for SCell

A.7.1.3.1 Test Purpose and Environment

The purpose of this test is to verify that the UE is capable of following the frame timing change of the connected eNode B and that the UE initial transmit timing accuracy, maximum amount of timing change in one adjustment, minimum and maximum adjustment rate are within the specified limits. This test will verify the requirements in clause 7.1.2.

For this test two cells are used. Cell 1 is PCell and Cell 2 is SCell. Both PCell and SCell are in the primary Timing Advance Group (pTAG). Table A.7.1.3.1-1 defines the strength of the transmitted signals and the propagation condition. The transmit timing is verified by the UE transmitting SRS using the configuration defined in Table A.7.1.3.1-2.

Table A.7.1.3.1-1: General test Parameters for UE Transmit Timing Accuracy Tests for E-UTRAN FDD

Parameter	Unit	Cell 1			Cell 2		
		Test 1	Test 2	Test 3	Test 1	Test 2	Test 3
E-UTRA RF Channel Number		1	1	1	2	2	2
Channel Bandwidth ($BW_{channel}$)	MHz	20	20	20	20	20	20
Active PCell		Cell 1	Cell 1	Cell 1			
Active SCell					Cell 2	Cell 2	Cell 2
TAG configuration		pTAG	pTAG	pTAG	pTAG	pTAG	pTAG
DRX cycle	ms	N/A	80 ^{Note5}	640 ^{Note5}	N/A	80 ^{Note5}	640 ^{Note5}
PDCCH/PCFICH/PHICH Reference measurement channel ^{Note1}		R.10 FDD	R.10 FDD	R.10 FDD	R.10 FDD	R.10 FDD	R.10 FDD

OCNG Pattern ^{Note2}		OP.12 FDD	OP.12 FDD	OP.12 FDD	OP.12 FDD	OP.12 FDD	OP.12 FDD
PBCH_RA	dB	0	0	0	0	0	0
PBCH_RB							
PSS_RA							
SSS_RA							
PCFICH_RB							
PHICH_RA							
PHICH_RB							
PDCCH_RA							
PDCCH_RB							
OCNG_RA ^{Note3}							
OCNG_RB ^{Note3}							
N_{oc}	dBm/15 kHz	-98	-98	-98	-98	-98	-98
\hat{E}_s/I_{ot}	dB	3	3	3	3	3	3
\hat{E}_s/N_{oc}	dB	3	3	3	3	3	3
I_0 ^{Note4}	dBm/18 MHz	-62.5	-62.5	-62.5	-62.5	-62.5	-62.5
Propagation condition	-	AWGN	AWGN	AWGN	AWGN	AWGN	AWGN
Note 1: For the reference measurement channels, see clause A.3.1. Note 2: For the OCNG pattern, see clause A.3.2. Note 3: OCNG shall be used such that both cells are fully allocated and a constant total transmitted power spectral density is achieved for all OFDM symbols. Note 4: I_0 level has been derived from other parameters for information purpose. It is not a settable parameter. Note 5: DRX related parameters are defined in Table A.7.1.3.1-3.							

Table A.7.1.3.1-2: Sounding Reference Symbol Configuration to be used in UE Transmit Timing Accuracy Tests for E-UTRAN FDD

Field	Cell 1			Cell 2			Comment
	Test 1	Test 2	Test 3	Test 1	Test 2	Test 3	
srsBandwidthConfiguration	bw5	bw5	bw5	bw5	bw5	bw5	
srsSubframeConfiguration	sc1	sc3	sc3	sc1	sc3	sc3	
ackNackSrsSimultaneousTransmission	FALSE	FALSE	FALSE	FALSE	FALSE	FALSE	
srsMaxUpPTS	N/A	N/A	N/A	N/A	N/A	N/A	Not applicable for FDD
srsBandwidth	0	0	0	0	0	0	No hopping
srsHoppingBandwidth	hbw0	hbw0	hbw0	hbw0	hbw0	hbw0	
frequencyDomainPosition	0	0	0	0	0	0	
duration	TRUE	TRUE	TRUE	TRUE	TRUE	TRUE	Indefinite duration
Srs-ConfigurationIndex	0	77	317	0	77	317	SRS periodicity of 2ms, 80 ms and 320ms for Test 1, 2 and 3, respectively.
transmissionComb	0	0	0	0	0	0	
cyclicShift	cs0	cs0	cs0	cs0	cs0	cs0	No cyclic shift
srsAntennaPort	an1	an1	an1	an1	an1	an1	Number of SRS antenna ports
NOTE: For further information see clause 6.3.2 in TS 36.331.							

Table A.7.1.3.1-3: drx-Configuration to be used in UE Transmit Timing Accuracy Test 2 and Test 3 for E-UTRAN FDD

Field	Test 2		Test 3		Comment
	Cell 1	Cell 2	Cell 1	Cell 2	
onDurationTimer	psf1	psf1	psf1	psf1	
drx-InactivityTimer	psf1	psf1	psf1	psf1	
drx-RetransmissionTimer	psf1	psf1	psf1	psf1	

longDRX-CycleStartOffset	sf80	sf80	Sf640	Sf640	
shortDRX	disable	disable	disable	Disable	
NOTE: For further information see clause 6.3.2 in TS 36.331.					

A.7.1.3.2 Test Requirements

For parameters specified in Tables A.7.1.3.1-1, and A.7.1.3.1-2 the initial transmit timing accuracy, the maximum amount of timing change in one adjustment, the minimum and the maximum adjustment rate shall be within the limits defined in clause 7.1.2.

The following sequence of events shall be used to verify that the requirements are met.

The test sequence shall be carried out in RRC_CONNECTED for both non-DRX (for Test 1) and DRX with a cycle length of 80 ms or a cycle length of 640 mss(Test 2 and 3, respectively):

- After the SCell (Cell 2) is activated, the test system shall verify that the UE transmit timing offsets of both PCell and SCell are within $N_{TA} \times T_S \pm 12 \times T_S$ with respect to the first detected path (in time) of the corresponding downlink frame of PCell (Cell 1).
- The test system adjusts the downlink transmit timing for the PCell (Cell 1) by $+64 \times T_S$ (for Test 1 and Test 2) or $+32 \times T_S$ (for Test 3) compared to that in (a).
- The test system shall verify that for Test 1 the adjustment step size and the adjustment rate shall be according to the requirements in clause 7.1.2 until the UE transmit timing offsets of both PCell and SCell are within $N_{TA} \times T_S \pm 12 \times T_S$ with respect to the first detected path (in time) of the corresponding downlink frame of PCell (Cell 1). Skip this step for Test 2 and Test 3.
- The test system shall verify that the UE transmit timing offsets of both PCell and SCell stay within $N_{TA} \times T_S \pm 12 \times T_S$ with respect to the first detected path (in time) of the corresponding downlink frame of PCell (Cell 1). For test 2 and test 3 the UE transmit timing offset shall be verified for the first transmission in the DRX cycle immediately after DL timing adjustment.

A.7.1.4 E-UTRAN TDD - UE Transmit Timing Accuracy Tests for SCell

A.7.1.4.1 Test Purpose and Environment

The purpose of this test is to verify that the UE is capable of following the frame timing change of the connected eNode B and that the UE initial transmit timing accuracy, maximum amount of timing change in one adjustment, minimum and maximum adjustment rate are within the specified limits. This test will verify the requirements in clause 7.1.2.

For this test two cells are used. Cell 1 is PCell and Cell 2 is SCell. Both PCell and SCell are in the primary Timing Advance Group (pTAG). Table A.7.1.4.1-1 defines the strength of the transmitted signals and the propagation condition. The transmit timing is verified by the UE transmitting SRS using the configuration defined in Table A.7.1.4.1-2.

Table A.7.1.4.1-1: Test Parameters for UE Transmit Timing Accuracy Tests for E-UTRAN TDD

Parameter	Unit	Cell 1			Cell 2		
		Test 1	Test 2	Test 3	Test 1	Test 2	Test 3
E-UTRA RF Channel Number		1	1	1	2	2	2
Channel Bandwidth (BW _{channel})	MHz	20	20	20	20	20	20
E-UTRA RF Channel Number		1	1	1	2	2	2
Active PCell		Cell 1	Cell 1	Cell 1			
Active SCell					Cell 2	Cell 2	Cell 2
TAG configuration		pTAG	pTAG	pTAG	pTAG	pTAG	pTAG
Special subframe configuration ^{Note1}		6	6	6	6	6	6
Uplink-downlink configuration ^{Note2}		1	1	1	1	1	1
DRX cycle	ms	OFF	80 ^{Note7}	640 ^{Note7}	OFF	80 ^{Note7}	640 ^{Note7}
PDCCH/PCFICH/PHICH Reference measurement channel ^{Note3}		R.10 TDD	R.10 TDD	R.10 TDD	R.10 TDD	R.10 TDD	R.10 TDD

OCNG Pattern ^{Note4}		OP.8 TDD	OP.8 TDD	OP.8 TDD	OP.8 TDD	OP.8 TDD	OP.8 TDD
PBCH_RA	dB	0	0	0	0	0	0
PBCH_RB							
PSS_RA							
SSS_RA							
PCFICH_RB							
PHICH_RA		0	0	0	0	0	0
PHICH_RB							
PDCCH_RA							
PDCCH_RB							
OCNG_RA ^{Note5}							
OCNG_RB ^{Note5}							
N_{oc}	dBm/15 kHz	-98	-98	-98	-98	-98	-98
\hat{E}_s/I_{ot}	dB	3	3	3	3	3	3
\hat{E}_s/N_{oc}	dB	3	3	3	3	3	3
I_o ^{Note6}	dBm/18 MHz	-62.5	-62.5	-62.5	-62.5	-62.5	-62.5
Propagation condition	-	AWGN	AWGN	AWGN	AWGN	AWGN	AWGN
<p>Note 1: For the special subframe configuration see table 4.2-1 in TS 36.211. Note 2: For the uplink-downlink configuration see table 4.2-2 in TS 36.211. Note 3: For the reference measurement channels, see clause A.3.1. Note 4: For the OCNG pattern, see clause A.3.2. Note 5: OCNG shall be used such that both cells are fully allocated and a constant total transmitted power spectral density is achieved for all OFDM symbols. Note 6: I_o level has been derived from other parameters for information purpose. It is not a settable parameter. Note 7: DRX related parameters are defined in Table A.7.1.4.1-3.</p>							

Table A.7.1.4.1-2: Sounding Reference Symbol Configuration to be used in UE Transmit Timing Accuracy Tests for E-UTRAN TDD

Field	Cell 1			Cell 2			Comment
	Test 1	Test 2	Test 3	Test 1	Test 2	Test 3	
srsBandwidthConfiguration	bw5	bw5	bw5	bw5	bw5	bw5	
srsSubframeConfiguration	sc3	sc3	sc3	sc3	sc3	sc3	Once every 5 subframes
ackNackSrsSimultaneous Transmission	FALSE	FALSE	FALSE	FALSE	FALSE	FALSE	
srsMaxUpPTS	FALSE	FALSE	FALSE	FALSE	FALSE	FALSE	
srsBandwidth	0	0	0	0	0	0	No hopping
srsHoppingBandwidth	hbw0	hbw0	hbw0	hbw0	hbw0	hbw0	
frequencyDomainPosition	0	0	0	0	0	0	
duration	TRUE	TRUE	TRUE	TRUE	TRUE	TRUE	Indefinite duration
Srs-ConfigurationIndex	15	85	325	15	85	325	SRS periodicity of 10, 80 ms and 320ms for Test 1, 2 and 3, respectively.
transmissionComb	0	0	0	0	0	0	
cyclicShift	cs0	cs0	cs0	cs0	cs0	cs0	No cyclic shift
srsAntennaPort	an1	an1	an1	an1	an1	an1	Number of SRS antenna ports
Note: For further information see clause 6.3.2 in TS 36.331.							

Table A.7.1.4.1-3: DRX Configuration to be used in UE Transmit Timing Accuracy Test 2 and Test 3 for E-UTRAN TDD

Field	Test 2	Test 3	Comment
-------	--------	--------	---------

	Cell 1	Cell 2	Cell 1	Cell 2	
onDurationTimer	psf1	psf1	psf1	psf1	
drx-InactivityTimer	psf1	psf1	psf1	psf1	
drx-RetransmissionTimer	psf1	psf1	psf1	psf1	
longDRX-CycleStartOffset	sf80	sf80	Sf640	Sf640	
shortDRX	disable	disable	disable	disable	
Note:	For further information see clause 6.3.2 in TS 36.331.				

A.7.1.4.2 Test Requirements

For parameters specified in Tables A.7.1.4.1-1 and A.7.1.4.1-2, the initial transmit timing accuracy, the maximum amount of timing change in one adjustment, the minimum and the maximum adjustment rate shall be within the limits defined in clause 7.1.2.

The following sequence of events shall be used to verify that the requirements are met.

The test sequence shall be carried out in RRC_CONNECTED for both non-DRX (for Test 1) and DRX with a cycle length of 80 ms or a cycle length of 640 ms (Test 2 and 3, respectively):

- After the SCell (Cell 2) is activated, the test system shall verify that the UE transmit timing offsets of both PCell and SCell are within $(N_{TA} + 624) \times T_S \pm 12 \times T_S$ with respect to the first detected path (in time) of the corresponding downlink frame of PCell (Cell 1).
- The test system adjusts the downlink transmit timing for the PCell (Cell 1) by $+64 \times T_S$ (for Test 1 and Test 2) or $+32 \times T_S$ (for Test 3) compared to that in (a).
- The test system shall verify that for test 1 the adjustment step size and the adjustment rate shall be according to the requirements in clause 7.1.2 until the UE transmit timing offsets of both PCell and SCell are within $(N_{TA} + 624) \times T_S \pm 12 \times T_S$ with respect to the first detected path (in time) of the corresponding downlink frame of PCell (Cell 1). Skip this step for test 2 and test 3.
- The test system shall verify that the UE transmit timing offsets of both PCell and SCell stay within $(N_{TA} + 624) \times T_S \pm 12 \times T_S$ with respect to the first detected path (in time) of the corresponding downlink frame of PCell (Cell 1). For test 2 and test 3 the UE transmit timing offset shall be verified for the first transmission in the DRX cycle immediately after DL timing adjustment.

A.7.1.4A E-UTRAN TDD - UE Transmit Timing Accuracy Tests for SCell for 20 MHz + 10 MHz

A.7.1.4A.1 Test Purpose and Environment

The purpose of this test case is the same as for the test defined in subclause A.7.1.4.1.

The parameters of this test are the same as defined in Subclause A.7.1.4.1 except that the values of the parameters in the Table A.7.1.4A.1-1 will replace the values of the corresponding parameters in A.7.1.4.1-1. Parameters used for the sounding reference symbol configuration and DRX configuration are unchanged from table A.7.1.4.1-2 and table A.7.1.4.1-3.

Table A.7.1.4A.1-1: Test Parameters for UE Transmit Timing Accuracy Tests for E-UTRAN TDD for 20 MHz +10 MHz

Parameter	Unit	Cell 1			Cell 2		
		Test 1	Test 2	Test 3	Test 1	Test 2	Test 3
Channel Bandwidth (BW _{channel})	MHz	20	20	20	10	10	10
PDCCH/PCFICH/PHICH Reference measurement channel ^{Note3}		R.10 TDD	R.10 TDD	R.10 TDD	R.6 TDD	R.6 TDD	R.6 TDD
OCNG Pattern ^{Note4}		OP.8 TDD	OP.8 TDD	OP.8 TDD	OP.2 TDD	OP.2 TDD	OP.2 TDD
I _o ^{Note6}	dBm/18 MHz	-62.5	-62.5	-62.5	N/A	N/A	N/A
	dBm/9 MHz	N/A	N/A	N/A	-65.5	-65.5	-65.5

A.7.1.4A.2 Test Requirements

The test requirements defined in section A.7.1.4.2 shall apply to this test case.

A.7.1.5 E-UTRAN FDD – UE Transmit Timing Accuracy Tests for 5MHz Bandwidth

A.7.1.5.1 Test Purpose and Environment

The purpose of this test case is the same as for the test defined in subclause A.7.1.1.1.

The parameters of this test are the same as defined in Subclause A.7.1.1.1 except that the values of the parameters in Test 1 in the Table A.7.1.5.1-1 will replace the values of the corresponding parameters in A.7.1.1.1-1. Only Test 1 is defined for the 5MHz bandwidth.

Table A.7.1.5.1-1: Test Parameters for UE Transmit Timing Accuracy Tests for E-UTRAN FDD for 5MHz bandwidth

Parameter	Unit	Value
		Test 1
Channel Bandwidth (BW_{channel})	MHz	5
PDCCH/PCFICH/PHICH Reference measurement channel ^{Note1}		R.11 FDD
OCNG Pattern ^{Note2}		OP.16 FDD
I_0 ^{Note4}	dBm/4.5 MHz	-68.5
Note 1: For the reference measurement channels, see clause A.3.1. Note 2: For the OCNG pattern, see clause A.3.2. Note 3: See Table A.7.1.1.1-1 for the other parameters. Note 4: This test is according to the principle defined in section A.3.7.2.		

A.7.1.5.2 Test Requirements

The test requirements defined in section A.7.1.1.2 shall apply to this test case.

A.7.1.6 E-UTRAN FDD – UE Transmit Timing Accuracy Tests for SCell in sTAG

A.7.1.6.1 Test Purpose and Environment

The purpose of this test is to verify that the UE is capable of following the frame timing change of the connected eNode B and that the UE initial transmit timing accuracy, maximum amount of timing change in one adjustment, minimum and maximum adjustment rate are within the specified limits for SCell in sTAG. This test will verify the requirements in clause 7.1.2.

For this test two cells are used. Cell 1 is PCell and Cell 2 is SCell. PCell is in the Primary Timing Advance Group (pTAG) and SCell is in the secondary Timing Advance Group (sTAG). Table A.7.1.6.1-1 defines the strength of the transmitted signals and the propagation condition. The transmit timing for SCell in sTAG is verified by the UE transmitting SRS using the configuration defined in Table A.7.1.6.1-2.

Table A.7.1.6.1-1: General test Parameters for UE Transmit Timing Accuracy Tests for SCell in sTAG for E-UTRAN FDD

Parameter	Unit	Cell 1		Cell 2	
		Test 1	Test 2	Test 1	Test 2
E-UTRA RF Channel Number		1	1	2	2

Channel Bandwidth ($BW_{channel}$)	MHz	10	10	10	10
Active PCell		Cell 1	Cell 1		
Active SCell				Cell 2	Cell 2
TAG configuration		pTAG	pTAG	sTAG	sTAG
DRX cycle	ms	OFF	80 ^{Note5}	OFF	80 ^{Note5}
PDCCH/PCFICH/PHICH Reference measurement channel ^{Note1}		R.6 FDD	R.6 FDD	R.6 FDD	R.6 FDD
OCNG Pattern ^{Note2}		OP.2 FDD	OP.2 FDD	OP.2 FDD	OP.2 FDD
PBCH_RA	dB	0	0	0	0
PBCH_RB					
PSS_RA					
SSS_RA					
PCFICH_RB					
PHICH_RA					
PHICH_RB					
PDCCH_RA					
PDCCH_RB					
OCNG_RA ^{Note3}					
OCNG_RB ^{Note3}					
N_{oc}	dBm/15 kHz	-98	-98	-98	-98
\hat{E}_s/I_{ot}	dB	3	3	3	3
\hat{E}_s/N_{oc}	dB	3	3	3	3
I_o ^{Note4}	dBm/9 MHz	-65.5	-65.5	-65.5	-65.5
Propagation condition	-	AWGN	AWGN	AWGN	AWGN
<p>Note 1: For the reference measurement channels, see clause A.3.1.</p> <p>Note 2: For the OCNG pattern, see clause A.3.2.</p> <p>Note 3: OCNG shall be used such that both cells are fully allocated and a constant total transmitted power spectral density is achieved for all OFDM symbols.</p> <p>Note 4: I_o level has been derived from other parameters for information purpose. It is not a settable parameter.</p> <p>Note 5: DRX related parameters are defined in Table A.7.1.6.1-3.</p>					

Table A.7.1.6.1-2: Sounding Reference Symbol Configuration to be used in UE Transmit Timing Accuracy Tests for Scell in sTAG for E-UTRAN FDD

Field	Cell 1		Cell 2		Comment
	Test 1	Test 2	Test 1	Test 2	
srsBandwidthConfiguration	bw5	bw5	bw5	bw5	
srsSubframeConfiguration	sc3	sc3	sc3	sc3	Once every 5 subframes
ackNackSrsSimultaneousTransmission	FALSE	FALSE	FALSE	FALSE	
srsMaxUpPTS	FALSE	FALSE	FALSE	FALSE	
srsBandwidth	0	0	0	0	No hopping
srsHoppingBandwidth	hbw0	hbw0	hbw0	hbw0	
frequencyDomainPosition	0	0	0	0	
duration	TRUE	TRUE	TRUE	TRUE	Indefinite duration
Srs-ConfigurationIndex	15	85	15	85	SRS periodicity of 10 and 80 ms for Test 1 and 2, respectively.
transmissionComb	0	0	0	0	
cyclicShift	cs0	cs0	cs0	cs0	No cyclic shift
srsAntennaPort	an1	an1	an1	an1	Number of SRS antenna ports
Note: For further information see clause 6.3.2 in TS 36.331.					

Table A.7.1.6.1-3: drx-Configuration to be used in Test 2 of UE Transmit Timing Accuracy for SCell in sTAG for E-UTRAN FDD

Field	Cell 1	Cell 2	Comment
onDurationTimer	psf1	psf1	
drx-InactivityTimer	psf1	psf1	
drx-RetransmissionTimer	psf1	psf1	
longDRX-CycleStartOffset	sf80	sf80	
shortDRX	disable	disable	
Note:	For further information see clause 6.3.2 in TS 36.331.		

A.7.1.6.2 Test Requirements

For parameters specified in Tables A.7.1.6.1-1, and A.7.1.6.1-2 the initial transmit timing accuracy, the maximum amount of timing change in one adjustment, the minimum and the maximum adjustment rate for SCell in sTAG shall be within the limits defined in clause 7.1.2.

The following sequence of events shall be used to verify that the requirements are met.

For Test1 and Test2, the test sequence shall be carried out in RRC_CONNECTED for both non-DRX and DRX with a cycle length of 80 ms:

- After the SCell (Cell 2) is activated, the test system shall verify that the UE transmit timing offsets for SCell in sTAG are within $N_{TA} \times T_S \pm 12 \times T_S$ with respect to the first detected path (in time) of the corresponding downlink frame of the activated SCell.
- The test system adjusts the downlink transmit timing for the activated SCell (Cell 2) by $+64 \times T_S$ (approximately $+2\mu s$) compared to that in (a).
- The test system shall verify that for Test 1 the adjustment step size and the adjustment rate for SCell in sTAG shall be according to the requirements in clause 7.1.2 until the UE transmit timing offsets of SCell within $N_{TA} \times T_S \pm 12 \times T_S$ with respect to the first detected path (in time) of the corresponding downlink frame of the activated SCell (Cell 2). Skip this step for Test 2.
- The test system shall verify that the UE transmit timing offsets of the SCell in sTAG stay within $N_{TA} \times T_S \pm 12 \times T_S$ with respect to the first detected path (in time) of the corresponding downlink frame of the activated SCell (Cell 2).

A.7.1.7 E-UTRAN TDD - UE Transmit Timing Accuracy Tests for SCell in sTAG

A.7.1.7.1 Test Purpose and Environment

The purpose of this test is to verify that the UE is capable of following the frame timing change of the connected eNode B and that the UE initial transmit timing accuracy, maximum amount of timing change in one adjustment, minimum and maximum adjustment rate are within the specified limits for SCell in sTAG. This test will verify the requirements in clause 7.1.2.

For this test two cells are used. Cell 1 is PCell and Cell 2 is SCell. PCell is in the Primary Timing Advance Group (pTAG) and SCell is in the secondary Timing Advance Group (sTAG). Table A.7.1.7.1-1 defines the strength of the transmitted signals and the propagation condition. The transmit timing for SCell in sTAG is verified by the UE transmitting SRS using the configuration defined in Table A.7.1.7.1-2.

Table A.7.1.7.1-1: Test Parameters for UE Transmit Timing Accuracy Tests for SCell in sTAG for E-UTRAN TDD

Parameter	Unit	Cell 1		Cell 2	
		Test 1	Test 2	Test 1	Test 2
E-UTRA RF Channel Number		1	1	2	2
Channel Bandwidth ($BW_{channel}$)	MHz	10	10	10	10
E-UTRA RF Channel Number		1	1	2	2
Active PCell		Cell 1	Cell 1		
Active SCell				Cell 2	Cell 2

TAG configuration		pTAG	pTAG	sTAG	sTAG
Special subframe configuration ^{Note1}		6	6	6	6
Uplink-downlink configuration ^{Note2}		1	1	1	1
DRX cycle	ms	OFF	80 ^{Note7}	OFF	80 ^{Note7}
PDCCH/PCFICH/PHICH Reference measurement channel ^{Note3}		R.6 TDD	R.6 TDD	R.6 TDD	R.6 TDD
OCNG Pattern ^{Note4}		OP.2 TDD	OP.2 TDD	OP.2 TDD	OP.2 TDD
PBCH_RA	dB	0	0	0	0
PBCH_RB					
PSS_RA					
SSS_RA					
PCFICH_RB					
PHICH_RA		0	0		0
PHICH_RB					
PDCCH_RA					
PDCCH_RB					
OCNG_RA ^{Note5}					
OCNG_RB ^{Note5}					
N_{oc}	dBm/15 kHz	-98	-98	-98	-98
\hat{E}_s/I_{ot}	dB	3	3	3	3
\hat{E}_s/N_{oc}	dB	3	3	3	3
I_o ^{Note6}	dBm/9 MHz	--65.5	--65.5	--65.5	--65.5
Propagation condition	-	AWGN	AWGN	AWGN	AWGN
<p>Note 1: For the special subframe configuration see table 4.2-1 in TS 36.211.</p> <p>Note 2: For the uplink-downlink configuration see table 4.2-2 in TS 36.211.</p> <p>Note 3: For the reference measurement channels, see clause A.3.1.</p> <p>Note 4: For the OCNG pattern, see clause A.3.2.</p> <p>Note 5: OCNG shall be used such that both cells are fully allocated and a constant total transmitted power spectral density is achieved for all OFDM symbols.</p> <p>Note 6: I_o level has been derived from other parameters for information purpose. It is not a settable parameter.</p> <p>Note 7: DRX related parameters are defined in Table A.7.1.7.1-3.</p>					

Table A.7.1.7.1-2: Sounding Reference Symbol Configuration to be used in UE Transmit Timing Accuracy Tests for Scell in sTAG for E-UTRAN TDD

Field	Cell 1		Cell 2		Comment
	Test 1	Test 2	Test 1	Test 2	
srsBandwidthConfiguration	bw5	bw5	bw5	bw5	
srsSubframeConfiguration	sc3	sc3	sc3	sc3	Once every 5 subframes
ackNackSrsSimultaneousTransmission	FALSE	FALSE	FALSE	FALSE	
srsMaxUpPTS	FALSE	FALSE	FALSE	FALSE	
srsBandwidth	0	0	0	0	No hopping
srsHoppingBandwidth	hbw0	hbw0	hbw0	hbw0	
frequencyDomainPosition	0	0	0	0	
duration	TRUE	TRUE	TRUE	TRUE	Indefinite duration
Srs-ConfigurationIndex	15	85	15	85	SRS periodicity of 10 and 80 ms for Test 1 and 2, respectively.
transmissionComb	0	0	0	0	
cyclicShift	cs0	cs0	cs0	cs0	No cyclic shift
srsAntennaPort	an1	an1	an1	an1	Number of SRS antenna ports
Note: For further information see clause 6.3.2 in TS 36.331.					

Table A.7.1.7.1-3: DRX Configuration to be used in Test 2 of UE Transmit Timing Accuracy for SCell in sTAG for E-UTRAN TDD

Field	Cell 1	Cell 2	Comment
onDurationTimer	psf1	psf1	
drx-InactivityTimer	psf1	psf1	
drx-RetransmissionTimer	psf1	psf1	
longDRX-CycleStartOffset	sf80	sf80	
shortDRX	disable	disable	
Note:	For further information see clause 6.3.2 in TS 36.331.		

A.7.1.7.2 Test Requirements

For parameters specified in Tables A.7.1.7.1-1 and A.7.1.7.1-2, the initial transmit timing accuracy, the maximum amount of timing change in one adjustment, the minimum and the maximum adjustment rate for SCell in sTAG shall be within the limits defined in clause 7.1.2.

The following sequence of events shall be used to verify that the requirements are met.

For Test 1 and Test 2, the test sequence shall be carried out in RRC_CONNECTED for both non-DRX and DRX with a cycle length of 80 ms:

- After the SCell (Cell 2) is activated, the test system shall verify that the UE transmit timing offsets for SCell in sTAG are within $(N_{TA} + 624) \times T_S \pm 12 \times T_S$ with respect to the first detected path (in time) of the corresponding downlink frame of the activated SCell (Cell 2).
- The test system adjusts the downlink transmit timing for the activated SCell (Cell 2) by $+64 \times T_S$ (approximately $+2\mu\text{s}$) compared to that in (a).
- The test system shall verify that for test 1 the adjustment step size and the adjustment rate for SCell in sTAG shall be according to the requirements in clause 7.1.2 until the UE transmit timing offsets of SCell are within $(N_{TA} + 624) \times T_S \pm 12 \times T_S$ with respect to the first detected path (in time) of the corresponding downlink frame of the activated SCell (Cell 2). Skip this step for test 2.
- The test system shall verify that the UE transmit timing offsets of the SCell in sTAG stay within $(N_{TA} + 624) \times T_S \pm 12 \times T_S$ with respect to the first detected path (in time) of the corresponding downlink frame of the activated SCell (Cell 2).

A.7.1.7A E-UTRAN TDD - UE Transmit Timing Accuracy Tests for SCell in sTAG for 20MHz +20MHz

A.7.1.7A.1 Test Purpose and Environment

The purpose of this test case is the same as for the test defined in subclause A.7.1.7. The test parameters are the same except those described in the following section. The listed parameter values in Tables A.7.1.7B.1.1-1 will replace the values of corresponding parameters in Tables A.7.1.7.1-1.

Table A.7.1.7A.1-1: Test Parameters for UE Transmit Timing Accuracy Tests for SCell in sTAG for E-UTRAN TDD with 20MHz +20MHz bandwidth

Parameter	Unit	Cell 1		Cell 2	
		Test 1	Test 2	Test 1	Test 2
E-UTRA RF Channel Number		1	1	2	2
Channel Bandwidth (BW_{channel})	MHz	20	20	20	20
PDCCH/PCFICH/PHICH Reference measurement channel defined in A.3.1.2.2		R.10 TDD	R.10 TDD	R.10 TDD	R.10 TDD
OCNG Pattern defined in A.3.2.2		OP.8 TDD	OP.8 TDD	OP.8 TDD	OP.8 TDD
I_0^{Note1}	dBm/18 MHz	-62.5	-62.5	-62.5	-62.5
Note 1: I_0 level has been derived from other parameters for information purpose. It is not a settable parameter.					

A.7.1.7A.2 Test Requirements

The test requirements defined in section A.7.1.7.2 shall apply to these test cases.

A.7.1.7B E-UTRAN TDD - UE Transmit Timing Accuracy Tests for SCell in sTAG for 20MHz +10MHz

A.7.1.7B.1 Test Purpose and Environment

The purpose of this test case is the same as for the test defined in subclause A.7.1.7. The test parameters are the same except those described in the following section. The listed parameter values in Tables A.7.1.7B.1-1 will replace the values of corresponding parameters in Tables A.7.1.7.1-1.

Table A.7.1.7B.1-1: Test Parameters for UE Transmit Timing Accuracy Tests for SCell in sTAG for E-UTRAN TDD with 20MHz +10MHz bandwidth

Parameter	Unit	Cell 1		Cell 2	
		Test 1	Test 2	Test 1	Test 2
E-UTRA RF Channel Number		1	1	2	2
Channel Bandwidth ($BW_{channel}$)	MHz	20	20	10	10
PDCCH/PCFICH/PHICH Reference measurement channel defined in A.3.1.2.2		R.10 TDD	R.10 TDD	R.6 TDD	R.6 TDD
OCNG Pattern defined in A.3.2.2		OP.8 TDD	OP.8 TDD	OP.2 TDD	OP.2 TDD
I_o^{Note1}	dBm/18 MHz	-62.5	-62.5	-	-
	dBm/9 MHz	-	-	-65.5	-65.5

Note 1: I_o level has been derived from other parameters for information purpose. It is not a settable parameter.

A.7.1.7B.2 Test Requirements

The test requirements defined in section A.7.1.7.2 shall apply to these test cases.

A.7.1.8 Void

A.7.1.8.1 Void

Table A.7.1.8.1-1: Void

A.7.1.8.2 Void

A.7.1.9 Void

A.7.1.9.1 Void

Table A.7.1.9.1-1: Void

A.7.1.9.2 Void

A.7.1.10 E-UTRAN FDD – UE Transmit Timing Accuracy Tests for Cat-M1 UE in CEModeA

A.7.1.10.1 Test Purpose and Environment

The purpose of this test is to verify that the Cat-M1 UE in CEModeA is capable of following the frame timing change of the connected eNode B and that the UE initial transmit timing accuracy, maximum amount of timing change in one adjustment, minimum and maximum adjustment rate are within the specified limits. This test will verify the requirements in clause 7.24.2.

For this test a single cell is used. Table A.7.1.10.1-1 defines the strength of the transmitted signals and the propagation condition. The transmit timing is verified by the UE transmitting SRS using the configuration defined in Table A.7.1.10.1-2.

Table A.7.1.10.1-1: Test Parameters for UE Transmit Timing Accuracy Tests for E-UTRAN FDD Cat-M1 UE under CEModeA

Parameter	Unit	Value		
		Test 1	Test 2	Test 3
E-UTRA RF Channel Number		1	1	1
Channel Bandwidth (BW_{channel})	MHz	10	10	10
DRX cycle	ms	N/A	80 ^{Note5}	640 ^{Note5}
PRACH Configuration		PRACH_4CE As specified in A.3.16		
MPDCCH Reference measurement channel ^{Note1}		R.16 FDD	R.16 FDD	R.16 FDD
OCNG Pattern ^{Note2}		OP.21 FDD	OP.21 FDD	OP.21 FDD
PBCH_RA	dB	0	0	0
PBCH_RB				
PSS_RA				
SSS_RA				
PHICH_RA				
PHICH_RB				
MPDCCH_RA				
MPDCCH_RB				
OCNG_RA ^{Note3}				
OCNG_RB ^{Note3}				
N_{oc}	dBm/15 kHz	-98	-98	-98
\hat{E}_s/I_{ot}	dB	3	3	3
\hat{E}_s/N_{oc}	dB	3	3	3
I_o ^{Note4}	dBm/9 MHz	-65.5	-65.5	-65.5
	dBm/1.08 MHz	N/A	N/A	N/A
Propagation condition	-	AWGN	AWGN	AWGN
Note 1: For the reference measurement channels, see clause A.3.1.				
Note 2: For the OCNG pattern, see clause A.3.2.				
Note 3: OCNG shall be used such that both cells are fully allocated and a constant total transmitted power spectral density is achieved for all OFDM symbols.				
Note 4: I_o level has been derived from other parameters for information purpose. It is not a settable parameter.				
Note 5: DRX related parameters are defined in Table A.7.1.10.1-3.				

Table A.7.1.10.1-2: Sounding Reference Symbol Configuration to be used in UE Transmit Timing Accuracy Tests for E-UTRAN FDD Cat-M1 UE under CEModeA

Field	Value			Comment
	Test 1	Test 2	Test 3	
srsBandwidthConfiguration	bw5	bw5	bw5	
srsSubframeConfiguration	sc1	sc3	sc3	
ackNackSrsSimultaneousTransmission	FALSE	FALSE	FALSE	
srsMaxUpPTS	N/A	N/A	N/A	Not applicable for FDD
srsBandwidth	0	0	0	No hopping
srsHoppingBandwidth	hbw0	hbw0	hbw0	
frequencyDomainPosition	0	0	0	
duration	TRUE	TRUE	TRUE	Indefinite duration
Srs-ConfigurationIndex	0	77	317	SRS periodicity of 2ms, 80 ms and 320ms for Test 1, 2 and 4, respectively.
transmissionComb	0	0	0	
cyclicShift	cs0	cs0	cs0	No cyclic shift
SRS-AntennaPort	an1			Number of antenna ports used for SRS transmission
Note 1: For further information see clause 6.3.2 in TS 36.331.				

Table A.7.1.10.1-3: drx-Configuration to be used in UE Transmit Timing Accuracy Test 2 and Test 3 for E-UTRAN FDD Cat-M1 UE under CEModeA

Field	Value		Comment
	Test 2	Test 3	
onDurationTimer	psf1	psf1	
drx-InactivityTimer	psf1	psf1	
drx-RetransmissionTimer	psf1	psf1	
longDRX-CycleStartOffset	sf80	sf640	
shortDRX	disable	disable	
Note 1: For further information see clause 6.3.2 in TS 36.331.			

A.7.1.10.2 Test Requirements

For parameters specified in Tables A.7.1.10.1-1 and A.7.1.10.1-2, the initial transmit timing accuracy, the maximum amount of timing change in one adjustment, the minimum and the maximum adjustment rate shall be within the limits defined in clause 7.24.2.

The following sequence of events shall be used to verify that the requirements are met.

For the 10MHz channel bandwidth, the test sequence shall be carried out in RRC_CONNECTED for both non-DRX (for Test1) and DRX with a cycle length of 80 ms or a cycle length of 640 ms (Tests 2 and 4, respectively):

- After a connection is set up with the cell, the test system shall verify that the UE transmit timing offset is within $N_{TA} \times T_S \pm 24 \times T_S$ with respect to the first detected path (in time) of the corresponding downlink frame of cell 1.
- The test system adjusts the downlink transmit timing for the cell by $+64 \times T_S$ (for Test 1 and Test 2) or $+32 \times T_S$ (for Test 3) compared to that in (a).
- The test system shall verify that for Test 1 the adjustment step size and the adjustment rate shall be according to the requirements in clause 7.24.2 until the UE transmit timing offset is within $N_{TA} \times T_S \pm 24 \times T_S$ with respect to the first detected path (in time) of the corresponding downlink frame of cell 1. Skip this step for Test 2 and Test 3.
- The test system shall verify that the UE transmit timing offset stays within $N_{TA} \times T_S \pm 24 \times T_S$ with respect to the first detected path (in time) of the corresponding downlink frame of cell 1. For test 2 and test 3 the UE transmit timing offset shall be verified for the first transmission in the DRX cycle immediately after DL timing adjustment.

A.7.1.11 E-UTRAN HD-FDD – UE Transmit Timing Accuracy Tests for Cat-M1 UE in CEModeA

A.7.1.11.1 Test Purpose and Environment

The purpose of this test is to verify that the Cat-M1 UE in CEModeA is capable of following the frame timing change of the connected eNode B and that the UE initial transmit timing accuracy, maximum amount of timing change in one adjustment, minimum and maximum adjustment rate are within the specified limits. This test will verify the requirements in clause 7.24.2.

For this test a single cell is used. Table A.7.1.11.1-1 defines the strength of the transmitted signals and the propagation condition. The transmit timing is verified by the UE transmitting SRS using the configuration defined in Table A.7.1.11.1-2.

Table A.7.1.11.1-1: Test Parameters for UE Transmit Timing Accuracy Tests for E-UTRAN HD-FDD Cat-M1 UE under CEModeA

Parameter	Unit	Value		
		Test 1	Test 2	Test 3
E-UTRA RF Channel Number		1	1	1
Channel Bandwidth (BW _{channel})	MHz	10	10	10
DRX cycle	ms	N/A	80 ^{Note5}	640 ^{Note5}
PRACH configuration		PRACH_4CE As specified in A.3.16		

MPDCCH Reference measurement channel ^{Note1}		R.6 HD-FDD	R.6 HD-FDD	R. 6 HD-FDD
OCNG Pattern ^{Note2}		OP.21 FDD	OP.21 FDD	OP.21 FDD
PBCH_RA	dB	0	0	0
PBCH_RB				
PSS_RA				
SSS_RA				
PHICH_RA				
PHICH_RB				
MPDCCH_RA				
MPDCCH_RB				
OCNG_RA ^{Note3}				
OCNG_RB ^{Note3}				
N_{oc}	dBm/15 kHz	-98	-98	-98
\hat{E}_s / I_{ot}	dB	3	3	3
\hat{E}_s / N_{oc}	dB	3	3	3
I_o ^{Note4}	dBm/9 MHz	-65.5	-65.5	-65.5
	dBm/1.08 MHz	N/A	N/A	N/A
Propagation condition	-	AWGN	AWGN	AWGN
<p>Note 1: For the reference measurement channels, see clause A.3.1.</p> <p>Note 2: For the OCNG pattern, see clause A.3.2.</p> <p>Note 3: OCNG shall be used such that both cells are fully allocated and a constant total transmitted power spectral density is achieved for all OFDM symbols.</p> <p>Note 4: I_o level has been derived from other parameters for information purpose. It is not a settable parameter.</p> <p>Note 5: DRX related parameters are defined in Table A.7.1.11.1-3.</p>				

Table A.7.1.11.1-2: Sounding Reference Symbol Configuration to be used in UE Transmit Timing Accuracy Tests for E-UTRAN HD-FDD Cat-M1 UE under CEModeA

Field	Value			Comment
	Test 1	Test 2	Test 3	
srsBandwidthConfiguration	bw5	bw5	bw5	
srsSubframeConfiguration	sc1	sc3	sc3	
ackNackSrsSimultaneousTransmission	FALSE	FALSE	FALSE	
srsMaxUpPTS	N/A	N/A	N/A	Not applicable for FDD
srsBandwidth	0	0	0	No hopping
srsHoppingBandwidth	hbw0	hbw0	hbw0	
frequencyDomainPosition	0	0	0	
duration	TRUE	TRUE	TRUE	Indefinite duration
Srs-ConfigurationIndex	7	77	317	SRS periodicity of 10ms, 80ms and 320ms for Test 1, 2 and 3, respectively.
transmissionComb	0	0	0	
cyclicShift	cs0	cs0	cs0	No cyclic shift
SRS-AntennaPort	an1			Number of antenna ports used for SRS transmission
Note 1: For further information see clause 6.3.2 in TS 36.331.				

Table A.7.1.11.1-3: drx-Configuration to be used in UE Transmit Timing Accuracy Test 2 and Test 3 for E-UTRAN HD-FDD Cat-M1 UE under CEModeA

Field	Value		Comment
	Test 2	Test 3	
onDurationTimer	psf1	psf1	
drx-InactivityTimer	psf1	psf1	
drx-RetransmissionTimer	psf1	psf1	
longDRX-CycleStartOffset	sf80	sf640	
shortDRX	disable	disable	
Note 1: For further information see clause 6.3.2 in TS 36.331.			

A.7.1.11.2 Test Requirements

For parameters specified in Tables A.7.1.11.1-1 and A.7.1.11.1-2, the initial transmit timing accuracy, the maximum amount of timing change in one adjustment, the minimum and the maximum adjustment rate shall be within the limits defined in clause 7.24.2.

The following sequence of events shall be used to verify that the requirements are met.

For the 10MHz channel bandwidth, the test sequence shall be carried out in RRC_CONNECTED for both non-DRX (for Test1) and DRX with a cycle length of 80 ms or a cycle length of 640 ms (Tests 2 and 4, respectively):

- After a connection is set up with the cell, the test system shall verify that the UE transmit timing offset is within $N_{TA} \times T_S \pm 24 \times T_S$ with respect to the first detected path (in time) of the corresponding downlink frame of cell 1.
- The test system adjusts the downlink transmit timing for the cell by $+64 \times T_S$ (for Test 1 and Test 2) or $+32 \times T_S$ (for Test 3) compared to that in (a).
- The test system shall verify that for Test 1 the adjustment step size and the adjustment rate shall be according to the requirements in clause 7.24.2 until the UE transmit timing offset is within $N_{TA} \times T_S \pm 24 \times T_S$ with respect to the first detected path (in time) of the corresponding downlink frame of cell 1. Skip this step for Test 2 and Test 3.
- The test system shall verify that the UE transmit timing offset stays within $N_{TA} \times T_S \pm 24 \times T_S$ with respect to the first detected path (in time) of the corresponding downlink frame of cell 1. For test 2 and test 3 the UE transmit timing offset shall be verified for the first transmission in the DRX cycle immediately after DL timing adjustment.

A.7.1.12 E-UTRAN TDD - UE Transmit Timing Accuracy Tests for Cat-M1 UE in CEModeA

A.7.1.12.1 Test Purpose and Environment

The purpose of this test is to verify that the UE is capable of following the frame timing change of the connected eNode B and that the UE initial transmit timing accuracy, maximum amount of timing change in one adjustment, minimum and maximum adjustment rate are within the specified limits. This test will verify the requirements in clause 7.24.2.

For this test a single cell is used. Table A.7.1.12.1-1 defines the strength of the transmitted signals and the propagation condition. The transmit timing is verified by the UE transmitting SRS using the configuration defined in Table A.7.1.12.1-2.

Table A.7.1.12.1-1: Test Parameters for UE Transmit Timing Accuracy Tests for E-UTRAN TDD Cat-M1 UE under CEModeA

Parameter	Unit	Value		
		Test 1	Test 2	Test 3
E-UTRA RF Channel Number		1	1	1
Channel Bandwidth ($BW_{channel}$)	MHz	10	10	10
Special subframe configuration ^{Note1}		6	6	6
Uplink-downlink configuration ^{Note2}		1	1	1
DRX cycle	ms	N/A	80 ^{Note7}	640 ^{Note7}
PRACH configuration		PRACH_4CE As specified in A.3.16		
MPDCCH Reference measurement channel ^{Note3}		R.14 TDD	R.14 TDD	R.14 TDD
OCNG Pattern ^{Note4}		OP.11 TDD	OP.11 TDD	OP.11 TDD
PBCH_RA	dB	0	0	0
PBCH_RB				
PSS_RA				
SSS_RA				
PHICH_RA		0	0	0
PHICH_RB				
MPDCCH_RA				
MPDCCH_RB				

OCNG_RA ^{Note5}				
OCNG_RB ^{Note5}				
N_{oc}	dBm/15 kHz	-98	-98	-98
\hat{E}_s/I_{ot}	dB	3	3	3
\hat{E}_s/N_{oc}	dB	3	3	3
I_0 ^{Note6}	dBm/9 MHz	-65.5	-65.5	-65.5
	dBm/1.08 MHz	N/A	N/A	N/A
Propagation condition	-	AWGN	AWGN	AWGN
<p>Note 1: For the special subframe configuration see table 4.2-1 in TS 36.211.</p> <p>Note 2: For the uplink-downlink configuration see table 4.2-2 in TS 36.211.</p> <p>Note 3: For the reference measurement channels, see clause A.3.1.</p> <p>Note 4: For the OCNG pattern, see clause A.3.2.</p> <p>Note 5: OCNG shall be used such that both cells are fully allocated and a constant total transmitted power spectral density is achieved for all OFDM symbols.</p> <p>Note 6: I_0 level has been derived from other parameters for information purpose. It is not a settable parameter.</p> <p>Note 7: DRX related parameters are defined in Table A.7.1.12.1-3.</p>				

Table A.7.1.12.1-2: Sounding Reference Symbol Configuration to be used in UE Transmit Timing Accuracy Tests for E-UTRAN TDD Cat-M1 UE under CEModeA

Field	Values			Comment
	Test 1	Test 2	Test 3	
srsBandwidthConfiguration	bw5	bw5	Bw5	
srsSubframeConfiguration	sc3	sc3	sc3	Once every 5 subframes
ackNackSrsSimultaneousTransmission	FALSE	FALSE	FALSE	
srsMaxUpPTS	FALSE	FALSE	FALSE	
srsBandwidth	0	0	0	No hopping
srsHoppingBandwidth	hbw0	hbw0	hbw0	
frequencyDomainPosition	0	0	0	
Duration	TRUE	TRUE	TRUE	Indefinite duration
Srs-ConfigurationIndex	15	85	325	SRS periodicity of 10, 80, 10 and 320 ms for Test 1, 2, 3 and 4 respectively.
transmissionComb	0	0	0	
cyclicShift	cs0	cs0	cs0	No cyclic shift
SRS-AntennaPort	an1			Number of antenna ports used for SRS transmission

Table A.7.1.12.1-3: DRX Configuration to be used in UE Transmit Timing Accuracy Test 2 and Test 3 for E-UTRAN TDD Cat-M1 UE under CEModeA

Field	Value		Comment
	Test 2	Test 3	
onDurationTimer	psf1	psf1	
drx-InactivityTimer	psf1	psf1	
drx-RetransmissionTimer	psf1	psf1	
longDRX-CycleStartOffset	Sf80	Sf640	
shortDRX	disable	disable	
Note: For further information see clause 6.3.2 in TS 36.331.			

A.7.1.12.2 Test Requirements

For parameters specified in Tables A.7.1.12.1-1 and A.7.1.12.1-2, the initial transmit timing accuracy, the maximum amount of timing change in one adjustment, the minimum and the maximum adjustment rate shall be within the limits defined in clause 7.24.2.

The following sequence of events shall be used to verify that the requirements are met.

For the 10MHz channel bandwidth, the test sequence shall be carried out in RRC_CONNECTED for both non-DRX (for Test1) and DRX with a cycle length of 80 ms or a cycle length of 640 ms (Tests 2 and 4, respectively):

- a) After a connection is set up with the cell, the test system shall verify that the UE transmit timing offset is within $(N_{TA} + 624) \times T_S \pm 24 \times T_S$ with respect to the first detected path (in time) of the corresponding downlink frame of cell 1.
- b) The test system adjusts the downlink transmit timing for the cell by $+64 \times T_S$ (for Test 1 and Test 2) or $+32 \times T_S$ (for Test 3) compared to that in (a).
- c) The test system shall verify that for test 1 the adjustment step size and the adjustment rate shall be according to the requirements in clause 7.24.2 until the UE transmit timing offset is within $(N_{TA} + 624) \times T_S \pm 24 \times T_S$ with respect to the first detected path (in time) of the corresponding downlink frame of cell 1. Skip this step for test 2 and test 3.
- d) The test system shall verify that the UE transmit timing offset stays within $(N_{TA} + 624) \times T_S \pm 24 \times T_S$ with respect to the first detected path (in time) of the corresponding downlink frame of cell 1. For test 2 and test 3 the UE transmit timing offset shall be verified for the first transmission in the DRX cycle immediately after DL timing adjustment.

A.7.1.13 3DL/3UL TDD CA UE Transmit Timing Accuracy Tests for 2 SCells

A.7.1.13.1 Test Purpose and Environment

The purpose of this test is to verify that the UE is capable of following the frame timing change of the connected eNode B and that the UE initial transmit timing accuracy, maximum amount of timing change in one adjustment, minimum and maximum adjustment rate are within the specified limits for SCell in sTAG. This test will verify the requirements in clause 7.1.2.

For this test three cells are used. Cell 1 is PCell, Cell 2 is SCell1 and Cell 3 is SCell2. PCell is in the Primary Timing Advance Group (pTAG) and SCell1 and SCell2 are in the secondary Timing Advance Group (sTAG). Table A.7.1.13.1-1 defines the strength of the transmitted signals and the propagation condition. The transmit timing for SCell1 and SCell2 in sTAG is verified by the UE transmitting SRS using the configuration defined in Table A.7.1.13.1-2.

Table A.7.1.13.1-1: Test Parameters for UE Transmit Timing Accuracy Tests for SCell1 and SCell2 in sTAG for 3DL/3UL TDD CAE-UTRAN TDD

Parameter	Unit	Cell 1		Cell 2		Cell 3	
		Test 1	Test 2	Test 1	Test 2	Test 1	Test 2
E-UTRA RF Channel Number		1	1	2	2	3	3
Channel Bandwidth ($BW_{channel}$)	MHz	5, 10, 20	5, 10, 20	5, 10, 20	5, 10, 20	5, 10, 20	5, 10, 20
Active PCell		Cell 1	Cell 1				
Active SCell				Cell 2	Cell 2	Cell 3	Cell 3
TAG configuration		pTAG	pTAG	sTAG	sTAG	sTAG	sTAG
Special subframe configuration ^{Note1}		6	6	6	6	6	6
Uplink-downlink configuration ^{Note2}		1	1	1	1	1	1
DRX cycle	ms	OFF	80 ^{Note7}	OFF	80 ^{Note7}	OFF	80 ^{Note7}
PDCCH/PCFICH/PHICH Reference measurement channel ^{Note3}		R.11 TDD, R.6 TDD, R.10 TDD	R.11 TDD, R.6 TDD, R.10 TDD	R.11 TDD, R.6 TDD, R.10 TDD	R.11 TDD, R.6 TDD, R.10 TDD	R.11 TDD, R.6 TDD, R.10 TDD	R.11 TDD, R.6 TDD, R.10 TDD
OCNG Pattern ^{Note4}		OP.10 TDD, OP.2 TDD, OP.8 TDD	OP.10 TDD, OP.2 TDD, OP.8 TDD	OP.10 TDD, OP.2 TDD, OP.8 TDD	OP.10 TDD, OP.2 TDD, OP.8 TDD	OP.10 TDD, OP.2 TDD, OP.8 TDD	OP.10 TDD, OP.2 TDD, OP.8 TDD
PBCH_RA	dB	0	0	0	0	0	0
PBCH_RB							
PSS_RA							
SSS_RA							
PCFICH_RB							
PHICH_RA							

PHICH_RB							
PDCCH_RA							
PDCCH_RB							
OCNG_RA ^{Note5}							
OCNG_RB ^{Note5}							
N_{oc}	dBm/ 15 kHz	-98	-98	-98	-98	-98	-98
\hat{E}_s/I_{ot}	dB	3	3	3	3	3	3
\hat{E}_s/N_{oc}	dB	3	3	3	3	3	3
I_o ^{Note6}	dBm/ 4.5 MHz	-68.5	-68.5	-68.5	-68.5	-68.5	-68.5
	dBm/ 9 MHz	--65.5	--65.5	--65.5	--65.5	--65.5	--65.5
	dBm/ 18MHz	-62.4	-62.4	-62.4	-62.4	-62.4	-62.4
Timing offset to Cell 1	μ s	-	-	0	0	0	0
Time alignment error relative to cell 1 ^{Note 8}	μ s	-	-	\leq TAE	\leq TAE	\leq TAE	\leq TAE
Propagation condition	-	AWGN	AWGN	AWGN	AWGN	AWGN	AWGN
<p>Note 1: For the special subframe configuration see table 4.2-1 in TS 36.211.</p> <p>Note 2: For the uplink-downlink configuration see table 4.2-2 in TS 36.211.</p> <p>Note 3: For the reference measurement channels, see clause A.3.1.</p> <p>Note 4: For the OCNG pattern, see clause A.3.2.</p> <p>Note 5: OCNG shall be used such that both cells are fully allocated and a constant total transmitted power spectral density is achieved for all OFDM symbols.</p> <p>Note 6: I_o level has been derived from other parameters for information purpose. It is not a settable parameter.</p> <p>Note 7: DRX related parameters are defined in Table A.7.1.x.1-3.</p> <p>Note 8: Time alignment error (TAE) as specified in TS 36.104 [30] clause 6.5.3.1. The TAE value depends upon the type of carrier aggregation.</p>							

Table A.7.1.13.1-2: Sounding Reference Symbol Configuration to be used in UE Transmit Timing Accuracy Tests for SCell1 and SCell2 in sTAG for 3DL/3UL TDD CA

Field	Cell 1		Cell 2		Cell 3		Comment
	Test 1	Test 2	Test 1	Test 2	Test 1	Test 2	
srsBandwidthConfiguration	bw5	bw5	bw5	bw5	bw5	bw5	
srsSubframeConfiguration	sc3	sc3	sc3	sc3	sc3	sc3	Once every 5 subframes
ackNackSrsSimultaneousTransmission	FALSE	FALSE	FALSE	FALSE	FALSE	FALSE	
srsMaxUpPTS	FALSE	FALSE	FALSE	FALSE	FALSE	FALSE	
srsBandwidth	0	0	0	0	0	0	No hopping
srsHoppingBandwidth	hbw0	hbw0	hbw0	hbw0	hbw0	hbw0	
frequencyDomainPosition	0	0	0	0	0	0	
duration	TRUE	TRUE	TRUE	TRUE	TRUE	TRUE	Indefinite duration
Srs-ConfigurationIndex	15	85	15	85	15	85	SRS periodicity of 10 and 80 ms for Test 1 and 2, respectively.
transmissionComb	0	0	0	0	0	0	
cyclicShift	cs0	cs0	cs0	cs0	cs0	cs0	No cyclic shift
srsAntennaPort	an1	an1	an1	an1	an1	an1	Number of SRS antenna ports
Note 1: For further information see clause 6.3.2 in TS 36.331.							

Table A.7.1.13.1-3: DRX Configuration to be used in Test 2 of UE Transmit Timing Accuracy for SCell1 and SCell2 in sTAG for 3DL/3UL TDD CA

Field	Cell 1	Cell 2	Cell 3	Comment
onDurationTimer	psf1	psf1	psf1	
drx-InactivityTimer	psf1	psf1	psf1	

drx-RetransmissionTimer	psf1	psf1	psf1	
longDRX-CycleStartOffset	sf80	sf80	sf80	
shortDRX	disable	disable	Disable	
Note 1: For further information see clause 6.3.2 in TS 36.331.				

A.7.1.13.2 Test Requirements

For parameters specified in Tables A.7.1.13.1-1, 7.1.8.1-2 and A.7.1.13.1-3, the initial transmit timing accuracy, the maximum amount of timing change in one adjustment, the minimum and the maximum adjustment rate for SCell1 and SCell2 in sTAG shall be within the limits defined in clause 7.1.2.

The following sequence of events shall be used to verify that the requirements are met.

For Test 1 and Test 2, the test sequence shall be carried out in RRC_CONNECTED for both non-DRX and DRX with a cycle length of 80 ms:

- After the SCell1 (Cell 2) and SCell2 (Cell3) are activated, the test system shall verify that the UE transmit timing offsets for SCell1 and SCell2 in sTAG are within $(N_{TA} + 624) \times T_{S \pm} \pm 12 \times T_S$ with respect to the first detected path (in time) of the corresponding downlink frame of the activated SCell1 (Cell 2) or SCell2 (Cell3).
- The test system adjusts the downlink transmit timing for the activated SCell1 (Cell 2) and SCell2 (Cell3) by $+64 \times T_S$ (approximately $+2 \mu s$) compared to that in (a).
- The test system shall verify that for test 1 the adjustment step size and the adjustment rate for SCell1 and SCell2 in sTAG shall be according to the requirements in clause 7.1.2 until the UE transmit timing offsets of SCell1 and SCell2 are within $(N_{TA} + 624) \times T_{S \pm} \pm 12 \times T_S$ with respect to the first detected path (in time) of the corresponding downlink frame of the activated SCell1 (Cell 2) or SCell2 (Cell3). Skip this step for test 2.
- The test system shall verify that the UE transmit timing offsets of the SCell1 and SCell2 in sTAG stay within $(N_{TA} + 624) \times T_{S \pm} \pm 12 \times T_S$ with respect to the first detected path (in time) of the corresponding downlink frame of the activated SCell1 (Cell 2) or SCell2 (Cell3).

A.7.1.14 E-UTRAN FDD – UE Transmit Timing Accuracy Tests for Cat-M1 UE in CEModeB

A.7.1.14.1 Test Purpose and Environment

The purpose of this test is to verify that the Cat-M1 UE in CEModeB is capable of following the frame timing change of the connected eNode B and that the UE initial transmit timing accuracy, maximum amount of timing change in one adjustment, minimum and maximum adjustment rate are within the specified limits. This test will verify the requirements in clause 7.24.2.

As specified in Clause 7.24.2 the UE adjusts its uplink timing at the end of of repetition period when configured with repetitions. By measuring the reception of the PUSCH, the transmit timing accuracy can be measured and the requirements can be verified. For this test a single cell is used. Table A.7.1.14.1-1 defines the strength of the transmitted signals and the propagation condition.

Table A.7.1.14.1-1: Test Parameters for UE Transmit Timing Accuracy Tests for E-UTRAN FDD Cat-M1 UE under CEModeB

Parameter	Unit	Value		
		Test 1	Test 2	Test 3
E-UTRA RF Channel Number		1	1	1
Channel Bandwidth ($BW_{channel}$)	MHz	10	10	10
DRX cycle	ms	N/A	80 ^{Note5}	640 ^{Note5}
MPDCCH Reference measurement channel ^{Note1}		R.18 FDD	R.18 FDD	R.18 FDD
OCNG Pattern ^{Note2}		OP.21 FDD	OP.21 FDD	OP.21 FDD
Number of repetitions	MPDCCH	128		
	PUSCH	32		
PBCH_RA	dB	0	0	0
PBCH_RB				
PSS_RA				
SSS_RA				

PHICH_RA				
PHICH_RB				
MPDCCH_RA				
MPDCCH_RB				
OCNG_RA ^{Note3}				
OCNG_RB ^{Note3}				
N_{oc}	dBm/15 kHz	-98	-98	-98
\hat{E}_s/I_{ot}	dB	-12	-12	-12
\hat{E}_s/N_{oc}	dB	-12	-12	-12
I_o ^{Note4}	dBm/9 MHz	-86.4	-86.4	-86.4
	dBm/1.08 MHz	N/A	N/A	N/A
Propagation condition	-	AWGN	AWGN	AWGN
Note 1: For the reference measurement channels, see clause A.3.1.				
Note 2: For the OCNG pattern, see clause A.3.2.				
Note 3: OCNG shall be used such that both cells are fully allocated and a constant total transmitted power spectral density is achieved for all OFDM symbols.				
Note 4: I_o level has been derived from other parameters for information purpose. It is not a settable parameter.				
Note 5: DRX related parameters are defined in Table A.7.1.14.1-2.				

Table A.7.1.14.1-2: drx-Configuration to be used in UE Transmit Timing Accuracy Test 2 and Test 3 for E-UTRAN FDD Cat-M1 UE under CEModeB

Field	Value		Comment
	Test 2	Test 3	
onDurationTimer	psf1	psf1	
drx-InactivityTimer	psf1	psf1	
drx-RetransmissionTimer	psf1	psf1	
longDRX-CycleStartOffset	sf80	sf640	
shortDRX	disable	disable	
Note: For further information see clause 6.3.2 in TS 36.331.			

A.7.1.14.2 Test Requirements

For parameters specified in Tables A.7.1.14.1-1 and A.7.1.14.1-2, the initial transmit timing accuracy, the maximum amount of timing change in one adjustment, the minimum and the maximum adjustment rate shall be within the limits defined in clause 7.24.2. The UE shall not adjust the the transmission timing autonomously during an ongoing repetition period. Adjustments can only be done at the end of a last subframe in a repetition period.

The following sequence of events shall be used to verify that the requirements are met.

For the 10MHz channel bandwidth, the test sequence shall be carried out in RRC_CONNECTED for both non-DRX (for Test1) and DRX with a cycle length of 80 ms or a cycle length of 640 ms (Tests 2 and 3, respectively):

- After a connection is set up with the cell, the test system shall verify that the UE transmit timing offset is within $N_{TA} \times T_S \pm 48 \times T_S$ with respect to the first detected path (in time) of the corresponding downlink frame of cell 1.
- The test system adjusts the downlink transmit timing for the cell by $+64 \times T_S$ (for Test 1 and Test 2) or $+32 \times T_S$ (for Test 3) compared to that in (a).
- The test system shall verify that for Test 1 the adjustment step size and the adjustment rate shall be according to the requirements in clause 7.24.2 until the UE transmit timing offset is within $N_{TA} \times T_S \pm 48 \times T_S$ with respect to the first detected path (in time) of the corresponding downlink frame of cell 1. Skip this step for Test 2 and Test 3.
- The test system shall verify that the UE transmit timing offset stays within $N_{TA} \times T_S \pm 48 \times T_S$ with respect to the first detected path (in time) of the corresponding downlink frame of cell 1. For test 2 and test 3 the UE transmit timing offset shall be verified for the first transmission in the DRX cycle immediately after DL timing adjustment.

A.7.1.15 E-UTRAN HD-FDD – UE Transmit Timing Accuracy Tests for Cat-M1 UE in CEModeB

A.7.1.15.1 Test Purpose and Environment

The purpose of this test is to verify that the Cat-M1 UE in CEModeB is capable of following the frame timing change of the connected eNode B and that the UE initial transmit timing accuracy, maximum amount of timing change in one adjustment, minimum and maximum adjustment rate are within the specified limits. This test will verify the requirements in clause 7.24.2.

As specified in Clause 7.24.2 the UE adjusts its uplink timing at the end of of repetition period when configured with repetitions. By measuring the reception of the PUSCH, the transmit timing accuracy can be measured and the requirements can be verified. For this test a single cell is used. Table A.7.1.15.1-1 defines the strength of the transmitted signals and the propagation condition.

Table A.7.1.15.1-1: Test Parameters for UE Transmit Timing Accuracy Tests for E-UTRAN HD-FDD Cat-M1 UE under CEModeB

Parameter	Unit	Value		
		Test 1	Test 2	Test 3
E-UTRA RF Channel Number		1	1	1
Channel Bandwidth (BW_{channel})	MHz	10	10	10
DRX cycle	ms	N/A	80 ^{Note5}	640 ^{Note5}
MPDCCH Reference measurement channel ^{Note1}		R.6 HD-FDD	R.6 HD-FDD	R. 6 HD-FDD
OCNG Pattern ^{Note2}		OP.21 FDD	OP.21 FDD	OP.21 FDD
Number of repetitions	MPDDCH	128		
	PUSCH	32		
PBCH_RA	dB	0	0	0
PBCH_RB				
PSS_RA				
SSS_RA				
PHICH_RA				
PHICH_RB				
MPDCCH_RA				
MPDCCH_RB				
OCNG_RA ^{Note3}				
OCNG_RB ^{Note3}				
N_{oc}				
\hat{E}_s/I_{ot}	dB	-12	-12	-12
\hat{E}_s/N_{oc}	dB	-12	-12	-12
I_o ^{Note4}	dBm/9 MHz	-86.4	-86.4	-86.4
	dBm/1.08 MHz	N/A	N/A	N/A
Propagation condition	-	AWGN	AWGN	AWGN
Note 1: For the reference measurement channels, see clause A.3.1.				
Note 2: For the OCNG pattern, see clause A.3.2.				
Note 3: OCNG shall be used such that both cells are fully allocated and a constant total transmitted power spectral density is achieved for all OFDM symbols.				
Note 4: I_o level has been derived from other parameters for information purpose. It is not a settable parameter.				
Note 5: DRX related parameters are defined in Table A.7.1.15.1-2.				

Table A.7.1.15.1-2: drx-Configuration to be used in UE Transmit Timing Accuracy Test 2 and Test 3 for E-UTRAN HD-FDD Cat-M1 UE under CEModeB

Field	Value		Comment
	Test 2	Test 3	
onDurationTimer	psf1	psf1	
drx-InactivityTimer	psf1	psf1	
drx-RetransmissionTimer	psf1	psf1	
longDRX-CycleStartOffset	sf80	sf640	

shortDRX	disable	disable	
Note: For further information see clause 6.3.2 in TS 36.331.			

A.7.1.15.2 Test Requirements

For parameters specified in Tables A.7.1.15.1-1 and A.7.1.15.1-2, the initial transmit timing accuracy, the maximum amount of timing change in one adjustment, the minimum and the maximum adjustment rate shall be within the limits defined in clause 7.24.2. The UE shall not adjust the the transmission timing autonomously during an ongoing repetition period. Adjustments can only be done at the end of a last subframe in a repetition period.

The following sequence of events shall be used to verify that the requirements are met.

For the 10MHz channel bandwidth, the test sequence shall be carried out in RRC_CONNECTED for both non-DRX (for Test1) and DRX with a cycle length of 80 ms or a cycle length of 640 ms (Tests 2 and 3, respectively):

- After a connection is set up with the cell, the test system shall verify that the UE transmit timing offset is within $N_{TA} \times T_S \pm 48 \times T_S$ with respect to the first detected path (in time) of the corresponding downlink frame of cell 1.
- The test system adjusts the downlink transmit timing for the cell by $+64 \times T_S$ (for Test 1 and Test 2) or $+32 \times T_S$ (for Test 3) compared to that in (a).
- The test system shall verify that for Test 1 the adjustment step size and the adjustment rate shall be according to the requirements in clause 7.24.2 until the UE transmit timing offset is within $N_{TA} \times T_S \pm 48 \times T_S$ with respect to the first detected path (in time) of the corresponding downlink frame of cell 1. Skip this step for Test 2 and Test 3.
- The test system shall verify that the UE transmit timing offset stays within $N_{TA} \times T_S \pm 48 \times T_S$ with respect to the first detected path (in time) of the corresponding downlink frame of cell 1. For test 2 and test 3 the UE transmit timing offset shall be verified for the first transmission in the DRX cycle immediately after DL timing adjustment.

A.7.1.16 E-UTRAN TDD - UE Transmit Timing Accuracy Tests for Cat-M1 UE in CEModeB

A.7.1.16.1 Test Purpose and Environment

The purpose of this test is to verify that the Cat-M1 UE in CEModeB is capable of following the frame timing change of the connected eNode B and that the UE initial transmit timing accuracy, maximum amount of timing change in one adjustment, minimum and maximum adjustment rate are within the specified limits. This test will verify the requirements in clause 7.24.2.

As specified in Clause 7.24.2 the UE adjusts its uplink timing at the end of of repetition period when configured with repetitions. By measuring the reception of the PUSCH, the transmit timing accuracy can be measured and the requirements can be verified. For this test a single cell is used. Table A.7.1.16.1-1 defines the strength of the transmitted signals and the propagation condition.

Table A.7.1.16.1-1: Test Parameters for UE Transmit Timing Accuracy Tests for E-UTRAN TDD Cat-M1 UE under CEModeB

Parameter	Unit	Value		
		Test 1	Test 2	Test 3
E-UTRA RF Channel Number		1	1	1
Channel Bandwidth (BW _{channel})	MHz	10	10	10
Special subframe configuration ^{Note1}		6	6	6
Uplink-downlink configuration ^{Note2}		1	1	1
DRX cycle	ms	N/A	80 ^{Note7}	640 ^{Note7}
MPDCCH Reference measurement channel ^{Note3}		R.14 TDD	R.14 TDD	R.14 TDD
OCNG Pattern ^{Note4}		OP.11 TDD	OP.11 TDD	OP.11 TDD
PBCH_RA	dB	0	0	0
Number of repetitions	MPDCCH	128		
	PUSCH	32		
PBCH_RB		0	0	0
PSS_RA				

SSS_RA				
PHICH_RA				
PHICH_RB				
MPDCCH_RA				
MPDCCH_RB				
OCNG_RA ^{Note5}				
OCNG_RB ^{Note5}				
N_{oc}	dBm/15 kHz	-98	-98	-98
\hat{E}_s/I_{ot}	dB	-12	-12	-12
\hat{E}_s/N_{oc}	dB	-12	-12	-12
I_o ^{Note6}	dBm/9 MHz	-86.4	-86.4	-86.4
	dBm/1.08 MHz	N/A	N/A	N/A
Propagation condition	-	AWGN	AWGN	AWGN
Note 1: For the special subframe configuration see table 4.2-1 in TS 36.211.				
Note 2: For the uplink-downlink configuration see table 4.2-2 in TS 36.211.				
Note 3: For the reference measurement channels, see clause A.3.1.				
Note 4: For the OCNG pattern, see clause A.3.2.				
Note 5: OCNG shall be used such that both cells are fully allocated and a constant total transmitted power spectral density is achieved for all OFDM symbols.				
Note 6: I_o level has been derived from other parameters for information purpose. It is not a settable parameter.				
Note 7: DRX related parameters are defined in Table A.7.1.16.1-2.				

Table A.7.1.16.1-2: DRX Configuration to be used in UE Transmit Timing Accuracy Test 2 and Test 3 for E-UTRAN TDD Cat-M1 UE under CEModeB

Field	Value		Comment
	Test 2	Test 3	
onDurationTimer	psf1	psf1	
drx-InactivityTimer	psf1	psf1	
drx-RetransmissionTimer	psf1	psf1	
longDRX-CycleStartOffset	sf80	Sf640	
shortDRX	disable	disable	
Note: For further information see clause 6.3.2 in TS 36.331.			

A.7.1.16.2 Test Requirements

For parameters specified in Tables A.7.1.16.1-1 and A.7.1.16.1-2, the initial transmit timing accuracy, the maximum amount of timing change in one adjustment, the minimum and the maximum adjustment rate shall be within the limits defined in clause 7.24.2. The UE shall not adjust the the transmission timing autonomously during an ongoing repetition period. Adjustments can only be done at the end of a last subframe in a repetition period.

The following sequence of events shall be used to verify that the requirements are met.

For the 10MHz channel bandwidth, the test sequence shall be carried out in RRC_CONNECTED for both non-DRX (for Test1) and DRX with a cycle length of 80 ms or a cycle length of 640 ms (Tests 2 and 3, respectively):

- After a connection is set up with the cell, the test system shall verify that the UE transmit timing offset is within $N_{TA} \times T_S \pm 48 \times T_S$ with respect to the first detected path (in time) of the corresponding downlink frame of cell 1.
- The test system adjusts the downlink transmit timing for the cell by $+64 \times T_S$ (for Test 1 and Test 2) or $+32 \times T_S$ (for Test 3) compared to that in (a).
- The test system shall verify that for Test 1 the adjustment step size and the adjustment rate shall be according to the requirements in clause 7.24.2 until the UE transmit timing offset is within $N_{TA} \times T_S \pm 48 \times T_S$ with respect to the first detected path (in time) of the corresponding downlink frame of cell 1. Skip this step for Test 2 and Test 3.
- The test system shall verify that the UE transmit timing offset stays within $N_{TA} \times T_S \pm 48 \times T_S$ with respect to the first detected path (in time) of the corresponding downlink frame of cell 1. For test 2 and test 3 the UE transmit

timing offset shall be verified for the first transmission in the DRX cycle immediately after DL timing adjustment.

A.7.1.17 E-UTRAN HD-FDD – UE Transmit Timing Accuracy Tests for Category NB1 UE In-Band mode under normal coverage

A.7.1.17.1 Test Purpose and Environment

The purpose of this test is to verify that the Category NB1 UE under normal coverage is capable of following the frame timing change of the connected eNode B and that the UE initial transmit timing accuracy, maximum amount of timing change in one adjustment, minimum and maximum adjustment rate are within the specified limits. This test will verify the requirements in clause 7.20.

For this test a single NB-IoT cell and a single LTE cell are used. Test parameters are given in Table A.7.1.17.1-1, Table A.7.1.17.1-2, and Table A.7.1.17.1-3. The transmit timing is verified by the UE transmitting NPUSCH.

Table A.7.1.17.1-1: General Test Parameters for UE Transmit Timing Accuracy Tests for E-UTRAN HD-FDD Category NB1 UE in In-Band mode under normal coverage

Parameter	Unit	Value
		Test 1
NB-IoT Operation mode		In-band
DRX		OFF
NPRACH configuration		NPRACH.R-1 As specified in A.3.18
NPDCCH repetition level		1
npdcch-StartSF-USS ^{Note 1}		v8
npdcch-NumRepetitions-r13 ^{Note 1}		r1
NPUSCH repetition level		1
Note 1: For further information see clause 6.7.3.2 in TS 36.331 [2].		

Table A.7.1.17.1-2: nCell specific Test Parameters for UE Transmit Timing Accuracy Tests for E-UTRAN HD-FDD Category NB1 UE in In-Band mode under normal coverage

Parameter	Unit	Value
		Test 1
RF Channel Number		1
BW _{channel}	kHz	200
PRB location within eCell		eCell BW _{channel} 5MHz: 17 eCell BW _{channel} 10MHz:30
NPDSCH parameter		eCell BW _{channel} 5MHz: R.17 HD-FDD eCell BW _{channel} 10MHz: R.15 HD-FDD
NPDCCH parameter		eCell BW _{channel} 5MHz: R.41 HD-FDD eCell BW _{channel} 10MHz: R.29 HD-FDD
NPBCH_RA	dB	-3
NPBCH_RB		
NPSS_RA		
NSSS_RA		
NPDCCH_RA		
NPDCCH_RB		
NPDSCH_RA		
NPDSCH_RB		
NOCNG_RA ^{Note1}		
NOCNG_RB ^{Note1}		
N_{oc}	dBm/15 kHz	Specified in Table A.7.1.17.1-3
\hat{E}_s/I_{ot}	dB	4

\hat{E}_s/N_{oc}	dB	4
Antenna Configuration		2x1
Propagation condition	-	AWGN
Note 1: NOCNG shall be used such that the cell is fully allocated and a constant total transmitted power spectral density is achieved for all OFDM symbols.		

Table A.7.1.17.1-3: eCell specific Test Parameters for UE Transmit Timing Accuracy Tests for E-UTRAN HD-FDD Category NB1 UE in In-Band mode under normal coverage

Parameter	Unit	Value
		Test 1
E-UTRA RF Channel Number		1
$BW_{channel}$	MHz	5 or 10
NOCNG Pattern	-	$BW_{channel}$ 5MHz: NOP.4 FDD $BW_{channel}$ 10MHz: NOP.1 FDD
PBCH_RA	dB	-3
PBCH_RB		
PSS_RA		
SSS_RA		
PCFICH_RB		
PHICH_RA		
PHICH_RB		
PDCCH_RA		
PDCCH_RB		
OCNG_RA ^{Note1}		
OCNG_RB ^{Note1}		
N_{oc}	dBm/15 kHz	-98
\hat{E}_s/N_{oc}	dB	4
Antenna configuration		2x1
Propagation condition	-	AWGN
Note 1: OCNG shall be used such that the cell is fully allocated and a constant total transmitted power spectral density is achieved for all OFDM symbols.		

A.7.1.17.2 Test Requirements

For parameters specified in Tables A.7.1.17.1-1, A.7.1.17.1-2, and A.7.1.17.1-3, the initial transmit timing accuracy, the maximum amount of timing change in one adjustment, the minimum and the maximum adjustment rate shall be within the limits defined in clause 7.20.2.

The following sequence of events shall be used to verify that the requirements are met.

The test sequence shall be carried out in RRC_CONNECTED:

- a) After a connection is set up with the cell, the test system sends NPDCCH including uplink grant for NPUSCH transmission and the test system shall measure the UE transmit timing offset ($n \times T_s$) and verify that it is within T_e ($n \times T_s \leq N_{TA} \times T_s \pm 80 \times T_s$) with respect to the first detected path (in time) of the corresponding downlink frame of NB-IoT cell 1.
- b) Using the value of n measured in a), the test system adjusts the downlink transmit timing for the cell:
 - if $n < 0$, by $+(144 - |n|) \times T_s$ compared to that in (a).
 - if $n \geq 0$, by $-(144 - |n|) \times T_s$ compared to that in (a).

The timing adjustment is performed monotonically in multiple steps of $|\Delta T| \leq 9 \times T_s$ per 256 ms (ΔT is to be defined in the test procedure) until the above required total timing change is achieved, during which no grant is transmitted for the UE.

- c) Immediately after (b), the test system sends NPDCCH including uplink grant for NPUSCH transmission and immediately after receiving NPUSCH the test system repeatedly sends NPDCCH including uplink grant for NPUSCH transmission until the UE transmit timing offset is within $N_{TA} \times T_S \pm 80 \times T_S$ with respect to the first detected path (in time) of the corresponding downlink frame of cell 1. The test system shall verify that the difference in timing between the first NPUSCH transmission in step c) and the NPUSCH transmission in step a) shall be not greater than the maximum amount of the magnitude of the timing change in one adjustment requirement in clause 7.20.2. Using the first NPUSCH transmission in step c) and subsequent NPUSCH transmissions. The test system shall verify that the adjustment step size and the adjustment rate shall be according to the requirements in clause 7.20.2 until the UE transmit timing offset is within $N_{TA} \times T_S \pm 80 \times T_S$ with respect to the first detected path (in time) of the corresponding downlink frame of cell 1.
- d) The test system the test system sends NPDCCH including uplink grant for NPUSCH transmission and shall verify that the UE transmit timing offset stays within $N_{TA} \times T_S \pm 80 \times T_S$ with respect to the first detected path (in time) of the corresponding downlink frame of NB-IoT cell 1.

A.7.1.18 E-UTRAN HD-FDD – UE Transmit Timing Accuracy Tests for Category NB1 UE In-band mode under enhanced coverage

A.7.1.18.1 Test Purpose and Environment

The purpose of this test is to verify that the Category NB1 UE under enhanced coverage is capable of following the frame timing change of the connected eNode B, that the UE initial transmit timing accuracy is within the specified limits and that the UE shall not adjust the uplink transmission timing autonomously during an ongoing repetition period other than at initial transmission. This test will verify the requirements in clause 7.20.

For this test a single NB-IoT cell and a single LTE cell are used. Test parameters are given in Table A.7.1.18.1-1, Table A.7.1.18.1-2, Table A.7.1.18.1-3, and Table A.7.1.18.1-4. The transmit timing is verified by the UE transmitting NPUSCH.

Table A.7.1.18.1-1: General Test Parameters for UE Transmit Timing Accuracy Tests for E-UTRAN HD-FDD Category NB1 UE in In-Band mode under enhanced coverage

Parameter	Unit	Value	
		Test 1	Test 2
NB-IoT Operation mode		In-band	In-band
DRX		OFF	ON
NPRACH configuration		NPRACH.R-1 As specified in A.3.18	
NPDCCH repetition level		32	32
npdcch-StartSF-USS ^{Note 2}		v2	v2
npdcch-NumRepetitions-r13 ^{Note 2}		r32	r32
NPUSCH resource units		1	1
NPUSCH repetition level		128	128
NPUSCH subcarrier spacing	kHz	15	15
NPUSCH number of subcarriers		1	1
NPUSCH modulation		$\pi/4$ QPSK	$\pi/4$ QPSK
NPUSCH Transport block size	Bits	40	40
Note 1: DRX related parameters are defined in Table A.7.1.18.1-4.			
Note 2: For further information see clause 6.7.3.2 in TS 36.331 [2].			

Table A.7.1.18.1-2: nCell specific Test Parameters for UE Transmit Timing Accuracy Tests for E-UTRAN HD-FDD Category NB1 UE in In-Band mode under enhanced coverage

Parameter	Unit	Value	
		Test 1	Test 2
RF Channel Number		1	1
BW _{channel}	kHz	200	200
PRB location within eCell		eCell1 BW _{channel} 5MHz: 17 eCell1 BW _{channel} 10MHz: 30	eCell1 BW _{channel} 5MHz: 17 eCell1 BW _{channel} 10MHz: 30
NPDSCH parameter		eCell1 BW _{channel} 5MHz: R.17 HD-FDD	eCell1 BW _{channel} 5MHz: R.17 HD-FDD

		eCell1 BW _{channel} 10MHz: R.15 HD-FDD	eCell1 BW _{channel} 10MHz: R.15 HD-FDD
NPDCCH parameter		eCell1 BW _{channel} 5MHz: R.41 HD-FDD eCell1 BW _{channel} 10MHz: R.29 HD-FDD	eCell1 BW _{channel} 5MHz: R.41 HD-FDD eCell1 BW _{channel} 10MHz: R.29 HD-FDD
NPBCH_RA	dB	-3	-3
NPBCH_RB			
NPSS_RA			
NSSS_RA			
NPDCCH_RA			
NPDCCH_RB			
NPDSCH_RA			
NPDSCH_RB			
NOCNG_RA ^{Note1}			
NOCNG_RB ^{Note1}			
N_{oc}	dBm/15 kHz	Specified in Table A.7.1.18.1-3	Specified in Table A.7.1.18.1-3
\hat{E}_s/I_{ot}	dB	-11	-11
\hat{E}_s/N_{oc}	dB	-11	-11
Antenna Configuration		2x1	2x1
Propagation condition	-	AWGN	AWGN
Note 1 NOCNG shall be used such that the cell is fully allocated and a constant total transmitted power spectral density is achieved for all OFDM symbols.			

Table A.7.1.18.1-3: eCell specific Test Parameters for UE Transmit Timing Accuracy Tests for E-UTRAN HD-FDD Category NB1 UE in In-Band mode under enhanced coverage

Parameter	Unit	Value	
		Test 1	Test 2
E-UTRA RF Channel Number		1	1
BW _{channel}	MHz	5 or 10	5 or 10
NOCNG pattern		BW _{channel} 5MHz: NOP.4 FDD BW _{channel} 10MHz: NOP.1 FDD	BW _{channel} 5MHz: NOP.4 FDD BW _{channel} 10MHz: NOP.1 FDD
PBCH_RA	dB	-3	-3
PBCH_RB			
PSS_RA			
SSS_RA			
PCFICH_RB			
PHICH_RA			
PHICH_RB			
PDCCH_RA			
PDCCH_RB			
OCNG_RA ^{Note1}			
OCNG_RB ^{Note1}			
N_{oc}	dBm/15 kHz	-98	-98
\hat{E}_s/N_{oc}	dB	-11	-11
Antenna Configuration		2x1	2x1
Propagation condition	-	AWGN	AWGN
Note 1 OCNG shall be used such that the cell is fully allocated and a constant total transmitted power spectral density is achieved for all OFDM symbols.			

Table A.7.1.18.1-4: drx-Configuration to be used in UE Transmit Timing Accuracy Test 2 for E-UTRAN HD-FDD Category NB1 UE In-band mode under enhanced coverage

Field	Value	Comment
-------	-------	---------

	Test 2	
onDurationTimer	pp1	
drx-InactivityTimer	pp0	
drx-RetransmissionTimer	pp0	
longDRX-CycleStartOffset	sf2048	
shortDRX	disable	
Note 1: For further information see clause 6.7.3 in TS 36.331 [2].		

A.7.1.18.2 Test Requirements

For parameters specified in Tables A.7.1.18.1-1, Tables A.7.1.18.1-2, Tables A.7.1.18.1-3 and Tables A.7.1.18.1-4, the initial transmit timing accuracy shall be within the limits defined in clause 7.20.2 and the UE shall not adjust the uplink transmission timing autonomously during an ongoing repetition period other than at initial transmission.

The following sequence of events shall be used to verify that the requirements are met.

The test sequence shall be carried out in RRC_CONNECTED for both non-DRX (for Test1) and DRX with a cycle length of 2048 ms (Tests 2):

- After a connection is set up with the cell, the test system sends NPDCCH including uplink grant for NPUSCH transmission and the test system shall measure the UE transmit timing offset ($n \times T_s$) and verify that it is within T_e ($n \times T_s \leq N_{TA} \times T_s \pm 80 \times T_s$) with respect to the first detected path (in time) of the corresponding downlink frame of NB-IoT cell 1.
- The test system sends NPDCCH including uplink grant for NPUSCH transmission. After 16ms from the initial NPUSCH transmission, the test system adjusts the downlink transmit timing for the cell, using the value of n measured in a),
 - if $n < 0$, by $+(144 - |n|) \times T_s$ compared to that in (a).
 - if $n \geq 0$, by $-(144 - |n|) \times T_s$ compared to that in (a).

The timing adjustment is performed monotonically in multiple steps of $|\Delta T| \leq 9 \times T_s$ per 256 ms (ΔT is to be defined in the test procedure) until the above required total timing change is achieved, during which no grant is transmitted for the UE.

- For test 2, the test system sends NPDCCH including uplink grant for NPUSCH transmission and shall verify that the UE transmit timing offset stays within $N_{TA} \times T_s \pm 80 \times T_s$ with respect to the first detected path (in time) of the corresponding downlink frame of NB-IoT cell 1. The UE transmit timing offset shall be verified for the first transmission in the DRX cycle immediately after DL timing adjustment.

A.7.1.19 E-UTRAN FDD - UE Transmit Timing Accuracy Test for RACH-less Handover

A.7.1.19.1 Test Purpose and Environment

This test is to verify the requirement for the UE initial transmit timing after RACH-less handover specified in clause 7.1.

The test scenario comprises of 1 E-UTRA FDD carrier and 2 cells as given in tables A.7.1.19.1-1 and A.7.1.19.1-2. The test consists of three successive time periods, with time durations of T1, T2 and T3 respectively. At the start of time duration T1, the UE may not have any timing information of cell 2.

A RRC message implying RACH-less handover with $targetTa = ta0$ shall be sent to the UE during period T2, after the UE has reported Event A3, and the PUSCH transmission in the cell2 is configured in the RRC message from cell1. T3 is defined as the end of the last TTI containing the RRC message implying handover.

The transmit timing is verified by the PUSCH transmitted by the UE

Table A.7.1.19.1-1: General test parameters for E-UTRAN FDD - UE Transmit Timing Accuracy Test for RACH-less Handover

Parameter	Unit	Value	Comment
-----------	------	-------	---------

PDSCH parameters			DL Reference Measurement Channel R.0 FDD	As specified in clause A.3.1.1.1
PCFICH/PDCCH/PHICH parameters			DL Reference Measurement Channel R.6 FDD	As specified in clause A.3.1.2.1
Initial conditions	Active cell		Cell 1	
	Neighbouring cell		Cell 2	
Final condition	Active cell		Cell 2	
E-UTRA RF Channel Number			1	Only one FDD carrier frequency is used.
Channel Bandwidth (BW_{channel})	MHz		10	
A3-Offset	dB		0	
Hysteresis	dB		0	
Time To Trigger	s		0	
Filter coefficient			0	L3 filtering is not used
ul-SchedInterval-r14			sf10	As specified in section 6.3.4 in TS 36.331
ul-StartSubframe-r14			0	As specified in section 6.3.4 in TS 36.331
DRX				OFF
CP length			Normal	
Time offset between cells			3 μ s	Synchronous cells
T1	s		5	
T2	s		≤ 5	
T3	s		1	

Table A.7.1.19.1-2: Cell specific test parameters for E-UTRAN FDD - UE Transmit Timing Accuracy Test for RACH-less Handover

Parameter	Unit	Cell 1			Cell 2		
		T1	T2	T3	T1	T2	T3
E-UTRA RF Channel Number		1			1		
BW _{channel}	MHz	10			10		
OCNG Patterns defined in A.3.2.1.1 (OP.1 FDD) and in A.3.2.1.2 (OP.2 FDD)		OP.1 FDD	OP.1 FDD	OP.2 FDD	OP.2 FDD	OP.2 FDD	OP.1 FDD
PBCH_RA	dB	0			0		
PBCH_RB	dB						
PSS_RA	dB						
SSS_RA	dB						
PCFICH_RB	dB						
PHICH_RA	dB						
PHICH_RB	dB						
PDCCH_RA	dB						
PDCCH_RB	dB						
PDSCH_RA	dB						
PDSCH_RB	dB						
OCNG_RA ^{Note 1}	dB						
OCNG_RB ^{Note 1}	dB						
\hat{E}_s/I_{ot}	dB						
N_{oc} ^{Note 2}	dBm/15 KHz	-98					
\hat{E}_s/N_{oc}	dB	8	8	8	- Infinity	11	11
RSRP ^{Note 3}	dBm/15 KHz	-90	-90	-90	- Infinity	-87	-87
Propagation Condition		AWGN					
Note 1:	OCNG shall be used such that both cells are fully allocated and a constant total transmitted power spectral density is achieved for all OFDM symbols.						
Note 2:	Interference from other cells and noise sources not specified in the test is assumed to be constant over subcarriers and time and shall be modelled as AWGN of appropriate power for N_{oc} to be fulfilled.						
Note 3:	RSRP levels have been derived from other parameters for information purposes. They are not settable parameters themselves.						

A.7.1.19.2 Test Requirements

When first PUSCH is transmitted to cell2, the test system shall verify that the UE transmit timing offset is within $N_{TA} \times T_s \pm 12 \times T_s$ with respect to the first detected path (in time) of the corresponding downlink frame of cell 2.

A.7.1.20 E-UTRAN TDD - UE Transmit Timing Accuracy Test for RACH-less Handover

A.7.1.20.1 Test Purpose and Environment

This test is to verify the requirement for the UE initial transmit timing after RACH-less handover specified in clause 7.1.

The test scenario comprises of 1 E-UTRA TDD carrier and 2 cells as given in tables A.7.1.20.1-1 and A.7.1.20.1-2. The test consists of three successive time periods, with time durations of T1, T2 and T3 respectively. At the start of time duration T1, the UE may not have any timing information of cell 2.

A RRC message implying RACH-less handover with $targetTa = ta0$ shall be sent to the UE during period T2, after the UE has reported Event A3, and the PUSCH transmission in the cell2 is configured in the RRC message from cell1. T3 is defined as the end of the last TTI containing the RRC message implying handover.

The transmit timing is verified by the PUSCH transmitted by the UE

Table A.7.1.20.1-1: General test parameters for E-UTRAN TDD - UE Transmit Timing Accuracy Test for RACH-less Handover

Parameter		Unit	Value	Comment
PDSCH parameters			DL Reference Measurement Channel R.0 TDD	As specified in clause A.3.1.1.2
PCFICH/PDCCHPHICH parameters			DL Reference Measurement Channel R.6 TDD	As specified in clause A.3.1.2.2
Initial conditions	Active cell		Cell 1	
	Neighbouring cell		Cell 2	
Final condition	Active cell		Cell 2	
E-UTRA RF Channel Number			1	Only one TDD carrier frequency is used.
Channel Bandwidth (BW_{channel})		MHz	10	
A3-Offset		dB	0	
Hysteresis		dB	0	
Time To Trigger		s	0	
Filter coefficient			0	L3 filtering is not used
ul-SchedInterval-r14			sf10	As specified in section 6.3.4 in TS 36.331
ul-StartSubframe-r14			2	As specified in section 6.3.4 in TS 36.331
DRX				OFF
CP length			Normal	
Special subframe configuration			6	As specified in table 4.2-1 in TS 36.211
Uplink-downlink configuration			1	As specified in table 4.2-2 in TS 36.211
Time offset between cells			3 μ s	Synchronous cells
T1		s	5	
T2		s	≤ 5	
T3		s	1	

Table A.7.1.20.1-2: Cell specific test parameters for E-UTRAN TDD - UE Transmit Timing Accuracy Test for RACH-less Handover

Parameter	Unit	Cell 1			Cell 2		
		T1	T2	T3	T1	T2	T3
E-UTRA RF Channel Number		1			1		
BW _{channel}	MHz	10			10		
OCNG Patterns defined in A.3.2.2.1 (OP.1 TDD) and in A.3.2.2.2 (OP.2 TDD)		OP.1 TDD	OP.1 TDD	OP.2 TDD	OP.2 TDD	OP.2 TDD	OP.1 TDD
PBCH_RA	dB	0			0		
PBCH_RB	dB						
PSS_RA	dB						
SSS_RA	dB						
PCFICH_RB	dB						
PHICH_RA	dB						
PHICH_RB	dB						
PDCCH_RA	dB						
PDCCH_RB	dB						
PDSCH_RA	dB						
PDSCH_RB	dB						
OCNG_RA ^{Note 1}	dB						
OCNG_RB ^{Note 1}	dB						
\hat{E}_s/I_{ot}	dB						
N_{oc} ^{Note 2}	dBm/15 KHz	-98					
\hat{E}_s/N_{oc}	dB	8	8	8	-Infinity	11	11
RSRP ^{Note 3}	dBm/15 KHz	-90	-90	-90	-Infinity	-87	-87
Propagation Condition		AWGN					
<p>Note 1: OCNG shall be used such that both cells are fully allocated and a constant total transmitted power spectral density is achieved for all OFDM symbols.</p> <p>Note 2: Interference from other cells and noise sources not specified in the test is assumed to be constant over subcarriers and time and shall be modelled as AWGN of appropriate power for N_{oc} to be fulfilled.</p> <p>Note 3: RSRP levels have been derived from other parameters for information purposes. They are not settable parameters themselves.</p>							

A.7.1.20.2 Test Requirements

When first PUSCH is transmitted to cell2, the test system shall verify that the UE transmit timing offset is within $(N_{TA} + 624) \times T_s \pm 12 \times T_s$ with respect to the first detected path (in time) of the corresponding downlink frame of cell 2.

A.7.1.21 E-UTRAN FDD – UE Transmit Timing Accuracy Tests for Cat-M2 UE in CEModeA

A.7.1.21.1 Test Purpose and Environment

The purpose of this test is to verify that the Cat-M2 UE in CEModeA is capable of following the frame timing change of the connected eNode B and that the UE initial transmit timing accuracy, maximum amount of timing change in one adjustment, minimum and maximum adjustment rate are within the specified limits. This test will verify the requirements in clause 7.26.2.

For this test a single cell is used. Table A.7.1.21.1-1 defines the strength of the transmitted signals and the propagation condition. The transmit timing is verified by the UE transmitting SRS using the configuration defined in Table A.7.1.21.1-2.

Table A.7.1.21.1-1: Test Parameters for UE Transmit Timing Accuracy Tests for E-UTRAN FDD Cat-M2 UE under CEModeA

Parameter	Unit	Value
-----------	------	-------

		Test 1	Test 2	Test 3
E-UTRA RF Channel Number		1	1	1
Channel Bandwidth (BW _{channel})	MHz	10	10	10
DRX cycle	ms	N/A	80 ^{Note5}	640 ^{Note5}
PRACH Configuration		PRACH_4CE As specified in A.3.16		
MPDCCH Reference measurement channel ^{Note1}		R.16 FDD	R.16 FDD	R.16 FDD
OCNG Pattern ^{Note2}		OP.21 FDD	OP.21 FDD	OP.21 FDD
PBCH_RA	dB	0	0	0
PBCH_RB				
PSS_RA				
SSS_RA				
PHICH_RA				
PHICH_RB				
MPDCCH_RA				
MPDCCH_RB				
OCNG_RA ^{Note3}				
OCNG_RB ^{Note3}				
N_{oc}	dBm/15 kHz	-98	-98	-98
\hat{E}_s / I_{ot}	dB	3	3	3
\hat{E}_s / N_{oc}	dB	3	3	3
I_0 ^{Note4}	dBm/9 MHz	-65.5	-65.5	-65.5
	dBm/1.08 MHz	N/A	N/A	N/A
Propagation condition	-	AWGN	AWGN	AWGN
Note 1: For the reference measurement channels, see clause A.3.1. Note 2: For the OCNG pattern, see clause A.3.2. Note 3: OCNG shall be used such that both cells are fully allocated and a constant total transmitted power spectral density is achieved for all OFDM symbols. Note 4: I_0 level has been derived from other parameters for information purpose. It is not a settable parameter. Note 5: DRX related parameters are defined in Table A.7.1.21.1-3.				

Table A.7.1.21.1-2: Sounding Reference Symbol Configuration to be used in UE Transmit Timing Accuracy Tests for E-UTRAN FDD Cat-M2 UE under CEModeA

Field	Value			Comment
	Test 1	Test 2	Test 3	
srsBandwidthConfiguration	bw5	bw5	bw5	
srsSubframeConfiguration	sc1	sc3	sc3	
ackNackSrsSimultaneousTransmission	FALSE	FALSE	FALSE	
srsMaxUpPTS	N/A	N/A	N/A	Not applicable for FDD
srsBandwidth	0	0	0	No hopping
srsHoppingBandwidth	hbw0	hbw0	hbw0	
frequencyDomainPosition	0	0	0	
duration	TRUE	TRUE	TRUE	Indefinite duration
Srs-ConfigurationIndex	0	77	317	SRS periodicity of 2ms, 80 ms and 320ms for Test 1, 2 and 3, respectively.
transmissionComb	0	0	0	
cyclicShift	cs0	cs0	cs0	No cyclic shift
SRS-AntennaPort	an1			Number of antenna ports used for SRS transmission
Note 1: For further information see clause 6.3.2 in TS 36.331.				

Table A.7.1.21.1-3: drx-Configuration to be used in UE Transmit Timing Accuracy Test 2 and Test 3 for E-UTRAN FDD Cat-M2 UE under CEModeA

Field	Value		Comment
	Test 2	Test 3	
onDurationTimer	psf1	psf1	
drx-InactivityTimer	psf1	psf1	
drx-RetransmissionTimer	psf1	psf1	

longDRX-CycleStartOffset	sf80	sf640	
shortDRX	disable	disable	
Note 1: For further information see clause 6.3.2 in TS 36.331.			

A.7.1.21.2 Test Requirements

For parameters specified in Tables A.7.1.21.1-1 and A.7.1.21.1-2, the initial transmit timing accuracy, the maximum amount of timing change in one adjustment, the minimum and the maximum adjustment rate shall be within the limits defined in clause 7.26.2.

The following sequence of events shall be used to verify that the requirements are met.

For the 10MHz channel bandwidth, the test sequence shall be carried out in RRC_CONNECTED for both non-DRX (for Test1) and DRX with a cycle length of 80 ms or a cycle length of 640 ms (Tests 2 and 3, respectively):

- After a connection is set up with the cell, the test system shall verify that the UE transmit timing offset is within $N_{TA} \times T_S \pm 12 \times T_S$ with respect to the first detected path (in time) of the corresponding downlink frame of cell 1.
- The test system adjusts the downlink transmit timing for the cell by $+64 \times T_S$ (for Test 1 and Test 2) or $+32 \times T_S$ (for Test 3) compared to that in (a).
- The test system shall verify that for Test 1 the adjustment step size and the adjustment rate shall be according to the requirements in clause 7.26.2 until the UE transmit timing offset is within $N_{TA} \times T_S \pm 12 \times T_S$ with respect to the first detected path (in time) of the corresponding downlink frame of cell 1. Skip this step for Test 2 and Test 3.
- The test system shall verify that the UE transmit timing offset stays within $N_{TA} \times T_S \pm 12 \times T_S$ with respect to the first detected path (in time) of the corresponding downlink frame of cell 1. For test 2 and test 3 the UE transmit timing offset shall be verified for the first transmission in the DRX cycle immediately after DL timing adjustment.

A.7.1.22 E-UTRAN HD-FDD – UE Transmit Timing Accuracy Tests for Cat-M2 UE in CEModeA

A.7.1.22.1 Test Purpose and Environment

The purpose of this test is to verify that the Cat-M2 UE in CEModeA is capable of following the frame timing change of the connected eNode B and that the UE initial transmit timing accuracy, maximum amount of timing change in one adjustment, minimum and maximum adjustment rate are within the specified limits. This test will verify the requirements in clause 7.26.2.

For this test a single cell is used. Table A.7.1.22.1-1 defines the strength of the transmitted signals and the propagation condition. The transmit timing is verified by the UE transmitting SRS using the configuration defined in Table A.7.1.22.1-2.

Table A.7.1.22.1-1: Test Parameters for UE Transmit Timing Accuracy Tests for E-UTRAN HD-FDD Cat-M2 UE under CEModeA

Parameter	Unit	Value		
		Test 1	Test 2	Test 3
E-UTRA RF Channel Number		1	1	1
Channel Bandwidth (BW _{channel})	MHz	10	10	10
DRX cycle	ms	N/A	80 ^{Note5}	640 ^{Note5}
PRACH configuration		PRACH_4CE As specified in A.3.16		
MPDCCH Reference measurement channel ^{Note1}		R.6 HD-FDD	R.6 HD-FDD	R.6 HD-FDD
OCNG Pattern ^{Note2}		OP.21 FDD	OP.21 FDD	OP.21 FDD
PBCH_RA	dB	0	0	0
PBCH_RB				
PSS_RA				
SSS_RA				
PHICH_RA				
PHICH_RB				

MPDCCH_RA				
MPDCCH_RB				
OCNG_RA ^{Note3}				
OCNG_RB ^{Note3}				
N_{oc}	dBm/15 kHz	-98	-98	-98
\hat{E}_s/I_{ot}	dB	3	3	3
\hat{E}_s/N_{oc}	dB	3	3	3
I_o ^{Note4}	dBm/9 MHz	-65.5	-65.5	-65.5
	dBm/1.08 MHz	N/A	N/A	N/A
Propagation condition	-	AWGN	AWGN	AWGN
<p>Note 1: For the reference measurement channels, see clause A.3.1.</p> <p>Note 2: For the OCNG pattern, see clause A.3.2.</p> <p>Note 3: OCNG shall be used such that both cells are fully allocated and a constant total transmitted power spectral density is achieved for all OFDM symbols.</p> <p>Note 4: I_o level has been derived from other parameters for information purpose. It is not a settable parameter.</p> <p>Note 5: DRX related parameters are defined in Table A.7.1.22.1-3.</p>				

Table A.7.1.22.1-2: Sounding Reference Symbol Configuration to be used in UE Transmit Timing Accuracy Tests for E-UTRAN HD-FDD Cat-M2 UE under CEModeA

Field	Value			Comment
	Test 1	Test 2	Test 3	
srsBandwidthConfiguration	bw5	bw5	bw5	
srsSubframeConfiguration	sc1	sc3	sc3	
ackNackSrsSimultaneousTransmission	FALSE	FALSE	FALSE	
srsMaxUpPTS	N/A	N/A	N/A	Not applicable for FDD
srsBandwidth	0	0	0	No hopping
srsHoppingBandwidth	hbw0	hbw0	hbw0	
frequencyDomainPosition	0	0	0	
duration	TRUE	TRUE	TRUE	Indefinite duration
Srs-ConfigurationIndex	0	77	317	SRS periodicity of 2ms, 80 ms and 320ms for Test 1, 2 and 3, respectively.
transmissionComb	0	0	0	
cyclicShift	cs0	cs0	cs0	No cyclic shift
SRS-AntennaPort	an1			Number of antenna ports used for SRS transmission
Note 1: For further information see clause 6.3.2 in TS 36.331.				

Table A.7.1.22.1-3: drx-Configuration to be used in UE Transmit Timing Accuracy Test 2 and Test 3 for E-UTRAN HD-FDD Cat-M2 UE under CEModeA

Field	Value		Comment
	Test 2	Test 3	
onDurationTimer	psf1	psf1	
drx-InactivityTimer	psf1	psf1	
drx-RetransmissionTimer	psf1	psf1	
longDRX-CycleStartOffset	sf80	sf640	
shortDRX	disable	disable	
Note 1: For further information see clause 6.3.2 in TS 36.331.			

A.7.1.22.2 Test Requirements

For parameters specified in Tables A.7.1.22.1-1 and A.7.1.22.1-2, the initial transmit timing accuracy, the maximum amount of timing change in one adjustment, the minimum and the maximum adjustment rate shall be within the limits defined in clause 7.26.2.

The following sequence of events shall be used to verify that the requirements are met.

For the 10MHz channel bandwidth, the test sequence shall be carried out in RRC_CONNECTED for both non-DRX (for Test1) and DRX with a cycle length of 80 ms or a cycle length of 640 ms (Tests 2 and 3, respectively):

- a) After a connection is set up with the cell, the test system shall verify that the UE transmit timing offset is within $N_{TA} \times T_S \pm 12 \times T_S$ with respect to the first detected path (in time) of the corresponding downlink frame of cell 1.
- b) The test system adjusts the downlink transmit timing for the cell by $+64 \times T_S$ (for Test 1 and Test 2) or $+32 \times T_S$ (for Test 3) compared to that in (a).
- c) The test system shall verify that for Test 1 the adjustment step size and the adjustment rate shall be according to the requirements in clause 7.26.2 until the UE transmit timing offset is within $N_{TA} \times T_S \pm 12 \times T_S$ with respect to the first detected path (in time) of the corresponding downlink frame of cell 1. Skip this step for Test 2 and Test 3.
- d) The test system shall verify that the UE transmit timing offset stays within $N_{TA} \times T_S \pm 12 \times T_S$ with respect to the first detected path (in time) of the corresponding downlink frame of cell 1. For test 2 and test 3 the UE transmit timing offset shall be verified for the first transmission in the DRX cycle immediately after DL timing adjustment.

A.7.1.23 E-UTRAN TDD - UE Transmit Timing Accuracy Tests for Cat-M2 UE in CEModeA

A.7.1.23.1 Test Purpose and Environment

The purpose of this test is to verify that the UE is capable of following the frame timing change of the connected eNode B and that the UE initial transmit timing accuracy, maximum amount of timing change in one adjustment, minimum and maximum adjustment rate are within the specified limits. This test will verify the requirements in clause 7.26.2.

For this test a single cell is used. Table A.7.1.23.1-1 defines the strength of the transmitted signals and the propagation condition. The transmit timing is verified by the UE transmitting SRS using the configuration defined in Table A.7.1.23.1-2.

Table A.7.1.23.1-1: Test Parameters for UE Transmit Timing Accuracy Tests for E-UTRAN TDD Cat-M2 UE under CEModeA

Parameter	Unit	Value		
		Test 1	Test 2	Test 3
E-UTRA RF Channel Number		1	1	1
Channel Bandwidth ($BW_{channel}$)	MHz	10	10	10
Special subframe configuration ^{Note1}		6	6	6
Uplink-downlink configuration ^{Note2}		1	1	1
DRX cycle	ms	N/A	80 ^{Note7}	640 ^{Note7}
PRACH configuration		PRACH_4CE As specified in A.3.16		
MPDCCH Reference measurement channel ^{Note3}		R.14 TDD	R.14 TDD	R.14 TDD
OCNG Pattern ^{Note4}		OP.11 TDD	OP.11 TDD	OP.11 TDD
PBCH_RA	dB	0	0	0
PBCH_RB				
PSS_RA				
SSS_RA				
PHICH_RA				
PHICH_RB		0	0	0
MPDCCH_RA				
MPDCCH_RB				
OCNG_RA ^{Note5}				
OCNG_RB ^{Note5}				
N_{oc}	dBm/15 kHz	-98	-98	-98
\hat{E}_s / I_{ot}	dB	3	3	3
\hat{E}_s / N_{oc}	dB	3	3	3
I_o ^{Note6}	dBm/9 MHz	-65.5	-65.5	-65.5

	dBm/1.08 MHz	N/A	N/A	N/A
Propagation condition	-	AWGN	AWGN	AWGN
Note 1:	For the special subframe configuration see table 4.2-1 in TS 36.211.			
Note 2:	For the uplink-downlink configuration see table 4.2-2 in TS 36.211.			
Note 3:	For the reference measurement channels, see clause A.3.1.			
Note 4:	For the OCNG pattern, see clause A.3.2.			
Note 5:	OCNG shall be used such that both cells are fully allocated and a constant total transmitted power spectral density is achieved for all OFDM symbols.			
Note 6:	Io level has been derived from other parameters for information purpose. It is not a settable parameter.			
Note 7:	DRX related parameters are defined in Table A.7.1.23.1-3.			

Table A.7.1.23.1-2: Sounding Reference Symbol Configuration to be used in UE Transmit Timing Accuracy Tests for E-UTRAN TDD Cat-M2 UE under CEModeA

Field	Values			Comment
	Test 1	Test 2	Test 3	
srsBandwidthConfiguration	bw5	bw5	bw5	
srsSubframeConfiguration	sc3	sc3	sc3	Once every 5 subframes
ackNackSrsSimultaneousTransmission	FALSE	FALSE	FALSE	
srsMaxUpPTS	FALSE	FALSE	FALSE	
srsBandwidth	0	0	0	No hopping
srsHoppingBandwidth	hbw0	hbw0	hbw0	
frequencyDomainPosition	0	0	0	
Duration	TRUE	TRUE	TRUE	Indefinite duration
Srs-ConfigurationIndex	15	85	325	SRS periodicity of 10, 80, and 320 ms for Test 1, 2, and 3, respectively.
transmissionComb	0	0	0	
cyclicShift	cs0	cs0	cs0	No cyclic shift
SRS-AntennaPort	an1			Number of antenna ports used for SRS transmission

Table A.7.1.23.1-3: DRX Configuration to be used in UE Transmit Timing Accuracy Test 2 and Test 3 for E-UTRAN TDD Cat-M2 UE under CEModeA

Field	Value		Comment
	Test 2	Test 3	
onDurationTimer	psf1	psf1	
drx-InactivityTimer	psf1	psf1	
drx-RetransmissionTimer	psf1	psf1	
longDRX-CycleStartOffset	sf80	Sf640	
shortDRX	disable	disable	
Note:	For further information see clause 6.3.2 in TS 36.331.		

A.7.1.23.2 Test Requirements

For parameters specified in Tables A.7.1.23.1-1 and A.7.1.23.1-2, the initial transmit timing accuracy, the maximum amount of timing change in one adjustment, the minimum and the maximum adjustment rate shall be within the limits defined in clause 7.26.2.

The following sequence of events shall be used to verify that the requirements are met.

For the 10MHz channel bandwidth, the test sequence shall be carried out in RRC_CONNECTED for both non-DRX (for Test1) and DRX with a cycle length of 80 ms or a cycle length of 640 ms (Tests 2 and 3, respectively):

- a) After a connection is set up with the cell, the test system shall verify that the UE transmit timing offset is within $(N_{TA} + 624) \times T_S \pm 12 \times T_S$ with respect to the first detected path (in time) of the corresponding downlink frame of cell 1.
- b) The test system adjusts the downlink transmit timing for the cell by $+64 \times T_S$ (for Test 1 and Test 2) or $+32 \times T_S$ (for Test 3) compared to that in (a).

- c) The test system shall verify that for test 1 the adjustment step size and the adjustment rate shall be according to the requirements in clause 7.26.2 until the UE transmit timing offset is within $(N_{TA} + 624) \times T_S \pm 12 \times T_S$ with respect to the first detected path (in time) of the corresponding downlink frame of cell 1. Skip this step for test 2 and test 3.
- d) The test system shall verify that the UE transmit timing offset stays within $(N_{TA} + 624) \times T_S \pm 12 \times T_S$ with respect to the first detected path (in time) of the corresponding downlink frame of cell 1. For test 2 and test 3 the UE transmit timing offset shall be verified for the first transmission in the DRX cycle immediately after DL timing adjustment.

A.7.1.24 E-UTRAN FDD – UE Transmit Timing Accuracy Tests for Cat-M2 UE in CEModeB

A.7.1.24.1 Test Purpose and Environment

The purpose of this test is to verify that the Cat-M2 UE in CEModeB is capable of following the frame timing change of the connected eNode B and that the UE initial transmit timing accuracy, maximum amount of timing change in one adjustment, minimum and maximum adjustment rate are within the specified limits. This test will verify the requirements in clause 7.26.2.

As specified in Clause 7.26.2 the UE adjusts its uplink timing at the end of of repetition period when configured with repetitions. By measuring the reception of the PUSCH, the transmit timing accuracy can be measured and the requirements can be verified. For this test a single cell is used. Table A.7.1.24.1-1 defines the strength of the transmitted signals and the propagation condition.

Table A.7.1.24.1-1: Test Parameters for UE Transmit Timing Accuracy Tests for E-UTRAN FDD Cat-M2 UE under CEModeB

Parameter	Unit	Value		
		Test 1	Test 2	Test 3
E-UTRA RF Channel Number		1	1	1
Channel Bandwidth ($BW_{channel}$)	MHz	10	10	10
DRX cycle	ms	N/A	80 ^{Note5}	640 ^{Note5}
MPDCCH Reference measurement channel ^{Note1}		R.18 FDD	R.18 FDD	R.18 FDD
OCNG Pattern ^{Note2}		OP.21 FDD	OP.21 FDD	OP.21 FDD
Number of repetitions	MPDCCH	128		
	PUSCH	32		
PBCH_RA	dB	0	0	0
PBCH_RB				
PSS_RA				
SSS_RA				
PHICH_RA				
PHICH_RB				
MPDCCH_RA				
MPDCCH_RB				
OCNG_RA ^{Note3}				
OCNG_RB ^{Note3}				
N_{oc}				
\hat{E}_s / I_{ot}	dB	-12	-12	-12
\hat{E}_s / N_{oc}	dB	-12	-12	-12
I_o ^{Note4}	dBm/9 MHz	-86.4	-86.4	-86.4
	dBm/1.08 MHz	N/A	N/A	N/A
Propagation condition	-	AWGN	AWGN	AWGN
Note 1:	For the reference measurement channels, see clause A.3.1.			
Note 2:	For the OCNG pattern, see clause A.3.2.			
Note 3:	OCNG shall be used such that both cells are fully allocated and a constant total transmitted power spectral density is achieved for all OFDM symbols.			
Note 4:	I_o level has been derived from other parameters for information purpose. It is not a settable parameter.			
Note 5:	DRX related parameters are defined in Table A.7.1.24.1-2.			

Table A.7.1.24.1-2: drx-Configuration to be used in UE Transmit Timing Accuracy Test 2 and Test 3 for E-UTRAN FDD Cat-M2 UE under CEModeB

Field	Value		Comment
	Test 2	Test 3	
onDurationTimer	psf1	psf1	
drx-InactivityTimer	psf1	psf1	
drx-RetransmissionTimer	psf1	psf1	
longDRX-CycleStartOffset	sf80	sf640	
shortDRX	disable	disable	
Note:	For further information see clause 6.3.2 in TS 36.331.		

A.7.1.24.2 Test Requirements

For parameters specified in Tables A.7.1.24.1-1 and A.7.1.24.1-2, the initial transmit timing accuracy, the maximum amount of timing change in one adjustment, the minimum and the maximum adjustment rate shall be within the limits defined in clause 7.26.2. The UE shall not adjust the the transmission timing autonomously during an ongoing repetition period. Adjustments can only be done at the end of a last subframe in a repetition period.

The following sequence of events shall be used to verify that the requirements are met.

For the 10MHz channel bandwidth, the test sequence shall be carried out in RRC_CONNECTED for both non-DRX (for Test1) and DRX with a cycle length of 80 ms or a cycle length of 640 ms (Tests 2 and 3, respectively):

- After a connection is set up with the cell, the test system shall verify that the UE transmit timing offset is within $N_{TA} \times T_S \pm 40 \times T_S$ with respect to the first detected path (in time) of the corresponding downlink frame of cell 1.
- The test system adjusts the downlink transmit timing for the cell by $+64 \times T_S$ (for Test 1 and Test 2) or $+32 \times T_S$ (for Test 3) compared to that in (a).
- The test system shall verify that for Test 1 the adjustment step size and the adjustment rate shall be according to the requirements in clause 7.26.2 until the UE transmit timing offset is within $N_{TA} \times T_S \pm 40 \times T_S$ with respect to the first detected path (in time) of the corresponding downlink frame of cell 1. Skip this step for Test 2 and Test 3.
- The test system shall verify that the UE transmit timing offset stays within $N_{TA} \times T_S \pm 40 \times T_S$ with respect to the first detected path (in time) of the corresponding downlink frame of cell 1. For test 2 and test 3 the UE transmit timing offset shall be verified for the first transmission in the DRX cycle immediately after DL timing adjustment.

A.7.1.25 E-UTRAN HD-FDD – UE Transmit Timing Accuracy Tests for Cat-M2 UE in CEModeB

A.7.1.25.1 Test Purpose and Environment

The purpose of this test is to verify that the Cat-M2 UE in CEModeB is capable of following the frame timing change of the connected eNode B and that the UE initial transmit timing accuracy, maximum amount of timing change in one adjustment, minimum and maximum adjustment rate are within the specified limits. This test will verify the requirements in clause 7.26.2.

As specified in Clause 7.26.2 the UE adjusts its uplink timing at the end of of repetition period when configured with repetitions. By measuring the reception of the PUSCH, the transmit timing accuracy can be measured and the requirements can be verified. For this test a single cell is used. Table A.7.1.25.1-1 defines the strength of the transmitted signals and the propagation condition.

Table A.7.1.25.1-1: Test Parameters for UE Transmit Timing Accuracy Tests for E-UTRAN HD-FDD Cat-M2 UE under CEModeB

Parameter	Unit	Value		
		Test 1	Test 2	Test 3
E-UTRA RF Channel Number		1	1	1

Channel Bandwidth (BW_{channel})	MHz	10	10	10
DRX cycle	ms	N/A	80 ^{Note5}	640 ^{Note5}
MPDCCH Reference measurement channel ^{Note1}		R.6 HD-FDD	R.6 HD-FDD	R. 6 HD-FDD
OCNG Pattern ^{Note2}		OP.21 FDD	OP.21 FDD	OP.21 FDD
Number of repetitions	MPDCCH	128		
	PUSCH	32		
PBCH_RA	dB	0	0	0
PBCH_RB				
PSS_RA				
SSS_RA				
PHICH_RA				
PHICH_RB				
MPDCCH_RA				
MPDCCH_RB				
OCNG_RA ^{Note3}				
OCNG_RB ^{Note3}				
N_{oc}				
\hat{E}_s/I_{ot}	dB	-12	-12	-12
\hat{E}_s/N_{oc}	dB	-12	-12	-12
I_o ^{Note4}	dBm/9 MHz	-86.4	-86.4	-86.4
	dBm/1.08 MHz	N/A	N/A	N/A
Propagation condition	-	AWGN	AWGN	AWGN
Note 1: For the reference measurement channels, see clause A.3.1.				
Note 2: For the OCNG pattern, see clause A.3.2.				
Note 3: OCNG shall be used such that both cells are fully allocated and a constant total transmitted power spectral density is achieved for all OFDM symbols.				
Note 4: I_o level has been derived from other parameters for information purpose. It is not a settable parameter.				
Note 5: DRX related parameters are defined in Table A.7.1.25.1-2.				

Table A.7.1.25.1-2: drx-Configuration to be used in UE Transmit Timing Accuracy Test 2 and Test 3 for E-UTRAN HD-FDD Cat-M2 UE under CEModeB

Field	Value		Comment
	Test 2	Test 3	
onDurationTimer	psf1	psf1	
drx-InactivityTimer	psf1	psf1	
drx-RetransmissionTimer	psf1	psf1	
longDRX-CycleStartOffset	sf80	sf640	
shortDRX	disable	disable	
Note: For further information see clause 6.3.2 in TS 36.331.			

A.7.1.25.2 Test Requirements

For parameters specified in Tables A.7.1.25.1-1 and A.7.1.25.1-2, the initial transmit timing accuracy, the maximum amount of timing change in one adjustment, the minimum and the maximum adjustment rate shall be within the limits defined in clause 7.26.2. The UE shall not adjust the the transmission timing autonomously during an ongoing repetition period. Adjustments can only be done at the end of a last subframe in a repetition period.

The following sequence of events shall be used to verify that the requirements are met.

For the 10MHz channel bandwidth, the test sequence shall be carried out in RRC_CONNECTED for both non-DRX (for Test1) and DRX with a cycle length of 80 ms or a cycle length of 640 ms (Tests 2 and 3, respectively):

- After a connection is set up with the cell, the test system shall verify that the UE transmit timing offset is within $N_{TA} \times T_S \pm 40 \times T_S$ with respect to the first detected path (in time) of the corresponding downlink frame of cell 1.
- The test system adjusts the downlink transmit timing for the cell by $+64 \times T_S$ (for Test 1 and Test 2) or $+32 \times T_S$ (for Test 3) compared to that in (a).

- c) The test system shall verify that for Test 1 the adjustment step size and the adjustment rate shall be according to the requirements in clause 7.26.2 until the UE transmit timing offset is within $N_{TA} \times T_S \pm 40 \times T_S$ with respect to the first detected path (in time) of the corresponding downlink frame of cell 1. Skip this step for Test 2 and Test 3.
- d) The test system shall verify that the UE transmit timing offset stays within $N_{TA} \times T_S \pm 40 \times T_S$ with respect to the first detected path (in time) of the corresponding downlink frame of cell 1. For test 2 and test 3 the UE transmit timing offset shall be verified for the first transmission in the DRX cycle immediately after DL timing adjustment.

A.7.1.26 E-UTRAN TDD - UE Transmit Timing Accuracy Tests for Cat-M2 UE in CEModeB

A.7.1.26.1 Test Purpose and Environment

The purpose of this test is to verify that the Cat-M2 UE in CEModeB is capable of following the frame timing change of the connected eNode B and that the UE initial transmit timing accuracy, maximum amount of timing change in one adjustment, minimum and maximum adjustment rate are within the specified limits. This test will verify the requirements in clause 7.26.2.

As specified in Clause 7.26.2 the UE adjusts its uplink timing at the end of of repetition period when configured with repetitions. By measuring the reception of the PUSCH, the transmit timing accuracy can be measured and the requirements can be verified. For this test a single cell is used. Table A.7.1.26.1-1 defines the strength of the transmitted signals and the propagation condition.

Table A.7.1.26.1-1: Test Parameters for UE Transmit Timing Accuracy Tests for E-UTRAN TDD Cat-M2 UE under CEModeB

Parameter		Unit	Value		
			Test 1	Test 2	Test 3
E-UTRA RF Channel Number			1	1	1
Channel Bandwidth ($BW_{channel}$)		MHz	10	10	10
Special subframe configuration ^{Note1}			6	6	6
Uplink-downlink configuration ^{Note2}			1	1	1
DRX cycle		ms	N/A	80 ^{Note7}	640 ^{Note7}
MPDCCH Reference measurement channel ^{Note3}			R.14 TDD	R.14 TDD	R.14 TDD
OCNG Pattern ^{Note4}			OP.11 TDD	OP.11 TDD	OP.11 TDD
PBCH_RA		dB	0	0	0
Number of repetitions	MPDCCH		128		
	PUSCH		32		
PBCH_RB			0	0	0
PSS_RA					
SSS_RA					
PHICH_RA					
PHICH_RB					
MPDCCH_RA					
MPDCCH_RB					
OCNG_RA ^{Note5}					
OCNG_RB ^{Note5}					
N_{oc}		dBm/15 kHz			
\hat{E}_s / I_{ot}		dB	-12	-12	-12
\hat{E}_s / N_{oc}		dB	-12	-12	-12
I_o ^{Note6}		dBm/9 MHz	-86.4	-86.4	-86.4
		dBm/1.08 MHz	N/A	N/A	N/A
Propagation condition		-	AWGN	AWGN	AWGN
Note 1: For the special subframe configuration see table 4.2-1 in TS 36.211.					
Note 2: For the uplink-downlink configuration see table 4.2-2 in TS 36.211.					
Note 3: For the reference measurement channels, see clause A.3.1.					
Note 4: For the OCNG pattern, see clause A.3.2.					

Note 5: OCNG shall be used such that both cells are fully allocated and a constant total transmitted power spectral density is achieved for all OFDM symbols.
 Note 6: lo level has been derived from other parameters for information purpose. It is not a settable parameter.
 Note 7: DRX related parameters are defined in Table A.7.1.26.1-2.

Table A.7.1.26.1-2: DRX Configuration to be used in UE Transmit Timing Accuracy Test 2 and Test 3 for E-UTRAN TDD Cat-M2 UE under CEModeB

Field	Value		Comment
	Test 2	Test 3	
onDurationTimer	psf1	psf1	
drx-InactivityTimer	psf1	psf1	
drx-RetransmissionTimer	psf1	psf1	
longDRX-CycleStartOffset	sf80	Sf640	
shortDRX	disable	disable	
Note: For further information see clause 6.3.2 in TS 36.331.			

A.7.1.26.2 Test Requirements

For parameters specified in Tables A.7.1.26.1-1 and A.7.1.26.1-2, the initial transmit timing accuracy, the maximum amount of timing change in one adjustment, the minimum and the maximum adjustment rate shall be within the limits defined in clause 7.26.2. The UE shall not adjust the the transmission timing autonomously during an ongoing repetition period. Adjustments can only be done at the end of a last subframe in a repetition period.

The following sequence of events shall be used to verify that the requirements are met.

For the 10MHz channel bandwidth, the test sequence shall be carried out in RRC_CONNECTED for both non-DRX (for Test1) and DRX with a cycle length of 80 ms or a cycle length of 640 ms (Tests 2 and 3, respectively):

- a) After a connection is set up with the cell, the test system shall verify that the UE transmit timing offset is within $N_{TA} \times T_S \pm 40 \times T_S$ with respect to the first detected path (in time) of the corresponding downlink frame of cell 1.
- b) The test system adjusts the downlink transmit timing for the cell by $+64 \times T_S$ (for Test 1 and Test 2) or $+32 \times T_S$ (for Test 3) compared to that in (a).
- c) The test system shall verify that for Test 1 the adjustment step size and the adjustment rate shall be according to the requirements in clause 7.26.2 until the UE transmit timing offset is within $N_{TA} \times T_S \pm 40 \times T_S$ with respect to the first detected path (in time) of the corresponding downlink frame of cell 1. Skip this step for Test 2 and Test 3.
- d) The test system shall verify that the UE transmit timing offset stays within $N_{TA} \times T_S \pm 40 \times T_S$ with respect to the first detected path (in time) of the corresponding downlink frame of cell 1. For test 2 and test 3 the UE transmit timing offset shall be verified for the first transmission in the DRX cycle immediately after DL timing adjustment.

A.7.1.27 E-UTRAN TDD – UE Transmit Timing Accuracy Tests for Category NB1 UE In-Band mode under normal coverage

A.7.1.27.1 Test Purpose and Environment

The purpose of this test is to verify that the Category NB1 UE under normal coverage is capable of following the frame timing change of the connected eNode B and that the UE initial transmit timing accuracy, maximum amount of timing change in one adjustment, minimum and maximum adjustment rate are within the specified limits. This test will verify the requirements in clause 7.20.

For this test a single NB-IoT cell and a single LTE cell are used. Test parameters are given in Table A.7.1.27.1-1, Table A.7.1.27.1-2, and Table A.7.1.27.1-3. The transmit timing is verified by the UE transmitting NPUSCH.

Table A.7.1.27.1-1: General Test Parameters for UE Transmit Timing Accuracy Tests for E-UTRAN TDD Category NB1 UE in In-Band mode under normal coverage

Parameter	Unit	Value	Comment
		Test 1	

NB-IoT Operation mode		In-band	
DRX		OFF	
Special subframe configuration		6	As specified in table 4.2-1 in TS 36.211 [16]
Uplink-downlink configuration		1	As specified in table 4.2-2 in TS 36.21 [16]1
NPRACH configuration		NPRACH.R-2	As specified in A.3.18
NPDCCH repetition level		1	
npdcch-StartSF-USS ^{Note 1}		v8	
npdcch-NumRepetitions-r13 ^{Note 1}		r1	
NPUSCH repetition level		1	
Note 1: For further information see clause 6.7.3.2 in TS 36.331 [2].			

Table A.7.1.27.1-2: nCell specific Test Parameters for UE Transmit Timing Accuracy Tests for E-UTRAN TDD Category NB1 UE in In-Band mode under normal coverage

Parameter	Unit	Value
		Test 1
RF Channel Number		1
BW _{channel}	kHz	200
PRB location within eCell		eCell BW _{channel} 10MHz:30
NPDSCH parameter		eCell BW _{channel} 10MHz: R.15 NB-TDD
NPDCCH parameter		eCell BW _{channel} 10MHz: R.29 NB-TDD
NPBCH_RA	dB	-3
NPBCH_RB		
NPSS_RA		
NSSS_RA		
NPDCCH_RA		
NPDCCH_RB		
NPDSCH_RA		
NPDSCH_RB		
NOCNG_RA ^{Note1}		
NOCNG_RB ^{Note1}		
N_{oc}	dBm/15 kHz	Specified in Table A.7.1.27.1-3
\hat{E}_s / I_{ot}	dB	4
\hat{E}_s / N_{oc}	dB	4
Antenna Configuration		2x1
Propagation condition	-	AWGN
Note 1 NOCNG shall be used such that the cell is fully allocated and a constant total transmitted power spectral density is achieved for all OFDM symbols.		

Table A.7.1.27.1-3: eCell specific Test Parameters for UE Transmit Timing Accuracy Tests for E-UTRAN TDD Category NB1 UE in In-Band mode under normal coverage

Parameter	Unit	Value
		Test 1
E-UTRA RF Channel Number		1
BW _{channel}	MHz	10
NOCNG Pattern	-	BW _{channel} 10MHz: NOP.1 TDD
PBCH_RA	dB	-3
PBCH_RB		
PSS_RA		
SSS_RA		
PCFICH_RB		
PHICH_RA		
PHICH_RB		
PDCCH_RA		
PDCCH_RB		
OCNG_RA ^{Note1}		
OCNG_RB ^{Note1}		
N_{oc}	dBm/15 kHz	-98

\hat{E}_s/N_{oc}	dB	4
Antenna configuration		2x1
Propagation condition	-	AWGN
Note 1: OCNG shall be used such that the cell is fully allocated and a constant total transmitted power spectral density is achieved for all OFDM symbols.		

A.7.1.27.2 Test Requirements

For parameters specified in Tables A.7.1.27.1-1, A.7.1.27.1-2, and A.7.1.27.1-3, the initial transmit timing accuracy, the maximum amount of timing change in one adjustment, the minimum and the maximum adjustment rate shall be within the limits defined in clause 7.20.2.

The following sequence of events shall be used to verify that the requirements are met.

The test sequence shall be carried out in RRC_CONNECTED:

- a) After a connection is set up with the cell, the test system sends NPDCCH including uplink grant for NPUSCH transmission and the test system shall measure the UE transmit timing offset ($n \times T_s$) and verify that it is within T_e ($n \times T_s \leq N_{TA} \times T_s \pm 80 \times T_s$) with respect to the first detected path (in time) of the corresponding downlink frame of NB-IoT cell 1.
- b) Using the value of n measured in a), the test system adjusts the downlink transmit timing for the cell:
 - if $n < 0$, by $+(144 - |n|) \times T_s$ compared to that in (a).
 - if $n \geq 0$, by $-(144 - |n|) \times T_s$ compared to that in (a).

The timing adjustment is performed monotonically in multiple steps of $|\Delta T| \leq 9 \times T_s$ per 256 ms (ΔT is to be defined in the test procedure) until the above required total timing change is achieved, during which no grant is transmitted for the UE.

- c) Immediately after (b), the test system sends NPDCCH including uplink grant for NPUSCH transmission and immediately after receiving NPUSCH the test system repeatedly sends NPDCCH including uplink grant for NPUSCH transmission until the UE transmit timing offset is within $N_{TA} \times T_s \pm 80 \times T_s$ with respect to the first detected path (in time) of the corresponding downlink frame of cell 1. The test system shall verify that the difference in timing between the first NPUSCH transmission in step c) and the NPUSCH transmission in step a) shall be not greater than the maximum amount of the magnitude of the timing change in one adjustment requirement in clause 7.20.2. Using the first NPUSCH transmission in step c) and subsequent NPUSCH transmissions. The test system shall verify that the adjustment step size and the adjustment rate shall be according to the requirements in clause 7.20.2 until the UE transmit timing offset is within $N_{TA} \times T_s \pm 80 \times T_s$ with respect to the first detected path (in time) of the corresponding downlink frame of cell 1.
- d) The test system the test system sends NPDCCH including uplink grant for NPUSCH transmission and shall verify that the UE transmit timing offset stays within $N_{TA} \times T_s \pm 80 \times T_s$ with respect to the first detected path (in time) of the corresponding downlink frame of NB-IoT cell 1.

A.7.1.28 E-UTRAN TDD – UE Transmit Timing Accuracy Tests for Category NB1 UE In-band mode under enhanced coverage

A.7.1.28.1 Test Purpose and Environment

The purpose of this test is to verify that the Category NB1 UE under enhanced coverage is capable of following the frame timing change of the connected eNode B, that the UE initial transmit timing accuracy is within the specified limits and that the UE shall not adjust the uplink transmission timing autonomously during an ongoing repetition period other than at initial transmission. This test will verify the requirements in clause 7.20.

For this test a single NB-IoT cell and a single LTE cell are used. Test parameters are given in Table A.7.1.28.1-1, Table A.7.1.28.1-2, Table A.7.1.28.1-3, and Table A.7.1.28.1-4. The transmit timing is verified by the UE transmitting NPUSCH.

Table A.7.1.28.1-1: General Test Parameters for UE Transmit Timing Accuracy Tests for E-UTRAN TDD Category NB1 UE in In-Band mode under enhanced coverage

Parameter	Unit	Value	
		Test 1	Test 2
NB-IoT Operation mode		In-band	In-band
DRX		OFF	ON
Special subframe configuration		6	
Uplink-downlink configuration		1	
NPRACH configuration		NPRACH.R-2	
NPDCCH repetition level		32	32
npdcch-StartSF-USS ^{Note 2}		v2	v2
npdcch-NumRepetitions-r13 ^{Note 2}		r32	r32
NPUSCH resource units		1	1
NPUSCH repetition level		128	128
NPUSCH subcarrier spacing	kHz	15	15
NPUSCH number of subcarriers		1	1
NPUSCH modulation		$\pi/4$ QPSK	$\pi/4$ QPSK
NPUSCH Transport block size	Bits	40	40
Note 1: DRX related parameters are defined in Table A.7.1.28.1-4.			
Note 2: For further information see clause 6.7.3.2 in TS 36.331 [2].			

Table A.7.1.28.1-2: nCell specific Test Parameters for UE Transmit Timing Accuracy Tests for E-UTRAN TDD Category NB1 UE in In-Band mode under enhanced coverage

Parameter	Unit	Value	
		Test 1	Test 2
RF Channel Number		1	1
BW _{channel}	kHz	200	200
PRB location within eCell		eCell1 BW _{channel} 10MHz: 30	eCell1 BW _{channel} 10MHz: 30
NPDSCH parameter		eCell1 BW _{channel} 10MHz: R.15 NB-TDD	eCell1 BW _{channel} 10MHz: R.15 NB-TDD
NPDCCH parameter		eCell1 BW _{channel} 10MHz:R.29 NB-TDD	eCell1 BW _{channel} 10MHz: R.29 NB-TDD
NPBCH_RA	dB	-3	-3
NPBCH_RB			
NPSS_RA			
NSSS_RA			
NPDCCH_RA			
NPDCCH_RB			
NPDSCH_RA			
NPDSCH_RB			
NOCNG_RA ^{Note1}			
NOCNG_RB ^{Note1}			
N_{oc}	dBm/15 kHz	Specified in Table A.7.1.28.1-3	Specified in Table A.7.1.28.1-3
\hat{E}_s/I_{ot}	dB	-11	-11
\hat{E}_s/N_{oc}	dB	-11	-11
Antenna Configuration		2x1	2x1
Propagation condition	-	AWGN	AWGN
Note 1: NOCNG shall be used such that the cell is fully allocated and a constant total transmitted power spectral density is achieved for all OFDM symbols.			

Table A.7.1.28.1-3: eCell specific Test Parameters for UE Transmit Timing Accuracy Tests for E-UTRAN TDD Category NB1 UE in In-Band mode under enhanced coverage

Parameter	Unit	Value	
		Test 1	Test 2
E-UTRA RF Channel Number		1	1
BW _{channel}	MHz	10	10

NOCNG pattern		BW _{channel} 10MHz: NOP.1 TDD	BW _{channel} 10MHz: NOP.1 TDD
PBCH_RA	dB	-3	-3
PBCH_RB			
PSS_RA			
SSS_RA			
PCFICH_RB			
PHICH_RA			
PHICH_RB			
PDCCH_RA			
PDCCH_RB			
OCNG_RA ^{Note1}			
OCNG_RB ^{Note1}			
N_{oc}			
\hat{E}_s/N_{oc}	dB	-11	-11
Antenna Configuration		2x1	2x1
Propagation condition	-	AWGN	AWGN
Note 1: OCNG shall be used such that the cell is fully allocated and a constant total transmitted power spectral density is achieved for all OFDM symbols.			

Table A.7.1.28.1-4: drx-Configuration to be used in UE Transmit Timing Accuracy Test 2 for E-UTRAN TDD Category NB1 UE In-band mode under enhanced coverage

Field	Value	Comment
	Test 2	
onDurationTimer	pp1	
drx-InactivityTimer	pp0	
drx-RetransmissionTimer	pp0	
longDRX-CycleStartOffset	sf2048	
shortDRX	disable	
Note 1: For further information see clause 6.7.3 in TS 36.331 [2].		

A.7.1.28.2 Test Requirements

For parameters specified in Tables A.7.1.28.1-1, Tables A.7.1.28.1-2, Tables A.7.1.28.1-3 and Tables A.7.1.28.1-4, the initial transmit timing accuracy shall be within the limits defined in clause 7.20.2 and the UE shall not adjust the uplink transmission timing autonomously during an ongoing repetition period other than at initial transmission.

The following sequence of events shall be used to verify that the requirements are met.

The test sequence shall be carried out in RRC_CONNECTED for both non-DRX (for Test1) and DRX with a cycle length of 2048 ms (Tests 2):

- a) After a connection is set up with the cell, the test system sends NPDCCH including uplink grant for NPUSCH transmission and the test system shall measure the UE transmit timing offset ($n \times T_s$) and verify that it is within T_e ($n \times T_s \leq N_{TA} \times T_s \pm 80 \times T_s$) with respect to the first detected path (in time) of the corresponding downlink frame of NB-IoT cell 1.
- b) The test system sends NPDCCH including uplink grant for NPUSCH transmission. After 16ms from the initial NPUSCH transmission, the test system adjusts the downlink transmit timing for the cell, using the value of n measured in a),
 - if $n < 0$, by $+(144 - |n|) \times T_s$ compared to that in (a).
 - if $n \geq 0$, by $-(144 - |n|) \times T_s$ compared to that in (a).

The timing adjustment is performed monotonically in multiple steps of $|\Delta T| \leq 9 \times T_s$ per 256 ms (ΔT is to be defined in the test procedure) until the above required total timing change is achieved, during which no grant is transmitted for the UE.

- c) For test 2, the test system sends NPDCCH including uplink grant for NPUSCH transmission and shall verify that the UE transmit timing offset stays within $N_{TA} \times T_S \pm 80 \times T_S$ with respect to the first detected path (in time) of the corresponding downlink frame of NB-IoT cell 1. The UE transmit timing offset shall be verified for the first transmission in the DRX cycle immediately after DL timing adjustment.

A.7.2 UE Timing Advance

A.7.2.1 E-UTRAN FDD – UE Timing Advance Adjustment Accuracy Test

A.7.2.1.1 Test Purpose and Environment

The purpose of the test is to verify E-UTRAN FDD Timing Advance adjustment accuracy requirements, defined in clause 7.3.2.2, in an AWGN model.

The test parameters are given in tables A.7.2.1.1-1, A.7.2.1.1-2, and A.7.2.1.1-3. The test consists of two successive time periods, with time duration of T1 and T2 respectively. In each time period, timing advance commands are sent to the UE and Sounding Reference Signals (SRS), as specified in table A.7.2.1.1-3, are sent from the UE and received by the test equipment. By measuring the reception of the SRS, the transmit timing, and hence the timing advance adjustment accuracy, can be measured.

During time period T1, the test equipment shall send one message with a Timing Advance Command MAC Control Element, as specified in Clause 6.1.3.5 in TS 36.321. The Timing Advance Command value shall be set to 31, which according to Clause 4.2.3 in TS 36.213 results in zero adjustment of the Timing Advance. In this way, a reference value for the timing advance used by the UE is established.

During time period T2, the test equipment shall send a sequence of messages with Timing Advance Command MAC Control Elements, with Timing Advance Command value specified in table A.7.2.1.1-2. This value shall result in changes of the timing advance used by the UE, and the accuracy of the change shall then be measured, using the SRS sent from the UE.

As specified in Clause 7.3.2.1, the UE adjusts its uplink timing at sub-frame n+6 for a timing advance command received in sub-frame n. This delay must be taken into account when measuring the timing advance adjustment accuracy, via the SRS sent from the UE.

The UE Time Alignment Timer, described in Clause 5.2 in TS 36.321, shall be configured so that it does not expire in the duration of the test.

Table A.7.2.1.1-1: General Test Parameters for E-UTRAN FDD Timing Advance Accuracy Test

Parameter	Unit	Value	Comment
PDSCH parameters		DL Reference Measurement Channel R.0 FDD	As specified in clause A.3.1.1.1
PCFICH/PDCCH/PHICH parameters		DL Reference Measurement Channel R.6 FDD	As specified in clause A.3.1.2.1
Timing Advance Command (T_A) value during T1		31	$N_{TA} = 0$ for the purpose of establishing a reference value from which the timing advance adjustment accuracy can be measured during T2
Timing Advance Command (T_A) value during T2		39	$N_{TA} = 128$
DRX		OFF	
T1	s	5	
T2	s	5	

Table A.7.2.1.1-2: Cell specific Test Parameters for E-UTRAN FDD Timing Advance Accuracy Test

Parameter	Unit	Value	
		T1	T2
E-UTRA RF Channel Number		1	
$BW_{channel}$	MHz	10	
OCNG Patterns defined in A.3.2.1.1 (OP.1 FDD)		OP.1 FDD	

PBCH_RA	dB	0	
PBCH_RB	dB		
PSS_RA	dB		
SSS_RA	dB		
PCFICH_RB	dB		
PHICH_RA	dB		
PHICH_RB	dB		
PDCCH_RA	dB		
PDCCH_RB	dB		
PDSCH_RA	dB		
PDSCH_RB	dB		
OCNG_RA ^{Note1}	dB		
OCNG_RB ^{Note1}	dB		
Timing Advance Command (T_A)			
\hat{E}_s / I_{ot}	dB	3	
N_{oc}	dBm/15 KHz	-98	
\hat{E}_s / N_{oc}	dB	3	
I_o ^{Note2}	dBm/9 MHz	-65.5	
Propagation Condition		AWGN	
Note 1: OCNG shall be used such that both cells are fully allocated and a constant total transmitted power spectral density is achieved for all OFDM symbols.			
Note 2: I_o level has been derived from other parameters for information purpose. It is not a settable parameter.			

Table A.7.2.1.1-3: Sounding Reference Symbol Configuration for E-UTRAN FDD Transmit Timing Accuracy Test

Field	Value	Comment
srsBandwidthConfiguration	bw5	
srsSubframeConfiguration	sc3	Once every 5 subframes
ackNackSrsSimultaneousTransmission	FALSE	
srsMaxUpPTS	N/A	Not applicable for E-UTRAN FDD
srsBandwidth	0	No hopping
srsHoppingBandwidth	hbw0	
frequencyDomainPosition	0	
Duration	TRUE	Indefinite duration
Srs-ConfigurationIndex	7	SRS periodicity of 10.
transmissionComb	0	
cyclicShift	cs0	No cyclic shift
SRS-AntennaPort	an1	Number of antenna ports used for SRS transmission
Note: For further information see clause 6.3.2 in TS 36.331.		

A.7.2.1.2 Test Requirements

The UE shall apply the signalled Timing Advance value to the transmission timing at the designated activation time i.e. 6 sub frames after the reception of the timing advance command.

The Timing Advance adjustment accuracy shall be within the limits specified in clause 7.3.2.2.

The rate of correct Timing Advance adjustments observed during repeated tests shall be at least 90%.

A.7.2.2 E-UTRAN TDD – UE Timing Advance Adjustment Accuracy Test

A.7.2.2.1 Test Purpose and Environment

The purpose of the test is to verify E-UTRAN TDD Timing Advance adjustment accuracy requirements, defined in clause 7.3.2.2, in an AWGN model.

The test parameters are given in tables A.7.2.2.1-1, A.7.2.2.1-2, and A.7.2.2.1-3. The test consists of two successive time periods, with time duration of T1 and T2 respectively. In each time period, timing advance commands are sent to the UE and Sounding Reference Signals (SRS), as specified in table A.7.2.2.1-3, are sent from the UE and received by the test equipment. By measuring the reception of the SRS, the transmit timing, and hence the timing advance adjustment accuracy, can be measured.

During time period T1, the test equipment shall send one message with a Timing Advance Command MAC Control Element, as specified in Clause 6.1.3.5 in TS 36.321. The Timing Advance Command value shall be set to 31, which according to Clause 4.2.3 in TS 36.213 results in zero adjustment of the Timing Advance. In this way, a reference value for the timing advance used by the UE is established.

During time period T2, the test equipment shall send a sequence of messages with Timing Advance Command MAC Control Elements, with Timing Advance Command value specified in table A.7.2.1.1-2. This value shall result in changes of the timing advance used by the UE, and the accuracy of the change shall then be measured, using the SRS sent from the UE.

As specified in Clause 7.3.2.1, the UE adjusts its uplink timing at sub-frame n+6 for a timing advance command received in sub-frame n. This delay must be taken into account when measuring the timing advance adjustment accuracy, via the SRS sent from the UE.

The UE Time Alignment Timer, described in Clause 5.2 in TS 36.321, shall be configured so that it does not expire in the duration of the test.

Table A.7.2.2.1-1: General Test Parameters for E-UTRAN TDD Timing Advance Accuracy Test

Parameter	Unit	Value	Comment
PDSCH parameters		DL Reference Measurement Channel R.0 TDD	As specified in clause A.3.1.1.2
PCFICH/PDCCH/PHICH parameters		DL Reference Measurement Channel R.6 TDD	As specified in clause A.3.1.2.2
Timing Advance Command (T_A) value during T1		31	$N_{TA} = 0$ for the purpose of establishing a reference value from which the timing advance adjustment accuracy can be measured during T2
Timing Advance Command (T_A) value during T2		39	$N_{TA} = 128$
DRX		OFF	
T1	s	5	
T2	s	5	

Table A.7.2.2.1-2: Cell specific Test Parameters for E-UTRAN TDD Timing Advance Accuracy Test

Parameter	Unit	Value	
		T1	T2
E-UTRA RF Channel Number		1	
BW _{channel}	MHz	10	
Special subframe configuration ^{Note1}		6	
Uplink-downlink configuration ^{Note2}		1	
OCNG Patterns defined in A.3.2.2.1 (OP.1 TDD)		OP.1 TDD	
PBCH_RA	dB	0	
PBCH_RB	dB		
PSS_RA	dB		
SSS_RA	dB		
PCFICH_RB	dB		
PHICH_RA	dB		
PHICH_RB	dB		
PDCCH_RA	dB		
PDCCH_RB	dB		
PDSCH_RA	dB		
PDSCH_RB	dB		
OCNG_RA ^{Note3}	dB		
OCNG_RB ^{Note3}	dB		
Timing Advance Command (T_A)			

\hat{E}_s/I_{ot}	dB	3
N_{oc}	dBm/15 KHz	-98
\hat{E}_s/N_{oc}	dB	3
I_o^{Note4}	dBm/9 MHz	-65.5
Propagation Condition		AWGN
<p>Note 1: For the special subframe configuration see table 4.2-1 in TS 36.211. Note 2: For the uplink-downlink configuration see table 4.2-2 in TS 36.211. Note 3: OCNG shall be used such that both cells are fully allocated and a constant total transmitted power spectral density is achieved for all OFDM symbols. Note 4: I_o level has been derived from other parameters for information purpose. It is not a settable parameter.</p>		

Table A.7.2.2.1-3: Sounding Reference Symbol Configuration for E-UTRAN TDD Transmit Timing Accuracy Test

Field	Value	Comment
srsBandwidthConfiguration	bw5	
srsSubframeConfiguration	sc3	Once every 5 subframes
ackNackSrsSimultaneousTransmission	FALSE	
srsMaxUpPTS	N/A	
srsBandwidth	bw0	No hopping
srsHoppingBandwidth	hbw0	
frequencyDomainPosition	0	
Duration	TRUE	Indefinite duration
Srs-ConfigurationIndex	15	SRS periodicity of 10ms.
transmissionComb	0	
cyclicShift	cs0	No cyclic shift
SRS-AntennaPort	an1	Number of antenna ports used for SRS transmission
Note: For further information see clause 6.3.2 in TS 36.331.		

A.7.2.2.2 Test Requirements

The UE shall apply the signalled Timing Advance value to the transmission timing at the designated activation time i.e. 6 sub frames after the reception of the timing advance command.

The Timing Advance adjustment accuracy shall be within the limits specified in clause 7.3.2.2.

The rate of correct Timing Advance adjustments observed during repeated tests shall be at least 90%.

A.7.2.3 E-UTRAN FDD – UE Timing Advance Adjustment Accuracy Test for 5MHz

A.7.2.3.1 Test Purpose and Environment

The purpose of this test case is the same as for the test defined in subclause A.7.2.1.1.

The parameters of this test are the same as defined in Subclause A.7.2.1.1 except that the values of the parameters in the Table A.7.2.3.1-1 will replace the values of the corresponding parameters in A.7.2.1.1-1, table A.7.2.3.1-2 will replace the values of the corresponding parameters in A.7.2.1.1-2. Parameters used for the sounding reference symbol configuration are unchanged from table A.7.2.1.1-3.

Table A.7.2.3.1-1: General Test Parameters for E-UTRAN FDD Timing Advance Accuracy Test for 5MHz bandwidth

Parameter	Unit	Value	Comment
-----------	------	-------	---------

PDSCH parameters		DL Reference Measurement Channel R.5 FDD	As specified in clause A.3.1.1.1
PCFICH/PDCCH/PHICH parameters		DL Reference Measurement Channel R.11 FDD	As specified in clause A.3.1.2.1
Note 1: For the reference measurement channels, see clause A.3.1.			
Note 2: See Table A.7.2.1.1-1 for the other parameters.			
Note 3: This test is according to the principle defined in section A.3.7.2			

Table A.7.2.3.1-2: Cell specific Test Parameters for E-UTRAN FDD Timing Advance Accuracy Test for 5MHz bandwidth

Parameter	Unit	Value	
		T1	T2
BW _{channel}	MHz	5	
OCNG Patterns defined in A.3.2.1.15 (OP.15 FDD)		OP.15 FDD	
I ₀ ^{Note2}	dBm/4.5 MHz	-68.5	
Note 1: For the reference measurement channels, see clause A.3.2.			
Note 2: See Table A.7.2.1.1-2 for the other parameters.			

A.7.2.3.2 Test Requirements

The test requirements defined in section A.7.2.1.2 shall apply to this test case.

A.7.2.4 E-UTRAN FDD – UE Timing Advance Adjustment Accuracy Test for SCell in sTAG

A.7.2.4.1 Test Purpose and Environment

The purpose of the test is to verify E-UTRAN FDD Timing Advance adjustment accuracy requirements, defined in clause 7.3.2.2, in an AWGN model.

The test parameters are given in tables A.7.2.4.1-1, A.7.2.4.1-2, and A.7.2.4.1-3. For this test two cells are used. Cell 1 is PCell and Cell 2 is SCell. PCell is in the primary Timing Advance Group (pTAG) and SCell is in the secondary Timing Advance Group (sTAG). The test consists of two successive time periods, with time duration of T1 and T2 respectively. In each time period, timing advance commands for sTAG are sent to the UE and Sounding Reference Signals (SRS), as specified in table A.7.2.4.1-3, are sent from the UE and received by the test equipment. By measuring the reception of the SRS, the transmit timing, and hence the timing advance adjustment accuracy, can be measured for SCell in sTAG.

During time period T1, the test equipment shall send one message with a Timing Advance Command MAC Control Element for sTAG, as specified in Clause 6.1.3.5 in TS 36.321. The Timing Advance Command value shall be set to 31, which according to Clause 4.2.3 in TS 36.213 results in zero adjustment of the Timing Advance. In this way, a reference value for the timing advance for sTAG used by the UE is established.

During time period T2, the test equipment shall send a sequence of messages with Timing Advance Command MAC Control Elements for sTAG, with Timing Advance Command value specified in table A.7.2.4.1-2. This value shall result in changes of the timing advance for sTAG used by the UE, and the accuracy of the change shall then be measured, using the SRS sent from the UE.

As specified in Clause 7.3.2.1, the UE adjusts its uplink timing at sub-frame n+6 for a timing advance command received in sub-frame n. This delay must be taken into account when measuring the timing advance adjustment accuracy, via the SRS sent from the UE.

The UE Time Alignment Timer, described in Clause 5.2 in TS 36.321, shall be configured so that it does not expire in the duration of the test.

Table A.7.2.4.1-1: General Test Parameters for E-UTRAN FDD Timing Advance Accuracy Test for SCell in sTAG

Parameter	Unit	Value	Comment
-----------	------	-------	---------

PDSCH parameters		DL Reference Measurement Channel R.0 FDD	As specified in clause A.3.1.1.1
PCFICH/PDCCH/PHICH parameters		DL Reference Measurement Channel R.6 FDD	As specified in clause A.3.1.2.1
Timing Advance Command (T_A) value during T1		31	$N_{TA} = 0$ for the purpose of establishing a reference value from which the timing advance adjustment accuracy can be measured during T2
Timing Advance Command (T_A) value during T2		39	$N_{TA} = 128$
DRX		OFF	
T1	s	5	
T2	s	5	

Table A.7.2.4.1-2: Cell specific Test Parameters for E-UTRAN FDD Timing Advance Accuracy Test for SCell in sTAG

Parameter	Unit	Value			
		Cell1		Cell2	
		T1	T2	T1	T2
E-UTRA RF Channel Number		1		2	
$BW_{channel}$	MHz	10		10	
Active PCell		Cell1	Cell1		
Active SCell				Cell2	Cell2
TAG configuration		pTAG	pTAG	sTAG	sTAG
OCNG Patterns defined in A.3.2.1.1 (OP.1 FDD)		OP.1 FDD		OP.1 FDD	
PBCH_RA	dB	0		0	
PBCH_RB	dB				
PSS_RA	dB				
SSS_RA	dB				
PCFICH_RB	dB				
PHICH_RA	dB				
PHICH_RB	dB				
PDCCH_RA	dB				
PDCCH_RB	dB				
PDSCH_RA	dB				
PDSCH_RB	dB				
OCNG_RA ^{Note1}	dB				
OCNG_RB ^{Note1}	dB				
Timing Advance Command (T_A)					
\hat{E}_s / I_{ot}	dB	3		3	
N_{oc}	dBm/15 KHz	-98		-98	
\hat{E}_s / N_{oc}	dB	3		3	
I_o ^{Note2}	dBm/9 MHz	-65.5		-65.5	
Propagation Condition		AWGN		AWGN	
Note 1: OCNG shall be used such that both cells are fully allocated and a constant total transmitted power spectral density is achieved for all OFDM symbols. Note 2: I_o level has been derived from other parameters for information purpose. It is not a settable parameter.					

Table A.7.2.4.1-3: Sounding Reference Symbol Configuration for E-UTRAN FDD Transmit Timing Accuracy Test for SCell in sTAG

Field	Value	Comment
srsBandwidthConfiguration	bw5	
srsSubframeConfiguration	sc3	Once every 5 subframes
ackNackSrsSimultaneousTransmission	FALSE	

srsMaxUpPTS	N/A	Not applicable for E-UTRAN FDD
srsBandwidth	0	No hopping
srsHoppingBandwidth	hbw0	
frequencyDomainPosition	0	
Duration	TRUE	Indefinite duration
Srs-ConfigurationIndex	7	SRS periodicity of 10.
transmissionComb	0	
cyclicShift	cs0	No cyclic shift
SRS-AntennaPort	an1	Number of antenna ports used for SRS transmission
Note: For further information see clause 6.3.2 in TS 36.331.		

A.7.2.4.2 Test Requirements

The UE shall apply the signalled Timing Advance value for SCell in sTAG to the transmission timing at the designated activation time i.e. 6 sub frames after the reception of the timing advance command.

The Timing Advance adjustment accuracy for SCell in sTAG shall be within the limits specified in clause 7.3.2.2.

The rate of correct Timing Advance adjustments observed during repeated tests shall be at least 90%.

A.7.2.5 E-UTRAN TDD – UE Timing Advance Adjustment Accuracy Test for SCell in sTAG

A.7.2.5.1 Test Purpose and Environment

The purpose of the test is to verify E-UTRAN TDD Timing Advance adjustment accuracy requirements, defined in clause 7.3.2.2, in an AWGN model.

The test parameters are given in tables A.7.2.5.1-1, A.7.2.5.1-2, and A.7.2.5.1-3. For this test two cells are used. Cell 1 is PCell and Cell 2 is SCell. PCell is in the primary Timing Advance Group (pTAG) and SCell is in the secondary Timing Advance Group (sTAG). The test consists of two successive time periods, with time duration of T1 and T2 respectively. In each time period, timing advance commands for sTAG are sent to the UE and Sounding Reference Signals (SRS), as specified in table A.7.2.5.1-3, are sent from the UE and received by the test equipment, but only for SCell. By measuring the reception of the SRS, the transmit timing, and hence the timing advance adjustment accuracy, can be measured for SCell in sTAG.

During time period T1, the test equipment shall send one message with a Timing Advance Command MAC Control Element for sTAG, as specified in Clause 6.1.3.5 in TS 36.321. The Timing Advance Command value shall be set to 31, which according to Clause 4.2.3 in TS 36.213 results in zero adjustment of the Timing Advance. In this way, a reference value for the timing advance used by the UE is established.

During time period T2, the test equipment shall send a sequence of messages with Timing Advance Command MAC Control Elements for sTAG, with Timing Advance Command value specified in table A.7.2.5.1-2. This value shall result in changes of the timing advance on SCell used by the UE, and the accuracy of the change shall then be measured, using the SRS sent from the UE.

As specified in Clause 7.3.2.1, the UE adjusts its uplink timing at sub-frame $n+6$ for a timing advance command received in sub-frame n . This delay must be taken into account when measuring the timing advance adjustment accuracy, via the SRS sent from the UE.

The UE Time Alignment Timer, described in Clause 5.2 in TS 36.321, shall be configured so that it does not expire in the duration of the test.

Table A.7.2.5.1-1: General Test Parameters for E-UTRAN TDD Timing Advance Accuracy Test for SCell in sTAG

Parameter	Unit	Value	Comment
PDSCH parameters		DL Reference Measurement Channel R.0 TDD	As specified in clause A.3.1.1.2
PCFICH/PDCCH/PHICH parameters		DL Reference Measurement Channel R.6 TDD	As specified in clause A.3.1.2.2

Timing Advance Command (T_A) value during T1		31	$N_{TA} = 0$ for the purpose of establishing a reference value from which the timing advance adjustment accuracy can be measured during T2
Timing Advance Command (T_A) value during T2		39	$N_{TA} = 128$
DRX		OFF	
T1	s	5	
T2	s	5	

Table A.7.2.5.1-2: Cell specific Test Parameters for E-UTRAN TDD Timing Advance Accuracy Test for SCell in sTAG

Parameter	Unit	Value			
		Cell 1		Cell 2	
		T1	T2	T1	T2
E-UTRA RF Channel Number		1		2	
$BW_{channel}$	MHz	10		10	
Active PCell		Cell1			
Active SCell				Cell2	
TAG configuration		pTAG		sTAG	
Special subframe configuration ^{Note1}		6		6	
Uplink-downlink configuration ^{Note2}		1		1	
OCNG Patterns defined in A.3.2.2.1 (OP.1 TDD)		OP.1 TDD		OP.1 TDD	
PBCH_RA	dB	0		0	
PBCH_RB	dB				
PSS_RA	dB				
SSS_RA	dB				
PCFICH_RB	dB				
PHICH_RA	dB				
PHICH_RB	dB				
PDCCH_RA	dB				
PDCCH_RB	dB				
PDSCH_RA	dB				
PDSCH_RB	dB				
OCNG_RA ^{Note3}	dB				
OCNG_RB ^{Note3}	dB				
Timing Advance Command (T_A)					
\hat{E}_s / I_{ot}	dB	3		3	
N_{oc}	dBm/15 KHz	-98		-98	
\hat{E}_s / N_{oc}	dB	3		3	
I_o ^{Note4}	dBm/9 MHz	-65.5		-65.5	
Propagation Condition		AWGN		AWGN	
Note 1: For the special subframe configuration see table 4.2-1 in TS 36.211. Note 2: For the uplink-downlink configuration see table 4.2-2 in TS 36.211. Note 3: OCNG shall be used such that both cells are fully allocated and a constant total transmitted power spectral density is achieved for all OFDM symbols. Note 4: I_o level has been derived from other parameters for information purpose. It is not a settable parameter.					

Table A.7.2.5.1-3: Sounding Reference Symbol Configuration for E-UTRAN TDD Transmit Timing Accuracy Test for SCell in sTAG

Field	Value	Comment
srsBandwidthConfiguration	bw5	
srsSubframeConfiguration	sc3	Once every 5 subframes
ackNackSrsSimultaneousTransmission	FALSE	

srsMaxUpPTS	N/A	
srsBandwidth	bw0	No hopping
srsHoppingBandwidth	hbw0	
frequencyDomainPosition	0	
Duration	TRUE	Indefinite duration
Srs-ConfigurationIndex	15	SRS periodicity of 10ms.
transmissionComb	0	
cyclicShift	cs0	No cyclic shift
SRS-AntennaPort	an1	Number of antenna ports used for SRS transmission
Note: For further information see clause 6.3.2 in TS 36.331.		

A.7.2.5.2 Test Requirements

The UE shall apply the signalled Timing Advance value for SCell in sTAG to the transmission timing at the designated activation time i.e. 6 sub frames after the reception of the timing advance command.

The Timing Advance adjustment accuracy for SCell in sTAG shall be within the limits specified in clause 7.3.2.2.

The rate of correct Timing Advance adjustments observed during repeated tests shall be at least 90%.

A.7.2.5A E-UTRAN TDD – UE Timing Advance Adjustment Accuracy Test for SCell in sTAG for 20 MHz +20 MHz

A.7.2.5A.1 Test Purpose and Environment

The purpose of this test case is the same as for the test defined in subclause A.7.2.5.1.

The parameters of this test are the same as defined in Subclause A.7.2.5.1 except that the values of the parameters in the Table A.7.2.5A.1-1 will replace the values of the corresponding parameters in A.7.2.5.1-1, table A.7.2.5A.1-2 will replace the values of the corresponding parameters in A.7.2.5.1-2. Parameters used for the sounding reference symbol configuration are unchanged from table A.7.2.5.1-3.

Table A.7.2.5A.1-1: General Test Parameters for E-UTRAN TDD Timing Advance Accuracy Test for SCell in sTAG for 20 MHz +20 MHz

Parameter	Unit	Value	Comment
PDSCH parameters		DL Reference Measurement Channel R.3 TDD	As specified in clause A.3.1.1.2
PCFICH/PDCCH/PHICH parameters		DL Reference Measurement Channel R.10 TDD	As specified in clause A.3.1.2.2

Table A.7.2.5A.1-2: Cell specific Test Parameters for E-UTRAN TDD Timing Advance Accuracy Test for SCell in sTAG for 20 MHz +20 MHz

Parameter	Unit	Value			
		Cell 1		Cell 2	
		T1	T2	T1	T2
BW _{channel}	MHz	20		20	
OCNG Patterns defined in A.3.2.2		OP.7 TDD		OP.7 TDD	
I ₀ ^{Note4}	dBm/18 MHz	-62.5		-62.5	

A.7.2.5A.2 Test Requirements

The test requirements defined in section A.7.2.5.2 shall apply to this test case.

A.7.2.5B E-UTRAN TDD – UE Timing Advance Adjustment Accuracy Test for SCell in sTAG for 20 MHz +10 MHz

A.7.2.5B.1 Test Purpose and Environment

The purpose of this test case is the same as for the test defined in subclause A.7.2.5.1.

The parameters of this test are the same as defined in Subclause A.7.2.5.1 except that the values of the parameters in the Table A.7.2.5B.1-1 will replace the values of the corresponding parameters in A.7.2.5.1-1, table A.7.2.5B.1-2 will replace the values of the corresponding parameters in A.7.2.5.1-2. Parameters used for the sounding reference symbol configuration are unchanged from table A.7.2.5.1-3.

Table A.7.2.5B.1-1: General Test Parameters for E-UTRAN TDD Timing Advance Accuracy Test for SCell in sTAG for 20 MHz +10 MHz

Parameter	Unit	Value	Comment
PDSCH parameters		For Cell 1: DL Reference Measurement Channel R.3 TDD For Cell 2: DL Reference Measurement Channel R.0 TDD	As specified in clause A.3.1.1.2
PCFICH/PDCCH/PHICH parameters		For Cell 1: DL Reference Measurement Channel R.10 TDD For Cell 2: DL Reference Measurement Channel R.6 TDD	As specified in clause A.3.1.2.2

Table A.7.2.5B.1-2: Cell specific Test Parameters for E-UTRAN TDD Timing Advance Accuracy Test for SCell in sTAG for 20 MHz +10 MHz

Parameter	Unit	Value			
		Cell 1		Cell 2	
		T1	T2	T1	T2
BW_{channel}	MHz	20		10	
OCNG Patterns defined in A.3.2.2		OP.7 TDD		OP.1 TDD	
I_0^{Note4}	dBm/18 MHz	-62.5		N/A	
	dBm/9 MHz	N/A		-65.5	

A.7.2.5B.2 Test Requirements

The test requirements defined in section A.7.2.5.2 shall apply to this test case.

A.7.2.6 E-UTRAN FDD Timing Advance Adjustment Accuracy Test for Cat-M1 UE in CEModeA

A.7.2.6.1 Test Purpose and Environment

The purpose of the test is to verify E-UTRAN FDD Timing Advance adjustment accuracy requirements for Cat-M1 UE configured with CEModeA, defined in clause 7.3.2.2, in an AWGN model.

The test parameters are given in tables A.7.2.6.1-1, A.7.2.6.1-2, and A.7.2.6.1-3. The test consists of two successive time periods, with time duration of T1 and T2 respectively. In each time period, timing advance commands are sent to the UE and Sounding Reference Signals (SRS), as specified in table A.7.2.1.1-3, are sent from the UE and received by the test equipment. By measuring the reception of the SRS, the transmit timing, and hence the timing advance adjustment accuracy, can be measured.

During time period T1, the test equipment shall send one message with a Timing Advance Command MAC Control Element, as specified in Clause 6.1.3.5 in TS 36.321. The Timing Advance Command value shall be set to 31, which according to Clause 4.2.3 in TS 36.213 results in zero adjustment of the Timing Advance. In this way, a reference value for the timing advance used by the UE is established.

During time period T2, the test equipment shall send a sequence of messages with Timing Advance Command MAC Control Elements, with Timing Advance Command value specified in table A.7.2.6.1-2. This value shall result in

changes of the timing advance used by the UE, and the accuracy of the change shall then be measured, using the SRS sent from the UE.

As specified in Clause 7.3.2.1, the UE adjusts its uplink timing at sub-frame $n+6$ for a timing advance command received in sub-frame n . This delay must be taken into account when measuring the timing advance adjustment accuracy, via the SRS sent from the UE.

The UE Time Alignment Timer, described in Clause 5.2 in TS 36.321, shall be configured so that it does not expire in the duration of the test.

Table A.7.2.6.1-1: General Test Parameters for E-UTRAN FDD Timing Advance Accuracy Test for Cat-M1 UE in CEModeA

Parameter	Unit	Value	Comment
PDSCH parameters: DL Reference Measurement Channel		R.20 FDD	As specified in clause A.3.1.4.1
MPDCCH parameters: DL Reference Measurement Channel		R.16 FDD	As specified in clause A.3.1.3.1
Timing Advance Command (T_A) value during T1		31	$N_{TA} = 0$ for the purpose of establishing a reference value from which the timing advance adjustment accuracy can be measured during T2
Timing Advance Command (T_A) value during T2		39	$N_{TA} = 128$
DRX		OFF	
T1	s	5	
T2	s	5	

Table A.7.2.6.1-2: Cell specific Test Parameters for E-UTRAN FDD UE Timing Advance Accuracy Test for Cat-M1 UE in CEModeA

Parameter	Unit	Value	
		T1	T2
E-UTRA RF Channel Number		1	
$BW_{channel}$	MHz	10	
PDSCH parameters: DL Reference Measurement Channel		R.20 FDD	
MPDCCH parameters: DL Reference Measurement Channel		R.16 FDD	
OCNG Patterns defined in A.3.2.1.21		OP.21 FDD	
PBCH_RA	dB	0	
PBCH_RB	dB		
PSS_RA	dB		
SSS_RA	dB		
PCFICH_RB	dB		
PHICH_RA	dB		
PHICH_RB	dB		
MPDCCH_RA	dB		
MPDCCH_RB	dB		
PDCCH_RA	dB		
PDCCH_RB	dB		
PDSCH_RA	dB		
PDSCH_RB	dB		
OCNG_RA ^{Note1}	dB		
OCNG_RB ^{Note1}	dB		
Timing Advance Command (T_A)			
\hat{E}_s / I_{ot}	dB	3	
N_{oc}	dBm/15 KHz	-98	

\hat{E}_s / N_{oc}	dB	3
$I_{o\text{Note2}}$	dBm/9 MHz	-65.5
Propagation Condition		AWGN
Note 1:	OCNG shall be used such that cells is fully allocated and a constant total transmitted power spectral density is achieved for all OFDM symbols.	
Note 2:	I _o level has been derived from other parameters for information purpose. It is not a settable parameter.	

Table A.7.2.6.1-3: Sounding Reference Symbol Configuration for E-UTRAN FDD UE Transmit Timing Accuracy Test for Cat-M1 UE in CEModeA

Field	Value	Comment
srsBandwidthConfiguration	Bw5	
srsSubframeConfiguration	sc3	Once every 5 subframes
ackNackSrsSimultaneousTransmission	FALSE	
srsMaxUpPTS	N/A	Not applicable for E-UTRAN FDD
srsBandwidth	0	No hopping
srsHoppingBandwidth	hbw0	
frequencyDomainPosition	0	
Duration	TRUE	Indefinite duration
Srs-ConfigurationIndex	17	SRS periodicity of 20.
transmissionComb	0	
cyclicShift	cs0	No cyclic shift
SRS-AntennaPort	an1	Number of antenna ports used for SRS transmission
Note 1:	For further information see clause 6.3.2 in TS 36.331.	

A.7.2.6.2 Test Requirements

The UE shall apply the signalled Timing Advance value to the transmission timing at the designated activation time i.e. 6 sub frames after the reception of the timing advance command.

The Timing Advance adjustment accuracy shall be within the limits specified in clause 7.3.2.2.

The rate of correct Timing Advance adjustments observed during repeated tests shall be at least 90%.

A.7.2.7 E-UTRAN HD-FDD UE Timing Advance Adjustment Accuracy Test for Cat-M1 UE in CEModeA

A.7.2.7.1 Test Purpose and Environment

The purpose of the test is to verify E-UTRAN HD-FDD Timing Advance adjustment accuracy requirements for Cat-M1 UE configured with CEModeA, defined in clause 7.3.2.2, in an AWGN model.

The test parameters are given in tables A.7.2.7.1-1, A.7.2.7.1-2, and A.7.2.7.1-3. The test consists of two successive time periods, with time duration of T1 and T2 respectively. In each time period, timing advance commands are sent to the UE and Sounding Reference Signals (SRS), as specified in table A.7.2.7.1-3, are sent from the UE and received by the test equipment. By measuring the reception of the SRS, the transmit timing, and hence the timing advance adjustment accuracy, can be measured.

During time period T1, the test equipment shall send one message with a Timing Advance Command MAC Control Element, as specified in Clause 6.1.3.5 in TS 36.321. The Timing Advance Command value shall be set to 31, which according to Clause 4.2.3 in TS 36.213 results in zero adjustment of the Timing Advance. In this way, a reference value for the timing advance used by the UE is established.

During time period T2, the test equipment shall send a sequence of messages with Timing Advance Command MAC Control Elements, with Timing Advance Command value specified in table A.7.2.7.1-2. This value shall result in changes of the timing advance used by the UE, and the accuracy of the change shall then be measured, using the SRS sent from the UE.

As specified in Clause 7.3.2.1, the UE adjusts its uplink timing at sub-frame n+6 for a timing advance command received in sub-frame n. This delay must be taken into account when measuring the timing advance adjustment accuracy, via the SRS sent from the UE.

The UE Time Alignment Timer, described in Clause 5.2 in TS 36.321, shall be configured so that it does not expire in the duration of the test.

Table A.7.2.7.1-1: General Test Parameters for E-UTRAN HD-FDD Timing Advance Accuracy Test for Cat-M1 UE in CEModeA

Parameter	Unit	Value	Comment
PDSCH parameters: DL Reference Measurement Channel		R.10 HD-FDD	As specified in clause A.3.1.4.2
MPDCCH parameters: DL Reference Measurement Channel		R.6 HD-FDD	As specified in clause A.3.1.3.2
Timing Advance Command (T_A) value during T1		31	$N_{TA} = 0$ for the purpose of establishing a reference value from which the timing advance adjustment accuracy can be measured during T2
Timing Advance Command (T_A) value during T2		39	$N_{TA} = 128$
DRX		OFF	
T1	s	5	
T2	s	5	

Table A.7.2.7.1-2: Cell specific Test Parameters for E-UTRAN HD-FDD Timing Advance Accuracy Test for Cat-M1 UE in CEModeA

Parameter	Unit	Value	
		T1	T2
E-UTRA RF Channel Number		1	
$BW_{channel}$	MHz	10	
PDSCH parameters: DL Reference Measurement Channel		R.10 HD-FDD	
MPDCCH parameters: DL Reference Measurement Channel		R.6 HD-FDD	
OCNG Patterns defined in A.3.2.1.21		OP.21 FDD	
PBCH_RA	dB	0	
PBCH_RB	dB		
PSS_RA	dB		
SSS_RA	dB		
PCFICH_RB	dB		
PHICH_RA	dB		
PHICH_RB	dB		
MPDCCH_RA	dB		
MPDCCH_RB	dB		
PDCCH_RA	dB		
PDCCH_RB	dB		
PDSCH_RA	dB		
PDSCH_RB	dB		
OCNG_RA ^{Note1}	dB		
OCNG_RB ^{Note1}	dB		
Timing Advance Command (T_A)			
\hat{E}_s / I_{ot}	dB	3	
N_{oc}	dBm/15 KHz	-98	
\hat{E}_s / N_{oc}	dB	3	
I_o ^{Note2}	dBm/9 MHz	-65.5	

Propagation Condition		AWGN
Note 1:	OCNG shall be used such that both cells are fully allocated and a constant total transmitted power spectral density is achieved for all OFDM symbols.	
Note 2:	lo level has been derived from other parameters for information purpose. It is not a settable parameter.	

Table A.7.2.7.1-3: Sounding Reference Symbol Configuration for E-UTRAN HD-FDD Transmit Timing Accuracy Test for Cat-M1 UE in CEModeA

Field	Value	Comment
srsBandwidthConfiguration	Bw5	
srsSubframeConfiguration	sc3	Once every 5 subframes
ackNackSrsSimultaneousTransmission	FALSE	
srsMaxUpPTS	N/A	
srsBandwidth	0	No hopping
srsHoppingBandwidth	hbw0	
frequencyDomainPosition	0	
Duration	TRUE	Indefinite duration
Srs-ConfigurationIndex	17	SRS periodicity of 20.
transmissionComb	0	
cyclicShift	cs0	No cyclic shift
SRS-AntennaPort	an1	Number of antenna ports used for SRS transmission
Note 1: For further information see clause 6.3.2 in TS 36.331.		

A.7.2.7.2 Test Requirements

The UE shall apply the signalled Timing Advance value to the transmission timing at the designated activation time i.e. 6 sub frames after the reception of the timing advance command.

The Timing Advance adjustment accuracy shall be within the limits specified in clause 7.3.2.2.

The rate of correct Timing Advance adjustments observed during repeated tests shall be at least 90%.

A.7.2.8 E-UTRAN TDD Timing Advance Adjustment Accuracy Test for Cat-M1 UE in CEModeA

A.7.2.8.1 Test Purpose and Environment

The purpose of the test is to verify E-UTRAN TDD Timing Advance adjustment accuracy requirements for Cat-M1 UE configured with CEModeA, defined in clause 7.3.2.2, in an AWGN model.

The test parameters are given in tables A.7.2.8.1-1, A.7.2.8.1-2, and A.7.2.8-3. The test consists of two successive time periods, with time duration of T1 and T2 respectively. In each time period, timing advance commands are sent to the UE and Sounding Reference Signals (SRS), as specified in table A.7.2.8.1-3, are sent from the UE and received by the test equipment. By measuring the reception of the SRS, the transmit timing, and hence the timing advance adjustment accuracy, can be measured.

During time period T1, the test equipment shall send one message with a Timing Advance Command MAC Control Element, as specified in Clause 6.1.3.5 in TS 36.321. The Timing Advance Command value shall be set to 31, which according to Clause 4.2.3 in TS 36.213 results in zero adjustment of the Timing Advance. In this way, a reference value for the timing advance used by the UE is established.

During time period T2, the test equipment shall send a sequence of messages with Timing Advance Command MAC Control Elements, with Timing Advance Command value specified in table A.7.2.8.1-2. This value shall result in changes of the timing advance used by the UE, and the accuracy of the change shall then be measured, using the SRS sent from the UE.

As specified in Clause 7.3.2.1, the UE adjusts its uplink timing at sub-frame n+6 for a timing advance command received in sub-frame n. This delay must be taken into account when measuring the timing advance adjustment accuracy, via the SRS sent from the UE.

The UE Time Alignment Timer, described in Clause 5.2 in TS 36.321, shall be configured so that it does not expire in the duration of the test.

Table A.7.2.8.1-1: General Test Parameters for E-UTRAN TDD Timing Advance Accuracy Test for Cat-M1 UE in CEModeA

Parameter	Unit	Value	Comment
PDSCH parameters: DL Reference Measurement Channel		R.16 TDD	As specified in clause A.3.1.4.3
MPDCCH parameters: DL Reference Measurement Channel		R.14 TDD	As specified in clause A.3.1.3.3
Timing Advance Command (T_A) value during T1		31	$N_{TA} = 0$ for the purpose of establishing a reference value from which the timing advance adjustment accuracy can be measured during T2
Timing Advance Command (T_A) value during T2		39	$N_{TA} = 128$
DRX		OFF	
T1	s	5	
T2	s	5	

Table A.7.2.8.1-2: Cell specific Test Parameters for E-UTRAN TDD Timing Advance Accuracy Test for Cat-M1 UE in CEModeA

Parameter	Unit	Value	
		T1	T2
E-UTRA RF Channel Number		1	
$BW_{channel}$	MHz	10	
PDSCH parameters: DL Reference Measurement Channel		R.16 TDD	
MPDCCH parameters: DL Reference Measurement Channel		R.14 TDD	
Special subframe configuration ^{Note1}		6	
Uplink-downlink configuration ^{Note2}		1	
OCNG Patterns defined in A.3.2.2.11		OP.11 TDD	
PBCH_RA	dB	0	
PBCH_RB	dB		
PSS_RA	dB		
SSS_RA	dB		
PCFICH_RB	dB		
PHICH_RA	dB		
PHICH_RB	dB		
MPDCCH_RA	dB		
MPDCCH_RB	dB		
PDCCH_RA	dB		
PDCCH_RB	dB		
PDSCH_RA	dB		
PDSCH_RB	dB		
OCNG_RA ^{Note3}	dB		
OCNG_RB ^{Note3}	dB		
Timing Advance Command (T_A)			
\hat{E}_s / I_{ot}	dB	3	
N_{oc}	dBm/15 KHz	-98	
\hat{E}_s / N_{oc}	dB	3	
I_o ^{Note4}	dBm/9 MHz	-65.5	
Propagation Condition		AWGN	

Note 1:	For the special subframe configuration see table 4.2-1 in TS 36.211.
Note 2:	For the uplink-downlink configuration see table 4.2-2 in TS 36.211.
Note 3:	OCNG shall be used such that both cells are fully allocated and a constant total transmitted power spectral density is achieved for all OFDM symbols.
Note 4:	lo level has been derived from other parameters for information purpose. It is not a settable parameter.

Table A.7.2.8.1-3: Sounding Reference Symbol Configuration for E-UTRAN TDD Transmit Timing Accuracy Test for Cat-M1 UE in CEModeA

Field	Value	Comment
srsBandwidthConfiguration	Bw5	
srsSubframeConfiguration	sc3	Once every 5 subframes
ackNackSrsSimultaneousTransmission	FALSE	
srsMaxUpPTS	N/A	
srsBandwidth	bw0	No hopping
srsHoppingBandwidth	hbw0	
frequencyDomainPosition	0	
Duration	TRUE	Indefinite duration
Srs-ConfigurationIndex	15	SRS periodicity of 10ms.
transmissionComb	0	
cyclicShift	cs0	No cyclic shift
SRS-AntennaPort	an1	Number of antenna ports used for SRS transmission
Note 1: For further information see clause 6.3.2 in TS 36.331.		

A.7.2.8.2 Test Requirements

The UE shall apply the signalled Timing Advance value to the transmission timing at the designated activation time i.e. 6 sub frames after the reception of the timing advance command.

The Timing Advance adjustment accuracy shall be within the limits specified in clause 7.3.2.2.

The rate of correct Timing Advance adjustments observed during repeated tests shall be at least 90%.

A.7.2.9 HD-FDD UE Timing Advance Adjustment Accuracy Test for UE Category NB1 in Standalone Mode under Enhance Coverage

A.7.2.9.1 Test Purpose and Environment

The purpose of the test is to verify E-UTRAN Timing Advance adjustment accuracy requirements for UE category NB1 in enhanced coverage, defined in clause 7.22.2.2, in an AWGN model.

The test parameters are given in tables A.7.2.9.1-1 and A.7.2.9.1-2. The test consists of two successive time periods, with time duration of T1 and T2 respectively. In each time period, timing advance commands are sent to the UE and the UE is scheduled in every uplink subframe to transmit NPUSCH, which is received by the test equipment. By measuring the reception of the NPUSCH, the transmit timing, and hence the timing advance adjustment accuracy, can be measured.

During time period T1, the test equipment shall send one message with a Timing Advance Command MAC Control Element, as specified in Clause 6.1.3.5 in TS 36.321. The Timing Advance Command value shall be set to 31, which according to Clause 16.1.2 in TS 36.213 results in zero adjustment of the Timing Advance. In this way, a reference value for the timing advance used by the UE is established.

During time period T2, the test equipment shall send a sequence of messages with Timing Advance Command MAC Control Elements, with Timing Advance Command value specified in table A.7.2.9.1-2. This value shall result in changes of the timing advance used by the UE, and the accuracy of the change shall then be measured, using the NPUSCH sent from the UE.

As specified in Clause 7.22.2.1, the UE adjusts its uplink timing at sub-frame $n+12$ for a timing advance command received in sub-frame n , where sub-frame n refers to the last subframe in the repetition period in which the MAC control element containing timing advance command was received. In addition, the UE shall not apply a TA command during an uplink repetition period. The timing advance adjustment accuracy is verified via the uplink transmission of

NPUSCH carrying ACK/NACK response to the NPDSCH carrying TA command. k_0 in ACK/NACK resource filed in DCI is set as 13.

The UE Time Alignment Timer, described in Clause 5.2 in TS 36.321, shall be configured so that it does not expire in the duration of the test.

Table A.7.2.9.1-1: General Test Parameters for E-UTRAN Timing Advance Accuracy Test for UE Category NB1 in Standalone Mode under Enhanced Coverage

Parameter	Unit	Value	Comment
NB-IoT operational mode		Standalone	
CP Length		Normal	
Timing Advance Command (T_A) value during T1		31	$N_{TA} = 0$ for the purpose of establishing a reference value from which the timing advance adjustment accuracy can be measured during T2
Timing Advance Command (T_A) value during T2		39	$N_{TA} = 128$
Number of repetitions	NPDCCH	128	
	NPDSCH	128	
	NPUSCH	32	
DRX		OFF	
T1	s	5	
T2	s	5	

Table A.7.2.9.1-2: Cell specific Test Parameters for E-UTRAN Timing Advance Accuracy Test for UE Category NB1 in Standalone Mode under Enhanced Coverage

Parameter	Unit	Value	
		T1	T2
E-UTRA RF Channel Number		1	
$BW_{channel}$	KHz	200	
NPDSCH parameters: DL Reference Measurement Channel defined in A.3.1.5.3		R.18 HD-FDD	
NPDCCH parameters: DL Reference Measurement Channel defined in A.3.1.6.3		R.30 HD-FDD	
NOCNG Patterns defined in A.3.2.3.3		NOP.3 FDD	
NPBCH_RA	dB	0	
NPBCH_RB	dB		
NPSS_RA	dB		
NSSS_RA	dB		
NPDCCH_RA	dB		
NPDCCH_RB	dB		
NPDSCH_RA	dB		
NPDSCH_RB	dB		
NOCNG_RA ^{Note1}	dB		
NOCNG_RB ^{Note1}	dB		
Timing Advance Command (T_A)		31	39
\hat{E}_s / I_{ot}	dB	-12	
N_{oc}	dBm/15 KHz	-88	
\hat{E}_s / N_{oc}	dB	-12	
I_o ^{Note2}	dBm/ 180 KHz	-76.9	
Antenna Configuration		1x1	
Propagation Condition		AWGN	

Note 1:	OCNG shall be used such that the cell is fully allocated and a constant total transmitted power spectral density is achieved for all OFDM symbols.
Note 2:	Io level has been derived from other parameters for information purpose. It is not a settable parameter.

A.7.2.9.2 Test Requirements

The UE shall apply the signalled Timing Advance value to the transmission timing at subframe $n+12$, where subframe n is the last subframe in the repetition period of NPDSCH in which the timing advance command is received by the UE.

The Timing Advance adjustment accuracy shall be within the limits specified in clause 7.22.2.2.

The rate of correct Timing Advance adjustments observed during repeated tests shall be at least 90%.

A.7.2.10 E-UTRAN FDD UE Timing Advance Adjustment Accuracy Test in CEModeB

A.7.2.10.1 Test Purpose and Environment

The purpose of the test is to verify E-UTRAN FDD Timing Advance adjustment accuracy requirements for Cat-M1 UE configured with CEModeB, defined in clause 7.3.2.2, in an AWGN model.

The test parameters are given in tables A.7.2.10.1-1 and A.7.2.10.1-2. The test consists of two successive time periods, with time duration of T1 and T2 respectively. In each time period, timing advance commands are sent to the UE and PUSCH are sent from the UE and received by the test equipment. By measuring the reception of the PUSCH, the transmit timing, and hence the timing advance adjustment accuracy, can be measured.

During time period T1, the test equipment shall send one message with a Timing Advance Command MAC Control Element, as specified in Clause 6.1.3.5 in TS 36.321. The Timing Advance Command value shall be set to 31, which according to Clause 4.2.3 in TS 36.213 results in zero adjustment of the Timing Advance. In this way, a reference value for the timing advance used by the UE is established.

During time period T2, the test equipment shall send a sequence of messages with Timing Advance Command MAC Control Elements, with Timing Advance Command value specified in table A.7.2.10.1-2. This value shall result in changes of the timing advance used by the UE, and the accuracy of the change shall then be measured, using PUSCH sent from the UE.

As specified in Clause 7.3.2.1, the UE adjusts its uplink timing at sub-frame $n+6$ for a timing advance command received in sub-frame n . This delay must be taken into account when measuring the timing advance adjustment accuracy, via PUSCH sent from the UE.

The UE Time Alignment Timer, described in Clause 5.2 in TS 36.321, shall be configured so that it does not expire in the duration of the test.

Table A.7.2.10.1-1: General Test Parameters for E-UTRAN FDD UE Timing Advance Adjustment Accuracy Test in CEModeB

Parameter	Unit	Value	Comment
Timing Advance Command (T_A) value during T1		31	$N_{TA} = 0$ for the purpose of establishing a reference value from which the timing advance adjustment accuracy can be measured during T2
Timing Advance Command (T_A) value during T2		39	$N_{TA} = 128$
DRX		OFF	
T1	s	5	
T2	s	5	
Number of repetitions of MPDCCH		128	
Number of repetitions of PUSCH		32	

Table A.7.2.10.1-2: Cell specific Test Parameters for E-UTRAN FDD UE Timing Advance Adjustment Accuracy Test in CEModeB

Parameter	Unit	Value
-----------	------	-------

		T1	T2		
E-UTRA RF Channel Number		1			
BW _{channel}	MHz	10			
PDSCH Reference Measurement Channel in clause A.3.1.4.4		R.22 FDD			
MPDCCH Reference Measurement Channel in clause A.3.1.3.4		R.18 FDD			
OCNG Patterns defined in A.3.2.1.21		OP.21 FDD			
PBCH_RA	dB	0			
PBCH_RB	dB				
PSS_RA	dB				
SSS_RA	dB				
PHICH_RA	dB				
PHICH_RB	dB				
MPDCCH_RA	dB				
MPDCCH_RB	dB				
PDSCH_RA	dB				
PDSCH_RB	dB				
OCNG_RA ^{Note1}	dB				
OCNG_RB ^{Note1}	dB				
Timing Advance Command (T_A)				31	39
N_{oc}	dBm/15 KHz			-98	
\hat{E}_s/N_{oc}	dB	-12			
\hat{E}_s/I_{ot} ^{Note2}	dB	-12			
RSRP ^{Note2}	dBm/15 KHz	-110			
I_o ^{Note2}	dBm/9 MHz	-69.95			
Propagation Condition		AWGN			
Antenna Configuration		1x1			
Note 1: OCNG shall be used such that cells is fully allocated and a constant total transmitted power spectral density is achieved for all OFDM symbols.					
Note 2: \hat{E}_s/I_{ot} , RSRP, I_o level has been derived from other parameters for information purpose. It is not a settable parameter.					

A.7.2.10.2 Test Requirements

The UE shall apply the signalled Timing Advance value to the transmission timing at the designated activation time i.e. 6 subframes after the reception of the timing advance command.

The Timing Advance adjustment accuracy shall be within the limits specified in clause 7.3.2.2.

The rate of correct Timing Advance adjustments observed during repeated tests shall be at least 90%.

When a repetition period is configured on the uplink, the UE shall not adjust the uplink transmission timing autonomously during an ongoing repetition period for which $R > 1$.

A.7.2.11 E-UTRAN HD-FDD UE Timing Advance Adjustment Accuracy Test in CEModeB

A.7.2.11.1 Test Purpose and Environment

The purpose of the test is to verify E-UTRAN HD-FDD Timing Advance adjustment accuracy requirements for Cat-M1 UE configured with CEModeB, defined in clause 7.3.2.2, in an AWGN model.

The test parameters are given in tables A.7.2.11.1-1 and A.7.2.11.1-2. The test consists of two successive time periods, with time duration of T1 and T2 respectively. In each time period, timing advance commands are sent to the UE and PUSCH are sent from the UE and received by the test equipment. By measuring the reception of the PUSCH, the transmit timing, and hence the timing advance adjustment accuracy, can be measured.

During time period T1, the test equipment shall send one message with a Timing Advance Command MAC Control Element, as specified in Clause 6.1.3.5 in TS 36.321. The Timing Advance Command value shall be set to 31, which

according to Clause 4.2.3 in TS 36.213 results in zero adjustment of the Timing Advance. In this way, a reference value for the timing advance used by the UE is established.

During time period T2, the test equipment shall send a sequence of messages with Timing Advance Command MAC Control Elements, with Timing Advance Command value specified in table A.7.2.11.1-2. This value shall result in changes of the timing advance used by the UE, and the accuracy of the change shall then be measured, using PUSCH sent from the UE.

As specified in Clause 7.3.2.1, the UE adjusts its uplink timing at sub-frame n+6 for a timing advance command received in sub-frame n. This delay must be taken into account when measuring the timing advance adjustment accuracy, via PUSCH sent from the UE.

The UE Time Alignment Timer, described in Clause 5.2 in TS 36.321, shall be configured so that it does not expire in the duration of the test.

Table A.7.2.11.1-1: General Test Parameters for E-UTRAN HD-FDD UE Timing Advance Adjustment Accuracy Test in CEModeB

Parameter	Unit	Value	Comment
Timing Advance Command (T_A) value during T1		31	$N_{TA} = 0$ for the purpose of establishing a reference value from which the timing advance adjustment accuracy can be measured during T2
Timing Advance Command (T_A) value during T2		39	$N_{TA} = 128$
DRX		OFF	
T1	s	5	
T2	s	5	
Number of repetitions of MPDCCH		128	
Number of repetitions of PUSCH		32	

Table A.7.2.11.1-2: Cell specific Test Parameters for E-UTRAN HD-FDD UE Timing Advance Adjustment Accuracy Test in CEModeB

Parameter	Unit	Value			
		T1	T2		
E-UTRA RF Channel Number		1			
$BW_{channel}$	MHz	10			
PDSCH Reference Measurement Channel in clause A.3.1.4.5		R.12 HD-FDD			
MPDCCH Reference Measurement Channel in clause A.3.1.3.5		R.8 HD-FDD			
OCNG Patterns defined in A.3.2.1.21		OP.21 FDD			
PBCH_RA	dB	0			
PBCH_RB	dB				
PSS_RA	dB				
SSS_RA	dB				
PHICH_RA	dB				
PHICH_RB	dB				
PDCCH_RA	dB				
PDCCH_RB	dB				
PDSCH_RA	dB				
PDSCH_RB	dB				
OCNG_RA ^{Note1}	dB				
OCNG_RB ^{Note1}	dB				
Timing Advance Command (T_A)				31	39
N_{oc}	dBm/15 KHz			-98	
\hat{E}_s / N_{oc}	dB	-12			
\hat{E}_s / I_{ot} ^{Note2}	dB	-12			
RSRP ^{Note2}	dBm/15 KHz	-110			
I_0 ^{Note2}	dBm/9 MHz	-69.95			
Propagation Condition		AWGN			
Antenna Configuration		1x1			

Note 1:	OCNG shall be used such that both cells are fully allocated and a constant total transmitted power spectral density is achieved for all OFDM symbols.
Note 2:	\hat{E}_s / I_{ot} , RSRP, I_0 level has been derived from other parameters for information purpose. It is not a settable parameter.

A.7.2.11.2 Test Requirements

The UE shall apply the signalled Timing Advance value to the transmission timing at the designated activation time i.e. 6 sub frames after the reception of the timing advance command.

The Timing Advance adjustment accuracy shall be within the limits specified in clause 7.3.2.2.

The rate of correct Timing Advance adjustments observed during repeated tests shall be at least 90%.

When a repetition period is configured on the uplink, the UE shall not adjust the uplink transmission timing autonomously during an ongoing repetition period for which $R > 1$.

A.7.2.12 E-UTRAN TDD UE Timing Advance Adjustment Accuracy Test in CEModeB

A.7.2.12.1 Test Purpose and Environment

The purpose of the test is to verify E-UTRAN TDD Timing Advance adjustment accuracy requirements for Cat-M1 UE configured with CEModeB, defined in clause 7.3.2.2, in an AWGN model.

The test parameters are given in tables A.7.2.12.1-1 and A.7.2.12.1-2. The test consists of two successive time periods, with time duration of T1 and T2 respectively. In each time period, timing advance commands are sent to the UE and PUSCH are sent from the UE and received by the test equipment. By measuring the reception of the PUSCH, the transmit timing, and hence the timing advance adjustment accuracy, can be measured.

During time period T1, the test equipment shall send one message with a Timing Advance Command MAC Control Element, as specified in Clause 6.1.3.5 in TS 36.321. The Timing Advance Command value shall be set to 31, which according to Clause 4.2.3 in TS 36.213 results in zero adjustment of the Timing Advance. In this way, a reference value for the timing advance used by the UE is established.

During time period T2, the test equipment shall send a sequence of messages with Timing Advance Command MAC Control Elements, with Timing Advance Command value specified in table A.7.2.12.1-2. This value shall result in changes of the timing advance used by the UE, and the accuracy of the change shall then be measured, using PUSCH sent from the UE.

As specified in Clause 7.3.2.1, the UE adjusts its uplink timing at sub-frame $n+6$ for a timing advance command received in sub-frame n . This delay must be taken into account when measuring the timing advance adjustment accuracy, via PUSCH sent from the UE.

The UE Time Alignment Timer, described in Clause 5.2 in TS 36.321, shall be configured so that it does not expire in the duration of the test.

Table A.7.2.12.1-1: General Test Parameters for E-UTRAN TDD UE Timing Advance Adjustment Accuracy Test in CEModeB

Parameter	Unit	Value	Comment
Timing Advance Command (T_A) value during T1		31	$N_{TA} = 0$ for the purpose of establishing a reference value from which the timing advance adjustment accuracy can be measured during T2
Timing Advance Command (T_A) value during T2		39	$N_{TA} = 128$
DRX		OFF	
T1	s	5	
T2	s	5	
Number of repetitions of MPDCCH		128	
Number of repetitions of PUSCH		32	

Table A.7.2.12.1-2: Cell specific Test Parameters for E-UTRAN TDD UE Timing Advance Adjustment Accuracy Test in CEModeB

Parameter	Unit	Value			
		T1	T2		
E-UTRA RF Channel Number		1			
$BW_{channel}$	MHz	10			
PDSCH Reference Measurement Channel in clause A.3.1.4.6		R.18 TDD			
MPDCCH Reference Measurement Channel in clause A.3.1.3.6		R.16 TDD			
Special subframe configuration ^{Note1}		6			
Uplink-downlink configuration ^{Note2}		1			
OCNG Patterns defined in A.3.2.2.11		OP.11 TDD			
PBCH_RA	dB	0			
PBCH_RB	dB				
PSS_RA	dB				
SSS_RA	dB				
PHICH_RA	dB				
PHICH_RB	dB				
PDCCH_RA	dB				
PDCCH_RB	dB				
PDSCH_RA	dB				
PDSCH_RB	dB				
OCNG_RA ^{Note3}	dB				
OCNG_RB ^{Note3}	dB				
Timing Advance Command (T_A)				31	39
N_{oc}	dBm/15 KHz			-98	
\hat{E}_s / N_{oc}	dB	-12			
\hat{E}_s / I_{ot} ^{Note4}	dB	-12			
RSRP ^{Note4}	dBm/15 KHz	-110			
I_o ^{Note4}	dBm/9 MHz	-69.95			
Propagation Condition		AWGN			
Antenna Configuration		1x1			
Note 1:	For the special subframe configuration see table 4.2-1 in TS 36.211.				
Note 2:	For the uplink-downlink configuration see table 4.2-2 in TS 36.211.				
Note 3:	OCNG shall be used such that both cells are fully allocated and a constant total transmitted power spectral density is achieved for all OFDM symbols.				
Note 4:	\hat{E}_s / I_{ot} , RSRP, I_o level has been derived from other parameters for information purpose. It is not a settable parameter.				

A.7.2.12.2 Test Requirements

The UE shall apply the signalled Timing Advance value to the transmission timing at the designated activation time i.e. 6 sub frames after the reception of the timing advance command.

The Timing Advance adjustment accuracy shall be within the limits specified in clause 7.3.2.2.

The rate of correct Timing Advance adjustments observed during repeated tests shall be at least 90%.

When a repetition period is configured on the uplink, the UE shall not adjust the uplink transmission timing autonomously during an ongoing repetition period for which $R > 1$.

A.7.2.13 E-UTRAN FDD – UE Timing Advance Adjustment delay Test for sTTI and *ShortProcessingTime=TRUE*

A.7.2.13.1 Test Purpose and Environment

The purpose of the test is to verify E-UTRAN FDD Timing Advance adjustment delay requirements when *ShortTTI-r15* is configured or *ShortProcessingTime=TRUE*, defined in clause 7.3.2.2, in an AWGN model.

The test consists of 4 tests. The test parameters are given in tables A.7.2.13.1-1, A.7.2.13.1-2, and A.7.2.13.1-3. In each test, timing advance command is sent to the UE and Sounding Reference Signals (SRS), as specified in table A.7.2.13.1-3, is sent from the UE and received by the test equipment. By measuring the reception of the SRS, the transmit timing, and hence the timing advance adjustment delay can be measured. The test equipment shall send a sequence of messages with Timing Advance Command MAC Control Elements, with Timing Advance Command value specified in table A.7.2.13.1-2.

In test 1, when *ShortTTI-r15* is not configured and *ShortProcessingTime=TRUE*, the UE adjusts its uplink timing at sub-frame $n+5$ for a timing advance command received in sub-frame n . In test 2, when *dl-STTI-Length-r15=slot*, the UE adjusts its uplink timing at the first subframe boundary following $n+8$ slot for a timing advance command received in slot n . In test 3, when *dl-STTI-Length-r15=subslot* and *proc-Timeline-r15= nplus4set1*, the UE adjusts its uplink timing at the first subframe boundary following $n+16$ subslot for a timing advance command received in subslot n . In test 4, when *dl-STTI-Length-r15=subslot* and *proc-Timeline-r15= nplus6set1* or

proc-Timeline-r15= nplus6set2, the UE adjusts its uplink timing at the first subframe boundary following $n+18$ subslot for a timing advance command received in subslot n . This delay must be taken into account when measuring the timing advance adjustment accuracy, via the SRS sent from the UE.

The UE Time Alignment Timer, described in Clause 5.2 in TS 36.321, shall be configured so that it does not expire in the duration of the test.

Table A.7.2.13.1-1: General Test Parameters for E-UTRAN FDD – UE Timing Advance Adjustment delay Test for sTTI and *ShortProcessingTime=TRUE*

Parameter	Unit	Value	Comment
PDSCH parameters		DL Reference Measurement Channel for FDD with slot duration TTI: R.8 FDD; DL Reference Measurement Channel for FDD with subslot duration TTI: R.9 FDD;	As specified in clause A.3.1.1.1
PCFICH/PDCCH/PHICH parameters		DL Reference Measurement Channel R.6 FDD	As specified in clause A.3.1.2.1
Timing Advance Command (T_A) value		39	$N_{TA} = 128$
DRX		OFF	
T1	s	5	
T2	s	5	

Table A.7.2.13.1-2: Cell specific Test Parameters E-UTRAN FDD – UE Timing Advance Adjustment delay Test for sTTI and *ShortProcessingTime=TRUE* (test1, test 2, test 3 and test 4)

Parameter	Unit	Value	
		T1	T2
E-UTRA RF Channel Number		1	
$BW_{channel}$	MHz	10	
OCNG Patterns defined in A.3.2.1.1 (OP.1 FDD)		OP.1 FDD	
PBCH_RA	dB		
PBCH_RB	dB		
PSS_RA	dB		
SSS_RA	dB		
PCFICH_RB	dB		
PHICH_RA	dB		
PHICH_RB	dB		

PDCCH_RA	dB	0	
PDCCH_RB	dB		
PDSCH_RA	dB		
PDSCH_RB	dB		
OCNG_RA ^{Note1}	dB		
OCNG_RB ^{Note1}	dB		
Timing Advance Command (T_A)		31	39
\hat{E}_s / I_{ot}	dB	3	
N_{oc}	dBm/15 KHz	-98	
\hat{E}_s / N_{oc}	dB	3	
I_o ^{Note2}	dBm/9 MHz	-65.5	
Propagation Condition		AWGN	
Note 1: OCNG shall be used such that both cells are fully allocated and a constant total transmitted power spectral density is achieved for all OFDM symbols.			
Note 2: I_o level has been derived from other parameters for information purpose. It is not a settable parameter.			

Table A.7.2.13.1-3: Sounding Reference Symbol Configuration for E-UTRAN FDD – UE Timing Advance Adjustment delay Test for sTTI and *ShortProcessingTime=TRUE*

Field	Value	Comment
srsBandwidthConfiguration	bw5	
srsSubframeConfiguration	sc3	Once every 5 subframes
ackNackSrsSimultaneousTransmission	FALSE	
srsMaxUpPTS	N/A	Not applicable for E-UTRAN FDD
srsBandwidth	0	No hopping
srsHoppingBandwidth	hbw0	
frequencyDomainPosition	0	
Duration	TRUE	Indefinite duration
Srs-ConfigurationIndex	7	SRS periodicity of 10.
transmissionComb	0	
cyclicShift	cs0	No cyclic shift
SRS-AntennaPort	an1	Number of antenna ports used for SRS transmission
Note: For further information see clause 6.3.2 in TS 36.331.		

A.7.2.13.2 Test Requirements

In test 1, the UE shall apply the signalled Timing Advance value to the transmission timing at the designated activation time i.e. 5 sub frames after the reception of the timing advance command in sub-frame n .

In test 2, the UE shall apply the signalled Timing Advance value to the transmission timing at the designated activation time i.e. at the first subframe boundary following 8 slots after the reception of the timing advance command in slot n .

In test 3, the UE shall apply the signalled Timing Advance value to the transmission timing at the designated activation time i.e. at the first subframe boundary following 16 subslots after the reception of the timing advance command in subslot n .

In test 4, the UE shall apply the signalled Timing Advance value to the transmission timing at the designated activation time i.e. at the first subframe boundary following 18 subslots after the reception of the timing advance command in subslot n .

The rate of correct Timing Advance adjustments observed during repeated tests shall be at least 90%.

A.7.2.14 E-UTRAN TDD – UE Timing Advance Adjustment delay Test for sTTI and *ShortProcessingTime=TRUE*

A.7.2.14.1 Test Purpose and Environment

The purpose of the test is to verify E-UTRAN TDD Timing Advance adjustment delay requirements when *ShortTTI-r15* is configured or *ShortProcessingTime=TRUE*, defined in clause 7.3.2.2, in an AWGN model.

The test consists of 2 tests. The test parameters are given in tables A.7.2.14.1-1, A.7.2.14.1-2, and A.7.2.14.1-3. In each test, timing advance command is sent to the UE and Sounding Reference Signals (SRS), as specified in table A.7.2.14.1-3, is sent from the UE and received by the test equipment. By measuring the reception of the SRS, the transmit timing, and hence the timing advance adjustment delay can be measured. The test equipment shall send a sequence of messages with Timing Advance Command MAC Control Elements, with Timing Advance Command value specified in table A.7.2.14.1-2.

In test 1, when *ShortTTI-r15* is not configured and *ShortProcessingTime=TRUE*, the UE adjusts its uplink timing at sub-frame $n+5$ for a timing advance command received in sub-frame n . In test 2, when *dl-STTI-Length-r15=slot*, the UE adjusts its uplink timing at the first subframe boundary following $n+8$ slot for a timing advance command received in slot n . This delay must be taken into account when measuring the timing advance adjustment accuracy, via the SRS sent from the UE.

The UE Time Alignment Timer, described in Clause 5.2 in TS 36.321, shall be configured so that it does not expire in the duration of the test.

Table A.7.2.14.1-1: General Test Parameters for E-UTRAN TDD – UE Timing Advance Adjustment delay Test for sTTI and *ShortProcessingTime=TRUE*

Parameter	Unit	Value	Comment
PDSCH parameters		DL Reference Measurement Channel for TDD slot duration TTI: R6 TDD;	As specified in clause A.3.1.1.1
PCFICH/PDCCH/PHICH parameters		DL Reference Measurement Channel R.6 TDD	As specified in clause A.3.1.2.1
Timing Advance Command (T_A) value		39	$N_{TA} = 128$
DRX		OFF	
T1	s	5	
T2	s	5	

Table A.7.2.14.1-2: Cell specific Test Parameters E-UTRAN TDD – UE Timing Advance Adjustment delay Test for sTTI and *ShortProcessingTime=TRUE* (test1 and test 2)

Parameter	Unit	Value	
		T1	T2
E-UTRA RF Channel Number		1	
$BW_{channel}$	MHz	10	
$BW_{channel}$	MHz	10	
Special subframe configuration ^{Note1}		6	
OCNG Patterns defined in A.3.2.2.1 (OP.1 TDD)		OP.1 TDD	
PBCH_RA	dB	0	
PBCH_RB	dB		
PSS_RA	dB		
SSS_RA	dB		
PCFICH_RB	dB		
PHICH_RA	dB		
PHICH_RB	dB		
PDCCH_RA	dB		
PDCCH_RB	dB		
PDSCH_RA	dB		
PDSCH_RB	dB		
OCNG_RA ^{Note1}	dB		
OCNG_RB ^{Note1}	dB		

Timing Advance Command (T_A)		31	39
\hat{E}_s / I_{ot}	dB	3	
N_{oc}	dBm/15 KHz	-98	
\hat{E}_s / N_{oc}	dB	3	
I_0^{Note2}	dBm/9 MHz	-65.5	
Propagation Condition		AWGN	
<p>Note 1: OCNG shall be used such that both cells are fully allocated and a constant total transmitted power spectral density is achieved for all OFDM symbols.</p> <p>Note 2: I_0 level has been derived from other parameters for information purpose. It is not a settable parameter.</p> <p>Note 3: OCNG shall be used such that both cells are fully allocated and a constant total transmitted power spectral density is achieved for all OFDM symbols.</p> <p>Note 4: I_0 level has been derived from other parameters for information purpose. It is not a settable parameter.</p>			

Table A.7.2.14.1-3: Sounding Reference Symbol Configuration for E-UTRAN TDD – UE Timing Advance Adjustment delay Test for sTTI and *ShortProcessingTime=TRUE*

Field	Value	Comment
srsBandwidthConfiguration	bw5	
srsSubframeConfiguration	sc3	Once every 5 subframes
ackNackSrsSimultaneousTransmission	FALSE	
srsMaxUpPTS	N/A	Not applicable for E-UTRAN TDD
srsBandwidth	0	No hopping
srsHoppingBandwidth	hbw0	
frequencyDomainPosition	0	
Duration	TRUE	Indefinite duration
Srs-ConfigurationIndex	7	SRS periodicity of 10.
transmissionComb	0	
cyclicShift	cs0	No cyclic shift
SRS-AntennaPort	an1	Number of antenna ports used for SRS transmission
Note: For further information see clause 6.3.2 in TS 36.331.		

A.7.2.14.2 Test Requirements

In test 1, the UE shall apply the signalled Timing Advance value to the transmission timing at the designated activation time i.e. 5 sub frames after the reception of the timing advance command in sub-frame n .

In test 2, the UE shall apply the signalled Timing Advance value to the transmission timing at the designated activation time i.e. at the first subframe boundary following 8 slots after the reception of the timing advance command in slot n .

The rate of correct Timing Advance adjustments observed during repeated tests shall be at least 90%.

A.7.2.15 E-UTRAN TDD – TDD UE Timing Advance Adjustment Accuracy Test for UE Category NB1 in Standalone Mode under Enhanced Coverage

A.7.2.15.1 Test Purpose and Environment

The purpose of the test is to verify E-UTRAN Timing Advance adjustment accuracy requirements for UE category NB1 in enhanced coverage, defined in clause 7.22.2.2, in an AWGN model.

The test parameters are given in tables A.7.2.15.1-1 and A.7.2.15.1-2. The test consists of two successive time periods, with time duration of T1 and T2 respectively. In each time period, timing advance commands are sent to the UE and the UE is scheduled in every uplink subframe to transmit NPUSCH, which is received by the test equipment. By measuring

the reception of the NPUSCH, the transmit timing, and hence the timing advance adjustment accuracy, can be measured.

During time period T1, the test equipment shall send one message with a Timing Advance Command MAC Control Element, as specified in Clause 6.1.3.5 in TS 36.321 [17]. The Timing Advance Command value shall be set to 31, which according to Clause 16.1.2 in TS 36.213 [3] results in zero adjustment of the Timing Advance. In this way, a reference value for the timing advance used by the UE is established.

During time period T2, the test equipment shall send a sequence of messages with Timing Advance Command MAC Control Elements, with Timing Advance Command value specified in table A.7.2.15.1-2. This value shall result in changes of the timing advance used by the UE, and the accuracy of the change shall then be measured, using the NPUSCH sent from the UE.

As specified in Clause 7.22.2.1, the UE adjusts its uplink timing at sub-frame $n+12$ for a timing advance command received in sub-frame n , where sub-frame n refers to the last subframe in the repetition period in which the MAC control element containing timing advance command was received. In addition, the UE shall not apply a TA command during an uplink repetition period. The timing advance adjustment accuracy is verified via the uplink transmission of NPUSCH carrying ACK/NACK response to the NPDSCH carrying TA command. k_0 in ACK/NACK resource filed in DCI is set as 13 or larger to refer to the first UL subframe after $n+12$.

The UE Time Alignment Timer, described in Clause 5.2 in TS 36.321 [17], shall be configured so that it does not expire in the duration of the test.

Table A.7.2.15.1-1: General Test Parameters for E-UTRAN Timing Advance Accuracy Test for UE Category NB1 in Standalone Mode under Enhanced Coverage

Parameter		Unit	Value	Comment
NB-IoT operational mode			Standalone	
CP Length			Normal	
Special subframe configuration			6	As specified in table 4.2-1 in TS 36.211 [16]
Uplink-downlink configuration			1	As specified in table 4.2-2 in TS 36.211 [16]
Timing Advance Command (T_A) value during T1			31	$N_{TA} = 0$ for the purpose of establishing a reference value from which the timing advance adjustment accuracy can be measured during T2
Timing Advance Command (T_A) value during T2			39	$N_{TA} = 128$
Number of repetitions	NPDCCH		128	
	NPDSCH		128	
	NPUSCH		32	
DRX			OFF	
T1		s	5	
T2		s	5	

Table A.7.2.15.1-2: Cell specific Test Parameters for E-UTRAN Timing Advance Accuracy Test for UE Category NB1 in Standalone Mode under Enhanced Coverage

Parameter	Unit	Value	
		T1	T2
E-UTRA RF Channel Number		1	
$BW_{channel}$	KHz	200	
NPDSCH parameters: DL Reference Measurement Channel defined in A.3.1.5.3		R.18 NB-TDD	
NPDCCH parameters: DL Reference Measurement Channel defined in A.3.1.6.3		R.30 NB-TDD	
NOCNG Patterns defined in A.3.2.3.3		NOP.3 TDD	
NPBCH_RA	dB		
NPBCH_RB	dB		

NPSS_RA	dB	0	
NSSS_RA	dB		
NPDCCH_RA	dB		
NPDCCH_RB	dB		
NPDSCH_RA	dB		
NPDSCH_RB	dB		
NOCNG_RA ^{Note1}	dB		
NOCNG_RB ^{Note1}	dB		
Timing Advance Command (T_A)		31	39
\hat{E}_s / I_{ot}	dB	-12	
N_{oc}	dBm/15 KHz	-88	
\hat{E}_s / N_{oc}	dB	-12	
I_o ^{Note2}	dBm/ 180 KHz	-76.9	
Antenna Configuration		1x1	
Propagation Condition		AWGN	
Note 1: OCNG shall be used such that the cell is fully allocated and a constant total transmitted power spectral density is achieved for all OFDM symbols.			
Note 2: I_o level has been derived from other parameters for information purpose. It is not a settable parameter.			

A.7.2.15.2 Test Requirements

The UE shall apply the signalled Timing Advance value to the transmission timing at subframe $n+12$, where subframe n is the last subframe in the repetition period of NPDSCH in which the timing advance command is received by the UE.

The Timing Advance adjustment accuracy shall be within the limits specified in clause 7.22.2.2.

The rate of correct Timing Advance adjustments observed during repeated tests shall be at least 90%.

A.7.3 Radio Link Monitoring

In the following section, any uplink signal transmitted by the UE is used for detecting the In-/Out-of-Sync state of the UE. In terms of measurement, the uplink signal is verified on the basis of the UE output power:

For intra-band contiguous carrier aggregation, transmit OFF power is measured as the mean power per component carrier.

For UE with multiple transmit antennas, transmit OFF power is measured as the mean power at each transmit connector.

- UE output power higher than Transmit OFF power -50 dBm (as defined in TS 36.101 [5]) means uplink signal
- UE output power equal to or less than Transmit OFF power -50 dBm (as defined in TS 36.101 [5]) means no uplink signal.

A.7.3.1 E-UTRAN FDD Radio Link Monitoring Test for Out-of-sync

A.7.3.1.1 Test Purpose and Environment

The purpose of this test is to verify that the UE properly detects the out of sync and in sync for the purpose of monitoring downlink radio link quality of the PCell. This test will partly verify the E-UTRAN FDD radio link monitoring requirements in clause 7.6.

The test parameters are given in Tables A.7.3.1.1-1, A.7.3.1.1-2 and A.7.3.1.1-3 below. There is one cell (cell 1), which is the active cell, in the test. The test consists of three successive time periods, with time duration of T1, T2 and T3 respectively. Figure A.7.3.1.1-1 shows the variation of the downlink SNR in the active cell to emulate out-of-sync and in-sync states. Prior to the start of the time duration T1, the UE shall be fully synchronized to cell 1. The UE shall be configured for periodic CQI reporting in PUCCH 1-0 mode with a reporting periodicity of 2 ms.

Table A.7.3.1.1-1: General test parameters for E-UTRAN FDD out-of-sync testing

Parameter		Unit	Value				Comment
			Test 1	Test 2	Test 3	Test 4	
PCFICH/PDCCH/PHICH parameters			R.6 FDD	R.7 FDD	R.6 FDD	R.7 FDD	As specified in section A.3.1.2.1. None of the PDCCH are intended for the UE under test
OCNG parameters			OP.2 FDD	OP.2 FDD	OP.2 FDD	OP.2 FDD	As specified in section A.3.2.1.2.
Active cell			Cell 1	Cell 1	Cell 1	Cell 1	Cell 1 is on E-UTRA RF channel number 1
CP length			Normal	Normal	Normal	Normal	
E-UTRA RF Channel Number			1	1	1	1	One E-UTRA FDD carrier frequency is used.
E-UTRA Channel Bandwidth (BW _{channel})		MHz	10	10	10	10	
Correlation Matrix and Antenna Configuration			1x2	2x2	1x2 Low	2x2 Low	Correlation Matrix and Antenna Configuration are defined in TS 36.101 [5] Annex B.2.3.2
Out of sync transmission parameters (Note 1)	DCI format		1A	1A	1A	1A	As defined in section 5.3.3.1.3 in TS 36.212
	Number of Control OFDM symbols		2	2	2	2	Out of sync threshold Q _{out} and the corresponding hypothetical PDCCH/PCFICH transmission parameters are as specified in section 7.6.1 and Table 7.6.1-1 respectively.
	Aggregation level	CCE	8	8	8	8	
	ρ _A , ρ _B		0	-3	0	-3	
	Ratio of PDCCH to RS EPRE	dB	4	1	4	1	
Ratio of PCFICH to RS EPRE	dB	4	1	4	1		
DRX			OFF	OFF	OFF	OFF	
Layer 3 filtering			<i>Enabled</i>	<i>Enabled</i>	<i>Enabled</i>	<i>Enabled</i>	<i>Counters: N310 = 1; N311 = 1</i>
T310 timer		ms	0	0	0	0	<i>T310 is disabled</i>
T311 timer		ms	1000	1000	1000	1000	T311 is enabled
Periodic CQI reporting mode			PUCCH 1-0	PUCCH 1-0	PUCCH 1-0	PUCCH 1-0	As defined in table 7.2.2-1 in TS 36.213.
CQI reporting periodicity		ms	2	2	2	2	Minimum CQI reporting periodicity
Propagation channel			AWGN	AWGN	ETU 70 Hz	ETU 70 Hz	.
T1		s	1	1	1	1	
T2		s	0.4	0.4	0.4	0.4	
T3		s	0.5	0.5	0.5	0.5	
Note 1: PDCCH/PCFICH corresponding to the out of sync transmission parameters need not be included in the Reference Measurement Channel.							

Table A.7.3.1.1-2: Cell specific test parameters for E-UTRAN FDD (cell # 1) for out-of-sync radio link monitoring tests # 1 and # 2

Parameter	Unit	Test 1			Test 2		
		T1	T2	T3	T1	T2	T3
E-UTRA RF Channel Number		1			1		
BW _{channel}	MHz	10			10		
Antenna Configuration		1x2			2x2		

OCNG Pattern defined in A.3.2.1 (FDD)		OP.2 FDD			OP.2 FDD		
P_A, P_B		0			-3		
PCFICH_RB	dB	4			1		
PDCCH_RA	dB	4			1		
PDCCH_RB	dB	4			1		
PBCH_RA	dB	0			-3		
PBCH_RB	dB						
PSS_RA	dB						
SSS_RA	dB						
PHICH_RA	dB						
PHICH_RB	dB						
PDSCH_RA	dB						
PDSCH_RB	dB						
OCNG_RA ^{Note 1}	dB						
OCNG_RB ^{Note 1}	dB						
SNR ^{Note 6,7}	dB	-4.7	-9.5	-13.5	-4.7	-9.5	-13.5
N_{oc}	dBm/15 kHz	-98			-98		
Propagation condition		AWGN			AWGN		
<p>Note 1: OCNG shall be used such that the resources in cell # 1 are fully allocated and a constant total transmitted power spectral density is achieved for all OFDM symbols.</p> <p>Note 2: The uplink resources for CQI reporting are assigned to the UE prior to the start of time period T1.</p> <p>Note 3: The timers and layer 3 filtering related parameters are configured prior to the start of time period T1.</p> <p>Note 4: The signal contains PDCCH for UEs other than the device under test as part of OCNG.</p> <p>Note 5: SNR levels correspond to the signal to noise ratio over the cell-specific reference signal REs.</p> <p>Note 6: The SNR in time periods T1, T2 and T3 is denoted as SNR1, SNR2 and SNR3 respectively in figure A.7.3.1.1-1.</p> <p>Note 7: The SNR values are specified for testing a UE which supports 2RX on at least one band. For testing of a UE which supports 4RX on all bands, the SNR during T3 is modified as specified in section A.3.8.1.</p>							

Table A.7.3.1.1-3: Cell specific test parameters for E-UTRAN FDD (cell # 1) for out-of-sync radio link monitoring tests # 3 and # 4

Parameter	Unit	Test 3			Test 4		
		T1	T2	T3	T1	T2	T3
E-UTRA RF Channel Number		1			1		
BW _{channel}	MHz	10			10		
Correlation Matrix and Antenna Configuration		1x2 Low			2x2 Low		
OCNG Pattern defined in A.3.2.1 (FDD)		OP.2 FDD			OP.2 FDD		
ρ_A, ρ_B		0			-3		
PCFICH_RB	dB	4			1		
PDCCH_RA	dB	4			1		
PDCCH_RB	dB	4			1		
PBCH_RA	dB	0			-3		
PBCH_RB	dB						
PSS_RA	dB						
SSS_RA	dB						
PHICH_RA	dB						
PHICH_RB	dB						
PDSCH_RA	dB						
PDSCH_RB	dB						
OCNG_RA ^{Note 1}	dB						
OCNG_RB ^{Note 1}	dB						
SNR ^{Note 6,7}	dB	-1.4	-5.5	-11.5	-2.3	-6.2	-12.2
N_{oc}	dBm/15 kHz	-98			-98		
Propagation condition		ETU 70 Hz			ETU 70 Hz		
<p>Note 1: OCNG shall be used such that the resources in cell # 1 are fully allocated and a constant total transmitted power spectral density is achieved for all OFDM symbols.</p> <p>Note 2: The uplink resources for CQI reporting are assigned to the UE prior to the start of time period T1.</p> <p>Note 3: The timers and layer 3 filtering related parameters are configured prior to the start of time period T1.</p> <p>Note 4: The signal contains PDCCH for UEs other than the device under test as part of OCNG.</p> <p>Note 5: SNR levels correspond to the signal to noise ratio over the cell-specific reference REs.</p> <p>Note 6: The SNR in time periods T1, T2 and T3 is denoted as SNR1, SNR2 and SNR3 respectively in figure A.7.3.1.1-1.</p> <p>Note 7: The SNR values are specified for testing a UE which supports 2RX on at least one band. For testing of a UE which supports 4RX on all bands, the SNR during T3 is modified as specified in section A.3.8.1.</p>							

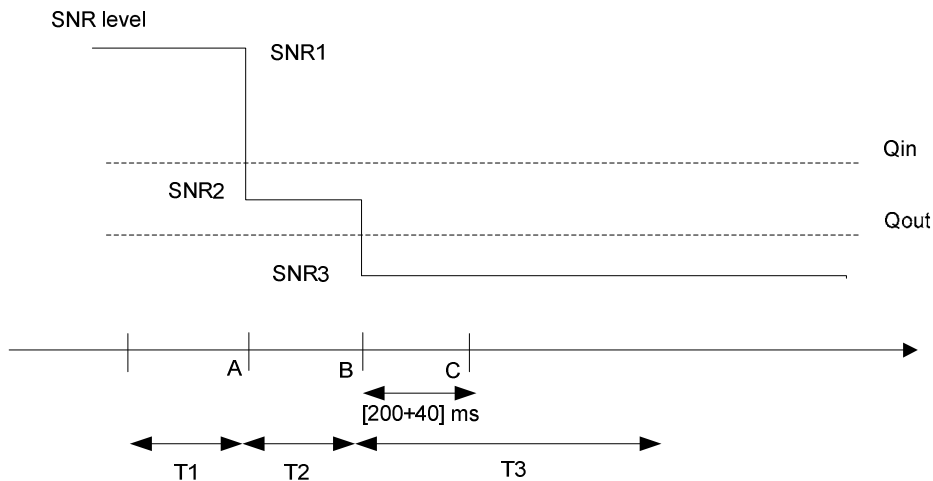

Figure A.7.3.1.1-1 SNR variation for out-of-sync testing

A.7.3.1.2 Test Requirements

The UE behaviour in each test during time durations T1, T2 and T3 shall be as follows:

During the period from time point A to time point B the UE shall transmit uplink signal at least in all subframes configured for CQI transmission according to the configured CQI reporting mode (PUCCH 1-0).

The UE shall stop transmitting uplink signal no later than time point C (240 ms after the start of time duration T3).

The rate of correct events observed during repeated tests shall be at least 90%.

A.7.3.2 E-UTRAN FDD Radio Link Monitoring Test for In-sync

A.7.3.2.1 Test Purpose and Environment

The purpose of this test is to verify that the UE properly detects the out of sync and in sync for the purpose of monitoring downlink radio link quality of the PCell. This test will partly verify the E-UTRAN FDD radio link monitoring requirements in clause 7.6.

The test parameters are given in Tables A.7.3.2.1-1 and A.7.3.2.1-2 below. There is one cell (cell 1), which is the active cell, in the test. The test consists of five successive time periods, with time duration of T1, T2, T3, T4 and T5 respectively. Figure A.7.3.2.1-1 shows the variation of the downlink SNR in the active cell to emulate out-of-sync and in-sync states. Prior to the start of the time duration T1, the UE shall be fully synchronized to cell 1. The UE shall be configured for periodic CQI reporting in PUCCH 1-0 mode with a reporting periodicity of 2 ms.

Table A.7.3.2.1-1: General test parameters for E-UTRAN FDD in-sync testing

Parameter		Unit	Value		Comment
			Test 1	Test 2	
PCFICH/PDCCH/PHICH parameters			R.6 FDD	R.7 FDD	As specified in clause A.3.1.2.1. None of the PDCCH are intended for the UE under test
OCNG parameters			OP.2 FDD	OP.2 FDD	As specified in clause A.3.2.1.2.
Active cell			Cell 1	Cell 1	Cell 1 is on E-UTRA RF channel number 1
CP length			Normal	Normal	
E-UTRA RF Channel Number			1	1	One E-UTRA FDD carrier frequency is used.
E-UTRA Channel Bandwidth (BW _{channel})		MHz	10	10	
Correlation Matrix and Antenna Configuration			1x2 Low	2x2 Low	Correlation Matrix and Antenna Configuration are defined in TS 36.101 [5] Annex B.2.3.2
In sync transmission parameters (Note 1)	DCI format		1C	1C	As defined in clause 5.3.3.1.4 in TS 36.212
	Number of Control OFDM symbols		2	2	In sync threshold Q _{in} and the corresponding hypothetical PDCCH/PCFICH transmission parameters are as specified in clause and Table 7.6.1-2
	Aggregation level	CCE	4	4	
	ρ_A, ρ_B		0	-3	

	Ratio of PDCCH to RS EPRE		0	-3	respectively.
	Ratio of PCFICH to RS EPRE		4	1	
Out of sync transmission parameters (Note 1)	DCI format		1A	1A	As defined in clause 5.3.3.1.3 in TS 36.212
	Number of Control OFDM symbols		2	2	Out of sync threshold Q_{out} and the corresponding hypothetical PDCCH/PCFICH transmission parameters are as specified in clause 7.6.1 and Table 7.6.1-1 respectively.
	Aggregation level	CCE	8	8	
	ρ_A, ρ_B		0	-3	
	Ratio of PDCCH to RS EPRE	dB	4	1	
	Ratio of PCFICH to RS EPRE	dB	4	1	
DRX			OFF	OFF	
Layer 3 filtering			Enabled	Enabled	Counters: N310 = 1; N311 = 1
T310 timer		ms	2000	2000	T310 is enabled
T311 timer		ms	1000	1000	T311 is enabled
Periodic CQI reporting mode			PUCCH 1-0	PUCCH 1-0	As defined in table 7.2.2-1 in TS 36.213.
CQI reporting periodicity		ms	2	2	Minimum CQI reporting periodicity
Propagation channel			ETU 70 Hz	ETU 70 Hz	
T1		s	0.5	0.5	
T2		s	0.4	0.4	
T3		s	1.46	1.46	
T4		s	0.4	0.4	
T5		s	1	1	
Note 1: PDCCH/PCFICH corresponding to the in-sync and out of sync transmission parameters need not be included in the Reference Measurement Channel.					

Table A.7.3.2.1-2: Cell specific test parameters for E-UTRAN FDD (cell # 1) for in-sync radio link monitoring tests # 1 and # 2

Parameter	Unit	Test 1					Test 2				
		T1	T2	T3	T4	T5	T1	T2	T3	T4	T5
E-UTRA RF Channel Number		1					1				
BW _{channel}	MHz	10					10				
Correlation Matrix and Antenna Configuration		1x2 Low					2x2 Low				
OCNG Pattern defined in A.3.2.1 (FDD)		OP.2 FDD					OP.2 FDD				

P_A, P_B		0					-3				
PCFICH_RB	dB	4					1				
PDCCH_RA	dB	0					-3				
PDCCH_RB	dB	0					-3				
PBCH_RA	dB	0					-3				
PBCH_RB	dB										
PSS_RA	dB										
SSS_RA	dB										
PHICH_RA	dB										
PHICH_RB	dB										
PDSCH_RA	dB										
PDSCH_RB	dB										
OCNG_RA ^{Note 1}	dB										
OCNG_RB ^{Note 1}	dB										
SNR ^{Note 6,7}	dB	-1.4	-5.5	-11.5	-6.4	-1.4	-2.3	-6.2	-12.2	-7.3	-2.3
N_{oc}	dBm/15 kHz	-98					-98				
Propagation condition		ETU 70 Hz					ETU 70 Hz				
<p>Note 1: OCNG shall be used such that the resources in cell # 1 are fully allocated and a constant total transmitted power spectral density is achieved for all OFDM symbols.</p> <p>Note 2: The uplink resources for CQI reporting are assigned to the UE prior to the start of time period T1.</p> <p>Note 3: The timers and layer 3 filtering related parameters are configured prior to the start of time period T1.</p> <p>Note 4: The signal contains PDCCH for UEs other than the device under test as part of OCNG.</p> <p>Note 5: SNR levels correspond to the signal to noise ratio over the cell-specific reference signal REs.</p> <p>Note 6: The SNR in time periods T1, T2, T3, T4 and T5 is denoted as SNR1, SNR2, SNR3, SNR4 and SNR5 respectively in figure A.7.3.2.1-1.</p> <p>Note 7: The SNR values are specified for testing a UE which supports 2RX on at least one band. For testing of a UE which supports 4RX on all bands, the SNR during T3 and T4 is modified as specified in section A.3.8.1.</p>											

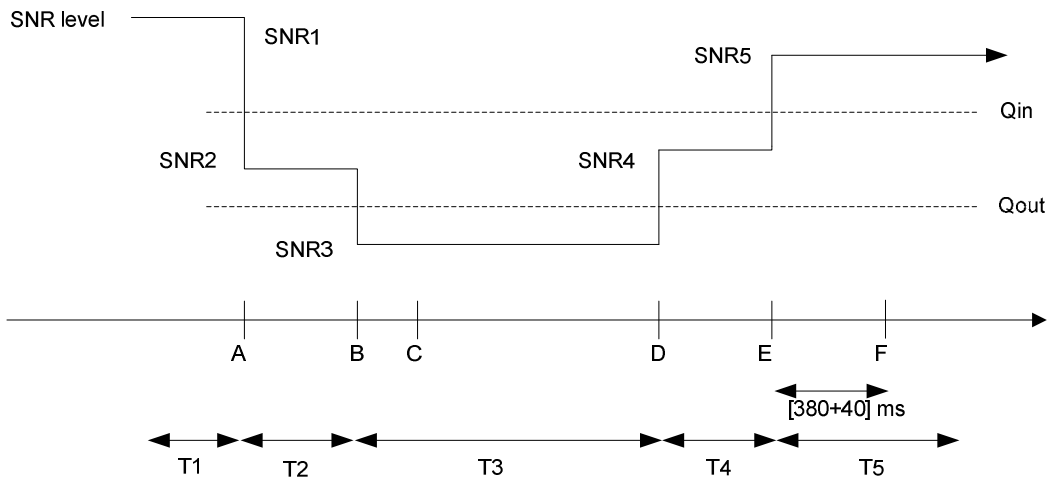

Figure A.7.3.2.1-1 SNR variation for in-sync testing

A.7.3.2.2 Test Requirements

The UE behaviour in each test during time durations T1, T2, T3, T4 and T5 shall be as follows:

During the period from time point A to time point F (420 ms after the start of time duration T5) the UE shall transmit uplink signal at least in all subframes configured for CQI transmission according to the configured CQI reporting mode (PUCCH 1-0).

The rate of correct events observed during repeated tests shall be at least 90%.

A.7.3.3 E-UTRAN TDD Radio Link Monitoring Test for Out-of-sync

A.7.3.3.1 Test Purpose and Environment

The purpose of this test is to verify that the UE properly detects the out of sync and in sync for the purpose of monitoring downlink radio link quality of the PCell. This test will partly verify the E-UTRAN TDD radio link monitoring requirements in clause 7.6.

The test parameters are given in Tables A.7.3.3.1-1, A.7.3.3.1-2 and A.7.3.3.1-3 below. There is one cell (cell 1), which is the active cell, in the test. The test consists of three successive time periods, with time duration of T1, T2 and T3 respectively. Figure A.7.3.3.1-1 shows the variation of the downlink SNR in the active cell to emulate out-of-sync and in-sync states. Prior to the start of the time duration T1, the UE shall be fully synchronized to cell 1. The UE shall be configured for periodic CQI reporting in PUCCH 1-0 mode with a reporting periodicity of 1 ms.

Table A.7.3.3.1-1: General test parameters for E-UTRAN TDD out-of-sync testing

Parameter		Unit	Value				Comment
			Test 1	Test 2	Test 3	Test 4	
PCFICH/PDCCH/PHICH parameters			R.6 TDD	R.7 TDD	R.6 TDD	R.7 TDD	As specified in clause A.3.1.2.2. None of the PDCCH are intended for the UE under test
OCNG parameters			OP.2 TDD	OP.2 TDD	OP.2 TDD	OP.2 TDD	As specified in clause A.3.2.2.2.
Active cell			Cell 1	Cell 1	Cell 1	Cell 1	Cell 1 is on E-UTRA RF channel number 1
CP length			Normal	Normal	Normal	Normal	
E-UTRA RF Channel Number			1	1	1	1	One E-UTRA TDD carrier frequency is used.
E-UTRA Channel Bandwidth ($BW_{channel}$)		MHz	10	10	10	10	
Correlation Matrix and Antenna Configuration			1x2	2x2	1x2 Low	2x2 Low	Correlation Matrix and Antenna Configuration are defined in TS 36.101 [5] Annex B.2.3.2
Out of sync transmission parameters (Note 1)	DCI format		1A	1A	1A	1A	As defined in clause 5.3.3.1.3 in TS 36.212
	Number of Control OFDM symbols		2	2	2	2	Out of sync threshold Q_{out} and the corresponding hypothetical PDCCH/PCFICH transmission parameters are as specified in clause 7.6.1 and Table 7.6.1-1 respectively.
	Aggregation level	CCE	8	8	8	8	
	ρ_A, ρ_B		0	-3	0	-3	
	Ratio of PDCCH to RS EPRE	dB	4	1	4	1	
Ratio of PCFICH to RS EPRE	dB	4	1	4	1		
DRX			OFF	OFF	OFF	OFF	
Layer 3 filtering			<i>Enabled</i>	<i>Enabled</i>	<i>Enabled</i>	<i>Enabled</i>	<i>Counters: N310 = 1; N311 = 1</i>
T310 timer		ms	0	0	0	0	<i>T310 is disabled</i>
T311 timer		ms	1000	1000	1000	1000	T311 is enabled
Periodic CQI reporting mode			PUCCH 1-0	PUCCH 1-0	PUCCH 1-0	PUCCH 1-0	As defined in table 7.2.2-1 in TS 36.213.
CQI reporting periodicity		ms	1	1	1	1	Minimum CQI reporting periodicity
Propagation channel			AWGN	AWGN	ETU 70 Hz	ETU 70 Hz	.
T1		s	1	1	1	1	
T2		s	0.4	0.4	0.4	0.4	
T3		s	0.5	0.5	0.5	0.5	

Note 1: PDCCH/PCFICH corresponding to the out of sync transmission parameters need not be included in the Reference Measurement Channel.

Table A.7.3.3.1-2: Cell specific test parameters for E-UTRAN TDD (cell # 1) for out-of-sync radio link monitoring tests # 1 and # 2

Parameter	Unit	Test 1			Test 2		
		T1	T2	T3	T1	T2	T3
E-UTRA RF Channel Number		1			1		
BW _{channel}	MHz	10			10		
Antenna Configuration		1x2			2x2		
Special subframe configuration ^{Note1}		6			6		
Uplink-downlink configuration ^{Note2}		1			1		
OCNG Pattern defined in A.3.2.2 (TDD)		OP.2 TDD			OP.2 TDD		
P_A, P_B		0			-3		
PCFICH_RB	dB	4			1		
PDCCH_RA	dB	4			1		
PDCCH_RB	dB	4			1		
PBCH_RA	dB	0			-3		
PBCH_RB	dB						
PSS_RA	dB						
SSS_RA	dB						
PHICH_RA	dB						
PHICH_RB	dB						
PDSCH_RA	dB						
PDSCH_RB	dB						
OCNG_RA ^{Note 3}	dB						
OCNG_RB ^{Note 3}	dB						
SNR ^{Note 8,9}	dB	-5.1	-9.1	-13.1	-5.2	-9.2	-13.2
N_{oc}	dBm/15 kHz	-98			-98		
Propagation condition		AWGN			AWGN		
<p>Note 1: For the special subframe configuration see table 4.2-1 in TS 36.211.</p> <p>Note 2: For the uplink-downlink configuration see table 4.2-2 in TS 36.211.</p> <p>Note 3: OCNG shall be used such that the resources in cell # 1 are fully allocated and a constant total transmitted power spectral density is achieved for all OFDM symbols.</p> <p>Note 4: The uplink resources for CQI reporting are assigned to the UE prior to the start of time period T1.</p> <p>Note 5: The timers and layer 3 filtering related parameters are configured prior to the start of time period T1.</p> <p>Note 6: The signal contains PDCCH for UEs other than the device under test as part of OCNG.</p> <p>Note 7: SNR levels correspond to the signal to noise ratio over the cell-specific reference signal REs.</p> <p>Note 8: The SNR in time periods T1, T2 and T3 is denoted as SNR1, SNR2 and SNR3 respectively in figure A.7.3.3.1-1.</p> <p>Note 9: The SNR values are specified for testing a UE which supports 2RX on at least one band. For testing of a UE which supports 4RX on all bands, the SNR during T3 is modified as specified in section A.3.8.1.</p>							

Table A.7.3.3.1-3: Cell specific test parameters for E-UTRAN TDD (cell # 1) for out-of-sync radio link monitoring tests # 3 and # 4

Parameter	Unit	Test 3			Test 4		
		T1	T2	T3	T1	T2	T3
E-UTRA RF Channel Number		1			1		
BW _{channel}	MHz	10			10		

Correlation Matrix and Antenna Configuration		1x2 Low			2x2 Low		
Special subframe configuration ^{Note1}		6			6		
Uplink-downlink configuration ^{Note2}		1			1		
OCNG Pattern defined in A.3.2.2 (TDD)		OP.2 TDD			OP.2 TDD		
ρ_A, ρ_B		0			-3		
PCFICH_RB	dB	4			1		
PDCCH_RA	dB	4			1		
PDCCH_RB	dB	4			1		
PBCH_RA	dB	0			-3		
PBCH_RB	dB						
PSS_RA	dB						
SSS_RA	dB						
PHICH_RA	dB						
PHICH_RB	dB						
PDSCH_RA	dB						
PDSCH_RB	dB						
OCNG_RA ^{Note 3}	dB						
OCNG_RB ^{Note 3}	dB						
SNR ^{Note 8}	dB	-1.4	-5.3	-11.3	-2.3	-5.9	-11.9
N_{oc}	dBm/15 kHz	-98			-98		
Propagation condition		ETU 70 Hz			ETU 70 Hz		
<p>Note 1: For the special subframe configuration see table 4.2-1 in TS 36.211.</p> <p>Note 2: For the uplink-downlink configuration see table 4.2-2 in TS 36.211.</p> <p>Note 3: OCNG shall be used such that the resources in cell # 1 are fully allocated and a constant total transmitted power spectral density is achieved for all OFDM symbols.</p> <p>Note 4: The uplink resources for CQI reporting are assigned to the UE prior to the start of time period T1.</p> <p>Note 5: The timers and layer 3 filtering related parameters are configured prior to the start of time period T1.</p> <p>Note 6: The signal contains PDCCH for UEs other than the device under test as part of OCNG.</p> <p>Note 7: SNR levels correspond to the signal to noise ratio over the cell-specific reference REs.</p> <p>Note 8: The SNR in time periods T1, T2 and T3 is denoted as SNR1, SNR2 and SNR3 respectively in figure A.7.3.3.1-1.</p>							

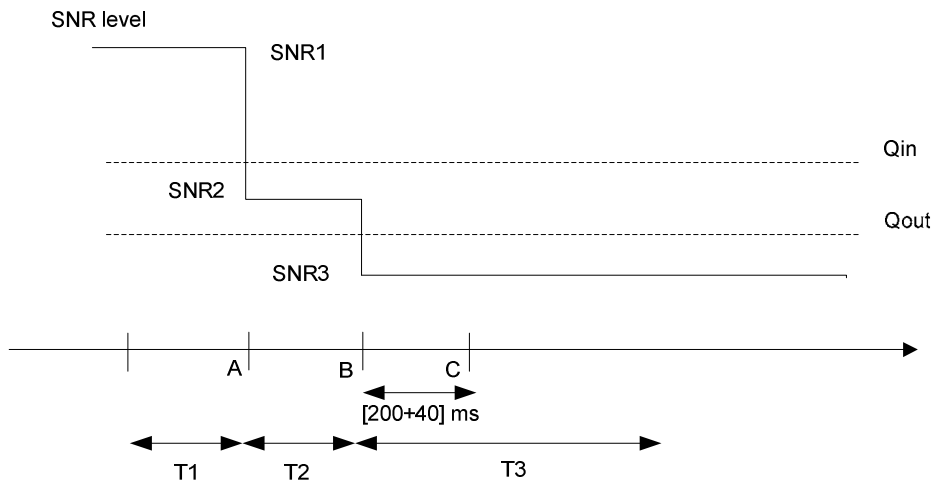

Figure A.7.3.3.1-1. SNR variation for out-of-sync testing

A.7.3.3.2 Test Requirements

The UE behaviour in each test during time durations T1, T2 and T3 shall be as follows:

During the period from time point A to time point B the UE shall transmit uplink signal at least in all uplink subframes configured for CQI transmission according to the configured CQI reporting mode (PUCCH 1-0).

The UE shall stop transmitting uplink signal no later than time point C (240 ms after the start of the time duration T3).

The rate of correct events observed during repeated tests shall be at least 90%.

A.7.3.4 E-UTRAN TDD Radio Link Monitoring Test for In-sync

A.7.3.4.1 Test Purpose and Environment

The purpose of this test is to verify that the UE properly detects the out of sync and in sync for the purpose of monitoring downlink radio link quality of the PCell. This test will partly verify the E-UTRAN TDD radio link monitoring requirements in clause 7.6.

The test parameters are given in Tables A.7.3.4.1-1 and A.7.3.4.1-2 below. There is one cell (cell 1), which is the active cell, in the test. The test consists of five successive time periods, with time duration of T1, T2, T3, T4 and T5 respectively. Figure A.7.3.4.1-1 shows the variation of the downlink SNR in the active cell to emulate out-of-sync and in-sync states. Prior to the start of the time duration T1, the UE shall be fully synchronized to cell 1. The UE shall be configured for periodic CQI reporting in PUCCH 1-0 mode with a reporting periodicity of 1 ms.

Table A.7.3.4.1-1: General test parameters for E-UTRAN TDD in-sync testing

Parameter		Unit	Value		Comment
			Test 1	Test 2	
PCFICH/PDCCH/PHICH parameters			R.6 TDD	R.7 TDD	As specified in clause A.3.1.2.2. None of the PDCCH are intended for the UE under test
OCNG parameters			OP.2 TDD	OP.2 TDD	As specified in clause A.3.2.2.2.
Active cell			Cell 1	Cell 1	Cell 1 is on E-UTRA RF channel number 1
CP length			Normal	Normal	
E-UTRA RF Channel Number			1	1	One E-UTRA FDD carrier frequency is used.
E-UTRA Channel Bandwidth (BW_{channel})		MHz	10	10	
Correlation Matrix and Antenna Configuration			1x2 Low	2x2 Low	Correlation Matrix and Antenna Configuration are defined in TS 36.101 [5] Annex B.2.3.2
In sync transmission parameters (Note 1)	DCI format		1C	1C	As defined in clause 5.3.3.1.4 in TS 36.212
	Number of Control OFDM symbols		2	2	In sync threshold Q_{in} and the corresponding hypothetical PDCCH/PCFICH transmission parameters are as specified in clause and Table 7.6.1-2 respectively.
	Aggregation level	CCE	4	4	
	ρ_A, ρ_B		0	-3	
	Ratio of PDCCH to RS EPRE		0	-3	

	Ratio of PCFICH to RS EPRE		4	1	
Out of sync transmission parameters (Note 1)	DCI format		1A	1A	As defined in clause 5.3.3.1.3 in TS 36.212
	Number of Control OFDM symbols		2	2	Out of sync threshold Q_{out} and the corresponding hypothetical PDCCH/PCFICH transmission parameters are as specified in clause 7.6.1 and Table 7.6.1-1 respectively.
	Aggregation level	CCE	8	8	
	ρ_A, ρ_B		0	-3	
	Ratio of PDCCH to RS EPRE	dB	4	1	
	Ratio of PCFICH to RS EPRE	dB	4	1	
DRX			OFF	OFF	
Layer 3 filtering			Enabled	Enabled	Counters: $N_{310} = 1; N_{311} = 1$
T310 timer		ms	2000	2000	T310 is enabled
T311 timer		ms	1000	1000	T311 is enabled
Periodic CQI reporting mode			PUCCH 1-0	PUCCH 1-0	As defined in table 7.2.2-1 in TS 36.213.
CQI reporting periodicity		ms	1	1	Minimum CQI reporting periodicity
Propagation channel			ETU 70 Hz	ETU 70 Hz	
T1		s	0.5	0.5	
T2		s	0.4	0.4	
T3		s	1.46	1.46	
T4		s	0.4	0.4	
T5		s	1	1	
Note 1: PDCCH/PCFICH corresponding to the in-sync and out of sync transmission parameters need not be included in the Reference Measurement Channel.					

Table A.7.3.4.1-2: Cell specific test parameters for E-UTRAN TDD (cell # 1) for in-sync radio link monitoring tests # 1 and # 2

Parameter	Unit	Test 1					Test 2				
		T1	T2	T3	T4	T5	T1	T2	T3	T4	T5
E-UTRA RF Channel Number		1					1				
BW _{channel}	MHz	10					10				
Correlation Matrix and Antenna Configuration		1x2 Low					2x2 Low				
Special subframe configuration ^{Note1}		6					6				
Uplink-downlink configuration ^{Note2}		1					1				

OCNG Pattern defined in A.3.2.2 (TDD)		OP.2 TDD					OP.2 TDD				
P_{A}, P_{B}		0					-3				
PCFICH_RB	dB	4					1				
PDCCH_RA	dB	0					-3				
PDCCH_RB	dB	0					-3				
PBCH_RA	dB	0					-3				
PBCH_RB	dB										
PSS_RA	dB										
SSS_RA	dB										
PHICH_RA	dB										
PHICH_RB	dB										
PDSCH_RA	dB										
PDSCH_RB	dB										
OCNG_RA ^{Note 3}	dB										
OCNG_RB ^{Note 3}	dB										
SNR ^{Note 8,9}	dB	-1.4	-5.3	-11.3	-6.4	-1.4	-2.3	-5.9	-11.9	-7.3	-2.3
N_{oc}	dBm/15 kHz	-98					-98				
Propagation condition		ETU 70 Hz					ETU 70 Hz				
<p>Note 1: For the special subframe configuration see table 4.2-1 in TS 36.211.</p> <p>Note 2: For the uplink-downlink configuration see table 4.2-2 in TS 36.211.</p> <p>Note 3: OCNG shall be used such that the resources in cell # 1 are fully allocated and a constant total transmitted power spectral density is achieved for all OFDM symbols.</p> <p>Note 4: The uplink resources for CQI reporting are assigned to the UE prior to the start of time period T1.</p> <p>Note 5: The timers and layer 3 filtering related parameters are configured prior to the start of time period T1.</p> <p>Note 6: The signal contains PDCCH for UEs other than the device under test as part of OCNG.</p> <p>Note 7: SNR levels correspond to the signal to noise ratio over the cell-specific reference signal REs.</p> <p>Note 8: The SNR in time periods T1, T2, T3, T4 and T5 is denoted as SNR1, SNR2, SNR3, SNR4 and SNR5 respectively in figure A.7.3.4.1-1.</p> <p>Note 9: The SNR values are specified for testing a UE which supports 2RX on at least one band. For testing of a UE which supports 4RX on all bands, the SNR during T3 and T4 is modified as specified in section A.3.8.1.</p>											

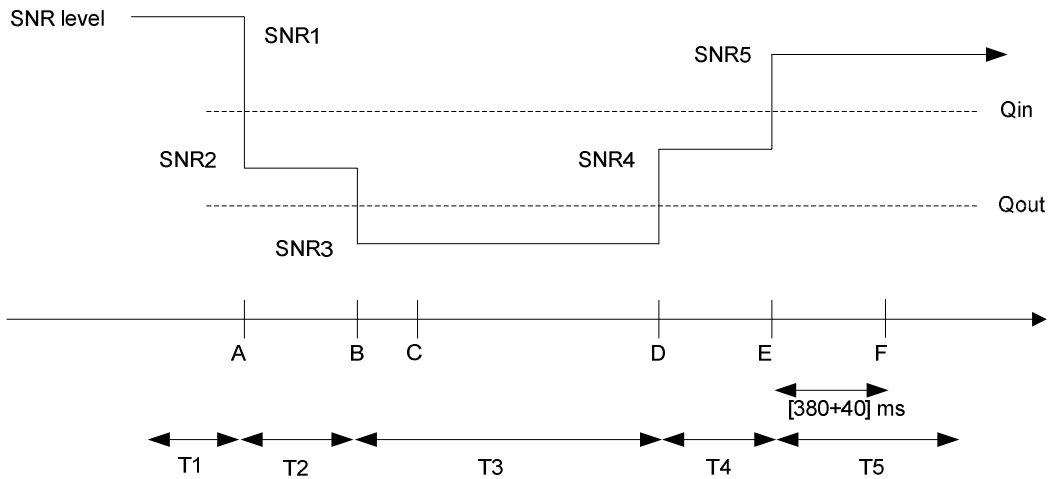

Figure A.7.3.4.1-1. SNR variation for in-sync testing

A.7.3.4.2 Test Requirements

The UE behaviour in each test during time durations T1, T2, T3, T4 and T5 shall be as follows:

During the period from time point A to time point F (420 ms after the start of time duration T5) the UE shall transmit uplink signal at least in all uplink subframes configured for CQI transmission according to the configured CQI mode (PUCCH 1-0).

The rate of correct events observed during repeated tests shall be at least 90%.

A.7.3.5 E-UTRAN FDD Radio Link Monitoring Test for Out-of-sync in DRX

A.7.3.5.1 Test Purpose and Environment

The purpose of this test is to verify that the UE properly detects the out of sync and in sync for the purpose of monitoring downlink radio link quality of the PCell when DRX is used. This test will partly verify the E-UTRAN FDD radio link monitoring requirements in clause 7.6.

The test parameters are given in Tables A.7.3.5.1-1, A.7.3.5.1-2, A.7.3.5.1-3 and A.7.3.5.1-4. There is one cell (cell 1), which is the active cell, in the test. The test consists of three successive time periods, with time duration of T1, T2 and T3 respectively. Figure A.7.3.5.1-1 shows the variation of the downlink SNR in the active cell to emulate out-of-sync and in-sync states. Prior to the start of the time duration T1, the UE shall be fully synchronized to cell 1. The UE shall be configured for periodic CQI reporting in PUCCH 1-0 mode with a reporting periodicity of 2 ms. In the test, DRX configuration is enabled and DRX inactivity timer has already been expired, i.e. UE tries to decode PDCCH and to send periodic CQI during the period when On-duration timer is running. Time alignment timers shall be set to “infinity” so that UL timing alignment is maintained during the test.

Table A.7.3.5.1-1: General test parameters for E-UTRAN FDD out-of-sync tests in DRX

Parameter		Unit	Value		Comment
			Test 1	Test 2	
PCFICH/PDCCH/PHICH parameters			R.7 FDD	R.6 FDD	As specified in clause A.3.1.2.1. None of the PDCCH are intended for the UE under test
OCNG parameters			OP.2 FDD	OP.2 FDD	As specified in clause A.3.2.1.2.
Active cell			Cell 1	Cell 1	Cell 1 is on E-UTRA RF channel number 1
CP length			Normal	Normal	
E-UTRA RF Channel Number			1	1	One E-UTRA FDD carrier frequency is used.
E-UTRA Channel Bandwidth (BW _{channel})		MHz	10	10	
Correlation Matrix and Antenna Configuration			2x2 Low	1x2	Correlation Matrix and Antenna Configuration are defined in TS 36.101 [5] Annex B.2.3.2
Out of sync transmission parameters (Note 1)	DCI format		1A	1A	As defined in clause 5.3.3.1.3 in TS 36.212
	Number of Control OFDM symbols		2	2	Out of sync threshold Q _{out} and the corresponding hypothetical PDCCH/PCFICH transmission parameters are as specified in clause 7.6.1 and Table 7.6.1-1 respectively.
	Aggregation level	CCE	8	8	
	ρ _A , ρ _B		-3	0	
	Ratio of PDCCH to RS EPRE	dB	1	4	
Ratio of PCFICH to RS EPRE	dB	1	4		
DRX cycle		ms	40	1280	See Table A.7.3.5.1-3
Layer 3 filtering			Enabled	Enabled	Counters: N310 = 1; N311 = 1
T310 timer		ms	0	0	T310 is disabled
T311 timer		ms	1000	1000	T311 is enabled
Periodic CQI reporting mode			PUCCH 1-0	PUCCH 1-0	As defined in table 7.2.2-1 in TS 36.213.
CQI reporting periodicity		ms	2	2	Minimum CQI reporting periodicity
Propagation channel			ETU 70 Hz	AWGN	.
T1		s	4	32	
T2		s	1.6	12.8	
T3		s	1.8	13	
Note 1: PDCCH/PCFICH corresponding to the out of sync transmission parameters need not be included in the Reference Measurement Channel.					

Table A.7.3.5.1-2: Cell specific test parameters for E-UTRAN FDD (cell # 1) for out-of-sync radio link monitoring tests # 1 and # 2 in DRX

Parameter	Unit	Test 1			Test 2		
		T1	T2	T3	T1	T2	T3
E-UTRA RF Channel Number		1			1		
BW _{channel}	MHz	10			10		
Correlation Matrix and Antenna Configuration		2x2 Low			1x2		

OCNG Pattern defined in A.3.2.1 (FDD)		OP.2 FDD			OP.2 FDD		
ρ_A, ρ_B		-3			0		
PCFICH_RB	dB	1			4		
PDCCH_RA	dB	1			4		
PDCCH_RB	dB	1			4		
PBCH_RA	dB	-3			0		
PBCH_RB	dB						
PSS_RA	dB						
SSS_RA	dB						
PHICH_RA	dB						
PHICH_RB	dB						
PDSCH_RA	dB						
PDSCH_RB	dB						
OCNG_RA ^{Note1}	dB						
OCNG_RB ^{Note1}	dB						
SNR ^{Note 6,7}	dB	-2.3	-6.2	-12.2	-4.7	-9.5	-13.5
N_{oc}	dBm/15 kHz	-98			-98		
Propagation condition		ETU 70 Hz			AWGN		
<p>Note 1: OCNG shall be used such that the resources in cell # 1 are fully allocated and a constant total transmitted power spectral density is achieved for all OFDM symbols.</p> <p>Note 2: The uplink resources for CQI reporting are assigned to the UE prior to the start of time period T1.</p> <p>Note 3: The timers and layer 3 filtering related parameters are configured prior to the start of time period T1.</p> <p>Note 4: The signal contains PDCCH for UEs other than the device under test as part of OCNG.</p> <p>Note 5: SNR levels correspond to the signal to noise ratio over the cell-specific reference signal REs.</p> <p>Note 6: The SNR in time periods T1, T2 and T3 is denoted as SNR1, SNR2 and SNR3 respectively in figure A.7.3.5.1-1.</p> <p>Note 7: The SNR values are specified for testing a UE which supports 2RX on at least one band. For testing of a UE which supports 4RX on all bands, the SNR during T3 is modified as specified in section A.3.8.1.</p>							

Table A.7.3.5.1-3: DRX-Configuration for E-UTRAN FDD out-of-sync tests

Field	Test1	Test2	Comment
	Value	Value	
onDurationTimer	psf2	psf2	As specified in clause 6.3.2 in TS 36.331
drx-InactivityTimer	psf1	psf1	
drx-RetransmissionTimer	psf1	psf1	
longDRX-CycleStartOffset	sf40	sf1280	
shortDRX	disable	disable	

Table A.7.3.5.1-4: TimeAlignmentTimer-Configuration for E-UTRAN FDD out-of-sync testing

Field	Test1	Test2	Comment
	Value	Value	
TimeAlignmentTimer	infinity	infinity	As specified in clause 6.3.2 in TS 36.331
sr-ConfigIndex	0	0	For further information see clause 6.3.2 in TS 36.331 and section 10.1 in TS 36.213.

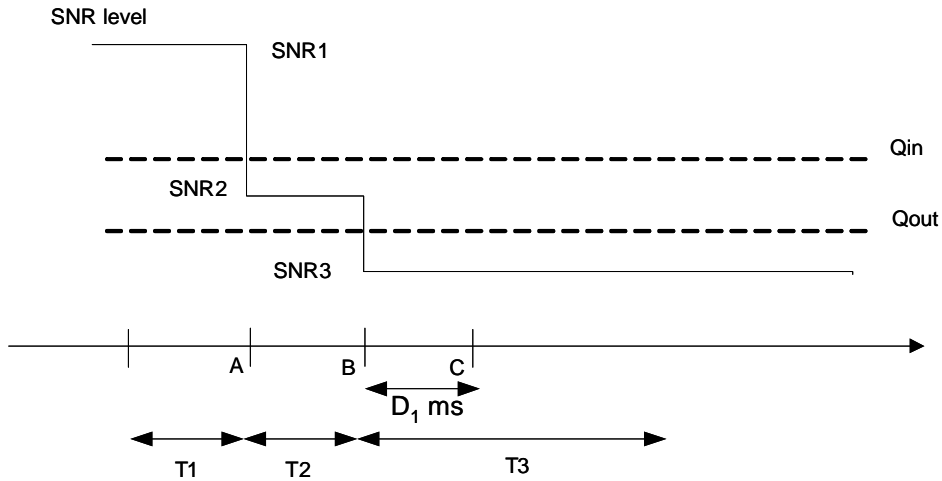

Figure A.7.3.5.1-1 SNR variation for out-of-sync testing in DRX

A.7.3.5.2 Test Requirements

The UE behaviour in each test during time durations T1, T2 and T3 shall be as follows:

In test 1 and test 2 during the period from time point A to time point B the UE shall transmit uplink signal at least once every DRX cycle, in the On-duration part of the cycle in the subframe according to the configured CQI reporting mode (PUCCH 1-0).

In test 1 the UE shall stop transmitting uplink signal no later than time point C (duration $D_1 = 900$ ms after the start of time duration T3).

In test 2 the UE shall stop transmitting uplink signal no later than time point C (duration $D_1 = 6500$ ms after the start of time duration T3).

The rate of correct events observed during repeated tests shall be at least 90%.

A.7.3.6 E-UTRAN FDD Radio Link Monitoring Test for In-sync in DRX

A.7.3.6.1 Test Purpose and Environment

The purpose of this test is to verify that the UE properly detects the out of sync and in sync for the purpose of monitoring downlink radio link quality of the PCell when DRX is used. This test will partly verify the E-UTRAN FDD radio link monitoring requirements in clause 7.6.

The test parameters are given in Tables A.7.3.6.1-1, A.7.3.6.1-2, A.7.3.6.1-3 and A.7.3.6.1-4. There is one cell (cell 1), which is the active cell, in the test. The test consists of five successive time periods, with time duration of T1, T2, T3, T4 and T5 respectively. Figure A.7.3.6.1-1 shows the variation of the downlink SNR in the active cell to emulate out-of-sync and in-sync states. Prior to the start of the time duration T1, the UE shall be fully synchronized to cell 1. The UE shall be configured for periodic CQI reporting in PUCCH 1-0 mode with a reporting periodicity of 2 ms. In the test, DRX configuration is enabled and DRX inactivity timer has already been expired, i.e. UE tries to decode PDCCH and to send periodic CQI during the period when On-duration timer is running. Time alignment timers shall be set to “infinity” so that UL timing alignment is maintained during the test.

Table A.7.3.6.1-1: General test parameters for E-UTRAN FDD in-sync test in DRX

Parameter		Unit	Value	Comment
PCFICH/PDCCH/PHICH parameters			R.6 FDD	As specified in clause A.3.1.2.1. None of the PDCCH are intended for the UE under test
OCNG parameters			OP.2 FDD	As specified in clause A.3.2.1.2.
Active cell			Cell 1	Cell 1 is on E-UTRA RF channel number 1
CP length			Normal	
E-UTRA RF Channel Number			1	One E-UTRA FDD carrier frequency is used.
E-UTRA Channel Bandwidth (BW_{channel})		MHz	10	
Antenna Configuration			1x2	
In sync transmission parameters (Note 1)	DCI format		1C	As defined in clause 5.3.3.1.4 in TS 36.212
	Number of Control OFDM symbols		2	In sync threshold Q_{in} and the corresponding hypothetical PDCCH/PCFICH transmission parameters are as specified in clause and Table 7.6.1-2 respectively.
	Aggregation level	CC E	4	
	ρ_A, ρ_B		0	
	Ratio of PDCCH to RS EPRE		0	
	Ratio of PCFICH to RS EPRE		4	
Out of sync transmission parameters (Note 1)	DCI format		1A	
Out of sync transmission parameters (Note 1)	Number of Control OFDM symbols		2	Out of sync threshold Q_{out} and the corresponding hypothetical PDCCH/PCFICH transmission parameters are as specified in clause 7.6.1 and Table 7.6.1-1 respectively.
	Aggregation level	CC E	8	
	ρ_A, ρ_B		0	
	Ratio of PDCCH to RS EPRE	dB	4	
	Ratio of PCFICH to RS EPRE	dB	4	
	DRX cycle	ms	40	
Layer 3 filtering		<i>Enabled</i>	<i>Counters:</i> $N_{310} = 1; N_{311} = 1$	
T310 timer	ms	2000	<i>T310 is enabled</i>	
T311 timer	ms	1000	T311 is enabled	
Periodic CQI reporting mode		PUCCH 1-0	As defined in table 7.2.2-1 in TS 36.213.	

CQI reporting periodicity	ms	2	Minimum CQI reporting periodicity
Propagation channel		AWGN	
T1	s	4	
T2	s	1.6	
T3	s	1.46	
T4	s	0.4	
T5	s	4	
Note 1: PDCCH/PCFICH corresponding to the in-sync and out of sync transmission parameters need not be included in the Reference Measurement Channel.			

Table A.7.3.6.1-2: Cell specific test parameters for E-UTRAN FDD (cell # 1) for in-sync radio link monitoring test # 1 in DRX

Parameter	Unit	Test 1				
		T1	T2	T3	T4	T5
E-UTRA RF Channel Number		1				
BW _{channel}	MHz	10				
Antenna Configuration		1x2				
OCNG Pattern defined in A.3.2.1 (FDD)		OP.2 FDD				
ρ_A, ρ_B		0				
PCFICH_RB	dB	4				
PDCCH_RA	dB	0				
PDCCH_RB	dB	0				
PBCH_RA	dB	0				
PBCH_RB	dB					
PSS_RA	dB					
SSS_RA	dB					
PHICH_RA	dB					
PHICH_RB	dB					
PDSCH_RA	dB					
PDSCH_RB	dB					
OCNG_RA ^{Note1}	dB					
OCNG_RB ^{Note1}	dB					
SNR ^{Note 6,7}	dB	-4.7	-9.5	-13.5	-8.7	-4.7
N_{oc}	dBm/15 kHz	-98				
Propagation condition		AWGN				
<p>Note 1: OCNG shall be used such that the resources in cell # 1 are fully allocated and a constant total transmitted power spectral density is achieved for all OFDM symbols.</p> <p>Note 2: The uplink resources for CQI reporting are assigned to the UE prior to the start of time period T1.</p> <p>Note 3: The timers and layer 3 filtering related parameters are configured prior to the start of time period T1.</p> <p>Note 4: The signal contains PDCCH for UEs other than the device under test as part of OCNG.</p> <p>Note 5: SNR levels correspond to the signal to noise ratio over the cell-specific reference signal REs.</p> <p>Note 6: The SNR in time periods T1, T2, T3, T4 and T5 is denoted as SNR1, SNR2, SNR3, SNR4 and SNR5 respectively in figure A.7.3.6.1-1.</p> <p>Note 7: The SNR values are specified for testing a UE which supports 2RX on at least one band. For testing of a UE which supports 4RX on all bands, the SNR during T3 and T4 is modified as specified in section A.3.8.1.</p>						

Table A.7.3.6.1-3: DRX-Configuration for E-UTRAN FDD out-of-sync tests

Field	Value	Comment
onDurationTimer	psf2	As specified in clause 6.3.2 in TS 36.331
drx-InactivityTimer	psf1	
drx-RetransmissionTimer	psf1	
longDRX-CycleStartOffset	sf40	
shortDRX	disable	

Table A.7.3.6.1-4: TimeAlignmentTimer -Configuration for E-UTRAN FDD out-of-sync testing

Field	Value	Comment
TimeAlignmentTimer	infinity	As specified in clause 6.3.2 in TS 36.331
sr-ConfigIndex	0	For further information see clause 6.3.2 in TS 36.331 and section 10.1 in TS 36.213.

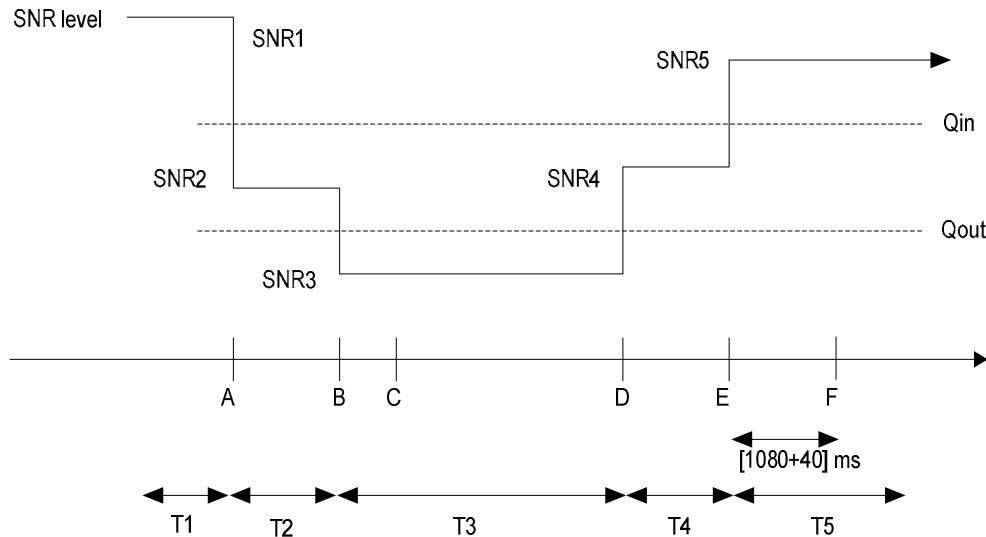

Figure A.7.3.6.1-1 SNR variation for in-sync testing in DRX

A.7.3.6.2 Test Requirements

The UE behaviour in each test during time durations T1, T2, T3, T4 and T5 shall be as follows:

During the period from time point A to time point F (1120 ms after the start of time duration T5) the UE shall transmit uplink signal at least once every DRX cycle, in the On-duration part of the cycle in the subframe according to the configured CQI reporting mode (PUCCH 1-0).

The rate of correct events observed during repeated tests shall be at least 90%.

A.7.3.7 E-UTRAN TDD Radio Link Monitoring Test for Out-of-sync in DRX

A.7.3.7.1 Test Purpose and Environment

The purpose of this test is to verify that the UE properly detects the out of sync and in sync for the purpose of monitoring downlink radio link quality of the PCell when DRX is used. This test will partly verify the E-UTRAN TDD radio link monitoring requirements in clause 7.6.

The test parameters are given in Tables A.7.3.7.1-1, A.7.3.7.1-2, A.7.3.7.1-3 and A.7.3.7.1-4. There is one cell (cell 1), which is the active cell, in the test. The test consists of three successive time periods, with time duration of T1, T2 and T3 respectively. Figure A.7.3.7.1-1 shows the variation of the downlink SNR in the active cell to emulate out-of-sync and in-sync states. Prior to the start of the time duration T1, the UE shall be fully synchronized to cell 1. The UE shall be configured for periodic CQI reporting in PUCCH 1-0 mode with a reporting periodicity of 1 ms. In the test, DRX configuration is enabled and DRX inactivity timer has already been expired, i.e. UE tries to decode PDCCH and to send periodic CQI during the period when On-duration timer is running. Time alignment timers shall be set to “infinity” so that UL timing alignment is maintained during the test.

Table A.7.3.7.1-1: General test parameters for E-UTRAN TDD out-of-sync tests in DRX

Parameter	Unit	Value		Comment
		Test 1	Test 2	

PCFICH/PDCCH/PHICH parameters			R.7 TDD	R.6 TDD	As specified in clause A.3.1.2.2. None of the PDCCH are intended for the UE under test
OCNG parameters			OP.2 TDD	OP.2 TDD	As specified in clause A.3.2.2.2.
Active cell			Cell 1	Cell 1	Cell 1 is on E-UTRA RF channel number 1
CP length			Normal	Normal	
E-UTRA RF Channel Number			1	1	One E-UTRA TDD carrier frequency is used.
E-UTRA Channel Bandwidth (BW _{channel})		MHz	10	10	
Correlation Matrix and Antenna Configuration			2x2 Low	1x2	Correlation Matrix and Antenna Configuration are defined in TS 36.101 [5] Annex B.2.3.2
Out of sync transmission parameters (Note 1)	DCI format		1A	1A	As defined in clause 5.3.3.1.3 in TS 36.212
	Number of Control OFDM symbols		2	2	Out of sync threshold Q _{out} and the corresponding hypothetical PDCCH/PCFICH transmission parameters are as specified in clause 7.6.1 and Table 7.6.1-1 respectively.
	Aggregation level	CCE	8	8	
	ρ _A , ρ _B		-3	0	
	Ratio of PDCCH to RS EPRE	dB	1	4	
Ratio of PCFICH to RS EPRE	dB	1	4		
DRX cycle		ms	40	1280	See Table A.7.3.7.1-3
Layer 3 filtering			Enabled	Enabled	Counters: N ₃₁₀ = 1; N ₃₁₁ = 1
T310 timer		ms	0	0	T310 is disabled
T311 timer		ms	1000	1000	T311 is enabled
Periodic CQI reporting mode			PUCCH 1-0	PUCCH 1-0	As defined in table 7.2.2-1 in TS 36.213.
CQI reporting periodicity		ms	1	1	Minimum CQI reporting periodicity
Propagation channel			ETU 70 Hz	AWGN	.
T1		s	4	32	
T2		s	1.6	12.8	
T3		s	1.8	13	
Note 1: PDCCH/PCFICH corresponding to the out of sync transmission parameters need not be included in the Reference Measurement Channel.					

Table A.7.3.7.1-2: Cell specific test parameters for E-UTRAN TDD (cell # 1) for out-of-sync radio link monitoring tests # 1 and # 2 in DRX

Parameter	Unit	Test 1			Test 2		
		T1	T2	T3	T1	T2	T3
E-UTRA RF Channel Number		1			1		
BW _{channel}	MHz	10			10		
Correlation Matrix and Antenna Configuration		2x2 Low			1x2		
Special subframe configuration ^{Note1}		6			6		
Uplink-downlink configuration ^{Note2}		1			1		

OCNG Pattern defined in A.3.2.2 (TDD)		OP.2 TDD			OP.2 TDD		
ρ_A, ρ_B		-3			0		
PCFICH_RB	dB	1			4		
PDCCH_RA	dB	1			4		
PDCCH_RB	dB	1			4		
PBCH_RA	dB	-3			0		
PBCH_RB	dB						
PSS_RA	dB						
SSS_RA	dB						
PHICH_RA	dB						
PHICH_RB	dB						
PDSCH_RA	dB						
PDSCH_RB	dB						
OCNG_RA ^{Note3}	dB						
OCNG_RB ^{Note3}	dB						
SNR ^{Note 8,9}	dB	-2.3	-5.9	-11.9	-5.1	-9.1	-13.1
N_{oc}	dBm/15 kHz	-98			-98		
Propagation condition		ETU 70 Hz			AWGN		
<p>Note 1: For the special subframe configuration see table 4.2-1 in TS 36.211.</p> <p>Note 2: For the uplink-downlink configuration see table 4.2-2 in TS 36.211.</p> <p>Note 3: OCNG shall be used such that the resources in cell # 1 are fully allocated and a constant total transmitted power spectral density is achieved for all OFDM symbols.</p> <p>Note 4: The uplink resources for CQI reporting are assigned to the UE prior to the start of time period T1.</p> <p>Note 5: The timers and layer 3 filtering related parameters are configured prior to the start of time period T1.</p> <p>Note 6: The signal contains PDCCH for UEs other than the device under test as part of OCNG.</p> <p>Note 7: SNR levels correspond to the signal to noise ratio over the cell-specific reference signal REs.</p> <p>Note 8: The SNR in time periods T1, T2 and T3 is denoted as SNR1, SNR2 and SNR3 respectively in figure A.7.3.7.1-1.</p> <p>Note 9: The SNR values are specified for testing a UE which supports 2RX on at least one band. For testing of a UE which supports 4RX on all bands, the SNR during T3 is modified as specified in section A.3.8.1.</p>							

Table A.7.3.7.1-3: DRX-Configuration for E-UTRAN TDD out-of-sync tests

Field	Test1	Test2	Comment
	Value	Value	
onDurationTimer	psf2	psf2	As specified in clause 6.3.2 in TS 36.331
drx-InactivityTimer	psf1	psf1	
drx-RetransmissionTimer	psf1	psf1	
longDRX-CycleStartOffset	sf40	sf1280	
shortDRX	disable	disable	

Table A.7.3.7.1-4: TimeAlignmentTimer -Configuration for E-UTRAN TDD out-of-sync testing

Field	Test1	Test2	Comment
	Value	Value	
TimeAlignmentTimer	infinity	infinity	As specified in clause 6.3.2 in TS 36.331
sr-ConfigIndex	2	2	For further information see clause 6.3.2 in TS 36.331 and section 10.1 in TS 36.213.

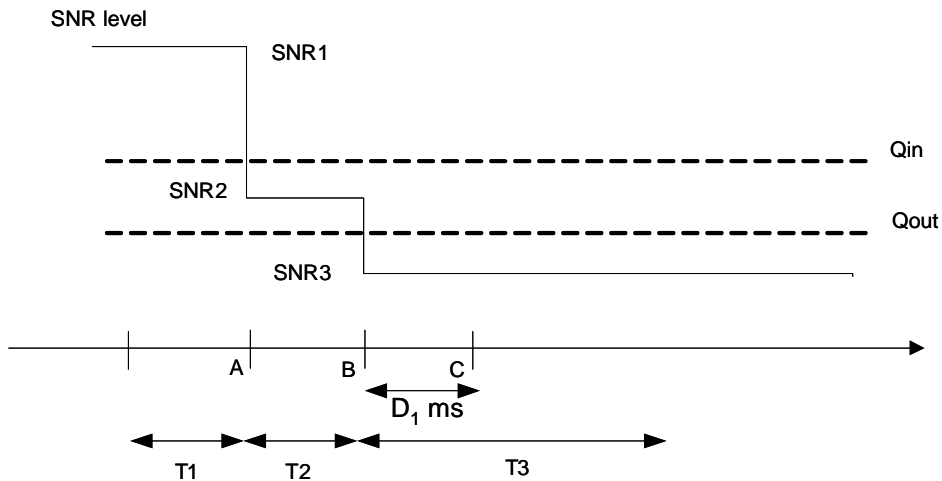

Figure A.7.3.7.1-1 SNR variation for out-of-sync testing in DRX

A.7.3.7.2 Test Requirements

The UE behaviour in each test during time durations T1, T2 and T3 shall be as follows:

In test 1 and test 2 during the period from time point A to time point B the UE shall transmit uplink signal at least once every DRX cycle, in the On-duration part of the cycle in the uplink subframe according to the configured CQI reporting mode (PUCCH 1-0).

In test 1 the UE shall stop transmitting uplink signal no later than time point C ($D_1 = 900$ ms after the start of time duration T3).

In test 2 the UE shall stop transmitting uplink signal no later than time point C (duration $D_1 = 6500$ ms after the start of time duration T3).

The rate of correct events observed during repeated tests shall be at least 90%.

A.7.3.8 E-UTRAN TDD Radio Link Monitoring Test for In-sync in DRX

A.7.3.8.1 Test Purpose and Environment

The purpose of this test is to verify that the UE properly detects the out of sync and in sync for the purpose of monitoring downlink radio link quality of the PCell when DRX is used. This test will partly verify the E-UTRAN TDD radio link monitoring requirements in clause 7.6.

The test parameters are given in Tables A.7.3.8.1-1, A.7.3.8.1-2, A.7.3.8.1-3 and A.7.3.8.1-4. There is one cell (cell 1), which is the active cell, in the test. The test consists of five successive time periods, with time duration of T1, T2, T3, T4 and T5 respectively. Figure A.7.3.8.1-1 shows the variation of the downlink SNR in the active cell to emulate out-of-sync and in-sync states. Prior to the start of the time duration T1, the UE shall be fully synchronized to cell 1. The UE shall be configured for periodic CQI reporting in PUCCH 1-0 mode with a reporting periodicity of 1 ms. In the test, DRX configuration is enabled and DRX inactivity timer has already been expired, i.e. UE tries to decode PDCCH and to send periodic CQI during the period when On-duration timer is running. Time alignment timers shall be set to “infinity” so that UL timing alignment is maintained during the test.

Table A.7.3.8.1-1: General test parameters for E-UTRAN TDD in-sync test in DRX

Parameter	Unit	Value	Comment
PCFICH/PDCCH/PHICH parameters		R.6 TDD	As specified in clause A.3.1.2.2. None of the PDCCH are intended for the UE under test
OCNG parameters		OP.2 TDD	As specified in clause A.3.2.2.2.
Active cell		Cell 1	Cell 1 is on E-UTRA RF channel number 1
CP length		Normal	

E-UTRA RF Channel Number			1	One E-UTRA TDD carrier frequency is used.
E-UTRA Channel Bandwidth ($BW_{channel}$)		MHz	10	
Antenna Configuration			1x2	
In sync transmission parameters (Note 1)	DCI format		1C	As defined in clause 5.3.3.1.4 in TS 36.212
	Number of Control OFDM symbols		2	In sync threshold Q_{in} and the corresponding hypothetical PDCCH/PCFICH transmission parameters are as specified in clause and Table 7.6.1-2 respectively.
	Aggregation level	CCE	4	
	ρ_A, ρ_B		0	
	Ratio of PDCCH to RS EPRE		0	
Ratio of PCFICH to RS EPRE		4		
Out of sync transmission parameters (Note 1)	DCI format		1A	As defined in clause 5.3.3.1.3 in TS 36.212
	Number of Control OFDM symbols		2	Out of sync threshold Q_{out} and the corresponding hypothetical PDCCH/PCFICH transmission parameters are as specified in clause 7.6.1 and Table 7.6.1-1 respectively.
	Aggregation level	CCE	8	
	ρ_A, ρ_B		0	
	Ratio of PDCCH to RS EPRE	dB	4	
Ratio of PCFICH to RS EPRE	dB	4		
DRX cycle		ms	40	See Table A.7.3.8.1-3
Layer 3 filtering			<i>Enabled</i>	Counters: $N_{310} = 1; N_{311} = 1$
T310 timer		ms	2000	T310 is enabled
T311 timer		ms	1000	T311 is enabled
Periodic CQI reporting mode			PUCCH 1-0	As defined in table 7.2.2-1 in TS 36.213.
CQI reporting periodicity		ms	1	Minimum CQI reporting periodicity
Propagation channel			AWGN	
T1		s	4	
T2		s	1.6	
T3		s	1.46	
T4		s	0.4	
T5		s	4	
Note 1: PDCCH/PCFICH corresponding to the in-sync and out of sync transmission parameters need not be included in the Reference Measurement Channel.				

Table A.7.3.8.1-2: Cell specific test parameters for E-UTRAN TDD (cell # 1) for in-sync radio link monitoring test # 1 in DRX

Parameter	Unit	Test 1				
		T1	T2	T3	T4	T5
E-UTRA RF Channel Number		1				
$BW_{channel}$	MHz	10				
Antenna Configuration		1x2				
Special subframe configuration ^{Note1}		6				
Uplink-downlink configuration ^{Note2}		1				
OCNG Pattern defined in A.3.2.2 (TDD)		OP.2 TDD				
ρ_A, ρ_B		0				
PCFICH_RB	dB	4				

PDCCH_RA	dB	0				
PDCCH_RB	dB	0				
PBCH_RA	dB	0				
PBCH_RB	dB					
PSS_RA	dB					
SSS_RA	dB					
PHICH_RA	dB					
PHICH_RB	dB					
PDSCH_RA	dB					
PDSCH_RB	dB					
OCNG_RA ^{Note3}	dB					
OCNG_RB ^{Note3}	dB					
SNR ^{Note 8,9}	dB	-5.1	-9.1	-13.1	-9.1	-5.1
N_{oc}	dBm/15 kHz	-98				
Propagation condition		AWGN				
<p>Note 1: For the special subframe configuration see table 4.2-1 in TS 36.211.</p> <p>Note 2: For the uplink-downlink configuration see table 4.2-2 in TS 36.211.</p> <p>Note 3: OCNG shall be used such that the resources in cell # 1 are fully allocated and a constant total transmitted power spectral density is achieved for all OFDM symbols.</p> <p>Note 4: The uplink resources for CQI reporting are assigned to the UE prior to the start of time period T1.</p> <p>Note 5: The timers and layer 3 filtering related parameters are configured prior to the start of time period T1.</p> <p>Note 6: The signal contains PDCCH for UEs other than the device under test as part of OCNG.</p> <p>Note 7: SNR levels correspond to the signal to noise ratio over the cell-specific reference signal REs.</p> <p>Note 8: The SNR in time periods T1, T2, T3, T4 and T5 is denoted as SNR1, SNR2, SNR3, SNR4 and SNR5 respectively in figure A.7.3.8.1-1.</p> <p>Note 9: The SNR values are specified for testing a UE which supports 2RX on at least one band. For testing of a UE which supports 4RX on all bands, the SNR during T3 and T4 is modified as specified in section A.3.8.1.</p>						

Table A.7.3.8.1-3: DRX-Configuration for E-UTRAN TDD out-of-sync tests

Field	Value	Comment
onDurationTimer	psf2	As specified in clause 6.3.2 in TS 36.331
drx-InactivityTimer	psf1	
drx-RetransmissionTimer	psf1	
longDRX-CycleStartOffset	sf40	
shortDRX	disable	

Table A.7.3.8.1-4: TimeAlignmentTimer -Configuration for E-UTRAN TDD out-of-sync testing

Field	Value	Comment
TimeAlignmentTimer	infinity	As specified in clause 6.3.2 in TS 36.331
sr-ConfigIndex	2	For further information see clause 6.3.2 in TS 36.331 and section 10.1 in TS 36.213.

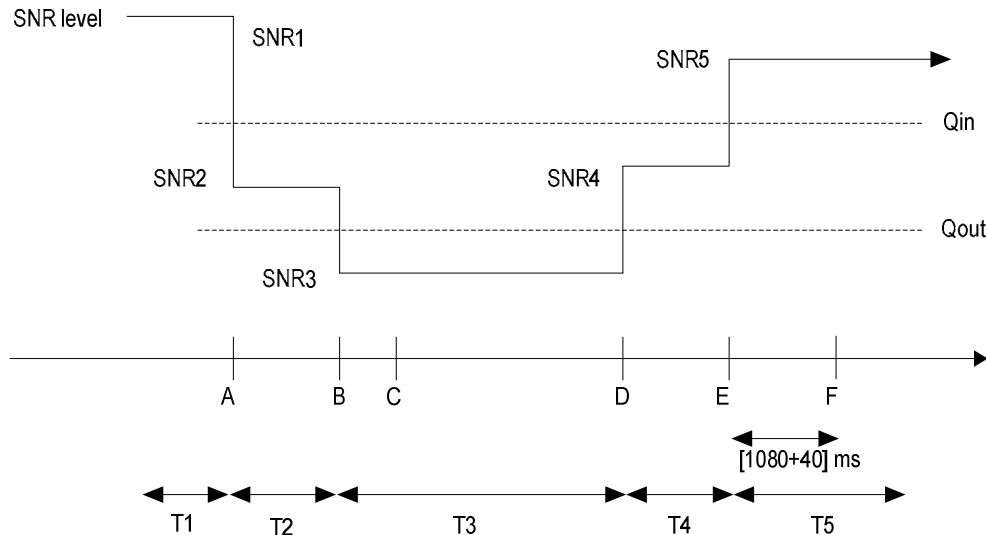

Figure A.7.3.8.1-1 SNR variation for in-sync testing in DRX

A.7.3.8.2 Test Requirements

The UE behaviour in each test during time durations T1, T2, T3, T4 and T5 shall be as follows:

During the period from time point A to time point F (1120 ms after the start of time duration T5) the UE shall transmit uplink signal at least once every DRX cycle, in the On-duration part of the cycle in the uplink subframe according to the configured CQI reporting mode (PUCCH 1-0).

The rate of correct events observed during repeated tests shall be at least 90%.

A.7.3.9 E-UTRAN FDD Radio Link Monitoring Test for Out-of-sync under Time Domain Measurement Resource Restriction and Non-MBSFN ABS

A.7.3.9.1 Test Purpose and Environment

The purpose of this test is to verify that the UE properly detects the out of sync and in sync for the purpose of monitoring downlink radio link quality of the serving cell under time domain measurement resource restriction when CRS assistance information is not provided. This test will partly verify the E-UTRAN FDD radio link monitoring requirements in clause 7.6.

The test parameters are given in Tables A.7.3.9.1-1 and A.7.3.9.1-2 below. The test consists of three successive time periods, with time duration of T1, T2 and T3 respectively. Figure A.7.3.9.1-1 shows the variation of the downlink SNR in the active cell to emulate out-of-sync and in-sync states. Prior to the start of the time duration T1, the UE shall be fully synchronized to cell 1. The UE shall be configured for periodic CQI reporting in PUCCH 1-0 mode with a reporting periodicity of 2 ms.

Non-MBSFN ABS pattern is configured in the aggressor Cell 2 in this test. The UE is configured by higher layers with a time domain measurement restriction pattern for performing serving cell measurements. The patterns shall be configured prior to the start of T1.

Table A.7.3.9.1-1: General test parameters for E-UTRAN FDD out-of-sync testing under time domain measurement resource restriction with non-MBSFN ABS

Parameter	Unit	Value	Comment
PCFICH/PDCCH/PHICH parameters		R.9.FDD	As specified in clause A.3.1.2.1. None of the PDCCH are intended for the UE under test
OCNG parameters		OP.6 FDD	As specified in clause A.3.2.1.6.
Serving cell (PCell)		Cell 1	Cell 1 is on E-UTRA RF channel number 1

Neighbor cell			Cell 2	Aggressor cell on E-UTRA RF channel number 1
Neighbor cell ABS configuration			Non-MBSFN ABS	As defined in Table A.3.4.1.2-1
CP length			Normal	
E-UTRA RF Channel Number			1	One E-UTRA FDD carrier frequency is used.
E-UTRA Channel Bandwidth ($BW_{channel}$)		MHz	10	
Correlation Matrix and Antenna Configuration			2x2 Low	Correlation Matrix and Antenna Configuration are defined in TS 36.101 [5] Annex B.2.3.2
Out of sync transmission parameters (Note 1)	DCI format		1A	As defined in clause 5.3.3.1.3 in TS 36.212
	Number of Control OFDM symbols		3	Out of sync threshold Q_{out} and the corresponding hypothetical PDCCH/PCFICH transmission parameters are as specified in clause 7.6.1 and Table 7.6.1-1 respectively.
	Aggregation level	CCE	8	
	ρ_A, ρ_B		-3	
	Ratio of PDCCH to RS EPRE	dB	1	
	Ratio of PCFICH to RS EPRE	dB	1	
DRX			OFF	
Layer 3 filtering			Enabled	Counters:: N310 = 1; N311 = 1
T310 timer		ms	0	T310 is disabled
T311 timer		ms	1000	T311 is enabled
Periodic CQI reporting mode			PUCCH 1-0	As defined in table 7.2.2-1 in TS 36.213.
CQI reporting periodicity		ms	2	Minimum CQI reporting periodicity
Time offset between cells			3 μ s	Synchronous cells
T1		s	1	
T2		s	0.4	
T3		s	0.5	
Physical cell ID PCI			$(PCI_{cell1} - PCI_{cell2}) \bmod 3 \neq 0$	Cell IDs are chosen such that CRS from cells 1 and 2 do not overlap in frequency
ABS pattern			'10000000100000001000000100000000'	FDD ABS Pattern Info IE, as defined in TS 36.423 [28], clause 9.2.54. Configured in Cell 2. The first/leftmost bit corresponds to the PCell subframe #0 of the radio frame satisfying $SN \bmod x = 0$, where x is the size of the bit string (40) divided by 10. No MBSFN subframes are configured in the ABS subframes.
Time domain measurement resource restriction pattern			'10000000100000001000000100000000'	Time domain measurement resource restriction pattern for serving cell measurement signalled to the UE in message measSubframePatternPCell-r10 as defined in TS 36.331, clause 6.3.2.
Note 1: PDCCH/PCFICH corresponding to the out of sync transmission parameters need not be included in the Reference Measurement Channel				

Table A.7.3.9.1-2: Cell specific test parameters for E-UTRAN FDD for out-of-sync radio link monitoring under time domain measurement resource restriction with non-MBSFN ABS

Parameter	Unit	Cell 1			Cell 2		
		T1	T2	T3	T1	T2	T3
E-UTRA RF Channel Number		1			1		
$BW_{channel}$	MHz	10			10		
Correlation Matrix and Antenna Configuration		2x2 Low			2x2 Low		

OCNG Pattern defined in A.3.2.1.6 (FDD)		OP.6 FDD			OP.6 FDD
ρ_A, ρ_B		-3			-3
PCFICH_RB	dB	1			Non-ABS and ABS subframe channel powers defined in Table A.3.4.1.2-1.
PDCCH_RA	dB	1			
PDCCH_RB	dB	1			
PBCH_RA	dB	-3			
PBCH_RB	dB				
PSS_RA	dB				
SSS_RA	dB				
PHICH_RA	dB				
PHICH_RB	dB				
PDSCH_RA	dB				
PDSCH_RB	dB				
OCNG_RA ^{Note1}	dB				
OCNG_RB ^{Note1}	dB				
SNR ^{Note 6,7}	dB	-1.3	-5.4	-12.4	5
N_{oc}	dBm/15 kHz	-98			-98
Propagation condition		ETU 30 Hz			ETU 30 Hz
<p>Note 1: OCNG shall be used such that the resources in cell # 1 are fully allocated and a constant total transmitted power spectral density is achieved for all OFDM symbols.</p> <p>Note 2: The uplink resources for CQI reporting are assigned to the UE prior to the start of time period T1.</p> <p>Note 3: The timers and layer 3 filtering related parameters are configured prior to the start of time period T1.</p> <p>Note 4: The signal contains PDCCH for UEs other than the device under test as part of OCNG.</p> <p>Note 5: SNR levels correspond to the signal quality, signal-to-interference-plus-noise ratio, on the CRS REs.</p> <p>Note 6: The SNR in the restricted measurement subframes during time periods T1, T2 and T3 is denoted as SNR1, SNR2 and SNR3 respectively in figure A.7.3. 9.1-1.</p> <p>Note 7: The SNR values are specified for testing a UE which supports 2RX on at least one band. For testing of a UE which supports 4RX on all bands, the SNR during T3 is modified as specified in section A.3.8.1.</p>					

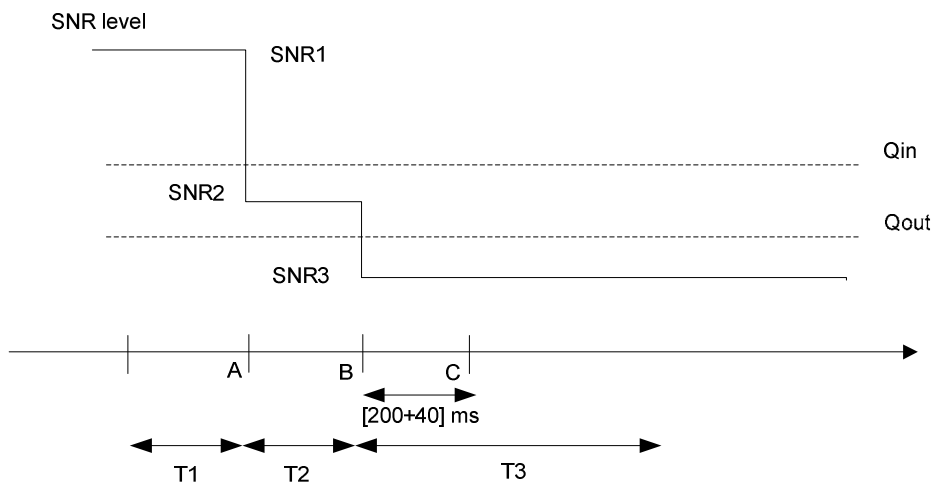

Figure A.7.3.9.1-1 SNR variation for out-of-sync testing

A.7.3.9.2 Test Requirements

The UE behaviour in each test during time durations T1, T2 and T3 shall be as follows:

During the period from time point A to time point B the UE shall transmit uplink signal at least in all subframes configured for CQI transmission according to the configured CQI reporting mode (PUCCH 1-0).

The UE shall stop transmitting uplink signal no later than time point C (240 ms after the start of time duration T3).

The rate of correct events observed during repeated tests shall be at least 90%.

A.7.3.10 E-UTRAN TDD Radio Link Monitoring Test for Out-of-sync under Time Domain Measurement Resource Restriction with Non-MBSFN ABS

A.7.3.10.1 Test Purpose and Environment

The purpose of this test is to verify that the UE properly detects the out of sync and in sync for the purpose of monitoring downlink radio link quality of the serving cell under time domain measurement resource restriction when CRS assistance information is not provided. This test will partly verify the E-UTRAN TDD radio link monitoring requirements in clause 7.6.

The test parameters are given in Tables A.7.3.10.1-1 and A.7.3.10.1-2 below. There are two cells, cell 1 is the serving cell and cell 2 is the neighbor aggressor cell. The test consists of three successive time periods, with time duration of T1, T2 and T3 respectively. Figure A.7.3.10.1-1 shows the variation of the downlink SNR in the active cell to emulate out-of-sync and in-sync states. Prior to the start of the time duration T1, the UE shall be fully synchronized to cell 1. The UE shall be configured for periodic CQI reporting in PUCCH 1-0 mode with a reporting periodicity of 1 ms.

Non-MBSFN ABS pattern is configured in Cell 2 in this test. The UE is configured by higher layers with a time domain measurement restriction pattern for performing serving cell measurements. The patterns shall be configured prior to the start of T1.

Table A.7.3.10.1-1: General test parameters for E-UTRAN TDD out-of-sync testing under time domain measurement resource restriction with non-MBSFN ABS

Parameter		Unit	Value	Comment
PCFICH/PDCCH/PHICH parameters			R.9 TDD	As specified in clause A.3.1.2.2. None of the PDCCH are intended for the UE under test
OCNG parameters			OP.2 TDD	As specified in clause A.3.2.2.2.
Serving cell			Cell 1	Cell 1 is on E-UTRA RF channel number 1
Neighbor cell			Cell 2	Cell 2 is the aggressor cell on E-UTRA RF channel number 1
Neighbor cell ABS configuration			Non-MBSFN ABS	As defined in Table A.3.4.1.2-1
CP length			Normal	
E-UTRA RF Channel Number			1	One E-UTRA TDD carrier frequency is used.
E-UTRA Channel Bandwidth ($BW_{channel}$)		MHz	10	
Correlation Matrix and Antenna Configuration			2x2 Low	Correlation Matrix and Antenna Configuration are defined in TS 36.101 [5] Annex B.2.3.2
Out of sync transmission parameters (Note 1)	DCI format		1A	As defined in clause 5.3.3.1.3 in TS 36.212
	Number of Control OFDM symbols		3	Out of sync threshold Q_{out} and the corresponding hypothetical PDCCH/PCFICH transmission parameters are as specified in clause 7.6.1 and Table 7.6.1-1 respectively.
	Aggregation level	CCE	8	
	ρ_A, ρ_B		-3	
	Ratio of PDCCH to RS EPRE	dB	1	
Ratio of PCFICH to RS EPRE	dB	1		
Physical cell ID PCI			$(PCI_{cell1} - PCI_{cell2}) \bmod 3 \neq 0$	Cell IDs are chosen such that CRS from cells 1 and 2 do not overlap in frequency.

ABS pattern		10000000001000000000	TDD ABS Pattern Info IE is configured in Cell 2 as defined in clause 9.2.54 in TS 36.423 [28]. The first/leftmost bit corresponds to the subframe #0 of the radio frame satisfying SFN mod x = 0, where x is the size of the bit string (20) divided by 10. No MBSFN subframes are configured in the ABS subframes.
Time domain measurement resource restriction pattern		10000000001000000000	MeasSubframePattern IE is configured in UE for serving cell measurement as defined in clause 6.3.6 in TS 36.331.
DRX		OFF	
Layer 3 filtering		Enabled	Counters: N310 = 1; N311 = 1
T310 timer	ms	0	T310 is disabled
T311 timer	ms	1000	T311 is enabled
Periodic CQI reporting mode		PUCCH 1-0	As defined in table 7.2.2-1 in TS 36.213.
CQI reporting periodicity	ms	1	Minimum CQI reporting periodicity
Time offset between cells	μs	3	
Propagation channel		ETU30	
T1	s	1	
T2	s	0.4	
T3	s	0.5	
Note 1: PDCCH/PCFICH corresponding to the out of sync transmission parameters need not be included in the Reference Measurement Channel.			

Table A.7.3.10.1-2: Cell specific test parameters for E-UTRAN TDD for out-of-sync radio link monitoring under time domain measurement resource restriction with non-MBSFN ABS

Parameter	Unit	Cell 1			Cell 2		
		T1	T2	T3	T1	T2	T3
E-UTRA RF Channel Number		1			1		
BW _{channel}	MHz	10			10		
Correlation Matrix and Antenna Configuration		2x2 Low			2x2 Low		
Special subframe configuration ^{Note1}		6			6		
Uplink-downlink configuration ^{Note2}		1			1		
OCNG Pattern defined in A.3.2.2 (TDD)		OP.2 TDD			OP.2 TDD		
ρ _A , ρ _B		-3			-3		
PCFICH_RB	dB	1			Non-ABS and ABS subframe channel powers defined in Table A.3.4.1.2-1.		
PDCCH_RA	dB	1					
PDCCH_RB	dB	1					
PBCH_RA	dB	-3					
PBCH_RB	dB						
PSS_RA	dB						
SSS_RA	dB						
PHICH_RA	dB						
PHICH_RB	dB						
PDSCH_RA	dB						
PDSCH_RB	dB						
OCNG_RA ^{Note 3}	dB						
OCNG_RB ^{Note 3}	dB						
SNR ^{Note 8,9}	dB	-1.3	-5.4	-12.4	5		
N _{oc}	dBm/15 kHz	-98			-98		
Propagation condition		ETU30			ETU30		

- Note 1: For the special subframe configuration see table 4.2-1 in TS 36.211.
- Note 2: For the uplink-downlink configuration see table 4.2-2 in TS 36.211.
- Note 3: OCNG shall be used such that the resources in cell # 1 are fully allocated and a constant total transmitted power spectral density is achieved for all OFDM symbols.
- Note 4: The uplink resources for CQI reporting are assigned to the UE prior to the start of time period T1.
- Note 5: The timers and layer 3 filtering related parameters are configured prior to the start of time period T1.
- Note 6: The signal contains PDCCH for UEs other than the device under test as part of OCNG.
- Note 7: SNR levels correspond to the signal to noise ratio over the cell-specific reference signal REs.
- Note 8: The SNR in time periods T1, T2 and T3 of active cell is denoted as SNR1, SNR2 and SNR3 respectively in figure A.7.3.10.1-1.
- Note 9: The SNR values are specified for testing a UE which supports 2RX on at least one band. For testing of a UE which supports 4RX on all bands, the SNR during T3 is modified as specified in section A.3.8.1.

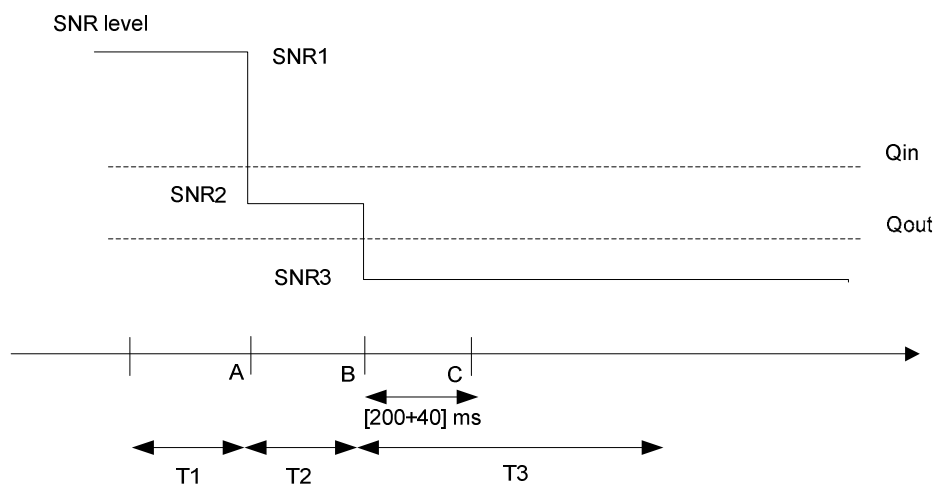

Figure A.7.3.10.1-1 SNR variation in active cell for out-of-sync testing under time domain measurement resource restriction with non-MBSFN ABS

A.7.3.10.2 Test Requirements

The UE behaviour in each test during time durations T1, T2 and T3 shall be as follows:

During the period from time point A to time point B the UE shall transmit uplink signal at least in all uplink subframes configured for CQI transmission according to the configured CQI reporting mode (PUCCH 1-0).

The UE shall stop transmitting uplink signal no later than time point C (240 ms after the start of the time duration T3).

The rate of correct events observed during repeated tests shall be at least 90%.

A.7.3.11 E-UTRAN FDD Radio Link Monitoring Test for In-sync for Non-MBSFN ABS

A.7.3.11.1 Test Purpose and Environment

The purpose of this test is to verify that the UE properly detects the out of sync and in sync for the purpose of monitoring downlink radio link quality of the serving cell under time domain measurement resource restriction when CRS assistance information is not provided. This test will partly verify the E-UTRAN FDD radio link monitoring requirements in clause 7.6.

The test parameters are given in Tables A.7.3.11.1-1 and A.7.3.11.1-2 below. There are two cells in the test: Cell 1 is the Active cell and Cell 2 is the Neighbor cell. The test consists of five successive time periods, with time duration of T1, T2, T3, T4 and T5 respectively. Figure A.7.3.11.1-1 shows the variation of the downlink SNR in the active cell to

emulate out-of-sync and in-sync states. Prior to the start of the time duration T1, the UE shall be fully synchronized to cell 1. The UE shall be configured for periodic CQI reporting in PUCCH 1-0 mode with a reporting periodicity of 2 ms.

Non-MBSFN ABS pattern is configured in Cell 2 in this test. The UE is configured by higher layers with a time domain measurement restriction pattern for performing serving cell measurements. The patterns shall be configured prior to the start of T1.

Table A.7.3.11.1-1: General test parameters for E-UTRAN FDD in-sync testing under time domain measurement resource restriction

Parameter		Unit	Value	Comment
PCFICH/PDCCH/PHICH parameters			R.9 FDD	As specified in clause A.3.1.2.1. None of the PDCCH are intended for the UE under test
OCNG parameters			OP.6 FDD	As specified in clause A.3.2.1.6.
Active cell			Cell 1	Cell 1 is on E-UTRA RF channel number 1
Neighbor cell			Cell 2	Cell 2 is on E-UTRA RF channel number 1; Cell 2 generates interference over restricted resources.
Neighbor cell ABS configuration			Non-MBSFN ABS	As defined in Table A.3.4.1.2-2
CP length			Normal	
E-UTRA RF Channel Number			1	One E-UTRA FDD carrier frequency is used.
E-UTRA Channel Bandwidth (BWchannel)		MHz	10	
Correlation Matrix and Antenna Configuration			2x2 Low	Correlation Matrix and Antenna Configuration are defined in TS 36.101 [5] Annex B.2.3.2
In sync transmission parameters for the active cell (Note 1)	DCI format		1C	As defined in clause 5.3.3.1.4 in TS 36.212
	Number of Control OFDM symbols		3	In sync threshold Q_{in} and the corresponding hypothetical PDCCH/PCFICH transmission parameters are as specified in clause and Table 7.6.1-2 respectively.
	Aggregation level	CC E	4	
	ρ_A, ρ_B		-3	
	Ratio of PDCCH to RS EPRE	dB	-3	
	Ratio of PCFICH to RS EPRE	dB	1	
Out of sync transmission parameters for active cell (Note 1)	DCI format		1A	
Out of sync transmission parameters for active cell (Note 1)	Number of Control OFDM symbols		3	Out of sync threshold Q_{out} and the corresponding hypothetical PDCCH/PCFICH transmission parameters are as specified in clause 7.6.1 and Table 7.6.1-1 respectively.
	Aggregation level	CC E	8	
	ρ_A, ρ_B		-3	
	Ratio of PDCCH to RS EPRE	dB	1	
	Ratio of PCFICH to RS EPRE	dB	1	
	DRX			
Layer 3 filtering			Enabled	Counters: N310 = 1; N311 = 1
T310 timer		ms	2000	T310 is enabled

T311 timer	ms	1000	T311 is enabled
Periodic CQI reporting mode		PUCCH 1-0	As defined in table 7.2.2-1 in TS 36.213.
CQI reporting periodicity	ms	2	Minimum CQI reporting periodicity
Time offset between cells	μs	3	
Propagation channel		ETU30	
T1	s	0.5	
T2	s	0.4	
T3	s	1.46	
T4	s	0.4	
T5	s	1	
Physical cell ID PCI		$(PCI_{cell1} - PCI_{cell2}) \bmod 3 \neq 0$	Cell IDs are chosen such that CRS from cells 1 and 2 do not overlap in frequency
ABS pattern		'10000000 100000001 000000010 000000100 00000'	FDD ABS Pattern Info IE, as defined in TS 36.423 [28], clause 9.2.54. Configured in Cell 2. The first/leftmost bit corresponds to the PCell subframe #0 of the radio frame satisfying $SFN \bmod x = 0$, where x is the size of the bit string (40) divided by 10. No MBSFN subframes are configured in the ABS subframes.
Time domain measurement resource restriction pattern		'10000000 100000001 000000010 000000100 00000'	Time domain measurement resource restriction pattern for serving cell measurement signalled to the UE in message measSubframePatternPCell-r10 as defined in TS 36.331, clause 6.3.2.
Note 1: PDCCH/PCFICH corresponding to the in-sync and out of sync transmission parameters need not be included in the Reference Measurement Channel.			

Table A.7.3.11.1-2: Cell specific test parameters for E-UTRAN FDD for in-sync radio link monitoring under time domain measurement resource restriction

Parameter	Unit	Cell 1					Cell 2				
		T1	T2	T3	T4	T5	T1	T2	T3	T4	T5
E-UTRA RF Channel Number		1					1				
BW _{channel}	MHz	10					10				
Correlation Matrix and Antenna Configuration		2x2 Low					2x2 Low				
PCFICH/PDCCH/PHICH parameters		R.9 FDD					R.9 FDD				
Number of Control OFDM symbols		3					3				
OCNG Pattern defined in A.3.2.1.6 (FDD)		OP.6 FDD					OP.6 FDD				
P_A, P_B		-3					-3				
PCFICH_RA	dB	1					Non-ABS and ABS subframe channel powers defined in Table A.3.4.1.2-2.				
PDCCH_RA	dB	-3									
PDCCH_RB	dB	-3									
PBCH_RA	dB										
PBCH_RB	dB										
PSS_RA	dB										
SSS_RA	dB										
PHICH_RA	dB	-3									

PHICH_RB	dB						
PDSCH_RA	dB						
PDSCH_RB	dB						
OCNG_RA ^{Note 1}	dB						
OCNG_RB ^{Note 1}	dB						
SNR ^{Note 6,7}	dB	-1.3	-5.4	-12.4	-7.3	-1.3	5
N_{oc}	dBm/15 kHz	-98					-98
Propagation condition		ETU30					ETU30
<p>Note 1: OCNG shall be used such that the resources in cell # 1 are fully allocated and a constant total transmitted power spectral density is achieved for all OFDM symbols.</p> <p>Note 2: The uplink resources for CQI reporting are assigned to the UE prior to the start of time period T1.</p> <p>Note 3: The timers and layer 3 filtering related parameters are configured prior to the start of time period T1.</p> <p>Note 4: The signal contains PDCCH for UEs other than the device under test as part of OCNG.</p> <p>Note 5: SNR levels correspond to the signal to noise ratio over the cell-specific reference signal REs.</p> <p>Note 6: The SNR in time periods T1, T2, T3, T4 and T5 of the active cell is denoted as SNR1, SNR2, SNR3, SNR4 and SNR5 respectively in figure A.7.3.11.1-1.</p> <p>Note 7: The SNR values are specified for testing a UE which supports 2RX on at least one band. For testing of a UE which supports 4RX on all bands, the SNR during T3 and T4 is modified as specified in section A.3.8.1.</p>							

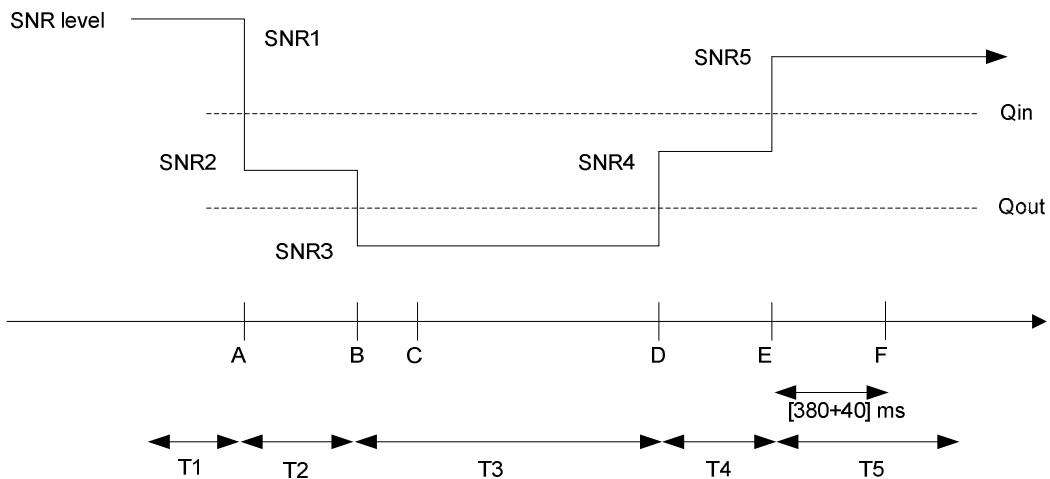

Figure A.7.3.11.1-1 SNR variation in the active cell for in-sync testing under time domain measurement resource restriction

A.7.3.11.2 Test Requirements

The UE behaviour in each test during time durations T1, T2, T3, T4 and T5 shall be as follows:

During the period from time point A to time point F (420 ms after the start of time duration T5) the UE shall transmit uplink signal at least in all subframes configured for CQI transmission according to the configured CQI reporting mode (PUCCH 1-0).

The rate of correct events observed during repeated tests shall be at least 90%.

A.7.3.12 E-UTRAN TDD Radio Link Monitoring Test for In-sync for Non-MBSFN ABS

A.7.3.12.1 Test Purpose and Environment

The purpose of this test is to verify that the UE properly detects the out of sync and in sync for the purpose of monitoring downlink radio link quality of the serving cell under time domain measurement resource restriction when CRS assistance information is not provided. This test will partly verify the E-UTRAN TDD radio link monitoring requirements in clause 7.6.

The test parameters are given in Tables A.7.3.12.1-1 and A.7.3.12.1-2 below. There are two cells in the test: Cell 1 is the Active cell and Cell 2 is the Neighbor cell. The test consists of five successive time periods, with time duration of T1, T2, T3, T4 and T5 respectively. Figure A.7.3.12.1-1 shows the variation of the downlink SNR in the active cell to emulate out-of-sync and in-sync states. Prior to the start of the time duration T1, the UE shall be fully synchronized to cell 1. The UE shall be configured for periodic CQI reporting in PUCCH 1-0 mode with a reporting periodicity of 1 ms.

Non-MBSFN ABS pattern is configured in the aggressor Cell 2 in this test. The UE is configured by higher layers with a time domain measurement restriction pattern for performing serving cell measurements. The patterns shall be configured prior to the start of T1.

Table A.7.3.12.1-1: General test parameters for E-UTRAN TDD in-sync testing under time domain measurement resource restriction

Parameter		Unit	Value	Comment
PCFICH/PDCCH/PHICH parameters			R.9 TDD	As specified in clause A.3.1.2.2. None of the PDCCH are intended for the UE under test
OCNG parameters			OP.2 TDD	As specified in clause A.3.2.2.2.
Active cell			Cell 1	Cell 1 is on E-UTRA RF channel number 1
Neighbor cell			Cell 2	Cell 2 is on E-UTRA RF channel number 1; Cell 2 generates interference over restricted resources.
Neighbor cell ABS configuration			Non-MBSFN ABS	As defined in Table A.3.4.1.2-2
CP length			Normal	
E-UTRA RF Channel Number			1	One E-UTRA TDD carrier frequency is used.
E-UTRA Channel Bandwidth (BW/channel)		MHz	10	
Correlation Matrix and Antenna Configuration			2x2 Low	Correlation Matrix and Antenna Configuration are defined in TS 36.101 [5] Annex B.2.3.2
In sync transmission parameters for the active cell (Note 1)	DCI format		1C	As defined in clause 5.3.3.1.4 in TS 36.212
	Number of Control OFDM symbols		3	In sync threshold Q_{in} and the corresponding hypothetical PDCCH/PCFICH transmission parameters are as specified in clause and Table 7.6.1-2 respectively.
	Aggregation level	CC E	4	
	ρ_A, ρ_B		-3	
	Ratio of PDCCH to RS EPRE	dB	-3	
Ratio of PCFICH to RS EPRE	dB	1		
Out of sync transmission parameters for active cell (Note 1)	DCI format		1A	As defined in clause 5.3.3.1.3 in TS 36.212
	Number of Control OFDM symbols		3	Out of sync threshold Q_{out} and the corresponding hypothetical PDCCH/PCFICH transmission parameters are as specified in clause 7.6.1 and Table 7.6.1-1 respectively.
	Aggregation level	CC E	8	
	ρ_A, ρ_B		-3	
	Ratio of PDCCH to RS EPRE	dB	1	

	Ratio of PCFICH to RS EPRE	dB	1	
DRX			OFF	
Layer 3 filtering			Enabled	Counters: N310 = 1; N311 = 1
T310 timer	ms		2000	T310 is enabled
T311 timer	ms		1000	T311 is enabled
Periodic CQI reporting mode			PUCCH 1-0	As defined in table 7.2.2-1 in TS 36.213.
CQI reporting periodicity	ms		1	Minimum CQI reporting periodicity
Time offset between cells	µs		3	
Propagation channel			ETU30	
T1	s		0.5	
T2	s		0.4	
T3	s		1.46	
T4	s		0.4	
T5	s		1	
Physical cell ID PCI			$(PCI_{cell1} - PCI_{cell2}) \bmod 3 \neq 0$	Cell IDs are chosen such that CRS from cells 1 and 2 do not overlap in frequency
ABS pattern			1000000000 1000000000	TDD ABS Pattern Info IE, as defined in TS 36.423 [28], clause 9.2.54. Configured in Cell 2. The first/leftmost bit corresponds to the subframe #0 of the radio frame satisfying $SFN \bmod x = 0$, where x is the size of the bit string (20) divided by 10. No MBSFN subframes are configured in the ABS subframes.
Time domain measurement resource restriction pattern			1000000000 1000000000	Time domain measurement resource restriction pattern for serving cell measurement signalled to the UE in message measSubframePatternPCell-r10 as defined in TS 36.331, clause 6.3.2. Configured in Cell 1.
Note 1: PDCCH/PCFICH corresponding to the in-sync and out of sync transmission parameters need not be included in the Reference Measurement Channel.				

Table A.7.3.12.1-2: Cell specific test parameters for E-UTRAN TDD for in-sync radio link monitoring under time domain measurement resource restriction

Parameter	Unit	Cell 1					Cell 2				
		T1	T2	T3	T4	T5	T1	T2	T3	T4	T5
E-UTRA RF Channel Number		1					1				
BW _{channel}	MHz	10					10				
Correlation Matrix and Antenna Configuration		2x2 Low					2x2 Low				
Special subframe configuration ^{Note1}		6					6				
Uplink-downlink configuration ^{Note2}		1					1				
PCFICH/PDCCH/PHICH parameters		R.9 TDD					R.9 TDD				
Number of Control OFDM symbols		3					3				

OCNG Pattern defined in A.3.2.2 (TDD)		OP.2 TDD					OP.2 TDD
P_A, P_B		-3					-3
PCFICH_RB	dB	1					Non-ABS and ABS subframe channel powers defined in Table A.3.4.1.2-2.
PDCCH_RA	dB	-3					
PDCCH_RB	dB	-3					
PBCH_RA	dB	-3					
PBCH_RB	dB						
PSS_RA	dB						
SSS_RA	dB						
PHICH_RA	dB						
PHICH_RB	dB						
PDSCH_RA	dB						
PDSCH_RB	dB						
OCNG_RA ^{Note 3}	dB						
OCNG_RB ^{Note 3}	dB						
SNR ^{Note 8,9}	dB	-1.3	-5.4	-12.4	-7.3	-1.3	5
N_{oc}	dBm/15 kHz	-98					-98
Propagation condition		ETU30					ETU30
<p>Note 1: For the special subframe configuration see table 4.2-1 in TS 36.211.</p> <p>Note 2: For the uplink-downlink configuration see table 4.2-2 in TS 36.211.</p> <p>Note 3: OCNG shall be used such that the resources in cell # 1 are fully allocated and a constant total transmitted power spectral density is achieved for all OFDM symbols.</p> <p>Note 4: The uplink resources for CQI reporting are assigned to the UE prior to the start of time period T1.</p> <p>Note 5: The timers and layer 3 filtering related parameters are configured prior to the start of time period T1.</p> <p>Note 6: The signal contains PDCCH for UEs other than the device under test as part of OCNG.</p> <p>Note 7: SNR levels correspond to the signal to noise ratio over the cell-specific reference signal REs.</p> <p>Note 8: The SNR in time periods T1, T2, T3, T4 and T5 of active cell is denoted as SNR1, SNR2, SNR3, SNR4 and SNR5 respectively in figure A.7.3.12.1-1.</p> <p>Note 9: The SNR values are specified for testing a UE which supports 2RX on at least one band. For testing of a UE which supports 4RX on all bands, the SNR during T3 and T4 is modified as specified in section A.3.8.1.</p>							

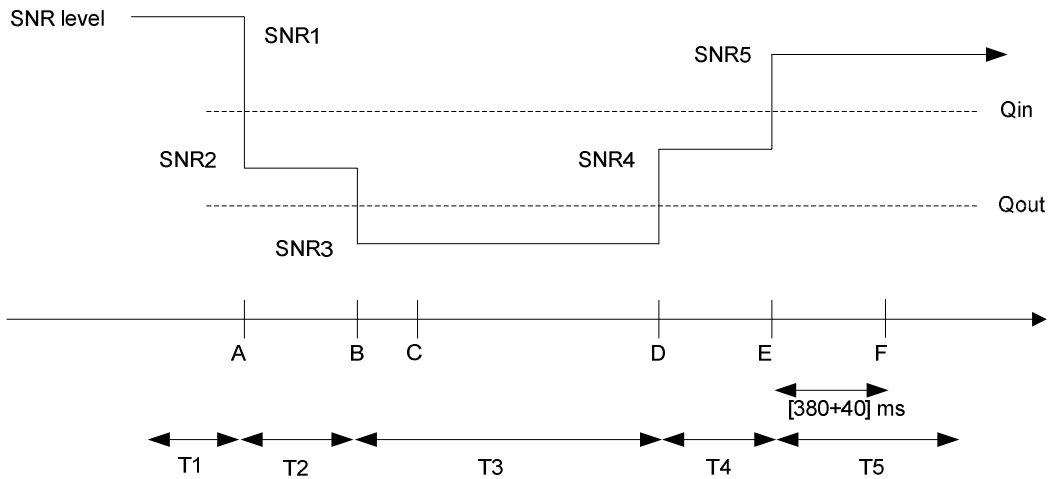

Figure A.7.3.12.1-1 SNR variation in active cell for in-sync testing under time domain measurement resource restriction

A.7.3.12.2 Test Requirements

The UE behaviour in each test during time durations T1, T2, T3, T4 and T5 shall be as follows:

During the period from time point A to time point F (420 ms after the start of time duration T5) the UE shall transmit uplink signal at least in all uplink subframes configured for CQI transmission according to the configured CQI mode (PUCCH 1-0).

The rate of correct events observed during repeated tests shall be at least 90%.

A.7.3.13 E-UTRAN FDD Radio Link Monitoring Test for Out-of-sync under Time Domain Measurement Resource Restriction with MBSFN ABS

A.7.3.13.1 Test Purpose and Environment

The purpose of this test is to verify that the UE properly detects the out of sync and in sync for the purpose of monitoring downlink radio link quality of the serving cell under time domain measurement resource restriction when CRS assistance information is not provided. This test will partly verify the E-UTRAN FDD radio link monitoring requirements in clause 7.6.

The test parameters are given in Tables A.7.3.13.1-1 and A.7.3.13.1-2 below. The test consists of three successive time periods, with time duration of T1, T2 and T3 respectively. Figure A.7.3.13.1-1 shows the variation of the downlink SNR in the active cell to emulate out-of-sync and in-sync states. Prior to the start of the time duration T1, the UE shall be fully synchronized to Cell 1. The UE shall be configured for periodic CQI reporting in PUCCH 1-0 mode with a reporting periodicity of 2 ms.

MBSFN ABS pattern is configured in the aggressor Cell 2 in this test. The UE is configured by higher layers with a time domain measurement restriction pattern for performing serving cell measurements. The patterns shall be configured prior to the start of T1.

Table A.7.3.13.1-1: General test parameters for E-UTRAN FDD out-of-sync testing under time domain measurement resource restriction with MBSFN ABS

Parameter	Unit	Value	Comment	
PCFICH/PDCCH/PHICH parameters		R.9.FDD	As specified in clause A.3.1.2.1. None of the PDCCH are intended for the UE under test	
OCNG parameters		OP.6 FDD for the serving cell (Cell 1) OP.9 FDD for the neighbour cell (Cell 2)	As specified in clause A.3.2.1.6 and A.3.2.1.9 respectively	
Serving cell (PCell)		Cell 1	Cell 1 is on E-UTRA RF channel number 1	
Neighbor cell		Cell 2	Aggressor cell on E-UTRA RF channel number 1	
Neighbor cell ABS configuration		MBSFN ABS	As defined in Table A.3.4.2.2-1	
CP length		Normal		
E-UTRA RF Channel Number		1	One E-UTRA FDD carrier frequency is used.	
E-UTRA Channel Bandwidth ($BW_{channel}$)	MHz	10		
Correlation Matrix and Antenna Configuration		2x2 Low	Correlation Matrix and Antenna Configuration are defined in TS 36.101 [5] Annex B.2.3.2	
Out of sync transmission parameters (Note 1)	DCI format		1A	As defined in clause 5.3.3.1.3 in TS 36.212
	Number of Control OFDM symbols		3	Out of sync threshold Q_{out} and the corresponding hypothetical PDCCH/PCFICH transmission parameters are as specified in clause 7.6.1 and Table 7.6.1-1 respectively.
	Aggregation level	CCE	8	
	ρ_A, ρ_B		-3	
	Ratio of PDCCH to RS EPRE	dB	1	
	Ratio of PCFICH to RS EPRE	dB	1	
DRX		OFF		
Layer 3 filtering		Enabled	Counters:: N310 = 1; N311 = 1	
T310 timer	ms	0	T310 is disabled	
T311 timer	ms	1000	T311 is enabled	
Periodic CQI reporting mode		PUCCH 1-0	As defined in table 7.2.2-1 in TS 36.213.	
CQI reporting periodicity	ms	2	Minimum CQI reporting periodicity	

Time offset between cells		3 μ s	Synchronous cells
T1	s	1	
T2	s	0.4	
T3	s	0.5	
Physical cell ID PCI		$(PCI_{cell1} - PCI_{cell2}) \bmod 3 = 0$, PCI_{cell1} not equal to PCI_{cell2}	Cell IDs are chosen such that CRS from cells 1 and 2 overlap in frequency
ABS pattern		'01000000100000001000000010000000'	FDD ABS Pattern Info IE, as defined in TS 36.423 [28], clause 9.2.54. Configured in Cell 2. The first/leftmost bit corresponds to the PCell subframe #0 of the radio frame satisfying $SFN \bmod x = 0$, where x is the size of the bit string (40) divided by 10. MBSFN subframes are configured in the ABS subframes.
Time domain measurement resource restriction pattern		'01000000100000001000000010000000'	Time domain measurement resource restriction pattern for serving cell measurement signalled to the UE in message measSubframePattern-Serv-r10 as defined in TS 36.331, clause 6.3.2.
Note 1: PDCCH/PCFICH corresponding to the out of sync transmission parameters need not be included in the Reference Measurement Channel			

Table A.7.3.13.1-2: Cell specific test parameters for E-UTRAN FDD for out-of-sync radio link monitoring under time domain measurement resource restriction with MBSFN ABS

Parameter	Unit	Cell 1			Cell 2		
		T1	T2	T3	T1	T2	T3
E-UTRA RF Channel Number		1			1		
$BW_{channel}$	MHz	10			10		
Correlation Matrix and Antenna Configuration		2x2 Low			2x2 Low		
OCNG Pattern defined in A.3.2.1 (FDD)		OP.6 FDD			OP.9 FDD		
ρ_A, ρ_B		-3			-3		
PCFICH_RA	dB	1			Non-ABS and ABS subframe channel powers defined in Table A.3.4.2.2-1.		
PDCCH_RA	dB	1					
PDCCH_RB	dB	1					
PBCH_RA	dB	-3					
PBCH_RB	dB						
PSS_RA	dB						
SSS_RA	dB						
PHICH_RA	dB						
PHICH_RB	dB						
PDSCH_RA	dB						
PDSCH_RB	dB						
OCNG_RA ^{Note1}	dB						
OCNG_RB ^{Note1}	dB						
SNR ^{Note 6,7}	dB	-1.3	-5.4	-12.4	5		
N_{oc}	dBm/15 kHz	-98			-98		
Propagation condition		ETU 30 Hz			ETU 30 Hz		

- Note 1: OCNG shall be used such that the resources in cell # 1 are fully allocated and a constant total transmitted power spectral density is achieved for all OFDM symbols.
- Note 2: The uplink resources for CQI reporting are assigned to the UE prior to the start of time period T1.
- Note 3: The timers and layer 3 filtering related parameters are configured prior to the start of time period T1.
- Note 4: The signal contains PDCCH for UEs other than the device under test as part of OCNG.
- Note 5: SNR levels correspond to the signal quality, signal-to-interference-plus-noise ratio, on the CRS REs.
- Note 6: The SNR in the restricted measurement subframes during time periods T1, T2 and T3 is denoted as SNR1, SNR2 and SNR3 respectively in figure A.7.3.13.1-1.
- Note 7: The SNR values are specified for testing a UE which supports 2RX on at least one band. For testing of a UE which supports 4RX on all bands, the SNR during T3 is modified as specified in section A.3.8.1.

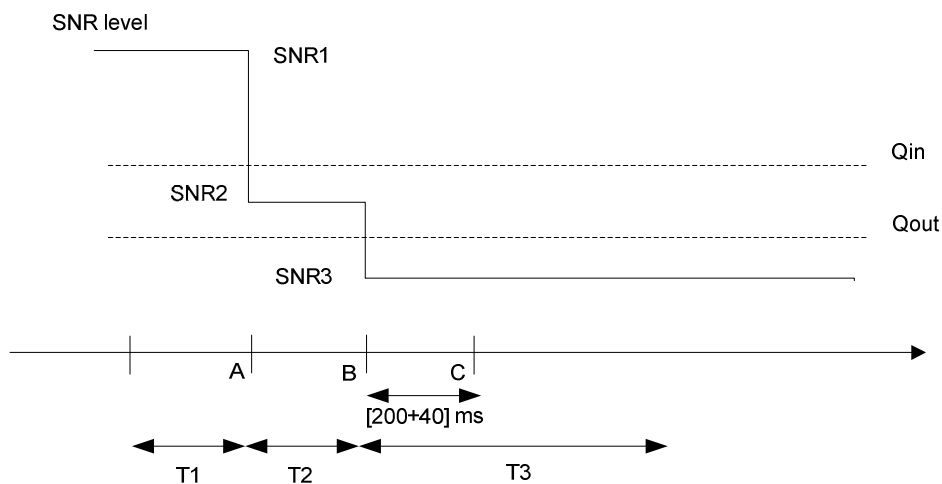

Figure A.7.3.13.1-1 SNR variation for out-of-sync testing

A.7.3.13.2 Test Requirements

The UE behaviour in each test during time durations T1, T2 and T3 shall be as follows:

During the period from time point A to time point B the UE shall transmit uplink signal at least in all subframes configured for CQI transmission according to the configured CQI reporting mode (PUCCH 1-0).

The UE shall stop transmitting uplink signal no later than time point C (240 ms after the start of time duration T3).

The rate of correct events observed during repeated tests shall be at least 90%.

A.7.3.14 E-UTRAN TDD Radio Link Monitoring Test for Out-of-sync under Time Domain Measurement Resource Restriction with MBSFN ABS

A.7.3.14.1 Test Purpose and Environment

The purpose of this test is to verify that the UE properly detects the out of sync and in sync for the purpose of monitoring downlink radio link quality of the serving cell under time domain measurement resource restriction when CRS assistance information is not provided. This test will partly verify the E-UTRAN TDD radio link monitoring requirements in clause 7.6.

The test parameters are given in Tables A.7.3.14.1-1 and A.7.3.14.1-2 below. The test consists of three successive time periods, with time duration of T1, T2 and T3 respectively. Figure A.7.3.14.1-1 shows the variation of the downlink SNR in the active cell to emulate out-of-sync and in-sync states. Prior to the start of the time duration T1, the UE shall be fully synchronized to Cell 1. The UE shall be configured for periodic CQI reporting in PUCCH 1-0 mode with a reporting periodicity of 2 ms.

MBSFN ABS pattern is configured in the aggressor Cell 2 in this test. The UE is configured by higher layers with a time domain measurement restriction pattern for performing serving cell measurements. The patterns shall be configured prior to the start of T1.

Table A.7.3.14.1-1: General test parameters for E-UTRAN TDD out-of-sync testing under time domain measurement resource restriction with MBSFN ABS

Parameter		Unit	Value	Comment
PCFICH/PDCCH/PHICH parameters			R.9.TDD	As specified in clause A.3.1.2.1. None of the PDCCH are intended for the UE under test
OCNG parameters			OP.2 TDD for the serving cell (Cell 1) OP.6 TDD for the neighbour cell (Cell 2)	As specified in clause A.3.2.2.2 and A.3.2.2.6 respectively
Serving cell (PCell)			Cell 1	Cell 1 is on E-UTRA RF channel number 1
Neighbor cell			Cell 2	Aggressor cell on E-UTRA RF channel number 1
Neighbor cell ABS configuration			MBSFN ABS	As defined in Table A.3.4.2.2-1
CP length			Normal	
E-UTRA RF Channel Number			1	One E-UTRA FDD carrier frequency is used.
E-UTRA Channel Bandwidth (BW_{channel})		MHz	10	
Correlation Matrix and Antenna Configuration			2x2 Low	Correlation Matrix and Antenna Configuration are defined in TS 36.101 [5] Annex B.2.3.2
Out of sync transmission parameters (Note 1)	DCI format		1A	As defined in clause 5.3.3.1.3 in TS 36.212
	Number of Control OFDM symbols		3	Out of sync threshold Q_{out} and the corresponding hypothetical PDCCH/PCFICH transmission parameters are as specified in clause 7.6.1 and Table 7.6.1-1 respectively.
	Aggregation level	CCE	8	
	ρ_A, ρ_B		-3	
	Ratio of PDCCH to RS EPRE	dB	1	
	Ratio of PCFICH to RS EPRE	dB	1	
DRX			OFF	
Layer 3 filtering			Enabled	Counters:: N310 = 1; N311 = 1
T310 timer		ms	0	T310 is disabled
T311 timer		ms	1000	T311 is enabled
Periodic CQI reporting mode			PUCCH 1-0	As defined in table 7.2.2-1 in TS 36.213.
CQI reporting periodicity		ms	1	Minimum CQI reporting periodicity
Time offset between cells			3 μ s	Synchronous cells
T1		s	1	
T2		s	0.4	
T3		s	0.5	
Physical cell ID PCI			$(PCI_{\text{cell1}} - PCI_{\text{cell2}}) \bmod 3 = 0$, PCI_{cell1} not equal to PCI_{cell2}	Cell IDs are chosen such that CRS from cells 1 and 2 overlap in frequency
ABS pattern			'0000100000000100000'	MBSFN ABS. TDD ABS Pattern Info IE, as defined in TS 36.423 [28], clause 9.2.54. Configured in Cell 2. The first/leftmost bit corresponds to the PCell subframe #0 of the radio frame satisfying $SFN \bmod x = 0$, where x is the size of the bit string (20) divided by 10. All ABS subframes are MBSFN subframes.

Time domain measurement resource restriction pattern		'00001000000000100000'	Time-domain measurement resource restriction pattern for serving cell measurements signalled to the UE in message measSubframePattern-Serv-r10 as defined in TS 36.331, clause 6.3.2.
Note 1: PDCCH/PCFICH corresponding to the out of sync transmission parameters need not be included in the Reference Measurement Channel			

Table A.7.3.14.1-2: Cell specific test parameters for E-UTRAN TDD for out-of-sync radio link monitoring under time domain measurement resource restriction with MBSFN ABS

Parameter	Unit	Cell 1			Cell 2		
		T1	T2	T3	T1	T2	T3
E-UTRA RF Channel Number		1			1		
BW _{channel}	MHz	10			10		
Special subframe configuration ^{Note1}		6			6		
Uplink-downlink configuration ^{Note2}		1			1		
Correlation Matrix and Antenna Configuration		2x2 Low			2x2 Low		
OCNG Pattern defined in A.3.2.2 (TDD)		OP.2 TDD			OP.6 TDD		
ρ_A, ρ_B		-3			-3		
PCFICH_RB	dB	1			Non-ABS and ABS subframe channel powers defined in Table A.3.4.2.2-1.		
PDCCH_RA	dB	1					
PDCCH_RB	dB	1					
PBCH_RA	dB	-3					
PBCH_RB	dB						
PSS_RA	dB						
SSS_RA	dB						
PHICH_RA	dB						
PHICH_RB	dB						
PDSCH_RA	dB						
PDSCH_RB	dB						
OCNG_RA ^{Note3}	dB						
OCNG_RB ^{Note3}	dB						
SNR ^{Note 7,8,9}	dB	-1.3	-5.4	-12.4	5		
N_{oc}	dBm/15 kHz	-98			-98		
Propagation condition		ETU 30 Hz			ETU 30 Hz		
<p>Note 1: For the special subframe configuration see table 4.2-1 in TS 36.211.</p> <p>Note 2: For the uplink-downlink subframe configuration see table 4.2-2 in TS 36.211.</p> <p>Note 3: OCNG shall be used such that the resources in cell # 1 are fully allocated and a constant total transmitted power spectral density is achieved for all OFDM symbols.</p> <p>Note 4: The uplink resources for CQI reporting are assigned to the UE prior to the start of time period T1.</p> <p>Note 5: The timers and layer 3 filtering related parameters are configured prior to the start of time period T1.</p> <p>Note 6: The signal contains PDCCH for UEs other than the device under test as part of OCNG.</p> <p>Note 7: SNR levels correspond to the signal quality, signal-to-interference-plus-noise ratio, on the CRS REs.</p> <p>Note 8: The SNR in the restricted measurement subframes during time periods T1, T2 and T3 is denoted as SNR1, SNR2 and SNR3 respectively in Figure A.7.3.14.1-1.</p> <p>Note 9: The SNR values are specified for testing a UE which supports 2RX on at least one band. For testing of a UE which supports 4RX on all bands, the SNR during T3 is modified as specified in section A.3.8.1.</p>							

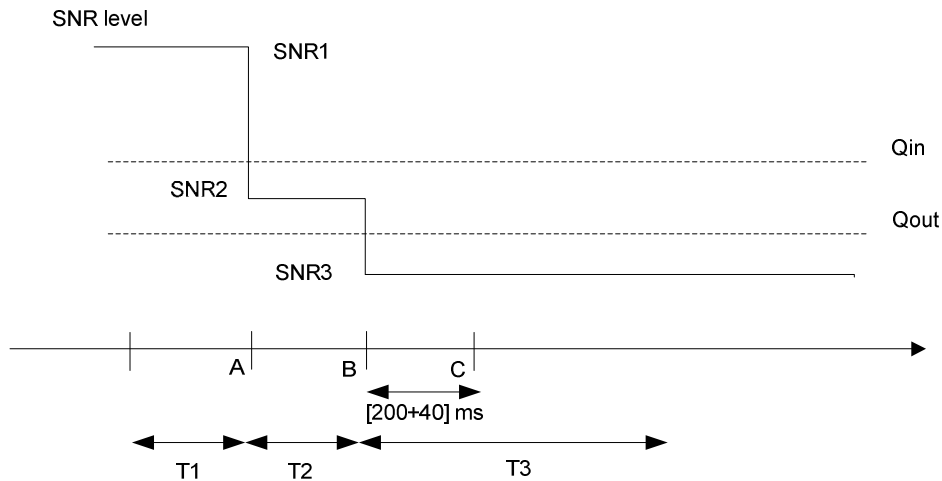

Figure A.7.3.14.1-1 SNR variation for out-of-sync testing

A.7.3.14.2 Test Requirements

The UE behaviour in each test during time durations T1, T2 and T3 shall be as follows:

During the period from time point A to time point B the UE shall transmit uplink signal at least in all subframes configured for CQI transmission according to the configured CQI reporting mode (PUCCH 1-0).

The UE shall stop transmitting uplink signal no later than time point C (240 ms after the start of time duration T3).

The rate of correct events observed during repeated tests shall be at least 90%.

A.7.3.15 E-UTRAN FDD Radio Link Monitoring Test for In-sync under Time Domain Measurement Resource Restriction with MBSFN ABS

A.7.3.15.1 Test Purpose and Environment

The purpose of this test is to verify that the UE properly detects the out of sync and in sync for the purpose of monitoring downlink radio link quality of the serving cell under time domain measurement resource restriction when CRS assistance information is not provided. This test will partly verify the E-UTRAN FDD radio link monitoring requirements in clause 7.6.

The test parameters are given in Tables A.7.3.15.1-1 and A.7.3.15.1-2 below. There are two cells, cell 1 is the serving cell and cell 2 is the neighbour aggressor cell. The test consists of five successive time periods, with time duration of T1, T2, T3, T4 and T5 respectively. Figure A.7.3.15.1-1 shows the variation of the downlink SNR in the active cell to emulate out-of-sync and in-sync states. Prior to the start of the time duration T1, the UE shall be fully synchronized to cell 1. The UE shall be configured for periodic CQI reporting in PUCCH 1-0 mode with a reporting periodicity of 2 ms.

MBSFN ABS pattern is configured in Cell 2 in this test. The UE is configured by higher layers with a time domain measurement restriction pattern for performing serving cell measurements. The patterns shall be configured prior to the start of T1.

Table A.7.3.15.1-1: General test parameters for E-UTRAN FDD in-sync testing under time domain measurement resource restriction with MBSFN ABS

Parameter	Unit	Value	Comment
PCFICH/PDCCH/PHICH parameters		R.9 FDD	As specified in clause A.3.1.2.1. None of the PDCCH are intended for the UE under test
Serving cell		Cell 1	Cell 1 is on E-UTRA RF channel number 1
Neighbour cell		Cell 2	Cell 2 is the aggressor cell on E-UTRA RF channel number 1
Neighbour cell ABS configuration		MBSFN ABS	As defined in Table A.3.4.2.2-2

OCNG parameters for Cell 1			OP.6 FDD	As specified in clause A.3.2.1.6.
OCNG parameters for Cell 2			OP.9 FDD	As specified in clause A.3.2.1.9.
CP length			Normal	
Neighbor cell ABS configuration			MBSFN ABS	
E-UTRA RF Channel Number			1	One E-UTRA FDD carrier frequency is used.
E-UTRA Channel Bandwidth (BWchannel)		MHz	10	
Correlation Matrix and Antenna Configuration			2x2 Low	Correlation Matrix and Antenna Configuration are defined in TS 36.101 [5] Annex B.2.3.2
In sync transmission parameters (Note 1)	DCI format		1C	As defined in clause 5.3.3.1.4 in TS 36.212
	Number of Control OFDM symbols		3	In sync threshold Q_{in} and the corresponding hypothetical PDCCH/PCFICH transmission parameters are as specified in clause and Table 7.6.1-2 respectively.
	Aggregation level	CCE	4	
	ρ_A, ρ_B		-3	
	Ratio of PDCCH to RS EPRE	dB	-3	
	Ratio of PCFICH to RS EPRE	dB	1	
Out of sync transmission parameters (Note 1)	DCI format		1A	As defined in clause 5.3.3.1.3 in TS 36.212
	Number of Control OFDM symbols		3	Out of sync threshold Q_{out} and the corresponding hypothetical PDCCH/PCFICH transmission parameters are as specified in clause 7.6.1 and Table 7.6.1-1 respectively.
	Aggregation level	CCE	8	
	ρ_A, ρ_B		-3	
	Ratio of PDCCH to RS EPRE	dB	1	
	Ratio of PCFICH to RS EPRE	dB	1	
Physical cell ID PCI			$(PCI_{cell1} - PCI_{cell2}) \bmod 3 = 0$, PCI_{cell1} not equal to PCI_{cell2}	Cell IDs are chosen such that CRS from cells 1 and 2 overlap in frequency.
ABS pattern			010000001000000010000 0000010000001000000	FDD ABS Pattern Info IE is configured in Cell 2 as defined in clause 9.2.54 in TS 36.423 [28]. The first/leftmost bit corresponds to the subframe #0 of the radio frame satisfying $SFN \bmod x = 0$, where x is the size of the bit string (40) divided by 10. All ABS subframes are MBSFN subframes.
Time domain measurement resource restriction pattern			010000001000000010000 0000010000001000000	MeasSubframePattern IE is configured in UE for serving cell measurement as defined in clause 6.3.6 in TS 36.331.
DRX			OFF	
Layer 3 filtering			Enabled	Counters: $N_{310} = 1$; $N_{311} = 1$
T310 timer		ms	2000	T310 is enabled
T311 timer		ms	1000	T311 is enabled
Periodic CQI reporting mode			PUCCH 1-0	As defined in table 7.2.2-1 in TS 36.213.
CQI reporting periodicity		ms	2	Minimum CQI reporting periodicity
Time offset between cells		μs	3	
Propagation channel			ETU30	

T1	s	0.5	
T2	s	0.4	
T3	s	1.46	
T4	s	0.4	
T5	s	1	
Note 1: PDCCH/PCFICH corresponding to the in-sync and out of sync transmission parameters need not be included in the Reference Measurement Channel.			

Table A.7.3.15.1-2: Cell specific test parameters for E-UTRAN FDD for in-sync radio link monitoring under time domain measurement resource restriction with MBSFN ABS

Parameter	Unit	Cell 1					Cell 2				
		T1	T2	T3	T4	T5	T1	T2	T3	T4	T5
E-UTRA RF Channel Number		1					1				
BW _{channel}	MHz	10					10				
Correlation Matrix and Antenna Configuration		2x2 Low					2x2 Low				
OCNG Pattern defined in A.3.2.1 (FDD)		OP.6 FDD					OP.9 FDD				
ρ_A, ρ_B		-3					-3				
PCFICH_RA	dB	1					Non-ABS and ABS subframe channel powers defined in Table A.3.4.2.2-2.				
PDCCH_RA	dB	-3									
PDCCH_RB	dB	-3									
PBCH_RA	dB	-3									
PBCH_RB	dB										
PSS_RA	dB										
SSS_RA	dB										
PHICH_RA	dB										
PHICH_RB	dB										
PDSCH_RA	dB										
PDSCH_RB	dB										
OCNG_RA ^{Note 1}	dB										
OCNG_RB ^{Note 1}	dB										
SNR ^{Note 6,7}	dB	-1.3	-5.4	-12.4	-7.3	-1.3					
N_{oc}	dBm/15 kHz	-98					-98				
Propagation condition		ETU30					ETU30				
<p>Note 1: OCNG shall be used such that the resources in Cell 1 are fully allocated and a constant total transmitted power spectral density is achieved for all OFDM symbols.</p> <p>Note 2: The uplink resources for CQI reporting are assigned to the UE prior to the start of time period T1.</p> <p>Note 3: The timers and layer 3 filtering related parameters are configured prior to the start of time period T1.</p> <p>Note 4: The signal contains PDCCH for UEs other than the device under test as part of OCNG.</p> <p>Note 5: SNR levels correspond to the signal to noise ratio over the cell-specific reference signal REs.</p> <p>Note 6: The SNR in time periods T1, T2, T3, T4 and T5 of the active cell is denoted as SNR1, SNR2, SNR3, SNR4 and SNR5 respectively in figure A.7.3.15.1-1.</p> <p>Note 7: The SNR values are specified for testing a UE which supports 2RX on at least one band. For testing of a UE which supports 4RX on all bands, the SNR during T3 and T4 is modified as specified in section A.3.8.1.</p>											

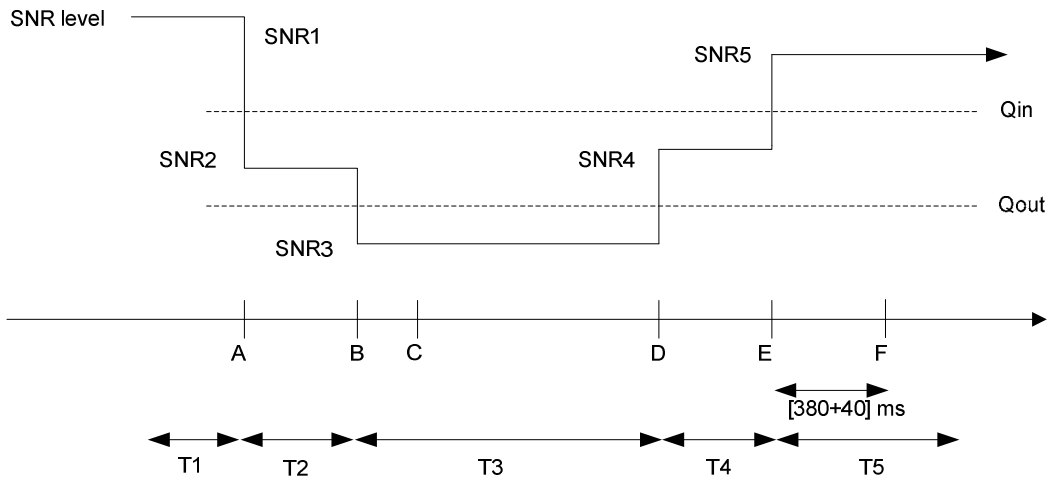

Figure A.7.3.15.1-1 SNR variation in the active cell for in-sync testing under time domain measurement resource restriction with MBSFN ABS

A.7.3.15.2 Test Requirements

The UE behaviour in each test during time durations T1, T2, T3, T4 and T5 shall be as follows:

During the period from time point A to time point F (420 ms after the start of time duration T5) the UE shall transmit uplink signal at least in all subframes configured for CQI transmission according to the configured CQI reporting mode (PUCCH 1-0).

The rate of correct events observed during repeated tests shall be at least 90%.

A.7.3.16 E-UTRAN TDD Radio Link Monitoring Test for In-sync under Time Domain Measurement Resource Restriction with MBSFN ABS

A.7.3.16.1 Test Purpose and Environment

The purpose of this test is to verify that the UE properly detects the out of sync and in sync for the purpose of monitoring downlink radio link quality of the serving cell under time domain measurement resource restriction when CRS assistance information is not provided. This test will partly verify the E-UTRAN TDD radio link monitoring requirements in clause 7.6.

The test parameters are given in Tables A.7.3.16.1-1 and A.7.3.16.1-2 below. There are two cells, cell 1 is the serving cell and cell 2 is the neighbour aggressor cell. The test consists of five successive time periods, with time duration of T1, T2, T3, T4 and T5 respectively. Figure A.7.3.15.1-1 shows the variation of the downlink SNR in the active cell to emulate out-of-sync and in-sync states. Prior to the start of the time duration T1, the UE shall be fully synchronized to cell 1. The UE shall be configured for periodic CQI reporting in PUCCH 1-0 mode with a reporting periodicity of 1 ms.

MBSFN ABS pattern is configured in Cell 2 in this test. The UE is configured by higher layers with a time domain measurement restriction pattern for performing serving cell measurements. The patterns shall be configured prior to the start of T1.

Table A.7.3.16.1-1: General test parameters for E-UTRAN TDD in-sync testing under time domain measurement resource restriction with MBSFN ABS

Parameter	Unit	Value	Comment
PCFICH/PDCCH/PHICH parameters		R.9 TDD	As specified in clause A.3.1.2.2. None of the PDCCH are intended for the UE under test
Serving cell		Cell 1	Cell 1 is on E-UTRA RF channel number 1
Neighbour cell		Cell 2	Cell 2 is the aggressor cell on E-UTRA RF channel number 1

Neighbour cell ABS configuration			MBSFN ABS	As defined in Table A.3.4.2.2-2
OCNG parameters for Cell 1			OP.2 TDD	As specified in clause A.3.2.2.2.
OCNG parameters for Cell 2			OP.6 TDD	As specified in clause A.3.2.2.6.
CP length			Normal	
Neighbor cell ABS configuration			MBSFN ABS	
E-UTRA RF Channel Number			1	One E-UTRA TDD carrier frequency is used.
E-UTRA Channel Bandwidth (BWchannel)		MHz	10	
Correlation Matrix and Antenna Configuration			2x2 Low	Correlation Matrix and Antenna Configuration are defined in TS 36.101 [5] Annex B.2.3.2
In sync transmission parameters (Note 1)	DCI format		1C	As defined in clause 5.3.3.1.4 in TS 36.212
	Number of Control OFDM symbols		3	In sync threshold Q_{in} and the corresponding hypothetical PDCCH/PCFICH transmission parameters are as specified in clause and Table 7.6.1-2 respectively.
	Aggregation level	CCE	4	
	ρ_A, ρ_B		-3	
	Ratio of PDCCH to RS EPRE	dB	-3	
	Ratio of PCFICH to RS EPRE	dB	1	
Out of sync transmission parameters (Note 1)	DCI format		1A	As defined in clause 5.3.3.1.3 in TS 36.212
	Number of Control OFDM symbols		3	Out of sync threshold Q_{out} and the corresponding hypothetical PDCCH/PCFICH transmission parameters are as specified in clause 7.6.1 and Table 7.6.1-1 respectively.
	Aggregation level	CCE	8	
	ρ_A, ρ_B		-3	
	Ratio of PDCCH to RS EPRE	dB	1	
	Ratio of PCFICH to RS EPRE	dB	1	
Physical cell ID PCI			$(PCI_{cell1} - PCI_{cell2}) \bmod 3 = 0$, PCI_{cell1} not equal to PCI_{cell2}	Cell IDs are chosen such that CRS from cells 1 and 2 overlap in frequency.
ABS pattern			00001000000000100000	TDD ABS Pattern Info IE is configured in Cell 2 as defined in clause 9.2.54 in TS 36.423 [28]. The first/leftmost bit corresponds to the subframe #0 of the radio frame satisfying $SFN \bmod x = 0$, where x is the size of the bit string (20) divided by 10. All ABS subframes are MBSFN subframes.
Time domain measurement resource restriction pattern			00001000000000100000	MeasSubframePattern IE is configured in UE for serving cell measurement as defined in clause 6.3.6 in TS 36.331.
DRX			OFF	
Layer 3 filtering			Enabled	Counters: $N_{310} = 1$; $N_{311} = 1$
T310 timer		ms	2000	T310 is enabled
T311 timer		ms	1000	T311 is enabled
Periodic CQI reporting mode			PUCCH 1-0	As defined in table 7.2.2-1 in TS 36.213.
CQI reporting periodicity		ms	1	Minimum CQI reporting periodicity

Time offset between cells	μs	3	
Propagation channel		ETU30	
T1	s	0.5	
T2	s	0.4	
T3	s	1.46	
T4	s	0.4	
T5	s	1	
Note 1: PDCCH/PCFICH corresponding to the in-sync and out of sync transmission parameters need not be included in the Reference Measurement Channel.			

Table A.7.3.16.1-2: Cell specific test parameters for E-UTRAN TDD for in-sync radio link monitoring under time domain measurement resource restriction with MBSFN ABS

Parameter	Unit	Cell 1					Cell 2				
		T1	T2	T3	T4	T5	T1	T2	T3	T4	T5
E-UTRA RF Channel Number		1					1				
BW _{channel}	MHz	10					10				
Correlation Matrix and Antenna Configuration		2x2 Low					2x2 Low				
Special subframe configuration ^{Note1}		6					6				
Uplink-downlink configuration ^{Note2}		1					1				
OCNG Pattern defined in A.3.2.2 (TDD)		OP.2 TDD					OP.6 TDD				
ρ _A , ρ _B		-3					-3				
PCFICH_RB	dB	1					Non-ABS and ABS subframe channel powers defined in Table A.3.4.2.2-2.				
PDCCH_RA	dB	-3									
PDCCH_RB	dB	-3									
PBCH_RA	dB	-3									
PBCH_RB	dB										
PSS_RA	dB										
SSS_RA	dB										
PHICH_RA	dB										
PHICH_RB	dB										
PDSCH_RA	dB										
PDSCH_RB	dB										
OCNG_RA ^{Note 1}	dB										
OCNG_RB ^{Note 1}	dB										
SNR ^{Note 8,9}	dB	-1.3	-5.4	-12.4	-7.3	-1.3	5				
N _{oc}	dBm/15 kHz	-98					-98				
Propagation condition		ETU30					ETU30				
<p>Note 1: For the special subframe configuration see table 4.2-1 in TS 36.211.</p> <p>Note 2: For the uplink-downlink configuration see table 4.2-2 in TS 36.211.</p> <p>Note 3: OCNG shall be used such that the resources in Cell 1 are fully allocated and a constant total transmitted power spectral density is achieved for all OFDM symbols.</p> <p>Note 4: The uplink resources for CQI reporting are assigned to the UE prior to the start of time period T1.</p> <p>Note 5: The timers and layer 3 filtering related parameters are configured prior to the start of time period T1.</p> <p>Note 6: The signal contains PDCCH for UEs other than the device under test as part of OCNG.</p> <p>Note 7: SNR levels correspond to the signal to noise ratio over the cell-specific reference signal REs.</p> <p>Note 8: The SNR in time periods T1, T2, T3, T4 and T5 of the active cell is denoted as SNR1, SNR2, SNR3, SNR4 and SNR5 respectively in figure A.7.3.16.1-1.</p> <p>Note 9: The SNR values are specified for testing a UE which supports 2RX on at least one band. For testing of a UE which supports 4RX on all bands, the SNR during T3 and T4 is modified as specified in section A.3.8.1.</p>											

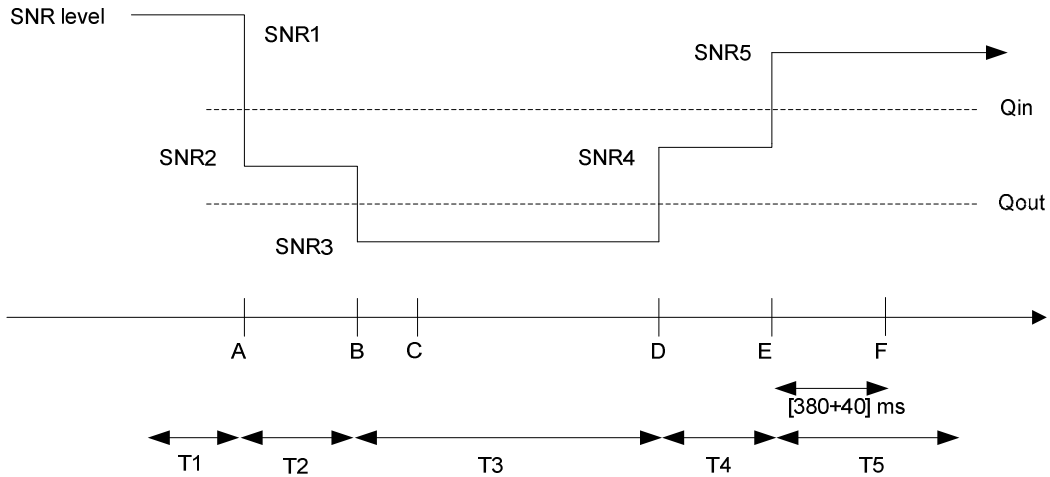

Figure A.7.3.16.1-1 SNR variation in the active cell for in-sync testing under time domain measurement resource restriction with MBSFN ABS

A.7.3.16.2 Test Requirements

The UE behaviour in each test during time durations T1, T2, T3, T4 and T5 shall be as follows:

During the period from time point A to time point F (420 ms after the start of time duration T5) the UE shall transmit uplink signal at least in all subframes configured for CQI transmission according to the configured CQI reporting mode (PUCCH 1-0).

The rate of correct events observed during repeated tests shall be at least 90%.

A.7.3.17 E-UTRAN FDD Radio Link Monitoring Test for Out-of-sync under Time Domain Measurement Resource Restriction with CRS Assistance Information and Non-MBSFN ABS

A.7.3.17.1 Test Purpose and Environment

The purpose of this test is to verify that the UE properly detects the out of sync and in sync for the purpose of monitoring downlink radio link quality of the PCell under time domain measurement resource restriction with CRS assistance information. This test will partly verify the E-UTRAN FDD radio link monitoring requirements in clause 7.6.

The test parameters are given in Tables A.7.3.17.1-1 and A.7.3.17.1-2 below. There are three active cells in the test: Cell 1 is the PCell cell and Cell 2 and 3 are the neighbour cells. The test consists of three successive time periods, with time duration of T1, T2 and T3 respectively. Figure A.7.3.17.1-1 shows the variation of the downlink SNR in the active cell to emulate out-of-sync and in-sync states. Prior to the start of the time duration T1, the UE shall be fully synchronized to cell 1. The UE shall be configured for periodic CQI reporting in PUCCH 1-0 mode with a reporting periodicity of 2 ms.

Non-MBSFN ABS pattern is configured in both Cell 2 and Cell 3 in this test. The UE is configured by higher layers with a time domain measurement restriction pattern for performing Pcell measurements. The UE is also provided via higher layers with the CRS assistance information for Cell 2 and Cell 3, which shall be valid during T1, T2 and T3 in this test. The non-MBSFN ABS pattern, the time domain measurement resource restriction pattern and the CRS assistance information shall be configured prior to the start of T1.

Table A.7.3.17.1-1: General test parameters for E-UTRAN FDD out-of-sync testing under time domain measurement resource restriction with CRS Assistance Information and Non-MBSFN ABS

Parameter	Unit	Value	Comment
PCFICH/PDCCH/PHICH parameters		R.7 FDD	As specified in clause A.3.1.2.1. None of the PDCCH are intended for the UE under test
OCNG parameters		OP.6 FDD	As specified in section A.3.2.1.6.
PCell		Cell 1	Cell 1 is on E-UTRA RF channel number 1

Neighbor cells			Cell 2 and Cell 3	Both of aggressor cells on E-UTRA RF channel number 1
Neighbor cell ABS configuration			Non-MBSFN ABS	As defined in Table A.3.4.1.2-1
CP length			Normal	
E-UTRA RF Channel Number			1	One E-UTRA FDD carrier frequency is used.
E-UTRA Channel Bandwidth ($BW_{channel}$)		MHz	10	
Correlation Matrix and Antenna Configuration			2x2 Low	Correlation Matrix and Antenna Configuration are defined in TS 36.101 [5] Annex B.2.3.2
Out of sync transmission parameters (Note 1)	DCI format		1A	As defined in clause 5.3.3.1.3 in TS 36.212
	Number of Control OFDM symbols		2	Out of sync threshold Q_{out} and the corresponding hypothetical PDCCH/PCFICH transmission parameters are as specified in clause 7.6.1 and Table 7.6.1-1 respectively.
	Aggregation level	CCE	8	
	ρ_A, ρ_B		-3	
	Ratio of PDCCH to RS EPRE	dB	1	
	Ratio of PCFICH to RS EPRE	dB	1	
DRX			OFF	
Layer 3 filtering			Enabled	Counters:: N310 = 1; N311 = 1
T310 timer		ms	0	T310 is disabled
T311 timer		ms	1000	T311 is enabled
Periodic CQI reporting mode			PUCCH 1-0	As defined in table 7.2.2-1 in TS 36.213.
CQI reporting periodicity		ms	2	Minimum CQI reporting periodicity
Time offset between cells		μ s	Cell 2 time offset with respect to Cell 1: 3 Cell 3 time offset with respect to Cell 1: 2	Three synchronous cells
Frequency shift between cells		Hz	Cell 2 frequency shift with respect to Cell 1: 300 Cell 3 frequency shift with respect to Cell 1: -100	
T1		s	1	
T2		s	0.4	
T3		s	0.5	
Physical cell IDs			$(PCI_{cell1} - PCI_{cell2}) \bmod 3 = 0$ $(PCI_{cell1} - PCI_{cell3}) \bmod 3 \neq 0$ PCI_{cell1} not equal to PCI_{cell2}	Cell PCIs are selected so that all conditions are met
ABS pattern			'10000000100000001000000010000000'	FDD ABS Pattern Info IE, as defined in TS 36.423 [28], clause 9.2.54. The first/leftmost bit corresponds to the PCell subframe #0 of the radio frame satisfying $SFN \bmod x = 0$, where x is the size of the bit string (40) divided by 10. No MBSFN subframes are configured in the ABS subframes. Configured in both Cell 2 and Cell 3 prior to the start of T1.
Time domain measurement resource restriction pattern			'10000000100000001000000010000000'	Time domain measurement resource restriction pattern for serving cell measurement signalled to the UE in message <i>measSubframePatternPCell-r10</i> as defined in TS 36.331, clause 6.3.2.
CRS assistance information	physCellId		see PCI conditions above	The CRS assistance information is provided for Cell 2 and Cell 3 in <i>CRS-AssistanceInfo</i> . It includes a single <i>MBSFN-SubframeConfig</i>
	antennaPort sCount		an2	

	mbsfn-SubframeConfigList		oneFrame = '000000'	element with subframe allocation oneFrame='000000'
Note 1: PDCCH/PCFICH corresponding to the out of sync transmission parameters need not be included in the Reference Measurement Channel				

Table A.7.3.17.1-2: Cell specific test parameters for E-UTRAN FDD for out-of-sync radio link monitoring under time domain measurement resource restriction with CRS Assistance Information and Non-MBSFN ABS

Parameter	Unit	Cell 1			Cell 2	Cell 3
		T1	T2	T3	T1-T3	T1-T3
E-UTRA RF Channel Number		1			1	1
BW _{channel}	MHz	10			10	10
Correlation Matrix and Antenna Configuration		2x2 Low			2x2 Low	2x2 Low
OCNG Pattern defined in A.3.2.1.6 (FDD)		OP.6 FDD			OP.6 FDD	OP.6 FDD
ρ _A , ρ _B		-3			-3	-3
PCFICH_RB	dB	1			Non-ABS and ABS subframe channel powers defined in Table A.3.4.1.2-1.	Non-ABS and ABS subframe channel powers defined in Table A.3.4.1.2-1.
PDCCH_RA	dB	1				
PDCCH_RB	dB	1				
PBCH_RA	dB	-3				
PBCH_RB	dB					
PSS_RA	dB					
SSS_RA	dB					
PHICH_RA	dB					
PHICH_RB	dB					
PDSCH_RA	dB					
PDSCH_RB	dB					
OCNG_RA ^{Note1}	dB					
OCNG_RB ^{Note1}	dB					
SNR ^{Note 6,7}	dB	-1.5	-5.2	-13.7		
N _{oc}	dBm/15 kHz	-98			-98	-98
Propagation condition		ETU 30 Hz			ETU 30 Hz	ETU 30 Hz
<p>Note 1: OCNG shall be used such that the resources in cell # 1 are fully allocated and a constant total transmitted power spectral density is achieved for all OFDM symbols.</p> <p>Note 2: The uplink resources for CQI reporting are assigned to the UE prior to the start of time period T1.</p> <p>Note 3: The timers and layer 3 filtering related parameters are configured prior to the start of time period T1.</p> <p>Note 4: The signal contains PDCCH for UEs other than the device under test as part of OCNG.</p> <p>Note 5: SNR levels correspond to the signal quality, signal-to-interference-plus-noise ratio, on the CRS REs.</p> <p>Note 6: The SNR in the restricted measurement subframes during time periods T1, T2 and T3 is denoted as SNR1, SNR2 and SNR3 respectively in figure A.7.3.17.1-1.</p> <p>Note 7: The SNR values are specified for testing a UE which supports 2RX on at least one band. For testing of a UE which supports 4RX on all bands, the SNR during T3 is modified as specified in section A.3.8.1.</p>						

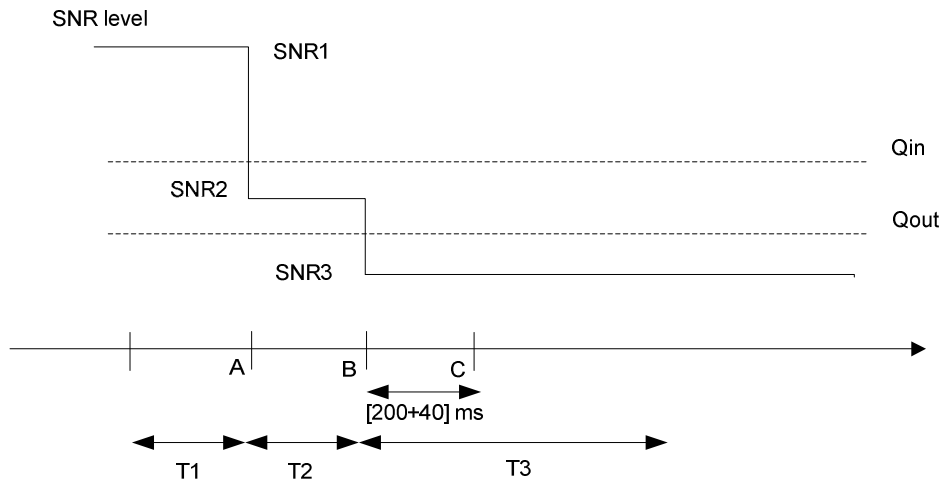

Figure A.7.3.17.1-1 SNR variation for out-of-sync testing

A.7.3.17.2 Test Requirements

The UE behaviour in each test during time durations T1, T2 and T3 shall be as follows:

During the period from time point A to time point B the UE shall transmit uplink signal at least in all subframes configured for CQI transmission according to the configured CQI reporting mode (PUCCH 1-0).

The UE shall stop transmitting uplink signal no later than time point C (240 ms after the start of time duration T3).

The rate of correct events observed during repeated tests shall be at least 90%.

A.7.3.18 E-UTRAN TDD Radio Link Monitoring Test for Out-of-sync under Time Domain Measurement Resource Restriction with CRS Assistance Information and Non-MBSFN ABS

A.7.3.18.1 Test Purpose and Environment

The purpose of this test is to verify that the UE properly detects the out of sync and in sync for the purpose of monitoring downlink radio link quality of the serving cell under time domain measurement resource restriction with CRS assistance information. This test will partly verify the E-UTRAN TDD radio link monitoring requirements in clause 7.6.

The test parameters are given in Tables A.7.3.18.1-1 and A.7.3.18.1-2 below. There are three active cells in the test: Cell 1 is the PCell cell and Cell 2 and 3 are the neighbour cells. The test consists of three successive time periods, with time duration of T1, T2 and T3 respectively. Figure A.7.3.18.1-1 shows the variation of the downlink SNR in the active cell to emulate out-of-sync and in-sync states. Prior to the start of the time duration T1, the UE shall be fully synchronized to cell 1. The UE shall be configured for periodic CQI reporting in PUCCH 1-0 mode with a reporting periodicity of 2 ms.

Non-MBSFN ABS pattern is configured in both Cell 2 and Cell 3 in this test. The UE is configured by higher layers with a time domain measurement restriction pattern for performing Pcell measurements. The UE is also provided via higher layers with the CRS assistance information for Cell 2 and Cell 3, which shall be valid during T1, T2 and T3 in this test. The non-MBSFN ABS pattern, the time domain measurement resource restriction pattern and the CRS assistance information shall be configured prior to the start of T1.

Table A.7.3.18.1-1: General test parameters for E-UTRAN TDD out-of-sync testing under time domain measurement resource restriction with CRS Assistance Information and Non-MBSFN ABS

Parameter	Unit	Value	Comment
PCFICH/PDCCH/PHICH parameters		R.7.TDD	As specified in clause A.3.1.2.2. None of the PDCCH are intended for the UE under test
OCNG parameters		OP.2 TDD	As specified in clause A.3.2.2.2

PCell			Cell 1	Cell 1 is on E-UTRA RF channel number 1
Neighbor cells			Cell 2 and Cell 3	Both of aggressor cells on E-UTRA RF channel number 1
Neighbor cell ABS configuration			Non-MBSFN ABS	As defined in Table A.3.4.1.2-1
CP length			Normal	
E-UTRA RF Channel Number			1	One E-UTRA TDD carrier frequency is used.
E-UTRA Channel Bandwidth ($BW_{channel}$)		MHz	10	
Correlation Matrix and Antenna Configuration			2x2 Low	Correlation Matrix and Antenna Configuration are defined in TS 36.101 [5] Annex B.2.3.2
Out of sync transmission parameters (Note 1)	DCI format		1A	As defined in clause 5.3.3.1.3 in TS 36.212
	Number of Control OFDM symbols		2	Out of sync threshold Q_{out} and the corresponding hypothetical PDCCH/PCFICH transmission parameters are as specified in clause 7.6.1 and Table 7.6.1-1 respectively.
	Aggregation level	CCE	8	
	ρ_A, ρ_B		-3	
	Ratio of PDCCH to RS EPRE	dB	1	
	Ratio of PCFICH to RS EPRE	dB	1	
DRX			OFF	
Layer 3 filtering			Enabled	Counters:: N310 = 1; N311 = 1
T310 timer		ms	0	T310 is disabled
T311 timer		ms	1000	T311 is enabled
Periodic CQI reporting mode			PUCCH 1-0	As defined in table 7.2.2-1 in TS 36.213.
CQI reporting periodicity		ms	1	Minimum CQI reporting periodicity
Time offset between cells		μ s	Cell 2 time offset with respect to Cell 1: 3 Cell 3 time offset with respect to Cell 1: 2	Three synchronous cells
Frequency shift between cells		Hz	Cell 2 frequency shift with respect to Cell 1: 300 Cell 3 frequency shift with respect to Cell 1: -100	
T1		s	1	
T2		s	0.4	
T3		s	0.5	
Physical cell IDs			$(PCI_{cell1} - PCI_{cell2}) \bmod 3 = 0$ $(PCI_{cell1} - PCI_{cell3}) \bmod 3 \neq 0$ PCI_{cell1} not equal to PCI_{cell2}	Cell PCIs are selected so that all conditions are met
ABS pattern			'0000100000000100000'	TDD ABS Pattern Info IE, as defined in TS 36.423 [28], clause 9.2.54. The first/leftmost bit corresponds to the PCell subframe #0 of the radio frame satisfying $SFN \bmod x = 0$, where x is the size of the bit string (20) divided by 10. No MBSFN subframes are configured in the ABS subframes. Configured in both Cell 2 and Cell 3 prior to the start of T1.
Time domain measurement resource restriction pattern			'0000100000000100000'	Time domain measurement resource restriction pattern for serving cell measurement signalled to the UE in message measSubframePatternPCell-r10 as defined in TS 36.331, clause 6.3.2.
CRS assistance information	physCellId		see PCI conditions above	The CRS assistance information is provided for Cell 2 only in <i>CRS-AssistanceInfo</i> . It includes a
	antennaPort sCount		an2	

	mbsfn-SubframeConfigList		oneFrame = '000000'	single MBSFN-SubframeConfig element with subframe allocation oneFrame='000000'
Note 1: PDCCH/PCFICH corresponding to the out of sync transmission parameters need not be included in the Reference Measurement Channel				

Table A.7.3.18.1-2: Cell specific test parameters for E-UTRAN TDD for out-of-sync radio link monitoring under time domain measurement resource restriction with CRS Assistance Information and Non-MBSFN ABS

Parameter	Unit	Cell 1			Cell 2	Cell 3
		T1	T2	T3	T1-T3	T1-T3
E-UTRA RF Channel Number		1			1	1
BW _{channel}	MHz	10			10	10
Special subframe configuration ^{Note1}		6			6	6
Uplink-downlink configuration ^{Note2}		1			1	1
Correlation Matrix and Antenna Configuration		2x2 Low			2x2 Low	2x2 Low
OCNG Pattern defined in A.3.2.2.2 (TDD)		OP.2 TDD			OP.2 TDD	OP.2 TDD
ρ _A , ρ _B		-3			-3	-3
PCFICH_RB	dB	1			Non-ABS and ABS subframe channel powers defined in Table A.3.4.1.2-1.	Non-ABS and ABS subframe channel powers defined in Table A.3.4.1.2-1.
PDCCH_RA	dB	1				
PDCCH_RB	dB	1				
PBCH_RA	dB	-3				
PBCH_RB	dB					
PSS_RA	dB					
SSS_RA	dB					
PHICH_RA	dB					
PHICH_RB	dB					
PDSCH_RA	dB					
PDSCH_RB	dB					
OCNG_RA ^{Note1}	dB					
OCNG_RB ^{Note1}	dB					
SNR ^{Note 6,9}	dB	-1.5	-5.2	-13.7		
N _{oc}	dBm/15 kHz	-98			-98	-98
Propagation condition		ETU 30 Hz			ETU 30 Hz	ETU 30 Hz
<p>Note 1: For the special subframe configuration see table 4.2-1 in TS 36.211.</p> <p>Note 2: For the uplink-downlink subframe configuration see table 4.2-2 in TS 36.211.</p> <p>Note 3: OCNG shall be used such that the resources in cell # 1 are fully allocated and a constant total transmitted power spectral density is achieved for all OFDM symbols.</p> <p>Note 4: The uplink resources for CQI reporting are assigned to the UE prior to the start of time period T1.</p> <p>Note 5: The timers and layer 3 filtering related parameters are configured prior to the start of time period T1.</p> <p>Note 6: The signal contains PDCCH for UEs other than the device under test as part of OCNG.</p> <p>Note 7: SNR levels correspond to the signal quality, signal-to-interference-plus-noise ratio, on the CRS REs.</p> <p>Note 8: The SNR in the restricted measurement subframes during time periods T1, T2 and T3 is denoted as SNR1, SNR2 and SNR3 respectively in Figure A.7.3.18.1-1.</p> <p>Note 9: The SNR values are specified for testing a UE which supports 2RX on at least one band. For testing of a UE which supports 4RX on all bands, the SNR during T3 is modified as specified in section A.3.8.1.</p>						

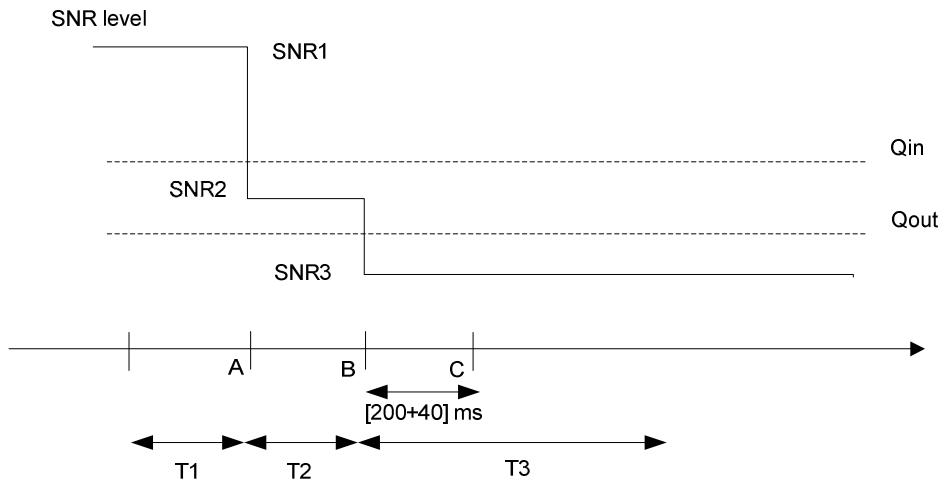

Figure A.7.3.18.1-1 SNR variation for out-of-sync testing

A.7.3.18.2 Test Requirements

The UE behaviour in each test during time durations T1, T2 and T3 shall be as follows:

During the period from time point A to time point B the UE shall transmit uplink signal at least in all subframes configured for CQI transmission according to the configured CQI reporting mode (PUCCH 1-0).

The UE shall stop transmitting uplink signal no later than time point C (240 ms after the start of time duration T3).

The rate of correct events observed during repeated tests shall be at least 90%.

A.7.3.19 E-UTRAN FDD Radio Link Monitoring Test for In-sync under Time Domain Measurement Resource Restriction with CRS assistance information and Non-MBSFN ABS

A.7.3.19.1 Test Purpose and Environment

The purpose of this test is to verify that the UE properly detects the out of sync and in sync for the purpose of monitoring downlink radio link quality of the PCell under time domain measurement resource restriction with CRS assistance information. This test will partly verify the E-UTRAN FDD radio link monitoring requirements in section 7.6.

The test parameters are given in Tables A.7.3.19.1-1 and A.7.3.19.1-2 below. There are three active cells in the test: Cell 1 is the PCell cell and Cell 2 and 3 are the neighbour cells. The test consists of five successive time periods, with time duration of T1, T2, T3, T4 and T5 respectively. Figure A.7.3.19.1-1 shows the variation of the downlink SNR in the active cell to emulate out-of-sync and in-sync states. Prior to the start of the time duration T1, the UE shall be fully synchronized to cell 1. The UE shall be configured for periodic CQI reporting in PUCCH 1-0 mode with a reporting periodicity of 2 ms.

Non-MBSFN ABS pattern is configured in both Cell 2 and Cell 3 in this test. The UE is configured by higher layers with a time domain measurement restriction pattern for performing PCell measurements. The UE is also provided via higher layers with the CRS assistance information for Cell 2 and Cell 3, which shall be valid during T1, T2, T3, T4 and T5 in this test. The Non-MBSFN ABS pattern, the time domain measurement resource restriction pattern and the CRS assistance information shall be configured prior to the start of T1.

Table A.7.3.19.1-1: General test parameters for E-UTRAN FDD in-sync radio link monitoring test

Parameter	Unit	Value			Comment
		Test 1			
		Cell 1	Cell 2	Cell 3	
PCFICH/PDCCH/PHICH parameters		R.9 FDD	R.9 FDD	R.9 FDD	As specified in section A.3.1.2.1.

					None of the PDCCH are intended for the UE under test	
OCNG parameters		OP.6 FDD	OP.6 FDD	OP.6 FDD	As specified in section A.3.2.1.6.	
Active cell		PCell	Neighbor Cell	Neighbor Cell	Cell 1, Cell 2 and Cell 3 are on E-UTRA RF channel number 1	
CP length		Normal	Normal	Normal		
E-UTRA RF Channel Number		1	1	1	One E-UTRA FDD carrier frequency is used.	
E-UTRA Channel Bandwidth (BW _{channel})	MHz	10	10	10		
Correlation Matrix and Antenna Configuration		2x2 Low	2x2 Low	2x2 Low	Correlation Matrix and Antenna Configuration are defined in TS 36.101 [5] Annex B.2.3.2	
Neighbor Cell ABS configuration		N/A	Non-MBSFN ABS		As defined in Table A.3.4.1.2-2	
ABS Pattern		N/A	'100000001 0000000100 0 0000100000 0010000000 ,	'100000001 0000000100 0 0000100000 0010000000 ,	FDD ABS Pattern Info IE, as defined in TS 36.423 [28], clause 9.2.54. The first/leftmost bit corresponds to the Pcell subframe #0 of the radio frame satisfying SFN mod x = 0, where x is the size of the bit string (40) divided by 10. No MBSFN subframes are configured in the ABS subframes. Configured in both Cell 2 and Cell 3 prior to the start of T1.	
Time domain measurement resource restriction pattern		'100000001 0000000100 0000010000 0001000000 0'	N/A	N/A	Time domain measurement resource restriction pattern for serving cell measurement signalled to the UE in message measSubframePatternPCell-r10 as defined in TS 36.331, clause 6.3.2.	
CRS assistant information	physCellId		N/A	see PCI conditions below	see PCI conditions below	The CRS assistance information is provided for Cell 2 and Cell 3 in CRS-AssistanceInfo. It includes a single MBSFN-SubframeConfig element with subframe allocation oneFrame='000000'
	antennaPortsCount			an2	an2	
	mbsfn-SubframeConfigList			oneFrame = '000000'	oneFrame = '000000'	
Time offset between cells (With respect to Cell 1)	us	0	3	2		
Frequency shift between cells (With respect to Cell 1)	Hz	0	300	-100		
Physical Cell ID		PCI _{cell1}	(PCI _{cell1} -PCI _{cell2}) mod3 = 0, PCI _{cell1} not equal to PCI _{cell2}	(PCI _{cell1} -PCI _{cell3}) mod3! = 0	Cell PCIs are selected so that all conditions are met	
In sync transmission parameters (Note 1)	DCI format	1C	1C	1C		
In sync transmission	Number of Control OFDM symbols	3	3	3	As defined in section 5.3.3.1.4 in TS 36.212	

parameters (Note 1)	Aggregation level	CCE	4	4	4	In sync threshold Q_{in} and the corresponding hypothetical PDCCH/PCFICH transmission parameters are as specified in section and Table 7.6.1-2 respectively.
	ρ_A, ρ_B		-3	-3	-3	
	Ratio of PDCCH to RS EPRE		-3	Non-ABS and ABS subframe channel powers defined in Table A.3.4.1.2-2.		
	Ratio of PCFICH to RS EPRE		1			
Out of sync transmission parameters (Note 1)	DCI format		1A	1A	1A	As defined in section 5.3.3.1.3 in TS 36.212
	Number of Control OFDM symbols		3	3	3	
	Aggregation level	CCE	8	8	8	Out of sync threshold Q_{out} and the corresponding hypothetical PDCCH/PCFICH transmission parameters are as specified in section 7.6.1 and Table 7.6.1-1 respectively.
	ρ_A, ρ_B		-3	-3	-3	
	Ratio of PDCCH to RS EPRE	dB	1	Non-ABS and ABS subframe channel powers defined in Table A.3.4.1.2-2.		
	Ratio of PCFICH to RS EPRE	dB	1			
DRX			OFF	OFF	OFF	
Layer 3 filtering			Enabled	Disable	Disable	Counters: N310 = 1; N311 = 1
T310 timer	ms		2000	N/A		T310 is enabled
T311 timer	ms		1000			T311 is enabled
Periodic CQI reporting mode			PUCCH 1-0			As defined in table 7.2.2-1 in TS 36.213.
CQI reporting periodicity	ms		2			Minimum CQI reporting periodicity
T1	s		0.5	N/A		
T2	s		0.4			
T3	s		1.46			
T4	s		0.4			
T5	s		1			
Note 1: PDCCH/PCFICH corresponding to the in-sync and out of sync transmission parameters need not be included in the Reference Measurement Channel.						

Table A.7.3.19.1-2: Cell specific test parameters for E-UTRAN FDD in-sync radio link monitoring test

Parameter	Unit	Test 1						
		Cell1					Cell2	Cell3
		T1	T2	T3	T4	T5	T1-T5	T1-T5
E-UTRA RF Channel Number		1					1	1
$BW_{channel}$	MHz	10					10	10
Correlation Matrix and Antenna Configuration		2x2 Low					2x2 Low	2x2 Low
PCFICH/PDCCH/PHICH parameters		R.9 FDD					R.9 FDD	R.9 FDD
OCNG Pattern defined in A.3.2.1 (FDD)		OP.6 FDD					OP.6 FDD	OP.6 FDD
ρ_A, ρ_B		-3					-3	-3
PCFICH_RB	dB	1					Non-ABS and ABS subframe channel powers defined in Table A.3.4.1.2-2.	
PDCCH_RA	dB	-3						
PDCCH_RB	dB							
PBCH_RA	dB							
PBCH_RB	dB							
PSS_RA	dB							
SSS_RA	dB							

PHICH_RA	dB							
PHICH_RB	dB							
PDSCH_RA	dB							
PDSCH_RB	dB							
OCNG_RA ^{Note 1}	dB							
OCNG_RB ^{Note 1}	dB							
SNR ^{Note 6,7}	dB	-1.5	-5.2	-13.7	-8.6	-1.5	4	2
N_{oc}	dBm/15 kHz	-98					-98	-98
Propagation condition	Hz	ETU 30					ETU 30	ETU 30
<p>Note 1: OCNG shall be used such that the resources in cell 1 are fully allocated and a constant total transmitted power spectral density is achieved for all OFDM symbols.</p> <p>Note 2: The uplink resources for CQI reporting are assigned to the UE prior to the start of time period T1.</p> <p>Note 3: The timers and layer 3 filtering related parameters are configured prior to the start of time period T1.</p> <p>Note 4: The signal contains PDCCH for UEs other than the device under test as part of OCNG.</p> <p>Note 5: SNR levels correspond to the signal to noise ratio over the cell-specific reference signal REs.</p> <p>Note 6: The SNR in time periods T1, T2, T3, T4 and T5 is denoted as SNR1, SNR2, SNR3, SNR4 and SNR5 respectively in figure A.7.3.19.1-1.</p> <p>Note 7: The SNR values are specified for testing a UE which supports 2RX on at least one band. For testing of a UE which supports 4RX on all bands, the SNR during T3 and T4 is modified as specified in section A.3.8.1.</p>								

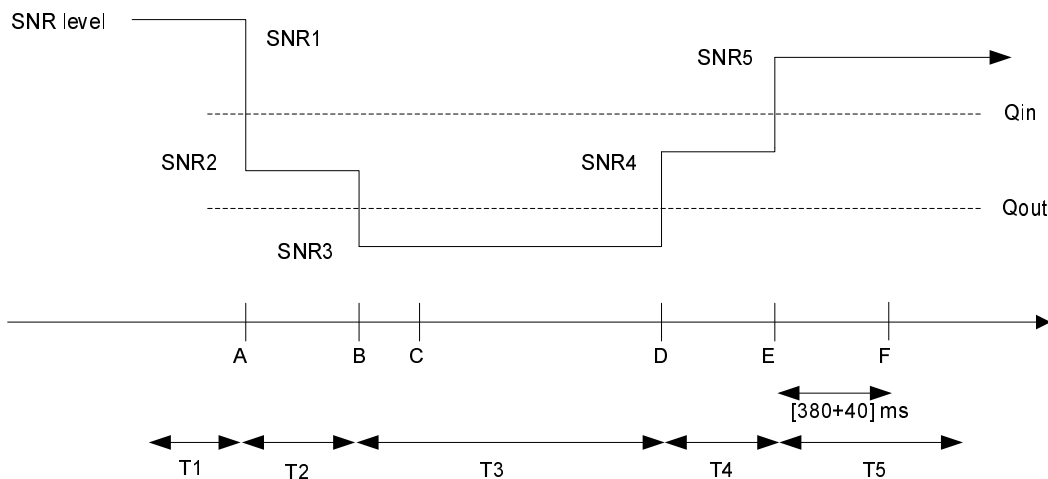

Figure A.7.3.19.1-1 SNR variation for in-sync testing

A.7.3.19.2 Test Requirements

The UE behaviour in each test during time durations T1, T2, T3, T4 and T5 shall be as follows:

During the period from time point A to time point F (420 ms after the start of time duration T5) the UE shall transmit uplink signal at least in all subframes configured for CQI transmission according to the configured CQI reporting mode (PUCCH 1-0).

The rate of correct events observed during repeated tests shall be at least 90%.

A.7.3.20 E-UTRAN TDD Radio Link Monitoring Test for In-sync under Time Domain Measurement Resource Restriction with CRS assistance information and Non-MBSFN ABS

A.7.3.20.1 Test Purpose and Environment

The purpose of this test is to verify that the UE properly detects the out of sync and in sync for the purpose of monitoring downlink radio link quality of the PCell under time domain measurement resource restriction with CRS assistance information. This test will partly verify the E-UTRAN TDD radio link monitoring requirements in section 7.6.

The test parameters are given in Tables A.7.3.20.1-1 and A.7.3.20.1-2 below. There are three active cells in the test: Cell 1 is the PCell and Cell 2 and 3 are the Neighbor cells. The test consists of five successive time periods, with time duration of T1, T2, T3, T4 and T5 respectively. Figure A.7.3.20.1-1 shows the variation of the downlink SNR in the PCell to emulate out-of-sync and in-sync states. Prior to the start of the time duration T1, the UE shall be fully synchronized to cell 1. The UE shall be configured for periodic CQI reporting in PUCCH 1-0 mode with a reporting periodicity of 2 ms.

Non-MBSFN ABS pattern is configured in both Cell 2 and Cell 3 in this test. The UE is configured by higher layers with a time domain measurement restriction pattern for performing PCell measurements. The UE is also provided via higher layers with the CRS assistance information for Cell 2 and Cell 3, which shall be valid during T1, T2, T3, T4 and T5 in this test. The Non-MBSFN ABS pattern, the time domain measurement resource restriction pattern and the CRS assistance information shall be configured prior to the start of T1.

Table A.7.3.20.1-1: General test parameters for E-UTRAN TDD in-sync radio link monitoring test

Parameter	Unit	Value			Comment
		Test 1			
		Cell 1	Cell 2	Cell 3	
PCFICH/PDCCH/PHICH parameters		R.9 TDD	R.9 TDD	R.9 TDD	As specified in section A.3.1.2.2. None of the PDCCH are intended for the UE under test
OCNG parameters		OP.2 TDD	OP.2 TDD	OP.2 TDD	As specified in section A.3.2.2.2.
Active cell		PCell	Neighbor Cell	Neighbor Cell	Cell 1, Cell 2 and Cell 3 are on E-UTRA RF channel number 1
CP length		Normal	Normal	Normal	
E-UTRA RF Channel Number		1	1	1	One E-UTRA TDD carrier frequency is used.
E-UTRA Channel Bandwidth (BW _{channel})	MHz	10	10	10	
Correlation Matrix and Antenna Configuration		2x2 Low	2x2 Low	2x2 Low	Correlation Matrix and Antenna Configuration are defined in TS 36.101 [5] Annex B.2.3.2
Neighbor Cell ABS configuration		N/A	Non-MBSFN ABS		As defined in Table A.3.4.1.2-1
ABS Pattern		N/A	'000010000 0000010000 0'	'000010000 0000010000 0'	TDD ABS Pattern Info IE, as defined in TS 36.423 [28], clause 9.2.54. Configured in Cell 2 and Cell 3. The first/leftmost bit corresponds to the Pcell subframe #0 of the radio frame satisfying SFN mod x = 0, where x is the size of the bit string (20) divided by 10. No MBSFN subframes are configured in the ABS subframes.
Time domain measurement resource restriction pattern		'000010000 0000010000 0'	N/A	N/A	Time domain measurement resource restriction pattern for serving cell measurement signalled to the UE in message measSubframePatternPCe ll-r10 as defined in TS 36.331, clause 6.3.2.
CRS assistant information	physCellId	N/A	see PCI conditions below	see PCI conditions below	The CRS assistance information is provided for Cell 2 and Cell 3 in CRS-

	antennaPorts Count			an2	an2	AssistanceInfo. It includes a single MBSFN-SubframeConfig element with subframe allocation oneFrame='000000'
	mbsfn-SubframeConfigList			oneFrame = '000000'	oneFrame = '000000'	
Time offset from Cell 1		us	0	3	2	
Frequency offset		Hz	0	300	-100	
Physical Cell ID			PCI _{cell1}	(PCI _{cell1} -PCI _{cell2}) mod3 = 0, PCI _{cell1} not equal to PCI _{cell2}	(PCI _{cell1} -PCI _{cell3}) mod3! = 0	Cell PCIs are selected so that all conditions are met
In sync transmission parameters (Note 1)	DCI format		1C	1C	1C	As defined in section 5.3.3.1.4 in TS 36.212
	Number of Control OFDM symbols		3	3	3	In sync threshold Q _{in} and the corresponding hypothetical PDCCH/PCFICH transmission parameters are as specified in section and Table 7.6.1-2 respectively.
	Aggregation level	CCE	4	4	4	
	ρ _A , ρ _B		-3	-3	-3	
	Ratio of PDCCH to RS EPRE		-3	Non-ABS and ABS subframe channel powers defined in Table A.3.4.1.2-2.		
	Ratio of PCFICH to RS EPRE		1			
Out of sync transmission parameters (Note 1)	DCI format		1A	1A	1A	As defined in section 5.3.3.1.3 in TS 36.212
	Number of Control OFDM symbols		3	3	3	Out of sync threshold Q _{out} and the corresponding hypothetical PDCCH/PCFICH transmission parameters are as specified in section 7.6.1 and Table 7.6.1-1 respectively.
	Aggregation level	CCE	8	8	8	
	ρ _A , ρ _B		-3	-3	-3	
	Ratio of PDCCH to RS EPRE	dB	1	Non-ABS and ABS subframe channel powers defined in Table A.3.4.1.2-2.		
	Ratio of PCFICH to RS EPRE	dB	1			
DRX			OFF	OFF	OFF	
Layer 3 filtering			Enabled	Disable	Disable	Counters: N310 = 1; N311 = 1
T310 timer		ms	2000	N/A		T310 is enabled
T311 timer		ms	1000			T311 is enabled
Periodic CQI reporting mode			PUCCH 1-0			As defined in table 7.2.2-1 in TS 36.213.
CQI reporting periodicity		ms	1			Minimum CQI reporting periodicity
T1		s	0.5	N/A		
T2		s	0.4			
T3		s	1.46			
T4		s	0.4			
T5		s	1			
Note 1: PDCCH/PCFICH corresponding to the in-sync and out of sync transmission parameters need not be included in the Reference Measurement Channel.						

Table A.7.3.20.1-2: Cell specific test parameters for E-UTRAN TDD in-sync radio link monitoring test

Parameter	Unit	Test 1		
		Cell1	Cell2	Cell3

		T1	T2	T3	T4	T5	T1-T5	T1-T5
E-UTRA RF Channel Number		1					1	1
BW _{channel}	MHz	10					10	10
Correlation Matrix and Antenna Configuration		2x2 Low					2x2 Low	2x2 Low
Special subframe configuration ^{Note 1}		6					6	6
Uplink-downlink configuration ^{Note 2}		1					1	1
PCFICH/PDCCH/PHICH parameters		R.9 TDD					R.9 TDD	R.9 TDD
OCNG Pattern defined in A.3.2.2 (TDD)		OP.2 TDD					OP.2 TDD	OP.2 TDD
ρ_A, ρ_B		-3					-3	-3
PCFICH_RB	dB	-3					Non-ABS and ABS subframe channel powers defined in Table A.3.4.1.2-2.	
PDCCH_RA	dB							
PDCCH_RB	dB							
PBCH_RA	dB							
PBCH_RB	dB							
PSS_RA	dB							
SSS_RA	dB							
PHICH_RA	dB							
PHICH_RB	dB							
PDSCH_RA	dB							
PDSCH_RB	dB							
OCNG_RA ^{Note 3}	dB							
OCNG_RB ^{Note 3}	dB							
SNR ^{Note 8,9}	dB							
N_{oc}	dBm/15 kHz	-98					-98	-98
Propagation condition	Hz	ETU 30					ETU 30	ETU 30
<p>Note 1: For the special subframe configuration see table 4.2-1 in 3GPP TS 36.211.</p> <p>Note 2: For the uplink-downlink configuration see table 4.2-2 in 3GPP TS 36.211.</p> <p>Note 3: OCNG shall be used such that the resources in cell # 1 are fully allocated and a constant total transmitted power spectral density is achieved for all OFDM symbols.</p> <p>Note 4: The uplink resources for CQI reporting are assigned to the UE prior to the start of time period T1.</p> <p>Note 5: The timers and layer 3 filtering related parameters are configured prior to the start of time period T1.</p> <p>Note 6: The signal contains PDCCH for UEs other than the device under test as part of OCNG.</p> <p>Note 7: SNR levels correspond to the signal to noise ratio over the cell-specific reference signal REs.</p> <p>Note 8: The SNR in time periods T1, T2, T3, T4 and T5 of active cell is denoted as SNR1, SNR2, SNR3, SNR4 and SNR5 respectively in figure A.7.3.20.1-1.</p> <p>Note 9: The SNR values are specified for testing a UE which supports 2RX on at least one band. For testing of a UE which supports 4RX on all bands, the SNR during T3 and T4 is modified as specified in section A.3.8.1.</p>								

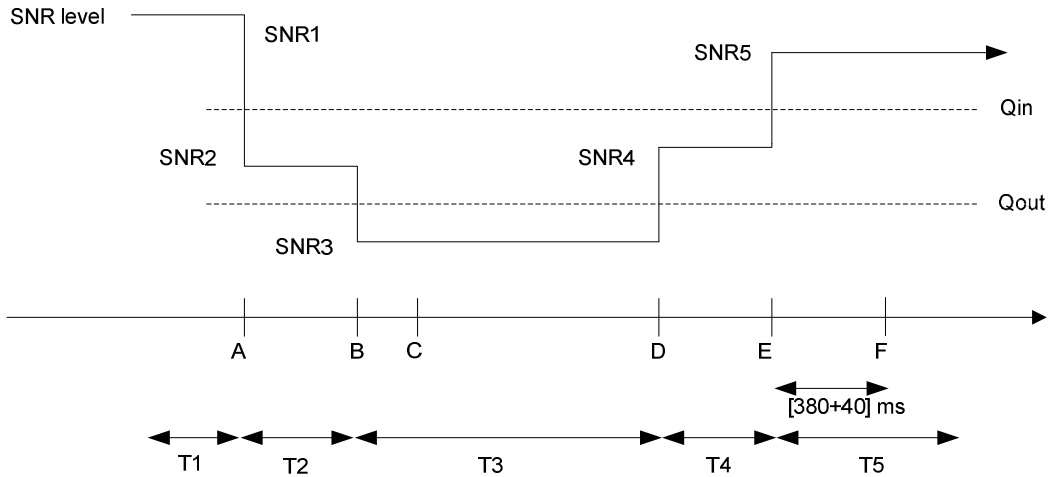

Figure A.7.3.20.1-1 SNR variation for in-sync testing

A.7.3.20.2 Test Requirements

The UE behaviour in each test during time durations T1, T2, T3, T4 and T5 shall be as follows:

During the period from time point A to time point F (420 ms after the start of time duration T5) the UE shall transmit uplink signal at least in all subframes configured for CQI transmission according to the configured CQI reporting mode (PUCCH 1-0).

The rate of correct events observed during repeated tests shall be at least 90%.

A.7.3.21 E-UTRAN FDD Radio Link Monitoring Test for In-sync under Time Domain Measurement Resource Restriction with CRS assistance information and MBSFN ABS

A.7.3.21.1 Test Purpose and Environment

The purpose of this test is to verify that the UE properly detects the out of sync and in sync for the purpose of monitoring downlink radio link quality of the PCell under time domain measurement resource restriction with CRS assistance information and MBSFN ABS. This test will partly verify the E-UTRAN FDD radio link monitoring requirements in section 7.6.

The test parameters are given in Tables A.7.3.21.1-1 and A.7.3.21.1-2 below. There are three active cells in the test: Cell 1 is the PCell cell and Cell 2 and 3 are the neighbour cells. The test consists of five successive time periods, with time duration of T1, T2, T3, T4 and T5 respectively. Figure A.7.3.21.1-1 shows the variation of the downlink SNR in the active cell to emulate out-of-sync and in-sync states. Prior to the start of the time duration T1, the UE shall be fully synchronized to cell 1. The UE shall be configured for periodic CQI reporting in PUCCH 1-0 mode with a reporting periodicity of 2 ms.

MBSFN ABS pattern is configured in both Cell 2 and Cell 3 in this test. The UE is configured by higher layers with a time domain measurement restriction pattern for performing PCell measurements. The UE is also provided via higher layers with the CRS assistance information for Cell 2 and Cell 3, which shall be valid during T1, T2, T3, T4 and T5 in this test. The MBSFN ABS pattern, the time domain measurement resource restriction pattern and the CRS assistance information shall be configured prior to the start of T1.

Table A.7.3.21.1-1: General test parameters for E-UTRAN FDD in-sync radio link monitoring test

Parameter	Unit	Value			Comment
		Test 1			
		Cell 1	Cell 2	Cell 3	
PCFICH/PDCCH/PHICH parameters		R.9 FDD	R.9 FDD	R.9 FDD	As specified in section A.3.1.2.1.

					None of the PDCCH are intended for the UE under test
OCNG parameters		OP.6 FDD	OP.9 FDD	OP.9 FDD	As specified in section A.3.2.1.
Active cell		PCell	Neighbor Cell	Neighbor Cell	Cell 1, Cell 2 and Cell 3 are on E-UTRA RF channel number 1
CP length		Normal	Normal	Normal	
E-UTRA RF Channel Number		1	1	1	One E-UTRA FDD carrier frequency is used.
E-UTRA Channel Bandwidth (BW _{channel})	MHz	10	10	10	
Correlation Matrix and Antenna Configuration		2x2 Low	2x2 Low	2x2 Low	Correlation Matrix and Antenna Configuration are defined in TS 36.101 [5] Annex B.2.3.2
Neighbor Cell ABS configuration		N/A	MBSFN ABS		As defined in Table A.3.4.2.2-2
ABS Pattern		N/A	'010000001 0000000100 0000000100 0000100000 0'	'010000001 0000000100 0000000100 0000100000 0'	FDD ABS Pattern Info IE, as defined in TS 36.423 [28], clause 9.2.54. The first/leftmost bit corresponds to the Pcell subframe #0 of the radio frame satisfying SFN mod x = 0, where x is the size of the bit string (40) divided by 10. MBSFN subframes are configured in the ABS subframes configured in Cell 2 and Cell 3 prior to the start of T1.
Time domain measurement resource restriction pattern		'010000001 0000000100 0000000100 0000100000 0'	N/A	N/A	Time domain measurement resource restriction pattern for serving cell measurement signalled to the UE in message measSubframePatternPCell-r10 as defined in TS 36.331, clause 6.3.2.
CRS assistance information	physCellId	N/A	see PCI conditions below	see PCI conditions below	The CRS assistance information is provided for Cell 2 and Cell 3 in CRS-AssistanceInfo. It includes a single MBSFN-SubframeConfig element with subframe allocation fourFrames = '100001000100000100001000010000'
	antennaPortsCount		an2	an2	
	mbsfn-SubframeConfigList		fourFrames = '100001000100000100001000010000'	fourFrames = '100001000100000100001000010000'	
Time offset between cells (With respect to Cell 1)	us	0	3	2	
Frequency shift between cells (With respect to Cell 1)	Hz	0	300	-100	
Physical Cell ID		PCI _{cell1}	(PCI _{cell1} -PCI _{cell2}) mod3 = 0, PCI _{cell1} not equal to PCI _{cell2}	(PCI _{cell1} -PCI _{cell3}) mod3 != 0	Cell PCIs are selected so that all conditions are met
In sync transmission parameters (Note 1)	DCI format	1C	1C	1C	
	Number of Control	3	3	3	As defined in section 5.3.3.1.4 in TS 36.212

In sync transmission parameters (Note 1)	OFDM symbols					In sync threshold Q_{in} and the corresponding hypothetical PDCCH/PCFICH transmission parameters are as specified in section and Table 7.6.1-2 respectively.	
	Aggregation level	CCE	4	4	4		
	ρ_A, ρ_B		-3	-3	-3		
	Ratio of PDCCH to RS EPRE		-3	Non-ABS and ABS subframe channel powers defined in Table A.3.4.2.2-2.			
	Ratio of PCFICH to RS EPRE		1				
Out of sync transmission parameters (Note 1)	DCI format		1A	1A	1A	As defined in section 5.3.3.1.3 in TS 36.212	
	Number of Control OFDM symbols		3	3	3		
	Aggregation level	CCE	8	8	8		Out of sync threshold Q_{out} and the corresponding hypothetical PDCCH/PCFICH transmission parameters are as specified in section 7.6.1 and Table 7.6.1-1 respectively.
	ρ_A, ρ_B		-3	-3	-3		
	Ratio of PDCCH to RS EPRE	dB	1	Non-ABS and ABS subframe channel powers defined in Table A.3.4.2.2-2.			
Ratio of PCFICH to RS EPRE	dB	1					
DRX			OFF	OFF	OFF		
Layer 3 filtering			Enabled	Disable	Disable	Counters: $N_{310} = 1; N_{311} = 1$	
T310 timer	ms		2000	N/A		T310 is enabled	
T311 timer	ms		1000			T311 is enabled	
Periodic CQI reporting mode			PUCCH 1-0			As defined in table 7.2.2-1 in TS 36.213.	
CQI reporting periodicity	ms		2			Minimum CQI reporting periodicity	
T1	s		0.5				
T2	s		0.4				
T3	s		1.46				
T4	s		0.4				
T5	s		1				
Note 1: PDCCH/PCFICH corresponding to the in-sync and out of sync transmission parameters need not be included in the Reference Measurement Channel.							

Table A.7.3.21.1-2: Cell specific test parameters for E-UTRAN FDD in-sync radio link monitoring test

Parameter	Unit	Test 1						
		Cell1					Cell2	Cell3
		T1	T2	T3	T4	T5	T1-T5	T1-T5
E-UTRA RF Channel Number		1					1	1
$BW_{channel}$	MHz	10					10	10
Correlation Matrix and Antenna Configuration		2x2 Low					2x2 Low	2x2 Low
PCFICH/PDCCH/PHICH parameters		R.9 FDD					R.9 FDD	R.9 FDD
OCNG Pattern defined in A.3.2.1 (FDD)		OP.6 FDD					OP.9 FDD	OP.9 FDD
ρ_A, ρ_B		-3					-3	-3
PCFICH_RA	dB	1					Non-ABS and ABS subframe channel powers defined in Table A.3.4.2.2-2.	
PDCCH_RA	dB							
PDCCH_RB	dB							
PBCH_RA	dB							
PBCH_RB	dB							

PSS_RA	dB	-3						
SSS_RA	dB							
PHICH_RA	dB							
PHICH_RB	dB							
PDSCH_RA	dB							
PDSCH_RB	dB							
OCNG_RA ^{Note 1}	dB							
OCNG_RB ^{Note 1}	dB							
SNR ^{Note 6,7}	dB	-1.5	-5.2	-13.7	-8.6	-1.5	4	2
N_{oc}	dBm/15 kHz	-98					-98	-98
Propagation condition	Hz	ETU 30					ETU 30	ETU 30
<p>Note 1: OCNG shall be used such that the resources in cell 1 are fully allocated and a constant total transmitted power spectral density is achieved for all OFDM symbols.</p> <p>Note 2: The uplink resources for CQI reporting are assigned to the UE prior to the start of time period T1.</p> <p>Note 3: The timers and layer 3 filtering related parameters are configured prior to the start of time period T1.</p> <p>Note 4: The signal contains PDCCH for UEs other than the device under test as part of OCNG.</p> <p>Note 5: SNR levels correspond to the signal to noise ratio over the cell-specific reference signal REs.</p> <p>Note 6: The SNR in time periods T1, T2, T3, T4 and T5 is denoted as SNR1, SNR2, SNR3, SNR4 and SNR5 respectively in figure A.7.3.21.1-1.</p> <p>Note 7: The SNR values are specified for testing a UE which supports 2RX on at least one band. For testing of a UE which supports 4RX on all bands, the SNR during T3 and T4 is modified as specified in section A.3.8.1.</p>								

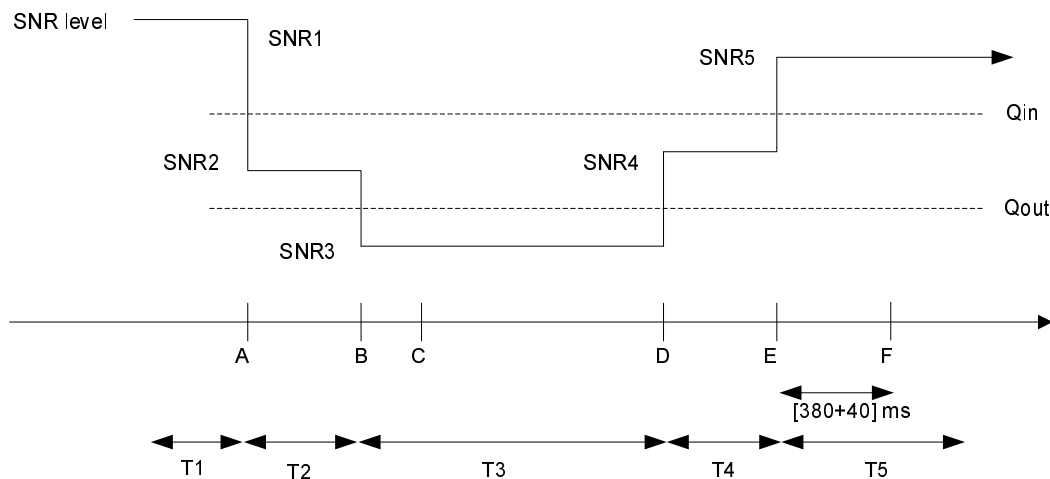

Figure A.7.3.21.1-1 SNR variation for in-sync testing

A.7.3.21.2 Test Requirements

The UE behaviour in each test during time durations T1, T2, T3, T4 and T5 shall be as follows:

During the period from time point A to time point F (420 ms after the start of time duration T5) the UE shall transmit uplink signal at least in all subframes configured for CQI transmission according to the configured CQI reporting mode (PUCCH 1-0).

The rate of correct events observed during repeated tests shall be at least 90%.

A.7.3.22 E-UTRAN TDD Radio Link Monitoring Test for In-sync under Time Domain Measurement Resource Restriction with CRS assistance information and MBSFN ABS

A.7.3.22.1 Test Purpose and Environment

The purpose of this test is to verify that the UE properly detects the out of sync and in sync for the purpose of monitoring downlink radio link quality of the PCell under time domain measurement resource restriction with CRS

assistance information. This test will partly verify the E-UTRAN TDD radio link monitoring requirements in section 7.6.

The test parameters are given in Tables A.7.3.22.1-1 and A.7.3.22.1-2 below. There are three active cells in the test: Cell 1 is the PCell and Cell 2 and 3 are the Neighbor cells. The test consists of five successive time periods, with time duration of T1, T2, T3, T4 and T5 respectively. Figure A.7.3.22.1-1 shows the variation of the downlink SNR in the PCell to emulate out-of-sync and in-sync states. Prior to the start of the time duration T1, the UE shall be fully synchronized to cell 1. The UE shall be configured for periodic CQI reporting in PUCCH 1-0 mode with a reporting periodicity of 2 ms.

MBSFN ABS pattern is configured in both Cell 2 and Cell 3 in this test. The UE is configured by higher layers with a time domain measurement restriction pattern for performing PCell measurements. The UE is also provided via higher layers with the CRS assistance information for Cell 2 and Cell 3, which shall be valid during T1, T2, T3, T4 and T5 in this test. The MBSFN ABS pattern, the time domain measurement resource restriction pattern and the CRS assistance information shall be configured prior to the start of T1.

Table A.7.3.22.1-1: General test parameters for E-UTRAN TDD in-sync radio link monitoring test

Parameter	Unit	Value			Comment
		Test 1			
		Cell 1	Cell 2	Cell 3	
PCFICH/PDCCH/PHICH parameters		R.9 TDD	R.9 TDD	R.9 TDD	As specified in section A.3.1.2.2. None of the PDCCH are intended for the UE under test
OCNG parameters		OP.2 TDD	OP.6 TDD	OP.6 TDD	As specified in section A.3.2.2.
Active cell		PCell	Neighbor Cell	Neighbor Cell	Cell 1, Cell 2 and Cell 3 are on E-UTRA RF channel number 1
CP length		Normal	Normal	Normal	
E-UTRA RF Channel Number		1	1	1	One E-UTRA TDD carrier frequency is used.
E-UTRA Channel Bandwidth (BW _{channel})	MHz	10	10	10	
Correlation Matrix and Antenna Configuration		2x2 Low	2x2 Low	2x2 Low	Correlation Matrix and Antenna Configuration are defined in TS 36.101 [5] Annex B.2.3.2
Neighbor Cell ABS configuration		N/A	MBSFN ABS		As defined in Table A.3.4.2.2-1
ABS Pattern		N/A	'000010000 0000010000 0'	'000010000 0000010000 0'	TDD ABS Pattern Info IE, as defined in TS 36.423 [28], clause 9.2.54. Configured in Cell 2 and Cell 3 The first/leftmost bit corresponds to the subframe #0 of the radio frame satisfying SFN mod 20 = 0, where x is the size of the bit string (20) divided by 10. MBSFN subframes are configured in the ABS subframes.
Time domain measurement resource restriction pattern		'000010000 0000010000 0'	N/A	N/A	Time domain measurement resource restriction pattern for serving cell measurement signalled to the UE in message measSubframePatternPCell-r10 as defined in TS 36.331, clause 6.3.2.

CRS assistance information	physCellId		N/A	see PCI conditions below	see PCI conditions below	The CRS assistance information is provided for Cell 2 and Cell 3 in CRS-AssistanceInfo. It includes a single MBSFN-SubframeConfig element with subframe allocation fourFrames = '0100001000000'
	antennaPortsCount			an2	an2	
	mbsfn-SubframeConfigList			fourFrames = '01000010000100000'	fourFrames = '01000010000100000'	
Time offset from Cell 1	us	0	3	2		
Frequency offset	Hz	0	300	-100		
Physical Cell ID		PCI _{cell1}	(PCI _{cell1} -PCI _{cell2}) mod3 = 0, PCI _{cell1} not equal to PCI _{cell2}	(PCI _{cell1} -PCI _{cell3}) mod3 != 0		Cell PCIs are selected so that all conditions are met
In sync transmission parameters (Note 1)	DCI format		1C	1C	1C	As defined in section 5.3.3.1.4 in TS 36.212
	Number of Control OFDM symbols		2	2	2	In sync threshold Q _{in} and the corresponding hypothetical PDCCH/PCFICH transmission parameters are as specified in section and Table 7.6.1-2 respectively.
	Aggregation level	CCE	4	4	4	
	ρ _A , ρ _B		-3	-3	-3	
	Ratio of PDCCH to RS EPRE		-3	Non-ABS and ABS subframe channel powers defined in Table A.3.4.1.2-2.		
	Ratio of PCFICH to RS EPRE		1			
DCI format		1A	1A	1A		
Out of sync transmission parameters (Note 1)	Number of Control OFDM symbols		2	2	2	Out of sync threshold Q _{out} and the corresponding hypothetical PDCCH/PCFICH transmission parameters are as specified in section 7.6.1 and Table 7.6.1-1 respectively.
	Aggregation level	CCE	8	8	8	
	ρ _A , ρ _B		-3	-3	-3	
	Ratio of PDCCH to RS EPRE	dB	1	Non-ABS and ABS subframe channel powers defined in Table A.3.4.1.2-2.		
	Ratio of PCFICH to RS EPRE	dB	1			
	DCI format		1A	1A	1A	
DRX		OFF	OFF	OFF		
Layer 3 filtering		Enabled	Disable	Disable	Counters: N310 = 1; N311 = 1	
T310 timer	ms	2000	N/A		T310 is enabled	
T311 timer	ms	1000			T311 is enabled	
Periodic CQI reporting mode		PUCCH 1-0			As defined in table 7.2.2-1 in TS 36.213.	
CQI reporting periodicity	ms	1			Minimum CQI reporting periodicity	
T1	s	0.5	N/A			
T2	s	0.4				
T3	s	1.46				
T4	s	0.4				
T5	s	1				
Note 1: PDCCH/PCFICH corresponding to the in-sync and out of sync transmission parameters need not be included in the Reference Measurement Channel.						

Table A.7.3.22.1-2: Cell specific test parameters for E-UTRAN TDD in-sync radio link monitoring test

Parameter	Unit	Test 1											
		Cell1					Cell2	Cell3					
		T1	T2	T3	T4	T5	T1-T5	T1-T5					
E-UTRA RF Channel Number		1					1	1					
$BW_{channel}$	MHz	10					10	10					
Correlation Matrix and Antenna Configuration		2x2 Low					2x2 Low	2x2 Low					
Special subframe configuration ^{Note 1}		6					6	6					
Uplink-downlink configuration ^{Note 2}		1					1	1					
PCFICH/PDCCH/PHICH parameters		R.9 TDD					R.9 TDD	R.9 TDD					
OCNG Pattern defined in A.3.2.2 (TDD)		OP.2 TDD					OP.6 TDD	OP.6 TDD					
ρ_A, ρ_B		-3					-3	-3					
PCFICH_RB	dB	1					Non-ABS and ABS subframe channel powers defined in Table A.3.4.2.2-1.						
PDCCH_RA	dB	-3											
PDCCH_RB	dB												
PBCH_RA	dB												
PBCH_RB	dB												
PSS_RA	dB												
SSS_RA	dB												
PHICH_RA	dB												
PHICH_RB	dB												
PDSCH_RA	dB												
PDSCH_RB	dB												
OCNG_RA ^{Note 3}	dB												
OCNG_RB ^{Note 3}	dB												
SNR ^{Note 8,9}	dB								-1.5	-5.2	-13.7	-8.6	-1.5
N_{oc}	dBm/15 kHz						-98					-98	-98
Propagation condition	Hz	ETU 30					ETU 30	ETU 30					
<p>Note 1: For the special subframe configuration see table 4.2-1 in 3GPP TS 36.211.</p> <p>Note 2: For the uplink-downlink configuration see table 4.2-2 in 3GPP TS 36.211.</p> <p>Note 3: OCNG shall be used such that the resources in cell # 1 are fully allocated and a constant total transmitted power spectral density is achieved for all OFDM symbols.</p> <p>Note 4: The uplink resources for CQI reporting are assigned to the UE prior to the start of time period T1.</p> <p>Note 5: The timers and layer 3 filtering related parameters are configured prior to the start of time period T1.</p> <p>Note 6: The signal contains PDCCH for UEs other than the device under test as part of OCNG.</p> <p>Note 7: SNR levels correspond to the signal to noise ratio over the cell-specific reference signal REs.</p> <p>Note 8: The SNR in time periods T1, T2, T3, T4 and T5 of active cell is denoted as SNR1, SNR2, SNR3, SNR4 and SNR5 respectively in figure A.7.3.22.1-1.</p> <p>Note 9: The SNR values are specified for testing a UE which supports 2RX on at least one band. For testing of a UE which supports 4RX on all bands, the SNR during T3 and T4 is modified as specified in section A.3.8.1.</p>													

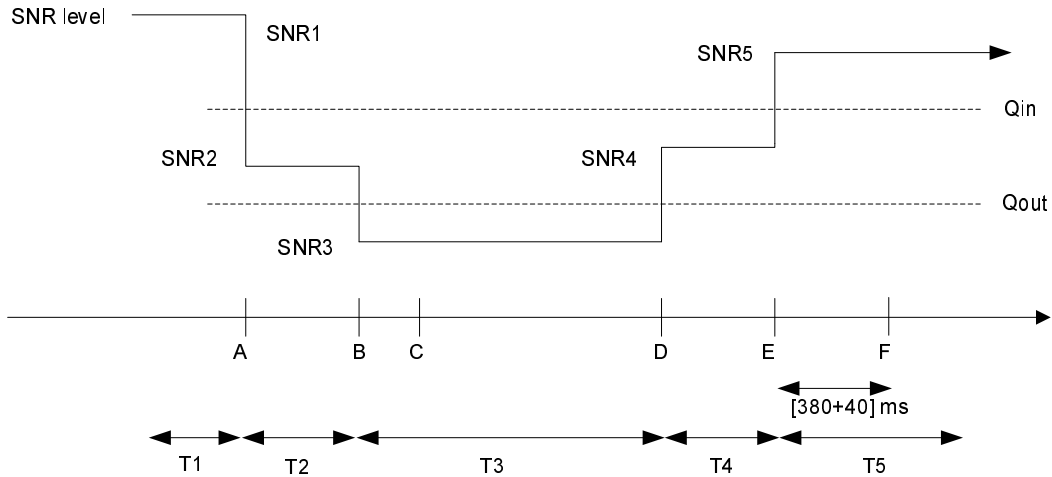

Figure A.7.3.22.1-1 SNR variation for in-sync testing

A.7.3.22.2 Test Requirements

The UE behaviour in each test during time durations T1, T2, T3, T4 and T5 shall be as follows:

During the period from time point A to time point F (420 ms after the start of time duration T5) the UE shall transmit uplink signal at least in all subframes configured for CQI transmission according to the configured CQI reporting mode (PUCCH 1-0).

The rate of correct events observed during repeated tests shall be at least 90%.

A.7.3.23 E-UTRAN FDD Radio Link Monitoring Test for Out-of-sync for 5MHz Bandwidth

A.7.3.23.1 Test Purpose and Environment

The purpose of this test case is the same as for the test defined in subclause A.7.3.1. The test parameters are the same except those described in the following section. The listed parameter values in Tables A.7.3.23.1-1 and A.7.3.23.1-2 will replace the values of corresponding parameters in Test 4 in Tables A.7.3.1.1-1 and A.7.3.1.1-2. Only Test 4 is defined for the 5MHz bandwidth.

Table A.7.3.23.1-1: General test parameters for E-UTRAN FDD out-of-sync testing under 5MHz Bandwidth

Parameter		Unit	Value	Comment
			Test 4	
PCFICH/PDCCH/PHICH parameters			R.12 FDD	As specified in clause A.3.1.2.1. None of the PDCCH are intended for the UE under test
OCNG parameters			OP.16 FDD	As specified in clause A.3.2.1.16.
E-UTRA Channel Bandwidth (BW _{channel})		MHz	5	
Out of sync transmission parameters (Note 1)	Number of Control OFDM Symbols		3	Out of sync threshold Q _{out} and the corresponding hypothetical PDCCH/PCFICH transmission parameters are as specified in clause 7.6.1 and Table 7.6.1-1 respectively.
Note 1: PDCCH/PCFICH corresponding to the out of sync transmission parameters need not be included in the Reference Measurement Channel.				
Note 2: See Table A.7.3.1.1-1 for other general test parameters.				
Note 3: This test is according to the principle defined in section A.3.7.2.				

Table A.7.3.23.1-2: Cell specific test parameters for E-UTRAN FDD for out-of-sync radio link monitoring test #4 under 5MHz Bandwidth

Parameter	Unit	Test 4		
		T1	T2	T3
$BW_{channel}$	MHz	5		
OCNG Pattern defined in A.3.2.1.16 (FDD)		OP.16 FDD		
SNR ^{Note 1,2}	dB	-2.3	-5.7	-12.2
Note 1:	See Table A.7.3.1.1-2 for other cell specific test parameters.			
Note 2:	The SNR values are specified for testing a UE which supports 2RX on at least one band. For testing of a UE which supports 4RX on all bands, the SNR during T3 is modified as specified in section A.3.8.1.			

A.7.3.23.2 Test Requirements

The requirements defined in section A.7.3.1.2 shall apply to this test case.

A.7.3.24 E-UTRAN FDD Radio Link Monitoring Test for In-sync for 5MHz Bandwidth

A.7.3.24.1 Test Purpose and Environment

The purpose of this test case is the same as for the Test 2 defined in subclause A.7.3.2. The test parameters are the same except those described in the following section. The listed parameter values in Tables A.7.3.24.1-1 and A.7.3.24.1-2 will replace the values of corresponding parameters in Tables A.7.3.2.1-1 and A.7.3.2.1-2.

Table A.7.3.24.1-1: General test parameters for E-UTRAN FDD in-sync testing

Parameter		Unit	Value	Comment
PCFICH/PDCCH/PHICH parameters			R.12 FDD	As specified in clause A.3.1.2.1. None of the PDCCH are intended for the UE under test
E-UTRA Channel Bandwidth ($BW_{channel}$)		MHz	5	
In sync transmission parameters (Note 1)	Number of Control OFDM symbols		3	In sync threshold Q_{in} and the corresponding hypothetical PDCCH/PCFICH transmission parameters are as specified in clause and Table 7.6.1-2 respectively.
Out of sync transmission parameters (Note 1)	Number of Control OFDM symbols		3	Out of sync threshold Q_{out} and the corresponding hypothetical PDCCH/PCFICH transmission parameters are as specified in clause 7.6.1 and Table 7.6.1-1 respectively.
Note 1: See Table A.7.3.2.1-1 for other general test parameters.				
Note 2: This test is performed according to the principle defined in section A.3.7.2				

Table A.7.3.24.1-2: Cell specific test parameters for E-UTRAN FDD (cell # 1) for in-sync radio link monitoring test

Parameter	Unit	T1	T2	T3	T4	T5
BW_{channel}	MHz	5				
OCNG Pattern defined in A.3.2.1.16 (FDD)		OP.16 FDD				
SNR ^{Note 1,2}	dB	-2.3	-5.7	-12.2	-7.3	-2.3
Propagation condition		ETU 70 Hz				
Note 1: See Table A.7.3.2.1-2 for other general test parameters.						
Note 2: The SNR values are specified for testing a UE which supports 2RX on at least one band. For testing of a UE which supports 4RX on all bands, the SNR during T3 and T4 is modified as specified in section A.3.8.1.						

A.7.3.24.2 Test Requirements

The requirements defined in section A.7.3.2.2 shall apply to this test case.

A.7.3.25 E-UTRAN FDD Radio Link Monitoring Test for In-sync in DRX for 5MHz Bandwidth

A.7.3.25.1 Test Purpose and Environment

The purpose of this test case is the same as for the Test 2 defined in subclause A.7.3.6. The test parameters are the same except those described in the following section. The listed parameter values in Tables A.7.3.25.1-1 and A.7.3.25.1-2 will replace the values of corresponding parameters in Tables A.7.3.6.1-1 and A.7.3.6.1-2.

Table A.7.3.25.1-1: General test parameters for E-UTRAN FDD in-sync testing

Parameter	Unit	Value	Comment
PCFICH/PDCCH/PHICH parameters		R.12 FDD	As specified in clause A.3.1.2.1. None of the PDCCH are intended for the UE under test
E-UTRA Channel Bandwidth (BW_{channel})	MHz	5	
In sync transmission parameters (Note 1)	Number of Control OFDM symbols	3	In sync threshold Q_{in} and the corresponding hypothetical PDCCH/PCFICH transmission parameters are as specified in clause and Table 7.6.1-2 respectively.
Out of sync transmission parameters (Note 1)	Number of Control OFDM symbols	3	Out of sync threshold Q_{out} and the corresponding hypothetical PDCCH/PCFICH transmission parameters are as specified in clause 7.6.1 and Table 7.6.1-1 respectively.
Note 1: See Table A.7.3.6.1-1 for other general test parameters.			
Note 2: This test is performed according to the principle defined in section A.3.7.2			

Table A.7.3.25.1-2: Cell specific test parameters for E-UTRAN FDD (cell # 1) for in-sync radio link monitoring test

Parameter	Unit	T1	T2	T3	T4	T5
-----------	------	----	----	----	----	----

$BW_{channel}$	MHz	5				
OCNG Pattern defined in A.3.2.1.16 (FDD)		OP.16 FDD				
SNR ^{Note 1,2}	dB	-2.3	-5.7	-12.2	-7.3	-2.3
Propagation condition		AWGN				
Note 1:	See Table A.7.3.6.1-2 for other general test parameters.					
Note 2:	The SNR values are specified for testing a UE which supports 2RX on at least one band. For testing of a UE which supports 4RX on all bands, the SNR during T3 and T4 is modified as specified in section A.3.8.1.					

A.7.3.25.2 Test Requirements

The requirements defined in section A.7.3.6.2 shall apply to this test case.

A.7.3.26 E-UTRAN FD-FDD Radio Link Monitoring Test for Out-of-sync for UE Category 0

A.7.3.26.1 Test Purpose and Environment

The purpose of this test is to verify that the FD-FDD category 0 UE properly detects the out of sync and in sync for the purpose of monitoring downlink radio link quality of the PCell. This test will partly verify the E-UTRAN FDD radio link monitoring requirements in clause 7.11.

The test parameters are given in Tables A.7.3.26.1-1, A.7.3.26.1-2 and A.7.3.26.1-3 below. There is one cell (cell 1), which is the active cell, in the test. The test consists of three successive time periods, with time duration of T1, T2 and T3 respectively. Figure A.7.3.26.1-1 shows the variation of the downlink SNR in the active cell to emulate out-of-sync and in-sync states. Prior to the start of the time duration T1, the UE shall be fully synchronized to cell 1. The UE shall be configured for periodic CQI reporting in PUCCH 1-0 mode with a reporting periodicity of 2 ms.

Table A.7.3.26.1-1: General test parameters for E-UTRAN FD-FDD out-of-sync testing for UE Category 0

Parameter		Unit	Value	Comment
Active cell			Cell 1	Cell 1 is on E-UTRA RF channel number 1
E-UTRA RF Channel Number			1	One E-UTRA FDD carrier frequency is used.
E-UTRA Channel Bandwidth ($BW_{channel}$)		MHz	10	
CP length			Normal	
Out of sync transmission parameters (Note 1)	DCI format		1A	As defined in section 5.3.3.1.3 in TS 36.212
	Number of Control OFDM symbols		2	Out of sync threshold Q_{out} and the corresponding hypothetical PDCCH/PCFICH transmission parameters are as specified in section 7.11.1 and Table 7.11.1-1 respectively.
	Aggregation level	CCE	8	
	ρ_A, ρ_B		-3	
	Ratio of PDCCH to RS EPRE	dB	4	
Ratio of PCFICH to RS EPRE	dB	1		
DRX			OFF	
Layer 3 filtering			Enabled	Counters: $N_{310} = 1; N_{311} = 1$
T310 timer		ms	0	T310 is disabled
T311 timer		ms	1000	T311 is enabled

Periodic CQI reporting mode		PUCCH 1-0	As defined in table 7.2.2-1 in TS 36.213.
CQI reporting periodicity	ms	2	Minimum CQI reporting periodicity
T1	s	1	
T2	s	0.4	
T3	s	0.5	
Note 1: PDCCH/PCFICH corresponding to the out of sync transmission parameters need not be included in the Reference Measurement Channel.			

Table A.7.3.26.1-2: Cell specific test parameters for E-UTRAN FD-FDD (cell # 1) for out-of-sync radio link monitoring tests for UE Category 0

Parameter	Unit	Test 1					
		T1	T2	T3			
E-UTRA RF Channel Number		1					
$BW_{channel}$	MHz	10					
PCFICH/PDCCH/PHICH parameters defined in A.3.1.2.1		R.7 FDD					
OCNG Pattern defined in A.3.2.1 (FDD)		OP.2 FDD					
ρ_A, ρ_B		-3					
PCFICH_RB	dB	1					
PDCCH_RA	dB	4					
PDCCH_RB	dB	4					
PBCH_RA	dB	-3					
PBCH_RB	dB						
PSS_RA	dB						
SSS_RA	dB						
PHICH_RA	dB						
PHICH_RB	dB						
PDSCH_RA	dB						
PDSCH_RB	dB						
OCNG_RA ^{Note 1}	dB						
OCNG_RB ^{Note 1}	dB						
N_{oc}	dBm/15 kHz				-98		
SNR ^{Note 6}	dB				-2.1	-6.9	-12.9
Propagation condition		ETU 70Hz					
Correlation Matrix and Antenna Configuration		2x1 Low					
Note 1: OCNG shall be used such that the resources in cell # 1 are fully allocated and a constant total transmitted power spectral density is achieved for all OFDM symbols.							
Note 2: The uplink resources for CQI reporting are assigned to the UE prior to the start of time period T1.							
Note 3: The timers and layer 3 filtering related parameters are configured prior to the start of time period T1.							
Note 4: The signal contains PDCCH for UEs other than the device under test as part of OCNG.							
Note 5: SNR levels correspond to the signal to noise ratio over the cell-specific reference signal REs.							
Note 6: The SNR in time periods T1, T2 and T3 is denoted as SNR1, SNR2 and SNR3 respectively in figure A.7.3.26.1-1.							

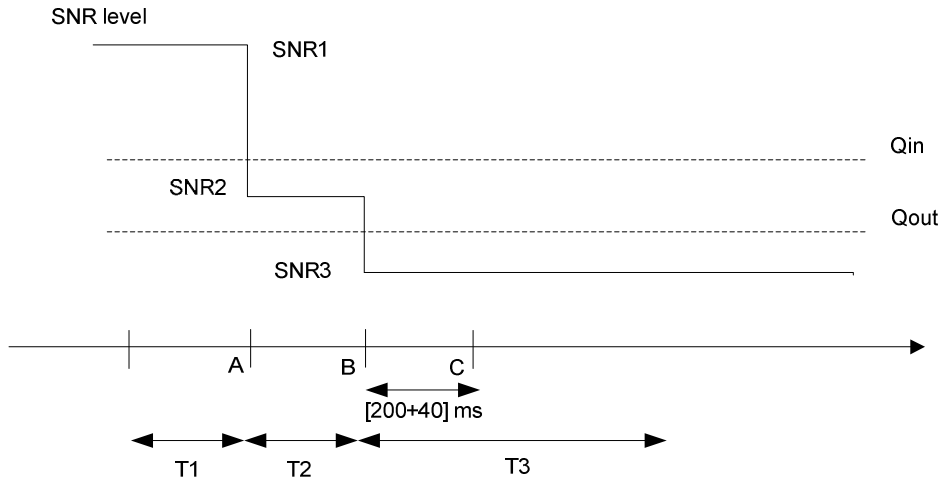

Figure A.7.3.26.1-1: SNR variation for out-of-sync testing

A.7.3.26.2 Test Requirements

The UE behaviour in each test during time durations T1, T2 and T3 shall be as follows:

During the period from time point A to time point B the UE shall transmit uplink signal at least in all subframes configured for CQI transmission according to the configured CQI reporting mode (PUCCH 1-0).

The UE shall stop transmitting uplink signal no later than time point C (240 ms after the start of time duration T3).

The rate of correct events observed during repeated tests shall be at least 90%.

A.7.3.27 E-UTRAN FD-FDD Radio Link Monitoring Test for In-sync for UE Category 0

A.7.3.27.1 Test Purpose and Environment

The purpose of this test is to verify that the FD-FDD category 0 UE properly detects the out of sync and in sync for the purpose of monitoring downlink radio link quality of the PCell. This test will partly verify the E-UTRAN FD-FDD radio link monitoring requirements in clause 7.11.

The test parameters are given in Tables A.7.3.27.1-1 and A.7.3.27.1-2 below. There is one cell (cell 1), which is the active cell, in the test. The test consists of five successive time periods, with time duration of T1, T2, T3, T4 and T5 respectively. Figure A.7.3.27.1-1 shows the variation of the downlink SNR in the active cell to emulate out-of-sync and in-sync states. Prior to the start of the time duration T1, the UE shall be fully synchronized to cell 1. The UE shall be configured for periodic CQI reporting in PUCCH 1-0 mode with a reporting periodicity of 2 ms.

Table A.7.3.27.1-1: General test parameters for E-UTRAN FD-FDD in-sync testing for UE Category 0

Parameter	Unit	Value	Comment
Active cell		Cell 1	Cell 1 is on E-UTRA RF channel number 1
E-UTRA RF Channel Number		1	One E-UTRA FDD carrier frequency is used.
E-UTRA Channel Bandwidth (BW _{channel})	MHz	10	
CP length		Normal	
In sync transmission parameters (Note 1)	DCI format	1C	As defined in clause 5.3.3.1.4 in TS 36.212
	Number of Control OFDM symbols	2	In sync threshold Q _{in} and the corresponding hypothetical PDCCH/PCFICH transmission parameters
	Aggregation level	CCE	4

	ρ_A, ρ_B		-3	are as specified in clause 7.11.1 and Table 7.11.1-2 respectively.
	Ratio of PDCCH to RS EPRE	dB	1	
	Ratio of PCFICH to RS EPRE	dB	1	
Out of sync transmission parameters (Note 1)	DCI format		1A	As defined in clause 5.3.3.1.3 in TS 36.212
	Number of Control OFDM symbols		2	Out of sync threshold Q_{out} and the corresponding hypothetical PDCCH/PCFICH transmission parameters are as specified in clause 7.11.1 and Table 7.11.1-1 respectively.
	Aggregation level	CCE	8	
	ρ_A, ρ_B		-3	
	Ratio of PDCCH to RS EPRE	dB	4	
Ratio of PCFICH to RS EPRE	dB	1		
DRX			OFF	
Layer 3 filtering			Enabled	Counters: N310 = 1; N311 = 1
T310 timer	ms		2000	T310 is enabled
T311 timer	ms		1000	T311 is enabled
Periodic CQI reporting mode			PUCCH 1-0	As defined in table 7.2.2-1 in TS 36.213.
CQI reporting periodicity	ms		2	Minimum CQI reporting periodicity
T1	s		0.5	
T2	s		0.4	
T3	s		1.46	
T4	s		0.4	
T5	s		1	
Note 1: PDCCH/PCFICH corresponding to the in-sync and out of sync transmission parameters need not be included in the Reference Measurement Channel.				

Table A.7.3.27.1-2: Cell specific test parameters for E-UTRAN FD-FDD (cell # 1) for in-sync radio link monitoring test for UE Category 0

Parameter	Unit	Test 1				
		T1	T2	T3	T4	T5
E-UTRA RF Channel Number		1				
$BW_{channel}$	MHz	10				
PCFICH/PDCCH/PHICH parameters defined in clause A.3.1.2.1		R.7 FDD				
OCNG Pattern defined in A.3.2.1 (FDD)		OP.2 FDD				
ρ_A, ρ_B		-3				
PCFICH_RB	dB	1				
PDCCH_RA	dB	1				
PDCCH_RB	dB	1				
PBCH_RA	dB	-3				
PBCH_RB	dB					
PSS_RA	dB					
SSS_RA	dB					
PHICH_RA	dB					
PHICH_RB	dB					
PDSCH_RA	dB					
PDSCH_RB	dB					
OCNG_RA ^{Note 1}	dB					
OCNG_RB ^{Note 1}	dB					

N_{oc}	dBm/15 kHz	-98				
SNR ^{Note 6}	dB	-2.1	-6.9	-12.9	-7.1	-2.1
Propagation condition		ETU 70Hz				
Correlation Matrix and Antenna Configuration		2x1 Low				
Note 1:	OCNG shall be used such that the resources in cell # 1 are fully allocated and a constant total transmitted power spectral density is achieved for all OFDM symbols.					
Note 2:	The uplink resources for CQI reporting are assigned to the UE prior to the start of time period T1.					
Note 3:	The timers and layer 3 filtering related parameters are configured prior to the start of time period T1.					
Note 4:	The signal contains PDCCH for UEs other than the device under test as part of OCNG.					
Note 5:	SNR levels correspond to the signal to noise ratio over the cell-specific reference signal REs.					
Note 6:	The SNR in time periods T1, T2, T3, T4 and T5 is denoted as SNR1, SNR2, SNR3, SNR4 and SNR5 respectively in figure A.7.3.27.1-1.					

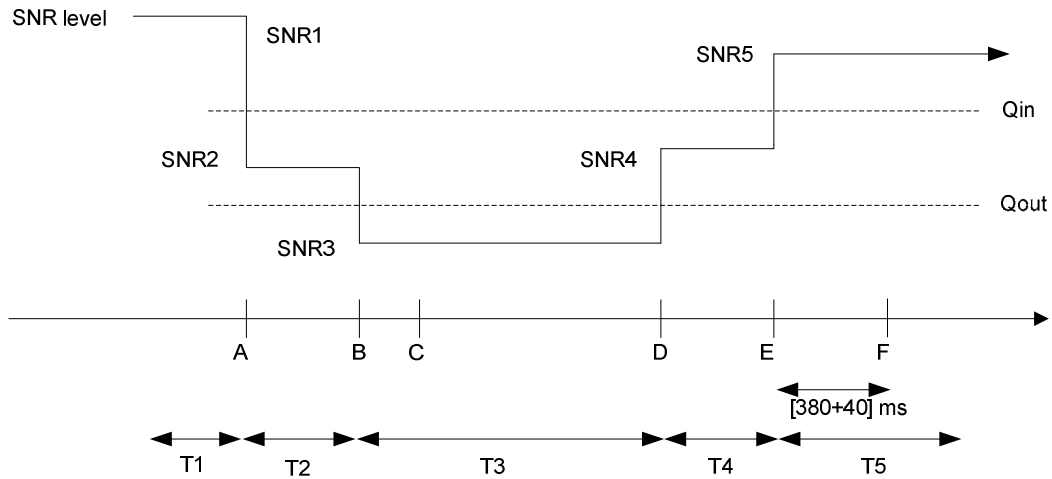

Figure A.7.3.27.1-1: SNR variation for in-sync testing

A.7.3.27.2 Test Requirements

The UE behaviour in each test during time durations T1, T2, T3, T4 and T5 shall be as follows:

During the period from time point A to time point F (420 ms after the start of time duration T5) the UE shall transmit uplink signal at least in all subframes configured for CQI transmission according to the configured CQI reporting mode (PUCCH 1-0).

The rate of correct events observed during repeated tests shall be at least 90%.

A.7.3.28 E-UTRAN FD-FDD Radio Link Monitoring Test for Out-of-sync in DRX for UE category 0

A.7.3.28.1 Test Purpose and Environment

The purpose of this test is to verify that the FD-FDD category 0 UE properly detects the out of sync and in sync for the purpose of monitoring downlink radio link quality of the PCell when DRX is used. This test will partly verify the E-UTRAN FD-FDD radio link monitoring requirements in clause 7.11.

The test parameters are given in Tables A.7.3.28.1-1, A.7.3.28.1-2, A.7.3.28.1-3 and A.7.3.28.1-4. There is one cell (cell 1), which is the active cell, in the test. The test consists of three successive time periods, with time duration of T1, T2 and T3 respectively. Figure A.7.3.28.1-1 shows the variation of the downlink SNR in the active cell to emulate out-of-sync and in-sync states. Prior to the start of the time duration T1, the UE shall be fully synchronized to cell 1. The

UE shall be configured for periodic CQI reporting in PUCCH 1-0 mode with a reporting periodicity of 2 ms. In the test, DRX configuration is enabled and DRX inactivity timer has already been expired, i.e. UE tries to decode PDCCH and to send periodic CQI during the period when On-duration timer is running. Time alignment timers shall be set to “infinity” so that UL timing alignment is maintained during the test.

Table A.7.3.28.1-1: General test parameters for E-UTRAN FD-FDD out-of-sync tests in DRX for UE category 0

Parameter		Unit	Value	Comment
Active cell			Cell 1	Cell 1 is on E-UTRA RF channel number 1
E-UTRA RF Channel Number			1	One E-UTRA FDD carrier frequency is used.
E-UTRA Channel Bandwidth (BW _{channel})		MHz	10	
CP length			Normal	
Out of sync transmission parameters (Note 1)	DCI format		1A	As defined in clause 5.3.3.1.3 in TS 36.212
	Number of Control OFDM symbols		2	Out of sync threshold Q _{out} and the corresponding hypothetical PDCCH/PCFICH transmission parameters are as specified in clause 7.11.1 and Table 7.11.1-1 respectively.
	Aggregation level	CCE	8	
	ρ_A, ρ_B		-3	
	Ratio of PDCCH to RS EPRE	dB	4	
Ratio of PCFICH to RS EPRE	dB	1		
DRX cycle		ms	1280	See Table A.7.3.28.1-3
Layer 3 filtering			Enabled	Counters: N310 = 1; N311 = 1
T310 timer		ms	0	T310 is disabled
T311 timer		ms	1000	T311 is enabled
Periodic CQI reporting mode			PUCCH 1-0	As defined in table 7.2.2-1 in TS 36.213.
CQI reporting periodicity		ms	2	Minimum CQI reporting periodicity
T1		s	32	
T2		s	12.8	
T3		s	13	
Note 1: PDCCH/PCFICH corresponding to the out of sync transmission parameters need not be included in the Reference Measurement Channel.				

Table A.7.3.28.1-2: Cell specific test parameters for E-UTRAN FD-FDD (cell # 1) for out-of-sync radio link monitoring tests in DRX for UE category 0

Parameter	Unit	Test 1		
		T1	T2	T3
E-UTRA RF Channel Number		1		
BW _{channel}	MHz	10		
PCFICH/PDCCH/PHICH parameters defined in clause A.3.1.2.1		R.7 FDD		
OCNG Pattern defined in A.3.2.1 (FDD)		OP.2 FDD		
ρ_A, ρ_B		-3		
PCFICH_RB	dB	1		
PDCCH_RA	dB	4		
PDCCH_RB	dB	4		
PBCH_RA	dB			
PBCH_RB	dB			
PSS_RA	dB			
SSS_RA	dB			

PHICH_RA	dB	-3		
PHICH_RB	dB			
PDSCH_RA	dB			
PDSCH_RB	dB			
OCNG_RA ^{Note1}	dB			
OCNG_RB ^{Note1}	dB			
N_{oc}	dBm/15 kHz	-98		
SNR ^{Note 6}	dB	-6.1	-10.0	-14.0
Propagation condition		AWGN		
Correlation Matrix and Antenna Configuration		2x1		
<p>Note 1: OCNG shall be used such that the resources in cell # 1 are fully allocated and a constant total transmitted power spectral density is achieved for all OFDM symbols.</p> <p>Note 2: The uplink resources for CQI reporting are assigned to the UE prior to the start of time period T1.</p> <p>Note 3: The timers and layer 3 filtering related parameters are configured prior to the start of time period T1.</p> <p>Note 4: The signal contains PDCCH for UEs other than the device under test as part of OCNG.</p> <p>Note 5: SNR levels correspond to the signal to noise ratio over the cell-specific reference signal REs.</p> <p>Note 6: The SNR in time periods T1, T2 and T3 is denoted as SNR1, SNR2 and SNR3 respectively in figure A.7.3.28.1-1.</p>				

Table A.7.3.28.1-3: DRX-Configuration for E-UTRAN FD-FDD out-of-sync tests for UE category 0

Field	Value	Comment
onDurationTimer	psf2	As specified in clause 6.3.2 in TS 36.331
drx-InactivityTimer	psf1	
drx-RetransmissionTimer	psf1	
longDRX-CycleStartOffset	sf1280	
shortDRX	disable	

Table A.7.3.28.1-4: *TimeAlignmentTimer* -Configuration for E-UTRAN FD-FDD out-of-sync testing for UE category 0

Field	Value	Comment
TimeAlignmentTimer	infinity	As specified in clause 6.3.2 in TS 36.331
sr-ConfigIndex	0	For further information see clause 6.3.2 in TS 36.331 and section 10.1 in TS 36.213.

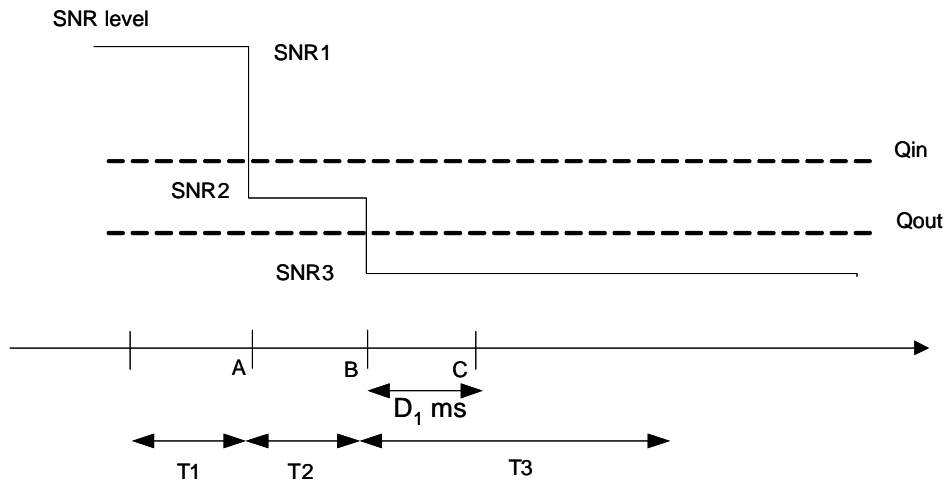

Figure A.7.3.28.1-1: SNR variation for out-of-sync testing in DRX

A.7.3.28.2 Test Requirements

The UE behaviour in each test during time durations T1, T2 and T3 shall be as follows:

During the period from time point A to time point B the UE shall transmit uplink signal at least once every DRX cycle, in the On-duration part of the cycle in the subframe according to the configured CQI reporting mode (PUCCH 1-0).

The UE shall stop transmitting uplink signal no later than time point C (duration $D_1 = 6500$ ms after the start of time duration T3).

The rate of correct events observed during repeated tests shall be at least 90%.

A.7.3.29 E-UTRAN FD-FDD Radio Link Monitoring Test for In-sync in DRX for UE Category 0

A.7.3.29.1 Test Purpose and Environment

The purpose of this test is to verify that the FD-FDD category 0 UE properly detects the out of sync and in sync for the purpose of monitoring downlink radio link quality of the PCell when DRX is used. This test will partly verify the E-UTRAN FD-FDD radio link monitoring requirements in clause 7.11.

The test parameters are given in Tables A.7.3.29.1-1, A.7.3.29.1-2, A.7.3.29.1-3 and A.7.3.29.1-4. There is one cell (cell 1), which is the active cell, in the test. The test consists of five successive time periods, with time duration of T1, T2, T3, T4 and T5 respectively. Figure A.7.3.29.1-1 shows the variation of the downlink SNR in the active cell to emulate out-of-sync and in-sync states. Prior to the start of the time duration T1, the UE shall be fully synchronized to cell 1. The UE shall be configured for periodic CQI reporting in PUCCH 1-0 mode with a reporting periodicity of 2 ms. In the test, DRX configuration is enabled and DRX inactivity timer has already been expired, i.e. UE tries to decode PDCCH and to send periodic CQI during the period when On-duration timer is running. Time alignment timers shall be set to “infinity” so that UL timing alignment is maintained during the test.

Table A.7.3.29.1-1: General test parameters for E-UTRAN FD-FDD in-sync test in DRX for UE category 0

Parameter	Unit	Value	Comment
Active cell		Cell 1	Cell 1 is on E-UTRA RF channel number 1
E-UTRA RF Channel Number		1	One E-UTRA FDD carrier frequency is used.
E-UTRA Channel Bandwidth ($BW_{channel}$)	MHz	10	
CP length		Normal	
	DCI format	1C	As defined in clause 5.3.3.1.4 in TS 36.212

In sync transmission parameters (Note 1)	Number of Control OFDM symbols		2	In sync threshold Q_{in} and the corresponding hypothetical PDCCH/PCFICH transmission parameters are as specified in clause 7.11.1 and Table 7.11.1-2 respectively.
	Aggregation level	CCE	4	
	ρ_A, ρ_B		-3	
	Ratio of PDCCH to RS EPRE		1	
	Ratio of PCFICH to RS EPRE		1	
Out of sync transmission parameters (Note 1)	DCI format		1A	As defined in clause 5.3.3.1.3 in TS 36.212
	Number of Control OFDM symbols		2	Out of sync threshold Q_{out} and the corresponding hypothetical PDCCH/PCFICH transmission parameters are as specified in clause 7.11.1 and Table 7.11.1-1 respectively.
	Aggregation level	CCE	8	
	ρ_A, ρ_B		-3	
	Ratio of PDCCH to RS EPRE	dB	4	
Ratio of PCFICH to RS EPRE	dB	1		
DRX cycle	ms		40	See Table 7.3.29.1-3
Layer 3 filtering			Enabled	Counters: $N_{310} = 1; N_{311} = 1$
T310 timer	ms		2000	T310 is enabled
T311 timer	ms		1000	T311 is enabled
Periodic CQI reporting mode			PUCCH 1-0	As defined in table 7.2.2-1 in TS 36.213.
CQI reporting periodicity	ms		2	Minimum CQI reporting periodicity
T1	s		4	
T2	s		1.6	
T3	s		1.46	
T4	s		0.4	
T5	s		4	
Note 1: PDCCH/PCFICH corresponding to the in-sync and out of sync transmission parameters need not be included in the Reference Measurement Channel.				

Table A.7.3.29.1-2: Cell specific test parameters for E-UTRAN FD-FDD (cell # 1) for in-sync radio link monitoring test in DRX for UE category 0

Parameter	Unit	Test 1				
		T1	T2	T3	T4	T5
E-UTRA RF Channel Number		1				
$BW_{channel}$	MHz	10				
PCFICH/PDCCH/PHICH parameters defined in clause A.3.1.2.1		R.7 FDD				
OCNG Pattern defined in A.3.2.1 (FDD)		OP.2 FDD				
ρ_A, ρ_B		-3				
PCFICH_RB	dB	1				
PDCCH_RA	dB	1				
PDCCH_RB	dB	1				
PBCH_RA	dB	-3				
PBCH_RB	dB					
PSS_RA	dB					
SSS_RA	dB					
PHICH_RA	dB					
PHICH_RB	dB					
PDSCH_RA	dB					
PDSCH_RB	dB					
OCNG_RA ^{Note1}	dB					
OCNG_RB ^{Note1}	dB					
N_{oc}	dBm/15 kHz	-98				
SNR ^{Note 8}	dB	-6.1	-10.0	-14.0	-10.1	-6.1
Propagation condition		AWGN				

Correlation Matrix and Antenna Configuration		2x1
<p>Note 1: OCNG shall be used such that the resources in cell # 1 are fully allocated and a constant total transmitted power spectral density is achieved for all OFDM symbols.</p> <p>Note 2: The uplink resources for CQI reporting are assigned to the UE prior to the start of time period T1.</p> <p>Note 3: The timers and layer 3 filtering related parameters are configured prior to the start of time period T1.</p> <p>Note 4: The signal contains PDCCH for UEs other than the device under test as part of OCNG.</p> <p>Note 5: SNR levels correspond to the signal to noise ratio over the cell-specific reference signal REs.</p> <p>Note 6: The SNR in time periods T1, T2, T3, T4 and T5 is denoted as SNR1, SNR2, SNR3, SNR4 and SNR5 respectively in figure A.7.3.29.1-1.</p>		

Table A.7.3.29.1-3: DRX-Configuration for E-UTRAN FD-FDD out-of-sync tests for UE category 0

Field	Value	Comment
onDurationTimer	psf2	As specified in clause 6.3.2 in TS 36.331
drx-InactivityTimer	psf1	
drx-RetransmissionTimer	psf1	
longDRX-CycleStartOffset	sf40	
shortDRX	disable	

Table A.7.3.29.1-4: TimeAlignmentTimer-Configuration for E-UTRAN FD-FDD out-of-sync testing for UE category 0

Field	Value	Comment
TimeAlignmentTimer	infinity	As specified in clause 6.3.2 in TS 36.331
sr-ConfigIndex	0	For further information see clause 6.3.2 in TS 36.331 and section 10.1 in TS 36.213.

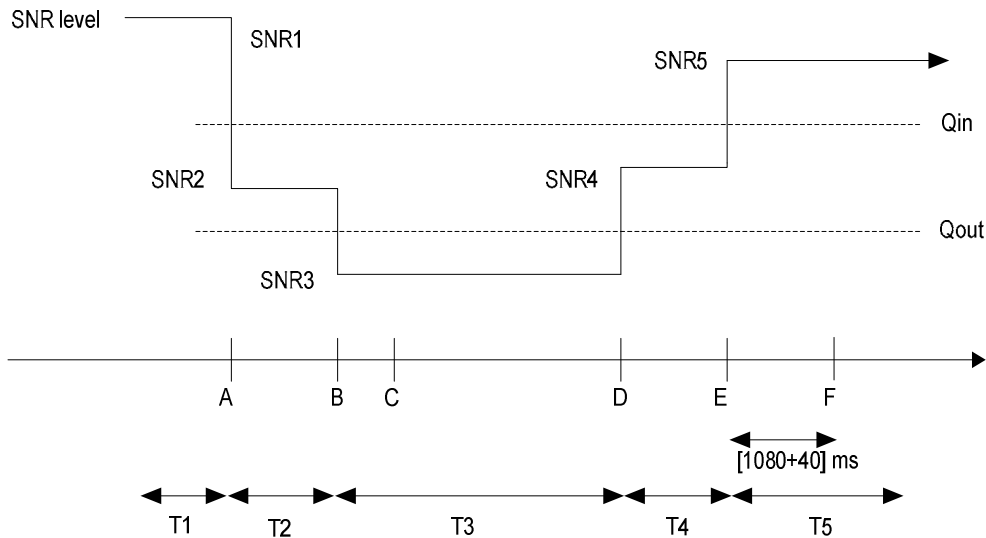

Figure A.7.3.29.1-1: SNR variation for in-sync testing in DRX

A.7.3.29.2 Test Requirements

The UE behaviour in each test during time durations T1, T2, T3, T4 and T5 shall be as follows:

During the period from time point A to time point F (1120 ms after the start of time duration T5) the UE shall transmit uplink signal at least once every DRX cycle, in the On-duration part of the cycle in the subframe according to the configured CQI reporting mode (PUCCH 1-0).

The rate of correct events observed during repeated tests shall be at least 90%.

A.7.3.30 E-UTRAN HD-FDD Radio Link Monitoring Test for Out-of-sync for UE Category 0

A.7.3.30.1 Test Purpose and Environment

The purpose of this test is to verify that the HD-FDD category 0 UE properly detects the out of sync and in sync for the purpose of monitoring downlink radio link quality of the PCell. This test will partly verify the E-UTRAN HD-FDD radio link monitoring requirements in clause 7.11.

The test parameters are given in Tables A.7.3.30.1-1, A.7.3.30.1-2 and A.7.3.30.1-3 below. There is one cell (cell 1), which is the active cell, in the test. The test consists of three successive time periods, with time duration of T1, T2 and T3 respectively. Figure A.7.3.30.1-1 shows the variation of the downlink SNR in the active cell to emulate out-of-sync and in-sync states. Prior to the start of the time duration T1, the UE shall be fully synchronized to cell 1. The UE shall be configured for periodic CQI reporting in PUCCH 1-0 mode with a reporting periodicity of 10 ms.

Table A.7.3.30.1-1: General test parameters for E-UTRAN HD-FDD out-of-sync testing for UE Category 0

Parameter		Unit	Value	Comment
Active cell			Cell 1	Cell 1 is on E-UTRA RF channel number 1
E-UTRA RF Channel Number			1	One E-UTRA FDD carrier frequency is used.
E-UTRA Channel Bandwidth (BW_{channel})		MHz	10	
CP length			Normal	
Out of sync transmission parameters (Note 1)	DCI format		1A	As defined in section 5.3.3.1.3 in TS 36.212
	Number of Control OFDM symbols		2	Out of sync threshold Q_{out} and the corresponding hypothetical PDCCH/PCFICH transmission parameters are as specified in section 7.11.1 and Table 7.11.1-1 respectively.
	Aggregation level	CCE	8	
	ρ_A, ρ_B		-3	
	Ratio of PDCCH to RS EPRE	dB	4	
Ratio of PCFICH to RS EPRE	dB	1		
DRX			OFF	
Layer 3 filtering			Enabled	Counters: $N_{310} = 1; N_{311} = 1$
T310 timer		ms	0	T310 is disabled
T311 timer		ms	1000	T311 is enabled
Periodic CQI reporting mode			PUCCH 1-0	As defined in table 7.2.2-1 in TS 36.213.
CQI reporting periodicity		ms	[10]	Minimum CQI reporting periodicity
T1		s	1	
T2		s	0.4	
T3		s	0.5	
Note 1: PDCCH/PCFICH corresponding to the out of sync transmission parameters need not be included in the Reference Measurement Channel.				

Table A.7.3.30.1-2: Cell specific test parameters for E-UTRAN HD-FDD (cell # 1) for out-of-sync radio link monitoring for UE Category 0

Parameter	Unit	Test 1		
		T1	T2	T3

E-UTRA RF Channel Number		1		
BW _{channel}	MHz	10		
PCFICH/PDCCH/PHICH parameters defined in section A.3.1.2.3		R.4 HD-FDD		
OCNG Pattern defined in A.3.2.1 (FDD)		OP.2 FDD		
ρ_A, ρ_B		-3		
PCFICH_RB	dB	1		
PDCCH_RA	dB	4		
PDCCH_RB	dB	4		
PBCH_RA	dB	-3		
PBCH_RB	dB			
PSS_RA	dB			
SSS_RA	dB			
PHICH_RA	dB			
PHICH_RB	dB			
PDSCH_RA	dB			
PDSCH_RB	dB			
OCNG_RA ^{Note 1}	dB			
OCNG_RB ^{Note 1}	dB			
N_{oc}	dBm/15 kHz	-98		
SNR ^{Note 6}	dB	-1.2	-6.0	-12.0
Propagation condition		ETU 70Hz		
Correlation Matrix and Antenna Configuration		2x1 Low		
<p>Note 1: OCNG shall be used such that the resources in cell # 1 are fully allocated and a constant total transmitted power spectral density is achieved for all OFDM symbols.</p> <p>Note 2: The uplink resources for CQI reporting are assigned to the UE prior to the start of time period T1.</p> <p>Note 3: The timers and layer 3 filtering related parameters are configured prior to the start of time period T1.</p> <p>Note 4: The signal contains PDCCH for UEs other than the device under test as part of OCNG.</p> <p>Note 5: SNR levels correspond to the signal to noise ratio over the cell-specific reference signal REs.</p> <p>Note 6: The SNR in time periods T1, T2 and T3 is denoted as SNR1, SNR2 and SNR3 respectively in figure A.7.3.30.1-1.</p>				

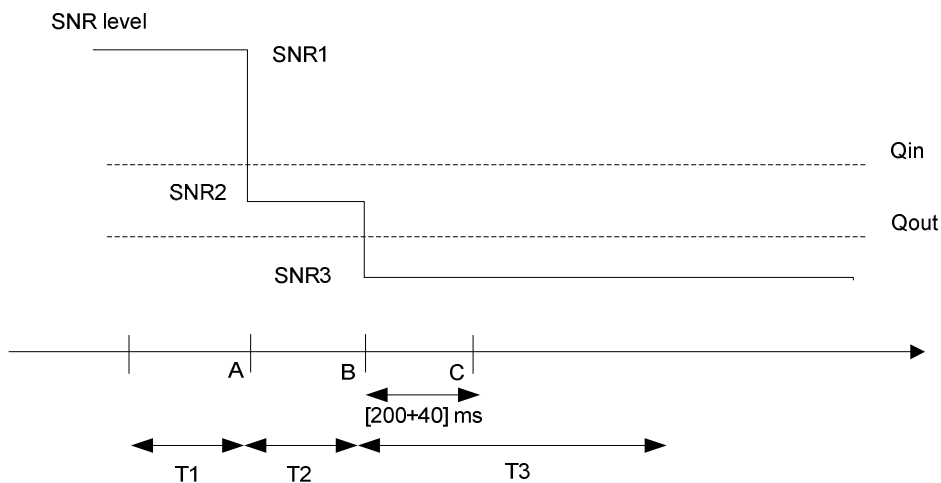

Figure A.7.3.30.1-1: SNR variation for out-of-sync testing

A.7.3.30.2 Test Requirements

The UE behaviour in each test during time durations T1, T2 and T3 shall be as follows:

During the period from time point A to time point B the UE shall transmit uplink signal at least in all subframes configured for CQI transmission according to the configured CQI reporting mode (PUCCH 1-0).

The UE shall stop transmitting uplink signal no later than time point C (240 ms after the start of time duration T3).

The rate of correct events observed during repeated tests shall be at least 90%.

A.7.3.31 E-UTRAN HD-FDD Radio Link Monitoring Test for In-sync for UE Category 0

A.7.3.31.1 Test Purpose and Environment

The purpose of this test is to verify that the HD-FDD category 0 UE properly detects the out of sync and in sync for the purpose of monitoring downlink radio link quality of the PCell. This test will partly verify the E-UTRAN HD-FDD radio link monitoring requirements in clause 7.11.

The test parameters are given in Tables A.7.3.31.1-1 and A.7.3.31.1-2 below. There is one cell (cell 1), which is the active cell, in the test. The test consists of five successive time periods, with time duration of T1, T2, T3, T4 and T5 respectively. Figure A.7.3.31.1-1 shows the variation of the downlink SNR in the active cell to emulate out-of-sync and in-sync states. Prior to the start of the time duration T1, the UE shall be fully synchronized to cell 1. The UE shall be configured for periodic CQI reporting in PUCCH 1-0 mode with a reporting periodicity of 10 ms.

Table A.7.3.31.1-1: General test parameters for E-UTRAN HD-FDD in-sync testing

Parameter		Unit	Value	Comment
Active cell			Cell 1	Cell 1 is on E-UTRA RF channel number 1
E-UTRA RF Channel Number			1	One E-UTRA FDD carrier frequency is used.
E-UTRA Channel Bandwidth (BW_{channel})		MHz	10	
CP length			Normal	
In sync transmission parameters (Note 1)	DCI format		1C	As defined in clause 5.3.3.1.4 in TS 36.212
	Number of Control OFDM symbols		2	In sync threshold Q_{in} and the corresponding hypothetical PDCCH/PCFICH transmission parameters are as specified in clause 7.11.1 and Table 7.11.1-2 respectively.
	Aggregation level	CCE	4	
	ρ_A, ρ_B		-3	
	Ratio of PDCCH to RS EPRE	dB	1	
Ratio of PCFICH to RS EPRE	dB	1		
Out of sync transmission parameters (Note 1)	DCI format		1A	As defined in clause 5.3.3.1.3 in TS 36.212
	Number of Control OFDM symbols		2	Out of sync threshold Q_{out} and the corresponding hypothetical PDCCH/PCFICH transmission parameters are as specified in clause 7.11.1 and Table 7.11.1-1 respectively.
	Aggregation level	CCE	8	
	ρ_A, ρ_B		-3	
	Ratio of PDCCH to RS EPRE	dB	4	
Ratio of PCFICH to RS EPRE	dB	1		
DRX			OFF	
Layer 3 filtering			Enabled	Counters: $N_{310} = 1; N_{311} = 1$
T310 timer		ms	2000	T310 is enabled
T311 timer		ms	1000	T311 is enabled
Periodic CQI reporting mode			PUCCH 1-0	As defined in table 7.2.2-1 in TS 36.213.
CQI reporting periodicity		ms	[10]	Minimum CQI reporting

			periodicity
T1	s	0.5	
T2	s	0.4	
T3	s	1.46	
T4	s	0.4	
T5	s	1	
Note 1: PDCCH/PCFICH corresponding to the in-sync and out of sync transmission parameters need not be included in the Reference Measurement Channel.			

Table A.7.3.31.1-2: Cell specific test parameters for E-UTRAN HD-FDD (cell # 1) for in-sync radio link monitoring test for UE category 0

Parameter	Unit	Test 1				
		T1	T2	T3	T4	T5
E-UTRA RF Channel Number		1				
BW _{channel}	MHz	10				
PCFICH/PDCCH/PHICH parameters defined in clause A.3.1.2.3		R.4 HD-FDD				
OCNG Pattern defined in A.3.2.1 (FDD)		OP.2 FDD				
ρ_A, ρ_B		-3				
PCFICH_RB	dB	1				
PDCCH_RA	dB	1				
PDCCH_RB	dB	1				
PBCH_RA	dB	-3				
PBCH_RB	dB					
PSS_RA	dB					
SSS_RA	dB					
PHICH_RA	dB					
PHICH_RB	dB					
PDSCH_RA	dB					
PDSCH_RB	dB					
OCNG_RA ^{Note 1}	dB					
OCNG_RB ^{Note 1}	dB					
N_{oc}	dBm/15 kHz	-98				
SNR ^{Note 6}	dB	-1.2	-6.0	-12.0	-6.2	-1.2
Propagation condition		ETU 70Hz				
Correlation Matrix and Antenna Configuration		2x1 low				
<p>Note 1: OCNG shall be used such that the resources in cell # 1 are fully allocated and a constant total transmitted power spectral density is achieved for all OFDM symbols.</p> <p>Note 2: The uplink resources for CQI reporting are assigned to the UE prior to the start of time period T1.</p> <p>Note 3: The timers and layer 3 filtering related parameters are configured prior to the start of time period T1.</p> <p>Note 4: The signal contains PDCCH for UEs other than the device under test as part of OCNG.</p> <p>Note 5: SNR levels correspond to the signal to noise ratio over the cell-specific reference signal REs.</p> <p>Note 6: The SNR in time periods T1, T2, T3, T4 and T5 is denoted as SNR1, SNR2, SNR3, SNR4 and SNR5 respectively in figure A.7.3.31.1-1.</p>						

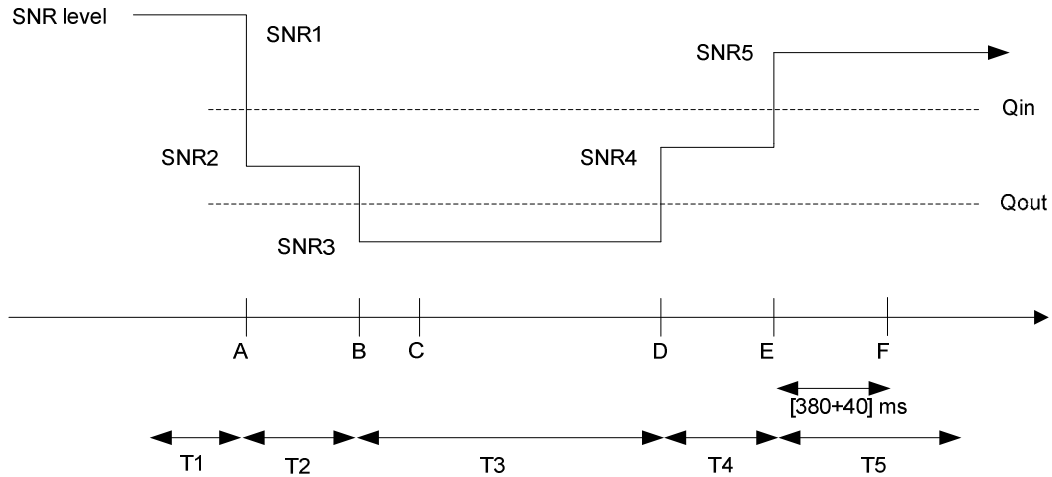

Figure A.7.3.31.1-1: SNR variation for in-sync testing

A.7.3.31.2 Test Requirements

The UE behaviour in each test during time durations T1, T2, T3, T4 and T5 shall be as follows:

During the period from time point A to time point F (420 ms after the start of time duration T5) the UE shall transmit uplink signal at least in all subframes configured for CQI transmission according to the configured CQI reporting mode (PUCCH 1-0).

The rate of correct events observed during repeated tests shall be at least 90%.

A.7.3.32 E-UTRAN HD-FDD Radio Link Monitoring Test for Out-of-sync in DRX for UE category 0

A.7.3.32.1 Test Purpose and Environment

The purpose of this test is to verify that the HD-FDD category 0 UE properly detects the out of sync and in sync for the purpose of monitoring downlink radio link quality of the PCell when DRX is used. This test will partly verify the E-UTRAN HD-FDD radio link monitoring requirements in clause 7.11.

The test parameters are given in Tables A.7.3.32.1-1, A.7.3.32.1-2, A.7.3.32.1-3 and A.7.3.32.1-4. There is one cell (cell 1), which is the active cell, in the test. The test consists of three successive time periods, with time duration of T1, T2 and T3 respectively. Figure A.7.3.32.1-1 shows the variation of the downlink SNR in the active cell to emulate out-of-sync and in-sync states. Prior to the start of the time duration T1, the UE shall be fully synchronized to cell 1. The UE shall be configured for periodic CQI reporting in PUCCH 1-0 mode with a reporting periodicity of 5ms. In the test, DRX configuration is enabled and DRX inactivity timer has already been expired, i.e. UE tries to decode PDCCH and to send periodic CQI during the period when On-duration timer is running. Time alignment timers shall be set to “infinity” so that UL timing alignment is maintained during the test.

Table A.7.3.32.1-1: General test parameters for E-UTRAN HD-FDD out-of-sync tests in DRX for UE category 0

Parameter		Unit	Value	Comment
Active cell			Cell 1	Cell 1 is on E-UTRA RF channel number 1
E-UTRA RF Channel Number			1	One E-UTRA FDD carrier frequency is used.
E-UTRA Channel Bandwidth (BW _{channel})		MHz	10	
CP length			Normal	
Out of sync transmission parameters (Note 1)	DCI format		1A	As defined in clause 5.3.3.1.3 in TS 36.212
	Number of Control OFDM symbols		2	Out of sync threshold Q _{out} and the corresponding hypothetical PDCCH/PCFICH transmission parameters are as specified in clause 7.11.1 and Table 7.11.1-1 respectively.
	Aggregation level	CCE	8	
	ρ_A, ρ_B		-3	
	Ratio of PDCCH to RS EPRE	dB	4	
Ratio of PCFICH to RS EPRE	dB	1		
DRX cycle		ms	1280	See Table A.7.3.32.1-3
Layer 3 filtering			Enabled	Counters: N310 = 1; N311 = 1
T310 timer		ms	0	T310 is disabled
T311 timer		ms	1000	T311 is enabled
Periodic CQI reporting mode			PUCCH 1-0	As defined in table 7.2.2-1 in TS 36.213.
CQI reporting periodicity		ms	5	Minimum CQI reporting periodicity
T1		s	32	
T2		s	12.8	
T3		s	13	
Note 1: PDCCH/PCFICH corresponding to the out of sync transmission parameters need not be included in the Reference Measurement Channel.				

Table A.7.3.32.1-2: Cell specific test parameters for E-UTRAN HD-FDD (cell # 1) for out-of-sync radio link monitoring tests in DRX for UE category 0

Parameter	Unit	Test 1		
		T1	T2	T3
E-UTRA RF Channel Number		1		
BW _{channel}	MHz	10		
PCFICH/PDCCH/PHICH parameters specified in clause A.3.1.2.3		R.4 HD-FDD		
OCNG Pattern defined in A.3.2.1 (FDD)		OP.2 FDD		
ρ_A, ρ_B		-3		
PCFICH_RB	dB	1		
PDCCH_RA	dB	4		
PDCCH_RB	dB	4		
PBCH_RA	dB	-3		
PBCH_RB	dB			
PSS_RA	dB			
SSS_RA	dB			
PHICH_RA	dB			
PHICH_RB	dB			
PDSCH_RA	dB			
PDSCH_RB	dB			
OCNG_RA ^{Note1}	dB			
OCNG_RB ^{Note1}	dB			
N_{oc}	dBm/15 kHz	-98		

SNR ^{Note 6}	dB	-5.4	-9.5	-13.5
Propagation condition		AWGN		
Correlation Matrix and Antenna Configuration		2x1		
Note 1:	OCNG shall be used such that the resources in cell # 1 are fully allocated and a constant total transmitted power spectral density is achieved for all OFDM symbols.			
Note 2:	The uplink resources for CQI reporting are assigned to the UE prior to the start of time period T1.			
Note 3:	The timers and layer 3 filtering related parameters are configured prior to the start of time period T1.			
Note 4:	The signal contains PDCCH for UEs other than the device under test as part of OCNG.			
Note 5:	SNR levels correspond to the signal to noise ratio over the cell-specific reference signal REs.			
Note 6:	The SNR in time periods T1, T2 and T3 is denoted as SNR1, SNR2 and SNR3 respectively in figure A.7.3.32.1-1.			

Table A.7.3.32.1-3: DRX-Configuration for E-UTRAN HD-FDD out-of-sync test for UE category 0

Field	Value	Comment
onDurationTimer	psf5	As specified in clause 6.3.2 in TS 36.331
drx-InactivityTimer	psf1	
drx-RetransmissionTimer	psf1	
longDRX-CycleStartOffset	sf1280	
shortDRX	disable	

Table A.7.3.32.1-4: TimeAlignmentTimer -Configuration for E-UTRAN HD-FDD out-of-sync testing for UE category 0

Field	Value	Comment
TimeAlignmentTimer	infinity	As specified in clause 6.3.2 in TS 36.331
sr-ConfigIndex	0	For further information see clause 6.3.2 in TS 36.331 and section 10.1 in TS 36.213.

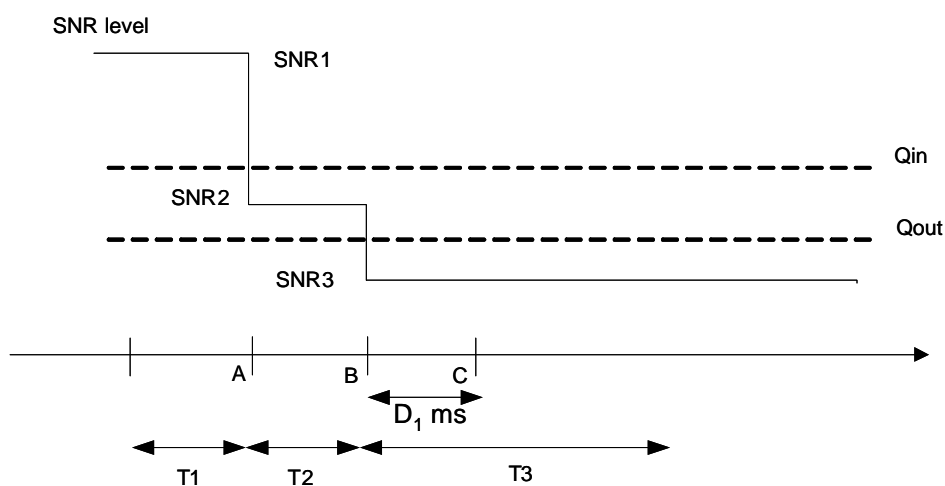

Figure A.7.3.32.1-1: SNR variation for out-of-sync testing in DRX

A.7.3.32.2 Test Requirements

The UE behaviour in each test during time durations T1, T2 and T3 shall be as follows:

During the period from time point A to time point B the UE shall transmit uplink signal at least once every DRX cycle, in the On-duration part of the cycle in the subframe according to the configured CQI reporting mode (PUCCH 1-0).

The UE shall stop transmitting uplink signal no later than time point C (duration $D_1 = 6500$ ms after the start of time duration T3).

The rate of correct events observed during repeated tests shall be at least 90%.

A.7.3.33 E-UTRAN HD-FDD Radio Link Monitoring Test for In-sync in DRX for UE Category 0

A.7.3.33.1 Test Purpose and Environment

The purpose of this test is to verify that the HD-FDD category 0 UE properly detects the out of sync and in sync for the purpose of monitoring downlink radio link quality of the PCell when DRX is used. This test will partly verify the E-UTRAN HD-FDD radio link monitoring requirements in clause 7.11.

The test parameters are given in Tables A.7.3.33.1-1, A.7.3.33.1-2, A.7.3.33.1-3 and A.7.3.33.1-4. There is one cell (cell 1), which is the active cell, in the test. The test consists of five successive time periods, with time duration of T1, T2, T3, T4 and T5 respectively. Figure A.7.3.33.1-1 shows the variation of the downlink SNR in the active cell to emulate out-of-sync and in-sync states. Prior to the start of the time duration T1, the UE shall be fully synchronized to cell 1. The UE shall be configured for periodic CQI reporting in PUCCH 1-0 mode with a reporting periodicity of 5 ms. In the test, DRX configuration is enabled and DRX inactivity timer has already been expired, i.e. UE tries to decode PDCCH and to send periodic CQI during the period when On-duration timer is running. Time alignment timers shall be set to "infinity" so that UL timing alignment is maintained during the test.

Table A.7.3.33.1-1: General test parameters for E-UTRAN HD-FDD in-sync test in DRX for UE category 0

Parameter		Unit	Value	Comment
Active cell			Cell 1	Cell 1 is on E-UTRA RF channel number 1
E-UTRA RF Channel Number			1	One E-UTRA FDD carrier frequency is used.
E-UTRA Channel Bandwidth (BW_{channel})		MHz	10	
CP length			Normal	
In sync transmission parameters (Note 1)	DCI format		1C	As defined in clause 5.3.3.1.4 in TS 36.212
	Number of Control OFDM symbols		2	In sync threshold Q_{in} and the corresponding hypothetical PDCCH/PCFICH transmission parameters are as specified in clause 7.11.1 and Table 7.11.1-2 respectively.
	Aggregation level	CCE	4	
	ρ_A, ρ_B		-3	
	Ratio of PDCCH to RS EPRE	dB	1	
	Ratio of PCFICH to RS EPRE	dB	1	
Out of sync transmission parameters (Note 1)	DCI format		1A	As defined in clause 5.3.3.1.3 in TS 36.212
	Number of Control OFDM symbols		2	Out of sync threshold Q_{out} and the corresponding hypothetical PDCCH/PCFICH transmission parameters are as specified in clause 7.11.1 and Table 7.11.1-1 respectively.
	Aggregation level	CCE	8	
	ρ_A, ρ_B		-3	
	Ratio of PDCCH to RS EPRE	dB	4	
	Ratio of PCFICH to RS EPRE	dB	1	
DRX cycle		ms	40	See Table A.7.3.33.1-3

Layer 3 filtering		Enabled	Counters: N310 = 1; N311 = 1
T310 timer	ms	2000	T310 is enabled
T311 timer	ms	1000	T311 is enabled
Periodic CQI reporting mode		PUCCH 1-0	As defined in table 7.2.2-1 in TS 36.213.
CQI reporting periodicity	ms	5	Minimum CQI reporting periodicity
T1	s	4	
T2	s	1.6	
T3	s	1.46	
T4	s	0.4	
T5	s	4	
Note 1: PDCCH/PCFICH corresponding to the in-sync and out of sync transmission parameters need not be included in the Reference Measurement Channel.			

Table A.7.3.33.1-2: Cell specific test parameters for E-UTRAN HD-FDD (cell # 1) for in-sync radio link monitoring test in DRX for UE category 0

Parameter	Unit	Test 1				
		T1	T2	T3	T4	T5
E-UTRA RF Channel Number		1				
$BW_{channel}$	MHz	10				
PCFICH/PDCCH/PHICH parameters specified in clause A.3.1.2.3		R.4 HD-FDD				
OCNG Pattern defined in A.3.2.1 (FDD)		OP.2 FDD				
ρ_A, ρ_B		-3				
PCFICH_RB	dB	1				
PDCCH_RA	dB	1				
PDCCH_RB	dB	1				
PBCH_RA	dB	-3				
PBCH_RB	dB					
PSS_RA	dB					
SSS_RA	dB					
PHICH_RA	dB					
PHICH_RB	dB					
PDSCH_RA	dB					
PDSCH_RB	dB					
OCNG_RA ^{Note1}	dB					
OCNG_RB ^{Note1}	dB					
N_{oc}	dBm/15 kHz	-98				
SNR ^{Note 6}	dB	-5.4	-9.5	-13.5	-9.4	-5.4
Propagation condition		AWGN				
Correlation Matrix and Antenna Configuration		2x1				
Note 1: OCNG shall be used such that the resources in cell # 1 are fully allocated and a constant total transmitted power spectral density is achieved for all OFDM symbols. Note 2: The uplink resources for CQI reporting are assigned to the UE prior to the start of time period T1. Note 3: The timers and layer 3 filtering related parameters are configured prior to the start of time period T1. Note 4: The signal contains PDCCH for UEs other than the device under test as part of OCNG. Note 5: SNR levels correspond to the signal to noise ratio over the cell-specific reference signal REs. Note 6: The SNR in time periods T1, T2, T3, T4 and T5 is denoted as SNR1, SNR2, SNR3, SNR4 and SNR5 respectively in figure A.7.3.33.1-1.						

Table A.7.3.33.1-3: DRX-Configuration for E-UTRAN HD-FDD out-of-sync test for UE category 0

Field	Value	Comment
onDurationTimer	psf5	As specified in clause 6.3.2 in TS 36.331
drx-InactivityTimer	psf1	

drx-RetransmissionTimer	psf1	
longDRX-CycleStartOffset	sf40	
shortDRX	disable	

Table A.7.3.33.1-4: TimeAlignmentTimer -Configuration for E-UTRAN HD-FDD out-of-sync testing for UE category 0

Field	Value	Comment
TimeAlignmentTimer	infinity	As specified in clause 6.3.2 in TS 36.331
sr-ConfigIndex	0	For further information see clause 6.3.2 in TS 36.331 and section 10.1 in TS 36.213.

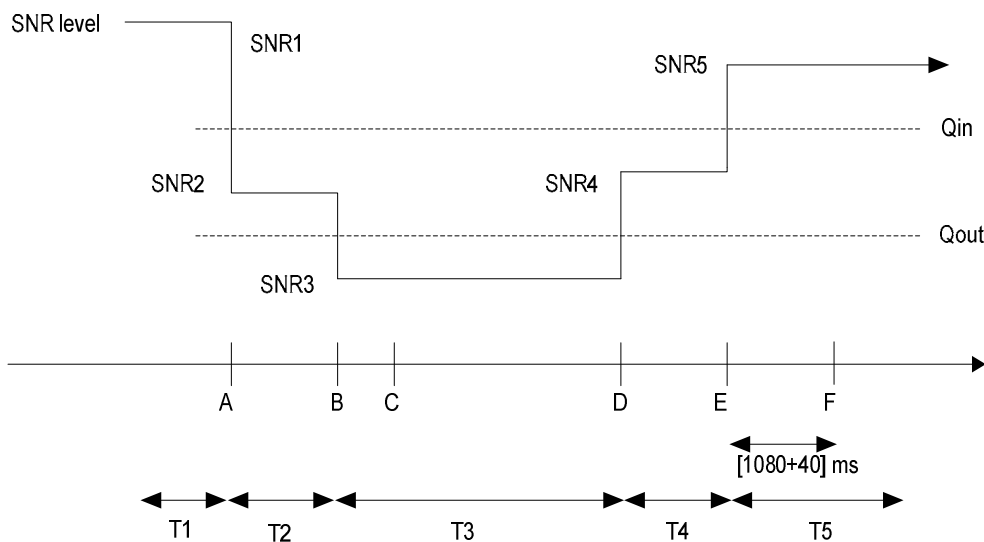

Figure A.7.3.33.1-1: SNR variation for in-sync testing in DRX

A.7.3.33.2 Test Requirements

The UE behaviour in each test during time durations T1, T2, T3, T4 and T5 shall be as follows:

During the period from time point A to time point F (1120 ms after the start of time duration T5) the UE shall transmit uplink signal at least once every DRX cycle, in the On-duration part of the cycle in the subframe according to the configured CQI reporting mode (PUCCH 1-0).

The rate of correct events observed during repeated tests shall be at least 90%.

A.7.3.34 E-UTRAN TDD Radio Link Monitoring Test for Out-of-sync for UE Category 0

A.7.3.34.1 Test Purpose and Environment

The purpose of this test is to verify that the TDD category 0 UE properly detects the out of sync and in sync for the purpose of monitoring downlink radio link quality of the PCell. This test will partly verify the E-UTRAN TDD radio link monitoring requirements in clause 7.11.

The test parameters are given in Tables A.7.3.34.1-1, A.7.3.34.1-2 and A.7.3.34.1-3 below. There is one cell (cell 1), which is the active cell, in the test. The test consists of three successive time periods, with time duration of T1, T2 and T3 respectively. Figure A.7.3.34.1-1 shows the variation of the downlink SNR in the active cell to emulate out-of-sync and in-sync states. Prior to the start of the time duration T1, the UE shall be fully synchronized to cell 1. The UE shall be configured for periodic CQI reporting in PUCCH 1-0 mode with a reporting periodicity of 1 ms.

Table A.7.3.34.1-1: General test parameters for E-UTRAN TDD out-of-sync testing for UE Category 0

Parameter		Unit	Value	Comment
Active cell			Cell 1	Cell 1 is on E-UTRA RF channel number 1
E-UTRA RF Channel Number			1	One E-UTRA TDD carrier frequency is used.
E-UTRA Channel Bandwidth (BW _{channel})		MHz	10	
CP length			Normal	
Out of sync transmission parameters (Note 1)	DCI format		1A	As defined in section 5.3.3.1.3 in TS 36.212
	Number of Control OFDM symbols		2	Out of sync threshold Q _{out} and the corresponding hypothetical PDCCH/PCFICH transmission parameters are as specified in section 7.11.1 and Table 7.11.1-1 respectively.
	Aggregation level	CCE	8	
	ρ _A , ρ _B		-3	
	Ratio of PDCCH to RS EPRE	dB	4	
Ratio of PCFICH to RS EPRE	dB	1		
DRX			OFF	
Layer 3 filtering			Enabled	Counters: N310 = 1; N311 = 1
T310 timer		ms	0	T310 is disabled
T311 timer		ms	1000	T311 is enabled
Periodic CQI reporting mode			PUCCH 1-0	As defined in table 7.2.2-1 in TS 36.213.
CQI reporting periodicity		ms	1	Minimum CQI reporting periodicity
T1		s	1	
T2		s	0.4	
T3		s	0.5	
Note 1: PDCCH/PCFICH corresponding to the out of sync transmission parameters need not be included in the Reference Measurement Channel.				

Table A.7.3.34.1-2: Cell specific test parameters for E-UTRAN TDD (cell # 1) for out-of-sync radio link monitoring for UE Category 0

Parameter	Unit	Test 1		
		T1	T2	T3
E-UTRA RF Channel Number		1		
BW _{channel}	MHz	10		
Special subframe configuration ^{Note 1}		6		
Uplink-downlink configuration ^{Note 1}		1		
PCFICH/PDCCH/PHICH parameters defined in section A.3.1.2.2		R.7 TDD		
OCNG Pattern defined in A.3.2.2 (TDD)		OP.2 TDD		
ρ _A , ρ _B		-3		
PCFICH_RB	dB	1		
PDCCH_RA	dB	4		
PDCCH_RB	dB	4		
PBCH_RA	dB			

PBCH_RB	dB	-3		
PSS_RA	dB			
SSS_RA	dB			
PHICH_RA	dB			
PHICH_RB	dB			
PDSCH_RA	dB			
PDSCH_RB	dB			
OCNG_RA ^{Note 2}	dB			
OCNG_RB ^{Note 2}	dB			
N_{oc}	dBm/15 kHz			
SNR ^{Note 7}	dB	-1.6	-5.9	-11.9
Propagation condition		ETU 70Hz		
Correlation Matrix and Antenna Configuration		2x1 Low		
Note 1:	For special subframe and uplink-downlink configurations see Tables 4.2-1 and 4.2-2 in TS 36.211.			
Note 2:	OCNG shall be used such that the resources in cell # 1 are fully allocated and a constant total transmitted power spectral density is achieved for all OFDM symbols.			
Note 3:	The uplink resources for CQI reporting are assigned to the UE prior to the start of time period T1.			
Note 4:	The timers and layer 3 filtering related parameters are configured prior to the start of time period T1.			
Note 5:	The signal contains PDCCH for UEs other than the device under test as part of OCNG.			
Note 6:	SNR levels correspond to the signal to noise ratio over the cell-specific reference signal REs.			
Note 7:	The SNR in time periods T1, T2 and T3 is denoted as SNR1, SNR2 and SNR3 respectively in figure A.7.3.34.1-1.			

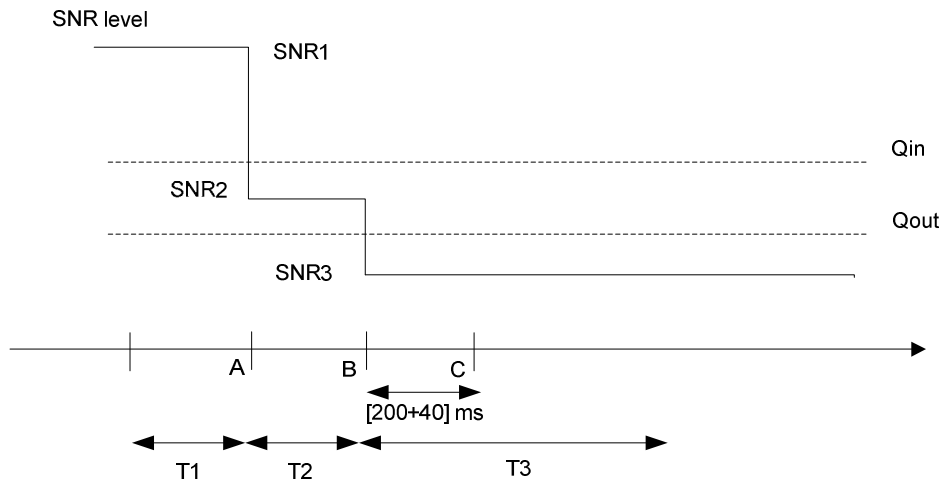

Figure A.7.3.34.1-1: SNR variation for out-of-sync testing

A.7.3.34.2 Test Requirements

The UE behaviour in each test during time durations T1, T2 and T3 shall be as follows:

During the period from time point A to time point B the UE shall transmit uplink signal at least in all uplink subframes configured for CQI transmission according to the configured CQI reporting mode (PUCCH 1-0).

The UE shall stop transmitting uplink signal no later than time point C (240 ms after the start of the time duration T3).

The rate of correct events observed during repeated tests shall be at least 90%.

A.7.3.35 E-UTRAN TDD Radio Link Monitoring Test for In-sync for UE category 0

A.7.3.35.1 Test Purpose and Environment

The purpose of this test is to verify that the TDD category 0 UE properly detects the out of sync and in sync for the purpose of monitoring downlink radio link quality of the PCell. This test will partly verify the E-UTRAN TDD radio link monitoring requirements in clause 7.11.

The test parameters are given in Tables A.7.3.35.1-1 and A.7.3.35.1-2 below. There is one cell (cell 1), which is the active cell, in the test. The test consists of five successive time periods, with time duration of T1, T2, T3, T4 and T5 respectively. Figure A.7.3.35.1-1 shows the variation of the downlink SNR in the active cell to emulate out-of-sync and in-sync states. Prior to the start of the time duration T1, the UE shall be fully synchronized to cell 1. The UE shall be configured for periodic CQI reporting in PUCCH 1-0 mode with a reporting periodicity of 1 ms.

Table A.7.3.35.1-1: General test parameters for E-UTRAN TDD in-sync testing

Parameter		Unit	Value	Comment
			Test 1	
Active cell			Cell 1	Cell 1 is on E-UTRA RF channel number 1
E-UTRA RF Channel Number			1	One E-UTRA TDD carrier frequency is used.
E-UTRA Channel Bandwidth (BW _{channel})		MHz	10	
CP length			Normal	
In sync transmission parameters (Note 1)	DCI format		1C	As defined in clause 5.3.3.1.4 in TS 36.212
	Number of Control OFDM symbols		2	In sync threshold Q _{in} and the corresponding hypothetical PDCCH/PCFICH transmission parameters are as specified in clause 7.11.1 and Table 7.11.1-2 respectively.
	Aggregation level	CCE	4	
	ρ_A, ρ_B		-3	
	Ratio of PDCCH to RS EPRE	dB	1	
Ratio of PCFICH to RS EPRE	dB	1		
Out of sync transmission parameters (Note 1)	DCI format		1A	As defined in clause 5.3.3.1.3 in TS 36.212
	Number of Control OFDM symbols		2	Out of sync threshold Q _{out} and the corresponding hypothetical PDCCH/PCFICH transmission parameters are as specified in clause 7.11.1 and Table 7.11.1-1 respectively.
	Aggregation level	CCE	8	
	ρ_A, ρ_B		-3	
	Ratio of PDCCH to RS EPRE	dB	4	
Ratio of PCFICH to RS EPRE	dB	1		
DRX			OFF	
Layer 3 filtering			Enabled	Counters: N310 = 1; N311 = 1
T310 timer		ms	2000	T310 is enabled
T311 timer		ms	1000	T311 is enabled
Periodic CQI reporting mode			PUCCH 1-0	As defined in table 7.2.2-1 in TS 36.213.
CQI reporting periodicity		ms	1	Minimum CQI reporting periodicity
T1		s	0.5	
T2		s	0.4	
T3		s	1.46	
T4		s	0.4	
T5		s	1	
Note 1: PDCCH/PCFICH corresponding to the in-sync and out of sync transmission parameters need not be included in the Reference Measurement Channel.				

Table A.7.3.35.1-2: Cell specific test parameters for E-UTRAN TDD (cell # 1) for in-sync radio link monitoring test

Parameter	Unit	Test 1									
		T1	T2	T3	T4	T5					
E-UTRA RF Channel Number		1									
BW _{channel}	MHz	10									
Special subframe configuration ^{Note 1}		6									
Uplink-downlink configuration ^{Note 1}		1									
PCFICH/PDCCH/PHICH parameters defined in section A.3.1.2.2		R.7 TDD									
OCNG Pattern defined in A.3.2.2 (TDD)		OP.2 TDD									
ρ_A, ρ_B		-3									
PCFICH_RA	dB	1									
PDCCH_RA	dB	1									
PDCCH_RB	dB	1									
PBCH_RA	dB	-3									
PBCH_RB	dB										
PSS_RA	dB										
SSS_RA	dB										
PHICH_RA	dB										
PHICH_RB	dB										
PDSCH_RA	dB										
PDSCH_RB	dB										
OCNG_RA ^{Note 2}	dB										
OCNG_RB ^{Note 2}	dB										
N_{oc}	dBm/15 kHz						-98				
SNR ^{Note 7}	dB						-1.6	-5.9	-11.9	-6.6	-1.6
Propagation condition							ETU 70Hz				
Correlation Matrix and Antenna Configuration							2x1 low				
Note 1: For special subframe and uplink-downlink configurations see Tables 4.2-1 and 4.2-2 in TS 36.211. Note 2: OCNG shall be used such that the resources in cell # 1 are fully allocated and a constant total transmitted power spectral density is achieved for all OFDM symbols. Note 3: The uplink resources for CQI reporting are assigned to the UE prior to the start of time period T1. Note 4: The timers and layer 3 filtering related parameters are configured prior to the start of time period T1. Note 5: The signal contains PDCCH for UEs other than the device under test as part of OCNG. Note 6: SNR levels correspond to the signal to noise ratio over the cell-specific reference signal REs. Note 7: The SNR in time periods T1, T2, T3, T4 and T5 is denoted as SNR1, SNR2, SNR3, SNR4 and SNR5 respectively in figure A.7.3.35.1-1.											

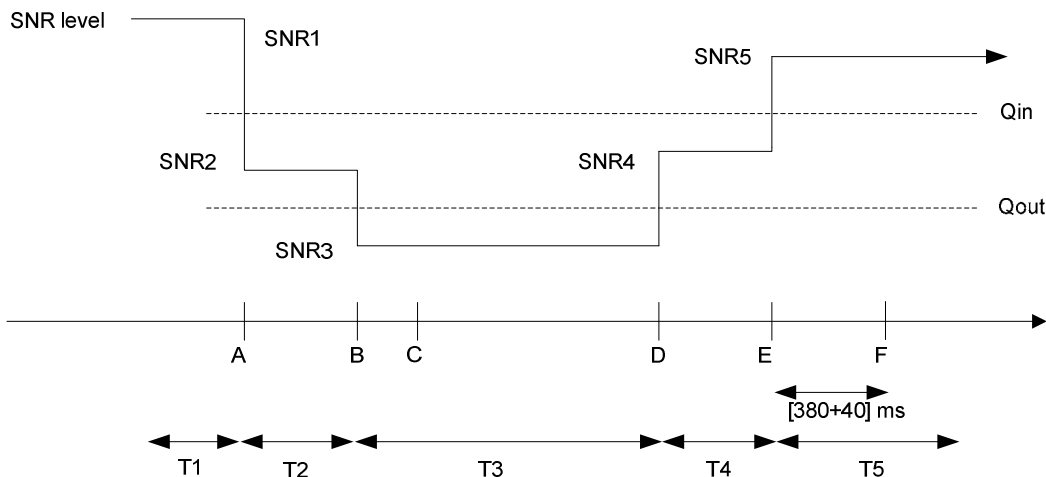

Figure A.7.3.35.1-1: SNR variation for in-sync testing

A.7.3.35.2 Test Requirements

The UE behaviour in each test during time durations T1, T2, T3, T4 and T5 shall be as follows:

During the period from time point A to time point F (420 ms after the start of time duration T5) the UE shall transmit uplink signal at least in all subframes configured for CQI transmission according to the configured CQI reporting mode (PUCCH 1-0).

The rate of correct events observed during repeated tests shall be at least 90%.

A.7.3.36 E-UTRAN TDD Radio Link Monitoring Test for Out-of-sync in DRX for UE category 0

A.7.3.36.1 Test Purpose and Environment

The purpose of this test is to verify that the TDD category 0 UE properly detects the out of sync and in sync for the purpose of monitoring downlink radio link quality of the PCell when DRX is used. This test will partly verify the E-UTRAN TDD radio link monitoring requirements in clause 7.11.

The test parameters are given in Tables A.7.3.36.1-1, A.7.3.36.1-2, A.7.3.36.1-3 and A.7.3.36.1-4. There is one cell (cell 1), which is the active cell, in the test. The test consists of three successive time periods, with time duration of T1, T2 and T3 respectively. Figure A.7.3.36.1-1 shows the variation of the downlink SNR in the active cell to emulate out-of-sync and in-sync states. Prior to the start of the time duration T1, the UE shall be fully synchronized to cell 1. The UE shall be configured for periodic CQI reporting in PUCCH 1-0 mode with a reporting periodicity of 1 ms. In the test, DRX configuration is enabled and DRX inactivity timer has already been expired, i.e. UE tries to decode PDCCH and to send periodic CQI during the period when On-duration timer is running. Time alignment timers shall be set to “infinity” so that UL timing alignment is maintained during the test.

Table A.7.3.36.1-1: General test parameters for E-UTRAN TDD out-of-sync test in DRX for UE category 0

Parameter	Unit	Value	Comment
Active cell		Cell 1	Cell 1 is on E-UTRA RF channel number 1
E-UTRA RF Channel Number		1	One E-UTRA TDD carrier frequency is used.
E-UTRA Channel Bandwidth (BWchannel)	MHz	10	
CP length		Normal	
DCI format		1A	As defined in clause 5.3.3.1.3 in TS 36.212

Out of sync transmission parameters (Note 1)	Number of Control OFDM symbols		2	Out of sync threshold Q_{out} and the corresponding hypothetical PDCCH/PCFICH transmission parameters are as specified in clause 7.11.1 and Table 7.11.1-1 respectively.
	Aggregation level	CCE	8	
	ρ_A, ρ_B		-3	
	Ratio of PDCCH to RS EPRE	dB	4	
	Ratio of PCFICH to RS EPRE	dB	1	
DRX cycle		ms	1280	See Table A.7.3.36.1-3
Layer 3 filtering			Enabled	Counters: $N_{310} = 1; N_{311} = 1$
T310 timer		ms	0	T310 is disabled
T311 timer		ms	1000	T311 is enabled
Periodic CQI reporting mode			PUCCH 1-0	As defined in table 7.2.2-1 in TS 36.213.
CQI reporting periodicity		ms	1	Minimum CQI reporting periodicity
T1		s	32	
T2		s	12.8	
T3		s	13	
Note 1: PDCCH/PCFICH corresponding to the out of sync transmission parameters need not be included in the Reference Measurement Channel.				

Table A.7.3.36.1-2: Cell specific test parameters for E-UTRAN TDD (cell # 1) for out-of-sync radio link monitoring test in DRX for UE category 0

Parameter	Unit	Test 2		
		T1	T2	T3
E-UTRA RF Channel Number		1		
$BW_{channel}$	MHz	10		
Special subframe configuration ^{Note 1}		6		
Uplink-downlink configuration ^{Note 1}		1		
PCFICH/PDCCH/PHICH parameters defined in section A.3.1.2.2		R.7 TDD		
OCNG Pattern defined in A.3.2.2 (TDD)		OP.2 TDD		
ρ_A, ρ_B		-3		
PCFICH_RB	dB	1		
PDCCH_RA	dB	4		
PDCCH_RB	dB	4		
PBCH_RA	dB	-3		
PBCH_RB	dB			
PSS_RA	dB			
SSS_RA	dB			
PHICH_RA	dB			
PHICH_RB	dB			
PDSCH_RA	dB			
PDSCH_RB	dB			
OCNG_RA ^{Note2}	dB			
OCNG_RB ^{Note2}	dB			
N_{oc}	dBm/15 kHz	-98		
SNR ^{Note 7}	dB	-5.6	-9.6	-13.6
Propagation condition		AWGN		

Correlation Matrix and Antenna Configuration		2x1
Note 1:	For special subframe and uplink-downlink configurations see Tables 4.2-1 and 4.2-2 in TS 36.211.	
Note 2:	OCNG shall be used such that the resources in cell # 1 are fully allocated and a constant total transmitted power spectral density is achieved for all OFDM symbols.	
Note 3:	The uplink resources for CQI reporting are assigned to the UE prior to the start of time period T1.	
Note 4:	The timers and layer 3 filtering related parameters are configured prior to the start of time period T1.	
Note 5:	The signal contains PDCCH for UEs other than the device under test as part of OCNG.	
Note 6:	SNR levels correspond to the signal to noise ratio over the cell-specific reference signal REs.	
Note 7:	The SNR in time periods T1, T2 and T3 is denoted as SNR1, SNR2 and SNR3 respectively in figure A.7.3.36.1-1.	

Table A.7.3.36.1-3: DRX-Configuration for E-UTRAN TDD out-of-sync test for UE category 0

Field	Value	Comment
onDurationTimer	psf2	As specified in clause 6.3.2 in TS 36.331
drx-InactivityTimer	psf1	
drx-RetransmissionTimer	psf1	
longDRX-CycleStartOffset	sf1280	
shortDRX	disable	

Table A.7.3.36.1-4: TimeAlignmentTimer -Configuration for E-UTRAN TDD out-of-sync testing for UE category 0

Field	Value	Comment
TimeAlignmentTimer	infinity	As specified in clause 6.3.2 in TS 36.331
sr-ConfigIndex	2	For further information see clause 6.3.2 in TS 36.331 and section 10.1 in TS 36.213.

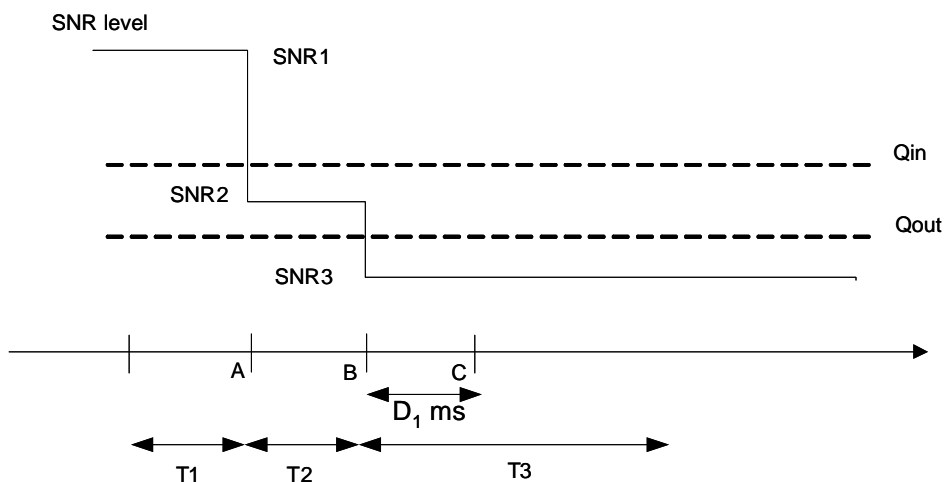

Figure A.7.3.36.1-1: SNR variation for out-of-sync testing in DRX

A.7.3.36.2 Test Requirements

The UE behaviour in each test during time durations T1, T2 and T3 shall be as follows:

During the period from time point A to time point B the UE shall transmit uplink signal at least once every DRX cycle, in the On-duration part of the cycle in the uplink subframe according to the configured CQI reporting mode (PUCCH 1-0).

The UE shall stop transmitting uplink signal no later than time point C (duration $D_1 = 6500$ ms after the start of time duration T3).

The rate of correct events observed during repeated tests shall be at least 90%.

A.7.3.37 E-UTRAN TDD Radio Link Monitoring Test for In-sync in DRX for UE category 0

A.7.3.37.1 Test Purpose and Environment

The purpose of this test is to verify that the TDD category 0 UE properly detects the out of sync and in sync for the purpose of monitoring downlink radio link quality of the PCell when DRX is used. This test will partly verify the E-UTRAN TDD radio link monitoring requirements in clause 7.11.

The test parameters are given in Tables A.7.3.37.1-1, A.7.3.37.1-2, A.7.3.37.1-3 and A.7.3.37.1-4. There is one cell (cell 1), which is the active cell, in the test. The test consists of five successive time periods, with time duration of T1, T2, T3, T4 and T5 respectively. Figure A.7.3.37.1-1 shows the variation of the downlink SNR in the active cell to emulate out-of-sync and in-sync states. Prior to the start of the time duration T1, the UE shall be fully synchronized to cell 1. The UE shall be configured for periodic CQI reporting in PUCCH 1-0 mode with a reporting periodicity of 1 ms. In the test, DRX configuration is enabled and DRX inactivity timer has already been expired, i.e. UE tries to decode PDCCH and to send periodic CQI during the period when On-duration timer is running. Time alignment timers shall be set to “infinity” so that UL timing alignment is maintained during the test.

Table A.7.3.37.1-1: General test parameters for E-UTRAN TDD in-sync test in DRX for UE category 0

Parameter		Unit	Value	Comment
Active cell			Cell 1	Cell 1 is on E-UTRA RF channel number 1
E-UTRA RF Channel Number			1	One E-UTRA TDD carrier frequency is used.
E-UTRA Channel Bandwidth ($BW_{channel}$)		MHz	10	
CP length			Normal	
In sync transmission parameters (Note 1)	DCI format		1C	As defined in clause 5.3.3.1.4 in TS 36.212
	Number of Control OFDM symbols		2	In sync threshold Q_{in} and the corresponding hypothetical PDCCH/PCFICH transmission parameters are as specified in clause 7.11.1 and Table 7.11.1-2 respectively.
	Aggregation level	CCE	4	
	ρ_A, ρ_B		-3	
	Ratio of PDCCH to RS EPRE	dB	1	
	Ratio of PCFICH to RS EPRE	dB	1	
Out of sync transmission parameters (Note 1)	DCI format		1A	As defined in clause 5.3.3.1.3 in TS 36.212
	Number of Control OFDM symbols		2	Out of sync threshold Q_{out} and the corresponding hypothetical PDCCH/PCFICH transmission parameters are as specified in clause 7.11.1 and Table 7.11.1-1 respectively.
	Aggregation level	CCE	8	
	ρ_A, ρ_B		-3	
	Ratio of PDCCH to RS EPRE	dB	4	
	Ratio of PCFICH to RS EPRE	dB	1	
DRX cycle		ms	40	See Table A.7.3.37.1-3
Layer 3 filtering			Enabled	Counters: $N_{310} = 1$; $N_{311} = 1$
T310 timer		ms	2000	T310 is enabled
T311 timer		ms	1000	T311 is enabled
Periodic CQI reporting mode			PUCCH 1-0	As defined in table 7.2.2-1 in TS 36.213.

CQI reporting periodicity	ms	1	Minimum CQI reporting periodicity
T1	s	4	
T2	s	1.6	
T3	s	1.46	
T4	s	0.4	
T5	s	4	
Note 1: PDCCH/PCFICH corresponding to the in-sync and out of sync transmission parameters need not be included in the Reference Measurement Channel.			

Table A.7.3.37.1-2: Cell specific test parameters for E-UTRAN TDD (cell # 1) for in-sync radio link monitoring test in DRX for UE category 0

Parameter	Unit	Test 1				
		T1	T2	T3	T4	T5
E-UTRA RF Channel Number		1				
BW _{channel}	MHz	10				
Special subframe configuration ^{Note 1}		6				
Uplink-downlink configuration ^{Note 1}		1				
PCFICH/PDCCH/PHICH parameters defined in section A.3.1.2.2		R.7 TDD				
OCNG Pattern defined in A.3.2.2 (TDD)		OP.2 TDD				
ρ_A, ρ_B		-3				
PCFICH_RB	dB	1				
PDCCH_RA	dB	1				
PDCCH_RB	dB	1				
PBCH_RA	dB	-3				
PBCH_RB	dB					
PSS_RA	dB					
SSS_RA	dB					
PHICH_RA	dB					
PHICH_RB	dB					
PDSCH_RA	dB					
PDSCH_RB	dB					
OCNG_RA ^{Note2}	dB					
OCNG_RB ^{Note2}	dB					
N_{oc}	dBm/15 kHz	-98				
SNR ^{Note 7}	dB	-5.6	-9.6	-13.6	-9.6	-5.6
Propagation condition		AWGN				
Correlation Matrix and Antenna Configuration		2x1				
Note 1: For special subframe and uplink-downlink configurations see Tables 4.2-1 and 4.2-2 in TS 36.211. Note 2: OCNG shall be used such that the resources in cell # 1 are fully allocated and a constant total transmitted power spectral density is achieved for all OFDM symbols. Note 3: The uplink resources for CQI reporting are assigned to the UE prior to the start of time period T1. Note 4: The timers and layer 3 filtering related parameters are configured prior to the start of time period T1. Note 5: The signal contains PDCCH for UEs other than the device under test as part of OCNG. Note 6: SNR levels correspond to the signal to noise ratio over the cell-specific reference signal REs. Note 7: The SNR in time periods T1, T2, T3, T4 and T5 is denoted as SNR1, SNR2, SNR3, SNR4 and SNR5 respectively in figure A.7.3.37.1-1.						

Table A.7.3.37.1-3: DRX-Configuration for E-UTRAN TDD out-of-sync test for UE category 0

Field	Value	Comment
onDurationTimer	psf2	As specified in clause 6.3.2 in TS 36.331
drx-InactivityTimer	psf1	
drx-RetransmissionTimer	psf1	

longDRX-CycleStartOffset	sf40	
shortDRX	disable	

Table A.7.3.37.1-4: TimeAlignmentTimer -Configuration for E-UTRAN TDD out-of-sync testing for UE category 0

Field	Value	Comment
TimeAlignmentTimer	infinity	As specified in clause 6.3.2 in TS 36.331
sr-ConfigIndex	2	For further information see clause 6.3.2 in TS 36.331 and section 10.1 in TS 36.213.

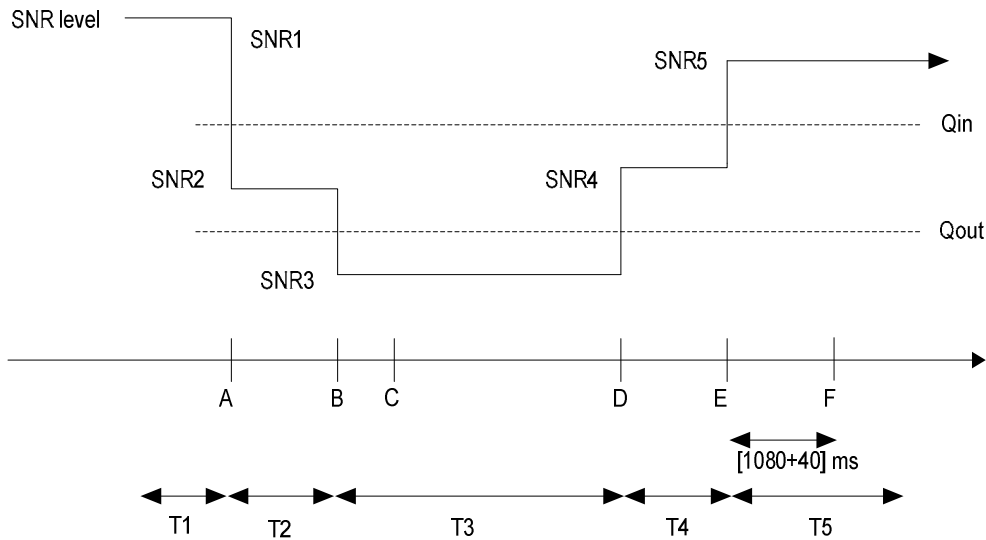

Figure A.7.3.37.1-1: SNR variation for in-sync testing in DRX

A.7.3.37.2 Test Requirements

The UE behaviour in each test during time durations T1, T2, T3, T4 and T5 shall be as follows:

During the period from time point A to time point F (1120 ms after the start of time duration T5) the UE shall transmit uplink signal at least once every DRX cycle, in the On-duration part of the cycle in the uplink subframe according to the configured CQI reporting mode (PUCCH 1-0).

The rate of correct events observed during repeated tests shall be at least 90%.

A.7.3.38 E-UTRAN FDD-FDD DC Radio Link Monitoring Test for Out-of-sync in DRX in synchronous DC

A.7.3.38.1 Test Purpose and Environment

The purpose of this test is to verify that the UE properly detects the out of sync for the purpose of monitoring downlink radio link quality of the PSCell when DRX is used. This test will partly verify the E-UTRAN FDD radio link monitoring requirements in clause 7.6.

The test parameters are given in Tables A.7.3.38.1-1, A.7.3.38.1-2, A.7.3.38.1-3, and A.7.3.38.1-4. There are two cells, cell 1 is PCell and cell 2 is PSCell, in the test. The test consists of three successive time periods with time duration of T1, T2 and T3 respectively. Figure A.7.3.38.1-1 shows the variation of the downlink SNR in the PCell and PSCell to emulate out-of-sync and in-sync states. Prior to the start of the time duration T1, the UE shall be fully synchronized to cell 1 and cell 2. The UE shall be configured for periodic CQI reporting in PUCCH 1-0 mode with a reporting periodicity of 2 ms. In the test, DRX configuration is enabled and DRX inactivity timer has already been expired, i.e.

UE tries to decode PDCCH and to send periodic CQI during the period when On-duration timer is running. Time alignment timers shall be set to “infinity” so that UL timing alignment is maintained during the test.

Table A.7.3.38.1-1: General test parameters for E-UTRAN FDD out-of-sync tests in DRX in synchronous dual connectivity

Parameter	Unit	Value	Comment	
Active cell		Cell 1 Cell 2	Cell 1 is PCell on E-UTRA RF channel number 1, and cell 2 is PSCell on E-UTRA RF channel number 2	
CP length		Normal		
E-UTRA RF Channel Number		1, 2	Two E-UTRA FDD carrier frequencies are used.	
E-UTRA Channel Bandwidth (BW _{channel})	MHz	5, 10, 20		
Correlation Matrix and Antenna Configuration		2x2 Low	Correlation Matrix and Antenna Configuration are defined in TS 36.101 [5] Annex B.2.3.2	
Out of sync transmission parameters (Note 1)	DCI format	1A	As defined in clause 5.3.3.1.3 in TS 36.212	
	Number of Control OFDM symbols	5MHz: 3 10MHz: 2 20MHz: 2	Out of sync threshold Q_{out} and the corresponding hypothetical PDCCH/PCFICH transmission parameters are as specified in clause 7.6.1 and Table 7.6.1-1 respectively.	
	Aggregation level	CCE		8
	ρ_A, ρ_B			-3
	Ratio of PDCCH to RS EPRE	dB		1
	Ratio of PCFICH to RS EPRE	dB		1
DRX cycle on cell 1	ms	640	See Table A.7.3.38.1-3	
DRX cycle on cell 2	ms	40	See Table A.7.3.38.1-3	
Timing offset between cell 1 and cell 2	μ s	33	For synchronous dual connectivity	
Layer 3 filtering		Enabled	Counters: N310 = 1; N311 = 1; N313 = 1; N314 = 1	
T310 timer	ms	0	T310 is disabled	
T311 timer	ms	1000	T311 is enabled	
T313 timer	ms	0	T313 is disabled	
Periodic CQI reporting mode		PUCCH 1-0	As defined in table 7.2.2-1 in TS 36.213.	
CQI reporting periodicity	ms	2	Minimum CQI reporting periodicity	
T1	s	4		
T2	s	1.6		
T3	s	1.8		
Note 1: PDCCH/PCFICH corresponding to the out of sync transmission parameters need not be included in the Reference Measurement Channel.				

Table A.7.3.38.1-2: Cell specific test parameters for E-UTRAN FDD out-of-sync radio link monitoring in DRX in synchronous dual connectivity

Parameter	Unit	Cell 1			Cell 2		
		T1	T2	T3	T1	T2	T3
E-UTRA RF Channel Number		1			2		
BW _{channel}	MHz	5, 10, 20			5, 10, 20		
Correlation Matrix and Antenna Configuration		2x2 Low			2x2 Low		
PCFICH/PDCCH/PHICH parameters None of the PDCCH are intended for the UE under test		5MHz: R.12 FDD 10MHz: R.7 FDD 20MHz: R.13 FDD			5MHz: R.12 FDD 10MHz: R.7 FDD 20MHz: R.13 FDD		
OCNG Pattern		5MHz: OP.16 FDD 10MHz: OP.2 FDD 20MHz: OP.12 FDD			5MHz: OP.16 FDD 10MHz: OP.2 FDD 20MHz: OP.12 FDD		
ρ_A, ρ_B		-3			-3		
PCFICH_RB	dB	1			1		
PDCCH_RA	dB	1			1		
PDCCH_RB	dB	1			1		

PBCH_RA	dB	-3			-3		
PBCH_RB	dB						
PSS_RA	dB						
SSS_RA	dB						
PHICH_RA	dB						
PHICH_RB	dB						
PDSCH_RA	dB						
PDSCH_RB	dB						
OCNG_RA ^{Note1}	dB						
OCNG_RB ^{Note1}	dB						
SNR ^{Note 6,7} (5MHz bandwidth)	dB	-2.3	-2.3	-2.3	-2.3	-5.7	-12.2
SNR ^{Note 6,7} (10MHz bandwidth)	dB	-2.3	-2.3	-2.3	-2.3	-6.2	-12.2
SNR ^{Note 6,7} (20MHz bandwidth)	dB	-2.9	-2.9	-2.9	-2.9	-6.8	-12.8
N_{oc}	dBm/15 kHz	-98			-98		
Propagation condition		ETU 70 Hz			ETU 70 Hz		
Time offset to cell1	μ s	-			33		
Note 1: OCNG shall be used such that the resources in cell 1 and cell 2 are fully allocated and a constant total transmitted power spectral density is achieved for all OFDM symbols.							
Note 2: The uplink resources for CQI reporting are assigned to the UE prior to the start of time period T1.							
Note 3: The timers and layer 3 filtering related parameters are configured prior to the start of time period T1.							
Note 4: The signal contains PDCCH for UEs other than the device under test as part of OCNG.							
Note 5: SNR levels correspond to the signal to noise ratio over the cell-specific reference signal REs.							
Note 6: The SNR in time periods T1, T2, and T3 are denoted as SNR1, SNR2 and SNR3 respectively in figure A.7.3.38.1-1.							
Note 7: The SNR values are specified for testing a UE which supports 2RX on the PSCell frequency. For testing of a UE which only supports 4RX on the PSCell frequency, the SNR during T3 is modified as specified in section A.3.8.1.							

Table A.7.3.38.1-3: DRX-Configuration for E-UTRAN FDD out-of-sync tests in synchronous dual connectivity

Field	Value		Comment
	Cell 1	Cell 2	
onDurationTimer	psf2	psf2	As specified in clause 6.3.2 in TS 36.331
drx-InactivityTimer	psf1	psf1	
drx-RetransmissionTimer	psf1	psf1	
longDRX-CycleStartOffset	Sf640	Sf40	
shortDRX	disable	disable	

Table A.7.3.38.1-4: TimeAlignmentTimer -Configuration for E-UTRAN FDD out-of-sync testing in synchronous dual connectivity

Field	Value	Comment
TimeAlignmentTimer	infinity	As specified in clause 6.3.2 in TS 36.331
sr-ConfigIndex	0	For further information see clause 6.3.2 in TS 36.331 and section 10.1 in TS 36.213.

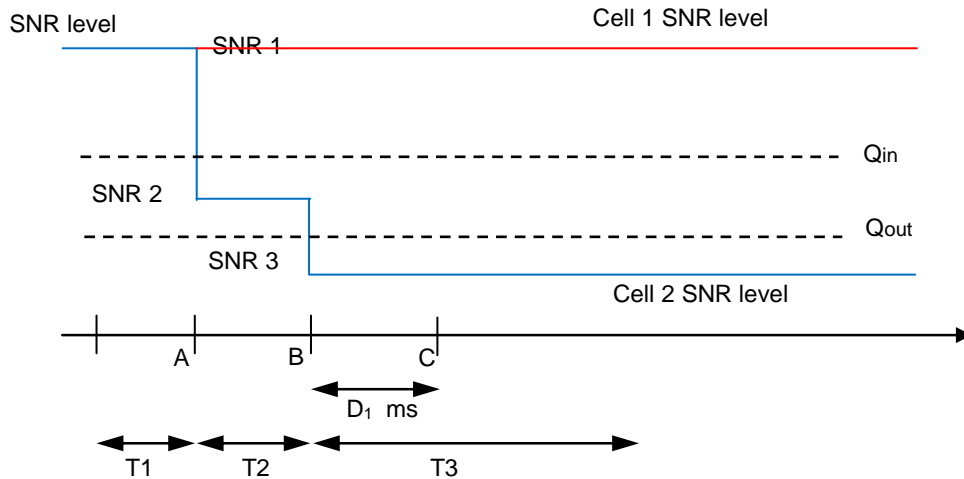

Figure A.7.3.38.1-1 SNR variation for out-of-sync testing in DRX

A.7.3.38.2 Test Requirements

The UE behaviour during time durations T1, T2, and T3 shall be as follows:

During time durations T1, T2 and T3, the UE shall transmit uplink signal at least in all subframes configured for CQI transmission on Cell1.

During the period from time point A to time point B the UE shall transmit uplink signal at least once every DRX cycle, in the On-duration part of the cycle in the uplink subframe on Cell2.

The UE shall stop transmitting uplink signal no later than time point C (duration D1 = 900 ms after the start of time duration T3) on PSCell.

The rate of correct events observed during repeated tests shall be at least 90%.

A.7.3.39 E-UTRAN FDD-FDD DC Radio Link Monitoring Test for Out-of-sync in DRX in asynchronous DC

A.7.3.39.1 Test Purpose and Environment

The purpose of this test is to verify that the UE properly detects the out of sync and in sync for the purpose of monitoring downlink radio link quality of the PSCell when DRX is used in asynchronous dual connectivity. This test will partly verify the E-UTRAN FDD radio link monitoring requirements in section 7.6.

The test parameters are given in Tables A.7.3.39.1-1, A.7.3.39.1-2, A.7.3.39.1-3 and A.7.3.39.1-4. There are two cells in the test. Cell 1 is PCell in MCG and cell 2 is PSCell in SCG. Before the test starts the UE is connected to cell 1 on radio channel 1 and to cell 2 on radio channel 2. The test consists of three successive time periods, with time duration of T1, T2 and T3 respectively. The downlink SNR in cell 1 keeps constant in the test. Figure A.7.3.39.1-1 shows the variation of the downlink SNR in the cell 2 to emulate out-of-sync and in-sync states. Prior to the start of the time duration T1, the UE shall be fully synchronized to cell 1 and cell 2 in asynchronous dual connectivity. For both cells, the UE shall be configured for periodic CQI reporting in PUCCH 1-0 mode with a reporting periodicity of 2 ms. In the test, DRX configuration is enabled and DRX inactivity timer has already been expired, i.e. UE tries to decode PDCCH and to send periodic CQI during the period when On-duration timer is running. Time alignment timers shall be set to “infinity” so that UL timing alignment is maintained during the test.

Table A.7.3.39.1-1: General test parameters for E-UTRAN FDD out-of-sync in DRX

Parameter	Unit	Value	Comment
Active cells		Cell 1 and cell 2	Cell 1 (PCell) is on E-UTRA RF channel number 1 and cell 2 (PSCell) is on E-UTRA RF channel number 2
CP length		Normal	

Correlation Matrix and Antenna Configuration			2x2 Low	Correlation Matrix and Antenna Configuration are defined in TS 36.101 [5] Annex B.2.3.2
Out of sync transmission parameters (Note 1)	DCI format		1A	As defined in section 5.3.3.1.3 in TS 36.212
	Number of Control OFDM symbols		5MHz: 3 10MHz: 2 20MHz: 2	Out of sync threshold Q_{out} and the corresponding hypothetical PDCCH/PCFICH transmission parameters are as specified in section 7.6.1 and Table 7.6.1-1 respectively.
	Aggregation level	CCE	8	
	ρ_A, ρ_B		-3	
	Ratio of PDCCH to RS EPRE	dB	1	
	Ratio of PCFICH to RS EPRE	dB	1	
DRX cycle in cell 1	ms		640	See Table A.7.3.39.1-3
DRX cycle in cell 2	ms		40	See Table A.7.3.39.1-3
Layer 3 filtering			Enabled	Counters: $N_{310} = 1; N_{311} = 1;$ $N_{313} = 1; N_{314} = 1;$
T310 timer	ms		0	T310 is disabled
T311 timer	ms		1000	T311 is enabled
T313 timer	ms		0	T313 is disabled
Periodic CQI reporting mode			PUCCH 1-0	As defined in table 7.2.2-1 in TS 36.213.
CQI reporting periodicity	ms		2	Minimum CQI reporting periodicity
T1	s		4	
T2	s		1.6	
T3	s		1.8	
<p>Note 1: PDCCH/PCFICH corresponding to the out of sync transmission parameters need not be included in the Reference Measurement Channel.</p> <p>Note 2: The test parameters in the table apply to both cell 1 and cell 2 unless specified otherwise.</p> <p>Note 3: Even a UE capable of both synchronous and asynchronous DC operations is required to pass this test case in accordance with the principle defined in section A.3.6.11.</p>				

Table A.7.3.39.1-2: Cell specific test parameters for E-UTRAN FDD for out-of-sync radio link monitoring in DRX

Parameter	Unit	Cell 1 (PCell)			Cell 2 (PSCell)		
		T1	T2	T3	T1	T2	T3
E-UTRA RF Channel Number		1			2		
E-UTRA Channel Bandwidth ($BW_{channel}$)	MHz	5, 10, 20			5, 10, 20		
PCFICH/PDCCH/PHI CH parameters. None of the PDCCH are intended for the UE under test.		5MHz: R.12 FDD 10MHz: R.7 FDD 20MHz: R.13 FDD			5MHz: R.12 FDD 10MHz: R.7 FDD 20MHz: R.13 FDD		
Correlation Matrix and Antenna Configuration		2x2 Low			2x2 Low		
OCNG Pattern defined in A.3.2.1 (FDD)		5MHz: OP.16 FDD 10MHz: OP.2 FDD 20MHz: OP.12 FDD			5MHz: OP.16 FDD 10MHz: OP.2 FDD 20MHz: OP.12 FDD		
ρ_A, ρ_B		-3			-3		
PCFICH_RB	dB	1			1		
PDCCH_RA	dB	1			1		
PDCCH_RB	dB	1			1		
PBCH_RA	dB	-3			-3		
PBCH_RB	dB						
PSS_RA	dB						
SSS_RA	dB						
PHICH_RA	dB						
PHICH_RB	dB						
PHICH_RB	dB						

PDSCH_RA		dB						
PDSCH_RB		dB						
OCNG_RA ^{Note1}		dB						
OCNG_RB ^{Note1}		dB						
SNR ^{Note 6,8}	5MHz BW _{channel}	dB	-2.3	-2.3	-2.3	-2.3	-5.7	-12.2
	10MHz BW _{channel}	dB	-2.3	-2.3	-2.3	-2.3	-6.2	-12.2
	20MHz BW _{channel}	dB	-2.9	-2.9	-2.9	-2.9	-6.8	-12.8
N_{oc}		dBm/15 kHz	-98			-98		
Propagation condition			ETU 70 Hz			ETU 70 Hz		
Receive time offset to cell1 ^{Note 7}		µs	-			500		
<p>Note 1: OCNG shall be used such that the resources in Cell 1 and Cell 2 are fully allocated and a constant total transmitted power spectral density is achieved for all OFDM symbols.</p> <p>Note 2: The uplink resources for CQI reporting are assigned to the UE prior to the start of time period T1.</p> <p>Note 3: The timers and layer 3 filtering related parameters are configured prior to the start of time period T1.</p> <p>Note 4: The signal contains PDCCH for UEs other than the device under test as part of OCNG.</p> <p>Note 5: SNR levels correspond to the signal to noise ratio over the cell-specific reference signal REs.</p> <p>Note 6: The SNR in time periods T1, T2 and T3 is denoted as SNR1, SNR2 and SNR3 respectively in figure A.7.3.39.1-1.</p> <p>Note 7: Receive time difference between subframe boundaries of signals received from the two cells at the UE antenna connector including time alignment error between the two cells.</p> <p>Note 8: The SNR values are specified for testing a UE which supports 2RX on the PSCell frequency. For testing of a UE which only supports 4RX on the PSCell frequency, the SNR during T3 is modified as specified in section A.3.8.1.</p>								

Table A.7.3.39.1-3: DRX-Configuration for E-UTRAN FDD out-of-sync tests

Field	Value		Comment
	Cell 1	Cell 2	
onDurationTimer	psf2	psf2	As specified in section 6.3.2 in 3GPP TS 36.331
drx-InactivityTimer	psf1	psf1	
drx-RetransmissionTimer	psf1	psf1	
longDRX-CycleStartOffset	sf640	sf40	
shortDRX	disable	disable	

Table A.7.3.39.1-4: TimeAlignmentTimer-Configuration for E-UTRAN FDD out-of-sync testing

Field	Value	Comment
TimeAlignmentTimer	infinity	As specified in section 6.3.2 in 3GPP TS 36.331
sr-ConfigIndex	0	For further information see section 6.3.2 in 3GPP TS 36.331 and section 10.1 in 3GPP TS 36.213.

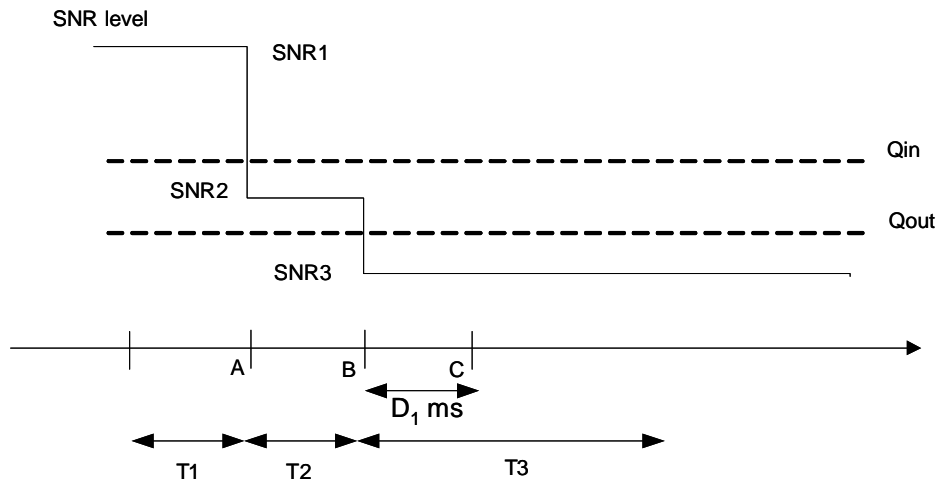

Figure A.7.3.39.1-1 SNR variation for out-of-sync test in DRX

A.7.3.39.2 Test Requirements

The UE behaviour in each test during time durations T1, T2 and T3 shall be as follows:

In the test, during time durations T1, T2 and T3, the UE shall transmit uplink signal on cell 1 at least once every DRX cycle, in the On-duration part of the cycle in the subframe according to the configured CQI reporting mode (PUCCH 1-0).

In the test, during the period from time point A to time point B the UE shall transmit uplink signal on cell 2 at least once every DRX cycle, in the On-duration part of the cycle in the subframe according to the configured CQI reporting mode (PUCCH 1-0).

In the test, the UE shall stop transmitting uplink signal on cell 2 no later than time point C (duration $D_1 = 900$ ms after the start of time duration T3).

The rate of correct events observed during repeated tests shall be at least 90%.

A.7.3.40 E-UTRAN TDD-TDD DC Radio Link Monitoring Test for Out-of-sync in DRX in synchronous DC

A.7.3.40.1 Test Purpose and Environment

The purpose of this test is to verify that the UE properly detects the out of sync for the purpose of monitoring downlink radio link quality of the PCell when DRX is used. This test will partly verify the E-UTRAN TDD radio link monitoring requirements in clause 7.6.

The test parameters are given in Tables A.7.3.40.1-1, A.7.3.40.1-2, A.7.3.40.1-3, and A.7.3.40.1-4. There are two cells, cell 1 is PCell and cell 2 is PSCell, in the test. The test consists of three successive time periods with time duration of T1, T2 and T3 respectively. Figure A.7.3.40.1-1 shows the variation of the downlink SNR in the PCell and PSCell to emulate out-of-sync and in-sync states. Prior to the start of the time duration T1, the UE shall be fully synchronized to cell 1 and cell 2. The UE shall be configured for periodic CQI reporting in PUCCH 1-0 mode with a reporting periodicity of 1 ms. In the test, DRX configuration is enabled and DRX inactivity timer has already been expired, i.e. UE tries to decode PDCCH and to send periodic CQI during the period when On-duration timer is running. Time alignment timers shall be set to “infinity” so that UL timing alignment is maintained during the test.

Table A.7.3.40.1-1: General test parameters for E-UTRAN TDD out-of-sync tests in DRX in synchronous dual connectivity

Parameter	Unit	Value	Comment
Active cell		Cell 1 Cell 2	Cell 1 is PCell on E-UTRA RF channel number 1, and cell 2 is PSCell on E-UTRA RF channel number 2

CP length		Normal	
E-UTRA RF Channel Number		1, 2	Two E-UTRA TDD carrier frequencies are used.
E-UTRA Channel Bandwidth (BW _{channel})	MHz	5, 10, 20	
Correlation Matrix and Antenna Configuration		2x2 Low	Correlation Matrix and Antenna Configuration are defined in TS 36.101 [5] Annex B.2.3.2
Out of sync transmission parameters (Note 1)	DCI format		1A
	Number of Control OFDM symbols		5MHz: 3 10MHz: 2 20MHz: 2
	Aggregation level	CCE	8
	ρ _A , ρ _B		-3
	Ratio of PDCCH to RS EPRE	dB	1
	Ratio of PCFICH to RS EPRE	dB	1
DRX cycle on cell 1	ms	640	See Table A.7.3.40.1-3
DRX cycle on cell 2	ms	40	See Table A.7.3.40.1-3
Timing offset between cell 1 and cell 2	μs	33	For synchronous dual connectivity
Layer 3 filtering		Enabled	Counters: N310 = 1; N311 = 1; N313 = 1; N314 = 1
T310 timer	ms	0	T310 is disabled
T311 timer	ms	1000	T311 is enabled
T313 timer	ms	0	T313 is disabled
Periodic CQI reporting mode		PUCCH 1-0	As defined in table 7.2.2-1 in TS 36.213.
CQI reporting periodicity	ms	1	Minimum CQI reporting periodicity
T1	s	4	
T2	s	1.6	
T3	s	1.8	
Note 1: PDCCH/PCFICH corresponding to the out of sync transmission parameters need not be included in the Reference Measurement Channel.			

Table A.7.3.40.1-2: Cell specific test parameters for E-UTRAN TDD out-of-sync radio link monitoring in DRX in synchronous dual connectivity

Parameter	Unit	Cell 1			Cell 2		
		T1	T2	T3	T1	T2	T3
E-UTRA RF Channel Number		1			2		
BW _{channel}	MHz	5, 10, 20			5, 10, 20		
Correlation Matrix and Antenna Configuration		2x2 Low			2x2 Low		
Special subframe configuration ^{Note1}		6			6		
Uplink-downlink configuration ^{Note2}		1			1		
PCFICH/PDCCH/PHICH parameters None of the PDCCH are intended for the UE under test		5MHz: R.12 TDD 10MHz: R.7 TDD 20MHz: R.13 TDD			5MHz: R.12 TDD 10MHz: R.7 TDD 20MHz: R.13 TDD		
OCNG Pattern		5MHz: OP.10 TDD 10MHz: OP.2 TDD 20MHz: OP.8 TDD			5MHz: OP.10 TDD 10MHz: OP.2 TDD 20MHz: OP.8 TDD		
ρ _A , ρ _B		-3			-3		
PCFICH_RB	dB	1			1		
PDCCH_RA	dB	1			1		
PDCCH_RB	dB	1			1		
PBCH_RA	dB	-3			-3		
PBCH_RB	dB						
PSS_RA	dB						
SSS_RA	dB						
PHICH_RA	dB						

PHICH_RB	dB						
PDSCH_RA	dB						
PDSCH_RB	dB						
OCNG_RA ^{Note3}	dB						
OCNG_RB ^{Note3}	dB						
SNR ^{Note 8,9} (5MHz bandwidth)	dB	-1.6	-1.6	-1.6	-1.6	-5.2	-11.9
SNR ^{Note 8,9} (10MHz bandwidth)	dB	-2.3	-2.3	-2.3	-2.3	-5.9	-11.9
SNR ^{Note 8,9} (20MHz bandwidth)	dB	-3.0	-3.0	-3.0	-3.0	-6.6	-12.6
N_{oc}	dBm/15 kHz	-98			-98		
Propagation condition		ETU 70 Hz			ETU 70 Hz		
Time offset to cell1	μs	-			33		
<p>Note 1: For the special subframe configuration see table 4.2-1 in TS 36.211.</p> <p>Note 2: For the uplink-downlink configuration see table 4.2-2 in TS 36.211.</p> <p>Note 3: OCNG shall be used such that the resources in cell # 1 are fully allocated and a constant total transmitted power spectral density is achieved for all OFDM symbols.</p> <p>Note 4: The uplink resources for CQI reporting are assigned to the UE prior to the start of time period T1.</p> <p>Note 5: The timers and layer 3 filtering related parameters are configured prior to the start of time period T1.</p> <p>Note 6: The signal contains PDCCH for UEs other than the device under test as part of OCNG.</p> <p>Note 7: SNR levels correspond to the signal to noise ratio over the cell-specific reference signal REs.</p> <p>Note 8: The SNR in time periods T1, T2 and T3 is denoted as SNR1, SNR2 and SNR3 respectively in figure A.7.3.40.1-1.</p> <p>Note 9: The SNR values are specified for testing a UE which supports 2RX on the PSCell frequency. For testing of a UE which only supports 4RX on the PSCell frequency, the SNR during T3 is modified as specified in section A.3.8.1.</p>							

Table A.7.3.40.1-3: DRX-Configuration for E-UTRAN TDD out-of-sync tests in synchronous dual connectivity

Field	Value		Comment
	Cell 1	Cell 2	
onDurationTimer	psf2	psf2	As specified in clause 6.3.2 in TS 36.331
drx-InactivityTimer	psf1	psf1	
drx-RetransmissionTimer	psf1	psf1	
longDRX-CycleStartOffset	Sf640	Sf40	
shortDRX	disable	disable	

Table A.7.3.26.1-4: TimeAlignmentTimer -Configuration for E-UTRAN FDD out-of-sync testing in synchronous dual connectivity

Field	Value	Comment
TimeAlignmentTimer	infinity	As specified in clause 6.3.2 in TS 36.331
sr-ConfigIndex	0	For further information see clause 6.3.2 in TS 36.331 and section 10.1 in TS 36.213.

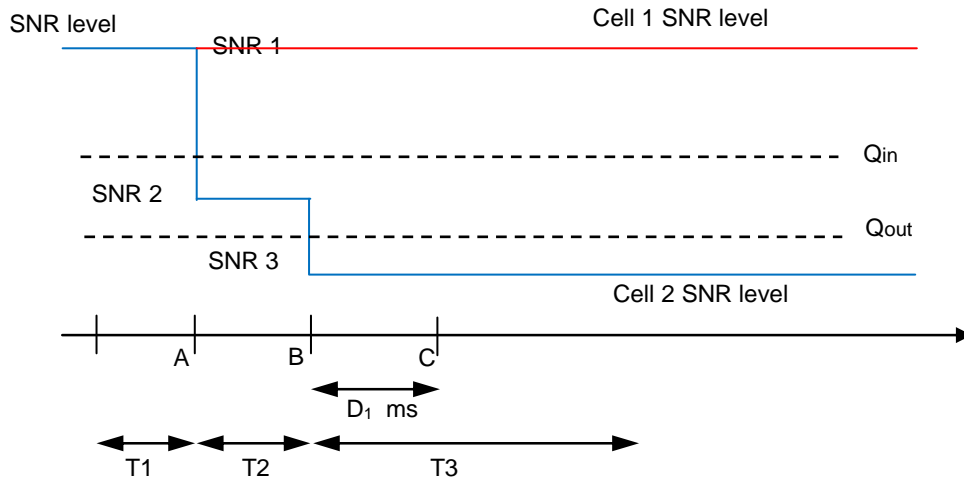

Figure A.7.3.40.1-1 SNR variation for out-of-sync testing in DRX

A.7.3.40.2 Test Requirements

The UE behaviour during time durations T1, T2, and T3 shall be as follows:

During time durations T1, T2 and T3, the UE shall transmit uplink signal at least in all subframes configured for CQI transmission on Cell1.

During the period from time point A to time point B the UE shall transmit uplink signal at least once every DRX cycle, in the On-duration part of the cycle in the uplink subframe on Cell2.

The UE shall stop transmitting uplink signal no later than time point C (duration D1 = 900 ms after the start of time duration T3) on PSCell.

The rate of correct events observed during repeated tests shall be at least 90%.

A.7.3.41 E-UTRAN FDD-FDD Radio Link Monitoring Test for In-sync in DRX in synchronous dual connectivity

A.7.3.41.1 Test Purpose and Environment

The purpose of this test is to verify that the UE properly detects the out of sync and in sync for the purpose of monitoring downlink radio link quality of the PSCell when DRX is used in dual connectivity. This test will partly verify the E-UTRAN FDD radio link monitoring requirements in clause 7.6.

The test parameters are given in Tables A.7.3.41.1-1, A.7.3.41.1-2, A.7.3.41.1-3 and A.7.3.41.1-4. There are two cells, cell 1 is PCell and cell 2 is PSCell, in the test. The test consists of five successive time periods, with time duration of T1, T2, T3, T4 and T5 respectively. Figure A.7.3.41.1-1 shows the variation of the downlink SNR in the PSCell to emulate out-of-sync and in-sync states. Prior to the start of the time duration T1, the UE shall be fully synchronized to cell 1 and cell 2. The UE shall be configured for periodic CQI reporting in PUCCH 1-0 mode with a reporting periodicity of 2 ms. In the test, DRX configuration for PCell and PSCell is enabled and DRX inactivity timer has already been expired, i.e. UE tries to decode PDCCH and to send periodic CQI during the period when On-duration timer is running. Time alignment timers shall be set to “infinity” so that UL timing alignment is maintained during the test.

Table A.7.3.41.1-1: General test parameters for E-UTRAN FDD-FDD Radio Link Monitoring Test for In-sync in DRX in synchronous dual connectivity

Parameter	Unit	Value	Comment
E-UTRA RF Channel Number		1, 2	Two E-UTRA FDD carrier frequency are used.
Active cell		Cell 1, Cell 2	Cell 1 is PCell on E-UTRA RF channel number 1, and cell 2 is PSCell on E-UTRA RF channel number 2

CP length			Normal	
In sync transmission parameters (Note 1)	DCI format		1C	As defined in clause 5.3.3.1.4 in TS 36.212
	Number of Control OFDM symbols		2	For 10MHz and 20MHz channel BW
	Number of Control OFDM symbols		3	For 5MHz channel BW
	Aggregation level	CCE	4	In sync threshold Q_{in} and the corresponding hypothetical PDCCH/PCFICH transmission parameters are as specified in clause 7.6.1 and Table 7.6.1-2 respectively.
	ρ_A, ρ_B		0	
	Ratio of PDCCH to RS EPRE		0	
	Ratio of PCFICH to RS EPRE		4	
Out of sync transmission parameters (Note 1)	DCI format		1A	As defined in clause 5.3.3.1.3 in TS 36.212
	Number of Control OFDM symbols		2	For 10MHz and 20MHz channel BW
	Number of Control OFDM symbols		3	For 5MHz channel BW
	Aggregation level	CCE	8	Out of sync threshold Q_{out} and the corresponding hypothetical PDCCH/PCFICH transmission parameters are as specified in clause 7.6.1 and Table 7.6.1-1 respectively.
	ρ_A, ρ_B		0	
	Ratio of PDCCH to RS EPRE	dB	4	
	Ratio of PCFICH to RS EPRE	dB	4	
DRX cycle on Cell 1	ms		640	See Table A.7.3.41.1-3
DRX cycle on Cell 2	ms		40	See Table A.7.3.41.1-3
Layer 3 filtering			Enabled	Counters: N310 = 1; N311 = 1, N313 = 1, N314 = 1
T310 timer	ms		2000	T310 is enabled
T311 timer	ms		1000	T311 is enabled
T313 timer	ms		2000	T313 is enabled
Periodic CQI reporting mode			PUCCH 1-0	As defined in table 7.2.2-1 in TS 36.213.
CQI reporting periodicity	ms		2	Minimum CQI reporting periodicity
T1	s		4	
T2	s		1.6	
T3	s		1.46	
T4	s		0.4	
T5	s		4	
Note 1: PDCCH/PCFICH corresponding to the in-sync and out of sync transmission parameters need not be included in the Reference Measurement Channel.				
Note 2: Even a UE capable of both synchronous and asynchronous DC operations is required to pass this test case in accordance with the principle defined in section A.3.11.				

Table A.7.3.41.1-2: Cell specific test parameters for E-UTRAN FDD-FDD Radio Link Monitoring Test for In-sync in DRX in synchronous dual connectivity

Parameter	Unit	Cell 1(PCell)	Cell 2 (PSCell)				
		T1 ~ T5	T1	T2	T3	T4	T5
E-UTRA RF Channel Number		1	2				
BW _{channel}	MHz	5: N _{RB,c} = 25 10: N _{RB,c} = 50 20: N _{RB,c} = 100	5: N _{RB,c} = 25 10: N _{RB,c} = 50 20: N _{RB,c} = 100				
PCFICH/PDCCH/PHICH parameters defined in A.3.1.2.1		5MHz: R.11 FDD 10MHz: R.6 FDD 20MHz: R.10 FDD	5MHz: R.11 FDD 10MHz: R.6 FDD 20MHz: R.10 FDD				
OCNG Pattern defined in A.3.2.1 (FDD)		5MHz: OP.16 FDD 10MHz: OP.2 FDD 20MHz: OP.12 FDD	5MHz: OP.16 FDD 10MHz: OP.2 FDD 20MHz: OP.12 FDD				
ρ_A, ρ_B		0	0				
PCFICH_RB	dB	4	4				
PDCCH_RA	dB	0	0				

PDCCH_RB		dB	0	0				
PBCH_RA		dB	0	0				
PBCH_RB		dB						
PSS_RA		dB						
SSS_RA		dB						
PHICH_RA		dB						
PHICH_RB		dB						
PDSCH_RA		dB						
PDSCH_RB		dB						
OCNG_RA ^{Note1}		dB						
OCNG_RB ^{Note1}		dB						
SNR ^{Note 6,8}	5MHz BW _{channel}	dB						
	10MHz BW _{channel}		-4.7	-4.7	-9.5	-13.5	-8.7	-4.7
	20MHz BW _{channel}		-4.7	-4.7	-9.5	-13.5	-8.7	-4.7
N_{oc}		dBm/15 kHz	-98					
Propagation condition			AWGN	AWGN				
Correlation Matrix and Antenna Configuration			1x2	1x2				
Receive time offset to cell1 ^{Note 7}		µs	-	33				
<p>Note 1: OCNG shall be used such that the resources in cell 1 and cell 2 are fully allocated and a constant total transmitted power spectral density is achieved for all OFDM symbols.</p> <p>Note 2: The uplink resources for CQI reporting are assigned to the UE prior to the start of time period T1.</p> <p>Note 3: The timers and layer 3 filtering related parameters are configured prior to the start of time period T1.</p> <p>Note 4: The signal contains PDCCH for UEs other than the device under test as part of OCNG.</p> <p>Note 5: SNR levels correspond to the signal to noise ratio over the cell-specific reference signal REs.</p> <p>Note 6: The SNR of cell 2 in time periods T1, T2, T3, T4 and T5 is denoted as SNR1, SNR2, SNR3, SNR4 and SNR5 respectively in figure A.7.3.41.1-1.</p> <p>Note 7: Receive time difference between subframe boundaries of signals received from the two cells at the UE antenna connector including time alignment error between the two cells.</p> <p>Note 8: The SNR values are specified for testing a UE which supports 2RX on the PSCell frequency. For testing of a UE which only supports 4RX on the PSCell frequency, the SNR during T3 and T4 is modified as specified in section A.3.8.1.</p>								

Table A.7.3.41.1-3: DRX-Configuration for E-UTRAN FDD-FDD Radio Link Monitoring Test for In-sync in DRX in synchronous dual connectivity

Field	Value		Comment
	Cell 1	Cell 2	
onDurationTimer	psf2	psf2	As specified in section 6.3.2 in 3GPP TS 36.331
drx-InactivityTimer	psf1	psf1	
drx-RetransmissionTimer	psf1	psf1	
longDRX-CycleStartOffset	sf640	sf40	
shortDRX	disable	disable	

Table A.7.3.41.1-4: TimeAlignmentTimer -Configuration for E-UTRAN FDD-FDD Radio Link Monitoring Test for In-sync in DRX in synchronous dual connectivity

Field	Value	Comment
TimeAlignmentTimer	infinity	As specified in clause 6.3.2 in TS 36.331
sr-ConfigIndex	0	For further information see clause 6.3.2 in TS 36.331 and section10.1 in TS 36.213.

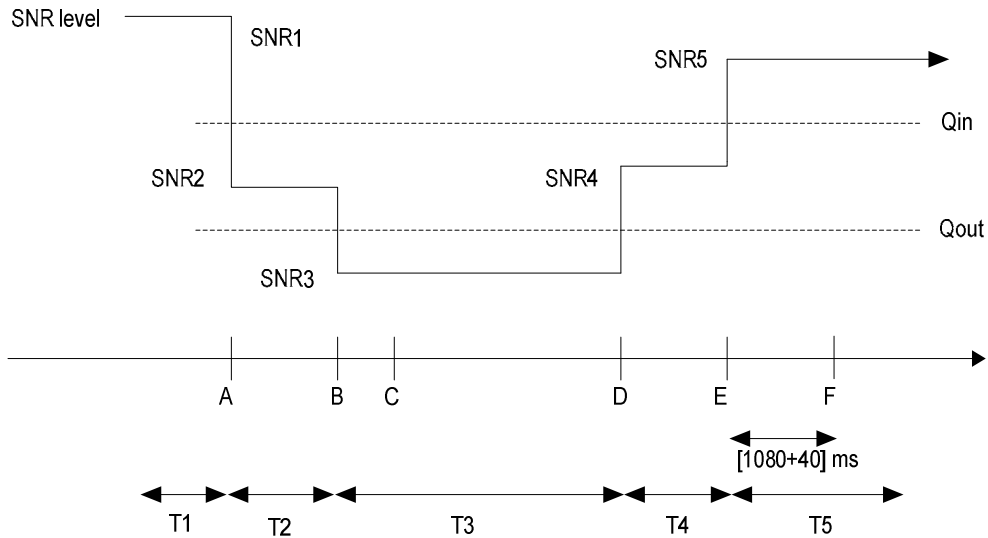

Figure A.7.3.41.1-1 SNR variation of cell 2 (PSCell) for in-sync testing in DRX

A.7.3.41.2 Test Requirements

The UE behaviour during time durations T1, T2, T3, T4 and T5 shall be as follows:

During the period from time point A to time point F (1120 ms after the start of time duration T5) the UE shall transmit uplink signal at least once every DRX cycle, in the On-duration part of the cycle in the subframe according to the configured CQI reporting mode (PUCCH 1-0) on PCell and PSCell.

The rate of correct events observed during repeated tests shall be at least 90%.

A.7.3.42 E-UTRAN FDD-FDD DC Radio Link Monitoring Test for In-sync in DRX in asynchronous DC

A.7.3.42.1 Test Purpose and Environment

The purpose of this test is to verify that the UE properly detects the out of sync and in sync for the purpose of monitoring downlink radio link quality of the PSCell when DRX is used in asynchronous dual connectivity. This test will partly verify the E-UTRAN FDD radio link monitoring requirements in clause 7.6.

The test parameters are given in Tables A.7.3.42.1-1, A.7.3.42.1-2, A.7.3.42.1-3 and A.7.3.42.1-4. There are two cells in the test. Cell 1 is PCell in MCG and cell 2 is PSCell in SCG. Before the test starts the UE is connected to cell 1 on radio channel 1 and to cell 2 on radio channel 2. The test consists of five successive time periods, with time duration of T1, T2, T3, T4 and T5 respectively. The downlink SNR in cell 1 keeps constant in the test. Figure A.7.3.42.1-1 shows the variation of the downlink SNR in cell 2 to emulate out-of-sync and in-sync states. Prior to the start of the time duration T1, the UE shall be fully synchronized to cell 1 and cell 2 in asynchronous dual connectivity. For both cell 1 and cell 2, the UE shall be configured for periodic CQI reporting in PUCCH 1-0 mode with a reporting periodicity of 2 ms. In the test, DRX configuration is enabled and DRX inactivity timer has already been expired, i.e. UE tries to decode PDCCH and to send periodic CQI during the period when On-duration timer is running. Time alignment timers shall be set to “infinity” so that UL timing alignment is maintained during the test.

Table A.7.3.42.1-1: General test parameters for E-UTRAN FDD in-sync test in DRX

Parameter	Unit	Value	Comment
Active cells		Cell 1 and cell 2	Cell 1 (PCell) is on E-UTRA RF channel number 1 and cell 2 (PSCell) is on E-UTRA RF channel number 2
CP length		Normal	
Antenna Configuration		1x2	

In sync transmission parameters (Note 1)	DCI format		1C	As defined in clause 5.3.3.1.4 in TS 36.212
	Number of Control OFDM symbols		5MHz: 3 10MHz: 2 20MHz: 2	In sync threshold Q_{in} and the corresponding hypothetical PDCCH/PCFICH transmission parameters are as specified in clause and Table 7.6.1-2 respectively.
	Aggregation level	CCE	4	
	ρ_A, ρ_B		0	
	Ratio of PDCCH to RS EPRE		0	
	Ratio of PCFICH to RS EPRE		4	
Out of sync transmission parameters (Note 1)	DCI format		1A	As defined in clause 5.3.3.1.3 in TS 36.212
	Number of Control OFDM symbols		2	Out of sync threshold Q_{out} and the corresponding hypothetical PDCCH/PCFICH transmission parameters are as specified in clause 7.6.1 and Table 7.6.1-1 respectively.
	Aggregation level	CCE	8	
	ρ_A, ρ_B		0	
	Ratio of PDCCH to RS EPRE	dB	4	
	Ratio of PCFICH to RS EPRE	dB	4	
DRX cycle in cell 1	ms		640	See Table A.7.3.42.1-3
DRX cycle in cell 2	ms		40	See Table A.7.3.42.1-3
Layer 3 filtering			<i>Enabled</i>	<i>Counters:</i> $N_{310} = 1; N_{311} = 1;$ $N_{313} = 1; N_{314} = 1$
T310 timer	ms		2000	<i>T310 is enabled</i>
T311 timer	ms		1000	T311 is enabled
T313 timer	ms		2000	T313 is enabled
Periodic CQI reporting mode			PUCCH 1-0	As defined in table 7.2.2-1 in TS 36.213.
CQI reporting periodicity	ms		2	Minimum CQI reporting periodicity
T1	s		4	
T2	s		1.6	
T3	s		1.46	
T4	s		0.4	
T5	s		4	
<p>Note 1: PDCCH/PCFICH corresponding to the in-sync and out of sync transmission parameters need not be included in the Reference Measurement Channel.</p> <p>Note 2: The parameters in the table apply to both cell 1 and cell 2 unless defined otherwise.</p> <p>Note 3: Even a UE capable of both synchronous and asynchronous DC operations is required to pass this test case in accordance with the principle defined in section A.3.6.11.</p>				

Table A.7.3.42.1-2: Cell specific test parameters for E-UTRAN FDD for in-sync radio link monitoring in DRX

Parameter	Unit	Cell 1 (PCell)	Cell 2 (PSCell)				
		T1 ~ T5	T1	T2	T3	T4	T5
E-UTRA RF Channel Number		1	2				
E-UTRA Channel Bandwidth ($BW_{channel}$)	MHz	5, 10, 20	5, 10, 20				
PCFICH/PDCCH/PHICH parameters. None of the PDCCH are intended for the UE under test.		5MHz: R.11 FDD 10MHz: R.6 FDD 20MHz: R.10 FDD	5MHz: R.11 FDD 10MHz: R.6 FDD 20MHz: R.10 FDD				
OCNG Pattern		5MHz: OP.16 FDD 10MHz: OP.2 FDD 20MHz: OP.12 FDD	5MHz: OP.16 FDD 10MHz: OP.2 FDD 20MHz: OP.12 FDD				
ρ_A, ρ_B		0	0				

PCFICH_RB		dB	4	4				
PDCCH_RA		dB	0	0				
PDCCH_RB		dB	0	0				
PBCH_RA		dB	0	0				
PBCH_RB		dB						
PSS_RA		dB						
SSS_RA		dB						
PHICH_RA		dB						
PHICH_RB		dB						
PDSCH_RA		dB						
PDSCH_RB		dB						
OCNG_RA ^{Note1}		dB						
OCNG_RB ^{Note1}		dB						
SNR ^{Note 6,8}	5MHz BW _{channel}	dB	-2.3	-2.3	-5.7	-12.2	-7.3	-2.3
	10MHz BW _{channel}	dB	-4.7	-4.7	-9.5	-13.5	-8.7	-4.7
	20MHz BW _{channel}	dB	-4.7	-4.7	-9.5	-13.5	-8.7	-4.7
N_{oc}		dBm/15 kHz	-98					
Propagation condition			AWGN					
Receive time offset to cell1 ^{Note 7}		µs	-	500				
<p>Note 1: OCNG shall be used such that the resources in cell 1 and cell 2 are fully allocated and a constant total transmitted power spectral density is achieved for all OFDM symbols.</p> <p>Note 2: The uplink resources for CQI reporting are assigned to the UE prior to the start of time period T1.</p> <p>Note 3: The timers and layer 3 filtering related parameters are configured prior to the start of time period T1.</p> <p>Note 4: The signal contains PDCCH for UEs other than the device under test as part of OCNG.</p> <p>Note 5: SNR levels correspond to the signal to noise ratio over the cell-specific reference signal REs.</p> <p>Note 6: The SNR of cell 2 in time periods T1, T2, T3, T4 and T5 is denoted as SNR1, SNR2, SNR3, SNR4 and SNR5 respectively in figure A.7.3.6.1-1.</p> <p>Note 7: Receive time difference between subframe boundaries of signals received from the two cells at the UE antenna connector including time alignment error between the two cells.</p> <p>Note 8: The SNR values are specified for testing a UE which supports 2RX on the PSCell frequency. For testing of a UE which only supports 4RX on the PSCell frequency, the SNR during T3 and T4 is modified as specified in section A.3.8.1.</p>								

Table A.7.3.42.1-3: DRX-Configuration for E-UTRAN FDD out-of-sync tests

Field	Cell 1	Cell 2	Comment
onDurationTimer	psf2	psf2	As specified in clause 6.3.2 in TS 36.331
drx-InactivityTimer	psf1	psf1	
drx-RetransmissionTimer	psf1	psf1	
longDRX-CycleStartOffset	sf640	sf40	
shortDRX	disable	disable	

Table A.7.3.42.1-4: TimeAlignmentTimer-Configuration for E-UTRAN FDD out-of-sync testing

Field	Value	Comment
TimeAlignmentTimer	infinity	As specified in clause 6.3.2 in TS 36.331
sr-ConfigIndex	0	For further information see clause 6.3.2 in TS 36.331 and section 10.1 in TS 36.213.

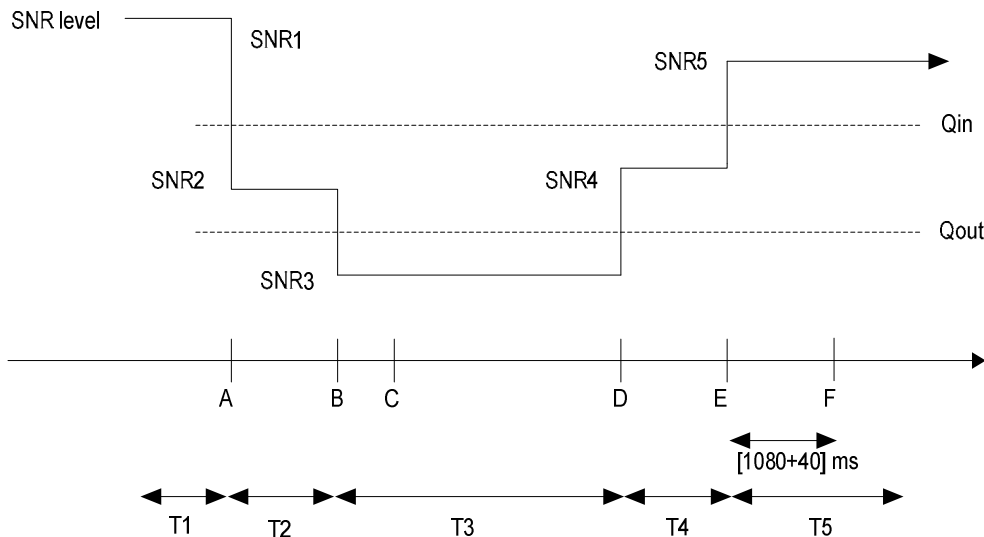

Figure A.7.3.42.1-1 Cell 2 SNR variation for in-sync testing in DRX

A.7.3.42.2 Test Requirements

The UE behaviour in each test during time durations T1, T2, T3, T4 and T5 shall be as follows:

During the period from time point A to time point F (1120 ms after the start of time duration T5) the UE shall transmit uplink signal on cell 2 at least once every DRX cycle, in the On-duration part of the cycle in the subframe according to the configured CQI reporting mode (PUCCH 1-0).

The rate of correct events observed during repeated tests shall be at least 90%.

A.7.3.43 E-UTRAN TDD-TDD Radio Link Monitoring Test for In-sync in DRX in synchronous dual connectivity

A.7.3.43.1 Test Purpose and Environment

The purpose of this test is to verify that the UE properly detects the out of sync and in sync for the purpose of monitoring downlink radio link quality of the PSCell when DRX is used in dual connectivity. This test will partly verify the E-UTRAN TDD radio link monitoring requirements in clause 7.6.

The test parameters are given in Tables A.7.3.43.1-1, A.7.3.43.1-2, A.7.3.43.1-3 and A.7.3.43.1-4. There are two cells, cell 1 is PCell and cell 2 is PSCell, in the test. The test consists of five successive time periods, with time duration of T1, T2, T3, T4 and T5 respectively. Figure A.7.3.43.1-1 shows the variation of the downlink SNR in the PSCell to emulate out-of-sync and in-sync states. Prior to the start of the time duration T1, the UE shall be fully synchronized to cell 1 and cell 2. The UE shall be configured for periodic CQI reporting in PUCCH 1-0 mode with a reporting periodicity of 1 ms. In the test, DRX configuration for PCell and PSCell is enabled and DRX inactivity timer has already been expired, i.e. UE tries to decode PDCCH and to send periodic CQI during the period when On-duration timer is running. Time alignment timers shall be set to “infinity” so that UL timing alignment is maintained during the test.

Table A.7.3.43.1-1: General test parameters for E-UTRAN TDD-TDD Radio Link Monitoring Test for In-sync in DRX in synchronous dual connectivity

Parameter	Unit	Value	Comment
E-UTRA RF Channel Number		1, 2	Two E-UTRA TDD carrier frequency are used.
Active cell		Cell 1, Cell 2	Cell 1 is PCell on E-UTRA RF channel number 1, and cell 2 is PSCell on E-UTRA RF channel number 2
CP length		Normal	

In sync transmission parameters (Note 1)	DCI format		1C	As defined in clause 5.3.3.1.4 in TS 36.212
	Number of Control OFDM symbols		2	For 10MHz and 20MHz channel BW
	Number of Control OFDM symbols		3	For 5MHz channel BW
	Aggregation level	CCE	4	In sync threshold Q_{in} and the corresponding hypothetical PDCCH/PCFICH transmission parameters are as specified in clause 7.6.1 and Table 7.6.1-2 respectively.
	ρ_A, ρ_B		0	
	Ratio of PDCCH to RS EPRE		0	
	Ratio of PCFICH to RS EPRE		4	
Out of sync transmission parameters (Note 1)	DCI format		1A	As defined in clause 5.3.3.1.3 in TS 36.212
	Number of Control OFDM symbols		2	For 10MHz and 20MHz channel BW
	Number of Control OFDM symbols		3	For 5MHz channel BW
	Aggregation level	CCE	8	Out of sync threshold Q_{out} and the corresponding hypothetical PDCCH/PCFICH transmission parameters are as specified in clause 7.6.1 and Table 7.6.1-1 respectively.
	ρ_A, ρ_B		0	
	Ratio of PDCCH to RS EPRE	dB	4	
	Ratio of PCFICH to RS EPRE	dB	4	
DRX cycle on Cell 1	ms		640	See Table A.7.3.43.1-3
DRX cycle on Cell 2	ms		40	See Table A.7.3.43.1-3
Layer 3 filtering			Enabled	Counters: N310 = 1; N311 = 1, N313 = 1, N314 = 1
T310 timer	ms		2000	T310 is enabled
T311 timer	ms		1000	T311 is enabled
T313 timer	ms		2000	T313 is enabled
Periodic CQI reporting mode			PUCCH 1-0	As defined in table 7.2.2-1 in TS 36.213.
CQI reporting periodicity	ms		1	Minimum CQI reporting periodicity
T1	s		4	
T2	s		1.6	
T3	s		1.46	
T4	s		0.4	
T5	s		4	
Note 1: PDCCH/PCFICH corresponding to the in-sync and out of sync transmission parameters need not be included in the Reference Measurement Channel.				
Note 2: Even a UE capable of both synchronous and asynchronous DC operations is required to pass this test case in accordance with the principle defined in section A.3.11.				

Table A.7.3.43.1-2: Cell specific test parameters for E-UTRAN TDD-TDD Radio Link Monitoring Test for In-sync in DRX in synchronous dual connectivity

Parameter	Unit	Cell 1 (PCell)	Cell 2 (PSCell)				
		T1 ~ T5	T1	T2	T3	T4	T5
E-UTRA RF Channel Number		1	2				
$BW_{channel}$	MHz	5: $N_{RB,c} = 25$ 10: $N_{RB,c} = 50$ 20: $N_{RB,c} = 100$	5: $N_{RB,c} = 25$ 10: $N_{RB,c} = 50$ 20: $N_{RB,c} = 100$				
Special subframe configuration ^{Note1}		6	6				
Uplink-downlink configuration ^{Note2}		1	1				
PCFICH/PDCCH/PHICH parameters defined in A.3.1.2.1		5MHz: R.11 TDD 10MHz: R.6 TDD 20MHz: R.10 TDD	5MHz: R.11 TDD 10MHz: R.6 TDD 20MHz: R.10 TDD				
OCNG Pattern defined in A.3.2.1 (FDD)		5MHz: OP.10 TDD 10MHz: OP.2 TDD 20MHz: OP.8 TDD	5MHz: OP.10 TDD 10MHz: OP.2 TDD 20MHz: OP.8 TDD				
ρ_A, ρ_B		0	0				

PCFICH_RB		dB	4	4				
PDCCH_RA		dB	0	0				
PDCCH_RB		dB	0	0				
PBCH_RA		dB	0	0				
PBCH_RB		dB						
PSS_RA		dB						
SSS_RA		dB						
PHICH_RA		dB						
PHICH_RB		dB						
PDSCH_RA		dB						
PDSCH_RB		dB						
OCNG_RA ^{Note1}		dB						
OCNG_RB ^{Note1}		dB						
SNR ^{Note 6,10}	5MHz BW _{channel}	dB	-5.1	-5.1	-9.1	-13.1	-9.1	-5.1
	10MHz BW _{channel}		-5.1	-5.1	-9.1	-13.1	-9.1	-5.1
	20MHz BW _{channel}		-5.1	-5.1	-9.1	-13.1	-9.1	-5.1
N_{oc}		dBm/15 kHz	-98					
Propagation condition			AWGN	AWGN				
Correlation Matrix and Antenna Configuration			1x2	1x2				
Receive time offset to cell1 ^{Note 9}		µs	-	33				
<p>Note 1: For the special subframe configuration see table 4.2-1 in TS 36.211.</p> <p>Note 2: For the uplink-downlink configuration see table 4.2-2 in TS 36.211.</p> <p>Note 3: OCNG shall be used such that the resources in cell # 1 are fully allocated and a constant total transmitted power spectral density is achieved for all OFDM symbols.</p> <p>Note 4: The uplink resources for CQI reporting are assigned to the UE prior to the start of time period T1.</p> <p>Note 5: The timers and layer 3 filtering related parameters are configured prior to the start of time period T1.</p> <p>Note 6: The signal contains PDCCH for UEs other than the device under test as part of OCNG.</p> <p>Note 7: SNR levels correspond to the signal to noise ratio over the cell-specific reference signal REs.</p> <p>Note 8: The SNR in time periods T1, T2, T3, T4 and T5 is denoted as SNR1, SNR2, SNR3, SNR4 and SNR5 respectively in figure A.7.3.43.1-1.</p> <p>Note 9: Receive time difference between subframe boundaries of signals received from the two cells at the UE antenna connector including time alignment error between the two cells.</p> <p>Note 10: The SNR values are specified for testing a UE which supports 2RX on the PSCell frequency. For testing of a UE which only supports 4RX on the PSCell frequency, the SNR during T3 and T4 is modified as specified in section A.3.8.1.</p>								

Table A.7.3.43.1-3: DRX-Configuration for E-UTRAN TDD-TDD Radio Link Monitoring Test for In-sync in DRX in synchronous dual connectivity

Field	Value		Comment
	Cell 1	Cell 2	
onDurationTimer	psf2	psf2	As specified in section 6.3.2 in 3GPP TS 36.331
drx-InactivityTimer	psf1	psf1	
drx-RetransmissionTimer	psf1	psf1	
longDRX-CycleStartOffset	sf640	sf40	
shortDRX	disable	disable	

Table A.7.3.43.1-4: TimeAlignmentTimer -Configuration for E-UTRAN TDD-TDD Radio Link Monitoring Test for In-sync in DRX in synchronous dual connectivity

Field	Value	Comment
TimeAlignmentTimer	infinity	As specified in clause 6.3.2 in TS 36.331
sr-ConfigIndex	0	For further information see clause 6.3.2 in TS 36.331 and section 10.1 in TS 36.213.

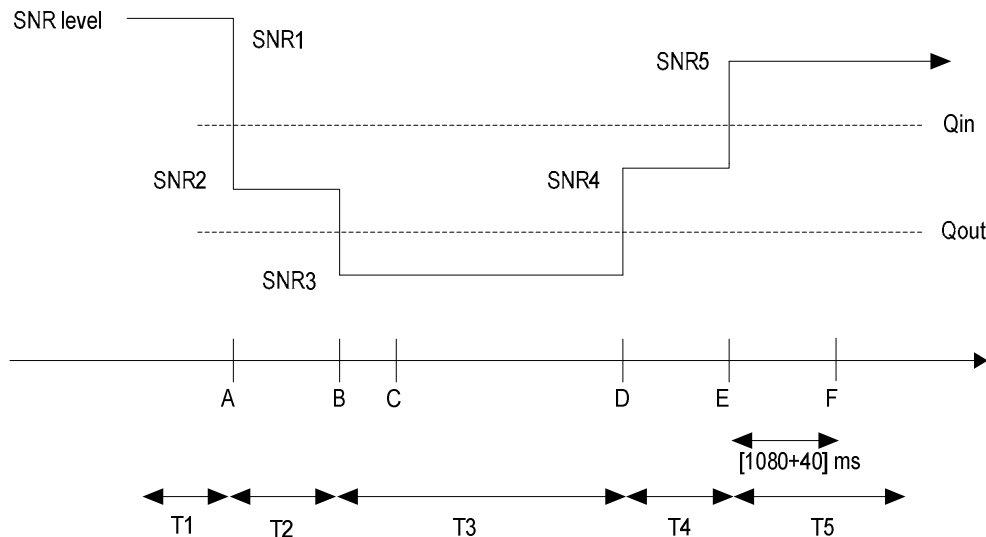

Figure A.7.3.43.1-1 SNR variation of cell 2 (PSCell) for in-sync testing in DRX

A.7.3.43.2 Test Requirements

The UE behaviour during time durations T1, T2, T3, T4 and T5 shall be as follows:

During the period from time point A to time point F (1120 ms after the start of time duration T5) the UE shall transmit uplink signal at least once every DRX cycle, in the On-duration part of the cycle in the subframe according to the configured CQI reporting mode (PUCCH 1-0) on PCell and PSCell.

The rate of correct events observed during repeated tests shall be at least 90%.

A.7.3.44 E-UTRAN TDD-FDD DC Radio Link Monitoring Test for Out-of-sync in DRX in synchronous DC with PCell in FDD

A.7.3.44.1 Test Purpose and Environment

The purpose of this test is to verify that the UE properly detects the out of sync for the purpose of monitoring downlink radio link quality of the PSCell when DRX is used. This test will partly verify the radio link monitoring requirements in clause 7.6.

The test parameters are given in Tables A.7.3.44.1-1, A.7.3.44.1-2, A.7.3.44.1-3, and A.7.3.44.1-4. There are two cells, cell 1 is PCell and cell 2 is PSCell, in the test. The test consists of three successive time periods with time duration of T1, T2 and T3 respectively. Figure A.7.3.44.1-1 shows the variation of the downlink SNR in the PCell and PSCell to emulate out-of-sync and in-sync states. Prior to the start of the time duration T1, the UE shall be fully synchronized to cell 1 and cell 2. The UE shall be configured for periodic CQI reporting in PUCCH 1-0 mode with a reporting periodicity of 2ms on cell 1 and 1ms on cell 2, respectively. In the test, DRX configuration is enabled and DRX inactivity timer has already been expired, i.e. UE tries to decode PDCCH and to send periodic CQI during the period when On-duration timer is running. Time alignment timers shall be set to “infinity” so that UL timing alignment is maintained during the test.

Table A.7.3.44.1-1: General test parameters for E-UTRAN TDD-FDD DC out-of-sync tests in DRX in synchronous dual connectivity with PCell in FDD

Parameter	Unit	Value	Comment
Active cell		Cell 1 Cell 2	Cell 1 is PCell on E-UTRA FDD RF channel number 1, and cell 2 is PSCell on E-UTRA TDD RF channel number 2
CP length		Normal	
E-UTRA RF Channel Number		1, 2	One E-UTRA FDD carrier frequency and one E-UTRA TDD carrier frequency are used.
E-UTRA Channel Bandwidth (BWchannel)	MHz	5, 10, 20	

Correlation Matrix and Antenna Configuration			2x2 Low	Correlation Matrix and Antenna Configuration are defined in TS 36.101 [5] Annex B.2.3.2
Out of sync transmission parameters (Note 1)	DCI format		1A	As defined in clause 5.3.3.1.3 in TS 36.212
	Number of Control OFDM symbols		2	Out of sync threshold Q_{out} and the corresponding hypothetical PDCCH/PCFICH transmission parameters are as specified in clause 7.6.1 and Table 7.6.1-1 respectively.
	Aggregation level	CCE	8	
	ρ_A, ρ_B		-3	
	Ratio of PDCCH to RS EPRE	dB	1	
Ratio of PCFICH to RS EPRE	dB	1		
DRX cycle on cell 1	ms		640	See Table A.7.3.38.1-3
DRX cycle on cell 2	ms		40	See Table A.7.3.38.1-3
Timing offset between cell 1 and cell 2	μ s		33	For synchronous dual connectivity
Layer 3 filtering			Enabled	Counters: N310 = 1; N311 = 1; N313 = 1; N314 = 1
T310 timer	ms		0	T310 is disabled
T311 timer	ms		1000	T311 is enabled
T313 timer	ms		0	T313 is disabled
Periodic CQI reporting mode			PUCCH 1-0	As defined in table 7.2.2-1 in TS 36.213.
T1	s		4	
T2	s		1.6	
T3	s		1.8	
Note 1: PDCCH/PCFICH corresponding to the out of sync transmission parameters need not be included in the Reference Measurement Channel.				

Table A.7.3.44.1-2: Cell specific test parameters for E-UTRAN TDD-FDD DC out-of-sync radio link monitoring in DRX in synchronous dual connectivity with PCell in FDD

Parameter	Unit	Cell 1			Cell 2		
		T1	T2	T3	T1	T2	T3
E-UTRA RF Channel Number		1			2		
$BW_{channel}$	MHz	5, 10, 20			5, 10, 20		
Correlation Matrix and Antenna Configuration		2x2 Low			2x2 Low		
Special subframe configuration ^{Note7}		-			6		
Uplink-downlink configuration ^{Note8}		-			1		
PCFICH/PDCCH/PHICH parameters None of the PDCCH are intended for the UE under test		5MHz: R.12 FDD 10MHz: R.7 FDD 20MHz: R.13 FDD			5MHz: R.12 TDD 10MHz: R.7 TDD 20MHz: R.13 TDD		
OCNG Pattern		5MHz: OP.16 FDD 10MHz: OP.2 FDD 20MHz: OP.12 FDD			5MHz: OP.10 TDD 10MHz: OP.2 TDD 20MHz: OP.8 TDD		
ρ_A, ρ_B		-3			-3		
PCFICH_RB	dB	1			1		
PDCCH_RA	dB	1			1		
PDCCH_RB	dB	1			1		
PBCH_RA	dB	-3			-3		
PBCH_RB	dB						
PSS_RA	dB						
SSS_RA	dB						
PHICH_RA	dB						
PHICH_RB	dB						
PDSCH_RA	dB						
PDSCH_RB	dB						
OCNG_RA ^{Note1}	dB						
OCNG_RB ^{Note1}	dB						

SNR ^{Note 6} (5MHz bandwidth)	dB	-2.3	-2.3	-2.3	-1.6	-5.2	-11.9
SNR ^{Note 6} (10MHz bandwidth)	dB	-2.3	-2.3	-2.3	-2.3	-5.9	-11.9
SNR ^{Note 6} (20MHz bandwidth)	dB	-2.9	-2.9	-2.9	-3.0	-6.6	-12.6
N_{oc}	dBm/15 kHz	-98			-98		
Propagation condition		ETU 70 Hz			ETU 70 Hz		
Time offset to cell1 ^{Note 9}	μ s	-			33		
CQI reporting periodicity	ms	2			1		
<p>Note 1: OCNG shall be used such that the resources in cell 1 and cell 2 are fully allocated and a constant total transmitted power spectral density is achieved for all OFDM symbols.</p> <p>Note 2: The uplink resources for CQI reporting are assigned to the UE prior to the start of time period T1.</p> <p>Note 3: The timers and layer 3 filtering related parameters are configured prior to the start of time period T1.</p> <p>Note 4: The signal contains PDCCH for UEs other than the device under test as part of OCNG.</p> <p>Note 5: SNR levels correspond to the signal to noise ratio over the cell-specific reference signal REs.</p> <p>Note 6: The SNR in time periods T1, T2, and T3 are denoted as SNR1, SNR2 and SNR3 respectively in figure A.7.3.38.1-1.</p> <p>Note 7: For the special subframe configuration see table 4.2-1 in TS 36.211.</p> <p>Note 8: For the uplink-downlink configuration see table 4.2-2 in TS 36.211.</p> <p>Note 9: Receive time difference between subframe boundaries of signals received from the two cells at the UE antenna connector including time alignment error between the two cells.</p>							

Table A.7.3.44.1-3: DRX-Configuration for E-UTRAN TDD-FDD DC out-of-sync tests in synchronous dual connectivity with PCell in FDD

Field	Value		Comment
	Cell 1	Cell 2	
onDurationTimer	psf2	psf2	As specified in clause 6.3.2 in TS 36.331
drx-InactivityTimer	psf1	psf1	
drx-RetransmissionTimer	psf1	psf1	
longDRX-CycleStartOffset	Sf640	Sf40	
shortDRX	disable	disable	

Table A.7.3.44.1-4: TimeAlignmentTimer -Configuration for E-UTRAN TDD-FDD DC out-of-sync testing in synchronous dual connectivity with PCell in FDD

Field	Value	Comment
TimeAlignmentTimer	infinity	As specified in clause 6.3.2 in TS 36.331
sr-ConfigIndex	0	For further information see clause 6.3.2 in TS 36.331 and section 10.1 in TS 36.213.

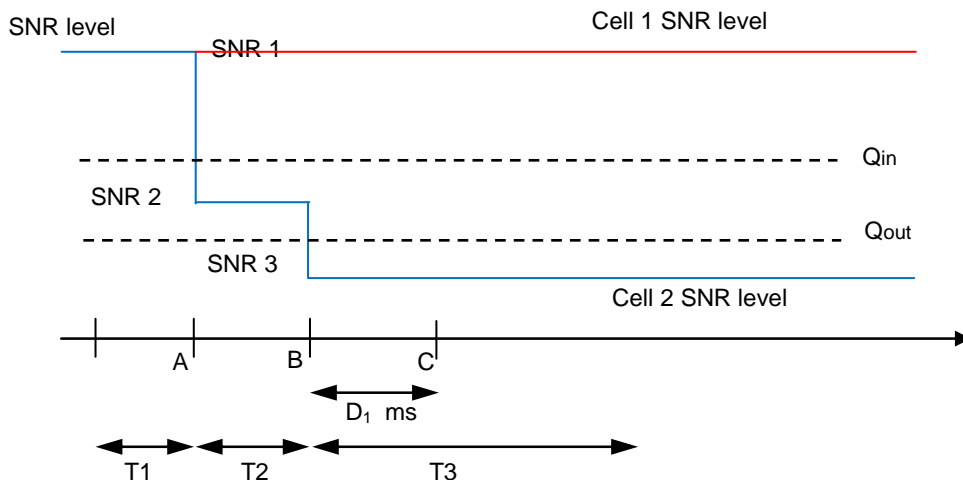

Figure A.7.3.44.1-1 SNR variation for out-of-sync testing in DRX

A.7.3.44.2 Test Requirements

The UE behaviour during time durations T1, T2, and T3 shall be as follows:

During time durations T1, T2 and T3, the UE shall transmit uplink signal at least in all subframes configured for CQI transmission on Cell1.

During the period from time point A to time point B the UE shall transmit uplink signal at least once every DRX cycle, in the On-duration part of the cycle in the uplink subframe on Cell2.

The UE shall stop transmitting uplink signal no later than time point C (duration D1 = 900 ms after the start of time duration T3) on PSCell.

The rate of correct events observed during repeated tests shall be at least 90%.

A.7.3.45 E-UTRAN TDD-FDD DC Radio Link Monitoring Test for Out-of-sync in DRX in synchronous DC with PCell in TDD

A.7.3.45.1 Test Purpose and Environment

The purpose of this test is to verify that the UE properly detects the out of sync for the purpose of monitoring downlink radio link quality of the PSCell when DRX is used. This test will partly verify the radio link monitoring requirements in clause 7.6.

The test parameters are given in Tables A.7.3.45.1-1, A.7.3.45.1-2, A.7.3.45.1-3, and A.7.3.45.1-4. There are two cells, cell 1 is PCell and cell 2 is PSCell, in the test. The test consists of three successive time periods with time duration of T1, T2 and T3 respectively. Figure A.7.3.45.1-1 shows the variation of the downlink SNR in the PCell and PSCell to emulate out-of-sync and in-sync states. Prior to the start of the time duration T1, the UE shall be fully synchronized to cell 1 and cell 2. The UE shall be configured for periodic CQI reporting in PUCCH 1-0 mode with a reporting periodicity of 1ms on cell 1 and 2ms on cell 2, respectively. In the test, DRX configuration is enabled and DRX inactivity timer has already been expired, i.e. UE tries to decode PDCCH and to send periodic CQI during the period when On-duration timer is running. Time alignment timers shall be set to “infinity” so that UL timing alignment is maintained during the test.

Table A.7.3.45.1-1: General test parameters for E-UTRAN TDD-FDD DC out-of-sync tests in DRX in synchronous dual connectivity with PCell in TDD

Parameter	Unit	Value	Comment	
Active cell		Cell 1 Cell 2	Cell 1 is PCell on E-UTRA TDD RF channel number 1, and cell 2 is PSCell on E-UTRA FDD RF channel number 2	
CP length		Normal		
E-UTRA RF Channel Number		1, 2	One E-UTRA TDD carrier frequencies and one E-UTRA FDD carrier frequencies are used.	
E-UTRA Channel Bandwidth (BW _{channel})	MHz	5, 10, 20		
Correlation Matrix and Antenna Configuration		2x2 Low	Correlation Matrix and Antenna Configuration are defined in TS 36.101 [5] Annex B.2.3.2	
Out of sync transmission parameters (Note 1)	DCI format		1A	As defined in clause 5.3.3.1.3 in TS 36.212
	Number of Control OFDM symbols		2	Out of sync threshold Q_{out} and the corresponding hypothetical PDCCH/PCFICH transmission parameters are as specified in clause 7.6.1 and Table 7.6.1-1 respectively.
	Aggregation level	CCE	8	
	ρ_A, ρ_B		-3	
	Ratio of PDCCH to RS EPRE	dB	1	
Ratio of PCFICH to RS EPRE	dB	1		
DRX cycle on cell 1	ms	640	See Table A.7.3.40.1-3	
DRX cycle on cell 2	ms	40	See Table A.7.3.40.1-3	
Timing offset between cell 1 and cell 2	μ s	33	For synchronous dual connectivity	
Layer 3 filtering		Enabled	Counters:	

			N310 = 1; N311 = 1; N313 = 1; N314 = 1
T310 timer	ms	0	T310 is disabled
T311 timer	ms	1000	T311 is enabled
T313 timer	ms	0	T313 is disabled
Periodic CQI reporting mode		PUCCH 1-0	As defined in table 7.2.2-1 in TS 36.213.
T1	s	4	
T2	s	1.6	
T3	s	1.8	
Note 1: PDCCH/PCFICH corresponding to the out of sync transmission parameters need not be included in the Reference Measurement Channel.			

Table A.7.3.45.1-2: Cell specific test parameters for E-UTRAN TDD-FDD DC out-of-sync radio link monitoring in DRX in synchronous dual connectivity with PCell in TDD

Parameter	Unit	Cell 1			Cell 2		
		T1	T2	T3	T1	T2	T3
E-UTRA RF Channel Number		1			2		
BW _{channel}	MHz	5, 10, 20			5, 10, 20		
Correlation Matrix and Antenna Configuration		2x2 Low			2x2 Low		
Special subframe configuration ^{Note1}		6			-		
Uplink-downlink configuration ^{Note2}		1			-		
PCFICH/PDCCH/PHICH parameters None of the PDCCH are intended for the UE under test		5MHz: R.12 TDD 10MHz: R.7 TDD 20MHz: R.13 TDD			5MHz: R.12 FDD 10MHz: R.7 FDD 20MHz: R.13 FDD		
OCNG Pattern		5MHz: OP.10 TDD 10MHz: OP.2 TDD 20MHz: OP.8 TDD			5MHz: OP.16 FDD 10MHz: OP.2 FDD 20MHz: OP.12 FDD		
ρ_A, ρ_B		-3			-3		
PCFICH_RB	dB	1			1		
PDCCH_RA	dB	1			1		
PDCCH_RB	dB	1			1		
PBCH_RA	dB	-3			-3		
PBCH_RB	dB						
PSS_RA	dB						
SSS_RA	dB						
PHICH_RA	dB						
PHICH_RB	dB						
PDSCH_RA	dB						
PDSCH_RB	dB						
OCNG_RA ^{Note3}	dB						
OCNG_RB ^{Note3}	dB						
SNR ^{Note 8} (5MHz bandwidth)	dB	-1.6	-1.6	-1.6	-2.3	-5.7	-12.2
SNR ^{Note 8} (10MHz bandwidth)	dB	-2.3	-2.3	-2.3	-2.3	-6.2	-12.2
SNR ^{Note 8} (20MHz bandwidth)	dB	-3.0	-3.0	-3.0	-2.9	-6.8	-12.8
N_{oc}	dBm/15 kHz	-98			-98		
Propagation condition		ETU 70 Hz			ETU 70 Hz		
Time offset to cell1 ^{Note 9}	μ s	-			33		
CQI reporting periodicity	ms	1			2		

- Note 1: For the special subframe configuration see table 4.2-1 in TS 36.211.
- Note 2: For the uplink-downlink configuration see table 4.2-2 in TS 36.211.
- Note 3: OCNG shall be used such that the resources in cell # 1 are fully allocated and a constant total transmitted power spectral density is achieved for all OFDM symbols.
- Note 4: The uplink resources for CQI reporting are assigned to the UE prior to the start of time period T1.
- Note 5: The timers and layer 3 filtering related parameters are configured prior to the start of time period T1.
- Note 6: The signal contains PDCCH for UEs other than the device under test as part of OCNG.
- Note 7: SNR levels correspond to the signal to noise ratio over the cell-specific reference signal REs.
- Note 8: The SNR in time periods T1, T2 and T3 is denoted as SNR1, SNR2 and SNR3 respectively in figure A.7.3.40.1-1.
- Note 9: Receive time difference between subframe boundaries of signals received from the two cells at the UE antenna connector including time alignment error between the two cells.

Table A.7.3.45.1-3: DRX-Configuration for E-UTRAN TDD-FDD DC out-of-sync tests in synchronous dual connectivity with PCell in TDD

Field	Value		Comment
	Cell 1	Cell 2	
onDurationTimer	psf2	psf2	As specified in clause 6.3.2 in TS 36.331
drx-InactivityTimer	psf1	psf1	
drx-RetransmissionTimer	psf1	psf1	
longDRX-CycleStartOffset	Sf640	Sf40	
shortDRX	disable	disable	

Table A.7.3.45.1-4: TimeAlignmentTimer -Configuration for E-UTRAN TDD-FDD CA out-of-sync testing in synchronous dual connectivity with PCell in TDD

Field	Value	Comment
TimeAlignmentTimer	infinity	As specified in clause 6.3.2 in TS 36.331
sr-ConfigIndex	0	For further information see clause 6.3.2 in TS 36.331 and section 10.1 in TS 36.213.

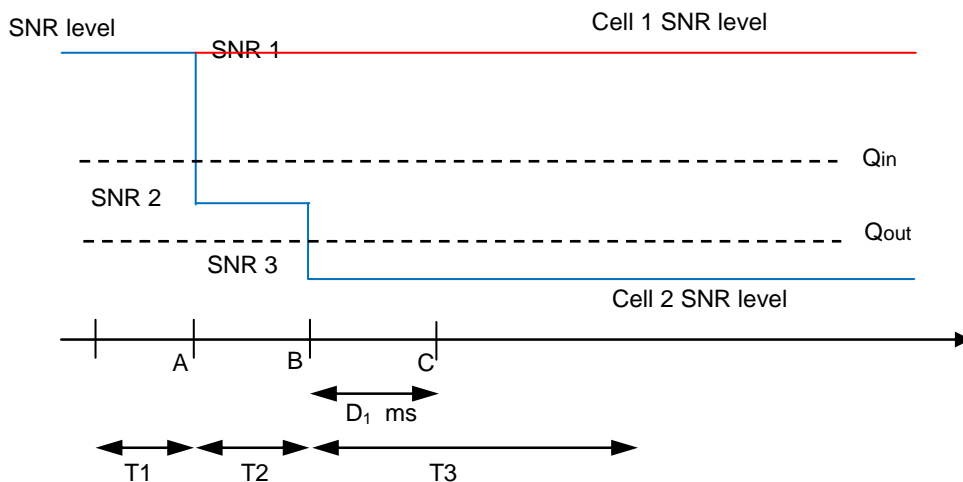

Figure A.7.3.45.1-1 SNR variation for out-of-sync testing in DRX

A.7.3.45.2 Test Requirements

The UE behaviour during time durations T1, T2, and T3 shall be as follows:

During time durations T1, T2 and T3, the UE shall transmit uplink signal at least in all subframes configured for CQI transmission on Cell1.

During the period from time point A to time point B the UE shall transmit uplink signal at least once every DRX cycle, in the On-duration part of the cycle in the uplink subframe on Cell2.

The UE shall stop transmitting uplink signal no later than time point C (duration D1 = 900 ms after the start of time duration T3) on PSCell.

The rate of correct events observed during repeated tests shall be at least 90%.

A.7.3.46 E-UTRAN TDD-FDD Radio Link Monitoring Test for In-sync in DRX for PSCell in synchronous DC with PCell in FDD

A.7.3.46.1 Test Purpose and Environment

The purpose of this test is to verify that the UE properly detects the out of sync and in sync for the purpose of monitoring downlink radio link quality of the PSCell when DRX is used in dual connectivity. This test will partly verify the E-UTRAN FDD and TDD radio link monitoring requirements in clause 7.6.

The test parameters are given in Tables A.7.3.46.1-1, A.7.3.46.1-2, A.7.3.46.1-3 and A.7.3.46.1-4. There are two cells, cell 1 is PCell and cell 2 is PSCell, in the test. The test consists of five successive time periods, with time duration of T1, T2, T3, T4 and T5 respectively. Figure A.7.3.46.1-1 shows the variation of the downlink SNR in the PSCell to emulate out-of-sync and in-sync states. Prior to the start of the time duration T1, the UE shall be fully synchronized to cell 1 and cell 2. The UE shall be configured for periodic CQI reporting in PUCCH 1-0 mode with a reporting periodicity of 2 ms on PCell and 1ms on PSCell. In the test, DRX configuration for PCell and PSCell is enabled and DRX inactivity timer has already been expired, i.e. UE tries to decode PDCCH and to send periodic CQI during the period when On-duration timer is running. Time alignment timers shall be set to “infinity” so that UL timing alignment is maintained during the test.

Table A.7.3.46.1-1: General test parameters for E-UTRAN TDD-FDD Radio Link Monitoring Test for In-sync in DRX for PSCell in synchronous DC with PCell in FDD

Parameter		Unit	Value	Comment
E-UTRA RF Channel Number			1, 2	One E-UTRA FDD carrier frequency and One E-UTRA TDD carrier frequency are used.
Active cell			Cell 1, Cell 2	Cell 1 is PCell on E-UTRA FDD RF channel number 1, and cell 2 is PSCell on E-UTRA TDD RF channel number 2
CP length			Normal	
In sync transmission parameters (Note 1)	DCI format		1C	As defined in clause 5.3.3.1.4 in TS 36.212
	Number of Control OFDM symbols		2	For 10MHz and 20MHz channel BW
	Number of Control OFDM symbols		3	For 5MHz channel BW
	Aggregation level	CCE	4	In sync threshold Q_{in} and the corresponding hypothetical PDCCH/PCFICH transmission parameters are as specified in clause 7.6.1 and Table 7.6.1-2 respectively.
	ρ_A, ρ_B		0	
	Ratio of PDCCH to RS EPRE		0	
Ratio of PCFICH to RS EPRE		4		
Out of sync transmission parameters (Note 1)	DCI format		1A	As defined in clause 5.3.3.1.3 in TS 36.212
	Number of Control OFDM symbols		2	For 10MHz and 20MHz channel BW
	Number of Control OFDM symbols		3	For 5MHz channel BW
	Aggregation level	CCE	8	Out of sync threshold Q_{out} and the corresponding hypothetical PDCCH/PCFICH transmission parameters are as specified in clause 7.6.1 and Table 7.6.1-1 respectively.
	ρ_A, ρ_B		0	
	Ratio of PDCCH to RS EPRE	dB	4	
Ratio of PCFICH to RS EPRE	dB	4		
DRX cycle on Cell 1		ms	640	See Table A.7.3.41.1-3
DRX cycle on Cell 2		ms	40	See Table A.7.3.41.1-3
Layer 3 filtering			Enabled	Counters:

			N310 = 1; N311 = 1, N313 = 1, N314 = 1
T310 timer	ms	2000	T310 is enabled
T311 timer	ms	1000	T311 is enabled
T313 timer	ms	2000	T313 is enabled
Periodic CQI reporting mode		PUCCH 1-0	As defined in table 7.2.2-1 in TS 36.213.
T1	s	4	
T2	s	1.6	
T3	s	1.46	
T4	s	0.4	
T5	s	4	
<p>Note 1: PDCCH/PCFICH corresponding to the in-sync and out of sync transmission parameters need not be included in the Reference Measurement Channel.</p> <p>Note 2: Even a UE capable of both synchronous and asynchronous DC operations is required to pass this test case in accordance with the principle defined in section A.3.11.</p>			

Table A.7.3.46.1-2: Cell specific test parameters for E-UTRAN TDD-FDD Radio Link Monitoring Test for In-sync in DRX for PSCell in synchronous DC with PCell in FDD

Parameter	Unit	Cell 1 (PCell)	Cell 2 (PSCell)				
		T1 ~ T5	T1	T2	T3	T4	T5
E-UTRA RF Channel Number		1	2				
BW _{channel}	MHz	5: N _{RB,c} = 25 10: N _{RB,c} = 50 20: N _{RB,c} = 100	5: N _{RB,c} = 25 10: N _{RB,c} = 50 20: N _{RB,c} = 100				
Special subframe configuration <small>Note1</small>		-	6				
Uplink-downlink configuration <small>Note2</small>		-	1				
PCFICH/PDCCH/PHICH parameters defined in A.3.1.2.1 and A.3.1.2.2		5MHz: R.11 FDD 10MHz: R.6 FDD 20MHz: R.10 FDD	5MHz: R.11 TDD 10MHz: R.6 TDD 20MHz: R.10 TDD				
OCNG Pattern defined in A.3.2.1 (FDD) and A.3.2.2 (TDD)		5MHz: OP.16 FDD 10MHz: OP.2 FDD 20MHz: OP.12 FDD	5MHz: OP.10 TDD 10MHz: OP.2 TDD 20MHz: OP.8 TDD				
ρ _A , ρ _B		0	0				
PCFICH_RB	dB	4	4				
PDCCH_RA	dB	0	0				
PDCCH_RB	dB	0	0				
PBCH_RA	dB	0	0				
PBCH_RB	dB						
PSS_RA	dB						
SSS_RA	dB						
PHICH_RA	dB						
PHICH_RB	dB						
PDSCH_RA	dB						
PDSCH_RB	dB						
OCNG_RA ^{Note3}	dB						
OCNG_RB ^{Note3}	dB						
SNR ^{Note 8}	5MHz BW _{channel}	-2.3	-5.1	-9.1	-13.1	-9.1	-5.1
	10MHz BW _{channel}	-4.7	-5.1	-9.1	-13.1	-9.1	-5.1
	20MHz BW _{channel}	-4.7	-5.1	-9.1	-13.1	-9.1	-5.1
N _{oc}	dBm/15 kHz	-98					
Propagation condition		AWGN	AWGN				
Correlation Matrix and Antenna Configuration		1x2	1x2				
Receive time offset to cell1 ^{Note 9}	μs	-	33				
CQI reporting periodicity	ms	2	1				

- Note 1: For the special subframe configuration see table 4.2-1 in TS 36.211.
- Note 2: For the uplink-downlink configuration see table 4.2-2 in TS 36.211.
- Note 3: OCNB shall be used such that the resources in cell 1 and cell 2 are fully allocated and a constant total transmitted power spectral density is achieved for all OFDM symbols.
- Note 4: The uplink resources for CQI reporting are assigned to the UE prior to the start of time period T1.
- Note 5: The timers and layer 3 filtering related parameters are configured prior to the start of time period T1.
- Note 6: The signal contains PDCCH for UEs other than the device under test as part of OCNB.
- Note 7: SNR levels correspond to the signal to noise ratio over the cell-specific reference signal REs.
- Note 8: The SNR of Cell 2 in time periods T1, T2, T3, T4 and T5 is denoted as SNR1, SNR2, SNR3, SNR4 and SNR5 respectively in figure A.7.3.46.1-1.
- Note 9: Receive time difference between subframe boundaries of signals received from the two cells at the UE antenna connector including time alignment error between the two cells.

Table A.7.3.46.1-3: DRX-Configuration for E-UTRAN TDD-FDD Radio Link Monitoring Test for In-sync in DRX for PSCell in synchronous DC with PCell in FDD

Field	Value		Comment
	Cell 1	Cell 2	
onDurationTimer	psf2	psf2	As specified in section 6.3.2 in 3GPP TS 36.331
drx-InactivityTimer	psf1	psf1	
drx-RetransmissionTimer	psf1	psf1	
longDRX-CycleStartOffset	sf640	sf40	
shortDRX	disable	disable	

Table A.7.3.46.1-4: TimeAlignmentTimer -Configuration for E-UTRAN TDD-FDD Radio Link Monitoring Test for In-sync in DRX for PSCell in synchronous DC with PCell in FDD

Field	Value	Comment
TimeAlignmentTimer	infinity	As specified in clause 6.3.2 in TS 36.331
sr-ConfigIndex	0	For further information see clause 6.3.2 in TS 36.331 and section 10.1 in TS 36.213.

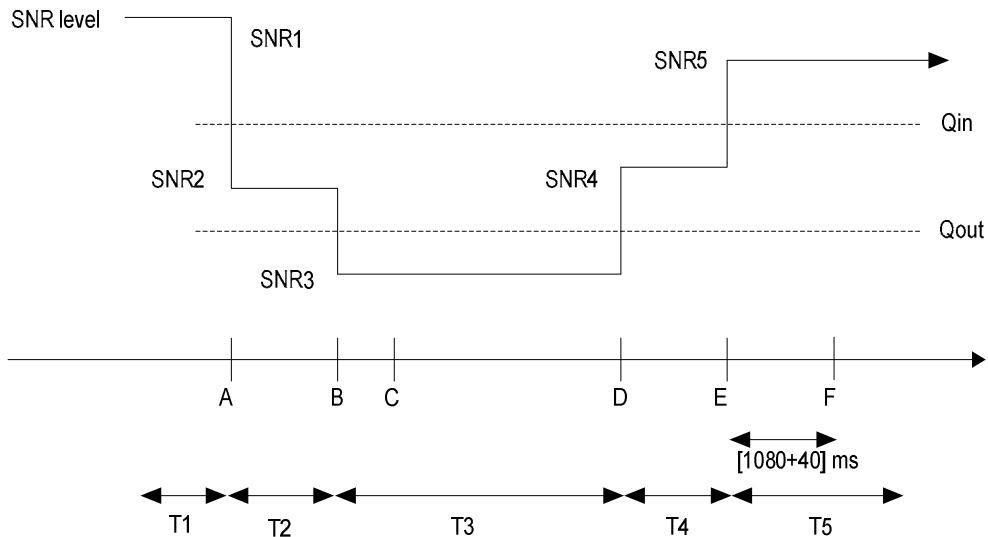

Figure A.7.3.46.1-1 SNR variation of cell 2 (PSCell) for in-sync testing in DRX

A.7.3.46.2 Test Requirements

The UE behaviour during time durations T1, T2, T3, T4 and T5 shall be as follows:

During the period from time point A to time point F (1120 ms after the start of time duration T5) the UE shall transmit uplink signal at least once every DRX cycle, in the On-duration part of the cycle in the subframe according to the configured CQI reporting mode (PUCCH 1-0) on PCell and PSCell.

The rate of correct events observed during repeated tests shall be at least 90%.

A.7.3.47 E-UTRAN TDD-FDD Radio Link Monitoring Test for In-sync in DRX for PSCell in synchronous DC with PCell in TDD

A.7.3.47.1 Test Purpose and Environment

The purpose of this test is to verify that the UE properly detects the out of sync and in sync for the purpose of monitoring downlink radio link quality of the PSCell when DRX is used in dual connectivity. This test will partly verify the E-UTRAN FDD and TDD radio link monitoring requirements in clause 7.6.

The test parameters are given in Tables A.7.3.47.1-1, A.7.3.47.1-2, A.7.3.47.1-3 and A.7.3.47.1-4. There are two cells, cell 1 is PCell and cell 2 is PSCell, in the test. The test consists of five successive time periods, with time duration of T1, T2, T3, T4 and T5 respectively. Figure A.7.3.47.1-1 shows the variation of the downlink SNR in the PSCell to emulate out-of-sync and in-sync states. Prior to the start of the time duration T1, the UE shall be fully synchronized to cell 1 and cell 2. The UE shall be configured for periodic CQI reporting in PUCCH 1-0 mode with a reporting periodicity of 1ms on PCell and 2ms on PSCell. In the test, DRX configuration for PCell and PSCell is enabled and DRX inactivity timer has already been expired, i.e. UE tries to decode PDCCH and to send periodic CQI during the period when On-duration timer is running. Time alignment timers shall be set to “infinity” so that UL timing alignment is maintained during the test.

Table A.7.3.47.1-1: General test parameters for E-UTRAN TDD-FDD Radio Link Monitoring Test for In-sync in DRX for PSCell in synchronous DC with PCell in TDD

Parameter		Unit	Value	Comment
E-UTRA RF Channel Number			1, 2	One E-UTRA TDD carrier frequency and One E-UTRA FDD carrier frequency are used.
Active cell			Cell 1, Cell 2	Cell 1 is PCell on E-UTRA TDD RF channel number 1, and cell 2 is PSCell on E-UTRA FDD RF channel number 2
CP length			Normal	
In sync transmission parameters (Note 1)	DCI format		1C	As defined in clause 5.3.3.1.4 in TS 36.212
	Number of Control OFDM symbols		2	For 10MHz and 20MHz channel BW
	Number of Control OFDM symbols		3	For 5MHz channel BW
	Aggregation level	CCE	4	In sync threshold Q_{in} and the corresponding hypothetical PDCCH/PCFICH transmission parameters are as specified in clause 7.6.1 and Table 7.6.1-2 respectively.
	ρ_A, ρ_B		0	
	Ratio of PDCCH to RS EPRE		0	
Ratio of PCFICH to RS EPRE		4		
Out of sync transmission parameters (Note 1)	DCI format		1A	As defined in clause 5.3.3.1.3 in TS 36.212
	Number of Control OFDM symbols		2	For 10MHz and 20MHz channel BW
	Number of Control OFDM symbols		3	For 5MHz channel BW
	Aggregation level	CCE	8	Out of sync threshold Q_{out} and the corresponding hypothetical PDCCH/PCFICH transmission parameters are as specified in clause 7.6.1 and Table 7.6.1-1 respectively.
	ρ_A, ρ_B		0	
	Ratio of PDCCH to RS EPRE	dB	4	
	Ratio of PCFICH to RS EPRE	dB	4	
DRX cycle on Cell 1		ms	640	See Table A.7.3.43.1-3
DRX cycle on Cell 2		ms	40	See Table A.7.3.43.1-3
Layer 3 filtering			Enabled	Counters: N310 = 1; N311 = 1, N313 = 1, N314 = 1
T310 timer		ms	2000	T310 is enabled
T311 timer		ms	1000	T311 is enabled

T313 timer	ms	2000	T313 is enabled
Periodic CQI reporting mode		PUCCH 1-0	As defined in table 7.2.2-1 in TS 36.213.
T1	s	4	
T2	s	1.6	
T3	s	1.46	
T4	s	0.4	
T5	s	4	
Note 1: PDCCH/PCFICH corresponding to the in-sync and out of sync transmission parameters need not be included in the Reference Measurement Channel.			
Note 2: Even a UE capable of both synchronous and asynchronous DC operations is required to pass this test case in accordance with the principle defined in section A.3.11.			

Table A.7.3.47.1-2: Cell specific test parameters for E-UTRAN TDD-FDD Radio Link Monitoring Test for In-sync in DRX for PSCell in synchronous DC with PCell in TDD

Parameter	Unit	Cell 1 (PCell)	Cell 2 (PSCell)				
		T1 ~ T5	T1	T2	T3	T4	T5
E-UTRA RF Channel Number		1	2				
BW _{channel}	MHz	5: N _{RB,c} = 25 10: N _{RB,c} = 50 20: N _{RB,c} = 100	5: N _{RB,c} = 25 10: N _{RB,c} = 50 20: N _{RB,c} = 100				
Special subframe configuration ^{Note1}		6	-				
Uplink-downlink configuration ^{Note2}		1	-				
PCFICH/PDCCH/PHICH parameters defined in A.3.1.2.1 and A.3.1.2.2		5MHz: R.11 TDD 10MHz: R.6 TDD 20MHz: R.10 TDD	5MHz: R.11 FDD 10MHz: R.6 FDD 20MHz: R.10 FDD				
OCNG Pattern defined in A.3.2.1 (FDD) and A.3.2.2 (TDD)		5MHz: OP.10 TDD 10MHz: OP.2 TDD 20MHz: OP.8 TDD	5MHz: OP.16 FDD 10MHz: OP.2 FDD 20MHz: OP.12 FDD				
ρ _A , ρ _B		0	0				
PCFICH_RB	dB	4	4				
PDCCH_RA	dB	0	0				
PDCCH_RB	dB	0	0				
PBCH_RA	dB	0	0				
PBCH_RB	dB						
PSS_RA	dB						
SSS_RA	dB						
PHICH_RA	dB						
PHICH_RB	dB						
PDSCH_RA	dB						
PDSCH_RB	dB						
OCNG_RA ^{Note1}	dB						
OCNG_RB ^{Note1}	dB						
SNR ^{Note 6}	5MHz BW _{channel}						
	10MHz BW _{channel}	-5.1	-4.7	-9.5	-13.5	-8.7	-4.7
	20MHz BW _{channel}	-5.1	-4.7	-9.5	-13.5	-8.7	-4.7
N _{oc}	dBm/15 kHz	-98					
Propagation condition		AWGN	AWGN				
Correlation Matrix and Antenna Configuration		1x2	1x2				
Receive time offset to cell1 ^{Note 9}	μs	-	33				
CQI reporting periodicity	ms	1	2				

- Note 1: For the special subframe configuration see table 4.2-1 in TS 36.211.
- Note 2: For the uplink-downlink configuration see table 4.2-2 in TS 36.211.
- Note 3: OCNB shall be used such that the resources in cell # 1 are fully allocated and a constant total transmitted power spectral density is achieved for all OFDM symbols.
- Note 4: The uplink resources for CQI reporting are assigned to the UE prior to the start of time period T1.
- Note 5: The timers and layer 3 filtering related parameters are configured prior to the start of time period T1.
- Note 6: The signal contains PDCCH for UEs other than the device under test as part of OCNB.
- Note 7: SNR levels correspond to the signal to noise ratio over the cell-specific reference signal REs.
- Note 8: The SNR of Cell 2 in time periods T1, T2, T3, T4 and T5 is denoted as SNR1, SNR2, SNR3, SNR4 and SNR5 respectively in figure A.7.3.47.1-1.
- Note 9: Receive time difference between subframe boundaries of signals received from the two cells at the UE antenna connector including time alignment error between the two cells.

Table A.7.3.47.1-3: DRX-Configuration for E-UTRAN TDD-FDD Radio Link Monitoring Test for In-sync in DRX for PSCell in synchronous DC with PCell in TDD

Field	Value		Comment
	Cell 1	Cell 2	
onDurationTimer	psf2	psf2	As specified in section 6.3.2 in 3GPP TS 36.331
drx-InactivityTimer	psf1	psf1	
drx-RetransmissionTimer	psf1	psf1	
longDRX-CycleStartOffset	sf640	sf40	
shortDRX	disable	disable	

Table A.7.3.47.1-4: TimeAlignmentTimer -Configuration for E-UTRAN TDD-TDD Radio Link Monitoring Test for In-sync in DRX for PSCell in synchronous DC with PCell in TDD

Field	Value	Comment
TimeAlignmentTimer	infinity	As specified in clause 6.3.2 in TS 36.331
sr-ConfigIndex	0	For further information see clause 6.3.2 in TS 36.331 and section 10.1 in TS 36.213.

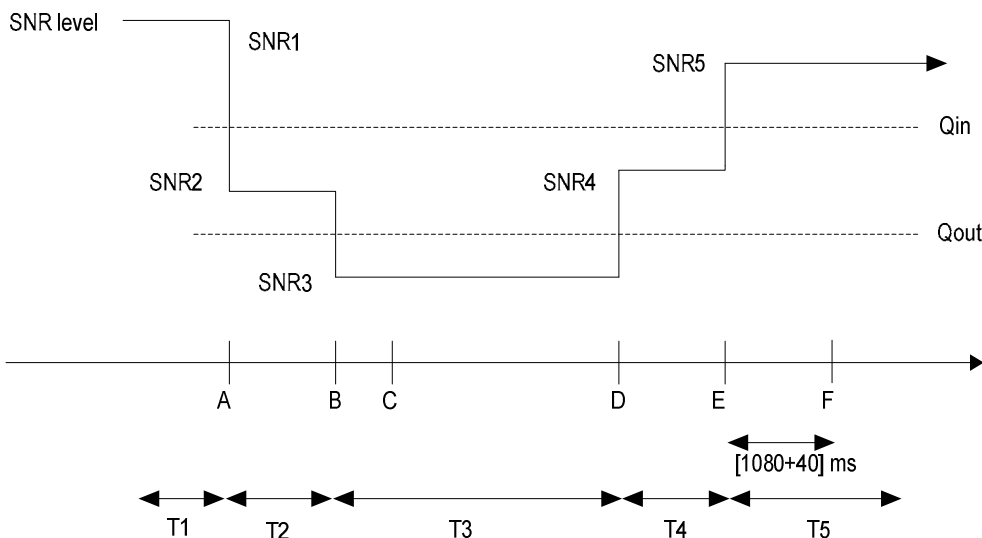

Figure A.7.3.47.1-1 SNR variation of cell 2 (PSCell) for in-sync testing in DRX

A.7.3.47.2 Test Requirements

The UE behaviour during time durations T1, T2, T3, T4 and T5 shall be as follows:

During the period from time point A to time point F (1120 ms after the start of time duration T5) the UE shall transmit uplink signal at least once every DRX cycle, in the On-duration part of the cycle in the subframe according to the configured CQI reporting mode (PUCCH 1-0) on PCell and PSCell.

The rate of correct events observed during repeated tests shall be at least 90%.

A.7.3.48 E-UTRAN FD-FDD Radio Link Monitoring Test for Out-of-sync for Cat-M1 UE in CEMode A

A.7.3.48.1 Test Purpose and Environment

The purpose of this test is to verify that the FD-FDD Cat-M1 UE properly detects the out of sync and in sync for the purpose of monitoring downlink radio link quality of the PCell in CEModeA. This test will partly verify the E-UTRAN FDD radio link monitoring requirements for Cat-M1 UE defined in clause 7.19.

The test parameters are given in Tables A.7.3.48.1-1 and A.7.3.48.1-2 below. There is one cell (cell 1), which is the active cell, in the test. The test consists of three successive time periods, with time duration of T1, T2 and T3 respectively. Figure A.7.3.48.1-1 shows the variation of the downlink SNR in the active cell to emulate out-of-sync and in-sync states. Prior to the start of the time duration T1, the UE shall be fully synchronized to cell 1. The UE shall be configured for periodic CQI reporting in PUCCH 1-0 mode without repetition with a reporting periodicity of 2 ms.

In the test, the RRC parameter *numberPRB-Pairs* is set to 6 and the RRC parameter *mPDCCH-NumRepetition* is set to 8. UE shall successfully complete the RRC reconfiguration accordingly prior to the start of time duration T1.

Table A.7.3.48.1-1: General test parameters for E-UTRAN FD-FDD out-of-sync testing for UE Cat-M1 in CEMode A

Parameter		Unit	Value	Comment
Active cell			Cell 1	Cell 1 is on E-UTRA RF channel number 1
CP length			Normal	
Out of sync transmission parameters (Note 1)	DCI format		6-1A	As defined in section 5.3.3.1.12 in TS 36.212
	Number of OFDM symbols for legacy control channels		2	Out of sync threshold Q_{out} and the corresponding hypothetical MPDCCH transmission parameters are as specified in section 7.19.2 and Table 7.19.2-1 respectively.
	M-PDCCH aggregation level	eCCE	24	
	M-PDCCH repetition level		8	
	ρ_A, ρ_B		-3	
DRX			OFF	
Layer 3 filtering			Enabled	Counters: $N_{310} = 1; N_{311} = 1$
T310 timer		ms	0	T310 is disabled
T311 timer		ms	1000	T311 is enabled
Periodic CQI reporting mode			PUCCH 1-0	As defined in table 7.2.2-1 in TS 36.213.
CQI reporting periodicity		ms	2	Minimum CQI reporting periodicity
T1		s	2	
T2		s	0.8	
T3		s	1.8	
Note 1: MPDCCH corresponding to the out of sync transmission parameters need not be included in the Reference Measurement Channel.				

Table A.7.3.48.1-2: Cell specific test parameters for E-UTRAN FD-FDD (cell # 1) for out-of-sync radio link monitoring tests for Cat-M1 in CEMode A

Parameter	Unit	Test 1		
		T1	T2	T3
E-UTRA RF Channel Number		1		
$BW_{channel}$	MHz	10		
MPDCCH parameters as defined in A.3.1.3.1		R.17 FDD		
OCNG Pattern defined in A.3.2.1.21 (FDD)		OP.21 FDD		
ρ_A, ρ_B		-3		
MPDCCH_RA	dB	0		
MPDCCH_RB	dB	0		
PBCH_RA	dB	-3		
PBCH_RB	dB			
PSS_RA	dB			
SSS_RA	dB			
OCNG_RA ^{Note 1}	dB			
OCNG_RB ^{Note 1}	dB			
N_{oc}	dBm/15 kHz	-98		
SNR ^{Note 6}	dB	0.1	-6.8	-15.8
Propagation condition		ETU 30Hz		
Correlation Matrix and Antenna Configuration		2x1 Low		
Note 1: OCNG shall be used such that the resources in cell # 1 are fully allocated and a constant total transmitted power spectral density is achieved for all OFDM symbols. Note 2: The uplink resources for CQI reporting are assigned to the UE prior to the start of time period T1. Note 3: The timers and layer 3 filtering related parameters are configured prior to the start of time period T1. Note 4: The signal contains PDCCH for UEs other than the device under test as part of OCNG. Note 5: SNR levels correspond to the signal to noise ratio over the cell-specific reference signal REs. Note 6: The SNR in time periods T1, T2 and T3 is denoted as SNR1, SNR2 and SNR3 respectively in figure A.7.3.48.1-1.				

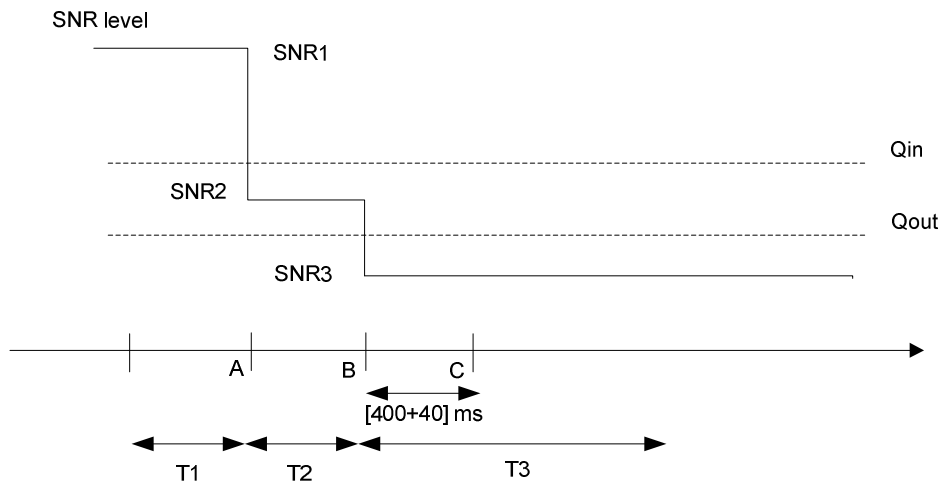

Figure A.7.3.48.1-1: SNR variation for out-of-sync testing

A.7.3.48.2 Test Requirements

The UE behaviour in each test during time durations T1, T2 and T3 shall be as follows:

During the period from time point A to time point B the UE shall transmit uplink signal at least in all subframes configured for CQI transmission according to the configured CQI reporting mode (PUCCH 1-0).

The UE shall stop transmitting uplink signal no later than time point C (440 ms after the start of time duration T3).

The rate of correct events observed during repeated tests shall be at least 90%.

A.7.3.49 E-UTRAN FD-FDD Radio Link Monitoring Test for In-Sync for Cat-M1 UE in CEMode A

A.7.3.49.1 Test Purpose and Environment

The purpose of this test is to verify that the FD-FDD Cat-M1 UE properly detects the out of sync and in sync for the purpose of monitoring downlink radio link quality of the PCell in CEModeA. This test will partly verify the E-UTRAN FDD radio link monitoring requirements for Cat-M1 UE defined in clause 7.19.

The test parameters are given in Tables A.7.3.49.1-1 and A.7.3.49.1-2 below. There is one cell (cell 1), which is the active cell, in the test. The test consists of five successive time periods, with time duration of T1, T2, T3, T4 and T5 respectively. Figure A.7.3.49.1-1 shows the variation of the downlink SNR in the active cell to emulate out-of-sync and in-sync states. Prior to the start of the time duration T1, the UE shall be fully synchronized to cell 1. The UE shall be configured for periodic CQI reporting in PUCCH 1-0 mode without repetition with a reporting periodicity of 2 ms.

In the test, the RRC parameter *numberPRB-Pairs* is set to 4 and the RRC parameter *mPDCCH-NumRepetition* is set to 4. UE shall successfully complete the RRC reconfiguration accordingly prior to the start of time duration T1.

Table A.7.3.49.1-1: General test parameters for E-UTRAN FD-FDD in-sync testing for UE Cat-M1 in CEMode A

Parameter		Unit	Value	Comment
Active cell			Cell 1	Cell 1 is on E-UTRA RF channel number 1
CP length			Normal	
In sync transmission parameters (Note 1)	DCI format		6-1A	As defined in section 5.3.3.1.12 in TS 36.212
	Number of OFDM symbols for legacy control channels		2	In sync threshold Q_{in} and the corresponding hypothetical MPDCCH transmission parameters are as specified in section 7.19.2 and Table 7.19.2-1 respectively.
	M-PDCCH aggregation level	eCCE	4	
	M-PDCCH repetition level		2	
	ρ_A, ρ_B		-3	
Out of sync transmission parameters (Note 1)	DCI format		6-1A	As defined in section 5.3.3.1.12 in TS 36.212
	Number of OFDM symbols for legacy control channels		2	Out of sync threshold Q_{out} and the corresponding hypothetical MPDCCH transmission parameters are as specified in section 7.19.2 and Table 7.19.2-1 respectively.
	M-PDCCH aggregation level	eCCE	16	
	M-PDCCH repetition level		4	

	ρ_A, ρ_B		-3	
DRX			OFF	
Layer 3 filtering			Enabled	Counters: N310 = 1; N311 = 1
T310 timer	ms		2000	T310 is enabled
T311 timer	ms		1000	T311 is enabled
Periodic CQI reporting mode			PUCCH 1-0	As defined in table 7.2.2-1 in TS 36.213.
CQI reporting periodicity	ms		2	Minimum CQI reporting periodicity
T1	s		2	
T2	s		0.8	
T3	s		1.36	
T4	s		0.4	
T5	s		2	
Note 1: MPDCCH corresponding to the out of sync transmission parameters need not be included in the Reference Measurement Channel.				

Table A.7.3.49.1-2: Cell specific test parameters for E-UTRAN FD-FDD (cell # 1) for in-sync radio link monitoring tests for Cat-M1 in CEMode A

Parameter	Unit	Test 1				
		T1	T2	T3	T4	T5
E-UTRA RF Channel Number		1				
$BW_{channel}$	MHz	10				
MPDCCH parameters as defined in A.3.1.3.1		R.17 FDD				
OCNG Pattern defined in A.3.2.1.21 (FDD)		OP.21 FDD				
ρ_A, ρ_B		-3				
MPDCCH_RA	dB	0				
MPDCCH_RB	dB	0				
PBCH_RA	dB	-3				
PBCH_RB	dB					
PSS_RA	dB					
SSS_RA	dB					
OCNG_RA ^{Note 1}	dB					
OCNG_RB ^{Note 1}	dB					
N_{oc}	dBm/15 kHz	-98				
SNR ^{Note 6}	dB	5.4	-3.8	-12.8	-1.6	5.4
Propagation condition		ETU 30Hz				
Correlation Matrix and Antenna Configuration		2x1 Low				
<p>Note 1: OCNG shall be used such that the resources in cell # 1 are fully allocated and a constant total transmitted power spectral density is achieved for all OFDM symbols.</p> <p>Note 2: The uplink resources for CQI reporting are assigned to the UE prior to the start of time period T1.</p> <p>Note 3: The timers and layer 3 filtering related parameters are configured prior to the start of time period T1.</p> <p>Note 4: The signal contains PDCCH for UEs other than the device under test as part of OCNG.</p> <p>Note 5: SNR levels correspond to the signal to noise ratio over the cell-specific reference signal REs.</p> <p>Note 6: The SNR in time periods T1, T2, T3, T4 and T5 is denoted as SNR1, SNR2, SNR3, SNR4 and SNR5 respectively in figure A.7.3.49.1-1.</p>						

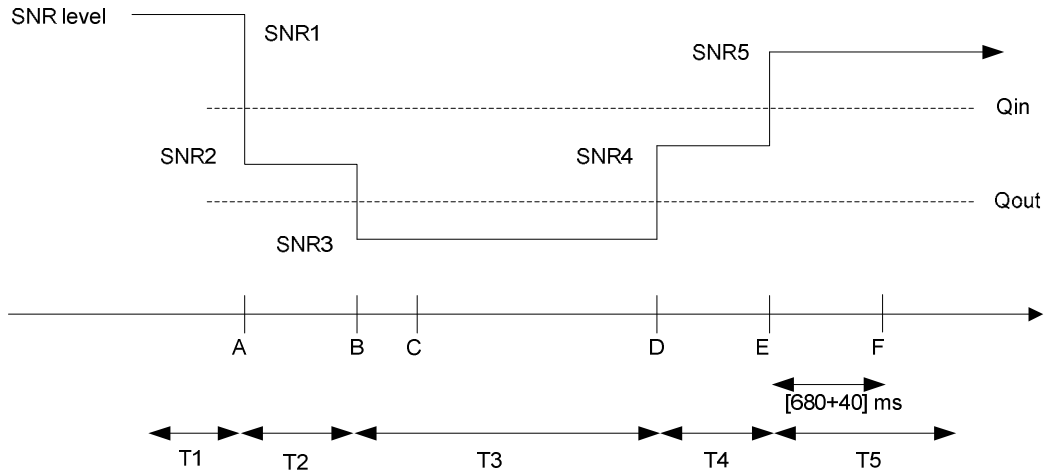

Figure A.7.3.49.1-1: SNR variation for in-sync testing

A.7.3.49.2 Test Requirements

The UE behaviour in each test during time durations T1, T2, T3, T4 and T5 shall be as follows:

During the period from time point A to time point F (720 ms after the start of time duration T5) the UE shall transmit uplink signal at least in all subframes configured for CQI transmission according to the configured CQI reporting mode (PUCCH 1-0).

The rate of correct events observed during repeated tests shall be at least 90%.

A.7.3.50 E-UTRAN FD-FDD Radio Link Monitoring Test for Out-of-sync in DRX for UE category M1 configured in CEMode A

A.7.3.50.1 Test Purpose and Environment

The purpose of this test is to verify that the FD-FDD category M1 UE configured in CEMode A properly detects the out of sync for the purpose of monitoring downlink radio link quality of the PCell when DRX is used. This test will partly verify the E-UTRAN FD-FDD radio link monitoring requirements in clause 7.19.

The test parameters are given in Tables A.7.3.50.1-1, A.7.3.50.1-2, A.7.3.50.1-3 and A.7.3.50.1-4. There is one cell (cell 1), which is the active cell, in the test. The test consists of three successive time periods, with time duration of T1, T2 and T3 respectively. Figure A.7.3.50.1-1 shows the variation of the downlink SNR in the active cell to emulate out-of-sync states. Prior to the start of the time duration T1, the UE shall be fully synchronized to cell 1. The UE shall be configured for periodic CQI reporting in PUCCH 1-0 mode with a reporting periodicity of 2 ms without repetition. In the test, DRX configuration is enabled and DRX inactivity timer has already been expired, i.e. UE tries to decode MPDCCH and to send periodic CQI during the period when On-duration timer is running. Time alignment timers shall be set to “infinity” so that UL timing alignment is maintained during the test.

In the test, the RRC parameter *numberPRB-Pairs* is set to 4 and the RRC parameter *mPDCCH-NumRepetition* is set 4. UE shall successfully complete the RRC reconfiguration accordingly prior to the start of time duration T1.

Table A.7.3.50.1-1: General test parameters for E-UTRAN FD-FDD out-of-sync tests in DRX for UE category M1 configured in CEMode A

Parameter		Unit	Value	Comment
Active cell			Cell 1	Cell 1 is on E-UTRA RF channel number 1
CP length			Normal	
Out of sync transmission parameters (Note 1)	DCI format		6-1A	As defined in section 5.3.3.1.12 in TS 36.212
	Number of OFDM symbols for legacy control channels		2	Out of sync threshold $Q_{out, Cat M1}$ and the corresponding hypothetical MPDCCH transmission parameters are as specified in clause 7.19.2 and Table 7.19.2-1 respectively.
	MPDCCH aggregation level	eCCE	16	
	MPDCCH repetition level		4	
	Ratio of MPDCCH to RS EPRE		0	
ρ_A, ρ_B		-3		
DRX cycle		ms	1280	See Table A.7.3.50.1-3
Layer 3 filtering			Enabled	Counters: N310 = 1; N311 = 1
T310 timer		ms	0	T310 is disabled
T311 timer		ms	1000	T311 is enabled
Periodic CQI reporting mode			PUCCH 1-0	As defined in table 7.2.2-1 in TS 36.213.
CQI reporting periodicity		ms	2	Minimum CQI reporting periodicity
T1		s	32	
T2		s	12.8	
T3		s	13	
Note 1: MPDCCH corresponding to the out of sync transmission parameters need not be included in the Reference Measurement Channel.				

Table A.7.3.50.1-2: Cell specific test parameters for E-UTRAN FD-FDD (cell # 1) for out-of-sync radio link monitoring tests in DRX for UE category M1 configured in CEMode A

Parameter	Unit	Test 1		
		T1	T2	T3
E-UTRA RF Channel Number		1		
$BW_{channel}$	MHz	10		
MPDCCH parameters defined in A.3.1.3		R.17 FDD		
OCNG Pattern defined in A.3.2.1 (FDD)		OP.21 FDD		
ρ_A, ρ_B		-3		
MPDCCH_RA	dB	0		
MPDCCH_RB	dB	0		
PBCH_RA	dB	-3		
PBCH_RB	dB			
PSS_RA	dB			
SSS_RA	dB			
OCNG_RA ^{Note1}	dB			
OCNG_RB ^{Note1}	dB			
N_{oc}	dBm/15 kHz			
SNR ^{Note 6}	dB	0.37	-6.98	-14.98
Propagation condition		AWGN		

Correlation Matrix and Antenna Configuration		2x1
Note 1:	OCNG shall be used such that the resources in cell # 1 are fully allocated and a constant total transmitted power spectral density is achieved for all OFDM symbols.	
Note 2:	The uplink resources for CQI reporting are assigned to the UE prior to the start of time period T1.	
Note 3:	The timers and layer 3 filtering related parameters are configured prior to the start of time period T1.	
Note 4:	The signal contains MPDCCH for UEs other than the device under test as part of OCNG.	
Note 5:	SNR levels correspond to the signal to noise ratio over the cell-specific reference signal REs.	
Note 6:	The SNR in time periods T1, T2 and T3 is denoted as SNR1, SNR2 and SNR3 respectively in figure A.7.3.50.1-1.	

Table A.7.3.50.1-3: DRX-Configuration for E-UTRAN FD-FDD out-of-sync tests for UE category M1 configured in CEMode A

Field	Value	Comment
onDurationTimer	psf10	As specified in clause 6.3.2 in TS 36.331
drx-InactivityTimer	psf1	
drx-RetransmissionTimer	psf1	
longDRX-CycleStartOffset	sf1280	
shortDRX	disable	

Table A.7.3.50.1-4: TimeAlignmentTimer -Configuration for E-UTRAN FD-FDD out-of-sync testing for UE category M1 configured in CEMode A

Field	Value	Comment
TimeAlignmentTimer	infinity	As specified in clause 6.3.2 in TS 36.331
sr-ConfigIndex	30	For further information see clause 6.3.2 in TS 36.331 and section 10.1 in TS 36.213.

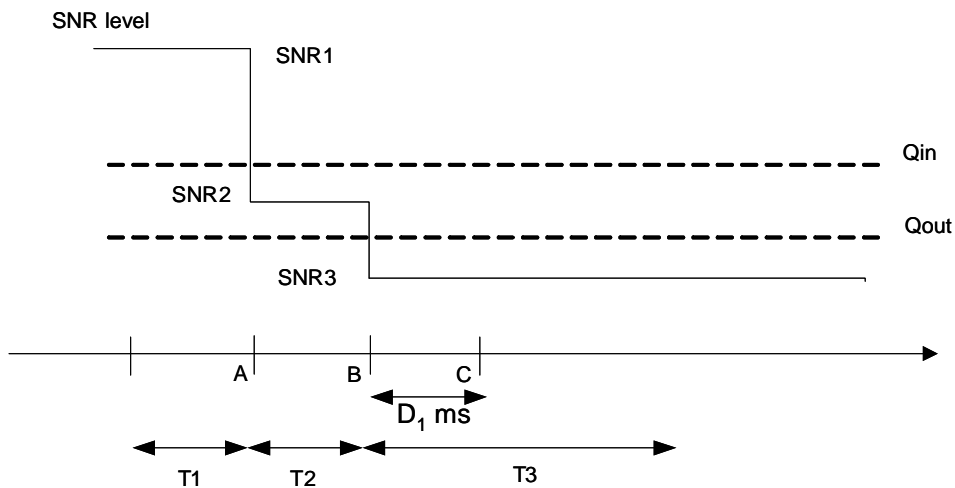

Figure A.7.3.50.1-1: SNR variation for out-of-sync testing in DRX

A.7.3.50.2 Test Requirements

The UE behaviour in each test during time durations T1, T2 and T3 shall be as follows:

During the period from time point A to time point B the UE shall transmit uplink signal at least once every DRX cycle, in the On-duration part of the cycle in the subframe according to the configured CQI reporting mode (PUCCH 1-0).

The UE shall stop transmitting uplink signal no later than time point C (duration $D_1 = 6500$ ms after the start of time duration T3).

The rate of correct events observed during repeated tests shall be at least 90%.

A.7.3.51 E-UTRAN FD-FDD Radio Link Monitoring Test for In-sync in DRX for UE Category M1 configured in CEMode A

A.7.3.51.1 Test Purpose and Environment

The purpose of this test is to verify that the FD-FDD category M1 UE configured in CEMode A properly detects the out of sync and in sync for the purpose of monitoring downlink radio link quality of the PCell when DRX is used. This test will partly verify the E-UTRAN FD-FDD radio link monitoring requirements in clause 7.19.

The test parameters are given in Tables A.7.3.51.1-1, A.7.3.51.1-2, A.7.3.51.1-3 and A.7.3.51.1-4. There is one cell (cell 1), which is the active cell, in the test. The test consists of five successive time periods, with time duration of T1, T2, T3, T4 and T5 respectively. Figure A.7.3.51.1-1 shows the variation of the downlink SNR in the active cell to emulate out-of-sync and in-sync states. Prior to the start of the time duration T1, the UE shall be fully synchronized to cell 1. The UE shall be configured for periodic CQI reporting in PUCCH 1-0 mode with a reporting periodicity of 2 ms without repetition. In the test, DRX configuration is enabled and DRX inactivity timer has already been expired, i.e. UE tries to decode MPDCCH and to send periodic CQI during the period when On-duration timer is running. Time alignment timers shall be set to “infinity” so that UL timing alignment is maintained during the test.

In the test, the RRC parameter *numberPRB-Pairs* is set to 6 and the RRC parameter *mPDCCH-NumRepetition* is set 8. UE shall successfully complete the RRC reconfiguration accordingly prior to the start of time duration T1.

Table A.7.3.51.1-1: General test parameters for E-UTRAN FD-FDD in-sync test in DRX for UE category M1 configured in CEMode A

Parameter		Unit	Value	Comment
Active cell			Cell 1	Cell 1 is on E-UTRA RF channel number 1
CP length			Normal	
In sync transmission parameters (Note 1)	DCI format		6-1A	As defined in section 5.3.3.1.12 in TS 36.212
	Number of OFDM symbols for legacy control channels		2	In sync threshold $Q_{in, Cat M1}$ and the corresponding hypothetical MPDCCH transmission parameters are as specified in clause 7.19.2 and Table 7.19.2-1 respectively.
	MPDCCH aggregation level	eCCE	8	
	MPDCCH repetition level		4	
	ρ_A, ρ_B		-3	
Ratio of MPDCCH to RS EPRE		0		
Out of sync transmission parameters (Note 1)	DCI format		6-1A	As defined in section 5.3.3.1.12 in TS 36.212
	Number of OFDM symbols for legacy control channels		2	Out of sync threshold $Q_{out, Cat M1}$ and the corresponding hypothetical MPDCCH transmission parameters are as specified in clause 7.19.2 and Table 7.19.2-1 respectively.
	MPDCCH aggregation level	eCCE	24	
	MPDCCH repetition level		8	
	ρ_A, ρ_B		-3	
Ratio of MPDCCH to RS EPRE	dB	0		
DRX cycle		ms	40	See Table A.7.3.51.1-3
Layer 3 filtering			Enabled	Counters: $N_{310} = 1; N_{311} = 1$
T310 timer		ms	2000	T310 is enabled
T311 timer		ms	1000	T311 is enabled

Periodic CQI reporting mode		PUCCH 1-0	As defined in table 7.2.2-1 in TS 36.213.
CQI reporting periodicity	ms	2	Minimum CQI reporting periodicity
T1	s	4	
T2	s	1.6	
T3	s	1.46	
T4	s	0.4	
T5	s	4	
Note 1: MPDCCH corresponding to the in-sync and out of sync transmission parameters need not be included in the Reference Measurement Channel.			

Table A.7.3.51.1-2: Cell specific test parameters for E-UTRAN FD-FDD (cell # 1) for in-sync radio link monitoring test in DRX for UE category M1 configured in CEMode A

Parameter	Unit	Test 1									
		T1	T2	T3	T4	T5					
E-UTRA RF Channel Number		1									
BW _{channel}	MHz	10									
MPDCCH parameters defined in A.3.1.3		R.17 FDD									
OCNG Pattern defined in A.3.2.1 (FDD)		OP.21 FDD									
ρ_A, ρ_B		-3									
MPDCCH_RA	dB	0									
MPDCCH_RB	dB	0									
PBCH_RA	dB										
PBCH_RB	dB										
PSS_RA	dB										
SSS_RA	dB										
OCNG_RA ^{Note1}	dB						-3				
OCNG_RB ^{Note1}	dB										
N_{oc}	dBm/15 kHz						-98				
SNR ^{Note 8}	dB	-4.58	-10	-18	-10.58	-4.58					
Propagation condition		AWGN									
Correlation Matrix and Antenna Configuration		2x1									
Note 1: OCNG shall be used such that the resources in cell # 1 are fully allocated and a constant total transmitted power spectral density is achieved for all OFDM symbols. Note 2: The uplink resources for CQI reporting are assigned to the UE prior to the start of time period T1. Note 3: The timers and layer 3 filtering related parameters are configured prior to the start of time period T1. Note 4: The signal contains MPDCCH for UEs other than the device under test as part of OCNG. Note 5: SNR levels correspond to the signal to noise ratio over the cell-specific reference signal REs. Note 6: The SNR in time periods T1, T2, T3, T4 and T5 is denoted as SNR1, SNR2, SNR3, SNR4 and SNR5 respectively in figure A.7.3.51.1-1.											

Table A.7.3.51.1-3: DRX-Configuration for E-UTRAN FD-FDD out-of-sync tests for UE category M1 configured in CEMode A

Field	Value	Comment
onDurationTimer	psf10	As specified in clause 6.3.2 in TS 36.331
drx-InactivityTimer	psf1	
drx-RetransmissionTimer	psf1	
longDRX-CycleStartOffset	sf40	
shortDRX	disable	

Table A.7.3.51.1-4: TimeAlignmentTimer -Configuration for E-UTRAN FD-FDD out-of-sync testing for UE category M1 configured in CEMode A

Field	Value	Comment
TimeAlignmentTimer	infinity	As specified in clause 6.3.2 in TS 36.331
sr-ConfigIndex	30	For further information see clause 6.3.2 in TS 36.331 and section 10.1 in TS 36.213.

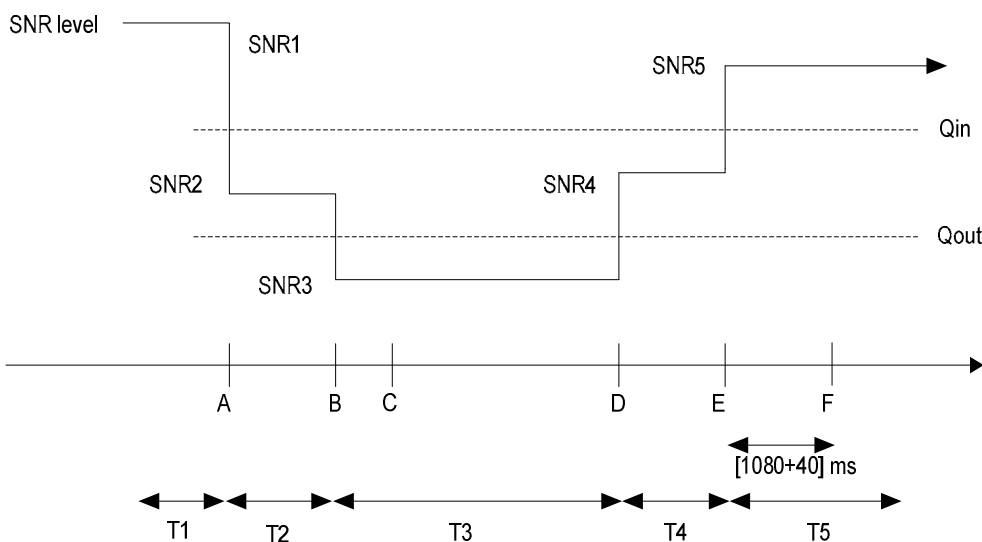

Figure A.7.3.51.1-1: SNR variation for in-sync testing in DRX

A.7.3.51.2 Test Requirements

The UE behaviour in each test during time durations T1, T2, T3, T4 and T5 shall be as follows:

During the period from time point A to time point F (1120 ms after the start of time duration T5) the UE shall transmit uplink signal at least once every DRX cycle, in the On-duration part of the cycle in the subframe according to the configured CQI reporting mode (PUCCH 1-0).

The rate of correct events observed during repeated tests shall be at least 90%.

A.7.3.52 E-UTRAN HD-FDD Radio Link Monitoring Test for Out-of-sync for Cat-M1 UE in CEMode A

A.7.3.52.1 Test Purpose and Environment

The purpose of this test is to verify that the HD-FDD Cat-M1 UE properly detects the out of sync and in sync for the purpose of monitoring downlink radio link quality of the PCell in CEModeA. This test will partly verify the E-UTRAN FDD radio link monitoring requirements for Cat-M1 UE defined in clause 7.19.

The test parameters are given in Tables A.7.3.52.1-1 and A.7.3.52.1-2 below. There is one cell (cell 1), which is the active cell, in the test. The test consists of three successive time periods, with time duration of T1, T2 and T3 respectively. Figure A.7.3.52.1-1 shows the variation of the downlink SNR in the active cell to emulate out-of-sync and in-sync states. Prior to the start of the time duration T1, the UE shall be fully synchronized to cell 1. The UE shall be configured for periodic CQI reporting in PUCCH 1-0 mode without repetition with a reporting periodicity of 20 ms.

In the test, the RRC parameter *numberPRB-Pairs* is set to 6 and the RRC parameter *mPDCCH-NumRepetition* is set to 8. UE shall successfully complete the RRC reconfiguration accordingly prior to the start of time duration T1.

Table A.7.3.52.1-1: General test parameters for E-UTRAN HD-FDD out-of-sync testing for UE Cat-M1 in CEMode A

Parameter		Unit	Value	Comment
Active cell			Cell 1	Cell 1 is on E-UTRA RF channel number 1
CP length			Normal	
Out of sync transmission parameters (Note 1)	DCI format		6-1A	As defined in section 5.3.3.1.12 in TS 36.212
	Number of OFDM symbols for legacy control channels		2	Out of sync threshold Q_{out} and the corresponding hypothetical MPDCCH transmission parameters are as specified in section 7.19.2 and Table 7.19.2-1 respectively.
	M-PDCCH aggregation level	eCCE	24	
	M-PDCCH repetition level		8	
	ρ_A, ρ_B		-3	
DRX			OFF	
Layer 3 filtering			Enabled	Counters: $N_{310} = 1$; $N_{311} = 1$
T310 timer		ms	0	T310 is disabled
T311 timer		ms	1000	T311 is enabled
Periodic CQI reporting mode			PUCCH 1-0	As defined in table 7.2.2-1 in TS 36.213.
CQI reporting periodicity		ms	20	Minimum CQI reporting periodicity
T1		s	2	
T2		s	0.8	
T3		s	1.8	
Note 1: MPDCCH transmission parameters corresponding to the in-sync and out of sync transmission need not be included in the Reference Measurement Channel.				

Table A.7.3.52.1-2: Cell specific test parameters for E-UTRAN HD-FDD (cell # 1) for out-of-sync radio link monitoring tests for Cat-M1 in CEMode A

Parameter	Unit	Test 1		
		T1	T2	T3
E-UTRA RF Channel Number		1		
$BW_{channel}$	MHz	10		
MPDCCH parameters as defined in A.3.1.3.1		R.7 HD-FDD		
OCNG Pattern defined in A.3.2.1.21 (FDD)		OP.21 FDD		
ρ_A, ρ_B		-3		
MPDCCH_RA	dB	0		
MPDCCH_RB	dB	0		
PBCH_RA	dB	-3		
PBCH_RB	dB			
PSS_RA	dB			
SSS_RA	dB			
OCNG_RA ^{Note 1}	dB			
OCNG_RB ^{Note 1}	dB			
N_{oc}	dBm/15 kHz			

SNR ^{Note 6}	dB	0.1	-6.8	-15.8
Propagation condition		ETU 30Hz		
Correlation Matrix and Antenna Configuration		2x1 Low		
<p>Note 1: OCNG shall be used such that the resources in cell # 1 are fully allocated and a constant total transmitted power spectral density is achieved for all OFDM symbols.</p> <p>Note 2: The uplink resources for CQI reporting are assigned to the UE prior to the start of time period T1.</p> <p>Note 3: The timers and layer 3 filtering related parameters are configured prior to the start of time period T1.</p> <p>Note 4: The signal contains PDCCH for UEs other than the device under test as part of OCNG.</p> <p>Note 5: SNR levels correspond to the signal to noise ratio over the cell-specific reference signal REs.</p> <p>Note 6: The SNR in time periods T1, T2 and T3 is denoted as SNR1, SNR2 and SNR3 respectively in figure A.7.3.x5.1-1.</p>				

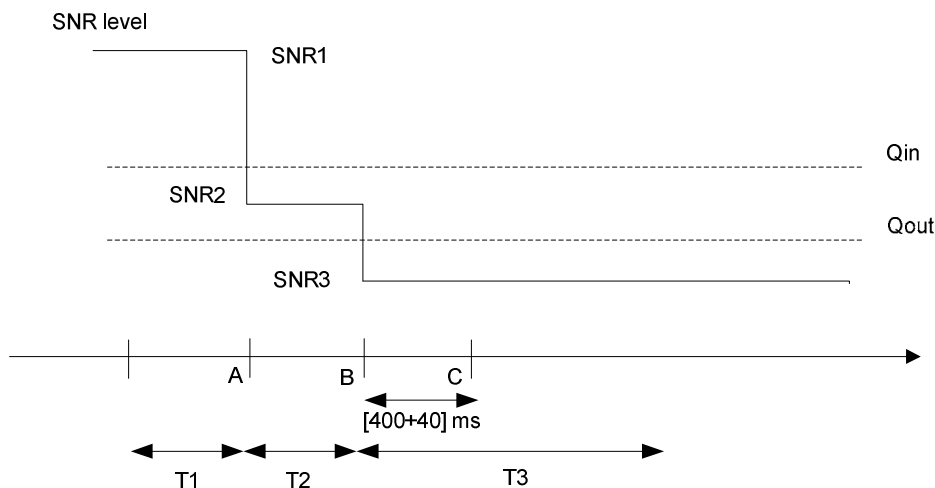

Figure A.7.3.52.1-1: SNR variation for out-of-sync testing

A.7.3.52.2 Test Requirements

The UE behaviour in each test during time durations T1, T2 and T3 shall be as follows:

During the period from time point A to time point B the UE shall transmit uplink signal at least in all subframes configured for CQI transmission according to the configured CQI reporting mode (PUCCH 1-0).

The UE shall stop transmitting uplink signal no later than time point C (440 ms after the start of time duration T3).

The rate of correct events observed during repeated tests shall be at least 90%.

A.7.3.53 E-UTRAN HD-FDD Radio Link Monitoring Test for In-Sync for Cat-M1 UE in CEMode A

A.7.3.53.1 Test Purpose and Environment

The purpose of this test is to verify that the HD-FDD Cat-M1 UE properly detects the out of sync and in sync for the purpose of monitoring downlink radio link quality of the PCell in CEModeA. This test will partly verify the E-UTRAN FDD radio link monitoring requirements for Cat-M1 UE defined in clause 7.19.

The test parameters are given in Tables A.7.3.53.1-1 and A.7.3.53.1-2 below. There is one cell (cell 1), which is the active cell, in the test. The test consists of five successive time periods, with time duration of T1, T2, T3, T4 and T5 respectively. Figure A.7.3.53.1-1 shows the variation of the downlink SNR in the active cell to emulate out-of-sync and

in-sync states. Prior to the start of the time duration T1, the UE shall be fully synchronized to cell 1. The UE shall be configured for periodic CQI reporting in PUCCH 1-0 mode without repetition with a reporting periodicity of 20 ms.

In the test, the RRC parameter *numberPRB-Pairs* is set to 4 and the RRC parameter *mPDCCH-NumRepetition* is set to 4. UE shall successfully complete the RRC reconfiguration accordingly prior to the start of time duration T1.

Table A.7.3.53.1-1: General test parameters for E-UTRAN HD-FDD in-sync testing for UE Cat-M1 in CEMode A

Parameter		Unit	Value	Comment
Active cell			Cell 1	Cell 1 is on E-UTRA RF channel number 1
CP length			Normal	
In sync transmission parameters (Note 1)	DCI format		6-1A	As defined in section 5.3.3.1.12 in TS 36.212
	Number of OFDM symbols for legacy control channels		2	In sync threshold Q_{in} and the corresponding hypothetical MPDCCH transmission parameters are as specified in section 7.19.2 and Table 7.19.2-1 respectively.
	M-PDCCH aggregation level	eCCE	4	
	M-PDCCH repetition level		2	
	ρ_A, ρ_B		-3	
DRX		OFF		
Out of sync transmission parameters (Note 1)				
DCI format			6-1A	As defined in section 5.3.3.1.12 in TS 36.212
Number of OFDM symbols for legacy control channels			2	Out of sync threshold Q_{out} and the corresponding hypothetical MPDCCH transmission parameters are as specified in section 7.19.2 and Table 7.19.2-1 respectively.
M-PDCCH aggregation level		eCCE	16	
M-PDCCH repetition level			4	
ρ_A, ρ_B			-3	
DRX			OFF	
Layer 3 filtering			Enabled	Counters: N310 = 1; N311 = 1
T310 timer		ms	2000	T310 is enabled
T311 timer		ms	1000	T311 is enabled
Periodic CQI reporting mode			PUCCH 1-0	As defined in table 7.2.2-1 in TS 36.213.
CQI reporting periodicity		ms	20	Minimum CQI reporting periodicity
T1		s	2	
T2		s	0.8	
T3		s	1.36	
T4		s	0.4	
T5		s	2	
Note 1: MPDCCH corresponding to the out of sync transmission parameters need not be included in the Reference Measurement Channel.				

Table A.7.3.53.1-2: Cell specific test parameters for E-UTRAN HD-FDD (cell # 1) for in-sync radio link monitoring tests for Cat-M1 in CEMode A

Parameter	Unit	Test 1				
		T1	T2	T3	T4	T5

E-UTRA RF Channel Number		1				
BW _{channel}	MHz	10				
MPDCCH parameters as defined in A.3.1.3.1		R.7 HD-FDD				
OCNG Pattern defined in A.3.2.1.21 (FDD)		OP.21 FDD				
ρ_A, ρ_B		-3				
MPDCCH_RA	dB	0				
MPDCCH_RB	dB	0				
PBCH_RA	dB	-3				
PBCH_RB	dB					
PSS_RA	dB					
SSS_RA	dB					
OCNG_RA ^{Note 1}	dB					
OCNG_RB ^{Note 1}	dB					
N_{oc}	dBm/15 kHz	-98				
SNR ^{Note 6}	dB	5.4	-3.8	-12.8	-1.6	5.4
Propagation condition		ETU 30Hz				
Correlation Matrix and Antenna Configuration		2x1 Low				
<p>Note 1: OCNG shall be used such that the resources in cell # 1 are fully allocated and a constant total transmitted power spectral density is achieved for all OFDM symbols.</p> <p>Note 2: The uplink resources for CQI reporting are assigned to the UE prior to the start of time period T1.</p> <p>Note 3: The timers and layer 3 filtering related parameters are configured prior to the start of time period T1.</p> <p>Note 4: The signal contains PDCCH for UEs other than the device under test as part of OCNG.</p> <p>Note 5: SNR levels correspond to the signal to noise ratio over the cell-specific reference signal REs.</p> <p>Note 6: The SNR in time periods T1, T2, T3, T4 and T5 is denoted as SNR1, SNR2, SNR3, SNR4 and SNR5 respectively in figure A.7.3.53.1-1.</p>						

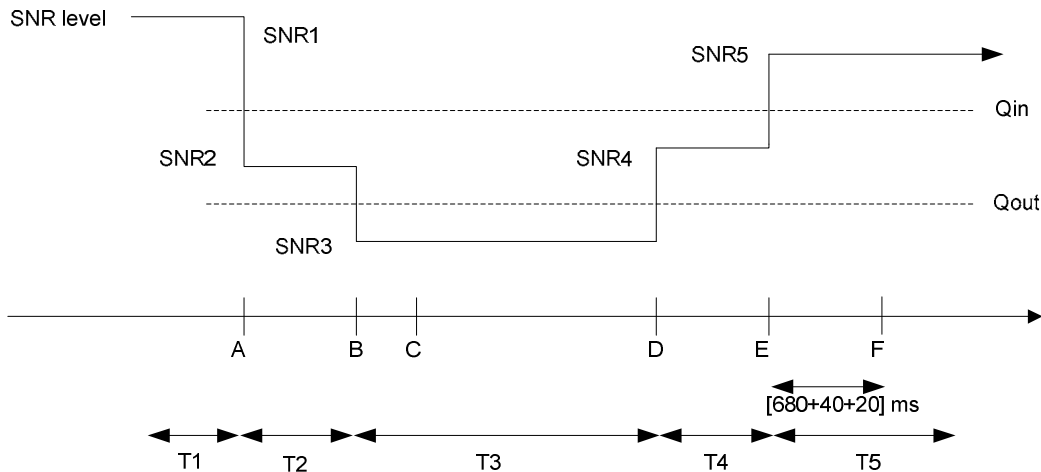

A.7.3.53.1-1: SNR variation for in-sync testing

Figure

A.7.3.53.2 Test Requirements

The UE behaviour in each test during time durations T1, T2, T3, T4 and T5 shall be as follows:

During the period from time point A to time point F (740 ms after the start of time duration T5) the UE shall transmit uplink signal at least in all subframes configured for CQI transmission according to the configured CQI reporting mode (PUCCH 1-0).

The rate of correct events observed during repeated tests shall be at least 90%.

A.7.3.54 E-UTRAN HD-FDD Radio Link Monitoring Test for Out-of-sync in DRX for UE category M1 configured in CEMode A

A.7.3.54.1 Test Purpose and Environment

The purpose of this test is to verify that the HD-FDD category M1 UE configured in CEMode A properly detects the out of sync for the purpose of monitoring downlink radio link quality of the PCell when DRX is used. This test will partly verify the E-UTRAN HD-FDD radio link monitoring requirements in clause 7.19.

The test parameters are given in Tables A.7.3.54.1-1, A.7.3.54.1-2, A.7.3.54.1-3 and A.7.3.54.1-4. There is one cell (cell 1), which is the active cell, in the test. The test consists of three successive time periods, with time duration of T1, T2 and T3 respectively. Figure A.7.3.54.1-1 shows the variation of the downlink SNR in the active cell to emulate out-of-sync states. Prior to the start of the time duration T1, the UE shall be fully synchronized to cell 1. The UE shall be configured for periodic CQI reporting in PUCCH 1-0 mode with a reporting periodicity of 20 ms without repetition. In the test, DRX configuration is enabled and DRX inactivity timer has already been expired, i.e. UE tries to decode MPDCCH and to send periodic CQI during the period when On-duration timer is running. Time alignment timers shall be set to "infinity" so that UL timing alignment is maintained during the test.

In the test, the RRC parameter *numberPRB-Pairs* is set to 4 and the RRC parameter *mPDCCH-NumRepetition* is set 4. UE shall successfully complete the RRC reconfiguration accordingly prior to the start of time duration T1.

Table A.7.3.54.1-1: General test parameters for E-UTRAN HD-FDD out-of-sync tests in DRX for UE category M1 configured in CEMode A

Parameter		Unit	Value	Comment
Active cell			Cell 1	Cell 1 is on E-UTRA RF channel number 1
CP length			Normal	
Out of sync transmission parameters (Note 1)	DCI format		6-1A	As defined in section 5.3.3.1.12 in TS 36.212
	Number of OFDM symbols for legacy control channels		2	Out of sync threshold $Q_{out, Cat M1}$ and the corresponding hypothetical MPDCCH transmission parameters are as specified in clause 7.19.2 and Table 7.19.2-1 respectively.
	MPDCCH aggregation level	eCCE	16	
	MPDCCH repetition level		4	
	ρ_A, ρ_B		-3	
Ratio of PDCCH to RS EPRE	dB	0		
DRX cycle		ms	1280	See Table A.7.3.54.1-3
Layer 3 filtering			Enabled	Counters: N310 = 1; N311 = 1
T310 timer		ms	0	T310 is disabled
T311 timer		ms	1000	T311 is enabled
Periodic CQI reporting mode			PUCCH 1-0	As defined in table 7.2.2-1 in TS 36.213.
CQI reporting periodicity		ms	20	
T1		s	32	
T2		s	12.8	
T3		s	13	
Note 1: MPDCCH corresponding to the out of sync transmission parameters need not be included in the Reference Measurement Channel.				

Table A.7.3.54.1-2: Cell specific test parameters for E-UTRAN HD-FDD (cell # 1) for out-of-sync radio link monitoring tests in DRX for UE category M1 configured in CEMode A

Parameter	Unit	Test 1		
		T1	T2	T3
E-UTRA RF Channel Number		1		
$BW_{channel}$	MHz	10		
MPDCCH parameters defined in A.3.1.3		R.7 HD-FDD		
OCNG Pattern defined in A.3.2.1 (FDD)		OP.21 FDD		
ρ_A, ρ_B		-3		
MPDCCH_RA	dB	0		
MPDCCH_RB	dB	0		
PBCH_RA	dB	-3		
PBCH_RB	dB			
PSS_RA	dB			
SSS_RA	dB			
OCNG_RA ^{Note1}	dB			
OCNG_RB ^{Note1}	dB	-3		
N_{oc}	dBm/15 kHz	-98		
SNR ^{Note 6}	dB	0.37	-6.98	-14.98
Propagation condition		AWGN		

Correlation Matrix and Antenna Configuration		2x1
Note 1:	OCNG shall be used such that the resources in cell # 1 are fully allocated and a constant total transmitted power spectral density is achieved for all OFDM symbols.	
Note 2:	The uplink resources for CQI reporting are assigned to the UE prior to the start of time period T1.	
Note 3:	The timers and layer 3 filtering related parameters are configured prior to the start of time period T1.	
Note 4:	The signal contains MPDCCH for UEs other than the device under test as part of OCNG.	
Note 5:	SNR levels correspond to the signal to noise ratio over the cell-specific reference signal REs.	
Note 6:	The SNR in time periods T1, T2 and T3 is denoted as SNR1, SNR2 and SNR3 respectively in figure A.7.3.54.1-1.	

Table A.7.3.54.1-3: DRX-Configuration for E-UTRAN HD-FDD out-of-sync tests for UE category M1 configured in CEMode A

Field	Value	Comment
onDurationTimer	psf20	As specified in clause 6.3.2 in TS 36.331
drx-InactivityTimer	psf1	
drx-RetransmissionTimer	psf1	
longDRX-CycleStartOffset	sf1280	
shortDRX	disable	

Table A.7.3.54.1-4: TimeAlignmentTimer-Configuration for E-UTRAN HD-FDD out-of-sync testing for UE category M1 configured in CEMode A

Field	Value	Comment
TimeAlignmentTimer	infinity	As specified in clause 6.3.2 in TS 36.331
sr-ConfigIndex	30	For further information see clause 6.3.2 in TS 36.331 and section 10.1 in TS 36.213.

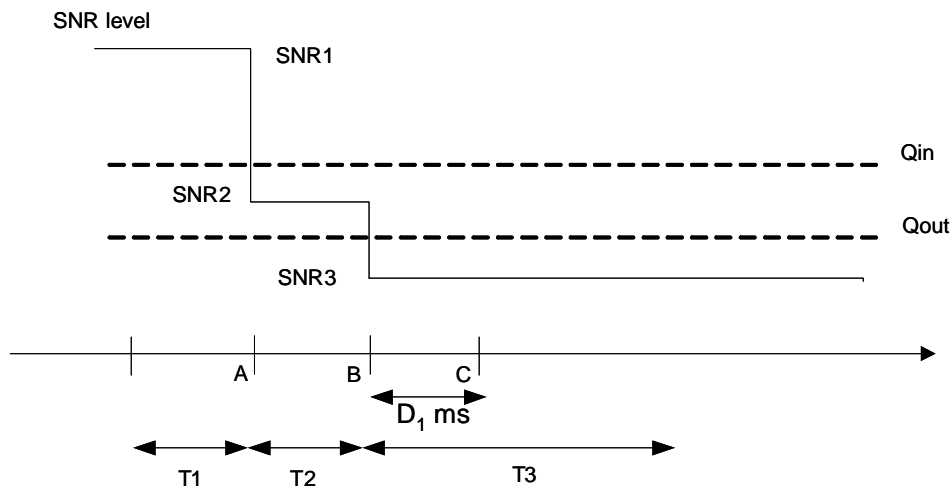

Figure A.7.3.54.1-1: SNR variation for out-of-sync testing in DRX

A.7.3.54.2 Test Requirements

The UE behaviour in each test during time durations T1, T2 and T3 shall be as follows:

During the period from time point A to time point B the UE shall transmit uplink signal at least once every DRX cycle, in the On-duration part of the cycle in the subframe according to the configured CQI reporting mode (PUCCH 1-0).

The UE shall stop transmitting uplink signal no later than time point C (duration $D_1 = 6520$ ms after the start of time duration T3).

The rate of correct events observed during repeated tests shall be at least 90%.

A.7.3.55 E-UTRAN HD-FDD Radio Link Monitoring Test for In-sync in DRX for UE Category M1 configured in CEMode A

A.7.3.55.1 Test Purpose and Environment

The purpose of this test is to verify that the HD-FDD category M1 UE configured in CEMode A properly detects the out of sync and in sync for the purpose of monitoring downlink radio link quality of the PCell when DRX is used. This test will partly verify the E-UTRAN HD-FDD radio link monitoring requirements in clause 7.19.

The test parameters are given in Tables A.7.3.55.1-1, A.7.3.55.1-2, A.7.3.55.1-3 and A.7.3.55.1-4. There is one cell (cell 1), which is the active cell, in the test. The test consists of five successive time periods, with time duration of T1, T2, T3, T4 and T5 respectively. Figure A.7.3.55.1-1 shows the variation of the downlink SNR in the active cell to emulate out-of-sync and in-sync states. Prior to the start of the time duration T1, the UE shall be fully synchronized to cell 1. The UE shall be configured for periodic CQI reporting in PUCCH 1-0 mode with a reporting periodicity of 20 ms without repetition. In the test, DRX configuration is enabled and DRX inactivity timer has already been expired, i.e. UE tries to decode MPDCCH and to send periodic CQI during the period when On-duration timer is running. Time alignment timers shall be set to “infinity” so that UL timing alignment is maintained during the test.

In the test, the RRC parameter *numberPRB-Pairs* is set to 6 and the RRC parameter *mPDCCH-NumRepetition* is set 8. UE shall successfully complete the RRC reconfiguration accordingly prior to the start of time duration T1.

Table A.7.3.55.1-1: General test parameters for E-UTRAN HD-FDD in-sync test in DRX for UE category M1 configured in CEMode A

Parameter		Unit	Value	Comment
Active cell			Cell 1	Cell 1 is on E-UTRA RF channel number 1
CP length			Normal	
In sync transmission parameters (Note 1)	DCI format		6-1A	As defined in section 5.3.3.1.12 in TS 36.212
	Number of OFDM symbols for legacy control channels		2	In sync threshold $Q_{in, Cat M1}$ and the corresponding hypothetical MPDCCH transmission parameters are as specified in clause 7.19.2 and Table 7.19.2-1 respectively.
	MPDCCH aggregation level	eCCE	8	
	MPDCCH repetition level		4	
	ρ_A, ρ_B		-3	
Ratio of MPDCCH to RS EPRE		0		
Out of sync transmission parameters (Note 1)	DCI format		6-1A	As defined in TS 36.212
	Number of OFDM symbols for legacy control channels		2	Out of sync threshold $Q_{out, Cat M1}$ and the corresponding hypothetical MPDCCH transmission parameters are as specified in clause 7.19.2 and Table 7.19.2-1 respectively.
	MPDCCH aggregation level	eCCE	24	
	MPDCCH repetition level		8	
	ρ_A, ρ_B		-3	
Ratio of MPDCCH to RS EPRE	dB	0		
DRX cycle		ms	40	See Table A.7.3.55.1-3
Layer 3 filtering			Enabled	Counters: N310 = 1; N311 = 1
T310 timer		ms	2000	T310 is enabled
T311 timer		ms	1000	T311 is enabled

Periodic CQI reporting mode		PUCCH 1-0	As defined in table 7.2.2-1 in TS 36.213.
CQI reporting periodicity	ms	20	
T1	s	4	
T2	s	1.6	
T3	s	1.46	
T4	s	0.4	
T5	s	4	
Note 1: MPDCCH corresponding to the in-sync and out of sync transmission parameters need not be included in the Reference Measurement Channel.			

Table A.7.3.55.1-2: Cell specific test parameters for E-UTRAN HD-FDD (cell # 1) for in-sync radio link monitoring test in DRX for UE category M1 configured in CEMode A

Parameter	Unit	Test 1									
		T1	T2	T3	T4	T5					
E-UTRA RF Channel Number		1									
BW _{channel}	MHz	10									
MPDCCH parameters defined in A.3.1.3		R.7 HD-FDD									
OCNG Pattern defined in A.3.2.1 (FDD)		OP.21 FDD									
ρ _A , ρ _B		-3									
MPDCCH_RA	dB	0									
MPDCCH_RB	dB	0									
PBCH_RA	dB										
PBCH_RB	dB										
PSS_RA	dB										
SSS_RA	dB										
OCNG_RA ^{Note1}	dB						-3				
OCNG_RB ^{Note1}	dB										
N _{oc}	dBm/15 kHz	-98									
SNR ^{Note 8}	dB	-4.58	-10	-18	-10.58	-4.58					
Propagation condition		AWGN									
Correlation Matrix and Antenna Configuration		2x1									
Note 1: OCNG shall be used such that the resources in cell # 1 are fully allocated and a constant total transmitted power spectral density is achieved for all OFDM symbols. Note 2: The uplink resources for CQI reporting are assigned to the UE prior to the start of time period T1. Note 3: The timers and layer 3 filtering related parameters are configured prior to the start of time period T1. Note 4: The signal contains MPDCCH for UEs other than the device under test as part of OCNG. Note 5: SNR levels correspond to the signal to noise ratio over the cell-specific reference signal REs. Note 6: The SNR in time periods T1, T2, T3, T4 and T5 is denoted as SNR1, SNR2, SNR3, SNR4 and SNR5 respectively in figure A.7.3.55.1-1.											

Table A.7.3.55.1-3: DRX-Configuration for E-UTRAN HD-FDD out-of-sync tests for UE category M1 configured in CEMode A

Field	Value	Comment
onDurationTimer	psf20	As specified in clause 6.3.2 in TS 36.331
drx-InactivityTimer	psf1	
drx-RetransmissionTimer	psf1	
longDRX-CycleStartOffset	sf40	
shortDRX	disable	

Table A.7.3.55.1-4: TimeAlignmentTimer-Configuration for E-UTRAN HD-FDD out-of-sync testing for UE category M1 configured in CEMode A

Field	Value	Comment
-------	-------	---------

TimeAlignmentTimer	infinity	As specified in clause 6.3.2 in TS 36.331
sr-ConfigIndex	30	For further information see clause 6.3.2 in TS 36.331 and section 10.1 in TS 36.213.

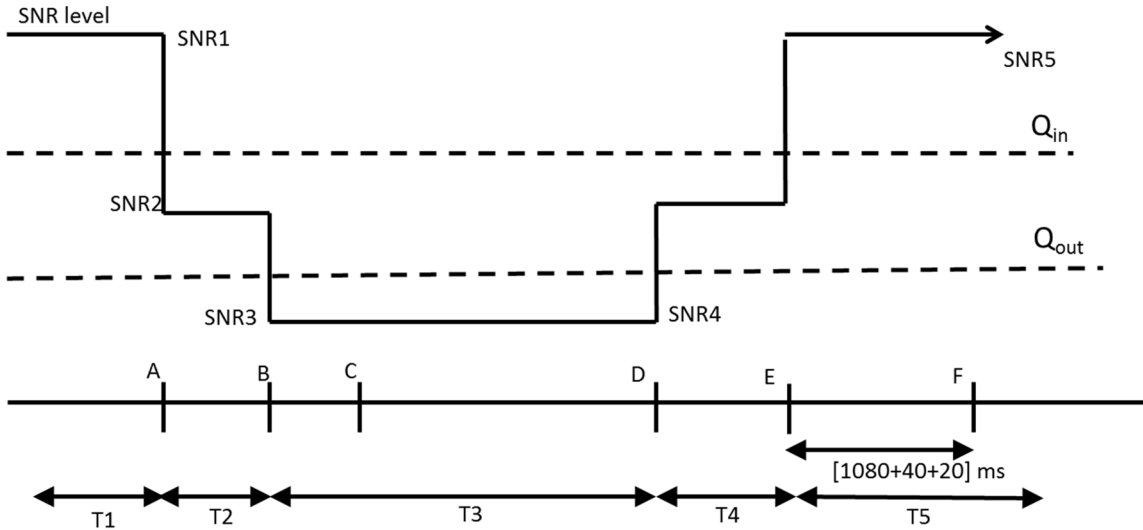

Figure A.7.3.55.1-1: SNR variation for in-sync testing in DRX

A.7.3.55.2 Test Requirements

The UE behaviour in each test during time durations T1, T2, T3, T4 and T5 shall be as follows:

During the period from time point A to time point F (1140 ms after the start of time duration T5) the UE shall transmit uplink signal at least once every DRX cycle, in the On-duration part of the cycle in the subframe according to the configured CQI reporting mode (PUCCH 1-0).

The rate of correct events observed during repeated tests shall be at least 90%.

A.7.3.56 E-UTRAN TDD Radio Link Monitoring Test for Out-of-sync for Cat-M1 UE in CEMode A

A.7.3.56.1 Test Purpose and Environment

The purpose of this test is to verify that the TDD Cat-M1 UE properly detects the out of sync and in sync for the purpose of monitoring downlink radio link quality of the PCell in CEModeA. This test will partly verify the E-UTRAN TDD radio link monitoring requirements for Cat-M1 UE defined in clause 7.19.

The test parameters are given in Tables A.7.3.56.1-1 and A.7.3.56.1-2 below. There is one cell (cell 1), which is the active cell, in the test. The test consists of three successive time periods, with time duration of T1, T2 and T3 respectively. Figure A.7.3.56.1-1 shows the variation of the downlink SNR in the active cell to emulate out-of-sync and in-sync states. Prior to the start of the time duration T1, the UE shall be fully synchronized to cell 1. The UE shall be configured for periodic CQI reporting in PUCCH 1-0 mode with a reporting periodicity of 1 ms.

In the test, the RRC parameter *numberPRB-Pairs* is set to 6 and the RRC parameter *mPDCCH-NumRepetition* is set to 8. UE shall successfully complete the RRC reconfiguration accordingly prior to the start of time duration T1.

Table A.7.3.56.1-1: General test parameters for E-UTRAN TDD out-of-sync testing for UE Cat-M1 in CEMode A

Parameter	Unit	Value	Comment
-----------	------	-------	---------

Active cell			Cell 1	Cell 1 is on E-UTRA RF channel number 1
CP length			Normal	
Out of sync transmission parameters (Note 1)	DCI format		6-1A	As defined in section 5.3.3.1.12 in TS 36.212
	Number of OFDM symbols for legacy control channels		2	Out of sync threshold Q_{out} and the corresponding hypothetical MPDCCH transmission parameters are as specified in section 7.19.2 and Table 7.19.2-1 respectively.
	M-PDCCH aggregation level	eCCE	24	
	M-PDCCH repetition level		8	
	ρ_A, ρ_B		-3	
DRX			OFF	
Layer 3 filtering			Enabled	Counters: N310 = 1; N311 = 1
T310 timer		ms	0	T310 is disabled
T311 timer		ms	1000	T311 is enabled
Periodic CQI reporting mode			PUCCH 1-0	As defined in table 7.2.2-1 in TS 36.213.
CQI reporting periodicity		ms	1	Minimum CQI reporting periodicity
T1		s	2	
T2		s	0.8	
T3		s	1.8	
Note 1: MPDCCH corresponding to the out of sync transmission parameters need not be included in the Reference Measurement Channel.				

Table A.7.3.56.1-2: Cell specific test parameters for E-UTRAN TDD (cell # 1) for out-of-sync radio link monitoring tests for Cat-M1 in CEMode A

Parameter	Unit	Test 1		
		T1	T2	T3
E-UTRA RF Channel Number		1		
$BW_{channel}$	MHz	10		
Special subframe configuration ^{Note 1}		6		
Uplink-downlink configuration ^{Note 1}		1		
MPDCCH parameters as defined in A.3.1.3.1		R.15 TDD ^{Note 8}		
OCNG Pattern defined in A.3.2.2.11 (TDD)		OP.11 TDD		
ρ_A, ρ_B		-3		
PBCH_RA	dB	-3		
PBCH_RB	dB			
PSS_RA	dB			
SSS_RA	dB			
OCNG_RA ^{Note 1}	dB			
OCNG_RB ^{Note 1}	dB			
N_{oc}	dBm/15 kHz	-98		
SNR ^{Note 7}	dB	-0.3	-7.1	-16.1

Propagation condition		ETU 30Hz
Correlation Matrix and Antenna Configuration		2x1 Low
Note 1:	For special subframe and uplink-downlink configurations see Tables 4.2-1 and 4.2-2 in TS 36.211.	
Note 2:	OCNG shall be used such that the resources in cell # 1 are fully allocated and a constant total transmitted power spectral density is achieved for all OFDM symbols.	
Note 3:	The uplink resources for CQI reporting are assigned to the UE prior to the start of time period T1.	
Note 4:	The timers and layer 3 filtering related parameters are configured prior to the start of time period T1.	
Note 5:	The signal contains PDCCH for UEs other than the device under test as part of OCNG.	
Note 6:	SNR levels correspond to the signal to noise ratio over the cell-specific reference signal REs.	
Note 7:	The SNR in time periods T1, T2 and T3 is denoted as SNR1, SNR2 and SNR3 respectively in figure A.7.3.56.1-1.	
Note 8:	Aggregation level and repetition levels specified in A.7.3.56.1-1 are used for this test.	

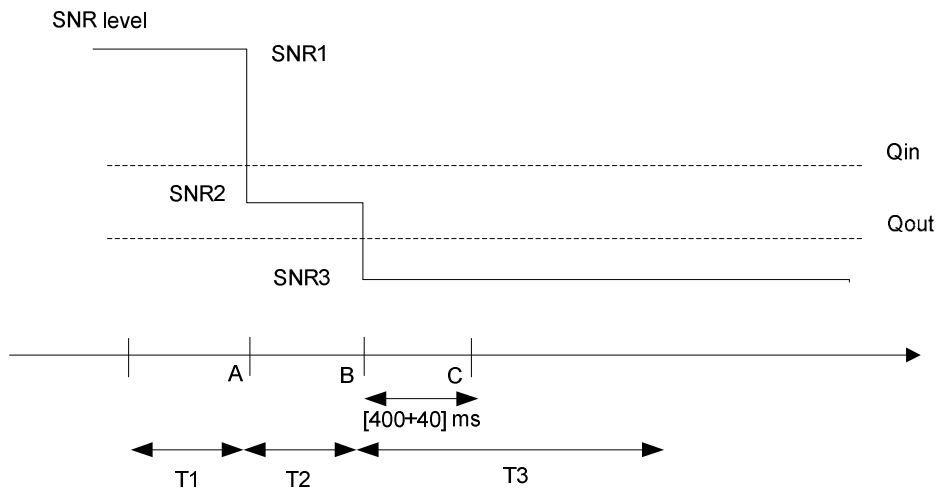

Figure A.7.3.56.1-1: SNR variation for out-of-sync testing

A.7.3.56.2 Test Requirements

The UE behaviour in each test during time durations T1, T2 and T3 shall be as follows:

During the period from time point A to time point B the UE shall transmit uplink signal at least in all subframes configured for CQI transmission according to the configured CQI reporting mode (PUCCH 1-0).

The UE shall stop transmitting uplink signal no later than time point C (440 ms after the start of time duration T3).

The rate of correct events observed during repeated tests shall be at least 90%.

A.7.3.57 E-UTRAN TDD Radio Link Monitoring Test for In-Sync for Cat-M1 UE in CEMode A

A.7.3.57.1 Test Purpose and Environment

The purpose of this test is to verify that the TDD Cat-M1 UE properly detects the out of sync and in sync for the purpose of monitoring downlink radio link quality of the PCell in CEModeA. This test will partly verify the E-UTRAN TDD radio link monitoring requirements for Cat-M1 UE defined in clause 7.19.

The test parameters are given in Tables A.7.3.57.1-1 and A.7.3.57.1-2 below. There is one cell (cell 1), which is the active cell, in the test. The test consists of five successive time periods, with time duration of T1, T2, T3, T4 and T5 respectively. Figure A.7.3.57.1-1 shows the variation of the downlink SNR in the active cell to emulate out-of-sync and in-sync states. Prior to the start of the time duration T1, the UE shall be fully synchronized to cell 1. The UE shall be configured for periodic CQI reporting in PUCCH 1-0 mode without repetition with a reporting periodicity of 1 ms.

In the test, the RRC parameter *numberPRB-Pairs* is set to 4 and the RRC parameter *mPDCCH-NumRepetition* is set to 4. UE shall successfully complete the RRC reconfiguration accordingly prior to the start of time duration T1.

Table A.7.3.57.1-1: General test parameters for E-UTRAN TDD in-sync testing for UE Cat-M1 in CEMode A

Parameter		Unit	Value	Comment
Active cell			Cell 1	Cell 1 is on E-UTRA RF channel number 1
CP length			Normal	
In sync transmission parameters (Note 1)	DCI format		6-1A	As defined in section 5.3.3.1.12 in TS 36.212
	Number of OFDM symbols for legacy control channels		2	In sync threshold Q_{in} and the corresponding hypothetical MPDCCH transmission parameters are as specified in section 7.19.2 and Table 7.19.2-1 respectively.
	M-PDCCH aggregation level	eCCE	4	
	M-PDCCH repetition level		2	
	ρ_A, ρ_B		-3	
Out of sync transmission parameters (Note 1)	DCI format		6-1A	As defined in section 5.3.3.1.12 in TS 36.212
	Number of OFDM symbols for legacy control channels		2	Out of sync threshold Q_{out} and the corresponding hypothetical MPDCCH transmission parameters are as specified in section 7.19.2 and Table 7.19.2-1 respectively.
	M-PDCCH aggregation level	eCCE	16	
	M-PDCCH repetition level		4	
	ρ_A, ρ_B		-3	
DRX			OFF	
Layer 3 filtering			Enabled	Counters: $N_{310} = 1; N_{311} = 1$
T310 timer		ms	2000	T310 is enabled
T311 timer		ms	1000	T311 is enabled
Periodic CQI reporting mode			PUCCH 1-0	As defined in table 7.2.2-1 in TS 36.213.
CQI reporting periodicity		ms	1	Minimum CQI reporting periodicity
T1		s	2	
T2		s	0.8	
T3		s	1.36	
T4		s	0.4	
T5		s	2	
Note 1: MPDCCH corresponding to the in-sync and out of sync transmission parameters need not be included in the Reference Measurement Channel.				

Table A.7.3.57.1-2: Cell specific test parameters for E-UTRAN TDD (cell # 1) for in-sync radio link monitoring tests for Cat-M1 in CEMode A

Parameter	Unit	Test 1				
		T1	T2	T3	T4	T5
E-UTRA RF Channel Number		1				
$BW_{channel}$	MHz	10				
Special subframe configuration ^{Note 1}		6				
Uplink-downlink configuration ^{Note 1}		1				
MPDCCH parameters as defined in A.3.1.3.1		R.15 TDD				
OCNG Pattern defined in A.3.2.2.11 (TDD)		OP.11 TDD				
ρ_A, ρ_B		-3				
MPDCCH_RA	dB	0				
MPDCCH_RB	dB	0				
PBCH_RA	dB	-3				
PBCH_RB	dB					
PSS_RA	dB					
SSS_RA	dB					
OCNG_RA ^{Note 2}	dB					
OCNG_RB ^{Note 2}	dB					
N_{oc}	dBm/15 kHz					
SNR	dB	5.1	-3.8	-12.8	-1.9	5.1
Propagation condition		ETU 30Hz				
Correlation Matrix and Antenna Configuration		2x1 Low				
Note 1:	For special subframe and uplink-downlink configurations see Tables 4.2-1 and 4.2-2 in TS 36.211.					
Note 2:	OCNG shall be used such that the resources in cell # 1 are fully allocated and a constant total transmitted power spectral density is achieved for all OFDM symbols.					
Note 3:	The uplink resources for CQI reporting are assigned to the UE prior to the start of time period T1.					
Note 4:	The timers and layer 3 filtering related parameters are configured prior to the start of time period T1.					
Note 5:	The signal contains PDCCH for UEs other than the device under test as part of OCNG.					
Note 6:	SNR levels correspond to the signal to noise ratio over the cell-specific reference signal REs.					
Note 7:	The SNR in time periods T1, T2, T3, T4 and T5 is denoted as SNR1, SNR2, SNR3, SNR4 and SNR5 respectively in figure A.7.3.57.1-1.					

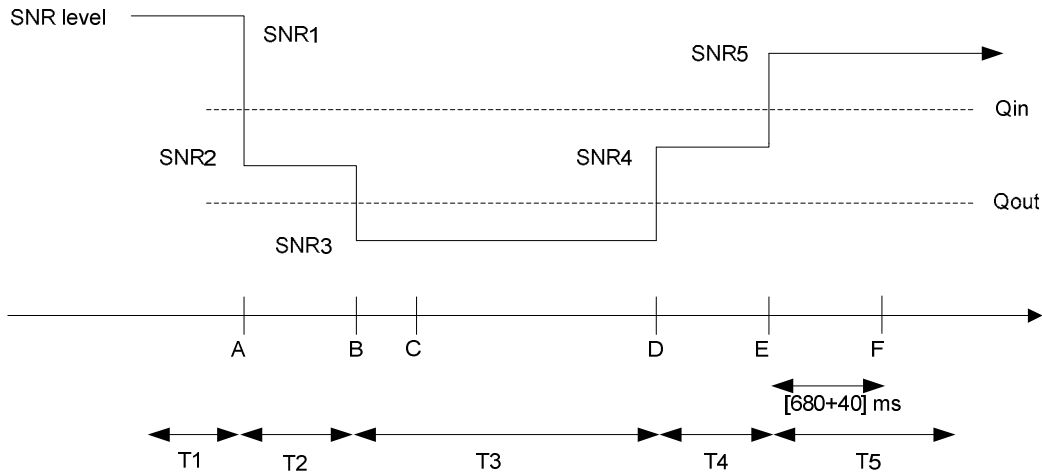

Figure

A.7.3.57.1-1: SNR variation for in-sync testing

A.7.3.57.2 Test Requirements

The UE behaviour in each test during time durations T1, T2, T3, T4 and T5 shall be as follows:

During the period from time point A to time point F (720 ms after the start of time duration T5) the UE shall transmit uplink signal at least in all subframes configured for CQI transmission according to the configured CQI reporting mode (PUCCH 1-0).

The rate of correct events observed during repeated tests shall be at least 90%.

A.7.3.58 E-UTRAN TDD Radio Link Monitoring Test for Out-of-sync in DRX for UE category M1 configured in CEMode A

A.7.3.58.1 Test Purpose and Environment

The purpose of this test is to verify that the TDD category M1 UE configured in CEMode A properly detects the out of sync for the purpose of monitoring downlink radio link quality of the PCell when DRX is used. This test will partly verify the E-UTRAN TDD radio link monitoring requirements in clause 7.19.

The test parameters are given in Tables A.7.3.58.1-1, A.7.3.58.1-2, A.7.3.58.1-3 and A.7.3.58.1-4. There is one cell (cell 1), which is the active cell, in the test. The test consists of three successive time periods, with time duration of T1, T2 and T3 respectively. Figure A.7.3.58.1-1 shows the variation of the downlink SNR in the active cell to emulate out-of-sync states. Prior to the start of the time duration T1, the UE shall be fully synchronized to cell 1. The UE shall be configured for periodic CQI reporting in PUCCH 1-0 mode with a reporting periodicity of 1 ms without repetition. In the test, DRX configuration is enabled and DRX inactivity timer has already been expired, i.e. UE tries to decode MPDCCH and to send periodic CQI during the period when On-duration timer is running. Time alignment timers shall be set to “infinity” so that UL timing alignment is maintained during the test.

In the test, the RRC parameter *numberPRB-Pairs* is set to 4 and the RRC parameter *mPDCCH-NumRepetition* is set 4. UE shall successfully complete the RRC reconfiguration accordingly prior to the start of time duration T1.

Table A.7.3.58.1-1: General test parameters for E-UTRAN TDD out-of-sync tests in DRX for UE category M1 configured in CEMode A

Parameter		Unit	Value	Comment
Active cell			Cell 1	Cell 1 is on E-UTRA RF channel number 1
CP length			Normal	
Out of sync transmission parameters (Note 1)	DCI format		6-1A	As defined in section 5.3.3.1.12 in TS 36.212
	Number of OFDM symbols for legacy control channels		2	Out of sync threshold $Q_{out, Cat M1}$ and the corresponding hypothetical MPDCCH transmission parameters are as specified in clause 7.19.2 and Table 7.19.2-1 respectively.
	MPDCCH aggregation level	eCCE	16	
	MPDCCH repetition level		4	
	ρ_A, ρ_B		-3	
Ratio of MPDCCH to RS EPRE	dB	0		
DRX cycle		ms	1280	See Table A.7.3.58.1-3
Layer 3 filtering			Enabled	Counters: N310 = 1; N311 = 1
T310 timer		ms	0	T310 is disabled
T311 timer		ms	1000	T311 is enabled
Periodic CQI reporting mode			PUCCH 1-0	As defined in table 7.2.2-1 in TS 36.213.
CQI reporting periodicity		ms	1	Minimum CQI reporting periodicity
T1		s	32	
T2		s	12.8	
T3		s	13	
Note 1: MPDCCH corresponding to the out of sync transmission parameters need not be included in the Reference Measurement Channel.				

Table A.7.3.58.1-2: Cell specific test parameters for E-UTRAN TDD (cell # 1) for out-of-sync radio link monitoring tests in DRX for UE category M1 configured in CEMode A

Parameter	Unit	Test 1		
		T1	T2	T3
E-UTRA RF Channel Number		1		
$BW_{channel}$	MHz	10		
Special subframe configuration		6		
Uplink-downlink configuration		1		
MPDCCH parameters defined in A.3.1.3		R.15 TDD		
OCNG Pattern defined in A.3.2.2 (TDD)		OP.11 TDD		
ρ_A, ρ_B		-3		
MPDCCH_RA	dB	0		
MPDCCH_RB	dB	0		
PBCH_RA	dB	-3		
PBCH_RB	dB			
PSS_RA	dB			
SSS_RA	dB			
OCNG_RA ^{Note1}	dB			
OCNG_RB ^{Note1}	dB			

N_{oc}	dBm/15 kHz	-98		
SNR ^{Note 6}	dB	0.55	-6.88	-14.88
Propagation condition		AWGN		
Correlation Matrix and Antenna Configuration		2x1		
Note 1:	OCNG shall be used such that the resources in cell # 1 are fully allocated and a constant total transmitted power spectral density is achieved for all OFDM symbols.			
Note 2:	The uplink resources for CQI reporting are assigned to the UE prior to the start of time period T1.			
Note 3:	The timers and layer 3 filtering related parameters are configured prior to the start of time period T1.			
Note 4:	The signal contains MPDCCH for UEs other than the device under test as part of OCNG.			
Note 5:	SNR levels correspond to the signal to noise ratio over the cell-specific reference signal REs.			
Note 6:	The SNR in time periods T1, T2 and T3 is denoted as SNR1, SNR2 and SNR3 respectively in figure A.7.3.58.1-1.			

Table A.7.3.58.1-3: DRX-Configuration for E-UTRAN TDD out-of-sync tests for UE category M1 configured in CEMode A

Field	Value	Comment
onDurationTimer	psf10	As specified in clause 6.3.2 in TS 36.331
drx-InactivityTimer	psf1	
drx-RetransmissionTimer	psf1	
longDRX-CycleStartOffset	sf1280	
shortDRX	disable	

Table A.7.3.58.1-4: TimeAlignmentTimer-Configuration for E-UTRAN TDD out-of-sync testing for UE category M1 configured in CEMode A

Field	Value	Comment
TimeAlignmentTimer	infinity	As specified in clause 6.3.2 in TS 36.331
sr-ConfigIndex	27	For further information see clause 6.3.2 in TS 36.331 and section 10.1 in TS 36.213.

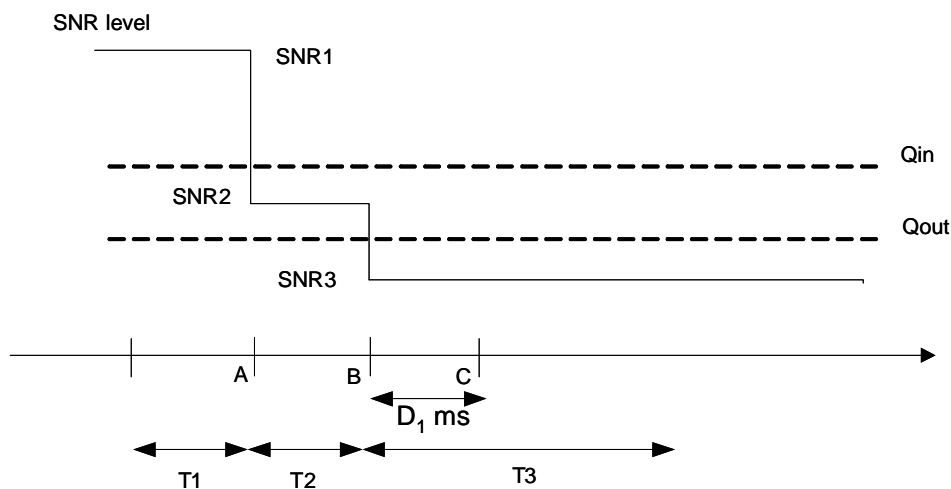

Figure A.7.3.58.1-1: SNR variation for out-of-sync testing in DRX

A.7.3.58.2 Test Requirements

The UE behaviour in each test during time durations T1, T2 and T3 shall be as follows:

During the period from time point A to time point B the UE shall transmit uplink signal at least once every DRX cycle, in the On-duration part of the cycle in the subframe according to the configured CQI reporting mode (PUCCH 1-0).

The UE shall stop transmitting uplink signal no later than time point C (duration $D_1 = 6500$ ms after the start of time duration T3).

The rate of correct events observed during repeated tests shall be at least 90%.

A.7.3.59 E-UTRAN TDD Radio Link Monitoring Test for In-sync in DRX for UE Category M1 configured in CEMode A

A.7.3.59.1 Test Purpose and Environment

The purpose of this test is to verify that the TDD category M1 UE configured in CEMode A properly detects the out of sync and in sync for the purpose of monitoring downlink radio link quality of the PCell when DRX is used. This test will partly verify the E-UTRAN TDD radio link monitoring requirements in clause 7.19.

The test parameters are given in Tables A.7.3.59.1-1, A.7.3.59.1-2, A.7.3.59.1-3 and A.7.3.59.1-4. There is one cell (cell 1), which is the active cell, in the test. The test consists of five successive time periods, with time duration of T1, T2, T3, T4 and T5 respectively. Figure A.7.3.59.1-1 shows the variation of the downlink SNR in the active cell to emulate out-of-sync and in-sync states. Prior to the start of the time duration T1, the UE shall be fully synchronized to cell 1. The UE shall be configured for periodic CQI reporting in PUCCH 1-0 mode with a reporting periodicity of 1 ms without repetition. In the test, DRX configuration is enabled and DRX inactivity timer has already been expired, i.e. UE tries to decode MPDCCH and to send periodic CQI during the period when On-duration timer is running. Time alignment timers shall be set to “infinity” so that UL timing alignment is maintained during the test.

In the test, the RRC parameter *numberPRB-Pairs* is set to 6 and the RRC parameter *mPDCCH-NumRepetition* is set 8. UE shall successfully complete the RRC reconfiguration accordingly prior to the start of time duration T1.

Table A.7.3.59.1-1: General test parameters for E-UTRAN TDD in-sync test in DRX for UE category M1 configured in CEMode A

Parameter		Unit	Value	Comment
Active cell			Cell 1	Cell 1 is on E-UTRA RF channel number 1
CP length			Normal	
In sync transmission parameters (Note 1)	DCI format		6-1A	As defined in section 5.3.3.1.12 in TS 36.212
	Number of OFDM symbols for legacy control channels		2	In sync threshold $Q_{in, Cat M1}$ and the corresponding hypothetical MPDCCH transmission parameters are as specified in clause 7.19.2 and Table 7.19.2-1 respectively.
	MPDCCH aggregation level	eCCE	8	
	MPDCCH repetition level		4	
	ρ_A, ρ_B		-3	
	Ratio of MPDCCH to RS EPRE		0	
Out of sync transmission parameters (Note 1)	DCI format		6-1A	As defined in section 5.3.3.1.12 in TS 36.212
	Number of OFDM symbols for legacy control channels		2	Out of sync threshold $Q_{out, Cat M1}$ and the corresponding hypothetical MPDCCH transmission parameters are as specified in clause 7.19.2 and Table 7.19.2-1 respectively.
	MPDCCH aggregation level	eCCE	24	
	MPDCCH repetition level		8	
	ρ_A, ρ_B		-3	
	Ratio of MPDCCH to RS EPRE	dB	0	
DRX cycle		ms	40	See Table A.7.3.59.1-3

Layer 3 filtering		Enabled	Counters: N310 = 1; N311 = 1
T310 timer	ms	2000	T310 is enabled
T311 timer	ms	1000	T311 is enabled
Periodic CQI reporting mode		PUCCH 1-0	As defined in table 7.2.2-1 in TS 36.213.
CQI reporting periodicity	ms	1	Minimum CQI reporting periodicity
T1	s	4	
T2	s	1.6	
T3	s	1.46	
T4	s	0.4	
T5	s	4	
Note 1: MPDCCH corresponding to the in-sync and out of sync transmission parameters need not be included in the Reference Measurement Channel.			

Table A.7.3.59.1-2: Cell specific test parameters for E-UTRAN TDD (cell # 1) for in-sync radio link monitoring test in DRX for UE category M1 configured in CEMode A

Parameter	Unit	Test 1				
		T1	T2	T3	T4	T5
E-UTRA RF Channel Number		1				
$BW_{channel}$	MHz	10				
Special subframe configuration		6				
Uplink-downlink configuration		1				
MPDCCH parameters defined in A.3.1.3		R.15 TDD				
OCNG Pattern defined in A.3.2.2 (TDD)		OP.11 TDD				
p_A, p_B		-3				
MPDCCH_RA	dB	0				
MPDCCH_RB	dB	0				
PBCH_RA	dB	-3				
PBCH_RB	dB					
PSS_RA	dB					
SSS_RA	dB					
OCNG_RA ^{Note1}	dB					
OCNG_RB ^{Note1}	dB					
N_{oc}	dBm/15 kHz					
SNR ^{Note 8}	dB	-4.5	-9.93	-17.93	-11.5	-4.5
Propagation condition		AWGN				
Correlation Matrix and Antenna Configuration		2x1				
Note 1: OCNG shall be used such that the resources in cell # 1 are fully allocated and a constant total transmitted power spectral density is achieved for all OFDM symbols. Note 2: The uplink resources for CQI reporting are assigned to the UE prior to the start of time period T1. Note 3: The timers and layer 3 filtering related parameters are configured prior to the start of time period T1. Note 4: The signal contains MPDCCH for UEs other than the device under test as part of OCNG. Note 5: SNR levels correspond to the signal to noise ratio over the cell-specific reference signal REs. Note 6: The SNR in time periods T1, T2, T3, T4 and T5 is denoted as SNR1, SNR2, SNR3, SNR4 and SNR5 respectively in figure A.7.3.59.1-1.						

Table A.7.3.59.1-3: DRX-Configuration for E-UTRAN TDD out-of-sync tests for UE category M1 configured in CEMode A

Field	Value	Comment
onDurationTimer	psf10	As specified in clause 6.3.2 in TS 36.331
drx-InactivityTimer	psf1	
drx-RetransmissionTimer	psf1	
longDRX-CycleStartOffset	sf40	

shortDRX	disable	
----------	---------	--

Table A.7.3.59.1-4: TimeAlignmentTimer -Configuration for E-UTRAN TDD out-of-sync testing for UE category M1 configured in CEMode A

Field	Value	Comment
TimeAlignmentTimer	infinity	As specified in clause 6.3.2 in TS 36.331
sr-ConfigIndex	27	For further information see clause 6.3.2 in TS 36.331 and section 10.1 in TS 36.213.

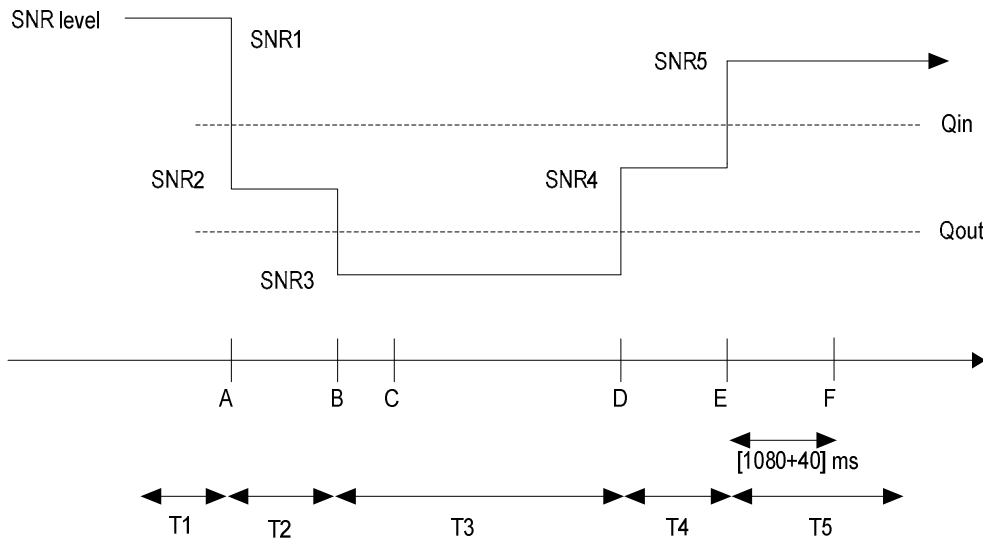

Figure A.7.3.59.1-1: SNR variation for in-sync testing in DRX

A.7.3.59.2 Test Requirements

The UE behaviour in each test during time durations T1, T2, T3, T4 and T5 shall be as follows:

During the period from time point A to time point F (1120 ms after the start of time duration T5) the UE shall transmit uplink signal at least once every DRX cycle, in the On-duration part of the cycle in the subframe according to the configured CQI reporting mode (PUCCH 1-0).

The rate of correct events observed during repeated tests shall be at least 90%.

A.7.3.60 HD-FDD Radio Link Monitoring Test for Out-of-sync in DRX for UE category NB1 In-band mode in normal coverage

A.7.3.60.1 Test Purpose and Environment

The purpose of this test is to verify that the HD-FDD category NB1 UE properly detects the out of sync for the purpose of monitoring downlink radio link quality of the NB-IoT Cell. This test will partly verify the NB-IoT HD-FDD radio link monitoring requirements in clause 7.23.

The test parameters are given in Tables A.7.3.60.1-1, A.7.3.60.1-2, A.7.3.60.1-2A, A.7.3.60.1-3 and A.7.3.60.1-4. nCell 1 is the active NB-IoT cell in the test. The test consists of four successive time periods with time duration of T1, T2, T3 and T4 respectively, excluding the transition time duration dT, where the SNR increases or decreases gradually in small steps. Figure A.7.3.60.1-1 shows the variation of the downlink SNR in the active cell to emulate out-of-sync state with the following testing procedure:

- Prior to the start of the time duration T1, the UE shall be fully synchronized to nCell1

- Starting at point A, the SNR is decreased in small steps from SNR1 to SNR2 within dT
- At the start of the time duration T2, the UE is provided with a UL grant with NPDCCH

Note: The UE is expected to decode the NPDCCH and complete the UL transmission during T2 according to the UL grant. The UE shall not be provisioned with any more UL grants until the start of time period T4.

- Starting at point B, the SNR is decreased in small steps from SNR2 to SNR3 within dT
- During T3, the SNR is kept as SNR3

Note: The UE is expected to detect OOS and declare RLF during T3.

- Starting at point C, the SNR is increased in small steps from SNR3 to SNR1 with dT
- At the start of the time period T4, the UE will be provided with another UL grant with NPDCCH

Note: The UE is not expected to decode the UL grant and conduct any UL transmission during T4, since the UE is expected to declare RLF during T3.

In the test, DRX configuration is enabled and DRX inactivity timer has already been expired, i.e. UE tries to decode the NPDCCH and complete the UL transmission when On-duration timer is running. Time alignment timers shall be set to “infinity” so that UL timing alignment is maintained during the test.

Table A.7.3.60.1-1: General test parameters for HD-FDD Radio Link Monitoring Test for Out-of-sync in DRX for UE category NB1 In-band mode in normal coverage

Parameter	Unit	Value	Comment
Active cell		nCell 1	
Neighbour cell		eCell 1	
CP length		Normal	
Deployment Mode		In-band	
NPDCCH transmission parameters R_{max}		8	Other NPDCCH parameters are defined in “out-of-sync” column in Table 7.23.2-1
DRX cycle	ms	256	See Table A.7.3.60.1-3
Layer 3 filtering ^{Note 2,3}		Enabled	Counters: N310 = 1 N311 = 1
T310 timer ^{Note 2,3}	ms	0	T310 is disabled
T311 timer ^{Note 2,3}	ms	1000	T311 is enabled
T1	s	5.12	
dT	S	0.8	
T2	s	10.24	
dT	S	0.7	
T3	s	5.12	
dT	S	1.4	
T4	s	5.12	
Note 1: NPDCCH corresponding to the out of sync transmission parameters need not be included in the Reference Measurement Channel. Note 2: N310, N311, T310 and T311 are defined in TS 36.331. Note 3: The timers and layer 3 filtering related parameters are configured prior to the start of time period T1.			

Table A.7.3.60.1-2: nCell specific test parameters for HD-FDD Radio Link Monitoring Test for Out-of-sync in DRX for UE category NB1 In-band mode in normal coverage

Parameter	Unit	nCell 1						
		T1	dT	T2	dT	T3	dT	T4
$BW_{channel}$	kHz	180						
PRB location within eCell		eCell 1 $BW_{channel}$ 5MHz: 17 eCell 1 $BW_{channel}$ 10MHz: 30						

NPDCCH parameters as defined in A.3.1.6.1		R.29 HD-FDD						
NPBCH_RA	dB	-3						
NPBCH_RB	dB							
NPSS_RA	dB							
NSSS_RA	dB							
NPDCCH_RA	dB							
NPDCCH_RB	dB							
NPDSCH_RA	dB							
NPDSCH_RB	dB							
OCNG_RA ^{Note 1}	dB							
OCNG_RB ^{Note 1}	dB							
N_{oc}	dBm/15 kHz	Specified in Table A.7.3.60.1-2A						
SNR ^{Note 4, 5}	dB	-3.1	Note 6	-9.1	Note 6	-14.1	Note 6	-3.1
Propagation condition		AWGN						
Configuration		2x1						
<p>Note 1: OCNG shall be used such that the cell is fully allocated and a constant total transmitted power spectral density is achieved for all OFDM symbols. The OCNG pattern is chosen during the test according to the presence of a DL reference measurement channel.</p> <p>Note 2: Void</p> <p>Note 3: Void</p> <p>Note 4: SNR levels correspond to the signal to noise ratio over the cell-specific reference signal REs.</p> <p>Note 5: The SNRs in time periods T1, T2, T3 and T4 are denoted as SNR1, SNR2, SNR3 and SNR1 respectively in figure A.7.3.60.1-1.</p> <p>Note 6: The Test system shall reduce its transmit power in steps of $((SNR2-SNR1) / (10*dT))$ dB every 100ms until SNR2 is achieved at the end of dT.</p> <p>Note 7: The Test system shall reduce its transmit power in steps of $((SNR3-SNR2) / (10*dT))$ dB every 100ms until SNR3 is achieved at the end of dT.</p> <p>Note 8: The Test system shall increase its transmit power in steps of $((SNR1-SNR3) / (10*dT))$ dB every 100ms until SNR1 is achieved at the end of dT.</p>								

Table A.7.3.60.1-2A: eCell 1 specific test parameters for HD-FDD Out-of-sync radio link monitoring test in DRX for UE category NB1 In-band mode in normal coverage

Parameter	Unit	eCell 1
		T1-T4
$BW_{channel}$	MHz	5 or 10
NOCNG Pattern	-	$BW_{channel}$ 5MHz: NOP.4 FDD $BW_{channel}$ 10MHz: NOP.1 FDD
PBCH_RA	dB	-3
PBCH_RB	dB	
PSS_RA	dB	
SSS_RA	dB	
PCFICH_RB	dB	
PDCCH_RA	dB	
PDCCH_RB	dB	
OCNG_RA ^{Note 1}	dB	
OCNG_RB ^{Note 1}	dB	
N_{oc} ^{Note2}	dBm/15 kHz	
\hat{E}_s / N_{oc}	dB	-12
Propagation Condition		AWGN
Antenna Configuration		2x1
<p>Note 1: OCNG shall be used such that the eCell is fully allocated and a constant total transmitted power spectral density is achieved for all OFDM symbols.</p> <p>Note 2: Interference from other cells and noise sources not specified in the test is assumed to be constant over subcarriers and time and shall be modelled as AWGN of appropriate power N_{oc}.</p>		

Table A.7.3.60.1-3: DRX-Configuration for HD-FDD Radio Link Monitoring Test for Out-of-sync in DRX for UE category NB1 In-band mode in normal coverage

Field	Value	Comment
onDurationTimer	pp1	As specified in clause 6.7.3 in TS 36.331
drx-InactivityTimer	pp0	
drx-RetransmissionTimer	pp0	
drx-StartOffset	0	

Table A.7.3.60.1-4: TimeAlignmentTimer-Configuration for NB-IoT HD-FDD out-of-sync testing for UE category NB1 In-band mode in normal coverage

Field	Value	Comment
TimeAlignmentTimer	infinity	As specified in clause 6.3.2 in TS 36.331

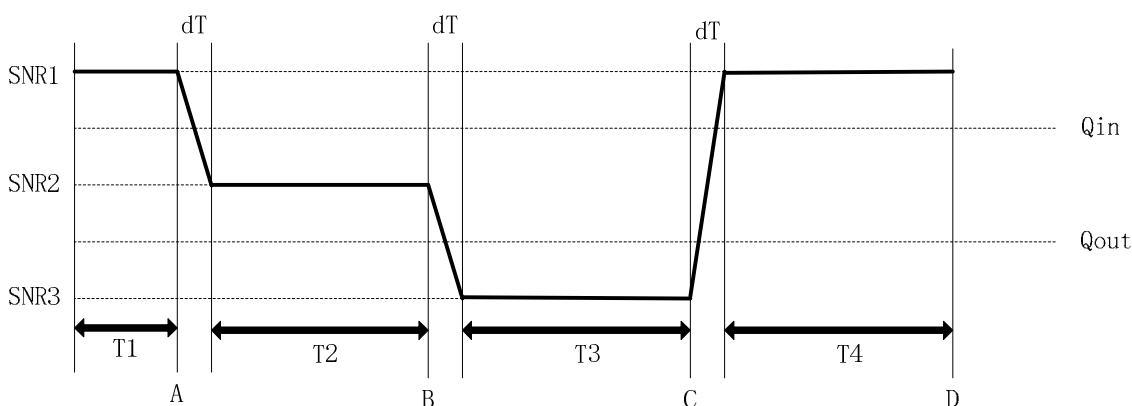

Figure A.7.3.60.1-1: SNR variation for out-of-sync testing in DRX for NB-IoT HD-FDD out-of-sync testing for UE category NB1 In-band mode in normal coverage

A.7.3.60.2 Test Requirements

The UE behaviors in each test shall be as follows:

- The UE shall complete the NPUSCH transmission during T2 according to the received UL grant;
- The UE shall not conduct any NPUSCH transmission during T4

A correct event is defined as UE behaves correctly in all above steps. The correct events observed during repeated tests shall be at least 90%.

A.7.3.61 HD-FDD Radio Link Monitoring Test for Out-of-sync in DRX for UE category NB1 In-band mode in enhanced coverage

A.7.3.61.1 Test Purpose and Environment

The purpose of this test is to verify that the HD-FDD category NB1 UE properly detects the out of sync for the purpose of monitoring downlink radio link quality of the NB-IoT Cell. This test will partly verify the NB-IoT HD-FDD radio link monitoring requirements in clause 7.23.

The test parameters are given in Tables A.7.3.61.1-1, A.7.3.61.1-2, A.7.3.61.1-2A, A.7.3.61.1-3 and A.7.3.61.1-4. nCell 1 is the active NB-IoT cell in the test. The test consists of four successive time periods with time duration of T1, T2, T3 and T4 respectively, excluding the transition time duration dT, where the SNR increases or decreases gradually in small steps. Figure A.7.3.61.1-1 shows the variation of the downlink SNR in the active cell to emulate out-of-sync state with the following testing procedure:

- Prior to the start of the time duration T1, the UE shall be fully synchronized to nCell1

- Starting at point A, the SNR is decreased in small steps from SNR1 to SNR2 within dT
- At the start of the time duration T2, the UE is provided with a UL grant with NPDCCH

Note: The UE is expected to decode the NPDCCH and complete the UL transmission during T2 according to the UL grant. The UE shall not be provisioned with any more UL grants until the start of time period T4.

- Starting at point B, the SNR is decreased in small steps from SNR2 to SNR3 within dT
- During T3, the SNR is kept as SNR3

Note: The UE is expected to detect OOS and declare RLF during T3.

- Starting at point C, the SNR is increased in small steps from SNR3 to SNR1 with dT
- At the start of the time period T4, the UE will be provided with another UL grant with NPDCCH

Note: The UE is not expected to decode the UL grant and conduct any UL transmission during T4, since the UE is expected to declare RLF during T3.

In the test, DRX configuration is enabled and DRX inactivity timer has already been expired, i.e. UE tries to decode the NPDCCH and complete the UL transmission when On-duration timer is running. Time alignment timers shall be set to “infinity” so that UL timing alignment is maintained during the test.

Table A.7.3.61.1-1: General test parameters for HD-FDD Radio Link Monitoring Test for Out-of-sync in DRX for UE category NB1 In-band mode in enhanced coverage

Parameter	Unit	Value	Comment
Active cell		nCell 1	
Neighbour cell		eCell 1	
CP length		Normal	
Deployment Mode		In-band	
NPDCCH transmission parameters R_{max}		16	Other NPDCCH parameters are defined in “out-of-sync” column in Table 7.23.2-1
DRX cycle	ms	256	See Table A.7.3.61.1-3
Layer 3 filtering ^{Note 2,3}		Enabled	Counters: N310 = 1 N311 = 1
T310 timer ^{Note 2,3}	ms	0	T310 is disabled
T311 timer ^{Note 2,3}	ms	1000	T311 is enabled
T1	s	5.12	
dT	s	0.7	
T2	s	10.24	
dT	s	0.8	
T3	s	5.12	
dT	s	1.4	
T4	s	5.12	
Note 1: NPDCCH corresponding to the out of sync transmission parameters need not be included in the Reference Measurement Channel. Note 2: N310, N311, T310 and T311 are defined in TS 36.331. Note 3: The timers and layer 3 filtering related parameters are configured prior to the start of time period T1.			

Table A.7.3.61.1-2: nCell specific test parameters for HD-FDD Radio Link Monitoring Test for Out-of-sync in DRX for UE category NB1 In-band mode in enhanced coverage

Parameter	Unit	nCell 1					
		T1	dT	T2	dT	T3	dT
$BW_{channel}$	kHz	180					
PRB location within eCell		eCell 1 $BW_{channel}$ 5MHz: 17 eCell 1 $BW_{channel}$ 10MHz: 30					

NPDCCH parameters as defined in A.3.1.6.1		R.29 HD-FDD						
NPBCH_RA	dB	-3						
NPBCH_RB	dB							
NPSS_RA	dB							
NSSS_RA	dB							
NPDCCH_RA	dB							
NPDCCH_RB	dB							
NPDSCH_RA	dB							
NPDSCH_RB	dB							
OCNG_RA ^{Note 1}	dB							
OCNG_RB ^{Note 1}	dB							
N_{oc}	dBm/15 kHz	Specified in Table A.7.3.61.1-2A						
SNR ^{Note 4, 5}	dB	-6.3	Note 6	-11.4	Note 7	-17.4	Note 8	-6.3
Propagation condition		AWGN						
Antenna Configuration		2x1						
<p>Note 1: OCNG shall be used such that the cell is fully allocated and a constant total transmitted power spectral density is achieved for all OFDM symbols. The OCNG pattern is chosen during the test according to the presence of a DL reference measurement channel.</p> <p>Note 2: Void</p> <p>Note 3: Void</p> <p>Note 4: SNR levels correspond to the signal to noise ratio over the cell-specific reference signal REs.</p> <p>Note 5: The SNRs in time periods T1, T2, T3 and T4 are denoted as SNR1, SNR2, SNR3 and SNR1 respectively in figure A.7.3.61.1-1.</p> <p>Note 6: The Test system shall reduce its transmit power in steps of $((SNR2-SNR1) / (10 \cdot dT))$ dB every 100ms until SNR2 is achieved at the end of dT.</p> <p>Note 7: The Test system shall reduce its transmit power in steps of $((SNR3-SNR2) / (10 \cdot dT))$ dB every 100ms until SNR3 is achieved at the end of dT.</p> <p>Note 8: The Test system shall increase its transmit power in steps of $((SNR1-SNR3) / (10 \cdot dT))$ dB every 100ms until SNR1 is achieved at the end of dT.</p>								

Table A.7.3.61.1-2A: eCell 1 specific test parameters for HD-FDD Out-of-sync radio link monitoring test in DRX for UE category NB1 In-band mode in enhanced coverage

Parameter	Unit	eCell 1
		T1-T4
$BW_{channel}$	MHz	5 or 10
NOCNG Pattern	-	$BW_{channel}$ 5MHz: NOP.4 FDD $BW_{channel}$ 10MHz: NOP.1 FDD
PBCH_RA	dB	-3
PBCH_RB	dB	
PSS_RA	dB	
SSS_RA	dB	
PCFICH_RB	dB	
PDCCH_RA	dB	
PDCCH_RB	dB	
OCNG_RA ^{Note 1}	dB	
OCNG_RB ^{Note 1}	dB	
N_{oc} ^{Note2}	dBm/15 kHz	
\hat{E}_s / N_{oc}	dB	-12
Propagation Condition		AWGN
Antenna Configuration		2x1
<p>Note 1: OCNG shall be used such that the eCell is fully allocated and a constant total transmitted power spectral density is achieved for all OFDM symbols.</p> <p>Note 2: Interference from other cells and noise sources not specified in the test is assumed to be constant over subcarriers and time and shall be modelled as AWGN of appropriate power N_{oc}.</p>		

Table A.7.3.61.1-3: DRX-Configuration for HD-FDD Radio Link Monitoring Test for Out-of-sync in DRX for UE category NB1 In-band mode in enhanced coverage

Field	Value	Comment
onDurationTimer	pp1	As specified in clause 6.7.3 in TS 36.331
drx-InactivityTimer	pp0	
drx-RetransmissionTimer	pp0	
drx-StartOffset	0	

Table A.7.3.61.1-4: TimeAlignmentTimer-Configuration for HD-FDD Radio Link Monitoring Test for Out-of-sync in DRX for UE category NB1 In-band mode in enhanced coverage

Field	Value	Comment
TimeAlignmentTimer	infinity	As specified in clause 6.3.2 in TS 36.331

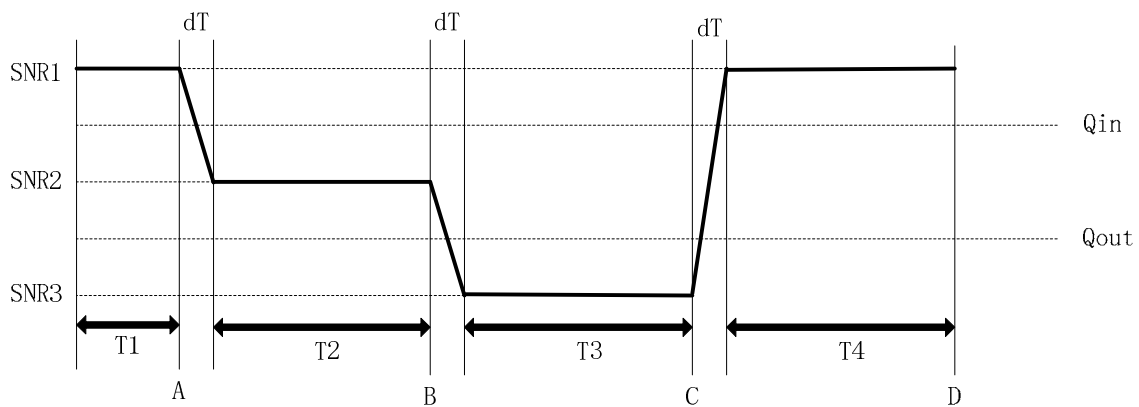

Figure A.7.3.61.1-1: SNR variation for HD-FDD Radio Link Monitoring Test for Out-of-sync in DRX for UE category NB1 In-band mode in enhanced coverage

A.7.3.61.2 Test Requirements

The UE behaviors in each test shall be as follows:

- The UE shall complete the NPUSCH transmission during T2 according to the received UL grant;
- The UE shall not conduct any NPUSCH transmission during T4.

A correct event is defined as UE behaves correctly in all above steps. The correct events observed during repeated tests shall be at least 90%.

A.7.3.62 HD-FDD Radio Link Monitoring Test for In-sync with DRX for UE Category NB1 In-Band mode in Enhanced Coverage

A.7.3.62.1 Test Purpose and Environment

The purpose of this test is to verify that the HD-FDD category NB1 UE configured in enhanced coverage properly detects the out of sync and in sync for the purpose of monitoring downlink radio link quality of the NB-IoT Cell when DRX is used. This test will partly verify the HD-FDD radio link monitoring requirements in clause 7.23.

The test parameters are given in Tables A.7.3.62.1-1, A.7.3.62.1-2, A.7.3.62.1-3, A.7.3.62.1-4 and A.7.3.62.1-5. nCell 1 is the active cell in the test. The test consists of three successive time periods, with time duration of T1, T2 and T3 respectively, excluding the transition time duration dT, where the SNR increases or decreases gradually in small steps. Figure A.7.3.62.1-1 shows the variation of the downlink SNR in the active cell to emulate out-of-sync and in-sync states.

Prior to the start of the time duration T1, the UE shall be fully be synchronized to nCell 1. The UE is scheduled in designated uplink subframes to transmit NPUSCH, which is received by the test equipment. By measuring the reception

of the NPUSCH, detection of out of sync and in sync requirements can be measured. In the test, DRX configuration is enabled and DRX inactivity timer has already been expired, i.e. UE tries to decode NPDCCH and to send NPUSCH during the period when On-duration timer is running. Time alignment timers shall be set to “infinity” so that UL timing alignment is maintained during the test.

The test setup in each test during time durations T1, T2 and T3 shall be as follows:

- During the period from time point A to time point B, the SNR is decreasing linearly from SNR1 to SNR2.
- During the period from time point C to time point D, the SNR is increasing linearly from SNR2 to SNR3.
- During the period T3, the test system shall send the UE a grant to transmit in uplink. UE under test is expected to decode the uplink grant and switch to uplink and complete the uplink transmission. During the period from time point A to time point D, the UE shall not be provisioned with any UL grant.
- Thereafter UE switches back to downlink.

In each run of the test, the test equipment selects NPDCCH repetition level, and sends the RRC configuration to the UE. NPDCCH repetition level is determined by RRC parameter *npdcch-NumRepetitions* [3]. UE shall successfully complete the RRC reconfiguration accordingly prior to the start of time duration T1.

Table A.7.3.62.1-1: General test parameters for HD-FDD in-sync test with DRX for UE category NB1 In-Band mode in enhanced coverage

Parameter		Unit	Value	Comment
NB-IoT operational mode			In-band	
Active cell			nCell 1	NB-IOT cell nCell1 is within E-UTRA cell eCell1
CP length			Normal	
In sync transmission parameters (Note 1)	DCI format		Format N1	As defined in TS 36.212[21]
	Number of OFDM symbols for legacy control channels		3	In sync threshold Q_{in_NB-IoT} and the corresponding hypothetical NPDCCH transmission parameters are as specified in clause 7.23.2 and Table 7.23.2-1 respectively.
	NPDCCH aggregation level	eCCE	2	
	NPDCCH repetition level		4	
	Ratio of NPDSCH to NRS EPRE		0	
	Ratio of NPDCCH to NRS EPRE		0	
Out of sync transmission parameters (Note 1)	DCI format		Format N1	As defined in TS 36.212 [21]
	Number of OFDM symbols for legacy control channels		3	Out of sync threshold Q_{out_NB-IoT} and the corresponding hypothetical NPDCCH transmission parameters are as specified in clause 7.23.2 and Table 7.23.2-1 respectively.
	NPDCCH aggregation level	eCCE	2	
	NPDCCH repetition level		16	
	Ratio of NPDSCH to NRS EPRE		0	
	Ratio of NPDCCH to RS EPRE	dB	0	
DRX cycle		ms	256	See Table A.7.3.62.1-4
Layer 3 filtering			Enabled	Counters: N310 = 1; N311 = 1
T310 timer		ms	4000	T310 is enabled
T311 timer		ms	1000	T311 is enabled
T1		s	4	
dT		s	1.4	
T2		s	2.12	
dT		s	1.4	
T3		s	4	
Note 1: NPDCCH corresponding to the in-sync and out of sync transmission parameters need not be included in the Reference Measurement Channel.				

Table A.7.3.62.1-2: nCell 1 specific test parameters for HD-FDD in-sync radio link monitoring test with DRX for UE category NB1 In-Band mode in enhanced coverage

Parameter	Unit	nCell 1				
		T1	dT	T2	dT	T3
$BW_{channel}$	kHz	180				
PRB location within eCell	-	eCell 1 $BW_{channel}$ 5MHz: 17 eCell 1 $BW_{channel}$ 10MHz: 30				
NPDCCH parameters defined in A.3.1.6.1		R.27 HD-FDD				
Ratio of NPDSCH to NRS EPRE		-3				
NPDCCH_RA	dB	-3				
NPDCCH_RB	dB	-3				
NPBCH_RA	dB	-3				
NPBCH_RB	dB					
NPSS_RA	dB					
NSSS_RA	dB					
NOCNG_RA ^{Note1}	dB					
NOCNG_RB ^{Note1}	dB					
N_{oc}	dBm/15 kHz					
SNR ^{Note 5, Note 6}	dB	-6.3	Note 7	-17.4	Note 8	-6.3
Propagation condition		AWGN				
Antenna Configuration		2x1				
<p>Note 1: OCNG shall be used such that the resources in ncell1 are fully allocated and a constant total transmitted power spectral density is achieved for all OFDM symbols.</p> <p>Note 2: The uplink resources for CQI reporting are assigned to the UE prior to the start of time period T1.</p> <p>Note 3: The timers and layer 3 filtering related parameters are configured prior to the start of time period T1.</p> <p>Note 4: The signal contains NPDCCH for UEs other than the device under test as part of OCNG.</p> <p>Note 5: SNR levels correspond to the signal to noise ratio over the cell-specific reference signal REs.</p> <p>Note 6: The SNR in time periods T1, T2 and T3 is denoted as SNR1, SNR2, and SNR1 respectively in figure A.7.3.62.1-1.</p> <p>Note 7: The Test system shall reduce its transmit power in steps of $((SNR2-SNR1) / (10*dT))$ dB every 100ms till SNR2 is achieved at the end of dT.</p> <p>Note 8: The Test system shall increase its transmit power in steps of $((SNR1-SNR2) / (10*dT))$ dB every 100ms till SNR1 is achieved at the end of dT.</p>						

Table A.7.3.62.1-3: eCell 1 specific test parameters for HD-FDD in-sync radio link monitoring test with DRX for UE category NB1 In-Band mode in enhanced coverage

Parameter	Unit	eCell 1
		T1-T3
$BW_{channel}$	MHz	5 or 10
NOCNG Pattern	-	$BW_{channel}$ 5MHz: NOP.4 FDD $BW_{channel}$ 10MHz: NOP.1 FDD
PBCH_RA	dB	-3
PBCH_RB	dB	
PSS_RA	dB	
SSS_RA	dB	
PCFICH_RB	dB	
PDCCH_RA	dB	
PDCCH_RB	dB	
OCNG_RA ^{Note 1}	dB	
OCNG_RB ^{Note 1}	dB	
N_{oc} ^{Note2}	dBm/15 kHz	
\hat{E}_s / N_{oc}	dB	-12
Propagation Condition		AWGN
Antenna Configuration		2x1

Note 1:	OCNG shall be used such that the eCell is fully allocated and a constant total transmitted power spectral density is achieved for all OFDM symbols.
Note 2:	Interference from other cells and noise sources not specified in the test is assumed to be constant over subcarriers and time and shall be modelled as AWGN of appropriate power N_{oc} .

Table A.7.3.62.1-4: DRX-Configuration for E-UTRAN HD-FDD in-sync tests with DRX for UE category NB1 In-Band mode in enhanced coverage

Field	Value	Comment
onDurationTimer	pp1	As specified in clause 6.3.2 in TS 36.331
drx-InactivityTimer	pp0	
drx-RetransmissionTimer	pp0	
longDRX-CycleStartOffset	Sf256	
shortDRX	disable	

Table A.7.3.62.1-5: TimeAlignmentTimer-Configuration for E-UTRAN HD-FDD in-sync tests with DRX for UE category NB1 In-Band mode in enhanced coverage

Field	Value	Comment
TimeAlignmentTimer	infinity	As specified in clause 6.3.2 in TS 36.331

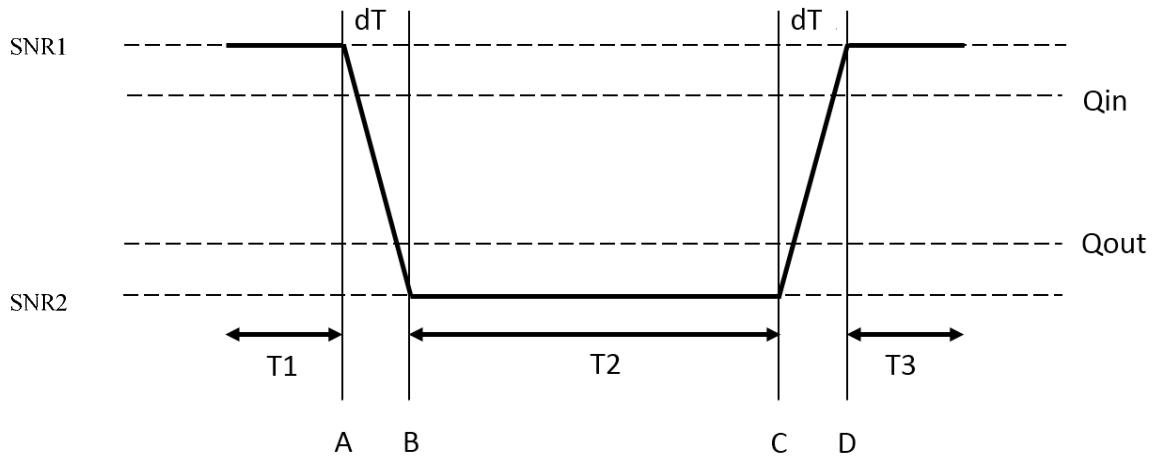

Figure A.7.3.62.1-1: SNR variation for in-sync testing with DRX

A.7.3.62.2 Test Requirements

The UE behaviour in each test shall be as follows:

During the period T3, the UE under test is expected to decode the uplink grant and switch to uplink and complete the uplink transmission. This is considered a correct event.

The rate of correct events observed during repeated tests shall be at least 90%.

A.7.3.63 HD-FDD Radio Link Monitoring Test for In-sync with DRX for UE Category NB1 In-Band mode in Normal Coverage

A.7.3.63.1 Test Purpose and Environment

The purpose of this test is to verify that the HD-FDD category NB1 UE configured in normal coverage properly detects the out of sync and in sync for the purpose of monitoring downlink radio link quality of the NB-IoT Cell when DRX is used. This test will partly verify the HD-FDD radio link monitoring requirements in clause 7.23.

The test parameters are given in Tables A.7.3.63.1-1, A.7.3.63.1-2, A.7.3.63.1-3, A.7.3.63.1-4 and A.7.3.63.1-5. nCell 1 is the active cell in the test. The test consists of three successive time periods, with time duration of T1, T2 and T3 respectively, excluding the transition time duration dT, where the SNR increases or decreases gradually in small steps. Figure A.7.3.63.1-1 shows the variation of the downlink SNR in the active cell to emulate out-of-sync and in-sync states.

Prior to the start of the time duration T1, the UE shall be fully be synchronized to nCell 1. The UE is scheduled in designated uplink subframes to transmit NPUSCH, which is received by the test equipment. By measuring the reception of the NPUSCH, detection of out of sync and in sync requirements can be measured. In the test, DRX configuration is enabled and DRX inactivity timer has already been expired, i.e. UE tries to decode NPDCCH and to send NPUSCH during the period when On-duration timer is running. Time alignment timers shall be set to “infinity” so that UL timing alignment is maintained during the test.

The test setup in each test during time durations T1, T2 and T3 are as follows:

- During the period from time point A to time point B, the SNR is decreasing linearly from SNR1 to SNR2.
- During the period from time point C to time point D, the SNR is increasing linearly from SNR2 to SNR3.
- During the period T3, the test system shall send the UE a grant to transmit in uplink. UE under test is expected to decode the uplink grant and switch to uplink and complete the uplink transmission. During the period from time point A to time point D, the UE shall not be provisioned with any UL grant.
- Thereafter UE switches back to downlink.

In each run of the test, the test equipment selects NPDCCH repetition level, and sends the RRC configuration to the UE. NPDCCH repetition level is determined by RRC parameter *npdcch-NumRepetitions* [2]. UE shall successfully complete the RRC reconfiguration accordingly prior to the start of time duration T1.

Table A.7.3.63.1-1: General test parameters for HD-FDD in-sync test with DRX for UE category NB1 In-Band mode in normal coverage

Parameter		Unit	Value	Comment
NB-IoT operational mode			In-band	
Active cell			nCell 1	NB-IOT cell nCell1 is within E-UTRA cell eCell1
CP length			Normal	
In sync transmission parameters (Note 1)	DCI format		Format N1	As defined in TS 36.212 [21]
	Number of OFDM symbols for legacy control channels		3	In sync threshold Q_{in_NB-IoT} and the corresponding hypothetical NPDCCH transmission parameters are as specified in clause 7.23.2 and Table 7.23.2-1 respectively.
	NPDCCH aggregation level	eCCE	2	
	NPDCCH repetition level		2	
	Ratio of NPDSCH to NRS EPRE		0	
Ratio of NPDCCH to NRS EPRE		0		
Out of sync transmission parameters (Note 1)	DCI format		Format N1	As defined in TS 36.212[21]
	Number of OFDM symbols for legacy control channels		3	Out of sync threshold Q_{out_NB-IoT} and the corresponding hypothetical NPDCCH transmission parameters are as specified in clause 7.23.2
NPDCCH aggregation level	eCCE	2		

	NPDCCH repetition level		8	and Table 7.23.2-1 respectively.
	Ratio of NPDSCH to NRS EPRE		0	
	Ratio of NPDCCH to RS EPRE	dB	0	
DRX cycle		ms	256	See Table A.7.3.63.1-4
Layer 3 filtering			Enabled	Counters: N310 = 1; N311 = 1
T310 timer		ms	4000	T310 is enabled
T311 timer		ms	1000	T311 is enabled
T1		s	4	
dT		s	1.4	
T2		s	2.12	
dT		s	1.4	
T3		s	4	
Note 1: NPDCCH corresponding to the in-sync and out of sync transmission parameters need not be included in the Reference Measurement Channel.				

Table A.7.3.63.1-2: nCell 1 specific test parameters for HD-FDD in-sync radio link monitoring test with DRX for UE category NB1 In-Band mode in normal coverage

Parameter	Unit	nCell 1				
		T1	dT	T2	dT	T3
$BW_{channel}$	kHz	180				
PRB location within eCell	-	eCell 1 $BW_{channel}$ 5MHz: 17 eCell 1 $BW_{channel}$ 10MHz: 30				
NPDCCH parameters defined in A.3.1.6.1		R.27 HD-FDD				
Ratio of NPDSCH to NRS EPRE		-3				
NPDCCH_RA	dB	-3				
NPDCCH_RB	dB	-3				
NPBCH_RA	dB	-3				
NPBCH_RB	dB					
NPSS_RA	dB					
NSSS_RA	dB					
NOCNG_RA ^{Note1}	dB					
NOCNG_RB ^{Note1}	dB					
N_{oc}	dBm/15 kHz	Specified in Table A.7.3.63.1-3				
SNR ^{Note 5, Note 6}	dB	-3.1	Note 7	-14.1	Note 8	-3.1
Propagation condition		AWGN				
Antenna Configuration		2x1				
<p>Note 1: OCNG shall be used such that the resources in ncell1 are fully allocated and a constant total transmitted power spectral density is achieved for all OFDM symbols.</p> <p>Note 2: The uplink resources for CQI reporting are assigned to the UE prior to the start of time period T1.</p> <p>Note 3: The timers and layer 3 filtering related parameters are configured prior to the start of time period T1.</p> <p>Note 4: The signal contains NPDCCH for UEs other than the device under test as part of OCNG.</p> <p>Note 5: SNR levels correspond to the signal to noise ratio over the cell-specific reference signal REs.</p> <p>Note 6: The SNR in time periods T1, T2 and T3 is denoted as SNR1, SNR2, and SNR1 respectively in figure A.7.3.63.1-1.</p> <p>Note 7: The Test system shall reduce its transmit power in steps of $((SNR2-SNR1) / (10*dT))$ dB every 100ms till SNR2 is achieved at the end of dT.</p> <p>Note 8: The Test system shall increase its transmit power in steps of $((SNR1-SNR2) / (10*dT))$ dB every 100ms till SNR1 is achieved at the end of dT.</p>						

Table A.7.3.63.1-3: eCell 1 specific test parameters for HD-FDD in-sync radio link monitoring test with DRX for UE category NB1 In-Band mode in normal coverage

Parameter	Unit	eCell 1
		T1-T3
$BW_{channel}$	MHz	5 or 10

NOCNG Pattern	-	BW _{channel} 5MHz: NOP.4 FDD BW _{channel} 10MHz: NOP.1 FDD
PBCH_RA	dB	-3
PBCH_RB	dB	
PSS_RA	dB	
SSS_RA	dB	
PCFICH_RB	dB	
PDCCH_RA	dB	
PDCCH_RB	dB	
OCNG_RA ^{Note 1}	dB	
OCNG_RB ^{Note 1}	dB	
N_{oc} ^{Note2}	dBm/15 kHz	-98
\hat{E}_s / N_{oc}	dB	4
Propagation Condition		AWGN
Antenna Configuration		2x1
<p>Note 1: OCNG shall be used such that the eCell is fully allocated and a constant total transmitted power spectral density is achieved for all OFDM symbols.</p> <p>Note 2: Interference from other cells and noise sources not specified in the test is assumed to be constant over subcarriers and time and shall be modelled as AWGN of appropriate power N_{oc}.</p>		

Table A.7.3.63.1-4: DRX-Configuration for E-UTRAN HD-FDD in-sync tests with DRX for UE category NB1 In-Band mode in normal coverage

Field	Value	Comment
onDurationTimer	pp1	As specified in clause 6.3.2 in TS 36.331
drx-InactivityTimer	pp0	
drx-RetransmissionTimer	pp0	
longDRX-CycleStartOffset	Sf256	
shortDRX	disable	

Table A.7.3.63.1-5: *TimeAlignmentTimer* -Configuration for E-UTRAN HD-FDD in-sync tests with DRX for UE category NB1 In-Band mode in normal coverage

Field	Value	Comment
TimeAlignmentTimer	infinity	As specified in clause 6.3.2 in TS 36.331

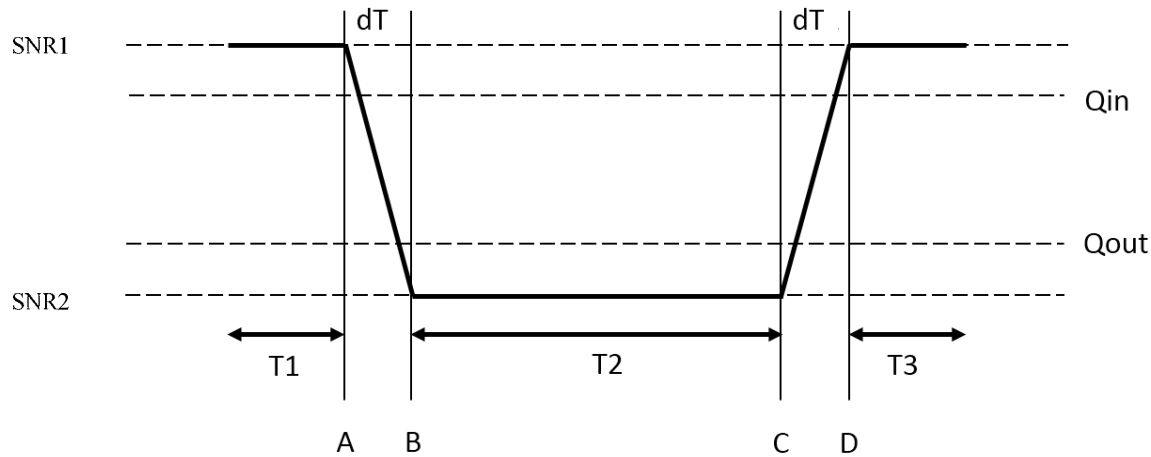

Figure A.7.3.63.1-1: SNR variation for in-sync testing with DRX

A.7.3.63.2 Test Requirements

The UE behaviour in each test shall be as follows:

During the period T3, the UE under test is expected to decode the uplink grant and switch to uplink and complete the uplink transmission. This is considered a correct event.

The rate of correct events observed during repeated tests shall be at least 90%.

A.7.3.64 HD-FDD Radio Link Monitoring Test for In-sync without DRX for UE Category NB1 In-Band mode in Normal Coverage

A.7.3.64.1 Test Purpose and Environment

The purpose of this test is to verify that the HD-FDD category NB1 UE configured in normal coverage properly detects the out of sync and in sync for the purpose of monitoring downlink radio link quality of the PCell when DRX is used. This test will partly verify the HD-FDD radio link monitoring requirements in clause 7.23.

The test parameters are given in Tables A.7.3.64.1-1, A.7.3.64.1-2, A.7.3.64.1-3, A.7.3.64.1-4 and A.7.3.64.1-5. nCell 1 is the active cell in the test. The test consists of three successive time periods, with time duration of T1, T2 and T3 respectively, excluding the transition time duration dT, where the SNR increases or decreases gradually in small steps. Figure A.7.3.64.1-1 shows the variation of the downlink SNR in the active cell to emulate out-of-sync and in-sync states.

Prior to the start of the time duration T1, the UE shall be fully be synchronized to nCell 1. The UE is scheduled in designated uplink subframes to transmit NPUSCH, which is received by the test equipment. By measuring the reception of the NPUSCH, detection of out of sync and in sync requirements can be measured. In the test, DRX configuration is disabled, i.e. UE tries to decode NPDCCH and to send NPUSCH during the period when On-duration timer is running. Time alignment timers shall be set to “infinity” so that UL timing alignment is maintained during the test.

The test setup in each test during time durations T1, T2, dT and T3 shall be as follows:

- During the period from time point A to time point B, the SNR is decreasing linearly from SNR1 to SNR2.
- During the period from time point C to time point D, the SNR is increasing linearly from SNR2 to SNR3.
- During the period T3, the test system shall send the UE a grant to transmit in uplink. UE under test is expected to decode the uplink grant and switch to uplink and complete the uplink transmission. During the period from time point A to time point D, the UE shall not be provisioned with any UL grant.
- Thereafter UE switches back to downlink.

In each run of the test, the test equipment selects NPDCCH repetition level, and sends the RRC configuration to the UE. UE shall successfully complete the RRC reconfiguration accordingly prior to the start of time duration T1.

Table A.7.3.64.1-1: General test parameters for HD-FDD in-sync test without DRX for UE category NB1 In-Band mode in normal coverage

Parameter		Unit	Value	Comment
NB-IoT operational mode			In-band	
Active cell			nCell 1	NB-IOT cell nCell1 is within E-UTRA cell eCell1
CP length			Normal	
In sync transmission parameters (Note 1)	DCI format		Format N1	As defined in TS 36.212 [21]
	Number of OFDM symbols for legacy control channels		3	In sync threshold Q_{in_NB-IoT} and the corresponding hypothetical NPDCCH transmission parameters are as specified in clause 7.23.2 and Table 7.23.2-1 respectively.
	NPDCCH aggregation level	eCCE	2	
	NPDCCH repetition level		2	
	Ratio of NPDSCH to NRS EPRE		0	
	Ratio of NPDCCH to NRS EPRE		0	
Out of sync transmission parameters (Note 1)	DCI format		Format N1	As defined in TS 36.212[21]
	Number of OFDM symbols for legacy control channels		3	Out of sync threshold Q_{out_NB-IoT} and the corresponding hypothetical NPDCCH transmission parameters are as specified in clause 7.23.2 and Table 7.23.2-1 respectively.
	NPDCCH aggregation level	eCCE	2	
	NPDCCH repetition level		8	
	Ratio of NPDSCH to NRS EPRE		0	
	Ratio of NPDCCH to RS EPRE	dB	0	
Layer 3 filtering			Enabled	Counters: N310 = 1; N311 = 1
T310 timer		ms	4000	T310 is enabled
T311 timer		ms	1000	T311 is enabled
T1		s	4	
dT		s	1.4	
T2		s	2.12	
dT		s	1.4	
T3		s	4	
Note 1: NPDCCH corresponding to the in-sync and out of sync transmission parameters need not be included in the Reference Measurement Channel.				

Table A.7.3.64.1-2: nCell 1 specific test parameters for HD-FDD in-sync radio link monitoring test without DRX for UE category NB1 In-Band mode in normal coverage

Parameter	Unit	nCell 1				
		T1	dT	T2	dT	T3
$BW_{channel}$	kHz	200				
PRB location within eCell	-	eCell 1 $BW_{channel}$ 5MHz: 17 eCell 1 $BW_{channel}$ 10MHz: 30				
NPDCCH parameters defined in A.3.1.6.1		R.27 HD-FDD				
NPDSCH_RA		-3				
NPDSCH_RB		-3				
NPDCCH_RA	dB	-3				
NPDCCH_RB	dB	-3				
NPBCH_RA	dB	-3				
NPBCH_RB	dB					
NPSS_RA	dB					
NSSS_RA	dB					
NOCNG_RA ^{Note1}	dB					
NOCNG_RB ^{Note1}	dB					

N_{oc}	dBm/15 kHz	Specified in Table A.7.3.64.1-3				
SNR ^{Note 5, Note 6}	dB	-3.1	Note 7	-14.1	Note 8	-3.1
Propagation condition		AWGN				
Antenna Configuration		2x1				
<p>Note 1: OCNG shall be used such that the resources in ncell1 are fully allocated and a constant total transmitted power spectral density is achieved for all OFDM symbols.</p> <p>Note 2: The uplink resources for CQI reporting are assigned to the UE prior to the start of time period T1.</p> <p>Note 3: The timers and layer 3 filtering related parameters are configured prior to the start of time period T1.</p> <p>Note 4: The signal contains NPDCCH for UEs other than the device under test as part of OCNG.</p> <p>Note 5: SNR levels correspond to the signal to noise ratio over the cell-specific reference signal REs.</p> <p>Note 6: The SNR in time periods T1, T2 and T3 is denoted as SNR1, SNR2, and SNR1 respectively in figure A.7.3.64.1-1.</p> <p>Note 7: The Test system shall reduce its transmit power in steps of $((SNR2-SNR1) / (10*dT))$ dB every 100ms till SNR2 is achieved at the end of dT.</p> <p>Note 8: The Test system shall increase its transmit power in steps of $((SNR1-SNR2) / (10*dT))$ dB every 100ms till SNR1 is achieved at the end of dT.</p>						

Table A.7.3.64.1-3: eCell 1 specific test parameters for HD-FDD in-sync radio link monitoring test without DRX for UE category NB1 In-Band mode in normal coverage

Parameter	Unit	eCell 1
		T1-T3
BW _{channel}	MHz	5 or 10
NOCNG Pattern	-	BW _{channel} 5MHz: NOP.4 FDD BW _{channel} 10MHz: NOP.1 FDD
PBCH_RA	dB	-3
PBCH_RB	dB	
PSS_RA	dB	
SSS_RA	dB	
PCFICH_RB	dB	
PDCCH_RA	dB	
PDCCH_RB	dB	
OCNG_RA ^{Note 1}	dB	
OCNG_RB ^{Note 1}	dB	
N_{oc} ^{Note2}	dBm/15 kHz	
\hat{E}_s / N_{oc}	dB	6
Propagation Condition		AWGN
Antenna Configuration		2x1
<p>Note 1: OCNG shall be used such that the eCell is fully allocated and a constant total transmitted power spectral density is achieved for all OFDM symbols.</p> <p>Note 2: Interference from other cells and noise sources not specified in the test is assumed to be constant over subcarriers and time and shall be modelled as AWGN of appropriate power N_{oc}.</p>		

Table A.7.3.64.1-4: TimeAlignmentTimer -Configuration for E-UTRAN HD-FDD in-sync tests without DRX for UE category NB1 In-Band mode in normal coverage

Field	Value	Comment
TimeAlignmentTimer	infinity	As specified in clause 6.3.2 in TS 36.331

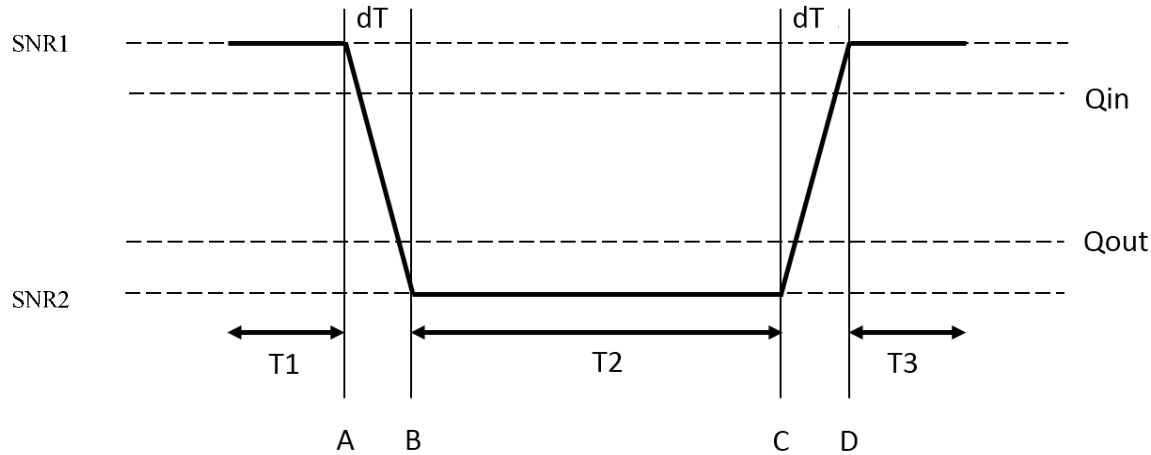

Figure A.7.3.64.1-1: SNR variation for in-sync testing without DRX

A.7.3.64.2 Test Requirements

The UE behavior in each test shall be as follows:

During the period T3, the UE under test is expected to decode the uplink grant and switch to uplink and complete the uplink transmission. This is considered a correct event.

The rate of correct events observed during repeated tests shall be at least 90%.

A.7.3.65 HD-FDD Radio Link Monitoring Test for In-sync without DRX for UE Category NB1 In-Band mode in Enhanced Coverage

A.7.3.65.1 Test Purpose and Environment

The purpose of this test is to verify that the HD-FDD category NB1 UE configured in enhanced coverage properly detects the out of sync and in sync for the purpose of monitoring downlink radio link quality of the PCell when DRX is used. This test will partly verify the HD-FDD radio link monitoring requirements in clause 7.23.

The test parameters are given in Tables A.7.3.65.1-1, A.7.3.65.1-2, A.7.3.65.1-3, A.7.3.65.1-4 and A.7.3.65.1-5. nCell 1 is the active cell in the test. The test consists of three successive time periods, with time duration of T1, T2 and T3 respectively, excluding the transition time duration dT, where the SNR increases or decreases gradually in small steps. Figure A.7.3.65.1-1 shows the variation of the downlink SNR in the active cell to emulate out-of-sync and in-sync states.

Prior to the start of the time duration T1, the UE shall be fully be synchronized to nCell 1. The UE is scheduled in designated uplink subframes to transmit NPUSCH, which is received by the test equipment. By measuring the reception of the NPUSCH, detection of out of sync and in sync requirements can be measured. In the test, DRX configuration is disabled, i.e. UE tries to decode NPDCCH and to send NPUSCH during the period when On-duration timer is running. Time alignment timers shall be set to “infinity” so that UL timing alignment is maintained during the test.

The test setup in each test during time durations T1, T2, dT and T3 shall be as follows:

- During the period from time point A to time point B, the SNR is decreasing linearly from SNR1 to SNR2.
- During the period from time point C to time point D, the SNR is increasing linearly from SNR2 to SNR3.
- During the period T3, the test system shall send the UE a grant to transmit in uplink. UE under test is expected to decode the uplink grant and switch to uplink and complete the uplink transmission. During the period from time point A to time point D, the UE shall not be provisioned with any UL grant.
- Thereafter UE switches back to downlink.

In each run of the test, the test equipment selects NPDCCH repetition level, and sends the RRC configuration to the UE. UE shall successfully complete the RRC reconfiguration accordingly prior to the start of time duration T1.

Table A.7.3.65.1-1: General test parameters for HD-FDD in-sync test without DRX for UE category NB1 In-Band mode in enhanced coverage

Parameter		Unit	Value	Comment
NB-IoT operational mode			In-band	
Active cell			nCell 1	NB-IOT cell nCell1 is within E-UTRA cell eCell1
CP length			Normal	
In sync transmission parameters (Note 1)	DCI format		Format N1	As defined in TS 36.212[21]
	Number of OFDM symbols for legacy control channels		3	In sync threshold Q_{in_NB-IoT} and the corresponding hypothetical NPDCCH transmission parameters are as specified in clause 7.23.2 and Table 7.23.2-1 respectively.
	NPDCCH aggregation level	eCCE	2	
	NPDCCH repetition level		4	
	Ratio of NPDSCH to NRS EPRE		0	
	Ratio of NPDCCH to NRS EPRE		0	
Out of sync transmission parameters (Note 1)	DCI format		Format N1	As defined in TS 36.212[21]
	Number of OFDM symbols for legacy control channels		3	Out of sync threshold Q_{out_NB-IoT} and the corresponding hypothetical NPDCCH transmission parameters are as specified in clause 7.23.2 and Table 7.23.2-1 respectively.
	NPDCCH aggregation level	eCCE	2	
	NPDCCH repetition level		16	
	Ratio of NPDSCH to NRS EPRE		0	
	Ratio of NPDCCH to RS EPRE	dB	0	
Layer 3 filtering			Enabled	Counters: N310 = 1; N311 = 1
T310 timer		ms	4000	T310 is enabled
T311 timer		ms	1000	T311 is enabled
T1		s	4	
dT		s	1.4	
T2		s	2.12	
dT		s	1.4	
T3		s	4	
Note 1: NPDCCH corresponding to the in-sync and out of sync transmission parameters need not be included in the Reference Measurement Channel.				

Table A.7.3.65.1-2: nCell 1 specific test parameters for HD-FDD in-sync radio link monitoring test without DRX for UE category NB1 In-Band mode in enhanced coverage

Parameter	Unit	nCell 1				
		T1	dT	T2	dT	T3
$BW_{channel}$	kHz	200				
PRB location within eCell	-	eCell 1 $BW_{channel}$ 5MHz: 17 eCell 1 $BW_{channel}$ 10MHz: 30				
NPDCCH parameters defined in A.3.1.6.1		R.27 HD-FDD				
NPDSCH_RA		-3				
NPDSCH_RB		-3				
NPDCCH_RA	dB	-3				
NPDCCH_RB	dB	-3				
NPBCH_RA	dB	-3				
NPBCH_RB	dB					
NPSS_RA	dB					
NSSS_RA	dB					
NOCNG_RA ^{Note1}	dB					
NOCNG_RB ^{Note1}	dB					

N_{oc}	dBm/15 kHz	Specified in Table A.7.3.65.1-3				
SNR ^{Note 5, Note 6}	dB	-6.3	Note 7	-17.4	Note 8	-6.3
Propagation condition		AWGN				
Antenna Configuration		2x1				
<p>Note 1: OCNG shall be used such that the resources in ncell1 are fully allocated and a constant total transmitted power spectral density is achieved for all OFDM symbols.</p> <p>Note 2: The uplink resources for CQI reporting are assigned to the UE prior to the start of time period T1.</p> <p>Note 3: The timers and layer 3 filtering related parameters are configured prior to the start of time period T1.</p> <p>Note 4: The signal contains NPDCCH for UEs other than the device under test as part of OCNG.</p> <p>Note 5: SNR levels correspond to the signal to noise ratio over the cell-specific reference signal REs.</p> <p>Note 6: The SNR in time periods T1, T2 and T3 is denoted as SNR1, SNR2, and SNR1 respectively in figure A.7.3.65.1-1.</p> <p>Note 7: The Test system shall reduce its transmit power in steps of $((SNR2-SNR1) / (10*dT))$ dB every 100ms till SNR2 is achieved at the end of dT.</p> <p>Note 8: The Test system shall increase its transmit power in steps of $((SNR1-SNR2) / (10*dT))$ dB every 100ms till SNR1 is achieved at the end of dT.</p>						

Table A.7.3.65.1-3: eCell 1 specific test parameters for HD-FDD in-sync radio link monitoring test without DRX for UE category NB1 In-Band mode in enhanced coverage

Parameter	Unit	eCell 1
		T1-T3
BW _{channel}	MHz	5 or 10
NOCNG Pattern	-	BW _{channel} 5MHz: NOP.4 FDD BW _{channel} 10MHz: NOP.1 FDD
PBCH_RA	dB	-3
PBCH_RB	dB	
PSS_RA	dB	
SSS_RA	dB	
PCFICH_RB	dB	
PDCCH_RA	dB	
PDCCH_RB	dB	
OCNG_RA ^{Note 1}	dB	
OCNG_RB ^{Note 1}	dB	
N_{oc} ^{Note2}	dBm/15 kHz	
\hat{E}_s / N_{oc}	dB	0
Propagation Condition		AWGN
Antenna Configuration		2x1
<p>Note 1: OCNG shall be used such that the eCell is fully allocated and a constant total transmitted power spectral density is achieved for all OFDM symbols.</p> <p>Note 2: Interference from other cells and noise sources not specified in the test is assumed to be constant over subcarriers and time and shall be modelled as AWGN of appropriate power N_{oc}.</p>		

Table A.7.3.65.1-4: TimeAlignmentTimer -Configuration for E-UTRAN HD-FDD in-sync tests without DRX for UE category NB1 In-Band mode in enhanced coverage

Field	Value	Comment
TimeAlignmentTimer	infinity	As specified in clause 6.3.2 in TS 36.331

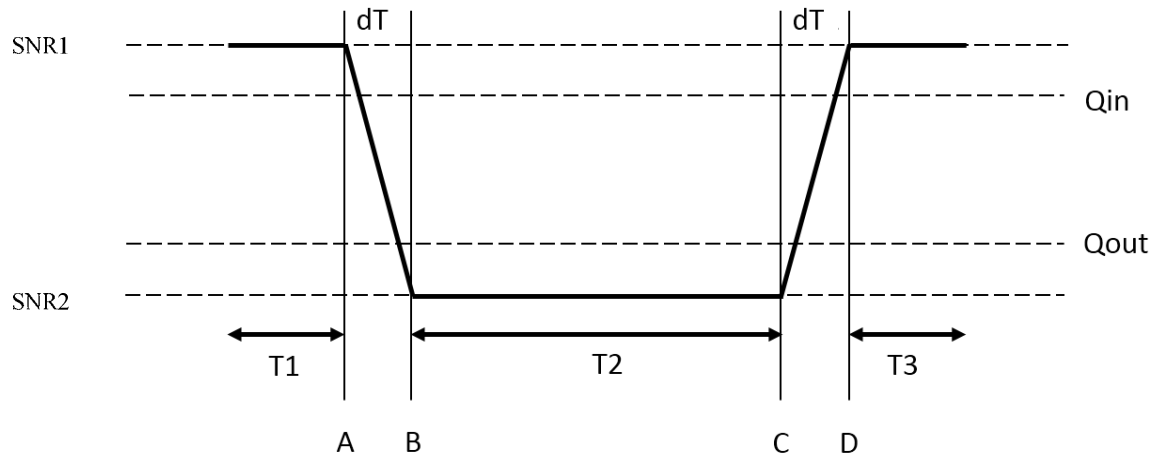

Figure A.7.3.65.1-1: SNR variation for in-sync testing without DRX

A.7.3.65.2 Test Requirements

The UE behavior in each test shall be as follows:

During the period T3, the UE under test is expected to decode the uplink grant and switch to uplink and complete the uplink transmission. This is considered a correct event.

The rate of correct events observed during repeated tests shall be at least 90%.

A.7.3.66 HD-FDD Radio Link Monitoring Test for Out-of-sync without DRX for UE Category NB1 Standalone mode in Normal Coverage

A.7.3.66.1 Test Purpose and Environment

The purpose of this test is to verify that the HD-FDD category NB1 UE properly detects the out of sync for the purpose of monitoring downlink radio link quality of the NB-IoT Cell. This test will partly verify the NB-IoT HD-FDD radio link monitoring requirements in clause 7.23.

The test parameters are given in Tables A.7.3.66.1-1 and A.7.3.66.1-2. nCell1 is the active NB-IoT cell in the test. The test consists of four successive time periods with time duration of T1, T2, T3 and T4 respectively, excluding the transition time duration dT, where the SNR increases or decreases gradually in small steps. Figure A.7.3.66.1-1 shows the variation of the downlink SNR in the active cell to emulate out-of-sync state with the following testing procedure:

- Prior to the start of the time duration T1, the UE shall be fully synchronized to nCell1
- Starting at point A, the SNR is decreased in small steps from SNR1 to SNR2 within dT
- At the start of the time duration T2, the UE is provided with a UL grant with NPDCCH

Note: The UE is expected to decode the NPDCCH and complete the UL transmission during T2 according to the UL grant. The UE shall not be provisioned with any more UL grants until the start of time period T4.

- Starting at point B, the SNR is decreased in small steps from SNR2 to SNR3 within dT
- During T3, the SNR is kept as SNR3

Note: The UE is expected to detect OOS and declare RLF during T3.

- Starting at point C, the SNR is increased in small steps from SNR3 to SNR1 with dT
- At the start of the time period T4, the UE will be provided with another UL grant with NPDCCH

Note: The UE is not expected to decode the UL grant and conduct any UL transmission during T4, since the UE is expected to declare RLF during T3.

Table A.7.3.66.1-1: General test parameters for HD-FDD Radio Link Monitoring Test for out-of-sync tests without DRX for UE Category NB1 Standalone mode in normal coverage

Parameter	Unit	Value	Comment
NB-IoT operational mode		Standalone	
Active cell		nCell 1	
CP length		Normal	
NPDCCH repetition level R_{max}		8	Other NPDCCH parameters are defined in "out-of-sync" column in Table 7.23.2-1
DRX		OFF	
Layer 3 filtering ^{Note 2,3}		Enabled	Counters: N310 = 1 N311 = 1
T310 timer ^{Note 2,3}	ms	0	T310 is disabled
T311 timer ^{Note 2,3}	ms	3000	T311 is enabled
T1	s	2	
dT	s	0.8	
T2	s	0.4	
dT	s	0.7	
T3	s	0.5	
dT	s	1.4	
T4	s	0.4	
Note 1:	NPDCCH corresponding to the out of sync transmission parameters need not be included in the Reference Measurement Channel.		
Note 2:	N310, N311, T310 and T311 are defined in TS 36.331.		
Note 3:	The timers and layer 3 filtering related parameters are configured prior to the start of time period T1.		

Table A.7.3.66.1-2: nCell1 specific test parameters for HD-FDD Radio Link Monitoring Test for out-of-sync without DRX for UE Category NB1 Standalone mode in normal coverage

Parameter	Unit	nCell 1						
		T1	dT	T2	dT	T3	dT	T4
NB-IoT Channel Bandwidth ($BW_{channel}$)	kHz	180						
OCNG Pattern as defined in A.3.2.3.3 ^{Note 1}		NOP.3 FDD						
NPDCCH parameters as defined in A.3.1.6.3		R.33 HD-FDD						
NPBCH_RA	dB	-3						
NPBCH_RB	dB							
NPSS_RA	dB							
NSSS_RA	dB							
NPDCCH_RA	dB							
NPDCCH_RB	dB							
NPDSCH_RA	dB							
NPDSCH_RB	dB							
OCNG_RA ^{Note 1}	dB							
OCNG_RB ^{Note 1}	dB							
N_{oc}	dBm/15 KHz	-98						
SNR ^{Note 4,5}	-	-3.1	Note 6	-9.1	Note 7	-14.1	Note 6	-3.1
Propagation Condition	-	AWGN						
Antenna Configuration	-	2x1						
Note 1:	OCNG shall be used such that the cell is fully allocated and a constant total transmitted power spectral density is achieved for all OFDM symbols. The OCNG pattern is chosen during the test according to the presence of a DL reference measurement channel.							
Note 2:	Void							
Note 3:	Void							
Note 4:	SNR levels correspond to the signal to noise ratio over the cell-specific reference signal REs.							
Note 5:	The SNRs in time periods T1, T2, T3 and T4 are denoted as SNR2, SNR3 and SNR1 respectively in figure A.7.3.66.1-1.							

- Note 6: The Test system shall reduce its transmit power in steps of $((\text{SNR2}-\text{SNR1}) / (10 \cdot dT))$ dB every 100ms until SNR2 is achieved at the end of dT.
- Note 7: The Test system shall reduce its transmit power in steps of $((\text{SNR3}-\text{SNR2}) / (10 \cdot dT))$ dB every 100ms until SNR3 is achieved at the end of dT.
- Note 8: The Test system shall increase its transmit power in steps of $((\text{SNR1}-\text{SNR3}) / (10 \cdot dT))$ dB every 100ms until SNR1 is achieved at the end of dT.

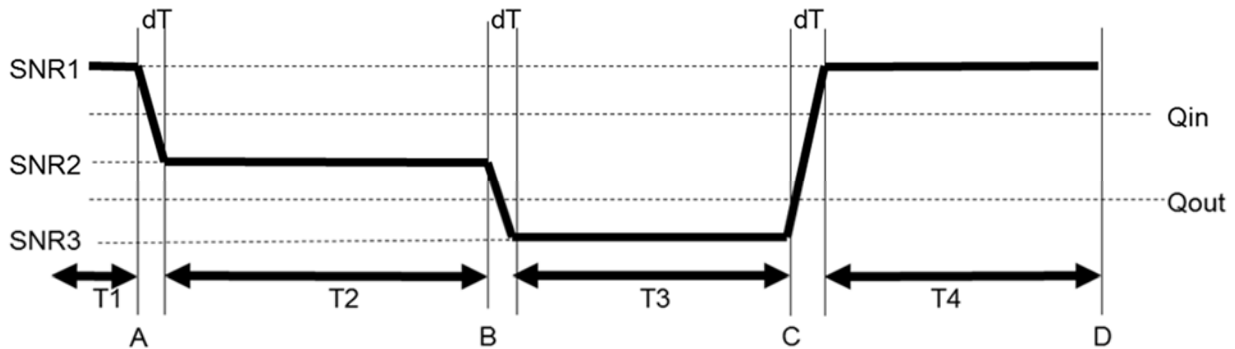

Figure A.7.3.66.1-1: SNR variation for out-of-sync testing

A.7.3.66.2 Test Requirements

The UE behaviors in each test shall be as follows:

- The UE shall complete the NPUSCH transmission during T2 according to the received UL grant;
- The UE shall not conduct any NPUSCH transmission during T4

A correct event is defined as UE behaves correctly in all above steps. The correct events observed during repeated tests shall be at least 90%.

A.7.3.67 HD-FDD Radio Link Monitoring Test for Out-of-sync without DRX for UE Category NB1 guard band mode in Enhanced Coverage

A.7.3.67.1 Test Purpose and Environment

The purpose of this test is to verify that the HD-FDD category NB1 UE properly detects the out of sync for the purpose of monitoring downlink radio link quality of the NB-IoT Cell. This test will partly verify the NB-IoT HD-FDD radio link monitoring requirements in clause 7.23.

The test parameters are given in Tables A.7.3.67.1-1 and A.7.3.67.1-2 below. nCell1 is the active NB-IoT cell, in the test. The test consists of four successive time periods with time duration of T1, T2, T3 and T4 respectively, excluding the transition time duration dT, where the SNR increases or decreases gradually in small steps. Figure A.7.3.67.1-1 shows the variation of the downlink SNR in the active cell to emulate out-of-sync state with the following testing procedure.

- Before the start of the time duration T1, the UE shall be fully synchronized to nCell1
- Starting at point A, the SNR is decreased in small steps from SNR1 to SNR2 with duration dT
- At the start of the time duration T2, the UE is provided with a UL grant with NPDCCH.

Note: The UE is expected to decode NPDCCH and complete the UL transmission during T2 according to the UL grant. The UE shall not be provisioned with any more UL grants until the start of time period T4.

- Starting at point B, the SNR is decreased in small steps from SNR2 to SNR3 with duration dT
- During T3, the SNR is kept at SNR3.

Note: The UE is expected to detect OOS and declare RLF during T3.

- Starting at point C, the SNR is increased in small steps from SNR3 to SNR1 with duration dT

- At the start of the time period T4, the UE will be provided with another UL grant with NPDCCH

Note: The UE is not expected to decode the UL grant and conduct the UL transmission during T4 since the UE is expected to declare RLF during T3.

Table A.7.3.67.1-1: General test parameters for HD-FDD Radio Link Monitoring Test for out-of-sync tests without DRX for UE Category NB1 Guard band mode in enhanced coverage

Parameter	Unit	Value	Comment
NB-IoT operational mode		Guardband	
Active cell		nCell 1	
CP length		Normal	
NB-IoT RF Channel Number		1	One NB-IoT carrier frequency
NPDCCH repetition level R_{max}		16	Other NPDCCH parameters are defined in "out-of-sync" column in Table 7.23.2-1
DRX		OFF	
Layer 3 filtering ^{Note 2}		Enabled	Counters: N310 = 1 N311 = 1
T310 timer ^{Note 2}	ms	0	T310 is disabled
T311 timer ^{Note 2}	ms	3000	T311 is enabled
T1	s	2	
dT	s	0.7	
T2	s	0.4	
dT	s	0.8	
T3	s	0.5	
dT	s	1.4	
T4	s	0.4	
Note 1: NPDCCH corresponding to the out of sync transmission parameters need not be included in the Reference Measurement Channel. Note 2: N310, N311, T310 and T311 are defined in TS 36.331. Note 3: The timers and layer 3 filtering related parameters are configured prior to the start of time period T1.			

Table A.7.3.67.1-2: nCell1 specific test parameters for HD-FDD Radio Link Monitoring Test for out-of-sync without DRX for UE Category NB1 Guard band mode in enhanced coverage

Parameter	Unit	nCell 1							
		T1	dT	T2	dT	T3	dT	T4	
$BW_{channel}$	kHz	180							
PRB location within eCell	-	eCell 1 $BW_{channel}$ 5MHz: 25 eCell 1 $BW_{channel}$ 10MHz: 50							
NPDCCH parameters as defined in A.3.1.6.5		R.37 HD-FDD							
NPBCH_RA	dB	-3							
NPBCH_RB	dB								
NPSS_RA	dB								
NSSS_RA	dB								
NPDCCH_RA	dB								
NPDCCH_RB	dB								
NPDSCH_RA	dB								
NPDSCH_RB	dB								
OCNG_RA ^{Note 1}	dB								
OCNG_RB ^{Note 1}	dB								

N_{oc}	dBm/15 KHz	Specified in Table A.7.3.67.1-3						
SNR ^{Note 4,5}	-	-6.3	Note 6	-11.4	Note 7	-17.4	Note 8	-6.3
Propagation Condition	-	AWGN						
Antenna Configuration	-	2x1						
Note 1:	OCNG shall be used such that the cell is fully allocated and a constant total transmitted power spectral density is achieved for all OFDM symbols. The OCNG pattern is chosen during the test according to the presence of a DL reference measurement channel.							
Note 2:	Void							
Note 3:	Void							
Note 4:	SNR levels correspond to the signal to noise ratio over the cell-specific reference signal REs.							
Note 5:	The SNR in time periods T1, T2, T3 and T4 is denoted as SNR1, SNR2, SNR3 and SNR1 respectively in figure A.7.3.67.1-1.							
Note 6:	The Test system shall reduce its transmit power in steps of $((SNR2-SNR1) / (10*dT))$ dB every 100ms until SNR2 is achieved at the end of dT.							
Note 7:	The Test system shall reduce its transmit power in steps of $((SNR3-SNR2) / (10*dT))$ dB every 100ms until SNR3 is achieved at the end of dT.							
Note 8:	The Test system shall increase its transmit power in steps of $((SNR1-SNR3) / (10*dT))$ dB every 100ms until SNR1 is achieved at the end of dT.							

Table A.7.3.67.1-3: eCell 1 specific test parameters for HD-FDD out-of-sync radio link monitoring test without DRX for UE category NB1 Guard band mode in enhanced coverage

Parameter	Unit	eCell 1
		T1-T4
BW _{channel}	MHz	5 or 10
NOCNG Pattern	-	BW _{channel} 5MHz: NOP.5 FDD BW _{channel} 10MHz: NOP.2 FDD
PBCH_RA	dB	-3
PBCH_RB	dB	
PSS_RA	dB	
SSS_RA	dB	
PCFICH_RB	dB	
PDCCH_RA	dB	
PDCCH_RB	dB	
OCNG_RA ^{Note 1}	dB	
OCNG_RB ^{Note 1}	dB	
N_{oc} ^{Note2}	dBm/15 kHz	
\hat{E}_s / N_{oc}	dB	-12
Propagation Condition		AWGN
Antenna Configuration		2x1
Note 1:	OCNG shall be used such that the eCell 1 is fully allocated and a constant total transmitted power spectral density is achieved for all OFDM symbols.	
Note 2:	Interference from other cells and noise sources not specified in the test is assumed to be constant over subcarriers and time and shall be modelled as AWGN of appropriate power N_{oc} .	

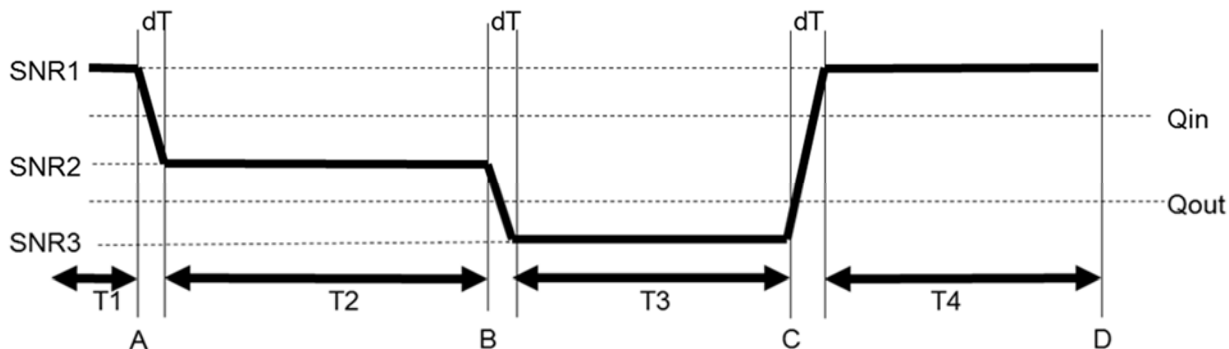

Figure A.7.3.67.1-1: SNR variation for out-of-sync testing

A.7.3.67.2 Test Requirements

The UE behaviors in each test shall be as follows:

- The UE shall complete the NPUSCH transmission during T2 according to the received UL grant;
- The UE shall not conduct any NPUSCH transmission during T4

A correct event is defined as UE behave correctly in all above steps. The correct events observed during repeated tests shall be at least 90%.

A.7.3.68 E-UTRAN FD-FDD Early Out-of-sync reporting Test for Cat-M1 UE in CEMode A

A.7.3.68.1 Test Purpose and Environment

The purpose of this test is to verify that the FD-FDD Cat-M1 UE properly detects an early out of sync event and makes correct reporting of it for the purpose of monitoring the downlink radio link quality of the PCell in CEModeA. This test will partly verify the E-UTRAN FDD radio link monitoring requirements for Cat-M1 UE defined in clause 7.19.

The test parameters are given in Tables A.7.3.68.1-1 and A.7.3.68.1-2 below. There is one cell (cell 1), which is the active cell, in the test. The test consists of three successive time periods, with time duration of T1, T2 and T3 respectively. Figure A.7.3.68.1-1 shows the variation of the downlink SNR in the active cell to emulate early out-of-sync and early in-sync states. Prior to the start of the time duration T1, the UE shall be fully synchronized to cell 1.

In the test, the RRC parameter *numberPRB-Pairs* is set to 4 and the RRC parameter *mPDCCH-NumRepetition* is set to 8. In addition, the UE is configured with *rlm-ReportConfig*. UE shall successfully complete the RRC reconfiguration accordingly prior to the start of time duration T1.

Table A.7.3.68.1-1: General test parameters for E-UTRAN FD-FDD early out-of-sync testing for UE Cat-M1 in CEMode A

Parameter		Unit	Value	Comment
Active cell			Cell 1	Cell 1 is on E-UTRA RF channel number 1
CP length			Normal	
Early Out of sync transmission parameters (Note 1)	DCI format		6-1A	As defined in section 5.3.3.1.12 in TS 36.212
	Number of OFDM symbols for legacy control channels		2	Early Out of sync threshold $Q_{E1_out_CatM1}$ and the corresponding hypothetical MPDCCH transmission parameters are as specified in section 7.19.2 and Table 7.19.2-2 respectively.
	M-PDCCH aggregation level	eCCE	8	
	M-PDCCH repetition level		4	
	ρ_A, ρ_B		-3	
DRX			OFF	
Layer 3 filtering			Enabled	Counters: N310 = 1; N311 = 1

T310 timer	ms	0	T310 is disabled
T311 timer	ms	1000	T311 is enabled
T1	s	2	
T2	s	0.8	
T3	s	1.8	
Note 1: MPDCCH corresponding to the early out of sync transmission parameters need not be included in the Reference Measurement Channel.			

Table A.7.3.68.1-2: Cell specific test parameters for E-UTRAN FD-FDD (cell # 1) for early out-of-sync radio link monitoring tests for Cat-M1 in CEMode A

Parameter	Unit	Test 1		
		T1	T2	T3
E-UTRA RF Channel Number		1		
BW_{channel}	MHz	10		
MPDCCH parameters as defined in A.3.1.3.1		R.17 FDD		
OCNG Pattern defined in A.3.2.1.21 (FDD)		OP.21 FDD		
ρ_A, ρ_B		-3		
MPDCCH_RA	dB	0		
MPDCCH_RB	dB	0		
PBCH_RA	dB	-3		
PBCH_RB	dB			
PSS_RA	dB			
SSS_RA	dB			
OCNG_RA ^{Note 1}	dB			
OCNG_RB ^{Note 1}	dB			
N_{oc}	dBm/15 kHz			
SNR ^{Note 5}	dB	0.1	-6.8	-15.8
Propagation condition		ETU 30Hz		
Correlation Matrix and Antenna Configuration		2x1 Low		
<p>Note 1: OCNG shall be used such that the resources in cell # 1 are fully allocated and a constant total transmitted power spectral density is achieved for all OFDM symbols.</p> <p>Note 2: The timers and layer 3 filtering related parameters are configured prior to the start of time period T1.</p> <p>Note 3: The signal contains PDCCH for UEs other than the device under test as part of OCNG.</p> <p>Note 4: SNR levels correspond to the signal to noise ratio over the cell-specific reference signal REs.</p> <p>Note 5: The SNR in time periods T1, T2 and T3 is denoted as SNR1, SNR2 and SNR3 respectively in figure A.7.3.68.1-1.</p>				

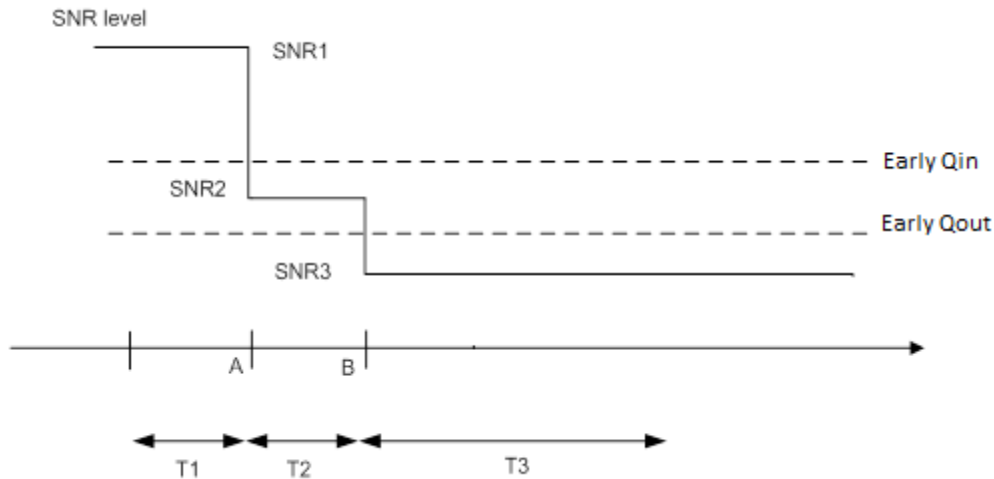

Figure A.7.3.68.1-1: SNR variation for early out-of-sync testing

A.7.3.68.2 Test Requirements

The UE shall compare the downlink radio link quality of the PCell over the last Q_{out_CatM1} evaluation, which is defined in 7.19.2.1, with the threshold $Q_{E1_out_CatM}$. When the estimated quality becomes worse than the threshold starting from time point B, Layer 1 of the UE shall trigger event E1 and send a report to the higher layers within Q_{out_CatM1} evaluation period.

The rate of correct events observed during repeated tests shall be at least 90%.

A.7.3.69 E-UTRAN HD-FDD Early Out-of-sync reporting Test for Cat-M1 UE in CEMode A

A.7.3.69.1 Test Purpose and Environment

The purpose of this test is to verify that the HD-FDD Cat-M1 UE properly detects an early out of sync event and makes correct reporting of it for the purpose of monitoring the downlink radio link quality of the PCell in CEModeA. This test will partly verify the E-UTRAN FDD radio link monitoring requirements for Cat-M1 UE defined in clause 7.19.

The test parameters are given in Tables A.7.3.69.1-1 and A.7.3.69.1-2 below. There is one cell (cell 1), which is the active cell, in the test. The test consists of three successive time periods, with time duration of T1, T2 and T3 respectively. Figure A.7.3.69.1-1 shows the variation of the downlink SNR in the active cell to emulate early out-of-sync and early in-sync states. Prior to the start of the time duration T1, the UE shall be fully synchronized to cell 1.

In the test, the RRC parameter *numberPRB-Pairs* is set to 4 and the RRC parameter *mPDCCH-NumRepetition* is set to 8. In addition, the UE is configured with *rlm-ReportConfig*. UE shall successfully complete the RRC reconfiguration accordingly prior to the start of time duration T1.

Table A.7.3.69.1-1: General test parameters for E-UTRAN HD-FDD early out-of-sync testing for UE Cat-M1 in CEMode A

Parameter	Unit	Value	Comment	
Active cell		Cell 1	Cell 1 is on E-UTRA RF channel number 1	
CP length		Normal		
Early Out of sync transmission parameters (Note 1)	DCI format		6-1A	As defined in section 5.3.3.1.12 in TS 36.212
	Number of OFDM symbols for legacy control channels		2	Early Out of sync threshold $Q_{E1_out_CatM1}$ and the corresponding hypothetical MPDCCH transmission parameters are as specified in section 7.19.2 and Table 7.19.2-2 respectively.
	M-PDCCH aggregation level	eCCE	8	
	M-PDCCH repetition level		4	

	ρ_A, ρ_B		-3	
DRX			OFF	
Layer 3 filtering			Enabled	Counters: N310 = 1; N311 = 1
T310 timer	ms		0	T310 is disabled
T311 timer	ms		1000	T311 is enabled
T1	s		2	
T2	s		0.8	
T3	s		1.8	
Note 1: MPDCCH corresponding to the early out of sync transmission parameters need not be included in the Reference Measurement Channel.				

Table A.7.3.69.1-2: Cell specific test parameters for E-UTRAN HD-FDD (cell # 1) for early out-of-sync radio link monitoring tests for Cat-M1 in CEMode A

Parameter	Unit	Test 1		
		T1	T2	T3
E-UTRA RF Channel Number		1		
$BW_{channel}$	MHz	10		
MPDCCH parameters as defined in A.3.1.3.2		R.7 HD-FDD		
OCNG Pattern defined in A.3.2.1.21 (FDD)		OP.21 FDD		
ρ_A, ρ_B		-3		
MPDCCH_RA	dB	0		
MPDCCH_RB	dB	0		
PBCH_RA	dB	-3		
PBCH_RB	dB			
PSS_RA	dB			
SSS_RA	dB			
OCNG_RA ^{Note 1}	dB			
OCNG_RB ^{Note 1}	dB			
N_{oc}	dBm/15 kHz	-98		
SNR ^{Note 5}	dB	0.1	-6.8	-15.8
Propagation condition		ETU 30Hz		
Correlation Matrix and Antenna Configuration		2x1 Low		
Note 1: OCNG shall be used such that the resources in cell # 1 are fully allocated and a constant total transmitted power spectral density is achieved for all OFDM symbols. Note 2: The timers and layer 3 filtering related parameters are configured prior to the start of time period T1. Note 3: The signal contains PDCCH for UEs other than the device under test as part of OCNG. Note 4: SNR levels correspond to the signal to noise ratio over the cell-specific reference signal REs. Note 5: The SNR in time periods T1, T2 and T3 is denoted as SNR1, SNR2 and SNR3 respectively in figure A.7.3.69.1-1.				

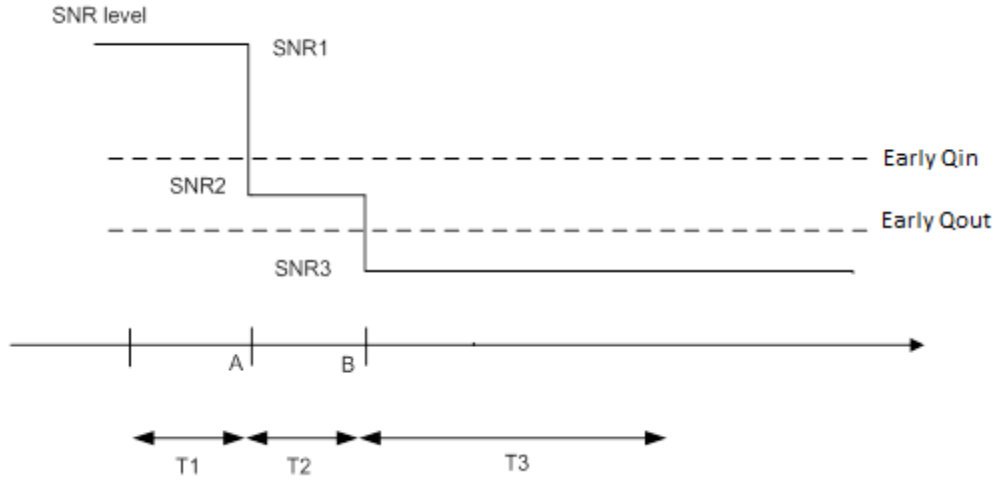

Figure A.7.3.69.1-1: SNR variation for early out-of-sync testing

A.7.3.69.2 Test Requirements

The UE shall compare the downlink radio link quality of the PCell over the last Q_{out_CatM1} evaluation, which is defined in 7.19.3.1, with the threshold $Q_{E1_out_CatM}$. When the estimated quality becomes worse than the threshold starting from time point B, Layer 1 of the UE shall trigger event E1 and send a report to the higher layers within Q_{out_CatM1} evaluation period.

The rate of correct events observed during repeated tests shall be at least 90%.

A.7.3.70 E-UTRAN TDD Early Out-of-sync reporting Test for Cat-M1 UE in CEMode A

A.7.3.70.1 Test Purpose and Environment

The purpose of this test is to verify that the TDD Cat-M1 UE properly detects an early out of sync event and makes correct reporting of it for the purpose of monitoring the downlink radio link quality of the PCell in CEModeA. This test will partly verify the E-UTRAN FDD radio link monitoring requirements for Cat-M1 UE defined in clause 7.19.

The test parameters are given in Tables A.7.3.70.1-1 and A.7.3.70.1-2 below. There is one cell (cell 1), which is the active cell, in the test. The test consists of three successive time periods, with time duration of T1, T2 and T3 respectively. Figure A.7.3.70.1-1 shows the variation of the downlink SNR in the active cell to emulate early out-of-sync and early in-sync states. Prior to the start of the time duration T1, the UE shall be fully synchronized to cell 1.

In the test, the RRC parameter *numberPRB-Pairs* is set to 4 and the RRC parameter *mPDCCH-NumRepetition* is set to 8. In addition, the UE is configured with *rlm-ReportConfig*. UE shall successfully complete the RRC reconfiguration accordingly prior to the start of time duration T1.

Table A.7.3.70.1-1: General test parameters for E-UTRAN TDD early out-of-sync testing for UE Cat-M1 in CEMode A

Parameter	Unit	Value	Comment	
Active cell		Cell 1	Cell 1 is on E-UTRA RF channel number 1	
CP length		Normal		
Early Out of sync transmission parameters (Note 1)	DCI format		6-1A	As defined in section 5.3.3.1.12 in TS 36.212
	Number of OFDM symbols for legacy control channels		2	Early Out of sync threshold $Q_{E1_out_CatM1}$ and the corresponding hypothetical MPDCCH transmission parameters are as specified in section 7.19.2 and Table 7.19.2-2 respectively.
	M-PDCCH aggregation level	eCCE	8	
	M-PDCCH repetition level		4	

	ρ_A, ρ_B		-3	
DRX			OFF	
Layer 3 filtering			Enabled	Counters: N310 = 1; N311 = 1
T310 timer	ms		0	T310 is disabled
T311 timer	ms		1000	T311 is enabled
T1	s		2	
T2	s		0.8	
T3	s		1.8	
Note 1: MPDCCH corresponding to the out of sync transmission parameters need not be included in the Reference Measurement Channel.				

Table A.7.3.70.1-2: Cell specific test parameters for E-UTRAN TDD (cell # 1) for early out-of-sync radio link monitoring tests for Cat-M1 in CEMode A

Parameter	Unit	Test 1		
		T1	T2	T3
E-UTRA RF Channel Number		1		
$BW_{channel}$	MHz	10		
Special subframe configuration ^{Note 1}		6		
Uplink-downlink configuration ^{Note 1}		1		
MPDCCH parameters as defined in A.3.1.3.3		R.15 TDD ^{Note 7}		
OCNG Pattern defined in A.3.2.2.11 (TDD)		OP.11 TDD		
ρ_A, ρ_B		-3		
MPDCCH_RA	dB	0		
MPDCCH_RB	dB	0		
PBCH_RA	dB	-3		
PBCH_RB	dB			
PSS_RA	dB			
SSS_RA	dB			
OCNG_RA ^{Note 1}	dB			
OCNG_RB ^{Note 1}	dB			
N_{oc}	dBm/15 kHz			
SNR ^{Note 6}	dB	-0.3	-7.1	-16.1
Propagation condition		ETU 30Hz		
Correlation Matrix and Antenna Configuration		2x1 Low		
<p>Note 1: For special subframe and uplink-downlink configurations see Tables 4.2-1 and 4.2-2 in TS 36.211.</p> <p>Note 2: OCNG shall be used such that the resources in cell # 1 are fully allocated and a constant total transmitted power spectral density is achieved for all OFDM symbols.</p> <p>Note 3: The timers and layer 3 filtering related parameters are configured prior to the start of time period T1.</p> <p>Note 4: The signal contains PDCCH for UEs other than the device under test as part of OCNG.</p> <p>Note 5: SNR levels correspond to the signal to noise ratio over the cell-specific reference signal REs.</p> <p>Note 6: The SNR in time periods T1, T2 and T3 is denoted as SNR1, SNR2 and SNR3 respectively in figure A.7.3.70.1-1.</p> <p>Note 7: Aggregation level and repetition levels specified in A.7.3.70.1-1 are used for this test.</p>				

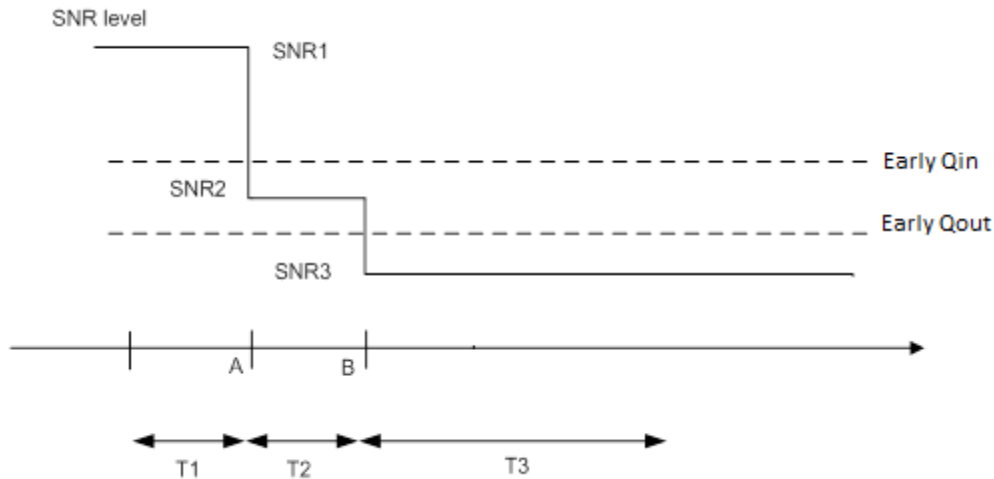

Figure A.7.3.70.1-1: SNR variation for early out-of-sync testing

A.7.3.70.2 Test Requirements

The UE shall compare the downlink radio link quality of the PCell over the last Q_{out_CatM1} evaluation, which is defined in 7.19.2.1, with the threshold $Q_{E1_out_CatM}$. When the estimated quality becomes worse than the threshold starting from time point B, Layer 1 of the UE shall trigger event E1 and send a report to the higher layers within Q_{out_CatM1} evaluation period.

The rate of correct events observed during repeated tests shall be at least 90%.

A.7.3.71 E-UTRAN FD-FDD Early In-Sync reporting Test for Cat-M1 UE in CEModeA

A.7.3.71.1 Test Purpose and Environment

The purpose of this test is to verify that the FD-FDD Cat-M1 UE properly detects an early in sync event and makes correct reporting of it for the purpose of monitoring the downlink radio link quality of the PCell in CEModeA. This test will partly verify the E-UTRAN FDD radio link monitoring requirements for Cat-M1 UE defined in clause 7.19.

The test parameters are given in Tables A.7.3.71.1-1 and A.7.3.71.1-2 below. There is one cell (cell 1), which is the active cell, in the test. The test consists of three successive time periods, with time duration of T1, T2 and T3 respectively. Figure A.7.3.71.1-1 shows the variation of the downlink SNR in the active cell to emulate early in-sync and early in-sync states. Prior to the start of the time duration T1, the UE shall be fully synchronized to cell 1.

In the test, the RRC parameter *numberPRB-Pairs* is set to 4 and the RRC parameter *mPDCCH-NumRepetition* is set to 8. In addition, the UE is configured with *rlm-ReportConfig*. UE shall successfully complete the RRC reconfiguration accordingly prior to the start of time duration T1.

Table A.7.3.71.1-1: General test parameters for E-UTRAN FD-FDD early in-sync testing for UE Cat-M1 in CEMode A

Parameter	Unit	Value	Comment	
Active cell		Cell 1	Cell 1 is on E-UTRA RF channel number 1	
CP length		Normal		
Early In sync transmission parameters (Note 1)	DCI format		6-1A	As defined in section 5.3.3.1.12 in TS 36.212
	Number of OFDM symbols for legacy control channels		2	Early in-sync threshold $Q_{E2_in_CatM1}$ and the corresponding hypothetical MPDCCH transmission parameters are as specified in section 7.19.2 and Table 7.19.2-2 respectively.
	M-PDCCH aggregation level	eCCE	8	
	M-PDCCH repetition level		1	

	ρ_A, ρ_B		-3	
DRX			OFF	
Layer 3 filtering			Enabled	Counters: N310 = 1; N311 = 1
T310 timer	ms	2000		T310 is enabled
T311 timer	ms	1000		T311 is enabled
T1	s	2		
T2	s	0.8		
T3	s	1.36		
T4	s	0.4		
T5	s	2		
Note 1: MPDCCH corresponding to the early in-sync transmission parameters need not be included in the Reference Measurement Channel.				

Table A.7.3.71.1-2: Cell specific test parameters for E-UTRAN FD-FDD (cell # 1) for early in-sync radio link monitoring tests for Cat-M1 in CEMode A

Parameter	Unit	Test 1				
		T1	T2	T3	T4	T5
E-UTRA RF Channel Number		1				
$BW_{channel}$	MHz	10				
MPDCCH parameters as defined in A.3.1.3.1		R.17 FDD				
OCNG Pattern defined in A.3.2.1.21 (FDD)		OP.21 FDD				
ρ_A, ρ_B		-3				
MPDCCH_RA	dB	0				
MPDCCH_RB	dB	0				
PBCH_RA	dB	-3				
PBCH_RB	dB					
PSS_RA	dB					
SSS_RA	dB					
OCNG_RA ^{Note 1}	dB					
OCNG_RB ^{Note 1}	dB					
N_{oc}	dBm/15 kHz	-98				
SNR ^{Note 6}	dB	5.4	-3.8	-12.8	-1.6	5.4
Propagation condition		ETU 30Hz				
Correlation Matrix and Antenna Configuration		2x1 Low				
Note 1: OCNG shall be used such that the resources in cell # 1 are fully allocated and a constant total transmitted power spectral density is achieved for all OFDM symbols. Note 2: The uplink resources for CQI reporting are assigned to the UE prior to the start of time period T1. Note 3: The timers and layer 3 filtering related parameters are configured prior to the start of time period T1. Note 4: The signal contains PDCCH for UEs other than the device under test as part of OCNG. Note 5: SNR levels correspond to the signal to noise ratio over the cell-specific reference signal REs. Note 6: The SNR in time periods T1, T2, T3, T4 and T5 is denoted as SNR1, SNR2, SNR3, SNR4 and SNR5 respectively in figure A.7.3.71.1-1.						

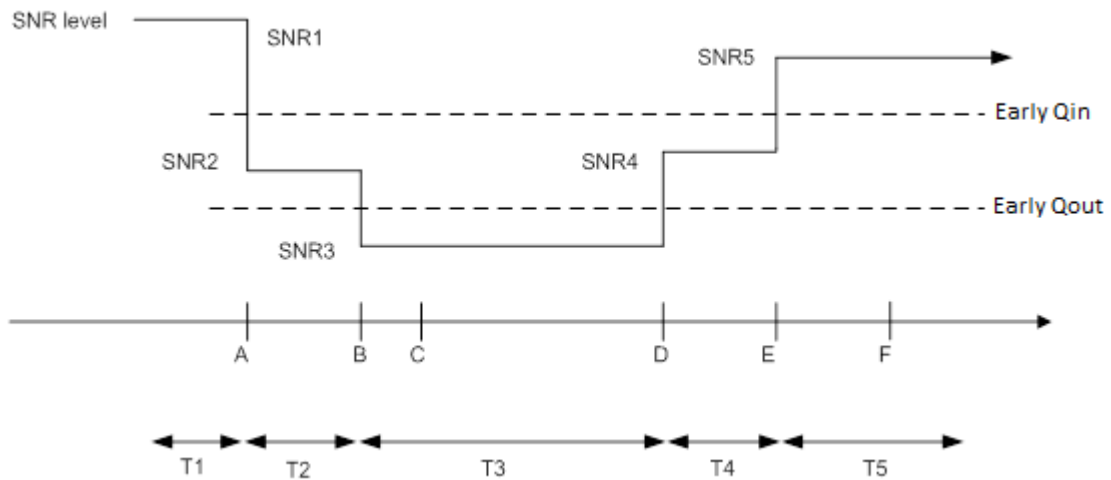

Figure A.7.3.71.1-1: SNR variation for early in-sync testing

A.7.3.71.2 Test Requirements

The UE shall compare the downlink radio link quality of the PCell over the last Q_{in_CatM1} evaluation, which is defined in 7.19.2.1, with the threshold $Q_{E2_in_CatM1}$. When the estimated quality becomes better than the threshold starting from time point E, Layer 1 of the UE shall trigger event E2 and send a report to the higher layers within Q_{in_CatM1} evaluation period.

The rate of correct events observed during repeated tests shall be at least 90%.

A.7.3.72 E-UTRAN HD-FDD Early In-Sync reporting Test for Cat-M1 UE in CEModeA

A.7.3.72.1 Test Purpose and Environment

The purpose of this test is to verify that the HD-FDD Cat-M1 UE properly detects an early in sync event and makes correct reporting of it for the purpose of monitoring the downlink radio link quality of the PCell in CEModeA. This test will partly verify the E-UTRAN FDD radio link monitoring requirements for Cat-M1 UE defined in clause 7.19.

The test parameters are given in Tables A.7.3.72.1-1 and A.7.3.72.1-2 below. There is one cell (cell 1), which is the active cell, in the test. The test consists of three successive time periods, with time duration of T1, T2 and T3 respectively. Figure A.7.3.72.1-1 shows the variation of the downlink SNR in the active cell to emulate early in-sync and early in-sync states. Prior to the start of the time duration T1, the UE shall be fully synchronized to cell 1.

In the test, the RRC parameter *numberPRB-Pairs* is set to 4 and the RRC parameter *mPDCCH-NumRepetition* is set to 8. In addition, the UE is configured with *rlm-ReportConfig*. UE shall successfully complete the RRC reconfiguration accordingly prior to the start of time duration T1.

Table A.7.3.72.1-1: General test parameters for E-UTRAN HD-FDD early in-sync testing for UE Cat-M1 in CEMode A

Parameter	Unit	Value	Comment	
Active cell		Cell 1	Cell 1 is on E-UTRA RF channel number 1	
CP length		Normal		
Early In sync transmission parameters (Note 1)	DCI format		6-1A	As defined in section 5.3.3.1.12 in TS 36.212
	Number of OFDM symbols for legacy control channels		2	Early in-sync threshold $Q_{E2_in_CatM1}$ and the corresponding hypothetical MPDCCH transmission parameters are as specified in section 7.19.2 and Table 7.19.2-2 respectively.
	M-PDCCH aggregation level	eCCE	8	
	M-PDCCH repetition level		1	
	ρ_A, ρ_B		-3	

DRX		OFF	
Layer 3 filtering		Enabled	Counters: N310 = 1; N311 = 1
T310 timer	ms	2000	T310 is enabled
T311 timer	ms	1000	T311 is enabled
T1	s	2	
T2	s	0.8	
T3	s	1.36	
T4	s	0.4	
T5	s	2	
Note 1: MPDCCH corresponding to the early in-sync transmission parameters need not be included in the Reference Measurement Channel.			

Table A.7.3.72.1-2: Cell specific test parameters for E-UTRAN HD-FDD (cell # 1) for early in-sync radio link monitoring tests for Cat-M1 in CEMode A

Parameter	Unit	Test 1				
		T1	T2	T3	T4	T5
E-UTRA RF Channel Number		1				
BW _{channel}	MHz	10				
MPDCCH parameters as defined in A.3.1.3.2		R.7 HD-FDD				
OCNG Pattern defined in A.3.2.1.21 (FDD)		OP.21 FDD				
ρ_A, ρ_B		-3				
MPDCCH_RA	dB	0				
MPDCCH_RB	dB	0				
PBCH_RA	dB	-3				
PBCH_RB	dB					
PSS_RA	dB					
SSS_RA	dB					
OCNG_RA ^{Note 1}	dB					
OCNG_RB ^{Note 1}	dB					
N_{oc}	dBm/15 kHz	-98				
SNR ^{Note 6}	dB	5.4	-3.8	-12.8	-1.6	5.4
Propagation condition		ETU 30Hz				
Correlation Matrix and Antenna Configuration		2x1 Low				
<p>Note 1: OCNG shall be used such that the resources in cell # 1 are fully allocated and a constant total transmitted power spectral density is achieved for all OFDM symbols.</p> <p>Note 2: The uplink resources for CQI reporting are assigned to the UE prior to the start of time period T1.</p> <p>Note 3: The timers and layer 3 filtering related parameters are configured prior to the start of time period T1.</p> <p>Note 4: The signal contains PDCCH for UEs other than the device under test as part of OCNG.</p> <p>Note 5: SNR levels correspond to the signal to noise ratio over the cell-specific reference signal REs.</p> <p>Note 6: The SNR in time periods T1, T2, T3, T4 and T5 is denoted as SNR1, SNR2, SNR3, SNR4 and SNR5 respectively in figure A.7.3.72.1-1.</p>						

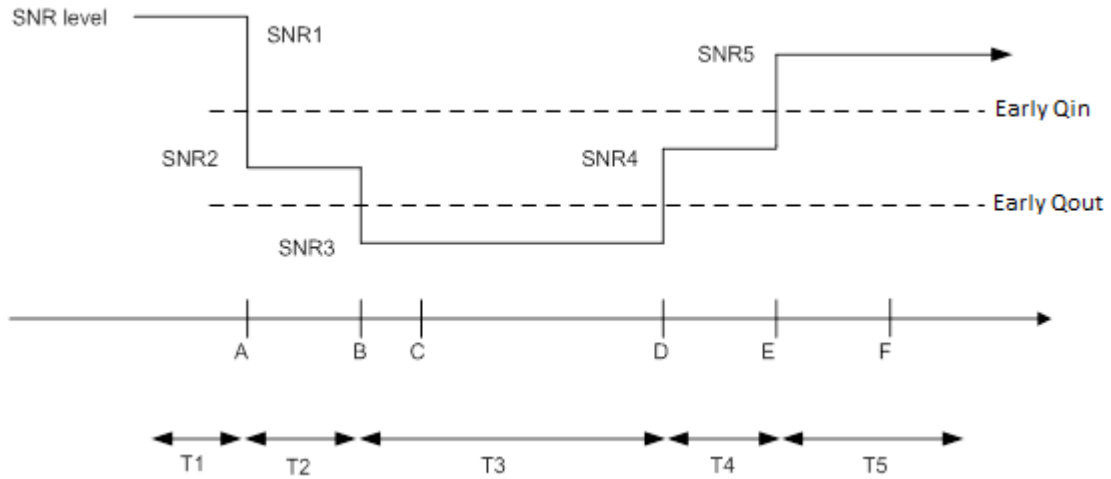

Figure A.7.3.72.1-1: SNR variation for early in-sync testing

A.7.3.72.2 Test Requirements

The UE shall compare the downlink radio link quality of the PCell over the last Q_{in_CatM1} evaluation, which is defined in 7.19.2.1, with the threshold $Q_{E2_in_CatM1}$. When the estimated quality becomes better than the threshold starting from time point E, Layer 1 of the UE shall trigger event E2 and send a report to the higher layers within Q_{in_CatM1} evaluation period.

The rate of correct events observed during repeated tests shall be at least 90%.

A.7.3.73 E-UTRAN TDD Early In-Sync reporting Test for Cat-M1 UE in CEModeA

A.7.3.73.1 Test Purpose and Environment

The purpose of this test is to verify that the TDD Cat-M1 UE properly detects an early in sync event and makes correct reporting of it for the purpose of monitoring the downlink radio link quality of the PCell in CEModeA. This test will partly verify the E-UTRAN FDD radio link monitoring requirements for Cat-M1 UE defined in clause 7.19.

The test parameters are given in Tables A.7.3.73.1-1 and A.7.3.73.1-2 below. There is one cell (cell 1), which is the active cell, in the test. The test consists of three successive time periods, with time duration of T1, T2 and T3 respectively. Figure A.7.3.73.1-1 shows the variation of the downlink SNR in the active cell to emulate early in-sync and early in-sync states. Prior to the start of the time duration T1, the UE shall be fully synchronized to cell 1.

In the test, the RRC parameter *numberPRB-Pairs* is set to 4 and the RRC parameter *mPDCCH-NumRepetition* is set to 8. In addition, the UE is configured with *rlm-ReportConfig*. UE shall successfully complete the RRC reconfiguration accordingly prior to the start of time duration T1.

Table A.7.3.73.1-1: General test parameters for E-UTRAN TDD early in-sync testing for UE Cat-M1 in CEMode A

Parameter	Unit	Value	Comment	
Active cell		Cell 1	Cell 1 is on E-UTRA RF channel number 1	
CP length		Normal		
Early In sync transmission parameters (Note 1)	DCI format		6-1A	As defined in section 5.3.3.1.12 in TS 36.212
	Number of OFDM symbols for legacy control channels		2	Early in-sync threshold $Q_{E2_in_CatM1}$ and the corresponding hypothetical MPDCCH transmission parameters are as specified in section 7.19.2 and Table 7.19.2-2 respectively.
	M-PDCCH aggregation level	eCCE	8	
	M-PDCCH repetition level		1	
	ρ_A, ρ_B		-3	

DRX		OFF	
Layer 3 filtering		Enabled	Counters: N310 = 1; N311 = 1
T310 timer	ms	2000	T310 is enabled
T311 timer	ms	1000	T311 is enabled
T1	s	2	
T2	s	0.8	
T3	s	1.36	
T4	s	0.4	
T5	s	2	
Note 1: MPDCCH corresponding to the early in-sync transmission parameters need not be included in the Reference Measurement Channel.			

Table A.7.3.73.1-2: Cell specific test parameters for E-UTRAN TDD (cell # 1) for early in-sync radio link monitoring tests for Cat-M1 in CEMode A

Parameter	Unit	Test 1				
		T1	T2	T3	T4	T5
E-UTRA RF Channel Number		1				
BW _{channel}	MHz	10				
Special subframe configuration Note 1		6				
Uplink-downlink configuration Note 1		1				
MPDCCH parameters as defined in A.3.1.3.3		R.15 TDD				
OCNG Pattern defined in A.3.2.1.11 (TDD)		OP.11 TDD				
ρ_A, ρ_B		-3				
MPDCCH_RA	dB	0				
MPDCCH_RB	dB	0				
PBCH_RA	dB	-3				
PBCH_RB	dB					
PSS_RA	dB					
SSS_RA	dB					
OCNG_RA ^{Note 1}	dB					
OCNG_RB ^{Note 1}	dB					
N_{oc}	dBm/15 kHz	-98				
SNR ^{Note 6}	dB	5.4	-3.8	-12.8	-1.6	5.4
Propagation condition		ETU 30Hz				
Correlation Matrix and Antenna Configuration		2x1 Low				
<p>Note 1: OCNG shall be used such that the resources in cell # 1 are fully allocated and a constant total transmitted power spectral density is achieved for all OFDM symbols.</p> <p>Note 2: The uplink resources for CQI reporting are assigned to the UE prior to the start of time period T1.</p> <p>Note 3: The timers and layer 3 filtering related parameters are configured prior to the start of time period T1.</p> <p>Note 4: The signal contains PDCCH for UEs other than the device under test as part of OCNG.</p> <p>Note 5: SNR levels correspond to the signal to noise ratio over the cell-specific reference signal REs.</p> <p>Note 6: The SNR in time periods T1, T2, T3, T4 and T5 is denoted as SNR1, SNR2, SNR3, SNR4 and SNR5 respectively in figure A.7.3.73.1-1.</p>						

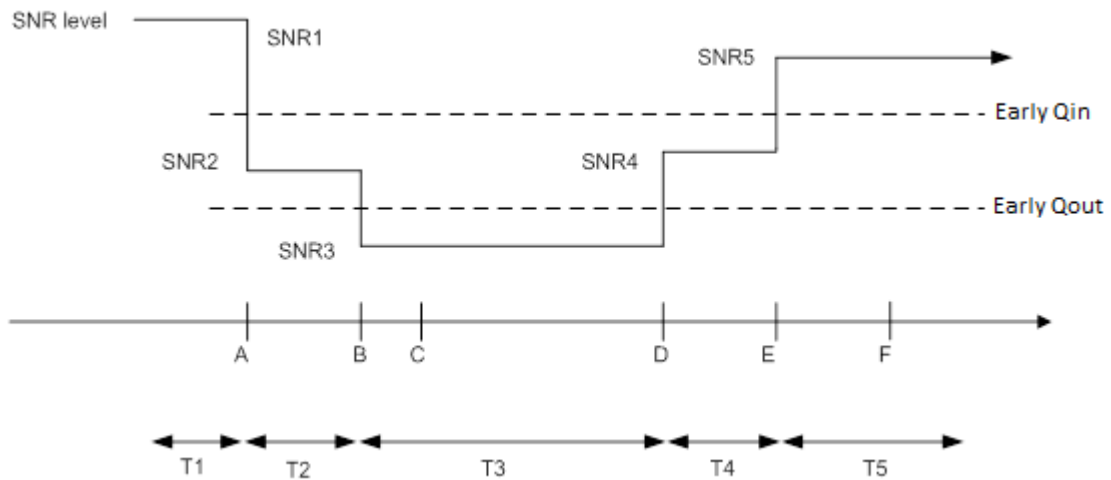

Figure A.7.3.73.1-1: SNR variation for early in-sync testing

A.7.3.73.2 Test Requirements

The UE shall compare the downlink radio link quality of the PCell over the last Q_{in_CatM1} evaluation, which is defined in 7.19.2.1, with the threshold $Q_{E2_in_CatM1}$. When the estimated quality becomes better than the threshold starting from time point E, Layer 1 of the UE shall trigger event E2 and send a report to the higher layers within Q_{in_CatM1} evaluation period.

The rate of correct events observed during repeated tests shall be at least 90%.

A.7.3.74 E-UTRAN FD-FDD Radio Link Monitoring Test for Out-of-sync for non-BL CE UE in CEMode A

A.7.3.74.1 Test Purpose and Environment

The purpose of this test is to verify that the FD-FDD non-BL CE UE properly detects the out of sync and in sync for the purpose of monitoring downlink radio link quality of the PCell in CEModeA. This test will partly verify the E-UTRAN FDD radio link monitoring requirements for non-BL CE UE defined in clause 7.19.

The test parameters are given in Tables A.7.3.74.1-1 and A.7.3.74.1-2 below. There is one cell (cell 1), which is the active cell, in the test. The test consists of three successive time periods, with time duration of T1, T2 and T3 respectively. Figure A.7.3.74.1-1 shows the variation of the downlink SNR in the active cell to emulate out-of-sync and in-sync states. Prior to the start of the time duration T1, the UE shall be fully synchronized to cell 1. The UE shall be configured for periodic CQI reporting in PUCCH 1-0 mode without repetition with a reporting periodicity of 2 ms.

In the test, the RRC parameter *numberPRB-Pairs* is set to 4 and the RRC parameter *mPDCCH-NumRepetition* is set to 8. UE shall successfully complete the RRC reconfiguration accordingly prior to the start of time duration T1.

Table A.7.3.74.1-1: General test parameters for E-UTRAN FD-FDD out-of-sync testing for non-BL CE UE in CEMode A

Parameter	Unit	Value	Comment
Active cell		Cell 1	Cell 1 is on E-UTRA RF channel number 1
CP length		Normal	
Out of sync transmission parameters (Note 1)	DCI format	6-1A	As defined in section 5.3.3.1.12 in TS 36.212
	Number of OFDM symbols for legacy control channels	2	Out of sync threshold Q_{out} and the corresponding hypothetical MPDCCH

	M-PDCCH aggregation level	eCCE	24	transmission parameters are as specified in section 7.19.2 and Table 7.19.2-1 respectively.
	M-PDCCH repetition level		4	
	ρ_A, ρ_B		-3	
DRX			OFF	
Layer 3 filtering			Enabled	Counters: N310 = 1; N311 = 1
T310 timer		ms	0	T310 is disabled
T311 timer		ms	1000	T311 is enabled
Periodic CQI reporting mode			PUCCH 1-0	As defined in table 7.2.2-1 in TS 36.213.
CQI reporting periodicity		ms	2	Minimum CQI reporting periodicity
T1		s	2	
T2		s	0.8	
T3		s	1.8	
Note 1: MPDCCH corresponding to the out of sync transmission parameters need not be included in the Reference Measurement Channel.				

Table A.7.3.74.1-2: Cell specific test parameters for E-UTRAN FD-FDD (cell # 1) for out-of-sync radio link monitoring tests for non-BL CE UE in CEMode A

Parameter	Unit	Test 1		
		T1	T2	T3
E-UTRA RF Channel Number		1		
$BW_{channel}$	MHz	10		
MPDCCH parameters as defined in A.3.1.3.1		R.17 FDD		
OCNG Pattern defined in A.3.2.1.21 (FDD)		OP.21 FDD		
ρ_A, ρ_B		-3		
MPDCCH_RA	dB	0		
MPDCCH_RB	dB	0		
PBCH_RA	dB	-3		
PBCH_RB	dB			
PSS_RA	dB			
SSS_RA	dB			
OCNG_RA ^{Note 1}	dB			
OCNG_RB ^{Note 1}	dB			
N_{oc}	dBm/15 kHz	-98		
SNR ^{Note 6}	dB	-1.5	-7.9	-15.9 ^{Note 7}
Propagation condition		ETU 30Hz		
Correlation Matrix and Antenna Configuration		2x2 Low 2x4 Low		

Note 1:	OCNG shall be used such that the resources in cell # 1 are fully allocated and a constant total transmitted power spectral density is achieved for all OFDM symbols.
Note 2:	The uplink resources for CQI reporting are assigned to the UE prior to the start of time period T1.
Note 3:	The timers and layer 3 filtering related parameters are configured prior to the start of time period T1.
Note 4:	The signal contains PDCCH for UEs other than the device under test as part of OCNG.
Note 5:	SNR levels correspond to the signal to noise ratio over the cell-specific reference signal REs.
Note 6:	The SNR in time periods T1, T2 and T3 is denoted as SNR1, SNR2 and SNR3 respectively in figure A.7.3.74.1-1.
Note 7:	For 4 Rx UE, SNR in T3 is -18.0 dB.

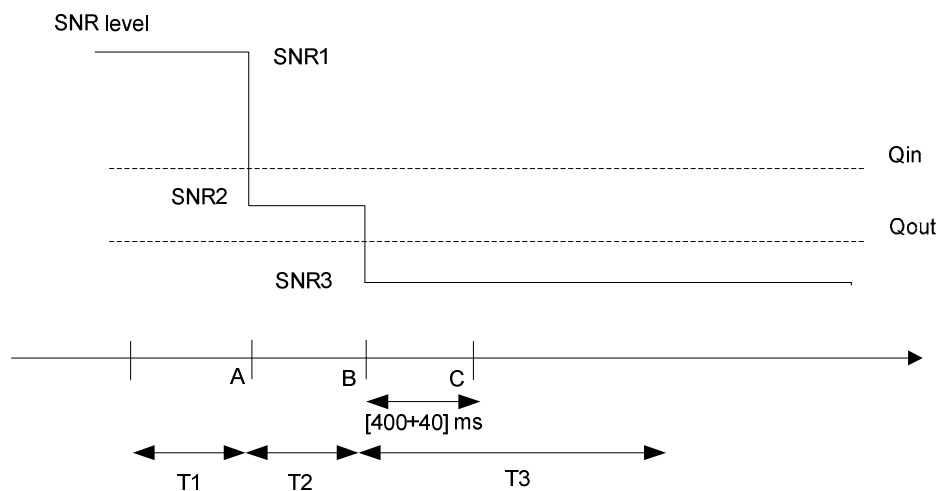

Figure A.7.3.74.1-1: SNR variation for out-of-sync testing

A.7.3.74.2 Test Requirements

The UE behaviour in each test during time durations T1, T2 and T3 shall be as follows:

During the period from time point A to time point B the UE shall transmit uplink signal at least in all subframes configured for CQI transmission according to the configured CQI reporting mode (PUCCH 1-0).

The UE shall stop transmitting uplink signal no later than time point C (440 ms after the start of time duration T3).

The rate of correct events observed during repeated tests shall be at least 90%.

A.7.3.75 E-UTRAN FD-FDD Radio Link Monitoring Test for In-Sync for non-BL CE UE in CEMode A

A.7.3.75.1 Test Purpose and Environment

The purpose of this test is to verify that the FD-FDD non-BL CE UE properly detects the out of sync and in sync for the purpose of monitoring downlink radio link quality of the PCell in CEModeA. This test will partly verify the E-UTRAN FDD radio link monitoring requirements for non-BL CE UE defined in clause 7.19.

The test parameters are given in Tables A.7.3.75.1-1 and A.7.3.75.1-2 below. There is one cell (cell 1), which is the active cell, in the test. The test consists of five successive time periods, with time duration of T1, T2, T3, T4 and T5 respectively. Figure A.7.3.75.1-1 shows the variation of the downlink SNR in the active cell to emulate out-of-sync and in-sync states. Prior to the start of the time duration T1, the UE shall be fully synchronized to cell 1. The UE shall be configured for periodic CQI reporting in PUCCH 1-0 mode without repetition with a reporting periodicity of 2 ms.

In the test, the RRC parameter *numberPRB-Pairs* is set to 4 and the RRC parameter *mPDCCH-NumRepetition* is set to 8. UE shall successfully complete the RRC reconfiguration accordingly prior to the start of time duration T1.

Table A.7.3.75.1-1: General test parameters for E-UTRAN FD-FDD in-sync testing for non-BL CE UE in CEMode A

Parameter		Unit	Value	Comment
Active cell			Cell 1	Cell 1 is on E-UTRA RF channel number 1
CP length			Normal	
In sync transmission parameters (Note 1)	DCI format		6-1A	As defined in section 5.3.3.1.12 in TS 36.212
	Number of OFDM symbols for legacy control channels		2	In sync threshold Q_{in} and the corresponding hypothetical MPDCCH transmission parameters are as specified in section 7.19.2 and Table 7.19.2-1 respectively.
	M-PDCCH aggregation level	eCCE	4	
	M-PDCCH repetition level		1	
	ρ_A, ρ_B		-3	
Out of sync transmission parameters (Note 1)	DCI format		6-1A	As defined in section 5.3.3.1.12 in TS 36.212
	Number of OFDM symbols for legacy control channels		2	Out of sync threshold Q_{out} and the corresponding hypothetical MPDCCH transmission parameters are as specified in section 7.19.2 and Table 7.19.2-1 respectively.
	M-PDCCH aggregation level	eCCE	16	
	M-PDCCH repetition level		2	
	ρ_A, ρ_B		-3	
DRX			OFF	
Layer 3 filtering			Enabled	Counters: $N_{310} = 1; N_{311} = 1$
T310 timer		ms	2000	T310 is enabled
T311 timer		ms	1000	T311 is enabled
Periodic CQI reporting mode			PUCCH 1-0	As defined in table 7.2.2-1 in TS 36.213.
CQI reporting periodicity		ms	2	Minimum CQI reporting periodicity
T1		s	2	
T2		s	0.8	
T3		s	1.36	
T4		s	0.4	
T5		s	2	
Note 1: MPDCCH corresponding to the out of sync transmission parameters need not be included in the Reference Measurement Channel.				

Table A.7.3.75.1-2: Cell specific test parameters for E-UTRAN FD-FDD (cell # 1) for in-sync radio link monitoring tests for non-BL CE UE in CEMode A

Parameter	Unit	Test 1				
		T1	T2	T3	T4	T5
E-UTRA RF Channel Number		1				
$BW_{channel}$	MHz	10				
MPDCCH parameters defined in A.3.1.3		R.17 FDD				

OCNG Pattern defined in A.3.2.1 (FDD)		OP.21 FDD				
ρ_A, ρ_B		-3				
MPDCCH_RA	dB	0				
MPDCCH_RB	dB	0				
PBCH_RA	dB	-3				
PBCH_RB	dB					
PSS_RA	dB					
SSS_RA	dB					
OCNG_RA ^{Note1}	dB					
OCNG_RB ^{Note1}	dB					
N_{oc}	dBm/15 kHz	-98				
SNR ^{Note 6}	dB	3.3	-4.8	-12.8 ^{Note 7}	-2.8	3.3
Propagation condition		ETU 30Hz				
Correlation Matrix and Antenna Configuration		2x2 Low 2x4 Low				
<p>Note 1: OCNG shall be used such that the resources in cell # 1 are fully allocated and a constant total transmitted power spectral density is achieved for all OFDM symbols.</p> <p>Note 2: The uplink resources for CQI reporting are assigned to the UE prior to the start of time period T1.</p> <p>Note 3: The timers and layer 3 filtering related parameters are configured prior to the start of time period T1.</p> <p>Note 4: The signal contains PDCCH for UEs other than the device under test as part of OCNG.</p> <p>Note 5: SNR levels correspond to the signal to noise ratio over the cell-specific reference signal REs.</p> <p>Note 6: The SNR in time periods T1, T2, T3, T4 and T5 is denoted as SNR1, SNR2, SNR3, SNR4 and SNR5 respectively in figure A.7.3.75.1-1.</p> <p>Note 7: For 4 Rx UE, SNR in T3 is -15.0 dB.</p>						

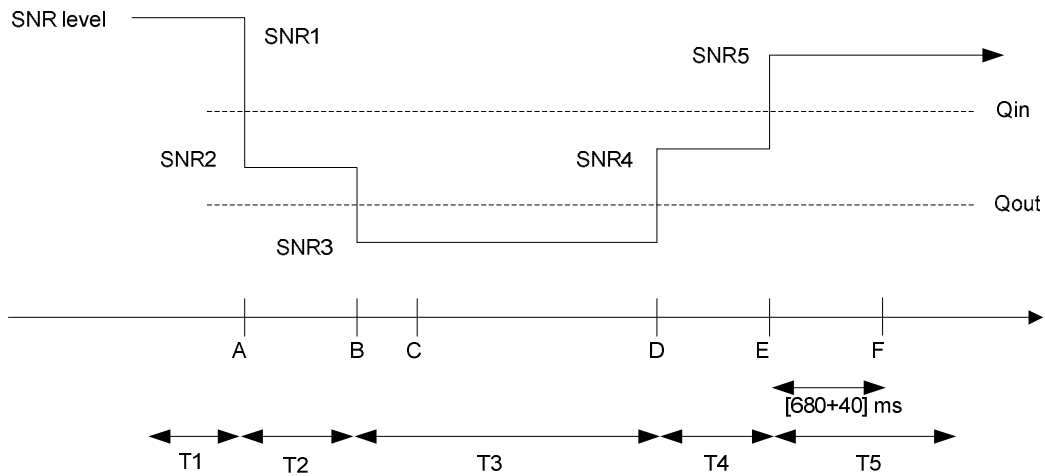

Figure A.7.3.75.1-1: SNR variation for in-sync testing

A.7.3.75.2 Test Requirements

The UE behaviour in each test during time durations T1, T2, T3, T4 and T5 shall be as follows:

During the period from time point A to time point F (720 ms after the start of time duration T5) the UE shall transmit uplink signal at least in all subframes configured for CQI transmission according to the configured CQI reporting mode (PUCCH 1-0).

The rate of correct events observed during repeated tests shall be at least 90%.

A.7.3.76 E-UTRAN FD-FDD Radio Link Monitoring Test for Out-of-sync in DRX for non-BL CE UE configured in CEMode A

A.7.3.76.1 Test Purpose and Environment

The purpose of this test is to verify that the FD-FDD non-BL CE UE configured in CEMode A properly detects the out of sync for the purpose of monitoring downlink radio link quality of the PCell when DRX is used. This test will partly verify the E-UTRAN FD-FDD radio link monitoring requirements in clause 7.19.

The test parameters are given in Tables A.7.3.76.1-1, A.7.3.76.1-2, A.7.3.76.1-3 and A.7.3.76.1-4. There is one cell (cell 1), which is the active cell, in the test. The test consists of three successive time periods, with time duration of T1, T2 and T3 respectively. Figure A.7.3.76.1-1 shows the variation of the downlink SNR in the active cell to emulate out-of-sync states. Prior to the start of the time duration T1, the UE shall be fully synchronized to cell 1. The UE shall be configured for periodic CQI reporting in PUCCH 1-0 mode with a reporting periodicity of 2 ms without repetition. In the test, DRX configuration is enabled and DRX inactivity timer has already been expired, i.e. UE tries to decode MPDCCH and to send periodic CQI during the period when On-duration timer is running. Time alignment timers shall be set to “infinity” so that UL timing alignment is maintained during the test.

In the test, the RRC parameter *numberPRB-Pairs* is set to 4 and the RRC parameter *mPDCCH-NumRepetition* is set 8. UE shall successfully complete the RRC reconfiguration accordingly prior to the start of time duration T1.

Table A.7.3.76.1-1: General test parameters for E-UTRAN FD-FDD out-of-sync tests in DRX for non-BL CE UE configured in CEMode A

Parameter		Unit	Value	Comment
Active cell			Cell 1	Cell 1 is on E-UTRA RF channel number 1
CP length			Normal	
Out of sync transmission parameters (Note 1)	DCI format		6-1A	As defined in section 5.3.3.1.12 in TS 36.212
	Number of OFDM symbols for legacy control channels		2	Out of sync threshold $Q_{out, Cat M1}$ and the corresponding hypothetical MPDCCH transmission parameters are as specified in clause 7.19.2 and Table 7.19.2-1 respectively.
	MPDCCH aggregation level	eCCE	16	
	MPDCCH repetition level		2	
	Ratio of MPDCCH to RS EPRE		0	
ρ_A, ρ_B		-3		
DRX cycle		ms	1280	See Table A.7.3.76.1-3
Layer 3 filtering			Enabled	Counters: $N_{310} = 1; N_{311} = 1$
T310 timer		ms	0	T310 is disabled
T311 timer		ms	1000	T311 is enabled
Periodic CQI reporting mode			PUCCH 1-0	As defined in table 7.2.2-1 in TS 36.213.
CQI reporting periodicity		ms	2	Minimum CQI reporting periodicity
T1		s	32	
T2		s	12.8	
T3		s	13	
Note 1: MPDCCH corresponding to the out of sync transmission parameters need not be included in the Reference Measurement Channel.				

Table A.7.3.76.1-2: Cell specific test parameters for E-UTRAN FD-FDD (cell # 1) for out-of-sync radio link monitoring tests in DRX for non-BL CE UE configured in CEMode A

Parameter	Unit	Test 1		
		T1	T2	T3
E-UTRA RF Channel Number		1		
$BW_{channel}$	MHz	10		
MPDCCH parameters defined in A.3.1.3		R.17 FDD		
OCNG Pattern defined in A.3.2.1 (FDD)		OP.21 FDD		
ρ_A, ρ_B		-3		
MPDCCH_RA	dB	0		
MPDCCH_RB	dB	0		
PBCH_RA	dB	-3		
PBCH_RB	dB			
PSS_RA	dB			
SSS_RA	dB			
OCNG_RA ^{Note1}	dB			
OCNG_RB ^{Note1}	dB	-3		
N_{oc}	dBm/15 kHz	-98		
SNR ^{Note 6}	dB	-0.9	-7.7	-14.7 ^{Note 7}
Propagation condition		AWGN		

Correlation Matrix and Antenna Configuration		2x2 2x4
Note 1:	OCNG shall be used such that the resources in cell # 1 are fully allocated and a constant total transmitted power spectral density is achieved for all OFDM symbols.	
Note 2:	The uplink resources for CQI reporting are assigned to the UE prior to the start of time period T1.	
Note 3:	The timers and layer 3 filtering related parameters are configured prior to the start of time period T1.	
Note 4:	The signal contains MPDCCH for UEs other than the device under test as part of OCNG.	
Note 5:	SNR levels correspond to the signal to noise ratio over the cell-specific reference signal REs.	
Note 6:	The SNR in time periods T1, T2 and T3 is denoted as SNR1, SNR2 and SNR3 respectively in figure A.7.3.76.1-1.	
Note 7:	For 4 Rx UE, SNR in T3 is -17.2 dB.	

Table A.7.3.76.1-3: DRX-Configuration for E-UTRAN FD-FDD out-of-sync tests for non-BL CE UE configured in CEMode A

Field	Value	Comment
onDurationTimer	psf10	As specified in clause 6.3.2 in TS 36.331
drx-InactivityTimer	psf1	
drx-RetransmissionTimer	psf1	
longDRX-CycleStartOffset	sf1280	
shortDRX	disable	

Table A.7.3.76.1-4: TimeAlignmentTimer-Configuration for E-UTRAN FD-FDD out-of-sync testing for non-BL CE UE configured in CEMode A

Field	Value	Comment
TimeAlignmentTimer	infinity	As specified in clause 6.3.2 in TS 36.331
sr-ConfigIndex	0	For further information see clause 6.3.2 in TS 36.331 and section 10.1 in TS 36.213.

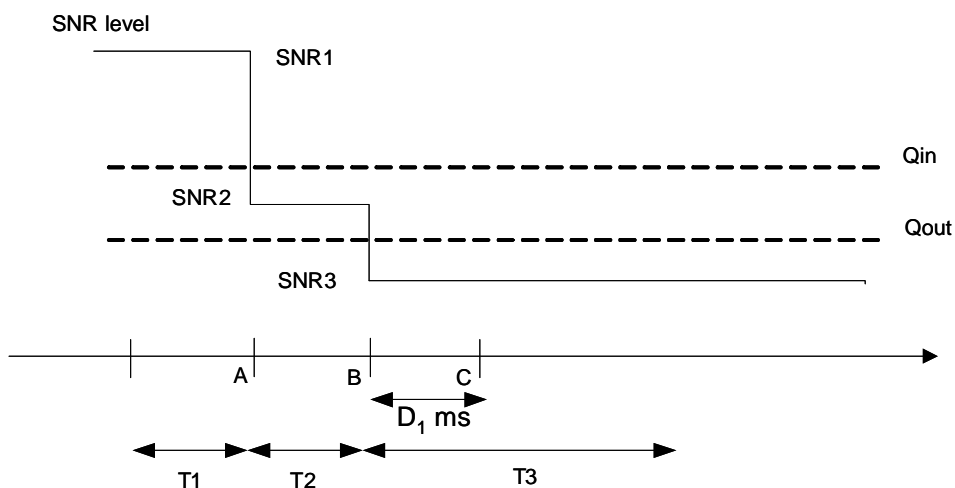

Figure A.7.3.76.1-1: SNR variation for out-of-sync testing in DRX

A.7.3.76.2 Test Requirements

The UE behaviour in each test during time durations T1, T2 and T3 shall be as follows:

During the period from time point A to time point B the UE shall transmit uplink signal at least once every DRX cycle, in the On-duration part of the cycle in the subframe according to the configured CQI reporting mode (PUCCH 1-0).

The UE shall stop transmitting uplink signal no later than time point C (duration $D_1 = 6500$ ms after the start of time duration T3).

The rate of correct events observed during repeated tests shall be at least 90%.

A.7.3.77 E-UTRAN FD-FDD Radio Link Monitoring Test for In-sync in DRX for non-BL CE UE configured in CEMode A

A.7.3.77.1 Test Purpose and Environment

The purpose of this test is to verify that the FD-FDD non-BL CE UE configured in CEMode A properly detects the out of sync and in sync for the purpose of monitoring downlink radio link quality of the PCell when DRX is used. This test will partly verify the E-UTRAN FD-FDD radio link monitoring requirements in clause 7.19.

The test parameters are given in Tables A.7.3.77.1-1, A.7.3.77.1-2, A.7.3.77.1-3 and A.7.3.77.1-4. There is one cell (cell 1), which is the active cell, in the test. The test consists of five successive time periods, with time duration of T1, T2, T3, T4 and T5 respectively. Figure A.7.3.77.1-1 shows the variation of the downlink SNR in the active cell to emulate out-of-sync and in-sync states. Prior to the start of the time duration T1, the UE shall be fully synchronized to cell 1. The UE shall be configured for periodic CQI reporting in PUCCH 1-0 mode with a reporting periodicity of 2 ms without repetition. In the test, DRX configuration is enabled and DRX inactivity timer has already been expired, i.e. UE tries to decode MPDCCH and to send periodic CQI during the period when On-duration timer is running. Time alignment timers shall be set to “infinity” so that UL timing alignment is maintained during the test.

In the test, the RRC parameter *numberPRB-Pairs* is set to 4 and the RRC parameter *mPDCCH-NumRepetition* is set 8. UE shall successfully complete the RRC reconfiguration accordingly prior to the start of time duration T1.

Table A.7.3.77.1-1: General test parameters for E-UTRAN FD-FDD in-sync test in DRX for non-BL CE UE configured in CEMode A

Parameter		Unit	Value	Comment
Active cell			Cell 1	Cell 1 is on E-UTRA RF channel number 1
CP length			Normal	
In sync transmission parameters (Note 1)	DCI format		6-1A	As defined in section 5.3.3.1.12 in TS 36.212
	Number of OFDM symbols for legacy control channels		2	In sync threshold $Q_{in, Cat M1}$ and the corresponding hypothetical MPDCCH transmission parameters are as specified in clause 7.19.2 and Table 7.19.2-1 respectively.
	MPDCCH aggregation level	eCCE	8	
	MPDCCH repetition level		2	
	ρ_A, ρ_B		-3	
Ratio of MPDCCH to RS EPRE		0		
Out of sync transmission parameters (Note 1)	DCI format		6-1A	As defined in section 5.3.3.1.12 in TS 36.212
	Number of OFDM symbols for legacy control channels		2	Out of sync threshold $Q_{out, Cat M1}$ and the corresponding hypothetical MPDCCH transmission parameters are as specified in clause 7.19.2 and Table 7.19.2-1 respectively.
	MPDCCH aggregation level	eCCE	24	
	MPDCCH repetition level		4	
	ρ_A, ρ_B		-3	
Ratio of MPDCCH to RS EPRE	dB	0		
DRX cycle		ms	40	See Table A.7.3.77.1-3
Layer 3 filtering			Enabled	Counters: $N_{310} = 1; N_{311} = 1$
T310 timer		ms	2000	T310 is enabled
T311 timer		ms	1000	T311 is enabled

Periodic CQI reporting mode		PUCCH 1-0	As defined in table 7.2.2-1 in TS 36.213.
CQI reporting periodicity	ms	2	Minimum CQI reporting periodicity
T1	s	4	
T2	s	1.6	
T3	s	1.46	
T4	s	0.4	
T5	s	4	
Note 1: MPDCCH corresponding to the in-sync and out of sync transmission parameters need not be included in the Reference Measurement Channel.			

Table A.7.3.77.1-2: Cell specific test parameters for E-UTRAN FD-FDD (cell # 1) for in-sync radio link monitoring test in DRX for non-BL CE UE configured in CEMode A

Parameter	Unit	Test 1									
		T1	T2	T3	T4	T5					
E-UTRA RF Channel Number		1									
BW _{channel}	MHz	10									
MPDCCH parameters defined in A.3.1.3		R.17 FDD									
OCNG Pattern defined in A.3.2.1 (FDD)		OP.21 FDD									
ρ_A, ρ_B		-3									
MPDCCH_RA	dB	0									
MPDCCH_RB	dB	0									
PBCH_RA	dB										
PBCH_RB	dB										
PSS_RA	dB										
SSS_RA	dB										
OCNG_RA ^{Note1}	dB						-3				
OCNG_RB ^{Note1}	dB										
N_{oc}	dBm/15 kHz						-98				
SNR ^{Note 6}	dB	-5.7	-9.5	-16.5 ^{Note 7}	-11.2	-5.2					
Propagation condition		AWGN									
Correlation Matrix and Antenna Configuration		2x2 2x4									
Note 1: OCNG shall be used such that the resources in cell # 1 are fully allocated and a constant total transmitted power spectral density is achieved for all OFDM symbols. Note 2: The uplink resources for CQI reporting are assigned to the UE prior to the start of time period T1. Note 3: The timers and layer 3 filtering related parameters are configured prior to the start of time period T1. Note 4: The signal contains MPDCCH for UEs other than the device under test as part of OCNG. Note 5: SNR levels correspond to the signal to noise ratio over the cell-specific reference signal REs. Note 6: The SNR in time periods T1, T2, T3, T4 and T5 is denoted as SNR1, SNR2, SNR3, SNR4 and SNR5 respectively in figure A.7.3.77.1-1. Note 7: For 4 Rx UE, SNR in T3 is -19.5 dB.											

Table A.7.3.77.1-3: DRX-Configuration for E-UTRAN FD-FDD out-of-sync tests for non-BL CE UE configured in CEMode A

Field	Value	Comment
onDurationTimer	psf10	As specified in clause 6.3.2 in TS 36.331
drx-InactivityTimer	psf1	
drx-RetransmissionTimer	psf1	
longDRX-CycleStartOffset	sf40	
shortDRX	disable	

Table A.7.3.77.1-4: TimeAlignmentTimer -Configuration for E-UTRAN FD-FDD out-of-sync testing for non-BL CE UE configured in CEMode A

Field	Value	Comment
TimeAlignmentTimer	infinity	As specified in clause 6.3.2 in TS 36.331
sr-ConfigIndex	0	For further information see clause 6.3.2 in TS 36.331 and section 10.1 in TS 36.213.

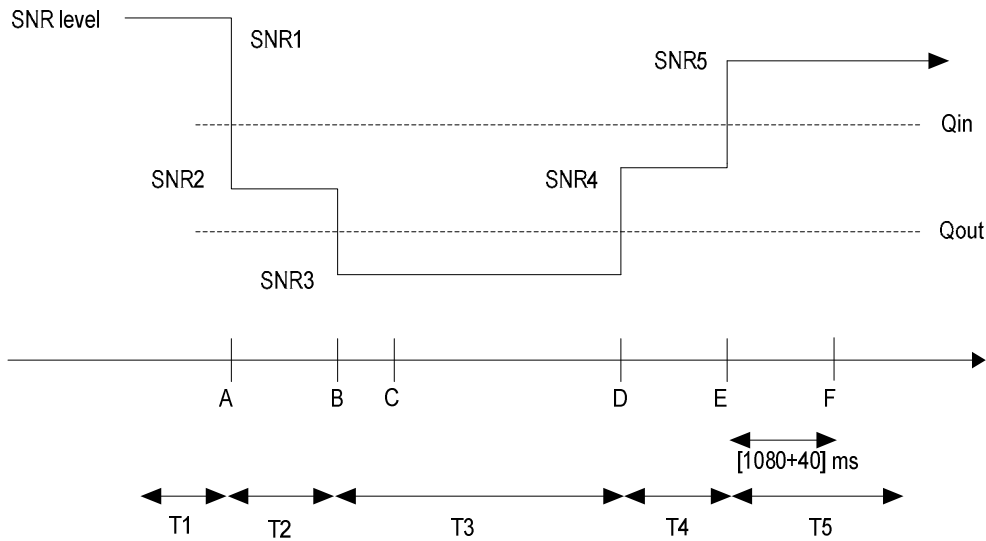

Figure A.7.3.77.1-1: SNR variation for in-sync testing in DRX

A.7.3.77.2 Test Requirements

The UE behaviour in each test during time durations T1, T2, T3, T4 and T5 shall be as follows:

During the period from time point A to time point F (1120 ms after the start of time duration T5) the UE shall transmit uplink signal at least once every DRX cycle, in the On-duration part of the cycle in the subframe according to the configured CQI reporting mode (PUCCH 1-0).

The rate of correct events observed during repeated tests shall be at least 90%.

A.7.3.78 E-UTRAN TDD Radio Link Monitoring Test for Out-of-sync for non-BL CE UE in CEMode A

A.7.3.78.1 Test Purpose and Environment

The purpose of this test is to verify that the TDD non-BL CE UE properly detects the out of sync and in sync for the purpose of monitoring downlink radio link quality of the PCell in CEModeA. This test will partly verify the E-UTRAN TDD radio link monitoring requirements for non-BL CE UE defined in clause 7.19.

The test parameters are given in Tables A.7.3.78.1-1 and A.7.3.78.1-2 below. There is one cell (cell 1), which is the active cell, in the test. The test consists of three successive time periods, with time duration of T1, T2 and T3 respectively. Figure A.7.3.78.1-1 shows the variation of the downlink SNR in the active cell to emulate out-of-sync and in-sync states. Prior to the start of the time duration T1, the UE shall be fully synchronized to cell 1. The UE shall be configured for periodic CQI reporting in PUCCH 1-0 mode with a reporting periodicity of 1 ms.

In the test, the RRC parameter *numberPRB-Pairs* is set to 4 and the RRC parameter *mPDCCH-NumRepetition* is set to 8. UE shall successfully complete the RRC reconfiguration accordingly prior to the start of time duration T1.

Table A.7.3.78.1-1: General test parameters for E-UTRAN TDD out-of-sync testing for non-BL CE UE in CEMode A

Parameter		Unit	Value	Comment
Active cell			Cell 1	Cell 1 is on E-UTRA RF channel number 1
CP length			Normal	
Out of sync transmission parameters (Note 1)	DCI format		6-1A	As defined in section 5.3.3.1.12 in TS 36.212
	Number of OFDM symbols for legacy control channels		2	Out of sync threshold Q_{out} and the corresponding hypothetical MPDCCH transmission parameters are as specified in section 7.19.2 and Table 7.19.2-1 respectively.
	M-PDCCH aggregation level	eCCE	24	
	M-PDCCH repetition level		4	
	ρ_A, ρ_B		-3	
DRX			OFF	
Layer 3 filtering			Enabled	Counters: $N_{310} = 1; N_{311} = 1$
T310 timer		ms	0	T310 is disabled
T311 timer		ms	1000	T311 is enabled
Periodic CQI reporting mode			PUCCH 1-0	As defined in table 7.2.2-1 in TS 36.213.
CQI reporting periodicity		ms	1	Minimum CQI reporting periodicity
T1		s	2	
T2		s	0.8	
T3		s	1.8	
Note 1: MPDCCH corresponding to the out of sync transmission parameters need not be included in the Reference Measurement Channel.				

Table A.7.3.78.1-2: Cell specific test parameters for E-UTRAN TDD (cell # 1) for out-of-sync radio link monitoring tests for non-BL CE CE in CEMode A

Parameter	Unit	Test 1		
		T1	T2	T3
E-UTRA RF Channel Number		1		
$BW_{channel}$	MHz	10		
Special subframe configuration ^{Note 1}		6		
Uplink-downlink configuration ^{Note 1}		1		
MPDCCH parameters as defined in A.3.1.3		R.15 TDD ^{Note 8}		
OCNG Pattern defined in A.3.2.2 (TDD)		OP.11 TDD		
ρ_A, ρ_B		-3		
PBCH_RA	dB	-3		
PBCH_RB	dB			
PSS_RA	dB			
SSS_RA	dB			
OCNG_RA ^{Note 1}	dB			
OCNG_RB ^{Note 1}	dB			

N_{oc}	dBm/15 kHz	-98		
SNR ^{Note 7}	dB	-1.5	-7.9	-15.9 ^{Note 9}
Propagation condition		ETU 30Hz		
Correlation Matrix and Antenna Configuration		2x2 Low 2x4 Low		
<p>Note 1: For special subframe and uplink-downlink configurations see Tables 4.2-1 and 4.2-2 in TS 36.211.</p> <p>Note 2: OCNB shall be used such that the resources in cell # 1 are fully allocated and a constant total transmitted power spectral density is achieved for all OFDM symbols.</p> <p>Note 3: The uplink resources for CQI reporting are assigned to the UE prior to the start of time period T1.</p> <p>Note 4: The timers and layer 3 filtering related parameters are configured prior to the start of time period T1.</p> <p>Note 5: The signal contains PDCCH for UEs other than the device under test as part of OCNB.</p> <p>Note 6: SNR levels correspond to the signal to noise ratio over the cell-specific reference signal REs.</p> <p>Note 7: The SNR in time periods T1, T2 and T3 is denoted as SNR1, SNR2 and SNR3 respectively in figure A.7.3.78.1-1.</p> <p>Note 8: Aggregation level and repetition levels specified in A.7.3.78.1-1 are used for this test.</p> <p>Note 9: For 4 Rx UE, SNR in T3 is -18.0 dB.</p>				

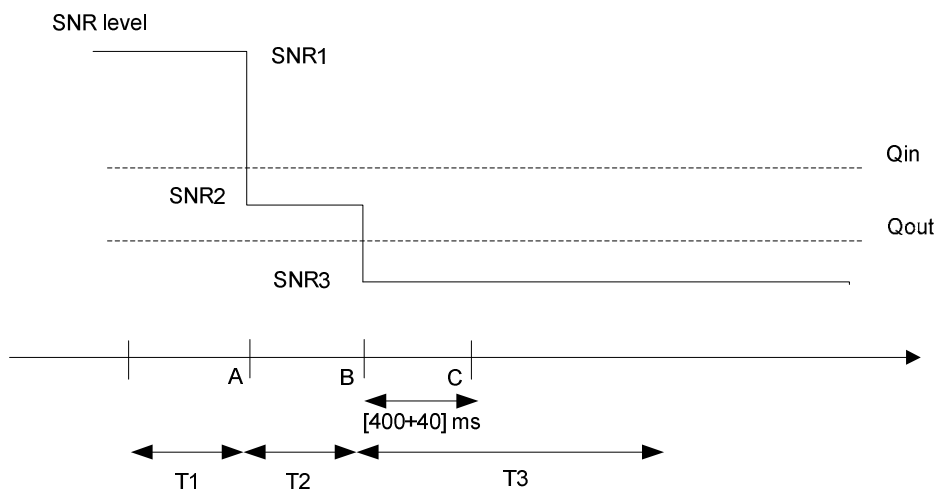

Figure A.7.3.78.1-1: SNR variation for out-of-sync testing

A.7.3.78.2 Test Requirements

The UE behaviour in each test during time durations T1, T2 and T3 shall be as follows:

During the period from time point A to time point B the UE shall transmit uplink signal at least in all subframes configured for CQI transmission according to the configured CQI reporting mode (PUCCH 1-0).

The UE shall stop transmitting uplink signal no later than time point C (440 ms after the start of time duration T3).

The rate of correct events observed during repeated tests shall be at least 90%.

A.7.3.79 E-UTRAN TDD Radio Link Monitoring Test for In-Sync for non-BL CE UE in CEMode A

A.7.3.79.1 Test Purpose and Environment

The purpose of this test is to verify that the TDD non-BL CE UE properly detects the out of sync and in sync for the purpose of monitoring downlink radio link quality of the PCell in CEModeA. This test will partly verify the E-UTRAN TDD radio link monitoring requirements for non-BL CE UE defined in clause 7.19.

The test parameters are given in Tables A.7.3.79.1-1 and A.7.3.79.1-2 below. There is one cell (cell 1), which is the active cell, in the test. The test consists of five successive time periods, with time duration of T1, T2, T3, T4 and T5 respectively. Figure A.7.3.79.1-1 shows the variation of the downlink SNR in the active cell to emulate out-of-sync and in-sync states. Prior to the start of the time duration T1, the UE shall be fully synchronized to cell 1. The UE shall be configured for periodic CQI reporting in PUCCH 1-0 mode without repetition with a reporting periodicity of 1 ms.

In the test, the RRC parameter *numberPRB-Pairs* is set to 4 and the RRC parameter *mPDCCH-NumRepetition* is set to 8. UE shall successfully complete the RRC reconfiguration accordingly prior to the start of time duration T1.

Table A.7.3.79.1-1: General test parameters for E-UTRAN TDD in-sync testing for non-BL CE UE in CEMode A

Parameter		Unit	Value	Comment
Active cell			Cell 1	Cell 1 is on E-UTRA RF channel number 1
CP length			Normal	
In sync transmission parameters (Note 1)	DCI format		6-1A	As defined in section 5.3.3.1.12 in TS 36.212
	Number of OFDM symbols for legacy control channels		2	In sync threshold Q_{in} and the corresponding hypothetical MPDCCH transmission parameters are as specified in section 7.19.2 and Table 7.19.2-1 respectively.
	M-PDCCH aggregation level	eCCE	4	
	M-PDCCH repetition level		1	
	ρ_A, ρ_B		-3	
DRX		OFF		
Out of sync transmission parameters (Note 1)	DCI format		6-1A	As defined in section 5.3.3.1.12 in TS 36.212
	Number of OFDM symbols for legacy control channels		2	Out of sync threshold Q_{out} and the corresponding hypothetical MPDCCH transmission parameters are as specified in section 7.19.2 and Table 7.19.2-1 respectively.
	M-PDCCH aggregation level	eCCE	16	
	M-PDCCH repetition level		2	
	ρ_A, ρ_B		-3	
DRX		OFF		
Layer 3 filtering		Enabled	Counters: $N_{310} = 1; N_{311} = 1$	
T310 timer	ms	2000	T310 is enabled	
T311 timer	ms	1000	T311 is enabled	
Periodic CQI reporting mode		PUCCH 1-0	As defined in table 7.2.2-1 in TS 36.213.	
CQI reporting periodicity	ms	1	Minimum CQI reporting periodicity	
T1	s	2		
T2	s	0.8		

T3	s	1.36	
T4	s	0.4	
T5	s	2	
Note 1: MPDCCH corresponding to the in-sync and out of sync transmission parameters need not be included in the Reference Measurement Channel.			

Table A.7.3.79.1-2: Cell specific test parameters for E-UTRAN TDD (cell # 1) for in-sync radio link monitoring tests for non-BL CE UE in CEMode A

Parameter	Unit	Test 1									
		T1	T2	T3	T4	T5					
E-UTRA RF Channel Number		1									
BW_{channel}	MHz	10									
Special subframe configuration <small>Note 1</small>		6									
Uplink-downlink configuration <small>Note 1</small>		1									
MPDCCH parameters as defined in A.3.1.3		R.15 TDD									
OCNG Pattern defined in A.3.2.2 (TDD)		OP.11 TDD									
ρ_A, ρ_B		-3									
MPDCCH_RA	dB	0									
MPDCCH_RB	dB	0									
PBCH_RA	dB	-3									
PBCH_RB	dB										
PSS_RA	dB										
SSS_RA	dB										
OCNG_RA <small>Note 2</small>	dB										
OCNG_RB <small>Note 2</small>	dB										
N_{oc}	dBm/15 kHz						-98				
SNR <small>Note 6</small>	dB						3.3	-4.8	-12.8 <small>Note 8</small>	-2.8	3.3
Propagation condition		AWGN									
Correlation Matrix and Antenna Configuration		2x2 2x4									
<p>Note 1: For special subframe and uplink-downlink configurations see Tables 4.2-1 and 4.2-2 in TS 36.211.</p> <p>Note 2: OCNG shall be used such that the resources in cell # 1 are fully allocated and a constant total transmitted power spectral density is achieved for all OFDM symbols.</p> <p>Note 3: The uplink resources for CQI reporting are assigned to the UE prior to the start of time period T1.</p> <p>Note 4: The timers and layer 3 filtering related parameters are configured prior to the start of time period T1.</p> <p>Note 5: The signal contains PDCCH for UEs other than the device under test as part of OCNG.</p> <p>Note 6: SNR levels correspond to the signal to noise ratio over the cell-specific reference signal REs.</p> <p>Note 7: The SNR in time periods T1, T2, T3, T4 and T5 is denoted as SNR1, SNR2, SNR3, SNR4 and SNR5 respectively in figure A.7.3.79.1-1.</p> <p>Note 8: For 4 Rx UE, SNR in T3 is -15.0 dB.</p>											

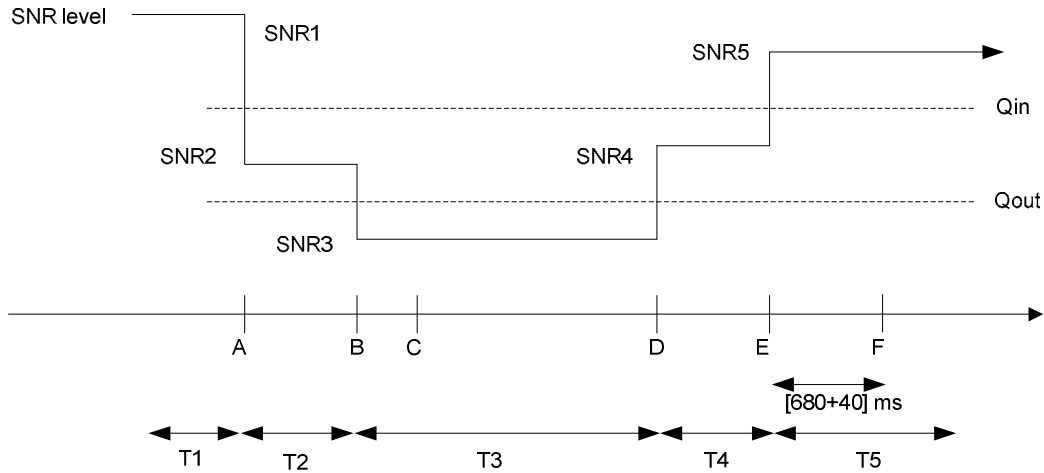

Figure A.7.3.79.1-1: SNR variation for in-sync testing

A.7.3.79.2 Test Requirements

The UE behaviour in each test during time durations T1, T2, T3, T4 and T5 shall be as follows:

During the period from time point A to time point F (720 ms after the start of time duration T5) the UE shall transmit uplink signal at least in all subframes configured for CQI transmission according to the configured CQI reporting mode (PUCCH 1-0).

The rate of correct events observed during repeated tests shall be at least 90%.

A.7.3.80 E-UTRAN TDD Radio Link Monitoring Test for Out-of-sync in DRX for non-BL CE UE configured in CEMode A

A.7.3.80.1 Test Purpose and Environment

The purpose of this test is to verify that the TDD non-BL CE UE configured in CEMode A properly detects the out of sync for the purpose of monitoring downlink radio link quality of the PCell when DRX is used. This test will partly verify the E-UTRAN TDD radio link monitoring requirements in clause 7.19.

The test parameters are given in Tables A.7.3.80.1-1, A.7.3.80.1-2, A.7.3.80.1-3 and A.7.3.80.1-4. There is one cell (cell 1), which is the active cell, in the test. The test consists of three successive time periods, with time duration of T1, T2 and T3 respectively. Figure A.7.3.80.1-1 shows the variation of the downlink SNR in the active cell to emulate out-of-sync states. Prior to the start of the time duration T1, the UE shall be fully synchronized to cell 1. The UE shall be configured for periodic CQI reporting in PUCCH 1-0 mode with a reporting periodicity of 1 ms without repetition. In the test, DRX configuration is enabled and DRX inactivity timer has already been expired, i.e. UE tries to decode MPDCCH and to send periodic CQI during the period when On-duration timer is running. Time alignment timers shall be set to “infinity” so that UL timing alignment is maintained during the test.

In the test, the RRC parameter *numberPRB-Pairs* is set to 4 and the RRC parameter *mPDCCH-NumRepetition* is set 8. UE shall successfully complete the RRC reconfiguration accordingly prior to the start of time duration T1.

Table A.7.3.80.1-1: General test parameters for E-UTRAN TDD out-of-sync tests in DRX for non-BL CE UE configured in CEMode A

Parameter		Unit	Value	Comment
Active cell			Cell 1	Cell 1 is on E-UTRA RF channel number 1
CP length			Normal	
Out of sync transmission parameters (Note 1)	DCI format		6-1A	As defined in section 5.3.3.1.12 in TS 36.212
	Number of OFDM symbols for legacy control channels		2	Out of sync threshold $Q_{out, Cat M1}$ and the corresponding hypothetical MPDCCH transmission parameters are as specified in clause 7.19.2 and Table 7.19.2-1 respectively.
	MPDCCH aggregation level	eCCE	16	
	MPDCCH repetition level		2	
	ρ_A, ρ_B		-3	
Ratio of MPDCCH to RS EPRE	dB	0		
DRX cycle		ms	1280	See Table A.7.3.80.1-3
Layer 3 filtering			Enabled	Counters: $N_{310} = 1; N_{311} = 1$
T310 timer		ms	0	T310 is disabled
T311 timer		ms	1000	T311 is enabled
Periodic CQI reporting mode			PUCCH 1-0	As defined in table 7.2.2-1 in TS 36.213.
CQI reporting periodicity		ms	1	Minimum CQI reporting periodicity
T1		s	32	
T2		s	12.8	
T3		s	13	
Note 1: MPDCCH corresponding to the out of sync transmission parameters need not be included in the Reference Measurement Channel.				

Table A.7.3.80.1-2: Cell specific test parameters for E-UTRAN TDD (cell # 1) for out-of-sync radio link monitoring tests in DRX for non-BL CE UE configured in CEMode A

Parameter	Unit	Test 1		
		T1	T2	T3
E-UTRA RF Channel Number		1		
$BW_{channel}$	MHz	10		
Special subframe configuration		6		
Uplink-downlink configuration		1		
MPDCCH parameters defined in A.3.1.3		R.15 TDD		
OCNG Pattern defined in A.3.2.2 (TDD)		OP.11 TDD		
ρ_A, ρ_B		-3		
MPDCCH_RA	dB	0		
MPDCCH_RB	dB	0		
PBCH_RA	dB	-3		
PBCH_RB	dB			
PSS_RA	dB			
SSS_RA	dB			
OCNG_RA ^{Note1}	dB			
OCNG_RB ^{Note1}	dB			

N_{oc}	dBm/15 kHz	-98		
SNR ^{Note 6}	dB	-0.9	-7.7	-14.7 ^{Note 7}
Propagation condition		AWGN		
Correlation Matrix and Antenna Configuration		2x2 2x4		
Note 1:	OCNG shall be used such that the resources in cell # 1 are fully allocated and a constant total transmitted power spectral density is achieved for all OFDM symbols.			
Note 2:	The uplink resources for CQI reporting are assigned to the UE prior to the start of time period T1.			
Note 3:	The timers and layer 3 filtering related parameters are configured prior to the start of time period T1.			
Note 4:	The signal contains MPDCCH for UEs other than the device under test as part of OCNG.			
Note 5:	SNR levels correspond to the signal to noise ratio over the cell-specific reference signal REs.			
Note 6:	The SNR in time periods T1, T2 and T3 is denoted as SNR1, SNR2 and SNR3 respectively in figure A.7.3.80.1-1.			
Note 7:	For 4 Rx UE, SNR in T3 is -17.2 dB.			

Table A.7.3.80.1-3: DRX-Configuration for E-UTRAN TDD out-of-sync tests for non-BL CE UE configured in CEMode A

Field	Value	Comment
onDurationTimer	psf10	As specified in clause 6.3.2 in TS 36.331
drx-InactivityTimer	psf1	
drx-RetransmissionTimer	psf1	
longDRX-CycleStartOffset	sf1280	
shortDRX	disable	

Table A.7.3.80.1-4: TimeAlignmentTimer-Configuration for E-UTRAN TDD out-of-sync testing for non-BL CE UE configured in CEMode A

Field	Value	Comment
TimeAlignmentTimer	infinity	As specified in clause 6.3.2 in TS 36.331
sr-ConfigIndex	0	For further information see clause 6.3.2 in TS 36.331 and section 10.1 in TS 36.213.

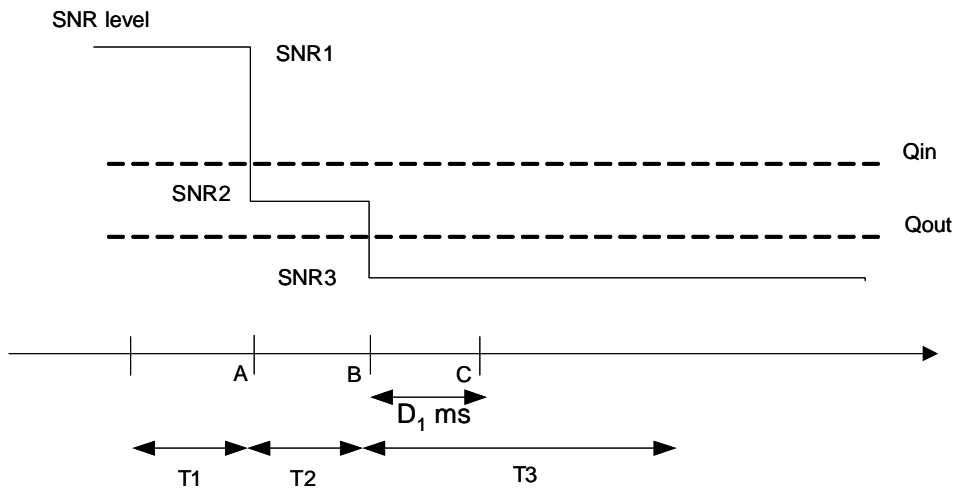

Figure A.7.3.80.1-1: SNR variation for out-of-sync testing in DRX

A.7.3.80.2 Test Requirements

The UE behaviour in each test during time durations T1, T2 and T3 shall be as follows:

During the period from time point A to time point B the UE shall transmit uplink signal at least once every DRX cycle, in the On-duration part of the cycle in the subframe according to the configured CQI reporting mode (PUCCH 1-0).

The UE shall stop transmitting uplink signal no later than time point C (duration $D_1 = 6500$ ms after the start of time duration T3).

The rate of correct events observed during repeated tests shall be at least 90%.

A.7.3.81 E-UTRAN TDD Radio Link Monitoring Test for In-sync in DRX for non-BL CE UE configured in CEMode A

A.7.3.81.1 Test Purpose and Environment

The purpose of this test is to verify that the TDD non-BL CE UE configured in CEMode A properly detects the out of sync and in sync for the purpose of monitoring downlink radio link quality of the PCell when DRX is used. This test will partly verify the E-UTRAN TDD radio link monitoring requirements in clause 7.19.

The test parameters are given in Tables A.7.3.81.1-1, A.7.3.81.1-2, A.7.3.81.1-3 and A.7.3.81.1-4. There is one cell (cell 1), which is the active cell, in the test. The test consists of five successive time periods, with time duration of T1, T2, T3, T4 and T5 respectively. Figure A.7.3.81.1-1 shows the variation of the downlink SNR in the active cell to emulate out-of-sync and in-sync states. Prior to the start of the time duration T1, the UE shall be fully synchronized to cell 1. The UE shall be configured for periodic CQI reporting in PUCCH 1-0 mode with a reporting periodicity of 1 ms without repetition. In the test, DRX configuration is enabled and DRX inactivity timer has already been expired, i.e. UE tries to decode MPDCCH and to send periodic CQI during the period when On-duration timer is running. Time alignment timers shall be set to “infinity” so that UL timing alignment is maintained during the test.

In the test, the RRC parameter *numberPRB-Pairs* is set to 4 and the RRC parameter *mPDCCH-NumRepetition* is set 8. UE shall successfully complete the RRC reconfiguration accordingly prior to the start of time duration T1.

Table A.7.3.81.1-1: General test parameters for E-UTRAN TDD in-sync test in DRX for non-BL CE UE configured in CEMode A

Parameter		Unit	Value	Comment
Active cell			Cell 1	Cell 1 is on E-UTRA RF channel number 1
CP length			Normal	
In sync transmission parameters (Note 1)	DCI format		6-1A	As defined in section 5.3.3.1.12 in TS 36.212
	Number of OFDM symbols for legacy control channels		2	In sync threshold $Q_{in, Cat M1}$ and the corresponding hypothetical MPDCCH transmission parameters are as specified in clause 7.19.2 and Table 7.19.2-1 respectively.
	MPDCCH aggregation level	eCCE	8	
	MPDCCH repetition level		2	
	ρ_A, ρ_B		-3	
Ratio of MPDCCH to RS EPRE		0		
Out of sync transmission parameters (Note 1)	DCI format		6-1A	As defined in section 5.3.3.1.12 in TS 36.212
	Number of OFDM symbols for legacy control channels		2	Out of sync threshold $Q_{out, Cat M1}$ and the corresponding hypothetical MPDCCH transmission parameters are as specified in clause 7.19.2 and Table 7.19.2-1 respectively.
	MPDCCH aggregation level	eCCE	24	
	MPDCCH repetition level		4	
	ρ_A, ρ_B		-3	
Ratio of MPDCCH to RS EPRE	dB	0		
DRX cycle		ms	40	See Table A.7.3.81.1-3

Layer 3 filtering		Enabled	Counters: N310 = 1; N311 = 1
T310 timer	ms	2000	T310 is enabled
T311 timer	ms	1000	T311 is enabled
Periodic CQI reporting mode		PUCCH 1-0	As defined in table 7.2.2-1 in TS 36.213.
CQI reporting periodicity	ms	1	Minimum CQI reporting periodicity
T1	s	4	
T2	s	1.6	
T3	s	1.46	
T4	s	0.4	
T5	s	4	
Note 1: MPDCCH corresponding to the in-sync and out of sync transmission parameters need not be included in the Reference Measurement Channel.			

Table A.7.3.81.1-2: Cell specific test parameters for E-UTRAN TDD (cell # 1) for in-sync radio link monitoring test in DRX for non-BL CE UE configured in CEMode A

Parameter	Unit	Test 1				
		T1	T2	T3	T4	T5
E-UTRA RF Channel Number		1				
$BW_{channel}$	MHz	10				
Special subframe configuration		6				
Uplink-downlink configuration		1				
MPDCCH parameters defined in A.3.1.3		R.15 TDD				
OCNG Pattern defined in A.3.2.2 (TDD)		OP.11 TDD				
ρ_A, ρ_B		-3				
MPDCCH_RA	dB	0				
MPDCCH_RB	dB	0				
PBCH_RA	dB	-3				
PBCH_RB	dB					
PSS_RA	dB					
SSS_RA	dB					
OCNG_RA ^{Note1}	dB					
OCNG_RB ^{Note1}	dB					
N_{oc}	dBm/15 kHz					
SNR ^{Note 6}	dB	-5.7	-9.5	-16.5 ^{Note 7}	-11.2	-5.2
Propagation condition		AWGN				
Correlation Matrix and Antenna Configuration		2x2 2x4				
Note 1: OCNG shall be used such that the resources in cell # 1 are fully allocated and a constant total transmitted power spectral density is achieved for all OFDM symbols. Note 2: The uplink resources for CQI reporting are assigned to the UE prior to the start of time period T1. Note 3: The timers and layer 3 filtering related parameters are configured prior to the start of time period T1. Note 4: The signal contains MPDCCH for UEs other than the device under test as part of OCNG. Note 5: SNR levels correspond to the signal to noise ratio over the cell-specific reference signal REs. Note 6: The SNR in time periods T1, T2, T3, T4 and T5 is denoted as SNR1, SNR2, SNR3, SNR4 and SNR5 respectively in figure A.7.3.81.1-1. Note 7: For 4 Rx UE, SNR in T3 is -19.5 dB.						

Table A.7.3.81.1-3: DRX-Configuration for E-UTRAN TDD out-of-sync tests for non-BL CE UE configured in CEMode A

Field	Value	Comment
onDurationTimer	psf10	As specified in clause 6.3.2 in TS 36.331
drx-InactivityTimer	psf1	
drx-RetransmissionTimer	psf1	

longDRX-CycleStartOffset	sf40
shortDRX	disable

Table A.7.3.81.1-4: TimeAlignmentTimer -Configuration for E-UTRAN TDD out-of-sync testing for non-BL CE UE configured in CEMode A

Field	Value	Comment
TimeAlignmentTimer	infinity	As specified in clause 6.3.2 in TS 36.331
sr-ConfigIndex	0	For further information see clause 6.3.2 in TS 36.331 and section 10.1 in TS 36.213.

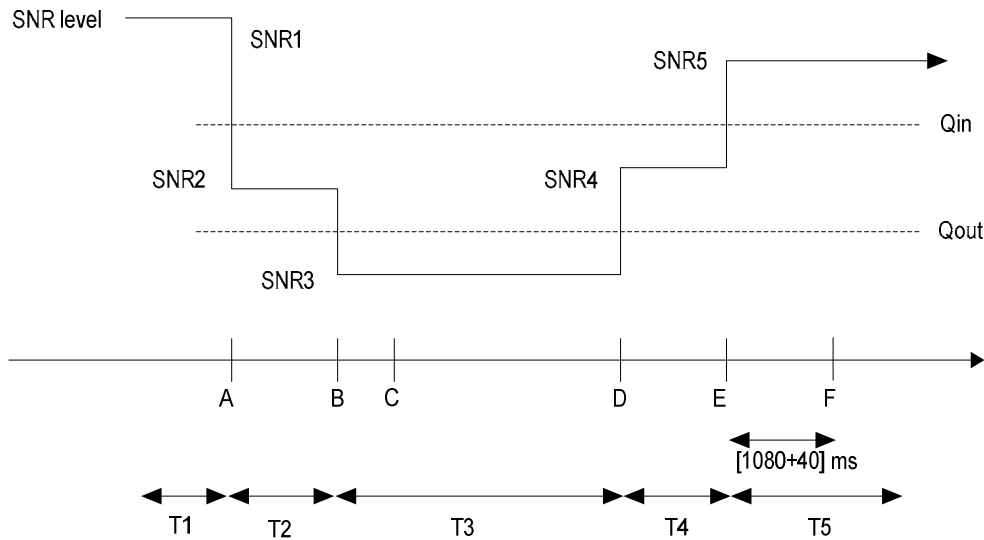

Figure A.7.3.81.1-1: SNR variation for in-sync testing in DRX

A.7.3.81.2 Test Requirements

The UE behaviour in each test during time durations T1, T2, T3, T4 and T5 shall be as follows:

During the period from time point A to time point F (1120 ms after the start of time duration T5) the UE shall transmit uplink signal at least once every DRX cycle, in the On-duration part of the cycle in the subframe according to the configured CQI reporting mode (PUCCH 1-0).

The rate of correct events observed during repeated tests shall be at least 90%.

A.7.3.82 E-UTRAN FD-FDD Early Out-of-sync reporting Test for Cat-M1 UE in CEModeB

A.7.3.82.1 Test Purpose and Environment

The purpose of this test is to verify that the FD-FDD Cat-M1 UE properly detects an early out of sync event and makes correct reporting of it for the purpose of monitoring the downlink radio link quality of the PCell in CEModeB. This test will partly verify the E-UTRAN FDD radio link monitoring requirements for Cat-M1 UE defined in clause 7.19.

The test parameters are given in Tables A.7.3.82.1-1 and A.7.3.82.1-2 below. There is one cell (cell 1), which is the active cell, in the test. The test consists of three successive time periods, with time duration of T1, T2 and T3 respectively. Figure A.7.3.82.1-1 shows the variation of the downlink SNR in the active cell to emulate early out-of-sync and early in-sync states. Prior to the start of the time duration T1, the UE shall be fully synchronized to cell 1.

In the test, the RRC parameter *numberPRB-Pairs* is set to 6 and the RRC parameter *mPDCCH-NumRepetition* is set to 128. In addition, the UE is configured with *rlm-ReportConfig*. UE shall successfully complete the RRC reconfiguration accordingly prior to the start of time duration T1.

Table A.7.3.82.1-1: General test parameters for E-UTRAN FD-FDD early out-of-sync testing for UE Cat-M1 in CEModeB

Parameter		Unit	Value	Comment
Active cell			Cell 1	Cell 1 is on E-UTRA RF channel number 1
CP length			Normal	
Early Out of sync transmission parameters (Note 1)	DCI format		6-1B	As defined in section 5.3.3.1.12 in TS 36.212
	Number of OFDM symbols for legacy control channels		2	Early Out of sync threshold $Q_{E1_out_CatM1}$ and the corresponding hypothetical MPDCCH transmission parameters are as specified in section 7.19.4 and Table 7.19.4-2 respectively.
	M-PDCCH aggregation level	eCCE	16	
	M-PDCCH repetition level		64	
	ρ_A, ρ_B		-3	
DRX			OFF	
Layer 3 filtering			Enabled	Counters: N310 = 1; N311 = 1
T310 timer		ms	1800	T310 is enabled
T314 timer		ms	0	T314 is disabled
T311 timer		ms	1000	T311 is enabled
T1		s	2	
T2		s	0.8	
T3		s	1.8	
Note 1: MPDCCH corresponding to the early out of sync transmission parameters need not be included in the Reference Measurement Channel.				

Table A.7.3.82.1-2: Cell specific test parameters for E-UTRAN FD-FDD (cell # 1) for early out-of-sync radio link monitoring tests for Cat-M1 in CEModeB

Parameter	Unit	Test 1		
		T1	T2	T3
E-UTRA RF Channel Number		1		
BW _{channel}	MHz	5: 10		
MPDCCH parameters as defined in A.3.1.3.4		R.19 FDD		
OCNG Pattern defined in A.3.2.1 (FDD)		5MHz: OP.22 FDD 10MHz: OP.21 FDD		
ρ_A, ρ_B		-3		
MPDCCH_RA	dB	0		
MPDCCH_RB	dB	0		
PBCH_RA	dB	-3		
PBCH_RB	dB			
PSS_RA	dB			
SSS_RA	dB			
OCNG_RA ^{Note 1}	dB			
OCNG_RB ^{Note 1}	dB			
N_{oc}	dBm/15 kHz			
SNR ^{Note 5}	dB	-10	-16.6	-22.6
Propagation condition		ETU 30Hz		
Correlation Matrix and Antenna Configuration		2x1 Low		

- | | |
|---------|--|
| Note 1: | OCNG shall be used such that the resources in cell # 1 are fully allocated and a constant total transmitted power spectral density is achieved for all OFDM symbols. |
| Note 2: | The timers and layer 3 filtering related parameters are configured prior to the start of time period T1. |
| Note 3: | The signal contains PDCCH for UEs other than the device under test as part of OCNG. |
| Note 4: | SNR levels correspond to the signal to noise ratio over the cell-specific reference signal REs. |
| Note 5: | The SNR in time periods T1, T2 and T3 is denoted as SNR1, SNR2 and SNR3 respectively in figure A.7.3.82.1-1. |

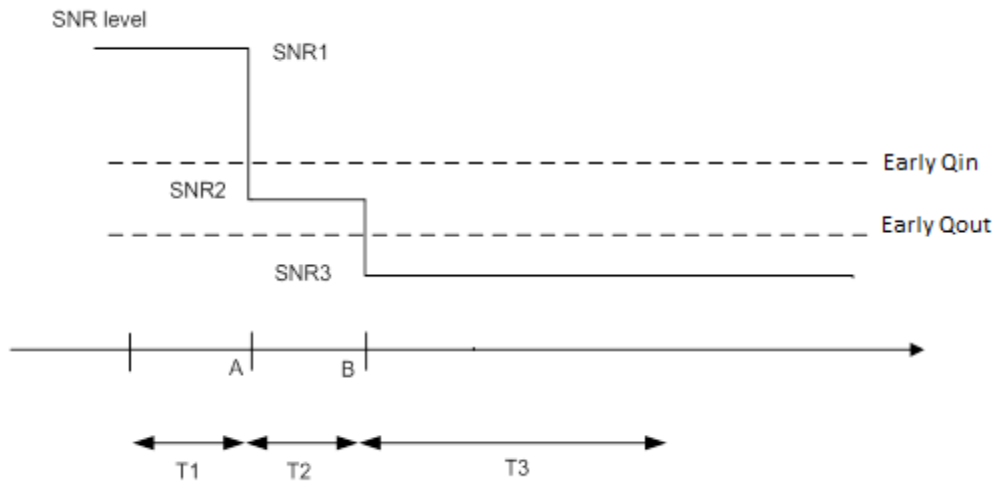

Figure A.7.3.82.1-1: SNR variation for early out-of-sync testing

A.7.3.82.2 Test Requirements

The UE shall compare the downlink radio link quality of the PCell over the last Q_{out_CatM1} evaluation, which is defined in 7.19.4.1, with the threshold $Q_{E1_out_CatM}$. When the estimated quality becomes worse than the threshold starting from time point B, Layer 1 of the UE shall trigger event E1 and send a report to the higher layers within Q_{out_CatM1} evaluation period.

The rate of correct events observed during repeated tests shall be at least 90%.

A.7.3.83 E-UTRAN FD-FDD Early In-Sync reporting Test for Cat-M1 UE in CEModeB

A.7.3.83.1 Test Purpose and Environment

The purpose of this test is to verify that the FD-FDD Cat-M1 UE properly detects an early in sync event and makes correct reporting of it for the purpose of monitoring the downlink radio link quality of the PCell in CEModeB. This test will partly verify the E-UTRAN FDD radio link monitoring requirements for Cat-M1 UE defined in clause 7.19.

The test parameters are given in Tables A.7.3.83.1-1 and A.7.3.83.1-2 below. There is one cell (cell 1), which is the active cell, in the test. The test consists of three successive time periods, with time duration of T1, T2 and T3 respectively. Figure A.7.3.83.1-1 shows the variation of the downlink SNR in the active cell to emulate early in-sync and early in-sync states. Prior to the start of the time duration T1, the UE shall be fully synchronized to cell 1.

In the test, the RRC parameter *numberPRB-Pairs* is set to 6 and the RRC parameter *mPDCCH-NumRepetition* is set to 128. In addition, the UE is configured with *rlm-ReportConfig*. UE shall successfully complete the RRC reconfiguration accordingly prior to the start of time duration T1.

Table A.7.3.83.1-1: General test parameters for E-UTRAN FD-FDD early in-sync testing for UE Cat-M1 in CEModeB

Parameter		Unit	Value	Comment
Active cell			Cell 1	Cell 1 is on E-UTRA RF channel number 1
CP length			Normal	
Early In sync transmission parameters (Note 1)	DCI format		6-1B	As defined in section 5.3.3.1.12 in TS 36.212 Early in-sync threshold $Q_{E2_in_CatM1}$ and the corresponding hypothetical MPDCCH transmission parameters are as specified in section 7.19.2 and Table 7.19.2-2 respectively.
	Number of OFDM symbols for legacy control channels		2	
	M-PDCCH aggregation level	eCCE	8	
	M-PDCCH repetition level		16	
	ρ_A, ρ_B		-3	
DRX			OFF	
Layer 3 filtering			Enabled	Counters: N310 = 1; N311 = 1
T310 timer		ms	2000	T310 is enabled
T311 timer		ms	1000	T311 is enabled
T315		ms	0	T315 is disabled
T1		s	2	
T2		s	0.8	
T3		s	1.36	
T4		s	0.4	
T5		s	2	
Note 1: MPDCCH corresponding to the early in-sync transmission parameters need not be included in the Reference Measurement Channel.				

Table A.7.3.83.1-2: Cell specific test parameters for E-UTRAN FD-FDD (cell # 1) for early in-sync radio link monitoring tests for Cat-M1 in CEModeB

Parameter	Unit	Test 1				
		T1	T2	T3	T4	T5
E-UTRA RF Channel Number		1				
$BW_{channel}$	MHz	5: 10				
MPDCCH parameters as defined in A.3.1.3.4		R.19 FDD				
OCNG Pattern defined in A.3.2.1 (FDD)		5MHz: OP.22 FDD 10MHz: OP.21 FDD				
ρ_A, ρ_B		-3				
MPDCCH_RA	dB	0				
MPDCCH_RB	dB	0				
PBCH_RA	dB	-3				
PBCH_RB	dB					
PSS_RA	dB					
SSS_RA	dB					
OCNG_RA ^{Note 1}	dB					
OCNG_RB ^{Note 1}	dB					
N_{oc}	dBm/15 kHz					
SNR ^{Note 6}	dB	-7	-16.6	-22.6	-15	-7
Propagation condition		ETU 30Hz				
Correlation Matrix and Antenna Configuration		2x1 Low				

- Note 1: OCNG shall be used such that the resources in cell # 1 are fully allocated and a constant total transmitted power spectral density is achieved for all OFDM symbols.
- Note 2: The uplink resources for CQI reporting are assigned to the UE prior to the start of time period T1.
- Note 3: The timers and layer 3 filtering related parameters are configured prior to the start of time period T1.
- Note 4: The signal contains PDCCH for UEs other than the device under test as part of OCNG.
- Note 5: SNR levels correspond to the signal to noise ratio over the cell-specific reference signal REs.
- Note 6: The SNR in time periods T1, T2, T3, T4 and T5 is denoted as SNR1, SNR2, SNR3, SNR4 and SNR5 respectively in figure A.7.3.83.1-1.

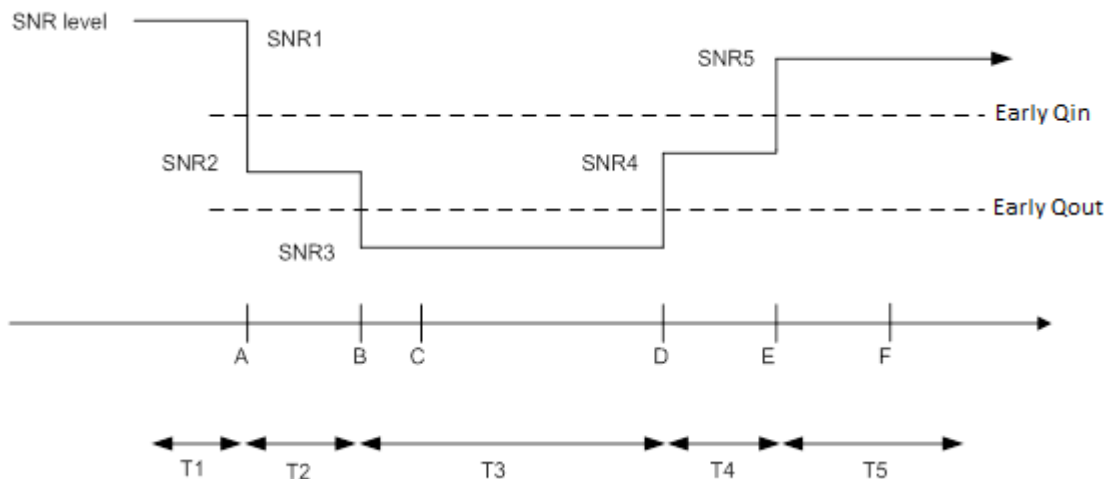

Figure A.7.3.83.1-1: SNR variation for early in-sync testing

A.7.3.83.2 Test Requirements

The UE shall compare the downlink radio link quality of the PCell over the last Q_{in_CatM1} evaluation, which is defined in 7.19.4.1, with the threshold $Q_{E2_in_CatM1}$. When the estimated quality becomes better than the threshold starting from time point E, Layer 1 of the UE shall trigger event E2 and send a report to the higher layers within Q_{in_CatM1} evaluation period.

The rate of correct events observed during repeated tests shall be at least 90%.

A.7.3.84 E-UTRAN HD-FDD Early Out-of-sync reporting Test for Cat-M1 UE in CEModeB

A.7.3.84.1 Test Purpose and Environment

The purpose of this test is to verify that the HD-FDD Cat-M1 UE properly detects an early out of sync event and makes correct reporting of it for the purpose of monitoring the downlink radio link quality of the PCell in CEModeB. This test will partly verify the E-UTRAN FDD radio link monitoring requirements for Cat-M1 UE defined in clause 7.19.

The test parameters are given in Tables A.7.3.84.1-1 and A.7.3.84.1-2 below. There is one cell (cell 1), which is the active cell, in the test. The test consists of three successive time periods, with time duration of T1, T2 and T3 respectively. Figure A.7.3.84.1-1 shows the variation of the downlink SNR in the active cell to emulate early out-of-sync and early in-sync states. Prior to the start of the time duration T1, the UE shall be fully synchronized to cell 1.

In the test, the RRC parameter *numberPRB-Pairs* is set to 6 and the RRC parameter *mPDCCH-NumRepetition* is set to 128. In addition, the UE is configured with *rlm-ReportConfig*. UE shall successfully complete the RRC reconfiguration accordingly prior to the start of time duration T1.

Table A.7.3.84.1-1: General test parameters for E-UTRAN HD-FDD early out-of-sync testing for UE Cat-M1 in CEModeB

Parameter	Unit	Value	Comment
Active cell		Cell 1	Cell 1 is on E-UTRA RF channel number 1
CP length		Normal	
DCI format		6-1B	As defined in section 5.3.3.1.12 in TS 36.212

Early Out of sync transmission parameters (Note 1)	Number of OFDM symbols for legacy control channels		2	Early Out of sync threshold $Q_{E1_out_CatM1}$ and the corresponding hypothetical MPDCCH transmission parameters are as specified in section 7.19.4 and Table 7.19.4-2 respectively.
	M-PDCCH aggregation level	eCCE	16	
	M-PDCCH repetition level		64	
	ρ_A, ρ_B		-3	
DRX			OFF	
Layer 3 filtering			Enabled	Counters: N310 = 1; N311 = 1
T310 timer		ms	1800	T310 is enabled
T314 timer		ms	0	T314 is disabled
T311 timer		ms	1000	T311 is enabled
T1		s	2	
T2		s	0.8	
T3		s	1.8	
Note 1: MPDCCH corresponding to the early out of sync transmission parameters need not be included in the Reference Measurement Channel.				

Table A.7.3.84.1-2: Cell specific test parameters for E-UTRAN HD-FDD (cell # 1) for early out-of-sync radio link monitoring tests for Cat-M1 in CEModeB

Parameter	Unit	Test 1		
		T1	T2	T3
E-UTRA RF Channel Number		1		
BW _{channel}	MHz	5: 10		
MPDCCH parameters as defined in A.3.1.3.5		R.9 HD-FDD		
OCNG Pattern defined in A.3.2.1 (FDD)		5MHz: OP.22 FDD 10MHz: OP.21 FDD		
ρ_A, ρ_B		-3		
MPDCCH_RA	dB	0		
MPDCCH_RB	dB	0		
PBCH_RA	dB	-3		
PBCH_RB	dB			
PSS_RA	dB			
SSS_RA	dB			
OCNG_RA ^{Note 1}	dB			
OCNG_RB ^{Note 1}	dB			
N_{oc}	dBm/15 kHz			
SNR ^{Note 5}	dB	-10	-16.6	-22.6
Propagation condition		ETU 30Hz		
Correlation Matrix and Antenna Configuration		2x1 Low		
<p>Note 1: OCNG shall be used such that the resources in cell # 1 are fully allocated and a constant total transmitted power spectral density is achieved for all OFDM symbols.</p> <p>Note 2: The timers and layer 3 filtering related parameters are configured prior to the start of time period T1.</p> <p>Note 3: The signal contains PDCCH for UEs other than the device under test as part of OCNG.</p> <p>Note 4: SNR levels correspond to the signal to noise ratio over the cell-specific reference signal REs.</p> <p>Note 5: The SNR in time periods T1, T2 and T3 is denoted as SNR1, SNR2 and SNR3 respectively in figure A.7.3.84.1-1.</p>				

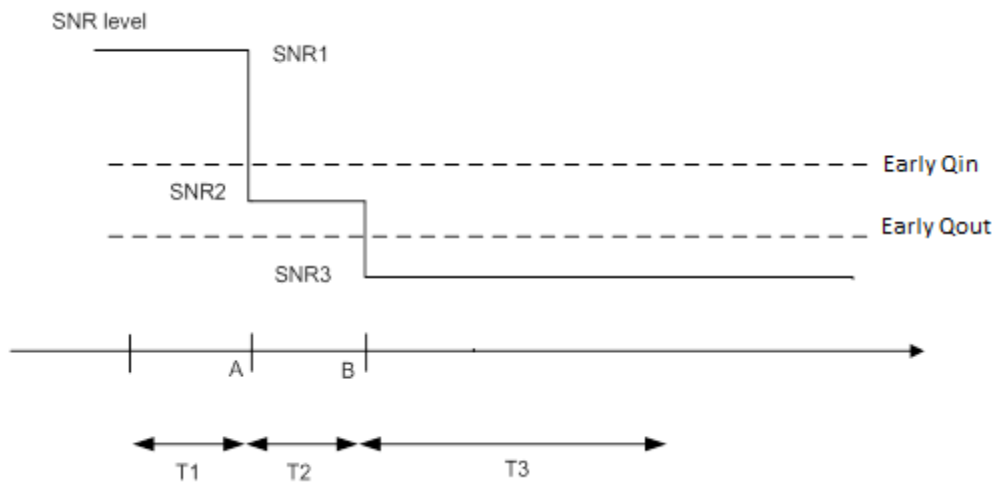

Figure A.7.3.84.1-1: SNR variation for early out-of-sync testing

A.7.3.84.2 Test Requirements

The UE shall compare the downlink radio link quality of the PCell over the last Q_{out_CatM1} evaluation, which is defined in 7.19.4.1, with the threshold $Q_{E1_out_CatM}$. When the estimated quality becomes worse than the threshold starting from time point B, Layer 1 of the UE shall trigger event E1 and send a report to the higher layers within Q_{out_CatM1} evaluation period.

The rate of correct events observed during repeated tests shall be at least 90%.

A.7.3.85 E-UTRAN HD-FDD Early In-Sync reporting Test for Cat-M1 UE in CEModeB

A.7.3.85.1 Test Purpose and Environment

The purpose of this test is to verify that the HD-FDD Cat-M1 UE properly detects an early in sync event and makes correct reporting of it for the purpose of monitoring the downlink radio link quality of the PCell in CEModeB. This test will partly verify the E-UTRAN FDD radio link monitoring requirements for Cat-M1 UE defined in clause 7.19.

The test parameters are given in Tables A.7.3.85.1-1 and A.7.3.85.1-2 below. There is one cell (cell 1), which is the active cell, in the test. The test consists of three successive time periods, with time duration of T1, T2 and T3 respectively. Figure A.7.3.85.1-1 shows the variation of the downlink SNR in the active cell to emulate early in-sync and early in-sync states. Prior to the start of the time duration T1, the UE shall be fully synchronized to cell 1.

In the test, the RRC parameter *numberPRB-Pairs* is set to 6 and the RRC parameter *mPDCCH-NumRepetition* is set to 128. In addition, the UE is configured with *rlm-ReportConfig*. UE shall successfully complete the RRC reconfiguration accordingly prior to the start of time duration T1.

Table A.7.3.85.1-1: General test parameters for E-UTRAN HD-FDD early in-sync testing for UE Cat-M1 in CEModeB

Parameter		Unit	Value	Comment
Active cell			Cell 1	Cell 1 is on E-UTRA RF channel number 1
CP length			Normal	
Early In sync transmission parameters (Note 1)	DCI format		6-1B	As defined in section 5.3.3.1.12 in TS 36.212
	Number of OFDM symbols for legacy control channels		2	Early in-sync threshold $Q_{E2_in_CatM1}$ and the corresponding hypothetical MPDCCH transmission parameters are as specified in section 7.19.2 and Table 7.19.2-2 respectively.
	M-PDCCH aggregation level	eCCE	8	
	M-PDCCH repetition level		16	

	ρ_A, ρ_B		-3	
DRX			OFF	
Layer 3 filtering			Enabled	Counters: N310 = 1; N311 = 1
T310 timer	ms	2000		T310 is enabled
T311 timer	ms	1000		T311 is enabled
T315	ms	0		T315 is disabled
T1	s	2		
T2	s	0.8		
T3	s	1.36		
T4	s	0.4		
T5	s	2		
Note 1: MPDCCH corresponding to the early in-sync transmission parameters need not be included in the Reference Measurement Channel.				

Table A.7.3.85.1-2: Cell specific test parameters for E-UTRAN HD-FDD (cell # 1) for early in-sync radio link monitoring tests for Cat-M1 in CEModeB

Parameter	Unit	Test 1				
		T1	T2	T3	T4	T5
E-UTRA RF Channel Number		1				
$BW_{channel}$	MHz	5: 10				
MPDCCH parameters as defined in A.3.1.3.5		R.9 HD-FDD				
OCNG Pattern defined in A.3.2.1 (FDD)		5MHz: OP.22 FDD 10MHz: OP.21 FDD				
ρ_A, ρ_B		-3				
MPDCCH_RA	dB	0				
MPDCCH_RB	dB	0				
PBCH_RA	dB	-3				
PBCH_RB	dB					
PSS_RA	dB					
SSS_RA	dB					
OCNG_RA ^{Note 1}	dB					
OCNG_RB ^{Note 1}	dB					
N_{oc}	dBm/15 kHz					
SNR ^{Note 6}	dB	-7	-16.6	-22.6	-15	-7
Propagation condition		ETU 30Hz				
Correlation Matrix and Antenna Configuration		2x1 Low				
Note 1: OCNG shall be used such that the resources in cell # 1 are fully allocated and a constant total transmitted power spectral density is achieved for all OFDM symbols. Note 2: The uplink resources for CQI reporting are assigned to the UE prior to the start of time period T1. Note 3: The timers and layer 3 filtering related parameters are configured prior to the start of time period T1. Note 4: The signal contains PDCCH for UEs other than the device under test as part of OCNG. Note 5: SNR levels correspond to the signal to noise ratio over the cell-specific reference signal REs. Note 6: The SNR in time periods T1, T2, T3, T4 and T5 is denoted as SNR1, SNR2, SNR3, SNR4 and SNR5 respectively in figure A.7.3.85.1-1.						

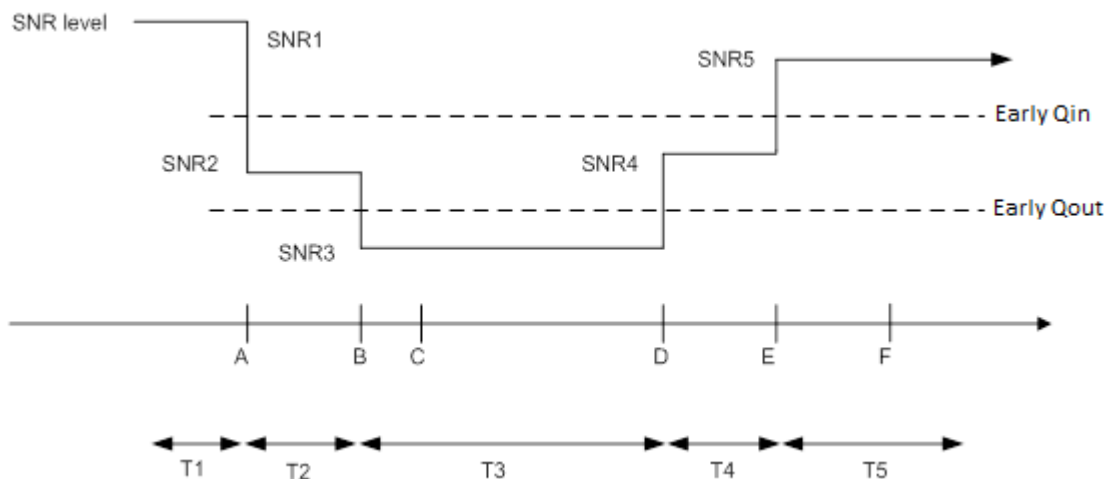

Figure A.7.3.85.1-1: SNR variation for early in-sync testing

A.7.3.85.2 Test Requirements

The UE shall compare the downlink radio link quality of the PCell over the last Q_{in_CatM1} evaluation, which is defined in 7.19.4.1, with the threshold $Q_{E2_in_CatM1}$. When the estimated quality becomes better than the threshold starting from time point E, Layer 1 of the UE shall trigger event E2 and send a report to the higher layers within Q_{in_CatM1} evaluation period.

The rate of correct events observed during repeated tests shall be at least 90%.

A.7.3.86 E-UTRAN TDD Early Out-of-sync reporting Test for Cat-M1 UE in CEModeB

A.7.3.86.1 Test Purpose and Environment

The purpose of this test is to verify that the TDD Cat-M1 UE properly detects an early out of sync event and makes correct reporting of it for the purpose of monitoring the downlink radio link quality of the PCell in CEModeB. This test will partly verify the E-UTRAN FDD radio link monitoring requirements for Cat-M1 UE defined in clause 7.19.

The test parameters are given in Tables A.7.3.86.1-1 and A.7.3.86.1-2 below. There is one cell (cell 1), which is the active cell, in the test. The test consists of three successive time periods, with time duration of T1, T2 and T3 respectively. Figure A.7.3.86.1-1 shows the variation of the downlink SNR in the active cell to emulate early out-of-sync and early in-sync states. Prior to the start of the time duration T1, the UE shall be fully synchronized to cell 1.

In the test, the RRC parameter *numberPRB-Pairs* is set to 6 and the RRC parameter *mPDCCH-NumRepetition* is set to 128. In addition, the UE is configured with *rlm-ReportConfig*. UE shall successfully complete the RRC reconfiguration accordingly prior to the start of time duration T1.

Table A.7.3.86.1-1: General test parameters for E-UTRAN TDD early out-of-sync testing for UE Cat-M1 in CEModeB

Parameter	Unit	Value	Comment	
Active cell		Cell 1	Cell 1 is on E-UTRA RF channel number 1	
CP length		Normal		
Early Out of sync transmission parameters (Note 1)	DCI format		6-1B	As defined in section 5.3.3.1.12 in TS 36.212
	Number of OFDM symbols for legacy control channels		2	Early Out of sync threshold $Q_{E1_out_CatM1}$ and the corresponding hypothetical MPDCCH transmission parameters are as specified in section 7.19.4 and Table 7.19.4-2 respectively.
	M-PDCCH aggregation level	eCCE	16	
	M-PDCCH repetition level		64	
	ρ_A, ρ_B		-3	

DRX		OFF	
Layer 3 filtering		Enabled	Counters: N310 = 1; N311 = 1
T310 timer	ms	1800	T310 is enabled
T314 timer	ms	0	T314 is disabled
T311 timer	ms	1000	T311 is enabled
T1	s	2	
T2	s	0.8	
T3	s	1.8	
Note 1: MPDCCH corresponding to the early out of sync transmission parameters need not be included in the Reference Measurement Channel.			

Table A.7.3.86.1-2: Cell specific test parameters for E-UTRAN TDD (cell # 1) for early out-of-sync radio link monitoring tests for Cat-M1 in CEModeB

Parameter	Unit	Test 1		
		T1	T2	T3
E-UTRA RF Channel Number		1		
BW _{channel}	MHz	5: 10		
Special subframe configuration <small>Note 1</small>		6		
Uplink-downlink configuration <small>Note 1</small>		1		
MPDCCH parameters as defined in A.3.1.3.6		R.17 TDD		
OCNG Pattern defined in A.3.2.2 (TDD)		5MHz: OP.10 TDD 10MHz: OP.11 TDD		
ρ_A, ρ_B		-3		
MPDCCH_RA	dB	0		
MPDCCH_RB	dB	0		
PBCH_RA	dB	-3		
PBCH_RB	dB			
PSS_RA	dB			
SSS_RA	dB			
OCNG_RA <small>Note 1</small>	dB			
OCNG_RB <small>Note 1</small>	dB			
N_{oc}	dBm/15 kHz			
SNR <small>Note 5</small>	dB	-10	-16.6	-22.6
Propagation condition		ETU 30Hz		
Correlation Matrix and Antenna Configuration		2x1 Low		
<p>Note 1: For special subframe and uplink-downlink configurations see Tables 4.2-1 and 4.2-2 in TS 36.211.</p> <p>Note 2: OCNG shall be used such that the resources in cell # 1 are fully allocated and a constant total transmitted power spectral density is achieved for all OFDM symbols.</p> <p>Note 3: The timers and layer 3 filtering related parameters are configured prior to the start of time period T1.</p> <p>Note 4: The signal contains PDCCH for UEs other than the device under test as part of OCNG.</p> <p>Note 5: SNR levels correspond to the signal to noise ratio over the cell-specific reference signal REs.</p> <p>Note 6: The SNR in time periods T1, T2 and T3 is denoted as SNR1, SNR2 and SNR3 respectively in figure A.7.3.86.1-1.</p> <p>Note 7: Aggregation level and repetition levels specified in A.7.3.86.1-1 are used for this test.</p>				

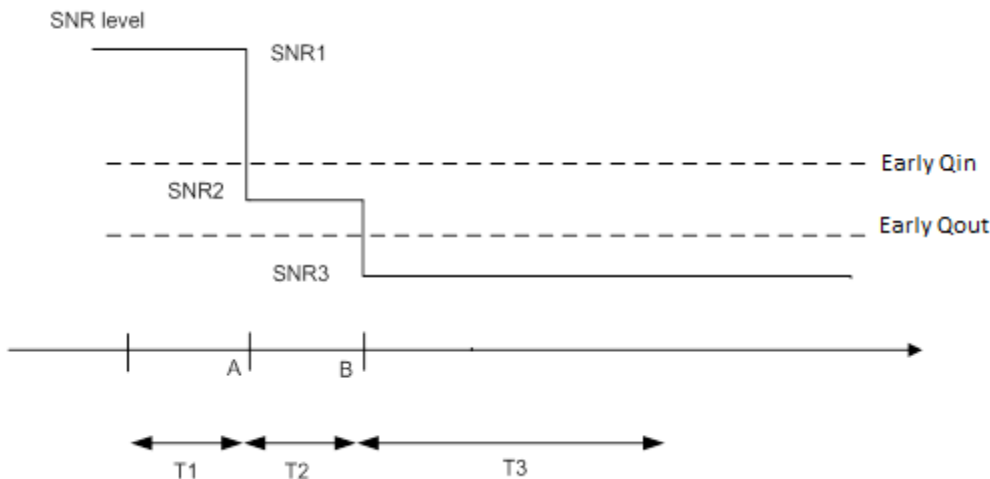

Figure A.7.3.86.1-1: SNR variation for early out-of-sync testing

A.7.3.86.2 Test Requirements

The UE shall compare the downlink radio link quality of the PCell over the last Q_{out_CatM1} evaluation, which is defined in 7.19.4.1, with the threshold $Q_{E1_out_CatM}$. When the estimated quality becomes worse than the threshold starting from time point B, Layer 1 of the UE shall trigger event E1 and send a report to the higher layers within Q_{out_CatM1} evaluation period.

The rate of correct events observed during repeated tests shall be at least 90%.

A.7.3.87 E-UTRAN TDD Early In-Sync reporting Test for Cat-M1 UE in CEModeB

A.7.3.87.1 Test Purpose and Environment

The purpose of this test is to verify that the TDD Cat-M1 UE properly detects an early in sync event and makes correct reporting of it for the purpose of monitoring the downlink radio link quality of the PCell in CEModeB. This test will partly verify the E-UTRAN FDD radio link monitoring requirements for Cat-M1 UE defined in clause 7.19.

The test parameters are given in Tables A.7.3.87.1-1 and A.7.3.87.1-2 below. There is one cell (cell 1), which is the active cell, in the test. The test consists of three successive time periods, with time duration of T1, T2 and T3 respectively. Figure A.7.3.87.1-1 shows the variation of the downlink SNR in the active cell to emulate early in-sync and early in-sync states. Prior to the start of the time duration T1, the UE shall be fully synchronized to cell 1.

In the test, the RRC parameter *numberPRB-Pairs* is set to 6 and the RRC parameter *mPDCCH-NumRepetition* is set to 128. In addition, the UE is configured with *rlm-ReportConfig*. UE shall successfully complete the RRC reconfiguration accordingly prior to the start of time duration T1.

Table A.7.3.87.1-1: General test parameters for E-UTRAN TDD early in-sync testing for UE Cat-M1 in CEModeB

Parameter	Unit	Value	Comment
Active cell		Cell 1	Cell 1 is on E-UTRA RF channel number 1
CP length		Normal	
Early In sync transmission parameters (Note 1)	DCI format		6-1B As defined in section 5.3.3.1.12 in TS 36.212
	Number of OFDM symbols for legacy control channels		2 Early in-sync threshold $Q_{E2_in_CatM1}$ and the corresponding hypothetical MPDCCH transmission parameters are as specified in section 7.19.2 and Table 7.19.2-2 respectively.
	M-PDCCH aggregation level	eCCE	8
	M-PDCCH repetition level		16

	ρ_A, ρ_B		-3	
DRX			OFF	
Layer 3 filtering			Enabled	Counters: N310 = 1; N311 = 1
T310 timer	ms	2000		T310 is enabled
T311 timer	ms	1000		T311 is enabled
T315	ms	0		T315 is disabled
T1	s	2		
T2	s	0.8		
T3	s	1.36		
T4	s	0.4		
T5	s	2		
Note 1: MPDCCH corresponding to the early in-sync transmission parameters need not be included in the Reference Measurement Channel.				

Table A.7.3.87.1-2: Cell specific test parameters for E-UTRAN TDD (cell # 1) for early in-sync radio link monitoring tests for Cat-M1 in CEModeB

Parameter	Unit	Test 1				
		T1	T2	T3	T4	T5
E-UTRA RF Channel Number		1				
BWchannel	MHz	5: 10				
Special subframe configuration ^{Note 1}		6				
Uplink-downlink configuration ^{Note 1}		1				
MPDCCH parameters as defined in A.3.1.3.6		R.17 TDD				
OCNG Pattern defined in A.3.2.2 (TDD)		5MHz: OP.10 TDD 10MHz: OP.11 TDD				
ρ_A, ρ_B		-3				
MPDCCH_RA	dB	0				
MPDCCH_RB	dB	0				
PBCH_RA	dB	-3				
PBCH_RB	dB					
PSS_RA	dB					
SSS_RA	dB					
OCNG_RA ^{Note 1}	dB					
OCNG_RB ^{Note 1}	dB					
N_{oc}	dBm/15 kHz					
SNR ^{Note 6}	dB	-7	-16.6	-22.6	-15	-7
Propagation condition		ETU 30Hz				
Correlation Matrix and Antenna Configuration		2x1 Low				
Note 1: For special subframe and uplink-downlink configurations see Tables 4.2-1 and 4.2-2 in TS 36.211. Note 2: OCNG shall be used such that the resources in cell # 1 are fully allocated and a constant total transmitted power spectral density is achieved for all OFDM symbols. Note 3: The timers and layer 3 filtering related parameters are configured prior to the start of time period T1. Note 4: The signal contains PDCCH for UEs other than the device under test as part of OCNG. Note 5: SNR levels correspond to the signal to noise ratio over the cell-specific reference signal REs. Note 6: The SNR in time periods T1, T2 and T3 is denoted as SNR1, SNR2 and SNR3 respectively in figure A.7.3.87.1-1. Note 7: Aggregation level and repetition levels specified in A.7.3.87.1-1 are used for this test.						

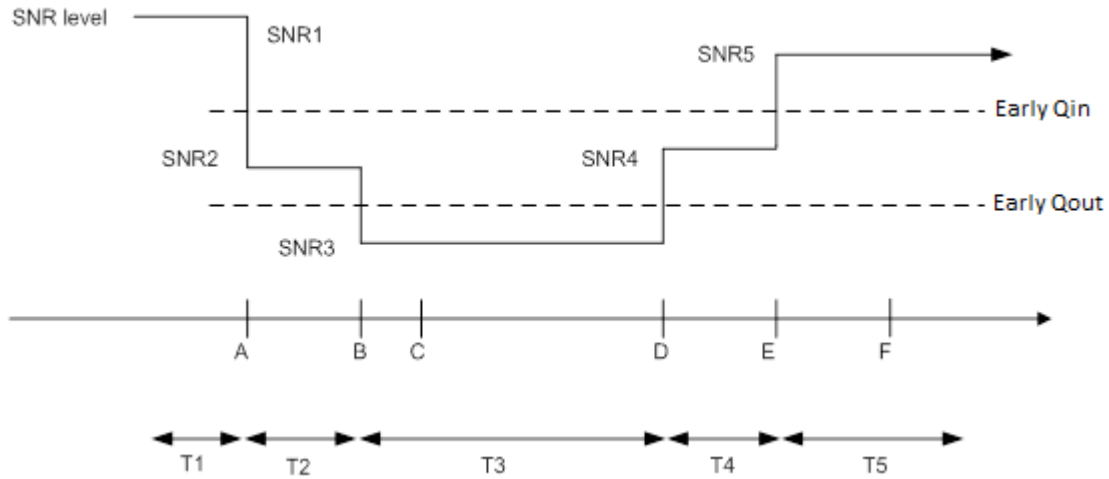

Figure A.7.3.87.1-1: SNR variation for early in-sync testing

A.7.3.87.2 Test Requirements

The UE shall compare the downlink radio link quality of the PCell over the last Q_{in_CatM1} evaluation, which is defined in 7.19.4.1, with the threshold $Q_{E2_in_CatM1}$. When the estimated quality becomes better than the threshold starting from time point E, Layer 1 of the UE shall trigger event E2 and send a report to the higher layers within Q_{in_CatM1} evaluation period.

The rate of correct events observed during repeated tests shall be at least 90%.

A.7.3.88 TDD Radio Link Monitoring Test for Out-of-sync in DRX for UE category NB1 In-band mode in normal coverage

A.7.3.88.1 Test Purpose and Environment

The purpose of this test is to verify that the TDD category NB1 UE properly detects the out of sync for the purpose of monitoring downlink radio link quality of the NB-IoT Cell. This test will partly verify the NB-IoT TDD radio link monitoring requirements in clause 7.23.

The test parameters are given in Tables A.7.3.88.1-1, A.7.3.88.1-2, A.7.3.88.1-2A, A.7.3.88.1-3 and A.7.3.88.1-4. nCell 1 is the active NB-IoT cell in the test. The test consists of four successive time periods with time duration of T1, T2, T3 and T4 respectively, excluding the transition time duration dT , where the SNR increases or decreases gradually in small steps. Figure A.7.3.88.1-1 shows the variation of the downlink SNR in the active cell to emulate out-of-sync state with the following testing procedure:

- Prior to the start of the time duration T1, the UE shall be fully synchronized to nCell1
- Starting at point A, the SNR is decreased in small steps from SNR1 to SNR2 within dT
- At the start of the time duration T2, the UE is provided with a UL grant with NPDCCH

Note: The UE is expected to decode the NPDCCH and complete the UL transmission during T2 according to the UL grant.

- Starting at point B, the SNR is decreased in small steps from SNR2 to SNR3 within dT
- During T3, the SNR is kept as SNR3

Note: The UE is expected to detect OOS and declare RLF during T3.

- Starting at point C, the SNR is increased in small steps from SNR3 to SNR1 with dT
- At the start of the time period T4, the UE will be provided with another UL grant with NPDCCH

Note: The UE is not expected to decode the UL grant and conduct any UL transmission during T4, since the UE is expected to declare RLF during T3.

In the test, DRX configuration is enabled and DRX inactivity timer has already been expired, i.e. UE tries to decode the NPDCCH and complete the UL transmission when On-duration timer is running. Time alignment timers shall be set to “infinity” so that UL timing alignment is maintained during the test.

Table A.7.3.88.1-1: General test parameters for TDD Radio Link Monitoring Test for Out-of-sync in DRX for UE category NB1 In-band mode in normal coverage

Parameter	Unit	Value	Comment
Active cell		nCell 1	
Neighbour cell		eCell 1	
CP length		Normal	
Deployment Mode		In-band	
NPDCCH transmission parameters R_{max}		8	Other NPDCCH parameters are defined in “out-of-sync” column in Table 7.23.2-1
Special subframe configuration		6	As specified in table 4.2-1 in TS 36.211 [16]
Uplink-downlink configuration		1	As specified in table 4.2-2 in TS 36.211 [16]
DRX cycle	ms	256	See Table A.7.3.88.1-3
Layer 3 filtering ^{Note 2,3}		Enabled	Counters: N310 = 1 N311 = 1
T310 timer ^{Note 2,3}	ms	0	T310 is disabled
T311 timer ^{Note 2,3}	ms	1000	T311 is enabled
T1	s	5.12	
dT	S	0.8	
T2	s	10.24	
dT	S	0.7	
T3	s	5.12	
dT	S	1.4	
T4	s	5.12	
Note 1: NPDCCH corresponding to the out of sync transmission parameters need not be included in the Reference Measurement Channel.			
Note 2: N310, N311, T310 and T311 are defined in TS 36.331 [2].			
Note 3: The timers and layer 3 filtering related parameters are configured prior to the start of time period T1.			

Table A.7.3.88.1-2: nCell specific test parameters for TDD Radio Link Monitoring Test for Out-of-sync in DRX for UE category NB1 In-band mode in normal coverage

Parameter	Unit	nCell 1						
		T1	dT	T2	dT	T3	dT	T4
$BW_{channel}$	kHz	180						
PRB location within eCell		eCell 1 $BW_{channel}$ 10MHz: 30						
NPDCCH parameters as defined in A.3.1.5.7		R.15 NB-TDD						
NPBCH_RA	dB	-3						
NPBCH_RB	dB							
NPSS_RA	dB							
NSSS_RA	dB							
NPDCCH_RA	dB							
NPDCCH_RB	dB							
NPDSCH_RA	dB							
NPDSCH_RB	dB							
OCNG_RA ^{Note 1}	dB							
OCNG_RB ^{Note 1}	dB							
N_{oc}	dBm/15 kHz	Specified in Table A.7.3.88.1-2A						
SNR ^{Note 4, 5}	dB	-3.1	Note 6	-9.1	Note 6	-14.1	Note 6	-3.1

Propagation condition		AWGN
Configuration		2x1
Note 1:	OCNG shall be used such that the cell is fully allocated and a constant total transmitted power spectral density is achieved for all OFDM symbols. The OCNG pattern is chosen during the test according to the presence of a DL reference measurement channel.	
Note 2:	Void	
Note 3:	Void	
Note 4:	SNR levels correspond to the signal to noise ratio over the cell-specific reference signal REs.	
Note 5:	The SNRs in time periods T1, T2, T3 and T4 are denoted as SNR1, SNR2, SNR3 and SNR1 respectively in figure A.7.3.88.1-1.	
Note 6:	The Test system shall reduce its transmit power in steps of $((SNR2-SNR1) / (10*dT))$ dB every 100ms until SNR2 is achieved at the end of dT.	
Note 7:	The Test system shall reduce its transmit power in steps of $((SNR3-SNR2) / (10*dT))$ dB every 100ms until SNR3 is achieved at the end of dT.	
Note 8:	The Test system shall increase its transmit power in steps of $((SNR1-SNR3) / (10*dT))$ dB every 100ms until SNR1 is achieved at the end of dT.	

Table A.7.3.88.1-2A: eCell 1 specific test parameters for TDD Out-of-sync radio link monitoring test in DRX for UE category NB1 In-band mode in normal coverage

Parameter	Unit	eCell 1
		T1-T4
$BW_{channel}$	MHz	10
NOCNG Pattern	-	$BW_{channel}$ 10MHz: NOP.1 TDD
PBCH_RA	dB	-3
PBCH_RB	dB	
PSS_RA	dB	
SSS_RA	dB	
PCFICH_RB	dB	
PDCCH_RA	dB	
PDCCH_RB	dB	
OCNG_RA ^{Note 1}	dB	
OCNG_RB ^{Note 1}	dB	
N_{oc} ^{Note2}	dBm/15 kHz	
\hat{E}_s / N_{oc}	dB	-12
Propagation Condition		AWGN
Antenna Configuration		2x1
Note 1:	OCNG shall be used such that the eCell is fully allocated and a constant total transmitted power spectral density is achieved for all OFDM symbols.	
Note 2:	Interference from other cells and noise sources not specified in the test is assumed to be constant over subcarriers and time and shall be modelled as AWGN of appropriate power N_{oc} .	

Table A.7.3.88.1-3: DRX-Configuration for TDD Radio Link Monitoring Test for Out-of-sync in DRX for UE category NB1 In-band mode in normal coverage

Field	Value	Comment
onDurationTimer	pp1	As specified in clause 6.7.3 in TS 36.331 [2]
drx-InactivityTimer	pp0	
drx-RetransmissionTimer	pp0	
drx-StartOffset	0	

Table A.7.3.88.1-4: TimeAlignmentTimer -Configuration for NB-IoT TDD out-of-sync testing for UE category NB1 In-band mode in normal coverage

Field	Value	Comment
TimeAlignmentTimer	infinity	As specified in clause 6.3.2 in TS 36.331 [2]

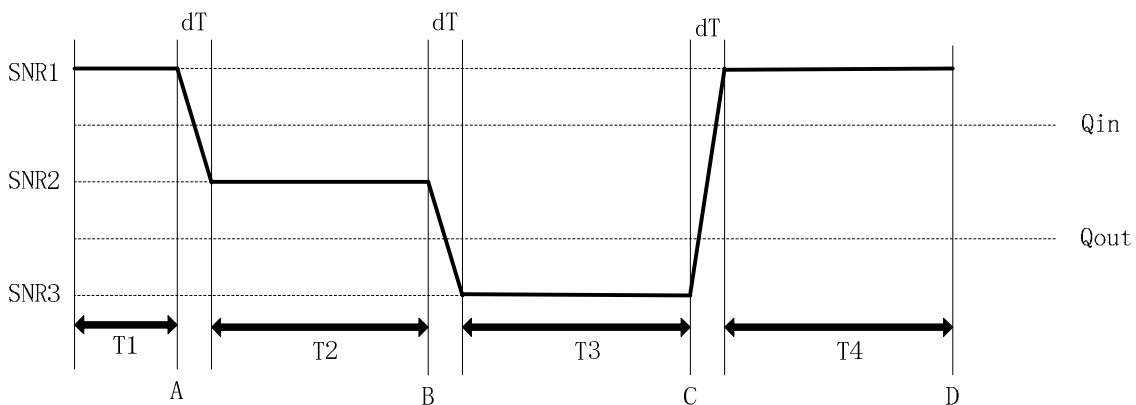

Figure A.7.3.88.1-1: SNR variation for out-of-sync testing in DRX for NB-IoT TDD out-of-sync testing for UE category NB1 In-band mode in normal coverage

A.7.3.88.2 Test Requirements

The UE behaviors in each test shall be as follows:

- The UE shall complete the NPUSCH transmission during T2 according to the received UL grant;
- The UE shall not conduct any NPUSCH transmission during T4

A correct event is defined as UE behaves correctly in all above steps. The correct events observed during repeated tests shall be at least 90%.

A.7.3.89 TDD Radio Link Monitoring Test for Out-of-sync in DRX for UE category NB1 In-band mode in enhanced coverage

A.7.3.89.1 Test Purpose and Environment

The purpose of this test is to verify that the TDD category NB1 UE properly detects the out of sync for the purpose of monitoring downlink radio link quality of the NB-IoT Cell. This test will partly verify the NB-IoT TDD radio link monitoring requirements in clause 7.23.

The test parameters are given in Tables A.7.3.89.1-1, A.7.3.89.1-2, A.7.3.89.1-2A, A.7.3.89.1-3 and A.7.3.89.1-4. nCell 1 is the active NB-IoT cell in the test. The test consists of four successive time periods with time duration of T1, T2, T3 and T4 respectively, excluding the transition time duration dT , where the SNR increases or decreases gradually in small steps. Figure A.7.3.89.1-1 shows the variation of the downlink SNR in the active cell to emulate out-of-sync state with the following testing procedure:

- Prior to the start of the time duration T1, the UE shall be fully synchronized to nCell1
- Starting at point A, the SNR is decreased in small steps from SNR1 to SNR2 within dT
- At the start of the time duration T2, the UE is provided with a UL grant with NPDCCH

Note: The UE is expected to decode the NPDCCH and complete the UL transmission during T2 according to the UL grant.

- Starting at point B, the SNR is decreased in small steps from SNR2 to SNR3 within dT
- During T3, the SNR is kept as SNR3

Note: The UE is expected to detect OOS and declare RLF during T3.

- Starting at point C, the SNR is increased in small steps from SNR3 to SNR1 with dT
- At the start of the time period T4, the UE will be provided with another UL grant with NPDCCH

Note: The UE is not expected to decode the UL grant and conduct any UL transmission during T4, since the UE is expected to declare RLF during T3.

In the test, DRX configuration is enabled and DRX inactivity timer has already been expired, i.e. UE tries to decode the NPDCCH and complete the UL transmission when On-duration timer is running. Time alignment timers shall be set to “infinity” so that UL timing alignment is maintained during the test.

Table A.7.3.89.1-1: General test parameters for TDD Radio Link Monitoring Test for Out-of-sync in DRX for UE category NB1 In-band mode in enhanced coverage

Parameter	Unit	Value	Comment
Active cell		nCell 1	
Neighbour cell		eCell 1	
CP length		Normal	
Deployment Mode		In-band	
NPDCCH transmission parameters R_{max}		16	Other NPDCCH parameters are defined in “out-of-sync” column in Table 7.23.2-1
Special subframe configuration		6	As specified in table 4.2-1 in TS 36.211 [16]
Uplink-downlink configuration		1	As specified in table 4.2-2 in TS 36.211 [16]
DRX cycle	ms	256	See Table A.7.3.61.1-3
Layer 3 filtering ^{Note 2,3}		Enabled	Counters: N310 = 1 N311 = 1
T310 timer ^{Note 2,3}	ms	0	T310 is disabled
T311 timer ^{Note 2,3}	ms	1000	T311 is enabled
T1	s	5.12	
dT	s	0.7	
T2	s	10.24	
dT	s	0.8	
T3	s	5.12	
dT	s	1.4	
T4	s	5.12	
Note 1: NPDCCH corresponding to the out of sync transmission parameters need not be included in the Reference Measurement Channel. Note 2: N310, N311, T310 and T311 are defined in TS 36.331 [2]. Note 3: The timers and layer 3 filtering related parameters are configured prior to the start of time period T1.			

Table A.7.3.89.1-2: nCell specific test parameters for TDD Radio Link Monitoring Test for Out-of-sync in DRX for UE category NB1 In-band mode in enhanced coverage

Parameter	Unit	nCell 1							
		T1	dT	T2	dT	T3	dT	T4	
$BW_{channel}$	kHz	180							
PRB location within eCell		eCell 1 $BW_{channel}$ 10MHz: 30							
NPDCCH parameters as defined in A.3.1.5.7		R.15 NB-TDD							
NPBCH_RA	dB	-3							
NPBCH_RB									
NPSS_RA									
NSSS_RA									
NPDCCH_RA									
NPDCCH_RB									
NPDSCH_RA									
NPDSCH_RB									
OCNG_RA ^{Note 1}									
OCNG_RB ^{Note 1}									

N_{oc}	dBm/15 kHz	Specified in Table A.7.3.89.1-2A						
SNR ^{Note 4, 5}	dB	-6.3	Note 6	-11.4	Note 7	-17.4	Note 8	-6.3
Propagation condition		AWGN						
Antenna Configuration		2x1						
Note 1:	OCNG shall be used such that the cell is fully allocated and a constant total transmitted power spectral density is achieved for all OFDM symbols. The OCNG pattern is chosen during the test according to the presence of a DL reference measurement channel.							
Note 2:	Void							
Note 3:	Void							
Note 4:	SNR levels correspond to the signal to noise ratio over the cell-specific reference signal REs.							
Note 5:	The SNRs in time periods T1, T2, T3 and T4 are denoted as SNR1, SNR2, SNR3 and SNR1 respectively in figure A.7.3.89.1-1.							
Note 6:	The Test system shall reduce its transmit power in steps of $((SNR2-SNR1) / (10*dT))$ dB every 100ms until SNR2 is achieved at the end of dT.							
Note 7:	The Test system shall reduce its transmit power in steps of $((SNR3-SNR2) / (10*dT))$ dB every 100ms until SNR3 is achieved at the end of dT.							
Note 8:	The Test system shall increase its transmit power in steps of $((SNR1-SNR3) / (10*dT))$ dB every 100ms until SNR1 is achieved at the end of dT.							

Table A.7.3.89.1-2A: eCell 1 specific test parameters for TDD Out-of-sync radio link monitoring test in DRX for UE category NB1 In-band mode in enhanced coverage

Parameter	Unit	eCell 1
		T1-T4
$BW_{channel}$	MHz	10
NOCNG Pattern	-	$BW_{channel}$ 10MHz: NOP.1 TDD
PBCH_RA	dB	-3
PBCH_RB	dB	
PSS_RA	dB	
SSS_RA	dB	
PCFICH_RB	dB	
PDCCH_RA	dB	
PDCCH_RB	dB	
OCNG_RA ^{Note 1}	dB	
OCNG_RB ^{Note 1}	dB	
N_{oc} ^{Note2}	dBm/15 kHz	
\hat{E}_s / N_{oc}	dB	-12
Propagation Condition		AWGN
Antenna Configuration		2x1
Note 1:	OCNG shall be used such that the eCell is fully allocated and a constant total transmitted power spectral density is achieved for all OFDM symbols.	
Note 2:	Interference from other cells and noise sources not specified in the test is assumed to be constant over subcarriers and time and shall be modelled as AWGN of appropriate power N_{oc} .	

Table A.7.3.89.1-3: DRX-Configuration for TDD Radio Link Monitoring Test for Out-of-sync in DRX for UE category NB1 In-band mode in enhanced coverage

Field	Value	Comment
onDurationTimer	pp1	As specified in clause 6.7.3 in TS 36.331 [2]
drx-InactivityTimer	pp0	
drx-RetransmissionTimer	pp0	
drx-StartOffset	0	

Table A.7.3.89.1-4: TimeAlignmentTimer -Configuration for TDD Radio Link Monitoring Test for Out-of-sync in DRX for UE category NB1 In-band mode in enhanced coverage

Field	Value	Comment
TimeAlignmentTimer	infinity	As specified in clause 6.3.2 in TS 36.331 [2]

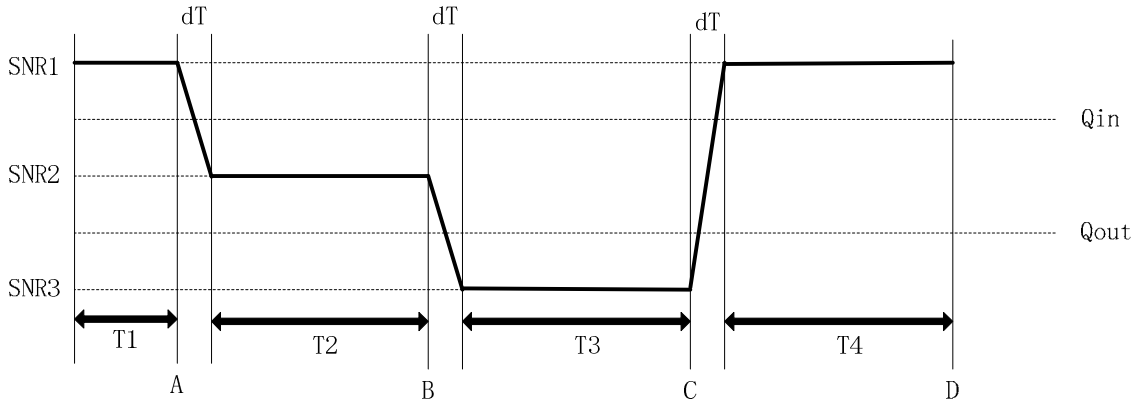

Figure A.7.3.89.1-1: SNR variation for TDD Radio Link Monitoring Test for Out-of-sync in DRX for UE category NB1 In-band mode in enhanced coverage

A.7.3.89.2 Test Requirements

The UE behaviors in each test shall be as follows:

- The UE shall complete the NPUSCH transmission during T2 according to the received UL grant;
- The UE shall not conduct any NPUSCH transmission during T4.

A correct event is defined as UE behaves correctly in all above steps. The correct events observed during repeated tests shall be at least 90%.

A.7.3.90 TDD Radio Link Monitoring Test for In-sync with DRX for UE Category NB1 In-Band mode in Normal Coverage

A.7.3.90.1 Test Purpose and Environment

The purpose of this test is to verify that the TDD category NB1 UE configured in normal coverage properly detects the out of sync and in sync for the purpose of monitoring downlink radio link quality of the NB-IoT Cell when DRX is used. This test will partly verify the TDD radio link monitoring requirements in clause 7.23.

The test parameters are given in Tables A.7.3.90.1-1, A.7.3.90.1-2, A.7.3.90.1-3, A.7.3.90.1-4 and A.7.3.90.1-5. nCell 1 is the active cell in the test. The test consists of three successive time periods, with time duration of T1, T2 and T3 respectively, excluding the transition time duration dT, where the SNR increases or decreases gradually in small steps. Figure A.7.3.90.1-1 shows the variation of the downlink SNR in the active cell to emulate out-of-sync and in-sync states.

Prior to the start of the time duration T1, the UE shall be fully be synchronized to nCell 1. The UE is scheduled in every uplink subframe to transmit NPUSCH, which is received by the test equipment. By measuring the reception of the NPUSCH, detection of out of sync and in sync requirements can be measured. In the test, DRX configuration is enabled and DRX inactivity timer has already been expired, i.e. UE tries to decode NPDCCH and to send NPUSCH during the period when On-duration timer is running. Time alignment timers shall be set to “infinity” so that UL timing alignment is maintained during the test.

The test setup in each test during time durations T1, T2 and T3 are as follows:

- During the period from time point A to time point B, the SNR is decreasing linearly from SNR1 to SNR2.
- During the period from time point C to time point D, the SNR is increasing linearly from SNR2 to SNR3.

- During the period T3, the test system shall send the UE a grant to transmit in uplink. UE under test is expected to decode the uplink grant and switch to uplink and complete the uplink transmission.
- Thereafter UE switches back to downlink.

In each run of the test, the test equipment selects NPDCCH repetition level, and sends the RRC configuration to the UE. NPDCCH repetition level is determined by RRC parameter *npdcch-NumRepetitions* [2]. UE shall successfully complete the RRC reconfiguration accordingly prior to the start of time duration T1.

Table A.7.3.90.1-1: General test parameters for TDD in-sync test with DRX for UE category NB1 In-Band mode in normal coverage

Parameter		Unit	Value	Comment
NB-IoT operational mode			In-band	
Active cell			nCell 1	NB-IOT cell nCell1 is within E-UTRA cell eCell1
CP length			Normal	
In sync transmission parameters (Note 1)	DCI format		Format N1	As defined in TS 36.212 [21]
	Number of OFDM symbols for legacy control channels		3	In sync threshold Q_{in_NB-IoT} and the corresponding hypothetical NPDCCH transmission parameters are as specified in clause 7.23.2 and Table 7.23.2-1 respectively.
	NPDCCH aggregation level	eCCE	2	
	NPDCCH repetition level		2	
	Ratio of NPDSCH to NRS EPRE		0	
	Ratio of NPDCCH to NRS EPRE		0	
Out of sync transmission parameters (Note 1)	DCI format		Format N1	As defined in TS 36.212 [21]
	Number of OFDM symbols for legacy control channels		3	Out of sync threshold Q_{out_NB-IoT} and the corresponding hypothetical NPDCCH transmission parameters are as specified in clause 7.23.2 and Table 7.23.2-1 respectively.
	NPDCCH aggregation level	eCCE	2	
	NPDCCH repetition level		8	
	Ratio of NPDSCH to NRS EPRE		0	
	Ratio of NPDCCH to RS EPRE	dB	0	
Special subframe configuration			6	As specified in table 4.2-1 in TS 36.211 [16]
Uplink-downlink configuration			1	As specified in table 4.2-1 in TS 36.211 [16]
DRX cycle		ms	256	See Table A.7.3.63.1-4
Layer 3 filtering			Enabled	Counters: N310 = 1; N311 = 1
T310 timer		ms	4000	T310 is enabled
T311 timer		ms	1000	T311 is enabled
T1		s	4	
dT		s	1.4	
T2		s	2.12	
dT		s	1.4	
T3		s	4	
Note 1: NPDCCH corresponding to the in-sync and out of sync transmission parameters need not be included in the Reference Measurement Channel.				

Table A.7.3.90.1-2: nCell 1 specific test parameters for TDD in-sync radio link monitoring test with DRX for UE category NB1 In-Band mode in normal coverage

Parameter	Unit	nCell 1				
		T1	dT	T2	dT	T3
BW _{channel}	kHz	180				
PRB location within eCell	-	eCell 1 BW _{channel} 10MHz: 30				

NPDCCH parameters defined in A.3.1.5.7		R.15 NB-TDD				
Ratio of NPDSCH to NRS EPRE		-3				
NPDCCH_RA	dB	-3				
NPDCCH_RB	dB	-3				
NPBCH_RA	dB	-3				
NPBCH_RB	dB					
NPSS_RA	dB					
NSSS_RA	dB					
NOCNG_RA ^{Note1}	dB					
NOCNG_RB ^{Note1}	dB					
N_{oc}	dBm/15 kHz					
SNR ^{Note 5, Note 6}	dB	-3.1	Note 7	-14.1	Note 8	-3.1
Propagation condition		AWGN				
Antenna Configuration		2x1				
<p>Note 1: OCNG shall be used such that the resources in ncell1 are fully allocated and a constant total transmitted power spectral density is achieved for all OFDM symbols.</p> <p>Note 2: The uplink resources for CQI reporting are assigned to the UE prior to the start of time period T1.</p> <p>Note 3: The timers and layer 3 filtering related parameters are configured prior to the start of time period T1.</p> <p>Note 4: The signal contains NPDCCH for UEs other than the device under test as part of OCNG.</p> <p>Note 5: SNR levels correspond to the signal to noise ratio over the cell-specific reference signal REs.</p> <p>Note 6: The SNR in time periods T1, T2 and T3 is denoted as SNR1, SNR2, and SNR1 respectively in figure A.7.3.90.1-1.</p> <p>Note 7: The Test system shall reduce its transmit power in steps of $((SNR2-SNR1) / (10*dT))$ dB every 100ms till SNR2 is achieved at the end of dT.</p> <p>Note 8: The Test system shall increase its transmit power in steps of $((SNR1-SNR2) / (10*dT))$ dB every 100ms till SNR1 is achieved at the end of dT.</p>						

Table A.7.3.90.1-3: eCell 1 specific test parameters for TDD in-sync radio link monitoring test with DRX for UE category NB1 In-Band mode in normal coverage

Parameter	Unit	eCell 1
		T1-T3
$BW_{channel}$	MHz	10
NOCNG Pattern	-	$BW_{channel}$ 10MHz: NOP.1 TDD
PBCH_RA	dB	-3
PBCH_RB	dB	
PSS_RA	dB	
SSS_RA	dB	
PCFICH_RB	dB	
PDCCH_RA	dB	
PDCCH_RB	dB	
OCNG_RA ^{Note 1}	dB	
OCNG_RB ^{Note 1}	dB	
N_{oc} ^{Note2}	dBm/15 kHz	
\hat{E}_s / N_{oc}	dB	4
Propagation Condition		AWGN
Antenna Configuration		2x1
<p>Note 1: OCNG shall be used such that the eCell is fully allocated and a constant total transmitted power spectral density is achieved for all OFDM symbols.</p> <p>Note 2: Interference from other cells and noise sources not specified in the test is assumed to be constant over subcarriers and time and shall be modelled as AWGN of appropriate power N_{oc}.</p>		

Table A.7.3.90.1-4: DRX-Configuration for E-UTRAN TDD in-sync tests with DRX for UE category NB1 In-Band mode in normal coverage

Field	Value	Comment
onDurationTimer	pp1	As specified in clause 6.3.2 in TS 36.331 [2]
drx-InactivityTimer	pp0	
drx-RetransmissionTimer	pp0	
longDRX-CycleStartOffset	Sf256	
shortDRX	disable	

Table A.7.3.90.1-5: TimeAlignmentTimer-Configuration for E-UTRAN TDD in-sync tests with DRX for UE category NB1 In-Band mode in normal coverage

Field	Value	Comment
TimeAlignmentTimer	infinity	As specified in clause 6.3.2 in TS 36.331 [2]

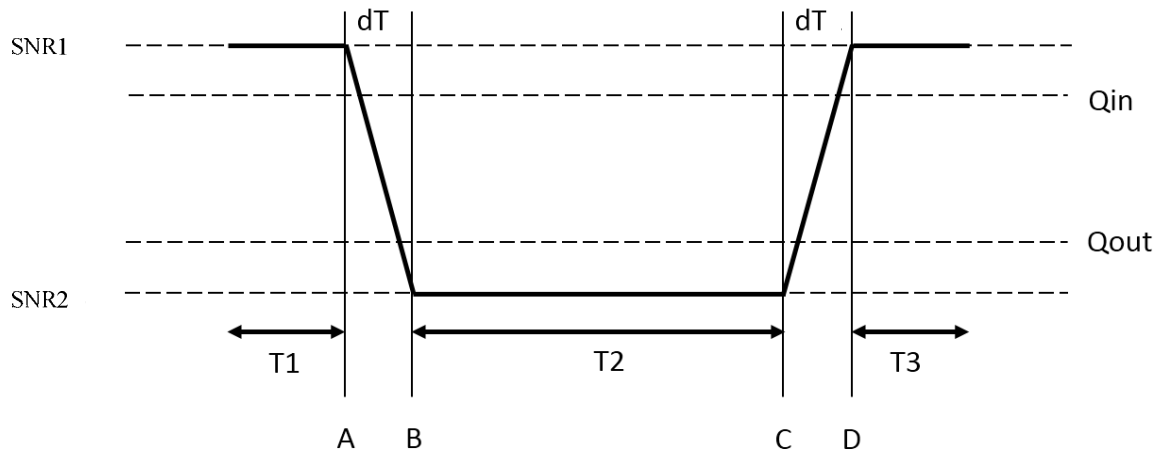

Figure A.7.3.90.1-1: SNR variation for in-sync testing with DRX

A.7.3.90.2 Test Requirements

The UE behaviour in each test shall be as follows:

During the period T3, the UE under test is expected to decode the uplink grant and switch to uplink and complete the uplink transmission. This is considered a correct event.

The rate of correct events observed during repeated tests shall be at least 90%.

A.7.3.91 TDD Radio Link Monitoring Test for In-sync with DRX for UE Category NB1 In-Band mode in Enhanced Coverage

A.7.3.91.1 Test Purpose and Environment

The purpose of this test is to verify that the TDD category NB1 UE configured in enhanced coverage properly detects the out of sync and in sync for the purpose of monitoring downlink radio link quality of the NB-IoT Cell when DRX is used. This test will partly verify the TDD radio link monitoring requirements in clause 7.23.

The test parameters are given in Tables A.7.3.91.1-1, A.7.3.91.1-2, A.7.3.91.1-3, A.7.3.91.1-4 and A.7.3.91.1-5. nCell 1 is the active cell in the test. The test consists of three successive time periods, with time duration of T1, T2 and T3 respectively, excluding the transition time duration dT, where the SNR increases or decreases gradually in small steps. Figure A.7.3.91.1-1 shows the variation of the downlink SNR in the active cell to emulate out-of-sync and in-sync states.

Prior to the start of the time duration T1, the UE shall be fully be synchronized to nCell 1. The UE is scheduled in every uplink subframe to transmit NPUSCH, which is received by the test equipment. By measuring the reception of the NPUSCH, detection of out of sync and in sync requirements can be measured. In the test, DRX configuration is enabled and DRX inactivity timer has already been expired, i.e. UE tries to decode NPDCCH and to send NPUSCH during the period when On-duration timer is running. Time alignment timers shall be set to “infinity” so that UL timing alignment is maintained during the test.

The test setup in each test during time durations T1, T2 and T3 shall be as follows:

- During the period from time point A to time point B, the SNR is decreasing linearly from SNR1 to SNR2.
- During the period from time point C to time point D, the SNR is increasing linearly from SNR2 to SNR3.
- During the period T3, the test system shall send the UE a grant to transmit in uplink. UE under test is expected to decode the uplink grant and switch to uplink and complete the uplink transmission.
- Thereafter UE switches back to downlink.

In each run of the test, the test equipment selects NPDCCH repetition level, and sends the RRC configuration to the UE. NPDCCH repetition level is determined by RRC parameter *npdcch-NumRepetitions* [3]. UE shall successfully complete the RRC reconfiguration accordingly prior to the start of time duration T1.

Table A.7.3.91.1-1: General test parameters for TDD in-sync test with DRX for UE category NB1 In-Band mode in enhanced coverage

Parameter		Unit	Value	Comment
NB-IoT operational mode			In-band	
Active cell			nCell 1	NB-IOT cell nCell1 is within E-UTRA cell eCell1
CP length			Normal	
In sync transmission parameters (Note 1)	DCI format		Format N1	As defined in TS 36.212 [21]
	Number of OFDM symbols for legacy control channels		3	In sync threshold Q_{in_NB-IoT} and the corresponding hypothetical NPDCCH transmission parameters are as specified in clause 7.23.2 and Table 7.23.2-1 respectively.
	NPDCCH aggregation level	eCCE	2	
	NPDCCH repetition level		4	
	Ratio of NPDSCH to NRS EPRE		0	
	Ratio of NPDCCH to NRS EPRE		0	
Out of sync transmission parameters (Note 1)	DCI format		Format N1	As defined in TS 36.212 [21]
	Number of OFDM symbols for legacy control channels		3	Out of sync threshold Q_{out_NB-IoT} and the corresponding hypothetical NPDCCH transmission parameters are as specified in clause 7.23.2 and Table 7.23.2-1 respectively.
	NPDCCH aggregation level	eCCE	2	
	NPDCCH repetition level		16	
	Ratio of NPDSCH to NRS EPRE		0	
	Ratio of NPDCCH to RS EPRE	dB	0	
Special subframe configuration			6	As specified in table 4.2-1 in TS 36.211 [16]
Uplink-downlink configuration			1	As specified in table 4.2-1 in TS 36.211 [16]
DRX cycle		ms	256	See Table A.7.3.62.1-4
Layer 3 filtering			Enabled	Counters: N310 = 1; N311 = 1
T310 timer		ms	4000	T310 is enabled
T311 timer		ms	1000	T311 is enabled
T1		s	4	
dT		s	1.4	
T2		s	2.12	

dT	s	1.4	
T3	s	4	
Note 1: NPDCCH corresponding to the in-sync and out of sync transmission parameters need not be included in the Reference Measurement Channel.			

Table A.7.3.91.1-2: nCell 1 specific test parameters for TDD in-sync radio link monitoring test with DRX for UE category NB1 In-Band mode in enhanced coverage

Parameter	Unit	nCell 1				
		T1	dT	T2	dT	T3
BW _{channel}	kHz	180				
PRB location within eCell	-	eCell 1 BW _{channel} 10MHz: 30				
NPDCCH parameters defined in A.3.1.5.7		R.15 NB-TDD				
Ratio of NPDSCH to NRS EPRE		-3				
NPDCCH_RA	dB	-3				
NPDCCH_RB	dB	-3				
NPBCH_RA	dB	-3				
NPBCH_RB	dB					
NPSS_RA	dB					
NSSS_RA	dB					
NOCNG_RA ^{Note1}	dB					
NOCNG_RB ^{Note1}	dB					
N _{oc}	dBm/15 kHz	Specified in Table A.7.3.91.1-3				
SNR ^{Note 5, Note 6}	dB	-6.3	Note 7	-17.4	Note 8	-6.3
Propagation condition		AWGN				
Antenna Configuration		2x1				
<p>Note 1: OCNG shall be used such that the resources in ncell1 are fully allocated and a constant total transmitted power spectral density is achieved for all OFDM symbols.</p> <p>Note 2: The uplink resources for CQI reporting are assigned to the UE prior to the start of time period T1.</p> <p>Note 3: The timers and layer 3 filtering related parameters are configured prior to the start of time period T1.</p> <p>Note 4: The signal contains NPDCCH for UEs other than the device under test as part of OCNG.</p> <p>Note 5: SNR levels correspond to the signal to noise ratio over the cell-specific reference signal REs.</p> <p>Note 6: The SNR in time periods T1, T2 and T3 is denoted as SNR1, SNR2, and SNR1 respectively in figure A.7.3.91.1-1.</p> <p>Note 7: The Test system shall reduce its transmit power in steps of (((SNR2-SNR1) / (10*dT)) dB every 100ms till SNR2 is achieved at the end of dT.</p> <p>Note 8: The Test system shall increase its transmit power in steps of (((SNR1-SNR2) / (10*dT)) dB every 100ms till SNR1 is achieved at the end of dT.</p>						

Table A.7.3.91.1-3: eCell 1 specific test parameters for TDD in-sync radio link monitoring test with DRX for UE category NB1 In-Band mode in enhanced coverage

Parameter	Unit	eCell 1
		T1-T3
BW _{channel}	MHz	10
NOCNG Pattern	-	BW _{channel} 10MHz: NOP.1 TDD
PBCH_RA	dB	-3
PBCH_RB	dB	
PSS_RA	dB	
SSS_RA	dB	
PCFICH_RB	dB	
PDCCH_RA	dB	
PDCCH_RB	dB	
OCNG_RA ^{Note 1}	dB	
OCNG_RB ^{Note 1}	dB	
N _{oc} ^{Note2}	dBm/15 kHz	
\hat{E}_s / N_{oc}	dB	-12

Propagation Condition		AWGN
Antenna Configuration		2x1
Note 1:	OCNG shall be used such that the eCell is fully allocated and a constant total transmitted power spectral density is achieved for all OFDM symbols.	
Note 2:	Interference from other cells and noise sources not specified in the test is assumed to be constant over subcarriers and time and shall be modelled as AWGN of appropriate power N_{oc} .	

Table A.7.3.91.1-4: DRX-Configuration for E-UTRAN TDD in-sync tests with DRX for UE category NB1 In-Band mode in enhanced coverage

Field	Value	Comment
onDurationTimer	pp1	As specified in clause 6.3.2 in TS 36.331 [2]
drx-InactivityTimer	pp0	
drx-RetransmissionTimer	pp0	
longDRX-CycleStartOffset	Sf256	
shortDRX	disable	

Table A.7.3.91.1-5: TimeAlignmentTimer -Configuration for E-UTRAN TDD in-sync tests with DRX for UE category NB1 In-Band mode in enhanced coverage

Field	Value	Comment
TimeAlignmentTimer	infinity	As specified in clause 6.3.2 in TS 36.331 [2]

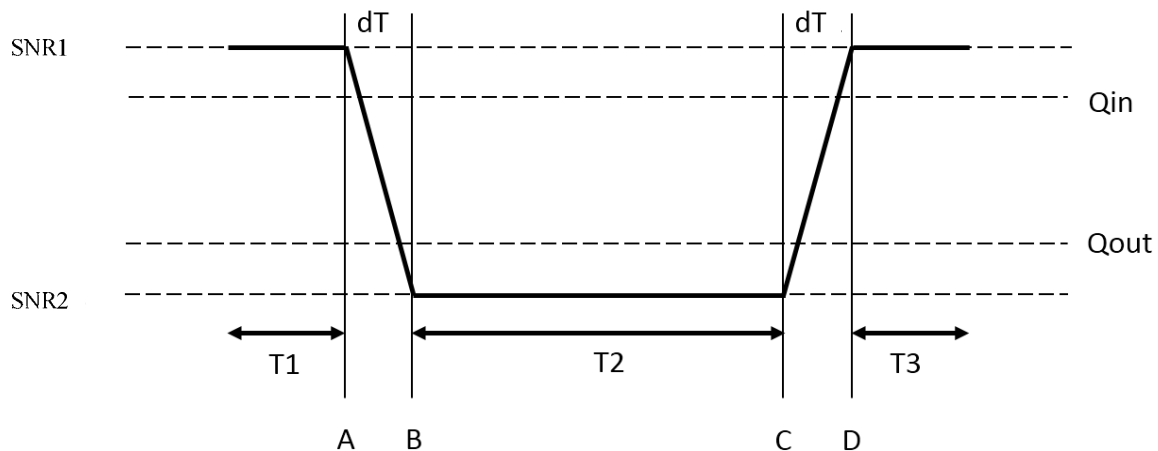

Figure A.7.3.91.1-1: SNR variation for in-sync testing with DRX

A.7.3.91.2 Test Requirements

The UE behaviour in each test shall be as follows:

During the period T3, the UE under test is expected to decode the uplink grant and switch to uplink and complete the uplink transmission. This is considered a correct event.

The rate of correct events observed during repeated tests shall be at least 90%.

A.7.3.92 TDD Radio Link Monitoring Test for In-sync without DRX for UE Category NB1 In-Band mode in Normal Coverage

A.7.3.92.1 Test Purpose and Environment

The purpose of this test is to verify that the TDD category NB1 UE configured in normal coverage properly detects the out of sync and in sync for the purpose of monitoring downlink radio link quality of the PCell when DRX is used. This test will partly verify the TDD radio link monitoring requirements in clause 7.23.

The test parameters are given in Tables A.7.3.92.1-1, A.7.3.92.1-2, A.7.3.92.1-3 and A.7.3.92.1-4. nCell 1 is the active cell in the test. The test consists of three successive time periods, with time duration of T1, T2 and T3 respectively, excluding the transition time duration dT, where the SNR increases or decreases gradually in small steps. Figure A.7.3.92.1-1 shows the variation of the downlink SNR in the active cell to emulate out-of-sync and in-sync states.

Prior to the start of the time duration T1, the UE shall be fully be synchronized to nCell 1. The UE is scheduled in every uplink subframe to transmit NPUSCH, which is received by the test equipment. By measuring the reception of the NPUSCH, detection of out of sync and in sync requirements can be measured. In the test, DRX configuration is disabled, i.e. UE tries to decode NPDCCH and to send NPUSCH during the period when On-duration timer is running. Time alignment timers shall be set to “infinity” so that UL timing alignment is maintained during the test.

The test setup in each test during time durations T1, T2, dT and T3 shall be as follows:

- During the period from time point A to time point B, the SNR is decreasing linearly from SNR1 to SNR2.
- During the period from time point C to time point D, the SNR is increasing linearly from SNR2 to SNR3.
- During the period T3, the test system shall send the UE a grant to transmit in uplink. UE under test is expected to decode the uplink grant and switch to uplink and complete the uplink transmission.
- Thereafter UE switches back to downlink.

In each run of the test, the test equipment selects NPDCCH repetition level, and sends the RRC configuration to the UE. UE shall successfully complete the RRC reconfiguration accordingly prior to the start of time duration T1.

Table A.7.3.92.1-1: General test parameters for TDD in-sync test without DRX for UE category NB1 In-Band mode in normal coverage

Parameter		Unit	Value	Comment
NB-IoT operational mode			In-band	
Active cell			nCell 1	NB-IOT cell nCell1 is within E-UTRA cell eCell1
CP length			Normal	
In sync transmission parameters (Note 1)	DCI format		Format N1	As defined in TS 36.212 [21]
	Number of OFDM symbols for legacy control channels		3	In sync threshold Q_{in_NB-IoT} and the corresponding hypothetical NPDCCH transmission parameters are as specified in clause 7.23.2 and Table 7.23.2-1 respectively.
	NPDCCH aggregation level	eCCE	2	
	NPDCCH repetition level		2	
	Ratio of NPDSCH to NRS EPRE		0	
	Ratio of NPDCCH to NRS EPRE		0	
Out of sync transmission parameters (Note 1)	DCI format		Format N1	As defined in TS 36.212 [21]
	Number of OFDM symbols for legacy control channels		3	Out of sync threshold Q_{out_NB-IoT} and the corresponding hypothetical NPDCCH transmission parameters are as specified in clause 7.23.2 and Table 7.23.2-1 respectively.
	NPDCCH aggregation level	eCCE	2	
	NPDCCH repetition level		8	
	Ratio of NPDSCH to NRS EPRE		0	

	Ratio of NPDCCH to RS EPRE	dB	0	
Special subframe configuration			6	As specified in table 4.2-1 in TS 36.211 [16]
Uplink-downlink configuration			1	As specified in table 4.2-1 in TS 36.211 [16]
Layer 3 filtering			Enabled	Counters: N310 = 1; N311 = 1
T310 timer		ms	4000	T310 is enabled
T311 timer		ms	1000	T311 is enabled
T1		s	4	
dT		s	1.4	
T2		s	2.12	
dT		s	1.4	
T3		s	4	
Note 1: NPDCCH corresponding to the in-sync and out of sync transmission parameters need not be included in the Reference Measurement Channel.				

Table A.7.3.92.1-2: nCell 1 specific test parameters for TDD in-sync radio link monitoring test without DRX for UE category NB1 In-Band mode in normal coverage

Parameter	Unit	nCell 1				
		T1	dT	T2	dT	T3
BW _{channel}	kHz	200				
PRB location within eCell	-	eCell 1 BW _{channel} 10MHz: 30				
NPDCCH parameters defined in A.3.1.5.7		R.15 NB-TDD				
NPDSCH_RA		-3				
NPDSCH_RB		-3				
NPDCCH_RA	dB	-3				
NPDCCH_RB	dB	-3				
NPBCH_RA	dB	-3				
NPBCH_RB	dB					
NPSS_RA	dB					
NSSS_RA	dB					
NOCNG_RA ^{Note1}	dB					
NOCNG_RB ^{Note1}	dB	Specified in Table A.7.3.92.1-3				
N _{oc}	dBm/15 kHz					
SNR ^{Note 5, Note 6}	dB	-3.1	Note 7	-14.1	Note 8	-3.1
Propagation condition		AWGN				
Antenna Configuration		2x1				
<p>Note 1: OCNG shall be used such that the resources in ncell1 are fully allocated and a constant total transmitted power spectral density is achieved for all OFDM symbols.</p> <p>Note 2: The uplink resources for CQI reporting are assigned to the UE prior to the start of time period T1.</p> <p>Note 3: The timers and layer 3 filtering related parameters are configured prior to the start of time period T1.</p> <p>Note 4: The signal contains NPDCCH for UEs other than the device under test as part of OCNG.</p> <p>Note 5: SNR levels correspond to the signal to noise ratio over the cell-specific reference signal REs.</p> <p>Note 6: The SNR in time periods T1, T2 and T3 is denoted as SNR1, SNR2, and SNR1 respectively in figure A.7.3.92.1-1.</p> <p>Note 7: The Test system shall reduce its transmit power in steps of (((SNR2-SNR1) / (10*dT)) dB every 100ms till SNR2 is achieved at the end of dT.</p> <p>Note 8: The Test system shall increase its transmit power in steps of (((SNR1-SNR2) / (10*dT)) dB every 100ms till SNR1 is achieved at the end of dT.</p>						

Table A.7.3.92.1-3: eCell 1 specific test parameters for TDD in-sync radio link monitoring test without DRX for UE category NB1 In-Band mode in normal coverage

Parameter	Unit	eCell 1
		T1-T3
BW _{channel}	MHz	10
NOCNG Pattern	-	BW _{channel} 10MHz: NOP.1 TDD

PBCH_RA	dB	-3
PBCH_RB	dB	
PSS_RA	dB	
SSS_RA	dB	
PCFICH_RB	dB	
PDCCH_RA	dB	
PDCCH_RB	dB	
OCNG_RA ^{Note 1}	dB	
OCNG_RB ^{Note 1}	dB	
N_{oc} ^{Note2}	dBm/15 kHz	-98
\hat{E}_s/N_{oc}	dB	6
Propagation Condition		AWGN
Antenna Configuration		2x1
Note 1: OCNG shall be used such that the eCell is fully allocated and a constant total transmitted power spectral density is achieved for all OFDM symbols.		
Note 2: Interference from other cells and noise sources not specified in the test is assumed to be constant over subcarriers and time and shall be modelled as AWGN of appropriate power N_{oc} .		

Table A.7.3.92.1-4: TimeAlignmentTimer -Configuration for E-UTRAN TDD in-sync tests without DRX for UE category NB1 In-Band mode in normal coverage

Field	Value	Comment
TimeAlignmentTimer	infinity	As specified in clause 6.3.2 in TS 36.331 [2]

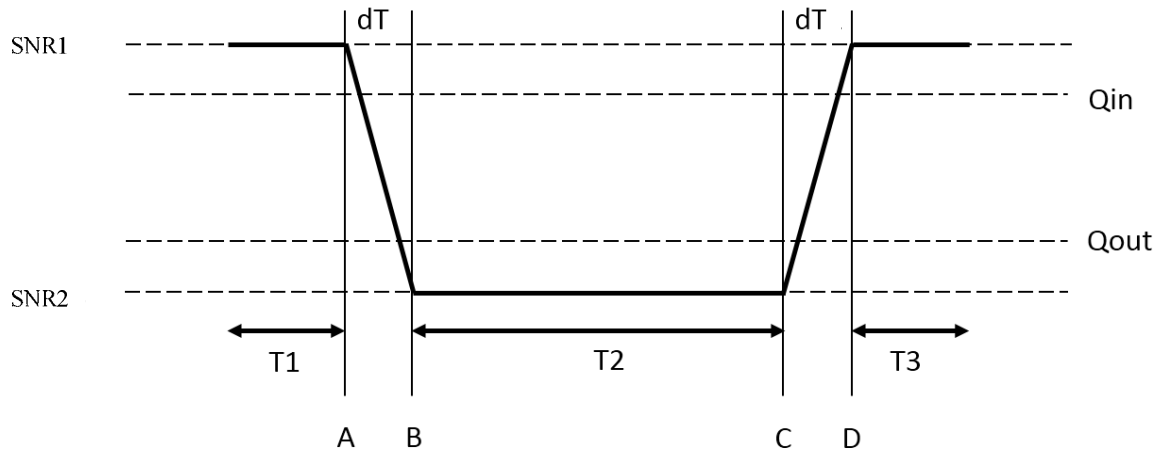

Figure A.7.3.92.1-1: SNR variation for in-sync testing without DRX

A.7.3.92.2 Test Requirements

The UE behavior in each test shall be as follows:

During the period T3, the UE under test is expected to decode the uplink grant and switch to uplink and complete the uplink transmission. This is considered a correct event.

The rate of correct events observed during repeated tests shall be at least 90%.

A.7.3.93 TDD Radio Link Monitoring Test for In-sync without DRX for UE Category NB1 In-Band mode in Enhanced Coverage

A.7.3.93.1 Test Purpose and Environment

The purpose of this test is to verify that the TDD category NB1 UE configured in enhanced coverage properly detects the out of sync and in sync for the purpose of monitoring downlink radio link quality of the PCell when DRX is used. This test will partly verify the TDD radio link monitoring requirements in clause 7.23.

The test parameters are given in Tables A.7.3.93.1-1, A.7.3.93.1-2, A.7.3.93.1-3 and A.7.3.93.1-4. nCell 1 is the active cell in the test. The test consists of three successive time periods, with time duration of T1, T2 and T3 respectively, excluding the transition time duration dT, where the SNR increases or decreases gradually in small steps. Figure A.7.3.93.1-1 shows the variation of the downlink SNR in the active cell to emulate out-of-sync and in-sync states.

Prior to the start of the time duration T1, the UE shall be fully be synchronized to nCell 1. The UE is scheduled in every uplink subframe to transmit NPUSCH, which is received by the test equipment. By measuring the reception of the NPUSCH, detection of out of sync and in sync requirements can be measured. In the test, DRX configuration is disabled, i.e. UE tries to decode NPDCCH and to send NPUSCH during the period when On-duration timer is running. Time alignment timers shall be set to “infinity” so that UL timing alignment is maintained during the test.

The test setup in each test during time durations T1, T2, dT and T3 shall be as follows:

- During the period from time point A to time point B, the SNR is decreasing linearly from SNR1 to SNR2.
- During the period from time point C to time point D, the SNR is increasing linearly from SNR2 to SNR3.
- During the period T3, the test system shall send the UE a grant to transmit in uplink. UE under test is expected to decode the uplink grant and switch to uplink and complete the uplink transmission.
- Thereafter UE switches back to downlink.

In each run of the test, the test equipment selects NPDCCH repetition level, and sends the RRC configuration to the UE. UE shall successfully complete the RRC reconfiguration accordingly prior to the start of time duration T1.

Table A.7.3.93.1-1: General test parameters for TDD in-sync test without DRX for UE category NB1 In-Band mode in enhanced coverage

Parameter		Unit	Value	Comment
NB-IoT operational mode			In-band	
Active cell			nCell 1	NB-IOT cell nCell1 is within E-UTRA cell eCell1
CP length			Normal	
In sync transmission parameters (Note 1)	DCI format		Format N1	As defined in TS 36.212 [21]
	Number of OFDM symbols for legacy control channels		3	In sync threshold Q_{in_NB-IoT} and the corresponding hypothetical NPDCCH transmission parameters are as specified in clause 7.23.2 and Table 7.23.2-1 respectively.
	NPDCCH aggregation level	eCCE	2	
	NPDCCH repetition level		4	
	Ratio of NPDSCH to NRS EPRE		0	
	Ratio of NPDCCH to NRS EPRE		0	
Out of sync transmission parameters (Note 1)	DCI format		Format N1	As defined in TS 36.212 [21]
	Number of OFDM symbols for legacy control channels		3	Out of sync threshold Q_{out_NB-IoT} and the corresponding hypothetical NPDCCH transmission parameters are as specified in clause 7.23.2 and Table 7.23.2-1 respectively.
	NPDCCH aggregation level	eCCE	2	
	NPDCCH repetition level		16	
Ratio of NPDSCH to NRS EPRE		0		

	Ratio of NPDCCH to RS EPRE	dB	0	
Special subframe configuration			6	As specified in table 4.2-1 in TS 36.211 [16]
Uplink-downlink configuration			1	As specified in table 4.2-1 in TS 36.211 [16]
Layer 3 filtering			Enabled	Counters: N310 = 1; N311 = 1
T310 timer		ms	4000	T310 is enabled
T311 timer		ms	1000	T311 is enabled
T1		s	4	
dT		s	1.4	
T2		s	2.12	
dT		s	1.4	
T3		s	4	
Note 1: NPDCCH corresponding to the in-sync and out of sync transmission parameters need not be included in the Reference Measurement Channel.				

Table A.7.3.93.1-2: nCell 1 specific test parameters for TDD in-sync radio link monitoring test without DRX for UE category NB1 In-Band mode in enhanced coverage

Parameter	Unit	nCell 1				
		T1	dT	T2	dT	T3
BW _{channel}	kHz	200				
PRB location within eCell	-	eCell 1 BW _{channel} 10MHz: 30				
NPDCCH parameters defined in A.3.1.5.7		R.15 NB-TDD				
NPDSCH_RA		-3				
NPDSCH_RB		-3				
NPDCCH_RA	dB	-3				
NPDCCH_RB	dB	-3				
NPBCH_RA	dB	-3				
NPBCH_RB	dB					
NPSS_RA	dB					
NSSS_RA	dB					
NOCNG_RA ^{Note1}	dB					
NOCNG_RB ^{Note1}	dB	Specified in Table A.7.3.93.1-3				
N _{oc}	dBm/15 kHz					
SNR ^{Note 5, Note 6}	dB	-6.3	Note 7	-17.4	Note 8	-6.3
Propagation condition		AWGN				
Antenna Configuration		2x1				
<p>Note 1: OCNG shall be used such that the resources in ncell1 are fully allocated and a constant total transmitted power spectral density is achieved for all OFDM symbols.</p> <p>Note 2: The uplink resources for CQI reporting are assigned to the UE prior to the start of time period T1.</p> <p>Note 3: The timers and layer 3 filtering related parameters are configured prior to the start of time period T1.</p> <p>Note 4: The signal contains NPDCCH for UEs other than the device under test as part of OCNG.</p> <p>Note 5: SNR levels correspond to the signal to noise ratio over the cell-specific reference signal REs.</p> <p>Note 6: The SNR in time periods T1, T2 and T3 is denoted as SNR1, SNR2, and SNR1 respectively in figure A.7.3.93.1-1.</p> <p>Note 7: The Test system shall reduce its transmit power in steps of (((SNR2-SNR1) / (10*dT)) dB every 100ms till SNR2 is achieved at the end of dT.</p> <p>Note 8: The Test system shall increase its transmit power in steps of (((SNR1-SNR2) / (10*dT)) dB every 100ms till SNR1 is achieved at the end of dT.</p>						

Table A.7.3.93.1-3: eCell 1 specific test parameters for TDD in-sync radio link monitoring test without DRX for UE category NB1 In-Band mode in enhanced coverage

Parameter	Unit	eCell 1
		T1-T3
BW _{channel}	MHz	10
NOCNG Pattern	-	BW _{channel} 10MHz: NOP.1 TDD

PBCH_RA	dB	-3
PBCH_RB	dB	
PSS_RA	dB	
SSS_RA	dB	
PCFICH_RB	dB	
PDCCH_RA	dB	
PDCCH_RB	dB	
OCNG_RA ^{Note 1}	dB	
OCNG_RB ^{Note 1}	dB	
N_{oc} ^{Note2}	dBm/15 kHz	-98
\hat{E}_s/N_{oc}	dB	0
Propagation Condition		AWGN
Antenna Configuration		2x1
Note 1: OCNG shall be used such that the eCell is fully allocated and a constant total transmitted power spectral density is achieved for all OFDM symbols.		
Note 2: Interference from other cells and noise sources not specified in the test is assumed to be constant over subcarriers and time and shall be modelled as AWGN of appropriate power N_{oc} .		

Table A.7.3.93.1-4: TimeAlignmentTimer -Configuration for E-UTRAN TDD in-sync tests without DRX for UE category NB1 In-Band mode in enhanced coverage

Field	Value	Comment
TimeAlignmentTimer	infinity	As specified in clause 6.3.2 in TS 36.331 [2]

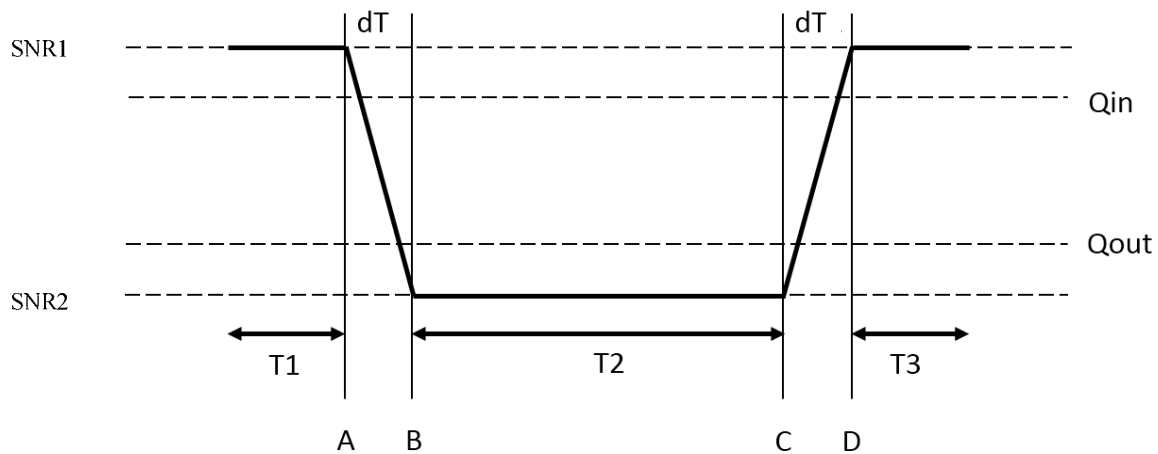

Figure A.7.3.93.1-1: SNR variation for in-sync testing without DRX

A.7.3.93.2 Test Requirements

The UE behavior in each test shall be as follows:

During the period T3, the UE under test is expected to decode the uplink grant and switch to uplink and complete the uplink transmission. This is considered a correct event.

The rate of correct events observed during repeated tests shall be at least 90%.

A.7.3.94 TDD Radio Link Monitoring Test for Out-of-sync without DRX for UE Category NB1 Standalone mode in Normal Coverage

A.7.3.94.1 Test Purpose and Environment

The purpose of this test is to verify that the TDD category NB1 UE properly detects the out of sync for the purpose of monitoring downlink radio link quality of the NB-IoT Cell. This test will partly verify the NB-IoT TDD radio link monitoring requirements in clause 7.23.

The test parameters are given in Tables A.7.3.94.1-1 and A.7.3.94.1-2. nCell1 is the active NB-IoT cell in the test. The test consists of four successive time periods with time duration of T1, T2, T3 and T4 respectively, excluding the transition time duration dT, where the SNR increases or decreases gradually in small steps. Figure A.7.3.94.1-1 shows the variation of the downlink SNR in the active cell to emulate out-of-sync state with the following testing procedure:

- Prior to the start of the time duration T1, the UE shall be fully synchronized to nCell1
- Starting at point A, the SNR is decreased in small steps from SNR1 to SNR2 within dT
- At the start of the time duration T2, the UE is provided with a UL grant with NPDCCH

Note: The UE is expected to decode the NPDCCH and complete the UL transmission during T2 according to the UL grant.

- Starting at point B, the SNR is decreased in small steps from SNR2 to SNR3 within dT
- During T3, the SNR is kept as SNR3

Note: The UE is expected to detect OOS and declare RLF during T3.

- Starting at point C, the SNR is increased in small steps from SNR3 to SNR1 with dT
- At the start of the time period T4, the UE will be provided with another UL grant with NPDCCH

Note: The UE is not expected to decode the UL grant and conduct any UL transmission during T4, since the UE is expected to declare RLF during T3.

Table A.7.3.94.1-1: General test parameters for TDD Radio Link Monitoring Test for out-of-sync tests without DRX for UE Category NB1 Standalone mode in normal coverage

Parameter	Unit	Value	Comment
NB-IoT operational mode		Standalone	
Active cell		nCell 1	
CP length		Normal	
NPDCCH repetition level R_{max}		8	Other NPDCCH parameters are defined in "out-of-sync" column in Table 7.23.2-1
Special subframe configuration		6	As specified in table 4.2-1 in TS 36.211 [16]
Uplink-downlink configuration		1	As specified in table 4.2-1 in TS 36.211 [16]
DRX		OFF	
Layer 3 filtering ^{Note 2,3}		Enabled	Counters: N310 = 1 N311 = 1
T310 timer ^{Note 2,3}	ms	0	T310 is disabled
T311 timer ^{Note 2,3}	ms	3000	T311 is enabled
T1	s	2	
dT	s	0.8	
T2	s	0.4	
dT	s	0.7	
T3	s	0.5	
dT	s	1.4	

T4	s	0.4
Note 1:	NPDCCH corresponding to the out of sync transmission parameters need not be included in the Reference Measurement Channel.	
Note 2:	N310, N311, T310 and T311 are defined in TS 36.331 [2].	
Note 3:	The timers and layer 3 filtering related parameters are configured prior to the start of time period T1.	

Table A.7.3.94.1-2: nCell1 specific test parameters for TDD Radio Link Monitoring Test for out-of-sync without DRX for UE Category NB1 Standalone mode in normal coverage

Parameter	Unit	nCell 1						
		T1	dT	T2	dT	T3	dT	T4
NB-IoT Channel Bandwidth ($BW_{channel}$)	kHz	180						
OCNG Pattern as defined in A.3.2.3.8 ^{Note 1}		NOP.3 TDD						
NPDCCH parameters as defined in A.3.1.5.8		R.19 NB-TDD						
NPBCH_RA	dB	-3						
NPBCH_RB	dB							
NPSS_RA	dB							
NSSS_RA	dB							
NPDCCH_RA	dB							
NPDCCH_RB	dB							
NPDSCH_RA	dB							
NPDSCH_RB	dB							
OCNG_RA ^{Note 1}	dB							
OCNG_RB ^{Note 1}	dB							
N_{oc}	dBm/15 KHz	-98						
SNR ^{Note 4,5}	-	-3.1	Note 6	-9.1	Note 7	-14.1	Note 6	-3.1
Propagation Condition	-	AWGN						
Antenna Configuration	-	2x1						
<p>Note 1: OCNG shall be used such that the cell is fully allocated and a constant total transmitted power spectral density is achieved for all OFDM symbols. The OCNG pattern is chosen during the test according to the presence of a DL reference measurement channel.</p> <p>Note 2: Void</p> <p>Note 3: Void</p> <p>Note 4: SNR levels correspond to the signal to noise ratio over the cell-specific reference signal REs.</p> <p>Note 5: The SNRs in time periods T1, T2, T3 and T4 are denoted as SNR2, SNR3 and SNR1 respectively in figure A.7.3.94.1-1.</p> <p>Note 6: The Test system shall reduce its transmit power in steps of $((SNR2-SNR1) / (10*dT))$ dB every 100ms until SNR2 is achieved at the end of dT.</p> <p>Note 7: The Test system shall reduce its transmit power in steps of $((SNR3-SNR2) / (10*dT))$ dB every 100ms until SNR3 is achieved at the end of dT.</p> <p>Note 8: The Test system shall increase its transmit power in steps of $((SNR1-SNR3) / (10*dT))$ dB every 100ms until SNR1 is achieved at the end of dT.</p>								

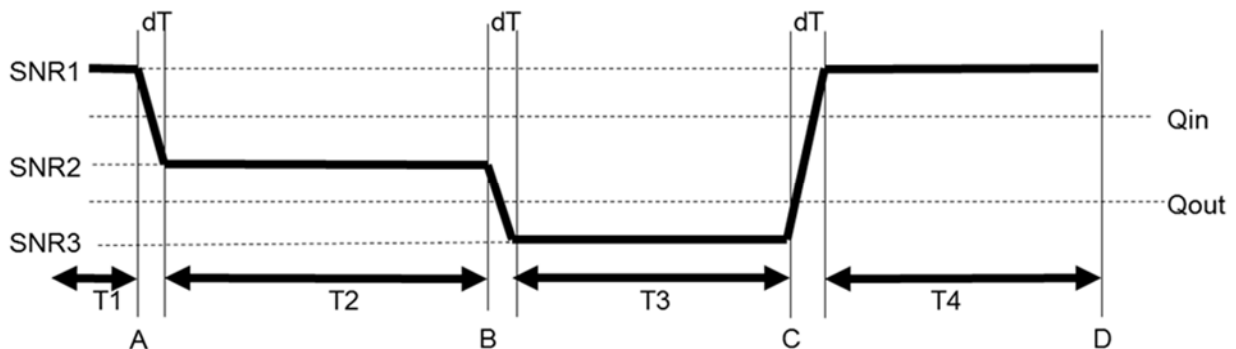

Figure A.7.3.94.1-1: SNR variation for out-of-sync testing

A.7.3.94.2 Test Requirements

The UE behaviors in each test shall be as follows:

- The UE shall complete the NPUSCH transmission during T2 according to the received UL grant;
- The UE shall not conduct any NPUSCH transmission during T4

A correct event is defined as UE behaves correctly in all above steps. The correct events observed during repeated tests shall be at least 90%.

A.7.3.95 TDD Radio Link Monitoring Test for Out-of-sync without DRX for UE Category NB1 guard band mode in Enhanced Coverage

A.7.3.95.1 Test Purpose and Environment

The purpose of this test is to verify that the TDD category NB1 UE properly detects the out of sync for the purpose of monitoring downlink radio link quality of the NB-IoT Cell. This test will partly verify the NB-IoT TDD radio link monitoring requirements in clause 7.23.

The test parameters are given in Tables A.7.3.95.1-1 and A.7.3.95.1-2 below. nCell1 is the active NB-IoT cell, in the test. The test consists of four successive time periods with time duration of T1, T2, T3 and T4 respectively, excluding the transition time duration dT, where the SNR increases or decreases gradually in small steps. Figure A.7.3.95.1-1 shows the variation of the downlink SNR in the active cell to emulate out-of-sync state with the following testing procedure.

- Before the start of the time duration T1, the UE shall be fully synchronized to nCell1
- Starting at point A, the SNR is decreased in small steps from SNR1 to SNR2 with duration dT
- At the start of the time duration T2, the UE is provided with a UL grant with NPDCCH.

Note: The UE is expected to decode NPDCCH and complete the UL transmission during T2 according to the UL grant.

- Starting at point B, the SNR is decreased in small steps from SNR2 to SNR3 with duration dT
- During T3, the SNR is kept at SNR3.

Note: The UE is expected to detect OOS and declare RLF during T3.

- Starting at point C, the SNR is increased in small steps from SNR3 to SNR1 with duration dT
- At the start of the time period T4, the UE will be provided with another UL grant with NPDCCH

Note: The UE is not expected to decode the UL grant and conduct the UL transmission during T4 since the UE is expected to declare RLF during T3.

Table A.7.3.95.1-1: General test parameters for TDD Radio Link Monitoring Test for out-of-sync tests without DRX for UE Category NB1 Guard band mode in enhanced coverage

Parameter	Unit	Value	Comment
NB-IoT operational mode		Guardband	
Active cell		nCell 1	
CP length		Normal	
NB-IoT RF Channel Number		1	One NB-IoT carrier frequency
NPDCCH repetition level R_{max}		16	Other NPDCCH parameters are defined in "out-of-sync" column in Table 7.23.2-1

Special subframe configuration		6	As specified in table 4.2-1 in TS 36.211 [16]
Uplink-downlink configuration		6	As specified in table 4.2-1 in TS 36.211 [16]
DRX		OFF	
Layer 3 filtering ^{Note 2}		Enabled	Counters: N310 = 1 N311 = 1
T310 timer ^{Note 2}	ms	0	T310 is disabled
T311 timer ^{Note 2}	ms	3000	T311 is enabled
T1	s	2	
dT	s	0.7	
T2	s	0.4	
dT	s	0.8	
T3	s	0.5	
dT	s	1.4	
T4	s	0.4	
<p>Note 1: NPDCCH corresponding to the out of sync transmission parameters need not be included in the Reference Measurement Channel.</p> <p>Note 2: N310, N311, T310 and T311 are defined in TS 36.331 [2].</p> <p>Note 3: The timers and layer 3 filtering related parameters are configured prior to the start of time period T1.</p>			

Table A.7.3.95.1-2: nCell1 specific test parameters for TDD Radio Link Monitoring Test for out-of-sync without DRX for UE Category NB1 Guard band mode in enhanced coverage

Parameter	Unit	nCell 1						
		T1	dT	T2	dT	T3	dT	T4
BW _{channel}	kHz	180						
PRB location within eCell	-	eCell 1 BW _{channel} 10MHz: 50						
NPDCCH parameters as defined in A.3.1.5.9		R.23 NB-TDD						
NPBCH_RA	dB	-3						
NPBCH_RB	dB							
NPSS_RA	dB							
NSSS_RA	dB							
NPDCCH_RA	dB							
NPDCCH_RB	dB							
NPDSCH_RA	dB							
NPDSCH_RB	dB							
OCNG_RA ^{Note 1}	dB							
OCNG_RB ^{Note 1}	dB							
N_{oc}	dBm/15 KHz	Specified in Table A.7.3.95.1-3						
SNR ^{Note 4,5}	-	-6.3	Note 6	-11.4	Note 7	-17.4	Note 8	-6.3
Propagation Condition	-	AWGN						
Antenna Configuration	-	2x1						
<p>Note 1: OCNG shall be used such that the cell is fully allocated and a constant total transmitted power spectral density is achieved for all OFDM symbols. The OCNG pattern is chosen during the test according to the presence of a DL reference measurement channel.</p> <p>Note 2: Void</p> <p>Note 3: Void</p> <p>Note 4: SNR levels correspond to the signal to noise ratio over the cell-specific reference signal REs.</p> <p>Note 5: The SNR in time periods T1, T2, T3 and T4 is denoted as SNR1, SNR2, SNR3 and SNR1 respectively in figure A.7.3.95.1-1.</p> <p>Note 6: The Test system shall reduce its transmit power in steps of ((SNR2-SNR1) / (10*dT)) dB every 100ms until SNR2 is achieved at the end of dT.</p> <p>Note 7: The Test system shall reduce its transmit power in steps of ((SNR3-SNR2) / (10*dT)) dB every 100ms until SNR3 is achieved at the end of dT.</p>								

Note 8: The Test system shall increase its transmit power in steps of $((SNR1-SNR3) / (10*dT))$ dB every 100ms until SNR1 is achieved at the end of dT.

Table A.7.3.95.1-3: eCell 1 specific test parameters for TDD out-of-sync radio link monitoring test without DRX for UE category NB1 Guard band mode in enhanced coverage

Parameter	Unit	eCell 1
		T1-T4
$BW_{channel}$	MHz	10
NOCNG Pattern	-	$BW_{channel}$ 10MHz: NOP.2 TDD
PBCH_RA	dB	-3
PBCH_RB	dB	
PSS_RA	dB	
SSS_RA	dB	
PCFICH_RB	dB	
PDCCH_RA	dB	
PDCCH_RB	dB	
OCNG_RA ^{Note 1}	dB	
OCNG_RB ^{Note 1}	dB	
N_{oc} ^{Note2}	dBm/15 kHz	
\hat{E}_s/N_{oc}	dB	-12
Propagation Condition		AWGN
Antenna Configuration		2x1
Note 1: OCNG shall be used such that the eCell 1 is fully allocated and a constant total transmitted power spectral density is achieved for all OFDM symbols. Note 2: Interference from other cells and noise sources not specified in the test is assumed to be constant over subcarriers and time and shall be modelled as AWGN of appropriate power N_{oc} .		

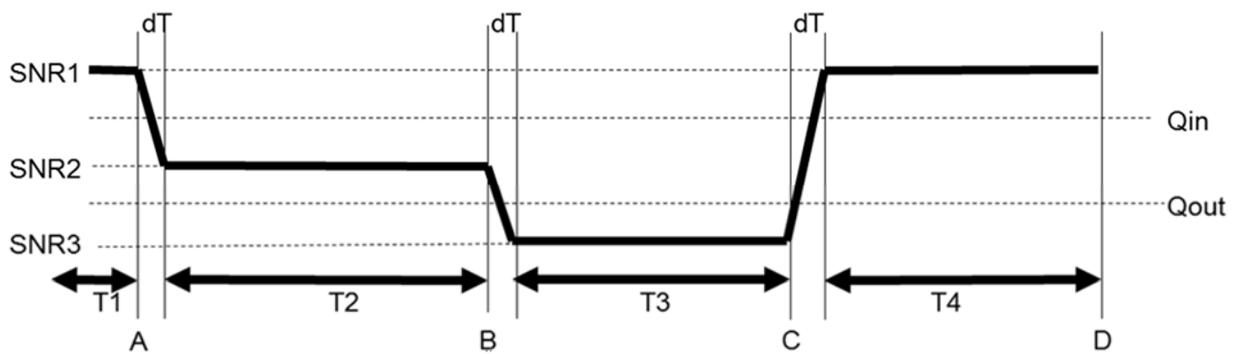

Figure A.7.3.95.1-1: SNR variation for out-of-sync testing

A.7.3.95.2 Test Requirements

The UE behaviors in each test shall be as follows:

- The UE shall complete the NPUSCH transmission during T2 according to the received UL grant;
- The UE shall not conduct any NPUSCH transmission during T4

A correct event is defined as UE behave correctly in all above steps. The correct events observed during repeated tests shall be at least 90%.

A.7.4 Interruption for Dual Connectivity

A.7.4.1 E-UTRAN FDD-FDD DC interruption at transitions between active and non-active during DRX in synchronous DC

A.7.4.1.1 Test Purpose and Environment

The purpose of this test is to verify that when PCell is in non-DRX and PSCell is in DRX, PCell interruptions due to transitions from active to non-active and from non-active to active during PSCell DRX the UE missed ACK/NACK does not exceed the limits. This test will verify the missed ACK/NACK rate for FDD PCell in dual connectivity requirements in clause 7.12.2.

The test parameters are given in Table A.7.4.1.1-1, A.7.4.1.1-2 and A.7.4.1.1-3 below. In the test there are two cells: Cell1 and Cell2. Cell1 is PCell and Cell2 is PSCell. PCell is continuously scheduled in DL while PSCell is not scheduled and has DRX configured. The test consists of one time period, with duration of T1. Prior to the start of the time duration T1, the UE shall be fully synchronized to Cell1 and Cell2. Cell1 shall be configured as PCell and Cell2 shall be configured as PSCell. Prior to start of T1 the DRX inactivity timer for the PSCell have already expired. During T1 the UE shall be continuously scheduled on PCell while not scheduled on PSCell.

Table A.7.4.1.1-1: General test parameters for E-UTRAN FDD-FDD DC interruption at transitions between active and non-active during DRX in synchronous DC

Parameter	Unit	Value	Comment
E-UTRA RF Channel Number		1, 2	Two radio channels are used for this test.
Active PCell		Cell1	PCell on RF channel number 1.
Configured PSCell		Cell2	PSCell on RF channel number 2.
CP length		Normal	
DRX		ON	DRX related parameters are defined in Table A.8.23.4.1-3
Measurement gap pattern Id		OFF	
T1	s	10	
Note 1:	This test verifies the RRM requirement which is independent of channel bandwidth and is performed according to the principle defined in section A.3.6.1.		
Note 2:	A UE capable of both synchronous and asynchronous DC operations is only required to pass this test case in accordance with the principle defined in section A.3.11.		

Table A.7.4.1.1-2: Cell specific test parameters for E-UTRAN FDD-FDD DC interruption at transitions between active and non-active during DRX in synchronous DC

Parameter	Unit	Cell1	Cell2
		T1	T1
E-UTRA RF Channel Number		1	2
BW _{channel}	MHz	5MHz: N _{RB,c} = 25 10MHz: N _{RB,c} = 50 20MHz: N _{RB,c} = 100	5MHz: N _{RB,c} = 25 10MHz: N _{RB,c} = 50 20MHz: N _{RB,c} = 100
PDSCH parameters: DL Reference Measurement Channel		5MHz: R.7 FDD 10MHz: R.3 FDD 20MHz: R.6 FDD	-
PCFICH/PDCCH/PHICH parameters: DL Reference Measurement Channel		5MHz: R.11 FDD 10MHz: R.6 FDD 20MHz: R.10 FDD	5MHz: R.11 FDD 10MHz: R.6 FDD 20MHz: R.10 FDD
OCNG Patterns		5MHz: OP.20 FDD 10MHz: OP.10 FDD 20MHz: OP.17 FDD	5MHz: OP.16 FDD 10MHz: OP.2 FDD 20MHz: OP.12 FDD
PBCH_RA	dB	0	0
PBCH_RB	dB		
PSS_RA	dB		
SSS_RA	dB		
PCFICH_RB	dB		
PHICH_RA	dB		

PHICH_PB	dB		
PDCCH_RA	dB		
PDCCH_PB	dB		
PDSCH_RA	dB		
PDSCH_RB	dB		
OCNG_RA ^{Note 1}	dB		
OCNG_RB ^{Note 1}	dB		
N_{oc} ^{Note 2}	dBm/15 KHz	-101	-101
\hat{E}_s / N_{oc}	dB	19	19
\hat{E}_s / I_{ot}	dB	19	19
RSRP ^{Note 3}	dBm/15 KHz	-82	-82
SCH_RP ^{Note 3}	dBm/15 KHz	-82	-82
I_o ^{Note 3}	dBm/Ch BW	-54.16 +10log($N_{RB,c} / 50$)	-54.16 +10log($N_{RB,c} / 50$)
Propagation Condition		AWGN	AWGN
Correlation Matrix and Antenna Configuration		1x2 Low	1x2 Low
Time offset to cell1 ^{Note 4}	μ s	-	33
<p>Note 1: OCNG shall be used such that both cells are fully allocated and a constant total transmitted power spectral density is achieved for all OFDM symbols.</p> <p>Note 2: Interference from other cells and noise sources not specified in the test is assumed to be constant over subcarriers and time and shall be modelled as AWGN of appropriate power for N_{oc} to be fulfilled.</p> <p>Note 3: RSRP, SCH_RP and I_o levels have been derived from other parameters for information purposes. They are not settable parameters themselves.</p> <p>Note 4: Receive time difference between subframe boundaries of signals received from the two cells at the UE antenna connector including time alignment error between the two cells.</p>			

Table A.7.4.1.1-3: DRX-Configuration for E-UTRAN FDD-FDD DC interruption at transitions between active and non-active during DRX in synchronous DC

Field	Cell1	Cell2	Comment
	Value	Value	
onDurationTimer	psf1	psf1	As specified in clause 6.3.2 in TS 36.331
drx-InactivityTimer ^{Note 1}	psf1	psf1	
drx-RetransmissionTimer	psf1	psf1	
longDRX-CycleStartOffset	sf80	Sf160	
shortDRX	disable	disable	
Note 1: UE is continuously scheduled in PCell			

A.7.4.1.2 Test Requirements

The UE shall be continuously scheduled in PCell during the entire length of T1. UE shall not be scheduled in PSCell during T1. During the time duration T1 the UE shall transmit at least 99% of ACK/NACK on PCell.

The UE shall not miss transmitting two consecutive ACK/NACK.

The rate of correct events observed during repeated tests shall be at least 90%.

A.7.4.2 E-UTRAN TDD-TDD DC interruption at transitions between active and non-active during DRX in synchronous DC

A.7.4.2.1 Test Purpose and Environment

The purpose of this test is to verify that when PCell is in non-DRX and PSCell is in DRX, PCell interruptions due to transitions from active to non-active and from non-active to active during PSCell DRX the UE missed ACK/NACK

does not exceed the limits. This test will verify the missed ACK/NACK rate for TDD PCell in dual connectivity requirements in clause 7.12.2.

The test parameters are given in Table A.7.4.2.1-1, A.7.4.2.1-2 and A.7.4.2.1-3 below. In the test there are two cells: Cell1 and Cell2. Cell1 is PCell and Cell2 is PSCell. PCell is continuously scheduled in DL while PSCell is not scheduled and has DRX configured. The test consists of one time period, with duration of T1. Prior to the start of the time duration T1, the UE shall be fully synchronized to Cell1 and Cell2. Cell1 shall be configured as PCell and Cell2 shall be configured as PSCell. Prior to start of T1 the DRX inactivity timer for the PSCell have already expired. During T1 the UE shall be continuously scheduled on PCell while not scheduled on PSCell.

Table A.7.4.2.1-1: General test parameters for E-UTRAN TDD-TDD DC interruption at transitions between active and non-active during DRX in synchronous DC

Parameter	Unit	Value	Comment
E-UTRA RF Channel Number		1, 2	Two radio channels are used for this test.
Active PCell		Cell1	PCell on RF channel number 1.
Configured PSCell		Cell2	PSCell on RF channel number 2.
Special subframe configuration		6	As specified in table 4.2-1 in TS 36.211. Applicable to cell 1
Uplink-downlink configuration		1	As specified in table 4.2-1 in TS 36.211. Applicable to Cell1
CP length		Normal	As specified in table 4.2-2 in TS 36.211. Applicable to Cell1
DRX		ON	DRX related parameters are defined in Table A.8.23.4.1-3
Measurement gap pattern Id		OFF	
T1	s	10	
Note 1: This test verifies the RRM requirement which is independent of channel bandwidth and is performed according to the principle defined in section A.3.6.1.			
Note 2: A UE capable of both synchronous and asynchronous DC operations is only required to pass this test case in accordance with the principle defined in section A.3.11.			

Table A.7.4.2.1-2: Cell specific test parameters for E-UTRAN TDD-TDD DC interruption at transitions between active and non-active during DRX in synchronous DC

Parameter	Unit	Cell1	Cell2
		T1	T1
E-UTRA RF Channel Number		1	2
BW _{channel}	MHz	5MHz: N _{RB,c} = 25 10MHz: N _{RB,c} = 50 20MHz: N _{RB,c} = 100	5MHz: N _{RB,c} = 25 10MHz: N _{RB,c} = 50 20MHz: N _{RB,c} = 100
PDSCH parameters: DL Reference Measurement Channel		5MHz: R.4 TDD 10MHz: R.0 TDD 20MHz: R.3 TDD	-
PCFICH/PDCCH/PHICH parameters: DL Reference Measurement Channel		5MHz: R.11 TDD 10MHz: R.6 TDD 20MHz: R.10 TDD	5MHz: R.11 TDD 10MHz: R.6 TDD 20MHz: R.10 TDD
OCNG Patterns		5MHz: OP.9 TDD 10MHz: OP.1 TDD 20MHz: OP.7 TDD	5MHz: OP.10 TDD 10MHz: OP.2 TDD 20MHz: OP.7 TDD
PBCH_RA	dB	0	0
PBCH_RB	dB		
PSS_RA	dB		
SSS_RA	dB		
PCFICH_RB	dB		
PHICH_RA	dB		
PHICH_PB	dB		
PDCCH_RA	dB		
PDCCH_PB	dB		
PDSCH_RA	dB		
PDSCH_RB	dB		

OCNG_RA ^{Note 1}	dB		
OCNG_RB ^{Note 1}	dB		
N_{oc} ^{Note 2}	dBm/15 KHz	-101	-101
\hat{E}_s / N_{oc}	dB	19	19
\hat{E}_s / I_{ot}	dB	19	19
RSRP ^{Note 3}	dBm/15 KHz	-82	-82
SCH_RP ^{Note 3}	dBm/15 KHz	-82	-82
I_o ^{Note 3}	dBm/Ch BW	-54.16 +10log ($N_{RB,c} / 50$)	-54.16 +10log ($N_{RB,c} / 50$)
Propagation Condition		AWGN	AWGN
Correlation Matrix and Antenna Configuration		1x2 Low	1x2 Low
Time offset to cell1 ^{Note 4}	μ s	-	33
<p>Note 1: OCNG shall be used such that both cells are fully allocated and a constant total transmitted power spectral density is achieved for all OFDM symbols.</p> <p>Note 2: Interference from other cells and noise sources not specified in the test is assumed to be constant over subcarriers and time and shall be modelled as AWGN of appropriate power for N_{oc} to be fulfilled.</p> <p>Note 3: RSRP, SCH_RP and I_o levels have been derived from other parameters for information purposes. They are not settable parameters themselves.</p> <p>Note 4: Receive time difference between subframe boundaries of signals received from the two cells at the UE antenna connector including time alignment error between the two cells.</p>			

Table A.7.4.2.1-3: DRX-Configuration for E-UTRAN TDD-TDD DC interruption at transitions between active and non-active during DRX in synchronous DC

Field	Cell1	Cell2	Comment
	Value	Value	
onDurationTimer	psf1	psf1	As specified in clause 6.3.2 in TS 36.331
drx-InactivityTimer ^{Note 1}	psf1	psf1	
drx-RetransmissionTimer	psf1	psf1	
longDRX-CycleStartOffset	sf80	Sf160	
shortDRX	disable	disable	
Note 1: UE is continuously scheduled in PCell			

A.7.4.2.2 Test Requirements

The UE shall be continuously scheduled in PCell during the entire length of T1. UE shall not be scheduled in PCell during T1. During the time duration T1 the UE shall transmit at least 99% of ACK/NACK on PCell.

The UE shall not miss transmitting two consecutive ACK/NACK.

The rate of correct events observed during repeated tests shall be at least 90%.

A.7.4.3 E-UTRAN FDD-FDD Interruption at transitions between active and non-active during DRX in asynchronous dual connectivity

A.7.4.3.1 Test Purpose and Environment

The purpose of this test is to verify that the UE fulfils the requirement on interruptions on PCell at transitions between active and non-active during DRX in TS36.133 section 7.12.2.

The test parameters are given in Table A.7.4.3.1-1, Table A.7.4.3.1-2 and Table A.7.4.3.1-3 below. In the test there are two cells: Cell 1 and Cell 2. Cell 1 is PCell on the FDD primary component (RF channel 1). Cell 2 is PCell on the FDD secondary component (RF channel 2). The test consists of 1 time period, with time duration of T1. PDCCH

indicating a new transmission on PCell shall be sent continuously during the whole time duration to ensure UE would not enter DRX state on PCell. PCell is in DRX state with 320ms DRX cycle.

Table A.7.4.3.1-1: General test parameters for E-UTRAN FDD-FDD Interruption at transitions between active and non-active during DRX in asynchronous dual connectivity

Parameter	Unit	Value	Comment
E-UTRA RF Channel Number		1, 2	Two radio channels are used for this test
Active Cell		Cell 1, Cell 2	Cell 1 is PCell on E-UTRA RF channel number 1, and cell 2 is PSCell on E-UTRA RF channel number 2
CP length		Normal	
DRX on Cell1		OFF	
DRX on Cell2	ms	320	
Filter coefficient		0	L3 filtering is not used
T1	s	5	
Note 1: Even a UE capable of both synchronous and asynchronous DC operations is required to pass this test case in accordance with the principle defined in section A.3.11.			

Table A.7.4.3.1-2: Cell specific test parameters for E-UTRAN FDD-FDD Interruption at transitions between active and non-active during DRX in asynchronous dual connectivity

Parameter	Unit	Cell 1	Cell 2
		T1	T1
E-UTRA RF Channel Number		1	2
BW _{channel}	MHz	5: N _{RB,c} = 25 10: N _{RB,c} = 50 20: N _{RB,c} = 100	5: N _{RB,c} = 25 10: N _{RB,c} = 50 20: N _{RB,c} = 100
PDSCH parameters		5MHz: R.7 FDD 10MHz: R.3 FDD 20MHz: R.6 FDD	-
PCFICH/PDCCH/PHICH parameters		5MHz: R.11 FDD 10MHz: R.6 FDD 20MHz: R.10 FDD	5MHz: R.11 FDD 10MHz: R.6 FDD 20MHz: R.10 FDD
OCNG Patterns defined in A.3.2.1		5MHz: OP.20 FDD 10MHz: OP.10 FDD 20MHz: OP.17 FDD	5MHz: OP.16 FDD 10MHz: OP.2 FDD 20MHz: OP.12 FDD
PBCH_RA	dB	0	0
PBCH_RB	dB		
PSS_RA	dB		
SSS_RA	dB		
PCFICH_RB	dB		
PHICH_RA	dB		
PHICH_PB	dB		
PDCCH_RA	dB		
PDCCH_PB	dB		
PDSCH_RA	dB		
PDSCH_RB	dB		
OCNG_RA ^{Note 1}	dB		
OCNG_RB ^{Note 1}	dB		
N _{oc} ^{Note 2}	dBm/15 KHz		
\hat{E}_s/N_{oc}	dB	19	19
\hat{E}_s/I_{ot}	dB	19	19
RSRP ^{Note 3}	dBm/15 KHz	-82	-82
SCH_RP ^{Note 3}	dBm/15 KHz	-82	-82
I _o ^{Note 3}	dBm/Ch BW	-54.16+10log(N _{RB,c} /50)	-54.16+10log(N _{RB,c} /50)
Propagation Condition		AWGN	AWGN
Correlation Matrix and Antenna Configuration		1x2 Low	1x2 Low

Receive timing offset to Cell1 ^{Note 4}	μs	-	500
Note 1:	OCNG shall be used such that both cells are fully allocated and a constant total transmitted power spectral density is achieved for all OFDM symbols.		
Note 2:	Interference from other cells and noise sources not specified in the test is assumed to be constant over subcarriers and time and shall be modelled as AWGN of appropriate power for N_{oc} to be fulfilled.		
Note 3:	RSRP, SCH_RP and Io levels have been derived from other parameters for information purposes. They are not settable parameters themselves.		
Note 4:	Receive time difference between subframe boundaries of signals received from the two cells at the UE antenna connector including time alignment error between the two cells.		

Table A.7.4.3.1-3: DRX-Configuration for E-UTRAN FDD-FDD Interruption at transitions between active and non-active during DRX in asynchronous dual connectivity

Field	PSCell	Comment
	Value	
onDurationTimer	psf1	
drx-InactivityTimer	psf1	
drx-RetransmissionTimer	psf1	
longDRX-CycleStartOffset	sf320	
shortDRX	disable	

Note: For further information see clause 6.3.2 in TS 36.331.

Table A.7.4.3.1-4: TimeAlignmentTimer -Configuration for E-UTRAN FDD-FDD Interruption at transitions between active and non-active during DRX in asynchronous dual connectivity

Field	PSCell	Comment
	Value	
TimeAlignmentTimer	sf500	As specified in clause 6.3.2 in TS 36.331
sr-ConfigIndex	0	For further information see clause 6.3.2 in TS 36.331 and section 10.1 in TS 36.213.

A.7.4.3.2 Test Requirements

The UE shall be scheduled on PCell continuously during the whole time duration T1. During time durations T1, at least 99% of all expected ACK/NACKs shall be transmitted on PCell by the UE.

Each interruption shall not exceed 1 subframe.

The rate of correct events observed during repeated tests shall be at least 90%.

A.7.4.4 E-UTRAN FDD-TDD DC interruption at transitions between active and non-active during DRX in synchronous DC

A.7.4.4.1 Test Purpose and Environment

The purpose of this test is to verify that when PCell is in non-DRX and PSCell is in DRX, PCell interruptions due to transitions from active to non-active and from non-active to active during PSCell DRX the UE missed ACK/NACK does not exceed the limits. This test will verify the missed ACK/NACK rate for FDD PCell in dual connectivity requirements in clause 7.12.2.

The test parameters are given in Table A.7.4.4.1-1, A.7.4.4.1-2 and A.7.4.4.1-3 below. In the test there are two cells: Cell1 and Cell2. Cell1 is PCell and Cell2 is PSCell. PCell is continuously scheduled in DL while PSCell is not scheduled and has DRX configured. The test consists of one time period, with duration of T1. Prior to the start of the time duration T1, the UE shall be fully synchronized to Cell1 and Cell2. Cell1 shall be configured as PCell and Cell2 shall be configured as PSCell. Prior to start of T1 the DRX inactivity timer for the PSCell have already expired. During T1 the UE shall be continuously scheduled on PCell while not scheduled on PSCell.

Table A.7.4.4.1-1: General test parameters for E-UTRAN FDD-TDD DC interruption at transitions between active and non-active during DRX in synchronous DC

Parameter	Unit	Value	Comment
E-UTRA RF Channel Number		1, 2	Two radio channels are used for this test.
Active PCell		Cell1	PCell on RF channel number 1.
Configured PSCell		Cell2	PSCell on RF channel number 2.
CP length		Normal	
DRX		ON	DRX related parameters are defined in Table A.8.23.4.1-3
Measurement gap pattern Id		OFF	
T1	s	10	
Note 1: This test verifies the RRM requirement which is independent of channel bandwidth and is performed according to the principle defined in section A.3.6.1.			
Note 2: A UE capable of both synchronous and asynchronous DC operations is only required to pass this test case in accordance with the principle defined in section A.3.11.			

Table A.7.4.4.1-2: Cell specific test parameters for E-UTRAN FDD-TDD DC interruption at transitions between active and non-active during DRX in synchronous DC

Parameter	Unit	Cell1	Cell2
		T1	T1
E-UTRA RF Channel Number		1	2
BW _{channel}	MHz	5MHz: N _{RB,c} = 25 10MHz: N _{RB,c} = 50 20MHz: N _{RB,c} = 100	5MHz: N _{RB,c} = 25 10MHz: N _{RB,c} = 50 20MHz: N _{RB,c} = 100
PDSCH parameters: DL Reference Measurement Channel		5MHz: R.7 FDD 10MHz: R.3 FDD 20MHz: R.6 FDD	-
PCFICH/PDCCH/PHICH parameters: DL Reference Measurement Channel		5MHz: R.11 FDD 10MHz: R.6 FDD 20MHz: R.10 FDD	5MHz: R.11 TDD 10MHz: R.6 TDD 20MHz: R.10 TDD
OCNG Patterns		5MHz: OP.20 FDD 10MHz: OP.10 FDD 20MHz: OP.17 FDD	5MHz: OP.10 TDD 10MHz: OP.2 TDD 20MHz: OP.8 TDD
Special subframe configuration		Not applicable	6
Uplink-downlink configuration		Not applicable	1
PBCH_RA	dB	0	0
PBCH_RB	dB		
PSS_RA	dB		
SSS_RA	dB		
PCFICH_RB	dB		
PHICH_RA	dB		
PHICH_PB	dB		
PDCCH_RA	dB		
PDCCH_PB	dB		
PDSCH_RA	dB		
PDSCH_RB	dB		
OCNG_RA ^{Note 1}	dB		
OCNG_RB ^{Note 1}	dB		
N _{oc} ^{Note 2}	dBm/15 KHz		
\hat{E}_s / N_{oc}	dB	19	19
\hat{E}_s / I_{ot}	dB	19	19
RSRP ^{Note 3}	dBm/15 KHz	-82	-82
SCH_RP ^{Note 3}	dBm/15 KHz	-82	-82

I_o ^{Note 3}	dBm/Ch BW	-54.16 +10log ($N_{RB,c}/50$)	-54.16 +10log ($N_{RB,c}/50$)
Propagation Condition		AWGN	AWGN
Correlation Matrix and Antenna Configuration		1x2 Low	1x2 Low
Time offset to cell1 ^{Note 4}	μ s	-	33
Note 1:	OCNG shall be used such that both cells are fully allocated and a constant total transmitted power spectral density is achieved for all OFDM symbols.		
Note 2:	Interference from other cells and noise sources not specified in the test is assumed to be constant over subcarriers and time and shall be modelled as AWGN of appropriate power for N_{oc} to be fulfilled.		
Note 3:	RSRP, SCH_RP and I_o levels have been derived from other parameters for information purposes. They are not settable parameters themselves.		
Note 4:	Receive time difference between subframe boundaries of signals received from the two cells at the UE antenna connector including time alignment error between the two cells.		

Table A.7.4.4.1-3: DRX-Configuration for E-UTRAN FDD-TDD DC interruption at transitions between active and non-active during DRX in synchronous DC

Field	Cell1	Cell2	Comment
	Value	Value	
onDurationTimer	psf1	psf1	As specified in clause 6.3.2 in TS 36.331
drx-InactivityTimer ^{Note 1}	psf1	psf1	
drx-RetransmissionTimer	psf1	psf1	
longDRX-CycleStartOffset	sf80	Sf160	
shortDRX	disable	disable	
Note 1: UE is continuously scheduled in PCell			

A.7.4.4.2 Test Requirements

The UE shall be continuously scheduled in PCell during the entire length of T1. UE shall not be scheduled in PSCell during T1. During the time duration T1 the UE shall transmit at least 99% of ACK/NACK on PCell.

The UE shall not miss transmitting two consecutive ACK/NACK.

The rate of correct events observed during repeated tests shall be at least 90%.

A.7.4.5 E-UTRAN TDD-FDD DC interruption at transitions between active and non-active during DRX in synchronous DC

A.7.4.5.1 Test Purpose and Environment

The purpose of this test is to verify that when PCell is in non-DRX and PSCell is in DRX, PCell interruptions due to transitions from active to non-active and from non-active to active during PSCell DRX the UE missed ACK/NACK does not exceed the limits. This test will verify the missed ACK/NACK rate for TDD PCell in dual connectivity requirements in clause 7.12.2.

The test parameters are given in Table A.7.4.5.1-1, A.7.4.5.1-2 and A.7.4.5.1-3 below. In the test there are two cells: Cell1 and Cell2. Cell1 is PCell and Cell2 is PSCell. PCell is continuously scheduled in DL while PSCell is not scheduled and has DRX configured. The test consists of one time period, with duration of T1. Prior to the start of the time duration T1, the UE shall be fully synchronized to Cell1 and Cell2. Cell1 shall be configured as PCell and Cell2 shall be configured as PSCell. Prior to start of T1 the DRX inactivity timer for the PSCell have already expired. During T1 the UE shall be continuously scheduled on PCell while not scheduled on PSCell.

Table A.7.4.5.1-1: General test parameters for E-UTRAN TDD-FDD DC interruption at transitions between active and non-active during DRX in synchronous DC

Parameter	Unit	Value	Comment
E-UTRA RF Channel Number		1, 2	Two radio channels are used for this test.

Active PCell		Cell1	PCell on RF channel number 1.
Configured PSCell		Cell2	PSCell on RF channel number 2.
Special subframe configuration		6	As specified in table 4.2-1 in TS 36.211. Applicable to cell 1
Uplink-downlink configuration		1	As specified in table 4.2-1 in TS 36.211. Applicable to Cell1
CP length		Normal	As specified in table 4.2-2 in TS 36.211. Applicable to Cell1
DRX		ON	DRX related parameters are defined in Table A.8.23.4.1-3
Measurement gap pattern Id		OFF	
T1	s	10	
<p>Note 1: This test verifies the RRM requirement which is independent of channel bandwidth and is performed according to the principle defined in section A.3.6.1.</p> <p>Note 2: A UE capable of both synchronous and asynchronous DC operations is only required to pass this test case in accordance with the principle defined in section A.3.11.</p>			

Table A.7.4.5.1-2: Cell specific test parameters for E-UTRAN TDD-FDD DC interruption at transitions between active and non-active during DRX in synchronous DC

Parameter	Unit	Cell1	Cell2
		T1	T1
E-UTRA RF Channel Number		1	2
BW _{channel}	MHz	5MHz: N _{RB,c} = 25 10MHz: N _{RB,c} = 50 20MHz: N _{RB,c} = 100	5MHz: N _{RB,c} = 25 10MHz: N _{RB,c} = 50 20MHz: N _{RB,c} = 100
PDSCH parameters: DL Reference Measurement Channel		5MHz: R.4 TDD 10MHz: R.0 TDD 20MHz: R.3 TDD	-
PCFICH/PDCCH/PHICH parameters: DL Reference Measurement Channel		5MHz: R.11 TDD 10MHz: R.6 TDD 20MHz: R.10 TDD	5MHz: R.11 FDD 10MHz: R.6 FDD 20MHz: R.10 FDD
OCNG Patterns		5MHz: OP.9 TDD 10MHz: OP.1 TDD 20MHz: OP.7 TDD	5MHz: OP.16 FDD 10MHz: OP.2 FDD 20MHz: OP.12 FDD
Special subframe configuration		6	Not applicable
Uplink-downlink configuration		1	Not applicable
PBCH_RA	dB	0	0
PBCH_RB	dB		
PSS_RA	dB		
SSS_RA	dB		
PCFICH_RB	dB		
PHICH_RA	dB		
PHICH_PB	dB		
PDCCH_RA	dB		
PDCCH_PB	dB		
PDSCH_RA	dB		
PDSCH_RB	dB		
OCNG_RA ^{Note 1}	dB		
OCNG_RB ^{Note 1}	dB		
N _{oc} ^{Note 2}	dBm/15 KHz	-101	-101
\hat{E}_s / N_{oc}	dB	19	19
\hat{E}_s / I_{ot}	dB	19	19
RSRP ^{Note 3}	dBm/15 KHz	-82	-82
SCH_RP ^{Note 3}	dBm/15 KHz	-82	-82

I_0 ^{Note 3}	dBm/Ch BW	-54.16 +10log ($N_{RB,c}/50$)	-54.16 +10log ($N_{RB,c}/50$)
Propagation Condition		AWGN	AWGN
Correlation Matrix and Antenna Configuration		1x2 Low	1x2 Low
Time offset to cell1 ^{Note 4}	μ s	-	33
<p>Note 1: OCNG shall be used such that both cells are fully allocated and a constant total transmitted power spectral density is achieved for all OFDM symbols.</p> <p>Note 2: Interference from other cells and noise sources not specified in the test is assumed to be constant over subcarriers and time and shall be modelled as AWGN of appropriate power for N_{oc} to be fulfilled.</p> <p>Note 3: RSRP and SCH_RP levels have been derived from other parameters for information purposes. They are not settable parameters themselves.</p> <p>Note 4: Receive time difference between subframe boundaries of signals received from the two cells at the UE antenna connector including time alignment error between the two cells.</p>			

Table A.7.4.5.1-3: DRX-Configuration for E-UTRAN TDD-FDD DC interruption at transitions between active and non-active during DRX in synchronous DC

Field	Cell1	Cell2	Comment
	Value	Value	
onDurationTimer	psf1	psf1	As specified in clause 6.3.2 in TS 36.331
drx-InactivityTimer ^{Note 1}	psf1	psf1	
drx-RetransmissionTimer	psf1	psf1	
longDRX-CycleStartOffset	sf80	Sf160	
shortDRX	disable	disable	
Note 1: UE is continuously scheduled in PCell			

A.7.4.5.2 Test Requirements

The UE shall be continuously scheduled in PCell during the entire length of T1. UE shall not be scheduled in PSCell during T1. During the time duration T1 the UE shall transmit at least 99% of ACK/NACK on PCell.

The UE shall not miss transmitting two consecutive ACK/NACK.

The rate of correct events observed during repeated tests shall be at least 90%.

A.7.4.6 E-UTRAN FDD-TDD DC interruption at SRS carrier based switching

A.7.4.6.1 Test Purpose and Environment

The purpose of this test is to verify that when a UE needs to transmit aperiodic SRS, the UE can perform carrier based switching to one PUSCH-less SCCs from a CC with PUSCH. The test will verify the interruption requirements on PCC in clause 7.12.2.7.

In the test there are three cells: cell1, cell2 and cell3. Cell1 and cell2 are PCell and PSCell on the FDD primary component carriers, Cell3 is activated SCell on the TDD secondary component carrier which operates in downlink without PUCCH/PUSCH. The UE is configured with the SRS switching between PCell and SCell. The test consists of two successive time periods, with duration of T1 and T2, respectively. During T1 the UE shall be continuously scheduled on PCell and PSCell. Immediately at the beginning of T2, a PDCCH with SRS-TPC-RNTI is sent to the UE to initiate SRS switching.

Table A.7.4.6.1-1: General test parameters for E-UTRAN FDD-TDD DC interruption at SRS carrier based switching

Parameter	Unit	Value	Comment
E-UTRA RF Channel Number		1, 2, 3	Three radio channels are used for this test
PCell		Cell 1	Primary cell on RF channel number 1
PSCell		Cell 2	Primary cell on RF channel number 2

Configured SCell		Cell 3	Configured deactivated secondary cell on RF channel number 3.
CP length		Normal	
DRX		OFF	Continuous monitoring of primary cell
Filter coefficient		0	L3 filtering is not used
T1	s	1	
T2	ms	40	UE shall perform SRS switching during T2
NOTE: This test verifies the RRM requirement which is independent of channel bandwidth and is performed according to the principle defined in section A.3.6.1.			

Table A.7.4.6.1-2: Cell specific test parameters for E-UTRAN FDD-TDD DC interruption at SRS carrier based switching

Parameter	Unit	Cell 1		Cell 2		Cell 3	
		T1	T2	T1	T2	T1	T2
E-UTRA RF Channel Number		1		2		3	
Special subframe configuration		-		6		6	
Uplink-downlink configuration		-		1		1	
BW _{channel}	MHz	5MHz: NRB,c = 25 10MHz: NRB,c = 50 20MHz: NRB,c = 100		5MHz: NRB,c = 25 10MHz: NRB,c = 50 20MHz: NRB,c = 100		5MHz: NRB,c = 25 10MHz: NRB,c = 50 20MHz: NRB,c = 100	
Measurement bandwidth	n_{PRB}	5MHz:18-24 10MHz:13-37 20MHz: 47-52		5MHz:18-24 10MHz:13-37 20MHz:47-52		5MHz:18-24 10MHz:13-37 20MHz:47-52	
PDSCH parameters: DL Reference Measurement Channel		5MHz: R.7 FDD 10MHz: R.3 FDD 20MHz: R.6 FDD		5MHz: R.7 FDD 10MHz: R.3 FDD 20MHz: R.6 FDD		5MHz: R.5 TDD 10MHz: R.0 TDD 20MHz: R.4 TDD	
PCFICH/PDCCH/PHICH parameters: DL Reference Measurement Channel		5MHz: R.11 FDD 10MHz: R.6 FDD 20MHz: R.10 FDD		5MHz: R.11 FDD 10MHz: R.6 FDD 20MHz: R.10 FDD		5MHz: R.11 TDD 10MHz: R.6 TDD 20MHz: R.10 TDD	
OCNG Pattern defined in A.3.2.1 and in A.3.2.2		5MHz: OP.20 FDD 10MHz: OP.10 FDD 20MHz: OP.17 FDD		5MHz: OP.20 FDD 10MHz: OP.10 FDD 20MHz: OP.17 FDD		5MHz: OP.15 TDD 10MHz: OP.1 TDD 20MHz: OP.11 TDD	
PBCH_RA	dB	0		0		0	
PBCH_RB	dB						
PSS_RA	dB						
SSS_RA	dB						
PCFICH_RB	dB						
PHICH_RA	dB						
PHICH_RB	dB						
PDCCH_RA	dB						
PDCCH_RB	dB						
PDSCH_RA	dB						
PDSCH_RB	dB						
OCNG_RA ^{Note 1}	dB						
OCNG_RB ^{Note 1}	dB						
N_{oc} ^{Note 2}	dBm/15 kHz						
RSRP ^{Note 3}	dBm/15 kHz	-82	-82	-82	-82	-82	-82
\hat{E}_s / I_{ot}	dB	16	16	16	16	16	16
SCH_RP ^{Note 3}	dBm/15 kHz	-82	-82	-82	-82	-82	-82
\hat{E}_s / N_{oc}	dB	16	16	16	16	16	16
I_o ^{Note 3}	dBm/Ch BW	-	-	-	-	-	-
		54.11+10log (NRB,c /50)	54.11+10log (NRB,c /50)	54.11+10log (NRB,c /50)	54.11+10log (NRB,c /50)	54.11+10log (NRB,c /50)	54.11+10log (NRB,c /50)
Propagation Condition		AWGN		AWGN		AWGN	

Correlation Matrix and Antenna Configuration		1x2 Low	1x2 Low	1x2 Low
timing offset to cell1	μs	-	3	-
timing offset to cell1	μs	-	-	33
Note 1:	OCNG shall be used such that all cells are fully allocated and a constant total transmitted power spectral density is achieved for all OFDM symbols.			
Note 2:	Interference from other cells and noise sources not specified in the test is assumed to be constant over subcarriers and time and shall be modelled as AWGN of appropriate power for N_{oc} to be fulfilled.			
Note 3:	E_s/I_{ot} , RSRP, SCH_RP and I_o have been derived from other parameters for information purposes. They are not settable parameters themselves.			
Note 4:	The uplink resources for CSI reporting are assigned to the UE prior to the start of time period T2.			

Table A.7.4.6.1-3: Sounding Reference Symbol Configuration for E-UTRAN FDD-TDD DC interruption at SRS carrier based switching

Field	Value	Comment
srsBandwidthConfiguration	bw5	
srsSubframeConfiguration	Sc8	Once every 5 subframes
ackNackSrsSimultaneousTransmission	FALSE	
srsMaxUpPTS	N/A	Not applicable for E-UTRAN FDD
srsBandwidth	0	No hopping
srsHoppingBandwidth	hbw0	
frequencyDomainPosition	0	
Duration	TRUE	Indefinite duration
Srs-ConfigurationIndex	47	SRS periodicity of 40ms.
transmissionComb	0	
cyclicShift	cs0	No cyclic shift
SRS-AntennaPort	an1	Number of antenna ports used for SRS transmission
Note:	For further information see clause 6.3.2 in TS 36.331.	

A.7.4.6.2 Test Requirements

The UE shall be continuously scheduled in PCell throughout the test and during the time duration T2, at most 6 ACK/NACK loss on PCell shall be detected.

The UE shall be continuously scheduled in PSCell throughout the test and during the time duration T2, at most 6 ACK/NACK loss on PSCell shall be detected.

The rate of correct events observed during repeated tests shall be at least 90%.

A.7.4.7 E-UTRAN TDD-TDD DC interruption at SRS carrier based switching

A.7.4.7.1 Test Purpose and Environment

The purpose of this test is to verify that when a UE needs to transmit aperiodic SRS, the UE can perform carrier based switching to one PUSCH-less SCCs from a CC with PUSCH. The test will verify the interruption requirements on PCC in clause 7.12.2.7.

In the test there are two cells: cell1, cell2 and cell3. Cell1 and cell2 are PCell and PSCell respectively on the TDD primary component carriers, Cell3 is activated SCell on the TDD secondary component carrier which operates in downlink without PUCCH/PUSCH. The UE is configured with the SRS switching between PCell and SCell. The test consists of two successive time periods, with duration of T1 and T2, respectively. During T1 the UE shall be continuously scheduled on PCell and PSCell. Immediately at the beginning of T2, a PDCCH with SRS-TPC-RNTI is sent to the UE to initiate SRS switching.

Table A.7.4.7.1-1: General test parameters for E-UTRAN TDD-TDD DC interruption at SRS carrier based switching

Parameter	Unit	Value	Comment
-----------	------	-------	---------

E-UTRA RF Channel Number		1, 2, 3	Two radio channels are used for this test
PCell		Cell 1	Primary cell on RF channel number 1
PSCell		Cell 2	Primary Secondary cell on RF channel number 2
Configured SCell		Cell 3	Configured deactivated secondary cell on RF channel number 3
CP length		Normal	
DRX		OFF	Continuous monitoring of primary cell
Filter coefficient		0	L3 filtering is not used
T1	s	5	
T2	s	5	UE shall perform SRS switching during T2
NOTE: This test verifies the RRM requirement which is independent of channel bandwidth and is performed according to the principle defined in section A.3.6.1.			

Table A.7.4.7.1-2: Cell specific test parameters for E-UTRAN TDD-TDD DC interruption at SRS carrier based switching

Parameter	Unit	Cell 1		Cell 2		Cell3	
		T1	T2	T1	T2	T1	T2
E-UTRA RF Channel Number		1		2		3	
Special subframe configuration		6		6		6	
Uplink-downlink configuration		1		1		1	
BW _{channel}	MHz	5MHz: NRB,c = 25 10MHz: NRB,c = 50 20MHz: NRB,c = 100		5MHz: NRB,c = 25 10MHz: NRB,c = 50 20MHz: NRB,c = 100		5MHz: NRB,c = 25 10MHz: NRB,c = 50 20MHz: NRB,c = 100	
Measurement bandwidth	<i>n_{PRB}</i>	5MHz:18-24 10MHz:13-37 20MHz:47-52		5MHz:18-24 10MHz:13-37 20MHz:47-52		5MHz:18-24 10MHz:13-37 20MHz:47-52	
PDSCH parameters: DL Reference Measurement Channel		5MHz: R.5 TDD 10MHz: R.0 TDD 20MHz: R.4 TDD		5MHz: R.5 TDD 10MHz: R.0 TDD 20MHz: R.4 TDD		5MHz: R.5 TDD 10MHz: R.0 TDD 20MHz: R.4 TDD	
PCFICH/PDCCH/PHICH parameters: DL Reference Measurement Channel		5MHz: R.11 TDD 10MHz: R.6 TDD 20MHz: R.10 TDD		5MHz: R.11 TDD 10MHz: R.6 TDD 20MHz: R.10 TDD		5MHz: R.11 TDD 10MHz: R.6 TDD 20MHz: R.10 TDD	
OCNG Pattern defined in A.3.2.2		5MHz: OP.15 TDD 10MHz: OP.1 TDD 20MHz: OP.11 TDD		5MHz: OP.15 TDD 10MHz: OP.1 TDD 20MHz: OP.11 TDD		5MHz: OP.15 TDD 10MHz: OP.1 TDD 20MHz: OP.11 TDD	
PBCH_RA	dB	0		0		0	
PBCH_RB	dB						
PSS_RA	dB						
SSS_RA	dB						
PCFICH_RB	dB						
PHICH_RA	dB						
PHICH_RB	dB						
PDCCH_RA	dB						
PDCCH_RB	dB						
PDSCH_RA	dB						
PDSCH_RB	dB						
OCNG_RA ^{Note 1}	dB						
OCNG_RB ^{Note 1}	dB						
<i>N_{oc}</i> ^{Note 2}	dBm/15 kHz						
RSRP ^{Note 3}	dBm/15 kHz	-82	-82	-82	-82	-82	-82
\hat{E}_s / I_{ot}	dB	16	16	16	16	16	16
SCH_RP ^{Note 3}	dBm/15 kHz	-82	-82	-82	-82	-82	-82
\hat{E}_s / N_{oc}	dB	16	16	16	16	16	16

I_0 ^{Note 3}	dBm/Ch BW	- 54.11+10log ($N_{RB,c}/50$)	- 54.11+10log ($N_{RB,c}/50$)	- 54.11+10log ($N_{RB,c}/50$)	- 54.11+10log ($N_{RB,c}/50$)	- 54.11+10log ($N_{RB,c}/50$)	- 54.11+10log ($N_{RB,c}/50$)
Propagation Condition		AWGN		AWGN		AWGN	
Correlation Matrix and Antenna Configuration		1x2 Low		1x2 Low		1x2 Low	
timing offset to cell1	μ s	-		3		-	
timing offset to cell1	μ s	-		-		33	
Note 1:	OCNG shall be used such that all cells are fully allocated and a constant total transmitted power spectral density is achieved for all OFDM symbols.						
Note 2:	Interference from other cells and noise sources not specified in the test is assumed to be constant over subcarriers and time and shall be modelled as AWGN of appropriate power for N_{oc} to be fulfilled.						
Note 3:	E_s/I_{ot} , RSRP, SCH_RP and I_0 have been derived from other parameters for information purposes. They are not settable parameters themselves.						
Note 4:	The uplink resources for CSI reporting are assigned to the UE prior to the start of time period T2.						
Note 5:	Time alignment error (TAE) as specified in TS 36.104 [30] clause 6.5.3.1. The TAE value depends upon the type of carrier aggregation.						

Table A.7.4.7.1-3: Sounding Reference Symbol Configuration for E-UTRAN TDD-TDD DC interruption at SRS carrier based switching

Field	Value	Comment
srsBandwidthConfiguration	bw5	
srsSubframeConfiguration	Sc8	Once every 5 subframes
ackNackSrsSimultaneousTransmission	FALSE	
srsMaxUpPTS	N/A	Not applicable for E-UTRAN FDD
srsBandwidth	0	No hopping
srsHoppingBandwidth	hbw0	
frequencyDomainPosition	0	
Duration	TRUE	Indefinite duration
Srs-ConfigurationIndex	47	SRS periodicity of 40ms.
transmissionComb	0	
cyclicShift	cs0	No cyclic shift
SRS-AntennaPort	an1	Number of antenna ports used for SRS transmission
Note:	For further information see clause 6.3.2 in TS 36.331.	

A.7.4.7.2 Test Requirements

The UE shall be continuously scheduled in PCell throughout the test and during the time duration T2, at most 4 ACK/NACK loss on PCell shall be detected.

The UE shall be continuously scheduled in PCell throughout the test and during the time duration T2, at most 4 ACK/NACK loss on PCell shall be detected.

The rate of correct events observed during repeated tests shall be at least 90%.

A.7.5 Proximity-based Services

A.7.5.1 E-UTRAN FDD – UE ProSe Direct Discovery Transmission Timing Accuracy Test

A.7.5.1.1 Test Purpose and Environment

The purpose of this test is to verify the timing requirements for ProSe Direct Discovery transmissions when PCell downlink timing is used as a reference with $N_{TA,SL} = 0$. This test will verify the requirements in clause 7.16.2.1.1.1

ProSe Direct Discovery transmissions. In the test the UE under test is configured for ProSe operation only on PCell and also the UE is configured only for PCell for WAN.

For this test, the UE is triggered by the test loop function or the upper layers to announce ProSe Direct Discovery.

The test parameters are given in Table A.7.5.1.1-1 below. There is one active cell (PCell) in this test. The transmit timing is verified using the transmission timing of PSDCH.

Table A.7.5.1.1-1: Test parameters for ProSe Transmission Timing Accuracy test for E-UTRAN FDD

Parameter	Unit	Value	Comment		
E-UTRA RF Channel Number		1			
Channel Bandwidth (BW_{channel})	MHz	5			
Active cell		Cell 1	E-UTRA FDD Cell1 on RF channel number 1		
CP length of Cell 1		Normal			
drx-Configuration		DRX_P1	As specified in Table A.3.12.2-1		
ProSe Direct Discovery resource pool configuration		As specified in Table A.3.12.4-1 (Configuration #1)	IE values unless specified otherwise in this test.		
PDCCH/PCFICH/PHICH Reference measurement channel ^{Note1}		R.11 FDD			
OCNG Pattern ^{Note2}		OP.16 FDD			
PBCH_RA	dB	0			
PBCH_RB					
PSS_RA					
SSS_RA					
PCFICH_RB					
PHICH_RA					
PHICH_RB					
PDCCH_RA					
PDCCH_RB					
OCNG_RA ^{Note3}					
OCNG_RB ^{Note3}					
N_{oc}			dBm/15 kHz	-98	
\hat{E}_s/N_{oc}			dB	3	
RSRP ^{Note4}	dBm/15 kHz	-95			
SCH_RP ^{Note 4}	dBm/15 kHz	-95			
Propagation condition		AWGN			
Note 1: For the reference measurement channels, see clause A.3.1. Note 2: For the OCNG pattern, see clause A.3.2. Note 3: OCNG shall be used such that both cells are fully allocated and a constant total transmitted power spectral density is achieved for all OFDM symbols. Note 4: RSRP levels have been derived from other parameters for information purposes. They are not settable parameters themselves.					

A.7.5.1.2 Test Requirements

For parameters specified in Tables A.7.5.1.1-1, the timing accuracy for ProSe Direct Discovery transmissions shall be within the limits defined in clause 7.16.2.

The following sequence of events shall be used to verify that the requirements are met.

For the 5MHz channel bandwidth, the test sequence shall be carried out in RRC_CONNECTED DRX with a cycle length of 320ms:

- After a connection is set up with the cell, the test system shall verify that the ProSe UE transmit timing offset is within $\pm 12 \times T_s$ with respect to the first detected path (in time) of the corresponding downlink frame of cell 1.
- The test system adjusts the downlink transmit timing for the cell by $+32 \times T_s$ (approximately $+1 \mu\text{s}$) compared to that in (a). The test system shall wait for at least one discovery period (320ms) before verifying the requirement again in (c).

- c) The test system shall verify that the UE transmit timing offset stays within $\pm 12 \times T_s$ with respect to the first detected path (in time) of the corresponding downlink frame of cell 1.

A.7.5.2 E-UTRAN TDD – UE ProSe Direct Discovery Transmission Timing Accuracy Test

A.7.5.2.1 Test Purpose and Environment

The purpose of this test is to verify the timing requirements for ProSe Direct Discovery transmissions when PCell downlink timing is used as a reference with $N_{TA,SL} = 0$. This test will verify the requirements in clause 7.16.2.1.1.1 for ProSe Direct Discovery transmissions. In the test the UE under test is configured for ProSe operation only on PCell and also the UE is configured only for PCell for WAN.

For this test, the UE is triggered by the test loop function or the upper layers to announce ProSe Direct Discovery.

The test parameters are given in Table A.7.5.2.1-1 below. There is one active cell (PCell) in this test. The transmit timing is verified using the transmission timing of PSDCH.

Table A.7.5.2.1-1: Test parameters for ProSe Transmission Timing Accuracy test for E-UTRAN TDD

Parameter	Unit	Value	Comment		
E-UTRA RF Channel Number		1			
Channel Bandwidth ($BW_{channel}$)	MHz	5			
Active cell		Cell 1	E-UTRA FDD Cell1 on RF channel number 1		
Uplink/Downlink Configuration		Config 0			
Special Subframe Configuration		6			
CP length of Cell 1		Normal			
drx-Configuration		DRX_P1	As specified in Table A.3.12.2-1		
ProSe Direct Discovery resource pool configuration		As specified in Table A.3.12.4-3 (Configuration #3)	IE values unless specified otherwise in this test.		
PDCCH/PCFICH/PHICH Reference measurement channel ^{Note1}		R.11 TDD			
OCNG Pattern ^{Note2}		OP.10 TDD			
PBCH_RA	dB	0			
PBCH_RB					
PSS_RA					
SSS_RA					
PCFICH_RB					
PHICH_RA					
PHICH_RB					
PDCCH_RA					
PDCCH_RB					
OCNG_RA ^{Note3}					
OCNG_RB ^{Note3}					
N_{oc}			dBm/15 kHz	-98	
\hat{E}_s / N_{oc}			dB	3	
RSRP ^{Note4}	dBm/15 kHz	-95			
SCH_RP ^{Note 4}	dBm/15 kHz	-95			
Propagation condition		AWGN			
Note 1: For the reference measurement channels, see clause A.3.1. Note 2: For the OCNG pattern, see clause A.3.2. Note 3: OCNG shall be used such that both cells are fully allocated and a constant total transmitted power spectral density is achieved for all OFDM symbols. Note 4: RSRP levels have been derived from other parameters for information purposes. They are not settable parameters themselves.					

A.7.5.1.2 Test Requirements

For parameters specified in Tables A.7.5.2.1-1, the timing accuracy for ProSe Direct Discovery transmissions shall be within the limits defined in clause 7.16.2.

The following sequence of events shall be used to verify that the requirements are met.

For the 5MHz channel bandwidth, the test sequence shall be carried out in RRC_CONNECTED DRX with a cycle length of 320ms:

- a) After a connection is set up with the cell, the test system shall verify that the ProSe UE transmit timing offset is within $624 \times T_s \pm 12 \times T_s$ with respect to the first detected path (in time) of the corresponding downlink frame of cell 1.
- b) The test system adjusts the downlink transmit timing for the cell by $+32 \times T_s$ (approximately $+1 \mu\text{s}$) compared to that in (a). The test system shall wait for at least one discovery period (320ms) before verifying the requirement again in (c).
- c) The test system shall verify that the UE transmit timing offset stays within $624 \times T_s \pm 12 \times T_s$ with respect to the first detected path (in time) of the corresponding downlink frame of cell 1.

A.7.5.3 E-UTRAN FDD - Interruptions due to ProSe Direct Discovery

A.7.5.3.1 Test Purpose and Environment

The purpose of this test is to verify the requirements related to the allowed PCell interruptions due to ProSe Direct Discovery defined in clause 7.16.3.1 and clause 7.16.3.3. In the test the UE under test is configured for ProSe operation only on PCell and also the UE is configured only for PCell for WAN.

For this test, the UE is triggered by the test loop function or the upper layers to monitor ProSe Direct Discovery.

The test parameters are given in Table A.7.5.3.1-1 and Table A.7.5.3.1-2 below. There is one active cell (PCell) in this test and 24 active Sidelink transmissions in this test (with 12 active Sidelink UEs per configured discovery subframe). Two tests (Test 1 and Test 2) are defined to verify interruptions due to synchronous (Test 1) and asynchronous (Test 2) ProSe Direct Discovery.

The tests consist of three successive time periods, with time duration of T1, T2 and T3 respectively.

During T1, the UE is in RRC_IDLE and monitoring the ProSe Direct Discovery announcements from other active Sidelink UEs on the ProSe Direct Discovery resources.

During T2, the test system establishes a RRC connection with the UE. No PDSCH traffic is scheduled for UE during T2, and the UE is expected to transmit *SidelinkUEInformation* indicating *discRxInterest* during T2. On reception of *SidelinkUEInformation*, the test system shall RRC reconfiguration message to the UE and wait for the UE to respond with RRC reconfiguration complete message before transitioning to T3. If the UE does not transmit *SidelinkUEInformation* for up to [2] sec, the test system shall transition to T3.

During T3, the UE is scheduled with PDSCH traffic on PCell downlink. The test system will count the missed ACK/NACKs during T3 to verify the allowed interruptions during ProSe Direct Discovery.

Table A.7.5.3.1-1: Test parameters for interruption due to ProSe Direct Discovery tests

Parameter	Unit	Value		Comment
		Test 1	Test 2	
E-UTRA RF Channel Number		1		
Channel Bandwidth (BW_{channel})	MHz	5		
Active cell		Cell 1		E-UTRA FDD Cell1 on RF channel number 1
CP length of Cell 1		Normal		
T1	s	5.12		
T2	s	Up to receiving RRC reconfiguration setup complete from the UE, or up to [2] sec if UE does not transmit <i>SidelinkUEInformation</i> during this period.		

T3	s	10.24	
----	---	-------	--

Table A.7.5.3.1-2: ProSe Direct Discovery configuration for interruption due to ProSe Direct Discovery tests

Parameter	Unit	Value		Comment
		Test 1	Test 2	
E-UTRA RF Channel Number		1		UL carrier frequency
Channel Bandwidth ($BW_{channel}$)	MHz	5		
ProSe Direct Discovery resource pool configuration		As specified in Table A.3.12.4-1 (Configuration #1)	As specified in Table A.3.12.4-2 (Configuration #2)	IE values unless specified otherwise in this test.
Active Sidelink UEs Configuration		PDP.1.FDD As specified in Table A.3.12.8.2-1	PDP.2.FDD As specified in Table A.3.12.8.2-1	Transmitting ProSe Direct Discovery (Test 1 and 2) and SLSS (for Test 2)

Table A.7.5.3.1-3: Cell specific test parameters for interruption due to ProSe Direct Discovery tests

Parameter		Unit	Cell 1		
			T1	T2	T3
E-UTRA RF Channel Number			1		
$BW_{channel}$		MHz	5		
UE RRC state			IDLE	CONNECTED	
Paging configuration	defaultPagingCycle		rf256	N/A	
	nB		T / 32		
DRX			N/A	OFF	
PDSCH Reference measurement channel defined in A.3.1.1.1 ^{Note1}			N/A	None	R.5 FDD
PDCCH/PCFICH/PHICH Reference measurement channel defined in A.3.1.2.1 ^{Note1}			R.11 FDD		
OCNG Pattern			OP.16 FDD	OP.15 FDD	
PBCH_RA		dB	0		
PBCH_RB					
PSS_RA					
SSS_RA					
PCFICH_RB					
PHICH_RA					
PHICH_RB					
PDCCH_RA					
PDCCH_RB					
PDSCH_RA					
PDSCH_RB					
OCNG_RA ^{Note 1}					
OCNG_RB ^{Note 1}					
N_{oc} ^{Note2}					
\hat{E}_s / N_{oc}		dB	16		
RSRP ^{Note3}		dBm/15 kHz	-82		
SCH_RP ^{Note 3}		dBm/15 kHz	-82		
Propagation Condition			AWGN		
<p>Note 1: OCNG shall be used such that cell is fully allocated and a constant total transmitted power spectral density is achieved for all OFDM symbols.</p> <p>Note 2: Interference from other cells and noise sources not specified in the test is assumed to be constant over subcarriers and time and shall be modelled as AWGN of appropriate power for N_{oc} to be fulfilled.</p> <p>Note 3: RSRP levels have been derived from other parameters for information purposes. They are not settable parameters themselves.</p>					

A.7.5.3.2 Test Requirements

The UE shall be scheduled on PCell continuously during T3.

In Test 1, at least 98.75% of all expected ACK/NACKs during T3 shall be transmitted by the ProSe UE. The missed ACK/NACKs can occur only on subframe 'n', if either $n\pm 1$ subframe is a discovery subframe, or if $n-3$, or $n-5$ is a discovery subframe.

NOTE: For the test configuration in Table A.7.5.3.1-1 and Table A.7.5.3.1-2, the specific subframes where missed ACK/NACKs are allowed are when $(\text{subframe mod } 320) = 159, 163, 162, 166$, corresponding to allowed interruptions on subframe 159 and 162.

In Test 2, at least 97.5% of all expected ACK/NACKs during T3 shall be transmitted by the ProSe UE. The missed ACK/NACK can occur only on subframe 'n', if either $n\pm 5$ subframe is a discovery or SLSS subframe, or if $n+1$, or $n-9$ is a discovery or SLSS subframe.

NOTE: For the test configuration in Table A.7.5.3.1-1 and Table A.7.5.3.1-2, the specific subframes where missed ACK/NACKs are allowed are when $(\text{subframe mod } 320) = 135, 139, 145, 149, 155, 159, 166, 170$, corresponding to allowed interruptions on subframes 135, 145, 155 and 166.

A.7.5.4 E-UTRAN FDD – UE ProSe Direct Communication Transmission Timing Accuracy Test

A.7.5.4.1 Test Purpose and Environment

The purpose of this test is to verify the timing requirements for ProSe Direct Communication transmissions when PCell downlink timing is used as a reference with $N_{TA,SL} = 0$. This test will verify the requirements in clause 7.16.2.1.1.1 for ProSe Direct Communication transmissions. In the test the UE under test is configured for ProSe operation only on PCell and also the UE is configured only for PCell for WAN.

For this test, the UE is triggered by the test loop function or the upper layers to transmit for ProSe Direct Communication.

The test parameters are given in Table A.7.5.4.1-1 below. There is one active cell (PCell) in this test. The test system will configure the ProSe UE to transmit SLSS in each period (40ms) by configuring *networkControlledSyncTx* as ON via dedicated RRC signaling. The transmit timing is verified using the transmission timing of SLSS transmissions.

Table A.7.5.4.1-1: Test parameters for ProSe Transmission Timing Accuracy test for E-UTRAN FDD

Parameter	Unit	Value	Comment
E-UTRA RF Channel Number		1	
Channel Bandwidth (BW_{channel})	MHz	5 or 10	Note 5
Active cell		Cell 1	E-UTRA FDD Cell1 on RF channel number 1
CP length of Cell 1		Normal	
drx-Configuration		DRX_P1	As specified in Table A.3.12.2-1
ProSe Direct Communication configuration		As specified in Table A.3.12.5-1 (Configuration #1)	IE values unless specified otherwise in this test.
<i>networkControlledSyncTx</i>		ON	Configured
PDCCH/PCFICH/PHICH Reference measurement channel ^{Note1}		5 MHz: R.11 FDD 10 MHz: R.6 FDD	
OCNG Pattern ^{Note2}		5 MHz: OP.16 FDD 10 MHz: OP.2 FDD	
PBCH_RA	dB	0	
PBCH_RB			
PSS_RA			
SSS_RA			
PCFICH_RB			
PHICH_RA			
PHICH_RB			
PDCCH_RA			
PDCCH_RB			

OCNG_RA ^{Note3}			
OCNG_RB ^{Note3}			
N_{oc}	dBm/15 kHz	-98	
\hat{E}_s/N_{oc}	dB	3	
RSRP ^{Note4}	dBm/15 kHz	-95	
SCH_RP ^{Note 4}	dBm/15 kHz	-95	
Propagation condition		AWGN	
<p>Note 1: For the reference measurement channels, see clause A.3.1.</p> <p>Note 2: For the OCNG pattern, see clause A.3.2.</p> <p>Note 3: OCNG shall be used such that both cells are fully allocated and a constant total transmitted power spectral density is achieved for all OFDM symbols.</p> <p>Note 4: RSRP levels have been derived from other parameters for information purposes. They are not settable parameters themselves.</p> <p>Note 5: This test is according to the principle defined in section A.3.12.3.</p>			

A.7.5.4.2 Test Requirements

For parameters specified in Tables A.7.5.4.1-1, the timing accuracy for ProSe Direct Communication transmissions shall be within the limits defined in clause 7.16.2. The timing accuracy is verified using SLSS transmissions.

The following sequence of events shall be used to verify that the requirements are met.

For 5MHz or 10MHz channel bandwidth, the test sequence shall be carried out in RRC_CONNECTED DRX with a cycle length of 320ms:

- a) After a connection is set up with the cell, the test system shall verify that the ProSe UE SLSS transmission timing offset is within $\pm 12 \times T_S$ with respect to the first detected path (in time) of the corresponding downlink frame of cell 1.
- b) The test system adjusts the downlink transmit timing for the cell by $+32 \times T_S$ (approximately $+1 \mu s$) compared to that in (a). The test system shall wait for at least one SLSS period (40ms) before verifying the requirement again in (c).
- c) The test system shall verify that the UE SLSS transmission timing offset stays within $\pm 12 \times T_S$ with respect to the first detected path (in time) of the corresponding downlink frame of cell 1.

A.7.5.5 E-UTRAN FDD - Interruptions due to ProSe Direct Communication

A.7.5.5.1 Test Purpose and Environment

The purpose of this test is to verify the requirements related to PCell interruptions due to ProSe Direct Communication defined in clause 7.16.3. In the test the UE under test is configured for ProSe operation only on PCell and also the UE is configured only for PCell for WAN.

For this test, the UE is triggered by the test loop function or the upper layers to monitor ProSe Direct Communication.

The test parameters are given in Table A.7.5.5.1-1, Table A.7.5.5.1-2 and Table A.7.5.5.1-3 below. There is one active cell (PCell) in this test and 12 (5MHz) or 16 (10 MHz) active Sidelink UEs in this test transmitting ProSe Direct Communication.

The test consists of three successive time periods, with time duration of T1, T2 and T3 respectively.

During T1, the UE is in RRC_IDLE and monitoring the ProSe Direct Communication transmission from other active Sidelink UEs on the ProSe Direct Communication resources.

During T2, the test system establishes a RRC connection with the UE. No PDSCH traffic is scheduled for UE during T2, and the UE is expected to transmit *SidelinkUEInformation* indicating *commRxInterestedFreq* during T2. On reception of *SidelinkUEInformation*, the test system shall RRC reconfiguration message to the UE and wait for the UE to respond with RRC reconfiguration complete message before transitioning to T3. If the UE does not transmit *SidelinkUEInformation* for up to [2] sec, the test system shall transition to T3.

During T3, the UE is scheduled with PDSCH traffic on PCell downlink. The test system will count the missed ACK/NACKs during T3 to verify the allowed interruptions during ProSe Direct Communication (no missed ACK/NACKs are allowed).

Table A.7.5.5.1-1: Test parameters for interruption due to ProSe Direct Communication tests

Parameter	Unit	Value	Comment
E-UTRA RF Channel Number		1	
Channel Bandwidth (BW_{channel})	MHz	5 or 10	According to principle defined in clause A.3.12.3
Active cell		Cell 1	E-UTRA FDD Cell1 on RF channel number 1
CP length of Cell 1		Normal	
T1	s	5.12	
T2	s	Up to receiving RRC reconfiguration setup complete from the UE, or up to [2] sec if UE does not transmit <i>SidelinkUEInformation</i> during this period.	
T3	s	10.24	
Note 1: This test is according to the principle defined in section A.3.12.3.			

Table A.7.5.5.1-2: ProSe Direct Communication specific configuration for interruption due to ProSe Direct Communication tests

Parameter	Unit	Value	Comment
E-UTRA RF Channel Number		1	UL carrier frequency
Channel Bandwidth (BW_{channel})	MHz	5 or 10	According to principle defined in clause A.3.12.3
ProSe Direct Communication configuration		As specified in Table A.3.12.5-1 (Configuration #1)	IE values unless specified otherwise in this test.
Active Sidelink UEs Configuration ^{Note 1}		PCP.1.FDD As specified in Table A.3.12.8.1-1	Transmitting ProSe Direct Communication (PSCCH + PSSCH)
Note 1: This test is according to the principle defined in section A.3.12.3.			

Table A.7.5.5.1-2: Cell specific test parameters for interruption due to ProSe Direct Communication tests

Parameter	Unit	Cell 1		
		T1	T2	T3
E-UTRA RF Channel Number		1		
BW_{channel} ^{Note 4}	MHz	5 or 10		
UE RRC state		IDLE	CONNECTED	
Paging configuration	defaultPagingCycle	rf256	N/A	
	nB	T / 32		
DRX		N/A	OFF	

PDSCH Reference measurement channel defined in A.3.1.1.1 ^{Note1, Note 4}		N/A	None	R.7 FDD (5MHz) or R.3 FDD (10MHz) (Note 5 applies)
PDCCH/PCFICH/PHICH Reference measurement channel defined in A.3.1.2.1 ^{Note1, Note 4}		5 MHz: R.11 FDD 10 MHz: R.6 FDD		
OCNG Pattern ^{Note 4}		5 MHz: OP.19 FDD 10 MHz: OP.6 FDD	OP.20 FDD (5MHz) or OP.10 FDD (10MHz)	
PBCH_RA	dB	0		
PBCH_RB				
PSS_RA				
SSS_RA				
PCFICH_RB				
PHICH_RA				
PHICH_RB				
PDCCH_RA				
PDCCH_RB				
PDSCH_RA				
PDSCH_RB				
OCNG_RA ^{Note 1}				
OCNG_RB ^{Note 1}				
N_{oc} ^{Note2}				
\hat{E}_s / N_{oc}	dB	16		
RSRP ^{Note3}	dBm/15 kHz	-82		
SCH_RP ^{Note 3}	dBm/15 kHz	-82		
Propagation Condition		AWGN		
<p>Note 1: OCNG shall be used such that cell is fully allocated and a constant total transmitted power spectral density is achieved for all OFDM symbols.</p> <p>Note 2: Interference from other cells and noise sources not specified in the test is assumed to be constant over subcarriers and time and shall be modelled as AWGN of appropriate power for N_{oc} to be fulfilled.</p> <p>Note 3: RSRP levels have been derived from other parameters for information purposes. They are not settable parameters themselves.</p> <p>Note 4: This test is according to the principle defined in section A.3.12.3.</p> <p>Note 5: The PDSCH scheduled subframes for R.7 FDD (5MHz) / R.3 FDD (10MHz) is changed as per the following bitmap that repeats every 40ms. PDSCH scheduled subframe bitmap: {01110111 11110111 11110111 11110111 11110110}.</p>				

A.7.5.5.2 Test Requirements

The UE shall be scheduled on PCell continuously during T3. During T3, 100% of all expected ACK/NACKs shall be transmitted by the ProSe UE.

A.7.5.6 E-UTRAN FDD - Interruptions due to ProSe Direct Discovery with discovery period less than 320ms

A.7.5.6.1 Test Purpose and Environment

The purpose of this test is to verify the requirements related to the allowed PCell interruptions due to ProSe Direct Discovery defined in clause 7.16.3.3 when the discovery period less than 320ms. In the test the UE under test is configured only with PCell with the ProSe operation on uplink carrier of the PCell.

This test is applicable to ProSe Direct Discovery capable UEs that support discovery periods of less than 320ms.

For this test, the UE is triggered by the test loop function or the upper layers to monitor ProSe Direct Discovery.

The test parameters are given in Table A.7.5.6.1-1, Table A.7.5.6.1-2, and Table A.7.5.6.1-3 below. There is one active cell (PCell) in this test and 24 active Sidelink transmissions in this test (with 12 active Sidelink UEs per configured discovery subframe).

The tests consist of three successive time periods, with time duration of T1, T2 and T3 respectively.

During T1, the UE is in RRC_IDLE and monitoring the ProSe Direct Discovery announcements from other active Sidelink UEs on the ProSe Direct Discovery resources.

During T2, the test system establishes a RRC connection with the UE. No PDSCH traffic is scheduled for UE during T2, and the UE is expected to transmit *SidelinkUEInformation* indicating *discRxInterest* during T2. On reception of *SidelinkUEInformation*, the test system shall RRC reconfiguration message to the UE and wait for the UE to respond with RRC reconfiguration complete message before transitioning to T3. If the UE does not transmit *SidelinkUEInformation* for up to [2] sec, the test system shall transition to T3.

During T3, the UE is scheduled with PDSCH traffic on PCell downlink. The test system will count the missed ACK/NACKs during T3 to verify the allowed interruptions during ProSe Direct Discovery.

Table A.7.5.6.1-1: Test parameters for interruption due to ProSe Direct Discovery test with discovery period less than 320ms for E-UTRAN FDD

Parameter	Unit	Value	Comment
E-UTRA RF Channel Number		1	
Channel Bandwidth (BW_{channel})	MHz	5	
Active cell		Cell 1	E-UTRA FDD Cell1 on RF channel number 1
CP length of Cell 1		Normal	
T1	s	0.64	
T2	s	Up to receiving RRC reconfiguration setup complete from the UE, or up to [2] sec if UE does not transmit <i>SidelinkUEInformation</i> during this period.	
T3	s	1.28	

Table A.7.5.6.1-2: ProSe Direct Discovery configuration for interruption test due to ProSe Direct Discovery with discovery period less than 320ms for E-UTRAN FDD

Parameter	Unit	Value	Comment
E-UTRA RF Channel Number		1	UL carrier frequency
Channel Bandwidth (BW_{channel})	MHz	5	
ProSe Direct Discovery resource pool configuration		As specified in Table A.3.12.4-4 (Configuration #4)	IE values unless specified otherwise in this test.
Active Sidelink UEs Configuration		PDP.1.FDD As specified in Table A.3.12.8.2-1	Transmitting ProSe Direct Discovery

Table A.7.5.6.1-3: Cell specific test parameters for interruption due to ProSe Direct Discovery test with discovery period less than 320ms for E-UTRAN FDD

Parameter	Unit	Cell 1		
		T1	T2	T3
E-UTRA RF Channel Number		1		
BW_{channel}	MHz	5		
UE RRC state		IDLE	CONNECTED	
Paging configuration	defaultPagingCycle	rf256	N/A	
	nB	T / 32		
DRX		N/A	OFF	

PDSCH Reference measurement channel defined in A.3.1.1.1 ^{Note1}		N/A	None	R.5 FDD
PDCCH/PCFICH/PHICH Reference measurement channel defined in A.3.1.2.1 ^{Note1}		R.11 FDD		
OCNG Pattern		OP.16 FDD		OP.15 FDD
PBCH_RA	dB	0		
PBCH_RB				
PSS_RA				
SSS_RA				
PCFICH_RB				
PHICH_RA				
PHICH_RB				
PDCCH_RA				
PDCCH_RB				
PDSCH_RA				
PDSCH_RB				
OCNG_RA ^{Note 1}				
OCNG_RB ^{Note 1}				
N_{oc} ^{Note2}	dBm/15 kHz	-98		
\hat{E}_s / N_{oc}	dB	16		
RSRP ^{Note3}	dBm/15 kHz	-82		
SCH_RP ^{Note 3}	dBm/15 kHz	-82		
Propagation Condition		AWGN		
<p>Note 1: OCNG shall be used such that cell is fully allocated and a constant total transmitted power spectral density is achieved for all OFDM symbols.</p> <p>Note 2: Interference from other cells and noise sources not specified in the test is assumed to be constant over subcarriers and time and shall be modelled as AWGN of appropriate power for N_{oc} to be fulfilled.</p> <p>Note 3: RSRP levels have been derived from other parameters for information purposes. They are not settable parameters themselves.</p>				

A.7.5.6.2 Test Requirements

The UE shall be scheduled on PCell continuously during T3.

The test system shall verify that at least 98.75% of all expected ACK/NACKs during T3 shall be transmitted by the ProSe UE. The missed ACK/NACKs can occur only on subframe 'n', if either $n \pm 1$ subframe is a discovery subframe, or if $n-3$, or $n-5$ is a discovery subframe.

NOTE: For the test configuration in Table A.7.5.6.1-1 and Table A.7.5.6.1-2, the specific subframes where missed ACK/NACKs are allowed are when $(\text{subframe mod } 40) = 19, 23, 22, 26$, corresponding to allowed interruptions on subframe $(\text{subframe mod } 40) = 19$ and 22.

A.7.5.7 E-UTRAN FDD-FDD - Interruptions due to ProSe Direct Discovery

A.7.5.7.1 Test Purpose and Environment

The purpose of this test is to verify the requirements related to the allowed PCell interruptions due to ProSe Direct Discovery defined in clause 7.16.3.1 and clause 7.16.3.3. In the test the UE under test is configured with PCell and one SCell, with ProSe operation configured on the PCell.

A UE that meets the requirements of this clause is not required to be tested for the requirements of clause 7.5.3.

For this test, the UE is triggered by the test loop function or the upper layers to monitor ProSe Direct Discovery.

The test parameters are given in Table A.7.5.7.1-1, Table A.7.5.7.1-2, and Table A.7.5.7.1-3 below. There are two configured component carriers: PCC and SCC, and two active cells: Cell 1 and Cell2. Cell1 is the PCell on PCC, and Cell 2 is the SCell on SCC. Sidelink operation is configured on the PCC UL. There are 24 active Sidelink transmissions in this test (with 12 active Sidelink UEs per configured discovery subframe). Two tests (Test 1 and Test 2) are defined to verify interruptions due to synchronous (Test 1) and asynchronous (Test 2) ProSe Direct Discovery.

The tests consist of three successive time periods, with time duration of T1, T2 and T3 respectively.

During T1, the UE is in RRC_IDLE and monitoring the ProSe Direct Discovery announcements from other active Sidelink UEs on the ProSe Direct Discovery resources.

During T2, the test system establishes a RRC connection with the UE. The test system shall configure the UE with the SCC. No PDSCH traffic is scheduled for UE during T2, and the UE is expected to transmit *SidelinkUEInformation* indicating *discRxInterest* during T2. On reception of *SidelinkUEInformation*, the test system shall RRC reconfiguration message to the UE and wait for the UE to respond with RRC reconfiguration complete message before transitioning to T3. If the UE does not transmit *SidelinkUEInformation* for up to [2] sec, the test system shall transition to T3.

During T3, the UE is scheduled with PDSCH traffic on both PCell and SCell downlink. The test system will count the missed ACK/NACKs during T3 to verify the allowed interruptions during ProSe Direct Discovery.

Table A.7.5.7.1-1: Test parameters for interruption due to ProSe Direct Discovery tests

Parameter	Unit	Value		Comment
		Test 1	Test 2	
E-UTRA RF Channel Number		1		
Channel Bandwidth (BW _{channel})	MHz	5		
Active cell		Cell 1, Cell 2		E-UTRA FDD Cell1 and Cell 2 on RF channel number 1 and 2, respectively
CP length of Cell 1, Cell 2		Normal		
T1	s	5.12		
T2	s	Up to receiving RRC reconfiguration setup complete from the UE, or up to [2] sec if UE does not transmit <i>SidelinkUEInformation</i> during this period.		
T3	s	10.24		

Table A.7.5.7.1-2: ProSe Direct Discovery configuration for interruption due to ProSe Direct Discovery tests

Parameter	Unit	Value		Comment
		Test 1	Test 2	
E-UTRA RF Channel Number		1		UL carrier frequency
Channel Bandwidth (BW _{channel})	MHz	5		
ProSe Direct Discovery resource pool configuration		As specified in Table A.3.12.4-1 (Configuration #1)	As specified in Table A.3.12.4-2 (Configuration #2)	IE values unless specified otherwise in this test.
Active Sidelink UEs Configuration		PDP.1.FDD As specified in Table A.3.12.8.2-1	PDP.2.FDD As specified in Table A.3.12.8.2-1	Transmitting ProSe Direct Discovery (Test 1 and 2) and SLSS (for Test 2)

Table A.7.5.7.1-3: Cell specific test parameters for interruption due to ProSe Direct Discovery tests

Parameter	Unit	Cell 1			Cell 2		
		T1	T2	T3	T1	T2	T3
E-UTRA RF Channel Number		1			2		
BW _{channel}	MHz	5			5		
UE RRC state		IDLE	CONNECTED		N/A		
Paging configuration	defaultPaging Cycle	rf256	N/A		N/A		
	nB	T / 32					
DRX		N/A	OFF		N/A	OFF	
PDSCH Reference measurement channel defined in A.3.1.1.1 ^{Note 1}		N/A	None	R.5 FDD	N/A	None	R.5 FDD

PDCCH/PCFICH/PHICH Reference measurement channel defined in A.3.1.2.1 ^{Note1}		R.11 FDD		R.11 FDD	
		OP.16 FDD	OP.15 FDD	OP.16 FDD	OP.15 FDD
OCNG Pattern					
PBCH_RA	dB	0	0	0	0
PBCH_RB					
PSS_RA					
SSS_RA					
PCFICH_RB					
PHICH_RA					
PHICH_RB					
PDCCH_RA					
PDCCH_RB					
PDSCH_RA					
PDSCH_RB					
OCNG_RA ^{Note 1}					
OCNG_RB ^{Note 1}					
N_{oc} ^{Note2}	dBm/15 kHz	-98	-98	-98	-98
\hat{E}_s / N_{oc}	dB	16	16	16	16
RSRP ^{Note3}	dBm/15 kHz	-82	-82	-82	-82
SCH_RP ^{Note 3}	dBm/15 kHz	-82	-82	-82	-82
Propagation Condition		AWGN	AWGN	AWGN	AWGN
Note 1:	OCNG shall be used such that cell is fully allocated and a constant total transmitted power spectral density is achieved for all OFDM symbols.				
Note 2:	Interference from other cells and noise sources not specified in the test is assumed to be constant over subcarriers and time and shall be modelled as AWGN of appropriate power for N_{oc} to be fulfilled.				
Note 3:	RSRP levels have been derived from other parameters for information purposes. They are not settable parameters themselves.				

A.7.5.7.2 Test Requirements

The UE shall be scheduled on PCell and SCell downlink continuously during T3.

In Test 1, at least 98.75% of all expected ACK/NACKs during T3 shall be transmitted by the ProSe UE. The missed ACK/NACKs can occur only on subframe 'n', if either $n\pm 1$ subframe is a discovery subframe, or if $n-3$, or $n-5$ is a discovery subframe.

NOTE: For the test configuration in Table A.7.5.12.1-1 and Table A.7.5.12.1-2, the specific subframes where missed ACK/NACKs are allowed are when $(\text{subframe mod } 320) = 159, 163, 162, 166$, corresponding to allowed interruptions on subframe 159 and 162.

In Test 2, at least 97.5% of all expected ACK/NACKs during T3 shall be transmitted by the ProSe UE. The missed ACK/NACK can occur only on subframe 'n', if either $n\pm 5$ subframe is a discovery or SLSS subframe, or if $n+1$, or $n-9$ is a discovery or SLSS subframe.

NOTE: For the test configuration in Table A.7.5.7.1-1 and Table A.7.5.7.1-2, the specific subframes where missed ACK/NACKs are allowed are when $(\text{subframe mod } 320) = 135, 139, 145, 149, 155, 159, 166, 170$, corresponding to allowed interruptions on subframes 135, 145, 155 and 166.

A.7.5.8 E-UTRAN FDD-FDD - Cell reselection and timing accuracy for ProSe Direct Discovery transmission on non-serving frequency

A.7.5.8.1 Test Purpose and Environment

The purpose of this test is to verify the requirements related to cell reselection and timing accuracy for ProSe Direct Discovery transmissions on a non-serving frequency defined in clauses 7.16.4 and 7.16.2.1.2, respectively. In the test the UE under test is configured with PCell on a serving frequency, and the PCell provides the ProSe Direct Discovery resources for a non-serving frequency.

This test is applicable for ProSe Direct Discovery capable UEs that support concurrent inter-band E-UTRAN and E-UTRAN ProSe operation, and indicates the support of inter-frequency discovery transmission using *discInterFreqTx*.

For this test, the UE is triggered by the test loop function or the upper layers to announce ProSe Direct Discovery.

The test parameters are given in Table A.7.5.8.1-1, Table A.7.5.8.1-2, and Table A.7.5.8.1-3 below. The test consists of one active serving cell (cell 1) on the serving RF channel 1, and two active non-serving cells (cell 2 and cell3) on the non-serving discovery RF channel 2.

The tests consist of three successive time periods, with time duration of T1, T2 and T3 respectively.

The serving cell (cell 1 on RF channel 1) is active during the entire test duration (T1, T2, T3) without any changes to cell 1 RSRP. Prior to start of the test, the test system shall verify that the UE is transmitting ProSe Direct Discovery transmissions on the non-serving RF channel 2.

During T1, only one non-serving cell (cell 2 on RF channel 2) is active. The UE is expected to be following the timing of cell 2 for its discovery transmissions on RF channel 2. During T2, cell 3 on the non-serving RF channel 2 is also turned ON and is configured to be better ranked than cell 2. The UE is expected to reselect to cell 3 for discovery transmit timing. During T3, RSRP of cell 2 is increased so that it becomes better ranked than cell 3. The UE is supposed to reselect back to cell 2 and follow its timing for discovery transmissions.

Table A.7.5.8.1-1: Test parameters for cell reselection and timing accuracy for ProSe Direct Discovery transmission on non-serving frequency test for E-UTRAN FDD-FDD

Parameter	Unit	Value	Comment
E-UTRA RF Channel Number		1, 2	RF channel 1 is serving RF channel 2 is non-serving
Channel Bandwidth ($BW_{channel}$)	MHz	5	
Active cell		Cell 1	Serving E-UTRA FDD cell on RF channel number 1
Non-serving cell		Cell 2, Cell 3	Non-serving E-UTRA FDD cells on RF channel number 2
CP length of Cell 1, 2, 3		Normal	
T1	s	2	
T2	s	14	
T3	s	5	

Table A.7.5.8.1-2: ProSe Direct Discovery configuration for cell reselection and timing accuracy for ProSe Direct Discovery transmission on non-serving frequency test for E-UTRAN FDD-FDD

Parameter	Unit	Value	Comment
E-UTRA RF Channel Number		2	UL carrier frequency
Channel Bandwidth ($BW_{channel}$)	MHz	5	
ProSe Direct Discovery resource pool configuration		As specified in Table A.3.12.4-5 (Configuration #5)	IE values unless specified otherwise in this test. Broadcasted in SIB19 by Cell 1 on RF channel 1
<i>discInterFreqList/carrierFreq</i>		RF channel 2 (UL frequency)	
<i>freqInfo/ul-CarrierFreq</i>		RF channel 2 (UL frequency)	
<i>rxParamsAddNeighFreq/physCellId</i>		{phyCellId of Cell 2, phyCellId of Cell 3}	
<i>txParamsAddNeighFreq/physCellId</i>		{phyCellId of Cell 2, phyCellId of Cell 3}	

Table A.7.5.8.1-3: Cell specific test parameters for cell reselection and timing accuracy for ProSe Direct Discovery transmission on non-serving frequency test for E-UTRAN FDD-FDD

Parameter	Unit	Cell 1	Cell 2	Cell 3
-----------	------	--------	--------	--------

		T1	T2	T3	T1	T2	T3	T1	T2	T3
E-UTRA RF Channel Number		1			2			2		
Serving / Non-serving		Serving			Non-serving			Non-serving		
BW _{channel}	MHz	5			5			5		
drx-Configuration		DRX_P1 As specified in Table A.3.12.2-1			N/A			N/A		
OCNG Patterns defined in A.3.2.1.2		OP.16 FDD			OP.19 FDD			OP.19 FDD		
PBCH_RA	dB	0			0			0		
PBCH_RB	dB									
PSS_RA	dB									
SSS_RA	dB									
PCFICH_RB	dB									
PHICH_RA	dB									
PHICH_RB	dB									
PDCCH_RA	dB									
PDCCH_RB	dB									
PDSCH_RA	dB									
PDSCH_RB	dB									
OCNG_RA ^{Note 1}	dB									
OCNG_RB ^{Note 1}	dB									
Timing offset	us									
N_{oc} ^{Note 2}	dBm/1 5 kHz	-98								
RSRP ^{Note 3}	dBm/1 5 kHz	-82			-82	-85	-82	-infinity	-82	-85
\hat{E}_s / I_{ot}	dB	16			16	-3.11	2.79	-infinity	2.79	-3.11
\hat{E}_s / N_{oc}	dB	16			16	13	16	-infinity	13	16
SCH_RP ^{Note 3}	dBm/1 5kHz	-82			-82	-85	-82	-infinity	-82	-85
Propagation Condition		AWGN			AWGN			AWGN		
Note 1:	OCNG shall be used such that cells are fully allocated and a constant total transmitted power spectral density is achieved for all OFDM symbols.									
Note 2:	Interference from other cells and noise sources not specified in the test is assumed to be constant over subcarriers and time and shall be modelled as AWGN of appropriate power for N_{oc} to be fulfilled.									
Note 3:	RSRP levels have been derived from other parameters for information purposes. They are not settable parameters themselves.									

A.7.5.8.2 Test Requirements

During T1, the test system shall verify that the transmit timing offset of discovery transmission on RF channel 2 is within $\pm 12 \times T_s$ with respect to the first detected path (in time) of the corresponding downlink frame of cell 2.

During T2, the UE is expected to reselect to cell 3 for discovery timing synchronization after cell reselection delay to a newly detectable cell from start of T2. After the period of cell reselection delay to a newly detectable cell from the start of T2, the test system shall verify that the transmit timing offset of discovery transmission on RF channel 2 are within $\pm 12 \times T_s$ with respect to the first detected path (in time) of the corresponding downlink frame of cell 3.

The cell reselection delay to a newly detectable cell for discovery transmission on non-serving carrier shall be 10.56s.

NOTE: The cell reselection delay to a newly detectable cell for discovery transmission on non-serving carrier can be expressed as $(T_{\text{detect,EUTRAN_ProSe_Intra}} + 1 \text{ discovery period})$.

During T3, the UE is expected to reselect back to cell 2 for discovery timing synchronization after cell reselection delay to an already detected cell from start of T3. After the period of cell reselection delay to a newly detectable cell from the start of T3, the test system shall verify that the transmit timing offset of discovery transmission on RF channel 2 are within $\pm 12 \times T_S$ with respect to the first detected path (in time) of the corresponding downlink frame of cell 2.

The cell reselection delay to an already detected cell for discovery transmission on non-serving carrier shall be 5.44s.

NOTE: The cell reselection delay to an already detected cell for discovery transmission on non-serving carrier can be expressed as $(T_{\text{evaluate, E-UTRAN_ProSe_Intra}} + 1 \text{ discovery period})$.

The rate of correct events observed during repeated tests shall be at least 90%.

A.7.5.9 E-UTRAN FDD-FDD - Interruptions due to ProSe Direct Discovery reception on non-serving frequency

A.7.5.9.1 Test Purpose and Environment

The purpose of this test is to verify the requirements related to interruptions due to ProSe Direct Discovery reception on a non-serving frequency as defined in clause 7.16.3.3 and 7.16.3.4. In the test the UE under test is configured with PCell on a serving frequency, and the PCell provides the ProSe Direct Discovery resources for a non-serving frequency.

This test is applicable for ProSe Direct Discovery capable UEs that support concurrent inter-band E-UTRAN and E-UTRAN ProSe operation.

For this test, the UE is triggered by the test loop function or the upper layers to monitor ProSe Direct Discovery.

The test parameters are given in Table A.7.5.9.1-1, Table A.7.5.9.1-2, and Table A.7.5.9.1-3 below. The test consists of one active serving cell (cell 1) on the serving RF channel 1, and one active non-serving cells (cell 2) on the non-serving discovery RF channel 2. There are 96 active Sidelink transmissions in this test (with 12 active Sidelink UEs per configured discovery subframe) on RF channel 2.

After the test system establishes a RRC connection with the UE, the UE is expected to transmit *SidelinkUEInformation* indicating *discRxInterest*. On reception of *SidelinkUEInformation*, the test system shall RRC reconfiguration message to the UE and wait for the UE to respond with RRC reconfiguration complete message before start of the test. Further, depending on UE implementation, the UE may request for discovery reception gaps (using *discRxGapReq*) for the ProSe Direct Discovery reception operation on the non-serving frequency. If gaps are requested, the test system shall configure the gaps as requested and modify the PDSCH scheduling on cell 1 for this UE such that the UE is not scheduled on the DL on the subframes configured as reception gaps.

The test shall start after the completion of the RRC reconfiguration is complete following the *SidelinkUEInformation* message transmission from the UE. The test system shall then continuously schedule the UE on DL of cell 1 (apart from any subframes that are configured as discovery gaps).

Table A.7.5.9.1-1: Test parameters for interruptions due to ProSe Direct Discovery reception on non-serving frequency test for E-UTRAN FDD-FDD

Parameter	Unit	Value	Comment
E-UTRA RF Channel Number		1, 2	RF channel 1 is serving RF channel 2 is non-serving
Channel Bandwidth (BW_{channel})	MHz	5	
Active cell		Cell 1	Serving E-UTRA FDD cell on RF channel number 1
Non-serving cell		Cell 2	Non-serving E-UTRA FDD cell on RF channel number 2
CP length of Cell 1, 2		Normal	

Table A.7.5.9.1-2: ProSe Direct Discovery configuration for interruptions due to ProSe Direct Discovery reception on non-serving frequency test for E-UTRAN FDD-FDD

Parameter	Unit	Value	Comment
E-UTRA RF Channel Number		2	UL carrier frequency
Channel Bandwidth ($BW_{channel}$)	MHz	5	
ProSe Direct Discovery resource pool configuration		As specified in Table A.3.12.4-5 (Configuration #5)	IE values unless specified otherwise in this test. Broadcasted in SIB19 by Cell 1 on RF channel 1
<i>discInterFreqList/carrierFreq</i>		RF channel 2 (UL frequency)	
<i>freqInfo/ul-CarrierFreq</i>		RF channel 2 (UL frequency)	
<i>rxParamsAddNeighFreq/physCellId</i>		{phyCellId of Cell 2}	
<i>txParamsAddNeighFreq/physCellId</i>		{phyCellId of Cell 2}	
<i>discResourcesNonPS/ discRxResourcesInterFreq/ tf-ResourceConfig/ subframeBitmap</i>		11111111 00000000 00000000 00000000 00000000	
Active Sidelink UEs Configuration		PDP.1.FDD As specified in Table A.3.12.8.2-1	Transmitting ProSe Direct Discovery on RF channel 2

Table A.7.5.9.1-3: Cell specific test parameters for interruptions due to ProSe Direct Discovery reception on non-serving frequency test for E-UTRAN FDD-FDD

Parameter	Unit	Cell 1	Cell 2
E-UTRA RF Channel Number		1	2
Serving/Non-serving		Serving	Non-serving
$BW_{channel}$	MHz	5	5
Correlation Matrix and Antenna Configuration		1x2 Low	1x2 Low
drx-Configuration		None	N/A
PDCCH/PCFICH/PHICH Reference measurement channel ^{Note1}		R.11 FDD	R.11 FDD
PDSCH Reference measurement channel defined in A.3.1.1.1 ^{Note1}		R.7 FDD (NOTE 5 applies)	N/A
OCNG Pattern defined in A.3.2.1		OP.20 FDD	OP.19 FDD
PCFICH_RB	dB	0	0
PDCCH_RA	dB		
PDCCH_RB	dB		
PBCH_RA	dB		
PBCH_RB	dB		
PSS_RA	dB		
SSS_RA	dB		
PHICH_RA	dB		
PHICH_RB	dB		
PDSCH_RA	dB		
PDSCH_RB	dB		
OCNG_RA ^{Note1}	dB		
OCNG_RB ^{Note1}	dB		
\hat{E}_s / N_{oc}	dB		
N_{oc}	dBm/15 kHz	-98	-98

RSRP ^{Note4}	dBm/15 kHz	-82	-82
SCH_RP ^{Note 4}	dBm/15 kHz	-82	-82
Propagation condition		AWGN	AWGN
<p>Note 1: For the reference measurement channels, see clause A.3.1.</p> <p>Note 2: For the OCNG pattern, see clause A.3.2.</p> <p>Note 3: OCNG shall be used such that cells are fully allocated and a constant total transmitted power spectral density is achieved for all OFDM symbols.</p> <p>Note 4: RSRP and SCH_RP levels have been derived from other parameters for information purposes. They are not settable parameters themselves.</p> <p>Note 5: Scheduling pattern for PDSCH modified to omit the subframes configured as Discovery Gaps in the test.</p>			

A.7.5.9.2 Test Requirements

The test system shall verify the allowed interruptions for ProSe Direct Discovery reception on non-serving frequency, and depends on the discovery gap configuration for the UE.

If no discovery gaps are configured, the test system shall verify that the total number of missed ACK/NACKs on the serving cell are less than 0.5%.

If discovery gaps are configured as requested by the UE, then test system shall verify that the missed ACK/NACKs, if any, correspond to locations as specified in subclause 7.16.3.4:

- Missed ACK/NACKs is allowed on a subframe n , if subframe n is configured as downlink reception gap (using *discRxGapConfig*) and either the subframe immediately preceding or immediately following that subframe is not configured as reception gap, and
- One additional missed ACK/NACK per discovery period is allowed on a subframe m , such that the subframe m is configured as reception gap.

A.7.5.10 E-UTRAN FDD-FDD - Interruptions due to ProSe Direct Discovery transmission on non-serving frequency

A.7.5.10.1 Test Purpose and Environment

The purpose of this test is to verify the requirements related to interruptions due to ProSe Direct Discovery reception on a non-serving frequency as defined in clause 7.16.3.3 and 7.16.3.4. In the test the UE under test is configured with PCell on a serving frequency, and the PCell provides the ProSe Direct Discovery resources for a non-serving frequency.

This test is applicable for ProSe Direct Discovery capable UEs that support concurrent inter-band E-UTRAN and E-UTRAN ProSe operation, and indicates the support of inter-frequency discovery transmission using *discInterFreqTx*.

For this test, the UE is triggered by the test loop function or the upper layers to announce ProSe Direct Discovery.

The test parameters are given in Table A.7.5.10.1-1, Table A.7.5.10.1-2, and Table A.7.5.10.1-3 below. The test consists of one active serving cell (cell 1) on the serving RF channel 1, and one active non-serving cells (cell 2) on the non-serving discovery RF channel 2.

After the test system establishes a RRC connection with the UE, the UE is expected to transmit *SidelinkUEInformation*. On reception of *SidelinkUEInformation*, the test system shall RRC reconfiguration message to the UE and wait for the UE to respond with RRC reconfiguration complete message before start of the test. Further, depending on UE implementation, the UE may request for discovery transmission and/or reception gaps (using *discTxGapReq* and/or *discRxGapReq*) for the ProSe Direct Discovery transmission operation on the non-serving frequency. If transmission gap is requested, the test system shall configure the transmission gap as requested. The test system shall not configure any reception gap for the UE for the purpose of this test.

The test shall start after the completion of the RRC reconfiguration is complete following the *SidelinkUEInformation* message transmission from the UE. The test system shall then continuously schedule the UE on DL of cell 1.

Table A.7.5.10.1-1: Test parameters for interruptions due to ProSe Direct Discovery transmission on non-serving frequency test for E-UTRAN FDD-FDD

Parameter	Unit	Value	Comment
E-UTRA RF Channel Number		1, 2	RF channel 1 is serving RF channel 2 is non-serving
Channel Bandwidth (BW_{channel})	MHz	5	
Active cell		Cell 1	Serving E-UTRA FDD cell on RF channel number 1
Non-serving cell		Cell 2	Non-serving E-UTRA FDD cell on RF channel number 2
CP length of Cell 1, 2		Normal	

Table A.7.5.10.1-2: ProSe Direct Discovery configuration for interruptions due to ProSe Direct Discovery transmission on non-serving frequency test for E-UTRAN FDD-FDD

Parameter	Unit	Value	Comment
E-UTRA RF Channel Number		2	UL carrier frequency
Channel Bandwidth (BW_{channel})	MHz	5	
ProSe Direct Discovery resource pool configuration		As specified in Table A.3.12.4-5 (Configuration #5)	IE values unless specified otherwise in this test. Broadcasted in SIB19 by Cell 1 on RF channel 1
<i>discInterFreqList/carrierFreq</i>		RF channel 2 (UL frequency)	
<i>freqInfo/ul-CarrierFreq</i>		RF channel 2 (UL frequency)	
<i>txParamsAddNeighFreq/physCellId</i>		{phyCellId of Cell 2}	
<i>discConfigOther/refCarrierCommon</i>		pCell	Configure UE to use pCell as reference for synchronization and measurements for discovery transmission on non-serving carrier
<i>discResourcesNonPS/discRxResourcesInterFreq</i>		Not configured	
<i>discResourcesNonPS/discTxResourcesInterFreq/</i> <i>tf-ResourceConfig/</i> <i>subframeBitmap</i>		11111111 00000000 00000000 00000000 00000000	
<i>discRxGapConfig</i>		Not configured	Within <i>SL-DiscConfig</i> in RRC reconfiguration message
<i>discTxGapConfig</i>		Configured as requested by UE in <i>discTxGapReq</i>	Within <i>SL-DiscConfig</i> in RRC connection reconfiguration message

Table A.7.5.10.1-3: Cell specific test parameters for interruptions due to ProSe Direct Discovery transmission on non-serving frequency test for E-UTRAN FDD-FDD

Parameter	Unit	Cell 1	Cell 2
E-UTRA RF Channel Number		1	2
Serving/Non-serving		Serving	Non-serving
BW_{channel}	MHz	5	5

Correlation Matrix and Antenna Configuration		1x2 Low	1x2 Low
drx-Configuration		None	N/A
PDCCH/PCFICH/PHICH Reference measurement channel ^{Note1}		R.11 FDD	R.11 FDD
PDSCH Reference measurement channel defined in A.3.1.1.1 ^{Note1}		R.7 FDD	N/A
OCNG Pattern defined in A.3.2.1		OP.20 FDD	OP.19 FDD
PCFICH_RB	dB	0	0
PDCCH_RA	dB		
PDCCH_RB	dB		
PBCH_RA	dB		
PBCH_RB	dB		
PSS_RA	dB		
SSS_RA	dB		
PHICH_RA	dB		
PHICH_RB	dB		
PDSCH_RA	dB		
PDSCH_RB	dB		
OCNG_RA ^{Note1}	dB		
OCNG_RB ^{Note1}	dB		
\hat{E}_s/N_{oc}	dB		
N_{oc}	dBm/15 kHz	-98	-98
RSRP ^{Note4}	dBm/15 kHz	-82	-82
SCH_RP ^{Note 4}	dBm/15 kHz	-82	-82
Propagation condition		AWGN	AWGN
<p>Note 1: For the reference measurement channels, see clause A.3.1.</p> <p>Note 2: For the OCNG pattern, see clause A.3.2.</p> <p>Note 3: OCNG shall be used such that cells are fully allocated and a constant total transmitted power spectral density is achieved for all OFDM symbols.</p> <p>Note 4: RSRP and SCH_RP levels have been derived from other parameters for information purposes. They are not settable parameters themselves.</p>			

A.7.5.10.2 Test Requirements

The test system shall verify the allowed interruptions for ProSe Direct Discovery transmission on non-serving frequency.

If no discovery transmission gaps are configured, the test system shall verify that the total number of missed ACK/NACKs on the serving cell are less than 0.5%.

If discovery transmission gaps are configured as requested by the UE, the test system shall verify that the number of missed ACK/NACKs are less than or equal to 5 missed ACK/NACKs during a discovery period (configured as 320ms in this test). Corresponding to discovery transmission on subframe n (with respect to PCell) on the non-serving carrier, the missed ACK/NACKs are allowed only on subframes $(n-1)$, n , $(n+1)$, $(n+3)$, $(n+5)$.

A.7.5.11 E-UTRAN FDD-FDD - Interruptions due to ProSe Direct Communication on non-serving frequency

A.7.5.11.1 Test Purpose and Environment

The purpose of this test is to verify the requirements related to interruptions due to ProSe Direct Communication on a non-serving frequency as defined in clause 7.16.3.5. In the test the UE under test is configured with PCell on a serving frequency, and is pre-configured with ProSe Direct Communication resources for a non-serving frequency.

This test is applicable for ProSe Direct Communication capable UEs that support concurrent inter-band E-UTRAN and E-UTRAN ProSe operation.

For this test, the UE is triggered by the test loop function or the upper layers to receive ProSe Direct Communication.

The test parameters are given in Table A.7.5.11.1-1, Table A.7.5.11.1-2, Table A.7.5.11.1-3 and Table A.7.5.11.1-4 below. The test consists of one active serving cell (cell 1) on the serving RF channel 1, and there are no active cells on RF channel 2. On RF channel 2, the test consists of one active SyncRef UE (SyncRef UE 1) transmitting synchronization signals and channels, and 12 (5MHz) or 16 (10 MHz) active Sidelink UEs in this test transmitting ProSe Direct Communication.

The serving cell (cell 1) on RF channel 1 is not broadcasting SIB18, and the UE is expected to use its preconfigured parameters for ProSe Direct Communication operation on RF channel 2.

The UE is continuously scheduled with PDSCH traffic on PCell downlink in RF channel 1.

Table A.7.5.11.1-1: Test parameters for interruptions due to ProSe Direct Communication on non-serving frequency test for E-UTRAN FDD-FDD

Parameter	Unit	Value	Comment
E-UTRA RF Channel Number		1, 2	RF channel 1 is serving RF channel 2 is non-serving
Channel Bandwidth ($BW_{channel}$)	MHz	5 or 10	According to principle defined in clause A.3.12.3
Active cell		Cell 1	Serving E-UTRA FDD cell on RF channel number 1 (Not broadcasting SIB18)
Active SyncRef UEs		SyncRef UE 1	Transmitting SLSS+MIB-SL on uplink of RF channel number 2
CP length of Cell 1		Normal	

Table A.7.5.11.1-2: ProSe Direct Communication configuration for interruptions due to ProSe Direct Communication on non-serving frequency test for E-UTRAN FDD-FDD

Parameter	Unit	Value	Comment
E-UTRA RF Channel Number		2	UL carrier frequency
Channel Bandwidth ($BW_{channel}$)	MHz	5 or 10	According to principle defined in clause A.3.12.3
ProSe Direct Communication resource pool configuration		As specified in Table A.3.12.5-2 (Configuration #2)	IE values unless specified otherwise in this test. (Preconfigured)
Active Sidelink UEs Configuration ^{Note 1}		PCP.1.FDD As specified in Table A.3.12.8.1-1	Transmitting ProSe Direct Communication (PSCCH + PSSCH) Using SyncRef UE1 as synchronization source

Note 1: This test is according to the principle defined in section A.3.12.3.

Table A.7.5.11.1-3: SyncRef UE specific test parameters for interruptions due to ProSe Direct Communication on non-serving frequency test for E-UTRAN FDD-FDD

Parameter	Unit	SyncRef UE 1
E-UTRA RF Channel Number		2
$BW_{channel}$ ^{Note 4}	MHz	5 or 10
ProSe Direct Communication resource pool configuration		As specified in Table A.3.12.5-1 (Configuration #1) Note resource pool is same as Configuration #2 used by ProSe UE.
syncOffsetIndicator		Set same as <i>syncOffsetIndicator1</i> in ProSe Direct Communication preconfiguration
slssid		30
inCoverage		TRUE
networkControlledSyncTx		ON

N_{oc} ^{Note1}	dBm/15 kHz	-98
\hat{E}_s / N_{oc}	dB	16
S-RSRP ^{Note2, Note3}	dBm/15 kHz	-82
Propagation Condition		AWGN
<p>Note 1: Interference from other cells and noise sources not specified in the test is assumed to be constant over subcarriers and time and shall be modelled as AWGN of appropriate power for to be fulfilled.</p> <p>Note 2: S-RSRP levels have been derived from other parameters for information purposes. They are not settable parameters themselves.</p> <p>Note 3: SSSS Es/lot is set the same as PSSS/PSBCH Es/lot.</p> <p>Note 4: This test is according to the principle defined in section A.3.12.3.</p>		

Table A.7.5.11.1-4: Cell specific test parameters for interruptions due to ProSe Direct Communication on non-serving frequency test for E-UTRAN FDD-FDD

Parameter	Unit	Cell1	
E-UTRA RF Channel Number		1	
E-UTRA RF Channel Number		1	
Serving/Non-serving		Serving	
BW _{channel} ^{Note 5}	MHz	5 or 10	
Correlation Matrix and Antenna Configuration		1x2 Low	
drx-Configuration		None	
PDCCH/PCFICH/PHICH Reference measurement channel ^{Note1, Note 5}		5 MHz: R.11 FDD 10 MHz: R.6 FDD	
PDSCH Reference measurement channel defined in A.3.1.1.1 ^{Note1, Note 5}		5MHz: R.7 FDD 10MHz: R.3 FDD	
OCNG Pattern defined in A.3.2.1		5 MHz: OP.20 FDD 10 MHz: OP.10 FDD	
PCFICH_RB	dB	0	
PDCCH_RA	dB		
PDCCH_RB	dB		
PBCH_RA	dB		
PBCH_RB	dB		
PSS_RA	dB		
SSS_RA	dB		
PHICH_RA	dB		
PHICH_RB	dB		
PDSCH_RA	dB		
PDSCH_RB	dB		
OCNG_RA ^{Note1}	dB		
OCNG_RB ^{Note1}	dB		
\hat{E}_s / N_{oc}	dB		16
N_{oc}	dBm/15 kHz		-98
RSRP ^{Note4}	dBm/15 kHz		-82
SCH_RP ^{Note 4}	dBm/15 kHz	-82	
Propagation condition		AWGN	
<p>Note 1: For the reference measurement channels, see clause A.3.1.</p> <p>Note 2: For the OCNG pattern, see clause A.3.2.</p> <p>Note 3: OCNG shall be used such that cell is fully allocated and a constant total transmitted power spectral density is achieved for all OFDM symbols.</p> <p>Note 4: RSRP and SCH_RP levels have been derived from other parameters for information purposes. They are not settable parameters themselves.</p> <p>Note 5: This test is according to the principle defined in section A.3.12.3.</p>			

A.7.5.11.2 Test Requirements

The test system shall verify that the total number of missed ACK/NACKs on the serving cell on RF channel 1 are less than 0.5%.

A.7.5.12 E-UTRAN FDD - Selection / Reselection of ProSe relay UE

A.7.5.12.1 Test Purpose and Environment

The purpose of this test is to verify the requirements related to selection / reselection of ProSe relay UE defined in clauses 7.16.5. In the test the UE under test is configured with PCell and is configured with ProSe Direct Discovery and ProSe Direct Communication resources as required for remote UE operation.

This test is applicable to UEs capable of ProSe Direct Discovery and ProSe Direct Communication, and further support the optional feature of sidelink remote UE operation.

The test parameters are given in Table A.7.5.12.1-1, Table A.7.5.12.1-2, Table A.7.5.12.1-3, Table A.7.5.12.1-4, and Table A.7.5.12.1-5 below. The test consists of one active serving cell (cell 1), and two active Sidelink relay UEs (Sidelink Relay UE 1, Sidelink Relay UE 2). The Sidelink relay UEs are configured to be transmitting relay discovery messages every discovery period.

The test system shall ensure that the remote UE under test has transmitted *SidelinkUEInformation* message and has been configured with the ProSe Direct Discovery resources for relay operation prior to the start of the test.

The tests consist of five successive time periods, with time duration of T1, T2, T3, and T4 respectively.

During T1, RSRP of cell 1 is kept higher than *threshHigh* (within *remoteUE-Config*), and the remote UE is not required to perform relay UE selection.

During T2, RSRP of cell 1 is configured to be lower than *threshHigh*. The UE is expected to start looking for relay UE and request the serving cell for ProSe Direct Communication resources for communicating with a candidate Sidelink Relay UE. The test system shall ensure that the UE under test transmits the *SidelinkUEInformation* message (requesting the ProSe Direct Communication resources) and has been configured the resource pool prior to end of T2 duration. During T2, the SD-RSRP of Sidelink Relay UE 1 and Sidelink Relay UE 2 is configured to be lower than the detection threshold and no relay UE will be available for the remote UE under test.

During T3, the SD-RSRP of Sidelink Relay UE 1 is raised above the detection threshold and the UE is expected to perform relay selection to Sidelink Relay 1. The test system can determine that the remote UE has selected a relay by monitoring the configured ProSe Direct Communication resource for the direct communication setup message to the relay UE.

During T4, the UE is expected to complete the direct communication setup with the relay UE. Note that the RSRP of the serving cell (cell 1) and the SD-RSRP of sidelink relay UEs is kept unchanged during T3. The period T3 ends when Sidelink Relay UE1 sends the direct communication accept message back to the remote UE.

During T5, SD-RSRP of Sidelink Relay UEs are modified such that the remote UE is expected to reselect to Sidelink Relay UE2.

Table A.7.5.12.1-1: Test parameters for selection / reselection of ProSe relay UE test for E-UTRAN FDD

Parameter	Unit	Value	Comment
E-UTRA RF Channel Number		1	
Channel Bandwidth ($BW_{channel}$)	MHz	5	
Active cell		Cell 1	Serving E-UTRA FDD cell on RF channel number 1 (Broadcasting SIB18 and SIB19)
Active Relay UEs		Relay UE 1, Relay UE 2	Transmitting relay discovery message
CP length of Cell 1		Normal	
T1	ms	100	
T2	s	Up to receiving RRC reconfiguration setup complete from the UE, or up to [1] sec if UE does not transmit <i>SidelinkUEInformation</i> during this period.	
T3	s	1	
T4	s	[2]	
T5	s	1	

Table A.7.5.12.1-2: ProSe Direct Discovery configuration for selection / reselection of ProSe relay UE test for E-UTRAN FDD

Parameter	Unit	Value	Comment
E-UTRA RF Channel Number		1	UL carrier frequency
Channel Bandwidth ($BW_{channel}$)	MHz	5	
ProSe Direct Discovery resource pool configuration		As specified in Table A.3.12.4-4 (Configuration #4)	IE values unless specified otherwise in this test.
<i>discRxPoolPS/numRetx</i>		3	
<i>discRxPoolPS/</i> <i>tf-ResourceConfig/</i> <i>offsetIndicator</i>		0	To align with communications resource pool offset
<i>discRxPoolPS/</i> <i>tf-ResourceConfig/</i> <i>subframeBitmap</i>		00111100 00000000 00000000 00000000 00000000	To avoid collision with communication resource pool, and allow for 4 retransmissions
<i>remoteUE-Config/threshHigh</i>		-91dBm	
Note 1: This test is according to the principle defined in section A.3.12.3.			

Table A.7.5.12.1-3: ProSe Direct Communication configuration for selection / reselection of ProSe relay UE test for E-UTRAN FDD

Parameter	Unit	Value	Comment
E-UTRA RF Channel Number		1	UL carrier frequency
Channel Bandwidth ($BW_{channel}$)	MHz	5	
ProSe Direct Communication resource pool configuration		As specified in Table A.3.12.5-1 (Configuration #1)	IE values unless specified otherwise in this test.
<i>commRxPool/</i> <i>sc-TFResourceConfig/</i> <i>subframeBitmap</i>		00000011 00000000 00000000 00000000 00000000	To avoid collision with discovery resource pool
<i>commTxPoolNormalCommon/</i> <i>sc-TFResourceConfig/</i> <i>subframeBitmap</i>		00000011 00000000 00000000 00000000 00000000	
<i>commTxAllowRelayCommon</i>		true	Configured in SIB18
Note 1: This test is according to the principle defined in section A.3.12.3.			

Table A.7.5.12.1-4: Sidelink Relay UE specific test parameters for selection / reselection of ProSe relay UE test for E-UTRAN FDD

Parameter	Unit	Relay UE 1					Relay UE 2				
		T1	T2	T3	T4	T5	T1	T2	T3	T4	T5
E-UTRA RF Channel Number		1 (UL frequency)									
$BW_{channel}$ ^{Note 4}	MHz	5									
ProSe Direct Discovery resource pool configuration		As specified in Table A.7.5.12.1-2									
Transmission frequency		Every discovery period (40ms) with 3 retransmissions per period									
Resource allocation		Non-overlapping PRBs									
N_{oc} ^{Note1}	dBm/15 kHz	-97									
\hat{E}_s / N_{oc}	dB	-inf	-inf	10.5	10.5	-1.5	-inf	-inf	-inf	-inf	10.5
SD-RSRP ^{Note2, Note 3}	dBm/15 kHz	-inf	-inf	-86.5	-86.5	-98.5	-inf	-inf	-inf	-inf	-86.5
Propagation Condition		AWGN									

Note 1:	Interference from other cells and noise sources not specified in the test is assumed to be constant over subcarriers and time and shall be modelled as AWGN of appropriate power for N_{oc} to be fulfilled.
Note 2:	SD-RSRP levels have been derived from other parameters for information purposes. They are not settable parameters themselves.
Note 3:	SSSS Es/lot is set the same as PSSS/PSBCH Es/lot.
Note 4:	This test is according to the principle defined in section A.3.12.3.

Table A.7.5.12.1-5: Cell specific test parameters for interruptions due to ProSe Direct Communication on non-serving frequency test for E-UTRAN FDD-FDD

Parameter	Unit	Cell1				
		T1	T2	T3	T4	T5
E-UTRA RF Channel Number		1				
Serving/Non-serving		Serving				
BW _{channel} ^{Note 5}	MHz	5				
Correlation Matrix and Antenna Configuration		1x2 Low				
drx-Configuration		DRX_P1 As specified in Table A.3.12.2-1				
PDCCH/PCFICH/PHICH Reference measurement channel ^{Note1, Note 5}		R.11 FDD				
OCNG Pattern defined in A.3.2.1		OP.16 FDD				
PCFICH_RB	dB	0				
PDCCH_RA	dB					
PDCCH_RB	dB					
PBCH_RA	dB					
PBCH_RB	dB					
PSS_RA	dB					
SSS_RA	dB					
PHICH_RA	dB					
PHICH_RB	dB					
PDSCH_RA	dB					
PDSCH_RB	dB					
OCNG_RA ^{Note1}	dB					
OCNG_RB ^{Note1}	dB					
N_{oc}	dBm/15 kHz	-97				
\hat{E}_s/N_{oc}	dB	10.5	1.5	1.5	1.5	1.5
RSRP ^{Note4}	dBm/15 kHz	-86.5	-95.5	-95.5	-95.5	-95.5
Propagation condition		AWGN				
Note 1:	For the reference measurement channels, see clause A.3.1.					
Note 2:	For the OCNG pattern, see clause A.3.2.					
Note 3:	OCNG shall be used such that cell is fully allocated and a constant total transmitted power spectral density is achieved for all OFDM symbols.					
Note 4:	RSRP levels have been derived from other parameters for information purposes. They are not settable parameters themselves.					
Note 5:	This test is according to the principle defined in section A.3.12.3.					

A.7.5.12.2 Test Requirements

Sidelink relay UE selection delay is defined as the time from the beginning of time period T3 to the moment when the UE selects the Sidelink Relay UE1 and transmits the PC5-SP direct communication setup message using ProSe Direct Communications.

The test system shall verify that the sidelink relay UE selection delay is less than 680ms.

NOTE: The sidelink relay UE selection delay can be expressed as ($T_{evaluate, ProSe_Relay_intra} + 1 \text{ sc-period}$).

Sidelink relay UE reselection time is defined as the time from the beginning of time period T5 to the moment when the UE reselects to Sidelink relay UE2 and transmits the direct communication setup message using ProSe Direct Communications.

The test system shall verify that the sidelink relay UE reselection delay is less than 800ms.

NOTE: The sidelink relay UE reselection delay can be expressed as ($T_{\text{measure, ProSe_Relay_Intra}} + T_{\text{evaluate, ProSe_Relay_intra}} + 1 \text{ sc-period}$).

A.7.6 Interruption for carrier aggregation

A.7.6.1 E-UTRAN FDD-TDD CA interruption at SRS carrier based switching

A.7.6.1.1 Test Purpose and Environment

The purpose of this test is to verify that when a UE needs to transmit periodic SRS, the UE can perform carrier based switching to one PUSCH-less SCCs from a CC with PUSCH. The test will verify the interruption requirements on PCC in clause 7.8.2.13

In the test there are two cells: cell1 and cell2. Cell1 is PCell on the FDD primary component carrier, Cell2 is activated SCell on the TDD secondary component carrier which operates in downlink without PUCCH/PUSCH. The UE is configured with the SRS switching between PCell and SCell. The test consists of two successive time periods, with duration of T1 and T2, respectively. During T1 the UE shall be continuously scheduled on PCell. Immediately at the beginning of T2, a PDCCH with SRS-TPC-RNTI is sent to the UE to initiate SRS switching.

Table A.7.6.1.1-1: General test parameters for E-UTRAN FDD-TDD CA interruption at SRS carrier based switching

Parameter	Unit	Value	Comment
E-UTRA RF Channel Number		1, 2	Two radio channels are used for this test
Active PCell		Cell 1	Primary cell on RF channel number 1.
Configured SCell		Cell 2	Configured deactivated secondary cell on RF channel number 2.
CP length		Normal	
DRX		OFF	Continuous monitoring of primary cell
Filter coefficient		0	L3 filtering is not used
T1	s	5	
T2	ms	40	UE shall perform SRS switching during T2
NOTE: This test verifies the RRM requirement which is independent of channel bandwidth and is performed according to the principle defined in section A.3.6.1.			

Table A.7.6.1.1-2: Cell specific test parameters for E-UTRAN FDD-TDD CA interruption at SRS carrier based switching

Parameter	Unit	Cell 1		Cell 2	
		T1	T2	T1	T2
E-UTRA RF Channel Number		1		2	
Special subframe configuration		-		6	
Uplink-downlink configuration		-		1	
BW _{channel}	MHz	5MHz: NRB,c = 25 10MHz: NRB,c = 50 20MHz: NRB,c = 100		5MHz: NRB,c = 25 10MHz: NRB,c = 50 20MHz: NRB,c = 100	
Measurement bandwidth	n_{PRB}	5MHz: 18-24 10MHz: 13-37 20MHz: 47-52		5MHz: 18-24 10MHz: 13-37 20MHz: 47-52	
PDSCH parameters: DL Reference Measurement Channel		5MHz: R.7 FDD 10MHz: R.3 FDD 20MHz: R.6 FDD		5MHz: R.5 TDD 10MHz: R.0 TDD 20MHz: R.4 TDD	
PCFICH/PDCCH/PHICH parameters:		5MHz: R.11 FDD 10MHz: R.6 FDD		5MHz: R.11 TDD 10MHz: R.6 TDD	

DL Reference Measurement Channel		20MHz: R.10 FDD		20MHz: R.10 TDD	
OCNG Pattern defined in A.3.2.1 and in A.3.2.2		5MHz: OP.20 FDD 10MHz: OP.10 FDD 20MHz: OP.17 FDD		5MHz: OP.15 TDD 10MHz: OP.1 TDD 20MHz: OP.11 TDD	
PBCH_RA	dB	0		0	
PBCH_RB	dB				
PSS_RA	dB				
SSS_RA	dB				
PCFICH_RB	dB				
PHICH_RA	dB				
PHICH_RB	dB				
PDCCH_RA	dB				
PDCCH_RB	dB				
PDSCH_RA	dB				
PDSCH_RB	dB				
OCNG_RA ^{Note 1}	dB				
OCNG_RB ^{Note 1}	dB				
N_{oc} ^{Note 2}	dBm/15 kHz	-98		-98	
RSRP ^{Note 3}	dBm/15 kHz	-82	-82	-82	-82
\hat{E}_s/I_{ot}	dB	16	16	16	16
SCH_RP ^{Note 3}	dBm/15 kHz	-82	-82	-82	-82
\hat{E}_s/N_{oc}	dB	16	16	16	16
I_o ^{Note 3}	dBm/Ch BW	-54.11+10log($N_{RB,c}/50$)	-54.11+10log($N_{RB,c}/50$)	-54.11+10log($N_{RB,c}/50$)	-54.11+10log($N_{RB,c}/50$)
Propagation Condition		AWGN		AWGN	
Correlation Matrix and Antenna Configuration		1x2 Low		1x2 Low	
timing offset to cell1	μs	-		0	
Time alignment error relative to cell 1 ^{Note 5}	μs	-		≤ TAE	
<p>Note 1: OCNG shall be used such that all cells are fully allocated and a constant total transmitted power spectral density is achieved for all OFDM symbols.</p> <p>Note 2: Interference from other cells and noise sources not specified in the test is assumed to be constant over subcarriers and time and shall be modelled as AWGN of appropriate power for N_{oc} to be fulfilled.</p> <p>Note 3: E_s/I_{ot}, RSRP, SCH_RP and I_o have been derived from other parameters for information purposes. They are not settable parameters themselves.</p> <p>Note 4: The uplink resources for CSI reporting are assigned to the UE prior to the start of time period T2.</p> <p>Note 5: Time alignment error (TAE) as specified in TS 36.104 [30] clause 6.5.3.1. The TAE value depends upon the type of carrier aggregation</p>					

Table A.7.6.1.1-3: Sounding Reference Symbol Configuration for E-UTRAN FDD-TDD CA interruption at SRS carrier based switching

Field	Value	Comment
srsBandwidthConfiguration	bw5	
srsSubframeConfiguration	sc8	Once every 5 subframes
ackNackSrsSimultaneousTransmission	FALSE	
srsMaxUpPTS	N/A	Not applicable for E-UTRAN FDD
srsBandwidth	0	No hopping
srsHoppingBandwidth	hbw0	
frequencyDomainPosition	0	
Duration	TRUE	Indefinite duration
Srs-ConfigurationIndex	47	SRS periodicity of 40ms.
transmissionComb	0	
cyclicShift	cs0	No cyclic shift

SRS-AntennaPort	an1	Number of antenna ports used for SRS transmission
Note: For further information see clause 6.3.2 in TS 36.331.		

A.7.6.1.2 Test Requirements

The UE shall be continuously scheduled in PCell throughout the test and during the time duration T2, at most 6 ACK/NACK loss on PCell shall be detected.

The rate of correct events observed during repeated tests shall be at least 90%.

A.7.6.2 E-UTRAN TDD-TDD CA interruption at SRS carrier based switching

A.7.6.2.1 Test Purpose and Environment

The purpose of this test is to verify that when a UE needs to transmit periodic SRS, the UE can perform carrier based switching to one PUSCH-less SCCs from a CC with PUSCH. The test will verify the interruption requirements on PCC in clause 7.8.2.13

In the test there are two cells: cell1 and cell2. Cell1 is PCell on the TDD primary component carrier, Cell2 is activated SCell on the TDD secondary component carrier which operates in downlink without PUCCH/PUSCH. The UE is configured with the SRS switching between PCell and SCell. The test consists of two successive time periods, with duration of T1 and T2, respectively. During T1 the UE shall be continuously scheduled on PCell. Immediately at the beginning of T2, a PDCCH with SRS-TPC-RNTI is sent to the UE to initiate SRS switching.

Table A.7.6.2.1-1: General test parameters for E-UTRAN TDD-TDD CA interruption at SRS carrier based switching

Parameter	Unit	Value	Comment
E-UTRA RF Channel Number		1, 2	Two radio channels are used for this test
Active PCell		Cell 1	Primary cell on RF channel number 1.
Configured SCell		Cell 2	Configured deactivated secondary cell on RF channel number 2.
CP length		Normal	
DRX		OFF	Continuous monitoring of primary cell
Filter coefficient		0	L3 filtering is not used
T1	s	5	
T2	ms	40	UE shall perform SRS switching during T2
NOTE: This test verifies the RRM requirement which is independent of channel bandwidth and is performed according to the principle defined in section A.3.6.1.			

Table A.7.6.2.1-2: Cell specific test parameters for E-UTRAN TDD-TDD CA interruption at SRS carrier based switching

Parameter	Unit	Cell 1		Cell 2	
		T1	T2	T1	T2
E-UTRA RF Channel Number		1		2	
Special subframe configuration		6		6	
Uplink-downlink configuration		1		1	
BW _{channel}	MHz	5MHz: NRB,c = 25 10MHz: NRB,c = 50 20MHz: NRB,c = 100		5MHz: NRB,c = 25 10MHz: NRB,c = 50 20MHz: NRB,c = 100	
Measurement bandwidth	n_{PRB}	5MHz:18-24 10MHz:13-37 20MHz:47-52		5MHz:18-24 10MHz:13-37 20MHz:47-52	
PDSCH parameters: DL Reference Measurement Channel		5MHz: R.5 TDD 10MHz: R.0 TDD 20MHz: R.4 TDD		5MHz: R.5 TDD 10MHz: R.0 TDD 20MHz: R.4 TDD	

PCFICH/PDCCH/PHICH parameters: DL Reference Measurement Channel		5MHz: R.11 TDD 10MHz: R.6 TDD 20MHz: R.10 TDD		5MHz: R.11 TDD 10MHz: R.6 TDD 20MHz: R.10 TDD	
OCNG Pattern defined in A.3.2.2		5MHz: OP.15 TDD 10MHz: OP.1 TDD 20MHz: OP.11 TDD		5MHz: OP.15 TDD 10MHz: OP.1 TDD 20MHz: OP.11 TDD	
PBCH_RA	dB	0		0	
PBCH_RB	dB				
PSS_RA	dB				
SSS_RA	dB				
PCFICH_RB	dB				
PHICH_RA	dB				
PHICH_RB	dB				
PDCCH_RA	dB				
PDCCH_RB	dB				
PDSCH_RA	dB				
PDSCH_RB	dB				
OCNG_RA ^{Note 1}	dB				
OCNG_RB ^{Note 1}	dB				
N_{oc} ^{Note 2}	dBm/15 kHz				
RSRP ^{Note 3}	dBm/15 kHz	-82	-82	-82	-82
\hat{E}_s/I_{ot}	dB	16	16	16	16
SCH_RP ^{Note 3}	dBm/15 kHz	-82	-82	-82	-82
\hat{E}_s/N_{oc}	dB	16	16	16	16
I_o ^{Note 3}	dBm/Ch BW	-	$-54.11+10\log(N_{RB,c}/50)$	$-54.11+10\log(N_{RB,c}/50)$	$-54.11+10\log(N_{RB,c}/50)$
Propagation Condition		AWGN		AWGN	
Correlation Matrix and Antenna Configuration		1x2 Low		1x2 Low	
timing offset to cell1	μs	-		0	
Time alignment error relative to cell 1 ^{Note 5}	μs	-		≤ TAE	
<p>Note 1: OCNG shall be used such that all cells are fully allocated and a constant total transmitted power spectral density is achieved for all OFDM symbols.</p> <p>Note 2: Interference from other cells and noise sources not specified in the test is assumed to be constant over subcarriers and time and shall be modelled as AWGN of appropriate power for N_{oc} to be fulfilled.</p> <p>Note 3: E_s/I_{ot}, RSRP, SCH_RP and I_o have been derived from other parameters for information purposes. They are not settable parameters themselves.</p> <p>Note 4: The uplink resources for CSI reporting are assigned to the UE prior to the start of time period T2.</p> <p>Note 5: Time alignment error (TAE) as specified in TS 36.104 [30] clause 6.5.3.1. The TAE value depends upon the type of carrier aggregation.</p>					

Table A.7.6.2.1-3: Sounding Reference Symbol Configuration for E-UTRAN TDD-TDD CA interruption at SRS carrier based switching

Field	Value	Comment
srsBandwidthConfiguration	bw5	
srsSubframeConfiguration	Sc8	Once every 5 subframes
ackNackSrsSimultaneousTransmission	FALSE	
srsMaxUpPTS	N/A	Not applicable for E-UTRAN FDD
srsBandwidth	0	No hopping
srsHoppingBandwidth	hbw0	
frequencyDomainPosition	0	
Duration	TRUE	Indefinite duration

Srs-ConfigurationIndex	47	SRS periodicity of 40ms.
transmissionComb	0	
cyclicShift	cs0	No cyclic shift
SRS-AntennaPort	an1	Number of antenna ports used for SRS transmission
Note:	For further information see clause 6.3.2 in TS 36.331.	

A.7.6.2.2 Test Requirements

The UE shall be continuously scheduled in PCell throughout the test and during the time duration T2, at most 4 ACK/NACK loss on PCell shall be detected.

The rate of correct events observed during repeated tests shall be at least 90%.

A.8 UE Measurements Procedures

The reference channels in this clause assume transmission of PDSCH with a maximum number of 5 HARQ transmissions unless otherwise specified.

A.8.1 E-UTRAN FDD Intra-frequency Measurements

A.8.1.1 E-UTRAN FDD-FDD intra-frequency event triggered reporting under fading propagation conditions in asynchronous cells

A.8.1.1.1 Test Purpose and Environment

The purpose of this test is to verify that the UE makes correct reporting of an event. This test will partly verify the FDD intra-frequency cell search requirements in clause 8.1.2.2.1.1.

The test parameters are given in Table A.8.1.1.1-1 and A.8.1.1.1-2 below. In the measurement control information it is indicated to the UE that event-triggered reporting with Event A3 is used. The test consists of two successive time periods, with time duration of T1, and T2 respectively. During time duration T1, the UE shall not have any timing information of cell 2.

Table A.8.1.1.1-1: General test parameters for E-UTRAN FDD-FDD intra-frequency event triggered reporting under fading propagation conditions in asynchronous cells

Parameter	Unit	Value	Comment
PDSCH parameters		DL Reference Measurement Channel R.0 FDD	As specified in clause A.3.1.1.1
PCFICH/PDCCH/PHICH parameters		DL Reference Measurement Channel R.6 FDD	As specified in clause A.3.1.2.1
Active cell		Cell 1	
Neighbour cell		Cell 2	Cell to be identified.
E-UTRA RF Channel Number		1	One FDD carrier frequency is used.
Channel Bandwidth (BW _{channel})	MHz	10	
A3-Offset	dB	-6	
CP length		Normal	
Hysteresis	dB	0	
Time To Trigger	s	0	
Filter coefficient		0	L3 filtering is not used
DRX			OFF
Time offset between cells		3 ms	Asynchronous cells
T1	s	5	
T2	s	5	

Table A.8.1.1.1-2: Cell specific test parameters for E-UTRAN FDD-FDD intra-frequency event triggered reporting under fading propagation conditions in asynchronous cells

Parameter	Unit	Cell 1		Cell 2	
		T1	T2	T1	T2
E-UTRA RF Channel Number		1		1	
BW _{channel}	MHz	10		10	
Correlation Matrix and Antenna Configuration		1x2 Low		1x2 Low	
OCNG Patterns defined in A.3.2.1.1 (OP.1 FDD) and in A.3.2.1.2 (OP.2 FDD)		OP.1 FDD		OP.2 FDD	
PBCH_RA	dB	0		0	
PBCH_RB	dB				
PSS_RA	dB				
SSS_RA	dB				
PCFICH_RB	dB				
PHICH_RA	dB				
PHICH_PB	dB				
PDCCH_RA	dB				
PDCCH_PB	dB				
PDSCH_RA	dB				
PDSCH_RB	dB				
OCNG_RA ^{Note 1}	dB				
OCNG_RB ^{Note 1}	dB				
\hat{E}_s/I_{ot}	dB				
N_{oc} ^{Note 3}	dBm/15 KHz	-98			
\hat{E}_s/N_{oc}	dB	4	4	-Infinity	4
RSRP ^{Note 4}	dBm/15 KHz	-94	-94	-Infinity	-94
SCH_RP ^{Note 4}	dBm/15 KHz	-94	-94	-Infinity	-94
Propagation Condition		ETU70			
<p>Note 1: OCNG shall be used such that both cells are fully allocated and a constant total transmitted power spectral density is achieved for all OFDM symbols.</p> <p>Note 2: The resources for uplink transmission are assigned to the UE prior to the start of time period T2.</p> <p>Note 3: Interference from other cells and noise sources not specified in the test is assumed to be constant over subcarriers and time and shall be modelled as AWGN of appropriate power for N_{oc} to be fulfilled.</p> <p>Note 4: RSRP and SCH_RP levels have been derived from other parameters for information purposes. They are not settable parameters themselves.</p>					

A.8.1.1.2 Test Requirements

The UE shall send one Event A3 triggered measurement report, with a measurement reporting delay less than 800 ms from the beginning of time period T2.

The UE shall not send event triggered measurement reports, as long as the reporting criteria are not fulfilled.

The rate of correct events observed during repeated tests shall be at least 90%.

NOTE: The actual overall delays measured in the test may be up to $2xTTI_{DCCH}$ higher than the measurement reporting delays above because of TTI insertion uncertainty of the measurement report in DCCH.

A.8.1.2 E-UTRAN FDD-FDD intra-frequency event triggered reporting under fading propagation conditions in synchronous cells

A.8.1.2.1 Test Purpose and Environment

The purpose of this test is to verify that the UE makes correct reporting of an event. This test will partly verify the FDD intra-frequency cell search requirements in clause 8.1.2.2.1.1

The test parameters are given in Table A.8.1.2.1-1 and A.8.1.2.1-2 below. In the measurement control information it is indicated to the UE that event-triggered reporting with Event A3 is used. PDCCHs indicating new transmissions or retransmissions shall be sent continuously to ensure that the UE would not enter the DRX state. The test consists of two successive time periods, with time duration of T1, and T2 respectively. During time duration T1, the UE shall not have any timing information of cell 2.

Table A.8.1.2.1-1: General test parameters for E-UTRAN FDD-FDD intra-frequency event triggered reporting under fading propagation conditions in synchronous cells

Parameter	Unit	Value	Comment
PDSCH parameters		DL Reference Measurement Channel R.0 FDD	As specified in clause A.3.1.1.1
PCFICH/PDCCH/PHICH parameters		DL Reference Measurement Channel R.6 FDD	As specified in clause A.3.1.2.1
Active cell		Cell 1	
Neighbour cell		Cell 2	Cell to be identified.
E-UTRA RF Channel Number		1	One FDD carrier frequency is used.
Channel Bandwidth (BW_{channel})	MHz	10	
A3-Offset	dB	-6	
CP length		Normal	
Hysteresis	dB	0	
Time To Trigger	s	0	
Filter coefficient		0	L3 filtering is not used
DRX		DRX_L	As specified in clause A.3.3
Time offset between cells		3 μ s	Synchronous cells
T1	s	5	
T2	s	5	

Table A.8.1.2.1-2: Cell specific test parameters for E-UTRAN FDD-FDD intra-frequency event triggered reporting under fading propagation conditions in synchronous cells

Parameter	Unit	Cell 1		Cell 2	
		T1	T2	T1	T2
E-UTRA RF Channel Number		1		1	
BW_{channel}	MHz	10		10	
Correlation Matrix and Antenna Configuration		1x2 Low		1x2 Low	
OCNG Patterns defined in A.3.2.1.1 (OP.1 FDD) and in A.3.2.1.2 (OP.2 FDD)		OP.1 FDD		OP.2 FDD	
PBCH_RA	dB	0		0	
PBCH_RB	dB				
PSS_RA	dB				
SSS_RA	dB				
PCFICH_RB	dB				
PHICH_RA	dB				
PHICH_RB	dB				
PDCCH_RA	dB				
PDCCH_RB	dB				
PDSCH_RA	dB				
PDSCH_RB	dB				
OCNG_RA ^{Note 1}	dB				
OCNG_RB ^{Note 1}	dB				
\hat{E}_s/I_{ot}	dB	4	-1.46	-Infinity	-1.46
N_{oc} ^{Note 3}	dBm/15 KHz	-98			
\hat{E}_s/N_{oc}	dB	4	4	-Infinity	4
RSRP ^{Note 4}	dBm/15 KHz	-94	-94	-Infinity	-94
SCH_RP ^{Note 4}	dBm/15 KHz	-94	-94	-Infinity	-94

Propagation Condition	ETU70
Note 1:	OCNG shall be used such that both cells are fully allocated and a constant total transmitted power spectral density is achieved for all OFDM symbols.
Note 2:	The resources for uplink transmission are assigned to the UE prior to the start of time period T2.
Note 3:	Interference from other cells and noise sources not specified in the test is assumed to be constant over subcarriers and time and shall be modelled as AWGN of appropriate power for N_{oc} to be fulfilled.
Note 4:	RSRP and SCH_RP levels have been derived from other parameters for information purposes. They are not settable parameters themselves.

A.8.1.2.2 Test Requirements

The UE shall send one Event A3 triggered measurement report, with a measurement reporting delay less than 800 ms from the beginning of time period T2.

The UE shall not send event triggered measurement reports, as long as the reporting criteria are not fulfilled.

The rate of correct events observed during repeated tests shall be at least 90%.

NOTE: The actual overall delays measured in the test may be up to $2 \times TTI_{DCCH}$ higher than the measurement reporting delays above because of TTI insertion uncertainty of the measurement report in DCCH.

A.8.1.3 E-UTRAN FDD-FDD intra-frequency event triggered reporting under fading propagation conditions in synchronous cells with DRX

A.8.1.3.1 Test Purpose and Environment

The purpose of the two tests is to verify that the UE makes correct reporting of an event in DRX. The tests will partly verify the FDD-FDD intra-frequency cell search in DRX requirements in clause 8.1.2.2.1.2.

The test parameters are given in Tables A.8.1.3.1-1, A.8.1.3.1-2, A.8.1.3.1-3 and A.8.1.3.1-4. In the measurement control information, it is indicated to the UE that event-triggered reporting with Event A3 is used. The test consists of two successive time periods, with time duration of T1, and T2 respectively. During time duration T1, the UE shall not have any timing information of cell 2.

In Test 1 UE needs to be provided at least once every 500ms with new Timing Advance Command MAC control element to restart the Time alignment timer to keep UE uplink time alignment. Furthermore UE is allocated with PUSCH resource at every DRX cycle.

In Test 2 the uplink time alignment is not maintained and UE needs to use RACH to obtain UL allocation for measurement reporting.

Table A.8.1.3.1-1: General test parameters for E-UTRAN FDD-FDD intra-frequency event triggered reporting under fading propagation conditions in synchronous cells when DRX is used

Parameter	Unit	Value		Comment
		Test 1	Test 2	
PDSCH parameters		DL Reference Measurement Channel R.0 FDD		As specified in clause A.3.1.1.1
PCFICH/PDCCH/PHICH parameters		DL Reference Measurement Channel R.6 FDD		As specified in clause A.3.1.2.1
Active cell		Cell 1		
Neighbour cell		Cell 2		Cell to be identified.
E-UTRA RF Channel Number		1		One FDD carrier frequency is used.
Channel Bandwidth (BW _{channel})	MHz	10		
A3-Offset	dB	-6		
CP length		Normal		
Hysteresis	dB	0		
Time To Trigger	s	0		
Filter coefficient		0		L3 filtering is not used
DRX		ON		DRX related parameters are defined in Table A.8.1.3.1-3

Time offset between cells		3 μ s	Synchronous cells
T1	s	5	
T2	s	5	30

Table A.8.1.3.1-2: Cell specific test parameters for E-UTRAN FDD-FDD intra-frequency event triggered reporting under fading propagation conditions in synchronous cells when DRX is used

Parameter	Unit	Cell 1		Cell 2	
		T1	T2	T1	T2
E-UTRA RF Channel Number		1		1	
BW _{channel}	MHz	10		10	
Correlation Matrix and Antenna Configuration		1x2 Low		1x2 Low	
OCNG Patterns defined in A.3.2.1.1 (OP.1 FDD) and in A.3.2.1.2 (OP.2 FDD)		OP.1 FDD		OP.2 FDD	
PBCH_RA	dB	0		0	
PBCH_RB	dB				
PSS_RA	dB				
SSS_RA	dB				
PCFICH_RB	dB				
PHICH_RA	dB				
PHICH_RB	dB				
PDCCH_RA	dB				
PDCCH_RB	dB				
PDSCH_RA	dB				
PDSCH_RB	dB				
OCNG_RA ^{Note 1}	dB				
OCNG_RB ^{Note 1}	dB				
\hat{E}_s/I_{ot}	dB				
N_{oc} ^{Note 2}	dBm/15 KHz	-98			
\hat{E}_s/N_{oc}	dB	4	4	-Infinity	4
RSRP ^{Note 3}	dBm/15 KHz	-94	-94	-Infinity	-94
SCH_RP ^{Note 3}	dBm/15 KHz	-94	-94	-Infinity	-94
Propagation Condition		ETU70			
Note 1: OCNG shall be used such that both cells are fully allocated and a constant total transmitted power spectral density is achieved for all OFDM symbols. Note 2: Interference from other cells and noise sources not specified in the test is assumed to be constant over subcarriers and time and shall be modelled as AWGN of appropriate power for N_{oc} to be fulfilled. Note 3: RSRP and SCH_RP levels have been derived from other parameters for information purposes. They are not settable parameters themselves.					

Table A.8.1.3.1-3: DRX-Configuration for E-UTRAN FDD-FDD intra-frequency event triggered reporting in DRX under fading propagation conditions in synchronous cells

Field	Test1	Test2	Comment
	Value	Value	
onDurationTimer	psf1	psf1	As specified in clause 6.3.2 in TS 36.331
drx-InactivityTimer	psf1	psf1	
drx-RetransmissionTimer	psf1	psf1	
longDRX-CycleStartOffset	sf40	sf1280	
shortDRX	disable	disable	

Table A.8.1.3.1-4: TimeAlignmentTimer-Configuration for E-UTRAN FDD-FDD intra-frequency event triggered reporting in DRX under fading propagation conditions in synchronous cells

Field	Test1	Test2	Comment
-------	-------	-------	---------

	Value	Value	
TimeAlignmentTimer	sf500	sf500	As specified in clause 6.3.2 in TS 36.331
sr-ConfigIndex	0	0	For further information see clause 6.3.2 in TS 36.331 and section 10.1 in TS 36.213.

A.8.1.3.2 Test Requirements

In Test 1, the UE shall send one Event A3 triggered measurement report, with a measurement reporting delay less than 800 ms from the beginning of time period T2. The measurement reporting delay is defined as the time from the beginning of time period T2 to the moment when the UE send the measurement report on PUSCH.

In Test 2, the UE shall send one Event A3 triggered measurement report, with a measurement reporting delay less than 25600 ms from the beginning of time period T2. The measurement reporting delay is defined as the time from the beginning of time period T2 to the moment when the UE starts to send preambles on the PRACH for scheduling request (SR) to obtain allocation to send the measurement report on PUSCH.

The UE shall not send event triggered measurement reports, as long as the reporting criteria are not fulfilled.

The rate of correct events observed during repeated tests shall be at least 90%.

NOTE 1: The actual overall delays measured in the test may be up to one DRX cycle higher than the measurement reporting delays above because UE is allowed to delay the initiation of the measurement reporting procedure to the next until the Active Time.

NOTE 2: In order to calculate the rate of correct events the system simulator shall verify that it has received correct Event A3 measurement report.

A.8.1.4 Void

A.8.1.5 E-UTRAN FDD - FDD Intra-frequency identification of a new CGI of E-UTRA cell using autonomous gaps

A.8.1.5.1 Test Purpose and Environment

This test is to verify the requirement for identification of a new CGI of E-UTRA cell with autonomous gaps in clause 8.1.2.2.3.

The test scenario comprises of one E-UTRA FDD carrier and two cells as given in tables A.8.1.5.1-1 and A.8.1.5.1-2. PDCCHs indicating new transmissions shall be sent continuously to ensure that the UE would have ACK/NACK sending during identifying a new CGI of E-UTRAN cell. The test consists of three successive time periods, with time durations of T1, T2 and T3 respectively. At the start of time duration T1, the UE does not have any timing information of cell 2. Starting T2, cell 2 becomes detectable and the UE is expected to detect and send a measurement report.

A RRC message implying SI reading shall be sent to the UE during period T2, after the UE has reported Event A3. The RRC message shall create a measurement report configuration with purpose *reportCGI* and *si-RequestForHO* set to TRUE. The start of T3 is the instant when the last TTI containing the RRC message implying SI reading is sent to the UE.

Table A.8.1.5.1-1: General test parameters for E-UTRAN FDD - FDD Intra-frequency identification of a new CGI of E-UTRA cell using autonomous gaps

Parameter	Unit	Value	Comment
PDSCCH parameters		DL Reference Measurement Channel R.3 FDD	As specified in clause A.3.1.1.1
PCFICH/PDCCH/PHICH parameters		DL Reference Measurement Channel R.6 FDD	As specified in clause A.3.1.2.1
Active cell		Cell 1	
Neighbour cell		Cell 2	Cell to be identified.
E-UTRA RF Channel Number		1	Only one FDD carrier frequency is used.

Channel Bandwidth ($BW_{channel}$)	MHz	10	
CP length		Normal	
A3-Offset	dB	-3	
Hysteresis	dB	0	
Time To Trigger	s	0	
Filter coefficient		0	L3 filtering is not used
DRX		OFF	
si-RequestForHO		TRUE	As specified in clause 5.5.3.1 in TS 36.331.
Time offset between cells	ms	3	Asynchronous cells
T1	s	5	
T2	s	≤10	
T3	s	5	

Table A.8.1.5.1-2: Cell specific test parameters for E-UTRAN FDD - FDD Intra-frequency identification of a new CGI of E-UTRA cell using autonomous gaps

Parameter	Unit	Cell 1			Cell 2		
		T1	T2	T3	T1	T2	T3
E-UTRA RF Channel Number		1			1		
$BW_{channel}$	MHz	10			10		
OCNG Patterns defined in A.3.2.1.10 (OP.10 FDD) and in A.3.2.1.2 (OP.2 FDD)		OP.10 FDD	OP.10 FDD	OP.10 FDD	OP.2 FDD	OP.2 FDD	OP.2 FDD
PBCH_RA	dB	0			0		
PBCH_RB	dB						
PSS_RA	dB						
SSS_RA	dB						
PCFICH_RB	dB						
PHICH_RA	dB						
PHICH_PB	dB						
PDCCH_RA	dB						
PDCCH_PB	dB						
PDSCH_RA	dB						
PDSCH_RB	dB						
OCNG_RA ^{Note 1}	dB						
OCNG_RB ^{Note 1}	dB						
\hat{E}_s / I_{ot}	dB	8	-3.3	-3.3	-Infinity	2.36	2.36
N_{oc} ^{Note 2}	dBm/15 KHz	-98					
\hat{E}_s / N_{oc}	dB	8	8	8	-Infinity	11	11
RSRP ^{Note 3}	dBm/15 KHz	-90	-90	-90	-Infinity	-87	-87
SCH_RP ^{Note 3}	dBm/15 KHz	-90	-90	-90	-Infinity	-87	-87
Propagation Condition		AWGN					
<p>Note 1: OCNG shall be used such that both cells are fully allocated and a constant total transmitted power spectral density is achieved for all OFDM symbols.</p> <p>Note 2: Interference from other cells and noise sources not specified in the test is assumed to be constant over subcarriers and time and shall be modelled as AWGN of appropriate power for N_{oc} to be fulfilled.</p> <p>Note 3: RSRP and SCH_RP levels have been derived from other parameters for information purposes. They are not settable parameters themselves.</p>							

A.8.1.5.2 Test Requirements

The UE shall transmit a measurement report containing the cell global identifier of cell 2 within 170 milliseconds from the start of T3.

$$\text{Test requirement} = \text{RRC Procedure delay} + T_{\text{identify_CGI, intra}} + \text{reporting delay}$$

$$= 15 + 150 + 2\text{ms from the start of T3}$$

= 167 ms, allow 170 ms.

The UE shall be scheduled continuously throughout the test, and from the start of T3 until 170 ms at least 80 ACK/NACK shall be detected as being transmitted by the UE.

The rate of correct events observed during repeated tests shall be at least 90%.

NOTE: The overall 80 ACK/NACK number is caused by two parts. Firstly, at least 60 ACK/NACK shall be sent during identifying the cell global identifier of cell 2 according to the requirement in Clause 8.1.2.2.3.1. Secondly, given that continuous DL data allocation, additional 20 ACK/NACK shall be sent from the start of T3 until 170 ms excludes 150 ms for identifying the cell global identifier of cell 2.

A.8.1.6 E-UTRAN FDD - FDD Intra-frequency identification of a new CGI of E-UTRA cell using autonomous gaps with DRX

A.8.1.6.1 Test Purpose and Environment

This test is to verify the requirement for identification of a new CGI of E-UTRA cell with autonomous gaps in clause 8.1.2.2.3. The requirement is verified in a DRX configuration.

The test scenario comprises of one E-UTRA FDD carrier and two cells as given in tables A.8.1.6.1-1, A.8.1.6.1-2, A.8.1.6.1-3 and A.8.1.6.1-4. The test consists of three successive time periods, with time durations of T1, T2 and T3 respectively. At the start of time duration T1, the UE does not have any timing information of cell 2. Starting T2, cell 2 becomes detectable and the UE is expected to detect and send a measurement report.

A RRC message implying SI reading shall be sent to the UE during period T2, after the UE has reported Event A3. The RRC message shall create a measurement report configuration with purpose *reportCGI* and *si-RequestForHO* set to TRUE. The start of T3 is the instant when the last TTI containing the RRC message implying SI reading is sent to the UE.

In the test UE needs to be provided at least once every 1280ms with new Timing Advance Command MAC control element to restart the Time alignment timer to keep UE uplink time alignment. Furthermore UE sends scheduling request (SR) to obtain allocation to send the measurement report on PUSCH.

Table A.8.1.6.1-1: General test parameters for E-UTRAN FDD - FDD Intra-frequency identification of a new CGI of E-UTRA cell using autonomous gaps with DRX

Parameter	Unit	Value	Comment
PDSCH parameters		DL Reference Measurement Channel R.0 FDD	As specified in clause A.3.1.1.1
PCFICH/PDCCH/PHICH parameters		DL Reference Measurement Channel R.6 FDD	As specified in clause A.3.1.2.1
Active cell		Cell 1	
Neighbour cell		Cell 2	Cell to be identified.
E-UTRA RF Channel Number		1	Only one FDD carrier frequency is used.
Channel Bandwidth ($BW_{channel}$)	MHz	10	
CP length		Normal	
A3-Offset	dB	-3	
Hysteresis	dB	0	
Time To Trigger	s	0	
Filter coefficient		0	L3 filtering is not used
DRX		ON	DRX related parameters are defined in Table A.8.1.6.1-3
si-RequestForHO		TRUE	As specified in clause 5.5.3.1 in TS 36.331.
Time offset between cells	ms	3	Asynchronous cells
T1	s	5	
T2	s	≤30	UE shall report cell within 25.6s (20 DRX cycles)
T3	s	5	

Table A.8.1.6.1-2: Cell specific test parameters for E-UTRAN FDD - FDD Intra-frequency identification of a new CGI of E-UTRA cell using autonomous gaps with DRX

Parameter	Unit	Cell 1			Cell 2		
		T1	T2	T3	T1	T2	T3
E-UTRA RF Channel Number		1			1		
BW _{channel}	MHz	10			10		
OCNG Patterns defined in A.3.2.1.1 (OP.1 FDD) and in A.3.2.1.2 (OP.2 FDD)		OP.1 FDD	OP.1 FDD	OP.1 FDD	OP.2 FDD	OP.2 FDD	OP.2 FDD
PBCH_RA	dB	0			0		
PBCH_RB	dB						
PSS_RA	dB						
SSS_RA	dB						
PCFICH_RB	dB						
PHICH_RA	dB						
PHICH_PB	dB						
PDCCH_RA	dB						
PDCCH_PB	dB						
PDSCH_RA	dB						
PDSCH_RB	dB						
OCNG_RA ^{Note 1}	dB						
OCNG_RB ^{Note 1}	dB						
\hat{E}_s / I_{ot}	dB	8	-3.3	-3.3	-Infinity	2.36	2.36
N_{oc} ^{Note 2}	dBm/15 KHz	-98					
\hat{E}_s / N_{oc}	dB	8	8	8	-Infinity	11	11
RSRP ^{Note 3}	dBm/15 KHz	-90	-90	-90	-Infinity	-87	-87
SCH_RP ^{Note 3}	dBm/15 KHz	-90	-90	-90	-Infinity	-87	-87
Propagation Condition		AWGN					
<p>Note 1: OCNG shall be used such that both cells are fully allocated and a constant total transmitted power spectral density is achieved for all OFDM symbols.</p> <p>Note 2: Interference from other cells and noise sources not specified in the test is assumed to be constant over subcarriers and time and shall be modelled as AWGN of appropriate power for N_{oc} to be fulfilled.</p> <p>Note 3: RSRP and SCH_RP levels have been derived from other parameters for information purposes. They are not settable parameters themselves.</p>							

Table A.8.1.6.1-3: DRX configuration for E-UTRAN FDD - FDD Intra-frequency identification of a new CGI of E-UTRA cell using autonomous gaps with DRX

Field	Value	Comment
onDurationTimer	psf1	As specified in clause 6.3.2 in TS 36.331
drx-InactivityTimer	psf1	
drx-RetransmissionTimer	psf1	
longDRX-CycleStartOffset	sf1280	
shortDRX	disable	

Table A.8.1.6.1-4: TimeAlignmentTimer-Configuration for E-UTRAN FDD - FDD Intra-frequency identification of a new CGI of E-UTRA cell using autonomous gaps with DRX

Field	Value	Comment
TimeAlignmentTimer	Infinity	As specified in clause 6.3.2 in TS 36.331
sr-ConfigIndex	0	For further information see clause 6.3.2 in TS 36.331 and section 10.1 in TS 36.213.

A.8.1.6.2 Test Requirements

The UE shall transmit a measurement report containing the cell global identifier of cell 2 within 170 milliseconds from the start of T3.

$$\begin{aligned} \text{Test requirement} &= \text{RRC Procedure delay} + T_{\text{identify_CGI, intra}} + \text{reporting delay} \\ &= 15 + 150 + 2\text{ms from the start of T3} \\ &= 167 \text{ ms, allow 170 ms.} \end{aligned}$$

The rate of correct events observed during repeated tests shall be at least 90%.

A.8.1.7 E-UTRAN FDD-FDD Intra-Frequency Event-Triggered Reporting under Time Domain Measurement Resource Restriction with Non-MBSFN ABS

A.8.1.7.1 Test Purpose and Environment

The purpose of this test is to verify that the UE correctly detects and reports Event A3 (Neighbour becomes offset better than PCell) defined in TS 36.331 [2] within the requirements specified in Clause 8.1.2.8.1.1 under a time domain measurement resource restriction and non-MBSFN ABS configured in the aggressor cell.

The test parameters are given in Tables A.8.1.7.1-1 and A.8.1.7.1-2 below. It is indicated to the UE in the measurement control information that event-triggered reporting with Event A3 is used. In the test there are two synchronous cells, Cell 1 and Cell 2, on the same RF channel. Cell 1 is the PCell, and it is also the aggressor cell to Cell 2. Cell 2 is the cell to be identified. The test consists of two successive time periods with time duration of T1 and T2, respectively. During time duration T1, the UE shall not have any timing information on Cell 2.

Non-MBSFN ABS pattern is configured for Cell 1 during the test. The UE is configured by higher layers via Cell 1 with a time domain measurement resource restriction pattern for performing E-UTRAN FDD intra-frequency measurements on neighbour cells. The UE is also configured with a time domain measurement resource restriction pattern for the PCell measurements. The information for both measurement patterns shall be provided to the UE via higher layers during T1.

Table A.8.1.7.1-1: General test parameters for E-UTRAN FDD-FDD intra-frequency event triggered reporting under time domain measurement resource restriction with non-MBSFN ABS

Parameter	Unit	Value	Comment
PDSCH parameters		DL Reference Measurement Channel R.0 FDD	As specified in clause A.3.1.1.1
PCFICH/PDCCH/PHICH parameters		DL Reference Measurement Channel R.6 FDD	As specified in clause A.3.1.2.1
PCell		Cell 1	Also the aggressor cell. Active in T1 and T2
Neighbour cell		Cell 2	Cell to be identified. Active only in T2.
PCell ABS configuration		Non-MBSFN ABS	As defined in Table A.3.4.1.1-1
E-UTRA RF Channel Number		1	One FDD carrier frequency is used
Channel Bandwidth (BW_{channel})	MHz	10	For all cells in the test
A3-Offset	dB	-11	
Event A3 measurement quantity		RSRP	
CP length		Normal	
Hysteresis	dB	0	
Time To Trigger	s	0	
Filter coefficient		0	L3 filtering is not used
DRX			OFF
Time offset between cells		3 μ s	Synchronous cells
T1	s	5	
T2	s	5	
Physical cell ID PCI		$(\text{PCI}_{\text{cell1}} - \text{PCI}_{\text{cell2}}) \bmod 6 \neq 0$	Cell PCIs are selected so that the condition is met

ABS pattern		'10000000100000001000 00001000000010000000'	FDD ABS Pattern Info IE, as defined in TS 36.423 [28], clause 9.2.54. Configured in Cell 1 during T1. The first/leftmost bit corresponds to the subframe #0 of the radio frame satisfying SFN mod x = 0, where x is the size of the bit string (40) divided by 10. No MBSFN subframes are configured in the ABS subframes.
Time domain measurement resource restriction pattern for neighbour cell measurements on RF Channel 1		'10000000100000001000 00001000000010000000'	Time domain measurement resource restriction pattern for neighbor cell measurement signalled to the UE in measSubframePattern-Neigh IE in measSubframePatternConfig-Neigh, as defined in TS 36.331, clause 6.3.5. Configured during T1 for Cell 2 measurements.
Time domain measurement resource restriction pattern for PCell measurements		'01000000010000000100 00000100000001000000'	Configured during T1 for Cell 1 measurements

Table A.8.1.7.1-2: Cell specific test parameters for E-UTRAN FDD-FDD intra-frequency event triggered reporting under time domain measurement resource restriction with non-MBSFN ABS

Parameter	Unit	Cell 1		Cell 2	
		T1	T2	T1	T2
E-UTRA RF Channel Number		1		1	
BW _{channel}	MHz	10		10	
Correlation Matrix and Antenna Configuration		1x2 Low		1x2 Low	
OCNG Patterns defined in A.3.2.1.5 (OP.5 FDD) and in A.3.2.1.6 (OP.6 FDD)		OP.5 FDD		OP.6 FDD	
PBCH_RA	dB	Non-ABS and ABS subframe channel powers defined in Table A.3.4.1.1-1.			
PBCH_RB					
PSS_RA					
SSS_RA					
PCFICH_RB					
PHICH_RA					
PHICH_RB					
PDCCH_RA					
PDCCH_RB					
PDSCH_RA					
PDSCH_RB					
OCNG_RA ^{Note 1}					
OCNG_RB ^{Note 1}					
N_{oc} ^{Note 3}					
$(\hat{E}_s / N_{oc})_{meas}$ ^{Note 5}	dB	1	1	-Infinity	-4
$(\hat{E}_s / N_{oc})_{ABS}$	dB	1	1	N/A	N/A
RSRP ^{Note 4,5}	dBm/15 kHz	-97	-97	-Infinity	-102
SCH_RP ^{Note 4}	dBm/15 kHz	-97	-97	-Infinity	-102
CRS \hat{E}_s / I_{ot}	dB	1	-0.5	-Infinity	-4
SCH \hat{E}_s / I_{ot}	dB	1	-0.5	-Infinity	-7.5
Propagation Condition		ETU30			

Note 1:	OCNG shall be used such that both cells are fully allocated and a constant total transmitted power spectral density is achieved for all OFDM symbols.
Note 2:	The resources for uplink transmission are assigned to the UE prior to the start of time period T2.
Note 3:	Interference from other cells and noise sources not specified in the test is assumed to be constant over subcarriers and time and shall be modelled as AWGN of appropriate power for N_{oc} to be fulfilled. Applies to all subframes.
Note 4:	RSRP and SCH_RP levels have been derived from other parameters for information purposes. They are not settable parameters themselves.
Note 5:	RSPP is estimated for Cell 2 during the restricted measurement subframes for neighbour cells. RSPP is estimated for Cell 1 during the PCell restricted subframes.

A.8.1.7.2 Test Requirements

The UE shall send one Event A3 triggered measurement report for Cell 2, with a measurement reporting delay less than 1000 ms from the beginning of time period T2.

The UE shall not send event-triggered measurement reports as long as the reporting criteria are not fulfilled.

The rate of correct events observed during repeated tests shall be at least 90% for the tested Event A3.

NOTE: The actual overall delays measured in the tests may be up to $2 \times TTI_{DCCH}$ higher than the measurement reporting delays above because of TTI insertion uncertainty of the measurement report in DCCH.

A.8.1.8 E-UTRAN FDD-FDD Intra-Frequency Event-Triggered Reporting under Time Domain Measurement Resource Restriction with CRS Assistance Information and Non-MBSFN ABS

A.8.1.8.1 Test Purpose and Environment

The purpose of this test is to verify that the UE correctly detects and reports Event A3 (neighbour becomes offset better than PCell) defined in TS 36.331 [2] within the requirements specified in Clause 8.1.2.8.3, when the UE is provided with a time-domain measurement resource restriction pattern and CRS assistance information, and when non-MBSFN ABS configured in the interfering cells.

The test parameters are given in Tables A.8.1.8.1-1 and A.8.1.8.1-2 below. It is indicated to the UE in the measurement control information that event-triggered reporting with Event A3 is used. In the test, there are three synchronous cells, Cell 1, Cell 2, and Cell 3, on the same RF channel. Cell 1 is the PCell. Cell 3 is the cell to be identified. A non-MBSFN ABS pattern is configured in each of the Cell 1 and Cell 2 during the entire test. The test consists of two successive time periods with time duration of T1 and T2, respectively. During time duration T1, the UE shall not have any timing information on Cell 3.

The UE is configured by higher layers with a time domain measurement resource restriction pattern for performing E-UTRAN FDD intra-frequency measurements on neighbour cells, namely Cell 3 measurements. The UE is also provided via higher layers with the CRS assistance information for Cell 2. The information for both measurement patterns and the CRS assistance information shall be provided via RRC to the UE during T1.

Table A.8.1.8.1-1: General test parameters for E-UTRAN FDD-FDD intra-frequency event triggered reporting under time domain measurement resource restriction with CRS assistance information and non-MBSFN ABS

Parameter	Unit	Value	Comment
PDSCH parameters		DL Reference Measurement Channel R.0 FDD	As specified in clause A.3.1.1.1
PCFICH/PDCCH/PHICH parameters		DL Reference Measurement Channel R.6 FDD	As specified in clause A.3.1.2.1
PCell		Cell 1	Also a first interfering cell to Cell 3. Active in T1 and T2.
Neighbour cells		Cell 2 and Cell 3	Cell 2 is a second interfering cell; Cell 2 is active in T1 and T2. Cell 3 is the cell to be identified; Cell 3 is active only in T2.
ABS transmission configuration		Non-MBSFN ABS	As defined in Table A.3.4.1.1-1

E-UTRA RF Channel Number		1	One FDD carrier frequency is used
Channel Bandwidth ($BW_{channel}$)	MHz	10	For all cells in the test
A3-Offset	dB	-14	
Event A3 measurement quantity		RSRP	
CP length		Normal	
Hysteresis	dB	0	
Time To Trigger	s	0	
Filter coefficient		0	L3 filtering is not used
DRX			OFF
Time offset between cells	μ s	Cell 2 offset with respect to Cell 1: 0 Cell 3 offset with respect to Cell 1: -2.5	Three synchronous cells
T1	S	5	
T2	S	5	
Physical cell IDs		$(PCI_{cell1} - PCI_{cell3}) \bmod 6 = 0$ $(PCI_{cell2} - PCI_{cell3}) \bmod 6 \neq 0$ PCI_{cell1} not equal to PCI_{cell3}	Cell PCIs are selected so that all conditions are met
ABS pattern		'1000000010000000100000 001000000010000000'	FDD ABS Pattern Info IE, as defined in TS 36.423 [28], clause 9.2.54. The first/leftmost bit corresponds to the Pcell subframe #0 of the radio frame satisfying $SFN \bmod x = 0$, where x is the size of the bit string (40) divided by 10. No MBSFN subframes are configured in the ABS subframes. Configured in Cell 1 and Cell 2 during T1.
Time domain measurement resource restriction pattern for neighbour cell measurements on RF Channel 1		'1000000010000000100000 001000000010000000'	Time domain measurement resource restriction pattern for neighbor cell measurement signalled to the UE in measSubframePatternNeigh IE in measSubframePatternConfigNeigh, as defined in TS 36.331, clause 6.3.5. Configured during T1 for Cell 3 measurements. The cell list in measSubframeCellList IE shall contain Cell 3 but not Cell 2.
Time domain measurement resource restriction pattern for PCell measurements		'0100000001000000010000 000100000001000000'	Configured during T1 for Cell 1 measurements
CRS assistance information	physCellId	see PCI conditions above	The CRS assistance information is provided for Cell 2 only in CRS-AssistanceInfo. It includes a single MBSFN-SubframeConfig element with subframe allocation <i>one Frame</i> ='000000'.
	antennaPortsCount	1	
	mbsfn-SubframeConfigList	<i>oneFrame</i> = '000000'	

Table A.8.1.8.1-2: Cell specific test parameters for E-UTRAN FDD-FDD intra-frequency event triggered reporting under time domain measurement resource restriction with CRS assistance information and non-MBSFN ABS

Parameter	Unit	Cell 1		Cell 2		Cell 3	
		T1	T2	T1	T2	T1	T2
E-UTRA RF Channel Number		1		1		1	
$BW_{channel}$	MHz	10		10		10	
Correlation Matrix and Antenna Configuration		1x2 Low		1x2 Low		1x2 Low	
OCNG Patterns defined in A.3.2.1.5 (OP.5 FDD) and in A.3.2.1.6 (OP.6 FDD)		OP.5 FDD		OP.6 FDD		N/A	OP.6 FDD
PBCH_RA	dB	Non-ABS and ABS subframe channel		Non-ABS and ABS subframe channel		N/A	0
PBCH_RB	dB						
PSS_RA	dB						

SSS_RA	dB	powers defined in Table A.3.4.1.1-1.		powers defined in Table A.3.4.1.1-1.			
PCFICH_RB	dB						
PHICH_RA	dB						
PHICH_RB	dB						
PDCCH_RA	dB						
PDCCH_RB	dB						
PDSCH_RA	dB						
PDSCH_RB	dB						
OCNG_RA ^{Note 1}	dB						
OCNG_RB ^{Note 1}	dB						
N_{oc} ^{Note 3}	dBm/15 kHz	-98					
(\hat{E}_s / N_{oc})	dB	4	4	2	2	-Infinity	-4
RSRP ^{Note 4}	dBm/15 kHz	-94	-94	-96	-96	-Infinity	-102
SCH_RP ^{Note 4}	dBm/15 kHz	-94	-94	-96	-96	-Infinity	-102
CRS \hat{E}_s / I_{ot} ^{Note 5}	dB	4	2.54	2	0.54	-Infinity	-9.46
SCH \hat{E}_s / I_{ot}	dB	-0.12	-0.75	-3.45	-3.92	-Infinity	-11.07
Propagation Condition		ETU30		ETU30		ETU30	
<p>NOTE 1: OCNG shall be used such that all cells are fully allocated and a constant total transmitted power spectral density is achieved for all OFDM symbols.</p> <p>NOTE 2: The resources for uplink transmission are assigned to the UE prior to the start of time period T2.</p> <p>NOTE 3: Interference from other cells and noise sources not specified in the test is assumed to be constant over subcarriers and time and shall be modelled as AWGN of appropriate power for N_{oc} to be fulfilled. Applies to all subframes.</p> <p>NOTE 4: RSRP, SCH_RP, and \hat{E}_s / I_{ot} levels have been derived from other parameters for information purposes. They are not settable parameters themselves.</p> <p>NOTE 5: Applies during the restricted measurement subframes configured for neighbour cell (Cell 3) measurements.</p>							

A.8.1.8.2 Test Requirements

The UE shall send one Event A3 triggered measurement report for Cell 3, with a measurement reporting delay less than 1000 ms from the beginning of time period T2.

The UE shall not send event-triggered measurement reports as long as the reporting criteria are not fulfilled.

The rate of correct events observed during repeated tests shall be at least 90% for the tested Event A3.

NOTE: The actual overall delays measured in the tests may be up to $2 \times TTI_{DCCH}$ higher than the measurement reporting delays above because of TTI insertion uncertainty of the measurement report in DCCH.

A.8.1.9 E-UTRAN FDD-FDD intra-frequency event triggered reporting under fading propagation conditions in asynchronous cells for 5MHz bandwidth

A.8.1.9.1 Test Purpose and Environment

The purpose of this test case is the same as for the test defined in subclause A.8.1.1.1.

The parameters of this test are the same as defined in Subclause A.8.1.1.1 except that the values of the parameters in the Table A.8.1.9.1-1 will replace the values of the corresponding parameters in A.8.1.1.1-1, and the values of the parameters in the Table A.8.1.9.1-2 will replace the values of the corresponding parameters in A.8.1.1.1-2.

Table A.8.1.9.1-1: General test parameters for E-UTRAN FDD-FDD intra-frequency event triggered reporting under fading propagation conditions in asynchronous cells for 5MHz bandwidth

Parameter	Unit	Value	Comment
-----------	------	-------	---------

PDSCH parameters		DL Reference Measurement Channel R.5 FDD	As specified in clause A.3.1.1.1
PCFICH/PDCCH/PHICH parameters		DL Reference Measurement Channel R.11 FDD	As specified in clause A.3.1.2.1
Note 1: See Table A.8.1.1.1-1 for the other parameters.			
Note 2: This test is according to the principle defined in section A.3.7.2.			

Table A.8.1.9.1-2: Cell specific test parameters for E-UTRAN FDD-FDD intra-frequency event triggered reporting under fading propagation conditions in asynchronous cells for 5MHz

Parameter	Unit	Cell 1		Cell 2	
		T1	T2	T1	T2
$BW_{channel}$	MHz	5		5	
OCNG Patterns defined in A.3.2.1.15 (OP.15 FDD) and A.3.2.1.16 (OP.16 FDD)		OP.15 FDD		OP.16 FDD	
Note 1: OCNG shall be used such that both cells are fully allocated and a constant total transmitted power spectral density is achieved for all OFDM symbols.					
Note 2: See Table A.8.1.1.1-2 for the other parameters.					

A.8.1.9.2 Test Requirements

The test requirements defined in section A.8.1.1.2 shall apply to this test case.

A.8.1.10 E-UTRAN FDD-FDD Intra-Frequency Event Triggered Reporting under Fading Propagation Conditions in Synchronous Cells with DRX for 5 MHz Bandwidth

A.8.1.10.1 Test Purpose and Environment

The purpose of the two tests is to verify that the UE makes correct reporting of an event in DRX. The tests will partly verify the FDD-FDD intra-frequency cell search in DRX requirements in clause 8.1.2.2.1.2.

The parameters of this test are the same as defined in Section A.8.1.3.1 except that the values of the parameters in the Table A.8.1.10.1-1 will replace the values of the corresponding parameters in A.8.1.3.1-1, and the values of the parameters in the Table A.8.1.10.1-2 will replace the values of the corresponding parameters in A.8.1.3.1-2.

Table A.8.1.10.1-1: General test parameters for E-UTRAN FDD-FDD intra-frequency event triggered reporting under fading propagation conditions in synchronous cells when DRX is used

Parameter	Unit	Value		Comment
		Test 1	Test 2	
PDSCH parameters		DL Reference Measurement Channel R.5 FDD		As specified in clause A.3.1.1.1
PCFICH/PDCCH/PHICH parameters		DL Reference Measurement Channel R.11 FDD		As specified in clause A.3.1.2.1
Channel Bandwidth ($BW_{channel}$)	MHz	5		
NOTE 1: See Table A.8.1.3.1-1 for the other parameters.				
NOTE 2: This test is according to the principle defined in Section A.3.7.2.				

Table A.8.1.10.1-2: Cell specific test parameters for E-UTRAN FDD-FDD intra-frequency event triggered reporting under fading propagation conditions in synchronous cells when DRX is used

Parameter	Unit	Cell 1		Cell 2	
		T1	T2	T1	T2
$BW_{channel}$	MHz	5		5	

OCNG Patterns defined in A.3.2.1.15 (OP.15 FDD) and in A.3.2.1.16 (OP.16 FDD)		OP.15 FDD	OP.16 FDD
NOTE 1: See Table A.8.1.3.1-2 for the other parameters.			

A.8.1.10.2 Test Requirements

The test requirements defined in Section A.8.1.3 shall apply to this test case.

A.8.1.11 E-UTRAN FDD-FDD intra-frequency event triggered reporting under fading propagation conditions in asynchronous cells for UE category 0

A.8.1.11.1 Test Purpose and Environment

The purpose of this test is to verify that the UE makes correct reporting of an event. This test will partly verify the FDD intra-frequency cell search requirements in clause 8.5.2.1.1.

The test parameters are given in Table A.8.1.11.1-1 and A.8.1.11.1-2 below. In the measurement control information it is indicated to the UE that event-triggered reporting with Event A3 is used. The test consists of two successive time periods, with time duration of T1, and T2 respectively. During time duration T1, the UE shall not have any timing information of cell 2.

Table A.8.1.11.1-1: General test parameters for E-UTRAN FDD-FDD intra-frequency event triggered reporting under fading propagation conditions in asynchronous cells

Parameter	Unit	Value	Comment
Active cell		Cell 1	
Neighbour cell		Cell 2	Cell to be identified.
E-UTRA RF Channel Number		1	One FDD carrier frequency is used.
Channel Bandwidth (BW _{channel})	MHz	10	
A3-Offset	dB	-10	
CP length		Normal	
Hysteresis	dB	0	
Time To Trigger	s	0	
Filter coefficient		0	L3 filtering is not used
DRX			OFF
Time offset between cells		3 ms	Asynchronous cells
T1	s	5	
T2	s	5	

Table A.8.1.11.1-2: Cell specific test parameters for E-UTRAN FDD-FDD intra-frequency event triggered reporting under fading propagation conditions in asynchronous cells

Parameter	Unit	Cell 1		Cell 2	
		T1	T2	T1	T2
E-UTRA RF Channel Number		1		1	
BW _{channel}	MHz	10		10	
Correlation Matrix and Antenna Configuration		2x1		2x1	
PDSCH parameters: DL Reference Measurement Channel defined in A.3.1.1.3		R.14 FDD		-	

PCFICH/PDCCH/PHICH parameters: DL Reference Measurement Channel defined in A.3.1.2.1		R.7 FDD		R.7 FDD	
OCNG Patterns defined in A.3.2.1.1 (OP.1 FDD) and in A.3.2.1.2 (OP.2 FDD)		OP.1 FDD		OP.2 FDD	
PBCH_RA	dB	-3		-3	
PBCH_RB	dB				
PSS_RA	dB				
SSS_RA	dB				
PCFICH_RB	dB				
PHICH_RA	dB				
PHICH_PB	dB				
PDCCH_RA	dB				
PDCCH_PB	dB				
PDSCH_RA	dB				
PDSCH_RB	dB				
OCNG_RA ^{Note 1}	dB				
OCNG_RB ^{Note 1}	dB				
\hat{E}_s/I_{ot}	dB				
N_{oc} ^{Note 3}	dBm/15 KHz	-98			
\hat{E}_s/N_{oc}	dB	7	7	-Infinity	4
RSRP ^{Note 4}	dBm/15 KHz	-91	-91	-Infinity	-94
SCH_RP ^{Note 4}	dBm/15 KHz	-91	-91	-Infinity	-94
I_o ^{Note 4}	dBm/9MHz	-62.43	-60.91	Specified in Cell 1 columns	
Propagation Condition		ETU70			
<p>Note 1: OCNG shall be used such that both cells are fully allocated and a constant total transmitted power spectral density is achieved for all OFDM symbols.</p> <p>Note 2: The resources for uplink transmission are assigned to the UE prior to the start of time period T2.</p> <p>Note 3: Interference from other cells and noise sources not specified in the test is assumed to be constant over subcarriers and time and shall be modelled as AWGN of appropriate power for N_{oc} to be fulfilled.</p> <p>Note 4: E_s/I_{ot}, RSRP, SCH_RP and I_o levels have been derived from other parameters for information purposes. They are not settable parameters themselves.</p>					

A.8.1.11.2 Test Requirements

The UE shall send one Event A3 triggered measurement report, with a measurement reporting delay less than 1000 ms from the beginning of time period T2.

The UE shall not send event triggered measurement reports, as long as the reporting criteria are not fulfilled.

The rate of correct events observed during repeated tests shall be at least 90%.

NOTE: The actual overall delays measured in the test may be up to $2 \times TTI_{DCCH}$ higher than the measurement reporting delays above because of TTI insertion uncertainty of the measurement report in DCCH.

A.8.1.12 E-UTRAN FDD-FDD intra-frequency event triggered reporting under fading propagation conditions in synchronous cells for UE category 0

A.8.1.12.1 Test Purpose and Environment

The purpose of this test is to verify that the UE makes correct reporting of an event. This test will partly verify the FDD intra-frequency cell search requirements in clause 8.5.2.1.1

The test parameters are given in Table A.8.1.12.1-1 and A.8.1.12.1-2 below. In the measurement control information it is indicated to the UE that event-triggered reporting with Event A3 is used. PDCCHs indicating new transmissions or retransmissions should be sent continuously to ensure that the UE would not enter the DRX state. The test consists of two successive time periods, with time duration of T1, and T2 respectively. During time duration T1, the UE shall not have any timing information of cell 2.

Table A.8.1.12.1-1: General test parameters for E-UTRAN FDD-FDD intra-frequency event triggered reporting under fading propagation conditions in synchronous cells

Parameter	Unit	Value	Comment
Active cell		Cell 1	
Neighbour cell		Cell 2	Cell to be identified.
E-UTRA RF Channel Number		1	One FDD carrier frequency is used.
Channel Bandwidth ($BW_{channel}$)	MHz	10	
A3-Offset	dB	-10	
CP length		Normal	
Hysteresis	dB	0	
Time To Trigger	s	0	
Filter coefficient		0	L3 filtering is not used
DRX		DRX_L	As specified in clause A.3.3
Time offset between cells		3 μ s	Synchronous cells
T1	s	5	
T2	s	5	

Table A.8.1.12.1-2: Cell specific test parameters for E-UTRAN FDD-FDD intra-frequency event triggered reporting under fading propagation conditions in synchronous cells

Parameter	Unit	Cell 1		Cell 2	
		T1	T2	T1	T2
E-UTRA RF Channel Number		1		1	
$BW_{channel}$	MHz	10		10	
Correlation Matrix and Antenna Configuration		2x1		2x1	
PDSCH parameters: DL Reference Measurement Channel defined in A.3.1.1.3		R.14 FDD		-	
PCFICH/PDCCH/PHICH parameters: DL Reference Measurement Channel defined in A.3.1.2.1		R.7 FDD		R.7 FDD	
OCNG Patterns defined in A.3.2.1.1 (OP.1 FDD) and in A.3.2.1.2 (OP.2 FDD)		OP.1 FDD		OP.2 FDD	
PBCH_RA	dB	-3		-3	
PBCH_RB	dB				
PSS_RA	dB				
SSS_RA	dB				
PCFICH_RB	dB				
PHICH_RA	dB				
PHICH_RB	dB				
PDCCH_RA	dB				
PDCCH_RB	dB				
PDSCH_RA	dB				
PDSCH_RB	dB				
OCNG_RA ^{Note 1}	dB				
OCNG_RB ^{Note 1}	dB				
\hat{E}_s / I_{ot}	dB				

N_{oc} <small>Note 3</small>	dBm/15 KHz	-98			
\hat{E}_s/N_{oc}	dB	7	7	-Infinity	4
RSRP <small>Note 4</small>	dBm/15 KHz	-91	-91	-Infinity	-94
SCH_RP <small>Note 4</small>	dBm/15 KHz	-91	-91	-Infinity	-94
I_o <small>Note 4</small>	dBm/9MHz	-62.43	-60.91	Specified in Cell 1 columns	
Propagation Condition		ETU70			
Note 1:	OCNG shall be used such that both cells are fully allocated and a constant total transmitted power spectral density is achieved for all OFDM symbols.				
Note 2:	The resources for uplink transmission are assigned to the UE prior to the start of time period T2.				
Note 3:	Interference from other cells and noise sources not specified in the test is assumed to be constant over subcarriers and time and shall be modelled as AWGN of appropriate power for N_{oc} to be fulfilled.				
Note 4:	Es/lot, RSRP, SCH_RP and I_o levels have been derived from other parameters for information purposes. They are not settable parameters themselves.				

A.8.1.12.2 Test Requirements

The UE shall send one Event A3 triggered measurement report, with a measurement reporting delay less than 1000 ms from the beginning of time period T2.

The UE shall not send event triggered measurement reports, as long as the reporting criteria are not fulfilled.

The rate of correct events observed during repeated tests shall be at least 90%.

NOTE: The actual overall delays measured in the test may be up to $2xTTI_{DCCH}$ higher than the measurement reporting delays above because of TTI insertion uncertainty of the measurement report in DCCH.

A.8.1.13 E-UTRAN FDD-FDD intra-frequency event triggered reporting under fading propagation conditions in synchronous cells with DRX for UE category 0

A.8.1.13.1 Test Purpose and Environment

The purpose of the two tests is to verify that the UE makes correct reporting of an event in DRX. The tests will partly verify the FDD-FDD intra-frequency cell search in DRX requirements in clause 8.5.2.1.1.2.

The test parameters are given in Tables A.8.1.13.1-1, A.8.1.13.1-2, A.8.1.13.1-3 and A.8.1.13.1-4. In the measurement control information, it is indicated to the UE that event-triggered reporting with Event A3 is used. The test consists of two successive time periods, with time duration of T1, and T2 respectively. During time duration T1, the UE shall not have any timing information of cell 2.

In Test 1 UE needs to be provided at least once every 500ms with new Timing Advance Command MAC control element to restart the Time alignment timer to keep UE uplink time alignment. Furthermore UE is allocated with PUSCH resource at every DRX cycle.

In Test 2 the uplink time alignment is not maintained and UE needs to use RACH to obtain UL allocation for measurement reporting.

Table A.8.1.13.1-1: General test parameters for E-UTRAN FDD-FDD intra-frequency event triggered reporting under fading propagation conditions in synchronous cells when DRX is used

Parameter	Unit	Value		Comment
		Test 1	Test 2	
Active cell		Cell 1		
Neighbour cell		Cell 2		Cell to be identified.
E-UTRA RF Channel Number		1		One FDD carrier frequency is used.
Channel Bandwidth ($BW_{channel}$)	MHz	10		
A3-Offset	dB	-10		
CP length		Normal		

Hysteresis	dB	0	
Time To Trigger	s	0	
Filter coefficient		0	L3 filtering is not used
DRX		ON	DRX related parameters are defined in Table A.8.1.13.1-3
Time offset between cells		3 μ s	Synchronous cells
T1	s	5	
T2	s	5	30

Table A.8.1.13.11-2: Cell specific test parameters for E-UTRAN FDD-FDD intra-frequency event triggered reporting under fading propagation conditions in synchronous cells when DRX is used

Parameter	Unit	Cell 1		Cell 2	
		T1	T2	T1	T2
E-UTRA RF Channel Number		1		1	
BW _{channel}	MHz	10		10	
Correlation Matrix and Antenna Configuration		2x1		2x1	
PDSCH parameters: DL Reference Measurement Channel defined in A.3.1.1.3		R.14 FDD		-	
PCFICH/PDCCH/PHICH parameters: DL Reference Measurement Channel defined in A.3.1.2.1		R.7 FDD		R.7 FDD	
OCNG Patterns defined in A.3.2.1.1 (OP.1 FDD) and in A.3.2.1.2 (OP.2 FDD)		OP.1 FDD		OP.2 FDD	
PBCH_RA	dB	-3		-3	
PBCH_RB	dB				
PSS_RA	dB				
SSS_RA	dB				
PCFICH_RB	dB				
PHICH_RA	dB				
PHICH_RB	dB				
PDCCH_RA	dB				
PDCCH_RB	dB				
PDSCH_RA	dB				
PDSCH_RB	dB				
OCNG_RA ^{Note 1}	dB				
OCNG_RB ^{Note 1}	dB				
\hat{E}_s / I_{ot}	dB				
N_{oc} ^{Note 2}	dBm/15 KHz	-98			
\hat{E}_s / N_{oc}	dB	7	7	-Infinity	4
RSRP ^{Note 3}	dBm/15 KHz	-91	-91	-Infinity	-9
SCH_RP ^{Note 3}	dBm/15 KHz	-91	-91	-Infinity	-94
I_o ^{Note 4}	dBm/9MHz	-62.43	-60.91	Specified in Cell 1 columns	
Propagation Condition		ETU70			
<p>Note 1: OCNG shall be used such that both cells are fully allocated and a constant total transmitted power spectral density is achieved for all OFDM symbols.</p> <p>Note 2: Interference from other cells and noise sources not specified in the test is assumed to be constant over subcarriers and time and shall be modelled as AWGN of appropriate power for N_{oc} to be fulfilled.</p> <p>Note 3: E_s/I_{ot}, RSRP, SCH_RP and I_o levels have been derived from other parameters for information purposes. They are not settable parameters themselves.</p>					

Table A.8.1.13.1-3: DRX-Configuration for E-UTRAN FDD-FDD intra-frequency event triggered reporting in DRX under fading propagation conditions in synchronous cells

Field	Test1	Test2	Comment
	Value	Value	
onDurationTimer	psf1	psf1	As specified in clause 6.3.2 in TS 36.331
drx-InactivityTimer	psf1	psf1	
drx-RetransmissionTimer	psf1	psf1	
longDRX-CycleStartOffset	sf40	sf1280	
shortDRX	disable	disable	

Table A.8.1.13.1-4: TimeAlignmentTimer -Configuration for E-UTRAN FDD-FDD intra-frequency event triggered reporting in DRX under fading propagation conditions in synchronous cells

Field	Test1	Test2	Comment
	Value	Value	
TimeAlignmentTimer	sf500	sf500	As specified in clause 6.3.2 in TS 36.331
sr-ConfigIndex	0	0	For further information see clause 6.3.2 in TS 36.331 and section 10.1 in TS 36.213.

A.8.1.13.2 Test Requirements

In Test 1, the UE shall send one Event A3 triggered measurement report, with a measurement reporting delay less than 1000 ms from the beginning of time period T2. The measurement reporting delay is defined as the time from the beginning of time period T2 to the moment when the UE send the measurement report on PUSCH.

In Test 2, the UE shall send one Event A3 triggered measurement report, with a measurement reporting delay less than 25600 ms from the beginning of time period T2. The measurement reporting delay is defined as the time from the beginning of time period T2 to the moment when the UE starts to send preambles on the PRACH for scheduling request (SR) to obtain allocation to send the measurement report on PUSCH.

The UE shall not send event triggered measurement reports, as long as the reporting criteria are not fulfilled.

The rate of correct events observed during repeated tests shall be at least 90%.

NOTE 1: The actual overall delays measured in the test may be up to one DRX cycle higher than the measurement reporting delays above because UE is allowed to delay the initiation of the measurement reporting procedure to the next until the Active Time.

NOTE 2: In order to calculate the rate of correct events the system simulator shall verify that it has received correct Event A3 measurement report.

A.8.1.14 E-UTRAN HD-FDD intra-frequency event triggered reporting under fading propagation conditions in asynchronous cells for UE category 0

A.8.1.14.1 Test Purpose and Environment

The purpose of this test is to verify that the UE makes correct reporting of an event. This test will partly verify the FDD intra-frequency cell search requirements in clause 8.5.2.1.2.1.

The test parameters are given in Table A.8.1.14.1-1 and A.8.1.14.1-2 below. In the measurement control information it is indicated to the UE that event-triggered reporting with Event A3 is used. The test consists of two successive time periods, with time duration of T1, and T2 respectively. During time duration T1, the UE shall not have any timing information of cell 2.

Table A.8.1.14.1-1: General test parameters for E-UTRAN HD-FDD intra-frequency event triggered reporting under fading propagation conditions in asynchronous cells

Parameter	Unit	Value	Comment
-----------	------	-------	---------

Active cell		Cell 1	
Neighbour cell		Cell 2	Cell to be identified.
E-UTRA RF Channel Number		1	One FDD carrier frequency is used.
Channel Bandwidth ($BW_{channel}$)	MHz	10	
A3-Offset	dB	-10	
CP length		Normal	
Hysteresis	dB	0	
Time To Trigger	s	0	
Filter coefficient		0	L3 filtering is not used
DRX			OFF
Time offset between cells		3 ms	Asynchronous cells
T1	s	5	
T2	s	5	

Table A.8.1.14.1-2: Cell specific test parameters for E-UTRAN HD-FDD intra-frequency event triggered reporting under fading propagation conditions in asynchronous cells

Parameter	Unit	Cell 1		Cell 2	
		T1	T2	T1	T2
E-UTRA RF Channel Number		1		1	
$BW_{channel}$	MHz	10		10	
Correlation Matrix and Antenna Configuration		2x1		2x1	
PDSCH parameters: DL Reference Measurement Channel defined in A.3.1.1.4		R.2 HD-FDD		-	
PCFICH/PDCCH/PHICH parameters: DL Reference Measurement Channel defined in A.3.1.2.3		R.4 HD-FDD		R.4 HD-FDD	
OCNG Patterns defined in A.3.2.1.1 (OP.1 FDD) and in A.3.2.1.2 (OP.2 FDD)		OP.1 FDD		OP.2 FDD	
PBCH_RA	dB	-3		-3	
PBCH_RB	dB				
PSS_RA	dB				
SSS_RA	dB				
PCFICH_RB	dB				
PHICH_RA	dB				
PHICH_PB	dB				
PDCCH_RA	dB				
PDCCH_PB	dB				
PDSCH_RA	dB				
PDSCH_RB	dB				
OCNG_RA ^{Note 1}	dB				
OCNG_RB ^{Note 1}	dB				
\hat{E}_s/I_{ot}	dB				
N_{oc} ^{Note 3}	dBm/15 KHz	-98			
\hat{E}_s/N_{oc}	dB	7	7	-Infinity	4
RSRP ^{Note 4}	dBm/15 KHz	-91	-91	-Infinity	-94
SCH_RP ^{Note 4}	dBm/15 KHz	-91	-91	-Infinity	-94
I_o ^{Note 4}	dBm/9MHz	-62.43	-60.91	Specified in Cell 1 columns	
Propagation Condition		ETU70			

Note 1:	OCNG shall be used such that both cells are fully allocated and a constant total transmitted power spectral density is achieved for all OFDM symbols.
Note 2:	The resources for uplink transmission are assigned to the UE prior to the start of time period T2.
Note 3:	Interference from other cells and noise sources not specified in the test is assumed to be constant over subcarriers and time and shall be modelled as AWGN of appropriate power for N_{oc} to be fulfilled.
Note 4:	Es/Iot, RSRP, SCH_RP and I _o levels have been derived from other parameters for information purposes. They are not settable parameters themselves.

A.8.1.14.2 Test Requirements

The UE shall send one Event A3 triggered measurement report, with a measurement reporting delay less than 1000 ms from the beginning of time period T2.

The UE shall not send event triggered measurement reports, as long as the reporting criteria are not fulfilled.

The rate of correct events observed during repeated tests shall be at least 90%.

NOTE: The actual overall delays measured in the test may be up to $2 \times TTI_{DCCH}$ higher than the measurement reporting delays above because of TTI insertion uncertainty of the measurement report in DCCH.

A.8.1.15 E-UTRAN HD-FDD intra-frequency event triggered reporting under fading propagation conditions in synchronous cells for UE category 0

A.8.1.15.1 Test Purpose and Environment

The purpose of this test is to verify that the UE makes correct reporting of an event. This test will partly verify the FDD intra-frequency cell search requirements in clause 8.5.2.1.2.1

The test parameters are given in Table A.8.1.15.1-1 and A.8.1.15.1-2 below. In the measurement control information it is indicated to the UE that event-triggered reporting with Event A3 is used. PDCCHs indicating new transmissions or retransmissions should be sent continuously to ensure that the UE would not enter the DRX state. The test consists of two successive time periods, with time duration of T1, and T2 respectively. During time duration T1, the UE shall not have any timing information of cell 2.

Table A.8.1.15.1-1: General test parameters for E-UTRAN HD-FDD intra-frequency event triggered reporting under fading propagation conditions in synchronous cells

Parameter	Unit	Value	Comment
Active cell		Cell 1	
Neighbour cell		Cell 2	Cell to be identified.
E-UTRA RF Channel Number		1	One FDD carrier frequency is used.
Channel Bandwidth (BW _{channel})	MHz	10	
A3-Offset	dB	-10	
CP length		Normal	
Hysteresis	dB	0	
Time To Trigger	s	0	
Filter coefficient		0	L3 filtering is not used
DRX		DRX_L	As specified in clause A.3.3
Time offset between cells		3 μs	Synchronous cells
T1	s	5	
T2	s	5	

Table A.8.1.15.1-2: Cell specific test parameters for E-UTRAN HD-FDD intra-frequency event triggered reporting under fading propagation conditions in synchronous cells

Parameter	Unit	Cell 1		Cell 2	
		T1	T2	T1	T2

E-UTRA RF Channel Number		1	1		
BW _{channel}	MHz	10	10		
Correlation Matrix and Antenna Configuration		2x1	2x1		
PDSCH parameters: DL Reference Measurement Channel defined in A.3.1.1.4		R.2 HD-FDD	-		
PCFICH/PDCCH/PHICH parameters: DL Reference Measurement Channel defined in A.3.1.2.3		R.4 HD-FDD	R.4 HD-FDD		
OCNG Patterns defined in A.3.2.1.1 (OP.1 FDD) and in A.3.2.1.2 (OP.2 FDD)		OP.1 FDD	OP.2 FDD		
PBCH_RA	dB	-3	-3		
PBCH_RB	dB				
PSS_RA	dB				
SSS_RA	dB				
PCFICH_RB	dB				
PHICH_RA	dB				
PHICH_RB	dB				
PDCCH_RA	dB				
PDCCH_RB	dB				
PDSCH_RA	dB				
PDSCH_RB	dB				
OCNG_RA ^{Note 1}	dB				
OCNG_RB ^{Note 1}	dB				
\hat{E}_s/I_{ot}	dB				
N_{oc} ^{Note 3}	dBm/15 KHz	-98			
\hat{E}_s/N_{oc}	dB	7	7	-Infinity	4
RSRP ^{Note 4}	dBm/15 KHz	-91	-91	-Infinity	-94
SCH_RP ^{Note 4}	dBm/15 KHz	-91	-91	-Infinity	-94
I_o ^{Note 4}	dBm/9MHz	-62.43	-60.91	Specified in Cell 1 columns	
Propagation Condition		ETU70			
<p>Note 1: OCNG shall be used such that both cells are fully allocated and a constant total transmitted power spectral density is achieved for all OFDM symbols.</p> <p>Note 2: The resources for uplink transmission are assigned to the UE prior to the start of time period T2.</p> <p>Note 3: Interference from other cells and noise sources not specified in the test is assumed to be constant over subcarriers and time and shall be modelled as AWGN of appropriate power for N_{oc} to be fulfilled.</p> <p>Note 4: E_s/I_{ot}, RSRP, SCH_RP and I_o levels have been derived from other parameters for information purposes. They are not settable parameters themselves.</p>					

A.8.1.15.2 Test Requirements

The UE shall send one Event A3 triggered measurement report, with a measurement reporting delay less than 1000 ms from the beginning of time period T2.

The UE shall not send event triggered measurement reports, as long as the reporting criteria are not fulfilled.

The rate of correct events observed during repeated tests shall be at least 90%.

NOTE: The actual overall delays measured in the test may be up to $2 \times TTI_{DCCH}$ higher than the measurement reporting delays above because of TTI insertion uncertainty of the measurement report in DCCH.

A.8.1.16 E-UTRAN HD-FDD intra-frequency event triggered reporting under fading propagation conditions in synchronous cells with DRX for UE category 0

A.8.1.16.1 Test Purpose and Environment

The purpose of the two tests is to verify that the UE makes correct reporting of an event in DRX. The tests will partly verify the FDD-FDD intra-frequency cell search in DRX requirements in clause 8.5.2.1.2.2.

The test parameters are given in Tables A.8.1.16.1-1, A.8.1.16.1-2, A.8.1.16.1-3 and A.8.1.16.1-4. In the measurement control information, it is indicated to the UE that event-triggered reporting with Event A3 is used. The test consists of two successive time periods, with time duration of T1, and T2 respectively. During time duration T1, the UE shall not have any timing information of cell 2.

In Test 1 UE needs to be provided at least once every 500ms with new Timing Advance Command MAC control element to restart the Time alignment timer to keep UE uplink time alignment. Furthermore UE is allocated with PUSCH resource at every DRX cycle.

In Test 2 the uplink time alignment is not maintained and UE needs to use RACH to obtain UL allocation for measurement reporting.

Table A.8.1.16.1-1: General test parameters for E-UTRAN HD-FDD intra-frequency event triggered reporting under fading propagation conditions in synchronous cells when DRX is used

Parameter	Unit	Value		Comment
		Test 1	Test 2	
Active cell		Cell 1		
Neighbour cell		Cell 2		Cell to be identified.
E-UTRA RF Channel Number		1		One FDD carrier frequency is used.
Channel Bandwidth (BW _{channel})	MHz	10		
A3-Offset	dB	-10		
CP length		Normal		
Hysteresis	dB	0		
Time To Trigger	s	0		
Filter coefficient		0		L3 filtering is not used
DRX		ON		DRX related parameters are defined in Table A.8.1.16.1-3
Time offset between cells		3 μs		Synchronous cells
T1	s	5		
T2	s	5	30	

Table A.8.1.16.1-2: Cell specific test parameters for E-UTRAN HD-FDD intra-frequency event triggered reporting under fading propagation conditions in synchronous cells when DRX is used

Parameter	Unit	Cell 1		Cell 2	
		T1	T2	T1	T2
E-UTRA RF Channel Number		1		1	
BW _{channel}	MHz	10		10	
Correlation Matrix and Antenna Configuration		2x1		2x1	
PDSCH parameters: DL Reference Measurement Channel defined in A.3.1.1.4		R.2 HD-FDD		-	
PCFICH/PDCCH/PHICH parameters: DL Reference Measurement Channel defined in A.3.1.2.3		R.4 HD-FDD		R.4 HD-FDD	

OCNG Patterns defined in A.3.2.1.1 (OP.1 FDD) and in A.3.2.1.2 (OP.2 FDD)		OP.1 FDD		OP.2 FDD	
PBCH_RA	dB	-3		-3	
PBCH_RB	dB				
PSS_RA	dB				
SSS_RA	dB				
PCFICH_RB	dB				
PHICH_RA	dB				
PHICH_RB	dB				
PDCCH_RA	dB				
PDCCH_RB	dB				
PDSCH_RA	dB				
PDSCH_RB	dB				
OCNG_RA ^{Note 1}	dB				
OCNG_RB ^{Note 1}	dB				
\hat{E}_s/I_{ot}	dB	7	1.54	-Infinity	-3.79
N_{oc} ^{Note 2}	dBm/15 KHz	-98			
\hat{E}_s/N_{oc}	dB	7	7	-Infinity	4
RSRP ^{Note 3}	dBm/15 KHz	-91	-91	-Infinity	-94
SCH_RP ^{Note 3}	dBm/15 KHz	-91	-91	-Infinity	-94
Propagation Condition		ETU70			
I_o ^{Note 4}	dBm/9MHz	-62.43	-60.91	Specified in Cell 1 columns	
<p>Note 1: OCNG shall be used such that both cells are fully allocated and a constant total transmitted power spectral density is achieved for all OFDM symbols.</p> <p>Note 2: Interference from other cells and noise sources not specified in the test is assumed to be constant over subcarriers and time and shall be modelled as AWGN of appropriate power for N_{oc} to be fulfilled.</p> <p>Note 3: E_s/I_{ot}, RSRP, SCH_RP and I_o levels have been derived from other parameters for information purposes. They are not settable parameters themselves.</p>					

Table A.8.1.16.1-3: DRX-Configuration for E-UTRAN HD-FDD intra-frequency event triggered reporting in DRX under fading propagation conditions in synchronous cells

Field	Test1	Test2	Comment
	Value	Value	
onDurationTimer	psf1	psf1	As specified in clause 6.3.2 in TS 36.331
drx-InactivityTimer	psf1	psf1	
drx-RetransmissionTimer	psf1	psf1	
longDRX-CycleStartOffset	sf40	sf1280	
shortDRX	disable	disable	

Table A.8.1.16.1-4: *TimeAlignmentTimer* -Configuration for E-UTRAN HD-FDD intra-frequency event triggered reporting in DRX under fading propagation conditions in synchronous cells

Field	Test1	Test2	Comment
	Value	Value	
TimeAlignmentTimer	sf500	sf500	As specified in clause 6.3.2 in TS 36.331
sr-ConfigIndex	0	0	For further information see clause 6.3.2 in TS 36.331 and section 10.1 in TS 36.213.

A.8.1.16.2 Test Requirements

In Test 1, the UE shall send one Event A3 triggered measurement report, with a measurement reporting delay less than 1000 ms from the beginning of time period T2. The measurement reporting delay is defined as the time from the beginning of time period T2 to the moment when the UE send the measurement report on PUSCH.

In Test 2, the UE shall send one Event A3 triggered measurement report, with a measurement reporting delay less than 25600 ms from the beginning of time period T2. The measurement reporting delay is defined as the time from the beginning of time period T2 to the moment when the UE starts to send preambles on the PRACH for scheduling request (SR) to obtain allocation to send the measurement report on PUSCH.

The UE shall not send event triggered measurement reports, as long as the reporting criteria are not fulfilled.

The rate of correct events observed during repeated tests shall be at least 90%.

NOTE 1: The actual overall delays measured in the test may be up to one DRX cycle higher than the measurement reporting delays above because UE is allowed to delay the initiation of the measurement reporting procedure to the next until the Active Time.

NOTE 2: In order to calculate the rate of correct events the system simulator shall verify that it has received correct Event A3 measurement report.

A.8.1.17 Void

A.8.1.18 Void

A.8.1.19 E-UTRAN FDD-FDD Intra-frequency identification of a new CGI of E-UTRA cell using autonomous gaps for UE category 0

A.8.1.19.1 Test Purpose and Environment

This test is to verify the requirement for identification of a new CGI of E-UTRA cell with autonomous gaps in clause 8.5.2.1.4.

The test scenario comprises of one E-UTRA FDD carrier and two cells as given in tables A.8.1.19.1-1 and A.8.1.19.1-2. PDCCHs indicating new transmissions should be sent continuously to ensure that the UE would have ACK/NACK sending during identifying a new CGI of E-UTRAN cell. The test consists of three successive time periods, with time durations of T1, T2 and T3 respectively. At the start of time duration T1, the UE does not have any timing information of cell 2. Starting T2, cell 2 becomes detectable and the UE is expected to detect and send a measurement report.

A RRC message implying SI reading shall be sent to the UE during period T2, after the UE has reported Event A3. The RRC message shall create a measurement report configuration with purpose *reportCGI* and *si-RequestForHO* set to TRUE. The start of T3 is the instant when the last TTI containing the RRC message implying SI reading is sent to the UE.

Table A.8.1.19.1-1: General test parameters for E-UTRAN FDD - FDD Intra-frequency identification of a new CGI of E-UTRA cell using autonomous gaps for UE category 0

Parameter	Unit	Value	Comment
PDSCH parameters		DL Reference Measurement Channel R.15 FDD	As specified in clause A.3.1.1.3
PCFICH/PDCCH/PHICH parameters		DL Reference Measurement Channel R.7 FDD	As specified in clause A.3.1.2.1
Active cell		Cell 1	
Neighbour cell		Cell 2	Cell to be identified.
E-UTRA RF Channel Number		1	Only one FDD carrier frequency is used.
Channel Bandwidth ($BW_{channel}$)	MHz	10	
CP length		Normal	
A3-Offset	dB	-3	
Hysteresis	dB	0	
Time To Trigger	s	0	
Filter coefficient		0	L3 filtering is not used
DRX		OFF	
si-RequestForHO		TRUE	As specified in clause 5.5.3.1 in TS 36.331.
T1	s	5	
T2	s	≤10	
T3	s	5	

Table A.8.1.19.1-2: Cell specific test parameters for E-UTRAN FDD - FDD Intra-frequency identification of a new CGI of E-UTRA cell using autonomous gaps for UE category 0

Parameter	Unit	Cell 1			Cell 2		
		T1	T2	T3	T1	T2	T3
E-UTRA RF Channel Number		1			1		
BW _{channel}	MHz	10			10		
Correlation Matrix and Antenna Configuration		2x1			2x1		
OCNG Patterns defined in A.3.2.1.10 (OP.10 FDD) and in A.3.2.1.2 (OP.2 FDD)		OP.10 FDD	OP.10 FDD	OP.10 FDD	OP.2 FDD	OP.2 FDD	OP.2 FDD
PBCH_RA	dB	-3			-3		
PBCH_RB	dB						
PSS_RA	dB						
SSS_RA	dB						
PCFICH_RB	dB	0			0		
PHICH_RA	dB	-3			-3		
PHICH_PB	dB	0			0		
PDCCH_RA	dB						
PDCCH_PB	dB						
PDSCH_RA	dB						
PDSCH_RB	dB	-3			-3		
OCNG_RA ^{Note 1}	dB	-3			-3		
OCNG_RB ^{Note 1}	dB						
\hat{E}_s/I_{ot}	dB	8	-3.3	-3.3	-Infinity	2.36	2.36
N_{oc} ^{Note 2}	dBm/15 KHz	-98					
\hat{E}_s/N_{oc}	dB	8	8	8	-Infinity	11	11
RSRP ^{Note 3}	dBm/15 KHz	-90	-90	-90	-Infinity	-87	-87
SCH_RP ^{Note 3}	dBm/15 KHz	-90	-90	-90	-Infinity	-87	-87
Propagation Condition		AWGN					
Timing offset to Cell 1	ms	-			3		
Note 1:	OCNG shall be used such that both cells are fully allocated and a constant total transmitted power spectral density is achieved for all OFDM symbols.						
Note 2:	Interference from other cells and noise sources not specified in the test is assumed to be constant over subcarriers and time and shall be modelled as AWGN of appropriate power for N_{oc} to be fulfilled.						
Note 3:	RSRP and SCH_RP levels have been derived from other parameters for information purposes. They are not settable parameters themselves.						

A.8.1.19.2 Test Requirements

The UE shall transmit a measurement report containing the cell global identifier of cell 2 within 210 milliseconds from the start of T3.

Test requirement = RRC Procedure delay + $T_{\text{identify_CGI_LC-UE, intra}}$ + reporting delay

= 15 + 190 + 2ms from the start of T3

= 207 ms, allow 210 ms.

The UE shall be scheduled continuously throughout the test, and from the start of T3 until 210 ms at least 112 ACK/NACK shall be detected as being transmitted by the UE.

The rate of correct events observed during repeated tests shall be at least 90%.

NOTE: The overall 112 ACK/NACK number is caused by two parts. Firstly, at least 92 ACK/NACK shall be sent during identifying the cell global identifier of cell 2 according to the requirement in Clause 8.5.2.1.4. Secondly, given that continuous DL data allocation, additional 20 ACK/NACK shall be sent from the start of T3 until 210 ms excludes 190 ms for identifying the cell global identifier of cell 2.

A.8.1.20 E-UTRAN FDD - FDD Intra-frequency identification of a new CGI of E-UTRA cell using autonomous gaps with DRX for UE category 0

A.8.1.20.1 Test Purpose and Environment

This test is to verify the requirement for identification of a new CGI of E-UTRA cell with autonomous gaps in clause 8.5.2.1.4. The requirement is verified in a DRX configuration.

The test scenario comprises of one E-UTRA FDD carrier and two cells as given in tables A.8.1.20.1-1, A.8.1.20.1-2, A.8.1.20.1-3 and A.8.1.20.1-4. The test consists of three successive time periods, with time durations of T1, T2 and T3 respectively. At the start of time duration T1, the UE does not have any timing information of cell 2. Starting T2, cell 2 becomes detectable and the UE is expected to detect and send a measurement report.

A RRC message implying SI reading shall be sent to the UE during period T2, after the UE has reported Event A3. The RRC message shall create a measurement report configuration with purpose *reportCGI* and *si-RequestForHO* set to TRUE. The start of T3 is the instant when the last TTI containing the RRC message implying SI reading is sent to the UE.

In the test UE needs to be provided at least once every 1280ms with new Timing Advance Command MAC control element to restart the Time alignment timer to keep UE uplink time alignment. Furthermore UE sends scheduling request (SR) to obtain allocation to send the measurement report on PUSCH.

Table A.8.1.20.1-1: General test parameters for E-UTRAN FDD - FDD Intra-frequency identification of a new CGI of E-UTRA cell using autonomous gaps with DRX for UE category 0

Parameter	Unit	Value	Comment
PDSCH parameters		DL Reference Measurement Channel R.15 FDD	As specified in clause A.3.1.1.3
PCFICH/PDCCH/PHICH parameters		DL Reference Measurement Channel R.7 FDD	As specified in clause A.3.1.2.1
Active cell		Cell 1	
Neighbour cell		Cell 2	Cell to be identified.
E-UTRA RF Channel Number		1	Only one FDD carrier frequency is used.
Channel Bandwidth ($BW_{channel}$)	MHz	10	
CP length		Normal	
A3-Offset	dB	-3	
Hysteresis	dB	0	
Time To Trigger	s	0	
Filter coefficient		0	L3 filtering is not used
DRX		ON	DRX related parameters are defined in Table A.8.1.6.1-3
si-RequestForHO		TRUE	As specified in clause 5.5.3.1 in TS 36.331.
T1	s	5	
T2	s	≤30	UE should report cell within 25.6s (20 DRX cycles)
T3	s	5	

Table A.8.1.20.1-2: Cell specific test parameters for E-UTRAN FDD - FDD Intra-frequency identification of a new CGI of E-UTRA cell using autonomous gaps with DRX for UE category 0

Parameter	Unit	Cell 1			Cell 2		
		T1	T2	T3	T1	T2	T3
E-UTRA RF Channel Number		1			1		
$BW_{channel}$	MHz	10			10		
Correlation Matrix and Antenna Configuration		2x1			2x1		
OCNG Patterns defined in A.3.2.1.1 (OP.1 FDD) and in A.3.2.1.2 (OP.2 FDD)		OP.1 FDD	OP.1 FDD	OP.1 FDD	OP.2 FDD	OP.2 FDD	OP.2 FDD
PBCH_RA	dB						
PBCH_RB	dB						

PSS_RA	dB	-3			-3		
SSS_RA	dB						
PCFICH_RB	dB	0			0		
PHICH_RA	dB	-3			-3		
PHICH_PB	dB						
PDCCH_RA	dB	0			0		
PDCCH_PB	dB						
PDSCH_RA	dB	-3			-3		
PDSCH_RB	dB						
OCNG_RA ^{Note 1}	dB						
OCNG_RB ^{Note 1}	dB						
\hat{E}_s/I_{ot}	dB	8	-3.3	-3.3	-Infinity	2.36	2.36
N_{oc} ^{Note 2}	dBm/15 KHz	-98					
\hat{E}_s/N_{oc}	dB	8	8	8	-Infinity	11	11
RSRP ^{Note 3}	dBm/15 KHz	-90	-90	-90	-Infinity	-87	-87
SCH_RP ^{Note 3}	dBm/15 KHz	-90	-90	-90	-Infinity	-87	-87
Propagation Condition		AWGN					
Timing offset to Cell 1	ms	-			3		
<p>Note 1: OCNG shall be used such that both cells are fully allocated and a constant total transmitted power spectral density is achieved for all OFDM symbols.</p> <p>Note 2: Interference from other cells and noise sources not specified in the test is assumed to be constant over subcarriers and time and shall be modelled as AWGN of appropriate power for N_{oc} to be fulfilled.</p> <p>Note 3: RSRP and SCH_RP levels have been derived from other parameters for information purposes. They are not settable parameters themselves.</p>							

Table A.8.1.20.1-3: DRX configuration for E-UTRAN FDD - FDD Intra-frequency identification of a new CGI of E-UTRA cell using autonomous gaps with DRX for UE category 0

Field	Value	Comment
onDurationTimer	psf1	As specified in clause 6.3.2 in TS 36.331
drx-InactivityTimer	psf1	
drx-RetransmissionTimer	psf1	
longDRX-CycleStartOffset	sf1280	
shortDRX	disable	

Table A.8.1.20.1-4: TimeAlignmentTimer -Configuration for E-UTRAN FDD - FDD Intra-frequency identification of a new CGI of E-UTRA cell using autonomous gaps with DRX for UE category 0

Field	Value	Comment
TimeAlignmentTimer	Infinity	As specified in clause 6.3.2 in TS 36.331
sr-ConfigIndex	0	For further information see clause 6.3.2 in TS 36.331 and section 10.1 in TS 36.213.

A.8.1.20.2 Test Requirements

The UE shall transmit a measurement report containing the cell global identifier of cell 2 within 210 milliseconds from the start of T3.

$$\text{Test requirement} = \text{RRC Procedure delay} + T_{\text{identify_CGI_LC-UE, intra}} + \text{reporting delay}$$

$$= 15 + 190 + 2\text{ms from the start of T3}$$

$$= 207 \text{ ms, allow 210 ms.}$$

The rate of correct events observed during repeated tests shall be at least 90%.

A.8.1.21 E-UTRAN HD - FDD Intra-frequency identification of a new CGI of E-UTRA cell using autonomous gaps for UE category 0

A.8.1.21.1 Test Purpose and Environment

This test is to verify the requirement for identification of a new CGI of E-UTRA cell with autonomous gaps in clause 8.5.2.1.5.

The test scenario comprises of one E-UTRA FDD carrier and two cells as given in tables A.8.1.21.1-1 and A.8.1.21.1-2. PDCCHs indicating new transmissions should be sent continuously to ensure that the UE would have ACK/NACK sending during identifying a new CGI of E-UTRAN cell. The test consists of three successive time periods, with time durations of T1, T2 and T3 respectively. At the start of time duration T1, the UE does not have any timing information of cell 2. Starting T2, cell 2 becomes detectable and the UE is expected to detect and send a measurement report.

A RRC message implying SI reading shall be sent to the UE during period T2, after the UE has reported Event A3. The RRC message shall create a measurement report configuration with purpose *reportCGI* and *si-RequestForHO* set to TRUE. The start of T3 is the instant when the last TTI containing the RRC message implying SI reading is sent to the UE.

Table A.8.1.21.1-1: General test parameters for E-UTRAN HD - FDD Intra-frequency identification of a new CGI of E-UTRA cell using autonomous gaps for UE category 0

Parameter	Unit	Value	Comment
PDSCH parameters		DL Reference Measurement Channel R.2 HD-FDD	As specified in clause A.3.1.1.4
PCFICH/PDCCH/PHICH parameters		DL Reference Measurement Channel R.4 HD-FDD	As specified in clause A.3.1.2.3
Active cell		Cell 1	
Neighbour cell		Cell 2	Cell to be identified.
E-UTRA RF Channel Number		1	Only one FDD carrier frequency is used.
Channel Bandwidth ($BW_{channel}$)	MHz	10	
CP length		Normal	
A3-Offset	dB	-3	
Hysteresis	dB	0	
Time To Trigger	s	0	
Filter coefficient		0	L3 filtering is not used
DRX		OFF	
si-RequestForHO		TRUE	As specified in clause 5.5.3.1 in TS 36.331.
T1	s	5	
T2	s	≤10	
T3	s	5	

Table A.8.1.21.1-2: Cell specific test parameters for E-UTRAN HD - FDD Intra-frequency identification of a new CGI of E-UTRA cell using autonomous gaps for UE category 0

Parameter	Unit	Cell 1			Cell 2		
		T1	T2	T3	T1	T2	T3
E-UTRA RF Channel Number		1			1		
$BW_{channel}$	MHz	10			10		
Correlation Matrix and Antenna Configuration		2x1			2x1		
OCNG Patterns defined in A.3.2.1.10 (OP.10 FDD) and in A.3.2.1.2 (OP.2 FDD)		OP.10 FDD	OP.10 FDD	OP.10 FDD	OP.2 FDD	OP.2 FDD	OP.2 FDD
PBCH_RA	dB	-3			-3		
PBCH_RB	dB						
PSS_RA	dB						
SSS_RA	dB						
PCFICH_RB	dB	0			0		
PHICH_RA	dB	-3			-3		

PHICH_PB	dB						
PDCCH_RA	dB	0			0		
PDCCH_PB	dB						
PDSCH_RA	dB						
PDSCH_RB	dB	-3			-3		
OCNG_RA ^{Note 1}	dB						
OCNG_RB ^{Note 1}	dB						
\hat{E}_s/I_{ot}	dB	8	-3.3	-3.3	-Infinity	2.36	2.36
N_{oc} ^{Note 2}	dBm/15 KHz	-98					
\hat{E}_s/N_{oc}	dB	8	8	8	-Infinity	11	11
RSRP ^{Note 3}	dBm/15 KHz	-90	-90	-90	-Infinity	-87	-87
SCH_RP ^{Note 3}	dBm/15 KHz	-90	-90	-90	-Infinity	-87	-87
Propagation Condition		AWGN					
Timing offset to Cell 1	ms	-			3		
<p>Note 1: OCNG shall be used such that both cells are fully allocated and a constant total transmitted power spectral density is achieved for all OFDM symbols.</p> <p>Note 2: Interference from other cells and noise sources not specified in the test is assumed to be constant over subcarriers and time and shall be modelled as AWGN of appropriate power for N_{oc} to be fulfilled.</p> <p>Note 3: RSRP and SCH_RP levels have been derived from other parameters for information purposes. They are not settable parameters themselves.</p>							

A.8.1.21.2 Test Requirements

The UE shall transmit a measurement report containing the cell global identifier of cell 2 within 210 milliseconds from the start of T3.

Test requirement = RRC Procedure delay + $T_{\text{identify_CGI_LC-UE, intra}}$ + reporting delay

= 15 + 190 + 2ms from the start of T3

= 207 ms, allow 210 ms.

The UE shall be scheduled continuously throughout the test, and from the start of T3 until 210 ms at least 112 ACK/NACK shall be detected as being transmitted by the UE.

The rate of correct events observed during repeated tests shall be at least 90%.

NOTE: The overall 112 ACK/NACK number is caused by two parts. Firstly, at least 92 ACK/NACK shall be sent during identifying the cell global identifier of cell 2 according to the requirement in Clause 8.5.2.1.5. Secondly, given that continuous DL data allocation, additional 20 ACK/NACK shall be sent from the start of T3 until 210 ms excludes 190 ms for identifying the cell global identifier of cell 2.

A.8.1.22 E-UTRAN HD - FDD Intra-frequency identification of a new CGI of E-UTRA cell using autonomous gaps with DRX for UE category 0

A.8.1.22.1 Test Purpose and Environment

This test is to verify the requirement for identification of a new CGI of E-UTRA cell with autonomous gaps in clause 8.5.2.1.5. The requirement is verified in a DRX configuration.

The test scenario comprises of one E-UTRA FDD carrier and two cells as given in tables A.8.1.22.1-1, A.8.1.22.1-2, A.8.1.22.1-3 and A.8.1.22.1-4. The test consists of three successive time periods, with time durations of T1, T2 and T3 respectively. At the start of time duration T1, the UE does not have any timing information of cell 2. Starting T2, cell 2 becomes detectable and the UE is expected to detect and send a measurement report.

A RRC message implying SI reading shall be sent to the UE during period T2, after the UE has reported Event A3. The RRC message shall create a measurement report configuration with purpose *reportCGI* and *si-RequestForHO* set to TRUE. The start of T3 is the instant when the last TTI containing the RRC message implying SI reading is sent to the UE.

In the test UE needs to be provided at least once every 1280ms with new Timing Advance Command MAC control element to restart the Time alignment timer to keep UE uplink time alignment. Furthermore UE sends scheduling request (SR) to obtain allocation to send the measurement report on PUSCH.

Table A.8.1.22.1-1: General test parameters for E-UTRAN HD - FDD Intra-frequency identification of a new CGI of E-UTRA cell using autonomous gaps with DRX for UE category 0

Parameter	Unit	Value	Comment
PDSCH parameters		DL Reference Measurement Channel R.2 HD-FDD	As specified in clause A.3.1.1.4
PCFICH/PDCCH/PHICH parameters		DL Reference Measurement Channel R.4 HD-FDD	As specified in clause A.3.1.2.3
Active cell		Cell 1	
Neighbour cell		Cell 2	Cell to be identified.
E-UTRA RF Channel Number		1	Only one FDD carrier frequency is used.
Channel Bandwidth ($BW_{channel}$)	MHz	10	
CP length		Normal	
A3-Offset	dB	-3	
Hysteresis	dB	0	
Time To Trigger	s	0	
Filter coefficient		0	L3 filtering is not used
DRX		ON	DRX related parameters are defined in Table A.8.1.6.1-3
si-RequestForHO		TRUE	As specified in clause 5.5.3.1 in TS 36.331.
T1	s	5	
T2	s	≤ 30	UE should report cell within 25.6s (20 DRX cycles)
T3	s	5	

Table A.8.1.22.1-2: Cell specific test parameters for E-UTRAN HD - FDD Intra-frequency identification of a new CGI of E-UTRA cell using autonomous gaps with DRX for UE category 0

Parameter	Unit	Cell 1			Cell 2		
		T1	T2	T3	T1	T2	T3
E-UTRA RF Channel Number		1			1		
$BW_{channel}$	MHz	10			10		
Correlation Matrix and Antenna Configuration		2x1			2x1		
OCNG Patterns defined in A.3.2.1.1 (OP.1 FDD) and in A.3.2.1.2 (OP.2 FDD)		OP.1 FDD	OP.1 FDD	OP.1 FDD	OP.2 FDD	OP.2 FDD	OP.2 FDD
PBCH_RA	dB						
PBCH_RB	dB						
PSS_RA	dB	-3			-3		
SSS_RA	dB						
PCFICH_RB	dB	0			0		
PHICH_RA	dB	-3			-3		
PHICH_PB	dB						
PDCCH_RA	dB	0			0		
PDCCH_PB	dB						
PDSCH_RA	dB						
PDSCH_RB	dB	-3			-3		
OCNG_RA ^{Note 1}	dB						
OCNG_RB ^{Note 1}	dB						
\hat{E}_s / I_{ot}	dB	8	-3.3	-3.3	-Infinity	2.36	2.36
N_{oc} ^{Note 2}	dBm/15 KHz	-98					
\hat{E}_s / N_{oc}	dB	8	8	8	-Infinity	11	11
RSRP ^{Note 3}	dBm/15 KHz	-90	-90	-90	-Infinity	-87	-87
SCH_RP ^{Note 3}	dBm/15 KHz	-90	-90	-90	-Infinity	-87	-87
Propagation Condition		AWGN					

Timing offset to Cell 1	ms	-	3
Note 1:	OCNG shall be used such that both cells are fully allocated and a constant total transmitted power spectral density is achieved for all OFDM symbols.		
Note 2:	Interference from other cells and noise sources not specified in the test is assumed to be constant over subcarriers and time and shall be modelled as AWGN of appropriate power for N_{oc} to be fulfilled.		
Note 3:	RSRP and SCH_RP levels have been derived from other parameters for information purposes. They are not settable parameters themselves.		

Table A.8.1.22.1-3: DRX configuration for E-UTRAN HD - FDD Intra-frequency identification of a new CGI of E-UTRA cell using autonomous gaps with DRX for UE category 0

Field	Value	Comment
onDurationTimer	psf1	As specified in clause 6.3.2 in TS 36.331
drx-InactivityTimer	psf1	
drx-RetransmissionTimer	psf1	
longDRX-CycleStartOffset	sf1280	
shortDRX	disable	

Table A.8.1.22.1-4: *TimeAlignmentTimer* - Configuration for E-UTRAN HD - FDD Intra-frequency identification of a new CGI of E-UTRA cell using autonomous gaps with DRX for UE category 0

Field	Value	Comment
TimeAlignmentTimer	Infinity	As specified in clause 6.3.2 in TS 36.331
sr-ConfigIndex	0	For further information see clause 6.3.2 in TS 36.331 and section 10.1 in TS 36.213.

A.8.1.22.2 Test Requirements

The UE shall transmit a measurement report containing the cell global identifier of cell 2 within 210 milliseconds from the start of T3.

$$\begin{aligned}
 \text{Test requirement} &= \text{RRC Procedure delay} + T_{\text{identify_CGL_LC-UE, intra}} + \text{reporting delay} \\
 &= 15 + 190 + 2\text{ms from the start of T3} \\
 &= 207 \text{ ms, allow 210 ms.}
 \end{aligned}$$

The rate of correct events observed during repeated tests shall be at least 90%.

A.8.1.23 E-UTRAN FDD-FDD intra-frequency event triggered reporting under fading propagation conditions in asynchronous cells for Cat-M1 UE in CEModeA

A.8.1.23.1 Test Purpose and Environment

The purpose of this test is to verify that the Cat-M1 UE makes correct reporting of an event. This test will partly verify the FDD intra-frequency cell search requirements for Cat-M1 UE in clause 8.13.2.1.1.1.

The test parameters are given in Table A.8.1.23.1-1 and A.8.1.23.1-2 below. In the measurement control information it is indicated to the UE that event-triggered reporting with Event A3 is used. The test consists of two successive time periods, with time duration of T1, and T2 respectively. During time duration T1, the UE shall not have any timing information of cell 2. At the beginning of T2 the transmission power of cell 2 is increased to the same level as for cell 1, and due to usage of an offset this shall result in reporting of Event A3.

Table A.8.1.23.1-1: General test parameters for E-UTRAN FDD-FDD intra-frequency event triggered reporting under fading propagation conditions in asynchronous cells for Cat-M1 UE in CEModeA

Parameter	Unit	Value	Comment
E-UTRA RF Channel Number		1	One radio channel is used.
Active cell		Cell 1	
Neighbour cell		Cell 2	Cell to be identified.
CP length		Normal	
DRX		OFF	
A3	Offset	dB	-6
	Hysteresis	dB	0
	Time To Trigger	S	0
Filter coefficient		0	L3 filtering is not used
Gap pattern ID		1	
T1	S	5	
T2	S	5	

Table A.8.1.23.1-2: Cell specific test parameters for E-UTRAN FDD-FDD intra-frequency event triggered reporting under fading propagation conditions in asynchronous cells for Cat-M1 UE in CEModeA

Parameter	Unit	Cell 1		Cell 2	
		T1	T2	T1	T2
E-UTRA RF Channel Number		1			
BW _{channel}	MHz	10			
PDSCH parameters: DL Reference Measurement Channel		R.21 FDD		-	
MPDCCH parameters: DL Reference Measurement Channel		R.17 FDD		R.17 FDD	
OCNG Patterns		OP.21 FDD		OP.6 FDD	
PBCH_RA	dB	-3		-3	
PBCH_RB	dB				
PSS_RA	dB				
SSS_RA	dB				
PCFICH_RB	dB				
PHICH_RA	dB				
PHICH_RB	dB				
MPDCCH_RA	dB				
MPDCCH_RB	dB				
PDSCH_RA	dB				
PDSCH_RB	dB				
OCNG_RA ^{Note 1}	dB				
OCNG_RB ^{Note 1}	dB				
N _{oc} ^{Note 2}	dBm/15 KHz				
\hat{E}_s/N_{oc}	dB	4	4	-Infinity	4
\hat{E}_s/I_{ot} ^{Note 3}	dB	4	-1.46	-Infinity	-1.46
RSRP ^{Note 3}	dBm/15 KHz	-94	-94	-Infinity	-94
SCH_RP ^{Note 3}	dBm/15 KHz	-94	-94	-Infinity	-94
I _o ^{Note 3}	dBm/9MHz	-64.76	-62.42	Specified in Cell 1 columns	
Propagation Condition		ETU30		ETU30	
Correlation Matrix and Antenna Configuration		2x1 Low		2x1 Low	
Timing offset to Cell 1	ms	-		3	

Note 1:	OCNG shall be used such that all cells are fully allocated and a constant total transmitted power spectral density is achieved for all OFDM symbols.
Note 2:	Interference from other cells and noise sources not specified in the test is assumed to be constant over subcarriers and time and shall be modelled as AWGN of appropriate power for N_{oc} to be fulfilled.
Note 3:	E_s/lot , $RSRP$, SCH_RP and I_o have been derived from other parameters for information purposes. They are not settable parameters themselves.
Note 4:	The resources for uplink transmission are assigned to the UE prior to the start of time period T2.

A.8.1.23.2 Test Requirements

The UE shall send one Event A3 triggered measurement report, with a measurement reporting delay less than 2.88s from the beginning of time period T2.

The UE shall not send event triggered measurement reports, as long as the reporting criteria are not fulfilled.

The rate of correct events observed during repeated tests shall be at least 90%.

NOTE: The actual overall delays measured in the test may be up to $2 \times TTI_{DCCCH}$ higher than the measurement reporting delays above because of TTI insertion uncertainty of the measurement report in DCCCH.

A.8.1.24 E-UTRAN FDD-FDD intra-frequency event triggered reporting under fading propagation conditions in synchronous cells for Cat-M1 UE in CEModeA

A.8.1.24.1 Test Purpose and Environment

The purpose of this test is to verify that the Cat-M1 UE makes correct reporting of an event. This test will partly verify the FDD intra-frequency cell search requirements in clause 8.13.2.1.1.1.

The test parameters are given in Table A.8.1.24.1-1 and A.8.1.24.1-2 below. In the measurement control information it is indicated to the UE that event-triggered reporting with Event A3 is used. MPDCCCHs indicating new transmissions or retransmissions shall be sent continuously to ensure that the UE would not enter the DRX state. The test consists of two successive time periods, with time duration of T1, and T2 respectively. During time duration T1, the UE shall not have any timing information of cell 2. At the beginning of T2 the transmission power of cell 2 is increased to the same level as for cell 1, and due to usage of an offset this shall result in reporting of Event A3.

Table A.8.1.24.1-1: General test parameters for E-UTRAN FDD-FDD intra-frequency event triggered reporting under fading propagation conditions in synchronous cells for Cat-M1 UE in CEModeA

Parameter		Unit	Value	Comment
E-UTRA RF Channel Number			1	One radio channel is used.
Active cell			Cell 1	
Neighbour cell			Cell 2	Cell to be identified.
CP length			Normal	
DRX			ON	DRX related parameters are defined in Table A.8.1.24.1-3
A3	Offset	dB	-6	
	Hysteresis	dB	0	
	Time To Trigger	s	0	
Filter coefficient			0	L3 filtering is not used
Gap pattern ID			1	Gap offset of 14 is used
T1		s	5	
T2		s	5	

Table A.8.1.24.1-2: Cell specific test parameters for E-UTRAN FDD-FDD intra-frequency event triggered reporting under fading propagation conditions for Cat-M1 UE in synchronous cells in CEModeA

Parameter	Unit	Cell 1		Cell 2	
		T1	T2	T1	T2

E-UTRA RF Channel Number		1			
BW _{channel}	MHz	10			
PDSCH parameters: DL Reference Measurement Channel		R.33 FDD		-	
MPDCCH parameters: DL Reference Measurement Channel		R.17 FDD		R.17 FDD	
OCNG Patterns		OP.21 FDD		OP.6 FDD	
PBCH_RA	dB	-3		-3	
PBCH_RB	dB				
PSS_RA	dB				
SSS_RA	dB				
PCFICH_RB	dB				
PHICH_RA	dB				
PHICH_RB	dB				
MPDCCH_RA	dB				
MPDCCH_RB	dB				
PDSCH_RA	dB				
PDSCH_RB	dB				
OCNG_RA ^{Note 1}	dB				
OCNG_RB ^{Note 1}	dB				
N_{oc} ^{Note 2}	dBm/15 KHz				
\hat{E}_s/N_{oc}	dB	4	4	-Infinity	4
\hat{E}_s/I_{ot} ^{Note 3}	dB	4	-1.46	-Infinity	-1.46
RSRP ^{Note 3}	dBm/15 KHz	-94	-94	-Infinity	-94
SCH_RP ^{Note 3}	dBm/15 KHz	-94	-94	-Infinity	-94
I_o ^{Note 3}	dBm/9MHz	-64.76	-62.42	Specified in Cell 1 columns	
Propagation Condition		ETU30		ETU30	
Correlation Matrix and Antenna Configuration		2x1 Low		2x1 Low	
Timing offset to Cell 1	μ s	-		3	
<p>Note 1: OCNG shall be used such that all cells are fully allocated and a constant total transmitted power spectral density is achieved for all OFDM symbols.</p> <p>Note 2: Interference from other cells and noise sources not specified in the test is assumed to be constant over subcarriers and time and shall be modelled as AWGN of appropriate power for N_{oc} to be fulfilled.</p> <p>Note 3: E_s/I_{ot}, RSRP, SCH_RP and I_o have been derived from other parameters for information purposes. They are not settable parameters themselves.</p> <p>Note 4: The resources for uplink transmission are assigned to the UE prior to the start of time period T2.</p>					

Table A.8.1.24.1-3: DRX-Configuration for E-UTRAN FDD-FDD intra-frequency event triggered reporting in under fading propagation conditions in synchronous cells for Cat-M1 UE in CEModeA

Field	Comment	
	Value	
onDurationTimer	psf20	As specified in clause 6.3.2 in TS 36.331
drx-InactivityTimer	psf1920	
drx-RetransmissionTimer	psf16	
longDRX-CycleStartOffset	sf1280	
shortDRX	disable	

A.8.1.24.2 Test Requirements

The UE shall send one Event A3 triggered measurement report, with a measurement reporting delay less than 2.88 s from the beginning of time period T2.

The UE shall not send event triggered measurement reports, as long as the reporting criteria are not fulfilled.

The rate of correct events observed during repeated tests shall be at least 90%.

NOTE: The actual overall delays measured in the test may be up to $2 \times TTI_{DCCH}$ higher than the measurement reporting delays above because of TTI insertion uncertainty of the measurement report in DCCH.

A.8.1.25 E-UTRAN FDD-FDD intra-frequency event triggered reporting under fading propagation conditions in synchronous cells for Cat-M1 UE in CEModeA in DRX

A.8.1.25.1 Test Purpose and Environment

The purpose of the two tests is to verify that the Cat-M1 UE makes correct reporting of an event in DRX. The tests will partly verify the FDD intra-frequency cell search in DRX requirements in clause 8.13.2.1.1.2.

The test parameters are given in Tables A.8.1.25.1-1, A.8.1.25.1-2, A.8.1.25.1-3 and A.8.1.25.1-4. In the measurement control information, it is indicated to the UE that event-triggered reporting with Event A3 is used. The test consists of two successive time periods, with time duration of T1, and T2 respectively. During time duration T1, the UE shall not have any timing information of cell 2. At the beginning of T2 the transmission power of cell 2 is increased to the same level as for cell 1, and due to usage of an offset this shall result in reporting of Event A3.

In Test 1 UE needs to be provided at least once every 500ms with new Timing Advance Command MAC control element to restart the Time alignment timer to keep UE uplink time alignment. Furthermore UE is allocated with PUSCH resource at every DRX cycle.

In Test 2 the uplink time alignment is not maintained and UE needs to use RACH to obtain UL allocation for measurement reporting.

Table A.8.1.25.1-1: General test parameters for E-UTRAN FDD-FDD intra-frequency event triggered reporting under fading propagation conditions in synchronous cells for Cat-M1 UE when DRX is used

Parameter	Unit	Value		Comment
		Test1	Test2	
E-UTRA RF Channel Number		1	1	One radio channel is used.
Active cell		Cell 1	Cell 1	
Neighbour cell		Cell 2	Cell 2	Cell to be identified.
CP length		Normal	Normal	
DRX		ON	ON	DRX related parameters are defined in Table A.8.1.25.1-3
A3	Offset	dB	-6	
	Hysteresis	dB	0	
	Time To Trigger	s	0	
Filter coefficient		0	0	L3 filtering is not used
Gap pattern ID		0	0	
T1	s	5	5	
T2	s	5	30	

Table A.8.1.25.1-2: Cell specific test parameters for E-UTRAN FDD-FDD intra-frequency event triggered reporting under fading propagation conditions in synchronous cells for Cat-M1 UE when DRX is used

Parameter	Unit	Cell 1		Cell 2	
		T1	T2	T1	T2
E-UTRA RF Channel Number		1			
BW _{channel}	MHz	10			
PDSCH parameters: DL Reference Measurement Channel		R.33 FDD		-	
MPDCCH parameters: DL Reference Measurement Channel		R.17 FDD		R.17 FDD	
OCNG Patterns		OP.21 FDD		OP.6 FDD	

PBCH_RA	dB	-3		-3	
PBCH_RB	dB				
PSS_RA	dB				
SSS_RA	dB				
PCFICH_RB	dB				
PHICH_RA	dB				
PHICH_RB	dB				
MPDCCH_RA	dB				
MPDCCH_RB	dB				
PDSCH_RA	dB				
PDSCH_RB	dB				
OCNG_RA ^{Note 1}	dB				
OCNG_RB ^{Note 1}	dB				
N_{oc} ^{Note 2}	dBm/15 KHz				
\hat{E}_s/N_{oc}	dB	4	4	-Infinity	4
\hat{E}_s/I_{ot} ^{Note 3}	dB	4	-1.46	-Infinity	-1.46
RSRP ^{Note 3}	dBm/15 KHz	-94	-94	-Infinity	-94
SCH_RP ^{Note 3}	dBm/15 KHz	-94	-94	-Infinity	-94
I_o ^{Note 3}	dBm/9MHz	-64.76	-62.42	Specified in Cell 1 columns	
Propagation Condition		ETU30		ETU30	
Correlation Matrix and Antenna Configuration		2x1 Low		2x1 Low	
Timing offset to Cell 1	μ s	-		3	
<p>Note 1: OCNG shall be used such that all cells are fully allocated and a constant total transmitted power spectral density is achieved for all OFDM symbols.</p> <p>Note 2: Interference from other cells and noise sources not specified in the test is assumed to be constant over subcarriers and time and shall be modelled as AWGN of appropriate power for N_{oc} to be fulfilled.</p> <p>Note 3: E_s/I_{ot}, RSRP, SCH_RP and I_o have been derived from other parameters for information purposes. They are not settable parameters themselves.</p> <p>Note 4: The resources for uplink transmission are assigned to the UE prior to the start of time period T2.</p>					

Table A.8.1.25.1-3: DRX-Configuration for E-UTRAN FDD-FDD intra-frequency event triggered reporting in DRX under fading propagation conditions in synchronous cells for Cat-M1 UE in CEModeA

Field	Test1	Test2	Comment
	Value	Value	
onDurationTimer	psf1	psf1	As specified in clause 6.3.2 in TS 36.331
drx-InactivityTimer	psf1	psf1	
drx-RetransmissionTimer	psf1	psf1	
longDRX-CycleStartOffset	sf40	sf1280	
shortDRX	disable	disable	

Table A.8.1.25.1-4: TimeAlignmentTimer -Configuration for E-UTRAN FDD-FDD intra-frequency event triggered reporting in DRX under fading propagation conditions in synchronous cells for Cat-M1 UE in CEModeA

Field	Test1	Test2	Comment
	Value	Value	
TimeAlignmentTimer	sf500	sf500	As specified in clause 6.3.2 in TS 36.331
sr-ConfigIndex	0	0	For further information see clause 6.3.2 in TS 36.331 and section 10.1 in TS 36.213.

A.8.1.25.2 Test Requirements

In Test 1, the UE shall send one Event A3 triggered measurement report, with a measurement reporting delay less than 1.44 s from the beginning of time period T2. The measurement reporting delay is defined as the time from the beginning of time period T2 to the moment when the UE send the measurement report on PUSCH.

In Test 2, the UE shall send one Event A3 triggered measurement report, with a measurement reporting delay less than 25600 ms from the beginning of time period T2. The measurement reporting delay is defined as the time from the beginning of time period T2 to the moment when the UE starts to send preambles on the PRACH for scheduling request (SR) to obtain allocation to send the measurement report on PUSCH.

The UE shall not send event triggered measurement reports, as long as the reporting criteria are not fulfilled.

The rate of correct events observed during repeated tests shall be at least 90%.

NOTE 1: The actual overall delays measured in the test may be up to one DRX cycle higher than the measurement reporting delays above because UE is allowed to delay the initiation of the measurement reporting procedure to the next until the Active Time.

NOTE 2: In order to calculate the rate of correct events the system simulator shall verify that it has received correct Event A3 measurement report.

A.8.1.26 E-UTRAN HD-FDD intra-frequency event triggered reporting under fading propagation conditions in asynchronous cells for Cat-M1 UE in CEModeA

A.8.1.26.1 Test Purpose and Environment

The purpose of this test is to verify that the Cat-M1 UE makes correct reporting of an event. This test will partly verify the HD-FDD intra-frequency cell search requirements in clause 8.13.2.1.2.1.

The test parameters are given in Table A.8.1.26.1-1 and A.8.1.26.1-2 below. In the measurement control information it is indicated to the UE that event-triggered reporting with Event A3 is used. The test consists of two successive time periods, with time duration of T1 and T2 respectively. During time duration T1, the UE shall not have any timing information of cell 2. At the beginning of T2 the transmission power of cell 2 is increased to the same level as for cell 1, and due to usage of an offset this shall result in reporting of Event A3.

Table A.8.1.26.1-1: General test parameters for E-UTRAN HD-FDD intra-frequency event triggered reporting under fading propagation conditions in asynchronous cells for Cat-M1 UE in CEModeA

Parameter		Unit	Value	Comment
E-UTRA RF Channel Number			1	One radio channel is used for this test
Active Cell			Cell 1	
Neighbour cell			Cell 2	Cell to be identified
CP length			Normal	
DRX			OFF	
A3	Offset	dB	-6	
	Hysteresis	dB	0	
	Time To Trigger	s	0	
Filter coefficient			0	L3 filtering is not used
Gap pattern ID			1	
T1		s	5	
T2		s	5	

Table A.8.1.26.1-2: Cell specific test parameters for E-UTRAN HD-FDD intra-frequency event triggered reporting under fading propagation conditions in asynchronous cells for Cat-M1 UE in CEModeA

Parameter	Unit	Cell 1		Cell 2	
		T1	T2	T1	T2
E-UTRA RF Channel Number		1			
BW _{channel}	MHz	10			

PDSCH parameters: DL Reference Measurement Channel		R. 25 HD-FDD		-	
MPDCCH parameters: DL Reference Measurement Channel		R.7 HD-FDD		R.7 HD-FDD	
OCNG Patterns		OP.21 FDD		OP.6 FDD	
PBCH_RA	dB	-3		-3	
PBCH_RB	dB				
PSS_RA	dB				
SSS_RA	dB				
PCFICH_RB	dB				
PHICH_RA	dB				
PHICH_RB	dB				
MPDCCH_RA	dB				
MPDCCH_RB	dB				
PDSCH_RA	dB				
PDSCH_RB	dB				
OCNG_RA ^{Note 1}	dB				
OCNG_RB ^{Note 1}	dB				
N _{oc} ^{Note 2}	dBm/15 kHz				
\bar{E}_s/N_{oc}	dB	4	4	-infinity	4
\bar{E}_s/I_{ot} ^{Note 3}	dB	4	-1.46	-infinity	-1.46
RSRP ^{Note 3}	dBm/15 kHz	-94	-94	-infinity	-94
SCH_RP ^{Note 3}	dBm/15 kHz	-94	-94	-infinity	-94
I _o ^{Note 3}	dBm/9MHz	-64.76	-62.42	Specified in Cell 1 columns	
Propagation Condition		ETU30		ETU30	
Correlation Matrix and Antenna Configuration		2x1 Low		2x1 Low	
Timing offset to Cell 1	ms	-		3	
<p>Note 1: OCNG shall be used such that all cells are fully allocated and a constant total transmitted power spectral density is achieved for all OFDM symbols.</p> <p>Note 2: Interference from other cells and noise sources not specified in the test is assumed to be constant over subcarriers and time and shall be modelled as AWGN of appropriate power for N_{oc} to be fulfilled.</p> <p>Note 3: E_s/I_{ot}, RSRP, SCH_RP and I_o have been derived from other parameters for information purposes. They are not settable parameters themselves.</p> <p>Note 4: The resources for uplink transmission are assigned to the UE prior to the start of time period T2.</p>					

A.8.1.26.2 Test Requirements

The UE shall send one Event A3 triggered measurement report, with a measurement reporting delay less than 2.88s from the beginning of time period T2.

The UE shall not send event triggered measurement reports as long as the reporting criteria are not fulfilled.

The rate of correct events observed during repeated tests shall be at least 90%.

NOTE: The actual overall delays measured in the tests may be up to $2 \times TTI_{DCCH}$ higher than the measurement reporting delays above because of TTI insertion uncertainty of the measurement report in DCCH.

A.8.1.27 E-UTRAN HD-FDD intra-frequency event triggered reporting under fading propagation conditions in synchronous cells for Cat-M1 UE in CEModeA

A.8.1.27.1 Test Purpose and Environment

The purpose of this test is to verify that the Cat-M1 UE makes correct reporting of an event. This test will partly verify the HD-FDD intra-frequency cell search requirements in clause 8.13.2.1.2.1.

The test parameters are given in Table A.8.1.27.1-1 and A.8.1.27.1-2 below. In the measurement control information it is indicated to the UE that event-triggered reporting with Event A3 is used. MPDCCHs indicating new transmissions or retransmissions shall be sent continuously to ensure that the UE would not enter the DRX state. The test consists of two successive time periods, with time duration of T1 and T2 respectively. During time duration T1, the UE shall not have any timing information of cell 2. At the beginning of T2 the transmission power of cell 2 is increased to the same level as for cell 1, and due to usage of an offset this shall result in reporting of Event A3.

Table A.8.1.27.1-1: General test parameters for E-UTRAN HD-FDD intra-frequency event triggered reporting under fading propagation conditions in synchronous cells for Cat-M1 UE in CEModeA

Parameter		Unit	Value	Comment
E-UTRA RF Channel Number			1	One radio channel is used for this test
Active cell			Cell 1	
Neighbour cell			Cell 2	Cell to be identified.
CP length			Normal	
DRX			ON	DRX related parameters are defined in Table A.8.1.27.1-3
A3	Offset	dB	-6	
	Hysteresis	dB	0	
	Time To Trigger	s	0	
Filter coefficient			0	L3 filtering is not used
Gap pattern ID			1	As specified in TS 36.133 clause 8.1.2.1.
T1		s	5	
T2		s	5	

Table A.8.1.27.1-2: Cell specific test parameters for E-UTRAN HD-FDD intra-frequency event triggered reporting under fading propagation conditions in synchronous cells for Cat-M1 UE in CEModeA

Parameter	Unit	Cell 1		Cell 2	
		T1	T2	T1	T2
E-UTRA RF Channel Number		1			
BW _{channel}	MHz	10			
PDSCCH parameters: DL Reference Measurement Channel		R.25 HD-FDD		-	
MPDCCH parameters: DL Reference Measurement Channel		R.7 HD-FDD		R.7 HD-FDD	
OCNG Patterns		OP.21 FDD		OP.6 FDD	
PBCH_RA	dB	-3		-3	
PBCH_RB	dB				
PSS_RA	dB				
SSS_RA	dB				
PCFICH_RB	dB				
PHICH_RA	dB				
PHICH_RB	dB				
MPDCCH_RA	dB				
MPDCCH_RB	dB				
PDSCH_RA	dB				
PDSCH_RB	dB				
OCNG_RA ^{Note 1}	dB				
OCNG_RB ^{Note 1}	dB				

N_{oc} Note 2	dBm/15 KHz	-98			
\hat{E}_s/N_{oc}	dB	4	4	-Infinity	4
\hat{E}_s/I_{ot} Note 3	dB	4	-1.46	-Infinity	-1.46
RSRP Note 3	dBm/15 KHz	-94	-94	-Infinity	-94
SCH_RP Note 3	dBm/15 KHz	-94	-94	-Infinity	-94
I_o Note 3	dBm/9MHz	-64.76	-62.42	Specified in Cell 1 columns	
Propagation Condition		ETU30		ETU30	
Correlation Matrix and Antenna Configuration		2x1 Low		2x1 Low	
Timing offset to Cell 1	μ s	-		3	
<p>Note 1: OCNG shall be used such that all cells are fully allocated and a constant total transmitted power spectral density is achieved for all OFDM symbols.</p> <p>Note 2: Interference from other cells and noise sources not specified in the test is assumed to be constant over subcarriers and time and shall be modelled as AWGN of appropriate power for N_{oc} to be fulfilled.</p> <p>Note 3: E_s/I_{ot}, RSRP, SCH_RP and I_o have been derived from other parameters for information purposes. They are not settable parameters themselves.</p> <p>Note 4: The resources for uplink transmission are assigned to the UE prior to the start of time period T2.</p>					

Table A.8.1.27.1-3: DRX-Configuration for E-UTRAN HD-FDD intra-frequency event triggered reporting in under fading propagation conditions in synchronous cells for Cat-M1 UE in CEModeA

Field	Comment	
	Value	
onDurationTimer	psf20	As specified in clause 6.3.2 in TS 36.331
drx-InactivityTimer	psf1920	
drx-RetransmissionTimer	psf16	
longDRX-CycleStartOffset	sf1280	
shortDRX	disable	

A.8.1.27.2 Test Requirements

The UE shall send one Event A3 triggered measurement report, with a measurement reporting delay less than 2.88s from the beginning of time period T2.

The UE shall not send event triggered measurement reports, as long as the reporting criteria are not fulfilled.

The rate of correct events observed during repeated tests shall be at least 90%.

NOTE: The actual overall delays measured in the test may be up to $2xTTI_{DCCH}$ higher than the measurement reporting delays above because of TTI insertion uncertainty of the measurement report in DCCH.

A.8.1.28 E-UTRAN HD-FDD intra-frequency event triggered reporting under fading propagation conditions in synchronous cells for Cat-M1 UE in CEModeA in DRX

A.8.1.28.1 Test Purpose and Environment

The purpose of the two tests is to verify that the Cat-M1 UE makes correct reporting of an event in DRX. The tests will partly verify the HD-FDD intra-frequency cell search in DRX requirements in clause 8.13.2.1.2.2.

The test parameters are given in Tables A.8.1.28.1-1, A.8.1.28.1-2, A.8.1.28.1-3 and A.8.1.28.1-4. In the measurement control information, it is indicated to the UE that event-triggered reporting with Event A3 is used. The test consists of two successive time periods, with time duration of T1, and T2 respectively. During time duration T1, the UE shall not have any timing information of cell 2.

In Test 1 UE needs to be provided at least once every 500ms with new Timing Advance Command MAC control element to restart the Time alignment timer to keep UE uplink time alignment. Furthermore UE is allocated with PUSCH resource at every DRX cycle.

In Test 2 the uplink time alignment is not maintained and UE needs to use RACH to obtain UL allocation for measurement reporting.

Table A.8.1.28.1-1: General test parameters for E-UTRAN HD-FDD intra-frequency event triggered reporting under fading propagation conditions in synchronous cells for Cat-M1 UE in CEModeA when DRX is used

Parameter		Unit	Value		Comment
			Test1	Test2	
E-UTRA RF Channel Number			1	1	One radio channel is used for this test
Active cell			Cell 1	Cell1	
Neighbour cell			Cell 2	Cell2	Cell to be identified.
CP length			Normal	Normal	
DRX			ON	ON	DRX related parameters are defined in Table A.8.1.28.1-3
A3	Offset	dB	-6	-6	
	Hysteresis	dB	0	0	
	Time To Trigger	s	0	0	
Filter coefficient			0	0	L3 filtering is not used
Gap pattern ID			0	0	As specified in TS 36.133 clause 8.1.2.1.
T1		s	5	5	
T2		s	5	35	

Table A.8.1.28.1-2: Cell specific test parameters for E-UTRAN HD-FDD intra-frequency event triggered reporting under fading propagation conditions in synchronous cells for Cat-M1 UE in CEModeA when DRX is used

Parameter	Unit	Cell 1		Cell 2	
		T1	T2	T1	T2
E-UTRA RF Channel Number		1			
BW _{channel}	MHz	10			
PDSCH parameters: DL Reference Measurement Channel		R.25 HD-FDD		-	
MPDCCH parameters: DL Reference Measurement Channel		R.7 HD-FDD		R.7 HD-FDD	
OCNG Patterns		OP.21 FDD		OP.6 FDD	
PBCH_RA	dB	-3		-3	
PBCH_RB	dB				
PSS_RA	dB				
SSS_RA	dB				
PCFICH_RB	dB				
PHICH_RA	dB				
PHICH_RB	dB				
MPDCCH_RA	dB				
MPDCCH_RB	dB				
PDSCH_RA	dB				
PDSCH_RB	dB				
OCNG_RA ^{Note 1}	dB				
OCNG_RB ^{Note 1}	dB				
N _{oc} ^{Note 2}	dBm/15 KHz				
\hat{E}_s/N_{oc}	dB	4	4	-Infinity	4
\hat{E}_s/I_{ot} ^{Note 3}	dB	4	-1.46	-Infinity	-1.46
RSRP ^{Note 3}	dBm/15 KHz	-94	-94	-Infinity	-94
SCH_RP ^{Note 3}	dBm/15 KHz	-94	-94	-Infinity	-94
I _o ^{Note 3}	dBm/9MHz	-64.76	-62.42	Specified in Cell 1 columns	

Propagation Condition		ETU30	ETU30
Correlation Matrix and Antenna Configuration		2x1 Low	2x1 Low
Timing offset to Cell 1	μ s	-	3
Note 1:	OCNG shall be used such that all cells are fully allocated and a constant total transmitted power spectral density is achieved for all OFDM symbols.		
Note 2:	Interference from other cells and noise sources not specified in the test is assumed to be constant over subcarriers and time and shall be modelled as AWGN of appropriate power for N_{oc} to be fulfilled.		
Note 3:	Es/lot, RSRP, SCH_RP and lo have been derived from other parameters for information purposes. They are not settable parameters themselves.		
Note 4:	The resources for uplink transmission are assigned to the UE prior to the start of time period T2.		

Table A.8.1.28.1-3: DRX-Configuration for E-UTRAN HD-FDD intra-frequency event triggered reporting in DRX under fading propagation conditions in synchronous cells for Cat-M1 UE in CEModeA

Field	Test1	Test2	Comment
	Value	Value	
onDurationTimer	psf1	psf1	As specified in clause 6.3.2 in TS 36.331
drx-InactivityTimer	psf1	psf1	
drx-RetransmissionTimer	psf1	psf1	
longDRX-CycleStartOffset	sf40	sf1280	
shortDRX	disable	disable	

Table A.8.1.28.1-4: TimeAlignmentTimer -Configuration for E-UTRAN HD-FDD intra-frequency event triggered reporting in DRX under fading propagation conditions in synchronous cells for Cat-M1 UE in CEModeA

Field	Test1	Test2	Comment
	Value	Value	
TimeAlignmentTimer	sf500	sf500	As specified in clause 6.3.2 in TS 36.331
sr-ConfigIndex	30	30	For further information see clause 6.3.2 in TS 36.331 and section 10.1 in TS 36.213.

A.8.1.28.2 Test Requirements

In Test 1, the UE shall send one Event A3 triggered measurement report, with a measurement reporting delay less than 1.44 s from the beginning of time period T2. The measurement reporting delay is defined as the time from the beginning of time period T2 to the moment when the UE send the measurement report on PUSCH.

In Test 2, the UE shall send one Event A3 triggered measurement report, with a measurement reporting delay less than 32 s from the beginning of time period T2. The measurement reporting delay is defined as the time from the beginning of time period T2 to the moment when the UE starts to send preambles on the PRACH for scheduling request (SR) to obtain allocation to send the measurement report on PUSCH.

The UE shall not send event triggered measurement reports, as long as the reporting criteria are not fulfilled.

The rate of correct events observed during repeated tests shall be at least 90%.

NOTE 1: The actual overall delays measured in the test may be up to one DRX cycle higher than the measurement reporting delays above because UE is allowed to delay the initiation of the measurement reporting procedure to the next until the Active Time.

NOTE 2: In order to calculate the rate of correct events the system simulator shall verify that it has received correct Event A3 measurement report.

A.8.1.29 E-UTRAN TDD intra-frequency event triggered reporting under fading propagation conditions in synchronous cells for Cat-M1 UE in CEModeA

A.8.1.29.1 Test Purpose and Environment

The purpose of this test is to verify that the Cat-M1 UE in CEModeA makes correct reporting of an event. This test will partly verify the TDD intra-frequency cell search requirements in clause 8.13.2.1.3.1.

The test parameters are given in Table A.8.1.29.1-1 and A.8.1.29.1-2 below. In the measurement control information it is indicated to the UE that event-triggered reporting with Event A3 is used. The test consists of two successive time periods, with time duration of T1 and T2 respectively. During time duration T1, the UE shall not have any timing information of cell 2. At the beginning of T2 the transmission power of cell 2 is increased to the same level as for cell 1, and due to usage of an offset this shall result in reporting of Event A3.

Table A.8.1.29.1-1: General test parameters for E-UTRAN TDD intra-frequency event triggered reporting under fading propagation conditions in synchronous cells for Cat-M1 UE in CEModeA

Parameter	Unit	Value	Comments
E-UTRA RF Channel Number		1	One radio channel is used for this test.
Active cell		Cell 1	
Neighbour cell		Cell 2	Cell to be identified.
CP length		Normal	
DRX		OFF	
A3	Offset	dB	-6
	Hysteresis	dB	0
	Time To Trigger	s	0
Special subframe configuration		6	As specified in table 4.2-1 in TS 36.211. The same configuration in both cells
Uplink-downlink configuration		1	As specified in table 4.2-2 in TS 36.211. The same configuration in both cells
Filter coefficient		0	L3 filtering is not used
Gap Pattern Id		1	
T1	s	5	
T2	s	5	

Table A.8.1.29.1-2: Cell specific test parameters for E-UTRAN TDD intra-frequency event triggered reporting under fading propagation conditions in synchronous cells for Cat-M1 UE in CEModeA

Parameter	Unit	Cell 1		Cell 2	
		T1	T2	T1	T2
E-UTRA RF Channel Number		1			
BW _{channel}	MHz	10			
PDSCH parameters: DL Reference Measurement Channel		R.17 TDD		-	
MPDCCH parameters: DL Reference Measurement Channel		R.15 TDD		R.15 TDD	
OCNG Patterns		OP.11 TDD		OP.2 TDD	
PBCH_RA	dB	-3			
PBCH_RB	dB				
PSS_RA	dB				
SSS_RA	dB				
PCFICH_RB	dB				
PHICH_RA	dB				
PHICH_RB	dB				
MPDCCH_RA	dB				
MPDCCH_RB	dB				
PDSCH_RA	dB				
PDSCH_RB	dB				
OCNG_RA ^{Note 1}	dB				

OCNG_RB ^{Note 1}	dB				
N _{oc} ^{Note 2}	dBm/15 kHz			-98	
\hat{E}_s/N_{oc}	dB	4	4	-Infinity	4
\hat{E}_s/I_{ot} ^{Note 3}	dB	4	-1.46	-Infinity	-1.46
RSRP ^{Note 3}	dBm/15 kHz	-94	-94	-Infinity	-94
SCH_RP ^{Note 3}	dBm/15 kHz	-94	-94	-Infinity	-94
I _o ^{Note 3}	dBm/9 MHz	-64.76	-62.42	-64.76	-62.42
Propagation Condition		ETU30		ETU30	
Correlation Matrix and Antenna Configuration		2x1 Low		2x1 Low	
Time offset to Cell 1	μ s	-		3	
Note 1	OCNG shall be used such that both cells are fully allocated and a constant total transmitted power spectral density is achieved for all OFDM symbols.				
Note 2:	Interference from other cells and noise sources not specified in the test is assumed to be constant over subcarriers and time and shall be modelled as AWGN of appropriate power for N _{oc} to be fulfilled.				
Note 3:	\hat{E}_s/I_{ot} , RSRP, SCH_RP and I _o levels have been derived from other parameters for information purposes. They are not settable parameters themselves.				
Note 4:	The resources for uplink transmission are assigned to the UE prior to the start of time period T2.				

A.8.1.29.2 Test Requirements

The UE shall send one Event A3 triggered measurement report, with a measurement reporting delay less than 2.88 second from the beginning of time period T2.

The UE shall not send event triggered measurement reports, as long as the reporting criteria are not fulfilled.

The rate of correct events observed during repeated tests shall be at least 90%.

NOTE: The actual overall delays measured in the test may be up to $2 \times TTI_{DCC}$ higher than the measurement reporting delays above because of TTI insertion uncertainty of the measurement report in DCC.

A.8.1.30 E-UTRAN TDD intra-frequency event triggered reporting under fading propagation conditions in synchronous cells for Cat-M1 UE in CEModeA in DRX

A.8.1.30.1 Test Purpose and Environment

The purpose of the two tests is to verify that the Cat-M1 UE in CEModeA makes correct reporting of an event in DRX. The tests will partly verify the TDD intra-frequency cell search in DRX requirements in clause 8.13.2.1.3.2.

The test parameters are given in Tables A.8.1.30.1-1, A.8.1.30.1-2, A.8.1.30.1-3 and A.8.1.30.1-4. In the measurement control information, it is indicated to the UE that event-triggered reporting with Event A3 is used. The test consists of two successive time periods, with time duration of T1, and T2 respectively. During time duration T1, the UE shall not have any timing information of cell 2. At the beginning of T2 the transmission power of cell 2 is increased to the same level as for cell 1, and due to usage of an offset this shall result in reporting of Event A3.

In Test 1 UE needs to be provided at least once every 500ms with new Timing Advance Command MAC control element to restart the Time alignment timer to keep UE uplink time alignment. Furthermore UE is allocated with PUSCH resource at every DRX cycle.

In Test 2 the uplink time alignment is not maintained and UE needs to use RACH to obtain UL allocation for measurement reporting.

Table A.8.1.30.1-1: General test parameters for E-UTRAN TDD intra-frequency event triggered reporting under fading propagation conditions in synchronous cells when DRX is used for Cat-M1 UE in CEModeA

Parameter	Unit	Value		Comments
		Test 1	Test 2	
E-UTRA RF Channel Number		1		One radio channel is used for both tests.
Active cell		Cell 1		
Neighbour cell		Cell 2		Cell to be identified.

CP length			Normal	
DRX			ON	
DRX related parameters are defined in Table A.8.1.30.1-3				
A3	Offset	dB	-6	
	Hysteresis	dB	0	
	Time To Trigger	s	0	
Special subframe configuration			6	
As specified in table 4.2-1 in TS 36.211. The same configuration in both cells				
Uplink-downlink configuration			1	
As specified in table 4.2-2 in TS 36.211. The same configuration in both cells				
Filter coefficient			0	
L3 filtering is not used				
Gap Pattern Id			0	
T1	s		5	
T2	s	5	30	

Table A.8.1.30.1-2: Cell specific test parameters for E-UTRAN TDD intra-frequency event triggered reporting under fading propagation conditions in synchronous cells when DRX is used for Cat-M1 UE in CEModeA

Parameter	Unit	Cell 1		Cell 2	
		T1	T2	T1	T2
E-UTRA RF Channel Number		1			
BW _{channel}	MHz	10			
PDSCH parameters: DL Reference Measurement Channel		R.17 TDD		-	
MPDCCH parameters: DL Reference Measurement Channel		R.15 TDD		R.15 TDD	
OCNG Patterns		OP.11 TDD		OP.2 TDD	
PBCH_RA	dB	-3			
PBCH_RB	dB				
PSS_RA	dB				
SSS_RA	dB				
PCFICH_RB	dB				
PHICH_RA	dB				
PHICH_RB	dB				
MPDCCH_RA	dB				
MPDCCH_RB	dB				
PDSCH_RA	dB				
PDSCH_RB	dB				
OCNG_RA ^{Note 1}	dB				
OCNG_RB ^{Note 1}	dB				
N _{oc} ^{Note 2}	dBm/15 kHz				
\hat{E}_s/N_{oc}	dB	4	4	-Infinity	4
\hat{E}_s/I_{ot} ^{Note 3}	dB	4	-1.46	-Infinity	-1.46
RSRP ^{Note 3}	dBm/15 kHz	-94	-94	-Infinity	-94
SCH_RP ^{Note 3}	dBm/15 kHz	-94	-94	-Infinity	-94
I _o ^{Note 3}	dBm/9 MHz	-64.76	-62.42	-64.76	-62.42
Propagation Condition		ETU30		ETU30	
Correlation Matrix and Antenna Configuration		2x1 Low		2x1 Low	
Time offset to Cell 1	μs	-		3	
Note 1	OCNG shall be used such that both cells are fully allocated and a constant total transmitted power spectral density is achieved for all OFDM symbols.				
Note 2:	Interference from other cells and noise sources not specified in the test is assumed to be constant over subcarriers and time and shall be modelled as AWGN of appropriate power for N _{oc} to be fulfilled.				
Note 3:	\hat{E}_s/I_{ot} , RSRP, SCH_RP and I _o levels have been derived from other parameters for information purposes. They are not settable parameters themselves.				
Note 4:	The resources for uplink transmission are assigned to the UE prior to the start of time period T2.				

Table A.8.1.30.1-3: DRX-Configuration for E-UTRAN TDD intra-frequency event triggered reporting in DRX under fading propagation conditions in synchronous cells

Field	Test1	Test2	Comment
	Value	Value	
onDurationTimer	psf1	psf1	As specified in clause 6.3.2 in TS 36.331
drx-InactivityTimer	psf1	psf1	
drx-RetransmissionTimer	psf1	psf1	
longDRX-CycleStartOffset	sf40	sf1280	
shortDRX	disable	disable	

Table A.8.1.30.1-4: TimeAlignmentTimer-Configuration for E-UTRAN TDD intra-frequency event triggered reporting in DRX under fading propagation conditions in synchronous cells

Field	Test1	Test2	Comment
	Value	Value	
TimeAlignmentTimer	sf500	sf500	As specified in clause 6.3.2 in TS 36.331
sr-ConfigIndex	2	2	For further information see clause 6.3.2 in TS 36.331 and clause 10.1 in TS 36.213.

A.8.1.30.2 Test Requirements

In Test 1, the UE shall send one Event A3 triggered measurement report, with a measurement reporting delay less than 1.44 second from the beginning of time period T2. The measurement reporting delay is defined as the time from the beginning of time period T2 to the moment when the UE send the measurement report on PUSCH.

In Test 2, the UE shall send one Event A3 triggered measurement report, with a measurement reporting delay less than 25.6 second from the beginning of time period T2. The measurement reporting delay is defined as the time from the beginning of time period T2 to the moment when the UE starts to send preambles on the PRACH for scheduling request (SR) to obtain allocation to send the measurement report on PUSCH.

The UE shall not send event triggered measurement reports, as long as the reporting criteria are not fulfilled.

The rate of correct events observed during repeated tests shall be at least 90%.

NOTE 1: The actual overall delays measured in the test may be up to one DRX cycle higher than the measurement reporting delays above because UE is allowed to delay the initiation of the measurement reporting procedure to the next until the Active Time.

NOTE 2: In order to calculate the rate of correct events the system simulator shall verify that it has received correct Event A3 measurement report.

A.8.1.31 E-UTRAN FDD-FDD intra-frequency event triggered reporting under fading propagation conditions in asynchronous cells for Cat-M1 UE in CEModeB

A.8.1.31.1 Test Purpose and Environment

The purpose of this test is to verify that the Cat-M1 UE makes correct reporting of an event. This test will partly verify the FDD intra-frequency cell search requirements for Cat-M1 UE in clause 8.13.3.1.1.1.

The test parameters are given in Table A.8.1.31.1-1 and A.8.1.31.1-2 below. In the measurement control information it is indicated to the UE that event-triggered reporting with Event A3 is used. The test consists of two successive time periods, with time duration of T1, and T2 respectively. During time duration T1, the UE shall not have any timing information of cell 2. At the beginning of T2 the transmission power of cell 2 is increased to the same level as for cell 1, and due to usage of an offset this shall result in reporting of Event A3.

Table A.8.1.31.1-1: General test parameters for E-UTRAN FDD-FDD intra-frequency event triggered reporting under fading propagation conditions in asynchronous cells for Cat-M1 UE in CEModeB

Parameter		Unit	Value	Comment
E-UTRA RF Channel Number			1	One radio channel is used.
Active cell			Cell 1	
Neighbour cell			Cell 2	Cell to be identified.
CP length			Normal	
DRX			OFF	
A3	Offset	dB	-8	
	Hysteresis	dB	0	
	Time To Trigger	s	0	
Filter coefficient			0	L3 filtering is not used
Gap pattern ID			0	
T1		s	5	
T2		s	≤325	

Table A.8.1.31.1-2: Cell specific test parameters for E-UTRAN FDD-FDD intra-frequency event triggered reporting under fading propagation conditions in asynchronous cells for Cat-M1 UE in CEModeB

Parameter	Unit	Cell 1		Cell 2	
		T1	T2	T1	T2
E-UTRA RF Channel Number		1			
BW _{channel}	MHz	10			
PDSCH parameters: DL Reference Measurement Channel		R.23 FDD		-	
MPDCCH parameters: DL Reference Measurement Channel		R.11 FDD		R.19 FDD	
OCNG Patterns		OP.21 FDD		OP.6 FDD	
PBCH_RA	dB	-3		-3	
PBCH_RB	dB				
PSS_RA	dB				
SSS_RA	dB				
PCFICH_RB	dB				
PHICH_RA	dB				
PHICH_RB	dB				
MPDCCH_RA	dB				
MPDCCH_PB	dB				
PDSCH_RA	dB				
PDSCH_RB	dB				
OCNG_RA ^{Note 1}	dB				
OCNG_RB ^{Note 1}	dB				
N_{oc} ^{Note 2}	dBm/15 KHz				
\hat{E}_s/N_{oc}	dB	-12	-12	-Infinity	-12
\hat{E}_s/I_{ot} ^{Note 3}	dB	-12	-12.27	-Infinity	-12.27
RSRP ^{Note 3}	dBm/15 KHz	-110	-110	-Infinity	-110
SCH_RP ^{Note 3}	dBm/15 KHz	-110	-110	-Infinity	-110
I_o ^{Note 3}	dBm/9MHz	-69.95	-69.70	Specified in Cell 1 columns	
Propagation Condition		ETU30		ETU30	
Correlation Matrix and Antenna Configuration		2x1 Low		2x1 Low	
Timing offset to Cell 1	ms	-		3	

Note 1:	OCNG shall be used such that all cells are fully allocated and a constant total transmitted power spectral density is achieved for all OFDM symbols.
Note 2:	Interference from other cells and noise sources not specified in the test is assumed to be constant over subcarriers and time and shall be modelled as AWGN of appropriate power for N_{oc} to be fulfilled.
Note 3:	E_s/lot , RSRP, SCH_RP and I_o have been derived from other parameters for information purposes. They are not settable parameters themselves.
Note 4:	The resources for uplink transmission are assigned to the UE prior to the start of time period T2.

A.8.1.31.2 Test Requirements

The UE shall send one Event A3 triggered measurement report, with a measurement reporting delay less than 320.8 s from the beginning of time period T2.

The UE shall not send event triggered measurement reports, as long as the reporting criteria are not fulfilled.

The rate of correct events observed during repeated tests shall be at least 90%.

NOTE: The actual overall delays measured in the test may be up to $2 \times TTI_{DCCH}$ higher than the measurement reporting delays above because of TTI insertion uncertainty of the measurement report in DCCH.

A.8.1.32 E-UTRAN FDD-FDD intra-frequency event triggered reporting under fading propagation conditions in synchronous cells for Cat-M1 UE in CEModeB

A.8.1.32.1 Test Purpose and Environment

The purpose of this test is to verify that the Cat-M1 UE makes correct reporting of an event. This test will partly verify the FDD intra-frequency cell search requirements in clause 8.13.3.1.1.1.

The test parameters are given in Table A.8.1.32.1-1 and A.8.1.32.1-2 below. In the measurement control information it is indicated to the UE that event-triggered reporting with Event A3 is used. MPDCCHs indicating new transmissions or retransmissions shall be sent continuously to ensure that the UE would not enter the DRX state. The test consists of two successive time periods, with time duration of T1, and T2 respectively. During time duration T1, the UE shall not have any timing information of cell 2. At the beginning of T2 the transmission power of cell 2 is increased to the same level as for cell 1, and due to usage of an offset this shall result in reporting of Event A3.

Table A.8.1.32.1-1: General test parameters for E-UTRAN FDD-FDD intra-frequency event triggered reporting under fading propagation conditions in synchronous cells for Cat-M1 UE in CEModeB

Parameter		Unit	Value	Comment
E-UTRA RF Channel Number			1	One radio channel is used.
Active cell			Cell 1	
Neighbour cell			Cell 2	Cell to be identified.
CP length			Normal	
DRX			OFF	
A3	Offset	dB	-8	
	Hysteresis	dB	0	
	Time To Trigger	s	0	
Filter coefficient			0	L3 filtering is not used
Gap pattern ID			0	
T1		s	5	
T2		s	≤ 325	

Table A.8.1.32.1-2: Cell specific test parameters for E-UTRAN FDD-FDD intra-frequency event triggered reporting under fading propagation conditions for Cat-M1 UE in synchronous cells in CEModeB

Parameter	Unit	Cell 1		Cell 2	
		T1	T2	T1	T2

E-UTRA RF Channel Number		1			
BW _{channel}	MHz	10			
PDSCH parameters: DL Reference Measurement Channel		R.23 FDD		-	
MPDCCH parameters: DL Reference Measurement Channel		R.19 FDD		R.19 FDD	
OCNG Patterns		OP.21 FDD		OP.6 FDD	
PBCH_RA	dB	-3		-3	
PBCH_RB	dB				
PSS_RA	dB				
SSS_RA	dB				
PCFICH_RB	dB				
PHICH_RA	dB				
PHICH_RB	dB				
MPDCCH_RA	dB				
MPDCCH_PB	dB				
PDSCH_RA	dB				
PDSCH_RB	dB				
OCNG_RA ^{Note 1}	dB				
OCNG_RB ^{Note 1}	dB				
N _{oc} ^{Note 2}	dBm/15 KHz				
\hat{E}_s/N_{oc}	dB	-12	-12	-Infinity	-12
\hat{E}_s/I_{ot} ^{Note 3}	dB	-12	-12.27	-Infinity	-12.27
RSRP ^{Note 3}	dBm/15 KHz	-110	-110	-Infinity	-110
SCH_RP ^{Note 3}	dBm/15 KHz	-110	-110	-Infinity	-110
I _o ^{Note 3}	dBm/9MHz	-69.95	-69.70	Specified in Cell 1 columns	
Propagation Condition		ETU30		ETU30	
Correlation Matrix and Antenna Configuration		2x1 Low		2x1 Low	
Timing offset to Cell 1	μs	-		3	
<p>Note 1: OCNG shall be used such that all cells are fully allocated and a constant total transmitted power spectral density is achieved for all OFDM symbols.</p> <p>Note 2: Interference from other cells and noise sources not specified in the test is assumed to be constant over subcarriers and time and shall be modelled as AWGN of appropriate power for N_{oc} to be fulfilled.</p> <p>Note 3: Es/Iot, RSRP, SCH_RP and Io have been derived from other parameters for information purposes. They are not settable parameters themselves.</p> <p>Note 4: The resources for uplink transmission are assigned to the UE prior to the start of time period T2.</p>					

A.8.1.32.2 Test Requirements

The UE shall send one Event A3 triggered measurement report, with a measurement reporting delay less than 320.8 s from the beginning of time period T2.

The UE shall not send event triggered measurement reports, as long as the reporting criteria are not fulfilled.

The rate of correct events observed during repeated tests shall be at least 90%.

NOTE: The actual overall delays measured in the test may be up to 2xTTI_{DCCH} higher than the measurement reporting delays above because of TTI insertion uncertainty of the measurement report in DCCH.

A.8.1.33 E-UTRAN HD-FDD intra-frequency event triggered reporting under fading propagation conditions in asynchronous cells for Cat-M1 UE in CEModeB

A.8.1.33.1 Test Purpose and Environment

The purpose of this test is to verify that the Cat-M1 UE makes correct reporting of an event. This test will partly verify the HD-FDD intra-frequency cell search requirements in clause 8.13.3.1.2.1.

The test parameters are given in Table A.8.1.33.1-1 and A.8.1.33.1-2 below. In the measurement control information it is indicated to the UE that event-triggered reporting with Event A3 is used. The test consists of two successive time periods, with time duration of T1 and T2 respectively. During time duration T1, the UE shall not have any timing information of cell 2. At the beginning of T2 the transmission power of cell 2 is increased to the same level as for cell 1, and due to usage of an offset this shall result in reporting of Event A3.

Table A.8.1.33.1-1: General test parameters for E-UTRAN HD-FDD intra-frequency event triggered reporting under fading propagation conditions in asynchronous cells for Cat-M1 UE in CEModeB

Parameter		Unit	Value	Comment
E-UTRA RF Channel Number			1	One radio channel is used for this test
Active Cell			Cell 1	
Neighbour cell			Cell 2	Cell to be identified
CP length			Normal	
DRX			OFF	
A3	Offset	dB	-8	
	Hysteresis	dB	0	
	Time To Trigger	s	0	
Filter coefficient			0	L3 filtering is not used
Gap pattern ID			0	
T1		s	5	
T2		s	≤325	

Table A.8.1.33.1-2: Cell specific test parameters for E-UTRAN HD-FDD intra-frequency event triggered reporting under fading propagation conditions in asynchronous cells for Cat-M1 UE in CEModeB

Parameter	Unit	Cell 1		Cell 2	
		T1	T2	T1	T2
E-UTRA RF Channel Number		1			
BW _{channel}	MHz	10			
PDSCH parameters: DL Reference Measurement Channel		R.13 HD-FDD		-	
MPDCCH parameters: DL Reference Measurement Channel		R.9 HD-FDD		R.9HD-FDD	
OCNG Patterns		OP.21 FDD		OP.6 FDD	
PBCH_RA	dB	-3			
PBCH_RB	dB				
PSS_RA	dB				
SSS_RA	dB				
PCFICH_RB	dB				
PHICH_RA	dB				
PHICH_RB	dB				
MPDCCH_RA	dB				
MPDCCH_PB	dB				
PDSCH_RA	dB				
PDSCH_RB	dB				
OCNG_RA ^{Note 1}	dB				
OCNG_RB ^{Note 1}	dB				

N_{oc} ^{Note 2}	dBm/15 kHz	-98			
\bar{E}_s/N_{oc}	dB	-12	-12	-infinity	-12
\bar{E}_s/I_{ot} ^{Note 3}	dB	-12	-12.27	-infinity	-12.27
RSRP ^{Note 3}	dBm/15 kHz	-110	-110	-infinity	-110
SCH_RP ^{Note 3}	dBm/15 kHz	-110	-110	-infinity	-110
I_o ^{Note 3}	dBm/9MHz	-69.95	-69.70	Specified in Cell 1 columns	
Propagation Condition		ETU30		ETU30	
Correlation Matrix and Antenna Configuration		2x1 Low		2x1 Low	
Timing offset to Cell 1	ms	-		3	
<p>Note 1: OCNB shall be used such that all cells are fully allocated and a constant total transmitted power spectral density is achieved for all OFDM symbols.</p> <p>Note 2: Interference from other cells and noise sources not specified in the test is assumed to be constant over subcarriers and time and shall be modelled as AWGN of appropriate power for N_{oc} to be fulfilled.</p> <p>Note 3: \bar{E}_s/I_{ot}, RSRP, SCH_RP and I_o have been derived from other parameters for information purposes. They are not settable parameters themselves.</p> <p>Note 4: The resources for uplink transmission are assigned to the UE prior to the start of time period T2.</p>					

A.8.1.33.2 Test Requirements

The UE shall send one Event A3 triggered measurement report, with a measurement reporting delay less than 320.8s from the beginning of time period T2.

The UE shall not send event triggered measurement reports as long as the reporting criteria are not fulfilled.

The rate of correct events observed during repeated tests shall be at least 90%.

NOTE: The actual overall delays measured in the tests may be up to $2 \times TTI_{DCCH}$ higher than the measurement reporting delays above because of TTI insertion uncertainty of the measurement report in DCCH.

A.8.1.34 E-UTRAN HD-FDD intra-frequency event triggered reporting under fading propagation conditions in synchronous cells for Cat-M1 UE in CEModeB

A.8.1.34.1 Test Purpose and Environment

The purpose of this test is to verify that the Cat-M1 UE makes correct reporting of an event. This test will partly verify the HD-FDD intra-frequency cell search requirements in clause 8.13.3.1.2.1.

The test parameters are given in Table A.8.1.34.1-1 and A.8.1.34.1-2 below. In the measurement control information it is indicated to the UE that event-triggered reporting with Event A3 is used. The test consists of two successive time periods, with time duration of T1 and T2 respectively. During time duration T1, the UE shall not have any timing information of cell 2. At the beginning of T2 the transmission power of cell 2 is increased to the same level as for cell 1, and due to usage of an offset this shall result in reporting of Event A3.

Table A.8.1.34.1-1: General test parameters for E-UTRAN HD-FDD intra-frequency event triggered reporting under fading propagation conditions in synchronous cells for Cat-M1 UE in CEModeB

Parameter		Unit	Value	Comment
E-UTRA RF Channel Number			1	One radio channel is used for this test
Active cell			Cell 1	
Neighbour cell			Cell 2	Cell to be identified.
CP length			Normal	
DRX			OFF	
A3	Offset	dB	-8	
	Hysteresis	dB	0	
	Time To Trigger	s	0	
Filter coefficient			0	L3 filtering is not used

Gap pattern ID		0	As specified in TS 36.133 clause 8.1.2.1.
T1	s	5	
T2	s	≤325	

Table A.8.1.34.1-2: Cell specific test parameters for E-UTRAN HD-FDD intra-frequency event triggered reporting under fading propagation conditions in synchronous cells for Cat-M1 UE in CEModeB

Parameter	Unit	Cell 1		Cell 2	
		T1	T2	T1	T2
E-UTRA RF Channel Number		1			
BW _{channel}	MHz	10			
PDSCH parameters: DL Reference Measurement Channel		R.13 HD-FDD		-	
MPDCCH parameters: DL Reference Measurement Channel		R.9 HD-FDD		R.9 HD-FDD	
OCNG Patterns		OP.21 FDD		OP.6 FDD	
PBCH_RA	dB	-3		-3	
PBCH_RB	dB				
PSS_RA	dB				
SSS_RA	dB				
PCFICH_RB	dB				
PHICH_RA	dB				
PHICH_RB	dB				
MPDCCH_RA	dB				
MPDCCH_PB	dB				
PDSCH_RA	dB				
PDSCH_RB	dB				
OCNG_RA ^{Note 1}	dB				
OCNG_RB ^{Note 1}	dB				
N_{oc} ^{Note 2}	dBm/15 KHz				
\hat{E}_s/N_{oc}	dB	-12	-12	-infinity	-12
\hat{E}_s/I_{ot} ^{Note 3}	dB	-12	-12.27	-infinity	-12.27
RSRP ^{Note 3}	dBm/15 KHz	-110	-110	-infinity	-110
SCH_RP ^{Note 3}	dBm/15 KHz	-110	-110	-infinity	-110
I_o ^{Note 3}	dBm/9MHz	-69.95	-69.70	Specified in Cell 1 columns	
Propagation Condition		ETU30		ETU30	
Correlation Matrix and Antenna Configuration		2x1 Low		2x1 Low	
Timing offset to Cell 1	μs	-		3	
<p>Note 1: OCNG shall be used such that all cells are fully allocated and a constant total transmitted power spectral density is achieved for all OFDM symbols.</p> <p>Note 2: Interference from other cells and noise sources not specified in the test is assumed to be constant over subcarriers and time and shall be modelled as AWGN of appropriate power for N_{oc} to be fulfilled.</p> <p>Note 3: E_s/I_{ot}, RSRP, SCH_RP and I_o have been derived from other parameters for information purposes. They are not settable parameters themselves.</p> <p>Note 4: The resources for uplink transmission are assigned to the UE prior to the start of time period T2.</p>					

A.8.1.34.2 Test Requirements

The UE shall send one Event A3 triggered measurement report, with a measurement reporting delay less than 320.8s from the beginning of time period T2.

The UE shall not send event triggered measurement reports, as long as the reporting criteria are not fulfilled.

The rate of correct events observed during repeated tests shall be at least 90%.

NOTE: The actual overall delays measured in the test may be up to $2 \times TTI_{DCCH}$ higher than the measurement reporting delays above because of TTI insertion uncertainty of the measurement report in DCCH.

A.8.1.35 E-UTRAN TDD intra-frequency event triggered reporting under fading propagation conditions in synchronous cells for Cat-M1 UE in CEModeB

A.8.1.35.1 Test Purpose and Environment

The purpose of this test is to verify that the Cat-M1 UE in CEModeB makes correct reporting of an event. This test will partly verify the TDD intra-frequency cell search requirements in clause 8.13.3.1.3.1.

The test parameters are given in Table A.8.1.35.1-1 and A.8.1.35.1-2 below. In the measurement control information it is indicated to the UE that event-triggered reporting with Event A3 is used. The test consists of two successive time periods, with time duration of T1 and T2 respectively. During time duration T1, the UE shall not have any timing information of cell 2. At the beginning of T2 the transmission power of cell 2 is increased to the same level as for cell 1, and due to usage of an offset this shall result in reporting of Event A3.

Table A.8.1.35.1-1: General test parameters for E-UTRAN TDD intra-frequency event triggered reporting under fading propagation conditions in synchronous cells for Cat-M1 UE in CEModeB

Parameter		Unit	Value	Comments
E-UTRA RF Channel Number			1	One radio channel is used for this test.
Active cell			Cell 1	
Neighbour cell			Cell 2	Cell to be identified.
CP length			Normal	
DRX			OFF	
A3	Offset	dB	-8	
	Hysteresis	dB	0	
	Time To Trigger	s	0	
Special subframe configuration			6	As specified in table 4.2-1 in TS 36.211. The same configuration in both cells
Uplink-downlink configuration			1	As specified in table 4.2-2 in TS 36.211. The same configuration in both cells
Filter coefficient			0	L3 filtering is not used
Gap Pattern Id			0	
T1		s	5	
T2		s	≤ 325	

Table A.8.1.35.1-2: Cell specific test parameters for E-UTRAN TDD intra-frequency event triggered reporting under fading propagation conditions in synchronous cells for Cat-M1 UE in CEModeB

Parameter	Unit	Cell 1		Cell 2	
		T1	T2	T1	T2
E-UTRA RF Channel Number		1			
$BW_{channel}$	MHz	10			
PDSCH parameters: DL Reference Measurement Channel		R.19 TDD		-	
MPDCCH parameters: DL Reference Measurement Channel		R.17 TDD		R.17 TDD	
OCNG Patterns		OP.11 TDD		OP.2 TDD	
PBCH_RA	dB	-3		-3	
PBCH_RB	dB				
PSS_RA	dB				
SSS_RA	dB				
PCFICH_RB	dB				
PHICH_RA	dB				
PHICH_RB	dB				
MPDCCH_RA	dB				
MPDCCH_RB	dB				

PDSCH_RA	dB				
PDSCH_RB	dB				
OCNG_RA ^{Note 1}	dB				
OCNG_RB ^{Note 1}	dB				
N _{oc} ^{Note 2}	dBm/15 kHz		-98		
\hat{E}_s/N_{oc}	dB	-12	-12	-Infinity	-12
\hat{E}_s/I_{ot} ^{Note 3}	dB	-12	-12.27	-Infinity	-12.27
RSRP ^{Note 3}	dBm/15 kHz	-110	-110	-Infinity	-110
SCH_RP ^{Note 3}	dBm/15 kHz	-110	-110	-Infinity	-110
I _o ^{Note 3}	dBm/9 MHz	-69.95	-69.70	Specified in Cell 1 columns	Specified in Cell 1 columns
Propagation Condition		ETU30		ETU30	
Correlation Matrix and Antenna Configuration		2x1 Low		2x1 Low	
Time offset to Cell 1	μ s	-		3	
Note 1	OCNG shall be used such that both cells are fully allocated and a constant total transmitted power spectral density is achieved for all OFDM symbols.				
Note 2:	Interference from other cells and noise sources not specified in the test is assumed to be constant over subcarriers and time and shall be modelled as AWGN of appropriate power for N _{oc} to be fulfilled.				
Note 3:	\hat{E}_s/I_{ot} , RSRP, SCH_RP and I _o levels have been derived from other parameters for information purposes. They are not settable parameters themselves.				
Note 4:	The resources for uplink transmission are assigned to the UE prior to the start of time period T2.				

A.8.1.35.2 Test Requirements

The UE shall send one Event A3 triggered measurement report, with a measurement reporting delay less than 323.2 seconds from the beginning of time period T2.

The UE shall not send event triggered measurement reports, as long as the reporting criteria are not fulfilled.

The rate of correct events observed during repeated tests shall be at least 90%.

NOTE: The actual overall delays measured in the test may be up to $2 \times TTI_{DCC}$ higher than the measurement reporting delays above because of TTI insertion uncertainty of the measurement report in DCC.

A.8.1.36 E-UTRAN FDD Intra-frequency identification of a new CGI of E-UTRA cell using autonomous gaps for Cat-M1 UE in CEModeB

A.8.1.36.1 Test Purpose and Environment

This test is to verify the requirement for identification of a new CGI of E-UTRA cell with autonomous gaps in clause 8.13.3.1.4.

The test scenario comprises of one E-UTRA FDD carrier and two cells as given in tables A.8.1.36.1-1 and A.8.1.36.1-2. The test consists of three successive time periods, with time durations of T1, T2 and T3 respectively. At the start of time duration T1, the UE does not have any timing information of cell 2. Starting T2, cell 2 becomes detectable and the UE is expected to detect and send a measurement report.

A RRC message implying SI reading shall be sent to the UE during period T2, after the UE has reported Event A3. The RRC message shall create a measurement report configuration with purpose *reportCGI* and *si-RequestForHO* set to TRUE. The start of T3 is the instant when the last TTI containing the RRC message implying SI reading is sent to the UE.

Table A.8.1.36.1-1: General test parameters for E-UTRAN FDD Intra-frequency identification of a new CGI of E-UTRA cell using autonomous gaps for Cat-M1 UE in CEModeB

Parameter	Unit	Value	Comment
Active cell		Cell 1	
Neighbour cell		Cell 2	Cell to be identified.
CP length		Normal	
A3-Offset	dB	-16	
Hysteresis	dB	0	

Time To Trigger	s	0	
Filter coefficient		0	L3 filtering is not used
DRX		OFF	
si-RequestForHO		TRUE	As specified in clause 5.5.3.1 in TS 36.331.
T1	s	5	
T2	s	≤ 325	
T3	s	7	

Table A.8.1.36.1-2: Cell specific test parameters for E-UTRAN FDD Intra-frequency identification of a new CGI of E-UTRA cell using autonomous gaps for Cat-M1 UE in CEModeB

Parameter	Unit	Cell 1			Cell 2				
		T1	T2	T3	T1	T2	T3		
E-UTRA RF Channel Number		1							
BW _{channel}	MHz	10							
PDSCH Reference Channel in clause A.3.1.4.4		R.23 FDD			N/A				
MPDCCH Reference Channel in clause A.3.1.3.4		R.19 FDD			N/A				
OCNG Patterns defined in A.3.2.1.21 (OP.21 FDD) and in A.3.2.1.6 (OP.6 FDD)		OP.21 FDD			OP.6 FDD				
PBCH_RA	dB								
PBCH_RB	dB								
PSS_RA	dB							-3	-3
SSS_RA	dB								
PHICH_RA	dB							-3	-3
PHICH_PB	dB								
MPDCCH_RA	dB							0	0
MPDCCH_PB	dB								
PDSCH_RA	dB							-3	-3
PDSCH_RB	dB								
OCNG_RA ^{Note 1}	dB								
OCNG_RB ^{Note 1}	dB								
N_{oc} ^{Note 2}	dBm/15 KHz	-98							
\hat{E}_s/N_{oc}	dB	8	8	8	-Infinity	-3	-3		
\hat{E}_s/I_{ot}		8	6.24	6.24	-Infinity	-11.64	-11.64		
RSRP ^{Note 3}	dBm/15 KHz	-90	-90	-90	-Infinity	-101	-101		
SCH_RP ^{Note 3}	dBm/15 KHz	-90	-90	-90	-Infinity	-101	-101		
I_o ^{Note 3}	dBm/9MHz	-61.58	-61.29	-61.29	Specified in columns for Cell 1				
Propagation Condition		AWGN			AWGN				
Antenna Configuration		2x1			2x1				
Timing offset to Cell 1	ms	-			3				
PBCH repetition					Configured as specified in TS 36.211 [16]				
SIB1-BR repetition level		-			16				
<p>Note 1: OCNG shall be used such that both cells are fully allocated and a constant total transmitted power spectral density is achieved for all OFDM symbols.</p> <p>Note 2: Interference from other cells and noise sources not specified in the test is assumed to be constant over subcarriers and time and shall be modelled as AWGN of appropriate power for N_{oc} to be fulfilled.</p> <p>Note 3: E_s/I_{ot}, RSRP, SCH_RP and I_o levels have been derived from other parameters for information purposes. They are not settable parameters themselves.</p>									

A.8.1.36.2 Test Requirements

The UE shall transmit a measurement report containing the cell global identifier of cell 2 within 5137 ms from the start of T3.

$$\begin{aligned} \text{Test requirement} &= \text{RRC Procedure delay} + T_{\text{identify_CGI_CatM1, intra}} + \text{reporting delay} \\ &= 15 + 5120 + 2 \text{ms from the start of T3} \\ &= 5137 \text{ ms.} \end{aligned}$$

The rate of correct events observed during repeated tests shall be at least 90%.

A.8.1.37 E-UTRAN FDD Intra-frequency identification of a new CGI of E-UTRA cell using autonomous gaps with DRX for Cat-M1 UE in CEModeB

A.8.1.37.1 Test Purpose and Environment

This test is to verify the requirement for identification of a new CGI of E-UTRA cell with autonomous gaps in clause 8.13.3.1.4. The requirement is verified in a DRX configuration.

The test scenario comprises of one E-UTRA FDD carrier and two cells as given in tables A.8.1.37.1-1 and A.8.1.37.1-2. The test consists of three successive time periods, with time durations of T1, T2 and T3 respectively. At the start of time duration T1, the UE does not have any timing information of cell 2. Starting T2, cell 2 becomes detectable and the UE is expected to detect and send a measurement report.

A RRC message implying SI reading shall be sent to the UE during period T2, after the UE has reported Event A3. The RRC message shall create a measurement report configuration with purpose *reportCGI* and *si-RequestForHO* set to TRUE. The start of T3 is the instant when the last TTI containing the RRC message implying SI reading is sent to the UE.

In the test UE needs to be provided at least once every 1280ms with new Timing Advance Command MAC control element to restart the Time alignment timer to keep UE uplink time alignment. Furthermore UE sends scheduling request (SR) to obtain allocation to send the measurement report on PUSCH.

Table A.8.1.37.1-1: General test parameters for E-UTRAN FDD Intra-frequency identification of a new CGI of E-UTRA cell using autonomous gaps with DRX for Cat-M1 UE in CEModeB

Parameter	Unit	Value	Comment
Active cell		Cell 1	
Neighbour cell		Cell 2	Cell to be identified.
Channel Bandwidth (BW_{channel})	MHz	10	
CP length		Normal	
A3-Offset	dB	-16	
Hysteresis	dB	0	
Time To Trigger	s	0	
Filter coefficient		0	L3 filtering is not used
DRX		ON	DRX related parameters are defined in Table A.8.1.37.1-3
si-RequestForHO		TRUE	As specified in clause 5.5.3.1 in TS 36.331.
T1	s	5	
T2	s	≤ 325	
T3	s	7	

Table A.8.1.37.1-2: Cell specific test parameters for E-UTRAN FDD Intra-frequency identification of a new CGI of E-UTRA cell using autonomous gaps with DRX for Cat-M1 UE in CEModeB

Parameter	Unit	Cell 1			Cell 2		
		T1	T2	T3	T1	T2	T3
E-UTRA RF Channel Number		1					

BW _{channel}	MHz	10					
PDSCH Reference Channel in clause A.3.1.4.4		R.23 FDD			N/A		
MPDCCH Reference Channel in clause A.3.1.3.4		R.19 FDD			N/A		
OCNG Patterns defined in A.3.2.1.21 (OP.21 FDD) and in A.3.2.1.6 (OP.6 FDD)		OP.21 FDD			OP.6 FDD		
PBCH_RA	dB	-3			-3		
PBCH_RB	dB						
PSS_RA	dB						
SSS_RA	dB						
PHICH_RA	dB	-3			-3		
PHICH_PB	dB						
MPDCCH_RA	dB	0			0		
MPDCCH_PB	dB						
PDSCH_RA	dB	-3			-3		
PDSCH_RB	dB						
OCNG_RA ^{Note 1}	dB						
OCNG_RB ^{Note 1}	dB						
N_{oc} ^{Note 2}		-98					
\hat{E}_s / N_{oc}	dB	8	8	8	-Infinity	-3	-3
\hat{E}_s / I_{ot}	dB	8	6.24	6.24	-Infinity	-11.64	-11.64
RSRP ^{Note 3}	dBm/15 KHz	-90	-90	-90	-Infinity	-101	-101
SCH_RP ^{Note 3}	dBm/15 KHz	-90	-90	-90	-Infinity	-101	-101
I_o ^{Note 3}	dBm/9MHz	-61.58	-61.29	-61.29	Specified in columns for Cell 1		
Propagation Condition		AWGN					
Antenna Configuration		2x1			2x1		
Timing offset to Cell 1	ms	-			3		
PBCH repetition					Configured as specified in TS 36.211 [16]		
SIB1-BR repetition level		-			16		
<p>Note 1: OCNG shall be used such that both cells are fully allocated and a constant total transmitted power spectral density is achieved for all OFDM symbols.</p> <p>Note 2: Interference from other cells and noise sources not specified in the test is assumed to be constant over subcarriers and time and shall be modelled as AWGN of appropriate power for N_{oc} to be fulfilled.</p> <p>Note 3: E_s/I_{ot}, RSRP, SCH_RP and I_o levels have been derived from other parameters for information purposes. They are not settable parameters themselves.</p>							

Table A.8.1.37.1-3: DRX configuration for E-UTRAN FDD Intra-frequency identification of a new CGI of E-UTRA cell using autonomous gaps with DRX for Cat-M1 UE in CEModeB

Field	Value	Comment
onDurationTimer	psf1	As specified in clause 6.3.2 in TS 36.331
drx-InactivityTimer	psf1	
drx-RetransmissionTimer	psf1	
longDRX-CycleStartOffset	sf1280	
shortDRX	disable	

Table A.8.1.37.1-4: TimeAlignmentTimer -Configuration for E-UTRAN FDD Intra-frequency identification of a new CGI of E-UTRA cell using autonomous gaps with DRX for Cat-M1 UE in CeModeB

Field	Value	Comment

TimeAlignmentTimer	Infinity	As specified in clause 6.3.2 in TS 36.331
sr-ConfigIndex	0	For further information see clause 6.3.2 in TS 36.331 and section 10.1 in TS 36.213.

A.8.1.37.2 Test Requirements

The UE shall transmit a measurement report containing the cell global identifier of cell 2 within 5120 ms from the start of T3.

Test requirement = RRC Procedure delay + $T_{\text{identify_CGI_CatM1, intra}}$ + reporting delay

= 15 + 5120 + 2ms from the start of T3

= 5137 ms.

The rate of correct events observed during repeated tests shall be at least 90%.

A.8.1.38 E-UTRAN HD - FDD Intra-frequency identification of a new CGI of E-UTRA cell using autonomous gaps for Cat-M1 UE in CEModeB

A.8.1.38.1 Test Purpose and Environment

This test is to verify the requirement for identification of a new CGI of E-UTRA cell with autonomous gaps in clause 8.13.3.1.5.

The test scenario comprises of one E-UTRA FDD carrier and two cells as given in tables A.8.1.38.1-1 and A.8.1.38.1-2. The test consists of three successive time periods, with time durations of T1, T2 and T3 respectively. At the start of time duration T1, the UE does not have any timing information of cell 2. Starting T2, cell 2 becomes detectable and the UE is expected to detect and send a measurement report.

A RRC message implying SI reading shall be sent to the UE during period T2, after the UE has reported Event A3. The RRC message shall create a measurement report configuration with purpose *reportCGI* and *si-RequestForHO* set to TRUE. The start of T3 is the instant when the last TTI containing the RRC message implying SI reading is sent to the UE.

Table A.8.1.38.1-1: General test parameters for E-UTRAN HD - FDD Intra-frequency identification of a new CGI of E-UTRA cell using autonomous gaps for Cat-M1 UE in CEModeB

Parameter	Unit	Value	Comment
Active cell		Cell 1	
Neighbour cell		Cell 2	Cell to be identified.
Channel Bandwidth (BW_{channel})	MHz	10	
CP length		Normal	
A3-Offset	dB	-16	
Hysteresis	dB	0	
Time To Trigger	s	0	
Filter coefficient		0	L3 filtering is not used
DRX		OFF	
si-RequestForHO		TRUE	As specified in clause 5.5.3.1 in TS 36.331.
T1	s	5	
T2	s	≤ 325	
T3	s	7	

Table A.8.1.38.1-2: Cell specific test parameters for E-UTRAN HD - FDD Intra-frequency identification of a new CGI of E-UTRA cell using autonomous gaps for Cat-M1 UE in CEModeB

Parameter	Unit	Cell 1			Cell 2		
		T1	T2	T3	T1	T2	T3
E-UTRA RF Channel Number			1			1	

$BW_{channel}$	MHz	10			10		
PDSCH Reference Channel in clause A.3.1.4.5		R.13 HD-FDD			N/A		
MPDCCH Reference Channel in clause A.3.1.3.5		R.9 HD-FDD			N/A		
OCNG Patterns defined in A.3.2.1.21 (OP.21 FDD) and in A.3.2.1.2 (OP.2 FDD)		OP.21 FDD	OP.21 FDD	OP.21 FDD	OP.6 FDD	OP.6 FDD	OP.6 FDD
PBCH_RA	dB						
PBCH_RB	dB						
PSS_RA	dB	-3			-3		
SSS_RA	dB						
PHICH_RA	dB	-3			-3		
PHICH_PB	dB						
MPDCCH_RA	dB	0			0		
MPDCCH_PB	dB						
PDSCH_RA	dB						
PDSCH_RB	dB	-3			-3		
OCNG_RA ^{Note 1}	dB						
OCNG_RB ^{Note 1}	dB						
N_{oc} ^{Note 2}		-98					
\hat{E}_s/N_{oc}	dB	8	8	8	-Infinity	-3	-3
\hat{E}_s/I_{ot}	dB	8	6.24	6.24	-Infinity	-11.64	-11.64
RSRP ^{Note 3}	dBm/15 KHz	-90	-90	-90	-Infinity	-101	-101
SCH_RP ^{Note 3}	dBm/15 KHz	-90	-90	-90	-Infinity	-101	-101
I_o ^{Note 3}	dBm/9MHz	-61.58	-61.29	-61.29	Specified in columns for Cell 1		
Propagation Condition		AWGN					
Antenna Configuration		2x1			2x1		
Timing offset to Cell 1	ms	-			3		
PBCH repetition					Configured as specified in TS 36.211 [16]		
SIB1-BR repetition level					16		
<p>Note 1: OCNG shall be used such that both cells are fully allocated and a constant total transmitted power spectral density is achieved for all OFDM symbols.</p> <p>Note 2: Interference from other cells and noise sources not specified in the test is assumed to be constant over subcarriers and time and shall be modelled as AWGN of appropriate power for N_{oc} to be fulfilled.</p> <p>Note 3: E_s/I_{ot}, RSRP, SCH_RP and I_o levels have been derived from other parameters for information purposes. They are not settable parameters themselves.</p>							

A.8.1.38.2 Test Requirements

The UE shall transmit a measurement report containing the cell global identifier of cell 2 within 5137 ms from the start of T3.

Test requirement = RRC Procedure delay + $T_{identify_CGI_Cat M1, intra}$ + reporting delay

= 15 + 5120 + 2ms from the start of T3

= 5137 ms.

The rate of correct events observed during repeated tests shall be at least 90%.

A.8.1.39 E-UTRAN HD - FDD Intra-frequency identification of a new CGI of E-UTRA cell using autonomous gaps with DRX for Cat-M1 UE in CEModeB

A.8.1.39.1 Test Purpose and Environment

This test is to verify the requirement for identification of a new CGI of E-UTRA cell with autonomous gaps in clause 8.13.3.1.5. The requirement is verified in a DRX configuration.

The test scenario comprises of one E-UTRA FDD carrier and two cells as given in tables A.8.1.39.1-1 and A.8.1.39.1-2. The test consists of three successive time periods, with time durations of T1, T2 and T3 respectively. At the start of time duration T1, the UE does not have any timing information of cell 2. Starting T2, cell 2 becomes detectable and the UE is expected to detect and send a measurement report.

A RRC message implying SI reading shall be sent to the UE during period T2, after the UE has reported Event A3. The RRC message shall create a measurement report configuration with purpose *reportCGI* and *si-RequestForHO* set to TRUE. The start of T3 is the instant when the last TTI containing the RRC message implying SI reading is sent to the UE.

In the test UE needs to be provided at least once every 1280ms with new Timing Advance Command MAC control element to restart the Time alignment timer to keep UE uplink time alignment. Furthermore UE sends scheduling request (SR) to obtain allocation to send the measurement report on PUSCH.

Table A.8.1.39.1-1: General test parameters for E-UTRAN HD - FDD Intra-frequency identification of a new CGI of E-UTRA cell using autonomous gaps with DRX for Cat-M1 UE in CEModeB

Parameter	Unit	Value	Comment
Active cell		Cell 1	
Neighbour cell		Cell 2	Cell to be identified.
Channel Bandwidth ($BW_{channel}$)	MHz	10	
CP length		Normal	
A3-Offset	dB	-16	
Hysteresis	dB	0	
Time To Trigger	s	0	
Filter coefficient		0	L3 filtering is not used
DRX		ON	DRX related parameters are defined in Table A.8.1.39.1-3
si-RequestForHO		TRUE	As specified in clause 5.5.3.1 in TS 36.331.
T1	s	5	
T2	s	≤ 325	
T3	s	7	

Table A.8.1.39.1-2: Cell specific test parameters for E-UTRAN HD - FDD Intra-frequency identification of a new CGI of E-UTRA cell using autonomous gaps with DRX for Cat-M1 UE in CEModeB

Parameter	Unit	Cell 1			Cell 2		
		T1	T2	T3	T1	T2	T3
E-UTRA RF Channel Number		1			1		
$BW_{channel}$	MHz	10			10		
PDSCH Reference Channel as specified in clause A.3.1.4.5		DL Reference Measurement Channel R.13 HD-FDD			N/A		
MPDCCH Reference Channel as specified in clause A.3.1.3.5		DL Reference Measurement Channel R.9 HD-FDD			N/A		
OCNG Patterns defined in A.3.2.1.21 (OP.21 FDD) and in A.3.2.1.6 (OP.6 FDD)		OP.21 FDD	OP.21 FDD	OP.21 FDD	OP.6 FDD	OP.6 FDD	OP.6 FDD
PBCH_RA	dB	-3			-3		
PBCH_RB	dB						
PSS_RA	dB						

SSS_RA	dB						
PHICH_RA	dB	-3			-3		
PHICH_PB	dB						
MPDCCH_RA	dB	0			0		
MPDCCH_PB	dB						
PDSCH_RA	dB	-3			-3		
PDSCH_RB	dB						
OCNG_RA ^{Note 1}	dB						
OCNG_RB ^{Note 1}	dB						
N_{oc} ^{Note 2}	dBm/15 KHz	-98					
\hat{E}_s / N_{oc}	dB	8	8	8	-Infinity	-3	-3
\hat{E}_s / I_{ot}	dB	8	6.24	6.24	-Infinity	-11.64	-11.64
RSRP ^{Note 3}	dBm/15 KHz	-90	-90	-90	-Infinity	-101	-101
SCH_RP ^{Note3}	dBm/15 KHz	-90	-90	-90	-Infinity	-101	-101
I_o ^{Note 3}	dBm/9MHz	-61.58	-61.29	-61.29	Specified in columns for Cell 1		
Propagation Condition		AWGN					
Antenna Configuration		2x1			2x1		
Timing offset to Cell 1	ms	-			3		
PBCH repetition		-			Configured as specified in TS 36.211 [16]		
SIB1-BR repetition level		-			16		
<p>Note 1: OCNG shall be used such that both cells are fully allocated and a constant total transmitted power spectral density is achieved for all OFDM symbols.</p> <p>Note 2: Interference from other cells and noise sources not specified in the test is assumed to be constant over subcarriers and time and shall be modelled as AWGN of appropriate power for N_{oc} to be fulfilled.</p> <p>Note 3: E_s/I_{ot}, RSRP, SCH_RP and I_o levels have been derived from other parameters for information purposes. They are not settable parameters themselves.</p>							

Table A.8.1.39.1-3: DRX configuration for E-UTRAN HD - FDD Intra-frequency identification of a new CGI of E-UTRA cell using autonomous gaps with DRX for Cat-M1 UE in CEModeB

Field	Value	Comment
onDurationTimer	psf1	As specified in clause 6.3.2 in TS 36.331
drx-InactivityTimer	psf1	
drx-RetransmissionTimer	psf1	
longDRX-CycleStartOffset	sf1280	
shortDRX	disable	

Table A.8.1.39.1-4: TimeAlignmentTimer - Configuration for E-UTRAN HD - FDD Intra-frequency identification of a new CGI of E-UTRA cell using autonomous gaps with DRX for Cat-M1 UE in CEModeB

Field	Value	Comment
TimeAlignmentTimer	Infinity	As specified in clause 6.3.2 in TS 36.331
sr-ConfigIndex	0	For further information see clause 6.3.2 in TS 36.331 and section 10.1 in TS 36.213.

A.8.1.39.2 Test Requirements

The UE shall transmit a measurement report containing the cell global identifier of cell 2 within 5137 ms from the start of T3.

$$\text{Test requirement} = \text{RRC Procedure delay} + T_{\text{identify_GI_CatM1,intra}} + \text{reporting delay}$$

$$= 15 + 5120 + 2\text{ms from the start of T3}$$

$$= 5137 \text{ ms.}$$

The rate of correct events observed during repeated tests shall be at least 90%.

A.8.1.40 E-UTRAN FDD-FDD intra-frequency event triggered reporting with DRX for UE configured with *highSpeedEnhancedMeasFlag*

A.8.1.40.1 Test Purpose and Environment

The purpose of the test is to verify that the UE makes correct reporting of an event in DRX when UE is configured with *highSpeedEnhancedMeasFlag*. The tests will partly verify the FDD-FDD intra-frequency cell search in DRX requirements for UE configured with *highSpeedEnhancedMeasFlag* in clause 8.1.2.2.1.2.

The test parameters are given in Tables A.8.1.40.1-1, A.8.1.40.1-2, A.8.1.40.1-3 and A.8.1.40.1-4. In the measurement control information, it is indicated to the UE that event-triggered reporting with Event A3 is used. At the same time, *highSpeedEnhancedMeasFlag* is broadcasted to UE. The test consists of two successive time periods, with time duration of T1 and T2 respectively. During time duration T1, the UE shall not have any timing information of cell 2.

The uplink time alignment is not maintained and UE needs to use RACH to obtain UL allocation for measurement reporting.

Table A.8.1.40.1-1: General test parameters for E-UTRAN FDD-FDD intra-frequency event triggered reporting with DRX for UE configured with *highSpeedEnhancedMeasFlag*

Parameter	Unit	Value	Comment
Active cell		Cell 1	
Neighbour cell		Cell 2	Cell to be identified.
A3-Offset	dB	-6	
CP length		Normal	
Hysteresis	dB	0	
Time To Trigger	s	0	
Filter coefficient		0	L3 filtering is not used
DRX		ON	DRX related parameters are defined in Table A.8.1.40.1-3
T1	s	5	
T2	s	30	

Table A.8.1.40.1-2: Cell specific test parameters for E-UTRAN FDD-FDD intra-frequency event triggered reporting with DRX for UE configured with *highSpeedEnhancedMeasFlag*

Parameter	Unit	Cell 1		Cell 2	
		T1	T2	T1	T2
E-UTRA RF Channel Number		1		1	
BW _{channel}	MHz	5MHz: NRB,c = 25 10MHz: NRB,c = 50 20MHz: NRB,c = 100		5MHz: NRB,c = 25 10MHz: NRB,c = 50 20MHz: NRB,c = 100	
PDSCH parameters		5MHz: R.5 FDD 10MHz: R.0 FDD 20MHz: R.4 FDD		-	
PCFICH/PDCCH/PHICH parameters		5MHz: R.11 FDD 10MHz: R.6 FDD 20MHz: R.10 FDD		-	
OCNG Patterns defined in A.3.2.1		5MHz: OP.15 FDD 10MHz: OP.1 FDD 20MHz: OP.11 FDD		5MHz: OP.16 FDD 10MHz: OP.2 FDD 20MHz: OP.12 FDD	
PBCH_RA	dB	-3		-3	
PBCH_RB	dB				
PSS_RA	dB				
SSS_RA	dB				
PCFICH_RB	dB				
PHICH_RA	dB				
PHICH_RB	dB				
PDCCH_RA	dB				
PDCCH_RB	dB				
PDSCH_RA	dB				

PDSCH_RB	dB				
OCNG_RA ^{Note 1}	dB				
OCNG_RB ^{Note 1}	dB				
N_{oc} ^{Note 2}	dBm/15 KHz			-98	
\hat{E}_s/N_{oc}	dB	4	4	-Infinity	4
\hat{E}_s/I_{ot}	dB	4	-1.46	-Infinity	-1.46
RSRP ^{Note 3}	dBm/15 KHz	-94	-94	-Infinity	-94
SCH_RP ^{Note 3}	dBm/15 KHz	-94	-94	-Infinity	-94
I_o ^{Note 3}	dBm/Ch BW	-64.76 +10log ($N_{RB,c}/50$)	-62.42 +10log ($N_{RB,c}/50$)	Specified in columns for Cell 1	
Propagation Condition		AWGN		AWGN 1750Hz ^{Note 4}	
Antenna Configuration		2x2		2x2	
Timing offset to Cell 1 Synchronous cells	us	-		3	
<p>Note 1: OCNG shall be used such that both cells are fully allocated and a constant total transmitted power spectral density is achieved for all OFDM symbols.</p> <p>Note 2: Interference from other cells and noise sources not specified in the test is assumed to be constant over subcarriers and time and shall be modelled as AWGN of appropriate power for N_{oc} to be fulfilled.</p> <p>Note 3: E_s/I_{ot}, RSRP, SCH_RP and I_o levels have been derived from other parameters for information purposes. They are not settable parameters themselves.</p> <p>Note 4: The AWGN 1750Hz condition is a non fading propagation channel with one tap. Doppler shift is a constant 1750Hz.</p>					

Table A.8.1.40.1-3: DRX-Configuration for E-UTRAN FDD-FDD intra-frequency event triggered reporting with DRX for UE configured with *highSpeedEnhancedMeasFlag*

Field	Value	Comment
onDurationTimer	psf1	As specified in clause 6.3.2 in TS 36.331
drx-InactivityTimer	psf1	
drx-RetransmissionTimer	psf1	
longDRX-CycleStartOffset	sf1280	
shortDRX	disable	

Table A.8.1.40.1-4: *TimeAlignmentTimer* -Configuration for E-UTRAN FDD-FDD intra-frequency event triggered reporting with DRX for UE configured with *highSpeedEnhancedMeasFlag*

Field	Value	Comment
TimeAlignmentTimer	sf500	As specified in clause 6.3.2 in TS 36.331
sr-ConfigIndex	0	For further information see clause 6.3.2 in TS 36.331 and section 10.1 in TS 36.213.

A.8.1.40.2 Test Requirements

The UE shall send one Event A3 triggered measurement report, with a measurement reporting delay less than 12800 ms from the beginning of time period T2. The measurement reporting delay is defined as the time from the beginning of time period T2 to the moment when the UE starts to send preambles on the PRACH for scheduling request (SR) to obtain allocation to send the measurement report on PUSCH.

The UE shall not send event triggered measurement reports, as long as the reporting criteria are not fulfilled.

The rate of correct events observed during repeated tests shall be at least 90%.

NOTE 1: The actual overall delays measured in the test may be up to one DRX cycle higher than the measurement reporting delays above because UE is allowed to delay the initiation of the measurement reporting procedure to the next until the Active Time.

NOTE 2: In order to calculate the rate of correct events the system simulator shall verify that it has received correct Event A3 measurement report.

A.8.1.41 E-UTRAN FDD intra-frequency event triggered reporting for serving cell under fading propagation conditions for UE category M1 in CEModeA without gap

A.8.1.41.1 Test Purpose and Environment

The purpose of this test is to verify that the Cat-M1 UE makes correct reporting of an event for serving cell without using any measurement gaps.

UE is not configured with any reporting configuration that requires measurement on any intra-frequency neighbour cell.

This test will partly verify the FDD-FDD intra-frequency cell measurement requirements in clause 8.13.2.1.1.

The test parameters are given in Table A.8.1.41.1-1 and A.8.1.41.1-2 below. In the measurement control information it is indicated to the UE that event-triggered reporting with Event A2 is used. The test consists of two successive time periods, with time duration of T1, and T2 respectively. At the beginning of T2 the transmission power of cell 1 is decreased, and this shall result in reporting of Event A2.

Table A.8.1.41.1-1: General test parameters

Parameter	Unit	Value	Comment
E-UTRA RF Channel Number		1	
Active cell		Cell 1	
CP length		Normal	
DRX		OFF	
A2	Threshold	dB	-96
	Hysteresis	dB	0
	Time To Trigger	S	0
Filter coefficient		0	L3 filtering is not used
R_{max}		8	As defined in <i>mPDCCH-NumRepetition</i> in [3]
G		1	As defined in <i>mPDCCH-startSF-UESS</i> in [3]
T1	S	5	
T2	S	5	

Table A.8.1.41.1-2: Cell specific test parameters

Parameter	Unit	Cell 1	
		T1	T2
E-UTRA RF Channel Number		1	
$BW_{channel}$	MHz	10	
PDSCH parameters: DL Reference Measurement Channel		R.21 FDD	
MPDCCH parameters: DL Reference Measurement Channel		R.17 FDD	
OCNG Patterns		OP.21 FDD	
PBCH_RA	dB	-3	
PBCH_RB	dB		
PSS_RA	dB		
SSS_RA	dB		
PCFICH_RB	dB		
PHICH_RA	dB		
PHICH_RB	dB		
MPDCCH_RA	dB		
MPDCCH_RB	dB		

PDSCH_RA	dB		
PDSCH_RB	dB		
OCNG_RA ^{Note 1}	dB		
OCNG_RB ^{Note 1}	dB		
N_{oc} ^{Note 2}	dBm/15 KHz	-104	-104
\hat{E}_s / N_{oc}	dB	19	-3
\hat{E}_s / I_{ot} ^{Note 3}	dB	19	-3
RSRP ^{Note 3}	dBm/15 KHz	-85	-107
SCH_RP ^{Note 3}	dBm/15 KHz	-85	-107
I_o ^{Note 3}	dBm/9MHz	-57.16	-74.45
Propagation Condition		ETU30	
Correlation Matrix and Antenna Configuration		2x1 Low	
<p>Note 1: OCNG shall be used such that all cells are fully allocated and a constant total transmitted power spectral density is achieved for all OFDM symbols.</p> <p>Note 2: Interference from noise sources not specified in the test is assumed to be constant over subcarriers and time and shall be modelled as AWGN of appropriate power for N_{oc} to be fulfilled.</p> <p>Note 3: E_s/I_{ot}, RSRP, SCH_RP and I_o have been derived from other parameters for information purposes. They are not settable parameters themselves.</p> <p>Note 4: The resources for uplink transmission are assigned to the UE prior to the start of time period T2.</p>			

A.8.1.41.2 Test Requirement

The UE shall send one Event A2 triggered measurement report, with a measurement reporting delay less than 480ms from the beginning of time period T2.

The UE shall not send event triggered measurement reports, as long as the reporting criteria are not fulfilled.

The rate of correct events observed during repeated tests shall be at least 90%.

NOTE: The actual overall delays measured in the test may be up to $2 \times TTI_{DCC}$ higher than the measurement reporting delays above because of TTI insertion uncertainty of the measurement report in DCC.

A.8.1.42 E-UTRAN HD-FDD intra-frequency event triggered reporting for serving cell under fading propagation conditions for UE category M1 in CEModeA without gap

A.8.1.42.1 Test Purpose and Environment

The purpose of this test is to verify that the Cat-M1 UE makes correct reporting of an event for serving cell without using any measurement gaps.

UE is not configured with any reporting configuration that requires measurement on any intra-frequency neighbour cell.

This test will partly verify the HD-FDD intra-frequency measurement requirements in clause 8.13.2.1.2.

The test parameters are given in Table A.8.1.42.1-1 and A.8.1.42.1-2 below. In the measurement control information it is indicated to the UE that event-triggered reporting with Event A2 is used. The test consists of two successive time periods, with time duration of T1, and T2 respectively. At the beginning of T2 the transmission power of cell 1 is decreased below the threshold, and this shall result in reporting of Event A2.

Table A.8.1.42.1-1: General test parameters

Parameter		Unit	Value	Comment
E-UTRA RF Channel Number			1	
Active cell			Cell 1	
CP length			Normal	
DRX			OFF	
A2	Threshold	dB	-96	
	Hysteresis	dB	0	
	Time To Trigger	S	0	

Filter coefficient		0	L3 filtering is not used
R_{max}		8	As defined in <i>mPDCCH-NumRepetition</i> in [3]
G		1	As defined in <i>mPDCCH-startSF-UeSS</i> in [3]
T1	S	5	
T2	S	5	

Table A.8.1.42.1-2: Cell specific test parameters

Parameter	Unit	Cell 1	
		T1	T2
E-UTRA RF Channel Number		1	
$BW_{channel}$	MHz	10	
PDSCH parameters: DL Reference Measurement Channel		R.11 HD-FDD	
MPDCCH parameters: DL Reference Measurement Channel		R.7 HD-FDD	
OCNG Patterns		OP.21 FDD	
PBCH_RA	dB	-3	
PBCH_RB	dB		
PSS_RA	dB		
SSS_RA	dB		
PCFICH_RB	dB		
PHICH_RA	dB		
PHICH_RB	dB		
MPDCCH_RA	dB		
MPDCCH_RB	dB		
PDSCH_RA	dB		
PDSCH_RB	dB		
OCNG_RA ^{Note 1}	dB		
OCNG_RB ^{Note 1}	dB		
N_{oc} ^{Note 2}	dBm/15 KHz		
\hat{E}_s / N_{oc}	dB	19	-3
\hat{E}_s / I_{ot} ^{Note 3}	dB	19	-3
RSRP ^{Note 3}	dBm/15 KHz	-85	-107
SCH_RP ^{Note 3}	dBm/15 KHz	-85	-107
I_o ^{Note 3}	dBm/9MHz	-57.16	-74.45
Propagation Condition		ETU30	
Correlation Matrix and Antenna Configuration		2x1 Low	
Note 1: OCNG shall be used such that all cells are fully allocated and a constant total transmitted power spectral density is achieved for all OFDM symbols.			
Note 2: Interference from noise sources not specified in the test is assumed to be constant over subcarriers and time and shall be modelled as AWGN of appropriate power for N_{oc} to be fulfilled.			
Note 3: E_s/I_{ot} , RSRP, SCH_RP and I_o have been derived from other parameters for information purposes. They are not settable parameters themselves.			
Note 4: The resources for uplink transmission are assigned to the UE prior to the start of time period T2.			

A.8.1.42.2 Test Requirement

The UE shall send one Event A2 triggered measurement report, with a measurement reporting delay less than 480ms from the beginning of time period T2.

The UE shall not send event triggered measurement reports, as long as the reporting criteria are not fulfilled.

The rate of correct events observed during repeated tests shall be at least 90%.

NOTE: The actual overall delays measured in the test may be up to $2 \times TTI_{DCCH}$ higher than the measurement reporting delays above because of TTI insertion uncertainty of the measurement report in DCCH.

A.8.2 E-UTRAN TDD Intra-frequency Measurements

A.8.2.1 E-UTRAN TDD-TDD intra-frequency event triggered reporting under fading propagation conditions in synchronous cells

A.8.2.1.1 Test Purpose and Environment

The purpose of this test is to verify that the UE makes correct reporting of an event. This test will partly verify the TDD intra-frequency cell search requirements in clause 8.1.2.2.1.

The test parameters are given in Table A.8.2.1.1-1 and A.8.2.1.1-2 below. In the measurement control information it is indicated to the UE that event-triggered reporting with Event A3 is used. PDCCHs indicating new transmissions or retransmissions shall be sent continuously to ensure that the UE would not enter the DRX state. The test consists of two successive time periods, with time duration of T1, and T2 respectively. During time duration T1, the UE shall not have any timing information of cell 2.

Table A.8.2.1.1-1: General test parameters for E-UTRAN TDD-TDD intra-frequency event triggered reporting under fading propagation conditions in synchronous cells

Parameter	Unit	Value	Comment
PDSCH parameters		DL Reference Measurement Channel R.0 TDD	As specified in clause A.3.1.1.2
PCFICH/PDCCH/PHICH parameters		DL Reference Measurement Channel R.6 TDD	As specified in clause A.3.1.2.2
Active cell		Cell 1	
Neighbour cell		Cell 2	Cell to be identified.
E-UTRA RF Channel Number		1	One TDD carrier frequency is used.
Channel Bandwidth (BW_{channel})	MHz	10	
A3-Offset	dB	-6	
CP length		Normal	
Special subframe configuration		6	As specified in table 4.2-1 in TS 36.211. The same configuration in both cells
Uplink-downlink configuration		1	As specified in table 4.2-2 in TS 36.211. The same configuration in both cells
Hysteresis	dB	0	
Time To Trigger	s	0	
Filter coefficient		0	L3 filtering is not used
DRX		DRX_L	As specified in clause A.3.3
Time offset between cells		3 μ s	Synchronous cells
T1	s	5	
T2	s	5	

Table A.8.2.1.1-2: Cell specific test parameters for E-UTRAN TDD-TDD intra-frequency event triggered reporting under fading propagation conditions in synchronous cells

Parameter	Unit	Cell 1		Cell 2	
		T1	T2	T1	T2
E-UTRA RF Channel Number		1		1	
BW_{channel}	MHz	10		10	
Correlation Matrix and Antenna Configuration		1x2 Low		1x2 Low	
OCNG Pattern defined in A.3.2.2.1 (OP.1 TDD) and in A.3.2.2.2 (OP.2)		OP.1 TDD		OP.2 TDD	
PBCH_RA	dB				
PBCH_RB	dB				
PSS_RA	dB				
SSS_RA	dB				
PCFICH_RB	dB				
PHICH_RA	dB				

PHICH_RB	dB	0		0	
PDCCH_RA	dB				
PDCCH_RB	dB				
PDSCH_RA	dB				
PDSCH_RB	dB				
OCNG_RA ^{Note 1}	dB				
OCNG_RB ^{Note 1}	dB				
N_{oc} ^{Note 3}	dBm/15 kHz	-98			
RSRP ^{Note 4}	dBm/15 kHz	-94	-94	-Infinity	-94
\hat{E}_s/I_{ot}	dB	4	-1.46	-Infinity	-1.46
SCH_RP ^{Note 4}	dBm/15 kHz	-94	-94	-Infinity	-94
\hat{E}_s/N_{oc}	dB	4	4	-Infinity	4
Propagation Condition		ETU70			
Note 1	OCNG shall be used such that both cells are fully allocated and a constant total transmitted power spectral density is achieved for all OFDM symbols.				
Note 2:	The resources for uplink transmission are assigned to the UE prior to the start of time period T2.				
Note 3:	Interference from other cells and noise sources not specified in the test is assumed to be constant over subcarriers and time and shall be modelled as AWGN of appropriate power for N_{oc} to be fulfilled.				
Note 4:	RSRP and SCH_RP levels have been derived from other parameters for information purposes. They are not settable parameters themselves.				

A.8.2.1.2 Test Requirements

The UE shall send one Event A3 triggered measurement report, with a measurement reporting delay less than 800 ms from the beginning of time period T2.

The UE shall not send event triggered measurement reports, as long as the reporting criteria are not fulfilled.

The rate of correct events observed during repeated tests shall be at least 90%.

NOTE: The actual overall delays measured in the test may be up to $2 \times TTI_{DCCH}$ higher than the measurement reporting delays above because of TTI insertion uncertainty of the measurement report in DCCH.

A.8.2.2 E-UTRAN TDD-TDD intra-frequency event triggered reporting under fading propagation conditions in synchronous cells with DRX

A.8.2.2.1 Test Purpose and Environment

The purpose of the two tests is to verify that the UE makes correct reporting of an event in DRX. The tests will partly verify the TDD-TDD intra-frequency cell search in DRX requirements in clause 8.1.2.2.1.2.

The test parameters are given in Tables A.8.1.3.1-1, A.8.1.3.1-2, A.8.1.3.1-3 and A.8.1.3.1-4. In the measurement control information, it is indicated to the UE that event-triggered reporting with Event A3 is used. The test consists of two successive time periods, with time duration of T1, and T2 respectively. During time duration T1, the UE shall not have any timing information of cell 2.

In Test 1 UE needs to be provided at least once every 500ms with new Timing Advance Command MAC control element to restart the Time alignment timer to keep UE uplink time alignment. Furthermore UE is allocated with PUSCH resource at every DRX cycle.

In Test 2 the uplink time alignment is not maintained and UE needs to use RACH to obtain UL allocation for measurement reporting.

Table A.8.2.2.1-1: General test parameters for E-UTRAN TDD-TDD intra-frequency event triggered reporting under fading propagation conditions in synchronous cells when DRX is used

Parameter	Unit	Value		Comment
		Test 1	Test 2	

PDSCH parameters		DL Reference Measurement Channel R.0 TDD	As specified in clause A.3.1.1.2
PCFICH/PDCCH/PHICH parameters		DL Reference Measurement Channel R.6 TDD	As specified in clause A.3.1.2.2
Active cell		Cell 1	
Neighbour cell		Cell 2	Cell to be identified.
E-UTRA RF Channel Number		1	One TDD carrier frequency is used.
Channel Bandwidth (BW_{channel})	MHz	10	
A3-Offset	dB	-6	
CP length		Normal	
Special subframe configuration		6	As specified in table 4.2-1 in TS 36.211. The same configuration in both cells
Uplink-downlink configuration		1	As specified in table 4.2-2 in TS 36.211. The same configuration in both cells
Hysteresis	dB	0	
Time To Trigger	s	0	
Filter coefficient		0	L3 filtering is not used
DRX		ON	DRX related parameters are defined in Table A.8.2.2.1-3
Time offset between cells		3 μ s	Synchronous cells
T1	s	5	
T2	s	5	30

Table A.8.2.2.1-2: Cell specific test parameters for E-UTRAN TDD-TDD intra-frequency event triggered reporting under fading propagation conditions in synchronous cells when DRX is used

Parameter	Unit	Cell 1		Cell 2	
		T1	T2	T1	T2
E-UTRA RF Channel Number		1		1	
BW_{channel}	MHz	10		10	
Correlation Matrix and Antenna Configuration		1x2 Low		1x2 Low	
OCNG Pattern defined in A.3.2.2.1 (OP.1 TDD) and in A.3.2.2.2 (OP.2)		OP.1 TDD		OP.2 TDD	
PBCH_RA	dB	0		0	
PBCH_RB	dB				
PSS_RA	dB				
SSS_RA	dB				
PCFICH_RB	dB				
PHICH_RA	dB				
PHICH_RB	dB				
PDCCH_RA	dB				
PDCCH_RB	dB				
PDSCH_RA	dB				
PDSCH_RB	dB				
OCNG_RA ^{Note 1}	dB				
OCNG_RB ^{Note 1}	dB				
N_{oc} ^{Note 2}	dBm/15 kHz				
RSRP ^{Note 3}	dBm/15 kHz	-94	-94	-Infinity	-94
\hat{E}_s/I_{ot}	dB	4	-1.46	-Infinity	-1.46
SCH_RP ^{Note 3}	dBm/15 kHz	-94	-94	-Infinity	-94
\hat{E}_s/N_{oc}	dB	4	4	-Infinity	4
Propagation Condition		ETU70			

Note 1: OCNG shall be used such that both cells are fully allocated and a constant total transmitted power spectral density is achieved for all OFDM symbols.

Note 2: Interference from other cells and noise sources not specified in the test is assumed to be constant over subcarriers and time and shall be modelled as AWGN of appropriate power for N_{oc} to be fulfilled.

Note 3: RSRP and SCH_RP levels have been derived from other parameters for information purposes. They are not settable parameters themselves.

Table A.8.2.2.1-3: DRX-Configuration for E-UTRAN TDD-TDD intra-frequency event triggered reporting in DRX under fading propagation conditions in synchronous cells

Field	Test1	Test2	Comment
	Value	Value	
onDurationTimer	psf1	psf1	As specified in clause 6.3.2 in TS 36.331
drx-InactivityTimer	psf1	psf1	
drx-RetransmissionTimer	psf1	psf1	
longDRX-CycleStartOffset	sf40	sf1280	
shortDRX	disable	disable	

Table A.8.2.2.1-4: TimeAlignmentTimer -Configuration for E-UTRAN TDD-TDD intra-frequency event triggered reporting in DRX under fading propagation conditions in synchronous cells

Field	Test1	Test2	Comment
	Value	Value	
TimeAlignmentTimer	sf500	sf500	As specified in clause 6.3.2 in TS 36.331
sr-ConfigIndex	2	2	For further information see clause 6.3.2 in TS 36.331 and clause 10.1 in TS 36.213.

A.8.2.2.2 Test Requirements

In Test 1, the UE shall send one Event A3 triggered measurement report, with a measurement reporting delay less than 800 ms from the beginning of time period T2. The measurement reporting delay is defined as the time from the beginning of time period T2 to the moment when the UE send the measurement report on PUSCH.

In Test 2, the UE shall send one Event A3 triggered measurement report, with a measurement reporting delay less than 25600 ms from the beginning of time period T2. The measurement reporting delay is defined as the time from the beginning of time period T2 to the moment when the UE starts to send preambles on the PRACH for scheduling request (SR) to obtain allocation to send the measurement report on PUSCH.

The UE shall not send event triggered measurement reports, as long as the reporting criteria are not fulfilled.

The rate of correct events observed during repeated tests shall be at least 90%.

NOTE: The actual overall delays measured in the test may be up to one DRX cycle higher than the measurement reporting delays above because UE is allowed to delay the initiation of the measurement reporting procedure to the next until the Active Time.

NOTE 2: In order to calculate the rate of correct events the system simulator shall verify that it has received correct Event A3 measurement report.

A.8.2.3 E-UTRAN TDD - TDD Intra-frequency identification of a new CGI of E-UTRA cell using autonomous gaps

A.8.2.3.1 Test Purpose and Environment

This test is to verify the requirement for identification of a new CGI of E-UTRA cell with autonomous gaps in clause 8.1.2.2.4.

The test scenario comprises of one E-UTRA TDD carrier and two cells as given in tables A.8.2.3.1-1 and A.8.2.3.1-2. PDCCHs indicating new transmissions shall be sent continuously to ensure that the UE would have ACK/NACK sending during identifying a new CGI of E-UTRAN cell. The test consists of three successive time periods, with time durations of T1, T2 and T3 respectively. At the start of time duration T1, the UE does not have any timing information of cell 2. Starting T2, cell 2 becomes detectable and the UE is expected to detect and send a measurement report.

A RRC message implying SI reading shall be sent to the UE during period T2, after the UE has reported Event A3. The RRC message shall create a measurement report configuration with purpose *reportCGI* and *si-RequestForHO* set to TRUE. The start of T3 is the instant when the last TTI containing the RRC message implying SI reading is sent to the UE.

Table A.8.2.3.1-1: General test parameters for E-UTRAN TDD - TDD Intra-frequency identification of a new CGI of E-UTRA cell using autonomous gaps

Parameter	Unit	Value	Comment
PDSCH parameters		DL Reference Measurement Channel R.0 TDD	As specified in clause A.3.1.1.2
PCFICH/PDCCH/PHICH parameters		DL Reference Measurement Channel R.6 TDD	As specified in clause A.3.1.2.2
Active cell		Cell 1	
Neighbour cell		Cell 2	Cell to be identified.
E-UTRA RF Channel Number		1	Only one TDD carrier frequency is used.
Channel Bandwidth (BW _{channel})	MHz	10	
CP length		Normal	
Special subframe configuration		6	As specified in table 4.2-1 in TS 36.211. The same configuration in both cells
Uplink-downlink configuration		1	As specified in table 4.2-2 in TS 36.211. The same configuration in both cells
A3-Offset	dB	-3	
Hysteresis	dB	0	
Time To Trigger	s	0	
Filter coefficient		0	L3 filtering is not used
DRX		OFF	
si-RequestForHO		TRUE	As specified in clause 5.5.3.1 in TS 36.331.
Time offset between cells	μs	3	Synchronous cells
T1	s	5	
T2	s	≤10	
T3	s	5	

Table A.8.2.3.1-2: Cell specific test parameters for E-UTRAN TDD - TDD Intra-frequency identification of a new CGI of E-UTRA cell using autonomous gaps

Parameter	Unit	Cell 1			Cell 2		
		T1	T2	T3	T1	T2	T3
E-UTRA RF Channel Number		1			1		
BW _{channel}	MHz	10			10		
OCNG Patterns defined in A.3.2.2.1 (OP.1 TDD) and in A.3.2.2.2 (OP.2 TDD)		OP.1 TDD	OP.1 TDD	OP.1 TDD	OP.2 TDD	OP.2 TDD	OP.2 TDD
PBCH_RA	dB	0			0		
PBCH_RB	dB						
PSS_RA	dB						
SSS_RA	dB						
PCFICH_RB	dB						
PHICH_RA	dB						
PHICH_RB	dB						
PDCCH_RA	dB						
PDCCH_RB	dB						
PDSCH_RA	dB						
PDSCH_RB	dB						

OCNG_RA ^{Note 1}	dB						
OCNG_RB ^{Note 1}	dB						
\hat{E}_s / I_{ot}	dB	8	-3.3	-3.3	-Infinity	2.36	2.36
N_{oc} ^{Note 2}	dBm/15 KHz	-98					
\hat{E}_s / N_{oc}	dB	8	8	8	-Infinity	11	11
RSRP ^{Note 3}	dBm/15 KHz	-90	-90	-90	-Infinity	-87	-87
SCH_RP ^{Note 3}	dBm/15 KHz	-90	-90	-90	-Infinity	-87	-87
Propagation Condition		AWGN					
<p>Note 1: OCNG shall be used such that both cells are fully allocated and a constant total transmitted power spectral density is achieved for all OFDM symbols.</p> <p>Note 2: Interference from other cells and noise sources not specified in the test is assumed to be constant over subcarriers and time and shall be modelled as AWGN of appropriate power for N_{oc} to be fulfilled.</p> <p>Note 3: RSRP and SCH_RP levels have been derived from other parameters for information purposes. They are not settable parameters themselves.</p>							

A.8.2.3.2 Test Requirements

The UE shall transmit a measurement report containing the cell global identifier of cell 2 within 170 milliseconds from the start of T3.

Test requirement = RRC Procedure delay + $T_{\text{identify_C_GI, intra}}$ + reporting delay

= 15 + 150 + 2ms from the start of T3

= 167 ms, allow 170 ms.

The UE shall be scheduled continuously throughout the test, and from the start of T3 until 170 ms at least 47 ACK/NACK shall be detected as being transmitted by the UE.

The rate of correct events observed during repeated tests shall be at least 90%.

NOTE: The overall 47 ACK/NACK number is caused by two parts. Firstly, at least 35 ACK/NACK shall be sent during identifying the cell global identifier of cell 2 according to the requirement for UL/DL configuration #1 in Table 8.1.2.2.4.1-1 of Clause 8.1.2.2.4.1. Secondly, given that continuous DL data allocation, additional 12 ACK/NACK shall be sent from the start of T3 until 170 ms excludes 150 ms for identifying the cell global identifier of cell 2.

A.8.2.4 E-UTRAN TDD - TDD Intra-frequency identification of a new CGI of E-UTRA cell using autonomous gaps with DRX

A.8.2.4.1 Test Purpose and Environment

This test is to verify the requirement for identification of a new CGI of E-UTRA cell with autonomous gaps in clause 8.1.2.2.4. The requirement is verified in a DRX configuration.

The test scenario comprises of one E-UTRA TDD carrier and two cells as given in tables A.8.2.4.1-1, A.8.2.4.1-2, A.8.2.4.1-3 and A.8.2.4.1-4. The test consists of three successive time periods, with time durations of T1, T2 and T3 respectively. At the start of time duration T1, the UE does not have any timing information of cell 2. Starting T2, cell 2 becomes detectable and the UE is expected to detect and send a measurement report.

A RRC message implying SI reading shall be sent to the UE during period T2, after the UE has reported Event A3. The RRC message shall create a measurement report configuration with purpose *reportCGI* and *si-RequestForHO* set to TRUE. The start of T3 is the instant when the last TTI containing the RRC message implying SI reading is sent to the UE.

In the test UE needs to be provided at least once every 1280ms with new Timing Advance Command MAC control element to restart the Time alignment timer to keep UE uplink time alignment. Furthermore UE sends scheduling request (SR) to obtain allocation to send the measurement report on PUSCH.

Table A.8.2.4.1-1: General test parameters for E-UTRAN TDD - TDD Intra-frequency identification of a new CGI of E-UTRA cell using autonomous gaps with DRX

Parameter	Unit	Value	Comment
PDSCH parameters		DL Reference Measurement Channel R.0 TDD	As specified in clause A.3.1.1.2
PCFICH/PDCCH/PHICH parameters		DL Reference Measurement Channel R.6 TDD	As specified in clause A.3.1.2.2
Active cell		Cell 1	
Neighbour cell		Cell 2	Cell to be identified.
E-UTRA RF Channel Number		1	Only one TDD carrier frequency is used.
Channel Bandwidth (BW _{channel})	MHz	10	
CP length		Normal	
Special subframe configuration		6	As specified in table 4.2-1 in TS 36.211. The same configuration in both cells
Uplink-downlink configuration		1	As specified in table 4.2-2 in TS 36.211. The same configuration in both cells
A3-Offset	dB	-3	
Hysteresis	dB	0	
Time To Trigger	s	0	
Filter coefficient		0	L3 filtering is not used
DRX		ON	DRX related parameters are defined in Table A.8.2.4.1-3
si-RequestForHO		TRUE	As specified in clause 5.5.3.1 in TS 36.331.
Time offset between cells	µs	3	Synchronous cells
T1	s	5	
T2	s	≤30	UE shall report cell within 25.6s (20 DRX cycles)
T3	s	5	

Table A.8.2.4.1-2: Cell specific test parameters for E-UTRAN TDD - TDD Intra-frequency identification of a new CGI of E-UTRA cell using autonomous gaps with DRX

Parameter	Unit	Cell 1			Cell 2		
		T1	T2	T3	T1	T2	T3
E-UTRA RF Channel Number		1			1		
BW _{channel}	MHz	10			10		
OCNG Patterns defined in A.3.2.2.1 (OP.1 TDD) and in A.3.2.2.2 (OP.2 TDD)		OP.1 TDD	OP.1 TDD	OP.1 TDD	OP.2 TDD	OP.2 TDD	OP.2 TDD
PBCH_RA	dB	0			0		
PBCH_RB	dB						
PSS_RA	dB						
SSS_RA	dB						
PCFICH_RB	dB						
PHICH_RA	dB						
PHICH_RB	dB						
PDCCH_RA	dB						
PDCCH_RB	dB						
PDSCH_RA	dB						
PDSCH_RB	dB						
OCNG_RA ^{Note 1}	dB						
OCNG_RB ^{Note 1}	dB						
\hat{E}_s/I_{ca}	dB	8	-3.3	-3.3	-Infinity	2.36	2.36
N_{oc} ^{Note 2}	dBm/15 KHz	-98					
\hat{E}_s/N_{oc}	dB	8	8	8	-Infinity	11	11
RSRP ^{Note 3}	dBm/15 KHz	-90	-90	-90	-Infinity	-87	-87
SCH_RP ^{Note 3}	dBm/15 KHz	-90	-90	-90	-Infinity	-87	-87
Propagation Condition		AWGN					

Note 1:	OCNG shall be used such that both cells are fully allocated and a constant total transmitted power spectral density is achieved for all OFDM symbols.
Note 2:	Interference from other cells and noise sources not specified in the test is assumed to be constant over subcarriers and time and shall be modelled as AWGN of appropriate power for N_{oc} to be fulfilled.
Note 3:	RSRP and SCH_RP levels have been derived from other parameters for information purposes. They are not settable parameters themselves.

Table A.8.2.4.1-3: DRX configuration for E-UTRAN TDD - TDD Intra-frequency identification of a new CGI of E-UTRA cell using autonomous gaps with DRX

Field	Value	Comment
onDurationTimer	psf1	As specified in clause 6.3.2 in TS 36.331
drx-InactivityTimer	psf1	
drx-RetransmissionTimer	psf1	
longDRX-CycleStartOffset	sf1280	
shortDRX	disable	

Table A.8.2.4.1-4: *TimeAlignmentTimer* -Configuration for E-UTRAN TDD - TDD Intra frequency identification of a new CGI of E-UTRA cell using autonomous gaps with DRX

Field	Value	Comment
TimeAlignmentTimer	Infinity	As specified in clause 6.3.2 in TS 36.331
sr-ConfigIndex	2	For further information see clause 6.3.2 in TS 36.331 and section 10.1 in TS 36.213.

A.8.2.4.2 Test Requirements

The UE shall transmit a measurement report containing the cell global identifier of cell 2 within 170 milliseconds from the start of T3.

Test requirement = RRC Procedure delay + $T_{\text{identify_CGI_intra}}$ + reporting delay

= 15 + 150 + 2ms from the start of T3

= 167 ms, allow 170 ms.

The rate of correct events observed during repeated tests shall be at least 90%.

A.8.2.5 E-UTRAN TDD-TDD Intra-Frequency Event-Triggered Reporting under Time Domain Measurement Resource Restriction with Non-MBSFN ABS

A.8.2.5.1 Test Purpose and Environment

The purpose of this test is to verify that the UE correctly detects and reports Event A3 (Neighbour becomes offset better than PCell) defined in TS 36.331 [2] within the requirements specified in Clause 8.1.2.8.2.1 under a time domain measurement resource restriction and non-MBSFN ABS configured in the aggressor cell.

The test parameters are given in Tables A.8.2.5.1-1 and A.8.2.5.1-2 below. It is indicated to the UE in the measurement control information that event-triggered reporting with Event A3 is used. In the test there are two synchronous cells, Cell 1 and Cell 2, on the same RF channel. Cell 1 is the PCell, and it is also the aggressor cell to Cell 2. Cell 2 is the cell to be identified. The test consists of two successive time periods with time duration of T1 and T2, respectively. During time duration T1, the UE shall not have any timing information on Cell 2.

Non-MBSFN ABS pattern is configured for Cell 1 during the test. The UE is configured by higher layers via Cell 1 with a time domain measurement resource restriction pattern for performing E-UTRAN TDD intra-frequency

measurements on neighbour cells. The UE is also configured with a time domain measurement resource restriction pattern for the PCell measurements. The information for both measurement patterns shall be provided to the UE via higher layers during T1.

Table A.8.2.5.1-1: General test parameters for E-UTRAN TDD-TDD intra-frequency event triggered reporting under time domain measurement resource restriction with non-MBSFN ABS

Parameter	Unit	Value	Comment
PDSCH parameters		DL Reference Measurement Channel R.0 TDD	As specified in clause A.3.1.1.2
PCFICH/PDCCH/PHICH parameters		DL Reference Measurement Channel R.6 TDD	As specified in clause A.3.1.2.2
PCell		Cell 1	Also the aggressor cell. Active in T1 and T2
Neighbour cell		Cell 2	Cell to be identified. Active only in T2.
PCell ABS configuration		Non-MBSFN ABS	As defined in Table A.3.4.1.1-1
E-UTRA RF Channel Number		1	One TDD carrier frequency is used.
Channel Bandwidth ($BW_{channel}$)	MHz	10	
A3-Offset	dB	-11	
Event A3 measurement quantity		RSRP	
CP length		Normal	
Special subframe configuration		6	As specified in Table 4.2-1 in TS 36.211. The same configuration in both cells
Uplink-downlink configuration		1	As specified in Table 4.2-2 in TS 36.211. The same configuration in both cells
Hysteresis	dB	0	
Time To Trigger	s	0	
Filter coefficient		0	L3 filtering is not used
DRX			OFF
Time offset between cells		3 μ s	Synchronous cells
T1	s	5	
T2	s	5	
Physical cell ID PCI		$(PCI_{cell1} - PCI_{cell2}) \bmod 6 \neq 0$	Cell PCIs are selected so that the condition is met
ABS pattern		'00000000010000000001'	TDD ABS Pattern Info IE, as defined in TS 36.423 [28], clause 9.2.54. Configured in Cell 1 during T1. The first/leftmost bit corresponds to the subframe #0 of the radio frame satisfying $SFN \bmod x = 0$, where x is the size of the bit string (20) divided by 10. No MBSFN subframes are configured in the ABS subframes.
Time domain measurement resource restriction pattern for neighbour cell measurements on RF Channel 1		'00000000010000000001'	Time domain measurement resource restriction pattern for neighbor cell measurement signalled to the UE in measSubframePattern-Neigh IE in measSubframePatternConfig-Neigh, as defined in TS 36.331, clause 6.3.5. Configured during T1 for Cell 2 measurements.
Time domain measurement resource restriction pattern for PCell measurements		'10000000001000000000'	Configured during T1 for Cell 1 measurements

Table A.8.2.5.1-2: Cell specific test parameters for E-UTRAN TDD-TDD intra-frequency event triggered reporting under time domain measurement resource restriction with non-MBSFN ABS

Parameter	Unit	Cell 1		Cell 2	
		T1	T2	T1	T2
E-UTRA RF Channel Number		1		1	
$BW_{channel}$	MHz	10		10	
Correlation Matrix and Antenna Configuration		1x2 Low		1x2 Low	

OCNG Pattern defined in A.3.2.2.1 (OP.1 TDD) and in A.3.2.2.2 (OP.2)		OP.1 TDD		OP.2 TDD		
PBCH_RA	dB	Non-ABS and ABS subframe channel powers defined in Table A.3.4.1.1-1.				0
PBCH_RB	dB					
PSS_RA	dB					
SSS_RA	dB					
PCFICH_RB	dB					
PHICH_RA	dB					
PHICH_RB	dB					
PDCCH_RA	dB					
PDCCH_RB	dB					
PDSCH_RA	dB					
PDSCH_RB	dB					
OCNG_RA ^{Note 1}	dB					
OCNG_RB ^{Note 1}	dB					
N_{oc} ^{Note 3}	dBm/15 kHz	-98				
$(\hat{E}_s / N_{oc})_{meas}$ ^{Note 5}	dB	1	1	-Infinity	-4	
$(\hat{E}_s / N_{oc})_{ABS}$	dB	1	1	N/A	N/A	
RSRP ^{Note 4,5}	dBm/15 kHz	-97	-97	-Infinity	-102	
SCH_RP ^{Note 4}	dBm/15 kHz	-97	-97	-Infinity	-102	
CRS \hat{E}_s / I_{ot}	dB	1	-0.5	-Infinity	-4	
SCH \hat{E}_s / I_{ot}	dB	1	-0.5	-Infinity	-7.5	
Propagation Condition		ETU30				
<p>Note 1: OCNG shall be used such that both cells are fully allocated and a constant total transmitted power spectral density is achieved for all OFDM symbols.</p> <p>Note 2: The resources for uplink transmission are assigned to the UE prior to the start of time period T2.</p> <p>Note 3: Interference from other cells and noise sources not specified in the test is assumed to be constant over subcarriers and time and shall be modelled as AWGN of appropriate power for N_{oc} to be fulfilled. Applies to all subframes.</p> <p>Note 4: RSRP and SCH_RP levels have been derived from other parameters for information purposes. They are not settable parameters themselves.</p> <p>Note 5: RSPP is estimated for Cell 2 during the restricted measurement subframes for neighbour cells. RSPP is estimated for Cell 1 during the PCell restricted subframes.</p>						

A.8.2.5.2 Test Requirements

The UE shall send one Event A3 triggered measurement report for Cell 2, with a measurement reporting delay less than 1000 ms from the beginning of time period T2.

The UE shall not send event-triggered measurement reports as long as the reporting criteria are not fulfilled.

The rate of correct events observed during repeated tests shall be at least 90% for the tested Event A3.

NOTE: The actual overall delays measured in the tests may be up to $2 \times TTI_{DCCH}$ higher than the measurement reporting delays above because of TTI insertion uncertainty of the measurement report in DCCH.

A.8.2.6 E-UTRAN TDD-TDD Intra-Frequency Event-Triggered Reporting under Time Domain Measurement Resource Restriction with CRS Assistance Information and Non-MBSFN ABS

A.8.2.6.1 Test Purpose and Environment

The purpose of this test is to verify that the UE correctly detects and reports Event A3 (neighbour becomes offset better than PCell) defined in TS 36.331 [2] within the requirements specified in Clause 8.1.2.8.4, when the UE is provided with a time-domain measurement resource restriction pattern and CRS assistance information, and when non-MBSFN ABS configured in the interfering cells.

The test parameters are given in Tables A.8.2.6.1-1 and A.8.2.6.1-2 below. It is indicated to the UE in the measurement control information that event-triggered reporting with Event A3 is used. In the test, there are three synchronous cells, Cell 1, Cell 2, and Cell 3, on the same RF channel. Cell 1 is the PCell. Cell 3 is the cell to be identified. A non-MBSFN ABS pattern is configured in each of the Cell 1 and Cell 2 during the entire test. The test consists of two successive time periods with time duration of T1 and T2, respectively. During time duration T1, the UE shall not have any timing information on Cell 3.

The UE is configured by higher layers with a time domain measurement resource restriction pattern for performing E-UTRAN TDD intra-frequency measurements on neighbour cells, namely Cell 3 measurements. The UE is also provided via higher layers with the CRS assistance information for Cell 2. The information for both measurement patterns and the CRS assistance information shall be provided via RRC to the UE during T1.

Table A.8.2.6.1-1: General test parameters for E-UTRAN TDD-TDD intra-frequency event triggered reporting under time domain measurement resource restriction with CRS assistance information and non-MBSFN ABS

Parameter	Unit	Value	Comment
PDSCH parameters		DL Reference Measurement Channel R.0 TDD	As specified in clause A.3.1.1.2
PCFICH/PDCCH/PHICH parameters		DL Reference Measurement Channel R.6 TDD	As specified in clause A.3.1.2.2
PCell		Cell 1	Also a first interfering cell to Cell 3. Active in T1 and T2.
Neighbour cells		Cell 2 and Cell 3	Cell 2 is a second interfering cell; Cell 2 is active in T1 and T2. Cell 3 is the cell to be identified; Cell 3 is active only in T2.
ABS transmission configuration		Non-MBSFN ABS	As defined in Table A.3.4.1.1-1
E-UTRA RF Channel Number		1	One TDD carrier frequency is used
Channel Bandwidth (BW_{channel})	MHz	10	For all cells in the test
A3-Offset	dB	-14	
Event A3 measurement quantity		RSRP	
CP length		Normal	
Special subframe configuration		6	As specified in Table 4.2-1 in TS 36.211. The same configuration in both cells
Uplink-downlink configuration		1	As specified in Table 4.2-2 in TS 36.211. The same configuration in both cells
Hysteresis	dB	0	
Time To Trigger	s	0	
Filter coefficient		0	L3 filtering is not used
DRX			OFF
Time offset between cells	μs	Cell 2 offset with respect to Cell 1: 0 Cell 3 offset with respect to Cell 1: -2.5	Three synchronous cells
T1	s	5	
T2	s	5	
Physical cell IDs		$(PCI_{\text{cell1}} - PCI_{\text{cell3}}) \bmod 6 = 0$ $(PCI_{\text{cell2}} - PCI_{\text{cell3}}) \bmod 6 \neq 0$ PCI_{cell1} not equal to PCI_{cell3}	Cell PCIs are selected so that all conditions are met
ABS pattern		'00000000010000000001'	TDD ABS Pattern Info IE, as defined in TS 36.423 [28], clause 9.2.54. The first/leftmost bit corresponds to the Pcell subframe #0 of the radio frame satisfying $\text{SFN} \bmod x = 0$, where x is the size of the bit string (20) divided by 10. No MBSFN subframes are configured in the ABS subframes. Provided to the UE for Cell 1 and Cell 2 during T1.

Time domain measurement resource restriction pattern for neighbour cell measurements on RF Channel 1			'00000000010000000001'	Time domain measurement resource restriction pattern for neighbor cell measurement signalled to the UE in measSubframePatternNeigh IE in measSubframePatternConfigNeigh, as defined in TS 36.331, clause 6.3.5. Provided to the UE during T1 for Cell 3 measurements. The cell list in measSubframeCellList IE shall contain Cell 3 but not Cell 2.
Time domain measurement resource restriction pattern for PCell measurements			'10000000001000000000'	Configured during T1 for Cell 1 measurements
CRS assistance information	physCellId		see PCI conditions above	The CRS assistance information is provided for Cell 2 only in CRS-AssistanceInfo. It includes a single MBSFN-SubframeConfig element with subframe allocation <i>oneFrame</i> ='000000'.
	antennaPortsCount		1	
	mbsfn-SubframeConfigList		<i>oneFrame</i> = '000000'	

Table A.8.2.6.1-2: Cell specific test parameters for E-UTRAN TDD-TDD intra-frequency event triggered reporting under time domain measurement resource restriction with CRS assistance information and non-MBSFN ABS

Parameter	Unit	Cell 1		Cell 2		Cell 3	
		T1	T2	T1	T2	T1	T2
E-UTRA RF Channel Number		1		1		1	
BW _{channel}	MHz	10		10		10	
Correlation Matrix and Antenna Configuration		1x2 Low		1x2 Low		1x2 Low	
OCNG Patterns defined in A.3.2.2.1 (OP.1 TDD) and in A.3.2.2.2 (OP.2 TDD)		OP.1 TDD		OP.2 TDD		N/A	OP.2 TDD
PBCH_RA	dB	Non-ABS and ABS subframe channel powers defined in Table A.3.4.1.1-1.		Non-ABS and ABS subframe channel powers defined in Table A.3.4.1.1-1.		N/A	0
PBCH_RB	dB						
PSS_RA	dB						
SSS_RA	dB						
PCFICH_RB	dB						
PHICH_RA	dB						
PHICH_RB	dB						
PDCCH_RA	dB						
PDCCH_RB	dB						
PDSCH_RA	dB						
PDSCH_RB	dB						
OCNG_RA ^{Note 1}	dB						
OCNG_RB ^{Note 1}	dB						
N_{oc} ^{Note 3}	dBm/15 kHz	-98					
(\hat{E}_s / N_{oc})	dB	4	4	2	2	-Infinity	-4
RSRP ^{Note 4}	dBm/15 kHz	-94	-94	-96	-96	-Infinity	-102
SCH_RP ^{Note 4}	dBm/15 kHz	-94	-94	-96	-96	-Infinity	-102
CRS \hat{E}_s / I_{ot} ^{Note 5}	dB	4	2.54	2	0.54	-Infinity	-9.46
SCH \hat{E}_s / I_{ot}	dB	-0.12	-0.75	-3.45	-3.92	-Infinity	-11.07
Propagation Condition		ETU30		ETU30		ETU30	

NOTE 1:	OCNG shall be used such that all cells are fully allocated and a constant total transmitted power spectral density is achieved for all OFDM symbols.
NOTE 2:	The resources for uplink transmission are assigned to the UE prior to the start of time period T2.
NOTE 3:	Interference from other cells and noise sources not specified in the test is assumed to be constant over subcarriers and time and shall be modelled as AWGN of appropriate power for N_{oc} to be fulfilled. Applies to all subframes.
NOTE 4:	RSRP, SCH_RP, and \hat{E}_s/I_{ot} levels have been derived from other parameters for information purposes. They are not settable parameters themselves.
NOTE 5:	Applies during the restricted measurement subframes configured for neighbour cell (Cell 3) measurements.

A.8.2.6.2 Test Requirements

The UE shall send one Event A3 triggered measurement report for Cell 3, with a measurement reporting delay less than 1000 ms from the beginning of time period T2.

The UE shall not send event-triggered measurement reports as long as the reporting criteria are not fulfilled.

The rate of correct events observed during repeated tests shall be at least 90% for the tested Event A3.

NOTE: The actual overall delays measured in the tests may be up to $2 \times TTI_{DCCH}$ higher than the measurement reporting delays above because of TTI insertion uncertainty of the measurement report in DCCH.

A.8.2.7 E-UTRAN TDD Intra-frequency identification of a new CGI of E-UTRA cell using autonomous gaps

A.8.2.7.1 Test Purpose and Environment

This test is to verify the requirement for identification of a new CGI of E-UTRA cell with autonomous gaps in clause 8.5.2.1.6.

The test scenario comprises of one E-UTRA TDD carrier and two cells as given in tables A.8.2.7.1-1 and A.8.2.7.1-2. PDCCHs indicating new transmissions should be sent continuously to ensure that the UE would have ACK/NACK sending during identifying a new CGI of E-UTRAN cell. The test consists of three successive time periods, with time durations of T1, T2 and T3 respectively. At the start of time duration T1, the UE does not have any timing information of cell 2. Starting T2, cell 2 becomes detectable and the UE is expected to detect and send a measurement report.

A RRC message implying SI reading shall be sent to the UE during period T2, after the UE has reported Event A3. The RRC message shall create a measurement report configuration with purpose *reportCGI* and *si-RequestForHO* set to TRUE. The start of T3 is the instant when the last TTI containing the RRC message implying SI reading is sent to the UE.

Table A.8.2.7.1-1: General test parameters for E-UTRAN TDD Intra-frequency identification of a new CGI of E-UTRA cell using autonomous gaps

Parameter	Unit	Value	Comment
PDSCH parameters		DL Reference Measurement Channel R.13 TDD	As specified in clause A.3.1.1.5
PCFICH/PDCCH/PHICH parameters		DL Reference Measurement Channel R.7 TDD	As specified in clause A.3.1.2.2
Active cell		Cell 1	
Neighbour cell		Cell 2	Cell to be identified.
E-UTRA RF Channel Number		1	Only one TDD carrier frequency is used.
Channel Bandwidth (BW _{channel})	MHz	10	
CP length		Normal	
Special subframe configuration		6	As specified in table 4.2-1 in TS 36.211. The same configuration in both cells
Uplink-downlink configuration		1	As specified in table 4.2-2 in TS 36.211. The same configuration in both cells
A3-Offset	dB	-3	
Hysteresis	dB	0	

Time To Trigger	s	0	
Filter coefficient		0	L3 filtering is not used
DRX		OFF	
si-RequestForHO		TRUE	As specified in clause 5.5.3.1 in TS 36.331.
T1	s	5	
T2	s	≤10	
T3	s	5	

Table A.8.2.7.1-2: Cell specific test parameters for E-UTRAN TDD Intra-frequency identification of a new CGI of E-UTRA cell using autonomous gaps

Parameter	Unit	Cell 1			Cell 2		
		T1	T2	T3	T1	T2	T3
E-UTRA RF Channel Number		1			1		
BW _{channel}	MHz	10			10		
Correlation Matrix and Antenna Configuration		2x1			2x1		
OCNG Patterns defined in A.3.2.2.1 (OP.1 TDD) and in A.3.2.2.2 (OP.2 TDD)		OP.1 TDD	OP.1 TDD	OP.1 TDD	OP.2 TDD	OP.2 TDD	OP.2 TDD
PBCH_RA	dB	-3			-3		
PBCH_RB	dB						
PSS_RA	dB						
SSS_RA	dB						
PCFICH_RB	dB	0			0		
PHICH_RA	dB	-3			-3		
PHICH_RB	dB						
PDCCH_RA	dB	0			0		
PDCCH_RB	dB						
PDSCH_RA	dB	-3			-3		
PDSCH_RB	dB						
OCNG_RA ^{Note 1}	dB						
OCNG_RB ^{Note 1}	dB						
\hat{E}_s / I_{ot}	dB	8	-3.3	-3.3	-Infinity	2.36	2.36
N_{oc} ^{Note 2}	dBm/15 KHz	-98					
\hat{E}_s / N_{oc}	dB	8	8	8	-Infinity	11	11
RSRP ^{Note 3}	dBm/15 KHz	-90	-90	-90	-Infinity	-87	-87
SCH_RP ^{Note 3}	dBm/15 KHz	-90	-90	-90	-Infinity	-87	-87
Propagation Condition		AWGN					
Timing offset to Cell 1	μs	-			3		
<p>Note 1: OCNG shall be used such that both cells are fully allocated and a constant total transmitted power spectral density is achieved for all OFDM symbols.</p> <p>Note 2: Interference from other cells and noise sources not specified in the test is assumed to be constant over subcarriers and time and shall be modelled as AWGN of appropriate power for N_{oc} to be fulfilled.</p> <p>Note 3: RSRP and SCH_RP levels have been derived from other parameters for information purposes. They are not settable parameters themselves.</p>							

A.8.2.7.2 Test Requirements

The UE shall transmit a measurement report containing the cell global identifier of cell 2 within 210 milliseconds from the start of T3.

Test requirement = RRC Procedure delay + $T_{\text{identify_C_GLLC_UE, intra}}$ + reporting delay

= 15 + 190 + 2ms from the start of T3

= 207 ms, allow 210 ms.

The UE shall be scheduled continuously throughout the test, and from the start of T3 until 210 ms at least 66 ACK/NACK shall be detected as being transmitted by the UE.

The rate of correct events observed during repeated tests shall be at least 90%.

NOTE: The overall 66 ACK/NACK number is caused by two parts. Firstly, at least 54 ACK/NACK shall be sent during identifying the cell global identifier of cell 2 according to the requirement for UL/DL configuration #1 in Table 8.1.2.2.4.1-1 of Clause 8.1.2.2.4.1. Secondly, given that continuous DL data allocation, additional 12 ACK/NACK shall be sent from the start of T3 until 210 ms excludes 190 ms for identifying the cell global identifier of cell 2.

A.8.2.8 E-UTRAN TDD Intra-frequency identification of a new CGI of E-UTRA cell using autonomous gaps with DRX

A.8.2.8.1 Test Purpose and Environment

This test is to verify the requirement for identification of a new CGI of E-UTRA cell with autonomous gaps in clause 8.5.2.1.6. The requirement is verified in a DRX configuration.

The test scenario comprises of one E-UTRA TDD carrier and two cells as given in tables A.8.2.8.1-1, A.8.2.8.1-2, A.8.2.8.1-3 and A.8.2.8.1-4. The test consists of three successive time periods, with time durations of T1, T2 and T3 respectively. At the start of time duration T1, the UE does not have any timing information of cell 2. Starting T2, cell 2 becomes detectable and the UE is expected to detect and send a measurement report.

A RRC message implying SI reading shall be sent to the UE during period T2, after the UE has reported Event A3. The RRC message shall create a measurement report configuration with purpose *reportCGI* and *si-RequestForHO* set to TRUE. The start of T3 is the instant when the last TTI containing the RRC message implying SI reading is sent to the UE.

In the test UE needs to be provided at least once every 1280ms with new Timing Advance Command MAC control element to restart the Time alignment timer to keep UE uplink time alignment. Furthermore UE sends scheduling request (SR) to obtain allocation to send the measurement report on PUSCH.

Table A.8.2.8.1-1: General test parameters for E-UTRAN TDD Intra-frequency identification of a new CGI of E-UTRA cell using autonomous gaps with DRX

Parameter	Unit	Value	Comment
PDSCH parameters		DL Reference Measurement Channel R.13 TDD	As specified in clause A.3.1.1.5
PCFICH/PDCCH/PHICH parameters		DL Reference Measurement Channel R.7 TDD	As specified in clause A.3.1.2.2
Active cell		Cell 1	
Neighbour cell		Cell 2	Cell to be identified.
E-UTRA RF Channel Number		1	Only one TDD carrier frequency is used.
Channel Bandwidth (BWchannel)	MHz	10	
CP length		Normal	
Special subframe configuration		6	As specified in table 4.2-1 in TS 36.211. The same configuration in both cells
Uplink-downlink configuration		1	As specified in table 4.2-2 in TS 36.211. The same configuration in both cells
A3-Offset	dB	-3	
Hysteresis	dB	0	
Time To Trigger	s	0	
Filter coefficient		0	L3 filtering is not used
DRX		ON	DRX related parameters are defined in Table A.8.2.4.1-3
si-RequestForHO		TRUE	As specified in clause 5.5.3.1 in TS 36.331.
T1	s	5	
T2	s	≤30	UE should report cell within 25.6s (20 DRX cycles)
T3	s	5	

Table A.8.2.8.1-2: Cell specific test parameters for E-UTRAN TDD Intra-frequency identification of a new CGI of E-UTRA cell using autonomous gaps with DRX

Parameter	Unit	Cell 1			Cell 2		
		T1	T2	T3	T1	T2	T3
E-UTRA RF Channel Number		1			1		
BW _{channel}	MHz	10			10		
Correlation Matrix and Antenna Configuration		2x1			2x1		
OCNG Patterns defined in A.3.2.2.1 (OP.1 TDD) and in A.3.2.2.2 (OP.2 TDD)		OP.1 TDD	OP.1 TDD	OP.1 TDD	OP.2 TDD	OP.2 TDD	OP.2 TDD
PBCH_RA	dB	-3			-3		
PBCH_RB	dB						
PSS_RA	dB						
SSS_RA	dB						
PCFICH_RB	dB	0			0		
PHICH_RA	dB	-3			-3		
PHICH_RB	dB	0			0		
PDCCH_RA	dB						
PDCCH_RB	dB						
PDSCH_RA	dB						
PDSCH_RB	dB	-3			-3		
OCNG_RA ^{Note 1}	dB						
OCNG_RB ^{Note 1}	dB						
\hat{E}_s / I_{ot}	dB	8	-3.3	-3.3	-Infinity	2.36	2.36
N_{oc} ^{Note 2}	dBm/15 KHz	-98					
\hat{E}_s / N_{oc}	dB	8	8	8	-Infinity	11	11
RSRP ^{Note 3}	dBm/15 KHz	-90	-90	-90	-Infinity	-87	-87
SCH_RP ^{Note 3}	dBm/15 KHz	-90	-90	-90	-Infinity	-87	-87
Propagation Condition		AWGN					
Timing offset to Cell 1	μs	-			3		
<p>Note 1: OCNG shall be used such that both cells are fully allocated and a constant total transmitted power spectral density is achieved for all OFDM symbols.</p> <p>Note 2: Interference from other cells and noise sources not specified in the test is assumed to be constant over subcarriers and time and shall be modelled as AWGN of appropriate power for N_{oc} to be fulfilled.</p> <p>Note 3: RSRP and SCH_RP levels have been derived from other parameters for information purposes. They are not settable parameters themselves.</p>							

Table A.8.2.8.1-3: DRX configuration for E-UTRAN TDD Intra-frequency identification of a new CGI of E-UTRA cell using autonomous gaps with DRX

Field	Value	Comment
onDurationTimer	psf1	As specified in clause 6.3.2 in TS 36.331
drx-InactivityTimer	psf1	
drx-RetransmissionTimer	psf1	
longDRX-CycleStartOffset	sf1280	
shortDRX	disable	

Table A.8.2.8.1-4: TimeAlignmentTimer-Configuration for E-UTRAN TDD Intra frequency identification of a new CGI of E-UTRA cell using autonomous gaps with DRX

Field	Value	Comment
TimeAlignmentTimer	Infinity	As specified in clause 6.3.2 in TS 36.331
sr-ConfigIndex	2	For further information see clause 6.3.2 in TS 36.331 and section 10.1 in TS 36.213.

A.8.2.8.2 Test Requirements

The UE shall transmit a measurement report containing the cell global identifier of cell 2 within 210 milliseconds from the start of T3.

Test requirement = RRC Procedure delay + $T_{\text{identify_C_GLLC-UE, intra}}$ + reporting delay

= 15 + 190 + 2ms from the start of T3

= 207 ms, allow 210 ms.

The rate of correct events observed during repeated tests shall be at least 90%.

A.8.2.9 E-UTRAN TDD Intra-frequency identification of a new CGI of E-UTRA cell using autonomous gaps for Cat-M1 UE in CEModeB

A.8.2.9.1 Test Purpose and Environment

This test is to verify the requirement for identification of a new CGI of E-UTRA cell with autonomous gaps in clause 8.13.3.1.6.

The test scenario comprises of one E-UTRA TDD carrier and two cells as given in tables A.8.2.9.1-1 and A.8.2.9.1-2. The test consists of three successive time periods, with time durations of T1, T2 and T3 respectively. At the start of time duration T1, the UE does not have any timing information of cell 2. Starting T2, cell 2 becomes detectable and the UE is expected to detect and send a measurement report.

A RRC message implying SI reading shall be sent to the UE during period T2, after the UE has reported Event A3. The RRC message shall create a measurement report configuration with purpose *reportCGI* and *si-RequestForHO* set to TRUE. The start of T3 is the instant when the last TTI containing the RRC message implying SI reading is sent to the UE.

Table A.8.2.9.1-1: General test parameters for E-UTRAN TDD Intra-frequency identification of a new CGI of E-UTRA cell using autonomous gaps for Cat-M1 UE in CEModeB

Parameter	Unit	Value	Comment
Active cell		Cell 1	
Neighbour cell		Cell 2	Cell to be identified.
Channel Bandwidth (BWchannel)	MHz	10	
CP length		Normal	
Special subframe configuration		6	As specified in table 4.2-1 in TS 36.211. The same configuration in both cells
Uplink-downlink configuration		1	As specified in table 4.2-2 in TS 36.211. The same configuration in both cells
A3-Offset	dB	-16	
Hysteresis	dB	0	
Time To Trigger	s	0	
Filter coefficient		0	L3 filtering is not used
DRX		OFF	
si-RequestForHO		TRUE	As specified in clause 5.5.3.1 in TS 36.331.
T1	s	5	
T2	s	≤325	
T3	s	7	

Table A.8.2.9.1-2: Cell specific test parameters for E-UTRAN TDD Intra-frequency identification of a new CGI of E-UTRA cell using autonomous gaps for Cat-M1 UE in CEModeB

Parameter	Unit	Cell 1			Cell 2		
		T1	T2	T3	T1	T2	T3
E-UTRA RF Channel Number		1			1		
BWchannel	MHz	10			10		

PDSCH reference measurement channel as specified in clause A.3.1.4.6		DL Reference Measurement Channel R.19 TDD			N/A		
MPDDCH reference channel as specified in clause A.3.1.3.6		DL Reference Measurement Channel R.16 TDD			N/A		
OCNG Patterns defined in A.3.2.2.1 (OP.1 TDD) and in A.3.2.2.2 (OP.2 TDD)		OP.11 TDD	OP.11 TDD	OP.11 TDD	OP.2 TDD	OP.2 TDD	OP.2 TDD
PBCH_RA	dB	-3			-3		
PBCH_RB	dB						
PSS_RA	dB						
SSS_RA	dB						
PCFICH_RB	dB	0			0		
PHICH_RA	dB	-3			-3		
PHICH_RB	dB	0			0		
PDCCH_RA	dB						
PDCCH_RB	dB	-3			-3		
PDSCH_RA	dB						
PDSCH_RB	dB						
OCNG_RA ^{Note 1}	dB						
OCNG_RB ^{Note 1}	dB	-98					
N_{oc} ^{Note 2}	dBm/15 KHz						
\hat{E}_s / N_{oc}	dB	8	8	8	-Infinity	-3	-3
\hat{E}_s / I_{ot}	dB	8	6.24	6.24	-Infinity	-11.64	-11.64
RSRP ^{Note 3}	dBm/15 KHz	-90	-90	-90	-Infinity	-101	-101
SCH_RP ^{Note 3}	dBm/15 KHz	-90	-90	-90	-Infinity	-101	-101
I_o ^{Note 3}	dBm/9MHz	-61.58	-61.29	-61.29	Specified in columns for Cell 1		
Propagation Condition		AWGN					
Antenna Configuration		2x1			2x1		
Timing offset to Cell 1	μ s	-			3		
PBCH repetition		-			Configured as specified in TS 36.211 [16]		
SIB1-BR repetition level		-			16		
<p>Note 1: OCNG shall be used such that both cells are fully allocated and a constant total transmitted power spectral density is achieved for all OFDM symbols.</p> <p>Note 2: Interference from other cells and noise sources not specified in the test is assumed to be constant over subcarriers and time and shall be modelled as AWGN of appropriate power for N_{oc} to be fulfilled.</p> <p>Note 3: E_s/I_{ot}, RSRP, SCH_RP and I_o levels have been derived from other parameters for information purposes. They are not settable parameters themselves.</p>							

A.8.2.9.2 Test Requirements

The UE shall transmit a measurement report containing the cell global identifier of cell 2 within 5137 ms from the start of T3.

Test requirement = RRC Procedure delay + $T_{\text{identify_C_GL_Cat_MI, intra}}$ + reporting delay

$$= 15 + 5120 + 2\text{ms from the start of T3}$$

$$= 5137 \text{ ms.}$$

The rate of correct events observed during repeated tests shall be at least 90%.

A.8.2.10 E-UTRAN TDD Intra-frequency identification of a new CGI of E-UTRA cell using autonomous gaps with DRX for Cat-M1 UE in CEModeB

A.8.2.10.1 Test Purpose and Environment

This test is to verify the requirement for identification of a new CGI of E-UTRA cell with autonomous gaps in clause 8.13.3.1.6. The requirement is verified in a DRX configuration.

The test scenario comprises of one E-UTRA TDD carrier and two cells as given in tables A.8.2.10.1-1 and A.8.2.10.1-2. The test consists of three successive time periods, with time durations of T1, T2 and T3 respectively. At the start of time duration T1, the UE does not have any timing information of cell 2. Starting T2, cell 2 becomes detectable and the UE is expected to detect and send a measurement report.

A RRC message implying SI reading shall be sent to the UE during period T2, after the UE has reported Event A3. The RRC message shall create a measurement report configuration with purpose *reportCGI* and *si-RequestForHO* set to TRUE. The start of T3 is the instant when the last TTI containing the RRC message implying SI reading is sent to the UE.

In the test UE needs to be provided at least once every 1280ms with new Timing Advance Command MAC control element to restart the Time alignment timer to keep UE uplink time alignment. Furthermore UE sends scheduling request (SR) to obtain allocation to send the measurement report on NPUSCH.

Table A.8.2.10.1-1: General test parameters for E-UTRAN TDD Intra-frequency identification of a new CGI of E-UTRA cell using autonomous gaps with DRX for Cat-M1 UE in CEModeB

Parameter	Unit	Value	Comment
Active cell		Cell 1	
Neighbour cell		Cell 2	Cell to be identified.
Channel Bandwidth (BW _{channel})	MHz	10	
CP length		Normal	
Special subframe configuration		6	As specified in table 4.2-1 in TS 36.211. The same configuration in both cells
Uplink-downlink configuration		1	As specified in table 4.2-2 in TS 36.211. The same configuration in both cells
A3-Offset	dB	-16	
Hysteresis	dB	0	
Time To Trigger	s	0	
Filter coefficient		0	L3 filtering is not used
DRX		ON	DRX related parameters are defined in Table A.8.2.8.1-3
si-RequestForHO		TRUE	As specified in clause 5.5.3.1 in TS 36.331.
T1	s	5	
T2	s	≤325	
T3	s	7	

Table A.8.2.10.1-2: Cell specific test parameters for E-UTRAN TDD Intra-frequency identification of a new CGI of E-UTRA cell using autonomous gaps with DRX for Cat-M1 UE in CEModeB

Parameter	Unit	Cell 1			Cell 2		
		T1	T2	T3	T1	T2	T3
E-UTRA RF Channel Number		1			1		
BW _{channel}	MHz	10			10		
PDSCH reference channel as specified in clause A.3.1.4.6		R.19 TDD			N/A		
MPDCCH reference channel as specified in clause A.3.1.3.6		R.16 TDD			N/A		

OCNG Patterns defined in A.3.2.2.11 (OP.11 TDD) and in A.3.2.2.2 (OP.2 TDD)		OP.11 TDD	OP.11 TDD	OP.11 TDD	OP.2 TDD	OP.2 TDD	OP.2 TDD
PBCH_RA	dB						
PBCH_RB	dB						
PSS_RA	dB	-3			-3		
SSS_RA	dB						
PCFICH_RB	dB	0			0		
PHICH_RA	dB	-3			-3		
PHICH_RB	dB						
PDCCH_RA	dB	0			0		
PDCCH_RB	dB						
PDSCH_RA	dB	-3			-3		
PDSCH_RB	dB						
OCNG_RA ^{Note 1}	dB						
OCNG_RB ^{Note 1}	dB						
N_{oc} ^{Note 2}	dBm/15 KHz	-98					
\hat{E}_s / N_{oc}	dB	8	8	8	-Infinity	-3	-3
\hat{E}_s / I_{ot}	dB	8	6.24	6.24	-Infinity	-11.64	-11.64
RSRP ^{Note 3}	dBm/15 KHz	-90	-90	-90	-Infinity	-101	-101
SCH_RP ^{Note 3}	dBm/15 KHz	-90	-90	-90	-Infinity	-101	-101
I_o ^{Note 3}	dBm/9MHz	-61.58	-61.29	-61.29	Specified in columns for Cell 1		
Antenna Configuration		2x1			2x1		
Propagation Condition		AWGN					
Timing offset to Cell 1	μ s	-			3		
PBCH repetition		-			Configured as specified in TS 36.211 [16]		
SIB1-BR repetition level		-			16		
<p>Note 1: OCNG shall be used such that both cells are fully allocated and a constant total transmitted power spectral density is achieved for all OFDM symbols.</p> <p>Note 2: Interference from other cells and noise sources not specified in the test is assumed to be constant over subcarriers and time and shall be modelled as AWGN of appropriate power for N_{oc} to be fulfilled.</p> <p>Note 3: E_s/I_{ot}, RSRP, SCH_RP and I_o levels have been derived from other parameters for information purposes. They are not settable parameters themselves.</p>							

Table A.8.2.10.1-3: DRX configuration for E-UTRAN TDD Intra-frequency identification of a new CGI of E-UTRA cell using autonomous gaps with DRX for Cat-M1 UE in CEModeB

Field	Value	Comment
onDurationTimer	psf1	As specified in clause 6.3.2 in TS 36.331
drx-InactivityTimer	psf1	
drx-RetransmissionTimer	psf1	
longDRX-CycleStartOffset	sf1280	
shortDRX	disable	

Table A.8.2.10.1-4: TimeAlignmentTimer -Configuration for E-UTRAN TDD Intra frequency identification of a new CGI of E-UTRA cell using autonomous gaps with DRX for Cat-M1 UE in CEModeB

Field	Value	Comment
TimeAlignmentTimer	Infinity	As specified in clause 6.3.2 in TS 36.331
sr-ConfigIndex	2	For further information see clause 6.3.2 in TS 36.331 and section 10.1 in TS 36.213.

A.8.2.10.2 Test Requirements

The UE shall transmit a measurement report containing the cell global identifier of cell 2 within 5137 ms from the start of T3.

Test requirement = RRC Procedure delay + $T_{\text{identify_C_GL_Cat_M1_intra}}$ + reporting delay

= 15 + 5120 + 2ms from the start of T3

= 5137 ms.

The rate of correct events observed during repeated tests shall be at least 90%.

A.8.2.11 E-UTRAN TDD-TDD intra-frequency event triggered reporting with DRX for UE configured with *highSpeedEnhancedMeasFlag*

A.8.2.11.1 Test Purpose and Environment

The purpose of the test is to verify that the UE makes correct reporting of an event in DRX when UE is configured with *highSpeedEnhancedMeasFlag*. The tests will partly verify the TDD-TDD intra-frequency cell search in DRX requirements for UE configured with *highSpeedEnhancedMeasFlag* in clause 8.1.2.2.1.2.

The test parameters are given in Tables A.8.2.11.1-1, A.8. 2.11.1-2, A.8. 2.11.1-3 and A.8. 2.11.1-4. In the measurement control information, it is indicated to the UE that event-triggered reporting with Event A3 is used. At the same time, *highSpeedEnhancedMeasFlag* is broadcasted to UE. The test consists of two successive time periods, with time duration of T1 and T2 respectively. During time duration T1, the UE shall not have any timing information of cell 2.

The uplink time alignment is not maintained and UE needs to use RACH to obtain UL allocation for measurement reporting.

Table A.8.2.11.1-1: General test parameters for E-UTRAN TDD-TDD intra-frequency event triggered reporting with DRX for UE configured with *highSpeedEnhancedMeasFlag*

Parameter	Unit	Value	Comment
Active cell		Cell 1	
Neighbour cell		Cell 2	Cell to be identified.
A3-Offset	dB	-6	
CP length		Normal	
Special subframe configuration		6	As specified in table 4.2-1 in TS 36.211. The same configuration in both cells
Uplink-downlink configuration		1	As specified in table 4.2-2 in TS 36.211. The same configuration in both cells
Hysteresis	dB	0	
Time To Trigger	s	0	
Filter coefficient		0	L3 filtering is not used
DRX		ON	DRX related parameters are defined in Table A.8.2.11.1-3
T1	s	5	
T2	s	30	

Table A.8.2.11.1-2: Cell specific test parameters for E-UTRAN TDD-TDD intra-frequency event triggered reporting with DRX for UE configured with *highSpeedEnhancedMeasFlag*

Parameter	Unit	Cell 1		Cell 2	
		T1	T2	T1	T2
E-UTRA RF Channel Number		1		1	
BW _{channel}	MHz	5MHz: NRB,c = 25 10MHz: NRB,c = 50 20MHz: NRB,c = 100		5MHz: NRB,c = 25 10MHz: NRB,c = 50 20MHz: NRB,c = 100	

PDSCH parameters:		5MHz: R.4 TDD 10MHz: R.0 TDD 20MHz: R.3 TDD	-		
PCFICH/PDCCH/PHICH parameters:		5MHz: R.11 TDD 10MHz: R.6 TDD 20MHz: R.10 TDD	-		
OCNG Pattern defined in A.3.2.2		5MHz: OP.9 TDD 10MHz: OP.1 TDD 20MHz: OP.7 TDD	5MHz: OP.10 TDD 10MHz: OP.2 TDD 20MHz: OP.8 TDD		
PBCH_RA	dB	-3	-3		
PBCH_RB	dB				
PSS_RA	dB				
SSS_RA	dB				
PCFICH_RB	dB				
PHICH_RA	dB				
PHICH_RB	dB				
PDCCH_RA	dB				
PDCCH_RB	dB				
PDSCH_RA	dB				
PDSCH_RB	dB				
OCNG_RA ^{Note 1}	dB				
OCNG_RB ^{Note 1}	dB				
N_{oc} ^{Note 2}	dBm/15 kHz			-98	
\hat{E}_s / N_{oc}	dB	4	4	-Infinity	4
\hat{E}_s / I_{ot}	dB	4	-1.46	-Infinity	-1.46
RSRP ^{Note 3}	dBm/15 kHz	-94	-94	-Infinity	-94
SCH_RP ^{Note 3}	dBm/15 kHz	-94	-94	-Infinity	-94
I_o ^{Note 3}	dBm/Ch BW	-64.76 +10log ($N_{RB,c} / 50$)	-62.42 +10log ($N_{RB,c} / 50$)	Specified in columns for Cell 1	
Propagation Condition		AWGN		AWGN 1750Hz ^{Note 4}	
Antenna Configuration		2x2		2x2	
Timing offset to Cell 1 Synchronous cells	us	-		3	
<p>Note 1: OCNG shall be used such that both cells are fully allocated and a constant total transmitted power spectral density is achieved for all OFDM symbols.</p> <p>Note 2: Interference from other cells and noise sources not specified in the test is assumed to be constant over subcarriers and time and shall be modelled as AWGN of appropriate power for N_{oc} to be fulfilled.</p> <p>Note 3: E_s/I_{ot}, RSRP, SCH_RP and I_o levels have been derived from other parameters for information purposes. They are not settable parameters themselves.</p> <p>Note 4: The AWGN 1750Hz condition is a non fading propagation channel with one tap. Doppler shift is a constant 1750Hz.</p>					

Table A.8.2.11.1-3: DRX-Configuration for E-UTRAN TDD-TDD intra-frequency event triggered reporting with DRX for UE configured with *highSpeedEnhancedMeasFlag*

Field	Value	Comment
onDurationTimer	psf1	As specified in clause 6.3.2 in TS 36.331 [2]
drx-InactivityTimer	psf1	
drx-RetransmissionTimer	psf1	
longDRX-CycleStartOffset	sf1280	
shortDRX	disable	

Table A.8.2.11.1-4: *TimeAlignmentTimer* -Configuration for E-UTRAN TDD-TDD intra-frequency event triggered reporting with DRX for UE configured with *highSpeedEnhancedMeasFlag*

Field	Value	Comment
TimeAlignmentTimer	sf500	As specified in clause 6.3.2 in TS 36.331 [2]

sr-ConfigIndex	2	For further information see clause 6.3.2 in TS 36.331 [2] and clause 10.1 in TS 36.213 [3].
----------------	---	---

A.8.2.11.2 Test Requirements

The UE shall send one Event A3 triggered measurement report, with a measurement reporting delay less than 12800 ms from the beginning of time period T2. The measurement reporting delay is defined as the time from the beginning of time period T2 to the moment when the UE starts to send preambles on the PRACH for scheduling request (SR) to obtain allocation to send the measurement report on PUSCH.

The UE shall not send event triggered measurement reports, as long as the reporting criteria are not fulfilled.

The rate of correct events observed during repeated tests shall be at least 90%.

NOTE: The actual overall delays measured in the test may be up to one DRX cycle higher than the measurement reporting delays above because UE is allowed to delay the initiation of the measurement reporting procedure to the next until the Active Time.

NOTE 2: In order to calculate the rate of correct events the system simulator shall verify that it has received correct Event A3 measurement report.

A.8.2.12 E-UTRAN TDD-TDD intra-frequency event triggered reporting under fading propagation conditions in synchronous cells for UE category 0

A.8.2.12.1 Test Purpose and Environment

The purpose of this test is to verify that the UE makes correct reporting of an event. This test case is applicable to UE category 0 as defined in Section 3.1. This test will partly verify the TDD intra-frequency cell search requirements in clause 8.5.2.1.3.1.

The test parameters are given in Table A.8.2.12.1-1 and A.8.2.12.1-2 below. In the measurement control information it is indicated to the UE that event-triggered reporting with Event A3 is used. PDCCHs indicating new transmissions or retransmissions should be sent continuously to ensure that the UE would not enter the DRX state. The test consists of two successive time periods, with time duration of T1, and T2 respectively. During time duration T1, the UE shall not have any timing information of cell 2.

Table A.8.2.12.1-1: General test parameters for E-UTRAN TDD-TDD intra-frequency event triggered reporting under fading propagation conditions in synchronous cells for UE category 0

Parameter	Unit	Value	Comment
Active cell		Cell 1	
Neighbour cell		Cell 2	Cell to be identified.
E-UTRA RF Channel Number		1	One TDD carrier frequency is used.
Channel Bandwidth (BW _{channel})	MHz	10	
A3-Offset	dB	-10	
CP length		Normal	
Special subframe configuration		6	As specified in table 4.2-1 in TS 36.211. The same configuration in both cells
Uplink-downlink configuration		1	As specified in table 4.2-2 in TS 36.211. The same configuration in both cells
Hysteresis	dB	0	
Time To Trigger	s	0	
Filter coefficient		0	L3 filtering is not used
DRX		DRX_L	As specified in clause A.3.3
Time offset between cells		3 μs	Synchronous cells
T1	s	5	
T2	s	5	

Table A.8.2.12.1-2: Cell specific test parameters for E-UTRAN TDD-TDD intra-frequency event triggered reporting under fading propagation conditions in synchronous cells for UE category 0

Parameter	Unit	Cell 1		Cell 2	
		T1	T2	T1	T2
E-UTRA RF Channel Number		1		1	
$BW_{channel}$	MHz	10		10	
Correlation Matrix and Antenna Configuration		2x1		2x1	
PDSCH parameters: DL Reference Measurement Channel defined in A.3.1.1.5		R.13 TDD		-	
PCFICH/PDCCH/PHICH parameters: DL Reference Measurement Channel defined in A.3.1.2.2		R.7 TDD		R.7 TDD	
OCNG Pattern defined in A.3.2.2.1 (OP.1 TDD) and in A.3.2.2.2 (OP.2)		OP.1 TDD		OP.2 TDD	
PBCH_RA	dB	-3		-3	
PBCH_RB	dB				
PSS_RA	dB				
SSS_RA	dB				
PCFICH_RB	dB				
PHICH_RA	dB				
PHICH_RB	dB				
PDCCH_RA	dB				
PDCCH_RB	dB				
PDSCH_RA	dB				
PDSCH_RB	dB				
OCNG_RA ^{Note 1}	dB				
OCNG_RB ^{Note 1}	dB				
N_{oc} ^{Note 3}	dBm/15 kHz				
RSRP ^{Note 4}	dBm/15 kHz	-91	-91	-Infinity	-94
\hat{E}_s/I_{ot}	dB	7	1.54	-Infinity	-3.79
SCH_RP ^{Note 4}	dBm/15 kHz	-91	-91	-Infinity	-94
\hat{E}_s/N_{oc}	dB	7	7	-Infinity	4
I_o ^{Note 4}	dBm/9MHz	-62.43	-60.91	Specified in Cell 1 columns	
Propagation Condition		ETU70		ETU70	
Note 1	OCNG shall be used such that both cells are fully allocated and a constant total transmitted power spectral density is achieved for all OFDM symbols.				
Note 2:	The resources for uplink transmission are assigned to the UE prior to the start of time period T2.				
Note 3:	Interference from other cells and noise sources not specified in the test is assumed to be constant over subcarriers and time and shall be modelled as AWGN of appropriate power for N_{oc} to be fulfilled.				
Note 4:	E_s/I_{ot} , RSRP, SCH_RP and I_o levels have been derived from other parameters for information purposes. They are not settable parameters themselves.				

A.8.2.12.2 Test Requirements

The UE shall send one Event A3 triggered measurement report, with a measurement reporting delay less than 1000 ms from the beginning of time period T2.

The UE shall not send event triggered measurement reports, as long as the reporting criteria are not fulfilled.

The rate of correct events observed during repeated tests shall be at least 90%.

NOTE: The actual overall delays measured in the test may be up to $2xTTI_{DCCCH}$ higher than the measurement reporting delays above because of TTI insertion uncertainty of the measurement report in DCCCH.

A.8.2.13 E-UTRAN TDD-TDD intra-frequency event triggered reporting under fading propagation conditions in synchronous cells with DRX for UE category 0

A.8.2.13.1 Test Purpose and Environment

The purpose of the two tests is to verify that the UE makes correct reporting of an event in DRX. This test case is applicable to UE category 0 as defined in Section 3.1. The tests will partly verify the TDD-TDD intra-frequency cell search in DRX requirements in clause 8.5.2.1.3.2.

The test parameters are given in Tables A.8.2.13.1-1, A.8.2.13.1-2, A.8.2.13.1-3 and A.8.2.13.1-4. In the measurement control information, it is indicated to the UE that event-triggered reporting with Event A3 is used. The test consists of two successive time periods, with time duration of T1, and T2 respectively. During time duration T1, the UE shall not have any timing information of cell 2.

In Test 1 UE needs to be provided at least once every 500ms with new Timing Advance Command MAC control element to restart the Time alignment timer to keep UE uplink time alignment. Furthermore UE is allocated with PUSCH resource at every DRX cycle.

In Test 2 the uplink time alignment is not maintained and UE needs to use RACH to obtain UL allocation for measurement reporting.

Table A.8.2.13.1-1: General test parameters for E-UTRAN TDD-TDD intra-frequency event triggered reporting under fading propagation conditions in synchronous cells when DRX is used for UE category 0

Parameter	Unit	Value		Comment
		Test 1	Test 2	
Active cell		Cell 1		
Neighbour cell		Cell 2		Cell to be identified.
E-UTRA RF Channel Number		1		One TDD carrier frequency is used.
Channel Bandwidth ($BW_{channel}$)	MHz	10		
A3-Offset	dB	-10		
CP length		Normal		
Special subframe configuration		6		As specified in table 4.2-1 in TS 36.211. The same configuration in both cells
Uplink-downlink configuration		1		As specified in table 4.2-2 in TS 36.211. The same configuration in both cells
Hysteresis	dB	0		
Time To Trigger	s	0		
Filter coefficient		0		L3 filtering is not used
DRX		ON		DRX related parameters are defined in Table A.8.2.13.1-3
Time offset between cells		3 μ s		Synchronous cells
T1	s	5		
T2	s	5	30	

Table A.8.2.13.1-2: Cell specific test parameters for E-UTRAN TDD-TDD intra-frequency event triggered reporting under fading propagation conditions in synchronous cells when DRX is used for UE category 0

Parameter	Unit	Cell 1		Cell 2	
		T1	T2	T1	T2
E-UTRA RF Channel Number		1		1	
$BW_{channel}$	MHz	10		10	
Correlation Matrix and Antenna Configuration		2x1		2x1	

PDSCH parameters: DL Reference Measurement Channel defined in A.3.1.1.5		R.13 TDD		-	
PCFICH/PDCCH/PHICH parameters: DL Reference Measurement Channel defined in A.3.1.2.2		R.7 TDD		R.7 TDD	
OCNG Pattern defined in A.3.2.2.1 (OP.1 TDD) and in A.3.2.2.2 (OP.2)		OP.1 TDD		OP.2 TDD	
PBCH_RA	dB	-3		-3	
PBCH_RB	dB				
PSS_RA	dB				
SSS_RA	dB				
PCFICH_RB	dB				
PHICH_RA	dB				
PHICH_RB	dB				
PDCCH_RA	dB				
PDCCH_RB	dB				
PDSCH_RA	dB				
PDSCH_RB	dB				
OCNG_RA ^{Note 1}	dB				
OCNG_RB ^{Note 1}	dB				
N_{oc} ^{Note 2}	dBm/15 kHz				
RSRP ^{Note 3}	dBm/15 kHz	-91	-91	-Infinity	-94
\hat{E}_s / I_{ot}	dB	7	1.54	-Infinity	-3.79
SCH_RP ^{Note 3}	dBm/15 kHz	-91	-91	-Infinity	-94
\hat{E}_s / N_{oc}	dB	7	7	-Infinity	4
I_o ^{Note 4}	dBm/9MHz	-62.43	-60.91	Specified in Cell 1 columns	
Propagation Condition		ETU70		ETU70	
<p>Note 1: OCNG shall be used such that both cells are fully allocated and a constant total transmitted power spectral density is achieved for all OFDM symbols.</p> <p>Note 2: Interference from other cells and noise sources not specified in the test is assumed to be constant over subcarriers and time and shall be modelled as AWGN of appropriate power for N_{oc} to be fulfilled.</p> <p>Note 3: E_s/I_{ot}, RSRP, SCH_RP and I_o levels have been derived from other parameters for information purposes. They are not settable parameters themselves.</p>					

Table A.8.2.13.1-3: DRX-Configuration for E-UTRAN TDD-TDD intra-frequency event triggered reporting in DRX under fading propagation conditions in synchronous cells for UE category 0

Field	Test1	Test2	Comment
	Value	Value	
onDurationTimer	psf1	psf1	As specified in clause 6.3.2 in TS 36.331
drx-InactivityTimer	psf1	psf1	
drx-RetransmissionTimer	psf1	psf1	
longDRX-CycleStartOffset	sf40	sf1280	
shortDRX	disable	disable	

Table A.8.2.13.1-4: TimeAlignmentTimer -Configuration for E-UTRAN TDD-TDD intra-frequency event triggered reporting in DRX under fading propagation conditions in synchronous cells for UE category 0

Field	Test1	Test2	Comment
	Value	Value	
TimeAlignmentTimer	sf500	sf500	As specified in clause 6.3.2 in TS 36.331

sr-ConfigIndex	2	2	For further information see clause 6.3.2 in TS 36.331 and clause 10.1 in TS 36.213.
----------------	---	---	---

A.8.2.13.2 Test Requirements

In Test 1, the UE shall send one Event A3 triggered measurement report, with a measurement reporting delay less than 1000 ms from the beginning of time period T2. The measurement reporting delay is defined as the time from the beginning of time period T2 to the moment when the UE send the measurement report on PUSCH.

In Test 2, the UE shall send one Event A3 triggered measurement report, with a measurement reporting delay less than 25600 ms from the beginning of time period T2. The measurement reporting delay is defined as the time from the beginning of time period T2 to the moment when the UE starts to send preambles on the PRACH for scheduling request (SR) to obtain allocation to send the measurement report on PUSCH.

The UE shall not send event triggered measurement reports, as long as the reporting criteria are not fulfilled.

The rate of correct events observed during repeated tests shall be at least 90%.

NOTE 1: The actual overall delays measured in the test may be up to one DRX cycle higher than the measurement reporting delays above because UE is allowed to delay the initiation of the measurement reporting procedure to the next until the Active Time.

NOTE 2: In order to calculate the rate of correct events the system simulator shall verify that it has received correct Event A3 measurement report.

A.8.2.14 E-UTRAN TDD intra-frequency event triggered reporting for serving cell under fading propagation conditions for UE category M1 in CEModeA without gap

A.8.2.14.1 Test Purpose and Environment

The purpose of this test is to verify that the Cat-M1 UE makes correct reporting of an event for serving cell without using any measurement gaps.

UE is not configured with any reporting configuration that requires measurement on any intra-frequency neighbour cell.

This test will partly verify the TDD intra-frequency measurement requirements in clause 8.13.2.1.3.

The test parameters are given in Table A.8.2.14.1-1 and A.8.2.14.1-2 below. In the measurement control information it is indicated to the UE that event-triggered reporting with Event A2 is used. The test consists of two successive time periods, with time duration of T1, and T2 respectively. At the beginning of T2 the transmission power of cell 1 is decreased below the threshold, and this shall result in reporting of Event A2.

Table A.8.2.14.1-1: General test parameters

Parameter	Unit	Value	Comment
E-UTRA RF Channel Number		1	
Active cell		Cell 1	
CP length		Normal	
DRX		OFF	
A2	Threshold	dB	-96
	Hysteresis	dB	0
	Time To Trigger	S	0
Filter coefficient		0	L3 filtering is not used
R_{max}		8	As defined in <i>mPDCCH-NumRepetition</i> in [3]
G		1	As defined in <i>mPDCCH-startSF-UESS</i> in [3]
T1	S	5	
T2	S	5	
Special subframe configuration		6	As specified in table 4.2-1 in TS 36.211. The same configuration in both cells

Uplink-downlink configuration		1	As specified in table 4.2-2 in TS 36.211. The same configuration in both cells
-------------------------------	--	---	---

Table A.8.2.14.1-2: Cell specific test parameters

Parameter	Unit	Cell 1	
		T1	T2
E-UTRA RF Channel Number		1	
$BW_{channel}$	MHz	10	
PDSCH parameters: DL Reference Measurement Channel		R.17 TDD	
MPDCCH parameters: DL Reference Measurement Channel		R.15 TDD	
OCNG Patterns		OP.11 TDD	
PBCH_RA	dB	-3	
PBCH_RB	dB		
PSS_RA	dB		
SSS_RA	dB		
PCFICH_RB	dB		
PHICH_RA	dB		
PHICH_RB	dB		
MPDCCH_RA	dB		
MPDCCH_RB	dB		
PDSCH_RA	dB		
PDSCH_RB	dB		
OCNG_RA ^{Note 1}	dB		
OCNG_RB ^{Note 1}	dB		
N_{oc} ^{Note 2}	dBm/15 KHz		
\hat{E}_s / N_{oc}	dB	19	-3
\hat{E}_s / I_{ot} ^{Note 3}	dB	19	-3
RSRP ^{Note 3}	dBm/15 KHz	-85	-107
SCH_RP ^{Note 3}	dBm/15 KHz	-85	-107
I_o ^{Note 3}	dBm/9MHz	-57.16	-74.45
Propagation Condition		ETU30	
Correlation Matrix and Antenna Configuration		2x1 Low	
<p>Note 1: OCNG shall be used such that all cells are fully allocated and a constant total transmitted power spectral density is achieved for all OFDM symbols.</p> <p>Note 2: Interference from noise sources not specified in the test is assumed to be constant over subcarriers and time and shall be modelled as AWGN of appropriate power for N_{oc} to be fulfilled.</p> <p>Note 3: E_s/I_{ot}, RSRP, SCH_RP and I_o have been derived from other parameters for information purposes. They are not settable parameters themselves.</p> <p>Note 4: The resources for uplink transmission are assigned to the UE prior to the start of time period T2.</p>			

A.8.2.14.2 Test Requirement

The UE shall send one Event A2 triggered measurement report, with a measurement reporting delay less than 480ms from the beginning of time period T2.

The UE shall not send event triggered measurement reports, as long as the reporting criteria are not fulfilled.

The rate of correct events observed during repeated tests shall be at least 90%.

NOTE: The actual overall delays measured in the test may be up to $2xTTI_{DCCH}$ higher than the measurement reporting delays above because of TTI insertion uncertainty of the measurement report in DCCH.

A.8.3 E-UTRAN FDD - FDD Inter-frequency Measurements

A.8.3.1 E-UTRAN FDD-FDD Inter-frequency event triggered reporting under fading propagation conditions in asynchronous cells

A.8.3.1.1 Test Purpose and Environment

The purpose of this test is to verify that the UE makes correct reporting of an event. This test will partly verify the FDD-FDD inter-frequency cell search requirements in clause 8.1.2.3.

The test parameters are given in Tables A.8.3.1.1-1 and A.8.3.1.1-2. In this test, there are two cells on different carrier frequencies and gap pattern configuration # 0 as defined in Table 8.1.2.1-1 is provided.

In the measurement control information, it is indicated to the UE that event-triggered reporting with Event A3 is used. The test consists of two successive time periods, with time duration of T1, and T2 respectively. During time duration T1, the UE shall not have any timing information of cell 2.

Table A.8.3.1.1-1: General test parameters for E-UTRAN FDD-FDD inter-frequency event triggered reporting in fading propagation conditions

Parameter	Unit	Value	Comment
PDSCH parameters		DL Reference Measurement Channel R.0 FDD	As specified in clause A.3.1.1.1
PCFICH/PDCCH/PHICH parameters		DL Reference Measurement Channel R.6 FDD	As specified in clause A.3.1.2.1
E-UTRA RF Channel Number		1, 2	Two FDD carrier frequencies are used.
Channel Bandwidth (BW _{channel})	MHz	10	
Active cell		Cell 1	Cell 1 is on RF channel number 1
Neighbour cell		Cell 2	Cell 2 is on RF channel number 2
Gap Pattern Id		0	As specified in TS 36.133 clause 8.1.2.1.
A3-Offset	dB	-6	
Hysteresis	dB	0	
CP length		Normal	
TimeToTrigger	s	0	
Filter coefficient		0	L3 filtering is not used
DRX		OFF	OFF
Time offset between cells		3 ms	Asynchronous cells
T1	s	5	
T2	s	5	

Table A.8.3.1.1-2: Cell specific test parameters for E-UTRAN FDD-FDD inter-frequency event triggered reporting under fading propagation conditions in synchronous cells

Parameter	Unit	Cell 1		Cell 2	
		T1	T2	T1	T2
E-UTRA RF Channel Number		1		2	
BW _{channel}	MHz	10		10	
Correlation Matrix and Antenna Configuration		1x2 Low		1x2 Low	
OCNG Patterns defined in A.3.2.1.1 (OP.1 FDD) and in A.3.2.1.2 (OP.2 FDD)		OP.1 FDD		OP.2 FDD	
PBCH_RA	dB	0		0	
PBCH_RB	dB				
PSS_RA	dB				
SSS_RA	dB				
PCFICH_RB	dB				
PHICH_RA	dB				
PHICH_RB	dB				
PDCCH_RA	dB				

PDCCH_RB	dB				
PDSCH_RA	dB				
PDSCH_RB	dB				
OCNG_RA ^{Note 1}	dB				
OCNG_RB ^{Note 1}	dB				
N_{oc} ^{Note 3}	dBm/15 kHz			-98	
RSRP ^{Note 4}	dBm/15 kHz	-94	-94	-Infinity	-91
\hat{E}_s / I_{ot}	dB	4	4	-Infinity	7
SCH_RP ^{Note 4}	dBm/15 kHz	-94	-94	-Infinity	-91
\hat{E}_s / N_{oc}	dB	4	4	-Infinity	7
Propagation Condition		ETU70			
<p>Note 1: OCNG shall be used such that both cells are fully allocated and a constant total transmitted power spectral density is achieved for all OFDM symbols.</p> <p>Note 2: The resources for uplink transmission are assigned to the UE prior to the start of time period T2.</p> <p>Note 3: Interference from other cells and noise sources not specified in the test is assumed to be constant over subcarriers and time and shall be modelled as AWGN of appropriate power for N_{oc} to be fulfilled.</p> <p>Note 4: RSRP and SCH_RP levels have been derived from other parameters for information purposes. They are not settable parameters themselves.</p>					

A.8.3.1.2 Test Requirements

The UE shall send one Event A3 triggered measurement report, with a measurement reporting delay less than 3840 ms from the beginning of time period T2.

The UE shall not send event triggered measurement reports, as long as the reporting criteria are not fulfilled.

The rate of correct events observed during repeated tests shall be at least 90%.

NOTE: The actual overall delays measured in the test may be up to $2 \times TTI_{DCC}$ higher than the measurement reporting delays above because of TTI insertion uncertainty of the measurement report in DCC.

A.8.3.2 E-UTRAN FDD-FDD Inter-frequency event triggered reporting when DRX is used under fading propagation conditions in asynchronous cells

A.8.3.2.1 Test Purpose and Environment

The purpose of these tests is to verify that the UE makes correct reporting of an event in DRX. These test will partly verify the FDD-FDD inter-frequency cell search requirements when DRX is used in clause 8.1.2.3.

The common test parameters are given in Tables A.8.3.2.1-1 and A.8.3.2.1-2. DRX configuration for Test1 and Test2 are given in Table A.8.3.2.1-3 and time alignment timer and scheduling request related parameters in Table A.8.3.2.1-4. In this tests, there are two cells on different carrier frequencies and gap pattern configuration # 0 as defined in Table 8.1.2.1-1 is provided.

In Test 1 UE needs to be provided at least once every 500ms with new Timing Advance Command MAC control element to restart the Time alignment timer to keep UE uplink time alignment. Furthermore UE is allocated with PUSCH resource at every DRX cycle. In Test 2 the uplink time alignment is not maintained and UE needs to use RACH to obtain UL allocation for measurement reporting.

In the measurement control information, it is indicated to the UE that event-triggered reporting with Event A3 is used. The tests consists of two successive time periods, with time duration of T1, and T2 respectively. During time duration T1, the UE shall not have any timing information of cell 2.

Table A.8.3.2.1-1: General test parameters for E-UTRAN FDD-FDD inter-frequency event triggered reporting when DRX is used in fading propagation conditions

Parameter	Unit	Test 1	Test 2	Comment
		Value		
PDSCH parameters		DL Reference Measurement Channel R.0 FDD		As specified in clause A.3.1.1.1 Note that UE may only be allocated at <i>On Duration</i>

PCFICH/PDCCH/PHICH parameters		DL Reference Measurement Channel R.6 FDD	As specified in clause A.3.1.2.1.
E-UTRA RF Channel Number		1, 2	Two FDD carrier frequencies are used.
Channel Bandwidth (BW _{channel})	MHz	10	
Active cell		Cell 1	Cell 1 is on RF channel number 1
Neighbour cell		Cell 2	Cell 2 is on RF channel number 2
Gap Pattern Id		0	As specified in TS 36.133 clause 8.1.2.1.
A3-Offset	dB	-6	
Hysteresis	dB	0	
CP length		Normal	
TimeToTrigger	s	0	
Filter coefficient		0	L3 filtering is not used
PRACH configuration		4	As specified in table 5.7.1-2 in TS 36.211
Access Barring Information	-	Not Sent	No additional delays in random access procedure.
DRX		ON	DRX related parameters are defined in Table A.8.3.2.1-3
Time offset between cells		3 ms	Asynchronous cells
T1	s	5	
T2	s	5	30

Table A.8.3.2.1-2: Cell specific test parameters for E-UTRAN FDD-FDD inter-frequency event triggered reporting under fading propagation conditions in synchronous cells

Parameter	Unit	Cell 1		Cell 2	
		T1	T2	T1	T2
E-UTRA RF Channel Number		1		2	
BW _{channel}	MHz	10		10	
Correlation Matrix and Antenna Configuration		1x2 Low		1x2 Low	
OCNG Patterns defined in A.3.2.1.1 (OP.1 FDD) and in A.3.2.1.2 (OP.2 FDD)		OP.1 FDD		OP.2 FDD	
PBCH_RA	dB	0		0	
PBCH_RB	dB				
PSS_RA	dB				
SSS_RA	dB				
PCFICH_RB	dB				
PHICH_RA	dB				
PHICH_RB	dB				
PDCCH_RA	dB				
PDCCH_RB	dB				
PDSCH_RA	dB				
PDSCH_RB	dB				
OCNG_RA ^{Note 1}	dB				
OCNG_RB ^{Note 1}	dB				
N_{oc} ^{Note 2}	dBm/15 kHz	-98			
RSRP ^{Note 3}	dBm/15 kHz	-94	-94	-Infinity	-91
\hat{E}_s / I_{ot}	dB	4	4	-Infinity	7
SCH_RP ^{Note 3}	dBm/15 kHz	-94	-94	-Infinity	-91
\hat{E}_s / N_{oc}	dB	4	4	-Infinity	7
Propagation Condition		ETU70			
<p>Note 1: OCNG shall be used such that both cells are fully allocated and a constant total transmitted power spectral density is achieved for all OFDM symbols.</p> <p>Note 2: Interference from other cells and noise sources not specified in the test is assumed to be constant over subcarriers and time and shall be modelled as AWGN of appropriate power for N_{oc} to be fulfilled.</p> <p>Note 3: RSRP and SCH_RP levels have been derived from other parameters for information purposes. They are not settable parameters themselves.</p>					

Table A.8.3.2.1-3: drx-Configuration to be used in E-UTRAN FDD-FDD inter-frequency event triggered reporting when DRX is used in fading propagation conditions

Field	Test1	Test2	Comment
	Value	Value	
onDurationTimer	psf1	psf1	
drx-InactivityTimer	psf1	psf1	
drx-RetransmissionTimer	psf1	psf1	
longDRX-CycleStartOffset	sf40	sf1280	
shortDRX	disable	disable	
Note: For further information see clause 6.3.2 in TS 36.331.			

Table A.8.3.2.1-4: TimeAlignmentTimer and sr-ConfigIndex -Configuration to be used in E-UTRAN FDD-FDD inter-frequency event triggered reporting when DRX is used in fading propagation conditions

Field	Test1	Test2	Comment
	Value	Value	
TimeAlignmentTimer	sf500	sf500	For further information see clause 6.3.2 in TS 36.331.
sr-ConfigIndex	0	0	For further information see clause 6.3.2 in TS 36.331 and section10.1 in TS 36.213..

A.8.3.2.2 Test Requirements

In Test1 the UE shall send one Event A3 triggered measurement report, with a measurement reporting delay less than 3840 ms from the beginning of time period T2. The measurement reporting delay is defined as the time from the beginning of time period T2, to the moment when the UE send the measurement report on PUSCH.

In Test2 the UE shall send one Event A3 triggered measurement report, with a measurement reporting delay less than 20*1280ms from the beginning of time period T2. The measurement reporting delay is defined as the time from the beginning of time period T2, to the moment when the UE starts to send preambles on the PRACH for scheduling request (SR) to obtain allocation to send the measurement report on PUSCH.

The UE shall not send event triggered measurement reports, as long as the reporting criteria are not fulfilled.

The rate of correct events observed during repeated tests shall be at least 90%.

NOTE 1: The actual overall delays measured in the test may be up to one DRX cycle higher than the measurement reporting delays above because UE is allowed to delay the initiation of the measurement reporting procedure to the next until the Active Time.

NOTE 2: In order to calculate the rate of correct events the system simulator shall verify that it has received correct Event A3 measurement report

A.8.3.3 E-UTRAN FDD-FDD inter-frequency event triggered reporting under AWGN propagation conditions in asynchronous cells with DRX when L3 filtering is used

A.8.3.3.1 Test Purpose and Environment

The purpose of this test is to verify that the UE makes correct reporting of an event in DRX when L3 filtering is used. This test will partly verify the FDD-FDD inter-frequency cell search in DRX requirements in clause 8.1.2.3.1.2 and the UE behaviour with the *filterCoefficient* defined in TS 36.331 [2].

The test parameters are given in Tables A.8.3.3.1-1, A.8.3.3.1-2, A.8.3.3.1-3 and A.8.3.3.1-4. In the measurement control information, it is indicated to the UE that event-triggered reporting with Event A3 and the filter coefficient is used. The test consists of two successive time periods, with time duration of T1, and T2 respectively. In this test, there are two cells on different carrier frequencies and gap pattern configuration # 1 as defined in Table 8.1.2.1-1 is provided.

The uplink time alignment is not maintained and UE needs to use RACH to obtain UL allocation for measurement reporting.

Table A.8.3.3.1-1: General test parameters for E-UTRAN FDD-FDD inter-frequency event triggered reporting under AWGN propagation conditions in asynchronous cells with DRX when L3 filtering is used

Parameter	Unit	Value	Comment
PDSCH parameters		DL Reference Measurement Channel R.0 FDD	As specified in clause A.3.1.1.1
PCFICH/PDCCH/PHICH parameters		DL Reference Measurement Channel R.6 FDD	As specified in clause A.3.1.2.1
Active cell		Cell 1	
Neighbour cell		Cell 2	Cell to be identified.
E-UTRA RF Channel Number		1, 2	Two FDD carrier frequencies are used.
Channel Bandwidth (BW _{channel})	MHz	10	
Gap Pattern Id		1	As specified in TS 36.133 clause 8.1.2.1.
Neighbour A3-Offset Ofn	dB	-14	
CP length		Normal	
Hysteresis	dB	0	
Time To Trigger	s	0	
Filter coefficient		9	L3 filtering is used
DRX		ON	DRX related parameters are defined in Table A.8.3.3.1-3
Time offset between cells		3 ms	Asynchronous cells
T1	S	30	
T2	S	9	

Table A.8.3.3.1-2: Cell specific test parameters for E-UTRAN FDD-FDD inter-frequency event triggered reporting under AWGN propagation conditions in asynchronous cells with DRX when L3 filtering is used

Parameter	Unit	Cell 1		Cell 2	
		T1	T2	T1	T2
E-UTRA RF Channel Number		1		2	
BW _{channel}	MHz	10		10	
OCNG Patterns defined in A.3.2.1.1 (OP.1 FDD) and in A.3.2.1.2 (OP.2 FDD)		OP.1 FDD		OP.2 FDD	
PBCH_RA	dB	0		0	
PBCH_RB	dB				
PSS_RA	dB				
SSS_RA	dB				
PCFICH_RB	dB				
PHICH_RA	dB				
PHICH_RB	dB				
PDCCH_RA	dB				
PDCCH_RB	dB				
PDSCH_RA	dB				
PDSCH_RB	dB				
OCNG_RA ^{Note 1}	dB				
OCNG_RB ^{Note 1}	dB				
\hat{E}_s / I_{ot}	dB	4	4	4	24
N_{oc} ^{Note 2}	dBm/15 KHz	-98			
\hat{E}_s / N_{oc}	dB	4	4	4	24
RSRP ^{Note 3}	dBm/15 KHz	-94	-94	-94	-74
SCH_RP ^{Note 3}	dBm/15 KHz	-94	-94	-94	-74
Propagation Condition		AWGN			

Note 1: OCNG shall be used such that both cells are fully allocated and a constant total transmitted power spectral density is achieved for all OFDM symbols.
 Note 2: Interference from other cells and noise sources not specified in the test is assumed to be constant over subcarriers and time and shall be modelled as AWGN of appropriate power for N_{oc} to be fulfilled.
 Note 3: RSRP and SCH_RP levels have been derived from other parameters for information purposes. They are not settable parameters themselves.

Table A.8.3.3.1-3: DRX-Configuration for E-UTRAN FDD-FDD inter-frequency event triggered reporting in DRX under AWGN propagation conditions in asynchronous cells with DRX when L3 filtering is used

Field	Value	Comment
onDurationTimer	psf1	As specified in clause 6.3.2 in TS 36.331
drx-InactivityTimer	psf1	
drx-RetransmissionTimer	psf1	
longDRX-CycleStartOffset	sf1280	
shortDRX	disable	

Table A.8.3.3.1-4: TimeAlignmentTimer -Configuration for E-UTRAN FDD-FDD inter-frequency event triggered reporting in DRX under AWGN propagation conditions in asynchronous cells with DRX when L3 filtering is used

Field	Value	Comment
TimeAlignmentTimer	sf500	As specified in clause 6.3.2 in TS 36.331
sr-ConfigIndex	0	For further information see clause 6.3.2 in TS 36.331 and section 10.1 in TS 36.213.

A.8.3.3.2 Test Requirements

The UE shall send one Event A3 triggered measurement report, with a measurement reporting delay less than 6400 ms from the beginning of time period T2. The measurement reporting delay is defined as the time from the beginning of time period T2 to the moment when the UE starts to send preambles on the PRACH for scheduling request (SR) to obtain allocation to send the measurement report on PUSCH.

The UE shall not send event triggered measurement reports, as long as the reporting criteria are not fulfilled.

The rate of correct events observed during repeated tests shall be at least 90%.

NOTE 1: The actual overall delays measured in the test may be up to one DRX cycle higher than the measurement reporting delays above because UE is allowed to delay the initiation of the measurement reporting procedure to the next until the Active Time.

NOTE 2: In order to calculate the rate of correct events the system simulator shall verify that it has received correct Event A3 measurement report.

A.8.3.4 E-UTRAN FDD - FDD Inter-frequency identification of a new CGI of E-UTRA cell using autonomous gaps

A.8.3.4.1 Test Purpose and Environment

This test is to verify the requirement for identification of a new CGI of E-UTRA cell with autonomous gaps in clause 8.1.2.3.5.

The test scenario comprises of two E-UTRA FDD carriers and one cell on each carrier as given in tables A.8.3.4.1-1 and A.8.3.4.1-2. PDCCHs indicating new transmissions shall be sent continuously to ensure that the UE would have ACK/NACK sending during identifying a new CGI of E-UTRAN cell. The test consists of three successive time periods, with time durations of T1, T2 and T3 respectively. At the start of time duration T1, the UE does not have any timing information of cell 2. Starting T2, cell 2 becomes detectable and the UE is expected to detect and send a measurement report. Gap pattern configuration with id #0 as specified in Table 8.1.2.1-1 is configured before T2 begins to enable inter-frequency monitoring.

A RRC message implying SI reading shall be sent to the UE during period T2, after the UE has reported Event A3. The RRC message shall create a measurement report configuration with purpose *reportCGI* and *si-RequestForHO* set to TRUE. The start of T3 is the instant when the last TTI containing the RRC message implying SI reading is sent to the UE. Measurement gaps shall be deconfigured before the start of T3.

Table A.8.3.4.1-1: General test parameters for E-UTRAN FDD - FDD Inter-frequency identification of a new CGI of E-UTRA cell using autonomous gaps

Parameter	Unit	Value	Comment
PDSCH parameters		DL Reference Measurement Channel R.3 FDD	As specified in clause A.3.1.1.1
PCFICH/PDCCH/PHICH parameters		DL Reference Measurement Channel R.6 FDD	As specified in clause A.3.1.2.1
E-UTRA RF channel number		1, 2	Two FDD carrier frequencies are used.
Channel Bandwidth ($BW_{channel}$)	MHz	10	
Active cell		Cell 1	Cell 1 is on RF channel number 1.
Neighbour cell		Cell 2	Cell 1 is on RF channel number 2.
CP length		Normal	
Gap Pattern Id		0	As specified in TS 36.133 clause 8.1.2.1.
A3-Offset	dB	-6	
Hysteresis	dB	0	
TimeToTrigger	s	0	
Filter coefficient		0	L3 filtering is not used
DRX		OFF	
si-RequestForHO		TRUE	As specified in clause 5.5.3.1 in TS 36.331.
Time offset between cells	ms	3	Asynchronous cells
T1	s	5	
T2	s	≤10	

T3	s	5	
----	---	---	--

Table A.8.3.4.1-2: Cell specific test parameters for E-UTRAN FDD - FDD Inter-frequency identification of a new CGI of E-UTRA cell using autonomous gaps

Parameter	Unit	Cell 1			Cell 2		
		T1	T2	T3	T1	T2	T3
E-UTRA RF Channel Number		1			2		
BW _{channel}	MHz	10			10		
OCNG Patterns defined in A.3.2.1.10 (OP.10 FDD) and in A.3.2.1.2 (OP.2 FDD)		OP.10 FDD	OP.10 FDD	OP.10 FDD	OP.2 FDD	OP.2 FDD	OP.2 FDD
PBCH_RA	dB	0			0		
PBCH_RB	dB						
PSS_RA	dB						
SSS_RA	dB						
PCFICH_RB	dB						
PHICH_RA	dB						
PHICH_PB	dB						
PDCCH_RA	dB						
PDCCH_PB	dB						
PDSCH_RA	dB						
PDSCH_RB	dB						
OCNG_RA ^{Note 1}	dB						
OCNG_RB ^{Note 1}	dB						
\hat{E}_s / I_{ot}	dB	4	4	4	-Infinity	7	7
N_{oc} ^{Note 2}	dBm/15 KHz	-98					
\hat{E}_s / N_{oc}	dB	4	4	4	-Infinity	7	7
RSRP ^{Note 3}	dBm/15 KHz	-94	-94	-94	-Infinity	-91	-91
SCH_RP ^{Note 3}	dBm/15 KHz	-94	-94	-94	-Infinity	-91	-91
Propagation Condition		AWGN					
Note 1: OCNG shall be used such that both cells are fully allocated and a constant total transmitted power spectral density is achieved for all OFDM symbols. Note 2: Interference from other cells and noise sources not specified in the test is assumed to be constant over subcarriers and time and shall be modelled as AWGN of appropriate power for N_{oc} to be fulfilled. Note 3: RSRP and SCH_RP levels have been derived from other parameters for information purposes. They are not settable parameters themselves.							

A.8.3.4.2 Test Requirements

The UE shall transmit a measurement report containing the cell global identifier of cell 2 within 170 milliseconds from the start of T3.

$$\text{Test requirement} = \text{RRC Procedure delay} + T_{\text{identify_C_GI_inter}} + \text{reporting delay}$$

$$= 15 + 150 + 2\text{ms from the start of T3}$$

$$= 167 \text{ ms, allow } 170 \text{ ms.}$$

The UE shall be scheduled continuously throughout the test, and from the start of T3 until 170 ms at least 80 ACK/NACK shall be detected as being transmitted by the UE.

The rate of correct events observed during repeated tests shall be at least 90%.

NOTE: The overall 80 ACK/NACK number is caused by two parts. Firstly, at least 60 ACK/NACK shall be sent during identifying the cell global identifier of cell 2 according to the requirement in Clause 8.1.2.3.5.1. Secondly, given that continuous DL data allocation, and the measurement gaps have been deconfigured before the start of T3, additional 20 ACK/NACK shall be sent from the start of T3 until 170 ms excludes 150 ms for identifying the cell global identifier of cell 2.

A.8.3.5 E-UTRAN FDD - FDD Inter-frequency identification of a new CGI of E-UTRA cell using autonomous gaps with DRX

This test is to verify the requirement for identification of a new CGI of E-UTRA cell with autonomous gaps in clause 8.1.2.3.5. The requirement is verified in a DRX configuration.

The test scenario comprises of two E-UTRA FDD carriers and one cell on each carrier as given in tables A.8.3.5.1-1, A.8.3.5.1-2, A.8.3.5.1-3 and A.8.3.5.1-4. The test consists of three successive time periods, with time durations of T1, T2 and T3 respectively. At the start of time duration T1, the UE does not have any timing information of cell 2. Starting T2, cell 2 becomes detectable and the UE is expected to detect and send a measurement report. Gap pattern configuration with id #0 as specified in Table 8.1.2.1-1 is configured before T2 begins to enable inter-frequency monitoring.

A RRC message implying SI reading shall be sent to the UE during period T2, after the UE has reported Event A3. The RRC message shall create a measurement report configuration with purpose *reportCGI* and *si-RequestForHO* set to TRUE. The start of T3 is the instant when the last TTI containing the RRC message implying SI reading is sent to the UE. Measurement gaps shall be deconfigured before the start of T3.

In the test UE needs to be provided at least once every 1280ms with new Timing Advance Command MAC control element to restart the Time alignment timer to keep UE uplink time alignment. Furthermore UE sends scheduling request (SR) to obtain allocation to send the measurement report on PUSCH.

Table A.8.3.5.1-1: General test parameters for E-UTRAN FDD - FDD Inter-frequency identification of a new CGI of E-UTRA cell using autonomous gaps with DRX

Parameter	Unit	Value	Comment
PDSCH parameters		DL Reference Measurement Channel R.0 FDD	As specified in clause A.3.1.1.1
PCFICH/PDCCH/PHICH parameters		DL Reference Measurement Channel R.6 FDD	As specified in clause A.3.1.2.1
E-UTRA RF channel number		1, 2	Two FDD carrier frequencies are used.
Channel Bandwidth ($BW_{channel}$)	MHz	10	
Active cell		Cell 1	Cell 1 is on RF channel number 1.
Neighbour cell		Cell 2	Cell 1 is on RF channel number 2.
CP length		Normal	
Gap Pattern Id		0	As specified in TS 36.133 clause 8.1.2.1.
A3-Offset	dB	-6	
Hysteresis	dB	0	
TimeToTrigger	s	0	
Filter coefficient		0	L3 filtering is not used
DRX		ON	DRX related parameters are defined in Table A.8.3.5.1-3
si-RequestForHO		TRUE	As specified in clause 5.5.3.1 in TS 36.331.
Time offset between cells	ms	3	Asynchronous cells
T1	s	5	
T2	s	≤30	UE shall report cell within 25.6s (20 DRX cycles)
T3	s	5	

Table A.8.3.5.1-2: Cell specific test parameters for E-UTRAN FDD - FDD Inter-frequency identification of a new CGI of E-UTRA cell using autonomous gaps with DRX

Parameter	Unit	Cell 1			Cell 2		
		T1	T2	T3	T1	T2	T3
E-UTRA RF Channel Number		1			2		
$BW_{channel}$	MHz	10			10		
OCNG Patterns defined in A.3.2.1.1 (OP.1 FDD) and in A.3.2.1.2 (OP.2 FDD)		OP.1 FDD	OP.1 FDD	OP.1 FDD	OP.2 FDD	OP.2 FDD	OP.2 FDD
PBCH_RA	dB						
PBCH_RB	dB						

PSS_RA	dB	0			0		
SSS_RA	dB						
PCFICH_RB	dB						
PHICH_RA	dB						
PHICH_PB	dB						
PDCCH_RA	dB						
PDCCH_PB	dB						
PDSCH_RA	dB						
PDSCH_RB	dB						
OCNG_RA ^{Note 1}	dB						
OCNG_RB ^{Note 1}	dB						
\hat{E}_s / I_{ot}	dB	4	4	4	-Infinity	7	7
N_{oc} ^{Note 2}	dBm/15 KHz	-98					
\hat{E}_s / N_{oc}	dB	4	4	4	-Infinity	7	7
RSRP ^{Note 3}	dBm/15 KHz	-94	-94	-94	-Infinity	-91	-91
SCH_RP ^{Note 3}	dBm/15 KHz	-94	-94	-94	-Infinity	-91	-91
Propagation Condition		AWGN					
<p>Note 1: OCNG shall be used such that both cells are fully allocated and a constant total transmitted power spectral density is achieved for all OFDM symbols.</p> <p>Note 2: Interference from other cells and noise sources not specified in the test is assumed to be constant over subcarriers and time and shall be modelled as AWGN of appropriate power for N_{oc} to be fulfilled.</p> <p>Note 3: RSRP and SCH_RP levels have been derived from other parameters for information purposes. They are not settable parameters themselves.</p>							

Table A.8.3.5.1-3: DRX configuration for E-UTRAN FDD - FDD Inter-frequency identification of a new CGI of E-UTRA cell using autonomous gaps with DRX

Field	Value	Comment
onDurationTimer	psf1	As specified in clause 6.3.2 in TS 36.331
drx-InactivityTimer	psf1	
drx-RetransmissionTimer	psf1	
longDRX-CycleStartOffset	sf1280	
shortDRX	disable	

Table A.8.3.5.1-4: TimeAlignmentTimer -Configuration for E-UTRAN FDD - FDD Inter-frequency identification of a new CGI of E-UTRA cell using autonomous gaps with DRX

Field	Value	Comment
TimeAlignmentTimer	Infinity	As specified in clause 6.3.2 in TS 36.331
sr-ConfigIndex	0	For further information see clause 6.3.2 in TS 36.331 and section 10.1 in TS 36.213.

A.8.3.5.2 Test Requirements

The UE shall transmit a measurement report containing the cell global identifier of cell 2 within 170 milliseconds from the start of T3.

$$\begin{aligned}
 \text{Test requirement} &= \text{RRC Procedure delay} + T_{\text{identify_C_GI_inter}} + \text{reporting delay} \\
 &= 15 + 150 + 2\text{ms from the start of T3} \\
 &= 167 \text{ ms, allow 170 ms.}
 \end{aligned}$$

The rate of correct events observed during repeated tests shall be at least 90%.

A.8.3.6 E-UTRAN FDD-FDD Inter-frequency event triggered reporting without measurement gaps under AWGN propagation conditions in asynchronous cells

A.8.3.6.1 Test Purpose and Environment

The purpose of this test is to verify that the UE makes correct reporting of an event without measurement gaps. This test will partly verify the FDD-FDD inter-frequency cell search requirements in section 8.1.2.3.

The test parameters are given in Tables A.8.3.6.1-1 and A.8.3.6.1-2. In this test, there are two cells on different carrier frequencies and no gaps are configured in this test. In the measurement control information, it is indicated to the UE that event-triggered reporting with Event A3 is used. The test consists of two successive time periods, with time duration of T1, and T2 respectively. During time duration T1, the UE shall not have any timing information of cell 2. PDCCH on the PCell shall be sent continuously to ensure that the UE sends ACK/NACKs throughout the test.

Table A.8.3.6.1-1: General test parameters for E-UTRAN FDD-FDD inter-frequency event triggered reporting without measurement gaps

Parameter	Unit	Value	Comment
PDSCH parameters		DL Reference Measurement Channel R.3 FDD	As specified in section A.3.1.1.1
PCFICH/PDCCH/PHICH parameters		DL Reference Measurement Channel R.6 FDD	As specified in section A.3.1.2.1
E-UTRA RF Channel Number		1, 2	Two FDD carrier frequencies are used.
Channel Bandwidth ($BW_{channel}$)	MHz	10	
Active PCell		Cell 1	Cell 1 is on RF channel number 1
Neighbour cell		Cell 2	Cell 2 is on RF channel number 2
A3-Offset	dB	-6	
Hysteresis	dB	0	
CP length		Normal	
TimeToTrigger	s	0	
Filter coefficient		0	L3 filtering is not used
DRX		OFF	OFF
Time offset between cells		3 ms	Asynchronous cells
T1	s	5	
T2	s	5	

Table A.8.3.6.1-2: Cell specific test parameters for E-UTRAN FDD-FDD inter-frequency event triggered reporting without measurement gaps

Parameter	Unit	Cell 1		Cell 2	
		T1	T2	T1	T2
E-UTRA RF Channel Number		1		2	
$BW_{channel}$	MHz	10		10	
OCNG Patterns defined in A.3.2.1.10 (OP.10 FDD) and in A.3.2.1.2 (OP.2 FDD)		OP.10 FDD		OP.2 FDD	
PBCH_RA	dB	0		0	
PBCH_RB	dB				
PSS_RA	dB				
SSS_RA	dB				
PCFICH_RB	dB				
PHICH_RA	dB				
PHICH_RB	dB				
PDCCH_RA	dB				
PDCCH_RB	dB				
PDSCH_RA	dB				
PDSCH_RB	dB				

OCNG_RA ^{Note 1}	dB				
OCNG_RB ^{Note 1}	dB				
N_{oc} ^{Note 2}	dBm/15 kHz			-98	
RSRP ^{Note 3}	dBm/15 kHz	-94	-94	-Infinity	-91
\hat{E}_s/I_{ot}	dB	4	4	-Infinity	7
SCH_RP ^{Note 3}	dBm/15 kHz	-94	-94	-Infinity	-91
\hat{E}_s/N_{oc}	dB	4	4	-Infinity	7
Propagation Condition		AWGN			
Note 1: OCNG shall be used such that both cells are fully allocated and a constant total transmitted power spectral density is achieved for all OFDM symbols.					
Note 2: Interference from other cells and noise sources not specified in the test is assumed to be constant over subcarriers and time and shall be modelled as AWGN of appropriate power for N_{oc} to be fulfilled.					
Note 3: RSRP and SCH_RP levels have been derived from other parameters for information purposes. They are not settable parameters themselves.					

A.8.3.6.2 Test Requirements

The UE shall send one Event A3 triggered measurement report, with a measurement reporting delay less than 3840 ms from the beginning of time period T2.

The UE shall not send event triggered measurement reports, as long as the reporting criteria are not fulfilled.

The UE shall send continuous ACK/NACK throughout the test, and from the start of T2 until Event A3 is reported, at least 85% ACK/NACK shall be detected.

For a test to be considered successful requirements on both event detection and percentage of transmitted ACK/NACKs have to be fulfilled simultaneously. The rate of correct events observed during repeated tests shall be at least 90%.

NOTE: The actual overall delays measured in the test may be up to $2 \times TTI_{DCCCH}$ higher than the measurement reporting delays above because of TTI insertion uncertainty of the measurement report in DCCCH.

A.8.3.7 E-UTRAN FDD-FDD Inter-frequency event triggered reporting under fading propagation conditions in asynchronous cells for Increased Carrier Monitoring without Reduced Performance Group

A.8.3.7.1 Test Purpose and Environment

The purpose of this test is to verify that the UE makes correct reporting of an event. This test will partly verify the FDD-FDD inter-frequency cell search requirements in clause 8.1.2.3.

The test parameters are given in Tables A.8.3.1.1-1 and A.8.3.1.1-2. In this test, there are four cells on different carrier frequencies and gap pattern configuration # 0 as defined in Table 8.1.2.1-1 is provided.

In the measurement control information, it is indicated to the UE that event-triggered reporting with Event A3 is used. The test consists of two successive time periods, with time duration of T1, and T2 respectively. During time duration T1, the UE shall not have any timing information of cells 2, 3 or 4.

Table A.8.3.7.1-1: General test parameters for E-UTRAN FDD-FDD inter-frequency event triggered reporting in fading propagation conditions

Parameter	Unit	Value	Comment
UE configured E-UTRA RF Channel Number		1, 2,3,4,5,6,7,8,9	Serving cell and eight FDD carrier frequencies are used in the UE neighbour cell list.
Active cell		Cell 1	Cell 1 is on RF channel number 1
Neighbour cells		Cell 2, Cell 3, Cell 4	Cells 2, 3, 4 are randomly selected to use different frequencies selected from frequencies 2,3,4,5,6,7,8,9
Gap Pattern Id		0	As specified in TS 36.133 clause 8.1.2.1.
A3-Offset	dB	-6	

Hysteresis	dB	0	
Reduced Performance Group Scaling factor	-	8	
CP length		Normal	
TimeToTrigger	s	0	
Filter coefficient		0	L3 filtering is not used
DRX		OFF	OFF
T1	s	5	
T2	s	40	

Table A.8.3.7.1-2: Cell specific test parameters for E-UTRAN FDD-FDD inter-frequency event triggered reporting under fading propagation conditions in synchronous cells (Cell # 1 and Cell # 2)

Parameter	Unit	Cell 1		Cell 2	
		T1	T2	T1	T2
E-UTRA RF Channel Number		1		Randomly selected from 2,3,4,5,6,7,8 such that cell 2 is in the normal performance group	
$BW_{channel}$	MHz	5MHz: $N_{RB} = 25$ 10MHz: $N_{RB} = 50$		5MHz: $N_{RB} = 25$ 10MHz: $N_{RB} = 50$	
Measurement bandwidth	n_{PRB}	5MHz: 10-15 10MHz: 22-27		5MHz: 10-15 10MHz: 22-27	
PDSCH Reference measurement channel defined in A.3.1.1.		5MHz: R.5 FDD 10MHz: R.0 FDD		-	
PDSCH allocation	n_{PRB}	5MHz: 7-17 10MHz: 13-36		-	
PDCCH/PCFICH/PHICH Reference measurement channel defined in A.3.1.2.		5MHz: R.11 FDD 10MHz: R.6 FDD		5MHz: R.11 FDD 10MHz: R.6 FDD	
OCNG Patterns defined in A.3.2.		5MHz: OP.15 FDD 10MHz: OP.1 FDD		5MHz: OP.16 FDD 10MHz: OP.2 FDD	
PBCH_RA	dB	0		0	
PBCH_RB	dB				
PSS_RA	dB				
SSS_RA	dB				
PCFICH_RB	dB				
PHICH_RA	dB				
PHICH_RB	dB				
PDCCH_RA	dB				
PDCCH_RB	dB				
PDSCH_RA	dB				
PDSCH_RB	dB				
OCNG_RA ^{Note 1}	dB				
OCNG_RB ^{Note 1}	dB				
N_{oc} ^{Note 3}	dBm/15 kHz				
\hat{E}_s/N_{oc}	dB	4	4	-Infinity	7
\hat{E}_s/I_{ot}	dB	4	4	-Infinity	7
RSRP ^{Note 4}	dBm/15 kHz	-94	-94	-Infinity	-91
SCH_RP ^{Note 4}	dBm/15 kHz	-94	-94	-Infinity	-91
I_o ^{Note 4}	dBm/ $BW_{channel}$	-	-	-	-
		$64.76+10\log(N_{RB,c}/50)$	$64.76+10\log(N_{RB,c}/50)$	$70.22+10\log(N_{RB,c}/50)$	$62.43+10\log(N_{RB,c}/50)$
Propagation Condition		ETU70		ETU70	
Correlation Matrix and Antenna Configuration		1x2 Low		1x2 Low	
Timing offset to cell 1	ms	-		3	

Note 1:	OCNG shall be used such that both cells are fully allocated and a constant total transmitted power spectral density is achieved for all OFDM symbols.
Note 2:	The resources for uplink transmission are assigned to the UE prior to the start of time period T2.
Note 3:	Interference from other cells and noise sources not specified in the test is assumed to be constant over subcarriers and time and shall be modelled as AWGN of appropriate power for N_{oc} to be fulfilled.
Note 4:	E_s/I_{ot} , RSRP, SCH_RP and I_o levels have been derived from other parameters for information purposes. They are not settable parameters themselves.

Table A.8.3.7.1-3: Cell specific test parameters for E-UTRAN FDD-FDD inter-frequency event triggered reporting under fading propagation conditions in synchronous cells (Cell # 3 and Cell # 4)

Parameter	Unit	Cell 3		Cell 4	
		T1	T2	T1	T2
E-UTRA RF Channel Number		Randomly selected from 2,3,4,5,6,7,8 such that cell 3 is in the normal performance group		Randomly selected from 2,3,4,5,6,7,8 such that cell 4 is in the normal performance group	
$BW_{channel}$	MHz	5MHz: $N_{RB} = 25$ 10MHz: $N_{RB} = 50$		5MHz: $N_{RB} = 25$ 10MHz: $N_{RB} = 50$	
Measurement bandwidth	n_{PRB}	5MHz: 10-15 10MHz: 22-27		5MHz: 10-15 10MHz: 22-27	
PDSCH Reference measurement channel defined in A.3.1.1.		-		-	
PDSCH allocation	n_{PRB}	-		-	
PDCCH/PCFICH/PHICH Reference measurement channel defined in A.3.1.2.		5MHz: R.11 FDD 10MHz: R.6 FDD		5MHz: R.11 FDD 10MHz: R.6 FDD	
OCNG Patterns defined in A.3.2.		5MHz: OP.16 FDD 10MHz: OP.2 FDD		5MHz: OP.16 FDD 10MHz: OP.2 FDD	
PBCH_RA	dB	0		0	
PBCH_RB	dB				
PSS_RA	dB				
SSS_RA	dB				
PCFICH_RB	dB				
PHICH_RA	dB				
PHICH_RB	dB				
PDCCH_RA	dB				
PDCCH_RB	dB				
PDSCH_RA	dB				
PDSCH_RB	dB				
OCNG_RA ^{Note 1}	dB				
OCNG_RB ^{Note 1}	dB				
N_{oc} ^{Note 3}	dBm/15 kHz				
\hat{E}_s/N_{oc}	dB	-Infinity	7	-Infinity	7
\hat{E}_s/I_{ot}	dB	-Infinity	7	-Infinity	7
RSRP ^{Note 4}	dBm/15 kHz	-Infinity	-91	-Infinity	-91
SCH_RP ^{Note 4}	dBm/15 kHz	-Infinity	-91	-Infinity	-91
I_o ^{Note 4}	dBm/ $BW_{channel}$	-	-	-	-
		$70.22+10\log(N_{RB,c}/50)$	$62.43+10\log(N_{RB,c}/50)$	$70.22+10\log(N_{RB,c}/50)$	$62.43+10\log(N_{RB,c}/50)$
Propagation Condition		ETU70		ETU70	
Correlation Matrix and Antenna Configuration		1x2 Low		1x2 Low	
Timing offset to cell 1	ms	3		3	

Note 1:	OCNG shall be used such that both cells are fully allocated and a constant total transmitted power spectral density is achieved for all OFDM symbols.
Note 2:	The resources for uplink transmission are assigned to the UE prior to the start of time period T2.
Note 3:	Interference from other cells and noise sources not specified in the test is assumed to be constant over subcarriers and time and shall be modelled as AWGN of appropriate power for N_{oc} to be fulfilled.
Note 4:	E_s/lot , RSRP, SCH_RP and I_o levels have been derived from other parameters for information purposes. They are not settable parameters themselves.

A.8.3.7.2 Test Requirements

The UE shall send Event A3 triggered measurement reports for cells 2, 3 and 4, with a measurement reporting delay less than 30.72s from the beginning of time period T2.

The UE shall not send event triggered measurement reports, as long as the reporting criteria are not fulfilled.

The rate of correct events observed during repeated tests shall be at least 90%.

NOTE: The actual overall delays measured in the test may be up to $2 \times TTI_{DCCCH}$ higher than the measurement reporting delays above because of TTI insertion uncertainty of the measurement report in DCCH.

A.8.3.8 FDD-FDD Interfrequency correct reporting of measurement events with reduced performance group configured, non DRX

A.8.3.8.1 Test Purpose and Environment

The purpose of this test is to verify that the UE makes correct reporting of an event. This test will partly verify the FDD-FDD inter-frequency cell measurement requirements for increased UE carrier monitoring in clause 8.1.2.3.

The test parameters are given in Tables A.8.3.8.1-1, A.8.3.8.1-2 and A.8.3.8.1-3. In this test, there are 4 cells on different carrier frequencies and gap pattern configuration #0 as defined in table A.8.3.8.1-1 is provided.

In the measurement control information, it is indicated to the UE that event-triggered reporting with Events A3 is used. The test consists of two successive time periods for every repetition, with time duration of T1, and T2 respectively. During time duration T1, the UE shall not have any timing information of neighbour cells. At the start of each repetition of T1, the test equipment provides signals for cell 1 (serving cell), and cells 2, 3 and 4 which are selected from the 8 cells which are configured in the UE neighbour cell list. Cells 2, 3 and 4 are chosen randomly, such that one frequency belongs to the normal performance group and two frequencies belong to the reduced performance group.

Table A.8.3.8.1-1: General test parameters for FDD-FDD Interfrequency correct reporting of measurement events with reduced performance group configured, non DRX

Parameter	Unit	Value	Comment
UE configured E-UTRA RF Channel Number		1,2,3,4,5,6,7,8,9	Serving cell and 8 FDD carrier frequencies are used in the UE neighbour cell list. Frequencies 5,6,7,8 and 9 are indicated to have reduced performance
Test equipment configuration		Cell 1 uses E-UTRA RF channel number 1 Cell 2,3,4 are randomly selected to use different frequencies selected from frequencies 2,3,4,5,6,7,8,9	Cell 1 uses E-UTRA RF channel number 1 Cell 2 is randomly selected to use different frequencies selected from E-UTRA frequencies 2, 3, 4. Cells 3, 4 are randomly selected to use different frequencies selected from E-UTRA frequencies 5, 6, 7, 8, 9.
Active cell		Cell 1	Cell 1 is on RF channel number 1
Gap Pattern Id		0	As specified in TS 36.133 clause 8.1.2.1.
A3-Offset	dB	-6	
Hysteresis	dB	0	
CP length		Normal	
TimeToTrigger	s	0	
Filter coefficient		0	L3 filtering is not used
DRX		OFF	OFF
Scaling factor configurations		8	As specified in TS 36.133 clause 8.1.2.1.1a

T1	s	5	
T2	s	155	

Table A.8.3.8.1-2: Cell specific test parameters for FDD-FDD Interfrequency correct reporting of measurement events with reduced performance group configured, non DRX (cell #1, cell #2)

Parameter	Unit	Cell 1		Cell 2	
		T1	T2	T1	T2
E-UTRA RF Channel Number		1		Randomly selected from 2,3,4 such that cell 2 is in the normal performance group	
BW _{channel}		5MHz: N _{RB} = 25 10MHz: N _{RB} = 50		5MHz: N _{RB} ,= 25 10MHz: N _{RB} ,= 50	
PDSCH parameters: DL Reference Measurement Channel As specified in clause A.3.1.1.1		5MHz: R.5 FDD 10MHz:R.0 FDD		-	
PCFICH/PDCCH/PHICH parameters: DL Reference Measurement Channel As specified in clause A.3.1.2.1		5MHz: R.11 FDD 10MHz:R.6 FDD		5MHz: R.11 FDD 10MHz:R.6 FDD	
OCNG Patterns defined in A.3.2.1.1, A.3.2.1.2 ,A.3.2.1.15 and A.3.2.1.16		5MHz: OP.15 FDD 10MHz:OP.1 FDD		5MHz: OP.16.FDD 10MHz:OP.2 FDD	
PBCH_RA	dB	0		0	
PBCH_RB	dB				
PSS_RA	dB				
SSS_RA	dB				
PCFICH_RB	dB				
PHICH_RA	dB				
PHICH_RB	dB				
PDCCH_RA	dB				
PDCCH_RB	dB				
PDSCH_RA	dB				
PDSCH_RB	dB				
OCNG_RA ^{Note 1}	dB				
OCNG_RB ^{Note 1}	dB				
N _{oc} ^{Note 3}	dBm/15 kHz				
\hat{E}_s / N_{oc}	dB	4	4	-Infinity	7
\hat{E}_s / I_{ot} ^{Note 4}	dB	4	4	-Infinity	7
RSRP ^{Note 4}	dBm/15 kHz	-94	-94	-Infinity	-91
SCH_RP ^{Note 4}	dBm/15 kHz	-94	-94	-Infinity	-91
Io ^{Note 4}	dBm/Ch BW	-64.76 +10log (N _{RB,c} /50)	-64.76 +10log (N _{RB,c} /50)	-70.22 +10log (N _{RB,c} /50)	-62.43 +10log (N _{RB,c} /50)
Propagation Condition		AWGN		AWGN	
Antenna Configuration		1x2		1x2	
Timing offset to Cell 1		-		3ms	
<p>Note 1: OCNG shall be used such that both cells are fully allocated and a constant total transmitted power spectral density is achieved for all OFDM symbols.</p> <p>Note 2: The resources for uplink transmission are assigned to the UE prior to the start of time period T2.</p> <p>Note 3: Interference from other cells and noise sources not specified in the test is assumed to be constant over subcarriers and time and shall be modelled as AWGN of appropriate power for N_{oc} to be fulfilled.</p> <p>Note 4: Es/Iot, RSRP, SCH_RP and Io have been derived from other parameters for information purposes. They are not settable parameters themselves.</p>					

Table A.8.3.8.1-3: Cell specific test parameters for FDD-FDD Interfrequency correct reporting of measurement events with reduced performance group configured, non DRX (cell #3, cell #4)

Parameter	Unit	Cell 3		Cell 4	
		T1	T2	T1	T2
E-UTRA RF Channel Number		Randomly selected from 5,6,7,8,9 such that cell 3 is in the reduced performance group		Randomly selected from 5,6,7,8,9 such that cell 4 is in the reduced performance group. Cell 4 RF channel is different from Cell 3 RF channel.	
BW _{channel}		5MHz: N _{RB} = 25 10MHz: N _{RB} = 50		5MHz: N _{RB} = 25 10MHz: N _{RB} = 50	
PDSCH parameters: DL Reference Measurement Channel As specified in clause A.3.1.1.1		-		-	
PCFICH/PDCCH/PHICH parameters: DL Reference Measurement Channel As specified in clause A.3.1.2.1		5MHz: R.11 FDD 10MHz:R.6 FDD		5MHz: R.11 FDD 10MHz:R.6 FDD	
OCNG Patterns defined in A.3.2.1.2 and A.3.2.1.16		5MHz: OP.16.FDD 10MHz:OP.2 FDD		5MHz: OP.16.FDD 10MHz:OP.2 FDD	
PBCH_RA	dB	0		0	
PBCH_RB	dB				
PSS_RA	dB				
SSS_RA	dB				
PCFICH_RB	dB				
PHICH_RA	dB				
PHICH_RB	dB				
PDCCH_RA	dB				
PDCCH_RB	dB				
PDSCH_RA	dB				
PDSCH_RB	dB				
OCNG_RA ^{Note 1}	dB				
OCNG_RB ^{Note 1}	dB				
N _{oc} ^{Note 3}	dBm/15 kHz				
\hat{E}_s / N_{oc}	dB	-Infinity	7	-Infinity	7
\hat{E}_s / I_{ot} ^{Note 4}	dB	-Infinity	7	-Infinity	7
RSRP ^{Note 4}	dBm/15 kHz	-Infinity	-91	-Infinity	-91
SCH_RP ^{Note 4}	dBm/15 kHz	-Infinity	-91	-Infinity	-91
I _o ^{Note 4}	dBm/Ch BW	-70.22 +10log (N _{RB,c} /50)	-62.43 +10log (N _{RB,c} /50)	-70.22 +10log (N _{RB,c} /50)	-62.43 +10log (N _{RB,c} /50)
Propagation Condition		AWGN		AWGN	
Antenna Configuration		1x2		1x2	
Timing offset to Cell 1		3ms		3ms	
<p>Note 1: OCNG shall be used such that both cells are fully allocated and a constant total transmitted power spectral density is achieved for all OFDM symbols.</p> <p>Note 2: The resources for uplink transmission are assigned to the UE prior to the start of time period T2.</p> <p>Note 3: Interference from other cells and noise sources not specified in the test is assumed to be constant over subcarriers and time and shall be modelled as AWGN of appropriate power for N_{oc} to be fulfilled.</p> <p>Note 4: Es/Iot, RSRP, SCH_RP and Io have been derived from other parameters for information purposes. They are not settable parameters themselves.</p>					

A.8.3.8.2 Test Requirements

The UE shall send Event A3 triggered measurement reports for cells 2, 3 and 4, with a measurement reporting delay less than 13.17s (cell 2) and 153.6s (cell 3 and 4) from the beginning of time period T2.

The UE shall not send event triggered measurement reports, as long as the reporting criteria are not fulfilled.

The rate of correct events observed during repeated tests shall be at least 90%.

NOTE: The actual overall delays measured in the test may be up to $2 \times TTI_{DCC}$ higher than the measurement reporting delays above because of TTI insertion uncertainty of the measurement report.

A.8.3.9 FDD-FDD Inter-frequency correct reporting of measurement events with reduced performance group configured, DRX

A.8.3.9.1 Test Purpose and Environment

The purpose of this test is to verify that the UE makes correct reporting of an event in DRX. This test will partly verify the FDD-FDD inter-frequency cell search requirements when DRX is used in clause 8.1.2.3.

The test parameters are given in Tables A.8.3.9.1-1, A.8.3.9.1-2, A.8.3.9.1-3 and A.8.3.9.1-4. In this test, there are four cells on different carrier frequencies and gap pattern configuration # 0 as defined in Table 8.1.2.1-1 is provided.

The UE needs to be provided at least once every 500ms with new Timing Advance Command MAC control element to restart the Time alignment timer to keep UE uplink time alignment. Furthermore UE is allocated with PUSCH resource at every DRX cycle..

In the measurement control information, it is indicated to the UE that event-triggered reporting with Event A3 is used. The test consists of two successive time periods for every repetition, with time duration of T1 and T2 respectively. During time duration T1, the UE shall not have any timing information of cell 2, 3 or 4. At the start of each repetition of T1, the test equipment provides signals for cell 1 (serving cell), and cells 2, 3 and 4 which are selected from the 8 cells on different frequencies which are configured in the UE neighbour cell list. Cells 2, 3 and 4 are chosen randomly, such that one frequency belongs to the normal performance group and two frequencies belong to the reduced performance group.

Table A.8.3.9.1-1: General test parameters for E-UTRAN FDD-FDD inter-frequency event triggered reporting for IncMon

Parameter	Unit	Value	Comment
UE configured E-UTRA RF Channel Number		1, 2,3,4,5,6,7,8,9	Serving cell and eight FDD carrier frequencies are used in the UE neighbour cell list. Frequencies 5,6,7,8 and 9 are indicated to have reduced performance
Test equipment configuration		Cell 1,2,3,4	Cell 1 uses E-UTRA RF channel number 1 Cells 2 are randomly selected to use different frequencies selected from E-UTRA frequencies 2, 3, 4. Cells 3, 4 are randomly selected to use different frequencies selected from E-UTRA frequencies 5, 6, 7, 8, 9.
Active cell		Cell 1	Cell 1 is on RF channel number 1
Neighbour cells		Cell 2,3,4	
Gap Pattern Id		0	As specified in TS 36.133 clause 8.1.2.1.
A3-Offset	dB	-5	
Hysteresis	dB	0	
CP length		Normal	
TimeToTrigger	s	0	
Filter coefficient		0	L3 filtering is not used
DRX		ON	DRX related parameters are defined in Table A.8.3.9.1-3
Scaling factor for reduced performance group		8	
T1	s	5	
T2	s	155	

Table A.8.3.9.1-2: Cell specific test parameters for E-UTRAN FDD-FDD inter-frequency event triggered reporting for IncMon

Parameter	Unit	Cell 1		Cell 2		Cell 3		Cell 4	
		T1	T2	T1	T2	T1	T2	T1	T2
E-UTRA RF Channel Number		1		Randomly selected from 2,3,4 such that cell 2 is in the normal performance group		Randomly selected from 5, 6, 7, 8, 9 such that cell 3 is in the reduced performance group		Randomly selected from 5, 6, 7, 8, 9 such that cell 4 is in the reduced performance group	
Channel Bandwidth (BW _{channel})	MHz	5MHz: NRB = 25 10MHz: NRB = 50		5MHz: NRB,= 25 10MHz: NRB,= 50		5MHz: NRB = 25 10MHz: NRB = 50		5MHz: NRB,= 25 10MHz: NRB,= 50	
PDSCH parameters as specified in clause A.3.1.1.1		5MHz: R.5 FDD 10MHz: R.0 FDD		-		-		-	
PCFICH/PDCCH/PHICH parameters as specified in clause A.3.1.2.1		5MHz: R.11 FDD 10MHz: R.6 FDD		5MHz: R.11 FDD 10MHz: R.6 FDD		5MHz: R.11 FDD 10MHz: R.6 FDD		5MHz: R.11 FDD 10MHz: R.6 FDD	
OCNG Patterns defined in A.3.2.1		5MHz: OP.15 FDD 10MHz: OP.1 FDD		5MHz: OP.16 FDD 10MHz: OP.2 FDD		5MHz: OP.16 FDD 10MHz: OP.2 FDD		5MHz: OP.16 FDD 10MHz: OP.2 FDD	
PBCH_RA	dB	0		0		0		0	
PBCH_RB	dB								
PSS_RA	dB								
SSS_RA	dB								
PCFICH_RB	dB								
PHICH_RA	dB								
PHICH_RB	dB								
PDCCH_RA	dB								
PDCCH_RB	dB								
PDSCH_RA	dB								
PDSCH_RB	dB								
OCNG_RA ^{Note 1}	dB								
OCNG_RB ^{Note 1}	dB								
N_{oc} ^{Note 3}	dBm/15 kHz								
\hat{E}_s / N_{oc}	dB	4	4	-Infinity	4	-Infinity	4	-Infinity	4
\hat{E}_s / I_{ot} ^{Note 4}	dB	4	4	-Infinity	4	-Infinity	4	-Infinity	4
RSRP ^{Note 4}	dBm/15 kHz	-94	-94	-Infinity	-94	-Infinity	-94	-Infinity	-94
SCH_RP ^{Note 4}	dBm/15 kHz	-94	-94	-Infinity	-94	-Infinity	-94	-Infinity	-94
I_o ^{Note 4}	dBm/Ch BW	$-64.76+10\log(N_{RB,c}/50)$	$-64.76+10\log(N_{RB,c}/50)$	$-70.22+10\log(N_{RB,c}/50)$	$-64.76+10\log(N_{RB,c}/50)$	$-70.22+10\log(N_{RB,c}/50)$	$-64.76+10\log(N_{RB,c}/50)$	$-70.22+10\log(N_{RB,c}/50)$	$-64.76+10\log(N_{RB,c}/50)$
Propagation Condition		AWGN		AWGN		AWGN		AWGN	
Antenna Configuration		1x2		1x2		1x2		1x2	
Time offset to cell1	ms	-		3		3		3	

Note 1: OCNG shall be used such that both cells are fully allocated and a constant total transmitted power spectral density is achieved for all OFDM symbols.

Note 2: The resources for uplink transmission are assigned to the UE prior to the start of time period T2.

Note 3: Interference from other cells and noise sources not specified in the test is assumed to be constant over subcarriers and time and shall be modelled as AWGN of appropriate power for N_{oc} to be fulfilled.

Note 4: E_s/I_{ot} , RSRP, SCH_RP and I_o levels have been derived from other parameters for information purposes. They are not settable parameters themselves.

Table A.8.3.9.1-3: *drx-Configuration* to be used in E-UTRAN FDD-FDD inter-frequency event triggered reporting when DRX is used for IncMon

Field	Value	Comment
onDurationTimer	psf1	
drx-InactivityTimer	psf1	
drx-RetransmissionTimer	psf1	
longDRX-CycleStartOffset	sf160	
shortDRX	disable	
Note:	For further information see clause 6.3.2 in TS 36.331.	

Table A.8.3.9.1-4: *TimeAlignmentTimer* and *sr-ConfigIndex* Configuration to be used in E-UTRAN FDD-FDD inter-frequency event triggered reporting when DRX is used for IncMon

Field	Value	Comment
TimeAlignmentTimer	sf500	For further information see clause 6.3.2 in TS 36.331.
sr-ConfigIndex	0	For further information see clause 6.3.2 in TS 36.331 and section 10.1 in TS 36.213..

A.8.3.9.2 Test Requirements

The UE shall send Event A3 triggered measurement reports for cells 2, 3 and 4, with a measurement reporting delay less than 13.2s (cell 2) and 153.6s (cell 3 and 4) from the beginning of time period T2.

The UE shall not send event triggered measurement reports, as long as the reporting criteria are not fulfilled.

The rate of correct events observed during repeated tests shall be at least 90%.

NOTE: The actual overall delays measured in the test may be up to $2 \times TTI_{DCC}$ higher than the measurement reporting delays above because of TTI insertion uncertainty of the measurement report.

Where:

When DRX cycle is 160ms, the delay requirement of cell identification and measurement period are specified in section 8.1.2.3.1.2 and Non DRX Requirements in clause 8.1.2.3.1.1 are applicable.

The requirement of inter frequency cell identification delay are specified as

$$T_{\text{Identify_Inter}} = T_{\text{Basic_Identify_Inter}} \cdot \frac{480}{T_{\text{Inter1}}} \cdot N_{\text{freq},n} \cdot K_n \quad \text{ms (normal performance) and}$$

$$T_{\text{Identify_Inter}} = T_{\text{Basic_Identify_Inter}} \cdot \frac{480}{T_{\text{Inter1}}} \cdot N_{\text{freq},r} \cdot K_r \quad \text{ms (reduced performance)}$$

$T_{\text{Basic_Identify_inter}}$ 480ms, See section 8.1.2.3.1.1

T_{Inter1} 60ms, See section 8.1.2.1

$N_{\text{freq},n}$ and $N_{\text{freq},r}$ 3 and 5 set in this test case.

K_n and K_r 8/7 and 8, See section 8.1.2.1.1a.

This gives 13165.7ms for cells 2 on normal carrier, and 153600ms for cell 3 and cell 4 on reduced carriers for Event A3 triggered measurement reporting delay. The test requirements allow 13.2s and 153.6s.

A.8.3.10 E-UTRAN FDD-FDD Inter-frequency event triggered reporting with MGL=3ms under fading propagation conditions in synchronous cells

A.8.3.10.1 Test Purpose and Environment

The purpose of this test is to verify that the UE makes correct reporting of an event with MGL=3ms when Gap pattern configuration #2 is configured. This test will partly verify the FDD-FDD inter-frequency cell search requirements in clause 8.1.2.3.

The test parameters are given in Tables A.8.3.10.1-1 and A.8.3.10.1-2. In this test, there are two cells on different carrier frequencies and gap pattern configuration # 2 as defined in Table 8.1.2.1-1 is provided. Time offset between frame boundaries of two cells has to be chosen such that the #0 or #5 subframes of the target cell is 500uS early relative to the 2nd subframe of the measurement gap.

In the measurement control information, it is indicated to the UE that event-triggered reporting with Event A3 is used. The test consists of two successive time periods, with time duration of T1, and T2 respectively. During time duration T1, the UE shall not have any timing information of cell 2.

Table A.8.3.10.1-1: General test parameters for E-UTRAN FDD-FDD inter-frequency event triggered reporting in fading propagation conditions

Parameter	Unit	Value	Comment
PDSCH parameters		DL Reference Measurement Channel R.0 FDD	As specified in clause A.3.1.1.1
PCFICH/PDCCH/PHICH parameters		DL Reference Measurement Channel R.6 FDD	As specified in clause A.3.1.2.1
E-UTRA RF Channel Number		1, 2	Two FDD carrier frequencies are used.
Channel Bandwidth (BW _{channel})	MHz	10	
Active cell		Cell 1	Cell 1 is on RF channel number 1
Neighbour cell		Cell 2	Cell 2 is on RF channel number 2
Gap Pattern Id		2	As specified in TS 36.133 clause 8.1.2.1.
A3-Offset	dB	-6	
Hysteresis	dB	0	
CP length		Normal	
TimeToTrigger	s	0	
Filter coefficient		0	L3 filtering is not used
DRX		OFF	OFF
T1	s	5	
T2	s	5	

Table A.8.3.10.1-2: Cell specific test parameters for E-UTRAN FDD-FDD inter-frequency event triggered reporting under fading propagation conditions in synchronous cells

Parameter	Unit	Cell 1		Cell 2	
		T1	T2	T1	T2
E-UTRA RF Channel Number		1		2	
BW _{channel}	MHz	10		10	
Correlation Matrix and Antenna Configuration		1x2 Low		1x2 Low	
OCNG Patterns defined in A.3.2.1.1 (OP.1 FDD) and in A.3.2.1.2 (OP.2 FDD)		OP.1 FDD		OP.2 FDD	
PBCH_RA	dB	0		0	
PBCH_RB	dB				
PSS_RA	dB				
SSS_RA	dB				
PCFICH_RB	dB				
PHICH_RA	dB				
PHICH_RB	dB				
PDCCH_RA	dB				

PDCCH_RB	dB				
PDSCH_RA	dB				
PDSCH_RB	dB				
OCNG_RA ^{Note 1}	dB				
OCNG_RB ^{Note 1}	dB				
N_{oc} ^{Note 3}	dBm/15 kHz			-98	
RSRP ^{Note 4}	dBm/15 kHz	-94	-94	-Infinity	-91
\hat{E}_s/I_{α}	dB	4	4	-Infinity	7
SCH_RP ^{Note 4}	dBm/15 kHz	-94	-94	-Infinity	-91
\hat{E}_s/N_{oc}	dB	4	4	-Infinity	7
Propagation Condition		ETU70			
<p>Note 1: OCNG shall be used such that both cells are fully allocated and a constant total transmitted power spectral density is achieved for all OFDM symbols.</p> <p>Note 2: The resources for uplink transmission are assigned to the UE prior to the start of time period T2.</p> <p>Note 3: Interference from other cells and noise sources not specified in the test is assumed to be constant over subcarriers and time and shall be modelled as AWGN of appropriate power for N_{oc} to be fulfilled.</p> <p>Note 4: RSRP and SCH_RP levels have been derived from other parameters for information purposes. They are not settable parameters themselves.</p>					

A.8.3.10.2 Test Requirements

The UE shall send one Event A3 triggered measurement report, with a measurement reporting delay less than 3840 ms from the beginning of time period T2.

The UE shall not send event triggered measurement reports, as long as the reporting criteria are not fulfilled.

The rate of correct events observed during repeated tests shall be at least 90%.

NOTE: The actual overall delays measured in the test may be up to $2 \times TTI_{DCCH}$ higher than the measurement reporting delays above because of TTI insertion uncertainty of the measurement report in DCCH.

A.8.3.11 E-UTRAN FDD-FDD Inter-frequency event triggered reporting under fading propagation conditions in asynchronous cells with burst gap

A.8.3.11.1 Test Purpose and Environment

The purpose of this test is to verify that the UE makes correct reporting of an event. This test will partly verify the FDD-FDD inter-frequency cell search requirements in clause 8.1.2.3, when configured with the burst gap.

The test parameters are given in Table A.8.3.11.1-1 and A.8.3.11.1-2. In this test, there are two cells on different carrier frequencies and non-uniform gap pattern configuration #1 as defined in Table 8.1.2.1-2 is provided.

In the measurement control information, it is indicated to the UE that event-triggered reporting with Event A4 is used. The test consists of two successive time periods, with time duration of T1, and T2 respectively. During time duration T1, the UE shall not have any timing information of cell 2.

Table A.8.3.11.1-1: General test parameters for E-UTRAN FDD-FDD inter-frequency event triggered reporting with burst gap in fading propagation conditions

Parameter	Unit	Value	Comment
PDSCH parameters		DL Reference Measurement Channel R.0 FDD	As specified in clause A.3.1.1.1
PCFICH/PDCCH/PHICH parameters		DL Reference Measurement Channel R.6 FDD	As specified in clause A.3.1.2.1
E-UTRA RF Channel Number		1, 2	Two FDD carrier frequencies are used.
Channel Bandwidth ($BW_{channel}$)	MHz	10	
Active cell		Cell 1	Cell 1 is on RF channel number 1
Neighbour cell		Cell 2	Cell 2 is on RF channel number 2
Gap Pattern Id		nonUniform1	As specified in TS 36.133 clause 8.1.2.1.

A4 Hysteresis	dB	0	Hysteresis for evaluation of event A4.
A4 Threshold RSRP	dBm	-99	Actual RSRP threshold for event A4. Needs to take absolute accuracy tolerance in section 9.1.11.1 into account plus margin.
A4 Time To Trigger	s	0	
CP length		Normal	
Filter coefficient		0	L3 filtering is not used
DRX		OFF	OFF
Time offset between cells		3 ms	Asynchronous cells
T1	s	5	
T2	s	15	

Table A.8.3.11.1-2: Cell specific test parameters for E-UTRAN FDD-FDD inter-frequency event triggered reporting with burst gap under fading propagation conditions in synchronous cells

Parameter	Unit	Cell 1		Cell 2	
		T1	T2	T1	T2
E-UTRA RF Channel Number		1		2	
BW _{channel}	MHz	10		10	
Correlation Matrix and Antenna Configuration		1x2 Low		1x2 Low	
OCNG Patterns defined in A.3.2.1.1 (OP.1 FDD) and in A.3.2.1.2 (OP.2 FDD)		OP.1 FDD		OP.2 FDD	
PBCH_RA	dB	0		0	
PBCH_RB	dB				
PSS_RA	dB				
SSS_RA	dB				
PCFICH_RB	dB				
PHICH_RA	dB				
PHICH_RB	dB				
PDCCH_RA	dB				
PDCCH_RB	dB				
PDSCH_RA	dB				
PDSCH_RB	dB				
OCNG_RA ^{Note 1}	dB				
OCNG_RB ^{Note 1}	dB				
N_{oc} ^{Note 3}	dBm/15 kHz				
RSRP ^{Note 4}	dBm/15 kHz	-82	-82	-Infinity	-91
\hat{E}_s/I_{α}	dB	16	16	-Infinity	7
SCH_RP ^{Note 4}	dBm/15 kHz	-82	-82	-Infinity	-91
\hat{E}_s/N_{oc}	dB	16	16	-Infinity	7
Propagation Condition		AWGN			
<p>Note 1: OCNG shall be used such that both cells are fully allocated and a constant total transmitted power spectral density is achieved for all OFDM symbols.</p> <p>Note 2: The resources for uplink transmission are assigned to the UE prior to the start of time period T2.</p> <p>Note 3: Interference from other cells and noise sources not specified in the test is assumed to be constant over subcarriers and time and shall be modelled as AWGN of appropriate power for N_{oc} to be fulfilled.</p> <p>Note 4: RSRP and SCH_RP levels have been derived from other parameters for information purposes. They are not settable parameters themselves.</p>					

A.8.3.11.2 Test Requirement

The UE shall send one Event A4 triggered measurement report, with a measurement reporting delay less than 10240 ms from the beginning of time period T2. During the test, downlink traffic is continuously scheduled From the start of T1 until the measurement report is received during T2, at least [100]% of all expected ACK/NACKs shall be transmitted by the UE.

The UE shall not send event triggered measurement reports, as long as the reporting criteria are not fulfilled.

The rate of correct events observed during repeated tests shall be at least 90%.

NOTE: The actual overall delays measured in the test may be up to $2xTTI_{DCCH}$ higher than the measurement reporting delays above because of TTI insertion uncertainty of the measurement report in DCCH.

A.8.3.12 E-UTRAN FDD-FDD Inter-frequency event triggered reporting under fading propagation conditions in asynchronous cells for UE category M1 with discontinuous MPDCCH monitoring in CEModeA

A.8.3.12.1 Test Purpose and Environment

The purpose of this test is to verify that the Cat-M1 UE makes correct reporting of an event with discontinuous MPDCCH monitoring. This test will partly verify the FDD-FDD inter-frequency cell search requirements in clause 8.13.2.6.1.

The test parameters are given in Table A.8.3.12.1-1 and A.8.3.12.1-2 below. In the measurement control information it is indicated to the UE that event-triggered reporting with Event A3 is used. The test consists of two successive time periods, with time duration of T1, and T2 respectively. During time duration T1, the UE shall not have any timing information of cell 2. At the beginning of T2 the transmission power of cell 2 is increased to the same level as for cell 1, and due to usage of an offset this shall result in reporting of Event A3.

Table A.8.3.12.1-1: General test parameters

Parameter	Unit	Value	Comment
E-UTRA RF Channel Number		1, 2	
Active cell		Cell 1	
Neighbour cell		Cell 2	Cell to be identified.
CP length		Normal	
DRX		OFF	
A3	Offset	dB	-6
	Hysteresis	dB	0
	Time To Trigger	S	0
Filter coefficient		0	L3 filtering is not used
Gap pattern ID		0	
R_{max}		8	As defined in <i>mPDCCH-NumRepetition</i> in [3]
G		10	As defined in <i>mPDCCH-startSF-UESS</i> in [3]
X		scheme10	As defined in <i>measGapSharingScheme</i> in [3]
T1	S	5	
T2	S	5	

Table A.8.3.12.1-2: Cell specific test parameters

Parameter	Unit	Cell 1		Cell 2	
		T1	T2	T1	T2
E-UTRA RF Channel Number		1		2	
$BW_{channel}$	MHz	10		10	
PDSCH parameters: DL Reference Measurement Channel		R.21 FDD		-	
MPDCCH parameters: DL Reference Measurement Channel		R.17 FDD		R.17 FDD	
OCNG Patterns		OP.21 FDD		OP.6 FDD	
PBCH_RA	dB				
PBCH_RB	dB				
PSS_RA	dB				
SSS_RA	dB				

PCFICH_RB	dB	-3		-3	
PHICH_RA	dB				
PHICH_RB	dB				
MPDCCH_RA	dB				
MPDCCH_RB	dB				
PDSCH_RA	dB				
PDSCH_RB	dB				
OCNG_RA ^{Note 1}	dB				
OCNG_RB ^{Note 1}	dB				
N_{oc} ^{Note 2}	dBm/15 KHz				
\hat{E}_s / N_{oc}	dB	4	4	-Infinity	4
\hat{E}_s / I_{ot} ^{Note 3}	dB	4	4	-Infinity	4
RSRP ^{Note 3}	dBm/15 KHz	-94	-94	-Infinity	-94
SCH_RP ^{Note 3}	dBm/15 KHz	-94	-94	-Infinity	-94
I_o ^{Note 3}	dBm/9MHz	-64.76	-64.76	-Infinity	-64.76
Propagation Condition		ETU30		ETU30	
Correlation Matrix and Antenna Configuration		2x1 Low		2x1 Low	
Timing offset to Cell 1	ms	-		3	
<p>Note 1: OCNG shall be used such that all cells are fully allocated and a constant total transmitted power spectral density is achieved for all OFDM symbols.</p> <p>Note 2: Interference from other cells and noise sources not specified in the test is assumed to be constant over subcarriers and time and shall be modelled as AWGN of appropriate power for N_{oc} to be fulfilled.</p> <p>Note 3: E_s/I_{ot}, RSRP, SCH_RP and I_o have been derived from other parameters for information purposes. They are not settable parameters themselves.</p> <p>Note 4: The resources for uplink transmission are assigned to the UE prior to the start of time period T2.</p>					

A.8.3.12.2 Test Requirement

The UE shall send one Event A3 triggered measurement report, with a measurement reporting delay less than 3.2 s from the beginning of time period T2.

The UE shall not send event triggered measurement reports, as long as the reporting criteria are not fulfilled.

The rate of correct events observed during repeated tests shall be at least 90%.

NOTE: The actual overall delays measured in the test may be up to $2 \times TTI_{DCCH}$ higher than the measurement reporting delays above because of TTI insertion uncertainty of the measurement report in DCCH.

A.8.3.13 E-UTRAN HD-FDD Inter-frequency event triggered reporting under fading propagation conditions in asynchronous cells for UE category M1 with discontinuous MPDCCH monitoring in CEModeA

A.8.3.13.1 Test Purpose and Environment

The purpose of this test is to verify that the Cat-M1 UE makes correct reporting of an event with discontinuous MPDCCH monitoring. This test will partly verify the HD-FDD inter-frequency cell search requirements in clause 8.13.2.6.2.

The test parameters are given in Table A.8.3.13.1-1 and A.8.3.13.1-2 below. In the measurement control information it is indicated to the UE that event-triggered reporting with Event A3 is used. The test consists of two successive time periods, with time duration of T1, and T2 respectively. During time duration T1, the UE shall not have any timing information of cell 2. At the beginning of T2 the transmission power of cell 2 is increased to the same level as for cell 1, and due to usage of an offset this shall result in reporting of Event A3.

Table A.8.3.13.1-1: General test parameters

Parameter	Unit	Value	Comment
E-UTRA RF Channel Number		1, 2	

Active cell			Cell 1	
Neighbour cell			Cell 2	Cell to be identified.
CP length			Normal	
DRX			OFF	
A3	Offset	dB	-6	
	Hysteresis	dB	0	
	Time To Trigger	S	0	
Filter coefficient			0	L3 filtering is not used
Gap pattern ID			0	
R_{max}			8	As defined in <i>mPDCCH-NumRepetition</i> in [3]
G			10	As defined in <i>mPDCCH-startSF-UeSS</i> in [3]
X			scheme10	As defined in <i>measGapSharingScheme</i> in [3]
T1	S		5	
T2	S		5	

Table A.8.3.13.1-2: Cell specific test parameters

Parameter	Unit	Cell 1		Cell 2	
		T1	T2	T1	T2
E-UTRA RF Channel Number		1		2	
$BW_{channel}$	MHz	10		10	
PDSCH parameters: DL Reference Measurement Channel		R.11 HD-FDD		-	
MPDCCH parameters: DL Reference Measurement Channel		R.7 HD-FDD		R.7 HD-FDD	
OCNG Patterns		OP.21 FDD		OP.6 FDD	
PBCH_RA	dB	-3		-3	
PBCH_RB	dB				
PSS_RA	dB				
SSS_RA	dB				
PCFICH_RB	dB				
PHICH_RA	dB				
PHICH_RB	dB				
MPDCCH_RA	dB				
MPDCCH_RB	dB				
PDSCH_RA	dB				
PDSCH_RB	dB				
OCNG_RA ^{Note 1}	dB				
OCNG_RB ^{Note 1}	dB				
N_{oc} ^{Note 2}	dBm/15 KHz				
\hat{E}_s / N_{oc}	dB	4	4	-Infinity	4
\hat{E}_s / I_{ot} ^{Note 3}	dB	4	4	-Infinity	4
RSRP ^{Note 3}	dBm/15 KHz	-94	-94	-Infinity	-94
SCH_RP ^{Note 3}	dBm/15 KHz	-94	-94	-Infinity	-94
I_o ^{Note 3}	dBm/9MHz	-64.76	-64.76	-Infinity	-64.76
Propagation Condition		ETU30		ETU30	
Correlation Matrix and Antenna Configuration		2x1 Low		2x1 Low	
Timing offset to Cell 1	ms	-		3	
<p>Note 1: OCNG shall be used such that all cells are fully allocated and a constant total transmitted power spectral density is achieved for all OFDM symbols.</p> <p>Note 2: Interference from other cells and noise sources not specified in the test is assumed to be constant over subcarriers and time and shall be modelled as AWGN of appropriate power for N_{oc} to be fulfilled.</p> <p>Note 3: E_s/I_{ot}, RSRP, SCH_RP and I_o have been derived from other parameters for information purposes. They are not settable parameters themselves.</p> <p>Note 4: The resources for uplink transmission are assigned to the UE prior to the start of time period T2.</p>					

A.8.3.13.2 Test Requirement

The UE shall send one Event A3 triggered measurement report, with a measurement reporting delay less than 3.2 s from the beginning of time period T2. During the test, downlink traffic is continuously scheduled.

The UE shall not send event triggered measurement reports, as long as the reporting criteria are not fulfilled.

The rate of correct events observed during repeated tests shall be at least 90%.

NOTE: The actual overall delays measured in the test may be up to $2 \times TTI_{DCCH}$ higher than the measurement reporting delays above because of TTI insertion uncertainty of the measurement report in DCCH.

A.8.3.14 E-UTRAN FDD-FDD inter-frequency event triggered reporting under fading propagation conditions in asynchronous cells for UE category M1 with discontinuous MPDCCH monitoring in CEModeB

A.8.3.14.1 Test Purpose and Environment

The purpose of this test is to verify that the Cat-M1 UE makes correct reporting of an event with discontinuous MPDCCH monitoring. This test will partly verify the FDD-FDD inter-frequency cell search requirements in clause 8.13.3.5.1.

The test parameters are given in Table A.8.3.14.1-1 and A.8.3.14.1-2 below. In the measurement control information it is indicated to the UE that event-triggered reporting with Event A3 is used. The test consists of two successive time periods, with time duration of T1, and T2 respectively. During time duration T1, the UE shall not have any timing information of cell 2. At the beginning of T2 the transmission power of cell 2 is increased to the same level as for cell 1, and due to usage of an offset this shall result in reporting of Event A3.

Table A.8.3.14.1-1: General test parameters

Parameter	Unit	Value	Comment
E-UTRA RF Channel Number		1, 2	
Active cell		Cell 1	
Neighbour cell		Cell 2	Cell to be identified.
CP length		Normal	
DRX		OFF	
A3	Offset	dB	-8
	Hysteresis	dB	0
	Time To Trigger	S	0
Filter coefficient		0	L3 filtering is not used
Gap pattern ID		0	
R_{max}		128	As defined in <i>mPDCCH-NumRepetition</i> in [3]
G		8	As defined in <i>mPDCCH-startSF-UeSS</i> in [3]
X		scheme01	As defined in <i>measGapSharingScheme</i> in [3]
T1	S	5	
T2	S	≤ 825	

Table A.8.3.14.1-2: Cell specific test parameters

Parameter	Unit	Cell 1		Cell 2	
		T1	T2	T1	T2
E-UTRA RF Channel Number		1		2	
$BW_{channel}$	MHz	10 for 10 MHz cell BW: 5 for 5 MHz cell BW		10 for 10 MHz cell BW: 5 for 5 MHz cell BW	
PDSCH parameters: DL Reference Measurement Channel		R.23 FDD for 10 MHz cell BW		-	
		R.31 FDD for 5 MHz cell BW			

MPDCCH parameters: DL Reference Measurement Channel		R.19 FDD for 10 MHz cell BW R.27 FDD for 10 MHz cell BW	R.19 FDD for 10 MHz cell BW R.27 FDD for 10 MHz cell BW
OCNG Patterns		OP.21 FDD for 10 MHz cell BW OP.22 FDD for 5 MHz cell BW	OP.6 FDD for 10 MHz cell BW: OP.19 FDD for 5 MHz cell BW
PBCH_RA	dB	-3	-3
PBCH_RB	dB		
PSS_RA	dB		
SSS_RA	dB		
PCFICH_RB	dB		
PHICH_RA	dB		
PHICH_RB	dB		
MPDCCH_RA	dB		
MPDCCH_RB	dB		
PDSCH_RA	dB		
PDSCH_RB	dB		
OCNG_RA ^{Note 1}	dB		
OCNG_RB ^{Note 1}	dB		
N_{oc} ^{Note 2}	dBm/15 KHz		
\hat{E}_s / N_{oc}	dB	-12	-12
\hat{E}_s / I_{ot} ^{Note 3}	dB	-12	-12
RSRP ^{Note 3}	dBm/15 KHz	-110	-110
SCH_RP ^{Note 3}	dBm/15 KHz	-110	-110
I_o ^{Note 3}	dBm/9MHz	-69.95	-69.95
	dBm/4.5 MHz	-72.96	-72.96
Propagation Condition		ETU30	ETU30
Correlation Matrix and Antenna Configuration		2x1 Low	2x1 Low
Timing offset to Cell 1	ms	-	3
<p>Note 1: OCNG shall be used such that all cells are fully allocated and a constant total transmitted power spectral density is achieved for all OFDM symbols.</p> <p>Note 2: Interference from other cells and noise sources not specified in the test is assumed to be constant over subcarriers and time and shall be modelled as AWGN of appropriate power for N_{oc} to be fulfilled.</p> <p>Note 3: E_s/I_{ot}, RSRP, SCH_RP and I_o have been derived from other parameters for information purposes. They are not settable parameters themselves.</p> <p>Note 4: The resources for uplink transmission are assigned to the UE prior to the start of time period T2.</p>			

A.8.3.14.2 Test Requirement

The UE shall send one Event A3 triggered measurement report, with a measurement reporting delay less than [819.2] s from the beginning of time period T2 which is derived from section 8.13.3.5.

The UE shall not send event triggered measurement reports, as long as the reporting criteria are not fulfilled.

The rate of correct events observed during repeated tests shall be at least 90%.

NOTE: The actual overall delays measured in the test may be up to $pusch-maxNumRepetitionCEmodeB \times TTI_{DCC}$ higher than the measurement reporting delays above because of TTI insertion uncertainty of the measurement report in DCCH, where $pusch-maxNumRepetitionCEmodeB$ [2] is the maximum number of PUSCH repetitions configured

A.8.3.15 E-UTRAN HD-FDD inter-frequency event triggered reporting under fading propagation conditions in asynchronous cells for UE category M1 with discontinuous MPDCCH monitoring in CEModeB

A.8.3.15.1 Test Purpose and Environment

The purpose of this test is to verify that the Cat-M1 UE makes correct reporting of an event with discontinuous MPDCCH monitoring. This test will partly verify the HD-FDD inter-frequency cell search requirements in clause 8.13.3.5.2.

The test parameters are given in Table A.8.3.15.1-1 and A.8.3.15.1-2 below. In the measurement control information it is indicated to the UE that event-triggered reporting with Event A3 is used. The test consists of two successive time periods, with time duration of T1, and T2 respectively. During time duration T1, the UE shall not have any timing information of cell 2. At the beginning of T2 the transmission power of cell 2 is increased to the same level as for cell 1, and due to usage of an offset this shall result in reporting of Event A3.

During the test, downlink traffic is continuously scheduled. MPDCCH is not collided with gap.

Table A.8.3.15.1-1: General test parameters

Parameter		Unit	Value	Comment
E-UTRA RF Channel Number			1, 2	
Active cell			Cell 1	
Neighbour cell			Cell 2	Cell to be identified.
CP length			Normal	
DRX			OFF	
A3	Offset	dB	-8	
	Hysteresis	dB	0	
	Time To Trigger	S	0	
Filter coefficient			0	L3 filtering is not used
Gap pattern ID			0	
<i>R</i> _{max}			128	As defined in <i>mPDCCH-NumRepetition</i> in [3]
<i>G</i>			8	As defined in <i>mPDCCH-startSF-UeSS</i> in [3]
<i>X</i>			scheme01	As defined in <i>measGapSharingScheme</i> in [3]
T1		S	5	
T2		S	≤825	

Table A.8.3.15.1-2: Cell specific test parameters

Parameter	Unit	Cell 1		Cell 2	
		T1	T2	T1	T2
E-UTRA RF Channel Number		1		2	
<i>BW</i> _{channel}	MHz	10 for 10 MHz cell BW 5 for 5 MHz cell BW		10 for 10 MHz cell BW: 5 for 5 MHz cell BW	
PDSCH parameters: DL Reference Measurement Channel		R.13 HD-FDD for 10 MHz cell BW R.21 HD-FDD for 5 MHz cell BW		-	
MPDCCH parameters: DL Reference Measurement Channel		R.9 HD-FDD for 10 MHz cell BW R.17 HD-FDD for 5 MHz cell BW:		R.9 HD-FDD for 10 MHz cell BW: R.17 HD-FDD for 5 MHz cell BW:	
OCNG Patterns		OP.21 FDD for 10 MHz cell BW OP.22 FDD for 5 MHz cell BW		OP.6 FDD for 10 MHz cell BW: OP.19 FDD for 5 MHz cell BW	
PBCH_RA	dB				
PBCH_RB	dB				
PSS_RA	dB				

SSS_RA	dB	-3		-3	
PCFICH_RB	dB				
PHICH_RA	dB				
PHICH_RB	dB				
MPDCCH_RA	dB				
MPDCCH_RB	dB				
PDSCH_RA	dB				
PDSCH_RB	dB				
OCNG_RA ^{Note 1}	dB				
OCNG_RB ^{Note 1}	dB				
N_{oc} ^{Note 2}	dBm/15 KHz	-98		-98	
\hat{E}_s / N_{oc}	dB	-12	-12	-Infinity	-12
\hat{E}_s / I_{ot} ^{Note 3}	dB	-12	-12	-Infinity	-12
RSRP ^{Note 3}	dBm/15 KHz	-110	-110	-Infinity	-110
SCH_RP ^{Note 3}	dBm/15 KHz	-110	-110	-Infinity	-110
I_o ^{Note 3}	dBm/9MHz	-69.95	-69.95	-Infinity	-69.95
	dBm/4.5 MHz	-72.96	-72.96	-Infinity	-72.96
Propagation Condition		ETU30		ETU30	
Correlation Matrix and Antenna Configuration		2x1 Low		2x1 Low	
Timing offset to Cell 1	ms	-		3	
<p>Note 1: OCNG shall be used such that all cells are fully allocated and a constant total transmitted power spectral density is achieved for all OFDM symbols.</p> <p>Note 2: Interference from other cells and noise sources not specified in the test is assumed to be constant over subcarriers and time and shall be modelled as AWGN of appropriate power for N_{oc} to be fulfilled.</p> <p>Note 3: E_s/I_{ot}, RSRP, SCH_RP and I_o have been derived from other parameters for information purposes. They are not settable parameters themselves.</p> <p>Note 4: The resources for uplink transmission are assigned to the UE prior to the start of time period T2.</p>					

A.8.3.15.2 Test Requirement

The UE shall send one Event A3 triggered measurement report, with a measurement reporting delay less than 819.2 s from the beginning of time period T2 which is derived from section 8.13.3.5.

The UE shall not send event triggered measurement reports, as long as the reporting criteria are not fulfilled.

The rate of correct events observed during repeated tests shall be at least 90%.

NOTE: The actual overall delays measured in the test may be up to $pusch-maxNumRepetitionCEmodeB \times TTI_{DCCH}$ higher than the measurement reporting delays above because of TTI insertion uncertainty of the measurement report in DCCH, where $pusch-maxNumRepetitionCEmodeB$ [2] is the maximum number of PUSCH repetitions configured

A.8.3.16 E-UTRAN FDD-FDD Inter-frequency event triggered reporting under fading propagation conditions in asynchronous cells for UE category M1 in CEModeA when DRX is used

A.8.3.16.1 Test Purpose and Environment

The purpose of this test is to verify that the Cat-M1 UE makes correct reporting of an event for inter-frequency. This test will partly verify the FDD-FDD inter-frequency cell search requirements in clause 8.13.2.6.1.

The test parameters are given in Table A.8.3.16.1-1, A.8.3.16.1-3 and A.8.3.16.1-4 below. In the measurement control information it is indicated to the UE that event-triggered reporting with Event A3 is used. The test consists of two successive time periods, with time duration of T1, and T2 respectively. During time duration T1, the UE shall not have any timing information of cell 2. At the beginning of T2 the transmission power of cell 2 is increased to the same level as for cell 1, and due to usage of an offset this shall result in reporting of Event A3.

In Test 1 UE needs to be provided at least once every 500ms with new Timing Advance Command MAC control element to restart the Time alignment timer to keep UE uplink time alignment. Furthermore UE is allocated with PUSCH resource at every DRX cycle.

In Test 2 the uplink time alignment is not maintained and UE needs to use RACH to obtain UL allocation for measurement reporting.

Table A.8.3.16.1-1: General test parameters

Parameter	Unit	Value		Comment
		Test1	Test2	
E-UTRA RF Channel Number		1, 2		
Active cell		Cell 1		
Neighbour cell		Cell 2		Cell to be identified.
CP length		Normal		
DRX		ON		
A3	Offset	dB	-6	
	Hysteresis	dB	0	
	Time To Trigger	S	0	
Filter coefficient		0		L3 filtering is not used
Gap pattern ID		0		
R_{max}		8		As defined in <i>mPDCCH-NumRepetition</i> in [3]
G		1		As defined in <i>mPDCCH-startSF-UESS</i> in [3]
X		scheme10		As defined in <i>measGapSharingScheme</i> in [3]
T1	S	5		
T2	S	10	60	

Table A.8.3.16.1-2: Cell specific test parameters

Parameter	Unit	Cell 1		Cell 2	
		T1	T2	T1	T2
E-UTRA RF Channel Number		1		2	
$BW_{channel}$	MHz	10		10	
PDSCH parameters: DL Reference Measurement Channel		R.21 FDD		-	
MPDCCH parameters: DL Reference Measurement Channel		R.17 FDD		R.17 FDD	
OCNG Patterns		OP.21 FDD		OP.6 FDD	
PBCH_RA	dB	-3		-3	
PBCH_RB	dB				
PSS_RA	dB				
SSS_RA	dB				
PCFICH_RB	dB				
PHICH_RA	dB				
PHICH_RB	dB				
MPDCCH_RA	dB				
MPDCCH_RB	dB				
PDSCH_RA	dB				
PDSCH_RB	dB				
OCNG_RA ^{Note 1}	dB				
OCNG_RB ^{Note 1}	dB				
N_{oc} ^{Note 2}	dBm/15 KHz				
\hat{E}_s / N_{oc}	dB	4	4	-Infinity	4
\hat{E}_s / I_{ot} ^{Note 3}	dB	4	4	-Infinity	4
RSRP ^{Note 3}	dBm/15 KHz	-94	-94	-Infinity	-94
SCH_RP ^{Note 3}	dBm/15 KHz	-94	-94	-Infinity	-94

I_0 ^{Note 3}	dBm/9MHz	-64.76	-64.76	-Infinity	-64.76
Propagation Condition		ETU30		ETU30	
Correlation Matrix and Antenna Configuration		2x1 Low		2x1 Low	
Timing offset to Cell 1	ms	-		3	
Note 1:	OCNG shall be used such that all cells are fully allocated and a constant total transmitted power spectral density is achieved for all OFDM symbols.				
Note 2:	Interference from other cells and noise sources not specified in the test is assumed to be constant over subcarriers and time and shall be modelled as AWGN of appropriate power for N_{oc} to be fulfilled.				
Note 3:	E_s/I_{ot} , RSRP, SCH_RP and I_0 have been derived from other parameters for information purposes. They are not settable parameters themselves.				
Note 4:	The resources for uplink transmission are assigned to the UE prior to the start of time period T2.				

Table A.8.3.16.1-3: DRX-Configuration

Field	Test1	Test2	Comment
	Value	Value	
onDurationTimer	psf1	psf1	As specified in clause 6.3.2 in TS 36.331
drx-InactivityTimer	psf1	psf1	
drx-RetransmissionTimer	psf1	psf1	
longDRX-CycleStartOffset	sf128	sf1280	
shortDRX	disable	disable	

Table A.8.3.16.1-4: TimeAlignmentTimer -Configuration

Field	Test1	Test2	Comment
	Value	Value	
TimeAlignmentTimer	sf500	sf500	As specified in clause 6.3.2 in TS 36.331
sr-ConfigIndex	0	0	For further information see clause 6.3.2 in TS 36.331 and section 10.1 in TS 36.213.

A.8.3.16.2 Test Requirement

In Test 1, the UE shall send one Event A3 triggered measurement report, with a measurement reporting delay less than 6.4 s from the beginning of time period T2. The measurement reporting delay is defined as the time from the beginning of time period T2 to the moment when the UE send the measurement report on PUSCH.

In Test 2, the UE shall send one Event A3 triggered measurement report, with a measurement reporting delay less than 51.2 s from the beginning of time period T2. The measurement reporting delay is defined as the time from the beginning of time period T2 to the moment when the UE starts to send preambles on the PRACH for scheduling request (SR) to obtain allocation to send the measurement report on PUSCH.

The UE shall not send event triggered measurement reports, as long as the reporting criteria are not fulfilled.

The rate of correct events observed during repeated tests shall be at least 90%.

NOTE 1: The actual overall delays measured in the test may be up to one DRX cycle higher than the measurement reporting delays above because UE is allowed to delay the initiation of the measurement reporting procedure to the next until the Active Time.

NOTE 2: In order to calculate the rate of correct events the system simulator shall verify that it has received correct Event A3 measurement report.

A.8.3.17 E-UTRAN HD-FDD inter-frequency event triggered reporting under fading propagation conditions in asynchronous cells for UE category M1 in CEModeA in DRX

A.8.3.17.1 Test Purpose and Environment

The purpose of this test is to verify that the Cat-M1 UE makes correct reporting of an event. This test will partly verify the HD-FDD inter-frequency cell search requirements in clause 8.13.2.6.2.

The test parameters are given in Table A.8.3.17.1-1, A.8.3.17.1-2, A.8.3.17.1-3 and A.8.3.13.1-4 below. In the measurement control information it is indicated to the UE that event-triggered reporting with Event A3 is used. The test consists of two successive time periods, with time duration of T1, and T2 respectively. During time duration T1, the UE shall not have any timing information of cell 2. At the beginning of T2 the transmission power of cell 2 is increased to the same level as for cell 1, and due to usage of an offset this shall result in reporting of Event A3.

In Test 1 UE needs to be provided at least once every 500ms with new Timing Advance Command MAC control element to restart the Time alignment timer to keep UE uplink time alignment. Furthermore UE is allocated with PUSCH resource at every DRX cycle.

In Test 2 the uplink time alignment is not maintained and UE needs to use RACH to obtain UL allocation for measurement reporting.

Table A.8.3.17.1-1: General test parameters

Parameter	Unit	Value		Comment
		Test1	Test2	
E-UTRA RF Channel Number		1, 2		
Active cell		Cell 1		
Neighbour cell		Cell 2		Cell to be identified.
CP length		Normal		
DRX		ON		
A3	Offset	dB	-6	
	Hysteresis	dB	0	
	Time To Trigger	S	0	
Filter coefficient		0		L3 filtering is not used
Gap pattern ID		0		
<i>R</i> _{max}		8		As defined in <i>mPDCCH-NumRepetition</i> in [3]
<i>G</i>		1		As defined in <i>mPDCCH-startSF-UESS</i> in [3]
<i>X</i>		scheme10		As defined in <i>measGapSharingScheme</i> in [3]
T1	S	5		
T2	S	10	60	

Table A.8.3.17.1-2: Cell specific test parameters

Parameter	Unit	Cell 1		Cell 2	
		T1	T2	T1	T2
E-UTRA RF Channel Number		1		2	
<i>BW</i> _{channel}	MHz	10		10	
PDSCH parameters: DL Reference Measurement Channel		R.11 HD-FDD		-	
MPDCCH parameters: DL Reference Measurement Channel		R.7 HD-FDD		R.7 HD-FDD	
OCNG Patterns		OP.21 FDD		OP.6 FDD	
PBCH_RA	dB				
PBCH_RB	dB				
PSS_RA	dB				
SSS_RA	dB				

PCFICH_RB	dB	-3		-3	
PHICH_RA	dB				
PHICH_RB	dB				
MPDCCH_RA	dB				
MPDCCH_RB	dB				
PDSCH_RA	dB				
PDSCH_RB	dB				
OCNG_RA ^{Note 1}	dB				
OCNG_RB ^{Note 1}	dB				
N_{oc} ^{Note 2}	dBm/15 KHz	-98		-98	
\hat{E}_s / N_{oc}	dB	4	4	-Infinity	4
\hat{E}_s / I_{ot} ^{Note 3}	dB	4	4	-Infinity	4
RSRP ^{Note 3}	dBm/15 KHz	-94	-94	-Infinity	-94
SCH_RP ^{Note 3}	dBm/15 KHz	-94	-94	-Infinity	-94
I_o ^{Note 3}	dBm/9MHz	-64.76	-64.76	-Infinity	-64.76
Propagation Condition		ETU30		ETU30	
Correlation Matrix and Antenna Configuration		2x1 Low		2x1 Low	
Timing offset to Cell 1	ms	-		3	
<p>Note 1: OCNG shall be used such that all cells are fully allocated and a constant total transmitted power spectral density is achieved for all OFDM symbols.</p> <p>Note 2: Interference from other cells and noise sources not specified in the test is assumed to be constant over subcarriers and time and shall be modelled as AWGN of appropriate power for N_{oc} to be fulfilled.</p> <p>Note 3: E_s/I_{ot}, RSRP, SCH_RP and I_o have been derived from other parameters for information purposes. They are not settable parameters themselves.</p> <p>Note 4: The resources for uplink transmission are assigned to the UE prior to the start of time period T2.</p>					

Table A.8.3.17.1-3: DRX-Configuration

Field	Test1	Test2	Comment
	Value	Value	
onDurationTimer	psf1	psf1	As specified in clause 6.3.2 in TS 36.331
drx-InactivityTimer	psf1	psf1	
drx-RetransmissionTimer	psf1	psf1	
longDRX-CycleStartOffset	sf128	sf1280	
shortDRX	disable	disable	

Table A.8.3.17.1-4: TimeAlignmentTimer -Configuration

Field	Test1	Test2	Comment
	Value	Value	
TimeAlignmentTimer	sf500	sf500	As specified in clause 6.3.2 in TS 36.331
sr-ConfigIndex	0	0	For further information see clause 6.3.2 in TS 36.331 and section 10.1 in TS 36.213.

A.8.3.17.2 Test Requirement

In Test 1, the UE shall send one Event A3 triggered measurement report, with a measurement reporting delay less than 6.4 s from the beginning of time period T2. The measurement reporting delay is defined as the time from the beginning of time period T2 to the moment when the UE send the measurement report on PUSCH.

In Test 2, the UE shall send one Event A3 triggered measurement report, with a measurement reporting delay less than 51.2 s from the beginning of time period T2. The measurement reporting delay is defined as the time from the beginning of time period T2 to the moment when the UE starts to send preambles on the PRACH for scheduling request (SR) to obtain allocation to send the measurement report on PUSCH.

The UE shall not send event triggered measurement reports, as long as the reporting criteria are not fulfilled.

The rate of correct events observed during repeated tests shall be at least 90%.

NOTE 1: The actual overall delays measured in the test may be up to one DRX cycle higher than the measurement reporting delays above because UE is allowed to delay the initiation of the measurement reporting procedure to the next until the Active Time.

NOTE 2: In order to calculate the r

A.8.3.18 E-UTRAN FDD-FDD inter-frequency event triggered reporting under fading propagation conditions in asynchronous cells for UE category M1 in CEModeB in DRX

A.8.3.18.1 Test Purpose and Environment

The purpose of this test is to verify that the Cat-M1 UE makes correct reporting of an event. This test will partly verify the FDD-FDD inter-frequency cell search requirements in clause 8.13.3.5.1.

The test parameters are given in Table A.8.3.18.1-1, A.8.3.18.1-2, A.8.3.18.1-3 and A.8.3.18.1-4 below. In the measurement control information it is indicated to the UE that event-triggered reporting with Event A3 is used. The test consists of two successive time periods, with time duration of T1, and T2 respectively. During time duration T1, the UE shall not have any timing information of cell 2. At the beginning of T2 the transmission power of cell 2 is increased to the same level as for cell 1, and due to usage of an offset this shall result in reporting of Event A3.

In Test 1 UE needs to be provided at least once every 500ms with new Timing Advance Command MAC control element to restart the Time alignment timer to keep UE uplink time alignment. Furthermore UE is allocated with PUSCH resource at every DRX cycle.

In Test 2 the uplink time alignment is not maintained and UE needs to use RACH to obtain UL allocation for measurement reporting.

Table A.8.3.18.1-1: General test parameters

Parameter	Unit	Value	Comment
E-UTRA RF Channel Number		1, 2	
Active cell		Cell 1	
Neighbour cell		Cell 2	Cell to be identified.
CP length		Normal	
DRX		ON	
A3	Offset	dB	-8
	Hysteresis	dB	0
	Time To Trigger	S	0
Filter coefficient		0	L3 filtering is not used
Gap pattern ID		0	
<i>R</i> _{max}		8	As defined in <i>mPDCCH-NumRepetition</i> in [3]
<i>G</i>		1	As defined in <i>mPDCCH-startSF-UESS</i> in [3]
<i>X</i>		scheme01	As defined in <i>measGapSharingScheme</i> in [3]
T1	S	5	
T2	S	≤650	≤1030

Table A.8.3.18.1-2: Cell specific test parameters

Parameter	Unit	Cell 1		Cell 2	
		T1	T2	T1	T2
E-UTRA RF Channel Number		1		2	
<i>BW</i> _{channel}	MHz	10 for 10 MHz cell BW: 5 for 5 MHz cell BW		10 for 10 MHz cell BW: 5 for 5 MHz cell BW	
PDSCH parameters: DL Reference Measurement Channel		R.23 FDD for 10 MHz cell BW R.31 FDD for 5 MHz cell BW		-	

MPDCCH parameters: DL Reference Measurement Channel		R.19 FDD for 10 MHz cell BW R.27 FDD for 5 MHz cell BW	R.19 FDD for 10 MHz cell BW R.27 FDD for 5 MHz cell BW
OCNG Patterns		OP.21 FDD for 10 MHz cell BW OP.22 FDD for 5 MHz cell BW	OP.6 FDD for 10 MHz cell BW: OP.19 FDD for 5 MHz cell BW
PBCH_RA	dB	-3	-3
PBCH_RB	dB		
PSS_RA	dB		
SSS_RA	dB		
PCFICH_RB	dB		
PHICH_RA	dB		
PHICH_RB	dB		
MPDCCH_RA	dB		
MPDCCH_RB	dB		
PDSCH_RA	dB		
PDSCH_RB	dB		
OCNG_RA ^{Note 1}	dB		
OCNG_RB ^{Note 1}	dB		
N_{oc} ^{Note 2}	dBm/15 KHz		
\hat{E}_s / N_{oc}	dB	-12	-12
\hat{E}_s / I_{ot} ^{Note 3}	dB	-12	-12
RSRP ^{Note 3}	dBm/15 KHz	-110	-110
SCH_RP ^{Note 3}	dBm/15 KHz	-110	-110
I_o ^{Note 3}	dBm/9MHz	-69.95	-69.95
	dBm/4.5 MHz	-72.96	-72.96
Propagation Condition		ETU30	ETU30
Correlation Matrix and Antenna Configuration		2x1 Low	2x1 Low
Timing offset to Cell 1	ms	-	3
<p>Note 1: OCNG shall be used such that all cells are fully allocated and a constant total transmitted power spectral density is achieved for all OFDM symbols.</p> <p>Note 2: Interference from other cells and noise sources not specified in the test is assumed to be constant over subcarriers and time and shall be modelled as AWGN of appropriate power for N_{oc} to be fulfilled.</p> <p>Note 3: E_s/I_{ot}, RSRP, SCH_RP and I_o have been derived from other parameters for information purposes. They are not settable parameters themselves.</p> <p>Note 4: The resources for uplink transmission are assigned to the UE prior to the start of time period T2.</p>			

Table A.8.3.18.1-3: DRX-Configuration

Field	Test1	Test2	Comment
	Value	Value	
onDurationTimer	psf1	psf1	As specified in clause 6.3.2 in TS 36.331
drx-InactivityTimer	psf1	psf1	
drx-RetransmissionTimer	psf1	psf1	
longDRX-CycleStartOffset	sf128	sf1280	
shortDRX	disable	disable	

Table A.8.3.18.1-4: TimeAlignmentTimer -Configuration

Field	Test1	Test2	Comment
	Value	Value	
TimeAlignmentTimer	sf500	sf500	As specified in clause 6.3.2 in TS 36.331
sr-ConfigIndex	0	0	For further information see clause 6.3.2 in TS 36.331 and section 10.1 in TS 36.213.

A.8.3.18.2 Test Requirement

In Test 1, the UE shall send one Event A3 triggered measurement report, with a measurement reporting delay less than 641.6 s from the beginning of time period T2. The measurement reporting delay is defined as the time from the beginning of time period T2 to the moment when the UE send the measurement report on PUSCH.

In Test 2, the UE shall send one Event A3 triggered measurement report, with a measurement reporting delay less than 1024 s from the beginning of time period T2. The measurement reporting delay is defined as the time from the beginning of time period T2 to the moment when the UE starts to send preambles on the PRACH for scheduling request (SR) to obtain allocation to send the measurement report on PUSCH.

The UE shall not send event triggered measurement reports, as long as the reporting criteria are not fulfilled.

The rate of correct events observed during repeated tests shall be at least 90%.

NOTE 1: The actual overall delays measured in the test may be up to one DRX cycle higher than the measurement reporting delays above because UE is allowed to delay the initiation of the measurement reporting procedure to the next until the Active Time.

NOTE 2: In order to calculate the rate of correct events the system simulator shall verify that it has received correct Event A3 measurement report.

A.8.3.19 E-UTRAN HD-FDD inter-frequency event triggered reporting under fading propagation conditions in asynchronous cells for UE category M1 in CEModeB in DRX

A.8.3.19.1 Test Purpose and Environment

The purpose of this test is to verify that the Cat-M1 UE makes correct reporting of an event. This test will partly verify the HD-FDD inter-frequency cell search requirements in clause 8.13.3.5.2.

The test parameters are given in Table A.8.3.19.1-1, A.8.3.19.1-2, A.8.3.19.1-3 and A.8.3.19.1-4 below. In the measurement control information it is indicated to the UE that event-triggered reporting with Event A3 is used. The test consists of two successive time periods, with time duration of T1, and T2 respectively. During time duration T1, the UE shall not have any timing information of cell 2. At the beginning of T2 the transmission power of cell 2 is increased to the same level as for cell 1, and due to usage of an offset this shall result in reporting of Event A3.

In Test 1 UE needs to be provided at least once every 500ms with new Timing Advance Command MAC control element to restart the Time alignment timer to keep UE uplink time alignment. Furthermore UE is allocated with PUSCH resource at every DRX cycle.

In Test 2 the uplink time alignment is not maintained and UE needs to use RACH to obtain UL allocation for measurement reporting.

Table A.8.3.19.1-1: General test parameters

Parameter	Unit	Value		Comment
		T1	T2	
E-UTRA RF Channel Number		1, 2		
Active cell		Cell 1		
Neighbour cell		Cell 2		Cell to be identified.
CP length		Normal		
DRX		ON		
A3	Offset	dB	-8	
	Hysteresis	dB	0	
	Time To Trigger	S	0	
Filter coefficient		0		L3 filtering is not used
Gap pattern ID		0		
R_{max}		8		As defined in <i>mPDCCH-NumRepetition</i> in [3]
G		1		As defined in <i>mPDCCH-startSF-UESS</i> in [3]

X		scheme01	As defined in <i>measGapSharingScheme</i> in [3]
T1	S	5	
T2	S	≤650	≤1030

Table A.8.3.19.1-2: Cell specific test parameters

Parameter	Unit	Cell 1		Cell 2	
		T1	T2	T1	T2
E-UTRA RF Channel Number		1		2	
BW _{channel}	MHz	10 for 10 MHz cell BW 5 for 5 MHz cell BW		10 for 10 MHz cell BW 5 for 5 MHz cell BW	
PDSCH parameters: DL Reference Measurement Channel		R.13 HD-FDD for 10 MHz cell BW R.21 HD-FDD for 5 MHz cel		-	
MPDCCH parameters: DL Reference Measurement Channel		R.9 HD-FDD for 10 MHz cell BW R.17 HD-FDD for 5 MHz cell BW:		R.9 HD-FDD for 10 MHz cell BW: R.17 HD-FDD for 5 MHz cell BW:	
OCNG Patterns		OP.21 FDD for 10 MHz cell BW OP.22 FDD for 5 MHz cell BW		OP.6 FDD for 10 MHz cell BW: OP.19 FDD for 5 MHz cell BW	
PBCH_RA	dB	-3		-3	
PBCH_RB	dB				
PSS_RA	dB				
SSS_RA	dB				
PCFICH_RB	dB				
PHICH_RA	dB				
PHICH_RB	dB				
MPDCCH_RA	dB				
MPDCCH_RB	dB				
PDSCH_RA	dB				
PDSCH_RB	dB				
OCNG_RA ^{Note 1}	dB				
OCNG_RB ^{Note 1}	dB				
N_{oc} ^{Note 2}	dBm/15 KHz				
\hat{E}_s / N_{oc}	dB	-12	-12	-Infinity	-12
\hat{E}_s / I_{ot} ^{Note 3}	dB	-12	-12	-Infinity	-12
RSRP ^{Note 3}	dBm/15 KHz	-110	-110	-Infinity	-110
SCH_RP ^{Note 3}	dBm/15 KHz	-110	-110	-Infinity	-110
I_o ^{Note 3}	dBm/9MHz	-69.95	-69.95	-Infinity	-69.95
	dBm/4.5 MHz	-72.96	-72.96	-Infinity	-72.96
Propagation Condition		ETU30		ETU30	
Correlation Matrix and Antenna Configuration		2x1 Low		2x1 Low	
Timing offset to Cell 1	ms	-		3	
<p>Note 1: OCNG shall be used such that all cells are fully allocated and a constant total transmitted power spectral density is achieved for all OFDM symbols.</p> <p>Note 2: Interference from other cells and noise sources not specified in the test is assumed to be constant over subcarriers and time and shall be modelled as AWGN of appropriate power for N_{oc} to be fulfilled.</p> <p>Note 3: E_s/I_{ot}, RSRP, SCH_RP and I_o have been derived from other parameters for information purposes. They are not settable parameters themselves.</p> <p>Note 4: The resources for uplink transmission are assigned to the UE prior to the start of time period T2.</p>					

Table A.8.3.19.1-3: DRX-Configuration

Field	Test1	Test2	Comment
	Value	Value	

onDurationTimer	psf1	psf1	As specified in clause 6.3.2 in TS 36.331
drx-InactivityTimer	psf1	psf1	
drx-RetransmissionTimer	psf1	psf1	
longDRX-CycleStartOffset	sf128	sf1280	
shortDRX	Disable	disable	

Table A.8.3.19.1-4: TimeAlignmentTimer -Configuration

Field	Test1	Test2	Comment
	Value	Value	
TimeAlignmentTimer	sf500	sf500	As specified in clause 6.3.2 in TS 36.331
sr-ConfigIndex	0	0	For further information see clause 6.3.2 in TS 36.331 and section 10.1 in TS 36.213.

A.8.3.19.2 Test Requirement

In Test 1, the UE shall send one Event A3 triggered measurement report, with a measurement reporting delay less than 641.6 s from the beginning of time period T2. The measurement reporting delay is defined as the time from the beginning of time period T2 to the moment when the UE send the measurement report on PUSCH.

In Test 2, the UE shall send one Event A3 triggered measurement report, with a measurement reporting delay less than 1024 s from the beginning of time period T2. The measurement reporting delay is defined as the time from the beginning of time period T2 to the moment when the UE starts to send preambles on the PRACH for scheduling request (SR) to obtain allocation to send the measurement report on PUSCH.

The UE shall not send event triggered measurement reports, as long as the reporting criteria are not fulfilled.

The rate of correct events observed during repeated tests shall be at least 90%.

NOTE 1: The actual overall delays measured in the test may be up to one DRX cycle higher than the measurement reporting delays above because UE is allowed to delay the initiation of the measurement reporting procedure to the next until the Active Time.

NOTE 2: In order to calculate the rate of correct events the system simulator shall verify that it has received correct Event A3 measurement report.

A.8.4 E-UTRAN TDD - TDD Inter-frequency Measurements

A.8.4.1 E-UTRAN TDD-TDD Inter-frequency event triggered reporting under fading propagation conditions in synchronous cells

A.8.4.1.1 Test Purpose and Environment

The purpose of this test is to verify that the UE makes correct reporting of an event. This test will partly verify the TDD-TDD inter-frequency cell search requirements in clause 8.1.2.3.2.

The test parameters are given in Table A.8.4.1.1-1 and A.8.4.1.1-2 below. In the measurement control information it is indicated to the UE that event-triggered reporting with Event A3 is used. The test consists of two successive time periods, with time duration of T1, and T2 respectively. During time duration T1, the UE shall not have any timing information of cell 2.

Table A.8.4.1.1-1: General test parameters for E-UTRAN TDD-TDD inter-frequency event triggered reporting in fading propagation conditions

Parameter	Unit	Value	Comment
PDSCH parameters		DL Reference Measurement Channel R.0 TDD	As specified in clause A.3.1.1.2
PCFICH/PDCCH/PHICH parameters		DL Reference Measurement Channel R.6 TDD	As specified in clause A.3.1.2.2
Gap Pattern Id		1	As specified in TS 36.133 clause 8.1.2.1.

Special subframe configuration		6	As specified in table 4.2-1 in TS 36.211. The same configuration in both cells
Uplink-downlink configuration		1	As specified in TS 36.211 clause 4.2 Table 4.2-2
CP length		Normal	
E-UTRA RF Channel Number		1, 2	Two TDD carrier frequencies are used.
Channel Bandwidth (BW_{channel})	MHz	10	
Active cell		Cell 1	Cell 1 is on RF channel number 1
Neighbour cell		Cell 2	Cell 2 is on RF channel number 2
A3-Offset	dB	-6	
Hysteresis	dB	0	
TimeToTrigger	s	0	
Filter coefficient		0	L3 filtering is not used
DRX		OFF	
Time offset between cells		3 μ s	Synchronous cells
T1	s	5	
T2	s	10	

Table A.8.4.1.1-2: Cell specific test parameters for E-UTRAN TDD-TDD inter-frequency event triggered reporting under fading propagation conditions in synchronous cells

Parameter	Unit	Cell 1		Cell 2	
		T1	T2	T1	T2
E-UTRA RF Channel Number		1		2	
BW_{channel}	MHz	10		10	
Correlation Matrix and Antenna Configuration		1x2 Low		1x2 Low	
OCNG Pattern defined in A.3.2.2.1 (OP.1 TDD) and in A.3.2.2.2 (OP.2)		OP.1 TDD		OP.2 TDD	
PBCH_RA	dB	0		0	
PBCH_RB	dB				
PSS_RA	dB				
SSS_RA	dB				
PCFICH_RB	dB				
PHICH_RA	dB				
PHICH_RB	dB				
PDCCH_RA	dB				
PDCCH_RB	dB				
PDSCH_RA	dB				
PDSCH_RB	dB				
OCNG_RA ^{Note 1}	dB				
OCNG_RB ^{Note 1}	dB				
\hat{E}_s / I_{α}	dB				
N_{oc} ^{Note 3}	dBm/15 kHz	-98			
RSRP ^{Note 4}	dBm/15 kHz	-94	-94	-Infinity	-91
SCH_RP ^{Note 4}	dBm/15 kHz	-94	-94	-infinity	-91
\hat{E}_s / N_{oc}	dB	4	4	-Infinity	7
Propagation Condition		ETU70			
Note 1: OCNG shall be used such that both cells are fully allocated and a constant total transmitted power spectral density is achieved for all OFDM symbols.					
Note 2: The resources for uplink transmission are assigned to the UE prior to the start of time period T2.					
Note 3: Interference from other cells and noise sources not specified in the test is assumed to be constant over subcarriers and time and shall be modelled as AWGN of appropriate power for N_{oc} to be fulfilled.					
Note 4: RSRP and SCH_RP levels have been derived from other parameters for information purposes. They are not settable parameters themselves.					

A.8.4.1.2 Test Requirements

The UE shall send one Event A3 triggered measurement report, with a measurement reporting delay less than 7680 ms from the beginning of time period T2.

The UE shall not send event triggered measurement reports, as long as the reporting criteria are not fulfilled.

The rate of correct events observed during repeated tests shall be at least 90%.

NOTE: The actual overall delays measured in the test may be up to $2 \times TTI_{DCCCH}$ higher than the measurement reporting delays above because of TTI insertion uncertainty of the measurement report in DCCCH.

A.8.4.2 E-UTRAN TDD-TDD Inter-frequency event triggered reporting when DRX is used under fading propagation conditions in synchronous cells

A.8.4.2.1 Test Purpose and Environment

The purpose of these tests is to verify that the UE makes correct reporting of an event in DRX. These test will partly verify the TDD-TDD inter-frequency cell search requirements when DRX is used in clause 8.1.2.3.

The common test parameters are given in Tables A.8.4.2.1-1 and A.8.4.2.1-2. DRX configuration for Test1 and Test2 are given in Table A.8.4.2.1-3 and time alignment timer and scheduling request related parameters in Table A.8.4.2.1-4. In these tests, there are two cells on different carrier frequencies and gap pattern configuration # 0 as defined in Table 8.1.2.1-1 is provided.

In Test 1 UE needs to be provided at least once every 500ms with new Timing Advance Command MAC control element to restart the Time alignment timer to keep UE uplink time alignment. Furthermore UE is allocated with PUSCH resource at every DRX cycle. In Test 2 the uplink time alignment is not maintained and UE needs to use RACH to obtain UL allocation for measurement reporting.

In the measurement control information, it is indicated to the UE that event-triggered reporting with Event A3 is used. The tests consists of two successive time periods, with time duration of T1, and T2 respectively. During time duration T1, the UE shall not have any timing information of cell 2.

Table A.8.4.2.1-1: General test parameters for E-UTRAN TDD-TDD inter-frequency event triggered reporting when DRX is used in fading propagation conditions

Parameter	Unit	Test 1	Test 2	Comment
		Value		
PDSCH parameters		DL Reference Measurement Channel R.0 TDD		As specified in clause A.3.1.1.2. Note that UE may only be allocated at <i>On Duration</i>
PCFICH/PDCCH/PHICH parameters		DL Reference Measurement Channel R.6 TDD		As specified in clause A.3.1.2.2.
E-UTRA RF Channel Number		1, 2		Two TDD carrier frequencies are used.
Channel Bandwidth ($BW_{channel}$)	MHz	10		
Active cell		Cell 1		Cell 1 is on RF channel number 1
Neighbour cell		Cell 2		Cell 2 is on RF channel number 2
Gap Pattern Id		0		As specified in TS 36.133 clause 8.1.2.1.
Uplink-downlink configuration		1		As specified in TS 36.211 clause 4.2 Table 4.2-2
Special subframe configuration		6		As specified in table 4.2-1 in TS 36.211. The same configuration in both cells
A3-Offset	dB	-6		
Hysteresis	dB	0		
CP length		Normal		
TimeToTrigger	s	0		
Filter coefficient		0		L3 filtering is not used
PRACH configuration		4		As specified in table 5.7.1-3 in TS 36.211
Access Barring Information	-	Not Sent		No additional delays in random access procedure.

DRX		ON	DRX related parameters are defined in Table A.8.4.2.1-3
Time offset between cells		3 μ s	Synchronous cells
T1	s	5	
T2	s	5	30

Table A.8.4.2.1-2: Cell specific test parameters for E-UTRAN TDD-TDD inter-frequency event triggered reporting under fading propagation conditions in synchronous cells

Parameter	Unit	Cell 1		Cell 2	
		T1	T2	T1	T2
E-UTRA RF Channel Number		1		2	
BW _{channel}	MHz	10		10	
Correlation Matrix and Antenna Configuration		1x2 Low		1x2 Low	
OCNG Patterns defined in A.3.2.2.1 (OP.1 TDD) and in A.3.2.2.2 (OP.2 TDD)		OP.1 TDD		OP.2 TDD	
PBCH_RA	dB	0		0	
PBCH_RB	dB				
PSS_RA	dB				
SSS_RA	dB				
PCFICH_RB	dB				
PHICH_RA	dB				
PHICH_RB	dB				
PDCCH_RA	dB				
PDCCH_RB	dB				
PDSCH_RA	dB				
PDSCH_RB	dB				
OCNG_RA ^{Note 1}	dB				
OCNG_RB ^{Note 1}	dB				
N_{oc} ^{Note 2}	dBm/15 kHz	-98			
RSRP ^{Note 3}	dBm/15 kHz	-94	-94	-Infinity	-91
\hat{E}_s/I_{ot}	dB	4	4	-Infinity	7
SCH_RP ^{Note 3}	dBm/15 kHz	-94	-94	-Infinity	-91
\hat{E}_s/N_{oc}	dB	4	4	-Infinity	7
Propagation Condition		ETU70			
Note 1: OCNG shall be used such that both cells are fully allocated and a constant total transmitted power spectral density is achieved for all OFDM symbols. Note 2: Interference from other cells and noise sources not specified in the test is assumed to be constant over subcarriers and time and shall be modelled as AWGN of appropriate power for N_{oc} to be fulfilled. Note 3: RSRP and SCH_RP levels have been derived from other parameters for information purposes. They are not settable parameters themselves.					

Table A.8.4.2.1-3: drx-Configuration to be used in E-UTRAN TDD-TDD inter-frequency event triggered reporting when DRX is used in fading propagation conditions

Field	Test1	Test2	Comment
	Value	Value	
onDurationTimer	psf1	psf1	
drx-InactivityTimer	psf1	psf1	
drx-RetransmissionTimer	psf1	psf1	
longDRX-CycleStartOffset	sf40	sf1280	
shortDRX	disable	disable	

Table A.8.4.2.1-4: *TimeAlignmentTimer* and *sr-ConfigIndex* -Configuration to be used in E-UTRAN TDD-TDD inter-frequency event triggered reporting when DRX is used in fading propagation conditions

Field	Test1	Test2	Comment
	Value	Value	
TimeAlignmentTimer	sf500	sf500	For further information see clause 6.3.2 in TS 36.331.
sr-ConfigIndex	2	2	For further information see clause 6.3.2 in TS 36.331 and 10.1 in TS 36.213.

A.8.4.2.2 Test Requirements

In Test1 the UE shall send one Event A3 triggered measurement report, with a measurement reporting delay less than 3840 ms from the beginning of time period T2. The measurement reporting delay is defined as the time from the beginning of time period T2, to the moment when the UE send the measurement report on PUSCH.

In Test2 the UE shall send one Event A3 triggered measurement report, with a measurement reporting delay less than 20×1280 ms from the beginning of time period T2. The measurement reporting delay is defined as the time from the beginning of time period T2, to the moment when the UE starts to send preambles on the PRACH for scheduling request (SR) to obtain allocation to send the measurement report on PUSCH.

The UE shall not send event triggered measurement reports, as long as the reporting criteria are not fulfilled.

The rate of correct events observed during repeated tests shall be at least 90%.

NOTE 1: The actual overall delays measured in the test may be up to one DRX cycle higher than the measurement reporting delays above because UE is allowed to delay the initiation of the measurement reporting procedure to the next until the Active Time.

NOTE 2: In order to calculate the rate of correct events the system simulator shall verify that it has received correct Event A3 measurement report.

A.8.4.3 E-UTRAN TDD-TDD inter-frequency event triggered reporting under AWGN propagation conditions in synchronous cells with DRX when L3 filtering is used

A.8.4.3.1 Test Purpose and Environment

The purpose of this test is to verify that the UE makes correct reporting of an event in DRX when L3 filtering is used. This test will partly verify the TDD-TDD inter-frequency cell search in DRX requirements in clause 8.1.2.3.2.2 and the UE behaviour with the filterCoefficient defined in TS 36.331 [2].

The test parameters are given in Tables A.8.4.3.1-1, A.8.4.3.1-2, A.8.4.3.1-3 and A.8.4.3.1-4. In the measurement control information, it is indicated to the UE that event-triggered reporting with Event A3 and the filter coefficient is used. The test consists of two successive time periods, with time duration of T1, and T2 respectively. In this test, there are two cells on different carrier frequencies and gap pattern configuration # 1 as defined in Table 8.1.2.1-1 is provided.

The uplink time alignment is not maintained and UE needs to use RACH to obtain UL allocation for measurement reporting.

Table A.8.4.3.1-1: General test parameters for E-UTRAN TDD-TDD inter-frequency event triggered reporting under AWGN propagation conditions with DRX when L3 filtering is used

Parameter	Unit	Value	Comment
PDSCH parameters		DL Reference Measurement Channel R.0 TDD	As specified in clause A.3.1.1.2
PCFICH/PDCCH/PHICH parameters		DL Reference Measurement Channel R.6 TDD	As specified in clause A.3.1.2.2
Active cell		Cell 1	
Neighbour cell		Cell 2	Cell to be identified.

E-UTRA RF Channel Number		1, 2	Two TDD carrier frequencies are used.
Channel Bandwidth ($BW_{channel}$)	MHz	10	
Time offset between cells	μ s	3	synchronous cells
Gap Pattern Id		1	As specified in TS 36.133 clause 8.1.2.1.
Uplink-downlink configuration of cells		1	As specified in table 4.2.2 in TS 36.211
Special subframe configuration of cells		6	As specified in table 4.2.1 in TS 36.211
Neighbour A3-Offset Ofn	dB	-14	
CP length		Normal	
Hysteresis	dB	0	
Time To Trigger	s	0	
Filter coefficient		9	L3 filtering is used
DRX		ON	DRX related parameters are defined in Table A.8.4.3.1-3
T1	s	30	
T2	s	9	

Table A.8.4.3.1-2: Cell specific test parameters for E-UTRAN TDD-TDD inter-frequency event triggered reporting under AWGN propagation conditions with DRX when L3 filtering is used

Parameter	Unit	Cell 1		Cell 2	
		T1	T2	T1	T2
E-UTRA RF Channel Number		1		2	
$BW_{channel}$	MHz	10		10	
OCNG Patterns defined in A.3.2.2.1 (OP.1 TDD) and in A.3.2.2.2 (OP.2 TDD)		OP.1 TDD		OP.2 TDD	
PBCH_RA	dB	0		0	
PBCH_RB	dB				
PSS_RA	dB				
SSS_RA	dB				
PCFICH_RB	dB				
PHICH_RA	dB				
PHICH_RB	dB				
PDCCH_RA	dB				
PDCCH_RB	dB				
PDSCH_RA	dB				
PDSCH_RB	dB				
OCNG_RA ^{Note 1}	dB				
OCNG_RB ^{Note 1}	dB				
\hat{E}_s / I_{ot}	dB				
N_{oc} ^{Note 2}	dBm/15 KHz	-98			
\hat{E}_s / N_{oc}	dB	4	4	4	24
RSRP ^{Note 3}	dBm/15 KHz	-94	-94	-94	-74
SCH_RP ^{Note 3}	dBm/15 KHz	-94	-94	-94	-74
Propagation Condition		AWGN			
<p>Note 1: OCNG shall be used such that both cells are fully allocated and a constant total transmitted power spectral density is achieved for all OFDM symbols.</p> <p>Note 2: Interference from other cells and noise sources not specified in the test is assumed to be constant over subcarriers and time and shall be modelled as AWGN of appropriate power for N_{oc} to be fulfilled.</p> <p>Note 3: RSRP and SCH_RP levels have been derived from other parameters for information purposes. They are not settable parameters themselves.</p>					

Table A.8.4.3.1-3: DRX-Configuration for E-UTRAN TDD-TDD inter-frequency event triggered reporting in DRX under AWGN propagation conditions with DRX when L3 filtering is used

Field	Value	Comment
onDurationTimer	psf1	As specified in clause 6.3.2 in TS 36.331

drx-InactivityTimer	psf1	
drx-RetransmissionTimer	sf1	
longDRX-CycleStartOffset	sf1280	
shortDRX	disable	

Table A.8.4.3.1-4: TimeAlignmentTimer -Configuration for E-UTRAN TDD-TDD inter-frequency event triggered reporting in DRX under AWGN propagation conditions with DRX when L3 filtering is used

Field	Value	Comment
TimeAlignmentTimer	sf500	As specified in clause 6.3.2 in TS 36.331
sr-ConfigIndex	2	For further information see clause 6.3.2 in TS 36.331 and section 10.1 in TS 36.213.

A.8.4.3.2 Test Requirements

The UE shall send one Event A3 triggered measurement report, with a measurement reporting delay less than 6400 ms from the beginning of time period T2. The measurement reporting delay is defined as the time from the beginning of time period T2 to the moment when the UE starts to send preambles on the PRACH for scheduling request (SR) to obtain allocation to send the measurement report on PUSCH.

The UE shall not send event triggered measurement reports, as long as the reporting criteria are not fulfilled.

The rate of correct events observed during repeated tests shall be at least 90%.

NOTE 1: The actual overall delays measured in the test may be up to one DRX cycle higher than the measurement reporting delays above because UE is allowed to delay the initiation of the measurement reporting procedure to the next until the Active Time.

NOTE 2: In order to calculate the rate of correct events the system simulator shall verify that it has received correct Event A3 measurement report.

A.8.4.4 E-UTRAN TDD - TDD Inter-frequency identification of a new CGI of E-UTRA cell using autonomous gaps

A.8.4.4.1 Test Purpose and Environment

This test is to verify the requirement for identification of a new CGI of E-UTRA cell with autonomous gaps in clause 8.1.2.3.7.

The test scenario comprises of two E-UTRA TDD carriers and one cell on each carrier as given in tables A.8.4.4.1-1 and A.8.4.4.1-2. PDCCHs indicating new transmissions shall be sent continuously to ensure that the UE would have ACK/NACK sending during identifying a new CGI of E-UTRAN cell. The test consists of three successive time periods, with time durations of T1, T2 and T3 respectively. At the start of time duration T1, the UE does not have any timing information of cell 2. Starting T2, cell 2 becomes detectable and the UE is expected to detect and send a measurement report. Gap pattern configuration with id #0 as specified in Table 8.1.2.1-1 is configured before T2 begins to enable inter-frequency monitoring.

A RRC message implying SI reading shall be sent to the UE during period T2, after the UE has reported Event A3. The RRC message shall create a measurement report configuration with purpose *reportCGI* and *si-RequestForHO* set to TRUE. The start of T3 is the instant when the last TTI containing the RRC message implying SI reading is sent to the UE. Measurement gaps shall be deconfigured before the start of T3.

Table A.8.4.4.1-1: General test parameters for E-UTRAN TDD - TDD Inter-frequency identification of a new CGI of E-UTRA cell using autonomous gaps

Parameter	Unit	Value	Comment
PDSCH parameters		DL Reference Measurement Channel R.0 TDD	As specified in clause A.3.1.1.2
PCFICH/PDCCH/PHICH parameters		DL Reference Measurement Channel R.6 TDD	As specified in clause A.3.1.2.2
E-UTRA RF channel number		1, 2	Two TDD carrier frequencies are used.
Channel Bandwidth (BW _{channel})	MHz	10	

Active cell		Cell 1	Cell 1 is on RF channel number 1.
Neighbour cell		Cell 2	Cell 1 is on RF channel number 2.
CP length		Normal	
Special subframe configuration		6	As specified in table 4.2-1 in TS 36.211. The same configuration in both cells
Uplink-downlink configuration		1	As specified in table 4.2-2 in TS 36.211. The same configuration in both cells
Gap Pattern Id		0	As specified in TS 36.133 clause 8.1.2.1.
A3-Offset	dB	-6	
Hysteresis	dB	0	
TimeToTrigger	s	0	
Filter coefficient		0	L3 filtering is not used
DRX		OFF	
si-RequestForHO		TRUE	As specified in clause 5.5.3.1 in TS 36.331.
Time offset between cells	μs	3	Synchronous cells
T1	s	5	
T2	s	≤10	
T3	s	5	

Table A.8.4.4.1-2: Cell specific test parameters for E-UTRAN TDD - TDD Inter-frequency identification of a new CGI of E-UTRA cell using autonomous gaps

Parameter	Unit	Cell 1			Cell 2		
		T1	T2	T3	T1	T2	T3
E-UTRA RF Channel Number		1			2		
BW _{channel}	MHz	10			10		
OCNG Patterns defined in A.3.2.2.1 (OP.1 TDD) and in A.3.2.2.2 (OP.2 TDD)		OP.1 TDD	OP.1 TDD	OP.1 TDD	OP.2 TDD	OP.2 TDD	OP.2 TDD
PBCH_RA	dB	0			0		
PBCH_RB	dB						
PSS_RA	dB						
SSS_RA	dB						
PCFICH_RB	dB						
PHICH_RA	dB						
PHICH_RB	dB						
PDCCH_RA	dB						
PDCCH_RB	dB						
PDSCH_RA	dB						
PDSCH_RB	dB						
OCNG_RA ^{Note 1}	dB						
OCNG_RB ^{Note 1}	dB						
\hat{E}_s/I_{out}	dB	4	4	4	-Infinity	7	7
N_{oc} ^{Note 2}	dBm/15 KHz	-98					
\hat{E}_s/N_{oc}	dB	4	4	4	-Infinity	7	7
RSRP ^{Note 3}	dBm/15 KHz	-94	-94	-94	-Infinity	-91	-91
SCH_RP ^{Note 3}	dBm/15 KHz	-94	-94	-94	-Infinity	-91	-91
Propagation Condition		AWGN					
<p>Note 1: OCNG shall be used such that both cells are fully allocated and a constant total transmitted power spectral density is achieved for all OFDM symbols.</p> <p>Note 2: Interference from other cells and noise sources not specified in the test is assumed to be constant over subcarriers and time and shall be modelled as AWGN of appropriate power for N_{oc} to be fulfilled.</p> <p>Note 3: RSRP and SCH_RP levels have been derived from other parameters for information purposes. They are not settable parameters themselves.</p>							

A.8.4.4.2 Test Requirements

The UE shall transmit a measurement report containing the cell global identifier of cell 2 within 170 milliseconds from the start of T3.

Test requirement = RRC Procedure delay + $T_{\text{identify_CGI_inter}}$ + reporting delay

= 15 + 150 + 2ms from the start of T3

= 167 ms, allow 170 ms.

The UE shall be scheduled continuously throughout the test, and from the start of T3 until 170 ms at least 42 ACK/NACK shall be detected as being transmitted by the UE.

The rate of correct events observed during repeated tests shall be at least 90%.

NOTE: The overall 42 ACK/NACK number is caused by two parts. Firstly, at least 30 ACK/NACK shall be sent during identifying the cell global identifier of cell 2 according to the requirement in Clause 8.1.2.3.7.1. Secondly, given that continuous DL data allocation, and the measurement gaps have been deconfigured before the start of T3, additional 12 ACK/NACK shall be sent from the start of T3 until 170 ms excludes 150 ms for identifying the cell global identifier of cell 2.

A.8.4.5 E-UTRAN TDD - TDD Inter-frequency identification of a new CGI of E-UTRA cell using autonomous gaps with DRX

A.8.4.5.1 Test Purpose and Environment

This test is to verify the requirement for identification of a new CGI of E-UTRA cell with autonomous gaps in clause 8.1.2.3.7. The requirement is verified in a DRX configuration.

The test scenario comprises of two E-UTRA TDD carriers and one cell on each carrier as given in tables A.8.4.5.1-1, A.8.4.5.1-2, A.8.4.5.1-3 and A.8.4.5.1-4. The test consists of three successive time periods, with time durations of T1, T2 and T3 respectively. At the start of time duration T1, the UE does not have any timing information of cell 2. Starting T2, cell 2 becomes detectable and the UE is expected to detect and send a measurement report. Gap pattern configuration with id #0 as specified in Table 8.1.2.1-1 is configured before T2 begins to enable inter-frequency monitoring.

A RRC message implying SI reading shall be sent to the UE during period T2, after the UE has reported Event A3. The RRC message shall create a measurement report configuration with purpose *reportCGI* and *si-RequestForHO* set to TRUE. The start of T3 is the instant when the last TTI containing the RRC message implying SI reading is sent to the UE. Measurement gaps shall be deconfigured before the start of T3.

In the test UE needs to be provided at least once every 1280ms with new Timing Advance Command MAC control element to restart the Time alignment timer to keep UE uplink time alignment. Furthermore UE sends scheduling request (SR) to obtain allocation to send the measurement report on PUSCH.

Table A.8.4.5.1-1: General test parameters for E-UTRAN TDD - TDD Inter-frequency identification of a new CGI of E-UTRA cell using autonomous gaps with DRX

Parameter	Unit	Value	Comment
PDSCH parameters		DL Reference Measurement Channel R.0 TDD	As specified in clause A.3.1.1.2
PCFICH/PDCCH/PHICH parameters		DL Reference Measurement Channel R.6 TDD	As specified in clause A.3.1.2.2
E-UTRA RF channel number		1, 2	Two TDD carrier frequencies are used.
Channel Bandwidth (BW_{channel})	MHz	10	
Active cell		Cell 1	Cell 1 is on RF channel number 1.
Neighbour cell		Cell 2	Cell 1 is on RF channel number 2.
CP length		Normal	
Special subframe configuration		6	As specified in table 4.2-1 in TS 36.211. The same configuration in both cells

Uplink-downlink configuration		1	As specified in table 4.2-2 in TS 36.211. The same configuration in both cells
Gap Pattern Id		0	As specified in TS 36.133 clause 8.1.2.1.
A3-Offset	dB	-6	
Hysteresis	dB	0	
TimeToTrigger	s	0	
Filter coefficient		0	L3 filtering is not used
DRX		ON	DRX related parameters are defined in Table A.8.4.5.1-3
si-RequestForHO		TRUE	As specified in clause 5.5.3.1 in TS 36.331.
Time offset between cells	µs	3	Synchronous cells
T1	s	5	
T2	s	≤30	UE shall report cell within 25.6s (20 DRX cycles)
T3	s	5	

Table A.8.4.5.1-2: Cell specific test parameters for E-UTRAN TDD - TDD Inter-frequency identification of a new CGI of E-UTRA cell using autonomous gaps with DRX

Parameter	Unit	Cell 1			Cell 2		
		T1	T2	T3	T1	T2	T3
E-UTRA RF Channel Number		1			2		
BW _{channel}	MHz	10			10		
OCNG Patterns defined in A.3.2.2.1 (OP.1 TDD) and in A.3.2.2.2 (OP.2 TDD)		OP.1 TDD	OP.1 TDD	OP.1 TDD	OP.2 TDD	OP.2 TDD	OP.2 TDD
PBCH_RA	dB	0			0		
PBCH_RB	dB						
PSS_RA	dB						
SSS_RA	dB						
PCFICH_RB	dB						
PHICH_RA	dB						
PHICH_RB	dB						
PDCCH_RA	dB						
PDCCH_RB	dB						
PDSCH_RA	dB						
PDSCH_RB	dB						
OCNG_RA ^{Note 1}	dB						
OCNG_RB ^{Note 1}	dB						
\hat{E}_s/I_{ot}	dB	4	4	4	-Infinity	7	7
N_{oc} ^{Note 2}	dBm/15 KHz	-98					
\hat{E}_s/N_{oc}	dB	4	4	4	-Infinity	7	7
RSRP ^{Note 3}	dBm/15 KHz	-94	-94	-94	-Infinity	-91	-91
SCH_RP ^{Note 3}	dBm/15 KHz	-94	-94	-94	-Infinity	-91	-91
Propagation Condition		AWGN					
<p>Note 1: OCNG shall be used such that both cells are fully allocated and a constant total transmitted power spectral density is achieved for all OFDM symbols.</p> <p>Note 2: Interference from other cells and noise sources not specified in the test is assumed to be constant over subcarriers and time and shall be modelled as AWGN of appropriate power for N_{oc} to be fulfilled.</p> <p>Note 3: RSRP and SCH_RP levels have been derived from other parameters for information purposes. They are not settable parameters themselves.</p>							

Table A.8.4.5.1-3: DRX configuration for E-UTRAN TDD - TDD Inter-frequency identification of a new CGI of E-UTRA cell using autonomous gaps with DRX

Field	Value	Comment
onDurationTimer	psf1	

drx-InactivityTimer	psf1	As specified in clause 6.3.2 in TS 36.331
drx-RetransmissionTimer	psf1	
longDRX-CycleStartOffset	sf1280	
shortDRX	disable	

Table A.8.4.5.1-4: TimeAlignmentTimer -Configuration for E-UTRAN TDD - TDD Inter-frequency identification of a new CGI of E-UTRA cell using autonomous gaps with DRX

Field	Value	Comment
TimeAlignmentTimer	Infinity	As specified in clause 6.3.2 in TS 36.331
sr-ConfigIndex	2	For further information see clause 6.3.2 in TS 36.331 and section 10.1 in TS 36.213.

A.8.4.5.2 Test Requirements

The UE shall transmit a measurement report containing the cell global identifier of cell 2 within 170 milliseconds from the start of T3.

Test requirement = RRC Procedure delay + $T_{\text{identify_C_GI_inter}}$ + reporting delay

= 15 + 150 + 2ms from the start of T3

= 167 ms, allow 170 ms.

The rate of correct events observed during repeated tests shall be at least 90%.

A.8.4.6 E-UTRAN TDD-TDD Inter-frequency event triggered reporting for TDD UL/DL configuration 0

A.8.4.6.1 Test Purpose and Environment

The purpose of this test is to verify that the UE makes correct reporting of an event. This test will partly verify the TDD-TDD inter-frequency cell search requirements in clause 8.1.2.3.2.

The test parameters are given in Table A.8.4.6.1-1 and A.8.4.6.1-2 below. In the measurement control information it is indicated to the UE that event-triggered reporting with Event A3 is used. The test consists of two successive time periods, with time duration of T1, and T2 respectively. During time duration T1, the UE shall not have any timing information of cell 2.

Table A.8.4.6.1-1: General test parameters for E-UTRAN TDD-TDD inter-frequency event triggered reporting for TDD UL/DL configuration 0

Parameter	Unit	Value	Comment
PDSCH parameters		DL Reference Measurement Channel R.5 TDD	As specified in clause A.3.1.1.2
PCFICH/PDCCH/PHICH parameters		DL Reference Measurement Channel R.6 TDD	As specified in clause A.3.1.2.2
Gap Pattern Id		1	As specified in TS 36.133 clause 8.1.2.1.
Special subframe configuration		6	As specified in table 4.2-1 in TS 36.211. The same configuration in both cells
Uplink-downlink configuration		0	As specified in TS 36.211 clause 4.2 Table 4.2-2
CP length		Normal	
E-UTRA RF Channel Number		1, 2	Two TDD carrier frequencies are used.
Channel Bandwidth (BW_{channel})	MHz	10	
Active cell		Cell 1	Cell 1 is on RF channel number 1
Neighbour cell		Cell 2	Cell 2 is on RF channel number 2
A3-Offset	dB	-6	

Hysteresis	dB	0	
TimeToTrigger	s	0	
Filter coefficient		0	L3 filtering is not used
DRX		OFF	
Time offset between cells		3 μ s	Synchronous cells
T1	s	5	
T2	s	10	

Table A.8.4.6.1-2: Cell specific test parameters for E-UTRAN TDD-TDD inter-frequency event triggered reporting for TDD UL/DL configuration 0

Parameter	Unit	Cell 1		Cell 2	
		T1	T2	T1	T2
E-UTRA RF Channel Number		1		2	
$BW_{channel}$	MHz	10		10	
Correlation Matrix and Antenna Configuration		1x2 Low		1x2 Low	
OCNG Pattern defined in A.3.2.2 (TDD)		OP.1 TDD		OP.2 TDD	
PBCH_RA	dB	0		0	
PBCH_RB	dB				
PSS_RA	dB				
SSS_RA	dB				
PCFICH_RB	dB				
PHICH_RA	dB				
PHICH_RB	dB				
PDCCH_RA	dB				
PDCCH_RB	dB				
PDSCH_RA	dB				
PDSCH_RB	dB				
OCNG_RA ^{Note 1}	dB				
OCNG_RB ^{Note 1}	dB				
\hat{E}_s / I_{ot}	dB				
N_{oc} ^{Note 3}	dBm/15 kHz	-98			
RSRP ^{Note 4}	dBm/15 kHz	-94	-94	-Infinity	-91
SCH_RP ^{Note 4}	dBm/15 kHz	-94	-94	-infinity	-91
\hat{E}_s / N_{oc}	dB	4	4	-Infinity	7
Propagation Condition		ETU70			
<p>Note 1: OCNG shall be used such that both cells are fully allocated and a constant total transmitted power spectral density is achieved for all OFDM symbols.</p> <p>Note 2: The resources for uplink transmission are assigned to the UE prior to the start of time period T2.</p> <p>Note 3: Interference from other cells and noise sources not specified in the test is assumed to be constant over subcarriers and time and shall be modelled as AWGN of appropriate power for N_{oc} to be fulfilled.</p> <p>Note 4: RSRP and SCH_RP levels have been derived from other parameters for information purposes. They are not settable parameters themselves.</p>					

A.8.4.6.2 Test Requirements

The UE shall send one Event A3 triggered measurement report, with a measurement reporting delay less than 7920 ms from the beginning of time period T2.

The UE shall not send event triggered measurement reports, as long as the reporting criteria are not fulfilled.

The rate of correct events observed during repeated tests shall be at least 90%.

NOTE: The actual overall delays measured in the test may be up to $2 \times TTI_{DCCH}$ higher than the measurement reporting delays above because of TTI insertion uncertainty of the measurement report in DCCH.

A.8.4.7 E-UTRAN TDD-TDD Inter-frequency event triggered reporting under fading propagation conditions in synchronous cells for Increased Carrier Monitoring without Reduced Performance Group

A.8.4.7.1 Test Purpose and Environment

The purpose of this test is to verify that the UE makes correct reporting of an event. This test will partly verify the TDD-TDD inter-frequency cell search requirements in clause 8.1.2.3.2.

The test parameters are given in Table A.8.4.1.1-1 and A.8.4.1.1-2 below. In the measurement control information it is indicated to the UE that event-triggered reporting with Event A3 is used. The test consists of two successive time periods, with time duration of T1, and T2 respectively. During time duration T1, the UE shall not have any timing information of cells 2, 3 or 4.

Table A.8.4.7.1-1: General test parameters for E-UTRAN TDD-TDD inter-frequency event triggered reporting in fading propagation conditions

Parameter	Unit	Value	Comment
UE configured E-UTRA RF Channel Number		1, 2,3,4,5,6,7,8,9	Serving cell and eight TDD carrier frequencies are used in the UE neighbour cell list.
Test equipment configuration		Cell 1 uses UTRA RF channel number 1 Cells 2,3,4 are randomly selected to use different frequencies selected from frequencies 2,3,4,5,6,7,8,9	
Gap Pattern Id		1	As specified in TS 36.133 clause 8.1.2.1.
CP length		Normal	
E-UTRA RF Channel Number		1, 2	Two TDD carrier frequencies are used.
Active cell		Cell 1	Cell 1 is on RF channel number 1
Neighbour cell		Cell 2	Cell 2 is on RF channel number 2
A3-Offset	dB	-6	
Hysteresis	dB	0	
TimeToTrigger	s	0	
Filter coefficient		0	L3 filtering is not used
DRX		OFF	
T1	s	5	
T2	s	80	

Table A.8.4.7.1-2: Cell specific test parameters for E-UTRAN TDD-TDD inter-frequency event triggered reporting under fading propagation conditions in synchronous cells (Cell # 1 and Cell # 2)

Parameter	Unit	Cell 1		Cell 2	
		T1	T2	T1	T2
E-UTRA RF Channel Number		1		Randomly selected from 2,3,4,5,6,7,8 such that cell 2 is in the normal performance group	
BW _{channel}	MHz	5MHz: N _{RB} = 25 10MHz: N _{RB} = 50		5MHz: N _{RB} = 25 10MHz: N _{RB} = 50	
Measurement bandwidth	n_{PRE}	5MHz: 10-15 10MHz: 22-27		5MHz: 10-15 10MHz: 22-27	
PDSCH Reference measurement channel defined in A.3.1.1.		5MHz: R.5 TDD 10MHz: R.0 TDD		-	
PDSCH allocation	n_{PRE}	5MHz: 7-17 10MHz: 13-36		-	
PDCCH/PCFICH/PHICH Reference measurement channel defined in A.3.1.2.		5MHz: R.11 TDD 10MHz: R.6 TDD		5MHz: R.11 TDD 10MHz: R.6 TDD	
OCNG Patterns defined in A.3.2.		5MHz: OP.15 TDD 10MHz: OP.1 TDD		5MHz: OP.16 TDD 10MHz: OP.2 TDD	

PBCH_RA	dB				
PBCH_RB	dB				
PSS_RA	dB				
SSS_RA	dB				
PCFICH_RB	dB				
PHICH_RA	dB				
PHICH_RB	dB	0		0	
PDCCH_RA	dB				
PDCCH_RB	dB				
PDSCH_RA	dB				
PDSCH_RB	dB				
OCNG_RA ^{Note 1}	dB				
OCNG_RB ^{Note 1}	dB				
N_{oc} ^{Note 3}	dBm/15 kHz	-98		-98	
\hat{E}_s/N_{oc}	dB	4	4	-Infinity	7
\hat{E}_s/I_{ot}	dB	4	4	-Infinity	7
RSRP ^{Note 4}	dBm/15 kHz	-94	-94	-Infinity	-91
SCH_RP ^{Note 4}	dBm/15 kHz	-94	-94	-infinity	-91
I_o ^{Note 4}	dBm/ BW _{channel}	-	-	-	-
		$64.76+10\log(N_{RB,c}/50)$	$64.76+10\log(N_{RB,c}/50)$	$70.22+10\log(N_{RB,c}/50)$	$62.43+10\log(N_{RB,c}/50)$
Propagation Condition		ETU70		ETU70	
Correlation Matrix and Antenna Configuration		1x2 Low		1x2 Low	
Timing offset to cell 1	ms	-		3	
<p>Note 1: OCNG shall be used such that both cells are fully allocated and a constant total transmitted power spectral density is achieved for all OFDM symbols.</p> <p>Note 2: The resources for uplink transmission are assigned to the UE priori to the start of time period T2.</p> <p>Note 3: Interference from other cells and noise sources not specified in the test is assumed to be constant over subcarriers and time and shall be modelled as AWGN of appropriate power for N_{oc} to be fulfilled.</p> <p>Note 4: RSRP and SCH_RP levels have been derived from other parameters for information purposes. They are not settable parameters themselves.</p>					

Table A.8.4.7.1-2: Cell specific test parameters for E-UTRAN TDD-TDD inter-frequency event triggered reporting under fading propagation conditions in synchronous cells (Cell # 3 and Cell # 4)

Parameter	Unit	Cell 3		Cell 4	
		T1	T2	T1	T2
E-UTRA RF Channel Number		Randomly selected from 2,3,4,5,6,7,8 such that cell 3 is in the normal performance group		Randomly selected from 2,3,4,5,6,7,8 such that cell 4 is in the normal performance group	
BW _{channel}	MHz	5MHz: N _{RB} = 25 10MHz: N _{RB} = 50		5MHz: N _{RB} = 25 10MHz: N _{RB} = 50	
Correlation Matrix and Antenna Configuration		1x2 Low		1x2 Low	
Measurement bandwidth	n_{PRE}	5MHz: 10-15 10MHz: 22-27		5MHz: 10-15 10MHz: 22-27	
PDSCH Reference measurement channel defined in A.3.1.1.		-		-	
PDSCH allocation	n_{PRE}	-		-	
PDCCH/PCFICH/PHICH Reference measurement channel defined in A.3.1.2.		5MHz: R.11 TDD 10MHz: R.6 TDD		5MHz: R.11 TDD 10MHz: R.6 TDD	
OCNG Patterns defined in A.3.2.		5MHz: OP.16 TDD 10MHz: OP.2 TDD		5MHz: OP.16 TDD 10MHz: OP.2 TDD	

PBCH_RA	dB				
PBCH_RB	dB				
PSS_RA	dB				
SSS_RA	dB				
PCFICH_RB	dB				
PHICH_RA	dB				
PHICH_RB	dB	0		0	
PDCCH_RA	dB				
PDCCH_RB	dB				
PDSCH_RA	dB				
PDSCH_RB	dB				
OCNG_RA ^{Note 1}	dB				
OCNG_RB ^{Note 1}	dB				
N_{oc} ^{Note 3}	dBm/15 kHz	-98		-98	
\hat{E}_s/N_{oc}	dB	-Infinity	7	-Infinity	7
\hat{E}_s/I_{ot}	dB	-Infinity	7	-Infinity	7
RSRP ^{Note 4}	dBm/15 kHz	-Infinity	-91	-Infinity	-91
SCH_RP ^{Note 4}	dBm/15 kHz	-infinity	-91	-infinity	-91
I_o ^{Note 4}	dBm/ BW _{channel}	-	-	-	-
		$70.22+10\log(N_{RB,c}/50)$	$62.43+10\log(N_{RB,c}/50)$	$70.22+10\log(N_{RB,c}/50)$	$62.43+10\log(N_{RB,c}/50)$
Propagation Condition		ETU70		ETU70	
Correlation Matrix and Antenna Configuration		1x2 Low		1x2 Low	
Timing offset to cell 1	ms	3		3	
<p>Note 1: OCNG shall be used such that both cells are fully allocated and a constant total transmitted power spectral density is achieved for all OFDM symbols.</p> <p>Note 2: The resources for uplink transmission are assigned to the UE priori to the start of time period T2.</p> <p>Note 3: Interference from other cells and noise sources not specified in the test is assumed to be constant over subcarriers and time and shall be modelled as AWGN of appropriate power for N_{oc} to be fulfilled.</p> <p>Note 4: RSRP and SCH_RP levels have been derived from other parameters for information purposes. They are not settable parameters themselves.</p>					

A.8.4.7.2 Test Requirements

The UE shall send Event A3 triggered measurement reports for cells 2, 3 and 4, with a measurement reporting delay less than 61.44s from the beginning of time period T2.

The UE shall not send event triggered measurement reports, as long as the reporting criteria are not fulfilled.

The rate of correct events observed during repeated tests shall be at least 90%.

NOTE: The actual overall delays measured in the test may be up to $2 \times TTI_{DCCH}$ higher than the measurement reporting delays above because of TTI insertion uncertainty of the measurement report in DCCH.

A.8.4.8 TDD-TDD Interfrequency correct reporting of measurement events with reduced performance group configured, non DRX

A.8.4.8.1 Test Purpose and Environment

The purpose of this test is to verify that the UE makes correct reporting of an event. This test will partly verify the TDD-TDD inter-frequency cell measurement requirements for increased UE carrier monitoring in clause 8.1.2.3.

The test parameters are given in Tables A.8.4.8.1-1, A.8.4.8.1-2 and A.8.4.8.1-3. In this test, there are 4 cells on different carrier frequencies and gap pattern configuration #0 as defined in table A.8.4.8.1-1 is provided.

In the measurement control information, it is indicated to the UE that event-triggered reporting with Events A3 is used. The test consists of two successive time periods for every repetition, with time duration of T1, and T2 respectively. During time duration T1, the UE shall not have any timing information of neighbour cells. At the start of each

repetition of T1, the test equipment provides signals for cell 1 (serving cell), and cells 2, 3 and 4 which are selected from the 8 cells which are configured in the UE neighbour cell list. Cells 2, 3 and 4 are chosen randomly, such that one frequency belongs to the normal performance group and two frequencies belong to the reduced performance group.

Table A.8.4.8.1-1: General test parameters for TDD-TDD Interfrequency correct reporting of measurement events with reduced performance group configured, non DRX

Parameter	Unit	Value	Comment
UE configured E-UTRA RF Channel Number		1,2,3,4,5,6,7,8,9	Serving cell and 8 TDD carrier frequencies are used in the UE neighbour cell list. Frequencies 5,6,7,8 and 9 are indicated to have reduced performance
Test equipment configuration		Cell 1 uses E-UTRA RF channel number 1 Cell 2,3,4 are randomly selected to use different frequencies selected from frequencies 2,3,4,5,6,7,8,9	Cell 1 uses E-UTRA RF channel number 1 Cells 2 are randomly selected to use different frequencies selected from E-UTRA frequencies 2, 3, 4. Cells 3, 4 are randomly selected to use different frequencies selected from E-UTRA frequencies 5, 6, 7, 8, 9.
Active cell		Cell 1	Cell 1 is on RF channel number 1
Gap Pattern Id		0	As specified in TS 36.133 clause 8.1.2.1.
A3-Offset	dB	-6	
Hysteresis	dB	0	
CP length		Normal	
TimeToTrigger	s	0	
Filter coefficient		0	L3 filtering is not used
DRX		OFF	OFF
Scaling factor configurations		8	As specified in TS 36.133 clause 8.1.2.1.1a
T1	s	5	
T2	s	155	

Table A.8.4.8.1-2: Cell specific test parameters for TDD-TDD Interfrequency correct reporting of measurement events with reduced performance group configured, non DRX (Cell #1 and Cell #2)

Parameter	Unit	Cell 1		Cell 2, Cell 3, Cell 4	
		T1	T2	T1	T2
E-UTRA RF Channel Number		1		Randomly selected from 2,3,4 such that cell 2 is in the normal performance group	
BW _{channel}		5MHz: N _{RB} = 25 10MHz: N _{RB} = 50		5MHz: N _{RB} = 25 10MHz: N _{RB} = 50	
Special subframe configuration ^{Note1}		6			
Uplink-downlink configuration ^{Note1}		1			
PDSCH parameters: DL Reference Measurement Channel As specified in clause A.3.1.1.2		5MHz: R.4 TDD 10MHz:R.0 TDD		-	
PCFICH/PDCCH/PHICH parameters: DL Reference Measurement Channel As specified in clause A.3.1.2.2		5MHz: R.11 TDD 10MHz:R.6 TDD		5MHz: R.11 TDD 10MHz:R.6 TDD	
OCNG Patterns defined in A.3.2.2.1, A.3.2.2.2 ,A.3.2.2.9 and A.3.2.2.10		5MHz: OP.9 TDD 10MHz:OP.1 TDD		5MHz: OP.10.TDD 10MHz:OP.2 TDD	
PBCH_RA	dB				
PBCH_RB	dB				
PSS_RA	dB				
SSS_RA	dB				
PCFICH_RB	dB				

PHICH_RA	dB	0		0	
PHICH_RB	dB				
PDCCH_RA	dB				
PDCCH_RB	dB				
PDSCH_RA	dB				
PDSCH_RB	dB				
OCNG_RA ^{Note 2}	dB				
OCNG_RB ^{Note 2}	dB				
N_{oc} ^{Note 4}	dBm/15 kHz	-98		-98	
\hat{E}_s / N_{oc}	dB	4	4	-Infinity	7
\hat{E}_s / I_{ot} ^{Note 5}	dB	4	4	-Infinity	7
RSRP ^{Note 5}	dBm/15 kHz	-94	-94	-Infinity	-91
SCH_RP ^{Note 5}	dBm/15 kHz	-94	-94	-Infinity	-91
I_o ^{Note 4}	dBm/Ch BW	-64.76 +10log ($N_{RB,c} / 50$)	-64.76 +10log ($N_{RB,c} / 50$)	-70.22 +10log ($N_{RB,c} / 50$)	-62.43 +10log ($N_{RB,c} / 50$)
Propagation Condition		AWGN		AWGN	
Antenna Configuration		1x2		1x2	
Timing offset to Cell 1		-		3 μ s	
<p>Note 1: For special subframe and uplink-downlink configurations see Tables 4.2-1 and 4.2-2 in TS 36.211.</p> <p>Note 2: OCNG shall be used such that both cells are fully allocated and a constant total transmitted power spectral density is achieved for all OFDM symbols.</p> <p>Note 3: The resources for uplink transmission are assigned to the UE priori to the start of time period T2.</p> <p>Note 4: Interference from other cells and noise sources not specified in the test is assumed to be constant over subcarriers and time and shall be modelled as AWGN of appropriate power for N_{oc} to be fulfilled.</p> <p>Note 5: E_s/I_{ot}, RSRP, SCH_RP and I_o have been derived from other parameters for information purposes. They are not settable parameters themselves.</p>					

Table A.8.4.8.1-3: Cell specific test parameters for TDD-TDD Interfrequency correct reporting of measurement events with reduced performance group configured, non DRX (Cell #3, Cell #4)

Parameter	Unit	Cell 3		Cell 4	
		T1	T2	T1	T2
E-UTRA RF Channel Number		Randomly selected from 5,6,7,8,9 such that cell 3 is in the reduced performance group		Randomly selected from 5,6,7,8,9 such that cell 4 is in the reduced performance group. Cell 4 RF channel is different from Cell 3 RF channel.	
BW _{channel}		5MHz: $N_{RB} = 25$ 10MHz: $N_{RB} = 50$		5MHz: $N_{RB} = 25$ 10MHz: $N_{RB} = 50$	
Special subframe configuration ^{Note1}		6			
Uplink-downlink configuration ^{Note1}		1			
PDSCH parameters: DL Reference Measurement Channel As specified in clause A.3.1.1.2		-		-	
PCFICH/PDCCH/PHICH parameters: DL Reference Measurement Channel As specified in clause A.3.1.2.2		5MHz: R.11 TDD 10MHz:R.6 TDD		5MHz: R.11 TDD 10MHz:R.6 TDD	
OCNG Patterns defined in A.3.2.2.2 and A.3.2.2.10		5MHz: OP.10.TDD 10MHz:OP.2 TDD		5MHz: OP.10.TDD 10MHz:OP.2 TDD	
PBCH_RA	dB				
PBCH_RB	dB				
PSS_RA	dB				
SSS_RA	dB				

PCFICH_RB	dB	0		0	
PHICH_RA	dB				
PHICH_RB	dB				
PDCCH_RA	dB				
PDCCH_RB	dB				
PDSCH_RA	dB				
PDSCH_RB	dB				
OCNG_RA ^{Note 2}	dB				
OCNG_RB ^{Note 2}	dB				
N_{oc} ^{Note 4}	dBm/15 kHz	-98		-98	
\hat{E}_s / N_{oc}	dB	-Infinity	7	-Infinity	7
\hat{E}_s / I_{ot} ^{Note 5}	dB	-Infinity	7	-Infinity	7
RSRP ^{Note 5}	dBm/15 kHz	-Infinity	-91	-Infinity	-91
SCH_RP ^{Note 5}	dBm/15 kHz	-Infinity	-91	-Infinity	-91
I_o ^{Note 5}	dBm/Ch BW	-70.22 +10log ($N_{RB,c} / 50$)	-62.43 +10log ($N_{RB,c} / 50$)	-70.22 +10log ($N_{RB,c} / 50$)	-62.43 +10log ($N_{RB,c} / 50$)
Propagation Condition		AWGN		AWGN	
Antenna Configuration		1x2		1x2	
Timing offset to Cell 1		3 μ s		3 μ s	
Note 1:	For special subframe and uplink-downlink configurations see Tables 4.2-1 and 4.2-2 in TS 36.211.				
Note 2:	OCNG shall be used such that both cells are fully allocated and a constant total transmitted power spectral density is achieved for all OFDM symbols.				
Note 3:	The resources for uplink transmission are assigned to the UE priori to the start of time period T2.				
Note 4:	Interference from other cells and noise sources not specified in the test is assumed to be constant over subcarriers and time and shall be modelled as AWGN of appropriate power for N_{oc} to be fulfilled.				
Note 5:	E_s/I_{ot} , RSRP, SCH_RP and I_o have been derived from other parameters for information purposes. They are not settable parameters themselves.				

A.8.4.8.2 Test Requirements

The UE shall send Event A3 triggered measurement reports for cells 2, 3 and 4, with a measurement reporting delay less than 13.17s (cell 2) and 153.6s (cell 3 and 4) from the beginning of time period T2.

The UE shall not send event triggered measurement reports, as long as the reporting criteria are not fulfilled.

The rate of correct events observed during repeated tests shall be at least 90%.

NOTE: The actual overall delays measured in the test may be up to $2xTTI_{DCC}$ higher than the measurement reporting delays above because of TTI insertion uncertainty of the measurement report.

A.8.4.9 TDD-TDD Inter-frequency correct reporting of measurement events with reduced performance group configured, DRX

A.8.4.9.1 Test Purpose and Environment

The purpose of this test is to verify that the UE makes correct reporting of an event in DRX. This test will partly verify the TDD-TDD inter-frequency cell search requirements when DRX is used in clause 8.1.2.3.

The test parameters are given in Tables A.8.4.9.1-1, A.8.4.9.1-2, A.8.4.9.1-3 and A.8.4.9.1-4. In this test, there are four cells on different carrier frequencies and gap pattern configuration # 0 as defined in Table 8.1.2.1-1 is provided.

The UE needs to be provided at least once every 500ms with new Timing Advance Command MAC control element to restart the Time alignment timer to keep UE uplink time alignment. Furthermore UE is allocated with PUSCH resource at every DRX cycle..

In the measurement control information, it is indicated to the UE that event-triggered reporting with Event A3 is used. The test consists of two successive time periods for every repetition, with time duration of T1 and T2 respectively. During time duration T1, the UE shall not have any timing information of cell 2, 3 or 4. At the start of each repetition of T1, the test equipment provides signals for cell 1 (serving cell), and cells 2, 3 and 4 which are selected from the 8 cells

on different frequencies which are configured in the UE neighbour cell list. Cells 2, 3 and 4 are chosen randomly, such that one frequency belongs to the normal performance group and two frequencies belong to the reduced performance group.

Table A.8.4.9.1-1: General test parameters for E-UTRAN TDD-TDD inter-frequency event triggered reporting for IncMon

Parameter	Unit	Value	Comment
UE configured E-UTRA RF Channel Number		1, 2,3,4,5,6,7,8,9	Serving cell and eight TDD carrier frequencies are used in the UE neighbour cell list. Frequencies 5,6,7,8 and 9 are indicated to have reduced performance
Test equipment configuration		Cell 1,2,3,4	Cell 1 uses E-UTRA RF channel number 1 Cells 2 are randomly selected to use different frequencies selected from E-UTRA frequencies 2, 3, 4. Cells 3, 4 are randomly selected to use different frequencies selected from E-UTRA frequencies 5, 6, 7, 8, 9.
Active cell		Cell 1	Cell 1 is on RF channel number 1
Neighbour cells		Cell 2,3,4	
Gap Pattern Id		0	As specified in TS 36.133 clause 8.1.2.1.
Special subframe configuration		6	As specified in table 4.2-1 in TS 36.211. The same configuration in both cells
Uplink-downlink configuration		1	As specified in TS 36.211 clause 4.2 Table 4.2-2
A3-Offset	dB	-5	
Hysteresis	dB	0	
CP length		Normal	
TimeToTrigger	s	0	
Filter coefficient		0	L3 filtering is not used
DRX		ON	DRX related parameters are defined in Table A.8.3.9.1-3
Scaling factor for reduced performance group		8	
T1	s	5	
T2	s	155	

Table A.8.4.9.1-2: Cell specific test parameters for E-UTRAN TDD-TDD inter-frequency event triggered reporting for IncMon

Parameter	Unit	Cell 1		Cell 2		Cell 3		Cell 4									
		T1	T2	T1	T2	T1	T2	T1	T2								
E-UTRA RF Channel Number		1		Randomly selected from 2,3,4 such that cell 2 is in the normal performance group		Randomly selected from 5, 6, 7, 8, 9 such that cell 3 is in the reduced performance group		Randomly selected from 5, 6, 7, 8, 9 such that cell 4 is in the reduced performance group									
Channel Bandwidth (BW _{channel})	MHz	5MHz: NRB = 25 10MHz: NRB = 50		5MHz: NRB,= 25 10MHz: NRB,= 50		5MHz: NRB = 25 10MHz: NRB = 50		5MHz: NRB,= 25 10MHz: NRB,= 50									
PDSCH parameters as specified in clause A.3.1.1.2		5MHz: R.4 TDD 10MHz: R.0 TDD		-		-		-									
PCFICH/PDCCH/PHICH parameters as specified in clause A.3.1.2.2		5MHz: R.11 TDD 10MHz: R.6 TDD		5MHz: R.11 TDD 10MHz: R.6 TDD		5MHz: R.11 TDD 10MHz: R.6 TDD		5MHz: R.11 TDD 10MHz: R.6 TDD									
OCNG Patterns defined in A.3.2.2		5MHz: OP.9 TDD 10MHz: OP.1 TDD		5MHz: OP.10 TDD 10MHz: OP.2 TDD		5MHz: OP.10 TDD 10MHz: OP.2 TDD		5MHz: OP.10 TDD 10MHz: OP.2 TDD									
PBCH_RA	dB	0		0		0		0									
PBCH_RB	dB																
PSS_RA	dB																
SSS_RA	dB																
PCFICH_RB	dB																
PHICH_RA	dB																
PHICH_RB	dB																
PDCCH_RA	dB																
PDCCH_RB	dB																
PDSCH_RA	dB																
PDSCH_RB	dB																
OCNG_RA ^{Note 1}	dB																
OCNG_RB ^{Note 1}	dB																
N_{oc} ^{Note 3}	dBm/15 kHz									-98		-98		-98		-98	
\hat{E}_s / N_{oc}	dB									4	4	-Infinity	4	-Infinity	4	-Infinity	4
\hat{E}_s / I_{ot} ^{Note 4}	dB	4	4	-Infinity	4	-Infinity	4	-Infinity	4								
RSRP ^{Note 4}	dBm/15 kHz	-94	-94	-Infinity	-94	-Infinity	-94	-Infinity	-94								
SCH_RP ^{Note 4}	dBm/15 kHz	-94	-94	-Infinity	-94	-Infinity	-94	-Infinity	-94								
I_o ^{Note 4}	dBm/Ch BW	$-64.76+10\log(N_{RB,c}/50)$	$-64.76+10\log(N_{RB,c}/50)$	$-70.22+10\log(N_{RB,c}/50)$	$-64.76+10\log(N_{RB,c}/50)$	$-70.22+10\log(N_{RB,c}/50)$	- $64.76+10\log(N_{RB,c}/50)$	$-70.22+10\log(N_{RB,c}/50)$	$-64.76+10\log(N_{RB,c}/50)$								
Propagation Condition		AWGN		AWGN		AWGN		AWGN									
Antenna Configuration		1x2		1x2		1x2		1x2									
Time offset to cell1	μs	-		3		3		3									

- Note 1: OCNG shall be used such that both cells are fully allocated and a constant total transmitted power spectral density is achieved for all OFDM symbols.
- Note 2: The resources for uplink transmission are assigned to the UE prior to the start of time period T2.
- Note 3: Interference from other cells and noise sources not specified in the test is assumed to be constant over subcarriers and time and shall be modelled as AWGN of appropriate power for N_{oc} to be fulfilled.
- Note 4: E_s/I_{ot} , RSRP, SCH_RP and I_o levels have been derived from other parameters for information purposes. They are not settable parameters themselves.

Table A.8.4.9.1-3: *drx-Configuration* to be used in E-UTRAN TDD-TDD inter-frequency event triggered reporting when DRX is used for IncMon

Field	Value	Comment
onDurationTimer	psf1	
drx-InactivityTimer	psf1	
drx-RetransmissionTimer	psf1	
longDRX-CycleStartOffset	sf160	
shortDRX	disable	
Note:	For further information see clause 6.3.2 in TS 36.331.	

Table A.8.4.9.1-4: *TimeAlignmentTimer* and *sr-ConfigIndex* Configuration to be used in E-UTRAN TDD-TDD inter-frequency event triggered reporting when DRX is used for IncMon

Field	Value	Comment
TimeAlignmentTimer	sf500	For further information see clause 6.3.2 in TS 36.331.
sr-ConfigIndex	0	For further information see clause 6.3.2 in TS 36.331 and section 10.1 in TS 36.213..

A.8.4.9.2 Test Requirements

The UE shall send Event A3 triggered measurement reports for cells 2, 3 and 4, with a measurement reporting delay less than 13.2s (cell 2) and 153.6s (cell 3 and 4) from the beginning of time period T2.

The UE shall not send event triggered measurement reports, as long as the reporting criteria are not fulfilled.

The rate of correct events observed during repeated tests shall be at least 90%.

NOTE: The actual overall delays measured in the test may be up to $2 \times TTI_{DCC}$ higher than the measurement reporting delays above because of TTI insertion uncertainty of the measurement report.

Where:

When DRX cycle is 160ms, the delay requirement of cell identification and measurement period are specified in section 8.1.2.3.1.2 and Non DRX Requirements in clause 8.1.2.3.1.1 are applicable.

The requirement of inter frequency cell identification delay are specified as

$$T_{\text{Identify_Inter}} = T_{\text{Basic_Identify_Inter}} \cdot \frac{480}{T_{\text{Inter1}}} \cdot N_{\text{freq},n} \cdot K_n \quad \text{ms (normal performance) and}$$

$$T_{\text{Identify_Inter}} = T_{\text{Basic_Identify_Inter}} \cdot \frac{480}{T_{\text{Inter1}}} \cdot N_{\text{freq},r} \cdot K_r \quad \text{ms (reduced performance)}$$

$T_{\text{Basic_Identify_inter}}$ 480ms, See section 8.1.2.3.1.1

T_{Inter1} 60ms, See section 8.1.2.1

$N_{\text{freq},n}$ and $N_{\text{freq},r}$ 3 and 5 set in this test case.

K_n and K_r 8/7 and 8, See section 8.1.2.1.1a.

This gives 13165.7ms for cells 2 on normal carrier, and 153600ms for cell 3 and cell 4 on reduced carriers for Event A3 triggered measurement reporting delay. The test requirements allow 13.2s and 153.6s.

A.8.4.10 E-UTRAN TDD-TDD Inter-frequency event triggered reporting with MGL=3ms under fading propagation conditions in synchronous cells

A.8.4.10.1 Test Purpose and Environment

The purpose of this test is to verify that the UE makes correct reporting of an event with MGL=3ms when Gap pattern configuration #3 is configured. Time offset between frame boundaries of two cells has to be chosen such that the #0 or #5 subframes of the target cell is 500uS early relative to the 2nd subframe of the measurement gap. This test will partly verify the TDD-TDD inter-frequency cell search requirements in clause 8.1.2.3.2.

The test parameters are given in Table A.8.4.10.1-1 and A.8.4.10.1-2 below. In the measurement control information it is indicated to the UE that event-triggered reporting with Event A3 is used and gap pattern configuration # 3 as defined in Table 8.1.2.1-1 is provided. The test consists of two successive time periods, with time duration of T1, and T2 respectively. During time duration T1, the UE shall not have any timing information of cell 2.

Table A.8.4.10.1-1: General test parameters for E-UTRAN TDD-TDD inter-frequency event triggered reporting in fading propagation conditions

Parameter	Unit	Value	Comment
PDSCH parameters		DL Reference Measurement Channel R.0 TDD	As specified in clause A.3.1.1.2
PCFICH/PDCCH/PHICH parameters		DL Reference Measurement Channel R.6 TDD	As specified in clause A.3.1.2.2
Gap Pattern Id		3	As specified in TS 36.133 clause 8.1.2.1.
Special subframe configuration		6	As specified in table 4.2-1 in TS 36.211. The same configuration in both cells
Uplink-downlink configuration		1	As specified in TS 36.211 clause 4.2 Table 4.2-2
CP length		Normal	
E-UTRA RF Channel Number		1, 2	Two TDD carrier frequencies are used.
Channel Bandwidth ($BW_{channel}$)	MHz	10	
Active cell		Cell 1	Cell 1 is on RF channel number 1
Neighbour cell		Cell 2	Cell 2 is on RF channel number 2
A3-Offset	dB	-6	
Hysteresis	dB	0	
TimeToTrigger	s	0	
Filter coefficient		0	L3 filtering is not used
DRX		OFF	
T1	s	5	
T2	s	10	

Table A.8.4.10.1-2: Cell specific test parameters for E-UTRAN TDD-TDD inter-frequency event triggered reporting under fading propagation conditions in synchronous cells

Parameter	Unit	Cell 1		Cell 2	
		T1	T2	T1	T2
E-UTRA RF Channel Number		1		2	
$BW_{channel}$	MHz	10		10	
Correlation Matrix and Antenna Configuration		1x2 Low		1x2 Low	
OCNG Pattern defined in A.3.2.2.1 (OP.1 TDD) and in A.3.2.2.2 (OP.2)		OP.1 TDD		OP.2 TDD	
PBCH_RA	dB	0		0	
PBCH_RB	dB				
PSS_RA	dB				
SSS_RA	dB				
PCFICH_RB	dB				
PHICH_RA	dB				
PHICH_RB	dB				
PDCCH_RA	dB				

PDCCH_RB	dB				
PDSCH_RA	dB				
PDSCH_RB	dB				
OCNG_RA ^{Note 1}	dB				
OCNG_RB ^{Note 1}	dB				
\hat{E}_s/I_{ot}	dB	4	4	-Infinity	7
N_{oc} ^{Note 3}	dBm/15 kHz	-98			
RSRP ^{Note 4}	dBm/15 kHz	-94	-94	-Infinity	-91
SCH_RP ^{Note 4}	dBm/15 kHz	-94	-94	-infinity	-91
\hat{E}_s/N_{oc}	dB	4	4	-Infinity	7
Propagation Condition		ETU70			
<p>Note 1: OCNG shall be used such that both cells are fully allocated and a constant total transmitted power spectral density is achieved for all OFDM symbols.</p> <p>Note 2: The resources for uplink transmission are assigned to the UE priori to the start of time period T2.</p> <p>Note 3: Interference from other cells and noise sources not specified in the test is assumed to be constant over subcarriers and time and shall be modelled as AWGN of appropriate power for N_{oc} to be fulfilled.</p> <p>Note 4: RSRP and SCH_RP levels have been derived from other parameters for information purposes. They are not settable parameters themselves.</p>					

A.8.4.10.2 Test Requirements

The UE shall send one Event A3 triggered measurement report, with a measurement reporting delay less than 7680 ms from the beginning of time period T2.

The UE shall not send event triggered measurement reports, as long as the reporting criteria are not fulfilled.

The rate of correct events observed during repeated tests shall be at least 90%.

NOTE: The actual overall delays measured in the test may be up to $2 \times TTI_{DCCH}$ higher than the measurement reporting delays above because of TTI insertion uncertainty of the measurement report in DCCH.

A.8.4.11 E-UTRAN TDD-TDD Inter-frequency event triggered reporting under fading propagation conditions in synchronous cells with burst gap

A.8.4.11.1 Test Purpose and Environment

The purpose of this test is to verify that the UE makes correct reporting of an event. This test will partly verify the TDD-TDD inter-frequency cell search requirements in clause 8.1.2.3.2, when configured with the burst gap.

The test parameters are given in Table A.8.4.11.1-1 and A.8.4.11.1-2 below, including non-uniform gap pattern configuration #1 in Table 8.1.2.1-2. In the measurement control information, it is indicated to the UE that event-triggered reporting with Event A4 is used. The test consists of two successive time periods, with time duration of T1, and T2 respectively. During time duration T1, the UE shall not have any timing information of cell 2.

Table A.8.4.11.1-1: General test parameters for E-UTRAN TDD-TDD inter-frequency event triggered reporting with burst gap in fading propagation conditions

Parameter	Unit	Value	Comment
PDSCH parameters		DL Reference Measurement Channel R.0 TDD	As specified in clause A.3.1.1.2
PCFICH/PDCCH/PHICH parameters		DL Reference Measurement Channel R.6 TDD	As specified in clause A.3.1.2.2
Gap Pattern Id		nonUniform1	As specified in TS 36.133 clause 8.1.2.1.
Special subframe configuration		6	As specified in table 4.2-1 in TS 36.211. The same configuration in both cells
Uplink-downlink configuration		1	As specified in TS 36.211 clause 4.2 Table 4.2-2
CP length		Normal	
E-UTRA RF Channel Number		1, 2	Two TDD carrier frequencies are used.

Channel Bandwidth (BW_{channel})	MHz	10	
Active cell		Cell 1	Cell 1 is on RF channel number 1
Neighbour cell		Cell 2	Cell 2 is on RF channel number 2
A4 Hysteresis	dB	0	Hysteresis for evaluation of event A4.
A4 Threshold RSRP	dBm	-99	Actual RSRP threshold for event A4. Needs to take absolute accuracy tolerance in section 9.1.11.1 into account plus margin.
A4 Time To Trigger	s	0	
Filter coefficient		0	L3 filtering is not used
DRX		OFF	
Time offset between cells		3 μ s	Synchronous cells
T1	s	5	
T2	s	15	

Table A.8.4.11.1-2: Cell specific test parameters for E-UTRAN TDD-TDD inter-frequency event triggered reporting with burst gap under fading propagation conditions in synchronous cells

Parameter	Unit	Cell 1		Cell 2	
		T1	T2	T1	T2
E-UTRA RF Channel Number		1		2	
BW_{channel}	MHz	10		10	
Correlation Matrix and Antenna Configuration		1x2 Low		1x2 Low	
OCNG Pattern defined in A.3.2.2.1 (OP.1 TDD) and in A.3.2.2.2 (OP.2)		OP.1 TDD		OP.2 TDD	
PBCH_RA	dB	0		0	
PBCH_RB	dB				
PSS_RA	dB				
SSS_RA	dB				
PCFICH_RB	dB				
PHICH_RA	dB				
PHICH_RB	dB				
PDCCH_RA	dB				
PDCCH_RB	dB				
PDSCH_RA	dB				
PDSCH_RB	dB				
OCNG_RA ^{Note 1}	dB				
OCNG_RB ^{Note 1}	dB				
$\hat{E}_s / I_{\text{ot}}$	dB				
N_{oc} ^{Note 3}	dBm/15 kHz	-98			
RSRP ^{Note 4}	dBm/15 kHz	-82	-82	-Infinity	-91
SCH_RP ^{Note 4}	dBm/15 kHz	-82	-82	-infinity	-91
$\hat{E}_s / N_{\text{oc}}$	dB	16	16	-Infinity	7
Propagation Condition		AWGN			
Note 1:	OCNG shall be used such that both cells are fully allocated and a constant total transmitted power spectral density is achieved for all OFDM symbols.				
Note 2:	The resources for uplink transmission are assigned to the UE prior to the start of time period T2.				
Note 3:	Interference from other cells and noise sources not specified in the test is assumed to be constant over subcarriers and time and shall be modelled as AWGN of appropriate power for N_{oc} to be fulfilled.				
Note 4:	RSRP and SCH_RP levels have been derived from other parameters for information purposes. They are not settable parameters themselves.				

A.8.4.11.2 Test Requirement

The UE shall send one Event A4 triggered measurement report, with a measurement reporting delay less than 10240 ms from the beginning of time period T2. During the test, downlink traffic is continuously scheduled. From the start of T1

until the measurement report is received during T2, at least [100]% of all expected ACK/NACKs shall be transmitted by the UE.

The UE shall not send event triggered measurement reports, as long as the reporting criteria are not fulfilled.

The rate of correct events observed during repeated tests shall be at least 90%.

NOTE: The actual overall delays measured in the test may be up to $2 \times TTI_{DCCCH}$ higher than the measurement reporting delays above because of TTI insertion uncertainty of the measurement report in DCCCH.

A.8.4.12 E-UTRAN TDD-TDD Inter-frequency event triggered reporting under fading propagation conditions in asynchronous cells for UE category M1 with discontinuous MPDCCH monitoring in CEModeA

A.8.4.12.1 Test Purpose and Environment

The purpose of this test is to verify that the Cat-M1 UE makes correct reporting of an event with discontinuous MPDCCH monitoring. This test will partly verify the TDD-TDD inter-frequency cell search requirements in clause 8.13.2.6.3.

The test parameters are given in Table A.8.4.12.1-1 and A.8.4.12.1-2 below. In the measurement control information it is indicated to the UE that event-triggered reporting with Event A3 is used. The test consists of two successive time periods, with time duration of T1, and T2 respectively. During time duration T1, the UE shall not have any timing information of cell 2. At the beginning of T2 the transmission power of cell 2 is increased to the same level as for cell 1, and due to usage of an offset this shall result in reporting of Event A3.

Table A.8.4.12.1-1: General test parameters

Parameter	Unit	Value	Comment
E-UTRA RF Channel Number		1, 2	
Active cell		Cell 1	
Neighbour cell		Cell 2	Cell to be identified.
CP length		Normal	
DRX		OFF	
A3	Offset	dB	-6
	Hysteresis	dB	0
	Time To Trigger	S	0
Filter coefficient		0	L3 filtering is not used
Gap pattern ID		0	
R_{max}		8	As defined in <i>mPDCCH-NumRepetition</i> in [3]
G		10	As defined in <i>mPDCCH-startSF-UESS</i> in [3]
X		scheme10	As defined in <i>measGapSharingScheme</i> in [3]
T1	S	5	
T2	S	5	
Special subframe configuration		6	As specified in table 4.2-1 in TS 36.211. The same configuration in both cells
Uplink-downlink configuration		1	As specified in table 4.2-2 in TS 36.211. The same configuration in both cells

Table A.8.4.12.1-2: Cell specific test parameters

Parameter	Unit	Cell 1		Cell 2	
		T1	T2	T1	T2
E-UTRA RF Channel Number		1		2	
$BW_{channel}$	MHz	10		10	
PDSCH parameters: DL Reference Measurement Channel		R.17 TDD		-	

MPDCCH parameters: DL Reference Measurement Channel		R.15 TDD		R.15 TDD	
OCNG Patterns		OP.11 TDD		OP.2 TDD	
PBCH_RA	dB	-3		-3	
PBCH_RB	dB				
PSS_RA	dB				
SSS_RA	dB				
PCFICH_RB	dB				
PHICH_RA	dB				
PHICH_RB	dB				
MPDCCH_RA	dB				
MPDCCH_RB	dB				
PDSCH_RA	dB				
PDSCH_RB	dB				
OCNG_RA ^{Note 1}	dB				
OCNG_RB ^{Note 1}	dB				
N_{oc} ^{Note 2}	dBm/15 KHz				
\hat{E}_s / N_{oc}	dB	4	4	-Infinity	4
\hat{E}_s / I_{ot} ^{Note 3}	dB	4	4	-Infinity	4
RSRP ^{Note 3}	dBm/15 KHz	-94	-94	-Infinity	-94
SCH_RP ^{Note 3}	dBm/15 KHz	-94	-94	-Infinity	-94
I_o ^{Note 3}	dBm/9MHz	-64.76	-64.76	-Infinity	-64.76
Propagation Condition		ETU30		ETU30	
Correlation Matrix and Antenna Configuration		2x1 Low		2x1 Low	
Timing offset to Cell 1	μ s	-		3	
<p>Note 1: OCNG shall be used such that all cells are fully allocated and a constant total transmitted power spectral density is achieved for all OFDM symbols.</p> <p>Note 2: Interference from other cells and noise sources not specified in the test is assumed to be constant over subcarriers and time and shall be modelled as AWGN of appropriate power for N_{oc} to be fulfilled.</p> <p>Note 3: E_s/I_{ot}, RSRP, SCH_RP and I_o have been derived from other parameters for information purposes. They are not settable parameters themselves.</p> <p>Note 4: The resources for uplink transmission are assigned to the UE prior to the start of time period T2.</p>					

A.8.4.12.2 Test Requirement

The UE shall send one Event A3 triggered measurement report, with a measurement reporting delay less than 3.2 s from the beginning of time period T2. During the test, downlink traffic is continuously scheduled.

The UE shall not send event triggered measurement reports, as long as the reporting criteria are not fulfilled.

The rate of correct events observed during repeated tests shall be at least 90%.

NOTE: The actual overall delays measured in the test may be up to $2 \times TTI_{DCCH}$ higher than the measurement reporting delays above because of TTI insertion uncertainty of the measurement report in DCCH.

A.8.4.13 E-UTRAN TDD-TDD inter-frequency event triggered reporting under fading propagation conditions in asynchronous cells for UE category M1 with discontinuous MPDCCH monitoring in CEModeB

A.8.4.13.1 Test Purpose and Environment

The purpose of this test is to verify that the Cat-M1 UE makes correct reporting of an event with discontinuous MPDCCH monitoring. This test will partly verify the TDD-TDD inter-frequency cell search requirements in clause 8.13.3.5.3.

The test parameters are given in Table A.8.4.13.1-1 and A.8.4.13.1-2 below. In the measurement control information it is indicated to the UE that event-triggered reporting with Event A3 is used. The test consists of two successive time periods, with time duration of T1, and T2 respectively. During time duration T1, the UE shall not have any timing

information of cell 2. At the beginning of T2 the transmission power of cell 2 is increased to the same level as for cell 1, and due to usage of an offset this shall result in reporting of Event A3.

Table A.8.4.13.1-1: General test parameters

Parameter	Unit	Value	Comment
E-UTRA RF Channel Number		1, 2	
Active cell		Cell 1	
Neighbour cell		Cell 2	Cell to be identified.
CP length		Normal	
DRX		OFF	
A3	Offset	dB	-8
	Hysteresis	dB	0
	Time To Trigger	S	0
Filter coefficient		0	L3 filtering is not used
Gap pattern ID		0	
<i>R</i> _{max}		128	As defined in <i>mPDCCH-NumRepetition</i> in [3]
<i>G</i>		8	As defined in <i>mPDCCH-startSF-UESS</i> in [3]
<i>X</i>		scheme01	As defined in <i>measGapSharingScheme</i> in [3]
T1	S	5	
T2	S	≤825	
Special subframe configuration		6	As specified in table 4.2-1 in TS 36.211. The same configuration in both cells
Uplink-downlink configuration		1	As specified in table 4.2-2 in TS 36.211. The same configuration in both cells

Table A.8.4.13.1-2: Cell specific test parameters

Parameter	Unit	Cell 1		Cell 2	
		T1	T2	T1	T2
E-UTRA RF Channel Number		1		2	
<i>BW</i> _{channel}	MHz	10		10	
PDSCH parameters: DL Reference Measurement Channel		R.19 TDD		-	
MPDCCH parameters: DL Reference Measurement Channel		R.17 TDD		R.17 TDD	
OCNG Patterns		OP.11 TDD		OP.2 TDD	
PBCH_RA	dB	-3		-3	
PBCH_RB	dB				
PSS_RA	dB				
SSS_RA	dB				
PCFICH_RB	dB				
PHICH_RA	dB				
PHICH_RB	dB				
MPDCCH_RA	dB				
MPDCCH_RB	dB				
PDSCH_RA	dB				
PDSCH_RB	dB				
OCNG_RA ^{Note 1}	dB				
OCNG_RB ^{Note 1}	dB				
<i>N</i> _{oc} ^{Note 2}	dBm/15 KHz				
\hat{E}_s / N_{oc}	dB	-12	-12	-Infinity	-12
\hat{E}_s / I_{ot} ^{Note 3}	dB	-12	-12	-Infinity	-12
RSRP ^{Note 3}	dBm/15 KHz	-110	-110	-Infinity	-110
SCH_RP ^{Note 3}	dBm/15 KHz	-110	-110	-Infinity	-110
<i>I</i> _o ^{Note 3}	dBm/9MHz	-69.95	-69.95	-Infinity	-69.95

Propagation Condition		ETU30	ETU30
Correlation Matrix and Antenna Configuration		2x1 Low	2x1 Low
Timing offset to Cell 1	μs	-	3
Note 1:	OCNG shall be used such that all cells are fully allocated and a constant total transmitted power spectral density is achieved for all OFDM symbols.		
Note 2:	Interference from other cells and noise sources not specified in the test is assumed to be constant over subcarriers and time and shall be modelled as AWGN of appropriate power for N_{oc} to be fulfilled.		
Note 3:	E_s/lot , RSRP, SCH_RP and I_o have been derived from other parameters for information purposes. They are not settable parameters themselves.		
Note 4:	The resources for uplink transmission are assigned to the UE prior to the start of time period T2.		

A.8.4.13.2 Test Requirement

The UE shall send one Event A3 triggered measurement report, with a measurement reporting delay less than 819.2 s from the beginning of time period T2, which is derived from section 8.13.3.5.

The UE shall not send event triggered measurement reports, as long as the reporting criteria are not fulfilled.

The rate of correct events observed during repeated tests shall be at least 90%.

NOTE: The actual overall delays measured in the test may be up to $\text{pusch-maxNumRepetitionCEmodeB} \times TTI_{DCCH}$ higher than the measurement reporting delays above because of TTI insertion uncertainty of the measurement report in DCCH, where $\text{pusch-maxNumRepetitionCEmodeB}$ [2] is the maximum number of PUSCH repetitions configured

A.8.4.14 E-UTRAN TDD-TDD inter-frequency event triggered reporting under fading propagation conditions in asynchronous cells for UE category M1 in CEModeA in DRX

A.8.4.14.1 Test Purpose and Environment

The purpose of this test is to verify that the Cat-M1 UE makes correct reporting of an event. This test will partly verify the TDD-TDD inter-frequency cell search requirements in clause 8.13.2.6.3.

The test parameters are given in Table A.8.4.14.1-1, A.8.4.14.1-2, A.8.4.14.1-3 and A.8.4.14.1-4 below. In the measurement control information it is indicated to the UE that event-triggered reporting with Event A3 is used. The test consists of two successive time periods, with time duration of T1, and T2 respectively. During time duration T1, the UE shall not have any timing information of cell 2. At the beginning of T2 the transmission power of cell 2 is increased to the same level as for cell 1, and due to usage of an offset this shall result in reporting of Event A3.

In Test 1 UE needs to be provided at least once every 500ms with new Timing Advance Command MAC control element to restart the Time alignment timer to keep UE uplink time alignment. Furthermore UE is allocated with PUSCH resource at every DRX cycle.

In Test 2 the uplink time alignment is not maintained and UE needs to use RACH to obtain UL allocation for measurement reporting.

Table A.8.4.14.1-1: General test parameters

Parameter	Unit	Value		Comment
		Test1	Test2	
E-UTRA RF Channel Number		1, 2		
Active cell		Cell 1		
Neighbour cell		Cell 2		Cell to be identified.
CP length		Normal		
DRX		ON		
A3	Offset	dB	-6	
	Hysteresis	dB	0	
	Time To Trigger	S	0	
Filter coefficient		0		L3 filtering is not used

Gap pattern ID		0	
R_{max}		8	As defined in <i>mPDCCH-NumRepetition</i> in [3]
G		1	As defined in <i>mPDCCH-startSF-UeSS</i> in [3]
X		scheme10	As defined in <i>measGapSharingScheme</i> in [3]
T1	S	5	
T2	S	10	60
Special subframe configuration		6	As specified in table 4.2-1 in TS 36.211. The same configuration in both cells
Uplink-downlink configuration		1	As specified in table 4.2-2 in TS 36.211. The same configuration in both cells

Table A.8.4.14.1-2: Cell specific test parameters

Parameter	Unit	Cell 1		Cell 2	
		T1	T2	T1	T2
E-UTRA RF Channel Number		1		2	
$BW_{channel}$	MHz	10		10	
PDSCH parameters: DL Reference Measurement Channel		R.17 TDD		-	
MPDCCH parameters: DL Reference Measurement Channel		R.15 TDD		R.15 TDD	
OCNG Patterns		OP.11 TDD		OP.2 TDD	
PBCH_RA	dB	-3		-3	
PBCH_RB	dB				
PSS_RA	dB				
SSS_RA	dB				
PCFICH_RB	dB				
PHICH_RA	dB				
PHICH_RB	dB				
MPDCCH_RA	dB				
MPDCCH_RB	dB				
PDSCH_RA	dB				
PDSCH_RB	dB				
OCNG_RA ^{Note 1}	dB				
OCNG_RB ^{Note 1}	dB				
N_{oc} ^{Note 2}	dBm/15 KHz				
\hat{E}_s / N_{oc}	dB	4	4	-Infinity	4
\hat{E}_s / I_{ot} ^{Note 3}	dB	4	4	-Infinity	4
RSRP ^{Note 3}	dBm/15 KHz	-94	-94	-Infinity	-94
SCH_RP ^{Note 3}	dBm/15 KHz	-94	-94	-Infinity	-94
I_o ^{Note 3}	dBm/9MHz	-64.76	-64.76	-Infinity	-64.76
Propagation Condition		ETU30		ETU30	
Correlation Matrix and Antenna Configuration		2x1 Low		2x1 Low	
Timing offset to Cell 1	μ s	-		3	
<p>Note 1: OCNG shall be used such that all cells are fully allocated and a constant total transmitted power spectral density is achieved for all OFDM symbols.</p> <p>Note 2: Interference from other cells and noise sources not specified in the test is assumed to be constant over subcarriers and time and shall be modelled as AWGN of appropriate power for N_{oc} to be fulfilled.</p> <p>Note 3: E_s/I_{ot}, RSRP, SCH_RP and I_o have been derived from other parameters for information purposes. They are not settable parameters themselves.</p> <p>Note 4: The resources for uplink transmission are assigned to the UE prior to the start of time period T2.</p>					

Table A.8.4.14.1-3: DRX-Configuration

Field	Test1	Test2	Comment
	Value	Value	
onDurationTimer	psf1	psf1	As specified in clause 6.3.2 in TS 36.331
drx-InactivityTimer	psf1	psf1	
drx-RetransmissionTimer	psf1	psf1	
longDRX-CycleStartOffset	sf128	sf1280	
shortDRX	disable	disable	

Table A.8.4.14.1-4: TimeAlignmentTimer-Configuration

Field	Test1	Test2	Comment
	Value	Value	
TimeAlignmentTimer	sf500	sf500	As specified in clause 6.3.2 in TS 36.331
sr-ConfigIndex	2	2	For further information see clause 6.3.2 in TS 36.331 and clause 10.1 in TS 36.213.

A.8.4.14.2 Test Requirement

In Test 1, the UE shall send one Event A3 triggered measurement report, with a measurement reporting delay less than 6.4 s from the beginning of time period T2. The measurement reporting delay is defined as the time from the beginning of time period T2 to the moment when the UE send the measurement report on PUSCH.

In Test 2, the UE shall send one Event A3 triggered measurement report, with a measurement reporting delay less than 51.2 s from the beginning of time period T2. The measurement reporting delay is defined as the time from the beginning of time period T2 to the moment when the UE starts to send preambles on the PRACH for scheduling request (SR) to obtain allocation to send the measurement report on PUSCH.

The UE shall not send event triggered measurement reports, as long as the reporting criteria are not fulfilled.

The rate of correct events observed during repeated tests shall be at least 90%.

NOTE 1: The actual overall delays measured in the test may be up to one DRX cycle higher than the measurement reporting delays above because UE is allowed to delay the initiation of the measurement reporting procedure to the next until the Active Time.

NOTE 2: In order to calculate the r

A.8.4.15 E-UTRAN TDD-TDD inter-frequency event triggered reporting under fading propagation conditions in asynchronous cells for UE category M1 in CEModeB in DRX

A.8.4.15.1 Test Purpose and Environment

The purpose of this test is to verify that the Cat-M1 UE makes correct reporting of an event with discontinuous MPDCCH monitoring. This test will partly verify the TDD-TDD inter-frequency cell search requirements in clause 8.13.3.5.3.

The test parameters are given in Table A.8.4.15.1-1, A.8.4.15.1-2, A.8.4.15.1-3 and A.8.4.15.1-4 below. In the measurement control information it is indicated to the UE that event-triggered reporting with Event A3 is used. The test consists of two successive time periods, with time duration of T1, and T2 respectively. During time duration T1, the UE shall not have any timing information of cell 2. At the beginning of T2 the transmission power of cell 2 is increased to the same level as for cell 1, and due to usage of an offset this shall result in reporting of Event A3.

In Test 1 UE needs to be provided at least once every 500ms with new Timing Advance Command MAC control element to restart the Time alignment timer to keep UE uplink time alignment. Furthermore UE is allocated with PUSCH resource at every DRX cycle.

In Test 2 the uplink time alignment is not maintained and UE needs to use RACH to obtain UL allocation for measurement reporting.

Table A.8.4.15.1-1: General test parameters

Parameter	Unit	Value		Comment
		Test1	Test2	
E-UTRA RF Channel Number		1, 2		
Active cell		Cell 1		
Neighbour cell		Cell 2		Cell to be identified.
CP length		Normal		
DRX		ON		
A3	Offset	dB	-8	
	Hysteresis	dB	0	
	Time To Trigger	S	0	
Filter coefficient		0		L3 filtering is not used
Gap pattern ID		0		
<i>R</i> _{max}		8		As defined in <i>mPDCCH-NumRepetition</i> in [3]
<i>G</i>		1		As defined in <i>mPDCCH-startSF-UeSS</i> in [3]
<i>X</i>		scheme01		As defined in <i>measGapSharingScheme</i> in [3]
T1	S	5		
T2	S	≤650	≤1050	
Special subframe configuration		6		As specified in table 4.2-1 in TS 36.211. The same configuration in both cells
Uplink-downlink configuration		1		As specified in table 4.2-2 in TS 36.211. The same configuration in both cells

Table A.8.4.15.1-2: Cell specific test parameters

Parameter	Unit	Cell 1		Cell 2	
		T1	T2	T1	T2
E-UTRA RF Channel Number		1		2	
<i>BW</i> _{channel}	MHz	10		10	
PDSCH parameters: DL Reference Measurement Channel		R.19 TDD		-	
MPDCCH parameters: DL Reference Measurement Channel		R.17 TDD		R.17 TDD	
OCNG Patterns		OP.11 TDD		OP.2 TDD	
PBCH_RA	dB	-3		-3	
PBCH_RB	dB				
PSS_RA	dB				
SSS_RA	dB				
PCFICH_RB	dB				
PHICH_RA	dB				
PHICH_RB	dB				
MPDCCH_RA	dB				
MPDCCH_RB	dB				
PDSCH_RA	dB				
PDSCH_RB	dB				
OCNG_RA ^{Note 1}	dB				
OCNG_RB ^{Note 1}	dB				
<i>N</i> _{oc} ^{Note 2}	dBm/15 KHz				
\hat{E}_s / N_{oc}	dB	-12	-12	-Infinity	-12
\hat{E}_s / I_{ot} ^{Note 3}	dB	-12	-12	-Infinity	-12
RSRP ^{Note 3}	dBm/15 KHz	-110	-110	-Infinity	-110
SCH_RP ^{Note 3}	dBm/15 KHz	-110	-110	-Infinity	-110

I_0 ^{Note 3}	dBm/9MHz	-69.95	-69.95	-Infinity	-69.95
Propagation Condition		ETU30		ETU30	
Correlation Matrix and Antenna Configuration		2x1 Low		2x1 Low	
Timing offset to Cell 1	μ s	-		3	
Note 1:	OCNG shall be used such that all cells are fully allocated and a constant total transmitted power spectral density is achieved for all OFDM symbols.				
Note 2:	Interference from other cells and noise sources not specified in the test is assumed to be constant over subcarriers and time and shall be modelled as AWGN of appropriate power for N_{oc} to be fulfilled.				
Note 3:	E_s/lot , RSRP, SCH_RP and I_0 have been derived from other parameters for information purposes. They are not settable parameters themselves.				
Note 4:	The resources for uplink transmission are assigned to the UE prior to the start of time period T2.				

Table A.8.4.15.1-3: DRX-Configuration

Field	Test1	Test2	Comment
	Value	Value	
onDurationTimer	psf1	psf1	As specified in clause 6.3.2 in TS 36.331
drx-InactivityTimer	psf1	psf1	
drx-RetransmissionTimer	psf1	psf1	
longDRX-CycleStartOffset	sf128	sf1280	
shortDRX	disable	disable	

Table A.8.4.15.1-4: TimeAlignmentTimer-Configuration

Field	Test1	Test2	Comment
	Value	Value	
TimeAlignmentTimer	sf500	sf500	As specified in clause 6.3.2 in TS 36.331
sr-ConfigIndex	2	2	For further information see clause 6.3.2 in TS 36.331 and clause 10.1 in TS 36.213.

A.8.4.15.2 Test Requirement

In Test 1, the UE shall send one Event A3 triggered measurement report, with a measurement reporting delay less than 641.6 s from the beginning of time period T2. The measurement reporting delay is defined as the time from the beginning of time period T2 to the moment when the UE send the measurement report on PUSCH.

In Test 2, the UE shall send one Event A3 triggered measurement report, with a measurement reporting delay less than 1024 s from the beginning of time period T2. The measurement reporting delay is defined as the time from the beginning of time period T2 to the moment when the UE starts to send preambles on the PRACH for scheduling request (SR) to obtain allocation to send the measurement report on PUSCH.

The UE shall not send event triggered measurement reports, as long as the reporting criteria are not fulfilled.

The rate of correct events observed during repeated tests shall be at least 90%.

NOTE 1: The actual overall delays measured in the test may be up to one DRX cycle higher than the measurement reporting delays above because UE is allowed to delay the initiation of the measurement reporting procedure to the next until the Active Time.

NOTE 2: In order to calculate the rate of correct events the system simulator shall verify that it has received correct Event A3 measurement report.

A.8.5 E-UTRAN FDD - UTRAN FDD Measurements

A.8.5.1 E-UTRAN FDD - UTRAN FDD event triggered reporting under fading propagation conditions

A.8.5.1.1 Test Purpose and Environment

The purpose of this test is to verify that the UE makes correct reporting of an event. This test will partly verify the E-UTRAN FDD- UTRAN FDD cell search requirements in clause 8.1.2.4.1.

The test parameters are given in Tables A.8.5.1.1-1, A.8.5.1.1-2 and A.8.5.1.1-3 below. In the measurement control information it is indicated to the UE that event-triggered reporting with Event B1 is used. The test consists of two successive time periods, with time duration of T1, and T2 respectively. During time duration T1, the UE shall not have any timing information of cell 2.

Table A.8.5.1.1-1: General test parameters for E-UTRAN FDD-UTRAN FDD event triggered reporting in fading propagation conditions

Parameter	Unit	Value	Comment
PDSCH parameters (E-UTRAN FDD)		DL Reference Measurement Channel R.0 FDD	As specified in clause A.3.1.1.1.
PCFICH/PDCCH/PHICH parameters (E-UTRAN FDD)		DL Reference Measurement Channel R.6 FDD	As specified in clause A.3.1.2.1.
Gap Pattern Id		1	As specified in TS 36.133 clause 8.1.2.1.
Active cell		Cell 1	Cell 1 is on E-UTRA RF channel number 1.
Neighbour cell		Cell 2	Cell 2 is on UTRA RF channel number 1.
CP length		Normal	Applicable to cell 1
E-UTRA RF Channel Number		1	One E-UTRA FDD carrier frequency is used.
E-UTRA Channel Bandwidth (BW _{channel})	MHz	10	
UTRA RF Channel Number		1	One UTRA FDD carrier frequency is used.
Inter-RAT (UTRA FDD) measurement quantity		CPICH Ec/Io	
b1-Threshold-UTRA	dB	-18	CPICH Ec/Io threshold for event B1.
Hysteresis	dB	0	
Time To Trigger	ms	0	
Filter coefficient		0	L3 filtering is not used.
DRX		OFF	
Monitored UTRA FDD cell list size		12	UTRA cells on UTRA RF channel 1 provided in the cell list.
T1	s	5	
T2	s	6	

Table A.8.5.1.1-2: Cell specific test parameters for E-UTRAN FDD (cell # 1) for event triggered reporting of UTRAN FDD cell under fading propagation conditions

Parameter	Unit	Cell 1	
		T1	T2
E-UTRA RF Channel Number		1	
BW _{channel}	MHz	10	
Correlation Matrix and Antenna Configuration		1x2 Low	
OCNG Pattern defined in A.3.2.1.1 (OP.1 FDD)		OP.1 FDD	
PBCH_RA	dB	0	
PBCH_RB	dB		
PSS_RA	dB		
SSS_RA	dB		
PCFICH_RB	dB		
PHICH_RA	dB		
PHICH_RB	dB		
PDCCH_RA	dB		
PDCCH_RB	dB		

PDSCH_RA	dB		
PDSCH_RB	dB		
OCNG_RA ^{Note 1}	dB		
OCNG_RB ^{Note 1}	dB		
\hat{E}_s / I_{ot}	dB	4	4
\hat{E}_s / N_{oc}	dB	4	4
N_{oc}	dBm/15 kHz	-98	
RSRP	dBm/15 kHz	-94	-94
SCH_RP	dBm/15 kHz	-94	-94
Propagation Condition		ETU70	
Note 1: OCNG shall be used such that both cells are fully allocated and a constant total transmitted power spectral density is achieved for all OFDM symbols.			
Note 2: The resources for uplink transmission are assigned to the UE prior to the start of time period T2.			

Table A.8.5.1.1-3: Cell specific test parameters for UTRAN FDD (cell # 2) for event triggered reporting of UTRAN FDD cell under fading propagation conditions

Parameter	Unit	Cell 2	
		T1	T2
UTRA RF Channel Number		1	1
CPICH_Ec/I _{or}	dB	-10	-10
PCCPCH_Ec/I _{or}	dB	-12	-12
SCH_Ec/I _{or}	dB	-12	-12
PICH_Ec/I _{or}	dB	-15	-15
DPCH_Ec/I _{or}	dB	N/A	N/A
OCNS		-0.941	-0.941
\hat{I}_{or} / I_{oc}	dB	-Infinity	-1.8
I_{oc}	dBm/3.84 MHz	-70	-70
CPICH_Ec/I _o	dB	-Infinity	-14
Propagation Condition		Case 5 (Note 3)	
Note 1: The DPCH level is controlled by the power control loop.			
Note 2: The power of the OCNS channel that is added shall make the total power from the cell to be equal to I _{or} .			
Note 3: Case 5 propagation conditions are defined in Annex A of TS 25.101.			

A.8.5.1.2 Test Requirements

The UE shall send one Event B1 triggered measurement report, with a measurement reporting delay less than 4800 ms from the beginning of time period T2.

The UE shall not send event triggered measurement reports, as long as the reporting criteria are not fulfilled.

The rate of correct events observed during repeated tests shall be at least 90%.

NOTE: The actual overall delays measured in the test may be up to $2 \times TTI_{DCCH}$ higher than the measurement reporting delays above because of TTI insertion uncertainty of the measurement report in DCCH.

A.8.5.2 E-UTRAN FDD - UTRAN FDD SON ANR cell search reporting under AWGN propagation conditions

A.8.5.2.1 Test Purpose and Environment

The purpose of this test is to verify that the UE makes correct reporting of the strongest UTRAN cell for SON automatic neighbour relations. This test will partly verify the E-UTRAN FDD - UTRAN FDD cell search requirements for identification of a new UTRA FDD cell for SON given in clause 8.1.2.4.7.1.

The test parameters are given in Tables A.8.5.2.1-1, A.8.5.2.1-2 and A.8.5.2.1-3 below. In the measurement control information it is indicated to the UE that periodical reporting with the purpose 'reportStrongestCellsForSON' is used.

The test consists of two successive time periods, with time duration of T1, and T2 respectively. Prior to the start of time period T1, an interRAT periodic measurement reporting configuration with purpose reportStrongestCellsForSON is configured, and linked to a UTRA measurement object corresponding to channel UARFCN 1. During time duration T1, the UE shall not have any timing information of cell 2.

Table A.8.5.2.1-1: General test parameters for E-UTRAN FDD-UTRAN FDD cell search reporting for SON ANR in AWGN propagation conditions

Parameter	Unit	Value	Comment
PDSCH parameters (E-UTRAN FDD)		DL Reference Measurement Channel R.0 FDD	As specified in clause A.3.1.1.1.
PCFICH/PDCCH/PHICH parameters (E-UTRAN FDD)		DL Reference Measurement Channel R.6 FDD	As specified in clause A.3.1.2.1.
Gap Pattern Id		1	As specified in TS 36.133 clause 8.1.2.1.
Active cell		Cell 1	Cell 1 is on E-UTRA RF channel number 1.
Neighbour cell		Cell 2	Cell 2 is on UTRA RF channel number 1.
CP length		Normal	Applicable to cell 1
E-UTRA RF Channel Number		1	One E-UTRA FDD carrier frequency is used.
E-UTRA Channel Bandwidth ($BW_{channel}$)	MHz	10	
UTRA RF Channel Number		1	One UTRA FDD carrier frequency is used.
Inter-RAT (UTRA FDD) measurement quantity		CPICH Ec/Io	
Filter coefficient		0	L3 filtering is not used.
DRX		OFF	
Monitored UTRA FDD cell list size		None	No explicit neighbour list is provided to the UE
T1	s	>5	During T1, cell 2 shall be powered off, and during the off time the primary scrambling code shall be changed, The intention is to ensure that cell 2 has not been detected by the UE prior to the start of period T2.
T2	s	6	

Table A.8.5.2.1-2: Cell specific test parameters for E-UTRAN FDD (cell # 1) for UTRAN FDD cell search for SON ANR under AWGN propagation conditions

Parameter	Unit	Cell 1	
		T1	T2
E-UTRA RF Channel Number		1	
$BW_{channel}$	MHz	10	
OCNG Pattern defined in A.3.2.1.1 (OP.1 FDD)		OP.1 FDD	
PBCH_RA	dB	0	
PBCH_RB	dB		
PSS_RA	dB		
SSS_RA	dB		
PCFICH_RB	dB		
PHICH_RA	dB		
PHICH_RB	dB		
PDCCH_RA	dB		
PDCCH_RB	dB		
PDSCH_RA	dB		
PDSCH_RB	dB		
OCNG_RA ^{Note 1}	dB		
OCNG_RB ^{Note 1}	dB		
\hat{E}_s / I_{ot}	dB		
N_{oc} ^{Note 3}	dBm/15 kHz	-98	
\hat{E}_s / N_{oc}	dB	4	4
RSRP ^{Note 4}	dBm/15 kHz	-94	-94
SCH_RP	dBm/15 kHz	-94	-94
Propagation Condition		AWGN	

Note 1:	OCNG shall be used such that both cells are fully allocated and a constant total transmitted power spectral density is achieved for all OFDM symbols.
Note 2:	The resources for uplink transmission are assigned to the UE prior to the start of time period T2.
Note 3:	Interference from other cells and noise sources not specified in the test is assumed to be constant over subcarriers and time and shall be modelled as AWGN of appropriate power for N_{oc} to be fulfilled.
Note 4:	RSRP levels have been derived from other parameters for information purposes. They are not settable parameters themselves.

Table A.8.5.2.1-3: Cell specific test parameters for UTRAN FDD (cell # 2) for UTRAN FDD cell search for SON ANR under AWGN propagation conditions

Parameter	Unit	Cell 2	
		T1	T2
UTRA RF Channel Number		1	1
CPICH_Ec/I _{or}	dB	-10	-10
PCCPCH_Ec/I _{or}	dB	-12	-12
SCH_Ec/I _{or}	dB	-12	-12
PICH_Ec/I _{or}	dB	-15	-15
DPCH_Ec/I _{or}	dB	N/A	N/A
OCNS		-0.941	-0.941
\hat{I}_{or}/I_{oc}	dB	-Infinity	-3.35
I_{oc}	dBm/3.84 MHz	-70	-70
CPICH_Ec/I _o	dB	-Infinity	-15
Propagation Condition		AWGN	
Note 1:	The DPCH level is controlled by the power control loop.		
Note 2:	The power of the OCNS channel that is added shall make the total power from the cell to be equal to I _{or} .		

A.8.5.2.2 Test Requirements

The UE shall send the first measurement report containing the primary scrambling code of cell 2, with a measurement reporting delay less than 4800 ms from the beginning of time period T2.

The rate of correct measurement reports observed with this delay during repeated tests shall be at least 90%.

NOTE: The actual overall delays measured in the test may be up to $2 \times TTI_{DCCCH}$ higher than the measurement reporting delays above because of TTI insertion uncertainty of the measurement report in DCCCH.

A.8.5.3 E-UTRAN FDD-UTRAN FDD event triggered reporting when DRX is used under fading propagation conditions

A.8.5.3.1 Test Purpose and Environment

The purpose of these tests is to verify that the UE makes correct reporting of an event in DRX. These tests will partly verify the E-UTRAN FDD-UTRAN FDD cell search requirements when DRX is used in clause 8.1.2.4.1.2.

In these tests, there are two cells, one E-UTRAN cell and one UTRAN cell, and gap pattern configuration # 0 as defined in Table 8.1.2.1-1 is provided.

The common test parameters are given in Table A.8.5.3.1-1. Cell specific test parameters are given in Table A.8.5.3.1-2 for E-UTRAN and in Table A.8.5.3.1-5 for UTRAN. DRX configuration for Test1 and Test2 are given in Table A.8.5.2.1-3 and time alignment timer and scheduling request related parameters in Table A.8.5.2.1-4.

In Test 1 UE needs to be provided at least once every 500ms with new Timing Advance Command MAC control element to restart the Time alignment timer to keep UE uplink time alignment. Furthermore UE is allocated with PUSCH resource at every DRX cycle. In Test 2 the uplink time alignment is not maintained and UE needs to use RACH to obtain UL allocation for measurement reporting.

In the measurement control information, it is indicated to the UE that event-triggered reporting with Event B1 is used. The tests consist of two successive time periods, with time duration of T1, and T2 respectively. During time duration T1, the UE shall not have any timing information of cell 2.

Table A.8.5.3.1-1: General test parameters for E-UTRAN FDD-UTRAN FDD event triggered reporting when DRX is used in fading propagation conditions

Parameter	Unit	Test 1	Test 2	Comment
		Value		
PDSCH parameters (E-UTRAN FDD)		DL Reference Measurement Channel R.0 FDD		As specified in clause A.3.1.1.1 Note that UE may only be allocated at <i>On Duration</i>
PCFICH/PDCCH/PHICH parameters (E-UTRAN FDD)		DL Reference Measurement Channel R.6 FDD		As specified in clause A.3.1.2.1.
Gap Pattern Id		0		As specified in TS 36.133 clause 8.1.2.1.
Active cell		Cell 1		Cell 1 is on E-UTRA RF channel number 1.
Neighbour cell		Cell 2		Cell 2 is on UTRA RF channel number 1.
CP length		Normal		Applicable to cell 1
E-UTRA RF Channel Number		1		One E-UTRA FDD carrier frequency is used.
E-UTRA Channel Bandwidth ($BW_{channel}$)	MHz	10		
UTRA RF Channel Number		1		One UTRA FDD carrier frequency is used.
Inter-RAT (UTRA FDD) measurement quantity		CPICH Ec/Io		
b1-Threshold-UTRA	dB	-18		CPICH Ec/Io threshold for event B1.
Hysteresis	dB	0		
TimeToTrigger	s	0		
Filter coefficient		0		L3 filtering is not used
PRACH configuration		4		As specified in table 5.7.1-2 in TS 36.211
Access Barring Information	-	Not Sent		No additional delays in random access procedure.
DRX		ON		DRX related parameters are defined in Table A.8.5.3.1-3
Monitored UTRA FDD cell list size		12		UTRA cells on UTRA RF channel 1 provided in the cell list.
T1	s	5		
T2	s	6	30	

Table A.8.5.3.1-2: Cell specific test parameters for E-UTRAN FDD (cell #1) event triggered reporting of UTRAN FDD cell when DRX is used under fading propagation conditions

Parameter	Unit	Cell 1			
		T1	T2		
E-UTRA RF Channel Number		1			
$BW_{channel}$	MHz	10			
Correlation Matrix and Antenna Configuration		1x2 Low			
OCNG Pattern defined in A.3.2.1.1 (OP.1 FDD)		OP.1 FDD			
PBCH_RA	dB	0			
PBCH_RB	dB				
PSS_RA	dB				
SSS_RA	dB				
PCFICH_RB	dB				
PHICH_RA	dB				
PHICH_RB	dB				
PDCCH_RA	dB				
PDCCH_RB	dB				
PDSCH_RA	dB				
PDSCH_RB	dB				
OCNG_RA ^{Note 1}	dB				
OCNG_RB ^{Note 1}	dB				
\hat{E}_s / I_{ot}	dB			4	4

N_{oc} <small>Note 2</small>	dBm/15 kHz	-98	
RSRP <small>Note 3</small>	dBm/15 kHz	-94	-94
SCH_RP	dBm/15 kHz	-94	-94
\hat{E}_s/N_{oc}	dB	4	4
Propagation Condition		ETU70	
<p>Note 1: OCNG shall be used such that both cells are fully allocated and a constant total transmitted power spectral density is achieved for all OFDM symbols.</p> <p>Note 2: Interference from other cells and noise sources not specified in the test is assumed to be constant over subcarriers and time and shall be modelled as AWGN of appropriate power for N_{oc} to be fulfilled.</p> <p>Note 3: RSRP and SCH_RP levels have been derived from other parameters for information purposes. They are not settable parameters themselves.</p>			

Table A.8.5.3.1-3: drx-Configuration to be used in E-UTRAN FDD-UTRAN FDD event triggered reporting when DRX is used in fading propagation conditions

Field	Test1	Test2	Comment
	Value	Value	
onDurationTimer	psf1	psf1	
drx-InactivityTimer	psf1	psf1	
drx-RetransmissionTimer	psf1	psf1	
longDRX-CycleStartOffset	sf40	sf1280	
shortDRX	Disable	Disable	
Note: For further information see clause 6.3.2 in TS 36.331.			

Table A.8.5.3.1-4: TimeAlignmentTimer and sr-ConfigIndex -Configuration to be used in E-UTRAN FDD-UTRAN FDD event triggered reporting when DRX is used in fading propagation conditions

Field	Test1	Test2	Comment
	Value	Value	
TimeAlignmentTimer	sf500	sf500	For further information see clause 6.3.2 in TS 36.331.
sr-ConfigIndex	0	0	For further information see clause 6.3.2 in TS 36.331 and section 10.1 in TS 36.213.

Table A.8.5.3.1-5: Cell specific test parameters for UTRAN FDD (cell # 2) for event triggered reporting of UTRAN FDD cell when DRX is used under fading propagation conditions

Parameter	Unit	Cell 2	
		T1	T2
UTRA RF Channel Number		1	
CPICH_Ec/lor	dB	-10	
PCCPCH_Ec/lor	dB	-12	
SCH_Ec/lor	dB	-12	
PICH_Ec/lor	dB	-15	
DPCH_Ec/lor	dB	N/A	
OCNS		-0.941	
\hat{I}_{or}/I_{oc}	dB	-Infinity	-1.8
I_{oc}	dBm/3.84 MHz	-70	
CPICH_Ec/lo	dB	-Infinity	-14
Propagation Condition		Case 5 (Note 3)	
<p>Note 1: The DPCH level is controlled by the power control loop.</p> <p>Note 2: The power of the OCNS channel that is added shall make the total power from the cell to be equal to I_{or}.</p> <p>Note 3: Case 5 propagation conditions are defined in Annex A of TS 25.101.</p>			

A.8.5.3.2 Test Requirements

In Test1 the UE shall send one Event B1 triggered measurement report, with a measurement reporting delay less than 2400 ms from the beginning of time period T2. The measurement reporting delay is defined as the time from the beginning of time period T2, to the moment when the UE sends the measurement report on PUSCH.

In Test2 the UE shall send one Event B1 triggered measurement report, with a measurement reporting delay less than 20×1280 ms from the beginning of time period T2. The measurement reporting delay is defined as the time from the beginning of time period T2, to the moment when the UE starts to send preambles on the PRACH for scheduling request (SR) to obtain allocation to send the measurement report on PUSCH.

The UE shall not send event triggered measurement reports, as long as the reporting criteria are not fulfilled.

The rate of correct events observed during repeated tests shall be at least 90%.

NOTE 1: The actual overall delays measured in the test may be up to one DRX cycle higher than the measurement reporting delays above because UE is allowed to delay the initiation of the measurement reporting procedure to the next until the Active Time.

NOTE 2: In order to calculate the rate of correct events the system simulator shall verify that it has received correct Event B1 measurement report.

A.8.5.4 E-UTRAN FDD - UTRAN FDD enhanced cell identification under AWGN propagation conditions

A.8.5.4.1 Test Purpose and Environment

The purpose of this test is to verify that the UE makes correct enhanced reporting of UTRAN cells. This test will partly verify the Enhanced UTRA FDD cell identification requirements in clause 8.1.2.4.1.1a.

The test parameters are given in Tables A.8.5.4.1-1, A.8.5.4.1-2 and A.8.5.4.1-3 below. In the measurement control information it is indicated to the UE that event-triggered reporting with Event B1 is used. The test consists of two successive time periods, with time duration of T1, and T2 respectively. During time period T1, gaps are activated and an interRAT measurement reporting configuration is configured, and linked to a UTRA measurement object corresponding to channel UARFCN 1. Prior to time duration T2, the UE shall not have any timing information of cell 2. Cell 2 is powered up at the beginning of the T2

Table A.8.5.4.1-1: General test parameters for E-UTRAN FDD - UTRAN FDD enhanced cell identification under AWGN propagation conditions

Parameter	Unit	Value	Comment
PDSCH parameters (E-UTRAN FDD)		DL Reference Measurement Channel R.0 FDD	As specified in clause A.3.1.1.1.
PCFICH/PDCCH/PHICH parameters (E-UTRAN FDD)		DL Reference Measurement Channel R.6 FDD	As specified in clause A.3.1.2.1.
Gap Pattern Id		0	As specified in TS 36.133 clause 8.1.2.1.
Active cell		Cell 1	Cell 1 is on E-UTRA RF channel number 1.
Neighbour cell		Cell 2	Cell 2 is on UTRA RF channel number 1.
CP length		Normal	Applicable to cell 1
E-UTRA RF Channel Number		1	One E-UTRA FDD carrier frequency is used.
E-UTRA Channel Bandwidth ($BW_{channel}$)	MHz	10	
UTRA RF Channel Number		1	One UTRA FDD carrier frequency is used.
Inter-RAT (UTRA FDD) measurement quantity		CPICH Ec/Io	
b1-Threshold-UTRA	dB	-18	CPICH Ec/Io threshold for event B1.
Hysteresis	dB	0	
Time To Trigger	ms	0	
Filter coefficient		0	L3 filtering is not used.
DRX		OFF	
Monitored UTRA FDD cell list size		12	UTRA cells on UTRA RF channel 1 provided in the cell list
T1	s	5	
T2	s	2	

Table A.8.5.4.1-2: Cell specific test parameters for cell #1 E-UTRAN FDD - UTRAN FDD enhanced cell identification under AWGN propagation conditions

Parameter	Unit	Cell 1	
		T1	T2
E-UTRA RF Channel Number		1	
BW _{channel}	MHz	10	
OCNG Pattern defined in A.3.2.1.1 (OP.1 FDD)		OP.1 FDD	
PBCH_RA	dB	0	
PBCH_RB	dB		
PSS_RA	dB		
SSS_RA	dB		
PCFICH_RB	dB		
PHICH_RA	dB		
PHICH_RB	dB		
PDCCH_RA	dB		
PDCCH_RB	dB		
PDSCH_RA	dB		
PDSCH_RB	dB		
OCNG_RA ^{Note 1}	dB		
OCNG_RB ^{Note 1}	dB		
\hat{E}_s/I_{ot}	dB		
N_{oc} ^{Note 3}	dBm/15 kHz	-98	
\hat{E}_s/N_{oc}	dB	4	4
RSRP ^{Note 4}	dBm/15 kHz	-94	-94
SCH_RP	dBm/15 kHz	-94	-94
Propagation Condition		AWGN	
<p>Note 1: OCNG shall be used such that both cells are fully allocated and a constant total transmitted power spectral density is achieved for all OFDM symbols.</p> <p>Note 2: The resources for uplink transmission are assigned to the UE prior to the start of time period T2.</p> <p>Note 3: Interference from other cells and noise sources not specified in the test is assumed to be constant over subcarriers and time and shall be modelled as AWGN of appropriate power for N_{oc} to be fulfilled.</p> <p>Note 4: RSRP levels have been derived from other parameters for information purposes. They are not settable parameters themselves.</p>			

Table A.8.5.4.1-3: Cell specific test parameters for cell #2 E-UTRAN FDD - UTRAN FDD enhanced cell identification under AWGN propagation conditions

Parameter	Unit	Cell 2	
		T1	T2
UTRA RF Channel Number		1	
CPICH_Ec/I _{or}	dB	-10	
PCCPCH_Ec/I _{or}	dB	-12	
SCH_Ec/I _{or}	dB	-12	
PICH_Ec/I _{or}	dB	-15	
DPCH_Ec/I _{or}	dB	N/A	
OCNS		-0.941	
\hat{I}_{or}/I_{oc}	dB	$-\infty$	0.02
I_{oc}	dBm/3.84 MHz	-70	
CPICH_Ec/I _o ^{Note 3}	dB	$-\infty$	-13
Propagation Condition		AWGN	
<p>Note 1: The DPCH level is controlled by the power control loop.</p> <p>Note 2: The power of the OCNS channel that is added shall make the total power from the cell to be equal to I_{or}.</p> <p>Note 3: This gives an SCH Ec/I_o of -15dB</p>			

A.8.5.4.2 Test Requirements

The UE shall send the first measurement report containing the primary scrambling code of cell 2, with a measurement reporting delay less than 960 ms from the beginning of time period T2. The rate of correct measurement reports observed with this delay during repeated tests shall be at least 90%.

NOTE: The actual overall delays measured in the test may be up to $2 \times TTI_{DCCCH}$ higher than the measurement reporting delays above because of TTI insertion uncertainty of the measurement report in DCCCH

A.8.5.5 E- UTRAN FDD - UTRAN FDD identification of a new CGI of UTRAN cell using autonomous gaps

A.8.5.5.1 Test Purpose and Environment

This test is to verify the requirement for identification of a new CGI of UTRA cell with autonomous gaps in clause 8.1.2.4.17.

The test parameters are given in Tables A.8.5.5.1-1, A.8.5.5.1-2 and A.8.5.5.1-3 below. The test consists of three successive time periods, with time durations of T1, T2 and T3 respectively. At the start of time duration T1, the UE does not have any timing information of cell 2. Starting T2, cell 2 becomes detectable and the UE is expected to detect and send a measurement report. Gap pattern configuration with id #0 as specified in Table 8.1.2.1-1 is configured before T2 begins to enable inter-frequency monitoring.

A RRC message implying SI reading shall be sent to the UE during period T2, after the UE has reported Event B1. The RRC message shall create a measurement report configuration with purpose *reportCGI* and *si-RequestForHO* set to TRUE. The start of T3 is the instant when the last TTI containing the RRC message implying SI reading is sent to the UE.

Table A.8.5.5.1-1: General test parameters for E-UTRAN FDD - UTRAN FDD identification of a new CGI of UTRAN cell using autonomous gaps

Parameter	Unit	Value	Comment
PDSCH parameters (E-UTRAN FDD)		DL Reference Measurement Channel R.0 FDD	As specified in clause A.3.1.1.1.
PCFICH/PDCCH/PHICH parameters (E-UTRAN FDD)		DL Reference Measurement Channel R.6 FDD	As specified in clause A.3.1.2.1.
Gap Pattern Id		0	As specified in TS 36.133 clause 8.1.2.1.
Active cell		Cell 1	Cell 1 is on E-UTRA RF channel number 1.
Neighbour cell		Cell 2	Cell 2 is on UTRA RF channel number 1.
CP length		Normal	Applicable to cell 1
E-UTRA RF Channel Number		1	One E-UTRA FDD carrier frequency is used.
E-UTRA Channel Bandwidth ($BW_{channel}$)	MHz	10	
UTRA RF Channel Number		1	One UTRA FDD carrier frequency is used.
Inter-RAT (UTRA FDD) measurement quantity		CPICH Ec/Io	
b1-Threshold-UTRA	dB	-18	CPICH Ec/Io threshold for event B1.
Hysteresis	dB	0	
Time To Trigger	ms	0	
Filter coefficient		0	L3 filtering is not used.
DRX		OFF	
SIB3_REP	Frames	32	Applicable for cell 2 SIB3 scheduling
SIB3_SEG_COUNT		1	Applicable for cell 2 SIB3 scheduling
si-RequestForHO		TRUE	As specified in clause 5.5.3.1 in TS 36.331.
Monitored UTRA FDD cell list size		12	UTRA cells on UTRA RF channel 1 provided in the cell list.
CSG id (of cell 2)		Set to any non-empty value	
T1	s	5	
T2	s	≤ 10	
T3	s	5	

Table A.8.5.5.1-2: Cell specific test parameters for cell #1 E-UTRAN FDD - UTRAN FDD identification of a new CGI of UTRAN cell using autonomous gaps

Parameter	Unit	Cell 1	
		T1	T2
E-UTRA RF Channel Number		1	
BW _{channel}	MHz	10	
OCNG Pattern defined in A.3.2.1.1 (OP.1 FDD)		OP.1 FDD	
PBCH_RA	dB	0	
PBCH_RB	dB		
PSS_RA	dB		
SSS_RA	dB		
PCFICH_RB	dB		
PHICH_RA	dB		
PHICH_RB	dB		
PDCCH_RA	dB		
PDCCH_RB	dB		
PDSCH_RA	dB		
PDSCH_RB	dB		
OCNG_RA ^{Note 1}	dB		
OCNG_RB ^{Note 1}	dB		
\hat{E}_s/I_{ot}	dB		
N_{oc} ^{Note 3}	dBm/15 kHz	-98	
\hat{E}_s/N_{oc}	dB	4	4
RSRP ^{Note 4}	dBm/15 kHz	-94	-94
SCH_RP	dBm/15 kHz	-94	-94
Propagation Condition		AWGN	
<p>Note 1: OCNG shall be used such that both cells are fully allocated and a constant total transmitted power spectral density is achieved for all OFDM symbols.</p> <p>Note 2: The resources for uplink transmission are assigned to the UE prior to the start of time period T2.</p> <p>Note 3: Interference from other cells and noise sources not specified in the test is assumed to be constant over subcarriers and time and shall be modelled as AWGN of appropriate power for N_{oc} to be fulfilled.</p> <p>Note 4: RSRP levels have been derived from other parameters for information purposes. They are not settable parameters themselves.</p>			

Table A.8.5.5.1-3: Cell specific test parameters for cell #2 E-UTRAN FDD - UTRAN FDD identification of a new CGI of UTRAN cell using autonomous gaps

Parameter	Unit	Cell 2	
		T1	T2
UTRA RF Channel Number		1	
CPICH_Ec/I _{or}	dB	-10	
PCCPCH_Ec/I _{or}	dB	-12	
SCH_Ec/I _{or}	dB	-12	
PICH_Ec/I _{or}	dB	-15	
DPCH_Ec/I _{or}	dB	N/A	
OCNS		-0.941	
\hat{I}_{or}/I_{oc}	dB	$-\infty$	0.02
I_{oc}	dBm/3.84 MHz	-70	
CPICH_Ec/I _o ^{Note 3}	dB	$-\infty$	-13
Propagation Condition		AWGN	
<p>Note 1: The DPCH level is controlled by the power control loop.</p> <p>Note 2: The power of the OCNS channel that is added shall make the total power from the cell to be equal to I_{or}.</p> <p>Note 3: This gives an SCH Ec/I_o of -15dB</p>			

A.8.5.5.2 Test Requirements

The UE shall transmit a measurement report containing the cell global identifier of cell 2 within [1965] milliseconds from the start of T3.

$$\begin{aligned} \text{Test requirement} &= \text{RRC Procedure delay} + T_{\text{identify_CGI, UTRAN FDD}} + \text{reporting delay} \\ &= 50 + [630] + 40 \cdot 32 + 2 \text{ms from the start of T3} \\ &= [1962] \text{ ms, allow [1965] ms.} \end{aligned}$$

The rate of correct events observed during repeated tests shall be at least 90%.

A.8.5.6 E-UTRAN FDD - UTRAN FDD event triggered reporting without measurement gaps under AWGN propagation conditions

A.8.5.6.1 Test Purpose and Environment

The purpose of this test is to verify that the UE makes correct reporting of an event without measurement gaps. This test will partly verify the E-UTRAN FDD- UTRAN FDD cell search requirements in clause 8.1.2.4.1.

The test parameters are given in Tables A.8.5.6.1-1, A.8.5.6.1-2 and A.8.5.6.1-3 below. In the measurement control information it is indicated to the UE that event-triggered reporting with Event B1 is used. The test consists of two successive time periods, with time duration of T1, and T2 respectively. During time duration T1, the UE shall not have any timing information of cell 2. PDCCH on the PCell shall be sent continuously to ensure that the UE sends ACK/NACKs throughout the test.

Table A.8.5.6.1-1: General test parameters for E-UTRAN FDD-UTRAN FDD event triggered reporting without measurement gaps under AWGN propagation conditions

Parameter	Unit	Value	Comment
PDSCH parameters (E-UTRAN FDD)		DL Reference Measurement Channel R.3 FDD	As specified in clause A.3.1.1.1.
PCFICH/PDCCH/PHICH parameters (E-UTRAN FDD)		DL Reference Measurement Channel R.6 FDD	As specified in clause A.3.1.2.1.
Active cell		Cell 1	Cell 1 is on E-UTRA RF channel number 1.
Neighbour cell		Cell 2	Cell 2 is on UTRA RF channel number 1.
CP length		Normal	Applicable to cell 1
E-UTRA RF Channel Number		1	One E-UTRA FDD carrier frequency is used.
E-UTRA Channel Bandwidth (BW _{channel})	MHz	10	
UTRA RF Channel Number		1	One UTRA FDD carrier frequency is used.
Inter-RAT (UTRA FDD) measurement quantity		CPICH Ec/Io	
b1-Threshold-UTRA	dB	-18	CPICH Ec/Io threshold for event B1.
Hysteresis	dB	0	
Time To Trigger	ms	0	
Filter coefficient		0	L3 filtering is not used.
DRX		OFF	
Monitored UTRA FDD cell list size		12	UTRA cells on UTRA RF channel 1 provided in the cell list.
T1	s	5	
T2	s	6	

Table A.8.5.6.1-2: Cell specific test parameters for E-UTRAN FDD (cell # 1) for event triggered reporting of UTRAN FDD cell without measurement gaps under AWGN propagation conditions

Parameter	Unit	Cell 1	
		T1	T2

E-UTRA RF Channel Number		1	
BW _{channel}	MHz	10	
OCNG Pattern defined in A.3.2.1.10 (OP.10 FDD)		OP.10 FDD	
PBCH_RA	dB	0	
PBCH_RB	dB		
PSS_RA	dB		
SSS_RA	dB		
PCFICH_RB	dB		
PHICH_RA	dB		
PHICH_RB	dB		
PDCCH_RA	dB		
PDCCH_RB	dB		
PDSCH_RA	dB		
PDSCH_RB	dB		
OCNG_RA ^{Note 1}	dB		
OCNG_RB ^{Note 1}	dB		
\hat{E}_s/I_{ot}	dB		
\hat{E}_s/N_{oc}	dB	4	4
N_{oc}	dBm/15 kHz	-98	
RSRP	dBm/15 kHz	-94	-94
SCH_RP	dBm/15 kHz	-94	-94
Propagation Condition		AWGN	
Note 1: OCNG shall be used such that both cells are fully allocated and a constant total transmitted power spectral density is achieved for all OFDM symbols.			
Note 2: The resources for uplink transmission are assigned to the UE prior to the start of time period T2.			

Table A.8.5.6.1-3: Cell specific test parameters for UTRAN FDD (cell # 2) for event triggered reporting of UTRAN FDD cell without measurement gaps under AWGN propagation conditions

Parameter	Unit	Cell 2	
		T1	T2
UTRA RF Channel Number		1	
CPICH_Ec/I _{or}	dB	-10	
PCCPCH_Ec/I _{or}	dB	-12	
SCH_Ec/I _{or}	dB	-12	
PICH_Ec/I _{or}	dB	-15	
DPCH_Ec/I _{or}	dB	N/A	
OCNS		-0.941	
\hat{I}_{or}/I_{oc}	dB	-Infinity	-1.8
I_{oc}	dBm/3.84 MHz	-70	
CPICH_Ec/I _o	dB	-Infinity	-14
Propagation Condition		AWGN	
Note 1: The DPCH level is controlled by the power control loop.			
Note 2: The power of the OCNS channel that is added shall make the total power from the cell to be equal to I _{or}			

A.8.5.6.2 Test Requirements

The UE shall send one Event B1 triggered measurement report, with a measurement reporting delay less than 4800 ms from the beginning of time period T2.

The UE shall not send event triggered measurement reports, as long as the reporting criteria are not fulfilled.

The UE shall send continuous ACK/NACK throughout the test, and from the start of T2 until Event B1 is reported, at least 85% ACK/NACK shall be detected.

For a test to be considered successful requirements on both event detection and percentage of transmitted ACK/NACKs have to be fulfilled simultaneously. The rate of correct events observed during repeated tests shall be at least 90%.

NOTE: The actual overall delays measured in the test may be up to $2xTTI_{DCCCH}$ higher than the measurement reporting delays above because of TTI insertion uncertainty of the measurement report in DCCCH.

A.8.5.7 E-UTRAN FDD - UTRAN FDD Event Triggered Reporting under Fading Propagation Conditions for 5 MHz Bandwidth

A.8.5.7.1 Test Purpose and Environment

The purpose of this test is to verify that the UE makes correct reporting of an event. This test will partly verify the E-UTRAN FDD- UTRAN FDD cell search requirements in clause 8.1.2.4.1.

The parameters of this test are the same as defined in Section A.8.5.1.1 except that the values of the parameters in the Table A.8.5.7.1-1 will replace the values of the corresponding parameters in A.8.5.1.1-1, and the values of the parameters in the Table A.8.5.7.1-2 will replace the values of the corresponding parameters in A.8.5.1.1-2.

Table A.8.5.7.1-1: General test parameters for E-UTRAN FDD-UTRAN FDD event triggered reporting in fading propagation conditions

Parameter	Unit	Value	Comment
PDSCH parameters (E-UTRAN FDD)		DL Reference Measurement Channel R.5 FDD	As specified in clause A.3.1.1.1.
PCFICH/PDCCH/PHICH parameters (E-UTRAN FDD)		DL Reference Measurement Channel R.11 FDD	As specified in clause A.3.1.2.1.
E-UTRA Channel Bandwidth ($BW_{channel}$)	MHz	5	
NOTE 1: See Table A.8.5.1.1-1 for the other parameters.			
NOTE 2: This test is according to the principle defined in Section A.3.7.2.			

Table A.8.5.7.1-2: Cell specific test parameters for E-UTRAN FDD (cell # 1) for event triggered reporting of UTRAN FDD cell under fading propagation conditions

Parameter	Unit	Cell 1	
		T1	T2
$BW_{channel}$	MHz	5	
OCNG Pattern defined in A.3.2.1.15		OP.15 FDD	
NOTE: See Table A.8.1.3.1-2 for the other parameters.			

A.8.5.7.2 Test Requirements

The test requirements defined in Section A.8.5.1 shall apply to this test case.

A.8.5.8 E-UTRA FDD InterRAT UTRA FDD correct reporting of measurement events with reduced performance group configured, non DRX

A.8.5.8.1 Test Purpose and Environment

The purpose of this test is to verify that the UE makes correct reporting of an event. This test will partly verify the E-UTRA FDD-UTRA FDD inter-RAT cell search requirements in clause 8.1.2.4.1.

The test parameters are given in Tables A.8.5.8.1-1 and A.8.5.8.1-2. In this test, there are two cells on different carrier frequencies and gap pattern configuration # 0 as defined in Table 8.1.2.1-1 is provided.

In the measurement control information, it is indicated to the UE that event-triggered reporting with Event B1 is used. The test consists of two successive time periods, with time duration of T1, and T2 respectively. During time duration T1, the UE shall not have any timing information of cell 2, 3 or 4. At the start of each repetition of T1, the test equipment provides signals for cell 1 (serving cell), and cells 2, 3 and 4 which are selected from the 8 cells which are configured in the UE neighbour cell list. Cells 2, 3 and 4 are chosen randomly, such that one frequency belongs to the normal performance group and two frequencies belong to the reduced performance group.

Table A.8.5.8.1-1: General test parameters for E-UTRAN FDD-UTRAN FDD for correct reporting of measurement events with reduced performance group configured, non DRX

Parameter	Unit	Value	Comment
UE configured E-UTRA RF Channel Number		1	Serving cell and six UTRA FDD carrier frequencies are used in the UE neighbour cell list. Frequencies 5,6 and 7 are indicated to have reduced performance
UE is configured UTRA RF channel numbers		2, 3, 4, 5, 6, 7	
Test equipment configuration		Cell 1 uses E-UTRA RF channel number 1 Cells 2,3,4 are randomly selected to use different frequencies selected from UTRA RF channel numbers 2,3,4,5,6,7	Cells 2, 3 and 4 are chosen randomly, such that one frequency belongs to the normal performance group and two frequencies belong to the reduced performance group
PDSCH parameters (E-UTRAN FDD)		DL Reference Measurement Channel R.0 FDD	As specified in clause A.3.1.1.1.
PCFICH/PDCCH/PHICH parameters (E-UTRAN FDD)		DL Reference Measurement Channel R.6 FDD	As specified in clause A.3.1.2.1.
Correlation Matrix and Antenna Configuration		1x2 low	
Active cell		Cell 1	Cell 1 is on RF channel number 1
Time offset with respect to cell1		0	
Gap Pattern Id		0	As specified in TS 36.133 clause 8.1.2.1.
Inter-RAT (UTRA FDD) measurement quantity		CPICH Ec/Io	
b1-Threshold-UTRA	dB	-18	
Hysteresis	dB	0	
CP length		Normal	
TimeToTrigger	s	0	
Filter coefficient		0	L3 filtering is not used
DRX		OFF	OFF
Scaling factor for reduced performance group		16	
T1	s	5	
T2	s	155	

Table A.8.5.8.1-2: Cell specific test parameters for E-UTRAN FDD (cell # 1) for correct reporting of measurement events with reduced performance group configured, non DRX

Parameter	Unit	Cell 1	
		T1	T2
E-UTRA RF Channel Number		1	
BW _{channel}	MHz	5MHz: N _{RB} = 25 10MHz: N _{RB} = 50	
Correlation Matrix and Antenna Configuration		1x2 Low	
OCNG Pattern defined in A.3.2.1.1 (OP.1 FDD)		OP.1 FDD	
PBCH_RA	dB	0	
PBCH_RB	dB		
PSS_RA	dB		
SSS_RA	dB		
PCFICH_RB	dB		
PHICH_RA	dB		
PHICH_RB	dB		
PDCCH_RA	dB		
PDCCH_RB	dB		
PDSCH_RA	dB		
PDSCH_RB	dB		
OCNG_RA ^{Note 1}	dB		
OCNG_RB ^{Note 1}	dB		

\hat{E}_s/I_{ot}	dB	4	4
\hat{E}_s/N_{oc}	dB	4	4
N_{oc}	dBm/15 kHz	-98	
RSRP	dBm/15 kHz	-94	-94
SCH_RP	dBm/15 kHz	-94	-94
Propagation Condition		ETU70	
Note 1: OCNG shall be used such that both cells are fully allocated and a constant total transmitted power spectral density is achieved for all OFDM symbols.			
Note 2: The resources for uplink transmission are assigned to the UE prior to the start of time period T2.			

Table A.8.5.8.1-3: Cell specific test parameters for UTRAN FDD (cell # 2, 3 and 4) for correct reporting of measurement events with reduced performance group configured, non DRX

Parameter	Unit	Cell 2		Cell 3		Cell 4	
		T1	T2	T1	T2	T1	T2
UTRA RF Channel Number		Cells 2 is randomly selected to use different frequencies selected from UTRA RF channel numbers 2,3,4,5,6,7		Cells 3 is randomly selected to use different frequencies selected from UTRA RF channel numbers 2,3,4,5,6,7		Cells 4 is randomly selected to use different frequencies selected from UTRA RF channel numbers 2,3,4,5,6,7	
CPICH_Ec/lor	dB	-10					
PCCPCH_Ec/lor	dB	-12					
SCH_Ec/lor	dB	-12					
PICH_Ec/lor	dB	-15					
DPCH_Ec/lor	dB	N/A					
OCNS		-0.941					
\hat{I}_{or}/I_{oc}	dB	- infinite y	-1.8	- infinite y	-1.8	- infinite y	-1.8
I_{oc}	dBm/3.84 MHz	-70					
CPICH_Ec/lo	dB	- infinite y	-14	- infinite y	-14	- infinite y	-14
Propagation Conditions		Case 5 (Note 3)					
Notes	TBD						

A.8.5.8.2 Test Requirements

The UE shall send Event B1 triggered measurement reports for cells 2, 3 and 4, with a measurement reporting delay less than 7.68s (cell 2) and 115,2s (cell 3 and 4) from the beginning of time period T2.

The UE shall not send event triggered measurement reports, as long as the reporting criteria are not fulfilled.

The rate of correct events observed during repeated tests shall be at least 90%.

NOTE: The actual overall delays measured in the test may be up to $2 \times TTI_{DCH}$ higher than the measurement reporting delays above because of TTI insertion uncertainty of the measurement report.

A.8.6 E-UTRAN TDD - UTRAN FDD Measurements

A.8.6.1 E-UTRAN TDD - UTRAN FDD event triggered reporting under fading propagation conditions

A.8.6.1.1 Test Purpose and Environment

The purpose of this test is to verify that the UE makes correct reporting of an event. This test will partly verify the E-UTRAN TDD- UTRAN FDD cell search requirements in clause 8.1.2.4.2.

The test parameters are given in Tables A.8.6.1.1-1, A.8.6.1.1-2 and A.8.6.1.1-3 below. In the measurement control information it is indicated to the UE that event-triggered reporting with Event B1 is used. The test consists of two successive time periods, with time duration of T1, and T2 respectively. During time duration T1, the UE shall not have any timing information of cell 2.

Table A.8.6.1.1-1: General test parameters for E-UTRAN TDD-UTRAN FDD event triggered reporting in fading propagation conditions

Parameter	Unit	Value	Comment
PDSCH parameters (E-UTRAN TDD)		DL Reference Measurement Channel R.0 TDD	As specified in clause A.3.1.1.2.
PCFICH/PDCCH/PHICH parameters (E-UTRAN TDD)		DL Reference Measurement Channel R.6 TDD	As specified in clause A.3.1.2.2.
Gap Pattern Id		1	As specified in TS 36.133 clause 8.1.2.1.
Active cell		Cell 1	Cell 1 is on E-UTRA RF channel number 1.
Neighbour cell		Cell 2	Cell 2 is on UTRA RF channel number 1.
Special subframe configuration		6	As specified in table 4.2-1 in TS 36.211. Applicable to cell 1.
Uplink-downlink configuration		1	As specified in table 4.2-2 in TS 36.211. Applicable to cell 1.
CP length		Normal	Applicable to cell 1.
E-UTRA RF Channel Number		1	One E-UTRA TDD carrier frequency is used.
E-UTRA Channel Bandwidth ($BW_{channel}$)	MHz	10	
UTRA RF Channel Number		1	One UTRA FDD carrier frequency is used.
Inter-RAT (UTRA FDD) measurement quantity		CPICH Ec/Io	
b1-Threshold-UTRA	dB	-18	CPICH Ec/Io threshold for event B1.
Hysteresis	dB	0	
Time To Trigger	ms	0	
Filter coefficient		0	L3 filtering is not used.
DRX		OFF	
Monitored UTRA cell list size		12	UTRA cells on UTRA RF channel 1 provided in the cell list.
T1	s	5	
T2	s	6	

Table A.8.6.1.1-2: Cell specific test parameters for E-UTRAN TDD (cell # 1) for event triggered reporting of UTRAN FDD cell under fading propagation conditions

Parameter	Unit	Cell 1	
		T1	T2
E-UTRA RF Channel Number		1	
$BW_{channel}$	MHz	10	
Correlation Matrix and Antenna Configuration		1x2 Low	
OCNG Pattern defined in A.3.2.2.1 (OP.1 TDD)		OP.1 TDD	
PBCH_RA	dB		
PBCH_RB	dB		
PSS_RA	dB		
SSS_RA	dB		
PCFICH_RB	dB		

PHICH_RA	dB	0	
PHICH_RB	dB		
PDCCH_RA	dB		
PDCCH_RB	dB		
PDSCH_RA	dB		
PDSCH_RB	dB		
OCNG_RA ^{Note 1}	dB		
OCNG_RB ^{Note 1}	dB		
\hat{E}_s/I_{ot}	dB	4	4
\hat{E}_s/N_{oc}	dB	4	4
N_{oc}	dBm/15 kHz	-98	
RSRP	dBm/15 kHz	-94	-94
SCH_RP	dBm/15 kHz	-94	-94
Propagation Condition		ETU70	
Note 1: OCNG shall be used such that both cells are fully allocated and a constant total transmitted power spectral density is achieved for all OFDM symbols.			
Note 2: The resources for uplink transmission are assigned to the UE prior to the start of time period T2.			

Table A.8.6.1.1-3: Cell specific test parameters for UTRAN FDD (cell # 2) for event triggered reporting of UTRAN FDD cell under fading propagation conditions

Parameter	Unit	Cell 2	
		T1	T2
UTRA RF Channel Number		1	
CPICH_Ec/I _{or}	dB	-10	
PCCPCH_Ec/I _{or}	dB	-12	
SCH_Ec/I _{or}	dB	-12	
PICH_Ec/I _{or}	dB	-15	
DPCH_Ec/I _{or}	dB	N/A	
OCNS		-0.941	
\hat{I}_{or}/I_{oc}	dB	-Infinity	-1.8
I_{oc}	dBm/3.84 MHz	-70	
CPICH_Ec/I _o	dB	-Infinity	-14
Propagation Condition		Case 5 (Note 3)	
Note 1: The DPCH level is controlled by the power control loop.			
Note 2: The power of the OCNS channel that is added shall make the total power from the cell to be equal to I _{or} .			
Note 3: Case 5 propagation conditions are defined in Annex A of TS 25.101.			

A.8.6.1.2 Test Requirements

The UE shall send one Event B1 triggered measurement report, with a measurement reporting delay less than 4800 ms from the beginning of time period T2.

The UE shall not send event triggered measurement reports, as long as the reporting criteria are not fulfilled.

The rate of correct events observed during repeated tests shall be at least 90%.

NOTE: The actual overall delays measured in the test may be up to 2xTTI_{DCCH} higher than the measurement reporting delays above because of TTI insertion uncertainty of the measurement report in DCCH.

A.8.6.2 E- UTRAN TDD - UTRAN FDD identification of a new CGI of UTRAN cell using autonomous gaps

A.8.6.2.1 Test Purpose and Environment

This test is to verify the requirement for identification of a new CGI of UTRA cell with autonomous gaps in clause 8.1.2.4.18.

The test parameters are given in Tables A.8.6.2.1-1, A.8.6.2.1-2 and A.8.6.2.1-3 below. The test consists of three successive time periods, with time durations of T1, T2 and T3 respectively. At the start of time duration T1, the UE does not have any timing information of cell 2. Starting T2, cell 2 becomes detectable and the UE is expected to detect and send a measurement report. Gap pattern configuration with id #0 as specified in Table 8.1.2.1-1 is configured before T2 begins to enable inter-frequency monitoring.

A RRC message implying SI reading shall be sent to the UE during period T2, after the UE has reported Event B1. The RRC message shall create a measurement report configuration with purpose *reportCGI* and *si-RequestForHO* set to TRUE. The start of T3 is the instant when the last TTI containing the RRC message implying SI reading is sent to the UE.

Table A.8.6.2.1-1: General test parameters for E-UTRAN TDD - UTRAN FDD identification of a new CGI of UTRAN cell using autonomous gaps

Parameter	Unit	Value	Comment
PDSCH parameters (E-UTRAN TDD)		DL Reference Measurement Channel R.0 TDD	As specified in clause A.3.1.1.2.
PCFICH/PDCCH/PHICH parameters (E-UTRAN TDD)		DL Reference Measurement Channel R.6 TDD	As specified in clause A.3.1.2.2.
Gap Pattern Id		0	As specified in TS 36.133 clause 8.1.2.1.
Active cell		Cell 1	Cell 1 is on E-UTRA RF channel number 1.
Neighbour cell		Cell 2	Cell 2 is on UTRA RF channel number 1.
Special subframe configuration		6	As specified in table 4.2-1 in TS 36.211. Applicable to cell 1.
Uplink-downlink configuration		1	As specified in table 4.2-2 in TS 36.211. Applicable to cell 1.
CP length		Normal	Applicable to cell 1.
E-UTRA RF Channel Number		1	One E-UTRA TDD carrier frequency is used.
E-UTRA Channel Bandwidth ($BW_{channel}$)	MHz	10	
UTRA RF Channel Number		1	One UTRA FDD carrier frequency is used.
Inter-RAT (UTRA FDD) measurement quantity		CPICH Ec/Io	
b1-Threshold-UTRA	dB	-18	CPICH Ec/Io threshold for event B1.
Hysteresis	dB	0	
Time To Trigger	ms	0	
Filter coefficient		0	L3 filtering is not used.
DRX		OFF	
SIB3_REP	Frames	32	Applicable for cell 2 SIB3 scheduling.
SIB3_SEG_COUNT		1	Applicable for cell 2 SIB3 scheduling.
si-RequestForHO		TRUE	As specified in clause 5.5.3.1 in TS 36.331.
Monitored UTRA FDD cell list size		12	UTRA cells on UTRA RF channel 1 provided in the cell list.
CSG id (of cell 2)		Set to any non-empty value	
T1	s	5	
T2	s	≤10	
T3	s	5	

Table A.8.6.2.1-2: Cell specific test parameters for cell #1 E-UTRAN TDD - UTRAN FDD identification of a new CGI of UTRAN cell using autonomous gaps

Parameter	Unit	Cell 1	
		T1	T2
E-UTRA RF Channel Number		1	
$BW_{channel}$	MHz	10	
OCNG Pattern defined in A.3.2.2.1 (OP.1 TDD)		OP.1 TDD	
PBCH_RA	dB	0	
PBCH_RB	dB		
PSS_RA	dB		
SSS_RA	dB		
PCFICH_RB	dB		
PHICH_RA	dB		
PHICH_RB	dB		
PDCCH_RA	dB		

PDCCH_RB	dB		
PDSCH_RA	dB		
PDSCH_RB	dB		
OCNG_RA ^{Note 1}	dB		
OCNG_RB ^{Note 1}	dB		
\hat{E}_s/I_{ot}	dB	4	4
N_{oc} ^{Note 3}	dBm/15 kHz	-98	
\hat{E}_s/N_{oc}	dB	4	4
RSRP ^{Note 4}	dBm/15 kHz	-94	-94
SCH_RP	dBm/15 kHz	-94	-94
Propagation Condition		AWGN	
<p>Note 1: OCNG shall be used such that both cells are fully allocated and a constant total transmitted power spectral density is achieved for all OFDM symbols.</p> <p>Note 2: The resources for uplink transmission are assigned to the UE prior to the start of time period T2.</p> <p>Note 3: Interference from other cells and noise sources not specified in the test is assumed to be constant over subcarriers and time and shall be modelled as AWGN of appropriate power for N_{oc} to be fulfilled.</p> <p>Note 4: RSRP levels have been derived from other parameters for information purposes. They are not settable parameters themselves.</p>			

Table A.8.6.2.1-3: Cell specific test parameters for cell #2 E-UTRAN TDD - UTRAN FDD identification of a new CGI of UTRAN cell using autonomous gaps

Parameter	Unit	Cell 2	
		T1	T2
UTRA RF Channel Number		1	
CPICH_Ec/I _{or}	dB	-10	
PCCPCH_Ec/I _{or}	dB	-12	
SCH_Ec/I _{or}	dB	-12	
PICH_Ec/I _{or}	dB	-15	
DPCH_Ec/I _{or}	dB	N/A	
OCNS		-0.941	
\hat{I}_{or}/I_{oc}	dB	-∞	0.02
I_{oc}	dBm/3.84 MHz	-70	
CPICH_Ec/I _o ^{Note 3}	dB	-∞	-13
Propagation Condition		AWGN	
<p>Note 1: The DPCH level is controlled by the power control loop.</p> <p>Note 2: The power of the OCNS channel that is added shall make the total power from the cell to be equal to I_{or}.</p> <p>Note 3: This gives an SCH Ec/I_o of -15dB</p>			

A.8.6.2.2 Test Requirements

The UE shall transmit a measurement report containing the cell global identifier of cell 2 within [1965] milliseconds from the start of T3.

Test requirement = RRC Procedure delay + T_{identify_CGI, UTRAN FDD} + reporting delay

= 50 + [630]+40*32 + 2ms from the start of T3

= [1962] ms, allow [1965] ms.

The rate of correct events observed during repeated tests shall be at least 90%.

A.8.6.3 E-UTRA TDD InterRAT UTRA FDD correct reporting of measurement events with reduced performance group configured, non DRX

A.8.6.3.1 Test Purpose and Environment

The purpose of this test is to verify that the UE makes correct reporting of an event. This test will partly verify the E-UTRA TDD-UTRA FDD inter-RAT cell search requirements in clause 8.1.2.4.2.

The test parameters are given in Tables A.8.6.3.1-1 and A.8.6.3.1-2. In this test, there are two cells on different carrier frequencies and gap pattern configuration # 0 as defined in Table 8.1.2.1-1 is provided.

In the measurement control information, it is indicated to the UE that event-triggered reporting with Event B1 is used. The test consists of two successive time periods, with time duration of T1, and T2 respectively. During time duration T1, the UE shall not have any timing information of cell 2, 3 or 4. At the start of each repetition of T1, the test equipment provides signals for cell 1 (serving cell), and cells 2, 3 and 4 which are selected from the 8 cells which are configured in the UE neighbour cell list. Cells 2, 3 and 4 are chosen randomly, such that one frequency belongs to the normal performance group and two frequencies belong to the reduced performance group.

Table A.8.6.3.1-1: General test parameters for E-UTRAN TDD-UTRAN FDD for correct reporting of measurement events with reduced performance group configured, non DRX

Parameter	Unit	Value	Comment
UE configured E-UTRA RF Channel Number		1	Serving cell and seven UTRA FDD carrier frequencies are used in the UE neighbour cell list. Frequencies 5,6 and 7 are indicated to have reduced performance
UE is configured UTRA RF channel numbers		2, 3, 4, 5, 6, 7,8	
Test equipment configuration		Cell 1 uses E-UTRA RF channel number 1 Cells 2,3,4 are randomly selected to use different frequencies selected from UTRA RF channel numbers 2,3,4,5,6,7,8	Cells 2, 3 and 4 are chosen randomly, such that one frequency belongs to the normal performance group and two frequencies belong to the reduced performance group
PDSCH parameters (E-UTRAN TDD)		DL Reference Measurement Channel R.0 TDD	As specified in clause A.3.1.1.2.
PCFICH/PDCCH/PHICH parameters (E-UTRAN TDD)		DL Reference Measurement Channel R.6 TDD	As specified in clause A.3.1.2.2
Correlation Matrix and Antenna Configuration		1x2 low	
Special subframe configuration		6	As specified in table 4.2-1 in TS 36.211. Applicable to cell 1
Uplink-downlink configuration		1	As specified in table 4.2-2 in TS 36.211. Applicable to cell 1
Active cell		Cell 1	Cell 1 is on RF channel number 1
Gap Pattern Id		0	As specified in TS 36.133 clause 8.1.2.1.
Inter-RAT (UTRA FDD) measurement quantity		CPICH Ec/Io	
b1-Threshold-UTRA	dB	-18	CPICH Ec/Io threshold for event B1
Hysteresis	dB	0	
CP length		Normal	
TimeToTrigger	s	0	
Filter coefficient		0	L3 filtering is not used
DRX		OFF	OFF
Scaling factor for reduced performance group		16	
T1	s	5	
T2	s	155	

Table A.8.6.3.1-2: Cell specific test parameters for E-UTRAN TDD (cell # 1) for correct reporting of measurement events with reduced performance group configured, non DRX

Parameter	Unit	Cell 1	
		T1	T2
E-UTRA RF Channel Number		1	
$BW_{channel}$	MHz	10	
Correlation Matrix and Antenna Configuration		1x2 Low	
OCNG Pattern defined in A.3.2.1.1 (OP.1 FDD)		OP.1 FDD	
PBCH_RA	dB	0	
PBCH_RB	dB		
PSS_RA	dB		
SSS_RA	dB		
PCFICH_RB	dB		
PHICH_RA	dB		
PHICH_RB	dB		
PDCCH_RA	dB		
PDCCH_RB	dB		
PDSCH_RA	dB		
PDSCH_RB	dB		
OCNG_RA ^{Note 1}	dB		
OCNG_RB ^{Note 1}	dB		
\hat{E}_s / I_{ot}	dB		
\hat{E}_s / N_{oc}	dB	4	4
N_{oc}	dBm/15 kHz	-98	
RSRP	dBm/15 kHz	-94	-94
SCH_RP	dBm/15 kHz	-94	-94
Propagation Condition		ETU70	
Note 1: OCNG shall be used such that both cells are fully allocated and a constant total transmitted power spectral density is achieved for all OFDM symbols.			
Note 2: The resources for uplink transmission are assigned to the UE prior to the start of time period T2.			

Table A.8.6.3.1-3: Cell specific test parameters for UTRAN FDD (cell # 2, 3 and 4) for correct reporting of measurement events with reduced performance group configured, non DRX

Parameter	Unit	Cell 2		Cell 3		Cell 4	
		T1	T2	T1	T2	T1	T2
UTRA RF Channel Number		Cells 2 is randomly selected to use different frequencies selected from UTRA RF channel numbers 2,3,4,5,6,7		Cells 3 is randomly selected to use different frequencies selected from UTRA RF channel numbers 2,3,4,5,6,7		Cells 4 is randomly selected to use different frequencies selected from UTRA RF channel numbers 2,3,4,5,6,7	
CPICH_Ec/lor	dB	-10					
PCCPCH_Ec/lor	dB	-12					
SCH_Ec/lor	dB	-12					
PICH_Ec/lor	dB	-15					
DPCH_Ec/lor	dB	N/A					
OCNS		-0.941					
\hat{I}_{or} / I_{oc}	dB	- infini y	-1.8	- infini y	-1.8	- infini y	-1.8
I_{oc}	dBm/3.84 MHz	-70					

CPICH_Ec/lo	dB	- infinite	-14	- infinite	-14	- infinite	-14
Propagation Conditions		Case 5 (Note 3)					
Notes TBD							

A.8.6.3.2 Test Requirements

The UE shall send Event B1 triggered measurement reports for cells 2, 3 and 4, with a measurement reporting delay less than 7.68s (cell 2) and 115,2s (cell 3 and 4) from the beginning of time period T2.

The UE shall not send event triggered measurement reports, as long as the reporting criteria are not fulfilled.

The rate of correct events observed during repeated tests shall be at least 90%.

NOTE: The actual overall delays measured in the test may be up to $2 \times TTI_{DCC}$ higher than the measurement reporting delays above because of TTI insertion uncertainty of the measurement report.

A.8.7 E-UTRAN TDD – UTRAN TDD Measurements

A.8.7.1 E-UTRAN TDD to UTRAN TDD cell search under fading propagation conditions

A.8.7.1.1 Test Purpose and Environment

A.8.7.1.1.1 Void

A.8.7.1.1.2 1.28 Mcps TDD option

The purpose of this test is to verify that the UE makes correct reporting of an event. This test will partly verify the E-UTRA TDD to UTRA TDD cell search requirements in clause 8.1.2.4.3 under fading propagation conditions.

This test scenario comprised of 1 E-UTRA TDD PCell, and 1 UTRA TDD cell to be searched. Test parameters are given in Table A.8.7.1.1.2-1, A.8.7.1.1.2-2, and A.8.7.1.1.2-3. Gap pattern configuration #0 as defined in table 8.1.2.1-1 is provided.

In the measurement control information, it is indicated to the UE that event-triggered reporting with Event B1 is used. The test consists of two successive time periods, with time duration of T1 and T2 respectively. During time duration T1, the UE shall not have any timing information of cell 2.

Table A.8.7.1.1.2-1: General test parameters for E-UTRA TDD to UTRA(1.28 Mcps TDD OPTION) cell search in fading propagation conditions

Parameter	Unit	Value	Comment
PDSCH parameters		DL Reference Measurement Channel R.0 TDD	As specified in clause A.3.1.1.2
PCFICH/PDCCH/PHICH parameters		DL Reference Measurement Channel R.6 TDD	As specified in clause A.3.1.2.2
Active cell		Cell 1	E-UTRA TDD cell
Neighbour cell		Cell 2	UTRA 1.28Mcps TDD Cell
Gap Pattern Id		0	As specified in TS 36.133 clause 8.1.2.1.
Uplink-downlink configuration of cell 1		1	As specified in table 4.2.2 in TS 36.211
Special subframe configuration of cell 1		6	As specified in table 4.2.1 in TS 36.211
CP length of cell 1		normal	
Hysteresis	dB	0	
TimeToTrigger	s	0	
Filter coefficient		0	L3 filtering is not used
DRX		OFF	
Time offset between cells		3 ms	Asynchronous cells
Ofn	dB	0	

Thresh	dBm	-87	
T1	s	5	
T2	s	10	

Table A.8.7.1.1.2-2: Cell specific test parameters for cell search E-UTRA TDD to UTRA TDD test case (cell 1)

Parameter	Unit	Cell 1	
		T1	T2
E-UTRA RF Channel Number		1	
BW _{channel}	MHz	10	
Correlation Matrix and Antenna Configuration		1x2 Low	
OCNG Pattern defined in A.3.2.2.1 (OP.1 TDD)		OP.1 TDD	
PBCH_RA	dB	0	0
PBCH_RB	dB		
PSS_RA	dB		
SSS_RA	dB		
PCFICH_RB	dB		
PHICH_RA	dB		
PHICH_RB	dB		
PDCCH_RA	dB		
PDCCH_RB	dB		
PDSCH_RA	dB		
PDSCH_RB	dB		
OCNG_RA ^{Note1}	dB		
OCNG_RB ^{Note1}	dB		
\hat{E}_s / I_{ot}	dB		
\hat{E}_s / N_{oc}	dB	9	9
N_{oc}	dBm/15kHz	-98	
RSRP	dBm/15kHz	-89	-89
SCH_RP	dBm/15kHz	-89	-89
Propagation Condition		ETU70	
Note 1: OCNG shall be used such that cell is fully allocated and a constant total transmitted power spectral density is achieved for all OFDM symbols. Note 2: The resources for uplink transmission are assigned to the UE prior to the start of time period T2.			

Table A.8.7.1.1.2-3: Cell specific test parameters for cell search E-UTRA TDD to UTRA TDD test case (cell 2)

Parameter	Unit	Cell 2 (UTRA)			
		0		DwPTS	
Timeslot Number		T1	T2	T1	T2
UTRA RF Channel Number ^{NOTE1}		Channel 2			
PCCPCH_Ec/Ior	dB	-3	-3		
DwPCH_Ec/Ior	dB			0	0
OCNS_Ec/Ior ^{NOTE2}	dB	-3	-3		
\hat{I}_{or} / I_{oc}	dB	-inf	5	-inf	5
I_{oc}	dBm/1.28 MHz	-80			
PCCPCH RSCP	dBm	-inf	-78	n.a.	n.a.
Propagation Condition		Case 3 ^{NOTE3}			

Note 1:	In the case of multi-frequency cell, the UTRA RF Channel Number is the primary frequency's channel number.
Note 2:	The power of the OCNS channel that is added shall make the total power from the cell to be equal to I_{or} .
Note 3:	Case 3 propagation conditions are defined in Annex B of TS 25.102

A.8.7.1.1.3 Void

A.8.7.1.2 Test Requirements

A.8.7.1.2.1 Void

A.8.7.1.2.2 1.28 Mcps TDD option

The UE shall send one Event B1 triggered measurement report, with a measurement reporting delay less than 6400 ms from the beginning of time period T2.

The UE shall not send event triggered measurement reports, as long as the reporting criteria are not fulfilled.

The rate of correct events observed during repeated tests shall be at least 90%.

NOTE: The actual overall delays measured in the test may be up to $2 \times TTI_{DCCCH}$ higher than the measurement reporting delays above because of TTI insertion uncertainty of the measurement report in DCCCH.

A.8.7.1.2.3 Void

A.8.7.2 E-UTRAN TDD-UTRAN TDD cell search when DRX is used under fading propagation conditions

A.8.7.2.1 Test Purpose and Environment

The purpose of these tests is to verify that the UE makes correct reporting of an event in DRX. These tests will partly verify the E-UTRAN TDD to UTRAN TDD inter-RAT cell search requirements when DRX is used in clause 8.1.2.4.3.2 under fading propagation conditions.

The common test parameters are given in Tables A.8.7.2.1-1, A.8.7.2.1-2 and A.8.7.2.1-3. DRX configuration for Test1 and Test2 are given in Table A.8.7.2.1-4 and time alignment timer and scheduling request related parameters in Table A.8.7.2.1-5. In these tests, there are two cells, 1 E-UTRAN TDD PCell and 1 UTRAN TDD cell to be searched, Gap pattern configuration # 0 as defined in table 8.1.2.1-1 is provided.

In Test 1 UE needs to be provided at least once every 500ms with new Timing Advance Command MAC control element to restart the Time alignment timer to keep UE uplink time alignment. Furthermore UE is allocated with PUSCH resource at every DRX cycle. In Test 2 the uplink time alignment is not maintained and UE needs to use RACH to obtain UL allocation for measurement reporting.

In the measurement control information, it is indicated to the UE that event-triggered reporting with Event B1 is used. The tests consist of two successive time periods, with time duration of T1, and T2 respectively. During time duration T1, the UE shall not have any timing information of cell 2.

Table A.8.7.2.1-1: General test parameters for E-UTRAN TDD to UTRAN 1.28Mcps TDD cell search when DRX is used in fading propagation conditions

Parameter	Unit	Test 1	Test 2	Comment
		Value		
PDSCH parameters		DL Reference Measurement Channel R.0 TDD		As specified in clause A.3.1.1.2. Note that UE may only be allocated at On Duration
PCFICH/PDCCH/PHICH parameters		DL Reference Measurement Channel R.6 TDD		As specified in clause A.3.1.2.2.
Active cell		Cell 1		E-UTRAN TDD cell
Neighbour cell		Cell 2		UTRAN 1.28Mcps TDD cell
Gap Pattern Id		0		As specified in TS 36.133 clause 8.1.2.1.
Uplink-downlink configuration		1		As specified in TS 36.211 clause 4.2 Table 4.2-2

Special subframe configuration		6	As specified in table 4.2-1 in TS 36.211. The same configuration in both cells
PRACH configuration		4	As specified in table 5.7.1-3 in TS 36.211
CP length of cell 1		Normal	
Ofn	dB	0	
Thresh	dBm	-83	Absolute P-CCPCH RSCP threshold for event B1
Hysteresis	dB	0	
TimeToTrigger	s	0	
Filter coefficient		0	L3 filtering is not used
Access Barring Information	-	Not Sent	No additional delays in random access procedure.
DRX		ON	DRX related parameters are defined in Table A.8.4.2.1-3
Time offset between cells		3 ms	Asynchronous cells
T1	s	5	
T2	s	8	30

Table A.8.7.2.1-2: Cell specific test parameters for E-UTRAN TDD to UTRAN 1.28Mcps TDD cell search when DRX is used in fading propagation conditions(cell 1)

Parameter	Unit	Cell 1	
		T1	T2
E-UTRA RF Channel Number		1	
BWchannel	MHz	10	
Correlation Matrix and Antenna Configuration		1x2 Low	
OCNG Patterns defined in A.3.2.2.1 (OP.1 TDD)		OP.1 TDD	
PBCH_RA	dB	0	0
PBCH_RB	dB		
PSS_RA	dB		
SSS_RA	dB		
PCFICH_RB	dB		
PHICH_RA	dB		
PHICH_RB	dB		
PDCCH_RA	dB		
PDCCH_RB	dB		
PDSCH_RA	dB		
PDSCH_RB	dB		
OCNG_RANote1	dB		
OCNG_RBNote1	dB		
\hat{E}_s / I_{ot}	dB		
\hat{E}_s / N_{oc}	dB	4	4
N_{oc} Note 2	dBm/15kHz	-98	
RSRP Note 3	dBm/15kHz	-94	-94
SCH_RP Note 3	dBm/15kHz	-94	-94
Propagation Condition		ETU70	
<p>Note 1: OCNG shall be used such that cell is fully allocated and a constant total transmitted power spectral density is achieved for all OFDM symbols.</p> <p>Note 2: Interference from other cells and noise sources not specified in the test is assumed to be constant over subcarriers and time and shall be modelled as AWGN of appropriate power for N_{oc} to be fulfilled.</p> <p>Note 3: RSRP and SCH_RP levels have been derived from other parameters for information purposes. They are not settable parameters themselves.</p>			

Table A.8.7.2.1-3: Cell specific test parameters for E-UTRAN TDD to UTRAN 1.28Mcps TDD cell search when DRX is used in fading propagation conditions(cell 2)

Parameter	Unit	Cell 2 (UTRA)			
		0		DwPTS	
Timeslot Number		T1	T2	T1	T2
UTRA RF Channel Number NOTE1		Channel 2			
PCCPCH_Ec/Ior	dB	-3	-3		
DwPCH_Ec/Ior	dB			0	0
OCNS_Ec/Ior ^{NOTE2}	dB	-3	-3		
\hat{I}_{or}/I_{oc}	dB	-inf	9	-inf	9
I_{oc}	dBm/1.28 MHz	-80			
PCCPCH RSCP	dBm	-inf	-74	n.a.	n.a.
Propagation Condition		Case 3 ^{NOTE3}			
Note 1:	In the case of multi-frequency cell, the UTRA RF Channel Number is the primary frequency's channel number.				
Note 2:	The power of the OCNS channel that is added shall make the total power from the cell to be equal to Ior.				
Note 3:	Case 3 propagation conditions are defined in Annex B of TS 25.102				

Table A.8.7.2.1-4: drx-Configuration to be used in E-UTRAN TDD to UTRAN 1.28Mcps TDD cell search when DRX is used in fading propagation conditions

Field	Test1	Test2	Comment
	Value	Value	
onDurationTimer	psf1	psf1	
drx-InactivityTimer	psf1	psf1	
drx-RetransmissionTimer	psf1	psf1	
longDRX-CycleStartOffset	sf40	sf1280	
shortDRX	disable	disable	

Table A.8.7.2.1-5: TimeAlignmentTimer and sr-ConfigIndex -Configuration to be used in E-UTRAN TDD to UTRAN 1.28Mcps TDD cell search when DRX is used in fading propagation conditions

Field	Test1	Test2	Comment
	Value	Value	
TimeAlignmentTimer	sf500	sf500	For further information see clause 6.3.2 in TS 36.331.
sr-ConfigIndex	2	2	For further information see clause 6.3.2 in TS 36.331 and 10.1 in TS 36.213.

A.8.7.2.2 Test Requirements

In Test1 the UE shall send one Event B1 triggered measurement report, with a measurement reporting delay less than 6400ms from the beginning of time period T2. The measurement reporting delay is defined as the time from the beginning of time period T2, to the moment when the UE send the measurement report on PUSCH.

In Test2 the UE shall send one Event B1 triggered measurement report, with a measurement reporting delay less than 25.6s from the beginning of time period T2. The measurement reporting delay is defined as the time from the beginning of time period T2, to the moment when the UE starts to send preambles on the PRACH for scheduling request (SR) to obtain allocation to send the measurement report on PUSCH.

The UE shall not send event triggered measurement reports, as long as the reporting criteria are not fulfilled.

The rate of correct events observed during repeated tests shall be at least 90%.

NOTE 1: The actual overall delays measured in the test may be up to one DRX cycle higher than the measurement reporting delays above because UE is allowed to delay the initiation of the measurement reporting procedure to the next until the Active Time.

NOTE 2: In order to calculate the rate of correct events the system simulator shall verify that it has received correct Event B1 measurement report

A.8.7.3 E-UTRAN TDD - UTRAN TDD SON ANR cell search reporting in AWGN propagation conditions

A.8.7.3.1 Test Purpose and Environment

The purpose of this test is to verify that the UE makes correct reporting of the strongest UTRAN TDD cell for SON automatic neighbour relations. This test will partly verify the E-UTRAN TDD - UTRAN TDD cell search requirements for identification of a new UTRA TDD cell for SON given in clause 8.1.2.4.13.

In the measurement control information it is indicated to the UE that periodical reporting with the purpose 'reportStrongestCellsForSON' is used. The test consists of two successive time periods, with time duration of T1, and T2 respectively. Prior to the start of time period T1, an interRATperiodic measurement reporting configuration with purpose reportStrongestCellsForSON is configured, and linked to a UTRA measurement object corresponding to channel UARFCN 1. During time duration T1, the UE shall not have any timing information of cell 2.

A.8.7.3.2 Test Parameters

The test parameters are given in Tables A.8.7.3.1-1, A.8.7.3.1-2 and A.8.7.3.1-3.

Table A.8.7.3.1-1: General test parameters for E-UTRAN TDD-UTRAN TDD cell search reporting for SON ANR in AWGN propagation conditions

Parameter	Unit	Value	Comment
PDSCH parameters (E-UTRAN TDD)		DL Reference Measurement Channel R.0 TDD	As specified in clause A.3.1.1.2
PCFICH/PDCCH/PHICH parameters (E-UTRAN TDD)		DL Reference Measurement Channel R.6 TDD	As specified in clause A.3.1.2.2
Gap Pattern Id		1	As specified in TS 36.133 clause 8.1.2.1.
Active cell		Cell 1	Cell 1 is on E-UTRA RF channel number 1.
Neighbour cell		Cell 2	Cell 2 is on UTRA RF channel number 1.
CP length		Normal	Applicable to cell 1
E-UTRA RF Channel Number		1	One E-UTRA TDD carrier frequency is used.
UTRA RF Channel Number		1	One UTRA TDD carrier frequency is used.
E-UTRA Channel Bandwidth (BW _{channel})	MHz	10	
Uplink-downlink configuration of cell 1		1	As specified in table 4.2.2 in TS 36.211
Special subframe configuration of cell 1		6	As specified in table 4.2.1 in TS 36.211
Inter-RAT (UTRA TDD) measurement quantity		P-CCPCH RSCP	
Filter coefficient		0	L3 filtering is not used.
DRX		OFF	
Monitored UTRA TDD cell list size		None	No explicit neighbour list is provided to the UE
T1	s	>5	During T1, cell 2 shall be powered off, and during the off time the primary scrambling code shall be changed, The intention is to ensure that cell 2 has not been detected by the UE prior to the start of period T2.
T2	s	14	

Table A.8.7.3.1-2: Cell specific test parameters for E-UTRAN TDD (cell # 1) for UTRAN TDD cell search for SON ANR under AWGN propagation conditions

Parameter	Unit	Cell 1	
		T1	T2
E-UTRA RF Channel Number		1	

BW _{channel}	MHz	10	
OCNG Patterns defined in A.3.2.2.1 (OP.1 TDD)		OP.1 TDD	
PBCH_RA	dB	0	
PBCH_RB	dB		
PSS_RA	dB		
SSS_RA	dB		
PCFICH_RB	dB		
PHICH_RA	dB		
PHICH_RB	dB		
PDCCH_RA	dB		
PDCCH_RB	dB		
PDSCH_RA	dB		
PDSCH_RB	dB		
OCNG_RA ^{Note 1}	dB		
OCNG_RB ^{Note 1}	dB		
\hat{E}_s / I_{ot}	dB	4	4
N_{oc} ^{Note 3}	dBm/15 kHz	-98	
\hat{E}_s / N_{oc}	dB	4	4
RSRP ^{Note 4}	dBm/15 kHz	-94	-94
SCH_RP	dBm/15 kHz	-94	-94
Propagation Condition		AWGN	
<p>Note 1: OCNG shall be used such that both cells are fully allocated and a constant total transmitted power spectral density is achieved for all OFDM symbols.</p> <p>Note 2: The resources for uplink transmission are assigned to the UE prior to the start of time period T2.</p> <p>Note 3: Interference from other cells and noise sources not specified in the test is assumed to be constant over subcarriers and time and shall be modelled as AWGN of appropriate power for N_{oc} to be fulfilled.</p> <p>Note 4: RSRP levels have been derived from other parameters for information purposes. They are not settable parameters themselves.</p>			

Table A.8.7.3.1-3: Cell specific test parameters for UTRAN TDD (cell # 2) for UTRAN TDD cell search for SON ANR under AWGN propagation conditions

Parameter	Unit	Cell 2			
		T1		T2	
UTRA RF Channel number ^{Note2}		Channel 2			
DL timeslot number		0	DwPTS	0	DwPTS
PCCPCH_Ec/lor	dB	-3		-3	
DwPCH_Ec/lor	dB		0		0
OCNS_Ec/lor	dB	-3		-3	
\hat{I}_{or}/I_{oc}	dB	-Infinity		5	
PCCPCH RSCP ^{Note1}	dBm	-Infinity	n.a.	-73	n.a.
I_o ^{Note1}	dBm/1.28MHz	-Infinity		-70.88	
I_{oc}	dBm/1.28MHz	-75			
Propagation condition		AWGN			
<p>Note 1: PCCPCH RSCP and I_o levels have been calculated from other parameters for information purposes. They are not settable parameters themselves.</p> <p>Note 2: In the case of multi-frequency network of 1.28 Mcps TDD, the UTRA RF Channel Number can be set for the primary frequency in this test.</p>					

A.8.7.3.3 Test Requirements

The UE shall send the first measurement report containing the physical cell identity of cell 2, with a measurement reporting delay less than 12800 ms from the beginning of time period T2.

The rate of correct measurement reports observed with this delay during repeated tests shall be at least 90%.

NOTE: The actual overall delays measured in the test may be up to $2 \times TTI_{DCCH}$ higher than the measurement reporting delays above because of TTI insertion uncertainty of the measurement report in DCCH.

A.8.7.4 E-UTRAN TDD - UTRAN TDD enhanced cell identification under AWGN propagation conditions

A.8.7.4.1 Test Purpose and Environment

The purpose of this test is to verify that the UE makes correct enhanced reporting of UTRAN TDD cells. This test will partly verify the Enhanced UTRA TDD cell identification requirements in clause 8.1.2.4.3.1.1a under AWGN propagation conditions.

The test parameters are given in Tables A.8.7.4.1-1, A.8.7.4.1-2 and A.8.7.4.1-3 below. In the measurement control information it is indicated to the UE that event-triggered reporting with Event B1 is used. The test consists of two successive time periods of T1 and T2 respectively. During time period T1, measurement gaps are activated and an inter-RAT measurement reporting configuration is configured with linkage to a UTRA measurement object corresponding to UARFCN channel number 1. Prior to time duration T2, the UE shall not have any timing information of cell 2. Cell 2 is powered up at the beginning of T2.

Table A.8.7.4.1-1: General test parameters for E-UTRAN TDD - UTRAN TDD enhanced cell identification under AWGN propagation conditions

Parameter	Unit	Value	Comment
PDSCH parameters (E-UTRAN TDD)		DL Reference Measurement Channel R.0 TDD	As specified in section A.3.1.1.2.
PCFICH/PDCCH/PHICH parameters (E-UTRAN TDD)		DL Reference Measurement Channel R.6 TDD	As specified in section A.3.1.2.2.
Gap Pattern Id		0	As specified in 3GPP TS 36.133 section 8.1.2.1.
Active cell		Cell 1	Cell 1 is on E-UTRA RF channel number 1.
Neighbour cell		Cell 2	Cell 2 is on UTRA RF channel number 1.
Time offset between cells	ms	3	Asynchronous cells
E-UTRA RF Channel Number		1	One E-UTRA TDD carrier frequency is used.
E-UTRA Channel Bandwidth (BW_{channel})	MHz	10	
CP length		Normal	Applicable to cell 1
Uplink-downlink configuration of cell 1		1	As specified in table 4.2.2 in TS 36.211
Special subframe configuration of cell 1		6	As specified in table 4.2.1 in TS 36.211
UTRA RF Channel Number		1	One UTRA TDD carrier frequency is used.
Inter-RAT (UTRA TDD) measurement quantity		P-CCPCH RSCP	
Thresh	dBm	-83	Absolute P-CCPCH RSCP threshold for event B1
Hysteresis	dB	0	
Time To Trigger	ms	0	
Filter coefficient		0	L3 filtering is not used.
DRX		OFF	
Monitored UTRA TDD cell list size		12	UTRA cells on UTRA RF channel 1 provided in the cell list
T1	s	5	
T2	s	2	

Table A.8.7.4.1-2: Cell specific test parameters for cell 1 in E-UTRAN TDD - UTRAN TDD enhanced cell identification test under AWGN propagation conditions

Parameter	Unit	Cell 1	
		T1	T2
E-UTRA RF Channel Number		1	
BW_{channel}	MHz	10	
OCNG Pattern defined in A.3.2.2.1 (OP.1 TDD)		OP.1 TDD	

PBCH_RA	dB	0			
PBCH_RB	dB				
PSS_RA	dB				
SSS_RA	dB				
PCFICH_RB	dB				
PHICH_RA	dB				
PHICH_RB	dB				
PDCCH_RA	dB				
PDCCH_RB	dB				
PDSCH_RA	dB				
PDSCH_RB	dB				
OCNG_RA ^{Note 1}	dB				
OCNG_RB ^{Note 1}	dB				
\hat{E}_s / I_{ot}	dB			4	4
N_{oc} ^{Note 3}	dBm/15 kHz			-98	
\hat{E}_s / N_{oc}	dB	4	4		
RSRP ^{Note 4}	dBm/15 kHz	-94	-94		
SCH_RP	dBm/15 kHz	-94	-94		
Propagation Condition		AWGN			
<p>Note 1: OCNG shall be used such that both cells are fully allocated and a constant total transmitted power spectral density is achieved for all OFDM symbols.</p> <p>Note 2: The resources for uplink transmission are assigned to the UE prior to the start of time period T2.</p> <p>Note 3: Interference from other cells and noise sources not specified in the test is assumed to be constant over subcarriers and time and shall be modelled as AWGN of appropriate power for N_{oc} to be fulfilled.</p> <p>Note 4: RSRP levels have been derived from other parameters for information purposes. They are not settable parameters themselves.</p>					

Table A.8.7.4.1-3: Cell specific test parameters for cell 2 in E-UTRAN TDD - UTRAN TDD enhanced cell identification test under AWGN propagation conditions

Parameter	Unit	Cell 2 (UTRA TDD)			
		0		DwPTS	
Timeslot Number		T1	T2	T1	T2
UTRA RF Channel Number ^{Note1}		Channel 1			
P-CCPCH_Ec/I _{or}	dB	-4.77	-4.77		
DwPCH_Ec/I _{or}	dB			0	0
OCNS_Ec/I _{or} ^{Note2}	dB	-1.76	-1.76		
\hat{I}_{or} / I_{oc}	dB	-inf	8	-inf	8
I_{oc}	dBm/1.28 MHz	-80			
P-CCPCH RSCP ^{Note3}	dBm	-inf	-76.77	n.a.	n.a.
P-CCPCH_Ec/I _o ^{Note3}	dB	-inf	-5.41	n.a.	n.a.
DwPCH_Ec/I _o ^{Note3}	dB	n.a.	n.a.	-inf	-0.64
Propagation Condition		AWGN			
<p>Note 1: In the case of multi-frequency cell, the UTRA RF Channel Number is the primary frequency's channel number.</p> <p>Note 2: The power of the OCNS channel that is added shall make the total power from the cell to be equal to I_{or}.</p> <p>Note 3: P-CCPCH RSRP, PCCPCH_Ec/I_o and DwPCH_Ec/I_o levels have been derived from other parameters for information purposes. They are not settable parameters themselves.</p>					

A.8.7.4.2 Test Requirements

The UE shall send the first measurement report containing the primary scrambling code of cell 2, with a measurement reporting delay less than 1120 ms from the beginning of time period T2.

The UE shall not send event triggered measurement reports, as long as the reporting criteria are not fulfilled.

The rate of correct measurement reports observed during repeated tests shall be at least 90%.

NOTE: The actual overall delays measured in the test may be up to $2 \times TTI_{DCCH}$ higher than the measurement reporting delays above because of TTI insertion uncertainty of the measurement report in DCCH

A.8.7.5 E-UTRA TDD InterRAT UTRA TDD correct reporting of measurement events with reduced performance group configured, non DRX

A.8.7.5.1 Test Purpose and Environment

The purpose of this test is to verify that the UE makes correct reporting of an event. This test will partly verify the E-UTRAN TDD- UTRAN TDD measurement requirements for increased UE carrier monitoring in clause 8.1.2.4.3.

The test parameters are given in Tables A.8.7.5.1-1, A.8.7.5.1-2 and A.8.7.5.1-3. In this test, there are 4 cells on different carrier frequencies and gap pattern configuration #0 as defined in table A.8.7.5.1-1 is provided.

In the measurement control information, it is indicated to the UE that event-triggered reporting with Events B1 is used. The test consists of two successive time periods for every repetition, with time duration of T1, and T2 respectively. During time duration T1, the UE shall not have any timing information of neighbour cells. At the start of each repetition of T1, the test equipment provides signals for cell 1 (serving cell), and cells 2, 3 and 4 which are selected from the 7 cells which are configured in the UE neighbour cell list. Cells 2, 3 and 4 are chosen randomly, such that one frequency belongs to the normal performance group and two frequencies belong to the reduced performance group.

Table A.8.7.5.1-1: General test parameters for E-UTRA TDD InterRAT UTRA TDD correct reporting of measurement events with reduced performance group configured, non DRX

Parameter	Unit	Value	Comment
UE configured E-UTRA RF Channel Number		1	Serving cell
UE is configured UTRA RF channel numbers		2, 3, 4, 5, 6, 7, 8	7 UTRA TDD carrier frequencies are used in the UE neighbour cell list. Frequencies 5,6, 7,and 8 are indicated to have reduced performance
Test equipment configuration		Cell 1 uses E-UTRA RF channel number 1 Cell 2,3,4 are randomly selected to use different frequencies selected from frequencies 2,3,4,5,6,7, 8	
Active cell		Cell 1	E-UTRA TDD cell
Gap Pattern Id		0	As specified in TS 36.133 clause 8.1.2.1.
CP length of cell 1		normal	
Inter-RAT measurement quantity		UTRA TDD PCCPCH RSCP	
B1 Threshold	dBm	-75	UTRA TDD PCCPCH RSCP threshold for event B1
Hysteresis	dB	0	
Ofn	dB	0	
TimeToTrigger	s	0	
Filter coefficient		0	L3 filtering is not used
DRX		OFF	
Scaling factor configurations		8	
T1	s	5	
T2	s	205	

Table A.8.7.5.1-2: Cell specific test parameters for E-UTRA TDD InterRAT UTRA TDD correct reporting of measurement events with reduced performance group configured, non DRX (cell #1)

Parameter	Unit	Cell 1	
		T1	T2
E-UTRA RF Channel Number		1	

$BW_{channel}$		5MHz: $N_{RB} = 25$ 10MHz: $N_{RB} = 50$	
Uplink-downlink configuration of cell 1 as specified in table 4.2.2 in TS 36.211		1	
Special subframe configuration of cell 1 as specified in table 4.2.1 in TS 36.211		6	
PDSCH parameters: DL Reference Measurement Channel as specified in clause A.3.1.1.2		5MHz: R.4 TDD 10MHz: R.0 TDD	
PCFICH/PDCCH/PHICH parameters: DL Reference Measurement Channel as specified in clause A.3.1.2.2		5MHz: R.11 TDD 10MHz:R.6 TDD	
OCNG Pattern defined in A.3.2.2.1 and A.3.2.2.9		5MHz: OP.9 TDD 10MHz:OP.1 TDD	
PBCH_RA	dB	0	
PBCH_RB	dB		
PSS_RA	dB		
SSS_RA	dB		
PCFICH_RB	dB		
PHICH_RA	dB		
PHICH_RB	dB		
PDCCH_RA	dB		
PDCCH_RB	dB		
PDSCH_RA	dB		
PDSCH_RB	dB		
OCNG_RA ^{Note 1}	dB		
OCNG_RB ^{Note 1}	dB		
N_{oc}	dBm/15 kHz		
\hat{E}_s / N_{oc}	dB	4	4
\hat{E}_s / I_{ot} ^{Note 3}	dB	4	4
RSRP ^{Note 3}	dBm/15 kHz	-94	-94
SCH_RP ^{Note 3}	dBm/15 kHz	-94	-94
I_o ^{Note 3}	dBm/Ch BW	-64.70 +10log ($N_{RB,c} / 50$)	-64.70 +10log ($N_{RB,c} / 50$)
Propagation Condition		ETU70	
Correlation Matrix and Antenna Configuration		1x2 Low	
<p>Note 1: OCNG shall be used such that both cells are fully allocated and a constant total transmitted power spectral density is achieved for all OFDM symbols.</p> <p>Note 2: The resources for uplink transmission are assigned to the UE prior to the start of time period T2.</p> <p>Note 3: E_s/I_{ot}, RSRP, SCH_RP and I_o have been derived from other parameters for information purposes. They are not settable parameters themselves.</p>			

Table A.8.7.5.1-3: Cell specific test parameters for E-UTRA TDD InterRAT UTRA TDD correct reporting of measurement events with reduced performance group configured, non DRX (cell #2, cell #3 and cell #4)

Parameter	Unit	Cell 2				Cell 3				Cell 4			
		T1		T2		T1		T2		T1		T2	
Timeslot Number		0	DwPTS	0	DwPTS	0	DwPTS	0	DwPTS	0	DwPTS	0	DwPTS
UTRA RF Channel Number (NOTE1)		Randomly selected from 2,3,4 such that cell 2 is in the normal performance group				Randomly selected from 5,6,7,8 such that cell 3 is in the reduced performance group				Randomly selected from 5,6,7,8 such that cell 4 is in the reduced performance group. Cell 4 RF channel is different from Cell 3 RF channel.			
PCCPCH_Ec/Ior	dB	-Infinity	-3			-Infinity	-3			-Infinity	-3		

DwPCH_Ec/I _{or}	dB	-Infinity		0	-Infinity		0	-Infinity		0
OCNS_Ec/I _{or}		-Infinity	-3		-Infinity	-3		-Infinity	-3	
\hat{I}_{or}/I_{oc}	dB	-Infinity	9		-Infinity	9		-Infinity	9	
I_{oc}	dBm/1.28 MHz	-70			-70			-70		
PCCPCH_RSCP Note 3	dB	-Infinity	-64		-Infinity	-64		-Infinity	-64	
I_o Note 3	dBm/1.28 MHz	-70.00	-	60.49	-70.00	-	60.49	-70.00	-	60.49
Propagation Condition		Case 3 (NOTE2)			Case 3 (NOTE2)			Case 3 (NOTE2)		
NOTE1: The DPCH of the cell is located in a timeslot other than 0.										
NOTE2: Case 3 propagation conditions are specified in TS25.102 Annex B										
NOTE3: PCCPCH_RSRP and I_o levels have been derived from other parameters for information purposes. They are not settable parameters themselves										

A.8.7.5.2 Test Requirements

The UE shall send Event B1 triggered measurement reports for cells 2, 3 and 4, with a measurement reporting delay less than 21.95s (cell 2) and 204.8s (cell 3 and 4) from the beginning of time period T2.

The UE shall not send event triggered measurement reports, as long as the reporting criteria are not fulfilled.

The rate of correct events observed during repeated tests shall be at least 90%.

NOTE: The actual overall delays measured in the test may be up to $2 \times TTI_{DCH}$ higher than the measurement reporting delays above because of TTI insertion uncertainty of the measurement report.

A.8.7A E-UTRAN FDD – UTRAN TDD Measurements

A.8.7A.1 E-UTRA FDD InterRAT UTRA TDD correct reporting of measurement events with reduced performance group configured, non DRX

A.8.7A.1.1 Test Purpose and Environment

The purpose of this test is to verify that the UE makes correct reporting of an event. This test will partly verify the E-UTRAN FDD- UTRAN TDD measurement requirements for increased UE carrier monitoring in clause 8.1.2.4.4.

The test parameters are given in Tables A.8.7A.1.1-1, A.8.7A.1.1-2 and A.8.7A.1.1-3. In this test, there are 4 cells on different carrier frequencies and gap pattern configuration #0 as defined in table A.8.7A.1.1-1 is provided.

In the measurement control information, it is indicated to the UE that event-triggered reporting with Events B1 is used. The test consists of two successive time periods for every repetition, with time duration of T1, and T2 respectively. During time duration T1, the UE shall not have any timing information of neighbour cells. At the start of each repetition of T1, the test equipment provides signals for cell 1 (serving cell), and cells 2, 3 and 4 which are selected from the 7 cells which are configured in the UE neighbour cell list. Cells 2, 3 and 4 are chosen randomly, such that one frequency belongs to the normal performance group and two frequencies belong to the reduced performance group.

Table A.8.7A.1.1-1: General test parameters for E-UTRA FDD InterRAT UTRA TDD correct reporting of measurement events with reduced performance group configured, non DRX

Parameter	Unit	Value	Comment
UE configured E-UTRA RF Channel Number		1	Serving cell
UE is configured UTRA RF channel numbers		2, 3, 4, 5, 6, 7, 8	7 UTRA TDD carrier frequencies are used in the UE neighbour cell list. Frequencies 5,6, 7,and 8 are indicated to have reduced performance
Test equipment configuration		Cell 1 uses E-UTRA RF channel number 1	

		Cell 2,3,4 are randomly selected to use different frequencies selected from frequencies 2,3,4,5,6,7, 8	
Active cell		Cell 1	E-UTRA FDD cell
Gap Pattern Id		0	As specified in TS 36.133 clause 8.1.2.1.
CP length of cell 1		normal	
Inter-RAT measurement quantity		UTRA TDD PCCPCH RSCP	
B1 Threshold	dBm	-75	UTRA TDD PCCPCH RSCP threshold for event B1
Hysteresis	dB	0	
TimeToTrigger	s	0	
Filter coefficient		0	L3 filtering is not used
DRX		OFF	
Scaling factor configurations		8	
T1	s	5	
T2	s	205	

Table A.8.7A.1.1-2: Cell specific test parameters for E-UTRA FDD InterRAT UTRA TDD correct reporting of measurement events with reduced performance group configured, non DRX (cell #1)

Parameter	Unit	Cell 1			
		T1	T2		
E-UTRA RF Channel Number		1			
BW _{channel}		5MHz: N _{RB} = 25 10MHz: N _{RB} = 50			
PDSCH parameters: DL Reference Measurement Channel as specified in clause A.3.1.1.1		5MHz: R.5 FDD 10MHz: R.0 FDD			
PCFICH/PDCCH/PHICH parameters: DL Reference Measurement Channel as specified in clause A.3.1.2.1		5MHz: R.11 FDD 10MHz:R.6 FDD			
OCNG Pattern defined in A.3.2.1.1 and A.3.2.1.15		5MHz: OP.15 FDD 10MHz:OP.1 FDD			
PBCH_RA	dB	0			
PBCH_RB	dB				
PSS_RA	dB				
SSS_RA	dB				
PCFICH_RB	dB				
PHICH_RA	dB				
PHICH_RB	dB				
PDCCH_RA	dB				
PDCCH_RB	dB				
PDSCH_RA	dB				
PDSCH_RB	dB				
OCNG_RA ^{Note 1}	dB				
OCNG_RB ^{Note 1}	dB				
N _{oc}	dBm/15 kHz			-98	
\hat{E}_s / N_{oc}	dB			4	4
\hat{E}_s / I_{ot} ^{Note 3}	dB	4	4		
RSRP ^{Note 3}	dBm/15 kHz	-94	-94		
SCH_RP ^{Note 3}	dBm/15 kHz	-94	-94		
I _o ^{Note 3}	dBm/Ch BW	-64.76 +10log (N _{RB,c} /50)	-64.76 +10log (N _{RB,c} /50)		
Propagation Condition		ETU70			
Correlation Matrix and Antenna Configuration		1x2 Low			

Note 1:	OCNG shall be used such that both cells are fully allocated and a constant total transmitted power spectral density is achieved for all OFDM symbols.
Note 2:	The resources for uplink transmission are assigned to the UE prior to the start of time period T2.
Note 3:	Es/Iot, RSRP, SCH_RP and Io have been derived from other parameters for information purposes. They are not settable parameters themselves.

Table A.8.7A.1.1-3: Cell specific test parameters for E-UTRA FDD InterRAT UTRA TDD correct reporting of measurement events with reduced performance group configured, non DRX (cell #2, cell #3 and cell #4)

Parameter	Unit	Cell 2				Cell 3				Cell 4			
		T1		T2		T1		T2		T1		T2	
Timeslot Number		0	DwPTS	0	DwPTS	0	DwPTS	0	DwPTS	0	DwPTS	0	DwPTS
UTRA RF Channel Number (NOTE1)		Randomly selected from 2,3,4 such that cell 2 is in the normal performance group				Randomly selected from 5,6,7,8 such that cell 3 is in the reduced performance group				Randomly selected from 5,6,7,8 such that cell 4 is in the reduced performance group. Cell 4 RF channel is different from Cell 3 RF channel.			
PCCPCH_Ec/Ior	dB	-Infinity	-3			-Infinity	-3			-Infinity	-3		
DwPCH_Ec/Ior	dB	-Infinity		0		-Infinity		0		-Infinity		0	
OCNS_Ec/Ior		-Infinity	-3			-Infinity	-3			-Infinity	-3		
\hat{I}_{or}/I_{oc}	dB	-Infinity	9			-Infinity	9			-Infinity	9		
I_{oc}	dBm/1.28 MHz	-70				-70				-70			
PCCPCH_RSCP Note 3	dB	-Infinity	-64			-Infinity	-64			-Infinity	-64		
I_o Note 3	dBm/1.28 MHz	-70.00	-	60.49		-70.00	-	60.49		-70.00	-	60.49	
Propagation Condition		Case 3 (NOTE2)				Case 3 (NOTE2)				Case 3 (NOTE2)			
NOTE1: The DPCH of the cell is located in a timeslot other than 0.													
NOTE2: Case 3 propagation conditions are specified in TS25.102 Annex B													
NOTE3: PCCPCH_RSRP and Io levels have been derived from other parameters for information purposes. They are not settable parameters themselves													

A.8.7A.1.2 Test Requirements

The UE shall send Event B1 triggered measurement reports for cells 2, 3 and 4, with a measurement reporting delay less than 21.95s (cell 2) and 204.8s (cell 3 and 4) from the beginning of time period T2.

The UE shall not send event triggered measurement reports, as long as the reporting criteria are not fulfilled.

The rate of correct events observed during repeated tests shall be at least 90%.

NOTE: The actual overall delays measured in the test may be up to $2xTTI_{DCH}$ higher than the measurement reporting delays above because of TTI insertion uncertainty of the measurement report.

A.8.8 E-UTRAN FDD – GSM Measurements

A.8.8.1 E-UTRAN FDD – GSM event triggered reporting in AWGN

A.8.8.1.1 Test Purpose and Environment

The purpose of this test is to verify that the UE makes correct reporting of an event when doing inter-RAT (GSM) measurements. This test will partly verify the E-UTRAN FDD - GSM cell search requirements in clause 8.1.2.4.5.

The test parameters are given in Tables A.8.8.1.1-1, A.8.8.1.1-2 and A.8.8.1.1-3 below. In the measurement control information it is indicated to the UE that event-triggered reporting with Event B1 is used. The test consists of two successive time periods, with time duration of T1, and T2 respectively. During time duration T1, the UE shall not have any timing information of cell 2.

Table A.8.8.1.1-1: General test parameters for E-UTRAN FDD-GSM event triggered reporting in AWGN

Parameter	Unit	Value	Comment
PDSCH parameters (E-UTRAN FDD)		DL Reference Measurement Channel R.0 FDD	As specified in clause A.3.1.1.1.
PCFICH/PDCCH/PHICH parameters (E-UTRAN FDD)		DL Reference Measurement Channel R.6 FDD	As specified in clause A.3.1.2.1.
Gap Pattern Id		0	As specified in TS 36.133 clause 8.1.2.1.
Active cell		Cell 1	Cell 1 is on E-UTRA RF channel number 1.
Neighbour cell		Cell 2	Cell 2 is on Absolute RF Channel Number 1 (GSM cell)
CP length		Normal	Applicable to cell 1
E-UTRA RF Channel Number		1	One E-UTRA FDD carrier frequency is used.
E-UTRA Channel Bandwidth (BW _{channel})	MHz	10	
Inter-RAT (GSM) measurement quantity		GSM Carrier RSSI	
b1-Threshold-GERAN	dBm	-80	GSM Carrier RSSI threshold for event B1.
Hysteresis	dB	0	
Time To Trigger	ms	0	
Filter coefficient		0	L3 filtering is not used.
DRX		OFF	
Monitored GSM cell list size		6 GSM neighbours including ARFCN 1	List of GSM cells provided before T2 starts.
T1	s	5	
T2	s	5	

Table A.8.8.1.1-2: Cell specific test parameters for E-UTRAN FDD (cell # 1) for event triggered reporting of GSM cell in AWGN

Parameter	Unit	Cell 1	
		T1	T2
E-UTRA RF Channel Number		1	
BW _{channel}	MHz	10	
OCNG Pattern defined in A.3.2.1.1 (OP.1 FDD)		OP.1 FDD	
PBCH_RA	dB	0	
PBCH_RB	dB		
PSS_RA	dB		
SSS_RA	dB		
PCFICH_RB	dB		
PHICH_RA	dB		
PHICH_RB	dB		
PDCCH_RA	dB		
PDCCH_RB	dB		
PDSCH_RA	dB		
PDSCH_RB	dB		
OCNG_RA ^{Note 1}	dB		
OCNG_RB ^{Note 1}	dB		
\hat{E}_s / I_{ot}	dB	4	4
\hat{E}_s / N_{oc}	dB	4	4
N_{oc}	dBm/15 kHz	-98	
RSRP	dBm/15 kHz	-94	-94
SCH_RP	dBm/15 kHz	-94	-94
Propagation Condition		AWGN	
Note 1: OCNG shall be used such that both cells are fully allocated and a constant total transmitted power spectral density is achieved for all OFDM symbols.			
Note 2: The resources for uplink transmission are assigned to the UE prior to the start of time period T2.			

Table A.8.8.1.1-3: Cell specific test parameters for GSM (cell # 2) for event triggered reporting of GSM cell in AWGN

Parameter	Unit	Cell 2	
		T1	T2
Absolute RF Channel Number		ARFNC 1	
RXLEV	dBm	-Infinity	-75
GSM BSIC		N/A	Valid

A.8.8.1.2 Test Requirements

The UE shall send one Event B1 triggered measurement report including BSIC of cell # 2, with a measurement reporting delay less than 3120 ms from the beginning of time period T2.

The UE shall not send event triggered measurement reports, as long as the reporting criteria are not fulfilled.

The rate of correct events observed during repeated tests shall be at least 90%.

NOTE 1: The actual overall delays measured in the test may be up to $2 \times T_{\text{TTI}_{\text{DCCH}}}$ higher than the measurement reporting delays above because of TTI insertion uncertainty of the measurement report in DCCCH.

NOTE 2: The delay for GSM cell identification with BSIC verified is equal to 3120 ms, which is the sum of the event triggered measurement reporting delay and the initial BSIC identification delay.

The event triggered measurement reporting delay = $2 \times T_{\text{Measurement Period, GSM}} = 2 \times 480\text{ms} = 960\text{ms}$.

Initial BSIC identification delay = 2160 ms.

A.8.8.2 E-UTRAN FDD-GSM event triggered reporting when DRX is used in AWGN

A.8.8.2.1 Test Purpose and Environment

The purpose of these tests is to verify that the UE makes correct reporting of an event in DRX. These tests will partly verify the E-UTRAN FDD-GSM cell search requirements when DRX is used in clause 8.1.2.4.5.2.

In these tests, there are two cells, one E-UTRAN cell and one GSM cell, and gap pattern configuration # 0 as defined in Table 8.1.2.1-1 is provided.

The common test parameters are given in Table A.8.8.2.1-1. Cell specific test parameters are given in Table A.8.8.2.1-2 for E-UTRAN and in Table A.8.8.2.1-5 for GSM. DRX configuration for Test1 and Test2 are given in Table A.8.8.2.1-3 and time alignment timer and scheduling request related parameters in Table A.8.8.2.1-4.

In Test 1 UE needs to be provided at least once every 500ms with new Timing Advance Command MAC control element to restart the Time alignment timer to keep UE uplink time alignment. Furthermore UE is allocated with PUSCH resource at every DRX cycle. In Test 2 the uplink time alignment is not maintained and UE needs to use RACH to obtain UL allocation for measurement reporting.

In the measurement control information, it is indicated to the UE that event-triggered reporting with Event B1 is used. The tests consist of two successive time periods, with time duration of T1, and T2 respectively. During time duration T1, the UE shall not have any timing information of cell 2.

Table A.8.8.2.1-1: General test parameters for E-UTRAN FDD-GSM event triggered reporting when DRX is used in AWGN

Parameter	Unit	Test 1	Test 2	Comment
		Value		
PDSCH parameters (E-UTRAN FDD)		DL Reference Measurement Channel R.0 FDD		As specified in clause A.3.1.1.1.
PCFICH/PDCCH/PHICH parameters (E-UTRAN FDD)		DL Reference Measurement Channel R.6 FDD		As specified in clause A.3.1.2.1.
Gap Pattern Id		0		As specified in TS 36.133 clause 8.1.2.1.
Active cell		Cell 1		Cell 1 is on E-UTRA RF channel number 1.

Neighbour cell		Cell 2	Cell 2 is on Absolute RF Channel Number 1 (GSM cell)
CP length		Normal	Applicable to cell 1
E-UTRA RF Channel Number		1	One E-UTRA FDD carrier frequency is used.
E-UTRA Channel Bandwidth ($BW_{channel}$)	MHz	10	
Inter-RAT (GSM) measurement quantity		GSM Carrier RSSI	
B1-Threshold-GERAN	dBm	-80	GSM Carrier RSSI threshold for event B1.
Hysteresis	dB	0	
TimeToTrigger	s	0	
Filter coefficient		0	L3 filtering is not used
PRACH configuration		4	As specified in table 5.7.1-2 in TS 36.211
Access Barring Information	-	Not Sent	No additional delays in random access procedure.
DRX		ON	DRX related parameters are defined in Table A.8.8.2.1-3
Monitored GSM cell list size		6 GSM neighbours including ARFCN 1	List of GSM cells provided before T2 starts.
T1	s	5	
T2	s	5	45

Table A.8.8.2.1-2: Cell specific test parameters for E-UTRAN FDD (cell #1) event triggered reporting of GSM cell when DRX is used in AWGN

Parameter	Unit	Cell 1	
		T1	T2
E-UTRA RF Channel Number		1	
$BW_{channel}$	MHz	10	
OCNG Pattern defined in A.3.2.1.1 (OP.1 FDD)		OP.1 FDD	
PBCH_RA	dB	0	
PBCH_RB	dB		
PSS_RA	dB		
SSS_RA	dB		
PCFICH_RB	dB		
PHICH_RA	dB		
PHICH_RB	dB		
PDCCH_RA	dB		
PDCCH_RB	dB		
PDSCH_RA	dB		
PDSCH_RB	dB		
OCNG_RA ^{Note 1}	dB		
OCNG_RB ^{Note 1}	dB		
\hat{E}_s / I_{ot}	dB		
N_{oc} ^{Note 2}	dBm/15 kHz	-98	
RSRP ^{Note 3}	dBm/15 kHz	-94	-94
SCH_RP	dBm/15 kHz	-94	-94
\hat{E}_s / N_{oc}	dB	4	4
Propagation Condition		AWGN	
<p>Note 1: OCNG shall be used such that both cells are fully allocated and a constant total transmitted power spectral density is achieved for all OFDM symbols.</p> <p>Note 2: Interference from other cells and noise sources not specified in the test is assumed to be constant over subcarriers and time and shall be modelled as AWGN of appropriate power for N_{oc} to be fulfilled.</p> <p>Note 3: RSRP and SCH_RP levels have been derived from other parameters for information purposes. They are not settable parameters themselves.</p>			

Table A.8.8.2.1-3: drx-Configuration to be used in E-UTRAN FDD-GSM event triggered reporting when DRX is used in AWGN

Field	Test1	Test2	Comment
	Value	Value	
onDurationTimer	psf1	psf1	
drx-InactivityTimer	psf1	psf1	
drx-RetransmissionTimer	psf1	psf1	
longDRX-CycleStartOffset	sf40	sf1280	
shortDRX	Disable	Disable	
Note: For further information see clause 6.3.2 in TS 36.331.			

Table A.8.8.2.1-4: TimeAlignmentTimer and sr-ConfigIndex -Configuration to be used in E-UTRAN FDD-GSM event triggered reporting when DRX is used in AWGN

Field	Test1	Test2	Comment
	Value	Value	
TimeAlignmentTimer	sf500	sf500	For further information see clause 6.3.2 in TS 36.331.
sr-ConfigIndex	0	0	For further information see clause 6.3.2 in TS 36.331 and clause 10.1 in TS 36.213.

Table A.8.8.2.1-5: Cell specific test parameters for GSM (cell # 2) for event triggered reporting of GSM cell when DRX is used in AWGN

Parameter	Unit	Cell 2	
		T1	T2
Absolute RF Channel Number		ARFNC 1	
RXLEV	dBm	-Infinity	-75
GSM BSIC		N/A	Valid

A.8.8.2.2 Test Requirements

In Test1 the UE shall send one Event B1 triggered measurement report including BSIC of cell # 2, with a measurement reporting delay less than 3120 ms from the beginning of time period T2. The measurement reporting delay is defined as the time from the beginning of time period T2, to the moment when the UE send the measurement report on PUSCH.

In Test2 the UE shall send one Event B1 triggered measurement report, with a measurement reporting delay less than 42.8 seconds from the beginning of time period T2. The measurement reporting delay is defined as the time from the beginning of time period T2, to the moment when the UE starts to send preambles on the PRACH for scheduling request (SR) to obtain allocation to send the measurement report on PUSCH.

The UE shall not send event triggered measurement reports, as long as the reporting criteria are not fulfilled.

The rate of correct events observed during repeated tests shall be at least 90%.

NOTE 1: The actual overall delays measured in the test may be up to one DRX cycle higher than the measurement reporting delays above because UE is allowed to delay the initiation of the measurement reporting procedure to the next until the Active Time.

NOTE 2: In order to calculate the rate of correct events the system simulator shall verify that it has received correct Event B1 measurement report

A.8.8.3 E-UTRAN FDD – GSM event triggered reporting in AWGN with enhanced BSIC identification

A.8.8.3.1 Test Purpose and Environment

The purpose of this test is to verify that the UE makes correct reporting of an event when doing inter-RAT (GSM) measurements with enhanced BSIC identification. This test will partly verify the E-UTRAN FDD - GSM cell search requirements in clause 8.1.2.4.5.1.2a

The test parameters are given in Tables A.8.8.3.1-1, A.8.8.1.1-2 and A.8.8.3.1-3 below. In the measurement control information it is indicated to the UE that event-triggered reporting with Event B1 is used. The test consists of two successive time periods, with time duration of T1, and T2 respectively. Prior time duration T1, the UE shall not have any timing information of cell 2. During time period T1, gaps are activated and an interRAT measurement reporting configuration is configured, and linked to a GSM measurement object including channel ARFCN 1. Cell 2 is powered up at the beginning of T2.

Table A.8.8.3.1-1: General test parameters for E-UTRAN FDD-GSM event triggered reporting in AWGN with enhanced BSIC identification

Parameter	Unit	Value	Comment
PDSCH parameters (E-UTRAN FDD)		DL Reference Measurement Channel R.0 FDD	As specified in clause A.3.1.1.1.
PCFICH/PDCCH/PHICH parameters (E-UTRAN FDD)		DL Reference Measurement Channel R.6 FDD	As specified in clause A.3.1.2.1.
Gap Pattern Id		0	As specified in TS 36.133 clause 8.1.2.1.
Active cell		Cell 1	Cell 1 is on E-UTRA RF channel number 1.
Neighbour cell		Cell 2	Cell 2 is on Absolute RF Channel Number 1 (GSM cell)
CP length		Normal	Applicable to cell 1
E-UTRA RF Channel Number		1	One E-UTRA FDD carrier frequency is used.
E-UTRA Channel Bandwidth (BW _{channel})	MHz	10	
Inter-RAT (GSM) measurement quantity		GSM Carrier RSSI	
b1-Threshold-GERAN	dBm	-80	GSM Carrier RSSI threshold for event B1.
Hysteresis	dB	0	
Time To Trigger	ms	0	
Filter coefficient		0	L3 filtering is not used.
DRX		OFF	
Monitored GSM cell list size		6 GSM neighbours including ARFCN 1	List of GSM cells provided before T2 starts.
T1	s	5	T1 ends at the end of the last TTI where the measurement configuration is given
T2	s	3	

Table A.8.8.3.1-2: Cell specific test parameters for E-UTRAN FDD (cell # 1) for event triggered reporting of GSM cell in AWGN with enhanced BSIC identification

Parameter	Unit	Cell 1	
		T1	T2
E-UTRA RF Channel Number		1	
BW _{channel}	MHz	10	
OCNG Pattern defined in A.3.2.1.1 (OP.1 FDD)		OP.1 FDD	
PBCH_RA	dB	0	
PBCH_RB	dB		
PSS_RA	dB		
SSS_RA	dB		
PCFICH_RB	dB		
PHICH_RA	dB		
PHICH_RB	dB		
PDCCH_RA	dB		
PDCCH_RB	dB		
PDSCH_RA	dB		
PDSCH_RB	dB		
OCNG_RA ^{Note 1}	dB		
OCNG_RB ^{Note 1}	dB		
\hat{E}_s / I_{ot}	dB		
\hat{E}_s / N_{oc}	dB	4	4
N_{oc}	dBm/15 kHz	-98	
RSRP	dBm/15 kHz	-94	-94

SCH_RP	dBm/15 kHz	-94	-94
Propagation Condition		AWGN	
Note 1:	OCNG shall be used such that both cells are fully allocated and a constant total transmitted power spectral density is achieved for all OFDM symbols.		
Note 2:	The resources for uplink transmission are assigned to the UE prior to the start of time period T2.		

Table A.8.8.3.1-3: Cell specific test parameters for GSM (cell # 2) for event triggered reporting of GSM cell in AWGN with enhanced BSIC identification

Parameter	Unit	Cell 2	
		T1	T2
Absolute RF Channel Number		ARFCN 1	
RXLEV	dBm	-∞	-75
GSM BSIC		N/A	Valid

A.8.8.3.2 Test Requirements

The UE shall send one Event B1 triggered measurement report including BSIC of cell # 2, with a measurement reporting delay less than 2280 ms from the beginning of time period T2.

The UE shall not send event triggered measurement reports, as long as the reporting criteria are not fulfilled.

The rate of correct events observed during repeated tests shall be at least 90%.

NOTE 1: The actual overall delays measured in the test may be up to $2 \times T_{TTI_{DCCCH}}$ higher than the measurement reporting delays above because of TTI insertion uncertainty of the measurement report in DCCH.

NOTE 2: The delay for GSM cell identification with BSIC verified is equal to 2280 ms, which is the sum of the event triggered measurement reporting delay and the enhanced initial BSIC identification delay.

The event triggered measurement reporting delay = $2 \times T_{\text{Measurement Period, GSM}} = 2 \times 480\text{ms} = 960\text{ms}$.

Initial BSIC identification delay = 1320 ms.

A.8.9 E-UTRAN FDD - UTRAN TDD measurements

A.8.9.1 E-UTRAN FDD - UTRAN TDD event triggered reporting in fading propagation conditions

A.8.9.1.1 Test Purpose and Environment

The purpose of this test is to verify that the UE makes correct reporting of an event. The test will partly verify the E-UTRAN FDD - UTRAN TDD cell search requirements in clause 8.1.2.4.4 in fading environment.

The test parameters are given in Table A.8.9.1.1-1, A.8.9.1.1-2 and A.8.9.1.1-3 below. In the measurement control information it is indicated to the UE that event-triggered reporting with Event B1 is used. The test consists of two successive time periods, with time duration of T1, and T2 respectively. During time duration T1, the UE shall not have any timing information of cell 2.

Table A.8.9.1.1-1: General test parameters for Event triggered reporting in fading propagation conditions

Parameter	Unit	Value	Comment
PDSCH parameters		DL Reference Measurement Channel R.0 FDD	As specified in clause A.3.1.1.1
PCFICH/PDCCH/PHICH parameters		DL Reference Measurement Channel R.6 FDD	As specified in clause A.3.1.2.1
Active cell		Cell 1	E-UTRA FDD Cell 1
Neighbour cell		Cell 2	UTRA TDD Cell 2 is to be identified.
Gap Pattern Id		1	As specified in TS 36.133 section 8.1.2.1. Measurement Gap Repetition Period = 80ms

Inter-RAT measurement quantity		UTRA TDD PCCPCH RSCP	
Threshold other system	dBm	-75	UTRA TDD PCCPCH RSCP threshold for event B1.
Hysteresis	dB	0	
CP length		Normal	
TimeToTrigger	s	0	
Filter coefficient		0	L3 filtering is not used
DRX			OFF
T1	s	5	
T2	s	15	

Table A.8.9.1.1-2: Cell specific test parameters for Event triggered reporting of UTRA TDD neighbours in fading propagation conditions (cell1)

Parameter	Unit	Cell 1	
		T1	T2
E-UTRA RF Channel Number		1	
$BW_{channel}$	MHz	10	
Correlation Matrix and Antenna Configuration		1x2 Low	
OCNG Patterns defined in A.3.2.1.1 (OP.1 FDD)		OP.1 FDD	
PBCH_RA	dB	0	
PBCH_RB	dB		
PSS_RA	dB		
SSS_RA	dB		
PCFICH_RB	dB		
PHICH_RA	dB		
PHICH_RB	dB		
PDCCH_RA	dB		
PDCCH_RB	dB		
PDSCH_RA	dB		
PDSCH_RB	dB		
OCNG_RA ^{Note 1}	dB		
OCNG_RB ^{Note 1}	dB		
N_{oc}	dBm/15KHz		
RSRP	dBm	-94	-94
\hat{E}_s/I_{ot}	dB	4	4
P-SCH_RP	dBm	-94	
S-SCH_RP	dBm	-94	
Propagation Condition		ETU70	
Note 1: OCNG shall be used such that cell 1 is fully allocated and a constant total transmitted power spectral density is achieved for all OFDM symbols. Note 2: The resources for uplink transmission are assigned to the UE prior to the start of time period T2.			

Table A.8.9.1.1-3: Cell specific test parameters for Event triggered reporting of UTRA TDD neighbours in fading propagation conditions (cell2)

Parameter	Unit	Cell 2			
		T1		T2	
Timeslot Number		0	DwPTS	0	DwPTS
UTRA RF Channel Number (NOTE1)		Channel1			
PCCPCH_Ec/I _{or}	dB	-Infinity		-3	
DwPCH_Ec/I _{or}	dB	-Infinity			0
OCNS_Ec/I _{or}		-Infinity		-3	
\hat{I}_{or}/I_{oc}	dB	-Infinity		9	

I_{oc}	dBm/1.28 MHz	-70		
PCCPCH_RSCP ^{Note 3}	dB	-Infinity	-64	
I_o ^{Note 3}	dBm/1.28 MHz	-70.00	-60.49	
Propagation Condition		Case 3 (NOTE2)		
NOTE1: The DPCH of the cell is located in a timeslot other than 0. NOTE2: Case 3 propagation conditions are specified in TS25.102 Annex B NOTE3: PCCPCH_RSRP and I_o levels have been derived from other parameters for information purposes. They are not settable parameters themselves				

A.8.9.1.2 Test Requirements

The UE shall send one Event B1 triggered measurement report, with a measurement reporting delay less than 12800 ms from the beginning of time period T2.

The UE shall not send event triggered measurement reports, as long as the reporting criteria are not fulfilled.

The rate of correct events observed during repeated tests shall be at least 90%.

NOTE: The actual overall delays measured in the test may be up to $2 \times TTI_{DCCH}$ higher than the measurement reporting delays above because of TTI insertion uncertainty of the measurement report in DCCH.

A.8.9.2 E-UTRAN FDD - UTRAN TDD enhanced cell identification under AWGN propagation conditions

A.8.9.2.1 Test Purpose and Environment

The purpose of this test is to verify that the UE makes correct enhanced reporting of UTRAN cells. This test will partly verify the enhanced UTRA TDD cell identification requirements in clause 8.1.2.4.4 under AWGN propagation conditions.

This test scenario comprised of 1 E-UTRA FDD serving cell, and 1 UTRA TDD cell to be searched. Test parameters are given in Table A.8.9.2.1-1, A.8.9.2.1-2, and A.8.9.2.1-3. In the measurement control information it is indicated to the UE that event-triggered reporting with Event B1 is used. The test consists of two successive time periods, with time duration of T1, and T2 respectively. During time period T1, gaps are activated and an interRAT measurement reporting configuration is configured, and linked to a UTRA measurement object corresponding to channel UARFCN 1. Prior to time duration T2, the UE shall not have any timing information of cell 2. Cell 2 is powered up at the beginning of the T2.

Table A.8.9.2.1-1: General test parameters for E-UTRAN FDD- UTRAN TDD enhanced cell search in AWGN propagation conditions

Parameter	Unit	Value	Comment
PDSCH parameters (E-UTRAN FDD)		DL Reference Measurement Channel R.0 FDD	As specified in clause A.3.1.1.1.
PCFICH/PDCCH/PHICH parameters (E-UTRAN FDD)		DL Reference Measurement Channel R.6 FDD	As specified in clause A.3.1.2.1.
Gap Pattern Id		0	As specified in TS 36.133 clause 8.1.2.1.
Active cell		Cell 1	Cell 1 is on E-UTRA RF channel number 1.
Neighbour cell		Cell 2	Cell 2 is on UTRA RF channel number 1.
CP length		Normal	Applicable to cell 1
E-UTRA RF Channel Number		1	One E-UTRA FDD carrier frequency is used.
E-UTRA Channel Bandwidth ($BW_{channel}$)	MHz	10	
UTRA RF Channel Number		1	One UTRA TDD carrier frequency is used.
Inter-RAT (UTRA TDD) measurement quantity		P-CCPCH RSCP	
Thresh	dBm	-83	Absolute P-CCPCH RSCP threshold for event B1
Hysteresis	dB	0	
Time To Trigger	ms	0	
Filter coefficient		0	L3 filtering is not used.
DRX		OFF	

Monitored UTRA TDD cell list size		12	UTRA cells on UTRA RF channel 1 provided in the cell list
Time offset between cells	ms	3	
T1	s	5	
T2	s	2	

Table A.8.9.2.1-2: Cell specific test parameters for cell #1 E-UTRAN FDD - UTRAN TDD enhanced cell identification under AWGN propagation conditions

Parameter	Unit	Cell 1	
		T1	T2
E-UTRA RF Channel Number		1	
BW _{channel}	MHz	10	
OCNG Patterns defined in A.3.2.1.1 (OP.1 FDD)		OP.1 FDD	
PBCH_RA	dB	0	
PBCH_RB	dB		
PSS_RA	dB		
SSS_RA	dB		
PCFICH_RB	dB		
PHICH_RA	dB		
PHICH_RB	dB		
PDCCH_RA	dB		
PDCCH_RB	dB		
PDSCH_RA	dB		
PDSCH_RB	dB		
OCNG_RA ^{Note 1}	dB		
OCNG_RB ^{Note 1}	dB		
\hat{E}_s / I_{ot}	dB		
N_{oc} ^{Note 3}	dBm/15 kHz	-98	
\hat{E}_s / N_{oc}	dB	4	4
RSRP ^{Note 4}	dBm/15 kHz	-94	-94
SCH_RP	dBm/15 kHz	-94	-94
Propagation Condition		AWGN	
<p>Note 1: OCNG shall be used such that both cells are fully allocated and a constant total transmitted power spectral density is achieved for all OFDM symbols.</p> <p>Note 2: The resources for uplink transmission are assigned to the UE prior to the start of time period T2.</p> <p>Note 3: Interference from other cells and noise sources not specified in the test is assumed to be constant over subcarriers and time and shall be modelled as AWGN of appropriate power for N_{oc} to be fulfilled.</p> <p>Note 4: RSRP levels have been derived from other parameters for information purposes. They are not settable parameters themselves.</p>			

Table A.8.9.2.1-3: Cell specific test parameters for cell #2 E-UTRAN FDD - UTRAN TDD enhanced cell identification under AWGN propagation conditions

Parameter	Unit	Cell 2 (UTRA TDD)			
		0		DwPTS	
Timeslot Number		T1	T2	T1	T2
UTRA RF Channel Number ^{Note1}		Channel 1			
P-CCPCH_Ec/Ior	dB	-4.77	-4.77		
DwPCH_Ec/Ior	dB			0	0
OCNS_Ec/Ior ^{Note2}	dB	-1.76	-1.76		
\hat{I}_{or} / I_{oc}	dB	-inf	8	-inf	8
I_{oc}	dBm/1.28 MHz	-80			
P-CCPCH RSCP ^{Note3}	dBm	-inf	-76.77	n.a.	n.a.
P-CCPCH_Ec/Io ^{Note3}	dB	-inf	-5.41	n.a.	n.a.
DwPCH_Ec/Io ^{Note3}	dB	n.a.	n.a.	-inf	-0.64

Propagation Condition		AWGN
Note 1:	In the case of multi-frequency cell, the UTRA RF Channel Number is the primary frequency's channel number.	
Note 2:	The power of the OCNS channel that is added shall make the total power from the cell to be equal to I_{or} .	
Note 3:	P-CCPCH RSRP, PCCPCH_Ec/I _o and DwPCH_Ec/I _o levels have been derived from other parameters for information purposes. They are not settable parameters themselves.	

A.8.9.2.2 Test Requirements

The UE shall send one Event B1 triggered measurement report, with a measurement reporting delay less than 1120 ms from the beginning of time period T2.

The UE shall not send event triggered measurement reports, as long as the reporting criteria are not fulfilled.

The rate of correct events observed during repeated tests shall be at least 90%.

NOTE: The actual overall delays measured in the test may be up to $2 \times TTI_{DCCCH}$ higher than the measurement reporting delays above because of TTI insertion uncertainty of the measurement report in DCCCH.

A.8.10 E-UTRAN TDD – GSM Measurements

A.8.10.1 E-UTRAN TDD – GSM event triggered reporting in AWGN

A.8.10.1.1 Test Purpose and Environment

The purpose of this test is to verify that the UE makes correct reporting of an event when doing inter-RAT (GSM) measurements. This test will partly verify the E-UTRAN TDD - GSM cell search requirements in clause 8.1.2.4.6.

The test parameters are given in Tables A.8.10.1.1-1, A.8.8.1.1-2 and A.8.10.1.1-3 below. In the measurement control information it is indicated to the UE that event-triggered reporting with Event B1 is used. The test consists of two successive time periods, with time duration of T1, and T2 respectively. During time duration T1, the UE shall not have any timing information of cell 2.

Table A.8.10.1.1-1: General test parameters for E-UTRAN TDD-GSM event triggered reporting in AWGN

Parameter	Unit	Value	Comment
PDSCH parameters (E-UTRAN TDD)		DL Reference Measurement Channel R.0 TDD	As specified in clause A.3.1.1.2.
PCFICH/PDCCH/PHICH parameters (E-UTRAN TDD)		DL Reference Measurement Channel R.6 TDD	As specified in clause A.3.1.2.2.
Gap Pattern Id		0	As specified in TS 36.133 clause 8.1.2.1.
Active cell		Cell 1	Cell 1 is on E-UTRA RF channel number 1.
Neighbour cell		Cell 2	Cell 2 is on Absolute RF Channel Number 1 (GSM cell)
Special subframe configuration		6	As specified in table 4.2-1 in TS 36.211
Uplink-downlink configuration		1	As specified in table 4.2-2 in TS 36.211
CP length		Normal	Applicable to cell 1
E-UTRA RF Channel Number		1	One E-UTRA TDD carrier frequency is used.
E-UTRA Channel Bandwidth (BW _{channel})	MHz	10	
Inter-RAT (GSM) measurement quantity		GSM Carrier RSSI	
b1-Threshold-GERAN	dBm	-80	GSM Carrier RSSI threshold for event B1.
Hysteresis	dB	0	
Time To Trigger	ms	0	
Filter coefficient		0	L3 filtering is not used.
DRX		OFF	
Monitored GSM cell list size		6 GSM neighbours including ARFCN 1	List of GSM cells provided before T2 starts.
T1	s	5	
T2	s	5	

Table A.8.10.1.1-2: Cell specific test parameters for E-UTRAN TDD (cell # 1) for event triggered reporting of GSM cell in AWGN

Parameter	Unit	Cell 1	
		T1	T2
E-UTRA RF Channel Number		1	
BW _{channel}	MHz	10	
OCNG Pattern defined in A.3.2.2.1 (OP.1 TDD)		OP.1 TDD	
PBCH_RA	dB	0	
PBCH_RB	dB		
PSS_RA	dB		
SSS_RA	dB		
PCFICH_RB	dB		
PHICH_RA	dB		
PHICH_RB	dB		
PDCCH_RA	dB		
PDCCH_RB	dB		
PDSCH_RA	dB		
PDSCH_RB	dB		
OCNG_RA ^{Note 1}	dB		
OCNG_RB ^{Note 1}	dB		
\hat{E}_s / I_{ot}	dB	4	4
N_{oc} ^{Note 3}	dBm/15 kHz	-98	
\hat{E}_s / N_{oc}	dB	4	4
RSRP ^{Note 4}	dBm/15 kHz	-94	-94
SCH_RP	dBm/15 kHz	-94	-94
Propagation Condition		AWGN	
Note 1:	OCNG shall be used such that both cells are fully allocated and a constant total transmitted power spectral density is achieved for all OFDM symbols.		
Note 2:	The resources for uplink transmission are assigned to the UE prior to the start of time period T2.		
Note 3:	Interference from other cells and noise sources not specified in the test is assumed to be constant over subcarriers and time and shall be modelled as AWGN of appropriate power for N_{oc} to be fulfilled.		
Note 4:	RSRP levels have been derived from other parameters for information purposes. They are not settable parameters themselves.		

Table A.8.10.1.1-3: Cell specific test parameters for GSM (cell # 2) for event triggered reporting of GSM cell in AWGN

Parameter	Unit	Cell 2	
		T1	T2
Absolute RF Channel Number		ARFNC 1	
RXLEV	dBm	-Infinity	-75
GSM BSIC		N/A	Valid
Propagation Condition		AWGN	

A.8.10.1.2 Test Requirements

The UE shall send one Event B1 triggered measurement report including the valid BSIC of cell # 2, with a measurement reporting delay less than 3120 ms from the beginning of time period T2.

The UE shall not send event triggered measurement reports, as long as the reporting criteria are not fulfilled.

The rate of correct events observed during repeated tests shall be at least 90%.

NOTE 1: The actual overall delays measured in the test may be up to $2 \times TTI_{DCCH}$ higher than the measurement reporting delays above because of TTI insertion uncertainty of the measurement report in DCCH.

NOTE 2: The delay for GSM cell identification with BSIC verified is equal to 3120 ms, which is the sum of the event triggered measurement reporting delay and the initial BSIC identification delay.

The event triggered measurement reporting delay = $2 * T_{\text{Measurement Period, GSM}} = 2 * 480\text{ms} = 960\text{ms}$.

Initial BSIC identification delay = 2160 ms.

A.8.10.2 E-UTRAN TDD-GSM event triggered reporting when DRX is used in AWGN

A.8.10.2.1 Test Purpose and Environment

The purpose of these tests is to verify that the UE makes correct reporting of an event in DRX. These tests will partly verify the E-UTRAN TDD-GSM cell search requirements when DRX is used in clause 8.1.2.4.6.

In these tests, there are two cells, one E-UTRAN cell and one GSM cell, and gap pattern configuration # 0 as defined in Table 8.1.2.1-1 is provided.

The common test parameters are given in Table A.8.10.2.1-1. Cell specific test parameters are given in Table A.8.10.2.1-2 for E-UTRAN and in Table A.8.10.2.1-5 for GSM. DRX configuration for Test1 and Test2 are given in Table A.8.10.2.1-3 and time alignment timer and scheduling request related parameters in Table A.8.10.2.1-4.

In Test 1 UE needs to be provided at least once every 500ms with new Timing Advance Command MAC control element to restart the Time alignment timer to keep UE uplink time alignment. Furthermore UE is allocated with PUSCH resource at every DRX cycle. In Test 2 the uplink time alignment is not maintained and UE needs to use RACH to obtain UL allocation for measurement reporting.

In the measurement control information, it is indicated to the UE that event-triggered reporting with Event B1 is used. The tests consist of two successive time periods, with time duration of T1, and T2 respectively. During time duration T1, the UE shall not have any timing information of cell 2.

Table A.8.10.2.1-1: General test parameters for E-UTRAN TDD-GSM event triggered reporting when DRX is used in AWGN

Parameter	Unit	Test 1	Test 2	Comment
		Value		
PDSCH parameters (E-UTRAN TDD)		DL Reference Measurement Channel R.0 TDD		As specified in clause A.3.1.1.2. Note that UE may only be allocated at <i>On Duration</i>
PCFICH/PDCCH/PHICH parameters (E-UTRAN TDD)		DL Reference Measurement Channel R.6 TDD		As specified in clause A.3.1.2.2.
Gap Pattern Id		0		As specified in TS 36.133 clause 8.1.2.1.
Active cell		Cell 1		Cell 1 is on E-UTRA RF channel number 1.
Neighbour cell		Cell 2		Cell 2 is on Absolute RF Channel Number 1 (GSM cell)
Special subframe configuration		6		As specified in table 4.2-1 in TS 36.211.
Uplink-downlink configuration		1		As specified in TS 36.211 clause 4.2 Table 4.2-2
CP length		Normal		Applicable to cell 1
E-UTRA RF Channel Number		1		One E-UTRA TDD carrier frequency is used.
E-UTRA Channel Bandwidth (BW_{channel})	MHz	10		
Inter-RAT (GSM) measurement quantity		GSM Carrier RSSI		
B1-Threshold-GERAN	dBm	-80		GSM Carrier RSSI threshold for event B1.
Hysteresis	dB	0		
TimeToTrigger	s	0		
Filter coefficient		0		L3 filtering is not used
PRACH configuration		4		As specified in table 5.7.1-2 in TS 36.211
Access Barring Information	-	Not Sent		No additional delays in random access procedure.
DRX		ON		DRX related parameters are defined in Table A.8.10.2.1-3
Monitored GSM cell list size		6 GSM neighbours including ARFCN 1		List of GSM cells provided before T2 starts.
T1	s	5		

T2	s	5	45	
----	---	---	----	--

Table A.8.10.2.1-2: Cell specific test parameters for E-UTRAN TDD (cell #1) event triggered reporting of GSM cell when DRX is used in AWGN

Parameter	Unit	Cell 1	
		T1	T2
E-UTRA RF Channel Number		1	
BW _{channel}	MHz	10	
OCNG Patterns defined in A.3.2.2.1 (OP.1 TDD)		OP.1 TDD	
PBCH_RA	dB	0	
PBCH_RB	dB		
PSS_RA	dB		
SSS_RA	dB		
PCFICH_RB	dB		
PHICH_RA	dB		
PHICH_RB	dB		
PDCCH_RA	dB		
PDCCH_RB	dB		
PDSCH_RA	dB		
PDSCH_RB	dB		
OCNG_RA ^{Note 1}	dB		
OCNG_RB ^{Note 1}	dB		
\hat{E}_s / I_{ot}	dB	4	4
N_{oc} ^{Note 2}	dBm/15 kHz	-98	
RSRP ^{Note 3}	dBm/15 kHz	-94	-94
SCH_RP	dBm/15 kHz	-94	-94
\hat{E}_s / N_{oc}	dB	4	4
Propagation Condition		AWGN	
Note 1: OCNG shall be used such that both cells are fully allocated and a constant total transmitted power spectral density is achieved for all OFDM symbols. Note 2: Interference from other cells and noise sources not specified in the test is assumed to be constant over subcarriers and time and shall be modelled as AWGN of appropriate power for N_{oc} to be fulfilled. Note 3: RSRP and SCH_RP levels have been derived from other parameters for information purposes. They are not settable parameters themselves.			

Table A.8.10.2.1-3: drx-Configuration to be used in E-UTRAN TDD-GSM event triggered reporting when DRX is used in AWGN

Field	Test1	Test2	Comment
	Value	Value	
onDurationTimer	psf1	psf1	
drx-InactivityTimer	psf1	psf1	
drx-RetransmissionTimer	psf1	psf1	
longDRX-CycleStartOffset	sf40	sf1280	
shortDRX	Disable	Disable	
Note: For further information see clause 6.3.2 in TS 36.331.			

Table A.8.10.2.1-4: TimeAlignmentTimer and sr-ConfigIndex -Configuration to be used in E-UTRAN TDD-GSM event triggered reporting when DRX is used in AWGN

Field	Test1	Test2	Comment
	Value	Value	
TimeAlignmentTimer	sf500	sf500	For further information see clause 6.3.2 in TS 36.331.
sr-ConfigIndex	2	2	For further information see clause 6.3.2 in TS 36.331 and clause 10.1 in TS 36.213.

Table A.8.10.2.1-5: Cell specific test parameters for GSM (cell # 2) for event triggered reporting of GSM cell when DRX is used in AWGN

Parameter	Unit	Cell 2	
		T1	T2
Absolute RF Channel Number		ARFNC 1	
RXLEV	dBm	-Infinity	-75
GSM BSIC		N/A	Valid

A.8.10.2.2 Test Requirements

In Test1 the UE shall send one Event B1 triggered measurement report including BSIC of cell # 2, with a measurement reporting delay less than 3120 ms from the beginning of time period T2. The measurement reporting delay is defined as the time from the beginning of time period T2, to the moment when the UE send the measurement report on PUSCH.

In Test2 the UE shall send one Event B1 triggered measurement report, with a measurement reporting delay less than 42.8 seconds from the beginning of time period T2. The measurement reporting delay is defined as the time from the beginning of time period T2, to the moment when the UE starts to send preambles on the PRACH for scheduling request (SR) to obtain allocation to send the measurement report on PUSCH.

The UE shall not send event triggered measurement reports, as long as the reporting criteria are not fulfilled.

The rate of correct events observed during repeated tests shall be at least 90%.

NOTE 1: The actual overall delays measured in the test may be up to one DRX cycle higher than the measurement reporting delays above because UE is allowed to delay the initiation of the measurement reporting procedure to the next until the Active Time.

NOTE 2: In order to calculate the rate of correct events the system simulator shall verify that it has received correct Event B1 measurement report

A.8.11 Monitoring of Multiple Layers

A.8.11.1 Multiple E-UTRAN FDD-FDD Inter-frequency event triggered reporting under fading propagation conditions

A.8.11.1.1 Test Purpose and Environment

The purpose of this test is to verify that the UE makes correct reporting of multiple events. This test will partly verify the FDD-FDD inter-frequency cell search requirements in clause 8.1.2.3.

The test parameters are given in Tables A.8.11.1.1.1-1 and A.8.11.1.1.1-2. In this test, there are three cells on different carrier frequencies and gap pattern configuration # 0 as defined in Table 8.1.2.1-1 is provided.

In the measurement control information, it is indicated to the UE that event-triggered reporting with Event A3 is used. The test consists of two successive time periods, with time duration of T1, and T2 respectively. During time duration T1, the UE shall not have any timing information of cell 2 or cell 3.

Table A. 8.11.1.1-1: General test parameters for Inter-frequency E-UTRA FDD – E-UTRA FDD and E-UTRA FDD cell search under fading

Parameter	Unit	Value	Comment
PDSCH parameters		DL Reference Measurement Channel R.0 FDD	As specified in clause A.3.1.1.1
PCFICH/PDCCH/PHICH parameters		DL Reference Measurement Channel R.6 FDD	As specified in clause A.3.1.2.1
E-UTRA RF Channel Number		1, 2, 3	Three FDD carrier frequencies are used.
Channel Bandwidth (BW _{channel})	MHz	10	
Active cell		Cell 1	Cell 1 is on RF channel number 1

Neighbour cell		Cell 2 and cell 3	Cell 2 is on RF channel number 2 and cell 3 is on RF channel number 3
Gap Pattern Id		0	As specified in TS 36.133 clause 8.1.2.1.
A3-Offset	dB	-6	
Hysteresis	dB	0	
CP length		Normal	
TimeToTrigger	s	0	
Filter coefficient		0	L3 filtering is not used
DRX		OFF	OFF
Time offset between E-UTRAN FDD cells		3 ms	Asynchronous cells
T1	s	5	
T2	s	10	

Table A.8.11.1.1-2: Cell specific test parameters for Inter-frequency E-UTRA FDD – E-UTRA FDD and E-UTRA FDD cell search under fading

Parameter	Unit	Cell 1		Cell 2		Cell 3	
		T1	T2	T1	T2	T1	T2
E-UTRA RF Channel Number		1		2		3	
BW _{channel}	MHz	10		10		10	
Correlation Matrix and Antenna Configuration		1x2		1x2 Low		1x2 Low	
OCNG Patterns defined in A.3.2.1.1 (OP.1 FDD) and in A.3.2.1.2 (OP.2 FDD)		OP.1 FDD		OP.2 FDD		OP.2 FDD	
PBCH_RA	dB	0		0		0	
PBCH_RB	dB						
PSS_RA	dB						
SSS_RA	dB						
PCFICH_RB	dB						
PHICH_RA	dB						
PHICH_RB	dB						
PDCCH_RA	dB						
PDCCH_RB	dB						
PDSCH_RA	dB						
PDSCH_RB	dB						
OCNG_RA ^{Note 1}	dB						
OCNG_RB ^{Note 1}	dB						
N_{oc} ^{Note 3}	dBm/15 kHz						
RSRP ^{Note 4}	dBm/15 kHz	-98	-98	-Infinity	-95	-Infinity	-95
\hat{E}_s/I_{ot}	dB	0	0	-Infinity	3	-Infinity	3
SCH_RP ^{Note 4}	dBm/15 kHz	-98	-98	-Infinity	-95	-Infinity	-95
\hat{E}_s/N_{oc}	dB	0	0	-Infinity	3	-Infinity	3
Propagation Condition		AWGN		ETU70		ETU70	
<p>Note 1: OCNG shall be used such that both cells are fully allocated and a constant total transmitted power spectral density is achieved for all OFDM symbols.</p> <p>Note 2: The resources for uplink transmission are assigned to the UE prior to the start of time period T2.</p> <p>Note 3: Interference from other cells and noise sources not specified in the test is assumed to be constant over subcarriers and time and shall be modelled as AWGN of appropriate power for N_{oc} to be fulfilled.</p> <p>Note 4: RSRP and SCH_RP levels have been derived from other parameters for information purposes. They are not settable parameters themselves.</p>							

A.8.11.1.2 Test Requirements

The UE shall send Event A3 triggered measurement reports for both cell 2 and cell 3, with a measurement reporting delay less than 7680 ms from the beginning of time period T2.

The UE shall not send event triggered measurement reports, as long as the reporting criteria are not fulfilled.

The rate of correct events observed during repeated tests shall be at least 90%.

NOTE: The actual overall delays measured in the test may be up to $2 \times TTI_{DCCCH}$ higher than the measurement reporting delays above because of TTI insertion uncertainty of the measurement report in DCCCH.

A.8.11.2 E-UTRAN TDD – E-UTRAN TDD and E-UTRAN TDD Inter-frequency event triggered reporting under fading propagation conditions

A.8.11.2.1 Test Purpose and Environment

The purpose of this test is to verify that the UE makes correct reporting of two events. This test will partly verify the TDD-TDD inter-frequency cell search requirements in clause 8.1.2.3.

The test parameters are given in Tables A.8.11.2.1-1 and A.8.11.2.1-2. In this test, there are three cells on different carrier frequencies and gap pattern configuration # 0 as defined in Table 8.1.2.1-1 is provided.

In the measurement control information, it is indicated to the UE that event-triggered reporting with Event A3 is used. The test consists of two successive time periods, with time duration of T1 and T2 respectively. During time duration T1, the UE shall not have any timing information of cell 2 and cell 3.

Table A.8.11.2.1-1: General test parameters for E-UTRAN TDD - E-UTRAN TDD and E-UTRAN TDD Inter-frequency event triggered reporting under fading propagation conditions

Parameter	Unit	Value	Comment
PDSCH parameters		DL Reference Measurement Channel R.0 TDD	As specified in clause A.3.1.1.2
PCFICH/PDCCH/PHICH parameters		DL Reference Measurement Channel R.6 TDD	As specified in clause A.3.1.2.2
Special subframe configuration		6	As specified in table 4.2-1 in TS 36.211. The same configuration in both cells
Uplink-downlink configuration		1	As specified in TS 36.211 clause 4.2 Table 4.2-2
E-UTRA RF Channel Number		1, 2, 3	Three TDD carrier frequencies are used.
Channel Bandwidth ($BW_{channel}$)	MHz	10	
Active cell		Cell 1	Cell 1 is on RF channel number 1
Neighbor cells		Cell 2 and Cell 3	Cell 2 and 3 are on RF channel numbers 2 and 3 respectively
Gap Pattern Id		0	As specified in TS 36.133 clause 8.1.2.1.
A3-Offset	dB	-6	
Hysteresis	dB	0	
CP length		Normal	
TimeToTrigger	s	0	
Filter coefficient		0	L3 filtering is not used
DRX		OFF	OFF
Time offset between cells		3 μ s	Synchronous cells
T1	s	5	
T2	s	10	

Table A.8.11.2.1-2: Cell specific test parameters for E-UTRAN TDD - E-UTRAN TDD and E-UTRAN TDD Inter-frequency event triggered reporting under fading propagation conditions cells

Parameter	Unit	Cell 1		Cell 2		Cell 3	
		T1	T2	T1	T2	T1	T2

E-UTRA RF Channel Number		1	2	3			
BW _{channel}	MHz	10	10	10			
Correlation Matrix and		1x2	1x2 Low	1x2 Low			
OCNG Patterns defined in A.3.2.2.1 (OP.1 TDD) and in A.3.2.2.2 (OP.2 TDD)		OP.1 TDD	OP.2 TDD	OP.2 TDD			
PBCH_RA	dB	0	0	0			
PBCH_RB	dB						
PSS_RA	dB						
SSS_RA	dB						
PCFICH_RB	dB						
PHICH_RA	dB						
PHICH_RB	dB						
PDCCH_RA	dB						
PDCCH_RB	dB						
PDSCH_RA	dB						
PDSCH_RB	dB						
OCNG_RA ^{Note 1}	dB						
OCNG_RB ^{Note 1}	dB						
N_{oc} ^{Note 3}	dBm/15 kHz				-98		
RSRP ^{Note 4}	dBm/15 kHz	-98	-98	-inf	-95	-inf	-95
\hat{E}_s / I_{ot}	dB	0	0	-inf	3	-inf	3
SCH_RP ^{Note 4}	dBm/15 kHz	-98	-98	-inf	-95	-inf	-95
\hat{E}_s / N_{oc}	dB	0	0	-inf	3	-inf	3
Propagation Condition		AWGN		ETU70		ETU70	
<p>Note 1: OCNG shall be used such that all cells are fully allocated and a constant total transmitted power spectral density is achieved for all OFDM symbols.</p> <p>Note 2: The resources for uplink transmission are assigned to the UE prior to the start of time period T2.</p> <p>Note 3: Interference from other cells and noise sources not specified in the test is assumed to be constant over subcarriers and time and shall be modelled as AWGN of appropriate power for N_{oc} to be fulfilled.</p> <p>Note 4: RSRP and SCH_RP levels have been derived from other parameters for information purposes. They are not settable parameters themselves.</p>							

A.8.11.2.2 Test Requirements

The UE shall send one Event A3 triggered measurement report for cell 2 with a measurement reporting delay less than 7680 ms from the beginning of time period T2.

The UE shall send one Event A3 triggered measurement report for cell 3 with a measurement reporting delay less than 7680 ms from the beginning of time period T2.

The UE shall not send event triggered measurement reports, as long as the reporting criteria are not fulfilled.

The rate of correct events observed during repeated tests shall be at least 90%.

NOTE 1: The actual overall delays measured in the test may be up to $2 \times TTI_{DCCH}$ higher than the measurement reporting delays above because of TTI insertion uncertainty of the measurement report in DCCH.

A.8.11.3 E-UTRAN FDD-FDD Inter-frequency and UTRAN FDD event triggered reporting under fading propagation conditions

A.8.11.3.1 Test Purpose and Environment

The purpose of this test is to verify that the UE makes correct reporting of an event when doing inter frequency and UTRAN FDD measurements. This test will partly verify the FDD-FDD inter-frequency cell search requirements in clause 8.1.2.3 and the E-UTRAN FDD- UTRAN FDD cell search requirements in clause 8.1.2.4.1.

The test parameters are given in Tables A.8.11.3.1-1, A.8.11.3.1-2 and A.8.11.3.1-3. In this test, there are two cells on different carrier frequencies and one cell on UTRAN carrier frequency and gap pattern configuration # 0 as defined in Table 8.1.2.1-1 is provided.

In the measurement control information, it is indicated to the UE that event-triggered reporting with Event A3 and B2 is used. The test consists of two successive time periods, with time duration of T1 and T2 respectively. During time duration T1, the UE shall not have any timing information of cell 2 and cell 3.

Table A.8.11.3.1-1: General test parameters for Combined inter-frequency and UTRAN event triggered reporting in fading propagation conditions

Parameter	Unit	Value	Comment
PDSCH parameters (E-UTRAN FDD)		DL Reference Measurement Channel R.0 FDD	As specified in clause A.3.1.1.1.
PCFICH/PDCCH/PHICH parameters (E-UTRAN FDD)		DL Reference Measurement Channel R.6 FDD	As specified in clause A.3.1.2.1.
Gap Pattern Id		0	As specified in TS 36.133 clause 8.1.2.1.
Active cell		Cell 1	Cell 1 is on E-UTRA RF channel number 1.
Neighbour cells		Cell 2, 3	Cell 2 is on E-UTRA RF channel number 2. Cell 3 is on UTRA RF channel number 1.
CP length		Normal	Applicable to cell 1
E-UTRA RF Channel Number		1, 2	Two FDD carrier frequencies are used.
E-UTRA Channel Bandwidth (BW _{channel})	MHz	10	
UTRA RF Channel Number		1	One UTRA FDD carrier frequency is used.
E-UTRAN FDD measurement quantity		RSRP	
Inter-RAT (UTRA FDD) measurement quantity		CPICH Ec/N0	
A3-Offset	dB	-6	
b2-Threshold-E-UTRA	dB	-86	RSRP threshold for event B2.
b2-Threshold-UTRA	dB	-18	CPICH Ec/N0 threshold for event B2.
Hysteresis	dB	0	
Time To Trigger	ms	0	
Filter coefficient		0	L3 filtering is not used.
DRX		OFF	
Monitored UTRA FDD cell list size		12	UTRA cells on UTRA RF channel 1 provided in the cell list.
Time offset between cells		3 ms	Asynchronous cells
T1	s	5	
T2	s	8	

Table A.8.11.3.1-2: Cell specific test parameters for Combined inter-frequency and UTRAN event triggered reporting in fading propagation conditions

Parameter	Unit	Cell 1		Cell 2	
		T1	T2	T1	T2
E-UTRA RF Channel Number		1		2	
BW _{channel}	MHz	10		10	
Correlation Matrix and Antenna Configuration		1x2		1x2 Low	
OCNG Patterns defined in A.3.2.1.1 (OP.1 FDD) and in A.3.2.1.2 (OP.2 FDD)		OP.1 FDD		OP.2 FDD	
PBCH_RA	dB	0		0	
PBCH_RB	dB				
PSS_RA	dB				
SSS_RA	dB				
PCFICH_RB	dB				
PHICH_RA	dB				
PHICH_RB	dB				
PDCCH_RA	dB				
PDCCH_RB	dB				

PDSCH_RA	dB				
PDSCH_RB	dB				
OCNG_RA ^{Note 1}	dB				
OCNG_RB ^{Note 1}	dB				
N_{oc} ^{Note 3}	dBm/15 kHz			-98	
RSRP ^{Note 4}	dBm/15 kHz	-94	-94	-Infinity	-91
\hat{E}_s / I_{ot}	dB	4	4	-Infinity	7
SCH_RP ^{Note 4}	dBm/15 kHz	-94	-94	-Infinity	-91
\hat{E}_s / N_{oc}	dB	4	4	-Infinity	7
Propagation Condition		AWGN		ETU70	
<p>Note 1: OCNG shall be used such that both cells are fully allocated and a constant total transmitted power spectral density is achieved for all OFDM symbols.</p> <p>Note 2: The resources for uplink transmission are assigned to the UE prior to the start of time period T2.</p> <p>Note 3: Interference from other cells and noise sources not specified in the test is assumed to be constant over subcarriers and time and shall be modelled as AWGN of appropriate power for N_{oc} to be fulfilled.</p> <p>Note 4: RSRP and SCH_RP levels have been derived from other parameters for information purposes. They are not settable parameters themselves.</p>					

Table A.8.11.3.1-3: Cell specific test parameters for UTRAN FDD (cell # 3) for event triggered reporting of UTRAN FDD cell under fading propagation conditions

Parameter	Unit	Cell 3	
		T1	T2
UTRA RF Channel Number			1
CPICH_Ec/lor	dB		-10
PCCPCH_Ec/lor	dB		-12
SCH_Ec/lor	dB		-12
PICH_Ec/lor	dB		-15
DPCH_Ec/lor	dB		N/A
OCNS			-0.941
\hat{I}_{or} / I_{oc}	dB	-Infinity	-1.8
I_{oc}	dBm/3.84 MHz		-70
CPICH_Ec/lo	dB	-Infinity	-14
Propagation Condition		Case 5 (Note 3)	
<p>Note 1: The DPCH level is controlled by the power control loop.</p> <p>Note 2: The power of the OCNS channel that is added shall make the total power from the cell to be equal to I_{or}.</p> <p>Note 3: Case 5 propagation conditions are defined in Annex A of TS 25.101.</p>			

A.8.11.3.2 Test Requirements

The UE shall send one Event A3 triggered measurement report, with a measurement reporting delay less than 7680 ms from the beginning of time period T2.

The UE shall send one Event B2 triggered measurement report, with a measurement reporting delay less than 4800 ms from the beginning of time period T2.

The UE shall not send event triggered measurement reports, as long as the reporting criteria are not fulfilled.

The rate of correct events observed during repeated tests shall be at least 90%.

NOTE: The actual overall delays measured in the test may be up to $2 \times TTI_{DCCCH}$ higher than the measurement reporting delays above because of TTI insertion uncertainty of the measurement report in DCCCH.

A.8.11.4 InterRAT E-UTRA TDD to E-UTRA TDD and UTRA TDD cell search test case

A.8.11.4.1 Test Purpose and Environment

This test is to verify that the UE makes correct reporting of an event when doing inter frequency measurements and UTRA TDD measurements. The test will partly verify the requirements in clause 8.1.2.3.2 combined 8.1.2.4.3 under fading propagation conditions.

This test scenario comprised of 2 E-UTRA TDD cells operating on different frequency, and 1 UTRA TDD cell. Test parameters are given in table A.8.11.4.1-1, A.8.11.4.1-2, and A.8.11.4.1-3. Gap pattern configuration #0 as defined in clause 8.1.2.1 is provided.

The test consists of 2 successive time periods, with time duration T1 and T2. In the measurement control information it is indicated to the UE that event-triggered reporting with Event A3 and B2 shall be used.

Table A.8.11.4.1-1: General test parameters for combined E-UTRA TDD inter-frequency and UTRA TDD cells search under fading propagation conditions

Parameter	Unit	Value	Comment
PDSCH parameters		DL Reference Measurement Channel R.0 TDD	As specified in clause A.3.1.1.2
PCFICH/PDCCH/PHICH parameters		DL Reference Measurement Channel R.6 TDD	As specified in clause A.3.1.2.2
Active cell		Cell 1	E-UTRA TDD cell is on RF channel number 1
Neighbour cell		Cell 2	E-UTRA TDD cell is on RF channel number 2
		Cell 3	1.28Mcps TDD cell
CP length of cell1 and cell2		Normal	
Uplink-downlink configuration of cell1 and cell2		1	As specified in Table 4.2-2 in TS 36.211. The same configuration in both cells
Special subframe configuration of cell1 and cell2		6	As specified in table 4.2-1 in TS 36.211. The same configuration in both cells
Gap Pattern Id		0	As specified in TS 36.133 clause 8.1.2.1.
E-UTRAN TDD measurement quantity		RSRP	
UTRAN TDD measurement quantity		RSCP	
DRX		OFF	
Ofn	dB	0	Parameter for A3 and B2 event
Ocn	dB	0	Parameter for A3 event
Hysteresis	dB	0	Parameter for A3 and B2 event
Ofs	dB	0	Parameter for A3 event
Ocs	dB	0	Parameter for A3 event
A3-Offset	dB	-6	Parameter for A3 event
Thresh1	dBm	-86	Absolute E-UTRAN RSRP threshold for event B2
Thresh2	dBm	-84	Absolute UTRAN RSCP threshold for event B2
TimeToTrigger	s	0	
Filter coefficient		0	L3 filtering is not used
Time offset between E-UTRAN TDD cells	μs	3	Synchronous cells
T1	s	>5	During T1, cell 2 and cell 3 shall be powered off. During the off time the physical layer cell identity of cell 2 shall be changed, and the primary scrambling code of cell 3 shall be changed.
T2	s	15	

Table A.8.11.4.1-2: Cell specific test parameters for combined E-UTRAN TDD inter-frequency and UTRA TDD cell search under fading propagation conditions(cell1 and cell2)

Parameter	Unit	Cell 1	Cell 2
-----------	------	--------	--------

		T1	T2	T1	T2
E-UTRA RF Channel Number		1		2	
BWchannel	MHz	10		10	
Correlation Matrix and Antenna Configuration		1x2		1x2 Low	
OCNG Pattern defined in A.3.2.2.1 (OP.1 TDD) and in A.3.2.2.2 (OP.2)		OP.1 TDD		OP.2 TDD	
PBCH_RA	dB	0		0	
PBCH_RB	dB				
PSS_RA	dB				
SSS_RA	dB				
PCFICH_RB	dB				
PHICH_RA	dB				
PHICH_RB	dB				
PDCCH_RA	dB				
PDCCH_RB	dB				
PDSCH_RA	dB				
PDSCH_RB	dB				
OCNG_RANote 1	dB				
OCNG_RBNote 1	dB				
\hat{E}_s / I_{ot}	dB				
\hat{E}_s / N_{oc}	dB	4	4	-Infinity	7
N_{oc}	dBm/15 kHz	-98			
RSRP	dBm/15 kHz	-94	-94	-Infinity	-91
SCH_RP	dBm/15 kHz	-94	-94	-infinity	-91
Propagation Condition		AWGN		ETU70	
Note 1: OCNG shall be used such that both cells are fully allocated and a constant total transmitted power spectral density is achieved for all OFDM symbols. Note 2: The resources for uplink transmission are assigned to the UE prior to the start of time period T2. Note 3: RSRP and SCH_RP levels have been derived from other parameters for information purposes. They are not settable parameters themselves.					

Table A.8.11.4.1-3: Cell specific test parameters for combined E-UTRA TDD inter-frequency and UTRA TDD cell search under fading propagation conditions(cell3)

Parameter	Unit	Cell 3 (UTRA)			
Timeslot Number		0		DwPTS	
		T1	T2	T1	T2
UTRA RF Channel Number*		Channel 3			
PCCPCH_Ec/lor	dB	-3			
DwPCH_Ec/lor	dB			0	
OCNS_Ec/lor	dB	-3			
\hat{I}_{or} / I_{oc}	dB	-Infinity	9	-Infinity	9
I_{oc}	dBm/1.28 MHz	-80			
PCCPCH RSCP	dBm	-Infinity	-74	n.a.	
Propagation Condition		Case 3			
Note1: The DPCH of all cells are located in a timeslot other than 0. Note2: In the case of multi-frequency network, the UTRA RF Channel Number can be set for the primary frequency in this test. Note3: P-CCPCH RSCP levels have been derived from other parameters for information purposes. They are not settable parameters themselves.					

A.8.11.4.2 Test Requirements

The UE shall send one Event A3 triggered measurement report, with a measurement reporting delay less than 7680ms from the beginning of time period T2.

The UE shall send one Event B2 triggered measurement report, with a measurement reporting delay less than 12.8s from the beginning of time period T2.

The UE shall not send event triggered measurement reports, as long as the reporting criteria are not fulfilled.

The rate of correct events observed during repeated tests shall be at least 90%.

NOTE: The actual overall delays measured in the test may be up to $2 \times TTI_{DCCH}$ higher than the measurement reporting delays above because of TTI insertion uncertainty of the measurement report in DCCH.

A.8.11.5 Combined E-UTRAN FDD – E-UTRA FDD and GSM cell search. E-UTRA cells in fading; GSM cell in static propagation conditions

A.8.11.5.1 Test Purpose and Environment

The purpose of this test is to verify that the UE makes correct reporting of multiple events when doing inter frequency and GSM measurements. This test will partly verify the E-UTRAN FDD-FDD inter-frequency cell search requirements in clause 8.1.2.3.1 and simultaneously the E-UTRAN FDD- GSM cell search requirements in clause 8.1.2.4.5.

The test parameters are given in Tables A.8.11.5.1-1, A.8.11.5.1-2 and A.8.11.5.1-3. In this test, there are two cells on different carrier frequencies and one GSM cell. Gap pattern configuration # 0 as defined in Table 8.1.2.1-1 is provided.

In the measurement control information, it is indicated to the UE that event-triggered reporting with Event A3 and B2 is used. The test consists of two successive time periods, with time duration of T1 and T2 respectively. During time duration T1, the UE shall not have any timing information of cell 2 and cell 3.

Table A.8.11.5.1-1: General test parameters for combined E-UTRAN FDD – E-UTRA FDD and GSM cell search. E-UTRA cells in fading; GSM cell in static propagation conditions

Parameter	Unit	Value	Comment
PDSCH parameters (E-UTRAN FDD)		DL Reference Measurement Channel R.0 FDD	As specified in clause A.3.1.1.1.
PCFICH/PDCCH/PHICH parameters (E-UTRAN FDD)		DL Reference Measurement Channel R.6 FDD	As specified in clause A.3.1.2.1.
Gap Pattern Id		0	As specified in TS 36.133 clause 8.1.2.1.
Active cell		Cell 1	Cell 1 is on E-UTRA RF channel number 1.
Neighbour cells		Cell 2, 3	Cell 2 is on E-UTRA RF channel number 2. Cell 3 is on Absolute RF Channel Number 3 (GSM cell).
CP length		Normal	Applicable to cell 1 and cell 2
E-UTRA Channel Bandwidth ($BW_{channel}$)	MHz	10	
E-UTRAN FDD measurement quantity		RSRP	
Hysteresis	dB	0	Parameter for A3 and B2 event
A3-Offset	dB	-6	
TimeToTrigger	s	0	
Filter coefficient		0	L3 filtering is not used
DRX		OFF	OFF
Time offset between E-UTRAN FDD cells	ms	3 ms	Asynchronous cells
Inter-RAT (GSM) measurement quantity		GSM Carrier RSSI	

b2-Threshold-E-UTRA	dBm	-83	RSRP threshold for event B2. This is the threshold for E-UTRA in the B2 configuration. E-UTRA PCell RSRP is below this throughout the test to account for measurement accuracy and fading
b2-Threshold-GERAN	dBm	-80	GSM Carrier RSSI threshold for event B2.
Monitored GSM cell list size		6 GSM neighbours including ARFCN 3	List of GSM cells provided before T2 starts.
T1	s	5	
T2	s	10	

Table A.8.11.5.1-2: Cell specific test parameters for E-UTRAN FDD cells for combined E-UTRAN FDD – E-UTRA FDD and GSM cell search. E-UTRA cells in fading; GSM cell in static propagation conditions

Parameter	Unit	Cell 1		Cell 2	
		T1	T2	T1	T2
E-UTRA RF Channel Number		1		2	
BW _{channel}	MHz	10		10	
Correlation Matrix and Antenna Configuration		1x2 Low		1x2 Low	
OCNG Patterns defined in A.3.2.1.1 (OP.1 FDD) and in A.3.2.1.2 (OP.2 FDD)		OP.1 FDD		OP.2 FDD	
PBCH_RA	dB	0		0	
PBCH_RB	dB				
PSS_RA	dB				
SSS_RA	dB				
PCFICH_RB	dB				
PHICH_RA	dB				
PHICH_RB	dB				
PDCCH_RA	dB				
PDCCH_RB	dB				
PDSCH_RA	dB				
PDSCH_RB	dB				
OCNG_RA ^{Note 1}	dB				
OCNG_RB ^{Note 1}	dB				
N_{oc} ^{Note 3}	dBm/15 kHz				
RSRP ^{Note 4}	dBm/15 kHz	-94	-94	-Infinity	-91
\hat{E}_s / I_{ot}	dB	4	4	-Infinity	7
SCH_RP ^{Note 4}	dBm/15 kHz	-94	-94	-Infinity	-91
\hat{E}_s / N_{oc}	dB	4	4	-Infinity	7
Propagation Condition		ETU70		ETU70	
<p>Note 1: OCNG shall be used such that both cells are fully allocated and a constant total transmitted power spectral density is achieved for all OFDM symbols.</p> <p>Note 2: The resources for uplink transmission are assigned to the UE prior to the start of time period T2.</p> <p>Note 3: Interference from other cells and noise sources not specified in the test is assumed to be constant over subcarriers and time and shall be modelled as AWGN of appropriate power for N_{oc} to be fulfilled.</p> <p>Note 4: RSRP and SCH_RP levels have been derived from other parameters for information purposes. They are not settable parameters themselves.</p>					

Table A.8.11.5.1-3: Cell specific test parameters for GSM (cell # 3) for combined E-UTRAN FDD – E-UTRA FDD and GSM cell search. E-UTRA cells in fading; GSM cell in static propagation conditions

Parameter	Unit	Cell 3	
		T1	T2

Absolute RF Channel Number		ARFCN3	
RXLEV	dBm	-Infinity	-75
GSM BSIC		N/A	Valid

A.8.11.5.2 Test Requirements

The UE shall send one Event A3 triggered measurement report for cell 2, with a measurement reporting delay less than 7680 ms from the beginning of time period T2.

The UE shall send one Event B2 triggered measurement report including BSIC of cell 3, with a measurement reporting delay less than 7200 ms from the beginning of time period T2.

The UE shall not send event triggered measurement reports, as long as the reporting criteria are not fulfilled.

The rate of correct events observed during repeated tests shall be at least 90%.

NOTE 1: The actual overall delays measured in the test may be up to $2 \times TTI_{DCCH}$ higher than the measurement reporting delays above because of TTI insertion uncertainty of the measurement report in DCCH.

NOTE 2: The delay for GSM cell identification with BSIC verified is equal to 7200 ms, which is the sum of the event triggered measurement reporting delay and the initial BSIC identification delay.

The event triggered measurement reporting delay = $2 \times T_{\text{Measurement Period, GSM}} = 2 \times N_{\text{freq}} \times 480\text{ms} = 1920\text{ms}$.

Initial BSIC identification delay = 5280 ms, when one carrier frequency other than GSM is monitored in the gaps.

A.8.11.6 Combined E-UTRAN TDD – E-UTRA TDD and GSM cell search. E-UTRA cells in fading; GSM cell in static propagation conditions

A.8.11.6.1 Test Purpose and Environment

The purpose of this test is to verify that the UE makes correct reporting of multiple events when doing inter frequency and GSM measurements. This test will partly verify the E-UTRAN TDD-TDD inter-frequency cell search requirements in clause 8.1.2.3.2 and simultaneously the E-UTRAN TDD- GSM cell search requirements in clause 8.1.2.4.6.

The test parameters are given in Tables A.8.11.6.1-1, A.8.11.6.1-2 and A.8.11.6.1-3. In this test, there are two cells on different carrier frequencies and one GSM cell. Gap pattern configuration # 0 as defined in Table 8.1.2.1-1 is provided.

In the measurement control information, it is indicated to the UE that event-triggered reporting with Event A3 and B2 is used. The test consists of two successive time periods, with time duration of T1 and T2 respectively. During time duration T1, the UE shall not have any timing information of cell 2 and cell 3.

Table A.8.11.6.1-1: General test parameters for combined E-UTRAN TDD – E-UTRA TDD and GSM cell search. E-UTRA cells in fading; GSM cell in static propagation conditions

Parameter	Unit	Value	Comment
PDSCH parameters (E-UTRAN TDD)		DL Reference Measurement Channel R.0 TDD	As specified in clause A.3.1.1.2.
PCFICH/PDCCH/PHICH parameters (E-UTRAN TDD)		DL Reference Measurement Channel R.6 TDD	As specified in clause A.3.1.2.2.
Special subframe configuration of cell1 and cell2		6	As specified in table 4.2-1 in TS 36.211. The same configuration in both cells
Uplink-downlink configuration of cell1 and cell2		1	As specified in TS 36.211 clause 4.2 Table 4.2-2
Gap Pattern Id		0	As specified in TS 36.133 clause 8.1.2.1.
Active cell		Cell 1	Cell 1 is on E-UTRA RF channel number 1.
Neighbour cells		Cell 2, 3	Cell 2 is on E-UTRA RF channel number 2. Cell 3 is on Absolute RF Channel Number 3 (GSM cell).

CP length		Normal	Applicable to cell 1 and cell 2
E-UTRA Channel Bandwidth (BW _{channel})	MHz	10	
E-UTRAN TDD measurement quantity		RSRP	
Hysteresis	dB	0	Parameter for A3 and B2 event
A3-Offset	dB	-6	
TimeToTrigger	s	0	
Filter coefficient		0	L3 filtering is not used
DRX		OFF	OFF
Time offset between E-UTRAN TDD cells	μs	3	Synchronous cells
Inter-RAT (GSM) measurement quantity		GSM Carrier RSSI	
b2-Threshold-E-UTRA	dBm	-83	RSRP threshold for event B2. This is the threshold for E-UTRA in the B2 configuration. E-UTRA PCell RSRP is below this throughout the test to account for measurement accuracy and fading
b2-Threshold-GERAN	dBm	-80	GSM Carrier RSSI threshold for event B2.
Monitored GSM cell list size		6 GSM neighbours including ARFCN 3	List of GSM cells provided before T2 starts.
T1	s	5	
T2	s	10	

Table A.8.11.6.1-2: Cell specific test parameters for E-UTRAN TDD cells for combined E-UTRAN TDD – E-UTRA TDD and GSM cell search. E-UTRA cells in fading; GSM cell in static propagation conditions

Parameter	Unit	Cell 1		Cell 2	
		T1	T2	T1	T2
E-UTRA RF Channel Number		1		2	
BW _{channel}	MHz	10		10	
Correlation Matrix and Antenna Configuration		1x2 Low		1x2 Low	
OCNG Patterns defined in A.3.2.2.1 (OP.1 TDD) and in A.3.2.2.2 (OP.2 TDD)		OP.1 TDD		OP.2 TDD	
PBCH_RA	dB	0		0	
PBCH_RB	dB				
PSS_RA	dB				
SSS_RA	dB				
PCFICH_RB	dB				
PHICH_RA	dB				
PHICH_RB	dB				
PDCCH_RA	dB				
PDCCH_RB	dB				
PDSCH_RA	dB				
PDSCH_RB	dB				
OCNG_RA ^{Note 1}	dB				
OCNG_RB ^{Note 1}	dB				
N _{oc} ^{Note 3}	dBm/15 kHz				
RSRP ^{Note 4}	dBm/15 kHz	-94	-94	-Infinity	-91
\hat{E}_s / I_{ot}	dB	4	4	-Infinity	7
SCH_RP ^{Note 4}	dBm/15 kHz	-94	-94	-Infinity	-91
\hat{E}_s / N_{oc}	dB	4	4	-Infinity	7
Propagation Condition		ETU70		ETU70	

Note 1: OCNB shall be used such that both cells are fully allocated and a constant total transmitted power spectral density is achieved for all OFDM symbols.

Note 2: The resources for uplink transmission are assigned to the UE prior to the start of time period T2.

Note 3: Interference from other cells and noise sources not specified in the test is assumed to be constant over subcarriers and time and shall be modelled as AWGN of appropriate power for N_{oc} to be fulfilled.

Note 4: RSRP and SCH_RP levels have been derived from other parameters for information purposes. They are not settable parameters themselves.

Table A.8.11.6.1-3: Cell specific test parameters for GSM (cell # 3) for combined E-UTRAN TDD – E-UTRA TDD and GSM cell search. E-UTRA cells in fading; GSM cell in static propagation conditions

Parameter	Unit	Cell 3	
		T1	T2
Absolute RF Channel Number		ARFCN3	
RXLEV	dBm	-Infinity	-75
GSM BSIC		N/A	Valid

A.8.11.6.2 Test Requirements

The UE shall send one Event A3 triggered measurement report for cell 2, with a measurement reporting delay less than 7680 ms from the beginning of time period T2.

The UE shall send one Event B2 triggered measurement report including BSIC of cell 3, with a measurement reporting delay less than 7200 ms from the beginning of time period T2.

The UE shall not send event triggered measurement reports, as long as the reporting criteria are not fulfilled.

The rate of correct events observed during repeated tests shall be at least 90%.

NOTE 1: The actual overall delays measured in the test may be up to $2 \times T_{TTI_{DCH}}$ higher than the measurement reporting delays above because of TTI insertion uncertainty of the measurement report in DCCH.

NOTE 2: The delay for GSM cell identification with BSIC verified is equal to 7200 ms, which is the sum of the event triggered measurement reporting delay and the initial BSIC identification delay.

The event triggered measurement reporting delay = $2 \times T_{\text{Measurement Period, GSM}} = 2 \times N_{\text{freq}} \times 480 \text{ms} = 1920 \text{ms}$.

Initial BSIC identification delay = 5280 ms, when one carrier frequency other than GSM is monitored in the gaps.

A.8.12 RSTD Intra-frequency Measurements

A.8.12.1 E-UTRAN FDD intra-frequency RSTD measurement reporting delay test case

A.8.12.1.1 Test Purpose and Environment

The purpose of the test is to verify that the RSTD measurement meets the requirements specified in Clause 8.1.2.5.1 in an environment with fading propagation conditions.

In the test there are three synchronous cells: Cell 1, Cell 2 and Cell 3. Cell 1 is the reference as well as the PCell. Cell 2 and Cell 3 are the neighbour cells. All cells are on the same RF channel.

The test consists of three consecutive time intervals, with duration of T1, T2 and T3. Cell 1 is active in T1, T2 and T3, whilst Cell 2 and Cell 3 are activated only in the beginning of T2. Cell 2 is active until the end of T3, and Cell 3 is active until the end of T2. The beginning of the time interval T2 shall be aligned with the first PRS positioning subframe of a positioning occasion in the reference cell, where the PRS positioning occasion is as defined in Clause 8.1.2.5.1. Cell 1 transmits PRS in T2, while Cell 2 transmits PRS only in T3, and Cell 3 transmits PRS only in T2. Note: The information on when PRS is muted is conveyed to the UE using PRS muting information.

The OTDOA assistance data as defined in TS 36.355, Clause 6.5.1, shall be provided to the UE during T1. The last TTI containing the OTDOA assistance data shall be provided to the UE ΔT ms before the start of T2, where $\Delta T = 150$ ms is the maximum processing time of the OTDOA assistance data.

The test parameters are as given in Table A.8.12.1.1-1, Table A.8.12.1.1-2, Table A.8.12.1.1-3 and Table A.8.12.1.1-4.

Table A.8.12.1.1-1: General test parameters for E-UTRAN FDD intra-frequency RSTD measurement reporting delay under fading propagation conditions

Parameter	Unit	Value	Comment
Reference cell		Cell 1	Reference cell is the cell in the OTDOA assistance data with respect to which the RSTD measurement is defined, as specified in TS 36.214 [4] and TS 36.355 [24]. The reference cell is the PCell in this test case.
Neighbor cells		Cell 2 and Cell 3	Cell 2 and Cell 3 appear at random places in the neighbour cell list in the OTDOA assistance data, but Cell 2 always appears in the first half of the list, whilst Cell 3 appears in the second half of the list.
PCFICH/PDCCH/PHICH parameters		DL Reference Measurement Channel R.6 FDD	As specified in clause A.3.1.2.1
Channel Bandwidth (BW_{channel})	MHz	10	
PRS Transmission Bandwidth	RB	50	PRS are transmitted over the system bandwidth
PRS configuration index I_{PRS}		171	This corresponds to periodicity of 320 ms and PRS subframe offset of $I_{\text{PRS}} - 160$ DL subframes, as defined in TS 36.211 [16], Table 6.10.4.3-1
Number of consecutive downlink positioning subframes N_{PRS}		1	As defined in TS 36.211 [16]. The number of subframes in a positioning occasion
Physical cell ID PCI		(PCI of Cell 1 – PCI of Cell 2) mod 6 = 0 and (PCI of Cell 1 – PCI of Cell 3) mod 6 = 0	The cell PCIs are selected such that the relative shifts of PRS patterns among cells are as given by the test parameters
CP length		Normal	
DRX		ON	DRX parameters are further specified in Table A.8.12.1.1-3
Radio frame receive time offset between the cells at the UE antenna connector	μs	Cell 2 to Cell 1: 1 Cell 3 to Cell 1: -1	PRS are transmitted from synchronous cells
Expected RSTD	μs	Cell 2: 3 Cell 3: 3 Other neighbour cells: randomly between -3 and 3	The expected RSTD is what is expected at the receiver. The corresponding parameter in the OTDOA assistance data specified in TS 36.355 [24] is the expectedRSTD indicator
Expected RSTD uncertainty for all neighbour cells	μs	5	The corresponding parameter in the OTDOA assistance data specified in TS 36.355 [24] is the expectedRSTD-Uncertainty index
Number of cells provided in OTDOA assistance data		16	Including the reference cell
PRS muting info		Cell 1: '11110000' Cell 2: '00001111' Cell 3: '11110000'	Corresponds to prs-MutingInfo defined in TS 36.355 [24]
T1	s	3	The length of the time interval from the beginning of each test
T2	s	1.28	The length of the time interval that follows immediately after time interval T1

T3	s	1.28	The length of the time interval that follows immediately after time interval T2
----	---	------	---

Table A.8.12.1.1-2: Cell-specific test parameters for E-UTRAN FDD intra-frequency RSTD measurement reporting delay under fading propagation conditions during T1

Parameter	Unit	Cell 1	Cell 2	Cell 3
E-UTRA RF Channel Number		1	1	1
Correlation Matrix and Antenna Configuration		1x2 Low	1x2 Low	1x2 Low
OCNG patterns defined in A.3.2.1		OP.5 FDD	N/A	N/A
PBCH_RA	dB	0	N/A	N/A
PBCH_RB				
PSS_RA				
SSS_RA				
PCFICH_RB				
PHICH_RA				
PHICH_RB				
PDCCH_RA				
PDCCH_RB				
OCNG_RA ^{Note 1}				
OCNG_RB ^{Note 1}				
N_{oc} ^{Note 3}	dBm/15 kHz	-95		
PRS \hat{E}_s/N_{oc}	dB	-Infinity	-Infinity	-Infinity
I_o ^{Note 4}	dBm/9 MHz	-67.22	-67.22	-67.22
\hat{E}_s/N_{oc}	dB	0	-Infinity	-Infinity
Propagation Condition		ETU30		
<p>Note 1: OCNG shall be used such that active cell (Cell 1) is fully allocated and a constant total transmitted power spectral density is achieved for all OFDM symbols.</p> <p>Note 2: The resources for uplink transmission are assigned to the UE prior to the start of time period T2.</p> <p>Note 3: Interference from other cells and noise sources not specified in the test are assumed to be constant over subcarriers and time and shall be modelled as AWGN of appropriate power for N_{oc} to be fulfilled.</p> <p>Note 4: I_o levels have been derived from other parameters and are given for information purpose. These are not settable test parameters.</p>				

Table A.8.12.1.1-3: Cell-specific test parameters for E-UTRAN FDD intra-frequency RSTD measurement reporting delay under fading propagation conditions during T2 and T3

Parameter	Unit	Cell 1		Cell 2		Cell 3	
		T2	T3	T2	T3	T2	T3
E-UTRA RF Channel Number		1		1		1	
Correlation Matrix and Antenna Configuration		1x2 Low		1x2 Low		1x2 Low	
OCNG patterns defined in A.3.2.1		OP.5 FDD		OP.6 FDD		OP.6 FDD	N/A
PBCH_RA	dB	0		0		0	N/A
PBCH_RB							
PSS_RA							
SSS_RA							

PCFICH_RB							
PHICH_RA							
PHICH_RB							
PDCCH_RA							
PDCCH_RB							
OCNG_RA ^{Note 1}							
OCNG_RB ^{Note 1}							
PRS_RA	dB	-3	N/A	N/A	3	3	N/A
N_{oc} ^{Note 3}	dBm/ 15 kHz	-98	-95	-98	-95	-98	-95
$PRS \hat{E}_s/N_{oc}$	dB	-1	-Infinity	-Infinity	-7	-7	-Infinity
$PRS \hat{E}_s/I_{ot}$ ^{Note 4}	dB	-1.79	-Infinity	-Infinity	-7	-9.54	-Infinity
I_o ^{Note 4}	dBm/ 9 MHz	-69.55	-67.08	-69.55	-67.08	-69.55	-67.08
PRP ^{Note 4}	dBm/ 15 kHz	-99	-Infinity	-Infinity	-102	-105	-Infinity
RSRP ^{Note 4}	dBm/ 15 kHz	-96	-93	-105	-105	-108	-Infinity
\hat{E}_s/N_{oc} ^{Note 4}	dB	2	2	-7	-10	-10	-Infinity
Propagation Condition		ETU30					
<p>Note 1: OCNG shall be used such that active cells (all, except Cell 3 in T3) are fully allocated and a constant total transmitted power spectral density is achieved for all OFDM symbols other than those in the subframes with transmitted PRS.</p> <p>Note 2: The resources for uplink transmission are assigned to the UE prior to the start of time period T2.</p> <p>Note 3: Interference from other cells and noise sources not specified in the test are assumed to be constant over subcarriers and time and shall be modelled as AWGN of appropriate power for N_{oc} to be fulfilled.</p> <p>Note 4: If PRS_RA is not "N/A", \hat{E}_s/N_{oc}, $PRS \hat{E}_s/I_{ot}$, I_o, RSRP and PRP levels have been derived from other parameters and are given for information purpose. If PRS_RA is "N/A", I_o and RSRP levels have been derived from other parameters and are given for information purpose. These are not settable test parameters. Interference conditions shall be applied to all PRS symbols of DL positioning subframes.</p>							

Table A.8.12.1.1-4: DRX parameters for the test of E-UTRAN FDD intra-frequency RSTD measurement reporting delay under fading propagation conditions

Field	Value	Comment
onDurationTimer	psf1	As specified in TS 36.331 [2], Clause 6.3.2
Drx-InactivityTimer	psf1	
drx-RetransmissionTimer	sf1	
longDRX-CycleStartOffset	sf320	
shortDRX	Disable	

A.8.12.1.2 Test Requirements

The RSTD measurement time fulfils the requirements specified in Clause 8.1.2.5.1.

The UE shall perform and report the RSTD measurements for Cell 2 and Cell 3 with respect to the reference cell in the OTDOA assistance data, Cell 1, within 2560 ms starting from the beginning of time interval T2.

The rate of the correct events for each neighbour cell observed during repeated tests shall be at least 90%, where the reported RSTD measurement for each correct event shall be within the RSTD reporting range specified in Clause 9.1.10.3, i.e., between RSTD_0000 and RSTD_12711.

NOTE: The RSTD measurement time in the test is derived from the following expression,

$$T_{PRS}(M-1) + 160 \left\lceil \frac{n}{M} \right\rceil, \text{ where } M=8 \text{ and } n=16 \text{ are the parameters specified in Clause 8.1.2.5.1, Table}$$

8.1.2.5.1-1, under Note 1. This gives the total RSTD measurement time of 2560 ms for Cell 2 and Cell 3 with respect to the reference cell Cell 1.

A.8.12.1.2A Test Requirements for UE Category 1bis

The RSTD measurement time fulfils the requirements specified in Clause 8.1.2.5.3.

The UE shall perform and report the RSTD measurements for Cell 2 and Cell 3 with respect to the reference cell in the OTDOA assistance data, Cell 1, within 4960 ms starting from the beginning of time interval T2.

The rate of the correct events for each neighbour cell observed during repeated tests shall be at least 90%, where the reported RSTD measurement for each correct event shall be within the RSTD reporting range specified in Clause 9.1.10.3, i.e., between RSTD_0000 and RSTD_12711.

NOTE: The RSTD measurement time in the test is derived from the following expression,

$$T_{PRS}(M-1) + 160 \left\lceil \frac{n}{M} \right\rceil, \text{ where } M=16 \text{ and } n=16 \text{ are the parameters specified in Clause 8.1.2.5.3,}$$

Table 8.1.2.5.3-1, under Note 1. This gives the total RSTD measurement time of 4960 ms for Cell 2 and Cell 3 with respect to the reference cell Cell 1.

The test parameters are as given in Table A.8.12.1.1-1, Table A.8.12.1.1-2, Table A.8.12.1.1-3 and Table A.8.12.1.1-4, with the exceptions given in Table A.8.12.1.2A-1.

Table A.8.12.1.2A-1: Specific test parameters for UE Category for 1Bis E-UTRAN FDD intra-frequency RSTD measurement reporting delay under fading propagation conditions

Parameter	Unit	Value	Comment
PRS muting info		Cell 1: '1111111100000000' Cell 2: '0000000011111111' Cell 3: '1111111100000000'	Corresponds to prs-MutingInfo defined in TS 36.355 [24]
T1	s	3	The length of the time interval from the beginning of each test
T2	s	2.56	The length of the time interval that follows immediately after time interval T1
T3	s	2.56	The length of the time interval that follows immediately after time interval T2

A.8.12.2 E-UTRAN TDD intra-frequency RSTD measurement reporting delay test case

A.8.12.2.1 Test Purpose and Environment

The purpose of the test is to verify that the RSTD measurement meets the requirements specified in Clause 8.1.2.5.2 in an environment with fading propagation conditions.

In the test there are three synchronous cells: Cell 1, Cell 2 and Cell 3. Cell 1 is the reference as well as the PCell. Cell 2 and Cell 3 are the neighbour cells. All cells are on the same RF channel.

The test consists of three consecutive time intervals, with duration of T1 and T2. Cell 1 is active in T1, T2 and T3, whilst Cell 2 and Cell 3 are activated only in the beginning of T2. Cell 2 is active until the end of T3, and Cell 3 is active until the end of T2. The beginning of the time interval T2 shall be aligned with the first PRS positioning subframe of a positioning occasion in the reference cell, where the PRS positioning occasion is as defined in Clause 8.1.2.5.1. Cell 1 transmits PRS in T2, while Cell 2 transmits PRS only in T3, and Cell 3 transmits PRS only in T2. Note: The information on when PRS is muted is conveyed to the UE using PRS muting information.

The OTDOA assistance data as defined in TS 36.355, Clause 6.5.1, shall be provided to the UE during T1. The last TTI containing the OTDOA assistance data shall be provided to the UE ΔT ms before the start of T2, where $\Delta T = 150$ ms is the maximum processing time of the OTDOA assistance data.

The test parameters are as given in Table A.8.12.2.1-1, Table A.8.12.2.1-2, Table A.8.12.2.1-3, and Table A.8.12.2.1-4.

Table A.8.12.2.1-1: General test parameters for E-UTRAN TDD intra-frequency RSTD measurement reporting delay under fading propagation conditions

Parameter	Unit	Value	Comment
Reference cell		Cell 1	Reference is the cell in the OTDOA assistance data with respect to which the RSTD measurement is defined, as specified in TS 36.214 [4] and TS 36.355 [24]. The reference cell is the PCell in this test case.
Neighbor cells		Cell 2 and Cell 3	Cell 2 and Cell 3 appear at random places in the neighbour cell list in the OTDOA assistance data, but Cell 2 always appears in the first half of the list, whilst Cell 3 appears in the second half of the list.
PCFICH/PDCCH/PHICH parameters		DL Reference Measurement Channel R.6 TDD	As specified in clause A.3.1.2.2
Channel Bandwidth (BW_{channel})	MHz	10	
PRS Transmission Bandwidth	RB	50	PRS are transmitted over the system bandwidth
PRS configuration index I_{PRS}		174	This corresponds to periodicity of 320 ms and PRS subframe offset of $I_{\text{PRS}} - 160$ DL subframes, as defined in TS 36.211 [16], Table 6.10.4.3-1
Number of consecutive downlink positioning subframes N_{PRS}		1	As defined in TS 36.211 [16]. The number of subframes in a positioning occasion
Physical cell ID PCI		(PCI of Cell 1 – PCI of Cell 2) mod 6 = 0 and (PCI of Cell 1 – PCI of Cell 3) mod 6 = 0	The cell PCIs are selected such that the relative shifts of PRS patterns among cells are as given by the test parameters
TDD uplink-downlink configuration		1	As specified in TS 36.211 [16], Clause 4.2; corresponds to a configuration with 5 ms switch-point periodicity and two downlink consecutive subframes
TDD special subframe configuration		6	As specified in TS 36.211 [16], Clause 4.2; corresponds to DwPTS of $19760 \cdot T_s$ and UpPTS of $4384 \cdot T_s$
CP length		Normal	The same CP length applies for DL and UL
DRX		ON	DRX parameters are further specified in Table A.8.12.2.1-3
Radio frame receive time offset between the cells at the UE antenna connector	μs	Cell 2 to Cell 1: 1 Cell 3 to Cell 1: -1	PRS are transmitted from synchronous cells
Expected RSTD	μs	Cell 2: 3 Cell 3: 3 Other neighbour cells: randomly between -3 and 3	The expected RSTD is what is expected at the receiver. The corresponding parameter in the OTDOA assistance data specified in TS 36.355 [24] is the expectedRSTD indicator
Expected RSTD uncertainty for all neighbour cells	μs	5	The corresponding parameter in the OTDOA assistance data specified in TS 36.355 [24] is the expectedRSTD-Uncertainty index
Number of cells provided in OTDOA assistance data		16	Including the reference cell

PRS muting info		Cell 1: '11110000' Cell 2: '00001111' Cell 3: '11110000'	Correponds to prs-MutingInfo defined in TS 36.355 [24]
T1	s	3	The length of the time interval from the beginning of each test
T2	s	1.28	The length of the time interval that follows immediately after time interval T1
T3	s	1.28	The length of the time interval that follows immediately after time interval T2

Table A.8.12.2.1-2: Cell-specific test parameters for E-UTRAN TDD intra-frequency RSTD measurement reporting delay under fading propagation conditions during T1

Parameter	Unit	Cell 1	Cell 2	Cell 3
E-UTRA RF Channel Number		1	1	1
Correlation Matrix and Antenna Configuration		1x2 Low	1x2 Low	1x2 Low
OCNG patterns defined in A.3.2.2		OP.1 TDD	N/A	N/A
PBCH_RA	dB	0	N/A	N/A
PBCH_RB				
PSS_RA				
SSS_RA				
PCFICH_RB				
PHICH_RA				
PHICH_RB				
PDCCH_RA				
PDCCH_RB				
OCNG_RA <small>Note 1</small>				
OCNG_RB <small>Note 1</small>				
N_{oc} <small>Note 3</small>	dBm/ 15 kHz	-95		
PRS \hat{E}_s/N_{oc}	dB	-Infinity	-Infinity	-Infinity
I_o <small>Note 4</small>	dBm/ 9 MHz	-67.22	-67.22	-67.22
\hat{E}_s/N_{oc}	dB	0	-Infinity	-Infinity
Propagation Condition		ETU30		
<p>Note 1: OCNG shall be used such that active cell (Cell 1) is fully allocated and a constant total transmitted power spectral density is achieved for all OFDM symbols.</p> <p>Note 2: The resources for uplink transmission are assigned to the UE prior to the start of time period T2.</p> <p>Note 3: Interference from other cells and noise sources not specified in the test are assumed to be constant over subcarriers and time and shall be modelled as AWGN of appropriate power for N_{oc} to be fulfilled.</p> <p>Note 4: I_o levels have been derived from other parameters and are given for information purpose. These are not settable test parameters.</p>				

Table A.8.12.2.1-3: Cell-specific test parameters for E-UTRAN TDD intra-frequency RSTD measurement reporting delay under fading propagation conditions

Parameter	Unit	Cell 1		Cell 2		Cell 3	
		T2	T3	T2	T3	T2	T3
E-UTRA RF Channel Number		1		1		1	
Correlation Matrix and Antenna Configuration		1x2 Low		1x2 Low		1x2 Low	
OCNG patterns defined in A.3.2.2		OP.1 TDD		OP.2 TDD		OP.2 TDD	N/A

PBCH_RA	dB	0	0	0	0	N/A	
PBCH_RB							
PSS_RA							
SSS_RA							
PCFICH_RB							
PHICH_RA							
PHICH_RB							
PDCCH_RA							
PDCCH_RB							
OCNG_RA <small>Note 1</small>							
OCNG_RB <small>Note 1</small>							
PRS_RA							dB
N_{oc} <small>Note 3</small>	dBm/ 15 kHz	-98	-95	-98	-95	-98	-95
\hat{E}_s/N_{oc}	dB	-1	-Infinity	-Infinity	-7	-7	-Infinity
\hat{E}_s/I_{ot} <small>Note 4</small>	dB	-1.79	-Infinity	-Infinity	-7	-9.54	-Infinity
I_o <small>Note 4</small>	dBm/ 9 MHz	-69.55	-67.08	-69.55	-67.08	-69.55	-67.08
PRP <small>Note 4</small>	dBm/ 15 kHz	-99	-Infinity	-Infinity	-102	-105	-Infinity
RSRP <small>Note 4</small>	dBm/ 15 kHz	-96	-93	-105	-105	-108	-Infinity
\hat{E}_s/N_{oc} <small>Note 4</small>	dB	2	2	-7	-10	-10	-Infinity
Propagation Condition	ETU30						
<p>Note 1: OCNG shall be used such that active cells (all, except Cell 3 in T3) are fully allocated and a constant total transmitted power spectral density is achieved for all OFDM symbols other than those in the subframes with transmitted PRS.</p> <p>Note 2: The resources for uplink transmission are assigned to the UE prior to the start of time period T2.</p> <p>Note 3: Interference from other cells and noise sources not specified in the test and assumed to be constant over subcarriers and time and shall be modelled as AWGN of appropriate power for N_{oc} to be fulfilled.</p> <p>Note 4: If PRS_RA is not "N/A", \hat{E}_s/N_{oc}, \hat{E}_s/I_{ot}, I_o, RSRP and PRP levels have been derived from other parameters and are given for information purpose. If PRS_RA is "N/A", I_o and RSRP levels have been derived from other parameters and are given for information purpose. These are not settable test parameters. Interference conditions shall be applied to all PRS symbols of DL positioning subframes.</p>							

Table A.8.12.2.1-4: DRX parameters for the test of E-UTRAN TDD intra-frequency RSTD measurement reporting delay under fading propagation conditions

Field	Value	Comment
onDurationTimer	psf1	As specified in TS 36.331 [2], Clause 6.3.2.
drx-InactivityTimer	psf1	
drx-RetransmissionTimer	sf1	
longDRX-CycleStartOffset	sf320	
shortDRX	disable	

A.8.12.2.2 Test Requirements

The RSTD measurement time fulfils the requirements specified in Clause 8.1.2.5.2.

The UE shall perform and report the RSTD measurements for Cell 2 and Cell 3 with respect to the reference cell in the OTDOA assistance data, Cell 1, within 2560 ms starting from the beginning of time interval T2.

The rate of the correct events for each neighbour cell observed during repeated tests shall be at least 90%, where the reported RSTD measurement for each correct event shall be within the RSTD reporting range specified in Clause 9.1.10.3, i.e., between RSTD_0000 and RSTD_12711.

NOTE: The RSTD measurement time in the test is derived from the following expression,

$$T_{PRS}(M-1) + 160 \left\lceil \frac{n}{M} \right\rceil, \text{ where } M=8 \text{ and } n=16 \text{ are the parameters specified for this test case in}$$

Clause 8.1.2.5.2, Table 8.1.2.5.2-1, under Note 1. This gives the total RSTD measurement time of 2560 ms for Cell 2 and Cell 3 with respect to the reference cell Cell 1.

A.8.12.2.2A Test Requirements for UE Category 1bis

The RSTD measurement time fulfils the requirements specified in Clause 8.1.2.5.4.

The UE shall perform and report the RSTD measurements for Cell 2 and Cell 3 with respect to the reference cell in the OTDOA assistance data, Cell 1, within 4960 ms starting from the beginning of time interval T2.

The rate of the correct events for each neighbour cell observed during repeated tests shall be at least 90%, where the reported RSTD measurement for each correct event shall be within the RSTD reporting range specified in Clause 9.1.10.3, i.e., between RSTD_0000 and RSTD_12711.

NOTE: The RSTD measurement time in the test is derived from the following expression,

$$T_{PRS}(M-1) + 160 \left\lceil \frac{n}{M} \right\rceil, \text{ where } M=16 \text{ and } n=16 \text{ are the parameters specified for this test case in}$$

Clause 8.1.2.5.4, Table 8.1.2.5.4-1, under Note 1. This gives the total RSTD measurement time of 4960 ms for Cell 2 and Cell 3 with respect to the reference cell Cell 1.

The test parameters are as given in Table A.8.12.2.1-1, Table A.8.12.2.1-2, Table A.8.12.2.1-3 and Table A.8.12.2.1-4, with the exceptions given in Table A.8.12.2.2A-1.

Table A.8.12.2.2A-1: Specific test parameters for UE Category for 1Bis E-UTRAN TDD intra-frequency RSTD measurement reporting delay under fading propagation conditions

Parameter	Unit	Value	Comment
PRS muting info		Cell 1: '1111111100000000' Cell 2: '0000000011111111' Cell 3: '1111111100000000'	Corresponds to prs-MutingInfo defined in TS 36.355 [24]
T1	s	3	The length of the time interval from the beginning of each test
T2	s	2.56	The length of the time interval that follows immediately after time interval T1
T3	s	2.56	The length of the time interval that follows immediately after time interval T2

A.8.12.3 E-UTRAN FDD intra-frequency RSTD measurement period test case in CE Mode A

A.8.12.3.1 Test Purpose and Environment

The purpose of the test is to verify for Cat-M1 and Cat-M2 UE in CE Mode A that the RSTD measurement meets the requirements specified in Sections 8.13.2.3.1 and 8.16.2.3.1, respectively, in an environment with fading propagation conditions. Test 1 is applicable for Cat-M1 and Cat-M2 supporting 1.4 MHz UE RF bandwidth, while Test 2 is applicable for Cat-M2 supporting 5 MHz UE RF bandwidth.

In the test there are three synchronous cells: Cell 1, Cell 2 and Cell 3. Cell 1 is the reference as well as the PCell. Cell 2 and Cell 3 are the neighbour cells. All cells are on the same RF channel.

The test consists of three consecutive time intervals, with duration of T1, T2 and T3. Cell 1 is active in T1, T2 and T3, whilst Cell 2 and Cell 3 are activated only in the beginning of T2. Cell 2 is active until the end of T3, and Cell 3 is active until the end of T2. The beginning of the time interval T2 shall be aligned with the first PRS positioning subframe of a positioning occasion in the reference cell, where the PRS positioning occasion is as defined in Clause 8.1.2.5.1. Cell 1 transmits PRS in T2, while Cell 2 transmits PRS only in T3, and Cell 3 transmits PRS only in T2. Note: The information on when PRS is muted is conveyed to the UE using PRS muting information.

The OTDOA assistance data as defined in TS 36.355, Clause 6.5.1, shall be provided to the UE during T1. The last TTI containing the OTDOA assistance data shall be provided to the UE ΔT ms before the start of T2, where $\Delta T = 150$ ms is the maximum processing time of the OTDOA assistance data.

The test parameters are as given in Table A.8.12.3.1-1, Table A.8.12.3.1-2, Table A.8.12.3.1-3 and Table A.8.12.3.1-4.

Table A.8.12.3.1-1: General test parameters for E-UTRAN FDD intra-frequency RSTD measurement reporting delay under fading propagation conditions

Parameter	Unit	Value		Comment
		Test 1	Test 2	
Reference cell		Cell 1		Reference cell is the cell in the OTDOA assistance data with respect to which the RSTD measurement is defined, as specified in TS 36.214 [4] and TS 36.355 [24]. The reference cell is the PCell in this test case.
Neighbor cells		Cell 2 and Cell 3		Cell 2 and Cell 3 appear at random places in the neighbour cell list in the OTDOA assistance data, but Cell 2 always appears in the first half of the list, whilst Cell 3 appears in the second half of the list.
MPDCCH		DL Reference Measurement Channel R.16 FDD		As specified in clause A.3.1.3.1
<i>mPDCCH-startSF-U ESS</i>		10		Parameter G in $T = r_{\max} \cdot G$ which determines subframe $k0$ in which MPDCCH starts
System Channel Bandwidth (BW_{channel})	MHz	10		
PRS Transmission Bandwidth	RB	50 ^{Note 1}		PRS are transmitted over the system bandwidth
PRS configuration index I_{PRS}		311		This corresponds to periodicity of 320 ms and PRS subframe offset of $I_{\text{PRS}} - 160$ DL subframes, as defined in TS 36.211 [16], Table 6.10.4.3-1
Number of consecutive downlink positioning subframes N_{PRS}		6	2	As defined in TS 36.211 [16]. The number of subframes in a positioning occasion
Physical cell ID PCI		(PCI of Cell 1 – PCI of Cell 2) mod 6 = 0 and (PCI of Cell 1 – PCI of Cell 3) mod 6 = 0		The cell PCIs are selected such that the relative shifts of PRS patterns among cells are as given by the test parameters
CP length		Normal		
DRX		ON		DRX parameters are further specified in Table A.8.12.3.1-3
Radio frame receive time offset between the cells at the UE antenna connector	μs	Cell 2 to Cell 1: 1 Cell 3 to Cell 1: -1		PRS are transmitted from synchronous cells
Expected RSTD	μs	Cell 2: 3 Cell 3: 3 Other neighbour cells: randomly between -3 and 3		The expected RSTD is what is expected at the receiver. The corresponding parameter in the OTDOA assistance data specified in TS 36.355 [24] is the expectedRSTD indicator
Expected RSTD uncertainty for all neighbour cells	μs	5		The corresponding parameter in the OTDOA assistance data specified in TS 36.355 [24] is the expectedRSTD-Uncertainty index
Number of cells provided in OTDOA assistance data		16		Including the reference cell

PRS muting info		Cell 1: '11110000' Cell 2: '00001111' Cell 3: '11110000'	Corresponds to prs-MutingInfo defined in TS 36.355 [24]
T1	s	3	The length of the time interval from the beginning of each test
T2	s	2.56	The length of the time interval that follows immediately after time interval T1
T3	s	2.56	The length of the time interval that follows immediately after time interval T2
NOTE 1: If the PRS transmission bandwidth is larger than the UE RF bandwidth, the UE is measuring RSTD within its RF bandwidth.			

Table A.8.12.3.1-2: Cell-specific test parameters for E-UTRAN FDD intra-frequency RSTD measurement reporting delay under fading propagation conditions during T1

Parameter	Unit	Cell 1	Cell 2	Cell 3
E-UTRA RF Channel Number		1	1	1
Correlation Matrix and Antenna Configuration		1x1	1x1	1x1
OCNG patterns defined in A.3.2.1		OP.21 FDD	N/A	N/A
PBCH_RA	dB	0	N/A	N/A
PBCH_RB				
PSS_RA				
SSS_RA				
PCFICH_RB				
PHICH_RA				
PHICH_RB				
PDCCH_RA				
PDCCH_RB				
OCNG_RA ^{Note 1}				
OCNG_RB ^{Note 1}				
N_{oc} ^{Note 3}	dBm/15 kHz	-95		
PRS \hat{E}_s/N_{oc}	dB	-Infinity	-Infinity	-Infinity
I_o ^{Note 4}	dBm/9 MHz	-67.22	-67.22	-67.22
\hat{E}_s/N_{oc}	dB	0	-Infinity	-Infinity
Propagation Condition		ETU30		
<p>Note 1: OCNG shall be used such that active cell (Cell 1) is fully allocated and a constant total transmitted power spectral density is achieved for all OFDM symbols.</p> <p>Note 2: The resources for uplink transmission are assigned to the UE prior to the start of time period T2.</p> <p>Note 3: Interference from other cells and noise sources not specified in the test are assumed to be constant over subcarriers and time and shall be modelled as AWGN of appropriate power for N_{oc} to be fulfilled.</p> <p>Note 4: I_o levels have been derived from other parameters and are given for information purpose. These are not settable test parameters.</p>				

Table A.8.12.3.1-3: Cell-specific test parameters for E-UTRAN FDD intra-frequency RSTD measurement reporting delay under fading propagation conditions during T2 and T3

Parameter	Unit	Cell 1		Cell 2		Cell 3	
		T2	T3	T2	T3	T2	T3

E-UTRA RF Channel Number		1		1		1	
Correlation Matrix and Antenna Configuration		1x1		1x1		1x1	
OCNG patterns defined in A.3.2.1		OP.21 FDD		OP.6 FDD		OP.6 FDD	N/A
PBCH_RA	dB	0		0		0	N/A
PBCH_RB							
PSS_RA							
SSS_RA							
PCFICH_RB							
PHICH_RA							
PHICH_RB							
PDCCH_RA							
PDCCH_RB							
OCNG_RA ^{Note 1}							
OCNG_RB ^{Note 1}							
PRS_RA	dB	-3	N/A	N/A	3	3	N/A
N_{oc} ^{Note 3}	dBm/15 kHz	-98	-95	-98	-95	-98	-95
$PRS \hat{E}_s/N_{oc}$	dB	-1	-Infinity	-Infinity	-7	-7	-Infinity
$PRS \hat{E}_s/I_{ot}$ ^{Note 4}	dB	-1.79	-Infinity	-Infinity	-7	-9.54	-Infinity
I_o ^{Note 4}	dBm/9 MHz	-69.55	-67.08	-69.55	-67.08	-69.55	-67.08
PRP ^{Note 4}	dBm/15 kHz	-99	-Infinity	-Infinity	-102	-105	-Infinity
RSRP ^{Note 4}	dBm/15 kHz	-96	-93	-105	-105	-108	-Infinity
\hat{E}_s/N_{oc} ^{Note 4}	dB	2	2	-7	-10	-10	-Infinity
Propagation Condition		ETU30					
<p>Note 1: OCNG shall be used such that active cells (all, except Cell 3 in T3) are fully allocated and a constant total transmitted power spectral density is achieved for all OFDM symbols other than those in the subframes with transmitted PRS.</p> <p>Note 2: The resources for uplink transmission are assigned to the UE prior to the start of time period T2.</p> <p>Note 3: Interference from other cells and noise sources not specified in the test are assumed to be constant over subcarriers and time and shall be modelled as AWGN of appropriate power for N_{oc} to be fulfilled.</p> <p>Note 4: If PRS_RA is not "N/A", \hat{E}_s/N_{oc}, $PRS \hat{E}_s/I_{ot}$, I_o, RSRP and PRP levels have been derived from other parameters and are given for information purpose. If PRS_RA is "N/A", I_o and RSRP levels have been derived from other parameters and are given for information purpose. These are not settable test parameters. Interference conditions shall be applied to all PRS symbols of DL positioning subframes.</p>							

Table A.8.12.3.1-4: DRX parameters for the test of E-UTRAN FDD intra-frequency RSTD measurement reporting delay under fading propagation conditions

Field	Value	Comment
onDurationTimer	psf1	As specified in TS 36.331 [2], Clause 6.3.2
Drx-InactivityTimer	psf1	
drx-RetransmissionTimer	sf1	
longDRX-CycleStartOffset	sf320	
shortDRX	Disable	

A.8.12.3.2 Test Requirements

For Cat-M1 UE in CE Mode A, the RSTD measurement time fulfils the requirements specified in Clause 8.13.2.3.1.

For Cat-M2 UE in CE Mode A, the RSTD measurement time fulfils the requirements specified in Clause 8.16.2.3.1.

In Test 1, the UE shall perform and report the RSTD measurements for Cell 2 and Cell 3 with respect to the reference cell in the OTDOA assistance data, Cell 1, within 5120 ms starting from the beginning of time interval T2.

In Test 2, the shall perform and report the RSTD measurements for Cell 2 and Cell 3 with respect to the reference cell in the OTDOA assistance data, Cell 1, within 5120 ms starting from the beginning of time interval T2.

The rate of the correct events for each neighbour cell observed during repeated tests shall be at least 90%, where the reported RSTD measurement for each correct event shall be within the RSTD reporting range specified in Clause 9.1.10.3, i.e., between RSTD_0000 and RSTD_12711.

NOTE: The RSTD measurement time in the test is derived from the following expression,

$$T_{PRS} (M - 1) + 320 \cdot \left\lceil \frac{n}{M} \right\rceil, \text{ where } M = 16 \text{ and } n = 16 \text{ are the parameters specified in}$$

Section 8.13.2.3.1 (for Cat-M1) and in Section 8.16.2.3.1 (for Cat-M2) under Note 1. This gives the total RSTD measurement time of 5120 ms for Cell 2 and Cell 3 with respect to the reference Cell 1.

A.8.12.4 E-UTRAN HD-FDD intra-frequency RSTD measurement period test case in CE Mode A

A.8.12.4.1 Test Purpose and Environment

The purpose of the test is to verify for Cat-M1 and Cat-M2 UE in CE Mode A that the RSTD measurement meets the requirements specified in Sections 8.13.2.3.3 and 8.16.2.3.3, respectively, in an environment with fading propagation conditions. Test 1 is applicable for Cat-M1 and Cat-M2 supporting 1.4 MHz UE RF bandwidth, while Test 2 is applicable for Cat-M2 supporting 5 MHz UE RF bandwidth.

In the test there are three synchronous cells: Cell 1, Cell 2 and Cell 3. Cell 1 is the reference as well as the PCell. Cell 2 and Cell 3 are the neighbour cells. All cells are on the same RF channel.

The test consists of three consecutive time intervals, with duration of T1, T2 and T3. Cell 1 is active in T1, T2 and T3, whilst Cell 2 and Cell 3 are activated only in the beginning of T2. Cell 2 is active until the end of T3, and Cell 3 is active until the end of T2. The beginning of the time interval T2 shall be aligned with the first PRS positioning subframe of a positioning occasion in the reference cell, where the PRS positioning occasion is as defined in Clause 8.1.2.5.1. Cell 1 transmits PRS in T2, while Cell 2 transmits PRS only in T3, and Cell 3 transmits PRS only in T2. Note: The information on when PRS is muted is conveyed to the UE using PRS muting information.

The OTDOA assistance data as defined in TS 36.355, Clause 6.5.1, shall be provided to the UE during T1. The last TTI containing the OTDOA assistance data shall be provided to the UE ΔT ms before the start of T2, where $\Delta T = 150$ ms is the maximum processing time of the OTDOA assistance data.

The test parameters are as given in Table A.8.12.4.1-1, Table A.8.12.4.1-2, Table A.8.12.4.1-3 and Table A.8.12.4.1-4.

Table A.8.12.4.1-1: General test parameters for E-UTRAN HD-FDD intra-frequency RSTD measurement reporting delay under fading propagation conditions

Parameter	Unit	Value		Comment
		Test 1	Test 2	
Reference cell		Cell 1		Reference cell is the cell in the OTDOA assistance data with respect to which the RSTD measurement is defined, as specified in TS 36.214 [4] and TS 36.355 [24]. The reference cell is the PCell in this test case.
Neighbor cells		Cell 2 and Cell 3		Cell 2 and Cell 3 appear at random places in the neighbour cell list in the OTDOA assistance data, but Cell 2 always appears in the first half of the list, whilst Cell 3 appears in the second half of the list.

MPDCCH		DL Reference Measurement Channel R.6 HD-FDD		As specified in clause A.3.1.3.1
$mPDCCH\text{-startSF-U ESS}$		10		Parameter G in $T = r_{\max} \cdot G$ which determines subframe $k0$ in which MPDCCH starts
System Channel Bandwidth (BW_{channel})	MHz	10		
PRS Transmission Bandwidth	RB	50 ^{Note 1}		PRS are transmitted over the system bandwidth
PRS configuration index I_{PRS}		311		This corresponds to periodicity of 320 ms and PRS subframe offset of $I_{\text{PRS}} - 160$ DL subframes, as defined in TS 36.211 [16], Table 6.10.4.3-1
Number of consecutive downlink positioning subframes N_{PRS}		6	2	As defined in TS 36.211 [16]. The number of subframes in a positioning occasion
Physical cell ID PCI		(PCI of Cell 1 – PCI of Cell 2) mod 6 = 0 and (PCI of Cell 1 – PCI of Cell 3) mod 6 = 0		The cell PCIs are selected such that the relative shifts of PRS patterns among cells are as given by the test parameters
CP length		Normal		
DRX		ON		DRX parameters are further specified in Table A.8.12.4.1-3
Radio frame receive time offset between the cells at the UE antenna connector	μs	Cell 2 to Cell 1: 1 Cell 3 to Cell 1: -1		PRS are transmitted from synchronous cells
Expected RSTD	μs	Cell 2: 3 Cell 3: 3 Other neighbour cells: randomly between -3 and 3		The expected RSTD is what is expected at the receiver. The corresponding parameter in the OTDOA assistance data specified in TS 36.355 [24] is the expectedRSTD indicator
Expected RSTD uncertainty for all neighbour cells	μs	5		The corresponding parameter in the OTDOA assistance data specified in TS 36.355 [24] is the expectedRSTD-Uncertainty index
Number of cells provided in OTDOA assistance data		16		Including the reference cell
PRS muting info		Cell 1: '11110000' Cell 2: '00001111' Cell 3: '11110000'		Corresponds to prs-MutingInfo defined in TS 36.355 [24]
T1	s	3		The length of the time interval from the beginning of each test
T2	s	2.56		The length of the time interval that follows immediately after time interval T1
T3	s	2.56		The length of the time interval that follows immediately after time interval T2
NOTE 1: If the PRS transmission bandwidth is larger than the UE RF bandwidth, the UE is measuring RSTD within its RF bandwidth.				

Table A.8.12.4.1-2: Cell-specific test parameters for E-UTRAN HD-FDD intra-frequency RSTD measurement reporting delay under fading propagation conditions during T1

Parameter	Unit	Cell 1	Cell 2	Cell 3
E-UTRA RF Channel Number		1	1	1
Correlation Matrix and Antenna Configuration		1x1	1x1	1x1
OCNG patterns defined in A.3.2.1		OP.21 FDD	N/A	N/A

PBCH_RA	dB	0	N/A	N/A
PBCH_RB				
PSS_RA				
SSS_RA				
PCFICH_RB				
PHICH_RA				
PHICH_RB				
PDCCH_RA				
PDCCH_RB				
OCNG_RA ^{Note 1}				
OCNG_RB ^{Note 1}				
N_{oc} ^{Note 3}				
PRS \hat{E}_s/N_{oc}	dB	-Infinity	-Infinity	-Infinity
I_o ^{Note 4}	dBm/ 9 MHz	-67.22	-67.22	-67.22
\hat{E}_s/N_{oc}	dB	0	-Infinity	-Infinity
Propagation Condition		ETU30		
<p>Note 1: OCNG shall be used such that active cell (Cell 1) is fully allocated and a constant total transmitted power spectral density is achieved for all OFDM symbols.</p> <p>Note 2: The resources for uplink transmission are assigned to the UE prior to the start of time period T2.</p> <p>Note 3: Interference from other cells and noise sources not specified in the test are assumed to be constant over subcarriers and time and shall be modelled as AWGN of appropriate power for N_{oc} to be fulfilled.</p> <p>Note 4: I_o levels have been derived from other parameters and are given for information purpose. These are not settable test parameters.</p>				

Table A.8.12.4.1-3: Cell-specific test parameters for E-UTRAN HD-FDD intra-frequency RSTD measurement reporting delay under fading propagation conditions during T2 and T3

Parameter	Unit	Cell 1		Cell 2		Cell 3	
		T2	T3	T2	T3	T2	T3
E-UTRA RF Channel Number		1		1		1	
Correlation Matrix and Antenna Configuration		1x1		1x1		1x1	
OCNG patterns defined in A.3.2.1		OP.21 FDD		OP.6 FDD		OP.6 FDD	N/A
PBCH_RA	dB	0	0	0	0	0	N/A
PBCH_RB							
PSS_RA							
SSS_RA							
PCFICH_RB							
PHICH_RA							
PHICH_RB							
PDCCH_RA							
PDCCH_RB							
OCNG_RA ^{Note 1}							
OCNG_RB ^{Note 1}							
PRS_RA							
N_{oc} ^{Note 3}	dBm/ 15 kHz	-98	-95	-98	-95	-98	-95
PRS \hat{E}_s/N_{oc}	dB	-1	-Infinity	-Infinity	-7	-7	-Infinity
PRS \hat{E}_s/I_{ot} ^{Note 4}	dB	-1.79	-Infinity	-Infinity	-7	-9.54	-Infinity
I_o ^{Note 4}	dBm/ 9 MHz	-69.55	-67.08	-69.55	-67.08	-69.55	-67.08

PRP ^{Note 4}	dBm/ 15 kHz	-99	-Infinity	-Infinity	-102	-105	-Infinity
RSRP ^{Note 4}	dBm/ 15 kHz	-96	-93	-105	-105	-108	-Infinity
\hat{E}_s/N_{oc} ^{Note 4}	dB	2	2	-7	-10	-10	-Infinity
Propagation Condition		ETU30					
Note 1:	OCNG shall be used such that active cells (all, except Cell 3 in T3) are fully allocated and a constant total transmitted power spectral density is achieved for all OFDM symbols other than those in the subframes with transmitted PRS.						
Note 2:	The resources for uplink transmission are assigned to the UE prior to the start of time period T2.						
Note 3:	Interference from other cells and noise sources not specified in the test are assumed to be constant over subcarriers and time and shall be modelled as AWGN of appropriate power for N_{oc} to be fulfilled.						
Note 4:	If PRS_RA is not "N/A", \hat{E}_s/N_{oc} , PRS \hat{E}_s/I_{ot} , I_o , RSRP and PRP levels have been derived from other parameters and are given for information purpose. If PRS_RA is "N/A", I_o and RSRP levels have been derived from other parameters and are given for information purpose. These are not settable test parameters. Interference conditions shall be applied to all PRS symbols of DL positioning subframes.						

Table A.8.12.4.1-4: DRX parameters for the test of E-UTRAN HD-FDD intra-frequency RSTD measurement reporting delay under fading propagation conditions

Field	Value	Comment
onDurationTimer	psf1	As specified in TS 36.331 [2], Clause 6.3.2
Drx-InactivityTimer	psf1	
drx-RetransmissionTimer	sf1	
longDRX-CycleStartOffset	sf320	
shortDRX	Disable	

A.8.12.4.2 Test Requirements

For Cat-M1 UE in CE Mode A, the RSTD measurement time fulfils the requirements specified in Clause 8.13.2.3.3.

For Cat-M2 UE in CE Mode A, the RSTD measurement time fulfils the requirements specified in Clause 8.16.2.3.3.

In Test 1, the UE shall perform and report the RSTD measurements for Cell 2 and Cell 3 with respect to the reference cell in the OTDOA assistance data, Cell 1, within 5120 ms starting from the beginning of time interval T2.

In Test 2, the shall perform and report the RSTD measurements for Cell 2 and Cell 3 with respect to the reference cell in the OTDOA assistance data, Cell 1, within 5120 ms starting from the beginning of time interval T2.

The rate of the correct events for each neighbour cell observed during repeated tests shall be at least 90%, where the reported RSTD measurement for each correct event shall be within the RSTD reporting range specified in Clause 9.1.10.3, i.e., between RSTD_0000 and RSTD_12711.

NOTE: The RSTD measurement time in the test is derived from the following expression,

$$T_{PRS} (M - 1) + 320 \cdot \left\lceil \frac{n}{M} \right\rceil, \text{ where } M = 16 \text{ and } n = 16 \text{ are the parameters specified in}$$

Section 8.13.2.3.3 (for Cat-M1) and in Section 8.16.2.3.3 (for Cat-M2) under Note 1. This gives the total RSTD measurement time of 5120 ms for Cell 2 and Cell 3 with respect to the reference Cell 1.

A.8.12.5 E-UTRAN TDD intra-frequency RSTD measurement period test case in CE Mode A

A.8.12.5.1 Test Purpose and Environment

The purpose of the test is to verify for Cat-M1 and Cat-M2 UE in CE Mode A that the RSTD measurement meets the requirements specified in Sections 8.13.2.3.2 and 8.16.2.3.2, respectively, in an environment with fading propagation conditions. Test 1 is applicable for Cat-M1 and Cat-M2 supporting 1.4 MHz UE RF bandwidth, while Test 2 is applicable for Cat-M2 supporting 5 MHz UE RF bandwidth.

In the test there are three synchronous cells: Cell 1, Cell 2 and Cell 3. Cell 1 is the reference as well as the PCell. Cell 2 and Cell 3 are the neighbour cells. All cells are on the same RF channel.

The test consists of three consecutive time intervals, with duration of T1, T2 and T3. Cell 1 is active in T1, T2 and T3, whilst Cell 2 and Cell 3 are activated only in the beginning of T2. Cell 2 is active until the end of T3, and Cell 3 is active until the end of T2. The beginning of the time interval T2 shall be aligned with the first PRS positioning subframe of a positioning occasion in the reference cell, where the PRS positioning occasion is as defined in Clause 8.1.2.5.1. Cell 1 transmits PRS in T2, while Cell 2 transmits PRS only in T3, and Cell 3 transmits PRS only in T2. Note: The information on when PRS is muted is conveyed to the UE using PRS muting information.

The OTDOA assistance data as defined in TS 36.355, Clause 6.5.1, shall be provided to the UE during T1. The last TTI containing the OTDOA assistance data shall be provided to the UE ΔT ms before the start of T2, where $\Delta T = 150$ ms is the maximum processing time of the OTDOA assistance data.

The test parameters are as given in Table A.8.12.5.1-1, Table A.8.12.5.1-2, Table A.8.12.5.1-3 and Table A.8.12.5.1-4.

Table A.8.12.5.1-1: General test parameters for E-UTRAN TDD intra-frequency RSTD measurement reporting delay under fading propagation conditions

Parameter	Unit	Value		Comment
		Test 1	Test 2	
Reference cell		Cell 1		Reference cell is the cell in the OTDOA assistance data with respect to which the RSTD measurement is defined, as specified in TS 36.214 [4] and TS 36.355 [24]. The reference cell is the PCell in this test case.
Neighbor cells		Cell 2 and Cell 3		Cell 2 and Cell 3 appear at random places in the neighbour cell list in the OTDOA assistance data, but Cell 2 always appears in the first half of the list, whilst Cell 3 appears in the second half of the list.
MPDCCH		DL Reference Measurement Channel R.14 TDD		As specified in clause A.3.1.3.1
<i>mPDCCH-startSF-UESS</i>		10		Parameter G in $T = r_{\max} \cdot G$ which determines subframe $k0$ in which MPDCCH starts
System Channel Bandwidth (BW_{channel})	MHz	10		
PRS Transmission Bandwidth	RB	50 ^{Note 1}		PRS are transmitted over the system bandwidth
PRS configuration index I_{PRS}		304		This corresponds to periodicity of 320 ms and PRS subframe offset of $I_{\text{PRS}} - 160$ DL subframes, as defined in TS 36.211 [16], Table 6.10.4.3-1
Number of consecutive downlink positioning subframes N_{PRS}		6	2	As defined in TS 36.211 [16]. The number of subframes in a positioning occasion

Physical cell ID PCI		$(\text{PCI of Cell 1} - \text{PCI of Cell 2}) \bmod 6 = 0$ and $(\text{PCI of Cell 1} - \text{PCI of Cell 3}) \bmod 6 = 0$	The cell PCIs are selected such that the relative shifts of PRS patterns among cells are as given by the test parameters
TDD uplink-downlink configuration		1	As specified in TS 36.211 [16], Clause 4.2; corresponds to a configuration with 5 ms switch-point periodicity and two downlink consecutive subframes
TDD special subframe configuration		6	As specified in TS 36.211 [16], Clause 4.2; corresponds to DwPTS of $19760 \cdot T_s$ and UpPTS of $4384 \cdot T_s$
CP length		Normal	
DRX		ON	DRX parameters are further specified in Table A.8.12.5.1-3
Radio frame receive time offset between the cells at the UE antenna connector	μs	Cell 2 to Cell 1: 1 Cell 3 to Cell 1: -1	PRS are transmitted from synchronous cells
Expected RSTD	μs	Cell 2: 3 Cell 3: 3 Other neighbour cells: randomly between -3 and 3	The expected RSTD is what is expected at the receiver. The corresponding parameter in the OTDOA assistance data specified in TS 36.355 [24] is the expectedRSTD indicator
Expected RSTD uncertainty for all neighbour cells	μs	5	The corresponding parameter in the OTDOA assistance data specified in TS 36.355 [24] is the expectedRSTD-Uncertainty index
Number of cells provided in OTDOA assistance data		16	Including the reference cell
PRS muting info		Cell 1: '11110000' Cell 2: '00001111' Cell 3: '11110000'	Corresponds to prs-MutingInfo defined in TS 36.355 [24]
T1	s	3	The length of the time interval from the beginning of each test
T2	s	2.56	The length of the time interval that follows immediately after time interval T1
T3	s	2.56	The length of the time interval that follows immediately after time interval T2
NOTE 1: If the PRS transmission bandwidth is larger than the UE RF bandwidth, the UE is measuring RSTD within its RF bandwidth.			

Table A.8.12.5.1-2: Cell-specific test parameters for E-UTRAN TDD intra-frequency RSTD measurement reporting delay under fading propagation conditions during T1

Parameter	Unit	Cell 1	Cell 2	Cell 3
E-UTRA RF Channel Number		1	1	1
Correlation Matrix and Antenna Configuration		1x1	1x1	1x1
OCNG patterns defined in A.3.2.1		OP.11 TDD	N/A	N/A
PBCH_RA	dB	0	N/A	N/A
PBCH_RB				
PSS_RA				
SSS_RA				
PCFICH_RB				
PHICH_RA				
PHICH_RB				
PDCCH_RA				

PDCCH_RB				
OCNG_RA ^{Note 1}				
OCNG_RB ^{Note 1}				
N_{oc} ^{Note 3}	dBm/ 15 kHz	-95		
PRS \hat{E}_s/N_{oc}	dB	-Infinity	-Infinity	-Infinity
I_o ^{Note 4}	dBm/ 9 MHz	-67.22	-67.22	-67.22
\hat{E}_s/N_{oc}	dB	0	-Infinity	-Infinity
Propagation Condition		ETU30		
<p>Note 1: OCNG shall be used such that active cell (Cell 1) is fully allocated and a constant total transmitted power spectral density is achieved for all OFDM symbols.</p> <p>Note 2: The resources for uplink transmission are assigned to the UE prior to the start of time period T2.</p> <p>Note 3: Interference from other cells and noise sources not specified in the test are assumed to be constant over subcarriers and time and shall be modelled as AWGN of appropriate power for N_{oc} to be fulfilled.</p> <p>Note 4: I_o levels have been derived from other parameters and are given for information purpose. These are not settable test parameters.</p>				

Table A.8.12.5.1-3: Cell-specific test parameters for E-UTRAN TDD intra-frequency RSTD measurement reporting delay under fading propagation conditions during T2 and T3

Parameter	Unit	Cell 1		Cell 2		Cell 3		
		T2	T3	T2	T3	T2	T3	
E-UTRA RF Channel Number		1		1		1		
Correlation Matrix and Antenna Configuration		1x1		1x1		1x1		
OCNG patterns defined in A.3.2.1		OP.11 TDD		OP.2 TDD		OP.2 TDD	N/A	
PBCH_RA	dB	0		0		0		N/A
PBCH_RB								
PSS_RA								
SSS_RA								
PCFICH_RB								
PHICH_RA								
PHICH_RB								
PDCCH_RA								
PDCCH_RB								
OCNG_RA ^{Note 1}								
OCNG_RB ^{Note 1}								
PRS_RA	dB	-3	N/A	N/A	3	3	N/A	
N_{oc} ^{Note 3}	dBm/ 15 kHz	-98	-95	-98	-95	-98	-95	
PRS \hat{E}_s/N_{oc}	dB	-1	-Infinity	-Infinity	-7	-7	-Infinity	
PRS \hat{E}_s/I_{ot} ^{Note 4}	dB	-1.79	-Infinity	-Infinity	-7	-9.54	-Infinity	
I_o ^{Note 4}	dBm/ 9 MHz	-69.55	-67.08	-69.55	-67.08	-69.55	-67.08	
PRP ^{Note 4}	dBm/ 15 kHz	-99	-Infinity	-Infinity	-102	-105	-Infinity	
RSRP ^{Note 4}	dBm/ 15 kHz	-96	-93	-105	-105	-108	-Infinity	
\hat{E}_s/N_{oc} ^{Note 4}	dB	2	2	-7	-10	-10	-Infinity	
Propagation Condition		ETU30						

Note 1:	OCNG shall be used such that active cells (all, except Cell 3 in T3) are fully allocated and a constant total transmitted power spectral density is achieved for all OFDM symbols other than those in the subframes with transmitted PRS.
Note 2:	The resources for uplink transmission are assigned to the UE prior to the start of time period T2.
Note 3:	Interference from other cells and noise sources not specified in the test are assumed to be constant over subcarriers and time and shall be modelled as AWGN of appropriate power for N_{oc} to be fulfilled.
Note 4:	If PRS_RA is not "N/A", \hat{E}_s/N_{oc} , PRS \hat{E}_s/I_{ot} , I_o , RSRP and PRP levels have been derived from other parameters and are given for information purpose. If PRS_RA is "N/A", I_o and RSRP levels have been derived from other parameters and are given for information purpose. These are not settable test parameters. Interference conditions shall be applied to all PRS symbols of DL positioning subframes.

Table A.8.12.5.1-4: DRX parameters for the test of E-UTRAN TDD intra-frequency RSTD measurement reporting delay under fading propagation conditions

Field	Value	Comment
onDurationTimer	psf1	As specified in TS 36.331 [2], Clause 6.3.2
Drx-InactivityTimer	psf1	
drx-RetransmissionTimer	sf1	
longDRX-CycleStartOffset	sf320	
shortDRX	Disable	

A.8.12.5.2 Test Requirements

For Cat-M1 UE in CE Mode A, the RSTD measurement time fulfils the requirements specified in Clause 8.13.2.3.2.

For Cat-M2 UE in CE Mode A, the RSTD measurement time fulfils the requirements specified in Clause 8.16.2.3.2.

In Test 1, the UE shall perform and report the RSTD measurements for Cell 2 and Cell 3 with respect to the reference cell in the OTDOA assistance data, Cell 1, within 5120 ms starting from the beginning of time interval T2.

In Test 2, the shall perform and report the RSTD measurements for Cell 2 and Cell 3 with respect to the reference cell in the OTDOA assistance data, Cell 1, within 5120 ms starting from the beginning of time interval T2.

The rate of the correct events for each neighbour cell observed during repeated tests shall be at least 90%, where the reported RSTD measurement for each correct event shall be within the RSTD reporting range specified in Clause 9.1.10.3, i.e., between RSTD_0000 and RSTD_12711.

NOTE: The RSTD measurement time in the test is derived from the following expression,

$$T_{PRS} (M - 1) + 320 \cdot \left\lceil \frac{n}{M} \right\rceil, \text{ where } M = 16 \text{ and } n = 16 \text{ are the parameters specified in}$$

Section 8.13.2.3.2 (for Cat-M1) and in Section 8.16.2.3.2 (for Cat-M2) under Note 1. This gives the total RSTD measurement time of 5120 ms for Cell 2 and Cell 3 with respect to the reference Cell 1.

A.8.12.6 E-UTRAN FDD intra-frequency RSTD measurement period test case in CE Mode B

A.8.12.6.1 Test Purpose and Environment

The purpose of the test is to verify for Cat-M1 and Cat-M2 UE in CEMode B that the RSTD measurement meets the requirements specified in Sections 8.13.3.3.1 and 8.16.3.1.1, respectively, in an environment with fading propagation conditions. Test 1 is applicable for Cat-M1 and Cat-M2 supporting 1.4 MHz UE RF bandwidth, while Test 2 is applicable for Cat-M2 supporting 5 MHz UE RF bandwidth.

In the test there are three synchronous cells: Cell 1, Cell 2 and Cell 3. Cell 1 is the reference as well as the PCell. Cell 2 and Cell 3 are the neighbour cells. All cells are on the same RF channel.

The test consists of three consecutive time intervals, with duration of T1, T2 and T3. Cell 1 is active in T1, T2 and T3, whilst Cell 2 and Cell 3 are activated only in the beginning of T2. Cell 2 is active until the end of T3, and Cell 3 is active until the end of T2. The beginning of the time interval T2 shall be aligned with the first PRS positioning subframe of a positioning occasion in the reference cell, where the PRS positioning occasion is as defined in Clause 8.1.2.5.1. Cell 1 transmits PRS in T2, while Cell 2 transmits PRS only in T3, and Cell 3 transmits PRS only in T2. Note: The information on when PRS is muted is conveyed to the UE using PRS muting information.

The OTDOA assistance data as defined in TS 36.355, Clause 6.5.1, shall be provided to the UE during T1. The last TTI containing the OTDOA assistance data shall be provided to the UE ΔT ms before the start of T2, where $\Delta T = 150$ ms is the maximum processing time of the OTDOA assistance data.

The test parameters are as given in Table A.8.12.6.1-1, Table A.8.12.6.1-2, Table A.8.12.6.1-3 and Table A.8.12.6.1-4.

Table A.8.12.6.1-1: General test parameters for E-UTRAN FDD intra-frequency RSTD measurement reporting delay under fading propagation conditions

Parameter	Unit	Value		Comment
		Test 1	Test 2	
Reference cell		Cell 1		Reference cell is the cell in the OTDOA assistance data with respect to which the RSTD measurement is defined, as specified in TS 36.214 [4] and TS 36.355 [24]. The reference cell is the PCell in this test case.
Neighbor cells		Cell 2 and Cell 3		Cell 2 and Cell 3 appear at random places in the neighbour cell list in the OTDOA assistance data, but Cell 2 always appears in the first half of the list, whilst Cell 3 appears in the second half of the list.
MPDCCH		DL Reference Measurement Channel R.18 FDD		As specified in clause A.3.1.3.1
<i>mPDCCH-startSF-UESS</i>		10		Parameter G in $T = r_{\max} \cdot G$ which determines subframe $k0$ in which MPDCCH starts
System Channel Bandwidth (BW_{channel})	MHz	10		
PRS Transmission Bandwidth	RB	50 ^{Note 1}		PRS are transmitted over the system bandwidth
PRS configuration index I_{PRS}		311		This corresponds to periodicity of 320 ms and PRS subframe offset of $I_{\text{PRS}} - 160$ DL subframes, as defined in TS 36.211 [16], Table 6.10.4.3-1
Number of consecutive downlink positioning subframes N_{PRS}		6	4	As defined in TS 36.211 [16]. The number of subframes in a positioning occasion
Physical cell ID PCI		(PCI of Cell 1 – PCI of Cell 2) mod 6 = 0 and (PCI of Cell 1 – PCI of Cell 3) mod 6 = 0		The cell PCIs are selected such that the relative shifts of PRS patterns among cells are as given by the test parameters
CP length		Normal		
DRX		ON		DRX parameters are further specified in Table A.8.12.6.1-3
Radio frame receive time offset between the cells at the UE antenna connector	μs	Cell 2 to Cell 1: 1 Cell 3 to Cell 1: -1		PRS are transmitted from synchronous cells
Expected RSTD	μs	Cell 2: 3 Cell 3: 3 Other neighbour cells: randomly between -3 and 3		The expected RSTD is what is expected at the receiver. The corresponding parameter in the OTDOA assistance data specified in TS 36.355 [24] is the expectedRSTD indicator

Expected RSTD uncertainty for all neighbour cells	μs	5		The corresponding parameter in the OTDOA assistance data specified in TS 36.355 [24] is the expectedRSTD-Uncertainty index
Number of cells provided in OTDOA assistance data		16		Including the reference cell
PRS muting info		Cell 1: '11110000' Cell 2: '00001111' Cell 3: '11110000'		Corresponds to prs-MutingInfo defined in TS 36.355 [24]
T1	s	3		The length of the time interval from the beginning of each test
T2	s	6.4	2.56	The length of the time interval that follows immediately after time interval T1
T3	s	6.4	2.56	The length of the time interval that follows immediately after time interval T2
NOTE 1: If the PRS transmission bandwidth is larger than the UE RF bandwidth, the UE is measuring RSTD within its RF bandwidth.				

Table A.8.12.6.1-2: Cell-specific test parameters for E-UTRAN FDD intra-frequency RSTD measurement reporting delay under fading propagation conditions during T1

Parameter	Unit	Cell 1	Cell 2	Cell 3
E-UTRA RF Channel Number		1	1	1
Correlation Matrix and Antenna Configuration		1x1	1x1	1x1
OCNG patterns defined in A.3.2.1		OP.21 FDD	N/A	N/A
PBCH_RA	dB	0	N/A	N/A
PBCH_RB				
PSS_RA				
SSS_RA				
PCFICH_RB				
PHICH_RA				
PHICH_RB				
PDCCH_RA				
PDCCH_RB				
OCNG_RA ^{Note 1}				
OCNG_RB ^{Note 1}				
N_{oc} ^{Note 3}				
PRS \hat{E}_s/N_{oc}	dB	-Infinity	-Infinity	-Infinity
I_o ^{Note 4}	dBm/9 MHz	-67.22	-67.22	-67.22
\hat{E}_s/N_{oc}	dB	0	-Infinity	-Infinity
Propagation Condition		ETU30		
<p>Note 1: OCNG shall be used such that active cell (Cell 1) is fully allocated and a constant total transmitted power spectral density is achieved for all OFDM symbols.</p> <p>Note 2: The resources for uplink transmission are assigned to the UE prior to the start of time period T2.</p> <p>Note 3: Interference from other cells and noise sources not specified in the test are assumed to be constant over subcarriers and time and shall be modelled as AWGN of appropriate power for N_{oc} to be fulfilled.</p> <p>Note 4: I_o levels have been derived from other parameters and are given for information purpose. These are not settable test parameters.</p>				

Table A.8.12.6.1-3: Cell-specific test parameters for E-UTRAN FDD intra-frequency RSTD measurement reporting delay under fading propagation conditions during T2 and T3

Parameter	Unit	Cell 1		Cell 2		Cell 3	
		T2	T3	T2	T3	T2	T3
E-UTRA RF Channel Number		1		1		1	
Correlation Matrix and Antenna Configuration		1x1		1x1		1x1	
OCNG patterns defined in A.3.2.1		OP.21 FDD		OP.6 FDD		OP.6 FDD	N/A
PBCH_RA	dB	0		0		0	N/A
PBCH_RB							
PSS_RA							
SSS_RA							
PCFICH_RB							
PHICH_RA							
PHICH_RB							
PDCCH_RA							
PDCCH_RB							
OCNG_RA ^{Note 1}							
OCNG_RB ^{Note 1}							
PRS_RA	dB	-3	N/A	N/A	3	3	N/A
N_{oc} ^{Note 3}	dBm/ 15 kHz	-98	-95	-98	-95	-98	-95
$PRS \hat{E}_s/N_{oc}$	dB	-12	-Infinity	-Infinity	-13	-13	-Infinity
$PRS \hat{E}_s/I_{ot}$ ^{Note 4}	dB	-12.21	-Infinity	-Infinity	-13	-13.27	-Infinity
I_o ^{Note 4}	dBm/ 9 MHz	-69.92	-67.18	-69.92	-67.18	-69.92	-67.18
PRP ^{Note 4}	dBm/ 15 kHz	-110	-Infinity	-Infinity	-108	-111	-Infinity
RSRP ^{Note 4}	dBm/ 15 kHz	-107	-104	-111	-111	-114	-Infinity
\hat{E}_s/N_{oc} ^{Note 4}	dB	-9	-9	-13	-16	-16	-Infinity
Propagation Condition		ETU30					
<p>Note 1: OCNG shall be used such that active cells (all, except Cell 3 in T3) are fully allocated and a constant total transmitted power spectral density is achieved for all OFDM symbols other than those in the subframes with transmitted PRS.</p> <p>Note 2: The resources for uplink transmission are assigned to the UE prior to the start of time period T2.</p> <p>Note 3: Interference from other cells and noise sources not specified in the test are assumed to be constant over subcarriers and time and shall be modelled as AWGN of appropriate power for N_{oc} to be fulfilled.</p> <p>Note 4: If PRS_RA is not "N/A", \hat{E}_s/N_{oc}, $PRS \hat{E}_s/I_{ot}$, I_o, RSRP and PRP levels have been derived from other parameters and are given for information purpose. If PRS_RA is "N/A", I_o and RSRP levels have been derived from other parameters and are given for information purpose. These are not settable test parameters. Interference conditions shall be applied to all PRS symbols of DL positioning subframes.</p>							

Table A.8.12.6.1-4: DRX parameters for the test of E-UTRAN FDD intra-frequency RSTD measurement reporting delay under fading propagation conditions

Field	Value	Comment
onDurationTimer	psf1	As specified in TS 36.331 [2], Clause 6.3.2
Drx-InactivityTimer	psf1	
drx-RetransmissionTimer	sf1	
longDRX-CycleStartOffset	sf320	
shortDRX	Disable	

A.8.12.6.2 Test Requirements

For Cat-M1 UE in CE Mode B, the RSTD measurement time fulfils the requirements specified in Clause 8.13.3.3.1.

For Cat-M2 UE in CE Mode B, the RSTD measurement time fulfils the requirements specified in Clause 8.16.3.1.1.

In Test 1, the UE shall perform and report the RSTD measurements for Cell 2 and Cell 3 with respect to the reference cell in the OTDOA assistance data, Cell 1, within 12800 ms starting from the beginning of time interval T2.

In Test 2, the shall perform and report the RSTD measurements for Cell 2 and Cell 3 with respect to the reference cell in the OTDOA assistance data, Cell 1, within 5120 ms starting from the beginning of time interval T2.

The rate of the correct events for each neighbour cell observed during repeated tests shall be at least 90%, where the reported RSTD measurement for each correct event shall be within the RSTD reporting range specified in Clause 9.1.10.3, i.e., between RSTD_0000 and RSTD_12711.

NOTE: The RSTD measurement time in the test is derived from the following expression,

$$T_{PRS} (M - 1) + 320 \cdot \left\lceil \frac{n}{M} \right\rceil, \text{ where } M = 16 \text{ and } n = 16 \text{ are the parameters for Test 1 and } M = 40 \text{ and}$$

$n = 16$ are the parameters for Test 2, specified in the corresponding requirements sections under Note 1. This gives the total RSTD measurement time of 12800 ms (Test 1) and 5120 ms (Test 2) for Cell 2 and Cell 3 with respect to the reference Cell 1.

A.8.12.7 E-UTRAN HD-FDD intra-frequency RSTD measurement period test case in CE Mode B

A.8.12.7.1 Test Purpose and Environment

The purpose of the test is to verify for Cat-M1 and Cat-M2 UE in CE Mode B that the RSTD measurement meets the requirements specified in Sections 8.13.3.3.3 and 8.16.3.1.3, respectively, in an environment with fading propagation conditions. Test 1 is applicable for Cat-M1 and Cat-M2 supporting 1.4 MHz UE RF bandwidth, while Test 2 is applicable for Cat-M2 supporting 5 MHz UE RF bandwidth.

In the test there are three synchronous cells: Cell 1, Cell 2 and Cell 3. Cell 1 is the reference as well as the PCell. Cell 2 and Cell 3 are the neighbour cells. All cells are on the same RF channel.

The test consists of three consecutive time intervals, with duration of T1, T2 and T3. Cell 1 is active in T1, T2 and T3, whilst Cell 2 and Cell 3 are activated only in the beginning of T2. Cell 2 is active until the end of T3, and Cell 3 is active until the end of T2. The beginning of the time interval T2 shall be aligned with the first PRS positioning subframe of a positioning occasion in the reference cell, where the PRS positioning occasion is as defined in Clause 8.1.2.5.1. Cell 1 transmits PRS in T2, while Cell 2 transmits PRS only in T3, and Cell 3 transmits PRS only in T2. Note: The information on when PRS is muted is conveyed to the UE using PRS muting information.

The OTDOA assistance data as defined in TS 36.355, Clause 6.5.1, shall be provided to the UE during T1. The last TTI containing the OTDOA assistance data shall be provided to the UE ΔT ms before the start of T2, where $\Delta T = 150$ ms is the maximum processing time of the OTDOA assistance data.

The test parameters are as given in Table A.8.12.7.1-1, Table A.8.12.7.1-2, Table A.8.12.7.1-3 and Table A.8.12.7.1-4.

Table A.8.12.7.1-1: General test parameters for E-UTRAN HD-FDD intra-frequency RSTD measurement reporting delay under fading propagation conditions

Parameter	Unit	Value		Comment
		Test 1	Test 2	
Reference cell		Cell 1		Reference cell is the cell in the OTDOA assistance data with respect to which the RSTD measurement is defined, as specified in TS 36.214 [4] and TS 36.355 [24]. The reference cell is the PCell in this test case.

Neighbor cells		Cell 2 and Cell 3		Cell 2 and Cell 3 appear at random places in the neighbour cell list in the OTDOA assistance data, but Cell 2 always appears in the first half of the list, whilst Cell 3 appears in the second half of the list.
MPDCCH		DL Reference Measurement Channel R.8 HD-FDD		As specified in clause A.3.1.3.1
<i>mPDCCH-startSF-UeSS</i>		10		Parameter G in $T = r_{\max} \cdot G$ which determines subframe $k0$ in which MPDCCH starts
System Channel Bandwidth (BW_{channel})	MHz	10		
PRS Transmission Bandwidth	RB	50 ^{Note 1}		PRS are transmitted over the system bandwidth
PRS configuration index I_{PRS}		311		This corresponds to periodicity of 320 ms and PRS subframe offset of $I_{\text{PRS}} - 160$ DL subframes, as defined in TS 36.211 [16], Table 6.10.4.3-1
Number of consecutive downlink positioning subframes N_{PRS}		6	4	As defined in TS 36.211 [16]. The number of subframes in a positioning occasion
Physical cell ID PCI		(PCI of Cell 1 – PCI of Cell 2) mod 6 = 0 and (PCI of Cell 1 – PCI of Cell 3) mod 6 = 0		The cell PCIs are selected such that the relative shifts of PRS patterns among cells are as given by the test parameters
CP length		Normal		
DRX		ON		DRX parameters are further specified in Table A.8.12.7.1-3
Radio frame receive time offset between the cells at the UE antenna connector	μs	Cell 2 to Cell 1: 1 Cell 3 to Cell 1: -1		PRS are transmitted from synchronous cells
Expected RSTD	μs	Cell 2: 3 Cell 3: 3 Other neighbour cells: randomly between -3 and 3		The expected RSTD is what is expected at the receiver. The corresponding parameter in the OTDOA assistance data specified in TS 36.355 [24] is the expectedRSTD indicator
Expected RSTD uncertainty for all neighbour cells	μs	5		The corresponding parameter in the OTDOA assistance data specified in TS 36.355 [24] is the expectedRSTD-Uncertainty index
Number of cells provided in OTDOA assistance data		16		Including the reference cell
PRS muting info		Cell 1: '11110000' Cell 2: '00001111' Cell 3: '11110000'		Corresponds to prs-MutingInfo defined in TS 36.355 [24]
T1	s	3		The length of the time interval from the beginning of each test
T2	s	6.4	2.56	The length of the time interval that follows immediately after time interval T1
T3	s	6.4	2.56	The length of the time interval that follows immediately after time interval T2
NOTE 1: If the PRS transmission bandwidth is larger than the UE RF bandwidth, the UE is measuring RSTD within its RF bandwidth.				

Table A.8.12.7.1-2: Cell-specific test parameters for E-UTRAN HD-FDD intra-frequency RSTD measurement reporting delay under fading propagation conditions during T1

Parameter	Unit	Cell 1	Cell 2	Cell 3
-----------	------	--------	--------	--------

E-UTRA RF Channel Number		1	1	1
Correlation Matrix and Antenna Configuration		1x1	1x1	1x1
OCNG patterns defined in A.3.2.1		OP.21 FDD	N/A	N/A
PBCH_RA	dB	0	N/A	N/A
PBCH_RB				
PSS_RA				
SSS_RA				
PCFICH_RB				
PHICH_RA				
PHICH_RB				
PDCCH_RA				
PDCCH_RB				
OCNG_RA ^{Note 1}				
OCNG_RB ^{Note 1}				
N_{oc} ^{Note 3}	dBm/ 15 kHz	-95		
$PR_S \hat{E}_s / N_{oc}$	dB	-Infinity	-Infinity	-Infinity
I_o ^{Note 4}	dBm/ 9 MHz	-67.22	-67.22	-67.22
\hat{E}_s / N_{oc}	dB	0	-Infinity	-Infinity
Propagation Condition		ETU30		
<p>Note 1: OCNG shall be used such that active cell (Cell 1) is fully allocated and a constant total transmitted power spectral density is achieved for all OFDM symbols.</p> <p>Note 2: The resources for uplink transmission are assigned to the UE prior to the start of time period T2.</p> <p>Note 3: Interference from other cells and noise sources not specified in the test are assumed to be constant over subcarriers and time and shall be modelled as AWGN of appropriate power for N_{oc} to be fulfilled.</p> <p>Note 4: I_o levels have been derived from other parameters and are given for information purpose. These are not settable test parameters.</p>				

Table A.8.12.7.1-3: Cell-specific test parameters for E-UTRAN HD-FDD intra-frequency RSTD measurement reporting delay under fading propagation conditions during T2 and T3

Parameter	Unit	Cell 1		Cell 2		Cell 3	
		T2	T3	T2	T3	T2	T3
E-UTRA RF Channel Number		1		1		1	
Correlation Matrix and Antenna Configuration		1x1		1x1		1x1	
OCNG patterns defined in A.3.2.1		OP.21 FDD		OP.6 FDD		OP.6 FDD	N/A
PBCH_RA	dB	0	N/A	N/A	3	3	N/A
PBCH_RB							
PSS_RA							
SSS_RA							
PCFICH_RB							
PHICH_RA							
PHICH_RB							
PDCCH_RA							
PDCCH_RB							
OCNG_RA ^{Note 1}							
OCNG_RB ^{Note 1}							
PR_S_RA	dB	-3	N/A	N/A	3	3	N/A

N_{oc} ^{Note 3}	dBm/ 15 kHz	-98	-95	-98	-95	-98	-95
PRS \hat{E}_s/N_{oc}	dB	-12	-Infinity	-Infinity	-13	-13	-Infinity
PRS \hat{E}_s/I_{ot} ^{Note 4}	dB	-12.21	-Infinity	-Infinity	-13	-13.27	-Infinity
I_o ^{Note 4}	dBm/ 9 MHz	-69.92	-67.18	-69.92	-67.18	-69.92	-67.18
PRP ^{Note 4}	dBm/ 15 kHz	-110	-Infinity	-Infinity	-108	-111	-Infinity
RSRP ^{Note 4}	dBm/ 15 kHz	-107	-104	-111	-111	-114	-Infinity
\hat{E}_s/N_{oc} ^{Note 4}	dB	-9	-9	-13	-16	-16	-Infinity
Propagation Condition		ETU30					
<p>Note 1: OCNG shall be used such that active cells (all, except Cell 3 in T3) are fully allocated and a constant total transmitted power spectral density is achieved for all OFDM symbols other than those in the subframes with transmitted PRS.</p> <p>Note 2: The resources for uplink transmission are assigned to the UE prior to the start of time period T2.</p> <p>Note 3: Interference from other cells and noise sources not specified in the test are assumed to be constant over subcarriers and time and shall be modelled as AWGN of appropriate power for N_{oc} to be fulfilled.</p> <p>Note 4: If PRS_RA is not "N/A", \hat{E}_s/N_{oc}, PRS \hat{E}_s/I_{ot}, I_o, RSRP and PRP levels have been derived from other parameters and are given for information purpose. If PRS_RA is "N/A", I_o and RSRP levels have been derived from other parameters and are given for information purpose. These are not settable test parameters. Interference conditions shall be applied to all PRS symbols of DL positioning subframes.</p>							

Table A.8.12.7.1-4: DRX parameters for the test of E-UTRAN HD-FDD intra-frequency RSTD measurement reporting delay under fading propagation conditions

Field	Value	Comment
onDurationTimer	psf1	As specified in TS 36.331 [2], Clause 6.3.2
Drx-InactivityTimer	psf1	
drx-RetransmissionTimer	sf1	
longDRX-CycleStartOffset	sf320	
shortDRX	Disable	

A.8.12.7.2 Test Requirements

For Cat-M1 UE in CE Mode B, the RSTD measurement time fulfils the requirements specified in Clause 8.13.3.3.3.

For Cat-M2 UE in CE Mode B, the RSTD measurement time fulfils the requirements specified in Clause 8.16.3.1.3.

In Test 1, the UE shall perform and report the RSTD measurements for Cell 2 and Cell 3 with respect to the reference cell in the OTDOA assistance data, Cell 1, within 12800 ms starting from the beginning of time interval T2.

In Test 2, the UE shall perform and report the RSTD measurements for Cell 2 and Cell 3 with respect to the reference cell in the OTDOA assistance data, Cell 1, within 5120 ms starting from the beginning of time interval T2.

The rate of the correct events for each neighbour cell observed during repeated tests shall be at least 90%, where the reported RSTD measurement for each correct event shall be within the RSTD reporting range specified in Clause 9.1.10.3, i.e., between RSTD_0000 and RSTD_12711.

NOTE: The RSTD measurement time in the test is derived from the following expression,

$$T_{PRS}(M-1) + 320 \cdot \left\lceil \frac{n}{M} \right\rceil, \text{ where } M=16 \text{ and } n=16 \text{ are the parameters for Test 1 and } M=40 \text{ and } n=16 \text{ are the parameters for Test 2, specified in the corresponding requirements sections under Note 1.}$$

This gives the total RSTD measurement time of 12800 ms (Test 1) and 5120 ms (Test 2) for Cell 2 and Cell 3 with respect to the reference Cell 1.

A.8.12.8 E-UTRAN TDD intra-frequency RSTD measurement period test case in CE Mode B

A.8.12.8.1 Test Purpose and Environment

The purpose of the test is to verify for Cat-M1 and Cat-M2 UE in CE Mode B that the RSTD measurement meets the requirements specified in Sections 8.13.3.3.2 and 8.16.3.1.2, respectively, in an environment with fading propagation conditions. Test 1 is applicable for Cat-M1 and Cat-M2 supporting 1.4 MHz UE RF bandwidth, while Test 2 is applicable for Cat-M2 supporting 5 MHz UE RF bandwidth.

In the test there are three synchronous cells: Cell 1, Cell 2 and Cell 3. Cell 1 is the reference as well as the PCell. Cell 2 and Cell 3 are the neighbour cells. All cells are on the same RF channel.

The test consists of three consecutive time intervals, with duration of T1, T2 and T3. Cell 1 is active in T1, T2 and T3, whilst Cell 2 and Cell 3 are activated only in the beginning of T2. Cell 2 is active until the end of T3, and Cell 3 is active until the end of T2. The beginning of the time interval T2 shall be aligned with the first PRS positioning subframe of a positioning occasion in the reference cell, where the PRS positioning occasion is as defined in Clause 8.1.2.5.1. Cell 1 transmits PRS in T2, while Cell 2 transmits PRS only in T3, and Cell 3 transmits PRS only in T2. Note: The information on when PRS is muted is conveyed to the UE using PRS muting information.

The OTDOA assistance data as defined in TS 36.355, Clause 6.5.1, shall be provided to the UE during T1. The last TTI containing the OTDOA assistance data shall be provided to the UE ΔT ms before the start of T2, where $\Delta T = 150$ ms is the maximum processing time of the OTDOA assistance data.

The test parameters are as given in Table A.8.12.8.1-1, Table A.8.12.8.1-2, Table A.8.12.8.1-3 and Table A.8.12.8.1-4.

Table A.8.12.8.1-1: General test parameters for E-UTRAN TDD intra-frequency RSTD measurement reporting delay under fading propagation conditions

Parameter	Unit	Value		Comment
		Test 1	Test 2	
Reference cell		Cell 1		Reference cell is the cell in the OTDOA assistance data with respect to which the RSTD measurement is defined, as specified in TS 36.214 [4] and TS 36.355 [24]. The reference cell is the PCell in this test case.
Neighbor cells		Cell 2 and Cell 3		Cell 2 and Cell 3 appear at random places in the neighbour cell list in the OTDOA assistance data, but Cell 2 always appears in the first half of the list, whilst Cell 3 appears in the second half of the list.
MPDCCH		DL Reference Measurement Channel R.16 TDD		As specified in clause A.3.1.3.1
<i>mPDCCH-startSF-U ESS</i>		10		Parameter G in $T = r_{\max} \cdot G$ which determines subframe $k0$ in which MPDCCH starts
System Channel Bandwidth (BW_{channel})	MHz	10		
PRS Transmission Bandwidth	RB	50 ^{Note 1}		PRS are transmitted over the system bandwidth

PRS configuration index I_{PRS}		304		This corresponds to periodicity of 320 ms and PRS subframe offset of $I_{PRS} - 160$ DL subframes, as defined in TS 36.211 [16], Table 6.10.4.3-1
Number of consecutive downlink positioning subframes N_{PRS}		6	4	As defined in TS 36.211 [16]. The number of subframes in a positioning occasion
Physical cell ID PCI		(PCI of Cell 1 – PCI of Cell 2)mod6=0 and (PCI of Cell 1 – PCI of Cell 3)mod6=0		The cell PCIs are selected such that the relative shifts of PRS patterns among cells are as given by the test parameters
TDD uplink-downlink configuration		1		As specified in TS 36.211 [16], Clause 4.2; corresponds to a configuration with 5 ms switch-point periodicity and two downlink consecutive subframes
TDD special subframe configuration		6		As specified in TS 36.211 [16], Clause 4.2; corresponds to DwPTS of $19760 \cdot T_s$ and UpPTS of $4384 \cdot T_s$
CP length		Normal		
DRX		ON		DRX parameters are further specified in Table A.8.12.8.1-3
Radio frame receive time offset between the cells at the UE antenna connector	μs	Cell 2 to Cell 1: 1 Cell 3 to Cell 1: -1		PRS are transmitted from synchronous cells
Expected RSTD	μs	Cell 2: 3 Cell 3: 3 Other neighbour cells: randomly between -3 and 3		The expected RSTD is what is expected at the receiver. The corresponding parameter in the OTDOA assistance data specified in TS 36.355 [24] is the expectedRSTD indicator
Expected RSTD uncertainty for all neighbour cells	μs	5		The corresponding parameter in the OTDOA assistance data specified in TS 36.355 [24] is the expectedRSTD-Uncertainty index
Number of cells provided in OTDOA assistance data		16		Including the reference cell
PRS muting info		Cell 1: '11110000' Cell 2: '00001111' Cell 3: '11110000'		Corresponds to prs-MutingInfo defined in TS 36.355 [24]
T1	s	3		The length of the time interval from the beginning of each test
T2	s	6.4	2.56	The length of the time interval that follows immediately after time interval T1
T3	s	6.4	2.56	The length of the time interval that follows immediately after time interval T2
NOTE 1: If the PRS transmission bandwidth is larger than the UE RF bandwidth, the UE is measuring RSTD within its RF bandwidth.				

Table A.8.12.8.1-2: Cell-specific test parameters for E-UTRAN TDD intra-frequency RSTD measurement reporting delay under fading propagation conditions during T1

Parameter	Unit	Cell 1	Cell 2	Cell 3
E-UTRA RF Channel Number		1	1	1
Correlation Matrix and Antenna Configuration		1x1	1x1	1x1
OCNG patterns defined in A.3.2.1		OP.11 TDD	N/A	N/A

PBCH_RA	dB	0	N/A	N/A
PBCH_RB				
PSS_RA				
SSS_RA				
PCFICH_RB				
PHICH_RA				
PHICH_RB				
PDCCH_RA				
PDCCH_RB				
OCNG_RA ^{Note 1}				
OCNG_RB ^{Note 1}				
N_{oc} ^{Note 3}				
PRS \hat{E}_s/N_{oc}	dB			
I_o ^{Note 4}	dBm/ 9 MHz			
\hat{E}_s/N_{oc}	dB			
Propagation Condition	ETU30			
<p>Note 1: OCNG shall be used such that active cell (Cell 1) is fully allocated and a constant total transmitted power spectral density is achieved for all OFDM symbols.</p> <p>Note 2: The resources for uplink transmission are assigned to the UE prior to the start of time period T2.</p> <p>Note 3: Interference from other cells and noise sources not specified in the test are assumed to be constant over subcarriers and time and shall be modelled as AWGN of appropriate power for N_{oc} to be fulfilled.</p> <p>Note 4: I_o levels have been derived from other parameters and are given for information purpose. These are not settable test parameters.</p>				

Table A.8.12.8.1-3: Cell-specific test parameters for E-UTRAN TDD intra-frequency RSTD measurement reporting delay under fading propagation conditions during T2 and T3

Parameter	Unit	Cell 1		Cell 2		Cell 3	
		T2	T3	T2	T3	T2	T3
E-UTRA RF Channel Number		1		1		1	
Correlation Matrix and Antenna Configuration		1x1		1x1		1x1	
OCNG patterns defined in A.3.2.1		OP.11 TDD		OP.2 TDD		OP.2 TDD	N/A
PBCH_RA	dB	0	0	0	0	0	N/A
PBCH_RB							
PSS_RA							
SSS_RA							
PCFICH_RB							
PHICH_RA							
PHICH_RB							
PDCCH_RA							
PDCCH_RB							
OCNG_RA ^{Note 1}							
OCNG_RB ^{Note 1}							
PRS_RA							
N_{oc} ^{Note 3}	dBm/ 15 kHz	-98	-95	-98	-95	-98	-95
PRS \hat{E}_s/N_{oc}	dB	-12	-Infinity	-Infinity	-13	-13	-Infinity
PRS \hat{E}_s/I_{ot} ^{Note 4}	dB	-12.21	-Infinity	-Infinity	-13	-13.27	-Infinity
I_o ^{Note 4}	dBm/ 9 MHz	-69.92	-67.18	-69.92	-67.18	-69.92	-67.18

PRP ^{Note 4}	dBm/ 15 kHz	-110	-Infinity	-Infinity	-108	-111	-Infinity
RSRP ^{Note 4}	dBm/ 15 kHz	-107	-104	-111	-111	-114	-Infinity
\hat{E}_s/N_{oc} ^{Note 4}	dB	-9	-9	-13	-16	-16	-Infinity
Propagation Condition		ETU30					
Note 1:	OCNG shall be used such that active cells (all, except Cell 3 in T3) are fully allocated and a constant total transmitted power spectral density is achieved for all OFDM symbols other than those in the subframes with transmitted PRS.						
Note 2:	The resources for uplink transmission are assigned to the UE prior to the start of time period T2.						
Note 3:	Interference from other cells and noise sources not specified in the test are assumed to be constant over subcarriers and time and shall be modelled as AWGN of appropriate power for N_{oc} to be fulfilled.						
Note 4:	If PRS_RA is not "N/A", \hat{E}_s/N_{oc} , PRS \hat{E}_s/I_{ot} , lo, RSRP and PRP levels have been derived from other parameters and are given for information purpose. If PRS_RA is "N/A", lo and RSRP levels have been derived from other parameters and are given for information purpose. These are not settable test parameters. Interference conditions shall be applied to all PRS symbols of DL positioning subframes.						

Table A.8.12.8.1-4: DRX parameters for the test of E-UTRAN TDD intra-frequency RSTD measurement reporting delay under fading propagation conditions

Field	Value	Comment
onDurationTimer	psf1	As specified in TS 36.331 [2], Clause 6.3.2
Drx-InactivityTimer	psf1	
drx-RetransmissionTimer	sf1	
longDRX-CycleStartOffset	sf320	
shortDRX	Disable	

A.8.12.8.2 Test Requirements

For Cat-M1 UE in CE Mode B, the RSTD measurement time fulfils the requirements specified in Clause 8.13.3.3.2.

For Cat-M2 UE in CE Mode B, the RSTD measurement time fulfils the requirements specified in Clause 8.16.3.1.2.

In Test 1, the UE shall perform and report the RSTD measurements for Cell 2 and Cell 3 with respect to the reference cell in the OTDOA assistance data, Cell 1, within 12800 ms starting from the beginning of time interval T2.

In Test 2, the shall perform and report the RSTD measurements for Cell 2 and Cell 3 with respect to the reference cell in the OTDOA assistance data, Cell 1, within 5120 ms starting from the beginning of time interval T2.

The rate of the correct events for each neighbour cell observed during repeated tests shall be at least 90%, where the reported RSTD measurement for each correct event shall be within the RSTD reporting range specified in Clause 9.1.10.3, i.e., between RSTD_0000 and RSTD_12711.

NOTE: The RSTD measurement time in the test is derived from the following expression,

$$T_{PRS}(M-1) + 320 \cdot \left\lceil \frac{n}{M} \right\rceil, \text{ where } M=16 \text{ and } n=16 \text{ are the parameters for Test 1 and } M=40 \text{ and } n$$

=16 are the parameters for Test 2, specified in the corresponding requirements sections under Note 1. This gives the total RSTD measurement time of 12800 ms (Test 1) and 5120 ms (Test 2) for Cell 2 and Cell 3 with respect to the reference Cell 1.

A.8.12.9 E-UTRAN FDD intra-frequency RSTD measurement period test case in CE Mode A with longer PRS occasions

A.8.12.9.1 Test Purpose and Environment

The purpose of the test is to verify for Cat-M1 and Cat-M2 UE in CE Mode A that the RSTD measurement meets the requirements specified in Sections 8.13.2.3.1 and 8.16.2.3.1, respectively, in an environment with fading propagation conditions when the UE requires measurement gaps for performing intra-frequency RSTD measurements. The test is applicable for Cat-M1 and Cat-M2 configured with 1.4 MHz UE RF bandwidth and supporting measurement gaps specified in Table 8.1.2.1-3.

In the test there are three synchronous cells: Cell 1, Cell 2 and Cell 3. Cell 1 is the reference as well as the PCell. Cell 2 and Cell 3 are the neighbour cells. All cells are on the same RF channel.

The UE requires measurement gaps to perform intra-frequency measurements. Measurement gap pattern configuration *rstd6* as defined in Table 8.1.2.1-3 is provided to the UE. The test consists of three consecutive time intervals, with duration of T1, T2 and T3. Cell 1 is active in T1, T2 and T3, whilst Cell 2 and Cell 3 are activated only in the beginning of T2. Cell 2 is active until the end of T3, and Cell 3 is active until the end of T2. The beginning of the time interval T2 shall be aligned with the first PRS positioning subframe of a positioning occasion in the reference cell, where the PRS positioning occasion is as defined in Clause 8.1.2.5.1. Cell 1 transmits PRS in T2, while Cell 2 transmits PRS only in T3, and Cell 3 transmits PRS only in T2. Note: The information on when PRS is muted is conveyed to the UE using PRS muting information.

The OTDOA assistance data as defined in TS 36.355, Clause 6.5.1, shall be provided to the UE during T1. The last TTI containing the OTDOA assistance data shall be provided to the UE ΔT ms before the start of T2, where $\Delta T = 150$ ms is the maximum processing time of the OTDOA assistance data.

The test parameters are as given in Table A.8.12.9.1-1, Table A.8.12.9.1-2, Table A.8.12.9.1-3 and Table A.8.12.9.1-4.

Table A.8.12.9.1-1: General test parameters for E-UTRAN FDD intra-frequency RSTD measurement reporting delay under fading propagation conditions

Parameter	Unit	Value	Comment
Reference cell		Cell 1	Reference cell is the cell in the OTDOA assistance data with respect to which the RSTD measurement is defined, as specified in TS 36.214 [4] and TS 36.355 [24]. The reference cell is the PCell in this test case.
Neighbor cells		Cell 2 and Cell 3	Cell 2 and Cell 3 appear at random places in the neighbour cell list in the OTDOA assistance data, but Cell 2 always appears in the first half of the list, whilst Cell 3 appears in the second half of the list.
MPDCCH		DL Reference Measurement Channel R.16 FDD	As specified in clause A.3.1.3.1
<i>mPDCCH-startSF-U ESS</i>		10	Parameter G in $T = r_{\max} \cdot G$ which determines subframe $k0$ in which MPDCCH starts
System Channel Bandwidth (BW_{channel})	MHz	10	
PRS Transmission Bandwidth	RB	6	PRS are transmitted in the center RBs
Gap pattern Id		<i>rstd6</i>	As specified in Table 8.1.2.1-3. Applies for measurements on Cell 1, Cell 2, and Cell 3
Gap offset		150	As specified in TS 36.331 [2], Clause 6.3.5

PRS configuration index I_{PRS}		311	This corresponds to periodicity of 320 ms and PRS subframe offset of $I_{PRS} - 160$ DL subframes, as defined in TS 36.211 [16], Table 6.10.4.3-1
Number of consecutive downlink positioning subframes N_{PRS}		12	As defined in TS 36.211 [16]. The number of subframes in a positioning occasion. Corresponds to parameter <i>add-numDL-Frames</i> in TS 36.355, for UE with <i>additional-prs-config</i> capability
		20	As defined in TS 36.211 [16]. The number of subframes in a positioning occasion. Corresponds to parameter <i>add-numDL-Frames</i> in TS 36.355, for UE with <i>densePrsConfig</i> capability
Physical cell ID PCI		(PCI of Cell 1 – PCI of Cell 2) mod 6 = 0 and (PCI of Cell 1 – PCI of Cell 3) mod 6 = 0	The cell PCIs are selected such that the relative shifts of PRS patterns among cells are as given by the test parameters
CP length		Normal	
DRX		ON	DRX parameters are further specified in Table A.8.12.9.1-3
Radio frame receive time offset between the cells at the UE antenna connector	μs	Cell 2 to Cell 1: 1 Cell 3 to Cell 1: -1	PRS are transmitted from synchronous cells
Expected RSTD	μs	Cell 2: 3 Cell 3: 3 Other neighbour cells: randomly between -3 and 3	The expected RSTD is what is expected at the receiver. The corresponding parameter in the OTDOA assistance data specified in TS 36.355 [24] is the <i>expectedRSTD</i> indicator
Expected RSTD uncertainty for all neighbour cells	μs	5	The corresponding parameter in the OTDOA assistance data specified in TS 36.355 [24] is the <i>expectedRSTD-Uncertainty</i> index
Number of cells provided in OTDOA assistance data		16	Including the reference cell
PRS muting info		Cell 1: '11110000' Cell 2: '00001111' Cell 3: '11110000'	Corresponds to <i>prs-MutingInfo</i> defined in TS 36.355 [24]
T1	s	2	The length of the time interval from the beginning of each test
T2	s	1.28	The length of the time interval that follows immediately after time interval T1
T3	s	1.60	The length of the time interval that follows immediately after time interval T2

Table A.8.12.9.1-2: Cell-specific test parameters for E-UTRAN FDD intra-frequency RSTD measurement reporting delay under fading propagation conditions during T1

Parameter	Unit	Cell 1	Cell 2	Cell 3
E-UTRA RF Channel Number		1	1	1
Correlation Matrix and Antenna Configuration		1x1	1x1	1x1
OCNG patterns defined in A.3.2.1		OP.21 FDD	N/A	N/A
PBCH_RA	dB	0	N/A	N/A

PBCH_RB				
PSS_RA				
SSS_RA				
PCFICH_RB				
PHICH_RA				
PHICH_RB				
PDCCH_RA				
PDCCH_RB				
OCNG_RA ^{Note 1}				
OCNG_RB ^{Note 1}				
N_{oc} ^{Note 3}	dBm/ 15 kHz	-95		
PRS \hat{E}_s/N_{oc}	dB	-Infinity	-Infinity	-Infinity
I_o ^{Note 4}	dBm/ 9 MHz	-67.22	-67.22	-67.22
\hat{E}_s/N_{oc}	dB	0	-Infinity	-Infinity
Propagation Condition		ETU30		
<p>Note 1: OCNG shall be used such that active cell (Cell 1) is fully allocated and a constant total transmitted power spectral density is achieved for all OFDM symbols.</p> <p>Note 2: The resources for uplink transmission are assigned to the UE prior to the start of time period T2.</p> <p>Note 3: Interference from other cells and noise sources not specified in the test are assumed to be constant over subcarriers and time and shall be modelled as AWGN of appropriate power for N_{oc} to be fulfilled.</p> <p>Note 4: I_o levels have been derived from other parameters and are given for information purpose. These are not settable test parameters.</p>				

Table A.8.12.9.1-3: Cell-specific test parameters for E-UTRAN FDD intra-frequency RSTD measurement reporting delay under fading propagation conditions during T2 and T3

Parameter	Unit	Cell 1		Cell 2		Cell 3	
		T2	T3	T2	T3	T2	T3
E-UTRA RF Channel Number		1		1		1	
Correlation Matrix and Antenna Configuration		1x1		1x1		1x1	
OCNG patterns defined in A.3.2.1		OP.21 FDD		OP.6 FDD		OP.6 FDD	N/A
PBCH_RA	dB	0		0		0	N/A
PBCH_RB							
PSS_RA							
SSS_RA							
PCFICH_RB							
PHICH_RA							
PHICH_RB							
PDCCH_RA							
PDCCH_RB							
OCNG_RA ^{Note 1}							
OCNG_RB ^{Note 1}							
PRS_RA	dB	-3	N/A	N/A	3	3	N/A
N_{oc} ^{Note 3}	dBm/ 15 kHz	-98	-95	-98	-95	-98	-95
PRS \hat{E}_s/N_{oc}	dB	-1	-Infinity	-Infinity	-7	-7	-Infinity
PRS \hat{E}_s/I_{ot} ^{Note 4}	dB	-1.79	-Infinity	-Infinity	-7	-9.54	-Infinity
I_o ^{Note 4}	dBm/ 9 MHz	-69.55	-67.08	-69.55	-67.08	-69.55	-67.08

PRP ^{Note 4}	dBm/ 15 kHz	-99	-Infinity	-Infinity	-102	-105	-Infinity
RSRP ^{Note 4}	dBm/ 15 kHz	-96	-93	-105	-105	-108	-Infinity
\hat{E}_s/N_{oc} ^{Note 4}	dB	2	2	-7	-10	-10	-Infinity
Propagation Condition		ETU30					
Note 1:	OCNG shall be used such that active cells (all, except Cell 3 in T3) are fully allocated and a constant total transmitted power spectral density is achieved for all OFDM symbols other than those in the subframes with transmitted PRS.						
Note 2:	The resources for uplink transmission are assigned to the UE prior to the start of time period T2.						
Note 3:	Interference from other cells and noise sources not specified in the test are assumed to be constant over subcarriers and time and shall be modelled as AWGN of appropriate power for N_{oc} to be fulfilled.						
Note 4:	If PRS_RA is not "N/A", \hat{E}_s/N_{oc} , PRS \hat{E}_s/I_{ot} , I_o , RSRP and PRP levels have been derived from other parameters and are given for information purpose. If PRS_RA is "N/A", I_o and RSRP levels have been derived from other parameters and are given for information purpose. These are not settable test parameters. Interference conditions shall be applied to all PRS symbols of DL positioning subframes.						

Table A.8.12.9.1-4: DRX parameters for the test of E-UTRAN FDD intra-frequency RSTD measurement reporting delay under fading propagation conditions

Field	Value	Comment
onDurationTimer	psf1	As specified in TS 36.331 [2], Clause 6.3.2
Drx-InactivityTimer	psf1	
drx-RetransmissionTimer	sf1	
longDRX-CycleStartOffset	sf320	
shortDRX	Disable	

A.8.12.9.2 Test Requirements

For Cat-M1 UE in CE Mode A, the RSTD measurement time fulfils the requirements specified in Clause 8.13.2.3.1.

For Cat-M2 UE in CE Mode A, the RSTD measurement time fulfils the requirements specified in Clause 8.16.2.3.1.

The UE shall perform and report the RSTD measurements for Cell 2 and Cell 3 with respect to the reference cell in the OTDOA assistance data, Cell 1, within 2880 ms starting from the beginning of time interval T2.

The rate of the correct events for each neighbour cell observed during repeated tests shall be at least 90%, where the reported RSTD measurement for each correct event shall be within the RSTD reporting range specified in Clause 9.1.10.3, i.e., between RSTD_0000 and RSTD_12711.

NOTE: The RSTD measurement time in the test is derived from the following expression,

$$T_{PRS} (M - 1) + 320 \cdot \left\lceil \frac{n}{M} \right\rceil, \text{ where } M = 8 \text{ and } n = 16 \text{ are the parameters specified in Section 8.13.2.3.1}$$

(for Cat-M1) and in Section 8.16.2.3.1 (for Cat-M2) under Note 1. This gives the total RSTD measurement time of 2880 ms for Cell 2 and Cell 3 with respect to the reference Cell 1.

A.8.12.10 E-UTRAN HD-FDD intra-frequency RSTD measurement period test case in CE Mode A with longer PRS occasions

A.8.12.10.1 Test Purpose and Environment

The purpose of the test is to verify for Cat-M1 and Cat-M2 UE in CE Mode A that the RSTD measurement meets the requirements specified in Sections 8.13.2.3.3 and 8.16.2.3.3, respectively, in an environment with fading propagation conditions when the UE requires measurement gaps for performing intra-frequency RSTD. The test is applicable for

Cat-M1 and Cat-M2 configured with 1.4 MHz UE RF bandwidth and supporting measurement gaps specified in Table 8.1.2.1-3.

In the test there are three synchronous cells: Cell 1, Cell 2 and Cell 3. Cell 1 is the reference as well as the PCell. Cell 2 and Cell 3 are the neighbour cells. All cells are on the same RF channel.

The UE requires measurement gaps to perform intra-frequency measurements. Measurement gap pattern configuration *rstd6* as defined in Table 8.1.2.1-3 is provided to the UE.

The test consists of three consecutive time intervals, with duration of T1, T2 and T3. Cell 1 is active in T1, T2 and T3, whilst Cell 2 and Cell 3 are activated only in the beginning of T2. Cell 2 is active until the end of T3, and Cell 3 is active until the end of T2. The beginning of the time interval T2 shall be aligned with the first PRS positioning subframe of a positioning occasion in the reference cell, where the PRS positioning occasion is as defined in Clause 8.1.2.5.1. Cell 1 transmits PRS in T2, while Cell 2 transmits PRS only in T3, and Cell 3 transmits PRS only in T2. Note: The information on when PRS is muted is conveyed to the UE using PRS muting information.

The OTDOA assistance data as defined in TS 36.355, Clause 6.5.1, shall be provided to the UE during T1. The last TTI containing the OTDOA assistance data shall be provided to the UE ΔT ms before the start of T2, where $\Delta T = 150$ ms is the maximum processing time of the OTDOA assistance data.

The test parameters are as given in Table A.8.12.10.1-1, Table A.8.12.10.1-2, Table A.8.12.10.1-3 and Table A.8.12.10.1-4.

Table A.8.12.10.1-1: General test parameters for E-UTRAN HD-FDD intra-frequency RSTD measurement reporting delay under fading propagation conditions

Parameter	Unit	Value	Comment
Reference cell		Cell 1	Reference cell is the cell in the OTDOA assistance data with respect to which the RSTD measurement is defined, as specified in TS 36.214 [4] and TS 36.355 [24]. The reference cell is the PCell in this test case.
Neighbor cells		Cell 2 and Cell 3	Cell 2 and Cell 3 appear at random places in the neighbour cell list in the OTDOA assistance data, but Cell 2 always appears in the first half of the list, whilst Cell 3 appears in the second half of the list.
MPDCCH		DL Reference Measurement Channel R.6 HD-FDD	As specified in clause A.3.1.3.1
<i>mPDCCH-startSF-UESS</i>		10	Parameter G in $T = r_{\max} \cdot G$ which determines subframe $k0$ in which MPDCCH starts
System Channel Bandwidth (BW_{channel})	MHz	10	
PRS Transmission Bandwidth	RB	6	PRS are transmitted in the center RBs
Gap pattern Id		<i>rstd6</i>	As specified in Table 8.1.2.1-3. Applies for measurements on Cell 1, Cell 2, and Cell 3
Gap offset		150	As specified in TS 36.331 [2], Clause 6.3.5
PRS configuration index I_{PRS}		311	This corresponds to periodicity of 320 ms and PRS subframe offset of $I_{\text{PRS}} - 160$ DL subframes, as defined in TS 36.211 [16], Table 6.10.4.3-1

Number of consecutive downlink positioning subframes N_{PRS}		12	As defined in TS 36.211 [16]. The number of subframes in a positioning occasion. Corresponds to parameter <i>add-numDL-Frames</i> in TS 36.355, for UE with <i>additional-prs-config</i> capability
		20	As defined in TS 36.211 [16]. The number of subframes in a positioning occasion. Corresponds to parameter <i>add-numDL-Frames</i> in TS 36.355, for UE with <i>densePrsConfig</i> capability
Physical cell ID PCI		(PCI of Cell 1 – PCI of Cell 2) mod 6 = 0 and (PCI of Cell 1 – PCI of Cell 3) mod 6 = 0	The cell PCIs are selected such that the relative shifts of PRS patterns among cells are as given by the test parameters
CP length		Normal	
DRX		ON	DRX parameters are further specified in Table A.8.12.4.1-3
Radio frame receive time offset between the cells at the UE antenna connector	μs	Cell 2 to Cell 1: 1 Cell 3 to Cell 1: -1	PRS are transmitted from synchronous cells
Expected RSTD	μs	Cell 2: 3 Cell 3: 3 Other neighbour cells: randomly between -3 and 3	The expected RSTD is what is expected at the receiver. The corresponding parameter in the OTDOA assistance data specified in TS 36.355 [24] is the <i>expectedRSTD</i> indicator
Expected RSTD uncertainty for all neighbour cells	μs	5	The corresponding parameter in the OTDOA assistance data specified in TS 36.355 [24] is the <i>expectedRSTD-Uncertainty</i> index
Number of cells provided in OTDOA assistance data		16	Including the reference cell
PRS muting info		Cell 1: '11110000' Cell 2: '00001111' Cell 3: '11110000'	Corresponds to <i>prs-MutingInfo</i> defined in TS 36.355 [24]
T1	s	2	The length of the time interval from the beginning of each test
T2	s	1.28	The length of the time interval that follows immediately after time interval T1
T3	s	1.60	The length of the time interval that follows immediately after time interval T2

Table A.8.12.10.1-2: Cell-specific test parameters for E-UTRAN HD-FDD intra-frequency RSTD measurement reporting delay under fading propagation conditions during T1

Parameter	Unit	Cell 1	Cell 2	Cell 3
E-UTRA RF Channel Number		1	1	1
Correlation Matrix and Antenna Configuration		1x1	1x1	1x1
OCNG patterns defined in A.3.2.1		OP.21 FDD	N/A	N/A
PBCH_RA	dB	0	N/A	N/A
PBCH_RB				
PSS_RA				
SSS_RA				
PCFICH_RB				
PHICH_RA				

PHICH_RB				
PDCCH_RA				
PDCCH_RB				
OCNG_RA ^{Note 1}				
OCNG_RB ^{Note 1}				
N_{oc} ^{Note 3}	dBm/ 15 kHz	-95		
PRS \hat{E}_s/N_{oc}	dB	-Infinity	-Infinity	-Infinity
I_o ^{Note 4}	dBm/ 9 MHz	-67.22	-67.22	-67.22
\hat{E}_s/N_{oc}	dB	0	-Infinity	-Infinity
Propagation Condition		ETU30		
<p>Note 1: OCNG shall be used such that active cell (Cell 1) is fully allocated and a constant total transmitted power spectral density is achieved for all OFDM symbols.</p> <p>Note 2: The resources for uplink transmission are assigned to the UE prior to the start of time period T2.</p> <p>Note 3: Interference from other cells and noise sources not specified in the test are assumed to be constant over subcarriers and time and shall be modelled as AWGN of appropriate power for N_{oc} to be fulfilled.</p> <p>Note 4: I_o levels have been derived from other parameters and are given for information purpose. These are not settable test parameters.</p>				

Table A.8.12.10.1-3: Cell-specific test parameters for E-UTRAN HD-FDD intra-frequency RSTD measurement reporting delay under fading propagation conditions during T2 and T3

Parameter	Unit	Cell 1		Cell 2		Cell 3			
		T2	T3	T2	T3	T2	T3		
E-UTRA RF Channel Number		1		1		1			
Correlation Matrix and Antenna Configuration		1x1		1x1		1x1			
OCNG patterns defined in A.3.2.1		OP.21 FDD		OP.6 FDD		OP.6 FDD	N/A		
PBCH_RA	dB	0		0		0		N/A	
PBCH_RB									
PSS_RA									
SSS_RA									
PCFICH_RB									
PHICH_RA									
PHICH_RB									
PDCCH_RA									
PDCCH_RB									
OCNG_RA ^{Note 1}									
OCNG_RB ^{Note 1}									
PRS_RA	dB	-3	N/A	N/A	3	3	N/A		
N_{oc} ^{Note 3}	dBm/ 15 kHz	-98	-95	-98	-95	-98	-95		
PRS \hat{E}_s/N_{oc}	dB	-1	-Infinity	-Infinity	-7	-7	-Infinity		
PRS \hat{E}_s/I_{ot} ^{Note 4}	dB	-1.79	-Infinity	-Infinity	-7	-9.54	-Infinity		
I_o ^{Note 4}	dBm/ 9 MHz	-69.55	-67.08	-69.55	-67.08	-69.55	-67.08		
PRP ^{Note 4}	dBm/ 15 kHz	-99	-Infinity	-Infinity	-102	-105	-Infinity		
RSRP ^{Note 4}	dBm/ 15 kHz	-96	-93	-105	-105	-108	-Infinity		
\hat{E}_s/N_{oc} ^{Note 4}	dB	2	2	-7	-10	-10	-Infinity		

Propagation Condition	ETU30
Note 1:	OCNG shall be used such that active cells (all, except Cell 3 in T3) are fully allocated and a constant total transmitted power spectral density is achieved for all OFDM symbols other than those in the subframes with transmitted PRS.
Note 2:	The resources for uplink transmission are assigned to the UE prior to the start of time period T2.
Note 3:	Interference from other cells and noise sources not specified in the test are assumed to be constant over subcarriers and time and shall be modelled as AWGN of appropriate power for N_{oc} to be fulfilled.
Note 4:	If PRS_RA is not "N/A", \hat{E}_s/N_{oc} , PRS \hat{E}_s/I_{ot} , lo, RSRP and PRP levels have been derived from other parameters and are given for information purpose. If PRS_RA is "N/A", lo and RSRP levels have been derived from other parameters and are given for information purpose. These are not settable test parameters. Interference conditions shall be applied to all PRS symbols of DL positioning subframes.

Table A.8.12.10.1-4: DRX parameters for the test of E-UTRAN HD-FDD intra-frequency RSTD measurement reporting delay under fading propagation conditions

Field	Value	Comment
onDurationTimer	psf1	As specified in TS 36.331 [2], Clause 6.3.2
Drx-InactivityTimer	psf1	
drx-RetransmissionTimer	sf1	
longDRX-CycleStartOffset	sf320	
shortDRX	Disable	

A.8.12.10.2 Test Requirements

For Cat-M1 UE in CE Mode A, the RSTD measurement time fulfils the requirements specified in Clause 8.13.2.3.3.

For Cat-M2 UE in CE Mode A, the RSTD measurement time fulfils the requirements specified in Clause 8.16.2.3.3.

The UE shall perform and report the RSTD measurements for Cell 2 and Cell 3 with respect to the reference cell in the OTDOA assistance data, Cell 1, within 2880 ms starting from the beginning of time interval T2.

The rate of the correct events for each neighbour cell observed during repeated tests shall be at least 90%, where the reported RSTD measurement for each correct event shall be within the RSTD reporting range specified in Clause 9.1.10.3, i.e., between RSTD_0000 and RSTD_12711.

NOTE: The RSTD measurement time in the test is derived from the following expression,

$$T_{PRS}(M-1) + 320 \cdot \left\lceil \frac{n}{M} \right\rceil, \text{ where } M=8 \text{ and } n=16 \text{ are the parameters specified in Section 8.13.2.3.3}$$

(for Cat-M1) and in Section 8.16.2.3.3 (for Cat-M2) under Note 1. This gives the total RSTD measurement time of 2880 ms for Cell 2 and Cell 3 with respect to the reference Cell 1.

A.8.12.11 E-UTRAN TDD intra-frequency RSTD measurement period test case in CE Mode A with longer PRS occasions

A.8.12.11.1 Test Purpose and Environment

The purpose of the test is to verify for Cat-M1 and Cat-M2 UE in CE Mode A that the RSTD measurement meets the requirements specified in Sections 8.13.2.3.2 and 8.16.2.3.2, respectively, in an environment with fading propagation conditions when the UE requires measurement gaps for performing intra-frequency RSTD measurements. The test is applicable for Cat-M1 and Cat-M2 configured with 1.4 MHz UE RF bandwidth and supporting measurement gaps specified in Table 8.1.2.1-3.

In the test there are three synchronous cells: Cell 1, Cell 2 and Cell 3. Cell 1 is the reference as well as the PCell. Cell 2 and Cell 3 are the neighbour cells. All cells are on the same RF channel.

The UE requires measurement gaps to perform intra-frequency measurements. Measurement gap pattern configuration *rstd12* as defined in Table 8.1.2.1-3 is provided to the UE.

The test consists of three consecutive time intervals, with duration of T1, T2 and T3. Cell 1 is active in T1, T2 and T3, whilst Cell 2 and Cell 3 are activated only in the beginning of T2. Cell 2 is active until the end of T3, and Cell 3 is active until the end of T2. The beginning of the time interval T2 shall be aligned with the first PRS positioning subframe of a positioning occasion in the reference cell, where the PRS positioning occasion is as defined in Clause 8.1.2.5.1. Cell 1 transmits PRS in T2, while Cell 2 transmits PRS only in T3, and Cell 3 transmits PRS only in T2. Note: The information on when PRS is muted is conveyed to the UE using PRS muting information.

The OTDOA assistance data as defined in TS 36.355, Clause 6.5.1, shall be provided to the UE during T1. The last TTI containing the OTDOA assistance data shall be provided to the UE ΔT ms before the start of T2, where $\Delta T = 150$ ms is the maximum processing time of the OTDOA assistance data.

The test parameters are as given in Table A.8.12.11.1-1, Table A.8.12.11.1-2, Table A.8.12.11.1-3 and Table A.8.12.11.1-4.

Table A.8.12.11.1-1: General test parameters for E-UTRAN TDD intra-frequency RSTD measurement reporting delay under fading propagation conditions

Parameter	Unit	Value	Comment
Reference cell		Cell 1	Reference cell is the cell in the OTDOA assistance data with respect to which the RSTD measurement is defined, as specified in TS 36.214 [4] and TS 36.355 [24]. The reference cell is the PCell in this test case.
Neighbor cells		Cell 2 and Cell 3	Cell 2 and Cell 3 appear at random places in the neighbour cell list in the OTDOA assistance data, but Cell 2 always appears in the first half of the list, whilst Cell 3 appears in the second half of the list.
MPDCCH		DL Reference Measurement Channel R.14 TDD	As specified in clause A.3.1.3.1
<i>mPDCCH-startSF-U ESS</i>		10	Parameter G in $T = r_{\max} \cdot G$ which determines subframe $k0$ in which MPDCCH starts
System Channel Bandwidth (BW_{channel})	MHz	10	
PRS Transmission Bandwidth	RB	6	PRS are transmitted in the center RBs
Gap pattern Id		<i>rstd12</i>	As specified in Table 8.1.2.1-3. Applies for measurements on Cell 1, Cell 2, and Cell 3
Gap offset		143	As specified in TS 36.331 [2], Clause 6.3.5
PRS configuration index I_{PRS}		304	This corresponds to periodicity of 320 ms and PRS subframe offset of $I_{\text{PRS}} - 160$ DL subframes, as defined in TS 36.211 [16], Table 6.10.4.3-1
Number of consecutive downlink positioning subframes N_{PRS}		12	As defined in TS 36.211 [16]. The number of subframes in a positioning occasion. Corresponds to parameter <i>add-numDL-Frames</i> in TS 36.355, for UE with <i>additional-prs-config</i> capability

		20	As defined in TS 36.211 [16]. The number of subframes in a positioning occasion. Corresponds to parameter <i>add-numDL-Frames</i> in TS 36.355, for UE with <i>densePrsConfig</i> capability
Physical cell ID PCI		(PCI of Cell 1 – PCI of Cell 2) mod 6 = 0 and (PCI of Cell 1 – PCI of Cell 3) mod 6 = 0	The cell PCIs are selected such that the relative shifts of PRS patterns among cells are as given by the test parameters
TDD uplink-downlink configuration		1	As specified in TS 36.211 [16], Clause 4.2; corresponds to a configuration with 5 ms switch-point periodicity and two downlink consecutive subframes
TDD special subframe configuration		6	As specified in TS 36.211 [16], Clause 4.2; corresponds to DwPTS of $19760 \cdot T_s$ and UpPTS of $4384 \cdot T_s$
CP length		Normal	
DRX		ON	DRX parameters are further specified in Table A.8.12.5.1-3
Radio frame receive time offset between the cells at the UE antenna connector	μs	Cell 2 to Cell 1: 1 Cell 3 to Cell 1: -1	PRS are transmitted from synchronous cells
Expected RSTD	μs	Cell 2: 3 Cell 3: 3 Other neighbour cells: randomly between -3 and 3	The expected RSTD is what is expected at the receiver. The corresponding parameter in the OTDOA assistance data specified in TS 36.355 [24] is the expectedRSTD indicator
Expected RSTD uncertainty for all neighbour cells	μs	5	The corresponding parameter in the OTDOA assistance data specified in TS 36.355 [24] is the expectedRSTD-Uncertainty index
Number of cells provided in OTDOA assistance data		16	Including the reference cell
PRS muting info		Cell 1: '11110000' Cell 2: '00001111' Cell 3: '11110000'	Corresponds to prs-MutingInfo defined in TS 36.355 [24]
T1	s	2	The length of the time interval from the beginning of each test
T2	s	1.28	The length of the time interval that follows immediately after time interval T1
T3	s	1.60	The length of the time interval that follows immediately after time interval T2

Table A.8.12.11.1-2: Cell-specific test parameters for E-UTRAN TDD intra-frequency RSTD measurement reporting delay under fading propagation conditions during T1

Parameter	Unit	Cell 1	Cell 2	Cell 3
E-UTRA RF Channel Number		1	1	1
Correlation Matrix and Antenna Configuration		1x1	1x1	1x1
OCNG patterns defined in A.3.2.1		OP.11 TDD	N/A	N/A
PBCH_RA	dB	0	N/A	N/A
PBCH_RB				
PSS_RA				
SSS_RA				

PCFICH_RB				
PHICH_RA				
PHICH_RB				
PDCCH_RA				
PDCCH_RB				
OCNG_RA ^{Note 1}				
OCNG_RB ^{Note 1}				
N_{oc} ^{Note 3}	dBm/ 15 kHz	-95		
PRS \hat{E}_s/N_{oc}	dB	-Infinity	-Infinity	-Infinity
I_o ^{Note 4}	dBm/ 9 MHz	-67.22	-67.22	-67.22
\hat{E}_s/N_{oc}	dB	0	-Infinity	-Infinity
Propagation Condition		ETU30		
<p>Note 1: OCNG shall be used such that active cell (Cell 1) is fully allocated and a constant total transmitted power spectral density is achieved for all OFDM symbols.</p> <p>Note 2: The resources for uplink transmission are assigned to the UE prior to the start of time period T2.</p> <p>Note 3: Interference from other cells and noise sources not specified in the test are assumed to be constant over subcarriers and time and shall be modelled as AWGN of appropriate power for N_{oc} to be fulfilled.</p> <p>Note 4: I_o levels have been derived from other parameters and are given for information purpose. These are not settable test parameters.</p>				

Table A.8.12.11.1-3: Cell-specific test parameters for E-UTRAN TDD intra-frequency RSTD measurement reporting delay under fading propagation conditions during T2 and T3

Parameter	Unit	Cell 1		Cell 2		Cell 3	
		T2	T3	T2	T3	T2	T3
E-UTRA RF Channel Number		1		1		1	
Correlation Matrix and Antenna Configuration		1x1		1x1		1x1	
OCNG patterns defined in A.3.2.1		OP.11 TDD		OP.2 TDD		OP.2 TDD	N/A
PBCH_RA	dB	0		0		0	N/A
PBCH_RB							
PSS_RA							
SSS_RA							
PCFICH_RB							
PHICH_RA							
PHICH_RB							
PDCCH_RA							
PDCCH_RB							
OCNG_RA ^{Note 1}							
OCNG_RB ^{Note 1}							
PRS_RA	dB	-3	N/A	N/A	3	3	N/A
N_{oc} ^{Note 3}	dBm/ 15 kHz	-98	-95	-98	-95	-98	-95
PRS \hat{E}_s/N_{oc}	dB	-1	-Infinity	-Infinity	-7	-7	-Infinity
PRS \hat{E}_s/I_{ot} ^{Note 4}	dB	-1.79	-Infinity	-Infinity	-7	-9.54	-Infinity
I_o ^{Note 4}	dBm/ 9 MHz	-69.55	-67.08	-69.55	-67.08	-69.55	-67.08
PRP ^{Note 4}	dBm/ 15 kHz	-99	-Infinity	-Infinity	-102	-105	-Infinity
RSRP ^{Note 4}	dBm/ 15 kHz	-96	-93	-105	-105	-108	-Infinity

\hat{E}_s/N_{oc} Note 4	dB	2	2	-7	-10	-10	-Infinity
Propagation Condition		ETU30					
Note 1:	OCNG shall be used such that active cells (all, except Cell 3 in T3) are fully allocated and a constant total transmitted power spectral density is achieved for all OFDM symbols other than those in the subframes with transmitted PRS.						
Note 2:	The resources for uplink transmission are assigned to the UE prior to the start of time period T2.						
Note 3:	Interference from other cells and noise sources not specified in the test are assumed to be constant over subcarriers and time and shall be modelled as AWGN of appropriate power for N_{oc} to be fulfilled.						
Note 4:	If PRS_RA is not "N/A", \hat{E}_s/N_{oc} , PRS \hat{E}_s/I_{ot} , I_o , RSRP and PRP levels have been derived from other parameters and are given for information purpose. If PRS_RA is "N/A", I_o and RSRP levels have been derived from other parameters and are given for information purpose. These are not settable test parameters. Interference conditions shall be applied to all PRS symbols of DL positioning subframes.						

Table A.8.12.11.1-4: DRX parameters for the test of E-UTRAN TDD intra-frequency RSTD measurement reporting delay under fading propagation conditions

Field	Value	Comment
onDurationTimer	psf1	As specified in TS 36.331 [2], Clause 6.3.2
Drx-InactivityTimer	psf1	
drx-RetransmissionTimer	sf1	
longDRX-CycleStartOffset	sf320	
shortDRX	Disable	

A.8.12.11.2 Test Requirements

For Cat-M1 UE in CE Mode A, the RSTD measurement time fulfils the requirements specified in Clause 8.13.2.3.2.

For Cat-M2 UE in CE Mode A, the RSTD measurement time fulfils the requirements specified in Clause 8.16.2.3.2.

The UE shall perform and report the RSTD measurements for Cell 2 and Cell 3 with respect to the reference cell in the OTDOA assistance data, Cell 1, within 2880 ms starting from the beginning of time interval T2.

The rate of the correct events for each neighbour cell observed during repeated tests shall be at least 90%, where the reported RSTD measurement for each correct event shall be within the RSTD reporting range specified in Clause 9.1.10.3, i.e., between RSTD_0000 and RSTD_12711.

NOTE: The RSTD measurement time in the test is derived from the following expression,

$$T_{PRS}(M-1) + 320 \cdot \left\lceil \frac{n}{M} \right\rceil, \text{ where } M=8 \text{ and } n=16 \text{ are the parameters specified in Section 8.13.2.3.2}$$

(for Cat-M1) and in Section 8.16.2.3.2 (for Cat-M2) under Note 1. This gives the total RSTD measurement time of 2880 ms for Cell 2 and Cell 3 with respect to the reference Cell 1.

A.8.12.12 E-UTRAN FDD intra-frequency RSTD measurement period test case in CE Mode B with longer PRS occasions

A.8.12.12.1 Test Purpose and Environment

The purpose of the test is to verify for Cat-M1 and Cat-M2 UE in CE Mode B that the RSTD measurement meets the requirements specified in Sections 8.13.3.3.1 and 8.16.3.1.1, respectively, in an environment with fading propagation conditions when the UE requires measurement gaps for performing intra-frequency RSTD measurements. The test is applicable for Cat-M1 and Cat-M2 UE supporting measurement gaps specified in Table 8.1.2.1-3. Test 1 is applicable for Cat-M1 and Cat-M2 supporting and configured with 1.4 MHz UE RF bandwidth, while Test 2 is applicable for Cat-M2 supporting and configured with 5 MHz UE RF bandwidth.

In the test there are three synchronous cells: Cell 1, Cell 2 and Cell 3. Cell 1 is the reference as well as the PCell. Cell 2 and Cell 3 are the neighbour cells. All cells are on the same RF channel.

The UE requires measurement gaps to perform intra-frequency measurements. Measurement gap pattern configuration *rstd12* and *rstd2* as defined in Table 8.1.2.1-3 is provided to the UE in Test 1 and Test 2, respectively. Each test consists of three consecutive time intervals, with duration of T1, T2 and T3. Cell 1 is active in T1, T2 and T3, whilst Cell 2 and Cell 3 are activated only in the beginning of T2. Cell 2 is active until the end of T3, and Cell 3 is active until the end of T2. The beginning of the time interval T2 shall be aligned with the first PRS positioning subframe of a positioning occasion in the reference cell, where the PRS positioning occasion is as defined in Clause 8.1.2.5.1. Cell 1 transmits PRS in T2, while Cell 2 transmits PRS only in T3, and Cell 3 transmits PRS only in T2. Note: The information on when PRS is muted is conveyed to the UE using PRS muting information.

The OTDOA assistance data as defined in TS 36.355 [24], Clause 6.5.1, shall be provided to the UE during T1. The last TTI containing the OTDOA assistance data shall be provided to the UE ΔT ms before the start of T2, where $\Delta T = 150$ ms is the maximum processing time of the OTDOA assistance data.

The test parameters are as given in Table A.8.12.12.1-1, Table A.8.12.12.1-2, Table A.8.12.12.1-3 and Table A.8.12.12.1-4.

Table A.8.12.12.1-1: General test parameters for E-UTRAN FDD intra-frequency RSTD measurement reporting delay under fading propagation conditions

Parameter	Unit	Value		Comment
		Test 1	Test 2	
Reference cell		Cell 1		Reference cell is the cell in the OTDOA assistance data with respect to which the RSTD measurement is defined, as specified in TS 36.214 [4] and TS 36.355 [24]. The reference cell is the PCell in this test case.
Neighbor cells		Cell 2 and Cell 3		Cell 2 and Cell 3 appear at random places in the neighbour cell list in the OTDOA assistance data, but Cell 2 always appears in the first half of the list, whilst Cell 3 appears in the second half of the list.
MPDCCH		DL Reference Measurement Channel R.18 FDD		As specified in clause A.3.1.3
<i>mPDCCH-startSF-UESS</i>		10		Parameter <i>G</i> in which determines subframe <i>k0</i> in which MPDCCH starts
System Channel Bandwidth (BW_{channel})	MHz	10		
PRS Transmission Bandwidth	RB	6	24	PRS are transmitted in the center RBs
Gap pattern Id		<i>rstd12</i>	<i>rstd2</i>	As specified in Table 8.1.2.1-3. Applies for measurements on Cell 1, Cell 2, and Cell 3
Gap offset		150		As specified in TS 36.331 [2], Clause 6.3.5
PRS configuration index I_{PRS}		311		This corresponds to periodicity of 320 ms and PRS subframe offset of $I_{\text{PRS}} - 160$ DL subframes, as defined in TS 36.211 [16], Table 6.10.4.3-1
Number of consecutive downlink positioning subframes N_{PRS}		30	8	As defined in TS 36.211 [16]. The number of subframes in a positioning occasion. Corresponds to parameter <i>add-numDL-Frames</i> in TS 36.355 [24], for UE with <i>additional-prs-config</i> capability

		40	10	As defined in TS 36.211 [16]. The number of subframes in a positioning occasion. Corresponds to parameter <i>add-numDL-Frames</i> in TS 36.355 [24], for UE with <i>densePrsConfig</i> capability
Physical cell ID PCI		(PCI of Cell 1 – PCI of Cell 2)mod6=0 and (PCI of Cell 1 – PCI of Cell 3)mod6=0		The cell PCIs are selected such that the relative shifts of PRS patterns among cells are as given by the test parameters
CP length		Normal		
DRX		ON		DRX parameters are further specified in Table A.8.12.9.1-3
Radio frame receive time offset between the cells at the UE antenna connector	μs	Cell 2 to Cell 1: 1 Cell 3 to Cell 1: -1		PRS are transmitted from synchronous cells
Expected RSTD	μs	Cell 2: 3 Cell 3: 3 Other neighbour cells: randomly between -3 and 3		The expected RSTD is what is expected at the receiver. The corresponding parameter in the OTDOA assistance data specified in TS 36.355 [24] is the <i>expectedRSTD</i> indicator
Expected RSTD uncertainty for all neighbour cells	μs	5		The corresponding parameter in the OTDOA assistance data specified in TS 36.355 [24] is the <i>expectedRSTD-Uncertainty</i> index
Number of cells provided in OTDOA assistance data		16		Including the reference cell
PRS muting info		Cell 1: '11110000' Cell 2: '00001111' Cell 3: '11110000'		Corresponds to <i>prs-MutingInfo</i> defined in TS 36.355 [24]
T1	s	3		The length of the time interval from the beginning of each test
T2	s	1.28		The length of the time interval that follows immediately after time interval T1
T3	s	1.60		The length of the time interval that follows immediately after time interval T2

Table A.8.12.12.1-2: Cell-specific test parameters for E-UTRAN FDD intra-frequency RSTD measurement reporting delay under fading propagation conditions during T1

Parameter	Unit	Cell 1	Cell 2	Cell 3
E-UTRA RF Channel Number		1	1	1
Correlation Matrix and Antenna Configuration		1x1	1x1	1x1
OCNG patterns defined in A.3.2.1		OP.21 FDD	N/A	N/A
PBCH_RA	dB	0	N/A	N/A
PBCH_RB				
PSS_RA				
SSS_RA				
PCFICH_RB				
PHICH_RA				
PHICH_RB				
PDCCH_RA				
PDCCH_RB				
OCNG_RA ^{Note 1}				
OCNG_RB ^{Note 1}				
N_{oc} ^{Note 3}	dBm/ 15 kHz	-95		

$\text{PRS } \hat{E}_s/N_{oc}$	dB	-Infinity	-Infinity	-Infinity
I_o ^{Note 4}	dBm/ 9 MHz	-67.22	-67.22	-67.22
\hat{E}_s/N_{oc}	dB	0	-Infinity	-Infinity
Propagation Condition		ETU30		
<p>Note 1: OCNG shall be used such that active cell (Cell 1) is fully allocated and a constant total transmitted power spectral density is achieved for all OFDM symbols.</p> <p>Note 2: The resources for uplink transmission are assigned to the UE prior to the start of time period T2.</p> <p>Note 3: Interference from other cells and noise sources not specified in the test are assumed to be constant over subcarriers and time and shall be modelled as AWGN of appropriate power for N_{oc} to be fulfilled.</p> <p>Note 4: I_o levels have been derived from other parameters and are given for information purpose. These are not settable test parameters.</p>				

Table A.8.12.12.1-3: Cell-specific test parameters for E-UTRAN FDD intra-frequency RSTD measurement reporting delay under fading propagation conditions during T2 and T3

Parameter	Unit	Cell 1		Cell 2		Cell 3	
		T2	T3	T2	T3	T2	T3
E-UTRA RF Channel Number		1		1		1	
Correlation Matrix and Antenna Configuration		1x1		1x1		1x1	
OCNG patterns defined in A.3.2.1		OP.21 FDD		OP.6 FDD		OP.6 FDD	N/A
PBCH_RA	dB	0		0		0	N/A
PBCH_RB							
PSS_RA							
SSS_RA							
PCFICH_RB							
PHICH_RA							
PHICH_RB							
PDCCH_RA							
PDCCH_RB							
OCNG_RA ^{Note 1}							
OCNG_RB ^{Note 1}							
PRS_RA	dB	-3	N/A	N/A	3	3	N/A
N_{oc} ^{Note 3}	dBm/ 15 kHz	-98	-95	-98	-95	-98	-95
$\text{PRS } \hat{E}_s/N_{oc}$	dB	-12	-Infinity	-Infinity	-13	-13	-Infinity
$\text{PRS } \hat{E}_s/I_{ot}$ ^{Note 4}	dB	-12.21	-Infinity	-Infinity	-13	-13.27	-Infinity
I_o ^{Note 4}	dBm/ 9 MHz	-69.92	-67.18	-69.92	-67.18	-69.92	-67.18
PRP ^{Note 4}	dBm/ 15 kHz	-110	-Infinity	-Infinity	-108	-111	-Infinity
RSRP ^{Note 4}	dBm/ 15 kHz	-107	-104	-111	-111	-114	-Infinity
\hat{E}_s/N_{oc} ^{Note 4}	dB	-9	-9	-13	-16	-16	-Infinity
Propagation Condition		ETU30					

Note 1:	OCNG shall be used such that active cells (all, except Cell 3 in T3) are fully allocated and a constant total transmitted power spectral density is achieved for all OFDM symbols other than those in the subframes with transmitted PRS.
Note 2:	The resources for uplink transmission are assigned to the UE prior to the start of time period T2.
Note 3:	Interference from other cells and noise sources not specified in the test are assumed to be constant over subcarriers and time and shall be modelled as AWGN of appropriate power for N_{oc} to be fulfilled.
Note 4:	If PRS_RA is not "N/A", \hat{E}_s/N_{oc} , PRS \hat{E}_s/I_{ot} , I_o , RSRP and PRP levels have been derived from other parameters and are given for information purpose. If PRS_RA is "N/A", I_o and RSRP levels have been derived from other parameters and are given for information purpose. These are not settable test parameters. Interference conditions shall be applied to all PRS symbols of DL positioning subframes.

Table A.8.12.12.1-4: DRX parameters for the test of E-UTRAN FDD intra-frequency RSTD measurement reporting delay under fading propagation conditions

Field	Value	Comment
onDurationTimer	psf1	As specified in TS 36.331 [2], Clause 6.3.2
Drx-InactivityTimer	psf1	
drx-RetransmissionTimer	sf1	
longDRX-CycleStartOffset	sf320	
shortDRX	Disable	

A.8.12.12.2 Test Requirements

For Cat-M1 UE in CE Mode B, the RSTD measurement time fulfils the requirements specified in Clause 8.13.3.3.1.

For Cat-M2 UE in CE Mode B, the RSTD measurement time fulfils the requirements specified in Clause 8.16.3.1.1.

In Test 1, the UE configured with 1.4 MHz RF bandwidth shall perform and report the RSTD measurements for Cell 2 and Cell 3 with respect to the reference cell in the OTDOA assistance data, Cell 1, within 2880 ms starting from the beginning of time interval T2.

In Test 2, the UE configured with 5 MHz RF bandwidth shall perform and report the RSTD measurements for Cell 2 and Cell 3 with respect to the reference cell in the OTDOA assistance data, Cell 1, within 2880 ms starting from the beginning of time interval T2.

The rate of the correct events for each neighbour cell observed during repeated tests shall be at least 90%, where the reported RSTD measurement for each correct event shall be within the RSTD reporting range specified in Clause 9.1.10.3, i.e., between RSTD_0000 and RSTD_12711.

NOTE: The RSTD measurement time in the test is derived from the following expression,

$$T_{PRS}(M-1) + 320 \cdot \left\lceil \frac{n}{M} \right\rceil, \text{ where } M=8 \text{ and } n=16 \text{ are the parameters specified in Section 8.13.3.3.1}$$

(for Cat-M1) and in Section 8.16.3.1.1 (for Cat-M2) under Note 1. This gives the total RSTD measurement time of 2880 ms for Cell 2 and Cell 3 with respect to the reference Cell 1.

A.8.12.13 E-UTRAN HD-FDD intra-frequency RSTD measurement period test case in CE Mode B with longer PRS occasions

A.8.12.13.1 Test Purpose and Environment

The purpose of the test is to verify for Cat-M1 and Cat-M2 UE in CE Mode B that the RSTD measurement meets the requirements specified in Sections 8.13.3.3.3 and 8.16.3.1.3, respectively, in an environment with fading propagation conditions when the UE requires measurement gaps for performing intra-frequency RSTD. The test is applicable for Cat-M1 and Cat-M2 UE supporting measurement gaps specified in Table 8.1.2.1-3. Test 1 is applicable for Cat-M1 and Cat-M2 supporting and configured with 1.4 MHz UE RF bandwidth, while Test 2 is applicable for Cat-M2 supporting and configured with 5 MHz UE RF bandwidth.

In the test there are three synchronous cells: Cell 1, Cell 2 and Cell 3. Cell 1 is the reference as well as the PCell. Cell 2 and Cell 3 are the neighbour cells. All cells are on the same RF channel.

The UE requires measurement gaps to perform intra-frequency measurements. Measurement gap pattern configuration *rstd12* and *rstd2* as defined in Table 8.1.2.1-3 is provided to the UE in Test 1 and Test 2, respectively. Each test consists of three consecutive time intervals, with duration of T1, T2 and T3. Cell 1 is active in T1, T2 and T3, whilst Cell 2 and Cell 3 are activated only in the beginning of T2. Cell 2 is active until the end of T3, and Cell 3 is active until the end of T2. The beginning of the time interval T2 shall be aligned with the first PRS positioning subframe of a positioning occasion in the reference cell, where the PRS positioning occasion is as defined in Clause 8.1.2.5.1. Cell 1 transmits PRS in T2, while Cell 2 transmits PRS only in T3, and Cell 3 transmits PRS only in T2. Note: The information on when PRS is muted is conveyed to the UE using PRS muting information.

The OTDOA assistance data as defined in TS 36.355 [24], Clause 6.5.1, shall be provided to the UE during T1. The last TTI containing the OTDOA assistance data shall be provided to the UE ΔT ms before the start of T2, where $\Delta T = 150$ ms is the maximum processing time of the OTDOA assistance data.

The test parameters are as given in Table A.8.12.13.1-1, Table A.8.12.13.1-2, Table A.8.12.13.1-3 and Table A.8.12.13.1-4.

Table A.8.12.13.1-1: General test parameters for E-UTRAN HD-FDD intra-frequency RSTD measurement reporting delay under fading propagation conditions

Parameter	Unit	Value		Comment
		Test 1	Test 2	
Reference cell		Cell 1		Reference cell is the cell in the OTDOA assistance data with respect to which the RSTD measurement is defined, as specified in TS 36.214 [4] and TS 36.355 [24]. The reference cell is the PCell in this test case.
Neighbor cells		Cell 2 and Cell 3		Cell 2 and Cell 3 appear at random places in the neighbour cell list in the OTDOA assistance data, but Cell 2 always appears in the first half of the list, whilst Cell 3 appears in the second half of the list.
MPDCCH		DL Reference Measurement Channel R.8 HD-FDD		As specified in clause A.3.1.3
<i>mPDCCH-startSF-UeSS</i>		10		Parameter G in which determines subframe <i>k0</i> in which MPDCCH starts
System Channel Bandwidth (BW_{channel})	MHz	10		
PRS Transmission Bandwidth	RB	6	24	PRS are transmitted in the center RBs
Gap pattern Id		<i>rstd12</i>	<i>rstd2</i>	As specified in Table 8.1.2.1-3. Applies for measurements on Cell 1, Cell 2, and Cell 3
Gap offset		150		As specified in TS 36.331 [2], Clause 6.3.5
PRS configuration index I_{PRS}		311		This corresponds to periodicity of 320 ms and PRS subframe offset of $I_{\text{PRS}} - 160$ DL subframes, as defined in TS 36.211 [16], Table 6.10.4.3-1
Number of consecutive downlink positioning subframes N_{PRS}		30	8	As defined in TS 36.211 [16]. The number of subframes in a positioning occasion. Corresponds to parameter <i>add-numDL-Frames</i> in TS 36.355 [24], for UE with <i>additional-prs-config</i> capability

		40	10	As defined in TS 36.211 [16]. The number of subframes in a positioning occasion. Corresponds to parameter <i>add-numDL-Frames</i> in TS 36.355 [24], for UE with <i>densePrsConfig</i> capability
Physical cell ID PCI		(PCI of Cell 1 – PCI of Cell 2)mod6=0 and (PCI of Cell 1 – PCI of Cell 3)mod6=0		The cell PCIs are selected such that the relative shifts of PRS patterns among cells are as given by the test parameters
CP length		Normal		
DRX		ON		DRX parameters are further specified in Table A.8.12.4.1-3
Radio frame receive time offset between the cells at the UE antenna connector	μs	Cell 2 to Cell 1: 1 Cell 3 to Cell 1: -1		PRS are transmitted from synchronous cells
Expected RSTD	μs	Cell 2: 3 Cell 3: 3 Other neighbour cells: randomly between -3 and 3		The expected RSTD is what is expected at the receiver. The corresponding parameter in the OTDOA assistance data specified in TS 36.355 [24] is the <i>expectedRSTD</i> indicator
Expected RSTD uncertainty for all neighbour cells	μs	5		The corresponding parameter in the OTDOA assistance data specified in TS 36.355 [24] is the <i>expectedRSTD-Uncertainty index</i>
Number of cells provided in OTDOA assistance data		16		Including the reference cell
PRS muting info		Cell 1: '11110000' Cell 2: '00001111' Cell 3: '11110000'		Corresponds to <i>prs-MutingInfo</i> defined in TS 36.355 [24]
T1	s	3		The length of the time interval from the beginning of each test
T2	s	1.28		The length of the time interval that follows immediately after time interval T1
T3	s	1.60		The length of the time interval that follows immediately after time interval T2

Table A.8.12.13.1-2: Cell-specific test parameters for E-UTRAN HD-FDD intra-frequency RSTD measurement reporting delay under fading propagation conditions during T1

Parameter	Unit	Cell 1	Cell 2	Cell 3
E-UTRA RF Channel Number		1	1	1
Correlation Matrix and Antenna Configuration		1x1	1x1	1x1
OCNG patterns defined in A.3.2.1		OP.21 FDD	N/A	N/A
PBCH_RA	dB	0	N/A	N/A
PBCH_RB				
PSS_RA				
SSS_RA				
PCFICH_RB				
PHICH_RA				
PHICH_RB				
PDCCH_RA				
PDCCH_RB				
OCNG_RA ^{Note 1}				
OCNG_RB ^{Note 1}				
N_{oc} ^{Note 3}	dBm/ 15 kHz	-95		

$PRS \hat{E}_s/N_{oc}$	dB	-Infinity	-Infinity	-Infinity
I_o ^{Note 4}	dBm/ 9 MHz	-67.22	-67.22	-67.22
\hat{E}_s/N_{oc}	dB	0	-Infinity	-Infinity
Propagation Condition		ETU30		
<p>Note 1: OCNG shall be used such that active cell (Cell 1) is fully allocated and a constant total transmitted power spectral density is achieved for all OFDM symbols.</p> <p>Note 2: The resources for uplink transmission are assigned to the UE prior to the start of time period T2.</p> <p>Note 3: Interference from other cells and noise sources not specified in the test are assumed to be constant over subcarriers and time and shall be modelled as AWGN of appropriate power for N_{oc} to be fulfilled.</p> <p>Note 4: I_o levels have been derived from other parameters and are given for information purpose. These are not settable test parameters.</p>				

Table A.8.12.13.1-3: Cell-specific test parameters for E-UTRAN HD-FDD intra-frequency RSTD measurement reporting delay under fading propagation conditions during T2 and T3

Parameter	Unit	Cell 1		Cell 2		Cell 3	
		T2	T3	T2	T3	T2	T3
E-UTRA RF Channel Number		1		1		1	
Correlation Matrix and Antenna Configuration		1x1		1x1		1x1	
OCNG patterns defined in A.3.2.1		OP.21 FDD		OP.6 FDD		OP.6 FDD	N/A
PBCH_RA	dB	0		0		0	N/A
PBCH_RB							
PSS_RA							
SSS_RA							
PCFICH_RB							
PHICH_RA							
PHICH_RB							
PDCCH_RA							
PDCCH_RB							
OCNG_RA ^{Note 1}							
OCNG_RB ^{Note 1}							
PRS_RA	dB	-3	N/A	N/A	3	3	N/A
N_{oc} ^{Note 3}	dBm/ 15 kHz	-98	-95	-98	-95	-98	-95
$PRS \hat{E}_s/N_{oc}$	dB	-12	-Infinity	-Infinity	-13	-13	-Infinity
$PRS \hat{E}_s/I_{ot}$ ^{Note 4}	dB	-12.21	-Infinity	-Infinity	-13	-13.27	-Infinity
I_o ^{Note 4}	dBm/ 9 MHz	-69.92	-67.18	-69.92	-67.18	-69.92	-67.18
PRP ^{Note 4}	dBm/ 15 kHz	-110	-Infinity	-Infinity	-108	-111	-Infinity
RSRP ^{Note 4}	dBm/ 15 kHz	-107	-104	-111	-111	-114	-Infinity
\hat{E}_s/N_{oc} ^{Note 4}	dB	-9	-9	-13	-16	-16	-Infinity
Propagation Condition		ETU30					

Note 1:	OCNG shall be used such that active cells (all, except Cell 3 in T3) are fully allocated and a constant total transmitted power spectral density is achieved for all OFDM symbols other than those in the subframes with transmitted PRS.
Note 2:	The resources for uplink transmission are assigned to the UE prior to the start of time period T2.
Note 3:	Interference from other cells and noise sources not specified in the test are assumed to be constant over subcarriers and time and shall be modelled as AWGN of appropriate power for N_{oc} to be fulfilled.
Note 4:	If PRS_RA is not "N/A", \hat{E}_s/N_{oc} , PRS \hat{E}_s/I_{ot} , I_o , RSRP and PRP levels have been derived from other parameters and are given for information purpose. If PRS_RA is "N/A", I_o and RSRP levels have been derived from other parameters and are given for information purpose. These are not settable test parameters. Interference conditions shall be applied to all PRS symbols of DL positioning subframes.

Table A.8.12.13.1-4: DRX parameters for the test of E-UTRAN HD-FDD intra-frequency RSTD measurement reporting delay under fading propagation conditions

Field	Value	Comment
onDurationTimer	psf1	As specified in TS 36.331 [2], Clause 6.3.2
Drx-InactivityTimer	psf1	
drx-RetransmissionTimer	sf1	
longDRX-CycleStartOffset	sf320	
shortDRX	Disable	

A.8.12.13.2 Test Requirements

For Cat-M1 UE in CE Mode B, the RSTD measurement time fulfils the requirements specified in Clause 8.13.3.3.3.

For Cat-M2 UE in CE Mode B, the RSTD measurement time fulfils the requirements specified in Clause 8.16.3.1.3.

In Test 1, the UE configured with 1.4 MHz RF bandwidth shall perform and report the RSTD measurements for Cell 2 and Cell 3 with respect to the reference cell in the OTDOA assistance data, Cell 1, within 2880 ms starting from the beginning of time interval T2.

In Test 2, the UE configured with 5 MHz RF bandwidth shall perform and report the RSTD measurements for Cell 2 and Cell 3 with respect to the reference cell in the OTDOA assistance data, Cell 1, within 2880 ms starting from the beginning of time interval T2.

The rate of the correct events for each neighbour cell observed during repeated tests shall be at least 90%, where the reported RSTD measurement for each correct event shall be within the RSTD reporting range specified in Clause 9.1.10.3, i.e., between RSTD_0000 and RSTD_12711.

NOTE: The RSTD measurement time in the test is derived from the following expression,

$$T_{PRS}(M-1) + 320 \cdot \left\lceil \frac{n}{M} \right\rceil, \text{ where } M=8 \text{ and } n=16 \text{ are the parameters specified in Section 8.13.3.3.3}$$

(for Cat-M1) and in Section 8.16.3.1.3 (for Cat-M2) under Note 1. This gives the total RSTD measurement time of 2880 ms for Cell 2 and Cell 3 with respect to the reference Cell 1.

A.8.12.14 E-UTRAN TDD intra-frequency RSTD measurement period test case in CE Mode B with longer PRS occasions

A.8.12.14.1 Test Purpose and Environment

The purpose of the test is to verify for Cat-M1 and Cat-M2 UE in CE Mode B that the RSTD measurement meets the requirements specified in Sections 8.13.3.3.2 and 8.16.3.1.2, respectively, in an environment with fading propagation conditions when the UE requires measurement gaps for performing intra-frequency RSTD measurements. The test is applicable for Cat-M1 and Cat-M2 UE supporting measurement gaps specified in Table 8.1.2.1-3. Test 1 is applicable for Cat-M1 and Cat-M2 supporting and configured with 1.4 MHz UE RF bandwidth, while Test 2 is applicable for Cat-M2 supporting and configured with 5 MHz UE RF bandwidth.

In the test there are three synchronous cells: Cell 1, Cell 2 and Cell 3. Cell 1 is the reference as well as the PCell. Cell 2 and Cell 3 are the neighbour cells. All cells are on the same RF channel.

The UE requires measurement gaps to perform intra-frequency measurements. Measurement gap pattern configuration *rstd15* and *rstd10* as defined in Table 8.1.2.1-3 is provided to the UE in Test 1 and Test 2, respectively. Each test consists of three consecutive time intervals, with duration of T1, T2 and T3. Cell 1 is active in T1, T2 and T3, whilst Cell 2 and Cell 3 are activated only in the beginning of T2. Cell 2 is active until the end of T3, and Cell 3 is active until the end of T2. The beginning of the time interval T2 shall be aligned with the first PRS positioning subframe of a positioning occasion in the reference cell, where the PRS positioning occasion is as defined in Clause 8.1.2.5.1. Cell 1 transmits PRS in T2, while Cell 2 transmits PRS only in T3, and Cell 3 transmits PRS only in T2. Note: The information on when PRS is muted is conveyed to the UE using PRS muting information.

The OTDOA assistance data as defined in TS 36.355 [24], Clause 6.5.1, shall be provided to the UE during T1. The last TTI containing the OTDOA assistance data shall be provided to the UE ΔT ms before the start of T2, where $\Delta T = 150$ ms is the maximum processing time of the OTDOA assistance data.

The test parameters are as given in Table A.8.12.14.1-1, Table A.8.12.14.1-2, Table A.8.12.14.1-3 and Table A.8.12.14.1-4.

Table A.8.12.14.1-1: General test parameters for E-UTRAN TDD intra-frequency RSTD measurement reporting delay under fading propagation conditions

Parameter	Unit	Value		Comment
		Test 1	Test 2	
Reference cell		Cell 1		Reference cell is the cell in the OTDOA assistance data with respect to which the RSTD measurement is defined, as specified in TS 36.214 [4] and TS 36.355 [24]. The reference cell is the PCell in this test case.
Neighbor cells		Cell 2 and Cell 3		Cell 2 and Cell 3 appear at random places in the neighbour cell list in the OTDOA assistance data, but Cell 2 always appears in the first half of the list, whilst Cell 3 appears in the second half of the list.
MPDCCH		DL Reference Measurement Channel R.16 TDD		As specified in clause A.3.1.3
<i>mPDCCH-startSF-UeSS</i>		10		Parameter G in which determines subframe <i>k0</i> in which MPDCCH starts
System Channel Bandwidth (BW_{channel})	MHz	10		
PRS Transmission Bandwidth	RB	6	24	PRS are transmitted in the center RBs
Gap pattern Id		<i>rstd15</i>	<i>rstd10</i>	As specified in Table 8.1.2.1-3. Applies for measurements on Cell 1, Cell 2, and Cell 3
Gap offset		143		As specified in TS 36.331 [2], Clause 6.3.5
PRS configuration index I_{PRS}		624		This corresponds to periodicity of 640 ms and PRS subframe offset of $I_{\text{PRS}} - 480$ DL subframes, as defined in TS 36.211 [16], Table 6.10.4.3-1
Number of consecutive downlink positioning subframes N_{PRS}		30	8	As defined in TS 36.211 [16]. The number of subframes in a positioning occasion. Corresponds to parameter <i>add-numDL-Frames</i> in TS 36.355 [24], for UE with <i>additional-prs-config</i> capability

		40	10	As defined in TS 36.211 [16]. The number of subframes in a positioning occasion. Corresponds to parameter <i>add-numDL-Frames</i> in TS 36.355 [24], for UE with <i>densePrsConfig</i> capability
Physical cell ID PCI		(PCI of Cell 1 – PCI of Cell 2) mod 6 = 0 and (PCI of Cell 1 – PCI of Cell 3) mod 6 = 0		The cell PCIs are selected such that the relative shifts of PRS patterns among cells are as given by the test parameters
TDD uplink-downlink configuration		2	1	As specified in TS 36.211 [16], Clause 4.2; corresponds to a configuration with 5 ms switch-point periodicity and two downlink consecutive subframes
TDD special subframe configuration		6		As specified in TS 36.211 [16], Clause 4.2; corresponds to DwPTS of $19760 \cdot T_s$ and UpPTS of $4384 \cdot T_s$
CP length		Normal		
DRX		ON		DRX parameters are further specified in Table A.8.12.5.1-3
Radio frame receive time offset between the cells at the UE antenna connector	μs	Cell 2 to Cell 1: 1 Cell 3 to Cell 1: -1		PRS are transmitted from synchronous cells
Expected RSTD	μs	Cell 2: 3 Cell 3: 3 Other neighbour cells: randomly between -3 and 3		The expected RSTD is what is expected at the receiver. The corresponding parameter in the OTDOA assistance data specified in TS 36.355 [24] is the expectedRSTD indicator
Expected RSTD uncertainty for all neighbour cells	μs	5		The corresponding parameter in the OTDOA assistance data specified in TS 36.355 [24] is the expectedRSTD-Uncertainty index
Number of cells provided in OTDOA assistance data		16		Including the reference cell
PRS muting info		Cell 1: '11110000' Cell 2: '00001111' Cell 3: '11110000'		Corresponds to prs-MutingInfo defined in TS 36.355 [24]
T1	s	3		The length of the time interval from the beginning of each test
T2	s	2.56		The length of the time interval that follows immediately after time interval T1
T3	s	2.56		The length of the time interval that follows immediately after time interval T2

Table A.8.12.14.1-2: Cell-specific test parameters for E-UTRAN TDD intra-frequency RSTD measurement reporting delay under fading propagation conditions during T1

Parameter	Unit	Cell 1	Cell 2	Cell 3
E-UTRA RF Channel Number		1	1	1
Correlation Matrix and Antenna Configuration		1x1	1x1	1x1
OCNG patterns defined in A.3.2.1		OP.11 TDD	N/A	N/A
PBCH_RA	dB	0	N/A	N/A
PBCH_RB				
PSS_RA				
SSS_RA				

PCFICH_RB				
PHICH_RA				
PHICH_RB				
PDCCH_RA				
PDCCH_RB				
OCNG_RA ^{Note 1}				
OCNG_RB ^{Note 1}				
N_{oc} ^{Note 3}	dBm/ 15 kHz	-95		
PRS \hat{E}_s/N_{oc}	dB	-Infinity	-Infinity	-Infinity
I_o ^{Note 4}	dBm/ 9 MHz	-67.22	-67.22	-67.22
\hat{E}_s/N_{oc}	dB	0	-Infinity	-Infinity
Propagation Condition		ETU30		
<p>Note 1: OCNG shall be used such that active cell (Cell 1) is fully allocated and a constant total transmitted power spectral density is achieved for all OFDM symbols.</p> <p>Note 2: The resources for uplink transmission are assigned to the UE prior to the start of time period T2.</p> <p>Note 3: Interference from other cells and noise sources not specified in the test are assumed to be constant over subcarriers and time and shall be modelled as AWGN of appropriate power for N_{oc} to be fulfilled.</p> <p>Note 4: I_o levels have been derived from other parameters and are given for information purpose. These are not settable test parameters.</p>				

Table A.8.12.14.1-3: Cell-specific test parameters for E-UTRAN TDD intra-frequency RSTD measurement reporting delay under fading propagation conditions during T2 and T3

Parameter	Unit	Cell 1		Cell 2		Cell 3	
		T2	T3	T2	T3	T2	T3
E-UTRA RF Channel Number		1		1		1	
Correlation Matrix and Antenna Configuration		1x1		1x1		1x1	
OCNG patterns defined in A.3.2.1		OP.11 TDD		OP.2 TDD		OP.2 TDD	N/A
PBCH_RA	dB	0		0		0	N/A
PBCH_RB							
PSS_RA							
SSS_RA							
PCFICH_RB							
PHICH_RA							
PHICH_RB							
PDCCH_RA							
PDCCH_RB							
OCNG_RA ^{Note 1}							
OCNG_RB ^{Note 1}							
PRS_RA	dB	-3	N/A	N/A	3	3	N/A
N_{oc} ^{Note 3}	dBm/ 15 kHz	-98	-95	-98	-95	-98	-95
PRS \hat{E}_s/N_{oc}	dB	-12	-Infinity	-Infinity	-13	-13	-Infinity
PRS \hat{E}_s/I_{ot} ^{Note 4}	dB	-12.21	-Infinity	-Infinity	-13	-13.27	-Infinity
I_o ^{Note 4}	dBm/ 9 MHz	-69.92	-67.18	-69.92	-67.18	-69.92	-67.18
PRP ^{Note 4}	dBm/ 15 kHz	-110	-Infinity	-Infinity	-108	-111	-Infinity
RSRP ^{Note 4}	dBm/ 15 kHz	-107	-104	-111	-111	-114	-Infinity

\hat{E}_s/N_{oc} <small>Note 4</small>	dB	-9	-9	-13	-16	-16	-Infinity
Propagation Condition		ETU30					
Note 1:	OCNG shall be used such that active cells (all, except Cell 3 in T3) are fully allocated and a constant total transmitted power spectral density is achieved for all OFDM symbols other than those in the subframes with transmitted PRS.						
Note 2:	The resources for uplink transmission are assigned to the UE prior to the start of time period T2.						
Note 3:	Interference from other cells and noise sources not specified in the test are assumed to be constant over subcarriers and time and shall be modelled as AWGN of appropriate power for N_{oc} to be fulfilled.						
Note 4:	If PRS_RA is not "N/A", \hat{E}_s/N_{oc} , PRS \hat{E}_s/I_{ot} , I_0 , RSRP and PRP levels have been derived from other parameters and are given for information purpose. If PRS_RA is "N/A", I_0 and RSRP levels have been derived from other parameters and are given for information purpose. These are not settable test parameters. Interference conditions shall be applied to all PRS symbols of DL positioning subframes.						

Table A.8.12.14.1-4: DRX parameters for the test of E-UTRAN TDD intra-frequency RSTD measurement reporting delay under fading propagation conditions

Field	Value	Comment
onDurationTimer	psf1	As specified in TS 36.331 [2], Clause 6.3.2
Drx-InactivityTimer	psf1	
drx-RetransmissionTimer	sf1	
longDRX-CycleStartOffset	sf320	
shortDRX	Disable	

A.8.12.14.2 Test Requirements

For Cat-M1 UE in CE Mode B, the RSTD measurement time fulfils the requirements specified in Clause 8.13.3.3.2.

For Cat-M2 UE in CE Mode B, the RSTD measurement time fulfils the requirements specified in Clause 8.16.3.1.2.

In Test 1, the UE configured with 1.4 MHz RF bandwidth shall perform and report the RSTD measurements for Cell 2 and Cell 3 with respect to the reference cell in the OTDOA assistance data, Cell 1, within 5760 ms starting from the beginning of time interval T2.

In Test 2, the UE configured with 5 MHz RF bandwidth shall perform and report the RSTD measurements for Cell 2 and Cell 3 with respect to the reference cell in the OTDOA assistance data, Cell 1, within 5760 ms starting from the beginning of time interval T2.

The rate of the correct events for each neighbour cell observed during repeated tests shall be at least 90%, where the reported RSTD measurement for each correct event shall be within the RSTD reporting range specified in Clause 9.1.10.3, i.e., between RSTD_0000 and RSTD_12711.

NOTE: The RSTD measurement time in the test is derived from the following expression, $T_{PRS}(M - 1) + 640 \cdot \left\lceil \frac{n}{M} \right\rceil$, where $M=8$ and $n=16$ are the parameters specified in Section 8.13.3.3.2 (for Cat-M1) and in Section 8.16.3.1.2 (for Cat-M2) under Note 1. This gives the total RSTD measurement time of 5760 ms for Cell 2 and Cell 3 with respect to the reference Cell 1.

A.8.13 RSTD Inter-frequency Measurements

A.8.13.1 E-UTRAN FDD-FDD inter-frequency RSTD measurement reporting delay test case with the reference cell on the serving carrier frequency

A.8.13.1.1 Test Purpose and Environment

The purpose of the test is to verify that the FDD-FDD inter-frequency RSTD measurement meets the requirements specified in Clause 8.1.2.6.1, specifically for Note 2 in Table 8.1.2.6.1-1, in an environment with fading propagation conditions.

In the test there are three synchronous cells: Cell 1, Cell 2 and Cell 3. Cell 1 is the reference as well as the PCell. Cell 2 and Cell 3 are the neighbour cells. Cell 1 is on FDD RF channel 1. Cell 2 and Cell 3 are on a FDD RF channel 2.

The UE requires measurement gaps to perform inter-frequency measurements. Gap pattern configuration # 0 as defined in Table 8.1.2.1-1 is provided and configured to not overlap with PRS subframes of Cell 1.

The test consists of three consecutive time intervals, with duration of T1, T2 and T3. Cell 1 is active in T1, T2 and T3, whilst Cell 2 and Cell 3 are activated only in the beginning of T2. Cell 2 is active until the end of T3, and Cell 3 is active until the end of T2. The beginning of the time interval T2 shall be aligned with the first PRS positioning subframe of a positioning occasion in the Cell 3, where the PRS positioning occasion is as defined in Clause 8.1.2.5.1. Cell 1 and Cell 3 transmit PRS only in T2. Cell 2 transmits PRS only in T3. Note: The information on when PRS is muted is conveyed to the UE using PRS muting information.

The OTDOA assistance data as defined in TS 36.355, Clause 6.5.1, shall be provided to the UE during T1. The last TTI containing the OTDOA assistance data shall be provided to the UE ΔT ms before the start of T2, where $\Delta T = 150$ ms is the maximum processing time of the OTDOA assistance data. The measurement gap configuration is known and configured in the UE at the start of T1. DRX is configured before T2.

The test parameters are as given in Table A.8.13.1.1-1, Table A.8.13.1.1-2, Table A.8.13.1.1-3 and Table A.8.13.1.1-4.

Table A.8.13.1.1-1: General test parameters for E-UTRAN FDD-FDD inter-frequency RSTD measurement reporting delay under fading propagation conditions

Parameter	Unit	Value	Comment
Reference cell		Cell 1	Reference cell is the cell with respect to which the RSTD measurement is defined, as specified in TS 36.214 [4]. The reference cell is the PCell on RF channel 1 in this test case.
Neighbor cells		Cell 2 and Cell 3	Cells on RF channel 2. The cells appear at random places in the neighbour cell list in the OTDOA assistance data, but Cell 2 always appears in the first half of the list, whilst Cell 3 appears in the second half of the list.
PCFICH/PDCCH/PHICH parameters		DL Reference Measurement Channel R.6 FDD	As specified in clause A.3.1.2.1
Channel Bandwidth (BW _{channel})	MHz	10	
PRS Bandwidth	RB	50	PRS bandwidth is as indicated in prs-Bandwidth in the OTDOA assistance data defined in [24]. Here, PRS are transmitted over the system bandwidth
Gap pattern Id		0	As specified in Table 8.1.2.1-1. Applies for measurements on Cell 2 and Cell 3
Gap offset		9	As specified in TS 36.331 [2], Clause 6.3.5

PRS configuration index I_{PRS}		Cell 1: 181, Cell 2, Cell 3: 171	This corresponds to periodicity of 320 ms and PRS subframe offset of $I_{PRS} - 160$ DL subframes, as defined in TS 36.211 [16], Table 6.10.4.3-1
Number of consecutive downlink positioning subframes N_{PRS}		1	As defined in TS 36.211 [16]. The number of subframes in a positioning occasion
Physical cell ID PCI		(PCI of Cell 1 – PCI of Cell 2)mod6=0 and (PCI of Cell 1 – PCI of Cell 3)mod6=0	The cell PCIs are selected such that the relative shifts of PRS patterns among cells are as given by the test parameters
CP length		Normal	
DRX		ON	DRX parameters are further specified in Table A.8.13.1.1-3.
prs-SubframeOffset		310	Number of subframes rounded to the closest integer. The corresponding parameter in the OTDOA assistance data is prs-SubframeOffset specified in TS 36.355 [24]
slotNumberOffset		0	The slot number offset at the transmitter between a neighbour cell and the assistance data reference cell specified in TS 36.355 [24]
Radio frame receive time offset between the cells at the UE antenna connector	μs	Cell 2 to Cell 1: 1 Cell 3 to Cell 1: -1	PRS are transmitted from synchronous cells
Expected RSTD	μs	Cell 2: -2 Cell 3: 2 Other neighbour cells: randomly between -3 and 3	The expected RSTD is what is expected at the receiver. The corresponding parameter in the OTDOA assistance data specified in TS 36.355 [24] is the expectedRSTD indicator
Expected RSTD uncertainty for all neighbour cells	μs	5	The corresponding parameter in the OTDOA assistance data specified in TS 36.355 [24] is the expectedRSTD-Uncertainty index
Number of cells provided in OTDOA assistance data		16	The list includes the reference cell (received in <i>OTDOA-ReferenceCellInfo</i> [24]) on RF channel 1 and 15 other cells on RF channel 2, all received in <i>OTDOA-ProvideAssistanceData</i> [24].
PRS muting info		Cell 1: '1111111100000000' Cell 2: '0000000011111111' Cell 3: '1111111100000000'	Corresponds to prs-MutingInfo defined in TS 36.355 [24]
T1	s	3	The length of the time interval from the beginning of each test
T2	s	2.48	The length of the time interval that follows immediately after time interval T1
T3	s	2.48	The length of the time interval that follows immediately after time interval T2

Table A.8.13.1.1-2: Cell-specific test parameters for E-UTRAN FDD-FDD inter-frequency RSTD measurement reporting delay under fading propagation conditions during T1

Parameter	Unit	Cell 1	Cell 2	Cell 3
E-UTRA RF Channel Number		1	2	2
Correlation Matrix and Antenna Configuration		1x2 Low	1x2 Low	1x2 Low

OCNG patterns defined in A.3.2.1		OP.5 FDD	N/A	N/A
PBCH_RA	dB	0	N/A	N/A
PBCH_RB				
PSS_RA				
SSS_RA				
PCFICH_RB				
PHICH_RA				
PHICH_RB				
PDCCH_RA				
PDCCH_RB				
OCNG_RA ^{Note 1}				
OCNG_RB ^{Note 1}				
N_{oc} ^{Note 3}	dBm/ 15 kHz	-95	-95	-95
PRS \hat{E}_s/N_{oc}	dB	-Infinity	-Infinity	-Infinity
I_o ^{Note 4}	dBm/ 9 MHz	-67.22	-67.22	-67.22
\hat{E}_s/N_{oc}	dB	0	-Infinity	-Infinity
Propagation Condition		ETU30		
<p>Note 1: OCNG shall be used such that the active cell (Cell 1) is fully allocated and a constant total transmitted power spectral density is achieved for all OFDM symbols.</p> <p>Note 2: The resources for uplink transmission are assigned to the UE prior to the start of time period T2.</p> <p>Note 3: Interference from other cells and noise sources not specified in the test are assumed to be constant over subcarriers and time and shall be modelled as AWGN of appropriate power for N_{oc} to be fulfilled.</p> <p>Note 4: I_o levels have been derived from other parameters and are given for information purpose. These are not settable test parameters.</p>				

Table A.8.13.1.1-3: Cell-specific test parameters for E-UTRAN FDD-FDD inter-frequency RSTD measurement reporting delay under fading propagation conditions during T2 and T3

Parameter	Unit	Cell 1		Cell 2		Cell 3	
		T2	T3	T2	T3	T2	T3
E-UTRA RF Channel Number		1		2		2	
Correlation Matrix and Antenna Configuration		1x2 Low		1x2 Low		1x2 Low	
OCNG patterns defined in A.3.2.1		OP.5 FDD		OP.6 FDD		OP.6 FDD	N/A
PBCH_RA	dB	0	0	0	0	0	N/A
PBCH_RB							
PSS_RA							
SSS_RA							
PCFICH_RB							
PHICH_RA							
PHICH_RB							
PDCCH_RA							
PDCCH_RB							
OCNG_RA ^{Note 1}							
OCNG_RB ^{Note 1}							
PRS_RA	dB	-3	N/A	N/A	3	3	N/A
N_{oc} ^{Note 3}	dBm/ 15 kHz	-98	-98	-98	-95	-98	-95
PRS \hat{E}_s/N_{oc}	dB	-1	-Infinity	-Infinity	-7	-8	-Infinity
PRS \hat{E}_s/I_{ot} ^{Note 4}	dB	-1	-Infinity	-Infinity	-7	-8	-Infinity

I_o ^{Note 4}	dBm/ 9 MHz	-69.68	-70.22	-70.11	-67.08	-70.11	-67.08
PRP ^{Note 4}	dBm/ 15 kHz	-99	-Infinity	-Infinity	-102	-106	-Infinity
RSRP ^{Note 4}	dBm/ 15 kHz	-96	-96	-105	-105	-109	-Infinity
\hat{E}_s/N_{oc} ^{Note 4}	dB	2	2	-7	-10	-11	-Infinity
Propagation Condition		ETU30					
<p>Note 1: OCNB shall be used such that active cells (all, except Cell 3 in T3) are fully allocated and a constant total transmitted power spectral density is achieved for all OFDM symbols other than those in the subframes with transmitted PRS.</p> <p>Note 2: The resources for uplink transmission are assigned to the UE prior to the start of time period T2.</p> <p>Note 3: Interference from other cells and noise sources not specified in the test are assumed to be constant over subcarriers and time and shall be modelled as AWGN of appropriate power for N_{oc} to be fulfilled.</p> <p>Note 4: If PRS_RA is not "N/A", \hat{E}_s/N_{oc}, PRS \hat{E}_s/I_{ot}, I_o, RSRP and PRP levels have been derived from other parameters and are given for information purpose. If PRS_RA is "N/A", I_o and RSRP levels have been derived from other parameters and are given for information purpose. These are not settable test parameters. Interference conditions shall be applied to all PRS symbols of DL positioning subframes</p>							

Table A.8.13.1.1-4: DRX parameters for the test of E-UTRAN FDD-FDD inter-frequency RSTD measurement reporting delay under fading propagation conditions

Field	Value	Comment
onDurationTimer	psf1	As specified in TS 36.331 [2], Clause 6.3.2
Drx-InactivityTimer	psf1	
drx-RetransmissionTimer	sf1	
longDRX-CycleStartOffset	sf320	
shortDRX	Disable	

A.8.13.1.2 Test Requirements

The RSTD measurement time fulfils the requirements specified in Clause 8.1.2.6.1.

The UE shall perform and report the RSTD measurements for Cell 2 and Cell 3 with respect to the reference cell Cell 1 within 4960 ms starting from the beginning of time interval T2.

The rate of the correct events for each neighbour cell observed during repeated tests shall be at least 90%, where the reported RSTD measurement for each correct event shall be within the RSTD reporting range specified in Clause 9.1.10.3, i.e., between RSTD_0000 and RSTD_12711.

NOTE: The RSTD measurement time in the test is derived from the following expression,

$$T_{PRS}(M-1) + 160 \left\lceil \frac{n}{M} \right\rceil, \text{ where } M=16 \text{ and } n=16 \text{ are the parameters specified in Clause 8.1.2.6.1,}$$

Table 8.1.2.6.1-1, under Note 2. This gives the total RSTD measurement time of 4960 ms for Cell 2 and Cell 3 with respect to the reference cell Cell 1.

A.8.13.1.2A Test Requirements for UE Category 1bis

The RSTD measurement time fulfils the requirements specified in Clause 8.1.2.6.5.

The UE shall perform and report the RSTD measurements for Cell 2 and Cell 3 with respect to the reference cell Cell 1 within 10080 ms starting from the beginning of time interval T2.

The rate of the correct events for each neighbour cell observed during repeated tests shall be at least 90%, where the reported RSTD measurement for each correct event shall be within the RSTD reporting range specified in Clause 9.1.10.3, i.e., between RSTD_0000 and RSTD_12711.

NOTE: The RSTD measurement time in the test is derived from the following expression,

$$T_{PRS}(M-1) + 160 \left\lceil \frac{n}{M} \right\rceil, \text{ where } M=32 \text{ and } n=16 \text{ are the parameters specified in Clause 8.1.2.6.5,}$$

Table 8.1.2.6.5-1, under Note 2. This gives the total RSTD measurement time of 10080 ms for Cell 2 and Cell 3 with respect to the reference cell Cell 1.

The test parameters are as given in Table A.8.13.1.1-1, Table A.8.13.1.1-2, Table A.8.13.1.1-3 and Table A.8.13.1.1-4, with the exceptions given in Table A.8.13.1.2A-1.

Table A.8.13.1.2A-1: Specific test parameters for UE Category for 1Bis E-UTRAN FDD-FDD inter-frequency RSTD measurement reporting delay under fading propagation conditions

Parameter	Unit	Value	Comment
PRS muting info		Cell 1: '11111111111111111000000000000000' Cell 2: '00000000000000001111111111111111' Cell 3: '11111111111111111000000000000000'	Corresponds to prs-MutingInfo defined in TS 36.355 [24]
T1	s	3	The length of the time interval from the beginning of each test
T2	s	5.12	The length of the time interval that follows immediately after time interval T1
T3	s	5.12	The length of the time interval that follows immediately after time interval T2

A.8.13.2 E-UTRAN TDD-TDD inter-frequency RSTD measurement reporting delay test case with the reference cell on the serving carrier frequency

A.8.13.2.1 Test Purpose and Environment

The purpose of the test is to verify that the TDD-TDD inter-frequency RSTD measurement meets the requirements specified in Clause 8.1.2.6.3, specifically for Note 2 in Table 8.1.2.6.3-1, in an environment with fading propagation conditions.

In the test there are three synchronous cells: Cell 1, Cell 2 and Cell 3. Cell 1 is the reference as well as the PCell. Cell 2 and Cell 3 are the neighbour cells. Cell 1 is on TDD RF channel 1. Cell 2 and Cell 3 are on TDD RF channel 2.

The UE requires measurement gaps to perform inter-frequency measurements. Gap pattern configuration # 0 as defined in Table 8.1.2.1-1 is provided and configured to not overlap with PRS subframes of Cell 1.

The test consists of three consecutive time intervals, with duration of T1 and T2. Cell 1 is active in T1, T2 and T3, whilst Cell 2 and Cell 3 are activated only in the beginning of T2. Cell 2 is active until the end of T3, and Cell 3 is active until the end of T2. The beginning of the time interval T2 shall be aligned with the first PRS positioning subframe of a positioning occasion in the Cell 3, where the PRS positioning occasion is as defined in Clause 8.1.2.5.1. Cell 1 and Cell 3 transmit PRS only in T2. Cell 2 transmits PRS only in T3. Note: The information on when PRS is muted is conveyed to the UE using PRS muting information.

The OTDOA assistance data as defined in TS 36.355, Clause 6.5.1, shall be provided to the UE during T1. The last TTI containing the OTDOA assistance data shall be provided to the UE ΔT ms before the start of T2, where $\Delta T = 150$ ms is the maximum processing time of the OTDOA assistance data. The measurement gap configuration is known and configured in the UE at the start of T1. DRX is configured before T2.

The test parameters are as given in Table A.8.13.2.1-1, Table A.8.13.2.1-2, Table A.8.13.2.1-3, and Table A.8.13.2.1-4.

Table A.8.13.2.1-1: General test parameters for E-UTRAN TDD-TDD inter-frequency RSTD measurement reporting delay under fading propagation conditions

Parameter	Unit	Value	Comment
Reference cell		Cell 1	Reference cell is the cell with respect to which the RSTD measurement is defined, as specified in TS 36.214 [4]. The reference cell is the PCell on RF channel 1 in this test case.
Neighbor cells		Cell 2 and Cell 3	Cells on RF channel 2. The cells appear at random places in the neighbour cell list in the OTDOA assistance data, but Cell 2 always appears in the first half of the list, whilst Cell 3 appears in the second half of the list.
PCFICH/PDCCH/PHICH parameters		DL Reference Measurement Channel R.6 TDD	As specified in clause A.3.1.2.2
Channel Bandwidth (BW _{channel})	MHz	10	
PRS Bandwidth	RB	50	PRS bandwidth is as indicated in prs-Bandwidth in the OTDOA assistance data defined in [24]. Here, PRS are transmitted over the system bandwidth
Gap pattern Id		0	As specified in Table 8.1.2.1-1. Applies for measurements on Cell 2 and Cell 3
Gap offset		12	As specified in TS 36.331 [2], Clause 6.3.5
PRS configuration index I_{PRS}		Cell 1: 184, Cell 2, Cell 3: 174	This corresponds to periodicity of 320 ms and PRS subframe offset of $I_{PRS} - 160$ DL subframes, as defined in TS 36.211 [16], Table 6.10.4.3-1
Number of consecutive downlink positioning subframes N_{PRS}		1	As defined in TS 36.211 [16]. The number of subframes in a positioning occasion
Physical cell ID PCI		(PCI of Cell 1 – PCI of Cell 2) mod 6 = 0 and (PCI of Cell 1 – PCI of Cell 3) mod 6 = 0	The cell PCIs are selected such that the relative shifts of PRS patterns among cells are as given by the test parameters
TDD uplink-downlink configuration		1	As specified in TS 36.211 [16], Clause 4.2; corresponds to a configuration with 5 ms switch-point periodicity and two downlink consecutive subframes
TDD special subframe configuration		6	As specified in TS 36.211 [16], Clause 4.2; corresponds to DwPTS of $19760 \cdot T_s$ and UpPTS of $4384 \cdot T_s$
CP length		Normal	The same CP length for DL and UL
DRX		ON	DRX parameters are further specified in Table A.8.13.2.1-3.
prs-SubframeOffset		310	Number of subframes rounded to the closest integer. The corresponding parameter in the OTDOA assistance data is prs-SubframeOffset specified in TS 36.355 [24]
slotNumberOffset		0	The slot number offset at the transmitter between a neighbour cell and the assistance data reference cell specified in TS 36.355 [24]
Radio frame receivetime offset between the cells at the UE antenna connecto	μs	Cell 2 to Cell 1: 1 Cell 3 to Cell 1: -1	PRS are transmitted from synchronous cells
Expected RSTD	μs	Cell 2: -2 Cell 3: 2 Other neighbour cells: randomly between -3 and 3	The expected RSTD is what is expected at the receiver. The corresponding parameter in the OTDOA assistance data specified in TS 36.355 [24] is the expectedRSTD indicator

Expected RSTD uncertainty for all neighbour cells	μs	5	The corresponding parameter in the OTDOA assistance data specified in TS 36.355 [24] is the expectedRSTD-Uncertainty index
Number of cells provided in OTDOA assistance data		16	The list includes the reference cell (received in <i>OTDOA-ReferenceCellInfo</i> [24]) on RF channel 1 and 15 other cells on RF channel 2, all received in <i>OTDOA-ProvideAssistanceData</i> [24].
PRS muting info		Cell 1: '1111111100000000' Cell 2: '0000000011111111' Cell 3: '1111111100000000'	Correponds to prs-MutingInfo defined in TS 36.355 [24]
T1	s	3	The length of the time interval from the beginning of each test
T2	s	2.48	The length of the time interval that follows immediately after time interval T1
T3	s	2.48	The length of the time interval that follows immediately after time interval T2

Table A.8.13.2.1-2: Cell-specific test parameters for E-UTRAN TDD-TDD inter-frequency RSTD measurement reporting delay under fading propagation conditions during T1

Parameter	Unit	Cell 1	Cell 2	Cell 3
E-UTRA RF Channel Number		1	2	2
Correlation Matrix and Antenna Configuration		1x2 Low	1x2 Low	1x2 Low
OCNG patterns defined in A.3.2.2		OP.1 TDD	N/A	N/A
PBCH_RA	dB	0	N/A	N/A
PBCH_RB				
PSS_RA				
SSS_RA				
PCFICH_RB				
PHICH_RA				
PHICH_RB				
PDCCH_RA				
PDCCH_RB				
OCNG_RA ^{Note 1}				
OCNG_RB ^{Note 1}				
N_{oc} ^{Note 3}	dBm/15 kHz	-95	-95	-95
PRS \hat{E}_s/N_{oc}	dB	-Infinity	-Infinity	-Infinity
I_o ^{Note 4}	dBm/9 MHz	-67.22	-67.22	-67.22
\hat{E}_s/N_{oc}	dB	0	-Infinity	-Infinity
Propagation Condition		ETU30		
<p>Note 1: OCNG shall be used such that the active cell (Cell 1) is fully allocated and a constant total transmitted power spectral density is achieved for all OFDM symbols.</p> <p>Note 2: The resources for uplink transmission are assigned to the UE prior to the start of time period T2.</p> <p>Note 3: Interference from other cells and noise sources not specified in the test are assumed to be constant over subcarriers and time and shall be modelled as AWGN of appropriate power for N_{oc} to be fulfilled.</p> <p>Note 4: I_o levels have been derived from other parameters and are given for information purpose. These are not settable test parameters.</p>				

Table A.8.13.2.1-3: Cell-specific test parameters for E-UTRAN TDD-TDD inter-frequency RSTD measurement reporting delay under fading propagation conditions

Parameter	Unit	Cell 1		Cell 2		Cell 3	
		T2	T3	T2	T3	T2	T3
E-UTRA RF Channel Number		1		2		2	
Correlation Matrix and Antenna Configuration		1x2 Low		1x2 Low		1x2 Low	
OCNG patterns defined in A.3.2.2		OP.1 TDD		OP.2 TDD		OP.2 TDD	N/A
PBCH_RA	dB	0		0		0	N/A
PBCH_RB							
PSS_RA							
SSS_RA							
PCFICH_RB							
PHICH_RA							
PHICH_RB							
PDCCH_RA							
PDCCH_RB							
OCNG_RA ^{Note 1}							
OCNG_RB ^{Note 1}							
PRS_RA	dB	-3	N/A	N/A	3	3	N/A
N_{oc} ^{Note 3}	dBm/15 kHz	-98	-98	-98	-95	-98	-95
PRS \hat{E}_s/N_{oc}	dB	-1	-Infinity	-Infinity	-7	-8	-Infinity
PRS \hat{E}_s/I_{ot} ^{Note 4}	dB	-1	-Infinity	-Infinity	-7	-8	-Infinity
I_o ^{Note 4}	dBm/9 MHz	-69.68	-70.22	-70.11	-67.08	-70.11	-67.08
PRP ^{Note 4}	dBm/15 kHz	-99	-Infinity	-Infinity	-102	-106	-Infinity
RSRP ^{Note 4}	dBm/15 kHz	-96	-96	-105	-105	-109	-Infinity
\hat{E}_s/N_{oc} ^{Note 4}	dB	2	2	-7	-10	-11	-Infinity
Propagation Condition		ETU30					
<p>Note 1: OCNG shall be used such that active cells (all, except Cell 3 in T3) are fully allocated and a constant total transmitted power spectral density is achieved for all OFDM symbols other than those in the subframes with transmitted PRS.</p> <p>Note 2: The resources for uplink transmission are assigned to the UE prior to the start of time period T2.</p> <p>Note 3: Interference from other cells and noise sources not specified in the test and assumed to be constant over subcarriers and time and shall be modelled as AWGN of appropriate power for N_{oc} to be fulfilled.</p> <p>Note 4: If PRS_RA is not "N/A", \hat{E}_s/N_{oc}, PRS \hat{E}_s/I_{ot}, I_o, RSRP and PRP levels have been derived from other parameters and are given for information purpose. If PRS_RA is "N/A", I_o and RSRP levels have been derived from other parameters and are given for information purpose. These are not settable test parameters. Interference conditions shall be applied to all PRS symbols of DL positioning subframes.</p>							

Table A.8.13.2.1-4: DRX parameters for the test of E-UTRAN TDD-TDD inter-frequency RSTD measurement reporting delay under fading propagation conditions

Field	Value	Comment
onDurationTimer	psf1	As specified in TS 36.331 [2], Clause 6.3.2.
drx-InactivityTimer	psf1	
drx-RetransmissionTimer	sf1	
longDRX-CycleStartOffset	sf320	

shortDRX	disable	
----------	---------	--

A.8.13.2.2 Test Requirements

The RSTD measurement time fulfils the requirements specified in Clause 8.1.2.6.3.

The UE shall perform and report the RSTD measurements for Cell 2 and Cell 3 with respect to the reference cell Cell 1 within 4960 ms starting from the beginning of time interval T2.

The rate of the correct events for each neighbour cell observed during repeated tests shall be at least 90%, where the reported RSTD measurement for each correct event shall be within the RSTD reporting range specified in Clause 9.1.10.3, i.e., between RSTD_0000 and RSTD_12711.

NOTE: The RSTD measurement time in the test is derived from the following expression,

$$T_{PRS}(M - 1) + 160 \left\lceil \frac{n}{M} \right\rceil, \text{ where } M=16 \text{ and } n=16 \text{ are the parameters specified in Clause 8.1.2.6.3,}$$

Table 8.1.2.6.3-1, under Note 2. This gives the total RSTD measurement time of 4960 ms for Cell 2 and Cell 3 with respect to the reference cell Cell 1.

A.8.13.2.2A Test Requirements for UE Category 1bis

The RSTD measurement time fulfils the requirements specified in Clause 8.1.2.6.7.

The UE shall perform and report the RSTD measurements for Cell 2 and Cell 3 with respect to the reference cell Cell 1 within 10080 ms starting from the beginning of time interval T2.

The rate of the correct events for each neighbour cell observed during repeated tests shall be at least 90%, where the reported RSTD measurement for each correct event shall be within the RSTD reporting range specified in Clause 9.1.10.3, i.e., between RSTD_0000 and RSTD_12711.

NOTE: The RSTD measurement time in the test is derived from the following expression,

$$T_{PRS}(M - 1) + 160 \left\lceil \frac{n}{M} \right\rceil, \text{ where } M=32 \text{ and } n=16 \text{ are the parameters specified in Clause 8.1.2.6.7,}$$

Table 8.1.2.6.7-1, under Note 2. This gives the total RSTD measurement time of 10080 ms for Cell 2 and Cell 3 with respect to the reference cell Cell 1.

The test parameters are as given in Table A.8.13.2.1-1, Table A.8.13.2.1-2, Table A.8.13.2.1-3 and Table A.8.13.2.1-4, with the exceptions given in Table A.8.13.2.2A-1.

Table A.8.13.2.2A-1: Specific test parameters for UE Category for 1Bis E-UTRAN TDD-TDD inter-frequency RSTD measurement reporting delay under fading propagation conditions

Parameter	Unit	Value	Comment
PRS muting info		Cell 1: '11111111111111111000000000000000' Cell 2: '00000000000000000111111111111111' Cell 3: '11111111111111111000000000000000'	Corresponds to prs-MutingInfo defined in TS 36.355 [24]
T1	s	3	The length of the time interval from the beginning of each test
T2	s	5.12	The length of the time interval that follows immediately after time interval T1
T3	s	5.12	The length of the time interval that follows immediately after time interval T2

A.8.13.3 E-UTRAN FDD inter-frequency RSTD measurement period test case in CE Mode A

A.8.13.3.1 Test Purpose and Environment

The purpose of the test is to verify for Cat-M1 and Cat-M2 UE in CE Mode A that the RSTD measurement meets the requirements specified in Sections 8.13.2.4.1 and 8.16.2.4.1, respectively, in an environment with fading propagation conditions. Test 1 is applicable for Cat-M1 and Cat-M2 supporting 1.4 MHz UE RF bandwidth, while Test 2 is applicable for Cat-M2 supporting 5 MHz UE RF bandwidth.

In the test there are three synchronous cells: Cell 1, Cell 2 and Cell 3. Cell 1 is the reference as well as the PCell. Cell 2 and Cell 3 are the neighbour cells. Cell 1 is on FDD RF channel 1. Cell 2 and Cell 3 are on a FDD RF channel 2.

The UE requires measurement gaps to perform inter-frequency measurements. Gap pattern configuration # 0 as defined in Table 8.1.2.1-1 is provided and configured to not overlap with PRS subframes of Cell 1.

The test consists of three consecutive time intervals, with duration of T1, T2 and T3. Cell 1 is active in T1, T2 and T3, whilst Cell 2 and Cell 3 are activated only in the beginning of T2. Cell 2 is active until the end of T3, and Cell 3 is active until the end of T2. The beginning of the time interval T2 shall be aligned with the first PRS positioning subframe of a positioning occasion in the reference cell, where the PRS positioning occasion is as defined in Clause 8.1.2.5.1. Cell 1 transmits PRS in T2, while Cell 2 transmits PRS only in T3, and Cell 3 transmits PRS only in T2. Note: The information on when PRS is muted is conveyed to the UE using PRS muting information.

The OTDOA assistance data as defined in TS 36.355, Clause 6.5.1, shall be provided to the UE during T1. The last TTI containing the OTDOA assistance data shall be provided to the UE ΔT ms before the start of T2, where $\Delta T = 150$ ms is the maximum processing time of the OTDOA assistance data. The measurement gap configuration is known and configured in the UE at the start of T1. DRX is configured before T2.

The test parameters are as given in Table A.8.13.3.1-1, Table A.8.13.3.1-2, Table A.8.13.3.1-3 and Table A.8.13.3.1-4.

Table A.8.13.3.1-1: General test parameters for E-UTRAN FDD inter-frequency RSTD measurement reporting delay under fading propagation conditions

Parameter	Unit	Value		Comment
		Test 1	Test 2	
Reference cell		Cell 1		Reference cell is the cell in the OTDOA assistance data with respect to which the RSTD measurement is defined, as specified in TS 36.214 [4] and TS 36.355 [24]. The reference cell is the PCell in this test case.
Neighbor cells		Cell 2 and Cell 3		Cell 2 and Cell 3 appear at random places in the neighbour cell list in the OTDOA assistance data, but Cell 2 always appears in the first half of the list, whilst Cell 3 appears in the second half of the list.
MPDCCH		DL Reference Measurement Channel R.16 FDD		As specified in clause A.3.1.3.1
<i>mPDCCH-startSF-UESS</i>		10		Parameter G in $T = r_{\max} \cdot G$ which determines subframe $k0$ in which MPDCCH starts in the serving cell.
System Channel Bandwidth (BW_{channel})	MHz	10		
Gap pattern Id		0		As specified in Table 8.1.2.1-1. Applies for measurements on Cell 2 and Cell 3
Gap offset		10		As specified in TS 36.331 [2], Clause 6.3.5
PRS Transmission Bandwidth	RB	50 ^{Note 1}		PRS are transmitted over the system bandwidth

PRS configuration index I_{PRS}		Cell 1: 181, Cell 2, Cell 3: 171		This corresponds to periodicity of 320 ms and PRS subframe offset of $I_{PRS} - 160$ DL subframes, as defined in TS 36.211 [16], Table 6.10.4.3-1
Number of consecutive downlink positioning subframes N_{PRS}		4	2	As defined in TS 36.211 [16]. The number of subframes in a positioning occasion
Physical cell ID PCI		(PCI of Cell 1 – PCI of Cell 2)mod6=0 and (PCI of Cell 1 – PCI of Cell 3)mod6=0		The cell PCIs are selected such that the relative shifts of PRS patterns among cells are as given by the test parameters
CP length		Normal		
DRX		ON		DRX parameters are further specified in Table A.8.13.3.1-3
prs-SubframeOffset		310		Number of subframes rounded to the closest integer. The corresponding parameter in the OTDOA assistance data is prs-SubframeOffset specified in TS 36.355 [24]
slotNumberOffset		0		The slot number offset at the transmitter between a neighbour cell and the assistance data reference cell specified in TS 36.355 [24]
Radio frame receive time offset between the cells at the UE antenna connector	µs	Cell 2 to Cell 1: 1 Cell 3 to Cell 1: -1		PRS are transmitted from synchronous cells
Expected RSTD	µs	Cell 2: -2 Cell 3: 2 Other neighbour cells: randomly between -3 and 3		The expected RSTD is what is expected at the receiver. The corresponding parameter in the OTDOA assistance data specified in TS 36.355 [24] is the expectedRSTD indicator
Expected RSTD uncertainty for all neighbour cells	µs	5		The corresponding parameter in the OTDOA assistance data specified in TS 36.355 [24] is the expectedRSTD-Uncertainty index
Number of cells provided in OTDOA assistance data		16		The list includes the reference cell (received in <i>OTDOA-ReferenceCellInfo</i> [24]) on RF channel 1 and 15 other cells on RF channel 2, all received in <i>OTDOA-ProvideAssistanceData</i> [24].
PRS muting info		Cell 1: '1111111100000000' Cell 2: '0000000011111111' Cell 3: '1111111110000000'		Corresponds to prs-MutingInfo defined in TS 36.355 [24]
T1	s	3		The length of the time interval from the beginning of each test
T2	s	7.68	5.12	The length of the time interval that follows immediately after time interval T1
T3	s	7.68	5.12	The length of the time interval that follows immediately after time interval T2
NOTE 1: If the PRS transmission bandwidth is larger than the UE RF bandwidth, the UE is measuring RSTD within its RF bandwidth.				

Table A.8.13.3.1-2: Cell-specific test parameters for E-UTRAN FDD inter-frequency RSTD measurement reporting delay under fading propagation conditions during T1

Parameter	Unit	Cell 1	Cell 2	Cell 3
-----------	------	--------	--------	--------

E-UTRA RF Channel Number		1	2	2
Correlation Matrix and Antenna Configuration		1x1	1x1	1x1
OCNG patterns defined in A.3.2.1		OP.21 FDD	N/A	N/A
PBCH_RA	dB	0	N/A	N/A
PBCH_RB				
PSS_RA				
SSS_RA				
PCFICH_RB				
PHICH_RA				
PHICH_RB				
PDCCH_RA				
PDCCH_RB				
OCNG_RA ^{Note 1}				
OCNG_RB ^{Note 1}				
N_{oc} ^{Note 3}	dBm/ 15 kHz	-95		
$PRS \hat{E}_s/N_{oc}$	dB	-Infinity	-Infinity	-Infinity
I_o ^{Note 4}	dBm/ 9 MHz	-67.22	-67.22	-67.22
\hat{E}_s/N_{oc}	dB	0	-Infinity	-Infinity
Propagation Condition		ETU30		
<p>Note 1: OCNG shall be used such that active cell (Cell 1) is fully allocated and a constant total transmitted power spectral density is achieved for all OFDM symbols.</p> <p>Note 2: The resources for uplink transmission are assigned to the UE prior to the start of time period T2.</p> <p>Note 3: Interference from other cells and noise sources not specified in the test are assumed to be constant over subcarriers and time and shall be modelled as AWGN of appropriate power for N_{oc} to be fulfilled.</p> <p>Note 4: I_o levels have been derived from other parameters and are given for information purpose. These are not settable test parameters.</p>				

Table A.8.13.3.1-3: Cell-specific test parameters for E-UTRAN FDD inter-frequency RSTD measurement reporting delay under fading propagation conditions during T2 and T3

Parameter	Unit	Cell 1		Cell 2		Cell 3	
		T2	T3	T2	T3	T2	T3
E-UTRA RF Channel Number		1		2		2	
Correlation Matrix and Antenna Configuration		1x1		1x1		1x1	
OCNG patterns defined in A.3.2.1		OP.21 FDD		OP.6 FDD		OP.6 FDD	N/A
PBCH_RA	dB	0	N/A	N/A	3	3	N/A
PBCH_RB							
PSS_RA							
SSS_RA							
PCFICH_RB							
PHICH_RA							
PHICH_RB							
PDCCH_RA							
PDCCH_RB							
OCNG_RA ^{Note 1}							
OCNG_RB ^{Note 1}							
PRS_RA	dB	-3	N/A	N/A	3	3	N/A

N_{oc} ^{Note 3}	dBm/ 15 kHz	-98	-98	-98	-95	-98	-95
PRS \hat{E}_s/N_{oc}	dB	-1	-Infinity	-Infinity	-7	-8	-Infinity
PRS \hat{E}_s/I_{ot} ^{Note 4}	dB	-1	-Infinity	-Infinity	-7	-8	-Infinity
I_o ^{Note 4}	dBm/ 9 MHz	-69.68	-70.22	-70.11	-67.08	-70.11	-67.08
PRP ^{Note 4}	dBm/ 15 kHz	-99	-Infinity	-Infinity	-102	-106	-Infinity
RSRP ^{Note 4}	dBm/ 15 kHz	-96	-96	-105	-105	-109	-Infinity
\hat{E}_s/N_{oc} ^{Note 4}	dB	2	2	-7	-10	-11	-Infinity
Propagation Condition		ETU30					
<p>Note 1: OCNG shall be used such that active cells (all, except Cell 3 in T3) are fully allocated and a constant total transmitted power spectral density is achieved for all OFDM symbols other than those in the subframes with transmitted PRS.</p> <p>Note 2: The resources for uplink transmission are assigned to the UE prior to the start of time period T2.</p> <p>Note 3: Interference from other cells and noise sources not specified in the test are assumed to be constant over subcarriers and time and shall be modelled as AWGN of appropriate power for N_{oc} to be fulfilled.</p> <p>Note 4: If PRS_RA is not "N/A", \hat{E}_s/N_{oc}, PRS \hat{E}_s/I_{ot}, I_o, RSRP and PRP levels have been derived from other parameters and are given for information purpose. If PRS_RA is "N/A", I_o and RSRP levels have been derived from other parameters and are given for information purpose. These are not settable test parameters. Interference conditions shall be applied to all PRS symbols of DL positioning subframes.</p>							

Table A.8.13.3.1-4: DRX parameters for the test of E-UTRAN FDD inter-frequency RSTD measurement reporting delay under fading propagation conditions

Field	Value	Comment
onDurationTimer	psf1	As specified in TS 36.331 [2], Clause 6.3.2
Drx-InactivityTimer	psf1	
drx-RetransmissionTimer	sf1	
longDRX-CycleStartOffset	sf320	
shortDRX	Disable	

A.8.13.3.2 Test Requirements

For Cat-M1 UE in CE Mode A, the RSTD measurement time fulfils the requirements specified in Clause 8.13.2.4.1.

For Cat-M2 UE in CE Mode A, the RSTD measurement time fulfils the requirements specified in Clause 8.16.2.4.1.

In Test 1, the UE shall perform and report the RSTD measurements for Cell 2 and Cell 3 with respect to the reference cell in the OTDOA assistance data, Cell 1, within 15360 ms starting from the beginning of time interval T2.

In Test 2, the UE shall perform and report the RSTD measurements for Cell 2 and Cell 3 with respect to the reference cell in the OTDOA assistance data, Cell 1, within 10240 ms starting from the beginning of time interval T2.

The rate of the correct events for each neighbour cell observed during repeated tests shall be at least 90%, where the reported RSTD measurement for each correct event shall be within the RSTD reporting range specified in Clause 9.1.10.3, i.e., between RSTD_0000 and RSTD_12711.

NOTE: The RSTD measurement time in the test is derived from the following expression,

$$T_{PRS}(M-1) + 320 \cdot \left\lceil \frac{n}{M} \right\rceil, \text{ where } M=48 \text{ and } n=16 \text{ are the parameters for Test 1 and } M=32 \text{ and } n$$

=16 are the parameters for Test 2, specified in the corresponding requirements sections, under Note 2. This gives the total RSTD measurement time of 15360 ms in Test 1 and 10240 ms in Test 2 for Cell 2 and Cell 3 with respect to the reference cell Cell 1.

A.8.13.4 E-UTRAN HD-FDD inter-frequency RSTD measurement period test case in CE Mode A

A.8.13.4.1 Test Purpose and Environment

The purpose of the test is to verify for Cat-M1 and Cat-M2 UE in CE Mode A that the RSTD measurement meets the requirements specified in Sections 8.13.2.4.3 and 8.16.2.4.3, respectively, in an environment with fading propagation conditions. Test 1 is applicable for Cat-M1 and Cat-M2 supporting 1.4 MHz UE RF bandwidth, while Test 2 is applicable for Cat-M2 supporting 5 MHz UE RF bandwidth.

In the test there are three synchronous cells: Cell 1, Cell 2 and Cell 3. Cell 1 is the reference as well as the PCell. Cell 2 and Cell 3 are the neighbour cells. Cell 1 is on FDD RF channel 1. Cell 2 and Cell 3 are on a FDD RF channel 2.

The UE requires measurement gaps to perform inter-frequency measurements. Gap pattern configuration # 0 as defined in Table 8.1.2.1-1 is provided and configured to not overlap with PRS subframes of Cell 1.

The test consists of three consecutive time intervals, with duration of T1, T2 and T3. Cell 1 is active in T1, T2 and T3, whilst Cell 2 and Cell 3 are activated only in the beginning of T2. Cell 2 is active until the end of T3, and Cell 3 is active until the end of T2. The beginning of the time interval T2 shall be aligned with the first PRS positioning subframe of a positioning occasion in the reference cell, where the PRS positioning occasion is as defined in Clause 8.1.2.5.1. Cell 1 transmits PRS in T2, while Cell 2 transmits PRS only in T3, and Cell 3 transmits PRS only in T2. Note: The information on when PRS is muted is conveyed to the UE using PRS muting information.

The OTDOA assistance data as defined in TS 36.355, Clause 6.5.1, shall be provided to the UE during T1. The last TTI containing the OTDOA assistance data shall be provided to the UE ΔT ms before the start of T2, where $\Delta T = 150$ ms is the maximum processing time of the OTDOA assistance data. The measurement gap configuration is known and configured in the UE at the start of T1. DRX is configured before T2.

The test parameters are as given in Table A.8.13.4.1-1, Table A.8.13.4.1-2, Table A.8.13.4.1-3 and Table A.8.13.4.1-4.

Table A.8.13.4.1-1: General test parameters for E-UTRAN HD-FDD inter-frequency RSTD measurement reporting delay under fading propagation conditions

Parameter	Unit	Value		Comment
		Test 1	Test 2	
Reference cell		Cell 1		Reference cell is the cell in the OTDOA assistance data with respect to which the RSTD measurement is defined, as specified in TS 36.214 [4] and TS 36.355 [24]. The reference cell is the PCell in this test case.
Neighbor cells		Cell 2 and Cell 3		Cell 2 and Cell 3 appear at random places in the neighbour cell list in the OTDOA assistance data, but Cell 2 always appears in the first half of the list, whilst Cell 3 appears in the second half of the list.
MPDCCH		DL Reference Measurement Channel R.6 HD-FDD		As specified in clause A.3.1.3.1
<i>mPDCCH-startSF-U ESS</i>		10		Parameter G in $T = r_{\max} \cdot G$ which determines subframe $k0$ in which MPDCCH starts in the serving cell.

System Channel Bandwidth (BW_{channel})	MHz	10		
Gap pattern Id		0		As specified in Table 8.1.2.1-1. Applies for measurements on Cell 2 and Cell 3
Gap offset		10		As specified in TS 36.331 [2], Clause 6.3.5
PRS Transmission Bandwidth	RB	50 ^{Note 1}		PRS are transmitted over the system bandwidth
PRS configuration index I_{PRS}		Cell 1: 181, Cell 2, Cell 3: 171		This corresponds to periodicity of 320 ms and PRS subframe offset of $I_{\text{PRS}} - 160$ DL subframes, as defined in TS 36.211 [16], Table 6.10.4.3-1
Number of consecutive downlink positioning subframes N_{PRS}		4	2	As defined in TS 36.211 [16]. The number of subframes in a positioning occasion
Physical cell ID PCI		(PCI of Cell 1 – PCI of Cell 2) mod 6 = 0 and (PCI of Cell 1 – PCI of Cell 3) mod 6 = 0		The cell PCIs are selected such that the relative shifts of PRS patterns among cells are as given by the test parameters
CP length		Normal		
DRX		ON		DRX parameters are further specified in Table A.8.13.3.1-3
prs-SubframeOffset		310		Number of subframes rounded to the closest integer. The corresponding parameter in the OTDOA assistance data is prs-SubframeOffset specified in TS 36.355 [24]
slotNumberOffset		0		The slot number offset at the transmitter between a neighbour cell and the assistance data reference cell specified in TS 36.355 [24]
Radio frame receive time offset between the cells at the UE antenna connector	μs	Cell 2 to Cell 1: 1 Cell 3 to Cell 1: -1		PRS are transmitted from synchronous cells
Expected RSTD	μs	Cell 2: -2 Cell 3: 2 Other neighbour cells: randomly between -3 and 3		The expected RSTD is what is expected at the receiver. The corresponding parameter in the OTDOA assistance data specified in TS 36.355 [24] is the expectedRSTD indicator
Expected RSTD uncertainty for all neighbour cells	μs	5		The corresponding parameter in the OTDOA assistance data specified in TS 36.355 [24] is the expectedRSTD-Uncertainty index
Number of cells provided in OTDOA assistance data		16		The list includes the reference cell (received in <i>OTDOA-ReferenceCellInfo</i> [24]) on RF channel 1 and 15 other cells on RF channel 2, all received in <i>OTDOA-ProvideAssistanceData</i> [24].
PRS muting info		Cell 1: '1111111100000000' Cell 2: '0000000011111111' Cell 3: '1111111110000000'		Corresponds to prs-MutingInfo defined in TS 36.355 [24]
T1	s	3		The length of the time interval from the beginning of each test
T2	s	7.68	5.12	The length of the time interval that follows immediately after time interval T1
T3	s	7.68	5.12	The length of the time interval that follows immediately after time interval T2

NOTE 1: If the PRS transmission bandwidth is larger than the UE RF bandwidth, the UE is measuring RSTD within its RF bandwidth.

Table A.8.13.4.1-2: Cell-specific test parameters for E-UTRAN HD-FDD inter-frequency RSTD measurement reporting delay under fading propagation conditions during T1

Parameter	Unit	Cell 1	Cell 2	Cell 3
E-UTRA RF Channel Number		1	2	2
Correlation Matrix and Antenna Configuration		1x1	1x1	1x1
OCNG patterns defined in A.3.2.1		OP.21 FDD	N/A	N/A
PBCH_RA	dB	0	N/A	N/A
PBCH_RB				
PSS_RA				
SSS_RA				
PCFICH_RB				
PHICH_RA				
PHICH_RB				
PDCCH_RA				
PDCCH_RB				
OCNG_RA ^{Note 1}				
OCNG_RB ^{Note 1}				
N_{oc} ^{Note 3}	dBm/ 15 kHz	-95		
PRS \hat{E}_s/N_{oc}	dB	-Infinity	-Infinity	-Infinity
I_o ^{Note 4}	dBm/ 9 MHz	-67.22	-67.22	-67.22
\hat{E}_s/N_{oc}	dB	0	-Infinity	-Infinity
Propagation Condition		ETU30		
<p>Note 1: OCNG shall be used such that active cell (Cell 1) is fully allocated and a constant total transmitted power spectral density is achieved for all OFDM symbols.</p> <p>Note 2: The resources for uplink transmission are assigned to the UE prior to the start of time period T2.</p> <p>Note 3: Interference from other cells and noise sources not specified in the test are assumed to be constant over subcarriers and time and shall be modelled as AWGN of appropriate power for N_{oc} to be fulfilled.</p> <p>Note 4: I_o levels have been derived from other parameters and are given for information purpose. These are not settable test parameters.</p>				

Table A.8.13.4.1-3: Cell-specific test parameters for E-UTRAN HD-FDD inter-frequency RSTD measurement reporting delay under fading propagation conditions during T2 and T3

Parameter	Unit	Cell 1		Cell 2		Cell 3	
		T2	T3	T2	T3	T2	T3
E-UTRA RF Channel Number		1		2		2	
Correlation Matrix and Antenna Configuration		1x1		1x1		1x1	
OCNG patterns defined in A.3.2.1		OP.21 FDD		OP.6 FDD		OP.6 FDD	N/A
PBCH_RA	dB	0		0		0	N/A
PBCH_RB							
PSS_RA							
SSS_RA							
PCFICH_RB							

PHICH_RA							
PHICH_RB							
PDCCH_RA							
PDCCH_RB							
OCNG_RA ^{Note 1}							
OCNG_RB ^{Note 1}							
PRS_RA	dB	-3	N/A	N/A	3	3	N/A
N_{oc} ^{Note 3}	dBm/ 15 kHz	-98	-98	-98	-95	-98	-95
$\text{PRS } \hat{E}_s/N_{oc}$	dB	-1	-Infinity	-Infinity	-7	-8	-Infinity
$\text{PRS } \hat{E}_s/I_{\text{tot}}$ ^{Note 4}	dB	-1	-Infinity	-Infinity	-7	-8	-Infinity
I_o ^{Note 4}	dBm/ 9 MHz	-69.68	-70.22	-70.11	-67.08	-70.11	-67.08
PRP ^{Note 4}	dBm/ 15 kHz	-99	-Infinity	-Infinity	-102	-106	-Infinity
RSRP ^{Note 4}	dBm/ 15 kHz	-96	-96	-105	-105	-109	-Infinity
\hat{E}_s/N_{oc} ^{Note 4}	dB	2	2	-7	-10	-11	-Infinity
Propagation Condition		ETU30					
<p>Note 1: OCNG shall be used such that active cells (all, except Cell 3 in T3) are fully allocated and a constant total transmitted power spectral density is achieved for all OFDM symbols other than those in the subframes with transmitted PRS.</p> <p>Note 2: The resources for uplink transmission are assigned to the UE prior to the start of time period T2.</p> <p>Note 3: Interference from other cells and noise sources not specified in the test are assumed to be constant over subcarriers and time and shall be modelled as AWGN of appropriate power for N_{oc} to be fulfilled.</p> <p>Note 4: If PRS_RA is not "N/A", \hat{E}_s/N_{oc}, $\text{PRS } \hat{E}_s/I_{\text{tot}}$, I_o, RSRP and PRP levels have been derived from other parameters and are given for information purpose. If PRS_RA is "N/A", I_o and RSRP levels have been derived from other parameters and are given for information purpose. These are not settable test parameters. Interference conditions shall be applied to all PRS symbols of DL positioning subframes.</p>							

Table A.8.13.4.1-4: DRX parameters for the test of E-UTRAN HD-FDD inter-frequency RSTD measurement reporting delay under fading propagation conditions

Field	Value	Comment
onDurationTimer	psf1	As specified in TS 36.331 [2], Clause 6.3.2
Drx-InactivityTimer	psf1	
drx-RetransmissionTimer	sf1	
longDRX-CycleStartOffset	sf320	
shortDRX	Disable	

A.8.13.4.2 Test Requirements

For Cat-M1 UE in CE Mode A, the RSTD measurement time fulfils the requirements specified in Clause 8.13.2.4.3.

For Cat-M2 UE in CE Mode A, the RSTD measurement time fulfils the requirements specified in Clause 8.16.2.4.3.

In Test 1, the UE shall perform and report the RSTD measurements for Cell 2 and Cell 3 with respect to the reference cell in the OTDOA assistance data, Cell 1, within 15360 ms starting from the beginning of time interval T2.

In Test 2, the shall perform and report the RSTD measurements for Cell 2 and Cell 3 with respect to the reference cell in the OTDOA assistance data, Cell 1, within 10240 ms starting from the beginning of time interval T2.

The rate of the correct events for each neighbour cell observed during repeated tests shall be at least 90%, where the reported RSTD measurement for each correct event shall be within the RSTD reporting range specified in Clause 9.1.10.3, i.e., between RSTD_0000 and RSTD_12711.

NOTE: The RSTD measurement time in the test is derived from the following expression,

$$T_{PRS}(M-1) + 320 \cdot \left\lceil \frac{n}{M} \right\rceil, \text{ where } M=48 \text{ and } n=16 \text{ are the parameters for Test 1 and } M=32 \text{ and } n$$

=16 are the parameters for Test 2, specified in the corresponding requirements sections, under Note 2. This gives the total RSTD measurement time of 15360 ms in Test 1 and 10240 ms in Test 2 for Cell 2 and Cell 3 with respect to the reference cell Cell 1.

A.8.13.5 E-UTRAN TDD inter-frequency RSTD measurement period test case in CE Mode A

A.8.13.5.1 Test Purpose and Environment

The purpose of the test is to verify for Cat-M1 and Cat-M2 UE in CE Mode A that the RSTD measurement meets the requirements specified in Sections 8.13.2.4.2 and 8.16.2.4.2, respectively, in an environment with fading propagation conditions. Test 1 is applicable for Cat-M1 and Cat-M2 supporting 1.4 MHz UE RF bandwidth, while Test 2 is applicable for Cat-M2 supporting 5 MHz UE RF bandwidth.

In the test there are three synchronous cells: Cell 1, Cell 2 and Cell 3. Cell 1 is the reference as well as the PCell. Cell 2 and Cell 3 are the neighbour cells. Cell 1 is on TDD RF channel 1. Cell 2 and Cell 3 are on a TDD RF channel 2.

The UE requires measurement gaps to perform inter-frequency measurements. Gap pattern configuration # 0 as defined in Table 8.1.2.1-1 is provided and configured to not overlap with PRS subframes of Cell 1.

The test consists of three consecutive time intervals, with duration of T1, T2 and T3. Cell 1 is active in T1, T2 and T3, whilst Cell 2 and Cell 3 are activated only in the beginning of T2. Cell 2 is active until the end of T3, and Cell 3 is active until the end of T2. The beginning of the time interval T2 shall be aligned with the first PRS positioning subframe of a positioning occasion in the reference cell, where the PRS positioning occasion is as defined in Clause 8.1.2.5.1. Cell 1 transmits PRS in T2, while Cell 2 transmits PRS only in T3, and Cell 3 transmits PRS only in T2. Note: The information on when PRS is muted is conveyed to the UE using PRS muting information.

The OTDOA assistance data as defined in TS 36.355, Clause 6.5.1, shall be provided to the UE during T1. The last TTI containing the OTDOA assistance data shall be provided to the UE ΔT ms before the start of T2, where $\Delta T = 150$ ms is the maximum processing time of the OTDOA assistance data. The measurement gap configuration is known and configured in the UE at the start of T1. DRX is configured before T2.

The test parameters are as given in Table A.8.13.5.1-1, Table A.8.13.5.1-2, Table A.8.13.5.1-3 and Table A.8.13.5.1-4.

Table A.8.13.5.1-1: General test parameters for E-UTRAN TDD inter-frequency RSTD measurement reporting delay under fading propagation conditions

Parameter	Unit	Value		Comment
		Test 1	Test 2	
Reference cell		Cell 1		Reference cell is the cell in the OTDOA assistance data with respect to which the RSTD measurement is defined, as specified in TS 36.214 [4] and TS 36.355 [24]. The reference cell is the PCell in this test case.
Neighbor cells		Cell 2 and Cell 3		Cell 2 and Cell 3 appear at random places in the neighbour cell list in the OTDOA assistance data, but Cell 2 always appears in the first half of the list, whilst Cell 3 appears in the second half of the list.
MPDCCH		DL Reference Measurement Channel R.14 TDD		As specified in clause A.3.1.3.1

<i>mPDCCH-startSF-U ESS</i>		10	Parameter G in $T = r_{\max} \cdot G$ which determines subframe $k0$ in which MPDCCH starts in the serving cell.	
System Channel Bandwidth (BW_{channel})	MHz	10		
Gap pattern Id		0	As specified in Table 8.1.2.1-1. Applies for measurements on Cell 2 and Cell 3	
Gap offset		13	As specified in TS 36.331 [2], Clause 6.3.5	
PRS Transmission Bandwidth	RB	50 ^{Note 1}	PRS are transmitted over the system bandwidth	
PRS configuration index I_{PRS}		Cell 1: 184, Cell 2, Cell 3: 174	This corresponds to periodicity of 320 ms and PRS subframe offset of $I_{\text{PRS}} - 160$ DL subframes, as defined in TS 36.211 [16], Table 6.10.4.3-1	
Number of consecutive downlink positioning subframes N_{PRS}		4	2	As defined in TS 36.211 [16]. The number of subframes in a positioning occasion
Physical cell ID PCI		(PCI of Cell 1 – PCI of Cell 2) mod 6 = 0 and (PCI of Cell 1 – PCI of Cell 3) mod 6 = 0	The cell PCIs are selected such that the relative shifts of PRS patterns among cells are as given by the test parameters	
TDD uplink-downlink configuration		1	As specified in TS 36.211 [16], Clause 4.2; corresponds to a configuration with 5 ms switch-point periodicity and two downlink consecutive subframes	
TDD special subframe configuration		6	As specified in TS 36.211 [16], Clause 4.2; corresponds to DwPTS of $19760 \cdot T_s$ and UpPTS of $4384 \cdot T_s$	
CP length		Normal		
DRX		ON	DRX parameters are further specified in Table A.8.13.3.1-3	
prs-SubframeOffset		310	Number of subframes rounded to the closest integer. The corresponding parameter in the OTDOA assistance data is prs-SubframeOffset specified in TS 36.355 [24]	
slotNumberOffset		0	The slot number offset at the transmitter between a neighbour cell and the assistance data reference cell specified in TS 36.355 [24]	
Radio frame receive time offset between the cells at the UE antenna connector	μs	Cell 2 to Cell 1: 1 Cell 3 to Cell 1: -1	PRS are transmitted from synchronous cells	
Expected RSTD	μs	Cell 2: -2 Cell 3: 2 Other neighbour cells: randomly between -3 and 3	The expected RSTD is what is expected at the receiver. The corresponding parameter in the OTDOA assistance data specified in TS 36.355 [24] is the expectedRSTD indicator	
Expected RSTD uncertainty for all neighbour cells	μs	5	The corresponding parameter in the OTDOA assistance data specified in TS 36.355 [24] is the expectedRSTD-Uncertainty index	

Number of cells provided in OTDOA assistance data		16		The list includes the reference cell (received in <i>OTDOA-ReferenceCellInfo</i> [24]) on RF channel 1 and 15 other cells on RF channel 2, all received in <i>OTDOA-ProvideAssistanceData</i> [24].
PRS muting info		Cell 1: '1111111100000000' Cell 2: '0000000011111111' Cell 3: '1111111100000000'		Corresponds to prs-MutingInfo defined in TS 36.355 [24]
T1	s	3		The length of the time interval from the beginning of each test
T2	s	7.68	5.12	The length of the time interval that follows immediately after time interval T1
T3	s	7.68	5.12	The length of the time interval that follows immediately after time interval T2
NOTE 1: If the PRS transmission bandwidth is larger than the UE RF bandwidth, the UE is measuring RSTD within its RF bandwidth.				

Table A.8.13.5.1-2: Cell-specific test parameters for E-UTRAN TDD inter-frequency RSTD measurement reporting delay under fading propagation conditions during T1

Parameter	Unit	Cell 1	Cell 2	Cell 3
E-UTRA RF Channel Number		1	2	2
Correlation Matrix and Antenna Configuration		1x1	1x1	1x1
OCNG patterns defined in A.3.2.1		OP.11 TDD	N/A	N/A
PBCH_RA	dB	0	N/A	N/A
PBCH_RB				
PSS_RA				
SSS_RA				
PCFICH_RB				
PHICH_RA				
PHICH_RB				
PDCCH_RA				
PDCCH_RB				
OCNG_RA ^{Note 1}				
OCNG_RB ^{Note 1}				
N_{oc} ^{Note 3}	dBm/ 15 kHz	-95		
PRS \hat{E}_s/N_{oc}	dB	-Infinity	-Infinity	-Infinity
I_o ^{Note 4}	dBm/ 9 MHz	-67.22	-67.22	-67.22
\hat{E}_s/N_{oc}	dB	0	-Infinity	-Infinity
Propagation Condition		ETU30		
<p>Note 1: OCNG shall be used such that active cell (Cell 1) is fully allocated and a constant total transmitted power spectral density is achieved for all OFDM symbols.</p> <p>Note 2: The resources for uplink transmission are assigned to the UE prior to the start of time period T2.</p> <p>Note 3: Interference from other cells and noise sources not specified in the test are assumed to be constant over subcarriers and time and shall be modelled as AWGN of appropriate power for N_{oc} to be fulfilled.</p> <p>Note 4: I_o levels have been derived from other parameters and are given for information purpose. These are not settable test parameters.</p>				

Table A.8.13.5.1-3: Cell-specific test parameters for E-UTRAN TDD inter-frequency RSTD measurement reporting delay under fading propagation conditions during T2 and T3

Parameter	Unit	Cell 1		Cell 2		Cell 3	
		T2	T3	T2	T3	T2	T3
E-UTRA RF Channel Number		1		2		2	
Correlation Matrix and Antenna Configuration		1x1		1x1		1x1	
OCNG patterns defined in A.3.2.1		OP.11 TDD		OP.2 TDD		OP.2 TDD	N/A
PBCH_RA	dB	0		0		0	N/A
PBCH_RB							
PSS_RA							
SSS_RA							
PCFICH_RB							
PHICH_RA							
PHICH_RB							
PDCCH_RA							
PDCCH_RB							
OCNG_RA ^{Note 1}							
OCNG_RB ^{Note 1}							
PRS_RA	dB	-3	N/A	N/A	3	3	N/A
N_{oc} ^{Note 3}	dBm/ 15 kHz	-98	-95	-98	-95	-98	-95
$PRS \hat{E}_s/N_{oc}$	dB	-1	-Infinity	-Infinity	-7	-7	-Infinity
$PRS \hat{E}_s/I_{ot}$ ^{Note 4}	dB	-1.79	-Infinity	-Infinity	-7	-9.54	-Infinity
I_o ^{Note 4}	dBm/ 9 MHz	-69.55	-67.08	-69.55	-67.08	-69.55	-67.08
PRP ^{Note 4}	dBm/ 15 kHz	-99	-Infinity	-Infinity	-102	-105	-Infinity
RSRP ^{Note 4}	dBm/ 15 kHz	-96	-93	-105	-105	-108	-Infinity
\hat{E}_s/N_{oc} ^{Note 4}	dB	2	2	-7	-10	-10	-Infinity
Propagation Condition		ETU30					
<p>Note 1: OCNG shall be used such that active cells (all, except Cell 3 in T3) are fully allocated and a constant total transmitted power spectral density is achieved for all OFDM symbols other than those in the subframes with transmitted PRS.</p> <p>Note 2: The resources for uplink transmission are assigned to the UE prior to the start of time period T2.</p> <p>Note 3: Interference from other cells and noise sources not specified in the test are assumed to be constant over subcarriers and time and shall be modelled as AWGN of appropriate power for N_{oc} to be fulfilled.</p> <p>Note 4: If PRS_RA is not "N/A", \hat{E}_s/N_{oc}, $PRS \hat{E}_s/I_{ot}$, I_o, RSRP and PRP levels have been derived from other parameters and are given for information purpose. If PRS_RA is "N/A", I_o and RSRP levels have been derived from other parameters and are given for information purpose. These are not settable test parameters. Interference conditions shall be applied to all PRS symbols of DL positioning subframes.</p>							

Table A.8.13.5.1-4: DRX parameters for the test of E-UTRAN TDD intr-frequency RSTD measurement reporting delay under fading propagation conditions

Field	Value	Comment
onDurationTimer	psf1	As specified in TS 36.331 [2], Clause 6.3.2
Drx-InactivityTimer	psf1	
drx-RetransmissionTimer	sf1	
longDRX-CycleStartOffset	sf320	

shortDRX	Disable	
----------	---------	--

A.8.13.5.2 Test Requirements

For Cat-M1 UE in CE Mode A, the RSTD measurement time fulfils the requirements specified in Clause 8.13.2.4.2.

For Cat-M2 UE in CE Mode A, the RSTD measurement time fulfils the requirements specified in Clause 8.16.2.4.2.

In Test 1, the UE shall perform and report the RSTD measurements for Cell 2 and Cell 3 with respect to the reference cell in the OTDOA assistance data, Cell 1, within 15360 ms starting from the beginning of time interval T2.

In Test 2, the shall perform and report the RSTD measurements for Cell 2 and Cell 3 with respect to the reference cell in the OTDOA assistance data, Cell 1, within 10240 ms starting from the beginning of time interval T2.

The rate of the correct events for each neighbour cell observed during repeated tests shall be at least 90%, where the reported RSTD measurement for each correct event shall be within the RSTD reporting range specified in Clause 9.1.10.3, i.e., between RSTD_0000 and RSTD_12711.

NOTE: The RSTD measurement time in the test is derived from the following expression,

$$T_{PRS}(M-1) + 320 \cdot \left\lceil \frac{n}{M} \right\rceil, \text{ where } M=48 \text{ and } n=16 \text{ are the parameters for Test 1 and } M=32 \text{ and } n$$

=16 are the parameters for Test 2, specified in the corresponding requirements sections, under Note 2.

This gives the total RSTD measurement time of 15360 ms in Test 1 and 10240 ms in Test 2 for Cell 2 and Cell 3 with respect to the reference cell Cell 1.

A.8.13.6 E-UTRAN FDD inter-frequency RSTD measurement period test case in CE Mode B

A.8.13.6.1 Test Purpose and Environment

The purpose of the test is to verify for Cat-M1 and Cat-M2 UE in CEMode B that the RSTD measurement meets the requirements specified in Sections 8.13.3.7.1 and 8.16.3.2.1, respectively, in an environment with fading propagation conditions. Test 1 is applicable for Cat-M1 and Cat-M2 supporting 1.4 MHz UE RF bandwidth, while Test 2 is applicable for Cat-M2 supporting 5 MHz UE RF bandwidth.

In the test there are three synchronous cells: Cell 1, Cell 2 and Cell 3. Cell 1 is the reference as well as the PCell. Cell 2 and Cell 3 are the neighbour cells. Cell 1 is on FDD RF channel 1. Cell 2 and Cell 3 are on a FDD RF channel 2.

The UE requires measurement gaps to perform inter-frequency measurements. Gap pattern configuration # 0 as defined in Table 8.1.2.1-1 is provided and configured to not overlap with PRS subframes of Cell 1.

The test consists of three consecutive time intervals, with duration of T1, T2 and T3. Cell 1 is active in T1, T2 and T3, whilst Cell 2 and Cell 3 are activated only in the beginning of T2. Cell 2 is active until the end of T3, and Cell 3 is active until the end of T2. The beginning of the time interval T2 shall be aligned with the first PRS positioning subframe of a positioning occasion in the reference cell, where the PRS positioning occasion is as defined in Clause 8.1.2.5.1. Cell 1 transmits PRS in T2, while Cell 2 transmits PRS only in T3, and Cell 3 transmits PRS only in T2. Note: The information on when PRS is muted is conveyed to the UE using PRS muting information.

The OTDOA assistance data as defined in TS 36.355, Clause 6.5.1, shall be provided to the UE during T1. The last TTI containing the OTDOA assistance data shall be provided to the UE ΔT ms before the start of T2, where $\Delta T = 150$ ms is the maximum processing time of the OTDOA assistance data. The measurement gap configuration is known and configured in the UE at the start of T1. DRX is configured before T2.

The test parameters are as given in Table A.8.13.6.1-1, Table A.8.13.6.1-2, Table A.8.13.6.1-3 and Table A.8.13.6.1-4.

Table A.8.13.6.1-1: General test parameters for E-UTRAN FDD inter-frequency RSTD measurement reporting delay under fading propagation conditions

Parameter	Unit	Value		Comment
		Test 1	Test 2	

Reference cell		Cell 1	Reference cell is the cell in the OTDOA assistance data with respect to which the RSTD measurement is defined, as specified in TS 36.214 [4] and TS 36.355 [24]. The reference cell is the PCell in this test case.	
Neighbor cells		Cell 2 and Cell 3	Cell 2 and Cell 3 appear at random places in the neighbour cell list in the OTDOA assistance data, but Cell 2 always appears in the first half of the list, whilst Cell 3 appears in the second half of the list.	
MPDCCH		DL Reference Measurement Channel R.16 FDD	As specified in clause A.3.1.3.1	
$mPDCCH\text{-startSF-UeSS}$		10	Parameter G in $T = r_{\max} \cdot G$ which determines subframe $k0$ in which MPDCCH starts in the serving cell.	
System Channel Bandwidth (BW_{channel})	MHz	10		
Gap pattern Id		0	As specified in Table 8.1.2.1-1. Applies for measurements on Cell 2 and Cell 3	
Gap offset		10	As specified in TS 36.331 [2], Clause 6.3.5	
PRS Transmission Bandwidth	RB	50 ^{Note 1}	PRS are transmitted over the system bandwidth	
PRS configuration index I_{PRS}		Cell 1: 181, Cell 2, Cell 3: 171	This corresponds to periodicity of 320 ms and PRS subframe offset of $I_{\text{PRS}} - 160$ DL subframes, as defined in TS 36.211 [16], Table 6.10.4.3-1	
Number of consecutive downlink positioning subframes N_{PRS}		4	4	As defined in TS 36.211 [16]. The number of subframes in a positioning occasion
Physical cell ID PCI		(PCI of Cell 1 – PCI of Cell 2) mod 6 = 0 and (PCI of Cell 1 – PCI of Cell 3) mod 6 = 0	The cell PCIs are selected such that the relative shifts of PRS patterns among cells are as given by the test parameters	
CP length		Normal		
DRX		ON	DRX parameters are further specified in Table A.8.13.3.1-3	
prs-SubframeOffset		310	Number of subframes rounded to the closest integer. The corresponding parameter in the OTDOA assistance data is prs-SubframeOffset specified in TS 36.355 [24]	
slotNumberOffset		0	The slot number offset at the transmitter between a neighbour cell and the assistance data reference cell specified in TS 36.355 [24]	
Radio frame receive time offset between the cells at the UE antenna connector	μs	Cell 2 to Cell 1: 1 Cell 3 to Cell 1: -1	PRS are transmitted from synchronous cells	
Expected RSTD	μs	Cell 2: -2 Cell 3: 2 Other neighbour cells: randomly between -3 and 3	The expected RSTD is what is expected at the receiver. The corresponding parameter in the OTDOA assistance data specified in TS 36.355 [24] is the expectedRSTD indicator	

Expected RSTD uncertainty for all neighbour cells	μs	5		The corresponding parameter in the OTDOA assistance data specified in TS 36.355 [24] is the expectedRSTD-Uncertainty index
Number of cells provided in OTDOA assistance data		16		The list includes the reference cell (received in <i>OTDOA-ReferenceCellInfo</i> [24]) on RF channel 1 and 15 other cells on RF channel 2, all received in <i>OTDOA-ProvideAssistanceData</i> [24].
PRS muting info		Cell 1: '1111111100000000' Cell 2: '0000000011111111' Cell 3: '1111111100000000'		Corresponds to prs-MutingInfo defined in TS 36.355 [24]
T1	s	3		The length of the time interval from the beginning of each test
T2	s	20.48	5.12	The length of the time interval that follows immediately after time interval T1
T3	s	20.48	5.12	The length of the time interval that follows immediately after time interval T2
NOTE 1: If the PRS transmission bandwidth is larger than the UE RF bandwidth, the UE is measuring RSTD within its RF bandwidth.				

Table A.8.13.6.1-2: Cell-specific test parameters for E-UTRAN FDD inter-frequency RSTD measurement reporting delay under fading propagation conditions during T1

Parameter	Unit	Cell 1	Cell 2	Cell 3
E-UTRA RF Channel Number		1	2	2
Correlation Matrix and Antenna Configuration		1x1	1x1	1x1
OCNG patterns defined in A.3.2.1		OP.21 FDD	N/A	N/A
PBCH_RA	dB	0	N/A	N/A
PBCH_RB				
PSS_RA				
SSS_RA				
PCFICH_RB				
PHICH_RA				
PHICH_RB				
PDCCH_RA				
PDCCH_RB				
OCNG_RA ^{Note 1}				
OCNG_RB ^{Note 1}				
N_{oc} ^{Note 3}	dBm/ 15 kHz	-95		
PRS \hat{E}_s/N_{oc}	dB	-Infinity	-Infinity	-Infinity
I_o ^{Note 4}	dBm/ 9 MHz	-67.22	-67.22	-67.22
\hat{E}_s/N_{oc}	dB	0	-Infinity	-Infinity
Propagation Condition		ETU30		

Note 1:	OCNG shall be used such that active cell (Cell 1) is fully allocated and a constant total transmitted power spectral density is achieved for all OFDM symbols.
Note 2:	The resources for uplink transmission are assigned to the UE prior to the start of time period T2.
Note 3:	Interference from other cells and noise sources not specified in the test are assumed to be constant over subcarriers and time and shall be modelled as AWGN of appropriate power for N_{oc} to be fulfilled.
Note 4:	lo levels have been derived from other parameters and are given for information purpose. These are not settable test parameters.

Table A.8.13.6.1-3: Cell-specific test parameters for E-UTRAN FDD inter-frequency RSTD measurement reporting delay under fading propagation conditions during T2 and T3

Parameter	Unit	Cell 1		Cell 2		Cell 3	
		T2	T3	T2	T3	T2	T3
E-UTRA RF Channel Number		1		2		2	
Correlation Matrix and Antenna Configuration		1x1		1x1		1x1	
OCNG patterns defined in A.3.2.1		OP.21 FDD		OP.6 FDD		OP.6 FDD	N/A
PBCH_RA	dB	0		0		0	N/A
PBCH_RB							
PSS_RA							
SSS_RA							
PCFICH_RB							
PHICH_RA							
PHICH_RB							
PDCCH_RA							
PDCCH_RB							
OCNG_RA ^{Note 1}							
OCNG_RB ^{Note 1}							
PRS_RA	dB	0	N/A	N/A	0	0	N/A
N_{oc} ^{Note 3}	dBm/15 kHz	-98	-95	-98	-95	-98	-95
$PRS \hat{E}_s / N_{oc}$	dB	-12	-Infinity	-Infinity	-13	-14	-Infinity
$PRS \hat{E}_s / I_{ot}$ ^{Note 4}	dB	-12	-Infinity	-Infinity	-13	-14	-Infinity
I_o ^{Note 4}	dBm/9 MHz	-70.17	-67.13	-70.19	-70.18	-70.19	-70.18
PRP ^{Note 4}	dBm/15 kHz	-110	-Infinity	-Infinity	-108	-112	-Infinity
RSRP ^{Note 4}	dBm/15 kHz	-110	-110	-114	-108	-112	-Infinity
\hat{E}_s / N_{oc} ^{Note 4}	dB	-9	-9	-14	-13	-14	-Infinity
Propagation Condition		ETU30					

Note 1:	OCNG shall be used such that active cells (all, except Cell 3 in T3) are fully allocated and a constant total transmitted power spectral density is achieved for all OFDM symbols other than those in the subframes with transmitted PRS.
Note 2:	The resources for uplink transmission are assigned to the UE prior to the start of time period T2.
Note 3:	Interference from other cells and noise sources not specified in the test are assumed to be constant over subcarriers and time and shall be modelled as AWGN of appropriate power for N_{oc} to be fulfilled.
Note 4:	If PRS_RA is not "N/A", \hat{E}_s/N_{oc} , PRS \hat{E}_s/I_{α} , Io, RSRP and PRP levels have been derived from other parameters and are given for information purpose. If PRS_RA is "N/A", Io and RSRP levels have been derived from other parameters and are given for information purpose. These are not settable test parameters. Interference conditions shall be applied to all PRS symbols of DL positioning subframes.

Table A.8.13.6.1-4: DRX parameters for the test of E-UTRAN FDD inter-frequency RSTD measurement reporting delay under fading propagation conditions

Field	Value	Comment
onDurationTimer	psf1	As specified in TS 36.331 [2], Clause 6.3.2
Drx-InactivityTimer	psf1	
drx-RetransmissionTimer	sf1	
longDRX-CycleStartOffset	sf320	
shortDRX	Disable	

A.8.13.6.2 Test Requirements

For Cat-M1 UE in CE Mode B, the RSTD measurement time fulfils the requirements specified in Clause 8.13.3.7.1.

For Cat-M2 UE in CE Mode B, the RSTD measurement time fulfils the requirements specified in Clause 8.16.3.2.1.

In Test 1, the UE shall perform and report the RSTD measurements for Cell 2 and Cell 3 with respect to the reference cell in the OTDOA assistance data, Cell 1, within 40960 ms starting from the beginning of time interval T2.

In Test 2, the shall perform and report the RSTD measurements for Cell 2 and Cell 3 with respect to the reference cell in the OTDOA assistance data, Cell 1, within 10240 ms starting from the beginning of time interval T2.

The rate of the correct events for each neighbour cell observed during repeated tests shall be at least 90%, where the reported RSTD measurement for each correct event shall be within the RSTD reporting range specified in Clause 9.1.10.3, i.e., between RSTD_0000 and RSTD_12711.

NOTE: The RSTD measurement time in the test is derived from the following expression,

$$T_{PRS}(M-1) + 320 \cdot \left\lceil \frac{n}{M} \right\rceil, \text{ where } M=128 \text{ and } n=16 \text{ are the parameters for Test 1 and } M=32 \text{ and } n$$

=16 are the parameters for Test 2, specified in the corresponding requirements sections, under Note 2.

This gives the total RSTD measurement time of 40960 ms in Test 1 and 10240 ms in Test 2 for Cell 2 and Cell 3 with respect to the reference cell Cell 1.

A.8.13.7 E-UTRAN HD-FDD inter-frequency RSTD measurement period test case in CE Mode B

A.8.13.7.1 Test Purpose and Environment

The purpose of the test is to verify for Cat-M1 and Cat-M2 UE in CE Mode B that the RSTD measurement meets the requirements specified in Sections 8.13.3.7.3 and 8.16.3.2.3, respectively, in an environment with fading propagation conditions. Test 1 is applicable for Cat-M1 and Cat-M2 supporting 1.4 MHz UE RF bandwidth, while Test 2 is applicable for Cat-M2 supporting 5 MHz UE RF bandwidth.

In the test there are three synchronous cells: Cell 1, Cell 2 and Cell 3. Cell 1 is the reference as well as the PCell. Cell 2 and Cell 3 are the neighbour cells. Cell 1 is on FDD RF channel 1. Cell 2 and Cell 3 are on a FDD RF channel 2.

The UE requires measurement gaps to perform inter-frequency measurements. Gap pattern configuration # 0 as defined in Table 8.1.2.1-1 is provided and configured to not overlap with PRS subframes of Cell 1.

The test consists of three consecutive time intervals, with duration of T1, T2 and T3. Cell 1 is active in T1, T2 and T3, whilst Cell 2 and Cell 3 are activated only in the beginning of T2. Cell 2 is active until the end of T3, and Cell 3 is active until the end of T2. The beginning of the time interval T2 shall be aligned with the first PRS positioning subframe of a positioning occasion in the reference cell, where the PRS positioning occasion is as defined in Clause 8.1.2.5.1. Cell 1 transmits PRS in T2, while Cell 2 transmits PRS only in T3, and Cell 3 transmits PRS only in T2. Note: The information on when PRS is muted is conveyed to the UE using PRS muting information.

The OTDOA assistance data as defined in TS 36.355, Clause 6.5.1, shall be provided to the UE during T1. The last TTI containing the OTDOA assistance data shall be provided to the UE ΔT ms before the start of T2, where $\Delta T = 150$ ms is the maximum processing time of the OTDOA assistance data. The measurement gap configuration is known and configured in the UE at the start of T1. DRX is configured before T2.

The test parameters are as given in Table A.8.13.7.1-1, Table A.8.13.7.1-2, Table A.8.13.7.1-3 and Table A.8.13.7.1-4.

Table A.8.13.7.1-1: General test parameters for E-UTRAN HD-FDD inter-frequency RSTD measurement reporting delay under fading propagation conditions

Parameter	Unit	Value		Comment
		Test 1	Test 2	
Reference cell		Cell 1		Reference cell is the cell in the OTDOA assistance data with respect to which the RSTD measurement is defined, as specified in TS 36.214 [4] and TS 36.355 [24]. The reference cell is the PCell in this test case.
Neighbor cells		Cell 2 and Cell 3		Cell 2 and Cell 3 appear at random places in the neighbour cell list in the OTDOA assistance data, but Cell 2 always appears in the first half of the list, whilst Cell 3 appears in the second half of the list.
MPDCCH		DL Reference Measurement Channel R.8 HD-FDD		As specified in clause A.3.1.3.1
$mPDCCH\text{-startSF-UeSS}$		10		Parameter G in $T = r_{\max} \cdot G$ which determines subframe $k0$ in which MPDCCH starts in the serving cell.
System Channel Bandwidth (BW_{channel})	MHz	10		
Gap pattern Id		0		As specified in Table 8.1.2.1-1. Applies for measurements on Cell 2 and Cell 3
Gap offset		10		As specified in TS 36.331 [2], Clause 6.3.5
PRS Transmission Bandwidth	RB	50 ^{Note 1}		PRS are transmitted over the system bandwidth
PRS configuration index I_{PRS}		Cell 1: 181, Cell 2, Cell 3: 171		This corresponds to periodicity of 320 ms and PRS subframe offset of $I_{\text{PRS}} - 160$ DL subframes, as defined in TS 36.211 [16], Table 6.10.4.3-1
Number of consecutive downlink positioning subframes N_{PRS}		4	4	As defined in TS 36.211 [16]. The number of subframes in a positioning occasion
Physical cell ID PCI		(PCI of Cell 1 – PCI of Cell 2) mod 6 = 0 and (PCI of Cell 1 – PCI of Cell 3) mod 6 = 0		The cell PCIs are selected such that the relative shifts of PRS patterns among cells are as given by the test parameters
CP length		Normal		

DRX		ON		DRX parameters are further specified in Table A.8.13.3.1-3
prs-SubframeOffset		310		Number of subframes rounded to the closest integer. The corresponding parameter in the OTDOA assistance data is prs-SubframeOffset specified in TS 36.355 [24]
slotNumberOffset		0		The slot number offset at the transmitter between a neighbour cell and the assistance data reference cell specified in TS 36.355 [24]
Radio frame receive time offset between the cells at the UE antenna connector	µs	Cell 2 to Cell 1: 1 Cell 3 to Cell 1: -1		PRS are transmitted from synchronous cells
Expected RSTD	µs	Cell 2: -2 Cell 3: 2 Other neighbour cells: randomly between -3 and 3		The expected RSTD is what is expected at the receiver. The corresponding parameter in the OTDOA assistance data specified in TS 36.355 [24] is the expectedRSTD indicator
Expected RSTD uncertainty for all neighbour cells	µs	5		The corresponding parameter in the OTDOA assistance data specified in TS 36.355 [24] is the expectedRSTD-Uncertainty index
Number of cells provided in OTDOA assistance data		16		The list includes the reference cell (received in <i>OTDOA-ReferenceCellInfo</i> [24]) on RF channel 1 and 15 other cells on RF channel 2, all received in <i>OTDOA-ProvideAssistanceData</i> [24].
PRS muting info		Cell 1: '1111111100000000' Cell 2: '0000000011111111' Cell 3: '1111111100000000'		Corresponds to prs-MutingInfo defined in TS 36.355 [24]
T1	s	3		The length of the time interval from the beginning of each test
T2	s	20.48	5.12	The length of the time interval that follows immediately after time interval T1
T3	s	20.48	5.12	The length of the time interval that follows immediately after time interval T2
NOTE 1: If the PRS transmission bandwidth is larger than the UE RF bandwidth, the UE is measuring RSTD within its RF bandwidth.				

Table A.8.13.7.1-2: Cell-specific test parameters for E-UTRAN HD-FDD inter-frequency RSTD measurement reporting delay under fading propagation conditions during T1

Parameter	Unit	Cell 1	Cell 2	Cell 3
E-UTRA RF Channel Number		1	2	2
Correlation Matrix and Antenna Configuration		1x1	1x1	1x1
OCNG patterns defined in A.3.2.1		OP.21 FDD	N/A	N/A
PBCH_RA	dB	0	N/A	N/A
PBCH_RB				
PSS_RA				
SSS_RA				
PCFICH_RB				
PHICH_RA				
PHICH_RB				

PDCCH_RA				
PDCCH_RB				
OCNG_RA ^{Note 1}				
OCNG_RB ^{Note 1}				
N_{oc} ^{Note 3}	dBm/ 15 kHz	-95		
PRS \hat{E}_s/N_{oc}	dB	-Infinity	-Infinity	-Infinity
I_o ^{Note 4}	dBm/ 9 MHz	-67.22	-67.22	-67.22
\hat{E}_s/N_{oc}	dB	0	-Infinity	-Infinity
Propagation Condition		ETU30		
<p>Note 1: OCNG shall be used such that active cell (Cell 1) is fully allocated and a constant total transmitted power spectral density is achieved for all OFDM symbols.</p> <p>Note 2: The resources for uplink transmission are assigned to the UE prior to the start of time period T2.</p> <p>Note 3: Interference from other cells and noise sources not specified in the test are assumed to be constant over subcarriers and time and shall be modelled as AWGN of appropriate power for N_{oc} to be fulfilled.</p> <p>Note 4: I_o levels have been derived from other parameters and are given for information purpose. These are not settable test parameters.</p>				

Table A.8.13.7.1-3: Cell-specific test parameters for E-UTRAN HD-FDD inter-frequency RSTD measurement reporting delay under fading propagation conditions during T2 and T3

Parameter	Unit	Cell 1		Cell 2		Cell 3	
		T2	T3	T2	T3	T2	T3
E-UTRA RF Channel Number		1		2		2	
Correlation Matrix and Antenna Configuration		1x1		1x1		1x1	
OCNG patterns defined in A.3.2.1		OP.21 FDD		OP.6 FDD		OP.6 FDD	N/A
PBCH_RA	dB	0		0		0	N/A
PBCH_RB							
PSS_RA							
SSS_RA							
PCFICH_RB							
PHICH_RA							
PHICH_RB							
PDCCH_RA							
PDCCH_RB							
OCNG_RA ^{Note 1}							
OCNG_RB ^{Note 1}							
PRS_RA	dB	-3	N/A	N/A	3	3	N/A
N_{oc} ^{Note 3}	dBm/ 15 kHz	-98	-95	-98	-95	-98	-95
PRS \hat{E}_s/N_{oc}	dB	-12	-Infinity	-Infinity	-13	-14	-Infinity
PRS \hat{E}_s/I_{ot} ^{Note 4}	dB	-12	-Infinity	-Infinity	-13	-14	-Infinity
I_o ^{Note 4}	dBm/ 9 MHz	-70.17	-67.13	-70.19	-70.18	-70.19	-70.18
PRP ^{Note 4}	dBm/ 15 kHz	-110	-Infinity	-Infinity	-108	-112	-Infinity
RSRP ^{Note 4}	dBm/ 15 kHz	-110	-110	-114	-108	-112	-Infinity
\hat{E}_s/N_{oc} ^{Note 4}	dB	-9	-9	-14	-13	-14	-Infinity
Propagation Condition		ETU30					

Note 1:	OCNG shall be used such that active cells (all, except Cell 3 in T3) are fully allocated and a constant total transmitted power spectral density is achieved for all OFDM symbols other than those in the subframes with transmitted PRS.
Note 2:	The resources for uplink transmission are assigned to the UE prior to the start of time period T2.
Note 3:	Interference from other cells and noise sources not specified in the test are assumed to be constant over subcarriers and time and shall be modelled as AWGN of appropriate power for N_{oc} to be fulfilled.
Note 4:	If PRS_RA is not "N/A", \hat{E}_s/N_{oc} , PRS \hat{E}_s/I_{ot} , I_o , RSRP and PRP levels have been derived from other parameters and are given for information purpose. If PRS_RA is "N/A", I_o and RSRP levels have been derived from other parameters and are given for information purpose. These are not settable test parameters. Interference conditions shall be applied to all PRS symbols of DL positioning subframes.

Table A.8.13.7.1-4: DRX parameters for the test of E-UTRAN HD-FDD inter-frequency RSTD measurement reporting delay under fading propagation conditions

Field	Value	Comment
onDurationTimer	psf1	As specified in TS 36.331 [2], Clause 6.3.2
Drx-InactivityTimer	psf1	
drx-RetransmissionTimer	sf1	
longDRX-CycleStartOffset	sf320	
shortDRX	Disable	

A.8.13.7.2 Test Requirements

For Cat-M1 UE in CE Mode B, the RSTD measurement time fulfils the requirements specified in Clause 8.13.3.7.3.

For Cat-M2 UE in CE Mode B, the RSTD measurement time fulfils the requirements specified in Clause 8.16.3.2.3.

In Test 1, the UE shall perform and report the RSTD measurements for Cell 2 and Cell 3 with respect to the reference cell in the OTDOA assistance data, Cell 1, within 40960 ms starting from the beginning of time interval T2.

In Test 2, the shall perform and report the RSTD measurements for Cell 2 and Cell 3 with respect to the reference cell in the OTDOA assistance data, Cell 1, within 10240 ms starting from the beginning of time interval T2.

The rate of the correct events for each neighbour cell observed during repeated tests shall be at least 90%, where the reported RSTD measurement for each correct event shall be within the RSTD reporting range specified in Clause 9.1.10.3, i.e., between RSTD_0000 and RSTD_12711.

NOTE: The RSTD measurement time in the test is derived from the following expression,

$$T_{PRS}(M-1) + 320 \cdot \left\lceil \frac{n}{M} \right\rceil, \text{ where } M=128 \text{ and } n=16 \text{ are the parameters for Test 1 and } M=32 \text{ and } n$$

=16 are the parameters for Test 2, specified in the corresponding requirements sections, under Note 2.

This gives the total RSTD measurement time of 40960 ms in Test 1 and 10240 ms in Test 2 for Cell 2 and Cell 3 with respect to the reference cell Cell 1.

A.8.13.8 E-UTRAN TDD inter-frequency RSTD measurement period test case in CE Mode B

A.8.13.8.1 Test Purpose and Environment

The purpose of the test is to verify for Cat-M1 and Cat-M2 UE in CE Mode B that the RSTD measurement meets the requirements specified in Sections 8.13.3.7.2 and 8.16.3.2.2, respectively, in an environment with fading propagation conditions. Test 1 is applicable for Cat-M1 and Cat-M2 supporting 1.4 MHz UE RF bandwidth, while Test 2 is applicable for Cat-M2 supporting 5 MHz UE RF bandwidth.

In the test there are three synchronous cells: Cell 1, Cell 2 and Cell 3. Cell 1 is the reference as well as the PCell. Cell 2 and Cell 3 are the neighbour cells. Cell 1 is on TDD RF channel 1. Cell 2 and Cell 3 are on a TDD RF channel 2.

The UE requires measurement gaps to perform inter-frequency measurements. Gap pattern configuration # 0 as defined in Table 8.1.2.1-1 is provided and configured to not overlap with PRS subframes of Cell 1.

The test consists of three consecutive time intervals, with duration of T1, T2 and T3. Cell 1 is active in T1, T2 and T3, whilst Cell 2 and Cell 3 are activated only in the beginning of T2. Cell 2 is active until the end of T3, and Cell 3 is active until the end of T2. The beginning of the time interval T2 shall be aligned with the first PRS positioning subframe of a positioning occasion in the reference cell, where the PRS positioning occasion is as defined in Clause 8.1.2.5.1. Cell 1 transmits PRS in T2, while Cell 2 transmits PRS only in T3, and Cell 3 transmits PRS only in T2. Note: The information on when PRS is muted is conveyed to the UE using PRS muting information.

The OTDOA assistance data as defined in TS 36.355, Clause 6.5.1, shall be provided to the UE during T1. The last TTI containing the OTDOA assistance data shall be provided to the UE ΔT ms before the start of T2, where $\Delta T = 150$ ms is the maximum processing time of the OTDOA assistance data. The measurement gap configuration is known and configured in the UE at the start of T1. DRX is configured before T2.

The test parameters are as given in Table A.8.13.8.1-1, Table A.8.13.8.1-2, Table A.8.13.8.1-3 and Table A.8.13.8.1-4.

Table A.8.13.8.1-1: General test parameters for E-UTRAN TDD inter-frequency RSTD measurement reporting delay under fading propagation conditions

Parameter	Unit	Value		Comment
		Test 1	Test 2	
Reference cell		Cell 1		Reference cell is the cell in the OTDOA assistance data with respect to which the RSTD measurement is defined, as specified in TS 36.214 [4] and TS 36.355 [24]. The reference cell is the PCell in this test case.
Neighbor cells		Cell 2 and Cell 3		Cell 2 and Cell 3 appear at random places in the neighbour cell list in the OTDOA assistance data, but Cell 2 always appears in the first half of the list, whilst Cell 3 appears in the second half of the list.
MPDCCH		DL Reference Measurement Channel R.16 TDD		As specified in clause A.3.1.3.1
<i>mPDCCH-startSF-UESS</i>		10		Parameter G in $T = r_{\max} \cdot G$ which determines subframe $k0$ in which MPDCCH starts in the serving cell.
System Channel Bandwidth (BW_{channel})	MHz	10		
Gap pattern Id		0		As specified in Table 8.1.2.1-1. Applies for measurements on Cell 2 and Cell 3
Gap offset		13		As specified in TS 36.331 [2], Clause 6.3.5
PRS Transmission Bandwidth	RB	50 ^{Note 1}		PRS are transmitted over the system bandwidth
PRS configuration index I_{PRS}		Cell 1: 184, Cell 2, Cell 3: 174		This corresponds to periodicity of 320 ms and PRS subframe offset of $I_{\text{PRS}} - 160$ DL subframes, as defined in TS 36.211 [16], Table 6.10.4.3-1
Number of consecutive downlink positioning subframes N_{PRS}		4	4	As defined in TS 36.211 [16]. The number of subframes in a positioning occasion
Physical cell ID PCI		(PCI of Cell 1 – PCI of Cell 2) mod 6 = 0 and (PCI of Cell 1 – PCI of Cell 3) mod 6 = 0		The cell PCIs are selected such that the relative shifts of PRS patterns among cells are as given by the test parameters

TDD uplink-downlink configuration		1	As specified in TS 36.211 [16], Clause 4.2; corresponds to a configuration with 5 ms switch-point periodicity and two downlink consecutive subframes	
TDD special subframe configuration		6	As specified in TS 36.211 [16], Clause 4.2; corresponds to DwPTS of $19760 \cdot T_s$ and UpPTS of $4384 \cdot T_s$	
CP length		Normal		
DRX		ON	DRX parameters are further specified in Table A.8.13.3.1-3	
prs-SubframeOffset		310	Number of subframes rounded to the closest integer. The corresponding parameter in the OTDOA assistance data is prs-SubframeOffset specified in TS 36.355 [24]	
slotNumberOffset		0	The slot number offset at the transmitter between a neighbour cell and the assistance data reference cell specified in TS 36.355 [24]	
Radio frame receive time offset between the cells at the UE antenna connector	μs	Cell 2 to Cell 1: 1 Cell 3 to Cell 1: -1	PRS are transmitted from synchronous cells	
Expected RSTD	μs	Cell 2: -2 Cell 3: 2 Other neighbour cells: randomly between -3 and 3	The expected RSTD is what is expected at the receiver. The corresponding parameter in the OTDOA assistance data specified in TS 36.355 [24] is the expectedRSTD indicator	
Expected RSTD uncertainty for all neighbour cells	μs	5	The corresponding parameter in the OTDOA assistance data specified in TS 36.355 [24] is the expectedRSTD-Uncertainty index	
Number of cells provided in OTDOA assistance data		16	The list includes the reference cell (received in <i>OTDOA-ReferenceCellInfo</i> [24]) on RF channel 1 and 15 other cells on RF channel 2, all received in <i>OTDOA-ProvideAssistanceData</i> [24].	
PRS muting info		Cell 1: '1111111100000000' Cell 2: '0000000011111111' Cell 3: '1111111100000000'	Corresponds to prs-MutingInfo defined in TS 36.355 [24]	
T1	s	3	The length of the time interval from the beginning of each test	
T2	s	20.48	5.12	The length of the time interval that follows immediately after time interval T1
T3	s	20.48	5.12	The length of the time interval that follows immediately after time interval T2
NOTE 1: If the PRS transmission bandwidth is larger than the UE RF bandwidth, the UE is measuring RSTD within its RF bandwidth.				

Table A.8.13.8.1-2: Cell-specific test parameters for E-UTRAN TDD inter-frequency RSTD measurement reporting delay under fading propagation conditions during T1

Parameter	Unit	Cell 1	Cell 2	Cell 3
E-UTRA RF Channel Number		1	2	2

Correlation Matrix and Antenna Configuration		1x1	1x1	1x1
OCNG patterns defined in A.3.2.1		OP.11 TDD	N/A	N/A
PBCH_RA	dB	0	N/A	N/A
PBCH_RB				
PSS_RA				
SSS_RA				
PCFICH_RB				
PHICH_RA				
PHICH_RB				
PDCCH_RA				
PDCCH_RB				
OCNG_RA ^{Note 1}				
OCNG_RB ^{Note 1}				
N_{oc} ^{Note 3}	dBm/ 15 kHz	-95		
$PRS \hat{E}_s / N_{oc}$	dB	-Infinity	-Infinity	-Infinity
I_o ^{Note 4}	dBm/ 9 MHz	-67.22	-67.22	-67.22
\hat{E}_s / N_{oc}	dB	0	-Infinity	-Infinity
Propagation Condition		ETU30		
<p>Note 1: OCNG shall be used such that active cell (Cell 1) is fully allocated and a constant total transmitted power spectral density is achieved for all OFDM symbols.</p> <p>Note 2: The resources for uplink transmission are assigned to the UE prior to the start of time period T2.</p> <p>Note 3: Interference from other cells and noise sources not specified in the test are assumed to be constant over subcarriers and time and shall be modelled as AWGN of appropriate power for N_{oc} to be fulfilled.</p> <p>Note 4: I_o levels have been derived from other parameters and are given for information purpose. These are not settable test parameters.</p>				

Table A.8.13.8.1-3: Cell-specific test parameters for E-UTRAN TDD inter-frequency RSTD measurement reporting delay under fading propagation conditions during T2 and T3

Parameter	Unit	Cell 1		Cell 2		Cell 3	
		T2	T3	T2	T3	T2	T3
E-UTRA RF Channel Number		1		2		2	
Correlation Matrix and Antenna Configuration		1x1		1x1		1x1	
OCNG patterns defined in A.3.2.1		OP.11 TDD		OP.2 TDD		OP.2 TDD	N/A
PBCH_RA	dB	0	0	0	0	0	N/A
PBCH_RB							
PSS_RA							
SSS_RA							
PCFICH_RB							
PHICH_RA							
PHICH_RB							
PDCCH_RA							
PDCCH_RB							
OCNG_RA ^{Note 1}							
OCNG_RB ^{Note 1}							
PRS_RA	dB	-3	N/A	N/A	3	3	N/A
N_{oc} ^{Note 3}	dBm/ 15 kHz	-98	-95	-98	-95	-98	-95

$\text{PRS } \hat{E}_s/N_{oc}$	dB	-12	-Infinity	-Infinity	-13	-14	-Infinity
$\text{PRS } \hat{E}_s/I_{ot}$ Note 4	dB	-12	-Infinity	-Infinity	-13	-14	-Infinity
I_o Note 4	dBm/ 9 MHz	-70.17	-67.13	-70.19	-70.18	-70.19	-70.18
PRP Note 4	dBm/ 15 kHz	-110	-Infinity	-Infinity	-108	-112	-Infinity
RSRP Note 4	dBm/ 15 kHz	-110	-110	-114	-108	-112	-Infinity
\hat{E}_s/N_{oc} Note 4	dB	-9	-9	-14	-13	-14	-Infinity
Propagation Condition		ETU30					
<p>Note 1: OCNG shall be used such that active cells (all, except Cell 3 in T3) are fully allocated and a constant total transmitted power spectral density is achieved for all OFDM symbols other than those in the subframes with transmitted PRS.</p> <p>Note 2: The resources for uplink transmission are assigned to the UE prior to the start of time period T2.</p> <p>Note 3: Interference from other cells and noise sources not specified in the test are assumed to be constant over subcarriers and time and shall be modelled as AWGN of appropriate power for N_{oc} to be fulfilled.</p> <p>Note 4: If PRS_RA is not "N/A", \hat{E}_s/N_{oc}, PRS \hat{E}_s/I_{ot}, I_o, RSRP and PRP levels have been derived from other parameters and are given for information purpose. If PRS_RA is "N/A", I_o and RSRP levels have been derived from other parameters and are given for information purpose. These are not settable test parameters. Interference conditions shall be applied to all PRS symbols of DL positioning subframes.</p>							

Table A.8.13.8.1-4: DRX parameters for the test of E-UTRAN TDD in-frequency RSTD measurement reporting delay under fading propagation conditions

Field	Value	Comment
onDurationTimer	psf1	As specified in TS 36.331 [2], Clause 6.3.2
Drx-InactivityTimer	psf1	
drx-RetransmissionTimer	sf1	
longDRX-CycleStartOffset	sf320	
shortDRX	Disable	

A.8.13.8.2 Test Requirements

For Cat-M1 UE in CE Mode B, the RSTD measurement time fulfils the requirements specified in Clause 8.13.3.7.2.

For Cat-M2 UE in CE Mode B, the RSTD measurement time fulfils the requirements specified in Clause 8.16.3.2.2.

In Test 1, the UE shall perform and report the RSTD measurements for Cell 2 and Cell 3 with respect to the reference cell in the OTDOA assistance data, Cell 1, within 40960 ms starting from the beginning of time interval T2.

In Test 2, the UE shall perform and report the RSTD measurements for Cell 2 and Cell 3 with respect to the reference cell in the OTDOA assistance data, Cell 1, within 10240 ms starting from the beginning of time interval T2.

The rate of the correct events for each neighbour cell observed during repeated tests shall be at least 90%, where the reported RSTD measurement for each correct event shall be within the RSTD reporting range specified in Clause 9.1.10.3, i.e., between RSTD_0000 and RSTD_12711.

NOTE: The RSTD measurement time in the test is derived from the following expression,

$$T_{PRS}(M-1) + 320 \cdot \left\lceil \frac{n}{M} \right\rceil, \text{ where } M=128 \text{ and } n=16 \text{ are the parameters for Test 1 and } M=32 \text{ and } n=16 \text{ are the parameters for Test 2, specified in the corresponding requirements sections, under Note 2.}$$

This gives the total RSTD measurement time of 40960 ms in Test 1 and 10240 ms in Test 2 for Cell 2 and Cell 3 with respect to the reference cell Cell 1.

A.8.13.9 E-UTRAN FDD inter-frequency RSTD measurement period test case in CE Mode A with longer PRS occasions

A.8.13.9.1 Test Purpose and Environment

The purpose of the test is to verify for Cat-M1 and Cat-M2 UE in CE Mode A that the RSTD measurement meets the requirements specified in Sections 8.13.2.4.1 and 8.16.2.4.1, respectively, in an environment with fading propagation conditions. The test is applicable for Cat-M1 and Cat-M2 configured with 1.4 MHz UE RF bandwidth and supporting measurement gaps specified in Table 8.1.2.1-3.

In the test there are three synchronous cells: Cell 1, Cell 2 and Cell 3. Cell 1 is the reference as well as the PCell. Cell 2 and Cell 3 are the neighbour cells. Cell 1 is on FDD RF channel 1. Cell 2 and Cell 3 are on a FDD RF channel 2.

The UE requires measurement gaps to perform inter-frequency measurements. Gap pattern configuration *rstd6* as defined in Table 8.1.2.1-3 is provided and configured to not overlap with PRS subframes of Cell 1.

The test consists of three consecutive time intervals, with duration of T1, T2 and T3. Cell 1 is active in T1, T2 and T3, whilst Cell 2 and Cell 3 are activated only in the beginning of T2. Cell 2 is active until the end of T3, and Cell 3 is active until the end of T2. The beginning of the time interval T2 shall be aligned with the first PRS positioning subframe of a positioning occasion in the reference cell, where the PRS positioning occasion is as defined in Clause 8.1.2.5.1. Cell 1 transmits PRS in T2, while Cell 2 transmits PRS only in T3, and Cell 3 transmits PRS only in T2. Note: The information on when PRS is muted is conveyed to the UE using PRS muting information.

The OTDOA assistance data as defined in TS 36.355, Clause 6.5.1, shall be provided to the UE during T1. The last TTI containing the OTDOA assistance data shall be provided to the UE ΔT ms before the start of T2, where $\Delta T = 150$ ms is the maximum processing time of the OTDOA assistance data. The measurement gap configuration is known and configured in the UE at the start of T1. DRX is configured before T2.

The test parameters are as given in Table A.8.13.9.1-1, Table A.8.13.9.1-2, Table A.8.13.9.1-3 and Table A.8.13.9.1-4.

Table A.8.13.9.1-1: General test parameters for E-UTRAN FDD inter-frequency RSTD measurement reporting delay under fading propagation conditions

Parameter	Unit	Value	Comment
Reference cell		Cell 1	Reference cell is the cell in the OTDOA assistance data with respect to which the RSTD measurement is defined, as specified in TS 36.214 [4] and TS 36.355 [24]. The reference cell is the PCell in this test case.
Neighbor cells		Cell 2 and Cell 3	Cell 2 and Cell 3 appear at random places in the neighbour cell list in the OTDOA assistance data, but Cell 2 always appears in the first half of the list, whilst Cell 3 appears in the second half of the list.
MPDCCH		DL Reference Measurement Channel R.16 FDD	As specified in clause A.3.1.3.1
<i>mPDCCH-startSF-U ESS</i>		10	Parameter <i>G</i> in $T = r_{\max} \cdot G$ which determines subframe <i>k0</i> in which MPDCCH starts in the serving cell.
System Channel Bandwidth (BW_{channel})	MHz	10	
Gap pattern Id		<i>rstd6</i>	As specified in Table 8.1.2.1-3. Applies for measurements on Cell 2 and Cell 3
Gap offset		91	As specified in TS 36.331 [2], Clause 6.3.5
PRS Transmission Bandwidth	RB	50 ^{Note 1}	PRS are transmitted over the system bandwidth

PRS configuration index I_{PRS}		Cell 1: 232, Cell 2, Cell 3: 252	This corresponds to periodicity of 320 ms and PRS subframe offset of $I_{PRS} - 160$ DL subframes, as defined in TS 36.211 [16], Table 6.10.4.3-1
Number of consecutive downlink positioning subframes N_{PRS}		12	As defined in TS 36.211 [16]. The number of subframes in a positioning occasion. Corresponds to parameter <i>add-numDL-Frames</i> in TS 36.355, for UE with <i>additional-prs-config</i> capability
		20	As defined in TS 36.211 [16]. The number of subframes in a positioning occasion. Corresponds to parameter <i>add-numDL-Frames</i> in TS 36.355, for UE with <i>densePrsConfig</i> capability
Physical cell ID PCI		(PCI of Cell 1 – PCI of Cell 2)mod6=0 and (PCI of Cell 1 – PCI of Cell 3)mod6=0	The cell PCIs are selected such that the relative shifts of PRS patterns among cells are as given by the test parameters
CP length		Normal	
DRX		ON	DRX parameters are further specified in Table A.8.13.3.1-3
prs-SubframeOffset		20	Number of subframes rounded to the closest integer. The corresponding parameter in the OTDOA assistance data is prs-SubframeOffset specified in TS 36.355 [24]
slotNumberOffset		0	The slot number offset at the transmitter between a neighbour cell and the assistance data reference cell specified in TS 36.355 [24]
Radio frame receive time offset between the cells at the UE antenna connector	μs	Cell 2 to Cell 1: 1 Cell 3 to Cell 1: -1	PRS are transmitted from synchronous cells
Expected RSTD	μs	Cell 2: -2 Cell 3: 2 Other neighbour cells: randomly between -3 and 3	The expected RSTD is what is expected at the receiver. The corresponding parameter in the OTDOA assistance data specified in TS 36.355 [24] is the expectedRSTD indicator
Expected RSTD uncertainty for all neighbour cells	μs	5	The corresponding parameter in the OTDOA assistance data specified in TS 36.355 [24] is the expectedRSTD-Uncertainty index
Number of cells provided in OTDOA assistance data		16	The list includes the reference cell (received in <i>OTDOA-ReferenceCellInfo</i> [24]) on RF channel 1 and 15 other cells on RF channel 2, all received in <i>OTDOA-ProvideAssistanceData</i> [24].
PRS muting info		Cell 1: '1111111100000000' Cell 2: '0000000011111111' Cell 3: '1111111100000000'	Corresponds to prs-MutingInfo defined in TS 36.355 [24]
T1	s	3	The length of the time interval from the beginning of each test
T2	s	2.56	The length of the time interval that follows immediately after time interval T1

T3	s	2.56	The length of the time interval that follows immediately after time interval T2
NOTE 1: If the PRS transmission bandwidth is larger than the UE RF bandwidth, the UE is measuring RSTD within its RF bandwidth.			

Table A.8.13.9.1-2: Cell-specific test parameters for E-UTRAN FDD inter-frequency RSTD measurement reporting delay under fading propagation conditions during T1

Parameter	Unit	Cell 1	Cell 2	Cell 3
E-UTRA RF Channel Number		1	2	2
Correlation Matrix and Antenna Configuration		1x1	1x1	1x1
OCNG patterns defined in A.3.2.1		OP.21 FDD	N/A	N/A
PBCH_RA	dB	0	N/A	N/A
PBCH_RB				
PSS_RA				
SSS_RA				
PCFICH_RB				
PHICH_RA				
PHICH_RB				
PDCCH_RA				
PDCCH_RB				
OCNG_RA ^{Note 1}				
OCNG_RB ^{Note 1}				
N_{oc} ^{Note 3}	dBm/15 kHz	-95		
PRS \hat{E}_s/N_{oc}	dB	-Infinity	-Infinity	-Infinity
I_o ^{Note 4}	dBm/9 MHz	-67.22	-67.22	-67.22
\hat{E}_s/N_{oc}	dB	0	-Infinity	-Infinity
Propagation Condition		ETU30		
<p>Note 1: OCNG shall be used such that active cell (Cell 1) is fully allocated and a constant total transmitted power spectral density is achieved for all OFDM symbols.</p> <p>Note 2: The resources for uplink transmission are assigned to the UE prior to the start of time period T2.</p> <p>Note 3: Interference from other cells and noise sources not specified in the test are assumed to be constant over subcarriers and time and shall be modelled as AWGN of appropriate power for N_{oc} to be fulfilled.</p> <p>Note 4: I_o levels have been derived from other parameters and are given for information purpose. These are not settable test parameters.</p>				

Table A.8.13.9.1-3: Cell-specific test parameters for E-UTRAN FDD inter-frequency RSTD measurement reporting delay under fading propagation conditions during T2 and T3

Parameter	Unit	Cell 1		Cell 2		Cell 3	
		T2	T3	T2	T3	T2	T3
E-UTRA RF Channel Number		1		2		2	
Correlation Matrix and Antenna Configuration		1x1		1x1		1x1	
OCNG patterns defined in A.3.2.1		OP.21 FDD		OP.6 FDD		OP.6 FDD	N/A
PBCH_RA	dB	0		0		0	N/A
PBCH_RB							

PSS_RA							
SSS_RA							
PCFICH_RB							
PHICH_RA							
PHICH_RB							
PDCCH_RA							
PDCCH_RB							
OCNG_RA ^{Note 1}							
OCNG_RB ^{Note 1}							
PRS_RA	dB	-3	N/A	N/A	3	3	N/A
N_{oc} ^{Note 3}	dBm/ 15 kHz	-98	-98	-98	-95	-98	-95
$PRS \hat{E}_s/N_{oc}$	dB	-1	-Infinity	-Infinity	-7	-8	-Infinity
$PRS \hat{E}_s/I_{ot}$ ^{Note 4}	dB	-1	-Infinity	-Infinity	-7	-8	-Infinity
I_o ^{Note 4}	dBm/ 9 MHz	-69.68	-70.22	-70.11	-67.08	-70.11	-67.08
PRP ^{Note 4}	dBm/ 15 kHz	-99	-Infinity	-Infinity	-102	-106	-Infinity
RSRP ^{Note 4}	dBm/ 15 kHz	-96	-96	-105	-105	-109	-Infinity
\hat{E}_s/N_{oc} ^{Note 4}	dB	2	2	-7	-10	-11	-Infinity
Propagation Condition		ETU30					
<p>Note 1: OCNG shall be used such that active cells (all, except Cell 3 in T3) are fully allocated and a constant total transmitted power spectral density is achieved for all OFDM symbols other than those in the subframes with transmitted PRS.</p> <p>Note 2: The resources for uplink transmission are assigned to the UE prior to the start of time period T2.</p> <p>Note 3: Interference from other cells and noise sources not specified in the test are assumed to be constant over subcarriers and time and shall be modelled as AWGN of appropriate power for N_{oc} to be fulfilled.</p> <p>Note 4: If PRS_RA is not "N/A", \hat{E}_s/N_{oc}, $PRS \hat{E}_s/I_{ot}$, I_o, RSRP and PRP levels have been derived from other parameters and are given for information purpose. If PRS_RA is "N/A", I_o and RSRP levels have been derived from other parameters and are given for information purpose. These are not settable test parameters. Interference conditions shall be applied to all PRS symbols of DL positioning subframes.</p>							

Table A.8.13.9.1-4: DRX parameters for the test of E-UTRAN FDD inter-frequency RSTD measurement reporting delay under fading propagation conditions

Field	Value	Comment
onDurationTimer	psf1	As specified in TS 36.331 [2], Clause 6.3.2
Drx-InactivityTimer	psf1	
drx-RetransmissionTimer	sf1	
longDRX-CycleStartOffset	sf320	
shortDRX	Disable	

A.8.13.9.2 Test Requirements

For Cat-M1 UE in CE Mode A, the RSTD measurement time fulfils the requirements specified in Clause 8.13.2.4.1.

For Cat-M2 UE in CE Mode A, the RSTD measurement time fulfils the requirements specified in Clause 8.16.2.4.1.

The UE shall perform and report the RSTD measurements for Cell 2 and Cell 3 with respect to the reference cell in the OTDOA assistance data, Cell 1, within 5120 ms starting from the beginning of time interval T2.

The rate of the correct events for each neighbour cell observed during repeated tests shall be at least 90%, where the reported RSTD measurement for each correct event shall be within the RSTD reporting range specified in Clause 9.1.10.3, i.e., between RSTD_0000 and RSTD_12711.

NOTE: The RSTD measurement time in the test is derived from the following expression,

$$T_{PRS}(M-1) + 320 \cdot \left\lceil \frac{n}{M} \right\rceil, \text{ where } M=16 \text{ and } n=16 \text{ are the parameters specified in the corresponding}$$

requirements sections, under Note 2. This gives the total RSTD measurement time of 5120 ms for Cell 2 and Cell 3 with respect to the reference Cell 1.

A.8.13.10 E-UTRAN HD-FDD inter-frequency RSTD measurement period test case in CE Mode A with longer PRS occasions

A.8.13.10.1 Test Purpose and Environment

The purpose of the test is to verify for Cat-M1 and Cat-M2 UE in CE Mode A that the RSTD measurement meets the requirements specified in Sections 8.13.2.4.3 and 8.16.2.4.3, respectively, in an environment with fading propagation conditions. The test is applicable for Cat-M1 and Cat-M2 supporting 1.4 MHz UE RF bandwidth and supporting measurement gaps specified in Table 8.1.2.1-3.

In the test there are three synchronous cells: Cell 1, Cell 2 and Cell 3. Cell 1 is the reference as well as the PCell. Cell 2 and Cell 3 are the neighbour cells. Cell 1 is on FDD RF channel 1. Cell 2 and Cell 3 are on a FDD RF channel 2.

The UE requires measurement gaps to perform inter-frequency measurements. Gap pattern configuration rstd6 as defined in Table 8.1.2.1-3 is provided and configured to not overlap with PRS subframes of Cell 1.

The test consists of three consecutive time intervals, with duration of T1, T2 and T3. Cell 1 is active in T1, T2 and T3, whilst Cell 2 and Cell 3 are activated only in the beginning of T2. Cell 2 is active until the end of T3, and Cell 3 is active until the end of T2. The beginning of the time interval T2 shall be aligned with the first PRS positioning subframe of a positioning occasion in the reference cell, where the PRS positioning occasion is as defined in Clause 8.1.2.5.1. Cell 1 transmits PRS in T2, while Cell 2 transmits PRS only in T3, and Cell 3 transmits PRS only in T2. Note: The information on when PRS is muted is conveyed to the UE using PRS muting information.

The OTDOA assistance data as defined in TS 36.355, Clause 6.5.1, shall be provided to the UE during T1. The last TTI containing the OTDOA assistance data shall be provided to the UE ΔT ms before the start of T2, where $\Delta T = 150$ ms is the maximum processing time of the OTDOA assistance data. The measurement gap configuration is known and configured in the UE at the start of T1. DRX is configured before T2.

The test parameters are as given in Table A.8.13.10.1-1, Table A.8.13.10.1-2, Table A.8.13.10.1-3 and Table A.8.13.10.1-4.

Table A.8.13.10.1-1: General test parameters for E-UTRAN HD-FDD inter-frequency RSTD measurement reporting delay under fading propagation conditions

Parameter	Unit	Value	Comment
Reference cell		Cell 1	Reference cell is the cell in the OTDOA assistance data with respect to which the RSTD measurement is defined, as specified in TS 36.214 [4] and TS 36.355 [24]. The reference cell is the PCell in this test case.
Neighbor cells		Cell 2 and Cell 3	Cell 2 and Cell 3 appear at random places in the neighbour cell list in the OTDOA assistance data, but Cell 2 always appears in the first half of the list, whilst Cell 3 appears in the second half of the list.
MPDCCH		DL Reference Measurement Channel R.6 HD-FDD	As specified in clause A.3.1.3.1

<i>mPDCCH-startSF-U ESS</i>		10	Parameter G in $T = r_{\max} \cdot G$ which determines subframe $k0$ in which MPDCCH starts in the serving cell.
System Channel Bandwidth (BW_{channel})	MHz	10	
Gap pattern Id		rstd6	As specified in Table 8.1.2.1-3. Applies for measurements on Cell 2 and Cell 3
Gap offset		91	As specified in TS 36.331 [2], Clause 6.3.5
PRS Transmission Bandwidth	RB	50 ^{Note 1}	PRS are transmitted over the system bandwidth
PRS configuration index I_{PRS}		Cell 1: 232, Cell 2, Cell 3: 252	This corresponds to periodicity of 320 ms and PRS subframe offset of $I_{\text{PRS}} - 160$ DL subframes, as defined in TS 36.211 [16], Table 6.10.4.3-1
Number of consecutive downlink positioning subframes N_{PRS}		12	As defined in TS 36.211 [16]. The number of subframes in a positioning occasion. Corresponds to parameter <i>add-numDL-Frames</i> in TS 36.355, for UE with <i>additional-prs-config</i> capability
		20	As defined in TS 36.211 [16]. The number of subframes in a positioning occasion. Corresponds to parameter <i>add-numDL-Frames</i> in TS 36.355, for UE with <i>densePrsConfig</i> capability
Physical cell ID PCI		(PCI of Cell 1 – PCI of Cell 2) mod 6 = 0 and (PCI of Cell 1 – PCI of Cell 3) mod 6 = 0	The cell PCIs are selected such that the relative shifts of PRS patterns among cells are as given by the test parameters
CP length		Normal	
DRX		ON	DRX parameters are further specified in Table A.8.13.3.1-3
prs-SubframeOffset		20	Number of subframes rounded to the closest integer. The corresponding parameter in the OTDOA assistance data is prs-SubframeOffset specified in TS 36.355 [24]
slotNumberOffset		0	The slot number offset at the transmitter between a neighbour cell and the assistance data reference cell specified in TS 36.355 [24]
Radio frame receive time offset between the cells at the UE antenna connector	μs	Cell 2 to Cell 1: 1 Cell 3 to Cell 1: -1	PRS are transmitted from synchronous cells
Expected RSTD	μs	Cell 2: -2 Cell 3: 2 Other neighbour cells: randomly between -3 and 3	The expected RSTD is what is expected at the receiver. The corresponding parameter in the OTDOA assistance data specified in TS 36.355 [24] is the expectedRSTD indicator
Expected RSTD uncertainty for all neighbour cells	μs	5	The corresponding parameter in the OTDOA assistance data specified in TS 36.355 [24] is the expectedRSTD-Uncertainty index

Number of cells provided in OTDOA assistance data		16	The list includes the reference cell (received in <i>OTDOA-ReferenceCellInfo</i> [24]) on RF channel 1 and 15 other cells on RF channel 2, all received in <i>OTDOA-ProvideAssistanceData</i> [24].
PRS muting info		Cell 1: '1111111100000000' Cell 2: '0000000011111111' Cell 3: '1111111100000000'	Corresponds to prs-MutingInfo defined in TS 36.355 [24]
T1	s	3	The length of the time interval from the beginning of each test
T2	s	2.56	The length of the time interval that follows immediately after time interval T1
T3	s	2.56	The length of the time interval that follows immediately after time interval T2
NOTE 1: If the PRS transmission bandwidth is larger than the UE RF bandwidth, the UE is measuring RSTD within its RF bandwidth.			

Table A.8.13.10.1-2: Cell-specific test parameters for E-UTRAN HD-FDD inter-frequency RSTD measurement reporting delay under fading propagation conditions during T1

Parameter	Unit	Cell 1	Cell 2	Cell 3
E-UTRA RF Channel Number		1	2	2
Correlation Matrix and Antenna Configuration		1x1	1x1	1x1
OCNG patterns defined in A.3.2.1		OP.21 FDD	N/A	N/A
PBCH_RA	dB	0	N/A	N/A
PBCH_RB				
PSS_RA				
SSS_RA				
PCFICH_RB				
PHICH_RA				
PHICH_RB				
PDCCH_RA				
PDCCH_RB				
OCNG_RA ^{Note 1}				
OCNG_RB ^{Note 1}				
N_{oc} ^{Note 3}	dBm/ 15 kHz	-95		
PRS \hat{E}_s/N_{oc}	dB	-Infinity	-Infinity	-Infinity
I_o ^{Note 4}	dBm/ 9 MHz	-67.22	-67.22	-67.22
\hat{E}_s/N_{oc}	dB	0	-Infinity	-Infinity
Propagation Condition		ETU30		
<p>Note 1: OCNG shall be used such that active cell (Cell 1) is fully allocated and a constant total transmitted power spectral density is achieved for all OFDM symbols.</p> <p>Note 2: The resources for uplink transmission are assigned to the UE prior to the start of time period T2.</p> <p>Note 3: Interference from other cells and noise sources not specified in the test are assumed to be constant over subcarriers and time and shall be modelled as AWGN of appropriate power for N_{oc} to be fulfilled.</p> <p>Note 4: I_o levels have been derived from other parameters and are given for information purpose. These are not settable test parameters.</p>				

Table A.8.13.10.1-3: Cell-specific test parameters for E-UTRAN HD-FDD inter-frequency RSTD measurement reporting delay under fading propagation conditions during T2 and T3

Parameter	Unit	Cell 1		Cell 2		Cell 3	
		T2	T3	T2	T3	T2	T3
E-UTRA RF Channel Number		1		2		2	
Correlation Matrix and Antenna Configuration		1x1		1x1		1x1	
OCNG patterns defined in A.3.2.1		OP.21 FDD		OP.6 FDD		OP.6 FDD	N/A
PBCH_RA	dB	0		0		0	N/A
PBCH_RB							
PSS_RA							
SSS_RA							
PCFICH_RB							
PHICH_RA							
PHICH_RB							
PDCCH_RA							
PDCCH_RB							
OCNG_RA ^{Note 1}							
OCNG_RB ^{Note 1}							
PRS_RA	dB	-3	N/A	N/A	3	3	N/A
N_{oc} ^{Note 3}	dBm/ 15 kHz	-98	-98	-98	-95	-98	-95
$PRS \hat{E}_s/N_{oc}$	dB	-1	-Infinity	-Infinity	-7	-8	-Infinity
$PRS \hat{E}_s/I_{ot}$ ^{Note 4}	dB	-1	-Infinity	-Infinity	-7	-8	-Infinity
I_o ^{Note 4}	dBm/ 9 MHz	-69.68	-70.22	-70.11	-67.08	-70.11	-67.08
PRP ^{Note 4}	dBm/ 15 kHz	-99	-Infinity	-Infinity	-102	-106	-Infinity
RSRP ^{Note 4}	dBm/ 15 kHz	-96	-96	-105	-105	-109	-Infinity
\hat{E}_s/N_{oc} ^{Note 4}	dB	2	2	-7	-10	-11	-Infinity
Propagation Condition		ETU30					
<p>Note 1: OCNG shall be used such that active cells (all, except Cell 3 in T3) are fully allocated and a constant total transmitted power spectral density is achieved for all OFDM symbols other than those in the subframes with transmitted PRS.</p> <p>Note 2: The resources for uplink transmission are assigned to the UE prior to the start of time period T2.</p> <p>Note 3: Interference from other cells and noise sources not specified in the test are assumed to be constant over subcarriers and time and shall be modelled as AWGN of appropriate power for N_{oc} to be fulfilled.</p> <p>Note 4: If PRS_RA is not "N/A", \hat{E}_s/N_{oc}, $PRS \hat{E}_s/I_{ot}$, I_o, RSRP and PRP levels have been derived from other parameters and are given for information purpose. If PRS_RA is "N/A", I_o and RSRP levels have been derived from other parameters and are given for information purpose. These are not settable test parameters. Interference conditions shall be applied to all PRS symbols of DL positioning subframes.</p>							

Table A.8.13.10.1-4: DRX parameters for the test of E-UTRAN HD-FDD inter-frequency RSTD measurement reporting delay under fading propagation conditions

Field	Value	Comment
onDurationTimer	psf1	As specified in TS 36.331 [2], Clause 6.3.2
Drx-InactivityTimer	psf1	
drx-RetransmissionTimer	sf1	
longDRX-CycleStartOffset	sf320	

shortDRX	Disable	
----------	---------	--

A.8.13.10.2 Test Requirements

For Cat-M1 UE in CE Mode A, the RSTD measurement time fulfils the requirements specified in Clause 8.13.2.4.3.

For Cat-M2 UE in CE Mode A, the RSTD measurement time fulfils the requirements specified in Clause 8.16.2.4.3.

The UE shall perform and report the RSTD measurements for Cell 2 and Cell 3 with respect to the reference cell in the OTDOA assistance data, Cell 1, within 5120 ms starting from the beginning of time interval T2.

The rate of the correct events for each neighbour cell observed during repeated tests shall be at least 90%, where the reported RSTD measurement for each correct event shall be within the RSTD reporting range specified in Clause 9.1.10.3, i.e., between RSTD_0000 and RSTD_12711.

NOTE: The RSTD measurement time in the test is derived from the following expression,

$$T_{PRS}(M-1) + 320 \cdot \left\lceil \frac{n}{M} \right\rceil$$

where $M=16$ and $n=16$ are the parameters specified in the corresponding requirements sections, under Note 2. This gives the total RSTD measurement time of 5120 ms for Cell 2 and Cell 3 with respect to the reference Cell 1.

A.8.13.11 E-UTRAN TDD inter-frequency RSTD measurement period test case in CE Mode A with longer PRS occasions

A.8.13.11.1 Test Purpose and Environment

The purpose of the test is to verify for Cat-M1 and Cat-M2 UE in CE Mode A that the RSTD measurement meets the requirements specified in Sections 8.13.2.4.2 and 8.16.2.4.2, respectively, in an environment with fading propagation conditions. The test is applicable for Cat-M1 and Cat-M2 configured with 1.4 MHz UE RF bandwidth and supporting measurement gaps specified in Table 8.1.2.1-3.

In the test there are three synchronous cells: Cell 1, Cell 2 and Cell 3. Cell 1 is the reference as well as the PCell. Cell 2 and Cell 3 are the neighbour cells. Cell 1 is on FDD RF channel 1. Cell 2 and Cell 3 are on a TDD RF channel 2.

The UE requires measurement gaps to perform inter-frequency measurements. Gap pattern configuration rstd6 as defined in Table 8.1.2.1-3 is provided and configured to not overlap with PRS subframes of Cell 1.

The test consists of three consecutive time intervals, with duration of T1, T2 and T3. Cell 1 is active in T1, T2 and T3, whilst Cell 2 and Cell 3 are activated only in the beginning of T2. Cell 2 is active until the end of T3, and Cell 3 is active until the end of T2. The beginning of the time interval T2 shall be aligned with the first PRS positioning subframe of a positioning occasion in the reference cell, where the PRS positioning occasion is as defined in Clause 8.1.2.5.1. Cell 1 transmits PRS in T2, while Cell 2 transmits PRS only in T3, and Cell 3 transmits PRS only in T2. Note: The information on when PRS is muted is conveyed to the UE using PRS muting information.

The OTDOA assistance data as defined in TS 36.355, Clause 6.5.1, shall be provided to the UE during T1. The last TTI containing the OTDOA assistance data shall be provided to the UE ΔT ms before the start of T2, where $\Delta T = 150$ ms is the maximum processing time of the OTDOA assistance data. The measurement gap configuration is known and configured in the UE at the start of T1. DRX is configured before T2.

The test parameters are as given in Table A.8.13.11.1-1, Table A.8.13.11.1-2, Table A.8.13.11.1-3 and Table A.8.13.11.1-4.

Table A.8.13.11.1-1: General test parameters for E-UTRAN TDD inter-frequency RSTD measurement reporting delay under fading propagation conditions

Parameter	Unit	Value	Comment
-----------	------	-------	---------

Reference cell		Cell 1	Reference cell is the cell in the OTDOA assistance data with respect to which the RSTD measurement is defined, as specified in TS 36.214 [4] and TS 36.355 [24]. The reference cell is the PCell in this test case.
Neighbor cells		Cell 2 and Cell 3	Cell 2 and Cell 3 appear at random places in the neighbour cell list in the OTDOA assistance data, but Cell 2 always appears in the first half of the list, whilst Cell 3 appears in the second half of the list.
MPDCCH		DL Reference Measurement Channel R.14 TDD	As specified in clause A.3.1.3.1
$mPDCCH\text{-startSF-UeSS}$		10	Parameter G in $T = r_{\max} \cdot G$ which determines subframe $k0$ in which MPDCCH starts in the serving cell.
System Channel Bandwidth (BW_{channel})	MHz	10	
Gap pattern Id		rstd12	As specified in Table 8.1.2.1-3. Applies for measurements on Cell 2 and Cell 3
Gap offset		91	As specified in TS 36.331 [2], Clause 6.3.5
PRS Transmission Bandwidth	RB	50 ^{Note 1}	PRS are transmitted over the system bandwidth
PRS configuration index I_{PRS}		Cell 1: 212, Cell 2, Cell 3: 252	This corresponds to periodicity of 320 ms and PRS subframe offset of $I_{\text{PRS}} - 160$ DL subframes, as defined in TS 36.211 [16], Table 6.10.4.3-1
Number of consecutive downlink positioning subframes N_{PRS}		12	As defined in TS 36.211 [16]. The number of subframes in a positioning occasion. Corresponds to parameter <i>add-numDL-Frames</i> in TS 36.355, for UE with <i>additional-prs-config</i> capability
		20	As defined in TS 36.211 [16]. The number of subframes in a positioning occasion. Corresponds to parameter <i>add-numDL-Frames</i> in TS 36.355, for UE with <i>densePrsConfig</i> capability
Physical cell ID PCI		(PCI of Cell 1 – PCI of Cell 2) mod 6 = 0 and (PCI of Cell 1 – PCI of Cell 3) mod 6 = 0	The cell PCIs are selected such that the relative shifts of PRS patterns among cells are as given by the test parameters
TDD uplink-downlink configuration		1	As specified in TS 36.211 [16], Clause 4.2; corresponds to a configuration with 5 ms switch-point periodicity and two downlink consecutive subframes
TDD special subframe configuration		6	As specified in TS 36.211 [16], Clause 4.2; corresponds to DwPTS of $19760 \cdot T_s$ and UpPTS of $4384 \cdot T_s$
CP length		Normal	
DRX		ON	DRX parameters are further specified in Table A.8.13.3.1-3

prs-SubframeOffset		40	Number of subframes rounded to the closest integer. The corresponding parameter in the OTDOA assistance data is prs-SubframeOffset specified in TS 36.355 [24]
slotNumberOffset		0	The slot number offset at the transmitter between a neighbour cell and the assistance data reference cell specified in TS 36.355 [24]
Radio frame receive time offset between the cells at the UE antenna connector	µs	Cell 2 to Cell 1: 1 Cell 3 to Cell 1: -1	PRS are transmitted from synchronous cells
Expected RSTD	µs	Cell 2: -2 Cell 3: 2 Other neighbour cells: randomly between -3 and 3	The expected RSTD is what is expected at the receiver. The corresponding parameter in the OTDOA assistance data specified in TS 36.355 [24] is the expectedRSTD indicator
Expected RSTD uncertainty for all neighbour cells	µs	5	The corresponding parameter in the OTDOA assistance data specified in TS 36.355 [24] is the expectedRSTD-Uncertainty index
Number of cells provided in OTDOA assistance data		16	The list includes the reference cell (received in <i>OTDOA-ReferenceCellInfo</i> [24]) on RF channel 1 and 15 other cells on RF channel 2, all received in <i>OTDOA-ProvideAssistanceData</i> [24].
PRS muting info		Cell 1: '1111111100000000' Cell 2: '0000000011111111' Cell 3: '1111111100000000'	Corresponds to prs-MutingInfo defined in TS 36.355 [24]
T1	s	3	The length of the time interval from the beginning of each test
T2	s	2.56	The length of the time interval that follows immediately after time interval T1
T3	s	2.56	The length of the time interval that follows immediately after time interval T2
NOTE 1: If the PRS transmission bandwidth is larger than the UE RF bandwidth, the UE is measuring RSTD within its RF bandwidth.			

Table A.8.13.11.1-2: Cell-specific test parameters for E-UTRAN TDD inter-frequency RSTD measurement reporting delay under fading propagation conditions during T1

Parameter	Unit	Cell 1	Cell 2	Cell 3
E-UTRA RF Channel Number		1	2	2
Correlation Matrix and Antenna Configuration		1x1	1x1	1x1
OCNG patterns defined in A.3.2.1		OP.11 TDD	N/A	N/A
PBCH_RA	dB	0	N/A	N/A
PBCH_RB				
PSS_RA				
SSS_RA				
PCFICH_RB				
PHICH_RA				
PHICH_RB				
PDCCH_RA				
PDCCH_RB				

OCNG_RA ^{Note 1}				
OCNG_RB ^{Note 1}				
N_{oc} ^{Note 3}	dBm/ 15 kHz	-95		
PRS \hat{E}_s/N_{oc}	dB	-Infinity	-Infinity	-Infinity
I_o ^{Note 4}	dBm/ 9 MHz	-67.22	-67.22	-67.22
\hat{E}_s/N_{oc}	dB	0	-Infinity	-Infinity
Propagation Condition		ETU30		
<p>Note 1: OCNG shall be used such that active cell (Cell 1) is fully allocated and a constant total transmitted power spectral density is achieved for all OFDM symbols.</p> <p>Note 2: The resources for uplink transmission are assigned to the UE prior to the start of time period T2.</p> <p>Note 3: Interference from other cells and noise sources not specified in the test are assumed to be constant over subcarriers and time and shall be modelled as AWGN of appropriate power for N_{oc} to be fulfilled.</p> <p>Note 4: I_o levels have been derived from other parameters and are given for information purpose. These are not settable test parameters.</p>				

Table A.8.13.11.1-3: Cell-specific test parameters for E-UTRAN TDD inter-frequency RSTD measurement reporting delay under fading propagation conditions during T2 and T3

Parameter	Unit	Cell 1		Cell 2		Cell 3	
		T2	T3	T2	T3	T2	T3
E-UTRA RF Channel Number		1		2		2	
Correlation Matrix and Antenna Configuration		1x1		1x1		1x1	
OCNG patterns defined in A.3.2.1		OP.11 TDD		OP.2 TDD		OP.2 TDD	N/A
PBCH_RA	dB	0		0		0	N/A
PBCH_RB							
PSS_RA							
SSS_RA							
PCFICH_RB							
PHICH_RA							
PHICH_RB							
PDCCH_RA							
PDCCH_RB							
OCNG_RA ^{Note 1}							
OCNG_RB ^{Note 1}							
PRS_RA	dB	-3	N/A	N/A	3	3	N/A
N_{oc} ^{Note 3}	dBm/ 15 kHz	-98	-95	-98	-95	-98	-95
PRS \hat{E}_s/N_{oc}	dB	-1	-Infinity	-Infinity	-7	-7	-Infinity
PRS \hat{E}_s/I_{ot} ^{Note 4}	dB	-1.79	-Infinity	-Infinity	-7	-9.54	-Infinity
I_o ^{Note 4}	dBm/ 9 MHz	-69.55	-67.08	-69.55	-67.08	-69.55	-67.08
PRP ^{Note 4}	dBm/ 15 kHz	-99	-Infinity	-Infinity	-102	-105	-Infinity
RSRP ^{Note 4}	dBm/ 15 kHz	-96	-93	-105	-105	-108	-Infinity
\hat{E}_s/N_{oc} ^{Note 4}	dB	2	2	-7	-10	-10	-Infinity
Propagation Condition		ETU30					

Note 1:	OCNG shall be used such that active cells (all, except Cell 3 in T3) are fully allocated and a constant total transmitted power spectral density is achieved for all OFDM symbols other than those in the subframes with transmitted PRS.
Note 2:	The resources for uplink transmission are assigned to the UE prior to the start of time period T2.
Note 3:	Interference from other cells and noise sources not specified in the test are assumed to be constant over subcarriers and time and shall be modelled as AWGN of appropriate power for N_{oc} to be fulfilled.
Note 4:	If PRS_RA is not "N/A", \hat{E}_s/N_{oc} , PRS \hat{E}_s/I_{ot} , I_o , RSRP and PRP levels have been derived from other parameters and are given for information purpose. If PRS_RA is "N/A", I_o and RSRP levels have been derived from other parameters and are given for information purpose. These are not settable test parameters. Interference conditions shall be applied to all PRS symbols of DL positioning subframes.

Table A.8.13.11.1-4: DRX parameters for the test of E-UTRAN TDD intre-frequency RSTD measurement reporting delay under fading propagation conditions

Field	Value	Comment
onDurationTimer	psf1	As specified in TS 36.331 [2], Clause 6.3.2
Drx-InactivityTimer	psf1	
drx-RetransmissionTimer	sf1	
longDRX-CycleStartOffset	sf320	
shortDRX	Disable	

A.8.13.11.2 Test Requirements

For Cat-M1 UE in CE Mode A, the RSTD measurement time fulfils the requirements specified in Clause 8.13.2.4.2.

For Cat-M2 UE in CE Mode A, the RSTD measurement time fulfils the requirements specified in Clause 8.16.2.4.2.

The UE shall perform and report the RSTD measurements for Cell 2 and Cell 3 with respect to the reference cell in the OTDOA assistance data, Cell 1, within 5120 ms starting from the beginning of time interval T2.

The rate of the correct events for each neighbour cell observed during repeated tests shall be at least 90%, where the reported RSTD measurement for each correct event shall be within the RSTD reporting range specified in Clause 9.1.10.3, i.e., between RSTD_0000 and RSTD_12711.

NOTE: The RSTD measurement time in the test is derived from the following expression,

$$T_{PRS} (M - 1) + 320 \cdot \left\lceil \frac{n}{M} \right\rceil, \text{ where } M = 16 \text{ and } n = 16 \text{ are the parameters specified in the}$$

corresponding requirements sections, under Note 2. This gives the total RSTD measurement time of 5120 ms for Cell 2 and Cell 3 with respect to the reference Cell 1.

A.8.13.12 E-UTRAN FDD inter-frequency RSTD measurement period test case in CE Mode B with longer PRS occasions

A.8.13.12.1 Test Purpose and Environment

The purpose of the test is to verify for Cat-M1 and Cat-M2 UE in CE Mode B that the RSTD measurement meets the requirements specified in Sections 8.13.3.7.1 and 8.16.3.2.1, respectively, in an environment with fading propagation conditions. The test is applicable for Cat-M1 and Cat-M2 UE supporting measurement gaps specified in Table 8.1.2.1-3. Test 1 is applicable for Cat-M1 and Cat-M2 supporting and configured with 1.4 MHz UE RF bandwidth, while Test 2 is applicable for Cat-M2 supporting and configured with 5 MHz UE RF bandwidth.

In the test there are three synchronous cells: Cell 1, Cell 2 and Cell 3. Cell 1 is the reference as well as the PCell. Cell 2 and Cell 3 are the neighbour cells. Cell 1 is on FDD RF channel 1. Cell 2 and Cell 3 are on a FDD RF channel 2.

The UE requires measurement gaps to perform inter-frequency measurements. Gap pattern configuration rstd12 and rstd2 as defined in Table 8.1.2.1-3 is provided to the UE in Test 1 and Test 2, respectively, and configured to not

overlap with PRS subframes of Cell 1. Each test consists of three consecutive time intervals, with duration of T1, T2 and T3. Cell 1 is active in T1, T2 and T3, whilst Cell 2 and Cell 3 are activated only in the beginning of T2. Cell 2 is active until the end of T3, and Cell 3 is active until the end of T2. The beginning of the time interval T2 shall be aligned with the first PRS positioning subframe of a positioning occasion in the reference cell, where the PRS positioning occasion is as defined in Clause 8.1.2.5.1. Cell 1 transmits PRS in T2, while Cell 2 transmits PRS only in T3, and Cell 3 transmits PRS only in T2. Note: The information on when PRS is muted is conveyed to the UE using PRS muting information.

The OTDOA assistance data as defined in TS 36.355 [24], Clause 6.5.1, shall be provided to the UE during T1. The last TTI containing the OTDOA assistance data shall be provided to the UE ΔT ms before the start of T2, where $\Delta T = 150$ ms is the maximum processing time of the OTDOA assistance data. The measurement gap configuration is known and configured in the UE at the start of T1. DRX is configured before T2.

The test parameters are as given in Table A.8.13.12.1-1, Table A.8.13.12.1-2, Table A.8.13.12.1-3 and Table A.8.13.12.1-4.

Table A.8.13.12.1-1: General test parameters for E-UTRAN FDD inter-frequency RSTD measurement reporting delay under fading propagation conditions

Parameter	Unit	Value		Comment
		Test 1	Test 2	
Reference cell		Cell 1		Reference cell is the cell in the OTDOA assistance data with respect to which the RSTD measurement is defined, as specified in TS 36.214 [4] and TS 36.355 [24]. The reference cell is the PCell in this test case.
Neighbor cells		Cell 2 and Cell 3		Cell 2 and Cell 3 appear at random places in the neighbour cell list in the OTDOA assistance data, but Cell 2 always appears in the first half of the list, whilst Cell 3 appears in the second half of the list.
MPDCCH		DL Reference Measurement Channel R.18 FDD		As specified in clause A.3.1.3
<i>mPDCCH-startSF-UESS</i>		10		Parameter <i>G</i> in which determines subframe <i>k0</i> in which MPDCCH starts in the serving cell.
System Channel Bandwidth (BW_{channel})	MHz	10		
Gap pattern Id		rstd12	rstd2	As specified in Table 8.1.2.1-3. Applies for measurements on Cell 2 and Cell 3
Gap offset		151		As specified in TS 36.331 [2], Clause 6.3.5
PRS Transmission Bandwidth	RB	50 ^{Note 1}		PRS are transmitted over the system bandwidth
PRS configuration index I_{PRS}		Cell 1: 232, Cell 2, Cell 3: 312		This corresponds to periodicity of 320 ms and PRS subframe offset of $I_{\text{PRS}} - 160$ DL subframes, as defined in TS 36.211 [16], Table 6.10.4.3-1
Number of consecutive downlink positioning subframes N_{PRS}		30	8	As defined in TS 36.211 [16]. The number of subframes in a positioning occasion. Corresponds to parameter <i>add-numDL-Frames</i> in TS 36.355 [24], for UE with <i>additional-prs-config</i> capability

		40	10	As defined in TS 36.211 [16]. The number of subframes in a positioning occasion. Corresponds to parameter <i>add-numDL-Frames</i> in TS 36.355 [24], for UE with <i>densePrsConfig</i> capability
Physical cell ID PCI		(PCI of Cell 1 – PCI of Cell 2)mod6=0 and (PCI of Cell 1 – PCI of Cell 3)mod6=0		The cell PCIs are selected such that the relative shifts of PRS patterns among cells are as given by the test parameters
CP length		Normal		
DRX		ON		DRX parameters are further specified in Table A.8.13.3.1-3
prs-SubframeOffset		80		Number of subframes rounded to the closest integer. The corresponding parameter in the OTDOA assistance data is prs-SubframeOffset specified in TS 36.355 [24]
slotNumberOffset		0		The slot number offset at the transmitter between a neighbour cell and the assistance data reference cell specified in TS 36.355 [24]
Radio frame receive time offset between the cells at the UE antenna connector	µs	Cell 2 to Cell 1: 1 Cell 3 to Cell 1: -1		PRS are transmitted from synchronous cells
Expected RSTD	µs	Cell 2: -2 Cell 3: 2 Other neighbour cells: randomly between -3 and 3		The expected RSTD is what is expected at the receiver. The corresponding parameter in the OTDOA assistance data specified in TS 36.355 [24] is the expectedRSTD indicator
Expected RSTD uncertainty for all neighbour cells	µs	5		The corresponding parameter in the OTDOA assistance data specified in TS 36.355 [24] is the expectedRSTD-Uncertainty index
Number of cells provided in OTDOA assistance data		16		The list includes the reference cell (received in <i>OTDOA-ReferenceCellInfo</i> [24]) on RF channel 1 and 15 other cells on RF channel 2, all received in <i>OTDOA-ProvideAssistanceData</i> [24].
PRS muting info		Cell 1: '1111111100000000' Cell 2: '0000000011111111' Cell 3: '1111111100000000'		Corresponds to prs-MutingInfo defined in TS 36.355 [24]
T1	s	3		The length of the time interval from the beginning of each test
T2	s	2.56		The length of the time interval that follows immediately after time interval T1
T3	s	2.56		The length of the time interval that follows immediately after time interval T2
NOTE 1: If the PRS transmission bandwidth is larger than the UE RF bandwidth, the UE is measuring RSTD within its RF bandwidth.				

Table A.8.13.12.1-2: Cell-specific test parameters for E-UTRAN FDD inter-frequency RSTD measurement reporting delay under fading propagation conditions during T1

Parameter	Unit	Cell 1	Cell 2	Cell 3
E-UTRA RF Channel Number		1	2	2

Correlation Matrix and Antenna Configuration		1x1	1x1	1x1
OCNG patterns defined in A.3.2.1		OP.21 FDD	N/A	N/A
PBCH_RA	dB	0	N/A	N/A
PBCH_RB				
PSS_RA				
SSS_RA				
PCFICH_RB				
PHICH_RA				
PHICH_RB				
PDCCH_RA				
PDCCH_RB				
OCNG_RA ^{Note 1}				
OCNG_RB ^{Note 1}				
N_{oc} ^{Note 3}	dBm/ 15 kHz	-95		
$PRS \hat{E}_s / N_{oc}$	dB	-Infinity	-Infinity	-Infinity
I_o ^{Note 4}	dBm/ 9 MHz	-67.22	-67.22	-67.22
\hat{E}_s / N_{oc}	dB	0	-Infinity	-Infinity
Propagation Condition		ETU30		
<p>Note 1: OCNG shall be used such that active cell (Cell 1) is fully allocated and a constant total transmitted power spectral density is achieved for all OFDM symbols.</p> <p>Note 2: The resources for uplink transmission are assigned to the UE prior to the start of time period T2.</p> <p>Note 3: Interference from other cells and noise sources not specified in the test are assumed to be constant over subcarriers and time and shall be modelled as AWGN of appropriate power for N_{oc} to be fulfilled.</p> <p>Note 4: I_o levels have been derived from other parameters and are given for information purpose. These are not settable test parameters.</p>				

Table A.8.13.12.1-3: Cell-specific test parameters for E-UTRAN FDD inter-frequency RSTD measurement reporting delay under fading propagation conditions during T2 and T3

Parameter	Unit	Cell 1		Cell 2		Cell 3	
		T2	T3	T2	T3	T2	T3
E-UTRA RF Channel Number		1		2		2	
Correlation Matrix and Antenna Configuration		1x1		1x1		1x1	
OCNG patterns defined in A.3.2.1		OP.21 FDD		OP.6 FDD		OP.6 FDD	N/A
PBCH_RA	dB	0	0	0	0	0	N/A
PBCH_RB							
PSS_RA							
SSS_RA							
PCFICH_RB							
PHICH_RA							
PHICH_RB							
PDCCH_RA							
PDCCH_RB							
OCNG_RA ^{Note 1}							
OCNG_RB ^{Note 1}							
PRS_RA	dB	-3	N/A	N/A	3	3	N/A
N_{oc} ^{Note 3}	dBm/ 15 kHz	-98	-95	-98	-95	-98	-95

$PRS \hat{E}_s/N_{oc}$	dB	-12	-Infinity	-Infinity	-13	-14	-Infinity
$PRS \hat{E}_s/I_{ot}$ Note 4	dB	-12	-Infinity	-Infinity	-13	-14	-Infinity
I_o Note 4	dBm/ 9 MHz	-70.17	-67.13	-70.19	-70.18	-70.19	-70.18
PRP Note 4	dBm/ 15 kHz	-110	-Infinity	-Infinity	-108	-112	-Infinity
RSRP Note 4	dBm/ 15 kHz	-110	-110	-114	-108	-112	-Infinity
\hat{E}_s/N_{oc} Note 4	dB	-9	-9	-14	-13	-14	-Infinity
Propagation Condition		ETU30					
<p>Note 1: OCNG shall be used such that active cells (all, except Cell 3 in T3) are fully allocated and a constant total transmitted power spectral density is achieved for all OFDM symbols other than those in the subframes with transmitted PRS.</p> <p>Note 2: The resources for uplink transmission are assigned to the UE prior to the start of time period T2.</p> <p>Note 3: Interference from other cells and noise sources not specified in the test are assumed to be constant over subcarriers and time and shall be modelled as AWGN of appropriate power for N_{oc} to be fulfilled.</p> <p>Note 4: If PRS_RA is not "N/A", \hat{E}_s/N_{oc}, $PRS \hat{E}_s/I_{ot}$, I_o, RSRP and PRP levels have been derived from other parameters and are given for information purpose. If PRS_RA is "N/A", I_o and RSRP levels have been derived from other parameters and are given for information purpose. These are not settable test parameters. Interference conditions shall be applied to all PRS symbols of DL positioning subframes.</p>							

Table A.8.13.12.1-4: DRX parameters for the test of E-UTRAN FDD inter-frequency RSTD measurement reporting delay under fading propagation conditions

Field	Value	Comment
onDurationTimer	psf1	As specified in TS 36.331 [2], Clause 6.3.2
Drx-InactivityTimer	psf1	
drx-RetransmissionTimer	sf1	
longDRX-CycleStartOffset	sf320	
shortDRX	Disable	

A.8.13.12.2 Test Requirements

For Cat-M1 UE in CE Mode B, the RSTD measurement time fulfils the requirements specified in Clause 8.13.3.7.1.

For Cat-M2 UE in CE Mode B, the RSTD measurement time fulfils the requirements specified in Clause 8.16.3.2.2.

In Test 1, the UE configured 1.4 MHz RF bandwidth shall perform and report the RSTD measurements for Cell 2 and Cell 3 with respect to the reference cell in the OTDOA assistance data, Cell 1, within 5120 ms starting from the beginning of time interval T2.

In Test 2, the UE configured with 5 MHz RF bandwidth shall perform and report the RSTD measurements for Cell 2 and Cell 3 with respect to the reference cell in the OTDOA assistance data, Cell 1, within 5120 ms starting from the beginning of time interval T2.

The rate of the correct events for each neighbour cell observed during repeated tests shall be at least 90%, where the reported RSTD measurement for each correct event shall be within the RSTD reporting range specified in Clause 9.1.10.3, i.e., between RSTD_0000 and RSTD_12711.

NOTE: The RSTD measurement time in the test is derived from the following expression, $T_{PRS}(M - 1) + 320 \cdot \left\lceil \frac{n}{M} \right\rceil$, where $M=16$ and $n=16$ are the parameters specified in the corresponding requirements sections, under Note 2. This gives the total RSTD measurement time of 5120 ms for Cell 2 and Cell 3 with respect to the reference Cell 1.

A.8.13.13 E-UTRAN HD-FDD inter-frequency RSTD measurement period test case in CE Mode B with longer PRS occasions

A.8.13.13.1 Test Purpose and Environment

The purpose of the test is to verify for Cat-M1 and Cat-M2 UE in CE Mode B that the RSTD measurement meets the requirements specified in Sections 8.13.3.7.3 and 8.16.3.2.3, respectively, in an environment with fading propagation conditions. The test is applicable for Cat-M1 and Cat-M2 UE supporting measurement gaps specified in Table 8.1.2.1-3. Test 1 is applicable for Cat-M1 and Cat-M2 supporting and configured with 1.4 MHz UE RF bandwidth, while Test 2 is applicable for Cat-M2 supporting and configured with 5 MHz UE RF bandwidth.

In the test there are three synchronous cells: Cell 1, Cell 2 and Cell 3. Cell 1 is the reference as well as the PCell. Cell 2 and Cell 3 are the neighbour cells. Cell 1 is on FDD RF channel 1. Cell 2 and Cell 3 are on a FDD RF channel 2.

The UE requires measurement gaps to perform inter-frequency measurements. Gap pattern configuration *rstd12* and *rstd2* as defined in Table 8.1.2.1-3 is provided to the UE in Test 1 and Test 2, respectively, and configured to not overlap with PRS subframes of Cell 1.

The test consists of three consecutive time intervals, with duration of T1, T2 and T3. Cell 1 is active in T1, T2 and T3, whilst Cell 2 and Cell 3 are activated only in the beginning of T2. Cell 2 is active until the end of T3, and Cell 3 is active until the end of T2. The beginning of the time interval T2 shall be aligned with the first PRS positioning subframe of a positioning occasion in the reference cell, where the PRS positioning occasion is as defined in Clause 8.1.2.5.1. Cell 1 transmits PRS in T2, while Cell 2 transmits PRS only in T3, and Cell 3 transmits PRS only in T2. Note: The information on when PRS is muted is conveyed to the UE using PRS muting information.

The OTDOA assistance data as defined in TS 36.355 [24], Clause 6.5.1, shall be provided to the UE during T1. The last TTI containing the OTDOA assistance data shall be provided to the UE ΔT ms before the start of T2, where $\Delta T = 150$ ms is the maximum processing time of the OTDOA assistance data. The measurement gap configuration is known and configured in the UE at the start of T1. DRX is configured before T2.

The test parameters are as given in Table A.8.13.13.1-1, Table A.8.13.13.1-2, Table A.8.13.13.1-3 and Table A.8.13.13.1-4.

Table A.8.13.13.1-1: General test parameters for E-UTRAN HD-FDD inter-frequency RSTD measurement reporting delay under fading propagation conditions

Parameter	Unit	Value		Comment
		Test 1	Test 2	
Reference cell		Cell 1		Reference cell is the cell in the OTDOA assistance data with respect to which the RSTD measurement is defined, as specified in TS 36.214 [4] and TS 36.355 [24]. The reference cell is the PCell in this test case.
Neighbor cells		Cell 2 and Cell 3		Cell 2 and Cell 3 appear at random places in the neighbour cell list in the OTDOA assistance data, but Cell 2 always appears in the first half of the list, whilst Cell 3 appears in the second half of the list.
MPDCCH		DL Reference Measurement Channel R.8 HD-FDD		As specified in clause A.3.1.3
<i>mPDCCH-startSF-U ESS</i>		10		Parameter <i>G</i> in which determines subframe <i>k0</i> in which MPDCCH starts in the serving cell.
System Channel Bandwidth (BW_{channel})	MHz	10		
Gap pattern Id		<i>rstd12</i>	<i>rstd2</i>	As specified in Table 8.1.2.1-3. Applies for measurements on Cell 2 and Cell 3
Gap offset		151		As specified in TS 36.331 [2], Clause 6.3.5

PRS Transmission Bandwidth	RB	50 ^{Note 1}		PRS are transmitted over the system bandwidth
PRS configuration index I_{PRS}		Cell 1: 232, Cell 2, Cell 3: 312		This corresponds to periodicity of 320 ms and PRS subframe offset of $I_{PRS} - 160$ DL subframes, as defined in TS 36.211 [16], Table 6.10.4.3-1
Number of consecutive downlink positioning subframes N_{PRS}		30	8	As defined in TS 36.211 [16]. The number of subframes in a positioning occasion. Corresponds to parameter <i>add-numDL-Frames</i> in TS 36.355 [24], for UE with <i>additional-prs-config</i> capability
		40	10	As defined in TS 36.211 [16]. The number of subframes in a positioning occasion. Corresponds to parameter <i>add-numDL-Frames</i> in TS 36.355 [24], for UE with <i>densePrsConfig</i> capability
Physical cell ID PCI		(PCI of Cell 1 – PCI of Cell 2) mod 6 = 0 and (PCI of Cell 1 – PCI of Cell 3) mod 6 = 0		The cell PCIs are selected such that the relative shifts of PRS patterns among cells are as given by the test parameters
CP length		Normal		
DRX		ON		DRX parameters are further specified in Table A.8.13.3.1-3
prs-SubframeOffset		80		Number of subframes rounded to the closest integer. The corresponding parameter in the OTDOA assistance data is prs-SubframeOffset specified in TS 36.355 [24]
slotNumberOffset		0		The slot number offset at the transmitter between a neighbour cell and the assistance data reference cell specified in TS 36.355 [24]
Radio frame receive time offset between the cells at the UE antenna connector	μs	Cell 2 to Cell 1: 1 Cell 3 to Cell 1: -1		PRS are transmitted from synchronous cells
Expected RSTD	μs	Cell 2: -2 Cell 3: 2 Other neighbour cells: randomly between -3 and 3		The expected RSTD is what is expected at the receiver. The corresponding parameter in the OTDOA assistance data specified in TS 36.355 [24] is the expectedRSTD indicator
Expected RSTD uncertainty for all neighbour cells	μs	5		The corresponding parameter in the OTDOA assistance data specified in TS 36.355 [24] is the expectedRSTD-Uncertainty index
Number of cells provided in OTDOA assistance data		16		The list includes the reference cell (received in <i>OTDOA-ReferenceCellInfo</i> [24]) on RF channel 1 and 15 other cells on RF channel 2, all received in <i>OTDOA-ProvideAssistanceData</i> [24].
PRS muting info		Cell 1: '1111111100000000' Cell 2: '0000000011111111' Cell 3: '1111111110000000'		Corresponds to prs-MutingInfo defined in TS 36.355 [24]
T1	s	3		The length of the time interval from the beginning of each test
T2	s	2.56		The length of the time interval that follows immediately after time interval T1

T3	s	2.56	The length of the time interval that follows immediately after time interval T2
NOTE 1: If the PRS transmission bandwidth is larger than the UE RF bandwidth, the UE is measuring RSTD within its RF bandwidth.			

Table A.8.13.13.1-2: Cell-specific test parameters for E-UTRAN HD-FDD inter-frequency RSTD measurement reporting delay under fading propagation conditions during T1

Parameter	Unit	Cell 1	Cell 2	Cell 3
E-UTRA RF Channel Number		1	2	2
Correlation Matrix and Antenna Configuration		1x1	1x1	1x1
OCNG patterns defined in A.3.2.1		OP.21 FDD	N/A	N/A
PBCH_RA	dB	0	N/A	N/A
PBCH_RB				
PSS_RA				
SSS_RA				
PCFICH_RB				
PHICH_RA				
PHICH_RB				
PDCCH_RA				
PDCCH_RB				
OCNG_RA ^{Note 1}				
OCNG_RB ^{Note 1}				
N_{oc} ^{Note 3}	dBm/15 kHz	-95		
PRS \hat{E}_s/N_{oc}	dB	-Infinity	-Infinity	-Infinity
I_o ^{Note 4}	dBm/9 MHz	-67.22	-67.22	-67.22
\hat{E}_s/N_{oc}	dB	0	-Infinity	-Infinity
Propagation Condition		ETU30		
<p>Note 1: OCNG shall be used such that active cell (Cell 1) is fully allocated and a constant total transmitted power spectral density is achieved for all OFDM symbols.</p> <p>Note 2: The resources for uplink transmission are assigned to the UE prior to the start of time period T2.</p> <p>Note 3: Interference from other cells and noise sources not specified in the test are assumed to be constant over subcarriers and time and shall be modelled as AWGN of appropriate power for N_{oc} to be fulfilled.</p> <p>Note 4: I_o levels have been derived from other parameters and are given for information purpose. These are not settable test parameters.</p>				

Table A.8.13.13.1-3: Cell-specific test parameters for E-UTRAN HD-FDD inter-frequency RSTD measurement reporting delay under fading propagation conditions during T2 and T3

Parameter	Unit	Cell 1		Cell 2		Cell 3	
		T2	T3	T2	T3	T2	T3
E-UTRA RF Channel Number		1		2		2	
Correlation Matrix and Antenna Configuration		1x1		1x1		1x1	
OCNG patterns defined in A.3.2.1		OP.21 FDD		OP.6 FDD		OP.6 FDD	N/A
PBCH_RA	dB	0		0		0	N/A
PBCH_RB							

PSS_RA							
SSS_RA							
PCFICH_RB							
PHICH_RA							
PHICH_RB							
PDCCH_RA							
PDCCH_RB							
OCNG_RA ^{Note 1}							
OCNG_RB ^{Note 1}							
PRS_RA	dB	-3	N/A	N/A	3	3	N/A
N_{oc} ^{Note 3}	dBm/ 15 kHz	-98	-95	-98	-95	-98	-95
PRS \hat{E}_s/N_{oc}	dB	-12	-Infinity	-Infinity	-13	-14	-Infinity
PRS \hat{E}_s/I_{ot} ^{Note 4}	dB	-12	-Infinity	-Infinity	-13	-14	-Infinity
I_o ^{Note 4}	dBm/ 9 MHz	-70.17	-67.13	-70.19	-70.18	-70.19	-70.18
PRP ^{Note 4}	dBm/ 15 kHz	-110	-Infinity	-Infinity	-108	-112	-Infinity
RSRP ^{Note 4}	dBm/ 15 kHz	-110	-110	-114	-108	-112	-Infinity
\hat{E}_s/N_{oc} ^{Note 4}	dB	-9	-9	-14	-13	-14	-Infinity
Propagation Condition		ETU30					
<p>Note 1: OCNG shall be used such that active cells (all, except Cell 3 in T3) are fully allocated and a constant total transmitted power spectral density is achieved for all OFDM symbols other than those in the subframes with transmitted PRS.</p> <p>Note 2: The resources for uplink transmission are assigned to the UE prior to the start of time period T2.</p> <p>Note 3: Interference from other cells and noise sources not specified in the test are assumed to be constant over subcarriers and time and shall be modelled as AWGN of appropriate power for N_{oc} to be fulfilled.</p> <p>Note 4: If PRS_RA is not "N/A", \hat{E}_s/N_{oc}, PRS \hat{E}_s/I_{ot}, I_o, RSRP and PRP levels have been derived from other parameters and are given for information purpose. If PRS_RA is "N/A", I_o and RSRP levels have been derived from other parameters and are given for information purpose. These are not settable test parameters. Interference conditions shall be applied to all PRS symbols of DL positioning subframes.</p>							

Table A.8.13.13.1-4: DRX parameters for the test of E-UTRAN HD-FDD inter-frequency RSTD measurement reporting delay under fading propagation conditions

Field	Value	Comment
onDurationTimer	psf1	As specified in TS 36.331 [2], Clause 6.3.2
Drx-InactivityTimer	psf1	
drx-RetransmissionTimer	sf1	
longDRX-CycleStartOffset	sf320	
shortDRX	Disable	

A.8.13.13.2 Test Requirements

For Cat-M1 UE in CE Mode B, the RSTD measurement time fulfils the requirements specified in Clause 8.13.3.7.3.

For Cat-M2 UE in CE Mode B, the RSTD measurement time fulfils the requirements specified in Clause 8.16.3.2.3.

In Test 1, the UE configured with 1.4 MHz RF bandwidth shall perform and report the RSTD measurements for Cell 2 and Cell 3 with respect to the reference cell in the OTDOA assistance data, Cell 1, within 5120 ms starting from the beginning of time interval T2.

In Test 2, the UE configured with 5 MHz RF bandwidth shall perform and report the RSTD measurements for Cell 2 and Cell 3 with respect to the reference cell in the OTDOA assistance data, Cell 1, within 5120 ms starting from the beginning of time interval T2.

The rate of the correct events for each neighbour cell observed during repeated tests shall be at least 90%, where the reported RSTD measurement for each correct event shall be within the RSTD reporting range specified in Clause 9.1.10.3, i.e., between RSTD_0000 and RSTD_12711.

NOTE: The RSTD measurement time in the test is derived from the following expression, $T_{PRS}(M - 1) + 320 \cdot \left\lceil \frac{n}{M} \right\rceil$, where $M=16$ and $n=16$ are the parameters specified in the corresponding requirements sections, under Note 2. This gives the total RSTD measurement time of 5120 ms for Cell 2 and Cell 3 with respect to the reference Cell 1.

A.8.13.14 E-UTRAN TDD inter-frequency RSTD measurement period test case in CE Mode B with longer PRS occasions

A.8.13.14.1 Test Purpose and Environment

The purpose of the test is to verify for Cat-M1 and Cat-M2 UE in CE Mode B that the RSTD measurement meets the requirements specified in Sections 8.13.3.7.2 and 8.16.3.2.2, respectively, in an environment with fading propagation conditions. The test is applicable for Cat-M1 and Cat-M2 UE supporting measurement gaps specified in Table 8.1.2.1-3. Test 1 is applicable for Cat-M1 and Cat-M2 supporting and configured with 1.4 MHz UE RF bandwidth, while Test 2 is applicable for Cat-M2 supporting and configured with 5 MHz UE RF bandwidth.

In the test there are three synchronous cells: Cell 1, Cell 2 and Cell 3. Cell 1 is the reference as well as the PCell. Cell 2 and Cell 3 are the neighbour cells. Cell 1 is on FDD RF channel 1. Cell 2 and Cell 3 are on a TDD RF channel 2.

The UE requires measurement gaps to perform inter-frequency measurements. Gap pattern configuration rstd15 and rstd10 as defined in Table 8.1.2.1-3 is provided to the UE in Test 1 and Test 2, respectively, and configured to not overlap with PRS subframes of Cell 1. Each test consists of three consecutive time intervals, with duration of T1, T2 and T3. Cell 1 is active in T1, T2 and T3, whilst Cell 2 and Cell 3 are activated only in the beginning of T2. Cell 2 is active until the end of T3, and Cell 3 is active until the end of T2. The beginning of the time interval T2 shall be aligned with the first PRS positioning subframe of a positioning occasion in the reference cell, where the PRS positioning occasion is as defined in Clause 8.1.2.5.1. Cell 1 transmits PRS in T2, while Cell 2 transmits PRS only in T3, and Cell 3 transmits PRS only in T2. Note: The information on when PRS is muted is conveyed to the UE using PRS muting information.

The OTDOA assistance data as defined in TS 36.355 [24], Clause 6.5.1, shall be provided to the UE during T1. The last TTI containing the OTDOA assistance data shall be provided to the UE ΔT ms before the start of T2, where $\Delta T = 150$ ms is the maximum processing time of the OTDOA assistance data. The measurement gap configuration is known and configured in the UE at the start of T1. DRX is configured before T2.

The test parameters are as given in Table A.8.13.14.1-1, Table A.8.13.14.1-2, Table A.8.13.14.1-3 and Table A.8.13.14.1-4.

Table A.8.13.14.1-1: General test parameters for E-UTRAN TDD inter-frequency RSTD measurement reporting delay under fading propagation conditions

Parameter	Unit	Value		Comment
		Test 1	Test 2	
Reference cell		Cell 1		Reference cell is the cell in the OTDOA assistance data with respect to which the RSTD measurement is defined, as specified in TS 36.214 [4] and TS 36.355 [24]. The reference cell is the PCell in this test case.
Neighbor cells		Cell 2 and Cell 3		Cell 2 and Cell 3 appear at random places in the neighbour cell list in the OTDOA assistance data, but Cell 2 always appears in the first half of the list, whilst Cell 3 appears in the second half of the list.

MPDCCH		DL Reference Measurement Channel R.16 TDD		As specified in clause A.3.1.3
$mPDCCH\text{-startSF}\text{-UESS}$		10		Parameter G in which determines subframe $k0$ in which MPDCCH starts in the serving cell.
System Channel Bandwidth (BW_{channel})	MHz	10		
Gap pattern Id		rstd15	rstd10	As specified in Table 8.1.2.1-3. Applies for measurements on Cell 2 and Cell 3
Gap offset		131		As specified in TS 36.331 [2], Clause 6.3.5
PRS Transmission Bandwidth	RB	50 ^{Note 1}		PRS are transmitted over the system bandwidth
PRS configuration index I_{PRS}		Cell 1: 532, Cell 2, Cell 3: 612		This corresponds to periodicity of 640 ms and PRS subframe offset of $I_{\text{PRS}} - 480$ DL subframes, as defined in TS 36.211 [16], Table 6.10.4.3-1
Number of consecutive downlink positioning subframes N_{PRS}		30	8	As defined in TS 36.211 [16]. The number of subframes in a positioning occasion. Corresponds to parameter $add\text{-}numDL\text{-}Frames$ in TS 36.355 [24], for UE with <i>additional-prs-config</i> capability
		40	10	As defined in TS 36.211 [16]. The number of subframes in a positioning occasion. Corresponds to parameter $add\text{-}numDL\text{-}Frames$ in TS 36.355 [24], for UE with <i>densePrsConfig</i> capability
Physical cell ID PCI		(PCI of Cell 1 – PCI of Cell 2) mod 6 = 0 and (PCI of Cell 1 – PCI of Cell 3) mod 6 = 0		The cell PCIs are selected such that the relative shifts of PRS patterns among cells are as given by the test parameters
TDD uplink-downlink configuration		2	1	As specified in TS 36.211 [16], Clause 4.2; corresponds to a configuration with 5 ms switch-point periodicity and two downlink consecutive subframes
TDD special subframe configuration		6		As specified in TS 36.211 [16], Clause 4.2; corresponds to DwPTS of $19760 \cdot T_s$ and UpPTS of $4384 \cdot T_s$
CP length		Normal		
DRX		ON		DRX parameters are further specified in Table A.8.13.3.1-3
prs-SubframeOffset		80		Number of subframes rounded to the closest integer. The corresponding parameter in the OTDOA assistance data is prs-SubframeOffset specified in TS 36.355 [24]
slotNumberOffset		0		The slot number offset at the transmitter between a neighbour cell and the assistance data reference cell specified in TS 36.355 [24]
Radio frame receive time offset between the cells at the UE antenna connector	μs	Cell 2 to Cell 1: 1 Cell 3 to Cell 1: -1		PRS are transmitted from synchronous cells

Expected RSTD	µs	Cell 2: -2 Cell 3: 2 Other neighbour cells: randomly between -3 and 3	The expected RSTD is what is expected at the receiver. The corresponding parameter in the OTDOA assistance data specified in TS 36.355 [24] is the expectedRSTD indicator
Expected RSTD uncertainty for all neighbour cells	µs	5	The corresponding parameter in the OTDOA assistance data specified in TS 36.355 [24] is the expectedRSTD-Uncertainty index
Number of cells provided in OTDOA assistance data		16	The list includes the reference cell (received in <i>OTDOA-ReferenceCellInfo</i> [24]) on RF channel 1 and 15 other cells on RF channel 2, all received in <i>OTDOA-ProvideAssistanceData</i> [24].
PRS muting info		Cell 1: '1111111100000000' Cell 2: '0000000011111111' Cell 3: '1111111100000000'	Corresponds to prs-MutingInfo defined in TS 36.355 [24]
T1	s	3	The length of the time interval from the beginning of each test
T2	s	5.12	The length of the time interval that follows immediately after time interval T1
T3	s	5.12	The length of the time interval that follows immediately after time interval T2
Note 1: If the PRS transmission bandwidth is larger than the UE RF bandwidth, the UE is measuring RSTD within its RF bandwidth.			

Table A.8.13.14.1-2: Cell-specific test parameters for E-UTRAN TDD inter-frequency RSTD measurement reporting delay under fading propagation conditions during T1

Parameter	Unit	Cell 1	Cell 2	Cell 3
E-UTRA RF Channel Number		1	2	2
Correlation Matrix and Antenna Configuration		1x1	1x1	1x1
OCNG patterns defined in A.3.2.1		OP.11 TDD	N/A	N/A
PBCH_RA	dB	0	N/A	N/A
PBCH_RB				
PSS_RA				
SSS_RA				
PCFICH_RB				
PHICH_RA				
PHICH_RB				
PDCCH_RA				
PDCCH_RB				
OCNG_RA ^{Note 1}				
OCNG_RB ^{Note 1}				
N_{oc} ^{Note 3}	dBm/ 15 kHz	-95		
PRS \hat{E}_s/N_{oc}	dB	-Infinity	-Infinity	-Infinity
I_0 ^{Note 4}	dBm/ 9 MHz	-67.22	-67.22	-67.22
\hat{E}_s/N_{oc}	dB	0	-Infinity	-Infinity
Propagation Condition		ETU30		

Note 1: OCNG shall be used such that active cell (Cell 1) is fully allocated and a constant total transmitted power spectral density is achieved for all OFDM symbols.

Note 2: The resources for uplink transmission are assigned to the UE prior to the start of time period T2.

Note 3: Interference from other cells and noise sources not specified in the test are assumed to be constant over subcarriers and time and shall be modelled as AWGN of appropriate power for N_{oc} to be fulfilled.

Note 4: I_o levels have been derived from other parameters and are given for information purpose. These are not settable test parameters.

Table A.8.13.14.1-3: Cell-specific test parameters for E-UTRAN TDD inter-frequency RSTD measurement reporting delay under fading propagation conditions during T2 and T3

Parameter	Unit	Cell 1		Cell 2		Cell 3	
		T2	T3	T2	T3	T2	T3
E-UTRA RF Channel Number		1		2		2	
Correlation Matrix and Antenna Configuration		1x1		1x1		1x1	
OCNG patterns defined in A.3.2.1		OP.11 TDD		OP.2 TDD		OP.2 TDD	N/A
PBCH_RA	dB	0		0		0	N/A
PBCH_RB							
PSS_RA							
SSS_RA							
PCFICH_RB							
PHICH_RA							
PHICH_RB							
PDCCH_RA							
PDCCH_RB							
OCNG_RA ^{Note 1}							
OCNG_RB ^{Note 1}							
PRS_RA	dB	-3	N/A	N/A	3	3	N/A
N_{oc} ^{Note 3}	dBm/15 kHz	-98	-95	-98	-95	-98	-95
$PRS \hat{E}_s / N_{oc}$	dB	-12	-Infinity	-Infinity	-13	-14	-Infinity
$PRS \hat{E}_s / I_{ot}$ ^{Note 4}	dB	-12	-Infinity	-Infinity	-13	-14	-Infinity
I_o ^{Note 4}	dBm/9 MHz	-70.17	-67.13	-70.19	-70.18	-70.19	-70.18
PRP ^{Note 4}	dBm/15 kHz	-110	-Infinity	-Infinity	-108	-112	-Infinity
RSRP ^{Note 4}	dBm/15 kHz	-110	-110	-114	-108	-112	-Infinity
\hat{E}_s / N_{oc} ^{Note 4}	dB	-9	-9	-14	-13	-14	-Infinity
Propagation Condition		ETU30					

Note 1:	OCNG shall be used such that active cells (all, except Cell 3 in T3) are fully allocated and a constant total transmitted power spectral density is achieved for all OFDM symbols other than those in the subframes with transmitted PRS.
Note 2:	The resources for uplink transmission are assigned to the UE prior to the start of time period T2.
Note 3:	Interference from other cells and noise sources not specified in the test are assumed to be constant over subcarriers and time and shall be modelled as AWGN of appropriate power for N_{oc} to be fulfilled.
Note 4:	If PRS_RA is not "N/A", \hat{E}_s/N_{oc} , PRS \hat{E}_s/I_{ot} , I_o , RSRP and PRP levels have been derived from other parameters and are given for information purpose. If PRS_RA is "N/A", I_o and RSRP levels have been derived from other parameters and are given for information purpose. These are not settable test parameters. Interference conditions shall be applied to all PRS symbols of DL positioning subframes.

Table A.8.13.14.1-4: DRX parameters for the test of E-UTRAN TDD intre-frequency RSTD measurement reporting delay under fading propagation conditions

Field	Value	Comment
onDurationTimer	psf1	As specified in TS 36.331 [2], Clause 6.3.2
Drx-InactivityTimer	psf1	
drx-RetransmissionTimer	sf1	
longDRX-CycleStartOffset	sf320	
shortDRX	Disable	

A.8.13.14.2 Test Requirements

For Cat-M1 UE in CE Mode B, the RSTD measurement time fulfils the requirements specified in Clause 8.13.3.7.2.

For Cat-M2 UE in CE Mode B, the RSTD measurement time fulfils the requirements specified in Clause 8.16.3.2.2.

In Test 1, the UE configured with 1.4 MHz RF bandwidth shall perform and report the RSTD measurements for Cell 2 and Cell 3 with respect to the reference cell in the OTDOA assistance data, Cell 1, within 10240 ms starting from the beginning of time interval T2.

In Test 2, the UE configured with 5 MHz RF bandwidth shall perform and report the RSTD measurements for Cell 2 and Cell 3 with respect to the reference cell in the OTDOA assistance data, Cell 1, within 10240 ms starting from the beginning of time interval T2. The rate of the correct events for each neighbour cell observed during repeated tests shall be at least 90%, where the reported RSTD measurement for each correct event shall be within the RSTD reporting range specified in Clause 9.1.10.3, i.e., between RSTD_0000 and RSTD_12711.

NOTE: The RSTD measurement time in the test is derived from the following expression, $T_{PRS}(M - 1) + 640 \cdot \left\lfloor \frac{n}{M} \right\rfloor$, where $M=16$ and $n=16$ are the parameters specified in the corresponding requirements sections, under Note 2. This gives the total RSTD measurement time of 10240 ms for Cell 2 and Cell 3 with respect to the reference Cell 1.

A.8.14 E-UTRAN TDD - FDD Inter-frequency Measurements

A.8.14.1 E-UTRAN TDD-FDD Inter-frequency event triggered reporting under fading propagation conditions in asynchronous cells

A.8.14.1.1 Test Purpose and Environment

The purpose of this test is to verify that the UE makes correct reporting of an event. This test will partly verify the TDD-FDD inter-frequency cell search requirements in clause 8.1.2.3.3.

The test parameters are given in Tables A.8.14.1.1-1 and A.8.14.1.1-2. In this test, there are two cells on different carrier frequencies and gap pattern configuration # 0 as defined in Table 8.1.2.1-1 is provided.

In the measurement control information, it is indicated to the UE that event-triggered reporting with Event A3 is used. The test consists of two successive time periods, with time duration of T1, and T2 respectively. During time duration T1, the UE shall not have any timing information of cell 2.

Table A.8.14.1.1-1: General test parameters for E-UTRAN TDD-FDD inter-frequency event triggered reporting in fading propagation conditions

Parameter	Unit	Value	Comment
Cell 1 PDSCH parameters		DL Reference Measurement Channel R.0 TDD	As specified in clause A.3.1.1.2
Cell 1 PCFICH/PDCCH/PHICH parameters		DL Reference Measurement Channel R.6 TDD	As specified in clause A.3.1.2.2
Cell1 Special subframe configuration		6	As specified in table 4.2-1 in TS 36.211.
Cell1 Uplink-downlink configuration		1	As specified in TS 36.211 clause 4.2 Table 4.2-2.
Cell 2 PCFICH/PDCCH/PHICH parameters		DL Reference Measurement Channel R.6 FDD	As specified in clause A.3.1.2.1
Cell 1 E-UTRA TDD RF Channel Number		1	One TDD carrier frequency is used.
Cell 2 E-UTRA FDD RF Channel Number		2	One FDD carrier frequency is used.
Channel Bandwidth (BW _{channel})	MHz	10	
Active cell		Cell 1	Cell 1 is on RF channel number 1
Neighbour cell		Cell 2	Cell 2 is on RF channel number 2
Gap Pattern Id		0	As specified in TS 36.133 clause 8.1.2.1.
A3-Offset	dB	-6	
Hysteresis	dB	0	
CP length		Normal	
TimeToTrigger	s	0	
Filter coefficient		0	L3 filtering is not used
DRX		OFF	OFF
Time offset between cells		3 ms	Asynchronous cells
T1	s	5	
T2	s	5	

Table A.8.14.1.1-2: Cell specific test parameters for E-UTRAN TDD-FDD inter-frequency event triggered reporting under fading propagation conditions in asynchronous cells

Parameter	Unit	Cell 1		Cell 2	
		T1	T2	T1	T2
E-UTRA RF Channel Number		1		2	
$BW_{channel}$	MHz	10		10	
Correlation Matrix and Antenna Configuration		1x2 Low		1x2 Low	
OCNG Patterns defined in A.3.2.2.1 (OP.1 TDD) and in A.3.2.1.2 (OP.2 FDD)		OP.1 TDD		OP.2 FDD	
PBCH_RA	dB	0		0	
PBCH_RB	dB				
PSS_RA	dB				
SSS_RA	dB				
PCFICH_RB	dB				
PHICH_RA	dB				
PHICH_RB	dB				
PDCCH_RA	dB				
PDCCH_RB	dB				
PDSCH_RA	dB				
PDSCH_RB	dB				
OCNG_RA ^{Note 1}	dB				
OCNG_RB ^{Note 1}	dB				
N_{oc} ^{Note 3}	dBm/15 kHz				
RSRP ^{Note 4}	dBm/15 kHz	-94	-94	-Infinity	-91
\hat{E}_s/I_{ot}	dB	4	4	-Infinity	7
SCH_RP ^{Note 4}	dBm/15 kHz	-94	-94	-Infinity	-91
\hat{E}_s/N_{oc}	dB	4	4	-Infinity	7
Propagation Condition		ETU70			
<p>Note 1: OCNG shall be used such that both cells are fully allocated and a constant total transmitted power spectral density is achieved for all OFDM symbols.</p> <p>Note 2: The resources for uplink transmission are assigned to the UE prior to the start of time period T2.</p> <p>Note 3: Interference from other cells and noise sources not specified in the test is assumed to be constant over subcarriers and time and shall be modelled as AWGN of appropriate power for N_{oc} to be fulfilled.</p> <p>Note 4: RSRP and SCH_RP levels have been derived from other parameters for information purposes. They are not settable parameters themselves.</p>					

A.8.14.1.2 Test Requirements

The UE shall send one Event A3 triggered measurement report, with a measurement reporting delay less than 3840 ms from the beginning of time period T2.

The UE shall not send event triggered measurement reports, as long as the reporting criteria are not fulfilled.

The rate of correct events observed during repeated tests shall be at least 90%.

NOTE: The actual overall delays measured in the test may be up to $2xTTI_{DCCH}$ higher than the measurement reporting delays above because of TTI insertion uncertainty of the measurement report in DCCH.

A.8.14.2 E-UTRAN TDD-FDD Inter-frequency event triggered reporting when DRX is used under fading propagation conditions in asynchronous cells

A.8.14.2.1 Test Purpose and Environment

The purpose of these tests is to verify that the UE makes correct reporting of an event in DRX. These test will partly verify the TDD-FDD inter-frequency cell search requirements when DRX is used in clause 8.1.2.3.

The common test parameters are given in Tables A.8.14.2.1-1 and A.8.14.2.1-2. DRX configuration for Test1 and Test2 are given in Table A.8.14.2.1-3 and time alignment timer and scheduling request related parameters in Table A.8.14.2.1-4. In these tests, there are two cells on different carrier frequencies and gap pattern configuration # 0 as defined in Table 8.1.2.1-1 is provided.

In Test 1 UE needs to be provided at least once every 500ms with new Timing Advance Command MAC control element to restart the Time alignment timer to keep UE uplink time alignment. Furthermore UE is allocated with PUSCH resource at every DRX cycle. In Test 2 the uplink time alignment is not maintained and UE needs to use RACH to obtain UL allocation for measurement reporting.

In the measurement control information, it is indicated to the UE that event-triggered reporting with Event A3 is used. The tests consist of two successive time periods, with time duration of T1, and T2 respectively. During time duration T1, the UE shall not have any timing information of cell 2.

Table A.8.14.2.1-1: General test parameters for E-UTRAN TDD-FDD inter-frequency event triggered reporting when DRX is used in fading propagation conditions

Parameter	Unit	Test 1	Test 2	Comment
		Value		
Cell1 PDSCH parameters		DL Reference Measurement Channel R.0 TDD		As specified in clause A.3.1.1.2. Note that UE may only be allocated at <i>On Duration</i>
Cell1PCFICH/PDCCH/PHICH parameters		DL Reference Measurement Channel R.6 TDD		As specified in clause A.3.1.2.2.
Cell2 PDSCH parameters		DL Reference Measurement Channel R.0 FDD		As specified in clause A.3.1.1.1. Note that UE may only be allocated at <i>On Duration</i>
Cell2PCFICH/PDCCH/PHICH parameters		DL Reference Measurement Channel R.6 FDD		As specified in clause A.3.1.2.1.
E-UTRA RF Channel Number		1		one TDD carrier frequencies is used.
E-UTRA RF Channel Number		2		one FDD carrier frequencies is used.
Channel Bandwidth ($BW_{channel}$)	MHz	10		
Active cell		Cell 1		Cell 1 is on RF channel number 1
Neighbour cell		Cell 2		Cell 2 is on RF channel number 2
Gap Pattern Id		0		As specified in TS 36.133 clause 8.1.2.1.
Cell1 Uplink-downlink configuration		1		As specified in TS 36.211 clause 4.2 Table 4.2-2
Cell1 Special subframe configuration		6		As specified in table 4.2-1 in TS 36.211. The same configuration in both cells
A3-Offset	dB	-6		
Hysteresis	dB	0		
CP length		Normal		
TimeToTrigger	s	0		
Filter coefficient		0		L3 filtering is not used
PRACH configuration		4		As specified in table 5.7.1-3 in TS 36.211
Access Barring Information	-	Not Sent		No additional delays in random access procedure.
DRX		ON		DRX related parameters are defined in Table A.8.14.2.1-3
Time offset between cells		3 ms		Asynchronous cells
T1	s	5		
T2	s	5	30	

Table A.8.14.2.1-2: Cell specific test parameters for E-UTRAN TDD-FDD inter-frequency event triggered reporting under fading propagation conditions in asynchronous cells

Parameter	Unit	Cell 1		Cell 2	
		T1	T2	T1	T2
E-UTRA RF Channel Number		1		2	
$BW_{channel}$	MHz	10		10	
Correlation Matrix and Antenna Configuration		1x2 Low		1x2 Low	
OCNG Patterns defined in A.3.2.2.1 (OP.1 TDD) and in A.3.2.1.2 (OP.2 FDD)		OP.1 TDD		OP.2 FDD	
PBCH_RA	dB	0		0	
PBCH_RB	dB				
PSS_RA	dB				
SSS_RA	dB				
PCFICH_RB	dB				
PHICH_RA	dB				
PHICH_RB	dB				
PDCCH_RA	dB				
PDCCH_RB	dB				
PDSCH_RA	dB				
PDSCH_RB	dB				
OCNG_RA ^{Note 1}	dB				
OCNG_RB ^{Note 1}	dB				
N_{oc} ^{Note 2}	dBm/15 kHz	-98			
RSRP ^{Note 3}	dBm/15 kHz	-94	-94	-Infinity	-91
\hat{E}_s/I_{ot}	dB	4	4	-Infinity	7
SCH_RP ^{Note 3}	dBm/15 kHz	-94	-94	-Infinity	-91
\hat{E}_s/N_{oc}	dB	4	4	-Infinity	7
Propagation Condition		ETU70			
Note 1: OCNG shall be used such that both cells are fully allocated and a constant total transmitted power spectral density is achieved for all OFDM symbols. Note 2: Interference from other cells and noise sources not specified in the test is assumed to be constant over subcarriers and time and shall be modelled as AWGN of appropriate power for N_{oc} to be fulfilled. Note 3: RSRP and SCH_RP levels have been derived from other parameters for information purposes. They are not settable parameters themselves.					

Table A.8.14.2.1-3: drx-Configuration to be used in E-UTRAN TDD-FDD inter-frequency event triggered reporting when DRX is used in fading propagation conditions

Field	Test1	Test2	Comment
	Value	Value	
onDurationTimer	psf1	psf1	
drx-InactivityTimer	psf1	psf1	
drx-RetransmissionTimer	psf1	psf1	
longDRX-CycleStartOffset	sf40	sf1280	
shortDRX	disable	disable	

Table A.8.14.2.1-4: TimeAlignmentTimer and sr-ConfigIndex -Configuration to be used in E-UTRAN TDD-FDD inter-frequency event triggered reporting when DRX is used in fading propagation conditions

Field	Test1	Test2	Comment
	Value	Value	
TimeAlignmentTimer	sf500	sf500	For further information see clause 6.3.2 in TS 36.331.

sr-ConfigIndex	2	2	For further information see clause 6.3.2 in TS 36.331 and 10.1 in TS 36.213.
----------------	---	---	--

A.8.14.2.2 Test Requirements

In Test1 the UE shall send one Event A3 triggered measurement report, with a measurement reporting delay less than 3840 ms from the beginning of time period T2. The measurement reporting delay is defined as the time from the beginning of time period T2, to the moment when the UE send the measurement report on PUSCH.

In Test2 the UE shall send one Event A3 triggered measurement report, with a measurement reporting delay less than 20*1280ms from the beginning of time period T2. The measurement reporting delay is defined as the time from the beginning of time period T2, to the moment when the UE starts to send preambles on the PRACH for scheduling request (SR) to obtain allocation to send the measurement report on PUSCH.

The UE shall not send event triggered measurement reports, as long as the reporting criteria are not fulfilled.

The rate of correct events observed during repeated tests shall be at least 90%.

NOTE 1: The actual overall delays measured in the test may be up to one DRX cycle higher than the measurement reporting delays above because UE is allowed to delay the initiation of the measurement reporting procedure to the next until the Active Time.

NOTE 2: In order to calculate the rate of correct events the system simulator shall verify that it has received correct Event A3 measurement report

A.8.14.3 E-UTRAN TDD - FDD Inter-frequency identification of a new CGI of E-UTRA cell using autonomous gaps

A.8.14.3.1 Test Purpose and Environment

This test is to verify the requirement for identification of a new CGI of E-UTRA cell with autonomous gaps in clause 8.1.2.3.6.

The test scenario comprises of one E-UTRA FDD carriers and one cell on each carrier as given in tables A.8.14.3.1-1 and A.8.14.3.1-2. PDCCHs indicating new transmissions shall be sent continuously to ensure that the UE would have ACK/NACK sending during identifying a new CGI of E-UTRAN cell. The test consists of three successive time periods, with time durations of T1, T2 and T3 respectively. At the start of time duration T1, the UE does not have any timing information of cell 2. Starting T2, cell 2 becomes detectable and the UE is expected to detect and send a measurement report. Gap pattern configuration with id #0 as specified in Table 8.1.2.1-1 is configured before T2 begins to enable inter-frequency monitoring.

A RRC message implying SI reading shall be sent to the UE during period T2, after the UE has reported Event A3. The RRC message shall create a measurement report configuration with purpose *reportCGI* and *si-RequestForHO* set to TRUE. The start of T3 is the instant when the last TTI containing the RRC message implying SI reading is sent to the UE. Measurement gaps shall be deconfigured before the start of T3.

Table A.8.14.3.1-1: General test parameters for E-UTRAN TDD - FDD Inter-frequency identification of a new CGI of E-UTRA cell using autonomous gaps

Parameter	Unit	Value	Comment
Cell1PDSCH parameters		DL Reference Measurement Channel R.0 TDD	As specified in clause A.3.1.1.2
Cell1 PCFICH/PDCCH/PHICH parameters		DL Reference Measurement Channel R.6 TDD	As specified in clause A.3.1.2.2
Cell2 PDSCH parameters		DL Reference Measurement Channel R.0 FDD	As specified in clause A.3.1.1.1
Cell2 PCFICH/PDCCH/PHICH parameters		DL Reference Measurement Channel R.6 FDD	As specified in clause A.3.1.2.1
Cell1 E-UTRA RF channel number		1	One TDD carrier is used
Cell2 E-UTRA RF channel number		2	One FDD carrier is used
Channel Bandwidth (BW _{channel})	MHz	10	
Active cell		Cell 1	Cell 1 is on RF channel number 1.
Neighbour cell		Cell 2	Cell 1 is on RF channel number 2.

CP length		Normal	
Cell1 special subframe configuration		6	As specified in table 4.2-1 in TS 36.211.
Cell1 Uplink-downlink configuration		1	As specified in table 4.2-2 in TS 36.211.
Gap Pattern Id		0	As specified in 3GPP TS 36.133 section 8.1.2.1.
A3-Offset	dB	-6	
Hysteresis	dB	0	
TimeToTrigger	s	0	
Filter coefficient		0	L3 filtering is not used
DRX		OFF	
si-RequestForHO		TRUE	As specified in clause 5.5.3.1 in TS 36.331.
Time offset between cells	ms	3	Asynchronous cells
T1	s	5	
T2	s	≤10	
T3	s	5	

Table A.8.14.3.1-2: Cell specific test parameters for E-UTRAN TDD - FDD Inter-frequency identification of a new CGI of E-UTRA cell using autonomous gaps

Parameter	Unit	Cell 1			Cell 2		
		T1	T2	T3	T1	T2	T3
E-UTRA RF Channel Number		1			2		
BW _{channel}	MHz	10			10		
OCNG Patterns defined in A.3.2.2.1 (OP.1 TDD) and in A.3.2.1.2 (OP.2 FDD)		OP.1 TDD	OP.1 TDD	OP.1 TDD	OP.2 FDD	OP.2 FDD	OP.2 FDD
PBCH_RA	dB	0			0		
PBCH_RB	dB						
PSS_RA	dB						
SSS_RA	dB						
PCFICH_RB	dB						
PHICH_RA	dB						
PHICH_PB	dB						
PDCCH_RA	dB						
PDCCH_PB	dB						
PDSCH_RA	dB						
PDSCH_RB	dB						
OCNG_RA ^{Note 1}	dB						
OCNG_RB ^{Note 1}	dB						
\hat{E}_s/I_{ot}	dB	4	4	4	-Infinity	7	7
N_{oc} ^{Note 2}	dBm/15 KHz	-98					
\hat{E}_s/N_{oc}	dB	4	4	4	-Infinity	7	7
RSRP ^{Note 3}	dBm/15 KHz	-94	-94	-94	-Infinity	-91	-91
SCH_RP ^{Note3}	dBm/15 KHz	-94	-94	-94	-Infinity	-91	-91
Propagation Condition		AWGN					
Note 1:	OCNG shall be used such that both cells are fully allocated and a constant total transmitted power spectral density is achieved for all OFDM symbols.						
Note 2:	Interference from other cells and noise sources not specified in the test is assumed to be constant over subcarriers and time and shall be modelled as AWGN of appropriate power for N_{oc} to be fulfilled.						
Note 3:	RSRP and SCH_RP levels have been derived from other parameters for information purposes. They are not settable parameters themselves.						

A.8.14.3.2 Test Requirements

The UE shall transmit a measurement report containing the cell global identifier of cell 2 within 170 milliseconds from the start of T3.

$$\begin{aligned} \text{Test requirement} &= \text{RRC Procedure delay} + T_{\text{identify_CGI_inter}} + \text{reporting delay} \\ &= 15 + 150 + 2\text{ms from the start of } T_3 \\ &= 167 \text{ ms, allow } 170 \text{ ms.} \end{aligned}$$

The UE shall be scheduled continuously throughout the test, and from the start of T3 until 170 ms at least 42 ACK/NACK shall be detected as being transmitted by the UE.

The rate of correct events observed during repeated tests shall be at least 90%.

NOTE: The overall 42 ACK/NACK number is caused by two parts. Firstly, at least 30 ACK/NACK shall be sent during identifying the cell global identifier of cell 2 according to the requirement in Clause 8.1.2.3.7.1. Secondly, given that continuous DL data allocation, and the measurement gaps have been deconfigured before the start of T3, additional 12 ACK/NACK shall be sent from the start of T3 until 170 ms excludes 150 ms for identifying the cell global identifier of cell 2.

A.8.15 E-UTRAN FDD - TDD Inter-frequency Measurements

A.8.15.1 E-UTRAN FDD-TDD Inter-frequency event triggered reporting under fading propagation conditions in asynchronous cells

A.8.15.1.1 Test Purpose and Environment

The purpose of this test is to verify that the UE makes correct reporting of an event. This test will partly verify the FDD-TDD inter-frequency cell search requirements in clause 8.1.2.3.4.

The test parameters are given in Table A.8.15.1.1-1 and A.8.15.1.1-2 below. In the measurement control information it is indicated to the UE that event-triggered reporting with Event A3 is used. The test consists of two successive time periods, with time duration of T1, and T2 respectively. During time duration T1, the UE shall not have any timing information of cell 2.

Table A.8.15.1.1-1: General test parameters for E-UTRAN FDD-TDD inter-frequency event triggered reporting in fading propagation conditions

Parameter	Unit	Value	Comment
Cell 1 PDSCH parameters		DL Reference Measurement Channel R.0 FDD	As specified in clause A.3.1.1.1
Cell 1 PCFICH/PDCCH/PHICH parameters		DL Reference Measurement Channel R.6 FDD	As specified in clause A.3.1.2.1
Cell 2 PCFICH/PDCCH/PHICH parameters		DL Reference Measurement Channel R.6 TDD	As specified in clause A.3.1.2.2
Gap Pattern Id		1	As specified in TS 36.133 clause 8.1.2.1.
Cell2 Special subframe configuration		6	As specified in table 4.2-1 in TS 36.211. Applicable to Cell 2.
Cell2 Uplink-downlink configuration		1	As specified in TS 36.211 clause 4.2 Table 4.2-2. Applicable to Cell 2.
CP length		Normal	
Cell 1 E-UTRA FDD RF Channel Number		1	One TDD carrier frequency is used.
Cell 2 E-UTRA TDD RF Channel Number		2	One FDD carrier frequency is used.
Channel Bandwidth (BW _{channel})	MHz	10	
Active cell		Cell 1	Cell 1 is on RF channel number 1
Neighbour cell		Cell 2	Cell 2 is on RF channel number 2
A3-Offset	dB	-6	
Hysteresis	dB	0	
TimeToTrigger	s	0	
Filter coefficient		0	L3 filtering is not used
DRX		OFF	
Time offset between cells		3 ms	Asynchronous cells

T1	s	5	
T2	s	10	

Table A.8.15.1.1-2: Cell specific test parameters for E-UTRAN FDD-TDD inter-frequency event triggered reporting under fading propagation conditions in synchronous cells

Parameter	Unit	Cell 1		Cell 2	
		T1	T2	T1	T2
E-UTRA RF Channel Number		1		2	
BW _{channel}	MHz	10		10	
Correlation Matrix and Antenna Configuration		1x2 Low		1x2 Low	
OCNG Pattern defined in A.3.2.1.1 (OP.1 FDD) and in A.3.2.2.2 (OP.2 TDD)		OP.1 FDD		OP.2 TDD	
PBCH_RA	dB	0		0	
PBCH_RB	dB				
PSS_RA	dB				
SSS_RA	dB				
PCFICH_RB	dB				
PHICH_RA	dB				
PHICH_RB	dB				
PDCCH_RA	dB				
PDCCH_RB	dB				
PDSCH_RA	dB				
PDSCH_RB	dB				
OCNG_RA ^{Note 1}	dB				
OCNG_RB ^{Note 1}	dB				
\hat{E}_s/I_{ot}	dB	4	4	-Infinity	7
N_{oc} ^{Note 3}	dBm/15 kHz	-98			
RSRP ^{Note 4}	dBm/15 kHz	-94	-94	-Infinity	-91
SCH_RP ^{Note 4}	dBm/15 kHz	-94	-94	-infinity	-91
\hat{E}_s/N_{oc}	dB	4	4	-Infinity	7
Propagation Condition		ETU70			
<p>Note 1: OCNG shall be used such that both cells are fully allocated and a constant total transmitted power spectral density is achieved for all OFDM symbols.</p> <p>Note 2: The resources for uplink transmission are assigned to the UE priori to the start of time period T2.</p> <p>Note 3: Interference from other cells and noise sources not specified in the test is assumed to be constant over subcarriers and time and shall be modelled as AWGN of appropriate power for N_{oc} to be fulfilled.</p> <p>Note 4: RSRP and SCH_RP levels have been derived from other parameters for information purposes. They are not settable parameters themselves.</p>					

A.8.15.1.2 Test Requirements

The UE shall send one Event A3 triggered measurement report, with a measurement reporting delay less than 7680 ms from the beginning of time period T2.

The UE shall not send event triggered measurement reports, as long as the reporting criteria are not fulfilled.

The rate of correct events observed during repeated tests shall be at least 90%.

NOTE: The actual overall delays measured in the test may be up to $2 \times TTI_{DCC}$ higher than the measurement reporting delays above because of TTI insertion uncertainty of the measurement report in DCC

A.8.15.2 E-UTRAN FDD-TDD Inter-frequency event triggered reporting when DRX is used under fading propagation conditions in asynchronous cells

A.8.15.2.1 Test Purpose and Environment

The purpose of these tests is to verify that the UE makes correct reporting of an event in DRX. These tests will partly verify the FDD-TDD inter-frequency cell search requirements when DRX is used in clause 8.1.2.3.4.

The common test parameters are given in Tables A.8.15.2.1-1 and A.8.15.2.1-2. DRX configuration for Test1 and Test2 are given in Table A.8.15.2.1-3 and time alignment timer and scheduling request related parameters in Table A.8.15.2.1-4. In these tests, there are two cells on different carrier frequencies and gap pattern configuration # 0 as defined in Table 8.1.2.1-1 is provided.

In Test 1 UE needs to be provided at least once every 500ms with new Timing Advance Command MAC control element to restart the Time alignment timer to keep UE uplink time alignment. Furthermore UE is allocated with PUSCH resource at every DRX cycle. In Test 2 the uplink time alignment is not maintained and UE needs to use RACH to obtain UL allocation for measurement reporting.

In the measurement control information, it is indicated to the UE that event-triggered reporting with Event A3 is used. The tests consist of two successive time periods, with time duration of T1, and T2 respectively. During time duration T1, the UE shall not have any timing information of cell 2.

Table A.8.15.2.1-1: General test parameters for E-UTRAN FDD-TDD inter-frequency event triggered reporting when DRX is used under fading propagation conditions in asynchronous cells

Parameter	Unit	Test 1	Test 2	Comment
		Value		
Cell 1 PDSCH parameters		DL Reference Measurement Channel R.0 FDD		As specified in clause A.3.1.1.1 Note that UE may only be allocated at <i>On Duration</i>
Cell 1 PCFICH/PDCCH/PHICH parameters		DL Reference Measurement Channel R.6 FDD		As specified in clause A.3.1.2.1.
Cell 2 PCFICH/PDCCH/PHICH parameters		DL Reference Measurement Channel R.6 TDD		As specified in clause A.3.1.2.2.
Cell 1 E-UTRA FDD RF Channel Number		1		One FDD carrier frequency is used.
Cell 2 E-UTRA TDD RF Channel Number		2		One TDD carrier frequency is used.
Channel Bandwidth ($BW_{channel}$)	MHz	10		
Active cell		Cell 1		Cell 1 is on RF channel number 1
Neighbour cell		Cell 2		Cell 2 is on RF channel number 2
Gap Pattern Id		0		As specified in TS 36.133 clause 8.1.2.1.
A3-Offset	dB	-6		
Hysteresis	dB	0		
CP length		Normal		
TimeToTrigger	s	0		
Filter coefficient		0		L3 filtering is not used
E-UTRA FDD PRACH configuration		4		As specified in table 5.7.1-2 in TS 36.211
Cell 2 Special subframe configuration		6		As specified in table 4.2-1 in TS 36.211
Cell 2 Uplink-downlink configuration		1		As specified in table 4.2-2 in TS 36.211
E-UTRA TDD Access Barring Information	-	Not Sent		No additional delays in random access procedure.
DRX		ON		DRX related parameters are defined in Table A.8.15.2.1-3
Time offset between cells	ms	3		Asynchronous cells
T1	s	5		
T2	s	5	30	

Table A.8.15.2.1-2: Cell specific test parameters for E-UTRAN FDD-TDD inter-frequency event triggered reporting when DRX is used under fading propagation conditions in asynchronous cells

Parameter	Unit	Cell 1		Cell 2	
		T1	T2	T1	T2
E-UTRA RF Channel Number		1		2	
$BW_{channel}$	MHz	10		10	
Correlation Matrix and Antenna Configuration		1x2 Low		1x2 Low	
OCNG Patterns defined in A.3.2.1.1 (OP.1 FDD) and in A.3.2.2.2 (OP.2 TDD)		OP.1 FDD		OP.2 TDD	
PBCH_RA	dB	0		0	
PBCH_RB	dB				
PSS_RA	dB				
SSS_RA	dB				
PCFICH_RB	dB				
PHICH_RA	dB				
PHICH_RB	dB				
PDCCH_RA	dB				
PDCCH_RB	dB				
PDSCH_RA	dB				
PDSCH_RB	dB				
OCNG_RA ^{Note 1}	dB				
OCNG_RB ^{Note 1}	dB				
N_{oc} ^{Note 2}	dBm/15 kHz	-98			
RSRP ^{Note 3}	dBm/15 kHz	-94	-94	-Infinity	-91
\hat{E}_s/I_{ot}	dB	4	4	-Infinity	7
SCH_RP ^{Note 3}	dBm/15 kHz	-94	-94	-Infinity	-91
\hat{E}_s/N_{oc}	dB	4	4	-Infinity	7
Propagation Condition		ETU70			
<p>Note 1: OCNG shall be used such that both cells are fully allocated and a constant total transmitted power spectral density is achieved for all OFDM symbols.</p> <p>Note 2: Interference from other cells and noise sources not specified in the test is assumed to be constant over subcarriers and time and shall be modelled as AWGN of appropriate power for N_{oc} to be fulfilled.</p> <p>Note 3: RSRP and SCH_RP levels have been derived from other parameters for information purposes. They are not settable parameters themselves.</p>					

Table A.8.15.2.1-3: drx-Configuration to be used in E-UTRAN FDD-TDD inter-frequency event triggered reporting when DRX is used under fading propagation conditions in asynchronous cells

Field	Test1	Test2	Comment
	Value	Value	
onDurationTimer	psf1	psf1	
drx-InactivityTimer	psf1	psf1	
drx-RetransmissionTimer	psf1	psf1	
longDRX-CycleStartOffset	sf40	sf1280	
shortDRX	disable	disable	

Note: For further information see clause 6.3.2 in TS 36.331.

Table A.8.15.2.1-4: TimeAlignmentTimer and sr-ConfigIndex -Configuration to be used in E-UTRAN FDD-TDD inter-frequency event triggered reporting when DRX is used under fading propagation conditions in asynchronous cells

Field	Test1	Test2	Comment
	Value	Value	
TimeAlignmentTimer	sf500	sf500	For further information see clause 6.3.2 in TS 36.331.

sr-ConfigIndex	0	0	For further information see clause 6.3.2 in TS 36.331 and section 10.1 in TS 36.213.
----------------	---	---	--

A.8.15.2.2 Test Requirements

In Test1 the UE shall send one Event A3 triggered measurement report, with a measurement reporting delay less than 3840 ms from the beginning of time period T2. The measurement reporting delay is defined as the time from the beginning of time period T2, to the moment when the UE send the measurement report on PUSCH.

In Test2 the UE shall send one Event A3 triggered measurement report, with a measurement reporting delay less than 20*1280ms from the beginning of time period T2. The measurement reporting delay is defined as the time from the beginning of time period T2, to the moment when the UE starts to send preambles on the PRACH for scheduling request (SR) to obtain allocation to send the measurement report on PUSCH.

The UE shall not send event triggered measurement reports, as long as the reporting criteria are not fulfilled.

The rate of correct events observed during repeated tests shall be at least 90%.

NOTE 1: The actual overall delays measured in the test may be up to one DRX cycle higher than the measurement reporting delays above because UE is allowed to delay the initiation of the measurement reporting procedure to the next until the Active Time.

NOTE 2: In order to calculate the rate of correct events the system simulator shall verify that it has received correct Event A3 measurement report.

A.8.15.3 E-UTRAN FDD - TDD Inter-frequency identification of a new CGI of E-UTRA cell using autonomous gaps

A.8.15.3.1 Test Purpose and Environment

This test is to verify the requirement for identification of a new CGI of E-UTRA cell with autonomous gaps in clause 8.1.2.3.8.

The test scenario comprises of one E-UTRA FDD carrier and one E-UTRA TDD carrier and one cell on each carrier as given in tables A.8.15.3-1 and A.8.15.3-2. PDCCHs indicating new transmissions shall be sent continuously to ensure that the UE would have ACK/NACK sending during identifying a new CGI of E-UTRAN cell. The test consists of three successive time periods, with time durations of T1, T2 and T3 respectively. At the start of time duration T1, the UE does not have any timing information of cell 2. Starting T2, cell 2 becomes detectable and the UE is expected to detect and send a measurement report. Gap pattern configuration with id #0 as specified in Table 8.1.2.1-1 is configured before T2 begins to enable inter-frequency monitoring.

A RRC message implying SI reading shall be sent to the UE during period T2, after the UE has reported Event A3. The RRC message shall create a measurement report configuration with purpose *reportCGI* and *si-RequestForHO* set to TRUE. The start of T3 is the instant when the last TTI containing the RRC message implying SI reading is sent to the UE. Measurement gaps shall be deconfigured before the start of T3.

Table A.8.15.3-1: General test parameters for E-UTRAN FDD - TDD Inter-frequency identification of a new CGI of E-UTRA cell using autonomous gaps

Parameter	Unit	Value	Comment
Cell1 PDSCH parameters		DL Reference Measurement Channel R.3 FDD	As specified in clause A.3.1.1.1
Cell1 PCFICH/PDCCH/PHICH parameters		DL Reference Measurement Channel R.6 FDD	As specified in clause A.3.1.2.1
Cell2 PCFICH/PDCCH/PHICH parameters		DL Reference Measurement Channel R.6 TDD	As specified in clause A.3.1.2.2
E-UTRA RF channel number		1, 2	One FDD and one TDD carrier frequency are used.
Channel Bandwidth ($BW_{channel}$)	MHz	10	
Active cell		Cell 1	Cell 1 is on RF channel number 1.
Neighbour cell		Cell 2	Cell 1 is on RF channel number 2.
CP length		Normal	

Cell 2 Special subframe configuration		6	As specified in table 4.2-1 in TS 36.211.
Cell 2 Uplink-downlink configuration		1	As specified in table 4.2-2 in TS 36.211.
Gap Pattern Id		0	As specified in TS 36.133 clause 8.1.2.1.
A3-Offset	dB	-6	
Hysteresis	dB	0	
TimeToTrigger	s	0	
Filter coefficient		0	L3 filtering is not used
DRX		OFF	
si-RequestForHO		TRUE	As specified in clause 5.5.3.1 in TS 36.331.
Time offset between cells	ms	3	Asynchronous cells
T1	s	5	
T2	s	≤10	
T3	s	5	

Table A.8.15.3-2: Cell specific test parameters for E-UTRAN FDD - TDD Inter-frequency identification of a new CGI of E-UTRA cell using autonomous gaps

Parameter	Unit	Cell 1			Cell 2		
		T1	T2	T3	T1	T2	T3
E-UTRA RF Channel Number		1			2		
BW _{channel}	MHz	10			10		
OCNG Patterns defined in A.3.2.1.10 (OP.10 FDD) and in A.3.2.2.1 (OP.2 TDD)		OP.10 FDD	OP.10 FDD	OP.10 FDD	OP.2 TDD	OP.2 TDD	OP.2 TDD
PBCH_RA	dB	0			0		
PBCH_RB	dB						
PSS_RA	dB						
SSS_RA	dB						
PCFICH_RB	dB						
PHICH_RA	dB						
PHICH_PB	dB						
PDCCH_RA	dB						
PDCCH_PB	dB						
PDSCH_RA	dB						
PDSCH_RB	dB						
OCNG_RA ^{Note 1}	dB						
OCNG_RB ^{Note 1}	dB						
\hat{E}_s/I_{ot}	dB	4	4	4	-Infinity	7	7
N_{oc} ^{Note 2}	dBm/15 KHz	-98					
\hat{E}_s/N_{oc}	dB	4	4	4	-Infinity	7	7
RSRP ^{Note 3}	dBm/15 KHz	-94	-94	-94	-Infinity	-91	-91
SCH_RP ^{Note 3}	dBm/15 KHz	-94	-94	-94	-Infinity	-91	-91
Propagation Condition		AWGN					
<p>Note 1: OCNG shall be used such that both cells are fully allocated and a constant total transmitted power spectral density is achieved for all OFDM symbols.</p> <p>Note 2: Interference from other cells and noise sources not specified in the test is assumed to be constant over subcarriers and time and shall be modelled as AWGN of appropriate power for N_{oc} to be fulfilled.</p> <p>Note 3: RSRP and SCH_RP levels have been derived from other parameters for information purposes. They are not settable parameters themselves.</p>							

A.8.15.3.2 Test Requirements

The UE shall transmit a measurement report containing the cell global identifier of cell 2 within 170 milliseconds from the start of T3.

$$\begin{aligned} \text{Test requirement} &= \text{RRC Procedure delay} + T_{\text{identify_CGI_inter}} + \text{reporting delay} \\ &= 15 + 150 + 2\text{ms from the start of } T_3 \\ &= 167 \text{ ms, allow } 170 \text{ ms.} \end{aligned}$$

The UE shall be scheduled continuously throughout the test, and from the start of T3 until 170 ms at least 60 ACK/NACK shall be detected as being transmitted by the UE.

The rate of correct events observed during repeated tests shall be at least 90%.

NOTE: The overall 80 ACK/NACK number is caused by two parts. Firstly, at least 60 ACK/NACK shall be sent during identifying the cell global identifier of cell 2 according to the requirement in Clause 8.1.2.3.5.1. Secondly, given that continuous DL data allocation, and the measurement gaps have been deconfigured before the start of T3, additional 20 ACK/NACK shall be sent from the start of T3 until 170 ms excludes 150 ms for identifying the cell global identifier of cell 2.

A.8.16 E-UTRAN Carrier Aggregation Measurements

A.8.16.1 E-UTRAN FDD event triggered reporting under deactivated SCell in non-DRX

A.8.16.1.1 Test Purpose and Environment

The purpose of this test is to verify that the UE correctly detects events A2 (Serving cell becomes worse than threshold) and A6 (Neighbour becomes better than SCell) defined in TS 36.331 [2] within the requirements stated in clause 8.3.3.2.1.

The test parameters are given in Tables A.8.16.1.1-1 and A.8.16.1.1-2 below. It is indicated to the UE in the measurement control information that event-triggered reporting with Events A2 (PCell and SCell) and A6 is used. The test consists of three successive time periods, with duration of T1, T2 and T3, respectively. During T1 the UE shall not have any information on cell 3. Immediately at beginning of T2 the transmission power of cell 3 is increased to same level as for cell 2, and due to usage of an offset this shall result in reporting of Event A6. At beginning of T3 the transmission powers of cells 1, 2 and 3 are reduced below a threshold value and this shall result in reporting of Event A2 for PCell and SCell, respectively.

Table A.8.16.1.1-1: General test parameters for E-UTRAN FDD event triggered reporting on configured but deactivated SCell in non-DRX under fading propagation conditions

Parameter	Unit	Value	Comment	
PDSCH parameters		DL Reference Measurement Channel R.0 FDD	As specified in clause A.3.1.1.1	
PCFICH/PDCCH/PHICH parameters		DL Reference Measurement Channel R.6 FDD	As specified in clause A.3.1.2.1	
E-UTRA RF Channel Number		1, 2	Two radio channels are used for this test	
Active PCell		Cell 1	Primary cell on RF channel number 1.	
Configured deactivated SCell		Cell 2	Configured deactivated secondary cell on RF channel number 2.	
Neighbour cell		Cell 3	Neighbor cell to be identified on RF channel number 2.	
Channel Bandwidth (BW _{channel})	MHz	10	Channel bandwidth for cells on primary and secondary component carriers	
CP length		Normal		
DRX		OFF	Continuous monitoring of primary cell	
A2	Hysteresis	dB	0	Hysteresis for evaluation of event A2.
	Threshold RSRP	dBm	-93	Actual RSRP threshold for event A2. Needs to take absolute accuracy tolerance in clause 9.1.11.1 into account plus margin.
	Time To Trigger	s	0	
A6	Hysteresis	dB	0	Hysteresis for evaluation of event A6.

	Offset	dB	-6	Offset parameter for evaluation of event A6. Needs to take relative accuracy tolerance in clause 9.1.11.2 into account plus margin.
	Report on leave		False	
	Time To Trigger	s	0	
Cell-individual offset for cells on RF channel number 1	dB	0		Individual offset for cells on primary component carrier.
Cell-individual offset for cells on RF channel number 2	dB	0		Individual offset for cells on secondary component carrier.
Filter coefficient		0		L3 filtering is not used
SCell measurement cycle (measCycleSCell)	ms	320		
Cell2 timing offset to cell1	μs	0		
Time alignment error between cell2 and cell1	μs	≤ Time alignment error as specified in TS 36.104 [30] clause 6.5.3.1.		The value of time alignment error depends upon the type of carrier aggregation.
Cell3 timing offset to cell1	μs	3		Synchronous cells
T1	s	5		During this time the UE shall be aware of cells 1 and 2 but not cell 3.
T2	s	≤12		UE shall report Event A6 within 6.4s (20×scellMeasCycle)
T3	s	5		UE shall report Event A2 within 200 ms and 1.6s for cells 1 and 2, respectively.
NOTE: This test verifies the RRM requirement which is independent of channel bandwidth and is performed according to the principle defined in section A.3.6.1.				

Table A.8.16.1.1-2: Cell specific test parameters for E-UTRAN FDD event triggered reporting on configured but deactivated SCell in non-DRX under fading propagation conditions

Parameter	Unit	Cell 1			Cell 2			Cell 3		
		T1	T2	T3	T1	T2	T3	T1	T2	T3
E-UTRA RF Channel Number		1			2			2		
BW _{channel}	MHz	10			10			10		
Correlation Matrix and Antenna Configuration		1x2 Low			1x2 Low			1x2 Low		
OCNG Patterns defined in A.3.2.1.1 (OP.1 FDD) and in A.3.2.1.2 (OP.2 FDD)		OP.1 FDD			OP.2 FDD			OP.2 FDD		
PBCH_RA	dB	0			0			0		
PBCH_RB	dB									
PSS_RA	dB									
SSS_RA	dB									
PCFICH_RB	dB									
PHICH_RA	dB									
PHICH_RB	dB									
PDCCH_RA	dB									
PDCCH_RB	dB									
PDSCH_RA	dB									
PDSCH_RB	dB									
OCNG_RA ^{Note 1}	dB	-101			-101			-infinity		
OCNG_RB ^{Note 1}	dB									
N _{oc} ^{Note 2}	dBm/15 kHz	-101			-101					
RSRP ^{Note 3}	dBm/15 kHz	-82	-82	-104	-82	-82	-104	-infinity	-82	-104
E _s /I _{ot}	dB	19	19	-3	19	-0.05	-4.76	-infinity	-0.05	-4.76
SCH_RP ^{Note 3}	dBm/15 kHz	-82	-82	-104	-82	-82	-104	-infinity	-82	-104
E _s /N _{oc}	dB	19	19	-3	19	19	-3	-infinity	19	-3
Propagation Condition		ETU70								

Note 1:	OCNG shall be used such that all cells are fully allocated and a constant total transmitted power spectral density is achieved for all OFDM symbols.
Note 2:	Interference from other cells and noise sources not specified in the test is assumed to be constant over subcarriers and time and shall be modelled as AWGN of appropriate power for N_{oc} to be fulfilled.
Note 3:	RSRP and SCH_RP levels have been derived from other parameters for information purposes. They are not settable parameters themselves.
Note 4:	The resources for uplink transmission are assigned to the UE prior to the start of time period T2.

A.8.16.1.2 Test Requirements

The UE shall send one Event A6 triggered measurement report with a measurement reporting delay of less than 6.4s ($20 \times \text{measCycleSCell}$) from the beginning of time T2.

The UE shall send one Event A2 triggered measurement report for Cell 1 with a measurement reporting delay of less than 200 ms from beginning of time T3.

The UE shall send one Event A2 triggered measurement report for Cell 2 with a measurement reporting delay of less than 1.6s ($5 \times \text{measCycleSCell}$) from beginning of time T3.

The UE shall not send event triggered measurement reports as long as the reporting criteria are not fulfilled.

The rate of correct events observed during repeated tests shall be at least 90% for each of the events.

NOTE: The actual overall delays measured in the tests may be up to $2 \times TTI_{DCCCH}$ higher than the measurement reporting delays above because of TTI insertion uncertainty of the measurement report in DCCCH.

A.8.16.2 E-UTRAN TDD event triggered reporting under deactivated SCell in non-DRX

A.8.16.2.1 Test Purpose and Environment

The purpose of this test is to verify that the UE correctly detects events A2 (Serving cell becomes worse than threshold) and A6 (Neighbour becomes better than SCell) defined in TS 36.331 [2] within the requirements stated in clause 8.3.3.2.1.

The test parameters are given in Tables A.8.16.2.1-1 and A.8.16.2.1-2 below. It is indicated to the UE in the measurement control information that event-triggered reporting with Events A2 (PCell and SCell) and A6 is used. The test consists of three successive time periods, with duration of T1, T2 and T3, respectively. During T1 the UE shall not have any information on cell 3. Immediately at beginning of T2 the transmission power of cell 3 is increased to same level as for cell 2, and due to usage of an offset this shall result in reporting of Event A6. At beginning of T3 the transmission powers of cells 1, 2 and 3 are reduced below a threshold value and this shall result in reporting of Event A2 for PCell and SCell, respectively.

Table A.8.16.2.1-1: General test parameters for E-UTRAN TDD event triggered reporting on configured but deactivated SCell in non-DRX under fading propagation conditions

Parameter	Unit	Value	Comment
PDSCH parameters		DL Reference Measurement Channel R.0 TDD	As specified in clause A.3.1.1.2
PCFICH/PDCCH/PHICH parameters		DL Reference Measurement Channel R.6 TDD	As specified in clause A.3.1.2.2
E-UTRA RF Channel Number		1, 2	Two radio channels are used for this test
Active PCell		Cell 1	Primary cell on RF channel number 1.
Configured deactivated SCell		Cell 2	Configured deactivated secondary cell on RF channel number 2.
Neighbour cell		Cell 3	Neighbor cell to be identified on RF channel number 2.
Channel Bandwidth (BW_{channel})	MHz	10	Channel bandwidth for cells on primary and secondary component carriers
CP length		Normal	
Special subframe configuration		6	As specified in table 4.2.1 in TS 36.211. The same configuration applies to all cells.

Uplink-downlink configuration			1	
DRX			OFF	Continuous monitoring of primary cell
A2	Hysteresis	dB	0	Hysteresis for evaluation of event A2.
	Threshold RSRP	dBm	-93	Actual RSRP threshold for event A2. Needs to take absolute accuracy tolerance in clause 9.1.11.1 into account plus margin.
	Time To Trigger	s	0	
A6	Hysteresis	dB	0	Hysteresis for evaluation of event A6.
	Offset	dB	-6	Offset parameter for evaluation of event A6. Needs to take relative accuracy tolerance in clause 9.1.11.2 into account plus margin.
	Report on leave		False	
	Time To Trigger	s	0	
Cell-individual offset for cells on RF channel number 1		dB	0	Individual offset for cells on primary component carrier.
Cell-individual offset for cells on RF channel number 2		dB	0	Individual offset for cells on secondary component carrier.
Filter coefficient			0	L3 filtering is not used
SCell measurement cycle (measCycleSCell)		ms	320	
Cell2 timing offset to cell1		µs	0	
Time alignment error between cell2 and cell1		µs	≤ Time alignment error as specified in TS 36.104 [30] clause 6.5.3.1.	The value of time alignment error depends upon the type of carrier aggregation.
Cell3 timing offset to cell1		µs	3	Synchronous cells
T1		s	5	During this time the UE shall be aware of cells 1 and 2 but not cell 3.
T2		s	≤12	UE shall report Event A6 within 6.4s (20xscellMeasCycle)
T3		s	5	UE shall report Event A2 within 200 ms and 1.6s for cells 1 and 2, respectively.
NOTE: This test verifies the RRM requirement which is independent of channel bandwidth and is performed according to the principle defined in section A.3.6.1.				

Table A.8.16.2.1-2: Cell specific test parameters for E-UTRAN TDD event triggered reporting on configured but deactivated SCell in non-DRX under fading propagation conditions

Parameter	Unit	Cell 1			Cell 2			Cell 3		
		T1	T2	T3	T1	T2	T3	T1	T2	T3
E-UTRA RF Channel Number		1			2			2		
BW _{channel}	MHz	10			10			10		
Correlation Matrix and Antenna Configuration		1x2 Low			1x2 Low			1x2 Low		
OCNG Patterns defined in A.3.2.2.1 (OP.1 TDD) and in A.3.2.2.2 (OP.2 TDD)		OP.1 TDD			OP.2 TDD			OP.2 TDD		
PBCH_RA	dB	0			0			0		
PBCH_RB	dB									
PSS_RA	dB									
SSS_RA	dB									
PCFICH_RB	dB									
PHICH_RA	dB									
PHICH_RB	dB									
PDCCH_RA	dB									
PDCCH_RB	dB									
PDSCH_RA	dB									
PDSCH_RB	dB									
OCNG_RA ^{Note 1}	dB	-101			-101					
OCNG_RB ^{Note 1}	dB									
N _{oc} ^{Note 2}	dBm/15 kHz									

RSRP ^{Note 3}	dBm/15 kHz	-82	-82	-104	-82	-82	-104	-infinity	-82	-104
\hat{E}_s/I_{ot}	dB	19	19	-3	19	-0.05	-4.76	-infinity	-0.05	-4.76
SCH_RP ^{Note 3}	dBm/15 kHz	-82	-82	-104	-82	-82	-104	-infinity	-82	-104
\hat{E}_s/N_{oc}	dB	19	19	-3	19	19	-3	-infinity	19	-3
Propagation Condition		ETU70								
Note 1:	OCNG shall be used such that all cells are fully allocated and a constant total transmitted power spectral density is achieved for all OFDM symbols.									
Note 2:	Interference from other cells and noise sources not specified in the test is assumed to be constant over subcarriers and time and shall be modelled as AWGN of appropriate power for N_{oc} to be fulfilled.									
Note 3:	RSRP and SCH_RP levels have been derived from other parameters for information purposes. They are not settable parameters themselves.									
Note 4:	The resources for uplink transmission are assigned to the UE prior to the start of time period T2.									

A.8.16.2.2 Test Requirements

The UE shall send one Event A6 triggered measurement report with a measurement reporting delay of less than 6.4s ($20 \times \text{measCycleSCell}$) from the beginning of time T2.

The UE shall send one Event A2 triggered measurement report for Cell 1 with a measurement reporting delay of less than 200 ms from beginning of time T3.

The UE shall send one Event A2 triggered measurement report for Cell 2 with a measurement reporting delay of less than 1.6s ($5 \times \text{measCycleSCell}$) from beginning of time T3.

The UE shall not send event triggered measurement reports as long as the reporting criteria are not fulfilled.

The rate of correct events observed during repeated tests shall be at least 90% for each of the events.

NOTE: The actual overall delays measured in the tests may be up to $2 \times TTI_{DCCCH}$ higher than the measurement reporting delays above because of TTI insertion uncertainty of the measurement report in DCCCH.

A.8.16.3 E-UTRAN FDD-FDD Event triggered reporting on deactivated SCell with PCell interruption in non-DRX

A.8.16.3.1 Test Purpose and Environment

The purpose of this test is to verify that the UE correctly detects event A6 (Neighbour becomes better than SCell) defined in TS 36.331 [2] within the requirements stated in clause 8.3.3.2.1 while at the same time fulfilling the requirement on interruption rate.

The test parameters are given in Table A.8.16.3.1-1 and A.8.16.3.1-2 below. In the test there are three synchronous cells: Cell1, Cell2 and Cell3. Cell1 is PCell, Cell2 is deactivated SCell, and Cell3 is the neighbour cell. It is indicated to the UE in the measurement control information that event-triggered reporting with Event A6 is used. The test consists of two successive time periods, with duration of T1 and T2, respectively. During T1 the UE shall not have any information of cell 3. Immediately at beginning of T2 the transmission power of cell 3 is increased to same level as for cell 2, and due to usage of an offset this shall result in reporting of Event A6. PDCCH indicating a new transmission on the PCell shall be sent continuously to ensure that the UE sends ACK/NACKs throughout the test.

Table A.8.16.3.1-1: General test parameters for E-UTRAN FDD-FDD Event triggered reporting on configured but deactivated SCell with PCell interruption in non-DRX

Parameter	Unit	Value	Comment
PDSCH parameters		DL Reference Measurement Channel R.3 FDD	As specified in clause A.3.1.1.1
PCFICH/PDCCH/PHICH parameters		DL Reference Measurement Channel R.6 FDD	As specified in clause A.3.1.2.1
E-UTRA RF Channel Number		1, 2	Two radio channels are used for this test
Active PCell		Cell 1	Primary cell on RF channel number 1.
Configured deactivated SCell		Cell 2	Configured deactivated secondary cell on RF channel number 2.
Neighbour cell		Cell 3	Neighbor cell to be identified on RF channel number 2.

Channel Bandwidth (BW _{channel})	MHz	10	Channel bandwidth for cells on primary and secondary component carriers	
CP length		Normal		
DRX		OFF	Continuous monitoring of primary cell	
A6	Hysteresis	dB	0	Hysteresis for evaluation of event A6.
	Offset	dB	-3	Offset parameter for evaluation of event A6. Needs to take relative accuracy tolerance in clause 9.1.11.2 into account plus margin.
	Report on leave		False	
	Time To Trigger	s	0	
Cell-individual offset for cells on RF channel number 1	dB	0	Individual offset for cells on primary component carrier.	
Cell-individual offset for cells on RF channel number 2	dB	0	Individual offset for cells on secondary component carrier.	
Filter coefficient		0	L3 filtering is not used	
SCell measurement cycle	ms	1280		
Cell2 timing offset to cell1	μs	0		
Time alignment error between cell2 and cell1	μs	≤ Time alignment error as specified in TS 36.104 [30] clause 6.5.3.1.	The value of time alignment error depends upon the type of carrier aggregation.	
Cell3 timing offset to cell1	μs	3	Synchronous cells	
T1	s	5	During this time the UE shall be aware of cells 1 and 2 but not cell 3.	
T2	s	≤30	UE shall report Event A6 within 25.6s (20×scellMeasCycle)	
NOTE: This test verifies the RRM requirement which is independent of channel bandwidth and is performed according to the principle defined in section A.3.6.1.				

Table A.8.16.3.1-2: Cell specific test parameters for E-UTRAN FDD-FDD Event triggered reporting on configured but deactivated SCell with PCell interruption in non-DRX

Parameter	Unit	Cell 1		Cell 2		Cell 3	
		T1	T2	T1	T2	T1	T2
E-UTRA RF Channel Number		1		2		2	
BW _{channel}	MHz	10		10		10	
OCNG Pattern defined in A.3.2.1.10 (OP.10 FDD) and in A.3.2.1.2 (OP.2)		OP.10 FDD		OP.2 FDD		OP.2 FDD	
PBCH_RA	dB	0		0		0	
PBCH_RB	dB						
PSS_RA	dB						
SSS_RA	dB						
PCFICH_RB	dB						
PHICH_RA	dB						
PHICH_RB	dB						
PDCCH_RA	dB						
PDCCH_RB	dB						
PDSCH_RA	dB						
PDSCH_RB	dB						
OCNG_RA ^{Note 1}	dB						
OCNG_RB ^{Note 1}	dB						
N _{oc} ^{Note 3}	dBm/15 kHz						
RSRP ^{Note 4}	dBm/15 kHz	-82	-82	-82	-82	-Infinity	-82
\hat{E}_s/I_{ot}	dB	16	16	16	-0.11	-Infinity	-0.11
SCH_RP ^{Note 4}	dBm/15 kHz	-82	-82	-82	-82	-Infinity	-82
\hat{E}_s/N_{oc}	dB	16	16	16	16	-Infinity	16
Propagation Condition		AWGN					

Note 1:	OCNG shall be used such that all cells are fully allocated and a constant total transmitted power spectral density is achieved for all OFDM symbols.
Note 2:	The resources for uplink transmission are assigned to the UE prior to the start of time period T2.
Note 3:	Interference from other cells and noise sources not specified in the test is assumed to be constant over subcarriers and time and shall be modelled as AWGN of appropriate power for N_{oc} to be fulfilled.
Note 4:	RSRP and SCH_RP levels have been derived from other parameters for information purposes. They are not settable parameters themselves.

A.8.16.3.2 Test Requirements

The UE shall send one Event A6 triggered measurement report, with a measurement reporting delay less than 25.6s from the beginning of time period T2.

The UE shall not send event triggered measurement reports, as long as the reporting criteria are not fulfilled.

The UE shall be scheduled on PCell continuously throughout the test. From the start of T1 until the measurement report is received during T2, at least 99.5% of all expected ACK/NACKs shall be transmitted by the UE.

For a test to be considered successful requirements on both event detection and percentage of transmitted ACK/NACKs have to be fulfilled simultaneously.

The rate of correct events observed during repeated tests shall be at least 90%.

NOTE: The actual overall delays measured in the test may be up to $2 \times TTI_{DCCH}$ higher than the measurement reporting delays above because of TTI insertion uncertainty of the measurement report in DCCH.

A.8.16.3A E-UTRAN FDD-FDD Event triggered reporting on deactivated SCell with network controlled PCell interruption in non-DRX

A.8.16.3A.1 Test Purpose and Environment

The purpose of this test is to verify that the UE configured with the network controlled small gap correctly detects event A6 (Neighbour becomes better than SCell) defined in TS 36.331 [2] within the requirements stated in clause 8.3.3.2.1 while at the same time fulfilling the requirement on the controlled interruption in clause 7.8.2.6.

The test parameters are given in Table A.8.16.3A.1-1 and A.8.16.3A.1-2 below. In the test there are three synchronous cells: Cell1, Cell2 and Cell3. Cell1 is PCell, Cell2 is deactivated SCell, and Cell3 is the neighbour cell. It is indicated to the UE in the measurement control information that event-triggered reporting with Event A6 is used. UE is also configured with the network controlled small gap of pattern Id 0 with gapOffset of zero. The test consists of two successive time periods, with duration of T1 and T2, respectively. During T1 the UE shall not have any information of cell 3. Immediately at beginning of T2 the transmission power of cell 3 is increased to same level as for cell 2, and due to usage of an offset this shall result in reporting of Event A6. PDCCH indicating a new transmission on the PCell shall be sent continuously according to the unicast PDSCH scheduling pattern in Table A.8.16.3A.1-1 to ensure that the UE sends ACK/NACKs throughout the test.

Table A.8.16.3A.1-1: General test parameters for E-UTRAN FDD-FDD Event triggered reporting on configured but deactivated SCell with network controlled PCell interruption in non-DRX

Parameter	Unit	Value	Comment
PDSCH parameters		DL Reference Measurement Channel R.3 FDD	As specified in clause A.3.1.1.1
PCFICH/PDCCH/PHICH parameters		DL Reference Measurement Channel R.6 FDD	As specified in clause A.3.1.2.1
E-UTRA RF Channel Number		1, 2	Two radio channels are used for this test
Active PCell		Cell 1	Primary cell on RF channel number 1.
Configured deactivated SCell		Cell 2	Configured deactivated secondary cell on RF channel number 2.
Neighbour cell		Cell 3	Neighbor cell to be identified on RF channel number 2.
Channel Bandwidth ($BW_{channel}$)	MHz	10	Channel bandwidth for cells on primary and secondary component carriers
CP length		Normal	
DRX		OFF	Continuous monitoring of primary cell

A6	Hysteresis	dB	0	Hysteresis for evaluation of event A6.
	Offset	dB	-3	Offset parameter for evaluation of event A6. Needs to take relative accuracy tolerance in clause 9.1.11.2 into account plus margin.
	Report on leave		False	
	Time To Trigger	s	0	
Cell-individual offset for cells on RF channel number 1	dB	0		Individual offset for cells on primary component carrier.
Cell-individual offset for cells on RF channel number 2	dB	0		Individual offset for cells on secondary component carrier.
Filter coefficient		0		L3 filtering is not used
SCell measurement cycle	ms	320		
Cell2 timing offset to cell1	μs	0		
Time alignment error between cell2 and cell1	μs	≤ Time alignment error as specified in TS 36.104 [30] clause 6.5.3.1.		The value of time alignment error depends upon the type of carrier aggregation.
Cell3 timing offset to cell1	μs	3		Synchronous cells
NCSG Pattern Id / gapOffset		0 / 0		(VIL1,ML,VIL2) = (1,4,1) for downlink and (1,4,2) for uplink
T1	s	5		During this time the UE shall be aware of cells 1 and 2 but not cell 3.
T2	s	≤30		UE shall report Event A6 within 25.6s (20xscellMeasCycle)
NOTE: This test verifies the RRM requirement which is independent of channel bandwidth and is performed according to the principle defined in section A.3.6.1.				

Table A.8.16.3A.1-2: Cell specific test parameters for E-UTRAN FDD-FDD Event triggered reporting on configured but deactivated SCell with network controlled PCell interruption in non-DRX

Parameter	Unit	Cell 1		Cell 2		Cell 3	
		T1	T2	T1	T2	T1	T2
E-UTRA RF Channel Number		1		2		2	
BW _{channel}	MHz	10		10		10	
OCNG Pattern defined in A.3.2.1.10 (OP.10 FDD) and in A.3.2.1.2 (OP.2)		OP.10 FDD		OP.2 FDD		OP.2 FDD	
PBCH_RA	dB	0		0		0	
PBCH_RB	dB						
PSS_RA	dB						
SSS_RA	dB						
PCFICH_RB	dB						
PHICH_RA	dB						
PHICH_RB	dB						
PDCCH_RA	dB						
PDCCH_RB	dB						
PDSCH_RA	dB						
PDSCH_RB	dB						
OCNG_RA ^{Note 1}	dB						
OCNG_RB ^{Note 1}	dB						
N _{oc} ^{Note 3}	dBm/15 kHz						
RSRP ^{Note 4}	dBm/15 kHz	-82	-82	-82	-82	-Infinity	-82
\hat{E}_s/I_{ot}	dB	16	16	16	-0.11	-Infinity	-0.11
SCH_RP ^{Note 4}	dBm/15 kHz	-82	-82	-82	-82	-Infinity	-82
\hat{E}_s/N_{oc}	dB	16	16	16	16	-Infinity	16
Propagation Condition		AWGN					
Note 1: OCNG shall be used such that all cells are fully allocated and a constant total transmitted power spectral density is achieved for all OFDM symbols.							
Note 2: The resources for uplink transmission are assigned to the UE prior to the start of time period T2.							

Note 3:	Interference from other cells and noise sources not specified in the test is assumed to be constant over subcarriers and time and shall be modelled as AWGN of appropriate power for N_{oc} to be fulfilled.
Note 4:	RSRP and SCH_RP levels have been derived from other parameters for information purposes. They are not settable parameters themselves.

A.8.16.3A.2 Test Requirements

The UE shall send one Event A6 triggered measurement report, with a measurement reporting delay less than 6.4s from the beginning of time period T2.

The UE shall not send event triggered measurement reports, as long as the reporting criteria are not fulfilled.

The UE shall be scheduled on PCell continuously throughout the test. From the start of T1 until the measurement report is received during T2, at least [100]% of all expected ACK/NACKs shall be transmitted by the UE.

For a test to be considered successful requirements on both event detection and percentage of transmitted ACK/NACKs have to be fulfilled simultaneously.

The rate of correct events observed during repeated tests shall be at least 90%.

NOTE: The actual overall delays measured in the test may be up to $2xTTI_{DCCH}$ higher than the measurement reporting delays above because of TTI insertion uncertainty of the measurement report in DCCH.

A.8.16.4 E-UTRAN TDD-TDD Event triggered reporting on deactivated SCell with PCell interruption in non-DRX

A.8.16.4.1 Test Purpose and Environment

The purpose of this test is to verify that the UE correctly detects event A6 (Neighbour becomes better than SCell) defined in TS 36.331 [2] within the requirements stated in clause 8.3.3.2.1 while at the same time fulfilling the requirement on interruption rate.

The test parameters are given in Table A.8.16.4.1-1 and A.8.16.4.1-2 below. In the test there are three synchronous cells: Cell1, Cell2 and Cell3. Cell1 is PCell, Cell2 is deactivated SCell, and Cell3 is the neighbour cell. It is indicated to the UE in the measurement control information that event-triggered reporting with Event A6 is used. The test consists of two successive time periods, with duration of T1 and T2, respectively. During T1 the UE shall not have any information of cell 3. Immediately at beginning of T2 the transmission power of cell 3 is increased to same level as for cell 2, and due to usage of an offset this shall result in reporting of Event A6. PDCCH indicating a new transmission on the PCell shall be sent continuously to ensure that the UE sends ACK/NACKs throughout the test.

Table A.8.16.4.1-1: General test parameters for E-UTRAN TDD-TDD Event triggered reporting on configured but deactivated SCell with PCell interruption in non-DRX

Parameter	Unit	Value	Comment
PDSCH parameters		DL Reference Measurement Channel R.0 TDD	As specified in clause A.3.1.1.2
PCFICH/PDCCH/PHICH parameters		DL Reference Measurement Channel R.6 TDD	As specified in clause A.3.1.2.2
E-UTRA RF Channel Number		1, 2	Two radio channels are used for this test
Active PCell		Cell 1	Primary cell on RF channel number 1.
Configured deactivated SCell		Cell 2	Configured deactivated secondary cell on RF channel number 2.
Neighbour cell		Cell 3	Neighbor cell to be identified on RF channel number 2.
Channel Bandwidth ($BW_{channel}$)	MHz	10	Channel bandwidth for cells on primary and secondary component carriers
CP length		Normal	
Special subframe configuration		6	As specified in table 4.2.1 in TS 36.211. The same configuration applies to all cells.
Uplink-downlink configuration		1	
DRX		OFF	Continuous monitoring of primary cell
A6 Hysteresis	dB	0	Hysteresis for evaluation of event A6.

	Offset	dB	-3	Offset parameter for evaluation of event A6. Needs to take relative accuracy tolerance in clause 9.1.11.2 into account plus margin.
	Report on leave		False	
	Time To Trigger	s	0	
Cell-individual offset for cells on RF channel number 1	dB	0		Individual offset for cells on primary component carrier.
Cell-individual offset for cells on RF channel number 2	dB	0		Individual offset for cells on secondary component carrier.
Filter coefficient		0		L3 filtering is not used
SCell measurement cycle	ms	1280		
Cell2 timing offset to cell1	μs	0		
Time alignment error between cell2 and cell1	μs	≤ Time alignment error as specified in TS 36.104 [30] clause 6.5.3.1.		The value of time alignment error depends upon the type of carrier aggregation.
Cell3 timing offset to cell1	μs	3		Synchronous cells
T1	s	5		During this time the UE shall be aware of cells 1 and 2 but not cell 3.
T2	s	≤30		UE shall report Event A6 within 25.6s (20×scellMeasCycle)
NOTE: This test verifies the RRM requirement which is independent of channel bandwidth and is performed according to the principle defined in section A.3.6.1.				

Table A.8.16.4.1-2: Cell specific test parameters for E-UTRAN TDD-TDD Event triggered reporting on configured but deactivated SCell with PCell interruption in non-DRX

Parameter	Unit	Cell 1		Cell 2		Cell 3	
		T1	T2	T1	T2	T1	T2
E-UTRA RF Channel Number		1		2		2	
BW _{channel}	MHz	10		10		10	
OCNG Pattern defined in A.3.2.2.1 (OP.1 TDD) and in A.3.2.2.2 (OP.2 TDD)		OP.1 TDD		OP.2 TDD		OP.2 TDD	
PBCH_RA	dB	0		0		0	
PBCH_RB	dB						
PSS_RA	dB						
SSS_RA	dB						
PCFICH_RB	dB						
PHICH_RA	dB						
PHICH_RB	dB						
PDCCH_RA	dB						
PDCCH_RB	dB						
PDSCH_RA	dB						
PDSCH_RB	dB						
OCNG_RA ^{Note 1}	dB						
OCNG_RB ^{Note 1}	dB						
N_{oc} ^{Note 3}	dBm/15 kHz						
RSRP ^{Note 4}	dBm/15 kHz	-82	-82	-82	-82	-Infinity	-82
\hat{E}_s/I_{ot}	dB	16	16	16	-0.11	-Infinity	-0.11
SCH_RP ^{Note 4}	dBm/15 kHz	-82	-82	-82	-82	-Infinity	-82
\hat{E}_s/N_{oc}	dB	16	16	16	16	-Infinity	16
Propagation Condition		AWGN					
<p>Note 1: OCNG shall be used such that all cells are fully allocated and a constant total transmitted power spectral density is achieved for all OFDM symbols.</p> <p>Note 2: The resources for uplink transmission are assigned to the UE prior to the start of time period T2.</p> <p>Note 3: Interference from other cells and noise sources not specified in the test is assumed to be constant over subcarriers and time and shall be modelled as AWGN of appropriate power for N_{oc} to be fulfilled.</p>							

Note 4: RSRP and SCH_RP levels have been derived from other parameters for information purposes. They are not settable parameters themselves.

A.8.16.4.2 Test Requirements

The UE shall send one Event A6 triggered measurement report, with a measurement reporting delay less than 25.6s from the beginning of time period T2.

The UE shall not send event triggered measurement reports, as long as the reporting criteria are not fulfilled.

The UE shall be scheduled on PCell continuously throughout the test. From the start of T1 until the measurement report is received during T2, at least 99.5% of all expected ACK/NACKs shall be transmitted by the UE.

For a test to be considered successful requirements on both event detection and percentage of transmitted ACK/NACKs have to be fulfilled simultaneously.

The rate of correct events observed during repeated tests shall be at least 90%.

NOTE: The actual overall delays measured in the test may be up to $2 \times TTI_{DCCH}$ higher than the measurement reporting delays above because of TTI insertion uncertainty of the measurement report in DCCH.

A.8.16.4A E-UTRAN TDD-TDD Event triggered reporting on deactivated SCell with PCell interruption in non-DRX

A.8.16.4A.1 Test Purpose and Environment

The purpose of this test is to verify that the UE configured with the network controlled small gap correctly detects event A6 (Neighbour becomes better than SCell) defined in TS 36.331 [2] within the requirements stated in clause 8.3.3.2.1 while at the same time fulfilling the requirement on the controlled interruption in clause 7.8.2.6.

The test parameters are given in Table A.8.16.4A.1-1 and A.8.16.4A.1-2 below. In the test there are three synchronous cells: Cell1, Cell2 and Cell3. Cell1 is PCell, Cell2 is deactivated SCell, and Cell3 is the neighbour cell. It is indicated to the UE in the measurement control information that event-triggered reporting with Event A6 is used. UE is also configured with the network controlled small gap of pattern Id 0 and gapOffset of zero. The test consists of two successive time periods, with duration of T1 and T2, respectively. During T1 the UE shall not have any information of cell 3. Immediately at beginning of T2 the transmission power of cell 3 is increased to same level as for cell 2, and due to usage of an offset this shall result in reporting of Event A6. PDCCH indicating a new transmission on the PCell shall be sent continuously according to the unicast PDSCH scheduling pattern in Table A.8.16.4A.1-1 to ensure that the UE sends ACK/NACKs throughout the test.

Table A.8.16.4A.1-1: General test parameters for E-UTRAN TDD-TDD Event triggered reporting on configured but deactivated SCell with network controlled PCell interruption in non-DRX

Parameter	Unit	Value	Comment
PDSCH parameters		DL Reference Measurement Channel R.0 TDD	As specified in clause A.3.1.1.2
PCFICH/PDCCH/PHICH parameters		DL Reference Measurement Channel R.6 TDD	As specified in clause A.3.1.2.2
E-UTRA RF Channel Number		1, 2	Two radio channels are used for this test
Active PCell		Cell 1	Primary cell on RF channel number 1.
Configured deactivated SCell		Cell 2	Configured deactivated secondary cell on RF channel number 2.
Neighbour cell		Cell 3	Neighbor cell to be identified on RF channel number 2.
Channel Bandwidth (BW _{channel})	MHz	10	Channel bandwidth for cells on primary and secondary component carriers
CP length		Normal	
Special subframe configuration		6	As specified in table 4.2.1 in TS 36.211. The same configuration applies to all cells.
Uplink-downlink configuration		1	

DRX			OFF	Continuous monitoring of primary cell
A6	Hysteresis	dB	0	Hysteresis for evaluation of event A6.
	Offset	dB	-3	Offset parameter for evaluation of event A6. Needs to take relative accuracy tolerance in clause 9.1.11.2 into account plus margin.
	Report on leave		False	
	Time To Trigger	s	0	
Cell-individual offset for cells on RF channel number 1		dB	0	Individual offset for cells on primary component carrier.
Cell-individual offset for cells on RF channel number 2		dB	0	Individual offset for cells on secondary component carrier.
Filter coefficient			0	L3 filtering is not used
SCell measurement cycle		ms	320	
Cell2 timing offset to cell1		μs	0	
Time alignment error between cell2 and cell1		μs	≤ Time alignment error as specified in TS 36.104 [30] clause 6.5.3.1.	The value of time alignment error depends upon the type of carrier aggregation.
Cell3 timing offset to cell1		μs	3	Synchronous cells
NCSG pattern Id / gap Offset			0 / 0	(VIL1,ML,VIL2) = (1,4,1) for downlink, and (1,4,2) for uplink
T1		s	5	During this time the UE shall be aware of cells 1 and 2 but not cell 3.
T2		s	≤30	UE shall report Event A6 within 25.6s (20xscellMeasCycle)
NOTE: This test verifies the RRM requirement which is independent of channel bandwidth and is performed according to the principle defined in section A.3.6.1.				

Table A.8.16.4A.1-2: Cell specific test parameters for E-UTRAN TDD-TDD Event triggered reporting on configured but deactivated SCell with network controlled PCell interruption in non-DRX

Parameter	Unit	Cell 1		Cell 2		Cell 3	
		T1	T2	T1	T2	T1	T2
E-UTRA RF Channel Number		1		2		2	
BW _{channel}	MHz	10		10		10	
OCNG Pattern defined in A.3.2.2.1 (OP.1 TDD) and in A.3.2.2.2 (OP.2 TDD)		OP.1 TDD		OP.2 TDD		OP.2 TDD	
PBCH_RA	dB	0		0		0	
PBCH_RB	dB						
PSS_RA	dB						
SSS_RA	dB						
PCFICH_RB	dB						
PHICH_RA	dB						
PHICH_RB	dB						
PDCCH_RA	dB						
PDCCH_RB	dB						
PDSCH_RA	dB						
PDSCH_RB	dB						
OCNG_RA ^{Note 1}	dB						
OCNG_RB ^{Note 1}	dB						
N_{oc} ^{Note 3}	dBm/15 kHz						
RSRP ^{Note 4}	dBm/15 kHz	-82	-82	-82	-82	-Infinity	-82
\hat{E}_s/I_{ot}	dB	16	16	16	-0.11	-Infinity	-0.11
SCH_RP ^{Note 4}	dBm/15 kHz	-82	-82	-82	-82	-Infinity	-82
\hat{E}_s/N_{oc}	dB	16	16	16	16	-Infinity	16
Propagation Condition		AWGN					

Note 1:	OCNG shall be used such that all cells are fully allocated and a constant total transmitted power spectral density is achieved for all OFDM symbols.
Note 2:	The resources for uplink transmission are assigned to the UE prior to the start of time period T2.
Note 3:	Interference from other cells and noise sources not specified in the test is assumed to be constant over subcarriers and time and shall be modelled as AWGN of appropriate power for N_{oc} to be fulfilled.
Note 4:	RSRP and SCH_RP levels have been derived from other parameters for information purposes. They are not settable parameters themselves.

A.8.16.4A.2 Test Requirements

The UE shall send one Event A6 triggered measurement report, with a measurement reporting delay less than 6.4s from the beginning of time period T2.

The UE shall not send event triggered measurement reports, as long as the reporting criteria are not fulfilled.

The UE shall be scheduled on PCell continuously throughout the test. From the start of T1 until the measurement report is received during T2, at least [100]% of all expected ACK/NACKs shall be transmitted by the UE.

For a test to be considered successful requirements on both event detection and percentage of transmitted ACK/NACKs have to be fulfilled simultaneously.

The rate of correct events observed during repeated tests shall be at least 90%.

NOTE: The actual overall delays measured in the test may be up to $2 \times TTI_{DCCH}$ higher than the measurement reporting delays above because of TTI insertion uncertainty of the measurement report in DCCH.

A.8.16.5 E-UTRAN FDD event triggered reporting under deactivated SCell in non-DRX for 20 MHz bandwidth

A.8.16.5.1 Test Purpose and Environment

The purpose of this test case is the same as for the test defined in subclause A.8.16.1. The test parameters are the same except those described in the following section. The listed parameter values in Tables A.8.16.5.1-1 and A.8.16.5.1-2 will replace the values of corresponding parameters in Tables A.8.16.1.1-1 and A.8.16.1.1-2.

Table A.8.16.5.1-1: General test parameters for E-UTRAN FDD event triggered reporting on configured but deactivated SCell in non-DRX under fading propagation conditions, 20 MHz

Parameter	Unit	Value	Comment
PDSCH parameters		DL Reference Measurement Channel R.4 FDD	As specified in section A.3.1.1.1
PCFICH/PDCCH/PHICH parameters		DL Reference Measurement Channel R.10 FDD	As specified in section A.3.1.2.1
Channel Bandwidth ($BW_{channel}$)	MHz	20	Channel bandwidth for cells on primary and secondary component carriers
A2 Threshold RSRP	dBm	-96	Actual RSRP threshold for event A2. Needs to take absolute accuracy tolerance in clause 9.1.11.1 into account plus margin.
Note 1:	See Table A.8.16.1.1-1 for other general test parameters.		
Note 2:	This test verifies the RRM requirement which is independent of channel bandwidth and is performed according to the principle defined in section A.3.6.1.		

Table A.8.16.5.1-2: Cell specific test parameters for E-UTRAN FDD event triggered reporting on configured but deactivated SCell in non-DRX under fading propagation conditions, 20 MHz

Parameter	Unit	Cell 1			Cell 2			Cell 3		
		T1	T2	T3	T1	T2	T3	T1	T2	T3
$BW_{channel}$	MHz	20			20			20		

OCNG Patterns defined in A.3.2.1.11 (OP.11 FDD) and in A.3.2.1.12 (OP.12 FDD)		OP.11 FDD			OP.12 FDD			OP.12 FDD		
$N_{oc}^{Note 2}$	dBm/15 kHz	-104			-104					
RSRP ^{Note 3}	dBm/15 kHz	-85	-85	-107	-85	-85	-107	-infinity	-85	-107
\bar{E}_s/I_{ot}	dB	19	19	-3	19	-0.05	-4.76	-infinity	-0.05	-4.76
SCH_RP ^{Note 3}	dBm/15 kHz	-85	-85	-107	-85	-85	-107	-infinity	-85	-107
\bar{E}_s/N_{oc}	dB	19	19	-3	19	19	-3	-infinity	19	-3
Note: See Table A.8.16.1.1-2 for other cell-specific test parameters.										

A.8.16.5.2 Test Requirements

The test requirements defined in section A.8.16.1.2 shall apply to this test case.

A.8.16.6 E-UTRAN TDD event triggered reporting under deactivated SCell in non-DRX for 20 MHz bandwidth

A.8.16.6.1 Test Purpose and Environment

The purpose of this test case is the same as for the test defined in subclause A.8.16.2. The test parameters are the same except those described in the following section. The listed parameter values in Tables A.8.16.6.1-1 and A.8.16.6.1-2 will replace the values of corresponding parameters in Tables A.8.16.2.1-1 and A.8.16.2.1-2.

Table A.8.16.6.1-1: General test parameters for E-UTRAN TDD event triggered reporting on configured but deactivated SCell in non-DRX under fading propagation conditions, 20 MHz

Parameter		Unit	Value	Comment
PDSCH parameters			DL Reference Measurement Channel R.3 TDD	As specified in section A.3.1.1.2
PCFICH/PDCCH/PHICH parameters			DL Reference Measurement Channel R.10 TDD	As specified in section A.3.1.2.2
Channel Bandwidth ($BW_{channel}$)		MHz	20	Channel bandwidth for cells on primary and secondary component carriers
A2	Threshold RSRP	dBm	-96	Actual RSRP threshold for event A2. Needs to take absolute accuracy tolerance in clause 9.1.11.1 into account plus margin.
Note 1: See Table A.8.16.2.1-1 for other general test parameters.				
Note 2: This test verifies the RRM requirement which is independent of channel bandwidth and is performed according to the principle defined in section A.3.6.1.				

Table A.8.16.6.1-2: Cell specific test parameters for E-UTRAN TDD event triggered reporting on configured but deactivated SCell in non-DRX under fading propagation conditions, 20 MHz

Parameter	Unit	Cell 1			Cell 2			Cell 3		
		T1	T2	T3	T1	T2	T3	T1	T2	T3
$BW_{channel}$	MHz	20			20			20		
OCNG Patterns defined in A.3.2.2.7 (OP.7 TDD) and in A.3.2.2.8 (OP.8 TDD)		OP.7 TDD			OP.8 TDD			OP.8 TDD		
$N_{oc}^{Note 2}$	dBm/15 kHz	-104			-104					

RSRP ^{Note 3}	dBm/15 kHz	-85	-85	-107	-85	-85	-107	-infinity	-85	-107
\hat{E}_s/I_{ot}	dB	19	19	-3	19	-0.05	-4.76	-infinity	-0.05	-4.76
SCH_RP ^{Note 3}	dBm/15 kHz	-85	-85	-107	-85	-85	-107	-infinity	-85	-107
\hat{E}_s/N_{oc}	dB	19	19	-3	19	19	-3	-infinity	19	-3
Note: See Table A.8.16.2.1-2 for other cell-specific test parameters.										

A.8.16.6.2 Test Requirements

The test requirements defined in section A.8.16.2.2 shall apply to this test case.

A.8.16.7 E-UTRA FDD event triggered reporting on deactivated SCell with PCell interruption in non-DRX for 20 MHz bandwidth

A.8.16.7.1 Test Purpose and Environment

The purpose of this test case is the same as for the test defined in subclause A.8.16.3. The test parameters are the same except those described in the following section. The listed parameter values in Tables A.8.16.7.1-1 and A.8.16.7.1-2 will replace the values of corresponding parameters in Tables A.8.16.3.1-1 and A.8.16.3.1-2.

Table A.8.16.7.1-1: General test parameters for E-UTRAN FDD event-triggered reporting on configured but deactivated SCell with PCell interruption in non-DRX, 20 MHz

Parameter	Unit	Value	Comment
PDSCH parameters		DL Reference Measurement Channel R.6 FDD	As specified in section A.3.1.1.1
PCFICH/PDCCH/PHICH parameters		DL Reference Measurement Channel R.10 FDD	As specified in section A.3.1.2.1
Channel Bandwidth ($BW_{channel}$)	MHz	20	Channel bandwidth for cells on primary and secondary component carriers
Note 1: See Table A.8.16.3.1-1 for other general test parameters.			
Note 2: This test verifies the RRM requirement which is independent of channel bandwidth and is performed according to the principle defined in section A.3.6.1.			

Table A.8.16.7.1-2: Cell specific test parameters for E-UTRAN FDD event triggered reporting on configured but deactivated SCell with PCell interruption in non-DRX, 20 MHz

Parameter	Unit	Cell 1		Cell 2		Cell 3	
		T1	T2	T1	T2	T1	T2
$BW_{channel}$	MHz	20		20		20	
OCNG Patterns defined in A.3.2.1.17 (OP.17 FDD) and in A.3.2.1.12 (OP.12 FDD)		OP.17 FDD		OP.12 FDD		OP.12 FDD	
N_{oc} ^{Note 3}	dBm/15 kHz	-101		-101			
RSRP ^{Note 4}	dBm/15 kHz	-85	-85	-85	-85	-Infinity	-85
\hat{E}_s/I_{ot}	dB	16	16	16	-0.11	-Infinity	-0.11
SCH_RP ^{Note 4}	dBm/15 kHz	-85	-85	-85	-85	-Infinity	-85
\hat{E}_s/N_{oc}	dB	16	16	16	16	-Infinity	16
Note: See Table A.8.16.3.1-2 for other cell-specific test parameters.							

A.8.16.7.2 Test Requirements

The test requirements defined in section A.8.16.3.2 shall apply to this test case.

A.8.16.8 E-UTRA TDD event triggered reporting on deactivated SCell with PCell interruption in non-DRX for 20 MHz bandwidth

A.8.16.8.1 Test Purpose and Environment

The purpose of this test case is the same as for the test defined in subclause A.8.16.4. The test parameters are the same except those described in the following section. The listed parameter values in Tables A.8.16.8.1-1 and A.8.16.8.1-2 will replace the values of corresponding parameters in Tables A.8.16.4.1-1 and A.8.16.4.1-2.

Table A.8.16.8.1-1: General test parameters for E-UTRAN TDD event-triggered reporting on configured but deactivated SCell with PCell interruption in non-DRX, 20 MHz

Parameter	Unit	Value	Comment
PDSCH parameters		DL Reference Measurement Channel R.3 TDD	As specified in section A.3.1.1.2
PCFICH/PDCCH/PHICH parameters		DL Reference Measurement Channel R.10 TDD	As specified in section A.3.1.2.2
Channel Bandwidth (BW_{channel})	MHz	20	Channel bandwidth for cells on primary and secondary component carriers
Note 1:	See Table A.8.16.4.1-1 for other general test parameters.		
Note 2:	This test verifies the RRM requirement which is independent of channel bandwidth and is performed according to the principle defined in section A.3.6.1.		

Table A.8.16.8.1-2: Cell specific test parameters for E-UTRAN TDD event triggered reporting on configured but deactivated SCell with PCell interruption in non-DRX, 20 MHz

Parameter	Unit	Cell 1		Cell 2		Cell 3	
		T1	T2	T1	T2	T1	T2
BW_{channel}	MHz	20		20		20	
OCNG Patterns defined in A.3.2.2.7 (OP.7 TDD) and in A.3.2.2.8 (OP.8 TDD)		OP.7 TDD		OP.8 TDD		OP.8 TDD	
N_{oc} ^{Note 3}	dBm/15 kHz	-101		-101			
RSRP ^{Note 4}	dBm/15 kHz	-85	-85	-85	-85	-Infinity	-85
\hat{E}_s/I_{ot}	dB	16	16	16	-0.11	-Infinity	-0.11
SCH_RP ^{Note 4}	dBm/15 kHz	-85	-85	-85	-85	-Infinity	-85
\hat{E}_s/N_{oc}	dB	16	16	16	16	-Infinity	16
Note:	See Table A.8.16.4.1-2 for other cell-specific test parameters.						

A.8.16.8.2 Test Requirements

The test requirements defined in section A.8.16.4.2 shall apply to this test case.

A.8.16.9 E-UTRAN FDD event triggered reporting under deactivated SCell in non-DRX for 10MHz+5MHz

A.8.16.9.1 Test Purpose and Environment

The purpose of this test case is the same as for the test defined in subclause A.8.16.1.1.

The test parameters are the same as defined in Subclause A.8.16.1.1 except those described in the following section. The listed parameter values in Tables A.8.16.9.1-1 and A.8.16.9.1-2 will replace the values of corresponding parameters in Tables A.8.16.1.1-1 and A.8.16.1.1-2.

Table A.8.16.9.1-1: General test parameters for E-UTRAN FDD event triggered reporting on configured but deactivated SCell in non-DRX under fading propagation conditions for 10MHz+5MHz bandwidth

Parameter	Unit	Value	Comment
Channel bandwidth for cells on primary carriers (BW_{channel})	MHz	10	Channel bandwidth for cells on primary carriers
Channel bandwidth for cells on secondary carriers (BW_{channel})	MHz	5	Channel bandwidth for cells on secondary carriers
Note 1: See Table A.8.16.1.1-1 for the other general parameters.			
Note 2: This test verifies the RRM requirement which is independent of channel bandwidth and is performed according to the principle defined in section A.3.6.1.			

Table A.8.16.9.1-2: Cell specific test parameters for E-UTRAN FDD event triggered reporting on configured but deactivated SCell in non-DRX under fading propagation conditions for 10MHz+5MHz bandwidth

Parameter	Unit	Cell 1			Cell 2			Cell 3		
		T1	T2	T3	T1	T2	T3	T1	T2	T3
BW_{channel}	MHz	10			5			5		
PDSCH Reference measurement channel defined in A.3.1.1.1		R.0 FDD			N/A			N/A		
PDSCH allocation	n_{PRB}	13—36			N/A			N/A		
PCFICH/PDCCH/PHICH parameters defined in A.3.1.2.1		R.6 FDD			R.11 FDD			R.11 FDD		
OCNG Patterns defined in A.3.2.1.1 (OP.1 FDD) and in A.3.2.1.16 (OP.16 FDD)		OP.1 FDD			OP.16 FDD			OP.16 FDD		
Note 1: See Table A.8.16.1.1-2 for the other specific parameters.										

A.8.16.9.2 Test Requirements

The test requirements defined in section A.8.16.1.2 shall apply to this test case.

A.8.16.10 E-UTRAN TDD event triggered reporting under deactivated SCell in non-DRX for 10MHz+5MHz

A.8.16.10.1 Test Purpose and Environment

The purpose of this test case is the same as for the test defined in subclause A.8.16.2.1.

The test parameters are the same as defined in Subclause A.8.16.2.1 except those described in the following section. The listed parameter values in Tables A.8.16.10.1-1 and A.8.16.10.1-2 will replace the values of corresponding parameters in Tables A.8.16.2.1-1 and A.8.16.2.1-2.

Table A.8.16.10.1-1: General test parameters for E-UTRAN TDD event triggered reporting on configured but deactivated SCell in non-DRX under fading propagation conditions for 10MHz+5MHz bandwidth

Parameter	Unit	Value	Comment
Channel bandwidth for cells on primary carriers (BW_{channel})	MHz	10	Channel bandwidth for cells on primary carriers
Channel bandwidth for cells on secondary carriers (BW_{channel})	MHz	5	Channel bandwidth for cells on secondary carriers

Note 1:	See Table A.8.16.2.1-1 for the other general parameters.
Note 2:	This test verifies the RRM requirement which is independent of channel bandwidth and is performed according to the principle defined in section A.3.6.1.

Table A.8.16.10.1-2: Cell specific test parameters for E-UTRAN TDD event triggered reporting on configured but deactivated SCell in non-DRX under fading propagation conditions for 10MHz+5MHz bandwidth

Parameter	Unit	Cell 1			Cell 2			Cell 3		
		T1	T2	T3	T1	T2	T3	T1	T2	T3
BW_{channel}	MHz	10			5			5		
PDSCH Reference measurement channel defined in A.3.1.1.2		R.0 TDD			N/A			N/A		
PDSCH allocation	n_{PRB}	13–36			N/A			N/A		
PCFICH/PDCCH/PHICH parameters defined in A.3.1.2.2		R.6 TDD			R.11 TDD			R.11 TDD		
OCNG Patterns defined in A.3.2.2.1 (OP.1 TDD) and in A.3.2.2.10 (OP.10 TDD)		OP.1 TDD			OP.10 TDD			OP.10 TDD		
Note 1: See Table A.8.16.2.1-2 for the other specific parameters.										

A.8.16.10.2 Test Requirements

The test requirements defined in section A.8.16.2.2 shall apply to this test case.

A.8.16.11 E-UTRAN FDD event triggered reporting on deactivating SCell with PCell interruption in non-DRX for 10MHz+5MHz

A.8.16.11.1 Test Purpose and Environment

The purpose of this test case is the same as for the test defined in subclause A.8.16.3. The test parameters are the same except those described in the following section. The listed parameter values in Tables A.8.16.11.1-1 and A.8.16.11.1-2 will replace the values of corresponding parameters in Tables A.8.16.3.1-1 and A.8.16.3.1-2.

Table A.8.16.11.1-1: General test parameters for E-UTRAN FDD event triggered reporting on deactivating SCell with PCell interruption in non-DRX for 10MHz+5MHz

Parameter	Unit	Value	Comment
Channel bandwidth for cells on primary carrier (BW_{channel})	MHz	10	Channel bandwidth for cells on primary component carrier
PDSCH parameters for cells on primary carriers		DL Reference Measurement Channel R.3 FDD	As specified in section A.3.1.1.1
PCFICH/PDCCH/PHICH parameters for cells on primary carriers		DL Reference Measurement Channel R.6 FDD	As specified in section A.3.1.2.1
Channel bandwidth for cells on secondary carriers (BW_{channel})	MHz	5	Channel bandwidth for cells on secondary component carrier
PCFICH/PDCCH/PHICH parameters for cells on secondary carrier		DL Reference Measurement Channel R.11 FDD	As specified in section A.3.1.2.1
Note 1: See Table A.8.16.3.1-1 for other general test parameters.			
Note 2: This test verifies the RRM requirement which is independent of channel bandwidth and is performed according to the principle defined in section A.3.6.1.			

Table A.8.16.11.1-2: Cell specific test parameters for E-UTRAN FDD event triggered reporting on deactivating SCell with PCell interruption in non-DRX for 10MHz+5MHz

Parameter	Unit	Cell 1		Cell 2		Cell 3	
		T1	T2	T1	T2	T1	T2
BW _{channel}	MHz	10		5		5	
OCNG Patterns defined in A.3.2.1		OP.10 FDD		OP.16 FDD		OP.16 FDD	
Note:	See Table A.8.16.3.1-2 for other cell-specific test parameters.						

A.8.16.11.2 Test Requirements

The test requirements defined in section A.8.16.3.2 shall apply to this test case.

A.8.16.12 E-UTRAN TDD event triggered reporting on deactivating SCell with PCell interruption in non-DRX for 10MHz+5MHz

A.8.16.12.1 Test Purpose and Environment

The purpose of this test case is the same as for the test defined in subclause A.8.16.4. The test parameters are the same except those described in the following section. The listed parameter values in Tables A.8.16.12.1-1 and A.8.16.12.1-2 will replace the values of corresponding parameters in Tables A.8.16.4.1-1 and A.8.16.4.1-2.

Table A.8.16.12.1-1: General test parameters for E-UTRAN TDD event triggered reporting on deactivating SCell with PCell interruption in non-DRX for 10MHz+5MHz

Parameter	Unit	Value	Comment
Channel bandwidth for cells on primary carrier (BW _{channel})	MHz	10	Channel bandwidth for cells on primary component carrier
PDSCH parameters for cells on primary carriers		DL Reference Measurement Channel R.0 TDD	As specified in section A.3.1.1.2
PCFICH/PDCCH/PHICH parameters for cells on primary carriers		DL Reference Measurement Channel R.6 TDD	As specified in section A.3.1.2.2
Channel bandwidth for cells on secondary carriers (BW _{channel})	MHz	5	Channel bandwidth for cells on secondary component carrier
PCFICH/PDCCH/PHICH parameters for cells on secondary carrier		DL Reference Measurement Channel R.11 TDD	As specified in section A.3.1.2.2
Note 1:	See Table A.8.16.4.1-1 for other general test parameters.		
Note 2:	This test verifies the RRM requirement which is independent of channel bandwidth and is performed according to the principle defined in section A.3.6.1.		

Table A.8.16.12.1-2: Cell specific test parameters for E-UTRAN TDD event triggered reporting on deactivating SCell with PCell interruption in non-DRX for 10MHz+5MHz

Parameter	Unit	Cell 1		Cell 2		Cell 3	
		T1	T2	T1	T2	T1	T2
BW _{channel}	MHz	10		5		5	
OCNG Patterns defined in A.3.2.2		OP.1 TDD		OP.10 TDD		OP.10 TDD	
Note:	See Table A.8.16.4.1-2 for other cell-specific test parameters.						

A.8.16.12.2 Test Requirements

The test requirements defined in section A.8.16.4.2 shall apply to this test case.

A.8.16.13 E-UTRAN FDD event triggered reporting under deactivated SCell in non-DRX for 5MHz +5 MHz bandwidth

A.8.16.13.1 Test Purpose and Environment

The purpose of this test case is the same as for the test defined in subclause A.8.16.1. The test parameters are the same except those described in the following section. The listed parameter values in Tables A.8.16.13.1-1 and A.8.16.13.1-2 will replace the values of corresponding parameters in Tables A.8.16.1.1-1 and A.8.16.1.1-2.

Table A.8.16.13.1-1: General test parameters for E-UTRAN FDD event triggered reporting on configured but deactivated SCell in non-DRX under fading propagation conditions, 5MHz +5 MHz bandwidth

Parameter	Unit	Value	Comment
PDSCH parameters		DL Reference Measurement Channel R.5 FDD	As specified in section A.3.1.1.1
PCFICH/PDCCH/PHICH parameters		DL Reference Measurement Channel R.11 FDD	As specified in section A.3.1.2.1
Channel Bandwidth (BW_{channel})	MHz	5	Channel bandwidth for cells on primary component carrier
Channel Bandwidth (BW_{channel})	MHz	5	Channel bandwidth for cells on secondary component carrier
Note 1: See Table A.8.16.1.1-1 for other general test parameters.			
Note 2: This test verifies the RRM requirement which is independent of channel bandwidth and is performed according to the principle defined in section A.3.6.1.			

Table A.8.16.13.1-2: Cell specific test parameters for E-UTRAN FDD event triggered reporting on configured but deactivated SCell in non-DRX under fading propagation conditions, 5MHz +5 MHz bandwidth

Parameter	Unit	Cell 1			Cell 2			Cell 3		
		T1	T2	T3	T1	T2	T3	T1	T2	T3
BW_{channel}	MHz	5			5			5		
OCNG Patterns defined in A.3.2.1.15 (OP.15.FDD) and in A.3.2.1.16 (OP.16 FDD)		OP.15 FDD			OP.16 FDD			OP.16 FDD		
Note: See Table A.8.16.1.1-2 for other cell-specific test parameters.										

A.8.16.13.2 Test Requirements

The test requirements defined in section A.8.16.1.2 shall apply to this test case.

A.8.16.14 E-UTRAN TDD event triggered reporting under deactivated SCell in non-DRX for 5 MHz +5 MHz bandwidth

A.8.16.14.1 Test Purpose and Environment

The purpose of this test case is the same as for the test defined in subclause A.8.16.2. The test parameters are the same except those described in the following section. The listed parameter values in Tables A.8.16.14.1-1 and A.8.16.14.1-2 will replace the values of corresponding parameters in Tables A.8.16.2.1-1 and A.8.16.2.1-2.

Table A.8.16.14.1-1: General test parameters for E-UTRAN TDD event triggered reporting on configured but deactivated SCell in non-DRX under fading propagation conditions, 5 MHz +5 MHz bandwidth

Parameter	Unit	Value	Comment
PDSCH parameters		DL Reference Measurement Channel R.4.TDD	As specified in section A.3.1.1.2
PCFICH/PDCCH/PHICH parameters		DL Reference Measurement Channel R.11 TDD	As specified in section A.3.1.2.2

Channel Bandwidth (BW _{channel})	MHz	5	Channel bandwidth for cells on primary component carrier
Channel Bandwidth (BW _{channel})	MHz	5	Channel bandwidth for cells on secondary component carrier
Note 1: See Table A.8.16.2.1-1 for other general test parameters.			
Note 2: This test verifies the RRM requirement which is independent of channel bandwidth and is performed according to the principle defined in section A.3.6.1.			

Table A.8.16.14.1-2: Cell specific test parameters for E-UTRAN TDD event triggered reporting on configured but deactivated SCell in non-DRX under fading propagation conditions, 5 MHz +5 MHz bandwidth

Parameter	Unit	Cell 1			Cell 2			Cell 3		
		T1	T2	T3	T1	T2	T3	T1	T2	T3
BW _{channel}	MHz	5			5			5		
OCNG Patterns defined in A.3.2.2.9 (OP.9 TDD) and in A.3.2.2.10 (OP.10 TDD)		OP.9 TDD			OP.10 TDD			OP.10 TDD		
Note: See Table A.8.16.2.1-2 for other cell-specific test parameters.										

A.8.16.14.2 Test Requirements

The test requirements defined in section A.8.16.2.2 shall apply to this test case.

A.8.16.15 E-UTRA FDD event triggered reporting on deactivated SCell with PCell interruption in non-DRX for 5 +5 MHz bandwidth

A.8.16.15.1 Test Purpose and Environment

The purpose of this test case is the same as for the test defined in subclause A.8.16.3. The test parameters are the same except those described in the following section. The listed parameter values in Tables A.8.16.15.1-1 and A.8.16.14.1-2 will replace the values of corresponding parameters in Tables A.8.16.3.1-1 and A.8.16.3.1-2.

Table A.8.16.15.1-1: General test parameters for E-UTRAN FDD event-triggered reporting on configured but deactivated SCell with PCell interruption in non-DRX, 5 + 5 MHz bandwidth

Parameter	Unit	Value	Comment
PDSCH parameters		DL Reference Measurement Channel R.7 FDD (Cell 1)	As specified in section A.3.1.1.1
PCFICH/PDCCH/PHICH parameters		DL Reference Measurement Channel R.11 FDD	As specified in section A.3.1.2.1
Channel Bandwidth (BW _{channel})	MHz	5	Channel bandwidth for cells on primary and secondary component carriers
Note 1: See Table A.8.16.3.1-1 for other general test parameters.			
Note 2: This test verifies the RRM requirement which is independent of channel bandwidth and is performed according to the principle defined in section A.3.6.1.			

Table A.8.16.15.1-2: Cell specific test parameters for E-UTRAN FDD event triggered reporting on configured but deactivated SCell with PCell interruption in non-DRX, 5+5 MHz bandwidth

Parameter	Unit	Cell 1		Cell 2		Cell 3	
		T1	T2	T1	T2	T1	T2
BW _{channel}	MHz	5		5		5	
OCNG Patterns defined in A.3.2.1.20 (OP.20 FDD) and in A.3.2.1.16 (OP.16 FDD)		OP.20 FDD		OP.16 FDD		OP.16 FDD	
Note: See Table A.8.16.3.1-2 for other cell-specific test parameters.							

A.8.16.7.2 Test Requirements

The test requirements defined in section A.8.16.3.2 shall apply to this test case.

A.8.16.16 E-UTRA TDD event triggered reporting on deactivated SCell with PCell interruption in non-DRX for 5+5 MHz bandwidth

A.8.16.16.1 Test Purpose and Environment

The purpose of this test case is the same as for the test defined in subclause A.8.16.4. The test parameters are the same except those described in the following section. The listed parameter values in Tables A.8.16.16.1-1 and A.8.16.16.1-2 will replace the values of corresponding parameters in Tables A.8.16.4.1-1 and A.8.16.4.1-2.

Table A.8.16.16.1-1: General test parameters for E-UTRAN TDD event-triggered reporting on configured but deactivated SCell with PCell interruption in non-DRX, 5+5 MHz bandwidth

Parameter	Unit	Value	Comment
PDSCH parameters		DL Reference Measurement Channel R.4 TDD	As specified in section A.3.1.1.2
PCFICH/PDCCH/PHICH parameters		DL Reference Measurement Channel R.11 TDD	As specified in section A.3.1.2.2
Channel Bandwidth (BW_{channel})	MHz	5	Channel bandwidth for cells on primary and secondary component carriers
Note 1: See Table A.8.16.4.1-1 for other general test parameters.			
Note 2: This test verifies the RRM requirement which is independent of channel bandwidth and is performed according to the principle defined in section A.3.6.1.			

Table A.8.16.16.1-2: Cell specific test parameters for E-UTRAN TDD event triggered reporting on configured but deactivated SCell with PCell interruption in non-DRX, 5+5 MHz bandwidth

Parameter	Unit	Cell 1		Cell 2		Cell 3	
		T1	T2	T1	T2	T1	T2
BW_{channel}	MHz	5		5		5	
OCNG Patterns defined in A.3.2.2.9 (OP.9 TDD) and in A.3.2.2.10 (OP.10 TDD)		OP.9 TDD		OP.10 TDD		OP.10 TDD	
Note: See Table A.8.16.4.1-2 for other cell-specific test parameters.							

A.8.16.16.2 Test Requirements

The test requirements defined in section A.8.16.4.2 shall apply to this test case.

A.8.16.17 E-UTRAN FDD activation and deactivation of known SCell in non-DRX

A.8.16.17.1 Test Purpose and Environment

The purpose of this test is to verify that the SCell activation and deactivation times are within the requirements stated in section 7.7, when the SCell is known by the UE at the time of activation.

The test parameters are given in Tables A.8.16.17.1-1 and cell-specific parameters in A.8.16.17.1-2 below. The test consists of three successive time periods, with duration of T1, T2 and T3, respectively. There are two carriers, each with one cell. Both cells have constant signal levels throughout the test. Before the test starts the UE is connected to Cell 1 (PCell) on radio channel 1 (PCC) but is not aware of Cell 2 on radio channel 2. The UE is only monitoring the PCC. The UE shall be continuously scheduled in the PCell throughout the whole test.

At the beginning of T1 the UE receives an RRC message by which the SCell (Cell 2) becomes configured on radio channel 2 (SCC). The UE now starts monitoring also the SCC. The test equipment sends a MAC message for activation of the SCell.

The point in time at which the MAC message is received at the UE antenna connector, in a subframe # denoted m which is an even number, defines the start of time period T2. The UE shall be able to report valid CSI for the activated SCell

at latest in subframe (m+24). The UE shall start reporting CSI in subframe (m+8) and shall report CQI index 0 (out-of-range) until the SCell activation has been completed. Any PCell interruption due to activation of SCell shall occur in the subframes (m+5) to (m+9).

Time period T3 starts when a MAC message for deactivation of SCell, sent from the test equipment to the UE in a subframe # denoted n which is an even number, is received at the UE antenna connector. The UE shall carry out deactivation of the SCell in a subframe (n+8), and any PCell interruption due to the deactivation shall occur in the subframes (n+5) to (n+9).

The test equipment verifies that potential interruption is carried out in the correct time span by monitoring ACK/NACK sent in PCell during activation and deactivation of SCell, respectively.

The test equipment verifies the activation time by counting the subframes from the time when the SCell activation command is sent until a CSI report with other than CQI index 0 is received.

The test equipment verifies the deactivation time by counting the subframes from the time when the SCell deactivation command is sent until CQI reporting for SCell is discontinued.

Table A.8.16.17.1-1: General test parameters for known SCell activation case

Parameter	Unit	Value	Comment
PDSCH parameters		DL Reference Measurement Channel R.3 FDD (Cell 1)	As specified in section A.3.1.1.1
PCFICH/PDCCH/PHICH parameters		DL Reference Measurement Channel R.6 FDD	As specified in section A.3.1.2.1
E-UTRA RF Channel Number		1, 2	Two radio channels are used for this test
Active PCell		Cell 1	Primary cell on RF channel number 1.
Configured deactivated SCell		Cell 2	Configured deactivated secondary cell on RF channel number 2.
CP length		Normal	
DRX		OFF	Continuous monitoring of primary cell
CQI/PMI periodicity and offset configuration index		0	CQI reporting for SCell every second subframe
Cell-individual offset for cells on RF channel number 1	dB	0	Individual offset for cells on primary component carrier.
Cell-individual offset for cells on RF channel number 2	dB	0	Individual offset for cells on secondary component carrier.
SCell measurement cycle (measCycleSCell)	ms	320	
Cell2 timing offset to cell1	μs	0	
Time alignment error between cell2 and cell1	μs	≤ Time alignment error as specified in 3GPP TS 36.104 [30] clause 6.5.3.1.	The value of time alignment error depends upon the type of carrier aggregation.
T1	s	7	During this time the PCell shall be known and the SCell configured and detected.
T2	s	1	During this time the UE shall activate the SCell.
T3	s	1	During this time the UE shall deactivate the SCell.
Note:	This test verifies the RRM requirement which is independent of channel bandwidth and is performed according to the principle defined in section A.3.6.1.		

Table A.8.16.17.1-2: Cell specific test parameters for E-UTRAN FDD known SCell activation

Parameter	Unit	Cell 1			Cell 2		
		T1	T2	T3	T1	T2	T3
E-UTRA RF Channel Number		1			2		
BW _{channel}	MHz	10			10		

OCNG Patterns defined in A.3.2.1.1 (OP.1 FDD) and in A.3.2.1.2 (OP.2 FDD)		OP.10 FDD	OP.2 FDD
PBCH_RA	dB		
PBCH_RB	dB		
PSS_RA	dB		
SSS_RA	dB		
PCFICH_RB	dB		
PHICH_RA	dB		
PHICH_RB	dB	0	0
PDCCH_RA	dB		
PDCCH_RB	dB		
PDSCH_RA	dB		
PDSCH_RB	dB		
OCNG_RA ^{Note 1}	dB		
OCNG_RB ^{Note 1}	dB		
N_{oc} ^{Note 2}	dBm/15 kHz	-104	-104
RSRP ^{Note 3}	dBm/15 kHz	-87	-87
\bar{E}_s/I_{ot}	dB	17	17
SCH_RP ^{Note 3}	dBm/15 kHz	-87	-87
\bar{E}_s/N_{oc}	dB	17	17
Propagation Condition		AWGN	
Note 1:	OCNG shall be used such that all cells are fully allocated and a constant total transmitted power spectral density is achieved for all OFDM symbols.		
Note 2:	Interference from other cells and noise sources not specified in the test is assumed to be constant over subcarriers and time and shall be modelled as AWGN of appropriate power for N_{oc} to be fulfilled.		
Note 3:	E_s/I_{ot} , RSRP and SCH_RP levels have been derived from other parameters for information purposes. They are not settable parameters themselves.		
Note 4:	The uplink resources for CSI reporting are assigned to the UE prior to the start of time period T2.		

A.8.16.17.2 Test Requirements

During T2 the UE shall send the first CSI report for SCell in a subframe (m+8), or in a subframe (m+10) if the subframe (m+8) was subject to interruption. Whether CSI report in subframe (m+8) was interrupted or not is checked by monitoring ACK/NACK sent in PCell in subframe (m+8).

During T2 the UE shall start sending CSI reports for SCell with non-zero CQI index at latest in a subframe (m+24).

During T3 the UE shall stop sending CSI reports for SCell at latest in a subframe (n+8).

During T2 interruption of PCell during SCell activation shall not happen outside the subframes (m+5) to (m+9).

During T3 interruption of PCell during SCell deactivation shall not happen outside the subframes (n+5) to (n+9).

The interruption of PCell shall not be more than the values specified for intra-band CA and inter-band CA in Section 7.8.2.

All of the above test requirements shall be fulfilled in order for the observed SCell activation delay and SCell deactivation delay to be counted as correct. The rate of correct observed SCell activation delay and SCell deactivation delay during repeated tests shall be at least 90%.

NOTE: During T2 if there are no uplink resources for reporting the valid CSI in a subframe (m+24) then the UE shall use the next available uplink resource for reporting the corresponding valid CSI.

A.8.16.17A E-UTRAN FDD activation and deactivation of known SCell in non-DRX for 20MHz

A.8.16.17A.1 Test Purpose and Environment

The purpose of this test case is the same as for the test defined in subclause A.8.16.17. The test parameters are the same except those described in the following section. The listed parameter values in Tables A.8.16.17A.1-1 and A.8.16.17A.1-2 will replace the values of corresponding parameters in Tables A.8.16.17.1-1 and A.8.16.17.1-2.

Table A.8.16.17A.1-1: General test parameters for known SCell activation case, 20MHz bandwidth

Parameter	Unit	Value	Comment
PDSCH parameters		DL Reference Measurement Channel R.6 FDD	As specified in section A.3.1.1.1
PCFICH/PDCCH/PHICH parameters		DL Reference Measurement Channel R.10 FDD	As specified in section A.3.1.2.1

Table A.8.16.17A.1-2: Cell specific test parameters for E-UTRAN FDD known SCell activation, 20MHz bandwidth

Parameter	Unit	Cell 1			Cell 2		
		T1	T2	T3	T1	T2	T3
BW _{channel}	MHz	20			20		
OCNG Patterns defined in A.3.2.1.17 (OP.17 FDD) and in A.3.2.1.12 (OP.12 FDD)		OP.17 FDD			OP.12.FDD		

A.8.16.17A.2 Test Requirements

The test requirements defined in section A.8.16.17.2 shall apply to this test case.

A.8.16.17B E-UTRAN FDD activation and deactivation of known SCell in non-DRX for 10MHz + 5MHz

A.8.16.17B.1 Test Purpose and Environment

The purpose of this test case is the same as for the test defined in subclause A.8.16.17. The test parameters are the same except those described in the following section. The listed parameter values in Tables A.8.16.17B.1-1 and A.8.16.17B.1-2 will replace the values of corresponding parameters in Tables A.8.16.17.1-1 and A.8.16.17.1-2.

Table A.8.16.17B.1-1: General test parameters for known SCell activation case, 10+5MHz bandwidth

Parameter	Unit	Value	Comment
PDSCH parameters		DL Reference Measurement Channel R.3 FDD (Cell 1)	As specified in section A.3.1.1.1
PCFICH/PDCCH/PHICH parameters		DL Reference Measurement Channel R.6 FDD (Cell 1) DL Reference Measurement Channel R.11 FDD (Cell 2)	As specified in section A.3.1.2.1

Table A.8.16.17B.1-2: Cell specific test parameters for E-UTRAN FDD known SCell activation, 10+5MHz bandwidth

Parameter	Unit	Cell 1			Cell 2		
		T1	T2	T3	T1	T2	T3
BW _{channel}	MHz	10			5		

OCNG Patterns defined in A.3.2.1.11 (OP.11 FDD) and in A.3.2.1.16 (OP.16 FDD)		OP.10 FDD	OP.16.FDD
---	--	-----------	-----------

A.8.16.17B.2 Test Requirements

The test requirements defined in section A.8.16.17.2 shall apply to this test case.

A.8.16.17C E-UTRAN FDD activation and deactivation of known SCell in non-DRX for 5MHz + 5MHz

A.8.16.17C.1 Test Purpose and Environment

The purpose of this test case is the same as for the test defined in subclause A.8.16.17. The test parameters are the same except those described in the following section. The listed parameter values in Tables A.8.16.17C.1-1 and A.8.16.17C.1-2 will replace the values of corresponding parameters in Tables A.8.16.17.1-1 and A.8.16.17.1-2.

Table A.8.16.17C.1-1: General test parameters for known SCell activation case, 5+5MHz bandwidth

Parameter	Unit	Value	Comment
PDSCH parameters		DL Reference Measurement Channel R.7 FDD (Cell 1)	As specified in section A.3.1.1.1
PCFICH/PDCCH/PHICH parameters		DL Reference Measurement Channel R.11 FDD	As specified in section A.3.1.2.1

Table A.8.16.17C.1-2: Cell specific test parameters for E-UTRAN FDD known SCell activation, 5+5MHz bandwidth

Parameter	Unit	Cell 1			Cell 2		
		T1	T2	T3	T1	T2	T3
BW _{channel}	MHz	5			5		
OCNG Patterns defined in A.3.2.1.15 (OP.15 FDD) and in A.3.2.1.16 (OP.16 FDD)		OP.20 FDD			OP.16.FDD		

A.8.16.17C.2 Test Requirements

The test requirements defined in section A.8.16.17.2 shall apply to this test case.

A.8.16.18 E-UTRAN TDD activation and deactivation of known SCell in non-DRX

A.8.16.18.1 Test Purpose and Environment

The purpose of this test is to verify that the SCell activation and deactivation times are within the requirements stated in section 7.7, when the SCell is known by the UE at the time of activation.

The test parameters are given in Tables A.8.16.18.1-1 and cell-specific parameters in A.8.16.18.1-2 below. The test consists of three successive time periods, with duration of T1, T2 and T3, respectively. There are two carriers, each with one cell. Both cells have constant signal levels throughout the test. Before the test starts the UE is connected to Cell 1 (PCell) on radio channel 1 (PCC) but is not aware of Cell 2 on radio channel 2. The UE is only monitoring the PCC. The UE shall be continuously scheduled in the PCell throughout the whole test.

At the beginning of T1 the UE receives an RRC message by which the SCell (Cell 2) becomes configured on radio channel 2 (SCC). The UE now starts monitoring also the SCC. The test equipment sends a MAC message for activation of the SCell.

The point in time at which the MAC message is received at the UE antenna connector, in a subframe # denoted m , where m is 4 or 9, defines the start of time period T2. The UE shall be able to report valid CSI for the activated SCell at latest in subframe $(m+24)$. The UE shall start reporting CSI in subframe $(m+8)$ and shall report CQI index 0 (out-of-range) until the SCell activation has been completed. Any PCell interruption due to activation of SCell shall occur in the subframes $(m+5)$ to $(m+11)$.

Time period T3 starts when a MAC message for deactivation of SCell, sent from the test equipment to the UE in a subframe # denoted n where n is 4 or 9, is received at the UE antenna connector. The UE shall carry out deactivation of the SCell and any PCell interruption due to the deactivation shall occur in the subframes $(n+5)$ to $(n+11)$.

The test equipment verifies that potential interruption is carried out in the correct time span by monitoring ACK/NACK sent in PCell during activation and deactivation of SCell, respectively.

The test equipment verifies the activation time by counting the subframes from the time when the SCell activation command is sent until a CSI report with other than CQI index 0 is received.

The test equipment verifies the deactivation time by counting the subframes from the time when the SCell deactivation command is sent until CQI reporting for SCell is discontinued.

Table A.8.16.18.1-1: General test parameters for known SCell activation case

Parameter	Unit	Value	Comment
PDSCH parameters		DL Reference Measurement Channel R.0 TDD	As specified in section A.3.1.1.2
PCFICH/PDCCH/PHICH parameters		DL Reference Measurement Channel R.6 TDD	As specified in section A.3.1.2.2
E-UTRA RF Channel Number		1, 2	Two radio channels are used for this test
Active PCell		Cell 1	Primary cell on RF channel number 1.
Configured deactivated SCell		Cell 2	Configured deactivated secondary cell on RF channel number 2.
Channel Bandwidth (BW_{channel})	MHz	10	Channel bandwidth for cells on primary and secondary component carriers
CP length		Normal	
Special subframe configuration		6	As specified in table 4.2.1 in TS 36.211. The same configuration applies to all cells.
Uplink-downlink configuration		1	
DRX		OFF	Continuous monitoring of primary cell
CQI/PMI periodicity and offset configuration index		0	CQI reporting for SCell every UL subframe
Cell-individual offset for cells on RF channel number 1	dB	0	Individual offset for cells on primary component carrier.
Cell-individual offset for cells on RF channel number 2	dB	0	Individual offset for cells on secondary component carrier.
SCell measurement cycle (measCycleSCell)	ms	320	
Cell2 timing offset to cell1	μs	0	
Time alignment error between cell2 and cell1	μs	\leq Time alignment error as specified in 3GPP TS 36.104 [30] clause 6.5.3.1.	The value of time alignment error depends upon the type of carrier aggregation.
Cell3 timing offset to cell1	μs	3	Synchronous cells
T1	s	7	During this time the PCell shall be known and the SCell configured and detected.
T2	s	1	During this time the UE shall activate the SCell.
T3	s	1	During this time the UE shall deactivate the SCell.
Note:	This test verifies the RRM requirement which is independent of channel bandwidth and is performed according to the principle defined in section A.3.6.1.		

Table A.8.16.18.1-2: Cell specific test parameters for E-UTRAN TDD known SCell activation

Parameter	Unit	Cell 1			Cell 2		
		T1	T2	T3	T1	T2	T3
E-UTRA RF Channel Number		1			2		
BW _{channel}	MHz	10			10		
OCNG Patterns defined in A.3.2.2.1 (OP.1 TDD) and in A.3.2.2.2 (OP.2 TDD)		OP.1 TDD			OP.2 TDD		
PBCH_RA	dB	0			0		
PBCH_RB	dB						
PSS_RA	dB						
SSS_RA	dB						
PCFICH_RB	dB						
PHICH_RA	dB						
PHICH_RB	dB						
PDCCH_RA	dB						
PDCCH_RB	dB						
PDSCH_RA	dB						
PDSCH_RB	dB						
OCNG_RA ^{Note 1}	dB						
OCNG_RB ^{Note 1}	dB						
N _{oc} ^{Note 2}	dBm/15 kHz						
RSRP ^{Note 3}	dBm/15 kHz	-87			-87		
\bar{E}_s/I_{ot}	dB	17			17		
SCH_RP ^{Note 3}	dBm/15 kHz	-87			-87		
\bar{E}_s/N_{oc}	dB	17			17		
Propagation Condition		AWGN					
Note 1:	OCNG shall be used such that all cells are fully allocated and a constant total transmitted power spectral density is achieved for all OFDM symbols.						
Note 2:	Interference from other cells and noise sources not specified in the test is assumed to be constant over subcarriers and time and shall be modelled as AWGN of appropriate power for N _{oc} to be fulfilled.						
Note 3:	Es/I _{ot} , RSRP and SCH_RP levels have been derived from other parameters for information purposes. They are not settable parameters themselves.						
Note 4:	The uplink resources for CSI reporting are assigned to the UE prior to the start of time period T2.						

A.8.16.18.2 Test Requirements

During T2 the UE shall send the first CSI report for SCell in a subframe (m+8), or in a subframe (m+9) if the subframe (m+8) was subject to interruption, or in a subframe (m+13) if the subframes (m+8) and (m+9) were subject to interruption when an intra-band SCell is activated. Whether CSI report in subframe (m+8) and/or (m+9) was interrupted or not is checked by monitoring ACK/NACK sent in PCell in subframe (m+8) and/or (m+9).

During T2 the UE shall start sending CSI reports for SCell with non-zero CQI index at latest in a subframe (m+24).

During T3 the UE shall stop sending CSI reports for SCell at latest in a subframe (m+8).

During T2 interruption of PCell during SCell activation shall not happen outside the subframes (m+5) to (m+11).

During T3 interruption of PCell during SCell deactivation shall not happen outside the subframes (n+5) to (n+11).

The interruption of PCell shall not be more than the values specified for intra-band CA and inter-band CA in Section 7.8.2.

All of the above test requirements shall be fulfilled in order for the observed SCell activation delay and SCell deactivation delay to be counted as correct. The rate of correct observed SCell activation delay and SCell deactivation delay during repeated tests shall be at least 90%.

NOTE: During T2 if there are no uplink resources for reporting the valid CSI in a subframe (m+24) then the UE shall use the next available uplink resource for reporting the corresponding valid CSI.

A.8.16.18A E-UTRAN TDD activation and deactivation of known SCell in non-DRX for 20MHz

A.8.16.18A.1 Test Purpose and Environment

The purpose of this test case is the same as for the test defined in subclause A.8.16.18. The test parameters are the same except those described in the following section. The listed parameter values in Tables A.8.16.18A.1-1 and A.8.16.18A.1-2 will replace the values of corresponding parameters in Tables A.8.16.18.1-1 and A.8.16.18.1-2.

Table A.8.16.18A.1-1: General test parameters for known SCell activation case, 20MHz bandwidth

Parameter	Unit	Value	Comment
PDSCH parameters		DL Reference Measurement Channel R.3 TDD	As specified in section A.3.1.1.2
PCFICH/PDCCH/PHICH parameters		DL Reference Measurement Channel R.10 TDD	As specified in section A.3.1.2.2

Table A.8.16.18A.1-2: Cell specific test parameters for E-UTRAN TDD known SCell activation, 20MHz bandwidth

Parameter	Unit	Cell 1			Cell 2		
		T1	T2	T3	T1	T2	T3
BW _{channel}	MHz	20			20		
OCNG Patterns defined in A.3.2.2.7 (OP.7 TDD) and in A.3.2.2.2 (OP.2 TDD)		OP.7 TDD			OP.8.TDD		

A.8.16.18A.2 Test Requirements

The test requirements defined in section A.8.16.18.2 shall apply to this test case.

A.8.16.18B E-UTRAN TDD activation and deactivation of known SCell in non-DRX for 10MHz + 5MHz

A.8.16.18B.1 Test Purpose and Environment

The purpose of this test case is the same as for the test defined in subclause A.8.16.18. The test parameters are the same except those described in the following section. The listed parameter values in Tables A.8.16.18B.1-1 and A.8.16.18B.1-2 will replace the values of corresponding parameters in Tables A.8.16.18.1-1 and A.8.16.18.1-2.

Table A.8.16.18B.1-1: General test parameters for known SCell activation case, 10 + 5MHz bandwidth

Parameter	Unit	Value	Comment
PDSCH parameters		DL Reference Measurement Channel R.0 TDD	As specified in section A.3.1.1.2
PCFICH/PDCCH/PHICH parameters		DL Reference Measurement Channel R.6 TDD (cell 1) DL Reference Measurement Channel R.11 TDD (cell 2)	As specified in section A.3.1.2.2

Table A.8.16.18B.1-2: Cell specific test parameters for E-UTRAN TDD known SCell activation, 10 + 5MHz bandwidth

Parameter	Unit	Cell 1			Cell 2		
		T1	T2	T3	T1	T2	T3
BW _{channel}	MHz	10			5		

OCNG Patterns defined in A.3.2.2.1 (OP.1 TDD) and in A.3.2.2.10 (OP.10 TDD)		OP.1 TDD	OP.10.TDD
---	--	----------	-----------

A.8.16.18B.2 Test Requirements

The test requirements defined in section A.8.16.18.2 shall apply to this test case.

A.8.16.18C E-UTRAN TDD activation and deactivation of known SCell in non-DRX for 5MHz + 5MHz

A.8.16.18C.1 Test Purpose and Environment

The purpose of this test case is the same as for the test defined in subclause A.8.16.18. The test parameters are the same except those described in the following section. The listed parameter values in Tables A.8.16.18C.1-1 and A.8.16.18C.1-2 will replace the values of corresponding parameters in Tables A.8.16.18.1-1 and A.8.16.18.1-2.

Table A.8.16.18C.1-1: General test parameters for known SCell activation case, 5MHz bandwidth

Parameter	Unit	Value	Comment
PDSCH parameters		DL Reference Measurement Channel R.4 TDD	As specified in section A.3.1.1.2
PCFICH/PDCCH/PHICH parameters		DL Reference Measurement Channel R.11 TDD	As specified in section A.3.1.2.2

Table A.8.16.18C.1-2: Cell specific test parameters for E-UTRAN TDD known SCell activation, 5MHz bandwidth

Parameter	Unit	Cell 1			Cell 2		
		T1	T2	T3	T1	T2	T3
BW _{channel}	MHz	5			5		
OCNG Patterns defined in A.3.2.2.9 (OP.9 TDD) and in A.3.2.2.10 (OP.10 TDD)		OP.9 TDD			OP.10.TDD		

A.8.16.18C.2 Test Requirements

The test requirements defined in section A.8.16.18.2 shall apply to this test case.

A.8.16.18D E-UTRAN TDD activation and deactivation of known SCell in non-DRX for 20MHz + 10MHz

A.8.16.18D.1 Test Purpose and Environment

The purpose of this test case is the same as for the test defined in subclause A.8.16.18. The test parameters are the same except those described in the following section. The listed parameter values in Tables A.8.16.18D.1-1 and A.8.16.18D.1-2 will replace the values of corresponding parameters in Tables A.8.16.18.1-1 and A.8.16.18.1-2.

Table A.8.16.18D.1-1: General test parameters for known SCell activation case, 20 + 10MHz bandwidth

Parameter	Unit	Value	Comment
PDSCH parameters		DL Reference Measurement Channel R.3 TDD	As specified in section A.3.1.1.2

PCFICH/PDCCH/PHICH parameters		DL Reference Measurement Channel R.10 TDD (cell 1) DL Reference Measurement Channel R.6 TDD (cell 2)	As specified in section A.3.1.2.2
-------------------------------	--	---	-----------------------------------

Table A.8.16.18D.1-2: Cell specific test parameters for E-UTRAN TDD known SCell activation, 20 + 10MHz bandwidth

Parameter	Unit	Cell 1			Cell 2		
		T1	T2	T3	T1	T2	T3
BW _{channel}	MHz	20			10		
OCNG Patterns defined in A.3.2.2.7 (OP.7 TDD) and in A.3.2.2.2 (OP.2 TDD)		OP.7 TDD			OP.2.TDD		

A.8.16.18D.2 Test Requirements

The test requirements defined in section A.8.16.18.2 shall apply to this test case.

A.8.16.19 E-UTRAN FDD activation and deactivation of unknown SCell in non-DRX

A.8.16.19.1 Test Purpose and Environment

The purpose of this test is to verify that the SCell activation and deactivation times are within the requirements stated in section 7.7, when the SCell is unknown by the UE at the time of activation.

The test parameters are given in Tables A.8.16.19.1-1 and cell-specific parameters in A.8.16.19.1-2 below. The test consists of three successive time periods, with duration of T1, T2 and T3, respectively. There are two carriers, each with one cell. Cell 1 has constant signal level throughout the test. Before the test starts the UE is connected to Cell 1 (PCell) on radio channel 1 (PCC) but is not aware of Cell 2 on radio channel 2. The UE is only monitoring the PCC. The UE shall be continuously scheduled in the PCell throughout the whole test.

At the beginning of T1 the UE receives an RRC message by which the SCell (cell2) becomes configured on radio channel 2 (SCC). During T1 the SCell is powered off and UE is not aware of SCell.

A MAC message for activation of SCell is sent by the test equipment 100ms after the RRC message, in a subframe # denoted m which is an even number. The point in time at which the MAC message for activation of SCell is received at the UE antenna connector defines the start of time period T2. Immediately at beginning of T2 the transmission power of cell 2 is increased to same level as for cell 1. The UE shall be able to report valid CSI for the activated SCell at latest in subframe (m+34) provided the SCell can be successfully detected on the first attempt. The UE shall start reporting CSI in subframe (m+8) and shall report CQI index 0 (out-of-range) until the SCell activation has been completed. Any PCell interruption due to activation of SCell shall occur in the subframes (m+5) to (m+9).

Time period T3 starts when a MAC message for deactivation of the SCell, sent from the test equipment to the UE in a subframe # denoted n which is an even number, is received at the UE antenna connector. The UE shall carry out deactivation of the SCell at latest in subframe (n+8), and any PCell interruption due to the deactivation shall occur in the subframes (n+5) to (n+9).

The test equipment verifies that potential interruption is carried out in the correct time span by monitoring ACK/NACK sent in PCell during activation of SCell, respectively.

The test equipment verifies the activation time by counting the subframes from the time when the SCell activation command is sent until a CSI report with other than CQI index 0 is received.

The test equipment verifies the deactivation time by counting the subframes from the time when the SCell1 deactivation command is sent until CQI reporting for SCell1 is discontinued.

Table A.8.16.19.1-1: General test parameters for unknown SCell activation case

Parameter	Unit	Value	Comment
PDSCH parameters		DL Reference Measurement Channel R.0 FDD	As specified in section A.3.1.1.1
PCFICH/PDCCH/PHICH parameters		DL Reference Measurement Channel R.6 FDD	As specified in section A.3.1.2.1
E-UTRA RF Channel Number		1, 2	Two radio channels are used for this test
Active PCell		Cell 1	Primary cell on RF channel number 1.
Configured deactivated SCell		Cell 2	Configured deactivated secondary cell on RF channel number 2.
CP length		Normal	
DRX		OFF	Continuous monitoring of primary cell
CQI/PMI periodicity and offset configuration index		0	CQI reporting for SCell every second subframe
SCell measurement cycle (measCycleSCell)	ms	320	
Cell2 timing offset to cell1	μs	0	
Time alignment error between cell2 and cell1	μs	≤ Time alignment error as specified in 3GPP TS 36.104 [30] clause 6.5.3.1.	The value of time alignment error depends upon the type of carrier aggregation.
T1	ms	100	During this time the PCell shall be known and the SCell configured, but not detected.
T2	s	1	During this time the UE shall activate the SCell.
T3	s	1	During this time the UE shall deactivate the SCell.
Note:	This test verifies the RRM requirement which is independent of channel bandwidth and is performed according to the principle defined in section A.3.6.1.		

Table A.8.16.19.1-2: Cell specific test parameters for E-UTRAN FDD unknown SCell activation

Parameter	Unit	Cell 1			Cell 2		
		T1	T2	T3	T1	T2	T3
E-UTRA RF Channel Number		1			2		
BW _{channel}	MHz	10			10		
OCNG Patterns defined in A.3.2.1.1 (OP.1 FDD) and in A.3.2.1.2 (OP.2 FDD)		OP.1 FDD			OP.2 FDD		
PBCH_RA	dB	0			0		
PBCH_RB	dB						
PSS_RA	dB						
SSS_RA	dB						
PCFICH_RB	dB						
PHICH_RA	dB						
PHICH_RB	dB						
PDCCH_RA	dB						
PDCCH_RB	dB						
PDSCH_RA	dB						
PDSCH_RB	dB						
OCNG_RA ^{Note 1}	dB						
OCNG_RB ^{Note 1}	dB						
N _{oc} ^{Note 2}	dBm/15 kHz						
RSRP ^{Note 3}	dBm/15 kHz	-87			-infinity	-87	
\bar{E}_s/I_{ot}	dB	17			-infinity	17	
SCH_RP ^{Note 3}	dBm/15 kHz	-87			-infinity	-87	
\bar{E}_s/N_{oc}	dB	17			-infinity	17	
Propagation Condition		AWGN					

Note 1:	OCNG shall be used such that all cells are fully allocated and a constant total transmitted power spectral density is achieved for all OFDM symbols.
Note 2:	Interference from other cells and noise sources not specified in the test is assumed to be constant over subcarriers and time and shall be modelled as AWGN of appropriate power for N_{oc} to be fulfilled.
Note 3:	E_s/lot , RSRP and SCH_RP levels have been derived from other parameters for information purposes. They are not settable parameters themselves.
Note 4:	The uplink resources for CSI reporting are assigned to the UE prior to the start of time period T2.

A.8.16.19.2 Test Requirements

During T2 the UE shall send the first CSI report for SCell (m+8), or in a subframe (m+10) if the subframe (m+8) was subject to interruption. Whether CSI report in subframe (m+8) was interrupted or not is checked by monitoring ACK/NACK sent in PCell in subframe (m+8).

During T2 the UE shall start sending CSI reports for SCell with non-zero CQI index at latest in a subframe (m+34).

During T3 the UE shall stop sending CSI reports for SCell1 at latest in a subframe (n+8).

During T2 Interruption of PCell during SCell activation shall not happen outside the subframes (m+5) to (m+9).

During T3 Interruption of PCell during SCell1 deactivation shall not happen outside the subframes (n+5) to (n+9).

The interruption of PCell shall not be more than the values specified for intra-band CA and inter-band CA in Section 7.8.2.

All of the above test requirements shall be fulfilled in order for the observed SCell activation delay to be counted as correct. The rate of correct observed SCell activation and deactivation delay during repeated tests shall be at least 90%.

NOTE: During T2 if there are no uplink resources for reporting the valid CSI in a subframe (m+34) then the UE shall use the next available uplink resource for reporting the corresponding valid CSI.

A.8.16.19A E-UTRAN FDD activation and deactivation of unknown SCell in non-DRX for 20MHz

A.8.16.19A.1 Test Purpose and Environment

The purpose of this test case is the same as for the test defined in subclause A.8.16.19. The test parameters are the same except those described in the following section. The listed parameter values in Tables A.8.16.19A.1-1 and A.8.16.19A.1-2 will replace the values of corresponding parameters in Tables A.8.16.19.1-1 and A.8.16.19.1-2.

Table A.8.16.19A.1-1: General test parameters for unknown SCell activation case, 20MHz bandwidth

Parameter	Unit	Value	Comment
PDSCH parameters		DL Reference Measurement Channel R.6 FDD	As specified in section A.3.1.1.1
PCFICH/PDCCH/PHICH parameters		DL Reference Measurement Channel R.10 FDD	As specified in section A.3.1.2.1

Table A.8.16.19A.1-2: Cell specific test parameters for E-UTRAN FDD unknown SCell activation, 20MHz bandwidth

Parameter	Unit	Cell 1			Cell 2		
		T1	T2	T3	T1	T2	T3
$BW_{channel}$	MHz	20			20		
OCNG Patterns defined in A.3.2.1.17 (OP.17 FDD) and in A.3.2.1.12 (OP.12 FDD)		OP.17 FDD			OP.12.FDD		

A.8.16.19A.2 Test Requirements

The test requirements defined in section A.8.16.19.2 shall apply to this test case.

A.8.16.19B E-UTRAN FDD activation and deactivation of unknown SCell in non-DRX for 10MHz + 5MHz

A.8.16.19B.1 Test Purpose and Environment

The purpose of this test case is the same as for the test defined in subclause A.8.16.19. The test parameters are the same except those described in the following section. The listed parameter values in Tables A.8.16.19B.1-1 and A.8.16.19B.1-2 will replace the values of corresponding parameters in Tables A.8.16.19.1-1 and A.8.16.19.1-2.

Table A.8.16.19B.1-1: General test parameters for unknown SCell activation case, 10+5MHz bandwidth

Parameter	Unit	Value	Comment
PDSCH parameters		DL Reference Measurement Channel R.3 FDD (Cell 1)	As specified in section A.3.1.1.1
PCFICH/PDCCH/PHICH parameters		DL Reference Measurement Channel R.6 FDD (Cell 1) DL Reference Measurement Channel R.11 FDD (Cell 2)	As specified in section A.3.1.2.1

Table A.8.16.19B.1-2: Cell specific test parameters for E-UTRAN FDD unknown SCell activation, 10+5MHz bandwidth

Parameter	Unit	Cell 1			Cell 2		
		T1	T2	T3	T1	T2	T3
BW _{channel}	MHz	10			5		
OCNG Patterns defined in A.3.2.1.11 (OP.11 FDD) and in A.3.2.1.16 (OP.16 FDD)		OP.10 FDD			OP.16.FDD		

A.8.16.19B.2 Test Requirements

The test requirements defined in section A.8.16.19.2 shall apply to this test case.

A.8.16.19C E-UTRAN FDD activation and deactivation of unknown SCell in non-DRX for 5MHz + 5MHz

A.8.16.19C.1 Test Purpose and Environment

The purpose of this test case is the same as for the test defined in subclause A.8.16.19. The test parameters are the same except those described in the following section. The listed parameter values in Tables A.8.16.19C.1-1 and A.8.16.19C.1-2 will replace the values of corresponding parameters in Tables A.8.16.19.1-1 and A.8.16.19.1-2.

Table A.8.16.19C.1-1: General test parameters for unknown SCell activation case, 5+5MHz bandwidth

Parameter	Unit	Value	Comment
PDSCH parameters		DL Reference Measurement Channel R.7 FDD (Cell 1)	As specified in section A.3.1.1.1
PCFICH/PDCCH/PHICH parameters		DL Reference Measurement Channel R.11 FDD	As specified in section A.3.1.2.1

Table A.8.16.19C.1-2: Cell specific test parameters for E-UTRAN FDD unknown SCell activation, 5+5MHz bandwidth

Parameter	Unit	Cell 1			Cell 2		
		T1	T2	T3	T1	T2	T3
BW _{channel}	MHz	5			5		
OCNG Patterns defined in A.3.2.1.15 (OP.15 FDD) and in A.3.2.1.16 (OP.16 FDD)		OP.20 FDD			OP.16.FDD		

A.8.16.19C.2 Test Requirements

The test requirements defined in section A.8.16.19.2 shall apply to this test case.

A.8.16.20 E-UTRAN TDD activation and deactivation of unknown SCell in non-DRX

A.8.16.20.1 Test Purpose and Environment

The purpose of this test is to verify that the SCell activation and deactivation times are within the requirements stated in section 7.7, when the SCell is unknown by the UE at the time of activation.

The test parameters are given in Tables A.8.16.20.1-1 and cell-specific parameters in A.8.16.20.1-2 below. The test consists of three successive time periods, with duration of T1, T2 and T3, respectively. There are two carriers, each with one cell. Cell 1 has constant signal level throughout the test. Before the test starts the UE is connected to Cell 1 (PCell) on radio channel 1 (PCC) but is not aware of Cell 2 on radio channel 2. The UE is only monitoring the PCC. The UE shall be continuously scheduled in the PCell throughout the whole test.

At the beginning of T1 the UE receives an RRC message by which the SCell (cell2) becomes configured on radio channel 2 (SCC). During T1 the signal level of SCell is powered off and UE is not aware of SCell.

A MAC message for activation of SCell is sent by the test equipment 100ms after the RRC message, in a subframe # denoted m, where m is 4 or 9. The point in time at which the MAC message for activation of SCell is received at the UE antenna connector defines the start of time period T2. Immediately at beginning of T2 the transmission power of cell 2 is increased to same level as for cell 1. The UE shall be able to report valid CSI for the activated SCell at latest in subframe (m+34) provided the SCell can be successfully detected on the first attempt. The UE shall start reporting CSI in subframe (m+8) and shall report CQI index 0 (out-of-range) until the SCell activation has been completed. Any PCell interruption due to activation of SCell shall occur in the subframes (m+5) to (m+11).

Time period T3 starts when a MAC message for deactivation of the SCell, sent from the test equipment to the UE in a subframe # denoted n, where n is 4 or 9, is received at the UE antenna connector. The UE shall carry out deactivation of the SCell at latest in subframe (n+8), and any PCell interruption due to the deactivation shall occur in the subframes (n+5) to (n+11).

The test equipment verifies that potential interruption is carried out in the correct time span by monitoring ACK/NACK sent in PCell during activation of SCell, respectively.

The test equipment verifies the activation time by counting the subframes from the time when the SCell activation command is sent until a CSI report with other than CQI index 0 is received.

The test equipment verifies the deactivation time by counting the subframes from the time when the SCell1 deactivation command is sent until CQI reporting for SCell1 is discontinued.

Table A.8.16.20.1-1: General test parameters for unknown SCell activation case

Parameter	Unit	Value	Comment
PDSCH parameters		DL Reference Measurement Channel R.0 TDD	As specified in section A.3.1.1.2
PCFICH/PDCCH/PHICH parameters		DL Reference Measurement Channel R.6 TDD	As specified in section A.3.1.2.2

E-UTRA RF Channel Number		1, 2	Two radio channels are used for this test
Active PCell		Cell 1	Primary cell on RF channel number 1.
Configured deactivated SCell		Cell 2	Configured deactivated secondary cell on RF channel number 2.
Channel Bandwidth (BW _{channel})	MHz	10	Channel bandwidth for cells on primary and secondary component carriers
CP length		Normal	
Special subframe configuration		6	As specified in table 4.2.1 in TS 36.211. The same configuration applies to all cells.
Uplink-downlink configuration		1	
DRX		OFF	Continuous monitoring of primary cell
CQI/PMI periodicity and offset configuration index		0	CQI reporting for SCell every UL subframe
SCell measurement cycle (measCycleSCell)	ms	320	
Cell2 timing offset to cell1	μs	0	
Time alignment error between cell2 and cell1	μs	≤ Time alignment error as specified in 3GPP TS 36.104 [30] clause 6.5.3.1.	The value of time alignment error depends upon the type of carrier aggregation.
Cell3 timing offset to cell1	μs	3	Synchronous cells
T1	ms	100	During this time the PCell shall be known and the SCell configured, but not detected.
T2	s	1	During this time the UE shall activate the SCell.
T3	s	1	During this time the UE shall deactivate the SCell.
Note:	This test verifies the RRM requirement which is independent of channel bandwidth and is performed according to the principle defined in section A.3.6.1.		

Table A.8.16.20.1-2: Cell specific test parameters for E-UTRAN TDD unknown SCell activation

Parameter	Unit	Cell 1			Cell 2		
		T1	T2	T3	T1	T2	T3
E-UTRA RF Channel Number		1			2		
BW _{channel}	MHz	10			10		
OCNG Patterns defined in A.3.2.2.1 (OP.1 TDD) and in A.3.2.2.2 (OP.2 TDD)		OP.1 TDD			OP.2 TDD		
PBCH_RA	dB	0			0		
PBCH_RB	dB						
PSS_RA	dB						
SSS_RA	dB						
PCFICH_RB	dB						
PHICH_RA	dB						
PHICH_RB	dB						
PDCCH_RA	dB						
PDCCH_RB	dB						
PDSCH_RA	dB						
PDSCH_RB	dB						
OCNG_RA ^{Note 1}	dB						
OCNG_RB ^{Note 1}	dB						
N _{oc} ^{Note 2}	dBm/15 kHz						
RSRP ^{Note 3}	dBm/15 kHz	-87			-infinity	-87	
E _s /I _{ot}	dB	17			-infinity	17	
SCH_RP ^{Note 3}	dBm/15 kHz	-87			-infinity	-87	
E _s /N _{oc}	dB	17			-infinity	17	
Propagation Condition		AWGN					

Note 1:	OCNG shall be used such that all cells are fully allocated and a constant total transmitted power spectral density is achieved for all OFDM symbols.
Note 2:	Interference from other cells and noise sources not specified in the test is assumed to be constant over subcarriers and time and shall be modelled as AWGN of appropriate power for N_{oc} to be fulfilled.
Note 3:	Es/lot, RSRP and SCH_RP levels have been derived from other parameters for information purposes. They are not settable parameters themselves.
Note 4:	The uplink resources for CSI reporting are assigned to the UE prior to the start of time period T2.

A.8.16.20.2 Test Requirements

During T2 the UE shall send the first CSI report for SCell at in a subframe (m+8), or in a subframe (m+9) if the subframe (m+8) was subject to interruption, or in a subframe (m+13) if the subframes (m+8) and (m+9) were subject to interruption when an intra-band SCell is activated. Whether first CSI report was interrupted or not is checked by monitoring ACK/NACK sent in PCell at the same time as the first CSI report.

During T2 the UE shall start sending CSI reports for SCell with non-zero CQI index at latest in a subframe (m+34).

During T3 the UE shall stop sending CSI reports for SCell1 at latest in a subframe (n+8).

During T2 Interruption of PCell during SCell activation shall not happen outside the subframes (m+5) to (m+11).

During T3 Interruption of PCell during SCell1 deactivation shall not happen outside the subframes (n+5) to (n+11).

The interruption of PCell shall not be more than the values specified for intra-band CA and inter-band CA in Section 7.8.2.

All of the above test requirements shall be fulfilled in order for the observed SCell activation delay to be counted as correct. The rate of correct observed SCell activation and deactivation delay during repeated tests shall be at least 90%.

NOTE: During T2 if there are no uplink resources for reporting the valid CSI in a subframe (m+34) then the UE shall use the next available uplink resource for reporting the corresponding valid CSI.

A.8.16.20A E-UTRAN TDD activation and deactivation of unknown SCell in non-DRX for 20MHz

A.8.16.20A.1 Test Purpose and Environment

The purpose of this test case is the same as for the test defined in subclause A.8.16.20. The test parameters are the same except those described in the following section. The listed parameter values in Tables A.8.16.20A.1-1 and A.8.16.20A.1-2 will replace the values of corresponding parameters in Tables A.8.16.20.1-1 and A.8.16.20.1-2.

Table A.8.16.20A.1-1: General test parameters for unknown SCell activation case, 20MHz bandwidth

Parameter	Unit	Value	Comment
PDSCH parameters		DL Reference Measurement Channel R.0 TDD	As specified in section A.3.1.1.2
PCFICH/PDCCH/PHICH parameters		DL Reference Measurement Channel R.6 TDD	As specified in section A.3.1.2.2

Table A.8.16.20A.1-2: Cell specific test parameters for E-UTRAN TDD unknown SCell activation, 20MHz bandwidth

Parameter	Unit	Cell 1			Cell 2		
		T1	T2	T3	T1	T2	T3
$BW_{channel}$	MHz	20			20		
OCNG Patterns defined in A.3.2.2.7 (OP.7 TDD) and in A.3.2.2.2 (OP.2 TDD)		OP.7 TDD			OP.2.TDD		

A.8.16.20A.2 Test Requirements

The test requirements defined in section A.8.16.20.2 shall apply to this test case.

A.8.16.20B E-UTRAN TDD activation and deactivation of unknown SCell in non-DRX for 10MHz + 5MHz

A.8.16.20B.1 Test Purpose and Environment

The purpose of this test case is the same as for the test defined in subclause A.8.16.20. The test parameters are the same except those described in the following section. The listed parameter values in Tables A.8.16.20B.1-1 and A.8.16.20B.1-2 will replace the values of corresponding parameters in Tables A.8.16.20.1-1 and A.8.16.20.1-2.

Table A.8.16.20B.1-1: General test parameters for unknown SCell activation case, 10 + 5MHz bandwidth

Parameter	Unit	Value	Comment
PDSCH parameters		DL Reference Measurement Channel R.0 TDD	As specified in section A.3.1.1.2
PCFICH/PDCCH/PHICH parameters		DL Reference Measurement Channel R.6 TDD (cell 1) DL Reference Measurement Channel R.12 TDD (cell 2)	As specified in section A.3.1.2.2

Table A.8.16.20B.1-2: Cell specific test parameters for E-UTRAN TDD unknown SCell activation, 10 + 5MHz bandwidth

Parameter	Unit	Cell 1			Cell 2		
		T1	T2	T3	T1	T2	T3
BW _{channel}	MHz	10			5		
OCNG Patterns defined in A.3.2.2.1 (OP.1 TDD) and in A.3.2.2.10 (OP.10 TDD)		OP.1 TDD			OP.10.TDD		

A.8.16.20B.2 Test Requirements

The test requirements defined in section A.8.16.20.2 shall apply to this test case.

A.8.16.20C E-UTRAN TDD activation and deactivation of unknown SCell in non-DRX for 5MHz + 5MHz

A.8.16.20C.1 Test Purpose and Environment

The purpose of this test case is the same as for the test defined in subclause A.8.16.20. The test parameters are the same except those described in the following section. The listed parameter values in Tables A.8.16.20C.1-1 and A.8.16.20C.1-2 will replace the values of corresponding parameters in Tables A.8.16.20.1-1 and A.8.16.20.1-2.

Table A.8.16.20C.1-1: General test parameters for unknown SCell activation case, 5MHz bandwidth

Parameter	Unit	Value	Comment
PDSCH parameters		DL Reference Measurement Channel R.4 TDD	As specified in section A.3.1.1.2
PCFICH/PDCCH/PHICH parameters		DL Reference Measurement Channel R.11 TDD	As specified in section A.3.1.2.2

Table A.8.16.20C.1-2: Cell specific test parameters for E-UTRAN TDD unknown SCell activation, 5MHz bandwidth

Parameter	Unit	Cell 1	Cell 2
-----------	------	--------	--------

		T1	T2	T3	T1	T2	T3
BW _{channel}	MHz	5			5		
OCNG Patterns defined in A.3.2.2.9 (OP.9 TDD) and in A.3.2.2.10 (OP.10 TDD)		OP.9 TDD			OP.10.TDD		

A.8.16.20C.2 Test Requirements

The test requirements defined in section A.8.16.20.2 shall apply to this test case.

A.8.16.20D E-UTRAN TDD activation and deactivation of unknown SCell in non-DRX for 20MHz + 10MHz

A.8.16.20D.1 Test Purpose and Environment

The purpose of this test case is the same as for the test defined in subclause A.8.16.20. The test parameters are the same except those described in the following section. The listed parameter values in Tables A.8.16.20D.1-1 and A.8.16.20D.1-2 will replace the values of corresponding parameters in Tables A.8.16.20.1-1 and A.8.16.20.1-2.

Table A.8.16.20D.1-1: General test parameters for unknown SCell activation case, 20 + 10MHz bandwidth

Parameter	Unit	Value	Comment
PDSCH parameters		DL Reference Measurement Channel R.3 TDD	As specified in section A.3.1.1.2
PCFICH/PDCCH/PHICH parameters		DL Reference Measurement Channel R.10 TDD (cell 1) DL Reference Measurement Channel R.6 TDD (cell 2)	As specified in section A.3.1.2.2

Table A.8.16.20D.1-2: Cell specific test parameters for E-UTRAN TDD unknown SCell activation, 20 + 10MHz bandwidth

Parameter	Unit	Cell 1			Cell 2		
		T1	T2	T3	T1	T2	T3
BW _{channel}	MHz	20			10		
OCNG Patterns defined in A.3.2.2.7 (OP.7 TDD) and in A.3.2.2.2 (OP.2 TDD)		OP.7 TDD			OP.2.TDD		

A.8.16.20D.2 Test Requirements

The test requirements defined in section A.8.16.20.2 shall apply to this test case.

A.8.16.21 E-UTRAN TDD event triggered reporting under deactivated SCell in non-DRX for 20MHz+10MHz

A.8.16.21.1 Test Purpose and Environment

The purpose of this test case is the same as for the test defined in subclause A.8.16.2.

The test parameters are given in Tables A.8.16.21.1-1 and A.8.16.21.1-2 below. It is indicated to the UE in the measurement control information that event-triggered reporting with Events A2 (PCell and SCell) and A6 is used. The test consists of three successive time periods, with duration of T1, T2 and T3, respectively. During T1 the UE shall not have any information on cell 3. Immediately at beginning of T2 the transmission power of cell 3 is increased to same level as for cell 2, and due to usage of an offset this shall result in reporting of Event A6. At beginning of T3 the

transmission powers of cells 1, 2 and 3 are reduced below a threshold value and this shall result in reporting of Event A2 for PCell and SCell, respectively.

Table A.8.16.21.1-1: E-UTRAN TDD event triggered reporting under deactivated SCell in non-DRX for 20MHz+10MHz

Parameter		Unit	Value	Comment
E-UTRA RF Channel Number			1, 2	Two radio channels are used for this test
Active PCell			Cell 1	Primary cell on RF channel number 1.
Configured deactivated SCell			Cell 2	Configured deactivated secondary cell on RF channel number 2.
Neighbour cell			Cell 3	Neighbor cell to be identified on RF channel number 2.
CP length			Normal	
Special subframe configuration			6	As specified in table 4.2.1 in TS 36.211. The same configuration applies to all cells.
Uplink-downlink configuration			1	
DRX			OFF	Continuous monitoring of primary cell
A2	Hysteresis	dB	0	Hysteresis for evaluation of event A2.
	Threshold RSRP	dBm	-96	Actual RSRP threshold for event A2. Needs to take absolute accuracy tolerance in clause 9.1.11.1 into account plus margin.
	Time To Trigger	s	0	
A6	Hysteresis	dB	0	Hysteresis for evaluation of event A6.
	Offset	dB	-6	Offset parameter for evaluation of event A6. Needs to take relative accuracy tolerance in clause 9.1.11.2 into account plus margin.
	Report on leave		False	
	Time To Trigger	s	0	
Cell-individual offset for cells on RF channel number 1		dB	0	Individual offset for cells on primary component carrier.
Cell-individual offset for cells on RF channel number 2		dB	0	Individual offset for cells on secondary component carrier.
Filter coefficient			0	L3 filtering is not used
SCell measurement cycle (measCycleSCell)		ms	320	
Cell2 timing offset to cell1		μs	0	
Time alignment error between cell2 and cell1		μs	≤ Time alignment error as specified in TS 36.104 [30] clause 6.5.3.1.	The value of time alignment error depends upon the type of carrier aggregation.
Cell3 timing offset to cell1		μs	3	Synchronous cells
T1		s	5	During this time the UE shall be aware of cells 1 and 2 but not cell 3.
T2		s	≤12	UE shall report Event A6 within 6.4s (20xscellMeasCycle)
T3		s	5	UE shall report Event A2 within 200 ms and 1.6s for cells 1 and 2, respectively.
NOTE: This test verifies the RRM requirement which is independent of channel bandwidth and is performed according to the principle defined in section C.3.3.1.				

Table A.8.16.21.1-2: Cell specific test parameters for E-UTRAN TDD event triggered reporting under deactivated SCell in non-DRX for 20MHz+10MHz

Parameter	Unit	Combination	Cell 1			Cell 2			Cell 3		
			T1	T2	T3	T1	T2	T3	T1	T2	T3
E-UTRA RF Channel Number		All	1			2			2		
BW _{channel}		20MHz+10MHz	20MHz: N _{RB,c} = 100			10MHz: N _{RB,c} = 50			10MHz: N _{RB,c} = 50		
		10MHz+20MHz	10MHz: N _{RB,c} = 50			20MHz: N _{RB,c} = 100			20MHz: N _{RB,c} = 100		
Correlation Matrix and Antenna Configuration		All	1x2 Low			1x2 Low			1x2 Low		

PDSCH Reference measurement channel defined in A.3.1.1.2		20MHz+10MHz	R.3 TDD			N/A			N/A		
		10MHz+20MHz	R.0 TDD			N/A			N/A		
PDCCH/PCFICH/PHICH Reference measurement channel defined in A.3.1.2.2		20MHz+10MHz	R.10 TDD			R.6 TDD			R.6 TDD		
		10MHz+20MHz	R.6 TDD			R.10 TDD			R.10 TDD		
OCNG Patterns defined in A.3.2.2		20MHz+10MHz	OP.7 TDD			OP.2 TDD			OP.2 TDD		
		10MHz+20MHz	OP.1 TDD			OP.8 TDD			OP.8 TDD		
PBCH_RA	dB	All	0			0			0		
PBCH_RB	dB										
PSS_RA	dB										
SSS_RA	dB										
PCFICH_RB	dB										
PHICH_RA	dB										
PHICH_RB	dB										
PDCCH_RA	dB										
PDCCH_RB	dB										
PDSCH_RA	dB										
PDSCH_RB	dB										
OCNG_RA ^{Note 1}	dB										
OCNG_RB ^{Note 1}	dB										
N _{oc} ^{Note 2}	dBm/15 kHz										
RSRP ^{Note 3}	dBm/15 kHz	All	-85	-85	-107	-85	-85	-107	-	-	-
E _s /I _{ot}	dB	All	19	19	-3	19.00	0.05	4.76	-	-	-
SCH_RP ^{Note 3}	dBm/15 kHz	All	-85	-85	-107	-85	-85	-107	-	-	-
E _s /N _{oc}	dB	All	19	19	-3	19	19	-3	-	-	-
Propagation Condition		All	ETU70								
<p>Note 1: OCNG shall be used such that all cells are fully allocated and a constant total transmitted power spectral density is achieved for all OFDM symbols.</p> <p>Note 2: Interference from other cells and noise sources not specified in the test is assumed to be constant over subcarriers and time and shall be modelled as AWGN of appropriate power for N_{oc} to be fulfilled.</p> <p>Note 3: RSRP and SCH_RP levels have been derived from other parameters for information purposes. They are not settable parameters themselves.</p> <p>Note 4: The resources for uplink transmission are assigned to the UE prior to the start of time period T2.</p>											

A.8.16.21.2 Test Requirements

The test requirements defined in section A.8.16.2.2 shall apply to this test case.

A.8.16.22 E-UTRAN TDD event triggered reporting on deactivating SCell with PCell interruption in non-DRX for 20MHz+10MHz

A.8.16.22.1 Test Purpose and Environment

The purpose of this test case is the same as for the test defined in subclause A.8.16.4.

The test parameters are given in Tables A.8.16.22.1-1 and A.8.16.22.1-2 below. In the test there are three synchronous cells: Cell1, Cell2 and Cell3. Cell1 is PCell, Cell2 is deactivated SCell, and Cell3 is the neighbour cell. It is indicated to the UE in the measurement control information that event-triggered reporting with Event A6 is used. The test consists of two successive time periods, with duration of T1 and T2, respectively. During T1 the UE shall not have any information of cell 3. Immediately at beginning of T2 the transmission power of cell 3 is increased to same level as for cell 2, and due to usage of an offset this shall result in reporting of Event A6. PDCCH indicating a new transmission on the PCell shall be sent continuously to ensure that the UE sends ACK/NACKs throughout the test.

Table A.8.16.22.1-1: General test parameters for E-UTRAN TDD event triggered reporting on deactivating SCell with PCell interruption in non-DRX for 20MHz+10MHz

Parameter	Unit	Value	Comment
-----------	------	-------	---------

E-UTRA RF Channel Number			1, 2	Two radio channels are used for this test
Active PCell			Cell 1	Primary cell on RF channel number 1.
Configured deactivated SCell			Cell 2	Configured deactivated secondary cell on RF channel number 2.
Neighbour cell			Cell 3	Neighbor cell to be identified on RF channel number 2.
CP length			Normal	
Special subframe configuration			6	As specified in table 4.2.1 in TS 36.211. The same configuration applies to all cells.
Uplink-downlink configuration			1	
DRX			OFF	Continuous monitoring of primary cell
A6	Hysteresis	dB	0	Hysteresis for evaluation of event A6.
	Offset	dB	-3	Offset parameter for evaluation of event A6. Needs to take relative accuracy tolerance in clause 9.1.11.2 into account plus margin.
	Report on leave		False	
	Time To Trigger	s	0	
Cell-individual offset for cells on RF channel number 1	dB		0	Individual offset for cells on primary component carrier.
Cell-individual offset for cells on RF channel number 2	dB		0	Individual offset for cells on secondary component carrier.
Filter coefficient			0	L3 filtering is not used
SCell measurement cycle	ms		1280	
Cell2 timing offset to cell1	µs		0	
Time alignment error between cell2 and cell1	µs		≤ Time alignment error as specified in TS 36.104 [30] clause 6.5.3.1.	The value of time alignment error depends upon the type of carrier aggregation.
Cell3 timing offset to cell1	µs		3	Synchronous cells
T1	s		5	During this time the UE shall be aware of cells 1 and 2 but not cell 3.
T2	s		≤30	UE shall report Event A6 within 25.6s (20×scellMeasCycle)
NOTE: This test verifies the RRM requirement which is independent of channel bandwidth and is performed according to the principle defined in section A.3.6.1.				

Table A.8.16.22.1-2: Cell specific test parameters for E-UTRAN TDD event triggered reporting on deactivating SCell with PCell interruption in non-DRX for 20MHz+10MHz

Parameter	Unit	Combination	Cell 1		Cell 2		Cell 3	
			T1	T2	T1	T2	T1	T2
E-UTRA RF Channel Number		All	1		2		2	
BW _{channel}		20MHz+10MHz	20MHz: N _{RB,c} = 100		10MHz: N _{RB,c} = 50		10MHz: N _{RB,c} = 50	
		10MHz+20MHz	10MHz: N _{RB,c} = 50		20MHz: N _{RB,c} = 100		20MHz: N _{RB,c} = 100	
PDSCH Reference measurement channel defined in A.3.1.1.2		20MHz+10MHz	R.3 TDD		N/A		N/A	
		10MHz+20MHz	R.0 TDD		N/A		N/A	
PDCCH/PCFICH/PHICH Reference measurement channel defined in A.3.1.2.2		20MHz+10MHz	R.10 TDD		R.6 TDD		R.6 TDD	
		10MHz+20MHz	R.6 TDD		R.10 TDD		R.10 TDD	
OCNG Pattern defined in A.3.2.2		20MHz+10MHz	OP.7 TDD		OP.2 TDD		OP.2 TDD	
		10MHz+20MHz	OP.1 TDD		OP.8 TDD		OP.8 TDD	
PBCH_RA	dB	All	0		0		0	
PBCH_RB	dB							
PSS_RA	dB							
SSS_RA	dB							
PCFICH_RB	dB							
PHICH_RA	dB							
PHICH_RB	dB							

PDCCH_RA	dB							
PDCCH_RB	dB							
PDSCH_RA	dB							
PDSCH_RB	dB							
OCNG_RA ^{Note 1}	dB							
OCNG_RB ^{Note 1}	dB							
N_{oc} ^{Note 3}	dBm/15 kHz	All	-101		-101			
RSRP ^{Note 4}	dBm/15 kHz	All	-85	-85	-85	-85	-Infinity	-85
\hat{E}_s/I_{ot}	dB	All	16	16	16	-0.11	-Infinity	-0.11
SCH_RP ^{Note 4}	dBm/15 kHz	All	-85	-85	-85	-85	-Infinity	-85
\hat{E}_s/N_{oc}	dB	All	16	16	16	16	-Infinity	16
Propagation Condition		All	AWGN		AWGN		AWGN	
<p>Note 1: OCNG shall be used such that all cells are fully allocated and a constant total transmitted power spectral density is achieved for all OFDM symbols.</p> <p>Note 2: The resources for uplink transmission are assigned to the UE prior to the start of time period T2.</p> <p>Note 3: Interference from other cells and noise sources not specified in the test is assumed to be constant over subcarriers and time and shall be modelled as AWGN of appropriate power for N_{oc} to be fulfilled.</p> <p>Note 4: RSRP and SCH_RP levels have been derived from other parameters for information purposes. They are not settable parameters themselves.</p>								

A.8.16.22.2 Test Requirements

The test requirements defined in section A.8.16.4.2 shall apply to this test case.

A.8.16.23 E-UTRAN TDD-FDD CA Event Triggered Reporting Under Deactivated SCell in Non-DRX with PCell in FDD

A.8.16.23.1 Test Purpose and Environment

The purpose of this test is to verify that in TDD-FDD CA with PCell in FDD the UE correctly detects events A2 (Serving cell becomes worse than threshold) and A6 (Neighbour becomes better than SCell) defined in TS 36.331 [2] within the requirements for SCell stated in clause 8.3.3.2.1 and the requirements for PCell stated in clause 8.3.2.

In this test case there are 3 cells: Cell 1, Cell 2 and Cell 3. Cell 1 is the PCell on the FDD primary component carrier, Cell 2 is the configured and deactivated SCell on the TDD secondary component carrier, and Cell 3 is the neighbor cell on the TDD secondary component carrier. It is indicated to the UE in the measurement control information that event-triggered reporting with Events A2 (PCell and SCell) and A6 is used. The test consists of three successive time periods, with duration of T1, T2 and T3, respectively. During T1 the UE shall not have any information on cell 3. Immediately at beginning of T2 the transmission power of cell 3 is increased to same level as for cell 2, and due to usage of an offset this shall result in reporting of Event A6. At the beginning of T3 the transmission powers of cells 1, 2 and 3 are reduced below a threshold value and this shall result in reporting of Event A2 for PCell and SCell, respectively.

The test parameters are given in Table A.8.16.23.1-1 and A.8.16.23.1-2 below.

Table A.8.16.23.1-1: General test parameters for E-UTRAN TDD-FDD CA event triggered reporting on configured but deactivated SCell in non-DRX under fading propagation conditions with PCell in FDD

Parameter	Unit	Value	Comment
E-UTRA RF Channel Number		1, 2	Two radio channels are used for this test
Active PCell		Cell 1	Primary cell on RF channel number 1.
Configured deactivated SCell		Cell 2	Configured deactivated secondary cell on RF channel number 2.
Neighbour cell		Cell 3	Neighbor cell to be identified on RF channel number 2.
CP length		Normal	
Special subframe configuration		6	As specified in table 4.2-1 in TS 36.211. The same configuration in TDD cells

Uplink-downlink configuration			1	As specified in table 4.2-2 in TS 36.211. The same configuration in TDD cells
DRX			OFF	Continuous monitoring of primary cell
A2	Hysteresis	dB	0	Hysteresis for evaluation of event A2.
	Threshold RSRP	dBm	-98	Actual RSRP threshold for event A2. Needs to take absolute accuracy tolerance in clause 9.1.11.1 into account plus margin.
	Time To Trigger	s	0	
A6	Hysteresis	dB	0	Hysteresis for evaluation of event A6.
	Offset	dB	-6	Offset parameter for evaluation of event A6. Needs to take relative accuracy tolerance in clause 9.1.11.2 into account plus margin.
	Report on leave		False	
	Time To Trigger	s	0	
Cell-individual offset for cells on RF channel number 1	dB		0	Individual offset for cells on primary component carrier.
Cell-individual offset for cells on RF channel number 2	dB		0	Individual offset for cells on secondary component carrier.
Filter coefficient			0	L3 filtering is not used
SCell measurement cycle (measCycleSCell)	ms		320	
T1	s		5	During this time the UE shall be aware of cells 1 and 2 but not cell 3.
T2	s		≤12	UE shall report Event A6 within 6.4s (20×scellMeasCycle)
T3	s		5	UE shall report Event A2 within 200 ms and 1.6s for cells 1 and 2, respectively.

Table A.8.16.23.1-2: Cell specific test parameters for E-UTRAN TDD-FDD CA event triggered reporting on configured but deactivated SCell in non-DRX under fading propagation conditions with PCell in FDD

Parameter	Unit	Cell 1			Cell 2			Cell 3		
		T1	T2	T3	T1	T2	T3	T1	T2	T3
E-UTRA RF Channel Number		1			2					
BW _{channel}		5MHz: N _{RB,c} = 25 10MHz: N _{RB,c} = 50 20MHz: N _{RB,c} = 100			5MHz: N _{RB,c} = 25 10MHz: N _{RB,c} = 50 20MHz: N _{RB,c} = 100					
PDSCH parameters: DL Reference Measurement Channel		5MHz: R.5 FDD 10MHz: R.0 FDD 20MHz: R.4 FDD			-			-		
PCFICH/PDCCH/PHICH parameters: DL Reference Measurement Channel		5MHz: R.11 FDD 10MHz: R.6 FDD 20MHz: R.10 FDD			5MHz: R.11 TDD 10MHz: R.6 TDD 20MHz: R.10 TDD			5MHz: R.11 TDD 10MHz: R.6 TDD 20MHz: R.10 TDD		
OCNG Patterns defined		5MHz: OP.15 FDD 10MHz: OP.1 FDD 20MHz: OP.11 FDD			5MHz: OP.10 TDD 10MHz: OP.2 TDD 20MHz: OP.8 TDD			5MHz: OP.10 TDD 10MHz: OP.2 TDD 20MHz: OP.8 TDD		
PBCH_RA	dB	0			0			0		
PBCH_RB	dB									
PSS_RA	dB									
SSS_RA	dB									
PCFICH_RB	dB									
PHICH_RA	dB									
PHICH_RB	dB									
PDCCH_RA	dB									
PDCCH_RB	dB									
PDSCH_RA	dB									
PDSCH_RB	dB									

OCNG_RA ^{Note 1}	dB									
OCNG_RB ^{Note 1}	dB									
N _{oc} ^{Note 2}	dBm/15 kHz	-104			-104					
\bar{E}_s/N_{oc}	dB	17	17	-3	17	17	-3	-infinity	17	-3
\bar{E}_s/I_{ot}	dB	17	17	-3	17	-0.09	-4.76	-infinity	-0.09	-4.76
RSRP ^{Note 3}	dBm/15 kHz	-87	-87	-107	-87	-87	-107	-infinity	-87	-107
SCH_RP ^{Note 3}	dBm/15 kHz	-87	-87	-107	-87	-87	-107	-infinity	-87	-107
I _o ^{Note 3}	dBm/Ch BW	-59.13 +10log (N _{RB,c} /50)	-59.13 +10log (N _{RB,c} /50)	-74.45 +10log (N _{RB,c} /50)	-59.17 +10log (N _{RB,c} /50)	-56.13 +10log (N _{RB,c} /50)	-73.20 +10log (N _{RB,c} /50)	Specified in columns for Cell 2		
Propagation Condition		AWGN			ETU70			ETU70		
Correlation Matrix and Antenna Configuration		1x2 Low			1x2 Low			1x2 Low		
Timing offset to Cell 1	μs	-			0			3		
Time alignment error relative to cell 1 ^{Note 5}	μs	-			≤ TAE			N/A		
Note 1:	OCNG shall be used such that all cells are fully allocated and a constant total transmitted power spectral density is achieved for all OFDM symbols.									
Note 2:	Interference from other cells and noise sources not specified in the test is assumed to be constant over subcarriers and time and shall be modelled as AWGN of appropriate power for N _{oc} to be fulfilled.									
Note 3:	Es/lot, RSRP, SCH_RP and I _o levels have been derived from other parameters for information purposes. They are not settable parameters themselves.									
Note 4:	The resources for uplink transmission are assigned to the UE prior to the start of time period T2.									
Note 5:	Time alignment error (TAE) as specified in TS 36.104 [30] clause 6.5.3.1. The TAE value depends upon the type of carrier aggregation.									

A.8.16.23.2 Test Requirements

The UE shall send one Event A6 triggered measurement report for cell 3 with a measurement reporting delay of less than 6.4s (20×measCycleSCell) from the beginning of time T2.

The UE shall send one Event A2 triggered measurement report for Cell 1 with a measurement reporting delay of less than 200 ms from beginning of time T3.

The UE shall send one Event A2 triggered measurement report for Cell 2 with a measurement reporting delay of less than 1.6s (5× measCycleSCell) from beginning of time T3.

The UE shall not send event triggered measurement reports as long as the reporting criteria are not fulfilled.

The rate of correct events observed during repeated tests shall be at least 90% for each of the events.

NOTE: The actual overall delays measured in the tests may be up to 2×TTIDCCH higher than the measurement reporting delays above because of TTI insertion uncertainty of the measurement report in DCCH.

A.8.16.24 E-UTRAN TDD-FDD CA Event Triggered Reporting Under Deactivated SCell in Non-DRX with PCell in TDD

A.8.16.24.1 Test Purpose and Environment

The purpose of this test is to verify that in TDD-FDD CA with PCell in TDD the UE correctly detects events A2 (Serving cell becomes worse than threshold) and A6 (Neighbour becomes better than SCell) defined in TS 36.331 [2] within the requirements for SCell stated in clause 8.3.3.2.1 and the requirements for PCell stated in clause 8.3.2.

In this test case there are 3 cells: Cell 1, Cell 2 and Cell 3. Cell 1 is the PCell on the TDD primary component carrier, Cell 2 is the configured and deactivated SCell on the FDD secondary component carrier, and Cell 3 is the neighbor cell on the FDD secondary component carrier. It is indicated to the UE in the measurement control information that event-

triggered reporting with Events A2 (PCell and SCell) and A6 is used. The test consists of three successive time periods, with duration of T1, T2 and T3, respectively. During T1 the UE shall not have any information on cell 3. Immediately at beginning of T2 the transmission power of cell 3 is increased to same level as for cell 2, and due to usage of an offset this shall result in reporting of Event A6. At the beginning of T3 the transmission powers of cells 1, 2 and 3 are reduced below a threshold value and this shall result in reporting of Event A2 for PCell and SCell, respectively.

The test parameters are given in Table A.8.16.24.1-1 and Table A.8.16.24.1-2.

Table A.8.16.24.1-1: General test parameters for E-UTRAN TDD-FDD CA event triggered reporting on configured but deactivated SCell in non-DRX under fading propagation conditions with PCell in TDD

Parameter		Unit	Value	Comment
E-UTRA RF Channel Number			1, 2	Two radio channels are used for this test
Active PCell			Cell 1	Primary cell on RF channel number 1.
Configured deactivated SCell			Cell 2	Configured deactivated secondary cell on RF channel number 2.
Neighbour cell			Cell 3	Neighbor cell to be identified on RF channel number 2.
CP length			Normal	
Special subframe configuration			6	As specified in table 4.2-1 in TS 36.211.
Uplink-downlink configuration			1	As specified in table 4.2-2 in TS 36.211.
DRX			OFF	Continuous monitoring of primary cell
A2	Hysteresis	dB	0	Hysteresis for evaluation of event A2.
	Threshold RSRP	dBm	-98	Actual RSRP threshold for event A2. Needs to take absolute accuracy tolerance in clause 9.1.11.1 into account plus margin.
	Time To Trigger	s	0	
A6	Hysteresis	dB	0	Hysteresis for evaluation of event A6.
	Offset	dB	-6	Offset parameter for evaluation of event A6. Needs to take relative accuracy tolerance in clause 9.1.11.2 into account plus margin.
	Report on leave		False	
	Time To Trigger	s	0	
Cell-individual offset for cells on RF channel number 1		dB	0	Individual offset for cells on primary component carrier.
Cell-individual offset for cells on RF channel number 2		dB	0	Individual offset for cells on secondary component carrier.
Filter coefficient			0	L3 filtering is not used
SCell measurement cycle (measCycleSCell)		ms	320	
T1		s	5	During this time the UE shall be aware of cells 1 and 2 but not cell 3.
T2		s	≤12	UE shall report Event A6 within 6.4s (20×scellMeasCycle)
T3		s	5	UE shall report Event A2 within 200 ms and 1.6s for cells 1 and 2, respectively.

Table A.8.16.24.1-2: Cell specific test parameters for E-UTRAN TDD-FDD CA event triggered reporting on configured but deactivated SCell in non-DRX under fading propagation conditions with PCell in TDD

Parameter	Unit	Cell 1			Cell 2			Cell 3		
		T1	T2	T3	T1	T2	T3	T1	T2	T3
E-UTRA RF Channel Number		1			2					
BW _{channel}		5MHz: N _{RB,c} = 25 10MHz: N _{RB,c} = 50 20MHz: N _{RB,c} = 100			5MHz: N _{RB,c} = 25 10MHz: N _{RB,c} = 50 20MHz: N _{RB,c} = 100					

PDSCH parameters: DL Reference Measurement Channel		5MHz: R.4 TDD 10MHz: R.0 TDD 20MHz: R.3 TDD			-			-		
PCFICH/PDCCH/PHICH parameters: DL Reference Measurement Channel		5MHz: R.11 TDD 10MHz: R.6 TDD 20MHz: R.10 TDD			5MHz: R.11 FDD 10MHz: R.6 FDD 20MHz: R.10 FDD			5MHz: R.11 FDD 10MHz: R.6 FDD 20MHz: R.10 FDD		
OCNG Patterns defined		5MHz: OP.9 TDD 10MHz: OP.1 TDD 20MHz: OP.7 TDD			5MHz: OP.16 FDD 10MHz: OP.2 FDD 20MHz: OP.12 FDD			5MHz: OP.16 FDD 10MHz: OP.2 FDD 20MHz: OP.12 FDD		
PBCH_RA	dB	0			0			0		
PBCH_RB	dB									
PSS_RA	dB									
SSS_RA	dB									
PCFICH_RB	dB									
PHICH_RA	dB									
PHICH_RB	dB									
PDCCH_RA	dB									
PDCCH_RB	dB									
PDSCH_RA	dB									
PDSCH_RB	dB									
OCNG_RA ^{Note 1}	dB									
OCNG_RB ^{Note 1}	dB									
N _{oc} ^{Note 2}	dBm/15 kHz	-104			-104					
E _s /N _{oc}	dB	17	17	-3	17	17	-3	-infinity	17	-3
E _s /I _{ot}	dB	17	17	-3	17	-0.09	-4.76	-infinity	-0.09	-4.76
RSRP ^{Note 3}	dBm/15 kHz	-87	-87	-107	-87	-87	-107	-infinity	-87	-107
SCH_RP ^{Note 3}	dBm/15 kHz	-87	-87	-107	-87	-87	-107	-infinity	-87	-107
I _o ^{Note 3}	dBm/Ch BW	-59.13 +10log (N _{RB,c} /50)	-59.13 +10log (N _{RB,c} /50)	-74.45 +10log (N _{RB,c} /50)	-59.17 +10log (N _{RB,c} /50)	-56.13 +10log (N _{RB,c} /50)	-73.20 +10log (N _{RB,c} /50)	Specified in columns for Cell 2		
Propagation Condition		AWGN			ETU70			ETU70		
Correlation Matrix and Antenna Configuration		1x2 Low			1x2 Low			1x2 Low		
Timing offset to Cell 1	μs	-			0			3		
Time alignment error relative to cell 1 ^{Note 5}	μs	-			≤ TAE			N/A		
<p>Note 1: OCNG shall be used such that all cells are fully allocated and a constant total transmitted power spectral density is achieved for all OFDM symbols.</p> <p>Note 2: Interference from other cells and noise sources not specified in the test is assumed to be constant over subcarriers and time and shall be modelled as AWGN of appropriate power for N_{oc} to be fulfilled.</p> <p>Note 3: E_s/I_{ot}, RSRP, SCH_RP and I_o levels have been derived from other parameters for information purposes. They are not settable parameters themselves.</p> <p>Note 4: The resources for uplink transmission are assigned to the UE prior to the start of time period T2.</p> <p>Note 5: Time alignment error (TAE) as specified in TS 36.104 [30] clause 6.5.3.1. The TAE value depends upon the type of carrier aggregation.</p>										

A.8.16.24.2 Test Requirements

The UE shall send one Event A6 triggered measurement report for cell3 with a measurement reporting delay of less than 6.4s (20× measCycleSCell) from the beginning of time T2.

The UE shall send one Event A2 triggered measurement report for Cell 1 with a measurement reporting delay of less than 200 ms from beginning of time T3.

The UE shall send one Event A2 triggered measurement report for Cell 2 with a measurement reporting delay of less than 1.6s ($5 \times \text{measCycleSCell}$) from beginning of time T3.

The UE shall not send event triggered measurement reports as long as the reporting criteria are not fulfilled.

The rate of correct events observed during repeated tests shall be at least 90% for each of the events.

NOTE: The actual overall delays measured in the tests may be up to $2 \times \text{TTIDCCH}$ higher than the measurement reporting delays above because of TTI insertion uncertainty of the measurement report in DCCH.

A.8.16.25 E-UTRAN TDD-FDD CA Event triggered reporting on deactivated SCell with PCell interruption in non-DRX with PCell in FDD

A.8.16.25.1 Test Purpose and Environment

The purpose of this test is to verify that in TDD-FDD CA with PCell in FDD the UE correctly detects event A6 (Neighbour becomes better than SCell) defined in TS 36.331 [2] within the requirements stated in clause 8.3.3.2.1 and the requirements for PCell stated in clause 8.3.2 while at the same time fulfilling the requirement on interruption rate.

In this test case there are three cells: Cell1, Cell2 and Cell3. Cell 1 is the PCell on the FDD primary component carrier, Cell 2 is the configured and deactivated SCell on the TDD secondary component carrier, and Cell 3 is the neighbor cell on the TDD secondary component carrier. It is indicated to the UE in the measurement control information that event-triggered reporting with Event A6 is used. The test consists of two successive time periods, with duration of T1 and T2, respectively. During T1 the UE shall not have any information of cell 3. Immediately at beginning of T2 the transmission power of cell 3 is increased to same level as for cell 2, and due to usage of an offset this shall result in reporting of Event A6. PDCCH indicating a new transmission on the PCell shall be sent continuously to ensure that the UE sends ACK/NACKs throughout the test.

The test parameters are given in Table A.8.16.25.1-1 and Table A.8.16.25.1-2 below.

Table A.8.16.25.1-1: General test parameters for E-UTRAN TDD-FDD CA Event triggered reporting on configured but deactivated SCell with PCell interruption in non-DRX with PCell in FDD

Parameter	Unit	Value	Comment	
E-UTRA RF Channel Number		1, 2	Two radio channels are used for this test	
Active PCell		Cell 1	Primary cell on RF channel number 1.	
Configured deactivated SCell		Cell 2	Configured deactivated secondary cell on RF channel number 2.	
Neighbour cell		Cell 3	Neighbor cell to be identified on RF channel number 2.	
CP length		Normal		
Special subframe configuration		6	As specified in table 4.2-1 in TS 36.211. The same configuration in TDD cells	
Uplink-downlink configuration		1	As specified in table 4.2-2 in TS 36.211. The same configuration in TDD cells	
DRX		OFF	Continuous monitoring of primary cell	
A6	Hysteresis	dB	0	Hysteresis for evaluation of event A6.
	Offset	dB	-3	Offset parameter for evaluation of event A6. Needs to take relative accuracy tolerance in clause 9.1.11.2 into account plus margin.
	Report on leave		False	
	Time To Trigger	s	0	
Cell-individual offset for cells on RF channel number 1	dB	0	Individual offset for cells on primary component carrier.	
Cell-individual offset for cells on RF channel number 2	dB	0	Individual offset for cells on secondary component carrier.	
Filter coefficient		0	L3 filtering is not used	
SCell measurement cycle (measCycleSCell)	ms	1280		
T1	s	5	During this time the UE shall be aware of cells 1 and 2 but not cell 3.	
T2	s	≤ 30	UE shall report Event A6 within 25.6s ($20 \times \text{scellMeasCycle}$)	

Table A.8.16.25.1-2: Cell specific test parameters for E-UTRAN TDD-FDD CA Event triggered reporting on configured but deactivated SCell with PCell interruption in non-DRX with PCell in FDD

Parameter	Unit	Cell 1		Cell 2		Cell 3	
		T1	T2	T1	T2	T1	T2
E-UTRA RF Channel Number		1		2			
BW _{channel}		5MHz: N _{RB,c} = 25 10MHz: N _{RB,c} = 50 20MHz: N _{RB,c} = 100		5MHz: N _{RB,c} = 25 10MHz: N _{RB,c} = 50 20MHz: N _{RB,c} = 100			
PDSCH parameters: DL Reference Measurement Channel		5MHz: R.7 FDD 10MHz: R.3 FDD 20MHz: R.6 FDD		-	-		
PCFICH/PDCCH/PHICH parameters: DL Reference Measurement Channel		5MHz: R.11 FDD 10MHz: R.6 FDD 20MHz: R.10 FDD		5MHz: R.11 TDD 10MHz: R.6 TDD 20MHz: R.10 TDD		5MHz: R.11 TDD 10MHz: R.6 TDD 20MHz: R.10 TDD	
OCNG Patterns defined		5MHz: OP.20 FDD 10MHz: OP.10 FDD 20MHz: OP.17 FDD		5MHz: OP.10 TDD 10MHz: OP.2 TDD 20MHz: OP.8 TDD		5MHz: OP.10 TDD 10MHz: OP.2 TDD 20MHz: OP.8 TDD	
PBCH_RA	dB	0		0		0	
PBCH_RB	dB						
PSS_RA	dB						
SSS_RA	dB						
PCFICH_RB	dB						
PHICH_RA	dB						
PHICH_RB	dB						
PDCCH_RA	dB						
PDCCH_RB	dB						
PDSCH_RA	dB						
PDSCH_RB	dB						
OCNG_RA ^{Note 1}	dB						
OCNG_RB ^{Note 1}	dB						
N _{oc} ^{Note 2}	dBm/15 kHz	-101		-101			
\bar{E}_s/N_{oc}	dB	16	16	16	16	-infinity	16
\bar{E}_s/I_{ot}	dB	16	16	16	-0.11	-infinity	-0.11
RSRP ^{Note 3}	dBm/15 kHz	-85	-85	-85	-85	-infinity	-85
SCH_RP ^{Note 3}	dBm/15 kHz	-85	-85	-85	-85	-infinity	-85
I _o ^{Note 3}	dBm/Ch BW	-57.11 +10log (N _{RB,c} /50)	-57.11 +10log (N _{RB,c} /50)	-57.11 +10log (N _{RB,c} /50)	-54.15 +10log (N _{RB,c} /50)	Specified in columns for Cell 2	
Propagation Condition		AWGN		AWGN		AWGN	
Correlation Matrix and Antenna Configuration		1x2 Low		1x2 Low		1x2 Low	
Timing offset to Cell 1	μs	-		0		3	
Time alignment error relative to cell 1 ^{Note 5}	μs	-		≤ TAE		N/A	

Note 1:	OCNG shall be used such that all cells are fully allocated and a constant total transmitted power spectral density is achieved for all OFDM symbols.
Note 2:	Interference from other cells and noise sources not specified in the test is assumed to be constant over subcarriers and time and shall be modelled as AWGN of appropriate power for N_{oc} to be fulfilled.
Note 3:	Es/lot, RSRP, SCH_RP and lo levels have been derived from other parameters for information purposes. They are not settable parameters themselves.
Note 4:	The resources for uplink transmission are assigned to the UE prior to the start of time period T2.
Note 5:	Time alignment error (TAE) as specified in TS 36.104 [30] clause 6.5.3.1. The TAE value depends upon the type of carrier aggregation.

A.8.16.25.2 Test Requirements

The UE shall send one Event A6 triggered measurement report for cell 3, with a measurement reporting delay less than 25.6s from the beginning of time period T2.

The UE shall not send event triggered measurement reports, as long as the reporting criteria are not fulfilled.

The UE shall be scheduled on PCell continuously throughout the test. From the start of T1 until the measurement report is received during T2, at least 99.5% of all expected ACK/NACKs shall be transmitted by the UE.

For a test to be considered successful requirements on both event detection and percentage of transmitted ACK/NACKs have to be fulfilled simultaneously.

The rate of correct events observed during repeated tests shall be at least 90%.

NOTE: The actual overall delays measured in the test may be up to $2xTTIDCCH$ higher than the measurement reporting delays above because of TTI insertion uncertainty of the measurement report in DCCH.

A.8.16.26 E-UTRAN TDD-FDD CA Event triggered reporting on deactivated SCell with PCell interruption in non-DRX with PCell in TDD

A.8.16.26.1 Test Purpose and Environment

The purpose of this test is to verify that in TDD-FDD CA with PCell in TDD the UE correctly detects event A6 (Neighbour becomes better than SCell) defined in TS 36.331 [2] within the requirements stated in clause 8.3.3.2.1 and the requirements for PCell stated in clause 8.3.2 while at the same time fulfilling the requirement on interruption rate.

In this test case there are three cells: Cell1, Cell2 and Cell3. Cell 1 is the PCell on the TDD primary component carrier, Cell 2 is the configured and deactivated SCell on the FDD secondary component carrier, and Cell 3 is the neighbor cell on the FDD secondary component carrier. It is indicated to the UE in the measurement control information that event-triggered reporting with Event A6 is used. The test consists of two successive time periods, with duration of T1 and T2, respectively. During T1 the UE shall not have any information of cell 3. Immediately at beginning of T2 the transmission power of cell 3 is increased to same level as for cell 2, and due to usage of an offset this shall result in reporting of Event A6. PDCCH indicating a new transmission on the PCell shall be sent continuously to ensure that the UE sends ACK/NACKs throughout the test.

The test parameters are given in Table A.8.16.26.1-1 and Table A.8.16.26.1-1 below.

Table A.8.16.26.1-1: General test parameters for E-UTRAN TDD-FDD CA Event triggered reporting on configured but deactivated SCell with PCell interruption in non-DRX with PCell in TDD

Parameter	Unit	Value	Comment
E-UTRA RF Channel Number		1, 2	Two radio channels are used for this test
Active PCell		Cell 1	Primary cell on RF channel number 1.
Configured deactivated SCell		Cell 2	Configured deactivated secondary cell on RF channel number 2.
Neighbour cell		Cell 3	Neighbor cell to be identified on RF channel number 2.
CP length		Normal	
Special subframe configuration		6	As specified in table 4.2-1 in TS 36.211. The same configuration in TDD cells
Uplink-downlink configuration		1	As specified in table 4.2-2 in TS 36.211. The same configuration in TDD cells

DRX			OFF	Continuous monitoring of primary cell
A6	Hysteresis	dB	0	Hysteresis for evaluation of event A6.
	Offset	dB	-3	Offset parameter for evaluation of event A6. Needs to take relative accuracy tolerance in clause 9.1.11.2 into account plus margin.
	Report on leave		False	
	Time To Trigger	s	0	
Cell-individual offset for cells on RF channel number 1	dB		0	Individual offset for cells on primary component carrier.
Cell-individual offset for cells on RF channel number 2	dB		0	Individual offset for cells on secondary component carrier.
Filter coefficient			0	L3 filtering is not used
SCell measurement cycle (measCycleSCell)	ms		1280	
T1	s		5	During this time the UE shall be aware of cells 1 and 2 but not cell 3.
T2	s		≤30	UE shall report Event A6 within 25.6s (20xscellMeasCycle)

Table A.8.16.26.1-2: Cell specific test parameters for E-UTRAN TDD-FDD CA Event triggered reporting on configured but deactivated SCell with PCell interruption in non-DRX with PCell in TDD

Parameter	Unit	Cell 1		Cell 2		Cell 3	
		T1	T2	T1	T2	T1	T2
E-UTRA RF Channel Number		1		2			
BW _{channel}		5MHz: N _{RB,c} = 25 10MHz: N _{RB,c} = 50 20MHz: N _{RB,c} = 100		5MHz: N _{RB,c} = 25 10MHz: N _{RB,c} = 50 20MHz: N _{RB,c} = 100			
PDSCH parameters: DL Reference Measurement Channel		5MHz: R.4 TDD 10MHz: R.0 TDD 20MHz: R.3 TDD		-		-	
PCFICH/PDCCH/PHICH parameters: DL Reference Measurement Channel		5MHz: R.11 TDD 10MHz: R.6 TDD 20MHz: R.10 TDD		5MHz: R.11 FDD 10MHz: R.6 FDD 20MHz: R.10 FDD		5MHz: R.11 FDD 10MHz: R.6 FDD 20MHz: R.10 FDD	
OCNG Patterns defined		5MHz: OP.9 TDD 10MHz: OP.1 TDD 20MHz: OP.7 TDD		5MHz: OP.16 FDD 10MHz: OP.2 FDD 20MHz: OP.12 FDD		5MHz: OP.16 FDD 10MHz: OP.2 FDD 20MHz: OP.12 FDD	
PBCH_RA	dB	0		0		0	
PBCH_RB	dB						
PSS_RA	dB						
SSS_RA	dB						
PCFICH_RB	dB						
PHICH_RA	dB						
PHICH_RB	dB						
PDCCH_RA	dB						
PDCCH_RB	dB						
PDSCH_RA	dB						
PDSCH_RB	dB						
OCNG_RA ^{Note 1}	dB						
OCNG_RB ^{Note 1}	dB						
N _{oc} ^{Note 2}	dBm/15 kHz						
\bar{E}_s/N_{oc}	dB	16	16	16	16	-infinity	16
\bar{E}_s/I_{ot}	dB	16	16	16	-0.11	-infinity	-0.11
RSRP ^{Note 3}	dBm/15 kHz	-85	-85	-85	-85	-infinity	-85
SCH_RP ^{Note 3}	dBm/15 kHz	-85	-85	-85	-85	-infinity	-85

I_0 ^{Note 3}	dBm/Ch BW	-57.11 +10log ($N_{RB,c}/50$)	-57.11 +10log ($N_{RB,c}/50$)	-57.11 +10log ($N_{RB,c}/50$)	-54.15 +10log ($N_{RB,c}/50$)	Specified in columns for Cell 2
Propagation Condition		AWGN		AWGN		AWGN
Correlation Matrix and Antenna Configuration		1x2 Low		1x2 Low		1x2 Low
Timing offset to Cell 1	μs	-		0		3
Time alignment error relative to cell 1 ^{Note 5}	μs	-		$\leq \text{TAE}$		N/A
<p>Note 1: OCNG shall be used such that all cells are fully allocated and a constant total transmitted power spectral density is achieved for all OFDM symbols.</p> <p>Note 2: Interference from other cells and noise sources not specified in the test is assumed to be constant over subcarriers and time and shall be modelled as AWGN of appropriate power for N_{oc} to be fulfilled.</p> <p>Note 3: E_s/lot, RSRP, SCH_RP and I_0 levels have been derived from other parameters for information purposes. They are not settable parameters themselves.</p> <p>Note 4: The resources for uplink transmission are assigned to the UE prior to the start of time period T2.</p> <p>Note 5: Time alignment error (TAE) as specified in TS 36.104 [30] clause 6.5.3.1. The TAE value depends upon the type of carrier aggregation.</p>						

A.8.16.26.2 Test Requirements

The UE shall send one Event A6 triggered measurement report for cell 3, with a measurement reporting delay less than 25.6s from the beginning of time period T2.

The UE shall not send event triggered measurement reports, as long as the reporting criteria are not fulfilled.

The UE shall be scheduled on PCell continuously throughout the test. From the start of T1 until the measurement report is received during T2, at least 99.5% of all expected ACK/NACKs shall be transmitted by the UE.

For a test to be considered successful requirements on both event detection and percentage of transmitted ACK/NACKs have to be fulfilled simultaneously.

The rate of correct events observed during repeated tests shall be at least 90%.

NOTE: The actual overall delays measured in the test may be up to $2 \times \text{TTIDCCH}$ higher than the measurement reporting delays above because of TTI insertion uncertainty of the measurement report in DCCH.

A.8.16.27 3 DL PCell in FDD CA Event Triggered Reporting with 2 Deactivated SCells in Non-DRX

A.8.16.27.1 Test Purpose and Environment

The purpose of this test is to verify that the UE correctly detects events A1 (Serving cell becomes better than threshold), A2 (Serving cell becomes worse than threshold) and A6 (Neighbour becomes better than SCell) defined in TS 36.331 [2] within the requirements stated in clause 8.3.3.2.1.

The test parameters are given in Tables A.8.16.27.1-1 and A.8.16.27.1-2 below. It is indicated to the UE in the measurement control information that event-triggered reporting with Events A1 (for only SCell1 i.e. cell2), A2 (PCell and SCells) and A6 is used. The test consists of three successive time periods, with duration of T1, T2 and T3, respectively. During T1 the UE shall not have any information on cell 4. At the beginning of T2 the transmission power of cell 4 is increased to the same level as for cell 3, and due to usage of an offset this shall result in reporting of Event A6. Also, at the beginning of T2 the transmission power of cell 2 is increased to the same level as for cell 1, which shall result in reporting of Event A1. At the beginning of T3 the transmission powers of cells 1, 2, 3 and 4 are reduced below a threshold value and this shall result in reporting of Event A2 for Cell 1, for Cell 2 and for Cell 3.

Table A.8.16.27.1-1: General test parameters for E-UTRAN TDD-FDD 3 DL CA event triggered reporting under fading propagation conditions with 2 configured but deactivated SCells in non-DRX with PCell in FDD

Parameter		Unit	Value	Comment
E-UTRA RF Channel Number			1, 2, 3	Three radio channels are used for this test
Active PCell			Cell 1	Primary cell on RF channel number 1.
Configured deactivated SCell			Cell 2	Configured deactivated secondary cell on RF channel number 2.
Configured deactivated SCell			Cell 3	Configured deactivated secondary cell on RF channel number 3.
Neighbour cell			Cell 4	Neighbour cell to be identified on RF channel number 3.
CP length			Normal	
DRX			OFF	Continuous monitoring of primary cell
Special subframe configuration			6	As specified in table 4.2-1 in TS 36.211. The same configuration applies to all TDD cells (cell2, cell3 and cell4).
Uplink-downlink configuration			1	As specified in table 4.2-2 in TS 36.211. The same configuration applies to all TDD cells (cell2, cell3 and cell4).
A1	Hysteresis	dB	0	Hysteresis for evaluation of event A1.
	Threshold RSRP	dBm	-98	Actual RSRP threshold for event A1. Needs to take absolute accuracy tolerance in section 9.1.11.1 into account plus margin.
	Time To Trigger	s	0	
A2	Hysteresis	dB	0	Hysteresis for evaluation of event A2.
	Threshold RSRP	dBm	-98	Actual RSRP threshold for event A2. Needs to take absolute accuracy tolerance in section 9.1.11.1 into account plus margin.
	Time To Trigger	s	0	
A6	Hysteresis	dB	0	Hysteresis for evaluation of event A6.
	Offset	dB	-6	Offset parameter for evaluation of event A6. Needs to take relative accuracy tolerance in section 9.1.11.2 into account plus margin.
	Report on leave		False	
	Time To Trigger	s	0	
Cell-individual offset for cells on RF channel number 1		dB	0	Individual offset for cells on primary component carrier.
Cell-individual offset for cells on RF channel number 2		dB	0	Individual offset for cells on secondary component carrier.
Cell-individual offset for cells on RF channel number 3		dB	0	Individual offset for cells on secondary component carrier.
Filter coefficient			0	L3 filtering is not used
SCell measurement cycle (measCycleSCell)		ms	320	
T1		s	5	During this time the cell1 and cell3 shall be known to the UE; but cell2 and cell 4 shall be unknown to the UE.
T2		s	≤12	UE should report Event A1 for cell2 and event A6 for cell4 within 6.4s (20xscellMeasCycle)
T3		s	5	UE should report Event A2 within 200 ms. 1.6s, and 1.6s for cells 1, 2 and 3, respectively.

Table A.8.16.27.1-2: Cell specific test parameters for E-UTRAN TDD-FDD 3 DL CA event triggered reporting under fading propagation conditions with 2 configured but deactivated SCells in non-DRX with PCell in FDD

Parameter	Unit	Cell 1			Cell 2			Cell 3			Cell 4		
		T1	T2	T3	T1	T2	T3	T1	T2	T3	T1	T2	T3
E-UTRA RF Channel Number		1			2			3					
BW _{channel}		5MHz: N _{RB,c} = 25 10MHz: N _{RB,c} = 50 20MHz: N _{RB,c} = 100			5MHz: N _{RB,c} = 25 10MHz: N _{RB,c} = 50 20MHz: N _{RB,c} = 100			5MHz: N _{RB,c} = 25 10MHz: N _{RB,c} = 50 20MHz: N _{RB,c} = 100					
PDSCH parameters: DL Reference Measurement Channel		5MHz: R.5 FDD 10MHz: R.0 FDD 20MHz: R.4 FDD			-			-			-		
PCFICH/PDCCH/PHICH parameters: DL Reference Measurement Channel		5MHz: R.11 FDD 10MHz: R.6 FDD 20MHz: R.10 FDD			5MHz: R.11 TDD 10MHz: R.6 TDD 20MHz: R.10 TDD			5MHz: R.11 TDD 10MHz: R.6 TDD 20MHz: R.10 TDD			5MHz: R.11 TDD 10MHz: R.6 TDD 20MHz: R.10 TDD		
OCNG Patterns		5MHz: OP.15 FDD 10MHz: OP.1 FDD 20MHz: OP.11 FDD			5MHz: OP.10 TDD 10MHz: OP.2 TDD 20MHz: OP.8 TDD			5MHz: OP.10 TDD 10MHz: OP.2 TDD 20MHz: OP.8 TDD			5MHz: OP.10 TDD 10MHz: OP.2 TDD 20MHz: OP.8 TDD		
PBCH_RA	dB	0			0			0			0		
PBCH_RB	dB												
PSS_RA	dB												
SSS_RA	dB												
PCFICH_RB	dB												
PHICH_RA	dB												
PHICH_RB	dB												
PDCCH_RA	dB												
PDCCH_RB	dB												
PDSCH_RA	dB												
PDSCH_RB	dB												
OCNG_RA ^{Note 1}	dB												
OCNG_RB ^{Note 1}	dB												
N _{oc} ^{Note 2}	dBm/15 KHz												
\bar{E}_s/N_{oc}	dB	17	17	-3	-infinity	17	-3	17	17	-3	-infinity	17	-3
\bar{E}_s/I_{ot} ^{Note 3}	dB	17	17	-3	-infinity	17	-3	17	-0.09	-4.76	-infinity	-0.09	-4.76
RSRP ^{Note 3}	dBm/15 kHz	-87	-87	-107	-infinity	-87	-107	-87	-87	-107	-infinity	-87	-107
SCH_RP ^{Note 3}	dBm/15 kHz	-87	-87	-107	-infinity	-87	-107	-87	-87	-107	-infinity	-87	-107
I _o ^{Note 3}	dBm/Ch BW	-59.13 +10log (N _{RB,c} /50)	-59.13 +10log (N _{RB,c} /50)	-74.45 +10log (N _{RB,c} /50)	-76.22 +10log (N _{RB,c} /50)	-59.13 +10log (N _{RB,c} /50)	-74.45 +10log (N _{RB,c} /50)	-59.13 +10log (N _{RB,c} /50)	-56.17 +10log (N _{RB,c} /50)	-73.20 +10log (N _{RB,c} /50)	Specified in columns for Cell 3		
Propagation Condition		AWGN			ETU70			ETU70			ETU70		
Correlation Matrix and Antenna Configuration		1x2			1x2 Low			1x2 Low			1x2 Low		

Timing offset to Cell 1	μs	-	0	0	3
Time alignment error relative to cell 1 ^{Note 5}	μs	-	$\leq \text{TAE}$	$\leq \text{TAE}$	N/A
Time alignment error relative to cell 2 ^{Note 5}	μs	-	-	$\leq \text{TAE}$	N/A
<p>Note 1: OCNG shall be used such that all cells are fully allocated and a constant total transmitted power spectral density is achieved for all OFDM symbols.</p> <p>Note 2: Interference from other cells and noise sources not specified in the test is assumed to be constant over subcarriers and time and shall be modelled as AWGN of appropriate power for N_{oc} to be fulfilled.</p> <p>Note 3: E_s/I_{ot}, RSRP, SCH_RP and I_o have been derived from other parameters for information purposes. They are not settable parameters themselves.</p> <p>Note 4: The resources for uplink transmission are assigned to the UE prior to the start of time period T2.</p> <p>Note 5: Time alignment error (TAE) as specified in TS 36.104 [30] clause 6.5.3.1. The TAE value depends upon the type of carrier aggregation.</p>					

A.8.16.27.2 Test Requirements

The UE shall send one Event A6 triggered measurement report for cell 4 with a measurement reporting delay of less than 6.4s ($20 \times \text{measCycleSCell}$) from the beginning of time T2.

The UE shall send one Event A1 triggered measurement report for Cell 2 with a measurement reporting delay of less than 6.4s ($20 \times \text{measCycleSCell}$) from beginning of time T2.

The UE shall send one Event A2 triggered measurement report for Cell 1 with a measurement reporting delay of less than 200 ms from beginning of time T3.

The UE shall send one Event A2 triggered measurement report for Cell 2 with a measurement reporting delay of less than 1.6s ($5 \times \text{measCycleSCell}$) from beginning of time T3.

The UE shall send one Event A2 triggered measurement report for Cell 3 with a measurement reporting delay of less than 1.6s ($5 \times \text{measCycleSCell}$) from beginning of time T3.

The UE shall not send event triggered measurement reports as long as the reporting criteria are not fulfilled.

The rate of correct events observed during repeated tests shall be at least 90% for each of the events.

NOTE: The actual overall delays measured in the tests may be up to $2 \times \text{TTI}_{\text{DCCH}}$ higher than the measurement reporting delays above because of TTI insertion uncertainty of the measurement report in DCCH.

A.8.16.28 3 DL PCell in TDD CA Event Triggered Reporting with 2 Deactivated SCells in Non-DRX

A.8.16.28.1 Test Purpose and Environment

The purpose of this test is to verify that the UE correctly detects events A1 (Serving cell becomes better than threshold), A2 (Serving cell becomes worse than threshold) and A6 (Neighbour becomes better than SCell) defined in TS 36.331 [2] within the requirements stated in clause 8.3.3.2.1.

The test parameters are given in Tables A.8.16.28.1-1 and A.8.16.28.1-2 below. It is indicated to the UE in the measurement control information that event-triggered reporting with Events A1 (for only SCell1 i.e. cell2), A2 (PCell and SCells) and A6 is used. The test consists of three successive time periods, with duration of T1, T2 and T3, respectively. During T1 the UE shall not have any information on cell 4. At the beginning of T2 the transmission power of cell 4 is increased to the same level as for cell 3, and due to usage of an offset this shall result in reporting of Event A6. Also, at the beginning of T2 the transmission power of cell 2 is increased to the same level as for cell 1, which shall result in reporting of Event A1. At the beginning of T3 the transmission powers of cells 1, 2, 3 and 4 are reduced below a threshold value and this shall result in reporting of Event A2 for Cell 1, for Cell 2 and for Cell 3.

Table A.8.16.28.1-1: General test parameters for E-UTRAN TDD-FDD 3 DL CA event triggered reporting under fading propagation conditions with 2 configured but deactivated SCells in non-DRX with PCell in TDD

Parameter	Unit	Value	Comment	
E-UTRA RF Channel Number		1, 2, 3	Three radio channels are used for this test	
Active PCell		Cell 1	Primary cell on RF channel number 1.	
Configured deactivated SCell		Cell 2	Configured deactivated secondary cell on RF channel number 2.	
Configured deactivated SCell		Cell 3	Configured deactivated secondary cell on RF channel number 3.	
Neighbour cell		Cell 4	Neighbour cell to be identified on RF channel number 3.	
CP length		Normal		
DRX		OFF	Continuous monitoring of primary cell	
Special subframe configuration		6	As specified in table 4.2-1 in TS 36.211. The same configuration applies to TDD cell (cell1).	
Uplink-downlink configuration		1	As specified in table 4.2-2 in TS 36.211. The same configuration applies to TDD cell (cell1).	
A1	Hysteresis	dB	0	Hysteresis for evaluation of event A1.

	Threshold RSRP	dBm	-98	Actual RSRP threshold for event A1. Needs to take absolute accuracy tolerance in section 9.1.11.1 into account plus margin.
	Time To Trigger	s	0	
A2	Hysteresis	dB	0	Hysteresis for evaluation of events A1 A2.
	Threshold RSRP	dBm	-98	Actual RSRP threshold for events A2. Needs to take absolute accuracy tolerance in section 9.1.11.1 into account plus margin.
	Time To Trigger	s	0	
A6	Hysteresis	dB	0	Hysteresis for evaluation of event A6.
	Offset	dB	-6	Offset parameter for evaluation of event A6. Needs to take relative accuracy tolerance in section 9.1.11.2 into account plus margin.
	Report on leave		False	
	Time To Trigger	s	0	
	Cell-individual offset for cells on RF channel number 1	dB	0	Individual offset for cells on primary component carrier.
	Cell-individual offset for cells on RF channel number 2	dB	0	Individual offset for cells on secondary component carrier.
	Cell-individual offset for cells on RF channel number 3	dB	0	Individual offset for cells on secondary component carrier.
	Filter coefficient		0	L3 filtering is not used
	SCell measurement cycle (measCycleSCell)	ms	320	
	T1	s	5	During this time the cell1 and cell3 shall be known to the UE; but cell2 and cell 4 shall be unknown to the UE.
	T2	s	≤12	UE should report Event A1 for cell2 and event A6 for cell4 within 6.4s (20×sCellMeasCycle)
	T3	s	5	UE should report Event A2 within 200 ms. 1.6s, and 1.6s for cells 1, 2 and 3, respectively.

Table A.8.16.28.1-2: Cell specific test parameters for E-UTRAN TDD-FDD 3 DL CA event triggered reporting under fading propagation

conditions with 2 configured but deactivated SCells in non-DRX with PCell in TDD

Parameter	Unit	Cell 1			Cell 2			Cell 3			Cell 4		
		T1	T2	T3	T1	T2	T3	T1	T2	T3	T1	T2	T3
E-UTRA RF Channel Number		1			2			3					
BW _{channel}		5MHz: N _{RB,c} = 25 10MHz: N _{RB,c} = 50 20MHz: N _{RB,c} = 100			5MHz: N _{RB,c} = 25 10MHz: N _{RB,c} = 50 20MHz: N _{RB,c} = 100			5MHz: N _{RB,c} = 25 10MHz: N _{RB,c} = 50 20MHz: N _{RB,c} = 100					
PDSCH parameters: DL Reference Measurement Channel		5MHz: R.4 TDD 10MHz: R.0 TDD 20MHz: R.3 TDD			-			-			-		
PCFICH/PDCCH/PHICH parameters: DL Reference Measurement Channel		5MHz: R.11 TDD 10MHz: R.6 TDD 20MHz: R.10 TDD			5MHz: R.11 FDD 10MHz: R.6 FDD 20MHz: R.10 FDD			5MHz: R.11 FDD 10MHz: R.6 FDD 20MHz: R.10 FDD			5MHz: R.11 FDD 10MHz: R.6 FDD 20MHz: R.10 FDD		
OCNG Patterns		5MHz: OP.9 TDD 10MHz: OP.1 TDD 20MHz: OP.7 TDD			5MHz: OP.16 FDD 10MHz: OP.2 FDD 20MHz: OP.12 FDD			5MHz: OP.16 FDD 10MHz: OP.2 FDD 20MHz: OP.12 FDD			5MHz: OP.16 FDD 10MHz: OP.2 FDD 20MHz: OP.12 FDD		
PBCH_RA	dB	0			0			0			0		
PBCH_RB	dB												
PSS_RA	dB												
SSS_RA	dB												
PCFICH_RB	dB												
PHICH_RA	dB												
PHICH_RB	dB												
PDCCH_RA	dB												
PDCCH_RB	dB												
PDSCH_RA	dB												
PDSCH_RB	dB												
OCNG_RA ^{Note 1}	dB												
OCNG_RB ^{Note 1}	dB												
N _{oc} ^{Note 2}	dBm/15 KHz	-104			-104			-104					
\bar{E}_s/N_{oc}	dB	17	17	-3	-infinity	17	-3	17	17	-3	-infinity	17	-3
\bar{E}_s/I_{ot} ^{Note 3}	dB	17	17	-3	-infinity	17	-3	17	-0.09	-4.76	-infinity	-0.09	-4.76
RSRP ^{Note 3}	dBm/15 kHz	-87	-87	-107	-infinity	-87	-107	-87	-87	-107	-infinity	-87	-107
SCH_RP ^{Note 3}	dBm/15 kHz	-87	-87	-107	-infinity	-87	-107	-87	-87	-107	-infinity	-87	-107
I _o ^{Note 3}	dBm/Ch BW	-59.13 +10log (N _{RB,c} /50)	-59.13 +10log (N _{RB,c} /50)	-74.45 +10log (N _{RB,c} /50)	-76.22 +10log (N _{RB,c} /50)	-59.13 +10log (N _{RB,c} /50)	-74.45 +10log (N _{RB,c} /50)	-59.13 +10log (N _{RB,c} /50)	-56.17 +10log (N _{RB,c} /50)	-73.20 +10log (N _{RB,c} /50)	Specified in columns for Cell 3		
Propagation Condition		AWGN			ETU70			ETU70			ETU70		
Correlation Matrix and Antenna Configuration		1x2			1x2 Low			1x2 Low			1x2 Low		

Timing offset to Cell 1	μs	-	0	0	3
Time alignment error relative to cell 1 ^{Note 5}	μs	-	$\leq \text{TAE}$	$\leq \text{TAE}$	N/A
Time alignment error relative to cell 2 ^{Note 5}	μs	-	-	$\leq \text{TAE}$	N/A
<p>Note 1: OCNG shall be used such that all cells are fully allocated and a constant total transmitted power spectral density is achieved for all OFDM symbols.</p> <p>Note 2: Interference from other cells and noise sources not specified in the test is assumed to be constant over subcarriers and time and shall be modelled as AWGN of appropriate power for N_{oc} to be fulfilled.</p> <p>Note 3: E_s/lot, RSRP, SCH_RP and I_o have been derived from other parameters for information purposes. They are not settable parameters themselves.</p> <p>Note 4: The resources for uplink transmission are assigned to the UE prior to the start of time period T2.</p> <p>Note 5: Time alignment error (TAE) as specified in TS 36.104 [30] clause 6.5.3.1. The TAE value depends upon the type of carrier aggregation.</p>					

A.8.16.28.2 Test Requirements

The UE shall send one Event A6 triggered measurement report for cell 4 with a measurement reporting delay of less than 6.4s ($20 \times \text{measCycleSCell}$) from the beginning of time T2.

The UE shall send one Event A1 triggered measurement report for Cell 2 with a measurement reporting delay of less than 6.4s ($20 \times \text{measCycleSCell}$) from beginning of time T2.

The UE shall send one Event A2 triggered measurement report for Cell 1 with a measurement reporting delay of less than 200 ms from beginning of time T3.

The UE shall send one Event A2 triggered measurement report for Cell 2 with a measurement reporting delay of less than 1.6s ($5 \times \text{measCycleSCell}$) from beginning of time T3.

The UE shall send one Event A2 triggered measurement report for Cell 3 with a measurement reporting delay of less than 1.6s ($5 \times \text{measCycleSCell}$) from beginning of time T3.

The UE shall not send event triggered measurement reports as long as the reporting criteria are not fulfilled.

The rate of correct events observed during repeated tests shall be at least 90% for each of the events.

NOTE: The actual overall delays measured in the tests may be up to $2 \times \text{TTI}_{\text{DCCH}}$ higher than the measurement reporting delays above because of TTI insertion uncertainty of the measurement report in DCCH.

A.8.16.29 3 DL FDD CA Event Triggered Reporting under Deactivated SCells in Non-DRX

A.8.16.29.1 Test Purpose and Environment

The purpose of this test is to verify that the UE correctly detects Events A1 (Serving cell becomes better than threshold), A2 (Serving cell becomes worse than threshold) and A6 (Neighbour becomes better than SCell) defined in TS 36.331 [2] within the requirements stated in clause 8.3.3.2.1.

The test parameters are given in Tables A.8.16.29.1-1 and A.8.16.29.1-2 below. It is indicated to the UE in the measurement control information that event-triggered reporting with Events A1 (SCell 1), Events A2 (PCell and SCell 1/2) and A6 is used. The test consists of three successive time periods, with duration of T1, T2 and T3, respectively. During T1 the UE shall not have any information on cell 4. Immediately at beginning of T2 the transmission power of cell 2 is increased above a threshold value such that this shall result in reporting of Event A1 for SCell 1, and cell 4 is increased to the same level as for Cell 3. Due to usage of an offset this shall result in reporting of Event A6. At beginning of T3 the transmission powers of cells 1, 2, 3 and 4 are reduced below a threshold value and this shall result in reporting of Event A2 for PCell and SCell 1/2, respectively.

Table A.8.16.29.1-1: General test parameters for E-UTRAN FDD event triggered reporting on configured but deactivated SCell in non-DRX under fading propagation conditions

Parameter		Unit	Value	Comment
E-UTRA RF Channel Number			1, 2, 3	Three radio channels are used for this test
Active PCell			Cell 1	Primary cell on RF channel number 1.
Configured deactivated SCell			Cell 2 (SCell 1)	Configured deactivated secondary cell 1 on RF channel number 2.
			Cell 3 (SCell 2)	Configured deactivated secondary cell 2 on RF channel number 3.
Neighbour cell			Cell 4	Neighbor cell to be identified on RF channel number 3.
CP length			Normal	
DRX			OFF	Continuous monitoring of primary cell
A1	Hysteresis	dB	0	Hysteresis for evaluation of event A1.
	Threshold RSRP	dBm	-98	Actual RSRP threshold for event A1. Needs to take absolute accuracy tolerance in clause 9.1.11.1 into account plus margin. No event A1 reporting is configured for cell 1 and 3.
	Time To Trigger	s	0	
A2	Hysteresis	dB	0	Hysteresis for evaluation of event A2.

	Threshold RSRP	dBm	-98	Actual RSRP threshold for event A2. Needs to take absolute accuracy tolerance in clause 9.1.11.1 into account plus margin.
	Time To Trigger	s	0	
A6	Hysteresis	dB	0	Hysteresis for evaluation of event A6.
	Offset	dB	-6	Offset parameter for evaluation of event A6. Needs to take relative accuracy tolerance in clause 9.1.11.2 into account plus margin.
	Report on leave		False	
	Time To Trigger	s	0	
	Cell-individual offset for cells on RF channel number 1	dB	0	Individual offset for cells on primary component carrier.
	Cell-individual offset for cells on RF channel number 2	dB	0	Individual offset for cells on secondary component carrier 1.
	Cell-individual offset for cells on RF channel number 3	dB	0	Individual offset for cells on secondary component carrier 2.
	Filter coefficient		0	L3 filtering is not used
	SCell measurement cycle (measCycleSCell) for SCell 1 and 2	ms	320	
	T1	s	5	During this time cell1 and cell3 shall be known to the UE; but cell2 and cell 4 shall be unknown to the UE.
	T2	s	≤12	UE should report Event A1 for cell2 and Event A6 for cell4 within 6.4s (20×sCellMeasCycle)
	T3	s	5	UE should report Event A2 within 200 ms, 1.6s and 1.6s for cells 1, 2 and 3, respectively.

Table A.8.16.29.1-2: Cell specific test parameters for E-UTRAN FDD event triggered reporting on configured but deactivated SCell in non-DRX under fading propagation conditions

Parameter	Unit	Cell 1			Cell 2			Cell 3			Cell 4		
		T1	T2	T3	T1	T2	T3	T1	T2	T3	T1	T2	T3
E-UTRA RF Channel Number		1			2			3					
BW _{channel}		5MHz: N _{RB,c} = 25 10MHz: N _{RB,c} = 50 20MHz: N _{RB,c} = 100			5MHz: N _{RB,c} = 25 10MHz: N _{RB,c} = 50 20MHz: N _{RB,c} = 100			5MHz: N _{RB,c} = 25 10MHz: N _{RB,c} = 50 20MHz: N _{RB,c} = 100					
PDSCH parameters: DL Reference Measurement Channel		5MHz: R.5 FDD 10MHz: R.0 FDD 20MHz: R.4 FDD			-			-			-		
PCFICH/PDCCH/PHICH parameters: DL Reference Measurement Channel		5MHz: R.11 FDD 10MHz: R.6 FDD 20MHz: R.10 FDD			5MHz: R.11 FDD 10MHz: R.6 FDD 20MHz: R.10 FDD			5MHz: R.11 FDD 10MHz: R.6 FDD 20MHz: R.10 FDD			5MHz: R.11 FDD 10MHz: R.6 FDD 20MHz: R.10 FDD		
OCNG Patterns		5MHz: OP.15 FDD 10MHz: OP.1 FDD 20MHz: OP.11 FDD			5MHz: OP.16 FDD 10MHz: OP.2 FDD 20MHz: OP.12 FDD			5MHz: OP.16 FDD 10MHz: OP.2 FDD 20MHz: OP.12 FDD			5MHz: OP.16 FDD 10MHz: OP.2 FDD 20MHz: OP.12 FDD		
PBCH_RA	dB	0			0			0			0		
PBCH_RB	dB												
PSS_RA	dB												
SSS_RA	dB												
PCFICH_RB	dB												
PHICH_RA	dB												
PHICH_RB	dB												
PDCCH_RA	dB												
PDCCH_RB	dB												
PDSCH_RA	dB												
PDSCH_RB	dB												
OCNG_RA ^{Note 1}	dB												
OCNG_RB ^{Note 1}	dB												
N _{oc} ^{Note 2}													
\bar{E}_s/N_{oc}	dB	17	17	-3	-infinity	17	-3	17	17	-3	-infinity	17	-3
\bar{E}_s/I_{ot} ^{Note 3}	dB	17	17	-3	-infinity	17	-3	17	-0.09	-4.76	-infinity	-0.05	-4.76
RSRP ^{Note 3}	dBm/15 kHz	-87	-87	-107	-infinity	-87	-107	-87	-87	-107	-infinity	-87	-107
SCH_RP ^{Note 3}	dBm/15 kHz	-87	-87	-107	-infinity	-87	-107	-87	-87	-107	-infinity	-87	-107
I _o ^{Note 3}	dBm/Ch BW	-59.13 +10log (N _{RB,c} /50)	-59.13 +10log (N _{RB,c} /50)	-74.45 +10log (N _{RB,c} /50)	-76.22 +10log (N _{RB,c} /50)	-59.13 +10log (N _{RB,c} /50)	-74.45 +10log (N _{RB,c} /50)	-59.13 +10log (N _{RB,c} /50)	-56.17 +10log (N _{RB,c} /50)	-73.20 +10log (N _{RB,c} /50)	Specified in columns for Cell 3		
Propagation Condition		AWGN			ETU70			ETU70			ETU70		

Correlation Matrix and Antenna Configuration		1x2	1x2 Low	1x2 Low	1x2 Low
Timing offset to Cell 1	μs	-	0	0	3
Time alignment error relative to cell 1 <small>Note 5</small>	μs	-	$\leq \text{TAE}$	$\leq \text{TAE}$	N/A
Time alignment error relative to cell 2 <small>Note 5</small>	μs	-	-	$\leq \text{TAE}$	N/A
<p>Note 1: OCNG shall be used such that all cells are fully allocated and a constant total transmitted power spectral density is achieved for all OFDM symbols.</p> <p>Note 2: Interference from other cells and noise sources not specified in the test is assumed to be constant over subcarriers and time and shall be modelled as AWGN of appropriate power for N_{oc} to be fulfilled.</p> <p>Note 3: E_s/I_{ot}, RSRP, SCH_RP and I_o have been derived from other parameters for information purposes. They are not settable parameters themselves.</p> <p>Note 4: The resources for uplink transmission are assigned to the UE prior to the start of time period T2.</p> <p>Note 5: Time alignment error (TAE) as specified in TS 36.104 [30] clause 6.5.3.1. The TAE value depends upon the type of carrier aggregation.</p>					

A.8.16.29.2 Test Requirements

The UE shall send one Event A6 triggered measurement report for cell 4 with a measurement reporting delay of less than 6.4s ($20 \times \text{measCycleSCell}$) from the beginning of time T2.

The UE shall send one Event A1 triggered measurement report for Cell 2 with a measurement reporting delay of less than 6.4s ($20 \times \text{measCycleSCell}$) from beginning of time T2.

The UE shall send one Event A2 triggered measurement report for Cell 1 with a measurement reporting delay of less than 200 ms from beginning of time T3.

The UE shall send one Event A2 triggered measurement report for Cell 2 with a measurement reporting delay of less than 1.6s ($5 \times \text{measCycleSCell}$) from beginning of time T3.

The UE shall send one Event A2 triggered measurement report for Cell 3 with a measurement reporting delay of less than 1.6s ($5 \times \text{measCycleSCell}$) from beginning of time T3.

The UE shall not send event triggered measurement reports as long as the reporting criteria are not fulfilled.

The rate of correct events observed during repeated tests shall be at least 90% for each of the events.

NOTE: The actual overall delays measured in the tests may be up to $2 \times \text{TTI}_{\text{DCCH}}$ higher than the measurement reporting delays above because of TTI insertion uncertainty of the measurement report in DCCH.

A.8.16.30 3 DL TDD CA Event Triggered Reporting under Deactivated SCells in Non-DRX

A.8.16.30.1 Test Purpose and Environment

The purpose of this test is to verify that the UE correctly detects Events A1 (Serving cell becomes better than threshold), A2 (Serving cell becomes worse than threshold) and A6 (Neighbour becomes better than SCell) defined in TS 36.331 [2] within the requirements stated in clause 8.3.3.2.1.

The test parameters are given in Tables A.8.16.30.1-1 and A.8.16.30.1-2 below. It is indicated to the UE in the measurement control information that event-triggered reporting with Events A1 (SCell 1), Events A2 (PCell and SCell 1/2) and A6 is used. The test consists of three successive time periods, with duration of T1, T2 and T3, respectively. During T1 the UE shall not have any information on cell 4. Immediately at beginning of T2 the transmission power of cell 2 is increased above a threshold value such that this shall result in reporting of Event A1 for SCell 1, and cell 4 is increased to the same level as for Cell 3. Due to usage of an offset this shall result in reporting of Event A6. At beginning of T3 the transmission powers of cells 1, 2, 3 and 4 are reduced below a threshold value and this shall result in reporting of Event A2 for PCell and SCell 1/2, respectively.

Table A.8.16.30.1-1: General test parameters for E-UTRAN TDD event triggered reporting on configured but deactivated SCell in non-DRX under fading propagation conditions

Parameter		Unit	Value	Comment
E-UTRA RF Channel Number			1, 2, 3	Three radio channels are used for this test
Active PCell			Cell 1	Primary cell on RF channel number 1.
Configured deactivated SCell			Cell 2 (SCell 1)	Configured deactivated secondary cell 1 on RF channel number 2.
			Cell 3 (SCell 2)	Configured deactivated secondary cell 2 on RF channel number 3.
Neighbour cell			Cell 4	Neighbor cell to be identified on RF channel number 3.
CP length			Normal	
DRX			OFF	Continuous monitoring of primary cell
A1	Hysteresis	dB	0	Hysteresis for evaluation of event A1.
	Threshold RSRP	dBm	-98	Actual RSRP threshold for event A1. Needs to take absolute accuracy tolerance in clause 9.1.11.1 into account plus margin. No event A1 reporting is configured for cell 1 and 3.
	Time To Trigger	s	0	
A2	Hysteresis	dB	0	Hysteresis for evaluation of event A2.

	Threshold RSRP	dBm	-98	Actual RSRP threshold for event A2. Needs to take absolute accuracy tolerance in clause 9.1.11.1 into account plus margin.
	Time To Trigger	s	0	
A6	Hysteresis	dB	0	Hysteresis for evaluation of event A6.
	Offset	dB	-6	Offset parameter for evaluation of event A6. Needs to take relative accuracy tolerance in clause 9.1.11.2 into account plus margin.
	Report on leave		False	
	Time To Trigger	s	0	
	Cell-individual offset for cells on RF channel number 1	dB	0	Individual offset for cells on primary component carrier.
	Cell-individual offset for cells on RF channel number 2	dB	0	Individual offset for cells on secondary component carrier 1.
	Cell-individual offset for cells on RF channel number 3	dB	0	Individual offset for cells on secondary component carrier 2.
	Filter coefficient		0	L3 filtering is not used
	SCell measurement cycle (measCycleSCell) for SCell 1 and 2	ms	320	
	T1	s	5	During this time cell1 and cell3 shall be known to the UE; but cell2 and cell 4 shall be unknown to the UE.
	T2	s	≤12	UE should report Event A1 for cell2 and Event A6 for cell4 within 6.4s (20×sCellMeasCycle)
	T3	s	5	UE should report Event A2 within 200 ms, 1.6s and 1.6s for cells 1, 2 and 3, respectively.

Table A.8.16.30.1-2: Cell specific test parameters for E-UTRAN TDD event triggered reporting on configured but deactivated SCell in non-DRX under fading propagation conditions

Parameter	Unit	Cell 1			Cell 2			Cell 3			Cell 4		
		T1	T2	T3	T1	T2	T3	T1	T2	T3	T1	T2	T3
E-UTRA RF Channel Number		1			2			3					
BW _{channel}		5MHz: N _{RB,c} = 25 10MHz: N _{RB,c} = 50 20MHz: N _{RB,c} = 100			5MHz: N _{RB,c} = 25 10MHz: N _{RB,c} = 50 20MHz: N _{RB,c} = 100			5MHz: N _{RB,c} = 25 10MHz: N _{RB,c} = 50 20MHz: N _{RB,c} = 100					
PDSCH parameters: DL Reference Measurement Channel		5MHz: R.4 TDD 10MHz: R.0 TDD 20MHz: R.3 TDD			-			-			-		
PCFICH/PDCCH/PHI CH parameters: DL Reference Measurement Channel		5MHz: R.11 TDD 10MHz: R.6 TDD 20MHz: R.10 TDD			5MHz: R.11 TDD 10MHz: R.6 TDD 20MHz: R.10 TDD			5MHz: R.11 TDD 10MHz: R.6 TDD 20MHz: R.10 TDD			5MHz: R.11 TDD 10MHz: R.6 TDD 20MHz: R.10 TDD		
OCNG Patterns		5MHz: OP.9 TDD 10MHz: OP.1 TDD 20MHz: OP.7 TDD			5MHz: OP.10 TDD 10MHz: OP.2 TDD 20MHz: OP.8 TDD			5MHz: OP.10 TDD 10MHz: OP.2 TDD 20MHz: OP.8 TDD			5MHz: OP.10 TDD 10MHz: OP.2 TDD 20MHz: OP.8 TDD		
PBCH_RA	dB	0			0			0			0		
PBCH_RB	dB												
PSS_RA	dB												
SSS_RA	dB												
PCFICH_RB	dB												
PHICH_RA	dB												
PHICH_RB	dB												
PDCCH_RA	dB												
PDCCH_RB	dB												
PDSCH_RA	dB												
PDSCH_RB	dB												
OCNG_RA ^{Note 1}	dB												
OCNG_RB ^{Note 1}	dB												
N _{oc} ^{Note 2}		-104			-104			-104					
\hat{E}_s/N_{oc}	dB	17	17	-3	-infinity	17	-3	17	17	-3	-infinity	17	-3
\hat{E}_s/I_{ot} ^{Note 3}	dB	17	17	-3	-infinity	17	-3	17	-0.09	-4.76	-infinity	-0.05	-4.76
RSRP ^{Note 3}	dBm/15 kHz	-87	-87	-107	-infinity	-87	-107	-87	-87	-107	-infinity	-87	-107
SCH_RP ^{Note 3}	dBm/15 kHz	-87	-87	-107	-infinity	-87	-107	-87	-87	-107	-infinity	-87	-107
I _o ^{Note 3}	dBm/Ch BW	-59.13 +10log (N _{RB,c} /50)	-59.13 +10log (N _{RB,c} /50)	-74.45 +10log (N _{RB,c} /50)	-76.22 +10log (N _{RB,c} /50)	-59.13 +10log (N _{RB,c} /50)	-74.45 +10log (N _{RB,c} /50)	-59.13 +10log (N _{RB,c} /50)	-56.17 +10log (N _{RB,c} /50)	-73.20 +10log (N _{RB,c} /50)	Specified in columns for Cell 3		

Propagation Condition		AWGN	ETU70	ETU70	ETU70
Correlation Matrix and Antenna Configuration		1x2 Low	1x2 Low	1x2 Low	1x2 Low
Timing offset to Cell 1	μs	-	0	0	3
Time alignment error relative to cell 1 ^{Note 5}	μs	-	$\leq \text{TAE}$	$\leq \text{TAE}$	N/A
Time alignment error relative to cell 2 ^{Note 5}	μs	-	-	$\leq \text{TAE}$	N/A
<p>Note 1: OCNG shall be used such that all cells are fully allocated and a constant total transmitted power spectral density is achieved for all OFDM symbols.</p> <p>Note 2: Interference from other cells and noise sources not specified in the test is assumed to be constant over subcarriers and time and shall be modelled as AWGN of appropriate power for N_{oc} to be fulfilled.</p> <p>Note 3: E_s/I_{ot}, RSRP, SCH_RP and I_o have been derived from other parameters for information purposes. They are not settable parameters themselves.</p> <p>Note 4: The resources for uplink transmission are assigned to the UE prior to the start of time period T2.</p> <p>Note 5: Time alignment error (TAE) as specified in TS 36.104 [30] clause 6.5.3.1. The TAE value depends upon the type of carrier aggregation.</p>					

A.8.16.30.2 Test Requirements

The UE shall send one Event A6 triggered measurement report for cell 4 with a measurement reporting delay of less than 6.4s ($20 \times \text{measCycleSCell}$) from the beginning of time T2.

The UE shall send one Event A1 triggered measurement report for Cell 2 with a measurement reporting delay of less than 6.4s ($20 \times \text{measCycleSCell}$) from beginning of time T2.

The UE shall send one Event A2 triggered measurement report for Cell 1 with a measurement reporting delay of less than 200 ms from beginning of time T3.

The UE shall send one Event A2 triggered measurement report for Cell 2 with a measurement reporting delay of less than 1.6s ($5 \times \text{measCycleSCell}$) from beginning of time T3.

The UE shall send one Event A2 triggered measurement report for Cell 3 with a measurement reporting delay of less than 1.6s ($5 \times \text{measCycleSCell}$) from beginning of time T3.

The UE shall not send event triggered measurement reports as long as the reporting criteria are not fulfilled.

The rate of correct events observed during repeated tests shall be at least 90% for each of the events.

NOTE: The actual overall delays measured in the tests may be up to $2 \times \text{TTI}_{\text{DCCH}}$ higher than the measurement reporting delays above because of TTI insertion uncertainty of the measurement report in PDCCH.

A.8.16.31 E-UTRAN TDD-FDD 3 DL CA Event Triggered Reporting on Deactivated SCell with PCell and SCell Interruptions in Non-DRX and with PCell in FDD

A.8.16.31.1 Test Purpose and Environment

The purpose of this test is to verify that the UE correctly detects event A6 (Neighbour becomes better than SCell) defined in TS 36.331 [2] within the requirements stated in clause 8.3.3.2.1 while at the same time fulfilling the requirement on interruption rate.

The test parameters are given in Table A.8.16.31.1-1 and A.8.16.31.1-2 below. In the test there are four cells: Cell 1, Cell 2, Cell 3 and Cell 4. Cell 1 is PCell on the FDD primary component (RF Channel 1), Cell 2 is SCell on the TDD secondary component (RF Channel 2), and Cell 3 is SCell on the TDD secondary component (RF Channel 3) and Cell 4 is the neighbour cell on the TDD secondary component (RF Channel 3). It is indicated to the UE in the measurement control information that event-triggered reporting with Event A6 is used. The test consists of four successive time periods, with duration of T1, T2, T3 and T4, respectively. During T1 and T2, both Cell2 and Cell3 are deactivated. During T1 the UE shall not have any information of cell 4. Immediately at beginning of T2 the transmission power of cell 4 is increased to same level as for cell 3, and due to usage of an offset this shall result in reporting of Event A6.

At the beginning of T3, the transmission power of Cell 4 is turned off and the test equipment sends a MAC message for activation of Cell 2 to UE but Cell3 remains deactivated. Immediately at beginning of T4 the transmission power of cell 4 is increased to same level as for cell 3, and due to usage of an offset this shall result in reporting of Event A6. The UE shall be continuously scheduled in the PCell throughout the whole test and continuously scheduled in Cell 2 during T4.

Table A.8.16.31.1-1: General test parameters for E-UTRAN TDD-FDD 3 DL CA Event Triggered Reporting on Deactivated SCell with PCell and SCell Interruptions in Non-DRX and with PCell in FDD

Parameter	Unit	Value	Comment
E-UTRA RF Channel Number		1, 2, 3	three radio channels are used for this test
Active PCell		Cell 1	Primary cell on RF channel number 1.
Configured deactivated SCell		Cell 2	Configured deactivated secondary cell on RF channel number 2.
Configured deactivated SCell		Cell 3	Configured deactivated secondary cell on RF channel number 3.
Neighbour cell		Cell 4	Neighbor cell to be identified on RF channel number 3.
CP length		Normal	

Special subframe configuration		6	As specified in table 4.2-1 in TS 36.211. The same configuration in TDD cells	
Uplink-downlink configuration		1	As specified in table 4.2-2 in TS 36.211. The same configuration in TDD cells	
DRX		OFF	Continuous monitoring of primary cell	
A6	Hysteresis	dB	0	Hysteresis for evaluation of event A6.
	Offset	dB	-3	Offset parameter for evaluation of event A6. Needs to take relative accuracy tolerance in clause 9.1.11.2 into account plus margin.
	Report on leave		False	
	Time To Trigger	s	0	
Cell-individual offset for cells on RF channel number 1	dB	0	Individual offset for cells on primary component carrier.	
Cell-individual offset for cells on RF channel number 2	dB	0	Individual offset for cells on secondary component carrier.	
Cell-individual offset for cells on RF channel number 3	dB	0	Individual offset for cells on secondary component carrier.	
Filter coefficient		0	L3 filtering is not used	
SCell measurement cycle	ms	640		
T1	s	4	During this time the UE shall be aware of cells 1, 2 and 3 but not cell 4.	
T2	s	≤ 15	UE should report Event A6 within 12.8s (20xscellMeasCycle)	
T3	s	4	During this time the UE shall activate cell 2	
T4	s	≤ 4	UE should report Event A6 within 3.2s (5xscellMeasCycle)	

Table A.8.16.31.1-2: Cell specific test parameters for E-UTRAN TDD-FDD 3 DL CA Event Triggered Reporting on Deactivated SCell with PCell and SCell Interruptions in Non-DRX and with PCell in FDD

Parameter	Unit	Cell 1				Cell 2				Cell 3				Cell 4			
		T1	T2	T3	T4	T1	T2	T3	T4	T1	T2	T3	T4	T1	T2	T3	T4
E-UTRA RF Channel Number		1				2				3				3			
BW _{channel}	MHz	5MHz: N _{RB,c} = 25 10MHz: N _{RB,c} = 50 20MHz: N _{RB,c} = 100				5MHz: N _{RB,c} = 25 10MHz: N _{RB,c} = 50 20MHz: N _{RB,c} = 100				5MHz: N _{RB,c} = 25 10MHz: N _{RB,c} = 50 20MHz: N _{RB,c} = 100				5MHz: N _{RB,c} = 25 10MHz: N _{RB,c} = 50 20MHz: N _{RB,c} = 100			
PDSCH parameters: DL Reference Measurement Channel		5MHz: R.7 FDD 10MHz: R.3 FDD 20MHz: R.6 FDD				N/A	N/A	N/A	5MHz: R.4 TDD 10MHz: R.0 TDD 20MHz: R.3 TDD	N/A				N/A			
PCFICH/PDCCH/PHICH parameters: DL Reference Measurement Channel		5MHz: R.11 FDD 10MHz: R.6 FDD 20MHz: R.10 FDD				5MHz: R.11 TDD 10MHz: R.6 TDD 20MHz: R.10 TDD				5MHz: R.11 TDD 10MHz: R.6 TDD 20MHz: R.10 TDD				5MHz: R.11 TDD 10MHz: R.6 TDD 20MHz: R.10 TDD			
OCNG Pattern defined in A.3.2.1 and A.3.2.2		5MHz: OP.20 FDD 10MHz: OP.10 FDD 20MHz: OP.17 FDD				5MHz: OP.10 TDD 10MHz: OP.10 TDD z: OP.2 TDD 20MHz: OP.8 TDD	5MHz: OP.10 TDD 10MHz: OP.10 TDD z: OP.2 TDD 20MHz: OP.8 TDD	5MHz: OP.10 TDD 10MHz: OP.10 TDD z: OP.2 TDD 20MHz: OP.8 TDD	5MHz: OP.9 TDD 10MHz: OP.10 TDD z: OP.1 TDD 20MHz: OP.7 TDD	5MHz: OP.10 TDD 10MHz: OP.2 TDD 20MHz: OP.8 TDD				5MHz: OP.10 TDD 10MHz: OP.2 TDD 20MHz: OP.8 TDD			
PBCH_RA	dB	0				0				0				0			
PBCH_RB	dB																
PSS_RA	dB																
SSS_RA	dB																
PCFICH_RB	dB																
PHICH_RA	dB																
PHICH_RB	dB																
PDCCH_RA	dB																
PDCCH_RB	dB																
PDSCH_RA	dB																

PDSCH_RB	dB																
OCNG_RA ^{Note 1}	dB																
OCNG_RB ^{Note 1}	dB																
N_{oc} ^{Note 3}	dBm/1 5 kHz	-101				-101				-101							
\hat{E}_s/N_{oc}	dB	16	16	16	16	16	16	16	16	16	16	16	16	- Infinite	16	- Infinite	16
\hat{E}_s/I_{ot} ^{Note 4}	dB	16	16	16	16	16	16	16	16	16	-0.11	16	-0.11	- Infinite	-0.11	- Infinite	-0.11
RSRP ^{Note 4}	dBm/1 5 kHz	-85	-85	-85	-85	-85	-85	-85	-85	-85	-85	-85	-85	- Infinite	-85	- Infinite	-85
SCH_RP ^{Note 4}	dBm/1 5 kHz	-85	-85	-85	-85	-85	-85	-85	-85	-85	-85	-85	-85	- Infinite	-85	- Infinite	-85
I_o ^{Note 4}	dBm/C h BW	- 57.11 +10log g ($N_{RB,c}$ /50)	-57.11 +10log ($N_{RB,c}$ /50)	- 57.11 +10log g ($N_{RB,c}$ /50)	- 57.1 +10log og ($N_{RB,c}$ /50)	-57.11 +10log ($N_{RB,c}$ /50)	-57.11 +10log ($N_{RB,c}$ /50)	-57.11 +10log ($N_{RB,c}$ /50)	-57.11 +10log ($N_{RB,c}$ /50)	- 57.11 +10log g ($N_{RB,c}$ /50)	- 54.15 +10log g ($N_{RB,c}$ /50)	- 57.11 +10log g ($N_{RB,c}$ /50)	- 54.15 +10log g ($N_{RB,c}$ /50)	- 57.11 +10log g ($N_{RB,c}$ /50)	- 54.15 +10log g ($N_{RB,c}$ /50)	- 57.11 +10log g ($N_{RB,c}$ /50)	- 54.15 +10log g ($N_{RB,c}$ /50)
Propagation Condition		AWGN				AWGN				AWGN				AWGN			
Antenna Configuration		1x2				1x2				1x2				1x2			
Timing offset to Cell 1	μ s	-				0				0				3			
Time alignment error relative to cell 1 ^{Note 5}	μ s	-				\leq TAE				\leq TAE				N/A			
Time alignment error relative to cell 2 ^{Note 5}	μ s	-				-				\leq TAE				N/A			
<p>Note 1: OCNG shall be used such that all cells are fully allocated and a constant total transmitted power spectral density is achieved for all OFDM symbols.</p> <p>Note 2: The resources for uplink transmission are assigned to the UE on cell1 prior to the start of time period T2 and on cell2 prior to the start of time period T4.</p> <p>Note 3: Interference from other cells and noise sources not specified in the test is assumed to be constant over subcarriers and time and shall be modelled as AWGN of appropriate power for N_{oc} to be fulfilled.</p> <p>Note 4: E_s/I_{ot}, RSRP, SCH_RP and I_o levels have been derived from other parameters for information purposes. They are not settable parameters themselves.</p> <p>Note 5: Time alignment error (TAE) as specified in TS 36.104 [30] clause 6.5.3.1. The TAE value depends upon the type of carrier aggregation.</p>																	

A.8.16.31.2 Test Requirements

The UE shall send one Event A6 triggered measurement report, with a measurement reporting delay less than 12.8s ($20 \times \text{scellMeasCycle}$) from the beginning of time period T2.

The UE shall send one Event A6 triggered measurement report, with a measurement reporting delay less than 3.2s ($5 \times \text{scellMeasCycle}$) from the beginning of time period T4.

The UE shall not send event triggered measurement reports, as long as the reporting criteria are not fulfilled.

The UE shall be scheduled on PCell continuously throughout the test. From the start of T1 until the measurement report is received during T2, at least 99.5% of all expected ACK/NACKs shall be transmitted by the UE.

The UE shall be scheduled on Cell2 continuously from the start of T4 to the end. From the start of T4 until the measurement report is received during T4, at least 99.5% of all expected ACK/NACKs shall be transmitted by the UE.

For a test to be considered successful requirements on both event detection and percentage of transmitted ACK/NACKs have to be fulfilled simultaneously.

The rate of correct events observed during repeated tests shall be at least 90%.

NOTE: The actual overall delays measured in the test may be up to $2 \times \text{TTI}_{\text{DCCH}}$ higher than the measurement reporting delays above because of TTI insertion uncertainty of the measurement report in DCCH.

A.8.16.32 E-UTRAN TDD-FDD 3 DL CA Event Triggered Reporting on Deactivated SCell with PCell and SCell Interruptions in Non-DRX and with PCell in TDD

A.8.16.32.1 Test Purpose and Environment

The purpose of this test is to verify that the UE correctly detects event A6 (Neighbour becomes better than SCell) defined in TS 36.331 [2] within the requirements stated in clause 8.3.3.2.1 while at the same time fulfilling the requirement on interruption rate.

The test parameters are given in Table A.8.16.32.1-1 and A.8.16.32.1-2 below. In the test there are four cells: Cell 1, Cell 2, Cell 3 and Cell 4. Cell 1 is PCell on the TDD primary component (RF Channel 1), Cell 2 is SCell on the FDD secondary component (RF Channel 2), and Cell 3 is SCell on the FDD secondary component (RF Channel 3) and Cell 4 is the neighbour cell on the FDD secondary component (RF Channel 3). It is indicated to the UE in the measurement control information that event-triggered reporting with Event A6 is used. The test consists of four successive time periods, with duration of T1, T2, T3 and T4, respectively. During T1 and T2, both Cell2 and Cell3 are deactivated. During T1 the UE shall not have any information of cell 4. Immediately at beginning of T2 the transmission power of cell 4 is increased to same level as for cell 3, and due to usage of an offset this shall result in reporting of Event A6.

At the beginning of T3, the transmission power of Cell 4 is turned off and the test equipment sends a MAC message for activation of Cell 2 to UE but Cell3 remains deactivated. Immediately at beginning of T4 the transmission power of Cell 4 is increased to same level as for Cell 3, and due to usage of an offset this shall result in reporting of Event A6. The UE shall be continuously scheduled in the PCell throughout the whole test and continuously scheduled in Cell2 during T4.

Table A.8.16.32.1-1: General test parameters for E-UTRAN TDD-FDD 3 DL CA Event Triggered Reporting on Deactivated SCell with PCell and SCell Interruptions in Non-DRX and with PCell in TDD

Parameter	Unit	Value	Comment
E-UTRA RF Channel Number		1, 2, 3	Three radio channels are used for this test
Active PCell		Cell 1	Primary cell on RF channel number 1.
Configured SCell		Cell 2	Configured secondary cell on RF channel number 2.
Configured SCell		Cell 3	Configured secondary cell on RF channel number 3.
Neighbour cell		Cell 4	Neighbor cell to be identified on RF channel number 3.
CP length		Normal	

Special subframe configuration on PCell			6	As specified in table 4.2.1 in TS 36.211. The same configuration applies to all cells.
Uplink-downlink configuration on PCell			1	
DRX			OFF	Continuous monitoring of primary cell
A6	Hysteresis	dB	0	Hysteresis for evaluation of event A6.
	Offset	dB	-3	Offset parameter for evaluation of event A6. Needs to take relative accuracy tolerance in clause 9.1.11.2 into account plus margin.
	Report on leave		False	
	Time To Trigger	s	0	
Cell-individual offset for cells on RF channel number 1		dB	0	Individual offset for cells on primary component carrier.
Cell-individual offset for cells on RF channel number 2		dB	0	Individual offset for cells on secondary component carrier.
Cell-individual offset for cells on RF channel number 3		dB	0	Individual offset for cells on secondary component carrier.
Filter coefficient			0	L3 filtering is not used
SCell measurement cycle		ms	640	
T1		s	4	During this time the UE shall be aware of cells 1, 2 and 3 but not cell 4.
T2		s	≤ 15	UE should report Event A6 within 12.8s (20xscellMeasCycle)
T3		s	4	During this time the UE shall activate cell 2
T4		s	≤ 4	UE should report Event A6 within 3.2s (5xscellMeasCycle)

Table A.8.16.32.1-2: Cell specific test parameters for E-UTRAN TDD-FDD 3 DL CA Event Triggered Reporting on Deactivated SCell with PCell and SCell Interruptions in Non-DRX and with PCell in TDD

Parameter	Unit	Cell 1				Cell 2				Cell 3				Cell 4			
		T1	T2	T3	T4	T1	T2	T3	T4	T1	T2	T3	T4	T1	T2	T3	T4
E-UTRA RF Channel Number		1				2				3				3			
BW _{channel}	MHz	5MHz: N _{RB,c} = 25 10MHz: N _{RB,c} = 50 20MHz: N _{RB,c} = 100				5MHz: N _{RB,c} = 25 10MHz: N _{RB,c} = 50 20MHz: N _{RB,c} = 100				5MHz: N _{RB,c} = 25 10MHz: N _{RB,c} = 50 20MHz: N _{RB,c} = 100				5MHz: N _{RB,c} = 25 10MHz: N _{RB,c} = 50 20MHz: N _{RB,c} = 100			
PDSCH parameters: DL Reference Measurement Channel		5MHz: R.4 TDD 10MHz: R.0 TDD 20MHz: R.3 TDD				N/A	N/A	N/A	5MHz: R.7 FDD 10MHz: R.3 FDD 20MHz: R.6 FDD	N/A				N/A			
PCFICH/PDCCH/PHICH parameters		5MHz: R.11 TDD 10MHz: R.6 TDD 20MHz: R.10 TDD				5MHz: R.11 FDD 10MHz: R.6 FDD 20MHz: R.10 FDD				5MHz: R.11 FDD 10MHz: R.6 FDD 20MHz: R.10 FDD				5MHz: R.11 FDD 10MHz: R.6 FDD 20MHz: R.10 FDD			
OCNG Pattern defined in A.3.2.1		5MHz: OP.9 TDD 10MHz: OP.1 TDD 20MHz: OP. 7 TDD				5MHz: OP.19FD D; 10MHz: O P.6 FDD; 20MHz: OP.14FD D	5MHz: OP.19FD D; 10MHz: O P.6 FDD; 20MHz: OP.14FD D	5MHz: OP.19FD D; 10MHz: O P.6 FDD; 20MHz: OP.14FD D	5MHz: OP.20 FDD; 10MHz: O P.10 FDD; 20MHz: OP.17 FDD	5MHz: OP.16FDD; 10MHz: OP.2 FDD; 20MHz: OP.12FDD				5MHz: OP.16FDD; 10MHz: OP.2 FDD; 20MHz: OP.12FDD			
PBCH_RA	dB	0				0				0				0			
PBCH_RB	dB																
PSS_RA	dB																
SSS_RA	dB																
PCFICH_RB	dB																
PHICH_RA	dB																
PHICH_RB	dB																
PDCCH_RA	dB																
PDCCH_RB	dB																
PDSCH_RA	dB																
PDSCH_RB	dB																
OCNG_RA ^{Note 1}	dB																
OCNG_RB ^{Note 1}	dB																
N _{oc} ^{Note 3}	dBm/ 15 kHz																

\hat{E}_s / N_{oc}	dB	16	16	16	16	16	16	16	16	16	16	16	16	- Infini ty	16	- Infini ty	16
\hat{E}_s / I_{ot} ^{Note 4}	dB	16	16	16	16	16	16	16	16	16	-0.11	16	-0.11	- Infini ty	-0.11	- Infini ty	-0.11
RSRP ^{Note 4}	dBm/ 15 kHz	-85	-85	-85	-85	-85	-85	-85	-85	-85	-85	-85	-85	- Infini ty	-85	- Infini ty	-85
SCH_RP ^{Note 4}	dBm/ 15 kHz	-85	-85	-85	-85	-85	-85	-85	-85	-85	-85	-85	-85	- Infini ty	-85	- Infini ty	-85
I_o ^{Note 4}	dBm/ Ch BW	- 57.1 1 +10l og (N _{RB,c} /50)	-57.11 +10log (N _{RB,c} /50)	- 57.1 1 +10l og (N _{RB,c} /50)	- 57.1 11 +1 0lo g (N _{R B,c /50)}	-57.11 +10log (N _{RB,c} /50)	-57.11 +10log (N _{RB,c} /50)	-57.11 +10log (N _{RB,c} /50)	-57.11 +10log (N _{RB,c} /50)	- 57.1 1 +10l og (N _{RB,c} /50)	- 54.1 5 +10l og (N _{RB,c} /50)	- 57.1 1 +10l og (N _{RB,c} /50)	- 54.1 5 +10l og (N _{RB,c} /50)	- 57.1 1 +10l og (N _{RB,c} /50)	- 54.1 5 +10l og (N _{RB,c} /50)	- 57.1 1 +10l og (N _{RB,c} /50)	- 54.1 5 +10l og (N _{RB,c} /50)
Propagation Condition		AWGN				AWGN				AWGN				AWGN			
Antenna Configuration		1x2				1x2				1x2				1x2			
Timing offset to Cell 1	μs	-				0				0				3			
Time alignment error relative to cell 1 ^{Note5}	μs	-				≤ TAE				≤ TAE				N/A			
Time alignment error relative to cell 2 ^{Note5}	μs	-				-				≤ TAE				N/A			

Note 1: OCNG shall be used such that all cells are fully allocated and a constant total transmitted power spectral density is achieved for all OFDM symbols.
 Note 2: The resources for uplink transmission are assigned to the UE on cell1 prior to the start of time period T2 and on cell2 prior to the start of time period T4.
 Note 3: Interference from other cells and noise sources not specified in the test is assumed to be constant over subcarriers and time and shall be modelled as AWGN of appropriate power for N_{oc} to be fulfilled.
 Note 4: Es/Iot, RSRP, SCH_RP and Io levels have been derived from other parameters for information purposes. They are not settable parameters themselves.
 Note 5: Time alignment error (TAE) as specified in TS 36.104 [30] clause 6.5.3.1. The TAE value depends upon the type of carrier aggregation.

A.8.16.32.2 Test Requirements

The UE shall send one Event A6 triggered measurement report, with a measurement reporting delay less than 12.8s ($20 \times \text{scellMeasCycle}$) from the beginning of time period T2.

The UE shall send one Event A6 triggered measurement report, with a measurement reporting delay less than 3.2s ($5 \times \text{scellMeasCycle}$) from the beginning of time period T4.

The UE shall not send event triggered measurement reports, as long as the reporting criteria are not fulfilled.

The UE shall be scheduled on PCell continuously throughout the test. From the start of T1 until the measurement report is received during T2, at least 99.5% of all expected ACK/NACKs shall be transmitted by the UE.

The UE shall be scheduled on Cell2 continuously from the beginning of T4 to the end. From the start of T4 until the measurement report is received during T4, at least 99.5% of all expected ACK/NACKs shall be transmitted by the UE.

For a test to be considered successful requirements on both event detection and percentage of transmitted ACK/NACKs have to be fulfilled simultaneously.

The rate of correct events observed during repeated tests shall be at least 90%.

NOTE: The actual overall delays measured in the test may be up to $2 \times \text{TTI}_{\text{DCCH}}$ higher than the measurement reporting delays above because of TTI insertion uncertainty of the measurement report in DCCH.

A.8.16.33 E-UTRAN FDD 3 DL CA Event Triggered Reporting on Deactivated SCell with PCell and SCell Interruptions in Non-DRX

A.8.16.33.1 Test Purpose and Environment

The purpose of this test is to verify that the UE correctly detects event A6 (Neighbour becomes better than SCell) defined in TS 36.331 [2] within the requirements stated in clause 8.3.3.2.1 while at the same time fulfilling the requirement on interruption rate.

The test parameters are given in Table A.8.16.33.1-1 and A.8.16.33.1-2 below. In the test there are four cells: Cell 1, Cell 2, Cell 3 and Cell 4. Cell 1 is PCell on the FDD primary component (RF Channel 1), Cell 2 is SCell on the FDD secondary component (RF Channel 2), and Cell 3 is SCell on the FDD secondary component (RF Channel 3) and Cell 4 is the neighbour cell on the FDD secondary component (RF Channel 3). It is indicated to the UE in the measurement control information that event-triggered reporting with Event A6 is used. The test consists of four successive time periods, with duration of T1, T2, T3 and T4, respectively. During T1 and T2, both Cell2 and Cell3 are deactivated. During T1 the UE shall not have any information of cell 4. Immediately at beginning of T2 the transmission power of cell 4 is increased to same level as for cell 3, and due to usage of an offset this shall result in reporting of Event A6.

At the beginning of T3, the transmission power of Cell 4 is turned off and the test equipment sends a MAC message for activation of Cell 2 to UE but Cell3 remains deactivated. Immediately at beginning of T4 the transmission power of Cell 4 is increased to same level as for Cell 3, and due to usage of an offset this shall result in reporting of Event A6. The UE shall be continuously scheduled in the PCell throughout the whole test and continuously scheduled in Cell2 during T4.

Table A.8.16.33.1-1: General test parameters for E-UTRAN FDD 3 DL CA Event Triggered Reporting on Deactivated SCell with PCell and SCell interruptions in Non-DRX

Parameter	Unit	Value	Comment
E-UTRA RF Channel Number		1, 2, 3	Three radio channels are used for this test
Active PCell		Cell 1	Primary cell on RF channel number 1.
Configured deactivated SCell		Cell 2	Configured deactivated secondary cell on RF channel number 2.
Configured deactivated SCell		Cell 3	Configured deactivated secondary cell on RF channel number 3.
Neighbour cell		Cell 4	Neighbor cell to be identified on RF channel number 3.
CP length		Normal	
DRX		OFF	Continuous monitoring of primary cell
A6 Hysteresis	dB	0	Hysteresis for evaluation of event A6.

	Offset	dB	-3	Offset parameter for evaluation of event A6. Needs to take relative accuracy tolerance in clause 9.1.11.2 into account plus margin.
	Report on leave		False	
	Time To Trigger	s	0	
	Cell-individual offset for cells on RF channel number 1	dB	0	Individual offset for cells on primary component carrier.
	Cell-individual offset for cells on RF channel number 2	dB	0	Individual offset for cells on secondary component carrier.
	Cell-individual offset for cells on RF channel number 3	dB	0	Individual offset for cells on secondary component carrier.
	Filter coefficient		0	L3 filtering is not used
	SCell measurement cycle	ms	640	
	T1	s	4	During this time the UE shall be aware of cells 1, 2 and 3 but not cell 4.
	T2	s	≤ 15	UE should report Event A6 within 12.8s (20xscellMeasCycle)
	T3	s	4	During this time the UE shall activate cell 2
	T4	s	≤ 4	UE should report Event A6 within 3.2s (5xscellMeasCycle)

Table A.8.16.33.1-2: Cell specific test parameters for E-UTRAN FDD 3 DL CA Event Triggered Reporting on Deactivated SCell with PCell and SCell interruptions in Non-DRX (Cell #1 and Cell #2)

Parameter	Unit	Cell 1				Cell 2				Cell 3				Cell 4			
		T1	T2	T3	T4	T1	T2	T3	T4	T1	T2	T3	T4	T1	T2	T3	T4
E-UTRA RF Channel Number		1				2				3				3			
BW _{channel}		5MHz: N _{RB,c} = 25 10MHz: N _{RB,c} = 50 20MHz: N _{RB,c} = 100				5MHz: N _{RB,c} = 25 10MHz: N _{RB,c} = 50 20MHz: N _{RB,c} = 100				5MHz: N _{RB,c} = 25 10MHz: N _{RB,c} = 50 20MHz: N _{RB,c} = 100				5MHz: N _{RB,c} = 25 10MHz: N _{RB,c} = 50 20MHz: N _{RB,c} = 100			
PDSCH parameters: DL Reference Measurement Channel		5MHz: R.7 FDD 10MHz: R.3 FDD 20MHz: R.6 FDD				N/A	N/A	N/A	5MHz: R.7 FDD 10MH z: R.3 FDD 20MH z: R.6 FDD	N/A				N/A			
PCFICH/PDCCH/PHICH parameters		5MHz: R.11 FDD 10MHz: R.6 FDD 20MHz: R.10 FDD				5MHz: R.11 FDD 10MHz: R.6 FDD 20MHz: R.10 FDD				5MHz: R.11 FDD 10MHz: R.6 FDD 20MHz: R.10 FDD				5MHz: R.11 FDD 10MHz: R.6 FDD 20MHz: R.10 FDD			
OCNG Pattern defined in A.3.2.1		5MHz: OP.20 FDD 10MHz: OP.10 FDD 20MHz: OP.17 FDD				5MHz: OP.19 FDD 10MH z: OP.6 FDD 20MH z: OP.14 FDD	5MHz: OP.19 FDD 10MHz: OP.6FD 20MHz: OP.14 FDD	5MHz: OP.19 FDD 10MH z: OP.6 FDD 20MH z: OP.14 FDD	5MHz: OP.20 FDD 10MH z: OP.10 FDD 20MH z: OP.17 FDD	5MHz: OP.16 FDD 10MHz: OP.2 FDD 20MHz: OP.12 FDD				5MHz: OP.16 FDD 10MHz: OP.2 FDD 20MHz: OP.12 FDD			
PBCH_RA	dB	0				0				0				0			
PBCH_RB	dB																
PSS_RA	dB																
SSS_RA	dB																
PCFICH_RB	dB																
PHICH_RA	dB																
PHICH_RB	dB																
PDCCH_RA	dB																
PDCCH_RB	dB																
PDSCH_RA	dB																
PDSCH_RB	dB																
OCNG_RA ^{Note 1}	dB																

OCNG_RB ^{Note 1}	dB																
N_{oc} ^{Note 3}	dBm/1 5 kHz	-101				-101				-101							
\hat{E}_s/N_{oc}	dB	16	16	16	16	16	16	16	16	16	16	16	16	-	16	-	16
\hat{E}_s/I_{ot} ^{Note 4}	dB	16	16	16	16	16	16	16	16	16	-0.11	16	-0.11	-	-0.11	-	-0.11
RSRP ^{Note 4}	dBm/1 5 kHz	-85	-85	-85	-85	-85	-85	-85	-85	-85	-85	-85	-85	-	-85	-	-85
SCH_RP ^{Note 4}	dBm/1 5 kHz	-85	-85	-85	-85	-85	-85	-85	-85	-85	-85	-85	-85	-	-85	-	-85
I_o ^{Note 4}	dBm/C h BW	-	-	-	-	-57.11	-57.11	-57.11	-57.11	-	-	-	-	-	-	-	-
		57.11	57.11	57.11	57.11	+10log	+10log	+10log	+10log	57.11	54.15	57.11	54.15	57.11	54.15	57.11	54.15
		+10log	+10log	+10log	+10log	(N _{RB,c}	(N _{RB,c}	(N _{RB,c}	(N _{RB,c}	+10log	+10log	+10log	+10log	+10log	+10log	+10log	+10log
		g	g	g	g	/50)	/50)	/50)	/50)	g	g	g	g	g	g	g	g
		(N _{RB,c}	(N _{RB,c}	(N _{RB,c}	(N _{RB,c}					(N _{RB,c}	(N _{RB,c}	(N _{RB,c}	(N _{RB,c}	(N _{RB,c}	(N _{RB,c}	(N _{RB,c}	(N _{RB,c}
		/50)	/50)	/50)	/50)					/50)	/50)	/50)	/50)	/50)	/50)	/50)	/50)
Propagation Condition		AWGN				AWGN				AWGN				AWGN			
Antenna Configuration		1x2				1x2				1x2				1x2			
Timing offset to Cell 1	μs	-				0				0				3			
Time alignment error relative to cell 1 ^{Note 5}	μs	-				≤ TAE				≤ TAE				N/A			
Time alignment error relative to cell 2 ^{Note 5}	μs	-				-				≤ TAE				N/A			
<p>Note 1: OCNG shall be used such that all cells are fully allocated and a constant total transmitted power spectral density is achieved for all OFDM symbols.</p> <p>Note 2: The resources for uplink transmission are assigned to the UE on cell1 from the start of time period T2 and on cell2 from the start of time period T4.</p> <p>Note 3: Interference from other cells and noise sources not specified in the test is assumed to be constant over subcarriers and time and shall be modelled as AWGN of appropriate power for N_{oc} to be fulfilled.</p> <p>Note 4: E_s/I_{ot}, RSRP, SCH_RP and I_o levels have been derived from other parameters for information purposes. They are not settable parameters themselves.</p> <p>Note 5: Time alignment error (TAE) as specified in TS 36.104 [30] clause 6.5.3.1. The TAE value depends upon the type of carrier aggregation.</p>																	

A.8.16.33.2 Test Requirements

The UE shall send one Event A6 triggered measurement report, with a measurement reporting delay less than 12.8s ($20 \times \text{scellMeasCycle}$) from the beginning of time period T2.

The UE shall send one Event A6 triggered measurement report, with a measurement reporting delay less than 3.2s ($5 \times \text{scellMeasCycle}$) from the beginning of time period T4.

The UE shall not send event triggered measurement reports, as long as the reporting criteria are not fulfilled.

The UE shall be scheduled on PCell continuously throughout the test. From the start of T1 until the measurement report is received during T2, at least 99.5% of all expected ACK/NACKs shall be transmitted by the UE.

The UE shall be scheduled on Cell2 continuously from the beginning of T4 to the end. From the start of T4 until the measurement report is received during T4, at least 99.5% of all expected ACK/NACKs shall be transmitted by the UE.

For a test to be considered successful requirements on both event detection and percentage of transmitted ACK/NACKs have to be fulfilled simultaneously.

The rate of correct events observed during repeated tests shall be at least 90%.

NOTE: The actual overall delays measured in the test may be up to $2 \times \text{TTI}_{\text{DCCH}}$ higher than the measurement reporting delays above because of TTI insertion uncertainty of the measurement report in DCCH.

A.8.16.34 E-UTRAN TDD 3 DL CA Event Triggered Reporting on Deactivated SCell with PCell and SCell Interruptions in Non-DRX

A.8.16.34.1 Test Purpose and Environment

The purpose of this test is to verify that the UE correctly detects event A6 (Neighbour becomes better than SCell) defined in TS 36.331 [2] within the requirements stated in clause 8.3.3.2.1 while at the same time fulfilling the requirement on interruption rate.

The test parameters are given in Table A.8.16.34.1-1 and A.8.16.34.1-2 below. In the test there are four cells: Cell 1, Cell 2, Cell 3 and Cell 4. Cell 1 is PCell on the TDD primary component (RF Channel 1), Cell 2 is SCell on the TDD secondary component (RF Channel 2), and Cell 3 is SCell on the TDD secondary component (RF Channel 3) and Cell 4 is the neighbour cell on the TDD secondary component (RF Channel 3). It is indicated to the UE in the measurement control information that event-triggered reporting with Event A6 is used. The test consists of four successive time periods, with duration of T1, T2, T3 and T4, respectively. During T1 and T2, both Cell2 and Cell3 are deactivated. During T1 the UE shall not have any information of cell 4. Immediately at beginning of T2 the transmission power of cell 4 is increased to same level as for cell 3, and due to usage of an offset this shall result in reporting of Event A6.

At the beginning of T3, the transmission power of Cell 4 is turned off and the test equipment sends a MAC message for activation of Cell 2 to UE but Cell3 remains deactivated. Immediately at beginning of T4 the transmission power of cell 4 is increased to same level as for cell 3, and due to usage of an offset this shall result in reporting of Event A6. The UE shall be continuously scheduled in the PCell throughout the whole test and continuously scheduled in Cell 2 during T4.

Table A.8.16.34.1-1: General test parameters for E-UTRAN TDD 3 DL CA Event Triggered Reporting on Deactivated SCell with PCell and SCell interruptions in Non-DRX

Parameter	Unit	Value	Comment
E-UTRA RF Channel Number		1, 2, 3	three radio channels are used for this test
Active PCell		Cell 1	Primary cell on RF channel number 1.
Configured deactivated SCell		Cell 2	Configured deactivated secondary cell on RF channel number 2.
Configured deactivated SCell		Cell 3	Configured deactivated secondary cell on RF channel number 3.
Neighbour cell		Cell 4	Neighbor cell to be identified on RF channel number 3.
CP length		Normal	
Special subframe configuration		6	As specified in table 4.2-1 in TS 36.211. The same configuration in both cells

Uplink-downlink configuration			1	As specified in table 4.2-2 in TS 36.211. The same configuration in both cells
DRX			OFF	Continuous monitoring of primary cell
A6	Hysteresis	dB	0	Hysteresis for evaluation of event A6.
	Offset	dB	-3	Offset parameter for evaluation of event A6. Needs to take relative accuracy tolerance in clause 9.1.11.2 into account plus margin.
	Report on leave		False	
	Time To Trigger	s	0	
Cell-individual offset for cells on RF channel number 1		dB	0	Individual offset for cells on primary component carrier.
Cell-individual offset for cells on RF channel number 2		dB	0	Individual offset for cells on secondary component carrier.
Cell-individual offset for cells on RF channel number 3		dB	0	Individual offset for cells on secondary component carrier.
Filter coefficient			0	L3 filtering is not used
SCell measurement cycle		ms	640	
T1		s	4	During this time the UE shall be aware of cells 1, 2 and 3 but not cell 4.
T2		s	≤15	UE should report Event A6 within 12.8s (20×scellMeasCycle)
T3		s	4	During this time the UE shall activate cell 2
T4		s	≤4	UE should report Event A6 within 3.2s (5×scellMeasCycle)

Table A.8.16.34.1-2: Cell specific test parameters for E-UTRAN TDD 3 DL CA Event Triggered Reporting on Deactivated SCell with PCell and SCell interruptions in Non-DRX

Parameter	Unit	Cell 1				Cell 2				Cell 3				Cell 4			
		T1	T2	T3	T4	T1	T2	T3	T4	T1	T2	T3	T4	T1	T2	T3	T4
E-UTRA RF Channel Number		1				2				3				3			
BW _{channel}	MHz	5MHz: N _{RB,c} = 25 10MHz: N _{RB,c} = 50 20MHz: N _{RB,c} = 100				5MHz: N _{RB,c} = 25 10MHz: N _{RB,c} = 50 20MHz: N _{RB,c} = 100				5MHz: N _{RB,c} = 25 10MHz: N _{RB,c} = 50 20MHz: N _{RB,c} = 100				5MHz: N _{RB,c} = 25 10MHz: N _{RB,c} = 50 20MHz: N _{RB,c} = 100			
PDSCH parameters: DL Reference Measurement Channel		5MHz: R.4 TDD 10MHz: R.0 TDD 20MHz: R.3 TDD				N/A	N/A	N/A	5MHz: R.4 TDD 10MHz: R.0 TDD 20MHz: R.3 TDD	N/A				N/A			
PCFICH/PDCCH/PHICH parameters: DL Reference Measurement Channel		5MHz: R.11 TDD 10MHz: R.6 TDD 20MHz: R.10 TDD				5MHz: R.11 TDD 10MHz: R.6 TDD 20MHz: R.10 TDD				5MHz: R.11 TDD 10MHz: R.6 TDD 20MHz: R.10 TDD				5MHz: R.11 TDD 10MHz: R.6 TDD 20MHz: R.10 TDD			
OCNG Pattern defined in A.3.2.2		5MHz: OP.9 TDD 10MHz: OP.1 TDD 20MHz: OP.7 TDD				5MHz: OP.10 TDD 10MHz: OP.10 TDD z: OP.2 TDD 20MHz: OP.8 TDD	5MHz: OP.10 TDD 10MHz: OP.10 TDD z: OP.2 TDD 20MHz: OP.8 TDD	5MHz: OP.10 TDD 10MHz: OP.10 TDD z: OP.2 TDD 20MHz: OP.8 TDD	5MHz: OP.9 TDD 10MHz: OP.1 TDD z: OP.1 TDD 20MHz: OP.7 TDD	5MHz: OP.10 TDD 10MHz: OP.2 TDD 20MHz: OP.8 TDD				5MHz: OP.10 TDD 10MHz: OP.2 TDD 20MHz: OP.8 TDD			
PBCH_RA	dB	0				0				0				0			
PBCH_RB	dB																
PSS_RA	dB																
SSS_RA	dB																
PCFICH_RB	dB																
PHICH_RA	dB																
PHICH_RB	dB																
PDCCH_RA	dB																
PDCCH_RB	dB																
PDSCH_RA	dB																

PDSCH_RB	dB																
OCNG_RA ^{Note 1}	dB																
OCNG_RB ^{Note 1}	dB																
N_{oc} ^{Note 3}	dBm/1 5 kHz	-101				-101				-101							
\hat{E}_s/N_{oc}	dB	16	16	16	16	16	16	16	16	16	16	16	16	- Infinite	16	- Infinite	16
\hat{E}_s/I_{ot} ^{Note 4}	dB	16	16	16	16	16	16	16	16	16	-0.11	16	-0.11	- Infinite	-0.11	- Infinite	-0.11
RSRP ^{Note 4}	dBm/1 5 kHz	-85	-85	-85	-85	-85	-85	-85	-85	-85	-85	-85	-85	- Infinite	-85	- Infinite	-85
SCH_RP ^{Note 4}	dBm/1 5 kHz	-85	-85	-85	-85	-85	-85	-85	-85	-85	-85	-85	-85	- Infinite	-85	- Infinite	-85
I_o ^{Note 4}	dBm/C h BW	- 57.11 +10log g ($N_{RB,c}$ /50)	-57.11 +10log ($N_{RB,c}$ /50)	- 57.11 +10log g ($N_{RB,c}$ /50)	- 57.1 +10log og ($N_{RB,c}$ /50)	-57.11 +10log ($N_{RB,c}$ /50)	-57.11 +10log ($N_{RB,c}$ /50)	-57.11 +10log ($N_{RB,c}$ /50)	-57.11 +10log ($N_{RB,c}$ /50)	- 57.11 +10log g ($N_{RB,c}$ /50)	- 54.15 +10log g ($N_{RB,c}$ /50)	- 57.11 +10log g ($N_{RB,c}$ /50)	- 54.15 +10log g ($N_{RB,c}$ /50)	- 57.11 +10log g ($N_{RB,c}$ /50)	- 54.15 +10log g ($N_{RB,c}$ /50)	- 57.11 +10log g ($N_{RB,c}$ /50)	- 54.15 +10log g ($N_{RB,c}$ /50)
Propagation Condition		AWGN				AWGN				AWGN				AWGN			
Antenna Configuration		1x2				1x2				1x2				1x2			
Timing offset to Cell 1	μ s	-				0				0				3			
Time alignment error relative to cell 1 ^{Note 5}	μ s	-				\leq TAE				\leq TAE				N/A			
Time alignment error relative to cell 2 ^{Note 5}	μ s	-				-				\leq TAE				N/A			
<p>Note 1: OCNG shall be used such that all cells are fully allocated and a constant total transmitted power spectral density is achieved for all OFDM symbols.</p> <p>Note 2: The resources for uplink transmission are assigned to the UE on cell1 prior to the start of time period T2 and on cell2 prior to the start of time period T4.</p> <p>Note 3: Interference from other cells and noise sources not specified in the test is assumed to be constant over subcarriers and time and shall be modelled as AWGN of appropriate power for N_{oc} to be fulfilled.</p> <p>Note 4: E_s/I_{ot}, RSRP, SCH_RP and I_o levels have been derived from other parameters for information purposes. They are not settable parameters themselves.</p> <p>Note 5: Time alignment error (TAE) as specified in TS 36.104 [30] clause 6.5.3.1. The TAE value depends upon the type of carrier aggregation.</p>																	

A.8.16.34.2 Test Requirements

The UE shall send one Event A6 triggered measurement report, with a measurement reporting delay less than 12.8s ($20 \times \text{scellMeasCycle}$) from the beginning of time period T2.

The UE shall send one Event A6 triggered measurement report, with a measurement reporting delay less than 3.2s ($5 \times \text{scellMeasCycle}$) from the beginning of time period T4.

The UE shall not send event triggered measurement reports, as long as the reporting criteria are not fulfilled.

The UE shall be scheduled on PCell continuously throughout the test. From the start of T1 until the measurement report is received during T2, at least 99.5% of all expected ACK/NACKs shall be transmitted by the UE.

The UE shall be scheduled on Cell2 continuously from the start of T4 to the end. From the start of T4 until the measurement report is received during T4, at least 99.5% of all expected ACK/NACKs shall be transmitted by the UE.

For a test to be considered successful requirements on both event detection and percentage of transmitted ACK/NACKs have to be fulfilled simultaneously.

The rate of correct events observed during repeated tests shall be at least 90%.

NOTE: The actual overall delays measured in the test may be up to $2 \times \text{TTI}_{\text{DCCH}}$ higher than the measurement reporting delays above because of TTI insertion uncertainty of the measurement report in DCCH.

A.8.16.35 3 DL PCell in FDD CA Activation and Deactivation of Known SCell in Non-DRX

A.8.16.35.1 Test Purpose and Environment

The purpose of this test is to verify that the SCell activation and deactivation times are within the requirements stated in section 7.7 for UE configured with two downlink SCells, when the SCell is known by the UE at the time of activation and PCell is in FDD.

The test parameters are given in Tables A.8.16.35.1-1 and cell-specific parameters in A.8.16.35.1-2 below. The test consists of three successive time periods, with duration of T1, T2 and T3, respectively. There are three carriers, each with one cell. All cells have constant signal levels throughout the test. Before the test starts the UE is connected to Cell 1 (PCell) on radio channel 1 (PCC) and deactivated Cell 3 (SCell2) on radio channel 3 (SCC2) but is not aware of Cell 2 (SCell1) on radio channel 2 (SCC1). The UE is only monitoring the PCC and SCC2. The UE shall be continuously scheduled in the PCell throughout the whole test.

At the beginning of T1 the UE receives an RRC message by which the SCell1 (Cell 2) becomes configured on radio channel 2 (SCC1). The UE now starts monitoring also the SCC1. The test equipment sends a MAC message for activation of the SCell1.

The point in time at which the MAC message is received at the UE antenna connector, in a subframe # denoted m which is an even number, defines the start of time period T2. At the beginning of T2 the test equipment sends a MAC message for activation of the SCell1. The UE receives the SCell2 activation command in a subframe ($m+10$) during activation of the SCell1. The UE shall be able to report valid CSI for the activated SCell1 at latest in subframe ($m+29$). The UE shall start reporting CSI for SCell1 in subframe ($m+8$) and shall report CQI index 0 (out-of-range) until the SCell activation has been completed. Any PCell interruption due to activation of SCells shall occur in the subframes ($m+5$) to ($m+9$) and ($m+15$) to ($m+19$).

Time period T3 starts when a MAC message for deactivation of SCell1, sent from the test equipment to the UE in a subframe # denoted n which is an even number, is received at the UE antenna connector. The test equipment sends a MAC message for deactivation of the SCell2 in subframe ($n+10$). The UE shall carry out deactivation of the SCell1 at latest in subframe ($n+8$), and any PCell interruption due to the deactivation of SCells shall occur in the subframes ($n+5$) to ($n+9$) and ($n+15$) to ($n+19$).

The test equipment verifies that potential interruption is carried out in the correct time span by monitoring ACK/NACK sent in PCell during activation and deactivation of SCell1, respectively.

The test equipment verifies the activation time by counting the subframes from the time when the SCell1 activation command is sent until a CSI report with other than CQI index 0 is received.

The test equipment verifies the deactivation time by counting the subframes from the time when the SCell1 deactivation command is sent until CQI reporting for SCell1 is discontinued.

Table A.8.16.35.1-1: General test parameters for known SCell1 activation case

Parameter	Unit	Value	Comment
E-UTRA RF Channel Number		1, 2, 3	Three radio channels are used for this test
Active PCell		Cell 1	Primary cell on RF channel number 1.
Deconfigured deactivated SCell1		Cell 2	Deconfigured deactivated secondary cell on RF channel number 2.
Configured deactivated SCell2		Cell 3	Configured deactivated secondary cell on RF channel number 3.
CP length		Normal	
DRX		OFF	Continuous monitoring of primary cell
CQI/PMI periodicity and offset configuration index		0	CQI reporting for SCell every second subframe
Cell-individual offset for cells on RF channel number 1	dB	0	Individual offset for cells on PCC.
Cell-individual offset for cells on RF channel number 2	dB	0	Individual offset for cells on SCC1.
Cell-individual offset for cells on RF channel number 3	dB	0	Individual offset for cells on SCC2.
SCell measurement cycle (measCycleSCell)	ms	320	
T1	s	7	During this time the PCell and SCell2 shall be known and the SCell1 configured and detected.
T2	s	1	During this time the UE shall activate the SCell1.
T3	s	1	During this time the UE shall deactivate the SCell1.

Table A.8.16.35.1-2: Cell specific test parameters for E-UTRAN TDD known SCell1 activation with PCell in FDD

Parameter	Unit	Cell 1			Cell 2			Cell 3		
		T1	T2	T3	T1	T2	T3	T1	T2	T3
E-UTRA RF Channel Number		1			2			3		
BW _{channel}	MHz	5MHz: N _{RB,c} = 25 10MHz: N _{RB,c} = 50 20MHz: N _{RB,c} = 100			5MHz: N _{RB,c} = 25 10MHz: N _{RB,c} = 50 20MHz: N _{RB,c} = 100			5MHz: N _{RB,c} = 25 10MHz: N _{RB,c} = 50 20MHz: N _{RB,c} = 100		
PDSCH parameters: DL Reference Measurement Channel		5MHz: R.7 FDD 10MHz: R.3 FDD 20MHz: R.6 FDD			-			-		
PCFICH/PDCCH/PHICH parameters: DL Reference Measurement Channel		5MHz: R.11 FDD 10MHz: R.6 FDD 20MHz: R.10 FDD			5MHz: R.11 TDD 10MHz: R.6 TDD 20MHz: R.10 TDD			5MHz: R.11 TDD 10MHz: R.6 TDD 20MHz: R.10 TDD		
OCNG Patterns		5MHz: OP.20 FDD 10MHz: OP.10 FDD 20MHz: OP.17 FDD			5MHz: OP.10 TDD 10MHz: OP.2 TDD 20MHz: OP.8 TDD			5MHz: OP.10 TDD 10MHz: OP.2 TDD 20MHz: OP.8 TDD		
PBCH_RA	dB	0			0			0		
PBCH_RB	dB									
PSS_RA	dB									
SSS_RA	dB									
PCFICH_RB	dB									
PHICH_RA	dB									
PHICH_RB	dB									
PDCCH_RA	dB									
PDCCH_RB	dB									
PDSCH_RA	dB									
PDSCH_RB	dB									

OCNG_RA ^{Note 1}	dB			
OCNG_RB ^{Note 1}	dB			
N _{oc} ^{Note 2}	dBm/15 kHz	-104	-104	-104
\bar{E}_s/N_{oc}	dB	17	17	17
\bar{E}_s/I_{ot}	dB	17	17	17
RSRP ^{Note 3}	dBm/15 kHz	-87	-87	-87
SCH_RP ^{Note 3}	dBm/15 kHz	-87	-87	-87
I _o ^{Note 3}	dBm/Ch BW	-59.13 +10log (N _{RB,c} /50)	-59.13 +10log (N _{RB,c} /50)	-59.13 +10log (N _{RB,c} /50)
Propagation Condition		AWGN	AWGN	AWGN
Antenna Configuration		1x2	1x2	1x2
Timing offset to Cell 1	μs	-	0	0
Time alignment error relative to cell 1 ^{Note 5}	μs	-	≤ TAE	≤ TAE
Time alignment error relative to cell 2 ^{Note 5}	μs	-	-	≤ TAE
<p>Note 1: OCNG shall be used such that all cells are fully allocated and a constant total transmitted power spectral density is achieved for all OFDM symbols.</p> <p>Note 2: Interference from other cells and noise sources not specified in the test is assumed to be constant over subcarriers and time and shall be modelled as AWGN of appropriate power for N_{oc} to be fulfilled.</p> <p>Note 3: E_s/I_{ot}, RSRP, SCH_RP and I_o levels have been derived from other parameters for information purposes. They are not settable parameters themselves.</p> <p>Note 4: The uplink resources for CSI reporting are assigned to the UE prior to the start of time period T2.</p> <p>Note 5: Time alignment error (TAE) as specified in TS 36.104 [30] clause 6.5.3.1. The TAE value depends upon the type of carrier aggregation.</p>				

A.8.16.35.2 Test Requirements

During T2 the UE shall send the first CSI report for SCell1 in a subframe (m+8), or in a subframe (m+10) if the subframe (m+8) was subject to interruption. Whether CSI report in subframe (m+8) was interrupted or not is checked by monitoring ACK/NACK sent in PCell in subframe (m+8).

During T2 the UE shall start sending CSI reports for SCell1 with non-zero CQI index at latest in a subframe (m+29).

During T3 the UE shall stop sending CSI reports for SCell1 at latest in a subframe (n+8).

During T2 interruption of PCell during SCells activation shall not happen outside the subframes (m+5) to (m+9) and outside the subframes (m+15) to (m+19).

During T3 interruption of PCell during SCells deactivation shall not happen outside the subframes (n+5) to (n+9) and outside the subframes (n+15) to (n+19).

The interruption of PCell shall not be more than the values specified for intra-band CA and inter-band CA in Section 7.8.2.

All of the above test requirements shall be fulfilled in order for the observed SCell1 activation delay and SCell1 deactivation delay to be counted as correct. The rate of correct observed SCell1 activation delay and SCell1 deactivation delay during repeated tests shall be at least 90%.

NOTE: During T2 if there are no uplink resources for reporting the valid CSI in a subframe (m+29) then the UE shall use the next available uplink resource for reporting the corresponding valid CSI.

A.8.16.36 3 DL PCell in TDD CA Activation and Deactivation of Known SCell in Non-DRX

A.8.16.36.1 Test Purpose and Environment

The purpose of this test is to verify that the SCell activation and deactivation times are within the requirements stated in section 7.7 for UE configured with two downlink SCells, when the SCell is known by the UE at the time of activation and PCell is in TDD.

The test parameters are given in Tables A.8.16.36.1-1 and cell-specific parameters in A.8.16.36.1-2 below. The test consists of three successive time periods, with duration of T1, T2 and T3, respectively. There are three carriers, each with one cell. All cells have constant signal levels throughout the test. Before the test starts the UE is connected to Cell 1 (PCell) on radio channel 1 (PCC) and deactivated Cell 3 (SCell2) on radio channel 3 (SCC2) but is not aware of Cell 2 (SCell1) on radio channel 2 (SCC1). The UE is only monitoring the PCC and SCC2. The UE shall be continuously scheduled in the PCell throughout the whole test.

At the beginning of T1 the UE receives an RRC message by which the SCell1 (Cell 2) becomes configured on radio channel 2 (SCC1). The UE now starts monitoring also the SCC1. The test equipment sends a MAC message for activation of the SCell1.

The point in time at which the MAC message is received at the UE antenna connector, in a subframe # denoted m , where m is 4 or 9, defines the start of time period T2. At the beginning of T2 the test equipment sends a MAC message for activation of the SCell1. The UE receives the SCell2 activation command in a subframe $(m+15)$ during activation of the SCell1. The UE shall be able to report valid CSI for the activated SCell1 at latest in a subframe $(m+29)$. The UE shall start reporting CSI for SCell1 in subframe $(m+8)$ and shall report CQI index 0 (out-of-range) until the SCell activation has been completed. Any PCell interruption due to activation of SCells shall occur in the subframes $(m+5)$ to $(m+11)$ and $(m+20)$ to $(m+26)$.

Time period T3 starts when a MAC message for deactivation of SCell1, sent from the test equipment to the UE in a subframe # denoted n , where n is 4 or 9, is received at the UE antenna connector. The test equipment sends a MAC message for deactivation of the SCell2 in subframe $(n+15)$. The UE shall carry out deactivation of the SCell1 at latest in subframe $(n+8)$, and any PCell interruption due to the deactivation of SCells shall occur in the subframes $(n+5)$ to $(n+11)$ and $(n+20)$ to $(n+26)$.

The test equipment verifies that potential interruption is carried out in the correct time span by monitoring ACK/NACK sent in PCell during activation and deactivation of SCell1, respectively.

The test equipment verifies the activation time by counting the subframes from the time when the SCell1 activation command is sent until a CSI report with other than CQI index 0 is received.

The test equipment verifies the deactivation time by counting the subframes from the time when the SCell1 deactivation command is sent until CQI reporting for SCell1 is discontinued.

Table A.8.16.36.1-1: General test parameters for known SCell1 activation case

Parameter	Unit	Value	Comment
E-UTRA RF Channel Number		1, 2, 3	Three radio channels are used for this test
Active PCell		Cell 1	Primary cell on RF channel number 1.
Deconfigured deactivated SCell		Cell 2	Deconfigured deactivated secondary cell on RF channel number 2.
Configured deactivated SCell2		Cell 3	Configured deactivated secondary cell on RF channel number 3.
CP length		Normal	
Special subframe configuration		6	As specified in table 4.2.1 in TS 36.211. The same configuration applies to all cells.
Uplink-downlink configuration		1	
DRX		OFF	Continuous monitoring of primary cell
CQI/PMI periodicity and offset configuration index		0	CQI reporting for SCell every UL subframe
Cell-individual offset for cells on RF channel number 1	dB	0	Individual offset for cells on PCC.

Cell-individual offset for cells on RF channel number 2	dB	0	Individual offset for cells on SCC1.
Cell-individual offset for cells on RF channel number 3	dB	0	Individual offset for cells on SCC1.
SCell measurement cycle (measCycleSCell)	ms	320	
T1	s	7	During this time the PCell and SCell2 shall be known and the SCell1 configured and detected.
T2	s	1	During this time the UE shall activate the SCell1.
T3	s	1	During this time the UE shall deactivate the SCell1.

Table A.8.16.36.1-2: Cell specific test parameters for E-UTRAN FDD known SCell1 activation with PCell in TDD

Parameter	Unit	Cell 1			Cell 2			Cell 3		
		T1	T2	T3	T1	T2	T3	T1	T2	T3
E-UTRA RF Channel Number		1			2			3		
BW _{channel}	MHz	5MHz: N _{RB,c} = 25 10MHz: N _{RB,c} = 50 20MHz: N _{RB,c} = 100			5MHz: N _{RB,c} = 25 10MHz: N _{RB,c} = 50 20MHz: N _{RB,c} = 100			5MHz: N _{RB,c} = 25 10MHz: N _{RB,c} = 50 20MHz: N _{RB,c} = 100		
PDSCH parameters: DL Reference Measurement Channel		5MHz: R.4 TDD 10MHz: R.0 TDD 20MHz: R.3 TDD			-			-		
PCFICH/PDCCH/PHICH parameters: DL Reference Measurement Channel		5MHz: R.11 TDD 10MHz: R.6 TDD 20MHz: R.10 TDD			5MHz: R.11 FDD 10MHz: R.6 FDD 20MHz: R.10 FDD			5MHz: R.11 FDD 10MHz: R.6 FDD 20MHz: R.10 FDD		
OCNG Patterns		5MHz: OP.9 TDD 10MHz: OP.1 TDD 20MHz: OP.7 TDD			5MHz: OP.16 FDD 10MHz: OP.2 FDD 20MHz: OP.12 FDD			5MHz: OP.16 FDD 10MHz: OP.2 FDD 20MHz: OP.12 FDD		
PBCH_RA	dB	0			0			0		
PBCH_RB	dB									
PSS_RA	dB									
SSS_RA	dB									
PCFICH_RB	dB									
PHICH_RA	dB									
PHICH_RB	dB									
PDCCH_RA	dB									
PDCCH_RB	dB									
PDSCH_RA	dB									
PDSCH_RB	dB									
OCNG_RA ^{Note 1}	dB									
OCNG_RB ^{Note 1}	dB									
N _{oc} ^{Note 2}	dBm/15 kHz									
\bar{E}_s/N_{oc}	dB	17			17			17		
\bar{E}_s/I_{ot}	dB	17			17			17		
RSRP ^{Note 3}	dBm/15 kHz	-87			-87			-87		
SCH_RP ^{Note 3}	dBm/15 kHz	-87			-87			-87		
I _o ^{Note 3}	dBm/Ch BW	-59.13 +10log (N _{RB,c} /50)			-59.13 +10log (N _{RB,c} /50)			-59.13 +10log (N _{RB,c} /50)		
Propagation Condition		AWGN			AWGN			AWGN		
Antenna Configuration		1x2			1x2			1x2		
Timing offset to Cell 1	μs	-			0			0		
Time alignment error relative to cell 1 ^{Note 5}	μs	-			≤ TAE			≤ TAE		
Time alignment error relative to cell 2 ^{Note 5}	μs	-			-			≤ TAE		

Note 1:	OCNG shall be used such that all cells are fully allocated and a constant total transmitted power spectral density is achieved for all OFDM symbols.
Note 2:	Interference from other cells and noise sources not specified in the test is assumed to be constant over subcarriers and time and shall be modelled as AWGN of appropriate power for N_{oc} to be fulfilled.
Note 3:	Es/lot, RSRP, SCH_RP and lo levels have been derived from other parameters for information purposes. They are not settable parameters themselves.
Note 4:	The uplink resources for CSI reporting are assigned to the UE prior to the start of time period T2.
Note 5:	Time alignment error (TAE) as specified in TS 36.104 [30] clause 6.5.3.1. The TAE value depends upon the type of carrier aggregation.

A.8.16.36.2 Test Requirements

During T2 the UE shall send the first CSI report for SCell1 in a subframe (m+8,) or in a subframe (m+9) if the subframe (m+8) was subject to interruption. Whether CSI report in subframe (m+8) was interrupted or not is checked by monitoring ACK/NACK sent in PCell in subframe (m+8).

During T2 the UE shall start sending CSI reports for SCell1 with non-zero CQI index at latest in a subframe (m+29).

During T3 the UE shall stop sending CSI reports for SCell at latest in a subframe (n+8).

During T2 interruption of PCell during SCells activation shall not happen outside the subframes (m+5) to (m+11) and outside the subframes (m+20) to (m+26).

During T3 interruption of PCell during SCells deactivation shall not happen outside the subframes (n+5) to (n+11) and outside the subframes (n+20) to (n+26).

The interruption of PCell shall not be more than the values specified for intra-band CA and inter-band CA in Section 7.8.2.

All of the above test requirements shall be fulfilled in order for the observed SCell1 activation delay and SCell1 deactivation delay to be counted as correct. The rate of correct observed SCell1 activation delay and SCell1 deactivation delay during repeated tests shall be at least 90%.

NOTE: During T2 if there are no uplink resources for reporting the valid CSI in a subframe (m+29) then the UE shall use the next available uplink resource for reporting the corresponding valid CSI.

A.8.16.37 3 DL FDD CA activation and deactivation of known SCell in non-DRX

A.8.16.37.1 Test Purpose and Environment

The purpose of this test is to verify that SCell activation and deactivation times are within the requirements stated in clause 7.7 for 3DL FDD carrier aggregation, when the SCells are known by the UE at the time of activation.

The test parameters are given in Tables A.8.16.37-1 and cell-specific parameters in A.8.16.37-2 below. The test consists of three successive time periods, with duration of T1, T2 and T3, respectively. There are three carriers, each with one cell. All cells have constant signal levels throughout the test. Before the test starts the UE is connected to Cell 1 (PCell) on radio channel 1 (PCC) and Cell 3 (deactivated SCell2) on radio channel 3 (SCC2), but is not aware of Cell 2 (SCell1) on radio channel 2 (SCC1). The UE is only monitoring the PCC and SCC2. The UE shall be continuously scheduled in the PCell throughout the whole test.

At the beginning of T1 the UE receives an RRC message by which the SCell1 (Cell 2) becomes configured on radio channel 2 (SCC1). The UE now starts monitoring also the SCC1. The test equipment sends a MAC message for activation of the SCell1.

The point in time at which the MAC message is received at the UE antenna connector, in a subframe # denoted m which is an even number, defines the start of time period T2. At the beginning of T2 the test equipment sends a MAC message for activation of the SCell1. The UE receives the SCell2 activation command in a subframe (m+10) during activation of the SCell1. The UE shall be able to report valid CSIs for the activated SCell1 at latest in a subframe (m+29). The UE shall start reporting CSI for SCell1 in subframe in (m+8) and shall report CQI index 0 (out-of-range) until the SCell activation has been completed. Any PCell interruption due to activation of SCells shall occur in the subframes (m+5) to (m+9ms) and (m+15) to (m+19).

Time period T3 starts when a MAC message for deactivation of SCell1, sent from the test equipment to the UE in a subframe # denoted n which is an even number, is received at the UE antenna connector. The test equipment sends a MAC message for deactivation of the SCell2 in subframe (n+10). The UE shall carry out deactivation of the SCell1 at latest in subframe (n+8), and any PCell interruption due to the deactivation of SCells shall occur in the subframes (n+5) to (n+9) and (n+15) to (n+19).

The test equipment verifies that potential interruption is carried out in the correct time span by monitoring ACK/NACK sent in PCell during activation and deactivation of SCells, respectively.

The test equipment verifies the activation time by counting the subframes from the time when the SCell1 activation command is sent until a CSI report with other than CQI index 0 is received.

The test equipment verifies the deactivation time by counting the subframes from the time when the SCell1 deactivation command is sent until CQI reporting for SCell1 is discontinued.

Table A.8.16.37-1: General test parameters for E-UTRAN FDD 3 DL CA activation and deactivation of known SCell in non-DRX

Parameter	Unit	Value	Comment
E-UTRA RF Channel Number		1, 2, 3	Three radio channels are used for this test
Active PCell		Cell 1	Primary cell on RF channel number 1.
Deconfigured SCell		Cell 2	Deconfigured secondary cell on RF channel number 2.
Configured deactivated SCell		Cell 3	Configured deactivated secondary cell on RF channel number 3.
CP length		Normal	
DRX		OFF	Continuous monitoring of primary cell
CQI/PMI periodicity and offset configuration index		0	CQI reporting for SCells every second subframe
Cell-individual offset for cells on RF channel number 1	dB	0	Individual offset for cells on PCC.
Cell-individual offset for cells on RF channel number 2	dB	0	Individual offset for cells on SCC1.
Cell-individual offset for cells on RF channel number 3	dB	0	Individual offset for cells on SCC2.
Filter coefficient		0	L3 filtering is not used
SCell measurement cycle (measCycleSCell)	ms	320	
T1	s	7	During this time the PCell and SCell2 shall be known and the SCell1 configured and detected.
T2	s	1	During this time the UE shall activate the SCell1 and SCell2.
T3	s	1	During this time the UE shall deactivate the SCell1 and SCell2.

Table A.8.16.37-2: Cell specific test parameters for E-UTRAN FDD 3 DL CA activation and deactivation of known SCell in non-DRX

Parameter	Unit	Cell 1			Cell 2			Cell 3		
		T1	T2	T3	T1	T2	T3	T1	T2	T3
E-UTRA RF Channel Number		1			2			3		
BW _{channel}		5MHz: N _{RB,c} = 25 10MHz: N _{RB,c} = 50 20MHz: N _{RB,c} = 100			5MHz: N _{RB,c} = 25 10MHz: N _{RB,c} = 50 20MHz: N _{RB,c} = 100			5MHz: N _{RB,c} = 25 10MHz: N _{RB,c} = 50 20MHz: N _{RB,c} = 100		
PDSCH parameters: DL Reference Measurement Channel		5MHz: R.7 FDD 10MHz: R.3 FDD 20MHz: R.6 FDD			-			-		
PCFICH/PDCCH/PHICH parameters: DL Reference Measurement Channel		5MHz: R.11 FDD 10MHz: R.6 FDD 20MHz: R.10 FDD			5MHz: R.11 FDD 10MHz: R.6 FDD 20MHz: R.10 FDD			5MHz: R.11 FDD 10MHz: R.6 FDD 20MHz: R.10 FDD		

OCNG Patterns		5MHz: OP.20 FDD 10MHz: OP.10 FDD 20MHz: OP.17 FDD	5MHz: OP.16 FDD 10MHz: OP.2 FDD 20MHz: OP.12 FDD	5MHz: OP.16 FDD 10MHz: OP.2 FDD 20MHz: OP.12 FDD
PBCH_RA	dB			
PBCH_RB	dB			
PSS_RA	dB			
SSS_RA	dB			
PCFICH_RB	dB			
PHICH_RA	dB			
PHICH_RB	dB	0	0	0
PDCCH_RA	dB			
PDCCH_RB	dB			
PDSCH_RA	dB			
PDSCH_RB	dB			
OCNG_RA ^{Note 1}	dB			
OCNG_RB ^{Note 1}	dB			
N_{oc} ^{Note 2}	dBm/15 kHz	-104	-104	-104
\bar{E}_s/N_{oc}	dB	17	17	17
\bar{E}_s/I_{ot} ^{Note 3}	dB	17	17	17
RSRP ^{Note 3}	dBm/15 kHz	-87	-87	-87
SCH_RP ^{Note 3}	dBm/15 kHz	-87	-87	-87
I_o ^{Note 3}	dBm/Ch BW	$-59.13+10\log(N_{RB,c}/50)$	$-59.13+10\log(N_{RB,c}/50)$	$-59.13+10\log(N_{RB,c}/50)$
Propagation Condition		AWGN	AWGN	AWGN
Antenna Configuration		1x2	1x2	1x2
Timing offset to Cell 1	μ s	-	0	0
Time alignment error relative to cell 1 ^{Note 5}	μ s	-	\leq TAE	\leq TAE
Time alignment error relative to cell 2 ^{Note 5}	μ s	-	-	\leq TAE
<p>Note 1: OCNG shall be used such that all cells are fully allocated and a constant total transmitted power spectral density is achieved for all OFDM symbols.</p> <p>Note 2: Interference from other cells and noise sources not specified in the test is assumed to be constant over subcarriers and time and shall be modelled as AWGN of appropriate power for N_{oc} to be fulfilled.</p> <p>Note 3: \bar{E}_s/I_{ot}, RSRP, SCH_RP and I_o have been derived from other parameters for information purposes. They are not settable parameters themselves.</p> <p>Note 4: The uplink resources for CSI reporting are assigned to the UE prior to the start of time period T2.</p> <p>Note 5: Time alignment error (TAE) as specified in TS 36.104 [30] clause 6.5.3.1. The TAE value depends upon the type of carrier aggregation.</p>				

A.8.16.37.2 Test Requirements

During T2 the UE shall send the first CSI report for SCell1 in a subframe (m+8), or in a subframe (m+10) if the subframe (m+8) was subject to interruption. Whether CSI report in subframe (m+8) was interrupted or not is checked by monitoring ACK/NACK sent in PCell in subframe (m+8).

During T2 the UE shall start sending CSI reports for SCell1 with non-zero CQI index at latest in a subframe (m+29).

During T3 the UE shall stop sending CSI reports for SCell1 at latest in a subframe (n+8).

During T2 interruption of PCell during SCells activation shall not happen outside the subframes (m+5) to (m+9) and outside the subframes (m+15) to (m+19).

During T3 interruption of PCell during SCells deactivation shall not happen outside the subframes (n+5) to (n+9) and outside the subframes (n+15) to (n+19).

The interruption of PCell shall not be more than the values specified for intra-band CA and inter-band CA in Section 7.8.2.

All of the above test requirements shall be fulfilled in order for the observed SCell1 activation delay and SCell1 deactivation delay to be counted as correct. The rate of correct observed SCell1 activation delay and SCell1 deactivation delay during repeated tests shall be at least 90%.

NOTE: During T2 if there are no uplink resources for reporting the valid CSI in a subframe (m+29) then the UE shall use the next available uplink resource for reporting the corresponding valid CSI.

A.8.16.38 3 DL TDD CA activation and deactivation of known SCell in non-DRX

A.8.16.38.1 Test Purpose and Environment

The purpose of this test is to verify that SCell activation and deactivation times are within the requirements stated in clause 7.7 for 3DL TDD carrier aggregation, when the SCells are known by the UE at the time of activation.

The test parameters are given in Tables A.8.16.38-1 and cell-specific parameters in A.8.16.38-2 below. The test consists of three successive time periods, with duration of T1, T2 and T3, respectively. There are three carriers, each with one cell. All cells have constant signal levels throughout the test. Before the test starts the UE is connected to Cell 1 (PCell) on radio channel 1 (PCC) and Cell 3 (deactivated SCell2) on radio channel 3 (SCC2), but is not aware of Cell 2 (SCell1) on radio channel 2 (SCC1). The UE is only monitoring the PCC and SCC2. The UE shall be continuously scheduled in the PCell throughout the whole test.

At the beginning of T1 the UE receives an RRC message by which the SCell1 (Cell 2) becomes configured on radio channel 2 (SCC1). The UE now starts monitoring also the SCC1. The test equipment sends a MAC message for activation of the SCell1.

The point in time at which the MAC message is received at the UE antenna connector, in a subframe # denoted m , where m is 4 or 9, defines the start of time period T2. At the beginning of T2 the test equipment sends a MAC message for activation of the SCell1. The UE receives the SCell2 activation command in a subframe ($m+15$) during activation of the SCell1. The UE shall be able to report valid CSIs for the activated SCell1 at latest in a subframe ($m+29$). The UE shall start reporting CSI for SCell1 for SCell1 in subframe ($m+8$) and shall report CQI index 0 (out-of-range) until the SCell activation has been completed. Any PCell interruption due to activation of SCells shall occur in the subframes ($m+5$) to ($m+11$) and ($m+20$) to ($m+26$).

Time period T3 starts when a MAC message for deactivation of SCell1, sent from the test equipment to the UE, in a subframe # denoted n , where n is 4 or 9, is received at the UE antenna connector. The test equipment sends a MAC message for deactivation of the SCell2 in subframe ($n+15$). The UE shall carry out deactivation of the SCell1 at latest in subframe ($n+8$), and any PCell interruption due to the deactivation of SCells shall occur in the subframes ($n+5$) to ($n+11$) and ($n+20$) to ($n+26$).

The test equipment verifies that potential interruption is carried out in the correct time span by monitoring ACK/NACK sent in PCell during activation and deactivation of SCells, respectively.

The test equipment verifies the activation time by counting the subframes from the time when the SCell1 activation command is sent until a CSI report with other than CQI index 0 is received.

The test equipment verifies the deactivation time by counting the subframes from the time when the SCell1 deactivation command is sent until CQI reporting for SCell1 is discontinued.

Table A.8.16.38-1: General test parameters for E-UTRAN TDD 3 DL CA activation and deactivation of known SCell in non-DRX

Parameter	Unit	Value	Comment
E-UTRA RF Channel Number		1, 2, 3	Three radio channels are used for this test
Active PCell		Cell 1	Primary cell on RF channel number 1.
Deconfigured SCell		Cell 2	Deconfigured secondary cell on RF channel number 2.
Configured deactivated SCell		Cell 3	Configured deactivated secondary cell on RF channel number 3.
CP length		Normal	
Special subframe configuration		6	As specified in table 4.2-1 in TS 36.211. The same configuration applies to all cells.
Uplink-downlink configuration		1	As specified in table 4.2-2 in TS 36.211. The same configuration applies to all cells
DRX		OFF	Continuous monitoring of primary cell
CQI/PMI periodicity and offset configuration index		0	CQI reporting for SCells every UL subframe
Cell-individual offset for cells on RF channel number 1	dB	0	Individual offset for cells on PCC.

Cell-individual offset for cells on RF channel number 2	dB	0	Individual offset for cells on SCC1.
Cell-individual offset for cells on RF channel number 3	dB	0	Individual offset for cells on SCC2.
Filter coefficient		0	L3 filtering is not used
SCell measurement cycle (measCycleSCell)	ms	320	
T1	s	7	During this time the PCell and SCell2 shall be known and the SCell1 configured and detected.
T2	s	1	During this time the UE shall activate the SCell1 and SCell2.
T3	s	1	During this time the UE shall deactivate the SCell1 and SCell2

Table A.8.16.38-2: Cell specific test parameters for E-UTRAN TDD 3 DL CA activation and deactivation of known SCell in non-DRX

Parameter	Unit	Cell 1			Cell 2			Cell 3		
		T1	T2	T3	T1	T2	T3	T1	T2	T3
E-UTRA RF Channel Number		1			2			3		
BW _{channel}		5MHz: N _{RB,c} = 25 10MHz: N _{RB,c} = 50 20MHz: N _{RB,c} = 100			5MHz: N _{RB,c} = 25 10MHz: N _{RB,c} = 50 20MHz: N _{RB,c} = 100			5MHz: N _{RB,c} = 25 10MHz: N _{RB,c} = 50 20MHz: N _{RB,c} = 100		
PDSCH parameters: DL Reference Measurement Channel		5MHz: R.4 TDD 10MHz: R.0 TDD 20MHz: R.3 TDD			-			-		
PCFICH/PDCCH/PHICH parameters: DL Reference Measurement Channel		5MHz: R.11 TDD 10MHz: R.6 TDD 20MHz: R.10 TDD			5MHz: R.11 TDD 10MHz: R.6 TDD 20MHz: R.10 TDD			5MHz: R.11 TDD 10MHz: R.6 TDD 20MHz: R.10 TDD		
OCNG Patterns		5MHz: OP.9 TDD 10MHz: OP.1 TDD 20MHz: OP.7 TDD			5MHz: OP.10 TDD 10MHz: OP.2 TDD 20MHz: OP.8 TDD			5MHz: OP.10 TDD 10MHz: OP.2 TDD 20MHz: OP.8 TDD		
PBCH_RA	dB	0			0			0		
PBCH_RB	dB									
PSS_RA	dB									
SSS_RA	dB									
PCFICH_RB	dB									
PHICH_RA	dB									
PHICH_RB	dB									
PDCCH_RA	dB									
PDCCH_RB	dB									
PDSCH_RA	dB									
PDSCH_RB	dB									
OCNG_RA ^{Note 1}	dB									
OCNG_RB ^{Note 1}	dB									
N _{oc} ^{Note 2}	dBm/15 kHz	-104			-104			-104		
E _s /N _{oc}	dB	17			17			17		
E _s /I _{ot} ^{Note 3}	dB	17			17			17		
RSRP ^{Note 3}	dBm/15 kHz	-87			-87			-87		
SCH_RP ^{Note 3}	dBm/15 kHz	-87			-87			-87		
I _o ^{Note 3}	dBm/Ch BW	-59.13+10log(N _{RB,c} /50)			-59.13+10log(N _{RB,c} /50)			-59.13+10log(N _{RB,c} /50)		
Propagation Condition		AWGN			AWGN			AWGN		
Antenna Configuration		1x2			1x2			1x2		
Timing offset to Cell 1	μs	-			0			0		
Time alignment error relative to cell 1 ^{Note 5}	μs	-			≤ TAE			≤ TAE		
Time alignment error relative to cell 2 ^{Note 5}	μs	-			-			≤ TAE		

Note 1:	OCNG shall be used such that all cells are fully allocated and a constant total transmitted power spectral density is achieved for all OFDM symbols.
Note 2:	Interference from other cells and noise sources not specified in the test is assumed to be constant over subcarriers and time and shall be modelled as AWGN of appropriate power for N_{oc} to be fulfilled.
Note 3:	E_s/I_{ot} , RSRP, SCH_RP and I_o have been derived from other parameters for information purposes. They are not settable parameters themselves.
Note 4:	The uplink resources for CSI reporting are assigned to the UE prior to the start of time period T2.
Note 5:	Time alignment error (TAE) as specified in TS 36.104 [30] clause 6.5.3.1. The TAE value depends upon the type of carrier aggregation.

A.8.16.38.2 Test Requirements

During T2 the UE shall send the first CSI report for SCell1 in a subframe (m+8), or in a subframe (m+9) if the subframe (m+8) was subject to interruption, or in a subframe (m+13) if the subframe (m+8) and (m+9) were subject to interruption when an intra-band SCell is activated. Whether CSI report in subframe (m+8) and/or (m+9) was interrupted or not is checked by monitoring ACK/NACK sent in PCell in subframe (m+8) and/or (m+9).

During T2 the UE shall start sending CSI reports for SCell1 with non-zero CQI index at latest in a subframe (m+29).

During T3 the UE shall stop sending CSI reports for SCell1 at latest in subframe (n+8).

During T2 interruption of PCell during SCells activation shall not happen outside the subframes (m+5) to (m+11) and outside the subframes (m+20) to (m+26).

During T3 interruption of PCell during SCells deactivation shall not happen outside the subframe (n+5) to (n+11) and outside the subframes (n+20) to (n+26).

The interruption of PCell shall not be more than the values specified for intra-band CA and inter-band CA in Section 7.8.2.

The UE shall not send event triggered measurement reports as long as the reporting criteria are not fulfilled.

All of the above test requirements shall be fulfilled in order for the observed SCell1 activation delay and SCell1 deactivation delay to be counted as correct. The rate of correct observed SCell1 activation delay and SCell1 deactivation delay during repeated tests shall be at least 90%.

NOTE: During T2 if there are no uplink resources for reporting the valid CSI in a subframe (m+29) then the UE shall use the next available uplink resource for reporting the corresponding valid CSI.

A.8.16.39 E-UTRA TDD-FDD 3DL CA Activation and Deactivation of Unknown SCell in Non-DRX with PCell in FDD

A.8.16.39.1 Test Purpose and Environment

The purpose of this test is to verify that the SCell activation and deactivation times are within the requirements stated in section 7.7 for UE configured with two downlink SCells, when the SCell is unknown by the UE at the time of activation.

The test parameters are given in Tables A.8.16.39.1-1 and cell-specific parameters in A.8.16.39.1-2 below. The test consists of three successive time periods, with duration of T1, T2 and T3, respectively. There are three carriers, each with one cell. Cell 1 is FDD cell, and Cell 2 and Cell 3 are TDD cells. Cell 1 and Cell 3 have constant signal levels throughout the test. Before the test starts the UE is connected to Cell 1 (PCell) on radio channel 1 (PCC) and Cell 3 (deactivated SCell2) on radio channel 3 (SCC2) but is not aware of Cell 2 (SCell1) on radio channel 2 (SCC1). The UE is only monitoring the PCC and SCC2. The UE shall be continuously scheduled in the PCell throughout the whole test.

At the beginning of T1 the UE receives an RRC message by which the Cell 2 (SCell1) becomes configured on radio channel 2 (SCC1). During T1 Cell 2 (SCell1) is powered off and UE is not aware of Cell 2 (SCell1).

A MAC message for activation of SCell1 is sent by the test equipment 100ms after the RRC message, in a subframe # denoted m which is an even number. The point in time at which the MAC message for activation of Cell 2 (SCell1) is received at the UE antenna connector defines the start of time period T2. Immediately at beginning of T2 the transmission power of Cell 2 (SCell1) is increased to same level as for Cell 1 (PCell). The test equipment sends a MAC message for activation of the Cell 3 (SCell2) in subframe (m+10). Since UE received SCell2 activation command during activation of SCell1, the UE shall be able to report valid CSI for the activated SCell1 at latest in subframe

(m+39) provided the SCell1 can be successfully detected on the first attempt. The UE shall start reporting CSI for SCell1 in subframe (m+8), and shall report CQI index 0 (out-of-range) until the SCell activation has been completed. Any PCell interruption due to activation of SCells shall occur in the subframes (m+5) to (m+9) and (m+15) to (m+19).

Time period T3 starts when a MAC message for deactivation of Cell 2 (SCell1), sent from the test equipment to the UE, in a subframe # denoted n which is an even number, is received at the UE antenna connector. The test equipment sends a MAC message for deactivation of the Cell 3 (SCell2) in subframe (n+10). The UE shall carry out deactivation of the Cell 2 (SCell1) at latest in subframe (n+8), and any PCell interruption due to the deactivation of SCells shall occur in subframes (n+5) to (n+9) and (n+10) to (n+19).

The test equipment verifies that potential interruption is carried out in the correct time span by monitoring ACK/NACK sent in PCell during activation and deactivation of SCell1, respectively.

The test equipment verifies the activation time by counting the subframes from the time when the Cell 2 (SCell1) activation command is sent until a CSI report with other than CQI index 0 is received.

The test equipment verifies the deactivation time by counting the subframes from the time when the Cell 2 (SCell1) deactivation command is sent until CQI reporting for SCell1 is discontinued.

Table A.8.16.39.1-1: General test parameters for unknown SCell1 activation case

Parameter	Unit	Value	Comment
E-UTRA RF Channel Number		1, 2, 3	Three radio channels are used for this test
Active PCell		Cell 1	Primary cell on RF channel number 1.
Deconfigured deactivated SCell1		Cell 2	Deconfigured deactivated secondary cell on RF channel number 2.
Configured deactivated SCell2		Cell 3	Configured deactivated secondary cell on RF channel number 3.
CP length		Normal	
DRX		OFF	Continuous monitoring of primary cell
CQI/PMI periodicity and offset configuration index		0	CQI reporting for SCell every second subframe
Cell-individual offset for cells on RF channel number 1	dB	0	Individual offset for cells on PCC.
Cell-individual offset for cells on RF channel number 2	dB	0	Individual offset for cells on SCC1.
Cell-individual offset for cells on RF channel number 3	dB	0	Individual offset for cells on SCC2.
SCell measurement cycle (measCycleSCell)	ms	320	
T1	ms	100	During this time the PCell and SCell2 shall be known and the SCell1 configured.
T2	s	1	During this time the UE shall activate the SCell1 and SCell2.
T3	s	1	During this time the UE shall deactivate the SCell1 and SCell2.
Note: This test verifies the RRM requirement which is independent of channel bandwidth and is performed according to the principle defined in section A.3.6.1.			

Table A.8.16.39.1-2: Cell specific test parameters for E-UTRAN TDD known SCell1 activation with PCell in FDD

Parameter	Unit	Cell 1			Cell 2			Cell 3		
		T1	T2	T3	T1	T2	T3	T1	T2	T3
E-UTRA RF Channel Number		1			2			3		
TDD special subframe configuration		-			6			6		
TDD uplink-downlink configuration		-			1			1		

BW _{channel}	MHz	5MHz: N _{RB,c} = 25 10MHz: N _{RB,c} = 50 20MHz: N _{RB,c} = 100	5MHz: N _{RB,c} = 25 10MHz: N _{RB,c} = 50 20MHz: N _{RB,c} = 100	5MHz: N _{RB,c} = 25 10MHz: N _{RB,c} = 50 20MHz: N _{RB,c} = 100
PDSCH parameters: DL Reference Measurement Channel		5MHz: R.7 FDD 10MHz: R.3 FDD 20MHz: R.6 FDD	-	-
PCFICH/PDCCH/PHICH parameters: DL Reference Measurement Channel		5MHz: R.11 FDD 10MHz: R.6 FDD 20MHz: R.10 FDD	5MHz: R.11 TDD 10MHz: R.6 TDD 20MHz: R.10 TDD	5MHz: R.11 TDD 10MHz: R.6 TDD 20MHz: R.10 TDD
OCNG Patterns		5MHz: OP.20 FDD 10MHz: OP.10 FDD 20MHz: OP.17 FDD	5MHz: OP.10 TDD 10MHz: OP.2 TDD 20MHz: OP.8 TDD	5MHz: OP.10 TDD 10MHz: OP.2 TDD 20MHz: OP.8 TDD
PBCH_RA	dB	0	0	0
PBCH_RB	dB			
PSS_RA	dB			
SSS_RA	dB			
PCFICH_RB	dB			
PHICH_RA	dB			
PHICH_RB	dB			
PDCCH_RA	dB			
PDCCH_RB	dB			
PDSCH_RA	dB			
PDSCH_RB	dB			
OCNG_RA ^{Note 1}	dB			
OCNG_RB ^{Note 1}	dB			
N _{oc} ^{Note 2}	dBm/15 kHz			
\bar{E}_s/N_{oc}	dB	17	-infinity	17
\bar{E}_s/I_{ot}	dB	17	-infinity	17
RSRP ^{Note 3}	dBm/15 kHz	-87	-infinity	-87
SCH_RP ^{Note 3}	dBm/15 kHz	-87	-infinity	-87
I _o ^{Note 3}	dBm/Ch BW	-59.13 +10log (N _{RB,c} /50)	-76.22 +10log (N _{RB,c} /50)	-59.13 +10log (N _{RB,c} /50)
Propagation Condition		AWGN	AWGN	AWGN
Antenna Configuration		1x2	1x2	1x2
Timing offset to Cell 1	μs	-	0	0
Time alignment error relative to cell 1 ^{Note 5}	μs	-	≤ TAE	≤ TAE
Time alignment error relative to cell 2 ^{Note 5}	μs	-	-	≤ TAE
Note 1:	OCNG shall be used such that all cells are fully allocated and a constant total transmitted power spectral density is achieved for all OFDM symbols.			
Note 2:	Interference from other cells and noise sources not specified in the test is assumed to be constant over subcarriers and time and shall be modelled as AWGN of appropriate power for N _{oc} to be fulfilled.			
Note 3:	Es/I _{ot} , RSRP, SCH_RP and I _o levels have been derived from other parameters for information purposes. They are not settable parameters themselves.			
Note 4:	The uplink resources for CSI reporting are assigned to the UE prior to the start of time period T2.			
Note 5:	Time alignment error (TAE) as specified in TS 36.104 [30] clause 6.5.3.1. The TAE value depends upon the type of carrier aggregation.			
Note 6:	TDD special subframe configuration and uplink-downlink configuration are as specified in Table 4.2-1 and 4.2-2 in TS36.211 [16]. The same configuration applies to all TDD cells.			

A.8.16.39.2 Test Requirements

During T2 the UE shall send the first CSI report for SCell1 at latest in a subframe (m+8), or in a subframe (m+10) if the subframe (m+8) was subject to interruption. Whether CSI report in subframe (m+8) was interrupted or not is checked by monitoring ACK/NACK sent in PCell in subframe (m+8).

During T2 the UE shall start sending CSI reports for SCell1 with non-zero CQI index at latest in a subframe (m+39).

During T3 the UE shall stop sending CSI reports for SCell1 at latest in a subframe (n+8).

During T2 interruption of PCell during SCells activation shall not happen outside subframes (m+5) to (m+9) and outside the subframes (m+15) to (m+19).

During T3 interruption of PCell during SCells deactivation shall not happen outside subframes (n+5) to (n+9) and outside subframes (n+15) to (n+19).

The interruption of PCell shall not be more than the values specified for intra-band CA and inter-band CA in Section 7.8.2.

All of the above test requirements shall be fulfilled in order for the observed SCell1 activation delay and SCell1 deactivation delay to be counted as correct. The rate of correct observed SCell1 activation delay and SCell1 deactivation delay during repeated tests shall be at least 90%.

NOTE: During T2 if there are no uplink resources for reporting the valid CSI in a subframe (m+39) then the UE shall use the next available uplink resource for reporting the corresponding valid CSI.

A.8.16.40 E-UTRA TDD-FDD 3DL CA Activation and Deactivation of Unknown SCell in Non-DRX with PCell in TDD

A.8.16.40.1 Test Purpose and Environment

The purpose of this test is to verify that the SCell activation and deactivation times are within the requirements stated in section 7.7 for UE configured with two downlink SCells, when the SCell is unknown by the UE at the time of activation.

The test parameters are given in Tables A.8.16.40.1-1 and cell-specific parameters in A.8.16.40.1-2 below. The test consists of three successive time periods, with duration of T1, T2 and T3, respectively. There are three carriers, each with one cell. Cell 1 is TDD cell, and Cell 2 and Cell 3 are FDD cells. Cell 1 and Cell 3 have constant signal levels throughout the test. Before the test starts the UE is connected to Cell 1 (PCell) on radio channel 1 (PCC) and Cell 3 (deactivated SCell2) on radio channel 3 (SCC2) but is not aware of Cell 2 (SCell1) on radio channel 2 (SCC1). The UE is only monitoring the PCC and SCC2. The UE shall be continuously scheduled in the PCell throughout the whole test.

At the beginning of T1 the UE receives an RRC message by which the Cell 2 (SCell1) becomes configured on radio channel 2 (SCC1). During T1 Cell 2 (SCell1) is powered off and UE is not aware of Cell 2 (SCell1).

A MAC message for activation of SCell1 is sent by the test equipment 100ms after the RRC message, in a subframe # denoted m, where m is 4 or 9. The point in time at which the MAC message for activation of Cell 2 (SCell1) is received at the UE antenna connector defines the start of time period T2. Immediately at beginning of T2 the transmission power of Cell 2 (SCell1) is increased to same level as for Cell 1 (PCell). The test equipment sends a MAC message for activation of the Cell 3 (SCell2) in subframe (m+15). Since UE received SCell2 activation command during activation of SCell1, the UE shall be able to report valid CSI for the activated SCell1 at latest in subframe (m+39) provided the SCell1 can be successfully detected on the first attempt. The UE shall start reporting CSI for SCell1 in subframe (m+8), and shall report CQI index 0 (out-of-range) until the SCell activation has been completed. Any PCell interruption due to activation of SCells shall occur in subframes (m+5) to (m+9) and (m+20) to (m+24).

Time period T3 starts when a MAC message for deactivation of Cell 2 (SCell1), sent from the test equipment to the UE in a subframe # denoted n, where n is 4 or 9, is received at the UE antenna connector. The test equipment sends a MAC message for deactivation of the Cell 3 (SCell2) in subframe (n+15). The UE shall carry out deactivation of the Cell 2 (SCell1) at latest in subframe (n+8), and any PCell interruption due to the deactivation of SCells shall occur in subframes (n+5) to (n+9) and (n+20) to (n+24).

The test equipment verifies that potential interruption is carried out in the correct time span by monitoring ACK/NACK sent in PCell during activation and deactivation of SCell1, respectively.

The test equipment verifies the activation time by counting the subframes from the time when the Cell 2 (SCell1) activation command is sent until a CSI report with other than CQI index 0 is received.

The test equipment verifies the deactivation time by counting the subframes from the time when the Cell 2 (SCell1) deactivation command is sent until CQI reporting for SCell1 is discontinued.

Table A.8.16.40.1-1: General test parameters for unknown SCell1 activation case

Parameter	Unit	Value	Comment
E-UTRA RF Channel Number		1, 2, 3	Three radio channels are used for this test
Active PCell		Cell 1	Primary cell on RF channel number 1.
Deconfigured deactivated SCell1		Cell 2	Deconfigured deactivated secondary cell on RF channel number 2.
Configured deactivated SCell2		Cell 3	Configured deactivated secondary cell on RF channel number 3.
CP length		Normal	
DRX		OFF	Continuous monitoring of primary cell
CQI/PMI periodicity and offset configuration index		0	CQI reporting for SCell every second subframe
Cell-individual offset for cells on RF channel number 1	dB	0	Individual offset for cells on PCC.
Cell-individual offset for cells on RF channel number 2	dB	0	Individual offset for cells on SCC1.
Cell-individual offset for cells on RF channel number 3	dB	0	Individual offset for cells on SCC2.
SCell measurement cycle (measCycleSCell)	ms	320	
T1	ms	100	During this time the PCell and SCell2 shall be known and the SCell1 configured.
T2	s	1	During this time the UE shall activate the SCell1 and SCell2.
T3	s	1	During this time the UE shall deactivate the SCell1 and SCell2.
Note: This test verifies the RRM requirement which is independent of channel bandwidth and is performed according to the principle defined in section A.3.6.1.			

Table A.8.16.40.1-2: Cell specific test parameters for E-UTRAN FDD known SCell1 activation with PCell in TDD

Parameter	Unit	Cell 1			Cell 2			Cell 3		
		T1	T2	T3	T1	T2	T3	T1	T2	T3
E-UTRA RF Channel Number		1			2			3		
TDD special subframe configuration		6			-			-		
TDD uplink-downlink configuration		1			-			-		
BW _{channel}	MHz	5MHz: N _{RB,c} = 25 10MHz: N _{RB,c} = 50 20MHz: N _{RB,c} = 100			5MHz: N _{RB,c} = 25 10MHz: N _{RB,c} = 50 20MHz: N _{RB,c} = 100			5MHz: N _{RB,c} = 25 10MHz: N _{RB,c} = 50 20MHz: N _{RB,c} = 100		
PDSCH parameters: DL Reference Measurement Channel		5MHz: R.4 TDD 10MHz: R.0 TDD 20MHz: R.3 TDD			-			-		
PCFICH/PDCCH/PHICH parameters: DL Reference Measurement Channel		5MHz: R.11 TDD 10MHz: R.6 TDD 20MHz: R.10 TDD			5MHz: R.11 FDD 10MHz: R.6 FDD 20MHz: R.10 FDD			5MHz: R.11 FDD 10MHz: R.6 FDD 20MHz: R.10 FDD		
OCNG Patterns		5MHz: OP.9 TDD 10MHz: OP.1 TDD 20MHz: OP.7 TDD			5MHz: OP.16 FDD 10MHz: OP.2 FDD 20MHz: OP.12 FDD			5MHz: OP.16 FDD 10MHz: OP.2 FDD 20MHz: OP.12 FDD		
PBCH_RA	dB	0			0			0		
PBCH_RB	dB									
PSS_RA	dB									

SSS_RA	dB				
PCFICH_RB	dB				
PHICH_RA	dB				
PHICH_RB	dB				
PDCCH_RA	dB				
PDCCH_RB	dB				
PDSCH_RA	dB				
PDSCH_RB	dB				
OCNG_RA ^{Note 1}	dB				
OCNG_RB ^{Note 1}	dB				
N _{oc} ^{Note 2}	dBm/15 kHz	-104		-104	-104
\bar{E}_s/N_{oc}	dB	17	-infinity	17	17
\bar{E}_s/I_{ot}	dB	17	-infinity	17	17
RSRP ^{Note 3}	dBm/15 kHz	-87	-infinity	-87	-87
SCH_RP ^{Note 3}	dBm/15 kHz	-87	-infinity	-87	-87
I _o ^{Note 3}	dBm/Ch BW	-59.13 +10log (N _{RB,c} /50)	-76.22 +10log (N _{RB,c} /50)	-59.13 +10log (N _{RB,c} /50)	-59.13 +10log (N _{RB,c} /50)
Propagation Condition		AWGN		AWGN	AWGN
Antenna Configuration		1x2		1x2	1x2
Timing offset to Cell 1	μs	-		0	0
Time alignment error relative to cell 1 ^{Note 5}	μs	-		≤ TAE	≤ TAE
Time alignment error relative to cell 2 ^{Note 5}	μs	-		-	≤ TAE
<p>Note 1: OCNG shall be used such that all cells are fully allocated and a constant total transmitted power spectral density is achieved for all OFDM symbols.</p> <p>Note 2: Interference from other cells and noise sources not specified in the test is assumed to be constant over subcarriers and time and shall be modelled as AWGN of appropriate power for N_{oc} to be fulfilled.</p> <p>Note 3: Es/I_{ot}, RSRP, SCH_RP and I_o levels have been derived from other parameters for information purposes. They are not settable parameters themselves.</p> <p>Note 4: The uplink resources for CSI reporting are assigned to the UE prior to the start of time period T2.</p> <p>Note 5: Time alignment error (TAE) as specified in TS 36.104 [30] clause 6.5.3.1. The TAE value depends upon the type of carrier aggregation.</p> <p>Note 6: TDD special subframe configuration and uplink-downlink configuration are as specified in Table 4.2-1 and 4.2-2 in TS36.211 [16]. The same configuration applies to all TDD cells.</p>					

A.8.16.40.2 Test Requirements

During T2 the UE shall send the first CSI report for SCell1 in a subframe (m+8), or in a subframe (m+9) if the subframe (m+8) was subject to interruption. Whether CSI report in subframe (m+8) was interrupted or not is checked by monitoring ACK/NACK sent in PCell in subframe (m+8).

During T2 the UE shall start sending CSI reports for SCell1 with non-zero CQI index at latest in a subframe (m+39).

During T3 the UE shall stop sending CSI reports for SCell1 at latest in a subframe (n+8).

During T2 interruption of PCell during SCells activation shall not happen outside subframes (m+5) and (m+9) and outside the subframes (m+20) to (m+24).

During T3 interruption of PCell during SCells deactivation shall not happen outside subframes (n+5) to (n+9) and outside subframes (n+20) to (n+24).

The interruption of PCell shall not be more than the values specified for intra-band CA and inter-band CA in Section 7.8.2.

All of the above test requirements shall be fulfilled in order for the observed SCell1 activation delay and SCell1 deactivation delay to be counted as correct. The rate of correct observed SCell1 activation delay and SCell1 deactivation delay during repeated tests shall be at least 90%.

NOTE: During T2 if there are no uplink resources for reporting the valid CSI in subframe (m+39) then the UE shall use the next available uplink resource for reporting the corresponding valid CSI.

A.8.16.41 3 DL FDD CA activation and deactivation of unknown SCell in non-DRX

A.8.16.41.1 Test Purpose and Environment

The purpose of this test is to verify that the SCell activation and deactivation times are within the requirements stated in clause 7.7 for 3DL FDD carrier aggregation, when the SCell is unknown by the UE at the time of activation.

The test parameters are given in Tables A.8.16.41-1 and cell-specific parameters in A.8.16.41-2 below. The test consists of three successive time periods, with duration of T1, T2 and T3, respectively. There are three carriers, each with one cell. Cell 1 and Cell 3 have constant signal levels throughout the test. Before the test starts the UE is connected to Cell 1 (PCell) on radio channel 1 (PCC) and Cell 3 (deactivated SCell2) on radio channel 3 (SCC2), but is not aware of Cell 2 (SCell1) on radio channel 2 (SCC1). The UE is only monitoring the PCC and SCC2. The UE shall be continuously scheduled in the PCell throughout the whole test.

At the beginning of T1 the UE receives an RRC message by which the Cell 2 (SCell1) becomes configured on radio channel 2 (SCC1). During T1 the signal level of Cell 2 (SCell1) is powered off and UE is not aware of Cell 2 (SCell1).

A MAC message for activation of the SCell1 is sent by the test equipment 100ms after the RRC message, in a subframe # denoted m which is an even number. The point in time at which the MAC message for activation of Cell 2 (SCell1) is received at the UE antenna connector defines the start of time period T2. Immediately at beginning of T2 the transmission power of Cell 2 (SCell1) is increased to same level as for Cell 1 (PCell). The test equipment sends a MAC message for activation of Cell 3 (SCell2) in subframe (m+10). Since UE received SCell2 activation command during activation of SCell1, the UE shall be able to report valid CSIs for the activated SCell1 at latest in subframe (m+39) provided the SCell1 can be successfully detected on the first attempt. The UE shall start reporting CSI in subframe (m+8) and shall report CQI index 0 (out-of-range) until the SCell activation has been completed. Any PCell interruption due to activation of SCells shall occur in the subframe (m+5) to (m+9) and (m+15) to (m+19).

Time period T3 starts when a MAC message for deactivation of Cell 2 (SCell1), sent from the test equipment to the UE in a subframe # denoted n, is received at the UE antenna connector. The test equipment sends a MAC message for deactivation of the Cell 3 (SCell2) in subframe (n+10). The UE shall carry out deactivation of Cell 2 (SCell1) at latest in subframe (n+8), and any PCell interruption due to the deactivation shall occur in the subframes (n+5) to (n+9) and (n+15) to (n+19).

The test equipment verifies that potential interruption is carried out in the correct time span by monitoring ACK/NACK sent in PCell during activation and deactivation of SCells, respectively.

The test equipment verifies the activation time by counting the subframes from the time when the Cell 2 (SCell1) activation command is sent until a CSI reports with other than CQI index 0 is received.

The test equipment verifies the deactivation time by counting the subframes from the time when the Cell 2 (SCell1) deactivation command is sent until CQI reporting for SCell1 is discontinued.

Table A.8.16.41-1: General test parameters for E-UTRAN FDD 3 DL CA activation and deactivation of unknown SCell in non-DRX

Parameter	Unit	Value	Comment
E-UTRA RF Channel Number		1, 2, 3	Three radio channels are used for this test
Active PCell		Cell 1	Primary cell on RF channel number 1.
Deconfigured SCell1		Cell 2	Deconfigured secondary cell on RF channel number 2.
Configured deactivated SCell2		Cell 3	Configured deactivated secondary cell on RF channel number 3.
CP length		Normal	
DRX		OFF	Continuous monitoring of primary cell
CQI/PMI periodicity and offset configuration index		0	CQI reporting for SCells every second subframe

Cell-individual offset for cells on RF channel number 1	dB	0	Individual offset for cells on PCC.
Cell-individual offset for cells on RF channel number 2	dB	0	Individual offset for cells on SCC1.
Cell-individual offset for cells on RF channel number 3	dB	0	Individual offset for cells on SCC2.
SCell measurement cycle (measCycleSCell)	ms	320	
T1	ms	100	During this time the PCell and SCell2 shall be known and the SCell1 configured.
T2	s	1	During this time the UE shall activate the SCell1 and SCell2.
T3	s	1	During this time the UE shall deactivate the SCell1 and SCell2.
Note:	This test verifies the RRM requirement which is independent of channel bandwidth and is performed according to the principle defined in section A.3.6.1.		

Table A.8.16.41-2: Cell specific test parameters for E-UTRAN FDD 3 DL CA activation and deactivation of unknown SCell in non-DRX

Parameter	Unit	Cell 1			Cell 2			Cell 3		
		T1	T2	T3	T1	T2	T3	T1	T2	T3
E-UTRA RF Channel Number		1			2			3		
BW _{channel}		5MHz: N _{RB,c} = 25 10MHz: N _{RB,c} = 50 20MHz: N _{RB,c} = 100			5MHz: N _{RB,c} = 25 10MHz: N _{RB,c} = 50 20MHz: N _{RB,c} = 100			5MHz: N _{RB,c} = 25 10MHz: N _{RB,c} = 50 20MHz: N _{RB,c} = 100		
PDSCH parameters: DL Reference Measurement Channel		5MHz: R.7 FDD 10MHz: R.3 FDD 20MHz: R.6 FDD			-			-		
PCFICH/PDCCH/PHICH parameters: DL Reference Measurement Channel		5MHz: R.11 FDD 10MHz: R.6 FDD 20MHz: R.10 FDD			5MHz: R.11 FDD 10MHz: R.6 FDD 20MHz: R.10 FDD			5MHz: R.11 FDD 10MHz: R.6 FDD 20MHz: R.10 FDD		
OCNG Patterns		5MHz: OP.20 FDD 10MHz: OP.10 FDD 20MHz: OP.17 FDD			5MHz: OP.16 FDD 10MHz: OP.2 FDD 20MHz: OP.12 FDD			5MHz: OP.16 FDD 10MHz: OP.2 FDD 20MHz: OP.12 FDD		
PBCH_RA	dB	0			0			0		
PBCH_RB	dB									
PSS_RA	dB									
SSS_RA	dB									
PCFICH_RB	dB									
PHICH_RA	dB									
PHICH_RB	dB									
PDCCH_RA	dB									
PDCCH_RB	dB									
PDSCH_RA	dB									
PDSCH_RB	dB									
OCNG_RA ^{Note 1}	dB									
OCNG_RB ^{Note 1}	dB									
N _{oc} ^{Note 2}	dBm/ 15 kHz									
\bar{E}_s/N_{oc}	dB	17			-infinity	17	17			
\bar{E}_s/I_{ot} ^{Note 3}	dB	17			-infinity	17	17			
RSRP ^{Note 3}	dBm/ 15 kHz	-87			-infinity	-87	-87			
SCH_RP ^{Note 3}	dBm/ 15 kHz	-87			-infinity	-87	-87			
I _o ^{Note 3}	dBm/ Ch BW	-59.13+10log (N _{RB,c} /50)			-76.22 +10log (N _{RB,c} /50)	-59.13+10log (N _{RB,c} /50)		-59.13+10log (N _{RB,c} /50)		
Propagation Condition		AWGN			AWGN			AWGN		
Antenna Configuration		1x2			1x2			1x2		
Timing offset to Cell 1	µs	-			0			0		

Time alignment error relative to cell 1 ^{Note 5}	μs	-	$\leq \text{TAE}$	$\leq \text{TAE}$
Time alignment error relative to Cell 2 ^{Note 5}	μs	-	-	$\leq \text{TAE}$
<p>Note 1: OCNB shall be used such that all cells are fully allocated and a constant total transmitted power spectral density is achieved for all OFDM symbols.</p> <p>Note 2: Interference from other cells and noise sources not specified in the test is assumed to be constant over subcarriers and time and shall be modelled as AWGN of appropriate power for N_{oc} to be fulfilled.</p> <p>Note 3: E_s/I_{ot}, RSRP, SCH_RP and I_o have been derived from other parameters for information purposes. They are not settable parameters themselves.</p> <p>Note 4: The uplink resources for CSI reporting are assigned to the UE prior to the start of time period T2.</p> <p>Note 5: The time alignment error (TAE) between two cells specified in TS36.104 [30] clause 6.5.3.1 (value depends upon the type of carrier aggregation).</p>				

A.8.16.41.2 Test Requirements

During T2 the UE shall send the first CSI report for SCell1 in a subframe (m+8), or in a subframe (m+10) if the subframe (m+8) was subject to interruption. Whether CSI report in subframe (m+8) was interrupted or not is checked by monitoring ACK/NACK sent in PCell in subframe (m+8).

During T2 the UE shall start sending CSI reports for SCell1 with non-zero CQI index at latest in a subframe (m+39).

During T3 the UE shall stop sending CSI reports for SCell1 at latest in a subframe (n+8).

During T2 interruption of PCell during SCells activation shall not happen outside the subframes (m+5) to (m+9) and outside the subframes (m+15) to (m+19).

During T2 interruption of PCell during SCells deactivation shall not happen outside the subframes (n+5) to (n+9) and outside the subframes (n+15) to (n+19).

The interruption of PCell shall not be more than the values specified for intra-band CA and inter-band CA in Section 7.8.2.

All of the above test requirements shall be fulfilled in order for the observed SCell1 activation delay and SCell1 deactivation delay to be counted as correct. The rate of correct observed SCell1 activation delay and SCell1 deactivation delay during repeated tests shall be at least 90%.

NOTE: During T2 if there are no uplink resources for reporting the valid CSI in a subframe (m+39) then the UE shall use the next available uplink resource for reporting the corresponding valid CSI.

A.8.16.42 3 DL TDD CA activation and deactivation of unknown SCell in non-DRX

A.8.16.42.1 Test Purpose and Environment

The purpose of this test is to verify that the SCell activation and deactivation times are within the requirements stated in clause 7.7 for 3DL TDD carrier aggregation, when the SCell is unknown by the UE at the time of activation.

The test parameters are given in Tables A.8.16.42-1 and cell-specific parameters in A.8.16.42-2 below. The test consists of three successive time periods, with duration of T1, T2 and T3, respectively. There are three carriers, each with one cell. Cell 1 and cell 3 have constant signal levels throughout the test. Before the test starts the UE is connected to Cell 1 (PCell) on radio channel 1 (PCC) and Cell 3 (deactivated SCell2) on radio channel 3 (SCC2), but is not aware of Cell 2 (SCell1) on radio channel 2 (SCC1). The UE is only monitoring the PCC and SCC2. The UE shall be continuously scheduled in the PCell throughout the whole test.

At the beginning of T1 the UE receives an RRC message by which the Cell 2 (SCell 1) becomes configured on radio channel 2 (SCC1). During T1 the signal level of Cell 2 (SCell 1) is powered off and UE is not aware of Cell 2 (SCell1).

A MAC message for activation of the SCell1 is sent by the test equipment 100ms after the RRC message, in a subframe # denoted m, where m is 4 or 9. The point in time at which the MAC message for activation of Cell 2 (SCell1) is received at the UE antenna connector defines the start of time period T2. Immediately at beginning of T2 the transmission power of Cell 2 (SCell1) is increased to same level as for Cell 1 (PCell). The test equipment sends a MAC message for activation of Cell 3 (SCell2) in subframe (m+15). Since UE received SCell2 activation command during activation of SCell1, the UE shall be able to report valid CSIs for the activated SCell1 at latest in subframe (m+39)

provided the SCell1 can be successfully detected on the first attempt. The UE shall start reporting CSI in subframe (m+8) and shall report CQI index 0 (out-of-range) until the SCell activation has been completed. Any PCell interruption due to activation of SCells shall occur in the subframes (m+5) to (m+11) and (m+20) to (m+26).

Time period T3 starts when a MAC message for deactivation of Cell 2 (SCell1), sent from the test equipment to the UE in a subframe # denoted n, where n is 4 or 9, is received at the UE antenna connector. The test equipment sends a MAC message for deactivation of the Cell 3 (SCell2) in subframe (n+15). The UE shall carry out deactivation of Cell 2 (SCell1) at latest in subframe (n+8), and any PCell interruption due to the deactivation of SCells shall occur in the subframes (n+5) to (n+11) and (n+20) to (n+26).

The test equipment verifies that potential interruption is carried out in the correct time span by monitoring ACK/NACK sent in PCell during activation and deactivation of SCells, respectively.

The test equipment verifies the activation time by counting the subframes from the time when the Cell 2 (SCell1) activation command is sent until a CSI reports with other than CQI index 0 is received.

The test equipment verifies the deactivation time by counting the subframes from the time when the Cell 2 (SCell1) deactivation command is sent until CQI reporting for SCell1 is discontinued.

Table A.8.16.42-1: General test parameters for E-UTRAN TDD 3 DL CA activation and deactivation of unknown SCell in non-DRX

Parameter	Unit	Value	Comment
E-UTRA RF Channel Number		1, 2, 3	Three radio channels are used for this test
Active PCell		Cell 1	Primary cell on RF channel number 1.
Deconfigured SCell1		Cell 2	Deconfigured secondary cell on RF channel number 2.
Configured deactivated SCell2		Cell 3	Configured deactivated secondary cell on RF channel number 3.
CP length		Normal	
Special subframe configuration		6	As specified in table 4.2-1 in TS 36.211 [16]. The same configuration applies to all cells.
Uplink-downlink configuration		1	As specified in table 4.2-2 in TS 36.211 [16]. The same configuration applies to all cells
DRX		OFF	Continuous monitoring of primary cell
CQI/PMI periodicity and offset configuration index		0	CQI reporting for SCells every UL subframe
Cell-individual offset for cells on RF channel number 1	dB	0	Individual offset for cells on PCC.
Cell-individual offset for cells on RF channel number 2	dB	0	Individual offset for cells on SCC1.
Cell-individual offset for cells on RF channel number 3	dB	0	Individual offset for cells on SCC2.
Filter coefficient		0	L3 filtering is not used
SCell measurement cycle (measCycleSCell)	ms	320	
T1	ms	100	During this time the PCell and SCell2 shall be known and the SCell1 configured,
T2	s	1	During this time the UE shall activate the SCell1 and SCell2.
T3	s	1	During this time the UE shall deactivate the SCell1 and SCell2
Note:	This test verifies the RRM requirement which is independent of channel bandwidth and is performed according to the principle defined in section A.3.6.1.		

Table A.8.16.42-2: Cell specific test parameters for E-UTRAN TDD 3 DL CA activation and deactivation of unknown SCell in non-DRX

Parameter	Unit	Cell 1			Cell 2			Cell 3		
		T1	T2	T3	T1	T2	T3	T1	T2	T3
E-UTRA RF Channel Number		1			2			3		
BW _{channel}		5MHz: N _{RB,c} = 25 10MHz: N _{RB,c} = 50 20MHz: N _{RB,c} = 100			5MHz: N _{RB,c} = 25 10MHz: N _{RB,c} = 50 20MHz: N _{RB,c} = 100			5MHz: N _{RB,c} = 25 10MHz: N _{RB,c} = 50 20MHz: N _{RB,c} = 100		

PDSCH parameters: DL Reference Measurement Channel		5MHz: R.4 TDD 10MHz: R.0 TDD 20MHz: R.3 TDD	-	-			
PCFICH/PDCCH/PHICH parameters: DL Reference Measurement Channel		5MHz: R.11 TDD 10MHz: R.6 TDD 20MHz: R.10 TDD	5MHz: R.11 TDD 10MHz: R.6 TDD 20MHz: R.10 TDD	5MHz: R.11 TDD 10MHz: R.6 TDD 20MHz: R.10 TDD			
OCNG Patterns		5MHz: OP.9 TDD 10MHz: OP.1 TDD 20MHz: OP.7 TDD	5MHz: OP.10 TDD 10MHz: OP.2 TDD 20MHz: OP.8 TDD	5MHz: OP.10 TDD 10MHz: OP.2 TDD 20MHz: OP.8 TDD			
PBCH_RA	dB	0	0	0			
PBCH_RB	dB						
PSS_RA	dB						
SSS_RA	dB						
PCFICH_RB	dB						
PHICH_RA	dB						
PHICH_RB	dB						
PDCCH_RA	dB						
PDCCH_RB	dB						
PDSCH_RA	dB						
PDSCH_RB	dB						
OCNG_RA ^{Note 1}	dB						
OCNG_RB ^{Note 1}	dB						
N _{oc} ^{Note 2}	dBm/ 15 kHz				-104	-104	-104
\bar{E}_s/N_{oc}	dB				17	-infin	17
\bar{E}_s/I_{ot} ^{Note 3}	dB	17	-infin	17			
RSRP ^{Note 3}	dBm/ 15 kHz	-87	-infin	-87			
SCH_RP ^{Note 3}	dBm/ 15 kHz	-87	-infin	-87			
I _o ^{Note 3}	dBm/ Ch BW	-59.13+10log (N _{RB,c} /50)	-76.22 +10log (N _{RB,c} /50)	-59.13+10log (N _{RB,c} /50)			
Propagation Condition		AWGN	AWGN	AWGN			
Antenna Configuration		1x2	1x2	1x2			
Timing offset to Cell 1	μs	-	0	0			
Time alignment error relative to cell 1 ^{Note 5}	μs	-	≤ TAE	≤ TAE			
Time alignment error relative to cell 2 ^{Note 5}	μs	-	-	≤ TAE			
<p>Note 1: OCNG shall be used such that all cells are fully allocated and a constant total transmitted power spectral density is achieved for all OFDM symbols.</p> <p>Note 2: Interference from other cells and noise sources not specified in the test is assumed to be constant over subcarriers and time and shall be modelled as AWGN of appropriate power for N_{oc} to be fulfilled.</p> <p>Note 3: E_s/I_{ot}, RSRP, SCH_RP and I_o have been derived from other parameters for information purposes. They are not settable parameters themselves.</p> <p>Note 4: The uplink resources for CSI reporting are assigned to the UE prior to the start of time period T2.</p> <p>Note 5: The time alignment error (TAE) between two cells specified in TS 36.104 [30] clause 6.5.3.1 (value depends upon the type of carrier aggregation).</p>							

A.8.16.42.2 Test Requirements

During T2 the UE shall send the first CSI report for SCell1 in a subframe (m+8), or in a subframe (m+9) if the subframe (m+8) was subject to interruption, or in a subframe (m+13) if the subframes (m+8) and (m+9) were subject to interruption when an intra-band SCell is activated. Whether CSI report in subframe (m+8) and/or (m+9) was interrupted or not is checked by monitoring ACK/NACK sent in PCell in subframe (m+8) and/or (m+9).

During T2 the UE shall start sending CSI reports for SCell1 with non-zero CQI index at latest in a subframe (m+39).

During T3 the UE shall stop sending CSI reports for SCell1 at latest in a subframe (n+8).

During T2 interruption of PCell during SCells activation shall not happen outside the subframes (m+5) to (m+11) and outside the subframes (m+20) to (m+26).

During T3 interruption of PCell during SCells deactivation shall not happen outside the subframes (n+5) to (n+11) and outside the subframes (n+20) to (n+26).

The interruption of PCell shall not be more than the values specified for intra-band CA and inter-band CA in Section 7.8.2.

All of the above test requirements shall be fulfilled in order for the observed SCell1 activation delay and SCell1 deactivation delay to be counted as correct. The rate of correct observed SCell1 activation delay and SCell1 deactivation delay during repeated tests shall be at least 90%.

NOTE: During T2 if there are no uplink resources for reporting the valid CSI in a subframe (m+39) then the UE shall use the next available uplink resource for reporting the corresponding valid CSI.

A.8.16.43 E-UTRAN TDD-FDD CA activation and deactivation of known SCell in non-DRX with PCell in FDD

A.8.16.43.1 Test Purpose and Environment

The purpose of this test is to verify that the SCell activation and deactivation times are within the requirements stated in section 7.7, when the SCell is known by the UE at the time of activation and PCell is in FDD.

The test parameters are given in Tables A.8.16.43.1-1 and cell-specific parameters in A.8.16.43.1-2 below. The test consists of three successive time periods, with duration of T1, T2 and T3, respectively. There are two carriers, each with one cell. Both cells have constant signal levels throughout the test. Before the test starts the UE is connected to Cell 1 (PCell) on radio channel 1 (PCC) but is not aware of Cell 2 on radio channel 2. The UE is only monitoring the PCC. The UE shall be continuously scheduled in the PCell throughout the whole test.

At the beginning of T1 the UE receives an RRC message by which the SCell (Cell 2) becomes configured on radio channel 2 (SCC). The UE now starts monitoring also the SCC. The test equipment sends a MAC message for activation of the SCell.

The point in time at which the MAC message is received at the UE antenna connector, in a subframe # denoted m which is an even number, defines the start of time period T2. The UE shall be able to report valid CSI for the activated SCell at latest in subframe (m+24). The UE shall start reporting CSI in subframe (m+8) and shall report CQI index 0 (out-of-range) until the SCell activation has been completed. Any PCell interruption due to activation of SCell shall occur in the subframes (m+5) to (m+9).

Time period T3 starts when a MAC message for deactivation of SCell, sent from the test equipment to the UE in a subframe # denoted n which is an even number, received at the UE antenna connector. The UE shall carry out deactivation of the SCell in a subframe (n+8), and any PCell interruption due to the deactivation shall occur in the subframes (n+5) to (n+9).

The test equipment verifies that potential interruption is carried out in the correct time span by monitoring ACK/NACK sent in PCell during activation and deactivation of SCell, respectively.

The test equipment verifies the activation time by counting the subframes from the time when the SCell activation command is sent until a CSI report with other than CQI index 0 is received.

The test equipment verifies the deactivation time by counting the subframes from the time when the SCell deactivation command is sent until CQI reporting for SCell is discontinued.

Table A.8.16.43.1-1: General test parameters for known SCell activation case

Parameter	Unit	Value	Comment
E-UTRA RF Channel Number		1, 2	Two radio channels are used for this test
Active PCell		Cell 1	Primary cell on RF channel number 1.
Deconfigured deactivated SCell		Cell 2	Deconfigured deactivated secondary cell on RF channel number 2.
CP length		Normal	

DRX		OFF	Continuous monitoring of primary cell
CQI/PMI periodicity and offset configuration index		0	CQI reporting for SCell every second subframe
Cell-individual offset for cells on RF channel number 1	dB	0	Individual offset for cells on primary component carrier.
Cell-individual offset for cells on RF channel number 2	dB	0	Individual offset for cells on secondary component carrier.
SCell measurement cycle (measCycleSCell)	ms	320	
T1	s	7	During this time the PCell shall be known and the SCell configured and detected.
T2	s	1	During this time the UE shall activate the SCell.
T3	s	1	During this time the UE shall deactivate the SCell.

Table A.8.16.43.1-2: Cell specific test parameters for E-UTRAN TDD known SCell activation with PCell in FDD

Parameter	Unit	Cell 1			Cell 2		
		T1	T2	T3	T1	T2	T3
E-UTRA RF Channel Number		1			2		
TDD special subframe configuration		-			6		
TDD uplink-downlink configuration		-			1		
BW _{channel}	MHz	5MHz: N _{RB,c} = 25 10MHz: N _{RB,c} = 50 20MHz: N _{RB,c} = 100			5MHz: N _{RB,c} = 25 10MHz: N _{RB,c} = 50 20MHz: N _{RB,c} = 100		
PDSCH parameters: DL Reference Measurement Channel		5MHz: R.7 FDD 10MHz: R.3 FDD 20MHz: R.6 FDD			-		
PCFICH/PDCCH/PHICH parameters: DL Reference Measurement Channel		5MHz: R.11 FDD 10MHz: R.6 FDD 20MHz: R.10 FDD			5MHz: R.11 TDD 10MHz: R.6 TDD 20MHz: R.10 TDD		
OCNG Patterns		5MHz: OP.20 FDD 10MHz: OP.10 FDD 20MHz: OP.17 FDD			5MHz: OP.10 TDD 10MHz: OP.2 TDD 20MHz: OP.8 TDD		
PBCH_RA	dB	0			0		
PBCH_RB	dB						
PSS_RA	dB						
SSS_RA	dB						
PCFICH_RB	dB						
PHICH_RA	dB						
PHICH_RB	dB						
PDCCH_RA	dB						
PDCCH_RB	dB						
PDSCH_RA	dB						
PDSCH_RB	dB						
OCNG_RA ^{Note 1}	dB						
OCNG_RB ^{Note 1}	dB						
N _{oc} ^{Note 2}	dBm/15 kHz						
\hat{E}_s/N_{oc}	dB	17			17		
\hat{E}_s/I_{ot}	dB	17			17		
RSRP ^{Note 3}	dBm/15 kHz	-87			-87		
SCH_RP ^{Note 3}	dBm/15 kHz	-87			-87		
I _o ^{Note 3}	dBm/Ch BW	-59.13 +10log (N _{RB,c} /50)			-59.13 +10log (N _{RB,c} /50)		
Propagation Condition		AWGN			AWGN		

Antenna Configuration		1x2	1x2
Timing offset to Cell 1	μs	-	0
Time alignment error relative to cell 1 ^{Note 5}	μs	-	$\leq \text{TAE}$
Note 1:	OCNG shall be used such that all cells are fully allocated and a constant total transmitted power spectral density is achieved for all OFDM symbols.		
Note 2:	Interference from other cells and noise sources not specified in the test is assumed to be constant over subcarriers and time and shall be modelled as AWGN of appropriate power for N_{oc} to be fulfilled.		
Note 3:	Es/lot, RSRP, SCH_RP and lo levels have been derived from other parameters for information purposes. They are not settable parameters themselves.		
Note 4:	The uplink resources for CSI reporting are assigned to the UE prior to the start of time period T2.		
Note 5:	Time alignment error (TAE) as specified in TS 36.104 [30] clause 6.5.3.1. The TAE value depends upon the type of carrier aggregation.		

A.8.16.43.2 Test Requirements

During T2 the UE shall send the first CSI report for SCell in a subframe (m+8), or in a subframe (m+10) if the subframe (m+8) was subject to interruption. Whether CSI report in subframe (m+8) was interrupted or not is checked by monitoring ACK/NACK sent in PCell in subframe (m+8).

During T2 the UE shall start sending CSI reports for SCell with non-zero CQI index at latest in a subframe (m+24).

During T3 the UE shall stop sending CSI reports for SCell at latest in a subframe (n+8).

During T2 interruption of PCell during SCell activation shall not happen outside the subframes (m+5) to (m+9).

During T3 interruption of PCell during SCell deactivation shall not happen outside the subframes (n+5) to (n+9).

The interruption of PCell shall not be more than the values specified for inter-band CA in Section 7.8.2.

All of the above test requirements shall be fulfilled in order for the observed SCell activation delay and SCell deactivation delay to be counted as correct. The rate of correct observed SCell activation delay and SCell deactivation delay during repeated tests shall be at least 90%.

NOTE: During T2 if there are no uplink resources for reporting the valid CSI in a subframe (m+24) then the UE shall use the next available uplink resource for reporting the corresponding valid CSI.

A.8.16.44 E-UTRAN TDD-FDD CA activation and deactivation of unknown SCell in non-DRX with PCell in FDD

A.8.16.44.1 Test Purpose and Environment

The purpose of this test is to verify that the SCell activation and deactivation times are within the requirements stated in section 7.7, when the SCell is unknown by the UE at the time of activation and PCell is in FDD.

The test parameters are given in Tables A.8.16.44.1-1 and cell-specific parameters in A.8.16.44.1-2 below. The test consists of three successive time periods, with duration of T1, T2 and T3, respectively. There are two carriers, each with one cell. Cell 1 has constant signal level throughout the test. Before the test starts the UE is connected to Cell 1 (PCell) on radio channel 1 (PCC) but is not aware of Cell 2 on radio channel 2. The UE is only monitoring the PCC. The UE shall be continuously scheduled in the PCell throughout the whole test.

At the beginning of T1 the UE receives an RRC message by which the SCell (Cell 2) becomes configured on radio channel 2 (SCC). During T1 the SCell is powered off and UE is not aware of SCell.

A MAC message for activation of SCell is sent by the test equipment 100ms after the RRC message, in a subframe # denoted m which is an even number. The point in time at which the MAC message for activation of SCell is received at the UE antenna connector defines the start of time period T2. Immediately at beginning of T2 the transmission power of cell 2 is increased to same level as for cell 1. The UE shall be able to report valid CSI for the activated SCell at latest in subframe (m+34) provided the SCell can be successfully detected on the first attempt. The UE shall start reporting CSI in subframe (m+8) and shall report CQI index 0 (out-of-range) until the SCell activation has been completed. Any PCell interruption due to activation of SCell shall occur in the subframes (m+5) to (m+9).

Time period T3 starts when a MAC message for deactivation of the SCell, sent from the test equipment to the UE in a subframe # denoted n which is an even number, is received at the UE antenna connector. The UE shall carry out deactivation of the SCell at latest in subframe (n+8), and any PCell interruption due to the deactivation shall occur in the subframes (n+5) to (n+9).

The test equipment verifies that potential interruption is carried out in the correct time span by monitoring ACK/NACK sent in PCell during activation and deactivation of SCell, respectively.

The test equipment verifies the activation time by counting the subframes from the time when the SCell activation command is sent until a CSI report with other than CQI index 0 is received.

The test equipment verifies the deactivation time by counting the subframes from the time when the SCell deactivation command is sent until CQI reporting for SCell1 is discontinued.

Table A.8.16.44.1-1: General test parameters for unknown SCell activation case

Parameter	Unit	Value	Comment
E-UTRA RF Channel Number		1, 2	Two radio channels are used for this test
Active PCell		Cell 1	Primary cell on RF channel number 1.
Deconfigured deactivated SCell		Cell 2	Deconfigured deactivated secondary cell on RF channel number 2.
CP length		Normal	
DRX		OFF	Continuous monitoring of primary cell
CQI/PMI periodicity and offset configuration index		0	CQI reporting for SCell every second subframe
Cell-individual offset for cells on RF channel number 1	dB	0	Individual offset for cells on primary component carrier.
Cell-individual offset for cells on RF channel number 2	dB	0	Individual offset for cells on secondary component carrier.
SCell measurement cycle (measCycleSCell)	ms	320	
T1	ms	100	During this time the PCell shall be known and the SCell configured, but not detected.
T2	s	1	During this time the UE shall activate the SCell.
T3	s	1	During this time the UE shall deactivate the SCell.

Table A.8.16.44.1-2: Cell specific test parameters for E-UTRAN TDD unknown SCell activation

Parameter	Unit	Cell 1			Cell 2		
		T1	T2	T3	T1	T2	T3
E-UTRA RF Channel Number		1			2		
TDD special subframe configuration		-			6		
TDD uplink-downlink configuration		-			1		
BW _{channel}	MHz	5MHz: N _{RB,c} = 25 10MHz: N _{RB,c} = 50 20MHz: N _{RB,c} = 100			5MHz: N _{RB,c} = 25 10MHz: N _{RB,c} = 50 20MHz: N _{RB,c} = 100		
PDSCH parameters: DL Reference Measurement Channel		5MHz: R.7 FDD 10MHz: R.3 FDD 20MHz: R.6 FDD			-		
PCFICH/PDCCH/PHICH parameters: DL Reference Measurement Channel		5MHz: R.11 FDD 10MHz: R.6 FDD 20MHz: R.10 FDD			5MHz: R.11 TDD 10MHz: R.6 TDD 20MHz: R.10 TDD		
OCNG Patterns		5MHz: OP.20 FDD 10MHz: OP.10 FDD 20MHz: OP.17 FDD			5MHz: OP.10 TDD 10MHz: OP.2 TDD 20MHz: OP.8 TDD		
PBCH_RA	dB	0			0		
PBCH_RB	dB						
PSS_RA	dB						
SSS_RA	dB						

PCFICH_RB	dB			
PHICH_RA	dB			
PHICH_RB	dB			
PDCCH_RA	dB			
PDCCH_RB	dB			
PDSCH_RA	dB			
PDSCH_RB	dB			
OCNG_RA ^{Note 1}	dB			
OCNG_RB ^{Note 1}	dB			
N _{oc} ^{Note 2}	dBm/15 kHz	-104	-104	
\bar{E}_s/N_{oc}	dB	17	-Infinity	17
\bar{E}_s/I_{ot}	dB	17	-Infinity	17
RSRP ^{Note 3}	dBm/15 kHz	-87	-Infinity	-87
SCH_RP ^{Note 3}	dBm/15 kHz	-87	-Infinity	-87
I _o ^{Note 3}	dBm/Ch BW	-59.13 +10log (N _{RB,c} /50)	-76.22 +10log (N _{RB,c} /50)	-59.13 +10log (N _{RB,c} /50)
Propagation Condition		AWGN	AWGN	
Antenna Configuration		1x2	1x2	
Timing offset to Cell 1	μs	-	0	
Time alignment error relative to cell 1 ^{Note 5}	μs	-	≤ TAE	
Note 1:	OCNG shall be used such that all cells are fully allocated and a constant total transmitted power spectral density is achieved for all OFDM symbols.			
Note 2:	Interference from other cells and noise sources not specified in the test is assumed to be constant over subcarriers and time and shall be modelled as AWGN of appropriate power for N _{oc} to be fulfilled.			
Note 3:	Es/I _{ot} , RSRP, SCH_RP and I _o levels have been derived from other parameters for information purposes. They are not settable parameters themselves.			
Note 4:	The uplink resources for CSI reporting are assigned to the UE prior to the start of time period T2.			
Note 5:	Time alignment error (TAE) as specified in TS 36.104 [30] clause 6.5.3.1. The TAE value depends upon the type of carrier aggregation.			

A.8.16.44.2 Test Requirements

During T2 the UE shall send the first CSI report for SCell (m+8), or in a subframe (m+10) if the subframe (m+8) was subject to interruption. Whether CSI report in subframe (m+8) was interrupted or not is checked by monitoring ACK/NACK sent in PCell in subframe (m+8).

During T2 the UE shall start sending CSI reports for SCell with non-zero CQI index at latest in a subframe (m+34).

During T3 the UE shall stop sending CSI reports for SCell at latest in a subframe (n+8).

During T2 interruption of PCell during SCell activation shall not happen outside the subframes (m+5) to (m+9).

During T3 interruption of PCell during SCell deactivation shall not happen outside the subframes (n+5) to (n+9).

The interruption of PCell shall not be more than the values specified for inter-band CA in Section 7.8.2.

All of the above test requirements shall be fulfilled in order for the observed SCell activation delay and SCell deactivation delay to be counted as correct. The rate of correct observed SCell activation and deactivation delay during repeated tests shall be at least 90%.

NOTE: During T2 if there are no uplink resources for reporting the valid CSI in a subframe (m+34) then the UE shall use the next available uplink resource for reporting the corresponding valid CSI.

A.8.16.45 E-UTRAN TDD-FDD CA activation and deactivation of known SCell in non-DRX with PCell in TDD

A.8.16.45.1 Test Purpose and Environment

The purpose of this test is to verify that the SCell activation and deactivation times are within the requirements stated in section 7.7, when the SCell is known by the UE at the time of activation and PCell is in TDD.

The test parameters are given in Tables A.8.16.45.1-1 and cell-specific parameters in A.8.16.45.1-2 below. The test consists of three successive time periods, with duration of T1, T2 and T3, respectively. There are two carriers, each with one cell. Both cells have constant signal levels throughout the test. Before the test starts the UE is connected to Cell 1 (PCell) on radio channel 1 (PCC) but is not aware of Cell 2 on radio channel 2. The UE is only monitoring the PCC. The UE shall be continuously scheduled in the PCell throughout the whole test.

At the beginning of T1 the UE receives an RRC message by which the SCell (Cell 2) becomes configured on radio channel 2 (SCC). The UE now starts monitoring also the SCC. The test equipment sends a MAC message for activation of the SCell.

The point in time at which the MAC message is received at the UE antenna connector, in a subframe # denoted m , where m is 4 or 9, defines the start of time period T2. The UE shall be able to report valid CSI for the activated SCell at latest in subframe $(m+24)$. The UE shall start reporting CSI in subframe $(m+8)$ and shall report CQI index 0 (out-of-range) until the SCell activation has been completed. Any PCell interruption due to activation of SCell shall occur in the subframes $(m+5)$ to $(m+11)$.

Time period T3 starts when a MAC message for deactivation of SCell, sent from the test equipment to the UE in a subframe # denoted n where n is 4 or 9, is received at the UE antenna connector. The UE shall carry out deactivation of the SCell at latest in subframe $(n+8)$, and any PCell interruption due to the deactivation shall occur in the subframes $(n+5)$ to $(n+11)$.

The test equipment verifies that potential interruption is carried out in the correct time span by monitoring ACK/NACK sent in PCell during activation and deactivation of SCell, respectively.

The test equipment verifies the activation time by counting the subframes from the time when the SCell activation command is sent until a CSI report with other than CQI index 0 is received.

The test equipment verifies the deactivation time by counting the subframes from the time when the SCell deactivation command is sent until CQI reporting for SCell is discontinued.

Table A.8.16.45.1-1: General test parameters for known SCell activation case

Parameter	Unit	Value	Comment
E-UTRA RF Channel Number		1, 2	Two radio channels are used for this test
Active PCell		Cell 1	Primary cell on RF channel number 1.
Deconfigured deactivated SCell		Cell 2	Deconfigured deactivated secondary cell on RF channel number 2.
CP length		Normal	
DRX		OFF	Continuous monitoring of primary cell
CQI/PMI periodicity and offset configuration index		0	CQI reporting for SCell every second subframe
Cell-individual offset for cells on RF channel number 1	dB	0	Individual offset for cells on primary component carrier.
Cell-individual offset for cells on RF channel number 2	dB	0	Individual offset for cells on secondary component carrier.
SCell measurement cycle (measCycleSCell)	ms	320	
T1	s	7	During this time the PCell shall be known and the SCell configured and detected.
T2	s	1	During this time the UE shall activate the SCell.
T3	s	1	During this time the UE shall deactivate the SCell.

Table A.8.16.45.1-2: Cell specific test parameters for E-UTRAN FDD known SCell activation with PCell in TDD

Parameter	Unit	Cell 1			Cell 2		
		T1	T2	T3	T1	T2	T3
E-UTRA RF Channel Number		1			2		
TDD special subframe configuration		6			-		
TDD uplink-downlink configuration		1			-		
BW _{channel}	MHz	5MHz: N _{RB,c} = 25 10MHz: N _{RB,c} = 50 20MHz: N _{RB,c} = 100			5MHz: N _{RB,c} = 25 10MHz: N _{RB,c} = 50 20MHz: N _{RB,c} = 100		
PDSCH parameters: DL Reference Measurement Channel		5MHz: R.4 TDD 10MHz: R.0 TDD 20MHz: R.3 TDD			-		
PCFICH/PDCCH/PHICH parameters: DL Reference Measurement Channel		5MHz: R.11 TDD 10MHz: R.6 TDD 20MHz: R.10 TDD			5MHz: R.11 FDD 10MHz: R.6 FDD 20MHz: R.10 FDD		
OCNG Patterns		5MHz: OP.9 TDD 10MHz: OP.1 TDD 20MHz: OP.7 TDD			5MHz: OP.16 FDD 10MHz: OP.2 FDD 20MHz: OP.12 FDD		
PBCH_RA	dB	0			0		
PBCH_RB	dB						
PSS_RA	dB						
SSS_RA	dB						
PCFICH_RB	dB						
PHICH_RA	dB						
PHICH_RB	dB						
PDCCH_RA	dB						
PDCCH_RB	dB						
PDSCH_RA	dB						
PDSCH_RB	dB						
OCNG_RA ^{Note 1}	dB						
OCNG_RB ^{Note 1}	dB						
N _{oc} ^{Note 2}	dBm/15 kHz						
\bar{E}_s/N_{oc}	dB	17			17		
\bar{E}_s/I_{ot}	dB	17			17		
RSRP ^{Note 3}	dBm/15 kHz	-87			-87		
SCH_RP ^{Note 3}	dBm/15 kHz	-87			-87		
I _o ^{Note 3}	dBm/Ch BW	-59.13 +10log (N _{RB,c} /50)			-59.13 +10log (N _{RB,c} /50)		
Propagation Condition		AWGN			AWGN		
Antenna Configuration		1x2			1x2		
Timing offset to Cell 1	μs	-			0		
Time alignment error relative to cell 1 ^{Note 5}	μs	-			≤ TAE		
Note 1:	OCNG shall be used such that all cells are fully allocated and a constant total transmitted power spectral density is achieved for all OFDM symbols.						
Note 2:	Interference from other cells and noise sources not specified in the test is assumed to be constant over subcarriers and time and shall be modelled as AWGN of appropriate power for N _{oc} to be fulfilled.						
Note 3:	Es/lot, RSRP, SCH_RP and I _o levels have been derived from other parameters for information purposes. They are not settable parameters themselves.						
Note 4:	The uplink resources for CSI reporting are assigned to the UE prior to the start of time period T2.						
Note 5:	Time alignment error (TAE) as specified in TS 36.104 [30] clause 6.5.3.1. The TAE value depends upon the type of carrier aggregation.						

A.8.16.45.2 Test Requirements

During T2 the UE shall send the first CSI report for SCell in a subframe (m+8), or in a subframe (m+9) if the subframe (m+8) was subject to interruption. Whether CSI report in subframe (m+8) was interrupted or not is checked by monitoring ACK/NACK sent in PCell in subframe (m+8).

During T2 the UE shall start sending CSI reports for SCell with non-zero CQI index at latest in a subframe (m+24).

During T3 the UE shall stop sending CSI reports for SCell at latest in a subframe (m+8).

During T2 interruption of PCell during SCell activation shall not happen outside the subframes (m+5) to (m+11).

During T3 interruption of PCell during SCell deactivation shall not happen outside the subframes (n+5) to (n+11).

The interruption of PCell shall not be more than the values specified for inter-band CA in Section 7.8.2.

All of the above test requirements shall be fulfilled in order for the observed SCell activation delay and SCell deactivation delay to be counted as correct. The rate of correct observed SCell activation delay and SCell deactivation delay during repeated tests shall be at least 90%.

NOTE: During T2 if there are no uplink resources for reporting the valid CSI in a subframe (m+24) then the UE shall use the next available uplink resource for reporting the corresponding valid CSI.

A.8.16.46 E-UTRAN TDD-FDD CA activation and deactivation of unknown SCell in non-DRX with PCell in TDD

A.8.16.46.1 Test Purpose and Environment

The purpose of this test is to verify that the SCell activation and deactivation times are within the requirements stated in section 7.7, when the SCell is unknown by the UE at the time of activation and PCell is in FDD.

The test parameters are given in Tables A.8.16.46.1-1 and cell-specific parameters in A.8.16.46.1-2 below. The test consists of three successive time periods, with duration of T1, T2 and T3, respectively. There are two carriers, each with one cell. Cell 1 has constant signal level throughout the test. Before the test starts the UE is connected to Cell 1 (PCell) on radio channel 1 (PCC) but is not aware of Cell 2 on radio channel 2. The UE is only monitoring the PCC. The UE shall be continuously scheduled in the PCell throughout the whole test.

At the beginning of T1 the UE receives an RRC message by which the SCell (Cell 2) becomes configured on radio channel 2 (SCC). During T1 the SCell is powered off and UE is not aware of SCell.

A MAC message for activation of SCell is sent by the test equipment 100ms after the RRC message, in a subframe # denoted m, where m is 4 or 9. The point in time at which the MAC message for activation of SCell is received at the UE antenna connector defines the start of time period T2. Immediately at beginning of T2 the transmission power of cell 2 is increased to same level as for cell 1. The UE shall be able to report valid CSI for the activated SCell at latest in subframe (m+34) provided the SCell can be successfully detected on the first attempt. The UE shall start reporting CSI in subframe (m+8) and shall report CQI index 0 (out-of-range) until the SCell activation has been completed. Any PCell interruption due to activation of SCell shall occur in the subframes (m+5) to (m+11).

Time period T3 starts when a MAC message for deactivation of the SCell, sent from the test equipment to the UE in a subframe # denoted n, where n is 4 or 9, is received at the UE antenna connector. The UE shall carry out deactivation of the SCell at latest in subframe (n+8), and any PCell interruption due to the deactivation shall occur in the subframes (n+5) to (n+11).

The test equipment verifies that potential interruption is carried out in the correct time span by monitoring ACK/NACK sent in PCell during activation of SCell, respectively.

The test equipment verifies the activation time by counting the subframes from the time when the SCell activation command is sent until a CSI report with other than CQI index 0 is received.

The test equipment verifies the deactivation time by counting the subframes from the time when the SCell1 deactivation command is sent until CQI reporting for SCell1 is discontinued.

Table A.8.16.46.1-1: General test parameters for unknown SCell activation case

Parameter	Unit	Value	Comment
-----------	------	-------	---------

E-UTRA RF Channel Number		1, 2	Two radio channels are used for this test
Active PCell		Cell 1	Primary cell on RF channel number 1.
Deconfigured deactivated SCell		Cell 2	Deconfigured deactivated secondary cell on RF channel number 2.
CP length		Normal	
DRX		OFF	Continuous monitoring of primary cell
CQI/PMI periodicity and offset configuration index		0	CQI reporting for SCell every second subframe
Cell-individual offset for cells on RF channel number 1	dB	0	Individual offset for cells on primary component carrier.
Cell-individual offset for cells on RF channel number 2	dB	0	Individual offset for cells on secondary component carrier.
SCell measurement cycle (measCycleSCell)	ms	320	
T1	s	100	During this time the PCell shall be known and the SCell configured, but not detected.
T2	s	1	During this time the UE shall activate the SCell.
T3	s	1	During this time the UE shall deactivate the SCell.

Table A.8.16.46.1-2: Cell specific test parameters for E-UTRAN FDD unknown SCell activation with PCell in TDD

Parameter	Unit	Cell 1			Cell 2		
		T1	T2	T3	T1	T2	T3
E-UTRA RF Channel Number		1			2		
TDD special subframe configuration		6			-		
TDD uplink-downlink configuration		1			-		
BW _{channel}	MHz	5MHz: N _{RB,c} = 25 10MHz: N _{RB,c} = 50 20MHz: N _{RB,c} = 100			5MHz: N _{RB,c} = 25 10MHz: N _{RB,c} = 50 20MHz: N _{RB,c} = 100		
PDSCH parameters: DL Reference Measurement Channel		5MHz: R.4 TDD 10MHz: R.0 TDD 20MHz: R.3 TDD			-		
PCFICH/PDCCH/PHICH parameters: DL Reference Measurement Channel		5MHz: R.11 TDD 10MHz: R.6 TDD 20MHz: R.10 TDD			5MHz: R.11 FDD 10MHz: R.6 FDD 20MHz: R.10 FDD		
OCNG Patterns		5MHz: OP.9 TDD 10MHz: OP.1 TDD 20MHz: OP.7 TDD			5MHz: OP.16 FDD 10MHz: OP.2 FDD 20MHz: OP.12 FDD		
PBCH_RA	dB	0			0		
PBCH_RB	dB						
PSS_RA	dB						
SSS_RA	dB						
PCFICH_RB	dB						
PHICH_RA	dB						
PHICH_RB	dB						
PDCCH_RA	dB						
PDCCH_RB	dB						
PDSCH_RA	dB						
PDSCH_RB	dB						
OCNG_RA ^{Note 1}	dB						
OCNG_RB ^{Note 1}	dB						
N _{oc} ^{Note 2}	dBm/15 kHz						
\hat{E}_s/N_{oc}	dB	17			-Infinity	17	
\hat{E}_s/I_{ot}	dB	17			-Infinity	17	
RSRP ^{Note 3}	dBm/15 kHz	-87			-Infinity	-87	

SCH_RP ^{Note 3}	dBm/15 kHz	-87	-Infinity	-87
Io ^{Note 3}	dBm/Ch BW	-59.13 +10log (N _{RB,c} /50)	-76.22 +10log (N _{RB,c} /50)	-59.13 +10log (N _{RB,c} /50)
Propagation Condition		AWGN	AWGN	
Antenna Configuration		1x2	1x2	
Timing offset to Cell 1	μs	-	0	
Time alignment error relative to cell 1 ^{Note 5}	μs	-	≤ TAE	
Note 1:	OCNG shall be used such that all cells are fully allocated and a constant total transmitted power spectral density is achieved for all OFDM symbols.			
Note 2:	Interference from other cells and noise sources not specified in the test is assumed to be constant over subcarriers and time and shall be modelled as AWGN of appropriate power for N _{oc} to be fulfilled.			
Note 3:	Es/lot, RSRP, SCH_RP and Io levels have been derived from other parameters for information purposes. They are not settable parameters themselves.			
Note 4:	The uplink resources for CSI reporting are assigned to the UE prior to the start of time period T2.			
Note 5:	Time alignment error (TAE) as specified in TS 36.104 [30] clause 6.5.3.1. The TAE value depends upon the type of carrier aggregation.			

A.8.16.46.2 Test Requirements

During T2 the UE shall send the first CSI report for SCell in a subframe (m+8), or in a subframe (m+9) if the subframe (m+8) was subject to interruption. Whether CSI report in subframe (m+8) was interrupted or not is checked by monitoring ACK/NACK sent in PCell in subframe (m+8).

During T2 the UE shall start sending CSI reports for SCell with non-zero CQI index at latest in a subframe (m+34).

During T3 the UE shall stop sending CSI reports for SCell at latest in a subframe (n+8).

During T2 Interruption of PCell during SCell activation shall not happen outside the subframes (m+5) to (m+11).

During T3 Interruption of PCell during SCell deactivation shall not happen outside the subframes (n+5) to (n+11).

The interruption of PCell shall not be more than the values specified for inter-band CA in Section 7.8.2.

All of the above test requirements shall be fulfilled in order for the observed SCell activation delay and SCell deactivation delay to be counted as correct. The rate of correct observed SCell activation and deactivation delay during repeated tests shall be at least 90%.

NOTE: During T2 if there are no uplink resources for reporting the valid CSI in a subframe (m+34) then the UE shall use the next available uplink resource for reporting the corresponding valid CSI.

A.8.16.47 2DL/2UL FDD CA activation and deactivation of known PUCCH SCell without valid TA in non-DRX

A.8.16.47.1 Test Purpose and Environment

The purpose of this test is to verify that SCell activation and deactivation are done within the required time period defined in clause 7.7 for 2DL/2UL FDD carrier aggregation, when PUCCH for a being activated SCell is configured on the SCell. The SCell is known by a UE and the UE does not have valid TA for an sTAG which the SCell belongs to at the time of activation.

Test parameters are given in Table A.8.16.47.1-1 and Table A.8.16.47.1-2. The test consists of three successive time periods with duration of T1, T2 and T3, respectively. There are two carriers. In each carrier only one cell exists. All cells have constant signal levels throughout the test. The UE shall be continuously scheduled in Cell 1 (PCell) throughout the test.

Before the test starts, the UE is connected to the PCell (Cell 1) on radio channel 1 (PCC), but is not aware of Cell 2 (SCell) on radio channel 2 (SCC). The PCell is in the pTAG and the SCell is in an sTAG. The UE is only monitoring the PCC.

At the beginning of T1, the UE receives an RRC message by which the SCell (Cell 2) gets configured with PUCCH on radio channel 2 (SCC). The UE now starts monitoring the SCC also. Test equipment sends a MAC message for activation of the SCell.

The MAC message for the activation is received at the UE antenna connector at subframe # denoted m, which is defined as the start of time period T2. Subframe m is an even number. The test equipment should send a PDCCH order to the UE to initiate RA procedure on the PUCCH SCell at subframe (m+24). The UE shall be able to report valid CSI for the activated SCell no later than subframe (m+58). Any PCell interruption due to the activation shall not occur outside subframe (m+5) to (m+9).

A MAC message for deactivation of the SCell is received at the UE antenna connector at subframe # denoted n, which is defined as the start of time period T3. The UE shall carry out the deactivation of the SCell no later than subframe (n+8). Any PCell interruption due to the deactivation shall not occur outside subframe (n+5) to (n+9).

The test equipment verifies that potential interruption is carried out in the correct time span by monitoring ACK/NACK sent in PCell during the activation and the deactivation, respectively.

The test equipment verifies the activation time by counting the subframes from the time when the SCell activation command is sent until a CSI report with other than CQI index 0 is received from the PUCCH SCell.

The test equipment verifies the deactivation time by counting the subframes from the time when the SCell deactivation command is sent until CQI reporting from the PUCCH SCell is discontinued.

Table A.8.16.47.1-1: General test parameters for 2DL/2UL FDD CA activation and deactivation of known PUCCH SCell without valid TA in non-DRX

Parameter	Unit	Value	Comment
E-UTRA RF Channel Number		1, 2	Two radio channels are used for the test.
Active PCell		Cell 1	Primary cell on RF channel number 1.
Deconfigured SCell		Cell 2	Deconfigured secondary cell on RF channel number 2.
CP length		Normal	
DRX		OFF	Continuous monitoring of primary cell.
CQI/PMI periodicity and offset configuration index		0	CQI reporting for SCell every second subframe.
Cell-individual offset for cells on RF channel number 1	dB	0	Individual offset for cells on PCC.
Cell-individual offset for cells on RF channel number 2	dB	0	Individual offset for cells on SCC.
Filter coefficient		0	L3 filtering is not used.
SCell measurement cycle (measCycleSCell)	ms	320	
TimeAlignmentTimer	ms	1280	Cell 1 in pTAG.
TimeAlignmentTimerSTAG	ms	1280	Cell 2 in sTAG.
T1	s	7	During this time the PCell shall be known and the SCell shall be configured and detected.
T2	s	1	During this time the UE shall activate the SCell.
T3	s	1	During this time the UE shall deactivate the SCell.

Table A.8.16.47.1-2: Cell specific test parameters for 2DL/2UL FDD CA activation and deactivation of known PUCCH SCell without valid TA in non-DRX

Parameter	Unit	Cell 1			Cell 2		
		T1	T2	T3	T1	T2	T3
E-UTRA RF Channel Number		1			2		
BW _{channel}		5MHz: N _{RB,c} = 25 10MHz: N _{RB,c} = 50 20MHz: N _{RB,c} = 100			5MHz: N _{RB,c} = 25 10MHz: N _{RB,c} = 50 20MHz: N _{RB,c} = 100		

PDSCH parameters: DL Reference Measurement Channel		5MHz: R.7 FDD 10MHz: R.3 FDD 20MHz: R.6 FDD	-
PCFICH/PDCCH/PHICH parameters: DL Reference Measurement Channel		5MHz: R.11 FDD 10MHz: R.6 FDD 20MHz: R.10 FDD	5MHz: R.11 FDD 10MHz: R.6 FDD 20MHz: R.10 FDD
OCNG Patterns		5MHz: OP.20 FDD 10MHz: OP.10 FDD 20MHz: OP.17 FDD	5MHz: OP.16 FDD 10MHz: OP.2 FDD 20MHz: OP.12 FDD
PBCH_RA	dB	0	0
PBCH_RB	dB		
PSS_RA	dB		
SSS_RA	dB		
PCFICH_RB	dB		
PHICH_RA	dB		
PHICH_RB	dB		
PDCCH_RA	dB		
PDCCH_RB	dB		
PDSCH_RA	dB		
PDSCH_RB	dB		
OCNG_RA ^{Note 1}	dB		
OCNG_RB ^{Note 1}	dB		
N _{oc} ^{Note 2}	dBm/15 kHz	-104	-104
\bar{E}_s/N_{oc}	dB	17	17
\bar{E}_s/I_{ot} ^{Note 3}	dB	17	17
RSRP ^{Note 3}	dBm/15 kHz	-87	-87
SCH_RP ^{Note 3}	dBm/15 kHz	-87	-87
I _o ^{Note 3}	dBm/Ch BW	-59.13+10log (N _{RB,c} /50)	-59.13+10log (N _{RB,c} /50)
Propagation Condition		AWGN	AWGN
Antenna Configuration		1x2	1x2
Timing offset to Cell 1	μs	-	0
Time alignment error relative to cell 1 ^{Note 5}	μs	-	≤ TAE
PRACH Configuration index ^{Note 6}		-	4
<p>Note 1: OCNG shall be used such that all cells are fully allocated and a constant total transmitted power spectral density is achieved for all OFDM symbols.</p> <p>Note 2: Interference from other cells and noise sources not specified in the test is assumed to be constant over subcarriers and time and shall be modelled as AWGN of appropriate power for N_{oc} to be fulfilled.</p> <p>Note 3: E_s/I_{ot}, RSRP, SCH_RP and I_o have been derived from other parameters for information purposes. They are not settable parameters themselves.</p> <p>Note 4: The uplink resources for CSI reporting are assigned to the UE prior to the start of time period T2.</p> <p>Note 5: Time alignment error (TAE) as specified in TS 36.104 [30] clause 6.5.3.1. The TAE value depends upon the type of carrier aggregation.</p> <p>Note 6: As specified in table 5.7.1-2 in TS 36.211.</p>			

A.8.16.47.2 Test Requirements

During T2 the UE shall start sending CSI report for the SCell with non-zero CQI index on the PUCCH SCell no later than subframe (m+58).

During T2 interruption of the PCell during the SCell activation shall not occur outside subframe (m+5) to (m+9).

During T3 the UE shall stop sending CSI reports from the PUCCH SCell no later than subframe (n+8).

During T3 interruption of the PCell during the SCell deactivation shall not occur outside subframe (n+5) to (n+9).

The interruption of the PCell shall not be more than the values specified for intra-band CA and inter-band CA in Section 7.8.2.

All of the above test requirements shall be fulfilled in order for the observed SCell activation and deactivation delay to be counted as correct.

NOTE: During T2 if there are no uplink resources for reporting the valid CSI in the subframe (m+58) then the UE shall use the next available uplink resource for reporting the corresponding valid CSI.

A.8.16.48 2DL/2UL TDD CA activation and deactivation of known PUCCH SCell without valid TA in non-DRX

A.8.16.48.1 Test Purpose and Environment

The purpose of this test is to verify that SCell activation and deactivation are done within the required time period defined in clause 7.7 for 2DL/2UL TDD carrier aggregation, when PUCCH for a being activated SCell is configured on the SCell. The SCell is known by a UE and the UE does not have valid TA for a sTAG which the SCell belongs to at the time of activation.

Test parameters are given in Tables A.8.16.48.1-1 and cell-specific parameters in A.8.16.48.1-2. The test consists of three successive time periods with duration of T1, T2 and T3, respectively. There are two carriers. In each carrier only one cell exists. All cells have constant signal levels throughout the test. The UE shall be continuously scheduled in Cell 1 (PCell) throughout the test.

Before the test starts, the UE is connected to the PCell (Cell 1) on radio channel 1 (PCC), but is not aware of Cell 2 (SCell) on radio channel 2 (SCC). The PCell is in the pTAG and the SCell is in a sTAG. The UE is only monitoring the PCC.

At the beginning of T1, the UE receives an RRC message by which the SCell (Cell 2) gets configured with PUCCH on radio channel 2 (SCC). The UE now starts monitoring the SCC also. A test equipment sends a MAC message for activation of the SCell.

The MAC message for the activation is received at the UE antenna connector at subframe # denoted m, which is defined as the start of time period T2. Subframe m is an even number. The test equipment should send a PDCCH order to the UE to initiate RA procedure on the PUCCH SCell at subframe (m+24). The UE shall be able to report valid CSI for the activated SCell no later than subframe (m+58). Any PCell interruption due to the activation shall not occur outside subframe (m+5) to (m+11).

A MAC message for deactivation of the SCell is received at the UE antenna connector at subframe # denoted n, which is defined as the start of time period T3. The UE shall carry out the deactivation of the SCell no later than subframe (n+8). Any PCell interruption due to the deactivation shall not occur outside subframe (n+5) to (n+11).

The test equipment verifies that potential interruption is carried out in the correct time span by monitoring ACK/NACK sent in PCell during the activation and the deactivation, respectively.

The test equipment verifies the activation time by counting the subframes from the time when the SCell activation command is sent until a CSI report with other than CQI index 0 is received from the PUCCH SCell.

The test equipment verifies the deactivation time by counting the subframes from the time when the SCell deactivation command is sent until CQI reporting from the PUCCH SCell is discontinued.

Table A.8.16.48.1-1: General test parameters for 2DL/2UL TDD CA activation and deactivation of known PUCCH SCell without valid TA in non-DRX

Parameter	Unit	Value	Comment
E-UTRA RF Channel Number		1, 2	Two radio channels are used for the test.
Active PCell		Cell 1	Primary cell on RF channel number 1.
Deconfigured SCell		Cell 2	Deconfigured secondary cell on RF channel number 2.
CP length		Normal	
DRX		OFF	Continuous monitoring of primary cell.
Special subframe configuration		6	As specified in table 4.2-1 in TS 36.211 [16]. The same configuration applies to all cells.
Uplink-downlink configuration		1	As specified in table 4.2-2 in TS 36.211 [16]. The same configuration applies to all cells.

CQI/PMI periodicity and offset configuration index		0	CQI reporting for SCells every second subframe.
Cell-individual offset for cells on RF channel number 1	dB	0	Individual offset for cells on PCC.
Cell-individual offset for cells on RF channel number 2	dB	0	Individual offset for cells on SCC.
Filter coefficient		0	L3 filtering is not used.
SCell measurement cycle (measCycleSCell)	ms	320	
TimeAlignmentTimer	ms	1280	Cell 1 in pTAG.
TimeAlignmentTimerSTAG	ms	1280	Cell 2 in sTAG.
T1	s	7	During this time the PCell shall be known and the SCell shall be configured and detected.
T2	s	1	During this time the UE shall activate the SCell.
T3	s	1	During this time the UE shall deactivate the SCell.

Table A.8.16.48.1-2: Cell specific test parameters for 2DL/2UL TDD CA activation and deactivation of known PUCCH SCell without valid TA in non-DRX

Parameter	Unit	Cell 1			Cell 2		
		T1	T2	T3	T1	T2	T3
E-UTRA RF Channel Number		1			2		
BW _{channel}		5MHz: N _{RB,c} = 25 10MHz: N _{RB,c} = 50 20MHz: N _{RB,c} = 100			5MHz: N _{RB,c} = 25 10MHz: N _{RB,c} = 50 20MHz: N _{RB,c} = 100		
PDSCH parameters: DL Reference Measurement Channel		5MHz: R.4 TDD 10MHz: R.0 TDD 20MHz: R.3 TDD			-		
PCFICH/PDCCH/PHICH parameters: DL Reference Measurement Channel		5MHz: R.11 TDD 10MHz: R.6 TDD 20MHz: R.10 TDD			5MHz: R.11 TDD 10MHz: R.6 TDD 20MHz: R.10 TDD		
OCNG Patterns		5MHz: OP.9 TDD 10MHz: OP.1 TDD 20MHz: OP.7 TDD			5MHz: OP.10 TDD 10MHz: OP.2 TDD 20MHz: OP.8 TDD		
PBCH_RA	dB	0			0		
PBCH_RB	dB						
PSS_RA	dB						
SSS_RA	dB						
PCFICH_RB	dB						
PHICH_RA	dB						
PHICH_RB	dB						
PDCCH_RA	dB						
PDCCH_RB	dB						
PDSCH_RA	dB						
PDSCH_RB	dB						
OCNG_RA ^{Note 1}	dB						
OCNG_RB ^{Note 1}	dB						
N _{oc} ^{Note 2}	dBm/15 kHz						
\bar{E}_s/N_{oc}	dB	17			17		
\bar{E}_s/I_{ot} ^{Note 3}	dB	17			17		
RSRP ^{Note 3}	dBm/15 kHz	-87			-87		
SCH_RP ^{Note 3}	dBm/15 kHz	-87			-87		
I _o ^{Note 3}	dBm/Ch BW	-59.13+10log(N _{RB,c} /50)			-59.13+10log(N _{RB,c} /50)		
Propagation Condition		AWGN			AWGN		
Antenna Configuration		1x2			1x2		
Timing offset to Cell 1	μs	-			0		
Time alignment error relative to cell 1 ^{Note 5}	μs	-			≤ TAE		

PRACH Configuration index		-	4
Note 1:	OCNG shall be used such that all cells are fully allocated and a constant total transmitted power spectral density is achieved for all OFDM symbols.		
Note 2:	Interference from other cells and noise sources not specified in the test is assumed to be constant over subcarriers and time and shall be modelled as AWGN of appropriate power for N_{oc} to be fulfilled.		
Note 3:	E_s/I_{ot} , RSRP, SCH_RP and I_o have been derived from other parameters for information purposes. They are not settable parameters themselves.		
Note 4:	The uplink resources for CSI reporting are assigned to the UE prior to the start of time period T2.		
Note 5:	Time alignment error (TAE) as specified in TS 36.104 [30] clause 6.5.3.1. The TAE value depends upon the type of carrier aggregation.		

A.8.16.48.2 Test Requirements

During T2 the UE shall start sending CSI report for the SCell with non-zero CQI index on the PUCCH SCell no later than subframe (m+58).

During T2 interruption of the PCell during the SCell activation shall not occur outside subframe (m+5) to (m+11).

During T3 the UE shall stop sending CSI reports from the PUCCH SCell no later than subframe (n+8).

During T3 interruption of the PCell during the SCell deactivation shall not occur outside subframe (n+5) to (n+11).

The interruption of the PCell shall not be more than the values specified for intra-band CA and inter-band CA in Section 7.8.2.

All of the above test requirements shall be fulfilled in order for the observed SCell activation and deactivation delay to be counted as correct.

NOTE: During T2 if there are no uplink resources for reporting the valid CSI in the subframe (m+58) then the UE shall use the next available uplink resource for reporting the corresponding valid CSI.

A.8.16.49 2DL/2UL TDD-FDD CA (FDD PCell) activation and deactivation of known PUCCH SCell without valid TA in non-DRX

A.8.16.49.1 Test Purpose and Environment

The purpose of this test is to verify that SCell activation and deactivation are done within the required time period defined in clause 7.7 for 2DL/2UL TDD-FDD carrier aggregation with PCell in FDD, when PUCCH for a being activated SCell is configured on the SCell. The SCell is known by a UE and the UE does not have valid TA for an sTAG which the SCell belongs to at the time of activation.

Test parameters are given in Table A.8.16.49.1-1 and Table A.8.16.49.1-2. The test consists of three successive time periods with duration of T1, T2 and T3, respectively. There are two carriers. In each carrier only one cell exists. All cells have constant signal levels throughout the test. The UE shall be continuously scheduled in Cell 1 (PCell) throughout the test.

Before the test starts, the UE is connected to the PCell (Cell 1) on radio channel 1 (PCC), but is not aware of Cell 2 (SCell) on radio channel 2 (SCC). The PCell is in the pTAG and the SCell is in an sTAG. The UE is only monitoring the PCC.

At the beginning of T1, the UE receives an RRC message by which the SCell (Cell 2) gets configured with PUCCH on radio channel 2 (SCC). The UE now starts monitoring the SCC also. Test equipment sends a MAC message for activation of the SCell.

The MAC message for the activation is received at the UE antenna connector at subframe # denoted m, which is defined as the start of time period T2. Subframe m is an even number. The test equipment should send a PDCCH order to the UE to initiate RA procedure on the PUCCH SCell at subframe (m+24). The UE shall be able to report valid CSI for the activated SCell no later than subframe (m+58). Any PCell interruption due to the activation shall not occur outside subframe (m+5) to (m+9).

A MAC message for deactivation of the SCell is received at the UE antenna connector at subframe # denoted n, which is defined as the start of time period T3. The UE shall carry out the deactivation of the SCell no later than subframe (n+8). Any PCell interruption due to the deactivation shall not occur outside subframe (n+5) to (n+9).

The test equipment verifies that potential interruption is carried out in the correct time span by monitoring ACK/NACK sent in PCell during the activation and the deactivation, respectively.

The test equipment verifies the activation time by counting the subframes from the time when the SCell activation command is sent until a CSI report with other than CQI index 0 is received from the PUCCH SCell.

The test equipment verifies the deactivation time by counting the subframes from the time when the SCell deactivation command is sent until CQI reporting from the PUCCH SCell is discontinued.

Table A.8.16.49.1-1: General test parameters for 2DL/2UL TDD-FDD CA (FDD PCell) activation and deactivation of known PUCCH SCell without valid TA in non-DRX

Parameter	Unit	Value	Comment
E-UTRA RF Channel Number		1, 2	Two radio channels are used for this test
Active PCell		Cell 1	Primary cell on RF channel number 1.
Deconfigured deactivated SCell		Cell 2	Deconfigured deactivated secondary cell on RF channel number 2.
CP length		Normal	
DRX		OFF	Continuous monitoring of primary cell
CQI/PMI periodicity and offset configuration index		0	CQI reporting for SCell every second subframe
Cell-individual offset for cells on RF channel number 1	dB	0	Individual offset for cells on PCC.
Cell-individual offset for cells on RF channel number 2	dB	0	Individual offset for cells on SCC.
SCell measurement cycle (measCycleSCell)	ms	320	
TimeAlignmentTimer	ms	1280	Cell 1 in pTAG.
TimeAlignmentTimerSTAG	ms	1280	Cell 2 in sTAG.
T1	s	7	During this time the PCell and SCell shall be known.
T2	s	1	During this time the UE shall activate the SCell.
T3	s	1	During this time the UE shall deactivate the SCell.

Table A.8.16.49.1-2: Cell specific test parameters for 2DL/2UL TDD-FDD CA (FDD PCell) activation and deactivation of known PUCCH SCell without valid TA in non-DRX

Parameter	Unit	Cell 1			Cell 2		
		T1	T2	T3	T1	T2	T3
E-UTRA RF Channel Number		1			2		
TDD special subframe configuration		-			6		
TDD uplink-downlink configuration		-			1		
BW _{channel}	MHz	5MHz: N _{RB,c} = 25 10MHz: N _{RB,c} = 50 20MHz: N _{RB,c} = 100			5MHz: N _{RB,c} = 25 10MHz: N _{RB,c} = 50 20MHz: N _{RB,c} = 100		
PDSCH parameters: DL Reference Measurement Channel		5MHz: R.7 FDD 10MHz: R.3 FDD 20MHz: R.6 FDD			-		
PCFICH/PDCCH/PHICH parameters: DL Reference Measurement Channel		5MHz: R.11 FDD 10MHz: R.6 FDD 20MHz: R.10 FDD			5MHz: R.11 TDD 10MHz: R.6 TDD 20MHz: R.10 TDD		

OCNG Patterns		5MHz: OP.20 FDD 10MHz: OP.10 FDD 20MHz: OP.17 FDD	5MHz: OP.10 TDD 10MHz: OP.2 TDD 20MHz: OP.8 TDD
PBCH_RA	dB	0	0
PBCH_RB	dB		
PSS_RA	dB		
SSS_RA	dB		
PCFICH_RB	dB		
PHICH_RA	dB		
PHICH_RB	dB		
PDCCH_RA	dB		
PDCCH_RB	dB		
PDSCH_RA	dB		
PDSCH_RB	dB		
OCNG_RA ^{Note 1}	dB		
OCNG_RB ^{Note 1}	dB		
N_{oc} ^{Note 2}	dBm/15 kHz		
\bar{E}_s/N_{oc}	dB	17	17
\bar{E}_s/I_{ot}	dB	17	17
RSRP ^{Note 3}	dBm/15 kHz	-87	-87
SCH_RP ^{Note 3}	dBm/15 kHz	-87	-87
I_o ^{Note 3}	dBm/Ch BW	-59.13 +10log ($N_{RB,c}/50$)	-59.13 +10log ($N_{RB,c}/50$)
Propagation Condition		AWGN	AWGN
Antenna Configuration		1x2	1x2
Timing offset to Cell 1	μ s	-	0
Time alignment error relative to cell 1 ^{Note 5}	μ s	-	\leq TAE
PRACH configuration Index ^{Note 7}		-	4
<p>Note 1: OCNG shall be used such that all cells are fully allocated and a constant total transmitted power spectral density is achieved for all OFDM symbols.</p> <p>Note 2: Interference from other cells and noise sources not specified in the test is assumed to be constant over subcarriers and time and shall be modelled as AWGN of appropriate power for N_{oc} to be fulfilled.</p> <p>Note 3: \bar{E}_s/I_{ot}, RSRP, SCH_RP and I_o levels have been derived from other parameters for information purposes. They are not settable parameters themselves.</p> <p>Note 4: The uplink resources for CSI reporting are assigned to the UE prior to the start of time period T2.</p> <p>Note 5: Time alignment error (TAE) as specified in TS 36.104 [30] clause 6.5.3.1. The TAE value depends upon the type of carrier aggregation.</p> <p>Note 6: TDD special subframe configuration and uplink-downlink configuration are as specified in Table 4.2-1 and 4.2-2 in TS36.211 [16].</p> <p>Note 7: As specified in table 5.7.1-2 in TS 36.211.</p>			

A.8.16.49.2 Test Requirements

During T2 the UE shall start sending CSI report for the SCell with non-zero CQI index on the PUCCH SCell no later than subframe (m+58).

During T2 interruption of the PCell during the SCell activation shall not occur outside subframe (m+5) to (m+9).

During T3 the UE shall stop sending CSI reports from the PUCCH SCell no later than subframe (n+8).

During T3 interruption of the PCell during the SCell deactivation shall not occur outside subframe (n+5) to (n+9).

The interruption of the PCell shall not be more than the values specified for intra-band CA and inter-band CA in Section 7.8.2.

All of the above test requirements shall be fulfilled in order for the observed SCell activation delay and SCell deactivation delay to be counted as correct.

NOTE: During T2 if there are no uplink resources for reporting the valid CSI in the subframe (m+58) then the UE shall use the next available uplink resource for reporting the corresponding valid CSI.

A.8.16.50 2DL/2UL TDD-FDD CA (TDD PCell) activation and deactivation of known PUCCH SCell without valid TA in non-DRX

A.8.16.50.1 Test Purpose and Environment

The purpose of this test is to verify that SCell activation and deactivation are done within the required time period defined in clause 7.7 for 2DL/2UL TDD-FDD carrier aggregation with PCell in TDD, when PUCCH for a being activated SCell is configured on the SCell. The SCell is known by a UE and the UE does not have valid TA for an sTAG which the SCell belongs to at the time of activation.

Test parameters are given in Tables A.8.16.50.1-1 and cell-specific parameters in A.8.16.50.1-2. The test consists of three successive time periods with duration of T1, T2 and T3, respectively. There are two carriers. In each carrier only one cell exists. All cells have constant signal levels throughout the test. The UE shall be continuously scheduled in Cell 1 (PCell) throughout the test.

Before the test starts, the UE is connected to the PCell (Cell 1) on radio channel 1 (PCC), but is not aware of Cell 2 (SCell) on radio channel 2 (SCC). The PCell is in the pTAG and the SCell is in an sTAG. The UE is only monitoring the PCC.

At the beginning of T1, the UE receives an RRC message by which the SCell (Cell 2) gets configured with PUCCH on radio channel 2 (SCC). The UE now starts monitoring the SCC also. The test equipment sends a MAC message for activation of the SCell.

The MAC message for the activation is received at the UE antenna connector at subframe # denoted m, which is defined as the start of time period T2. Subframe m is an even number. The test equipment should send a PDCCH order to the UE to initiate RA procedure on the PUCCH SCell at subframe (m+24). The UE shall be able to report valid CSI for the activated SCell no later than subframe (m+58). Any PCell interruption due to the activation shall not occur outside subframe (m+5) to (m+9).

A MAC message for deactivation of the SCell is received at the UE antenna connector at subframe # denoted n, which is defined as the start of time period T3. The UE shall carry out the deactivation of the SCell no later than subframe (n+8). Any PCell interruption due to the deactivation shall not occur outside subframe (n+5) to (n+9).

The test equipment verifies that potential interruption is carried out in the correct time span by monitoring ACK/NACK sent in PCell during activation and deactivation of SCell, respectively.

The test equipment verifies the activation time by counting the subframes from the time when the SCell activation command is sent until a CSI report with other than CQI index 0 is received from the PUCCH SCell.

The test equipment verifies the deactivation time by counting the subframes from the time when the SCell deactivation command is sent until CQI reporting from the PUCCH SCell is discontinued.

Table A.8.16.50.1-1: General test parameters for 2DL/2UL TDD-FDD CA (TDD PCell) activation and deactivation of known PUCCH SCell without valid TA in non-DRX

Parameter	Unit	Value	Comment
E-UTRA RF Channel Number		1, 2	Two radio channels are used for this test
Active PCell		Cell 1	Primary cell on RF channel number 1.
Deconfigured SCell		Cell 2	Deconfigured secondary cell on RF channel number 2.
CP length		Normal	
DRX		OFF	Continuous monitoring of primary cell
CQI/PMI periodicity and offset configuration index		0	CQI reporting for SCell every second subframe
Cell-individual offset for cells on RF channel number 1	dB	0	Individual offset for cells on PCC.
Cell-individual offset for cells on RF channel number 2	dB	0	Individual offset for cells on SCC.
Filter coefficient		0	L3 filtering is not used
SCell measurement cycle (measCycleSCell)	ms	320	

TimeAlignmentTimer	ms	1280	Cell 1 in pTAG.
TimeAlignmentTimerSTAG	ms	1280	Cell 2 in sTAG.
T1	s	7	During this time the PCell shall be known and the SCell configured and detected.
T2	s	1	During this time the UE shall activate the SCell.
T3	s	1	During this time the UE shall deactivate the SCell.

Table A.8.16.50.1-2: Cell specific test parameters for 2DL/2UL TDD-FDD CA (TDD PCell) activation and deactivation of known PUCCH SCell without valid TA in non-DRX

Parameter	Unit	Cell 1			Cell 2		
		T1	T2	T3	T1	T2	T3
E-UTRA RF Channel Number		1			2		
TDD special subframe configuration		6					
TDD uplink-downlink configuration		1					
BW _{channel}		5MHz: N _{RB,c} = 25 10MHz: N _{RB,c} = 50 20MHz: N _{RB,c} = 100			5MHz: N _{RB,c} = 25 10MHz: N _{RB,c} = 50 20MHz: N _{RB,c} = 100		
PDSCH parameters: DL Reference Measurement Channel		5MHz: R.4 TDD 10MHz: R.0 TDD 20MHz: R.3 TDD			-		
PCFICH/PDCCH/PHICH parameters: DL Reference Measurement Channel		5MHz: R.11 TDD 10MHz: R.6 TDD 20MHz: R.10 TDD			5MHz: R.11 FDD 10MHz: R.6 FDD 20MHz: R.10 FDD		
OCNG Patterns		5MHz: OP.9 TDD 10MHz: OP.1 TDD 20MHz: OP.7 TDD			5MHz: OP.16 FDD 10MHz: OP.2 FDD 20MHz: OP.12 FDD		
PBCH_RA	dB	0			0		
PBCH_RB	dB						
PSS_RA	dB						
SSS_RA	dB						
PCFICH_RB	dB						
PHICH_RA	dB						
PHICH_RB	dB						
PDCCH_RA	dB						
PDCCH_RB	dB						
PDSCH_RA	dB						
PDSCH_RB	dB						
OCNG_RA ^{Note 1}	dB						
OCNG_RB ^{Note 1}	dB						
N _{oc} ^{Note 2}	dBm/15 kHz						
E _s /N _{oc}	dB	17			17		
E _s /I _{ot} ^{Note 3}	dB	17			17		
RSRP ^{Note 3}	dBm/15 kHz	-87			-87		
SCH_RP ^{Note 3}	dBm/15 kHz	-87			-87		
I _o ^{Note 3}	dBm/Ch BW	-59.13+10log (N _{RB,c} /50)			-59.13+10log (N _{RB,c} /50)		
Propagation Condition		AWGN			AWGN		
Antenna Configuration		1x2			1x2		
Timing offset to Cell 1	μs	-			0		
Time alignment error relative to cell 1 ^{Note 5}	μs	-			≤ TAE		
PRACH Configuration index		-			4		

Note 1:	OCNG shall be used such that all cells are fully allocated and a constant total transmitted power spectral density is achieved for all OFDM symbols.
Note 2:	Interference from other cells and noise sources not specified in the test is assumed to be constant over subcarriers and time and shall be modelled as AWGN of appropriate power for N_{oc} to be fulfilled.
Note 3:	E_s/I_{ot} , RSRP, SCH_RP and I_o have been derived from other parameters for information purposes. They are not settable parameters themselves.
Note 4:	The uplink resources for CSI reporting are assigned to the UE prior to the start of time period T2.
Note 5:	Time alignment error (TAE) as specified in TS 36.104 [30] clause 6.5.3.1. The TAE value depends upon the type of carrier aggregation.
Note 6:	TDD special subframe configuration and uplink-downlink configuration are as specified in Table 4.2-1 and 4.2-2 in TS36.211 [16].

A.8.16.50.2 Test Requirements

During T2 the UE shall start sending CSI reports for SCell with non-zero CQI index on the PUCCH SCell at latest in a subframe (m+58).

During T2 interruption of the PCell during the SCell activation shall not occur outside subframe (m+5) to (m+9).

During T3 the UE shall stop sending CSI reports from the PUCCH SCell no later than subframe (n+8).

During T3 interruption of the PCell during the SCell deactivation shall not occur outside subframe (n+5) to (n+9).

The interruption of the PCell shall not be more than the values specified for intra-band CA and inter-band CA in Section 7.8.2.

All of the above test requirements shall be fulfilled in order for the observed SCell activation and deactivation delay to be counted as correct.

NOTE: During T2 if there are no uplink resources for reporting the valid CSI in the subframe (m+58) then the UE shall use the next available uplink resource for reporting the corresponding valid CSI.

A.8.16.51 E-UTRAN 4 DL FDD CA Event Triggered Reporting with 3 deactivated SCells in Non-DRX

A.8.16.51.1 Test Purpose and Environment

The purpose of this test is to verify that the UE correctly detects events A1 (Serving cell becomes better than threshold), A2 (Serving cell becomes worse than threshold) and A6 (Neighbour becomes better than SCell) defined in TS 36.331 [2] within the requirements stated in clause 8.3.3.2.1.

In this test case there are 5 cells. Cell 1 is the PCell on the FDD PCC F1. Cell 2 is the configured and deactivated SCell on the FDD SCC F2. Cell 3 is the configured and deactivated SCell on the FDD SCC F3. Cell 4 is the configured and deactivated SCell on the FDD SCC F4, and cell 5 is the neighbor cell on the FDD SCC F4.

The test parameters are given in Tables A.8.16.51.1-1 and A.8.16.51.1-2 below. It is indicated to the UE in the measurement control information that event-triggered reporting with Events A1 (cell2), A2 (PCell and SCells) and A6 are used. The test consists of three successive time periods, with duration of T1, T2 and T3, respectively. During T1 the UE shall not have any information on cell 5. At the beginning of T2 the transmission power of cell 5 is increased to the same level as for cell 4, and due to usage of an offset this shall result in reporting of Event A6. Also, at the beginning of T2 the transmission power of cell 2 is increased to the same level as for cell 1, which shall result in reporting of Event A1. At the beginning of T3 the transmission powers of cells 1, 2, 3, 4 and 5 are reduced below a threshold value and this shall result in reporting of Event A2 for Cell 1, for Cell 2, for Cell3 and for Cell 4.

Table A.8.16.51.1-1: General test parameters for E-UTRAN FDD-FDD 4 DL CA event triggered reporting under fading propagation conditions with 3 configured but deactivated SCells in non-DRX with PCell in FDD

Parameter	Unit	Value	Comment
E-UTRA RF Channel Number		1, 2, 3, 4	Three radio channels are used for this test
Active PCell		Cell 1	Primary cell on RF channel number 1.
Configured deactivated SCell		Cell 2	Configured deactivated secondary cell on RF channel number 2.

Configured deactivated SCell			Cell 3	Configured deactivated secondary cell on RF channel number 3.
Configured deactivated SCell			Cell 4	Configured deactivated secondary cell on RF channel number 4.
Neighbour cell			Cell 5	Neighbour cell to be identified on RF channel number 4.
CP length			Normal	
DRX			OFF	Continuous monitoring of primary cell
A1	Hysteresis	dB	0	Hysteresis for evaluation of event A1.
	Threshold RSRP	dBm	-98	Actual RSRP threshold for event A1. Needs to take absolute accuracy tolerance in section 9.1.11.1 into account plus margin.
	Time To Trigger	s	0	
A2	Hysteresis	dB	0	Hysteresis for evaluation of event A2.
	Threshold RSRP	dBm	-98	Actual RSRP threshold for event A2. Needs to take absolute accuracy tolerance in section 9.1.11.1 into account plus margin.
	Time To Trigger	s	0	
A6	Hysteresis	dB	0	Hysteresis for evaluation of event A6.
	Offset	dB	-6	Offset parameter for evaluation of event A6. Needs to take relative accuracy tolerance in section 9.1.11.2 into account plus margin.
	Report on leave		False	
	Time To Trigger	s	0	
Cell-individual offset for cells on RF channel number 1		dB	0	Individual offset for cells on primary component carrier.
Cell-individual offset for cells on RF channel number 2		dB	0	Individual offset for cells on secondary component carrier.
Cell-individual offset for cells on RF channel number 3		dB	0	Individual offset for cells on secondary component carrier.
Cell-individual offset for cells on RF channel number 4		dB	0	Individual offset for cells on secondary component carrier.
Filter coefficient			0	L3 filtering is not used
SCell measurement cycle (measCycleSCell)		ms	320	
T1		s	5	During this time the cell1, cell3, cell4 shall be known to the UE; but cell2 and cell 5 shall be unknown to the UE.
T2		s	≤12	UE should report Event A1 for cell2 and event A6 for cell5 within 6.4s (20xscellMeasCycle)
T3		s	5	UE should report Event A2 within 200 ms for cell1, and 1.6s for cells 2, 3 and 4.

Table A.8.16.51.1-2: Cell specific test parameters for E-UTRAN FDD-FDD 4 DL CA event triggered reporting under fading propagation conditions with 3 configured but deactivated SCells in non-DRX

Parameter	Unit	Cell 1			Cell 2			Cell 3			Cell 4			Cell 5		
		T1	T2	T3	T1	T2	T3	T1	T2	T3	T1	T2	T3	T1	T2	T3
E-UTRA RF Channel Number		1			2			3			4					
BW _{channel}		5MHz: N _{RB,c} = 25 10MHz: N _{RB,c} = 50 20MHz: N _{RB,c} = 100			5MHz: N _{RB,c} = 25 10MHz: N _{RB,c} = 50 20MHz: N _{RB,c} = 100			5MHz: N _{RB,c} = 25 10MHz: N _{RB,c} = 50 20MHz: N _{RB,c} = 100			5MHz: N _{RB,c} = 25 10MHz: N _{RB,c} = 50 20MHz: N _{RB,c} = 100					
PDSCH parameters: DL Reference Measurement Channel		5MHz: R.5 FDD 10MHz: R.0 FDD 20MHz: R.4 FDD			-			-			-			-		
PCFICH/PDCCH/PHICH parameters: DL Reference Measurement Channel		5MHz: R.11 FDD 10MHz: R.6 FDD 20MHz: R.10 FDD			5MHz: R.11 FDD 10MHz: R.6 FDD 20MHz: R.10 FDD			5MHz: R.11 FDD 10MHz: R.6 FDD 20MHz: R.10 FDD			5MHz: R.11 FDD 10MHz: R.6 FDD 20MHz: R.10 FDD			5MHz: R.11 FDD 10MHz: R.6 FDD 20MHz: R.10 FDD		
OCNG Patterns		5MHz: OP.15 FDD 10MHz: OP.1 FDD 20MHz: OP.11 FDD			5MHz: OP.16 FDD 10MHz: OP.2 FDD 20MHz: OP.12 FDD			5MHz: OP.16 FDD 10MHz: OP.2 FDD 20MHz: OP.12 FDD			5MHz: OP.16 FDD 10MHz: OP.2 FDD 20MHz: OP.12 FDD			5MHz: OP.16 FDD 10MHz: OP.2 FDD 20MHz: OP.12 FDD		
PBCH_RA	dB	0			0			0			0			0		
PBCH_RB	dB															
PSS_RA	dB															
SSS_RA	dB															
PCFICH_RB	dB															
PHICH_RA	dB															
PHICH_RB	dB															
PDCCH_RA	dB															
PDCCH_RB	dB															
PDSCH_RA	dB															
PDSCH_RB	dB															
OCNG_RA ^{Note 1}	dB															
OCNG_RB ^{Note 1}	dB															
N _{oc} ^{Note 2}	dBm/15 KHz															
\bar{E}_g/N_{oc}	dB	17	17	-3	-infinity	17	-3	17	17	-3	17	17	-3	-infinity	17	-3
\bar{E}_g/I_{ot} ^{Note 3}	dB	17	17	-3	-infinity	17	-3	17	17	-3	17	-0.09	-4.76	-infinity	-0.09	-4.76
RSRP ^{Note 3}	dBm/15 kHz	-87	-87	-107	-infinity	-87	-107	-87	-87	-107	-87	-87	-107	-infinity	-87	-107
SCH_RP ^{Note 3}	dBm/15 kHz	-87	-87	-107	-infinity	-87	-107	-87	-87	-107	-87	-87	-107	-infinity	-87	-107
I _o ^{Note 3}	dBm/Ch BW	-59.13 +10log (N _{RB,c} /50)	-59.13 +10log (N _{RB,c} /50)	-74.45 +10log (N _{RB,c} /50)	-76.22 +10log (N _{RB,c} /50)	-59.13 +10log (N _{RB,c} /50)	-74.45 +10log (N _{RB,c} /50)	-59.13 +10log (N _{RB,c} /50)	-59.13 +10log (N _{RB,c} /50)	-74.45 +10log (N _{RB,c} /50)	-59.13 +10log (N _{RB,c} /50)	-56.17 +10log (N _{RB,c} /50)	-73.20 +10log (N _{RB,c} /50)	Specified in columns for Cell 4		
Propagation Condition		AWGN			ETU70			ETU70			ETU70			ETU70		
Correlation Matrix and Antenna Configuration		1x2			1x2 Low			1x2 Low			1x2 Low			1x2 Low		
Timing offset to Cell 1	μs	-			0			0			0			3		
Time alignment error relative to cell 1 ^{Note 5}	μs	-			≤ TAE			≤ TAE			≤ TAE			N/A		
Time alignment error relative to cell 2 ^{Note 5}	μs	-			-			≤ TAE			≤ TAE			N/A		
Time alignment error relative to cell 3 ^{Note 5}	μs	-			-			-			≤ TAE			N/A		

- Note 1: OCNG shall be used such that all cells are fully allocated and a constant total transmitted power spectral density is achieved for all OFDM symbols.
- Note 2: Interference from other cells and noise sources not specified in the test is assumed to be constant over subcarriers and time and shall be modelled as AWGN of appropriate power for N_{oc} to be fulfilled.
- Note 3: E_s/I_{ot} , RSRP, SCH_RP and I_o have been derived from other parameters for information purposes. They are not settable parameters themselves.
- Note 4: The resources for uplink transmission are assigned to the UE prior to the start of time period T2.
- Note 5: Time alignment error (TAE) as specified in TS 36.104 [30] clause 6.5.3.1. The TAE value depends upon the type of carrier aggregation.

A.8.16.51.2 Test Requirements

The UE shall send one Event A6 triggered measurement report for Cell 5 with a measurement reporting delay of less than 6.4s ($20 \times \text{measCycleSCell}$) from the beginning of time T2.

The UE shall send one Event A1 triggered measurement report for Cell 2 with a measurement reporting delay of less than 6.4s ($20 \times \text{measCycleSCell}$) from beginning of time T2.

The UE shall send one Event A2 triggered measurement report for Cell 1 with a measurement reporting delay of less than 200 ms from beginning of time T3.

The UE shall send one Event A2 triggered measurement report for Cell 2 with a measurement reporting delay of less than 1.6s ($5 \times \text{measCycleSCell}$) from beginning of time T3.

The UE shall send one Event A2 triggered measurement report for Cell 3 with a measurement reporting delay of less than 1.6s ($5 \times \text{measCycleSCell}$) from beginning of time T3.

The UE shall send one Event A2 triggered measurement report for Cell 4 with a measurement reporting delay of less than 1.6s ($5 \times \text{measCycleSCell}$) from beginning of time T3.

The UE shall not send event triggered measurement reports as long as the reporting criteria are not fulfilled.

The rate of correct events observed during repeated tests shall be at least 90% for each of the events.

NOTE: The actual overall delays measured in the tests may be up to $2 \times \text{TTI}_{\text{DCCH}}$ higher than the measurement reporting delays above because of TTI insertion uncertainty of the measurement report in DCCH.

A.8.16.52 E-UTRAN 4 DL TDD CA Event Triggered Reporting with 3 deactivated SCells in Non-DRX

A.8.16.52.1 Test Purpose and Environment

The purpose of this test is to verify that the UE correctly detects events A1 (Serving cell becomes better than threshold), A2 (Serving cell becomes worse than threshold) and A6 (Neighbour becomes better than SCell) defined in TS 36.331 [2] within the requirements stated in clause 8.3.3.2.1.

In this test case there are 5 cells. Cell 1 is the PCell on the TDD PCC F1. Cell 2 is the configured and deactivated SCell on the TDD SCC F2. Cell 3 is the configured and deactivated SCell on the TDD SCC F3. Cell 4 is the configured and deactivated SCell on the TDD SCC F4, and cell 5 is the neighbor cell on the TDD SCC F4.

The test parameters are given in Tables A.8.16.52.1-1 and A.8.16.52.1-2 below. It is indicated to the UE in the measurement control information that event-triggered reporting with Events A1 (cell2), A2 (PCell and SCells) and A6 are used. The test consists of three successive time periods, with duration of T1, T2 and T3, respectively. During T1 the UE shall not have any information on cell 5. At the beginning of T2 the transmission power of cell 5 is increased to the same level as for cell 4, and due to usage of an offset this shall result in reporting of Event A6. Also, at the beginning of T2 the transmission power of cell 2 is increased to the same level as for cell 1, which shall result in reporting of Event A1. At the beginning of T3 the transmission powers of cells 1, 2, 3, 4 and 5 are reduced below a threshold value and this shall result in reporting of Event A2 for Cell 1, for Cell 2, for Cell3 and for Cell 4.

Table A.8.16.52.1-1: General test parameters for E-UTRAN TDD-TDD 4 DL CA event triggered reporting under fading propagation conditions with 3 configured but deactivated SCells in non-DRX

Parameter		Unit	Value	Comment
E-UTRA RF Channel Number			1, 2, 3, 4	Three radio channels are used for this test
Active PCell			Cell 1	Primary cell on RF channel number 1.
Configured deactivated SCell			Cell 2	Configured deactivated secondary cell on RF channel number 2.
Configured deactivated SCell			Cell 3	Configured deactivated secondary cell on RF channel number 3.
Configured deactivated SCell			Cell 4	Configured deactivated secondary cell on RF channel number 4.
Neighbour cell			Cell 5	Neighbour cell to be identified on RF channel number 4.
CP length			Normal	
DRX			OFF	Continuous monitoring of primary cell
Special subframe configuration			6	As specified in table 4.2-1 in TS 36.211. The same configuration applies to all TDD cells
Uplink-downlink configuration			1	As specified in table 4.2-2 in TS 36.211. The same configuration applies to all TDD cells.
A1	Hysteresis	dB	0	Hysteresis for evaluation of event A1.
	Threshold RSRP	dBm	-98	Actual RSRP threshold for event A1. Needs to take absolute accuracy tolerance in section 9.1.11.1 into account plus margin.
	Time To Trigger	s	0	
A2	Hysteresis	dB	0	Hysteresis for evaluation of event A2.
	Threshold RSRP	dBm	-98	Actual RSRP threshold for event A2. Needs to take absolute accuracy tolerance in section 9.1.11.1 into account plus margin.
	Time To Trigger	s	0	
A6	Hysteresis	dB	0	Hysteresis for evaluation of event A6.
	Offset	dB	-6	Offset parameter for evaluation of event A6. Needs to take relative accuracy tolerance in section 9.1.11.2 into account plus margin.
	Report on leave		False	
	Time To Trigger	s	0	
Cell-individual offset for cells on RF channel number 1		dB	0	Individual offset for cells on primary component carrier.
Cell-individual offset for cells on RF channel number 2		dB	0	Individual offset for cells on secondary component carrier.
Cell-individual offset for cells on RF channel number 3		dB	0	Individual offset for cells on secondary component carrier.
Cell-individual offset for cells on RF channel number 4		dB	0	Individual offset for cells on secondary component carrier.
Filter coefficient			0	L3 filtering is not used
SCell measurement cycle (measCycleSCell)		ms	320	
T1		s	5	During this time the cell1 and cell3 shall be known to the UE; but cell2 and cell 5 shall be unknown to the UE.
T2		s	≤12	UE should report Event A1 for cell2 and event A6 for cell5 within 6.4s (20xscellMeasCycle)
T3		s	5	UE should report Event A2 within 200 ms for cell 1, and 1.6s for cells 2, 3 and 4.

Table A.8.16.52.1-2: Cell specific test parameters for E-UTRAN TDD-TDD 4 DL CA event triggered reporting under fading propagation conditions with 3 configured but deactivated SCells in non-DRX

Parameter	Unit	Cell 1			Cell 2			Cell 3			Cell 4			Cell 5		
		T1	T2	T3	T1	T2	T3	T1	T2	T3	T1	T2	T3	T1	T2	T3
E-UTRA RF Channel Number		1			2			3			4					
BW _{channel}		5MHz: N _{RB,c} = 25 10MHz: N _{RB,c} = 50 20MHz: N _{RB,c} = 100			5MHz: N _{RB,c} = 25 10MHz: N _{RB,c} = 50 20MHz: N _{RB,c} = 100			5MHz: N _{RB,c} = 25 10MHz: N _{RB,c} = 50 20MHz: N _{RB,c} = 100			5MHz: N _{RB,c} = 25 10MHz: N _{RB,c} = 50 20MHz: N _{RB,c} = 100					
PDSCH parameters: DL Reference Measurement Channel		5MHz: R.5 TDD 10MHz: R.0 TDD 20MHz: R.4 TDD			-			-			-			-		
PCFICH/PDCCH/PHICH parameters: DL Reference Measurement Channel		5MHz: R.11 TDD 10MHz: R.6 TDD 20MHz: R.10 TDD			5MHz: R.11 TDD 10MHz: R.6 TDD 20MHz: R.10 TDD			5MHz: R.11 TDD 10MHz: R.6 TDD 20MHz: R.10 TDD			5MHz: R.11 TDD 10MHz: R.6 TDD 20MHz: R.10 TDD			5MHz: R.11 TDD 10MHz: R.6 TDD 20MHz: R.10 TDD		
OCNG Patterns		5MHz: OP.15 TDD 10MHz: OP.1 TDD 20MHz: OP.11 TDD			5MHz: OP.16 TDD 10MHz: OP.2 TDD 20MHz: OP.12 TDD			5MHz: OP.16 TDD 10MHz: OP.2 TDD 20MHz: OP.12 TDD			5MHz: OP.16 TDD 10MHz: OP.2 TDD 20MHz: OP.12 TDD			5MHz: OP.16 TDD 10MHz: OP.2 TDD 20MHz: OP.12 TDD		
PBCH_RA	dB	0			0			0			0			0		
PBCH_RB	dB															
PSS_RA	dB															
SSS_RA	dB															
PCFICH_RB	dB															
PHICH_RA	dB															
PHICH_RB	dB															
PDCCH_RA	dB															
PDCCH_RB	dB															
PDSCH_RA	dB															
PDSCH_RB	dB															
OCNG_RA ^{Note 1}	dB															
OCNG_RB ^{Note 1}	dB															
N _{oc} ^{Note 2}	dBm/15 KHz															
\bar{E}_s/N_{oc}	dB	17	17	-3	- infinity	17	-3	17	17	-3	17	17	-3	- infinity	17	-3
\bar{E}_s/I_{ot} ^{Note 3}	dB	17	17	-3	- infinity	17	-3	17	17	-3	17	-0.09	-4.76	- infinity	-0.09	-4.76
RSRP ^{Note 3}	dBm/15 kHz	-87	-87	-107	- infinity	-87	-107	-87	-87	-107	-87	-87	-107	- infinity	-87	-107
SCH_RP ^{Note 3}	dBm/15 kHz	-87	-87	-107	- infinity	-87	-107	-87	-87	-107	-87	-87	-107	- infinity	-87	-107
I _o ^{Note 3}	dBm/Ch BW	-59.13 +10log (N _{RB,c} /50)	-59.13 +10log (N _{RB,c} /50)	-74.45 +10log (N _{RB,c} /50)	-76.22 +10log (N _{RB,c} /50)	-59.13 +10log (N _{RB,c} /50)	-74.45 +10log (N _{RB,c} /50)	-59.13 +10log (N _{RB,c} /50)	-59.13 +10log (N _{RB,c} /50)	-74.45 +10log (N _{RB,c} /50)	-59.13 +10log (N _{RB,c} /50)	-56.17 +10log (N _{RB,c} /50)	-73.20 +10log (N _{RB,c} /50)	Specified in columns for Cell 4		
Propagation Condition		AWGN			ETU70			ETU70			ETU70			ETU70		

Correlation Matrix and Antenna Configuration		1x2	1x2 Low	1x2 Low	1x2 Low	1x2 Low
Timing offset to Cell 1	μs	-	0	0	0	3
Time alignment error relative to cell 1 ^{Note 5}	μs	-	$\leq \text{TAE}$	$\leq \text{TAE}$	$\leq \text{TAE}$	N/A
Time alignment error relative to cell 2 ^{Note 5}	μs	-	-	$\leq \text{TAE}$	$\leq \text{TAE}$	N/A
Time alignment error relative to cell 3 ^{Note 5}	μs	-	-	-	$\leq \text{TAE}$	N/A

Note 1: OCNG shall be used such that all cells are fully allocated and a constant total transmitted power spectral density is achieved for all OFDM symbols.

Note 2: Interference from other cells and noise sources not specified in the test is assumed to be constant over subcarriers and time and shall be modelled as AWGN of appropriate power for N_{oc} to be fulfilled.

Note 3: E_s/I_{ot} , RSRP, SCH_RP and I_o have been derived from other parameters for information purposes. They are not settable parameters themselves.

Note 4: The resources for uplink transmission are assigned to the UE prior to the start of time period T2.

Note 5: Time alignment error (TAE) as specified in TS 36.104 [30] clause 6.5.3.1. The TAE value depends upon the type of carrier aggregation.

A.8.16.52.2 Test Requirements

The UE shall send one Event A6 triggered measurement report for Cell 5 with a measurement reporting delay of less than 6.4s ($20 \times \text{measCycleSCell}$) from the beginning of time T2.

The UE shall send one Event A1 triggered measurement report for Cell 2 with a measurement reporting delay of less than 6.4s ($20 \times \text{measCycleSCell}$) from beginning of time T2.

The UE shall send one Event A2 triggered measurement report for Cell 1 with a measurement reporting delay of less than 200 ms from beginning of time T3.

The UE shall send one Event A2 triggered measurement report for Cell 2 with a measurement reporting delay of less than 1.6s ($5 \times \text{measCycleSCell}$) from beginning of time T3.

The UE shall send one Event A2 triggered measurement report for Cell 3 with a measurement reporting delay of less than 1.6s ($5 \times \text{measCycleSCell}$) from beginning of time T3.

The UE shall send one Event A2 triggered measurement report for Cell 4 with a measurement reporting delay of less than 1.6s ($5 \times \text{measCycleSCell}$) from beginning of time T3.

The UE shall not send event triggered measurement reports as long as the reporting criteria are not fulfilled.

The rate of correct events observed during repeated tests shall be at least 90% for each of the events.

NOTE: The actual overall delays measured in the tests may be up to $2 \times \text{TTI}_{\text{DCCH}}$ higher than the measurement reporting delays above because of TTI insertion uncertainty of the measurement report in DCCH.

A.8.16.53 4 DL PCell in FDD CA Event Triggered Reporting with 3 Deactivated SCells in Non-DRX

A.8.16.53.1 Test Purpose and Environment

The purpose of this test is to verify that the UE correctly detects events A1 (Serving cell becomes better than threshold), A2 (Serving cell becomes worse than threshold) and A6 (Neighbour becomes better than SCell) defined in TS 36.331 [2] within the requirements stated in clause 8.3.3.2.1.

The test parameters are given in Tables A.8.16.53.1-1, A.8.16.53.1-2 and A.8.16.53.1-3 below. It is indicated to the UE in the measurement control information that event-triggered reporting with Events A1 (for only SCell1 i.e. cell2), A2 (PCell and SCells) and A6 is used. The test consists of three successive time periods, with duration of T1, T2 and T3, respectively. During T1 the UE shall not have any information on cell 5. At the beginning of T2 the transmission power of cell 5 is increased to the same level as for cell 4, and due to usage of an offset this shall result in reporting of Event A6. Also, at the beginning of T2 the transmission power of cell 2 is increased to the same level as for cell 1, which shall result in reporting of Event A1. At the beginning of T3 the transmission powers of cells 1, 2, 3 and 4 are reduced below a threshold value and this shall result in reporting of Event A2 for Cell 1, for Cell 2, for Cell 3 and for Cell 4.

Table A.8.16.53.1-1: General test parameters for E-UTRAN TDD-FDD 4 DL CA event triggered reporting under fading propagation conditions with 3 configured but deactivated SCells in non-DRX with PCell in FDD

Parameter	Unit	Value	Comment
E-UTRA RF Channel Number		1, 2, 3, 4	Three radio channels are used for this test
Active PCell		Cell 1	Primary cell on RF channel number 1.
Configured deactivated SCell		Cell 2	Configured deactivated secondary cell on RF channel number 2.
Configured deactivated SCell		Cell 3	Configured deactivated secondary cell on RF channel number 3.
Configured deactivated SCell		Cell 4	Configured deactivated secondary cell on RF channel number 4.
Neighbour cell		Cell 5	Neighbour cell to be identified on RF channel number 4.
CP length		Normal	
DRX		OFF	Continuous monitoring of primary cell
Special subframe configuration		6	As specified in table 4.2-1 in TS 36.211. The same configuration applies to all TDD cells (cell2, cell3, cell4 and cell5).

Uplink-downlink configuration			1	As specified in table 4.2-2 in TS 36.211. The same configuration applies to all TDD cells (cell2, cell3, cell4 and cell5).
A1	Hysteresis	dB	0	Hysteresis for evaluation of event A1.
	Threshold RSRP	dBm	-98	Actual RSRP threshold for event A1. Needs to take absolute accuracy tolerance in section 9.1.11.1 into account plus margin.
	Time To Trigger	s	0	
A2	Hysteresis	dB	0	Hysteresis for evaluation of event A2.
	Threshold RSRP	dBm	-98	Actual RSRP threshold for event A2. Needs to take absolute accuracy tolerance in section 9.1.11.1 into account plus margin.
	Time To Trigger	s	0	
A6	Hysteresis	dB	0	Hysteresis for evaluation of event A6.
	Offset	dB	-6	Offset parameter for evaluation of event A6. Needs to take relative accuracy tolerance in section 9.1.11.2 into account plus margin.
	Report on leave		False	
	Time To Trigger	s	0	
Cell-individual offset for cells on RF channel number 1		dB	0	Individual offset for cells on primary component carrier.
Cell-individual offset for cells on RF channel number 2		dB	0	Individual offset for cells on secondary component carrier.
Cell-individual offset for cells on RF channel number 3		dB	0	Individual offset for cells on secondary component carrier.
Cell-individual offset for cells on RF channel number 4		dB	0	Individual offset for cells on secondary component carrier.
Filter coefficient			0	L3 filtering is not used
SCell measurement cycle (measCycleSCell)		ms	320	For cell2, cell3 and cell4
T1		s	5	During this time the cell1, cell3 and cell4 shall be known to the UE; but cell2 and cell5 shall be unknown to the UE.
T2		s	≤12	UE should report Event A1 for cell2 and event A6 for cell5 within 6.4s (20×scellMeasCycle)
T3		s	5	UE should report Event A2 within 200 ms for cell1 and within 1.6s for each of cells2, 3 and 4.

Table A.8.16.53.1-2: Cell specific test parameters for E-UTRAN TDD-FDD 4 DL CA event triggered reporting under fading propagation conditions with 3 configured but deactivated SCells in non-DRX with PCell in FDD

Parameter	Unit	Cell 1			Cell 2			Cell3		
		T1	T2	T3	T1	T2	T3	T1	T2	T3
E-UTRA RF Channel Number		1			2			3		
$BW_{channel}$		5MHz: $N_{RB,c} = 25$ 10MHz: $N_{RB,c} = 50$ 20MHz: $N_{RB,c} = 100$			5MHz: $N_{RB,c} = 25$ 10MHz: $N_{RB,c} = 50$ 20MHz: $N_{RB,c} = 100$			5MHz: $N_{RB,c} = 25$ 10MHz: $N_{RB,c} = 50$ 20MHz: $N_{RB,c} = 100$		
PDSCH parameters: DL Reference Measurement Channel		5MHz: R.5 FDD 10MHz: R.0 FDD 20MHz: R.4 FDD			-			-		
PCFICH/PDCCH/PHICH parameters: DL Reference Measurement Channel		5MHz: R.11 FDD 10MHz: R.6 FDD 20MHz: R.10 FDD			5MHz: R.11 TDD 10MHz: R.6 TDD 20MHz: R.10 TDD			5MHz: R.11 TDD 10MHz: R.6 TDD 20MHz: R.10 TDD		
OCNG Patterns		5MHz: OP.15 FDD 10MHz: OP.1 FDD 20MHz: OP.11 FDD			5MHz: OP.10 TDD 10MHz: OP.2 TDD 20MHz: OP.8 TDD			5MHz: OP.10 TDD 10MHz: OP.2 TDD 20MHz: OP.8 TDD		
PBCH_RA	dB	0			0			0		
PBCH_RB	dB									
PSS_RA	dB									
SSS_RA	dB									
PCFICH_RB	dB									
PHICH_RA	dB									
PHICH_RB	dB									
PDCCH_RA	dB									
PDCCH_RB	dB									
PDSCH_RA	dB									
PDSCH_RB	dB									
OCNG_RA ^{Note 1}	dB									
OCNG_RB ^{Note 1}	dB									
N_{oc} ^{Note 2}	dBm/15 KHz									
\bar{E}_s/N_{oc}	dB	17	17	-3	- infinity	17	-3	17	17	-3
\bar{E}_s/I_{ot} ^{Note 3}	dB	17	17	-3	- infinity	17	-3	17	17	-3
RSRP ^{Note 3}	dBm/15 kHz	-87	-87	-107	- infinity	-87	-107	-87	-87	-107
SCH_RP ^{Note 3}	dBm/15 kHz	-87	-87	-107	- infinity	-87	-107	-87	-87	-107
I_o ^{Note 3}	dBm/Ch BW	-59.13 +10log ($N_{RB,c}$ /50)	-59.13 +10log ($N_{RB,c}$ /50)	-74.45 +10log ($N_{RB,c}$ /50)	-76.22 +10log ($N_{RB,c}$ /50)	-59.13 +10log ($N_{RB,c}$ /50)	-74.45 +10log ($N_{RB,c}$ /50)	-59.13 +10log ($N_{RB,c}$ /50)	-59.13 +10log ($N_{RB,c}$ /50)	-74.45 +10log ($N_{RB,c}$ /50)
Propagation Condition		AWGN			ETU70			ETU70		
Correlation Matrix and Antenna Configuration		1x2 Low			1x2 Low			1x2 Low		
Timing offset to cell1	μ s	-			0			0		
Time alignment error relative to cell1 ^{Note 5}	μ s	-			\leq TAE			\leq TAE		
Time alignment error relative to cell 2 ^{Note 5}	μ s	\leq TAE			-			\leq TAE		
Time alignment error relative to cell 3 ^{Note 5}	μ s	\leq TAE			\leq TAE			-		
Time alignment error relative to cell 4 ^{Note 5}	μ s	\leq TAE			\leq TAE			\leq TAE		
Note 1:	OCNG shall be used such that all cells are fully allocated and a constant total transmitted power spectral density is achieved for all OFDM symbols.									
Note 2:	Interference from other cells and noise sources not specified in the test is assumed to be constant over subcarriers and time and shall be modelled as AWGN of appropriate power for N_{oc} to be fulfilled.									
Note 3:	E_s/I_{ot} , RSRP, SCH_RP and I_o have been derived from other parameters for information purposes. They are not settable parameters themselves.									
Note 4:	The resources for uplink transmission are assigned to the UE prior to the start of time period T2.									
Note 5:	Time alignment error (TAE) as specified in TS 36.104 [30] clause 6.5.3.1. The TAE value depends upon the type of carrier aggregation.									

Table A.8.16.53.1-3: Cell specific test parameters for E-UTRAN TDD-FDD 4 DL CA event triggered reporting under fading propagation conditions with 3 configured but deactivated SCells in non-DRX with PCell in FDD

Parameter	Unit	Cell 4			Cell 5		
		T1	T2	T3	T1	T2	T3
E-UTRA RF Channel Number		4					
$BW_{channel}$		5MHz: $N_{RB,c} = 25$ 10MHz: $N_{RB,c} = 50$ 20MHz: $N_{RB,c} = 100$					
PDSCH parameters: DL Reference Measurement Channel		-			-		
PCFICH/PDCCH/PHICH parameters: DL Reference Measurement Channel		5MHz: R.11 TDD 10MHz: R.6 TDD 20MHz: R.10 TDD			5MHz: R.11 TDD 10MHz: R.6 TDD 20MHz: R.10 TDD		
OCNG Patterns		5MHz: OP.10 TDD 10MHz: OP.2 TDD 20MHz: OP.8 TDD			5MHz: OP.10 TDD 10MHz: OP.2 TDD 20MHz: OP.8 TDD		
PBCH_RA	dB	0			0		
PBCH_RB	dB						
PSS_RA	dB						
SSS_RA	dB						
PCFICH_RB	dB						
PHICH_RA	dB						
PHICH_RB	dB						
PDCCH_RA	dB						
PDCCH_RB	dB						
PDSCH_RA	dB						
PDSCH_RB	dB						
OCNG_RA ^{Note 1}	dB						
OCNG_RB ^{Note 1}	dB						
N_{oc} ^{Note 2}	dBm/15 KHz						
\bar{E}_s/N_{oc}	dB	17	17	-3	-infinity	17	-3
\bar{E}_s/I_{ot} ^{Note 3}	dB	17	-0.09	-4.76	-infinity	-0.09	-4.76
RSRP ^{Note 3}	dBm/15 kHz	-87	-87	-107	-infinity	-87	-107
SCH_RP ^{Note 3}	dBm/15 kHz	-87	-87	-107	-infinity	-87	-107
I_o ^{Note 3}	dBm/Ch BW	-59.13 +10log ($N_{RB,c}$ /50)	-56.17 +10log ($N_{RB,c}$ /50)	-73.20 +10log ($N_{RB,c}$ /50)	Specified in columns for Cell 4		
Propagation Condition		ETU70			ETU70		
Correlation Matrix and Antenna Configuration		1x2 Low			1x2 Low		
Timing offset to Cell 1	μs	0			3		
Time alignment error relative to cell 1 ^{Note 5}	μs	-			N/A		
Time alignment error relative to cell 2 ^{Note 5}	μs	-			N/A		
Time alignment error relative to cell 3 ^{Note 5}	μs	-			N/A		
Time alignment error relative to cell 4 ^{Note 5}	μs	-			N/A		
<p>Note 1: OCNG shall be used such that all cells are fully allocated and a constant total transmitted power spectral density is achieved for all OFDM symbols.</p> <p>Note 2: Interference from other cells and noise sources not specified in the test is assumed to be constant over subcarriers and time and shall be modelled as AWGN of appropriate power for N_{oc} to be fulfilled.</p> <p>Note 3: \bar{E}_s/I_{ot}, RSRP, SCH_RP and I_o have been derived from other parameters for information purposes. They are not settable parameters themselves.</p> <p>Note 4: The resources for uplink transmission are assigned to the UE prior to the start of time period T2.</p> <p>Note 5: Time alignment error (TAE) as specified in TS 36.104 [30] clause 6.5.3.1. The TAE value depends upon the type of carrier aggregation.</p>							

A.8.16.53.2 Test Requirements

The UE shall send one Event A6 triggered measurement report for Cell 5 with a measurement reporting delay of less than 6.4s ($20 \times \text{measCycleSCell}$) from the beginning of time T2.

The UE shall send one Event A1 triggered measurement report for Cell 2 with a measurement reporting delay of less than 6.4s ($20 \times \text{measCycleSCell}$) from beginning of time T2.

The UE shall send one Event A2 triggered measurement report for Cell 1 with a measurement reporting delay of less than 200 ms from beginning of time T3.

The UE shall send one Event A2 triggered measurement report for Cell 2 with a measurement reporting delay of less than 1.6s ($5 \times \text{measCycleSCell}$) from beginning of time T3.

The UE shall send one Event A2 triggered measurement report for Cell 3 with a measurement reporting delay of less than 1.6s ($5 \times \text{measCycleSCell}$) from beginning of time T3.

The UE shall send one Event A2 triggered measurement report for Cell 4 with a measurement reporting delay of less than 1.6s ($5 \times \text{measCycleSCell}$) from beginning of time T3.

The UE shall not send event triggered measurement reports as long as the reporting criteria are not fulfilled.

The rate of correct events observed during repeated tests shall be at least 90% for each of the events.

NOTE: The actual overall delays measured in the tests may be up to $2 \times \text{TTI}_{\text{DCCH}}$ higher than the measurement reporting delays above because of TTI insertion uncertainty of the measurement report in DCCH.

A.8.16.54 4 DL PCell in TDD CA Event Triggered Reporting with 3 Deactivated SCells in Non-DRX

A.8.16.54.1 Test Purpose and Environment

The purpose of this test is to verify that the UE correctly detects events A1 (Serving cell becomes better than threshold), A2 (Serving cell becomes worse than threshold) and A6 (Neighbour becomes better than SCell) defined in TS 36.331 [2] within the requirements stated in clause 8.3.3.2.1.

The test parameters are given in Tables A.8.16.54.1-1, A.8.16.54.1-2 and A.8.16.54.1-3 below. It is indicated to the UE in the measurement control information that event-triggered reporting with Events A1 (for only SCell1 i.e. cell2), A2 (PCell and SCells) and A6 is used. The test consists of three successive time periods, with duration of T1, T2 and T3, respectively. During T1 the UE shall not have any information on cell 5. At the beginning of T2 the transmission power of cell 5 is increased to the same level as for cell 4, and due to usage of an offset this shall result in reporting of Event A6. Also, at the beginning of T2 the transmission power of cell 2 is increased to the same level as for cell 1, which shall result in reporting of Event A1. At the beginning of T3 the transmission powers of cells 1, 2, 3 and 4 are reduced below a threshold value and this shall result in reporting of Event A2 for Cell 1, for Cell 2, for Cell 3 and for Cell 4.

Table A.8.16.54.1-1: General test parameters for E-UTRAN TDD-FDD 4 DL CA event triggered reporting under fading propagation conditions with 3 configured but deactivated SCells in non-DRX with PCell in TDD

Parameter	Unit	Value	Comment
E-UTRA RF Channel Number		1, 2, 3, 4	Three radio channels are used for this test
Active PCell		Cell 1	Primary cell on RF channel number 1.
Configured deactivated SCell		Cell 2	Configured deactivated secondary cell on RF channel number 2.
Configured deactivated SCell		Cell 3	Configured deactivated secondary cell on RF channel number 3.
Configured deactivated SCell		Cell 4	Configured deactivated secondary cell on RF channel number 4.
Neighbour cell		Cell 5	Neighbour cell to be identified on RF channel number 4.
CP length		Normal	
DRX		OFF	Continuous monitoring of primary cell
Special subframe configuration		6	As specified in table 4.2-1 in TS 36.211. The configuration applies to the TDD cell (cell1).

Uplink-downlink configuration			1	As specified in table 4.2-2 in TS 36.211. The configuration applies to the TDD cell (cell1).
A1	Hysteresis	dB	0	Hysteresis for evaluation of event A1.
	Threshold RSRP	dBm	-98	Actual RSRP threshold for event A1. Needs to take absolute accuracy tolerance in section 9.1.11.1 into account plus margin.
	Time To Trigger	s	0	
A2	Hysteresis	dB	0	Hysteresis for evaluation of event A2.
	Threshold RSRP	dBm	-98	Actual RSRP threshold for event A2. Needs to take absolute accuracy tolerance in section 9.1.11.1 into account plus margin.
	Time To Trigger	s	0	
A6	Hysteresis	dB	0	Hysteresis for evaluation of event A6.
	Offset	dB	-6	Offset parameter for evaluation of event A6. Needs to take relative accuracy tolerance in section 9.1.11.2 into account plus margin.
	Report on leave		False	
	Time To Trigger	s	0	
Cell-individual offset for cells on RF channel number 1		dB	0	Individual offset for cells on primary component carrier.
Cell-individual offset for cells on RF channel number 2		dB	0	Individual offset for cells on secondary component carrier.
Cell-individual offset for cells on RF channel number 3		dB	0	Individual offset for cells on secondary component carrier.
Cell-individual offset for cells on RF channel number 4		dB	0	Individual offset for cells on secondary component carrier.
Filter coefficient			0	L3 filtering is not used
SCell measurement cycle (measCycleSCell)		ms	320	For cell2, cell3 and cell4
T1		s	5	During this time the cell1, cell3 and cell4 shall be known to the UE; but cell2 and cell5 shall be unknown to the UE.
T2		s	≤12	UE should report Event A1 for cell2 and event A6 for cell5 within 6.4s (20×sCellMeasCycle)
T3		s	5	UE should report Event A2 within 200 ms for cell1 and within 1.6s for each of cells2, 3 and 4.

Table A.8.16.54.1-2: Cell specific test parameters for E-UTRAN TDD-FDD 4 DL CA event triggered reporting under fading propagation conditions with 3 configured but deactivated SCells in non-DRX with PCell in TDD

Parameter	Unit	Cell 1			Cell 2			Cell3		
		T1	T2	T3	T1	T2	T3	T1	T2	T3
E-UTRA RF Channel Number		1			2			3		
BW _{channel}		5MHz: N _{RB,c} = 25 10MHz: N _{RB,c} = 50 20MHz: N _{RB,c} = 100			5MHz: N _{RB,c} = 25 10MHz: N _{RB,c} = 50 20MHz: N _{RB,c} = 100			5MHz: N _{RB,c} = 25 10MHz: N _{RB,c} = 50 20MHz: N _{RB,c} = 100		
PDSCH parameters: DL Reference Measurement Channel		5MHz: R.4 TDD 10MHz: R.0 TDD 20MHz: R.3 TDD			-			-		
PCFICH/PDCCH/PHICH parameters: DL Reference Measurement Channel		5MHz: R.11 TDD 10MHz: R.6 TDD 20MHz: R.10 TDD			5MHz: R.11 FDD 10MHz: R.6 FDD 20MHz: R.10 FDD			5MHz: R.11 FDD 10MHz: R.6 FDD 20MHz: R.10 FDD		
OCNG Patterns		5MHz: OP.9 TDD 10MHz: OP.1 TDD 20MHz: OP.7 TDD			5MHz: OP.16 FDD 10MHz: OP.2 FDD 20MHz: OP.12 FDD			5MHz: OP.16 FDD 10MHz: OP.2 FDD 20MHz: OP.12 FDD		
PBCH_RA	dB	0			0			0		
PBCH_RB	dB									
PSS_RA	dB									
SSS_RA	dB									
PCFICH_RB	dB									
PHICH_RA	dB									
PHICH_RB	dB									
PDCCH_RA	dB									
PDCCH_RB	dB									
PDSCH_RA	dB									
PDSCH_RB	dB									
OCNG_RA ^{Note 1}	dB									
OCNG_RB ^{Note 1}	dB									
N _{oc} ^{Note 2}	dBm/15 KHz									
\bar{E}_s/N_{oc}	dB	17	17	-3	- infinity	17	-3	17	17	-3
\bar{E}_s/I_{ot} ^{Note 3}	dB	17	17	-3	- infinity	17	-3	17	17	-3
RSRP ^{Note 3}	dBm/15 kHz	-87	-87	-107	- infinity	-87	-107	-87	-87	-107
SCH_RP ^{Note 3}	dBm/15 kHz	-87	-87	-107	- infinity	-87	-107	-87	-87	-107
I _o ^{Note 3}	dBm/Ch BW	-59.13 +10log (N _{RB,c} /50)	-59.13 +10log (N _{RB,c} /50)	-74.45 +10log (N _{RB,c} /50)	-76.22 +10log (N _{RB,c} /50)	-59.13 +10log (N _{RB,c} /50)	-74.45 +10log (N _{RB,c} /50)	-59.13 +10log (N _{RB,c} /50)	-59.13 +10log (N _{RB,c} /50)	-74.45 +10log (N _{RB,c} /50)
Propagation Condition		AWGN			ETU70			ETU70		
Correlation Matrix and Antenna Configuration		1x2 Low			1x2 Low			1x2 Low		
Timing offset to cell1	μs	-			0			0		
Time alignment error relative to cell1 ^{Note5}	μs	-			≤ TAE			≤ TAE		
Time alignment error relative to cell 2 ^{Note 5}	μs	≤ TAE			-			≤ TAE		
Time alignment error relative to cell 3 ^{Note 5}	μs	≤ TAE			≤ TAE			-		
Time alignment error relative to cell 4 ^{Note 5}	μs	≤ TAE			≤ TAE			≤ TAE		
Note 1:	OCNG shall be used such that all cells are fully allocated and a constant total transmitted power spectral density is achieved for all OFDM symbols.									
Note 2:	Interference from other cells and noise sources not specified in the test is assumed to be constant over subcarriers and time and shall be modelled as AWGN of appropriate power for N _{oc} to be fulfilled.									
Note 3:	Es/I _{ot} , RSRP, SCH_RP and I _o have been derived from other parameters for information purposes. They are not settable parameters themselves.									
Note 4:	The resources for uplink transmission are assigned to the UE prior to the start of time period T2.									
Note 5:	Time alignment error (TAE) as specified in TS 36.104 [30] clause 6.5.3.1. The TAE value depends upon the type of carrier aggregation.									

Table A.8.16.54.1-3: Cell specific test parameters for E-UTRAN TDD-FDD 4 DL CA event triggered reporting under fading propagation conditions with 3 configured but deactivated SCells in non-DRX with PCell in TDD

Parameter	Unit	Cell 4			Cell 5		
		T1	T2	T3	T1	T2	T3
E-UTRA RF Channel Number		4					
BW _{channel}		5MHz: N _{RB,c} = 25 10MHz: N _{RB,c} = 50 20MHz: N _{RB,c} = 100					
PDSCH parameters: DL Reference Measurement Channel		-			-		
PCFICH/PDCCH/PHICH parameters: DL Reference Measurement Channel		5MHz: R.11 FDD 10MHz: R.6 FDD 20MHz: R.10 FDD			5MHz: R.11 FDD 10MHz: R.6 FDD 20MHz: R.10 FDD		
OCNG Patterns		5MHz: OP.16 FDD 10MHz: OP.2 FDD 20MHz: OP.12 FDD			5MHz: OP.16 FDD 10MHz: OP.2 FDD 20MHz: OP.12 FDD		
PBCH_RA	dB	0			0		
PBCH_RB	dB						
PSS_RA	dB						
SSS_RA	dB						
PCFICH_RB	dB						
PHICH_RA	dB						
PHICH_RB	dB						
PDCCH_RA	dB						
PDCCH_RB	dB						
PDSCH_RA	dB						
PDSCH_RB	dB						
OCNG_RA ^{Note 1}	dB						
OCNG_RB ^{Note 1}	dB						
N _{oc} ^{Note 2}	dBm/15 KHz						
\bar{E}_s/N_{oc}	dB	17	17	-3	-infinity	17	-3
\bar{E}_s/I_{ot} ^{Note 3}	dB	17	-0.09	-4.76	-infinity	-0.09	-4.76
RSRP ^{Note 3}	dBm/15 kHz	-87	-87	-107	-infinity	-87	-107
SCH_RP ^{Note 3}	dBm/15 kHz	-87	-87	-107	-infinity	-87	-107
I _o ^{Note 3}	dBm/Ch BW	-59.13 +10log (N _{RB,c} /50)	-56.17 +10log (N _{RB,c} /50)	-73.20 +10log (N _{RB,c} /50)	Specified in columns for Cell 4		
Propagation Condition		ETU70			ETU70		
Correlation Matrix and Antenna Configuration		1x2 Low			1x2 Low		
Timing offset to cell1	μs	0			3		
Time alignment error relative to cell1 ^{Note 5}	μs	-			N/A		
Time alignment error relative to cell2 ^{Note 5}	μs	-			N/A		
Time alignment error relative to cell3 ^{Note 5}	μs	-			N/A		
Time alignment error relative to cell4 ^{Note 5}	μs	-			N/A		
Note 1:	OCNG shall be used such that all cells are fully allocated and a constant total transmitted power spectral density is achieved for all OFDM symbols.						
Note 2:	Interference from other cells and noise sources not specified in the test is assumed to be constant over subcarriers and time and shall be modelled as AWGN of appropriate power for N _{oc} to be fulfilled.						
Note 3:	Es/I _{ot} , RSRP, SCH_RP and I _o have been derived from other parameters for information purposes. They are not settable parameters themselves.						
Note 4:	The resources for uplink transmission are assigned to the UE prior to the start of time period T2.						
Note 5:	Time alignment error (TAE) as specified in TS 36.104 [30] clause 6.5.3.1. The TAE value depends upon the type of carrier aggregation.						

A.8.16.54.2 Test Requirements

The UE shall send one Event A6 triggered measurement report for Cell 5 with a measurement reporting delay of less than 6.4s ($20 \times \text{measCycleSCell}$) from the beginning of time T2.

The UE shall send one Event A1 triggered measurement report for Cell 2 with a measurement reporting delay of less than 6.4s ($20 \times \text{measCycleSCell}$) from beginning of time T2.

The UE shall send one Event A2 triggered measurement report for Cell 1 with a measurement reporting delay of less than 200 ms from beginning of time T3.

The UE shall send one Event A2 triggered measurement report for Cell 2 with a measurement reporting delay of less than 1.6s ($5 \times \text{measCycleSCell}$) from beginning of time T3.

The UE shall send one Event A2 triggered measurement report for Cell 3 with a measurement reporting delay of less than 1.6s ($5 \times \text{measCycleSCell}$) from beginning of time T3.

The UE shall send one Event A2 triggered measurement report for Cell 4 with a measurement reporting delay of less than 1.6s ($5 \times \text{measCycleSCell}$) from beginning of time T3.

The UE shall not send event triggered measurement reports as long as the reporting criteria are not fulfilled.

The rate of correct events observed during repeated tests shall be at least 90% for each of the events.

NOTE: The actual overall delays measured in the tests may be up to $2 \times \text{TTI}_{\text{DCCH}}$ higher than the measurement reporting delays above because of TTI insertion uncertainty of the measurement report in DCCH.

A.8.16.55 E-UTRAN FDD 4 DL CA Event Triggered Reporting on Deactivated SCell with PCell and SCell Interruptions in Non-DRX

A.8.16.55.1 Test Purpose and Environment

The purpose of this test is to verify that the UE correctly detects event A6 (Neighbour becomes better than SCell) defined in TS 36.331 [2] within the requirements stated in clause 8.3.3.2.1 while at the same time fulfilling the requirement on interruption rate.

The test parameters are given in Table A.8.16.55.1-1, A.8.16.55.1-2 and A.8.16.55.1-3 below. In the test there are five cells: Cell 1, Cell 2, Cell 3, Cell 4 and Cell 5. Cell 1 is PCell on the FDD primary component (RF Channel 1), Cell 2 is SCell on the FDD secondary component (RF Channel 2), Cell 3 is SCell on the FDD secondary component (RF Channel 3), Cell 4 is SCell on the FDD secondary component (RF Channel 4) and Cell 5 is the neighbour cell on the FDD secondary component (RF Channel 4). It is indicated to the UE in the measurement control information that event-triggered reporting with Event A6 is used. The test consists of four successive time periods, with duration of T1, T2, T3 and T4, respectively. During T1 and T2, Cell2, Cell3 and Cell4 are deactivated. During T1 the UE shall not have any information of Cell 5. Immediately at beginning of T2 the transmission power of Cell 5 is increased to same level as for Cell 4, and due to usage of an offset this shall result in reporting of Event A6.

At the beginning of T3, the transmission power of Cell 5 is turned off, and the test equipment sends a MAC message for activation of Cell 2 to UE but Cell3 and Cell4 remains deactivated. Immediately at beginning of T4 the transmission power of Cell 5 is increased to same level as for Cell 4, and due to usage of an offset this shall result in reporting of Event A6. The UE shall be continuously scheduled in the PCell throughout the whole test and continuously scheduled in Cell2 during T4.

Table A.8.16.55.1-1: General test parameters for E-UTRAN FDD 4 DL CA Event Triggered Reporting on Deactivated SCell with PCell and SCell interruptions in Non-DRX

Parameter	Unit	Value	Comment
E-UTRA RF Channel Number		1, 2, 3, 4	Four radio channels are used for this test
Active PCell		Cell 1	Primary cell on RF channel number 1.
Configured deactivated SCell		Cell 2	Configured deactivated secondary cell on RF channel number 2.
Configured deactivated SCell		Cell 3	Configured deactivated secondary cell on RF channel number 3.
Configured deactivated SCell		Cell 4	Configured deactivated secondary cell on RF channel number 4.

Neighbour cell		Cell 5	Neighbor cell to be identified on RF channel number 4.	
CP length		Normal		
DRX		OFF	Continuous monitoring of primary cell	
A6	Hysteresis	dB	0	Hysteresis for evaluation of event A6.
	Offset	dB	-3	Offset parameter for evaluation of event A6. Needs to take relative accuracy tolerance in clause 9.1.11.2 into account plus margin.
	Report on leave		False	
	Time To Trigger	s	0	
Cell-individual offset for cells on RF channel number 1	dB	0	Individual offset for cells on primary component carrier.	
Cell-individual offset for cells on RF channel number 2	dB	0	Individual offset for cells on secondary component carrier.	
Cell-individual offset for cells on RF channel number 3	dB	0	Individual offset for cells on secondary component carrier.	
Cell-individual offset for cells on RF channel number 4	dB	0	Individual offset for cells on secondary component carrier.	
Filter coefficient		0	L3 filtering is not used	
SCell measurement cycle	ms	640		
T1	s	4	During this time the UE shall be aware of cells 1, 2, 3 and 4 but not cell 5.	
T2	s	≤ 15	UE should report Event A6 within 12.8s (20xscellMeasCycle)	
T3	s	4	During this time the UE shall activate cell 2	
T4	s	≤ 4	UE should report Event A6 within 3.2s (5xscellMeasCycle)	

Table A.8.16.55.1-2: Cell specific test parameters for E-UTRAN FDD 4 DL CA Event Triggered Reporting on Deactivated SCell with PCell and SCell interruptions in Non-DRX (Cell #1, Cell #2, Cell #3, Cell #4)

Parameter	Unit	Cell 1				Cell 2				Cell 3				Cell 4			
		T1	T2	T3	T4	T1	T2	T3	T4	T1	T2	T3	T4	T1	T2	T3	T4
E-UTRA RF Channel Number		1				2				3				4			
BW _{channel}		5MHz: N _{RB,c} = 25 10MHz: N _{RB,c} = 50 20MHz: N _{RB,c} = 100				5MHz: N _{RB,c} = 25 10MHz: N _{RB,c} = 50 20MHz: N _{RB,c} = 100				5MHz: N _{RB,c} = 25 10MHz: N _{RB,c} = 50 20MHz: N _{RB,c} = 100				5MHz: N _{RB,c} = 25 10MHz: N _{RB,c} = 50 20MHz: N _{RB,c} = 100			
PDSCH parameters: DL Reference Measurement Channel		5MHz: R.7 FDD 10MHz: R.3 FDD 20MHz: R.6 FDD				N/A	N/A	N/A	5MHz: R.7 FDD 10MHz: R.3 FDD 20MHz: R.6 FDD	N/A				N/A			
PCFICH/PDCCH/PHICH parameters		5MHz: R.11 FDD 10MHz: R.6 FDD 20MHz: R.10 FDD				5MHz: R.11 FDD 10MHz: R.6 FDD 20MHz: R.10 FDD				5MHz: R.11 FDD 10MHz: R.6 FDD 20MHz: R.10 FDD				5MHz: R.11 FDD 10MHz: R.6 FDD 20MHz: R.10 FDD			
OCNG Pattern defined in A.3.2.1		5MHz: OP.20 FDD 10MHz: OP.10 FDD 20MHz: OP.17 FDD				5MHz: OP.19 FDD 10MHz: OP.6 FDD 20MHz: OP.14 FDD	5MHz: OP.19 FDD 10MHz: OP.6 FDD 20MHz: OP.14 FDD	5MHz: OP.19 FDD 10MHz: OP.6 FDD 20MHz: OP.14 FDD	5MHz: OP.20 FDD 10MHz: OP.10 FDD 20MHz: OP.17 FDD	5MHz: OP.16 FDD 10MHz: OP.2 FDD 20MHz: OP.12 FDD				5MHz: OP.16 FDD 10MHz: OP.2 FDD 20MHz: OP.12 FDD			
PBCH_RA	dB	0				0				0				0			
PBCH_RB	dB																
PSS_RA	dB																
SSS_RA	dB																
PCFICH_RB	dB																
PHICH_RA	dB																
PHICH_RB	dB																
PDCCH_RA	dB																
PDCCH_RB	dB																
PDSCH_RA	dB																
PDSCH_RB	dB																
OCNG_RA ^{Note 1}	dB																

OCNG_RB ^{Note 1}	dB																
N_{oc} ^{Note 3}	dBm/1 5 kHz	-101				-101				-101				-101			
\hat{E}_s/N_{oc}	dB	16	16	16	16	16	16	16	16	16	16	16	16	16	16	16	16
\hat{E}_s/I_{ot} ^{Note 4}	dB	16	16	16	16	16	16	16	16	16	16	16	16	16	-0.11	16	-0.11
RSRP ^{Note 4}	dBm/1 5 kHz	-85	-85	-85	-85	-85	-85	-85	-85	-85	-85	-85	-85	-85	-85	-85	-85
SCH_RP ^{Note 4}	dBm/1 5 kHz	-85	-85	-85	-85	-85	-85	-85	-85	-85	-85	-85	-85	-85	-85	-85	-85
I_o ^{Note 4}	dBm/C h BW	-	-	-	-	-57.11 +10log ($N_{RB,c}$ /50)	-57.11 +10log ($N_{RB,c}$ /50)	-57.11 +10log ($N_{RB,c}$ /50)	-57.11 +10log ($N_{RB,c}$ /50)	-	-	-	-	-	-	-	-
		57.11 +10log g ($N_{RB,c}$ /50)	57.11 +10log g ($N_{RB,c}$ /50)	57.11 +10log g ($N_{RB,c}$ /50)	57.11 +10log g ($N_{RB,c}$ /50)					57.11 +10log g ($N_{RB,c}$ /50)	57.11 +10log g ($N_{RB,c}$ /50)	57.11 +10log g ($N_{RB,c}$ /50)	57.11 +10log g ($N_{RB,c}$ /50)	57.11 +10log g ($N_{RB,c}$ /50)	54.15 +10log g ($N_{RB,c}$ /50)	57.11 +10log g ($N_{RB,c}$ /50)	54.15 +10log g ($N_{RB,c}$ /50)
Propagation Condition		AWGN				AWGN				AWGN				AWGN			
Antenna Configuration		1x2				1x2				1x2				1x2			
Timing offset to Cell 1	μs	-				0				0				0			
Time alignment error relative to cell 1 ^{Note 5}	μs	-				≤ TAE				≤ TAE				≤ TAE			
Time alignment error relative to cell 2 ^{Note 5}	μs	-				-				≤ TAE				≤ TAE			
Time alignment error relative to cell 3 ^{Note 5}	μs	-				-				-				≤ TAE			

Note 1: OCNG shall be used such that all cells are fully allocated and a constant total transmitted power spectral density is achieved for all OFDM symbols.
 Note 2: The resources for uplink transmission are assigned to the UE on cell1 from the start of time period T2 and on cell2 from the start of time period T4.
 Note 3: Interference from other cells and noise sources not specified in the test is assumed to be constant over subcarriers and time and shall be modelled as AWGN of appropriate power for N_{oc} to be fulfilled.
 Note 4: E_s/I_{ot} , RSRP, SCH_RP and I_o levels have been derived from other parameters for information purposes. They are not settable parameters themselves.
 Note 5: Time alignment error (TAE) as specified in TS 36.104 [30] clause 6.5.3.1. The TAE value depends upon the type of carrier aggregation.

Table A.8.16.55.1-3: Cell specific test parameters for E-UTRAN FDD 4 DL CA Event Triggered Reporting on Deactivated SCell with PCell and SCell interruptions in Non-DRX (Cell #5)

Parameter	Unit	Cell 5			
		T1	T2	T3	T4
E-UTRA RF Channel Number		4			
BW _{channel}		5MHz: N _{RB,c} = 25 10MHz: N _{RB,c} = 50 20MHz: N _{RB,c} = 100			
PDSCH parameters: DL Reference Measurement Channel		N/A			
PCFICH/PDCCH/PHICH parameters		5MHz: R.11 FDD 10MHz: R.6 FDD 20MHz: R.10 FDD			
OCNG Pattern defined in A.3.2.1		5MHz: OP.16 FDD 10MHz: OP.2 FDD 20MHz: OP.12 FDD			
PBCH_RA	dB	0			
PBCH_RB	dB				
PSS_RA	dB				
SSS_RA	dB				
PCFICH_RB	dB				
PHICH_RA	dB				
PHICH_RB	dB				
PDCCH_RA	dB				
PDCCH_RB	dB				
PDSCH_RA	dB				
PDSCH_RB	dB				
OCNG_RA ^{Note 1}	dB				
OCNG_RB ^{Note 1}	dB				
N _{oc} ^{Note 3}	dBm/15 kHz				
\hat{E}_s / N_{oc}	dB	-infinity	16	-infinity	16
\hat{E}_s / I_{ot} ^{Note 4}	dB	-infinity	-0.11	-infinity	-0.11
RSRP ^{Note 4}	dBm/15 kHz	-infinity	-85	-infinity	-85
SCH_RP ^{Note 4}	dBm/15 kHz	-infinity	-85	-infinity	-85
I _o ^{Note 4}	dBm/Ch BW	-57.11 +10log (N _{RB,c} /50)	-54.15 +10log (N _{RB,c} /50)	-57.11 +10log (N _{RB,c} /50)	-54.15 +10log (N _{RB,c} /50)
Propagation Condition		AWGN			
Antenna Configuration		1x2			
Timing offset to Cell 1	μs	3			
Time alignment error relative to cell 1 ^{Note 5}	μs	N/A			
Time alignment error relative to cell 2 ^{Note 5}	μs	N/A			
Time alignment error relative to cell 3 ^{Note 5}	μs	N/A			
<p>Note 1: OCNG shall be used such that all cells are fully allocated and a constant total transmitted power spectral density is achieved for all OFDM symbols.</p> <p>Note 2: Void</p> <p>Note 3: Interference from other cells and noise sources not specified in the test is assumed to be constant over subcarriers and time and shall be modelled as AWGN of appropriate power for N_{oc} to be fulfilled.</p> <p>Note 4: Es/I_{ot}, RSRP, SCH_RP and I_o levels have been derived from other parameters for information purposes. They are not settable parameters themselves.</p> <p>Note 5: Time alignment error (TAE) as specified in TS 36.104 [30] clause 6.5.3.1. The TAE value depends upon the type of carrier aggregation.</p>					

A.8.16.55.2 Test Requirements

The UE shall send one Event A6 triggered measurement report, with a measurement reporting delay less than 12.8s ($20 \times \text{scellMeasCycle}$) from the beginning of time period T2.

The UE shall send one Event A6 triggered measurement report, with a measurement reporting delay less than 3.2s ($5 \times \text{scellMeasCycle}$) from the beginning of time period T4.

The UE shall not send event triggered measurement reports, as long as the reporting criteria are not fulfilled.

The UE shall be scheduled on PCell continuously throughout the test. From the start of T1 until the measurement report is received during T2, at least 99.5% of all expected ACK/NACKs shall be transmitted by the UE.

The UE shall be scheduled on Cell2 continuously from the beginning of T4 to the end. From the start of T4 until the measurement report is received during T4, at least 99.5% of all expected ACK/NACKs shall be transmitted by the UE.

For a test to be considered successful requirements on both event detection and percentage of transmitted ACK/NACKs have to be fulfilled simultaneously.

The rate of correct events observed during repeated tests shall be at least 90%.

NOTE: The actual overall delays measured in the test may be up to $2 \times \text{TTI}_{\text{DCCH}}$ higher than the measurement reporting delays above because of TTI insertion uncertainty of the measurement report in DCCH.

A.8.16.56 E-UTRAN TDD 4 DL CA Event Triggered Reporting on Deactivated SCell with PCell and SCell Interruptions in Non-DRX

A.8.16.56.1 Test Purpose and Environment

The purpose of this test is to verify that the UE correctly detects event A6 (Neighbour becomes better than SCell) defined in TS 36.331 [2] within the requirements stated in clause 8.3.3.2.1 while at the same time fulfilling the requirement on interruption rate.

The test parameters are given in Table A.8.16.56.1-1, A.8.16.56.1-2 and A.8.16.56.1-3 below. In the test there are five cells: Cell 1, Cell 2, Cell 3, Cell 4 and Cell 5. Cell 1 is PCell on the TDD primary component (RF Channel 1), Cell 2 is SCell on the TDD secondary component (RF Channel 2), Cell 3 is SCell on the TDD secondary component (RF Channel 3), Cell 4 is SCell on the TDD secondary component (RF Channel 4) and Cell 5 is the neighbour cell on the TDD secondary component (RF Channel 4). It is indicated to the UE in the measurement control information that event-triggered reporting with Event A6 is used. The test consists of four successive time periods, with duration of T1, T2, T3 and T4, respectively. During T1 and T2, Cell2, Cell3 and Cell4 are deactivated. During T1 the UE shall not have any information of Cell 5. Immediately at beginning of T2 the transmission power of Cell 5 is increased to same level as for Cell 3, and due to usage of an offset this shall result in reporting of Event A6.

At the beginning of T3, the transmission power of Cell 5 is turned off, and the test equipment sends a MAC message for activation of Cell 2 to UE but Cell3 and Cell4 remains deactivated. Immediately at beginning of T4 the transmission power of Cell 5 is increased to same level as for Cell 3, and due to usage of an offset this shall result in reporting of Event A6. The UE shall be continuously scheduled in the PCell throughout the whole test and continuously scheduled in Cell2 during T4.

Table A.8.16.56.1-1: General test parameters for E-UTRAN TDD 4 DL CA Event Triggered Reporting on Deactivated SCell with PCell and SCell interruptions in Non-DRX

Parameter	Unit	Value	Comment
E-UTRA RF Channel Number		1, 2, 3, 4	Four radio channels are used for this test
Active PCell		Cell 1	Primary cell on RF channel number 1.
Configured deactivated SCell		Cell 2	Configured deactivated secondary cell on RF channel number 2.
Configured deactivated SCell		Cell 3	Configured deactivated secondary cell on RF channel number 3.
Configured deactivated SCell		Cell 4	Configured deactivated secondary cell on RF channel number 4.

Neighbour cell		Cell 5	Neighbor cell to be identified on RF channel number 4.	
CP length		Normal		
Special subframe configuration		6	As specified in table 4.2-1 in TS 36.211. The same configuration in all cells	
Uplink-downlink configuration		1	As specified in table 4.2-2 in TS 36.211. The same configuration in all cells	
DRX		OFF	Continuous monitoring of primary cell	
A6	Hysteresis	dB	0	Hysteresis for evaluation of event A6.
	Offset	dB	-3	Offset parameter for evaluation of event A6. Needs to take relative accuracy tolerance in clause 9.1.11.2 into account plus margin.
	Report on leave		False	
	Time To Trigger	s	0	
Cell-individual offset for cells on RF channel number 1	dB	0	Individual offset for cells on primary component carrier.	
Cell-individual offset for cells on RF channel number 2	dB	0	Individual offset for cells on secondary component carrier.	
Cell-individual offset for cells on RF channel number 3	dB	0	Individual offset for cells on secondary component carrier.	
Cell-individual offset for cells on RF channel number 3	dB	0	Individual offset for cells on secondary component carrier.	
Filter coefficient		0	L3 filtering is not used	
SCell measurement cycle	ms	640		
T1	s	4	During this time the UE shall be aware of cells 1, 2, 3 and 4 but not cell 5.	
T2	s	≤ 15	UE should report Event A6 within 12.8s ($20 \times \text{sCellMeasCycle}$)	
T3	s	4	During this time the UE shall activate cell 2	
T4	s	≤ 4	UE should report Event A6 within 3.2s ($5 \times \text{sCellMeasCycle}$)	

Table A.8.16.56.1-2: Cell specific test parameters for E-UTRAN TDD 4 DL CA Event Triggered Reporting on Deactivated SCell with PCell and SCell interruptions in Non-DRX (Cell #1, Cell #2, Cell #3, Cell #4)

Parameter	Unit	Cell 1				Cell 2				Cell 3				Cell 4			
		T1	T2	T3	T4	T1	T2	T3	T4	T1	T2	T3	T4	T1	T2	T3	T4
E-UTRA RF Channel Number		1				2				3				4			
BW _{channel}		5MHz: N _{RB,c} = 25 10MHz: N _{RB,c} = 50 20MHz: N _{RB,c} = 100				5MHz: N _{RB,c} = 25 10MHz: N _{RB,c} = 50 20MHz: N _{RB,c} = 100				5MHz: N _{RB,c} = 25 10MHz: N _{RB,c} = 50 20MHz: N _{RB,c} = 100				5MHz: N _{RB,c} = 25 10MHz: N _{RB,c} = 50 20MHz: N _{RB,c} = 100			
PDSCH parameters: DL Reference Measurement Channel		5MHz: R.4 TDD 10MHz: R.0 TDD 20MHz: R.3 TDD				N/A	N/A	N/A	5MHz: R.4 TDD 10MHz: R.0 TDD 20MHz: R.3 TDD	N/A				N/A			
PCFICH/PDCCH/PHICH parameters		5MHz: R.11 TDD 10MHz: R.6 TDD 20MHz: R.10 TDD				5MHz: R.11 TDD 10MHz: R.6 TDD 20MHz: R.10 TDD				5MHz: R.11 TDD 10MHz: R.6 TDD 20MHz: R.10 TDD				5MHz: R.11 TDD 10MHz: R.6 TDD 20MHz: R.10 TDD			
OCNG Pattern defined in A.3.2.1		5MHz: OP.9 TDD 10MHz: OP.1 TDD 20MHz: OP.7 TDD				5MHz: OP.10 TDD 10MHz: OP.10 TDD 20MHz: OP.8 TDD	5MHz: OP.10 TDD 10MHz: OP.10 TDD 20MHz: OP.8 TDD	5MHz: OP.10 TDD 10MHz: OP.10 TDD 20MHz: OP.8 TDD	5MHz: OP.9 TDD 10MHz: OP.1 TDD 20MHz: OP.7 TDD	5MHz: OP.10 TDD 10MHz: OP.2 TDD 20MHz: OP.8 TDD				5MHz: OP.10 TDD 10MHz: OP.2 TDD 20MHz: OP.8 TDD			
PBCH_RA	dB	0				0				0				0			
PBCH_RB	dB																
PSS_RA	dB																
SSS_RA	dB																
PCFICH_RB	dB																
PHICH_RA	dB																
PHICH_RB	dB																
PDCCH_RA	dB																
PDCCH_RB	dB																
PDSCH_RA	dB																
PDSCH_RB	dB																
OCNG_RA ^{Note 1}	dB																

OCNG_RB ^{Note 1}	dB																
N_{oc} ^{Note 3}	dBm/1 5 kHz	-101				-101				-101				-101			
\hat{E}_s/N_{oc}	dB	16	16	16	16	16	16	16	16	16	16	16	16	16	16	16	16
\hat{E}_s/I_{ot} ^{Note 4}	dB	16	16	16	16	16	16	16	16	16	16	16	16	16	-0.11	16	-0.11
RSRP ^{Note 4}	dBm/1 5 kHz	-85	-85	-85	-85	-85	-85	-85	-85	-85	-85	-85	-85	85	-85	85	-85
SCH_RP ^{Note 4}	dBm/1 5 kHz	-85	-85	-85	-85	-85	-85	-85	-85	-85	-85	-85	-85	85	-85	85	-85
I_o ^{Note 4}	dBm/C h BW	-	-	-	-	-57.11 +10log ($N_{RB,c}$ /50)	-57.11 +10log ($N_{RB,c}$ /50)	-57.11 +10log ($N_{RB,c}$ /50)	-57.11 +10log ($N_{RB,c}$ /50)	-	-	-	-	-	-	-	-
		57.11 +10log g ($N_{RB,c}$ /50)	57.11 +10log g ($N_{RB,c}$ /50)	57.11 +10log g ($N_{RB,c}$ /50)	57.11 +10log g ($N_{RB,c}$ /50)					57.11 +10log g ($N_{RB,c}$ /50)	57.11 +10log g ($N_{RB,c}$ /50)	57.11 +10log g ($N_{RB,c}$ /50)	57.11 +10log g ($N_{RB,c}$ /50)	57.11 +10log g ($N_{RB,c}$ /50)	54.15 +10log g ($N_{RB,c}$ /50)	57.11 +10log g ($N_{RB,c}$ /50)	54.15 +10log g ($N_{RB,c}$ /50)
Propagation Condition		AWGN				AWGN				AWGN				AWGN			
Antenna Configuration		1x2				1x2				1x2				1x2			
Timing offset to Cell 1	μs	-				0				0				0			
Time alignment error relative to cell 1 ^{Note 5}	μs	-				≤ TAE				≤ TAE				≤ TAE			
Time alignment error relative to cell 2 ^{Note 5}	μs	-				-				≤ TAE				≤ TAE			
Time alignment error relative to cell 3 ^{Note 5}	μs	-				-				-				≤ TAE			

Note 1: OCNG shall be used such that all cells are fully allocated and a constant total transmitted power spectral density is achieved for all OFDM symbols.
 Note 2: The resources for uplink transmission are assigned to the UE on cell1 from the start of time period T2 and on cell2 from the start of time period T4.
 Note 3: Interference from other cells and noise sources not specified in the test is assumed to be constant over subcarriers and time and shall be modelled as AWGN of appropriate power for N_{oc} to be fulfilled.
 Note 4: E_s/I_{ot} , RSRP, SCH_RP and I_o levels have been derived from other parameters for information purposes. They are not settable parameters themselves.
 Note 5: Time alignment error (TAE) as specified in TS 36.104 [30] clause 6.5.3.1. The TAE value depends upon the type of carrier aggregation.

Table A.8.16.56.1-3: Cell specific test parameters for E-UTRAN TDD 4 DL CA Event Triggered Reporting on Deactivated SCell with PCell and SCell interruptions in Non-DRX (Cell #5)

Parameter	Unit	Cell 5			
		T1	T2	T3	T4
E-UTRA RF Channel Number		4			
BW _{channel}		5MHz: N _{RB,c} = 25 10MHz: N _{RB,c} = 50 20MHz: N _{RB,c} = 100			
PDSCH parameters: DL Reference Measurement Channel		N/A			
PCFICH/PDCCH/PHICH parameters		5MHz: R.11 TDD 10MHz: R.6 TDD 20MHz: R.10 TDD			
OCNG Pattern defined in A.3.2.1		5MHz: OP.10 TDD 10MHz: OP.2 TDD 20MHz: OP.8 TDD			
PBCH_RA	dB	0			
PBCH_RB	dB				
PSS_RA	dB				
SSS_RA	dB				
PCFICH_RB	dB				
PHICH_RA	dB				
PHICH_RB	dB				
PDCCH_RA	dB				
PDCCH_RB	dB				
PDSCH_RA	dB				
PDSCH_RB	dB				
OCNG_RA ^{Note 1}	dB				
OCNG_RB ^{Note 1}	dB				
N_{oc} ^{Note 3}	dBm/15 kHz				
\hat{E}_s / N_{oc}	dB	-infinity	16	-infinity	16
\hat{E}_s / I_{ot} ^{Note 4}	dB	-infinity	-0.11	-infinity	-0.11
RSRP ^{Note 4}	dBm/15 kHz	-infinity	-85	-infinity	-85
SCH_RP ^{Note 4}	dBm/15 kHz	-infinity	-85	-infinity	-85
I_o ^{Note 4}	dBm/Ch BW	-57.11 +10log (N _{RB,c} /50)	-54.15 +10log (N _{RB,c} /50)	-57.11 +10log (N _{RB,c} /50)	-54.15 +10log (N _{RB,c} /50)
Propagation Condition		AWGN			
Antenna Configuration		1x2			
Timing offset to Cell 1	μs	3			
Time alignment error relative to cell 1 ^{Note 5}	μs	N/A			
Time alignment error relative to cell 2 ^{Note 5}	μs	N/A			
Time alignment error relative to cell 3 ^{Note 5}	μs	N/A			
Note 1:	OCNG shall be used such that all cells are fully allocated and a constant total transmitted power spectral density is achieved for all OFDM symbols.				
Note 2:	Void				
Note 3:	Interference from other cells and noise sources not specified in the test is assumed to be constant over subcarriers and time and shall be modelled as AWGN of appropriate power for N_{oc} to be fulfilled.				
Note 4:	E_s/I_{ot} , RSRP, SCH_RP and I_o levels have been derived from other parameters for information purposes. They are not settable parameters themselves.				
Note 5:	Time alignment error (TAE) as specified in TS 36.104 [30] clause 6.5.3.1. The TAE value depends upon the type of carrier aggregation.				

A.8.16.56.2 Test Requirements

The UE shall send one Event A6 triggered measurement report, with a measurement reporting delay less than 12.8s ($20 \times \text{scellMeasCycle}$) from the beginning of time period T2.

The UE shall send one Event A6 triggered measurement report, with a measurement reporting delay less than 3.2s ($5 \times \text{scellMeasCycle}$) from the beginning of time period T4.

The UE shall not send event triggered measurement reports, as long as the reporting criteria are not fulfilled.

The UE shall be scheduled on PCell continuously throughout the test. From the start of T1 until the measurement report is received during T2, at least 99.5% of all expected ACK/NACKs shall be transmitted by the UE.

The UE shall be scheduled on Cell2 continuously from the beginning of T4 to the end. From the start of T4 until the measurement report is received during T4, at least 99.5% of all expected ACK/NACKs shall be transmitted by the UE.

For a test to be considered successful requirements on both event detection and percentage of transmitted ACK/NACKs have to be fulfilled simultaneously.

The rate of correct events observed during repeated tests shall be at least 90%.

NOTE: The actual overall delays measured in the test may be up to $2 \times \text{TTI}_{\text{DCCH}}$ higher than the measurement reporting delays above because of TTI insertion uncertainty of the measurement report in DCCH.

A.8.16.57 E-UTRAN FDD 4DL CA activation and deactivation of know SCell in non-DRX

A.8.16.57.1 Test Purpose and Environment

The purpose of this test is to verify that the SCell activation and deactivation times are within the requirements stated in section 7.7 for UE configured with three downlink SCells, when the SCell is known by the UE at the time of activation and PCell is in FDD.

The test parameters are given in Tables A.8.16.57.1-1 and cell-specific parameters in A.8.16.57.1-2 below. The test consists of three successive time periods, with duration of T1, T2 and T3, respectively. There are four carriers, each with one cell. All cells have constant signal levels throughout the test. Before the test starts the UE is connected to Cell1 (PCell) on radio channel 1 (PCC), Cell 3 (deactivated SCell2) on radio channel 3 (SCC2) and Cell4 (deactivated SCell3) on radio channel 4 (SCC3), but is not aware of Cell2 (SCell1) on radio channel 2 (SCC1). The UE is only monitoring the PCC, SCC2 and SCC3. The UE shall be continuously scheduled in the PCell throughout the whole test.

At the beginning of T1 the UE receives an RRC message by which the SCell1 (Cell2) becomes configured on radio channel 2 (SCC1). The UE now starts monitoring also the SCC1. The test equipment sends a MAC message for activation of the SCell1.

The point in time at which the MAC message is received at the UE antenna connector, in a subframe #denoted m which is an even number, defines the start of time period T2. At the beginning of T2 the test equipment sends a MAC message for activation of the SCell1. The UE receives the SCell2 activation command in a subframe ($m+10$) and receives the SCell3 activation command in a subframe ($m+20$) during activation of the SCell1. The UE shall be able to report valid CSIs for the activated SCell at latest in a subframe ($m+34$). The UE shall start reporting CSI for SCell1 in subframe in ($m+8$) and shall report CQI index 0 (out-of-range) until the subframe activation has been completed. Any PCell interruption due to activation of SCells shall occur in the subframe ($m+5$) to ($m+9$), ($m+15$) to ($m+19$) and ($m+25$) to ($m+29$).

Time period T3 starts when a MAC message for deactivation of SCell1, send from the test equipment to the UE in a subframe #denoted n , is received at the UE antenna connector. The test equipment sends a MAC message for deactivation of the SCell2 in subframe ($n+10$) and send a MAC message for deactivation of the SCell3 in subframe ($n+20$). The UE shall carry out deactivation of the SCell1 at latest in subframe ($n+8$), and any interruption due to the deactivation of SCells shall occur in the subframe ($n+5$) to ($n+9$), ($n+15$) to ($n+19$) and ($n+25$) to ($n+29$).

The test equipment verifies that potential interruption is carried out in the correct time span by monitoring ACK/NACK sent in PCell during activation and deactivation of SCell1, respectively.

The test equipment verifies the activation time by counting the subframes from the time when the SCell1 activation command is sent until a CSI report with other than CQI index 0 is received.

The test equipment verifies the deactivation time by counting the subframes from the time when the SCell1 deactivation command is sent until CQI reporting for SCell1 is discontinued.

Table A.8.16.57.1-1: General test parameters for known SCell1 activation case

Parameter	Unit	Value	Comment
E-UTRA RF Channel Number		1, 2, 3,4	Four radio channels are used for this test
Active PCell		Cell 1	Primary cell on RF channel number 1.
Deconfigured deactivated SCell1		Cell 2	Deconfigured deactivated secondary cell on RF channel number 2.
Configured deactivated SCell2		Cell 3	Configured deactivated secondary cell on RF channel number 3.
Configured deactivated SCell3		Cell 4	Configured deactivated secondary cell on RF channel number 4.
CP length		Normal	
DRX		OFF	Continuous monitoring of primary cell
CQI/PMI periodicity and offset configuration index		0	CQI reporting for SCell every second subframe
Cell-individual offset for cells on RF channel number 1	dB	0	Individual offset for cells on PCC.
Cell-individual offset for cells on RF channel number 2	dB	0	Individual offset for cells on SCC1.
Cell-individual offset for cells on RF channel number 3	dB	0	Individual offset for cells on SCC2.
Cell-individual offset for cells on RF channel number 4	dB	0	Individual offset for cells on SCC3.
Filter coefficient		0	L3 filtering is not used
SCell measurement cycle (measCycleSCell)	ms	320	
T1	s	7	During this time the PCell, SCell2 and SCell3 shall be known and the SCell1 configured and detected.
T2	s	1	During this time the UE shall activate the SCell1.
T3	s	1	During this time the UE shall deactivate the SCell1.

Table A.8.16.57.1-2: Cell specific test parameters for E-UTRAN FDD 4 DL CA activation and deactivation of known SCell in non-DRX

Parameter	Unit	Cell 1			Cell 2			Cell 3			Cell 4		
		T1	T2	T3	T1	T2	T3	T1	T2	T3	T1	T2	T3
E-UTRA RF Channel Number		1			2			3			4		
BW _{channel}	MHz	5MHz: N _{RB,c} = 25 10MHz: N _{RB,c} = 50 20MHz: N _{RB,c} = 100			5MHz: N _{RB,c} = 25 10MHz: N _{RB,c} = 50 20MHz: N _{RB,c} = 100			5MHz: N _{RB,c} = 25 10MHz: N _{RB,c} = 50 20MHz: N _{RB,c} = 100			5MHz: N _{RB,c} = 25 10MHz: N _{RB,c} = 50 20MHz: N _{RB,c} = 100		
PDSCH parameters: DL Reference Measurement Channel		5MHz: R.7 FDD 10MHz: R.3 FDD 20MHz: R.6 FDD			-			-			-		
PCFICH/PDCCH/PHICH parameters: DL Reference Measurement Channel		5MHz: R.11 FDD 10MHz: R.6 FDD 20MHz: R.10 FDD			5MHz: R.11 FDD 10MHz: R.6 FDD 20MHz: R.10 FDD			5MHz: R.11 FDD 10MHz: R.6 FDD 20MHz: R.10 FDD			5MHz: R.11 FDD 10MHz: R.6 FDD 20MHz: R.10 FDD		
OCNG Patterns		5MHz: OP.20 FDD 10MHz: OP.10 FDD 20MHz: OP.17 FDD			5MHz: OP.16 FDD 10MHz: OP.2 FDD 20MHz: OP.12 FDD			5MHz: OP.16 FDD 10MHz: OP.2 FDD 20MHz: OP.12 FDD			5MHz: OP.16 FDD 10MHz: OP.2 FDD 20MHz: OP.12 FDD		
PBCH_RA	dB	0			0			0			0		
PBCH_RB	dB												
PSS_RA	dB												
SSS_RA	dB												
PCFICH_RB	dB												
PHICH_RA	dB												
PHICH_RB	dB												
PDCCH_RA	dB												
PDCCH_RB	dB												
PDSCH_RA	dB												
PDSCH_RB	dB												
OCNG_RA ^{Note 1}	dB												
OCNG_RB ^{Note 1}	dB												

N_{oc} ^{Note 2}	dBm/15 kHz	-104	-104	-104	-104
\hat{E}_s/N_{oc}	dB	17	17	17	17
\hat{E}_s/I_{ot}	dB	17	17	17	17
RSRP ^{Note 3}	dBm/15 kHz	-87	-87	-87	-87
SCH_RP ^{Note 3}	dBm/15 kHz	-87	-87	-87	-87
I_o ^{Note 3}	dBm/Ch BW	-59.13 +10log ($N_{RB,c}/50$)	-59.13 +10log ($N_{RB,c}/50$)	-59.13 +10log ($N_{RB,c}/50$)	-59.13 +10log ($N_{RB,c}/50$)
Propagation Condition		AWGN	AWGN	AWGN	AWGN
Antenna Configuration		1x2	1x2	1x2	1x2
Timing offset to Cell 1	μ s	-	0	0	0
Time alignment error relative to cell 1 ^{Note 5}	μ s	-	\leq TAE	\leq TAE	\leq TAE
Time alignment error relative to cell 2 ^{Note 5}	μ s	-	-	\leq TAE	\leq TAE
Time alignment error relative to cell 3 ^{Note 5}	μ s	-	-	-	\leq TAE
Note 1:	OCNG shall be used such that all cells are fully allocated and a constant total transmitted power spectral density is achieved for all OFDM symbols.				
Note 2:	Interference from other cells and noise sources not specified in the test is assumed to be constant over subcarriers and time and shall be modelled as AWGN of appropriate power for N_{oc} to be fulfilled.				
Note 3:	E_s/I_{ot} , RSRP, SCH_RP and I_o levels have been derived from other parameters for information purposes. They are not settable parameters themselves.				
Note 4:	The uplink resources for CSI reporting are assigned to the UE prior to the start of time period T2.				
Note 5:	Time alignment error (TAE) as specified in TS 36.104 [30] clause 6.5.3.1. The TAE value depends upon the type of carrier aggregation.				

A.8.16.57.2 Test Requirements

During T2, the UE shall send the first CSI report for SCell1 in a subframe (m+8), or in a subframe (m+10) if the subframe (m+8) was subject to interruption. Whether CSI report in subframe (m+8) was interrupted or not is checked by monitoring ACK/NACK sent in PCell in subframe (m+8).

During T2 the UE shall start sending CSI reports for SCell1 with non-zero CQI index at latest in a subframe (m+34).

During T3 the UE shall stop sending CSI reports for SCell1 at latest in a subframe (n+8).

During T2 interruption of PCell during SCells activation shall not happen outside the subframes (m+5) to (m+9), outside the subframes (m+15) to (m+19) and outside the subframes (m+25) to (m+29).

During T3 interruption of PCell during SCells deactivation shall not happen outside the subframes (n+5) to (n+9), outside the subframes (n+15) to (n+19) and outside the subframes (n+25) to (n+29).

The interruption of PCell shall not be more than the values specified for intra-band CA and inter-band CA in Section 7.8.2.

All of the above test requirements shall be fulfilled in order for the observed SCell1 activation delay and SCell1 deactivation delay to be counted as correct. The rate of correct observed SCell1 activation delay and SCell1 deactivation delay during repeated tests shall be at least 90%.

NOTE: During T2 if there are no uplink resources for reporting the valid CSI in a subframe (m+34) then the UE shall use the next available uplink resource for reporting the corresponding valid CSI.

A.8.16.58 E-UTRAN TDD 4DL CA activation and deactivation of know SCell in non-DRX

A.8.16.58.1 Test Purpose and Environment

The purpose of this test is to verify that SCell activation and deactivation times are within the requirements stated in clause 7.7 for 4DL TDD carrier aggregation, when the SCells are known by the UE at the time of activation.

The test parameters are given in Tables A.8.16.58-1 and cell-specific parameters in A.8.16.58-2 below. The test consists of three successive time periods, with duration of T1, T2 and T3, respectively. There are four carriers, each with one cell. All cells have

constant signal levels throughout the test. Before the test starts the UE is connected to Cell 1 (PCell) on radio channel 1 (PCC), Cell 3 (deactivated SCell2) on radio channel 3 (SCC2) and Cell 4 (deactivated SCell3) on radio channel 4 (SCC3), but is not aware of Cell 2 (SCell1) on radio channel 2 (SCC1). The UE is only monitoring the PCC, SCC2 and SCC3. The UE shall be continuously scheduled in the PCell throughout the whole test.

At the beginning of T1 the UE receives an RRC message by which the SCell1 (Cell 2) becomes configured on radio channel 2 (SCC1). The UE now starts monitoring also the SCC1. The test equipment sends a MAC message for activation of the SCell1.

The point in time at which the MAC message is received at the UE antenna connector, in a subframe # denoted m , where m is 4 or 9, defines the start of time period T2. At the beginning of T2 the test equipment sends a MAC message for activation of the SCell1. The UE receives the SCell2 and SCell3 activation command in a subframe ($m+15$) during activation of the SCell1. The UE shall be able to report valid CSIs for the activated SCell1 at latest in a subframe ($m+34$). The UE shall start reporting CSI for SCell1 in subframe ($m+8$) and shall report CQI index 0 (out-of-range) until the SCell activation has been completed. Any PCell interruption due to activation of SCells shall occur in the subframes ($m+5$) to ($m+11$) and ($m+20$) to ($m+26$).

Time period T3 starts when a MAC message for deactivation of SCell1, sent from the test equipment to the UE, in a subframe # denoted n , where n is 4 or 9, is received at the UE antenna connector. The test equipment sends a MAC message for deactivation of the SCell2 in subframe ($n+15$) and for deactivation of the SCell3 in subframe ($n+30$). The UE shall carry out deactivation of the SCell1 at latest in subframe ($n+8$), and any PCell interruption due to the deactivation of SCells shall occur in the subframes ($n+5$) to ($n+11$), ($n+20$) to ($n+26$) and ($n+35$) to ($n+41$).

The test equipment verifies that potential interruption is carried out in the correct time span by monitoring ACK/NACK sent in PCell during activation and deactivation of SCells, respectively.

The test equipment verifies the activation time by counting the subframes from the time when the SCell1 activation command is sent until a CSI report with other than CQI index 0 is received.

The test equipment verifies the deactivation time by counting the subframes from the time when the SCell1 deactivation command is sent until CQI reporting for SCell1 is discontinued.

Table A.8.16.58-1: General test parameters for E-UTRAN TDD 4 DL CA activation and deactivation of known SCell in non-DRX

Parameter	Unit	Value	Comment
E-UTRA RF Channel Number		1, 2, 3,4	Four radio channels are used for this test
Active PCell		Cell 1	Primary cell on RF channel number 1.
Deconfigured SCell		Cell 2	Deconfigured secondary cell on RF channel number 2.
Configured deactivated SCell		Cell 3	Configured deactivated secondary cell on RF channel number 3.
Configured deactivated SCell		Cell 4	Configured deactivated secondary cell on RF channel number 4.
CP length		Normal	
Special subframe configuration		6	As specified in table 4.2-1 in TS 36.211. The same configuration applies to all cells.
Uplink-downlink configuration		1	As specified in table 4.2-2 in TS 36.211. The same configuration applies to all cells
DRX		OFF	Continuous monitoring of primary cell
CQI/PMI periodicity and offset configuration index		0	CQI reporting for SCells every UL subframe
Cell-individual offset for cells on RF channel number 1	dB	0	Individual offset for cells on PCC.
Cell-individual offset for cells on RF channel number 2	dB	0	Individual offset for cells on SCC1.
Cell-individual offset for cells on RF channel number 3	dB	0	Individual offset for cells on SCC2.
Cell-individual offset for cells on RF channel number 4	dB	0	Individual offset for cells on SCC3.
Filter coefficient		0	L3 filtering is not used
SCell measurement cycle (measCycleSCell)	ms	320	
T1	s	7	During this time the PCell, SCell2 and SCell3 shall be known and the SCell1 configured and detected.
T2	s	1	During this time the UE shall activate the SCell1.
T3	s	1	During this time the UE shall deactivate the SCell1.

Table A.8.16.58-2: Cell specific test parameters for E-UTRAN TDD 4 DL CA activation and deactivation of known SCell in non-DRX

Parameter	Unit	Cell 1			Cell 2			Cell 3			Cell 4		
		T1	T2	T3	T1	T2	T3	T1	T2	T3	T1	T2	T3
E-UTRA RF Channel Number		1			2			3			4		
BW _{channel}		5MHz: N _{RB,c} = 25 10MHz: N _{RB,c} = 50 20MHz: N _{RB,c} = 100			5MHz: N _{RB,c} = 25 10MHz: N _{RB,c} = 50 20MHz: N _{RB,c} = 100			5MHz: N _{RB,c} = 25 10MHz: N _{RB,c} = 50 20MHz: N _{RB,c} = 100			5MHz: N _{RB,c} = 25 10MHz: N _{RB,c} = 50 20MHz: N _{RB,c} = 100		
PDSCH parameters: DL Reference Measurement Channel		5MHz: R.4 TDD 10MHz: R.0 TDD 20MHz: R.3 TDD			-			-			-		
PCFICH/PDCCH/PHICH parameters: DL Reference Measurement Channel		5MHz: R.11 TDD 10MHz: R.6 TDD 20MHz: R.10 TDD			5MHz: R.11 TDD 10MHz: R.6 TDD 20MHz: R.10 TDD			5MHz: R.11 TDD 10MHz: R.6 TDD 20MHz: R.10 TDD			5MHz: R.11 TDD 10MHz: R.6 TDD 20MHz: R.10 TDD		
OCNG Patterns		5MHz: OP.9 TDD 10MHz: OP.1 TDD 20MHz: OP.7 TDD			5MHz: OP.10 TDD 10MHz: OP.2 TDD 20MHz: OP.8 TDD			5MHz: OP.10 TDD 10MHz: OP.2 TDD 20MHz: OP.8 TDD			5MHz: OP.10 TDD 10MHz: OP.2 TDD 20MHz: OP.8 TDD		
PBCH_RA	dB	0			0			0			0		
PBCH_RB	dB												
PSS_RA	dB												
SSS_RA	dB												
PCFICH_RB	dB												
PHICH_RA	dB												
PHICH_RB	dB												
PDCCH_RA	dB												
PDCCH_RB	dB												
PDSCH_RA	dB												
PDSCH_RB	dB												
OCNG_RA ^{Note 1}	dB												
OCNG_RB ^{Note 1}	dB												
N _{oc} ^{Note 2}	dBm/15 kHz												
\bar{E}_s/N_{oc}	dB	17			17			17			17		
\bar{E}_s/I_{ot} ^{Note 3}	dB	17			17			17			17		
RSRP ^{Note 3}	dBm/15 kHz	-87			-87			-87			-87		
SCH_RP ^{Note 3}	dBm/15 kHz	-87			-87			-87			-87		
I _o ^{Note 3}	dBm/C h BW	-59.13+10log (N _{RB,c} /50)			-59.13+10log (N _{RB,c} /50)			-59.13+10log (N _{RB,c} /50)			-59.13+10log (N _{RB,c} /50)		
Propagation Condition		AWGN			AWGN			AWGN			AWGN		
Antenna Configuration		1x2			1x2			1x2			1x2		
Timing offset to Cell 1	μs	-			0			0			0		
Time alignment error relative to cell 1 ^{Note 5}	μs	-			≤ TAE			≤ TAE			≤ TAE		
Time alignment error relative to cell 2 ^{Note 5}	μs	-			-			≤ TAE			≤ TAE		
Time alignment error relative to cell 3 ^{Note 5}	μs	-			-			-			≤ TAE		
<p>Note 1: OCNG shall be used such that all cells are fully allocated and a constant total transmitted power spectral density is achieved for all OFDM symbols.</p> <p>Note 2: Interference from other cells and noise sources not specified in the test is assumed to be constant over subcarriers and time and shall be modelled as AWGN of appropriate power for N_{oc} to be fulfilled.</p> <p>Note 3: E_s/I_{ot}, RSRP, SCH_RP and I_o have been derived from other parameters for information purposes. They are not settable parameters themselves.</p> <p>Note 4: The uplink resources for CSI reporting are assigned to the UE prior to the start of time period T2.</p> <p>Note 5: Time alignment error (TAE) as specified in TS 36.104 [30] clause 6.5.3.1. The TAE value depends upon the type of carrier aggregation.</p>													

A.8.16.58.2 Test Requirements

During T2 the UE shall send the first CSI report for SCell1 in a subframe (m+8), or in a subframe (m+9) if the subframe (m+8) was subject to interruption, or in a subframe (m+13) if the subframe (m+8) and (m+9) were subject to interruption when an intra-band

SCell is activated. Whether CSI report in subframe (m+8) and/or (m+9) was interrupted or not is checked by monitoring ACK/NACK sent in PCell in subframe (m+8) and/or (m+9).

During T2 the UE shall start sending CSI reports for SCell1 with non-zero CQI index at latest in a subframe (m+34).

During T3 the UE shall stop sending CSI reports for SCell1 at latest in subframe (n+8).

During T2 interruption of PCell during SCells activation shall not happen outside the subframes (m+5) to (m+11) and outside the subframes (m+20) to (m+26).

During T3 interruption of PCell during SCells deactivation shall not happen outside the subframes (n+5) to (n+11), outside the subframes (n+20) to (n+26) and outside the subframes (n+35) to (n+41).

The interruption of PCell shall not be more than the values specified for intra-band CA and inter-band CA in Section 7.8.2.

The UE shall not send event triggered measurement reports as long as the reporting criteria are not fulfilled.

All of the above test requirements shall be fulfilled in order for the observed SCell1 activation delay and SCell1 deactivation delay to be counted as correct. The rate of correct observed SCell1 activation delay and SCell1 deactivation delay during repeated tests shall be at least 90%.

NOTE: During T2 if there are no uplink resources for reporting the valid CSI in a subframe (m+34) then the UE shall use the next available uplink resource for reporting the corresponding valid CSI.

A.8.16.59 E-UTRAN PCell in FDD FDD-TDD 4 DL CA activation and deactivation of known SCell in non-DRX

A.8.16.59.1 Test Purpose and Environment

The purpose of this test is to verify that the SCell activation and deactivation times are within the requirements stated in section 7.7 for UE configured with three downlink SCells, when the SCell is known by the UE at the time of activation and PCell is in FDD.

The test parameters are given in Tables A.8.16.59.1-1 and cell-specific parameters in A.8.16.59.1-2 and A.8.16.59.1-3 below. The test consists of three successive time periods, with duration of T1, T2 and T3, respectively. There are four carriers, each with one cell. All cells have constant signal levels throughout the test. Before the test starts the UE is connected to Cell 1 (PCell) on radio channel 1 (PCC), deactivated Cell 3 (SCell2) on radio channel 3 (SCC2) and deactivated Cell 4 (SCell3) on radio channel 4 (SCC3) but is not aware of Cell 2 (SCell1) on radio channel 2 (SCC1). The UE is only monitoring PCC, SCC2 and SCC3. The UE shall be continuously scheduled in PCell throughout the whole test.

At the beginning of T1 the UE receives an RRC message by which the SCell1 becomes configured on SCC1. The UE now starts monitoring also SCC1. The test equipment sends a MAC message for activation of SCell1.

The point in time at which the MAC message is received at the UE antenna connector, in a subframe # denoted m which is an even number, defines the start of time period T2. The UE receives a MAC message for activation of SCell2 in a subframe (m+10) and a MAC message for activation of SCell3 in subframe (m+20) during activation of SCell1. The UE shall be able to report valid CSI for the activated SCell1 at latest in subframe (m+34). The UE shall start reporting CSI for SCell1 in subframe (m+8) and shall report CQI index 0 (out-of-range) until the SCell activation has been completed. Any PCell interruption due to activation of SCells shall not occur outside subframes (m+5) to (m+9), (m+15) to (m+19) and (m+25) to (m+29).

Time period T3 starts when a MAC message for deactivation of SCell1, sent from the test equipment to the UE in a subframe # denoted n, is received at the UE antenna connector. The test equipment sends a MAC message for deactivation of the SCell2 in subframe (n+10) and a MAC message for deactivation of the SCell3 in subframe (n+20). The UE shall carry out deactivation of the SCell1 at latest in subframe (n+8), and any PCell interruption due to the deactivation of SCells shall not occur outside subframes (n+5) to (n+9), (n+15) to (n+19) and (n+25) to (n+29).

The test equipment verifies that potential interruption is carried out in the correct time span by monitoring ACK/NACK sent in PCell during activation and deactivation of SCell1, respectively.

The test equipment verifies the activation time by counting the subframes from the time when SCell1 activation command is sent until a CSI report with other than CQI index 0 is received.

The test equipment verifies the deactivation time by counting the subframes from the time when SCell1 deactivation command is sent until CQI reporting for SCell1 is discontinued.

Table A.8.16.59.1-1: General test parameters for known SCell1 activation case

Parameter	Unit	Value	Comment
E-UTRA RF Channel Number		1, 2, 3, 4	Four radio channels are used for this test
Active PCell		Cell 1	Primary cell on RF channel number 1.
Deconfigured deactivated SCell1		Cell 2	Deconfigured deactivated secondary cell on RF channel number 2.
Configured deactivated SCell2		Cell 3	Configured deactivated secondary cell on RF channel number 3.
Configured deactivated SCell3		Cell 4	Configured deactivated secondary cell on RF channel number 4.
CP length		Normal	
DRX		OFF	Continuous monitoring of primary cell
CQI/PMI periodicity and offset configuration index		0	CQI reporting for SCell every second subframe
Cell-individual offset for cells on RF channel number 1	dB	0	Individual offset for cells on PCC.
Cell-individual offset for cells on RF channel number 2	dB	0	Individual offset for cells on SCC1.
Cell-individual offset for cells on RF channel number 3	dB	0	Individual offset for cells on SCC2.
Cell-individual offset for cells on RF channel number 4	dB	0	Individual offset for cells on SCC3.
SCell measurement cycle (measCycleSCell)	ms	320	
T1	s	7	During this time the PCell, SCell2 and SCell3 shall be known and the SCell1 configured and detected.
T2	s	1	During this time the UE shall activate the SCell1, SCell2, and SCell3.
T3	s	1	During this time the UE shall deactivate the SCell1, SCell2, and SCell3.

Table A.8.16.59.1-2: Cell specific test parameters for E-UTRAN TDD known SCell1 activation with PCell in FDD

Parameter	Unit	Cell 1			Cell 2			Cell 3		
		T1	T2	T3	T1	T2	T3	T1	T2	T3
E-UTRA RF Channel Number		1			2			3		
BW _{channel}	MHz	5MHz: N _{RB,c} = 25 10MHz: N _{RB,c} = 50 20MHz: N _{RB,c} = 100			5MHz: N _{RB,c} = 25 10MHz: N _{RB,c} = 50 20MHz: N _{RB,c} = 100			5MHz: N _{RB,c} = 25 10MHz: N _{RB,c} = 50 20MHz: N _{RB,c} = 100		
Special subframe configuration		-			6			6		
Uplink-downlink configuration		-			1			1		
PDSCH parameters: DL Reference Measurement Channel		5MHz: R.7 FDD 10MHz: R.3 FDD 20MHz: R.6 FDD			-			-		
PCFICH/PDCCH/PHICH H parameters: DL Reference Measurement Channel		5MHz: R.11 FDD 10MHz: R.6 FDD 20MHz: R.10 FDD			5MHz: R.11 TDD 10MHz: R.6 TDD 20MHz: R.10 TDD			5MHz: R.11 TDD 10MHz: R.6 TDD 20MHz: R.10 TDD		
OCNG Patterns		5MHz: OP.20 FDD 10MHz: OP.10 FDD 20MHz: OP.17 FDD			5MHz: OP.10 TDD 10MHz: OP.2 TDD 20MHz: OP.8 TDD			5MHz: OP.10 TDD 10MHz: OP.2 TDD 20MHz: OP.8 TDD		
PBCH_RA	dB	0			0			0		
PBCH_RB	dB									
PSS_RA	dB									
SSS_RA	dB									
PCFICH_RB	dB									
PHICH_RA	dB									
PHICH_RB	dB									
PDCCH_RA	dB									
PDCCH_RB	dB									
PDSCH_RA	dB									
PDSCH_RB	dB									

OCNG_RA ^{Note 1}	dB			
OCNG_RB ^{Note 1}	dB			
N _{oc} ^{Note 2}	dBm/15 kHz	-104	-104	-104
\hat{E}_s/N_{oc}	dB	17	17	17
\hat{E}_s/I_{ot}	dB	17	17	17
RSRP ^{Note 3}	dBm/15 kHz	-87	-87	-87
SCH_RP ^{Note 3}	dBm/15 kHz	-87	-87	-87
I _o ^{Note 3}	dBm/Ch BW	-59.13 +10log (N _{RB,c} /50)	-59.13 +10log (N _{RB,c} /50)	-59.13 +10log (N _{RB,c} /50)
Propagation Condition		AWGN	AWGN	AWGN
Antenna Configuration		1x2	1x2	1x2
Timing offset to Cell 1	μs	-	0	0
Time alignment error relative to cell 1 ^{Note 5}	μs	-	≤ TAE	≤ TAE
Time alignment error relative to cell 2 ^{Note 5}	μs	-	-	≤ TAE
Time alignment error relative to cell 3 ^{Note 5}	μs	-	-	-
<p>Note 1: OCNG shall be used such that all cells are fully allocated and a constant total transmitted power spectral density is achieved for all OFDM symbols.</p> <p>Note 2: Interference from other cells and noise sources not specified in the test is assumed to be constant over subcarriers and time and shall be modelled as AWGN of appropriate power for N_{oc} to be fulfilled.</p> <p>Note 3: Es/lot, RSRP, SCH_RP and I_o levels have been derived from other parameters for information purposes. They are not settable parameters themselves.</p> <p>Note 4: The uplink resources for CSI reporting are assigned to the UE prior to the start of time period T2.</p> <p>Note 5: Time alignment error (TAE) as specified in TS 36.104 [30] clause 6.5.3.1. The TAE value depends upon the type of carrier aggregation.</p>				

Table A.8.16.59.1-3: Cell specific test parameters for E-UTRAN TDD known SCell1 activation with PCell in FDD

Parameter	Unit	Cell 4						
		T1	T2	T3				
E-UTRA RF Channel Number		4						
BW _{channel}	MHz	5MHz: N _{RB,c} = 25 10MHz: N _{RB,c} = 50 20MHz: N _{RB,c} = 100						
Special subframe configuration		6						
Uplink-downlink configuration		1						
PDSCH parameters: DL Reference Measurement Channel		-						
PCFICH/PDCCH/PHICH parameters: DL Reference Measurement Channel		5MHz: R.11 TDD 10MHz: R.6 TDD 20MHz: R.10 TDD						
OCNG Patterns		5MHz: OP.10 TDD 10MHz: OP.2 TDD 20MHz: OP.8 TDD						
PBCH_RA	dB	0						
PBCH_RB	dB							
PSS_RA	dB							
SSS_RA	dB							
PCFICH_RB	dB							
PHICH_RA	dB							
PHICH_RB	dB							
PDCCH_RA	dB							
PDCCH_RB	dB							
PDSCH_RA	dB							
PDSCH_RB	dB							
OCNG_RA ^{Note 1}	dB							

OCNG_RB ^{Note 1}	dB			
N _{oc} ^{Note 2}	dBm/15 kHz	-104		
\bar{E}_s/N_{oc}	dB	17		
\bar{E}_s/I_{ot}	dB	17		
RSRP ^{Note 3}	dBm/15 kHz	-87		
SCH_RP ^{Note 3}	dBm/15 kHz	-87		
I _o ^{Note 3}	dBm/Ch BW	-59.13 +10log (N _{RB,c} /50)		
Propagation Condition		AWGN		
Antenna Configuration		1x2		
Timing offset to Cell 1	μs	0		
Time alignment error relative to cell 1 ^{Note 5}	μs	≤ TAE		
Time alignment error relative to cell 2 ^{Note 5}	μs	≤ TAE		
Time alignment error relative to cell 3 ^{Note 5}	μs	≤ TAE		
<p>Note 1: OCNG shall be used such that all cells are fully allocated and a constant total transmitted power spectral density is achieved for all OFDM symbols.</p> <p>Note 2: Interference from other cells and noise sources not specified in the test is assumed to be constant over subcarriers and time and shall be modelled as AWGN of appropriate power for N_{oc} to be fulfilled.</p> <p>Note 3: Es/I_{ot}, RSRP, SCH_RP and I_o levels have been derived from other parameters for information purposes. They are not settable parameters themselves.</p> <p>Note 4: The uplink resources for CSI reporting are assigned to the UE prior to the start of time period T2.</p> <p>Note 5: Time alignment error (TAE) as specified in TS 36.104 [30] clause 6.5.3.1. The TAE value depends upon the type of carrier aggregation.</p>				

A.8.16.59.2 Test Requirements

During T2 the UE shall send the first CSI report for SCell1 in a subframe (m+8), or in a subframe (m+10) if the subframe (m+8) was subject to interruption. Whether CSI report in subframe (m+8) was interrupted or not is checked by monitoring ACK/NACK sent in PCell in subframe (m+8).

During T2 the UE shall start sending CSI reports for SCell1 with non-zero CQI index at latest in a subframe (m+34).

During T3 the UE shall stop sending CSI reports for SCell1 at latest in a subframe (n+8).

During T2 interruption of PCell during SCells activation shall not happen outside the subframes (m+5) to (m+9), outside the subframes (m+15) to (m+19), and outside the subframes (m+25) to (m+29).

During T3 interruption of PCell during SCells deactivation shall not happen outside the subframes (n+5) to (n+9), outside the subframes (n+15) to (n+19), and (n+25) to (n+29).

The interruption of PCell shall not be more than the values specified for intra-band CA and inter-band CA in Section 7.8.2.

All of the above test requirements shall be fulfilled in order for the observed SCell1 activation delay and SCell1 deactivation delay to be counted as correct. The rate of correct observed SCell1 activation delay and SCell1 deactivation delay during repeated tests shall be at least 90%.

NOTE: During T2 if there are no uplink resources for reporting the valid CSI in a subframe (m+34) then the UE shall use the next available uplink resource for reporting the corresponding valid CSI.

A.8.16.60 E-UTRAN PCell in TDD FDD-TDD 4 DL CA activation and deactivation of known SCell in non-DRX

A.8.16.60.1 Test Purpose and Environment

The purpose of this test is to verify that the SCell activation and deactivation times are within the requirements stated in section 7.7 for UE configured with three downlink SCells, when the SCell is known by the UE at the time of activation and PCell is in TDD.

The test parameters are given in Tables A.8.16.60.1-1 and cell-specific parameters in A.8.16.60.1-2 and A.8.16.60.1-3 below. The test consists of three successive time periods, with duration of T1, T2 and T3, respectively. There are four carriers, each with one cell. All cells have constant signal levels throughout the test. Before the test starts the UE is connected to Cell 1 (PCell) on radio

channel 1 (PCC), deactivated Cell 3 (SCell2) on radio channel 3 (SCC2) and deactivated Cell 4 (SCell3) on radio channel 4 (SCC3) but is not aware of Cell 2 (SCell1) on radio channel 2 (SCC1). The UE is only monitoring the PCC, SCC2 and SCC3. The UE shall be continuously scheduled in PCell throughout the whole test.

At the beginning of T1 the UE receives an RRC message by which the SCell1 becomes configured on SCC1. The UE now starts monitoring also SCC1. The test equipment sends a MAC message for activation of the SCell1.

The point in time at which the MAC message is received at the UE antenna connector, in a subframe # denoted m , where m is 4 or 9, defines the start of time period T2. The UE receives a MAC message for activation of SCell 2 and SCell3 in a subframe ($m+15$) during activation of the SCell1. The UE shall be able to report valid CSI for the activated SCell1 at latest in a subframe ($m+34$). The UE shall start reporting CSI for SCell1 in subframe ($m+8$) and shall report CQI index 0 (out-of-range) until the SCell activation has been completed. Any PCell interruption due to activation of SCells shall not occur outside subframes ($m+5$) to ($m+11$) and ($m+20$) to ($m+26$).

Time period T3 starts when a MAC message for deactivation of SCell1, sent from the test equipment to the UE in a subframe # denoted n , where n is 4 or 9, is received at the UE antenna connector. The test equipment sends a MAC message for deactivation of the SCell2 in subframe ($n+15$) and a MAC message for deactivation of the SCell3 in subframe ($n+30$). The UE shall carry out deactivation of the SCell1 at latest in subframe ($n+8$), and any PCell interruption due to the deactivation of SCells shall not occur outside subframes ($n+5$) to ($n+11$), ($n+20$) to ($n+26$) and ($n+35$) to ($n+41$).

The test equipment verifies that potential interruption is carried out in the correct time span by monitoring ACK/NACK sent in PCell during activation and deactivation of SCell1, respectively.

The test equipment verifies the activation time by counting the subframes from the time when SCell1 activation command is sent until a CSI report with other than CQI index 0 is received.

The test equipment verifies the deactivation time by counting the subframes from the time when SCell1 deactivation command is sent until CQI reporting for SCell1 is discontinued.

Table A.8.16.60.1-1: General test parameters for known SCell1 activation case

Parameter	Unit	Value	Comment
E-UTRA RF Channel Number		1, 2, 3, 4	Four radio channels are used for this test
Active PCell		Cell 1	Primary cell on RF channel number 1.
Deconfigured deactivated SCell		Cell 2	Deconfigured deactivated secondary cell on RF channel number 2.
Configured deactivated SCell2		Cell 3	Configured deactivated secondary cell on RF channel number 3.
Configured deactivated SCell3		Cell 4	Configured deactivated secondary cell on RF channel number 4.
CP length		Normal	
DRX		OFF	Continuous monitoring of primary cell
CQI/PMI periodicity and offset configuration index		0	CQI reporting for SCell every UL subframe
Cell-individual offset for cells on RF channel number 1	dB	0	Individual offset for cells on PCC.
Cell-individual offset for cells on RF channel number 2	dB	0	Individual offset for cells on SCC1.
Cell-individual offset for cells on RF channel number 3	dB	0	Individual offset for cells on SCC2.
Cell-individual offset for cells on RF channel number 4	dB	0	Individual offset for cells on SCC3.
SCell measurement cycle (measCycleSCell)	ms	320	
T1	s	7	During this time the PCell, SCell2 and SCell3 shall be known and the SCell1 configured and detected.
T2	s	1	During this time the UE shall activate the SCell1, SCell2, and SCell3.
T3	s	1	During this time the UE shall deactivate the SCell1, SCell2, and SCell3.

Table A.8.16.60.1-2: Cell specific test parameters for E-UTRAN FDD known SCell1 activation with PCell in TDD

Parameter	Unit	Cell 1	Cell 2	Cell 3
-----------	------	--------	--------	--------

		T1	T2	T3	T1	T2	T3	T1	T2	T3
E-UTRA RF Channel Number		1			2			3		
BW _{channel}	MHz	5MHz: N _{RB,c} = 25 10MHz: N _{RB,c} = 50 20MHz: N _{RB,c} = 100			5MHz: N _{RB,c} = 25 10MHz: N _{RB,c} = 50 20MHz: N _{RB,c} = 100			5MHz: N _{RB,c} = 25 10MHz: N _{RB,c} = 50 20MHz: N _{RB,c} = 100		
Special subframe configuration		6			-			-		
Uplink-downlink configuration		1			-			-		
PDSCH parameters: DL Reference Measurement Channel		5MHz: R.4 TDD 10MHz: R.0 TDD 20MHz: R.3 TDD			-			-		
PCFICH/PDCCH/PHICH parameters: DL Reference Measurement Channel		5MHz: R.11 TDD 10MHz: R.6 TDD 20MHz: R.10 TDD			5MHz: R.11 FDD 10MHz: R.6 FDD 20MHz: R.10 FDD			5MHz: R.11 FDD 10MHz: R.6 FDD 20MHz: R.10 FDD		
OCNG Patterns		5MHz: OP.9 TDD 10MHz: OP.1 TDD 20MHz: OP.7 TDD			5MHz: OP.16 FDD 10MHz: OP.2 FDD 20MHz: OP.12 FDD			5MHz: OP.16 FDD 10MHz: OP.2 FDD 20MHz: OP.12 FDD		
PBCH_RA	dB	0			0			0		
PBCH_RB	dB									
PSS_RA	dB									
SSS_RA	dB									
PCFICH_RB	dB									
PHICH_RA	dB									
PHICH_RB	dB									
PDCCH_RA	dB									
PDCCH_RB	dB									
PDSCH_RA	dB									
PDSCH_RB	dB									
OCNG_RA ^{Note 1}	dB									
OCNG_RB ^{Note 1}	dB									
N _{oc} ^{Note 2}	dBm/15 kHz									
\bar{E}_s/N_{oc}	dB	17			17			17		
\bar{E}_s/I_{ot}	dB	17			17			17		
RSRP ^{Note 3}	dBm/15 kHz	-87			-87			-87		
SCH_RP ^{Note 3}	dBm/15 kHz	-87			-87			-87		
I _o ^{Note 3}	dBm/Ch BW	-59.13 +10log (N _{RB,c} /50)			-59.13 +10log (N _{RB,c} /50)			-59.13 +10log (N _{RB,c} /50)		
Propagation Condition		AWGN			AWGN			AWGN		
Antenna Configuration		1x2			1x2			1x2		
Timing offset to Cell 1	μs	-			0			0		
Time alignment error relative to cell 1 ^{Note 5}	μs	-			≤ TAE			≤ TAE		
Time alignment error relative to cell 2 ^{Note 5}	μs	-			-			≤ TAE		
Time alignment error relative to cell 3 ^{Note 5}	μs	-			-			-		
<p>Note 1: OCNG shall be used such that all cells are fully allocated and a constant total transmitted power spectral density is achieved for all OFDM symbols.</p> <p>Note 2: Interference from other cells and noise sources not specified in the test is assumed to be constant over subcarriers and time and shall be modelled as AWGN of appropriate power for N_{oc} to be fulfilled.</p> <p>Note 3: Es/I_{ot}, RSRP, SCH_RP and I_o levels have been derived from other parameters for information purposes. They are not settable parameters themselves.</p> <p>Note 4: The uplink resources for CSI reporting are assigned to the UE prior to the start of time period T2.</p> <p>Note 5: Time alignment error (TAE) as specified in TS 36.104 [30] clause 6.5.3.1. The TAE value depends upon the type of carrier aggregation.</p>										

Table A.8.16.60.1-3: Cell specific test parameters for E-UTRAN FDD known SCell1 activation with PCell in TDD

Parameter	Unit	Cell 4								
		T1	T2	T3						
E-UTRA RF Channel Number		4								

BW _{channel}	MHz	5MHz: N _{RB,c} = 25 10MHz: N _{RB,c} = 50 20MHz: N _{RB,c} = 100			
Special subframe configuration		-			
Uplink-downlink configuration		-			
PDSCH parameters: DL Reference Measurement Channel		-			
PCFICH/PDCCH/PHICH parameters: DL Reference Measurement Channel		5MHz: R.11 FDD 10MHz: R.6 FDD 20MHz: R.10 FDD			
OCNG Patterns		5MHz: OP.16 FDD 10MHz: OP.2 FDD 20MHz: OP.12 FDD			
PBCH_RA	dB	0			
PBCH_RB	dB				
PSS_RA	dB				
SSS_RA	dB				
PCFICH_RB	dB				
PHICH_RA	dB				
PHICH_RB	dB				
PDCCH_RA	dB				
PDCCH_RB	dB				
PDSCH_RA	dB				
PDSCH_RB	dB				
OCNG_RA ^{Note 1}	dB				
OCNG_RB ^{Note 1}	dB				
N _{oc} ^{Note 2}	dBm/15 kHz		-104		
\bar{E}_s/N_{oc}	dB		17		
\bar{E}_s/I_{ot}	dB	17			
RSRP ^{Note 3}	dBm/15 kHz	-87			
SCH_RP ^{Note 3}	dBm/15 kHz	-87			
I _o ^{Note 3}	dBm/Ch BW	-59.13 +10log (N _{RB,c} /50)			
Propagation Condition		AWGN			
Antenna Configuration		1x2			
Timing offset to Cell 1	μs	0			
Time alignment error relative to cell 1 ^{Note 5}	μs	≤ TAE			
Time alignment error relative to cell 2 ^{Note 5}	μs	≤ TAE			
Time alignment error relative to cell 3 ^{Note 5}	μs	≤ TAE			
<p>Note 1: OCNG shall be used such that all cells are fully allocated and a constant total transmitted power spectral density is achieved for all OFDM symbols.</p> <p>Note 2: Interference from other cells and noise sources not specified in the test is assumed to be constant over subcarriers and time and shall be modelled as AWGN of appropriate power for N_{oc} to be fulfilled.</p> <p>Note 3: Es/I_{ot}, RSRP, SCH_RP and I_o levels have been derived from other parameters for information purposes. They are not settable parameters themselves.</p> <p>Note 4: The uplink resources for CSI reporting are assigned to the UE prior to the start of time period T2.</p> <p>Note 5: Time alignment error (TAE) as specified in TS 36.104 [30] clause 6.5.3.1. The TAE value depends upon the type of carrier aggregation.</p>					

A.8.16.60.2 Test Requirements

During T2 the UE shall send the first CSI report for SCell1 in a subframe (m+8), or in a subframe (m+9) if the subframe (m+8) was subject to interruption. Whether CSI report in subframe (m+8) was interrupted or not is checked by monitoring ACK/NACK sent in PCell in subframe (m+8).

During T2 the UE shall start sending CSI reports for SCell1 with non-zero CQI index at latest in a subframe (m+34).

During T3 the UE shall stop sending CSI reports for SCell at latest in a subframe (n+8).

During T2 interruption of PCell during SCells activation shall not happen outside the subframes (m+5) to (m+11) and outside the subframes (m+20) to (m+26).

During T3 interruption of PCell during SCells deactivation shall not happen outside the subframes (n+5) to (n+11), outside the subframes (n+20) to (n+26) and outside the subframes (n+35) to (n+41).

The interruption of PCell shall not be more than the values specified for intra-band CA and inter-band CA in Section 7.8.2.

All of the above test requirements shall be fulfilled in order for the observed SCell1 activation delay and SCell1 deactivation delay to be counted as correct. The rate of correct observed SCell1 activation delay and SCell1 deactivation delay during repeated tests shall be at least 90%.

NOTE: During T2 if there are no uplink resources for reporting the valid CSI in a subframe (m+34) then the UE shall use the next available uplink resource for reporting the corresponding valid CSI.

A.8.16.61 E-UTRAN FDD 4DL CA activation and deactivation of unknown SCell in non-DRX

A.8.16.61.1 Test Purpose and Environment

The purpose of this test is to verify that the SCell activation and deactivation times are within the requirements stated in section 7.7 for UE configured with four downlink SCells, when the SCell is unknown by the UE at the time of activation and PCell is in FDD.

The test parameters are given in Tables A.8.16.61.1-1 and cell-specific parameters in A.8.16.61.1-2 below. The test consists of three successive time periods, with duration of T1, T2 and T3, respectively. There are four carriers, each with one cell. Cell 1, Cell 3, and Cell 4 have constant signal levels throughout the test. Before the test starts the UE is connected to Cell1 (PCell) on radio channel 1 (PCC), Cell 3 (deactivated SCell2) on radio channel 3 (SCC2) and Cell4 (deactivated SCell3) on radio channel 4 (SCC3), but is not aware of Cell2 (SCell1) on radio channel 2 (SCC1). The UE is only monitoring the PCC, SCC2 and SCC3. The UE shall be continuously scheduled in the PCell throughout the whole test.

At the beginning of T1 the UE receives an RRC message by which the Cell 2 (SCell1) becomes configured on radio channel 2 (SCC1). During T1 the signal level of Cell 2 (SCell1) is powered off and UE is not aware of Cell 2 (SCell1).

A MAC message for activation of the SCell1 is sent by the test equipment 100ms after the RRC message, in a subframe # denoted m which is an even number. The point in time at which the MAC message for activation of Cell 2 (SCell1) is received at the UE antenna connector defines the start of time period T2. Immediately at beginning of T2 the transmission power of Cell 2 (SCell1) is increased to same level as for Cell 1 (PCell). The test equipment sends a MAC message for activation of Cell 3 (SCell2) and Cell4 (SCell 3) in subframe (m+10) and subframe (m+20), respectively. Since UE received SCell2 activation command during activation of SCell1, the UE shall be able to report valid CSIs for the activated SCell1 at latest in subframe (m+44) provided the SCell1 can be successfully detected on the first attempt. The UE shall start reporting CSI in subframe (m+8) and shall report CQI index 0 (out-of-range) until the SCell activation has been completed. Any PCell interruption due to activation of SCells shall occur in the subframes (m+5) to (m+9), (m+15) to (m+19) and (m+25) to (m+29).

Time period T3 starts when a MAC message for deactivation of Cell 2 (SCell1), sent from the test equipment to the UE in a subframe # denoted n, is received at the UE antenna connector. The test equipment sends a MAC message for deactivation of the Cell 3 (SCell2) and Cell4 (SCell3) in subframe (n+10) and (n+20), respectively. The UE shall carry out deactivation of Cell 2 (SCell1) at latest in subframe (n+8), and any PCell interruption due to the deactivation of SCells shall occur in the subframes (n+5) to (n+9), (n+15) to (n+19) and (n+25) to (n+29).

The test equipment verifies that potential interruption is carried out in the correct time span by monitoring ACK/NACK sent in PCell during activation and deactivation of SCells, respectively.

The test equipment verifies the activation time by counting the subframes from the time when the Cell 2 (SCell1) activation command is sent until a CSI reports with other than CQI index 0 is received.

The test equipment verifies the deactivation time by counting the subframes from the time when the Cell 2 (SCell1) deactivation command is sent until CQI reporting for SCell1 is discontinued.

Table A.8.16.61.1-1: General test parameters for unknown SCell1 activation case

Parameter	Unit	Value	Comment
E-UTRA RF Channel Number		1, 2, 3,4	Four radio channels are used for this test
Active PCell		Cell 1	Primary cell on RF channel number 1.

Deconfigured SCell1		Cell 2	Deconfigured secondary cell on RF channel number 2.
Configured deactivated SCell2		Cell 3	Configured deactivated secondary cell on RF channel number 3.
Configured deactivated SCell3		Cell 4	Configured deactivated secondary cell on RF channel number 4.
CP length		Normal	
DRX		OFF	Continuous monitoring of primary cell
CQI/PMI periodicity and offset configuration index		0	CQI reporting for SCell every second subframe
Cell-individual offset for cells on RF channel number 1	dB	0	Individual offset for cells on PCC.
Cell-individual offset for cells on RF channel number 2	dB	0	Individual offset for cells on SCC1.
Cell-individual offset for cells on RF channel number 3	dB	0	Individual offset for cells on SCC2.
Cell-individual offset for cells on RF channel number 4	dB	0	Individual offset for cells on SCC3.
Filter coefficient		0	L3 filtering is not used
SCell measurement cycle (measCycleSCell)	ms	320	
T1	ms	100	During this time the PCell, SCell2 and SCell3 shall be known and the SCell1 configured.
T2	s	1	During this time the UE shall activate the SCell1.
T3	s	1	During this time the UE shall deactivate the SCell1.

Table A.8.16.61.1-2: Cell specific test parameters for E-UTRAN FDD 4 DL CA activation and deactivation of known SCell in non-DRX

Parameter	Unit	Cell 1			Cell 2			Cell 3			Cell 4		
		T1	T2	T3	T1	T2	T3	T1	T2	T3	T1	T2	T3
E-UTRA RF Channel Number		1			2			3			4		
BW _{channel}	MHz	5MHz: N _{RB,c} = 25 10MHz: N _{RB,c} = 50 20MHz: N _{RB,c} = 100			5MHz: N _{RB,c} = 25 10MHz: N _{RB,c} = 50 20MHz: N _{RB,c} = 100			5MHz: N _{RB,c} = 25 10MHz: N _{RB,c} = 50 20MHz: N _{RB,c} = 100			5MHz: N _{RB,c} = 25 10MHz: N _{RB,c} = 50 20MHz: N _{RB,c} = 100		
PDSCH parameters: DL Reference Measurement Channel		5MHz: R.7 FDD 10MHz: R.3 FDD 20MHz: R.6 FDD			-			-			-		
PCFICH/PDCCH/PHICH parameters: DL Reference Measurement Channel		5MHz: R.11 FDD 10MHz: R.6 FDD 20MHz: R.10 FDD			5MHz: R.11 FDD 10MHz: R.6 FDD 20MHz: R.10 FDD			5MHz: R.11 FDD 10MHz: R.6 FDD 20MHz: R.10 FDD			5MHz: R.11 FDD 10MHz: R.6 FDD 20MHz: R.10 FDD		
OCNG Patterns		5MHz: OP.20 FDD 10MHz: OP.10 FDD 20MHz: OP.17 FDD			5MHz: OP.16 FDD 10MHz: OP.2 FDD 20MHz: OP.12 FDD			5MHz: OP.16 FDD 10MHz: OP.2 FDD 20MHz: OP.12 FDD			5MHz: OP.16 FDD 10MHz: OP.2 FDD 20MHz: OP.12 FDD		
PBCH_RA	dB	0			0			0			0		
PBCH_RB	dB												
PSS_RA	dB												
SSS_RA	dB												
PCFICH_RB	dB												
PHICH_RA	dB												
PHICH_RB	dB												
PDCCH_RA	dB												
PDCCH_RB	dB												
PDSCH_RA	dB												
PDSCH_RB	dB												
OCNG_RA ^{Note 1}	dB												
OCNG_RB ^{Note 1}	dB												
N _{oc} ^{Note 2}	dBm/15 kHz												
\hat{E}_s/N_{oc}	dB	17			-infinity			17			17		
\hat{E}_s/I_{ot} ^{Note 3}	dB	17			-infinity			17			17		
RSRP ^{Note 3}	dBm/15 kHz	-87			-infinity			-87			-87		

SCH_RP ^{Note 3}	dBm/15 kHz	-87	-infinity	-87	-87	-87
Io ^{Note 3}	dBm/Ch BW	-59.13 +10log (N _{RB,c} /50)	-76.22 +10log (N _{RB,c} /50)	-59.13 +10log (N _{RB,c} /50)	-59.13 +10log (N _{RB,c} /50)	-59.13 +10log (N _{RB,c} /50)
Propagation Condition		AWGN	AWGN	AWGN	AWGN	AWGN
Antenna Configuration		1x2	1x2	1x2	1x2	1x2
Timing offset to Cell 1	μs	-	0	0	0	0
Time alignment error relative to cell 1 ^{Note 5}	μs	-	≤ TAE	≤ TAE	≤ TAE	≤ TAE
Time alignment error relative to cell 2 ^{Note 5}	μs	-	-	≤ TAE	≤ TAE	≤ TAE
Time alignment error relative to cell 3 ^{Note 5}	μs	-	-	-	-	≤ TAE
Note 1:	OCNG shall be used such that all cells are fully allocated and a constant total transmitted power spectral density is achieved for all OFDM symbols.					
Note 2:	Interference from other cells and noise sources not specified in the test is assumed to be constant over subcarriers and time and shall be modelled as AWGN of appropriate power for N _{oc} to be fulfilled.					
Note 3:	Es/Iot, RSRP, SCH_RP and Io levels have been derived from other parameters for information purposes. They are not settable parameters themselves.					
Note 4:	The uplink resources for CSI reporting are assigned to the UE prior to the start of time period T2.					
Note 5:	Time alignment error (TAE) as specified in TS 36.104 [30] clause 6.5.3.1. The TAE value depends upon the type of carrier aggregation.					

A.8.16.61.2 Test Requirements

During T2, the UE shall send the first CSI report for SCell1 in a subframe (m+8), or in a subframe (m+10) if the subframe (m+8) was subject to interruption. Whether CSI report in subframe (m+8) was interrupted or not is checked by monitoring ACK/NACK sent in PCell in subframe (m+8).

During T2 the UE shall start sending CSI reports for SCell1 with non-zero CQI index at latest in a subframe (m+44).

During T3 the UE shall stop sending CSI reports for SCell1 at latest in a subframe (n+8).

During T2 interruption of PCell during SCells activation shall not happen outside the subframes (m+5) to (m+9), outside the subframes (m+15) to (m+19) and outside the subframes (m+25) to (m+29).

During T3 interruption of PCell during SCells deactivation shall not happen outside the subframes (n+5) to (n+9), outside the subframes (n+15) to (n+19) and outside the subframes (n+25) to (n+29).

The interruption of PCell shall not be more than the values specified for intra-band CA and inter-band CA in Section 7.8.2.

All of the above test requirements shall be fulfilled in order for the observed SCell1 activation delay and SCell1 deactivation delay to be counted as correct. The rate of correct observed SCell1 activation delay and SCell1 deactivation delay during repeated tests shall be at least 90%.

NOTE: During T2 if there are no uplink resources for reporting the valid CSI in a subframe (m+44) then the UE shall use the next available uplink resource for reporting the corresponding valid CSI.

A.8.16.62 E-UTRAN TDD 4DL CA activation and deactivation of unknown SCell in non-DRX

A.8.16.62.1 Test Purpose and Environment

The purpose of this test is to verify that SCell activation and deactivation times are within the requirements stated in clause 7.7 for 4DL TDD carrier aggregation, when the SCells are unknown by the UE at the time of activation.

The test parameters are given in Tables A.8.16.62-1 and cell-specific parameters in A.8.16.62-2 below. The test consists of three successive time periods, with duration of T1, T2 and T3, respectively. There are four carriers, each with one cell. Cell 1, Cell 3, and Cell 4 have constant signal levels throughout the test. Before the test starts the UE is connected to Cell 1 (PCell) on radio channel 1 (PCC), Cell 3 (deactivated SCell2) on radio channel 3 (SCC2) and Cell 4 (deactivated SCell3) on radio channel 4 (SCC3), but is not aware of Cell 2 (SCell1) on radio channel 2 (SCC1). The UE is only monitoring the PCC, SCC2 and SCC3. The UE shall be continuously scheduled in the PCell throughout the whole test.

At the beginning of T1 the UE receives an RRC message by which the Cell 2 (SCell 1) becomes configured on radio channel 2 (SCC1). During T1 the signal level of Cell 2 (SCell 1) is powered off and UE is not aware of Cell 2 (SCell1).

A MAC message for activation of the SCell1 is sent by the test equipment 100ms after the RRC message, in a subframe # denoted m, where m is 4 or 9. The point in time at which the MAC message for activation of Cell 2 (SCell1) is received at the UE antenna connector defines the start of time period T2. Immediately at beginning of T2 the transmission power of Cell 2 (SCell1) is increased to same level as for Cell 1 (PCell). The test equipment sends a MAC message for activation of Cell 3 (SCell2) and Cell 4 (SCell3) in subframe (m+15) and subframe (m+30), respectively. Since UE received SCell2 activation command during activation of SCell1, the UE shall be able to report valid CSIs for the activated SCell1 at latest in subframe (m+44) provided the SCell1 can be successfully detected on the first attempt. The UE shall start reporting CSI in subframe (m+8) and shall report CQI index 0 (out-of-range) until the SCell activation has been completed. Any PCell interruption due to activation of SCells shall occur in the subframes (m+5) to (m+11), (m+20) to (m+26) and (m+35) to (m+41).

Time period T3 starts when a MAC message for deactivation of Cell 2 (SCell1), sent from the test equipment to the UE in a subframe # denoted n, where n is 4 or 9, is received at the UE antenna connector. The test equipment sends a MAC message for deactivation of the Cell 3 (SCell2) and Cell 4 (SCell3) in subframe (n+15) and (n+30), respectively. The UE shall carry out deactivation of Cell 2 (SCell1) at latest in subframe (n+8), and any PCell interruption due to the deactivation of SCells shall occur in the subframes (n+5) to (n+11), (n+20) to (n+26) and (n+35) to (n+41).

The test equipment verifies that potential interruption is carried out in the correct time span by monitoring ACK/NACK sent in PCell during activation and deactivation of SCells, respectively.

The test equipment verifies the activation time by counting the subframes from the time when the Cell 2 (SCell1) activation command is sent until a CSI reports with other than CQI index 0 is received.

The test equipment verifies the deactivation time by counting the subframes from the time when the Cell 2 (SCell1) deactivation command is sent until CQI reporting for SCell1 is discontinued.

Table A.8.16.62-1: General test parameters for E-UTRAN TDD 4 DL CA activation and deactivation of unknown SCell in non-DRX

Parameter	Unit	Value	Comment
E-UTRA RF Channel Number		1, 2, 3,4	Four radio channels are used for this test
Active PCell		Cell 1	Primary cell on RF channel number 1.
Deconfigured SCell		Cell 2	Deconfigured secondary cell on RF channel number 2.
Configured deactivated SCell		Cell 3	Configured deactivated secondary cell on RF channel number 3.
Configured deactivated SCell		Cell 4	Configured deactivated secondary cell on RF channel number 4.
CP length		Normal	
Special subframe configuration		6	As specified in table 4.2-1 in TS 36.211. The same configuration applies to all cells.
Uplink-downlink configuration		1	As specified in table 4.2-2 in TS 36.211. The same configuration applies to all cells
DRX		OFF	Continuous monitoring of primary cell
CQI/PMI periodicity and offset configuration index		0	CQI reporting for SCells every UL subframe
Cell-individual offset for cells on RF channel number 1	dB	0	Individual offset for cells on PCC.
Cell-individual offset for cells on RF channel number 2	dB	0	Individual offset for cells on SCC1.
Cell-individual offset for cells on RF channel number 3	dB	0	Individual offset for cells on SCC2.
Cell-individual offset for cells on RF channel number 4	dB	0	Individual offset for cells on SCC3.
Filter coefficient		0	L3 filtering is not used
SCell measurement cycle (measCycleSCell)	ms	320	
T1	ms	100	During this time the PCell, SCell2 and SCell3 shall be known and the SCell1 configured.
T2	s	1	During this time the UE shall activate the SCell1.
T3	s	1	During this time the UE shall deactivate the SCell1.

Table A.8.16.62-2: Cell specific test parameters for E-UTRAN TDD 4 DL CA activation and deactivation of unknown SCell in non-DRX

Parameter	Unit	Cell 1			Cell 2			Cell 3			Cell 4		
		T1	T2	T3	T1	T2	T3	T1	T2	T3	T1	T2	T3
E-UTRA RF Channel Number		1			2			3			4		
BW _{channel}		5MHz: N _{RB,c} = 25 10MHz: N _{RB,c} = 50 20MHz: N _{RB,c} = 100			5MHz: N _{RB,c} = 25 10MHz: N _{RB,c} = 50 20MHz: N _{RB,c} = 100			5MHz: N _{RB,c} = 25 10MHz: N _{RB,c} = 50 20MHz: N _{RB,c} = 100			5MHz: N _{RB,c} = 25 10MHz: N _{RB,c} = 50 20MHz: N _{RB,c} = 100		
PDSCH parameters: DL Reference Measurement Channel		5MHz: R.4 TDD 10MHz: R.0 TDD 20MHz: R.3 TDD			-			-			-		
PCFICH/PDCCH/PHICH parameters: DL Reference Measurement Channel		5MHz: R.11 TDD 10MHz: R.6 TDD 20MHz: R.10 TDD			5MHz: R.11 TDD 10MHz: R.6 TDD 20MHz: R.10 TDD			5MHz: R.11 TDD 10MHz: R.6 TDD 20MHz: R.10 TDD			5MHz: R.11 TDD 10MHz: R.6 TDD 20MHz: R.10 TDD		
OCNG Patterns		5MHz: OP.9 TDD 10MHz: OP.1 TDD 20MHz: OP.7 TDD			5MHz: OP.10 TDD 10MHz: OP.2 TDD 20MHz: OP.8 TDD			5MHz: OP.10 TDD 10MHz: OP.2 TDD 20MHz: OP.8 TDD			5MHz: OP.10 TDD 10MHz: OP.2 TDD 20MHz: OP.8 TDD		
PBCH_RA	dB	0			0			0			0		
PBCH_RB	dB												
PSS_RA	dB												
SSS_RA	dB												
PCFICH_RB	dB												
PHICH_RA	dB												
PHICH_RB	dB												
PDCCH_RA	dB												
PDCCH_RB	dB												
PDSCH_RA	dB												
PDSCH_RB	dB												
OCNG_RA ^{Note 1}	dB												
OCNG_RB ^{Note 1}	dB												
N _{oc} ^{Note 2}	dBm/15 kHz												
\bar{E}_s/N_{oc}	dB	17			-infinity			17			17		
\bar{E}_s/I_{ot} ^{Note 3}	dB	17			-infinity			17			17		
RSRP ^{Note 3}	dBm/15 kHz	-87			-infinity			-87			-87		
SCH_RP ^{Note 3}	dBm/15 kHz	-87			-infinity			-87			-87		
I _o ^{Note 3}	dBm/C h BW	-59.13+10log (N _{RB,c} /50)			-76.22 +10log (N _{RB,c} /50)			-59.13+10log (N _{RB,c} /50)			-59.13+10log (N _{RB,c} /50)		
Propagation Condition		AWGN			AWGN			AWGN			AWGN		
Antenna Configuration		1x2			1x2			1x2			1x2		
Timing offset to Cell 1	μs	-			0			0			0		
Time alignment error relative to cell 1 ^{Note 5}	μs	-			≤ TAE			≤ TAE			≤ TAE		
Time alignment error relative to cell 2 ^{Note 5}	μs	-			-			≤ TAE			≤ TAE		
Time alignment error relative to cell 3 ^{Note 5}	μs	-			-			-			≤ TAE		
Note 1:	OCNG shall be used such that all cells are fully allocated and a constant total transmitted power spectral density is achieved for all OFDM symbols.												
Note 2:	Interference from other cells and noise sources not specified in the test is assumed to be constant over subcarriers and time and shall be modelled as AWGN of appropriate power for N _{oc} to be fulfilled.												
Note 3:	E _s /I _{ot} , RSRP, SCH_RP and I _o have been derived from other parameters for information purposes. They are not settable parameters themselves.												
Note 4:	The uplink resources for CSI reporting are assigned to the UE prior to the start of time period T2.												
Note 5:	Time alignment error (TAE) as specified in TS 36.104 [30] clause 6.5.3.1. The TAE value depends upon the type of carrier aggregation.												

A.8.16.62.2 Test Requirements

During T2 the UE shall send the first CSI report for SCell1 in a subframe (m+8), or in a subframe (m+9) if the subframe (m+8) was subject to interruption, or in a subframe (m+13) if the subframe (m+8) and (m+9) were subject to interruption when an intra-band

SCell is activated. Whether CSI report in subframe (m+8) and/or (m+9) was interrupted or not is checked by monitoring ACK/NACK sent in PCell in subframe (m+8) and/or (m+9).

During T2 the UE shall start sending CSI reports for SCell1 with non-zero CQI index at latest in a subframe (m+44).

During T3 the UE shall stop sending CSI reports for SCell1 at latest in subframe (n+8).

During T2 interruption of PCell during SCells activation shall not happen outside the subframes (m+5) to (m+11), outside the subframes (m+20) to (m+26), and outside the subframes (n+35) to (n+41).

During T3 interruption of PCell during SCells deactivation shall not happen outside the subframes (n+5) to (n+11), outside the subframes (n+20) to (n+26) and outside the subframes (n+35) to (n+41).

The interruption of PCell shall not be more than the values specified for intra-band CA and inter-band CA in Section 7.8.2.

The UE shall not send event triggered measurement reports as long as the reporting criteria are not fulfilled.

All of the above test requirements shall be fulfilled in order for the observed SCell1 activation delay and SCell1 deactivation delay to be counted as correct. The rate of correct observed SCell1 activation delay and SCell1 deactivation delay during repeated tests shall be at least 90%.

NOTE: During T2 if there are no uplink resources for reporting the valid CSI in a subframe (m+44) then the UE shall use the next available uplink resource for reporting the corresponding valid CSI.

A.8.16.63 E-UTRAN PCell in FDD FDD-TDD 4 DL CA activation and deactivation of unknown SCell in non-DRX

A.8.16.63.1 Test Purpose and Environment

The purpose of this test is to verify that the SCell activation and deactivation times are within the requirements stated in section 7.7 for UE configured with three downlink SCells, when the SCell is unknown by the UE at the time of activation and PCell is in FDD.

The test parameters are given in Tables A.8.16.63.1-1 and cell-specific parameters in A.8.16.63.1-2 and A.8.16.63.1-3 below. The test consists of three successive time periods, with duration of T1, T2 and T3, respectively. There are four carriers, each with one cell. Cell 1, Cell 3 and Cell 4 have constant signal levels throughout the test. Before the test starts the UE is connected to Cell 1 (PCell) on radio channel 1 (PCC), deactivated Cell 3 (SCell2) on radio channel 3 (SCC2) and deactivated Cell 4 (SCell3) on radio channel 4 (SCC3) but is not aware of Cell 2 (SCell1) on radio channel 2 (SCC1). The UE is only monitoring PCC, SCC2 and SCC3. The UE shall be continuously scheduled in PCell throughout the whole test.

At the beginning of T1 the UE receives an RRC message by which SCell1 becomes configured on SCC1. During T1 SCell1 is powered off and the UE is not aware of SCell1.

A MAC message for activation of SCell1 is sent by the test equipment 100ms after the RRC message, in a subframe # denoted m which is an even number. The point in time at which the MAC message for activation of SCell1 is received at the UE antenna connector defines the start of time period T2. Immediately at beginning of T2 transmission power of SCell1 is increased to same level as for PCell. The test equipment sends a MAC message for activation of the SCell2 in subframe (m+10) and a MAC message for activation of the SCell3 in subframe (m+20) during activation of SCell1. The UE shall be able to report valid CSI for the activated SCell1 at latest in subframe (m+44) provided SCell1 can be successfully detected on the first attempt. The UE shall start reporting CSI for SCell1 in subframe (m+8) and shall report CQI index 0 (out-of-range) until the SCell activation has been completed. Any PCell interruption due to activation of SCells shall not occur outside subframes (m+5) to (m+9), (m+15) to (m+19) and (m+25) to (m+29).

Time period T3 starts when a MAC message for deactivation of SCell1, sent from the test equipment to the UE in a subframe # denoted n, is received at the UE antenna connector. The test equipment sends a MAC message for deactivation of the SCell2 in subframe (n+10) and a MAC message for deactivation of the SCell3 in subframe (n+20). The UE shall carry out deactivation of SCell1 at latest in subframe (n+8), and any PCell interruption due to the deactivation of SCells shall not occur outside subframes (n+5) to (n+9), (n+15) to (n+19) and (n+25) to (n+29).

The test equipment verifies that potential interruption is carried out in the correct time span by monitoring ACK/NACK sent in PCell during activation and deactivation of SCell1, respectively.

The test equipment verifies the activation time by counting the subframes from the time when SCell1 activation command is sent until a CSI report with other than CQI index 0 is received.

The test equipment verifies the deactivation time by counting the subframes from the time when SCell1 deactivation command is sent until CQI reporting for SCell1 is discontinued.

Table A.8.16.63.1-1: General test parameters for unknown SCell1 activation case

Parameter	Unit	Value	Comment
E-UTRA RF Channel Number		1, 2, 3, 4	Four radio channels are used for this test
Active PCell		Cell 1	Primary cell on RF channel number 1.
Deconfigured deactivated SCell1		Cell 2	Deconfigured deactivated secondary cell on RF channel number 2.
Configured deactivated SCell2		Cell 3	Configured deactivated secondary cell on RF channel number 3.
Configured deactivated SCell3		Cell 4	Configured deactivated secondary cell on RF channel number 4.
CP length		Normal	
DRX		OFF	Continuous monitoring of primary cell
CQI/PMI periodicity and offset configuration index		0	CQI reporting for SCell every second subframe
Cell-individual offset for cells on RF channel number 1	dB	0	Individual offset for cells on PCC.
Cell-individual offset for cells on RF channel number 2	dB	0	Individual offset for cells on SCC1.
Cell-individual offset for cells on RF channel number 3	dB	0	Individual offset for cells on SCC2.
Cell-individual offset for cells on RF channel number 4	dB	0	Individual offset for cells on SCC3.
SCell measurement cycle (measCycleSCell)	ms	320	
T1	ms	100	During this time the PCell, SCell2 and SCell3 shall be known and the SCell1 configured.
T2	s	1	During this time the UE shall activate the SCell1, SCell2, and SCell3.
T3	s	1	During this time the UE shall deactivate the SCell1, SCell2, and SCell3.

Table A.8.16.63.1-2: Cell specific test parameters for E-UTRAN TDD unknown SCell1 activation with PCell in FDD

Parameter	Unit	Cell 1			Cell 2			Cell 3		
		T1	T2	T3	T1	T2	T3	T1	T2	T3
E-UTRA RF Channel Number		1			2			3		
BW _{channel}	MHz	5MHz: N _{RB,c} = 25 10MHz: N _{RB,c} = 50 20MHz: N _{RB,c} = 100			5MHz: N _{RB,c} = 25 10MHz: N _{RB,c} = 50 20MHz: N _{RB,c} = 100			5MHz: N _{RB,c} = 25 10MHz: N _{RB,c} = 50 20MHz: N _{RB,c} = 100		
Special subframe configuration		-			6			6		
Uplink-downlink configuration		-			1			1		
PDSCH parameters: DL Reference Measurement Channel		5MHz: R.7 FDD 10MHz: R.3 FDD 20MHz: R.6 FDD			-			-		
PCFICH/PDCCH/PHICH parameters: DL Reference Measurement Channel		5MHz: R.11 FDD 10MHz: R.6 FDD 20MHz: R.10 FDD			5MHz: R.11 TDD 10MHz: R.6 TDD 20MHz: R.10 TDD			5MHz: R.11 TDD 10MHz: R.6 TDD 20MHz: R.10 TDD		
OCNG Patterns		5MHz: OP.20 FDD 10MHz: OP.10 FDD 20MHz: OP.17 FDD			5MHz: OP.10 TDD 10MHz: OP.2 TDD 20MHz: OP.8 TDD			5MHz: OP.10 TDD 10MHz: OP.2 TDD 20MHz: OP.8 TDD		
PBCH_RA	dB	0			0			0		
PBCH_RB	dB									
PSS_RA	dB									
SSS_RA	dB									
PCFICH_RB	dB									
PHICH_RA	dB									
PHICH_RB	dB									
PDCCH_RA	dB									

PDCCH_RB	dB				
PDSCH_RA	dB				
PDSCH_RB	dB				
OCNG_RA ^{Note 1}	dB				
OCNG_RB ^{Note 1}	dB				
N _{oc} ^{Note 2}	dBm/15 kHz	-104	-104	-104	-104
\bar{E}_s/N_{oc}	dB	17	-infinity	17	17
\bar{E}_s/I_{ot}	dB	17	-infinity	17	17
RSRP ^{Note 3}	dBm/15 kHz	-87	-infinity	-87	-87
SCH_RP ^{Note 3}	dBm/15 kHz	-87	-infinity	-87	-87
I _o ^{Note 3}	dBm/Ch BW	-59.13 +10log(N _{RB,c} /50)	-76.22 +10log(N _{RB,c} /50)	-59.13 +10log(N _{RB,c} /50)	-59.13 +10log(N _{RB,c} /50)
Propagation Condition		AWGN	AWGN	AWGN	AWGN
Antenna Configuration		1x2	1x2	1x2	1x2
Timing offset to Cell 1	μs	-	0	0	0
Time alignment error relative to cell 1 ^{Note 5}	μs	-	≤ TAE	≤ TAE	≤ TAE
Time alignment error relative to cell 2 ^{Note 5}	μs	-	-	-	≤ TAE
Time alignment error relative to cell 3 ^{Note 5}	μs	-	-	-	-
<p>Note 1: OCNG shall be used such that all cells are fully allocated and a constant total transmitted power spectral density is achieved for all OFDM symbols.</p> <p>Note 2: Interference from other cells and noise sources not specified in the test is assumed to be constant over subcarriers and time and shall be modelled as AWGN of appropriate power for N_{oc} to be fulfilled.</p> <p>Note 3: Es/I_{ot}, RSRP, SCH_RP and I_o levels have been derived from other parameters for information purposes. They are not settable parameters themselves.</p> <p>Note 4: The uplink resources for CSI reporting are assigned to the UE prior to the start of time period T2.</p> <p>Note 5: Time alignment error (TAE) as specified in TS 36.104 [30] clause 6.5.3.1. The TAE value depends upon the type of carrier aggregation.</p>					

Table A.8.16.63.1-3: Cell specific test parameters for E-UTRAN TDD unknown SCell1 activation with PCell in FDD

Parameter	Unit	Cell 4						
		T1	T2	T3				
E-UTRA RF Channel Number		4						
BW _{channel}	MHz	5MHz: N _{RB,c} = 25 10MHz: N _{RB,c} = 50 20MHz: N _{RB,c} = 100						
Special subframe configuration		6						
Uplink-downlink configuration		1						
PDSCH parameters: DL Reference Measurement Channel		-						
PCFICH/PDCCH/PHICH parameters: DL Reference Measurement Channel		5MHz: R.11 TDD 10MHz: R.6 TDD 20MHz: R.10 TDD						
OCNG Patterns		5MHz: OP.10 TDD 10MHz: OP.2 TDD 20MHz: OP.8 TDD						
PBCH_RA	dB	0						
PBCH_RB	dB							
PSS_RA	dB							
SSS_RA	dB							
PCFICH_RB	dB							
PHICH_RA	dB							
PHICH_RB	dB							
PDCCH_RA	dB							
PDCCH_RB	dB							

PDSCH_RA	dB			
PDSCH_RB	dB			
OCNG_RA ^{Note 1}	dB			
OCNG_RB ^{Note 1}	dB			
N _{oc} ^{Note 2}	dBm/15 kHz	-104		
\bar{E}_s/N_{oc}	dB	17		
\bar{E}_s/I_{ot}	dB	17		
RSRP ^{Note 3}	dBm/15 kHz	-87		
SCH_RP ^{Note 3}	dBm/15 kHz	-87		
I _o ^{Note 3}	dBm/Ch BW	-59.13 +10log (N _{RB,c} /50)		
Propagation Condition		AWGN		
Antenna Configuration		1x2		
Timing offset to Cell 1	μs	0		
Time alignment error relative to cell 1 ^{Note 5}	μs	≤ TAE		
Time alignment error relative to cell 2 ^{Note 5}	μs	≤ TAE		
Time alignment error relative to cell 3 ^{Note 5}	μs	≤ TAE		
<p>Note 1: OCNG shall be used such that all cells are fully allocated and a constant total transmitted power spectral density is achieved for all OFDM symbols.</p> <p>Note 2: Interference from other cells and noise sources not specified in the test is assumed to be constant over subcarriers and time and shall be modelled as AWGN of appropriate power for N_{oc} to be fulfilled.</p> <p>Note 3: Es/lot, RSRP, SCH_RP and I_o levels have been derived from other parameters for information purposes. They are not settable parameters themselves.</p> <p>Note 4: The uplink resources for CSI reporting are assigned to the UE prior to the start of time period T2.</p> <p>Note 5: Time alignment error (TAE) as specified in TS 36.104 [30] clause 6.5.3.1. The TAE value depends upon the type of carrier aggregation.</p>				

A.8.16.63.2 Test Requirements

During T2 the UE shall send the first CSI report for SCell1 in a subframe (m+8), or in a subframe (m+10) if the subframe (m+8) was subject to interruption. Whether CSI report in subframe (m+8) was interrupted or not is checked by monitoring ACK/NACK sent in PCell in subframe (m+8).

During T2 the UE shall start sending CSI reports for SCell1 with non-zero CQI index at latest in a subframe (m+44).

During T3 the UE shall stop sending CSI reports for SCell1 at latest in a subframe (n+8).

During T2 interruption of PCell during SCells activation shall not happen outside the subframes (m+5) to (m+9), outside the subframes (m+15) to (m+19), and outside the subframes (m+25) to (m+29).

During T3 interruption of PCell during SCells deactivation shall not happen outside the subframes (n+5) to (n+9), outside the subframes (n+15) to (n+19), and (n+25) to (n+29).

The interruption of PCell shall not be more than the values specified for intra-band CA and inter-band CA in Section 7.8.2.

All of the above test requirements shall be fulfilled in order for the observed SCell1 activation delay and SCell1 deactivation delay to be counted as correct. The rate of correct observed SCell1 activation delay and SCell1 deactivation delay during repeated tests shall be at least 90%.

NOTE: During T2 if there are no uplink resources for reporting the valid CSI in a subframe (m+44) then the UE shall use the next available uplink resource for reporting the corresponding valid CSI.

A.8.16.64 E-UTRAN PCell in TDD FDD-TDD 4 DL CA activation and deactivation of unknown SCell in non-DRX

A.8.16.64.1 Test Purpose and Environment

The purpose of this test is to verify that the SCell activation and deactivation times are within the requirements stated in section 7.7 for UE configured with three downlink SCells, when the SCell is unknown by the UE at the time of activation and PCell is in TDD.

The test parameters are given in Tables A.8.16.64.1-1 and cell-specific parameters in A.8.16.64.1-2 and A.8.16.64.1-3 below. The test consists of three successive time periods, with duration of T1, T2 and T3, respectively. There are four carriers, each with one cell. Cell 1, Cell 3 and Cell 4 have constant signal levels throughout the test. Before the test starts the UE is connected to Cell 1 (PCell) on radio channel 1 (PCC), deactivated Cell 3 (SCell2) on radio channel 3 (SCC2) and deactivated Cell 4 (SCell3) on radio channel 4 (SCC3) but is not aware of Cell 2 (SCell1) on radio channel 2 (SCC1). The UE is only monitoring PCC, SCC2 and SCC3. The UE shall be continuously scheduled in PCell throughout the whole test.

At the beginning of T1 the UE receives an RRC message by which SCell1 becomes configured on SCC1. During T1 SCell1 is powered off and the UE is not aware of SCell1.

A MAC message for activation of SCell1 is sent by the test equipment 100ms after the RRC message, in a subframe # denoted m which is 4 or 9. The point in time at which the MAC message for activation of SCell1 is received at the UE antenna connector defines the start of time period T2. Immediately at beginning of T2 the transmission power of SCell1 is increased to same level as for PCell. The test equipment sends a MAC message for activation of SCell2 in subframe (m+15) and a MAC message for activation of SCell3 in subframe (m+30) during activation of SCell1. The UE shall be able to report valid CSI for the activated SCell1 at latest in subframe (m+44) provided the SCell1 can be successfully detected on the first attempt. The UE shall start reporting CSI for SCell1 in subframe (m+8) and shall report CQI index 0 (out-of-range) until the SCell activation has been completed. Any PCell interruption due to activation of SCells shall not occur outside subframes (m+5) to (m+11), (m+20) to (m+26) and (m+35) to (m+41).

Time period T3 starts when a MAC message for deactivation of SCell1, sent from the test equipment to the UE in a subframe # denoted n, where n is 4 or 9, is received at the UE antenna connector. The test equipment sends a MAC message for deactivation of the SCell2 in subframe (n+15) and a MAC message for deactivation of the SCell3 in subframe (n+30). The UE shall carry out deactivation of SCell1 at latest in subframe (n+8), and any PCell interruption due to the deactivation of SCells shall not occur outside subframes (n+5) to (n+11), (n+20) to (n+26) and (n+35) to (n+41).

The test equipment verifies that potential interruption is carried out in the correct time span by monitoring ACK/NACK sent in PCell during activation and deactivation of SCell1, respectively.

The test equipment verifies the activation time by counting the subframes from time when the SCell1 activation command is sent until a CSI report with other than CQI index 0 is received.

The test equipment verifies the deactivation time by counting the subframes from time when the SCell1 deactivation command is sent until CQI reporting for SCell1 is discontinued.

Table A.8.16.64.1-1: General test parameters for unknown SCell1 activation case

Parameter	Unit	Value	Comment
E-UTRA RF Channel Number		1, 2, 3, 4	Four radio channels are used for this test
Active PCell		Cell 1	Primary cell on RF channel number 1.
Deconfigured deactivated SCell		Cell 2	Deconfigured deactivated secondary cell on RF channel number 2.
Configured deactivated SCell2		Cell 3	Configured deactivated secondary cell on RF channel number 3.
Configured deactivated SCell3		Cell 4	Configured deactivated secondary cell on RF channel number 4.
CP length		Normal	
DRX		OFF	Continuous monitoring of primary cell
CQI/PMI periodicity and offset configuration index		0	CQI reporting for SCell every UL subframe
Cell-individual offset for cells on RF channel number 1	dB	0	Individual offset for cells on PCC.
Cell-individual offset for cells on RF channel number 2	dB	0	Individual offset for cells on SCC1.
Cell-individual offset for cells on RF channel number 3	dB	0	Individual offset for cells on SCC2.
Cell-individual offset for cells on RF channel number 4	dB	0	Individual offset for cells on SCC3.
SCell measurement cycle (measCycleSCell)	ms	320	
T1	ms	100	During this time the PCell, SCell2 and SCell3 shall be known and the SCell1 configured.
T2	s	1	During this time the UE shall activate the SCell1, SCell2, and SCell3.

T3	s	1	During this time the UE shall deactivate the SCell1, SCell2, and SCell3.
----	---	---	--

Table A.8.16.64.1-2: Cell specific test parameters for E-UTRAN FDD unknown SCell1 activation with PCell in TDD

Parameter	Unit	Cell 1			Cell 2			Cell 3		
		T1	T2	T3	T1	T2	T3	T1	T2	T3
E-UTRA RF Channel Number		1			2			3		
BW _{channel}	MHz	5MHz: N _{RB,c} = 25 10MHz: N _{RB,c} = 50 20MHz: N _{RB,c} = 100			5MHz: N _{RB,c} = 25 10MHz: N _{RB,c} = 50 20MHz: N _{RB,c} = 100			5MHz: N _{RB,c} = 25 10MHz: N _{RB,c} = 50 20MHz: N _{RB,c} = 100		
Special subframe configuration		6			-			-		
Uplink-downlink configuration		1			-			-		
PDSCH parameters: DL Reference Measurement Channel		5MHz: R.4 TDD 10MHz: R.0 TDD 20MHz: R.3 TDD			-			-		
PCFICH/PDCCH/PHICH parameters: DL Reference Measurement Channel		5MHz: R.11 TDD 10MHz: R.6 TDD 20MHz: R.10 TDD			5MHz: R.11 FDD 10MHz: R.6 FDD 20MHz: R.10 FDD			5MHz: R.11 FDD 10MHz: R.6 FDD 20MHz: R.10 FDD		
OCNG Patterns		5MHz: OP.9 TDD 10MHz: OP.1 TDD 20MHz: OP.7 TDD			5MHz: OP.16 FDD 10MHz: OP.2 FDD 20MHz: OP.12 FDD			5MHz: OP.16 FDD 10MHz: OP.2 FDD 20MHz: OP.12 FDD		
PBCH_RA	dB	0			0			0		
PBCH_RB	dB									
PSS_RA	dB									
SSS_RA	dB									
PCFICH_RB	dB									
PHICH_RA	dB									
PHICH_RB	dB									
PDCCH_RA	dB									
PDCCH_RB	dB									
PDSCH_RA	dB									
PDSCH_RB	dB									
OCNG_RA ^{Note 1}	dB									
OCNG_RB ^{Note 1}	dB									
N _{oc} ^{Note 2}	dBm/15 kHz									
\bar{E}_s/N_{oc}	dB	17			17			17		
\bar{E}_s/I_{ot}	dB	17			17			17		
RSRP ^{Note 3}	dBm/15 kHz	-87			-87			-87		
SCH_RP ^{Note 3}	dBm/15 kHz	-87			-87			-87		
I _o ^{Note 3}	dBm/Ch BW	-59.13 +10log (N _{RB,c} /50)			-59.13 +10log (N _{RB,c} /50)			-59.13 +10log (N _{RB,c} /50)		
Propagation Condition		AWGN			AWGN			AWGN		
Antenna Configuration		1x2			1x2			1x2		
Timing offset to Cell 1	μs	-			0			0		
Time alignment error relative to cell 1 ^{Note 5}	μs	-			≤ TAE			≤ TAE		
Time alignment error relative to cell 2 ^{Note 5}	μs	-			-			≤ TAE		
Time alignment error relative to cell 3 ^{Note 5}	μs	-			-			-		
Note 1:	OCNG shall be used such that all cells are fully allocated and a constant total transmitted power spectral density is achieved for all OFDM symbols.									
Note 2:	Interference from other cells and noise sources not specified in the test is assumed to be constant over subcarriers and time and shall be modelled as AWGN of appropriate power for N _{oc} to be fulfilled.									
Note 3:	Es/I _{ot} , RSRP, SCH_RP and I _o levels have been derived from other parameters for information purposes. They are not settable parameters themselves.									
Note 4:	The uplink resources for CSI reporting are assigned to the UE prior to the start of time period T2.									
Note 5:	Time alignment error (TAE) as specified in TS 36.104 [30] clause 6.5.3.1. The TAE value depends upon the type of carrier aggregation.									

Table A.8.16.64.1-3: Cell specific test parameters for E-UTRAN FDD unknown SCell1 activation with PCell in TDD

Parameter	Unit	Cell 4									
		T1	T2	T3							
E-UTRA RF Channel Number		4									
BW _{channel}	MHz	5MHz: N _{RB,c} = 25 10MHz: N _{RB,c} = 50 20MHz: N _{RB,c} = 100									
Special subframe configuration		-									
Uplink-downlink configuration		-									
PDSCH parameters: DL Reference Measurement Channel		-									
PCFICH/PDCCH/PHICH parameters: DL Reference Measurement Channel		5MHz: R.11 FDD 10MHz: R.6 FDD 20MHz: R.10 FDD									
OCNG Patterns		5MHz: OP.16 FDD 10MHz: OP.2 FDD 20MHz: OP.12 FDD									
PBCH_RA	dB	0									
PBCH_RB	dB										
PSS_RA	dB										
SSS_RA	dB										
PCFICH_RB	dB										
PHICH_RA	dB										
PHICH_RB	dB										
PDCCH_RA	dB										
PDCCH_RB	dB										
PDSCH_RA	dB										
PDSCH_RB	dB										
OCNG_RA ^{Note 1}	dB										
OCNG_RB ^{Note 1}	dB										
N _{oc} ^{Note 2}	dBm/15 kHz				-104						
\bar{E}_s/N_{oc}	dB				17						
\bar{E}_s/I_{ot}	dB	17									
RSRP ^{Note 3}	dBm/15 kHz	-87									
SCH_RP ^{Note 3}	dBm/15 kHz	-87									
I _o ^{Note 3}	dBm/Ch BW	-59.13 +10log (N _{RB,c} /50)									
Propagation Condition		AWGN									
Antenna Configuration		1x2									
Timing offset to Cell 1	μs	0									
Time alignment error relative to cell 1 ^{Note 5}	μs	≤ TAE									
Time alignment error relative to cell 2 ^{Note 5}	μs	≤ TAE									
Time alignment error relative to cell 3 ^{Note 5}	μs	≤ TAE									
<p>Note 1: OCNG shall be used such that all cells are fully allocated and a constant total transmitted power spectral density is achieved for all OFDM symbols.</p> <p>Note 2: Interference from other cells and noise sources not specified in the test is assumed to be constant over subcarriers and time and shall be modelled as AWGN of appropriate power for N_{oc} to be fulfilled.</p> <p>Note 3: Es/I_{ot}, RSRP, SCH_RP and I_o levels have been derived from other parameters for information purposes. They are not settable parameters themselves.</p> <p>Note 4: The uplink resources for CSI reporting are assigned to the UE prior to the start of time period T2.</p> <p>Note 5: Time alignment error (TAE) as specified in TS 36.104 [30] clause 6.5.3.1. The TAE value depends upon the type of carrier aggregation.</p>											

A.8.16.64.2 Test Requirements

During T2 the UE shall send the first CSI report for SCell1 in a subframe (m+8), or in a subframe (m+9) if the subframe (m+8) was subject to interruption. Whether CSI report in subframe (m+8) was interrupted or not is checked by monitoring ACK/NACK sent in PCell in subframe (m+8).

During T2 the UE shall start sending CSI reports for SCell1 with non-zero CQI index at latest in a subframe (m+44).

During T3 the UE shall stop sending CSI reports for SCell at latest in a subframe (n+8).

During T2 interruption of PCell during SCells activation shall not happen outside the subframes (m+5) to (m+11), outside the subframes (m+20) to (m+26), and outside the subframes (m+35) to (m+41).

During T3 interruption of PCell during SCells deactivation shall not happen outside the subframes (n+5) to (n+11), outside the subframes (n+20) to (n+26) and outside the subframes (n+35) to (n+41).

The interruption of PCell shall not be more than the values specified for intra-band CA and inter-band CA in Section 7.8.2.

All of the above test requirements shall be fulfilled in order for the observed SCell1 activation delay and SCell1 deactivation delay to be counted as correct. The rate of correct observed SCell1 activation delay and SCell1 deactivation delay during repeated tests shall be at least 90%.

NOTE: During T2 if there are no uplink resources for reporting the valid CSI in a subframe (m+44) then the UE shall use the next available uplink resource for reporting the corresponding valid CSI.

A.8.16.65 5 DL FDD-TDD with PCell in FDD CA Event Triggered Reporting with 4 Deactivated SCells in Non-DRX

A.8.16.65.1 Test Purpose and Environment

The purpose of this test is to verify that the UE correctly detects events A1 (Serving cell becomes better than threshold), A2 (Serving cell becomes worse than threshold) and A6 (Neighbour becomes better than SCell) defined in TS 36.331 [2] within the requirements stated in clause 8.3.3.2.1.

The test parameters are given in Tables A.8.16.65.1-1, A.8.16.65.1-2 and A.8.16.65.1-3 below. It is indicated to the UE in the measurement control information that event-triggered reporting with Events A1 (for only SCell1 i.e. cell2), A2 (PCell and SCells) and A6 is used. The test consists of three successive time periods, with duration of T1, T2 and T3, respectively. During T1 the UE shall not have any information on cell 6. At the beginning of T2 the transmission power of cell 6 is increased to the same level as for cell 5, and due to usage of an offset this shall result in reporting of Event A6. Also, at the beginning of T2 the transmission power of cell 2 is increased to the same level as for cell 1, which shall result in reporting of Event A1. At the beginning of T3 the transmission powers of cells 1, 2, 3, 4 and 5 are reduced below a threshold value and this shall result in reporting of Event A2 for Cell 1, for Cell 2, for Cell 3, for Cell 4 and for Cell 5.

Table A.8.16.65.1-1: General test parameters for E-UTRAN TDD-FDD 5 DL CA event triggered reporting under fading propagation conditions with 4 configured but deactivated SCells in non-DRX with PCell in FDD

Parameter	Unit	Value	Comment	
E-UTRA RF Channel Number		1, 2, 3, 4, 5	Five radio channels are used for this test	
Active PCell		Cell 1	Primary cell on RF channel number 1.	
Configured deactivated SCell		Cell 2	Configured deactivated secondary cell on RF channel number 2.	
Configured deactivated SCell		Cell 3	Configured deactivated secondary cell on RF channel number 3.	
Configured deactivated SCell		Cell 4	Configured deactivated secondary cell on RF channel number 4.	
Configured deactivated SCell		Cell 5	Configured deactivated secondary cell on RF channel number 5.	
Neighbour cell		Cell 6	Neighbour cell to be identified on RF channel number 5.	
CP length		Normal		
DRX		OFF	Continuous monitoring of primary cell	
Special subframe configuration		6	As specified in table 4.2-1 in TS 36.211. The same configuration applies to all TDD cells (cell2, cell3, cell4, cell5 and cell6).	
Uplink-downlink configuration		1	As specified in table 4.2-2 in TS 36.211. The same configuration applies to all TDD cells (cell2, cell3, cell4, cell5 and cell6).	
A1	Hysteresis	dB	0	Hysteresis for evaluation of event A1.

	Threshold RSRP	dBm	-98	Actual RSRP threshold for event A1. Needs to take absolute accuracy tolerance in section 9.1.11.1 into account plus margin.
	Time To Trigger	s	0	
A2	Hysteresis	dB	0	Hysteresis for evaluation of event A2.
	Threshold RSRP	dBm	-98	Actual RSRP threshold for event A2. Needs to take absolute accuracy tolerance in section 9.1.11.1 into account plus margin.
	Time To Trigger	s	0	
A6	Hysteresis	dB	0	Hysteresis for evaluation of event A6.
	Offset	dB	-6	Offset parameter for evaluation of event A6. Needs to take relative accuracy tolerance in section 9.1.11.2 into account plus margin.
	Report on leave		False	
	Time To Trigger	s	0	
Cell-individual offset for cells on RF channel number 1		dB	0	Individual offset for cells on primary component carrier.
Cell-individual offset for cells on RF channel number 2		dB	0	Individual offset for cells on secondary component carrier.
Cell-individual offset for cells on RF channel number 3		dB	0	Individual offset for cells on secondary component carrier.
Cell-individual offset for cells on RF channel number 4		dB	0	Individual offset for cells on secondary component carrier.
Cell-individual offset for cells on RF channel number 5		dB	0	Individual offset for cells on secondary component carrier.
Filter coefficient			0	L3 filtering is not used
SCell measurement cycle (measCycleSCell)		ms	320	For cell2, cell3, cell4 and cell5
T1		s	5	During this time the cell1, cell3, cell4 and cell5 shall be known to the UE; but cell2 and cell6 shall be unknown to the UE.
T2		s	≤12	UE should report Event A1 for cell2 and event A6 for cell6 within 6.4s (20×sCellMeasCycle)
T3		s	5	UE should report Event A2 within 200 ms for cell1 and within 1.6s for each of cells 2, 3, 4 and 5.

Table A.8.16.65.1-2: Cell specific test parameters for E-UTRAN TDD-FDD 5 DL CA event triggered reporting under fading propagation conditions with 4 configured but deactivated SCells in non-DRX with PCell in FDD

Parameter	Unit	Cell 1			Cell 2			Cell3		
		T1	T2	T3	T1	T2	T3	T1	T2	T3
E-UTRA RF Channel Number		1			2			3		
BW _{channel}		5MHz: N _{RB,c} = 25 10MHz: N _{RB,c} = 50 20MHz: N _{RB,c} = 100			5MHz: N _{RB,c} = 25 10MHz: N _{RB,c} = 50 20MHz: N _{RB,c} = 100			5MHz: N _{RB,c} = 25 10MHz: N _{RB,c} = 50 20MHz: N _{RB,c} = 100		
PDSCH parameters: DL Reference Measurement Channel		5MHz: R.5 FDD 10MHz: R.0 FDD 20MHz: R.4 FDD			-			-		
PCFICH/PDCCH/PHICH parameters: DL Reference Measurement Channel		5MHz: R.11 FDD 10MHz: R.6 FDD 20MHz: R.10 FDD			5MHz: R.11 TDD 10MHz: R.6 TDD 20MHz: R.10 TDD			5MHz: R.11 TDD 10MHz: R.6 TDD 20MHz: R.10 TDD		
OCNG Patterns		5MHz: OP.15 FDD 10MHz: OP.1 FDD 20MHz: OP.11 FDD			5MHz: OP.10 TDD 10MHz: OP.2 TDD 20MHz: OP.8 TDD			5MHz: OP.10 TDD 10MHz: OP.2 TDD 20MHz: OP.8 TDD		
PBCH_RA	dB	0			0			0		
PBCH_RB	dB									
PSS_RA	dB									
SSS_RA	dB									
PCFICH_RB	dB									
PHICH_RA	dB									
PHICH_RB	dB									
PDCCH_RA	dB									
PDCCH_RB	dB									
PDSCH_RA	dB									
PDSCH_RB	dB									
OCNG_RA ^{Note 1}	dB									
OCNG_RB ^{Note 1}	dB									
N _{oc} ^{Note 2}	dBm/15 KHz	-104			-104			-104		
\bar{E}_s/N_{oc}	dB	17	17	-3	- infinity	17	-3	17	17	-3
\bar{E}_s/I_{ot} ^{Note 3}	dB	17	17	-3	- infinity	17	-3	17	17	-3
RSRP ^{Note 3}	dBm/15 kHz	-87	-87	-107	- infinity	-87	-107	-87	-87	-107
SCH_RP ^{Note 3}	dBm/15 kHz	-87	-87	-107	- infinity	-87	-107	-87	-87	-107
I _o ^{Note 3}	dBm/Ch BW	-59.13 +10log (N _{RB,c} /50)	-59.13 +10log (N _{RB,c} /50)	-74.45 +10log (N _{RB,c} /50)	-76.22 +10log (N _{RB,c} /50)	-59.13 +10log (N _{RB,c} /50)	-74.45 +10log (N _{RB,c} /50)	-59.13 +10log (N _{RB,c} /50)	-59.13 +10log (N _{RB,c} /50)	-74.45 +10log (N _{RB,c} /50)
Propagation Condition		AWGN			ETU70			ETU70		
Correlation Matrix and Antenna Configuration		1x2 Low			1x2 Low			1x2 Low		
Timing offset to Cell 1	μs	-			0			0		
Time alignment error relative to cell1 ^{Note 5}	μs	-			≤ TAE			≤ TAE		
Time alignment error relative to cell 2 ^{Note 5}	μs	≤ TAE			-			≤ TAE		
Time alignment error relative to cell 3 ^{Note 5}	μs	≤ TAE			≤ TAE			-		
Time alignment error relative to cell 4 ^{Note 5}	μs	≤ TAE			≤ TAE			≤ TAE		
Time alignment error relative to cell 5 ^{Note 5}	μs	≤ TAE			≤ TAE			≤ TAE		

Note 1: OCNG shall be used such that all cells are fully allocated and a constant total transmitted power spectral density is achieved for all OFDM symbols.

Note 2: Interference from other cells and noise sources not specified in the test is assumed to be constant over subcarriers and time and shall be modelled as AWGN of appropriate power for N_{oc} to be fulfilled.

Note 3: Es/I_{ot}, RSRP, SCH_RP and I_o have been derived from other parameters for information purposes. They are not settable parameters themselves.

Note 4: The resources for uplink transmission are assigned to the UE prior to the start of time period T2.

Note 5: Time alignment error (TAE) as specified in TS 36.104 [30] clause 6.5.3.1. The TAE value depends upon the type of carrier aggregation.

Table A.8.16.65.1-3: Cell specific test parameters for E-UTRAN TDD-FDD 5 DL CA event triggered reporting under fading propagation conditions with 4 configured but deactivated SCells in non-DRX with PCell in FDD

Parameter	Unit	Cell 4			Cell 5			Cell 6		
		T1	T2	T3	T1	T2	T3	T1	T2	T3
E-UTRA RF Channel Number		4			5					
BW _{channel}		5MHz: N _{RB,c} = 25 10MHz: N _{RB,c} = 50 20MHz: N _{RB,c} = 100			5MHz: N _{RB,c} = 25 10MHz: N _{RB,c} = 50 20MHz: N _{RB,c} = 100					
PDSCH parameters: DL Reference Measurement Channel		-			-			-		
PCFICH/PDCCH/PHICH parameters: DL Reference Measurement Channel		5MHz: R.11 TDD 10MHz: R.6 TDD 20MHz: R.10 TDD			5MHz: R.11 TDD 10MHz: R.6 TDD 20MHz: R.10 TDD			5MHz: R.11 TDD 10MHz: R.6 TDD 20MHz: R.10 TDD		
OCNG Patterns		5MHz: OP.10 TDD 10MHz: OP.2 TDD 20MHz: OP.8 TDD			5MHz: OP.10 TDD 10MHz: OP.2 TDD 20MHz: OP.8 TDD			5MHz: OP.10 TDD 10MHz: OP.2 TDD 20MHz: OP.8 TDD		
PBCH_RA	dB	0			0			0		
PBCH_RB	dB									
PSS_RA	dB									
SSS_RA	dB									
PCFICH_RB	dB									
PHICH_RA	dB									
PHICH_RB	dB									
PDCCH_RA	dB									
PDCCH_RB	dB									
PDSCH_RA	dB									
PDSCH_RB	dB									
OCNG_RA ^{Note 1}	dB									
OCNG_RB ^{Note 1}	dB									
N _{oc} ^{Note 2}	dBm/15 KHz									
\bar{E}_s/N_{oc}	dB	17	17	-3	17	17	-3	-infinity	17	-3
\bar{E}_s/I_{ot} ^{Note 3}	dB	17	17	-3	17	-0.09	-4.76	-infinity	-0.09	-4.76
RSRP ^{Note 3}	dBm/15 kHz	-87	-87	-107	-87	-87	-107	-infinity	-87	-107
SCH_RP ^{Note 3}	dBm/15 kHz	-87	-87	-107	-87	-87	-107	-infinity	-87	-107
I _o ^{Note 3}	dBm/Ch BW	-59.13 +10log (N _{RB,c} /50)	-59.13 +10log (N _{RB,c} /50)	-74.45 +10log (N _{RB,c} /50)	-59.13 +10log (N _{RB,c} /50)	-56.17 +10log (N _{RB,c} /50)	-73.20 +10log (N _{RB,c} /50)	Specified in columns for Cell 5		
Propagation Condition		ETU70			ETU70			ETU70		
Correlation Matrix and Antenna Configuration		1x2 Low			1x2 Low			1x2 Low		
Timing offset to Cell 1	μs	0			0			3		
Time alignment error relative to cell1 ^{Note 5}	μs	-			-			NA		
Time alignment error relative to cell2 ^{Note 5}	μs	-			-			NA		
Time alignment error relative to cell3 ^{Note 5}	μs	-			-			NA		
Time alignment error relative to cell4 ^{Note 5}	μs	-			-			NA		
Time alignment error relative to cell5 ^{Note 5}	μs	-			-			NA		

Note 1: OCNG shall be used such that all cells are fully allocated and a constant total transmitted power spectral density is achieved for all OFDM symbols.
 Note 2: Interference from other cells and noise sources not specified in the test is assumed to be constant over subcarriers and time and shall be modelled as AWGN of appropriate power for N_{oc} to be fulfilled.
 Note 3: Es/I_{ot}, RSRP, SCH_RP and I_o have been derived from other parameters for information purposes. They are not settable parameters themselves.
 Note 4: The resources for uplink transmission are assigned to the UE prior to the start of time period T2.
 Note 5: Time alignment error (TAE) as specified in TS 36.104 [30] clause 6.5.3.1. The TAE value depends upon the type of carrier aggregation.

A.8.16.65.2 Test Requirements

The UE shall send one Event A6 triggered measurement report for Cell 6 with a measurement reporting delay of less than 6.4s ($20 \times \text{measCycleSCell}$) from the beginning of time T2.

The UE shall send one Event A1 triggered measurement report for Cell 2 with a measurement reporting delay of less than 6.4s ($20 \times \text{measCycleSCell}$) from beginning of time T2.

The UE shall send one Event A2 triggered measurement report for Cell 1 with a measurement reporting delay of less than 200 ms from beginning of time T3.

The UE shall send one Event A2 triggered measurement report for Cell 2 with a measurement reporting delay of less than 1.6s ($5 \times \text{measCycleSCell}$) from beginning of time T3.

The UE shall send one Event A2 triggered measurement report for Cell 3 with a measurement reporting delay of less than 1.6s ($5 \times \text{measCycleSCell}$) from beginning of time T3.

The UE shall send one Event A2 triggered measurement report for Cell 4 with a measurement reporting delay of less than 1.6s ($5 \times \text{measCycleSCell}$) from beginning of time T3.

The UE shall send one Event A2 triggered measurement report for Cell 5 with a measurement reporting delay of less than 1.6s ($5 \times \text{measCycleSCell}$) from beginning of time T3.

The UE shall not send event triggered measurement reports as long as the reporting criteria are not fulfilled.

The rate of correct events observed during repeated tests shall be at least 90% for each of the events.

NOTE: The actual overall delays measured in the tests may be up to $2 \times \text{TTI}_{\text{DCCH}}$ higher than the measurement reporting delays above because of TTI insertion uncertainty of the measurement report in DCCH.

A.8.16.66 5 DL FDD-TDD with PCell in TDD CA Event Triggered Reporting with 4 Deactivated SCells in Non-DRX

A.8.16.66.1 Test Purpose and Environment

The purpose of this test is to verify that the UE correctly detects events A1 (Serving cell becomes better than threshold), A2 (Serving cell becomes worse than threshold) and A6 (Neighbour becomes better than SCell) defined in TS 36.331 [2] within the requirements stated in clause 8.3.3.2.1.

The test parameters are given in Tables A.8.16.66.1-1, Tables A.8.16.66.1-2 and A.8.16.66.1-3 below. It is indicated to the UE in the measurement control information that event-triggered reporting with Events A1 (for only SCell1 i.e. cell2), A2 (PCell and SCells) and A6 is used. The test consists of three successive time periods, with duration of T1, T2 and T3, respectively. During T1 the UE shall not have any information on cell 6. At the beginning of T2 the transmission power of cell 6 is increased to the same level as for cell 5, and due to usage of an offset this shall result in reporting of Event A6. Also, at the beginning of T2 the transmission power of cell 2 is increased to the same level as for cell 1, which shall result in reporting of Event A1. At the beginning of T3 the transmission powers of cells 1, 2, 3, 4 and 5 are reduced below a threshold value and this shall result in reporting of Event A2 for Cell 1, for Cell 2, for Cell 3, for Cell 4 and for Cell 5.

Table A.8.16.66.1-1: General test parameters for E-UTRAN TDD-FDD 5 DL CA event triggered reporting under fading propagation conditions with 4 configured but deactivated SCells in non-DRX with PCell in TDD

Parameter	Unit	Value	Comment
E-UTRA RF Channel Number		1, 2, 3, 4, 5	Five radio channels are used for this test
Active PCell		Cell 1	Primary cell on RF channel number 1.
Configured deactivated SCell		Cell 2	Configured deactivated secondary cell on RF channel number 2.
Configured deactivated SCell		Cell 3	Configured deactivated secondary cell on RF channel number 3.
Configured deactivated SCell		Cell 4	Configured deactivated secondary cell on RF channel number 4.
Configured deactivated SCell		Cell 5	Configured deactivated secondary cell on RF channel number 5.
Neighbour cell		Cell 6	Neighbour cell to be identified on RF channel number 5.
CP length		Normal	
DRX		OFF	Continuous monitoring of primary cell

Special subframe configuration			6	As specified in table 4.2-1 in TS 36.211. The configuration applies to the TDD cell (cell1).
Uplink-downlink configuration			1	As specified in table 4.2-2 in TS 36.211. The configuration applies to the TDD cell (cell1).
A1	Hysteresis	dB	0	Hysteresis for evaluation of event A1.
	Threshold RSRP	dBm	-98	Actual RSRP threshold for event A1. Needs to take absolute accuracy tolerance in section 9.1.11.1 into account plus margin.
	Time To Trigger	s	0	
A2	Hysteresis	dB	0	Hysteresis for evaluation of event A2.
	Threshold RSRP	dBm	-98	Actual RSRP threshold for event A2. Needs to take absolute accuracy tolerance in section 9.1.11.1 into account plus margin.
	Time To Trigger	s	0	
A6	Hysteresis	dB	0	Hysteresis for evaluation of event A6.
	Offset	dB	-6	Offset parameter for evaluation of event A6. Needs to take relative accuracy tolerance in section 9.1.11.2 into account plus margin.
	Report on leave		False	
	Time To Trigger	s	0	
Cell-individual offset for cells on RF channel number 1		dB	0	Individual offset for cells on primary component carrier.
Cell-individual offset for cells on RF channel number 2		dB	0	Individual offset for cells on secondary component carrier.
Cell-individual offset for cells on RF channel number 3		dB	0	Individual offset for cells on secondary component carrier.
Cell-individual offset for cells on RF channel number 4		dB	0	Individual offset for cells on secondary component carrier.
Cell-individual offset for cells on RF channel number 5		dB	0	Individual offset for cells on secondary component carrier.
Filter coefficient			0	L3 filtering is not used
SCell measurement cycle (measCycleSCell)		ms	320	For cell2, cell3, cell4 and cell5
T1		s	5	During this time the cell1, cell3, cell4 and cell5 shall be known to the UE; but cell2 and cell6 shall be unknown to the UE.
T2		s	≤12	UE should report Event A1 for cell2 and event A6 for cell6 within 6.4s (20xscellMeasCycle)
T3		s	5	UE should report Event A2 within 200 ms for cell1 and within 1.6s for each of cells 2, 3, 4 and 5.

Table A.8.16.66.1-2: Cell specific test parameters for E-UTRAN TDD-FDD 5 DL CA event triggered reporting under fading propagation conditions with 4 configured but deactivated SCells in non-DRX with PCell in TDD

Parameter	Unit	Cell 1			Cell 2			Cell3		
		T1	T2	T3	T1	T2	T3	T1	T2	T3
E-UTRA RF Channel Number		1			2			3		
BW _{channel}		5MHz: N _{RB,c} = 25 10MHz: N _{RB,c} = 50 20MHz: N _{RB,c} = 100			5MHz: N _{RB,c} = 25 10MHz: N _{RB,c} = 50 20MHz: N _{RB,c} = 100			5MHz: N _{RB,c} = 25 10MHz: N _{RB,c} = 50 20MHz: N _{RB,c} = 100		
PDSCH parameters: DL Reference Measurement Channel		5MHz: R.4 TDD 10MHz: R.0 TDD 20MHz: R.3 TDD			-			-		
PCFICH/PDCCH/PHICH parameters: DL Reference Measurement Channel		5MHz: R.11 TDD 10MHz: R.6 TDD 20MHz: R.10 TDD			5MHz: R.11 FDD 10MHz: R.6 FDD 20MHz: R.10 FDD			5MHz: R.11 FDD 10MHz: R.6 FDD 20MHz: R.10 FDD		
OCNG Patterns		5MHz: OP.9 TDD 10MHz: OP.1 TDD 20MHz: OP.7 TDD			5MHz: OP.16 FDD 10MHz: OP.2 FDD 20MHz: OP.12 FDD			5MHz: OP.16 FDD 10MHz: OP.2 FDD 20MHz: OP.12 FDD		
PBCH_RA	dB	0			0			0		
PBCH_RB	dB									
PSS_RA	dB									
SSS_RA	dB									
PCFICH_RB	dB									
PHICH_RA	dB									
PHICH_RB	dB									
PDCCH_RA	dB									
PDCCH_RB	dB									
PDSCH_RA	dB									
PDSCH_RB	dB									
OCNG_RA ^{Note 1}	dB									
OCNG_RB ^{Note 1}	dB									
N _{oc} ^{Note 2}	dBm/15 KHz	-104			-104			-104		
\bar{E}_s/N_{oc}	dB	17	17	-3	-infinity	17	-3	17	17	-3
\bar{E}_s/I_{ot} ^{Note 3}	dB	17	17	-3	-infinity	17	-3	17	17	-3
RSRP ^{Note 3}	dBm/15 kHz	-87	-87	-107	-infinity	-87	-107	-87	-87	-107
SCH_RP ^{Note 3}	dBm/15 kHz	-87	-87	-107	-infinity	-87	-107	-87	-87	-107
I _o ^{Note 3}	dBm/Ch BW	-59.13 +10log (N _{RB,c} /50)	-59.13 +10log (N _{RB,c} /50)	-74.45 +10log (N _{RB,c} /50)	-76.22 +10log (N _{RB,c} /50)	-59.13 +10log (N _{RB,c} /50)	-74.45 +10log (N _{RB,c} /50)	-59.13 +10log (N _{RB,c} /50)	-59.13 +10log (N _{RB,c} /50)	-74.45 +10log (N _{RB,c} /50)
Propagation Condition		AWGN			ETU70			ETU70		
Correlation Matrix and Antenna Configuration		1x2 Low			1x2 Low			1x2 Low		
Timing offset to Cell 1	μs	-			0			0		
Time alignment error relative to cell 1 ^{Note 5}	μs	-			≤ TAE			≤ TAE		
Time alignment error relative to cell 2 ^{Note 5}	μs	≤ TAE			-			≤ TAE		
Time alignment error relative to cell 3 ^{Note 5}	μs	≤ TAE			≤ TAE			-		
Time alignment error relative to cell 4 ^{Note 5}	μs	≤ TAE			≤ TAE			≤ TAE		
Time alignment error relative to cell 5 ^{Note 5}	μs	≤ TAE			≤ TAE			≤ TAE		

- Note 1: OCNB shall be used such that all cells are fully allocated and a constant total transmitted power spectral density is achieved for all OFDM symbols.
- Note 2: Interference from other cells and noise sources not specified in the test is assumed to be constant over subcarriers and time and shall be modelled as AWGN of appropriate power for N_{oc} to be fulfilled.
- Note 3: E_s/I_{ot} , RSRP, SCH_RP and I_o have been derived from other parameters for information purposes. They are not settable parameters themselves.
- Note 4: The resources for uplink transmission are assigned to the UE prior to the start of time period T2.
- Note 5: Time alignment error (TAE) as specified in TS 36.104 [30] clause 6.5.3.1. The TAE value depends upon the type of carrier aggregation.

Table A.8.16.66.1-3: Cell specific test parameters for E-UTRAN TDD-FDD 5 DL CA event triggered reporting under fading propagation conditions with 4 configured but deactivated SCells in non-DRX with PCell in FDD

Parameter	Unit	Cell 4			Cell 5			Cell 6		
		T1	T2	T3	T1	T2	T3	T1	T2	T3
E-UTRA RF Channel Number		4			5					
BW _{channel}		5MHz: $N_{RB,c} = 25$ 10MHz: $N_{RB,c} = 50$ 20MHz: $N_{RB,c} = 100$			5MHz: $N_{RB,c} = 25$ 10MHz: $N_{RB,c} = 50$ 20MHz: $N_{RB,c} = 100$					
PDSCH parameters: DL Reference Measurement Channel		-			-			-		
PCFICH/PDCCH/PHI CH parameters: DL Reference Measurement Channel		5MHz: R.11 FDD 10MHz: R.6 FDD 20MHz: R.10 FDD			5MHz: R.11 FDD 10MHz: R.6 FDD 20MHz: R.10 FDD			5MHz: R.11 FDD 10MHz: R.6 FDD 20MHz: R.10 FDD		
OCNG Patterns		5MHz: OP.16 FDD 10MHz: OP.2 FDD 20MHz: OP.12 FDD			5MHz: OP.16 FDD 10MHz: OP.2 FDD 20MHz: OP.12 FDD			5MHz: OP.16 FDD 10MHz: OP.2 FDD 20MHz: OP.12 FDD		
PBCH_RA	dB	0			0			0		
PBCH_RB	dB									
PSS_RA	dB									
SSS_RA	dB									
PCFICH_RB	dB									
PHICH_RA	dB									
PHICH_RB	dB									
PDCCH_RA	dB									
PDCCH_RB	dB									
PDSCH_RA	dB									
PDSCH_RB	dB									
OCNG_RA ^{Note 1}	dB									
OCNG_RB ^{Note 1}	dB									
N_{oc} ^{Note 2}	dBm/15 KHz									
\bar{E}_s/N_{oc}	dB	17	17	-3	17	17	-3	-infinity	17	-3
\bar{E}_s/I_{ot} ^{Note 3}	dB	17	17	-3	17	-0.09	-4.76	-infinity	-0.09	-4.76
RSRP ^{Note 3}	dBm/15 kHz	-87	-87	-107	-87	-87	-107	-infinity	-87	-107
SCH_RP ^{Note 3}	dBm/15 kHz	-87	-87	-107	-87	-87	-107	-infinity	-87	-107
I_o ^{Note 3}	dBm/Ch BW	-59.13 +10log ($N_{RB,c}$ /50)	-59.13 +10log ($N_{RB,c}$ /50)	-74.45 +10log ($N_{RB,c}$ /50)	-59.13 +10log ($N_{RB,c}$ /50)	-56.17 +10log ($N_{RB,c}$ /50)	-73.20 +10log ($N_{RB,c}$ /50)	Specified in columns for Cell 5		
Propagation Condition		ETU70			ETU70			ETU70		
Correlation Matrix and Antenna Configuration		1x2 Low			1x2 Low			1x2 Low		
Timing offset to Cell 1	μ s	0			0			3		
Time alignment error relative to cell1 ^{Note 5}	μ s	-			-			NA		
Time alignment error relative to cell2 ^{Note 5}	μ s	-			-			NA		
Time alignment error relative to cell3 ^{Note 5}	μ s	-			-			NA		
Time alignment error relative to cell4 ^{Note 5}	μ s	-			-			NA		
Time alignment error relative to cell5 ^{Note 5}	μ s	-			-			NA		

Note 1:	OCNG shall be used such that all cells are fully allocated and a constant total transmitted power spectral density is achieved for all OFDM symbols.
Note 2:	Interference from other cells and noise sources not specified in the test is assumed to be constant over subcarriers and time and shall be modelled as AWGN of appropriate power for N_{oc} to be fulfilled.
Note 3:	E_s/I_{ot} , RSRP, SCH_RP and I_o have been derived from other parameters for information purposes. They are not settable parameters themselves.
Note 4:	The resources for uplink transmission are assigned to the UE prior to the start of time period T2.
Note 5:	Time alignment error (TAE) as specified in TS 36.104 [30] clause 6.5.3.1. The TAE value depends upon the type of carrier aggregation.

A.8.16.66.2 Test Requirements

The UE shall send one Event A6 triggered measurement report for Cell 6 with a measurement reporting delay of less than 6.4s ($20 \times \text{measCycleSCell}$) from the beginning of time T2.

The UE shall send one Event A1 triggered measurement report for Cell 2 with a measurement reporting delay of less than 6.4s ($20 \times \text{measCycleSCell}$) from beginning of time T2.

The UE shall send one Event A2 triggered measurement report for Cell 1 with a measurement reporting delay of less than 200 ms from beginning of time T3.

The UE shall send one Event A2 triggered measurement report for Cell 2 with a measurement reporting delay of less than 1.6s ($5 \times \text{measCycleSCell}$) from beginning of time T3.

The UE shall send one Event A2 triggered measurement report for Cell 3 with a measurement reporting delay of less than 1.6s ($5 \times \text{measCycleSCell}$) from beginning of time T3.

The UE shall send one Event A2 triggered measurement report for Cell 4 with a measurement reporting delay of less than 1.6s ($5 \times \text{measCycleSCell}$) from beginning of time T3.

The UE shall send one Event A2 triggered measurement report for Cell 5 with a measurement reporting delay of less than 1.6s ($5 \times \text{measCycleSCell}$) from beginning of time T3.

The UE shall not send event triggered measurement reports as long as the reporting criteria are not fulfilled.

The rate of correct events observed during repeated tests shall be at least 90% for each of the events.

NOTE: The actual overall delays measured in the tests may be up to $2 \times TTI_{DCCH}$ higher than the measurement reporting delays above because of TTI insertion uncertainty of the measurement report in DCCH.

A.8.16.67 5 DL FDD-TDD with PCell in FDD CA activation and deactivation of Unknown SCell in non-DRX

A.8.16.67.1 Test Purpose and Environment

The purpose of this test is to verify that the SCell activation and deactivation times are within the requirements stated in section 7.7 for UE configured with four downlink SCells, when the SCell is unknown by the UE at the time of activation and PCell is in FDD.

The test parameters are given in Tables A.8.16.67.1-1 and cell-specific parameters in A.8.16.67.1-2 and A.8.16.67.1-3 below. The test consists of three successive time periods, with duration of T1, T2 and T3, respectively. There are five carriers, each with one cell. Cell 1, Cell 3, Cell 4 and Cell5 have constant signal levels throughout the test. Before the test starts the UE is connected to Cell 1 (PCell) on radio channel 1 (PCC), deactivated Cell 3 (SCell2) on radio channel 3 (SCC2), deactivated Cell 4 (SCell3) on radio channel 4 (SCC3) and deactivated Cell 5 (SCell4) on radio channel 5 (SCC4) but is not aware of Cell 2 (SCell1) on radio channel 2 (SCC1). The UE is only monitoring PCC, SCC2, SCC3 and SCC4. The UE shall be continuously scheduled in PCell throughout the whole test.

At the beginning of T1 the UE receives an RRC message by which the SCell1 becomes configured on SCC1. During T1 SCell1 is powered off and the UE is not aware of SCell1.

A MAC message for activation of SCell1 is sent by the test equipment 100ms after the RRC message, in a subframe # denoted m which is an even number. The point in time at which the MAC message for activation of SCell1 is received at the UE antenna connector defines the start of time period T2. Immediately at beginning of T2 transmission power of SCell1 is increased to same level as for PCell. The test equipment sends a MAC message for activation of SCell2 in a subframe (m+10), a MAC message for activation of SCell3 in subframe (m+20), and a MAC message for activation of SCell4 in a subframe (m+30) during activation of SCell1. The UE shall be able to report valid CSI for the activated SCell1 at latest in subframe (m+49). The UE shall start reporting CSI for SCell1 in subframe (m+8) and shall report CQI index 0 (out-of-range) until the SCell activation has been completed. Any

PCell interruption due to activation of SCells shall not occur outside subframes (m+5) to (m+9), (m+15) to (m+19), (m+25) to (m+29), and (m+35) to (m+39).

Time period T3 starts when a MAC message for deactivation of SCell1, sent from the test equipment to the UE in a subframe # denoted n, is received at the UE antenna connector. The test equipment sends a MAC message for deactivation of the SCell2 in subframe (n+10), a MAC message for deactivation of the SCell3 in subframe (n+20), and a MAC message for deactivation of the SCell4 in subframe (n+30). The UE shall carry out deactivation of SCell1 at latest in subframe (n+8), and any PCell interruption due to the deactivation of SCells shall not occur outside subframes (n+5) to (n+9), (n+15) to (n+19), (n+25) to (n+29), and (n+35) to (n+39).

The test equipment verifies that potential interruption is carried out in the correct time span by monitoring ACK/NACK sent in PCell during activation and deactivation of SCell1, respectively.

The test equipment verifies the activation time by counting the subframes from the time when SCell1 activation command is sent until a CSI report with other than CQI index 0 is received.

The test equipment verifies the deactivation time by counting the subframes from the time when SCell1 deactivation command is sent until CQI reporting for SCell1 is discontinued.

Table A.8.16.67.1-1: General test parameters for unknown SCell1 activation case

Parameter	Unit	Value	Comment
E-UTRA RF Channel Number		1, 2, 3, 4, 5	Five radio channels are used for this test
Active PCell		Cell 1	Primary cell on RF channel number 1.
Deconfigured deactivated SCell1		Cell 2	Deconfigured deactivated secondary cell on RF channel number 2.
Configured deactivated SCell2		Cell 3	Configured deactivated secondary cell on RF channel number 3.
Configured deactivated SCell3		Cell 4	Configured deactivated secondary cell on RF channel number 4.
Configured deactivated SCell4		Cell 5	Configured deactivated secondary cell on RF channel number 5.
CP length		Normal	
DRX		OFF	Continuous monitoring of primary cell
CQI/PMI periodicity and offset configuration index		0	CQI reporting for SCell every second subframe
Cell-individual offset for cells on RF channel number 1	dB	0	Individual offset for cells on PCC.
Cell-individual offset for cells on RF channel number 2	dB	0	Individual offset for cells on SCC1.
Cell-individual offset for cells on RF channel number 3	dB	0	Individual offset for cells on SCC2.
Cell-individual offset for cells on RF channel number 4	dB	0	Individual offset for cells on SCC3.
Cell-individual offset for cells on RF channel number 5	dB	0	Individual offset for cells on SCC4.
SCell measurement cycle (measCycleSCell)	ms	320	
T1	ms	100	During this time the PCell, SCell2, SCell3 and SCell4 shall be known and the SCell1 configured.
T2	s	1	During this time the UE shall activate the SCell1, SCell2, SCell3 and SCell4.
T3	s	1	During this time the UE shall deactivate the SCell1, SCell2, SCell3 and SCell4.

Table A.8.16.67.1-2: Cell specific test parameters for E-UTRAN TDD unknown SCell1 activation with PCell in FDD

Parameter	Unit	Cell 1			Cell 2			Cell 3		
		T1	T2	T3	T1	T2	T3	T1	T2	T3
E-UTRA RF Channel Number		1			2			3		

BW _{channel}	MHz	5MHz: N _{RB,c} = 25 10MHz: N _{RB,c} = 50 20MHz: N _{RB,c} = 100	5MHz: N _{RB,c} = 25 10MHz: N _{RB,c} = 50 20MHz: N _{RB,c} = 100	5MHz: N _{RB,c} = 25 10MHz: N _{RB,c} = 50 20MHz: N _{RB,c} = 100
Special subframe configuration		-	6	6
Uplink-downlink configuration		-	1	1
PDSCH parameters: DL Reference Measurement Channel		5MHz: R.7 FDD 10MHz: R.3 FDD 20MHz: R.6 FDD	-	-
PCFICH/PDCCH/PHICH parameters: DL Reference Measurement Channel		5MHz: R.11 FDD 10MHz: R.6 FDD 20MHz: R.10 FDD	5MHz: R.11 TDD 10MHz: R.6 TDD 20MHz: R.10 TDD	5MHz: R.11 TDD 10MHz: R.6 TDD 20MHz: R.10 TDD
OCNG Patterns		5MHz: OP.20 FDD 10MHz: OP.10 FDD 20MHz: OP.17 FDD	5MHz: OP.10 TDD 10MHz: OP.2 TDD 20MHz: OP.8 TDD	5MHz: OP.10 TDD 10MHz: OP.2 TDD 20MHz: OP.8 TDD
PBCH_RA	dB	0	0	0
PBCH_RB	dB			
PSS_RA	dB			
SSS_RA	dB			
PCFICH_RB	dB			
PHICH_RA	dB			
PHICH_RB	dB			
PDCCH_RA	dB			
PDCCH_RB	dB			
PDSCH_RA	dB			
PDSCH_RB	dB			
OCNG_RA ^{Note 1}	dB			
OCNG_RB ^{Note 1}	dB			
N _{oc} ^{Note 2}	dBm/15 kHz			
\bar{E}_s/N_{oc}	dB	17	-infinity	17
\bar{E}_s/I_{ot}	dB	17	-infinity	17
RSRP ^{Note 3}	dBm/15 kHz	-87	-infinity	-87
SCH_RP ^{Note 3}	dBm/15 kHz	-87	-infinity	-87
I _o ^{Note 3}	dBm/Ch BW	-59.13 +10log (N _{RB,c} /50)	-76.22 +10log (N _{RB,c} /50)	-59.13 +10log (N _{RB,c} /50)
Propagation Condition		AWGN	AWGN	AWGN
Antenna Configuration		1x2	1x2	1x2
Timing offset to Cell 1	μs	-	0	0
Time alignment error relative to cell 1 ^{Note 5}	μs	-	≤ TAE	≤ TAE
Time alignment error relative to cell 2 ^{Note 5}	μs	-	-	≤ TAE
Time alignment error relative to cell 3 ^{Note 5}	μs	-	-	-
Time alignment error relative to cell 4 ^{Note 5}	μs	-	-	-
<p>Note 1: OCNG shall be used such that all cells are fully allocated and a constant total transmitted power spectral density is achieved for all OFDM symbols.</p> <p>Note 2: Interference from other cells and noise sources not specified in the test is assumed to be constant over subcarriers and time and shall be modelled as AWGN of appropriate power for N_{oc} to be fulfilled.</p> <p>Note 3: Es/I_{ot}, RSRP, SCH_RP and I_o levels have been derived from other parameters for information purposes. They are not settable parameters themselves.</p> <p>Note 4: The uplink resources for CSI reporting are assigned to the UE prior to the start of time period T2.</p> <p>Note 5: Time alignment error (TAE) as specified in TS 36.104 [30] clause 6.5.3.1. The TAE value depends upon the type of carrier aggregation.</p>				

Table A.8.16.67.1-3: Cell specific test parameters for E-UTRAN TDD unknown SCell1 activation with PCell in FDD

Parameter	Unit	Cell 4			Cell 5					
		T1	T2	T3	T1	T2	T3			
E-UTRA RF Channel Number		4			5					
BW _{channel}	MHz	5MHz: N _{RB,c} = 25 10MHz: N _{RB,c} = 50 20MHz: N _{RB,c} = 100			5MHz: N _{RB,c} = 25 10MHz: N _{RB,c} = 50 20MHz: N _{RB,c} = 100					
Special subframe configuration		6			6					
Uplink-downlink configuration		1			1					
PDSCH parameters: DL Reference Measurement Channel		-			-					
PCFICH/PDCCH/PHICH parameters: DL Reference Measurement Channel		5MHz: R.11 TDD 10MHz: R.6 TDD 20MHz: R.10 TDD			5MHz: R.11 TDD 10MHz: R.6 TDD 20MHz: R.10 TDD					
OCNG Patterns		5MHz: OP.10 TDD 10MHz: OP.2 TDD 20MHz: OP.8 TDD			5MHz: OP.10 TDD 10MHz: OP.2 TDD 20MHz: OP.8 TDD					
PBCH_RA	dB	0			0					
PBCH_RB	dB									
PSS_RA	dB									
SSS_RA	dB									
PCFICH_RB	dB									
PHICH_RA	dB									
PHICH_RB	dB									
PDCCH_RA	dB									
PDCCH_RB	dB									
PDSCH_RA	dB									
PDSCH_RB	dB									
OCNG_RA ^{Note 1}	dB									
OCNG_RB ^{Note 1}	dB									
N _{oc} ^{Note 2}	dBm/15 kHz									
\bar{E}_s/N_{oc}	dB	17			17					
\bar{E}_s/I_{ot}	dB	17			17					
RSRP ^{Note 3}	dBm/15 kHz	-87			-87					
SCH_RP ^{Note 3}	dBm/15 kHz	-87			-87					
I _o ^{Note 3}	dBm/Ch BW	-59.13 +10log (N _{RB,c} /50)			-59.13 +10log (N _{RB,c} /50)					
Propagation Condition		AWGN			AWGN					
Antenna Configuration		1x2			1x2					
Timing offset to Cell 1	μs	0			0					
Time alignment error relative to cell 1 ^{Note 5}	μs	≤ TAE			≤ TAE					
Time alignment error relative to cell 2 ^{Note 5}	μs	≤ TAE			≤ TAE					
Time alignment error relative to cell 3 ^{Note 5}	μs	≤ TAE			≤ TAE					
Time alignment error relative to cell 4 ^{Note 5}	μs	-			≤ TAE					
<p>Note 1: OCNG shall be used such that all cells are fully allocated and a constant total transmitted power spectral density is achieved for all OFDM symbols.</p> <p>Note 2: Interference from other cells and noise sources not specified in the test is assumed to be constant over subcarriers and time and shall be modelled as AWGN of appropriate power for N_{oc} to be fulfilled.</p> <p>Note 3: Es/I_{ot}, RSRP, SCH_RP and I_o levels have been derived from other parameters for information purposes. They are not settable parameters themselves.</p> <p>Note 4: The uplink resources for CSI reporting are assigned to the UE prior to the start of time period T2.</p> <p>Note 5: Time alignment error (TAE) as specified in TS 36.104 [30] clause 6.5.3.1. The TAE value depends upon the type of carrier aggregation.</p>										

A.8.16.67.2 Test Requirements

During T2 the UE shall send the first CSI report for SCell1 in a subframe (m+8), or in a subframe (m+10) if the subframe (m+8) was subject to interruption. Whether CSI report in subframe (m+8) was interrupted or not is checked by monitoring ACK/NACK sent in PCell in subframe (m+8).

During T2 the UE shall start sending CSI reports for SCell1 with non-zero CQI index at latest in a subframe (m+49).

During T3 the UE shall stop sending CSI reports for SCell1 at latest in a subframe (n+8).

During T2 interruption of PCell during SCells activation shall not happen outside the subframes (m+5) to (m+9), outside the subframes (m+15) to (m+19), outside the subframes (m+25) to (m+29), and outside the subframes (m+35) to (m+39).

During T3 interruption of PCell during SCells deactivation shall not happen outside the subframes (n+5) to (n+9), outside the subframes (n+15) to (n+19), outside the subframes (n+25) to (n+29), and outside the subframes (n+35) to (n+39).

The interruption of PCell shall not be more than the values specified for intra-band CA and inter-band CA in Section 7.8.2.

All of the above test requirements shall be fulfilled in order for the observed SCell1 activation delay and SCell1 deactivation delay to be counted as correct. The rate of correct observed SCell1 activation delay and SCell1 deactivation delay during repeated tests shall be at least 90%.

NOTE: During T2 if there are no uplink resources for reporting the valid CSI in a subframe (m+49) then the UE shall use the next available uplink resource for reporting the corresponding valid CSI.

A.8.16.68 5 DL FDD-TDD with PCell in TDD CA activation and deactivation of Unknown SCell in non-DRX

A.8.16.68.1 Test Purpose and Environment

The purpose of this test is to verify that the SCell activation and deactivation times are within the requirements stated in section 7.7 for UE configured with four downlink SCells, when the SCell is unknown by the UE at the time of activation and PCell is in TDD.

The test parameters are given in Tables A.8.16.68.1-1 and cell-specific parameters in A.8.16.68.1-2 and A.8.16.68.1-3 below. The test consists of three successive time periods, with duration of T1, T2 and T3, respectively. There are five carriers, each with one cell. Cell 1, Cell 3, Cell 4 and Cell 5 have constant signal levels throughout the test. Before the test starts the UE is connected to Cell 1 (PCell) on radio channel 1 (PCC), deactivated Cell 3 (SCell2) on radio channel 3 (SCC2), deactivated Cell 4 (SCell3) on radio channel 4 (SCC3) and deactivated Cell 5 (SCell4) on radio channel 5 (SCC4) but is not aware of Cell 2 (SCell1) on radio channel 2 (SCC1). The UE is only monitoring PCC, SCC2, SCC3 and SCC4. The UE shall be continuously scheduled in the PCell throughout the whole test.

At the beginning of T1 the UE receives an RRC message by which SCell1 becomes configured on SCC1. The UE now starts monitoring also the SCC1. During T1 SCell1 is powered off and the UE is not aware of SCell1.

A MAC message for activation of SCell1 is sent by the test equipment 100ms after the RRC message, in a subframe # denoted m which is 4 or 9. The point in time at which the MAC message for activation of SCell1 is received at the UE antenna connector defines the start of time period T2. Immediately at beginning of T2 transmission power of SCell1 is increased to same level as for PCell. Immediately at beginning of T2 transmission power of SCell1 is increased to same level as for PCell. The test equipment sends a MAC message for activation of SCell2, SCell3 and SCell4 in subframe (m+15) during activation of SCell1. The UE shall be able to report valid CSI for the activated SCell1 at latest in a subframe (m+49). The UE shall start reporting CSI for SCell1 in subframe (m+8) and shall report CQI index 0 (out-of-range) until the SCell activation has been completed. Any PCell interruption due to activation of SCells shall not occur outside subframes (m+5) to (m+11) and (m+20) to (m+26).

Time period T3 starts when a MAC message for deactivation of SCell1, sent from the test equipment to the UE in a subframe # denoted n, where n is 4 or 9, is received at the UE antenna connector. The test equipment sends a MAC message for deactivation of the SCell2 in subframe (n+15), a MAC message for deactivation of the SCell3 in subframe (n+30), and a MAC message for deactivation of the SCell4 in subframe (n+45). The UE shall carry out deactivation of SCell1 at latest in subframe (n+8), and any PCell interruption due to the deactivation of SCells shall not occur outside subframes (n+5) to (n+11), (n+20) to (n+26), (n+35) to (n+41) and (n+50) to (n+56).

The test equipment verifies that potential interruption is carried out in the correct time span by monitoring ACK/NACK sent in PCell during activation and deactivation of SCell1, respectively.

The test equipment verifies the activation time by counting the subframes from the time when SCell1 activation command is sent until a CSI report with other than CQI index 0 is received.

The test equipment verifies the deactivation time by counting the subframes from the time when SCell1 deactivation command is sent until CQI reporting for SCell1 is discontinued.

Table A.8.16.68.1-1: General test parameters for unknown SCell1 activation case

Parameter	Unit	Value	Comment
E-UTRA RF Channel Number		1, 2, 3, 4, 5	Five radio channels are used for this test
Active PCell		Cell 1	Primary cell on RF channel number 1.
Deconfigured deactivated SCell		Cell 2	Deconfigured deactivated secondary cell on RF channel number 2.
Configured deactivated SCell2		Cell 3	Configured deactivated secondary cell on RF channel number 3.
Configured deactivated SCell3		Cell 4	Configured deactivated secondary cell on RF channel number 4.
Configured deactivated SCell4		Cell 5	Configured deactivated secondary cell on RF channel number 5.
CP length		Normal	
DRX		OFF	Continuous monitoring of primary cell
CQI/PMI periodicity and offset configuration index		0	CQI reporting for SCell every UL subframe
Cell-individual offset for cells on RF channel number 1	dB	0	Individual offset for cells on PCC.
Cell-individual offset for cells on RF channel number 2	dB	0	Individual offset for cells on SCC1.
Cell-individual offset for cells on RF channel number 3	dB	0	Individual offset for cells on SCC2.
Cell-individual offset for cells on RF channel number 4	dB	0	Individual offset for cells on SCC3.
Cell-individual offset for cells on RF channel number 5	dB	0	Individual offset for cells on SCC4.
SCell measurement cycle (measCycleSCell)	ms	320	
T1	ms	100	During this time the PCell, SCell2, SCell3 and SCell4 shall be known and the SCell1 configured.
T2	s	1	During this time the UE shall activate the SCell1, SCell2, SCell3 and SCell4.
T3	s	1	During this time the UE shall deactivate the SCell1, SCell2, SCell3 and SCell4.

Table A.8.16.68.1-2: Cell specific test parameters for E-UTRAN FDD unknown SCell1 activation with PCell in TDD

Parameter	Unit	Cell 1			Cell 2			Cell 3		
		T1	T2	T3	T1	T2	T3	T1	T2	T3
E-UTRA RF Channel Number		1			2			3		
BW _{channel}	MHz	5MHz: N _{RB,c} = 25 10MHz: N _{RB,c} = 50 20MHz: N _{RB,c} = 100			5MHz: N _{RB,c} = 25 10MHz: N _{RB,c} = 50 20MHz: N _{RB,c} = 100			5MHz: N _{RB,c} = 25 10MHz: N _{RB,c} = 50 20MHz: N _{RB,c} = 100		
Special subframe configuration		6			-			-		
Uplink-downlink configuration		1			-			-		
PDSCH parameters: DL Reference Measurement Channel		5MHz: R.4 TDD 10MHz: R.0 TDD 20MHz: R.3 TDD			-			-		
PCFICH/PDCCH/PHICH parameters: DL Reference Measurement Channel		5MHz: R.11 TDD 10MHz: R.6 TDD 20MHz: R.10 TDD			5MHz: R.11 FDD 10MHz: R.6 FDD 20MHz: R.10 FDD			5MHz: R.11 FDD 10MHz: R.6 FDD 20MHz: R.10 FDD		
OCNG Patterns		5MHz: OP.9 TDD 10MHz: OP.1 TDD 20MHz: OP.7 TDD			5MHz: OP.16 FDD 10MHz: OP.2 FDD 20MHz: OP.12 FDD			5MHz: OP.16 FDD 10MHz: OP.2 FDD 20MHz: OP.12 FDD		
PBCH_RA	dB	0			0			0		

PBCH_RB	dB				
PSS_RA	dB				
SSS_RA	dB				
PCFICH_RB	dB				
PHICH_RA	dB				
PHICH_RB	dB				
PDCCH_RA	dB				
PDCCH_RB	dB				
PDSCH_RA	dB				
PDSCH_RB	dB				
OCNG_RA ^{Note 1}	dB				
OCNG_RB ^{Note 1}	dB				
N _{oc} ^{Note 2}	dBm/15 kHz	-104	-104	-104	-104
\bar{E}_s/N_{oc}	dB	17	-infinity	17	17
\bar{E}_s/I_{ot}	dB	17	-infinity	17	17
RSRP ^{Note 3}	dBm/15 kHz	-87	-infinity	-87	-87
SCH_RP ^{Note 3}	dBm/15 kHz	-87	-infinity	-87	-87
I _o ^{Note 3}	dBm/Ch BW	-59.13 +10log(N _{RB,c} /50)	-76.22 +10log(N _{RB,c} /50)	-59.13 +10log(N _{RB,c} /50)	-59.13 +10log(N _{RB,c} /50)
Propagation Condition		AWGN	AWGN	AWGN	AWGN
Antenna Configuration		1x2	1x2	1x2	1x2
Timing offset to Cell 1	μs	-	0	0	0
Time alignment error relative to cell 1 ^{Note 5}	μs	-	≤ TAE	≤ TAE	≤ TAE
Time alignment error relative to cell 2 ^{Note 5}	μs	-	-	≤ TAE	≤ TAE
Time alignment error relative to cell 3 ^{Note 5}	μs	-	-	-	-
Time alignment error relative to cell 4 ^{Note 5}	μs	-	-	-	-
<p>Note 1: OCNG shall be used such that all cells are fully allocated and a constant total transmitted power spectral density is achieved for all OFDM symbols.</p> <p>Note 2: Interference from other cells and noise sources not specified in the test is assumed to be constant over subcarriers and time and shall be modelled as AWGN of appropriate power for N_{oc} to be fulfilled.</p> <p>Note 3: Es/I_{ot}, RSRP, SCH_RP and I_o levels have been derived from other parameters for information purposes. They are not settable parameters themselves.</p> <p>Note 4: The uplink resources for CSI reporting are assigned to the UE prior to the start of time period T2.</p> <p>Note 5: Time alignment error (TAE) as specified in TS 36.104 [30] clause 6.5.3.1. The TAE value depends upon the type of carrier aggregation.</p>					

Table A.8.16.68.1-3: Cell specific test parameters for E-UTRAN FDD unknown SCell1 activation with PCell in TDD

Parameter	Unit	Cell 4			Cell 5					
		T1	T2	T3	T1	T2	T3			
E-UTRA RF Channel Number		4			5					
BW _{channel}	MHz	5MHz: N _{RB,c} = 25 10MHz: N _{RB,c} = 50 20MHz: N _{RB,c} = 100			5MHz: N _{RB,c} = 25 10MHz: N _{RB,c} = 50 20MHz: N _{RB,c} = 100					
Special subframe configuration		-			-					
Uplink-downlink configuration		-			-					
PDSCH parameters: DL Reference Measurement Channel		-			-					
PCFICH/PDCCH/PHICH parameters: DL Reference Measurement Channel		5MHz: R.11 FDD 10MHz: R.6 FDD 20MHz: R.10 FDD			5MHz: R.11 FDD 10MHz: R.6 FDD 20MHz: R.10 FDD					

OCNG Patterns		5MHz: OP.16 FDD 10MHz: OP.2 FDD 20MHz: OP.12 FDD	5MHz: OP.16 FDD 10MHz: OP.2 FDD 20MHz: OP.12 FDD	
PBCH_RA	dB	0	0	
PBCH_RB	dB			
PSS_RA	dB			
SSS_RA	dB			
PCFICH_RB	dB			
PHICH_RA	dB			
PHICH_RB	dB			
PDCCH_RA	dB			
PDCCH_RB	dB			
PDSCH_RA	dB			
PDSCH_RB	dB			
OCNG_RA ^{Note 1}	dB			
OCNG_RB ^{Note 1}	dB			
N_{oc} ^{Note 2}	dBm/15 kHz			
\hat{E}_s/N_{oc}	dB	17	17	
\hat{E}_s/I_{ot}	dB	17	17	
RSRP ^{Note 3}	dBm/15 kHz	-87	-87	
SCH_RP ^{Note 3}	dBm/15 kHz	-87	-87	
I_o ^{Note 3}	dBm/Ch BW	-59.13 +10log ($N_{RB,c}/50$)	-59.13 +10log ($N_{RB,c}/50$)	
Propagation Condition		AWGN	AWGN	
Antenna Configuration		1x2	1x2	
Timing offset to Cell 1	μ s	0	0	
Time alignment error relative to cell 1 ^{Note 5}	μ s	\leq TAE	\leq TAE	
Time alignment error relative to cell 2 ^{Note 5}	μ s	\leq TAE	\leq TAE	
Time alignment error relative to cell 3 ^{Note 5}	μ s	\leq TAE	\leq TAE	
Time alignment error relative to cell 4 ^{Note 5}	μ s	-	\leq TAE	
<p>Note 1: OCNG shall be used such that all cells are fully allocated and a constant total transmitted power spectral density is achieved for all OFDM symbols.</p> <p>Note 2: Interference from other cells and noise sources not specified in the test is assumed to be constant over subcarriers and time and shall be modelled as AWGN of appropriate power for N_{oc} to be fulfilled.</p> <p>Note 3: E_s/I_{ot}, RSRP, SCH_RP and I_o levels have been derived from other parameters for information purposes. They are not settable parameters themselves.</p> <p>Note 4: The uplink resources for CSI reporting are assigned to the UE prior to the start of time period T2.</p> <p>Note 5: Time alignment error (TAE) as specified in TS 36.104 [30] clause 6.5.3.1. The TAE value depends upon the type of carrier aggregation.</p>				

A.8.16.68.2 Test Requirements

During T2 the UE shall send the first CSI report for SCell1 in a subframe (m+8,) or in a subframe (m+9) if the subframe (m+8) was subject to interruption. Whether CSI report in subframe (m+8) was interrupted or not is checked by monitoring ACK/NACK sent in PCell in subframe (m+8).

During T2 the UE shall start sending CSI reports for SCell1 with non-zero CQI index at latest in a subframe (m+49).

During T3 the UE shall stop sending CSI reports for SCell at latest in a subframe (n+8).

During T2 interruption of PCell during SCells activation shall not happen outside the subframes (m+5) to (m+11) and outside the subframes (m+20) to (m+26).

During T3 interruption of PCell during SCells deactivation shall not happen outside the subframes (n+5) to (n+11), outside the subframes (n+20) to (n+26), outside the subframes (n+35) to (n+41), and outside the subframes (n+50) to (n+56).

The interruption of PCell shall not be more than the values specified for intra-band CA and inter-band CA in Section 7.8.2.

All of the above test requirements shall be fulfilled in order for the observed SCell1 activation delay and SCell1 deactivation delay to be counted as correct. The rate of correct observed SCell1 activation delay and SCell1 deactivation delay during repeated tests shall be at least 90%.

NOTE: During T2 if there are no uplink resources for reporting the valid CSI in a subframe (m+49) then the UE shall use the next available uplink resource for reporting the corresponding valid CSI.

A.8.16.69 5 DL FDD CA activation and deactivation of unknown SCell in non-DRX

A.8.16.69.1 Test Purpose and Environment

The purpose of this test is to verify that the SCell activation and deactivation times are within the requirements stated in section 7.7 for UE configured with five downlink SCells, when the SCell is unknown by the UE at the time of activation and PCell is in FDD.

The test parameters are given in Tables A.8.16.69.1-1 and cell-specific parameters in A.8.16.69.1-2 below. The test consists of three successive time periods, with duration of T1, T2 and T3, respectively. There are five carriers, each with one cell. Cell 1, Cell 3, Cell 4, and Cell 5 have constant signal levels throughout the test. Before the test starts the UE is connected to Cell1 (PCell) on radio channel 1 (PCC), Cell 3 (deactivated SCell2) on radio channel 3 (SCC2), Cell 4 (deactivated SCell3) on radio channel 4 (SCC3) and Cell5 (deactivated SCell4) on radio channel 5 (SCC4) but is not aware of Cell2 (SCell1) on radio channel 2 (SCC1). The UE is only monitoring the PCC, SCC2, SCC3 and SCC4. The UE shall be continuously scheduled in the PCell throughout the whole test.

At the beginning of T1 the UE receives an RRC message by which the Cell 2 (SCell1) becomes configured on radio channel 2 (SCC1). During T1 the signal level of Cell 2 (SCell1) is powered off and UE is not aware of Cell 2 (SCell1).

A MAC message for activation of the SCell1 is sent by the test equipment 100ms after the RRC message, in a subframe # denoted m which is an even number. The point in time at which the MAC message for activation of Cell 2 (SCell1) is received at the UE antenna connector defines the start of time period T2. Immediately at beginning of T2 the transmission power of Cell 2 (SCell1) is increased to same level as for Cell 1 (PCell). The test equipment sends a MAC message for activation of Cell 3 (SCell2), Cell4 (SCell 3) and Cell5 (SCell 4) in subframe (m+10), subframe (m+20) and subframe (m+30) respectively. Since UE received SCell2 activation command during activation of SCell1, the UE shall be able to report valid CSIs for the activated SCell1 at latest in subframe (m+49) provided the SCell1 can be successfully detected on the first attempt. The UE shall start reporting CSI in subframe (m+8) and shall report CQI index 0 (out-of-range) until the SCell activation has been completed. Any PCell interruption due to activation of SCells shall occur in the subframes (m+5) to (m+9), (m+15) to (m+19), (m+25) to (m+29) and (m+35) to (m+39).

Time period T3 starts when a MAC message for deactivation of Cell 2 (SCell1), sent from the test equipment to the UE in a subframe # denoted n, is received at the UE antenna connector. The test equipment sends a MAC message for deactivation of the Cell 3 (SCell2), Cell4 (SCell3) and Cell5 (SCell4) in subframe (n+10), subframe (n+20), subframe (n+30), respectively. The UE shall carry out deactivation of Cell 2 (SCell1) at latest in subframe (n+8), and any PCell interruption due to the deactivation of SCells shall occur in the subframes (n+5) to (n+9), (n+15) to (n+19), (n+25) to (n+29) and (n+35) to (n+39).

The test equipment verifies that potential interruption is carried out in the correct time span by monitoring ACK/NACK sent in PCell during activation and deactivation of SCells, respectively.

The test equipment verifies the activation time by counting the subframes from the time when the Cell 2 (SCell1) activation command is sent until a CSI reports with other than CQI index 0 is received.

The test equipment verifies the deactivation time by counting the subframes from the time when the Cell 2 (SCell1) deactivation command is sent until CQI reporting for SCell1 is discontinued.

Table A.8.16.69.1-1: General test parameters for unknown SCell1 activation case

Parameter	Unit	Value	Comment
E-UTRA RF Channel Number		1, 2, 3,4,5	Five radio channels are used for this test
Active PCell		Cell 1	Primary cell on RF channel number 1.
Deconfigured SCell1		Cell 2	Deconfigured secondary cell on RF channel number 2.
Configured deactivated SCell2		Cell 3	Configured deactivated secondary cell on RF channel number 3.
Configured deactivated SCell3		Cell 4	Configured deactivated secondary cell on RF channel number 4.
Configured deactivated SCell3		Cell 5	Configured deactivated secondary cell on RF channel number 5.
CP length		Normal	
DRX		OFF	Continuous monitoring of primary cell

CQI/PMI periodicity and offset configuration index		0	CQI reporting for SCell every second subframe
Cell-individual offset for cells on RF channel number 1	dB	0	Individual offset for cells on PCC.
Cell-individual offset for cells on RF channel number 2	dB	0	Individual offset for cells on SCC1.
Cell-individual offset for cells on RF channel number 3	dB	0	Individual offset for cells on SCC2.
Cell-individual offset for cells on RF channel number 4	dB	0	Individual offset for cells on SCC3.
Cell-individual offset for cells on RF channel number 5	dB	0	Individual offset for cells on SCC4.
Filter coefficient		0	L3 filtering is not used
SCell measurement cycle (measCycleSCell)	ms	320	
T1	ms	100	During this time the PCell, SCell2, SCell3 and SCell4 shall be known and the SCell1 configured.
T2	s	1	During this time the UE shall activate the SCell1.
T3	s	1	During this time the UE shall deactivate the SCell1.

Table A.8.16.69.1-2: Cell specific test parameters for E-UTRAN FDD 5 DL CA activation and deactivation of unknown SCell in non-DRX

Parameter	Unit	Cell 1			Cell 2			Cell 3			Cell 4			Cell 5		
		T1	T2	T3	T1	T2	T3	T1	T2	T3	T1	T2	T3	T1	T2	T3
E-UTRA RF Channel Number		1			2			3			4			5		
BW _{channel}	MHz	5MHz: N _{RB,c} = 25 10MHz: N _{RB,c} = 50 20MHz: N _{RB,c} = 100			5MHz: N _{RB,c} = 25 10MHz: N _{RB,c} = 50 20MHz: N _{RB,c} = 100			5MHz: N _{RB,c} = 25 10MHz: N _{RB,c} = 50 20MHz: N _{RB,c} = 100			5MHz: N _{RB,c} = 25 10MHz: N _{RB,c} = 50 20MHz: N _{RB,c} = 100			5MHz: N _{RB,c} = 25 10MHz: N _{RB,c} = 50 20MHz: N _{RB,c} = 100		
PDSCH parameters: DL Reference Measurement Channel		5MHz: R.7 FDD 10MHz: R.3 FDD 20MHz: R.6 FDD			-			-			-			-		
PCFICH/PDCCH/PHICH parameters: DL Reference Measurement Channel		5MHz: R.11 FDD 10MHz: R.6 FDD 20MHz: R.10 FDD			5MHz: R.11 FDD 10MHz: R.6 FDD 20MHz: R.10 FDD			5MHz: R.11 FDD 10MHz: R.6 FDD 20MHz: R.10 FDD			5MHz: R.11 FDD 10MHz: R.6 FDD 20MHz: R.10 FDD			5MHz: R.11 FDD 10MHz: R.6 FDD 20MHz: R.10 FDD		
OCNG Patterns		5MHz: OP.20 FDD 10MHz: OP.10 FDD 20MHz: OP.17 FDD			5MHz: OP.16 FDD 10MHz: OP.2 FDD 20MHz: OP.12 FDD			5MHz: OP.16 FDD 10MHz: OP.2 FDD 20MHz: OP.12 FDD			5MHz: OP.16 FDD 10MHz: OP.2 FDD 20MHz: OP.12 FDD			5MHz: OP.16 FDD 10MHz: OP.2 FDD 20MHz: OP.12 FDD		
PBCH_RA	dB	0			0			0			0			0		
PBCH_RB	dB															
PSS_RA	dB															
SSS_RA	dB															
PCFICH_RB	dB															
PHICH_RA	dB															
PHICH_RB	dB															
PDCCH_RA	dB															
PDCCH_RB	dB															
PDSCH_RA	dB															
PDSCH_RB	dB															
OCNG_RA ^{Note 1}	dB															
OCNG_RB ^{Note 1}	dB															
N _{oc} ^{Note 2}	dBm/15 kHz															
\hat{E}_s/N_{oc}	dB	17			-infinity			17			17			17		
\hat{E}_s/I_{ot} ^{Note 3}	dB	17			-infinity			17			17			17		

RSRP ^{Note 3}	dBm/ 15 kHz	-87	-infinity	-87	-87	-87	-87
SCH_RP ^{Note 3}	dBm/ 15 kHz	-87	-infinity	-87	-87	-87	-87
Io ^{Note 3}	dBm/ Ch BW	-59.13 +10log (N _{RB,c} /50)	-76.22 +10log (N _{RB,c} /50)	-59.13 +10log (N _{RB,c} /50)	-59.13 +10log (N _{RB,c} /50)	-59.13 +10log (N _{RB,c} /50)	-59.13 +10log (N _{RB,c} /50)
Propagation Condition		AWGN		AWGN		AWGN	
Antenna Configuration		1x2		1x2		1x2	
Timing offset to Cell 1	μs	-	0	0	0	0	0
Time alignment error relative to cell 1 ^{Note 5}	μs	-	≤ TAE	≤ TAE	≤ TAE	≤ TAE	≤ TAE
Time alignment error relative to cell 2 ^{Note 5}	μs	-	-	≤ TAE	≤ TAE	≤ TAE	≤ TAE
Time alignment error relative to cell 3 ^{Note 5}	μs	-	-	-	≤ TAE	≤ TAE	≤ TAE
Time alignment error relative to cell 4 ^{Note 5}	μs	-	-	-	-	-	≤ TAE
<p>Note 1: OCNB shall be used such that all cells are fully allocated and a constant total transmitted power spectral density is achieved for all OFDM symbols.</p> <p>Note 2: Interference from other cells and noise sources not specified in the test is assumed to be constant over subcarriers and time and shall be modelled as AWGN of appropriate power for N_{oc} to be fulfilled.</p> <p>Note 3: Es/Iot, RSRP, SCH_RP and Io levels have been derived from other parameters for information purposes. They are not settable parameters themselves.</p> <p>Note 4: The uplink resources for CSI reporting are assigned to the UE prior to the start of time period T2.</p> <p>Note 5: Time alignment error (TAE) as specified in TS 36.104 [30] clause 6.5.3.1. The TAE value depends upon the type of carrier aggregation.</p>							

A.8.16.69.2 Test Requirements

During T2, the UE shall send the first CSI report for SCell1 in a subframe (m+8), or in a subframe (m+10) if the subframe (m+8) was subject to interruption. Whether CSI report in subframe (m+8) was interrupted or not is checked by monitoring ACK/NACK sent in PCell in subframe (m+8).

During T2 the UE shall start sending CSI reports for SCell1 with non-zero CQI index at latest in a subframe (m+49).

During T3 the UE shall stop sending CSI reports for SCell1 at latest in a subframe (n+8).

During T2 interruption of PCell during SCells activation shall not happen outside the subframes (m+5) to (m+9), outside the subframes (m+15) to (m+19), outside the subframes (m+25) to (m+29) and outside the subframes (m+35) to (m+39).

During T3 interruption of PCell during SCells deactivation shall not happen outside the subframes (n+5) to (n+9), outside the subframes (n+15) to (n+19), outside the subframes (n+25) to (n+29) and outside the subframes (n+35) to (n+39).

The interruption of PCell shall not be more than the values specified for intra-band CA and inter-band CA in Section 7.8.2.

All of the above test requirements shall be fulfilled in order for the observed SCell1 activation delay and SCell1 deactivation delay to be counted as correct. The rate of correct observed SCell1 activation delay and SCell1 deactivation delay during repeated tests shall be at least 90%.

NOTE: During T2 if there are no uplink resources for reporting the valid CSI in a subframe (m+49) then the UE shall use the next available uplink resource for reporting the corresponding valid CSI.

A.8.16.70 5 DL TDD CA activation and deactivation of unknown SCell in non-DRX

A.8.16.70.1 Test Purpose and Environment

The purpose of this test is to verify that SCell activation and deactivation times are within the requirements stated in clause 7.7 for 5DL TDD carrier aggregation, when the SCells are unknown by the UE at the time of activation.

The test parameters are given in Tables A.8.16.70.1-1 and cell-specific parameters in A.8.16.70.1-2 below. The test consists of three successive time periods, with duration of T1, T2 and T3, respectively. There are five carriers, each with one cell. Cell 1, Cell 3, Cell 4, and Cell 5 have constant signal levels throughout the test. Before the test starts the UE is connected to Cell 1 (PCell) on radio channel 1 (PCC), Cell 3 (deactivated SCell2) on radio channel 3 (SCC2), Cell 4 (deactivated SCell3) on radio channel 4 (SCC3) and Cell 5 (deactivated SCell4) on radio channel 5 (SCC4), but is not aware of Cell 2 (SCell1) on radio channel 2 (SCC1). The UE is only monitoring the PCC, SCC2, SCC3 and SCC4. The UE shall be continuously scheduled in the PCell throughout the whole test.

At the beginning of T1 the UE receives an RRC message by which the Cell 2 (SCell 1) becomes configured on radio channel 2 (SCC1). During T1 the signal level of Cell 2 (SCell 1) is powered off and UE is not aware of Cell 2 (SCell1).

A MAC message for activation of the SCell1 is sent by the test equipment 100ms after the RRC message, in a subframe # denoted m, where m is 4 or 9. The point in time at which the MAC message for activation of Cell 2 (SCell1) is received at the UE antenna connector defines the start of time period T2. Immediately at beginning of T2 the transmission power of Cell 2 (SCell1) is increased to same level as for Cell 1 (PCell). The test equipment sends a MAC message for activation of Cell 3 (SCell2), Cell 4 (SCell3) and Cell 5 (SCell4) in subframe (m+15). Since UE received SCell2 activation command during activation of SCell1, the UE shall be able to report valid CSIs for the activated SCell1 at latest in subframe (m+49) provided the SCell1 can be successfully detected on the first attempt. The UE shall start reporting CSI in subframe (m+8) and shall report CQI index 0 (out-of-range) until the SCell activation has been completed. Any PCell interruption due to activation of SCells shall occur in the subframes (m+5) to (m+11) and (m+20) to (m+26).

Time period T3 starts when a MAC message for deactivation of Cell 2 (SCell1), sent from the test equipment to the UE in a subframe # denoted n, where n is 4 or 9, is received at the UE antenna connector. The test equipment sends a MAC message for deactivation of the Cell 3 (SCell2), Cell 4 (SCell3) and Cell 5 (SCell4) in subframe (n+15), (n+30) and (n+45), respectively. The UE shall carry out deactivation of Cell 2 (SCell1) at latest in subframe (n+8), and any PCell interruption due to the deactivation of SCells shall occur in the subframes (n+5) to (n+11), (n+20) to (n+26), (n+35) to (n+41) and (n+50) to (n+56).

The test equipment verifies that potential interruption is carried out in the correct time span by monitoring ACK/NACK sent in PCell during activation and deactivation of SCells, respectively.

The test equipment verifies the activation time by counting the subframes from the time when the Cell 2 (SCell1) activation command is sent until a CSI reports with other than CQI index 0 is received.

The test equipment verifies the deactivation time by counting the subframes from the time when the Cell 2 (SCell1) deactivation command is sent until CQI reporting for SCell1 is discontinued.

Table A.8.16.70.1-1: General test parameters for E-UTRAN TDD 5 DL CA activation and deactivation of unknown SCell in non-DRX

Parameter	Unit	Value	Comment
E-UTRA RF Channel Number		1, 2, 3,4,5	Five radio channels are used for this test
Active PCell		Cell 1	Primary cell on RF channel number 1.
Deconfigured SCell		Cell 2	Deconfigured secondary cell on RF channel number 2.
Configured deactivated SCell		Cell 3	Configured deactivated secondary cell on RF channel number 3.
Configured deactivated SCell		Cell 4	Configured deactivated secondary cell on RF channel number 4.
Configured deactivated SCell		Cell 5	Configured deactivated secondary cell on RF channel number 5.
CP length		Normal	
Special subframe configuration		6	As specified in table 4.2-1 in TS 36.211. The same configuration applies to all cells.
Uplink-downlink configuration		1	As specified in table 4.2-2 in TS 36.211. The same configuration applies to all cells
DRX		OFF	Continuous monitoring of primary cell
CQI/PMI periodicity and offset configuration index		0	CQI reporting for SCells every UL subframe
Cell-individual offset for cells on RF channel number 1	dB	0	Individual offset for cells on PCC.
Cell-individual offset for cells on RF channel number 2	dB	0	Individual offset for cells on SCC1.
Cell-individual offset for cells on RF channel number 3	dB	0	Individual offset for cells on SCC2.
Cell-individual offset for cells on RF channel number 4	dB	0	Individual offset for cells on SCC3.

Cell-individual offset for cells on RF channel number 5	dB	0	Individual offset for cells on SCC4.
Filter coefficient		0	L3 filtering is not used
SCell measurement cycle (measCycleSCell)	ms	320	
T1	ms	100	During this time the PCell, SCell2, SCell3 and SCell4 shall be known and the SCell1 configured.
T2	s	1	During this time the UE shall activate the SCell1.
T3	s	1	During this time the UE shall deactivate the SCell1.

Table A.8.16.70.1-2: Cell specific test parameters for E-UTRAN TDD 4 DL CA activation and deactivation of unknown SCell in non-DRX

Parameter	Unit	Cell 1			Cell 2			Cell 3			Cell 4			Cell5		
		T1	T2	T3	T1	T2	T3	T1	T2	T3	T1	T2	T3	T1	T2	T3
E-UTRA RF Channel Number		1			2			3			4			5		
BW _{channel}		5MHz: N _{RB,c} = 25 10MHz: N _{RB,c} = 50 20MHz: N _{RB,c} = 100			5MHz: N _{RB,c} = 25 10MHz: N _{RB,c} = 50 20MHz: N _{RB,c} = 100			5MHz: N _{RB,c} = 25 10MHz: N _{RB,c} = 50 20MHz: N _{RB,c} = 100			5MHz: N _{RB,c} = 25 10MHz: N _{RB,c} = 50 20MHz: N _{RB,c} = 100			5MHz: N _{RB,c} = 25 10MHz: N _{RB,c} = 50 20MHz: N _{RB,c} = 100		
PDSCH parameters: DL Reference Measurement Channel		5MHz: R.4 TDD 10MHz: R.0 TDD 20MHz: R.3 TDD			-			-			-			-		
PCFICH/PDCCH/PCH parameters: DL Reference Measurement Channel		5MHz: R.11 TDD 10MHz: R.6 TDD 20MHz: R.10 TDD			5MHz: R.11 TDD 10MHz: R.6 TDD 20MHz: R.10 TDD			5MHz: R.11 TDD 10MHz: R.6 TDD 20MHz: R.10 TDD			5MHz: R.11 TDD 10MHz: R.6 TDD 20MHz: R.10 TDD			5MHz: R.11 TDD 10MHz: R.6 TDD 20MHz: R.10 TDD		
OCNG Patterns		5MHz: OP.9 TDD 10MHz: OP.1 TDD 20MHz: OP.7 TDD			5MHz: OP.10 TDD 10MHz: OP.2 TDD 20MHz: OP.8 TDD			5MHz: OP.10 TDD 10MHz: OP.2 TDD 20MHz: OP.8 TDD			5MHz: OP.10 TDD 10MHz: OP.2 TDD 20MHz: OP.8 TDD			5MHz: OP.10 TDD 10MHz: OP.2 TDD 20MHz: OP.8 TDD		
PBCH_RA	dB	0			0			0			0			0		
PBCH_RB	dB															
PSS_RA	dB															
SSS_RA	dB															
PCFICH_RB	dB															
PHICH_RA	dB															
PHICH_RB	dB															
PDCCH_RA	dB															
PDCCH_RB	dB															
PDSCH_RA	dB															
PDSCH_RB	dB															
OCNG_RA ^{Note 1}	dB															
OCNG_RB ^{Note 1}	dB															
N _{oc} ^{Note 2}	dBm/15 kHz															
\bar{E}_s/N_{oc}	dB	17			- infinity			17			17			17		
\bar{E}_s/I_{ot} ^{Note 3}	dB	17			- infinity			17			17			17		
RSRP ^{Note 3}	dBm/15 kHz	-87			- infinity			-87			-87			-87		

SCH_RP ^{Note 3}	dBm/ 15 kHz	-87	- infinity	-87	-87	-87	-87
Io ^{Note 3}	dBm/ Ch BW	$-59.13+10\log(N_{RB,c}/50)$	$-76.22+10\log(N_{RB,c}/50)$	$-59.13+10\log(N_{RB,c}/50)$	$-59.13+10\log(N_{RB,c}/50)$	$-59.13+10\log(N_{RB,c}/50)$	$-59.13+10\log(N_{RB,c}/50)$
Propagation Condition		AWGN	AWGN	AWGN	AWGN	AWGN	AWGN
Antenna Configuration		1x2	1x2	1x2	1x2	1x2	1x2
Timing offset to Cell 1	μs	-	0	0	0	0	0
Time alignment error relative to cell 1 ^{Note 5}	μs	-	$\leq \text{TAE}$	$\leq \text{TAE}$	$\leq \text{TAE}$	$\leq \text{TAE}$	$\leq \text{TAE}$
Time alignment error relative to cell 2 ^{Note 5}	μs	-	-	$\leq \text{TAE}$	$\leq \text{TAE}$	$\leq \text{TAE}$	$\leq \text{TAE}$
Time alignment error relative to cell 3 ^{Note 5}	μs	-	-	-	$\leq \text{TAE}$	$\leq \text{TAE}$	$\leq \text{TAE}$
Time alignment error relative to cell 4 ^{Note 5}	μs	-	-	-	-	-	$\leq \text{TAE}$
<p>Note 1: OCNB shall be used such that all cells are fully allocated and a constant total transmitted power spectral density is achieved for all OFDM symbols.</p> <p>Note 2: Interference from other cells and noise sources not specified in the test is assumed to be constant over subcarriers and time and shall be modelled as AWGN of appropriate power for N_{oc} to be fulfilled.</p> <p>Note 3: E_s/I_{ot}, RSRP, SCH_RP and I_o have been derived from other parameters for information purposes. They are not settable parameters themselves.</p> <p>Note 4: The uplink resources for CSI reporting are assigned to the UE prior to the start of time period T2.</p> <p>Note 5: Time alignment error (TAE) as specified in TS 36.104 [30] clause 6.5.3.1. The TAE value depends upon the type of carrier aggregation.</p>							

A.8.16.70.2 Test Requirements

During T2 the UE shall send the first CSI report for SCell1 in a subframe (m+8), or in a subframe (m+9) if the subframe (m+8) was subject to interruption, or in a subframe (m+13) if the subframe (m+8) and (m+9) were subject to interruption when an intra-band SCell is activated. Whether CSI report in subframe (m+8) and/or (m+9) was interrupted or not is checked by monitoring ACK/NACK sent in PCell in subframe (m+8) and/or (m+9).

During T2 the UE shall start sending CSI reports for SCell1 with non-zero CQI index at latest in a subframe (m+49).

During T3 the UE shall stop sending CSI reports for SCell1 at latest in subframe (n+8).

During T2 interruption of PCell during SCells activation shall not happen outside the subframes (m+5) to (m+11) and outside the subframes (m+20) to (m+26).

During T3 interruption of PCell during SCells deactivation shall not happen outside the subframes (n+5) to (n+11), outside the subframes (n+20) to (n+26), outside the subframes (n+35) to (n+41) and outside the subframes (n+50) to (n+56).

The interruption of PCell shall not be more than the values specified for intra-band CA and inter-band CA in Section 7.8.2.

The UE shall not send event triggered measurement reports as long as the reporting criteria are not fulfilled.

All of the above test requirements shall be fulfilled in order for the observed SCell1 activation delay and SCell1 deactivation delay to be counted as correct. The rate of correct observed SCell1 activation delay and SCell1 deactivation delay during repeated tests shall be at least 90%.

NOTE: During T2 if there are no uplink resources for reporting the valid CSI in a subframe (m+49) then the UE shall use the next available uplink resource for reporting the corresponding valid CSI.

A.8.16.71 5 DL FDD CA Event Triggered Reporting with Deactivated SCells in Non-DRX

A.8.16.71.1 Test Purpose and Environment

The purpose of this test is to verify that the UE correctly detects events A1 (Serving cell becomes better than threshold), A2 (Serving cell becomes worse than threshold) and A6 (Neighbour becomes better than SCell) defined in TS 36.331 [2] within the requirements stated in clause 8.3.3.2.1.

In this test case there are 6 cells. Cell 1 is the PCell on the FDD PCC F1. Cell 2 is the configured and deactivated SCell on the FDD SCC F2. Cell 3 is the configured and deactivated SCell on the FDD SCC F3. Cell 4 is the configured and deactivated SCell on the FDD SCC F4. Cell 5 is the configured and deactivated SCell on the FDD SCC F5, and cell 6 is the neighbor cell on the FDD SCC F5.

The test parameters are given in Tables A.8.16.71.1-1 and A.8.16.71.1-2 below. It is indicated to the UE in the measurement control information that event-triggered reporting with Events A1 (cell2), A2 (PCell and SCells) and A6 are used. The test consists of three successive time periods, with duration of T1, T2 and T3, respectively. During T1 the UE shall not have any information on cell 6. At the beginning of T2 the transmission power of cell 6 is increased to the same level as for cell 5, and due to usage of an offset this shall result in reporting of Event A6. Also, at the beginning of T2 the transmission power of cell 2 is increased to the same level as for cell 1, which shall result in reporting of Event A1. At the beginning of T3 the transmission powers of cells 1, 2, 3, 4, 5 and 6 are reduced below a threshold value and this shall result in reporting of Event A2 for Cell 1, for Cell 2, for Cell3, for Cell 4 and for Cell 5.

Table A.8.16.71.1-1: General test parameters for E-UTRAN FDD-FDD 5 DL CA event triggered reporting under fading propagation conditions with 4 configured but deactivated SCells in non-DRX

Parameter		Unit	Value	Comment
E-UTRA RF Channel Number			1, 2, 3, 4, 5	Five radio channels are used for this test
Active PCell			Cell 1	Primary cell on RF channel number 1.
Configured deactivated SCell			Cell 2	Configured deactivated secondary cell on RF channel number 2.
Configured deactivated SCell			Cell 3	Configured deactivated secondary cell on RF channel number 3.
Configured deactivated SCell			Cell 4	Configured deactivated secondary cell on RF channel number 4.
Configured deactivated SCell			Cell 5	Configured deactivated secondary cell on RF channel number 5.
Neighbour cell			Cell 6	Neighbour cell to be identified on RF channel number 6.
CP length			Normal	
DRX			OFF	Continuous monitoring of primary cell
A1	Hysteresis	dB	0	Hysteresis for evaluation of event A1.
	Threshold RSRP	dBm	-98	Actual RSRP threshold for event A1. Needs to take absolute accuracy tolerance in section 9.1.11.1 into account plus margin.
	Time To Trigger	s	0	
A2	Hysteresis	dB	0	Hysteresis for evaluation of event A2.
	Threshold RSRP	dBm	-98	Actual RSRP threshold for event A2. Needs to take absolute accuracy tolerance in section 9.1.11.1 into account plus margin.
	Time To Trigger	s	0	
A6	Hysteresis	dB	0	Hysteresis for evaluation of event A6.
	Offset	dB	-6	Offset parameter for evaluation of event A6. Needs to take relative accuracy tolerance in section 9.1.11.2 into account plus margin.
	Report on leave		False	
	Time To Trigger	s	0	
Cell-individual offset for cells on RF channel number 1		dB	0	Individual offset for cells on primary component carrier.
Cell-individual offset for cells on RF channel number 2		dB	0	Individual offset for cells on secondary component carrier.
Cell-individual offset for cells on RF channel number 3		dB	0	Individual offset for cells on secondary component carrier.
Cell-individual offset for cells on RF channel number 4		dB	0	Individual offset for cells on secondary component carrier.
Cell-individual offset for cells on RF channel number 5		dB	0	Individual offset for cells on secondary component carrier.

Filter coefficient		0	L3 filtering is not used
SCell measurement cycle (measCycleSCell)	ms	320	
T1	s	5	During this time the cell1 cell3 cell4 cell5 shall be known to the UE; but cell2 and cell 6 shall be unknown to the UE.
T2	s	≤ 12	UE should report Event A1 for cell2 and event A6 for cell6 within 6.4s (20xscellMeasCycle)
T3	s	5	UE should report Event A2 within 200 ms for cell1, and 1.6s for cells 2, 3, 4 and 5.

Table A.8.16.71.1-2: Cell specific test parameters for E-UTRAN FDD-FDD 5 DL CA event triggered reporting under fading propagation conditions with 4 configured but deactivated SCells in non-DRX

Parameter	Unit	Cell 1			Cell 2			Cell 3			Cell 4			Cell 5			Cell 6		
		T1	T2	T3	T1	T2	T3	T1	T2	T3	T1	T2	T3	T1	T2	T3	T1	T2	T3
E-UTRA RF Channel Number		1			2			3			4			5					
BW _{channel}		5MHz: N _{RB,c} = 25 10MHz: N _{RB,c} = 50 20MHz: N _{RB,c} = 100			5MHz: N _{RB,c} = 25 10MHz: N _{RB,c} = 50 20MHz: N _{RB,c} = 100			5MHz: N _{RB,c} = 25 10MHz: N _{RB,c} = 50 20MHz: N _{RB,c} = 100			5MHz: N _{RB,c} = 25 10MHz: N _{RB,c} = 50 20MHz: N _{RB,c} = 100			5MHz: N _{RB,c} = 25 10MHz: N _{RB,c} = 50 20MHz: N _{RB,c} = 100					
PDSCH parameters: DL Reference Measurement Channel		5MHz: R.5 FDD 10MHz: R.0 FDD 20MHz: R.4 FDD			-			-			-			-			-		
PCFICH/PDCCH/PHICH parameters: DL Reference Measurement Channel		5MHz: R.11 FDD 10MHz: R.6 FDD 20MHz: R.10 FDD			5MHz: R.11 FDD 10MHz: R.6 FDD 20MHz: R.10 FDD			5MHz: R.11 FDD 10MHz: R.6 FDD 20MHz: R.10 FDD			5MHz: R.11 FDD 10MHz: R.6 FDD 20MHz: R.10 FDD			5MHz: R.11 FDD 10MHz: R.6 FDD 20MHz: R.10 FDD			5MHz: R.11 FDD 10MHz: R.6 FDD 20MHz: R.10 FDD		
OCNG Patterns		5MHz: OP.15 FDD 10MHz: OP.1 FDD 20MHz: OP.11 FDD			5MHz: OP.16 FDD 10MHz: OP.2 FDD 20MHz: OP.12 FDD			5MHz: OP.16 FDD 10MHz: OP.2 FDD 20MHz: OP.12 FDD			5MHz: OP.16 FDD 10MHz: OP.2 FDD 20MHz: OP.12 FDD			5MHz: OP.16 FDD 10MHz: OP.2 FDD 20MHz: OP.12 FDD			5MHz: OP.16 FDD 10MHz: OP.2 FDD 20MHz: OP.12 FDD		
PBCH_RA	dB	0			0			0			0			0			0		
PBCH_RB	dB																		
PSS_RA	dB																		
SSS_RA	dB																		
PCFICH_RB	dB																		
PHICH_RA	dB																		
PHICH_RB	dB																		
PDCCH_RA	dB																		
PDCCH_RB	dB																		
PDSCH_RA	dB																		
PDSCH_RB	dB																		
OCNG_RA ^{Note 1}	dB																		
OCNG_RB ^{Note 1}	dB																		
N _{oc} ^{Note 2}	dBm/15 KHz																		
\hat{E}_s/N_{oc}	dB	17	17	-3	-infinity	17	-3	17	17	-3	17	17	-3	17	17	-3	-infinity	17	-3
\hat{E}_s/I_{ot} ^{Note 3}	dB	17	17	-3	-infinity	17	-3	17	17	-3	17	17	-3	17	-0.09	-4.76	-infinity	0.05	4.76
RSRP ^{Note 3}	dBm/15 kHz	-87	-87	-107	-infinity	-87	-107	-87	-87	-107	-87	-87	-107	-87	-87	-107	-infinity	-87	-107
SCH_RP ^{Note 3}	dBm/15 kHz	-87	-87	-107	-infinity	-87	-107	-87	-87	-107	-87	-87	-107	-87	-87	-107	-infinity	-87	-107
I _o ^{Note 3}	dBm/C h BW	-59.13 +10log(N _{RB,c} /50)	-59.13 +10log(N _{RB,c} /50)	-74.45 +10log(N _{RB,c} /50)	-76.22 +10log(N _{RB,c} /50)	-59.13 +10log(N _{RB,c} /50)	-74.45 +10log(N _{RB,c} /50)	-59.13 +10log(N _{RB,c} /50)	-59.13 +10log(N _{RB,c} /50)	-74.45 +10log(N _{RB,c} /50)	-59.13 +10log(N _{RB,c} /50)	-59.13 +10log(N _{RB,c} /50)	-74.45 +10log(N _{RB,c} /50)	-59.13 +10log(N _{RB,c} /50)	-56.17 +10log(N _{RB,c} /50)	-73.20 +10log(N _{RB,c} /50)	Specified in columns for Cell 5		
Propagation Condition		AWGN			ETU70			ETU70			ETU70			ETU70			ETU70		

Correlation Matrix and Antenna Configuration		1x2	1x2 Low	1x2 Low	1x2 Low	1x2 Low	1x2 Low
Timing offset to Cell 1	μs	-	0	0	0	0	3
Time alignment error relative to cell 1 ^{Note 5}	μs	-	$\leq \text{TAE}$	$\leq \text{TAE}$	$\leq \text{TAE}$	$\leq \text{TAE}$	N/A
Time alignment error relative to cell 2 ^{Note 5}	μs	-	-	$\leq \text{TAE}$	$\leq \text{TAE}$	$\leq \text{TAE}$	N/A
Time alignment error relative to cell 3 ^{Note 5}	μs	-	-	-	$\leq \text{TAE}$	$\leq \text{TAE}$	N/A
Time alignment error relative to cell 4 ^{Note 5}	μs	-	-	-	-	$\leq \text{TAE}$	N/A

Note 1: OCNG shall be used such that all cells are fully allocated and a constant total transmitted power spectral density is achieved for all OFDM symbols.

Note 2: Interference from other cells and noise sources not specified in the test is assumed to be constant over subcarriers and time and shall be modelled as AWGN of appropriate power for N_{oc} to be fulfilled.

Note 3: E_s/I_{ot} , RSRP, SCH_RP and I_o have been derived from other parameters for information purposes. They are not settable parameters themselves.

Note 4: The resources for uplink transmission are assigned to the UE prior to the start of time period T2.

Note 5: Time alignment error (TAE) as specified in TS 36.104 [30] clause 6.5.3.1. The TAE value depends upon the type of carrier aggregation.

A.8.16.71.2 Test Requirements

The UE shall send one Event A6 triggered measurement report for cell 6 with a measurement reporting delay of less than 6.4s ($20 \times \text{measCycleSCell}$) from the beginning of time T2.

The UE shall send one Event A1 triggered measurement report for Cell 2 with a measurement reporting delay of less than 6.4s ($20 \times \text{measCycleSCell}$) from beginning of time T2.

The UE shall send one Event A2 triggered measurement report for Cell 1 with a measurement reporting delay of less than 200 ms from beginning of time T3.

The UE shall send one Event A2 triggered measurement report for Cell 2 with a measurement reporting delay of less than 1.6s ($5 \times \text{measCycleSCell}$) from beginning of time T3.

The UE shall send one Event A2 triggered measurement report for Cell 3 with a measurement reporting delay of less than 1.6s ($5 \times \text{measCycleSCell}$) from beginning of time T3.

The UE shall send one Event A2 triggered measurement report for Cell 4 with a measurement reporting delay of less than 1.6s ($5 \times \text{measCycleSCell}$) from beginning of time T3.

The UE shall send one Event A2 triggered measurement report for Cell 5 with a measurement reporting delay of less than 1.6s ($5 \times \text{measCycleSCell}$) from beginning of time T3.

The UE shall not send event triggered measurement reports as long as the reporting criteria are not fulfilled.

The rate of correct events observed during repeated tests shall be at least 90% for each of the events.

NOTE: The actual overall delays measured in the tests may be up to $2 \times \text{TTI}_{\text{DCCH}}$ higher than the measurement reporting delays above because of TTI insertion uncertainty of the measurement report in DCCH.

A.8.16.72 5 DL TDD CA Event Triggered Reporting with Deactivated SCells in Non-DRX

A.8.16.72.1 Test Purpose and Environment

The purpose of this test is to verify that the UE correctly detects events A1 (Serving cell becomes better than threshold), A2 (Serving cell becomes worse than threshold) and A6 (Neighbour becomes better than SCell) defined in TS 36.331 [2] within the requirements stated in clause 8.3.3.2.1.

In this test case there are 6 cells. Cell 1 is the PCell on the TDD PCC F1. Cell 2 is the configured and deactivated SCell on the TDD SCC F2. Cell 3 is the configured and deactivated SCell on the TDD SCC F3. Cell 4 is the configured and deactivated SCell on the TDD SCC F4. Cell 5 is the configured and deactivated SCell on the TDD SCC F5, and cell 6 is the neighbor cell on the TDD SCC F5.

The test parameters are given in Tables A.8.16.72.1-1 and A.8.16.72.1-2 below. It is indicated to the UE in the measurement control information that event-triggered reporting with Events A1 (cell2), A2 (PCell and SCells) and A6 are used. The test consists of three successive time periods, with duration of T1, T2 and T3, respectively. During T1 the UE shall not have any information on cell 6. At the beginning of T2 the transmission power of cell 6 is increased to the same level as for cell 5, and due to usage of an offset this shall result in reporting of Event A6. Also, at the beginning of T2 the transmission power of cell 2 is increased to the same level as for cell 1, which shall result in reporting of Event A1. At the beginning of T3 the transmission powers of cells 1, 2, 3, 4, 5 and 6 are reduced below a threshold value and this shall result in reporting of Event A2 for Cell 1, for Cell 2, for Cell3, for Cell4 and for Cell 5.

Table A.8.16.72.1-1: General test parameters for E-UTRAN TDD-TDD 5 DL CA event triggered reporting under fading propagation conditions with 4 configured but deactivated SCells in non-DRX with PCell in TDD

Parameter	Unit	Value	Comment
E-UTRA RF Channel Number		1, 2, 3, 4, 5	Five radio channels are used for this test
Active PCell		Cell 1	Primary cell on RF channel number 1.
Configured deactivated SCell		Cell 2	Configured deactivated secondary cell on RF channel number 2.
Configured deactivated SCell		Cell 3	Configured deactivated secondary cell on RF channel number 3.

Configured deactivated SCell			Cell 4	Configured deactivated secondary cell on RF channel number 4.
Configured deactivated SCell			Cell 5	Configured deactivated secondary cell on RF channel number 5.
Neighbour cell			Cell 6	Neighbour cell to be identified on RF channel number 5.
CP length			Normal	
DRX			OFF	Continuous monitoring of primary cell
Special subframe configuration			6	As specified in table 4.2-1 in TS 36.211. The same configuration applies to all TDD cells
Uplink-downlink configuration			1	As specified in table 4.2-2 in TS 36.211. The same configuration applies to all TDD cells
A1	Hysteresis	dB	0	Hysteresis for evaluation of event A1.
	Threshold RSRP	dBm	-98	Actual RSRP threshold for event A1. Needs to take absolute accuracy tolerance in section 9.1.11.1 into account plus margin.
	Time To Trigger	s	0	
A2	Hysteresis	dB	0	Hysteresis for evaluation of event A2.
	Threshold RSRP	dBm	-98	Actual RSRP threshold for event A2. Needs to take absolute accuracy tolerance in section 9.1.11.1 into account plus margin.
	Time To Trigger	s	0	
A6	Hysteresis	dB	0	Hysteresis for evaluation of event A6.
	Offset	dB	-6	Offset parameter for evaluation of event A6. Needs to take relative accuracy tolerance in section 9.1.11.2 into account plus margin.
	Report on leave		False	
	Time To Trigger	s	0	
Cell-individual offset for cells on RF channel number 1		dB	0	Individual offset for cells on primary component carrier.
Cell-individual offset for cells on RF channel number 2		dB	0	Individual offset for cells on secondary component carrier.
Cell-individual offset for cells on RF channel number 3		dB	0	Individual offset for cells on secondary component carrier.
Cell-individual offset for cells on RF channel number 4		dB	0	Individual offset for cells on secondary component carrier.
Cell-individual offset or cells on RF channel number 5		dB	0	Individual offset for cells on secondary component carrier.
Filter coefficient			0	L3 filtering is not used
SCell measurement cycle (measCycleSCell)		ms	320	
T1		s	5	During this time the cell1, cell3, cell 4, cell 5 shall be known to the UE; but cell2 and cell 6 shall be unknown to the UE.
T2		s	≤12	UE should report Event A1 for cell2 and event A6 for cell6 within 6.4s (20xscellMeasCycle)
T3		s	5	UE should report Event A2 within 200 ms for cell 1, and 1.6s for cells 2, 3, 4, 5.

Table A.8.16.72.1-2: Cell specific test parameters for E-UTRAN TDD-TDD 5 DL CA event triggered reporting under fading propagation conditions with 4 configured but deactivated SCells in non-DRX with PCell in TDD

Parameter	Unit	Cell 1			Cell 2			Cell 3			Cell 4			Cell 5			Cell 6		
		T1	T2	T3	T2	T2	T3	T1	T2	T3	T1	T2	T3	T1	T2	T3	T1	T2	T3
E-UTRA RF Channel Number		1			2			3			4			5					
BW _{channel}		5MHz: N _{RB,c} = 25 10MHz: N _{RB,c} = 50 20MHz: N _{RB,c} = 100			5MHz: N _{RB,c} = 25 10MHz: N _{RB,c} = 50 20MHz: N _{RB,c} = 100			5MHz: N _{RB,c} = 25 10MHz: N _{RB,c} = 50 20MHz: N _{RB,c} = 100			5MHz: N _{RB,c} = 25 10MHz: N _{RB,c} = 50 20MHz: N _{RB,c} = 100			5MHz: N _{RB,c} = 25 10MHz: N _{RB,c} = 50 20MHz: N _{RB,c} = 100					
PDSCH parameters: DL Reference Measurement Channel		5MHz: R.5 TDD 10MHz: R.0 TDD 20MHz: R.4 TDD			-			-			-			-			-		
PCFICH/PDCCH/PHICH parameters: DL Reference Measurement Channel		5MHz: R.11 TDD 10MHz: R.6 TDD 20MHz: R.10 TDD			5MHz: R.11 TDD 10MHz: R.6 TDD 20MHz: R.10 TDD			5MHz: R.11 TDD 10MHz: R.6 TDD 20MHz: R.10 TDD			5MHz: R.11 TDD 10MHz: R.6 TDD 20MHz: R.10 TDD			5MHz: R.11 TDD 10MHz: R.6 TDD 20MHz: R.10 TDD			5MHz: R.11 TDD 10MHz: R.6 TDD 20MHz: R.10 TDD		
OCNG Patterns		5MHz: OP.15 TDD 10MHz: OP.1 TDD 20MHz: OP.11 TDD			5MHz: OP.16 TDD 10MHz: OP.2 TDD 20MHz: OP.12 TDD			5MHz: OP.16 TDD 10MHz: OP.2 TDD 20MHz: OP.12 TDD			5MHz: OP.16 TDD 10MHz: OP.2 TDD 20MHz: OP.12 TDD			5MHz: OP.16 TDD 10MHz: OP.2 TDD 20MHz: OP.12 TDD			5MHz: OP.16 TDD 10MHz: OP.2 TDD 20MHz: OP.12 TDD		
PBCH_RA	dB	0			0			0			0			0			0		
PBCH_RB	dB																		
PSS_RA	dB																		
SSS_RA	dB																		
PCFICH_RB	dB																		
PHICH_RA	dB																		
PHICH_RB	dB																		
PDCCH_RA	dB																		
PDCCH_RB	dB																		
PDSCH_RA	dB																		
PDSCH_RB	dB																		
OCNG_RA ^{Note 1}	dB																		
OCNG_RB ^{Note 1}	dB																		
N _{oc} ^{Note 2}	dBm/15 KHz																		
\hat{E}_s/N_{oc}	dB	17	17	-3	-infinity	17	-3	17	17	-3	17	17	-3	17	17	-3	-infinity	17	-3
\hat{E}_s/I_{ot} ^{Note 3}	dB	17	17	-3	-infinity	17	-3	17	17	-3	17	17	-3	17	-0.09	-4.76	-infinity	0.09	4.76
RSRP ^{Note 3}	dBm/15 kHz	-87	-87	-107	-infinity	-87	-107	-87	-87	-107	-87	-87	-107	-87	-87	-107	-infinity	-87	-107
SCH_RP ^{Note 3}	dBm/15 kHz	-87	-87	-107	-infinity	-87	-107	-87	-87	-107	-87	-87	-107	-87	-87	-107	-infinity	-87	-107
I _o ^{Note 3}	dBm/C h BW	-59.13 +10log(N _{RB,c} /50)	-59.13 +10log(N _{RB,c} /50)	-74.45 +10log(N _{RB,c} /50)	-76.22 +10log(N _{RB,c} /50)	-59.13 +10log(N _{RB,c} /50)	-74.45 +10log(N _{RB,c} /50)	-59.13 +10log(N _{RB,c} /50)	-59.13 +10log(N _{RB,c} /50)	-74.45 +10log(N _{RB,c} /50)	-59.13 +10log(N _{RB,c} /50)	-59.13 +10log(N _{RB,c} /50)	-74.45 +10log(N _{RB,c} /50)	-59.13 +10log(N _{RB,c} /50)	-56.17 +10log(N _{RB,c} /50)	-73.20 +10log(N _{RB,c} /50)	Specified in columns for Cell 5		
Propagation Condition		AWGN			ETU70			ETU70			ETU70			ETU70			ETU70		

Correlation Matrix and Antenna Configuration		1x2	1x2 Low	1x2 Low	1x2 Low	1x2 Low	1x2 Low
Timing offset to Cell 1	μs	-	0	0	0	0	3
Time alignment error relative to cell 1 ^{Note 5}	μs	-	$\leq \text{TAE}$	$\leq \text{TAE}$	$\leq \text{TAE}$	$\leq \text{TAE}$	N/A
Time alignment error relative to cell 2 ^{Note 5}	μs	-	-	$\leq \text{TAE}$	$\leq \text{TAE}$	$\leq \text{TAE}$	N/A
Time alignment error relative to cell 3 ^{Note 5}	μs	-	-	-	$\leq \text{TAE}$	$\leq \text{TAE}$	N/A
Time alignment error relative to cell 4 ^{Note 5}	μs	-	-	-	-	$\leq \text{TAE}$	N/A

Note 1: OCNG shall be used such that all cells are fully allocated and a constant total transmitted power spectral density is achieved for all OFDM symbols.

Note 2: Interference from other cells and noise sources not specified in the test is assumed to be constant over subcarriers and time and shall be modelled as AWGN of appropriate power for N_{oc} to be fulfilled.

Note 3: E_s/I_{ot} , RSRP, SCH_RP and I_o have been derived from other parameters for information purposes. They are not settable parameters themselves.

Note 4: The resources for uplink transmission are assigned to the UE prior to the start of time period T2.

Note 5: Time alignment error (TAE) as specified in TS 36.104 [30] clause 6.5.3.1. The TAE value depends upon the type of carrier aggregation.

A.8.16.72.2 Test Requirements

The UE shall send one Event A6 triggered measurement report for cell 6 with a measurement reporting delay of less than 6.4s ($20 \times \text{measCycleSCell}$) from the beginning of time T2.

The UE shall send one Event A1 triggered measurement report for Cell 2 with a measurement reporting delay of less than 6.4s ($20 \times \text{measCycleSCell}$) from beginning of time T2.

The UE shall send one Event A2 triggered measurement report for Cell 1 with a measurement reporting delay of less than 200 ms from beginning of time T3.

The UE shall send one Event A2 triggered measurement report for Cell 2 with a measurement reporting delay of less than 1.6s ($5 \times \text{measCycleSCell}$) from beginning of time T3.

The UE shall send one Event A2 triggered measurement report for Cell 3 with a measurement reporting delay of less than 1.6s ($5 \times \text{measCycleSCell}$) from beginning of time T3.

The UE shall send one Event A2 triggered measurement report for Cell 4 with a measurement reporting delay of less than 1.6s ($5 \times \text{measCycleSCell}$) from beginning of time T3.

The UE shall send one Event A2 triggered measurement report for Cell 5 with a measurement reporting delay of less than 1.6s ($5 \times \text{measCycleSCell}$) from beginning of time T3.

The UE shall not send event triggered measurement reports as long as the reporting criteria are not fulfilled.

The rate of correct events observed during repeated tests shall be at least 90% for each of the events.

NOTE: The actual overall delays measured in the tests may be up to $2 \times \text{TTI}_{\text{DCCH}}$ higher than the measurement reporting delays above because of TTI insertion uncertainty of the measurement report in DCCH.

A.8.16.73 5 DL FDD CA Event Triggered Reporting on Deactivated SCell with PCell and SCell Interruptions in Non-DRX

A.8.16.73.1 Test Purpose and Environment

The purpose of this test is to verify that the UE correctly detects event A6 (Neighbour becomes better than SCell) defined in TS 36.331 [2] within the requirements stated in clause 8.3.3.2.1 while at the same time fulfilling the requirement on interruption rate.

The test parameters are given in Table A.8.16.73.1-1, A.8.16.73.1-2 and A.8.16.73.1-2 below. In the test there are six cells: Cell 1, Cell 2, Cell 3, Cell 4, Cell 5 and Cell 6. Cell 1 is PCell on the FDD primary component (RF Channel 1), Cell 2 is SCell on the FDD secondary component (RF Channel 2), Cell 3 is SCell on the FDD secondary component (RF Channel 3), Cell 4 is SCell on the FDD secondary component (RF Channel 4) and Cell 5 is SCell on the FDD secondary component (RF Channel 5) and Cell 6 is the neighbour cell on the FDD secondary component (RF Channel 5). It is indicated to the UE in the measurement control information that event-triggered reporting with Event A6 is used. The test consists of four successive time periods, with duration of T1, T2, T3 and T4, respectively. During T1 and T2, Cell2, Cell3, Cell4 and Cell5 are deactivated. During T1 the UE shall not have any information of Cell 6. Immediately at beginning of T2 the transmission power of Cell 6 is increased to same level as for Cell 3, and due to usage of an offset this shall result in reporting of Event A6.

At the beginning of T3, the transmission power of Cell 6 is turned off, and the test equipment sends a MAC message for activation of Cell 2 to UE but Cell3, Cell4 and Cell5 remains deactivated. Immediately at beginning of T4 the transmission power of Cell 6 is increased to same level as for Cell 3, and due to usage of an offset this shall result in reporting of Event A6. The UE shall be continuously scheduled in the PCell throughout the whole test and continuously scheduled in Cell2 during T4.

Table A.8.16.73.1-1: General test parameters for E-UTRAN FDD 5 DL CA Event Triggered Reporting on Deactivated SCell with PCell and SCell interruptions in Non-DRX

Parameter	Unit	Value	Comment
E-UTRA RF Channel Number		1, 2, 3, 4, 5	Five radio channels are used for this test
Active PCell		Cell 1	Primary cell on RF channel number 1.
Configured deactivated SCell		Cell 2	Configured deactivated secondary cell on RF channel number 2.

Configured deactivated SCell		Cell 3	Configured deactivated secondary cell on RF channel number 3.	
Configured deactivated SCell		Cell 4	Configured deactivated secondary cell on RF channel number 4.	
Configured deactivated SCell		Cell 5	Configured deactivated secondary cell on RF channel number 5.	
Neighbour cell		Cell 6	Neighbor cell to be identified on RF channel number 5.	
CP length		Normal		
DRX		OFF	Continuous monitoring of primary cell	
A6	Hysteresis	dB	0	Hysteresis for evaluation of event A6.
	Offset	dB	-3	Offset parameter for evaluation of event A6. Needs to take relative accuracy tolerance in clause 9.1.11.2 into account plus margin.
	Report on leave		False	
	Time To Trigger	s	0	
Cell-individual offset for cells on RF channel number 1	dB	0	Individual offset for cells on primary component carrier.	
Cell-individual offset for cells on RF channel number 2	dB	0	Individual offset for cells on secondary component carrier.	
Cell-individual offset for cells on RF channel number 3	dB	0	Individual offset for cells on secondary component carrier.	
Cell-individual offset for cells on RF channel number 4	dB	0	Individual offset for cells on secondary component carrier.	
Cell-individual offset for cells on RF channel number 5	dB	0	Individual offset for cells on secondary component carrier.	
Filter coefficient		0	L3 filtering is not used	
SCell measurement cycle	ms	640		
T1	s	4	During this time the UE shall be aware of cells 1, 2, 3, 4 and 5 but not cell 6.	
T2	s	≤15	UE should report Event A6 within 12.8s (20×sCellMeasCycle)	
T3	s	4	During this time the UE shall activate cell 2	
T4	s	≤4	UE should report Event A6 within 3.2s (5×sCellMeasCycle)	

Table A.8.16.73.1-2: Cell specific test parameters for E-UTRAN FDD 5 DL CA Event Triggered Reporting on Deactivated SCell with PCell and SCell interruptions in Non-DRX (Cell #1, Cell #2, Cell #3, Cell #4)

Parameter	Unit	Cell 1				Cell 2				Cell 3				Cell 4			
		T1	T2	T3	T4	T1	T2	T3	T4	T1	T2	T3	T4	T1	T2	T3	T4
E-UTRA RF Channel Number		1				2				3				4			
BW _{channel}		5MHz: N _{RB,c} = 25 10MHz: N _{RB,c} = 50 20MHz: N _{RB,c} = 100				5MHz: N _{RB,c} = 25 10MHz: N _{RB,c} = 50 20MHz: N _{RB,c} = 100				5MHz: N _{RB,c} = 25 10MHz: N _{RB,c} = 50 20MHz: N _{RB,c} = 100				5MHz: N _{RB,c} = 25 10MHz: N _{RB,c} = 50 20MHz: N _{RB,c} = 100			
PDSCH parameters: DL Reference Measurement Channel		5MHz: R.7 FDD 10MHz: R.3 FDD 20MHz: R.6 FDD				N/A	N/A	N/A	5MHz: R.7 FDD 10MHz: R.3 FDD 20MHz: R.6 FDD	N/A				N/A			
PCFICH/PDCCH/PHICH parameters		5MHz: R.11 FDD 10MHz: R.6 FDD 20MHz: R.10 FDD				5MHz: R.11 FDD 10MHz: R.6 FDD 20MHz: R.10 FDD				5MHz: R.11 FDD 10MHz: R.6 FDD 20MHz: R.10 FDD				5MHz: R.11 FDD 10MHz: R.6 FDD 20MHz: R.10 FDD			
OCNG Pattern defined in A.3.2.1		5MHz: OP.20 FDD 10MHz: OP.10 FDD 20MHz: OP.17 FDD				5MHz: OP.19 FDD 10MHz: OP.6 FDD 20MHz: OP.14 FDD	5MHz: OP.19 FDD 10MHz: OP.6 FDD 20MHz: OP.14 FDD	5MHz: OP.19 FDD 10MHz: OP.6 FDD 20MHz: OP.14 FDD	5MHz: OP.20 FDD 10MHz: OP.10 FDD 20MHz: OP.17 FDD	5MHz: OP.16 FDD 10MHz: OP.2 FDD 20MHz: OP.12 FDD				5MHz: OP.16 FDD 10MHz: OP.2 FDD 20MHz: OP.12 FDD			
PBCH_RA	dB	0				0				0				0			
PBCH_RB	dB																
PSS_RA	dB																
SSS_RA	dB																
PCFICH_RB	dB																
PHICH_RA	dB																
PHICH_RB	dB																
PDCCH_RA	dB																
PDCCH_RB	dB																
PDSCH_RA	dB																
PDSCH_RB	dB																
OCNG_RA ^{Note 1}	dB																

OCNG_RB ^{Note 1}	dB																	
N_{oc} ^{Note 3}	dBm/1 5 kHz	-101				-101				-101				-101				
\hat{E}_s/N_{oc}	dB	16	16	16	16	16	16	16	16	16	16	16	16	16	16	16	16	
\hat{E}_s/I_{ot} ^{Note 4}	dB	16	16	16	16	16	16	16	16	16	-0.11	16	-0.11	16	-0.11	16	-0.11	
RSRP ^{Note 4}	dBm/1 5 kHz	-85	-85	-85	-85	-85	-85	-85	-85	-85	-85	-85	-85	85	-85	85	-85	
SCH_RP ^{Note 4}	dBm/1 5 kHz	-85	-85	-85	-85	-85	-85	-85	-85	-85	-85	-85	-85	85	-85	85	-85	
I_o ^{Note 4}	dBm/C h BW	-	-	-	-	-57.11 +10log ($N_{RB,c}$ /50)	-57.11 +10log ($N_{RB,c}$ /50)	-57.11 +10log ($N_{RB,c}$ /50)	-57.11 +10log ($N_{RB,c}$ /50)	-	57.11 +10log g ($N_{RB,c}$ /50)	54.15 +10log g ($N_{RB,c}$ /50)	57.11 +10log g ($N_{RB,c}$ /50)	54.15 +10log g ($N_{RB,c}$ /50)	57.11 +10log g ($N_{RB,c}$ /50)	54.15 +10log g ($N_{RB,c}$ /50)	57.11 +10log g ($N_{RB,c}$ /50)	54.15 +10log g ($N_{RB,c}$ /50)
Propagation Condition		AWGN				AWGN				AWGN				AWGN				
Antenna Configuration		1x2				1x2				1x2				1x2				
Timing offset to Cell 1	μ s	-				0				0				0				
Time alignment error relative to cell 1 ^{Note 5}	μ s	-				\leq TAE				\leq TAE				\leq TAE				
Time alignment error relative to cell 2 ^{Note 5}	μ s	-				-				\leq TAE				\leq TAE				
Time alignment error relative to cell 3 ^{Note 5}	μ s	-				-				-				\leq TAE				
Time alignment error relative to cell 4 ^{Note 5}	μ s	-				-				-				-				
<p>Note 1: OCNG shall be used such that all cells are fully allocated and a constant total transmitted power spectral density is achieved for all OFDM symbols.</p> <p>Note 2: The resources for uplink transmission are assigned to the UE on cell1 from the start of time period T2 and on cell2 from the start of time period T4.</p> <p>Note 3: Interference from other cells and noise sources not specified in the test is assumed to be constant over subcarriers and time and shall be modelled as AWGN of appropriate power for N_{oc} to be fulfilled.</p> <p>Note 4: E_s/I_{ot}, RSRP, SCH_RP and I_o levels have been derived from other parameters for information purposes. They are not settable parameters themselves.</p> <p>Note 5: Time alignment error (TAE) as specified in TS 36.104 [30] clause 6.5.3.1. The TAE value depends upon the type of carrier aggregation.</p>																		

Table A.8.16.73.1-3: Cell specific test parameters for E-UTRAN FDD 5 DL CA Event Triggered Reporting on Deactivated SCell with PCell and SCell interruptions in Non-DRX (Cell #5 and Cell #6)

Parameter	Unit	Cell 5				Cell 6			
		T1	T2	T3	T4	T1	T2	T3	T4
E-UTRA RF Channel Number		5				5			
BW _{channel}		5MHz: N _{RB,c} = 25 10MHz: N _{RB,c} = 50 20MHz: N _{RB,c} = 100				5MHz: N _{RB,c} = 25 10MHz: N _{RB,c} = 50 20MHz: N _{RB,c} = 100			
PDSCH parameters: DL Reference Measurement Channel		N/A				N/A			
PCFICH/PDCCH/PHICH parameters		5MHz: R.11 FDD 10MHz: R.6 FDD 20MHz: R.10 FDD				5MHz: R.11 FDD 10MHz: R.6 FDD 20MHz: R.10 FDD			
OCNG Pattern defined in A.3.2.1		5MHz: OP.16 FDD 10MHz: OP.6 FDD 20MHz: OP.14 FDD				5MHz: OP.16 FDD 10MHz: OP.6 FDD 20MHz: OP.14 FDD			
PBCH_RA	dB	0				0			
PBCH_RB	dB								
PSS_RA	dB								
SSS_RA	dB								
PCFICH_RB	dB								
PHICH_RA	dB								
PHICH_RB	dB								
PDCCH_RA	dB								
PDCCH_RB	dB								
PDSCH_RA	dB								
PDSCH_RB	dB								
OCNG_RA ^{Note 1}	dB								
OCNG_RB ^{Note 1}	dB								
N _{oc} ^{Note 3}	dBm/15 kHz								
\hat{E}_s/N_{oc}	dB	16	16	16	16	- infinity	16	- infinity	16
\hat{E}_s/I_{ot} ^{Note 4}	dB	16	-0.11	16	-0.11	- infinity	-0.11	- infinity	-0.11
RSRP ^{Note 4}	dBm/15 kHz	-85	-85	-85	-85	- infinity	-85	- infinity	-85
SCH_RP ^{Note 4}	dBm/15 kHz	-85	-85	-85	-85	- infinity	-85	- infinity	-85
I _o ^{Note 4}	dBm/Ch BW	-57.11 +10log(N _{RB,c} /50)	-54.15 +10log(N _{RB,c} /50)	-57.11 +10log(N _{RB,c} /50)	-54.15 +10log(N _{RB,c} /50)	-57.11 +10log(N _{RB,c} /50)	-54.15 +10log(N _{RB,c} /50)	-57.11 +10log(N _{RB,c} /50)	-54.15 +10log(N _{RB,c} /50)
Propagation Condition		AWGN				AWGN			
Antenna Configuration		1x2				1x2			
Timing offset to Cell 1	µs	0				3			
Time alignment error relative to cell 1 ^{Note 5}	µs	≤ TAE				N/A			
Time alignment error relative to cell 2 ^{Note 5}	µs	≤ TAE				N/A			
Time alignment error relative to cell 3 ^{Note 5}	µs	≤ TAE				N/A			
Time alignment error relative to cell 4 ^{Note 5}	µs	≤ TAE				N/A			
<p>Note 1: OCNG shall be used such that all cells are fully allocated and a constant total transmitted power spectral density is achieved for all OFDM symbols.</p> <p>Note 2: Void</p> <p>Note 3: Interference from other cells and noise sources not specified in the test is assumed to be constant over subcarriers and time and shall be modelled as AWGN of appropriate power for N_{oc} to be fulfilled.</p> <p>Note 4: Es/Iot, RSRP, SCH_RP and Io levels have been derived from other parameters for information purposes. They are not settable parameters themselves.</p>									

Note 5: Time alignment error (TAE) as specified in TS 36.104 [30] clause 6.5.3.1. The TAE value depends upon the type of carrier aggregation.

A.8.16.73.2 Test Requirements

The UE shall send one Event A6 triggered measurement report, with a measurement reporting delay less than 12.8s ($20 \times \text{scellMeasCycle}$) from the beginning of time period T2.

The UE shall send one Event A6 triggered measurement report, with a measurement reporting delay less than 3.2s ($5 \times \text{scellMeasCycle}$) from the beginning of time period T4.

The UE shall not send event triggered measurement reports, as long as the reporting criteria are not fulfilled.

The UE shall be scheduled on PCell continuously throughout the test. From the start of T1 until the measurement report is received during T2, at least 99.5% of all expected ACK/NACKs shall be transmitted by the UE.

The UE shall be scheduled on Cell2 continuously from the beginning of T4 to the end. From the start of T4 until the measurement report is received during T4, at least 99.5% of all expected ACK/NACKs shall be transmitted by the UE.

For a test to be considered successful requirements on both event detection and percentage of transmitted ACK/NACKs have to be fulfilled simultaneously.

The rate of correct events observed during repeated tests shall be at least 90%.

NOTE: The actual overall delays measured in the test may be up to $2 \times \text{TTI}_{\text{DCCH}}$ higher than the measurement reporting delays above because of TTI insertion uncertainty of the measurement report in DCCH.

A.8.16.74 5 DL TDD CA Event Triggered Reporting on Deactivated SCell with PCell and SCell Interruptions in Non-DRX

A.8.16.74.1 Test Purpose and Environment

The purpose of this test is to verify that the UE correctly detects event A6 (Neighbour becomes better than SCell) defined in TS 36.331 [2] within the requirements stated in clause 8.3.3.2.1 while at the same time fulfilling the requirement on interruption rate.

The test parameters are given in Table A.8.16.74.1-1, A.8.16.74.1-2 and A.8.16.74.1-3 below. In the test there are six cells: Cell 1, Cell 2, Cell 3, Cell 4, Cell 5 and Cell 6. Cell 1 is PCell on the TDD primary component (RF Channel 1), Cell 2 is SCell on the TDD secondary component (RF Channel 2), Cell 3 is SCell on the TDD secondary component (RF Channel 3), Cell 4 is SCell on the TDD secondary component (RF Channel 4) and Cell 5 is SCell on the TDD secondary component (RF Channel 5) and Cell 6 is the neighbour cell on the TDD secondary component (RF Channel 5). It is indicated to the UE in the measurement control information that event-triggered reporting with Event A6 is used. The test consists of four successive time periods, with duration of T1, T2, T3 and T4, respectively. During T1 and T2, Cell2, Cell3, Cell4 and Cell5 are deactivated. During T1 the UE shall not have any information of Cell 6. Immediately at beginning of T2 the transmission power of Cell 6 is increased to same level as for Cell 3, and due to usage of an offset this shall result in reporting of Event A6.

At the beginning of T3, the transmission power of Cell 6 is turned off, and the test equipment sends a MAC message for activation of Cell 2 to UE but Cell3, Cell4 and Cell5 remains deactivated. Immediately at beginning of T4 the transmission power of Cell 6 is increased to same level as for Cell 3, and due to usage of an offset this shall result in reporting of Event A6. The UE shall be continuously scheduled in the PCell throughout the whole test and continuously scheduled in Cell2 during T4.

Table A.8.16.74.1-1: General test parameters for E-UTRAN TDD 5 DL CA Event Triggered Reporting on Deactivated SCell with PCell and SCell interruptions in Non-DRX

Parameter	Unit	Value	Comment
E-UTRA RF Channel Number		1, 2, 3, 4, 5	Five radio channels are used for this test
Active PCell		Cell 1	Primary cell on RF channel number 1.
Configured deactivated SCell		Cell 2	Configured deactivated secondary cell on RF channel number 2.
Configured deactivated SCell		Cell 3	Configured deactivated secondary cell on RF channel number 3.

Configured deactivated SCell		Cell 4	Configured deactivated secondary cell on RF channel number 4.	
Configured deactivated SCell		Cell 5	Configured deactivated secondary cell on RF channel number 5.	
Neighbour cell		Cell 6	Neighbor cell to be identified on RF channel number 5.	
CP length		Normal		
Special subframe configuration		6	As specified in table 4.2-1 in TS 36.211. The same configuration in all cells	
Uplink-downlink configuration		1	As specified in table 4.2-2 in TS 36.211. The same configuration in all cells	
DRX		OFF	Continuous monitoring of primary cell	
A6	Hysteresis	dB	0	Hysteresis for evaluation of event A6.
	Offset	dB	-3	Offset parameter for evaluation of event A6. Needs to take relative accuracy tolerance in clause 9.1.11.2 into account plus margin.
	Report on leave		False	
	Time To Trigger	s	0	
Cell-individual offset for cells on RF channel number 1	dB	0	Individual offset for cells on primary component carrier.	
Cell-individual offset for cells on RF channel number 2	dB	0	Individual offset for cells on secondary component carrier.	
Cell-individual offset for cells on RF channel number 3	dB	0	Individual offset for cells on secondary component carrier.	
Cell-individual offset for cells on RF channel number 4	dB	0	Individual offset for cells on secondary component carrier.	
Cell-individual offset for cells on RF channel number 5	dB	0	Individual offset for cells on secondary component carrier.	
Filter coefficient		0	L3 filtering is not used	
SCell measurement cycle	ms	640		
T1	s	4	During this time the UE shall be aware of cells 1, 2, 3, 4 and 5 but not cell 6.	
T2	s	≤15	UE should report Event A6 within 12.8s (20×scellMeasCycle)	
T3	s	4	During this time the UE shall activate cell 2	
T4	s	≤4	UE should report Event A6 within 3.2s (5×scellMeasCycle)	

Table A.8.16.74.1-2: Cell specific test parameters for E-UTRAN TDD 5 DL CA Event Triggered Reporting on Deactivated SCell with PCell and SCell interruptions in Non-DRX (Cell #1, Cell #2, Cell #3 and Cell #4)

Parameter	Unit	Cell 1				Cell 2				Cell 3				Cell 4			
		T1	T2	T3	T4	T1	T2	T3	T4	T1	T2	T3	T4	T1	T2	T3	T4
E-UTRA RF Channel Number		1				2				3				4			
BW _{channel}		5MHz: N _{RB,c} = 25 10MHz: N _{RB,c} = 50 20MHz: N _{RB,c} = 100				5MHz: N _{RB,c} = 25 10MHz: N _{RB,c} = 50 20MHz: N _{RB,c} = 100				5MHz: N _{RB,c} = 25 10MHz: N _{RB,c} = 50 20MHz: N _{RB,c} = 100				5MHz: N _{RB,c} = 25 10MHz: N _{RB,c} = 50 20MHz: N _{RB,c} = 100			
PDSCH parameters: DL Reference Measurement Channel		5MHz: R.4 TDD 10MHz: R.0 TDD 20MHz: R.3 TDD				N/A	N/A	N/A	5MHz: R.4 TDD 10MHz: R.0 TDD 20MHz: R.3 TDD	N/A				N/A			
PCFICH/PDCCH/PHICH parameters		5MHz: R.11 TDD 10MHz: R.6 TDD 20MHz: R.10 TDD				5MHz: R.11 TDD 10MHz: R.6 TDD 20MHz: R.10 TDD				5MHz: R.11 TDD 10MHz: R.6 TDD 20MHz: R.10 TDD				5MHz: R.11 TDD 10MHz: R.6 TDD 20MHz: R.10 TDD			
OCNG Pattern defined in A.3.2.1		5MHz: OP.9 TDD 10MHz: OP.1 TDD 20MHz: OP.7 TDD				5MHz: OP.10 TDD 10MHz: OP.10 TDD 20MHz: OP.8 TDD	5MHz: OP.10 TDD 10MHz: OP.10 TDD 20MHz: OP.8 TDD	5MHz: OP.10 TDD 10MHz: OP.10 TDD 20MHz: OP.8 TDD	5MHz: OP.9 TDD 10MHz: OP.1 TDD 20MHz: OP.7 TDD	5MHz: OP.10 TDD 10MHz: OP.2 TDD 20MHz: OP.8 TDD				5MHz: OP.10 TDD 10MHz: OP.2 TDD 20MHz: OP.8 TDD			
PBCH_RA	dB	0				0				0				0			
PBCH_RB	dB																
PSS_RA	dB																
SSS_RA	dB																
PCFICH_RB	dB																
PHICH_RA	dB																
PHICH_RB	dB																
PDCCH_RA	dB																
PDCCH_RB	dB																
PDSCH_RA	dB																
PDSCH_RB	dB																
OCNG_RA ^{Note 1}	dB																

OCNG_RB ^{Note 1}	dB																	
N_{oc} ^{Note 3}	dBm/1 5 kHz	-101				-101				-101				-101				
\hat{E}_s/N_{oc}	dB	16	16	16	16	16	16	16	16	16	16	16	16	16	16	16	16	
\hat{E}_s/I_{ot} ^{Note 4}	dB	16	16	16	16	16	16	16	16	16	-0.11	16	-0.11	16	-0.11	16	-0.11	
RSRP ^{Note 4}	dBm/1 5 kHz	-85	-85	-85	-85	-85	-85	-85	-85	-85	-85	-85	-85	85	-85	85	-85	
SCH_RP ^{Note 4}	dBm/1 5 kHz	-85	-85	-85	-85	-85	-85	-85	-85	-85	-85	-85	-85	85	-85	85	-85	
I_o ^{Note 4}	dBm/C h BW	-	-	-	-	-57.11 +10log ($N_{RB,c}$ /50)	-57.11 +10log ($N_{RB,c}$ /50)	-57.11 +10log ($N_{RB,c}$ /50)	-57.11 +10log ($N_{RB,c}$ /50)	-	57.11 +10log g ($N_{RB,c}$ /50)	54.15 +10log g ($N_{RB,c}$ /50)	57.11 +10log g ($N_{RB,c}$ /50)	54.15 +10log g ($N_{RB,c}$ /50)	57.11 +10log g ($N_{RB,c}$ /50)	54.15 +10log g ($N_{RB,c}$ /50)	57.11 +10log g ($N_{RB,c}$ /50)	54.15 +10log g ($N_{RB,c}$ /50)
Propagation Condition		AWGN				AWGN				AWGN				AWGN				
Antenna Configuration		1x2				1x2				1x2				1x2				
Timing offset to Cell 1	μ s	-				0				0				0				
Time alignment error relative to cell 1 ^{Note 5}	μ s	-				\leq TAE				\leq TAE				\leq TAE				
Time alignment error relative to cell 2 ^{Note 5}	μ s	-				-				\leq TAE				\leq TAE				
Time alignment error relative to cell 3 ^{Note 5}	μ s	-				-				-				\leq TAE				
Time alignment error relative to cell 4 ^{Note 5}	μ s	-				-				-				-				

Note 1: OCNG shall be used such that all cells are fully allocated and a constant total transmitted power spectral density is achieved for all OFDM symbols.
 Note 2: The resources for uplink transmission are assigned to the UE on cell1 from the start of time period T2 and on cell2 from the start of time period T4.
 Note 3: Interference from other cells and noise sources not specified in the test is assumed to be constant over subcarriers and time and shall be modelled as AWGN of appropriate power for N_{oc} to be fulfilled.
 Note 4: E_s/I_{ot} , RSRP, SCH_RP and I_o levels have been derived from other parameters for information purposes. They are not settable parameters themselves.
 Note 5: Time alignment error (TAE) as specified in TS 36.104 [30] clause 6.5.3.1. The TAE value depends upon the type of carrier aggregation.

Table A.8.16.74.1-3: Cell specific test parameters for E-UTRAN TDD 5 DL CA Event Triggered Reporting on Deactivated SCell with PCell and SCell interruptions in Non-DRX (Cell #5 and Cell #6)

Parameter	Unit	Cell 5				Cell 6			
		T1	T2	T3	T4	T1	T2	T3	T4
E-UTRA RF Channel Number		5				5			
BW _{channel}		5MHz: N _{RB,c} = 25 10MHz: N _{RB,c} = 50 20MHz: N _{RB,c} = 100				5MHz: N _{RB,c} = 25 10MHz: N _{RB,c} = 50 20MHz: N _{RB,c} = 100			
PDSCH parameters: DL Reference Measurement Channel		N/A				N/A			
PCFICH/PDCCH/PHICH parameters		5MHz: R.11 TDD 10MHz: R.6 TDD 20MHz: R.10 TDD				5MHz: R.11 TDD 10MHz: R.6 TDD 20MHz: R.10 TDD			
OCNG Pattern defined in A.3.2.1		5MHz: OP.10 TDD 10MHz: OP.2 TDD 20MHz: OP.8 TDD				5MHz: OP.10 TDD 10MHz: OP.2 TDD 20MHz: OP.8 TDD			
PBCH_RA	dB	0				0			
PBCH_RB	dB								
PSS_RA	dB								
SSS_RA	dB								
PCFICH_RB	dB								
PHICH_RA	dB								
PHICH_RB	dB								
PDCCH_RA	dB								
PDCCH_RB	dB								
PDSCH_RA	dB								
PDSCH_RB	dB								
OCNG_RA ^{Note 1}	dB								
OCNG_RB ^{Note 1}	dB								
N _{oc} ^{Note 3}	dBm/15 kHz								
\hat{E}_s/N_{oc}	dB	16	16	16	16	-infinity	16	-infinity	16
\hat{E}_s/I_{ot} ^{Note 4}	dB	16	-0.11	16	-0.11	-infinity	-0.11	-infinity	-0.11
RSRP ^{Note 4}	dBm/15 kHz	-85	-85	-85	-85	-infinity	-85	-infinity	-85
SCH_RP ^{Note 4}	dBm/15 kHz	-85	-85	-85	-85	-infinity	-85	-infinity	-85
I _o ^{Note 4}	dBm/Ch BW	-57.11 +10log(N _{RB,c} /50)	-54.15 +10log(N _{RB,c} /50)	-57.11 +10log(N _{RB,c} /50)	-54.15 +10log(N _{RB,c} /50)	-57.11 +10log(N _{RB,c} /50)	-54.15 +10log(N _{RB,c} /50)	-57.11 +10log(N _{RB,c} /50)	-54.15 +10log(N _{RB,c} /50)
Propagation Condition		AWGN				AWGN			
Antenna Configuration		1x2				1x2			
Timing offset to Cell 1	μs	0				3			
Time alignment error relative to cell 1 ^{Note 5}	μs	≤ TAE				N/A			
Time alignment error relative to cell 2 ^{Note 5}	μs	≤ TAE				N/A			
Time alignment error relative to cell 3 ^{Note 5}	μs	≤ TAE				N/A			
Time alignment error relative to cell 4 ^{Note 5}	μs	≤ TAE				N/A			
<p>Note 1: OCNG shall be used such that all cells are fully allocated and a constant total transmitted power spectral density is achieved for all OFDM symbols.</p> <p>Note 2: Void</p> <p>Note 3: Interference from other cells and noise sources not specified in the test is assumed to be constant over subcarriers and time and shall be modelled as AWGN of appropriate power for N_{oc} to be fulfilled.</p> <p>Note 4: Es/Iot, RSRP, SCH_RP and Io levels have been derived from other parameters for information purposes. They are not settable parameters themselves.</p>									

Note 5: Time alignment error (TAE) as specified in TS 36.104 [30] clause 6.5.3.1. The TAE value depends upon the type of carrier aggregation.

A.8.16.74.2 Test Requirements

The UE shall send one Event A6 triggered measurement report, with a measurement reporting delay less than 12.8s ($20 \times \text{scellMeasCycle}$) from the beginning of time period T2.

The UE shall send one Event A6 triggered measurement report, with a measurement reporting delay less than 3.2s ($5 \times \text{scellMeasCycle}$) from the beginning of time period T4.

The UE shall not send event triggered measurement reports, as long as the reporting criteria are not fulfilled.

The UE shall be scheduled on PCell continuously throughout the test. From the start of T1 until the measurement report is received during T2, at least 99.5% of all expected ACK/NACKs shall be transmitted by the UE.

The UE shall be scheduled on Cell2 continuously from the beginning of T4 to the end. From the start of T4 until the measurement report is received during T4, at least 99.5% of all expected ACK/NACKs shall be transmitted by the UE.

For a test to be considered successful requirements on both event detection and percentage of transmitted ACK/NACKs have to be fulfilled simultaneously.

The rate of correct events observed during repeated tests shall be at least 90%.

NOTE: The actual overall delays measured in the test may be up to $2 \times \text{TTI}_{\text{DCCH}}$ higher than the measurement reporting delays above because of TTI insertion uncertainty of the measurement report in DCCH.

A.8.16.75 5 DL FDD-TDD with PCell in FDD CA activation and deactivation of known SCell in non-DRX

A.8.16.75.1 Test Purpose and Environment

The purpose of this test is to verify that the SCell activation and deactivation times are within the requirements stated in section 7.7 for UE configured with four downlink SCells, when the SCell is known by the UE at the time of activation and PCell is in FDD.

The test parameters are given in Tables A.8.16.75.1-1 and cell-specific parameters in A.8.16.75.1-2 and A.8.16.75.1-3 below. The test consists of three successive time periods, with duration of T1, T2 and T3, respectively. There are five carriers, each with one cell. All cells have constant signal levels throughout the test. Before the test starts the UE is connected to Cell 1 (PCell) on radio channel 1 (PCC), deactivated Cell 3 (SCell2) on radio channel 3 (SCC2), deactivated Cell 4 (SCell3) on radio channel 4 (SCC3) and deactivated Cell 5 (SCell4) on radio channel 5 (SCC4) but is not aware of Cell 2 (SCell1) on radio channel 2 (SCC1). The UE is only monitoring PCC, SCC2, SCC3 and SCC4. The UE shall be continuously scheduled in PCell throughout the whole test.

At the beginning of T1 the UE receives an RRC message by which the SCell1 becomes configured on SCC1. The UE now starts monitoring also SCC1. The test equipment sends a MAC message for activation of SCell1.

The point in time at which the MAC message is received at the UE antenna connector, in a subframe # denoted m which is an even number, defines the start of time period T2. The UE receives a MAC message for activation of SCell2 in a subframe ($m+10$), a MAC message for activation of SCell3 in subframe ($m+20$), and a MAC message for activation of SCell4 in a subframe ($m+30$) during activation of SCell1. The UE shall be able to report valid CSI for the activated SCell1 at latest in subframe ($m+39$). The UE shall start reporting CSI for SCell1 in subframe ($m+8$) and shall report CQI index 0 (out-of-range) until the SCell activation has been completed. Any PCell interruption due to activation of SCells shall not occur outside subframes ($m+5$) to ($m+9$), ($m+15$) to ($m+19$), ($m+25$) to ($m+29$), and ($m+35$) to ($m+39$).

Time period T3 starts when a MAC message for deactivation of SCell1, sent from the test equipment to the UE in a subframe # denoted n , is received at the UE antenna connector. The test equipment sends a MAC message for deactivation of the SCell2 in subframe ($n+10$), a MAC message for deactivation of the SCell3 in subframe ($n+20$), and a MAC message for deactivation of the SCell4 in subframe ($n+30$). The UE shall carry out deactivation of the SCell1 at latest in subframe ($n+8$), and any PCell interruption due to the deactivation of SCells shall not occur outside subframes ($n+5$) to ($n+9$), ($n+15$) to ($n+19$), ($n+25$) to ($n+29$), and ($n+35$) to ($n+39$).

The test equipment verifies that potential interruption is carried out in the correct time span by monitoring ACK/NACK sent in PCell during activation and deactivation of SCell1, respectively.

The test equipment verifies the activation time by counting the subframes from the time when SCell1 activation command is sent until a CSI report with other than CQI index 0 is received.

The test equipment verifies the deactivation time by counting the subframes from the time when SCell1 deactivation command is sent until CQI reporting for SCell1 is discontinued.

Table A.8.16.75.1-1: General test parameters for known SCell1 activation case

Parameter	Unit	Value	Comment
E-UTRA RF Channel Number		1, 2, 3, 4, 5	Five radio channels are used for this test
Active PCell		Cell 1	Primary cell on RF channel number 1.
Deconfigured deactivated SCell1		Cell 2	Deconfigured deactivated secondary cell on RF channel number 2.
Configured deactivated SCell2		Cell 3	Configured deactivated secondary cell on RF channel number 3.
Configured deactivated SCell3		Cell 4	Configured deactivated secondary cell on RF channel number 4.
Configured deactivated SCell4		Cell 5	Configured deactivated secondary cell on RF channel number 5.
CP length		Normal	
DRX		OFF	Continuous monitoring of primary cell
CQI/PMI periodicity and offset configuration index		0	CQI reporting for SCell every second subframe
Cell-individual offset for cells on RF channel number 1	dB	0	Individual offset for cells on PCC.
Cell-individual offset for cells on RF channel number 2	dB	0	Individual offset for cells on SCC1.
Cell-individual offset for cells on RF channel number 3	dB	0	Individual offset for cells on SCC2.
Cell-individual offset for cells on RF channel number 4	dB	0	Individual offset for cells on SCC3.
Cell-individual offset for cells on RF channel number 5	dB	0	Individual offset for cells on SCC4.
SCell measurement cycle (measCycleSCell)	ms	320	
T1	s	7	During this time the PCell, SCell2, SCell3 and SCell4 shall be known and the SCell1 configured and detected.
T2	s	1	During this time the UE shall activate the SCell1, SCell2, SCell3 and SCell4.
T3	s	1	During this time the UE shall deactivate the SCell1, SCell2, SCell3 and SCell4.

Table A.8.16.75.1-2: Cell specific test parameters for E-UTRAN TDD known SCell1 activation with PCell in FDD

Parameter	Unit	Cell 1			Cell 2			Cell 3		
		T1	T2	T3	T1	T2	T3	T1	T2	T3
E-UTRA RF Channel Number		1			2			3		
BW _{channel}	MHz	5MHz: N _{RB,c} = 25 10MHz: N _{RB,c} = 50 20MHz: N _{RB,c} = 100			5MHz: N _{RB,c} = 25 10MHz: N _{RB,c} = 50 20MHz: N _{RB,c} = 100			5MHz: N _{RB,c} = 25 10MHz: N _{RB,c} = 50 20MHz: N _{RB,c} = 100		
Special subframe configuration		-			6			6		
Uplink-downlink configuration		-			1			1		
PDSCH parameters: DL Reference Measurement Channel		5MHz: R.7 FDD 10MHz: R.3 FDD 20MHz: R.6 FDD			-			-		

PCFICH/PDCCH/PHICH parameters: DL Reference Measurement Channel		5MHz: R.11 FDD 10MHz: R.6 FDD 20MHz: R.10 FDD	5MHz: R.11 TDD 10MHz: R.6 TDD 20MHz: R.10 TDD	5MHz: R.11 TDD 10MHz: R.6 TDD 20MHz: R.10 TDD
OCNG Patterns		5MHz: OP.20 FDD 10MHz: OP.10 FDD 20MHz: OP.17 FDD	5MHz: OP.10 TDD 10MHz: OP.2 TDD 20MHz: OP.8 TDD	5MHz: OP.10 TDD 10MHz: OP.2 TDD 20MHz: OP.8 TDD
PBCH_RA	dB	0	0	0
PBCH_RB	dB			
PSS_RA	dB			
SSS_RA	dB			
PCFICH_RB	dB			
PHICH_RA	dB			
PHICH_RB	dB			
PDCCH_RA	dB			
PDCCH_RB	dB			
PDSCH_RA	dB			
PDSCH_RB	dB			
OCNG_RA ^{Note 1}	dB			
OCNG_RB ^{Note 1}	dB			
N _{oc} ^{Note 2}	dBm/15 kHz	-104	-104	-104
\bar{E}_s/N_{oc}	dB	17	17	17
\bar{E}_s/I_{ot}	dB	17	17	17
RSRP ^{Note 3}	dBm/15 kHz	-87	-87	-87
SCH_RP ^{Note 3}	dBm/15 kHz	-87	-87	-87
I _o ^{Note 3}	dBm/Ch BW	-59.13 +10log (N _{RB,c} /50)	-59.13 +10log (N _{RB,c} /50)	-59.13 +10log (N _{RB,c} /50)
Propagation Condition		AWGN	AWGN	AWGN
Antenna Configuration		1x2	1x2	1x2
Timing offset to Cell 1	μs	-	0	0
Time alignment error relative to cell 1 ^{Note 5}	μs	-	≤ TAE	≤ TAE
Time alignment error relative to cell 2 ^{Note 5}	μs	-	-	≤ TAE
Time alignment error relative to cell 3 ^{Note 5}	μs	-	-	-
Time alignment error relative to cell 4 ^{Note 5}	μs	-	-	-
<p>Note 1: OCNG shall be used such that all cells are fully allocated and a constant total transmitted power spectral density is achieved for all OFDM symbols.</p> <p>Note 2: Interference from other cells and noise sources not specified in the test is assumed to be constant over subcarriers and time and shall be modelled as AWGN of appropriate power for N_{oc} to be fulfilled.</p> <p>Note 3: Es/I_{ot}, RSRP, SCH_RP and I_o levels have been derived from other parameters for information purposes. They are not settable parameters themselves.</p> <p>Note 4: The uplink resources for CSI reporting are assigned to the UE prior to the start of time period T2.</p> <p>Note 5: Time alignment error (TAE) as specified in TS 36.104 [30] clause 6.5.3.1. The TAE value depends upon the type of carrier aggregation.</p>				

Table A.8.16.75.1-3: Cell specific test parameters for E-UTRAN TDD known SCell1 activation with PCell in FDD

Parameter	Unit	Cell 4			Cell 5					
		T1	T2	T3	T1	T2	T3			
E-UTRA RF Channel Number		4			5					
BW _{channel}	MHz	5MHz: N _{RB,c} = 25 10MHz: N _{RB,c} = 50 20MHz: N _{RB,c} = 100			5MHz: N _{RB,c} = 25 10MHz: N _{RB,c} = 50 20MHz: N _{RB,c} = 100					
Special subframe configuration		6			6					

Uplink-downlink configuration		1	1	
PDSCH parameters: DL Reference Measurement Channel		-	-	
PCFICH/PDCCH/PHICH H parameters: DL Reference Measurement Channel		5MHz: R.11 TDD 10MHz: R.6 TDD 20MHz: R.10 TDD	5MHz: R.11 TDD 10MHz: R.6 TDD 20MHz: R.10 TDD	
OCNG Patterns		5MHz: OP.10 TDD 10MHz: OP.2 TDD 20MHz: OP.8 TDD	5MHz: OP.10 TDD 10MHz: OP.2 TDD 20MHz: OP.8 TDD	
PBCH_RA	dB	0	0	
PBCH_RB	dB			
PSS_RA	dB			
SSS_RA	dB			
PCFICH_RB	dB			
PHICH_RA	dB			
PHICH_RB	dB			
PDCCH_RA	dB			
PDCCH_RB	dB			
PDSCH_RA	dB			
PDSCH_RB	dB			
OCNG_RA ^{Note 1}	dB			
OCNG_RB ^{Note 1}	dB			
N_{oc} ^{Note 2}	dBm/15 kHz			
\bar{E}_s/N_{oc}	dB	17	17	
\bar{E}_s/I_{ot}	dB	17	17	
RSRP ^{Note 3}	dBm/15 kHz	-87	-87	
SCH_RP ^{Note 3}	dBm/15 kHz	-87	-87	
I_o ^{Note 3}	dBm/Ch BW	-59.13 +10log ($N_{RB,c}/50$)	-59.13 +10log ($N_{RB,c}/50$)	
Propagation Condition		AWGN	AWGN	
Antenna Configuration		1x2	1x2	
Timing offset to Cell 1	μ s	0	0	
Time alignment error relative to cell 1 ^{Note 5}	μ s	\leq TAE	\leq TAE	
Time alignment error relative to cell 2 ^{Note 5}	μ s	\leq TAE	\leq TAE	
Time alignment error relative to cell 3 ^{Note 5}	μ s	\leq TAE	\leq TAE	
Time alignment error relative to cell 4 ^{Note 5}	μ s	-	\leq TAE	
<p>Note 1: OCNG shall be used such that all cells are fully allocated and a constant total transmitted power spectral density is achieved for all OFDM symbols.</p> <p>Note 2: Interference from other cells and noise sources not specified in the test is assumed to be constant over subcarriers and time and shall be modelled as AWGN of appropriate power for N_{oc} to be fulfilled.</p> <p>Note 3: E_s/I_{ot}, RSRP, SCH_RP and I_o levels have been derived from other parameters for information purposes. They are not settable parameters themselves.</p> <p>Note 4: The uplink resources for CSI reporting are assigned to the UE prior to the start of time period T2.</p> <p>Note 5: Time alignment error (TAE) as specified in TS 36.104 [30] clause 6.5.3.1. The TAE value depends upon the type of carrier aggregation.</p>				

A.8.16.75.2 Test Requirements

During T2 the UE shall send the first CSI report for SCell1 in a subframe (m+8), or in a subframe (m+10) if the subframe (m+8) was subject to interruption. Whether CSI report in subframe (m+8) was interrupted or not is checked by monitoring ACK/NACK sent in PCell in subframe (m+8).

During T2 the UE shall start sending CSI reports for SCell1 with non-zero CQI index at latest in a subframe (m+39).

During T3 the UE shall stop sending CSI reports for SCell1 at latest in a subframe (n+8).

During T2 interruption of PCell during SCells activation shall not happen outside the subframes (m+5) to (m+9), outside the subframes (m+15) to (m+19), outside the subframes (m+25) to (m+29), and outside the subframes (m+35) to (m+39).

During T3 interruption of PCell during SCells deactivation shall not happen outside the subframes (n+5) to (n+9), outside the subframes (n+15) to (n+19), outside the subframes (n+25) to (n+29), and outside the subframes (n+25) to (n+29).

The interruption of PCell shall not be more than the values specified for intra-band CA and inter-band CA in Section 7.8.2.

All of the above test requirements shall be fulfilled in order for the observed SCell1 activation delay and SCell1 deactivation delay to be counted as correct. The rate of correct observed SCell1 activation delay and SCell1 deactivation delay during repeated tests shall be at least 90%.

NOTE: During T2 if there are no uplink resources for reporting the valid CSI in a subframe (m+39) then the UE shall use the next available uplink resource for reporting the corresponding valid CSI.

A.8.16.76 5 DL FDD-TDD with PCell in TDD CA activation and deactivation of known SCell in non-DRX

A.8.16.76.1 Test Purpose and Environment

The purpose of this test is to verify that the SCell activation and deactivation times are within the requirements stated in section 7.7 for UE configured with four downlink SCells, when the SCell is known by the UE at the time of activation and PCell is in TDD.

The test parameters are given in Tables A.8.16.76.1-1 and cell-specific parameters in A.8.16.76.1-2 and A.8.16.76.1-3 below. The test consists of three successive time periods, with duration of T1, T2 and T3, respectively. There are five carriers, each with one cell. All cells have constant signal levels throughout the test. Before the test starts the UE is connected to Cell 1 (PCell) on radio channel 1 (PCC), deactivated Cell 3 (SCell2) on radio channel 3 (SCC2), deactivated Cell 4 (SCell3) on radio channel 4 (SCC3) and deactivated Cell 5 (SCell4) on radio channel 5 (SCC4) but is not aware of Cell 2 (SCell1) on radio channel 2 (SCC1). The UE is only monitoring PCC, SCC2, SCC3 and SCC4. The UE shall be continuously scheduled in the PCell throughout the whole test.

At the beginning of T1 the UE receives an RRC message by which SCell1 becomes configured on SCC1. The UE now starts monitoring also the SCC1. The test equipment sends a MAC message for activation of SCell1.

The point in time at which the MAC message is received at the UE antenna connector, in a subframe # denoted m, where m is 4 or 9, defines the start of time period T2. The UE receives a MAC message for activation of the SCell 2, SCell3 and SCell4 in a subframe (m+15) during activation of SCell1. The UE shall be able to report valid CSI for the activated SCell1 at latest in a subframe (m+39). The UE shall start reporting CSI for SCell1 in subframe (m+8) and shall report CQI index 0 (out-of-range) until the SCell activation has been completed. Any PCell interruption due to activation of SCells shall not occur outside subframes (m+5) to (m+11) and (m+20) to (m+26).

Time period T3 starts when a MAC message for deactivation of SCell1, sent from the test equipment to the UE in a subframe # denoted n, where n is 4 or 9, is received at the UE antenna connector. The test equipment sends a MAC message for deactivation of the SCell2 in subframe (n+15), a MAC message for deactivation of the SCell3 in subframe (n+30), and a MAC message for deactivation of the SCell4 in subframe (n+45). The UE shall carry out deactivation of SCell1 at latest in subframe (n+8), and any PCell interruption due to the deactivation of SCells shall not occur outside subframes (n+5) to (n+11), (n+20) to (n+26), (n+35) to (n+41) and (n+50) to (n+56).

The test equipment verifies that potential interruption is carried out in the correct time span by monitoring ACK/NACK sent in PCell during activation and deactivation of SCell1, respectively.

The test equipment verifies the activation time by counting the subframes from the time when SCell1 activation command is sent until a CSI report with other than CQI index 0 is received.

The test equipment verifies the deactivation time by counting the subframes from the time when SCell1 deactivation command is sent until CQI reporting for SCell1 is discontinued.

Table A.8.16.76.1-1: General test parameters for known SCell1 activation case

Parameter	Unit	Value	Comment
E-UTRA RF Channel Number		1, 2, 3, 4, 5	Five radio channels are used for this test
Active PCell		Cell 1	Primary cell on RF channel number 1.
Deconfigured deactivated SCell		Cell 2	Deconfigured deactivated secondary cell on RF channel number 2.
Configured deactivated SCell2		Cell 3	Configured deactivated secondary cell on RF channel number 3.
Configured deactivated SCell3		Cell 4	Configured deactivated secondary cell on RF channel number 4.
Configured deactivated SCell4		Cell 5	Configured deactivated secondary cell on RF channel number 5.
CP length		Normal	
DRX		OFF	Continuous monitoring of primary cell
CQI/PMI periodicity and offset configuration index		0	CQI reporting for SCell every UL subframe
Cell-individual offset for cells on RF channel number 1	dB	0	Individual offset for cells on PCC.
Cell-individual offset for cells on RF channel number 2	dB	0	Individual offset for cells on SCC1.
Cell-individual offset for cells on RF channel number 3	dB	0	Individual offset for cells on SCC2.
Cell-individual offset for cells on RF channel number 4	dB	0	Individual offset for cells on SCC3.
Cell-individual offset for cells on RF channel number 5	dB	0	Individual offset for cells on SCC4.
SCell measurement cycle (measCycleSCell)	ms	320	
T1	s	7	During this time the PCell, SCell2, SCell3 and SCell4 shall be known and the SCell1 configured and detected.
T2	s	1	During this time the UE shall activate the SCell1, SCell2, SCell3 and SCell4.
T3	s	1	During this time the UE shall deactivate the SCell1, SCell2, SCell3 and SCell4.

Table A.8.16.76.1-2: Cell specific test parameters for E-UTRAN FDD known SCell1 activation with PCell in TDD

Parameter	Unit	Cell 1			Cell 2			Cell 3		
		T1	T2	T3	T1	T2	T3	T1	T2	T3
E-UTRA RF Channel Number		1			2			3		
BW _{channel}	MHz	5MHz: N _{RB,c} = 25 10MHz: N _{RB,c} = 50 20MHz: N _{RB,c} = 100			5MHz: N _{RB,c} = 25 10MHz: N _{RB,c} = 50 20MHz: N _{RB,c} = 100			5MHz: N _{RB,c} = 25 10MHz: N _{RB,c} = 50 20MHz: N _{RB,c} = 100		
Special subframe configuration		6			-			-		
Uplink-downlink configuration		1			-			-		
PDSCH parameters: DL Reference Measurement Channel		5MHz: R.4 TDD 10MHz: R.0 TDD 20MHz: R.3 TDD			-			-		
PCFICH/PDCCH/PHICH parameters: DL Reference Measurement Channel		5MHz: R.11 TDD 10MHz: R.6 TDD 20MHz: R.10 TDD			5MHz: R.11 FDD 10MHz: R.6 FDD 20MHz: R.10 FDD			5MHz: R.11 FDD 10MHz: R.6 FDD 20MHz: R.10 FDD		
OCNG Patterns		5MHz: OP.9 TDD 10MHz: OP.1 TDD 20MHz: OP.7 TDD			5MHz: OP.16 FDD 10MHz: OP.2 FDD 20MHz: OP.12 FDD			5MHz: OP.16 FDD 10MHz: OP.2 FDD 20MHz: OP.12 FDD		
PBCH_RA	dB	0			0			0		
PBCH_RB	dB	0			0			0		

PSS_RA	dB			
SSS_RA	dB			
PCFICH_RB	dB			
PHICH_RA	dB			
PHICH_RB	dB			
PDCCH_RA	dB			
PDCCH_RB	dB			
PDSCH_RA	dB			
PDSCH_RB	dB			
OCNG_RA ^{Note 1}	dB			
OCNG_RB ^{Note 1}	dB			
N _{oc} ^{Note 2}	dBm/15 kHz	-104	-104	-104
E _s /N _{oc}	dB	17	17	17
E _s /I _{ot}	dB	17	17	17
RSRP ^{Note 3}	dBm/15 kHz	-87	-87	-87
SCH_RP ^{Note 3}	dBm/15 kHz	-87	-87	-87
I _o ^{Note 3}	dBm/Ch BW	-59.13 +10log (N _{RB,c} /50)	-59.13 +10log (N _{RB,c} /50)	-59.13 +10log (N _{RB,c} /50)
Propagation Condition		AWGN	AWGN	AWGN
Antenna Configuration		1x2	1x2	1x2
Timing offset to Cell 1	μs	-	0	0
Time alignment error relative to cell 1 ^{Note 5}	μs	-	≤ TAE	≤ TAE
Time alignment error relative to cell 2 ^{Note 5}	μs	-	-	≤ TAE
Time alignment error relative to cell 3 ^{Note 5}	μs	-	-	-
Time alignment error relative to cell 4 ^{Note 5}	μs	-	-	-
<p>Note 1: OCNG shall be used such that all cells are fully allocated and a constant total transmitted power spectral density is achieved for all OFDM symbols.</p> <p>Note 2: Interference from other cells and noise sources not specified in the test is assumed to be constant over subcarriers and time and shall be modelled as AWGN of appropriate power for N_{oc} to be fulfilled.</p> <p>Note 3: E_s/I_{ot}, RSRP, SCH_RP and I_o levels have been derived from other parameters for information purposes. They are not settable parameters themselves.</p> <p>Note 4: The uplink resources for CSI reporting are assigned to the UE prior to the start of time period T2.</p> <p>Note 5: Time alignment error (TAE) as specified in TS 36.104 [30] clause 6.5.3.1. The TAE value depends upon the type of carrier aggregation.</p>				

Table A.8.16.76.1-3: Cell specific test parameters for E-UTRAN FDD known SCell1 activation with PCell in TDD

Parameter	Unit	Cell 4			Cell 5					
		T1	T2	T3	T1	T2	T3			
E-UTRA RF Channel Number		4			5					
BW _{channel}	MHz	5MHz: N _{RB,c} = 25 10MHz: N _{RB,c} = 50 20MHz: N _{RB,c} = 100			5MHz: N _{RB,c} = 25 10MHz: N _{RB,c} = 50 20MHz: N _{RB,c} = 100					
Special subframe configuration		-			-					
Uplink-downlink configuration		-			-					
PDSCH parameters: DL Reference Measurement Channel		-			-					
PCFICH/PDCCH/PHICH parameters: DL Reference Measurement Channel		5MHz: R.11 FDD 10MHz: R.6 FDD 20MHz: R.10 FDD			5MHz: R.11 FDD 10MHz: R.6 FDD 20MHz: R.10 FDD					

OCNG Patterns		5MHz: OP.16 FDD 10MHz: OP.2 FDD 20MHz: OP.12 FDD	5MHz: OP.16 FDD 10MHz: OP.2 FDD 20MHz: OP.12 FDD	
PBCH_RA	dB	0	0	
PBCH_RB	dB			
PSS_RA	dB			
SSS_RA	dB			
PCFICH_RB	dB			
PHICH_RA	dB			
PHICH_RB	dB			
PDCCH_RA	dB			
PDCCH_RB	dB			
PDSCH_RA	dB			
PDSCH_RB	dB			
OCNG_RA ^{Note 1}	dB			
OCNG_RB ^{Note 1}	dB			
N_{oc} ^{Note 2}	dBm/15 kHz	-104	-104	
\bar{E}_s/N_{oc}	dB	17	17	
\bar{E}_s/I_{ot}	dB	17	17	
RSRP ^{Note 3}	dBm/15 kHz	-87	-87	
SCH_RP ^{Note 3}	dBm/15 kHz	-87	-87	
I_o ^{Note 3}	dBm/Ch BW	-59.13 +10log ($N_{RB,c}/50$)	-59.13 +10log ($N_{RB,c}/50$)	
Propagation Condition		AWGN	AWGN	
Antenna Configuration		1x2	1x2	
Timing offset to Cell 1	μ s	0	0	
Time alignment error relative to cell 1 ^{Note 5}	μ s	\leq TAE	\leq TAE	
Time alignment error relative to cell 2 ^{Note 5}	μ s	\leq TAE	\leq TAE	
Time alignment error relative to cell 3 ^{Note 5}	μ s	\leq TAE	\leq TAE	
Time alignment error relative to cell 4 ^{Note 5}	μ s	-	\leq TAE	
<p>Note 1: OCNG shall be used such that all cells are fully allocated and a constant total transmitted power spectral density is achieved for all OFDM symbols.</p> <p>Note 2: Interference from other cells and noise sources not specified in the test is assumed to be constant over subcarriers and time and shall be modelled as AWGN of appropriate power for N_{oc} to be fulfilled.</p> <p>Note 3: E_s/I_{ot}, RSRP, SCH_RP and I_o levels have been derived from other parameters for information purposes. They are not settable parameters themselves.</p> <p>Note 4: The uplink resources for CSI reporting are assigned to the UE prior to the start of time period T2.</p> <p>Note 5: Time alignment error (TAE) as specified in TS 36.104 [30] clause 6.5.3.1. The TAE value depends upon the type of carrier aggregation.</p>				

A.8.16.76.2 Test Requirements

During T2 the UE shall send the first CSI report for SCell1 in a subframe (m+8), or in a subframe (m+9) if the subframe (m+8) was subject to interruption. Whether CSI report in subframe (m+8) was interrupted or not is checked by monitoring ACK/NACK sent in PCell in subframe (m+8).

During T2 the UE shall start sending CSI reports for SCell1 with non-zero CQI index at latest in a subframe (m+39).

During T3 the UE shall stop sending CSI reports for SCell at latest in a subframe (n+8).

During T2 interruption of PCell during SCells activation shall not happen outside the subframes (m+5) to (m+11) and outside the subframes (m+20) to (m+26).

During T3 interruption of PCell during SCells deactivation shall not happen outside the subframes (n+5) to (n+11), outside the subframes (n+20) to (n+26), outside the subframes (n+35) to (n+41), and outside the subframes (n+50) to (n+56).

The interruption of PCell shall not be more than the values specified for intra-band CA and inter-band CA in Section 7.8.2.

All of the above test requirements shall be fulfilled in order for the observed SCell1 activation delay and SCell1 deactivation delay to be counted as correct. The rate of correct observed SCell1 activation delay and SCell1 deactivation delay during repeated tests shall be at least 90%.

NOTE: During T2 if there are no uplink resources for reporting the valid CSI in a subframe (m+39) then the UE shall use the next available uplink resource for reporting the corresponding valid CSI.

A.8.16.77 5 DL FDD CA activation and deactivation of known SCell in non-DRX

A.8.16.77.1 Test Purpose and Environment

The purpose of this test is to verify that the SCell activation and deactivation times are within the requirements stated in section 7.7 for UE configured with four downlink SCells, when the SCell is known by the UE at the time of activation and PCell is in FDD.

The test parameters are given in Tables A.8.16.77.1-1 and cell-specific parameters in A.8.16.77.1-2 below. The test consists of three successive time periods, with duration of T1, T2 and T3, respectively. There are five carriers, each with one cell. All cells have constant signal levels throughout the test. Before the test starts the UE is connected to Cell1 (PCell) on radio channel 1 (PCC), Cell 3 (deactivated SCell2) on radio channel 3 (SCC2), Cell4 (deactivated SCell3) on radio channel 4 (SCC3) and Cell5 (deactivated SCell4) on radio channel 5 (SCC4) but is not aware of Cell2 (SCell1) on radio channel 2 (SCC1). The UE is only monitoring the PCC, SCC2, SCC3 and SCC4. The UE shall be continuously scheduled in the PCell throughout the whole test.

At the beginning of T1 the UE receives an RRC message by which the SCell1 (Cell2) becomes configured on radio channel 2 (SCC1). The UE now starts monitoring also the SCC1. The test equipment sends a MAC message for activation of the SCell1.

The point in time at which the MAC message is received at the UE antenna connector, in a subframe #denoted m which is an even number, defines the start of time period T2. At the beginning of T2 the test equipment sends a MAC message for activation of the SCell1. The UE receives the activation command for SCell2, SCell3 and SCell4 in subframes (m+10), (m+20) and (m+30) during activation of the SCell1. The UE shall be able to report valid CSIs for the activated SCell at latest in a subframe (m+39). The UE shall start reporting CSI for SCell1 in subframe in (m+8) and shall report CQI index 0 (out-of-range) until the subframe activation has been completed. Any PCell interruption due to activation of SCells shall occur in the subframe (m+5) to (m+9), (m+15) to (m+19), (m+25) to (m+29) and (m+35) to (m+39).

Time period T3 starts when a MAC message for deactivation of SCell1, send from the test equipment to the UE in a subframe #denoted n, is received at the UE antenna connector. The test equipment sends a MAC message for deactivation of the SCell2, SCell3 and SCell4 in subframe (n+10), (n+20) and (n+30). The UE shall carry out deactivation of the SCell1 at latest in subframe (n+8), and any interruption due to the deactivation of SCells shall occur in the subframe (n+5) to (n+9), (n+15) to (n+19), (n+25) to (n+29) and (n+35) to (n+39).

The test equipment verifies that potential interruption is carried out in the correct time span by monitoring ACK/NACK sent in PCell during activation and deactivation of SCell1, respectively.

The test equipment verifies the activation time by counting the subframes from the time when the SCell1 activation command is sent until a CSI report with other than CQI index 0 is received.

The test equipment verifies the deactivation time by counting the subframes from the time when the SCell1 deactivation command is sent until CQI reporting for SCell1 is discontinued.

Table A.8.16.77.1-1: General test parameters for known SCell1 activation case

Parameter	Unit	Value	Comment
E-UTRA RF Channel Number		1, 2, 3, 4, 5	Five radio channels are used for this test
Active PCell		Cell 1	Primary cell on RF channel number 1.
Deconfigured deactivated SCell1		Cell 2	Deconfigured deactivated secondary cell on RF channel number 2.
Configured deactivated SCell2		Cell 3	Configured deactivated secondary cell on RF channel number 3.

Configured deactivated SCell3		Cell 4	Configured deactivated secondary cell on RF channel number 4.
Configured deactivated SCell3		Cell 5	Configured deactivated secondary cell on RF channel number 5.
CP length		Normal	
DRX		OFF	Continuous monitoring of primary cell
CQI/PMI periodicity and offset configuration index		0	CQI reporting for SCell every second subframe
Cell-individual offset for cells on RF channel number 1	dB	0	Individual offset for cells on PCC.
Cell-individual offset for cells on RF channel number 2	dB	0	Individual offset for cells on SCC1.
Cell-individual offset for cells on RF channel number 3	dB	0	Individual offset for cells on SCC2.
Cell-individual offset for cells on RF channel number 4	dB	0	Individual offset for cells on SCC3.
Cell-individual offset for cells on RF channel number 5	dB	0	Individual offset for cells on SCC4.
Filter coefficient		0	L3 filtering is not used
SCell measurement cycle (measCycleSCell)	ms	320	
T1	s	7	During this time the PCell, SCell2, SCell3 and SCell4 shall be known and the SCell1 configured and detected.
T2	s	1	During this time the UE shall activate the SCell1.
T3	s	1	During this time the UE shall deactivate the SCell1.

Table A.8.16.77.1-2: Cell specific test parameters for E-UTRAN FDD 5 DL CA activation and deactivation of known SCell in non-DRX

Parameter	Unit	Cell 1			Cell 2			Cell 3			Cell 4			Cell 5		
		T1	T2	T3	T1	T3	T3	T1	T2	T3	T1	T2	T3	T1	T2	T3
E-UTRA RF Channel Number		1			2			3			4			5		
BW _{channel}	MHz	5MHz: N _{RB,c} = 25 10MHz: N _{RB,c} = 50 20MHz: N _{RB,c} = 100			5MHz: N _{RB,c} = 25 10MHz: N _{RB,c} = 50 20MHz: N _{RB,c} = 100			5MHz: N _{RB,c} = 25 10MHz: N _{RB,c} = 50 20MHz: N _{RB,c} = 100			5MHz: N _{RB,c} = 25 10MHz: N _{RB,c} = 50 20MHz: N _{RB,c} = 100			5MHz: N _{RB,c} = 25 10MHz: N _{RB,c} = 50 20MHz: N _{RB,c} = 100		
PDSCH parameters: DL Reference Measurement Channel		5MHz: R.7 FDD 10MHz: R.3 FDD 20MHz: R.6 FDD			-			-			-			-		
PCFICH/PDCCH/PHICH parameters: DL Reference Measurement Channel		5MHz: R.11 FDD 10MHz: R.6 FDD 20MHz: R.10 FDD			5MHz: R.11 FDD 10MHz: R.6 FDD 20MHz: R.10 FDD			5MHz: R.11 FDD 10MHz: R.6 FDD 20MHz: R.10 FDD			5MHz: R.11 FDD 10MHz: R.6 FDD 20MHz: R.10 FDD			5MHz: R.11 FDD 10MHz: R.6 FDD 20MHz: R.10 FDD		
OCNG Patterns		5MHz: OP.20 FDD 10MHz: OP.10 FDD 20MHz: OP.17 FDD			5MHz: OP.16 FDD 10MHz: OP.2 FDD 20MHz: OP.12 FDD			5MHz: OP.16 FDD 10MHz: OP.2 FDD 20MHz: OP.12 FDD			5MHz: OP.16 FDD 10MHz: OP.2 FDD 20MHz: OP.12 FDD			5MHz: OP.16 FDD 10MHz: OP.2 FDD 20MHz: OP.12 FDD		
PBCH_RA	dB	0			0			0			0			0		
PBCH_RB	dB															
PSS_RA	dB															
SSS_RA	dB															
PCFICH_RB	dB															
PHICH_RA	dB															
PHICH_RB	dB															
PDCCH_RA	dB															
PDCCH_RB	dB															

PDSCH_RA	dB					
PDSCH_RB	dB					
OCNG_RA ^{Note 1}	dB					
OCNG_RB ^{Note 1}	dB					
N_{oc} ^{Note 2}	dBm/ 15 kHz	-104	-104	-104	-104	-104
\bar{E}_s/N_{oc}	dB	17	17	17	17	17
\bar{E}_s/I_{ot}	dB	17	17	17	17	17
RSRP ^{Note 3}	dBm/ 15 kHz	-87	-87	-87	-87	-87
SCH_RP ^{Note 3}	dBm/ 15 kHz	-87	-87	-87	-87	-87
I_o ^{Note 3}	dBm/ Ch BW	-59.13 +10log ($N_{RB,c}/50$)	-59.13 +10log ($N_{RB,c}/50$)	-59.13 +10log ($N_{RB,c}/50$)	-59.13 +10log ($N_{RB,c}/50$)	-59.13 +10log ($N_{RB,c}/50$)
Propagation Condition		AWGN	AWGN	AWGN	AWGN	AWGN
Antenna Configuration		1x2	1x2	1x2	1x2	1x2
Timing offset to Cell 1	μ s	-	0	0	0	0
Time alignment error relative to cell 1 ^{Note 5}	μ s	-	\leq TAE	\leq TAE	\leq TAE	\leq TAE
Time alignment error relative to cell 2 ^{Note 5}	μ s	-	-	\leq TAE	\leq TAE	\leq TAE
Time alignment error relative to cell 3 ^{Note 5}	μ s	-	-	-	\leq TAE	\leq TAE
Time alignment error relative to cell 4 ^{Note 5}	μ s	-	-	-	-	\leq TAE
Note 1: OCNG shall be used such that all cells are fully allocated and a constant total transmitted power spectral density is achieved for all OFDM symbols.						
Note 2: Interference from other cells and noise sources not specified in the test is assumed to be constant over subcarriers and time and shall be modelled as AWGN of appropriate power for N_{oc} to be fulfilled.						
Note 3: E_s/I_{ot} , RSRP, SCH_RP and I_o levels have been derived from other parameters for information purposes. They are not settable parameters themselves.						
Note 4: The uplink resources for CSI reporting are assigned to the UE prior to the start of time period T2.						
Note 5: Time alignment error (TAE) as specified in TS 36.104 [30] clause 6.5.3.1. The TAE value depends upon the type of carrier aggregation.						

A.8.16.77.2 Test Requirements

During T2, the UE shall send the first CSI report for SCell1 in a subframe (m+8), or in a subframe (m+10) if the subframe (m+8) was subject to interruption. Whether CSI report in subframe (m+8) was interrupted or not is checked by monitoring ACK/NACK sent in PCell in subframe (m+8).

During T2 the UE shall start sending CSI reports for SCell1 with non-zero CQI index at latest in a subframe (m+39).

During T3 the UE shall stop sending CSI reports for SCell1 at latest in a subframe (n+8).

During T2 interruption of PCell during SCells activation shall not happen outside the subframes (m+5) to (m+9), outside the subframes (m+15) to (m+19), outside the subframes (m+25) to (m+29) and outside the subframes (m+35) to (m+39).

During T3 interruption of PCell during SCells deactivation shall not happen outside the subframes (n+5) to (n+9), outside the subframes (n+15) to (n+19), outside the subframes (n+25) to (n+29) and outside the subframes (n+35) to (n+39).

The interruption of PCell shall not be more than the values specified for intra-band CA and inter-band CA in Section 7.8.2.

All of the above test requirements shall be fulfilled in order for the observed SCell1 activation delay and SCell1 deactivation delay to be counted as correct. The rate of correct observed SCell1 activation delay and SCell1 deactivation delay during repeated tests shall be at least 90%.

NOTE: During T2 if there are no uplink resources for reporting the valid CSI in a subframe (m+39) then the UE shall use the next available uplink resource for reporting the corresponding valid CSI.

A.8.16.78 5 DL TDD CA activation and deactivation of known SCell in non-DRX

A.8.16.78.1 Test Purpose and Environment

The purpose of this test is to verify that SCell activation and deactivation times are within the requirements stated in clause 7.7 for 5DL TDD carrier aggregation, when the SCells are known by the UE at the time of activation.

The test parameters are given in Tables A.8.16.78.1-1 and cell-specific parameters in A.8.16.78.1-2 below. The test consists of three successive time periods, with duration of T1, T2 and T3, respectively. There are five carriers, each with one cell. All cells have constant signal levels throughout the test. Before the test starts the UE is connected to Cell 1 (PCell) on radio channel 1 (PCC), Cell 3 (deactivated SCell2) on radio channel 3 (SCC2), Cell 4 (deactivated SCell3) on radio channel 4 (SCC3) and Cell 5 (deactivated SCell4) on radio channel 5 (SCC4), but is not aware of Cell 2 (SCell1) on radio channel 2 (SCC1). The UE is only monitoring the PCC, SCC2, SCC3 and SCC4. The UE shall be continuously scheduled in the PCell throughout the whole test.

At the beginning of T1 the UE receives an RRC message by which the SCell1 (Cell 2) becomes configured on radio channel 2 (SCC1). The UE now starts monitoring also the SCC1. The test equipment sends a MAC message for activation of the SCell1.

The point in time at which the MAC message is received at the UE antenna connector, in a subframe # denoted m, where m is 4 or 9, defines the start of time period T2. At the beginning of T2 the test equipment sends a MAC message for activation of the SCell1. The UE receives the SCell2, SCell3 and SCell4 activation command in a subframe (m+15), during activation of the SCell1. The UE shall be able to report valid CSIs for the activated SCell1 at latest in a subframe (m+39). The UE shall start reporting CSI for SCell1 in subframe (m+8) and shall report CQI index 0 (out-of-range) until the SCell activation has been completed. Any PCell interruption due to activation of SCells shall occur in the subframes (m+5) to (m+12) and (m+20) to (m+26).

Time period T3 starts when a MAC message for deactivation of SCell1, sent from the test equipment to the UE, in a subframe # denoted n, where n is 4 or 9, is received at the UE antenna connector. The test equipment sends MAC message for deactivation of the SCell2 in subframe (n+15), MAC message for deactivation of the SCell3 in subframe (n+30) and MAC message for deactivation of the SCell4 in subframe (n+45). The UE shall carry out deactivation of the SCell1 at latest in subframe (n+8), and any PCell interruption due to the deactivation of SCells shall occur in the subframes (n+5) to (n+12), (n+20) to (n+26), (n+35) to (n+41) and (n+50) to (n+56).

The test equipment verifies that potential interruption is carried out in the correct time span by monitoring ACK/NACK sent in PCell during activation and deactivation of SCells, respectively.

The test equipment verifies the activation time by counting the subframes from the time when the SCell1 activation command is sent until a CSI report with other than CQI index 0 is received.

The test equipment verifies the deactivation time by counting the subframes from the time when the SCell1 deactivation command is sent until CQI reporting for SCell1 is discontinued.

Table A.8.16.78.1-1: General test parameters for E-UTRAN TDD 5 DL CA activation and deactivation of known SCell in non-DRX

Parameter	Unit	Value	Comment
E-UTRA RF Channel Number		1, 2, 3,4,5	Five radio channels are used for this test
Active PCell		Cell 1	Primary cell on RF channel number 1.
Deconfigured SCell		Cell 2	Deconfigured secondary cell on RF channel number 2.
Configured deactivated SCell		Cell 3	Configured deactivated secondary cell on RF channel number 3.
Configured deactivated SCell		Cell 4	Configured deactivated secondary cell on RF channel number 4.

Configured deactivated SCell		Cell 5	Configured deactivated secondary cell on RF channel number 5.
CP length		Normal	
Special subframe configuration		6	As specified in table 4.2-1 in TS 36.211. The same configuration applies to all cells.
Uplink-downlink configuration		1	As specified in table 4.2-2 in TS 36.211. The same configuration applies to all cells
DRX		OFF	Continuous monitoring of primary cell
CQI/PMI periodicity and offset configuration index		0	CQI reporting for SCells every UL subframe
Cell-individual offset for cells on RF channel number 1	dB	0	Individual offset for cells on PCC.
Cell-individual offset for cells on RF channel number 2	dB	0	Individual offset for cells on SCC1.
Cell-individual offset for cells on RF channel number 3	dB	0	Individual offset for cells on SCC2.
Cell-individual offset for cells on RF channel number 4	dB	0	Individual offset for cells on SCC3.
Cell-individual offset for cells on RF channel number 5	dB	0	Individual offset for cells on SCC4.
Filter coefficient		0	L3 filtering is not used
SCell measurement cycle (measCycleSCell)	ms	320	
T1	s	7	During this time the PCell, SCell2, SCell3 and SCell4 shall be known and the SCell1 configured and detected.
T2	s	1	During this time the UE shall activate the SCell1.
T3	s	1	During this time the UE shall deactivate the SCell1.

Table A.8.16.78.1-2: Cell specific test parameters for E-UTRAN TDD 4 DL CA activation and deactivation of known SCell in non-DRX

Parameter	Unit	Cell 1			Cell 2			Cell 3			Cell 4			Cell5		
		T1	T2	T3	T1	T2	T3	T1	T2	T3	T1	T2	T3	T1	T2	T3
E-UTRA RF Channel Number		1			2			3			4			5		
BW _{channel}		5MHz: N _{RB,c} = 25 10MHz: N _{RB,c} = 50 20MHz: N _{RB,c} = 100			5MHz: N _{RB,c} = 25 10MHz: N _{RB,c} = 50 20MHz: N _{RB,c} = 100			5MHz: N _{RB,c} = 25 10MHz: N _{RB,c} = 50 20MHz: N _{RB,c} = 100			5MHz: N _{RB,c} = 25 10MHz: N _{RB,c} = 50 20MHz: N _{RB,c} = 100			5MHz: N _{RB,c} = 25 10MHz: N _{RB,c} = 50 20MHz: N _{RB,c} = 100		
PDSCH parameters: DL Reference Measurement Channel		5MHz: R.4 TDD 10MHz: R.0 TDD 20MHz: R.3 TDD			-			-			-			-		
PCFICH/PDCCH/PHICH parameters: DL Reference Measurement Channel		5MHz: R.11 TDD 10MHz: R.6 TDD 20MHz: R.10 TDD			5MHz: R.11 TDD 10MHz: R.6 TDD 20MHz: R.10 TDD			5MHz: R.11 TDD 10MHz: R.6 TDD 20MHz: R.10 TDD			5MHz: R.11 TDD 10MHz: R.6 TDD 20MHz: R.10 TDD			5MHz: R.11 TDD 10MHz: R.6 TDD 20MHz: R.10 TDD		
OCNG Patterns		5MHz: OP.9 TDD 10MHz: OP.1 TDD 20MHz: OP.7 TDD			5MHz: OP.10 TDD 10MHz: OP.2 TDD 20MHz: OP.8 TDD			5MHz: OP.10 TDD 10MHz: OP.2 TDD 20MHz: OP.8 TDD			5MHz: OP.10 TDD 10MHz: OP.2 TDD 20MHz: OP.8 TDD			5MHz: OP.10 TDD 10MHz: OP.2 TDD 20MHz: OP.8 TDD		
PBCH_RA	dB	0			0			0			0			0		
PBCH_RB	dB															
PSS_RA	dB															
SSS_RA	dB															
PCFICH_RB	dB															
PHICH_RA	dB															
PHICH_RB	dB															
PDCCH_RA	dB															
PDCCH_RB	dB															
PDSCH_RA	dB															
PDSCH_RB	dB															
OCNG_RA ^{Note 1}	dB															
OCNG_RB ^{Note 1}	dB															
N _{oc} ^{Note 2}	dBm/15 kHz															
E _s /N _{oc}	dB	17			17			17			17					

\bar{E}_s/I_{ot} ^{Note 3}	dB	17	17	17	17	17
RSRP ^{Note 3}	dBm/1 5 kHz	-87	-87	-87	-87	-87
SCH_RP ^{Note 3}	dBm/1 5 kHz	-87	-87	-87	-87	-87
I_o ^{Note 3}	dBm/C h BW	$-59.13+10\log$ $(N_{RB,c}/50)$	$-59.13+10\log$ $(N_{RB,c}/50)$	$-59.13+10\log$ $(N_{RB,c}/50)$	$-59.13+10\log$ $(N_{RB,c}/50)$	$-59.13+10\log$ $(N_{RB,c}/50)$
Propagation Condition		AWGN	AWGN	AWGN	AWGN	AWGN
Antenna Configuration		1x2	1x2	1x2	1x2	1x2
Timing offset to Cell 1	μ s	-	0	0	0	0
Time alignment error relative to cell 1 ^{Note 5}	μ s	-	\leq TAE	\leq TAE	\leq TAE	\leq TAE
Time alignment error relative to cell 2 ^{Note 5}	μ s	-	-	\leq TAE	\leq TAE	\leq TAE
Time alignment error relative to cell 3 ^{Note 5}	μ s	-	-	-	\leq TAE	\leq TAE
Time alignment error relative to cell 4 ^{Note 5}	μ s	-	-	-	-	\leq TAE
<p>Note 1: OCNG shall be used such that all cells are fully allocated and a constant total transmitted power spectral density is achieved for all OFDM symbols.</p> <p>Note 2: Interference from other cells and noise sources not specified in the test is assumed to be constant over subcarriers and time and shall be modelled as AWGN of appropriate power for N_{oc} to be fulfilled.</p> <p>Note 3: \bar{E}_s/I_{ot}, RSRP, SCH_RP and I_o have been derived from other parameters for information purposes. They are not settable parameters themselves.</p> <p>Note 4: The uplink resources for CSI reporting are assigned to the UE prior to the start of time period T2.</p> <p>Note 5: Time alignment error (TAE) as specified in TS 36.104 [30] clause 6.5.3.1. The TAE value depends upon the type of carrier aggregation.</p>						

A.8.16.78.2 Test Requirements

During T2 the UE shall send the first CSI report for SCell1 in a subframe (m+8), or in a subframe (m+9) if the subframe (m+8) was subject to interruption, or in a subframe (m+13) if the subframe (m+8) and (m+9) were subject to interruption when an intra-band SCell is activated. Whether CSI report in subframe (m+8) and/or (m+9) was interrupted or not is checked by monitoring ACK/NACK sent in PCell in subframe (m+8) and/or (m+9).

During T2 the UE shall start sending CSI reports for SCell1 with non-zero CQI index at latest in a subframe (m+39).

During T3 the UE shall stop sending CSI reports for SCell1 at latest in subframe (n+8).

During T2 interruption of PCell during SCells activation shall not happen outside the subframes (m+5) to (m+12) and outside the subframes (m+20) to (m+26).

During T3 interruption of PCell during SCells deactivation shall not happen outside the subframes (n+5) to (n+11), outside the subframes (n+20) to (n+26), outside the subframes (n+35) to (n+41) and outside the subframes (n+50) to (n+56).

The interruption of PCell shall not be more than the values specified for intra-band CA and inter-band CA in Section 7.8.2.

The UE shall not send event triggered measurement reports as long as the reporting criteria are not fulfilled.

All of the above test requirements shall be fulfilled in order for the observed SCell1 activation delay and SCell1 deactivation delay to be counted as correct. The rate of correct observed SCell1 activation delay and SCell1 deactivation delay during repeated tests shall be at least 90%.

NOTE: During T2 if there are no uplink resources for reporting the valid CSI in a subframe (m+39) then the UE shall use the next available uplink resource for reporting the corresponding valid CSI.

A.8.16.79 E-UTRAN PCell in FDD FDD-TDD 4 DL CA Event Triggered Reporting on Deactivated SCell with PCell and SCell Interruptions in Non-DRX

A.8.16.79.1 Test Purpose and Environment

The purpose of this test is to verify that the UE correctly detects event A6 (Neighbour becomes better than SCell) defined in TS 36.331 [2] within the requirements stated in clause 8.3.3.2.1 while at the same time fulfilling the requirement on interruption rate.

The test parameters are given in Table A.8.16.79.1-1, A.8.16.79.1-2 and A.8.16.79.1-3 below. In the test there are five cells: Cell 1, Cell 2, Cell 3, Cell 4 and Cell 5. Cell 1 is PCell on the FDD primary component (RF Channel 1), Cell 2 is SCell on the TDD secondary component (RF Channel 2), Cell 3 is SCell on the TDD secondary component (RF Channel 3), Cell 4 is SCell on the TDD secondary component (RF Channel 4) and Cell 5 is the neighbour cell on the TDD secondary component (RF Channel 4). It is indicated to the UE in the measurement control information that event-triggered reporting with Event A6 is used. The test consists of four successive time periods, with duration of T1, T2, T3 and T4, respectively. During T1 and T2, Cell2, Cell3 and Cell4 are deactivated. During T1 the UE shall not have any information of Cell 5. Immediately at beginning of T2 the transmission power of Cell 5 is increased to same level as for Cell 3, and due to usage of an offset this shall result in reporting of Event A6.

At the beginning of T3, the transmission power of Cell 5 is turned off, and the test equipment sends a MAC message for activation of Cell 2 to UE but Cell3 and Cell4 remains deactivated. Immediately at beginning of T4 the transmission power of Cell 5 is increased to same level as for Cell 3, and due to usage of an offset this shall result in reporting of Event A6. The UE shall be continuously scheduled in the PCell throughout the whole test and continuously scheduled in Cell2 during T4.

Table A.8.16.79.1-1: General test parameters for E-UTRAN PCell in FDD FDD-TDD 4 DL CA Event Triggered Reporting on Deactivated SCell with PCell and SCell Interruptions in Non-DRX

Parameter		Unit	Value	Comment
E-UTRA RF Channel Number			1, 2, 3, 4	Four radio channels are used for this test
Active PCell			Cell 1	Primary cell on RF channel number 1.
Configured deactivated SCell			Cell 2	Configured deactivated secondary cell on RF channel number 2.
Configured deactivated SCell			Cell 3	Configured deactivated secondary cell on RF channel number 3.
Configured deactivated SCell			Cell 4	Configured deactivated secondary cell on RF channel number 4.
Neighbour cell			Cell 5	Neighbor cell to be identified on RF channel number 4.
CP length			Normal	
DRX			OFF	Continuous monitoring of primary cell
A6	Hysteresis	dB	0	Hysteresis for evaluation of event A6.
	Offset	dB	-3	Offset parameter for evaluation of event A6. Needs to take relative accuracy tolerance in clause 9.1.11.2 into account plus margin.
	Report on leave		False	
	Time To Trigger	s	0	
Cell-individual offset for cells on RF channel number 1		dB	0	Individual offset for cells on primary component carrier.
Cell-individual offset for cells on RF channel number 2		dB	0	Individual offset for cells on secondary component carrier.
Cell-individual offset for cells on RF channel number 3		dB	0	Individual offset for cells on secondary component carrier.
Cell-individual offset for cells on RF channel number 4		dB	0	Individual offset for cells on secondary component carrier.
Filter coefficient			0	L3 filtering is not used
SCell measurement cycle		ms	640	
T1		s	4	During this time the UE shall be aware of cells 1, 2, 3 and 4 but not cell 5.
T2		s	≤15	UE should report Event A6 within 12.8s (20xscellMeasCycle)

T3	s	4	During this time the UE shall activate cell 2
T4	s	≤ 4	UE should report Event A6 within 3.2s (5xscellMeasCycle)

Table A.8.16.79.1-2: Cell specific test parameters for E-UTRAN PCell in FDD FDD-TDD 4 DL CA Event Triggered Reporting on Deactivated SCell with PCell and SCell Interruptions in Non-DRX (Cell #1, Cell #2, Cell #3, Cell #4)

Parameter	Unit	Cell 1				Cell 2				Cell 3				Cell 4			
		T1	T2	T3	T4	T1	T2	T3	T4	T1	T2	T3	T4	T1	T2	T3	T4
E-UTRA RF Channel Number		1				2				3				4			
BW _{channel}		5MHz: N _{RB,c} = 25 10MHz: N _{RB,c} = 50 20MHz: N _{RB,c} = 100				5MHz: N _{RB,c} = 25 10MHz: N _{RB,c} = 50 20MHz: N _{RB,c} = 100				5MHz: N _{RB,c} = 25 10MHz: N _{RB,c} = 50 20MHz: N _{RB,c} = 100				5MHz: N _{RB,c} = 25 10MHz: N _{RB,c} = 50 20MHz: N _{RB,c} = 100			
PDSCH parameters: DL Reference Measurement Channel		5MHz: R.7 FDD 10MHz: R.3 FDD 20MHz: R.6 FDD				N/A	N/A	N/A	5MHz: R.4 TDD 10MHz: R.0 TDD 20MHz: R.3 TDD	N/A				N/A			
PCFICH/PDCCH/PHICH parameters		5MHz: R.11 FDD 10MHz: R.6 FDD 20MHz: R.10 FDD				5MHz: R.11 TDD 10MHz: R.6 TDD 20MHz: R.10 TDD				5MHz: R.11 TDD 10MHz: R.6 TDD 20MHz: R.10 TDD				5MHz: R.11 TDD 10MHz: R.6 TDD 20MHz: R.10 TDD			
OCNG Pattern defined in A.3.2.1		5MHz: OP.20 FDD 10MHz: OP.10 FDD 20MHz: OP.17 FDD				5MHz: OP.10 TDD 10MHz: OP.10 TDD z: OP.2 TDD 20MHz: OP.8 TDD	5MHz: OP.10 TDD 10MHz: OP.10 TDD z: OP.2 TDD 20MHz: OP.8 TDD	5MHz: OP.10 TDD 10MHz: OP.10 TDD z: OP.2 TDD 20MHz: OP.8 TDD	5MHz: OP.9 TDD 10MHz: OP.1 TDD z: OP.7 TDD	5MHz: OP.10 TDD 10MHz: OP.2 TDD 20MHz: OP.8 TDD				5MHz: OP.10 TDD 10MHz: OP.2 TDD 20MHz: OP.8 TDD			
PBCH_RA	dB	0				0				0				0			
PBCH_RB	dB																
PSS_RA	dB																
SSS_RA	dB																
PCFICH_RB	dB																
PHICH_RA	dB																
PHICH_RB	dB																
PDCCH_RA	dB																
PDCCH_RB	dB																
PDSCH_RA	dB																
PDSCH_RB	dB																
OCNG_RA ^{Note 1}	dB																

OCNG_RB ^{Note 1}	dB																	
N_{oc} ^{Note 3}	dBm/1 5 kHz	-101				-101				-101				-101				
\hat{E}_s/N_{oc}	dB	16	16	16	16	16	16	16	16	16	16	16	16	16	16	16	16	
\hat{E}_s/I_{ot} ^{Note 4}	dB	16	16	16	16	16	16	16	16	16	-0.11	16	-0.11	16	-0.11	16	-0.11	
RSRP ^{Note 4}	dBm/1 5 kHz	-85	-85	-85	-85	-85	-85	-85	-85	-85	-85	-85	-85	85	-85	85	-85	
SCH_RP ^{Note 4}	dBm/1 5 kHz	-85	-85	-85	-85	-85	-85	-85	-85	-85	-85	-85	-85	85	-85	85	-85	
I_o ^{Note 4}	dBm/C h BW	-	-	-	-	-57.11 +10log (N _{RB,c} /50)	-57.11 +10log (N _{RB,c} /50)	-57.11 +10log (N _{RB,c} /50)	-57.11 +10log (N _{RB,c} /50)	-	57.11 +10log g (N _{RB,c} /50)	54.15 +10log g (N _{RB,c} /50)	57.11 +10log g (N _{RB,c} /50)	54.15 +10log g (N _{RB,c} /50)	57.11 +10log g (N _{RB,c} /50)	54.15 +10log g (N _{RB,c} /50)	57.11 +10log g (N _{RB,c} /50)	54.15 +10log g (N _{RB,c} /50)
Propagation Condition		AWGN				AWGN				AWGN				AWGN				
Antenna Configuration		1x2				1x2				1x2				1x2				
Timing offset to Cell 1	μs	-				0				0				0				
Time alignment error relative to cell 1 ^{Note 5}	μs	-				≤ TAE				≤ TAE				≤ TAE				
Time alignment error relative to cell 2 ^{Note 5}	μs	-				-				≤ TAE				≤ TAE				
Time alignment error relative to cell 3 ^{Note 5}	μs	-				-				-				≤ TAE				

Note 1: OCNG shall be used such that all cells are fully allocated and a constant total transmitted power spectral density is achieved for all OFDM symbols.

Note 2: The resources for uplink transmission are assigned to the UE on cell1 from the start of time period T2 and on cell2 from the start of time period T4.

Note 3: Interference from other cells and noise sources not specified in the test is assumed to be constant over subcarriers and time and shall be modelled as AWGN of appropriate power for N_{oc} to be fulfilled.

Note 4: E_s/I_{ot} , RSRP, SCH_RP and I_o levels have been derived from other parameters for information purposes. They are not settable parameters themselves.

Note 5: Time alignment error (TAE) as specified in TS 36.104 [30] clause 6.5.3.1. The TAE value depends upon the type of carrier aggregation.

Table A.8.16.79.1-3: Cell specific test parameters for E-UTRAN PCell in FDD FDD-TDD 4 DL CA Event Triggered Reporting on Deactivated SCell with PCell and SCell Interruptions in Non-DRX (Cell #5)

Parameter	Unit	Cell 5			
		T1	T2	T3	T4
E-UTRA RF Channel Number		4			
BW _{channel}		5MHz: N _{RB,c} = 25 10MHz: N _{RB,c} = 50 20MHz: N _{RB,c} = 100			
PDSCH parameters: DL Reference Measurement Channel		N/A			
PCFICH/PDCCH/PHICH parameters		5MHz: R.11 TDD 10MHz: R.6 TDD 20MHz: R.10 TDD			
OCNG Pattern defined in A.3.2.1		5MHz: OP.10 TDD 10MHz: OP.2 TDD 20MHz: OP.8 TDD			
PBCH_RA	dB	0			
PBCH_RB	dB				
PSS_RA	dB				
SSS_RA	dB				
PCFICH_RB	dB				
PHICH_RA	dB				
PHICH_RB	dB				
PDCCH_RA	dB				
PDCCH_RB	dB				
PDSCH_RA	dB				
PDSCH_RB	dB				
OCNG_RA ^{Note 1}	dB				
OCNG_RB ^{Note 1}	dB				
N_{oc} ^{Note 3}	dBm/15 kHz				
\hat{E}_s / N_{oc}	dB	-infinity	16	-infinity	16
\hat{E}_s / I_{ot} ^{Note 4}	dB	-infinity	-0.11	-infinity	-0.11
RSRP ^{Note 4}	dBm/15 kHz	-infinity	-85	-infinity	-85
SCH_RP ^{Note 4}	dBm/15 kHz	-infinity	-85	-infinity	-85
I_o ^{Note 4}	dBm/Ch BW	-57.11 +10log (N _{RB,c} /50)	-54.15 +10log (N _{RB,c} /50)	-57.11 +10log (N _{RB,c} /50)	-54.15 +10log (N _{RB,c} /50)
Propagation Condition		AWGN			
Antenna Configuration		1x2			
Timing offset to Cell 1	μs	3			
Time alignment error relative to cell 1 ^{Note 5}	μs	N/A			
Time alignment error relative to cell 2 ^{Note 5}	μs	N/A			
Time alignment error relative to cell 3 ^{Note 5}	μs	N/A			
Note 1:	OCNG shall be used such that all cells are fully allocated and a constant total transmitted power spectral density is achieved for all OFDM symbols.				
Note 2:	Void				
Note 3:	Interference from other cells and noise sources not specified in the test is assumed to be constant over subcarriers and time and shall be modelled as AWGN of appropriate power for N_{oc} to be fulfilled.				
Note 4:	E_s/I_{ot} , RSRP, SCH_RP and I_o levels have been derived from other parameters for information purposes. They are not settable parameters themselves.				

Note 5: Time alignment error (TAE) as specified in TS 36.104 [30] clause 6.5.3.1.
The TAE value depends upon the type of carrier aggregation.

A.8.16.79.2 Test Requirements

The UE shall send one Event A6 triggered measurement report, with a measurement reporting delay less than 12.8s ($20 \times \text{scellMeasCycle}$) from the beginning of time period T2.

The UE shall send one Event A6 triggered measurement report, with a measurement reporting delay less than 3.2s ($5 \times \text{scellMeasCycle}$) from the beginning of time period T4.

The UE shall not send event triggered measurement reports, as long as the reporting criteria are not fulfilled.

The UE shall be scheduled on PCell continuously throughout the test. From the start of T1 until the measurement report is received during T2, at least 99.5% of all expected ACK/NACKs shall be transmitted by the UE.

The UE shall be scheduled on Cell2 continuously from the beginning of T4 to the end. From the start of T4 until the measurement report is received during T4, at least 99.5% of all expected ACK/NACKs shall be transmitted by the UE.

For a test to be considered successful requirements on both event detection and percentage of transmitted ACK/NACKs have to be fulfilled simultaneously.

The rate of correct events observed during repeated tests shall be at least 90%.

NOTE: The actual overall delays measured in the test may be up to $2 \times \text{TTI}_{\text{DCCH}}$ higher than the measurement reporting delays above because of TTI insertion uncertainty of the measurement report in DCCH.

A.8.16.80 E-UTRAN PCell in TDD TDD-FDD 4 DL CA Event Triggered Reporting on Deactivated SCell with PCell and SCell Interruptions in Non-DRX

A.8.16.80.1 Test Purpose and Environment

The purpose of this test is to verify that the UE correctly detects event A6 (Neighbour becomes better than SCell) defined in TS 36.331 [2] within the requirements stated in clause 8.3.3.2.1 while at the same time fulfilling the requirement on interruption rate.

The test parameters are given in Table A.8.16.80.1-1, A.8.16.80.1-2 and A.8.16.80.1-3 below. In the test there are five cells: Cell 1, Cell 2, Cell 3, Cell 4 and Cell 5. Cell 1 is PCell on the TDD primary component (RF Channel 1), Cell 2 is SCell on the FDD secondary component (RF Channel 2), Cell 3 is SCell on the FDD secondary component (RF Channel 3), Cell 4 is SCell on the FDD secondary component (RF Channel 4) and Cell 5 is the neighbour cell on the FDD secondary component (RF Channel 4). It is indicated to the UE in the measurement control information that event-triggered reporting with Event A6 is used. The test consists of four successive time periods, with duration of T1, T2, T3 and T4, respectively. During T1 and T2, Cell2, Cell3 and Cell4 are deactivated. During T1 the UE shall not have any information of Cell 5. Immediately at beginning of T2 the transmission power of Cell 5 is increased to same level as for Cell 3, and due to usage of an offset this shall result in reporting of Event A6.

At the beginning of T3, the transmission power of Cell 5 is turned off, and the test equipment sends a MAC message for activation of Cell 2 to UE but Cell3 and Cell4 remains deactivated. Immediately at beginning of T4 the transmission power of Cell 5 is increased to same level as for Cell 3, and due to usage of an offset this shall result in reporting of Event A6. The UE shall be continuously scheduled in the PCell throughout the whole test and continuously scheduled in Cell2 during T4.

Table A.8.16.80.1-1: General test parameters for E-UTRAN PCell in TDD TDD-FDD 4 DL CA Event Triggered Reporting on Deactivated SCell with PCell and SCell Interruptions in Non-DRX

Parameter	Unit	Value	Comment
E-UTRA RF Channel Number		1, 2, 3, 4	Four radio channels are used for this test
Active PCell		Cell 1	Primary cell on RF channel number 1.
Configured deactivated SCell		Cell 2	Configured deactivated secondary cell on RF channel number 2.

Configured deactivated SCell		Cell 3	Configured deactivated secondary cell on RF channel number 3.	
Configured deactivated SCell		Cell 4	Configured deactivated secondary cell on RF channel number 4.	
Neighbour cell		Cell 5	Neighbor cell to be identified on RF channel number 4.	
CP length		Normal		
Special subframe configuration		6	As specified in table 4.2-1 in TS 36.211. The same configuration in all cells	
Uplink-downlink configuration		1	As specified in table 4.2-2 in TS 36.211. The same configuration in all cells	
DRX		OFF	Continuous monitoring of primary cell	
A6	Hysteresis	dB	0	Hysteresis for evaluation of event A6.
	Offset	dB	-3	Offset parameter for evaluation of event A6. Needs to take relative accuracy tolerance in clause 9.1.11.2 into account plus margin.
	Report on leave		False	
	Time To Trigger	s	0	
Cell-individual offset for cells on RF channel number 1	dB	0	Individual offset for cells on primary component carrier.	
Cell-individual offset for cells on RF channel number 2	dB	0	Individual offset for cells on secondary component carrier.	
Cell-individual offset for cells on RF channel number 3	dB	0	Individual offset for cells on secondary component carrier.	
Cell-individual offset for cells on RF channel number 3	dB	0	Individual offset for cells on secondary component carrier.	
Filter coefficient		0	L3 filtering is not used	
SCell measurement cycle	ms	640		
T1	s	4	During this time the UE shall be aware of cells 1, 2, 3 and 4 but not cell 5.	
T2	s	≤15	UE should report Event A6 within 12.8s (20×sCellMeasCycle)	
T3	s	4	During this time the UE shall activate cell 2	
T4	s	≤4	UE should report Event A6 within 3.2s (5×sCellMeasCycle)	

Table A.8.16.80.1-2: Cell specific test parameters for E-UTRAN PCell in TDD TDD-FDD 4 DL CA Event Triggered Reporting on Deactivated SCell with PCell and SCell Interruptions in Non-DRX (Cell #1, Cell #2, Cell #3, Cell #4)

Parameter	Unit	Cell 1				Cell 2				Cell 3				Cell 4			
		T1	T2	T3	T4	T1	T2	T3	T4	T1	T2	T3	T4	T1	T2	T3	T4
E-UTRA RF Channel Number		1				2				3				4			
BW _{channel}		5MHz: N _{RB,c} = 25 10MHz: N _{RB,c} = 50 20MHz: N _{RB,c} = 100				5MHz: N _{RB,c} = 25 10MHz: N _{RB,c} = 50 20MHz: N _{RB,c} = 100				5MHz: N _{RB,c} = 25 10MHz: N _{RB,c} = 50 20MHz: N _{RB,c} = 100				5MHz: N _{RB,c} = 25 10MHz: N _{RB,c} = 50 20MHz: N _{RB,c} = 100			
PDSCH parameters: DL Reference Measurement Channel		5MHz: R.4 TDD 10MHz: R.0 TDD 20MHz: R.3 TDD				N/A	N/A	N/A	5MHz: R.7 FDD 10MH z: R.3 FDD 20MH z: R.6 FDD	N/A				N/A			
PCFICH/PDCCH/PHICH parameters		5MHz: R.11 TDD 10MHz: R.6 TDD 20MHz: R.10 TDD				5MHz: R.11 FDD 10MHz: R.6 FDD 20MHz: R.10 FDD				5MHz: R.11 FDD 10MHz: R.6 FDD 20MHz: R.10 FDD				5MHz: R.11 FDD 10MHz: R.6 FDD 20MHz: R.10 FDD			
OCNG Pattern defined in A.3.2.1		5MHz: OP.9 TDD 10MHz: OP.1 TDD 20MHz: OP.7 TDD				5MHz: OP.16 FDD 10MH z: OP.2 FDD 20MH z: OP.12 FDD	5MHz: OP.16 FDD 10MH z: OP.2 FDD 20MH z: OP.12 FDD	5MHz: OP.16 FDD 10MH z: OP.2 FDD 20MH z: OP.12 FDD	5MHz: OP.20 FDD 10MH z: OP.10 FDD 20MH z: OP.17 FDD	5MHz: OP.16 FDD 10MHz: OP.2 FDD 20MHz: OP.12 FDD				5MHz: OP.16 FDD 10MHz: OP.2 FDD 20MHz: OP.12 FDD			
PBCH_RA	dB	0				0				0				0			
PBCH_RB	dB																
PSS_RA	dB																
SSS_RA	dB																
PCFICH_RB	dB																
PHICH_RA	dB																
PHICH_RB	dB																
PDCCH_RA	dB																
PDCCH_RB	dB																
PDSCH_RA	dB																
PDSCH_RB	dB																
OCNG_RA ^{Note 1}	dB																

OCNG_RB ^{Note 1}	dB																
N_{oc} ^{Note 3}	dBm/1 5 kHz	-101				-101				-101				-101			
\hat{E}_s/N_{oc}	dB	16	16	16	16	16	16	16	16	16	16	16	16	16	16	16	16
\hat{E}_s/I_{ot} ^{Note 4}	dB	16	16	16	16	16	16	16	16	16	-0.11	16	-0.11	16	-0.11	16	-0.11
RSRP ^{Note 4}	dBm/1 5 kHz	-85	-85	-85	-85	-85	-85	-85	-85	-85	-85	-85	-85	85	-85	85	-85
SCH_RP ^{Note 4}	dBm/1 5 kHz	-85	-85	-85	-85	-85	-85	-85	-85	-85	-85	-85	-85	85	-85	85	-85
I_o ^{Note 4}	dBm/C h BW	- 57.11 +10log g (N _{RB,c} /50)	- 57.11 +10log g (N _{RB,c} /50)	- 57.11 +10log g (N _{RB,c} /50)	- 57.11 +10log g (N _{RB,c} /50)	-57.11 +10log (N _{RB,c} /50)	-57.11 +10log (N _{RB,c} /50)	-57.11 +10log (N _{RB,c} /50)	-57.11 +10log (N _{RB,c} /50)	- 57.11 +10log g (N _{RB,c} /50)	- 54.15 +10log g (N _{RB,c} /50)	- 57.11 +10log g (N _{RB,c} /50)	- 54.15 +10log g (N _{RB,c} /50)	- 57.11 +10log g (N _{RB,c} /50)	- 54.15 +10log g (N _{RB,c} /50)	- 57.11 +10log g (N _{RB,c} /50)	- 54.15 +10log g (N _{RB,c} /50)
Propagation Condition		AWGN				AWGN				AWGN				AWGN			
Antenna Configuration		1x2				1x2				1x2				1x2			
Timing offset to Cell 1	μs	-				0				0				0			
Time alignment error relative to cell 1 ^{Note 5}	μs	-				≤ TAE				≤ TAE				≤ TAE			
Time alignment error relative to cell 2 ^{Note 5}	μs	-				-				≤ TAE				≤ TAE			
Time alignment error relative to cell 3 ^{Note 5}	μs	-				-				-				≤ TAE			
<p>Note 1: OCNG shall be used such that all cells are fully allocated and a constant total transmitted power spectral density is achieved for all OFDM symbols.</p> <p>Note 2: The resources for uplink transmission are assigned to the UE on cell1 from the start of time period T2 and on cell2 from the start of time period T4.</p> <p>Note 3: Interference from other cells and noise sources not specified in the test is assumed to be constant over subcarriers and time and shall be modelled as AWGN of appropriate power for N_{oc} to be fulfilled.</p> <p>Note 4: E_s/I_{ot}, RSRP, SCH_RP and I_o levels have been derived from other parameters for information purposes. They are not settable parameters themselves.</p> <p>Note 5: Time alignment error (TAE) as specified in TS 36.104 [30] clause 6.5.3.1. The TAE value depends upon the type of carrier aggregation.</p>																	

Table A.8.16.80.1-3: Cell specific test parameters for E-UTRAN PCell in TDD TDD-FDD 4 DL CA Event Triggered Reporting on Deactivated SCell with PCell and SCell Interruptions in Non-DRX (Cell #5)

Parameter	Unit	Cell 5			
		T1	T2	T3	T4
E-UTRA RF Channel Number		4			
BW _{channel}		5MHz: N _{RB,c} = 25 10MHz: N _{RB,c} = 50 20MHz: N _{RB,c} = 100			
PDSCH parameters: DL Reference Measurement Channel		N/A			
PCFICH/PDCCH/PHICH parameters		5MHz: R.11 FDD 10MHz: R.6 FDD 20MHz: R.10 FDD			
OCNG Pattern defined in A.3.2.1		5MHz: OP.20 FDD 10MHz: OP.10 FDD 20MHz: OP.17 FDD			
PBCH_RA	dB	0			
PBCH_RB	dB				
PSS_RA	dB				
SSS_RA	dB				
PCFICH_RB	dB				
PHICH_RA	dB				
PHICH_RB	dB				
PDCCH_RA	dB				
PDCCH_RB	dB				
PDSCH_RA	dB				
PDSCH_RB	dB				
OCNG_RA ^{Note 1}	dB				
OCNG_RB ^{Note 1}	dB				
N_{oc} ^{Note 3}	dBm/15 kHz				
\hat{E}_s / N_{oc}	dB	-infinity	16	-infinity	16
\hat{E}_s / I_{ot} ^{Note 4}	dB	-infinity	-0.11	-infinity	-0.11
RSRP ^{Note 4}	dBm/15 kHz	-infinity	-85	-infinity	-85
SCH_RP ^{Note 4}	dBm/15 kHz	-infinity	-85	-infinity	-85
I_o ^{Note 4}	dBm/Ch BW	-57.11 +10log (N _{RB,c} /50)	-54.15 +10log (N _{RB,c} /50)	-57.11 +10log (N _{RB,c} /50)	-54.15 +10log (N _{RB,c} /50)
Propagation Condition		AWGN			
Antenna Configuration		1x2			
Timing offset to Cell 1	μs	3			
Time alignment error relative to cell 1 ^{Note 5}	μs	N/A			
Time alignment error relative to cell 2 ^{Note 5}	μs	N/A			
Time alignment error relative to cell 3 ^{Note 5}	μs	N/A			
<p>Note 1: OCNG shall be used such that all cells are fully allocated and a constant total transmitted power spectral density is achieved for all OFDM symbols.</p> <p>Note 2: Void</p> <p>Note 3: Interference from other cells and noise sources not specified in the test is assumed to be constant over subcarriers and time and shall be modelled as AWGN of appropriate power for N_{oc} to be fulfilled.</p> <p>Note 4: E_s/I_{ot}, RSRP, SCH_RP and I_o levels have been derived from other parameters for information purposes. They are not settable parameters themselves.</p>					

Note 5: Time alignment error (TAE) as specified in TS 36.104 [30] clause 6.5.3.1.
The TAE value depends upon the type of carrier aggregation.

A.8.16.80.2 Test Requirements

The UE shall send one Event A6 triggered measurement report, with a measurement reporting delay less than 12.8s ($20 \times \text{scellMeasCycle}$) from the beginning of time period T2.

The UE shall send one Event A6 triggered measurement report, with a measurement reporting delay less than 3.2s ($5 \times \text{scellMeasCycle}$) from the beginning of time period T4.

The UE shall not send event triggered measurement reports, as long as the reporting criteria are not fulfilled.

The UE shall be scheduled on PCell continuously throughout the test. From the start of T1 until the measurement report is received during T2, at least 99.5% of all expected ACK/NACKs shall be transmitted by the UE.

The UE shall be scheduled on Cell2 continuously from the beginning of T4 to the end. From the start of T4 until the measurement report is received during T4, at least 99.5% of all expected ACK/NACKs shall be transmitted by the UE.

For a test to be considered successful requirements on both event detection and percentage of transmitted ACK/NACKs have to be fulfilled simultaneously.

The rate of correct events observed during repeated tests shall be at least 90%.

NOTE: The actual overall delays measured in the test may be up to $2 \times \text{TTI}_{\text{DCCH}}$ higher than the measurement reporting delays above because of TTI insertion uncertainty of the measurement report in DCCH.

A.8.16.81 E-UTRAN PCell in FDD FDD-TDD 5 DL CA Event Triggered Reporting on Deactivated SCell with PCell and SCell Interruptions in Non-DRX

A.8.16.81.1 Test Purpose and Environment

The purpose of this test is to verify that the UE correctly detects event A6 (Neighbour becomes better than SCell) defined in TS 36.331 [2] within the requirements stated in clause 8.3.3.2.1 while at the same time fulfilling the requirement on interruption rate.

The test parameters are given in Table A.8.16.81.1-1, A.8.16.81.1-2 and A.8.16.81.1-3 below. In the test there are five cells: Cell 1, Cell 2, Cell 3, Cell 4, Cell 5 and Cell 6. Cell 1 is PCell on the FDD primary component (RF Channel 1), Cell 2 is SCell on the TDD secondary component (RF Channel 2), Cell 3 is SCell on the TDD secondary component (RF Channel 3), Cell 4 is SCell on the TDD secondary component (RF Channel 4), Cell 5 is SCell on the TDD secondary component (RF Channel 5) and Cell 6 is the neighbour cell on the TDD secondary component (RF Channel 4). It is indicated to the UE in the measurement control information that event-triggered reporting with Event A6 is used. The test consists of four successive time periods, with duration of T1, T2, T3 and T4, respectively. During T1 and T2, Cell2, Cell3, Cell4 and Cell5 are deactivated. During T1 the UE shall not have any information of Cell 6. Immediately at beginning of T2 the transmission power of Cell 6 is increased to same level as for Cell 5, and due to usage of an offset this shall result in reporting of Event A6.

At the beginning of T3, the transmission power of Cell 6 is turned off, and the test equipment sends a MAC message for activation of Cell 2 to UE but Cell 3, Cell 4 and Cell5 remains deactivated. Immediately at beginning of T4 the transmission power of Cell 6 is increased to same level as for Cell 5, and due to usage of an offset this shall result in reporting of Event A6. The UE shall be continuously scheduled in the PCell throughout the whole test and continuously scheduled in Cell2 during T4.

Table A.8.16.81.1-1: General test parameters for E-UTRAN PCell in FDD FDD-TDD 5 DL CA Event Triggered Reporting on Deactivated SCell with PCell and SCell Interruptions in Non-DRX

Parameter	Unit	Value	Comment
E-UTRA RF Channel Number		1, 2, 3, 4, 5	Four radio channels are used for this test
Active PCell		Cell 1	Primary cell on RF channel number 1.
Configured deactivated SCell		Cell 2	Configured deactivated secondary cell on RF channel number 2.

Configured deactivated SCell			Cell 3	Configured deactivated secondary cell on RF channel number 3.
Configured deactivated SCell			Cell 4	Configured deactivated secondary cell on RF channel number 4.
Configured deactivated SCell			Cell 5	Configured deactivated secondary cell on RF channel number 5.
Neighbour cell			Cell 6	Neighbor cell to be identified on RF channel number 5.
CP length			Normal	
Special subframe configuration			6	As specified in table 4.2-1 in TS 36.211. The same configuration in TDD cells
Uplink-downlink configuration			1	As specified in table 4.2-2 in TS 36.211. The same configuration in TDD cells
DRX			OFF	Continuous monitoring of primary cell
A6	Hysteresis	dB	0	Hysteresis for evaluation of event A6.
	Offset	dB	-3	Offset parameter for evaluation of event A6. Needs to take relative accuracy tolerance in clause 9.1.11.2 into account plus margin.
	Report on leave		False	
	Time To Trigger	s	0	
Cell-individual offset for cells on RF channel number 1		dB	0	Individual offset for cells on primary component carrier.
Cell-individual offset for cells on RF channel number 2		dB	0	Individual offset for cells on secondary component carrier.
Cell-individual offset for cells on RF channel number 3		dB	0	Individual offset for cells on secondary component carrier.
Cell-individual offset for cells on RF channel number 4		dB	0	Individual offset for cells on secondary component carrier.
Cell-individual offset for cells on RF channel number 5		dB	0	Individual offset for cells on secondary component carrier.
Filter coefficient			0	L3 filtering is not used
SCell measurement cycle		ms	640	
T1		s	4	During this time the UE shall be aware of cells 1, 2, 3, 4 and 5 but not cell 6.
T2		s	≤15	UE should report Event A6 within 12.8s (20×sCellMeasCycle)
T3		s	4	During this time the UE shall activate cell 2
T4		s	≤4	UE should report Event A6 within 3.2s (5×sCellMeasCycle)

Table A.8.16.81.1-2: Cell specific test parameters for E-UTRAN PCell in FDD FDD-TDD 5 DL CA Event Triggered Reporting on Deactivated SCell with PCell and SCell Interruptions in Non-DRX (Cell #1, Cell #2, Cell #3, Cell #4)

Parameter	Unit	Cell 1				Cell 2				Cell 3				Cell 4			
		T1	T2	T3	T4	T1	T2	T3	T4	T1	T2	T3	T4	T1	T2	T3	T4
E-UTRA RF Channel Number		1				2				3				4			
BW _{channel}		5MHz: N _{RB,c} = 25 10MHz: N _{RB,c} = 50 20MHz: N _{RB,c} = 100				5MHz: N _{RB,c} = 25 10MHz: N _{RB,c} = 50 20MHz: N _{RB,c} = 100				5MHz: N _{RB,c} = 25 10MHz: N _{RB,c} = 50 20MHz: N _{RB,c} = 100				5MHz: N _{RB,c} = 25 10MHz: N _{RB,c} = 50 20MHz: N _{RB,c} = 100			
PDSCH parameters: DL Reference Measurement Channel		5MHz: R.7 FDD 10MHz: R.3 FDD 20MHz: R.6 FDD				N/A	N/A	N/A	5MHz: R.4 TDD 10MHz: R.0 TDD 20MHz: R.3 TDD	N/A				N/A			
PCFICH/PDCCH/PHICH parameters		5MHz: R.11 FDD 10MHz: R.6 FDD 20MHz: R.10 FDD				5MHz: R.11 TDD 10MHz: R.6 TDD 20MHz: R.10 TDD				5MHz: R.11 TDD 10MHz: R.6 TDD 20MHz: R.10 TDD				5MHz: R.11 TDD 10MHz: R.6 TDD 20MHz: R.10 TDD			
OCNG Pattern defined in A.3.2.1		5MHz: OP.20 FDD 10MHz: OP.10 FDD 20MHz: OP.17 FDD				5MHz: OP.10 TDD 10MHz: OP.10 TDD z: OP.2 TDD 20MHz: OP.8 TDD	5MHz: OP.10 TDD 10MHz: OP.10 TDD z: OP.2 TDD 20MHz: OP.8 TDD	5MHz: OP.10 TDD 10MHz: OP.10 TDD z: OP.2 TDD 20MHz: OP.8 TDD	5MHz: OP.9 TDD 10MHz: OP.1 TDD z: OP.7 TDD	5MHz: OP.10 TDD 10MHz: OP.2 TDD 20MHz: OP.8 TDD				5MHz: OP.10 TDD 10MHz: OP.2 TDD 20MHz: OP.8 TDD			
PBCH_RA	dB	0				0				0				0			
PBCH_RB	dB																
PSS_RA	dB																
SSS_RA	dB																
PCFICH_RB	dB																
PHICH_RA	dB																
PHICH_RB	dB																
PDCCH_RA	dB																
PDCCH_RB	dB																
PDSCH_RA	dB																
PDSCH_RB	dB																
OCNG_RA ^{Note 1}	dB																

OCNG_RB ^{Note 1}	dB																
N_{oc} ^{Note 3}	dBm/1 5 kHz	-101				-101				-101				-101			
\hat{E}_s/N_{oc}	dB	16	16	16	16	16	16	16	16	16	16	16	16	16	16	16	16
\hat{E}_s/I_{ot} ^{Note 4}	dB	16	16	16	16	16	16	16	16	16	-0.11	16	-0.11	16	-0.11	16	-0.11
RSRP ^{Note 4}	dBm/1 5 kHz	-85	-85	-85	-85	-85	-85	-85	-85	-85	-85	-85	-85	85	-85	85	-85
SCH_RP ^{Note 4}	dBm/1 5 kHz	-85	-85	-85	-85	-85	-85	-85	-85	-85	-85	-85	-85	85	-85	85	-85
I_o ^{Note 4}	dBm/C h BW	- 57.11 +10log g (N _{RB,c} /50)	- 57.11 +10log g (N _{RB,c} /50)	- 57.11 +10log g (N _{RB,c} /50)	- 57.11 +10log g (N _{RB,c} /50)	-57.11 +10log (N _{RB,c} /50)	-57.11 +10log (N _{RB,c} /50)	-57.11 +10log (N _{RB,c} /50)	-57.11 +10log (N _{RB,c} /50)	- 57.11 +10log g (N _{RB,c} /50)	- 54.15 +10log g (N _{RB,c} /50)	- 57.11 +10log g (N _{RB,c} /50)	- 54.15 +10log g (N _{RB,c} /50)	- 57.11 +10log g (N _{RB,c} /50)	- 54.15 +10log g (N _{RB,c} /50)	- 57.11 +10log g (N _{RB,c} /50)	- 54.15 +10log g (N _{RB,c} /50)
Propagation Condition		AWGN				AWGN				AWGN				AWGN			
Antenna Configuration		1x2				1x2				1x2				1x2			
Timing offset to Cell 1	μs	-				0				0				0			
Time alignment error relative to cell 1 ^{Note 5}	μs	-				≤ TAE				≤ TAE				≤ TAE			
Time alignment error relative to cell 2 ^{Note 5}	μs	-				-				≤ TAE				≤ TAE			
Time alignment error relative to cell 3 ^{Note 5}	μs	-				-				-				≤ TAE			
<p>Note 1: OCNG shall be used such that all cells are fully allocated and a constant total transmitted power spectral density is achieved for all OFDM symbols.</p> <p>Note 2: The resources for uplink transmission are assigned to the UE on cell1 from the start of time period T2 and on cell2 from the start of time period T4.</p> <p>Note 3: Interference from other cells and noise sources not specified in the test is assumed to be constant over subcarriers and time and shall be modelled as AWGN of appropriate power for N_{oc} to be fulfilled.</p> <p>Note 4: E_s/I_{ot}, RSRP, SCH_RP and I_o levels have been derived from other parameters for information purposes. They are not settable parameters themselves.</p> <p>Note 5: Time alignment error (TAE) as specified in TS 36.104 [30] clause 6.5.3.1. The TAE value depends upon the type of carrier aggregation.</p>																	

Table A.8.16.81.1-3: Cell specific test parameters for E-UTRAN PCell in FDD FDD-TDD 5 DL CA Event Triggered Reporting on Deactivated SCell with PCell and SCell Interruptions in Non-DRX (Cell #5, Cell #6)

Parameter	Unit	Cell 5				Cell 6			
		T1	T2	T3	T4	T1	T2	T3	T4
E-UTRA RF Channel Number		5				5			
BW _{channel}		5MHz: N _{RB,c} = 25 10MHz: N _{RB,c} = 50 20MHz: N _{RB,c} = 100				5MHz: N _{RB,c} = 25 10MHz: N _{RB,c} = 50 20MHz: N _{RB,c} = 100			
PDSCH parameters: DL Reference Measurement Channel		N/A				N/A			
PCFICH/PDCCH/PHICH parameters		5MHz: R.11 TDD 10MHz: R.6 TDD 20MHz: R.10 TDD				5MHz: R.11 TDD 10MHz: R.6 TDD 20MHz: R.10 TDD			
OCNG Pattern defined in A.3.2.1		5MHz: OP.10 TDD 10MHz: OP.2 TDD 20MHz: OP.8 TDD				5MHz: OP.10 TDD 10MHz: OP.2 TDD 20MHz: OP.8 TDD			
PBCH_RA	dB	0				0			
PBCH_RB	dB								
PSS_RA	dB								
SSS_RA	dB								
PCFICH_RB	dB								
PHICH_RA	dB								
PHICH_RB	dB								
PDCCH_RA	dB								
PDCCH_RB	dB								
PDSCH_RA	dB								
PDSCH_RB	dB								
OCNG_RA ^{Note 1}	dB								
OCNG_RB ^{Note 1}	dB								
N _{oc} ^{Note 3}	dBm/15 kHz								
\hat{E}_s/N_{oc}	dB	16	16	16	16	-infinity	16	-infinity	16
\hat{E}_s/I_{ot} ^{Note 4}	dB	16	-0.11	16	-0.11	-infinity	-0.11	-infinity	-0.11
RSRP ^{Note 4}	dBm/15 kHz	85	-85	85	-85	-infinity	-85	-infinity	-85
SCH_RP ^{Note 4}	dBm/15 kHz	85	-85	85	-85	-infinity	-85	-infinity	-85
I _o ^{Note 4}	dBm/Ch BW	-57.11 +10log (N _{RB,c} /50)	-54.15 +10log (N _{RB,c} /50)	-57.11 +10log (N _{RB,c} /50)	-54.15 +10log (N _{RB,c} /50)	-57.11 +10log (N _{RB,c} /50)	-54.15 +10log (N _{RB,c} /50)	-57.11 +10log (N _{RB,c} /50)	-54.15 +10log (N _{RB,c} /50)
Propagation Condition		AWGN				AWGN			
Antenna Configuration		1x2				1x2			
Timing offset to Cell 1	μs	0				3			
Time alignment error relative to cell 1 ^{Note 5}	μs	≤ TAE				N/A			
Time alignment error relative to cell 2 ^{Note 5}	μs	≤ TAE				N/A			
Time alignment error relative to cell 3 ^{Note 5}	μs	≤ TAE				N/A			
<p>Note 1: OCNG shall be used such that all cells are fully allocated and a constant total transmitted power spectral density is achieved for all OFDM symbols.</p> <p>Note 2: Void</p> <p>Note 3: Interference from other cells and noise sources not specified in the test is assumed to be constant over subcarriers and time and shall be modelled as AWGN of appropriate power for N_{oc} to be fulfilled.</p> <p>Note 4: Es/I_{ot}, RSRP, SCH_RP and I_o levels have been derived from other parameters for information purposes. They are not settable parameters themselves.</p> <p>Note 5: Time alignment error (TAE) as specified in TS 36.104 [30] clause 6.5.3.1. The TAE value depends upon the type of carrier aggregation.</p>									

A.8.16.81.2 Test Requirements

The UE shall send one Event A6 triggered measurement report, with a measurement reporting delay less than 12.8s ($20 \times \text{scellMeasCycle}$) from the beginning of time period T2.

The UE shall send one Event A6 triggered measurement report, with a measurement reporting delay less than 3.2s ($5 \times \text{scellMeasCycle}$) from the beginning of time period T4.

The UE shall not send event triggered measurement reports, as long as the reporting criteria are not fulfilled.

The UE shall be scheduled on PCell continuously throughout the test. From the start of T1 until the measurement report is received during T2, at least 99.5% of all expected ACK/NACKs shall be transmitted by the UE.

The UE shall be scheduled on Cell2 continuously from the beginning of T4 to the end. From the start of T4 until the measurement report is received during T4, at least 99.5% of all expected ACK/NACKs shall be transmitted by the UE.

For a test to be considered successful requirements on both event detection and percentage of transmitted ACK/NACKs have to be fulfilled simultaneously.

The rate of correct events observed during repeated tests shall be at least 90%.

NOTE: The actual overall delays measured in the test may be up to $2 \times \text{TTI}_{\text{DCCH}}$ higher than the measurement reporting delays above because of TTI insertion uncertainty of the measurement report in DCCH.

A.8.16.82 E-UTRAN PCell in TDD TDD-FDD 5 DL CA Event Triggered Reporting on Deactivated SCell with PCell and SCell Interruptions in Non-DRX

A.8.16.82.1 Test Purpose and Environment

The purpose of this test is to verify that the UE correctly detects event A6 (Neighbour becomes better than SCell) defined in TS 36.331 [2] within the requirements stated in clause 8.3.3.2.1 while at the same time fulfilling the requirement on interruption rate.

The test parameters are given in Table A.8.16.82.1-1, A.8.16.82.1-2 and A.8.16.82.1-3 below. In the test there are five cells: Cell 1, Cell 2, Cell 3, Cell 4, Cell 5 and Cell 6. Cell 1 is PCell on the TDD primary component (RF Channel 1), Cell 2 is SCell on the FDD secondary component (RF Channel 2), Cell 3 is SCell on the FDD secondary component (RF Channel 3), Cell 4 is SCell on the FDD secondary component (RF Channel 4), Cell 5 is SCell on the FDD secondary component (RF Channel 5) and Cell 6 is the neighbour cell on the FDD secondary component (RF Channel 4). It is indicated to the UE in the measurement control information that event-triggered reporting with Event A6 is used. The test consists of four successive time periods, with duration of T1, T2, T3 and T4, respectively. During T1 and T2, Cell2, Cell3, Cell4 and Cell5 are deactivated. During T1 the UE shall not have any information of Cell 6. Immediately at beginning of T2 the transmission power of Cell 6 is increased to same level as for Cell 5, and due to usage of an offset this shall result in reporting of Event A6.

At the beginning of T3, the transmission power of Cell 6 is turned off, and the test equipment sends a MAC message for activation of Cell 2 to UE but Cell3, Cell4 and Cell5 remains deactivated. Immediately at beginning of T4 the transmission power of Cell 6 is increased to same level as for Cell 5, and due to usage of an offset this shall result in reporting of Event A6. The UE shall be continuously scheduled in the PCell throughout the whole test and continuously scheduled in Cell2 during T4.

Table A.8.16.82.1-1: General test parameters for E-UTRAN PCell in TDD TDD-FDD 5 DL CA Event Triggered Reporting on Deactivated SCell with PCell and SCell Interruptions in Non-DRX

Parameter	Unit	Value	Comment
E-UTRA RF Channel Number		1, 2, 3, 4	Four radio channels are used for this test
Active PCell		Cell 1	Primary cell on RF channel number 1.
Configured deactivated SCell		Cell 2	Configured deactivated secondary cell on RF channel number 2.
Configured deactivated SCell		Cell 3	Configured deactivated secondary cell on RF channel number 3.

Configured deactivated SCell		Cell 4	Configured deactivated secondary cell on RF channel number 4.	
Configured deactivated SCell		Cell 5	Configured deactivated secondary cell on RF channel number 5.	
Neighbour cell		Cell 6	Neighbor cell to be identified on RF channel number 5.	
CP length		Normal		
Special subframe configuration		6	As specified in table 4.2-1 in TS 36.211. The same configuration in all cells	
Uplink-downlink configuration		1	As specified in table 4.2-2 in TS 36.211. The same configuration in all cells	
DRX		OFF	Continuous monitoring of primary cell	
A6	Hysteresis	dB	0	Hysteresis for evaluation of event A6.
	Offset	dB	-3	Offset parameter for evaluation of event A6. Needs to take relative accuracy tolerance in clause 9.1.11.2 into account plus margin.
	Report on leave		False	
	Time To Trigger	s	0	
Cell-individual offset for cells on RF channel number 1	dB	0	Individual offset for cells on primary component carrier.	
Cell-individual offset for cells on RF channel number 2	dB	0	Individual offset for cells on secondary component carrier.	
Cell-individual offset for cells on RF channel number 3	dB	0	Individual offset for cells on secondary component carrier.	
Cell-individual offset for cells on RF channel number 4	dB	0	Individual offset for cells on secondary component carrier.	
Cell-individual offset for cells on RF channel number 5	dB	0	Individual offset for cells on secondary component carrier.	
Filter coefficient		0	L3 filtering is not used	
SCell measurement cycle	ms	640		
T1	s	4	During this time the UE shall be aware of cells 1, 2, 3, 4 and 5 but not cell 6.	
T2	s	≤15	UE should report Event A6 within 12.8s (20×sCellMeasCycle)	
T3	s	4	During this time the UE shall activate cell 2	
T4	s	≤4	UE should report Event A6 within 3.2s (5×sCellMeasCycle)	

Table A.8.16.82.1-2: Cell specific test parameters for E-UTRAN PCell in TDD TDD-FDD 5 DL CA Event Triggered Reporting on Deactivated SCell with PCell and SCell Interruptions in Non-DRX (Cell #1, Cell #2, Cell #3, Cell #4)

Parameter	Unit	Cell 1				Cell 2				Cell 3				Cell 4			
		T1	T2	T3	T4	T1	T2	T3	T4	T1	T2	T3	T4	T1	T2	T3	T4
E-UTRA RF Channel Number		1				2				3				4			
BW _{channel}		5MHz: N _{RB,c} = 25 10MHz: N _{RB,c} = 50 20MHz: N _{RB,c} = 100				5MHz: N _{RB,c} = 25 10MHz: N _{RB,c} = 50 20MHz: N _{RB,c} = 100				5MHz: N _{RB,c} = 25 10MHz: N _{RB,c} = 50 20MHz: N _{RB,c} = 100				5MHz: N _{RB,c} = 25 10MHz: N _{RB,c} = 50 20MHz: N _{RB,c} = 100			
PDSCH parameters: DL Reference Measurement Channel		5MHz: R.4 TDD 10MHz: R.0 TDD 20MHz: R.3 TDD				N/A	N/A	N/A	5MHz: R.7 FDD 10MH z: R.3 FDD 20MH z: R.6 FDD	N/A				N/A			
PCFICH/PDCCH/PHICH parameters		5MHz: R.11 TDD 10MHz: R.6 TDD 20MHz: R.10 TDD				5MHz: R.11 FDD 10MHz: R.6 FDD 20MHz: R.10 FDD				5MHz: R.11 FDD 10MHz: R.6 FDD 20MHz: R.10 FDD				5MHz: R.11 FDD 10MHz: R.6 FDD 20MHz: R.10 FDD			
OCNG Pattern defined in A.3.2.1		5MHz: OP.9 TDD 10MHz: OP.1 TDD 20MHz: OP.7 TDD				5MHz: OP.16 FDD 10MH z: OP.2 FDD 20MH z: OP.12 FDD	5MHz: OP.16 FDD 10MH z: OP.2 FDD 20MH z: OP.12 FDD	5MHz: OP.16 FDD 10MH z: OP.2 FDD 20MH z: OP.12 FDD	5MHz: OP.20 FDD 10MH z: OP.10 FDD 20MH z: OP.17 FDD	5MHz: OP.16 FDD 10MHz: OP.2 FDD 20MHz: OP.12 FDD				5MHz: OP.16 FDD 10MHz: OP.2 FDD 20MHz: OP.12 FDD			
PBCH_RA	dB	0				0				0				0			
PBCH_RB	dB																
PSS_RA	dB																
SSS_RA	dB																
PCFICH_RB	dB																
PHICH_RA	dB																
PHICH_RB	dB																
PDCCH_RA	dB																
PDCCH_RB	dB																
PDSCH_RA	dB																
PDSCH_RB	dB																
OCNG_RA ^{Note 1}	dB																

OCNG_RB ^{Note 1}	dB																
N_{oc} ^{Note 3}	dBm/1 5 kHz	-101				-101				-101				-101			
\hat{E}_s/N_{oc}	dB	16	16	16	16	16	16	16	16	16	16	16	16	16	16	16	16
\hat{E}_s/I_{ot} ^{Note 4}	dB	16	16	16	16	16	16	16	16	16	16	16	16	16	16	16	16
RSRP ^{Note 4}	dBm/1 5 kHz	-85	-85	-85	-85	-85	-85	-85	-85	-85	-85	-85	-85	85	-85	85	-85
SCH_RP ^{Note 4}	dBm/1 5 kHz	-85	-85	-85	-85	-85	-85	-85	-85	-85	-85	-85	-85	85	-85	85	-85
I_o ^{Note 4}	dBm/C h BW	- 57.11 +10log g (N _{RB,c} /50)	- 57.11 +10log g (N _{RB,c} /50)	- 57.11 +10log g (N _{RB,c} /50)	- 57.11 +10log g (N _{RB,c} /50)	-57.11 +10log (N _{RB,c} /50)	-57.11 +10log (N _{RB,c} /50)	-57.11 +10log (N _{RB,c} /50)	-57.11 +10log (N _{RB,c} /50)	- 57.11 +10log g (N _{RB,c} /50)	- 57.11 +10log g (N _{RB,c} /50)	- 57.11 +10log g (N _{RB,c} /50)	- 57.11 +10log g (N _{RB,c} /50)	- 57.11 +10log g (N _{RB,c} /50)	- 57.11 +10log g (N _{RB,c} /50)	- 57.11 +10log g (N _{RB,c} /50)	- 57.11 +10log g (N _{RB,c} /50)
Propagation Condition		AWGN				AWGN				AWGN				AWGN			
Antenna Configuration		1x2				1x2				1x2				1x2			
Timing offset to Cell 1	μs	-				0				0				0			
Time alignment error relative to cell 1 ^{Note 5}	μs	-				≤ TAE				≤ TAE				≤ TAE			
Time alignment error relative to cell 2 ^{Note 5}	μs	-				-				≤ TAE				≤ TAE			
Time alignment error relative to cell 3 ^{Note 5}	μs	-				-				-				≤ TAE			
<p>Note 1: OCNG shall be used such that all cells are fully allocated and a constant total transmitted power spectral density is achieved for all OFDM symbols.</p> <p>Note 2: The resources for uplink transmission are assigned to the UE on cell1 from the start of time period T2 and on cell2 from the start of time period T4.</p> <p>Note 3: Interference from other cells and noise sources not specified in the test is assumed to be constant over subcarriers and time and shall be modelled as AWGN of appropriate power for N_{oc} to be fulfilled.</p> <p>Note 4: E_s/I_{ot}, RSRP, SCH_RP and I_o levels have been derived from other parameters for information purposes. They are not settable parameters themselves.</p> <p>Note 5: Time alignment error (TAE) as specified in TS 36.104 [30] clause 6.5.3.1. The TAE value depends upon the type of carrier aggregation.</p>																	

Table A.8.16.82.1-3: Cell specific test parameters for E-UTRAN PCell in TDD TDD-FDD 5 DL CA Event Triggered Reporting on Deactivated SCell with PCell and SCell Interruptions in Non-DRX (Cell #5, Cell #6)

Parameter	Unit	Cell 5				Cell 6			
		T1	T2	T3	T4	T1	T2	T3	T4
E-UTRA RF Channel Number		5				5			
BW _{channel}		5MHz: N _{RB,c} = 25 10MHz: N _{RB,c} = 50 20MHz: N _{RB,c} = 100				5MHz: N _{RB,c} = 25 10MHz: N _{RB,c} = 50 20MHz: N _{RB,c} = 100			
PDSCH parameters: DL Reference Measurement Channel		N/A				N/A			
PCFICH/PDCCH/PHICH parameters		5MHz: R.11 FDD 10MHz: R.6 FDD 20MHz: R.10 FDD				5MHz: R.11 FDD 10MHz: R.6 FDD 20MHz: R.10 FDD			
OCNG Pattern defined in A.3.2.1		5MHz: OP.16 FDD 10MHz: OP.2 FDD 20MHz: OP.12 FDD				5MHz: OP.20 FDD 10MHz: OP.10 FDD 20MHz: OP.17 FDD			
PBCH_RA	dB	0				0			
PBCH_RB	dB								
PSS_RA	dB								
SSS_RA	dB								
PCFICH_RB	dB								
PHICH_RA	dB								
PHICH_RB	dB								
PDCCH_RA	dB								
PDCCH_RB	dB								
PDSCH_RA	dB								
PDSCH_RB	dB								
OCNG_RA ^{Note 1}	dB								
OCNG_RB ^{Note 1}	dB								
N_{oc} ^{Note 3}	dBm/15 kHz								
\hat{E}_s/N_{oc}	dB	16	16	16	16	-infinity	16	-infinity	16
\hat{E}_s/I_{ot} ^{Note 4}	dB	16	-0.11	16	-0.11	-infinity	-0.11	-infinity	-0.11
RSRP ^{Note 4}	dBm/15 kHz	85	-85	85	-85	-infinity	-85	-infinity	-85
SCH_RP ^{Note 4}	dBm/15 kHz	85	-85	85	-85	-infinity	-85	-infinity	-85
I_o ^{Note 4}	dBm/Ch BW	-57.11 +10log (N _{RB,c} /50)	-54.15 +10log (N _{RB,c} /50)	-57.11 +10log (N _{RB,c} /50)	-54.15 +10log (N _{RB,c} /50)	-57.11 +10log (N _{RB,c} /50)	-54.15 +10log (N _{RB,c} /50)	-57.11 +10log (N _{RB,c} /50)	-54.15 +10log (N _{RB,c} /50)
Propagation Condition		AWGN				AWGN			
Antenna Configuration		1x2				1x2			
Timing offset to Cell 1	μs	0				3			
Time alignment error relative to cell 1 ^{Note 5}	μs	≤ TAE				N/A			
Time alignment error relative to cell 2 ^{Note 5}	μs	≤ TAE				N/A			
Time alignment error relative to cell 3 ^{Note 5}	μs	≤ TAE				N/A			
<p>Note 1: OCNG shall be used such that all cells are fully allocated and a constant total transmitted power spectral density is achieved for all OFDM symbols.</p> <p>Note 2: Void</p> <p>Note 3: Interference from other cells and noise sources not specified in the test is assumed to be constant over subcarriers and time and shall be modelled as AWGN of appropriate power for N_{oc} to be fulfilled.</p> <p>Note 4: E_s/I_{ot}, RSRP, SCH_RP and I_o levels have been derived from other parameters for information purposes. They are not settable parameters themselves.</p> <p>Note 5: Time alignment error (TAE) as specified in TS 36.104 [30] clause 6.5.3.1. The TAE value depends upon the type of carrier aggregation.</p>									

A.8.16.82.2 Test Requirements

The UE shall send one Event A6 triggered measurement report, with a measurement reporting delay less than 12.8s ($20 \times \text{scellMeasCycle}$) from the beginning of time period T2.

The UE shall send one Event A6 triggered measurement report, with a measurement reporting delay less than 3.2s ($5 \times \text{scellMeasCycle}$) from the beginning of time period T4.

The UE shall not send event triggered measurement reports, as long as the reporting criteria are not fulfilled.

The UE shall be scheduled on PCell continuously throughout the test. From the start of T1 until the measurement report is received during T2, at least 99.5% of all expected ACK/NACKs shall be transmitted by the UE.

The UE shall be scheduled on Cell2 continuously from the beginning of T4 to the end. From the start of T4 until the measurement report is received during T4, at least 99.5% of all expected ACK/NACKs shall be transmitted by the UE.

For a test to be considered successful requirements on both event detection and percentage of transmitted ACK/NACKs have to be fulfilled simultaneously.

The rate of correct events observed during repeated tests shall be at least 90%.

NOTE: The actual overall delays measured in the test may be up to $2 \times \text{TTI}_{\text{DCCH}}$ higher than the measurement reporting delays above because of TTI insertion uncertainty of the measurement report in DCCH.

A.8.16.83 3 DL CA Event Triggered Reporting under Deactivated SCells in Non-DRX with generic duplex modes

A.8.16.83.1 Test Purpose and Environment

The purpose of this test is to verify that the UE correctly detects events A1 (Serving cell becomes better than threshold), A2 (Serving cell becomes worse than threshold) and A6 (Neighbour becomes better than SCell) defined in TS 36.331 [2] within the requirements stated in clause 8.3.3.2.1.

Note on the applicability: the requirement tested in the specific duplex-mode test cases A.8.16.27, A.8.16.28, A.8.16.29 and A.8.16.30 does not need to be tested in the generic duplex-mode test case A.8.16.83.

The test parameters are given in Tables A.8.16.83.1-1 and A.8.16.83.1-2 below. It is indicated to the UE in the measurement control information that event-triggered reporting with Events A1 (for only SCell1 i.e. cell2), A2 (PCell and SCells) and A6 is used. The test consists of three successive time periods, with duration of T1, T2 and T3, respectively. During T1 the UE shall not have any information on cell 4. At the beginning of T2 the transmission power of cell 4 is increased to the same level as for cell 3, and due to usage of an offset this shall result in reporting of Event A6. Also, at the beginning of T2 the transmission power of cell 2 is increased to the same level as for cell 1, which shall result in reporting of Event A1. At the beginning of T3 the transmission powers of cells 1, 2, 3 and 4 are reduced below a threshold value and this shall result in reporting of Event A2 for Cell 1, for Cell 2 and for Cell 3. Cells 1, 2, 3 and 4 may operate in either FDD or TDD duplex mode according to test configuration.

Table A.8.16.83.1-1: General test parameters for E-UTRAN generic duplex mode 3 DL CA event triggered reporting under fading propagation conditions with 2 configured but deactivated SCells in non-DRX

Parameter	Unit	Value	Comment	
E-UTRA RF Channel Number		1, 2, 3	Three radio channels are used for this test	
Active PCell		Cell 1	Primary cell on RF channel number 1.	
Configured deactivated SCell		Cell 2	Configured deactivated secondary cell on RF channel number 2.	
Configured deactivated SCell		Cell 3	Configured deactivated secondary cell on RF channel number 3.	
Neighbour cell		Cell 4	Neighbour cell to be identified on RF channel number 3.	
CP length		Normal		
DRX		OFF	Continuous monitoring of primary cell	
Special subframe configuration		6	As specified in table 4.2-1 in TS 36.211. The same configuration applies to any TDD cells (cell1, cell2, cell3 and cell4 may be configured for FDD or TDD operation).	
Uplink-downlink configuration		1	As specified in table 4.2-2 in TS 36.211. The same configuration applies to any TDD cells (cell1, cell2, cell3 and cell4 may be configured for FDD or TDD operation).	
A1	Hysteresis	dB	0	Hysteresis for evaluation of event A1.

	Threshold RSRP	dBm	-98	Actual RSRP threshold for event A1. Needs to take absolute accuracy tolerance in section 9.1.11.1 into account plus margin.
	Time To Trigger	s	0	
A2	Hysteresis	dB	0	Hysteresis for evaluation of event A2.
	Threshold RSRP	dBm	-98	Actual RSRP threshold for event A2. Needs to take absolute accuracy tolerance in section 9.1.11.1 into account plus margin.
	Time To Trigger	s	0	
A6	Hysteresis	dB	0	Hysteresis for evaluation of event A6.
	Offset	dB	-6	Offset parameter for evaluation of event A6. Needs to take relative accuracy tolerance in section 9.1.11.2 into account plus margin.
	Report on leave		False	
	Time To Trigger	s	0	
Cell-individual offset for cells on RF channel number 1		dB	0	Individual offset for cells on primary component carrier.
Cell-individual offset for cells on RF channel number 2		dB	0	Individual offset for cells on secondary component carrier.
Cell-individual offset for cells on RF channel number 3		dB	0	Individual offset for cells on secondary component carrier.
Filter coefficient			0	L3 filtering is not used
SCell measurement cycle (measCycleSCell)		ms	320	
T1		s	5	During this time the cell1 and cell3 shall be known to the UE; but cell2 and cell 4 shall be unknown to the UE.
T2		s	≤12	UE should report Event A1 for cell2 and event A6 for cell4 within 6.4s (20×scellMeasCycle)
T3		s	5	UE should report Event A2 within 200 ms. 1.6s, and 1.6s for cells 1, 2 and 3, respectively.

Table A.8.16.83.1-2: Cell specific test parameters for E-UTRAN generic duplex modes 3 DL CA event triggered reporting under fading propagation conditions with 2 configured but deactivated SCells in non-DRX

Parameter	Unit	Cell 1			Cell 2			Cell 3			Cell 4		
		T1	T2	T3	T1	T2	T3	T1	T2	T3	T1	T2	T3
E-UTRA RF Channel Number		1			2			3					
Duplex mode		FDD or TDD			FDD or TDD			FDD or TDD					
BW _{channel}		5MHz: N _{RB,c} = 25 10MHz: N _{RB,c} = 50 20MHz: N _{RB,c} = 100			5MHz: N _{RB,c} = 25 10MHz: N _{RB,c} = 50 20MHz: N _{RB,c} = 100			5MHz: N _{RB,c} = 25 10MHz: N _{RB,c} = 50 20MHz: N _{RB,c} = 100					
PDSCH parameters: DL Reference Measurement Channel		5MHz: R.5 FDD 10MHz: R.0 FDD 20MHz: R.4 FDD 5MHz: R.4 TDD 10MHz: R.0 TDD 20MHz: R.3 TDD			-			-			-		
PCFICH/PDCCH/PHI CH parameters: DL Reference Measurement Channel		5MHz: R.11 FDD 10MHz: R.6 FDD 20MHz: R.10 FDD 5MHz: R.11 TDD 10MHz: R.6 TDD 20MHz: R.10 TDD			5MHz FDD: R.11 FDD 10MHz FDD: R.6 FDD 20MHz FDD: R.10 FDD 5MHz TDD: R.11 TDD 10MHz TDD: R.6 TDD 20MHz TDD: R.10 TDD			5MHz FDD: R.11 FDD 10MHz FDD: R.6 FDD 20MHz FDD: R.10 FDD 5MHz TDD: R.11 TDD 10MHz TDD: R.6 TDD 20MHz TDD: R.10 TDD			5MHz FDD: R.11 FDD 10MHz FDD: R.6 FDD 20MHz FDD: R.10 FDD 5MHz TDD: R.11 TDD 10MHz TDD: R.6 TDD 20MHz TDD: R.10 TDD		
OCNG Patterns		5MHz: OP.15 FDD 10MHz: OP.1 FDD 20MHz: OP.11 FDD 5MHz: OP.9 TDD 10MHz: OP.1 TDD 20MHz: OP.7 TDD			5MHz FDD: OP.16 FDD 10MHz FDD: OP.2 FDD 20MHz FDD: OP.12 FDD 5MHz TDD: OP.10 TDD 10MHz TDD: OP.2 TDD 20MHz TDD: OP.8 TDD			5MHz FDD: OP.16 FDD 10MHz FDD: OP.2 FDD 20MHz FDD: OP.12 FDD 5MHz TDD: OP.10 TDD 10MHz TDD: OP.2 TDD 20MHz TDD: OP.8 TDD			5MHz FDD: OP.16 FDD 10MHz FDD: OP.2 FDD 20MHz FDD: OP.12 FDD 5MHz TDD: OP.10 TDD 10MHz TDD: OP.2 TDD 20MHz TDD: OP.8 TDD		
PBCH_RA	dB	0			0			0			0		
PBCH_RB	dB												
PSS_RA	dB												
SSS_RA	dB												
PCFICH_RB	dB												
PHICH_RA	dB												
PHICH_RB	dB												
PDCCH_RA	dB												
PDCCH_RB	dB												
PDSCH_RA	dB												
PDSCH_RB	dB												
OCNG_RA ^{Note 1}	dB												
OCNG_RB ^{Note 1}	dB												
N _{oc} ^{Note 2}	dBm/15 KHz												

\bar{E}_s/N_{oc}	dB	17	17	-3	-infinity	17	-3	17	17	-3	-infinity	17	-3
\bar{E}_s/I_{ot} ^{Note 3}	dB	17	17	-3	-infinity	17	-3	17	-0.09	-4.76	-infinity	-0.09	-4.76
RSRP ^{Note 3}	dBm/15 kHz	-87	-87	-107	-infinity	-87	-107	-87	-87	-107	-infinity	-87	-107
SCH_RP ^{Note 3}	dBm/15 kHz	-87	-87	-107	-infinity	-87	-107	-87	-87	-107	-infinity	-87	-107
I_o ^{Note 3}	dBm/Ch BW	-59.13 +10log ($N_{RB,c}$ /50)	-59.13 +10log ($N_{RB,c}$ /50)	-74.45 +10log ($N_{RB,c}$ /50)	-76.22 +10log ($N_{RB,c}$ /50)	-59.13 +10log ($N_{RB,c}$ /50)	-74.45 +10log ($N_{RB,c}$ /50)	-59.13 +10log ($N_{RB,c}$ /50)	-56.17 +10log ($N_{RB,c}$ /50)	-73.20 +10log ($N_{RB,c}$ /50)	Specified in columns for Cell 3		
Propagation Condition		AWGN			ETU70			ETU70			ETU70		
Correlation Matrix and Antenna Configuration		1x2			1x2 Low			1x2 Low			1x2 Low		
Timing offset to Cell 1	μ s	-			0			0			3		
Time alignment error relative to cell 1 ^{Note 5}	μ s	-			\leq TAE			\leq TAE			N/A		
Time alignment error relative to cell 2 ^{Note 5}	μ s	-			-			\leq TAE			N/A		
<p>Note 1: OCNG shall be used such that all cells are fully allocated and a constant total transmitted power spectral density is achieved for all OFDM symbols.</p> <p>Note 2: Interference from other cells and noise sources not specified in the test is assumed to be constant over subcarriers and time and shall be modelled as AWGN of appropriate power for N_{oc} to be fulfilled.</p> <p>Note 3: \bar{E}_s/I_{ot}, RSRP, SCH_RP and I_o have been derived from other parameters for information purposes. They are not settable parameters themselves.</p> <p>Note 4: The resources for uplink transmission are assigned to the UE prior to the start of time period T2.</p> <p>Note 5: Time alignment error (TAE) as specified in TS 36.104 [30] clause 6.5.3.1. The TAE value depends upon the type of carrier aggregation.</p>													

A.8.16.83.2 Test Requirements

The UE shall send one Event A6 triggered measurement report for cell 4 with a measurement reporting delay of less than 6.4s ($20 \times \text{measCycleSCell}$) from the beginning of time T2.

The UE shall send one Event A1 triggered measurement report for Cell 2 with a measurement reporting delay of less than 6.4s ($20 \times \text{measCycleSCell}$) from beginning of time T2.

The UE shall send one Event A2 triggered measurement report for Cell 1 with a measurement reporting delay of less than 200 ms from beginning of time T3.

The UE shall send one Event A2 triggered measurement report for Cell 2 with a measurement reporting delay of less than 1.6s ($5 \times \text{measCycleSCell}$) from beginning of time T3.

The UE shall send one Event A2 triggered measurement report for Cell 3 with a measurement reporting delay of less than 1.6s ($5 \times \text{measCycleSCell}$) from beginning of time T3.

The UE shall not send event triggered measurement reports as long as the reporting criteria are not fulfilled.

The rate of correct events observed during repeated tests shall be at least 90% for each of the events.

NOTE: The actual overall delays measured in the tests may be up to $2 \times \text{TTI}_{\text{DCCH}}$ higher than the measurement reporting delays above because of TTI insertion uncertainty of the measurement report in DCCH.

A.8.16.84 3 DL CA Event Triggered Reporting on Deactivated SCell with PCell and SCell Interruptions in Non-DRX with generic duplex modes

A.8.16.84.1 Test Purpose and Environment

The purpose of this test is to verify that the UE correctly detects event A6 (Neighbour becomes better than SCell) defined in TS 36.331 [2] within the requirements stated in clause 8.3.3.2.1 while at the same time fulfilling the requirement on interruption rate.

Note on the applicability: the requirement tested in the specific duplex-mode test cases A.8.16.31, A.8.16.32, A.8.16.33 and A.8.16.34 does not need to be tested in the generic duplex-mode test case A.8.16.84.

The test parameters are given in Table A.8.16.84.1-1 and A.8.16.84.1-2 below. In the test there are four cells: Cell 1, Cell 2, Cell 3 and Cell 4. Cell 1 is PCell on the primary component (RF Channel 1), Cell 2 is SCell on the secondary component (RF Channel 2), and Cell 3 is SCell on the secondary component (RF Channel 3) and Cell 4 is the neighbour cell on the secondary component (RF Channel 3). It is indicated to the UE in the measurement control information that event-triggered reporting with Event A6 is used. The test consists of four successive time periods, with duration of T1, T2, T3 and T4, respectively. During T1 and T2, both Cell2 and Cell3 are deactivated. During T1 the UE shall not have any information of cell 4. Immediately at beginning of T2 the transmission power of cell 4 is increased to same level as for cell 3, and due to usage of an offset this shall result in reporting of Event A6.

At the beginning of T3, the transmission power of Cell 4 is turned off and the test equipment sends a MAC message for activation of Cell 2 to UE but Cell3 remains deactivated. Immediately at beginning of T4 the transmission power of cell 4 is increased to same level as for cell 3, and due to usage of an offset this shall result in reporting of Event A6. The UE shall be continuously scheduled in the PCell throughout the whole test and continuously scheduled in Cell 2 during T4. Cells 1, 2, 3 and 4 may operate in either FDD or TDD duplex mode according to test configuration.

Table A.8.16.84.1-1: General test parameters for E-UTRAN 3 DL CA Event Triggered Reporting on Deactivated SCell with PCell and SCell Interruptions in Non-DRX and with PCell with generic duplex modes

Parameter	Unit	Value	Comment
E-UTRA RF Channel Number		1, 2, 3	three radio channels are used for this test
Active PCell		Cell 1	Primary cell on RF channel number 1.
Configured deactivated SCell		Cell 2	Configured deactivated secondary cell on RF channel number 2.
Configured deactivated SCell		Cell 3	Configured deactivated secondary cell on RF channel number 3.

Neighbour cell			Cell 4	Neighbor cell to be identified on RF channel number 3.
CP length			Normal	
Special subframe configuration			6	As specified in table 4.2-1 in TS 36.211. The same configuration applies to any TDD cells (cell1, cell2, cell3 and cell4 may be configured for FDD or TDD operation).
Uplink-downlink configuration			1	As specified in table 4.2-2 in TS 36.211. The same configuration applies to any TDD cells (cell1, cell2, cell3 and cell4 may be configured for FDD or TDD operation).
DRX			OFF	Continuous monitoring of primary cell
A6	Hysteresis	dB	0	Hysteresis for evaluation of event A6.
	Offset	dB	-3	Offset parameter for evaluation of event A6. Needs to take relative accuracy tolerance in clause 9.1.11.2 into account plus margin.
	Report on leave		False	
	Time To Trigger	s	0	
Cell-individual offset for cells on RF channel number 1		dB	0	Individual offset for cells on primary component carrier.
Cell-individual offset for cells on RF channel number 2		dB	0	Individual offset for cells on secondary component carrier.
Cell-individual offset for cells on RF channel number 3		dB	0	Individual offset for cells on secondary component carrier.
Filter coefficient			0	L3 filtering is not used
SCell measurement cycle		ms	640	
T1		s	4	During this time the UE shall be aware of cells 1, 2 and 3 but not cell 4.
T2		s	≤15	UE should report Event A6 within 12.8s (20xscellMeasCycle)
T3		s	4	During this time the UE shall activate cell 2
T4		s	≤4	UE should report Event A6 within 3.2s (5xscellMeasCycle)

Table A.8.16.84.1-2: Cell specific test parameters for E-UTRAN 3 DL CA Event Triggered Reporting on Deactivated SCell with PCell and SCell Interruptions in Non-DRX with generic duplex modes

Parameter	Unit	Cell 1				Cell 2				Cell 3				Cell 4			
		T1	T2	T3	T4	T1	T2	T3	T4	T1	T2	T3	T4	T1	T2	T3	T4
E-UTRA RF Channel Number		1				2				3				3			
BW _{channel}	MHz	5MHz: N _{RB,c} = 25 10MHz: N _{RB,c} = 50 20MHz: N _{RB,c} = 100				5MHz: N _{RB,c} = 25 10MHz: N _{RB,c} = 50 20MHz: N _{RB,c} = 100				5MHz: N _{RB,c} = 25 10MHz: N _{RB,c} = 50 20MHz: N _{RB,c} = 100				5MHz: N _{RB,c} = 25 10MHz: N _{RB,c} = 50 20MHz: N _{RB,c} = 100			
PDSCH parameters: DL Reference Measurement Channel		5MHz: R.7 FDD 10MHz: R.3 FDD 20MHz: R.6 FDD 5MHz: R.4 TDD 10MHz: R.0 TDD 20MHz: R.3 TDD				N/A	N/A	N/A	5MHz: R.7 FDD 10MHz: R.3 FDD 20MHz: R.6 FDD 5MHz: R.4 TDD 10MHz: R.0 TDD 20MHz: R.3 TDD	N/A				N/A			
PCFICH/PDCCH/PHICH parameters: DL Reference Measurement Channel		5MHz: R.11 FDD 10MHz: R.6 FDD 20MHz: R.10 FDD 5MHz: R.11 TDD 10MHz: R.6 TDD 20MHz: R.10 TDD				5MHz: R.11 FDD 10MHz: R.6 FDD 20MHz: R.10 FDD 5MHz: R.11 TDD 10MHz: R.6 TDD 20MHz: R.10 TDD				5MHz: R.11 FDD 10MHz: R.6 FDD 20MHz: R.10 FDD 5MHz: R.11 TDD 10MHz: R.6 TDD 20MHz: R.10 TDD				5MHz: R.11 FDD 10MHz: R.6 FDD 20MHz: R.10 FDD 5MHz: R.11 TDD 10MHz: R.6 TDD 20MHz: R.10 TDD			
OCNG Pattern defined in A.3.2.1 and A.3.2.2		5MHz: OP.20 FDD 10MHz: OP.10 FDD 20MHz: OP.17 FDD 5MHz: OP.9 TDD 10MHz: OP.1 TDD 20MHz: OP. 7 TDD				5MHz: OP.19FD D; 10MHz:OP.6 FDD; 20MHz: OP.14FD D 5MHz: OP.10 TDD 10MHz: OP.2 TDD	5MHz: OP.19FD D; 10MHz:OP.6 FDD; 20MHz: OP.14FD D 5MHz: OP.10 TDD 10MHz: OP.2 TDD	5MHz: OP.19FD D; 10MHz:OP.6 FDD; 20MHz: OP.14FD D 5MHz: OP.10 TDD 10MHz: OP.2 TDD	5MHz: OP.20 FDD; 10MHz:OP.10 FDD; 20MHz: OP.17 FDD 5MHz: OP.9 TDD; 10MHz: OP.1 TDD 20MHz: OP.17 FDD	5MHz: OP.16FDD; 10MHz:OP.2 FDD; 20MHz: OP.12FDD 5MHz: OP.10 TDD 10MHz: OP.2 TDD 20MHz: OP.8 TDD	5MHz: OP.16FDD; 10MHz:OP.2 FDD; 20MHz: OP.12FDD 5MHz: OP.10 TDD 10MHz: OP.2 TDD 20MHz: OP.8 TDD						

						20MHz: OP.8 TDD	20MHz: OP.8 TDD	20MHz: OP.8 TDD									
PBCH_RA	dB	0				0				0				0			
PBCH_RB	dB																
PSS_RA	dB																
SSS_RA	dB																
PCFICH_RB	dB																
PHICH_RA	dB																
PHICH_RB	dB																
PDCCH_RA	dB																
PDCCH_RB	dB																
PDSCH_RA	dB																
PDSCH_RB	dB																
OCNG_RA ^{Note 1}	dB																
OCNG_RB ^{Note 1}	dB																
N_{oc} ^{Note 3}	dBm/ 15 kHz	-101				-101				-101							
\hat{E}_s/N_{oc}	dB	16	16	16	16	16	16	16	16	16	16	16	16	- Infini ty	16	- Infini ty	16
\hat{E}_s/I_{ot} ^{Note 4}	dB	16	16	16	16	16	16	16	16	16	-0.11	16	-0.11	- Infini ty	-0.11	- Infini ty	-0.11
RSRP ^{Note 4}	dBm/ 15 kHz	-85	-85	-85	-85	-85	-85	-85	-85	-85	-85	-85	-85	- Infini ty	-85	- Infini ty	-85
SCH_RP ^{Note 4}	dBm/ 15 kHz	-85	-85	-85	-85	-85	-85	-85	-85	-85	-85	-85	-85	- Infini ty	-85	- Infini ty	-85
I_o ^{Note 4}	dBm/ Ch BW	- 57.1 1 +10l og (N _{RB,c} /50)	-57.11 +10log (N _{RB,c} /50)	- 57.1 1 +10l og (N _{RB,c} /50)	- 57.1 1 +10l og (N _{RB,c} /50)	-57.11 +10log (N _{RB,c} /50)	-57.11 +10log (N _{RB,c} /50)	-57.11 +10log (N _{RB,c} /50)	-57.11 +10log (N _{RB,c} /50)	- 57.1 1 +10l og (N _{RB,c} /50)	- 54.1 5 +10l og (N _{RB,c} /50)	- 57.1 1 +10l og (N _{RB,c} /50)	- 54.1 5 +10l og (N _{RB,c} /50)	- 57.1 1 +10l og (N _{RB,c} /50)	- 54.1 5 +10l og (N _{RB,c} /50)	- 57.1 1 +10l og (N _{RB,c} /50)	- 54.1 5 +10l og (N _{RB,c} /50)
Propagation Condition		AWGN				AWGN				AWGN				AWGN			
Antenna Configuration		1x2				1x2				1x2				1x2			

Timing offset to Cell 1	μs	-	0	0	3
Time alignment error relative to cell 1 <small>Note 5</small>	μs	-	$\leq \text{TAE}$	$\leq \text{TAE}$	N/A
Time alignment error relative to cell 2 <small>Note 5</small>	μs	-	-	$\leq \text{TAE}$	N/A
<p>Note 1: OCNG shall be used such that all cells are fully allocated and a constant total transmitted power spectral density is achieved for all OFDM symbols.</p> <p>Note 2: The resources for uplink transmission are assigned to the UE on cell1 prior to the start of time period T2 and on cell2 prior to the start of time period T4.</p> <p>Note 3: Interference from other cells and noise sources not specified in the test is assumed to be constant over subcarriers and time and shall be modelled as AWGN of appropriate power for N_{oc} to be fulfilled.</p> <p>Note 4: E_s/lot, RSRP, SCH_RP and I_o levels have been derived from other parameters for information purposes. They are not settable parameters themselves.</p> <p>Note 5: Time alignment error (TAE) as specified in TS 36.104 [30] clause 6.5.3.1. The TAE value depends upon the type of carrier aggregation.</p>					

A.8.16.84.2 Test Requirements

The UE shall send one Event A6 triggered measurement report, with a measurement reporting delay less than 12.8s ($20 \times \text{scellMeasCycle}$) from the beginning of time period T2.

The UE shall send one Event A6 triggered measurement report, with a measurement reporting delay less than 3.2s ($5 \times \text{scellMeasCycle}$) from the beginning of time period T4.

The UE shall not send event triggered measurement reports, as long as the reporting criteria are not fulfilled.

The UE shall be scheduled on PCell continuously throughout the test. From the start of T1 until the measurement report is received during T2, at least 99.5% of all expected ACK/NACKs shall be transmitted by the UE.

The UE shall be scheduled on Cell2 continuously from the start of T4 to the end. From the start of T4 until the measurement report is received during T4, at least 99.5% of all expected ACK/NACKs shall be transmitted by the UE.

For a test to be considered successful requirements on both event detection and percentage of transmitted ACK/NACKs have to be fulfilled simultaneously.

The rate of correct events observed during repeated tests shall be at least 90%.

NOTE: The actual overall delays measured in the test may be up to $2 \times \text{TTI}_{\text{DCCCH}}$ higher than the measurement reporting delays above because of TTI insertion uncertainty of the measurement report in DCCCH.

A.8.16.85 3 DL CA Activation and Deactivation of Known SCell in Non-DRX with generic duplex modes

A.8.16.85.1 Test Purpose and Environment

The purpose of this test is to verify that the SCell activation and deactivation times are within the requirements stated in section 7.7 for UE configured with two downlink SCells, when the SCell is known by the UE at the time of activation.

Note on the applicability: the requirement tested in the specific duplex-mode test cases A.8.16.35, A.8.16.36, A.8.16.37, A.8.16.38, does not need to be tested in the generic duplex-mode test case A.8.16.85.

The test parameters are given in Tables A.8.16.85.1-1 and cell-specific parameters in A.8.16.85.1-2 below. The test consists of three successive time periods, with duration of T1, T2 and T3, respectively. There are three carriers, each with one cell. Cell 1, Cell 2 and Cell 3 may operate in either FDD or TDD duplex mode according to test configuration. All cells have constant signal levels throughout the test. Before the test starts the UE is connected to Cell 1 (PCell) on radio channel 1 (PCC) and deactivated Cell 3 (SCell2) on radio channel 3 (SCC2) but is not aware of Cell 2 (SCell1) on radio channel 2 (SCC1). The UE is only monitoring the PCC and SCC2. The UE shall be continuously scheduled in the PCell throughout the whole test.

At the beginning of T1 the UE receives an RRC message by which the SCell1 (Cell 2) becomes configured on radio channel 2 (SCC1). The UE now starts monitoring also the SCC1. The test equipment sends a MAC message for activation of the SCell1.

The point in time at which the MAC message is received at the UE antenna connector, in a subframe # denoted m , where m is an even number for FDD PCell and 4 or 9 for TDD PCell, defines the start of time period T2. The UE receives the SCell2 activation command in the subframe ($m+10$) for FDD PCell and ($m+15$) for TDD PCell during activation of the SCell1. The UE shall be able to report valid CSI for the activated SCell1 at latest in a subframe ($m+29$). The UE shall start reporting CSI for SCell1 in subframe ($m+8$) and shall report CQI index 0 (out-of-range) until the SCell activation has been completed. Any PCell interruption due to activation of SCells shall occur in subframes ($m+5$) to ($m+9$) and ($m+15$) to ($m+19$) for FDD PCell and ($m+5$) to ($m+11$) and ($m+20$) to ($m+26$) for TDD PCell.

Time period T3 starts when a MAC message for deactivation of SCell1, sent from the test equipment to the UE in a subframe # denoted n , where n is an even number for FDD PCell and 4 or 9 for TDD PCell, is received at the UE antenna connector. The test equipment sends a MAC message for deactivation of the SCell2 in subframe ($n+10$) for FDD PCell and ($n+15$) for TDD PCell. The UE shall carry out deactivation of the SCell1 at latest in subframe ($n+8$), and any PCell interruption due to the deactivation of SCells shall occur in the subframes ($n+5$) to ($n+9$) and ($n+15$) to ($n+19$) for FDD PCell and ($n+5$) to ($n+11$) and ($n+20$) to ($n+26$) for TDD PCell.

The test equipment verifies that potential interruption is carried out in the correct time span by monitoring ACK/NACK sent in PCell during activation and deactivation of SCell1, respectively.

The test equipment verifies the activation time by counting the subframes from the time when the SCell1 activation command is sent until a CSI report with other than CQI index 0 is received.

The test equipment verifies the deactivation time by counting the subframes from the time when the SCell1 deactivation command is sent until CQI reporting for SCell1 is discontinued.

Table A.8.16.85.1-1: General test parameters for known SCell1 activation case

Parameter	Unit	Value	Comment
E-UTRA RF Channel Number		1, 2, 3	Three radio channels are used for this test
Active PCell		Cell 1	Primary cell on RF channel number 1.
Deconfigured deactivated SCell		Cell 2	Deconfigured deactivated secondary cell on RF channel number 2.
Configured deactivated SCell2		Cell 3	Configured deactivated secondary cell on RF channel number 3.
CP length		Normal	
DRX		OFF	Continuous monitoring of primary cell
CQI/PMI periodicity and offset configuration index		0	CQI reporting for SCell every UL subframe
Cell-individual offset for cells on RF channel number 1	dB	0	Individual offset for cells on PCC.
Cell-individual offset for cells on RF channel number 2	dB	0	Individual offset for cells on SCC1.
Cell-individual offset for cells on RF channel number 3	dB	0	Individual offset for cells on SCC1.
SCell measurement cycle (measCycleSCell)	ms	320	
T1	s	7	During this time the PCell and SCell2 shall be known and the SCell1 configured and detected.
T2	s	1	During this time the UE shall activate the SCell1.
T3	s	1	During this time the UE shall deactivate the SCell1.

Table A.8.16.85.1-2: Cell specific test parameters for known SCell1 activation

Parameter	Unit	Cell 1			Cell 2			Cell 3		
		T1	T2	T3	T1	T2	T3	T1	T2	T3
E-UTRA RF Channel Number		1			2			3		
Duplex mode		FDD or TDD			FDD or TDD			FDD or TDD		
TDD special subframe configuration		6			6			6		
TDD uplink-downlink configuration		1			1			1		
BW _{channel}	MHz	5MHz: N _{RB,c} = 25 10MHz: N _{RB,c} = 50 20MHz: N _{RB,c} = 100			5MHz: N _{RB,c} = 25 10MHz: N _{RB,c} = 50 20MHz: N _{RB,c} = 100			5MHz: N _{RB,c} = 25 10MHz: N _{RB,c} = 50 20MHz: N _{RB,c} = 100		
PDSCH parameters: DL Reference Measurement Channel		5MHz: R.7 FDD 10MHz: R.3 FDD 20MHz: R.6 FDD 5MHz: R.4 TDD 10MHz: R.0 TDD 20MHz: R.3 TDD			-			-		

PCFICH/PDCCH/PHICH parameters: DL Reference Measurement Channel		5MHz: R.11 FDD 10MHz: R.6 FDD 20MHz: R.10 FDD 5MHz: R.11 TDD 10MHz: R.6 TDD 20MHz: R.10 TDD	5MHz: R.11 FDD 10MHz: R.6 FDD 20MHz: R.10 FDD 5MHz: R.11 TDD 10MHz: R.6 TDD 20MHz: R.10 TDD	5MHz: R.11 FDD 10MHz: R.6 FDD 20MHz: R.10 FDD 5MHz: R.11 TDD 10MHz: R.6 TDD 20MHz: R.10 TDD
OCNG Patterns		5MHz: OP.20 FDD 10MHz: OP.10 FDD 20MHz: OP.17 FDD 5MHz: OP.9 TDD 10MHz: OP.1 TDD 20MHz: OP.7 TDD	5MHz: OP.16 FDD 10MHz: OP.2 FDD 20MHz: OP.12 FDD 5MHz: OP.10 TDD 10MHz: OP.2 TDD 20MHz: OP.8 TDD	5MHz: OP.16 FDD 10MHz: OP.2 FDD 20MHz: OP.12 FDD 5MHz: OP.10 TDD 10MHz: OP.2 TDD 20MHz: OP.8 TDD
PBCH_RA	dB	0	0	0
PBCH_RB	dB			
PSS_RA	dB			
SSS_RA	dB			
PCFICH_RB	dB			
PHICH_RA	dB			
PHICH_RB	dB			
PDCCH_RA	dB			
PDCCH_RB	dB			
PDSCH_RA	dB			
PDSCH_RB	dB			
OCNG_RA ^{Note 1}	dB			
OCNG_RB ^{Note 1}	dB			
N _{oc} ^{Note 2}	dBm/15 kHz			
\bar{E}_s/N_{oc}	dB	17	17	17
\bar{E}_s/I_{ot}	dB	17	17	17
RSRP ^{Note 3}	dBm/15 kHz	-87	-87	-87
SCH_RP ^{Note 3}	dBm/15 kHz	-87	-87	-87
I _o ^{Note 3}	dBm/Ch BW	-59.13 +10log (N _{RB,c} /50)	-59.13 +10log (N _{RB,c} /50)	-59.13 +10log (N _{RB,c} /50)
Propagation Condition		AWGN	AWGN	AWGN
Antenna Configuration		1x2	1x2	1x2
Timing offset to Cell 1	μs	-	0	0
Time alignment error relative to cell 1 ^{Note 5}	μs	-	≤ TAE	≤ TAE
Time alignment error relative to cell 2 ^{Note 5}	μs	-	-	≤ TAE
<p>Note 1: OCNG shall be used such that all cells are fully allocated and a constant total transmitted power spectral density is achieved for all OFDM symbols.</p> <p>Note 2: Interference from other cells and noise sources not specified in the test is assumed to be constant over subcarriers and time and shall be modelled as AWGN of appropriate power for N_{oc} to be fulfilled.</p> <p>Note 3: Es/lot, RSRP, SCH_RP and I_o levels have been derived from other parameters for information purposes. They are not settable parameters themselves.</p> <p>Note 4: The uplink resources for CSI reporting are assigned to the UE prior to the start of time period T2.</p> <p>Note 5: Time alignment error (TAE) as specified in TS 36.104 [30] clause 6.5.3.1. The TAE value depends upon the type of carrier aggregation.</p>				

A.8.16.85.2 Test Requirements

During T2 the UE shall send the first CSI report for SCell1 in subframe (m+8), or in subframe (m+10) for FDD PCell and (m+9) for TDD PCell, if the subframe (m+8) was subject to interruption, or in subframe (m+13) for TDD PCell, if the subframes (m+9) and (m+8) were subject to interruption. Whether CSI report in subframe (m+8) / (m+9) was interrupted or not is checked by monitoring ACK/NACK sent in PCell in subframe (m+8) / (m+9).

During T2 the UE shall start sending CSI reports for SCell1 with non-zero CQI index at latest in a subframe (m+29).

During T3 the UE shall stop sending CSI reports for SCell at latest in a subframe (n+8).

During T2 interruption of PCell during SCells activation shall not happen outside subframes (m+5) to (m+11) and (m+15) to (m+19) for FDD PCell, and not happen outside subframes (m+5) to (m+11) and (m+20) to (m+26) for TDD PCell.

During T3 interruption of PCell during SCells deactivation shall not happen outside subframes (n+5) to (n+11) and (n+15) to (n+19) for FDD PCell, and not happen outside subframes (n+5) to (n+11) and (n+20) to (n+26) for TDD PCell.

The interruption of PCell shall not be more than the values specified for intra-band CA and inter-band CA in Section 7.8.2.

All of the above test requirements shall be fulfilled in order for the observed SCell1 activation delay and SCell1 deactivation delay to be counted as correct. The rate of correct observed SCell1 activation delay and SCell1 deactivation delay during repeated tests shall be at least 90%.

NOTE: During T2 if there are no uplink resources for reporting the valid CSI in a subframe (m+29) then the UE shall use the next available uplink resource for reporting the corresponding valid CSI.

A.8.16.86 3 DL CA Activation and Deactivation of Unknown SCell in Non-DRX with generic duplex modes

A.8.16.86.1 Test Purpose and Environment

The purpose of this test is to verify that the SCell activation and deactivation times are within the requirements stated in section 7.7 for UE configured with two downlink SCells, when the SCell is unknown by the UE at the time of activation.

Note on the applicability: the requirement tested in the specific duplex-mode test cases A.8.16.39, A.8.16.40, A.8.16.41, A.8.16.42, does not need to be tested in the generic duplex-mode test case A.8.16.86.

The test parameters are given in Tables A.8.16.86.1-1 and cell-specific parameters in A.8.16.86.1-2 below. The test consists of three successive time periods, with duration of T1, T2 and T3, respectively. There are three carriers, each with one cell. Cell 1, Cell 2 and Cell 3 may operate in either FDD or TDD duplex mode according to test configuration. Cell 1 and Cell 3 have constant signal levels throughout the test. Before the test starts the UE is connected to Cell 1 (PCell) on radio channel 1 (PCC) and Cell 3 (deactivated SCell2) on radio channel 3 (SCC2) but is not aware of Cell 2 (SCell1) on radio channel 2 (SCC1). The UE is only monitoring the PCC and SCC2. The UE shall be continuously scheduled in the PCell throughout the whole test.

At the beginning of T1 the UE receives an RRC message by which the Cell 2 (SCell1) becomes configured on radio channel 2 (SCC1). During T1 Cell 2 (SCell1) is powered off and UE is not aware of Cell 2 (SCell1).

A MAC message for activation of SCell1 is sent by the test equipment 100ms after the RRC message, in a subframe # denoted m, where m is an even number for FDD PCell and 4 or 9 for TDD PCell. The point in time at which the MAC message for activation of Cell 2 (SCell1) is received at the UE antenna connector defines the start of time period T2. Immediately at beginning of T2 the transmission power of Cell 2 (SCell1) is increased to same level as for Cell 1 (PCell). The test equipment sends a MAC message for activation of the Cell 3 (SCell2) in subframe (m+10) for FDD PCell and (m+15) for TDD PCell. Since UE received SCell2 activation command during activation of SCell1, the UE shall be able to report valid CSI for the activated SCell1 at latest in subframe (m+39) provided the SCell1 can be successfully detected on the first attempt. The UE shall start reporting CSI for SCell1 in subframe (m+8), and shall report CQI index 0 (out-of-range) until the SCell activation has been completed. Any PCell interruption due to activation of SCells shall occur in subframes (m+5) to (m+9) and (m+15) to (m+19) for FDD PCell, and (m+5) to (m+11) and (m+20) to (m+26) for TDD PCell.

Time period T3 starts when a MAC message for deactivation of Cell 2 (SCell1), sent from the test equipment to the UE in a subframe # denoted n, where n is an even number for FDD PCell and 4 or 9 for TDD PCell, is received at the UE antenna connector. The test equipment sends a MAC message for deactivation of the Cell 3 (SCell2) in subframe (n+10) for FDD PCell and (n+15) for TDD PCell. The UE shall carry out deactivation of the Cell 2 (SCell1) at latest in subframe (n+8), and any PCell interruption due to the deactivation of SCells shall occur in subframes (n+5) to (n+9) and (n+15) to (n+19) for FDD PCell, and (n+5) to (n+11) and (n+20) to (n+26) for TDD PCell.

The test equipment verifies that potential interruption is carried out in the correct time span by monitoring ACK/NACK sent in PCell during activation and deactivation of SCell1, respectively.

The test equipment verifies the activation time by counting the subframes from the time when the Cell 2 (SCell1) activation command is sent until a CSI report with other than CQI index 0 is received.

The test equipment verifies the deactivation time by counting the subframes from the time when the Cell 2 (SCell1) deactivation command is sent until CQI reporting for SCell1 is discontinued.

Table A.8.16.86.1-1: General test parameters for unknown SCell1 activation case

Parameter	Unit	Value	Comment
E-UTRA RF Channel Number		1, 2, 3	Three radio channels are used for this test
Active PCell		Cell 1	Primary cell on RF channel number 1.
Deconfigured deactivated SCell1		Cell 2	Deconfigured deactivated secondary cell on RF channel number 2.
Configured deactivated SCell2		Cell 3	Configured deactivated secondary cell on RF channel number 3.
CP length		Normal	
DRX		OFF	Continuous monitoring of primary cell
CQI/PMI periodicity and offset configuration index		0	CQI reporting for SCell every second subframe
Cell-individual offset for cells on RF channel number 1	dB	0	Individual offset for cells on PCC.
Cell-individual offset for cells on RF channel number 2	dB	0	Individual offset for cells on SCC1.
Cell-individual offset for cells on RF channel number 3	dB	0	Individual offset for cells on SCC2.
SCell measurement cycle (measCycleSCell)	ms	320	
T1	ms	100	During this time the PCell and SCell2 shall be known and the SCell1 configured.
T2	s	1	During this time the UE shall activate the SCell1 and SCell2.
T3	s	1	During this time the UE shall deactivate the SCell1 and SCell2.
Note:	This test verifies the RRM requirement which is independent of channel bandwidth and is performed according to the principle defined in section A.3.6.1.		

Table A.8.16.86.1-2: Cell specific test parameters for E-UTRAN FDD known SCell1 activation

Parameter	Unit	Cell 1			Cell 2			Cell 3		
		T1	T2	T3	T1	T2	T3	T1	T2	T3
E-UTRA RF Channel Number		1			2			3		
Duplex mode		FDD or TDD			FDD or TDD			FDD or TDD		
TDD special subframe configuration		6			6			6		
TDD uplink-downlink configuration		1			1			1		
BW _{channel}	MHz	5MHz: N _{RB,c} = 25 10MHz: N _{RB,c} = 50 20MHz: N _{RB,c} = 100			5MHz: N _{RB,c} = 25 10MHz: N _{RB,c} = 50 20MHz: N _{RB,c} = 100			5MHz: N _{RB,c} = 25 10MHz: N _{RB,c} = 50 20MHz: N _{RB,c} = 100		
PDSCH parameters: DL Reference Measurement Channel		5MHz: R.7 FDD 10MHz: R.3 FDD 20MHz: R.6 FDD 5MHz: R.4 TDD 10MHz: R.0 TDD 20MHz: R.3 TDD			-			-		

PCFICH/PDCCH/PHICH parameters: DL Reference Measurement Channel		5MHz: R.11 FDD 10MHz: R.6 FDD 20MHz: R.10 FDD 5MHz: R.11 TDD 10MHz: R.6 TDD 20MHz: R.10 TDD	5MHz: R.11 FDD 10MHz: R.6 FDD 20MHz: R.10 FDD 5MHz: R.11 TDD 10MHz: R.6 TDD 20MHz: R.10 TDD	5MHz: R.11 FDD 10MHz: R.6 FDD 20MHz: R.10 FDD 5MHz: R.11 TDD 10MHz: R.6 TDD 20MHz: R.10 TDD
OCNG Patterns		5MHz: OP.20 FDD 10MHz: OP.10 FDD 20MHz: OP.17 FDD 5MHz: OP.9 TDD 10MHz: OP.1 TDD 20MHz: OP.7 TDD	5MHz: OP.16 FDD 10MHz: OP.2 FDD 20MHz: OP.12 FDD 5MHz: OP.10 TDD 10MHz: OP.2 TDD 20MHz: OP.8 TDD	5MHz: OP.16 FDD 10MHz: OP.2 FDD 20MHz: OP.12 FDD 5MHz: OP.10 TDD 10MHz: OP.2 TDD 20MHz: OP.8 TDD
PBCH_RA	dB	0	0	0
PBCH_RB	dB			
PSS_RA	dB			
SSS_RA	dB			
PCFICH_RB	dB			
PHICH_RA	dB			
PHICH_RB	dB			
PDCCH_RA	dB			
PDCCH_RB	dB			
PDSCH_RA	dB			
PDSCH_RB	dB			
OCNG_RA ^{Note 1}	dB			
OCNG_RB ^{Note 1}	dB			
N _{oc} ^{Note 2}	dBm/15 kHz			
\bar{E}_s/N_{oc}	dB	17	-infinity	17
\bar{E}_s/I_{ot}	dB	17	-infinity	17
RSRP ^{Note 3}	dBm/15 kHz	-87	-infinity	-87
SCH_RP ^{Note 3}	dBm/15 kHz	-87	-infinity	-87
I _o ^{Note 3}	dBm/Ch BW	-59.13 +10log (N _{RB,c} /50)	-76.22 +10log (N _{RB,c} /50)	-59.13 +10log (N _{RB,c} /50)
Propagation Condition		AWGN	AWGN	AWGN
Antenna Configuration		1x2	1x2	1x2
Timing offset to Cell 1	μs	-	0	0
Time alignment error relative to cell 1 ^{Note 5}	μs	-	≤ TAE	≤ TAE
Time alignment error relative to cell 2 ^{Note 5}	μs	-	-	≤ TAE
<p>Note 1: OCNG shall be used such that all cells are fully allocated and a constant total transmitted power spectral density is achieved for all OFDM symbols.</p> <p>Note 2: Interference from other cells and noise sources not specified in the test is assumed to be constant over subcarriers and time and shall be modelled as AWGN of appropriate power for N_{oc} to be fulfilled.</p> <p>Note 3: Es/I_{ot}, RSRP, SCH_RP and I_o levels have been derived from other parameters for information purposes. They are not settable parameters themselves.</p> <p>Note 4: The uplink resources for CSI reporting are assigned to the UE prior to the start of time period T2.</p> <p>Note 5: Time alignment error (TAE) as specified in TS 36.104 [30] clause 6.5.3.1. The TAE value depends upon the type of carrier aggregation.</p> <p>Note 6: TDD special subframe configuration and uplink-downlink configuration are as specified in Table 4.2-1 and 4.2-2 in TS36.211 [16]. The same configuration applies to all TDD cells.</p>				

A.8.16.86.2 Test Requirements

During T2 the UE shall send the first CSI report for SCell12 in a subframe (m+8), or in subframe (m+10) for FDD PCell and (m+9) for TDD PCell, if the subframe (m+8) was subject to interruption, or in subframe (m+13) for TDD PCell, if the subframes (m+8) and (m+9) were subject to interruption. Whether CSI report in subframe (m+8) / (m+9) was interrupted or not is checked by monitoring ACK/NACK sent in PCell in subframe (m+8) / (m+9).

During T2 the UE shall start sending CSI reports for SCell1 with non-zero CQI index at latest in a subframe (m+39).

During T3 the UE shall stop sending CSI reports for SCell1 at latest in a subframe (n+8).

During T2 interruption of PCell during SCells activation shall not happen outside subframes (m+5) to (m+9) and (m+15) to (m+19) for FDD PCell, and not happen outside subframes (m+5) to (m+11) and (m+20) to (m+26) for TDD PCell.

During T3 interruption of PCell during SCells deactivation shall not happen outside subframes (n+5) to (n+9) and (n+15) to (n+19) for FDD PCell, and not happen outside subframes (n+5) to (n+11) and (n+20) to (n+26) for TDD PCell.

The interruption of PCell shall not be more than the values specified for intra-band CA and inter-band CA in Section 7.8.2.

All of the above test requirements shall be fulfilled in order for the observed SCell1 activation delay and SCell1 deactivation delay to be counted as correct. The rate of correct observed SCell1 activation delay and SCell1 deactivation delay during repeated tests shall be at least 90%.

NOTE: During T2 if there are no uplink resources for reporting the valid CSI in subframe (m+39) then the UE shall use the next available uplink resource for reporting the corresponding valid CSI.

A.8.16.87 4 DL CA Event Triggered Reporting under Deactivated SCells in Non-DRX with generic duplex modes

A.8.16.87.1 Test Purpose and Environment

The purpose of this test is to verify that the UE correctly detects events A1 (Serving cell becomes better than threshold), A2 (Serving cell becomes worse than threshold) and A6 (Neighbour becomes better than SCell) defined in TS 36.331 [2] within the requirements stated in clause 8.3.3.2.1.

Note on the applicability: the requirement tested in the specific duplex-mode test cases A.8.16.51, A.8.16.52, A.8.16.53 and A.8.16.54 does not need to be tested in the generic duplex-mode test case A.8.16.87.

The test parameters are given in Tables A.8.16.87.1-1, A.8.16.87.1-2 and A.8.16.87.1-3 below. It is indicated to the UE in the measurement control information that event-triggered reporting with Events A1 (for only SCell1 i.e. cell2), A2 (PCell and SCells) and A6 is used. The test consists of three successive time periods, with duration of T1, T2 and T3, respectively. During T1 the UE shall not have any information on cell 5. At the beginning of T2 the transmission power of cell 5 is increased to the same level as for cell 4, and due to usage of an offset this shall result in reporting of Event A6. Also, at the beginning of T2 the transmission power of cell 2 is increased to the same level as for cell 1, which shall result in reporting of Event A1. At the beginning of T3 the transmission powers of cells 1, 2, 3 and 4 are reduced below a threshold value and this shall result in reporting of Event A2 for Cell 1, for Cell 2, for Cell 3 and for Cell 4. Cells 1, 2, 3, 4 and 5 may operate in either FDD or TDD duplex mode according to test configuration.

Table A.8.16.87.1-1: General test parameters for E-UTRAN 4 DL CA event triggered reporting under fading propagation conditions with 3 configured but deactivated SCells in non-DRX with generic duplex modes

Parameter	Unit	Value	Comment
E-UTRA RF Channel Number		1, 2, 3, 4	Three radio channels are used for this test
Active PCell		Cell 1	Primary cell on RF channel number 1.
Configured deactivated SCell		Cell 2	Configured deactivated secondary cell on RF channel number 2.
Configured deactivated SCell		Cell 3	Configured deactivated secondary cell on RF channel number 3.
Configured deactivated SCell		Cell 4	Configured deactivated secondary cell on RF channel number 4.

Neighbour cell			Cell 5	Neighbour cell to be identified on RF channel number 4.
CP length			Normal	
DRX			OFF	Continuous monitoring of primary cell
Special subframe configuration			6	As specified in table 4.2-1 in TS 36.211. The same configuration applies to any TDD cells (cell1, cell2, cell3, cell4 and cell5 may be configured for FDD or TDD operation).
Uplink-downlink configuration			1	As specified in table 4.2-2 in TS 36.211. The same configuration applies to any TDD cells (cell1, cell2, cell3, cell 4 and cell5 may be configured for FDD or TDD operation).
A1	Hysteresis	dB	0	Hysteresis for evaluation of event A1.
	Threshold RSRP	dBm	-98	Actual RSRP threshold for event A1. Needs to take absolute accuracy tolerance in section 9.1.11.1 into account plus margin.
	Time To Trigger	s	0	
A2	Hysteresis	dB	0	Hysteresis for evaluation of event A2.
	Threshold RSRP	dBm	-98	Actual RSRP threshold for event A2. Needs to take absolute accuracy tolerance in section 9.1.11.1 into account plus margin.
	Time To Trigger	s	0	
A6	Hysteresis	dB	0	Hysteresis for evaluation of event A6.
	Offset	dB	-6	Offset parameter for evaluation of event A6. Needs to take relative accuracy tolerance in section 9.1.11.2 into account plus margin.
	Report on leave		False	
	Time To Trigger	s	0	
Cell-individual offset for cells on RF channel number 1		dB	0	Individual offset for cells on primary component carrier.
Cell-individual offset for cells on RF channel number 2		dB	0	Individual offset for cells on secondary component carrier.
Cell-individual offset for cells on RF channel number 3		dB	0	Individual offset for cells on secondary component carrier.
Cell-individual offset for cells on RF channel number 4		dB	0	Individual offset for cells on secondary component carrier.
Filter coefficient			0	L3 filtering is not used
SCell measurement cycle (measCycleSCell)		ms	320	For cell2, cell3 and cell4
T1		s	5	During this time the cell1, cell3 and cell4 shall be known to the UE; but cell2 and cell5 shall be unknown to the UE.
T2		s	≤12	UE should report Event A1 for cell2 and event A6 for cell5 within 6.4s (20xscellMeasCycle)
T3		s	5	UE should report Event A2 within 200 ms for cell1 and within 1.6s for each of cells2, 3 and 4.

Table A.8.16.87.1-2: Cell specific test parameters for E-UTRAN 4 DL CA event triggered reporting under fading propagation conditions with 3 configured but deactivated SCells in non-DRX with generic duplex modes

Parameter	Unit	Cell 1			Cell 2			Cell3		
		T1	T2	T3	T1	T2	T3	T1	T2	T3
E-UTRA RF Channel Number		1			2			3		
BW _{channel}		5MHz: N _{RB,c} = 25 10MHz: N _{RB,c} = 50 20MHz: N _{RB,c} = 100			5MHz: N _{RB,c} = 25 10MHz: N _{RB,c} = 50 20MHz: N _{RB,c} = 100			5MHz: N _{RB,c} = 25 10MHz: N _{RB,c} = 50 20MHz: N _{RB,c} = 100		
PDSCH parameters: DL Reference Measurement Channel		5MHz: R.5 FDD 10MHz: R.0 FDD 20MHz: R.4 FDD 5MHz: R.4 TDD 10MHz: R.0 TDD 20MHz: R.3 TDD			-			-		
PCFICH/PDCCH/PHICH parameters: DL Reference Measurement Channel		5MHz: R.11 FDD 10MHz: R.6 FDD 20MHz: R.10 FDD 5MHz: R.11 TDD 10MHz: R.6 TDD 20MHz: R.10 TDD			5MHz: R.11 FDD 10MHz: R.6 FDD 20MHz: R.10 FDD 5MHz: R.11 TDD 10MHz: R.6 TDD 20MHz: R.10 TDD			5MHz: R.11 FDD 10MHz: R.6 FDD 20MHz: R.10 FDD 5MHz: R.11 TDD 10MHz: R.6 TDD 20MHz: R.10 TDD		
OCNG Patterns		5MHz: OP.15 FDD 10MHz: OP.1 FDD 20MHz: OP.11 FDD 5MHz: OP.9 TDD 10MHz: OP.1 TDD 20MHz: OP.7 TDD			5MHz: OP.16 FDD 10MHz: OP.2 FDD 20MHz: OP.12 FDD 5MHz: OP.10 TDD 10MHz: OP.2 TDD 20MHz: OP.8 TDD			5MHz: OP.16 FDD 10MHz: OP.2 FDD 20MHz: OP.12 FDD 5MHz: OP.10 TDD 10MHz: OP.2 TDD 20MHz: OP.8 TDD		
PBCH_RA	dB	0			0			0		
PBCH_RB	dB									
PSS_RA	dB									
SSS_RA	dB									
PCFICH_RB	dB									
PHICH_RA	dB									
PHICH_RB	dB									
PDCCH_RA	dB									
PDCCH_RB	dB									
PDSCH_RA	dB									
PDSCH_RB	dB									
OCNG_RA ^{Note 1}	dB									
OCNG_RB ^{Note 1}	dB									
N _{oc} ^{Note 2}	dBm/15 KHz									
E _s /N _{oc}	dB	17	17	-3	-infinity	17	-3	17	17	-3
E _s /I _{ot} ^{Note 3}	dB	17	17	-3	-infinity	17	-3	17	17	-3
RSRP ^{Note 3}	dBm/15 kHz	-87	-87	-107	-infinity	-87	-107	-87	-87	-107
SCH_RP ^{Note 3}	dBm/15 kHz	-87	-87	-107	-infinity	-87	-107	-87	-87	-107
I _o ^{Note 3}	dBm/Ch BW	-59.13 +10log (N _{RB,c} /50)	-59.13 +10log (N _{RB,c} /50)	-74.45 +10log (N _{RB,c} /50)	-76.22 +10log (N _{RB,c} /50)	-59.13 +10log (N _{RB,c} /50)	-74.45 +10log (N _{RB,c} /50)	-59.13 +10log (N _{RB,c} /50)	-59.13 +10log (N _{RB,c} /50)	-74.45 +10log (N _{RB,c} /50)
Propagation Condition		AWGN			ETU70			ETU70		
Correlation Matrix and Antenna Configuration		1x2 Low			1x2 Low			1x2 Low		
Timing offset to cell1	μs	-			0			0		
Time alignment error relative to cell1 ^{Note 5}	μs	-			≤ TAE			≤ TAE		
Time alignment error relative to cell 2 ^{Note 5}	μs	≤ TAE			-			≤ TAE		
Time alignment error relative to cell 3 ^{Note 5}	μs	≤ TAE			≤ TAE			-		
Time alignment error relative to cell 4 ^{Note 5}	μs	≤ TAE			≤ TAE			≤ TAE		

- Note 1: OCNB shall be used such that all cells are fully allocated and a constant total transmitted power spectral density is achieved for all OFDM symbols.
- Note 2: Interference from other cells and noise sources not specified in the test is assumed to be constant over subcarriers and time and shall be modelled as AWGN of appropriate power for N_{oc} to be fulfilled.
- Note 3: E_s/I_{ot} , RSRP, SCH_RP and I_o have been derived from other parameters for information purposes. They are not settable parameters themselves.
- Note 4: The resources for uplink transmission are assigned to the UE prior to the start of time period T2.
- Note 5: Time alignment error (TAE) as specified in TS 36.104 [30] clause 6.5.3.1. The TAE value depends upon the type of carrier aggregation.

Table A.8.16.87.1-3: Cell specific test parameters for E-UTRAN 4 DL CA event triggered reporting under fading propagation conditions with 3 configured but deactivated SCCells in non-DRX with generic duplex modes

Parameter	Unit	Cell 4			Cell 5		
		T1	T2	T3	T1	T2	T3
E-UTRA RF Channel Number		4					
$BW_{channel}$		5MHz: $N_{RB,c} = 25$ 10MHz: $N_{RB,c} = 50$ 20MHz: $N_{RB,c} = 100$					
PDSCH parameters: DL Reference Measurement Channel		-			-		
PCFICH/PDCCH/PHICH parameters: DL Reference Measurement Channel		5MHz: R.11 FDD 10MHz: R.6 FDD 20MHz: R.10 FDD 5MHz: R.11 TDD 10MHz: R.6 TDD 20MHz: R.10 TDD			5MHz: R.11 FDD 10MHz: R.6 FDD 20MHz: R.10 FDD 5MHz: R.11 TDD 10MHz: R.6 TDD 20MHz: R.10 TDD		
OCNB Patterns		5MHz: OP.16 FDD 10MHz: OP.2 FDD 20MHz: OP.12 FDD 5MHz: OP.10 TDD 10MHz: OP.2 TDD 20MHz: OP.8 TDD			5MHz: OP.16 FDD 10MHz: OP.2 FDD 20MHz: OP.12 FDD 5MHz: OP.10 TDD 10MHz: OP.2 TDD 20MHz: OP.8 TDD		
PBCH_RA	dB	0			0		
PBCH_RB	dB						
PSS_RA	dB						
SSS_RA	dB						
PCFICH_RB	dB						
PHICH_RA	dB						
PHICH_RB	dB						
PDCCH_RA	dB						
PDCCH_RB	dB						
PDSCH_RA	dB						
PDSCH_RB	dB						
OCNB_RA ^{Note 1}	dB						
OCNB_RB ^{Note 1}	dB						
N_{oc} ^{Note 2}	dBm/15 KHz						
\bar{E}_s/N_{oc}	dB	17	17	-3	-infinity	17	-3
\bar{E}_s/I_{ot} ^{Note 3}	dB	17	-0.09	-4.76	-infinity	-0.09	-4.76
RSRP ^{Note 3}	dBm/15 kHz	-87	-87	-107	-infinity	-87	-107
SCH_RP ^{Note 3}	dBm/15 kHz	-87	-87	-107	-infinity	-87	-107
I_o ^{Note 3}	dBm/Ch BW	-59.13 +10log ($N_{RB,c}$ /50)	-56.17 +10log ($N_{RB,c}$ /50)	-73.20 +10log ($N_{RB,c}$ /50)	Specified in columns for Cell 4		
Propagation Condition		ETU70			ETU70		
Correlation Matrix and Antenna Configuration		1x2 Low			1x2 Low		
Timing offset to Cell 1	μ s	0			3		
Time alignment error relative to cell 1 ^{Note 5}	μ s	-			N/A		
Time alignment error relative to cell 2 ^{Note 5}	μ s	-			N/A		

Time alignment error relative to cell 3 ^{Note 5}	μs	-	N/A
Time alignment error relative to cell 4 ^{Note 5}	μs	-	N/A
Note 1: OCNG shall be used such that all cells are fully allocated and a constant total transmitted power spectral density is achieved for all OFDM symbols.			
Note 2: Interference from other cells and noise sources not specified in the test is assumed to be constant over subcarriers and time and shall be modelled as AWGN of appropriate power for N_{oc} to be fulfilled.			
Note 3: E_s/I_{ot} , RSRP, SCH_RP and I_o have been derived from other parameters for information purposes. They are not settable parameters themselves.			
Note 4: The resources for uplink transmission are assigned to the UE prior to the start of time period T2.			
Note 5: Time alignment error (TAE) as specified in TS 36.104 [30] clause 6.5.3.1. The TAE value depends upon the type of carrier aggregation.			

A.8.16.87.2 Test Requirements

The UE shall send one Event A6 triggered measurement report for Cell 5 with a measurement reporting delay of less than 6.4s ($20 \times \text{measCycleSCell}$) from the beginning of time T2.

The UE shall send one Event A1 triggered measurement report for Cell 2 with a measurement reporting delay of less than 6.4s ($20 \times \text{measCycleSCell}$) from beginning of time T2.

The UE shall send one Event A2 triggered measurement report for Cell 1 with a measurement reporting delay of less than 200 ms from beginning of time T3.

The UE shall send one Event A2 triggered measurement report for Cell 2 with a measurement reporting delay of less than 1.6s ($5 \times \text{measCycleSCell}$) from beginning of time T3.

The UE shall send one Event A2 triggered measurement report for Cell 3 with a measurement reporting delay of less than 1.6s ($5 \times \text{measCycleSCell}$) from beginning of time T3.

The UE shall send one Event A2 triggered measurement report for Cell 4 with a measurement reporting delay of less than 1.6s ($5 \times \text{measCycleSCell}$) from beginning of time T3.

The UE shall not send event triggered measurement reports as long as the reporting criteria are not fulfilled.

The rate of correct events observed during repeated tests shall be at least 90% for each of the events.

NOTE: The actual overall delays measured in the tests may be up to $2 \times \text{TTI}_{\text{DCCH}}$ higher than the measurement reporting delays above because of TTI insertion uncertainty of the measurement report in DCCH.

A.8.16.88 4 DL CA Event Triggered Reporting on Deactivated SCell with PCell and SCell Interruptions in Non-DRX with generic duplex modes

A.8.16.88.1 Test Purpose and Environment

The purpose of this test is to verify that the UE correctly detects event A6 (Neighbour becomes better than SCell) defined in TS 36.331 [2] within the requirements stated in clause 8.3.3.2.1 while at the same time fulfilling the requirement on interruption rate.

Note on the applicability: the requirement tested in the specific duplex-mode test cases A.8.16.55, A.8.16.56, A.8.16.79 and A.8.16.80 does not need to be tested in the generic duplex-mode test case A.8.16.88.

The test parameters are given in Table A.8.16.88.1-1, A.8.16.88.1-2 and A.8.16.88.1-3 below. In the test there are five cells: Cell 1, Cell 2, Cell 3, Cell 4 and Cell 5. Cell 1 is PCell on the primary component (RF Channel 1), Cell 2 is SCell on the secondary component (RF Channel 2), Cell 3 is SCell on the secondary component (RF Channel 3), Cell 4 is SCell on the secondary component (RF Channel 4) and Cell 5 is the neighbour cell on the secondary component (RF Channel 4). It is indicated to the UE in the measurement control information that event-triggered reporting with Event A6 is used. The test consists of four successive time periods, with duration of T1, T2, T3 and T4, respectively. During T1 and T2, Cell2, Cell3 and Cell4 are deactivated. During T1 the UE shall not have any information of Cell 5. Immediately at beginning of T2 the transmission power of Cell 5 is increased to same level as for Cell 3, and due to usage of an offset this shall result in reporting of Event A6.

At the beginning of T3, the transmission power of Cell 5 is turned off, and the test equipment sends a MAC message for activation of Cell 2 to UE but Cell3 and Cell4 remains deactivated. Immediately at beginning of T4 the transmission power of Cell 5 is increased to same level as for Cell 3, and due to usage of an offset this shall result in reporting of Event A6. The UE shall be continuously scheduled in the PCell throughout the whole test and continuously scheduled in Cell2 during T4. Cells 1, 2, 3, 4 and 5 may operate in either FDD or TDD duplex mode according to test configuration.

Table A.8.16.88.1-1: General test parameters for E-UTRAN 4 DL CA Event Triggered Reporting on Deactivated SCell with PCell and SCell Interruptions in Non-DRX with generic duplex modes

Parameter	Unit	Value	Comment
E-UTRA RF Channel Number		1, 2, 3, 4	Four radio channels are used for this test

Active PCell			Cell 1	Primary cell on RF channel number 1.
Configured deactivated SCell			Cell 2	Configured deactivated secondary cell on RF channel number 2.
Configured deactivated SCell			Cell 3	Configured deactivated secondary cell on RF channel number 3.
Configured deactivated SCell			Cell 4	Configured deactivated secondary cell on RF channel number 4.
Neighbour cell			Cell 5	Neighbor cell to be identified on RF channel number 4.
CP length			Normal	
DRX			OFF	Continuous monitoring of primary cell
Special subframe configuration			6	As specified in table 4.2-1 in TS 36.211. The same configuration applies to any TDD cells (cell1, cell2, cell3, cell4 and cell5 may be configured for FDD or TDD operation).
Uplink-downlink configuration			1	As specified in table 4.2-2 in TS 36.211. The same configuration applies to any TDD cells (cell1, cell2, cell3, cell 4 and cell5 may be configured for FDD or TDD operation).
A6	Hysteresis	dB	0	Hysteresis for evaluation of event A6.
	Offset	dB	-3	Offset parameter for evaluation of event A6. Needs to take relative accuracy tolerance in clause 9.1.11.2 into account plus margin.
	Report on leave		False	
	Time To Trigger	s	0	
Cell-individual offset for cells on RF channel number 1		dB	0	Individual offset for cells on primary component carrier.
Cell-individual offset for cells on RF channel number 2		dB	0	Individual offset for cells on secondary component carrier.
Cell-individual offset for cells on RF channel number 3		dB	0	Individual offset for cells on secondary component carrier.
Cell-individual offset for cells on RF channel number 4		dB	0	Individual offset for cells on secondary component carrier.
Filter coefficient			0	L3 filtering is not used
SCell measurement cycle		ms	640	
T1		s	4	During this time the UE shall be aware of cells 1, 2, 3 and 4 but not cell 5.
T2		s	≤15	UE should report Event A6 within 12.8s (20×sCellMeasCycle)
T3		s	4	During this time the UE shall activate cell 2
T4		s	≤4	UE should report Event A6 within 3.2s (5×sCellMeasCycle)

Table A.8.16.88.1-2: Cell specific test parameters for E-UTRAN 4 DL CA Event Triggered Reporting on Deactivated SCell with PCell and SCell Interruptions in Non-DRX with generic duplex modes (Cell #1, Cell #2, Cell #3, Cell #4)

Parameter	Unit	Cell 1				Cell 2				Cell 3				Cell 4			
		T1	T2	T3	T4	T1	T2	T3	T4	T1	T2	T3	T4	T1	T2	T3	T4
E-UTRA RF Channel Number		1				2				3				4			
BW _{channel}		5MHz: N _{RB,c} = 25 10MHz: N _{RB,c} = 50 20MHz: N _{RB,c} = 100				5MHz: N _{RB,c} = 25 10MHz: N _{RB,c} = 50 20MHz: N _{RB,c} = 100				5MHz: N _{RB,c} = 25 10MHz: N _{RB,c} = 50 20MHz: N _{RB,c} = 100				5MHz: N _{RB,c} = 25 10MHz: N _{RB,c} = 50 20MHz: N _{RB,c} = 100			
PDSCH parameters: DL Reference Measurement Channel		5MHz: R.7 FDD 10MHz: R.3 FDD 20MHz: R.6 FDD 5MHz: R.4 TDD 10MHz: R.0 TDD 20MHz: R.3 TDD				N/A	N/A	N/A	5MHz: R.7 FDD 10MH z: R.3 FDD 20MH z: R.6 FDD 5MHz: R.4 TDD 10MH z: R.0 TDD 20MH z: R.3 TDD	N/A				N/A			
PCFICH/PDCCH/PHICH parameters		5MHz: R.11 FDD 10MHz: R.6 FDD 20MHz: R.10 FDD 5MHz: R.11 TDD 10MHz: R.6 TDD 20MHz: R.10 TDD				5MHz: R.11 FDD 10MHz: R.6 FDD 20MHz: R.10 FDD 5MHz: R.11 TDD 10MHz: R.6 TDD 20MHz: R.10 TDD				5MHz: R.11 FDD 10MHz: R.6 FDD 20MHz: R.10 FDD 5MHz: R.11 TDD 10MHz: R.6 TDD 20MHz: R.10 TDD				5MHz: R.11 FDD 10MHz: R.6 FDD 20MHz: R.10 FDD 5MHz: R.11 TDD 10MHz: R.6 TDD 20MHz: R.10 TDD			
OCNG Pattern defined in A.3.2.1		5MHz: OP.20 FDD 10MHz: OP.10 FDD 20MHz: OP.17 FDD 5MHz: OP.9 TDD 10MHz: OP.1 TDD 20MHz: OP.7 TDD				5MHz: OP.19 FDD 10MH z: OP.6 FDD 20MH z:	5MHz: OP.19 FDD 10MH z: OP.6 FDD 20MH z:	5MHz: OP.19 FDD 10MH z: OP.6 FDD 20MH z:	5MHz: OP.20 FDD 10MH z: OP.10 FDD 20MH z:	5MHz: OP.16 FDD 10MHz: OP.2 FDD 20MHz: OP.12 FDD 5MHz: OP.10 TDD 10MHz: OP.2 TDD 20MHz: OP.8 TDD				5MHz: OP.16 FDD 10MHz: OP.2 FDD 20MHz: OP.12 FDD 5MHz: OP.10 TDD 10MHz: OP.2 TDD 20MHz: OP.8 TDD			

						OP.14 FDD	OP.14 FDD	OP.14 FDD	OP.17 FDD									
						5MHz: OP.10 TDD 10MH z: OP.2 TDD 20MH z: OP.8 TDD	5MHz: OP.10 TDD 10MH z: OP.2 TDD 20MH z: OP.8 TDD	5MHz: OP.10 TDD 10MH z: OP.2 TDD 20MH z: OP.8 TDD	5MHz: OP.9 TDD 10MH z: OP.1 TDD 20MH z: OP.7 TDD									
PBCH_RA	dB	0				0				0				0				
PBCH_RB	dB	0				0				0				0				
PSS_RA	dB	0				0				0				0				
SSS_RA	dB	0				0				0				0				
PCFICH_RB	dB	0				0				0				0				
PHICH_RA	dB	0				0				0				0				
PHICH_RB	dB	0				0				0				0				
PDCCH_RA	dB	0				0				0				0				
PDCCH_RB	dB	0				0				0				0				
PDSCH_RA	dB	0				0				0				0				
PDSCH_RB	dB	0				0				0				0				
OCNG_RA ^{Note 1}	dB	0				0				0				0				
OCNG_RB ^{Note 1}	dB	0				0				0				0				
N_{oc} ^{Note 3}	dBm/1 5 kHz	-101				-101				-101				-101				
\hat{E}_s/N_{oc}	dB	16	16	16	16	16	16	16	16	16	16	16	16	16	16	16	16	
\hat{E}_s/I_{ot} ^{Note 4}	dB	16	16	16	16	16	16	16	16	16	-0.11	16	-0.11	16	-0.11	16	-0.11	
RSRP ^{Note 4}	dBm/1 5 kHz	-85	-85	-85	-85	-85	-85	-85	-85	-85	-85	-85	-85	-85	85	-85	85	-85
SCH_RP ^{Note 4}	dBm/1 5 kHz	-85	-85	-85	-85	-85	-85	-85	-85	-85	-85	-85	-85	-85	85	-85	85	-85
I_o ^{Note 4}	dBm/C h BW	-	-	-	-	-57.11 +10log ($N_{RB,c}$ /50)	-57.11 +10log ($N_{RB,c}$ /50)	-57.11 +10log ($N_{RB,c}$ /50)	-57.11 +10log ($N_{RB,c}$ /50)	-	57.11 +10log g ($N_{RB,c}$ /50)	54.15 +10log g ($N_{RB,c}$ /50)	57.11 +10log g ($N_{RB,c}$ /50)	54.15 +10log g ($N_{RB,c}$ /50)	57.11 +10log g ($N_{RB,c}$ /50)	54.15 +10log g ($N_{RB,c}$ /50)	57.11 +10log g ($N_{RB,c}$ /50)	54.15 +10log g ($N_{RB,c}$ /50)
Propagation Condition		AWGN				AWGN				AWGN				AWGN				

Antenna Configuration		1x2	1x2	1x2	1x2
Timing offset to Cell 1	μs	-	0	0	0
Time alignment error relative to cell 1 ^{Note 5}	μs	-	≤ TAE	≤ TAE	≤ TAE
Time alignment error relative to cell 2 ^{Note 5}	μs	-	-	≤ TAE	≤ TAE
Time alignment error relative to cell 3 ^{Note 5}	μs	-	-	-	≤ TAE
<p>Note 1: OCNG shall be used such that all cells are fully allocated and a constant total transmitted power spectral density is achieved for all OFDM symbols.</p> <p>Note 2: The resources for uplink transmission are assigned to the UE on cell1 from the start of time period T2 and on cell2 from the start of time period T4.</p> <p>Note 3: Interference from other cells and noise sources not specified in the test is assumed to be constant over subcarriers and time and shall be modelled as AWGN of appropriate power for N_{oc} to be fulfilled.</p> <p>Note 4: Es/lot, RSRP, SCH_RP and Io levels have been derived from other parameters for information purposes. They are not settable parameters themselves.</p> <p>Note 5: Time alignment error (TAE) as specified in TS 36.104 [30] clause 6.5.3.1. The TAE value depends upon the type of carrier aggregation.</p>					

Table A.8.16.88.1-3: Cell specific test parameters for E-UTRAN 4 DL CA Event Triggered Reporting on Deactivated SCell with PCell and SCell Interruptions in Non-DRX with generic duplex modes(Cell #5)

Parameter	Unit	Cell 5			
		T1	T2	T3	T4
E-UTRA RF Channel Number		4			
$BW_{channel}$		5MHz: $N_{RB,c} = 25$ 10MHz: $N_{RB,c} = 50$ 20MHz: $N_{RB,c} = 100$			
PDSCH parameters: DL Reference Measurement Channel		N/A			
PCFICH/PDCCH/PHICH parameters		5MHz: R.11 FDD 10MHz: R.6 FDD 20MHz: R.10 FDD 5MHz: R.11 TDD 10MHz: R.6 TDD 20MHz: R.10 TDD			
OCNG Pattern defined in A.3.2.1		5MHz: OP.16 FDD 10MHz: OP.2 FDD 20MHz: OP.12 FDD 5MHz: OP.10 TDD 10MHz: OP.2 TDD 20MHz: OP.8 TDD			
PBCH_RA	dB	0			
PBCH_RB	dB				
PSS_RA	dB				
SSS_RA	dB				
PCFICH_RB	dB				
PHICH_RA	dB				
PHICH_RB	dB				
PDCCH_RA	dB				
PDCCH_RB	dB				
PDSCH_RA	dB				
PDSCH_RB	dB				
OCNG_RA ^{Note 1}	dB				
OCNG_RB ^{Note 1}	dB				
N_{oc} ^{Note 3}	dBm/15 kHz				
\hat{E}_s/N_{oc}	dB	-infinity	16	-infinity	16
\hat{E}_s/I_{ot} ^{Note 4}	dB	-infinity	-0.11	-infinity	-0.11
RSRP ^{Note 4}	dBm/15 kHz	-infinity	-85	-infinity	-85
SCH_RP ^{Note 4}	dBm/15 kHz	-infinity	-85	-infinity	-85
I_o ^{Note 4}	dBm/Ch BW	-57.11 +10log ($N_{RB,c}$ /50)	-54.15 +10log ($N_{RB,c}$ /50)	-57.11 +10log ($N_{RB,c}$ /50)	-54.15 +10log ($N_{RB,c}$ /50)
Propagation Condition		AWGN			
Antenna Configuration		1x2			
Timing offset to Cell 1	μ s	3			
Time alignment error relative to cell 1 ^{Note 5}	μ s	N/A			
Time alignment error relative to cell 2 ^{Note 5}	μ s	N/A			
Time alignment error relative to cell 3 ^{Note 5}	μ s	N/A			
Note 1:	OCNG shall be used such that all cells are fully allocated and a constant total transmitted power spectral density is achieved for all OFDM symbols.				
Note 2:	Void				

Note 3:	Interference from other cells and noise sources not specified in the test is assumed to be constant over subcarriers and time and shall be modelled as AWGN of appropriate power for N_{oc} to be fulfilled.
Note 4:	Es/lot, RSRP, SCH_RP and Io levels have been derived from other parameters for information purposes. They are not settable parameters themselves.
Note 5:	Time alignment error (TAE) as specified in TS 36.104 [30] clause 6.5.3.1. The TAE value depends upon the type of carrier aggregation.

A.8.16.88.2 Test Requirements

The UE shall send one Event A6 triggered measurement report, with a measurement reporting delay less than 12.8s ($20 \times \text{scellMeasCycle}$) from the beginning of time period T2.

The UE shall send one Event A6 triggered measurement report, with a measurement reporting delay less than 3.2s ($5 \times \text{scellMeasCycle}$) from the beginning of time period T4.

The UE shall not send event triggered measurement reports, as long as the reporting criteria are not fulfilled.

The UE shall be scheduled on PCell continuously throughout the test. From the start of T1 until the measurement report is received during T2, at least 99.5% of all expected ACK/NACKs shall be transmitted by the UE.

The UE shall be scheduled on Cell2 continuously from the beginning of T4 to the end. From the start of T4 until the measurement report is received during T4, at least 99.5% of all expected ACK/NACKs shall be transmitted by the UE.

For a test to be considered successful requirements on both event detection and percentage of transmitted ACK/NACKs have to be fulfilled simultaneously.

The rate of correct events observed during repeated tests shall be at least 90%.

NOTE: The actual overall delays measured in the test may be up to $2 \times \text{TTI}_{\text{DCCH}}$ higher than the measurement reporting delays above because of TTI insertion uncertainty of the measurement report in DCCH.

A.8.16.89 4 DL CA Activation and Deactivation of Known SCell in Non-DRX with generic duplex modes

A.8.16.89.1 Test Purpose and Environment

The purpose of this test is to verify that the SCell activation and deactivation times are within the requirements stated in section 7.7 for UE configured with three downlink SCells, when the SCell is known by the UE at the time of activation.

Note on the applicability: the requirement tested in the specific duplex-mode test cases A.8.16.57, A.8.16.58, A.8.16.59, A.8.16.60, does not need to be tested in the generic duplex-mode test case A.8.16.89.

The test parameters are given in Tables A.8.16.89.1-1 and cell-specific parameters in A.8.16.89.1-2 and A.8.16.89.1-3 below. The test consists of three successive time periods, with duration of T1, T2 and T3, respectively. There are four carriers, each with one cell. Cells may operate in either FDD or TDD duplex mode according to test configuration. All cells have constant signal levels throughout the test. Before the test starts the UE is connected to Cell 1 (PCell) on radio channel 1 (PCC), deactivated Cell 3 (SCell2) on radio channel 3 (SCC2) and deactivated Cell 4 (SCell3) on radio channel 4 (SCC3) but is not aware of Cell 2 (SCell1) on radio channel 2 (SCC1). The UE is only monitoring the PCC, SCC2 and SCC3. The UE shall be continuously scheduled in PCell throughout the whole test.

At the beginning of T1 the UE receives an RRC message by which the SCell1 becomes configured on SCC1. The UE now starts monitoring also SCC1. The test equipment sends a MAC message for activation of the SCell1.

The point in time at which the MAC message is received at the UE antenna connector, in a subframe # denoted m, where m is an even number for FDD PCell and 4 or 9 for TDD PCell, defines the start of time period T2. The UE receives a MAC message for activation of SCell2 in subframe (m+10) for FDD PCell and (m+15) for TDD PCell and a MAC message for activation of SCell3 in subframe (m+20) for FDD PCell and (m+15) for TDD PCell during activation of the SCell1. The UE shall be able to report valid CSI for the activated SCell1 at latest in a subframe (m+34). The UE shall start reporting CSI for SCell1 in subframe (m+8) and shall report CQI index 0 (out-of-range) until the SCell activation has been completed. Any PCell interruption due to activation of SCells shall not occur outside subframes (m+5) to (m+9), (m+15) to (m+19) and (m+25) to (m+29) for FDD PCell, and not outside subframes (m+5) to (m+11) and (m+20) to (m+26) for TDD PCell.

Time period T3 starts when a MAC message for deactivation of SCell1, sent from the test equipment to the UE in a subframe # denoted n, where n is an even number for FDD PCell and 4 or 9 for TDD PCell, is received at the UE antenna connector. The test equipment sends a MAC message for deactivation of SCell2 in subframe (n+10) for FDD PCell and (n+15) for TDD PCell and a MAC message for deactivation of SCell3 in subframe (n+20) for FDD PCell and (n+30) for TDD PCell. The UE shall carry out deactivation of the SCell1 at latest in subframe (n+8), and any PCell interruption due to the deactivation of SCells shall not occur outside subframes (n+5) to (n+9), (n+15) to (n+19) and (n+25) to (n+29) for FDD PCell, and not outside subframes (n+5) to (n+11), (n+20) to (n+26) and (n+35) to (n+41) for TDD PCell.

The test equipment verifies that potential interruption is carried out in the correct time span by monitoring ACK/NACK sent in PCell during activation and deactivation of SCell1, respectively.

The test equipment verifies the activation time by counting the subframes from the time when SCell1 activation command is sent until a CSI report with other than CQI index 0 is received.

The test equipment verifies the deactivation time by counting the subframes from the time when SCell1 deactivation command is sent until CQI reporting for SCell1 is discontinued.

Table A.8.16.89.1-1: General test parameters for known SCell1 activation case

Parameter	Unit	Value	Comment
E-UTRA RF Channel Number		1, 2, 3, 4	Four radio channels are used for this test
Active PCell		Cell 1	Primary cell on RF channel number 1.
Deconfigured deactivated SCell		Cell 2	Deconfigured deactivated secondary cell on RF channel number 2.
Configured deactivated SCell2		Cell 3	Configured deactivated secondary cell on RF channel number 3.
Configured deactivated SCell3		Cell 4	Configured deactivated secondary cell on RF channel number 4.
CP length		Normal	
DRX		OFF	Continuous monitoring of primary cell
CQI/PMI periodicity and offset configuration index		0	CQI reporting for SCell every UL subframe
Cell-individual offset for cells on RF channel number 1	dB	0	Individual offset for cells on PCC.
Cell-individual offset for cells on RF channel number 2	dB	0	Individual offset for cells on SCC1.
Cell-individual offset for cells on RF channel number 3	dB	0	Individual offset for cells on SCC2.
Cell-individual offset for cells on RF channel number 4	dB	0	Individual offset for cells on SCC3.
Filter coefficient		0	L3 filtering is not used.
SCell measurement cycle (measCycleSCell)	ms	320	
T1	s	7	During this time the PCell, SCell2 and SCell3 shall be known and the SCell1 configured and detected.
T2	s	1	During this time the UE shall activate the SCell1, SCell2, and SCell3.
T3	s	1	During this time the UE shall deactivate the SCell1, SCell2, and SCell3.

Table A.8.16.89.1-2: Cell specific test parameters for E-UTRAN FDD known SCell1 activation

Parameter	Unit	Cell 1			Cell 2			Cell 3		
		T1	T2	T3	T1	T2	T3	T1	T2	T3
E-UTRA RF Channel Number		1			2			3		
Duplex mode		FDD or TDD			FDD or TDD			FDD or TDD		
TDD Special subframe configuration		6			6			6		
TDD Uplink-downlink configuration		1			1			1		
BW _{channel}	MHz	5MHz: N _{RB,c} = 25 10MHz: N _{RB,c} = 50 20MHz: N _{RB,c} = 100			5MHz: N _{RB,c} = 25 10MHz: N _{RB,c} = 50 20MHz: N _{RB,c} = 100			5MHz: N _{RB,c} = 25 10MHz: N _{RB,c} = 50 20MHz: N _{RB,c} = 100		

PDSCH parameters: DL Reference Measurement Channel		5MHz: R.7 FDD 10MHz: R.3 FDD 20MHz: R.6 FDD 5MHz: R.4 TDD 10MHz: R.0 TDD 20MHz: R.3 TDD	-	-
PCFICH/PDCCH/PHICH parameters: DL Reference Measurement Channel		5MHz: R.11 FDD 10MHz: R.6 FDD 20MHz: R.10 FDD 5MHz: R.11 TDD 10MHz: R.6 TDD 20MHz: R.10 TDD	5MHz: R.11 FDD 10MHz: R.6 FDD 20MHz: R.10 FDD 5MHz: R.11 TDD 10MHz: R.6 TDD 20MHz: R.10 TDD	5MHz: R.11 FDD 10MHz: R.6 FDD 20MHz: R.10 FDD 5MHz: R.11 TDD 10MHz: R.6 TDD 20MHz: R.10 TDD
OCNG Patterns		5MHz: OP.20 FDD 10MHz: OP.10 FDD 20MHz: OP.17 FDD 5MHz: OP.9 TDD 10MHz: OP.1 TDD 20MHz: OP.7 TDD	5MHz: OP.16 FDD 10MHz: OP.2 FDD 20MHz: OP.12 FDD 5MHz: OP.10 TDD 10MHz: OP.2 TDD 20MHz: OP.8 TDD	5MHz: OP.16 FDD 10MHz: OP.2 FDD 20MHz: OP.12 FDD 5MHz: OP.10 TDD 10MHz: OP.2 TDD 20MHz: OP.8 TDD
PBCH_RA	dB	0	0	0
PBCH_RB	dB			
PSS_RA	dB			
SSS_RA	dB			
PCFICH_RB	dB			
PHICH_RA	dB			
PHICH_RB	dB			
PDCCH_RA	dB			
PDCCH_RB	dB			
PDSCH_RA	dB			
PDSCH_RB	dB			
OCNG_RA ^{Note 1}	dB			
OCNG_RB ^{Note 1}	dB			
N _{oc} ^{Note 2}	dBm/15 kHz			
E _s /N _{oc}	dB	17	17	17
E _s /I _{ot}	dB	17	17	17
RSRP ^{Note 3}	dBm/15 kHz	-87	-87	-87
SCH_RP ^{Note 3}	dBm/15 kHz	-87	-87	-87
I _o ^{Note 3}	dBm/Ch BW	-59.13 +10log (N _{RB,c} /50)	-59.13 +10log (N _{RB,c} /50)	-59.13 +10log (N _{RB,c} /50)
Propagation Condition		AWGN	AWGN	AWGN
Antenna Configuration		1x2	1x2	1x2
Timing offset to Cell 1	μs	-	0	0
Time alignment error relative to cell 1 ^{Note 5}	μs	-	≤ TAE	≤ TAE
Time alignment error relative to cell 2 ^{Note 5}	μs	-	-	≤ TAE
Time alignment error relative to cell 3 ^{Note 5}	μs	-	-	-
<p>Note 1: OCNG shall be used such that all cells are fully allocated and a constant total transmitted power spectral density is achieved for all OFDM symbols.</p> <p>Note 2: Interference from other cells and noise sources not specified in the test is assumed to be constant over subcarriers and time and shall be modelled as AWGN of appropriate power for N_{oc} to be fulfilled.</p> <p>Note 3: E_s/I_{ot}, RSRP, SCH_RP and I_o levels have been derived from other parameters for information purposes. They are not settable parameters themselves.</p> <p>Note 4: The uplink resources for CSI reporting are assigned to the UE prior to the start of time period T2.</p> <p>Note 5: Time alignment error (TAE) as specified in TS 36.104 [30] clause 6.5.3.1. The TAE value depends upon the type of carrier aggregation.</p>				

Table A.8.16.89.1-3: Cell specific test parameters for known SCell1 activation

Parameter	Unit	Cell 4							
		T1	T2	T3					

E-UTRA RF Channel Number		4			
Duplex mode		FDD or TDD			
TDD Special subframe configuration		6			
TDD Uplink-downlink configuration		1			
$BW_{channel}$	MHz	5MHz: $N_{RB,c} = 25$ 10MHz: $N_{RB,c} = 50$ 20MHz: $N_{RB,c} = 100$			
PDSCH parameters: DL Reference Measurement Channel		-			
PCFICH/PDCCH/PHICH parameters: DL Reference Measurement Channel		5MHz: R.11 FDD 10MHz: R.6 FDD 20MHz: R.10 FDD 5MHz: R.11 TDD 10MHz: R.6 TDD 20MHz: R.10 TDD			
OCNG Patterns		5MHz: OP.16 FDD 10MHz: OP.2 FDD 20MHz: OP.12 FDD 5MHz: OP.10 TDD 10MHz: OP.2 TDD 20MHz: OP.8 TDD			
PBCH_RA	dB	0			
PBCH_RB	dB				
PSS_RA	dB				
SSS_RA	dB				
PCFICH_RB	dB				
PHICH_RA	dB				
PHICH_RB	dB				
PDCCH_RA	dB				
PDCCH_RB	dB				
PDSCH_RA	dB				
PDSCH_RB	dB				
OCNG_RA ^{Note 1}	dB				
OCNG_RB ^{Note 1}	dB				
N_{oc} ^{Note 2}	dBm/15 kHz		-104		
\bar{E}_s/N_{oc}	dB		17		
\bar{E}_s/I_{ot}	dB	17			
RSRP ^{Note 3}	dBm/15 kHz	-87			
SCH_RP ^{Note 3}	dBm/15 kHz	-87			
I_o ^{Note 3}	dBm/Ch BW	-59.13 +10log ($N_{RB,c} / 50$)			
Propagation Condition		AWGN			
Antenna Configuration		1x2			
Timing offset to Cell 1	μs	0			
Time alignment error relative to cell 1 ^{Note 5}	μs	$\leq TAE$			
Time alignment error relative to cell 2 ^{Note 5}	μs	$\leq TAE$			
Time alignment error relative to cell 3 ^{Note 5}	μs	$\leq TAE$			
<p>Note 1: OCNG shall be used such that all cells are fully allocated and a constant total transmitted power spectral density is achieved for all OFDM symbols.</p> <p>Note 2: Interference from other cells and noise sources not specified in the test is assumed to be constant over subcarriers and time and shall be modelled as AWGN of appropriate power for N_{oc} to be fulfilled.</p> <p>Note 3: E_s/I_{ot}, RSRP, SCH_RP and I_o levels have been derived from other parameters for information purposes. They are not settable parameters themselves.</p> <p>Note 4: The uplink resources for CSI reporting are assigned to the UE prior to the start of time period T2.</p> <p>Note 5: Time alignment error (TAE) as specified in TS 36.104 [30] clause 6.5.3.1. The TAE value depends upon the type of carrier aggregation.</p>					

A.8.16.89.2 Test Requirements

During T2 the UE shall send the first CSI report for SCell1 in subframe (m+8), or in subframe (m+10) for FDD PCell and (m+9) for TDD PCell, if the subframe (m+8) was subject to interruption, or in subframe (m+13) for TDD PCell, if the subframes (m+8) and (m+9) were subject to interruption. Whether CSI report in subframe (m+8) / (m+9) was interrupted or not is checked by monitoring ACK/NACK sent in PCell in subframe (m+8) / (m+9).

During T2 the UE shall start sending CSI reports for SCell1 with non-zero CQI index at latest in a subframe (m+34).

During T3 the UE shall stop sending CSI reports for SCell at latest in a subframe (n+8).

During T2 interruption of PCell during SCells activation shall not happen outside subframes (m+5) to (m+9), (m+15) to (m+19) and (m+25) to (m+29) for FDD PCell, and not happen outside subframes (m+5) to (m+11) and (m+20) to (m+26) for TDD PCell.

During T3 interruption of PCell during SCells deactivation shall not happen outside subframes (n+5) to (n+9), (n+15) to (n+19) and (n+25) to (n+29) for FDD PCell, and not happen outside subframes (n+5) to (n+11), (n+20) to (n+26) and (n+35) to (n+41) for TDD PCell.

The interruption of PCell shall not be more than the values specified for intra-band CA and inter-band CA in Section 7.8.2.

All of the above test requirements shall be fulfilled in order for the observed SCell1 activation delay and SCell1 deactivation delay to be counted as correct. The rate of correct observed SCell1 activation delay and SCell1 deactivation delay during repeated tests shall be at least 90%.

NOTE: During T2 if there are no uplink resources for reporting the valid CSI in a subframe (m+34) then the UE shall use the next available uplink resource for reporting the corresponding valid CSI.

A.8.16.90 4 DL CA Activation and Deactivation of Unknown SCell in Non-DRX with generic duplex modes

A.8.16.90.1 Test Purpose and Environment

The purpose of this test is to verify that the SCell activation and deactivation times are within the requirements stated in section 7.7 for UE configured with three downlink SCells, when the SCell is unknown by the UE at the time of activation.

Note on the applicability: the requirement tested in the specific duplex-mode test cases A.8.16.61, A.8.16.62, A.8.16.63, A.8.16.64, does not need to be tested in the generic duplex-mode test case A.8.16.90.

The test parameters are given in Tables A.8.16.90.1-1 and cell-specific parameters in A.8.16.90.1-2 and A.8.16.90.1-3 below. The test consists of three successive time periods, with duration of T1, T2 and T3, respectively. There are four carriers, each with one cell. Cells may operate in either FDD or TDD duplex mode according to test configuration. Cell 1, Cell 3 and Cell 4 have constant signal levels throughout the test. Before the test starts the UE is connected to Cell 1 (PCell) on radio channel 1 (PCC), deactivated Cell 3 (SCell2) on radio channel 3 (SCC2) and deactivated Cell 4 (SCell3) on radio channel 4 (SCC3) but is not aware of Cell 2 (SCell1) on radio channel 2 (SCC1). The UE is only monitoring PCC, SCC2 and SCC3. The UE shall be continuously scheduled in PCell throughout the whole test.

At the beginning of T1 the UE receives an RRC message by which SCell1 becomes configured on SCC1. During T1 SCell1 is powered off and the UE is not aware of SCell1.

A MAC message for activation of SCell1 is sent by the test equipment 100ms after the RRC message, in a subframe # denoted m, where m is an even number for FDD PCell and 4 or 9 for TDD PCell. The point in time at which the MAC message for activation of SCell1 is received at the UE antenna connector defines the start of time period T2. Immediately at beginning of T2 the transmission power of SCell1 is increased to same level as for PCell. The test equipment sends a MAC message for activation of SCell2 in subframe (m+10) for FDD PCell and (m+15) for TDD PCell, and a MAC message for activation of SCell3 in subframe (m+20) for FDD PCell and (m+30) for TDD PCell during activation of SCell1. The UE shall be able to report valid CSI for the activated SCell1 at latest in subframe (m+44) provided the SCell1 can be successfully detected on the first attempt. The UE shall start reporting CSI for SCell1 in subframe (m+8) and shall report CQI index 0 (out-of-range) until the SCell activation has been completed. Any PCell interruption due to activation of SCells shall not occur outside subframes (m+5) to (m+9), (m+15) to (m+19) and (m+25) to (m+29) for FDD PCell, and not outside subframes (m+5) to (m+11), (m+20) to (m+26) and (m+35) to (m+41) for TDD PCell.

Time period T3 starts when a MAC message for deactivation of SCell1, sent from the test equipment to the UE in a subframe # denoted n, where n is an even number for FDD PCell and 4 or 9 for TDD PCell, is received at the UE antenna connector. The test equipment sends a MAC message for deactivation of the SCell2 in subframe (n+10) for FDD PCell and (n+15) for TDD PCell, and a MAC message for deactivation of the SCell3 in subframe (n+20) in FDD PCell and (n+30) for TDD PCell. The UE shall carry out deactivation of SCell1 at latest in subframe (n+8), and any PCell interruption due to the deactivation of SCells shall not occur

outside subframes (n+5) to (n+9), (n+15) to (n+19) and (n+25) to (n+29) for FDD PCell, and not outside subframes (n+5) to (n+11), (n+20) to (n+26) and (n+35) to (n+41) for TDD PCell.

The test equipment verifies that potential interruption is carried out in the correct time span by monitoring ACK/NACK sent in PCell during activation and deactivation of SCell1, respectively.

The test equipment verifies the activation time by counting the subframes from time when the SCell1 activation command is sent until a CSI report with other than CQI index 0 is received.

The test equipment verifies the deactivation time by counting the subframes from time when the SCell1 deactivation command is sent until CQI reporting for SCell1 is discontinued.

Table A.8.16.90.1-1: General test parameters for unknown SCell1 activation case

Parameter	Unit	Value	Comment
E-UTRA RF Channel Number		1, 2, 3, 4	Four radio channels are used for this test
Active PCell		Cell 1	Primary cell on RF channel number 1.
Deconfigured deactivated SCell		Cell 2	Deconfigured deactivated secondary cell on RF channel number 2.
Configured deactivated SCell2		Cell 3	Configured deactivated secondary cell on RF channel number 3.
Configured deactivated SCell3		Cell 4	Configured deactivated secondary cell on RF channel number 4.
CP length		Normal	
DRX		OFF	Continuous monitoring of primary cell
CQI/PMI periodicity and offset configuration index		0	CQI reporting for SCell every UL subframe
Cell-individual offset for cells on RF channel number 1	dB	0	Individual offset for cells on PCC.
Cell-individual offset for cells on RF channel number 2	dB	0	Individual offset for cells on SCC1.
Cell-individual offset for cells on RF channel number 3	dB	0	Individual offset for cells on SCC2.
Cell-individual offset for cells on RF channel number 4	dB	0	Individual offset for cells on SCC3.
Filter coefficient		0	L3 filtering is not used.
SCell measurement cycle (measCycleSCell)	ms	320	
T1	ms	100	During this time the PCell, SCell2 and SCell3 shall be known and the SCell1 configured.
T2	s	1	During this time the UE shall activate the SCell1, SCell2, and SCell3.
T3	s	1	During this time the UE shall deactivate the SCell1, SCell2, and SCell3.

Table A.8.16.90.1-2: Cell specific test parameters for unknown SCell1 activation

Parameter	Unit	Cell 1			Cell 2			Cell 3		
		T1	T2	T3	T1	T2	T3	T1	T2	T3
E-UTRA RF Channel Number		1			2			3		
Duplex mode		FDD or TDD			FDD or TDD			FDD or TDD		
TDD Special subframe configuration		6			6			6		
TDD Uplink-downlink configuration		1			1			1		
BW _{channel}	MHz	5MHz: N _{RB,c} = 25 10MHz: N _{RB,c} = 50 20MHz: N _{RB,c} = 100			5MHz: N _{RB,c} = 25 10MHz: N _{RB,c} = 50 20MHz: N _{RB,c} = 100			5MHz: N _{RB,c} = 25 10MHz: N _{RB,c} = 50 20MHz: N _{RB,c} = 100		
PDSCH parameters: DL Reference Measurement Channel		5MHz: R.7 FDD 10MHz: R.3 FDD 20MHz: R.6 FDD 5MHz: R.4 TDD 10MHz: R.0 TDD 20MHz: R.3 TDD			-			-		

PCFICH/PDCCH/PHICH parameters: DL Reference Measurement Channel		5MHz: R.11 FDD 10MHz: R.6 FDD 20MHz: R.10 FDD 5MHz: R.11 TDD 10MHz: R.6 TDD 20MHz: R.10 TDD	5MHz: R.11 FDD 10MHz: R.6 FDD 20MHz: R.10 FDD 5MHz: R.11 TDD 10MHz: R.6 TDD 20MHz: R.10 TDD	5MHz: R.11 FDD 10MHz: R.6 FDD 20MHz: R.10 FDD 5MHz: R.11 TDD 10MHz: R.6 TDD 20MHz: R.10 TDD
OCNG Patterns		5MHz: OP.20 FDD 10MHz: OP.10 FDD 20MHz: OP.17 FDD 5MHz: OP.9 TDD 10MHz: OP.1 TDD 20MHz: OP.7 TDD	5MHz: OP.16 FDD 10MHz: OP.2 FDD 20MHz: OP.12 FDD 5MHz: OP.10 TDD 10MHz: OP.2 TDD 20MHz: OP.8 TDD	5MHz: OP.16 FDD 10MHz: OP.2 FDD 20MHz: OP.12 FDD 5MHz: OP.10 TDD 10MHz: OP.2 TDD 20MHz: OP.8 TDD
PBCH_RA	dB	0	0	0
PBCH_RB	dB			
PSS_RA	dB			
SSS_RA	dB			
PCFICH_RB	dB			
PHICH_RA	dB			
PHICH_RB	dB			
PDCCH_RA	dB			
PDCCH_RB	dB			
PDSCH_RA	dB			
PDSCH_RB	dB			
OCNG_RA ^{Note 1}	dB			
OCNG_RB ^{Note 1}	dB			
N _{oc} ^{Note 2}	dBm/15 kHz	-104	-104	-104
\bar{E}_s/N_{oc}	dB	17	-infinity	17
\bar{E}_s/I_{ot}	dB	17	-infinity	17
RSRP ^{Note 3}	dBm/15 kHz	-87	-infinity	-87
SCH_RP ^{Note 3}	dBm/15 kHz	-87	-infinity	-87
I _o ^{Note 3}	dBm/Ch BW	-59.13 +10log (N _{RB,c} /50)	-76.22 +10log (N _{RB,c} /50)	-59.13 +10log (N _{RB,c} /50)
Propagation Condition		AWGN	AWGN	AWGN
Antenna Configuration		1x2	1x2	1x2
Timing offset to Cell 1	μs	-	0	0
Time alignment error relative to cell 1 ^{Note 5}	μs	-	≤ TAE	≤ TAE
Time alignment error relative to cell 2 ^{Note 5}	μs	-	-	≤ TAE
Time alignment error relative to cell 3 ^{Note 5}	μs	-	-	-
<p>Note 1: OCNG shall be used such that all cells are fully allocated and a constant total transmitted power spectral density is achieved for all OFDM symbols.</p> <p>Note 2: Interference from other cells and noise sources not specified in the test is assumed to be constant over subcarriers and time and shall be modelled as AWGN of appropriate power for N_{oc} to be fulfilled.</p> <p>Note 3: Es/I_{ot}, RSRP, SCH_RP and I_o levels have been derived from other parameters for information purposes. They are not settable parameters themselves.</p> <p>Note 4: The uplink resources for CSI reporting are assigned to the UE prior to the start of time period T2.</p> <p>Note 5: Time alignment error (TAE) as specified in TS 36.104 [30] clause 6.5.3.1. The TAE value depends upon the type of carrier aggregation.</p>				

Table A.8.16.90.1-3: Cell specific test parameters for unknown SCell1 activation

Parameter	Unit	Cell 4		
		T1	T2	T3
E-UTRA RF Channel Number		4		
Duplex mode		FDD or TDD		
TDD Special subframe configuration		6		

TDD Uplink-downlink configuration		1		
BW _{channel}	MHz	5MHz: N _{RB,c} = 25 10MHz: N _{RB,c} = 50 20MHz: N _{RB,c} = 100		
PDSCH parameters: DL Reference Measurement Channel		-		
PCFICH/PDCCH/PHICH parameters: DL Reference Measurement Channel		5MHz: R.11 FDD 10MHz: R.6 FDD 20MHz: R.10 FDD 5MHz: R.11 TDD 10MHz: R.6 TDD 20MHz: R.10 TDD		
OCNG Patterns		5MHz: OP.16 FDD 10MHz: OP.2 FDD 20MHz: OP.12 FDD 5MHz: OP.10 TDD 10MHz: OP.2 TDD 20MHz: OP.8 TDD		
PBCH_RA	dB	0		
PBCH_RB	dB			
PSS_RA	dB			
SSS_RA	dB			
PCFICH_RB	dB			
PHICH_RA	dB			
PHICH_RB	dB			
PDCCH_RA	dB			
PDCCH_RB	dB			
PDSCH_RA	dB			
PDSCH_RB	dB			
OCNG_RA ^{Note 1}	dB			
OCNG_RB ^{Note 1}	dB			
N _{oc} ^{Note 2}	dBm/15 kHz		-104	
\bar{E}_s/N_{oc}	dB	17		
\bar{E}_s/I_{ot}	dB	17		
RSRP ^{Note 3}	dBm/15 kHz	-87		
SCH_RP ^{Note 3}	dBm/15 kHz	-87		
I _o ^{Note 3}	dBm/Ch BW	-59.13 +10log (N _{RB,c} /50)		
Propagation Condition		AWGN		
Antenna Configuration		1x2		
Timing offset to Cell 1	μs	0		
Time alignment error relative to cell 1 ^{Note 5}	μs	≤ TAE		
Time alignment error relative to cell 2 ^{Note 5}	μs	≤ TAE		
Time alignment error relative to cell 3 ^{Note 5}	μs	≤ TAE		
<p>Note 1: OCNG shall be used such that all cells are fully allocated and a constant total transmitted power spectral density is achieved for all OFDM symbols.</p> <p>Note 2: Interference from other cells and noise sources not specified in the test is assumed to be constant over subcarriers and time and shall be modelled as AWGN of appropriate power for N_{oc} to be fulfilled.</p> <p>Note 3: Es/I_{ot}, RSRP, SCH_RP and I_o levels have been derived from other parameters for information purposes. They are not settable parameters themselves.</p> <p>Note 4: The uplink resources for CSI reporting are assigned to the UE prior to the start of time period T2.</p> <p>Note 5: Time alignment error (TAE) as specified in TS 36.104 [30] clause 6.5.3.1. The TAE value depends upon the type of carrier aggregation.</p>				

A.8.16.90.2 Test Requirements

During T2 the UE shall send the first CSI report for SCell1 in a subframe (m+8), or in a subframe (m+10) for FDD PCell and (m+9) for TDD PCell, if the subframe (m+8) was subject to interruption, or in subframe (m+13) for TDD PCell, if the subframes

(m+8) and (m+9) were subject to interruption. Whether CSI report in subframe (m+8) / (m+9) was interrupted or not is checked by monitoring ACK/NACK sent in PCell in subframe (m+8) / (m+9).

During T2 the UE shall start sending CSI reports for SCell1 with non-zero CQI index at latest in a subframe (m+44).

During T3 the UE shall stop sending CSI reports for SCell at latest in a subframe (n+8).

During T2 interruption of PCell during SCells activation shall not happen outside subframes (m+5) to (m+9), (m+15) to (m+19) and (m+25) to (m+29) for FDD PCell, and not happen outside subframes (m+5) to (m+11), (m+20) to (m+26) and (m+35) to (m+41) for TDD PCell.

During T3 interruption of PCell during SCells deactivation shall not happen outside subframes (n+5) to (n+9), (n+15) to (n+19) and (n+25) to (n+29) for FDD PCell, and not happen outside subframes (n+5) to (n+11), (n+20) to (n+26) and (n+35) to (n+41) for TDD PCell.

The interruption of PCell shall not be more than the values specified for intra-band CA and inter-band CA in Section 7.8.2.

All of the above test requirements shall be fulfilled in order for the observed SCell1 activation delay and SCell1 deactivation delay to be counted as correct. The rate of correct observed SCell1 activation delay and SCell1 deactivation delay during repeated tests shall be at least 90%.

NOTE: During T2 if there are no uplink resources for reporting the valid CSI in a subframe (m+44) then the UE shall use the next available uplink resource for reporting the corresponding valid CSI.

A.8.16.91 5 DL CA Event Triggered Reporting under Deactivated SCells in Non-DRX with generic duplex modes

A.8.16.91.1 Test Purpose and Environment

The purpose of this test is to verify that the UE correctly detects events A1 (Serving cell becomes better than threshold), A2 (Serving cell becomes worse than threshold) and A6 (Neighbour becomes better than SCell) defined in TS 36.331 [2] within the requirements stated in clause 8.3.3.2.1.

Note on the applicability: the requirement tested in the specific duplex-mode test cases A.8.16.71, A.8.16.72, A.8.65 and A.8.16.66 does not need to be tested in the generic duplex-mode test case A.8.16.91.

The test parameters are given in Tables A.8.16.91.1-1, A.8.16.91.1-2 and A.8.16.91.1-3 below. It is indicated to the UE in the measurement control information that event-triggered reporting with Events A1 (for only SCell1 i.e. cell2), A2 (PCell and SCells) and A6 is used. The test consists of three successive time periods, with duration of T1, T2 and T3, respectively. During T1 the UE shall not have any information on cell 6. At the beginning of T2 the transmission power of cell 6 is increased to the same level as for cell 5, and due to usage of an offset this shall result in reporting of Event A6. Also, at the beginning of T2 the transmission power of cell 2 is increased to the same level as for cell 1, which shall result in reporting of Event A1. At the beginning of T3 the transmission powers of cells 1, 2, 3, 4 and 5 are reduced below a threshold value and this shall result in reporting of Event A2 for Cell 1, for Cell 2, for Cell 3, for Cell 4 and for Cell 5. Cells 1, 2, 3, 4, 5 and 6 may operate in either FDD or TDD duplex mode according to test configuration.

Table A.8.16.91.1-1: General test parameters for E-UTRAN 5 DL CA event triggered reporting under fading propagation conditions with 4 configured but deactivated SCells in non-DRX with generic duplex modes

Parameter	Unit	Value	Comment
E-UTRA RF Channel Number		1, 2, 3, 4, 5	Five radio channels are used for this test
Active PCell		Cell 1	Primary cell on RF channel number 1.
Configured deactivated SCell		Cell 2	Configured deactivated secondary cell on RF channel number 2.
Configured deactivated SCell		Cell 3	Configured deactivated secondary cell on RF channel number 3.
Configured deactivated SCell		Cell 4	Configured deactivated secondary cell on RF channel number 4.
Configured deactivated SCell		Cell 5	Configured deactivated secondary cell on RF channel number 5.
Neighbour cell		Cell 6	Neighbour cell to be identified on RF channel number 5.
CP length		Normal	
DRX		OFF	Continuous monitoring of primary cell
Special subframe configuration		6	As specified in table 4.2-1 in TS 36.211. The same configuration applies to all TDD cells (cell2, cell3, cell4, cell5 and cell6).

Uplink-downlink configuration			1	As specified in table 4.2-2 in TS 36.211. The same configuration applies to all TDD cells (cell2, cell3, cell4, cell5 and cell6).
A1	Hysteresis	dB	0	Hysteresis for evaluation of event A1.
	Threshold RSRP	dBm	-98	Actual RSRP threshold for event A1. Needs to take absolute accuracy tolerance in section 9.1.11.1 into account plus margin.
	Time To Trigger	s	0	
A2	Hysteresis	dB	0	Hysteresis for evaluation of event A2.
	Threshold RSRP	dBm	-98	Actual RSRP threshold for event A2. Needs to take absolute accuracy tolerance in section 9.1.11.1 into account plus margin.
	Time To Trigger	s	0	
A6	Hysteresis	dB	0	Hysteresis for evaluation of event A6.
	Offset	dB	-6	Offset parameter for evaluation of event A6. Needs to take relative accuracy tolerance in section 9.1.11.2 into account plus margin.
	Report on leave		False	
	Time To Trigger	s	0	
Cell-individual offset for cells on RF channel number 1		dB	0	Individual offset for cells on primary component carrier.
Cell-individual offset for cells on RF channel number 2		dB	0	Individual offset for cells on secondary component carrier.
Cell-individual offset for cells on RF channel number 3		dB	0	Individual offset for cells on secondary component carrier.
Cell-individual offset for cells on RF channel number 4		dB	0	Individual offset for cells on secondary component carrier.
Cell-individual offset for cells on RF channel number 5		dB	0	Individual offset for cells on secondary component carrier.
Filter coefficient			0	L3 filtering is not used
SCell measurement cycle (measCycleSCell)		ms	320	For cell2, cell3, cell4 and cell5
T1		s	5	During this time the cell1, cell3, cell4 and cell5 shall be known to the UE; but cell2 and cell6 shall be unknown to the UE.
T2		s	≤12	UE should report Event A1 for cell2 and event A6 for cell6 within 6.4s (20×scellMeasCycle)
T3		s	5	UE should report Event A2 within 200 ms for cell1 and within 1.6s for each of cells 2, 3, 4 and 5.

Table A.8.16.91.1-2: Cell specific test parameters for E-UTRAN 5 DL CA event triggered reporting under fading propagation conditions with 4 configured but deactivated SCells in non-DRX with generic duplex modes

Parameter	Unit	Cell 1			Cell 2			Cell3		
		T1	T2	T3	T1	T2	T3	T1	T2	T3
E-UTRA RF Channel Number		1			2			3		
BW _{channel}		5MHz: N _{RB,c} = 25 10MHz: N _{RB,c} = 50 20MHz: N _{RB,c} = 100			5MHz: N _{RB,c} = 25 10MHz: N _{RB,c} = 50 20MHz: N _{RB,c} = 100			5MHz: N _{RB,c} = 25 10MHz: N _{RB,c} = 50 20MHz: N _{RB,c} = 100		
PDSCH parameters: DL Reference Measurement Channel		5MHz: R.5 FDD 10MHz: R.0 FDD 20MHz: R.4 FDD 5MHz: R.4 TDD 10MHz: R.0 TDD 20MHz: R.3 TDD			-			-		
PCFICH/PDCCH/PHICH parameters: DL Reference Measurement Channel		5MHz: R.11 FDD 10MHz: R.6 FDD 20MHz: R.10 FDD 5MHz: R.11 TDD 10MHz: R.6 TDD 20MHz: R.10 TDD			5MHz: R.11 FDD 10MHz: R.6 FDD 20MHz: R.10 FDD 5MHz: R.11 TDD 10MHz: R.6 TDD 20MHz: R.10 TDD			5MHz: R.11 FDD 10MHz: R.6 FDD 20MHz: R.10 FDD 5MHz: R.11 TDD 10MHz: R.6 TDD 20MHz: R.10 TDD		
OCNG Patterns		5MHz: OP.15 FDD 10MHz: OP.1 FDD 20MHz: OP.11 FDD 5MHz: OP.9 TDD 10MHz: OP.1 TDD 20MHz: OP.7 TDD			5MHz: OP.16 FDD 10MHz: OP.2 FDD 20MHz: OP.12 FDD 5MHz: OP.10 TDD 10MHz: OP.2 TDD 20MHz: OP.8 TDD			5MHz: OP.16 FDD 10MHz: OP.2 FDD 20MHz: OP.12 FDD 5MHz: OP.10 TDD 10MHz: OP.2 TDD 20MHz: OP.8 TDD		
PBCH_RA	dB	0			0			0		
PBCH_RB	dB									
PSS_RA	dB									
SSS_RA	dB									
PCFICH_RB	dB									
PHICH_RA	dB									
PHICH_RB	dB									
PDCCH_RA	dB									
PDCCH_RB	dB									
PDSCH_RA	dB									
PDSCH_RB	dB									
OCNG_RA ^{Note 1}	dB									
OCNG_RB ^{Note 1}	dB									
N _{oc} ^{Note 2}	dBm/15 KHz									
E _s /N _{oc}	dB	17	17	-3	-infinity	17	-3	17	17	-3
E _s /I _{ot} ^{Note 3}	dB	17	17	-3	-infinity	17	-3	17	17	-3
RSRP ^{Note 3}	dBm/15 kHz	-87	-87	-107	-infinity	-87	-107	-87	-87	-107
SCH_RP ^{Note 3}	dBm/15 kHz	-87	-87	-107	-infinity	-87	-107	-87	-87	-107
I _o ^{Note 3}	dBm/Ch BW	-59.13 +10log (N _{RB,c} /50)	-59.13 +10log (N _{RB,c} /50)	-74.45 +10log (N _{RB,c} /50)	-76.22 +10log (N _{RB,c} /50)	-59.13 +10log (N _{RB,c} /50)	-74.45 +10log (N _{RB,c} /50)	-59.13 +10log (N _{RB,c} /50)	-59.13 +10log (N _{RB,c} /50)	-74.45 +10log (N _{RB,c} /50)
Propagation Condition		AWGN			ETU70			ETU70		
Correlation Matrix and Antenna Configuration		1x2 Low			1x2 Low			1x2 Low		
Timing offset to Cell 1	μs	-			0			0		
Time alignment error relative to cell1 ^{Note 5}	μs	-			≤ TAE			≤ TAE		
Time alignment error relative to cell 2 ^{Note 5}	μs	≤ TAE			-			≤ TAE		

Time alignment error relative to cell 3 ^{Note 5}	μs	≤ TAE	≤ TAE	-
Time alignment error relative to cell 4 ^{Note 5}	μs	≤ TAE	≤ TAE	≤ TAE
Time alignment error relative to cell 5 ^{Note 5}	μs	≤ TAE	≤ TAE	≤ TAE

Note 1: OCNG shall be used such that all cells are fully allocated and a constant total transmitted power spectral density is achieved for all OFDM symbols.

Note 2: Interference from other cells and noise sources not specified in the test is assumed to be constant over subcarriers and time and shall be modelled as AWGN of appropriate power for N_{oc} to be fulfilled.

Note 3: E_s/I_{ot} , RSRP, SCH_RP and I_o have been derived from other parameters for information purposes. They are not settable parameters themselves.

Note 4: The resources for uplink transmission are assigned to the UE prior to the start of time period T2.

Note 5: Time alignment error (TAE) as specified in TS 36.104 [30] clause 6.5.3.1. The TAE value depends upon the type of carrier aggregation.

Table A.8.16.91.1-3: Cell specific test parameters for E-UTRAN 5 DL CA event triggered reporting under fading propagation conditions with 4 configured but deactivated SCells in non-DRX with generic duplex modes

Parameter	Unit	Cell 4			Cell 5			Cell 6		
		T1	T2	T3	T1	T2	T3	T1	T2	T3
E-UTRA RF Channel Number		4			5					
BW _{channel}		5MHz: $N_{RB,c} = 25$ 10MHz: $N_{RB,c} = 50$ 20MHz: $N_{RB,c} = 100$			5MHz: $N_{RB,c} = 25$ 10MHz: $N_{RB,c} = 50$ 20MHz: $N_{RB,c} = 100$					
PDSCH parameters: DL Reference Measurement Channel		-			-			-		
PCFICH/PDCCH/PHI CH parameters: DL Reference Measurement Channel		5MHz: R.11 FDD 10MHz: R.6 FDD 20MHz: R.10 FDD 5MHz: R.11 TDD 10MHz: R.6 TDD 20MHz: R.10 TDD			5MHz: R.11 FDD 10MHz: R.6 FDD 20MHz: R.10 FDD 5MHz: R.11 TDD 10MHz: R.6 TDD 20MHz: R.10 TDD			5MHz: R.11 FDD 10MHz: R.6 FDD 20MHz: R.10 FDD 5MHz: R.11 TDD 10MHz: R.6 TDD 20MHz: R.10 TDD		
OCNG Patterns		5MHz: OP.16 FDD 10MHz: OP.2 FDD 20MHz: OP.12 FDD 5MHz: OP.10 TDD 10MHz: OP.2 TDD 20MHz: OP.8 TDD			5MHz: OP.16 FDD 10MHz: OP.2 FDD 20MHz: OP.12 FDD 5MHz: OP.10 TDD 10MHz: OP.2 TDD 20MHz: OP.8 TDD			5MHz: OP.16 FDD 10MHz: OP.2 FDD 20MHz: OP.12 FDD 5MHz: OP.10 TDD 10MHz: OP.2 TDD 20MHz: OP.8 TDD		
PBCH_RA	dB	0			0			0		
PBCH_RB	dB									
PSS_RA	dB									
SSS_RA	dB									
PCFICH_RB	dB									
PHICH_RA	dB									
PHICH_RB	dB									
PDCCH_RA	dB									
PDCCH_RB	dB									
PDSCH_RA	dB									
PDSCH_RB	dB									
OCNG_RA ^{Note 1}	dB									
OCNG_RB ^{Note 1}	dB									
N_{oc} ^{Note 2}	dBm/15 KHz	-104			-104					
\hat{E}_s/N_{oc}	dB	17	17	-3	17	17	-3	-infinity	17	-3
\hat{E}_s/I_{ot} ^{Note 3}	dB	17	17	-3	17	-0.09	-4.76	-infinity	-0.09	-4.76
RSRP ^{Note 3}	dBm/15 kHz	-87	-87	-107	-87	-87	-107	-infinity	-87	-107
SCH_RP ^{Note 3}	dBm/15 kHz	-87	-87	-107	-87	-87	-107	-infinity	-87	-107

I_0 ^{Note 3}	dBm/Ch BW	-59.13 +10log ($N_{RB,c}$ /50)	-59.13 +10log ($N_{RB,c}$ /50)	-74.45 +10log ($N_{RB,c}$ /50)	-59.13 +10log ($N_{RB,c}$ /50)	-56.17 +10log ($N_{RB,c}$ /50)	-73.20 +10log ($N_{RB,c}$ /50)	Specified in columns for Cell 5
Propagation Condition		ETU70			ETU70			ETU70
Correlation Matrix and Antenna Configuration		1x2 Low			1x2 Low			1x2 Low
Timing offset to Cell 1	μ s	0			0			3
Time alignment error relative to cell1 ^{Note 5}	μ s	-			-			NA
Time alignment error relative to cell2 ^{Note 5}	μ s	-			-			NA
Time alignment error relative to cell3 ^{Note 5}	μ s	-			-			NA
Time alignment error relative to cell4 ^{Note 5}	μ s	-			-			NA
Time alignment error relative to cell5 ^{Note 5}	μ s	-			-			NA

- Note 1: OCNB shall be used such that all cells are fully allocated and a constant total transmitted power spectral density is achieved for all OFDM symbols.
- Note 2: Interference from other cells and noise sources not specified in the test is assumed to be constant over subcarriers and time and shall be modelled as AWGN of appropriate power for N_{oc} to be fulfilled.
- Note 3: E_s/I_0 , RSRP, SCH_RP and I_0 have been derived from other parameters for information purposes. They are not settable parameters themselves.
- Note 4: The resources for uplink transmission are assigned to the UE prior to the start of time period T2.
- Note 5: Time alignment error (TAE) as specified in TS 36.104 [30] clause 6.5.3.1. The TAE value depends upon the type of carrier aggregation.

A.8.16.91.2 Test Requirements

The UE shall send one Event A6 triggered measurement report for Cell 6 with a measurement reporting delay of less than 6.4s ($20 \times \text{measCycleSCell}$) from the beginning of time T2.

The UE shall send one Event A1 triggered measurement report for Cell 2 with a measurement reporting delay of less than 6.4s ($20 \times \text{measCycleSCell}$) from beginning of time T2.

The UE shall send one Event A2 triggered measurement report for Cell 1 with a measurement reporting delay of less than 200 ms from beginning of time T3.

The UE shall send one Event A2 triggered measurement report for Cell 2 with a measurement reporting delay of less than 1.6s ($5 \times \text{measCycleSCell}$) from beginning of time T3.

The UE shall send one Event A2 triggered measurement report for Cell 3 with a measurement reporting delay of less than 1.6s ($5 \times \text{measCycleSCell}$) from beginning of time T3.

The UE shall send one Event A2 triggered measurement report for Cell 4 with a measurement reporting delay of less than 1.6s ($5 \times \text{measCycleSCell}$) from beginning of time T3.

The UE shall send one Event A2 triggered measurement report for Cell 5 with a measurement reporting delay of less than 1.6s ($5 \times \text{measCycleSCell}$) from beginning of time T3.

The UE shall not send event triggered measurement reports as long as the reporting criteria are not fulfilled.

The rate of correct events observed during repeated tests shall be at least 90% for each of the events.

NOTE: The actual overall delays measured in the tests may be up to $2 \times TTI_{DCCH}$ higher than the measurement reporting delays above because of TTI insertion uncertainty of the measurement report in DCCH.

A.8.16.92 5 DL CA Event Triggered Reporting on Deactivated SCell with PCell and SCell Interruptions in Non-DRX with generic duplex modes

A.8.16.92.1 Test Purpose and Environment

The purpose of this test is to verify that the UE correctly detects event A6 (Neighbour becomes better than SCell) defined in TS 36.331 [2] within the requirements stated in clause 8.3.3.2.1 while at the same time fulfilling the requirement on interruption rate.

Note on the applicability: the requirement tested in the specific duplex-mode test cases A.8.16.73, A.8.16.74, A.8.16.81 and A.8.16.82 does not need to be tested in the generic duplex-mode test case A.8.16.92.

The test parameters are given in Table A.8.16.92.1-1, A.8.16.92.1-2 and A.8.16.92.1-3 below. In the test there are five cells: Cell 1, Cell 2, Cell 3, Cell 4, Cell 5 and Cell 6. Cell 1 is PCell on the primary component (RF Channel 1), Cell 2 is SCell on the secondary component (RF Channel 2), Cell 3 is SCell on the secondary component (RF Channel 3), Cell 4 is SCell on the secondary component (RF Channel 4), Cell 5 is SCell on the secondary component (RF Channel 5) and Cell 6 is the neighbour cell on the secondary component (RF Channel 4). It is indicated to the UE in the measurement control information that event-triggered reporting with Event A6 is used. The test consists of four successive time periods, with duration of T1, T2, T3 and T4, respectively. During T1 and T2, Cell2, Cell3, Cell4 and Cell5 are deactivated. During T1 the UE shall not have any information of Cell 6. Immediately at beginning of T2 the transmission power of Cell 6 is increased to same level as for Cell 5, and due to usage of an offset this shall result in reporting of Event A6. Cells 1, 2, 3, 4, 5 and 6 may operate in either FDD or TDD duplex mode according to test configuration.

At the beginning of T3, the transmission power of Cell 6 is turned off, and the test equipment sends a MAC message for activation of Cell 2 to UE but Cell 3, Cell 4 and Cell5 remains deactivated. Immediately at beginning of T4 the transmission power of Cell 6 is increased to same level as for Cell 5, and due to usage of an offset this shall result in reporting of Event A6. The UE shall be continuously scheduled in the PCell throughout the whole test and continuously scheduled in Cell2 during T4.

Table A.8.16.92.1-1: General test parameters for E-UTRAN 5 DL CA Event Triggered Reporting on Deactivated SCell with PCell and SCell Interruptions in Non-DRX with generic duplex modes

Parameter	Unit	Value	Comment	
E-UTRA RF Channel Number		1, 2, 3, 4, 5	Four radio channels are used for this test	
Active PCell		Cell 1	Primary cell on RF channel number 1.	
Configured deactivated SCell		Cell 2	Configured deactivated secondary cell on RF channel number 2.	
Configured deactivated SCell		Cell 3	Configured deactivated secondary cell on RF channel number 3.	
Configured deactivated SCell		Cell 4	Configured deactivated secondary cell on RF channel number 4.	
Configured deactivated SCell		Cell 5	Configured deactivated secondary cell on RF channel number 5.	
Neighbour cell		Cell 6	Neighbor cell to be identified on RF channel number 5.	
CP length		Normal		
Special subframe configuration		6	As specified in table 4.2-1 in TS 36.211. The same configuration applies to all TDD cells (cell2, cell3, cell4, cell5 and cell6).	
Uplink-downlink configuration		1	As specified in table 4.2-2 in TS 36.211. The same configuration applies to all TDD cells (cell2, cell3, cell4, cell5 and cell6).	
DRX		OFF	Continuous monitoring of primary cell	
A6	Hysteresis	dB	0	Hysteresis for evaluation of event A6.
	Offset	dB	-3	Offset parameter for evaluation of event A6. Needs to take relative accuracy tolerance in clause 9.1.11.2 into account plus margin.
	Report on leave		False	
	Time To Trigger	s	0	

Cell-individual offset for cells on RF channel number 1	dB	0	Individual offset for cells on primary component carrier.
Cell-individual offset for cells on RF channel number 2	dB	0	Individual offset for cells on secondary component carrier.
Cell-individual offset for cells on RF channel number 3	dB	0	Individual offset for cells on secondary component carrier.
Cell-individual offset for cells on RF channel number 4	dB	0	Individual offset for cells on secondary component carrier.
Cell-individual offset for cells on RF channel number 5	dB	0	Individual offset for cells on secondary component carrier.
Filter coefficient		0	L3 filtering is not used
SCell measurement cycle	ms	640	
T1	s	4	During this time the UE shall be aware of cells 1, 2, 3, 4 and 5 but not cell 6.
T2	s	≤ 15	UE should report Event A6 within 12.8s (20×sCellMeasCycle)
T3	s	4	During this time the UE shall activate cell 2
T4	s	≤ 4	UE should report Event A6 within 3.2s (5×sCellMeasCycle)

Table A.8.16.92.1-2: Cell specific test parameters for E-UTRAN 5 DL CA Event Triggered Reporting on Deactivated SCell with PCell and SCell Interruptions in Non-DRX with generic duplex modes (Cell #1, Cell #2, Cell #3, Cell #4)

Parameter	Unit	Cell 1				Cell 2				Cell 3				Cell 4			
		T1	T2	T3	T4	T1	T2	T3	T4	T1	T2	T3	T4	T1	T2	T3	T4
E-UTRA RF Channel Number		1				2				3				4			
BW _{channel}		5MHz: N _{RB,c} = 25 10MHz: N _{RB,c} = 50 20MHz: N _{RB,c} = 100				5MHz: N _{RB,c} = 25 10MHz: N _{RB,c} = 50 20MHz: N _{RB,c} = 100				5MHz: N _{RB,c} = 25 10MHz: N _{RB,c} = 50 20MHz: N _{RB,c} = 100				5MHz: N _{RB,c} = 25 10MHz: N _{RB,c} = 50 20MHz: N _{RB,c} = 100			
PDSCH parameters: DL Reference Measurement Channel		5MHz: R.7 FDD 10MHz: R.3 FDD 20MHz: R.6 FDD 5MHz: R.4 TDD 10MHz: R.0 TDD 20MHz: R.3 TDD				N/A	N/A	N/A	5MHz: R.7 FDD 10MH z: R.3 FDD 20MH z: R.6 FDD 5MHz: R.4 TDD 10MH z: R.0 TDD 20MH z: R.3 TDD	N/A				N/A			
PCFICH/PDCCH/PHICH parameters		5MHz: R.11 FDD 10MHz: R.6 FDD 20MHz: R.10 FDD 5MHz: R.11 TDD 10MHz: R.6 TDD 20MHz: R.10 TDD				5MHz: R.11 FDD 10MHz: R.6 FDD 20MHz: R.10 FDD 5MHz: R.11 TDD 10MHz: R.6 TDD 20MHz: R.10 TDD				5MHz: R.11 FDD 10MHz: R.6 FDD 20MHz: R.10 FDD 5MHz: R.11 TDD 10MHz: R.6 TDD 20MHz: R.10 TDD				5MHz: R.11 FDD 10MHz: R.6 FDD 20MHz: R.10 FDD 5MHz: R.11 TDD 10MHz: R.6 TDD 20MHz: R.10 TDD			
OCNG Pattern defined in A.3.2.1		5MHz: OP.20 FDD 10MHz: OP.10 FDD 20MHz: OP.17 FDD 5MHz: OP.9 TDD 10MHz: OP.1 TDD 20MHz: OP.7 TDD				5MHz: OP.19 FDD 10MH z: OP.6 FDD 20MH z:	5MHz: OP.19 FDD 10MH z: OP.6 FDD 20MH z:	5MHz: OP.19 FDD 10MH z: OP.6 FDD 20MH z:	5MHz: OP.20 FDD 10MH z: OP.10 FDD 20MH z:	5MHz: OP.16 FDD 10MHz: OP.2 FDD 20MHz: OP.12 FDD 5MHz: OP.10 TDD 10MHz: OP.2 TDD 20MHz: OP.8 TDD				5MHz: OP.16 FDD 10MHz: OP.2 FDD 20MHz: OP.12 FDD 5MHz: OP.10 TDD 10MHz: OP.2 TDD 20MHz: OP.8 TDD			

			OP.14 FDD	OP.14 FDD	OP.14 FDD	OP.17 FDD													
			5MHz: OP.10 TDD 10MH z: OP.2 TDD 20MH z: OP.8 TDD	5MHz: OP.10 TDD 10MH z: OP.2 TDD 20MH z: OP.8 TDD	5MHz: OP.10 TDD 10MH z: OP.2 TDD 20MH z: OP.8 TDD	5MHz: OP.9 TDD 10MH z: OP.1 TDD 20MH z: OP.7 TDD													
PBCH_RA	dB	0				0				0				0					
PBCH_RB	dB	0				0				0				0					
PSS_RA	dB	0				0				0				0					
SSS_RA	dB	0				0				0				0					
PCFICH_RB	dB	0				0				0				0					
PHICH_RA	dB	0				0				0				0					
PHICH_RB	dB	0				0				0				0					
PDCCH_RA	dB	0				0				0				0					
PDCCH_RB	dB	0				0				0				0					
PDSCH_RA	dB	0				0				0				0					
PDSCH_RB	dB	0				0				0				0					
OCNG_RA ^{Note 1}	dB	0				0				0				0					
OCNG_RB ^{Note 1}	dB	0				0				0				0					
N_{oc} ^{Note 3}	dBm/1 5 kHz	-101				-101				-101				-101					
\hat{E}_s/N_{oc}	dB	16	16	16	16	16	16	16	16	16	16	16	16	16	16	16	16		
\hat{E}_s/I_{ot} ^{Note 4}	dB	16	16	16	16	16	16	16	16	16	-0.11	16	-0.11	16	-0.11	16	-0.11		
RSRP ^{Note 4}	dBm/1 5 kHz	-85	-85	-85	-85	-85	-85	-85	-85	-85	-85	-85	-85	-85	85	-85	85	-85	
SCH_RP ^{Note 4}	dBm/1 5 kHz	-85	-85	-85	-85	-85	-85	-85	-85	-85	-85	-85	-85	-85	85	-85	85	-85	
I_o ^{Note 4}	dBm/C h BW	-	-	-	-	-57.11 +10log ($N_{RB,c}$ /50)	-57.11 +10log ($N_{RB,c}$ /50)	-57.11 +10log ($N_{RB,c}$ /50)	-57.11 +10log ($N_{RB,c}$ /50)	-	-	-	-	-	-	-	-	-	-
		57.11 +10log g ($N_{RB,c}$ /50)	57.11 +10log g ($N_{RB,c}$ /50)	57.11 +10log g ($N_{RB,c}$ /50)	57.11 +10log g ($N_{RB,c}$ /50)					57.11 +10log g ($N_{RB,c}$ /50)	54.15 +10log g ($N_{RB,c}$ /50)	57.11 +10log g ($N_{RB,c}$ /50)	54.15 +10log g ($N_{RB,c}$ /50)	57.11 +10log g ($N_{RB,c}$ /50)	54.15 +10log g ($N_{RB,c}$ /50)	57.11 +10log g ($N_{RB,c}$ /50)	54.15 +10log g ($N_{RB,c}$ /50)		
Propagation Condition		AWGN				AWGN				AWGN				AWGN					

Antenna Configuration		1x2	1x2	1x2	1x2
Timing offset to Cell 1	μs	-	0	0	0
Time alignment error relative to cell 1 ^{Note 5}	μs	-	$\leq \text{TAE}$	$\leq \text{TAE}$	$\leq \text{TAE}$
Time alignment error relative to cell 2 ^{Note 5}	μs	-	-	$\leq \text{TAE}$	$\leq \text{TAE}$
Time alignment error relative to cell 3 ^{Note 5}	μs	-	-	-	$\leq \text{TAE}$
<p>Note 1: OCNG shall be used such that all cells are fully allocated and a constant total transmitted power spectral density is achieved for all OFDM symbols.</p> <p>Note 2: The resources for uplink transmission are assigned to the UE on cell1 from the start of time period T2 and on cell2 from the start of time period T4.</p> <p>Note 3: Interference from other cells and noise sources not specified in the test is assumed to be constant over subcarriers and time and shall be modelled as AWGN of appropriate power for N_{oc} to be fulfilled.</p> <p>Note 4: Es/lot, RSRP, SCH_RP and Io levels have been derived from other parameters for information purposes. They are not settable parameters themselves.</p> <p>Note 5: Time alignment error (TAE) as specified in TS 36.104 [30] clause 6.5.3.1. The TAE value depends upon the type of carrier aggregation.</p>					

Table A.8.16.92.1-3: Cell specific test parameters for E-UTRAN 5 DL CA Event Triggered Reporting on Deactivated SCell with PCell and SCell Interruptions in Non-DRX with generic duplex modes (Cell #5, Cell #6)

Parameter	Unit	Cell 5				Cell 6			
		T1	T2	T3	T4	T1	T2	T3	T4
E-UTRA RF Channel Number		5				5			
BW _{channel}		5MHz: N _{RB,c} = 25 10MHz: N _{RB,c} = 50 20MHz: N _{RB,c} = 100				5MHz: N _{RB,c} = 25 10MHz: N _{RB,c} = 50 20MHz: N _{RB,c} = 100			
PDSCH parameters: DL Reference Measurement Channel		N/A				N/A			
PCFICH/PDCCH/PHICH parameters		5MHz: R.11 FDD 10MHz: R.6 FDD 20MHz: R.10 FDD 5MHz: R.11 TDD 10MHz: R.6 TDD 20MHz: R.10 TDD				5MHz: R.11 FDD 10MHz: R.6 FDD 20MHz: R.10 FDD 5MHz: R.11 TDD 10MHz: R.6 TDD 20MHz: R.10 TDD			
OCNG Pattern defined in A.3.2.1		5MHz: OP.16 FDD 10MHz: OP.2 FDD 20MHz: OP.12 FDD 5MHz: OP.10 TDD 10MHz: OP.2 TDD 20MHz: OP.8 TDD				5MHz: OP.16 FDD 10MHz: OP.2 FDD 20MHz: OP.12 FDD 5MHz: OP.10 TDD 10MHz: OP.2 TDD 20MHz: OP.8 TDD			
PBCH_RA	dB	0				0			
PBCH_RB	dB								
PSS_RA	dB								
SSS_RA	dB								
PCFICH_RB	dB								
PHICH_RA	dB								
PHICH_RB	dB								
PDCCH_RA	dB								
PDCCH_RB	dB								
PDSCH_RA	dB								
PDSCH_RB	dB								
OCNG_RA ^{Note 1}	dB								
OCNG_RB ^{Note 1}	dB								
N _{oc} ^{Note 3}	dBm/15 kHz								
\hat{E}_s / N_{oc}	dB	16	16	16	16	-infinity	16	-infinity	16
\hat{E}_s / I_{ot} ^{Note 4}	dB	16	-0.11	16	-0.11	-infinity	-0.11	-infinity	-0.11
RSRP ^{Note 4}	dBm/15 kHz	85	-85	85	-85	-infinity	-85	-infinity	-85
SCH_RP ^{Note 4}	dBm/15 kHz	85	-85	85	-85	-infinity	-85	-infinity	-85
I _o ^{Note 4}	dBm/Ch BW	-57.11 +10log(N _{RB,c} /50)	-54.15 +10log(N _{RB,c} /50)	-57.11 +10log(N _{RB,c} /50)	-54.15 +10log(N _{RB,c} /50)	-57.11 +10log(N _{RB,c} /50)	-54.15 +10log(N _{RB,c} /50)	-57.11 +10log(N _{RB,c} /50)	-54.15 +10log(N _{RB,c} /50)
Propagation Condition		AWGN				AWGN			
Antenna Configuration		1x2				1x2			
Timing offset to Cell 1	μs	0				3			
Time alignment error relative to cell 1 ^{Note 5}	μs	≤ TAE				N/A			
Time alignment error relative to cell 2 ^{Note 5}	μs	≤ TAE				N/A			
Time alignment error relative to cell 3 ^{Note 5}	μs	≤ TAE				N/A			
<p>Note 1: OCNG shall be used such that all cells are fully allocated and a constant total transmitted power spectral density is achieved for all OFDM symbols.</p> <p>Note 2: Void</p> <p>Note 3: Interference from other cells and noise sources not specified in the test is assumed to be constant over subcarriers and time and shall be modelled as AWGN of appropriate power for N_{oc} to be fulfilled.</p>									

Note 4:	Es/lot, RSRP, SCH_RP and lo levels have been derived from other parameters for information purposes. They are not settable parameters themselves.
Note 5:	Time alignment error (TAE) as specified in TS 36.104 [30] clause 6.5.3.1. The TAE value depends upon the type of carrier aggregation.

A.8.16.92.2 Test Requirements

The UE shall send one Event A6 triggered measurement report, with a measurement reporting delay less than 12.8s ($20 \times \text{scellMeasCycle}$) from the beginning of time period T2.

The UE shall send one Event A6 triggered measurement report, with a measurement reporting delay less than 3.2s ($5 \times \text{scellMeasCycle}$) from the beginning of time period T4.

The UE shall not send event triggered measurement reports, as long as the reporting criteria are not fulfilled.

The UE shall be scheduled on PCell continuously throughout the test. From the start of T1 until the measurement report is received during T2, at least 99.5% of all expected ACK/NACKs shall be transmitted by the UE.

The UE shall be scheduled on Cell2 continuously from the beginning of T4 to the end. From the start of T4 until the measurement report is received during T4, at least 99.5% of all expected ACK/NACKs shall be transmitted by the UE.

For a test to be considered successful requirements on both event detection and percentage of transmitted ACK/NACKs have to be fulfilled simultaneously.

The rate of correct events observed during repeated tests shall be at least 90%.

NOTE: The actual overall delays measured in the test may be up to $2 \times \text{TTI}_{\text{DCCH}}$ higher than the measurement reporting delays above because of TTI insertion uncertainty of the measurement report in DCCH.

A.8.16.93 5 DL CA Activation and Deactivation of Known SCell in Non-DRX with generic duplex modes

A.8.16.93.1 Test Purpose and Environment

The purpose of this test is to verify that the SCell activation and deactivation times are within the requirements stated in section 7.7 for UE configured with four downlink SCells, when the SCell is known by the UE at the time of activation .

Note on the applicability: the requirement tested in the specific duplex-mode test cases A.8.16.75, A.8.16.76, A.8.16.77, A.8.16.78, does not need to be tested in the generic duplex-mode test case A.8.16.93.

The test parameters are given in Tables A.8.16.93.1-1 and cell-specific parameters in A.8.16.93.1-2 and A.8.16.93.1-3 below. The test consists of three successive time periods, with duration of T1, T2 and T3, respectively. There are five carriers, each with one cell. Cells may operate in either FDD or TDD duplex mode according to test configuration. All cells have constant signal levels throughout the test. Before the test starts the UE is connected to Cell 1 (PCell) on radio channel 1 (PCC), deactivated Cell 3 (SCell2) on radio channel 3 (SCC2), deactivated Cell 4 (SCell3) on radio channel 4 (SCC3) and deactivated Cell 5 (SCell4) on radio channel 5 (SCC4) but is not aware of Cell 2 (SCell1) on radio channel 2 (SCC1). The UE is only monitoring PCC, SCC2, SCC3 and SCC4. The UE shall be continuously scheduled in the PCell throughout the whole test.

At the beginning of T1 the UE receives an RRC message by which SCell1 becomes configured on SCC1. The UE now starts monitoring also the SCC1. The test equipment sends a MAC message for activation of SCell1.

The point in time at which the MAC message is received at the UE antenna connector, in a subframe # denoted m, where m is an even number for FDD PCell and 4 or 9 for TDD PCell, defines the start of time period T2. The UE receives a MAC message for activation of SCell2 in subframe (m+10) for FDD PCell and (m+15) for TDD PCell, a MAC message for activation of SCell3 in subframe (m+20) for FDD PCell and (m+15) for TDD PCell, and a MAC message for activation of SCell4 in subframe (m+30) for FDD PCell and (m+15) for TDD PCell during activation of SCell1. The UE shall be able to report valid CSI for the activated SCell1 at latest in a subframe (m+39). The UE shall start reporting CSI for SCell1 in subframe (m+8) and shall report CQI index 0 (out-of-range) until the SCell activation has been completed. Any PCell interruption due to activation of SCells shall not occur outside subframes (m+5) to (m+9), (m+15) to (m+19), (m+25) to (m+29) and (m+35) to (m+39) for FDD PCell, and not outside subframes (m+5) to (m+11) and (m+20) to (m+26) for TDD PCell.

Time period T3 starts when a MAC message for deactivation of SCell1, sent from the test equipment to the UE in a subframe # denoted n, where n is an even number for FDD PCell and 4 or 9 for TDD PCell, is received at the UE antenna connector. The test equipment sends a MAC message for deactivation of the SCell2 in subframe (n+10) for FDD PCell and (n+15) for TDD PCell, a MAC message for deactivation of the SCell3 in subframe (n+20) for FDD PCell and (n+30) for TDD PCell, and a MAC message for deactivation of the SCell4 in subframe (n+30) for FDD PCell and (n+45) for TDD PCell. The UE shall carry out deactivation

of SCell1 at latest in subframe (n+8), and any PCell interruption due to the deactivation of SCells shall not occur outside subframes (n+5) to (n+9), (n+15) to (n+19), (n+25) to (n+29) and (n+35) to (n+39) for FDD PCell, and not outside subframes (n+5) to (n+11), (n+20) to (n+26), (n+35) to (n+41) and (n+50) to (n+56) for TDD PCell.

The test equipment verifies that potential interruption is carried out in the correct time span by monitoring ACK/NACK sent in PCell during activation and deactivation of SCell1, respectively.

The test equipment verifies the activation time by counting the subframes from the time when SCell1 activation command is sent until a CSI report with other than CQI index 0 is received.

The test equipment verifies the deactivation time by counting the subframes from the time when SCell1 deactivation command is sent until CQI reporting for SCell1 is discontinued.

Table A.8.16.93.1-1: General test parameters for known SCell1 activation case

Parameter	Unit	Value	Comment
E-UTRA RF Channel Number		1, 2, 3, 4, 5	Five radio channels are used for this test
Active PCell		Cell 1	Primary cell on RF channel number 1.
Deconfigured deactivated SCell		Cell 2	Deconfigured deactivated secondary cell on RF channel number 2.
Configured deactivated SCell2		Cell 3	Configured deactivated secondary cell on RF channel number 3.
Configured deactivated SCell3		Cell 4	Configured deactivated secondary cell on RF channel number 4.
Configured deactivated SCell4		Cell 5	Configured deactivated secondary cell on RF channel number 5.
CP length		Normal	
DRX		OFF	Continuous monitoring of primary cell
CQI/PMI periodicity and offset configuration index		0	CQI reporting for SCell every UL subframe
Cell-individual offset for cells on RF channel number 1	dB	0	Individual offset for cells on PCC.
Cell-individual offset for cells on RF channel number 2	dB	0	Individual offset for cells on SCC1.
Cell-individual offset for cells on RF channel number 3	dB	0	Individual offset for cells on SCC2.
Cell-individual offset for cells on RF channel number 4	dB	0	Individual offset for cells on SCC3.
Cell-individual offset for cells on RF channel number 5	dB	0	Individual offset for cells on SCC4.
Filter coefficient		0	L3 filtering is not used.
SCell measurement cycle (measCycleSCell)	ms	320	
T1	s	7	During this time the PCell, SCell2, SCell3 and SCell4 shall be known and the SCell1 configured and detected.
T2	s	1	During this time the UE shall activate the SCell1, SCell2, SCell3 and SCell4.
T3	s	1	During this time the UE shall deactivate the SCell1, SCell2, SCell3 and SCell4.

Table A.8.16.93.1-2: Cell specific test parameters for known SCell1 activation

Parameter	Unit	Cell 1			Cell 2			Cell 3		
		T1	T2	T3	T1	T2	T3	T1	T2	T3
E-UTRA RF Channel Number		1			2			3		
Duplex mode		FDD or TDD			FDD or TDD			FDD or TDD		
TDD Special subframe configuration		6			6			6		
TDD Uplink-downlink configuration		1			1			1		
BW _{channel}	MHz	5MHz: N _{RB,c} = 25 10MHz: N _{RB,c} = 50 20MHz: N _{RB,c} = 100			5MHz: N _{RB,c} = 25 10MHz: N _{RB,c} = 50 20MHz: N _{RB,c} = 100			5MHz: N _{RB,c} = 25 10MHz: N _{RB,c} = 50 20MHz: N _{RB,c} = 100		

PDSCH parameters: DL Reference Measurement Channel		5MHz: R.7 FDD 10MHz: R.3 FDD 20MHz: R.6 FDD 5MHz: R.4 TDD 10MHz: R.0 TDD 20MHz: R.3 TDD	-	-
PCFICH/PDCCH/PHICH parameters: DL Reference Measurement Channel		5MHz: R.11 FDD 10MHz: R.6 FDD 20MHz: R.10 FDD 5MHz: R.11 TDD 10MHz: R.6 TDD 20MHz: R.10 TDD	5MHz: R.11 FDD 10MHz: R.6 FDD 20MHz: R.10 FDD 5MHz: R.11 TDD 10MHz: R.6 TDD 20MHz: R.10 TDD	5MHz: R.11 FDD 10MHz: R.6 FDD 20MHz: R.10 FDD 5MHz: R.11 TDD 10MHz: R.6 TDD 20MHz: R.10 TDD
OCNG Patterns		5MHz: OP.20 FDD 10MHz: OP.10 FDD 20MHz: OP.17 FDD 5MHz: OP.9 TDD 10MHz: OP.1 TDD 20MHz: OP.7 TDD	5MHz: OP.16 FDD 10MHz: OP.2 FDD 20MHz: OP.12 FDD 5MHz: OP.10 TDD 10MHz: OP.2 TDD 20MHz: OP.8 TDD	5MHz: OP.16 FDD 10MHz: OP.2 FDD 20MHz: OP.12 FDD 5MHz: OP.10 TDD 10MHz: OP.2 TDD 20MHz: OP.8 TDD
PBCH_RA	dB			
PBCH_RB	dB			
PSS_RA	dB			
SSS_RA	dB			
PCFICH_RB	dB			
PHICH_RA	dB			
PHICH_RB	dB	0	0	0
PDCCH_RA	dB			
PDCCH_RB	dB			
PDSCH_RA	dB			
PDSCH_RB	dB			
OCNG_RA ^{Note 1}	dB			
OCNG_RB ^{Note 1}	dB			
N _{oc} ^{Note 2}	dBm/15 kHz	-104	-104	-104
\bar{E}_s/N_{oc}	dB	17	17	17
\bar{E}_s/I_{ot}	dB	17	17	17
RSRP ^{Note 3}	dBm/15 kHz	-87	-87	-87
SCH_RP ^{Note 3}	dBm/15 kHz	-87	-87	-87
I _o ^{Note 3}	dBm/Ch BW	-59.13 +10log (N _{RB,c} /50)	-59.13 +10log (N _{RB,c} /50)	-59.13 +10log (N _{RB,c} /50)
Propagation Condition		AWGN	AWGN	AWGN
Antenna Configuration		1x2	1x2	1x2
Timing offset to Cell 1	μs	-	0	0
Time alignment error relative to cell 1 ^{Note 5}	μs	-	≤ TAE	≤ TAE
Time alignment error relative to cell 2 ^{Note 5}	μs	-	-	≤ TAE
Time alignment error relative to cell 3 ^{Note 5}	μs	-	-	-
Time alignment error relative to cell 4 ^{Note 5}	μs	-	-	-
<p>Note 1: OCNG shall be used such that all cells are fully allocated and a constant total transmitted power spectral density is achieved for all OFDM symbols.</p> <p>Note 2: Interference from other cells and noise sources not specified in the test is assumed to be constant over subcarriers and time and shall be modelled as AWGN of appropriate power for N_{oc} to be fulfilled.</p> <p>Note 3: Es/I_{ot}, RSRP, SCH_RP and I_o levels have been derived from other parameters for information purposes. They are not settable parameters themselves.</p> <p>Note 4: The uplink resources for CSI reporting are assigned to the UE prior to the start of time period T2.</p> <p>Note 5: Time alignment error (TAE) as specified in TS 36.104 [30] clause 6.5.3.1. The TAE value depends upon the type of carrier aggregation.</p>				

Table A.8.16.76.1-3: Cell specific test parameters for known SCell1 activation

Parameter	Unit	Cell 4			Cell 5					
		T1	T2	T3	T1	T2	T3			
E-UTRA RF Channel Number		4			5					
Duplex mode		FDD or TDD			FDD or TDD					
TDD Special subframe configuration		6			6					
TDD Uplink-downlink configuration		1			1					
BW _{channel}	MHz	5MHz: N _{RB,c} = 25 10MHz: N _{RB,c} = 50 20MHz: N _{RB,c} = 100			5MHz: N _{RB,c} = 25 10MHz: N _{RB,c} = 50 20MHz: N _{RB,c} = 100					
PDSCH parameters: DL Reference Measurement Channel		-			-					
PCFICH/PDCCH/PHICH parameters: DL Reference Measurement Channel		5MHz: R.11 FDD 10MHz: R.6 FDD 20MHz: R.10 FDD 5MHz: R.11 TDD 10MHz: R.6 TDD 20MHz: R.10 TDD			5MHz: R.11 FDD 10MHz: R.6 FDD 20MHz: R.10 FDD 5MHz: R.11 TDD 10MHz: R.6 TDD 20MHz: R.10 TDD					
OCNG Patterns		5MHz: OP.16 FDD 10MHz: OP.2 FDD 20MHz: OP.12 FDD 5MHz: OP.10 TDD 10MHz: OP.2 TDD 20MHz: OP.8 TDD			5MHz: OP.16 FDD 10MHz: OP.2 FDD 20MHz: OP.12 FDD 5MHz: OP.10 TDD 10MHz: OP.2 TDD 20MHz: OP.8 TDD					
PBCH_RA	dB	0			0					
PBCH_RB	dB									
PSS_RA	dB									
SSS_RA	dB									
PCFICH_RB	dB									
PHICH_RA	dB									
PHICH_RB	dB									
PDCCH_RA	dB									
PDCCH_RB	dB									
PDSCH_RA	dB									
PDSCH_RB	dB									
OCNG_RA ^{Note 1}	dB									
OCNG_RB ^{Note 1}	dB									
N _{oc} ^{Note 2}	dBm/15 kHz									
\bar{E}_s/N_{oc}	dB	17			17					
\bar{E}_s/I_{ot}	dB	17			17					
RSRP ^{Note 3}	dBm/15 kHz	-87			-87					
SCH_RP ^{Note 3}	dBm/15 kHz	-87			-87					
I _o ^{Note 3}	dBm/Ch BW	-59.13 +10log (N _{RB,c} /50)			-59.13 +10log (N _{RB,c} /50)					
Propagation Condition		AWGN			AWGN					
Antenna Configuration		1x2			1x2					
Timing offset to Cell 1	μs	0			0					
Time alignment error relative to cell 1 ^{Note 5}	μs	≤ TAE			≤ TAE					
Time alignment error relative to cell 2 ^{Note 5}	μs	≤ TAE			≤ TAE					
Time alignment error relative to cell 3 ^{Note 5}	μs	≤ TAE			≤ TAE					
Time alignment error relative to cell 4 ^{Note 5}	μs	-			≤ TAE					

Note 1:	OCNG shall be used such that all cells are fully allocated and a constant total transmitted power spectral density is achieved for all OFDM symbols.
Note 2:	Interference from other cells and noise sources not specified in the test is assumed to be constant over subcarriers and time and shall be modelled as AWGN of appropriate power for N_{oc} to be fulfilled.
Note 3:	Es/lot, RSRP, SCH_RP and lo levels have been derived from other parameters for information purposes. They are not settable parameters themselves.
Note 4:	The uplink resources for CSI reporting are assigned to the UE prior to the start of time period T2.
Note 5:	Time alignment error (TAE) as specified in TS 36.104 [30] clause 6.5.3.1. The TAE value depends upon the type of carrier aggregation.

A.8.16.93.2 Test Requirements

During T2 the UE shall send the first CSI report for SCell1 in a subframe (m+8), or in a subframe (m+10) for FDD PCell and (m+9) for TDD PCell, if the subframe (m+8) was subject to interruption, or in subframe (m+13) for TDD PCell, if the subframes (m+8) and (m+9) were subject to interruption. Whether CSI report in subframe (m+8) / (m+9) was interrupted or not is checked by monitoring ACK/NACK sent in PCell in subframe (m+8) / (m+9).

During T2 the UE shall start sending CSI reports for SCell1 with non-zero CQI index at latest in a subframe (m+39).

During T3 the UE shall stop sending CSI reports for SCell at latest in a subframe (n+8).

During T2 interruption of PCell during SCells activation shall not happen outside subframes (m+5) to (m+9), (m+15) to (m+19), (m+25) to (m+29) and (m+35) to (m+39) for FDD PCell, and not happen outside subframes (m+5) to (m+11) and (m+20) to (m+26) for TDD PCell.

During T3 interruption of PCell during SCells deactivation shall not happen outside subframes (n+5) to (n+9), (n+15) to (n+19), (n+25) to (n+29) and (n+35) to (n+39) for FDD PCell, and not happen outside subframes (n+5) to (n+11), (n+20) to (n+26), (n+35) to (n+41) and (n+50) to (n+56) for TDD PCell.

The interruption of PCell shall not be more than the values specified for intra-band CA and inter-band CA in Section 7.8.2.

All of the above test requirements shall be fulfilled in order for the observed SCell1 activation delay and SCell1 deactivation delay to be counted as correct. The rate of correct observed SCell1 activation delay and SCell1 deactivation delay during repeated tests shall be at least 90%.

NOTE: During T2 if there are no uplink resources for reporting the valid CSI in a subframe (m+39) then the UE shall use the next available uplink resource for reporting the corresponding valid CSI.

A.8.16.94 5 DL CA Activation and Deactivation of Unknown SCell in Non-DRX with generic duplex modes

A.8.16.94.1 Test Purpose and Environment

The purpose of this test is to verify that the SCell activation and deactivation times are within the requirements stated in section 7.7 for UE configured with four downlink SCells, when the SCell is unknown by the UE at the time of activation.

Note on the applicability: the requirement tested in the specific duplex-mode test cases A.8.16.67, A.8.16.68, A.8.16.69, A.8.16.70, does not need to be tested in the generic duplex-mode test case A.8.16.94.

The test parameters are given in Tables A.8.16.94.1-1 and cell-specific parameters in A.8.16.94.1-2 and A.8.16.94.1-3 below. The test consists of three successive time periods, with duration of T1, T2 and T3, respectively. There are five carriers, each with one cell. Cells may operate in either FDD or TDD duplex mode according to test configuration. Cell 1, Cell 3, Cell 4 and Cell5 have constant signal levels throughout the test. Before the test starts the UE is connected to Cell 1 (PCell) on radio channel 1 (PCC), deactivated Cell 3 (SCell2) on radio channel 3 (SCC2), deactivated Cell 4 (SCell3) on radio channel 4 (SCC3) and deactivated Cell 5 (SCell4) on radio channel 5 (SCC4) but is not aware of Cell 2 (SCell1) on radio channel 2 (SCC1). The UE is only monitoring PCC, SCC2, SCC3 and SCC4. The UE shall be continuously scheduled in the PCell throughout the whole test.

At the beginning of T1 the UE receives an RRC message by which SCell1 becomes configured on SCC1. The UE now starts monitoring also the SCC1. During T1 SCell1 is powered off and the UE is not aware of SCell1.

A MAC message for activation of SCell1 is sent by the test equipment 100ms after the RRC message, in a subframe # denoted m, where m is an even number for FDD PCell and 4 or 9 for TDD PCell. The point in time at which the MAC message for activation of SCell1 is received at the UE antenna connector defines the start of time period T2. Immediately at beginning of T2 transmission power of SCell1 is increased to same level as for PCell. The test equipment sends a MAC message for activation of SCell2 in subframe (m+10) for FDD PCell and (m+15) for TDD PCell, a MAC message for activation of SCell3 in subframe (m+20) for

FDD PCell and (m+15) for TDD PCell, and a MAC message for activation of SCell4 in a subframe (m+30) for FDD PCell and (m+15) for TDD PCell during activation of SCell1. The UE shall be able to report valid CSI for the activated SCell1 at latest in a subframe (m+49). The UE shall start reporting CSI for SCell1 in subframe (m+8) and shall report CQI index 0 (out-of-range) until the SCell activation has been completed. Any PCell interruption due to activation of SCells shall not occur outside subframes (m+5) to (m+9), (m+15) to (m+19), (m+25) to (m+29) and (m+35) to (m+39) for FDD PCell, and not outside subframes (m+5) to (m+11) and (m+20) to (m+26) for TDD PCell.

Time period T3 starts when a MAC message for deactivation of SCell1, sent from the test equipment to the UE in a subframe # denoted n, where n is an even number for FDD PCell and 4 or 9 for TDD PCell, is received at the UE antenna connector. The test equipment sends a MAC message for deactivation of the SCell2 in subframe (n+10) for FDD PCell and (n+15) for TDD PCell, a MAC message for deactivation of the SCell3 in subframe (n+20) for FDD PCell and (n+30) for TDD PCell, and a MAC message for deactivation of the SCell4 in subframe (n+30) for FDD PCell and (n+45) for TDD PCell. The UE shall carry out deactivation of SCell1 at latest in subframe (n+8), and any PCell interruption due to the deactivation of SCells shall not occur outside subframes (n+5) to (n+9), (n+15) to (n+19), (n+25) to (n+29) and (n+35) to (n+39) for FDD PCell, and not outside subframes (n+5) to (n+11), (n+20) to (n+26), (n+35) to (n+41) and (n+50) to (n+56) for TDD PCell.

The test equipment verifies that potential interruption is carried out in the correct time span by monitoring ACK/NACK sent in PCell during activation and deactivation of SCell1, respectively.

The test equipment verifies the activation time by counting the subframes from the time when SCell1 activation command is sent until a CSI report with other than CQI index 0 is received.

The test equipment verifies the deactivation time by counting the subframes from the time when SCell1 deactivation command is sent until CQI reporting for SCell1 is discontinued.

Table A.8.16.94.1-1: General test parameters for unknown SCell1 activation case

Parameter	Unit	Value	Comment
E-UTRA RF Channel Number		1, 2, 3, 4, 5	Five radio channels are used for this test
Active PCell		Cell 1	Primary cell on RF channel number 1.
Deconfigured deactivated SCell		Cell 2	Deconfigured deactivated secondary cell on RF channel number 2.
Configured deactivated SCell2		Cell 3	Configured deactivated secondary cell on RF channel number 3.
Configured deactivated SCell3		Cell 4	Configured deactivated secondary cell on RF channel number 4.
Configured deactivated SCell4		Cell 5	Configured deactivated secondary cell on RF channel number 5.
CP length		Normal	
DRX		OFF	Continuous monitoring of primary cell
CQI/PMI periodicity and offset configuration index		0	CQI reporting for SCell every UL subframe
Cell-individual offset for cells on RF channel number 1	dB	0	Individual offset for cells on PCC.
Cell-individual offset for cells on RF channel number 2	dB	0	Individual offset for cells on SCC1.
Cell-individual offset for cells on RF channel number 3	dB	0	Individual offset for cells on SCC2.
Cell-individual offset for cells on RF channel number 4	dB	0	Individual offset for cells on SCC3.
Cell-individual offset for cells on RF channel number 5	dB	0	Individual offset for cells on SCC4.
Filter coefficient		0	L3 filtering is not used.
SCell measurement cycle (measCycleSCell)	ms	320	
T1	ms	100	During this time the PCell, SCell2, SCell3 and SCell4 shall be known and the SCell1 configured.
T2	s	1	During this time the UE shall activate the SCell1, SCell2, SCell3 and SCell4.
T3	s	1	During this time the UE shall deactivate the SCell1, SCell2, SCell3 and SCell4.

Table A.8.16.94.1-2: Cell specific test parameters for unknown SCell1 activation

Parameter	Unit	Cell 1			Cell 2			Cell 3		
		T1	T2	T3	T1	T2	T3	T1	T2	T3

E-UTRA RF Channel Number		1	2	3
Duplex mode		FDD or TDD	FDD or TDD	FDD or TDD
TDD Special subframe configuration		6	6	6
TDD Uplink-downlink configuration		1	1	1
BW _{channel}	MHz	5MHz: N _{RB,c} = 25 10MHz: N _{RB,c} = 50 20MHz: N _{RB,c} = 100	5MHz: N _{RB,c} = 25 10MHz: N _{RB,c} = 50 20MHz: N _{RB,c} = 100	5MHz: N _{RB,c} = 25 10MHz: N _{RB,c} = 50 20MHz: N _{RB,c} = 100
PDSCH parameters: DL Reference Measurement Channel		5MHz: R.7 FDD 10MHz: R.3 FDD 20MHz: R.6 FDD 5MHz: R.4 TDD 10MHz: R.0 TDD 20MHz: R.3 TDD	-	-
PCFICH/PDCCH/PHICH parameters: DL Reference Measurement Channel		5MHz: R.11 FDD 10MHz: R.6 FDD 20MHz: R.10 FDD 5MHz: R.11 TDD 10MHz: R.6 TDD 20MHz: R.10 TDD	5MHz: R.11 FDD 10MHz: R.6 FDD 20MHz: R.10 FDD 5MHz: R.11 TDD 10MHz: R.6 TDD 20MHz: R.10 TDD	5MHz: R.11 FDD 10MHz: R.6 FDD 20MHz: R.10 FDD 5MHz: R.11 TDD 10MHz: R.6 TDD 20MHz: R.10 TDD
OCNG Patterns		5MHz: OP.20 FDD 10MHz: OP.10 FDD 20MHz: OP.17 FDD 5MHz: OP.9 TDD 10MHz: OP.1 TDD 20MHz: OP.7 TDD	5MHz: OP.16 FDD 10MHz: OP.2 FDD 20MHz: OP.12 FDD 5MHz: OP.10 TDD 10MHz: OP.2 TDD 20MHz: OP.8 TDD	5MHz: OP.16 FDD 10MHz: OP.2 FDD 20MHz: OP.12 FDD 5MHz: OP.10 TDD 10MHz: OP.2 TDD 20MHz: OP.8 TDD
PBCH_RA	dB	0	0	0
PBCH_RB	dB			
PSS_RA	dB			
SSS_RA	dB			
PCFICH_RB	dB			
PHICH_RA	dB			
PHICH_RB	dB			
PDCCH_RA	dB			
PDCCH_RB	dB			
PDSCH_RA	dB			
PDSCH_RB	dB			
OCNG_RA ^{Note 1}	dB			
OCNG_RB ^{Note 1}	dB			
N _{oc} ^{Note 2}	dBm/15 kHz			
$\frac{E_s}{N_{oc}}$	dB	17	-infinity	17
$\frac{E_s}{I_{ot}}$	dB	17	-infinity	17
RSRP ^{Note 3}	dBm/15 kHz	-87	-infinity	-87
SCH_RP ^{Note 3}	dBm/15 kHz	-87	-infinity	-87
I _o ^{Note 3}	dBm/Ch BW	-59.13 +10log (N _{RB,c} /50)	-76.22 +10log (N _{RB,c} /50)	-59.13 +10log (N _{RB,c} /50)
Propagation Condition		AWGN	AWGN	AWGN
Antenna Configuration		1x2	1x2	1x2
Timing offset to Cell 1	μs	-	0	0
Time alignment error relative to cell 1 ^{Note 5}	μs	-	≤ TAE	≤ TAE
Time alignment error relative to cell 2 ^{Note 5}	μs	-	-	≤ TAE
Time alignment error relative to cell 3 ^{Note 5}	μs	-	-	-

Time alignment error relative to cell 4 ^{Note 5}	μs	-	-	-
Note 1:	OCNG shall be used such that all cells are fully allocated and a constant total transmitted power spectral density is achieved for all OFDM symbols.			
Note 2:	Interference from other cells and noise sources not specified in the test is assumed to be constant over subcarriers and time and shall be modelled as AWGN of appropriate power for N_{oc} to be fulfilled.			
Note 3:	E_s/I_{ot} , RSRP, SCH_RP and I_o levels have been derived from other parameters for information purposes. They are not settable parameters themselves.			
Note 4:	The uplink resources for CSI reporting are assigned to the UE prior to the start of time period T2.			
Note 5:	Time alignment error (TAE) as specified in TS 36.104 [30] clause 6.5.3.1. The TAE value depends upon the type of carrier aggregation.			

Table A.8.16.94.1-3: Cell specific test parameters for unknown SCell1 activation

Parameter	Unit	Cell 4			Cell 5					
		T1	T2	T3	T1	T2	T3			
E-UTRA RF Channel Number		4			5					
Duplex mode		FDD or TDD			FDD or TDD					
TDD Special subframe configuration		6			6					
TDD Uplink-downlink configuration		1			1					
BW _{channel}	MHz	5MHz: $N_{RB,c} = 25$ 10MHz: $N_{RB,c} = 50$ 20MHz: $N_{RB,c} = 100$			5MHz: $N_{RB,c} = 25$ 10MHz: $N_{RB,c} = 50$ 20MHz: $N_{RB,c} = 100$					
PDSCH parameters: DL Reference Measurement Channel		-			-					
PCFICH/PDCCH/PHICH parameters: DL Reference Measurement Channel		5MHz: R.11 FDD 10MHz: R.6 FDD 20MHz: R.10 FDD 5MHz: R.11 TDD 10MHz: R.6 TDD 20MHz: R.10 TDD			5MHz: R.11 FDD 10MHz: R.6 FDD 20MHz: R.10 FDD 5MHz: R.11 TDD 10MHz: R.6 TDD 20MHz: R.10 TDD					
OCNG Patterns		5MHz: OP.16 FDD 10MHz: OP.2 FDD 20MHz: OP.12 FDD 5MHz: OP.10 TDD 10MHz: OP.2 TDD 20MHz: OP.8 TDD			5MHz: OP.16 FDD 10MHz: OP.2 FDD 20MHz: OP.12 FDD 5MHz: OP.10 TDD 10MHz: OP.2 TDD 20MHz: OP.8 TDD					
PBCH_RA	dB	0			0					
PBCH_RB	dB									
PSS_RA	dB									
SSS_RA	dB									
PCFICH_RB	dB									
PHICH_RA	dB									
PHICH_RB	dB									
PDCCH_RA	dB									
PDCCH_RB	dB									
PDSCH_RA	dB									
PDSCH_RB	dB									
OCNG_RA ^{Note 1}	dB									
OCNG_RB ^{Note 1}	dB									
N_{oc} ^{Note 2}	dBm/15 kHz	-104			-104					
\bar{E}_s/N_{oc}	dB	17			17					
\bar{E}_s/I_{ot}	dB	17			17					
RSRP ^{Note 3}	dBm/15 kHz	-87			-87					
SCH_RP ^{Note 3}	dBm/15 kHz	-87			-87					

I_0 ^{Note 3}	dBm/Ch BW	-59.13 +10log ($N_{RB,c}/50$)	-59.13 +10log ($N_{RB,c}/50$)	
Propagation Condition		AWGN	AWGN	
Antenna Configuration		1x2	1x2	
Timing offset to Cell 1	μs	0	0	
Time alignment error relative to cell 1 ^{Note 5}	μs	$\leq \text{TAE}$	$\leq \text{TAE}$	
Time alignment error relative to cell 2 ^{Note 5}	μs	$\leq \text{TAE}$	$\leq \text{TAE}$	
Time alignment error relative to cell 3 ^{Note 5}	μs	$\leq \text{TAE}$	$\leq \text{TAE}$	
Time alignment error relative to cell 4 ^{Note 5}	μs	-	$\leq \text{TAE}$	
<p>Note 1: OCNG shall be used such that all cells are fully allocated and a constant total transmitted power spectral density is achieved for all OFDM symbols.</p> <p>Note 2: Interference from other cells and noise sources not specified in the test is assumed to be constant over subcarriers and time and shall be modelled as AWGN of appropriate power for N_{oc} to be fulfilled.</p> <p>Note 3: E_s/lot, $RSRP$, SCH_RP and I_0 levels have been derived from other parameters for information purposes. They are not settable parameters themselves.</p> <p>Note 4: The uplink resources for CSI reporting are assigned to the UE prior to the start of time period T2.</p> <p>Note 5: Time alignment error (TAE) as specified in TS 36.104 [30] clause 6.5.3.1. The TAE value depends upon the type of carrier aggregation.</p>				

A.8.16.94.2 Test Requirements

During T2 the UE shall send the first CSI report for SCell1 in a subframe (m+8), or in a subframe (m+10) for FDD PCell and (m+9) for TDD PCell, if the subframe (m+8) was subject to interruption, or in subframe (m+13) for TDD PCell, if the subframes (m+8) and (m+9) were subject to interruption. Whether CSI report in subframe (m+8) / (m+9) was interrupted or not is checked by monitoring ACK/NACK sent in PCell in subframe (m+8) / (m+9).

During T2 the UE shall start sending CSI reports for SCell1 with non-zero CQI index at latest in a subframe (m+49).

During T3 the UE shall stop sending CSI reports for SCell at latest in a subframe (n+8).

During T2 interruption of PCell during SCells activation shall not happen outside subframes (m+5) to (m+9), (m+15) to (m+19), (m+25) to (m+29) and (m+35) to (m+39) for FDD PCell, and not happen outside subframes (m+5) to (m+11) and (m+20) to (m+26) for TDD PCell.

During T3 interruption of PCell during SCells deactivation shall not happen outside subframes (n+5) to (n+9), (n+15) to (n+19), (n+25) to (n+29) and (n+35) to (n+39) for FDD PCell, and not happen outside subframes (n+5) to (n+11), (n+20) to (n+26), (n+35) to (n+41) and (n+50) to (n+56) for TDD PCell.

The interruption of PCell shall not be more than the values specified for intra-band CA and inter-band CA in Section 7.8.2.

All of the above test requirements shall be fulfilled in order for the observed SCell1 activation delay and SCell1 deactivation delay to be counted as correct. The rate of correct observed SCell1 activation delay and SCell1 deactivation delay during repeated tests shall be at least 90%.

NOTE: During T2 if there are no uplink resources for reporting the valid CSI in a subframe (m+49) then the UE shall use the next available uplink resource for reporting the corresponding valid CSI.

A.8.16.95 6 DL CA Event Triggered Reporting under Deactivated SCells in Non-DRX with generic duplex modes

A.8.16.95.1 Test Purpose and Environment

The purpose of this test is to verify that the UE correctly detects events A1 (Serving cell becomes better than threshold), A2 (Serving cell becomes worse than threshold) and A6 (Neighbour becomes better than SCell) defined in TS 36.331 [2] within the requirements stated in clause 8.3.3.2.1.

The test parameters are given in Tables A.8.16.95.1-1, A.8.16.95.1-2, A.8.16.95.1-3 and A.8.16.95.1-4 below. It is indicated to the UE in the measurement control information that event-triggered reporting with Events A1 (for only SCell1 i.e. cell2), A2 (PCell and SCells) and A6 is used. The test consists of three successive time periods, with duration of T1, T2 and T3, respectively. During T1 the UE shall not have any information on cell 7. At the beginning of T2 the transmission power of cell 7 is increased to the same level as for cell 6, and due to usage of an offset this shall result in reporting of Event A6. Also, at the beginning of T2 the

transmission power of cell 2 is increased to the same level as for cell 1, which shall result in reporting of Event A1. At the beginning of T3 the transmission powers of cells 1, 2, 3, 4, 5 and 6 are reduced below a threshold value and this shall result in reporting of Event A2 for Cell 1, for Cell 2, for Cell 3, for Cell 4, for Cell 5 and Cell 6. Cells 1, 2, 3, 4, 5, 6 and 7 may operate in either FDD or TDD duplex mode according to test configuration.

Table A.8.16.95.1-1: General test parameters for E-UTRAN 6 DL CA event triggered reporting under fading propagation conditions with 5 configured but deactivated SCells in non-DRX with generic duplex modes

Parameter		Unit	Value	Comment
E-UTRA RF Channel Number			1, 2, 3, 4, 5, 6	Six radio channels are used for this test
Active PCell			Cell 1	Primary cell on RF channel number 1.
Configured deactivated SCell			Cell 2	Configured deactivated secondary cell on RF channel number 2.
Configured deactivated SCell			Cell 3	Configured deactivated secondary cell on RF channel number 3.
Configured deactivated SCell			Cell 4	Configured deactivated secondary cell on RF channel number 4.
Configured deactivated SCell			Cell 5	Configured deactivated secondary cell on RF channel number 5.
Configured deactivated SCell			Cell 6	Configured deactivated secondary cell on RF channel number 6.
Neighbour cell			Cell 7	Neighbour cell to be identified on RF channel number 6.
CP length			Normal	
DRX			OFF	Continuous monitoring of primary cell
TDD special subframe configuration			6	As specified in table 4.2-1 in TS 36.211. The same configuration applies to all TDD cells (cell2, cell3, cell4, cell5, cell6 and cell 7).
TDD uplink-downlink configuration			1	As specified in table 4.2-2 in TS 36.211. The same configuration applies to all TDD cells (cell2, cell3, cell4, cell5, cell6 and cell 7).
A1	Hysteresis	dB	0	Hysteresis for evaluation of event A1.
	Threshold RSRP	dBm	-98	Actual RSRP threshold for event A1. Needs to take absolute accuracy tolerance in section 9.1.11.1 into account plus margin.
	Time To Trigger	s	0	
A2	Hysteresis	dB	0	Hysteresis for evaluation of event A2.
	Threshold RSRP	dBm	-98	Actual RSRP threshold for event A2. Needs to take absolute accuracy tolerance in section 9.1.11.1 into account plus margin.
	Time To Trigger	s	0	
A6	Hysteresis	dB	0	Hysteresis for evaluation of event A6.
	Offset	dB	-6	Offset parameter for evaluation of event A6. Needs to take relative accuracy tolerance in section 9.1.11.2 into account plus margin.
	Report on leave		False	
	Time To Trigger	s	0	
Cell-individual offset for cells on RF channel number 1		dB	0	Individual offset for cells on primary component carrier.
Cell-individual offset for cells on RF channel number 2		dB	0	Individual offset for cells on secondary component carrier.
Cell-individual offset for cells on RF channel number 3		dB	0	Individual offset for cells on secondary component carrier.
Cell-individual offset for cells on RF channel number 4		dB	0	Individual offset for cells on secondary component carrier.
Cell-individual offset for cells on RF channel number 5		dB	0	Individual offset for cells on secondary component carrier.
Cell-individual offset for cells on RF channel number 6		dB	0	Individual offset for cells on secondary component carrier.
Filter coefficient			0	L3 filtering is not used
SCell measurement cycle (measCycleSCell)		ms	320	For cell2, cell3, cell4, cell5 and cell6
T1		s	5	During this time the cell1, cell3, cell4, cell5 and cell6 shall be known to the UE; but cell2 and cell7 shall be unknown to the UE.
T2		s	≤12	UE should report Event A1 for cell2 and event A6 for cell7 within 6.4s (20xscellMeasCycle)

T3	s	5	UE should report Event A2 within 200 ms for cell1 and within 1.6s for each of cells 2, 3, 4, 5 and 6.
----	---	---	---

Table A.8.16.95.1-2: Cell specific test parameters for E-UTRAN 6 DL CA event triggered reporting under fading propagation conditions with 5 configured but deactivated SCells in non-DRX with generic duplex modes

Parameter	Unit	Cell 1			Cell 2			Cell3		
		T1	T2	T3	T1	T2	T3	T1	T2	T3
E-UTRA RF Channel Number		1			2			3		
BW _{channel}		5MHz: N _{RB,c} = 25 10MHz: N _{RB,c} = 50 20MHz: N _{RB,c} = 100			5MHz: N _{RB,c} = 25 10MHz: N _{RB,c} = 50 20MHz: N _{RB,c} = 100			5MHz: N _{RB,c} = 25 10MHz: N _{RB,c} = 50 20MHz: N _{RB,c} = 100		
PDSCH parameters: DL Reference Measurement Channel		5MHz: R.5 FDD 10MHz: R.0 FDD 20MHz: R.4 FDD 5MHz: R.4 TDD 10MHz: R.0 TDD 20MHz: R.3 TDD			-			-		
PCFICH/PDCCH/PHICH parameters: DL Reference Measurement Channel		5MHz: R.11 FDD 10MHz: R.6 FDD 20MHz: R.10 FDD 5MHz: R.11 TDD 10MHz: R.6 TDD 20MHz: R.10 TDD			5MHz: R.11 FDD 10MHz: R.6 FDD 20MHz: R.10 FDD 5MHz: R.11 TDD 10MHz: R.6 TDD 20MHz: R.10 TDD			5MHz: R.11 FDD 10MHz: R.6 FDD 20MHz: R.10 FDD 5MHz: R.11 TDD 10MHz: R.6 TDD 20MHz: R.10 TDD		
OCNG Patterns		5MHz: OP.15 FDD 10MHz: OP.1 FDD 20MHz: OP.11 FDD 5MHz: OP.9 TDD 10MHz: OP.1 TDD 20MHz: OP.7 TDD			5MHz: OP.16 FDD 10MHz: OP.2 FDD 20MHz: OP.12 FDD 5MHz: OP.10 TDD 10MHz: OP.2 TDD 20MHz: OP.8 TDD			5MHz: OP.16 FDD 10MHz: OP.2 FDD 20MHz: OP.12 FDD 5MHz: OP.10 TDD 10MHz: OP.2 TDD 20MHz: OP.8 TDD		
PBCH_RA	dB	0			0			0		
PBCH_RB	dB									
PSS_RA	dB									
SSS_RA	dB									
PCFICH_RB	dB									
PHICH_RA	dB									
PHICH_RB	dB									
PDCCH_RA	dB									
PDCCH_RB	dB									
PDSCH_RA	dB									
PDSCH_RB	dB									
OCNG_RA ^{Note 1}	dB									
OCNG_RB ^{Note 1}	dB									
N _{oc} ^{Note 2}	dBm/15 KHz									
\bar{E}_s/N_{oc}	dB	17	17	-3	-	17	-3	17	17	-3
\bar{E}_s/I_{ot} ^{Note 3}	dB	17	17	-3	-	17	-3	17	17	-3
RSRP ^{Note 3}	dBm/15 kHz	-87	-87	-107	-	-87	-107	-87	-87	-107
SCH_RP ^{Note 3}	dBm/15 kHz	-87	-87	-107	-	-87	-107	-87	-87	-107
I _o ^{Note 3}	dBm/C h BW	-59.13 +10log (N _{RB,c} /50)	-59.13 +10log (N _{RB,c} /50)	-74.45 +10log (N _{RB,c} /50)	-76.22 +10log (N _{RB,c} /50)	-59.13 +10log (N _{RB,c} /50)	-74.45 +10log (N _{RB,c} /50)	-59.13 +10log (N _{RB,c} /50)	-59.13 +10log (N _{RB,c} /50)	-74.45 +10log (N _{RB,c} /50)
Propagation Condition		AWGN			ETU70			ETU70		
Correlation Matrix and Antenna Configuration		1x2 Low			1x2 Low			1x2 Low		
Timing offset to Cell 1	μs	-			0			0		
Time alignment error relative to cell1 ^{Note 5}	μs	-			≤ TAE			≤ TAE		

Time alignment error relative to cell 2 ^{Note 5}	μs	≤ TAE	-	≤ TAE
Time alignment error relative to cell 3 ^{Note 5}	μs	≤ TAE	≤ TAE	-
Time alignment error relative to cell 4 ^{Note 5}	μs	≤ TAE	≤ TAE	≤ TAE
Time alignment error relative to cell 5 ^{Note 5}	μs	≤ TAE	≤ TAE	≤ TAE
Time alignment error relative to cell 6 ^{Note 5}	μs	≤ TAE	≤ TAE	≤ TAE
<p>Note 1: OCNG shall be used such that all cells are fully allocated and a constant total transmitted power spectral density is achieved for all OFDM symbols.</p> <p>Note 2: Interference from other cells and noise sources not specified in the test is assumed to be constant over subcarriers and time and shall be modelled as AWGN of appropriate power for N_{oc} to be fulfilled.</p> <p>Note 3: E_s/I_{ot}, RSRP, SCH_RP and I_o have been derived from other parameters for information purposes. They are not settable parameters themselves.</p> <p>Note 4: The resources for uplink transmission are assigned to the UE prior to the start of time period T2.</p> <p>Note 5: Time alignment error (TAE) as specified in TS 36.104 [30] clause 6.5.3.1. The TAE value depends upon the type of carrier aggregation.</p>				

Table A.8.16.95.1-3: Cell specific test parameters for E-UTRAN 6 DL CA event triggered reporting under fading propagation conditions with 5 configured but deactivated SCells in non-DRX with generic duplex modes

Parameter	Unit	Cell 4			Cell 5			Cell 6		
		T1	T2	T3	T1	T2	T3	T1	T2	T3
E-UTRA RF Channel Number		4			5			6		
BW _{channel}		5MHz: N _{RB,c} = 25 10MHz: N _{RB,c} = 50 20MHz: N _{RB,c} = 100			5MHz: N _{RB,c} = 25 10MHz: N _{RB,c} = 50 20MHz: N _{RB,c} = 100			5MHz: N _{RB,c} = 25 10MHz: N _{RB,c} = 50 20MHz: N _{RB,c} = 100		
PDSCH parameters: DL Reference Measurement Channel		-			-			-		
PCFICH/PDCCH/PHICH parameters: DL Reference Measurement Channel		5MHz: R.11 FDD 10MHz: R.6 FDD 20MHz: R.10 FDD 5MHz: R.11 TDD 10MHz: R.6 TDD 20MHz: R.10 TDD			5MHz: R.11 FDD 10MHz: R.6 FDD 20MHz: R.10 FDD 5MHz: R.11 TDD 10MHz: R.6 TDD 20MHz: R.10 TDD			5MHz: R.11 FDD 10MHz: R.6 FDD 20MHz: R.10 FDD 5MHz: R.11 TDD 10MHz: R.6 TDD 20MHz: R.10 TDD		
OCNG Patterns		5MHz: OP.16 FDD 10MHz: OP.2 FDD 20MHz: OP.12 FDD 5MHz: OP.10 TDD 10MHz: OP.2 TDD 20MHz: OP.8 TDD			5MHz: OP.16 FDD 10MHz: OP.2 FDD 20MHz: OP.12 FDD 5MHz: OP.10 TDD 10MHz: OP.2 TDD 20MHz: OP.8 TDD			5MHz: OP.16 FDD 10MHz: OP.2 FDD 20MHz: OP.12 FDD 5MHz: OP.10 TDD 10MHz: OP.2 TDD 20MHz: OP.8 TDD		
PBCH_RA	dB	0			0			0		
PBCH_RB	dB									
PSS_RA	dB									
SSS_RA	dB									
PCFICH_RB	dB									
PHICH_RA	dB									
PHICH_RB	dB									
PDCCH_RA	dB									
PDCCH_RB	dB									
PDSCH_RA	dB									
PDSCH_RB	dB									
OCNG_RA ^{Note 1}	dB									
OCNG_RB ^{Note 1}	dB									
N _{oc} ^{Note 2}	dBm/15 KHz									
\bar{E}_s/N_{oc}	dB	17	17	-3	17	17	-3	17	17	-3
\bar{E}_s/I_{ot} ^{Note 3}	dB	17	17	-3	17	17	-3	17	-0.09	-4.76
RSRP ^{Note 3}	dBm/15 kHz	-87	-87	-107	-87	-87	-107	-87	-87	-107

SCH_RP ^{Note 3}	dBm/15 kHz	-87	-87	-107	-87	-87	-107	-87	-87	-107
Io ^{Note 3}	dBm/Ch BW	-59.13 +10log (N _{RB,c} /50)	-59.13 +10log (N _{RB,c} /50)	-74.45 +10log (N _{RB,c} /50)	-59.13 +10log (N _{RB,c} /50)	-59.13 +10log (N _{RB,c} /50)	-74.45 +10log (N _{RB,c} /50)	-59.13 +10log (N _{RB,c} /50)	-56.17 +10log (N _{RB,c} /50)	-73.20 +10log (N _{RB,c} /50)
Propagation Condition		ETU70			ETU70			ETU70		
Correlation Matrix and Antenna Configuration		1x2 Low			1x2 Low			1x2 Low		
Timing offset to Cell 1	μs	0			0			0		
Time alignment error relative to cell1 ^{Note 5}	μs	-			-			-		
Time alignment error relative to cell2 ^{Note 5}	μs	-			-			-		
Time alignment error relative to cell3 ^{Note 5}	μs	-			-			-		
Time alignment error relative to cell4 ^{Note 5}	μs	-			-			-		
Time alignment error relative to cell5 ^{Note 5}	μs	-			-			-		
Time alignment error relative to cell6 ^{Note 5}	μs	-			-			-		
Note 1:	OCNG shall be used such that all cells are fully allocated and a constant total transmitted power spectral density is achieved for all OFDM symbols.									
Note 2:	Interference from other cells and noise sources not specified in the test is assumed to be constant over subcarriers and time and shall be modelled as AWGN of appropriate power for N _{oc} to be fulfilled.									
Note 3:	Es/lot, RSRP, SCH_RP and Io have been derived from other parameters for information purposes. They are not settable parameters themselves.									
Note 4:	The resources for uplink transmission are assigned to the UE prior to the start of time period T2.									
Note 5:	Time alignment error (TAE) as specified in TS 36.104 [30] clause 6.5.3.1. The TAE value depends upon the type of carrier aggregation.									

Table A.8.16.95.1-4: Cell specific test parameters for E-UTRAN 6 DL CA event triggered reporting under fading propagation conditions with 5 configured but deactivated SCells in non-DRX with generic duplex modes

Parameter	Unit	Cell 7		
		T1	T2	T3
E-UTRA RF Channel Number		6		
BW _{channel}		5MHz: N _{RB,c} = 25 10MHz: N _{RB,c} = 50 20MHz: N _{RB,c} = 100		
PDSCH parameters: DL Reference Measurement Channel		-		
PCFICH/PDCCH/PHICH parameters: DL Reference Measurement Channel		5MHz: R.11 FDD 10MHz: R.6 FDD 20MHz: R.10 FDD 5MHz: R.11 TDD 10MHz: R.6 TDD 20MHz: R.10 TDD		
OCNG Patterns		5MHz: OP.16 FDD 10MHz: OP.2 FDD 20MHz: OP.12 FDD 5MHz: OP.10 TDD 10MHz: OP.2 TDD 20MHz: OP.8 TDD		
PBCH_RA	dB	0		
PBCH_RB	dB			
PSS_RA	dB			
SSS_RA	dB			
PCFICH_RB	dB			
PHICH_RA	dB			
PHICH_RB	dB			
PDCCH_RA	dB			

PDCCH_RB	dB			
PDSCH_RA	dB			
PDSCH_RB	dB			
OCNG_RA ^{Note 1}	dB			
OCNG_RB ^{Note 1}	dB			
N _{oc} ^{Note 2}	dBm/15 KHz	-104		
\bar{E}_s/N_{oc}	dB	-infinity	17	-3
\bar{E}_s/I_{ot} ^{Note 3}	dB	-infinity	-0.09	-4.76
RSRP ^{Note 3}	dBm/15 kHz	-infinity	-87	-107
SCH_RP ^{Note 3}	dBm/15 kHz	-infinity	-87	-107
I _o ^{Note 3}	dBm/Ch BW	Specified in columns for Cell 6		
Propagation Condition		ETU70		
Correlation Matrix and Antenna Configuration		1x2 Low		
Timing offset to Cell 1	μ s	3		
Time alignment error relative to cell1 ^{Note 5}	μ s	NA		
Time alignment error relative to cell2 ^{Note 5}	μ s	NA		
Time alignment error relative to cell3 ^{Note 5}	μ s	NA		
Time alignment error relative to cell4 ^{Note 5}	μ s	NA		
Time alignment error relative to cell5 ^{Note 5}	μ s	NA		
Time alignment error relative to cell6 ^{Note 5}	μ s	NA		
<p>Note 1: OCNG shall be used such that all cells are fully allocated and a constant total transmitted power spectral density is achieved for all OFDM symbols.</p> <p>Note 2: Interference from other cells and noise sources not specified in the test is assumed to be constant over subcarriers and time and shall be modelled as AWGN of appropriate power for N_{oc} to be fulfilled.</p> <p>Note 3: Es/I_{ot}, RSRP, SCH_RP and I_o have been derived from other parameters for information purposes. They are not settable parameters themselves.</p> <p>Note 4: The resources for uplink transmission are assigned to the UE prior to the start of time period T2.</p> <p>Note 5: Time alignment error (TAE) as specified in TS 36.104 [30] clause 6.5.3.1. The TAE value depends upon the type of carrier aggregation.</p>				

A.8.16.95.2 Test Requirements

The UE shall send one Event A6 triggered measurement report for Cell 7 with a measurement reporting delay of less than 6.4s ($20 \times \text{measCycleSCell}$) from the beginning of time T2.

The UE shall send one Event A1 triggered measurement report for Cell 2 with a measurement reporting delay of less than 6.4s ($20 \times \text{measCycleSCell}$) from beginning of time T2.

The UE shall send one Event A2 triggered measurement report for Cell 1 with a measurement reporting delay of less than 200 ms from beginning of time T3.

The UE shall send one Event A2 triggered measurement report for Cell 2 with a measurement reporting delay of less than 1.6s ($5 \times \text{measCycleSCell}$) from beginning of time T3.

The UE shall send one Event A2 triggered measurement report for Cell 3 with a measurement reporting delay of less than 1.6s ($5 \times \text{measCycleSCell}$) from beginning of time T3.

The UE shall send one Event A2 triggered measurement report for Cell 4 with a measurement reporting delay of less than 1.6s ($5 \times \text{measCycleSCell}$) from beginning of time T3.

The UE shall send one Event A2 triggered measurement report for Cell 5 with a measurement reporting delay of less than 1.6s ($5 \times \text{measCycleSCell}$) from beginning of time T3.

The UE shall send one Event A2 triggered measurement report for Cell 6 with a measurement reporting delay of less than 1.6s ($5 \times \text{measCycleSCell}$) from beginning of time T3.

The UE shall not send event triggered measurement reports as long as the reporting criteria are not fulfilled.

The rate of correct events observed during repeated tests shall be at least 90% for each of the events.

NOTE: The actual overall delays measured in the tests may be up to $2 \times TTI_{DCCH}$ higher than the measurement reporting delays above because of TTI insertion uncertainty of the measurement report in DCCH.

A.8.16.96 6 DL CA Event Triggered Reporting on Deactivated SCell with PCell and SCell Interruptions in Non-DRX with generic duplex modes

A.8.16.96.1 Test Purpose and Environment

The purpose of this test is to verify that the UE correctly detects event A6 (Neighbour becomes better than SCell) defined in TS 36.331 [2] within the requirements stated in clause 8.3.3.2.1 while at the same time fulfilling the requirement on interruption rate.

The test parameters are given in Table A.8.16.96.1-1, A.8.16.96.1-2 and A.8.16.96.1-3 below. In the test there are seven cells: Cell 1, Cell 2, Cell 3, Cell 4, Cell 5, Cell 6 and Cell 7. Cell 1 is PCell on the primary component (RF Channel 1), Cell 2 is SCell on the secondary component (RF Channel 2), Cell 3 is SCell on the secondary component (RF Channel 3), Cell 4 is SCell on the secondary component (RF Channel 4), Cell 5 is SCell on the secondary component (RF Channel 5), Cell 6 is SCell on the secondary component (RF Channel 6) and Cell 7 is the neighbour cell on the secondary component (RF Channel 6). It is indicated to the UE in the measurement control information that event-triggered reporting with Event A6 is used. The test consists of four successive time periods, with duration of T1, T2, T3 and T4, respectively. During T1 and T2, Cell2, Cell3, Cell4, Cell5 and Cell6 are deactivated. During T1 the UE shall not have any information of Cell 7. Immediately at beginning of T2 the transmission power of Cell 7 is increased to same level as for Cell 6, and due to usage of an offset this shall result in reporting of Event A6. Cells 1, 2, 3, 4, 5, 6 and 7 may operate in either FDD or TDD duplex mode according to test configuration.

At the beginning of T3, the transmission power of Cell 7 is turned off, and the test equipment sends a MAC message for activation of Cell 2 to UE but Cell 3, Cell 4, Cell5 and Cell6 remains deactivated. Immediately at beginning of T4 the transmission power of Cell 7 is increased to same level as for Cell 6, and due to usage of an offset this shall result in reporting of Event A6. The UE shall be continuously scheduled in the PCell throughout the whole test and continuously scheduled in Cell2 during T4.

Table A.8.16.96.1-1: General test parameters for E-UTRAN 6 DL CA Event Triggered Reporting on Deactivated SCell with PCell and SCell Interruptions in Non-DRX with generic duplex modes

Parameter	Unit	Value	Comment
E-UTRA RF Channel Number		1, 2, 3, 4, 5, 6	Six radio channels are used for this test
Active PCell		Cell 1	Primary cell on RF channel number 1.
Configured deactivated SCell		Cell 2	Configured deactivated secondary cell on RF channel number 2.
Configured deactivated SCell		Cell 3	Configured deactivated secondary cell on RF channel number 3.
Configured deactivated SCell		Cell 4	Configured deactivated secondary cell on RF channel number 4.
Configured deactivated SCell		Cell 5	Configured deactivated secondary cell on RF channel number 5.
Configured deactivated SCell		Cell 6	Configured deactivated secondary cell on RF channel number 6.
Neighbour cell		Cell 7	Neighbor cell to be identified on RF channel number 6.
CP length		Normal	
TDD special subframe configuration		6	As specified in table 4.2-1 in TS 36.211. The same configuration applies to all TDD cells (cell2, cell3, cell4, cell5, cell6 and cell7).
TDD uplink-downlink configuration		1	As specified in table 4.2-2 in TS 36.211. The same configuration applies to all TDD cells (cell2, cell3, cell4, cell5, cell6 and cell7).
DRX		OFF	Continuous monitoring of primary cell

A6	Hysteresis	dB	0	Hysteresis for evaluation of event A6.
	Offset	dB	-3	Offset parameter for evaluation of event A6. Needs to take relative accuracy tolerance in clause 9.1.11.2 into account plus margin.
	Report on leave		False	
	Time To Trigger	s	0	
Cell-individual offset for cells on RF channel number 1	dB	0	Individual offset for cells on primary component carrier.	
Cell-individual offset for cells on RF channel number 2	dB	0	Individual offset for cells on secondary component carrier.	
Cell-individual offset for cells on RF channel number 3	dB	0	Individual offset for cells on secondary component carrier.	
Cell-individual offset for cells on RF channel number 4	dB	0	Individual offset for cells on secondary component carrier.	
Cell-individual offset for cells on RF channel number 5	dB	0	Individual offset for cells on secondary component carrier.	
Cell-individual offset for cells on RF channel number 6	dB	0	Individual offset for cells on secondary component carrier.	
Filter coefficient		0	L3 filtering is not used	
SCell measurement cycle	ms	640		
T1	s	4	During this time the UE shall be aware of cells 1, 2, 3, 4, 5, and 6 but not cell 7.	
T2	s	≤ 15	UE should report Event A6 within 12.8s (20×sCellMeasCycle)	
T3	s	4	During this time the UE shall activate cell 2	
T4	s	≤ 4	UE should report Event A6 within 3.2s (5×sCellMeasCycle)	

Table A.8.16.96.1-2: Cell specific test parameters for E-UTRAN 6 DL CA Event Triggered Reporting on Deactivated SCell with PCell and SCell Interruptions in Non-DRX with generic duplex modes (Cell #1, Cell #2, Cell #3, Cell #4)

Parameter	Unit	Cell 1				Cell 2				Cell 3				Cell 4			
		T1	T2	T3	T4	T1	T2	T3	T4	T1	T2	T3	T4	T1	T2	T3	T4
E-UTRA RF Channel Number		1				2				3				4			
BW _{channel}		5MHz: N _{RB,c} = 25 10MHz: N _{RB,c} = 50 20MHz: N _{RB,c} = 100				5MHz: N _{RB,c} = 25 10MHz: N _{RB,c} = 50 20MHz: N _{RB,c} = 100				5MHz: N _{RB,c} = 25 10MHz: N _{RB,c} = 50 20MHz: N _{RB,c} = 100				5MHz: N _{RB,c} = 25 10MHz: N _{RB,c} = 50 20MHz: N _{RB,c} = 100			
PDSCH parameters: DL Reference Measurement Channel		5MHz: R.7 FDD 10MHz: R.3 FDD 20MHz: R.6 FDD 5MHz: R.4 TDD 10MHz: R.0 TDD 20MHz: R.3 TDD				N/A	N/A	N/A	5MHz: R.7 FDD 10MH z: R.3 FDD 20MH z: R.6 FDD 5MHz: R.4 TDD 10MH z: R.0 TDD 20MH z: R.3 TDD	N/A				N/A			
PCFICH/PDCCH/PHICH parameters		5MHz: R.11 FDD 10MHz: R.6 FDD 20MHz: R.10 FDD 5MHz: R.11 TDD 10MHz: R.6 TDD 20MHz: R.10 TDD				5MHz: R.11 FDD 10MHz: R.6 FDD 20MHz: R.10 FDD 5MHz: R.11 TDD 10MHz: R.6 TDD 20MHz: R.10 TDD				5MHz: R.11 FDD 10MHz: R.6 FDD 20MHz: R.10 FDD 5MHz: R.11 TDD 10MHz: R.6 TDD 20MHz: R.10 TDD				5MHz: R.11 FDD 10MHz: R.6 FDD 20MHz: R.10 FDD 5MHz: R.11 TDD 10MHz: R.6 TDD 20MHz: R.10 TDD			
OCNG Pattern defined in A.3.2.1		5MHz: OP.20 FDD 10MHz: OP.10 FDD 20MHz: OP.17 FDD 5MHz: OP.9 TDD 10MHz: OP.1 TDD 20MHz: OP.7 TDD				5MHz: OP.16 FDD 10MH z: OP.2 FDD 20MH z:	5MHz: OP.16 FDD 10MH z: OP.2 FDD 20MH z:	5MHz: OP.16 FDD 10MH z: OP.2 FDD 20MH z:	5MHz: OP.20 FDD 10MH z: OP.10 FDD 20MH z:	5MHz: OP.16 FDD 10MHz: OP.2 FDD 20MHz: OP.12 FDD 5MHz: OP.10 TDD 10MHz: OP.2 TDD 20MHz: OP.8 TDD				5MHz: OP.16 FDD 10MHz: OP.2 FDD 20MHz: OP.12 FDD 5MHz: OP.10 TDD 10MHz: OP.2 TDD 20MHz: OP.8 TDD			

			OP.12 FDD	OP.12 FDD	OP.12 FDD	OP.17 FDD											
			5MHz: OP.10 TDD 10MH z: OP.2 TDD 20MH z: OP.8 TDD	5MHz: OP.10 TDD 10MH z: OP.2 TDD 20MH z: OP.8 TDD	5MHz: OP.10 TDD 10MH z: OP.2 TDD 20MH z: OP.8 TDD	5MHz: OP.9 TDD 10MH z: OP.1 TDD 20MH z: OP.7 TDD											
PBCH_RA	dB	0				0				0				0			
PBCH_RB	dB																
PSS_RA	dB																
SSS_RA	dB																
PCFICH_RB	dB																
PHICH_RA	dB																
PHICH_RB	dB																
PDCCH_RA	dB																
PDCCH_RB	dB																
PDSCH_RA	dB																
PDSCH_RB	dB																
OCNG_RA ^{Note 1}	dB																
OCNG_RB ^{Note 1}	dB																
N_{oc} ^{Note 3}	dBm/1 5 kHz																
\hat{E}_s/N_{oc}	dB	16	16	16	16	16	16	16	16	16	16	16	16	16	16	16	16
\hat{E}_s/I_{ot} ^{Note 4}	dB	16	16	16	16	16	16	16	16	16	-0.11	16	-0.11	16	-0.11	16	-0.11
RSRP ^{Note 4}	dBm/1 5 kHz	-85	-85	-85	-85	-85	-85	-85	-85	-85	-85	-85	-85	85	-85	85	-85
SCH_RP ^{Note 4}	dBm/1 5 kHz	-85	-85	-85	-85	-85	-85	-85	-85	-85	-85	-85	-85	85	-85	85	-85
I_o ^{Note 4}	dBm/C h BW	- 57.11 +10lg g (N _{RB,c} /50)	- 57.11 +10lg g (N _{RB,c} /50)	- 57.11 +10lg g (N _{RB,c} /50)	- 57.11 +10lg g (N _{RB,c} /50)	-57.11 +10log (N _{RB,c} /50)	-57.11 +10log (N _{RB,c} /50)	-57.11 +10log (N _{RB,c} /50)	-57.11 +10log (N _{RB,c} /50)	- 57.11 +10lg g (N _{RB,c} /50)	- 54.15 +10lg g (N _{RB,c} /50)	- 57.11 +10lg g (N _{RB,c} /50)	- 54.15 +10lg g (N _{RB,c} /50)	- 57.11 +10lg g (N _{RB,c} /50)	- 54.15 +10lg g (N _{RB,c} /50)	- 57.11 +10lg g (N _{RB,c} /50)	- 54.15 +10lg g (N _{RB,c} /50)
Propagation Condition		AWGN				AWGN				AWGN				AWGN			

Antenna Configuration		1x2	1x2	1x2	1x2
Timing offset to Cell 1	μs	-	0	0	0
Time alignment error relative to cell 1 ^{Note 5}	μs	-	$\leq \text{TAE}$	$\leq \text{TAE}$	$\leq \text{TAE}$
Time alignment error relative to cell 2 ^{Note 5}	μs	-	-	$\leq \text{TAE}$	$\leq \text{TAE}$
Time alignment error relative to cell 3 ^{Note 5}	μs	-	-	-	$\leq \text{TAE}$
<p>Note 1: OCNG shall be used such that all cells are fully allocated and a constant total transmitted power spectral density is achieved for all OFDM symbols.</p> <p>Note 2: The resources for uplink transmission are assigned to the UE on cell1 from the start of time period T2 and on cell2 from the start of time period T4.</p> <p>Note 3: Interference from other cells and noise sources not specified in the test is assumed to be constant over subcarriers and time and shall be modelled as AWGN of appropriate power for N_{oc} to be fulfilled.</p> <p>Note 4: Es/lot, RSRP, SCH_RP and Io levels have been derived from other parameters for information purposes. They are not settable parameters themselves.</p> <p>Note 5: Time alignment error (TAE) as specified in TS 36.104 [30] clause 6.5.3.1. The TAE value depends upon the type of carrier aggregation.</p>					

Table A.8.16.96.1-3: Cell specific test parameters for E-UTRAN 6 DL CA Event Triggered Reporting on Deactivated SCell with PCell and SCell Interruptions in Non-DRX with generic duplex modes (Cell #5, Cell #6, Cell #7)

Parameter	Unit	Cell 5				Cell 6				Cell 7			
		T1	T2	T3	T4	T1	T2	T3	T4	T1	T2	T3	T4
E-UTRA RF Channel Number		5				6				6			
$BW_{channel}$		5MHz: $N_{RB,c} = 25$ 10MHz: $N_{RB,c} = 50$ 20MHz: $N_{RB,c} = 100$				5MHz: $N_{RB,c} = 25$ 10MHz: $N_{RB,c} = 50$ 20MHz: $N_{RB,c} = 100$				5MHz: $N_{RB,c} = 25$ 10MHz: $N_{RB,c} = 50$ 20MHz: $N_{RB,c} = 100$			
PDSCH parameters: DL Reference Measurement Channel		N/A				N/A				N/A			
PCFICH/PDCCH/PHICH parameters		5MHz: R.11 FDD 10MHz: R.6 FDD 20MHz: R.10 FDD 5MHz: R.11 TDD 10MHz: R.6 TDD 20MHz: R.10 TDD				5MHz: R.11 FDD 10MHz: R.6 FDD 20MHz: R.10 FDD 5MHz: R.11 TDD 10MHz: R.6 TDD 20MHz: R.10 TDD				5MHz: R.11 FDD 10MHz: R.6 FDD 20MHz: R.10 FDD 5MHz: R.11 TDD 10MHz: R.6 TDD 20MHz: R.10 TDD			
OCNG Pattern defined in A.3.2.1		5MHz: OP.16 FDD 10MHz: OP.2 FDD 20MHz: OP.12 FDD 5MHz: OP.10 TDD 10MHz: OP.2 TDD 20MHz: OP.8 TDD				5MHz: OP.16 FDD 10MHz: OP.2 FDD 20MHz: OP.12 FDD 5MHz: OP.10 TDD 10MHz: OP.2 TDD 20MHz: OP.8 TDD				5MHz: OP.16 FDD 10MHz: OP.2 FDD 20MHz: OP.12 FDD 5MHz: OP.10 TDD 10MHz: OP.2 TDD 20MHz: OP.8 TDD			
PBCH_RA	dB	0				0				0			
PBCH_RB	dB												
PSS_RA	dB												
SSS_RA	dB												
PCFICH_RB	dB												
PHICH_RA	dB												
PHICH_RB	dB												
PDCCH_RA	dB												
PDCCH_RB	dB												
PDSCH_RA	dB												
PDSCH_RB	dB												
OCNG_RA ^{Note 1}	dB												
OCNG_RB ^{Note 1}	dB												
N_{oc} ^{Note 3}	dBm/15 kHz												
\hat{E}_s/N_{oc}	dB	16	16	16	16	16	16	16	16	-infinity	16	-infinity	16

\hat{E}_s/I_{ot} Note 4	dB	16	-0.11	16	-0.11	16	-0.11	16	-0.11	-infinity	-0.11	-infinity	-0.11
RSRP Note 4	dBm/15 kHz	85	-85	85	-85	85	-85	85	-85	-infinity	-85	-infinity	-85
SCH_RP Note 4	dBm/15 kHz	85	-85	85	-85	85	-85	85	-85	-infinity	-85	-infinity	-85
I_o Note 4	dBm/Ch BW	-57.11 +10log ($N_{RB,c}$ /50)	-54.15 +10log ($N_{RB,c}$ /50)	-57.11 +10log ($N_{RB,c}$ /50)	-54.15 +10log ($N_{RB,c}$ /50)	-57.11 +10log ($N_{RB,c}$ /50)	-54.15 +10log ($N_{RB,c}$ /50)	-57.11 +10log ($N_{RB,c}$ /50)	-54.15 +10log ($N_{RB,c}$ /50)	-57.11 +10log ($N_{RB,c}$ /50)	-54.15 +10log ($N_{RB,c}$ /50)	-57.11 +10log ($N_{RB,c}$ /50)	-54.15 +10log ($N_{RB,c}$ /50)
Propagation Condition		AWGN				AWGN				AWGN			
Antenna Configuration		1x2				1x2				1x2			
Timing offset to Cell 1	μ s	0				0				3			
Time alignment error relative to cell 1 Note 5	μ s	\leq TAE				\leq TAE				N/A			
Time alignment error relative to cell 2 Note 5	μ s	\leq TAE				\leq TAE				N/A			
Time alignment error relative to cell 3 Note 5	μ s	\leq TAE				\leq TAE				N/A			
Note 1:	OCNG shall be used such that all cells are fully allocated and a constant total transmitted power spectral density is achieved for all OFDM symbols.												
Note 2:	Void												
Note 3:	Interference from other cells and noise sources not specified in the test is assumed to be constant over subcarriers and time and shall be modelled as AWGN of appropriate power for N_{oc} to be fulfilled.												
Note 4:	E_s/I_{ot} , RSRP, SCH_RP and I_o levels have been derived from other parameters for information purposes. They are not settable parameters themselves.												
Note 5:	Time alignment error (TAE) as specified in TS 36.104 [30] clause 6.5.3.1. The TAE value depends upon the type of carrier aggregation.												

A.8.16.96.2 Test Requirements

The UE shall send one Event A6 triggered measurement report, with a measurement reporting delay less than $12.8s$ ($20 \times \text{scellMeasCycle}$) from the beginning of time period T2.

The UE shall send one Event A6 triggered measurement report, with a measurement reporting delay less than $3.2s$ ($5 \times \text{scellMeasCycle}$) from the beginning of time period T4.

The UE shall not send event triggered measurement reports, as long as the reporting criteria are not fulfilled.

The UE shall be scheduled on PCell continuously throughout the test. From the start of T1 until the measurement report is received during T2, at least 99.5% of all expected ACK/NACKs shall be transmitted by the UE.

The UE shall be scheduled on Cell2 continuously from the beginning of T4 to the end. From the start of T4 until the measurement report is received during T4, at least 99.5% of all expected ACK/NACKs shall be transmitted by the UE.

For a test to be considered successful requirements on both event detection and percentage of transmitted ACK/NACKs have to be fulfilled simultaneously.

The rate of correct events observed during repeated tests shall be at least 90%.

NOTE: The actual overall delays measured in the test may be up to $2 \times \text{TTI}_{\text{DCCH}}$ higher than the measurement reporting delays above because of TTI insertion uncertainty of the measurement report in DCCH.

A.8.16.97 6 DL CA Activation and Deactivation of Known SCell in Non-DRX with generic duplex modes

A.8.16.97.1 Test Purpose and Environment

The purpose of this test is to verify that the SCell activation and deactivation times are within the requirements stated in section 7.7 for UE configured with five downlink SCells, when the SCell is known by the UE at the time of activation.

The test parameters are given in Tables A.8.16.97.1-1 and cell-specific parameters in A.8.16.97.1-2 and A.8.16.97.1-3 below. The test consists of three successive time periods, with duration of T1, T2 and T3, respectively. There are six carriers, each with one cell. Cells may operate in either FDD or TDD duplex mode according to test configuration. All cells have constant signal levels throughout the test. Before the test starts the UE is connected to Cell 1 (PCell) on radio channel 1 (PCC), deactivated Cell 3 (SCell2) on radio channel 3 (SCC2), deactivated Cell 4 (SCell3) on radio channel 4 (SCC3), deactivated Cell 5 (SCell4) on radio channel 5 (SCC4) and deactivated Cell 6 (SCell5) on radio channel 6 (SCC5) but is not aware of Cell 2 (SCell1) on radio channel 2 (SCC1). The UE is only monitoring PCC, SCC2, SCC3, SCC4, and SCC5. The UE shall be continuously scheduled in the PCell throughout the whole test.

At the beginning of T1 the UE receives an RRC message by which SCell1 becomes configured on SCC1. The UE now starts monitoring also the SCC1. The test equipment sends a MAC message for activation of SCell1.

The point in time at which the MAC message is received at the UE antenna connector, in a subframe # denoted m , where m is an even number for FDD PCell and 4 or 9 for TDD PCell, defines the start of time period T2. The UE receives a MAC message for activation of SCell2 in subframe $(m+10)$ for FDD PCell and $(m+15)$ for TDD PCell, a MAC message for activation of SCell3 in subframe $(m+20)$ for FDD PCell and $(m+15)$ for TDD PCell, a MAC message for activation of SCell4 in subframe $(m+30)$ for FDD PCell and a MAC message for activation of SCell5 in subframe $(m+40)$ for FDD PCell and $(m+15)$ for TDD PCell during activation of SCell1. The UE shall be able to report valid CSI for the activated SCell1 at latest in a subframe $(m+44)$. The UE shall start reporting CSI for SCell1 in subframe $(m+8)$ and shall report CQI index 0 (out-of-range) until the SCell activation has been completed. Any PCell interruption due to activation of SCells shall not occur outside subframes $(m+5)$ to $(m+9)$, $(m+15)$ to $(m+19)$, $(m+25)$ to $(m+29)$, $(m+35)$ to $(m+39)$, and $(m+45)$ to $(m+49)$ for FDD PCell, and not outside subframes $(m+5)$ to $(m+11)$, $(m+20)$ to $(m+26)$ for TDD PCell.

Time period T3 starts when a MAC message for deactivation of SCell1, sent from the test equipment to the UE in a subframe # denoted n , where n is an even number for FDD PCell and 4 or 9 for TDD PCell, is received at the UE antenna connector. The test equipment sends a MAC message for deactivation of the SCell2 in subframe $(n+10)$ for FDD PCell and $(n+15)$ for TDD PCell, a MAC message for deactivation of the SCell3 in subframe $(n+20)$ for FDD PCell and $(n+30)$ for TDD PCell, a MAC message for deactivation of the SCell4 in subframe $(n+30)$ for FDD PCell and $(n+45)$ for TDD PCell, and a MAC message for deactivation of the SCell5 in subframe $(n+40)$ for FDD PCell and $(n+60)$ for TDD PCell. The UE shall carry out deactivation of SCell1 at latest in subframe $(n+8)$, and any PCell interruption due to the deactivation of SCells shall not occur outside subframes $(n+5)$ to $(n+9)$, $(n+15)$ to $(n+19)$, $(n+25)$

to (n+29), (n+35) to (n+39) and (n+45) to (n+49) for FDD PCell, and not outside subframes (n+5) to (n+11), (n+20) to (n+26), (n+35) to (n+41), (n+50) to (n+56) and (n+65) to (n+71) for TDD PCell.

The test equipment verifies that potential interruption is carried out in the correct time span by monitoring ACK/NACK sent in PCell during activation and deactivation of SCell1, respectively.

The test equipment verifies the activation time by counting the subframes from the time when SCell1 activation command is sent until a CSI report with other than CQI index 0 is received.

The test equipment verifies the deactivation time by counting the subframes from the time when SCell1 deactivation command is sent until CQI reporting for SCell1 is discontinued.

Table A.8.16.97.1-1: General test parameters for known SCell1 activation case

Parameter	Unit	Value	Comment
E-UTRA RF Channel Number		1, 2, 3, 4, 5, 6	Six radio channels are used for this test
Active PCell		Cell 1	Primary cell on RF channel number 1.
Deconfigured deactivated SCell		Cell 2	Deconfigured deactivated secondary cell on RF channel number 2.
Configured deactivated SCell2		Cell 3	Configured deactivated secondary cell on RF channel number 3.
Configured deactivated SCell3		Cell 4	Configured deactivated secondary cell on RF channel number 4.
Configured deactivated SCell4		Cell 5	Configured deactivated secondary cell on RF channel number 5.
Configured deactivated SCell5		Cell 6	Configured deactivated secondary cell on RF channel number 6.
CP length		Normal	
DRX		OFF	Continuous monitoring of primary cell
CQI/PMI periodicity and offset configuration index		0	CQI reporting for SCell every UL subframe
Cell-individual offset for cells on RF channel number 1	dB	0	Individual offset for cells on PCC.
Cell-individual offset for cells on RF channel number 2	dB	0	Individual offset for cells on SCC1.
Cell-individual offset for cells on RF channel number 3	dB	0	Individual offset for cells on SCC2.
Cell-individual offset for cells on RF channel number 4	dB	0	Individual offset for cells on SCC3.
Cell-individual offset for cells on RF channel number 5	dB	0	Individual offset for cells on SCC4.
Cell-individual offset for cells on RF channel number 6	dB	0	Individual offset for cells on SCC5.
Filter coefficient		0	L3 filtering is not used.
SCell measurement cycle (measCycleSCell)	ms	320	
T1	s	7	During this time the PCell, SCell2, SCell3, SCell4 and SCell5 shall be known and the SCell1 configured and detected.
T2	s	1	During this time the UE shall activate the SCell1, SCell2, SCell3, SCell4 and SCell5.
T3	s	1	During this time the UE shall deactivate the SCell1, SCell2, SCell3, SCell4 and SCell5.

Table A.8.16.97.1-2: Cell specific test parameters for known SCell1 activation

Parameter	Unit	Cell 1			Cell 2			Cell 3		
		T1	T2	T3	T1	T2	T3	T1	T2	T3
E-UTRA RF Channel Number		1			2			3		
Duplex mode		FDD or TDD			FDD or TDD			FDD or TDD		
TDD special subframe configuration		6			6			6		

TDD uplink-downlink configuration		1	1	1
BW _{channel}	MHz	5MHz: N _{RB,c} = 25 10MHz: N _{RB,c} = 50 20MHz: N _{RB,c} = 100	5MHz: N _{RB,c} = 25 10MHz: N _{RB,c} = 50 20MHz: N _{RB,c} = 100	5MHz: N _{RB,c} = 25 10MHz: N _{RB,c} = 50 20MHz: N _{RB,c} = 100
PDSCH parameters: DL Reference Measurement Channel		5MHz: R.7 FDD 10MHz: R.3 FDD 20MHz: R.6 FDD 5MHz: R.4 TDD 10MHz: R.0 TDD 20MHz: R.3 TDD	-	-
PCFICH/PDCCH/PHICH parameters: DL Reference Measurement Channel		5MHz: R.11 FDD 10MHz: R.6 FDD 20MHz: R.10 FDD 5MHz: R.11 TDD 10MHz: R.6 TDD 20MHz: R.10 TDD	5MHz: R.11 FDD 10MHz: R.6 FDD 20MHz: R.10 FDD 5MHz: R.11 TDD 10MHz: R.6 TDD 20MHz: R.10 TDD	5MHz: R.11 FDD 10MHz: R.6 FDD 20MHz: R.10 FDD 5MHz: R.11 TDD 10MHz: R.6 TDD 20MHz: R.10 TDD
OCNG Patterns		5MHz: OP.20 FDD 10MHz: OP.10 FDD 20MHz: OP.17 FDD 5MHz: OP.9 TDD 10MHz: OP.1 TDD 20MHz: OP.7 TDD	5MHz: OP.16 FDD 10MHz: OP.2 FDD 20MHz: OP.12 FDD 5MHz: OP.10 TDD 10MHz: OP.2 TDD 20MHz: OP.8 TDD	5MHz: OP.16 FDD 10MHz: OP.2 FDD 20MHz: OP.12 FDD 5MHz: OP.10 TDD 10MHz: OP.2 TDD 20MHz: OP.8 TDD
PBCH_RA	dB	0	0	0
PBCH_RB	dB			
PSS_RA	dB			
SSS_RA	dB			
PCFICH_RB	dB			
PHICH_RA	dB			
PHICH_RB	dB			
PDCCH_RA	dB			
PDCCH_RB	dB			
PDSCH_RA	dB			
PDSCH_RB	dB			
OCNG_RA ^{Note 1}	dB			
OCNG_RB ^{Note 1}	dB			
N _{oc} ^{Note 2}	dBm/15 kHz			
\bar{E}_s/N_{oc}	dB	17	17	17
\bar{E}_s/I_{ot}	dB	17	17	17
RSRP ^{Note 3}	dBm/15 kHz	-87	-87	-87
SCH_RP ^{Note 3}	dBm/15 kHz	-87	-87	-87
I _o ^{Note 3}	dBm/Ch BW	-59.13 +10log (N _{RB,c} /50)	-59.13 +10log (N _{RB,c} /50)	-59.13 +10log (N _{RB,c} /50)
Propagation Condition		AWGN	AWGN	AWGN
Antenna Configuration		1x2	1x2	1x2
Timing offset to Cell 1	μs	-	0	0
Time alignment error relative to cell 1 ^{Note 5}	μs	-	≤ TAE	≤ TAE
Time alignment error relative to cell 2 ^{Note 5}	μs	-	-	≤ TAE
Time alignment error relative to cell 3 ^{Note 5}	μs	-	-	-
Time alignment error relative to cell 4 ^{Note 5}	μs	-	-	-
Time alignment error relative to cell 5 ^{Note 5}	μs	-	-	-

Note 1: OCNB shall be used such that all cells are fully allocated and a constant total transmitted power spectral density is achieved for all OFDM symbols.

Note 2: Interference from other cells and noise sources not specified in the test is assumed to be constant over subcarriers and time and shall be modelled as AWGN of appropriate power for N_{oc} to be fulfilled.

Note 3: E_s/I_{ot} , RSRP, SCH_RP and I_o levels have been derived from other parameters for information purposes. They are not settable parameters themselves.

Note 4: The uplink resources for CSI reporting are assigned to the UE prior to the start of time period T2.

Note 5: Time alignment error (TAE) as specified in TS 36.104 [30] clause 6.5.3.1. The TAE value depends upon the type of carrier aggregation.

Table A.8.16.97.1-3: Cell specific test parameters for known SCell1 activation

Parameter	Unit	Cell 4			Cell 5			Cell 6		
		T1	T2	T3	T1	T2	T3	T1	T2	T3
E-UTRA RF Channel Number		4			5			6		
Duplex mode		FDD or TDD			FDD or TDD			FDD or TDD		
TDD special subframe configuration		6			6			6		
TDD uplink-downlink configuration		1			1			1		
BW _{channel}	MHz	5MHz: N _{RB,c} = 25 10MHz: N _{RB,c} = 50 20MHz: N _{RB,c} = 100			5MHz: N _{RB,c} = 25 10MHz: N _{RB,c} = 50 20MHz: N _{RB,c} = 100			5MHz: N _{RB,c} = 25 10MHz: N _{RB,c} = 50 20MHz: N _{RB,c} = 100		
PDSCH parameters: DL Reference Measurement Channel		-			-			-		
PCFICH/PDCCH/PHICH parameters: DL Reference Measurement Channel		5MHz: R.11 FDD 10MHz: R.6 FDD 20MHz: R.10 FDD 5MHz: R.11 TDD 10MHz: R.6 TDD 20MHz: R.10 TDD			5MHz: R.11 FDD 10MHz: R.6 FDD 20MHz: R.10 FDD 5MHz: R.11 TDD 10MHz: R.6 TDD 20MHz: R.10 TDD			5MHz: R.11 FDD 10MHz: R.6 FDD 20MHz: R.10 FDD 5MHz: R.11 TDD 10MHz: R.6 TDD 20MHz: R.10 TDD		
OCNB Patterns		5MHz: OP.16 FDD 10MHz: OP.2 FDD 20MHz: OP.12 FDD 5MHz: OP.10 TDD 10MHz: OP.2 TDD 20MHz: OP.8 TDD			5MHz: OP.16 FDD 10MHz: OP.2 FDD 20MHz: OP.12 FDD 5MHz: OP.10 TDD 10MHz: OP.2 TDD 20MHz: OP.8 TDD			5MHz: OP.16 FDD 10MHz: OP.2 FDD 20MHz: OP.12 FDD 5MHz: OP.10 TDD 10MHz: OP.2 TDD 20MHz: OP.8 TDD		
PBCH_RA	dB	0			0			0		
PBCH_RB	dB									
PSS_RA	dB									
SSS_RA	dB									
PCFICH_RB	dB									
PHICH_RA	dB									
PHICH_RB	dB									
PDCCH_RA	dB									
PDCCH_RB	dB									
PDSCH_RA	dB									
PDSCH_RB	dB									
OCNB_RA ^{Note 1}	dB									
OCNB_RB ^{Note 1}	dB									
N _{oc} ^{Note 2}	dBm/15 kHz									
\bar{E}_s/N_{oc}	dB	17			17			17		
\bar{E}_s/I_{ot}	dB	17			17			17		
RSRP ^{Note 3}	dBm/15 kHz	-87			-87			-87		
SCH_RP ^{Note 3}	dBm/15 kHz	-87			-87			-87		

I_0 ^{Note 3}	dBm/Ch BW	-59.13 +10log ($N_{RB,c}/50$)	-59.13 +10log ($N_{RB,c}/50$)	-59.13 +10log ($N_{RB,c}/50$)
Propagation Condition		AWGN	AWGN	AWGN
Antenna Configuration		1x2	1x2	1x2
Timing offset to Cell 1	μs	0	0	0
Time alignment error relative to cell 1 ^{Note 5}	μs	$\leq \text{TAE}$	$\leq \text{TAE}$	$\leq \text{TAE}$
Time alignment error relative to cell 2 ^{Note 5}	μs	$\leq \text{TAE}$	$\leq \text{TAE}$	$\leq \text{TAE}$
Time alignment error relative to cell 3 ^{Note 5}	μs	$\leq \text{TAE}$	$\leq \text{TAE}$	$\leq \text{TAE}$
Time alignment error relative to cell 4 ^{Note 5}	μs	-	$\leq \text{TAE}$	$\leq \text{TAE}$
Time alignment error relative to cell 5 ^{Note 5}	μs	-	-	$\leq \text{TAE}$
<p>Note 1: OCNG shall be used such that all cells are fully allocated and a constant total transmitted power spectral density is achieved for all OFDM symbols.</p> <p>Note 2: Interference from other cells and noise sources not specified in the test is assumed to be constant over subcarriers and time and shall be modelled as AWGN of appropriate power for N_{oc} to be fulfilled.</p> <p>Note 3: E_s/lot, RSRP, SCH_RP and I_0 levels have been derived from other parameters for information purposes. They are not settable parameters themselves.</p> <p>Note 4: The uplink resources for CSI reporting are assigned to the UE prior to the start of time period T2.</p> <p>Note 5: Time alignment error (TAE) as specified in TS 36.104 [30] clause 6.5.3.1. The TAE value depends upon the type of carrier aggregation.</p>				

A.8.16.97.2 Test Requirements

During T2 the UE shall send the first CSI report for SCell1 in a subframe (m+8), or in a subframe (m+10) for FDD PCell and (m+9) for TDD PCell, if the subframe (m+8) was subject to interruption, or in subframe (m+13) for TDD PCell, if the subframes (m+8) and (m+9) were subject to interruption. Whether CSI report in subframe (m+8) / (m+9) was interrupted or not is checked by monitoring ACK/NACK sent in PCell in subframe (m+8) / (m+9).

During T2 the UE shall start sending CSI reports for SCell1 with non-zero CQI index at latest in a subframe (m+44).

During T3 the UE shall stop sending CSI reports for SCell at latest in a subframe (n+8).

During T2 interruption of PCell during SCells activation shall not happen outside subframes (m+5) to (m+9), (m+15) to (m+19), (m+25) to (m+29), (m+35) to (m+39) and (m+45) to (m+49) for FDD PCell, and not happen outside subframes (m+5) to (m+11), (m+20) to (m+26) for TDD PCell.

During T3 interruption of PCell during SCells deactivation shall not happen outside subframes (n+5) to (n+9), (n+15) to (n+19), (n+25) to (n+29), (n+35) to (n+39) and (m+45) to (m+49) for FDD PCell, and not happen outside subframes (n+5) to (n+11), (n+20) to (n+26), (n+35) to (n+41), (n+50) to (n+56), and (n+65) to (n+71) for TDD PCell.

The interruption of PCell shall not be more than the values specified for intra-band CA and inter-band CA in Section 7.8.2.

All of the above test requirements shall be fulfilled in order for the observed SCell1 activation delay and SCell1 deactivation delay to be counted as correct. The rate of correct observed SCell1 activation delay and SCell1 deactivation delay during repeated tests shall be at least 90%.

NOTE: During T2 if there are no uplink resources for reporting the valid CSI in a subframe (m+44) then the UE shall use the next available uplink resource for reporting the corresponding valid CSI.

A.8.16.98 6 DL CA Activation and Deactivation of Unknown SCell in Non-DRX with generic duplex modes

A.8.16.98.1 Test Purpose and Environment

The purpose of this test is to verify that the SCell activation and deactivation times are within the requirements stated in section 7.7 for UE configured with five downlink SCells, when the SCell is unknown by the UE at the time of activation.

The test parameters are given in Tables A.8.16.98.1-1 and cell-specific parameters in A.8.16.98.1-2 and A.8.16.98.1-3 below. The test consists of three successive time periods, with duration of T1, T2 and T3, respectively. There are six carriers, each with one cell. Cells may operate in either FDD or TDD duplex mode according to test configuration. Cell 1, Cell 3, Cell 4, Cell5 and Cell6 have constant signal levels throughout the test. Before the test starts the UE is connected to Cell 1 (PCell) on radio channel 1 (PCC), deactivated Cell 3 (SCell2) on radio channel 3 (SCC2), deactivated Cell 4 (SCell3) on radio channel 4 (SCC3), deactivated Cell 5 (SCell4) on radio channel 5 (SCC4) and deactivated Cell 6 (SCell5) on radio channel 6 (SCC5) but is not aware of Cell 2 (SCell1) on radio channel 2 (SCC1). The UE is only monitoring PCC, SCC2, SCC3, SCC4 and SCC5. The UE shall be continuously scheduled in the PCell throughout the whole test.

At the beginning of T1 the UE receives an RRC message by which SCell1 becomes configured on SCC1. The UE now starts monitoring also the SCC1. During T1 SCell1 is powered off and the UE is not aware of SCell1.

A MAC message for activation of SCell1 is sent by the test equipment 100ms after the RRC message, in a subframe # denoted m, where m is an even number for FDD PCell and 4 or 9 for TDD PCell. The point in time at which the MAC message for activation of SCell1 is received at the UE antenna connector defines the start of time period T2. Immediately at beginning of T2 transmission power of SCell1 is increased to same level as for PCell. The test equipment sends a MAC message for activation of SCell2 in subframe (m+10) for FDD PCell and (m+15) for TDD PCell, a MAC message for activation of SCell3 in subframe (m+20) for FDD PCell and (m+15) for TDD PCell, a MAC message for activation of SCell4 in a subframe (m+30) for FDD PCell and (m+15) for TDD PCell during activation of SCell1 and a MAC message for activation of SCell5 in a subframe (m+40) for FDD PCell and (m+15) for TDD PCell during activation of SCell1. The UE shall be able to report valid CSI for the activated SCell1 at latest in a subframe (m+54). The UE shall start reporting CSI for SCell1 in subframe (m+8) and shall report CQI index 0 (out-of-range) until the SCell activation has been completed. Any PCell interruption due to activation of SCells shall not occur outside subframes (m+5) to (m+9), (m+15) to (m+19), (m+25) to (m+29), (m+35) to (m+39) and (m+45) to (m+49) for FDD PCell, and not outside subframes (m+5) to (m+11) and (m+20) to (m+26) for TDD PCell.

Time period T3 starts when a MAC message for deactivation of SCell1, sent from the test equipment to the UE in a subframe # denoted n, where n is an even number for FDD PCell and 4 or 9 for TDD PCell, is received at the UE antenna connector. The test equipment sends a MAC message for deactivation of the SCell2 in subframe (n+10) for FDD PCell and (n+15) for TDD PCell, a MAC message for deactivation of the SCell3 in subframe (n+20) for FDD PCell and (n+30) for TDD PCell, a MAC message for deactivation of the SCell4 in subframe (n+30) for FDD PCell and (n+45) for TDD PCell and a MAC message for deactivation of the SCell5 in subframe (n+40) for FDD PCell and (n+60) for TDD PCell. The UE shall carry out deactivation of SCell1 at latest in subframe (n+8), and any PCell interruption due to the deactivation of SCells shall not occur outside subframes (n+5) to (n+9), (n+15) to (n+19), (n+25) to (n+29), (n+35) to (n+39) and (n+45) to (n+49) for FDD PCell, and not outside subframes (n+5) to (n+11), (n+20) to (n+26), (n+35) to (n+41), (n+50) to (n+56) and (n+65) to (n+71) for TDD PCell.

The test equipment verifies that potential interruption is carried out in the correct time span by monitoring ACK/NACK sent in PCell during activation and deactivation of SCell1, respectively.

The test equipment verifies the activation time by counting the subframes from the time when SCell1 activation command is sent until a CSI report with other than CQI index 0 is received.

The test equipment verifies the deactivation time by counting the subframes from the time when SCell1 deactivation command is sent until CQI reporting for SCell1 is discontinued.

Table A.8.16.98.1-1: General test parameters for unknown SCell1 activation case

Parameter	Unit	Value	Comment
E-UTRA RF Channel Number		1, 2, 3, 4, 5, 6	Six radio channels are used for this test
Active PCell		Cell 1	Primary cell on RF channel number 1.
Deconfigured deactivated SCell		Cell 2	Deconfigured deactivated secondary cell on RF channel number 2.
Configured deactivated SCell2		Cell 3	Configured deactivated secondary cell on RF channel number 3.
Configured deactivated SCell3		Cell 4	Configured deactivated secondary cell on RF channel number 4.
Configured deactivated SCell4		Cell 5	Configured deactivated secondary cell on RF channel number 5.
Configured deactivated SCell5		Cell 6	Configured deactivated secondary cell on RF channel number 6.
CP length		Normal	

DRX		OFF	Continuous monitoring of primary cell
CQI/PMI periodicity and offset configuration index		0	CQI reporting for SCell every UL subframe
Cell-individual offset for cells on RF channel number 1	dB	0	Individual offset for cells on PCC.
Cell-individual offset for cells on RF channel number 2	dB	0	Individual offset for cells on SCC1.
Cell-individual offset for cells on RF channel number 3	dB	0	Individual offset for cells on SCC2.
Cell-individual offset for cells on RF channel number 4	dB	0	Individual offset for cells on SCC3.
Cell-individual offset for cells on RF channel number 5	dB	0	Individual offset for cells on SCC4.
Cell-individual offset for cells on RF channel number 6	dB	0	Individual offset for cells on SCC5.
Filter coefficient		0	L3 filtering is not used.
SCell measurement cycle (measCycleSCell)	ms	320	
T1	ms	100	During this time the PCell, SCell2, SCell3, SCell4 and SCell5 shall be known and the SCell1 configured.
T2	s	1	During this time the UE shall activate the SCell1, SCell2, SCell3, SCell4 and SCell5.
T3	s	1	During this time the UE shall deactivate the SCell1, SCell2, SCell3, SCell4 and SCell5.

Table A.8.16.98.1-2: Cell specific test parameters for unknown SCell1 activation

Parameter	Unit	Cell 1			Cell 2			Cell 3		
		T1	T2	T3	T1	T2	T3	T1	T2	T3
E-UTRA RF Channel Number		1			2			3		
Duplex mode		FDD or TDD			FDD or TDD			FDD or TDD		
TDD special subframe configuration		6			6			6		
TDD uplink-downlink configuration		1			1			1		
BW _{channel}	MHz	5MHz: N _{RB,c} = 25 10MHz: N _{RB,c} = 50 20MHz: N _{RB,c} = 100			5MHz: N _{RB,c} = 25 10MHz: N _{RB,c} = 50 20MHz: N _{RB,c} = 100			5MHz: N _{RB,c} = 25 10MHz: N _{RB,c} = 50 20MHz: N _{RB,c} = 100		
PDSCH parameters: DL Reference Measurement Channel		5MHz: R.7 FDD 10MHz: R.3 FDD 20MHz: R.6 FDD 5MHz: R.4 TDD 10MHz: R.0 TDD 20MHz: R.3 TDD			-			-		
PCFICH/PDCCH/PHICH parameters: DL Reference Measurement Channel		5MHz: R.11 FDD 10MHz: R.6 FDD 20MHz: R.10 FDD 5MHz: R.11 TDD 10MHz: R.6 TDD 20MHz: R.10 TDD			5MHz: R.11 FDD 10MHz: R.6 FDD 20MHz: R.10 FDD 5MHz: R.11 TDD 10MHz: R.6 TDD 20MHz: R.10 TDD			5MHz: R.11 FDD 10MHz: R.6 FDD 20MHz: R.10 FDD 5MHz: R.11 TDD 10MHz: R.6 TDD 20MHz: R.10 TDD		
OCNG Patterns		5MHz: OP.20 FDD 10MHz: OP.10 FDD 20MHz: OP.17 FDD 5MHz: OP.9 TDD 10MHz: OP.1 TDD 20MHz: OP.7 TDD			5MHz: OP.16 FDD 10MHz: OP.2 FDD 20MHz: OP.12 FDD 5MHz: OP.10 TDD 10MHz: OP.2 TDD 20MHz: OP.8 TDD			5MHz: OP.16 FDD 10MHz: OP.2 FDD 20MHz: OP.12 FDD 5MHz: OP.10 TDD 10MHz: OP.2 TDD 20MHz: OP.8 TDD		
PBCH_RA	dB	0			0			0		

PBCH_RB	dB				
PSS_RA	dB				
SSS_RA	dB				
PCFICH_RB	dB				
PHICH_RA	dB				
PHICH_RB	dB				
PDCCH_RA	dB				
PDCCH_RB	dB				
PDSCH_RA	dB				
PDSCH_RB	dB				
OCNG_RA ^{Note 1}	dB				
OCNG_RB ^{Note 1}	dB				
N _{oc} ^{Note 2}	dBm/15 kHz	-104	-104	-104	-104
\bar{E}_s/N_{oc}	dB	17	-infinity	17	17
\bar{E}_s/I_{ot}	dB	17	-infinity	17	17
RSRP ^{Note 3}	dBm/15 kHz	-87	-infinity	-87	-87
SCH_RP ^{Note 3}	dBm/15 kHz	-87	-infinity	-87	-87
I _o ^{Note 3}	dBm/Ch BW	-59.13 +10log(N _{RB,c} /50)	-76.22 +10log(N _{RB,c} /50)	-59.13 +10log(N _{RB,c} /50)	-59.13 +10log(N _{RB,c} /50)
Propagation Condition		AWGN	AWGN	AWGN	AWGN
Antenna Configuration		1x2	1x2	1x2	1x2
Timing offset to Cell 1	μs	-	0	0	0
Time alignment error relative to cell 1 ^{Note 5}	μs	-	≤ TAE	≤ TAE	≤ TAE
Time alignment error relative to cell 2 ^{Note 5}	μs	-	-	≤ TAE	≤ TAE
Time alignment error relative to cell 3 ^{Note 5}	μs	-	-	-	-
Time alignment error relative to cell 4 ^{Note 5}	μs	-	-	-	-
Time alignment error relative to cell 5 ^{Note 5}	μs	-	-	-	-
<p>Note 1: OCNG shall be used such that all cells are fully allocated and a constant total transmitted power spectral density is achieved for all OFDM symbols.</p> <p>Note 2: Interference from other cells and noise sources not specified in the test is assumed to be constant over subcarriers and time and shall be modelled as AWGN of appropriate power for N_{oc} to be fulfilled.</p> <p>Note 3: Es/I_{ot}, RSRP, SCH_RP and I_o levels have been derived from other parameters for information purposes. They are not settable parameters themselves.</p> <p>Note 4: The uplink resources for CSI reporting are assigned to the UE prior to the start of time period T2.</p> <p>Note 5: Time alignment error (TAE) as specified in TS 36.104 [30] clause 6.5.3.1. The TAE value depends upon the type of carrier aggregation.</p>					

Table A.8.16.98.1-3: Cell specific test parameters for unknown SCell1 activation

Parameter	Unit	Cell 4			Cell 5			Cell 6		
		T1	T2	T3	T1	T2	T3	T1	T2	T3
E-UTRA RF Channel Number		4			5			6		
Duplex mode		FDD or TDD			FDD or TDD			FDD or TDD		
TDD special subframe configuration		6			6			6		
TDD uplink-downlink configuration		1			1			1		
BW _{channel}	MHz	5MHz: N _{RB,c} = 25 10MHz: N _{RB,c} = 50 20MHz: N _{RB,c} = 100			5MHz: N _{RB,c} = 25 10MHz: N _{RB,c} = 50 20MHz: N _{RB,c} = 100			5MHz: N _{RB,c} = 25 10MHz: N _{RB,c} = 50 20MHz: N _{RB,c} = 100		
PDSCH parameters: DL Reference Measurement Channel		-			-			-		

PCFICH/PDCCH/PHICH parameters: DL Reference Measurement Channel		5MHz: R.11 FDD 10MHz: R.6 FDD 20MHz: R.10 FDD 5MHz: R.11 TDD 10MHz: R.6 TDD 20MHz: R.10 TDD	5MHz: R.11 FDD 10MHz: R.6 FDD 20MHz: R.10 FDD 5MHz: R.11 TDD 10MHz: R.6 TDD 20MHz: R.10 TDD	5MHz: R.11 FDD 10MHz: R.6 FDD 20MHz: R.10 FDD 5MHz: R.11 TDD 10MHz: R.6 TDD 20MHz: R.10 TDD
OCNG Patterns		5MHz: OP.16 FDD 10MHz: OP.2 FDD 20MHz: OP.12 FDD 5MHz: OP.10 TDD 10MHz: OP.2 TDD 20MHz: OP.8 TDD	5MHz: OP.16 FDD 10MHz: OP.2 FDD 20MHz: OP.12 FDD 5MHz: OP.10 TDD 10MHz: OP.2 TDD 20MHz: OP.8 TDD	5MHz: OP.16 FDD 10MHz: OP.2 FDD 20MHz: OP.12 FDD 5MHz: OP.10 TDD 10MHz: OP.2 TDD 20MHz: OP.8 TDD
PBCH_RA	dB	0	0	0
PBCH_RB	dB			
PSS_RA	dB			
SSS_RA	dB			
PCFICH_RB	dB			
PHICH_RA	dB			
PHICH_RB	dB			
PDCCH_RA	dB			
PDCCH_RB	dB			
PDSCH_RA	dB			
PDSCH_RB	dB			
OCNG_RA ^{Note 1}	dB			
OCNG_RB ^{Note 1}	dB			
N _{oc} ^{Note 2}	dBm/15 kHz	-104	-104	-104
\bar{E}_s/N_{oc}	dB	17	17	17
\bar{E}_s/I_{ot}	dB	17	17	17
RSRP ^{Note 3}	dBm/15 kHz	-87	-87	-87
SCH_RP ^{Note 3}	dBm/15 kHz	-87	-87	-87
I _o ^{Note 3}	dBm/Ch BW	-59.13 +10log (N _{RB,c} /50)	-59.13 +10log (N _{RB,c} /50)	-59.13 +10log (N _{RB,c} /50)
Propagation Condition		AWGN	AWGN	AWGN
Antenna Configuration		1x2	1x2	1x2
Timing offset to Cell 1	μs	0	0	0
Time alignment error relative to cell 1 ^{Note 5}	μs	≤ TAE	≤ TAE	≤ TAE
Time alignment error relative to cell 2 ^{Note 5}	μs	≤ TAE	≤ TAE	≤ TAE
Time alignment error relative to cell 3 ^{Note 5}	μs	≤ TAE	≤ TAE	≤ TAE
Time alignment error relative to cell 4 ^{Note 5}	μs	-	≤ TAE	≤ TAE
Time alignment error relative to cell 5 ^{Note 5}	μs	-	-	≤ TAE
<p>Note 1: OCNG shall be used such that all cells are fully allocated and a constant total transmitted power spectral density is achieved for all OFDM symbols.</p> <p>Note 2: Interference from other cells and noise sources not specified in the test is assumed to be constant over subcarriers and time and shall be modelled as AWGN of appropriate power for N_{oc} to be fulfilled.</p> <p>Note 3: Es/I_{ot}, RSRP, SCH_RP and I_o levels have been derived from other parameters for information purposes. They are not settable parameters themselves.</p> <p>Note 4: The uplink resources for CSI reporting are assigned to the UE prior to the start of time period T2.</p> <p>Note 5: Time alignment error (TAE) as specified in TS 36.104 [30] clause 6.5.3.1. The TAE value depends upon the type of carrier aggregation.</p>				

A.8.16.98.2 Test Requirements

During T2 the UE shall send the first CSI report for SCell1 in a subframe (m+8), or in a subframe (m+10) for FDD PCell and (m+9) for TDD PCell, if the subframe (m+8) was subject to interruption, or in subframe (m+13) for TDD PCell, if the subframes (m+8) and (m+9) were subject to interruption. Whether CSI report in subframe (m+8) / (m+9) was interrupted or not is checked by monitoring ACK/NACK sent in PCell in subframe (m+8) / (m+9).

During T2 the UE shall start sending CSI reports for SCell1 with non-zero CQI index at latest in a subframe (m+54).

During T3 the UE shall stop sending CSI reports for SCell at latest in a subframe (n+8).

During T2 interruption of PCell during SCells activation shall not happen outside subframes (m+5) to (m+9), (m+15) to (m+19), (m+25) to (m+29), (m+35) to (m+39) and (m+45) to (m+49) for FDD PCell, and not happen outside subframes (m+5) to (m+11) and (m+20) to (m+26) for TDD PCell.

During T3 interruption of PCell during SCells deactivation shall not happen outside subframes (n+5) to (n+9), (n+15) to (n+19), (n+25) to (n+29), (n+35) to (n+39) and (n+45) to (n+49) for FDD PCell, and not happen outside subframes (n+5) to (n+11), (n+20) to (n+26), (n+35) to (n+41), (n+50) to (n+56) and (n+65) to (n+71) for TDD PCell.

The interruption of PCell shall not be more than the values specified for intra-band CA and inter-band CA in Section 7.8.2.

All of the above test requirements shall be fulfilled in order for the observed SCell1 activation delay and SCell1 deactivation delay to be counted as correct. The rate of correct observed SCell1 activation delay and SCell1 deactivation delay during repeated tests shall be at least 90%.

NOTE: During T2 if there are no uplink resources for reporting the valid CSI in a subframe (m+54) then the UE shall use the next available uplink resource for reporting the corresponding valid CSI.

A.8.16.99 7 DL CA Event Triggered Reporting under Deactivated SCells in Non-DRX with generic duplex modes

A.8.16.99.1 Test Purpose and Environment

The purpose of this test is to verify that the UE correctly detects events A1 (Serving cell becomes better than threshold), A2 (Serving cell becomes worse than threshold) and A6 (Neighbour becomes better than SCell) defined in TS 36.331 [2] within the requirements stated in clause 8.3.3.2.1.

The test parameters are given in Tables A.8.16.99.1-1, A.8.16.99.1-2, A.8.16.99.1-3 and A.8.16.99.1-4 below. It is indicated to the UE in the measurement control information that event-triggered reporting with Events A1 (for only SCell1 i.e. cell2), A2 (PCell and SCells) and A6 is used. The test consists of three successive time periods, with duration of T1, T2 and T3, respectively. During T1 the UE shall not have any information on cell 8. At the beginning of T2 the transmission power of cell 8 is increased to the same level as for cell 7, and due to usage of an offset this shall result in reporting of Event A6. Also, at the beginning of T2 the transmission power of cell 2 is increased to the same level as for cell 1, which shall result in reporting of Event A1. At the beginning of T3 the transmission powers of cells 1, 2, 3, 4, 5, 6 and 7 are reduced below a threshold value and this shall result in reporting of Event A2 for Cell 1, for Cell 2, for Cell 3, for Cell 4, for Cell 5, for Cell 6 and Cell 7. Cells 1, 2, 3, 4, 5, 6, 7 and 8 may operate in either FDD or TDD duplex mode according to test configuration.

Table A.8.16.99.1-1: General test parameters for E-UTRAN 7 DL CA event triggered reporting under fading propagation conditions with 6 configured but deactivated SCells in non-DRX with generic duplex modes

Parameter	Unit	Value	Comment
E-UTRA RF Channel Number		1, 2, 3, 4, 5, 6, 7	Seven radio channels are used for this test
Active PCell		Cell 1	Primary cell on RF channel number 1.
Configured deactivated SCell		Cell 2	Configured deactivated secondary cell on RF channel number 2.
Configured deactivated SCell		Cell 3	Configured deactivated secondary cell on RF channel number 3.
Configured deactivated SCell		Cell 4	Configured deactivated secondary cell on RF channel number 4.
Configured deactivated SCell		Cell 5	Configured deactivated secondary cell on RF channel number 5.

Configured deactivated SCell			Cell 6	Configured deactivated secondary cell on RF channel number 6.
Configured deactivated SCell			Cell 7	Configured deactivated secondary cell on RF channel number 7.
Neighbour cell			Cell 8	Neighbour cell to be identified on RF channel number 7.
CP length			Normal	
DRX			OFF	Continuous monitoring of primary cell
TDD special subframe configuration			6	As specified in table 4.2-1 in TS 36.211. The same configuration applies to all TDD cells (cell2, cell3, cell4, cell5, cell6, cell 7 and cell 8).
TDD uplink-downlink configuration			1	As specified in table 4.2-2 in TS 36.211. The same configuration applies to all TDD cells (cell2, cell3, cell4, cell5, cell6, cell 7 and cell 8).
A1	Hysteresis	dB	0	Hysteresis for evaluation of event A1.
	Threshold RSRP	dBm	-98	Actual RSRP threshold for event A1. Needs to take absolute accuracy tolerance in section 9.1.11.1 into account plus margin.
	Time To Trigger	s	0	
A2	Hysteresis	dB	0	Hysteresis for evaluation of event A2.
	Threshold RSRP	dBm	-98	Actual RSRP threshold for event A2. Needs to take absolute accuracy tolerance in section 9.1.11.1 into account plus margin.
	Time To Trigger	s	0	
A6	Hysteresis	dB	0	Hysteresis for evaluation of event A6.
	Offset	dB	-6	Offset parameter for evaluation of event A6. Needs to take relative accuracy tolerance in section 9.1.11.2 into account plus margin.
	Report on leave		False	
	Time To Trigger	s	0	
Cell-individual offset for cells on RF channel number 1		dB	0	Individual offset for cells on primary component carrier.
Cell-individual offset for cells on RF channel number 2		dB	0	Individual offset for cells on secondary component carrier.
Cell-individual offset for cells on RF channel number 3		dB	0	Individual offset for cells on secondary component carrier.
Cell-individual offset for cells on RF channel number 4		dB	0	Individual offset for cells on secondary component carrier.
Cell-individual offset for cells on RF channel number 5		dB	0	Individual offset for cells on secondary component carrier.
Cell-individual offset for cells on RF channel number 6		dB	0	Individual offset for cells on secondary component carrier.
Cell-individual offset for cells on RF channel number 7		dB	0	Individual offset for cells on secondary component carrier.
Filter coefficient			0	L3 filtering is not used
SCell measurement cycle (measCycleSCell)		ms	320	For cell2, cell3, cell4, cell5, cell6 and cell7
T1		s	5	During this time the cell1, cell3, cell4, cell5, cell6 and cell7 shall be known to the UE; but cell2 and cell8 shall be unknown to the UE.
T2		s	≤12	UE should report Event A1 for cell2 and event A6 for cell8 within 6.4s (20xscellMeasCycle)
T3		s	5	UE should report Event A2 within 200 ms for cell1 and within 1.6s for each of cells 2, 3, 4, 5, 6, and 7

Table A.8.16.99.1-2: Cell specific test parameters for E-UTRAN 7 DL CA event triggered reporting under fading propagation conditions with 6 configured but deactivated SCells in non-DRX with generic duplex modes

Parameter	Unit	Cell 1			Cell 2			Cell3		
		T1	T2	T3	T1	T2	T3	T1	T2	T3
E-UTRA RF Channel Number		1			2			3		
BW _{channel}		5MHz: N _{RB,c} = 25 10MHz: N _{RB,c} = 50 20MHz: N _{RB,c} = 100			5MHz: N _{RB,c} = 25 10MHz: N _{RB,c} = 50 20MHz: N _{RB,c} = 100			5MHz: N _{RB,c} = 25 10MHz: N _{RB,c} = 50 20MHz: N _{RB,c} = 100		
PDSCH parameters: DL Reference Measurement Channel		5MHz: R.5 FDD 10MHz: R.0 FDD 20MHz: R.4 FDD 5MHz: R.4 TDD 10MHz: R.0 TDD 20MHz: R.3 TDD			-			-		
PCFICH/PDCCH/PHICH parameters: DL Reference Measurement Channel		5MHz: R.11 FDD 10MHz: R.6 FDD 20MHz: R.10 FDD 5MHz: R.11 TDD 10MHz: R.6 TDD 20MHz: R.10 TDD			5MHz: R.11 FDD 10MHz: R.6 FDD 20MHz: R.10 FDD 5MHz: R.11 TDD 10MHz: R.6 TDD 20MHz: R.10 TDD			5MHz: R.11 FDD 10MHz: R.6 FDD 20MHz: R.10 FDD 5MHz: R.11 TDD 10MHz: R.6 TDD 20MHz: R.10 TDD		
OCNG Patterns		5MHz: OP.15 FDD 10MHz: OP.1 FDD 20MHz: OP.11 FDD 5MHz: OP.9 TDD 10MHz: OP.1 TDD 20MHz: OP.7 TDD			5MHz: OP.16 FDD 10MHz: OP.2 FDD 20MHz: OP.12 FDD 5MHz: OP.10 TDD 10MHz: OP.2 TDD 20MHz: OP.8 TDD			5MHz: OP.16 FDD 10MHz: OP.2 FDD 20MHz: OP.12 FDD 5MHz: OP.10 TDD 10MHz: OP.2 TDD 20MHz: OP.8 TDD		
PBCH_RA	dB	0			0			0		
PBCH_RB	dB									
PSS_RA	dB									
SSS_RA	dB									
PCFICH_RB	dB									
PHICH_RA	dB									
PHICH_RB	dB									
PDCCH_RA	dB									
PDCCH_RB	dB									
PDSCH_RA	dB									
PDSCH_RB	dB									
OCNG_RA ^{Note 1}	dB									
OCNG_RB ^{Note 1}	dB									
N _{oc} ^{Note 2}	dBm/15 KHz									
E _s /N _{oc}	dB	17	17	-3	-infinity	17	-3	17	17	-3
E _s /I _{ot} ^{Note 3}	dB	17	17	-3	-infinity	17	-3	17	17	-3
RSRP ^{Note 3}	dBm/15 kHz	-87	-87	-107	-infinity	-87	-107	-87	-87	-107
SCH_RP ^{Note 3}	dBm/15 kHz	-87	-87	-107	-infinity	-87	-107	-87	-87	-107
I _o ^{Note 3}	dBm/Ch BW	-59.13 +10log (N _{RB,c} /50)	-59.13 +10log (N _{RB,c} /50)	-74.45 +10log (N _{RB,c} /50)	-76.22 +10log (N _{RB,c} /50)	-59.13 +10log (N _{RB,c} /50)	-74.45 +10log (N _{RB,c} /50)	-59.13 +10log (N _{RB,c} /50)	-59.13 +10log (N _{RB,c} /50)	-74.45 +10log (N _{RB,c} /50)
Propagation Condition		AWGN			ETU70			ETU70		
Correlation Matrix and Antenna Configuration		1x2 Low			1x2 Low			1x2 Low		
Timing offset to Cell 1	μs	-			0			0		
Time alignment error relative to cell1 ^{Note 5}	μs	-			≤ TAE			≤ TAE		
Time alignment error relative to cell 2 ^{Note 5}	μs	≤ TAE			-			≤ TAE		

Time alignment error relative to cell 3 ^{Note 5}	μs	≤ TAE	≤ TAE	-
Time alignment error relative to cell 4 ^{Note 5}	μs	≤ TAE	≤ TAE	≤ TAE
Time alignment error relative to cell 5 ^{Note 5}	μs	≤ TAE	≤ TAE	≤ TAE
Time alignment error relative to cell 6 ^{Note 5}	μs	≤ TAE	≤ TAE	≤ TAE
Time alignment error relative to cell 7 ^{Note 5}	μs	≤ TAE	≤ TAE	≤ TAE
<p>Note 1: OCNB shall be used such that all cells are fully allocated and a constant total transmitted power spectral density is achieved for all OFDM symbols.</p> <p>Note 2: Interference from other cells and noise sources not specified in the test is assumed to be constant over subcarriers and time and shall be modelled as AWGN of appropriate power for N_{oc} to be fulfilled.</p> <p>Note 3: E_s/I_{ot}, RSRP, SCH_RP and I_o have been derived from other parameters for information purposes. They are not settable parameters themselves.</p> <p>Note 4: The resources for uplink transmission are assigned to the UE prior to the start of time period T2.</p> <p>Note 5: Time alignment error (TAE) as specified in TS 36.104 [30] clause 6.5.3.1. The TAE value depends upon the type of carrier aggregation.</p>				

Table A.8.16.99.1-3: Cell specific test parameters for E-UTRAN 7 DL CA event triggered reporting under fading propagation conditions with 6 configured but deactivated SCells in non-DRX with generic duplex modes

Parameter	Unit	Cell 4			Cell 5			Cell 6		
		T1	T2	T3	T1	T2	T3	T1	T2	T3
E-UTRA RF Channel Number		4			5			6		
BW _{channel}		5MHz: N _{RB,c} = 25 10MHz: N _{RB,c} = 50 20MHz: N _{RB,c} = 100			5MHz: N _{RB,c} = 25 10MHz: N _{RB,c} = 50 20MHz: N _{RB,c} = 100			5MHz: N _{RB,c} = 25 10MHz: N _{RB,c} = 50 20MHz: N _{RB,c} = 100		
PDSCH parameters: DL Reference Measurement Channel		-			-			-		
PCFICH/PDCCH/PHICH parameters: DL Reference Measurement Channel		5MHz: R.11 FDD 10MHz: R.6 FDD 20MHz: R.10 FDD 5MHz: R.11 TDD 10MHz: R.6 TDD 20MHz: R.10 TDD			5MHz: R.11 FDD 10MHz: R.6 FDD 20MHz: R.10 FDD 5MHz: R.11 TDD 10MHz: R.6 TDD 20MHz: R.10 TDD			5MHz: R.11 FDD 10MHz: R.6 FDD 20MHz: R.10 FDD 5MHz: R.11 TDD 10MHz: R.6 TDD 20MHz: R.10 TDD		
OCNB Patterns		5MHz: OP.16 FDD 10MHz: OP.2 FDD 20MHz: OP.12 FDD 5MHz: OP.10 TDD 10MHz: OP.2 TDD 20MHz: OP.8 TDD			5MHz: OP.16 FDD 10MHz: OP.2 FDD 20MHz: OP.12 FDD 5MHz: OP.10 TDD 10MHz: OP.2 TDD 20MHz: OP.8 TDD			5MHz: OP.16 FDD 10MHz: OP.2 FDD 20MHz: OP.12 FDD 5MHz: OP.10 TDD 10MHz: OP.2 TDD 20MHz: OP.8 TDD		
PBCH_RA	dB	0			0			0		
PBCH_RB	dB									
PSS_RA	dB									
SSS_RA	dB									
PCFICH_RB	dB									
PHICH_RA	dB									
PHICH_RB	dB									
PDCCH_RA	dB									
PDCCH_RB	dB									
PDSCH_RA	dB									
PDSCH_RB	dB									
OCNB_RA ^{Note 1}	dB									
OCNB_RB ^{Note 1}	dB									
N_{oc} ^{Note 2}	dBm/15 KHz	-104			-104			-104		
\bar{E}_s/N_{oc}	dB	17	17	-3	17	17	-3	17	17	-3
\bar{E}_s/I_{ot} ^{Note 3}	dB	17	17	-3	17	17	-3	17	17	-3
RSRP ^{Note 3}	dBm/15 kHz	-87	-87	-107	-87	-87	-107	-87	-87	-107

SCH_RP ^{Note 3}	dBm/15 kHz	-87	-87	-107	-87	-87	-107	-87	-87	-107
Io ^{Note 3}	dBm/Ch BW	-59.13 +10log (N _{RB,c} /50)	-59.13 +10log (N _{RB,c} /50)	-74.45 +10log (N _{RB,c} /50)	-59.13 +10log (N _{RB,c} /50)	-59.13 +10log (N _{RB,c} /50)	-74.45 +10log (N _{RB,c} /50)	-59.13 +10log (N _{RB,c} /50)	-59.13 +10log (N _{RB,c} /50)	-74.45 +10log (N _{RB,c} /50)
Propagation Condition		ETU70			ETU70			ETU70		
Correlation Matrix and Antenna Configuration		1x2 Low			1x2 Low			1x2 Low		
Timing offset to Cell 1	μs	0			0			0		
Time alignment error relative to cell1 ^{Note 5}	μs	-			-			-		
Time alignment error relative to cell2 ^{Note 5}	μs	-			-			-		
Time alignment error relative to cell3 ^{Note 5}	μs	-			-			-		
Time alignment error relative to cell4 ^{Note 5}	μs	-			-			-		
Time alignment error relative to cell5 ^{Note 5}	μs	-			-			-		
Time alignment error relative to cell6 ^{Note 5}	μs	-			-			-		
Time alignment error relative to cell7 ^{Note 5}	μs	-			-			-		
<p>Note 1: OCNG shall be used such that all cells are fully allocated and a constant total transmitted power spectral density is achieved for all OFDM symbols.</p> <p>Note 2: Interference from other cells and noise sources not specified in the test is assumed to be constant over subcarriers and time and shall be modelled as AWGN of appropriate power for N_{oc} to be fulfilled.</p> <p>Note 3: Es/Iot, RSRP, SCH_RP and Io have been derived from other parameters for information purposes. They are not settable parameters themselves.</p> <p>Note 4: The resources for uplink transmission are assigned to the UE prior to the start of time period T2.</p> <p>Note 5: Time alignment error (TAE) as specified in TS 36.104 [30] clause 6.5.3.1. The TAE value depends upon the type of carrier aggregation.</p>										

Table A.8.16.99.1-4: Cell specific test parameters for E-UTRAN 7 DL CA event triggered reporting under fading propagation conditions with 6 configured but deactivated SCells in non-DRX with generic duplex modes

Parameter	Unit	Cell 7			Cell 8		
		T1	T2	T3	T1	T2	T3
E-UTRA RF Channel Number		7					
BW _{channel}		5MHz: N _{RB,c} = 25 10MHz: N _{RB,c} = 50 20MHz: N _{RB,c} = 100			5MHz: N _{RB,c} = 25 10MHz: N _{RB,c} = 50 20MHz: N _{RB,c} = 100		
PDSCH parameters: DL Reference Measurement Channel		-			-		
PCFICH/PDCCH/PHICH parameters: DL Reference Measurement Channel		5MHz: R.11 FDD 10MHz: R.6 FDD 20MHz: R.10 FDD 5MHz: R.11 TDD 10MHz: R.6 TDD 20MHz: R.10 TDD			5MHz: R.11 FDD 10MHz: R.6 FDD 20MHz: R.10 FDD 5MHz: R.11 TDD 10MHz: R.6 TDD 20MHz: R.10 TDD		
OCNG Patterns		5MHz: OP.16 FDD 10MHz: OP.2 FDD 20MHz: OP.12 FDD 5MHz: OP.10 TDD 10MHz: OP.2 TDD 20MHz: OP.8 TDD			5MHz: OP.16 FDD 10MHz: OP.2 FDD 20MHz: OP.12 FDD 5MHz: OP.10 TDD 10MHz: OP.2 TDD 20MHz: OP.8 TDD		
PBCH_RA	dB	0			0		
PBCH_RB	dB						
PSS_RA	dB						
SSS_RA	dB						
PCFICH_RB	dB						

PHICH_RA	dB						
PHICH_RB	dB						
PDCCH_RA	dB						
PDCCH_RB	dB						
PDSCH_RA	dB						
PDSCH_RB	dB						
OCNG_RA ^{Note 1}	dB						
OCNG_RB ^{Note 1}	dB						
N_{oc} ^{Note 2}	dBm/15 KHz	-104			-104		
\bar{E}_s/N_{oc}	dB	17	17	-3	-infinity	17	-3
\bar{E}_s/I_{ot} ^{Note 3}	dB	17	-0.09	-4.76	-infinity	-0.09	-4.76
RSRP ^{Note 3}	dBm/15 kHz	-87	-87	-107	-infinity	-87	-107
SCH_RP ^{Note 3}	dBm/15 kHz	-87	-87	-107	-infinity	-87	-107
I_o ^{Note 3}	dBm/Ch BW	-59.13 +10log ($N_{RB,c}/50$)	-56.17 +10log ($N_{RB,c}/50$)	-73.20 +10log ($N_{RB,c}/50$)	Specified in columns for Cell 7		
Propagation Condition		ETU70			ETU70		
Correlation Matrix and Antenna Configuration		1x2 Low			1x2 Low		
Timing offset to Cell 1	μ s	0			3		
Time alignment error relative to cell1 ^{Note 5}	μ s	-			NA		
Time alignment error relative to cell2 ^{Note 5}	μ s	-			NA		
Time alignment error relative to cell3 ^{Note 5}	μ s	-			NA		
Time alignment error relative to cell4 ^{Note 5}	μ s	-			NA		
Time alignment error relative to cell5 ^{Note 5}	μ s	-			NA		
Time alignment error relative to cell6 ^{Note 5}	μ s	-			NA		
Time alignment error relative to cell7 ^{Note 5}	μ s	-			NA		
Note 1:	OCNG shall be used such that all cells are fully allocated and a constant total transmitted power spectral density is achieved for all OFDM symbols.						
Note 2:	Interference from other cells and noise sources not specified in the test is assumed to be constant over subcarriers and time and shall be modelled as AWGN of appropriate power for N_{oc} to be fulfilled.						
Note 3:	E_s/I_{ot} , RSRP, SCH_RP and I_o have been derived from other parameters for information purposes. They are not settable parameters themselves.						
Note 4:	The resources for uplink transmission are assigned to the UE prior to the start of time period T2.						
Note 5:	Time alignment error (TAE) as specified in TS 36.104 [30] clause 6.5.3.1. The TAE value depends upon the type of carrier aggregation.						

A.8.16.99.2 Test Requirements

The UE shall send one Event A6 triggered measurement report for Cell 8 with a measurement reporting delay of less than 6.4s ($20 \times \text{measCycleSCell}$) from the beginning of time T2.

The UE shall send one Event A1 triggered measurement report for Cell 2 with a measurement reporting delay of less than 6.4s ($20 \times \text{measCycleSCell}$) from beginning of time T2.

The UE shall send one Event A2 triggered measurement report for Cell 1 with a measurement reporting delay of less than 200 ms from beginning of time T3.

The UE shall send one Event A2 triggered measurement report for Cell 2 with a measurement reporting delay of less than 1.6s ($5 \times \text{measCycleSCell}$) from beginning of time T3.

The UE shall send one Event A2 triggered measurement report for Cell 3 with a measurement reporting delay of less than 1.6s ($5 \times \text{measCycleSCell}$) from beginning of time T3.

The UE shall send one Event A2 triggered measurement report for Cell 4 with a measurement reporting delay of less than 1.6s ($5 \times \text{measCycleSCell}$) from beginning of time T3.

The UE shall send one Event A2 triggered measurement report for Cell 5 with a measurement reporting delay of less than 1.6s ($5 \times \text{measCycleSCell}$) from beginning of time T3.

The UE shall send one Event A2 triggered measurement report for Cell 6 with a measurement reporting delay of less than 1.6s ($5 \times \text{measCycleSCell}$) from beginning of time T3.

The UE shall send one Event A2 triggered measurement report for Cell 7 with a measurement reporting delay of less than 1.6s ($5 \times \text{measCycleSCell}$) from beginning of time T3.

The UE shall not send event triggered measurement reports as long as the reporting criteria are not fulfilled.

The rate of correct events observed during repeated tests shall be at least 90% for each of the events.

NOTE: The actual overall delays measured in the tests may be up to $2 \times \text{TTI}_{\text{DCCH}}$ higher than the measurement reporting delays above because of TTI insertion uncertainty of the measurement report in DCCH.

A.8.16.100 7 DL CA Event Triggered Reporting on Deactivated SCell with PCell and SCell Interruptions in Non-DRX with generic duplex modes

A.8.16.100.1 Test Purpose and Environment

The purpose of this test is to verify that the UE correctly detects event A6 (Neighbour becomes better than SCell) defined in TS 36.331 [2] within the requirements stated in clause 8.3.3.2.1 while at the same time fulfilling the requirement on interruption rate.

The test parameters are given in Table A.8.16.100.1-1, A.8.16.100.1-2 and A.8.16.100.1-3 below. In the test there are seven cells: Cell 1, Cell 2, Cell 3, Cell 4, Cell 5, Cell 6, Cell 7 and Cell 8. Cell 1 is PCell on the primary component (RF Channel 1), Cell 2 is SCell on the secondary component (RF Channel 2), Cell 3 is SCell on the secondary component (RF Channel 3), Cell 4 is SCell on the secondary component (RF Channel 4), Cell 5 is SCell on the secondary component (RF Channel 5), Cell 6 is SCell on the secondary component (RF Channel 6), Cell 7 is SCell on the secondary component (RF Channel 7) and Cell 8 is the neighbour cell on the secondary component (RF Channel 7). It is indicated to the UE in the measurement control information that event-triggered reporting with Event A6 is used. The test consists of four successive time periods, with duration of T1, T2, T3 and T4, respectively. During T1 and T2, Cell2, Cell3, Cell4, Cell5, Cell6 and Cell7 are deactivated. During T1 the UE shall not have any information of Cell 8. Immediately at beginning of T2 the transmission power of Cell 8 is increased to same level as for Cell 7, and due to usage of an offset this shall result in reporting of Event A6. Cells 1, 2, 3, 4, 5, 6, 7 and 8 may operate in either FDD or TDD duplex mode according to test configuration.

At the beginning of T3, the transmission power of Cell 8 is turned off, and the test equipment sends a MAC message for activation of Cell 2 to UE but Cell 3, Cell 4, Cell5, Cell6 and Cell7 remains deactivated. Immediately at beginning of T4 the transmission power of Cell 8 is increased to same level as for Cell 7, and due to usage of an offset this shall result in reporting of Event A6. The UE shall be continuously scheduled in the PCell throughout the whole test and continuously scheduled in Cell2 during T4.

Table A.8.16.100.1-1: General test parameters for E-UTRAN 7 DL CA Event Triggered Reporting on Deactivated SCell with PCell and SCell Interruptions in Non-DRX with generic duplex modes

Parameter	Unit	Value	Comment
E-UTRA RF Channel Number		1, 2, 3, 4, 5, 6, 7	Seven radio channels are used for this test
Active PCell		Cell 1	Primary cell on RF channel number 1.
Configured deactivated SCell		Cell 2	Configured deactivated secondary cell on RF channel number 2.
Configured deactivated SCell		Cell 3	Configured deactivated secondary cell on RF channel number 3.
Configured deactivated SCell		Cell 4	Configured deactivated secondary cell on RF channel number 4.
Configured deactivated SCell		Cell 5	Configured deactivated secondary cell on RF channel number 5.
Configured deactivated SCell		Cell 6	Configured deactivated secondary cell on RF channel number 6.
Configured deactivated SCell		Cell 7	Configured deactivated secondary cell on RF channel number 7.

Neighbour cell		Cell 8	Neighbor cell to be identified on RF channel number 7.	
CP length		Normal		
TDD special subframe configuration		6	As specified in table 4.2-1 in TS 36.211. The same configuration applies to all TDD cells (cell2, cell3, cell4, cell5, cell6, cell7 and cell8).	
TDD uplink-downlink configuration		1	As specified in table 4.2-2 in TS 36.211. The same configuration applies to all TDD cells (cell2, cell3, cell4, cell5, cell6, cell7 and cell8).	
DRX		OFF	Continuous monitoring of primary cell	
A6	Hysteresis	dB	0	Hysteresis for evaluation of event A6.
	Offset	dB	-3	Offset parameter for evaluation of event A6. Needs to take relative accuracy tolerance in clause 9.1.11.2 into account plus margin.
	Report on leave		False	
	Time To Trigger	s	0	
Cell-individual offset for cells on RF channel number 1	dB	0	Individual offset for cells on primary component carrier.	
Cell-individual offset for cells on RF channel number 2	dB	0	Individual offset for cells on secondary component carrier.	
Cell-individual offset for cells on RF channel number 3	dB	0	Individual offset for cells on secondary component carrier.	
Cell-individual offset for cells on RF channel number 4	dB	0	Individual offset for cells on secondary component carrier.	
Cell-individual offset for cells on RF channel number 5	dB	0	Individual offset for cells on secondary component carrier.	
Cell-individual offset for cells on RF channel number 6	dB	0	Individual offset for cells on secondary component carrier.	
Cell-individual offset for cells on RF channel number 7	dB	0	Individual offset for cells on secondary component carrier.	
Filter coefficient		0	L3 filtering is not used	
SCell measurement cycle	ms	640		
T1	s	4	During this time the UE shall be aware of cells 1, 2, 3, 4, 5, 6, and 7 but not cell 8.	
T2	s	≤15	UE should report Event A6 within 12.8s (20×scellMeasCycle)	
T3	s	4	During this time the UE shall activate cell 2	
T4	s	≤4	UE should report Event A6 within 3.2s (5×scellMeasCycle)	

Table A.8.16.100.1-2: Cell specific test parameters for E-UTRAN 7 DL CA Event Triggered Reporting on Deactivated SCell with PCell and SCell Interruptions in Non-DRX with generic duplex modes (Cell #1, Cell #2, Cell #3, Cell #4)

Parameter	Unit	Cell 1				Cell 2				Cell 3				Cell 4			
		T1	T2	T3	T4	T1	T2	T3	T4	T1	T2	T3	T4	T1	T2	T3	T4
E-UTRA RF Channel Number		1				2				3				4			
BW _{channel}		5MHz: N _{RB,c} = 25 10MHz: N _{RB,c} = 50 20MHz: N _{RB,c} = 100				5MHz: N _{RB,c} = 25 10MHz: N _{RB,c} = 50 20MHz: N _{RB,c} = 100				5MHz: N _{RB,c} = 25 10MHz: N _{RB,c} = 50 20MHz: N _{RB,c} = 100				5MHz: N _{RB,c} = 25 10MHz: N _{RB,c} = 50 20MHz: N _{RB,c} = 100			
PDSCH parameters: DL Reference Measurement Channel		5MHz: R.7 FDD 10MHz: R.3 FDD 20MHz: R.6 FDD 5MHz: R.4 TDD 10MHz: R.0 TDD 20MHz: R.3 TDD				N/A	N/A	N/A	5MHz: R.7 FDD 10MH z: R.3 FDD 20MH z: R.6 FDD 5MHz: R.4 TDD 10MH z: R.0 TDD 20MH z: R.3 TDD	N/A				N/A			
PCFICH/PDCCH/PHICH parameters		5MHz: R.11 FDD 10MHz: R.6 FDD 20MHz: R.10 FDD 5MHz: R.11 TDD 10MHz: R.6 TDD 20MHz: R.10 TDD				5MHz: R.11 FDD 10MHz: R.6 FDD 20MHz: R.10 FDD 5MHz: R.11 TDD 10MHz: R.6 TDD 20MHz: R.10 TDD				5MHz: R.11 FDD 10MHz: R.6 FDD 20MHz: R.10 FDD 5MHz: R.11 TDD 10MHz: R.6 TDD 20MHz: R.10 TDD				5MHz: R.11 FDD 10MHz: R.6 FDD 20MHz: R.10 FDD 5MHz: R.11 TDD 10MHz: R.6 TDD 20MHz: R.10 TDD			
OCNG Pattern defined in A.3.2.1		5MHz: OP.20 FDD 10MHz: OP.10 FDD 20MHz: OP.17 FDD 5MHz: OP.9 TDD 10MHz: OP.1 TDD 20MHz: OP.7 TDD				5MHz: OP.16 FDD 10MH z: OP.2 FDD 20MH z:	5MHz: OP.16 FDD 10MH z: OP.2 FDD 20MH z:	5MHz: OP.16 FDD 10MH z: OP.2 FDD 20MH z:	5MHz: OP.20 FDD 10MH z: OP.10 FDD 20MH z:	5MHz: OP.16 FDD 10MHz: OP.2 FDD 20MHz: OP.12 FDD 5MHz: OP.10 TDD 10MHz: OP.2 TDD 20MHz: OP.8 TDD				5MHz: OP.16 FDD 10MHz: OP.2 FDD 20MHz: OP.12 FDD 5MHz: OP.10 TDD 10MHz: OP.2 TDD 20MHz: OP.8 TDD			

						OP.12 FDD	OP.12 FDD	OP.12 FDD	OP.17 FDD								
						5MHz: OP.10 TDD 10MH z: OP.2 TDD 20MH z: OP.8 TDD	5MHz: OP.10 TDD 10MH z: OP.2 TDD 20MH z: OP.8 TDD	5MHz: OP.10 TDD 10MH z: OP.2 TDD 20MH z: OP.8 TDD	5MHz: OP.9 TDD 10MH z: OP.1 TDD 20MH z: OP.7 TDD								
PBCH_RA	dB	0				0				0				0			
PBCH_RB	dB																
PSS_RA	dB																
SSS_RA	dB																
PCFICH_RB	dB																
PHICH_RA	dB																
PHICH_RB	dB																
PDCCH_RA	dB																
PDCCH_RB	dB																
PDSCH_RA	dB																
PDSCH_RB	dB																
OCNG_RA ^{Note 1}	dB																
OCNG_RB ^{Note 1}	dB																
N_{oc} ^{Note 3}	dBm/1 5 kHz																
\hat{E}_s/N_{oc}	dB	16	16	16	16	16	16	16	16	16	16	16	16	16	16	16	16
\hat{E}_s/I_{ot} ^{Note 4}	dB	16	16	16	16	16	16	16	16	16	-0.11	16	-0.11	16	-0.11	16	-0.11
RSRP ^{Note 4}	dBm/1 5 kHz	-85	-85	-85	-85	-85	-85	-85	-85	-85	-85	-85	-85	85	-85	85	-85
SCH_RP ^{Note 4}	dBm/1 5 kHz	-85	-85	-85	-85	-85	-85	-85	-85	-85	-85	-85	-85	85	-85	85	-85
I_o ^{Note 4}	dBm/C h BW	- 57.11 +10lg g ($N_{RB,c}$ /50)	- 57.11 +10lg g ($N_{RB,c}$ /50)	- 57.11 +10lg g ($N_{RB,c}$ /50)	- 57.11 +10lg g ($N_{RB,c}$ /50)	-57.11 +10log ($N_{RB,c}$ /50)	-57.11 +10log ($N_{RB,c}$ /50)	-57.11 +10log ($N_{RB,c}$ /50)	-57.11 +10log ($N_{RB,c}$ /50)	- 57.11 +10lg g ($N_{RB,c}$ /50)	- 54.15 +10lg g ($N_{RB,c}$ /50)	- 57.11 +10lg g ($N_{RB,c}$ /50)	- 54.15 +10lg g ($N_{RB,c}$ /50)	- 57.11 +10lg g ($N_{RB,c}$ /50)	- 54.15 +10lg g ($N_{RB,c}$ /50)	- 57.11 +10lg g ($N_{RB,c}$ /50)	- 54.15 +10lg g ($N_{RB,c}$ /50)
Propagation Condition		AWGN				AWGN				AWGN				AWGN			

Antenna Configuration		1x2	1x2	1x2	1x2
Timing offset to Cell 1	μs	-	0	0	0
Time alignment error relative to cell 1 ^{Note 5}	μs	-	$\leq \text{TAE}$	$\leq \text{TAE}$	$\leq \text{TAE}$
Time alignment error relative to cell 2 ^{Note 5}	μs	-	-	$\leq \text{TAE}$	$\leq \text{TAE}$
Time alignment error relative to cell 3 ^{Note 5}	μs	-	-	-	$\leq \text{TAE}$
<p>Note 1: OCNG shall be used such that all cells are fully allocated and a constant total transmitted power spectral density is achieved for all OFDM symbols.</p> <p>Note 2: The resources for uplink transmission are assigned to the UE on cell1 from the start of time period T2 and on cell2 from the start of time period T4.</p> <p>Note 3: Interference from other cells and noise sources not specified in the test is assumed to be constant over subcarriers and time and shall be modelled as AWGN of appropriate power for N_{oc} to be fulfilled.</p> <p>Note 4: Es/lot, RSRP, SCH_RP and Io levels have been derived from other parameters for information purposes. They are not settable parameters themselves.</p> <p>Note 5: Time alignment error (TAE) as specified in TS 36.104 [30] clause 6.5.3.1. The TAE value depends upon the type of carrier aggregation.</p>					

Table A.8.16.100.1-3: Cell specific test parameters for E-UTRAN 5 DL CA Event Triggered Reporting on Deactivated SCell with PCell and SCell Interruptions in Non-DRX with generic duplex modes (Cell #5, Cell #6, Cell #7, Cell #8)

Parameter	Unit	Cell 5				Cell 6				Cell 7				Cell 8			
		T1	T2	T3	T4	T1	T2	T3	T4	T1	T2	T3	T4	T1	T2	T3	T4
E-UTRA RF Channel Number		5				6				7							
$BW_{channel}$		5MHz: $N_{RB,c} = 25$ 10MHz: $N_{RB,c} = 50$ 20MHz: $N_{RB,c} = 100$				5MHz: $N_{RB,c} = 25$ 10MHz: $N_{RB,c} = 50$ 20MHz: $N_{RB,c} = 100$				5MHz: $N_{RB,c} = 25$ 10MHz: $N_{RB,c} = 50$ 20MHz: $N_{RB,c} = 100$				5MHz: $N_{RB,c} = 25$ 10MHz: $N_{RB,c} = 50$ 20MHz: $N_{RB,c} = 100$			
PDSCH parameters: DL Reference Measurement Channel		N/A				N/A				N/A				N/A			
PCFICH/PDCCH/PHICH parameters		5MHz: R.11 FDD 10MHz: R.6 FDD 20MHz: R.10 FDD 5MHz: R.11 TDD 10MHz: R.6 TDD 20MHz: R.10 TDD				5MHz: R.11 FDD 10MHz: R.6 FDD 20MHz: R.10 FDD 5MHz: R.11 TDD 10MHz: R.6 TDD 20MHz: R.10 TDD				5MHz: R.11 FDD 10MHz: R.6 FDD 20MHz: R.10 FDD 5MHz: R.11 TDD 10MHz: R.6 TDD 20MHz: R.10 TDD				5MHz: R.11 FDD 10MHz: R.6 FDD 20MHz: R.10 FDD 5MHz: R.11 TDD 10MHz: R.6 TDD 20MHz: R.10 TDD			
OCNG Pattern defined in A.3.2.1		5MHz: OP.16 FDD 10MHz: OP.2 FDD 20MHz: OP.12 FDD 5MHz: OP.10 TDD 10MHz: OP.2 TDD 20MHz: OP.8 TDD				5MHz: OP.16 FDD 10MHz: OP.2 FDD 20MHz: OP.12 FDD 5MHz: OP.10 TDD 10MHz: OP.2 TDD 20MHz: OP.8 TDD				5MHz: OP.16 FDD 10MHz: OP.2 FDD 20MHz: OP.12 FDD 5MHz: OP.10 TDD 10MHz: OP.2 TDD 20MHz: OP.8 TDD				5MHz: OP.16 FDD 10MHz: OP.2 FDD 20MHz: OP.12 FDD 5MHz: OP.10 TDD 10MHz: OP.2 TDD 20MHz: OP.8 TDD			
PBCH_RA	dB	0				0				0				0			
PBCH_RB	dB																
PSS_RA	dB																
SSS_RA	dB																
PCFICH_RB	dB																
PHICH_RA	dB																
PHICH_RB	dB																
PDCCH_RA	dB																
PDCCH_RB	dB																
PDSCH_RA	dB																
PDSCH_RB	dB																
OCNG_RA ^{Note 1}	dB																
OCNG_RB ^{Note 1}	dB																
N_{oc} ^{Note 3}	dBm/1 5 kHz																

\hat{E}_s/N_{oc}	dB	16	16	16	16	16	16	16	16	16	16	16	16	- infinite	16	- infinity	16
\hat{E}_s/I_{ot} ^{Note 4}	dB	16	-0.11	16	-0.11	16	-0.11	16	-0.11	16	-0.11	16	-0.11	- infinite	-0.11	- infinity	-0.11
RSRP ^{Note 4}	dBm/1 5 kHz	85	-85	85	-85	85	-85	85	-85	85	-85	85	-85	- infinite	-85	- infinity	-85
SCH_RP ^{Note 4}	dBm/1 5 kHz	85	-85	85	-85	85	-85	85	-85	85	-85	85	-85	- infinite	-85	- infinity	-85
I_o ^{Note 4}	dBm/C h BW	- 57.11 +10log g (N _{RB,c} /50)	- 54.15 +10log g (N _{RB,c} /50)	- 57.11 +10log g (N _{RB,c} /50)	- 54.15 +10log g (N _{RB,c} /50)	- 57.11 +10log g (N _{RB,c} /50)	- 54.15 +10log g (N _{RB,c} /50)	- 57.11 +10log g (N _{RB,c} /50)	- 54.15 +10log g (N _{RB,c} /50)	- 57.11 +10log g (N _{RB,c} /50)	-54.15 +10log g (N _{RB,c} /50)	-57.11 +10log g (N _{RB,c} /50)	-54.15 +10log g (N _{RB,c} /50)	- 57.11 +10log g (N _{RB,c} /50)	-54.15 +10log g (N _{RB,c} /50)	-57.11 +10log g (N _{RB,c} /50)	-54.15 +10log g (N _{RB,c} /50)
Propagation Condition		AWGN				AWGN				AWGN				AWGN			
Antenna Configuration		1x2				1x2				1x2				1x2			
Timing offset to Cell 1	μs	0				0				0				3			
Time alignment error relative to cell 1 ^{Note 5}	μs	≤ TAE				≤ TAE				≤ TAE				N/A			
Time alignment error relative to cell 2 ^{Note 5}	μs	≤ TAE				≤ TAE				≤ TAE				N/A			
Time alignment error relative to cell 3 ^{Note 5}	μs	≤ TAE				≤ TAE				≤ TAE				N/A			

Note 1: OCNG shall be used such that all cells are fully allocated and a constant total transmitted power spectral density is achieved for all OFDM symbols.

Note 2: Void

Note 3: Interference from other cells and noise sources not specified in the test is assumed to be constant over subcarriers and time and shall be modelled as AWGN of appropriate power for N_{oc} to be fulfilled.

Note 4: E_s/I_{ot} , RSRP, SCH_RP and I_o levels have been derived from other parameters for information purposes. They are not settable parameters themselves.

Note 5: Time alignment error (TAE) as specified in TS 36.104 [30] clause 6.5.3.1. The TAE value depends upon the type of carrier aggregation.

A.8.16.100.2 Test Requirements

The UE shall send one Event A6 triggered measurement report, with a measurement reporting delay less than $12.8s$ ($20 \times \text{scellMeasCycle}$) from the beginning of time period T2.

The UE shall send one Event A6 triggered measurement report, with a measurement reporting delay less than $3.2s$ ($5 \times \text{scellMeasCycle}$) from the beginning of time period T4.

The UE shall not send event triggered measurement reports, as long as the reporting criteria are not fulfilled.

The UE shall be scheduled on PCell continuously throughout the test. From the start of T1 until the measurement report is received during T2, at least 99.5% of all expected ACK/NACKs shall be transmitted by the UE.

The UE shall be scheduled on Cell2 continuously from the beginning of T4 to the end. From the start of T4 until the measurement report is received during T4, at least 99.5% of all expected ACK/NACKs shall be transmitted by the UE.

For a test to be considered successful requirements on both event detection and percentage of transmitted ACK/NACKs have to be fulfilled simultaneously.

The rate of correct events observed during repeated tests shall be at least 90%.

NOTE: The actual overall delays measured in the test may be up to $2 \times \text{TTI}_{\text{DCCH}}$ higher than the measurement reporting delays above because of TTI insertion uncertainty of the measurement report in DCCH.

A.8.16.101 7 DL CA Activation and Deactivation of Known SCell in Non-DRX with generic duplex modes

A.8.16.101.1 Test Purpose and Environment

The purpose of this test is to verify that the SCell activation and deactivation times are within the requirements stated in section 7.7 for UE configured with six downlink SCells, when the SCell is known by the UE at the time of activation.

The test parameters are given in Tables A.8.16.101.1-1 and cell-specific parameters in A.8.16.101.1-2, A.8.16.101.1-3 and A.8.16.101.1-4 below. The test consists of three successive time periods, with duration of T1, T2 and T3, respectively. There are seven carriers, each with one cell. Cells may operate in either FDD or TDD duplex mode according to test configuration. All cells have constant signal levels throughout the test. Before the test starts the UE is connected to Cell 1 (PCell) on radio channel 1 (PCC), deactivated Cell 3 (SCell2) on radio channel 3 (SCC2), deactivated Cell 4 (SCell3) on radio channel 4 (SCC3), deactivated Cell 5 (SCell4) on radio channel 5 (SCC4), deactivated Cell 6 (SCell5) on radio channel 6 (SCC5) and deactivated Cell 7 (SCell6) on radio channel 6 (SCC6) but is not aware of Cell 2 (SCell1) on radio channel 2 (SCC1). The UE is only monitoring PCC, SCC2, SCC3, SCC4, SCC5 and SCC6. The UE shall be continuously scheduled in the PCell throughout the whole test.

At the beginning of T1 the UE receives an RRC message by which SCell1 becomes configured on SCC1. The UE now starts monitoring also the SCC1. The test equipment sends a MAC message for activation of SCell1.

The point in time at which the MAC message is received at the UE antenna connector, in a subframe # denoted m , where m is an even number for FDD PCell and 4 or 9 for TDD PCell, defines the start of time period T2. The UE receives a MAC message for activation of SCell2 in subframe $(m+10)$ for FDD PCell and $(m+15)$ for TDD PCell, a MAC message for activation of SCell3 in subframe $(m+20)$ for FDD PCell and $(m+15)$ for TDD PCell, a MAC message for activation of SCell4 in subframe $(m+30)$ for FDD PCell and $(m+15)$ for TDD, a MAC message for activation of SCell5 in subframe $(m+40)$ for FDD PCell and $(m+15)$ for TDD PCell, and a MAC message for activation of SCell6 in subframe $(m+50)$ for FDD PCell and $(m+15)$ for TDD PCell during activation of SCell1. The UE shall be able to report valid CSI for the activated SCell1 at latest in a subframe $(m+49)$. The UE shall start reporting CSI for SCell1 in subframe $(m+8)$ and shall report CQI index 0 (out-of-range) until the SCell activation has been completed. Any PCell interruption due to activation of SCells shall not occur outside subframes $(m+5)$ to $(m+9)$, $(m+15)$ to $(m+19)$, $(m+25)$ to $(m+29)$, $(m+35)$ to $(m+39)$, $(m+45)$ to $(m+49)$ and $(m+55)$ to $(m+59)$ for FDD PCell, and not outside subframes $(m+5)$ to $(m+11)$ and $(m+20)$ to $(m+26)$ for TDD PCell.

Time period T3 starts when a MAC message for deactivation of SCell1, sent from the test equipment to the UE in a subframe # denoted n , where n is an even number for FDD PCell and 4 or 9 for TDD PCell, is received at the UE antenna connector. The test equipment sends a MAC message for deactivation of the SCell2 in subframe $(n+10)$ for FDD PCell and $(n+15)$ for TDD PCell, a MAC message for deactivation of the SCell3 in subframe $(n+20)$ for FDD PCell and $(n+30)$ for TDD PCell, and a MAC message for deactivation of the SCell4 in subframe $(n+30)$ for FDD PCell and $(n+45)$ for TDD PCell, a MAC message for deactivation of the SCell5 in subframe $(n+40)$ for FDD PCell and

(n+60) for TDD PCell, and a MAC message for deactivation of the SCell6 in subframe (n+50) for FDD PCell and (n+75) for TDD PCell. The UE shall carry out deactivation of SCell1 at latest in subframe (n+8), and any PCell interruption due to the deactivation of SCells shall not occur outside subframes (n+5) to (n+9), (n+15) to (n+19), (n+25) to (n+29), (n+35) to (n+39), (n+45) to (n+49) and (n+55) to (n+59) for FDD PCell, and not outside subframes (n+5) to (n+11), (n+20) to (n+26), (n+35) to (n+41), (n+50) to (n+56), (n+65) to (n+71), and (n+70) to (n+76) for TDD PCell.

The test equipment verifies that potential interruption is carried out in the correct time span by monitoring ACK/NACK sent in PCell during activation and deactivation of SCell1, respectively.

The test equipment verifies the activation time by counting the subframes from the time when SCell1 activation command is sent until a CSI report with other than CQI index 0 is received.

The test equipment verifies the deactivation time by counting the subframes from the time when SCell1 deactivation command is sent until CQI reporting for SCell1 is discontinued.

Table A.8.16.101.1-1: General test parameters for known SCell1 activation case

Parameter	Unit	Value	Comment
E-UTRA RF Channel Number		1, 2, 3, 4, 5, 6, 7	Seven radio channels are used for this test
Active PCell		Cell 1	Primary cell on RF channel number 1.
Deconfigured deactivated SCell		Cell 2	Deconfigured deactivated secondary cell on RF channel number 2.
Configured deactivated SCell2		Cell 3	Configured deactivated secondary cell on RF channel number 3.
Configured deactivated SCell3		Cell 4	Configured deactivated secondary cell on RF channel number 4.
Configured deactivated SCell4		Cell 5	Configured deactivated secondary cell on RF channel number 5.
Configured deactivated SCell5		Cell 6	Configured deactivated secondary cell on RF channel number 6.
Configured deactivated SCell6		Cell 7	Configured deactivated secondary cell on RF channel number 7.
CP length		Normal	
DRX		OFF	Continuous monitoring of primary cell
CQI/PMI periodicity and offset configuration index		0	CQI reporting for SCell every UL subframe
Cell-individual offset for cells on RF channel number 1	dB	0	Individual offset for cells on PCC.
Cell-individual offset for cells on RF channel number 2	dB	0	Individual offset for cells on SCC1.
Cell-individual offset for cells on RF channel number 3	dB	0	Individual offset for cells on SCC2.
Cell-individual offset for cells on RF channel number 4	dB	0	Individual offset for cells on SCC3.
Cell-individual offset for cells on RF channel number 5	dB	0	Individual offset for cells on SCC4.
Cell-individual offset for cells on RF channel number 6	dB	0	Individual offset for cells on SCC5.
Cell-individual offset for cells on RF channel number 7	dB	0	Individual offset for cells on SCC6.
Filter coefficient		0	L3 filtering is not used.
SCell measurement cycle (measCycleSCell)	ms	320	
T1	s	7	During this time the PCell, SCell2, SCell3, SCell4, SCell5, and SCell6 shall be known and the SCell1 configured and detected.
T2	s	1	During this time the UE shall activate the SCell1, SCell2, SCell3, SCell4, SCell5, and SCell6.
T3	s	1	During this time the UE shall deactivate the SCell1, SCell2, SCell3, SCell4, SCell5, and SCell6.

Table A.8.16.101.1-2: Cell specific test parameters for known SCell1 activation

Parameter	Unit	Cell 1			Cell 2			Cell 3		
		T1	T2	T3	T1	T2	T3	T1	T2	T3
E-UTRA RF Channel Number		1			2			3		
Duplex mode		FDD or TDD			FDD or TDD			FDD or TDD		
TDD special subframe configuration		6			6			6		
TDD uplink-downlink configuration		1			1			1		
BW _{channel}	MHz	5MHz: N _{RB,c} = 25 10MHz: N _{RB,c} = 50 20MHz: N _{RB,c} = 100			5MHz: N _{RB,c} = 25 10MHz: N _{RB,c} = 50 20MHz: N _{RB,c} = 100			5MHz: N _{RB,c} = 25 10MHz: N _{RB,c} = 50 20MHz: N _{RB,c} = 100		
PDSCH parameters: DL Reference Measurement Channel		5MHz: R.7 FDD 10MHz: R.3 FDD 20MHz: R.6 FDD 5MHz: R.4 TDD 10MHz: R.0 TDD 20MHz: R.3 TDD			-			-		
PCFICH/PDCCH/PHICH parameters: DL Reference Measurement Channel		5MHz: R.11 FDD 10MHz: R.6 FDD 20MHz: R.10 FDD 5MHz: R.11 TDD 10MHz: R.6 TDD 20MHz: R.10 TDD			5MHz: R.11 FDD 10MHz: R.6 FDD 20MHz: R.10 FDD 5MHz: R.11 TDD 10MHz: R.6 TDD 20MHz: R.10 TDD			5MHz: R.11 FDD 10MHz: R.6 FDD 20MHz: R.10 FDD 5MHz: R.11 TDD 10MHz: R.6 TDD 20MHz: R.10 TDD		
OCNG Patterns		5MHz: OP.20 FDD 10MHz: OP.10 FDD 20MHz: OP.17 FDD 5MHz: OP.9 TDD 10MHz: OP.1 TDD 20MHz: OP.7 TDD			5MHz: OP.16 FDD 10MHz: OP.2 FDD 20MHz: OP.12 FDD 5MHz: OP.10 TDD 10MHz: OP.2 TDD 20MHz: OP.8 TDD			5MHz: OP.16 FDD 10MHz: OP.2 FDD 20MHz: OP.12 FDD 5MHz: OP.10 TDD 10MHz: OP.2 TDD 20MHz: OP.8 TDD		
PBCH_RA	dB	0			0			0		
PBCH_RB	dB									
PSS_RA	dB									
SSS_RA	dB									
PCFICH_RB	dB									
PHICH_RA	dB									
PHICH_RB	dB									
PDCCH_RA	dB									
PDCCH_RB	dB									
PDSCH_RA	dB									
PDSCH_RB	dB									
OCNG_RA ^{Note 1}	dB									
OCNG_RB ^{Note 1}	dB									
N _{oc} ^{Note 2}	dBm/15 kHz									
\bar{E}_s/N_{oc}	dB	17			17			17		
\bar{E}_s/I_{ot}	dB	17			17			17		
RSRP ^{Note 3}	dBm/15 kHz	-87			-87			-87		
SCH_RP ^{Note 3}	dBm/15 kHz	-87			-87			-87		
I _o ^{Note 3}	dBm/Ch BW	-59.13 +10log (N _{RB,c} /50)			-59.13 +10log (N _{RB,c} /50)			-59.13 +10log (N _{RB,c} /50)		
Propagation Condition		AWGN			AWGN			AWGN		
Antenna Configuration		1x2			1x2			1x2		
Timing offset to Cell 1	μs	-			0			0		
Time alignment error relative to cell 1 ^{Note 5}	μs	-			≤ TAE			≤ TAE		

Time alignment error relative to cell 2 ^{Note 5}	μs	-	-	≤ TAE
Time alignment error relative to cell 3 ^{Note 5}	μs	-	-	-
Time alignment error relative to cell 4 ^{Note 5}	μs	-	-	-
Time alignment error relative to cell 5 ^{Note 5}	μs	-	-	-
Time alignment error relative to cell 6 ^{Note 5}	μs	-	-	-
<p>Note 1: OCNB shall be used such that all cells are fully allocated and a constant total transmitted power spectral density is achieved for all OFDM symbols.</p> <p>Note 2: Interference from other cells and noise sources not specified in the test is assumed to be constant over subcarriers and time and shall be modelled as AWGN of appropriate power for N_{oc} to be fulfilled.</p> <p>Note 3: Es/lot, RSRP, SCH_RP and I_o levels have been derived from other parameters for information purposes. They are not settable parameters themselves.</p> <p>Note 4: The uplink resources for CSI reporting are assigned to the UE prior to the start of time period T2.</p> <p>Note 5: Time alignment error (TAE) as specified in TS 36.104 [30] clause 6.5.3.1. The TAE value depends upon the type of carrier aggregation.</p>				

Table A.8.16.101.1-3: Cell specific test parameters for known SCell1 activation

Parameter	Unit	Cell 4			Cell 5			Cell 6		
		T1	T2	T3	T1	T2	T3	T1	T2	T3
E-UTRA RF Channel Number		4			5			6		
Duplex mode		FDD or TDD			FDD or TDD			FDD or TDD		
TDD special subframe configuration		6			6			6		
TDD uplink-downlink configuration		1			1			1		
BW _{channel}	MHz	5MHz: N _{RB,c} = 25 10MHz: N _{RB,c} = 50 20MHz: N _{RB,c} = 100			5MHz: N _{RB,c} = 25 10MHz: N _{RB,c} = 50 20MHz: N _{RB,c} = 100			5MHz: N _{RB,c} = 25 10MHz: N _{RB,c} = 50 20MHz: N _{RB,c} = 100		
PDSCH parameters: DL Reference Measurement Channel		-			-			-		
PCFICH/PDCCH/PHICH parameters: DL Reference Measurement Channel		5MHz: R.11 FDD 10MHz: R.6 FDD 20MHz: R.10 FDD 5MHz: R.11 TDD 10MHz: R.6 TDD 20MHz: R.10 TDD			5MHz: R.11 FDD 10MHz: R.6 FDD 20MHz: R.10 FDD 5MHz: R.11 TDD 10MHz: R.6 TDD 20MHz: R.10 TDD			5MHz: R.11 FDD 10MHz: R.6 FDD 20MHz: R.10 FDD 5MHz: R.11 TDD 10MHz: R.6 TDD 20MHz: R.10 TDD		
OCNB Patterns		5MHz: OP.16 FDD 10MHz: OP.2 FDD 20MHz: OP.12 FDD 5MHz: OP.10 TDD 10MHz: OP.2 TDD 20MHz: OP.8 TDD			5MHz: OP.16 FDD 10MHz: OP.2 FDD 20MHz: OP.12 FDD 5MHz: OP.10 TDD 10MHz: OP.2 TDD 20MHz: OP.8 TDD			5MHz: OP.16 FDD 10MHz: OP.2 FDD 20MHz: OP.12 FDD 5MHz: OP.10 TDD 10MHz: OP.2 TDD 20MHz: OP.8 TDD		
PBCH_RA	dB	0			0			0		
PBCH_RB	dB									
PSS_RA	dB									
SSS_RA	dB									
PCFICH_RB	dB									
PHICH_RA	dB									
PHICH_RB	dB									
PDCCH_RA	dB									
PDCCH_RB	dB									
PDSCH_RA	dB									
PDSCH_RB	dB									
OCNB_RA ^{Note 1}	dB									

OCNG_RB ^{Note 1}	dB			
N _{oc} ^{Note 2}	dBm/15 kHz	-104	-104	-104
\bar{E}_s/N_{oc}	dB	17	17	17
\bar{E}_s/I_{ot}	dB	17	17	17
RSRP ^{Note 3}	dBm/15 kHz	-87	-87	-87
SCH_RP ^{Note 3}	dBm/15 kHz	-87	-87	-87
I _o ^{Note 3}	dBm/Ch BW	-59.13 +10log (N _{RB,c} /50)	-59.13 +10log (N _{RB,c} /50)	-59.13 +10log (N _{RB,c} /50)
Propagation Condition		AWGN	AWGN	AWGN
Antenna Configuration		1x2	1x2	1x2
Timing offset to Cell 1	μs	0	0	0
Time alignment error relative to cell 1 ^{Note 5}	μs	≤ TAE	≤ TAE	≤ TAE
Time alignment error relative to cell 2 ^{Note 5}	μs	≤ TAE	≤ TAE	≤ TAE
Time alignment error relative to cell 3 ^{Note 5}	μs	≤ TAE	≤ TAE	≤ TAE
Time alignment error relative to cell 4 ^{Note 5}	μs	-	≤ TAE	≤ TAE
Time alignment error relative to cell 5 ^{Note 5}	μs	-	-	≤ TAE
Time alignment error relative to cell 6 ^{Note 5}	μs	-	-	≤ TAE
<p>Note 1: OCNG shall be used such that all cells are fully allocated and a constant total transmitted power spectral density is achieved for all OFDM symbols.</p> <p>Note 2: Interference from other cells and noise sources not specified in the test is assumed to be constant over subcarriers and time and shall be modelled as AWGN of appropriate power for N_{oc} to be fulfilled.</p> <p>Note 3: Es/I_{ot}, RSRP, SCH_RP and I_o levels have been derived from other parameters for information purposes. They are not settable parameters themselves.</p> <p>Note 4: The uplink resources for CSI reporting are assigned to the UE prior to the start of time period T2.</p> <p>Note 5: Time alignment error (TAE) as specified in TS 36.104 [30] clause 6.5.3.1. The TAE value depends upon the type of carrier aggregation.</p>				

Table A.8.16.101.1-4: Cell specific test parameters for known SCell1 activation

Parameter	Unit	Cell 7						
		T1	T2	T3				
E-UTRA RF Channel Number		7						
Duplex mode		FDD or TDD						
TDD special subframe configuration		6						
TDD uplink-downlink configuration		1						
BW _{channel}	MHz	5MHz: N _{RB,c} = 25 10MHz: N _{RB,c} = 50 20MHz: N _{RB,c} = 100						
PDSCH parameters: DL Reference Measurement Channel		-						
PCFICH/PDCCH/PHICH parameters: DL Reference Measurement Channel		5MHz: R.11 FDD 10MHz: R.6 FDD 20MHz: R.10 FDD 5MHz: R.11 TDD 10MHz: R.6 TDD 20MHz: R.10 TDD						

OCNG Patterns		5MHz: OP.16 FDD 10MHz: OP.2 FDD 20MHz: OP.12 FDD 5MHz: OP.10 TDD 10MHz: OP.2 TDD 20MHz: OP.8 TDD		
PBCH_RA	dB	0		
PBCH_RB	dB			
PSS_RA	dB			
SSS_RA	dB			
PCFICH_RB	dB			
PHICH_RA	dB			
PHICH_RB	dB			
PDCCH_RA	dB			
PDCCH_RB	dB			
PDSCH_RA	dB			
PDSCH_RB	dB			
OCNG_RA ^{Note 1}	dB			
OCNG_RB ^{Note 1}	dB			
N _{oc} ^{Note 2}	dBm/15 kHz			
\bar{E}_s/N_{oc}	dB	17		
\bar{E}_s/I_{ot}	dB	17		
RSRP ^{Note 3}	dBm/15 kHz	-87		
SCH_RP ^{Note 3}	dBm/15 kHz	-87		
I _o ^{Note 3}	dBm/Ch BW	-59.13 +10log (N _{RB,c} /50)		
Propagation Condition		AWGN		
Antenna Configuration		1x2		
Timing offset to Cell 1	μs	0		
Time alignment error relative to cell 1 ^{Note 5}	μs	≤ TAE		
Time alignment error relative to cell 2 ^{Note 5}	μs	≤ TAE		
Time alignment error relative to cell 3 ^{Note 5}	μs	≤ TAE		
Time alignment error relative to cell 4 ^{Note 5}	μs	≤ TAE		
Time alignment error relative to cell 5 ^{Note 5}	μs	≤ TAE		
Time alignment error relative to cell 6 ^{Note 5}	μs	≤ TAE		
<p>Note 1: OCNG shall be used such that all cells are fully allocated and a constant total transmitted power spectral density is achieved for all OFDM symbols.</p> <p>Note 2: Interference from other cells and noise sources not specified in the test is assumed to be constant over subcarriers and time and shall be modelled as AWGN of appropriate power for N_{oc} to be fulfilled.</p> <p>Note 3: Es/I_{ot}, RSRP, SCH_RP and I_o levels have been derived from other parameters for information purposes. They are not settable parameters themselves.</p> <p>Note 4: The uplink resources for CSI reporting are assigned to the UE prior to the start of time period T2.</p> <p>Note 5: Time alignment error (TAE) as specified in TS 36.104 [30] clause 6.5.3.1. The TAE value depends upon the type of carrier aggregation.</p>				

A.8.16.101.2 Test Requirements

During T2 the UE shall send the first CSI report for SCell1 in a subframe (m+8), or in a subframe (m+10) for FDD PCell and (m+9) for TDD PCell, if the subframe (m+8) was subject to interruption, or in subframe (m+13) for TDD PCell, if the subframes (m+8) and (m+9) were subject to interruption. Whether CSI report in subframe (m+8) / (m+9) was interrupted or not is checked by monitoring ACK/NACK sent in PCell in subframe (m+8) / (m+9).

During T2 the UE shall start sending CSI reports for SCell1 with non-zero CQI index at latest in a subframe (m+49).

During T3 the UE shall stop sending CSI reports for SCell at latest in a subframe (n+8).

During T2 interruption of PCell during SCells activation shall not happen outside subframes (m+5) to (m+9), (m+15) to (m+19), (m+25) to (m+29), (m+35) to (m+39), (m+45) to (m+49) and (m+55) to (m+59) for FDD PCell, and not happen outside subframes (m+5) to (m+11) and (m+20) to (m+26) for TDD PCell.

During T3 interruption of PCell during SCells deactivation shall not happen outside subframes (n+5) to (n+9), (n+15) to (n+19), (n+25) to (n+29), (n+35) to (n+39), (n+45) to (n+49) and (n+55) to (n+59) for FDD PCell, and not happen outside subframes (n+5) to (n+11), (n+20) to (n+26), (n+35) to (n+41), (n+50) to (n+56), (n+65) to (n+71) and (n+80) to (n+86) for TDD PCell.

The interruption of PCell shall not be more than the values specified for intra-band CA and inter-band CA in Section 7.8.2.

All of the above test requirements shall be fulfilled in order for the observed SCell1 activation delay and SCell1 deactivation delay to be counted as correct. The rate of correct observed SCell1 activation delay and SCell1 deactivation delay during repeated tests shall be at least 90%.

NOTE: During T2 if there are no uplink resources for reporting the valid CSI in a subframe (m+49) then the UE shall use the next available uplink resource for reporting the corresponding valid CSI.

A.8.16.102 7 DL CA Activation and Deactivation of Unknown SCell in Non-DRX with generic duplex modes

A.8.16.102.1 Test Purpose and Environment

The purpose of this test is to verify that the SCell activation and deactivation times are within the requirements stated in section 7.7 for UE configured with six downlink SCells, when the SCell is unknown by the UE at the time of activation.

The test parameters are given in Tables A.8.16.102.1-1 and cell-specific parameters in A.8.16.102.1-2, A.8.16.102.1-3 and A.8.16.102.1-4 below. The test consists of three successive time periods, with duration of T1, T2 and T3, respectively. There are seven carriers, each with one cell. Cells may operate in either FDD or TDD duplex mode according to test configuration. Cell 1, Cell 3, Cell 4, Cell5, Cell6 and Cell7 have constant signal levels throughout the test. Before the test starts the UE is connected to Cell 1 (PCell) on radio channel 1 (PCC), deactivated Cell 3 (SCell2) on radio channel 3 (SCC2), deactivated Cell 4 (SCell3) on radio channel 4 (SCC3), deactivated Cell 5 (SCell4) on radio channel 5 (SCC4), deactivated Cell 6 (SCell5) on radio channel 6 (SCC5) and deactivated Cell 7 (SCell6) on radio channel 7 (SCC6) but is not aware of Cell 2 (SCell1) on radio channel 2 (SCC1). The UE is only monitoring PCC, SCC2, SCC3, SCC4, SCC5 and SCC6. The UE shall be continuously scheduled in the PCell throughout the whole test.

At the beginning of T1 the UE receives an RRC message by which SCell1 becomes configured on SCC1. The UE now starts monitoring also the SCC1. During T1 SCell1 is powered off and the UE is not aware of SCell1.

A MAC message for activation of SCell1 is sent by the test equipment 100ms after the RRC message, in a subframe # denoted m, where m is an even number for FDD PCell and 4 or 9 for TDD PCell. The point in time at which the MAC message for activation of SCell1 is received at the UE antenna connector defines the start of time period T2. Immediately at beginning of T2 transmission power of SCell1 is increased to same level as for PCell. The test equipment sends a MAC message for activation of SCell2 in subframe (m+10) for FDD PCell and (m+15) for TDD PCell, a MAC message for activation of SCell3 in subframe (m+20) for FDD PCell and (m+15) for TDD PCell, a MAC message for activation of SCell4 in a subframe (m+30) for FDD PCell and (m+15) for TDD PCell during activation of SCell1, a MAC message for activation of SCell5 in a subframe (m+40) for FDD PCell and (m+15) for TDD PCell during activation of SCell1 and a MAC message for activation of SCell6 in a subframe (m+50) for FDD PCell and (m+15) for TDD PCell during activation of SCell1. The UE shall be able to report valid CSI for the activated SCell1 at latest in a subframe (m+59). The UE shall start reporting CSI for SCell1 in subframe (m+8) and shall report CQI index 0 (out-of-range) until the SCell activation has been completed. Any PCell interruption due to activation of SCells shall not occur outside subframes (m+5) to (m+9), (m+15) to (m+19), (m+25) to (m+29), (m+35) to (m+39), (m+45) to (m+49) and (m+55) to (m+59) for FDD PCell, and not outside subframes (m+5) to (m+11) and (m+20) to (m+26) for TDD PCell.

Time period T3 starts when a MAC message for deactivation of SCell1, sent from the test equipment to the UE in a subframe # denoted n, where n is an even number for FDD PCell and 4 or 9 for TDD PCell, is received at the UE antenna connector. The test equipment sends a MAC message for deactivation of the SCell2 in subframe (n+10) for

FDD PCell and (n+15) for TDD PCell, a MAC message for deactivation of the SCell3 in subframe (n+20) for FDD PCell and (n+30) for TDD PCell, a MAC message for deactivation of the SCell4 in subframe (n+30) for FDD PCell and (n+45) for TDD PCell, a MAC message for deactivation of the SCell5 in subframe (n+40) for FDD PCell and (n+60) for TDD PCell and a MAC message for deactivation of the SCell6 in subframe (n+50) for FDD PCell and (n+65) for TDD PCell. The UE shall carry out deactivation of SCell1 at latest in subframe (n+8), and any PCell interruption due to the deactivation of SCells shall not occur outside subframes (n+5) to (n+9), (n+15) to (n+19), (n+25) to (n+29), (n+35) to (n+39), (n+45) to (n+49) and (n+55) to (n+59) for FDD PCell, and not outside subframes (n+5) to (n+11), (n+20) to (n+26), (n+35) to (n+41), (n+50) to (n+56), (n+65) to (n+71) and (n+80) to (n+86) TDD PCell.

The test equipment verifies that potential interruption is carried out in the correct time span by monitoring ACK/NACK sent in PCell during activation and deactivation of SCell1, respectively.

The test equipment verifies the activation time by counting the subframes from the time when SCell1 activation command is sent until a CSI report with other than CQI index 0 is received.

The test equipment verifies the deactivation time by counting the subframes from the time when SCell1 deactivation command is sent until CQI reporting for SCell1 is discontinued.

Table A.8.16.102.1-1: General test parameters for unknown SCell1 activation case

Parameter	Unit	Value	Comment
E-UTRA RF Channel Number		1, 2, 3, 4, 5, 6, 7	Seven radio channels are used for this test
Active PCell		Cell 1	Primary cell on RF channel number 1.
Deconfigured deactivated SCell		Cell 2	Deconfigured deactivated secondary cell on RF channel number 2.
Configured deactivated SCell2		Cell 3	Configured deactivated secondary cell on RF channel number 3.
Configured deactivated SCell3		Cell 4	Configured deactivated secondary cell on RF channel number 4.
Configured deactivated SCell4		Cell 5	Configured deactivated secondary cell on RF channel number 5.
Configured deactivated SCell5		Cell 6	Configured deactivated secondary cell on RF channel number 6.
Configured deactivated SCell6		Cell 7	Configured deactivated secondary cell on RF channel number 7.
CP length		Normal	
DRX		OFF	Continuous monitoring of primary cell
CQI/PMI periodicity and offset configuration index		0	CQI reporting for SCell every UL subframe
Cell-individual offset for cells on RF channel number 1	dB	0	Individual offset for cells on PCC.
Cell-individual offset for cells on RF channel number 2	dB	0	Individual offset for cells on SCC1.
Cell-individual offset for cells on RF channel number 3	dB	0	Individual offset for cells on SCC2.
Cell-individual offset for cells on RF channel number 4	dB	0	Individual offset for cells on SCC3.
Cell-individual offset for cells on RF channel number 5	dB	0	Individual offset for cells on SCC4.
Cell-individual offset for cells on RF channel number 6	dB	0	Individual offset for cells on SCC5.
Cell-individual offset for cells on RF channel number 7	dB	0	Individual offset for cells on SCC6.
Filter coefficient		0	L3 filtering is not used.
SCell measurement cycle (measCycleSCell)	ms	320	
T1	ms	100	During this time the PCell, SCell2, SCell3, SCell4, SCell5 and SCell6 shall be known and the SCell1 configured.
T2	s	1	During this time the UE shall activate the SCell1, SCell2, SCell3, SCell4, SCell5 and SCell6.
T3	s	1	During this time the UE shall deactivate the SCell1, SCell2, SCell3, SCell4, SCell5 and SCell6.

Table A.8.16.102.1-2: Cell specific test parameters for unknown SCell1 activation

Parameter	Unit	Cell 1			Cell 2			Cell 3		
		T1	T2	T3	T1	T2	T3	T1	T2	T3
E-UTRA RF Channel Number		1			2			3		
Duplex mode		FDD or TDD			FDD or TDD			FDD or TDD		
TDD special subframe configuration		6			6			6		
TDD uplink-downlink configuration		1			1			1		
BW _{channel}	MHz	5MHz: N _{RB,c} = 25 10MHz: N _{RB,c} = 50 20MHz: N _{RB,c} = 100			5MHz: N _{RB,c} = 25 10MHz: N _{RB,c} = 50 20MHz: N _{RB,c} = 100			5MHz: N _{RB,c} = 25 10MHz: N _{RB,c} = 50 20MHz: N _{RB,c} = 100		
PDSCH parameters: DL Reference Measurement Channel		5MHz: R.7 FDD 10MHz: R.3 FDD 20MHz: R.6 FDD 5MHz: R.4 TDD 10MHz: R.0 TDD 20MHz: R.3 TDD			-			-		
PCFICH/PDCCH/PHICH parameters: DL Reference Measurement Channel		5MHz: R.11 FDD 10MHz: R.6 FDD 20MHz: R.10 FDD 5MHz: R.11 TDD 10MHz: R.6 TDD 20MHz: R.10 TDD			5MHz: R.11 FDD 10MHz: R.6 FDD 20MHz: R.10 FDD 5MHz: R.11 TDD 10MHz: R.6 TDD 20MHz: R.10 TDD			5MHz: R.11 FDD 10MHz: R.6 FDD 20MHz: R.10 FDD 5MHz: R.11 TDD 10MHz: R.6 TDD 20MHz: R.10 TDD		
OCNG Patterns		5MHz: OP.20 FDD 10MHz: OP.10 FDD 20MHz: OP.17 FDD 5MHz: OP.9 TDD 10MHz: OP.1 TDD 20MHz: OP.7 TDD			5MHz: OP.16 FDD 10MHz: OP.2 FDD 20MHz: OP.12 FDD 5MHz: OP.10 TDD 10MHz: OP.2 TDD 20MHz: OP.8 TDD			5MHz: OP.16 FDD 10MHz: OP.2 FDD 20MHz: OP.12 FDD 5MHz: OP.10 TDD 10MHz: OP.2 TDD 20MHz: OP.8 TDD		
PBCH_RA	dB	0			0			0		
PBCH_RB	dB									
PSS_RA	dB									
SSS_RA	dB									
PCFICH_RB	dB									
PHICH_RA	dB									
PHICH_RB	dB									
PDCCH_RA	dB									
PDCCH_RB	dB									
PDSCH_RA	dB									
PDSCH_RB	dB									
OCNG_RA ^{Note 1}	dB									
OCNG_RB ^{Note 1}	dB									
N _{oc} ^{Note 2}	dBm/15 kHz									
\bar{E}_s/N_{oc}	dB	17			-infinity	17	17			
\bar{E}_s/I_{ot}	dB	17			-infinity	17	17			
RSRP ^{Note 3}	dBm/15 kHz	-87			-infinity	-87	-87			
SCH_RP ^{Note 3}	dBm/15 kHz	-87			-infinity	-87	-87			
I _o ^{Note 3}	dBm/Ch BW	-59.13 +10log (N _{RB,c} /50)			-76.22 +10log (N _{RB,c} /50)	-59.13 +10log (N _{RB,c} /50)	-59.13 +10log (N _{RB,c} /50)			
Propagation Condition		AWGN			AWGN			AWGN		

Antenna Configuration		1x2	1x2	1x2
Timing offset to Cell 1	μs	-	0	0
Time alignment error relative to cell 1 ^{Note 5}	μs	-	≤ TAE	≤ TAE
Time alignment error relative to cell 2 ^{Note 5}	μs	-	-	≤ TAE
Time alignment error relative to cell 3 ^{Note 5}	μs	-	-	-
Time alignment error relative to cell 4 ^{Note 5}	μs	-	-	-
Time alignment error relative to cell 5 ^{Note 5}	μs	-	-	-
Time alignment error relative to cell 6 ^{Note 5}	μs	-	-	-
<p>Note 1: OCNG shall be used such that all cells are fully allocated and a constant total transmitted power spectral density is achieved for all OFDM symbols.</p> <p>Note 2: Interference from other cells and noise sources not specified in the test is assumed to be constant over subcarriers and time and shall be modelled as AWGN of appropriate power for N_{oc} to be fulfilled.</p> <p>Note 3: Es/lot, RSRP, SCH_RP and I_o levels have been derived from other parameters for information purposes. They are not settable parameters themselves.</p> <p>Note 4: The uplink resources for CSI reporting are assigned to the UE prior to the start of time period T2.</p> <p>Note 5: Time alignment error (TAE) as specified in TS 36.104 [30] clause 6.5.3.1. The TAE value depends upon the type of carrier aggregation.</p>				

Table A.8.16.102.1-3: Cell specific test parameters for unknown SCell1 activation

Parameter	Unit	Cell 4			Cell 5			Cell 6		
		T1	T2	T3	T1	T2	T3	T1	T2	T3
E-UTRA RF Channel Number		4			5			6		
Duplex mode		FDD or TDD			FDD or TDD			FDD or TDD		
TDD special subframe configuration		6			6			6		
TDD uplink-downlink configuration		1			1			1		
BW _{channel}	MHz	5MHz: N _{RB,c} = 25 10MHz: N _{RB,c} = 50 20MHz: N _{RB,c} = 100			5MHz: N _{RB,c} = 25 10MHz: N _{RB,c} = 50 20MHz: N _{RB,c} = 100			5MHz: N _{RB,c} = 25 10MHz: N _{RB,c} = 50 20MHz: N _{RB,c} = 100		
PDSCH parameters: DL Reference Measurement Channel		-			-			-		
PCFICH/PDCCH/PHICH parameters: DL Reference Measurement Channel		5MHz: R.11 FDD 10MHz: R.6 FDD 20MHz: R.10 FDD 5MHz: R.11 TDD 10MHz: R.6 TDD 20MHz: R.10 TDD			5MHz: R.11 FDD 10MHz: R.6 FDD 20MHz: R.10 FDD 5MHz: R.11 TDD 10MHz: R.6 TDD 20MHz: R.10 TDD			5MHz: R.11 FDD 10MHz: R.6 FDD 20MHz: R.10 FDD 5MHz: R.11 TDD 10MHz: R.6 TDD 20MHz: R.10 TDD		
OCNG Patterns		5MHz: OP.16 FDD 10MHz: OP.2 FDD 20MHz: OP.12 FDD 5MHz: OP.10 TDD 10MHz: OP.2 TDD 20MHz: OP.8 TDD			5MHz: OP.16 FDD 10MHz: OP.2 FDD 20MHz: OP.12 FDD 5MHz: OP.10 TDD 10MHz: OP.2 TDD 20MHz: OP.8 TDD			5MHz: OP.16 FDD 10MHz: OP.2 FDD 20MHz: OP.12 FDD 5MHz: OP.10 TDD 10MHz: OP.2 TDD 20MHz: OP.8 TDD		
PBCH_RA	dB	0			0			0		
PBCH_RB	dB									
PSS_RA	dB									
SSS_RA	dB									
PCFICH_RB	dB									
PHICH_RA	dB									
PHICH_RB	dB									
PDCCH_RA	dB									

PDCCH_RB	dB			
PDSCH_RA	dB			
PDSCH_RB	dB			
OCNG_RA ^{Note 1}	dB			
OCNG_RB ^{Note 1}	dB			
N _{oc} ^{Note 2}	dBm/15 kHz	-104	-104	-104
\bar{E}_s/N_{oc}	dB	17	17	17
\bar{E}_s/I_{ot}	dB	17	17	17
RSRP ^{Note 3}	dBm/15 kHz	-87	-87	-87
SCH_RP ^{Note 3}	dBm/15 kHz	-87	-87	-87
I _o ^{Note 3}	dBm/Ch BW	-59.13 +10log (N _{RB,c} /50)	-59.13 +10log (N _{RB,c} /50)	-59.13 +10log (N _{RB,c} /50)
Propagation Condition		AWGN	AWGN	AWGN
Antenna Configuration		1x2	1x2	1x2
Timing offset to Cell 1	μs	0	0	0
Time alignment error relative to cell 1 ^{Note 5}	μs	≤ TAE	≤ TAE	≤ TAE
Time alignment error relative to cell 2 ^{Note 5}	μs	≤ TAE	≤ TAE	≤ TAE
Time alignment error relative to cell 3 ^{Note 5}	μs	≤ TAE	≤ TAE	≤ TAE
Time alignment error relative to cell 4 ^{Note 5}	μs	-	≤ TAE	≤ TAE
Time alignment error relative to cell 5 ^{Note 5}	μs	-	-	≤ TAE
Time alignment error relative to cell 6 ^{Note 5}	μs	-	-	-
<p>Note 1: OCNG shall be used such that all cells are fully allocated and a constant total transmitted power spectral density is achieved for all OFDM symbols.</p> <p>Note 2: Interference from other cells and noise sources not specified in the test is assumed to be constant over subcarriers and time and shall be modelled as AWGN of appropriate power for N_{oc} to be fulfilled.</p> <p>Note 3: Es/I_{ot}, RSRP, SCH_RP and I_o levels have been derived from other parameters for information purposes. They are not settable parameters themselves.</p> <p>Note 4: The uplink resources for CSI reporting are assigned to the UE prior to the start of time period T2.</p> <p>Note 5: Time alignment error (TAE) as specified in TS 36.104 [30] clause 6.5.3.1. The TAE value depends upon the type of carrier aggregation.</p>				

Table A.8.16.102.1-4: Cell specific test parameters for unknown SCell1 activation

Parameter	Unit	Cell 7						
		T1	T2	T3				
E-UTRA RF Channel Number		7						
Duplex mode		FDD or TDD						
TDD special subframe configuration		6						
TDD uplink-downlink configuration		1						
BW _{channel}	MHz	5MHz: N _{RB,c} = 25 10MHz: N _{RB,c} = 50 20MHz: N _{RB,c} = 100						
PDSCH parameters: DL Reference Measurement Channel		-						

PCFICH/PDCCH/PHICH parameters: DL Reference Measurement Channel		5MHz: R.11 FDD 10MHz: R.6 FDD 20MHz: R.10 FDD 5MHz: R.11 TDD 10MHz: R.6 TDD 20MHz: R.10 TDD		
OCNG Patterns		5MHz: OP.16 FDD 10MHz: OP.2 FDD 20MHz: OP.12 FDD 5MHz: OP.10 TDD 10MHz: OP.2 TDD 20MHz: OP.8 TDD		
PBCH_RA	dB	0		
PBCH_RB	dB			
PSS_RA	dB			
SSS_RA	dB			
PCFICH_RB	dB			
PHICH_RA	dB			
PHICH_RB	dB			
PDCCH_RA	dB			
PDCCH_RB	dB			
PDSCH_RA	dB			
PDSCH_RB	dB			
OCNG_RA ^{Note 1}	dB			
OCNG_RB ^{Note 1}	dB			
N _{oc} ^{Note 2}	dBm/15 kHz	-104		
\bar{E}_s/N_{oc}	dB	17		
\bar{E}_s/I_{ot}	dB	17		
RSRP ^{Note 3}	dBm/15 kHz	-87		
SCH_RP ^{Note 3}	dBm/15 kHz	-87		
I _o ^{Note 3}	dBm/Ch BW	-59.13 +10log (N _{RB,c} /50)		
Propagation Condition		AWGN		
Antenna Configuration		1x2		
Timing offset to Cell 1	μs	0		
Time alignment error relative to cell 1 ^{Note 5}	μs	≤ TAE		
Time alignment error relative to cell 2 ^{Note 5}	μs	≤ TAE		
Time alignment error relative to cell 3 ^{Note 5}	μs	≤ TAE		
Time alignment error relative to cell 4 ^{Note 5}	μs	≤ TAE		
Time alignment error relative to cell 5 ^{Note 5}	μs	≤ TAE		
Time alignment error relative to cell 6 ^{Note 5}	μs	≤ TAE		
<p>Note 1: OCNG shall be used such that all cells are fully allocated and a constant total transmitted power spectral density is achieved for all OFDM symbols.</p> <p>Note 2: Interference from other cells and noise sources not specified in the test is assumed to be constant over subcarriers and time and shall be modelled as AWGN of appropriate power for N_{oc} to be fulfilled.</p> <p>Note 3: Es/I_{ot}, RSRP, SCH_RP and I_o levels have been derived from other parameters for information purposes. They are not settable parameters themselves.</p> <p>Note 4: The uplink resources for CSI reporting are assigned to the UE prior to the start of time period T2.</p> <p>Note 5: Time alignment error (TAE) as specified in TS 36.104 [30] clause 6.5.3.1. The TAE value depends upon the type of carrier aggregation.</p>				

A.8.16.102.2 Test Requirements

During T2 the UE shall send the first CSI report for SCell1 in a subframe (m+8), or in a subframe (m+10) for FDD PCell and (m+9) for TDD PCell, if the subframe (m+8) was subject to interruption, or in subframe (m+13) for TDD PCell, if the subframes (m+8) and (m+9) were subject to interruption. Whether CSI report in subframe (m+8) / (m+9) was interrupted or not is checked by monitoring ACK/NACK sent in PCell in subframe (m+8) / (m+9).

During T2 the UE shall start sending CSI reports for SCell1 with non-zero CQI index at latest in a subframe (m+59).

During T3 the UE shall stop sending CSI reports for SCell at latest in a subframe (n+8).

During T2 interruption of PCell during SCells activation shall not happen outside subframes (m+5) to (m+9), (m+15) to (m+19), (m+25) to (m+29), (m+35) to (m+39), (m+45) to (m+49) and (m+55) to (m+59) for FDD PCell, and not happen outside subframes (m+5) to (m+11) and (m+20) to (m+26) for TDD PCell.

During T3 interruption of PCell during SCells deactivation shall not happen outside subframes (n+5) to (n+9), (n+15) to (n+19), (n+25) to (n+29), (n+35) to (n+39), (n+45) to (n+49) and (n+55) to (n+59) for FDD PCell, and not happen outside subframes (n+5) to (n+11), (n+20) to (n+26), (n+35) to (n+41), (n+50) to (n+56), (n+65) to (n+71) and (n+80) to (n+86) for TDD PCell.

The interruption of PCell shall not be more than the values specified for intra-band CA and inter-band CA in Section 7.8.2.

All of the above test requirements shall be fulfilled in order for the observed SCell1 activation delay and SCell1 deactivation delay to be counted as correct. The rate of correct observed SCell1 activation delay and SCell1 deactivation delay during repeated tests shall be at least 90%.

NOTE: During T2 if there are no uplink resources for reporting the valid CSI in a subframe (m+59) then the UE shall use the next available uplink resource for reporting the corresponding valid CSI.

A.8.16.103 Hibernation and Activation of Known SCell in Non-DRX with generic duplex modes

A.8.16.103.1 Test Purpose and Environment

The purpose of this test is to verify that the SCell hibernation and activation delays are within the requirements stated in section 7.7 for UE configured with a single downlink SCell, when the SCell is known by the UE at the time of hibernation and activation.

The test parameters are given in Tables A.8.16.101. 3-1 and cell-specific parameters in A.8.16.103.1-2 below. The test consists of five successive time periods, with duration of T1, T2, T3, T4, and T5, respectively. There are two carriers, each with one cell. Cell 1 and Cell 2 operate in either FDD or TDD duplex mode according to test configuration. Both cells have constant signal levels throughout the test. Before the test starts the UE is connected to Cell 1 (PCell) on radio channel 1 (PCC) but is not aware of Cell 2 (SCell1) on radio channel 2 (SCC1). The UE is only monitoring the PCC. The UE shall be continuously scheduled in the PCell throughout the whole test.

At the beginning of T1 the UE receives an RRC message by which the SCell1 (Cell 2) becomes configured on radio channel 2 (SCC1). The UE starts measuring the SCC1. The test equipment sends a MAC message for hibernation of the SCell1.

The point in time at which the MAC message is received at the UE antenna connector, in a subframe # denoted m which is an even number, defines the start of time period T2. The UE shall be able to report valid CSI for the hibernated (dormant) SCell at latest in subframe (m+24). The UE shall start reporting CSI in subframe (m+8) and shall report CQI index 0 (out-of-range) if the UE has available uplink resources to report CQI for the SCell but has not completed the SCell hibernation. Any PCell interruption due to hibernation of the SCell shall occur in the subframes (m+5) to (m+9) if FDD PCell and (m+5) to (m+11) if TDD PCell.

Time period T3 starts when a MAC message for the activation of the SCell, sent from the test equipment to the UE in a subframe # denoted n which is an even number, is received at the UE antenna connector. The UE shall accomplish the activation of the dormant SCell no later than subframe (n+8) in FDD SCell and (n+11) in TDD SCell. Any PCell interruption due to the activation shall occur in the subframes (n+5) to (n+7) in FDD PCell, and (n+5) to (n+10) in TDD PCell.

Time period T4 starts when a MAC message for the hibernation of the activated SCell, sent from the test equipment to the UE in a subframe # denoted o which is an even number, is received at the UE antenna connector. The UE shall accomplish the hibernation of the SCell in a subframe (o+8). Any PCell interruption due to the hibernation shall occur in the subframes (o+5) to (o+9) for FDD PCell and (o+5) to (o+11) for TDD PCell.

During T3 and T4, the UE shall be continuously scheduled in the SCell1.

Time period T5 starts when a MAC message for deactivation of the dormant SCell, sent from the test equipment to the UE in a subframe # denoted p which is an even number, is received at the UE antenna connector. The UE shall accomplish the deactivation of the dormant SCell in a subframe (p+8). Any PCell interruption due to the hibernation shall occur in the subframes (p+5) to (p+9) for FDD PCell, and (p+5) to (p+11) for TDD PCell.

The test equipment verifies that potential interruption is carried out in the correct time span by monitoring ACK/NACK sent in PCell during activation, hibernation and deactivation of SCell, respectively.

The test equipment verifies the hibernation time by counting the subframes from the time when the SCell hibernation command is sent and until a CSI report with other than CQI index 0 is received.

The test equipment verifies the activation time by checking the delay until receiving the first ACK/NACK sent from the SCell being activated.

The test equipment verifies the CSI report from the dormant SCell after the hibernation procedure is completed contains CQI index other than 0.

The test equipment verifies the deactivation time by counting the subframes from the time when the SCell deactivation command is sent until CQI reporting for SCell is discontinued.

Table A.8.16.103.1-1: General test parameters for known SCell hibernation and activation case

Parameter	Unit	Value	Comment
E-UTRA RF Channel Number		1, 2	Two radio channels are used for this test
Active PCell		Cell 1	Primary cell on RF channel number 1.
Deconfigured deactivated SCell		Cell 2	Deconfigured deactivated secondary cell on RF channel number 2.
CP length		Normal	
DRX		OFF	Continuous monitoring of primary cell
CQI/PMI periodicity and offset configuration index		0	
Cell-individual offset for cells on RF channel number 1	dB	0	Individual offset for cells on PCC.
Cell-individual offset for cells on RF channel number 2	dB	0	Individual offset for cells on SCC1.
SCell measurement cycle (measCycleSCell)	ms	320	
T1	s	7	During this time the PCell shall be known and the SCell1 is configured and detected.
T2	s	1	During this time the UE shall hibernate the SCell1 and report a valid CQI.
T3	s	1	During this time the UE shall activate the SCell1 and report a valid CQI.
T4	s	1	During this time the UE shall hibernate the SCell1 and report a valid CQI.
T5	s	1	During this time the UE shall deactivate the SCell1.

Table A.8.16.103.1-2: Cell specific test parameters for known SCell hibernation and activation

Parameter	Unit	Cell 1					Cell 2				
		T1	T2	T3	T4	T5	T1	T2	T3	T4	T5
E-UTRA RF Channel Number		1					2				
Duplex mode		FDD or TDD					FDD or TDD				

TDD special subframe configuration		6	6
TDD uplink-downlink configuration		1	1
BW _{channel}	MHz	5MHz: N _{RB,c} = 25 10MHz: N _{RB,c} = 50 20MHz: N _{RB,c} = 100	5MHz: N _{RB,c} = 25 10MHz: N _{RB,c} = 50 20MHz: N _{RB,c} = 100
PDSCH parameters: DL Reference Measurement Channel		5MHz: R.7 FDD 10MHz: R.3 FDD 20MHz: R.6 FDD 5MHz: R.4 TDD 10MHz: R.0 TDD 20MHz: R.3 TDD	5MHz: R.7 FDD (Note 6) 10MHz: R.3 FDD (Note 6) 20MHz: R.6 FDD (Note 6) 5MHz: R.4 TDD (Note 6) 10MHz: R.0 TDD (Note 6) 20MHz: R.3 TDD (Note 6)
PCFICH/PDCCH/PHICH parameters: DL Reference Measurement Channel		5MHz: R.11 FDD 10MHz: R.6 FDD 20MHz: R.10 FDD 5MHz: R.11 TDD 10MHz: R.6 TDD 20MHz: R.10 TDD	5MHz: R.11 FDD 10MHz: R.6 FDD 20MHz: R.10 FDD 5MHz: R.11 TDD 10MHz: R.6 TDD 20MHz: R.10 TDD
OCNG Patterns		5MHz: OP.20 FDD 10MHz: OP.10 FDD 20MHz: OP.17 FDD 5MHz: OP.9 TDD 10MHz: OP.1 TDD 20MHz: OP.7 TDD	5MHz: OP.16 FDD 10MHz: OP.2 FDD 20MHz: OP.12 FDD 5MHz: OP.10 TDD 10MHz: OP.2 TDD 20MHz: OP.8 TDD
PBCH_RA	dB	0	0
PBCH_RB	dB		
PSS_RA	dB		
SSS_RA	dB		
PCFICH_RB	dB		
PHICH_RA	dB		
PHICH_RB	dB		
PDCCH_RA	dB		
PDCCH_RB	dB		
PDSCH_RA	dB		
PDSCH_RB	dB		
OCNG_RA ^{Note 1}	dB		
OCNG_RB ^{Note 1}	dB		
N _{oc} ^{Note 2}	dBm/15 kHz	-104	-104
\bar{E}_s/N_{oc}	dB	17	17
\bar{E}_s/I_{ot}	dB	17	17
RSRP ^{Note 3}	dBm/15 kHz	-87	-87
SCH_RP ^{Note 3}	dBm/15 kHz	-87	-87
I _o ^{Note 3}	dBm/Ch BW	-59.13 +10log (N _{RB,c} /50)	-59.13 +10log (N _{RB,c} /50)
Propagation Condition		AWGN	AWGN
Antenna Configuration		1x2	1x2

Timing offset to Cell 1	μs	-	0
Time alignment error relative to cell 1 ^{Note 5}	μs	-	$\leq \text{TAE}$
<p>Note 1: OCNG shall be used such that all cells are fully allocated, and a constant total transmitted power spectral density is achieved for all OFDM symbols.</p> <p>Note 2: Interference from other cells and noise sources not specified in the test is assumed to be constant over subcarriers and time and shall be modelled as AWGN of appropriate power for N_{oc} to be fulfilled.</p> <p>Note 3: Es/lot, RSRP, SCH_RP and lo levels have been derived from other parameters for information purposes. They are not settable parameters themselves.</p> <p>Note 4: The uplink resources for CSI reporting are assigned to the UE prior to the start of time period T2.</p> <p>Note 5: Time alignment error (TAE) as specified in TS 36.104 [30] clause 6.5.3.1. The TAE value depends upon the type of carrier aggregation.</p> <p>Note 6: PDSCH RMC is only applicable to T3 and T4 period. Scheduling in T4 is only to verify that UE does not keep the SCell in activated state after receiving MAC CE for hibernation.</p>			

A.8.16.103.2 Test Requirements

During T2 the UE shall send the first CSI report for SCell1 in subframe (m+8), or in subframe (m+10) for FDD PCell and (m+9) for TDD PCell, if the subframe (m+8) was subject to interruption, or in subframe (m+13) for TDD PCell, if the subframes (m+9) and (m+8) were subject to interruption. Whether CSI report in subframe (m+8) / (m+9) was interrupted or not is checked by monitoring ACK/NACK sent in PCell in subframe (m+8) / (m+9).

During T2 the UE shall start sending CSI reports for SCell1 with non-zero CQI index at latest in a subframe (m+24) and continue to send CSI reports for SCell 1 with non-zero CQI index until the beginning of T3.

During T2, interruption of PCell during SCell activation between subframe (m+5) to (m+9) for FDD PCell, or (m+5) to (m+11) for TDD PCell, shall not be more than the values specified for intra-band CA and inter-band CA in Section 7.8.2.

During T2, the missing ACK/NACK sent in PCell outside subframes (m+5) to (m+9) for FDD PCell, or (m+5) to (m+11) for TDD PCell, shall be less than 0.5% of the total number of the expected ACK/NACK.

During T3 the UE shall continue to send CSI reports for SCell1 with non-zero CQI index unless the CQI measurement or CQI reporting is interrupted by the SCell activation.

During T3, the UE shall send ACK/NACK for the PDSCH data scheduled after subframe (n+8) for FDD SCell1 and (n+11) for TDD SCell1.

During T3, interruption of PCell during SCell activation shall not happen outside subframes (n+5) to (n+7) for FDD PCell and (n+5) to (n+10) for TDD PCell. Interruption of PCell during SCell activation between subframe (n+5) to (n+7) for FDD PCell, or (n+5) to (n+10) for TDD PCell, shall not be more than the values specified for intra-band CA and inter-band CA in Section 7.8.2.

During T4, the UE shall not send ACK/NACK for the PDSCH data scheduled in SCell1 after subframe (o+8).

During T4, the UE shall send CSI report for SCell 1 with non-zero CQI index after subframe (o+9) for FDD PCell and (o+11) for TDD PCell and continue to send CSI reports for SCell 1 with non-zero CQI index until the beginning of T5.

During T4, interruption of PCell during SCell hibernation between subframe (o+5) to (o+9) for FDD PCell, or (o+5) to (o+11) for TDD PCell, shall not be more than the values specified for intra-band CA and inter-band CA in Section 7.8.2.

During T4, the missing ACK/NACK sent in PCell outside subframes (o+5) to (o+9) for FDD PCell, or (o+5) to (o+11) for TDD PCell, shall be less than 0.5% of the total number of the expected ACK/NACK.

During T5, the UE shall stop sending CSI report for SCell at latest in a subframe (p+8).

During T5, interruption of PCell during SCells deactivation shall not happen outside subframes (p+5) to (n+9) for FDD PCell, and not outside subframes (p+5) to (p+11) for TDD PCell.

All of the above test requirements shall be fulfilled in order for the observed SCell1 hibernation delay, activation delay and deactivation delay to be counted as correct. The rate of correct observed SCell1 hibernation delay, activation delay and SCell1 deactivation delay during repeated tests shall be at least 90%.

NOTE: During T2 if there are no uplink resources for reporting the valid CSI in a subframe ($m+24$) then the UE shall use the next available uplink resource for reporting the corresponding valid CSI.

A.8.16.104 Hibernation and Activation of Unknown SCell in Non-DRX with generic duplex modes

A.8.16.104.1 Test Purpose and Environment

The purpose of this test is to verify that the SCell hibernation and activation delays are within the requirements stated in section 7.7 for UE configured with single downlink SCells, when the SCell is unknown by the UE at the time of hibernation and activation.

The test parameters are given in Tables A.8.16.104.1-1 and cell-specific parameters in A.8.16.104.1-2 below. The test consists of five successive time periods, with duration of T1, T2, T3, T4, and T5, respectively. There are two carriers, each with one cell. Cell 1 and Cell 2 may operate in either FDD or TDD duplex mode according to test configuration. Cell 1 has constant signal levels throughout the test. Before the test starts the UE is connected to Cell 1 (PCell) on radio channel 1 (PCC) but is not aware of Cell 2 (SCell1) on radio channel 2 (SCC1). The UE is only monitoring the PCC. The UE shall be continuously scheduled in the PCell throughout the whole test.

At the beginning of T1 the UE receives an RRC message by which the SCell1 (Cell 2) becomes configured on radio channel 2 (SCC1). During T1 the SCell 1 is powered off and UE is not aware of SCell.

A MAC message for hibernation of SCell is sent by the test equipment 100ms after the RRC message, in a subframe # denoted m which is an even number. The point in time at which the MAC message for hibernation of SCell is received at the UE antenna connector defines the start of time period T2. Immediately at beginning of T2 the transmission power of Cell 2 is increased to same level as for Cell 1. The UE shall be able to report valid CSI for the hibernated (dormant) SCell at latest in subframe ($m+34$) provided that the SCell 1 can be successfully detected on the first attempt. The UE shall start reporting CSI in subframe ($m+8$) and shall report CQI index 0 (out-of-range) until the SCell hibernation has been completed. Any PCell interruption due to activation of SCell shall occur in the subframes ($m+5$) to ($m+9$) if FDD PCell and ($m+5$) to ($m+11$) if TDD PCell.

Time period T3 starts when a MAC message for the activation of SCell, sent from the test equipment to the UE in a subframe # denoted n which is an even number, is received at the UE antenna connector. The UE shall carry out the activation of the SCell in a subframe ($n+8$) in FDD SCell and ($n+11$) in TDD SCell. Any PCell interruption due to the activation shall occur in the subframes ($n+5$) to ($n+7$) in FDD PCell, and ($n+5$) to ($n+10$) in TDD PCell.

Time period T4 starts when a MAC message for the hibernation of the activated SCell, sent from the test equipment to the UE in a subframe # denoted o which is an even number, is received at the UE antenna connector. The UE shall carry out the hibernation of the SCell in a subframe ($o+8$). Any PCell interruption due to the hibernation shall occur in the subframes ($o+5$) to ($o+9$) for FDD PCell and ($o+5$) to ($o+11$) for TDD PCell.

During T3 and T4, the UE shall be continuously scheduled in the SCell1.

Time period T5 starts when a MAC message for deactivation of the dormant SCell, sent from the test equipment to the UE in a subframe # denoted p which is an even number, is received at the UE antenna connector. The UE shall carry out deactivation of the dormant SCell in a subframe ($p+8$). Any PCell interruption due to the hibernation shall occur in the subframes ($p+5$) to ($p+9$) for FDD PCell, and ($p+5$) to ($p+11$) for TDD PCell.

The test equipment verifies that potential interruption is carried out in the correct time span by monitoring ACK/NACK sent in PCell during activation, hibernation and deactivation of SCell, respectively.

The test equipment verifies the hibernation time by counting the subframes from the time when the SCell hibernation command is sent until a CSI report with other than CQI index 0 is received.

The test equipment verifies the activation time by monitoring ACK/NACK sent in SCell after the hibernation delay specified in section 7.7.14.

The test equipment verifies the CSI report from the dormant SCell after the hibernation procedure is completed contains CQI index other than 0.

The test equipment verifies the deactivation time by counting the subframes from the time when the SCell deactivation command is sent until CQI reporting for SCell is discontinued.

Table A.8.16.104.1-1: General test parameters for unknown SCell hibernation and activation case

Parameter	Unit	Value	Comment
E-UTRA RF Channel Number		1, 2	Two radio channels are used for this test
Active PCell		Cell 1	Primary cell on RF channel number 1.
Deconfigured deactivated SCell		Cell 2	Deconfigured deactivated secondary cell on RF channel number 2.
CP length		Normal	
DRX		OFF	Continuous monitoring of primary cell
CQI/PMI periodicity and offset configuration index		0	
Cell-individual offset for cells on RF channel number 1	dB	0	Individual offset for cells on PCC.
Cell-individual offset for cells on RF channel number 2	dB	0	Individual offset for cells on SCC1.
SCell measurement cycle (measCycleSCell)	ms	320	
T1	ms	100	During this time the PCell shall be known and the SCell1 is configured and detected.
T2	s	1	During this time the UE shall hibernate the SCell1 and report a valid CQI.
T3	s	1	During this time the UE shall activate the SCell1.
T4	s	1	During this time the UE shall hibernate the SCell1 and report a valid CQI.
T5	s	1	During this time the UE shall deactivate the SCell1.

Table A.8.16.104.1-2: Cell specific test parameters for unknown SCell hibernation and activation

Parameter	Unit	Cell 1					Cell 2				
		T1	T2	T3	T4	T5	T1	T2	T3	T4	T5
E-UTRA RF Channel Number		1					2				
Duplex mode		FDD or TDD					FDD or TDD				
TDD special subframe configuration		6					6				
TDD uplink-downlink configuration		1					1				
BW _{channel}	MHz	5MHz: N _{RB,c} = 25 10MHz: N _{RB,c} = 50 20MHz: N _{RB,c} = 100					5MHz: N _{RB,c} = 25 10MHz: N _{RB,c} = 50 20MHz: N _{RB,c} = 100				
PDSCH parameters: DL Reference Measurement Channel		5MHz: R.7 FDD 10MHz: R.3 FDD 20MHz: R.6 FDD 5MHz: R.4 TDD 10MHz: R.0 TDD 20MHz: R.3 TDD					5MHz: R.7 FDD (Note 6) 10MHz: R.3 FDD (Note 6) 20MHz: R.6 FDD (Note 6) 5MHz: R.4 TDD (Note 6) 10MHz: R.0 TDD (Note 6) 20MHz: R.3 TDD (Note 6)				

PCFICH/ PDCCH/P HICH paramete rs: DL Referenc e Measure ment Channel		5MHz: R.11 FDD 10MHz: R.6 FDD 20MHz: R.10 FDD 5MHz: R.11 TDD 10MHz: R.6 TDD 20MHz: R.10 TDD	5MHz: R.11 FDD 10MHz: R.6 FDD 20MHz: R.10 FDD 5MHz: R.11 TDD 10MHz: R.6 TDD 20MHz: R.10 TDD	
OCNG Patterns		5MHz: OP.20 FDD 10MHz: OP.10 FDD 20MHz: OP.17 FDD 5MHz: OP.9 TDD 10MHz: OP.1 TDD 20MHz: OP.7 TDD	5MHz: OP.16 FDD 10MHz: OP.2 FDD 20MHz: OP.12 FDD 5MHz: OP.10 TDD 10MHz: OP.2 TDD 20MHz: OP.8 TDD	
PBCH_R A	dB	0	0	
PBCH_R B	dB			
PSS_RA	dB			
SSS_RA	dB			
PCFICH_ RB	dB			
PHICH_R A	dB			
PHICH_R B	dB			
PDCCH_ RA	dB			
PDCCH_ RB	dB			
PDSCH_ RA	dB			
PDSCH_ RB	dB			
OCNG_R A ^{Note 1}	dB			
OCNG_R B ^{Note 1}	dB			
N _{oc} ^{Note 2}	dBm/15 kHz			
\hat{E}_s/N_{oc}	dB	17	- infinity	17
\hat{E}_s/I_{ot}	dB	17	- infinity	17
RSRP ^{Note 3}	dBm/15 kHz	-87	- infinity	-87
SCH_RP ^{Note 3}	dBm/15 kHz	-87	- infinity	-87
I _o ^{Note 3}	dBm/Ch BW	-59.13 +10log (N _{RB,c} /50)	-76.22 +10log (N _{RB,c} /50)	-59.13 +10log (N _{RB,c} /50)
Propagati on Condition		AWGN	AWGN	
Antenna Configura tion		1x2	1x2	
Timing offset to Cell 1	μs	-	0	

Time alignment error relative to cell 1 ^{Note 5}	μs	-	$\leq \text{TAE}$
Note 1:	OCNG shall be used such that all cells are fully allocated, and a constant total transmitted power spectral density is achieved for all OFDM symbols.		
Note 2:	Interference from other cells and noise sources not specified in the test is assumed to be constant over subcarriers and time and shall be modelled as AWGN of appropriate power for N_{oc} to be fulfilled.		
Note 3:	Es/lot, RSRP, SCH_RP and Io levels have been derived from other parameters for information purposes. They are not settable parameters themselves.		
Note 4:	The uplink resources for CSI reporting are assigned to the UE prior to the start of time period T2.		
Note 5:	Time alignment error (TAE) as specified in TS 36.104 [30] clause 6.5.3.1. The TAE value depends upon the type of carrier aggregation.		
Note 6:	PDSCH RMC is only applicable to T3 and T4 period. Scheduling in T4 is only to verify that UE does not keep the SCell in activated state after receiving MAC CE for hibernation.		

A.8.16.104.2 Test Requirements

During T2 the UE shall send the first CSI report for SCell1 in subframe (m+8), or in subframe (m+10) for FDD PCell and (m+9) for TDD PCell, if the subframe (m+8) was subject to interruption, or in subframe (m+13) for TDD PCell, if the subframes (m+9) and (m+8) were subject to interruption. Whether CSI report in subframe (m+8) / (m+9) was interrupted or not is checked by monitoring ACK/NACK sent in PCell in subframe (m+8) / (m+9).

During T2 the UE shall start sending CSI reports for SCell1 with non-zero CQI index at latest in a subframe (m+34) and continue to send CSI reports for SCell 1 with non-zero CQI index until the beginning of T3.

During T2, interruption of PCell during SCell activation between subframe (m+5) to (m+9) for FDD PCell, or (m+5) to (m+11) for TDD PCell, shall not be more than the values specified for intra-band CA and inter-band CA in Section 7.8.2.

During T2, the missing ACK/NACK sent in PCell outside subframes (m+5) to (m+9) for FDD PCell, or (m+5) to (m+11) for TDD PCell, shall be less than 0.5% of the total number of the expected ACK/NACK.

During T3, the UE shall send ACK/NACK for the PDSCH data scheduled after subframe (n+8) for FDD SCell1 and (n+11) for TDD SCell1.

During T3, interruption of PCell during SCell activation shall not happen outside subframes (n+5) to (n+7) for FDD PCell and (n+5) to (n+10) for TDD PCell. Interruption of PCell during SCell activation between subframe (n+5) to (n+7) for FDD PCell, or (n+5) to (n+10) for TDD PCell, shall not be more than the values specified for intra-band CA and inter-band CA in Section 7.8.2.

During T4, the UE shall not send ACK/NACK for the PDSCH data scheduled in SCell1 after subframe (o+8).

During T4, the UE shall send CSI report for SCell 1 with non-zero CQI index after subframe (o+9) for FDD PCell and (o+11) for TDD PCell.

During T4, interruption of PCell during SCell hibernation between subframe (o+5) to (o+9) for FDD PCell, or (o+5) to (o+11) for TDD PCell, shall not be more than the values specified for intra-band CA and inter-band CA in Section 7.8.2.

During T4, the missing ACK/NACK sent in PCell outside subframes (o+5) to (o+9) for FDD PCell, or (o+5) to (o+11) for TDD PCell, shall be less than 0.5% of the total number of the expected ACK/NACK.

During T5, the UE shall stop sending CSI report for SCell at latest in a subframe (p+8).

During T5, interruption of PCell during SCells deactivation shall not happen outside subframes (p+5) to (n+9) for FDD PCell, and not outside subframes (p+5) to (p+11) for TDD PCell.

All of the above test requirements shall be fulfilled in order for the observed SCell1 hibernation delay, activation delay and deactivation delay to be counted as correct. The rate of correct observed SCell1 hibernation delay, activation delay and SCell1 deactivation delay during repeated tests shall be at least 90%.

NOTE: During T2 if there are no uplink resources for reporting the valid CSI in a subframe (m+34) then the UE shall use the next available uplink resource for reporting the corresponding valid CSI.

A.8.16.105 Idle Mode measurements of inter-frequency CA candidate cells for early reporting

A.8.16.105.1 Test Purpose and Environment

The purpose of this test is to verify that the UE properly retains the detected cell status for the idle mode CA measurement when UE transitions from RRC Connected mode to Idle mode when the UE has entered Idle mode, and that the UE performs the required measurements on the serving cell and the configured overlapping inter-frequency carrier for idle mode measurement reporting. This test will partly verify the Idle mode CA measurements in clause 4.9.

The test parameters are given in Tables A.8.16.105.1-1, A.8.16.105.1-2, A.8.16.105.1-3 and A.8.16.105.1-4 below. In the test there are two cells, cell 1 is the PCell in connected mode, and cell 2 is the SCell in connected mode.

The test consists of 4 successive time periods, with time duration of T1, T2, T3 and T4 respectively. Prior to the start of the time duration T1, the UE shall be fully synchronized to cell 1 and cell 2. During T1 cell 2, SCell, shall be configured and activated. The UE shall be configured for periodic CSI reporting in the PCell with a reporting periodicity of [5] ms. Time duration T2 starts [50] ms after SCell is activated. After T2, the UE is configured with idle mode CA measurements on SCell carrier (which is also configured for idle mode mobility). In the test, connected mode

DRX configuration is not enabled. The connection is released after the UE has sent valid CQI report for the activated SCell. T3 starts when the connection is released. During the time periods T3 UE is in Idle mode. The UE is configured to perform inter-frequency measurements in idle mode on the SCell carrier (overlapping carrier). During T3, [500] ms after T3, the signal level of the inter-frequency carrier configured for idle mode measurements (overlapping carrier) is changed. At T4 the UE is paged for connection setup and requested by the network to send idle mode measurements.

Table A.8.16.105.1-1: General test parameters for Connected mode Idle Mode measurements of inter-frequency CA candidate cells for early reporting.

Parameter	Unit	Value	Comment
PDSCH parameters		5MHz: R.5 FDD 10MHz: R.0 FDD 20MHz: R.4 FDD 5MHz: OP.4 TDD 10MHz: OP.0 TDD 20MHz: OP.3 TDD	As specified in clause A.3.1.1.1
PCFICH/PDCCH/PHICH parameters		5MHz: R.11 FDD 10MHz: R.6 FDD 20MHz: R.10 FDD 5MHz: OP.11 TDD 10MHz: OP.6 TDD 20MHz: OP.10 TDD	As specified in clause A.3.1.2.1
E-UTRA RF Channel Number		1, 2	Two FDD carrier frequencies are used.
Channel Bandwidth (BW _{channel})	MHz	5MHz, N _{RB,c} = 25 10MHz, N _{RB,c} = 50 20MHz, N _{RB,c} = 100	5MHz, N _{RB,c} = 25 10MHz, N _{RB,c} = 50 20MHz, N _{RB,c} = 100
PCell		Cell 1	Cell 1 is on RF channel number 1
SCell		Cell 2	Cell 2 is on RF channel number 2
CP length		Normal	
DRX		OFF	OFF
T331	S	300	
T1	S	10	Prior to T1 UE shall be fully synchronized to cell 1 and cell 2. During T1 UE shall be configured with CA with Cell 1 as PCell and Cell 2 as SCell. Cell 2, SCell, shall be configured and activated. The UE shall be configured for periodic CSI reporting in the PCell with a reporting periodicity of [5] ms. T1 starts when the SCell is activated. When UE reports valid CQI for the activated SCell T2 is started.

T2	S	3	During T2 RRC Connection is configured with idle mode CA measurements in cell 2. Connection is released after configuration and valid CQI report has been transmitted for the SCell.
T4	S	10	UE is paged for connection setup. During the connection setup the UE is requested to send an early measurement report.

Table A.8.16.105.1-2: Cell specific test parameters for Connected mode for Idle Mode measurements of inter-frequency CA candidate cells for early reporting.

Parameter	Unit	Cell 1			Cell 2		
		T1	T2	T4	T1	T2	T4
E-UTRA RF Channel Number		1			2		
Duplex Mode		FDD or TDD			FDD or TDD		
TDD special subframe configuration		6			6		
TDD uplink-downlink configuration		1			1		
BW _{channel}	MHz	5MHz, N _{RB,c} = 25 10MHz, N _{RB,c} = 50 20MHz, N _{RB,c} = 100			5MHz, N _{RB,c} = 25 10MHz, N _{RB,c} = 50 20MHz, N _{RB,c} = 100		
Correlation Matrix and Antenna Configuration		1x2 Low			1x2 Low		
OCNG Patterns defined in A.3.2.1.1 (OP.1 FDD) and in A.3.2.1.2 (OP.2 FDD)		5MHz: OP.15 FDD 10MHz: OP.1 FDD 20MHz: OP.11 FDD 5MHz: OP.9 TDD 10MHz: OP.1 TDD 20MHz: OP.7 TDD			5MHz: OP.16 FDD 10MHz: OP.2 FDD 20MHz: OP.12 FDD 5MHz: OP.10 TDD 10MHz: OP.2 TDD 20MHz: OP.8 TDD		
PBCH_RA	dB	0			0		
PBCH_RB	dB						
PSS_RA	dB						
SSS_RA	dB						
PCFICH_RB	dB						
PHICH_RA	dB						
PHICH_RB	dB						
PDCCH_RA	dB						
PDCCH_RB	dB						
PDSCH_RA	dB						
PDSCH_RB	dB						
OCNG_RA ^{Note 1}	dB						
OCNG_RB ^{Note 1}	dB						
N _{oc} ^{Note 3}	dBm/15 kHz						
RSRP ^{Note 4}	dBm/15 kHz	-94			-98		
\hat{E}_s / I_{ot}	dB	4			0		
SCH_RP ^{Note 4}	dBm/15 kHz	-94			-98		
\hat{E}_s / N_{oc}	dB	4			0		
Propagation Condition		AWGN					
<p>Note 1: OCNG shall be used such that both cells are fully allocated, and a constant total transmitted power spectral density is achieved for all OFDM symbols.</p> <p>Note 2: The resources for uplink transmission are assigned to the UE prior to the start of time period T2.</p> <p>Note 3: Interference from other cells and noise sources not specified in the test is assumed to be constant over subcarriers and time and shall be modelled as AWGN of appropriate power for N_{oc} to be fulfilled.</p> <p>Note 4: RSRP and SCH_RP levels have been derived from other parameters for information purposes. They are not settable parameters themselves.</p>							

Table A.8.16.105.1-3: General test parameters for Idle Mode for Idle Mode measurements of inter-frequency CA candidate cells for early reporting

Parameter		Unit	Value	Comment
Tx condition	Active cell		Cell 1	Former PCell
	Neighbour cell		Cell 2	Former SCell
E-UTRA RF Channel Number			1	FDD carrier frequency for Cell 1.
E-UTRA RF Channel Number			2	FDD carrier frequency for Cell 2.
Channel Bandwidth ($BW_{channel}$)		MHz	10	Channel BW for RF channel 1
Channel Bandwidth ($BW_{channel}$)		MHz	10	Channel BW for RF channel 2
PRACH configuration			4	As specified in table 5.7.1-2 in TS 36.211
DRX cycle length		ms	1280	The value shall be used for all cells in the test.
T3		s	[10]	T3 is started when connection is released. During T3, UE is in idle mode. Cell 1 and Cell 2 are both still detectable by the UE during T3 and prior to the start of period T4. The signal level of Cell 2 for idle mode measurements is changed [500]ms after release of the connection.

Table A.8.16.105.1-4: Cell specific test parameters for Idle Mode for Idle Mode measurements of inter-frequency CA candidate cells for early reporting

Parameter	Unit	Cell 1	Cell 2
		T3	T3
E-UTRA RF Channel Number	MHz	1	2
$BW_{channel}$	MHz	5MHz, $N_{RB,c} = 25$ 10MHz, $N_{RB,c} = 50$ 20MHz, $N_{RB,c} = 100$	5MHz, $N_{RB,c} = 25$ 10MHz, $N_{RB,c} = 50$ 20MHz, $N_{RB,c} = 100$
OCNG Patterns defined in A.3.2.1.2 (OP.2 FDD)		5MHz: OP.15 FDD 10MHz: OP.1 FDD 20MHz: OP.11 FDD 5MHz: OP.9 TDD 10MHz: OP.1 TDD 20MHz: OP.7 TDD	5MHz: OP.15 FDD 10MHz: OP.1 FDD 20MHz: OP.11 FDD 5MHz: OP.9 TDD 10MHz: OP.1 TDD 20MHz: OP.7 TDD
PBCH_RA	dB	0	0
PBCH_RB			
PSS_RA			
SSS_RA			
PCFICH_RB			
PHICH_RA			
PHICH_RB			
PDCCH_RA			
PDCCH_RB			
PDSCH_RA			
PDSCH_RB			
OCNG_RA ^{Note 1}			
OCNG_RB ^{Note 1}			
Qrxlevmin	dBm	-140	-140
Pcompensation	dB	0	0
Qhysts	dB	0	0
Qoffset _{s, n}	dB	0	0
Cell_selection_and_reselection_quality_measurement		RSRP	RSRP
N_{oc} ^{Note2}	dBm/15 kHz	-98	
\hat{E}_s / I_{ot}	dB	16	14

\hat{E}_s / N_{oc}	dB	16	14
RSRP <small>Note3</small>	dBm/15 kHz	-82	-84
Treselection	s	0	0
Reselection offset	dB	0	0
Sintrasearch	dB	Not sent	Not sent
SnonIntraSearchP	dB	50	Not sent
SnonIntraSearchQ	dB	Not sent	Not sent
Propagation Condition		AWGN	
Note 1:	OCNG shall be used such that both cells are fully allocated and a constant total transmitted power spectral density is achieved for all OFDM symbols.		
Note 2:	Interference from other cells and noise sources not specified in the test is assumed to be constant over subcarriers and time and shall be modelled as AWGN of appropriate power for N_{oc} to be fulfilled.		
Note 3:	RSRP levels have been derived from other parameters for information purposes. They are not settable parameters themselves.		

A.8.16.105.2 Test Requirements

The UE behaviour during time durations T2, T3 and T4 shall be as follows:

During time durations T2 the UE shall start transmitting valid CSI reports for the activated SCell at least in all subframes configured for SCell CSI reporting on Cell 1 (PCell).

During the time-period T3 the connection is released, and UE enters idle mode. During the time period T3 the UE is in Idle mode and the signal level of cell 2 is changed. The UE shall not perform reselection. The UE shall perform Idle Mode CA measurement according to Section 4.9.

At the start of T4 the UE is paged for connection setup. During the connection setup the UE is requested to transmit early measurement report. The UE shall send early measurement report to the PCell.

After receiving the requested early measurement report, the test equipment verifies the accuracy of measurement reported for serving Cell 1 and Cell 2 meets the requirements in Section 9.1.2B and Section 9.1.3B, respectively and test ends.

The rate of correct events observed during repeated tests shall be at least 90%.

A.8.16.106 Direct Activation of Known SCell in Non-DRX with generic duplex modes

A.8.16.106.1 Test Purpose and Environment

The purpose of this test is to verify that the direct SCell activation delays are within the requirements stated in clause 7.7.18 for UE configured with a single downlink SCell, when the SCell is known by the UE at the time of direct activation.

The test parameters are given in Tables A.8.16.106.1-1 and cell-specific parameters in A.8.16.106.1-2 below. The test consists of three successive time periods, with duration of T1, T2 and T3, respectively. There are two carriers, each with one cell. Cell 1 and Cell 2 operate in either FDD or TDD duplex mode according to test configuration. Both cells have constant signal levels throughout the test. Before the test starts the UE is connected to Cell 1 (PCell) on radio channel 1 (PCC) but is not aware of Cell 2 (SCell1) on radio channel 2 (SCC1). The UE is only monitoring the PCC. The UE shall be continuously scheduled in the PCell throughout the whole test.

At the beginning of T1, the UE is configured to measure radio channel 2 and starts detecting the Cell 2 (SCell1) on radio channel 2 (SCC1). Measurement gap pattern with ID #0 as specified in Table 8.1.2.1-1 is configured to enable inter-frequency monitoring on SCC1. During T1 Cell 2 is detected and measured and measurement report is sent by the UE to the test equipment. Thereafter measurement gaps are deconfigured by the test equipment. Test equipment sends the RRCConnectionReconfiguration message for the activation of the SCell within N_{act_known} to ensure the configured SCell is known.

Time period T2 starts when UE receives the *RRCCONNECTIONRECONFIGURATION* message for the activation of the SCell, sent from the test equipment to the UE received in a subframe # denoted m at the UE antenna connector.

The E-UTRAN shall use *RRCCONNECTIONRECONFIGURATION* message with parameter *sCellState* set to *activated* for the SCell1 (Cell 2), which causes the SCell1 to become configured and activated on radio channel 2 (SCC1). The message is sent from the test equipment to the UE and is received in a subframe # denoted m at the UE antenna connector. The UE shall accomplish the activation of the SCell no later than subframe $(m + N_{direct})$.

Time period T3 starts at $(m + N_{direct})$, at which point UE shall be reporting a valid CQI for both PCell and SCell1.

During T3, the UE shall be continuously scheduled in the SCell1.

The test equipment verifies the activation time by counting the subframes from the time when the direct SCell activation is sent and until a CSI report with other than CQI index 0 is received.

The test equipment verifies the CSI report from the direct activated SCell after the activation procedure is completed contains CQI index other than 0.

Table A.8.16.106.1-1: General test parameters for known SCell direct activation case

Parameter	Unit	Value	Comment
E-UTRA RF Channel Number		1, 2	Two radio channels are used for this test
Active PCell		Cell 1	Primary cell on RF channel number 1.
Deconfigured deactivated SCell		Cell 2	Deconfigured deactivated secondary cell on RF channel number 2.
CP length		Normal	
DRX		OFF	Continuous monitoring of primary cell
Gap Pattern Id		0	As specified in clause 8.1.2.1.
CQI/PMI periodicity and offset configuration index		0	
Cell-individual offset for cells on RF channel number 1	dB	0	Individual offset for cells on PCC.
Cell-individual offset for cells on RF channel number 2	dB	0	Individual offset for cells on SCC1.
SCell measurement cycle (measCycleSCell)	ms	320	
T1	s	1	During this time the PCell shall be known and the SCell1 is detected, and UE shall report a valid CQI for PCell.
T2	s	N_{direct}	During this time the UE shall be configured with directly activated SCell1.
T3	s	1	During this time the UE shall report a valid CQI for both PCell and SCell1.

Table A.8.16.106.1-2: Cell specific test parameters for known SCell direct activation case

Parameter	Unit	Cell 1			Cell 2		
		T1	T2	T3	T1	T2	T3
E-UTRA RF Channel Number		1			2		
Duplex mode		FDD or TDD			FDD or TDD		
TDD special subframe configuration		6			6		
TDD uplink-downlink configuration		1			1		
BW _{channel}	MHZ	5MHZ: $N_{RB,c} = 25$ 10MHZ: $N_{RB,c} = 50$ 20MHZ: $N_{RB,c} = 100$			5MHZ: $N_{RB,c} = 25$ 10MHZ: $N_{RB,c} = 50$ 20MHZ: $N_{RB,c} = 100$		

PDSCH parameters: DL Reference Measurement Channel		5MHz: R.7 FDD 10MHz: R.3 FDD 20MHz: R.6 FDD 5MHz: R.4 TDD 10MHz: R.0 TDD 20MHz: R.3 TDD	5MHz: R.7 FDD 10MHz: R.3 FDD 20MHz: R.6 FDD 5MHz: R.4 TDD 10MHz: R.0 TDD 20MHz: R.3 TDD
PCFICH/PDCC H/PHICH parameters: DL Reference Measurement Channel		5MHz: R.11 FDD 10MHz: R.6 FDD 20MHz: R.10 FDD 5MHz: R.11 TDD 10MHz: R.6 TDD 20MHz: R.10 TDD	5MHz: R.11 FDD 10MHz: R.6 FDD 20MHz: R.10 FDD 5MHz: R.11 TDD 10MHz: R.6 TDD 20MHz: R.10 TDD
OCNG Patterns		5MHz: OP.20 FDD 10MHz: OP.10 FDD 20MHz: OP.17 FDD 5MHz: OP.9 TDD 10MHz: OP.1 TDD 20MHz: OP.7 TDD	5MHz: OP.16 FDD 10MHz: OP.2 FDD 20MHz: OP.12 FDD 5MHz: OP.10 TDD 10MHz: OP.2 TDD 20MHz: OP.8 TDD
PBCH_RA	dB	0	0
PBCH_RB	dB		
PSS_RA	dB		
SSS_RA	dB		
PCFICH_RB	dB		
PHICH_RA	dB		
PHICH_RB	dB		
PDCCH_RA	dB		
PDCCH_RB	dB		
PDSCH_RA	dB		
PDSCH_RB	dB		
OCNG_RA ^{Note 1}	dB		
OCNG_RB ^{Note 1}	dB		
N_{oc} ^{Note 2}	dBm/15 kHz		
\bar{E}_s/N_{oc}	dB	17	17
\bar{E}_s/I_{ot}	dB	17	17
RSRP ^{Note 3}	dBm/15 kHz	-87	-87
SCH_RP ^{Note 3}	dBm/15 kHz	-87	-87
I_o ^{Note 3}	dBm/Ch BW	-59.13 +10log ($N_{RB,c}/50$)	-59.13 +10log ($N_{RB,c}/50$)
Propagation Condition		AWGN	AWGN
Antenna Configuration		1x2	1x2
Timing offset to Cell 1	μ s	-	0
Time alignment error relative to cell 1 ^{Note 5}	μ s	-	\leq TAE
<p>Note 1: OCNG shall be used such that all cells are fully allocated, and a constant total transmitted power spectral density is achieved for all OFDM symbols.</p> <p>Note 2: Interference from other cells and noise sources not specified in the test is assumed to be constant over subcarriers and time and shall be modelled as AWGN of appropriate power for N_{oc} to be fulfilled.</p> <p>Note 3: \bar{E}_s/I_{ot}, RSRP, SCH_RP and I_o levels have been derived from other parameters for information purposes. They are not settable parameters themselves.</p> <p>Note 4: The uplink resources for CSI reporting are assigned to the UE prior to the start of time period T2.</p> <p>Note 5: Time alignment error (TAE) as specified in TS 36.104 [30] clause 6.5.3.1. The TAE value depends upon the type of carrier aggregation.</p>			

A.8.16.106.2 Test Requirements

The UE shall accomplish the activation of the SCell no later than subframe $m+N_{direct}$.

Time period T3 starts at $(m+ N_{direct})$, at which point UE shall be reporting a valid CQI for both PCell and SCell1.

NOTE: The direct SCell activation delay, N_{direct} , can be expressed as: $N_{direct} = T_{RRC_Process} [+T_1] + T_{time_direct}$, where:

$T_{RRC_Process}$ is the RRC procedure delay = 20 ms which is the RRC procedure delay defined for SCell addition in clause 11.2 of TS 36.331 [2],

T_1 is the delay from subframe $m+ T_{RRC_Process}$ until the transmission of RRCConnectionReconfigurationComplete message

T_{time_direct} is the direct SCell activation delay. If the SCell is known, then T_{time_direct} is 20 ms. If the SCell is unknown, then T_{time_direct} is 30 ms provided the SCell can be successfully detected on the first attempt.

This gives a total of $N_{direct} = 20 + T_1 + 20$ ms = $40 + T_1$ ms for FDD and TDD.

During T3 the UE shall send CSI reports for SCell1 with non-zero CQI index and continue to send CSI reports for SCell 1 with non-zero CQI index until the end of T3. All of the above test requirements shall be fulfilled in order for the observed SCell1 direct activation delay to be counted as correct. The rate of correct observed SCell1 direct activation delay during repeated tests shall be at least 90%.

A.8.17 RSTD Measurements for E-UTRAN Carrier Aggregation

A.8.17.1 E-UTRAN FDD RSTD measurement reporting delay test case

A.8.17.1.1 Test Purpose and Environment

The purpose of the test case is to verify that the RSTD measurements meet the requirements specified in Clause 8.4 in a synchronized network environment with fading propagation conditions. This test case will verify the measurement period requirements specified in Clause 8.4.3 for RSTD measurements performed on the secondary component carrier and also the measurement period requirements for RSTD measurements performed on both the primary and secondary component carriers specified in Clause 8.4.4.

In the tests, there are two configured component carriers: PCC and SCC, and three synchronous cells: Cell 1, Cell 2 and Cell 3. Cell 1 is PCell on the PCC, Cell 2 is an active SCell on the SCC, and Cell 3 is a neighbour cell on the SCC. In all tests, Cell 2 is the OTDOA assistance data reference cell.

The test case includes two tests. Test 1 is designed for the scenario where the UE receives OTDOA assistance data with cells on SCC, and the UE is expected to report RSTD measurements performed on SCC only. Test 2 is designed for the scenario where the UE receives OTDOA assistance data with cells on PCC and SCC, and the UE is expected to report RSTD measurements performed on PCC and on SCC.

Each test consists of three consecutive time intervals, with duration of T1, T2 and T3. Cell 1 is active in T1, T2 and T3, whilst Cell 2 is active only in T2 and T3, and Cell 3 is active only during T2. The beginning of the time interval T2 shall be aligned with the first PRS positioning subframe of a positioning occasion in the OTDOA assistance data reference cell, where the PRS positioning occasion is as defined in Clause 8.1.2.5.1. Cell 1 transmits PRS in T2, while Cell 2 transmits PRS only in T3, and Cell 3 transmits PRS only in T2.

Note: The information on when PRS is muted is conveyed to the UE using PRS muting information.

The OTDOA assistance data as defined in TS 36.355, Clause 6.5.1.1, shall be provided to the UE during T1. The last TTI containing the OTDOA assistance data shall be provided to the UE ΔT ms before the start of T2, where $\Delta T = 150$ ms is the maximum processing time of the OTDOA assistance data.

The test parameters are as given in Table A.8.17.1.1-1, Table A.8.17.1.1-2, Table A.8.17.1.1-3 and Table A.8.17.1.1-4.

Table A.8.17.1.1-1: General test parameters for E-UTRAN FDD RSTD measurement reporting delay under fading propagation conditions for carrier aggregation

Parameter	Unit	Value		Comment
		Test 1	Test 2	
PCell		Cell 1		PCell is on RF channel 1 (PCC).
SCell		Cell 2		SCell on RF channel 2 (SCC). Cell 2 is the assistance data reference cell.
Other neighbor cell		Cell 3		Neighbor cell on RF channel 2 (SCC).
PCFICH/PDCCH/PHICH parameters		DL Reference Measurement Channel R.6 FDD		As specified in clause A.3.1.2.1
Channel Bandwidth ($BW_{channel}$)	MHz	10		
PRS Transmission Bandwidth	RB	50		PRS are transmitted over the system bandwidth
PRS configuration index I_{PRS}		171 for all cells on PCC 181 for all cells on SCC		This corresponds to periodicity of 320 ms and PRS subframe offset of $I_{PRS} - 160$ DL subframes, as defined in TS 36.211 [16], Table 6.10.4.3-1
Number of consecutive downlink positioning subframes N_{PRS}		1		As defined in TS 36.211 [16]. The number of subframes in a positioning occasion
Physical cell ID PCI		$(\text{PCI of Cell 2} - \text{PCI of Cell 3}) \bmod 6 = 0$		The PCI of Cell 1 is selected randomly. PCIs of Cell 2 and Cell 3 are selected randomly such that the relative subcarrier shifts of PRS patterns among these cells are as given by the condition
CP length		Normal		
DRX		ON		DRX parameters are further specified in Table A.8.17.1.1-3
Radio frame receive time offset between the cells at the UE antenna connector	μs	Cell 1 to Cell 2: 1 Cell 3 to Cell 2: -1		PRS are transmitted from synchronous cells
Time alignment error between cell2 and cell1	μs	\leq Time alignment error as specified in 3GPP TS 36.104 [30] clause 6.5.3.1.		The value of time alignment error depends upon the type of carrier aggregation.
Expected RSTD	μs	Cell 3: 2 Other neighbour cells: randomly between -3 and 3	Cell 1: -2 Cell 3: 2 Other neighbour cells: randomly between -3 and 3	The expected RSTD is what is expected at the receiver. The corresponding parameter in the OTDOA assistance data specified in TS 36.355 [24] is the expectedRSTD indicator
Expected RSTD uncertainty for all neighbour cells	μs	5		The corresponding parameter in the OTDOA assistance data specified in TS 36.355 [24] is the expectedRSTD-Uncertainty index
		16 cells in total		

Cells in OTDOA assistance data		OTDOA neighbor cells include Cell 3 and other 14 cells on SCC	OTDOA neighbor cells include Cell 1 and other 7 cells on PCC, and Cell 3 and other 6 cells on SCC	The list includes the reference cell (received in <i>OTDOA-ReferenceCellInfo</i> [24]) and 15 other cells, all received in <i>OTDOA-ProvideAssistanceData</i> [24]. Cell 1 (when included) appears at random places in the first half of the neighbour cell list in the OTDOA assistance data. Cell 3 always appears at random places in the second half of the list.
prs-SubframeOffset		Cells on PCC: 310 Cells on SCC, except reference cell: 0		Subframe offset, counted in full subframes. The corresponding parameter in the OTDOA assistance data is prs-SubframeOffset specified in TS 36.355 [24]
slotNumberOffset		Cells on PCC: 0 Cells on SCC, except reference cell: 0		The slot number offset at the transmitter between a neighbour cell and the assistance data reference cell. The corresponding parameter in the OTDOA assistance data is slotNumberOffset specified in TS 36.355 [24].
PRS muting info		Cell 1: '11110000' Cell 2: '00001111' Cell 3: '11110000'	Cell 1: '1111111100000000' Cell 2: '0000000011111111' Cell 3: '1111111100000000'	Corresponds to prs-MutingInfo defined in TS 36.355 [24]
T1	s	3		The length of the time interval from the beginning of each test
T2	s	1.28	2.48	The length of the time interval that follows immediately after time interval T1
T3	s	1.28	2.48	The length of the time interval that follows immediately after time interval T2

Table A.8.17.1.1-2: Cell-specific test parameters for E-UTRAN FDD RSTD measurement reporting delay under fading propagation conditions during T1 for carrier aggregation

Parameter	Unit	Cell 1	Cell 2	Cell 3
E-UTRA RF Channel Number		1	N/A	N/A
Correlation Matrix and Antenna Configuration		1x2 Low	1x2 Low	1x2 Low
OCNG patterns defined in A.3.2.1		OP.5 FDD	N/A	N/A
PBCH_RA	dB	0	N/A	N/A
PBCH_RB				
PSS_RA				
SSS_RA				
PCFICH_RB				
PHICH_RA				
PHICH_RB				
PDCCH_RA				
PDCCH_RB				
OCNG_RA ^{Note 1}				
OCNG_RB ^{Note 1}				

N_{oc} ^{Note 3}	dBm/ 15 kHz	-95	N/A	N/A
PRS \hat{E}_s/N_{oc}	dB	-Infinity	-Infinity	-Infinity
I_o ^{Note 4}	dBm/ 9 MHz	-67.22	N/A	N/A
\hat{E}_s/N_{oc}	dB	0	-Infinity	-Infinity
Propagation Condition		ETU30		
<p>Note 1: OCNB shall be used such that active cell (Cell 1) is fully allocated and a constant total transmitted power spectral density is achieved for all OFDM symbols.</p> <p>Note 2: The resources for uplink transmission are assigned to the UE prior to the start of time period T2.</p> <p>Note 3: Interference from other cells and noise sources not specified in the test are assumed to be constant over subcarriers and time and shall be modelled as AWGN of appropriate power for N_{oc} to be fulfilled.</p> <p>Note 4: I_o levels have been derived from other parameters and are given for information purpose. These are not settable test parameters.</p>				

Table A.8.17.1.1-3: Cell-specific test parameters for E-UTRAN FDD RSTD measurement reporting delay under fading propagation conditions during T2 and T3 for carrier aggregation

Parameter	Unit	Cell 1		Cell 2		Cell 3		
		T2	T3	T2	T3	T2	T3	
E-UTRA RF Channel Number		1		2		2		
Correlation Matrix and Antenna Configuration		1x2 Low		1x2 Low		1x2 Low		
OCNB patterns defined in A.3.2.1		OP.5 FDD		OP.6 FDD		OP.6 FDD	N/A	
PBCH_RA	dB	0		0		0		N/A
PBCH_RB								
PSS_RA								
SSS_RA								
PCFICH_RB								
PHICH_RA								
PHICH_RB								
PDCCH_RA								
PDCCH_RB								
OCNB_RA ^{Note 1}								
OCNB_RB ^{Note 1}								
PRS_RA	dB	-6	N/A	N/A	3	3	N/A	
N_{oc} ^{Note 3}	dBm/ 15 kHz	-98	-98	-98	-95	-98	-95	
PRS \hat{E}_s/N_{oc}	dB	-4	-Infinity	-Infinity	-1	-8	-Infinity	
PRS \hat{E}_s/I_{ot} ^{Note 4}	dB	-4	-Infinity	-Infinity	-1	-8	-Infinity	
I_o ^{Note 4}	dBm/ 9 MHz	-69.94	N/A	N/A	-66.68	-70.11	N/A	
PRP ^{Note 4}	dBm/ 15 kHz	-102	-Infinity	-Infinity	-96	-106	-Infinity	
RSRP ^{Note 4}	dBm/ 15 kHz	-96	-96	-105	-99	-109	-Infinity	
\hat{E}_s/N_{oc} ^{Note 4}	dB	2	2	-7	-4	-11	-Infinity	
Propagation Condition		ETU30						

Note 1:	OCNG shall be used such that active cells (all, except Cell 3 in T3) are fully allocated and a constant total transmitted power spectral density is achieved for all OFDM symbols other than those in the subframes with transmitted PRS.
Note 2:	The resources for uplink transmission are assigned to the UE prior to the start of time period T2.
Note 3:	Interference from other cells and noise sources not specified in the test are assumed to be constant over subcarriers and time and shall be modelled as AWGN of appropriate power for N_{oc} to be fulfilled.
Note 4:	If PRS_RA is not "N/A", \hat{E}_s/N_{oc} , PRS \hat{E}_s/I_{ot} , I_o , RSRP and PRP levels have been derived from other parameters and are given for information purpose. If PRS_RA is "N/A", I_o and RSRP levels have been derived from other parameters and are given for information purpose. These are not settable test parameters. Interference conditions shall be applied to all PRS symbols of DL positioning subframes.

Table A.8.17.1.1-4: DRX parameters for the test of E-UTRAN FDD intra-frequency RSTD measurement reporting delay under fading propagation conditions for carrier aggregation

Field	Value	Comment
onDurationTimer	psf1	As specified in TS 36.331 [2], Clause 6.3.2
Drx-InactivityTimer	psf1	
drx-RetransmissionTimer	sf1	
longDRX-CycleStartOffset	sf320	
shortDRX	Disable	

A.8.17.1.2 Test Requirements

The RSTD measurement time fulfils the requirements specified in Clause 8.4.

In Test 1, the UE shall perform and report the RSTD measurements from Cell 2 and Cell 3 within 2560 ms starting from the beginning of time interval T2.

In Test 2, the UE shall perform and report the RSTD measurements from Cell 1 and Cell 2, and RSTD measurements from Cell 2 and Cell 3 within 4960 ms starting from the beginning of time interval T2.

The rate of the correct events for each neighbour cell observed during repeated tests shall be at least 90%, where the reported RSTD measurement for each correct event shall be within the RSTD reporting range specified in Clause 9.1.10.3, i.e., between RSTD_0000 and RSTD_12711.

NOTE: The RSTD measurement times in the tests are derived from the following expression,

$$T_{PRS}(M-1) + 160 \left\lceil \frac{n}{M} \right\rceil,$$

where $M=8$ and $n=16$ for Test 1, and $M=16$ and $n=16$ for Test 2. For Test 1, the M and n parameters specified in Clause 8.1.2.5.1, Table 8.1.2.5.1-1, under Note 1, which gives the total RSTD measurement time of 2560 ms for Cell 3 with respect to the reference cell Cell 2. For Test 2, the M and n parameters are specified in Clause 8.1.2.6.1, Table 8.1.2.6.1-1, under Note 1, which gives the total RSTD measurement time of 4960 ms for reporting the RSTD measurements of Cell 1 and Cell 3 with respect to the reference cell Cell 2.

A.8.17.2 E-UTRAN TDD RSTD measurement reporting delay test case

A.8.17.2.1 Test Purpose and Environment

The purpose of the test case is to verify that the RSTD measurements meet the requirements specified in Clause 8.4 in a synchronized network environment with fading propagation conditions. This test case will verify the measurement period requirements specified in Clause 8.4.3 for RSTD measurements performed on the secondary component carrier and also the measurement period requirements for RSTD measurements performed on both the primary and secondary component carriers specified in Clause 8.4.4.

In the tests, there are two configured component carriers: PCC and SCC, and three synchronous cells: Cell 1, Cell 2 and Cell 3. Cell 1 is PCell on the PCC, Cell 2 is an active SCell on the SCC, and Cell 3 is a neighbour cell on the SCC. In all tests, Cell 2 is the OTDOA assistance data reference cell.

The test case includes two tests. Test 1 is designed for the scenario where the UE receives OTDOA assistance data with cells on SCC, and the UE is expected to report RSTD measurements performed on SCC only. Test 2 is designed for the scenario where the UE receives OTDOA assistance data with cells on PCC and SCC, and the UE is expected to report RSTD measurements performed on PCC and on SCC.

Each test consists of three consecutive time intervals, with duration of T1, T2 and T3. Cell 1 is active in T1, T2 and T3, whilst Cell 2 is active only in T2 and T3, and Cell 3 is active only during T2. The beginning of the time interval T2 shall be aligned with the first PRS positioning subframe of a positioning occasion in the OTDOA assistance data reference cell, where the PRS positioning occasion is as defined in Clause 8.1.2.5.1. Cell 1 transmits PRS in T2, while Cell 2 transmits PRS only in T3, and Cell 3 transmits PRS only in T2.

Note: The information on when PRS is muted is conveyed to the UE using PRS muting information.

The OTDOA assistance data as defined in TS 36.355, Clause 6.5.1.1, shall be provided to the UE during T1. The last TTI containing the OTDOA assistance data shall be provided to the UE ΔT ms before the start of T2, where $\Delta T = 150$ ms is the maximum processing time of the OTDOA assistance data.

The test parameters are as given in Table A.8.17.2.1-1, Table A.8.17.2.1-2, Table A.8.17.2.1-3 and Table A.8.17.2.1-4.

Table A.8.17.2.1-1: General test parameters for E-UTRAN TDD RSTD measurement reporting delay under fading propagation conditions for carrier aggregation

Parameter	Unit	Value		Comment
		Test 1	Test 2	
PCell		Cell 1		PCell is on RF channel 1 (PCC).
SCell		Cell 2		SCell on RF channel 2 (SCC). Cell 2 is the assistance data reference cell.
Other neighbor cell		Cell 3		Neighbor cell on RF channel 2 (SCC).
PCFICH/PDCCH/PHICH parameters		DL Reference Measurement Channel R.6 TDD		As specified in clause A.3.1.2.2
Channel Bandwidth (BW_{channel})	MHz	10		
PRS Transmission Bandwidth	RB	50		PRS are transmitted over the system bandwidth
PRS configuration index I_{PRS}		174 for all cells on PCC 184 for all cells on SCC		This corresponds to periodicity of 320 ms and PRS subframe offset of $I_{\text{PRS}} - 160$ DL subframes, as defined in TS 36.211 [16], Table 6.10.4.3-1
Number of consecutive downlink positioning subframes N_{PRS}		1		As defined in TS 36.211 [16]. The number of subframes in a positioning occasion
Physical cell ID PCI		$(\text{PCI of Cell 2} - \text{PCI of Cell 3}) \bmod 6 = 0$		The PCI of Cell 1 is selected randomly. PCIs of Cell 2 and Cell 3 are selected randomly such that the relative subcarrier shifts of PRS patterns among these cells are as given by the condition
TDD uplink-downlink configuration		1		As specified in TS 36.211 [16], Clause 4.2; corresponds to a configuration with 5 ms switch-point periodicity and two downlink consecutive subframes
TDD special subframe configuration		6		As specified in TS 36.211 [16], Clause 4.2; corresponds to DwPTS of $19760 \cdot T_s$ and UpPTS of $4384 \cdot T_s$
CP length		Normal		

DRX		ON		DRX parameters are further specified in Table A.8.17.2.1-3
Radio frame receive time offset between the cells at the UE antenna connector	μs	Cell 1 to Cell 2: 1 Cell 3 to Cell 2: -1		PRS are transmitted from synchronous cells
Time alignment error between cell2 and cell1	μs	≤ Time alignment error as specified in 3GPP TS 36.104 [30] clause 6.5.3.1.		The value of time alignment error depends upon the type of carrier aggregation.
Expected RSTD	μs	Cell 3: 2 Other neighbour cells: randomly between -3 and 3	Cell 1: -2 Cell 3: 2 Other neighbour cells: randomly between -3 and 3	The expected RSTD is what is expected at the receiver. The corresponding parameter in the OTDOA assistance data specified in TS 36.355 [24] is the expectedRSTD indicator
Expected RSTD uncertainty for all neighbour cells	μs	5		The corresponding parameter in the OTDOA assistance data specified in TS 36.355 [24] is the expectedRSTD-Uncertainty index
Cells in OTDOA assistance data		16 cells in total		The list includes the reference cell (received in <i>OTDOA-ReferenceCellInfo</i> [24]) and 15 other cells, all received in <i>OTDOA-ProvideAssistanceData</i> [24]. Cell 1 (when included) appears at random places in the first half of the neighbour cell list in the OTDOA assistance data. Cell 3 always appears at random places in the second half of the list.
		OTDOA neighbor cells include Cell 3 and other 14 cells on SCC	OTDOA neighbor cells include Cell 1 and other 7 cells on PCC, and Cell 3 and other 6 cells on SCC	
prs-SubframeOffset		Cells on PCC: 310 Cells on SCC, except reference cell: 0		Subframe offset, counted in full subframes. The corresponding parameter in the OTDOA assistance data is prs-SubframeOffset specified in TS 36.355 [24]
slotNumberOffset		Cells on PCC: 0 Cells on SCC, except reference cell: 0		The slot number offset at the transmitter between a neighbour cell and the assistance data reference cell. The corresponding parameter in the OTDOA assistance data is slotNumberOffset specified in TS 36.355 [24].
PRS muting info		Cell 1: '11110000' Cell 2: '00001111' Cell 3: '11110000'	Cell 1: '1111111100000000' Cell 2: '0000000011111111' Cell 3: '1111111100000000'	Corresponds to prs-MutingInfo defined in TS 36.355 [24]
T1	s	3		The length of the time interval from the beginning of each test
T2	s	1.28	2.48	The length of the time interval that follows immediately after time interval T1
T3	s	1.28	2.48	The length of the time interval that follows immediately after time interval T2

Table A.8.17.2.1-2: Cell-specific test parameters for E-UTRAN TDD RSTD measurement reporting delay under fading propagation conditions during T1 for carrier aggregation

Parameter	Unit	Cell 1	Cell 2	Cell 3
-----------	------	--------	--------	--------

E-UTRA RF Channel Number		1	N/A	N/A
Correlation Matrix and Antenna Configuration		1x2 Low	1x2 Low	1x2 Low
OCNG patterns defined in A.3.2.2		OP.1 TDD	N/A	N/A
PBCH_RA	dB	0	N/A	N/A
PBCH_RB				
PSS_RA				
SSS_RA				
PCFICH_RB				
PHICH_RA				
PHICH_RB				
PDCCH_RA				
PDCCH_RB				
OCNG_RA ^{Note 1}				
OCNG_RB ^{Note 1}				
N_{oc} ^{Note 3}	dBm/15 kHz	-95	N/A	N/A
$PRS \hat{E}_s/N_{oc}$	dB	-Infinity	-Infinity	-Infinity
I_o ^{Note 4}	dBm/9 MHz	-67.22	N/A	N/A
\hat{E}_s/N_{oc}	dB	0	-Infinity	-Infinity
Propagation Condition		ETU30		
<p>Note 1: OCNG shall be used such that active cell (Cell 1) is fully allocated and a constant total transmitted power spectral density is achieved for all OFDM symbols.</p> <p>Note 2: The resources for uplink transmission are assigned to the UE prior to the start of time period T2.</p> <p>Note 3: Interference from other cells and noise sources not specified in the test are assumed to be constant over subcarriers and time and shall be modelled as AWGN of appropriate power for N_{oc} to be fulfilled.</p> <p>Note 4: I_o levels have been derived from other parameters and are given for information purpose. These are not settable test parameters.</p>				

Table A.8.17.2.1-3: Cell-specific test parameters for E-UTRAN TDD RSTD measurement reporting delay under fading propagation conditions during T2 and T3 for carrier aggregation

Parameter	Unit	Cell 1		Cell 2		Cell 3	
		T2	T3	T2	T3	T2	T3
E-UTRA RF Channel Number		1		2		2	
Correlation Matrix and Antenna Configuration		1x2 Low		1x2 Low		1x2 Low	
OCNG patterns defined in A.3.2.2		OP.1 TDD		OP.2 TDD		OP.2 TDD	N/A
PBCH_RA	dB	0	0	0	0	N/A	N/A
PBCH_RB							
PSS_RA							
SSS_RA							
PCFICH_RB							
PHICH_RA							
PHICH_RB							
PDCCH_RA							
PDCCH_RB							
OCNG_RA ^{Note 1}							
OCNG_RB ^{Note 1}							

PRS_RA	dB	-6	N/A	N/A	3	3	N/A
N_{oc} <small>Note 3</small>	dBm/ 15 kHz	-98	-98	-98	-95	-98	-95
PRS \hat{E}_s/N_{oc}	dB	-4	-Infinity	-Infinity	-1	-8	-Infinity
PRS \hat{E}_s/I_{ot} <small>Note 4</small>	dB	-4	-Infinity	-Infinity	-1	-8	-Infinity
I_o <small>Note 4</small>	dBm/ 9 MHz	-69.94	N/A	N/A	-66.68	-70.11	N/A
PRP <small>Note 4</small>	dBm/ 15 kHz	-102	-Infinity	-Infinity	-96	-106	-Infinity
RSRP	dBm/ 15 kHz	-96	-96	-105	-99	-109	-Infinity
\hat{E}_s/N_{oc} <small>Note 4</small>	dB	2	2	-7	-4	-11	-Infinity
Propagation Condition		ETU30					
<p>Note 1: OCNG shall be used such that active cells (all, except Cell 3 in T3) are fully allocated and a constant total transmitted power spectral density is achieved for all OFDM symbols other than those in the subframes with transmitted PRS.</p> <p>Note 2: The resources for uplink transmission are assigned to the UE prior to the start of time period T2.</p> <p>Note 3: Interference from other cells and noise sources not specified in the test are assumed to be constant over subcarriers and time and shall be modelled as AWGN of appropriate power for N_{oc} to be fulfilled.</p> <p>Note 4: If PRS_RA is not "N/A", \hat{E}_s/N_{oc}, PRS \hat{E}_s/I_{ot}, I_o, RSRP and PRP levels have been derived from other parameters and are given for information purpose. If PRS_RA is "N/A", I_o and RSRP levels have been derived from other parameters and are given for information purpose. These are not settable test parameters. Interference conditions shall be applied to all PRS symbols of DL positioning subframes.</p>							

Table A.8.17.2.1-4: DRX parameters for the test of E-UTRAN TDD intra-frequency RSTD measurement reporting delay under fading propagation conditions for carrier aggregation

Field	Value	Comment
onDurationTimer	psf1	As specified in TS 36.331 [2], Clause 6.3.2
drx-InactivityTimer	psf1	
drx-RetransmissionTimer	sf1	
longDRX-CycleStartOffset	sf320	
shortDRX	Disable	

A.8.17.2.2 Test Requirements

The RSTD measurement time fulfils the requirements specified in Clause 8.4.

In Test 1, the UE shall perform and report the RSTD measurements from Cell 2 and Cell 3 within 2560 ms starting from the beginning of time interval T2.

In Test 2, the UE shall perform and report the RSTD measurements from Cell 1 and Cell 2, and RSTD measurements from Cell 2 and Cell 3 within 4960 ms starting from the beginning of time interval T2.

The rate of the correct events for each neighbour cell observed during repeated tests shall be at least 90%, where the reported RSTD measurement for each correct event shall be within the RSTD reporting range specified in Clause 9.1.10.3, i.e., between RSTD_0000 and RSTD_12711.

NOTE: The RSTD measurement times in the tests are derived from the following expression,

$$T_{PRS}(M-1) + 160 \left\lceil \frac{n}{M} \right\rceil,$$

where $M=8$ and $n=16$ for Test 1, and $M=16$ and $n=16$ for Test 2. For Test 1, the M and n parameters specified in Clause 8.1.2.5.1, Table 8.1.2.5.1-1, under Note 1, which gives the total RSTD measurement time of 2560 ms for Cell 3 with respect to the reference cell Cell 2. For Test 2, the M and n parameters are specified in Clause 8.1.2.6.1, Table 8.1.2.6.1-1, under Note 1, which gives the total RSTD measurement time of 4960 ms for reporting the RSTD measurements of Cell 1 and Cell 3 with respect to the reference cell Cell 2.

A.8.17.3 E-UTRAN FDD RSTD Measurement Reporting Test Case for 20 MHz

A.8.17.3.1 Test Purpose and Environment

The purpose of this test is the same as defined in Subclause A.8.17.1.1.

The parameters of this test are the same as defined in Subclause A.8.17.1.1 except that the values of the parameters in Table A.8.17.3.1-1, Table A.8.17.3.1-2 and Table A.8.17.3.1-3 will replace the values of the corresponding parameters in Table A.8.17.1.1-1, Table A.8.17.1.1-2 and Table A.8.17.1.1-3, respectively.

Note: This test verifies the RRM requirement which is independent of channel bandwidth and is performed according to the principle defined in section A.3.6.1.

Table A.8.17.3.1-1: General test parameters for E-UTRAN FDD RSTD measurement reporting delay under fading propagation conditions for carrier aggregation

Parameter	Unit	Value		Comment
		Test 1	Test 2	
PCFICH/PDCCH/PHICH parameters		DL Reference Measurement Channel R.10 FDD		As specified in section A.3.1.2.1
Channel Bandwidth (BW_{channel})	MHz	20		
PRS Transmission Bandwidth	RB	100		PRS are transmitted over the system bandwidth
Note 1: See Table A.8.17.1.1-1 for the other parameters.				
Note 2: This test verifies the RRM requirement which is independent of channel bandwidth and is performed according to the principle defined in section A.3.6.1.				

Table A.8.17.3.1-2: Cell-specific test parameters for E-UTRAN FDD RSTD measurement reporting delay under fading propagation conditions during T1 for carrier aggregation

Parameter	Unit	Cell 1	Cell 2	Cell 3
OCNG patterns defined in A.3.2.1		OP.13 FDD	N/A	N/A
I_0 ^{Note 1}	dBm/ 18 MHz	-64.21	N/A	N/A
Note 1: I_0 levels have been derived from other parameters for information purposes. They are not settable parameters themselves.				
Note 2: See Table A.8.17.1.1-2 for the other parameters.				

Table A.8.17.3.1-3: Cell-specific test parameters for E-UTRAN FDD RSTD measurement reporting delay under fading propagation conditions during T2 and T3 for carrier aggregation

Parameter	Unit	Cell 1		Cell 2		Cell 3	
		T2	T3	T2	T3	T2	T3
OCNG patterns defined in A.3.2.1		OP.13 FDD		OP.14 FDD		OP.14 FDD	N/A
I_0 ^{Note 1}	dBm/ 18 MHz	-66.93	N/A	N/A	-63.67	-67.09	N/A

Note 1: I_0 levels have been derived from other parameters for information purposes. They are not settable parameters themselves.

Note 2: See Table A.8.17.1.1-3 for the other parameters.

A.8.17.3.2 Test Requirements

The test requirements defined in section A.8.17.1.2 shall apply in this test case.

A.8.17.4 E-UTRAN TDD RSTD Measurement Reporting Test Case for 20 MHz

A.8.17.4.1 Test Purpose and Environment

The purpose of this test is the same as defined in Subclause A.8.17.2.1.

The parameters of this test are the same as defined in Subclause A.8.17.2.1 except that the values of the parameters in Table A.8.17.4.1-1, Table A.8.17.4.1-2 and Table A.8.17.4.1-3 will replace the values of the corresponding parameters in Table A.8.17.2.1-1, Table A.8.17.2.1-2 and Table A.8.17.2.1-3, respectively.

Note: This test verifies the RRM requirement which is independent of channel bandwidth and is performed according to the principle defined in section A.3.6.1.

Table A.8.17.4.1-1: General test parameters for E-UTRAN TDD RSTD measurement reporting delay under fading propagation conditions for carrier aggregation

Parameter	Unit	Value		Comment
		Test 1	Test 2	
PCFICH/PDCCH/PHICH parameters		DL Reference Measurement Channel R.10 TDD		As specified in section A.3.1.2.2
Channel Bandwidth (BW_{channel})	MHz	20		
PRS Transmission Bandwidth	RB	100		PRS are transmitted over the system bandwidth
Note 1: See Table A.8.17.2.1-1 for the other parameters.				
Note 2: This test verifies the RRM requirement which is independent of channel bandwidth and is performed according to the principle defined in section A.3.6.1.				

Table A.8.17.4.1-2: Cell-specific test parameters for E-UTRAN TDD RSTD measurement reporting delay under fading propagation conditions during T1 for carrier aggregation

Parameter	Unit	Cell 1	Cell 2	Cell 3
OCNG patterns defined in A.3.2.2		OP.7 TDD	N/A	N/A
I_0 ^{Note 1}	dBm/ 18 MHz	-64.21	N/A	N/A
Note 1: I_0 levels have been derived from other parameters for information purposes. They are not settable parameters themselves.				
Note 2: See Table A.8.17.2.1-2 for the other parameters.				

Table A.8.17.4.1-3: Cell-specific test parameters for E-UTRAN TDD RSTD measurement reporting delay under fading propagation conditions during T2 and T3 for carrier aggregation

Parameter	Unit	Cell 1		Cell 2		Cell 3	
		T2	T3	T2	T3	T2	T3
OCNG patterns defined in A.3.2.2		OP.7 TDD		OP.8 TDD		OP.8 TDD	N/A
I_0 ^{Note 1}	dBm/ 18 MHz	-66.93	N/A	N/A	-63.67	-67.09	N/A

Note 1: I_0 levels have been derived from other parameters for information purposes. They are not settable parameters themselves.
 Note 2: See Table A.8.17.2.1-3 for the other parameters.

A.8.17.4.2 Test Requirements

The test requirements defined in section A.8.17.2.2 shall apply in this test case.

A.8.17.5 E-UTRAN FDD RSTD Measurement Reporting Test Case for 10MHz+5MHz

A.8.17.5.1 Test Purpose and Environment

The purpose of this test is the same as defined in Subclause A.8.17.1.1.

The parameters of this test are the same as defined in Subclause A.8.17.1.1 except that the values of the parameters in Table A.8.17.5.1-1, Table A.8.17.5.1-2 and Table A.8.17.5.1-3 will replace the values of the corresponding parameters in Table A.8.17.1.1-1, Table A.8.17.1.1-2 and Table A.8.17.1.1-3, respectively.

Note: This test verifies the RRM requirement which is independent of channel bandwidth and is performed according to the principle defined in section A.3.6.1.

Table A.8.17.5.1-1: General test parameters for E-UTRAN FDD RSTD measurement reporting delay under fading propagation conditions for carrier aggregation

Parameter	Unit	Value		Comment
		Test 1	Test 2	
PCFICH/PDCCH/PHICH parameters		Cell 1: R.6 FDD Cell 2: R.11 FDD Cell 3: R.11 FDD	Cell 1: R.6 FDD Cell 2: R.11 FDD Cell 3: R.11 FDD	As specified in section A.3.1.2.1
Channel Bandwidth ($BW_{channel}$)	MHz	Cell 1: 10 Cell 2: 5 Cell 3: 5	Cell 1: 10 Cell 2: 5 Cell 3: 5	
PRS Transmission Bandwidth	RB	Cell 1: 50 Cell 2: 25 Cell 3: 25	Cell 1: 50 Cell 2: 25 Cell 3: 25	PRS are transmitted over the system bandwidth
PRS occasion length N_{PRS}		Cell 1: 1 Cell 2: 2 Cell 3: 2	Cell 1: 1 Cell 2: 2 Cell 3: 2	
Note 1: See Table A.8.17.1.1-1 for the other parameters. Note 2: This test verifies the RRM requirement which is independent of channel bandwidth and is performed according to the principle defined in section A.3.6.1.				

Table A.8.17.5.1-2: Cell-specific test parameters for E-UTRAN FDD RSTD measurement reporting delay under fading propagation conditions during T1 for carrier aggregation

Parameter	Unit	Cell 1	Cell 2	Cell 3
I_0 ^{Note 1}	dBm/9 MHz	-67.22	N/A	N/A
	dBm/4.5MHz	N/A	N/A	N/A
Note 1: I_0 levels have been derived from other parameters for information purposes. They are not settable parameters themselves. Note 2: See Table A.8.17.1.1-2 for the other parameters.				

Table A.8.17.5.1-3: Cell-specific test parameters for E-UTRAN FDD RSTD measurement reporting delay under fading propagation conditions during T2 and T3 for carrier aggregation

Parameter	Unit	Cell 1		Cell 2		Cell 3	
		T2	T3	T2	T3	T2	T3

OCNG patterns defined in A.3.2.1		OP.5 FDD		OP.19 FDD		OP.19 FDD	N/A
I _o ^{Note 1}	dBm/9 MHz	-69.94	N/A	N/A	N/A	N/A	N/A
	dBm/4.5MHz	N/A	N/A	N/A	-69.69	-73.12	N/A
Note 1: I _o levels have been derived from other parameters for information purposes. They are not settable parameters themselves.							
Note 2: See Table A.8.17.1.1-3 for the other parameters.							

A.8.17.5.2 Test Requirements

The test requirements defined in section A.8.17.1.2 shall apply in this test case.

A.8.17.6 E-UTRAN TDD RSTD Measurement Reporting Test Case for 10MHz+5MHz

A.8.17.6.1 Test Purpose and Environment

The purpose of this test is the same as defined in Subclause A.8.17.2.1.

The parameters of this test are the same as defined in Subclause A.8.17.2.1 except that the values of the parameters in Table A.8.17.6.1-1, Table A.8.17.6.1-2 and Table A.8.17.6.1-1 will replace the values of the corresponding parameters in Table A.8.17.2.1-1, Table A.8.17.2.1-2 and Table A.8.17.2.1-3, respectively.

Note: This test verifies the RRM requirement which is independent of channel bandwidth and is performed according to the principle defined in section A.3.6.1.

Table A.8.17.6.1-1: General test parameters for E-UTRAN TDD RSTD measurement reporting delay under fading propagation conditions for carrier aggregation

Parameter	Unit	Value		Comment
		Test 1	Test 2	
PCFICH/PDCCH/PHICH parameters		Cell 1: R.6 TDD Cell 2: R.11 TDD Cell 3: R.11 TDD	Cell 1: R.6 TDD Cell 2: R.11 TDD Cell 3: R.11 TDD	As specified in section A.3.1.2.2
Channel Bandwidth (BW _{channel})	MHz	Cell 1: 10 Cell 2: 5 Cell 3: 5	Cell 1: 10 Cell 2: 5 Cell 3: 5	
PRS Transmission Bandwidth	RB	Cell 1: 50 Cell 2: 25 Cell 3: 25	Cell 1: 50 Cell 2: 25 Cell 3: 25	PRS are transmitted over the system bandwidth
PRS occasion length N _{PRS}		Cell 1: 1 Cell 2: 2 Cell 3: 2	Cell 1: 1 Cell 2: 2 Cell 3: 2	
Note 1: See Table A.8.17.2.1-1 for the other parameters.				
Note 2: This test verifies the RRM requirement which is independent of channel bandwidth and is performed according to the principle defined in section A.3.6.1.				

Table A.8.17.6.1-2: Cell-specific test parameters for E-UTRAN TDD RSTD measurement reporting delay under fading propagation conditions during T1 for carrier aggregation

Parameter	Unit	Cell 1	Cell 2	Cell 3
I _o ^{Note 1}	dBm/9 MHz	-67.22	N/A	N/A
	dBm/4.5MHz	N/A	N/A	N/A
Note 1: I _o levels have been derived from other parameters for information purposes. They are not settable parameters themselves.				
Note 2: See Table A.8.17.1.1-2 for the other parameters.				

Table A.8.17.6.1-3: Cell-specific test parameters for E-UTRAN TDD RSTD measurement reporting delay under fading propagation conditions during T2 and T3 for carrier aggregation

Parameter	Unit	Cell 1		Cell 2		Cell 3	
		T2	T3	T2	T3	T2	T3
OCNG patterns defined in A.3.2.1		OP.1 TDD		OP.10 TDD		OP.10 TDD	N/A
I_o ^{Note 1}	dBm/9 MHz	-69.94	N/A	N/A	N/A	N/A	N/A
	dBm/4.5MHz	N/A	N/A	N/A	-69.69	-73.12	N/A
Note 1:	I _o levels have been derived from other parameters for information purposes. They are not settable parameters themselves.						
Note 2:	See Table A.8.17.1.1-3 for the other parameters.						

A.8.17.6.2 Test Requirements

The test requirements defined in section A.8.17.2.2 shall apply in this test case.

A.8.17.7 E-UTRAN FDD RSTD Measurement Reporting Test Case for 5 + 5 MHz Bandwidth

A.8.17.7.1 Test Purpose and Environment

The purpose of this test is the same as defined in Subclause A.8.17.1.1.

The parameters of this test are the same as defined in Subclause A.8.17.1.1 except that the values of the parameters in Table A.8.17.7.1-1, Table A.8.17.7.1-2 and Table A.8.17.7.1-1 will replace the values of the corresponding parameters in Table A.8.17.1.1-1, Table A.8.17.1.1-2 and Table A.8.17.1.1-3, respectively.

Note: This test verifies the RRM requirement which is independent of channel bandwidth and is performed according to the principle defined in section A.3.6.1.

Table A.8.17.7.1-1: General test parameters for E-UTRAN FDD RSTD measurement reporting delay under fading propagation conditions for carrier aggregation

Parameter	Unit	Value		Comment
		Test 1	Test 2	
PCFICH/PDCCH/PHICH parameters		DL Reference Measurement Channel R.11 FDD		As specified in section A.3.1.2.1
Channel Bandwidth ($BW_{channel}$)	MHz	5		
PRS Transmission Bandwidth	RB	25		PRS are transmitted over the system bandwidth
PRS occasion length N_{PRS}		2		
Note 1:	See Table A.8.17.1.1-1 for the other parameters.			
Note 2:	This test verifies the RRM requirement which is independent of channel bandwidth and is performed according to the principle defined in section A.3.6.1.			

Table A.8.17.7.1-2: Cell-specific test parameters for E-UTRAN FDD RSTD measurement reporting delay under fading propagation conditions during T1 for carrier aggregation

Parameter	Unit	Cell 1	Cell 2	Cell 3
OCNG patterns defined in A.3.2.1		OP.18 FDD	N/A	N/A
I_o ^{Note 1}	dBm/4.5 MHz	-70.23	N/A	N/A
Note 1:	I _o levels have been derived from other parameters for information purposes. They are not settable parameters themselves.			
Note 2:	See Table A.8.17.1.1-2 for the other parameters.			

Table A.8.17.7.1-3: Cell-specific test parameters for E-UTRAN FDD RSTD measurement reporting delay under fading propagation conditions during T2 and T3 for carrier aggregation

Parameter	Unit	Cell 1		Cell 2		Cell 3	
		T2	T3	T2	T3	T2	T3
OCNG patterns defined in A.3.2.1		OP.18 FDD		OP.19 FDD		OP.19 FDD	N/A
I_0 ^{Note 1}	dBm/ 4.5 MHz	-72.95	N/A	N/A	-69.69	-73.12	N/A
Note 1: I_0 levels have been derived from other parameters for information purposes. They are not settable parameters themselves.							
Note 2: See Table A.8.17.1.1-3 for the other parameters.							

A.8.17.7.2 Test Requirements

The test requirements defined in section A.8.17.1.2 shall apply in this test case.

A.8.17.8 E-UTRAN TDD RSTD Measurement Reporting Test Case for 5+5 MHz bandwidth

A.8.17.8.1 Test Purpose and Environment

The purpose of this test is the same as defined in Subclause A.8.17.2.1.

The parameters of this test are the same as defined in Subclause A.8.17.2.1 except that the values of the parameters in Table A.8.17.8.1-1, Table A.8.17.8.1-2 and Table A.8.17.8.1-1 will replace the values of the corresponding parameters in Table A.8.17.2.1-1, Table A.8.17.2.1-2 and Table A.8.17.2.1-3, respectively.

Note: This test verifies the RRM requirement which is independent of channel bandwidth and is performed according to the principle defined in section A.3.6.1.

Table A.8.17.8.1-1: General test parameters for E-UTRAN TDD RSTD measurement reporting delay under fading propagation conditions for carrier aggregation

Parameter	Unit	Value		Comment
		Test 1	Test 2	
PCFICH/PDCCH/PHICH parameters		DL Reference Measurement Channel R.11 TDD		As specified in section A.3.1.2.1
Channel Bandwidth (BW_{channel})	MHz	5		
PRS Transmission Bandwidth	RB	25		PRS are transmitted over the system bandwidth
PRS occasion length N_{PRS}		2		
Note 1: See Table A.8.17.2.1-1 for the other parameters.				
Note 2: This test verifies the RRM requirement which is independent of channel bandwidth and is performed according to the principle defined in section A.3.6.1.				

Table A.8.17.8.1-2: Cell-specific test parameters for E-UTRAN TDD RSTD measurement reporting delay under fading propagation conditions during T1 for carrier aggregation

Parameter	Unit	Cell 1	Cell 2	Cell 3
OCNG patterns defined in A.3.2.1		OP.9 TDD	N/A	N/A
I_0 ^{Note 1}	dBm/ 4.5 MHz	-70.23	N/A	N/A

Note 1:	Io levels have been derived from other parameters for information purposes. They are not settable parameters themselves.
Note 2:	See Table A.8.17.2.1-2 for the other parameters.

Table A.8.17.8.1-3: Cell-specific test parameters for E-UTRAN TDD RSTD measurement reporting delay under fading propagation conditions during T2 and T3 for carrier aggregation

Parameter	Unit	Cell 1		Cell 2		Cell 3	
		T2	T3	T2	T3	T2	T3
OCNG patterns defined in A.3.2.1		OP.9 TDD		OP.10 TDD		OP.10 TDD	N/A
Io ^{Note 1}	dBm/ 4.5 MHz	-72.95	N/A	N/A	-69.69	-73.12	N/A
Note 1:	Io levels have been derived from other parameters for information purposes. They are not settable parameters themselves.						
Note 2:	See Table A.8.17.2.1-3 for the other parameters.						

A.8.17.8.2 Test Requirements

The test requirements defined in section A.8.17.2.2 shall apply in this test case.

A.8.17.9 E-UTRAN TDD RSTD Measurement Reporting Test Case for 20MHz+10MHz

A.8.17.9.1 Test Purpose and Environment

The purpose of this test is the same as defined in Subclause A.8.17.2.1.

The parameters of this test are the same as defined in Subclause A.8.17.2.1 except that the values of the parameters in Table A.8.17.9.1-1, Table A.8.17.9.1-2 and Table A.8.17.9.1-1 will replace the values of the corresponding parameters in Table A.8.17.2.1-1, Table A.8.17.2.1-2 and Table A.8.17.2.1-3, respectively.

Note: This test verifies the RRM requirement which is independent of channel bandwidth and is performed according to the principle defined in section A.3.6.1.

Table A.8.17.9.1-1: General test parameters for E-UTRAN TDD RSTD measurement reporting delay under fading propagation conditions for carrier aggregation

Parameter	Unit	Value		Comment
		Test 1	Test 2	
PCFICH/PDCCH/PHICH parameters		Cell 1: R.10 TDD Cell 2: R.6 TDD Cell 3: R.6 TDD	Cell 1: R.10 TDD Cell 2: R.6 TDD Cell 3: R.6 TDD	As specified in section A.3.1.2.2
Channel Bandwidth (BW _{channel})	MHz	Cell 1: 20 Cell 2: 10 Cell 3: 10	Cell 1: 20 Cell 2: 10 Cell 3: 10	
PRS Transmission Bandwidth	RB	Cell 1: 100 Cell 2: 50 Cell 3: 50	Cell 1: 100 Cell 2: 50 Cell 3: 50	PRS are transmitted over the system bandwidth
Note 1:	See Table A.8.17.2.1-1 for the other parameters.			
Note 2:	This test verifies the RRM requirement which is independent of channel bandwidth and is performed according to the principle defined in section A.3.6.1.			

Table A.8.17.9.1-2: Cell-specific test parameters for E-UTRAN TDD RSTD measurement reporting delay under fading propagation conditions during T1 for carrier aggregation

Parameter	Unit	Cell 1	Cell 2	Cell 3
Io ^{Note 1}	dBm/ 18 MHz	-64.21	N/A	N/A

	dBm/ 9 MHz	N/A	N/A	N/A
Note 1:	I _o levels have been derived from other parameters for information purposes. They are not settable parameters themselves.			
Note 2:	See Table A.8.17.1.1-2 for the other parameters.			

Table A.8.17.9.1-3: Cell-specific test parameters for E-UTRAN TDD RSTD measurement reporting delay under fading propagation conditions during T2 and T3 for carrier aggregation

Parameter	Unit	Cell 1		Cell 2		Cell 3	
		T2	T3	T2	T3	T2	T3
OCNG patterns defined in A.3.2.1		OP.7 TDD		OP.2 TDD		OP.2 TDD	N/A
I _o ^{Note 1}	dBm/ 18 MHz	-66.93	N/A	N/A	N/A	N/A	N/A
	dBm/ 9MHz	N/A	N/A	N/A	-66.68	-70.11	N/A
Note 1:	I _o levels have been derived from other parameters for information purposes. They are not settable parameters themselves.						
Note 2:	See Table A.8.17.1.1-3 for the other parameters.						

A.8.17.9.2 Test Requirements

The test requirements defined in section A.8.17.2.2 shall apply in this test case.

A.8.17.10 E-UTRAN 3 DL FDD CA RSTD Measurement Reporting Delay Test Case

A.8.17.10.1 Test Purpose and Environment

The purpose of the test case is to verify that the RSTD measurements meet the requirements specified in Clause 8.4 in a synchronized network environment with fading propagation conditions. This test case will verify the measurement period requirements specified in Clause 8.4.3 for RSTD measurements performed on the same secondary component carrier, the measurement period requirements for RSTD measurements performed on both the primary and secondary component carriers specified in Clause 8.4.4, and also the measurement period requirements for RSTD measurements performed on different secondary component carriers specified in Clause 8.4.5.

In the tests, there are three configured component carriers: PCC, SCC1 and SCC2, and four synchronous cells: Cell 1, Cell 2, Cell 3 and Cell 4. Cell 1 is PCell on the PCC, Cell 2 is SCell on the SCC1, Cell 3 is SCell on the SCC2 and Cell 4 is a neighbour cell on the SCC2. In all tests, Cell 3 is the OTDOA assistance data reference cell.

The test case includes two tests. Test 1 is designed for the scenario where the UE receives OTDOA assistance data with cells only on SCC2, and the UE is expected to report RSTD measurements performed on SCC2 only. Test 2 is designed for the scenario where the UE receives OTDOA assistance data with cells on PCC, SCC1 and SCC2, and the UE is expected to report RSTD measurements performed on PCC, SCC1 and SCC2.

Each test consists of three consecutive time intervals, with duration of T1, T2 and T3. Cell 1 is active in T1, T2 and T3, Cell 2 is active only in T2 and T3, Cell 3 is active only during T2 and T3, and Cell 4 is active only during T2. The beginning of the time interval T2 shall be aligned with the first PRS positioning subframe of a positioning occasion in the OTDOA assistance data reference cell, where the PRS positioning occasion is as defined in Clause 8.1.2.5.1. Cell 1 transmits PRS in T2, Cell 2 transmits PRS only in T3, and Cell 3 transmits PRS only in T3, and Cell 4 transmits PRS only in T2.

Note: The information on when PRS is muted is conveyed to the UE using PRS muting information.

The OTDOA assistance data as defined in TS 36.355, Clause 6.5.1.1, shall be provided to the UE during T1. The last TTI containing the OTDOA assistance data shall be provided to the UE ΔT ms before the start of T2, where $\Delta T = 150$ ms is the maximum processing time of the OTDOA assistance data.

The test parameters are as given in Table A.8.17.10.1-1, Table A.8.17.10.1-2, Table A.8.17.10.1-3 and Table A.8.17.10.1-4.

Table A.8.17.10.1-1: General test parameters for E-UTRAN FDD RSTD measurement reporting delay under fading propagation conditions for carrier aggregation

Parameter	Unit	Value		Comment
		Test 1	Test 2	
PCell		Cell 1		PCell is on RF channel 1 (PCC).
SCell 1		Cell 2		SCell 1 on RF channel 2 (SCC1).
SCell 2		Cell 3		SCell 2 on RF channel 3 (SCC2). Cell 3 is the assistance data reference cell.
Other neighbor cell		Cell 4		Neighbor cell on RF channel 3 (SCC2).
PRS configuration index I_{PRS}		171 for all cells on PCC 181 for all cells on SCC1 191 for all cells on SCC2		This corresponds to periodicity of 320 ms and PRS subframe offset of $I_{PRS} - 160$ DL subframes, as defined in TS 36.211 [16], Table 6.10.4.3-1
Physical cell ID PCI		$(\text{PCI of Cell 3} - \text{PCI of Cell 4}) \bmod 6 = 0$		The PCIs of Cell 1 and Cell 2 are selected randomly. PCIs of Cell 3 and Cell 4 are selected randomly such that the relative subcarrier shifts of PRS patterns among these cells are as given by the condition
CP length		Normal		
DRX		ON		DRX parameters are further specified in Table A.8.17.10.1-3
Radio frame receive time offset between the cells at the UE antenna connector	μs	Cell 1 to Cell 3: 1 Cell 2 to Cell 3: -1 Cell 4 to Cell 3: 3		PRS are transmitted from synchronous cells
Time alignment errors between cell1, cell2 and cell3	μs	\leq Time alignment error as specified in 3GPP TS 36.104 [30] clause 6.5.3.1.		The value of time alignment error depends upon the type of carrier aggregation.
Expected RSTD	μs	Cell 4: 2 Other neighbour cells: randomly between -3 and 3	Cell 1: -2 Cell 2: 0 Cell 4: 2 Other neighbour cells: randomly between -3 and 3	The expected RSTD is what is expected at the receiver. The corresponding parameter in the OTDOA assistance data specified in TS 36.355 [24] is the expectedRSTD indicator
Expected RSTD uncertainty for all neighbour cells	μs	5		The corresponding parameter in the OTDOA assistance data specified in TS 36.355 [24] is the expectedRSTD-Uncertainty index
Cells in OTDOA assistance data		16 cells in total		The list includes the reference cell (received in <i>OTDOA-ReferenceCellInfo</i> [24]) and 15 other cells, all received in <i>OTDOA-ProvideAssistanceData</i> [24]. Cell 1 and Cell 2 (when included) appears at random places in the first half of the neighbour cell list in the OTDOA assistance data. Cell 4 always appears at random places in the second half of the list.
		OTDOA neighbor cells include Cell 4 and other 14 cells on SCC2	OTDOA neighbor cells include Cell 1 and other 3 cells on PCC, Cell 2 and other 3 cells on SCC1 and Cell 4 and other 6 cells on SCC2	
'prs-SubframeOffset		Cells on PCC: 300 Cells on SCC1: 310 Cells on SCC2, except reference cell: 0		Subframe offset, counted in full subframes. The corresponding parameter in the OTDOA assistance data is prs-SubframeOffset specified in TS 36.355 [24]

slotNumberOffset		Cells on PCC: 0 Cells on SCC1: 0 Cells on SCC2, except reference cell: 0		The slot number offset at the transmitter between a neighbour cell and the assistance data reference cell. The corresponding parameter in the OTDOA assistance data is slotNumberOffset specified in TS 36.355 [24].
PRS muting info		Cell 1: '11110000' Cell 2: '00001111' Cell 3: '11110000' Cell 4: '00001111'	Cell 1: '1111111100000000' Cell 2: '0000000011111111' Cell 3: '1111111100000000' Cell 4: 0000000011111111'	Corresponds to prs-MutingInfo defined in TS 36.355 [24]
T1	s	3		The length of the time interval from the beginning of each test
T2	s	1.28	2.48	The length of the time interval that follows immediately after time interval T1
T3	s	1.28	2.48	The length of the time interval that follows immediately after time interval T2

Table A.8.17.10.1-2: Cell-specific test parameters for E-UTRAN FDD RSTD measurement reporting delay under fading propagation conditions during T1 for carrier aggregation

Parameter	Unit	Cell 1	Cell 2	Cell 3	Cell 4
E-UTRA RF Channel Number		1	N/A	N/A	N/A
Channel Bandwidth (BW _{channel})	MHz	5,10,20	N/A	N/A	N/A
Correlation Matrix and Antenna Configuration		1x2 Low	1x2 Low	1x2 Low	1x2 Low
PCFICH/PDCCH/PHICH parameters as specified in clause A.3.1.2.1		5MHz: R.11 FDD 10MHz: R.6 FDD 20MHz: R.10 FDD	N/A	N/A	N/A
OCNG patterns defined in A.3.2.1		5MHz: OP.18 FDD 10MHz: OP.5 FDD 20MHz: OP.13 FDD	N/A	N/A	N/A
PBCH_RA	dB	0	N/A	N/A	N/A
PBCH_RB					
PSS_RA					
SSS_RA					
PCFICH_RB					
PHICH_RA					
PHICH_RB					
PDCCH_RA					
PDCCH_RB					
OCNG_RA ^{Note 1}					
OCNG_RB ^{Note 1}					
N_{oc} ^{Note 3}	dBm/15 kHz	-95	N/A	N/A	N/A
\hat{E}_s/N_{oc}	dB	-Infinity	-Infinity	-Infinity	-Infinity

I_o ^{Note 4}	dBm/ 9 MHz	-67.22 +10log ($N_{RB,c}/50$)	N/A	N/A	N/A
\hat{E}_s/N_{oc}	dB	0	-Infinity	-Infinity	-Infinity
Propagation Condition		ETU30			
Note 1:	OCNG shall be used such that active cell (Cell 1) is fully allocated and a constant total transmitted power spectral density is achieved for all OFDM symbols.				
Note 2:	The resources for uplink transmission are assigned to the UE prior to the start of time period T2.				
Note 3:	Interference from other cells and noise sources not specified in the test are assumed to be constant over subcarriers and time and shall be modelled as AWGN of appropriate power for N_{oc} to be fulfilled.				
Note 4:	I_o levels have been derived from other parameters and are given for information purpose. These are not settable test parameters.				

Table A.8.17.10.1-3: Cell-specific test parameters for E-UTRAN FDD RSTD measurement reporting delay under fading propagation conditions during T2 and T3 for carrier aggregation

Parameter	Unit	Cell 1		Cell 2		Cell 3		Cell 4		
		T2	T3	T2	T3	T2	T3	T2	T3	
E-UTRA RF Channel Number		1		2		3		3		
Channel Bandwidth ($BW_{channel}$)	MHz	5,10,20		5,10,20		5,10,20		5,10,20		
Correlation Matrix and Antenna Configuration		1x2 Low		1x2 Low		1x2 Low		1x2 Low		
PCFICH/PDCCH/PHICH parameters as specified in clause A.3.1.2.1		5MHz: R.11 FDD 10MHz: R.6 FDD 20MHz: R.10 FDD		5MHz: R.11 FDD 10MHz: R.6 FDD 20MHz: R.10 FDD		5MHz: R.11 FDD 10MHz: R.6 FDD 20MHz: R.10 FDD		5MHz: R.11 FDD 10MHz: R.6 FDD 20MHz: R.10 FDD		
OCNG patterns defined in A.3.2.1 (There is no PDSCH allocated in the subframe transmitting PRS)		5MHz: OP.18 FDD 10MHz: OP.5 FDD 20MHz: OP.13 FDD		5MHz: OP.19 FDD 10MHz: OP.6 FDD 20MHz: OP.14 FDD		5MHz: OP.19 FDD 10MHz: OP.6 FDD 20MHz: OP.14 FDD		5MHz: OP.19 FDD 10MHz: OP.6 FDD 20MHz: OP.14 FDD		
PRS Transmission Bandwidth (PRS transmission bandwidth depends on selected channel bandwidth. PRS are transmitted over the system bandwidth)	RB	5MHz: 25 10MHz: 50 20MHz:100		5MHz: 25 10MHz: 50 20MHz:100		5MHz: 25 10MHz: 50 20MHz:100		5MHz: 25 10MHz: 50 20MHz:100		
Number of consecutive downlink positioning subframes N_{PRS} , N_{PRS} also depends on selected channel bandwidth. As defined in TS 36.211 [16]. The number of subframes in a positioning occasion		5MHz: 2 10MHz: 1 20MHz:1		5MHz: 2 10MHz: 1 20MHz:1		5MHz: 2 10MHz: 1 20MHz:1		5MHz: 2 10MHz: 1 20MHz:1		
PBCH_RA	dB	0		0		0		0		N/A
PBCH_RB										
PSS_RA										
SSS_RA										
PCFICH_RB										

PHICH_RA									
PHICH_RB									
PDCCH_RA									
PDCCH_RB									
OCNG_RA ^{Note 1}									
OCNG_RB ^{Note 1}									
PRS_RA	dB	-6	N/A	N/A	3	N/A	3	3	N/A
N_{oc} ^{Note 3}	dBm/ 15 kHz	-98	-98	-98	-95	-98	-95	-98	-95
$PRS \hat{E}_s/N_{oc}$	dB	-4	-	-	-1	-	-1	-8	-
$PRS \hat{E}_s/I_{ot}$ ^{Note 4}	dB	-4	-	-	-1	-	-1	-8	-
I_o ^{Note 4}	dBm/ 9 MHz	-69.94 +10log ($N_{RB,c}$ /50)	N/A	N/A	-66.68 +10log ($N_{RB,c}$ /50)	N/A	-66.68 +10log ($N_{RB,c}$ /50)	-70.11 +10log ($N_{RB,c}$ /50)	N/A
PRP ^{Note 4}	dBm/ 15 kHz	-102	-	-	-96	-	-96	-106	-
RSRP ^{Note 4}	dBm/ 15 kHz	-96	-96	-105	-99	-105	-99	-109	-
\hat{E}_s/N_{oc} ^{Note 4}	dB	2	2	-7	-4	-7	-4	-11	-
Propagation Condition		ETU30							
<p>Note 1: OCNG shall be used such that active cells (all, except Cell 3 in T3) are fully allocated and a constant total transmitted power spectral density is achieved for all OFDM symbols other than those in the subframes with transmitted PRS.</p> <p>Note 2: The resources for uplink transmission are assigned to the UE prior to the start of time period T2.</p> <p>Note 3: Interference from other cells and noise sources not specified in the test are assumed to be constant over subcarriers and time and shall be modelled as AWGN of appropriate power for N_{oc} to be fulfilled.</p> <p>Note 4: If PRS_RA is not "N/A", \hat{E}_s/N_{oc}, $PRS \hat{E}_s/I_{ot}$, I_o, RSRP and PRP levels have been derived from other parameters and are given for information purpose. If PRS_RA is "N/A", I_o and RSRP levels have been derived from other parameters and are given for information purpose. These are not settable test parameters. Interference conditions shall be applied to all PRS symbols of DL positioning subframes.</p>									

Table A.8.17.10.1-4: DRX parameters for the test of E-UTRAN FDD intra-frequency RSTD measurement reporting delay under fading propagation conditions for carrier aggregation

Field	Value	Comment
onDurationTimer	psf1	As specified in TS 36.331 [2], Clause 6.3.2
Drx-InactivityTimer	psf1	
drx-RetransmissionTimer	sf1	
longDRX-CycleStartOffset	sf320	
shortDRX	Disable	

A.8.17.10.2 Test Requirements

The RSTD measurement time fulfils the requirements specified in Clause 8.4.

In Test 1, the UE shall perform and report the RSTD measurements from Cell 4 and Cell 3 within 2560 ms starting from the beginning of time interval T2.

In Test 2, the UE shall perform and report the RSTD measurements from Cell 1 and Cell 3, RSTD measurements from Cell 2 and Cell 3, and RSTD measurements from Cell 4 and Cell 3 within 4960 ms starting from the beginning of time interval T2.

The rate of the correct events for each neighbour cell observed during repeated tests shall be at least 90%, where the reported RSTD measurement for each correct event shall be within the RSTD reporting range specified in Clause 9.1.10.3, i.e., between RSTD_0000 and RSTD_12711.

NOTE: The RSTD measurement times in the tests are derived from the following expression,

$$T_{PRS}(M-1) + 160 \left\lceil \frac{n}{M} \right\rceil,$$

where $M=8$ and $N=16$ for Test 1, and $M=16$ and $N=16$ for Test 2. For Test 1, the M and N parameters specified in Clause 8.1.2.5.1, Table 8.1.2.5.1-1, under Note 1, which gives the total RSTD measurement time of 2560 ms for Cell 4 with respect to the reference cell Cell 3. For Test 2, the M and N parameters are specified in Clause 8.1.2.6.1, Table 8.1.2.6.1-1, under Note 1, which gives the total RSTD measurement time of 4960 ms for reporting the RSTD measurements of Cell 1, Cell 2 and Cell 4 with respect to the reference cell Cell 3.

A.8.17.11 E-UTRAN 3 DL TDD CA RSTD Measurement Reporting Delay Test Case

A.8.17.11.1 Test Purpose and Environment

The purpose of the test case is to verify that the RSTD measurements meet the requirements specified in Clause 8.4 in a synchronized network environment with fading propagation conditions. This test case will verify the measurement period requirements specified in Clause 8.4.3 for RSTD measurements performed on the same secondary component carrier, the measurement period requirements for RSTD measurements performed on both the primary and secondary component carriers specified in Clause 8.4.4, and also the measurement period requirements for RSTD measurements performed on different secondary component carriers specified in Clause 8.4.5.

In the tests, there are three configured component carriers: PCC, SCC1 and SCC2, and four synchronous cells: Cell 1, Cell 2, Cell 3 and Cell 4. Cell 1 is PCell on the PCC, Cell 2 is SCell on the SCC1, Cell 3 is SCell on the SCC2 and Cell 4 is a neighbour cell on the SCC2. In all tests, Cell 3 is the OTDOA assistance data reference cell.

The test case includes two tests. Test 1 is designed for the scenario where the UE receives OTDOA assistance data with cells only on SCC2, and the UE is expected to report RSTD measurements performed on SCC2 only. Test 2 is designed for the scenario where the UE receives OTDOA assistance data with cells on PCC, SCC1 and SCC2, and the UE is expected to report RSTD measurements performed on PCC, SCC1 and SCC2.

Each test consists of three consecutive time intervals, with duration of T1, T2 and T3. Cell 1 is active in T1, T2 and T3, Cell 2 is active only in T2 and T3, Cell 3 is active only during T2 and T3, and Cell 4 is active only during T2. The beginning of the time interval T2 shall be aligned with the first PRS positioning subframe of a positioning occasion in the OTDOA assistance data reference cell, where the PRS positioning occasion is as defined in Clause 8.1.2.5.1. Cell 1 transmits PRS in T2, Cell 2 transmits PRS only in T3, and Cell 3 transmits PRS only in T3, and Cell 4 transmits PRS only in T2.

Note: The information on when PRS is muted is conveyed to the UE using PRS muting information.

The OTDOA assistance data as defined in TS 36.355, Clause 6.5.1.1, shall be provided to the UE during T1. The last TTI containing the OTDOA assistance data shall be provided to the UE ΔT ms before the start of T2, where $\Delta T = 150$ ms is the maximum processing time of the OTDOA assistance data.

The test parameters are as given in Table A.8.17.11.1-1, Table A.8.17.11.1-2, Table A.8.17.11.1-3 and Table A.8.17.11.1-4.

Table A.8.17.11.1-1: General test parameters for E-UTRAN TDD RSTD measurement reporting delay under fading propagation conditions for carrier aggregation

Parameter	Unit	Value		Comment
		Test 1	Test 2	
PCell		Cell 1		PCell is on RF channel 1 (PCC).
SCell 1		Cell 2		SCell 1 on RF channel 2 (SCC1).

SCell 2		Cell 3	SCell 2 on RF channel 3 (SCC2). Cell 3 is the assistance data reference cell.
Other neighbor cell		Cell 4	Neighbor cell on RF channel 3 (SCC2).
Channel Bandwidth (BW _{channel})	MHz	5MHz or 10MHz or 20MHz	All channels in a test have the same bandwidth.
PRS configuration index I_{PRS}		174 for all cells on PCC 184 for all cells on SCC1 194 for all cells on SCC2	This corresponds to periodicity of 320 ms and PRS subframe offset of $I_{PRS} - 160$ DL subframes, as defined in TS 36.211 [16], Table 6.10.4.3-1
Physical cell ID PCI		(PCI of Cell 3 – PCI of Cell 4) mod 6 = 0	The PCIs of Cell 1 and Cell 2 are selected randomly. PCIs of Cell 3 and Cell 4 are selected randomly such that the relative subcarrier shifts of PRS patterns among these cells are as given by the condition
TDD uplink-downlink configuration		1	As specified in TS 36.211 [16], Clause 4.2; corresponds to a configuration with 5 ms switch-point periodicity and two downlink consecutive subframes
TDD special subframe configuration		6	As specified in TS 36.211 [16], Clause 4.2; corresponds to DwPTS of $19760 \cdot T_s$ and UpPTS of $4384 \cdot T_s$
CP length		Normal	
DRX		ON	DRX parameters are further specified in Table A.8.17.11.1-3
Radio frame receive time offset between the cells at the UE antenna connector	μs	Cell 1 to Cell 3: 1 Cell 2 to Cell 3: -1 Cell 4 to Cell 3: 3	PRS are transmitted from synchronous cells
Time alignment errors among cell1, cell2 and cell3	μs	\leq Time alignment error as specified in 3GPP TS 36.104 [30] clause 6.5.3.1.	The value of time alignment error depends upon the type of carrier aggregation.
Expected RSTD	μs	Cell 4: 2 Other neighbour cells: randomly between -3 and 3	The expected RSTD is what is expected at the receiver. The corresponding parameter in the OTDOA assistance data specified in TS 36.355 [24] is the expectedRSTD indicator
Expected RSTD uncertainty for all neighbour cells	μs	5	The corresponding parameter in the OTDOA assistance data specified in TS 36.355 [24] is the expectedRSTD-Uncertainty index
Cells in OTDOA assistance data		16 cells in total	The list includes the reference cell (received in OTDOA-

		OTDOA neighbor cells include Cell 4 and other 14 cells on SCC2	OTDOA neighbor cells include Cell 1 and other 3 cells on PCC, Cell 2 and other 3 cells on SCC1 and Cell 4 and other 6 cells on SCC2	<i>ReferenceCellInfo</i> [24]) and 15 other cells, all received in <i>OTDOA-ProvideAssistanceData</i> [24]. Cell 1 and Cell 2 (when included) appears at random places in the first half of the neighbour cell list in the OTDOA assistance data. Cell 4 always appears at random places in the second half of the list.
prs-SubframeOffset		Cells on PCC: 300 Cells on SCC1: 310 Cells on SCC2, except reference cell: 0		Subframe offset, counted in full subframes. The corresponding parameter in the OTDOA assistance data is prs-SubframeOffset specified in TS 36.355 [24]
slotNumberOffset		Cells on PCC: 0 Cells on SCC1: 0 Cells on SCC2, except reference cell: 0		The slot number offset at the transmitter between a neighbour cell and the assistance data reference cell. The corresponding parameter in the OTDOA assistance data is slotNumberOffset specified in TS 36.355 [24].
PRS muting info		Cell 1: '11110000' Cell 2: '00001111' Cell 3: '11110000' Cell 4: '00001111'	Cell 1: '1111111100000000' Cell 2: '0000000011111111' Cell 3: '1111111100000000' Cell 4: '0000000011111111'	Corresponds to prs-MutingInfo defined in TS 36.355 [24]
T1	s	3		The length of the time interval from the beginning of each test
T2	s	1.28	2.48	The length of the time interval that follows immediately after time interval T1
T3	s	1.28	2.48	The length of the time interval that follows immediately after time interval T2

Table A.8.17.11.1-2: Cell-specific test parameters for E-UTRAN TDD RSTD measurement reporting delay under fading propagation conditions during T1 for carrier aggregation

Parameter	Unit	Cell 1	Cell 2	Cell 3	Cell 4
E-UTRA RF Channel Number		1	N/A	N/A	N/A
Channel Bandwidth (BW _{channel})	MHz	5,10,20	N/A	N/A	N/A
Correlation Matrix and Antenna Configuration		1x2 Low	1x2 Low	1x2 Low	1x2 Low

PCFICH/PDCCH/PHICH parameters as specified in clause A.3.1.2.1		5MHz: R11 TDD 10MHz: R6 TDD 20MHz: R10 TDD	N/A	N/A	N/A
OCNG patterns defined in A.3.2.2		5MHz: OP.10 TDD 10MHz: OP.1 TDD 20MHz: OP.7 TDD	N/A	N/A	N/A
PBCH_RA	dB	0	N/A	N/A	N/A
PBCH_RB					
PSS_RA					
SSS_RA					
PCFICH_RB					
PHICH_RA					
PHICH_RB					
PDCCH_RA					
PDCCH_RB					
OCNG_RA ^{Note 1}					
OCNG_RB ^{Note 1}					
N_{oc} ^{Note 3}	dBm/ 15 kHz	-95	N/A	N/A	N/A
$PRS \hat{E}_s / N_{oc}$	dB	-Infinity	-Infinity	-Infinity	-Infinity
I_o ^{Note 4}	dBm/ 9 MHz	-67.22 +10log ($N_{RB,c} / 50$)	N/A	N/A	N/A
\hat{E}_s / N_{oc}	dB	0	-Infinity	-Infinity	-Infinity
Propagation Condition		ETU30			
<p>Note 1: OCNG shall be used such that active cell (Cell 1) is fully allocated and a constant total transmitted power spectral density is achieved for all OFDM symbols.</p> <p>Note 2: The resources for uplink transmission are assigned to the UE prior to the start of time period T2.</p> <p>Note 3: Interference from other cells and noise sources not specified in the test are assumed to be constant over subcarriers and time and shall be modelled as AWGN of appropriate power for N_{oc} to be fulfilled.</p> <p>Note 4: I_o levels have been derived from other parameters and are given for information purpose. These are not settable test parameters.</p>					

Table A.8.17.11.1-3: Cell-specific test parameters for E-UTRAN TDD RSTD measurement reporting delay under fading propagation conditions during T2 and T3 for carrier aggregation

Parameter	Unit	Cell 1		Cell 2		Cell 3		Cell 4	
		T2	T3	T2	T3	T2	T3	T2	T3
E-UTRA RF Channel Number		1		2		3		3	
Correlation Matrix and Antenna Configuration		1x2 Low		1x2 Low		1x2 Low		1x2 Low	
Channel Bandwidth ($BW_{channel}$)	MHz	5,10,20		5,10,20		5,10,20		5,10,20	

PCFICH/PDCCH/PHICH parameters as specified in clause A.3.1.2.1		5MHz: R11 TDD 10MHz: R6 TDD 20MHz: R10 TDD	5MHz: R11 TDD 10MHz: R6 TDD 20MHz: R10 TDD	5MHz: R11 TDD 10MHz: R6 TDD 20MHz: R10 TDD	5MHz: R11 TDD 10MHz: R6 TDD 20MHz: R10 TDD	N/A			
OCNG patterns defined in A.3.2.1		5MHz: OP.10 TDD 10MHz: OP.1 TDD 20MHz: OP.7 TDD	5MHz: OP.10 TDD 10MHz: OP.1 TDD 20MHz: OP.7 TDD	5MHz: OP.10 TDD 10MHz: OP.1 TDD 20MHz: OP.7 TDD	5MHz: OP.10 TDD 10MHz: OP.1 TDD 20MHz: OP.7 TDD	N/A			
PRS Transmission Bandwidth (PRS transmission bandwidth depends on selected channel bandwidth. PRS are transmitted over the system bandwidth)	RB	5MHz: 25 10MHz: 50 20MHz:100	5MHz: 25 10MHz: 50 20MHz:100	5MHz: 25 10MHz: 50 20MHz:100	5MHz: 25 10MHz: 50 20MHz:100	N/A			
Number of consecutive downlink positioning subframes N_{PRS} . N_{PRS} also depends on selected channel bandwidth. As defined in TS 36.211 [16]. The number of subframes in a positioning occasion		5MHz: 2 10MHz: 1 20MHz:1	5MHz: 2 10MHz: 1 20MHz:1	5MHz: 2 10MHz: 1 20MHz:1	5MHz: 2 10MHz: 1 20MHz:1	N/A			
PBCH_RA	dB	0	0	0	0	N/A			
PBCH_RB									
PSS_RA									
SSS_RA									
PCFICH_RB									
PHICH_RA									
PHICH_RB									
PDCCH_RA									
PDCCH_RB									
OCNG_RA ^{Note 1}									
OCNG_RB ^{Note 1}									
PRS_RA	dB	-6	N/A	N/A	3	N/A	3	3	N/A
N_{oc} ^{Note 3}	dBm/ 15 kHz	-98	-98	-98	-95	-98	-95	-98	-95
PRS \hat{E}_s/N_{oc}	dB	-4	-	-	-1	-	-1	-8	-
PRS \hat{E}_s/I_{ot} ^{Note 4}	dB	-4	-	-	-1	-	-1	-8	-
I_o ^{Note 4}	dBm/ 9 MHz	-69.94 +10log ($N_{RB,c}$ /50)	N/A	N/A	-66.68 +10log ($N_{RB,c}$ /50)	N/A	-66.68 +10log ($N_{RB,c}$ /50)	-70.11 +10log ($N_{RB,c}$ /50)	N/A
PRP ^{Note 4}	dBm/ 15 kHz	-102	-	-	-96	-	-96	-106	-

RSRP ^{Note 4}	dBm/ 15 kHz	-96	-96	-105	-99	-105	-99	-109	- Infinity
\hat{E}_s/N_{oc} ^{Note 4}	dB	2	2	-7	-4	-7	-4	-11	- Infinity
Propagation Condition		ETU30							
<p>Note 1: OCNG shall be used such that active cells (all, except Cell 3 in T3) are fully allocated and a constant total transmitted power spectral density is achieved for all OFDM symbols other than those in the subframes with transmitted PRS.</p> <p>Note 2: The resources for uplink transmission are assigned to the UE prior to the start of time period T2.</p> <p>Note 3: Interference from other cells and noise sources not specified in the test are assumed to be constant over subcarriers and time and shall be modelled as AWGN of appropriate power for N_{oc} to be fulfilled.</p> <p>Note 4: If PRS_RA is not "N/A", \hat{E}_s/N_{oc}, PRS \hat{E}_s/I_{ot}, lo, RSRP and PRP levels have been derived from other parameters and are given for information purpose. If PRS_RA is "N/A", lo and RSRP levels have been derived from other parameters and are given for information purpose. These are not settable test parameters. Interference conditions shall be applied to all PRS symbols of DL positioning subframes.</p>									

Table A.8.17.11.1-4: DRX parameters for the test of E-UTRAN TDD intra-frequency RSTD measurement reporting delay under fading propagation conditions for carrier aggregation

Field	Value	Comment
onDurationTimer	psf1	As specified in TS 36.331 [2], Clause 6.3.2
Drx-InactivityTimer	psf1	
drx-RetransmissionTimer	sf1	
longDRX-CycleStartOffset	sf320	
shortDRX	Disable	

A.8.17.11.2 Test Requirements

The RSTD measurement time fulfils the requirements specified in Clause 8.4.

In Test 1, the UE shall perform and report the RSTD measurements from Cell 4 and Cell 3 within 2560 ms starting from the beginning of time interval T2.

In Test 2, the UE shall perform and report the RSTD measurements from Cell 1 and Cell 3, RSTD measurements from Cell 2 and Cell 3, and RSTD measurements from Cell 4 and Cell 3 within 4960 ms starting from the beginning of time interval T2.

The rate of the correct events for each neighbour cell observed during repeated tests shall be at least 90%, where the reported RSTD measurement for each correct event shall be within the RSTD reporting range specified in Clause 9.1.10.3, i.e., between RSTD_0000 and RSTD_12711.

NOTE: The RSTD measurement times in the tests are derived from the following expression,

$$T_{PRS}(M-1) + 160 \left\lceil \frac{n}{M} \right\rceil,$$

where $M=8$ and $n=16$ for Test 1, and $M=16$ and $n=16$ for Test 2. For Test 1, the M and n parameters specified in Clause 8.1.2.5.1, Table 8.1.2.5.1-1, under Note 1, which gives the total RSTD measurement time of 2560 ms for Cell 4 with respect to the reference cell Cell 3. For Test 2, the M and n parameters are specified in Clause 8.1.2.6.1, Table 8.1.2.6.1-1, under Note 1, which gives the total RSTD measurement time of 4960 ms for reporting the RSTD measurements of Cell 1, Cell 2 and Cell 4 with respect to the reference cell Cell 3.

A.8.18 E-UTRAN TDD – HRPD Measurements

A.8.18.1 E-UTRAN TDD-HRPD event triggered reporting under fading propagation conditions

A.8.18.1.1 Test Purpose and Environment

The purpose of this test is to verify that the UE makes correct reporting of an event. This test will partly verify the E-UTRAN TDD- HRPD cell search requirements in clause 8.1.2.4.12.

The test parameters are given in Tables A.8.18.1.1-1, A.8.18.1.1-2 and A.8.18.1.1-3 below. In the measurement control information it is indicated to the UE that event-triggered reporting with Event B1 is used. The test consists of two successive time periods, with time duration of T1, and T2 respectively. During time duration T1, the UE shall not have any timing information of cell 2.

Table A.8.18.1.1-1: General test parameters for E-UTRAN TDD to HRPD event triggered reporting under fading propagation conditions

Parameter	Unit	Value	Comment
PDSCH parameters		DL Reference Measurement Channel R.0 TDD	As specified in clause A.3.1.1.2
PCFICH/PDCCH/PHICH parameters		DL Reference Measurement Channel R.6 TDD	As specified in clause A.3.1.2.2
Active cell		Cell 1	E-UTRAN TDD cell
Neighbouring cell		Cell 2	HRPD cell
Gap Pattern Id		1	As specified in TS 36.133 clause 8.1.2.1.
E-UTRAN TDD measurement quantity		RSRP	
Inter-RAT (HRPD) measurement quantity		CDMA2000 HRPD Pilot Strength	
b1-ThresholdCDMA2000	dB	-7	Absolute 'CDMA2000 HRPD Pilot Strength' threshold for event B1
Hysteresis	dB	0	
TimeToTrigger	s	0	
Filter coefficient		0	L3 filtering is not used
DRX		OFF	Non-DRX test
Access Barring Information	-	Not sent	No additional delays in random access procedure
E-UTRA RF Channel Number		1	One E-UTRA TDD carrier frequency is used.
E-UTRA Channel Bandwidth (BW _{channel})	MHz	10	
Uplink-downlink configuration of cell 1		1	As specified in table 4.2.2 in TS 36.211
Special subframe configuration of cell 1		6	As specified in table 4.2.1 in TS 36.211
HRPD RF Channel Number		1	One HRPD carrier frequency is used.
HRPD neighbour cell list size		8	HRPD cells on HRPD RF channel 1 provided in the cell list before T2.
cdma2000-SearchWindowSize		8 (60 PN chips)	Search window size as defined in clause 6.3.5 in TS 36.331
T1	s	5	
T2	s	3	

Table A.8.18.1.1-2: Cell specific test parameters for E-UTRAN TDD cell#1 for event triggered reporting under fading propagation conditions

Parameter	Unit	Cell 1 (E-UTRA)	
		T1	T2
E-UTRA RF Channel number		1	
BW _{channel}	MHz	10	

Correlation Matrix and Antenna Configuration		1x2 Low	
OCNG Patterns defined in TS36.133 A.3.2.2.1 (OP.1 TDD)		OP.1 TDD	
PBCH_RA	dB	0	
PBCH_RB	dB		
PSS_RA	dB		
SSS_RA	dB		
PCFICH_RB	dB		
PHICH_RA	dB		
PHICH_RB	dB		
PDCCH_RA	dB		
PDCCH_RB	dB		
PDSCH_RA	dB		
PDSCH_RB	dB		
OCNG_RA ^{Note 1}	dB		
OCNG_RB ^{Note 1}	dB		
N_{oc} ^{Note 2}	dBm/15 kHz	-98	
RSRP ^{Note 3}	dBm/15 KHz	-98	-98
\hat{E}_s / N_{oc}	dB	0	0
\hat{E}_s / I_{ot}	dB	0	0
Propagation Condition		ETU70	
<p>Note 1: OCNG shall be used such that both cells are fully allocated and a constant total transmitted power spectral density is achieved for all OFDM symbols.</p> <p>Note 2: Interference from other cells and noise sources not specified in the test is assumed to be constant over subcarriers and time and shall be modelled as AWGN of appropriate power for N_{oc} to be fulfilled.</p> <p>Note 3: RSRP levels have been derived from other parameters for information purposes. They are not settable parameters themselves.</p>			

Table A.8.18.1.1-3: Cell specific test parameters for HRPD (cell # 2) for event triggered reporting under fading propagation conditions

Parameter	Unit	Cell 2 (HRPD)	
		T1	T2
$\frac{\text{Control } E_b}{N_t}$ (38.4 kbps)	dB	21	
$\frac{\text{Control } E_b}{N_t}$ (76.8 kbps)	dB	18	
\hat{I}_{or} / I_{oc}	dB	-infinity	0
I_{oc}	dBm/1.2288 MHz	-55	
CDMA2000 HRPD Pilot Strength	dB	-infinity	-3
Propagation Condition		ETU70	

A.8.18.1.2 Test Requirements

The UE shall send one Event B1 triggered measurement report, with a measurement reporting delay less than 2134 ms from the beginning of time period T2.

The UE shall not send event triggered measurement reports, as long as the reporting criteria are not fulfilled.

The rate of correct events observed during repeated tests shall be at least 90%.

NOTE: The actual overall delays measured in the test may be up to $2 \times TTI_{DCCH}$ higher than the measurement reporting delays above because of TTI insertion uncertainty of the measurement report in DCCH.

A.8.19 E-UTRAN TDD – CDMA2000 1X Measurements

A.8.19.1 E-UTRAN TDD – CDMA2000 1X event triggered reporting under fading propagation conditions

A.8.19.1.1 Test Purpose and Environment

The purpose of this test is to verify that the UE makes correct reporting of an event. This test will partly verify the E-UTRAN TDD- CDMA2000 1X cell search requirements in clause 8.1.2.4.10.

The test parameters are given in Tables A.8.19.1.1-1, A.8.19.1.1-2 and A.8.19.1.1-3 below. In the measurement control information it is indicated to the UE that event-triggered reporting with Event B1 is used. The test consists of two successive time periods, with time duration of T1, and T2 respectively. During time duration T1, the UE shall not have any timing information of cell 2.

Table A.8.19.1.1-1: General test parameters for E-UTRAN TDD-CDMA2000 1X event triggered reporting in fading propagation conditions

Parameter	Unit	Value	Comment
PDSCH parameters (E-UTRAN TDD)		DL Reference Measurement Channel R.0 TDD	As specified in clause A.3.1.1.2.
PCFICH/PDCCH/PHICH parameters (E-UTRAN TDD)		DL Reference Measurement Channel R.6 TDD	As specified in clause A.3.1.2.2.
Gap Pattern Id		1	As specified in TS 36.133 clause 8.1.2.1.
Active cell		Cell 1	Cell 1 is on E-UTRA RF channel number 1.
Neighbour cell		Cell 2	Cell 2 is on CDMA2000 1X RF channel number 1.
Special subframe configuration		6	As specified in table 4.2-1 in TS 36.211. Applicable to cell 1.
Uplink-downlink configuration		1	As specified in table 4.2-2 in TS 36.211. Applicable to cell 1.
CP length		Normal	Applicable to cell 1.
E-UTRA RF Channel Number		1	One E-UTRA TDD carrier frequency is used.
E-UTRA Channel Bandwidth ($BW_{channel}$)	MHz	10	
CDMA2000 1X Channel Number		1	One CDMA2000 1X carrier frequency is used.
Inter-RAT (CDMA2000 1X) measurement quantity		CDMA2000 1xRTT Pilot Strength	
B1-Threshold-CDMA2000	dB	-14	Absolute 'CDMA2000 1xRTT Pilot Strength' threshold for event B1
Hysteresis	dB	0	
Time To Trigger	ms	0	
Filter coefficient		0	L3 filtering is not used.
DRX		OFF	
cdma2000 1X neighbour cell list size		8	cdma2000 1X cells on cdma2000 1X RF channel 1 provided in the cell list before T2.
cdma2000-SearchWindowSize		8 (60 PN chips)	Search window size as defined in clause 6.3.5 in TS 36.331
T1	s	5	
T2	s	3	

Table A.8.19.1.1-2: Cell specific test parameters for E-UTRAN TDD (cell # 1) for event triggered reporting of CDMA2000 1X cell under fading propagation conditions

Parameter	Unit	Cell 1	
		T1	T2
E-UTRA RF Channel Number		1	
$BW_{channel}$	MHz	10	
Correlation Matrix and Antenna Configuration		1x2 Low	

OCNG Pattern defined in A.3.2.2.1 (OP.1 TDD)		OP.1 TDD	
PBCH_RA	dB	0	
PBCH_RB	dB		
PSS_RA	dB		
SSS_RA	dB		
PCFICH_RB	dB		
PHICH_RA	dB		
PHICH_RB	dB		
PDCCH_RA	dB		
PDCCH_RB	dB		
PDSCH_RA	dB		
PDSCH_RB	dB		
OCNG_RA ^{Note 1}	dB		
OCNG_RB ^{Note 1}	dB		
\hat{E}_s/I_{ot}	dB		
\hat{E}_s/N_{oc}	dB	4	4
N_{oc}	dBm/15 kHz	-98	
RSRP	dBm/15 kHz	-94	-94
SCH_RP	dBm/15 kHz	-94	-94
Propagation Condition		ETU70	
Note 1: OCNG shall be used such that both cells are fully allocated and a constant total transmitted power spectral density is achieved for all OFDM symbols.			
Note 2: The resources for uplink transmission are assigned to the UE prior to the start of time period T2.			

Table A.8.19.1.1-3: Cell specific test parameters for CDMA2000 1X (cell # 2) for event triggered reporting of CDMA2000 1X cell under fading propagation conditions

Parameter	Unit	Cell 2 (cdma2000 1X)	
		T1	T2
$\frac{Pilot E_c}{I_{or}}$	dB	-7	
$\frac{Sync E_c}{I_{or}}$	dB	-16	
$\frac{Paging E_c}{I_{or}}$ (4.8 kbps)	dB	-12	
\hat{I}_{or}/I_{oc}	dB	-infinity	0
I_{oc}	dBm/1.2288 MHz	-55	
CDMA2000 1xRTT Pilot Strength	dB	-infinity	-10
Propagation Condition		ETU70	

A.8.19.1.2 Test Requirements

The UE shall send one Event B1 triggered measurement report, with a measurement reporting delay less than 2134 ms from the beginning of time period T2.

The UE shall not send event triggered measurement reports, as long as the reporting criteria are not fulfilled.

The rate of correct events observed during repeated tests shall be at least 90%.

NOTE: The actual overall delays measured in the test may be up to 2xTTIDCCH higher than the measurement reporting delays above because of TTI insertion uncertainty of the measurement report in DCCH.

A.8.20 Inter-frequency/RAT Measurements in CA mode

A.8.20.1 E-UTRAN FDD-FDD Inter-frequency event triggered reporting under fading propagation conditions in asynchronous cells

It is not necessary for CA UEs to be tested in A.8.3.1 if this case is done.

A.8.20.1.1 Test Purpose and Environment

The purpose of this test is to verify that the UE makes correct reporting of an event. This test will partly verify the FDD-FDD inter-frequency cell search requirements in clause 8.1.2.3.

The test parameters are given in Tables A.8.20.1.1-1 and A.8.20.1.1-2. In this test, there are three cells on different carrier frequencies and gap pattern configuration # 0 as defined in Table 8.1.2.1-1 is provided.

In the measurement control information, it is indicated to the UE that event-triggered reporting with Event A3 is used. The test consists of two successive time periods, with time duration of T1, and T2 respectively. During time duration T1, the UE shall not have any timing information of cell 2.

Table A.8.20.1.1-1: General test parameters for E-UTRAN FDD-FDD inter-frequency event triggered reporting in fading propagation conditions

Parameter	Unit	Value	Comment
PDSCH parameters		DL Reference Measurement Channel R.0 FDD	As specified in clause A.3.1.1.1
PCFICH/PDCCH/PHICH parameters		DL Reference Measurement Channel R.6 FDD	As specified in clause A.3.1.2.1
E-UTRA RF Channel Number		1, 2	Two FDD carrier frequencies are used.
E-UTRA RF Channel Number for Scell		3	One FDD carrier frequencies is used
Channel Bandwidth (BW _{channel})	MHz	10	
Active cell		Cell 1	Cell 1 is on RF channel number 1
Neighbour cell		Cell 2	Cell 2 is on RF channel number 2
Configured active Scell		Cell 3	Cell 3 is on RF channel number 3
Gap Pattern Id		0	As specified in TS 36.133 clause 8.1.2.1.
A3-Offset	dB	-6	
Hysteresis	dB	0	
CP length		Normal	
TimeToTrigger	s	0	
Filter coefficient		0	L3 filtering is not used
DRX		OFF	OFF
Cell2 timing offset to cell1	ms	3	Asynchronous cells
Cell3 timing offset to cell1	μs	0	Synchronous cells
Time alignment error between cell3 and cell1	μs	≤ Time alignment error as specified in 3GPP TS 36.104 [30] clause 6.5.3.1.	The value of time alignment error depends upon the type of carrier aggregation.
T1	s	5	
T2	s	5	

Table A.8.20.1.1-2: Cell specific test parameters for E-UTRAN FDD-FDD inter-frequency event triggered reporting under fading propagation conditions in synchronous cells

Parameter	Unit	Cell 1		Cell 2		Cell 3	
		T1	T2	T1	T2	T1	T2
E-UTRA RF Channel Number		1		2		3	
BW _{channel}	MHz	10		10		10	
Correlation Matrix and Antenna Configuration		1x2 Low		1x2 Low		1x2 Low	

OCNG Patterns defined in A.3.2.1.1 (OP.1 FDD) and in A.3.2.1.2 (OP.2 FDD)		OP.1 FDD		OP.2 FDD		OP.1 FDD	
PBCH_RA	dB	0		0		0	
PBCH_RB	dB						
PSS_RA	dB						
SSS_RA	dB						
PCFICH_RB	dB						
PHICH_RA	dB						
PHICH_RB	dB						
PDCCH_RA	dB						
PDCCH_RB	dB						
PDSCH_RA	dB						
PDSCH_RB	dB						
OCNG_RA ^{Note 1}	dB						
OCNG_RB ^{Note 1}	dB						
N_{oc} ^{Note 3}	dBm/15 kHz	-98					
RSRP ^{Note 4}	dBm/15 kHz	-94	-94	-Infinity	-91	-94	-94
\hat{E}_s/I_{α}	dB	4	4	-Infinity	7	4	4
SCH_RP ^{Note 4}	dBm/15 kHz	-94	-94	-Infinity	-91	-94	-94
\hat{E}_s/N_{oc}	dB	4	4	-Infinity	7	4	4
Propagation Condition		ETU70					
<p>Note 1: OCNG shall be used such that both cells are fully allocated and a constant total transmitted power spectral density is achieved for all OFDM symbols.</p> <p>Note 2: The resources for uplink transmission are assigned to the UE prior to the start of time period T2.</p> <p>Note 3: Interference from other cells and noise sources not specified in the test is assumed to be constant over subcarriers and time and shall be modelled as AWGN of appropriate power for N_{oc} to be fulfilled.</p> <p>Note 4: RSRP and SCH_RP levels have been derived from other parameters for information purposes. They are not settable parameters themselves.</p>							

A.8.20.1.2 Test Requirements

The UE shall send one Event A3 triggered measurement report, with a measurement reporting delay less than 3840 ms from the beginning of time period T2.

The UE shall not send event triggered measurement reports, as long as the reporting criteria are not fulfilled.

The rate of correct events observed during repeated tests shall be at least 90%.

NOTE: The actual overall delays measured in the test may be up to $2 \times TTI_{DCCH}$ higher than the measurement reporting delays above because of TTI insertion uncertainty of the measurement report in DCCH.

A.8.20.2 E-UTRAN TDD-TDD Inter-frequency event triggered reporting under fading propagation conditions in synchronous cells

It is not necessary for CA UEs to be tested in A.8.4.1 if this case is done.

A.8.20.2.1 Test Purpose and Environment

The purpose of this test is to verify that the UE makes correct reporting of an event. This test will partly verify the TDD-TDD inter-frequency cell search requirements in clause 8.1.2.3.4.

The test parameters are given in Table A.8.20.2.1-1 and A.8.20.2.1-2 below. In the measurement control information it is indicated to the UE that event-triggered reporting with Event A3 is used. The test consists of two successive time periods, with time duration of T1, and T2 respectively. During time duration T1, the UE shall not have any timing information of cell 2.

Table A.8.20.2.1-1: General test parameters for E-UTRAN TDD-TDD inter-frequency event triggered reporting in fading propagation conditions

Parameter	Unit	Value	Comment
PDSCH parameters		DL Reference Measurement Channel R.0 TDD	As specified in clause A.3.1.1.2
PCFICH/PDCCH/PHICH parameters		DL Reference Measurement Channel R.6 TDD	As specified in clause A.3.1.2.2
Gap Pattern Id		1	As specified in TS 36.133 clause 8.1.2.1.
Special subframe configuration		6	As specified in table 4.2-1 in TS 36.211. The same configuration in both cells
Uplink-downlink configuration		1	As specified in TS 36.211 clause 4.2 Table 4.2-2
CP length		Normal	
E-UTRA RF Channel Number		1, 2	Two TDD carrier frequencies are used.
E-UTRA RF Channel Number for Scell		3	One TDD carrier frequencies is used
Channel Bandwidth (BW _{channel})	MHz	10	
Active cell		Cell 1	Cell 1 is on RF channel number 1
Neighbour cell		Cell 2	Cell 2 is on RF channel number 2
Configured active Scell		Cell 3	Cell 3 is on RF channel number 3
A3-Offset	dB	-6	
Hysteresis	dB	0	
TimeToTrigger	s	0	
Filter coefficient		0	L3 filtering is not used
DRX		OFF	
Cell2 timing offset to cell1	μs	3	Synchronous cells
Cell3 timing offset to cell1	μs	0	Synchronous cells
Time alignment error between cell3 and cell1	μs	≤ Time alignment error as specified in 3GPP TS 36.104 [30] clause 6.5.3.1.	The value of time alignment error depends upon the type of carrier aggregation.
T1	s	5	
T2	s	10	

Table A.8.20.2.1-2: Cell specific test parameters for E-UTRAN TDD-TDD inter-frequency event triggered reporting under fading propagation conditions in synchronous cells

Parameter	Unit	Cell 1		Cell 2		Cell 3	
		T1	T2	T1	T2	T1	T2
E-UTRA RF Channel Number		1		2		3	
$BW_{channel}$	MHz	10		10		10	
Correlation Matrix and Antenna Configuration		1x2 Low		1x2 Low		1x2 Low	
OCNG Pattern defined in A.3.2.2.1 (OP.1 TDD) and in A.3.2.2.2 (OP.2)		OP.1 TDD		OP.2 TDD		OP.1 TDD	
PBCH_RA	dB	0		0		0	
PBCH_RB	dB						
PSS_RA	dB						
SSS_RA	dB						
PCFICH_RB	dB						
PHICH_RA	dB						
PHICH_RB	dB						
PDCCH_RA	dB						
PDCCH_RB	dB						
PDSCH_RA	dB						
PDSCH_RB	dB						
OCNG_RA ^{Note 1}	dB						
OCNG_RB ^{Note 1}	dB						
\hat{E}_s / I_{ot}	dB						
N_{oc} ^{Note 3}	dBm/15 kHz	-98					
RSRP ^{Note 4}	dBm/15 kHz	-94	-94	-Infinity	-91	-94	-94
SCH_RP ^{Note 4}	dBm/15 kHz	-94	-94	-infinity	-91	-94	-94
\hat{E}_s / N_{oc}	dB	4	4	-Infinity	7	4	4
Propagation Condition		ETU70					
<p>Note 1: OCNG shall be used such that both cells are fully allocated and a constant total transmitted power spectral density is achieved for all OFDM symbols.</p> <p>Note 2: The resources for uplink transmission are assigned to the UE priori to the start of time period T2.</p> <p>Note 3: Interference from other cells and noise sources not specified in the test is assumed to be constant over subcarriers and time and shall be modelled as AWGN of appropriate power for N_{oc} to be fulfilled.</p> <p>Note 4: RSRP and SCH_RP levels have been derived from other parameters for information purposes. They are not settable parameters themselves.</p>							

A.8.20.2.2 Test Requirements

The UE shall send one Event A3 triggered measurement report, with a measurement reporting delay less than 7680 ms from the beginning of time period T2.

The UE shall not send event triggered measurement reports, as long as the reporting criteria are not fulfilled.

The rate of correct events observed during repeated tests shall be at least 90%.

NOTE: The actual overall delays measured in the test may be up to $2 \times TTI_{DCCH}$ higher than the measurement reporting delays above because of TTI insertion uncertainty of the measurement report in DCCH.

A.8.20.2A E-UTRAN TDD-TDD Inter-frequency event triggered reporting under fading propagation conditions in synchronous cells for 20 MHz +20 MHz bandwidth.

A.8.20.2A.1 Test Purpose and Environment

The purpose of this test case is the same as for the test defined in subclause A.8.20.2. The test parameters are the same except those described in the following section. The listed parameter values in Tables A.8.20.2A.1-1 and A.8.20.2A.1-2 will replace the values of corresponding parameters in Tables A.8.20.2.1-1 and A.8.20.2.1-2.

Table A.8.20.2A.1-1: General test parameters for E-UTRAN TDD-TDD Inter-frequency event triggered reporting under fading propagation conditions in synchronous cells for 20 MHz +20 MHz bandwidth

Parameter	Unit	Value	Comment
PDSCH parameters		DL Reference Measurement Channel R.3 TDD	As specified in clause A.3.1.1.2
PCFICH/PDCCH/PHICH parameters		DL Reference Measurement Channel R.10 TDD	As specified in clause A.3.1.2.2
Channel Bandwidth (BW _{channel})	MHz	20	
Note 1:	See Table A.8.20.2.1-1 for other general test parameters.		
Note 2:	This test verifies the RRM requirement which is independent of channel bandwidth and is performed according to the principle defined in section A.3.6.1.		

Table A.8.20.2A.1-2: Cell specific test parameters for E-UTRAN TDD-TDD Inter-frequency event triggered reporting under fading propagation conditions in synchronous cells for 20 MHz +20 MHz bandwidth

Parameter	Unit	Cell 1		Cell 2		Cell 3	
		T1	T2	T1	T2	T1	T2
BW _{channel}	MHz	20		20		20	
OCNG Pattern defined in A.3.2.2		OP.7 TDD		OP.8 TDD		OP.7 TDD	
Note 1:	See Table A.8.20.2.1-1 for other general test parameters.						

A.8.20.2A.2 Test Requirements

The test requirements defined in section A.8.20.2.2 shall apply to this test case.

A.8.20.2B E-UTRAN TDD-TDD Inter-frequency event triggered reporting under fading propagation conditions in synchronous cells for 20 MHz +10 MHz bandwidth.

A.8.20.2B.1 Test Purpose and Environment

The purpose of this test case is the same as for the test defined in subclause A.8.20.2.

The test parameters given in Tables A.8.20.2B.1-1 and A.8.20.2B.1-2 below. In the measurement control information it is indicated to the UE that event-triggered reporting with Event A3 is used. The test consists of two successive time periods, with time duration of T1, and T2 respectively. During time duration T1, the UE shall not have any timing information of cell 2.

Table A.8.20.2B.1-1: General test parameters for E-UTRAN TDD-TDD Inter-frequency event triggered reporting under fading propagation conditions in synchronous cells for 20 MHz +10 MHz bandwidth

Parameter	Unit	Value	Comment
Gap Pattern Id		1	As specified in TS 36.133 clause 8.1.2.1.
Special subframe configuration		6	As specified in table 4.2-1 in TS 36.211. The same configuration in both cells

Uplink-downlink configuration		1	As specified in TS 36.211 clause 4.2 Table 4.2-2
CP length		Normal	
E-UTRA RF Channel Number		1, 2	Two TDD carrier frequencies are used.
E-UTRA RF Channel Number for Scell		3	One TDD carrier frequencies is used
Active cell		Cell 1	Cell 1 is on RF channel number 1
Neighbour cell		Cell 2	Cell 2 is on RF channel number 2
Configured active Scell		Cell 3	Cell 3 is on RF channel number 3
A3-Offset	dB	-6	
Hysteresis	dB	0	
TimeToTrigger	s	0	
Filter coefficient		0	L3 filtering is not used
DRX		OFF	
Cell2 timing offset to cell1	μs	3	Synchronous cells
Cell3 timing offset to cell1	μs	0	Synchronous cells
Time alignment error between cell3 and cell1	μs	≤ Time alignment error as specified in 3GPP TS 36.104 [30] clause 6.5.3.1.	The value of time alignment error depends upon the type of carrier aggregation.
T1	s	5	
T2	s	10	
Note 1: This test verifies the RRM requirement which is independent of channel bandwidth and is performed according to the principle defined in section A.3.6.1.			

Table A.8.20.2B.1-2: Cell specific test parameters for E-UTRAN TDD-TDD Inter-frequency event triggered reporting under fading propagation conditions in synchronous cells for 20 MHz +10 MHz bandwidth

Parameter	Unit	Combination	Cell 1		Cell 2		Cell 3	
			T1	T2	T1	T2	T1	T2
E-UTRA RF Channel Number		All	1		2		3	
BW _{channel}	MHz	20MHz+10MHz	20MHz: N _{RB,c} = 100		10MHz: N _{RB,c} = 50		10MHz: N _{RB,c} = 50	
		10MHz+20MHz	10MHz: N _{RB,c} = 50		20MHz: N _{RB,c} = 100		20MHz: N _{RB,c} = 100	
Correlation Matrix and Antenna Configuration		All	1x2 Low		1x2 Low		1x2 Low	
PDSCH Reference measurement channel defined in A.3.1.1.2		20MHz+10MHz	DL Reference Measurement Channel R.3 TDD		N/A		DL Reference Measurement Channel R.0 TDD	
		10MHz+20MHz	DL Reference Measurement Channel R.0 TDD		N/A		DL Reference Measurement Channel R.3 TDD	
PDCCH/PCFICH/PHICH Reference measurement channel defined in A.3.1.2.2		20MHz+10MHz	DL Reference Measurement Channel R.10 TDD		DL Reference Measurement Channel R.6 TDD		DL Reference Measurement Channel R.6 TDD	
		10MHz+20MHz	DL Reference Measurement Channel R.6 TDD		DL Reference Measurement Channel R.10 TDD		DL Reference Measurement Channel R.10 TDD	
OCNG Pattern defined in A.3.2.2 (TDD)		20MHz+10MHz	OP.7 TDD		OP.2 TDD		OP.1 TDD	
		10MHz+20MHz	OP.1 TDD		OP.8 TDD		OP.7 TDD	
PBCH_RA	dB	All	0		0		0	
PBCH_RB	dB							
PSS_RA	dB							
SSS_RA	dB							
PCFICH_RB	dB							
PHICH_RA	dB							
PHICH_RB	dB							
PDCCH_RA	dB							
PDCCH_RB	dB							

PDSCH_RA	dB							
PDSCH_RB	dB							
OCNG_RA ^{Note 1}	dB							
OCNG_RB ^{Note 1}	dB							
\hat{E}_s/I_{ot}	dB	All	4	4	-Infinity	7	4	4
N_{oc} ^{Note 3}	dBm/15 kHz	All	-98		-98		-98	
RSRP ^{Note 4}	dBm/15 kHz	All	-94	-94	-Infinity	-91	-94	-94
SCH_RP ^{Note 4}	dBm/15 kHz	All	-94	-94	-infinity	-91	-94	-94
\hat{E}_s/N_{oc}	dB	All	4	4	-Infinity	7	4	4
Propagation Condition		All	ETU70		ETU70		ETU70	
<p>Note 1: OCNG shall be used such that both cells are fully allocated and a constant total transmitted power spectral density is achieved for all OFDM symbols.</p> <p>Note 2: The resources for uplink transmission are assigned to the UE prior to the start of time period T2.</p> <p>Note 3: Interference from other cells and noise sources not specified in the test is assumed to be constant over subcarriers and time and shall be modelled as AWGN of appropriate power for N_{oc} to be fulfilled.</p> <p>Note 4: E_s/I_{ot}, RSRP and SCH_RP levels have been derived from other parameters for information purposes. They are not settable parameters themselves.</p>								

A.8.20.2B.2 Test Requirements

The test requirements defined in section A.8.20.2.2 shall apply to this test case.

A.8.20.3 E-UTRAN FDD - UTRAN FDD event triggered reporting under fading propagation conditions

It is not necessary for CA UEs to be tested in A.8.5.1 if this case is done.

A.8.20.3.1 Test Purpose and Environment

The purpose of this test is to verify that the UE makes correct reporting of an event. This test will partly verify the E-UTRAN FDD- UTRAN FDD cell search requirements in clause 8.1.2.4.1.

The test parameters are given in Tables A.8.20.3.1-1, A.8.20.3.1-2 and A.8.20.3.1-3 below. In the measurement control information it is indicated to the UE that event-triggered reporting with Event B1 is used. The test consists of two successive time periods, with time duration of T1, and T2 respectively. During time duration T1, the UE shall not have any timing information of cell 2.

Table A.8.20.3.1-1: General test parameters for E-UTRAN FDD-UTRAN FDD event triggered reporting in fading propagation conditions

Parameter	Unit	Value	Comment
PDSCH parameters (E-UTRAN FDD)		DL Reference Measurement Channel R.0 FDD	As specified in clause A.3.1.1.1.
PCFICH/PDCCH/PHICH parameters (E-UTRAN FDD)		DL Reference Measurement Channel R.6 FDD	As specified in clause A.3.1.2.1.
Gap Pattern Id		1	As specified in TS 36.133 clause 8.1.2.1.
Active cell		Cell 1	Cell 1 is on E-UTRA RF channel number 1.
Neighbour cell		Cell 2	Cell 2 is on UTRA RF channel number 1.
Configured active Scell		Cell 3	Cell 3 is on E-UTRA RF channel number 2.
CP length		Normal	Applicable to cell 1
E-UTRA RF Channel Number		1	One E-UTRA FDD carrier frequency is used.
E-UTRA RF Channel Number for Scell		2	One E-UTRA FDD carrier frequency is used.
E-UTRA Channel Bandwidth (BW _{channel})	MHz	10	

UTRA RF Channel Number		1	One UTRA FDD carrier frequency is used.
Inter-RAT (UTRA FDD) measurement quantity		CPICH Ec/Io	
b1-Threshold-UTRA	dB	-18	CPICH Ec/Io threshold for event B1.
Hysteresis	dB	0	
Time To Trigger	ms	0	
Filter coefficient		0	L3 filtering is not used.
DRX		OFF	
Monitored UTRA FDD cell list size		12	UTRA cells on UTRA RF channel 1 provided in the cell list.
T1	s	5	
T2	s	6	

Table A.8.20.3.1-2: Cell specific test parameters for E-UTRAN FDD (cell # 1, cell # 3) for event triggered reporting of UTRAN FDD cell under fading propagation conditions

Parameter	Unit	Cell 1		Cell 3	
		T1	T2	T1	T2
E-UTRA RF Channel Number		1		2	
BW _{channel}	MHz	10		10	
Correlation Matrix and Antenna Configuration		1x2 Low		1x2 Low	
OCNG Pattern defined in A.3.2.1.1 (OP.1 FDD)		OP.1 FDD		OP.1 FDD	
PBCH_RA	dB	0		0	
PBCH_RB	dB				
PSS_RA	dB				
SSS_RA	dB				
PCFICH_RB	dB				
PHICH_RA	dB				
PHICH_RB	dB				
PDCCH_RA	dB				
PDCCH_RB	dB				
PDSCH_RA	dB				
PDSCH_RB	dB				
OCNG_RA ^{Note 1}	dB				
OCNG_RB ^{Note 1}	dB				
\hat{E}_s / I_{ot}	dB				
\hat{E}_s / N_{oc}	dB	4	4	4	
N_{oc}	dBm/15 kHz	-98			
RSRP	dBm/15 kHz	-94	-94	-94	
SCH_RP	dBm/15 kHz	-94	-94	-94	
Propagation Condition		ETU70			
Note 1: OCNG shall be used such that both cells are fully allocated and a constant total transmitted power spectral density is achieved for all OFDM symbols.					
Note 2: The resources for uplink transmission are assigned to the UE prior to the start of time period T2.					

Table A.8.20.3.1-3: Cell specific test parameters for UTRAN FDD (cell # 2) for event triggered reporting of UTRAN FDD cell under fading propagation conditions

Parameter	Unit	Cell 2	
		T1	T2
UTRA RF Channel Number		1	
CPICH_Ec/Ior	dB	-10	

PCCPCH_Ec/I _{or}	dB	-12	
SCH_Ec/I _{or}	dB	-12	
PICH_Ec/I _{or}	dB	-15	
DPCH_Ec/I _{or}	dB	N/A	
OCNS		-0.941	
\hat{I}_{or}/I_{oc}	dB	-Infinity	-1.8
I_{oc}	dBm/3.84 MHz	-70	
CPICH_Ec/I _o	dB	-Infinity	-14
Propagation Condition		Case 5 (Note 3)	
Note 1: The DPCH level is controlled by the power control loop.			
Note 2: The power of the OCNS channel that is added shall make the total power from the cell to be equal to I _{or}			
Note3: Case 5 propagation conditions are defined in Annex A of 3GPP TS 25.101.			

A.8.20.3.2 Test Requirements

The UE shall send one Event B1 triggered measurement report, with a measurement reporting delay less than 4800 ms from the beginning of time period T2.

The UE shall not send event triggered measurement reports, as long as the reporting criteria are not fulfilled.

The rate of correct events observed during repeated tests shall be at least 90%.

NOTE: The actual overall delays measured in the test may be up to $2 \times TTI_{DCC}$ higher than the measurement reporting delays above because of TTI insertion uncertainty of the measurement report in DCC.

A.8.20.4 E-UTRAN TDD to UTRAN TDD cell search under fading propagation conditions

It is not necessary for CA UEs to be tested in A.8.7.1 if this case is done.

A.8.20.4.1 Test Purpose and Environment

A.8.20.4.1.1 1.28 Mcps TDD option

The purpose of this test is to verify that the UE makes correct reporting of an event. This test will partly verify the E-UTRA TDD to UTRA TDD cell search requirements in clause 8.1.2.4.3 under fading propagation conditions.

This test scenario comprised of 1 E-UTRA TDD PCell, 1 E-UTRA TDD SCell and 1 UTRA TDD cell to be searched. Test parameters are given in Table A.8.20.4.1.2-1, A.8.20.4.1.2-2, and A.8.20.4.1.2-3. Gap pattern configuration #0 as defined in table 8.1.2.1-1 is provided.

In the measurement control information, it is indicated to the UE that event-triggered reporting with Event B1 is used. The test consists of two successive time periods, with time duration of T1 and T2 respectively. During time duration T1, the UE shall not have any timing information of cell 2.

Table A.8.20.4.1.1-1: General test parameters for E-UTRA TDD to UTRA(1.28 Mcps TDD OPTION) cell search in fading propagation conditions

Parameter	Unit	Value	Comment
PDSCH parameters		DL Reference Measurement Channel R.0 TDD	As specified in clause A.3.1.1.2
PCFICH/PDCCH/PHICH parameters		DL Reference Measurement Channel R.6 TDD	As specified in clause A.3.1.2.2
E-UTRA RF Channel Number		1	One E-UTRA TDD carrier frequency is used.
E-UTRA RF Channel Number for SCell		2	One E-UTRA TDD carrier frequency is used.
Active cell		Cell 1	E-UTRA TDD cell
Neighbour cell		Cell 2	UTRA 1.28Mcps TDD Cell
Configured active SCell		Cell 3	E-UTRA TDD cell
Gap Pattern Id		0	As specified in TS 36.133 clause 8.1.2.1.

Uplink-downlink configuration of cell 1		1	As specified in table 4.2.2 in TS 36.211
Special subframe configuration of cell 1		6	As specified in table 4.2.1 in TS 36.211
CP length of cell 1		normal	
Hysteresis	dB	0	
TimeToTrigger	s	0	
Filter coefficient		0	L3 filtering is not used
DRX		OFF	
Time offset between cells		3 ms	Asynchronous cells
Ofn	dB	0	
Thresh	dBm	-87	
T1	s	5	
T2	s	10	

Table A.8.20.4.1.1-2: Cell specific test parameters for cell search E-UTRA TDD to UTRA TDD test case (cell 1, cell3)

Parameter	Unit	Cell 1		Cell 3	
		T1	T2	T1	T2
E-UTRA RF Channel Number		1		2	
BW _{channel}	MHz	10		10	
Correlation Matrix and Antenna Configuration		1x2 Low		1x2 Low	
OCNG Pattern defined in A.3.2.2.1 (OP.1 TDD)		OP.1 TDD		OP.1 TDD	
PBCH_RA	dB	0	0	0	0
PBCH_RB	dB				
PSS_RA	dB				
SSS_RA	dB				
PCFICH_RB	dB				
PHICH_RA	dB				
PHICH_RB	dB				
PDCCH_RA	dB				
PDCCH_RB	dB				
PDSCH_RA	dB				
PDSCH_RB	dB				
OCNG_RA ^{Note1}	dB				
OCNG_RB ^{Note1}	dB				
\hat{E}_s / I_{ot}	dB				
\hat{E}_s / N_{oc}	dB	9	9	9	9
N_{oc}	dBm/15kHz	-98			
RSRP	dBm/15kHz	-89	-89	-89	-89
SCH_RP	dBm/15kHz	-89	-89	-89	-89
Propagation Condition		ETU70			
Note 1: OCNG shall be used such that cell is fully allocated and a constant total transmitted power spectral density is achieved for all OFDM symbols.					
Note 2: The resources for uplink transmission are assigned to the UE prior to the start of time period T2.					

Table A.8.20.4.1.1-3: Cell specific test parameters for cell search E-UTRA TDD to UTRA TDD test case (cell 2)

Parameter	Unit	Cell 2 (UTRA)			
		0		DwPTS	
Timeslot Number		T1	T2	T1	T2
UTRA RF Channel Number ^{NOTE1}		Channel 2			
PCCPCH_Ec/I _{or}	dB	-3	-3		
DwPCH_Ec/I _{or}	dB			0	0
OCNS_Ec/I _{or} ^{NOTE2}	dB	-3	-3		
\hat{I}_{or} / I_{oc}	dB	-inf	5	-inf	5

I_{oc}	dBm/1.2 8 MHz	-80			
PCCPCH RSCP	dBm	-inf	-78	n.a.	n.a.
Propagation Condition	Case 3 ^{NOTE3}				
Note 1:	In the case of multi-frequency cell, the UTRA RF Channel Number is the primary frequency's channel number.				
Note 2:	The power of the OCNS channel that is added shall make the total power from the cell to be equal to I_{or} .				
Note 3:	Case 3 propagation conditions are defined in Annex B of TS 25.102				

A.8.20.4.2 Test Requirements

A.8.20.4.2.1 1.28 Mcps TDD option

The UE shall send one Event B1 triggered measurement report, with a measurement reporting delay less than 6400 ms from the beginning of time period T2.

The UE shall not send event triggered measurement reports, as long as the reporting criteria are not fulfilled.

The rate of correct events observed during repeated tests shall be at least 90%.

NOTE: The actual overall delays measured in the test may be up to $2 \times TTI_{DCCH}$ higher than the measurement reporting delays above because of TTI insertion uncertainty of the measurement report in DCCH.

A.8.20.4A E-UTRAN TDD with 20 MHz +20 MHz bandwidth to UTRAN TDD cell search under fading propagation conditions

A.8.20.4A.1 Test Purpose and Environment

A.8.20.4A.1.1 1.28 Mcps TDD option

The purpose of this test case is the same as for the test defined in subclause A.8.20.4. The test parameters are the same except those described in the following section. The listed parameter values in Tables A.8. 20.4A.1.1-1 and A.8. 20.4A.1.1-2 will replace the values of corresponding parameters in Tables A.8. 20.4.1.1-1 and A.8. 20.4.1.1-2.

Table A.8.20.4A.1.1-1: General test parameters for E-UTRA TDD with 20MHz +20MHz bandwidth to UTRA(1.28 Mcps TDD OPTION) cell search in fading propagation conditions

Parameter	Unit	Value	Comment
PDSCH parameters		DL Reference Measurement Channel R.3 TDD	As specified in section A.3.1.1.2
PCFICH/PDCCH/PHICH parameters		DL Reference Measurement Channel R.10 TDD	As specified in section A.3.1.2.2
Note 1:	See Table A.8.20.4.1.1-1 for other general test parameters.		
Note 2:	This test verifies the RRM requirement which is independent of channel bandwidth and is performed according to the principle defined in section A.3.6.1.		

Table A.8.20.4A.1.1-2: Cell specific test parameters for cell search E-UTRA TDD with 20MHz +20MHz bandwidth to UTRA TDD test case (cell 1, cell3)

Parameter	Unit	Cell 1		Cell 3	
		T1	T2	T1	T2
BW _{channel}	MHz	20		20	
OCNG Pattern defined in A.3.2.2		OP.7 TDD		OP.7 TDD	
Propagation Condition		ETU70			
Note 1:	See Table A.8.20.4.1.1-2 for other general test parameters.				
Note 2:	This test verifies the RRM requirement which is independent of channel bandwidth and is performed according to the principle defined in section A.3.6.1.				

A.8.20.4A.2 Test Requirements

A.8.20.4A.2.1 1.28 Mcps TDD option

The test requirements defined in section A.8.20.4.2.1 shall apply to this test case.

A.8.20.4B E-UTRAN TDD with 20 MHz +10 MHz bandwidth to UTRAN TDD cell search under fading propagation conditions

A.8.20.4B.1 Test Purpose and Environment

A.8.20.4B.1.1 1.28 Mcps TDD option

The purpose of this test case is the same as for the test defined in subclause A.8.20.4.

This test scenario comprised of 1 E-UTRA TDD PCell, 1 E-UTRA TDD SCell and 1 UTRA TDD cell to be searched. The test parameters are given in Tables A.8. 20.4B.1.1-1, A.8. 20.4B.1.1-2 and A.8.20.4B.1.1-3. Gap pattern configuration #0 as defined in table 8.1.2.1-1 is provided.

In the measurement control information, it is indicated to the UE that event-triggered reporting with Event B1 is used. The test consists of two successive time periods, with time duration of T1 and T2 respectively. During time duration T1, the UE shall not have any timing information of cell 2.

Table A.8.20.4B.1.1-1: General test parameters for E-UTRA TDD with 20MHz +10MHz bandwidth to UTRA(1.28 Mcps TDD OPTION) cell search in fading propagation conditions

Parameter	Unit	Value	Comment
E-UTRA RF Channel Number		1	One E-UTRA TDD carrier frequency is used.
E-UTRA RF Channel Number for Scell		2	One E-UTRA TDD carrier frequency is used.
Active cell		Cell 1	E-UTRA TDD cell
Neighbour cell		Cell 2	UTRA 1.28Mcps TDD Cell
Configured active SCell		Cell 3	E-UTRA TDD cell
Gap Pattern Id		0	As specified in TS 36.133 clause 8.1.2.1.
Uplink-downlink configuration of cell 1		1	As specified in table 4.2.2 in TS 36.211
Special subframe configuration of cell 1		6	As specified in table 4.2.1 in TS 36.211
CP length of cell 1		normal	
Hysteresis	dB	0	
TimeToTrigger	s	0	
Filter coefficient		0	L3 filtering is not used
DRX		OFF	
Time offset between cells		3 ms	Asynchronous cells
Ofn	dB	0	
Thresh	dBm	-87	
T1	s	5	
T2	s	10	

Table A.8.20.4B.1.1-2: Cell specific test parameters for cell search E-UTRA TDD with 20MHz +10MHz bandwidth to UTRA TDD test case (cell 1, cell3)

Parameter	Unit	Combination	Cell 1		Cell 3	
			T1	T2	T1	T2
E-UTRA RF Channel Number		All	1		2	
BW _{channel}		20MHz+10MHz	20		10	
		10MHz+20MHz	10		20	
Correlation Matrix and Antenna Configuration		All	1x2 Low		1x2 Low	
PDSCH Reference measurement channel defined in A.3.1.1.2		20MHz+10MHz	R.3 TDD		R.0 TDD	
		10MHz+20MHz	R.0 TDD		R.3 TDD	
PDCCH/PCFICH/PHICH Reference measurement channel defined in A.3.1.2.2		20MHz+10MHz	R.10 TDD		R.6 TDD	
		10MHz+20MHz	R.6 TDD		R.10 TDD	
OCNG Pattern defined in A.3.2.2		20MHz+10MHz	OP.7 TDD		OP.1 TDD	
		10MHz+20MHz	OP.1 TDD		OP.7 TDD	
PBCH_RA	dB	All	0	0	0	0

PBCH_RB	dB					
PSS_RA	dB					
SSS_RA	dB					
PCFICH_RB	dB					
PHICH_RA	dB					
PHICH_RB	dB					
PDCCH_RA	dB					
PDCCH_RB	dB					
PDSCH_RA	dB					
PDSCH_RB	dB					
OCNG_RA ^{Note1}	dB					
OCNG_RB ^{Note1}	dB					
\hat{E}_s / I_{α}	dB	All	9	9	9	9
\hat{E}_s / N_{oc}	dB	All	9	9	9	9
N_{oc}	dBm/15kHz	All	-98			
RSRP	dBm/15kHz	All	-89	-89	-89	-89
SCH_RP	dBm/15kHz	All	-89	-89	-89	-89
Propagation Condition		All	ETU70			
Note 1: OCNG shall be used such that cell is fully allocated and a constant total transmitted power spectral density is achieved for all OFDM symbols.						
Note 2: The resources for uplink transmission are assigned to the UE prior to the start of time period T2.						

Table A.8.20.4B.1.1-3: Cell specific test parameters for cell search E-UTRA TDD with 20MHz +10MHz bandwidth to UTRA TDD test case (cell 2)

Parameter	Unit	Cell 2 (UTRA)			
		0		DwPTS	
Timeslot Number		T1	T2	T1	T2
UTRA RF Channel Number ^{NOTE1}		Channel 2			
PCCPCH_Ec/I _{or}	dB	-3	-3		
DwPCH_Ec/I _{or}	dB			0	0
OCNS_Ec/I _{or} ^{NOTE2}	dB	-3	-3		
\hat{I}_{or} / I_{oc}	dB	-inf	5	-inf	5
I_{oc}	dBm/1.28 MHz	-80			
PCCPCH RSCP	dBm	-inf	-78	n.a.	n.a.
Propagation Condition		Case 3 ^{NOTE3}			
Note 1: In the case of multi-frequency cell, the UTRA RF Channel Number is the primary frequency's channel number.					
Note 2: The power of the OCNS channel that is added shall make the total power from the cell to be equal to I _{or} .					
Note 3: Case 3 propagation conditions are defined in Annex B of TS 25.102					

A.8.20.4B.2 Test Requirements

A.8.20.4B.2.1 1.28 Mcps TDD option

The test requirements defined in section A.8.20.4.2.1 shall apply to this test case.

A.8.21 CSG Proximity Indication Testing Case for E-UTRAN FDD – FDD Inter frequency

Note : The test case in this section forms the basis for a signalling test for CSG proximity detection.

A.8.21.1 Test Purpose and Environment

The purpose of this test is to verify the UE has implemented properly the feature for indicating that the UE is entering or leaving the proximity of one or more CSG member cells based on proximity detection with an autonomous search function, as defined by the requirements in Section 6.4.

The test case consists of three successive segments: Test Preparation, Negative Test, and Positive Test. The test scenario comprises of three E-UTRAN FDD cells on different carriers. Cell 1 represents the serving cell in the proximity of the CSG cell, Cell 2 the CSG cell, and Cell 3 the serving cell not in the proximity of the CSG cell. The description of the test procedure is shown in Table A.8.21-1. The general test parameters and cell specific test parameters are presented in Table A.8.21-2 and Table A.8.21-3 respectively.

Table A.8.21-1: Description of the test procedures

Parameter	Cell Status	Comment
Test Preparation		
Initial Condition	Cell 1 is active	Clean up the UE memory to be free from previously stored cell information for proximity detection. Turn on the UE and allow sufficient time for the UE to select to Cell 1.
Time duration T1	Cell 1 and Cell 2 are active	Turn on Cell 2 at the start of T1. Perform manual CSG selection towards Cell 2. The UE is expected to store necessary information for later proximity detection.
End condition		Turn off the UE. Turn off Cell 1 and Cell 2.
Negative Test		
Initial Condition	Cell 3 is active	Turn on Cell 3. Turn on the UE and set up the UE in connected mode with Cell 3..
Time duration T2	Cell 3 is active	Configure the UE with proximity indication control by sending the Reconfiguration message with ReportProximityConfig at the start of T2. The UE is not expected to report "entering" proximity in the negative test.
End condition		Turn off the UE. Turn off Cell 3.
Positive Test		
Initial Condition	Cell 1 is active	Turn on Cell 1. Turn on the UE and set up the UE in connected mode with Cell 1.
Time duration T3	Cell 1 and Cell 2 are active	Turn on Cell 2 at the start of T3. Configure the UE with proximity indication control by sending the Reconfiguration message with reportProximityConfig at the start of T3. The UE is expected to report "entering" proximity before end of T3.
End condition		Turn off the UE. Turn off Cell 1 and Cell 2.

Table A.8.21-2: General test parameters for E-UTRAN FDD-FDD inter frequency cell proximity detection test case

Parameter	Unit	Value	Comment
PDSCH parameters		DL Reference Measurement Channel R.0 FDD	As specified in section A.3.1.1.1
PDSCH allocation	n_{PRB}	2—3	13—36
PCFICH/PDCCH/PHICH parameters		DL Reference Measurement Channel R.6 FDD	As specified in section A.3.1.2.1
A3-Offset	dB	-4	
Hysteresis	dB	0	
TimeToTrigger	s	0	
Filter coefficient		0	L3 filtering is not used
DRX		off	As specified in section A.3.3
PRACH configuration		4	As specified in table 5.7.1-2 in 3GPP TS 36.211
Access Barring Information	-	Not sent	No additional delays in random access procedure
Time offset between cells		3 ms	Asynchronous cells
Gap pattern configuration Id		0	As specified in Table 8.1.2.1-1 started before T1 starts

Time duration T1	s	[10]	Defined to give enough time for the UE to complete the manual reselection to Cell 2.
Time duration T2	s	[360]	Defined to be longer enough to see whether the UE will report enter “proximity” indication.
Time duration T3 ^{Note 1}	s	[<=360]	The time duration for a UE to report enters “proximity” when the UE is near a CSG cell.
<p>Note 1: The maximum allowed time duration for the UE to decide either entering or leaving “proximity” is 360s. To reduce test time, T3 may end once UE reports entering “proximity”.</p> <p>Note 2: The test case assumes an environment where CSG proximity detection results not being impact by non-3GPP signals, such as GPS and WiFi. When the test case is being executed, the UE may ignore any radio signals which are not provided by the test setup which it would otherwise use in proximity estimation.</p>			

Table A.8.21-3: Cell specific test parameters for E-UTRAN FDD-FDD inter frequency cell proximity detection test case

Parameter	Unit	Cell 1			Cell 2		
		T1	T2	T3	T1	T2	T3
E-UARFCN		Channel 1			Channel 2		
CSG indicator		False			True	N/A	True
Physical cell global identity		1	1	1	2	N/A	2
CSG identity		Not sent			Sent	N/A	Sent
BW _{channel}	MHz	10			10		
OCNG Patterns defined in A.3.2.1.1 (OP.1 FDD) and in A.3.2.1.2 (OP.2 FDD)		OP.1 FDD	N/A	OP.2 FDD	OP.2 FDD	N/A	OP.2 FDD
PBCH_RA	dB	0			0		
PBCH_RB	dB						
PSS_RA	dB						
SSS_RA	dB						
PCFICH_RB	dB						
PHICH_RA	dB						
PHICH_RB	dB						
PDCCH_RA	dB						
PDCCH_RB	dB						
PDSCH_RA	dB						
PDSCH_RB	dB						
OCNG_RA ^{Note 1}	dB						
OCNG_RB ^{Note 1}	dB						
\hat{E}_s / I_{ot}	dB						
N_{oc} ^{Note 2}	dBm/15 kHz	-98			-98		
\hat{E}_s / N_{oc}	dB	0	-inf	4	7	-inf	7
RSRP ^{Note 3}	dBm/15 KHz	-98	-inf	-94	-91	-inf	-91
Propagation Condition		AWGN			AWGN		
<p>Note 1: OCNG shall be used such that both cells are fully allocated and a constant total transmitted power spectral density is achieved for all OFDM symbols.</p> <p>Note 2: Interference from other cells and noise sources not specified in the test is assumed to be constant over subcarriers and time and shall be modelled as AWGN of appropriate power for N_{oc} to be fulfilled.</p> <p>Note 3: RSRP levels have been derived from other parameters for information purposes. They are not settable parameters themselves.</p>							

Table A.8.21-4: Cell specific test parameters for E-UTRAN FDD-FDD inter frequency cell proximity detection test case (Cell 3)

Parameter	Unit	Cell 3		
		T1	T2	T3

E-UARFCN		Channel 1	
CSG indicator		False	
Physical cell global identity		3	
CSG identity		Not sent	
BW_{channel}	MHz	10	
OCNG Patterns defined in A.3.2.1.1 (OP.1 FDD) and in A.3.2.1.2 (OP.2 FDD)		N/A	
PBCH_RA	dB	0	
PBCH_RB	dB		
PSS_RA	dB		
SSS_RA	dB		
PCFICH_RB	dB		
PHICH_RA	dB		
PHICH_RB	dB		
PDCCH_RA	dB		
PDCCH_RB	dB		
PDSCH_RA	dB		
PDSCH_RB	dB		
OCNG_RA ^{Note 1}	dB		
OCNG_RB ^{Note 1}	dB		
\hat{E}_s / I_{ot}	dB		-inf
N_{oc} ^{Note 2}	dBm/15 kHz		-98
\hat{E}_s / N_{oc}	dB	-inf	
RSRP ^{Note 3}	dBm/15 KHz	-inf	
Propagation Condition		AWGN	
<p>Note 1: OCNG shall be used such that both cells are fully allocated and a constant total transmitted power spectral density is achieved for all OFDM symbols.</p> <p>Note 2: Interference from other cells and noise sources not specified in the test is assumed to be constant over subcarriers and time and shall be modelled as AWGN of appropriate power for N_{oc} to be fulfilled.</p> <p>Note 3: RSRP levels have been derived from other parameters for information purposes. They are not settable parameters themselves</p>			

A.8.21.2 Test Requirements

The UE shall not send an "entering" proximity indication in T2 during Negative Test.

The UE shall send an "entering" proximity indication in T3 during Positive Test.

A.8.22 E-UTRAN Discovery Signal Measurements

A.8.22.1 E-UTRAN FDD-FDD intra-frequency event triggered reporting under fading propagation conditions in synchronous cells in DRX based on CRS based discovery signal

A.8.22.1.1 Test Purpose and Environment

The purpose of the test is to verify that the UE makes correct reporting of an event when discovery signal is configured in DRX. The test will partly verify the FDD-FDD intra-frequency cell search in DRX requirements in clause 8.6.2.1.1.

The test parameters are given in Tables A.8.22.1.1-1, A.8.22.1.1-2, A.8.22.1.1-3 and A.8.22.1.1-4. In the measurement control information, it is indicated to the UE performing CRS based discovery signals measurement and event-triggered reporting with Event A3 is configured. The test consists of two successive time periods, with time duration of T1, and T2 respectively. During time duration T1, the UE shall not have any timing information of cell 2.

UE needs to be provided at least once every 500ms with new Timing Advance Command MAC control element to restart the Time alignment timer to keep UE uplink time alignment. Furthermore UE is allocated with PUSCH resource at every DRX cycle.

Table A.8.22.1.1-1: General test parameters for E-UTRAN FDD-FDD intra-frequency event triggered reporting under fading propagation conditions in synchronous cells in DRX based on CRS based discovery signal

Parameter	Unit	Value	Comment
Active cell		Cell 1	
Neighbour cell		Cell 2	Cell to be identified.
E-UTRA RF Channel Number		1	One FDD carrier frequency is used.
DMTC period	ms	160	As specified in IE MeasDS-Config in TS 36.331
dmtc-PeriodOffset	ms	10	As specified in IE MeasDS-Config in TS 36.331
Discovery signal occasion duration	ms	1	As specified in IE MeasDS-Config in TS 36.331
A3-Offset	dB	-6	
CP length		Normal	
Hysteresis	dB	0	
Time To Trigger	s	0	
Filter coefficient		0	L3 filtering is not used
DRX		ON	DRX related parameters are defined in Table A.8.22.1.1-3
T1	s	5	
T2	s	10	

Table A.8.22.1.1-2: Cell specific test parameters for E-UTRAN FDD-FDD intra-frequency event triggered reporting under fading propagation conditions in synchronous cells in DRX based on CRS based discovery signal

Parameter	Unit	Cell 1		Cell 2	
		T1	T2	T1	T2
E-UTRA RF Channel Number		1		1	
BW _{channel}	MHz	10		10	
Measurement bandwidth	n_{PRB}	13-37		13-37	
PDSCH parameters: DL Reference Measurement Channel		R.0 FDD		-	
PCFICH/PDCCH/PHICH parameters: DL Reference Measurement Channel		R.6 FDD		R.6 FDD	
OCNG Patterns defined in A.3.2.1.1 (OP.1 FDD) and in A.3.2.1.2 (OP.2 FDD)		OP.1 FDD		OP.2 FDD	
PBCH_RA	dB	0		0	
PBCH_RB	dB				
PSS_RA	dB				
SSS_RA	dB				
PCFICH_RB	dB				
PHICH_RA	dB				
PHICH_RB	dB				
PDCCH_RA	dB				
PDCCH_RB	dB				
PDSCH_RA	dB				
PDSCH_RB	dB				
OCNG_RA ^{Note 1}	dB				

OCNG_RB ^{Note 1}	dB				
N_{oc} ^{Note 2}	dBm/15 KHz			-98	
\hat{E}_s/N_{oc}	dB	4	4	-Infinity	4
\hat{E}_s/I_{ot}	dB	4	-1.46	-Infinity	-1.46
RSRP ^{Note 3}	dBm/15 KHz	-94	-94	-Infinity	-94
SCH_RP ^{Note 3}	dBm/15 KHz	-94	-94	-Infinity	-94
I_o ^{Note 3}	dBm/9MHz	-64.76	-62.42	Specified in columns for Cell 1	
Propagation Condition		ETU30		ETU30	
Correlation Matrix and Antenna Configuration		1x2 Low		1x2 Low	
Timing offset to Cell 1	μ s	-		2.3 (CP/2)	
<p>Note 1: OCNG shall be used such that both cells are fully allocated and a constant total transmitted power spectral density is achieved for all OFDM symbols.</p> <p>Note 2: Interference from other cells and noise sources not specified in the test is assumed to be constant over subcarriers and time and shall be modelled as AWGN of appropriate power for N_{oc} to be fulfilled.</p> <p>Note 3: E_s/I_{ot}, RSRP and SCH_RP and I_o levels have been derived from other parameters for information purposes. They are not settable parameters themselves.</p>					

Table A.8.22.1.1-3: DRX-Configuration for E-UTRAN FDD-FDD intra-frequency event triggered reporting under fading propagation conditions in synchronous cells in DRX based on CRS based discovery signal

Field	Value	Comment
onDurationTimer	psf1	As specified in clause 6.3.2 in TS 36.331
drx-InactivityTimer	psf1	
drx-RetransmissionTimer	psf1	
longDRX-CycleStartOffset	sf256	
shortDRX	disable	

Table A.8.22.1.1-4: TimeAlignmentTimer-Configuration for E-UTRAN FDD-FDD intra-frequency event triggered reporting under fading propagation conditions in synchronous cells in DRX based on CRS based discovery signal

Field	Value	Comment
TimeAlignmentTimer	sf500	As specified in clause 6.3.2 in TS 36.331
sr-ConfigIndex	0	For further information see clause 6.3.2 in TS 36.331 and section 10.1 in TS 36.213.

A.8.22.1.2 Test Requirements

The UE shall send one Event A3 triggered measurement report, with a measurement reporting delay less than 4864ms from the beginning of time period T2. The measurement reporting delay is defined as the time from the beginning of time period T2 to the moment when the UE send the measurement report on PUSCH.

The UE shall not send event triggered measurement reports, as long as the reporting criteria are not fulfilled.

The rate of correct events observed during repeated tests shall be at least 90%.

NOTE 1: The actual overall delays measured in the test may be up to one DRX cycle higher than the measurement reporting delays above because UE is allowed to delay the initiation of the measurement reporting procedure to the next until the Active Time.

NOTE 2: In order to calculate the rate of correct events the system simulator shall verify that it has received correct Event A3 measurement report.

A.8.22.2 E-UTRAN TDD-TDD intra-frequency event triggered reporting under fading propagation conditions in synchronous cells in DRX based on CRS based discovery signal

A.8.22.2.1 Test Purpose and Environment

The purpose of the test is to verify that the UE makes correct reporting of an event when discovery signal is configured in DRX. The test will partly verify the TDD-TDD intra-frequency cell search in DRX requirements in clause 8.6.2.1.1.

The test parameters are given in Tables A.8.22.2.1-1, A.8.22.2.1-2, A.8.22.2.1-3 and A.8.22.2.1-4. In the measurement control information, it is indicated to the UE performing CRS based discovery signals measurement and event-triggered reporting with Event A3 is configured. The test consists of two successive time periods, with time duration of T1, and T2 respectively. During time duration T1, the UE shall not have any timing information of cell 2.

UE needs to be provided at least once every 500ms with new Timing Advance Command MAC control element to restart the Time alignment timer to keep UE uplink time alignment. Furthermore UE is allocated with PUSCH resource at every DRX cycle.

Table A.8.22.2.1-1: General test parameters for E-UTRAN TDD-TDD intra-frequency event triggered reporting under fading propagation conditions in synchronous cells in DRX based on CRS based discovery signal

Parameter	Unit	Value	Comment
Active cell		Cell 1	
Neighbour cell		Cell 2	Cell to be identified.
E-UTRA RF Channel Number		1	One TDD carrier frequency is used.
Special subframe configuration		6	As specified in table 4.2-1 in TS 36.211. The same configuration in both cells
Uplink-downlink configuration		1	As specified in table 4.2-2 in TS 36.211. The same configuration in both cells
DMTC period	ms	160	As specified in IE MeasDS-Config in TS 36.331
dmtc-PeriodOffset	ms	10	As specified in IE MeasDS-Config in TS 36.331
Discovery signal occasion duration	ms	2	As specified in IE MeasDS-Config in TS 36.331
A3-Offset	dB	-6	
CP length		Normal	
Hysteresis	dB	0	
Time To Trigger	s	0	
Filter coefficient		0	L3 filtering is not used
DRX		ON	DRX related parameters are defined in Table A.8.22.2.1-3
T1	s	5	
T2	s	10	

Table A.8.22.2.1-2: Cell specific test parameters for E-UTRAN TDD-TDD intra-frequency event triggered reporting under fading propagation conditions in synchronous cells in DRX based on CRS based discovery signal

Parameter	Unit	Cell 1		Cell 2	
		T1	T2	T1	T2
E-UTRA RF Channel Number		1		1	
BW _{channel}	MHz	10		10	
Measurement bandwidth	n_{PRB}	13-37		13-37	

PDSCH parameters: DL Reference Measurement Channel		R.0 TDD		-	
PCFICH/PDCCH/PHICH parameters: DL Reference Measurement Channel		R.6 TDD		R.6 TDD	
OCNG Patterns defined in A.3.2.2.1 (OP.1 TDD) and in A.3.2.2.2 (OP.2 TDD)		OP.1 TDD		OP.2 TDD	
PBCH_RA	dB	0		0	
PBCH_RB	dB				
PSS_RA	dB				
SSS_RA	dB				
PCFICH_RB	dB				
PHICH_RA	dB				
PHICH_RB	dB				
PDCCH_RA	dB				
PDCCH_RB	dB				
PDSCH_RA	dB				
PDSCH_RB	dB				
OCNG_RA ^{Note 1}	dB				
OCNG_RB ^{Note 1}	dB				
N_{oc} ^{Note 2}	dBm/15 KHz	-98			
\hat{E}_s / N_{oc}	dB	4	4	-Infinity	4
\hat{E}_s / I_{ot}	dB	4	-1.46	-Infinity	-1.46
RSRP ^{Note 3}	dBm/15 KHz	-94	-94	-Infinity	-94
SCH_RP ^{Note 3}	dBm/15 KHz	-94	-94	-Infinity	-94
I_o ^{Note 3}	dBm/9MHz	-64.76	-62.42	Specified in columns for Cell 1	
Propagation Condition		ETU30		ETU30	
Correlation Matrix and Antenna Configuration		1x2 Low		1x2 Low	
Timing offset to Cell 1	μ s	-		2.3 (CP/2)	
<p>Note 1: OCNG shall be used such that both cells are fully allocated and a constant total transmitted power spectral density is achieved for all OFDM symbols.</p> <p>Note 2: Interference from other cells and noise sources not specified in the test is assumed to be constant over subcarriers and time and shall be modelled as AWGN of appropriate power for N_{oc} to be fulfilled.</p> <p>Note 3: E_s/I_{ot}, RSRP and SCH_RP and I_o levels have been derived from other parameters for information purposes. They are not settable parameters themselves.</p>					

Table A.8.22.2.1-3: DRX-Configuration for E-UTRAN TDD-TDD intra-frequency event triggered reporting under fading propagation conditions in synchronous cells in DRX based on CRS based discovery signal

Field	Value	Comment
onDurationTimer	psf1	As specified in clause 6.3.2 in TS 36.331
drx-InactivityTimer	psf1	
drx-RetransmissionTimer	psf1	
longDRX-CycleStartOffset	sf256	
shortDRX	disable	

Table A.8.22.2.1-4: TimeAlignmentTimer-Configuration for E-UTRAN TDD-TDD intra-frequency event triggered reporting under fading propagation conditions in synchronous cells in DRX based on CRS based discovery signal

Field	Value	Comment
TimeAlignmentTimer	sf500	As specified in clause 6.3.2 in TS 36.331

sr-ConfigIndex	0	For further information see clause 6.3.2 in TS 36.331 and section 10.1 in TS 36.213.
----------------	---	--

A.8.22.2.2 Test Requirements

The UE shall send one Event A3 triggered measurement report, with a measurement reporting delay less than 4864ms from the beginning of time period T2. The measurement reporting delay is defined as the time from the beginning of time period T2 to the moment when the UE send the measurement report on PUSCH.

The UE shall not send event triggered measurement reports, as long as the reporting criteria are not fulfilled.

The rate of correct events observed during repeated tests shall be at least 90%.

NOTE 1: The actual overall delays measured in the test may be up to one DRX cycle higher than the measurement reporting delays above because UE is allowed to delay the initiation of the measurement reporting procedure to the next until the Active Time.

NOTE 2: In order to calculate the rate of correct events the system simulator shall verify that it has received correct Event A3 measurement report.

A.8.22.3 E-UTRAN FDD-FDD inter-frequency event triggered reporting under fading propagation conditions in DRX based on CRS based discovery signal

A.8.22.3.1 Test Purpose and Environment

The purpose of the test is to verify that the UE makes correct reporting of an event when discovery signal is configured in DRX. The test will partly verify the FDD-FDD inter-frequency measurement requirements in clause 8.6.2.2.1.

The test parameters are given in Tables A.8.22.3.1-1, A.8.22.3.1-2, A.8.22.3.1-3 and A.8.22.3.1-4. In the measurement control information, it is indicated to the UE performing CRS based discovery signals measurement and event-triggered reporting with Event A3 is configured. Entire discovery signal occasion should be contained in the measurement gap. The subframe contained discovery signal for the measurement is not overlapped with the first 0.5ms period and the last 0.5ms period in every gap.

UE needs to be provided at least once every 500ms with new Timing Advance Command MAC control element to restart the Time alignment timer to keep UE uplink time alignment. Furthermore UE is allocated with PUSCH resource at every DRX cycle.

The test consists of two successive time periods, with time duration of T1, and T2 respectively. During time duration T1, the UE shall not have any timing information of cell 2.

Table A.8.22.3.1-1: General test parameters for E-UTRAN FDD-FDD inter-frequency event triggered reporting under fading propagation conditions in DRX based on CRS based discovery signal

Parameter	Unit	Value	Comment
E-UTRA RF Channel Number		1, 2	Two FDD carrier frequencies are used.
Active cell		Cell 1	Cell 1 is on RF channel number 1
Neighbour cell		Cell 2	Cell 1 is on RF channel number 2
Gap Pattern Id		0	As specified in TS 36.133 clause 8.1.2.1.
Gap Offset		9	As specified in TS 36.331 clause 6.3.5
DMTC period	ms	160	As specified in IE MeasDS-Config in TS 36.331
dmtc-PeriodOffset	ms	10	As specified in IE MeasDS-Config in TS 36.331
Discovery signal occasion duration	ms	1	As specified in IE MeasDS-Config in TS 36.331

A3-Offset	dB	-6	
Hysteresis	dB	0	
CP length		Normal	
Time To Trigger	s	0	
Filter coefficient		0	L3 filtering is not used
PRACH configuration		4	As specified in table 5.7.1-2 in TS 36.211
Access Barring Information	-	Not Sent	No additional delays in random access procedure.
DRX		ON	DRX related parameters are defined in Table A.8.22.3.1-3
T1	s	5	
T2	s	10	

Table A.8.22.3.1-2: Cell specific test parameters for E-UTRAN FDD-FDD inter-frequency event triggered reporting under fading propagation conditions in DRX based on CRS based discovery signal

Parameter	Unit	Cell 1		Cell 2	
		T1	T2	T1	T2
E-UTRA RF Channel Number		1		2	
BW _{channel}	MHz	10		10	
Measurement bandwidth	n_{PRB}	13-37		13-37	
PDSCH parameters: DL Reference Measurement Channel		R.0 FDD		-	
PCFICH/PDCCH/PHICH parameters: DL Reference Measurement Channel		R.6 FDD		R.6 FDD	
OCNG Patterns defined in A.3.2.1.1 (OP.1 FDD) and in A.3.2.1.2 (OP.2 FDD)		OP.1 FDD		OP.2 FDD	
PBCH_RA	dB	0		0	
PBCH_RB	dB				
PSS_RA	dB				
SSS_RA	dB				
PCFICH_RB	dB				
PHICH_RA	dB				
PHICH_RB	dB				
PDCCH_RA	dB				
PDCCH_RB	dB				
PDSCH_RA	dB				
PDSCH_RB	dB				
OCNG_RA ^{Note 1}	dB				
OCNG_RB ^{Note 1}	dB				
N_{oc} ^{Note 2}	dBm/15 kHz				
\hat{E}_s / N_{oc}	dB	4	4	-Infinity	7
\hat{E}_s / I_{ot}	dB	4	4	-Infinity	7
RSRP ^{Note 3}	dBm/15 kHz	-94	-94	-Infinity	-91
SCH_RP ^{Note 3}	dBm/15 kHz	-94	-94	-Infinity	-91
I_o ^{Note 3}	dBm/9MHz	-64.76	-64.76	-70.22	-62.43
Propagation Condition		ETU30		ETU30	
Correlation Matrix and Antenna Configuration		1x2 Low		1x2 Low	
Timing offset to Cell 1	μ s	-		3	

Note 1:	OCNG shall be used such that both cells are fully allocated and a constant total transmitted power spectral density is achieved for all OFDM symbols.
Note 2:	Interference from other cells and noise sources not specified in the test is assumed to be constant over subcarriers and time and shall be modelled as AWGN of appropriate power for N_{oc} to be fulfilled.
Note 3:	Es/lot, RSRP and SCH_RP and lo levels have been derived from other parameters for information purposes. They are not settable parameters themselves.

Table A.8.22.3.1-3: DRX-Configuration for E-UTRAN FDD-FDD inter-frequency event triggered reporting under fading propagation conditions in DRX based on CRS based discovery signal

Field	Value	Comment
onDurationTimer	psf1	As specified in clause 6.3.2 in TS 36.331
drx-InactivityTimer	psf1	
drx-RetransmissionTimer	psf1	
longDRX-CycleStartOffset	sf256	
shortDRX	disable	

Table A.8.22.3.1-4: *TimeAlignmentTimer* -Configuration for E-UTRAN FDD-FDD inter-frequency event triggered reporting under fading propagation conditions in DRX based on CRS based discovery signal

Field	Value	Comment
TimeAlignmentTimer	sf500	As specified in clause 6.3.2 in TS 36.331
sr-ConfigIndex	0	For further information see clause 6.3.2 in TS 36.331 and section 10.1 in TS 36.213.

A.8.22.3.2 Test Requirements

UE shall send one Event A3 triggered measurement report, with a measurement reporting delay less than 5120 ms from the beginning of time period T2. The measurement reporting delay is defined as the time from the beginning of time period T2, to the moment when the UE starts to send preambles on the PRACH for scheduling request (SR) to obtain allocation to send the measurement report on PUSCH.

The UE shall not send event triggered measurement reports, as long as the reporting criteria are not fulfilled.

The rate of correct events observed during repeated tests shall be at least 90%.

NOTE 1: The actual overall delays measured in the test may be up to one DRX cycle higher than the measurement reporting delays above because UE is allowed to delay the initiation of the measurement reporting procedure to the next until the Active Time.

NOTE 2: In order to calculate the rate of correct events the system simulator shall verify that it has received correct Event A3 measurement report.

A.8.22.4 E-UTRAN TDD-TDD inter-frequency event triggered reporting under fading propagation conditions in DRX based on CRS based discovery signal

A.8.22.4.1 Test Purpose and Environment

The purpose of the test is to verify that the UE makes correct reporting of an event when discovery signal is configured in DRX. The test will partly verify the FDD-FDD inter-frequency measurement requirements in clause 8.6.2.2.1.

The test parameters are given in Tables A.8.22.4.1-1, A.8.22.4.1-2, A.8.22.4.1-3 and A.8.22.4.1-4. In the measurement control information, it is indicated to the UE performing CRS based discovery signals measurement and event-triggered reporting with Event A3 is configured. Entire discovery signal occasion should be contained in the measurement gap. The subframe contained discovery signal for the measurement is not overlapped with the first 0.5ms period and the last 0.5ms period in every gap.

UE needs to be provided at least once every 500ms with new Timing Advance Command MAC control element to restart the Time alignment timer to keep UE uplink time alignment. Furthermore UE is allocated with PUSCH resource at every DRX cycle.

The test consists of two successive time periods, with time duration of T1, and T2 respectively. During time duration T1, the UE shall not have any timing information of cell 2.

Table A.8.22.4.1-1: General test parameters for E-UTRAN TDD-TDD inter-frequency event triggered reporting under fading propagation conditions in DRX based on CRS based discovery signal

Parameter	Unit	Value	Comment
E-UTRA RF Channel Number		1, 2	Two TDD carrier frequencies are used.
Active cell		Cell 1	Cell 1 is on RF channel number 1
Neighbour cell		Cell 2	Cell 2 is on RF channel number 2
Gap Pattern Id		0	As specified in TS 36.133 clause 8.1.2.1.
Gap Offset		9	As specified in TS 36.331 clause 6.3.5
Uplink-downlink configuration		1	As specified in table 4.2-2 in TS 36.211. The same configuration in both cells
Special subframe configuration		6	As specified in table 4.2-1 in TS 36.211. The same configuration in both cells
DMTC period	ms	160	As specified in IE MeasDS-Config in TS 36.331
dmtc-PeriodOffset	ms	10	As specified in IE MeasDS-Config in TS 36.331
Discovery signal occasion duration	ms	2	As specified in IE MeasDS-Config in TS 36.331
A3-Offset	dB	-6	
Hysteresis	dB	0	
CP length		Normal	
Time To Trigger	s	0	
Filter coefficient		0	L3 filtering is not used
PRACH configuration		4	As specified in table 5.7.1-2 in TS 36.211
Access Barring Information	-	Not Sent	No additional delays in random access procedure.
DRX		ON	DRX related parameters are defined in Table A.8.22.4.1-3
T1	s	5	
T2	s	10	

Table A.8.22.4.1-2: Cell specific test parameters for E-UTRAN TDD-TDD inter-frequency event triggered reporting under fading propagation conditions in DRX based on CRS based discovery signal

Parameter	Unit	Cell 1		Cell 2	
		T1	T2	T1	T2
E-UTRA RF Channel Number		1		2	
BW _{channel}	MHz	10		10	
Measurement bandwidth	n_{PRB}	13-37		13-37	
PDSCH parameters: DL Reference Measurement Channel		R.0 TDD		-	
PCFICH/PDCCH/PHICH parameters: DL Reference Measurement Channel		R.6 TDD		R.6 TDD	
OCNG Patterns defined in A.3.2.2.1 (OP.1 TDD) and in A.3.2.2.2 (OP.2 TDD)		OP.1 TDD		OP.2 TDD	
PBCH_RA	dB				

PBCH_RB	dB				
PSS_RA	dB				
SSS_RA	dB				
PCFICH_RB	dB				
PHICH_RA	dB	0		0	
PHICH_RB	dB				
PDCCH_RA	dB				
PDCCH_RB	dB				
PDSCH_RA	dB				
PDSCH_RB	dB				
OCNG_RA ^{Note 1}	dB				
OCNG_RB ^{Note 1}	dB				
N_{oc} ^{Note 2}	dBm/15 kHz	-98			
\hat{E}_s / N_{oc}	dB	4	4	-Infinity	7
\hat{E}_s / I_{ot}	dB	4	4	-Infinity	7
RSRP ^{Note 3}	dBm/15 kHz	-94	-94	-Infinity	-91
SCH_RP ^{Note 3}	dBm/15 kHz	-94	-94	-Infinity	-91
I_o ^{Note 3}	dBm/9MHz	-64.76	-64.76	-70.22	-62.43
Propagation Condition		ETU30		ETU30	
Correlation Matrix and Antenna Configuration		1x2 Low		1x2 Low	
Timing offset to Cell 1	μ s	-		3 (Synchronous cells)	
<p>Note 1: OCNG shall be used such that both cells are fully allocated and a constant total transmitted power spectral density is achieved for all OFDM symbols.</p> <p>Note 2: Interference from other cells and noise sources not specified in the test is assumed to be constant over subcarriers and time and shall be modelled as AWGN of appropriate power for N_{oc} to be fulfilled.</p> <p>Note 3: E_s/I_{ot}, RSRP and SCH_RP and I_o levels have been derived from other parameters for information purposes. They are not settable parameters themselves.</p>					

Table A.8.22.4.1-3: DRX-Configuration for E-UTRAN TDD-TDD inter-frequency event triggered reporting under fading propagation conditions in DRX based on CRS based discovery signal

Field	Value	Comment
onDurationTimer	psf1	As specified in clause 6.3.2 in TS 36.331
drx-InactivityTimer	psf1	
drx-RetransmissionTimer	psf1	
longDRX-CycleStartOffset	sf256	
shortDRX	disable	

Table A.8.22.4.1-4: TimeAlignmentTimer-Configuration for E-UTRAN TDD-TDD inter-frequency event triggered reporting under fading propagation conditions in DRX based on CRS based discovery signal

Field	Value	Comment
TimeAlignmentTimer	sf500	As specified in clause 6.3.2 in TS 36.331
sr-ConfigIndex	0	For further information see clause 6.3.2 in TS 36.331 and section 10.1 in TS 36.213.

A.8.22.4.2 Test Requirements

UE shall send one Event A3 triggered measurement report, with a measurement reporting delay less than 5120 ms from the beginning of time period T2. The measurement reporting delay is defined as the time from the beginning of time period T2, to the moment when the UE starts to send preambles on the PRACH for scheduling request (SR) to obtain allocation to send the measurement report on PUSCH.

The UE shall not send event triggered measurement reports, as long as the reporting criteria are not fulfilled.

The rate of correct events observed during repeated tests shall be at least 90%.

NOTE 1: The actual overall delays measured in the test may be up to one DRX cycle higher than the measurement reporting delays above because UE is allowed to delay the initiation of the measurement reporting procedure to the next until the Active Time.

NOTE 2: In order to calculate the rate of correct events the system simulator shall verify that it has received correct Event A3 measurement report.

A.8.22.5 E-UTRAN FDD-FDD intra-frequency event triggered reporting in DRX based on CSI-RS based discovery signal

A.8.22.5.1 Test Purpose and Environment

The purpose of the test is to verify that the UE makes correct reporting of an event in DRX. The test will partly verify the FDD-FDD intra-frequency cell search in DRX requirements in clause 8.6.3.1.1.2.

The test parameters are given in Tables A.8.22.5.1-1, A.8.22.5.1-2, A.8.22.5.1-3 and A.8.22.5.1-4. In the measurement control information, it is indicated to the UE that event-triggered reporting with Event C2 is used. The test consists of two successive time periods, with time duration of T1, and T2 respectively. During time duration T1, the UE shall not have any timing information of cell 2.

The UE needs to be provided at least once every 500ms with new Timing Advance Command MAC control element to restart the Time alignment timer to keep UE uplink time alignment. Furthermore UE is allocated with PUSCH resource at every DRX cycle.

Table A.8.22.5.1-1: General test parameters for E-UTRAN FDD-FDD intra-frequency event triggered reporting for DRS measurement based on CSI-RS with DRX

Parameter	Unit	Value	Comment
		Test 1	
Active cell		Cell 1	
Neighbour cell		Cell 2	Cell to be identified.
E-UTRA RF Channel Number		1	One FDD carrier frequency is used.
DMTC period [2]	ms	160	
DMTC period offset [2]	ms	10	
Discovery signal occasion duration	ms	1	
c2-Offset	dB	-6	
CP length		Normal	
Hysteresis	dB	0	
Time To Trigger	s	0	
Filter coefficient		0	L3 filtering is not used
DRX		ON	DRX related parameters are defined in Table A.8.22.5.1-3
Time offset between cells		2.3 μ s	CP/2 or Synchronous cells
T1	s	5	
T2	s	10	

Table A.8.22.5.1-2: Cell specific test parameters for E-UTRAN FDD-FDD intra-frequency event triggered reporting for DRS measurement based on CSI-RS with DRX

Parameter	Unit	Cell 1		Cell 2	
		T1	T2	T1	T2
E-UTRA RF Channel Number		1		1	
$BW_{channel}$	MHZ	10		10	
Measurement bandwidth	n_{PRB}	13-37		13-37	
PDSCH parameters		DL Reference Measurement Channel R.0 FDD as in A.3.1.1.1			
PCFICH/PDCCH/PHICH parameters		DL Reference Measurement Channel R.6 FDD as in A.3.1.2.1		DL Reference Measurement Channel R.6 FDD as in A.3.1.2.1	

Correlation Matrix and Antenna Configuration		1x2 Low		1x2 Low	
OCNG Patterns defined in A.3.2.1.1 (OP.1 FDD) and in A.3.2.1.2 (OP.2 FDD)		OP.1 FDD		OP.2 FDD	
PBCH_RA	dB	0		0	
PBCH_RB	dB				
PSS_RA	dB				
SSS_RA	dB				
PCFICH_RB	dB				
PHICH_RA	dB				
PHICH_PB	dB				
PDCCH_RA	dB				
PDCCH_PB	dB				
PDSCH_RA	dB				
PDSCH_RB	dB				
OCNG_RA ^{Note 1}	dB				
OCNG_RB ^{Note 1}	dB				
p-C-r10 [2]	dB				
N_{oc} ^{Note 3}	dBm/15 KHz	-98			
CRS \hat{E}_s/N_{oc}	dB	4	4	-Infinity	4
CSI-RS \hat{E}_s/N_{oc}	dB	10	10	-Infinity	10
CRS \hat{E}_s/I_{ot}	dB	4	-1.46	-Infinity	-1.46
CSI-RS \hat{E}_s/I_{ot}	dB	10	4.54	-Infinity	4.54
RSRP ^{Note 4}	dBm/15 KHz	-94	-94	-Infinity	-94
CSI-RSRP ^{Note 4}	dBm/15 KHz	-88	-88	-Infinity	-88
SCH_RP ^{Note 4}	dBm/15 KHz	-94	-94	-Infinity	-94
I_o ^{Note 4}	dBm/9 MHz	-64.76	-62.42	Specified in columns for cell1	
CSI reference signal configurations [16]		2		4	
CSI-RS periodicity	ms	10		10	
CSI-RS subframe offset		0		0	
CSI-RS individual offset [2]	dB	0		0	
CSI-RS muting		Enable		Enable	
Propagation Condition		ETU30		ETU30	
Timing offset to cell 1	us	-		2.3 (CP/2)	
<p>Note 1: OCNG shall be used such that both cells are fully allocated and a constant total transmitted power spectral density is achieved for all OFDM symbols.</p> <p>Note 2: The resources for uplink transmission are assigned to the UE prior to the start of time period T2.</p> <p>Note 3: Interference from other cells and noise sources not specified in the test is assumed to be constant over subcarriers and time and shall be modelled as AWGN of appropriate power for N_{oc} to be fulfilled.</p> <p>Note 4: RSRP, CSI-RSRP, SCH_RP and I_o levels have been derived from other parameters for information purposes. They are not settable parameters themselves.</p>					

Table A.8.22.5.1-3: DRX-Configuration for E-UTRAN FDD-FDD intra-frequency event triggered reporting in DRX under fading propagation conditions in synchronous cells

Field	Value	Comment
onDurationTimer	psf1	As specified in clause 6.3.2 in TS 36.331
drx-InactivityTimer	psf1	
drx-RetransmissionTimer	psf1	
longDRX-CycleStartOffset	Sf256	
shortDRX	disable	

Table A.8.22.5.1-4: TimeAlignmentTimer -Configuration for E-UTRAN FDD-FDD intra-frequency event triggered reporting in DRX under fading propagation conditions in synchronous cells

Field	Value	Comment
TimeAlignmentTimer	sf500	As specified in clause 6.3.2 in TS 36.331
sr-ConfigIndex	0	For further information see clause 6.3.2 in TS 36.331 and section 10.1 in TS 36.213.

A.8.22.5.2 Test Requirements

In Test 1, the UE shall send one Event C2 triggered measurement report, with a measurement reporting delay less than 5632ms ($T_{\text{Identify_intra_SCE_DRX}} + T_{\text{Measurement_Period_intra_FDD_CSI-RS_DRX}} = 16 * \max\{T_{\text{DMTC_periodicity}}, \text{DRX cycle length}\} + 3 * \text{Max}\{T_{\text{DMTC_periodicity}}, \text{DRX cycle length}\} + 3 * \text{Max}\{T_{\text{DMTC_periodicity}}, \text{DRX cycle length}\} = 22 * \text{Max}\{T_{\text{DMTC_periodicity}}, \text{DRX cycle length}\}$) from the beginning of time period T2. The measurement reporting delay is defined as the time from the beginning of time period T2 to the moment when the UE send the measurement report on PUSCH.

The UE shall not send event triggered measurement reports, as long as the reporting criteria are not fulfilled.

The rate of correct events observed during repeated tests shall be at least 90%.

NOTE 1: The actual overall delays measured in the test may be up to one DRX cycle higher than the measurement reporting delays above because UE is allowed to delay the initiation of the measurement reporting procedure to the next until the Active Time.

NOTE 2: In order to calculate the rate of correct events the system simulator shall verify that it has received correct Event C2 measurement report.

A.8.22.6 E-UTRAN TDD-TDD intra-frequency event triggered reporting in DRX based on CSI-RS based discovery signal

A.8.22.6.1 Test Purpose and Environment

The purpose of the test is to verify that the UE makes correct reporting of an event in DRX. The test will partly verify the TDD-TDD intra-frequency cell search in DRX requirements in clause 8.6.3.1.2.2.

The test parameters are given in Tables A.8.22.6.1-1, A.8.22.6.1-2, A.8.22.6.1-3 and A.8.22.6.1-4. In the measurement control information, it is indicated to the UE that event-triggered reporting with Event C2 is used. The test consists of two successive time periods, with time duration of T1, and T2 respectively. During time duration T1, the UE shall not have any timing information of cell 2.

UE needs to be provided at least once every 500ms with new Timing Advance Command MAC control element to restart the Time alignment timer to keep UE uplink time alignment. Furthermore UE is allocated with PUSCH resource at every DRX cycle.

Table A.8.22.6.1-1: General test parameters for E-UTRAN TDD-TDD intra-frequency event triggered reporting for DRS measurement based on CSI-RS with DRX

Parameter	Unit	Value	Comment
		Test 1	
Active cell		Cell 1	
Neighbour cell		Cell 2	Cell to be identified.
E-UTRA RF Channel Number		1	One TDD carrier frequency is used.
DMTC period [2]	ms	160	
DMTC period offset [2]	ms	10	
Discovery signal occasion duration	ms	2	
c2-Offset	dB	-6	
CP length		Normal	

Special subframe configuration		6	As specified in table 4.2-1 in TS 36.211. The same configuration in both cells
Uplink-downlink configuration		1	As specified in table 4.2-2 in TS 36.211. The same configuration in both cells
Hysteresis	dB	0	
Time To Trigger	s	0	
Filter coefficient		0	L3 filtering is not used
DRX		ON	DRX related parameters are defined in Table A.8.22.6.1-3
T1	s	5	
T2	s	10	

Table A.8.22.6.1-2: Cell specific test parameters for E-UTRAN TDD-TDD intra-frequency event triggered reporting for DRS measurement based on CSI-RS with DRX

Parameter	Unit	Cell 1		Cell 2	
		T1	T2	T1	T2
E-UTRA RF Channel Number		1		1	
BW _{channel}	MHz	10		10	
Measurement bandwidth	<i>nPRB</i>	13-37		13-37	
PDSCH parameters		DL Reference Measurement Channel R.0 TDD as in A.3.1.1.2			
PCFICH/PDCCH/PHICH parameters		DL Reference Measurement Channel R.6 TDD as in A.3.1.2.2		DL Reference Measurement Channel R.6 TDD as in A.3.1.2.2	
Correlation Matrix and Antenna Configuration		1x2 Low		1x2 Low	
OCNG Patterns defined in A.3.2.1.1 (OP.1 TDD) and in A.3.2.1.2 (OP.2 TDD)		OP.1 TDD		OP.2 TDD	
PBCH_RA	dB	0		0	
PBCH_RB	dB				
PSS_RA	dB				
SSS_RA	dB				
PCFICH_RB	dB				
PHICH_RA	dB				
PHICH_PB	dB				
PDCCH_RA	dB				
PDCCH_PB	dB				
PDSCH_RA	dB				
PDSCH_RB	dB				
OCNG_RA ^{Note 1}	dB				
OCNG_RB ^{Note 1}	dB				
p-C-r10 [2]	dB				
N_{oc} ^{Note 3}	dBm/15 KHz	-98			
CRS \hat{E}_s/N_{oc}	dB	4	4	-Infinity	4
CSI-RS \hat{E}_s/N_{oc}	dB	10	10	-Infinity	10
CRS \hat{E}_s/I_{ot}	dB	4	-1.46	-Infinity	-1.46
CSI-RS \hat{E}_s/I_{ot}	dB	10	4.54	-Infinity	4.54
RSRP ^{Note 4}	dBm/15 KHz	-94	-94	-Infinity	-94
CSI-RSRP ^{Note 4}	dBm/15 KHz	-88	-88	-Infinity	-88
I_o ^{Note 4}	dBm/9 MHz	-64.76	-62.42	Specified in columns for cell1	
SCH_RP ^{Note 4}	dBm/15 KHz	-94	-94	-Infinity	-94
Propagation Condition		ETU30			
CSI reference signal configurations [16]		2		4	

CSI-RS periodicity	ms	10	10
CSI-RS subframe offset		0	0
CSI-RS individual offset [2]	dB	0	0
CSI-RS muting		Enable	Enable
Timing offset to cell 1	us	0	2.3 (CP/2)
Note 1:	OCNG shall be used such that both cells are fully allocated and a constant total transmitted power spectral density is achieved for all OFDM symbols.		
Note 2:	The resources for uplink transmission are assigned to the UE prior to the start of time period T2.		
Note 3:	Interference from other cells and noise sources not specified in the test is assumed to be constant over subcarriers and time and shall be modelled as AWGN of appropriate power for N_{oc} to be fulfilled.		
Note 4:	RSRP, CSI-RSRP, SCH_RP and Io levels have been derived from other parameters for information purposes. They are not settable parameters themselves.		

Table A.8.22.6.1-3: DRX-Configuration for E-UTRAN TDD-TDD intra-frequency event triggered reporting in DRX under fading propagation conditions in synchronous cells

Field	Value	Comment
onDurationTimer	psf1	As specified in clause 6.3.2 in TS 36.331
drx-InactivityTimer	psf1	
drx-RetransmissionTimer	psf1	
longDRX-CycleStartOffset	Sf256	
shortDRX	disable	

Table A.8.22.6.1-4: TimeAlignmentTimer-Configuration for E-UTRAN TDD-TDD intra-frequency event triggered reporting in DRX under fading propagation conditions in synchronous cells

Field	Value	Comment
TimeAlignmentTimer	sf500	As specified in clause 6.3.2 in TS 36.331
sr-ConfigIndex	0	For further information see clause 6.3.2 in TS 36.331 and section 10.1 in TS 36.213.

A.8.22.6.2 Test Requirements

The UE shall send one Event C2 triggered measurement report, with a measurement reporting delay less than 5632 ms from the beginning of time period T2. The measurement reporting delay is defined as the time from the beginning of time period T2 to the moment when the UE send the measurement report on PUSCH.

The UE shall not send event triggered measurement reports, as long as the reporting criteria are not fulfilled.

The rate of correct events observed during repeated tests shall be at least 90%.

NOTE 1: The actual overall delays measured in the test may be up to one DRX cycle higher than the measurement reporting delays above because UE is allowed to delay the initiation of the measurement reporting procedure to the next until the Active Time.

NOTE 2: In order to calculate the rate of correct events the system simulator shall verify that it has received correct Event C2 measurement report.

A.8.22.7 E-UTRAN FDD-FDD Inter-frequency event triggered reporting in DRX based on CSI-RS based discovery signal

A.8.22.7.1 Test Purpose and Environment

The purpose of the test is to verify that the UE makes correct reporting of an event in DRX. The test will partly verify the FDD-FDD inter-frequency cell search in DRX requirements in clause 8.6.3.2.1.2.

The test parameters are given in Tables A.8.22.7.1-1, A.8.22.7.1-2, A.8.22.7.1-3 and A.8.22.7.1-4. In the measurement control information, it is indicated to the UE that event-triggered reporting with Event C1 is used. Entire discovery signal occasion should be contained in the measurement gap. The subframe contained discovery signal for the measurement is not overlapped with the first 0.5ms period and the last 0.5ms period in every gap.

The test consists of two successive time periods, with time duration of T1, and T2 respectively. During time duration T1, the UE shall not have any timing information of cell 2.

The UE needs to be provided at least once every 500ms with new Timing Advance Command MAC control element to restart the Time alignment timer to keep UE uplink time alignment. Furthermore UE is allocated with PUSCH resource at every DRX cycle.

Table A.8.22.7.1-1: General test parameters for E-UTRAN FDD-FDD inter-frequency event triggered reporting for DRS measurement based on CSI-RS with DRX

Parameter	Unit	Value	Comment
		Test 1	
Active cell		Cell 1	
Neighbour cell		Cell 2	Cell to be identified.
E-UTRA RF Channel Number		1,2	Two FDD carrier frequency is used.
Gap Pattern Id		0	As specified in TS 36.133 clause 8.1.2.1.
Gap Offset		9	As specified in TS 36.331 clause 6.3.5
DMTC period [2]	ms	160	
DMTC period offset [2]	ms	10	
Discovery signal occasion duration	ms	1	
C1 Threshold	dB	-96	
CP length		Normal	
Hysteresis	dB	0	
Time To Trigger	s	0	
Filter coefficient		0	L3 filtering is not used
DRX		ON	DRX related parameters are defined in Table A.8.22.7.1-3
T1	s	5	
T2	s	10	

Table A.8.22.7.1-2: Cell specific test parameters for E-UTRAN FDD-FDD inter-frequency event triggered reporting for DRS measurement based on CSI-RS with DRX

Parameter	Unit	Cell 1		Cell 2	
		T1	T2	T1	T2
E-UTRA RF Channel Number		1		2	
BW _{channel}	MHz	10		10	
Measurement bandwidth	<i>n_{PRB}</i>	13-37		13-37	
PDSCH parameters		DL Reference Measurement Channel R.0 FDD as in A.3.1.1.1			
PCFICH/PDCCH/PHICH parameters		DL Reference Measurement Channel R.6 FDD as in A.3.1.2.1		DL Reference Measurement Channel R.6 FDD as in A.3.1.2.1	
Correlation Matrix and Antenna Configuration		1x2 Low		1x2 Low	
OCNG Patterns defined in A.3.2.1.1 (OP.1 FDD) and in A.3.2.1.2 (OP.2 FDD)		OP.1 FDD		OP.2 FDD	
PBCH_RA	dB				
PBCH_RB	dB				
PSS_RA	dB				
SSS_RA	dB				
PCFICH_RB	dB				

PHICH_RA	dB	0		0	
PHICH_PB	dB				
PDCCH_RA	dB				
PDCCH_PB	dB				
PDSCH_RA	dB				
PDSCH_RB	dB				
OCNG_RA ^{Note 1}	dB				
OCNG_RB ^{Note 1}	dB				
p-C-r10 [2]	dB	-6	-6	-6	-6
N_{oc} ^{Note 3}	dBm/15 KHz	-98			
CRS \hat{E}_s/N_{oc}	dB	4	4	-Infinity	7
CSI-RS \hat{E}_s/N_{oc}	dB	10	10	-Infinity	13
CRS \hat{E}_s/I_{ot}	dB	4	4	-Infinity	7
CSI-RS \hat{E}_s/I_{ot}	dB	10	10	-Infinity	13
RSRP ^{Note 4}	dBm/15 KHz	-94	-94	-Infinity	-91
CSI-RSRP ^{Note 4}	dBm/15 KHz	-88	-88	-Infinity	-85
SCH_RP ^{Note 4}	dBm/15 KHz	-94	-94	-Infinity	-91
I_o ^{Note 4}	dBm/9 MHz	-64.76	-64.76	-70.22	-62.43
Propagation Condition		ETU30			
CSI reference signal configurations [16]		2		4	
CSI-RS periodicity	ms	10		10	
CSI-RS subframe offset		0		0	
CSI-RS individual offset [2]	dB	0		0	
CSI-RS muting		Enable		Enable	
Timing offset to cell 1	us	-		3us	
Note 1:	OCNG shall be used such that both cells are fully allocated and a constant total transmitted power spectral density is achieved for all OFDM symbols.				
Note 2:	The resources for uplink transmission are assigned to the UE prior to the start of time period T2.				
Note 3:	Interference from other cells and noise sources not specified in the test is assumed to be constant over subcarriers and time and shall be modelled as AWGN of appropriate power for N_{oc} to be fulfilled.				
Note 4:	RSRP, CSI-RSRP, SCH_RP and I_o levels have been derived from other parameters for information purposes. They are not settable parameters themselves.				

Table A.8.22.7.1-3: DRX-Configuration for E-UTRAN FDD-FDD inter-frequency event triggered reporting in DRX under fading propagation conditions in synchronous cells

Field	Value	Comment
onDurationTimer	psf1	
drx-InactivityTimer	psf1	
drx-RetransmissionTimer	psf1	
longDRX-CycleStartOffset	Sf256	
shortDRX	disable	

Table A.8.22.7.1-4: TimeAlignmentTimer-Configuration for E-UTRAN FDD-FDD inter-frequency event triggered reporting in DRX under fading propagation conditions in synchronous cells

Field	Value	Comment
TimeAlignmentTimer	sf500	For further information see clause 6.3.2 in TS 36.331.
sr-ConfigIndex	0	For further information see clause 6.3.2 in TS 36.331 and section 10.1 in TS 36.213..

A.8.22.7.2 Test Requirements

The UE shall send one Event C1 triggered measurement report, with a measurement reporting delay less than 5888ms from the beginning of time period T2. The measurement reporting delay is defined as the time from the beginning of time period T2, to the moment when the UE send the measurement report on PUSCH.

The UE shall not send event triggered measurement reports, as long as the reporting criteria are not fulfilled.

The rate of correct events observed during repeated tests shall be at least 90%.

NOTE 1: The actual overall delays measured in the test may be up to one DRX cycle higher than the measurement reporting delays above because UE is allowed to delay the initiation of the measurement reporting procedure to the next until the Active Time.

NOTE 2: In order to calculate the rate of correct events the system simulator shall verify that it has received correct Event C1 measurement report

A.8.22.8 E-UTRAN TDD-TDD inter-frequency event triggered reporting under fading propagation condition in DRX based on CSI-RS based discovery signal

A.8.22.8.1 Test Purpose and Environment

The purpose of the test is to verify that the UE makes correct reporting of an event in DRX. The test will partly verify the TDD-TDD inter-frequency cell search in DRX requirements in clause 8.6.3.2.2.2.

The test parameters are given in Tables A.8.22.8.1-1, A.8.22.8.1-2, A.8.22.8.1-3 and A.8.22.8.1-4. In the measurement control information, it is indicated to the UE that event-triggered reporting with Event C1 is used. Entire discovery signal occasion should be contained in the measurement gap. The subframe contained discovery signal for the measurement is not overlapped with the first 0.5ms period and the last 0.5ms period in every gap.

The test consists of two successive time periods, with time duration of T1, and T2 respectively. During time duration T1, the UE shall not have any timing information of cell 2.

The UE needs to be provided at least once every 500ms with new Timing Advance Command MAC control element to restart the Time alignment timer to keep UE uplink time alignment. Furthermore UE is allocated with PUSCH resource at every DRX cycle.

Table A.8.22.8.1-1: General test parameters for E-UTRAN TDD-TDD inter-frequency event triggered reporting for DRX measurement based on CSI-RS with DRX

Parameter	Unit	Test 1	Comment
		Value	
E-UTRA RF Channel Number		1, 2	Two TDD carrier frequencies are used.
Channel Bandwidth ($BW_{channel}$)	MHz	10	
Active cell		Cell 1	Cell 1 is on RF channel number 1
Neighbour cell		Cell 2	Cell 2 is on RF channel number 2
Gap Pattern Id		0	As specified in TS 36.133 clause 8.1.2.1.
Gap Offset		9	As specified in TS 36.331 clause 6.3.5
Uplink-downlink configuration		1	As specified in TS 36.211 clause 4.2 Table 4.2-2
Special subframe configuration		6	As specified in table 4.2-1 in TS 36.211. The same configuration in both cells
DMTC period [2]	ms	160	
DMTC period offset [2]	ms	10	
Discovery signal occasion duration	ms	2	
C1 Threshold	dB	-96	
Hysteresis	dB	0	
CP length		Normal	
TimeToTrigger	s	0	
Filter coefficient		0	L3 filtering is not used

PRACH configuration		4	As specified in table 5.7.1-3 in TS 36.211
Access Barring Information	-	Not Sent	No additional delays in random access procedure.
DRX		ON	DRX related parameters are defined in Table A.8.22.8.1-3
T1	s	5	
T2	s	10	

Table A.8.22.8.1-2: Cell specific test parameters for E-UTRAN TDD-TDD inter-frequency event triggered reporting for DRS measurement based on CSI-RS with DRX

Parameter	Unit	Cell 1		Cell 2	
		T1	T2	T1	T2
E-UTRA RF Channel Number		1		2	
BW _{channel}	MHz	10		10	
Measurement bandwidth	n_{PRB}	13-37		13-37	
PDSCH parameters		DL Reference Measurement Channel R.0 TDD as in A.3.1.1.2			
PCFICH/PDCCH/PHICH parameters		DL Reference Measurement Channel R.6 TDD as in A.3.1.2.2.		DL Reference Measurement Channel R.6 TDD as in A.3.1.2.2.	
Correlation Matrix and Antenna Configuration		1x2 Low		1x2 Low	
OCNG Patterns defined in A.3.2.1.1 (OP.1 TDD) and in A.3.2.1.2 (OP.2 TDD)		OP.1 TDD		OP.2 TDD	
PBCH_RA	dB	0		0	
PBCH_RB	dB				
PSS_RA	dB				
SSS_RA	dB				
PCFICH_RB	dB				
PHICH_RA	dB				
PHICH_PB	dB				
PDCCH_RA	dB				
PDCCH_PB	dB				
PDSCH_RA	dB				
PDSCH_RB	dB				
OCNG_RA ^{Note 1}	dB				
OCNG_RB ^{Note 1}	dB				
p-C-r10 [2]	dB				
N_{oc} ^{Note 3}	dBm/15 KHz	-98			
CRS \hat{E}_s/N_{oc}	dB	4	4	-Infinity	7
CSI-RS \hat{E}_s/N_{oc}	dB	10	10	-Infinity	13
CRS \hat{E}_s/I_{ot}	dB	4	4	-Infinity	7
CSI-RS \hat{E}_s/I_{ot}	dB	10	10	-Infinity	13
RSRP ^{Note 4}	dBm/15 KHz	-94	-94	-Infinity	-91
CSI-RSRP ^{Note 4}	dBm/15 KHz	-88	-88	-Infinity	-85
SCH_RP ^{Note 4}	dBm/15 KHz	-94	-94	-Infinity	-91
I_o ^{Note 4}	dBm/9 MHz	-64.76	-64.76	-70.22	-62.43
Propagation Condition		ETU30			
CSI reference signal configurations [16]		2		4	
CSI-RS periodicity	ms	10		10	
CSI-RS subframe offset		0		0	

CSI-RS individual offset [2]	dB	0	0
CSI-RS muting		Enable	Enable
Timing offset to cell 1	us	-	3
Note 1:	OCNG shall be used such that both cells are fully allocated and a constant total transmitted power spectral density is achieved for all OFDM symbols.		
Note 2:	The resources for uplink transmission are assigned to the UE prior to the start of time period T2.		
Note 3:	Interference from other cells and noise sources not specified in the test is assumed to be constant over subcarriers and time and shall be modelled as AWGN of appropriate power for N_{oc} to be fulfilled.		
Note 4:	RSRP, CSI-RSRP, SCH_RP and Io levels have been derived from other parameters for information purposes. They are not settable parameters themselves.		

Table A.8.22.8.1-3: DRX-Configuration for E-UTRAN TDD-TDD inter-frequency event triggered reporting in DRX under fading propagation conditions in synchronous cells

Field	Value	Comment
onDurationTimer	psf1	As specified in clause 6.3.2 in TS 36.331
drx-InactivityTimer	psf1	
drx-RetransmissionTimer	psf1	
longDRX-CycleStartOffset	Sf256	
shortDRX	disable	

Table A.8.22.8.1-4: *TimeAlignmentTimer* -Configuration for E-UTRAN TDD-TDD inter-frequency event triggered reporting in DRX under fading propagation conditions in synchronous cells

Field	Value	Comment
TimeAlignmentTimer	sf500	As specified in clause 6.3.2 in TS 36.331
sr-ConfigIndex	0	For further information see clause 6.3.2 in TS 36.331 and section 10.1 in TS 36.213.

A.8.22.8.2 Test Requirements

In Test 1, the UE shall send one Event C1 triggered measurement report, with a measurement reporting delay less than 5888ms from the beginning of time period T2. The measurement reporting delay is defined as the time from the beginning of time period T2 to the moment when the UE send the measurement report on PUSCH.

The UE shall not send event triggered measurement reports, as long as the reporting criteria are not fulfilled.

The rate of correct events observed during repeated tests shall be at least 90%.

NOTE 1: The actual overall delays measured in the test may be up to one DRX cycle higher than the measurement reporting delays above because UE is allowed to delay the initiation of the measurement reporting procedure to the next until the Active Time.

NOTE 2: In order to calculate the rate of correct events the system simulator shall verify that it has received correct Event C1 measurement report.

A.8.22.9 E-UTRAN FDD event triggered reporting under deactivated SCell in non-DRX based on CRS based discovery signal

A.8.22.9.1 Test Purpose and Environment

The purpose of this test is to verify that the UE correctly detects events A2 (Serving cell becomes worse than threshold) and A6 (Neighbour becomes better than SCell) defined in TS 36.331 [2] when CRS based discovery signal is configured within the requirements stated in clause 8.7.2.4.1.

The test parameters are given in Tables A.8.22.9.1-1 and A.8.22.9.1-2 below. It is indicated to the UE in the measurement control information that event-triggered reporting with Events A2 (PCell and SCell) and A6 is used. The test consists of three successive time periods, with duration of T1, T2 and T3, respectively. During T1 the UE shall not have any information on cell 3. Immediately at beginning of T2 the transmission power of cell 3 is increased to same level as for cell 2, and due to usage of an offset this shall result in reporting of Event A6. At beginning of T3 the transmission powers of cells 1, 2 and 3 are reduced below a threshold value and this shall result in reporting of Event A2 for PCell and SCell, respectively.

Table A.8.22.9.1-1: General test parameters for E-UTRAN FDD event triggered reporting under deactivated SCell in non-DRX based on CRS based discovery signal

Parameter		Unit	Value	Comment
E-UTRA RF Channel Number			1, 2	Two radio channels are used for this test
Active PCell			Cell 1	Primary cell on RF channel number 1.
Configured deactivated SCell			Cell 2	Configured deactivated secondary cell on RF channel number 2.
Neighbour cell			Cell 3	Neighbor cell to be identified on RF channel number 2.
CP length			Normal	
DRX			OFF	Continuous monitoring of primary cell
DMTC period		ms	160	As specified in IE MeasDS-Config in TS 36.331
dmtc-PeriodOffset for cells 2 and 3		ms	10	As specified in IE MeasDS-Config in TS 36.331
Discovery signal occasion duration		ms	1	As specified in IE MeasDS-Config in TS 36.331
A2	Hysteresis	dB	0	Hysteresis for evaluation of event A2.
	Threshold RSRP	dBm	-93	Actual RSRP threshold for event A2. Needs to take absolute accuracy tolerance in clause 9.1.14.2 into account plus margin.
	Time To Trigger	s	0	
A6	Hysteresis	dB	0	Hysteresis for evaluation of event A6.
	Offset	dB	-6	Offset parameter for evaluation of event A6. Needs to take relative accuracy tolerance in clause 9.1.14.2 into account plus margin.
	Report on leave		False	
	Time To Trigger	s	0	
Cell-individual offset for cells on RF channel number 1		dB	0	Individual offset for cells on primary component carrier.
Cell-individual offset for cells on RF channel number 2		dB	0	Individual offset for cells on secondary component carrier.
Filter coefficient			0	L3 filtering is not used
SCell measurement cycle (measCycleSCell)		ms	320	
T1		s	10	
T2		s	10	
T3		s	5	
NOTE: This test verifies the RRM requirement which is independent of channel bandwidth and is performed according to the principle defined in section A.3.6.1.				

Table A.8.22.9.1-2: Cell specific test parameters for E-UTRAN FDD event triggered reporting under deactivated SCell in non-DRX based on CRS based discovery signal

Parameter	Unit	Cell 1			Cell 2			Cell 3		
		T1	T2	T3	T1	T2	T3	T1	T2	T3
E-UTRA RF Channel Number		1			2			2		
BW _{channel}	MHz	10			10			10		
Measurement bandwidth	n_{PRB}	13-37			13-37			13-37		

PDSCH parameters: DL Reference Measurement Channel		R.0 FDD			-			-		
PCFICH/PDCCH/PHICH parameters: DL Reference Measurement Channel		R.6 FDD			R.6 FDD			R.6 FDD		
OCNG Patterns defined in A.3.2.1.1 (OP.1 FDD) and in A.3.2.1.2 (OP.2 FDD)		OP.1 FDD			OP.2 FDD			OP.2 FDD		
PBCH_RA	dB	0			0			0		
PBCH_RB	dB									
PSS_RA	dB									
SSS_RA	dB									
PCFICH_RB	dB									
PHICH_RA	dB									
PHICH_RB	dB									
PDCCH_RA	dB									
PDCCH_RB	dB									
PDSCH_RA	dB									
PDSCH_RB	dB									
OCNG_RA ^{Note 1}	dB									
OCNG_RB ^{Note 1}	dB									
N_{oc} ^{Note 2}	dBm/15 kHz									
\bar{E}_s/N_{oc}	dB	19	19	-3	19	19	-3	-infinity	19	-3
\bar{E}_s/I_{ot}	dB	19	19	-3	19	-0.05	-4.76	-infinity	-0.05	-4.76
RSRP ^{Note 3}	dBm/15 kHz	-82	-82	-104	-82	-82	-104	-infinity	-82	-104
SCH_RP ^{Note 3}	dBm/15 kHz	-82	-82	-104	-82	-82	-104	-infinity	-82	-104
I_o ^{Note 3}	dBm/9MHz	-54.16	-54.16	-71.45	-54.16	-51.18	-70.20	Specified in columns for Cell 2		
Propagation Condition		ETU30			ETU30			ETU30		
Correlation Matrix and Antenna Configuration		1x2 Low			1x2 Low			1x2 Low		
Timing offset to Cell 1	μ s	-			0			-		
Time alignment error relative to cell 1 ^{Note 5}	μ s	-			\leq TAE			N/A		
Timing offset to Cell 2	μ s	-			-			2.3 (CP/2)		
<p>Note 1: OCNG shall be used such that all cells are fully allocated and a constant total transmitted power spectral density is achieved for all OFDM symbols.</p> <p>Note 2: Interference from other cells and noise sources not specified in the test is assumed to be constant over subcarriers and time and shall be modelled as AWGN of appropriate power for N_{oc} to be fulfilled.</p> <p>Note 3: E_s/I_{ot}, RSRP and SCH_RP and I_o levels have been derived from other parameters for information purposes. They are not settable parameters themselves.</p> <p>Note 4: The resources for uplink transmission are assigned to the UE prior to the start of time period T2.</p> <p>Note 5: Time alignment error (TAE) as specified in TS 36.104 [30] clause 6.5.3.1. The TAE value depends upon the type of carrier aggregation.</p>										

A.8.22.9.2 Test Requirements

The UE shall send one Event A6 triggered measurement report with a measurement reporting delay of less than $5.12s (13 \times measCycleSCell + T_{measure_scc_CRS})$ from the beginning of time T2.

The UE shall send one Event A2 triggered measurement report for Cell 1 with a measurement reporting delay of less than $480 (3 \times T_{DMTC_periodicity})$ ms from beginning of time T3.

The UE shall send one Event A2 triggered measurement report for Cell 2 with a measurement reporting delay of less than $960ms (3 \times measCycleSCell)$ from beginning of time T3.

The UE shall not send event triggered measurement reports as long as the reporting criteria are not fulfilled.

The rate of correct events observed during repeated tests shall be at least 90% for each of the events.

NOTE: The actual overall delays measured in the tests may be up to $2 \times TTI_{DCCH}$ higher than the measurement reporting delays above because of TTI insertion uncertainty of the measurement report in DCCH.

A.8.22.10 E-UTRAN TDD event triggered reporting under deactivated SCell in non-DRX based on CRS based discovery signal

A.8.22.10.1 Test Purpose and Environment

The purpose of this test is to verify that the UE correctly detects events A2 (Serving cell becomes worse than threshold) and A6 (Neighbour becomes better than SCell) defined in TS 36.331 [2] when CRS based discovery signal is configured within the requirements stated in clause 8.7.2.4.1.

The test parameters are given in Tables A.8.22.10.1-1 and A.8.22.10.1-2 below. It is indicated to the UE in the measurement control information that event-triggered reporting with Events A2 (PCell and SCell) and A6 is used. The test consists of three successive time periods, with duration of T1, T2 and T3, respectively. During T1 the UE shall not have any information on cell 3. Immediately at beginning of T2 the transmission power of cell 3 is increased to same level as for cell 2, and due to usage of an offset this shall result in reporting of Event A6. At beginning of T3 the transmission powers of cells 1, 2 and 3 are reduced below a threshold value and this shall result in reporting of Event A2 for PCell and SCell, respectively.

Table A.8.22.10.1-1: General test parameters for E-UTRAN TDD event triggered reporting under deactivated SCell in non-DRX based on CRS based discovery signal

Parameter	Unit	Value	Comment	
E-UTRA RF Channel Number		1, 2	Two radio channels are used for this test	
Active PCell		Cell 1	Primary cell on RF channel number 1.	
Configured deactivated SCell		Cell 2	Configured deactivated secondary cell on RF channel number 2.	
Neighbour cell		Cell 3	Neighbor cell to be identified on RF channel number 2.	
CP length		Normal		
Special subframe configuration		6	As specified in table 4.2.1 in TS 36.211. The same configuration applies to all cells.	
Uplink-downlink configuration		1		
DRX		OFF	Continuous monitoring of primary cell	
DMTC period	ms	160	As specified in IE MeasDS-Config in TS 36.331	
dmtc-PeriodOffset for cells 2 and 3	ms	10	As specified in IE MeasDS-Config in TS 36.331	
Discovery signal occasion duration	ms	2	As specified in IE MeasDS-Config in TS 36.331	
A2	Hysteresis	dB	0	Hysteresis for evaluation of event A2.
	Threshold RSRP	dBm	-93	Actual RSRP threshold for event A2. Needs to take absolute accuracy tolerance in clause 9.1.14.2 into account plus margin.
	Time To Trigger	s	0	
A6	Hysteresis	dB	0	Hysteresis for evaluation of event A6.
	Offset	dB	-6	Offset parameter for evaluation of event A6. Needs to take relative accuracy tolerance in clause 9.1.14.2 into account plus margin.
	Report on leave		False	
	Time To Trigger	s	0	
Cell-individual offset for cells on RF channel number 1	dB	0	Individual offset for cells on primary component carrier.	
Cell-individual offset for cells on RF channel number 2	dB	0	Individual offset for cells on secondary component carrier.	
Filter coefficient		0	L3 filtering is not used	
SCell measurement cycle (measCycleSCell)	ms	320		
T1	s	10		
T2	s	10		
T3	s	5		
NOTE:	This test verifies the RRM requirement which is independent of channel bandwidth and is performed according to the principle defined in section A.3.6.1.			

Table A.8.22.10.1-2: Cell specific test parameters for E-UTRAN TDD event triggered reporting under deactivated SCell in non-DRX based on CRS based discovery signal

Parameter	Unit	Cell 1			Cell 2			Cell 3		
		T1	T2	T3	T1	T2	T3	T1	T2	T3
E-UTRA RF Channel Number		1			2			2		
BW _{channel}	MHz	10			10			10		
Measurement bandwidth	n_{PRB}	13-37			13-37			13-37		
PDSCH parameters: DL Reference Measurement Channel		R.0 TDD			-			-		
PCFICH/PDCCH/PHICH parameters: DL Reference Measurement Channel		R.6 TDD			R.6 TDD			R.6 TDD		
OCNG Patterns defined in A.3.2.2.1 (OP.1 TDD) and in A.3.2.2.2 (OP.2 TDD)		OP.1 TDD			OP.2 TDD			OP.2 TDD		
PBCH_RA	dB	0			0			0		
PBCH_RB	dB									
PSS_RA	dB									
SSS_RA	dB									
PCFICH_RB	dB									
PHICH_RA	dB									
PHICH_RB	dB									
PDCCH_RA	dB									
PDCCH_RB	dB									
PDSCH_RA	dB									
PDSCH_RB	dB									
OCNG_RA ^{Note 1}	dB									
OCNG_RB ^{Note 1}	dB									
N _{oc} ^{Note 2}	dBm/15 kHz									
\bar{E}_s/N_{oc}	dB	19	19	-3	19	19	-3	-infinity	19	-3
\bar{E}_s/I_{ot}	dB	19	19	-3	19	-0.05	-4.76	-infinity	-0.05	-4.76
RSRP ^{Note 3}	dBm/15 kHz	-82	-82	-104	-82	-82	-104	-infinity	-82	-104
SCH_RP ^{Note 3}	dBm/15 kHz	-82	-82	-104	-82	-82	-104	-infinity	-82	-104
I _o ^{Note 3}	dBm/9MHz	-54.16	-54.16	-71.45	-54.16	-51.18	-70.20	Specified in columns for Cell 2		
Propagation Condition		ETU30			ETU30			ETU30		
Correlation Matrix and Antenna Configuration		1x2 Low			1x2 Low			1x2 Low		
Timing offset to Cell 1	μs	-			0			-		
Time alignment error relative to cell 1 ^{Note 5}	μs	-			≤ TAE			N/A		
Timing offset to Cell 2	μs	-			-			2.3 (CP/2)		
<p>Note 1: OCNG shall be used such that all cells are fully allocated and a constant total transmitted power spectral density is achieved for all OFDM symbols.</p> <p>Note 2: Interference from other cells and noise sources not specified in the test is assumed to be constant over subcarriers and time and shall be modelled as AWGN of appropriate power for N_{oc} to be fulfilled.</p> <p>Note 3: Es/I_{ot}, RSRP and SCH_RP and I_o levels have been derived from other parameters for information purposes. They are not settable parameters themselves.</p> <p>Note 4: The resources for uplink transmission are assigned to the UE prior to the start of time period T2.</p> <p>Note 5: Time alignment error (TAE) as specified in TS 36.104 [30] clause 6.5.3.1. The TAE value depends upon the type of carrier aggregation.</p>										

A.8.22.10.2 Test Requirements

The UE shall send one Event A6 triggered measurement report with a measurement reporting delay of less than 5.12s ($13 \times measCycleSCell + T_{measure_scc_CRS}$) from the beginning of time T2.

The UE shall send one Event A2 triggered measurement report for Cell 1 with a measurement reporting delay of less than 480 ($3 \times T_{DMTC_periodicity}$) ms from beginning of time T3.

The UE shall send one Event A2 triggered measurement report for Cell 2 with a measurement reporting delay of less than 960ms ($3 \times measCycleSCell$) from beginning of time T3.

The UE shall not send event triggered measurement reports as long as the reporting criteria are not fulfilled.

The rate of correct events observed during repeated tests shall be at least 90% for each of the events.

NOTE: The actual overall delays measured in the tests may be up to $2 \times TTI_{DCCH}$ higher than the measurement reporting delays above because of TTI insertion uncertainty of the measurement report in DCCH.

A.8.22.11 E-UTRAN FDD event triggered reporting under deactivated SCell in non-DRX based on CSI-RS based discovery signal

A.8.22.11.1 Test Purpose and Environment

The purpose of this test is to verify that the UE correctly detects events C1 (CSI-RS resource becomes better than threshold) defined in TS 36.331 [2] within the requirements stated in clause 8.7.3.4.1.

The test parameters are given in Tables A.8.22.11.1-1 and A.8.22.11.1-2 below. It is indicated to the UE in the measurement control information that event-triggered reporting with Events C1 is used. The test consists of three successive time periods, with duration of T1, T2 and T3, respectively. During T1 and T2 the UE shall not have any information on cell 3. Immediately at beginning of T3 the transmission power of cell 3 is increased above a threshold value and this shall result in reporting of Event C1. At beginning of T2 the transmission powers of cells 1 and 2 are increased above a threshold value and this shall result in reporting of Event C1 for PCell and SCell, respectively.

Table A.8.22.11.1-1: General test parameters for E-UTRAN FDD event triggered reporting on configured but deactivated SCell in non-DRX under fading propagation conditions for CSI-RS based measurements under discovery signal

Parameter	Unit	Value	Comment	
E-UTRA RF Channel Number		1, 2	Two radio channels are used for this test	
Active PCell		Cell 1	Primary cell on RF channel number 1.	
Configured deactivated SCell		Cell 2	Configured deactivated secondary cell on RF channel number 2.	
Neighbour cell		Cell 3	Neighbor cell to be identified on RF channel number 2.	
DMTC period	ms	160	As specified in IE MeasDS-Config in TS 36.331	
dmtc-PeriodOffset for cells 2 and 3	ms	10	As specified in IE MeasDS-Config in TS 36.331	
Discovery signal occasion duration	ms	1	As specified in IE MeasDS-Config in TS 36.331	
CP length		Normal		
DRX		OFF	Continuous monitoring of primary cell	
C1	Hysteresis	dB	0	Hysteresis for evaluation of event C1.
	Threshold CSI-RSRP	dBm	-90	Actual RSRP threshold for event C1. Needs to take absolute accuracy tolerance in clause 9.1.14.3 into account plus margin.
	Time To Trigger	s	0	
Cell-individual offset for cells on RF channel number 1	dB	0	Individual offset for cells on primary component carrier.	
Cell-individual offset for cells on RF channel number 2	dB	0	Individual offset for cells on secondary component carrier.	
Filter coefficient		0	L3 filtering is not used	
SCell measurement cycle (measCycleSCell)	ms	320		
T1	s	5		
T2	s	5		
T3	s	10		

NOTE: This test verifies the RRM requirement which is independent of channel bandwidth and is performed according to the principle defined in section A.3.6.1.

Table A.8.22.11.1-2: Cell specific test parameters for E-UTRAN FDD event triggered reporting on configured but deactivated SCell in non-DRX under fading propagation conditions for CSI-RS based measurements under discovery signal

Parameter	Unit	Cell 1			Cell 2			Cell 3		
		T1	T2	T3	T1	T2	T3	T1	T2	T3
E-UTRA RF Channel Number		1			2			2		
BW _{channel}	MHz	10			10			10		
Measurement bandwidth	<i>nPRB</i>	13-37			13-37			13-37		
PDSCH parameters		DL Reference Measurement Channel R.0 FDD as in A.3.1.1.1								
PCFICH/PDCCH/PHICH parameters		DL Reference Measurement Channel R.6 FDD as in A.3.1.2.1			DL Reference Measurement Channel R.6 FDD as in A.3.1.2.1			DL Reference Measurement Channel R.6 FDD as in A.3.1.2.1		
Correlation Matrix and Antenna Configuration		1x2 Low			1x2 Low			1x2 Low		
OCNG Patterns defined in A.3.2.1.1 (OP.1 FDD) and in A.3.2.1.2 (OP.2 FDD)		OP.1 FDD			OP.2 FDD			OP.2 FDD		
PBCH_RA	dB	0			0			0		
PBCH_RB	dB									
PSS_RA	dB									
SSS_RA	dB									
PCFICH_RB	dB									
PHICH_RA	dB									
PHICH_RB	dB									
PDCCH_RA	dB									
PDCCH_RB	dB									
PDSCH_RA	dB									
PDSCH_RB	dB									
OCNG_RA ^{Note 1}	dB									
OCNG_RB ^{Note 1}	dB									
N _{oc} ^{Note 2}	dBm/15 kHz	-101			-101					
RSRP ^{Note 3}	dBm/15 kHz	-104	-84	-84	-104	-84	-84	-infinity	-infinity	-84
CSI-RSRP ^{Note 3}	dBm/15 kHz	-98	-78	-78	-98	-78	-78	-infinity	-infinity	-78
SCH_RP ^{Note 3}	dBm/15 kHz	-104	-84	-84	-104	-84	-84	-infinity	-infinity	-84
CRS \hat{E}_s/N_{oc}	dB	-3	17	17	-3	17	17	-infinity	-infinity	17
CSI-RS \hat{E}_s/N_{oc}	dB	3	23	23	3	23	23	-infinity	-infinity	23
CRS \hat{E}_s/I_{ot}	dB	-3	17	17	-3	17	-0.09	-infinity	-infinity	-0.09
CSI-RS \hat{E}_s/I_{ot}	dB	3	23	23	3	23	5.91	-infinity	-infinity	5.91
CSI-RS resource configurations [16]		2			4			6		
p-C-r10 [2]	dB	-6			-6			-6		
CSI-RS periodicity	ms	10			10			10		

CSI-RS subframe offset		0	0	0
CSI-RS individual offset [2]	[dB]	0	0	0
CSI-RS muting		Enable	Enable	Enable
Propagation Condition		ETU30	ETU30	ETU30
Time offset to cell 1	us	0	0	2.3 (CP/2)
Time alignment error relative to cell1 ^{Note 5}	us	-	≤ TAE	N/A
Timing offset to Cell 2	μs	-	-	2.3 (CP/2)
Note 1:	OCNG shall be used such that all cells are fully allocated and a constant total transmitted power spectral density is achieved for all OFDM symbols.			
Note 2:	Interference from other cells and noise sources not specified in the test is assumed to be constant over subcarriers and time and shall be modelled as AWGN of appropriate power for N_{oc} to be fulfilled.			
Note 3:	RSRP, CSI-RSRP and SCH_RP levels have been derived from other parameters for information purposes. They are not settable parameters themselves.			
Note 4:	The resources for uplink transmission are assigned to the UE prior to the start of time period T2.			
Note 5:	Time alignment error (TAE) as specified in TS 36.104 [30] clause 6.5.3.1. The TAE value depends upon the type of carrier aggregation.			

A.8.22.11.2 Test Requirements

The UE shall send one Event C1 triggered measurement report for Cell 3 with a measurement reporting delay of less than 6.08s ($T_{\text{identify_scc_SCE}} + T_{\text{measure_scc_CSI-RS}} = 13 * \text{measCycleSCell} + T_{\text{measure_scc_CRS}} + T_{\text{measure_scc_CSI-RS}} = 13 * \text{measCycleSCell} + 3 * \text{measCycleSCell} + 3 * \text{measCycleSCell}$) from the beginning of time T3.

The UE shall send one Event C1 triggered measurement report for Cell 1 with a measurement reporting delay of less than 480 ms ($3 * T_{\text{DMTC_periodicity}}$) from beginning of time T2.

The UE shall send one Event C1 triggered measurement report for Cell 2 with a measurement reporting delay of less than 960ms ($3 * \text{measCycleSCell}$) from beginning of time T2.

The UE shall not send event triggered measurement reports as long as the reporting criteria are not fulfilled.

The rate of correct events observed during repeated tests shall be at least 90% for each of the events.

NOTE: The actual overall delays measured in the tests may be up to $2 * T_{\text{TTI}_{\text{DCCH}}}$ higher than the measurement reporting delays above because of TTI insertion uncertainty of the measurement report in DCCH.

A.8.22.12 E-UTRAN TDD event triggered reporting under deactivated SCell in non-DRX based on CSI-RS based discovery signal

A.8.22.12.1 Test Purpose and Environment

The purpose of this test is to verify that the UE correctly detects event C1 (CSI-RS resource becomes better than threshold) defined in TS 36.331 [2] within the requirements stated in clause 8.7.3.4.1.

The test parameters are given in Tables A.8.22.12.1-1 and A.8.22.12.1-2 below. It is indicated to the UE in the measurement control information that event-triggered reporting with Events C1 is used. The test consists of three successive time periods, with duration of T1, T2 and T3, respectively. During T1 and T2 the UE shall not have any information on cell 3. Immediately at beginning of T3 the transmission power of cell 3 is increased above a threshold value and this shall result in reporting of Event C1. At beginning of T2 the transmission powers of cells 1 and 2 are increased above a threshold value and this shall result in reporting of Event C1 for PCell and SCell, respectively.

Table A.8.22.12.1-1: General test parameters for E-UTRAN TDD event triggered reporting on configured but deactivated SCell in non-DRX under fading propagation conditions for CSI-RS based measurements under discovery signal

Parameter	Unit	Value	Comment
E-UTRA RF Channel Number		1, 2	Two radio channels are used for this test
Active PCell		Cell 1	Primary cell on RF channel number 1.
Configured deactivated SCell		Cell 2	Configured deactivated secondary cell on RF channel number 2.

Neighbour cell		Cell 3	Neighbor cell to be identified on RF channel number 2.	
DMTC period	ms	160	As specified in IE MeasDS-Config in TS 36.331	
dmtc-PeriodOffset for cells 2 and 3	ms	10	As specified in IE MeasDS-Config in TS 36.331	
Discovery signal occasion duration	ms	1	As specified in IE MeasDS-Config in TS 36.331	
Channel Bandwidth ($BW_{channel}$)	MHz	10	Channel bandwidth for cells on primary and secondary component carriers	
CP length		Normal		
Special subframe configuration		6	As specified in table 4.2.1 in TS 36.211. The same configuration applies to all cells.	
Uplink-downlink configuration		1		
DRX		OFF	Continuous monitoring of primary cell	
C1	Hysteresis	dB	0	Hysteresis for evaluation of event C1.
	Threshold CSI-RSRP	dBm	-90	Actual RSRP threshold for event C1. Needs to take absolute accuracy tolerance in clause 9.1.14.3 into account plus margin.
	Time To Trigger	s	0	
Cell-individual offset for cells on RF channel number 1	dB	0	Individual offset for cells on primary component carrier.	
Cell-individual offset for cells on RF channel number 2	dB	0	Individual offset for cells on secondary component carrier.	
Filter coefficient		0	L3 filtering is not used	
SCell measurement cycle ($measCycleSCell$)	ms	320		
T1	s	5		
T2	s	5		
T3	s	10		
NOTE: This test verifies the RRM requirement which is independent of channel bandwidth and is performed according to the principle defined in section A.3.6.1.				

Table A.8.22.12.1-2: Cell specific test parameters for E-UTRAN TDD event triggered reporting on configured but deactivated SCell in non-DRX under fading propagation conditions for CSI-RS based measurements under discovery signal

Parameter	Unit	Cell 1			Cell 2			Cell 3		
		T1	T2	T3	T1	T2	T3	T1	T2	T3
E-UTRA RF Channel Number		1			2			2		
$BW_{channel}$	MHz	10			10			10		
Measurement bandwidth	n_{PRB}	13-37			13-37			13-37		
PDSCH parameters		DL Reference Measurement Channel R.0 TDD As in A.3.1.1.2								
PCFICH/PDCCH/PHICH parameters		DL Reference Measurement Channel R.6 TDD as in A.3.1.2.2			DL Reference Measurement Channel R.6 TDD as in A.3.1.2.2			DL Reference Measurement Channel R.6 TDD as in A.3.1.2.2		
Correlation Matrix and Antenna Configuration		1x2 Low			1x2 Low			1x2 Low		
OCNG Patterns defined in A.3.2.1.1 (OP.1 TDD) and in A.3.2.1.2 (OP.2 TDD)		OP.1 TDD			OP.2 TDD			OP.2 TDD		
PBCH_RA	dB	0			0			0		
PBCH_RB	dB									
PSS_RA	dB									
SSS_RA	dB									
PCFICH_RB	dB									
PHICH_RA	dB									
PHICH_RB	dB									

PDCCH_RA	dB									
PDCCH_RB	dB									
PDSCH_RA	dB									
PDSCH_RB	dB									
OCNG_RA ^{Note 1}	dB									
OCNG_RB ^{Note 1}	dB									
N _{oc} ^{Note 2}	dBm/15 kHz	-101			-101					
RSRP ^{Note 3}	dBm/15 kHz	-104	-84	-84	-104	-84	-84	-infinity	-infinity	-84
CSI-RSRP ^{Note 3}	dBm/15 kHz	-98	-78	-78	-98	-78	-78	-infinity	-infinity	-78
SCH_RP ^{Note 3}	dBm/15 kHz	-104	-84	-84	-104	-84	-84	-infinity	-infinity	-84
CRS \hat{E}_s/N_{oc}	dB	-3	17	17	-3	17	17	-infinity	-infinity	17
CSI-RS \hat{E}_s/N_{oc}	dB	3	23	23	3	23	23	-infinity	-infinity	23
CRS \hat{E}_s/I_{ot}	dB	-3	17	17	-3	17	-0.09	-infinity	-infinity	-0.09
CSI-RS \hat{E}_s/I_{ot}	dB	3	23	23	3	23	5.91	-infinity	-infinity	5.91
Propagation Condition		ETU30			ETU30			ETU30		
CSI-RS resource configurations [16]		0			2			4		
CSI-RS periodicity	10	10			10			10		
CSI-RS subframe offset		0			0			0		
CSI-RS individual offset [2]	[dB]	0			0			0		
CSI-RS muting		Enable			Enable			Enable		
p-C-r10 [2]	dB	-6			-6			-6		
Time offset to cell 1	us	0			0			2.3 (CP/2)		
Time alignment error relative to cell1 ^{Note 5}	us	-			≤ TAE			N/A		
Timing offset to Cell 2	μs	-			-			2.3 (CP/2)		
<p>Note 1: OCNG shall be used such that all cells are fully allocated and a constant total transmitted power spectral density is achieved for all OFDM symbols.</p> <p>Note 2: Interference from other cells and noise sources not specified in the test is assumed to be constant over subcarriers and time and shall be modelled as AWGN of appropriate power for N_{oc} to be fulfilled.</p> <p>Note 3: RSRP, CSI-RSRP and SCH_RP levels have been derived from other parameters for information purposes. They are not settable parameters themselves.</p> <p>Note 4: The resources for uplink transmission are assigned to the UE prior to the start of time period T2.</p> <p>Note 5: Time alignment error (TAE) as specified in TS 36.104 [30] clause 6.5.3.1. The TAE value depends upon the type of carrier aggregation.</p>										

A.8.22.12.2 Test Requirements

The UE shall send one Event C1 triggered measurement report for Cell 3 with a measurement reporting delay of less than 6.08s ($T_{identify_scc_SCE} + T_{measure_scc_CSI-RS} = 13 * measCycleSCell + T_{measure_scc_CRS} + T_{measure_scc_CSI-RS} = 13 * measCycleSCell + 3 * measCycleSCell + 3 * measCycleSCell$) from the beginning of time T3.

The UE shall send one Event C1 triggered measurement report for Cell 1 with a measurement reporting delay of less than 480 ms ($3 * T_{DMTC_periodicity}$) from beginning of time T2.

The UE shall send one Event C1 triggered measurement report for Cell 2 with a measurement reporting delay of less than 960ms ($3 * measCycleSCell$) from beginning of time T2.

The UE shall not send event triggered measurement reports as long as the reporting criteria are not fulfilled.

The rate of correct events observed during repeated tests shall be at least 90% for each of the events.

NOTE: The actual overall delays measured in the tests may be up to $2 \times TTI_{DCCH}$ higher than the measurement reporting delays above because of TTI insertion uncertainty of the measurement report in DCCH.

A.8.23 E-UTRAN Dual Connectivity Measurements

A.8.23.1 E-UTRAN FDD-FDD DC intra-frequency event triggered reporting with DRX in synchronous DC

A.8.23.1.1 Test Purpose and Environment

The purpose of this test is to verify that the UE makes correct reporting of intra frequency measurement. This test will partly verify the FDD intra-frequency cell search requirements in clause 8.8.2 and 8.8.3.

The test parameters are given in Table A.8.23.1.1-1, A.8.23.1.1-2, A.8.23.1.1-3 and A.8.23.1.1-4 below. In the test there are two cells: Cell1 and Cell2. Cell1 is PCell and Cell2 is PSCell. In the measurement control information it is indicated to the UE that event-triggered reporting with Events A1 (PCell and PSCell) and A2 (PCell and PSCell) is used. The test consists of three successive time periods, with duration of T1, T2 and T3, respectively. Prior to the start of the time duration T1, the UE shall be fully synchronized to Cell1 and Cell2. Prior to the start of the time duration T1, DRX configurations on MCG and SCG are enabled and DRX inactivity timers for MCG and SCG have already been expired. Immediately at beginning of T2 the transmission powers of Cell1 and Cell2 are reduced below a threshold value of event A2 and this shall result in reporting of Event A2 for PCell and PSCell, respectively. Immediately after receiving the reporting of event A2 for both PCell and PSCell, PDCCH indicating a new transmission on Cell1 shall be sent continuously to ensure that the UE would not enter the DRX state on MCG throughout T3. At beginning of T3 the transmission powers of Cell1 and Cell2 are increased above a threshold value of event A1 and this shall result in reporting of Event A1 for PCell and PSCell, respectively.

When MCG DRX is used, the uplink time alignment of Cell1 is not maintained and UE needs to use RACH to obtain UL allocation for measurement reporting in Cell1. When SCG DRX is used, the UE needs to be provided at least once every 500ms with new Timing Advance Command MAC control element to restart the Time alignment timer to keep UE uplink time alignment in Cell2. Furthermore UE is allocated with PUSCH resource at every DRX cycle.

Table A.8.23.1.1-1: General test parameters for E-UTRAN FDD-FDD DC intra-frequency event triggered reporting with DRX in synchronous DC

Parameter		Unit	Value	Comment
E-UTRA RF Channel Number			1, 2	Two radio channels are used for this test.
Active PCell			Cell1	PCell on RF channel number 1.
Configured PSCell			Cell2	PSCell on RF channel number 2.
A1	Hysteresis	dB	0	Hysteresis for evaluation of event A1.
	Threshold RSRP	dBm	-95	Actual RSRP threshold for event A1. Needs to take absolute accuracy tolerance in clause 9.1.11.1 and 9.1.11.2 into account plus margin.
	Time To Trigger	s	0	
A2	Hysteresis	dB	0	Hysteresis for evaluation of event A2.
	Threshold RSRP	dBm	-99	Actual RSRP threshold for event A2. Needs to take absolute accuracy tolerance in clause 9.1.11.1 and 9.1.11.2 into account plus margin.
	Time To Trigger	s	0	
CP length			Normal	
DRX			ON	DRX related parameters are defined in Table A.8.23.1.1-3
Cell-individual offset for cells on RF channel number 1		dB	0	Individual offset for cells on primary component carrier.
Cell-individual offset for cells on RF channel number 2		dB	0	Individual offset for cells on carrier frequency of Cell2.
Filter coefficient			0	L3 filtering is not used
T1		s	2	

T2	s	10	
T3	s	1	
Note 1: Void			
Note 2: A UE capable of both synchronous and asynchronous DC operations is not required to pass this test case in accordance with the principle defined in section A.3.11.			

Table A.8.23.1.1-2: Cell specific test parameters for E-UTRAN FDD-FDD DC intra-frequency event triggered reporting with DRX in synchronous DC

Parameter	Unit	Cell 1			Cell 2		
		T1	T2	T3	T1	T2	T3
E-UTRA RF Channel Number		1			2		
BW _{channel}	MHz	5MHz: N _{RB,c} = 25 10MHz: N _{RB,c} = 50 20MHz: N _{RB,c} = 100			5MHz: N _{RB,c} = 25 10MHz: N _{RB,c} = 50 20MHz: N _{RB,c} = 100		
PDSCH parameters: DL Reference Measurement Channel		5MHz: R.5 FDD 10MHz: R.0 FDD 20MHz: R.4 FDD			5MHz: R.5 FDD 10MHz: R.0 FDD 20MHz: R.4 FDD		
PCFICH/PDCCH/PHICH parameters: DL Reference Measurement Channel		5MHz: R.11 FDD 10MHz: R.6 FDD 20MHz: R.10 FDD			5MHz: R.11 FDD 10MHz: R.6 FDD 20MHz: R.10 FDD		
OCNG Patterns		5MHz: OP.15 FDD 10MHz: OP.1 FDD 20MHz: OP.11 FDD			5MHz: OP.15 FDD 10MHz: OP.1 FDD 20MHz: OP.11 FDD		
PBCH_RA	dB	0			0		
PBCH_RB	dB						
PSS_RA	dB						
SSS_RA	dB						
PCFICH_RB	dB						
PHICH_RA	dB						
PHICH_PB	dB						
PDCCH_RA	dB						
PDCCH_PB	dB						
PDSCH_RA	dB						
PDSCH_RB	dB						
OCNG_RA ^{Note 1}	dB						
OCNG_RB ^{Note 1}	dB						
N_{oc} ^{Note 2}	dBm/15 KHz						
\hat{E}_s/N_{oc}	dB	16	-2.5	20	16	-2.5	20
\hat{E}_s/I_{ot} ^{Note 3}	dB	16	-2.5	20	16	-2.5	20
RSRP ^{Note 3}	dBm/15 KHz	-88	-106.5	-84	-88	-106.5	-84
SCH_RP ^{Note 3}	dBm/15 KHz	-88	-106.5	-84	-88	-106.5	-84
I_o ^{Note 3}	dBm/Ch BW	-60.11 +10log (N _{RB,c} /50)	-74.28 +10log (N _{RB,c} /50)	-56.18 +10log (N _{RB,c} /50)	-60.11 +10log (N _{RB,c} /50)	-74.28 +10log (N _{RB,c} /50)	-56.18 +10log (N _{RB,c} /50)
Propagation Condition		ETU70			ETU70		
Correlation Matrix and Antenna Configuration		1x2 Low			1x2 Low		
Receive Time offset to cell1 ^{Note 5}	μs	-			33		

Note 1:	OCNG shall be used such that both cells are fully allocated and a constant total transmitted power spectral density is achieved for all OFDM symbols.
Note 2:	Interference from other cells and noise sources not specified in the test is assumed to be constant over subcarriers and time and shall be modelled as AWGN of appropriate power for Noc to be fulfilled.
Note 3:	Es/lot, RSRP, SCH_RP and lo levels have been derived from other parameters for information purposes. They are not settable parameters themselves.
Note 4:	The resources for uplink transmission in Cell1 are assigned to the UE prior to the start of time period T3.
Note 5:	Receive time difference between subframe boundaries of signals received from the two cells at the UE antenna connector including time alignment error between the two cells.

Table A.8.23.1.1-3: DRX-Configuration for E-UTRAN FDD-FDD DC intra-frequency event triggered reporting with DRX in synchronous DC

Field	Cell1	Cell2	Comment
	Value	Value	
onDurationTimer	psf1	psf1	As specified in clause 6.3.2 in TS 36.331
drx-InactivityTimer	psf1	psf1	
drx-RetransmissionTimer	psf1	psf1	
longDRX-CycleStartOffset	sf1280	sf80	
shortDRX	disable	disable	

Table A.8.23.1.1-4: TimeAlignmentTimer-Configuration for E-UTRAN FDD-FDD DC intra-frequency event triggered reporting with DRX in synchronous DC

Field	Cell1	Cell2	Comment
	Value	Value	
TimeAlignmentTimer	sf500	sf500	As specified in clause 6.3.2 in TS 36.331
sr-ConfigIndex	0	0	For further information see clause 6.3.2 in TS 36.331 and section10.1 in TS 36.213.

A.8.23.1.2 Test Requirements

The UE shall send one Event A2 triggered report for PCell on PCell with a measurement reporting delay less than 6.4s (5*MCG_DRX cycle) from the beginning of time period T2. The measurement reporting delay is defined as the time from the beginning of time period T2 to the moment when the UE starts to send preambles on the PRACH to obtain allocation to send the measurement report on PUSCH.

The UE shall send one Event A2 triggered report for PSCell on PCell with a measurement reporting delay less than 400ms (5*SCG_DRX cycle) from the beginning of time period T2. The measurement reporting delay is defined as the time from the beginning of time period T2 to the moment when the UE starts to send preambles on the PRACH to obtain allocation to send the measurement report on PUSCH.

The UE shall send one Event A1 triggered report for PCell on PCell with a measurement reporting delay less than 200ms from the beginning of time period T3. The measurement reporting delay is defined as the time from the beginning of time period T3 to the moment when the UE sends the measurement report on PUSCH.

The UE shall send one Event A1 triggered report for PSCell on PCell with a measurement reporting delay less than 400ms (5*SCG_DRX cycle) from the beginning of time period T3. The measurement reporting delay is defined as the time from the beginning of time period T3 to the moment when the UE sends the measurement report on PUSCH.

The UE shall not send event triggered measurement reports, as long as the reporting criteria are not fulfilled.

The rate of correct events observed during repeated tests shall be at least 90%.

A.8.23.2 E-UTRAN FDD-FDD DC intra-frequency event triggered reporting with DRX in asynchronous DC

A.8.23.2.1 Test Purpose and Environment

The purpose of this test is to verify that the UE makes correct reporting of intra frequency measurement. This test will partly verify the FDD intra-frequency cell search requirements in clause 8.8.2 and 8.8.3.

The test parameters are given in Table A.8.23.2.1-1, A.8.23.2.1-2, A.8.23.2.1-3 and A.8.23.2.1-4 below. In the test there are two cells: Cell1 and Cell2. Cell1 is PCell and Cell2 is PSCell. In the measurement control information it is indicated to the UE that event-triggered reporting with Events A1 (PCell and PSCell) and A2 (PCell and PSCell) is used. The test consists of three successive time periods, with duration of T1, T2 and T3, respectively. Prior to the start of the time duration T1, the UE shall be fully synchronized to Cell1 and Cell2. Prior to the start of the time duration T1, DRX configurations on MCG and SCG are enabled and DRX inactivity timers for MCG and SCG have already been expired. Immediately at beginning of T2 the transmission powers of Cell1 and Cell2 are reduced below a threshold value of event A2 and this shall result in reporting of Event A2 for PCell and PSCell, respectively. Immediately after receiving the reporting of event A2 for both PCell and PSCell, PDCCH indicating a new transmission on Cell1 shall be sent continuously to ensure UE would not enter DRX state on MCG throughout T3. At beginning of T3 the transmission powers of Cell1 and Cell2 are increased above a threshold value of event A1 and this shall result in reporting of Event A1 for PCell and PSCell, respectively.

When MCG DRX is used, the uplink time alignment of Cell1 is not maintained and UE needs to use RACH to obtain UL allocation for measurement reporting in Cell1. When SCG DRX is used, the UE needs to be provided at least once every 500ms with new Timing Advance Command MAC control element to restart the Time alignment timer to keep UE uplink time alignment in Cell2. Furthermore UE is allocated with PUSCH resource at every DRX cycle.

Table A.8.23.2.1-1: General test parameters for E-UTRAN FDD-FDD DC intra-frequency event triggered reporting with DRX in asynchronous DC

Parameter	Unit	Value	Comment	
E-UTRA RF Channel Number		1, 2	Two radio channels are used for this test.	
Active PCell		Cell1	PCell on RF channel number 1.	
Configured PSCell		Cell2	PSCell on RF channel number 2.	
A1	Hysteresis	dB	0	Hysteresis for evaluation of event A1.
	Threshold RSRP	dBm	-95	Actual RSRP threshold for event A1. Needs to take absolute accuracy tolerance in clause 9.1.11.1 and 9.1.11.2 into account plus margin.
	Time To Trigger	s	0	
A2	Hysteresis	dB	0	Hysteresis for evaluation of event A2.
	Threshold RSRP	dBm	-99	Actual RSRP threshold for event A2. Needs to take absolute accuracy tolerance in clause 9.1.11.1 and 9.1.11.2 into account plus margin.
	Time To Trigger	s	0	
CP length		Normal		
DRX		ON	DRX related parameters are defined in Table A.8.23.2.1-3	
Cell-individual offset for cells on RF channel number 1	dB	0	Individual offset for cells on primary component carrier.	
Cell-individual offset for cells on RF channel number 2	dB	0	Individual offset for cells on carrier frequency of Cell2.	
Filter coefficient		0	L3 filtering is not used	
T1	s	2		
T2	s	10		
T3	s	1		
Note 1:	Void			
Note 2:	Even a UE capable of both synchronous and asynchronous DC operations is required to pass this test case in accordance with the principle defined in section A.3.11.			

Table A.8.23.2.1-2: Cell specific test parameters for E-UTRAN FDD-FDD DC intra-frequency event triggered reporting with DRX in asynchronous DC

Parameter	Unit	Cell 1			Cell 2		
		T1	T2	T3	T1	T2	T3
E-UTRA RF Channel Number		1			2		
$BW_{channel}$	MHz	5MHz: $N_{RB,c} = 25$ 10MHz: $N_{RB,c} = 50$ 20MHz: $N_{RB,c} = 100$			5MHz: $N_{RB,c} = 25$ 10MHz: $N_{RB,c} = 50$ 20MHz: $N_{RB,c} = 100$		
PDSCH parameters: DL Reference Measurement Channel		5MHz: R.5 FDD 10MHz: R.0 FDD 20MHz: R.4 FDD			5MHz: R.5 FDD 10MHz: R.0 FDD 20MHz: R.4 FDD		
PCFICH/PDCCH/PHICH parameters: DL Reference Measurement Channel		5MHz: R.11 FDD 10MHz: R.6 FDD 20MHz: R.10 FDD			5MHz: R.11 FDD 10MHz: R.6 FDD 20MHz: R.10 FDD		
OCNG Patterns		5MHz: OP.15 FDD 10MHz: OP.1 FDD 20MHz: OP.11 FDD			5MHz: OP.15 FDD 10MHz: OP.1 FDD 20MHz: OP.11 FDD		
PBCH_RA	dB	0			0		
PBCH_RB	dB						
PSS_RA	dB						
SSS_RA	dB						
PCFICH_RB	dB						
PHICH_RA	dB						
PHICH_PB	dB						
PDCCH_RA	dB						
PDCCH_PB	dB						
PDSCH_RA	dB						
PDSCH_RB	dB						
OCNG_RA ^{Note 1}	dB						
OCNG_RB ^{Note 1}	dB						
N_{oc} ^{Note 2}	dBm/15 KHz						
\hat{E}_s / N_{oc}	dB	16	-2.5	20	16	-2.5	20
\hat{E}_s / I_{ot} ^{Note 3}	dB	16	-2.5	20	16	-2.5	20
RSRP ^{Note 3}	dBm/15 KHz	-88	-106.5	-84	-88	-106.5	-84
SCH_RP ^{Note 3}	dBm/15 KHz	-88	-106.5	-84	-88	-106.5	-84
I_o ^{Note 3}	dBm/Ch BW	-60.11 +10log ($N_{RB,c}$ /50)	-74.28 +10log ($N_{RB,c}$ /50)	-56.18 +10log ($N_{RB,c}$ /50)	-60.11 +10log ($N_{RB,c}$ /50)	-74.28 +10log ($N_{RB,c}$ /50)	-56.18 +10log ($N_{RB,c}$ /50)
Propagation Condition		ETU70			ETU70		
Correlation Matrix and Antenna Configuration		1x2 Low			1x2 Low		
Receive Time offset to cell1 ^{Note 5}	μ s	-			500		
<p>Note 1: OCNG shall be used such that both cells are fully allocated and a constant total transmitted power spectral density is achieved for all OFDM symbols.</p> <p>Note 2: Interference from other cells and noise sources not specified in the test is assumed to be constant over subcarriers and time and shall be modelled as AWGN of appropriate power for N_{oc} to be fulfilled.</p> <p>Note 3: E_s/I_{ot}, RSRP, SCH_RP and I_o levels have been derived from other parameters for information purposes. They are not settable parameters themselves.</p> <p>Note 4: The resources for uplink transmission in Cell1 are assigned to the UE prior to the start of time period T3.</p> <p>Note 5: Receive time difference between subframe boundaries of signals received from the two cells at the UE antenna connector including time alignment error between the two cells.</p>							

Table A.8.23.2.1-3: DRX-Configuration for E-UTRAN FDD-FDD DC intra-frequency event triggered reporting with DRX in asynchronous DC

Field	Cell1	Cell2	Comment
-------	-------	-------	---------

	Value	Value	
onDurationTimer	psf1	psf1	As specified in clause 6.3.2 in TS 36.331
drx-InactivityTimer	psf1	psf1	
drx-RetransmissionTimer	psf1	psf1	
longDRX-CycleStartOffset	sf1280	sf80	
shortDRX	disable	disable	

Table A.8.23.2.1-4: TimeAlignmentTimer -Configuration for E-UTRAN FDD-FDD DC intra-frequency event triggered reporting with DRX in asynchronous DC

Field	Cell1	Cell2	Comment
	Value	Value	
TimeAlignmentTimer	sf500	sf500	As specified in clause 6.3.2 in TS 36.331
sr-ConfigIndex	0	0	For further information see clause 6.3.2 in TS 36.331 and section10.1 in TS 36.213.

A.8.23.2.2 Test Requirements

The UE shall send one Event A2 triggered report for PCell on PCell with a measurement reporting delay less than 6.4s (5*MCG_DRX cycle) from the beginning of time period T2. The measurement reporting delay is defined as the time from the beginning of time period T2 to the moment when the UE starts to send preambles on the PRACH to obtain allocation to send the measurement report on PUSCH.

The UE shall send one Event A2 triggered report for PSCell on PCell with a measurement reporting delay less than 400ms (5*SCG_DRX cycle) from the beginning of time period T2. The measurement reporting delay is defined as the time from the beginning of time period T2 to the moment when the UE starts to send preambles on the PRACH to obtain allocation to send the measurement report on PUSCH.

The UE shall send one Event A1 triggered report for PCell on PCell with a measurement reporting delay less than 200ms from the beginning of time period T3. The measurement reporting delay is defined as the time from the beginning of time period T3 to the moment when the UE sends the measurement report on PUSCH.

The UE shall send one Event A1 triggered report for PSCell on PCell with a measurement reporting delay less than 400ms (5*SCG_DRX cycle) from the beginning of time period T3. The measurement reporting delay is defined as the time from the beginning of time period T3 to the moment when the UE sends the measurement report on PUSCH.

The UE shall not send event triggered measurement reports, as long as the reporting criteria are not fulfilled.

The rate of correct events observed during repeated tests shall be at least 90%.

A.8.23.3 E-UTRAN TDD-TDD DC intra-frequency event triggered reporting with DRX in synchronous DC

A.8.23.3.1 Test Purpose and Environment

The purpose of this test is to verify that the UE makes correct reporting of intra frequency measurement. This test will partly verify the TDD intra-frequency cell search requirements in clause 8.8.2 and 8.8.3.

The test parameters are given in Table A.8.23.3.1-1, A.8.23.3.1-2, A.8.23.3.1-3 and A.8.23.3.1-4 below. In the test there are two cells: Cell1 and Cell2. Cell1 is PCell and Cell2 is PSCell. In the measurement control information it is indicated to the UE that event-triggered reporting with Events A1 (PCell and PSCell) and A2 (PCell and PSCell) is used. The test consists of three successive time periods, with duration of T1, T2 and T3, respectively. Prior to the start of the time duration T1, the UE shall be fully synchronized to Cell1 and Cell2. Prior to the start of the time duration T1, DRX configurations on MCG and SCG are enabled and DRX inactivity timers for MCG and SCG have already been expired. Immediately at beginning of T2 the transmission powers of Cell1 and Cell2 are reduced below a threshold value of event A2 and this shall result in reporting of Event A2 for PCell and PSCell, respectively. Immediately after receiving the reporting of event A2 for both PCell and PSCell, PDCCH indicating a new transmission on Cell1 shall be sent continuously to ensure UE would not enter DRX state on MCG throughout T3. At beginning of T3 the transmission powers of Cell1 and Cell2 are increased above a threshold value of event A1 and this shall result in reporting of Event A1 for PCell and PSCell, respectively.

When MCG DRX is used, the uplink time alignment of Cell1 is not maintained and UE needs to use RACH to obtain UL allocation for measurement reporting in Cell1. When SCG DRX is used, the UE needs to be provided at least once every 500ms with new Timing Advance Command MAC control element to restart the Time alignment timer to keep UE uplink time alignment in Cell2. Furthermore UE is allocated with PUSCH resource at every DRX cycle.

Table A.8.23.3.1-1: General test parameters for E-UTRAN TDD-TDD DC intra-frequency event triggered reporting with DRX in synchronous DC

Parameter		Unit	Value	Comment
E-UTRA RF Channel Number			1, 2	Two radio channels are used for this test.
Active PCell			Cell1	PCell on RF channel number 1.
Configured PSCell			Cell2	PSCell on RF channel number 2.
A1	Hysteresis	dB	0	Hysteresis for evaluation of event A1.
	Threshold RSRP	dBm	-95	Actual RSRP threshold for event A1. Needs to take absolute accuracy tolerance in clause 9.1.11.1 and 9.1.11.2 into account plus margin.
	Time To Trigger	s	0	
A2	Hysteresis	dB	0	Hysteresis for evaluation of event A2.
	Threshold RSRP	dBm	-99	Actual RSRP threshold for event A2. Needs to take absolute accuracy tolerance in clause 9.1.11.1 and 9.1.11.2 into account plus margin.
	Time To Trigger	s	0	
CP length			Normal	
DRX			ON	DRX related parameters are defined in Table A.8.23.3.1-3
Cell-individual offset for cells on RF channel number 1		dB	0	Individual offset for cells on primary component carrier.
Cell-individual offset for cells on RF channel number 2		dB	0	Individual offset for cells on carrier frequency of Cell2.
Filter coefficient			0	L3 filtering is not used
T1		s	5	
T2		s	10	
T3		s	1	
NOTE1: Void				

Table A.8.23.3.1-2: Cell specific test parameters for E-UTRAN TDD-TDD DC intra-frequency event triggered reporting with DRX in synchronous DC

Parameter	Unit	Cell 1			Cell 2		
		T1	T2	T3	T1	T2	T3
E-UTRA RF Channel Number		1			2		
BW _{channel}	MHz	5MHz: N _{RB,c} = 25 10MHz: N _{RB,c} = 50 20MHz: N _{RB,c} = 100			5MHz: N _{RB,c} = 25 10MHz: N _{RB,c} = 50 20MHz: N _{RB,c} = 100		
Special subframe configuration ^{Note 6}		6			6		
Uplink-downlink configuration ^{Note 6}		1			1		
PDSCH parameters: DL Reference Measurement Channel		5MHz: R.4 TDD 10MHz: R.0 TDD 20MHz: R.3 TDD			5MHz: R.4 TDD 10MHz: R.0 TDD 20MHz: R.3 TDD		
PCFICH/PDCCH/PHICH parameters: DL Reference Measurement Channel		5MHz: R.11 TDD 10MHz: R.6 TDD 20MHz: R.10 TDD			5MHz: R.11 TDD 10MHz: R.6 TDD 20MHz: R.10 TDD		
OCNG Patterns		5MHz: OP.9 TDD 10MHz: OP.1 TDD 20MHz: OP.7 TDD			5MHz: OP.9 TDD 10MHz: OP.1 TDD 20MHz: OP.7 TDD		
PBCH_RA	dB	0			0		
PBCH_RB	dB						

PSS_RA	dB						
SSS_RA	dB						
PCFICH_RB	dB						
PHICH_RA	dB						
PHICH_PB	dB						
PDCCH_RA	dB						
PDCCH_PB	dB						
PDSCH_RA	dB						
PDSCH_RB	dB						
OCNG_RA ^{Note 1}	dB						
OCNG_RB ^{Note 1}	dB						
N_{oc} ^{Note 2}	dBm/15 KHz	-104			-104		
\hat{E}_s / N_{oc}	dB	16	-2.5	20	16	-2.5	20
\hat{E}_s / I_{ot} ^{Note 3}	dB	16	-2.5	20	16	-2.5	20
RSRP ^{Note 3}	dBm/15 KHz	-88	-106.5	-84	-88	-106.5	-84
SCH_RP ^{Note 3}	dBm/15 KHz	-88	-106.5	-84	-88	-106.5	-84
I_o ^{Note 3}	dBm/Ch BW	-60.11 +10log ($N_{RB,c}$ /50)	-74.28 +10log ($N_{RB,c}$ /50)	-56.18 +10log ($N_{RB,c}$ /50)	-60.11 +10log ($N_{RB,c}$ /50)	-74.28 +10log ($N_{RB,c}$ /50)	-56.18 +10log ($N_{RB,c}$ /50)
Propagation Condition		ETU70			ETU70		
Correlation Matrix and Antenna Configuration		1x2 Low			1x2 Low		
Receive Time offset to cell1 ^{Note 5}	µs	-			33		
<p>Note 1: OCNG shall be used such that both cells are fully allocated and a constant total transmitted power spectral density is achieved for all OFDM symbols.</p> <p>Note 2: Interference from other cells and noise sources not specified in the test is assumed to be constant over subcarriers and time and shall be modelled as AWGN of appropriate power for N_{oc} to be fulfilled.</p> <p>Note 3: E_s/I_{ot}, RSRP, SCH_RP and I_o levels have been derived from other parameters for information purposes. They are not settable parameters themselves.</p> <p>Note 4: The resources for uplink transmission in Cell1 are assigned to the UE prior to the start of time period T3.</p> <p>Note 5: Receive time difference between subframe boundaries of signals received from the two cells at the UE antenna connector including time alignment error between the two cells.</p> <p>Note 6: For special subframe and uplink-downlink configurations see Tables 4.2-1 and 4.2-2 in TS 36.211 [16].</p>							

Table A.8.23.3.1-3: DRX-Configuration for E-UTRAN TDD-TDD DC intra-frequency event triggered reporting with DRX in synchronous DC

Field	Cell1	Cell2	Comment
	Value	Value	
onDurationTimer	psf1	psf1	As specified in clause 6.3.2 in TS 36.331
drx-InactivityTimer	psf1	psf1	
drx-RetransmissionTimer	psf1	psf1	
longDRX-CycleStartOffset	sf1280	sf80	
shortDRX	disable	disable	

Table A.8.23.3.1-4: TimeAlignmentTimer-Configuration for E-UTRAN TDD-TDD DC intra-frequency event triggered reporting with DRX in synchronous DC

Field	Cell1	Cell2	Comment
	Value	Value	
TimeAlignmentTimer	sf500	sf500	As specified in clause 6.3.2 in TS 36.331
sr-ConfigIndex	0	0	For further information see clause 6.3.2 in TS 36.331 and section 10.1 in TS 36.213.

A.8.23.3.2 Test Requirements

The UE shall send one Event A2 triggered report for PCell on PCell with a measurement reporting delay less than 6.4s (5*MCG_DRX cycle) from the beginning of time period T2. The measurement reporting delay is defined as the time from the beginning of time period T2 to the moment when the UE starts to send preambles on the PRACH to obtain allocation to send the measurement report on PUSCH.

The UE shall send one Event A2 triggered report for PSCell on PCell with a measurement reporting delay less than 400ms (5*SCG_DRX cycle) from the beginning of time period T2. The measurement reporting delay is defined as the time from the beginning of time period T2 to the moment when the UE starts to send preambles on the PRACH to obtain allocation to send the measurement report on PUSCH.

The UE shall send one Event A1 triggered report for PCell on PCell with a measurement reporting delay less than 200ms from the beginning of time period T3. The measurement reporting delay is defined as the time from the beginning of time period T3 to the moment when the UE sends the measurement report on PUSCH.

The UE shall send one Event A1 triggered report for PSCell on PCell with a measurement reporting delay less than 400ms (5*SCG_DRX cycle) from the beginning of time period T3. The measurement reporting delay is defined as the time from the beginning of time period T3 to the moment when the UE sends the measurement report on PUSCH.

The UE shall not send event triggered measurement reports, as long as the reporting criteria are not fulfilled.

The rate of correct events observed during repeated tests shall be at least 90%.

A.8.23.4 E-UTRAN FDD-FDD DC inter-frequency event triggered reporting with DRX in synchronous DC

A.8.23.4.1 Test Purpose and Environment

The purpose of this test is to verify that the UE makes correct reporting of inter frequency measurement. This test will partly verify the FDD inter-frequency cell search requirements in clause 8.8.4.

The test parameters are given in Table A.8.23.4.1-1, A.8.23.4.1-2, A.8.23.4.1-3 and A.8.23.4.1-4 below. In the test there are three cells: Cell1, Cell2 and Cell3. Cell1 is PCell, Cell2 is PSCell and Cell3 is a neighbour cell. In the measurement control information it is indicated to the UE that event-triggered reporting with Events A3 (PCell) is used. The test consists of two successive time periods, with duration of T1 and T2, respectively. Prior to the start of the time duration T1, the UE shall be fully synchronized to Cell1 and Cell2. During T1 the UE shall not have any information on Cell3. Prior to the start of the time duration T1, DRX configurations on MCG and SCG are enabled and DRX inactivity timers for MCG and SCG have already been expired.

In this test, UE needs to be provided at least once every 500ms with new Timing Advance Command MAC control element to restart the Time alignment timer to keep UE uplink time alignment in Cell1. Furthermore UE is allocated with PUSCH resource at every DRX cycle.

Table A.8.23.4.1-1: General test parameters for E-UTRAN FDD-FDD DC inter-frequency event triggered reporting with DRX in synchronous DC

Parameter	Unit	Value	Comment	
E-UTRA RF Channel Number		1, 2, 3	Three radio channels are used for this test.	
Active PCell		Cell1	PCell on RF channel number 1.	
Configured PSCell		Cell2	PSCell on RF channel number 2.	
Neighbour cell		Cell3	Neighbour cell on RF channel number 3.	
A3	Hysteresis	dB	0	Hysteresis for evaluation of event A3.
	A3-offset	dB	-6	
	Time To Trigger	s	0	
CP length		Normal		
DRX		ON	DRX related parameters are defined in Table A.8.23.4.1-3	
Measurement gap pattern Id		0		
Cell-individual offset for cells on RF channel number 1	dB	0	Individual offset for cells on primary component carrier.	

Cell-individual offset for cells on RF channel number 2	dB	0	Individual offset for cells on carrier frequency of Cell2.
Cell-individual offset for cells on RF channel number 3	dB	0	Individual offset for cells on carrier frequency of Cell3.
Filter coefficient		0	L3 filtering is not used
T1	s	5	
T2	s	5	
Note 1: Void			
Note 2: A UE capable of both synchronous and asynchronous DC operations is not required to pass this test case in accordance with the principle defined in section A.3.11.			

Table A.8.23.4.1-2: Cell specific test parameters for E-UTRAN FDD-FDD DC inter-frequency event triggered reporting with DRX in synchronous DC

Parameter	Unit	Cell1		Cell2		Cell3	
		T1	T2	T1	T2	T1	T2
E-UTRA RF Channel Number		1		2		3	
BW _{channel}	MHz	5MHz: N _{RB,c} = 25 10MHz: N _{RB,c} = 50 20MHz: N _{RB,c} = 100		5MHz: N _{RB,c} = 25 10MHz: N _{RB,c} = 50 20MHz: N _{RB,c} = 100		5MHz: N _{RB,c} = 25 10MHz: N _{RB,c} = 50 20MHz: N _{RB,c} = 100	
PDSCH parameters: DL Reference Measurement Channel		5MHz: R.5 FDD 10MHz: R.0 FDD 20MHz: R.4 FDD		5MHz: R.5 FDD 10MHz: R.0 FDD 20MHz: R.4 FDD		-	
PCFICH/PDCCH/PHICH parameters: DL Reference Measurement Channel		5MHz: R.11 FDD 10MHz: R.6 FDD 20MHz: R.10 FDD		5MHz: R.11 FDD 10MHz: R.6 FDD 20MHz: R.10 FDD		5MHz: R.11 FDD 10MHz: R.6 FDD 20MHz: R.10 FDD	
OCNG Patterns		5MHz: OP.15 FDD 10MHz: OP.1 FDD 20MHz: OP.11 FDD		5MHz: OP.15 FDD 10MHz: OP.1 FDD 20MHz: OP.11 FDD		5MHz: OP.16 FDD 10MHz: OP.2 FDD 20MHz: OP.12 FDD	
PBCH_RA	dB	0		0		0	
PBCH_RB	dB						
PSS_RA	dB						
SSS_RA	dB						
PCFICH_RB	dB						
PHICH_RA	dB						
PHICH_PB	dB						
PDCCH_RA	dB						
PDCCH_PB	dB						
PDSCH_RA	dB						
PDSCH_RB	dB						
OCNG_RA ^{Note 1}	dB						
OCNG_RB ^{Note 1}	dB						
N_{oc} ^{Note 2}	dBm/15 KHz						
\hat{E}_s / N_{oc}	dB	4	4	4	4	-infinity	7
\hat{E}_s / I_{ot} ^{Note 3}	dB	4	4	4	4	-infinity	7
RSRP ^{Note 3}	dBm/15 KHz	-97	-97	-97	-97	-infinity	-94
SCH_RP ^{Note 3}	dBm/15 KHz	-97	-97	-97	-97	-infinity	-94
I_o ^{Note 3}	dBm/Ch BW	-67.76 +10log (N _{RB,c} /50)	-67.76 +10log (N _{RB,c} /50)	-67.76 +10log (N _{RB,c} /50)	-67.76 +10log (N _{RB,c} /50)	-73.22 +10log (N _{RB,c} /50)	-65.43 +10log (N _{RB,c} /50)
Propagation Condition		ETU70		ETU70		ETU70	
Correlation Matrix and Antenna Configuration		1x2 Low		1x2 Low		1x2 Low	
Receive Time offset to cell1 ^{Note 4}	µs	-		33		-	

Time offset to cell1	μs	-	-	3
Note 1:	OCNG shall be used such that both cells are fully allocated and a constant total transmitted power spectral density is achieved for all OFDM symbols.			
Note 2:	Interference from other cells and noise sources not specified in the test is assumed to be constant over subcarriers and time and shall be modelled as AWGN of appropriate power for N_{oc} to be fulfilled.			
Note 3:	Es/lot, RSRP, SCH_RP and lo levels have been derived from other parameters for information purposes. They are not settable parameters themselves.			
Note 4:	Receive time difference between subframe boundaries of signals received from the two cells at the UE antenna connector including time alignment error between the two cells.			

Table A.8.23.4.1-3: DRX-Configuration for E-UTRAN FDD-FDD DC inter-frequency event triggered reporting with DRX in synchronous DC

Field	Cell1	Cell2	Comment
	Value	Value	
onDurationTimer	psf1	psf1	As specified in clause 6.3.2 in TS 36.331
drx-InactivityTimer	psf1	psf1	
drx-RetransmissionTimer	psf1	psf1	
longDRX-CycleStartOffset	sf80	sf1280	
shortDRX	disable	disable	

Table A.8.23.4.1-4: TimeAlignmentTimer -Configuration for E-UTRAN FDD-FDD DC inter-frequency event triggered reporting with DRX in synchronous DC

Field	Cell1	Cell2	Comment
	Value	Value	
TimeAlignmentTimer	sf500	sf500	As specified in clause 6.3.2 in TS 36.331
sr-ConfigIndex	0	0	For further information see clause 6.3.2 in TS 36.331 and section10.1 in TS 36.213.

A.8.23.4.2 Test Requirements

The UE shall send one Event A3 triggered measurement report for Cell 3 on PCell, with a measurement reporting delay less than 3.84s from the beginning of time period T2. The measurement reporting delay is defined as the time from the beginning of time period T2 to the moment when the UE sends the measurement report on PUSCH.

The UE shall not send event triggered measurement reports, as long as the reporting criteria are not fulfilled.

The rate of correct events observed during repeated tests shall be at least 90%.

A.8.23.5 E-UTRAN FDD-FDD DC inter-frequency event triggered reporting with DRX in asynchronous DC

A.8.23.5.1 Test Purpose and Environment

The purpose of this test is to verify that the UE makes correct reporting of inter frequency measurement. This test will partly verify the FDD inter-frequency cell search requirements in clause 8.8.4.

The test parameters are given in Table A.8.23.5.1-1, A.8.23.5.1-2, A.8.23.5.1-3 and A.8.23.5.1-4 below. In the test there are three cells: Cell1, Cell2 and Cell3. Cell1 is PCell, Cell2 is PSCell and Cell3 is a neighbour cell. In the measurement control information it is indicated to the UE that event-triggered reporting with Events A3 (PCell) is used. The test consists of two successive time periods, with duration of T1 and T2, respectively. Prior to the start of the time duration T1, the UE shall be fully synchronized to Cell1 and Cell2. During T1 the UE shall not have any information on Cell3. Prior to the start of the time duration T1, DRX configurations on MCG and SCG are enabled and DRX inactivity timers for MCG and SCG have already been expired.

In this test, UE needs to be provided at least once every 500ms with new Timing Advance Command MAC control element to restart the Time alignment timer to keep UE uplink time alignment in Cell1. Furthermore UE is allocated with PUSCH resource at every DRX cycle.

Table A.8.23.5.1-1: General test parameters for E-UTRAN FDD-FDD DC inter-frequency event triggered reporting with DRX in asynchronous DC

Parameter		Unit	Value	Comment
E-UTRA RF Channel Number			1, 2, 3	Three radio channels are used for this test.
Active PCell			Cell1	PCell on RF channel number 1.
Configured PSCell			Cell2	PSCell on RF channel number 2.
Neighbour cell			Cell3	Neighbour cell on RF channel number 3.
A3	Hysteresis	dB	0	Hysteresis for evaluation of event A3.
	A3-offset	dB	-6	
	Time To Trigger	s	0	
CP length			Normal	
DRX			ON	DRX related parameters are defined in Table A.8.23.4.1-3
Measurement gap pattern Id			0	
Cell-individual offset for cells on RF channel number 1		dB	0	Individual offset for cells on primary component carrier.
Cell-individual offset for cells on RF channel number 2		dB	0	Individual offset for cells on carrier frequency of Cell2.
Cell-individual offset for cells on RF channel number 3		dB	0	Individual offset for cells on carrier frequency of Cell3.
Filter coefficient			0	L3 filtering is not used
T1		s	5	
T2		s	5	
Note 1: Void				
Note 2: Even a UE capable of both synchronous and asynchronous DC operations is required to pass this test case in accordance with the principle defined in section A.3.11.				

Table A.8.23.5.1-2: Cell specific test parameters for E-UTRAN FDD-FDD DC inter-frequency event triggered reporting with DRX in asynchronous DC

Parameter	Unit	Cell1		Cell2		Cell3	
		T1	T2	T1	T2	T1	T2
E-UTRA RF Channel Number		1		2		3	
BW _{channel}	MHz	5MHz: N _{RB,c} = 25 10MHz: N _{RB,c} = 50 20MHz: N _{RB,c} = 100		5MHz: N _{RB,c} = 25 10MHz: N _{RB,c} = 50 20MHz: N _{RB,c} = 100		5MHz: N _{RB,c} = 25 10MHz: N _{RB,c} = 50 20MHz: N _{RB,c} = 100	
PDSCH parameters: DL Reference Measurement Channel		5MHz: R.5 FDD 10MHz: R.0 FDD 20MHz: R.4 FDD		5MHz: R.5 FDD 10MHz: R.0 FDD 20MHz: R.4 FDD		-	
PCFICH/PDCCH/PHICH parameters: DL Reference Measurement Channel		5MHz: R.11 FDD 10MHz: R.6 FDD 20MHz: R.10 FDD		5MHz: R.11 FDD 10MHz: R.6 FDD 20MHz: R.10 FDD		5MHz: R.11 FDD 10MHz: R.6 FDD 20MHz: R.10 FDD	
OCNG Patterns		5MHz: OP.15 FDD 10MHz: OP.1 FDD 20MHz: OP.11 FDD		5MHz: OP.15 FDD 10MHz: OP.1 FDD 20MHz: OP.11 FDD		5MHz: OP.16 FDD 10MHz: OP.2 FDD 20MHz: OP.12 FDD	
PBCH_RA	dB	0		0		0	
PBCH_RB	dB						
PSS_RA	dB						
SSS_RA	dB						
PCFICH_RB	dB						
PHICH_RA	dB						
PHICH_PB	dB						
PDCCH_RA	dB						
PDCCH_PB	dB						
PDSCH_RA	dB						
PDSCH_RB	dB						
OCNG_RA ^{Note 1}	dB						

OCNG_RB ^{Note 1}	dB						
N_{oc} ^{Note 2}	dBm/15 KHz	-101		-101		-101	
\hat{E}_s / N_{oc}	dB	4	4	4	4	-infinity	7
\hat{E}_s / I_{ot} ^{Note 3}	dB	4	4	4	4	-infinity	7
RSRP ^{Note 3}	dBm/15 KHz	-97	-97	-97	-97	-infinity	-94
SCH_RP ^{Note 3}	dBm/15 KHz	-97	-97	-97	-97	-infinity	-94
I_o ^{Note 3}	dBm/Ch BW	-67.76 +10log(N _{RB,c} /50)	-67.76 +10log(N _{RB,c} /50)	-67.76 +10log(N _{RB,c} /50)	-67.76 +10log(N _{RB,c} /50)	-73.22 +10log(N _{RB,c} /50)	-65.43 +10log(N _{RB,c} /50)
Propagation Condition		ETU70		ETU70		ETU70	
Correlation Matrix and Antenna Configuration		1x2 Low		1x2 Low		1x2 Low	
Receive time offset to cell1 ^{Note 4}	μs	-		500		-	
Time offset to cell1	μs	-		-		400	
<p>Note 1: OCNG shall be used such that both cells are fully allocated and a constant total transmitted power spectral density is achieved for all OFDM symbols.</p> <p>Note 2: Interference from other cells and noise sources not specified in the test is assumed to be constant over subcarriers and time and shall be modelled as AWGN of appropriate power for N_{oc} to be fulfilled.</p> <p>Note 3: E_s/I_{ot}, RSRP, SCH_RP and I_o levels have been derived from other parameters for information purposes. They are not settable parameters themselves.</p> <p>Note 4: Receive time difference between subframe boundaries of signals received from the two cells at the UE antenna connector including time alignment error between the two cells.</p>							

Table A.8.23.5.1-3: DRX-Configuration for E-UTRAN FDD-FDD DC inter-frequency event triggered reporting with DRX in asynchronous DC

Field	Cell1	Cell2	Comment
	Value	Value	
onDurationTimer	psf1	psf1	As specified in clause 6.3.2 in TS 36.331
drx-InactivityTimer	psf1	psf1	
drx-RetransmissionTimer	psf1	psf1	
longDRX-CycleStartOffset	sf80	sf1280	
shortDRX	disable	disable	

Table A.8.23.5.1-4: TimeAlignmentTimer -Configuration for E-UTRAN FDD-FDD DC inter-frequency event triggered reporting with DRX in asynchronous DC

Field	Cell1	Cell2	Comment
	Value	Value	
TimeAlignmentTimer	sf500	sf500	As specified in clause 6.3.2 in TS 36.331
sr-ConfigIndex	0	0	For further information see clause 6.3.2 in TS 36.331 and section 10.1 in TS 36.213.

A.8.23.5.2 Test Requirements

The UE shall send one Event A3 triggered measurement report for Cell 3 on PCell, with a measurement reporting delay less than 3.84s from the beginning of time period T2. The measurement reporting delay is defined as the time from the beginning of time period T2 to the moment when the UE sends the measurement report on PUSCH.

The UE shall not send event triggered measurement reports, as long as the reporting criteria are not fulfilled.

The rate of correct events observed during repeated tests shall be at least 90%.

A.8.23.6 E-UTRAN TDD-TDD DC inter-frequency event triggered reporting with DRX in synchronous DC

A.8.23.6.1 Test Purpose and Environment

The purpose of this test is to verify that the UE makes correct reporting of inter frequency measurement. This test will partly verify the TDD inter-frequency cell search requirements in clause 8.8.4.

The test parameters are given in Table A.8.23.6.1-1, A.8.23.6.1-2, A.8.23.6.1-3 and A.8.23.6.1-4 below. In the test there are three cells: Cell1, Cell2 and Cell3. Cell1 is PCell, Cell2 is PSCell and Cell3 is a neighbour cell. In the measurement control information it is indicated to the UE that event-triggered reporting with Events A3 (PCell) is used. The test consists of two successive time periods, with duration of T1 and T2, respectively. Prior to the start of the time duration T1, the UE shall be fully synchronized to Cell1 and Cell2. During T1 the UE shall not have any information on Cell3. Prior to the start of the time duration T1, DRX configurations on MCG and SCG are enabled and DRX inactivity timers for MCG and SCG have already been expired.

In this test, UE needs to be provided at least once every 500ms with new Timing Advance Command MAC control element to restart the Time alignment timer to keep UE uplink time alignment in Cell1. Furthermore UE is allocated with PUSCH resource at every DRX cycle.

Table A.8.23.6.1-1: General test parameters for E-UTRAN TDD-TDD DC inter-frequency event triggered reporting with DRX in synchronous DC

Parameter		Unit	Value	Comment
E-UTRA RF Channel Number			1, 2, 3	Three radio channels are used for this test.
Active PCell			Cell1	PCell on RF channel number 1.
Configured PSCell			Cell2	PSCell on RF channel number 2.
Neighbour cell			Cell3	Neighbour cell on RF channel number 3.
A3	Hysteresis	dB	0	Hysteresis for evaluation of event A3.
	A3-offset	dB	-6	
	Time To Trigger	s	0	
CP length			Normal	
DRX			ON	DRX related parameters are defined in Table A.8.23.4.1-3
Measurement gap pattern Id			0	
Cell-individual offset for cells on RF channel number 1		dB	0	Individual offset for cells on primary component carrier.
Cell-individual offset for cells on RF channel number 2		dB	0	Individual offset for cells on carrier frequency of Cell2.
Cell-individual offset for cells on RF channel number 3		dB	0	Individual offset for cells on carrier frequency of Cell3.
Filter coefficient			0	L3 filtering is not used
T1		s	5	
T2		s	5	
Note 1: Void				

Table A.8.23.6.1-2: Cell specific test parameters for E-UTRAN TDD-TDD DC inter-frequency event triggered reporting with DRX in synchronous DC

Parameter	Unit	Cell1		Cell2		Cell3	
		T1	T2	T1	T2	T1	T2
E-UTRA RF Channel Number		1		2		3	
BW _{channel}	MHz	5MHz: N _{RB,c} = 25 10MHz: N _{RB,c} = 50 20MHz: N _{RB,c} = 100		5MHz: N _{RB,c} = 25 10MHz: N _{RB,c} = 50 20MHz: N _{RB,c} = 100		5MHz: N _{RB,c} = 25 10MHz: N _{RB,c} = 50 20MHz: N _{RB,c} = 100	
Special subframe configuration ^{Note 5}		6		6		6	

Uplink-downlink configuration ^{Note 5}		1		1		1	
PDSCH parameters: DL Reference Measurement Channel		5MHz: R.4 TDD 10MHz: R.0 TDD 20MHz: R.3 TDD		5MHz: R.4 TDD 10MHz: R.0 TDD 20MHz: R.3 TDD		-	
PCFICH/PDCCH/PHICH parameters: DL Reference Measurement Channel		5MHz: R.11 TDD 10MHz: R.6 TDD 20MHz: R.10 TDD		5MHz: R.11 TDD 10MHz: R.6 TDD 20MHz: R.10 TDD		5MHz: R.11 TDD 10MHz: R.6 TDD 20MHz: R.10 TDD	
OCNG Patterns		5MHz: OP.9 TDD 10MHz: OP.1 TDD 20MHz: OP.7 TDD		5MHz: OP.9 TDD 10MHz: OP.1 TDD 20MHz: OP.7 TDD		5MHz: OP.10 TDD 10MHz: OP.2 TDD 20MHz: OP.8 TDD	
PBCH_RA	dB	0		0		0	
PBCH_RB	dB						
PSS_RA	dB						
SSS_RA	dB						
PCFICH_RB	dB						
PHICH_RA	dB						
PHICH_PB	dB						
PDCCH_RA	dB						
PDCCH_PB	dB						
PDSCH_RA	dB						
PDSCH_RB	dB						
OCNG_RA ^{Note 1}	dB						
OCNG_RB ^{Note 1}	dB						
N_{oc} ^{Note 2}	dBm/15 KHz						
\hat{E}_s / N_{oc}	dB	4	4	4	4	-infinity	7
\hat{E}_s / I_{ot} ^{Note 3}	dB	4	4	4	4	-infinity	7
RSRP ^{Note 3}	dBm/15 KHz	-97	-97	-97	-97	-infinity	-94
SCH_RP ^{Note 3}	dBm/15 KHz	-97	-97	-97	-97	-infinity	-94
I_o ^{Note 3}	dBm/Ch BW	-67.76 +10log ($N_{RB,c}$ /50)	-67.76 +10log ($N_{RB,c}$ /50)	-67.76 +10log ($N_{RB,c}$ /50)	-67.76 +10log ($N_{RB,c}$ /50)	-73.22 +10log ($N_{RB,c}$ /50)	-65.43 +10log ($N_{RB,c}$ /50)
Propagation Condition		ETU70		ETU70		ETU70	
Correlation Matrix and Antenna Configuration		1x2 Low		1x2 Low		1x2 Low	
Receive Time offset to cell1 ^{Note 4}	μ s	-		33		-	
Time offset to cell1	μ s	-		-		3	
<p>Note 1: OCNG shall be used such that both cells are fully allocated and a constant total transmitted power spectral density is achieved for all OFDM symbols.</p> <p>Note 2: Interference from other cells and noise sources not specified in the test is assumed to be constant over subcarriers and time and shall be modelled as AWGN of appropriate power for N_{oc} to be fulfilled.</p> <p>Note 3: E_s/I_{ot}, RSRP, SCH_RP and I_o levels have been derived from other parameters for information purposes. They are not settable parameters themselves.</p> <p>Note 4: Receive time difference between subframe boundaries of signals received from the two cells at the UE antenna connector including time alignment error between the two cells.</p> <p>Note 5: For special subframe and uplink-downlink configurations see Tables 4.2-1 and 4.2-2 in TS 36.211 [16].</p>							

Table A.8.23.6.1-3: DRX-Configuration for E-UTRAN TDD-TDD DC inter-frequency event triggered reporting with DRX in synchronous DC

Field	Cell1	Cell2	Comment
	Value	Value	
onDurationTimer	psf1	psf1	As specified in clause 6.3.2 in TS 36.331
drx-InactivityTimer	psf1	psf1	
drx-RetransmissionTimer	psf1	psf1	
longDRX-CycleStartOffset	sf80	sf1280	
shortDRX	disable	disable	

Table A.8.23.6.1-4: TimeAlignmentTimer -Configuration for E-UTRAN TDD-TDD DC inter-frequency event triggered reporting with DRX in synchronous DC

Field	Cell1	Cell2	Comment
	Value	Value	
TimeAlignmentTimer	sf500	sf500	As specified in clause 6.3.2 in TS 36.331
sr-ConfigIndex	0	0	For further information see clause 6.3.2 in TS 36.331 and section 10.1 in TS 36.213.

A.8.23.6.2 Test Requirements

The UE shall send one Event A3 triggered measurement report for Cell 3 on PCell, with a measurement reporting delay less than 3.84s from the beginning of time period T2. The measurement reporting delay is defined as the time from the beginning of time period T2 to the moment when the UE sends the measurement report on PUSCH.

The UE shall not send event triggered measurement reports, as long as the reporting criteria are not fulfilled.

The rate of correct events observed during repeated tests shall be at least 90%.

A.8.23.7 E-UTRAN FDD-FDD Addition and Release Delay of known PSCell in Synchronous DC

A.8.23.7.1 Test Purpose and Environment

The purpose of this test is to verify that the PSCell addition and release delays under synchronous dual connectivity are within the requirements stated in section 7.14 for the case when the PSCell is known by the UE at the time of addition.

The test parameters are given in Tables A.8.23.7.1-1 and cell-specific parameters in A.8.23.7.1-2 below. The test consists of five successive time periods with duration of T1, T2, T3, T4 and T5 respectively. There are two carriers each with one cell. Before the test starts the UE is connected to Cell 1 (PCell) on radio channel 1 (PCC) but is not aware of Cell 2 on radio channel 2. The UE is only monitoring the PCC. During T1 only Cell1 is known to the UE.

Before the start of T2 it is indicated to the UE in the measurement control information that event-triggered reporting with Event A4 is configured for neighbour cell (Cell2). Before the start of T2 the UE is configured with the measurement gaps (gap pattern Id # 0). The Cell2 becomes known to the UE during T2. Therefore during T2 the UE shall report Event A4. After receiving the Event A4, the test system shall send a RRC message to the UE to release the measurement gaps.

The test system shall send a RRC message to the UE to add PSCell (Cell 2) on radio channel 2. The RRC message (to add PSCell) also includes a request for the UE to start periodic CSI reporting for the PSCell after the PSCell has been successfully added. The RRC message to add PSCell shall be sent to the UE during period T2, after the measurement gaps are released by the test system. The point in time at which the RRC message to add PSCell (Cell2) is received at the UE antenna connector defines the start of time period T3.

The test system shall observe the periodic reporting of CSI for PSCell during T4. The point in time at which the UE has sent PRACH to the PSCell (Cell 2) defines the start of time period T4.

The test system shall send a RRC message to the UE to release PSCell (Cell 2) on radio channel 2. The RRC message to release PSCell (Cell2) shall be sent to the UE during time period T4, after the UE has sent at least one CQI report with non-zero CQI index for PSCell (Cell 2). The point in time at which the RRC message to release PSCell (Cell2) is received at the UE antenna connector defines the start of time period T5.

Table A.8.23.7.1-1: General test parameters for known PSCell addition and release case

Parameter		Unit	Value	Comment
E-UTRA RF Channel Number			1, 2	Two radio channels are used for this test
Initial Condition	Active PCell		Cell1	PCell on RF channel number 1.
	Neighbour cell		Cell2	Neighbour cell on RF channel number 2.
Final Condition	Active PCell		Cell1	PCell on RF channel number 1.
	PSCell		Cell2	PSCell on RF channel number 2.

A4	Hysteresis	dB	0	Hysteresis for evaluation of event A4.
	Threshold RSRP	dBm	-93	Actual RSRP threshold for event A4. Needs to take absolute accuracy tolerance in section 9.1.11.1 into account plus margin.
	Time To Trigger	s	0	
CP length			Normal	
DRX			OFF	Continuous monitoring of primary cell
Measurement gap pattern Id			0	Gaps are configured before T2 and released before T3.
CQI/PMI periodicity and offset configuration index on cell2			0	CQI reporting for PSCell every second subframe
Cell-individual offset for cells on RF channel number 1		dB	0	Individual offset for cells on primary component carrier.
Cell-individual offset for cells on RF channel number 2		dB	0	Individual offset for cells on carrier frequency of cell2.
T1		s	5	During this time the PCell shall be known and cell2 shall be unknown.
T2		s	≤ 5	During this time the UE shall identify neighbour cell (cell2) and report event A4.
T3		s	1	During this time the UE adds the PSCell.
T4		s	1	During this time the UE sends CSI reports for PSCell.
T5		s	1	During this time the UE releases the PSCell.
Note 1: Void				
Note 2: A UE capable of both synchronous and asynchronous DC operations is not required to pass this test case in accordance with the principle defined in section A.3.11.				

Table A.8.23.7.1-2: Cell specific test parameters for E-UTRAN FDD known PSCell addition and release

Parameter	Unit	Cell 1					Cell 2				
		T1	T2	T3	T4	T5	T1	T2	T3	T4	T5
E-UTRA RF Channel Number		1					2				
BW _{channel}	MHz	5MHz: N _{RB,c} = 25 10MHz: N _{RB,c} = 50 20MHz: N _{RB,c} = 100					5MHz: N _{RB,c} = 25 10MHz: N _{RB,c} = 50 20MHz: N _{RB,c} = 100				
PDSCH parameters: DL Reference Measurement Channel		5MHz: R.5 FDD 10MHz: R.0 FDD 20MHz: R.4 FDD					-				
PCFICH/PDCCH/PHICH parameters: DL Reference Measurement Channel		5MHz: R.11 FDD 10MHz: R.6 FDD 20MHz: R.10 FDD					5MHz: R.11 FDD 10MHz: R.6 FDD 20MHz: R.10 FDD				
OCNG Patterns		5MHz: OP.15 FDD 10MHz: OP.1 FDD 20MHz: OP.11 FDD					5MHz: OP.16 FDD 10MHz: OP.2 FDD 20MHz: OP.12 FDD				
PBCH_RA	dB	0					0				
PBCH_RB	dB										
PSS_RA	dB										
SSS_RA	dB										
PCFICH_RB	dB										
PHICH_RA	dB										
PHICH_RB	dB										
PDCCH_RA	dB										
PDCCH_RB	dB										
PDSCH_RA	dB										
PDSCH_RB	dB										
OCNG_RA ^{Note 1}	dB										
OCNG_RB ^{Note 1}	dB										
N _{oc} ^{Note 2}	dBm/15 kHz										
\hat{E}_s/N_{oc}	dB	19	19	19	19	19	-infinity	0	0	0	0
\hat{E}_s/I_{ot} ^{Note 3}	dB	19	19	19	19	19	infinity	0	0	0	0
RSRP ^{Note 3}	dBm/15 kHz	-82	-82	-82	-82	-82	-infinity	-85	-85	-85	-85
SCH_RP ^{Note 3}	dBm/15 kHz	-82	-82	-82	-82	-82	-infinity	-85	-85	-85	-85
I _o ^{Note 3}	dBm/C h BW	-54.16 +10log(N _{RB,c} /50)	-54.16 +10log(N _{RB,c} /50)	-54.16 +10log(N _{RB,c} /50)	-54.16 +10log(N _{RB,c} /50)	-54.16 +10log(N _{RB,c} /50)	N/A	-54.21 +10log(N _{RB,c} /50)	-54.21 +10log(N _{RB,c} /50)	-54.21 +10log(N _{RB,c} /50)	-54.21 +10log(N _{RB,c} /50)
Propagation Condition		AWGN					AWGN				
Antenna Configuration		1x2					1x2				
Receive time offset to cell1 ^{Note 4}	μs	-					33				
PRACH configuration Index ^{Note 5}		4					2				
<p>Note 1: OCNG shall be used such that all cells are fully allocated and a constant total transmitted power spectral density is achieved for all OFDM symbols.</p> <p>Note 2: Interference from other cells and noise sources not specified in the test is assumed to be constant over subcarriers and time and shall be modelled as AWGN of appropriate power for N_{oc} to be fulfilled.</p> <p>Note 3: \hat{E}_s/I_{ot}, RSRP, SCH_RP and I_o levels have been derived from other parameters for information purposes. They are not settable parameters themselves.</p> <p>Note 4: Receive time difference between subframe boundaries of signals received from the two cells at the UE antenna connector including time alignment error between the two cells.</p> <p>Note 5: As specified in table 5.7.1-2 in TS 36.211.</p> <p>Note 6: The uplink resources for CSI reporting are assigned to the UE prior to the start of time period T4.</p>											

A.8.23.7.2 Test Requirements

The UE shall transmit the PRACH to PSCell at latest 115 ms into T3.

The UE shall send at least one CSI report for PSCell with non-zero CQI index during T4.

The UE shall periodically send CSI reports for PSCell after the UE has sent first CQI report with non-zero CQI index during T4

The UE shall stop sending CSI reports for PSCell in at latest 16ms into T5.

All of the above test requirements shall be fulfilled in order for the observed PSCell addition delay and PSCell release delay to be counted as correct. The rate of correct observed PSCell addition delay and PSCell release delay during repeated tests shall be at least 90%.

NOTE: The PSCell addition delay can be expressed as follows as specified in Clause 7.14.2:

$$T_{\text{config_PSCell}} = 15\text{ms} + T_{\text{activation_time}} + 50\text{ms} + T_{\text{PCell_DU}} + T_{\text{PSCell_DU}}$$

Where:

$T_{\text{activation_time}} = 20 \text{ ms}$ (cell2 is known to the UE);

$T_{\text{PCell_DU}} = 0$ (due to PRACH configurations in cell1 and cell2 being orthogonal in time, i.e. non-overlapping in time);

$T_{\text{PSCell_DU}} = 30 \text{ ms}$ (delay due to PRACH transmission to cell2).

This gives a total of 115 ms.

A.8.23.8 E-UTRAN FDD-FDD Addition and Release Delay of known PSCell in Asynchronous DC

A.8.23.8.1 Test Purpose and Environment

The purpose of this test is to verify that the PSCell addition and release delays under asynchronous dual connectivity are within the requirements stated in section 7.14 for the case when the PSCell is known by the UE at the time of addition.

The test parameters are given in Tables A.8.23.8.1-1 and cell-specific parameters in A.8.23.8.1-2 below. The test consists of five successive time periods with duration of T1, T2, T3, T4 and T5 respectively. There are two carriers each with one cell. Before the test starts the UE is connected to Cell 1 (PCell) on radio channel 1 (PCC) but is not aware of Cell 2 on radio channel 2. The UE is only monitoring the PCC. During T1 only Cell1 is known to the UE.

Before the start of T2 it is indicated to the UE in the measurement control information that event-triggered reporting with Event A4 is configured for neighbour cell (Cell2). Before the start of T2 the UE is configured with the measurement gaps (gap pattern Id # 0). The Cell2 becomes known to the UE during T2. Therefore during T2 the UE shall report Event A4. After receiving the Event A4, the test system shall send a RRC message to the UE to release the measurement gaps.

The test system shall send a RRC message to the UE to add PSCell (Cell 2) on radio channel 2. The RRC message (to add PSCell) also includes a request for the UE to start periodic CSI reporting for the PSCell after the PSCell has been successfully added. The RRC message to add PSCell shall be sent to the UE during period T2, after the measurement gaps are released by the test system. The point in time at which the RRC message to add PSCell (Cell2) is received at the UE antenna connector defines the start of time period T3.

The test system shall observe the periodic reporting of CSI for PSCell during T4. The point in time at which the UE has sent PRACH to the PSCell (Cell 2) defines the start of time period T4.

The test system shall send a RRC message to the UE to release PSCell (Cell 2) on radio channel 2. The RRC message to release PSCell (Cell2) shall be sent to the UE during time period T4, after the UE has sent at least one CQI report with non-zero CQI index for PSCell (Cell 2). The point in time at which the RRC message to release PSCell (Cell2) is received at the UE antenna connector defines the start of time period T5.

Table A.8.23.8.1-1: General test parameters for known PSCell addition and release case

Parameter	Unit	Value	Comment
E-UTRA RF Channel Number		1, 2	Two radio channels are used for this test
Active PCell		Cell1	PCell on RF channel number 1.

Initial Condition	Neighbour cell		Cell2	Neighbour cell on RF channel number 2.
Final Condition	Active PCell		Cell1	PCell on RF channel number 1.
	PSCell		Cell2	PSCell on RF channel number 2.
A4	Hysteresis	dB	0	Hysteresis for evaluation of event A4.
	Threshold RSRP	dBm	-93	Actual RSRP threshold for event A4. Needs to take absolute accuracy tolerance in section 9.1.11.1 into account plus margin.
	Time To Trigger	s	0	
CP length			Normal	
DRX			OFF	Continuous monitoring of primary cell
Measurement gap pattern Id			0	Gaps are configured before T2 and released before T3.
CQI/PMI periodicity and offset configuration index on cell2			0	CQI reporting for PSCell every second subframe
Cell-individual offset for cells on RF channel number 1		dB	0	Individual offset for cells on primary component carrier.
Cell-individual offset for cells on RF channel number 2		dB	0	Individual offset for cells on carrier frequency of cell2.
T1		s	5	During this time the PCell shall be known and cell2 shall be unknown.
T2		s	≤ 5	During this time the UE shall identify neighbour cell (cell2) and report event A4.
T3		s	1	During this time the UE adds the PSCell.
T4		s	1	During this time the UE sends CSI reports for PSCell.
T5		s	1	During this time the UE releases the PSCell.
Note 1: Void				
Note 2: Even a UE capable of both synchronous and asynchronous DC operations is required to pass this test case in accordance with the principle defined in section A.3.11.				

Table A.8.22.8.1-2: Cell specific test parameters for E-UTRAN FDD known PSCell addition and release

Parameter	Unit	Cell 1					Cell 2					
		T1	T2	T3	T4	T5	T1	T2	T3	T4	T5	
E-UTRA RF Channel Number		1					2					
BW _{channel}	MHz	5MHz: N _{RB,c} = 25 10MHz: N _{RB,c} = 50 20MHz: N _{RB,c} = 100					5MHz: N _{RB,c} = 25 10MHz: N _{RB,c} = 50 20MHz: N _{RB,c} = 100					
PDSCH parameters: DL Reference Measurement Channel		5MHz: R.5 FDD 10MHz: R.0 FDD 20MHz: R.4 FDD					-					
PCFICH/PDCCH/PHICH parameters: DL Reference Measurement Channel		5MHz: R.11 FDD 10MHz: R.6 FDD 20MHz: R.10 FDD					5MHz: R.11 FDD 10MHz: R.6 FDD 20MHz: R.10 FDD					
OCNG Patterns		5MHz: OP.15 FDD 10MHz: OP.1 FDD 20MHz: OP.11 FDD					5MHz: OP.16 FDD 10MHz: OP.2 FDD 20MHz: OP.12 FDD					
PBCH_RA	dB	0					0					
PBCH_RB	dB											
PSS_RA	dB											
SSS_RA	dB											
PCFICH_RB	dB											
PHICH_RA	dB											
PHICH_RB	dB											
PDCCH_RA	dB											
PDCCH_RB	dB											
PDSCH_RA	dB											
PDSCH_RB	dB											
OCNG_RA ^{Note 1}	dB											
OCNG_RB ^{Note 1}	dB											
N _{oc} ^{Note 2}	dBm/15 kHz											-101
\hat{E}_s/N_{oc}	dB	19	19	19	19	19	- infinity	0	0	0	0	
\hat{E}_s/I_{ot} ^{Note 3}	dB	19	19	19	19	19	infinity	0	0	0	0	
RSRP ^{Note 3}	dBm/15 kHz	-82	-82	-82	-82	-82	- infinity	-85	-85	-85	-85	
SCH_RP ^{Note 3}	dBm/15 kHz	-82	-82	-82	-82	-82	- infinity	-85	-85	-85	-85	
I _o ^{Note 3}	dBm/C h BW	-54.16 +10log (N _{RB,c} /50)	-54.16 +10log (N _{RB,c} /50)	-54.16 +10log (N _{RB,c} /50)	-54.16 +10log (N _{RB,c} /50)	-54.16 +10log (N _{RB,c} /50)	N/A	-54.21 +10log (N _{RB,c} /50)	-54.21 +10log (N _{RB,c} /50)	-54.21 +10log (N _{RB,c} /50)	-54.21 +10log (N _{RB,c} /50)	
Propagation Condition		AWGN					AWGN					
Antenna Configuration		1x2					1x2					
Receive time offset to cell1 ^{Note 4}	μs	-					500					
PRACH configuration Index ^{Note 5}		4					2					

- Note 1: OCNG shall be used such that all cells are fully allocated and a constant total transmitted power spectral density is achieved for all OFDM symbols.
- Note 2: Interference from other cells and noise sources not specified in the test is assumed to be constant over subcarriers and time and shall be modelled as AWGN of appropriate power for N_{oc} to be fulfilled.
- Note 3: \hat{E}_s/I_{ot} , RSRP, SCH_RP and I_o levels have been derived from other parameters for information purposes. They are not settable parameters themselves.
- Note 4: Receive time difference between subframe boundaries of signals received from the two cells at the UE antenna connector including time alignment error between the two cells.
- Note 5: As specified in table 5.7.1-2 in TS 36.211
- Note 6: The uplink resources for CSI reporting are assigned to the UE prior to the start of time period T4.

A.8.23.8.2 Test Requirements

The UE shall transmit the PRACH to PSCell at latest 115 ms into T3.

The UE shall send at least one CSI report for PSCell with non-zero CQI index during T4.

The UE shall periodically send CSI reports for PSCell after the UE has sent first CQI report with non-zero CQI index during T4

The UE shall stop sending CSI reports for PSCell in at latest 16ms into T5.

All of the above test requirements shall be fulfilled in order for the observed PSCell addition delay and PSCell release delay to be counted as correct. The rate of correct observed PSCell addition delay and PSCell release delay during repeated tests shall be at least 90%.

NOTE: The PSCell addition delay can be expressed as follows as specified in Clause 7.14.2:

$$T_{\text{config_PSCell}} = 15\text{ms} + T_{\text{activation_time}} + 50\text{ms} + T_{\text{PCell_DU}} + T_{\text{PSCell_DU}}$$

Where:

$T_{\text{activation_time}} = 20 \text{ ms}$ (cell2 is known to the UE);

$T_{\text{PCell_DU}} = 0$ (due to PRACH configurations in cell1 and cell2 being orthogonal in time, i.e. non-overlapping in time);

$T_{\text{PSCell_DU}} = 30 \text{ ms}$ (delay due to PRACH transmission to cell2).

This gives a total of 115 ms.

A.8.23.9 E-UTRAN TDD Addition and Release Delay of known PSCell in Synchronous DC

A.8.23.9.1 Test Purpose and Environment

The purpose of this test is to verify that the PSCell addition and release delays under synchronous dual connectivity are within the requirements stated in section 7.14 for the case when the PSCell is known by the UE at the time of addition.

The test parameters are given in Tables A.8.23.9.1-1 and cell-specific parameters in A.8.23.9.1-2 below. The test consists of five successive time periods, with duration of T1, T2, T3, T4 and T5 respectively. There are two carriers each with one cell. Before the test starts the UE is connected to Cell 1 (PCell) on radio channel 1 (PCC) but is not aware of Cell 2 on radio channel 2. The UE is only monitoring the PCC. During T1 only Cell1 is known to the UE.

Before the start of T2 it is indicated to the UE in the measurement control information that event-triggered reporting with Event A4 is configured for neighbour cell (Cell2). Before the start of T2 the UE is configured with the measurement gaps (gap pattern Id # 0). The Cell2 becomes known to the UE during T2. Therefore during T2 the UE shall report Event A4. After receiving the Event A4, the test system shall send a RRC message to the UE to release the measurement gaps.

The test system shall send a RRC message to the UE to add PSCell (Cell 2) on radio channel 2. The RRC message (to add PSCell) also includes a request for the UE to start periodic CSI reporting for the PSCell after the PSCell has been successfully added. The RRC message to add PSCell shall be sent to the UE during period T2, after the measurement gaps are released by the test system. The point in time at which the RRC message to add PSCell (Cell2) is received at the UE antenna connector defines the start of time period T3.

The test system shall observe the periodic reporting of CSI for PSCell during T4. The point in time at which the UE has sent PRACH to the PSCell (Cell 2) defines the start of time period T4.

The test system shall send a RRC message to the UE to release PSCell (Cell 2) on radio channel 2. The RRC message to release PSCell (Cell2) shall be sent to the UE during time period T4, after the UE has sent at least one CQI report with non-zero CQI index for PSCell (Cell 2). The point in time at which the RRC message to release PSCell (Cell2) is received at the UE antenna connector defines the start of time period T5.

Table A.8.23.9.1-1: General test parameters for known PSCell addition and release case

Parameter	Unit	Value	Comment
E-UTRA RF Channel Number		1, 2	Two radio channels are used for this test
Initial Condition	Active PCell	Cell1	PCell on RF channel number 1.
	Neighbour cell	Cell2	Neighbour cell on RF channel number 2.

Final Condition	Active PCell		Cell1	PCell on RF channel number 1.
	PSCell		Cell2	PSCell on RF channel number 2.
A4	Hysteresis	dB	0	Hysteresis for evaluation of event A4.
	Threshold RSRP	dBm	-93	Actual RSRP threshold for event A4. Needs to take absolute accuracy tolerance in section 9.1.11.1 into account plus margin.
	Time To Trigger	s	0	
CP length			Normal	
DRX			OFF	Continuous monitoring of primary cell
Measurement gap pattern Id			0	Gaps are configured before T2 and released before T3.
PRACH configuration on cell2			53	As specified in table 5.7.1-3 in TS 36.211
CQI/PMI periodicity and offset configuration index on cell2			0	CQI reporting for PSCell every uplink subframe
Cell-individual offset for cells on RF channel number 1		dB	0	Individual offset for cells on primary component carrier.
Cell-individual offset for cells on RF channel number 2		dB	0	Individual offset for cells on carrier frequency of cell2.
T1		s	5	During this time the PCell shall be known and cell2 shall be unknown.
T2		s	≤ 5	During this time the UE shall identify neighbour cell (cell2) and report event A4.
T3		s	1	During this time the UE adds the PSCell.
T4		s	1	During this time the UE sends CSI reports for PSCell.
T5		s	1	During this time the UE releases the PSCell.
Note 1: Void				

Table A.8.23.9.1-2: Cell specific test parameters for E-UTRAN TDD known PSCell addition and release

Parameter	Unit	Cell 1					Cell 2				
		T1	T2	T3	T4	T5	T1	T2	T3	T4	T5
E-UTRA RF Channel Number		1					2				
BW _{channel}	MHz	5MHz: N _{RB,c} = 25 10MHz: N _{RB,c} = 50 20MHz: N _{RB,c} = 100					5MHz: N _{RB,c} = 25 10MHz: N _{RB,c} = 50 20MHz: N _{RB,c} = 100				
Special subframe configuration ^{Note 7}		6					6				
Uplink-downlink configuration ^{Note 7}		1					1				
PDSCH parameters: DL Reference Measurement Channel		5MHz: R.4 TDD 10MHz: R.0 TDD 20MHz: R.3 TDD					-				
PCFICH/PDCCH/PHICH parameters: DL Reference Measurement Channel		5MHz: R.11 TDD 10MHz: R.6 TDD 20MHz: R.10 TDD					5MHz: R.11 TDD 10MHz: R.6 TDD 20MHz: R.10 TDD				
OCNG Patterns		5MHz: OP.9 TDD 10MHz: OP.1 TDD 20MHz: OP.7 TDD					5MHz: OP.10 TDD 10MHz: OP.2 TDD 20MHz: OP.8 TDD				
PBCH_RA	dB	0					0				
PBCH_RB	dB										
PSS_RA	dB										
SSS_RA	dB										
PCFICH_RB	dB										
PHICH_RA	dB										
PHICH_RB	dB										
PDCCH_RA	dB										
PDCCH_RB	dB										
PDSCH_RA	dB										
PDSCH_RB	dB										
OCNG_RA ^{Note 1}	dB										
OCNG_RB ^{Note 1}	dB										

N_{oc} ^{Note 2}	dBm/15 kHz	-101					N/A	-85			
\hat{E}_s/N_{oc}	dB	19	19	19	19	19	-infinity	0	0	0	0
\hat{E}_s/I_{ot} ^{Note 3}	dB	19	19	19	19	19	infinity	0	0	0	0
RSRP ^{Note 3}	dBm/15 kHz	-82	-82	-82	-82	-82	-infinity	-85	-85	-85	-85
SCH_RP ^{Note 3}	dBm/15 kHz	-82	-82	-82	-82	-82	-infinity	-85	-85	-85	-85
I_o ^{Note 3}	dBm/C h BW	-54.16 +10log($N_{RB,c}/50$)	-54.16 +10log($N_{RB,c}/50$)	-54.16 +10log($N_{RB,c}/50$)	-54.16 +10log($N_{RB,c}/50$)	-54.16 +10log($N_{RB,c}/50$)	N/A	-54.21 +10log($N_{RB,c}/50$)	-54.21 +10log($N_{RB,c}/50$)	-54.21 +10log($N_{RB,c}/50$)	-54.21 +10log($N_{RB,c}/50$)
Propagation Condition		AWGN						AWGN			
Antenna Configuration		1x2						1x2			
Receive time offset to cell1 ^{Note 4}	μ s	-						33			
PRACH configuration Index ^{Note 5}		56						50			
Note 1:	OCNG shall be used such that all cells are fully allocated and a constant total transmitted power spectral density is achieved for all OFDM symbols.										
Note 2:	Interference from other cells and noise sources not specified in the test is assumed to be constant over subcarriers and time and shall be modelled as AWGN of appropriate power for N_{oc} to be fulfilled.										
Note 3:	\hat{E}_s/I_{ot} , RSRP, SCH_RP and I_o levels have been derived from other parameters for information purposes. They are not settable parameters themselves.										
Note 4:	Receive time difference between subframe boundaries of signals received from the two cells at the UE antenna connector including time alignment error between the two cells.										
Note 5:	As specified in table 5.7.1-3 in TS 36.211										
Note 6:	The uplink resources for CSI reporting are assigned to the UE prior to the start of time period T4.										
Note 7:	For special subframe and uplink-downlink configurations see Tables 4.2-1 and 4.2-2 in TS 36.211 [16].										

A.8.23.9.2 Test Requirements

The UE shall transmit the PRACH to PSCell at latest 115 ms into T3.

The UE shall send at least one CSI report for PSCell with non-zero CQI index during T4.

The UE shall periodically send CSI reports for PSCell after the UE has sent first CQI report with non-zero CQI index during T4

The UE shall stop sending CSI reports for PSCell in at latest 16ms into T5.

All of the above test requirements shall be fulfilled in order for the observed PSCell addition delay and PSCell release delay to be counted as correct. The rate of correct observed PSCell addition delay and PSCell release delay during repeated tests shall be at least 90%.

NOTE: The PSCell addition delay can be expressed as follows as specified in Clause 7.14.2:

$$T_{\text{config_PSCell}} = 15\text{ms} + T_{\text{activation_time}} + 50\text{ms} + T_{\text{PCell_DU}} + T_{\text{PSCell_DU}}$$

Where:

$T_{\text{activation_time}} = 20$ ms (cell2 is known to the UE);

$T_{\text{PCell_DU}} = 0$ (due to PRACH configurations in cell1 and cell2 being orthogonal in time, i.e. non-overlapping in time);

$T_{\text{PSCell_DU}} = 30$ ms (delay due to PRACH transmission to cell2).

This gives a total of 115 ms.

A.8.23.10 E-UTRAN TDD-FDD DC intra-frequency event triggered reporting with DRX in synchronous DC with PCell in FDD

A.8.23.10.1 Test Purpose and Environment

The purpose of this test is to verify that the UE makes correct reporting of PCell and PSCell intra frequency measurement. This test will partly verify the intra-frequency measurement requirements in clause 8.8.2 and clause 8.8.3.

The test parameters are given in Table A.8.23.10.1-1, A.8.23.10.1-2, A.8.23.10.1-3 and A.8.23.10.1-4 below. In the test there are two cells: Cell1 and Cell2. Cell1 is PCell and Cell2 is PSCell. In the measurement control information it is indicated to the UE that event-triggered reporting with Events A1 (PCell and PSCell) and A2 (PCell and PSCell) is used. The test consists of three successive time periods, with duration of T1, T2 and T3, respectively. Prior to the start of the time duration T1, the UE shall be fully synchronized to Cell1 and Cell2. Prior to the start of the time duration T1, DRX configurations on MCG and SCG are enabled and DRX inactivity timers for MCG and SCG have expired. Immediately at beginning of T2 the transmission powers of Cell1 and Cell2 are reduced below a threshold value of event A2 and this shall result in reporting of Event A2 for PCell and PSCell, respectively. Immediately after receiving the reporting of event A2 for both PCell and PSCell, PDCCH indicating a new transmission on Cell1 shall be sent continuously to ensure that the UE would not enter the DRX state on MCG throughout T3. At beginning of T3 the transmission powers of Cell1 and Cell2 are increased above a threshold value of event A1 and this shall result in reporting of Event A1 for PCell and PSCell, respectively.

When MCG DRX is used, the uplink time alignment of Cell1 is not maintained and UE needs to use RACH to obtain UL allocation for measurement reporting in Cell1. When SCG DRX is used, the UE needs to be provided at least once every 500ms with new Timing Advance Command MAC control element to restart the Time alignment timer to keep UE uplink time alignment in Cell2. Furthermore UE is allocated with PUSCH resource at every DRX cycle.

Table A.8.23.10.1-1: General test parameters for E-UTRAN TDD-FDD DC intra-frequency event triggered reporting with DRX in synchronous DC with PCell in FDD

Parameter	Unit	Value	Comment	
E-UTRA RF Channel Number		1, 2	Two radio channels are used for this test.	
Active PCell		Cell1	PCell on RF channel number 1.	
Configured PSCell		Cell2	PSCell on RF channel number 2.	
A1	Hysteresis	dB	0	Hysteresis for evaluation of event A1.
	Threshold RSRP	dBm	-95	Actual RSRP threshold for event A1. Needs to take absolute accuracy tolerance in clause 9.1.11.1 and 9.1.11.2 into account plus margin.
	Time To Trigger	s	0	
A2	Hysteresis	dB	0	Hysteresis for evaluation of event A2.
	Threshold RSRP	dBm	-99	Actual RSRP threshold for event A2. Needs to take absolute accuracy tolerance in clause 9.1.11.1 and 9.1.11.2 into account plus margin.
	Time To Trigger	s	0	
CP length		Normal		
Special subframe configuration		6	As specified in table 4.2-1 in TS 36.211. This configuration is for the TDD PSCell.	
Uplink-downlink configuration		1	As specified in table 4.2-2 in TS 36.211. The configuration is for the TDD PSCell.	
DRX		ON	DRX related parameters are defined in Table A.8.23.10.1-3	
Cell-individual offset for cells on RF channel number 1	dB	0	Individual offset for cells on primary component carrier.	
Cell-individual offset for cells on RF channel number 2	dB	0	Individual offset for cells on carrier frequency of Cell2.	
Filter coefficient		0	L3 filtering is not used	
T1	s	2		
T2	s	10		
T3	s	1		

Note 1: This test verifies the RRM requirement which is independent of channel bandwidth and is performed according to the principle defined in section A.3.6.1.
 Note 2: A UE capable of both synchronous and asynchronous DC operations is not required to pass this test case in accordance with the principle defined in section A.3.6.11.

Table A.8.23.10.1-2: Cell specific test parameters for E-UTRAN TDD-FDD DC intra-frequency event triggered reporting with DRX in synchronous DC with PCell in FDD

Parameter	Unit	Cell 1			Cell 2		
		T1	T2	T3	T1	T2	T3
E-UTRA RF Channel Number		1			2		
BW _{channel}	MHz	5MHz: N _{RB,c} = 25 10MHz: N _{RB,c} = 50 20MHz: N _{RB,c} = 100			5MHz: N _{RB,c} = 25 10MHz: N _{RB,c} = 50 20MHz: N _{RB,c} = 100		
PDSCH parameters: DL Reference Measurement Channel		5MHz: R.5 FDD 10MHz: R.0 FDD 20MHz: R.4 FDD			5MHz: R.4 TDD 10MHz: R.0 TDD 20MHz: R.3 TDD		
PCFICH/PDCCH/PHICH parameters: DL Reference Measurement Channel		5MHz: R.11 FDD 10MHz: R.6 FDD 20MHz: R.10 FDD			5MHz: R.11 TDD 10MHz: R.6 TDD 20MHz: R.10 TDD		
OCNG Patterns		5MHz: OP.15 FDD 10MHz: OP.1 FDD 20MHz: OP.11 FDD			5MHz: OP.9 TDD 10MHz: OP.1 TDD 20MHz: OP.7 TDD		
PBCH_RA	dB	0			0		
PBCH_RB	dB						
PSS_RA	dB						
SSS_RA	dB						
PCFICH_RB	dB						
PHICH_RA	dB						
PHICH_PB	dB						
PDCCH_RA	dB						
PDCCH_PB	dB						
PDSCH_RA	dB						
PDSCH_RB	dB						
OCNG_RA ^{Note 1}	dB						
OCNG_RB ^{Note 1}	dB						
N _{oc} ^{Note 2}	dBm/15 KHz						
\hat{E}_s / N_{oc}	dB	16	-2.5	20	16	-2.5	20
\hat{E}_s / I_{ot}	dB	16	-2.5	20	16	-2.5	20
RSRP ^{Note 3}	dBm/15 KHz	-88	-106.5	-84	-88	-106.5	-84
SCH_RP ^{Note 3}	dBm/15 KHz	-88	-106.5	-84	-88	-106.5	-84
I _o ^{Note 3}	dBm/Ch BW	-60.11 +10log (N _{RB,c} /50)	-74.28 +10log (N _{RB,c} /50)	-56.18 +10log (N _{RB,c} /50)	-60.11 +10log (N _{RB,c} /50)	-74.28 +10log (N _{RB,c} /50)	-56.18 +10log (N _{RB,c} /50)
Propagation Condition		ETU70			ETU70		
Correlation Matrix and Antenna Configuration		1x2 Low			1x2 Low		
Receive Time offset to cell1 ^{Note 5}	µs	-			33		
Note 1: OCNG shall be used such that both cells are fully allocated and a constant total transmitted power spectral density is achieved for all OFDM symbols. Note 2: Interference from other cells and noise sources not specified in the test is assumed to be constant over subcarriers and time and shall be modelled as AWGN of appropriate power for N _{oc} to be fulfilled. Note 3: RSRP, SCH_RP and I _o levels have been derived from other parameters for information purposes. They are not settable parameters themselves. Note 4: The resources for uplink transmission in Cell1 are assigned to the UE prior to the start of time period T3. Note 5: Receive time difference between subframe boundaries of signals received from the two cells at the UE antenna connector including time alignment error between the two cells.							

Table A.8.23.10.1-3: DRX-Configuration for E-UTRAN TDD-FDD DC intra-frequency event triggered reporting with DRX in synchronous DC with PCell in FDD

Field	Cell1	Cell2	Comment
	Value	Value	
onDurationTimer	psf1	psf1	As specified in clause 6.3.2 in TS 36.331
drx-InactivityTimer	psf1	psf1	
drx-RetransmissionTimer	psf1	psf1	
longDRX-CycleStartOffset	sf1280	sf80	
shortDRX	disable	disable	

Table A.8.23.10.1-4: TimeAlignmentTimer -Configuration for E-UTRAN TDD-FDD DC intra-frequency event triggered reporting with DRX in synchronous DC with PCell in FDD

Field	Cell1	Cell2	Comment
	Value	Value	
TimeAlignmentTimer	sf500	sf500	As specified in clause 6.3.2 in TS 36.331
sr-ConfigIndex	0	0	For further information see clause 6.3.2 in TS 36.331 and section10.1 in TS 36.213.

A.8.23.10.2 Test Requirements

The UE shall send one Event A2 triggered report for PCell on PCell with a measurement reporting delay less than 6.4s (5*MCG_DRX cycle) from the beginning of time period T2. The measurement reporting delay is defined as the time from the beginning of time period T2 to the moment when the UE starts to send preambles on the PRACH to obtain allocation to send the measurement report on PUSCH.

The UE shall send one Event A2 triggered report for PSCell on PCell with a measurement reporting delay less than 400ms (5*SCG_DRX cycle) from the beginning of time period T2. The measurement reporting delay is defined as the time from the beginning of time period T2 to the moment when the UE starts to send preambles on the PRACH to obtain allocation to send the measurement report on PUSCH.

The UE shall send one Event A1 triggered report for PCell on PCell with a measurement reporting delay less than 200ms from the beginning of time period T3. The measurement reporting delay is defined as the time from the beginning of time period T3 to the moment when the UE sends the measurement report on PUSCH.

The UE shall send one Event A1 triggered report for PSCell on PCell with a measurement reporting delay less than 400ms (5*SCG_DRX cycle) from the beginning of time period T3. The measurement reporting delay is defined as the time from the beginning of time period T3 to the moment when the UE sends the measurement report on PUSCH.

The UE shall not send event triggered measurement reports, as long as the reporting criteria are not fulfilled.

The rate of correct events observed during repeated tests shall be at least 90%.

A.8.23.11 E-UTRAN TDD-FDD DC intra-frequency event triggered reporting with DRX in synchronous DC with PCell in TDD

A.8.23.11.1 Test Purpose and Environment

The purpose of this test is to verify that the UE makes correct reporting of PCell and PSCell intra frequency measurement. This test will partly verify the intra-frequency measurement requirements in clause 8.8.2 and clause 8.8.3.

The test parameters are given in Table A.8.23.11.1-1, A.8.23.11.1-2, A.8.23.11.1-3 and A.8.23.11.1-4 below. In the test there are two cells: Cell1 and Cell2. Cell1 is PCell and Cell2 is PSCell. In the measurement control information it is indicated to the UE that event-triggered reporting with Events A1 (PCell and PSCell) and A2 (PCell and PSCell) is used. The test consists of three successive time periods, with duration of T1, T2 and T3, respectively. Prior to the start of the time duration T1, the UE shall be fully synchronized to Cell1 and Cell2. Prior to the start of the time duration T1, DRX configurations on MCG and SCG are enabled and DRX inactivity timers for MCG and SCG have already been expired. Immediately at beginning of T2 the transmission powers of Cell1 and Cell2 are reduced below a threshold

value of event A2 and this shall result in reporting of Event A2 for PCell and PSCell, respectively. Immediately after receiving the reporting of event A2 for both PCell and PSCell, PDCCH indicating a new transmission on Cell1 shall be sent continuously to ensure UE would not enter DRX state on MCG throughout T3. At beginning of T3 the transmission powers of Cell1 and Cell2 are increased above a threshold value of event A1 and this shall result in reporting of Event A1 for PCell and PSCell, respectively.

When MCG DRX is used, the uplink time alignment of Cell1 is not maintained and UE needs to use RACH to obtain UL allocation for measurement reporting in Cell1. When SCG DRX is used, the UE needs to be provided at least once every 500ms with new Timing Advance Command MAC control element to restart the Time alignment timer to keep UE uplink time alignment in Cell2. Furthermore UE is allocated with PUSCH resource at every DRX cycle.

Table A.8.23.11.1-1: General test parameters for E-UTRAN TDD-FDD DC intra-frequency event triggered reporting with DRX in synchronous DC with PCell in TDD

Parameter		Unit	Value	Comment
E-UTRA RF Channel Number			1, 2	Two radio channels are used for this test.
Active PCell			Cell1	PCell on RF channel number 1.
Configured PSCell			Cell2	PSCell on RF channel number 2.
A1	Hysteresis	dB	0	Hysteresis for evaluation of event A1.
	Threshold RSRP	dBm	-95	Actual RSRP threshold for event A1. Needs to take absolute accuracy tolerance in clause 9.1.11.1 and 9.1.11.2 into account plus margin.
	Time To Trigger	s	0	
A2	Hysteresis	dB	0	Hysteresis for evaluation of event A2.
	Threshold RSRP	dBm	-99	Actual RSRP threshold for event A2. Needs to take absolute accuracy tolerance in clause 9.1.11.1 and 9.1.11.2 into account plus margin.
	Time To Trigger	s	0	
CP length			Normal	
Special subframe configuration			6	As specified in table 4.2-1 in TS 36.211. The configuration is the TDD PCell
Uplink-downlink configuration			1	As specified in table 4.2-2 in TS 36.211. The configuration is for TDD PCell
DRX			ON	DRX related parameters are defined in Table A.8.23.3.1-3
Cell-individual offset for cells on RF channel number 1		dB	0	Individual offset for cells on primary component carrier.
Cell-individual offset for cells on RF channel number 2		dB	0	Individual offset for cells on carrier frequency of Cell2.
Filter coefficient			0	L3 filtering is not used
T1		s	5	
T2		s	10	
T3		s	1	
NOTE 1: This test verifies the RRM requirement which is independent of channel bandwidth and is performed according to the principle defined in section A.3.6.1.				

Table A.8.23.11.1-2: Cell specific test parameters for E-UTRAN TDD-FDD DC intra-frequency event triggered reporting with DRX in synchronous DC with PCell in TDD

Parameter	Unit	Cell 1			Cell 2		
		T1	T2	T3	T1	T2	T3
E-UTRA RF Channel Number		1			2		
BW _{channel}	MHz	5MHz: N _{RB,c} = 25 10MHz: N _{RB,c} = 50 20MHz: N _{RB,c} = 100			5MHz: N _{RB,c} = 25 10MHz: N _{RB,c} = 50 20MHz: N _{RB,c} = 100		
PDSCH parameters: DL Reference Measurement Channel		5MHz: R.4 TDD 10MHz: R.0 TDD 20MHz: R.3 TDD			5MHz: R.5 FDD 10MHz: R.0 FDD 20MHz: R.4 FDD		

PCFICH/PDCCH/PHICH parameters: DL Reference Measurement Channel		5MHz: R.11 TDD 10MHz: R.6 TDD 20MHz: R.10 TDD			5MHz: R.11 FDD 10MHz: R.6 FDD 20MHz: R.10 FDD		
OCNG Patterns		5MHz: OP.9 TDD 10MHz: OP.1 TDD 20MHz: OP.7 TDD			5MHz: OP.15 FDD 10MHz: OP.1 FDD 20MHz: OP.11 FDD		
PBCH_RA	dB	0			0		
PBCH_RB	dB						
PSS_RA	dB						
SSS_RA	dB						
PCFICH_RB	dB						
PHICH_RA	dB						
PHICH_PB	dB						
PDCCH_RA	dB						
PDCCH_PB	dB						
PDSCH_RA	dB						
PDSCH_RB	dB						
OCNG_RA ^{Note 1}	dB						
OCNG_RB ^{Note 1}	dB						
N_{oc} ^{Note 2}	dBm/15 KHz						
\hat{E}_s / N_{oc}	dB	16	-2.5	20	16	-2.5	20
\hat{E}_s / I_{ot}	dB	16	-2.5	20	16	-2.5	20
RSRP ^{Note 3}	dBm/15 KHz	-88	-106.5	-84	-88	-106.5	-84
SCH_RP ^{Note 3}	dBm/15 KHz	-88	-106.5	-84	-88	-106.5	-84
I_o ^{Note 3}	dBm/Ch BW	-60.11 +10log(N _{RB,c} /50)	-74.28 +10log(N _{RB,c} /50)	-56.18 +10log(N _{RB,c} /50)	-60.11 +10log(N _{RB,c} /50)	-74.28 +10log(N _{RB,c} /50)	-56.18 +10log(N _{RB,c} /50)
Propagation Condition		ETU70			ETU70		
Correlation Matrix and Antenna Configuration		1x2 Low			1x2 Low		
Receive Time offset to cell1 ^{Note 5}	µs	-			33		
<p>Note 1: OCNG shall be used such that both cells are fully allocated and a constant total transmitted power spectral density is achieved for all OFDM symbols.</p> <p>Note 2: Interference from other cells and noise sources not specified in the test is assumed to be constant over subcarriers and time and shall be modelled as AWGN of appropriate power for N_{oc} to be fulfilled.</p> <p>Note 3: RSRP, SCH_RP and I_o levels have been derived from other parameters for information purposes. They are not settable parameters themselves.</p> <p>Note 4: The resources for uplink transmission in Cell1 are assigned to the UE prior to the start of time period T3.</p> <p>Note 5: Receive time difference between subframe boundaries of signals received from the two cells at the UE antenna connector including time alignment error between the two cells.</p>							

Table A.8.23.11-3: DRX-Configuration for E-UTRAN TDD-FDD DC intra-frequency event triggered reporting with DRX in synchronous DC with PCell in TDD

Field	Cell1	Cell2	Comment
	Value	Value	
onDurationTimer	psf1	psf1	As specified in clause 6.3.2 in TS 36.331
drx-InactivityTimer	psf1	psf1	
drx-RetransmissionTimer	psf1	psf1	
longDRX-CycleStartOffset	sf1280	sf80	
shortDRX	disable	disable	

Table A.8.23.11.1-4: TimeAlignmentTimer-Configuration for E-UTRAN TDD-FDD DC intra-frequency event triggered reporting with DRX in synchronous DC with PCell in TDD

Field	Cell1	Cell2	Comment
	Value	Value	

TimeAlignmentTimer	sf500	sf500	As specified in clause 6.3.2 in TS 36.331
sr-ConfigIndex	0	0	For further information see clause 6.3.2 in TS 36.331 and section 10.1 in TS 36.213.

A.8.23.11.2 Test Requirements

The UE shall send one Event A2 triggered report for PCell on PCell with a measurement reporting delay less than 6.4s (5*MCG_DRX cycle) from the beginning of time period T2. The measurement reporting delay is defined as the time from the beginning of time period T2 to the moment when the UE starts to send preambles on the PRACH to obtain allocation to send the measurement report on PUSCH.

The UE shall send one Event A2 triggered report for PSCell on PCell with a measurement reporting delay less than 400ms (5*SCG_DRX cycle) from the beginning of time period T2. The measurement reporting delay is defined as the time from the beginning of time period T2 to the moment when the UE starts to send preambles on the PRACH to obtain allocation to send the measurement report on PUSCH.

The UE shall send one Event A1 triggered report for PCell on PCell with a measurement reporting delay less than 200ms from the beginning of time period T3. The measurement reporting delay is defined as the time from the beginning of time period T3 to the moment when the UE sends the measurement report on PUSCH.

The UE shall send one Event A1 triggered report for PSCell on PCell with a measurement reporting delay less than 400ms (5*SCG_DRX cycle) from the beginning of time period T3. The measurement reporting delay is defined as the time from the beginning of time period T3 to the moment when the UE sends the measurement report on PUSCH.

The UE shall not send event triggered measurement reports, as long as the reporting criteria are not fulfilled.

The rate of correct events observed during repeated tests shall be at least 90%.

A.8.23.12 E-UTRAN TDD-FDD DC inter-frequency event triggered reporting with DRX in synchronous DC with PCell in FDD

A.8.23.12.1 Test Purpose and Environment

The purpose of this test is to verify that the UE makes correct reporting of inter frequency measurement. This test will partly verify the inter-frequency cell search requirements in clause 8.8.4.

The test parameters are given in Tables A.8.23.12.1-1, A.8.23.12.1-2, A.8.23.12.1-3 and A.8.23.12.1-4 below. In the test there are three cells: Cell1, Cell2 and Cell3. Cell1 is PCell, Cell2 is PSCell and Cell3 is a neighbour cell. In the measurement control information it is indicated to the UE that event-triggered reporting with Event A3 (PCell) is used. The test consists of two successive time periods, with duration of T1 and T2, respectively. Prior to the start of the time duration T1, the UE shall be fully synchronized to Cell1 and Cell2. During T1 the UE shall not have any information on Cell3. Prior to the start of the time duration T1, DRX configurations on MCG and SCG are enabled and DRX inactivity timers for MCG and SCG have already been expired.

In this test, UE needs to be provided at least once every 500ms with new Timing Advance Command MAC control element to restart the Time alignment timer to keep UE uplink time alignment in Cell1. Furthermore the UE is allocated with PUSCH resource at every DRX cycle.

Table A.8.23.12.1-1: General test parameters for E-UTRAN TDD-FDD DC inter-frequency event triggered reporting with DRX in synchronous DC with PCell in FDD

Parameter	Unit	Value	Comment	
E-UTRA RF Channel Number		1, 2, 3	Three radio channels are used for this test.	
Active PCell		Cell1	PCell on RF channel number 1.	
Configured PSCell		Cell2	PSCell on RF channel number 2.	
Neighbour cell		Cell3	Neighbour cell on RF channel number 3.	
A3	Hysteresis	dB	0	Hysteresis for evaluation of event A3.
	A3-offset	dB	-6	
	Time To Trigger	s	0	
CP length		Normal		

DRX		ON	DRX related parameters are defined in Table A.8.23.12.1-3
Measurement gap pattern Id		0	
Cell-individual offset for cells on RF channel number 1	dB	0	Individual offset for cells on primary component carrier.
Cell-individual offset for cells on RF channel number 2	dB	0	Individual offset for cells on carrier frequency of Cell2.
Cell-individual offset for cells on RF channel number 3	dB	0	Individual offset for cells on carrier frequency of Cell3.
Filter coefficient		0	L3 filtering is not used
T1	s	5	
T2	s	5	
Note 1: A UE capable of both synchronous and asynchronous DC operations is not required to pass this test case in accordance with the principle defined in section A.3.11.			

Table A.8.23.12.1-2: Cell specific test parameters for E-UTRAN TDD-FDD DC inter-frequency event triggered reporting with DRX in synchronous DC with PCell in FDD

Parameter	Unit	Cell1		Cell2		Cell3	
		T1	T2	T1	T2	T1	T2
E-UTRA RF Channel Number		1		2		3	
BW _{channel}	MHz	5MHz: N _{RB,c} = 25 10MHz: N _{RB,c} = 50 20MHz: N _{RB,c} = 100		5MHz: N _{RB,c} = 25 10MHz: N _{RB,c} = 50 20MHz: N _{RB,c} = 100		5MHz: N _{RB,c} = 25 10MHz: N _{RB,c} = 50 20MHz: N _{RB,c} = 100	
Special subframe configuration ^{Note5}		-		6		6	
Uplink-downlink configuration ^{Note5}		-		1		1	
PDSCH parameters: DL Reference Measurement Channel		5MHz: R.5 FDD 10MHz: R.0 FDD 20MHz: R.4 FDD		5MHz: R.4 TDD 10MHz: R.0 TDD 20MHz: R.3 TDD		-	
PCFICH/PDCCH/PHICH parameters: DL Reference Measurement Channel		5MHz: R.11 FDD 10MHz: R.6 FDD 20MHz: R.10 FDD		5MHz: R.11 TDD 10MHz: R.6 TDD 20MHz: R.10 TDD		5MHz: R.11 TDD 10MHz: R.6 TDD 20MHz: R.10 TDD	
OCNG Patterns		5MHz: OP.15 FDD 10MHz: OP.1 FDD 20MHz: OP.11 FDD		5MHz: OP.9 TDD 10MHz: OP.1 TDD 20MHz: OP.7 TDD		5MHz: OP.10 TDD 10MHz: OP.2 TDD 20MHz: OP.8 TDD	
PBCH_RA	dB	0		0		0	
PBCH_RB	dB						
PSS_RA	dB						
SSS_RA	dB						
PCFICH_RB	dB						
PHICH_RA	dB						
PHICH_PB	dB						
PDCCH_RA	dB						
PDCCH_PB	dB						
PDSCH_RA	dB						
PDSCH_RB	dB						
OCNG_RA ^{Note 1}	dB						
OCNG_RB ^{Note 1}	dB						
N_{oc} ^{Note 2}	dBm/15 KHz						
\hat{E}_s / N_{oc}	dB	4	4	4	4	-infinity	7
\hat{E}_s / I_{ot}	dB	4	4	4	4	-infinity	7
RSRP ^{Note 3}	dBm/15 KHz	-97	-97	-97	-97	-infinity	-94
SCH_RP ^{Note 3}	dBm/15 KHz	-97	-97	-97	-97	-infinity	-94

I_0 ^{Note 3}	dBm/Ch BW	-67.76 +10log ($N_{RB,c}$ /50)	-67.76 +10log ($N_{RB,c}$ /50)	-67.76 +10log ($N_{RB,c}$ /50)	-67.76 +10log ($N_{RB,c}$ /50)	N/A	-65.43 +10log ($N_{RB,c}$ /50)
Propagation Condition		ETU70		ETU70		ETU70	
Correlation Matrix and Antenna Configuration		1x2 Low		1x2 Low		1x2 Low	
Receive Time offset to cell1 ^{Note 4}	μ s	-		33		-	
Time offset to cell1	μ s	-		-		3	
Note 1:	OCNG shall be used such that both cells are fully allocated and a constant total transmitted power spectral density is achieved for all OFDM symbols.						
Note 2:	Interference from other cells and noise sources not specified in the test is assumed to be constant over subcarriers and time and shall be modelled as AWGN of appropriate power for N_{oc} to be fulfilled.						
Note 3:	E_s/lot , RSRP, SCH_RP and I_0 levels have been derived from other parameters for information purposes. They are not settable parameters themselves.						
Note 4:	Receive time difference between subframe boundaries of signals received from the two cells at the UE antenna connector including time alignment error between the two cells.						
Note 5:	For special subframe and uplink-downlink configurations see Tables 4.2-1 and 4.2-2 in TS 36.211 [16].						

Table A.8.23.12.1-3: DRX-Configuration for E-UTRAN TDD-FDD DC inter-frequency event triggered reporting with DRX in synchronous DC with PCell in FDD

Field	Cell1	Cell2	Comment
	Value	Value	
onDurationTimer	psf1	psf1	As specified in clause 6.3.2 in TS 36.331 [2]
drx-InactivityTimer	psf1	psf1	
drx-RetransmissionTimer	psf1	psf1	
longDRX-CycleStartOffset	sf80	sf1280	
shortDRX	disable	disable	

Table A.8.23.12.1-4: TimeAlignmentTimer-Configuration for E-UTRAN TDD-FDD DC inter-frequency event triggered reporting with DRX in synchronous DC with PCell in FDD

Field	Cell1	Cell2	Comment
	Value	Value	
TimeAlignmentTimer	sf500	sf500	As specified in clause 6.3.2 in TS 36.331 [2]
sr-ConfigIndex	0	0	For further information see clause 6.3.2 in TS 36.331 [2] and section 10.1 in TS 36.213 [3].

A.8.23.12.2 Test Requirements

The UE shall send one Event A3 triggered measurement report for Cell 3 on PCell, with a measurement reporting delay less than 3.84s from the beginning of time period T2. The measurement reporting delay is defined as the time from the beginning of time period T2 to the moment when the UE sends the measurement report on PUSCH.

The UE shall not send event triggered measurement reports, as long as the reporting criteria are not fulfilled.

The rate of correct events observed during repeated tests shall be at least 90%.

A.8.23.13 E-UTRAN TDD-FDD DC inter-frequency event triggered reporting with DRX in synchronous DC with PCell in TDD

A.8.23.13.1 Test Purpose and Environment

The purpose of this test is to verify that the UE makes correct reporting of inter frequency measurement. This test will partly verify the inter-frequency cell search requirements in clause 8.8.4.

The test parameters are given in Table A.8.23.13.1-1, A.8.23.13.1-2, A.8.23.13.1-3 and A.8.23.13.1-4 below. In the test there are three cells: Cell1, Cell2 and Cell3. Cell1 is PCell, Cell2 is PSCell and Cell3 is a neighbour cell. In the

measurement control information it is indicated to the UE that event-triggered reporting with Events A3 (PCell) is used. The test consists of two successive time periods, with duration of T1 and T2, respectively. Prior to the start of the time duration T1, the UE shall be fully synchronized to Cell1 and Cell2. During T1 the UE shall not have any information on Cell3. Prior to the start of the time duration T1, DRX configurations on MCG and SCG are enabled and DRX inactivity timers for MCG and SCG have already been expired.

In this test, UE needs to be provided at least once every 500ms with new Timing Advance Command MAC control element to restart the Time alignment timer to keep UE uplink time alignment in Cell1. Furthermore the UE is allocated with PUSCH resource at every DRX cycle.

Table A.8.23.13.1-1: General test parameters for E-UTRAN TDD-FDD DC inter-frequency event triggered reporting with DRX in synchronous DC with PCell in TDD

Parameter		Unit	Value	Comment
E-UTRA RF Channel Number			1, 2, 3	Three radio channels are used for this test.
Active PCell			Cell1	PCell on RF channel number 1.
Configured PSCell			Cell2	PSCell on RF channel number 2.
Neighbour cell			Cell3	Neighbour cell on RF channel number 3.
A3	Hysteresis	dB	0	Hysteresis for evaluation of event A3.
	A3-offset	dB	-6	
	Time To Trigger	s	0	
CP length			Normal	
DRX			ON	DRX related parameters are defined in Table A.8.23.13.1-3
Measurement gap pattern Id			0	
Cell-individual offset for cells on RF channel number 1		dB	0	Individual offset for cells on primary component carrier.
Cell-individual offset for cells on RF channel number 2		dB	0	Individual offset for cells on carrier frequency of Cell2.
Cell-individual offset for cells on RF channel number 3		dB	0	Individual offset for cells on carrier frequency of Cell3.
Filter coefficient			0	L3 filtering is not used
T1		s	5	
T2		s	5	
Note 1: A UE capable of both synchronous and asynchronous DC operations is not required to pass this test case in accordance with the principle defined in section A.3.11.				

Table A.8.23.13.1-2: Cell specific test parameters for E-UTRAN TDD-FDD DC inter-frequency event triggered reporting with DRX in synchronous DC with PCell in TDD

Parameter	Unit	Cell1		Cell2		Cell3	
		T1	T2	T1	T2	T1	T2
E-UTRA RF Channel Number		1		2		3	
BW _{channel}	MHz	5MHz: N _{RB,c} = 25 10MHz: N _{RB,c} = 50 20MHz: N _{RB,c} = 100		5MHz: N _{RB,c} = 25 10MHz: N _{RB,c} = 50 20MHz: N _{RB,c} = 100		5MHz: N _{RB,c} = 25 10MHz: N _{RB,c} = 50 20MHz: N _{RB,c} = 100	
Special subframe configuration ^{Note5}		6		-		-	
Uplink-downlink configuration ^{Note5}		1		-		-	
PDSCH parameters: DL Reference Measurement Channel		5MHz: R.4 TDD 10MHz: R.0 TDD 20MHz: R.3 TDD		5MHz: R.5 FDD 10MHz: R.0 FDD 20MHz: R.4 FDD		-	
PCFICH/PDCCH/PHICH parameters: DL Reference Measurement Channel		5MHz: R.11 TDD 10MHz: R.6 TDD 20MHz: R.10 TDD		5MHz: R.11 FDD 10MHz: R.6 FDD 20MHz: R.10 FDD		5MHz: R.11 FDD 10MHz: R.6 FDD 20MHz: R.10 FDD	

OCNG Patterns		5MHz: OP.9 TDD 10MHz: OP.1 TDD 20MHz: OP.7 TDD		5MHz: OP.15 FDD 10MHz: OP.1 FDD 20MHz: OP.11 FDD		5MHz: OP.16 FDD 10MHz: OP.2 FDD 20MHz: OP.12 FDD	
PBCH_RA	dB	0		0		0	
PBCH_RB	dB						
PSS_RA	dB						
SSS_RA	dB						
PCFICH_RB	dB						
PHICH_RA	dB						
PHICH_PB	dB						
PDCCH_RA	dB						
PDCCH_PB	dB						
PDSCH_RA	dB						
PDSCH_RB	dB						
OCNG_RA ^{Note 1}	dB						
OCNG_RB ^{Note 1}	dB						
N_{oc} ^{Note 2}	dBm/15 KHz	-101		-101		N/A	-101
\hat{E}_s / N_{oc}	dB	4	4	4	4	-infinity	7
\hat{E}_s / I_{ot}	dB	4	4	4	4	-infinity	7
RSRP ^{Note 3}	dBm/15 KHz	-97	-97	-97	-97	-infinity	-94
SCH_RP ^{Note 3}	dBm/15 KHz	-97	-97	-97	-97	-infinity	-94
I_o ^{Note 3}	dBm/Ch BW	-67.76 +10log (N _{RB,c} /50)	-67.76 +10log (N _{RB,c} /50)	-67.76 +10log (N _{RB,c} /50)	-67.76 +10log (N _{RB,c} /50)	N/A	-65.43 +10log (N _{RB,c} /50)
Propagation Condition		ETU70		ETU70		ETU70	
Correlation Matrix and Antenna Configuration		1x2 Low		1x2 Low		1x2 Low	
Receive Time offset to cell1 ^{Note 4}	μs	-		33		-	
Time offset to cell1	μs	-		-		3	
<p>Note 1: OCNG shall be used such that both cells are fully allocated and a constant total transmitted power spectral density is achieved for all OFDM symbols.</p> <p>Note 2: Interference from other cells and noise sources not specified in the test is assumed to be constant over subcarriers and time and shall be modelled as AWGN of appropriate power for N_{oc} to be fulfilled.</p> <p>Note 3: E_s/I_{ot}, RSRP, SCH_RP and I_o levels have been derived from other parameters for information purposes. They are not settable parameters themselves.</p> <p>Note 4: Receive time difference between subframe boundaries of signals received from the two cells at the UE antenna connector including time alignment error between the two cells.</p> <p>Note 5: For special subframe and uplink-downlink configurations see Tables 4.2-1 and 4.2-2 in TS 36.211 [16].</p>							

Table A.8.23.13.1-3: DRX-Configuration for E-UTRAN TDD-FDD DC inter-frequency event triggered reporting with DRX in synchronous DC with PCell in TDD

Field	Cell1	Cell2	Comment
	Value	Value	
onDurationTimer	psf1	psf1	As specified in clause 6.3.2 in TS 36.331 [2]
drx-InactivityTimer	psf1	psf1	
drx-RetransmissionTimer	psf1	psf1	
longDRX-CycleStartOffset	sf80	sf1280	
shortDRX	disable	disable	

Table A.8.23.13.1-4: TimeAlignmentTimer -Configuration for E-UTRAN TDD-FDD DC inter-frequency event triggered reporting with DRX in synchronous DC with PCell in TDD

Field	Cell1	Cell2	Comment
	Value	Value	
TimeAlignmentTimer	sf500	sf500	As specified in clause 6.3.2 in TS 36.331 [2]

sr-ConfigIndex	0	0	For further information see clause 6.3.2 in TS 36.331 [2] and section 10.1 in TS 36.213 [3].
----------------	---	---	--

A.8.23.13.2 Test Requirements

The UE shall send one Event A3 triggered measurement report for Cell 3 on PCell, with a measurement reporting delay less than 3.84s from the beginning of time period T2. The measurement reporting delay is defined as the time from the beginning of time period T2 to the moment when the UE sends the measurement report on PUSCH.

The UE shall not send event triggered measurement reports, as long as the reporting criteria are not fulfilled.

The rate of correct events observed during repeated tests shall be at least 90%.

A.8.23.14 E-UTRAN TDD-FDD Addition and Release Delay of known PSCell in Synchronous DC with PCell in FDD

A.8.23.14.1 Test Purpose and Environment

The purpose of this test is to verify that the PSCell addition and release delays under synchronous dual connectivity are within the requirements stated in section 7.14 for the case when the PSCell is known by the UE at the time of addition.

The test parameters are given in Tables A.8.23.14.1-1 and cell-specific parameters in A.8.23.14.1-2 below. The test consists of five successive time periods with duration of T1, T2, T3, T4 and T5 respectively. There are two carriers each with one cell. Before the test starts the UE is connected to Cell 1 (PCell) on radio channel 1 (PCC) but is not aware of Cell 2 on radio channel 2. The UE is only monitoring the PCC. During T1 only Cell1 is known to the UE.

Before the start of T2 it is indicated to the UE in the measurement control information that event-triggered reporting with Event A4 is configured for neighbour cell (Cell2). Before the start of T2 the UE is configured with the measurement gaps (gap pattern Id # 0). The Cell2 becomes known to the UE during T2. Therefore during T2 the UE shall report Event A4. After receiving the Event A4, the test system shall send a RRC message to the UE to release the measurement gaps.

The test system shall send a RRC message to the UE to add PSCell (Cell 2) on radio channel 2. The RRC message (to add PSCell) also includes a request for the UE to start periodic CSI reporting for the PSCell after the PSCell has been successfully added. The RRC message to add PSCell shall be sent to the UE during period T2, after the measurement gaps are released by the test system. The point in time at which the RRC message to add PSCell (Cell2) is received at the UE antenna connector defines the start of time period T3.

The test system shall observe the periodic reporting of CSI for PSCell during T4. The point in time at which the UE has sent PRACH to the PSCell (Cell 2) defines the start of time period T4.

The test system shall send a RRC message to the UE to release PSCell (Cell 2) on radio channel 2. The RRC message to release PSCell (Cell2) shall be sent to the UE during time period T4, after the UE has sent at least one CQI report with non-zero CQI index for PSCell (Cell 2). The point in time at which the RRC message to release PSCell (Cell2) is received at the UE antenna connector defines the start of time period T5.

Table A.8.23.14.1-1: General test parameters for known PSCell addition and release case

Parameter		Unit	Value	Comment
E-UTRA RF Channel Number			1, 2	Two radio channels are used for this test
Initial Condition	Active PCell		Cell1	PCell on RF channel number 1.
	Neighbour cell		Cell2	Neighbour cell on RF channel number 2.
Final Condition	Active PCell		Cell1	PCell on RF channel number 1.
	PSCell		Cell2	PSCell on RF channel number 2.
A4	Hysteresis	dB	0	Hysteresis for evaluation of event A4.
	Threshold RSRP	dBm	-93	Actual RSRP threshold for event A4. Needs to take absolute accuracy tolerance in section 9.1.11.1 into account plus margin.
	Time To Trigger	s	0	
CP length			Normal	
DRX			OFF	Continuous monitoring of primary cell
Measurement gap pattern Id			0	Gaps are configured before T2 and released before T3.

CQI/PMI periodicity and offset configuration index on cell2		0	CQI reporting for PSCell every second subframe
Cell-individual offset for cells on RF channel number 1	dB	0	Individual offset for cells on primary component carrier.
Cell-individual offset for cells on RF channel number 2	dB	0	Individual offset for cells on carrier frequency of cell2.
T1	s	5	During this time the PCell shall be known and cell2 shall be unknown.
T2	s	≤ 5	During this time the UE shall identify neighbour cell (cell2) and report event A4.
T3	s	1	During this time the UE adds the PSCell.
T4	s	1	During this time the UE sends CSI reports for PSCell.
T5	s	1	During this time the UE releases the PSCell.
Note 1:	This test verifies the RRM requirement which is independent of channel bandwidth and is performed according to the principle defined in section A.3.6.1.		
Note 2:	A UE capable of both synchronous and asynchronous DC operations is not required to pass this test case in accordance with the principle defined in section A.3.6.11.		

Table A.8.23.14.1-2: Cell specific test parameters for E-UTRAN known PSCell addition and release

Parameter	Unit	Cell 1					Cell 2					
		T1	T2	T3	T4	T5	T1	T2	T3	T4	T5	
E-UTRA RF Channel Number		1					2					
Special subframe configuration		N/A					6					
Uplink-downlink configuration		N/A					1					
BW _{channel}	MHz	5MHz: N _{RB,c} = 25 10MHz: N _{RB,c} = 50 20MHz: N _{RB,c} = 100					5MHz: N _{RB,c} = 25 10MHz: N _{RB,c} = 50 20MHz: N _{RB,c} = 100					
PDSCH parameters: DL Reference Measurement Channel		5MHz: R.5 FDD 10MHz: R.0 FDD 20MHz: R.4 FDD					-					
PCFICH/PDCCH/PHICH parameters: DL Reference Measurement Channel		5MHz: R.11 FDD 10MHz: R.6 FDD 20MHz: R.10 FDD					5MHz: R.11 TDD 10MHz: R.6 TDD 20MHz: R.10 TDD					
OCNG Patterns		5MHz: OP.15 FDD 10MHz: OP.1 FDD 20MHz: OP.11 FDD					5MHz: OP.10 TDD 10MHz: OP.2 TDD 20MHz: OP.8 TDD					
PBCH_RA	dB	0					0					
PBCH_RB	dB											
PSS_RA	dB											
SSS_RA	dB											
PCFICH_RB	dB											
PHICH_RA	dB											
PHICH_RB	dB											
PDCCH_RA	dB											
PDCCH_RB	dB											
PDSCH_RA	dB											
PDSCH_RB	dB											
OCNG_RA ^{Note 1}	dB											
OCNG_RB ^{Note 1}	dB											
N _{oc} ^{Note 2}	dBm/15 kHz											-101
\hat{E}_s/N_{oc}	dB	19	19	19	19	19	-infinity	0	0	0	0	
\hat{E}_s/I_{ot}	dB	19	19	19	19	19	infinity	0	0	0	0	
RSRP ^{Note 3}	dBm/15 kHz	-82	-82	-82	-82	-82	-infinity	-85	-85	-85	-85	
SCH_RP ^{Note 3}	dBm/15 kHz	-82	-82	-82	-82	-82	-infinity	-85	-85	-85	-85	
I _o ^{Note 3}	dBm/C h BW	-54.16 +10log(N _{RB,c} /50)	-54.16 +10log(N _{RB,c} /50)	-54.16 +10log(N _{RB,c} /50)	-54.16 +10log(N _{RB,c} /50)	-54.16 +10log(N _{RB,c} /50)	N/A	-54.21 +10log(N _{RB,c} /50)	-54.21 +10log(N _{RB,c} /50)	-54.21 +10log(N _{RB,c} /50)	-54.21 +10log(N _{RB,c} /50)	
Propagation Condition		AWGN					AWGN					
Antenna Configuration		1x2					1x2					
Receive time offset to cell1 ^{Note 4}	µs	-					33					
PRACH configuration Index ^{Note 5}		4					50					
<p>Note 1: OCNG shall be used such that all cells are fully allocated and a constant total transmitted power spectral density is achieved for all OFDM symbols.</p> <p>Note 2: Interference from other cells and noise sources not specified in the test is assumed to be constant over subcarriers and time and shall be modelled as AWGN of appropriate power for N_{oc} to be fulfilled.</p> <p>Note 3: \hat{E}_s/I_{ot}, RSRP, SCH_RP and I_o levels have been derived from other parameters for information purposes. They are not settable parameters themselves.</p> <p>Note 4: Receive time difference between subframe boundaries of signals received from the two cells at the UE antenna connector including time alignment error between the two cells.</p> <p>Note 5: As specified in table 5.7.1-2 in TS 36.211.</p> <p>Note 6: The uplink resources for CSI reporting are assigned to the UE prior to the start of time period T4.</p>												

A.8.23.14.2 Test Requirements

The UE shall transmit the PRACH to PSCell at latest 115 ms into T3.

The UE shall send at least one CSI report for PSCell with non-zero CQI index during T4.

The UE shall stop sending CSI reports for PSCell in at latest 16ms into T5.

All of the above test requirements shall be fulfilled in order for the observed PSCell addition delay and PSCell release delay to be counted as correct. The rate of correct observed PSCell addition delay and PSCell release delay during repeated tests shall be at least 90%.

NOTE: The PSCell addition delay can be expressed as follows as specified in Clause 7.14.2:

$$T_{\text{config_PSCell}} = 15\text{ms} + T_{\text{activation_time}} + 50\text{ms} + T_{\text{PCell_DU}} + T_{\text{PSCell_DU}}$$

Where:

$T_{\text{activation_time}} = 20 \text{ ms}$ (cell2 is known to the UE);

$T_{\text{PCell_DU}} = 0$ (due to PRACH configurations in cell1 and cell2 being orthogonal in time, i.e. non-overlapping in time);

$T_{\text{PSCell_DU}} = 30 \text{ ms}$ (delay due to PRACH transmission to cell2).

This gives a total of 115 ms.

A.8.23.15 E-UTRAN TDD-FDD Addition and Release Delay of known PSCell in Synchronous DC with PCell in TDD

A.8.23.15.1 Test Purpose and Environment

The purpose of this test is to verify that the PSCell addition and release delays under synchronous dual connectivity are within the requirements stated in section 7.14 for the case when the PSCell is known by the UE at the time of addition.

The test parameters are given in Tables A.8.23.15.1-1 and cell-specific parameters in A.8.23.15.1-2 below. The test consists of five successive time periods with duration of T1, T2, T3, T4 and T5 respectively. There are two carriers each with one cell. Before the test starts the UE is connected to Cell 1 (PCell) on radio channel 1 (PCC) but is not aware of Cell 2 on radio channel 2. The UE is only monitoring the PCC. During T1 only Cell1 is known to the UE.

Before the start of T2 it is indicated to the UE in the measurement control information that event-triggered reporting with Event A4 is configured for neighbour cell (Cell2). Before the start of T2 the UE is configured with the measurement gaps (gap pattern Id # 0). The Cell2 becomes known to the UE during T2. Therefore during T2 the UE shall report Event A4. After receiving the Event A4, the test system shall send a RRC message to the UE to release the measurement gaps.

The test system shall send a RRC message to the UE to add PSCell (Cell 2) on radio channel 2. The RRC message (to add PSCell) also includes a request for the UE to start periodic CSI reporting for the PSCell after the PSCell has been successfully added. The RRC message to add PSCell shall be sent to the UE during period T2, after the measurement gaps are released by the test system. The point in time at which the RRC message to add PSCell (Cell2) is received at the UE antenna connector defines the start of time period T3.

The test system shall observe the periodic reporting of CSI for PSCell during T4. The point in time at which the UE has sent PRACH to the PSCell (Cell 2) defines the start of time period T4.

The test system shall send a RRC message to the UE to release PSCell (Cell 2) on radio channel 2. The RRC message to release PSCell (Cell2) shall be sent to the UE during time period T4, after the UE has sent at least one CQI report with non-zero CQI index for PSCell (Cell 2). The point in time at which the RRC message to release PSCell (Cell2) is received at the UE antenna connector defines the start of time period T5.

Table A.8.23.15.1-1: General test parameters for known PSCell addition and release case

Parameter	Unit	Value	Comment
E-UTRA RF Channel Number		1, 2	Two radio channels are used for this test
Active PCell		Cell1	PCell on RF channel number 1.

Initial Condition	Neighbour cell		Cell2	Neighbour cell on RF channel number 2.
Final Condition	Active PCell		Cell1	PCell on RF channel number 1.
	PSCell		Cell2	PSCell on RF channel number 2.
A4	Hysteresis	dB	0	Hysteresis for evaluation of event A4.
	Threshold RSRP	dBm	-93	Actual RSRP threshold for event A4. Needs to take absolute accuracy tolerance in section 9.1.11.1 into account plus margin.
	Time To Trigger	s	0	
CP length			Normal	
DRX			OFF	Continuous monitoring of primary cell
Measurement gap pattern Id			0	Gaps are configured before T2 and released before T3.
CQI/PMI periodicity and offset configuration index on cell2			0	CQI reporting for PSCell every second subframe
Cell-individual offset for cells on RF channel number 1		dB	0	Individual offset for cells on primary component carrier.
Cell-individual offset for cells on RF channel number 2		dB	0	Individual offset for cells on carrier frequency of cell2.
T1		s	5	During this time the PCell shall be known and cell2 shall be unknown.
T2		s	≤ 5	During this time the UE shall identify neighbour cell (cell2) and report event A4.
T3		s	1	During this time the UE adds the PSCell.
T4		s	1	During this time the UE sends CSI reports for PSCell.
T5		s	1	During this time the UE releases the PSCell.
Note 1:	This test verifies the RRM requirement which is independent of channel bandwidth and is performed according to the principle defined in section A.3.6.1.			
Note 2:	A UE capable of both synchronous and asynchronous DC operations is not required to pass this test case in accordance with the principle defined in section A.3.6.11.			

Table A.8.23.15.1-2: Cell specific test parameters for E-UTRAN known PSCell addition and release

Parameter	Unit	Cell 1					Cell 2					
		T1	T2	T3	T4	T5	T1	T2	T3	T4	T5	
E-UTRA RF Channel Number		1					2					
Special subframe configuration		6					N/A					
Uplink-downlink configuration		1					N/A					
BW _{channel}	MHz	5MHz: N _{RB,c} = 25 10MHz: N _{RB,c} = 50 20MHz: N _{RB,c} = 100					5MHz: N _{RB,c} = 25 10MHz: N _{RB,c} = 50 20MHz: N _{RB,c} = 100					
PDSCH parameters: DL Reference Measurement Channel		5MHz: R.4 TDD 10MHz: R.0 TDD 20MHz: R.3 TDD					-					
PCFICH/PDCCH/PHICH parameters: DL Reference Measurement Channel		5MHz: R.11 TDD 10MHz: R.6 TDD 20MHz: R.10 TDD					5MHz: R.11 FDD 10MHz: R.6 FDD 20MHz: R.10 FDD					
OCNG Patterns		5MHz: OP.9 TDD 10MHz: OP.1 TDD 20MHz: OP.7 TDD					5MHz: OP.16 FDD 10MHz: OP.2 FDD 20MHz: OP.12 FDD					
PBCH_RA	dB	0					0					
PBCH_RB	dB											
PSS_RA	dB											
SSS_RA	dB											
PCFICH_RB	dB											
PHICH_RA	dB											
PHICH_RB	dB											
PDCCH_RA	dB											
PDCCH_RB	dB											
PDSCH_RA	dB											
PDSCH_RB	dB											
OCNG_RA ^{Note 1}	dB											
OCNG_RB ^{Note 1}	dB											
N _{oc} ^{Note 2}	dBm/15 kHz											-101
\hat{E}_s/N_{oc}	dB	19	19	19	19	19	-infinity	0	0	0	0	
\hat{E}_s/I_{ot}	dB	19	19	19	19	19	infinity	0	0	0	0	
RSRP ^{Note 3}	dBm/15 kHz	-82	-82	-82	-82	-82	-infinity	-85	-85	-85	-85	
SCH_RP ^{Note 3}	dBm/15 kHz	-82	-82	-82	-82	-82	-infinity	-85	-85	-85	-85	
I _o ^{Note 3}	dBm/Ch BW	-54.16 +10log(N _{RB,c} /50)	-54.16 +10log(N _{RB,c} /50)	-54.16 +10log(N _{RB,c} /50)	-54.16 +10log(N _{RB,c} /50)	-54.16 +10log(N _{RB,c} /50)	N/A	-54.21 +10log(N _{RB,c} /50)	-54.21 +10log(N _{RB,c} /50)	-54.21 +10log(N _{RB,c} /50)	-54.21 +10log(N _{RB,c} /50)	
Propagation Condition		AWGN					AWGN					
Antenna Configuration		1x2					1x2					
Receive time offset to cell1 ^{Note 4}	µs	-					33					
PRACH configuration Index ^{Note 5}		56					2					
<p>Note 1: OCNG shall be used such that all cells are fully allocated and a constant total transmitted power spectral density is achieved for all OFDM symbols.</p> <p>Note 2: Interference from other cells and noise sources not specified in the test is assumed to be constant over subcarriers and time and shall be modelled as AWGN of appropriate power for N_{oc} to be fulfilled.</p> <p>Note 3: \hat{E}_s/I_{ot}, RSRP, SCH_RP and I_o levels have been derived from other parameters for information purposes. They are not settable parameters themselves.</p> <p>Note 4: Receive time difference between subframe boundaries of signals received from the two cells at the UE antenna connector including time alignment error between the two cells.</p> <p>Note 5: As specified in table 5.7.1-2 in TS 36.211.</p> <p>Note 6: The uplink resources for CSI reporting are assigned to the UE prior to the start of time period T4.</p>												

A.8.23.15.2 Test Requirements

The UE shall transmit the PRACH to PSCell at latest 115 ms into T3.

The UE shall send at least one CSI report for PSCell with non-zero CQI index during T4.

The UE shall stop sending CSI reports for PSCell in at latest 16ms into T5.

All of the above test requirements shall be fulfilled in order for the observed PSCell addition delay and PSCell release delay to be counted as correct. The rate of correct observed PSCell addition delay and PSCell release delay during repeated tests shall be at least 90%.

NOTE: The PSCell addition delay can be expressed as follows as specified in Clause 7.14.2:

$$T_{\text{config_PSCell}} = 15\text{ms} + T_{\text{activation_time}} + 50\text{ms} + T_{\text{PCell_DU}} + T_{\text{PSCell_DU}}$$

Where:

$T_{\text{activation_time}} = 20$ ms (cell2 is known to the UE);

$T_{\text{PCell_DU}} = 0$ (due to PRACH configurations in cell1 and cell2 being orthogonal in time, i.e. non-overlapping in time);

$T_{\text{PSCell_DU}} = 30$ ms (delay due to PRACH transmission to cell2).

This gives a total of 115 ms.

A.8.23.16 E-UTRAN FDD-FDD DC SSTD measurement reporting delay with no DRX in asynchronous DC

A.8.23.16.1 Test Purpose and Environment

The purpose of this test is to verify that the UE makes correct reporting of SSTD measurements. The test partially verifies the requirement in SSTD Measurements for E-UTRA Dual Connectivity, section 8.8.7. This test is applicable to UEs which support asynchronous dual connectivity and support SSTD measurements.

The test parameters are given in Tables A.8.23.16.1-1 and A.8.23.16.1-2. In this test there are 2 cells, a PCell and a PSCell, on different frequencies.

The test consists of two time phases, T1 and T2. During T1 a dual connectivity connection is established. At the end of T1 a measurement with the IE reportSSTD-Meas set to TRUE is configured by the test equipment, such that the measurement configuration is available to the UE at the transition from T1 to T2. The SSTD reporting delay is the time from the start of T2 until an SSTD measurement report is transmitted by the UE.

Table A.8.23.16.1-1: General test parameters for E-UTRAN FDD-FDD DC SSTD measurement reporting delay with no DRX in asynchronous DC

Parameter	Unit	Value	Comment
E-UTRA RF Channel Number		1, 2	Two radio channels are used for this test.
Active PCell		Cell1	PCell on RF channel number 1.
Configured PSCell		Cell2	PSCell on RF channel number 2.
CP length		Normal	
DRX		OFF	
T1	s	2	
T2	s	10	
Note 1: This test verifies the RRM requirement which is independent of channel bandwidth and is performed according to the principle defined in section A.3.6.1.			

Table A.8.23.16.1-2: Cell specific test parameters for E-UTRAN FDD-FDD DC SSTD measurement reporting delay with no DRX in asynchronous DC

Parameter	Unit	Cell 1		Cell 2	
		T1	T2	T1	T2
E-UTRA RF Channel Number		1		2	

$BW_{channel}$	MHz	5MHz: $N_{RB,c} = 25$ 10MHz: $N_{RB,c} = 50$ 20MHz: $N_{RB,c} = 100$		5MHz: $N_{RB,c} = 25$ 10MHz: $N_{RB,c} = 50$ 20MHz: $N_{RB,c} = 100$	
PDSCH parameters: DL Reference Measurement Channel		5MHz: R.5 FDD 10MHz: R.0 FDD 20MHz: R.4 FDD		5MHz: R.5 FDD 10MHz: R.0 FDD 20MHz: R.4 FDD	
PCFICH/PDCCH/PHICH parameters: DL Reference Measurement Channel		5MHz: R.11 FDD 10MHz: R.6 FDD 20MHz: R.10 FDD		5MHz: R.11 FDD 10MHz: R.6 FDD 20MHz: R.10 FDD	
OCNG Patterns		5MHz: OP.15 FDD 10MHz: OP.1 FDD 20MHz: OP.11 FDD		5MHz: OP.15 FDD 10MHz: OP.1 FDD 20MHz: OP.11 FDD	
PBCH_RA	dB				
PBCH_RB	dB				
PSS_RA	dB				
SSS_RA	dB				
PCFICH_RB	dB				
PHICH_RA	dB				
PHICH_PB	dB	0		0	
PDCCH_RA	dB				
PDCCH_PB	dB				
PDSCH_RA	dB				
PDSCH_RB	dB				
OCNG_RA ^{Note 1}	dB				
OCNG_RB ^{Note 1}	dB				
N_{oc} ^{Note 2}	dBm/15 KHz	-104		-104	
\hat{E}_s / N_{oc}	dB	-3	-3	-3	-3
\hat{E}_s / I_{ot}	dB	-3	-3	-3	-3
RSRP ^{Note 3}	dBm/15 KHz	-107	-107	-107	-74.28
SCH_RP ^{Note 3}	dBm/15 KHz	-107	-107	-107	-107
I_o ^{Note 3}	dBm/Ch BW	-74.45 +10log ($N_{RB,c} / 50$)	-74.45 +10log ($N_{RB,c} / 50$)	-74.45 +10log ($N_{RB,c} / 50$)	-74.45 +10log ($N_{RB,c} / 50$)
Propagation Condition		ETU70		ETU70	
Correlation Matrix and Antenna Configuration		1x2 Low		1x2 Low	
Receive Time offset to cell1 ^{Note 4}	μ s	-		33	
<p>Note 1: OCNG shall be used such that both cells are fully allocated and a constant total transmitted power spectral density is achieved for all OFDM symbols.</p> <p>Note 2: Interference from other cells and noise sources not specified in the test is assumed to be constant over subcarriers and time and shall be modelled as AWGN of appropriate power for N_{oc} to be fulfilled.</p> <p>Note 3: RSRP, SCH_RP and I_o levels have been derived from other parameters for information purposes. They are not settable parameters themselves.</p> <p>Note 4: Receive time difference between subframe boundaries of signals received from the two cells at the UE antenna connector including time alignment error between the two cells.</p>					

A.8.23.16.2 Test Requirements

The UE shall send a measurement report containing a *MeasResultSSTD* IE within RRC procedure delay + 200ms + 2 x TTI_{DCCH} = 217ms from the start of T2.

A.8.23.17 E-UTRAN FDD-FDD DC SSTD measurement reporting delay with DRX in asynchronous DC

A.8.23.17.1 Test Purpose and Environment

The purpose of this test is to verify that the UE makes correct reporting of SSTD measurements. The test partially verifies the requirement in SSTD Measurements for E-UTRA Dual Connectivity, section 8.8.7. This test is applicable to UEs which support asynchronous dual connectivity and support SSTD measurements.

The test parameters are given in Tables A.8.23.17.1-1, A.8.23.17.1-2 and A.8.23.17.1-3. In this test there are 2 cells, a PCell and a PSCell, on different frequencies.

The test consists of two time phases, T1 and T2. During T1 a dual connectivity connection is established. At the end of T1 a measurement with the IE reportSSTD-Meas set to TRUE is configured by the test equipment, such that the measurement configuration is available to the UE at the transition from T1 to T2. The SSTD reporting delay is the time from the start of T2 until an SSTD measurement report is transmitted by the UE.

Table A.8.23.17.1-1: General test parameters for E-UTRAN FDD-FDD DC SSTD measurement reporting delay with DRX in asynchronous DC

Parameter	Unit	Value	Comment
E-UTRA RF Channel Number		1, 2	Two radio channels are used for this test.
Active PCell		Cell1	PCell on RF channel number 1.
Configured PSCell		Cell2	PSCell on RF channel number 2.
CP length		Normal	
DRX		ON	DRX related parameters are defined in Table A.8.23.17.1-3
T1	s	2	
T2	s	10	
Note 1: This test verifies the RRM requirement which is independent of channel bandwidth and is performed according to the principle defined in section A.3.6.1.			

Table A.8.23.17.1-2: Cell specific test parameters for E-UTRAN FDD-FDD DC SSTD measurement reporting delay with DRX in asynchronous DC

Parameter	Unit	Cell 1		Cell 2	
		T1	T2	T1	T2
E-UTRA RF Channel Number		1		2	
BW _{channel}	MHz	5MHz: N _{RB,c} = 25 10MHz: N _{RB,c} = 50 20MHz: N _{RB,c} = 100		5MHz: N _{RB,c} = 25 10MHz: N _{RB,c} = 50 20MHz: N _{RB,c} = 100	
PDSCH parameters: DL Reference Measurement Channel		5MHz: R.5 FDD 10MHz: R.0 FDD 20MHz: R.4 FDD		5MHz: R.5 FDD 10MHz: R.0 FDD 20MHz: R.4 FDD	
PCFICH/PDCCH/PHICH parameters: DL Reference Measurement Channel		5MHz: R.11 FDD 10MHz: R.6 FDD 20MHz: R.10 FDD		5MHz: R.11 FDD 10MHz: R.6 FDD 20MHz: R.10 FDD	
OCNG Patterns		5MHz: OP.15 FDD 10MHz: OP.1 FDD 20MHz: OP.11 FDD		5MHz: OP.15 FDD 10MHz: OP.1 FDD 20MHz: OP.11 FDD	
PBCH_RA	dB	0		0	
PBCH_RB	dB				
PSS_RA	dB				
SSS_RA	dB				
PCFICH_RB	dB				
PHICH_RA	dB				
PHICH_PB	dB				
PDCCH_RA	dB				
PDCCH_PB	dB				
PDSCH_RA	dB				
PDSCH_RB	dB				
OCNG_RA ^{Note 1}	dB				
OCNG_RB ^{Note 1}	dB				
N _{oc} ^{Note 2}	dBm/15 KHz				
\hat{E}_s / N_{oc}	dB	-3	-3	-3	-3
\hat{E}_s / I_{ot}	dB	-3	-3	-3	-3
RSRP ^{Note 3}	dBm/15 KHz	-107	-107	-107	-74.28
SCH_RP ^{Note 3}	dBm/15 KHz	-107	-107	-107	-107

I_0 ^{Note 3}	dBm/Ch BW	-74.45 +10log ($N_{RB,c}/50$)	-74.45 +10log ($N_{RB,c}/50$)	-74.45 +10log ($N_{RB,c}/50$)	-74.45 +10log ($N_{RB,c}/50$)
Propagation Condition		ETU70		ETU70	
Correlation Matrix and Antenna Configuration		1x2 Low		1x2 Low	
Receive Time offset to cell1 ^{Note 4}	μ s	-		500	
<p>Note 1: OCNG shall be used such that both cells are fully allocated and a constant total transmitted power spectral density is achieved for all OFDM symbols.</p> <p>Note 2: Interference from other cells and noise sources not specified in the test is assumed to be constant over subcarriers and time and shall be modelled as AWGN of appropriate power for N_{oc} to be fulfilled.</p> <p>Note 3: RSRP, SCH_RP and I_0 levels have been derived from other parameters for information purposes. They are not settable parameters themselves.</p> <p>Note 4: Receive time difference between subframe boundaries of signals received from the two cells at the UE antenna connector including time alignment error between the two cells.</p>					

Table A.8.23.17.1-3: DRX-Configuration for E-UTRAN FDD-FDD DC SSTD measurement reporting delay with DRX in asynchronous DC

Field	PCell Value	PSCell Value	Comment
onDurationTimer	psf1	psf1	
drx-InactivityTimer	psf1	psf1	
drx-RetransmissionTimer	psf1	psf1	
longDRX-CycleStartOffset	sf320	sf320	
shortDRX	disable	disable	
Note 1: For further information see clause 6.3.2 in TS 36.331.			

A.8.23.17.2 Test Requirements

The UE shall send a measurement report containing a *MeasResultSSTD* IE within RRC procedure delay + $5 \cdot 320\text{ms} + 2 \times TTI_{DCC}$ = 1617ms from the start of T2.

A.8.23.18 E-UTRAN FDD - FDD DC Intra-frequency identification of a new CGI of E-UTRA cell using autonomous gaps in synchronous DC

A.8.23.18.1 Test Purpose and Environment

This test is to verify the requirement for identification of a new CGI of E-UTRA cell with autonomous gaps in clause 8.8.5.1.

The test scenario comprises of two E-UTRA FDD carriers and three cells as given in tables A.8.23.18.1-1 and A.8.23.18.1-2. Cell 1 is PCell, Cell 2 is PSCell and Cell 3 is neighbour cell. PDCCHs indicating new transmissions shall be sent continuously on PCell and PSCell to ensure that the UE would have ACK/NACK sending during identifying a new CGI of E-UTRAN cell. The test consists of three successive time periods, with time durations of T1, T2 and T3 respectively. At the start of time duration T1, the UE does not have any timing information of cell 3. Starting T2, cell 2 becomes detectable and the UE is expected to detect and send a measurement report.

A RRC message implying SI reading shall be sent to the UE during period T2, after the UE has reported Event A3. The RRC message shall create a measurement report configuration with purpose *reportCGI* and *si-RequestForHO* set to TRUE. The start of T3 is the instant when the last TTI containing the RRC message implying SI reading is sent to the UE.

Table A.8.23.18.1-1: General test parameters for E-UTRAN FDD - FDD DC Intra-frequency identification of a new CGI of E-UTRA cell using autonomous gaps in synchronous DC

Parameter	Unit	Value	Comment	
E-UTRA RF Channel Number		1, 2	Two radio channels are used for this test.	
Active PCell		Cell1	PCell on RF channel number 1.	
Active PSCell		Cell2	PSCell on RF channel number 2.	
Neighbour cell		Cell3	Neighbour cell on RF channel number 2.	
A3	Hysteresis	dB	0	Hysteresis for evaluation of event A3.
	A3-offset	dB	-3	
	Time To Trigger	s	0	
CP length		Normal		

DRX		OFF	DRX related parameters are defined in Table A.8.23.4.1-3
si-RequestForHO		TRUE	As specified in clause 5.5.3.1 in TS 36.331.
Cell-individual offset for cells on RF channel number 1	dB	0	Individual offset for cells on primary component carrier.
Cell-individual offset for cells on RF channel number 2	dB	0	Individual offset for cells on carrier frequency of Cell2.
Filter coefficient		0	L3 filtering is not used
T1	s	5	
T2	s	≤10	
T3	s	5	

Table A.8.23.18.1-2: Cell specific test parameters for E-UTRAN FDD - FDD DC Intra-frequency identification of a new CGI of E-UTRA cell using autonomous gaps in synchronous DC

Parameter	Unit	Cell 1			Cell 2			Cell 3		
		T1	T2	T3	T1	T2	T3	T1	T2	T3
E-UTRA RF Channel Number		1			2					
BW _{channel}	MHz	5MHz: N _{RB,c} = 25 10MHz: N _{RB,c} = 50 20MHz: N _{RB,c} = 100			5MHz: N _{RB,c} = 25 10MHz: N _{RB,c} = 50 20MHz: N _{RB,c} = 100			5MHz: N _{RB,c} = 25 10MHz: N _{RB,c} = 50 20MHz: N _{RB,c} = 100		
PDSCH parameters:		5MHz: R.7 FDD 10MHz: R.3 FDD 20MHz: R.6 FDD			5MHz: R.7 FDD 10MHz: R.3 FDD 20MHz: R.6 FDD			-		
PCFICH/PDCCH/PHICH parameters:		5MHz: R.11 FDD 10MHz: R.6 FDD 20MHz: R.10 FDD			5MHz: R.11 FDD 10MHz: R.6 FDD 20MHz: R.10 FDD			5MHz: R.11 FDD 10MHz: R.6 FDD 20MHz: R.10 FDD		
OCNG Patterns defined in A.3.2.1		5MHz: OP.20 FDD 10MHz: OP.10 FDD 20MHz: OP.17 FDD			5MHz: OP.20 FDD 10MHz: OP.10 FDD 20MHz: OP.17 FDD			5MHz: OP.16 FDD 10MHz: OP.2 FDD 20MHz: OP.12 FDD		
PBCH_RA	dB	0			0			0		
PBCH_RB	dB									
PSS_RA	dB									
SSS_RA	dB									
PCFICH_RB	dB									
PHICH_RA	dB									
PHICH_PB	dB									
PDCCH_RA	dB									
PDCCH_PB	dB									
PDSCH_RA	dB									
PDSCH_RB	dB									
OCNG_RA ^{Note 1}	dB									
OCNG_RB ^{Note 1}	dB									
N _{oc} ^{Note 2}	dBm/15 KHz	-98			-98					
\hat{E}_s / N_{oc}	dB	8	8	8	8	8	8	-Infinity	11	11
\hat{E}_s / I_{ot} ^{Note 3}	dB	8	8	8	8	-3.3	-3.3	-Infinity	2.36	2.36
RSRP ^{Note 3}	dBm/15 KHz	-90	-90	-90	-90	-90	-90	-Infinity	-87	-87
SCH_RP ^{Note3}	dBm/15 KHz	-90	-90	-90	-90	-90	-90	-Infinity	-87	-87
I _o ^{Note 3}	dBm/Ch BW	-61.58 +10log(N _{RB,c} /50)	-61.58 +10log(N _{RB,c} /50)	-61.58 +10log(N _{RB,c} /50)	-61.58 +10log(N _{RB,c} /50)	-57.23 +10log(N _{RB,c} /50)	-57.23 +10log(N _{RB,c} /50)	Specified in columns for Cell 2		
Propagation Condition		AWGN			AWGN			AWGN		
Correlation Matrix and Antenna Configuration		1x2 Low			1x2 Low			1x2 Low		
Time offset to cell1	μs	-			33			3		

Note 1:	OCNG shall be used such that both cells are fully allocated and a constant total transmitted power spectral density is achieved for all OFDM symbols.
Note 2:	Interference from other cells and noise sources not specified in the test is assumed to be constant over subcarriers and time and shall be modelled as AWGN of appropriate power for N_{oc} to be fulfilled.
Note 3:	\hat{E}_s/I_{ot} , RSRP, I_o and SCH_RP levels have been derived from other parameters for information purposes. They are not settable parameters themselves.

A.8.23.18.2 Test Requirements

The UE shall transmit a measurement report containing the cell global identifier of cell 2 within 170 milliseconds from the start of T3.

$$\begin{aligned} \text{Test requirement} &= \text{RRC Procedure delay} + T_{\text{identify_CGI, intra}} + \text{reporting delay} \\ &= 15 + 150 + 2\text{ms from the start of T3} \\ &= 167 \text{ ms, allow 170 ms.} \end{aligned}$$

The UE shall be scheduled continuously throughout the test, and from the start of T3 until 170 ms at least 80 ACK/NACK shall be detected as being transmitted by the UE.

The rate of correct events observed during repeated tests shall be at least 90%.

NOTE: The overall 80 ACK/NACK number is caused by two parts. Firstly, at least 60 ACK/NACK shall be sent during identifying the cell global identifier of cell 2 according to the requirement in Clause 8.1.2.2.3.1. Secondly, given that continuous DL data allocation, additional 20 ACK/NACK shall be sent from the start of T3 until 170 ms excludes 150 ms for identifying the cell global identifier of cell 2.

A.8.23.19 E-UTRAN FDD - FDD DC Intra-frequency identification of a new CGI of E-UTRA cell using autonomous gaps in asynchronous DC

A.8.23.19.1 Test Purpose and Environment

This test is to verify the requirement for identification of a new CGI of E-UTRA cell with autonomous gaps in clause 8.8.5.1.

The test scenario comprises of two E-UTRA FDD carriers and three cells as given in tables A.8.23.19.1-1 and A.8.23.19.1-2. Cell 1 is PCell, Cell 2 is PSCell and Cell 3 is neighbour cell. PDCCHs indicating new transmissions shall be sent continuously on PCell and PSCell to ensure that the UE would have ACK/NACK sending during identifying a new CGI of E-UTRAN cell. The test consists of three successive time periods, with time durations of T1, T2 and T3 respectively. At the start of time duration T1, the UE does not have any timing information of cell 3. Starting T2, cell 2 becomes detectable and the UE is expected to detect and send a measurement report.

A RRC message implying SI reading shall be sent to the UE during period T2, after the UE has reported Event A3. The RRC message shall create a measurement report configuration with purpose *reportCGI* and *si-RequestForHO* set to TRUE. The start of T3 is the instant when the last TTI containing the RRC message implying SI reading is sent to the UE.

Table A.8.23.19.1-1: General test parameters for E-UTRAN FDD - FDD DC Intra-frequency identification of a new CGI of E-UTRA cell using autonomous gaps in asynchronous DC

Parameter	Unit	Value	Comment
E-UTRA RF Channel Number		1, 2	Two radio channels are used for this test.
Active PCell		Cell1	PCell on RF channel number 1.
Active PSCell		Cell2	PSCell on RF channel number 2.
Neighbour cell		Cell3	Neighbour cell on RF channel number 2.
A3	Hysteresis	dB	0
	A3-offset	dB	-3
	Time To Trigger	s	0
CP length		Normal	
DRX		OFF	DRX related parameters are defined in Table A.8.23.4.1-3
si-RequestForHO		TRUE	As specified in clause 5.5.3.1 in TS 36.331.

Cell-individual offset for cells on RF channel number 1	dB	0	Individual offset for cells on primary component carrier.
Cell-individual offset for cells on RF channel number 2	dB	0	Individual offset for cells on carrier frequency of Cell2.
Filter coefficient		0	L3 filtering is not used
T1	s	5	
T2	s	≤10	
T3	s	5	

Table A.8.23.19.1-2: Cell specific test parameters for E-UTRAN FDD - FDD DC Intra-frequency identification of a new CGI of E-UTRA cell using autonomous gaps in asynchronous DC

Parameter	Unit	Cell 1			Cell 2			Cell 3		
		T1	T2	T3	T1	T2	T3	T1	T2	T3
E-UTRA RF Channel Number		1			2					
BW _{channel}	MHz	5MHz: N _{RB,c} = 25 10MHz: N _{RB,c} = 50 20MHz: N _{RB,c} = 100			5MHz: N _{RB,c} = 25 10MHz: N _{RB,c} = 50 20MHz: N _{RB,c} = 100			5MHz: N _{RB,c} = 25 10MHz: N _{RB,c} = 50 20MHz: N _{RB,c} = 100		
PDSCH parameters:		5MHz: R.7 FDD 10MHz: R.3 FDD 20MHz: R.6 FDD			5MHz: R.7 FDD 10MHz: R.3 FDD 20MHz: R.6 FDD			-		
PCFICH/PDCCH/PHICH parameters:		5MHz: R.11 FDD 10MHz: R.6 FDD 20MHz: R.10 FDD			5MHz: R.11 FDD 10MHz: R.6 FDD 20MHz: R.10 FDD			5MHz: R.11 FDD 10MHz: R.6 FDD 20MHz: R.10 FDD		
OCNG Patterns defined in A.3.2.1		5MHz: OP.20 FDD 10MHz: OP.10 FDD 20MHz: OP.17 FDD			5MHz: OP.20 FDD 10MHz: OP.10 FDD 20MHz: OP.17 FDD			5MHz: OP.16 FDD 10MHz: OP.2 FDD 20MHz: OP.12 FDD		
PBCH_RA	dB	0			0			0		
PBCH_RB	dB									
PSS_RA	dB									
SSS_RA	dB									
PCFICH_RB	dB									
PHICH_RA	dB									
PHICH_PB	dB									
PDCCH_RA	dB									
PDCCH_PB	dB									
PDSCH_RA	dB									
PDSCH_RB	dB									
OCNG_RA ^{Note 1}	dB									
OCNG_RB ^{Note 1}	dB									
N _{oc} ^{Note 2}	dBm/15 KHz	-98			-98					
\hat{E}_s/N_{oc}	dB	8	8	8	8	8	8	-Infinity	11	11
\hat{E}_s/I_{ot} ^{Note 3}	dB	8	8	8	8	-3.3	-3.3	-Infinity	2.36	2.36
RSRP ^{Note 3}	dBm/15 KHz	-90	-90	-90	-90	-90	-90	-Infinity	-87	-87
SCH_RP ^{Note3}	dBm/15 KHz	-90	-90	-90	-90	-90	-90	-Infinity	-87	-87
I _o ^{Note 3}	dBm/Ch BW	-61.58 +10log(N _{RB,c} /50)	-61.58 +10log(N _{RB,c} /50)	-61.58 +10log(N _{RB,c} /50)	-61.58 +10log(N _{RB,c} /50)	-57.23 +10log(N _{RB,c} /50)	-57.23 +10log(N _{RB,c} /50)	Specified in columns for Cell 2		
Propagation Condition		AWGN			AWGN			AWGN		
Correlation Matrix and Antenna Configuration		1x2 Low			1x2 Low			1x2 Low		
Time offset to cell1	μs	-			500			3		
<p>Note 1: OCNG shall be used such that both cells are fully allocated and a constant total transmitted power spectral density is achieved for all OFDM symbols.</p> <p>Note 2: Interference from other cells and noise sources not specified in the test is assumed to be constant over subcarriers and time and shall be modelled as AWGN of appropriate power for N_{oc} to be fulfilled.</p> <p>Note 3: \hat{E}_s/I_{ot}, RSRP, I_o and SCH_RP levels have been derived from other parameters for information purposes. They are not settable parameters themselves.</p>										

A.8.23.19.2 Test Requirements

The UE shall transmit a measurement report containing the cell global identifier of cell 2 within 170 milliseconds from the start of T3.

$$\begin{aligned} \text{Test requirement} &= \text{RRC Procedure delay} + T_{\text{identify_CGI, intra}} + \text{reporting delay} \\ &= 15 + 150 + 2\text{ms from the start of T3} \\ &= 167 \text{ ms, allow 170 ms.} \end{aligned}$$

The UE shall be scheduled continuously throughout the test, and from the start of T3 until 170 ms at least 80 ACK/NACK shall be detected as being transmitted by the UE.

The rate of correct events observed during repeated tests shall be at least 90%.

NOTE: The overall 80 ACK/NACK number is caused by two parts. Firstly, at least 60 ACK/NACK shall be sent during identifying the cell global identifier of cell 2 according to the requirement in Clause 8.1.2.2.3.1. Secondly, given that continuous DL data allocation, additional 20 ACK/NACK shall be sent from the start of T3 until 170 ms excludes 150 ms for identifying the cell global identifier of cell 2.

A.8.23.20 E-UTRAN TDD - TDD DC Intra-frequency identification of a new CGI of E-UTRA cell using autonomous gaps in synchronous DC

A.8.23.20.1 Test Purpose and Environment

This test is to verify the requirement for identification of a new CGI of E-UTRA cell with autonomous gaps in clause 8.8.5.1.

The test scenario comprises of two E-UTRA TDD carriers and three cells as given in tables A.8.23.20.1-1 and A.8.23.20.1-2. Cell 1 is PCell, Cell 2 is PSCell and Cell 3 is neighbour cell. PDCCHs indicating new transmissions shall be sent continuously on PCell and PSCell to ensure that the UE would have ACK/NACK sending during identifying a new CGI of E-UTRAN cell. The test consists of three successive time periods, with time durations of T1, T2 and T3 respectively. At the start of time duration T1, the UE does not have any timing information of cell 3. Starting T2, cell 2 becomes detectable and the UE is expected to detect and send a measurement report.

A RRC message implying SI reading shall be sent to the UE during period T2, after the UE has reported Event A3. The RRC message shall create a measurement report configuration with purpose *reportCGI* and *si-RequestForHO* set to TRUE. The start of T3 is the instant when the last TTI containing the RRC message implying SI reading is sent to the UE.

Table A.8.23.20.1-1: General test parameters for E-UTRAN TDD - TDD DC Intra-frequency identification of a new CGI of E-UTRA cell using autonomous gaps in synchronous DC

Parameter	Unit	Value	Comment	
E-UTRA RF Channel Number		1, 2	Two radio channels are used for this test.	
Active PCell		Cell1	PCell on RF channel number 1.	
Active PSCell		Cell2	PSCell on RF channel number 2.	
Neighbour cell		Cell3	Neighbour cell on RF channel number 2.	
A3	Hysteresis	dB	0	Hysteresis for evaluation of event A3.
	A3-offset	dB	-3	
	Time To Trigger	s	0	
CP length		Normal		
DRX		OFF	DRX related parameters are defined in Table A.8.23.4.1-3	
Special subframe configuration		6	As specified in table 4.2-1 in TS 36.211. The same configuration applies to all cells.	
Uplink-downlink configuration		1	As specified in table 4.2-2 in TS 36.211. The same configuration applies to all cells.	
si-RequestForHO		TRUE	As specified in clause 5.5.3.1 in TS 36.331.	
Cell-individual offset for cells on RF channel number 1	dB	0	Individual offset for cells on primary component carrier.	

Cell-individual offset for cells on RF channel number 2	dB	0	Individual offset for cells on carrier frequency of Cell2.
Filter coefficient		0	L3 filtering is not used
T1	s	5	
T2	s	≤10	
T3	s	5	

Table A.8.23.20.1-2: Cell specific test parameters for E-UTRAN TDD - TDD DC Intra-frequency identification of a new CGI of E-UTRA cell using autonomous gaps in synchronous DC

Parameter	Unit	Cell 1			Cell 2			Cell 3		
		T1	T2	T3	T1	T2	T3	T1	T2	T3
E-UTRA RF Channel Number		1			2					
BW _{channel}	MHz	5MHz: N _{RB,c} = 25 10MHz: N _{RB,c} = 50 5MHz: N _{RB,c} = 25			5MHz: N _{RB,c} = 25 10MHz: N _{RB,c} = 50 5MHz: N _{RB,c} = 25			5MHz: N _{RB,c} = 25 10MHz: N _{RB,c} = 50 5MHz: N _{RB,c} = 25		
PDSCH parameters:		5MHz: R.4 TDD 10MHz: R.0 TDD 20MHz: R.3 TDD			5MHz: R.4 TDD 10MHz: R.0 TDD 20MHz: R.3 TDD			-		
PCFICH/PDCCH/PHICH parameters:		5MHz: R.11 TDD 10MHz: R.6 TDD 20MHz: R.10 TDD			5MHz: R.11 TDD 10MHz: R.6 TDD 20MHz: R.10 TDD			5MHz: R.11 TDD 10MHz: R.6 TDD 20MHz: R.10 TDD		
OCNG Patterns defined in A.3.2.2		5MHz: OP.9 TDD 10MHz: OP.1 TDD 20MHz: OP.7 TDD			5MHz: OP.9 TDD 10MHz: OP.1 TDD 20MHz: OP.7 TDD			5MHz: OP.10 TDD 10MHz: OP.2 TDD 20MHz: OP.8 TDD		
PBCH_RA	dB	0			0			0		
PBCH_RB	dB									
PSS_RA	dB									
SSS_RA	dB									
PCFICH_RB	dB									
PHICH_RA	dB									
PHICH_PB	dB									
PDCCH_RA	dB									
PDCCH_PB	dB									
PDSCH_RA	dB									
PDSCH_RB	dB									
OCNG_RA ^{Note 1}	dB									
OCNG_RB ^{Note 1}	dB									
N _{oc} ^{Note 2}	dBm/15 KHz									
\hat{E}_s / N_{oc}	dB	8	8	8	8	8	8	-Infinity	11	11
\hat{E}_s / I_{ot} ^{Note 3}	dB	8	8	8	8	-3.3	-3.3	-Infinity	2.36	2.36
RSRP ^{Note 3}	dBm/15 KHz	-90	-90	-90	-90	-90	-90	-Infinity	-87	-87
SCH_RP ^{Note 3}	dBm/15 KHz	-90	-90	-90	-90	-90	-90	-Infinity	-87	-87
I _o ^{Note 3}	dBm/Ch BW	-61.58 +10log(N _{RB,c} /50)	-61.58 +10log(N _{RB,c} /50)	-61.58 +10log(N _{RB,c} /50)	-61.58 +10log(N _{RB,c} /50)	-57.23 +10log(N _{RB,c} /50)	-57.23 +10log(N _{RB,c} /50)	Specified in columns for Cell 2		
Propagation Condition		AWGN			AWGN			AWGN		
Correlation Matrix and Antenna Configuration		1x2 Low			1x2 Low			1x2 Low		
Time offset to cell1	μs	-			33			3		
<p>Note 1: OCNG shall be used such that both cells are fully allocated and a constant total transmitted power spectral density is achieved for all OFDM symbols.</p> <p>Note 2: Interference from other cells and noise sources not specified in the test is assumed to be constant over subcarriers and time and shall be modelled as AWGN of appropriate power for N_{oc} to be fulfilled.</p> <p>Note 3: \hat{E}_s / I_{ot}, RSRP, I_o and SCH_RP levels have been derived from other parameters for information purposes. They are not settable parameters themselves.</p>										

A.8.23.20.2 Test Requirements

The UE shall transmit a measurement report containing the cell global identifier of cell 2 within 170 milliseconds from the start of T3.

$$\begin{aligned} \text{Test requirement} &= \text{RRC Procedure delay} + T_{\text{identify_CGI, intra}} + \text{reporting delay} \\ &= 15 + 150 + 2\text{ms from the start of T3} \\ &= 167 \text{ ms, allow 170 ms.} \end{aligned}$$

The UE shall be scheduled continuously throughout the test, and from the start of T3 until 170 ms at least 80 ACK/NACK shall be detected as being transmitted by the UE.

The rate of correct events observed during repeated tests shall be at least 90%.

NOTE: The overall 80 ACK/NACK number is caused by two parts. Firstly, at least 60 ACK/NACK shall be sent during identifying the cell global identifier of cell 2 according to the requirement in Clause 8.1.2.2.3.1. Secondly, given that continuous DL data allocation, additional 20 ACK/NACK shall be sent from the start of T3 until 170 ms excludes 150 ms for identifying the cell global identifier of cell 2.

A.8.23.21 E-UTRAN FDD - FDD DC Inter-frequency identification of a new CGI of E-UTRA cell using autonomous gaps in synchronous DC

A.8.23.21.1 Test Purpose and Environment

This test is to verify the requirement for identification of a new CGI of E-UTRA cell using autonomous gaps in synchronous DC in clause 8.8.6.1.

The test scenario comprises of three E-UTRA FDD cells, PCell (Cell 1), PSCell (Cell 2) and neighbour cell (Cell 3) and each cell on one carrier as given in tables A.8.23.21.1-1 and A.8.23.21.1-2. PDCCHs indicating new transmissions shall be sent continuously to ensure that the UE would have ACK/NACK sending during identifying a new CGI of E-UTRAN cell. The test consists of three successive time periods, with time durations of T1, T2 and T3 respectively. At the start of time duration T1, the UE does not have any timing information of cell 3. Starting T2, cell 3 becomes detectable and the UE is expected to detect and send a measurement report. Gap pattern configuration with id #0 as specified in Table 8.1.2.1-1 is configured before T2 begins to enable inter-frequency monitoring.

A RRC message implying SI reading shall be sent to the UE during period T2, after the UE has reported Event A3. The RRC message shall create a measurement report configuration with purpose *reportCGI* and *si-RequestForHO* set to UE. The start of T3 is the instant when the last TTI containing the RRC message implying SI reading is sent to the UE. Measurement gaps shall be deconfigured before the start of T3.

Table A.8.23.21.1-1: General test parameters for E-UTRAN FDD - FDD Inter-frequency identification of a new CGI of E-UTRA cell using autonomous gaps in synchronous DC

Parameter	Unit	Value	Comment
E-UTRA RF channel number		1, 2, 3	Three FDD carrier frequencies are used.
Active cell		Cell 1, Cell 2	Cell 1 is on RF channel number 1 Cell 2 is on RF channel number 2
Neighbour cell		Cell 3	Cell 3 is on RF channel number 3.
CP length		Normal	
Gap Pattern Id		0	As specified in TS 36.133 clause 8.1.2.1.
A3-Offset	dB	-6	
Hysteresis	dB	0	
TimeToTrigger	s	0	
Filter coefficient		0	L3 filtering is not used
DRX		OFF	
si-RequestForHO		TRUE	As specified in clause 5.5.3.1 in TS 36.331.
T1	s	5	
T2	s	≤10	
T3	s	5	

Table A.8.23.21.1-2: Cell specific test parameters for E-UTRAN FDD - FDD Inter-frequency identification of a new CGI of E-UTRA cell using autonomous gaps in synchronous DC

Parameter	Unit	Cell 1			Cell 2			Cell 3		
		T1	T2	T3	T1	T2	T3	T1	T2	T3
E-UTRA RF Channel Number		1			2			3		
BW _{channel}	MHz	5MHz: N _{RB,c} = 25 10MHz: N _{RB,c} = 50 20MHz: N _{RB,c} = 100			5MHz: N _{RB,c} = 25 10MHz: N _{RB,c} = 50 20MHz: N _{RB,c} = 100			5MHz: N _{RB,c} = 25 10MHz: N _{RB,c} = 50 20MHz: N _{RB,c} = 100		
PDSCH parameters defined in A.3.1.1.1		5MHz: R.7 FDD 10MHz: R.3 FDD 20MHz: R.6 FDD			5MHz: R.7 FDD, 10MHz: R.3 FDD, 20MHz: R.6 FDD			-		
PCFICH/PDCCH/PHICH parameters defined in A.3.1.2.1		5MHz: R.11 FDD 10MHz: R.6 FDD 20MHz: R.10 FDD			5MHz: R.11 FDD 10MHz: R.6 FDD 20MHz: R.10 FDD			5MHz: R.11 FDD 10MHz: R.6 FDD 20MHz: R.10 FDD		
OCNG Patterns defined in A.3.2.1		5MHz: OP.20 FDD 10MHz: OP.10 FDD 20MHz: OP.17 FDD			5MHz: OP.20 FDD 10MHz: OP.10 FDD 20MHz: OP.17 FDD			5MHz: OP.16 FDD 10MHz: OP.2 FDD 20MHz: OP.12 FDD		
PBCH_RA	dB	0			0			0		
PBCH_RB	dB									
PSS_RA	dB									
SSS_RA	dB									
PCFICH_RB	dB									
PHICH_RA	dB									
PHICH_PB	dB									
PDCCH_RA	dB									
PDCCH_PB	dB									
PDSCH_RA	dB									
PDSCH_RB	dB									
OCNG_RA ^{Note 1}	dB									
OCNG_RB ^{Note 1}	dB									
N_{oc} ^{Note 2}	dBm/15 KHz	-98			-98			-98		
\hat{E}_s / N_{oc}	dB	4	4	4	4	4	4	-Infinity	7	7
\hat{E}_s / I_{ot} ^{Note 3}	dB	4	4	4	4	4	4	-Infinity	7	7
RSRP ^{Note 3}	dBm/15 KHz	-94	-94	-94	-94	-94	-94	-Infinity	-91	-91
SCH_RP ^{Note 3}	dBm/15 KHz	-94	-94	-94	-94	-94	-94	-Infinity	-91	-91
I_o ^{Note 3}	dBm/Ch BW	-64.76 +10log (N _{RB,c} /50)	-64.76 +10log (N _{RB,c} /50)	-64.76 +10log (N _{RB,c} /50)	-64.76 +10log (N _{RB,c} /50)	-64.76 +10log (N _{RB,c} /50)	-64.76 +10log (N _{RB,c} /50)	-70.22 +10log (N _{RB,c} /50)	-62.42 +10log (N _{RB,c} /50)	-62.42 +10log (N _{RB,c} /50)
Propagation Condition		AWGN			AWGN			AWGN		
Correlation Matrix and Antenna Configuration		1x2 Low			1x2 Low			1x2 Low		
timing offset to cell1	µs	-			33			3		
Note 1:	OCNG shall be used such that both cells are fully allocated and a constant total transmitted power spectral density is achieved for all OFDM symbols.									
Note 2:	Interference from other cells and noise sources not specified in the test is assumed to be constant over subcarriers and time and shall be modelled as AWGN of appropriate power for N_{oc} to be fulfilled.									
Note 3:	\hat{E}_s / I_{ot} , RSRP, I_o and SCH_RP levels have been derived from other parameters for information purposes. They are not settable parameters themselves.									

A.8.23.21.2 Test Requirements

The UE shall transmit a measurement report containing the cell global identifier of cell 3 within 170 milliseconds from the start of T3.

Test requirement = RRC Procedure delay + $T_{\text{identify_C_GI, inter}}$ + reporting delay

= 15 + 150 + 2ms from the start of T3

= 167 ms, allow 170 ms.

The UE shall be scheduled continuously throughout the test, and from the start of T3 until 170 ms at least 80 ACK/NACK shall be detected both on cells in MCG and SCG as being transmitted by the UE.

The rate of correct events observed during repeated tests shall be at least 90%.

NOTE: The overall 80 ACK/NACK number is caused by two parts. Firstly, at least 60 ACK/NACK shall be sent both on cells in MCG and SCG during identifying the cell global identifier of cell 3 according to the requirement in Clause 8.8.6.1. Secondly, given that continuous DL data allocation, and the measurement gaps have been deconfigured before the start of T3, additional 20 ACK/NACK shall be sent both on cells in MCG and SCG from the start of T3 until 170 ms excludes 150 ms for identifying the cell global identifier of cell 3.

A.8.23.22 E-UTRAN FDD - FDD DC Inter-frequency identification of a new CGI of E-UTRA cell using autonomous gaps in asynchronous DC

A.8.23.22.1 Test Purpose and Environment

This test is to verify the requirement for identification of a new CGI of E-UTRA cell using autonomous gaps in asynchronous DC in clause 8.8.6.1.

The test scenario comprises of three E-UTRA FDD cells, PCell (Cell 1), PSCell (Cell 2) and neighbour cell (Cell 3) and each cell on one carrier as given in tables A.8.23.22.1-1 and A.8.23.22.1-2. PDCCHs indicating new transmissions shall be sent continuously to ensure that the UE would have ACK/NACK sending during identifying a new CGI of E-UTRAN cell. The test consists of three successive time periods, with time durations of T1, T2 and T3 respectively. At the start of time duration T1, the UE does not have any timing information of cell 3. Starting T2, cell 3 becomes detectable and the UE is expected to detect and send a measurement report. Gap pattern configuration with id #0 as specified in Table 8.1.2.1-1 is configured before T2 begins to enable inter-frequency monitoring.

A RRC message implying SI reading shall be sent to the UE during period T2, after the UE has reported Event A3. The RRC message shall create a measurement report configuration with purpose *reportCGI* and *si-RequestForHO* set to TRUE. The start of T3 is the instant when the last TTI containing the RRC message implying SI reading is sent to the UE. Measurement gaps shall be deconfigured before the start of T3.

Table A.8.23.22.1-1: General test parameters for E-UTRAN FDD - FDD Inter-frequency identification of a new CGI of E-UTRA cell using autonomous gaps in asynchronous DC

Parameter	Unit	Value	Comment
E-UTRA RF channel number		1, 2, 3	Three FDD carrier frequencies are used.
Active cell		Cell 1, Cell 2	Cell 1 is on RF channel number 1 Cell 2 is on RF channel number 2
Neighbour cell		Cell 3	Cell 3 is on RF channel number 3.
CP length		Normal	
Gap Pattern Id		0	As specified in TS 36.133 clause 8.1.2.1.
A3-Offset	dB	-6	
Hysteresis	dB	0	
TimeToTrigger	s	0	
Filter coefficient		0	L3 filtering is not used
DRX		OFF	
si-RequestForHO		TRUE	As specified in clause 5.5.3.1 in TS 36.331.
T1	s	5	
T2	s	≤10	
T3	s	5	

Table A.8.23.22.1-2: Cell specific test parameters for E-UTRAN FDD - FDD Inter-frequency identification of a new CGI of E-UTRA cell using autonomous gaps in asynchronous DC

Parameter	Unit	Cell 1			Cell 2			Cell 3		
		T1	T2	T3	T1	T2	T3	T1	T2	T3
E-UTRA RF Channel Number		1			2			3		
BW _{channel}	MHz	5MHz: N _{RB,c} = 25 10MHz: N _{RB,c} = 50 20MHz: N _{RB,c} = 100			5MHz: N _{RB,c} = 25 10MHz: N _{RB,c} = 50 20MHz: N _{RB,c} = 100			5MHz: N _{RB,c} = 25 10MHz: N _{RB,c} = 50 20MHz: N _{RB,c} = 100		

PDSCH parameters defined in A.3.1.1.1		5MHz: R.7 FDD 10MHz: R.3 FDD 20MHz: R.6 FDD	5MHz: R.7 FDD 10MHz: R.3 FDD 20MHz: R.6 FDD	-						
PCFICH/PDCCH/PHICH parameters defined in A.3.1.2.1		5MHz: R.11 FDD 10MHz: R.6 FDD 20MHz: R.10 FDD	5MHz: R.11 FDD 10MHz: R.6 FDD 20MHz: R.10 FDD	5MHz: R.11 FDD 10MHz: R.6 FDD 20MHz: R.10 FDD						
OCNG Patterns defined in A.3.2.1		5MHz: OP.20 FDD 10MHz: OP.10 FDD 20MHz: OP.17 FDD	5MHz: OP.20 FDD 10MHz: OP.10 FDD 20MHz: OP.17 FDD	5MHz: OP.16 FDD 10MHz: OP.2 FDD 20MHz: OP.12 FDD						
PBCH_RA	dB	0	0	0						
PBCH_RB	dB									
PSS_RA	dB									
SSS_RA	dB									
PCFICH_RB	dB									
PHICH_RA	dB									
PHICH_PB	dB									
PDCCH_RA	dB									
PDCCH_PB	dB									
PDSCH_RA	dB									
PDSCH_RB	dB									
OCNG_RANote 1	dB									
OCNG_RBNote 1	dB									
N_{oc} Note 2	dBm/15 KHz				-98					
\hat{E}_s / N_{oc}	dB	4	4	4	4	4	4	-Infinity	7	7
\hat{E}_s / I_{ot} Note 3	dB	4	4	4	4	4	4	-Infinity	7	7
RSRP Note 3	dBm/15 KHz	-94	-94	-94	-94	-94	-94	-Infinity	-91	-91
SCH_RP Note3	dBm/15 KHz	-94	-94	-94	-94	-94	-94	-Infinity	-91	-91
I_o Note 3	dBm/Ch BW	-64.76 +10log _g ($N_{RB,c}$ /50)	-64.76 +10log _g ($N_{RB,c}$ /50)	-64.76 +10log _g ($N_{RB,c}$ /50)	-64.76 +10log _g ($N_{RB,c}$ /50)	-64.76 +10log _g ($N_{RB,c}$ /50)	-64.76 +10log _g ($N_{RB,c}$ /50)	-70.22 +10log _g ($N_{RB,c}$ /50)	-62.42 +10log _g ($N_{RB,c}$ /50)	-62.42 +10log _g ($N_{RB,c}$ /50)
Propagation Condition		AWGN			AWGN			AWGN		
Correlation Matrix and Antenna Configuration		1x2 Low			1x2 Low			1x2 Low		
timing offset to cell1	μs	-			500			3		
<p>Note 1: OCNG shall be used such that both cells are fully allocated and a constant total transmitted power spectral density is achieved for all OFDM symbols.</p> <p>Note 2: Interference from other cells and noise sources not specified in the test is assumed to be constant over subcarriers and time and shall be modelled as AWGN of appropriate power for N_{oc} to be fulfilled.</p> <p>Note 3: \hat{E}_s / I_{ot}, RSRP, I_o and SCH_RP levels have been derived from other parameters for information purposes. They are not settable parameters themselves.</p>										

A.8.23.22.2 Test Requirements

The UE shall transmit a measurement report containing the cell global identifier of cell 3 within 170 milliseconds from the start of T3.

$$\text{Test requirement} = T_{\text{RRC Procedure delay}} + T_{\text{identify_C_GL_inter}} + \text{reporting delay}$$

$$= 15 + 150 + 2\text{ms from the start of T3}$$

$$= 167 \text{ ms, allow 170 ms.}$$

The UE shall be scheduled continuously throughout the test, and from the start of T3 until 170 ms at least 80 ACK/NACK shall be detected both on cells in MCG and SCG as being transmitted by the UE.

The rate of correct events observed during repeated tests shall be at least 90%.

NOTE: The overall 80 ACK/NACK number is caused by two parts. Firstly, at least 60 ACK/NACK shall be sent both on cells in MCG and SCG during identifying the cell global identifier of cell 3 according to the requirement in Clause 8.8.6.1. Secondly, given that continuous DL data allocation, and the measurement gaps have been deconfigured before the start of T3, additional 20 ACK/NACK shall be sent both on cells in MCG and SCG from the start of T3 until 170 ms excludes 150 ms for identifying the cell global identifier of cell 3.

A.8.23.23 E-UTRAN TDD - TDD DC Inter-frequency identification of a new CGI of E-UTRA cell using autonomous gaps in synchronous DC

A.8.23.23.1 Test Purpose and Environment

This test is to verify the requirement for identification of a new CGI of E-UTRA cell using autonomous gaps in synchronous DC in clause 8.8.6.1.

The test scenario comprises of three E-UTRA TDD cells, PCell (Cell 1), PSCell (Cell 2) and neighbour cell (Cell 3) and each cell on one carrier as given in tables A.8.23.23.1-1 and A.8.23.23.1-2. PDCCHs indicating new transmissions shall be sent continuously to ensure that the UE would have ACK/NACK sending during identifying a new CGI of E-UTRAN cell. The test consists of three successive time periods, with time durations of T1, T2 and T3 respectively. At the start of time duration T1, the UE does not have any timing information of cell 3. Starting T2, cell 3 becomes detectable and the UE is expected to detect and send a measurement report. Gap pattern configuration with id #0 as specified in Table 8.1.2.1-1 is configured before T2 begins to enable inter-frequency monitoring.

A RRC message implying SI reading shall be sent to the UE during period T2, after the UE has reported Event A3. The RRC message shall create a measurement report configuration with purpose *reportCGI* and *si-RequestForHO* set to TRUE. The start of T3 is the instant when the last TTI containing the RRC message implying SI reading is sent to the UE. Measurement gaps shall be deconfigured before the start of T3.

Table A.8.23.23.1-1: General test parameters for E-UTRAN TDD - TDD Inter-frequency identification of a new CGI of E-UTRA cell using autonomous gaps in synchronous DC

Parameter	Unit	Value	Comment
E-UTRA RF channel number		1, 2, 3	Three TDD carrier frequencies are used.
Active cell		Cell 1, Cell 2	Cell 1 is on RF channel number 1 Cell 2 is on RF channel number 2.
Neighbour cell		Cell 3	Cell 3 is on RF channel number 3.
CP length		Normal	
Special subframe configuration		6	As specified in table 4.2-1 in TS 36.211. The same configuration in both cells
Uplink-downlink configuration		1	As specified in table 4.2-2 in TS 36.211. The same configuration in both cells
Gap Pattern Id		0	As specified in TS 36.133 clause 8.1.2.1.
A3-Offset	dB	-6	
Hysteresis	dB	0	
TimeToTrigger	s	0	
Filter coefficient		0	L3 filtering is not used
DRX		OFF	
si-RequestForHO		TRUE	As specified in clause 5.5.3.1 in TS 36.331.
T1	s	5	
T2	s	≤10	
T3	s	5	

Table A.8.23.23.1-2: Cell specific test parameters for E-UTRAN TDD - TDD Inter-frequency identification of a new CGI of E-UTRA cell using autonomous gaps in synchronous DC

Parameter	Unit	Cell 1			Cell 2			Cell 3		
		T1	T2	T3	T1	T2	T3	T1	T2	T3
E-UTRA RF Channel Number		1			2			3		

BW _{channel}	MHz	5MHz: N _{RB,c} = 25 10MHz: N _{RB,c} = 50 20MHz: N _{RB,c} = 100			5MHz: N _{RB,c} = 25 10MHz: N _{RB,c} = 50 20MHz: N _{RB,c} = 100			5MHz: N _{RB,c} = 25 10MHz: N _{RB,c} = 50 20MHz: N _{RB,c} = 100		
PDSCH parameters defined in A.3.1.1.2		5MHz: R.4 TDD 10MHz: R.0 TDD 20MHz: R.3 TDD			5MHz: R.4 TDD 10MHz: R.0 TDD 20MHz: R.3 TDD			-		
PCFICH/PDCCH/PHICH parameters defined in A.3.1.2.2		5MHz: R.11 TDD 10MHz: R.6 TDD 20MHz: R.10 TDD			5MHz: R.11 TDD 10MHz: R.6 TDD 20MHz: R.10 TDD			5MHz: R.11 TDD 10MHz: R.6 TDD 20MHz: R.10 TDD		
OCNG Patterns defined in A.3.2.2		5MHz: OP.9 TDD 10MHz: OP.1 TDD 20MHz: OP.7 TDD			5MHz: OP.9 TDD 10MHz: OP.1 TDD 20MHz: OP.7 TDD			5MHz: OP.10 TDD 10MHz: OP.2 TDD 20MHz: OP.8 TDD		
PBCH_RA	dB	0			0			0		
PBCH_RB	dB									
PSS_RA	dB									
SSS_RA	dB									
PCFICH_RB	dB									
PHICH_RA	dB									
PHICH_RB	dB									
PDCCH_RA	dB									
PDCCH_RB	dB									
PDSCH_RA	dB									
PDSCH_RB	dB									
OCNG_RA ^{Note 1}	dB									
OCNG_RB ^{Note 1}	dB									
N _{oc} ^{Note 2}	dBm/15 KHz									
\hat{E}_s/N_{oc}	dB	4	4	4	4	4	4	-Infinity	7	7
\hat{E}_s/I_{ot} ^{Note 3}	dB	4	4	4	4	4	4	-Infinity	7	7
RSRP ^{Note 3}	dBm/15 KHz	-94	-94	-94	-94	-94	-94	-Infinity	-91	-91
SCH_RP ^{Note3}	dBm/15 KHz	-94	-94	-94	-94	-94	-94	-Infinity	-91	-91
I _o ^{Note 3}	dBm/Ch BW	-64.76 +10log(N _{RB,c} /50)	-64.76 +10log(N _{RB,c} /50)	-64.76 +10log(N _{RB,c} /50)	-64.76 +10log(N _{RB,c} /50)	-64.76 +10log(N _{RB,c} /50)	-64.76 +10log(N _{RB,c} /50)	-70.22 +10log(N _{RB,c} /50)	-62.42 +10log(N _{RB,c} /50)	-62.42 +10log(N _{RB,c} /50)
Propagation Condition		AWGN			AWGN			AWGN		
Correlation Matrix and Antenna Configuration		1x2 Low			1x2 Low			1x2 Low		
timing offset to cell1	μs	-			33			3		
<p>Note 1: OCNG shall be used such that both cells are fully allocated and a constant total transmitted power spectral density is achieved for all OFDM symbols.</p> <p>Note 2: Interference from other cells and noise sources not specified in the test is assumed to be constant over subcarriers and time and shall be modelled as AWGN of appropriate power for N_{oc} to be fulfilled.</p> <p>Note 3: \hat{E}_s/I_{ot}, RSRP, I_o and SCH_RP levels have been derived from other parameters for information purposes. They are not settable parameters themselves.</p>										

A.8.23.23.2 Test Requirements

The UE shall transmit a measurement report containing the cell global identifier of cell 3 within 170 milliseconds from the start of T3.

$$\begin{aligned}
 \text{Test requirement} &= \text{RRC Procedure delay} + T_{\text{identify_C_GI_inter}} + \text{reporting delay} \\
 &= 15 + 150 + 2\text{ms from the start of T3} \\
 &= 167 \text{ ms, allow 170 ms.}
 \end{aligned}$$

The UE shall be scheduled continuously throughout the test, and from the start of T3 until 170 ms at least 42 ACK/NACK shall be detected both on cells in MCG and SCG as being transmitted by the UE.

The rate of correct events observed during repeated tests shall be at least 90%.

NOTE: The overall 42 ACK/NACK number is caused by two parts. Firstly, at least 30 ACK/NACK shall be sent both on cells in MCG and SCG during identifying the cell global identifier of cell 3 according to the requirement in Clause 8.8.6.1. Secondly, given that continuous DL data allocation and the measurement gaps have been deconfigured before the start of T3, additional 12 ACK/NACK shall be sent both on cells in MCG and SCG from the start of T3 until 170 ms excludes 150 ms for identifying the cell global identifier of cell 3.

A.8.23.24 E-UTRAN FDD-FDD DC activation and deactivation of known SCell in Non-DRX in synchronous DC

A.8.23.24.1 Test Purpose and Environment

The purpose of this test is to verify that SCell activation and deactivation requirements specified in clause 7.18 for Dual Connectivity, when the SCell is known by the UE at the time of activation.

The test parameters are given in Tables A.8.23.24-1 and cell-specific parameters in A.8.23.24-2 below. The test consists of three successive time periods, with duration of T1, T2 and T3, respectively. There are three carriers, each with one cell. All cells have constant signal levels throughout the test. Before the test starts the UE is connected to Cell 1 (PCell) on radio channel 1 (PCC) and Cell 2 (PSCell) on radio channel 2, but is not aware of Cell 3 (SCell1 in MCG) on radio channel 3 (SCC1). The UE is only monitoring the PCC and the frequency of PSCell. The UE shall be continuously scheduled in the PCell and PSCell throughout the whole test.

At the beginning of T1 the UE receives an RRC message by which the SCell1 becomes configured on SCC1. The UE now starts monitoring also the SCC1. The test equipment sends a MAC message for activation of the SCell1.

The point in time at which a MAC message is received at the UE antenna connector, in a subframe # denoted m which is an even number, defines the start of time period T2. The UE shall be able to report valid CSI for the activated SCell1 at latest in a subframe (m+24). The UE shall start reporting CSI for SCell1 in subframe in (m+8) and shall report CQI index 0 (out-of-range) until the SCell activation has been completed. Any PCell and PSCell interruption due to activation of SCell1 shall not occur outside subframes (m+5) to (m+9).

Time period T3 starts when a MAC message for deactivation of SCell1, sent from the test equipment to the UE in a subframe # denoted n, is received at the UE antenna connector. The UE shall carry out deactivation of SCell1 at latest in subframe (n+8), and any PCell and PSCell interruption due to the deactivation of SCell1 shall not occur outside subframes (n+5) to (n+9).

The test equipment verifies that potential interruption is carried out in the correct time span by monitoring ACK/NACK sent in PCell and PSCell during activation and deactivation of the SCell1, respectively.

The test equipment verifies the activation time by counting the subframes from the time when the SCell1 activation command is sent until a CSI report with other than CQI index 0 is received.

The test equipment verifies the deactivation time by counting the subframes from the time when the SCell1 deactivation command is sent until CQI reporting for SCell1 is discontinued.

Table A.8.23.24-1: General test parameters for E-UTRAN FDD-FDD DC activation and deactivation of known SCell in non-DRX

Parameter	Unit	Value	Comment
E-UTRA RF Channel Number		1, 2, 3	Three radio channels are used for this test
Active PCell		Cell 1	PCell on RF channel number 1.
Configured PSCell		Cell 2	PSCell on RF channel number 2.
Deconfigured SCell in MCG		Cell 3	Deconfigured SCell in MCG on RF channel number 3.
CP length		Normal	
DRX		OFF	Continuous monitoring of primary cell
CQI/PMI periodicity and offset configuration index		0	CQI reporting for SCells every second subframe
Cell-individual offset for cells on RF channel number 1	dB	0	Individual offset for cells on PCC.
Cell-individual offset for cells on RF channel number 2	dB	0	Individual offset for cells on the frequency of PSCell.
Cell-individual offset for cells on RF channel number 3	dB	0	Individual offset for cells on SCC1.
Filter coefficient		0	L3 filtering is not used
SCell measurement cycle (measCycleSCell)	ms	320	

T1	s	7	During this time the PCell and PSCell shall be known and the SCell1 configured and detected.
T2	s	1	During this time the UE shall activate the SCell1.
T3	s	1	During this time the UE shall deactivate the SCell1.

Table A.8.23.24-2: Cell specific test parameters for E-UTRAN FDD-FDD DC activation and deactivation of known SCell in non-DRX

Parameter	Unit	Cell 1			Cell 2			Cell 3		
		T1	T2	T3	T1	T2	T3	T1	T2	T3
E-UTRA RF Channel Number		1			2			3		
BW _{channel}		5MHz: N _{RB,c} = 25 10MHz: N _{RB,c} = 50 20MHz: N _{RB,c} = 100			5MHz: N _{RB,c} = 25 10MHz: N _{RB,c} = 50 20MHz: N _{RB,c} = 100			5MHz: N _{RB,c} = 25 10MHz: N _{RB,c} = 50 20MHz: N _{RB,c} = 100		
PDSCH parameters: DL Reference Measurement Channel		5MHz: R.7 FDD 10MHz: R.3 FDD 20MHz: R.6 FDD			5MHz: R.7 FDD 10MHz: R.3 FDD 20MHz: R.6 FDD			N/A		
PCFICH/PDCCH/PHICH parameters: DL Reference Measurement Channel		5MHz: R.11 FDD 10MHz: R.6 FDD 20MHz: R.10 FDD			5MHz: R.11 FDD 10MHz: R.6 FDD 20MHz: R.10 FDD			5MHz: R.11 FDD 10MHz: R.6 FDD 20MHz: R.10 FDD		
OCNG Patterns		5MHz: OP.20 FDD 10MHz: OP.10 FDD 20MHz: OP.17 FDD			5MHz: OP.20 FDD 10MHz: OP.10 FDD 20MHz: OP.17 FDD			5MHz: OP.16 FDD 10MHz: OP.2 FDD 20MHz: OP.12 FDD		
PBCH_RA	dB	0			0			0		
PBCH_RB	dB									
PSS_RA	dB									
SSS_RA	dB									
PCFICH_RB	dB									
PHICH_RA	dB									
PHICH_RB	dB									
PDCCH_RA	dB									
PDCCH_RB	dB									
PDSCH_RA	dB									
PDSCH_RB	dB									
OCNG_RA ^{Note 1}	dB									
OCNG_RB ^{Note 1}	dB									
N _{oc} ^{Note 2}	dBm/15 kHz									
\bar{E}_s/N_{oc}	dB	17			17			17		
\bar{E}_s/I_{ot} ^{Note 3}	dB	17			17			17		
RSRP ^{Note 3}	dBm/15 kHz	-87			-87			-87		
SCH_RP ^{Note 3}	dBm/15 kHz	-87			-87			-87		
I _o ^{Note 3}	dBm/Ch BW	-59.13+10log (N _{RB,c} /50)			-59.13+10log (N _{RB,c} /50)			-59.13+10log (N _{RB,c} /50)		
Propagation Condition		AWGN			AWGN			AWGN		
Antenna Configuration		1x2			1x2			1x2		
Receive timing offset to Cell1 ^{Note 5}	μs	-			33			≤ TAE		
Receive timing offset to Cell2 ^{Note 5}	μs	-			-			33		
Note 1:	OCNG shall be used such that all cells are fully allocated and a constant total transmitted power spectral density is achieved for all OFDM symbols.									
Note 2:	Interference from other cells and noise sources not specified in the test is assumed to be constant over subcarriers and time and shall be modelled as AWGN of appropriate power for N _{oc} to be fulfilled.									
Note 3:	\bar{E}_s/I_{ot} , RSRP, SCH_RP and I _o have been derived from other parameters for information purposes. They are not settable parameters themselves.									
Note 4:	The uplink resources for CSI reporting are assigned to the UE prior to the start of time period T2.									
Note 5:	Receive time difference between subframe boundaries of signals received from the two cells at the UE antenna connector including time alignment error between the two cells.									

A.8.23.24.2 Test Requirements

During T2 the UE shall send the first CSI report for SCell1 in a subframe (m+8), or in a subframe (m+10) if the subframe (m+8) was subject to interruption. Whether CSI report in subframe (m+8) was interrupted or not is checked by monitoring ACK/NACK sent in PCell in subframe (m+8).

During T2 the UE shall start sending CSI reports for SCell1 with non-zero CQI index at latest in a subframe (m+24).

During T3 the UE shall stop sending CSI reports for SCell1 at latest in a subframe (n+8).

During T2 interruption of PCell during the SCell activation shall not happen outside the subframes (m+5) to (m+9).

During T2 interruption of PSCell during the SCell activation shall not happen outside the subframes (m+5) to (m+9).

During T3 interruption of PCell during the SCell deactivation shall not happen outside the subframes (n+5) to (n+9).

During T3 interruption of PSCell during the SCell deactivation shall not happen outside the subframes (n+5) to (n+9).

The interruption of PCell shall not be more than 1ms.

The interruption of PSCell shall not be more than 1ms.

All of the above test requirements shall be fulfilled in order for the observed SCell1 activation delay and SCell1 deactivation delay to be counted as correct. The rate of correct observed SCell1 activation delay and SCell1 deactivation delay during repeated tests shall be at least 90%.

NOTE: During T2 if there are no uplink resources for reporting the valid CSI in a subframe (m+24) then the UE shall use the next available uplink resource for reporting the corresponding valid CSI.

A.8.23.25 E-UTRAN FDD-FDD DC activation and deactivation of known SCell in Non-DRX in asynchronous DC

A.8.23.25.1 Test Purpose and Environment

The purpose of this test is to verify that SCell activation and deactivation requirements specified in clause 7.18 for Dual Connectivity, when the SCell is known by the UE at the time of activation.

The test parameters are given in Tables A.8.23.25-1 and cell-specific parameters in A.8.23.25-2 below. The test consists of three successive time periods, with duration of T1, T2 and T3, respectively. There are three carriers, each with one cell. All cells have constant signal levels throughout the test. Before the test starts the UE is connected to Cell 1 (PCell) on radio channel 1 (PCC) and Cell 2 (PSCell) on radio channel 2, but is not aware of Cell 3 (SCell1 in MCG) on radio channel 3 (SCC1). The UE is only monitoring the PCC and the frequency of PSCell. The UE shall be continuously scheduled in the PCell and PSCell throughout the whole test.

At the beginning of T1 the UE receives an RRC message by which the SCell1 becomes configured on SCC1. The UE now starts monitoring also the SCC1. The test equipment sends a MAC message for activation of SCell1.

The point in time at which a MAC message is received at the UE antenna connector, in a subframe # denoted m which is an even number, defines the start of time period T2. The UE shall be able to report valid CSI for the activated SCell1 at latest in a subframe (m+24). The UE shall start reporting CSI for SCell1 in subframe (m+8) and shall report CQI index 0 (out-of-range) until the SCell activation has been completed. Any PCell and PSCell interruption due to activation of SCell1 shall not occur outside subframes (m+5) to (m+9).

Time period T3 starts when a MAC message for deactivation of SCell1, sent from the test equipment to the UE in a subframe # denoted n, where n is 4 or 9, is received at the UE antenna connector. The UE shall carry out deactivation of SCell1 at latest in subframe (n+8), and any PCell and PSCell interruption due to the deactivation of the SCell shall not occur outside subframes (n+5) to (n+9).

The test equipment verifies that potential interruption is carried out in the correct time span by monitoring ACK/NACK sent in PCell and PSCell during activation and deactivation of SCell1, respectively.

The test equipment verifies the activation time by counting the subframes from the time when the SCell1 activation command is sent until a CSI report with other than CQI index 0 is received.

The test equipment verifies the deactivation time by counting the subframes from the time when the SCell1 deactivation command is sent until CQI reporting for SCell1 is discontinued.

Table A.8.23.25-1: General test parameters for E-UTRAN FDD-FDD DC activation and deactivation of known SCell in non-DRX

Parameter	Unit	Value	Comment
E-UTRA RF Channel Number		1, 2, 3	Three radio channels are used for this test
Active PCell		Cell 1	PCell on RF channel number 1.
Configured PScell		Cell 2	PScell on RF channel number 2.
Deconfigured SCell in MCG		Cell 3	Deconfigured SCell in MCG on RF channel number 3.
CP length		Normal	
DRX		OFF	Continuous monitoring of primary cell
CQI/PMI periodicity and offset configuration index		0	CQI reporting for SCells every second subframe
Cell-individual offset for cells on RF channel number 1	dB	0	Individual offset for cells on PCC.
Cell-individual offset for cells on RF channel number 2	dB	0	Individual offset for cells on the frequency of PScell.
Cell-individual offset for cells on RF channel number 3	dB	0	Individual offset for cells on SCC1.
Filter coefficient		0	L3 filtering is not used
SCell measurement cycle (measCycleSCell)	ms	320	
T1	s	7	During this time the PCell and PScell shall be known and the SCell1 configured and detected.
T2	s	1	During this time the UE shall activate the SCell1.
T3	s	1	During this time the UE shall deactivate the SCell1.

Table A.8.23.25-2: Cell specific test parameters for E-UTRAN FDD-FDD DC activation and deactivation of known SCell in non-DRX

Parameter	Unit	Cell 1			Cell 2			Cell 3		
		T1	T2	T3	T1	T2	T3	T1	T2	T3
E-UTRA RF Channel Number		1			2			3		
BW _{channel}		5MHz: N _{RB,c} = 25 10MHz: N _{RB,c} = 50 20MHz: N _{RB,c} = 100			5MHz: N _{RB,c} = 25 10MHz: N _{RB,c} = 50 20MHz: N _{RB,c} = 100			5MHz: N _{RB,c} = 25 10MHz: N _{RB,c} = 50 20MHz: N _{RB,c} = 100		
PDSCH parameters: DL Reference Measurement Channel		5MHz: R.7 FDD 10MHz: R.3 FDD 20MHz: R.6 FDD			5MHz: R.7 FDD 10MHz: R.3 FDD 20MHz: R.6 FDD			N/A		
PCFICH/PDCCH/PHICH parameters: DL Reference Measurement Channel		5MHz: R.11 FDD 10MHz: R.6 FDD 20MHz: R.10 FDD			5MHz: R.11 FDD 10MHz: R.6 FDD 20MHz: R.10 FDD			5MHz: R.11 FDD 10MHz: R.6 FDD 20MHz: R.10 FDD		
OCNG Patterns		5MHz: OP.20 FDD 10MHz: OP.10 FDD 20MHz: OP.17 FDD			5MHz: OP.20 FDD 10MHz: OP.10 FDD 20MHz: OP.17 FDD			5MHz: OP.16 FDD 10MHz: OP.2 FDD 20MHz: OP.12 FDD		
PBCH_RA	dB	0			0			0		
PBCH_RB	dB									
PSS_RA	dB									
SSS_RA	dB									
PCFICH_RB	dB									
PHICH_RA	dB									
PHICH_RB	dB									
PDCCH_RA	dB									
PDCCH_RB	dB									
PDSCH_RA	dB									
PDSCH_RB	dB									
OCNG_RA ^{Note 1}	dB									
OCNG_RB ^{Note 1}	dB									
N _{oc} ^{Note 2}	dBm/15 kHz									
\bar{E}_s/N_{oc}	dB	17			17			17		
\bar{E}_s/I_{ot} ^{Note 3}	dB	17			17			17		
RSRP ^{Note 3}	dBm/15 kHz	-87			-87			-87		

SCH_RP ^{Note 3}	dBm/15 kHz	-87	-87	-87
I _o ^{Note 3}	dBm/Ch BW	-59.13+10log (N _{RB,c} /50)	-59.13+10log (N _{RB,c} /50)	-59.13+10log (N _{RB,c} /50)
Propagation Condition		AWGN	AWGN	AWGN
Antenna Configuration		1x2	1x2	1x2
Receive timing offset to Cell1 ^{Note 5}	μs	-	500	≤ TAE
Receive timing offset to Cell2 ^{Note 5}	μs	-	-	500
<p>Note 1: OCNG shall be used such that all cells are fully allocated and a constant total transmitted power spectral density is achieved for all OFDM symbols.</p> <p>Note 2: Interference from other cells and noise sources not specified in the test is assumed to be constant over subcarriers and time and shall be modelled as AWGN of appropriate power for N_{oc} to be fulfilled.</p> <p>Note 3: E_s/I_{ot}, RSRP, SCH_RP and I_o have been derived from other parameters for information purposes. They are not settable parameters themselves.</p> <p>Note 4: The uplink resources for CSI reporting are assigned to the UE prior to the start of time period T2.</p> <p>Note 5: Receive time difference between subframe boundaries of signals received from the two cells at the UE antenna connector including time alignment error between the two cells.</p>				

A.8.23.25.2 Test Requirements

During T2 the UE shall send the first CSI report for SCell1 in a subframe (m+8), or in a subframe (m+10) if the subframe (m+8) was subject to interruption. Whether CSI report in subframe (m+8) was interrupted or not is checked by monitoring ACK/NACK sent in PCell in subframe (m+8).

During T2 the UE shall start sending CSI reports for SCell1 with non-zero CQI index at latest in a subframe (m+24).

During T3 the UE shall stop sending CSI reports for SCell1 at latest in a subframe (n+8).

During T2 interruption of PCell during the SCell activation shall not happen outside the subframes (m+5) to (m+9).

During T2 interruption of PSCell during the SCell activation shall not happen outside the subframes (m+5) to (m+9).

During T3 interruption of PCell during the SCell deactivation shall not happen outside the subframes (n+5) to (n+9).

During T3 interruption of PSCell during the SCell deactivation shall not happen outside the subframes (n+5) to (n+9).

The interruption of PCell shall not be more than 1ms.

The interruption of PSCell shall not be more than 2ms.

All of the above test requirements shall be fulfilled in order for the observed SCell1 activation delay and SCell1 deactivation delay to be counted as correct. The rate of correct observed SCell1 activation delay and SCell1 deactivation delay during repeated tests shall be at least 90%.

NOTE: During T2 if there are no uplink resources for reporting the valid CSI in a subframe (m+24) then the UE shall use the next available uplink resource for reporting the corresponding valid CSI.

A.8.23.26 E-UTRAN TDD-TDD DC activation and deactivation of known SCell in Non-DRX in synchronous DC

A.8.23.26.1 Test Purpose and Environment

The purpose of this test is to verify that SCell activation and deactivation requirements specified in clause 7.18 for Dual Connectivity, when the SCell is known by the UE at the time of activation.

The test parameters are given in Tables A.8.23.26-1 and cell-specific parameters in A.8.23.26-2 below. The test consists of three successive time periods, with duration of T1, T2 and T3, respectively. There are three carriers, each with one cell. All cells have constant signal levels throughout the test. Before the test starts the UE is connected to Cell 1 (PCell) on radio channel 1 (PCC) and Cell 2 (PSCell) on radio channel 2, but is not aware of Cell 3 (SCell1 in MCG) on radio channel 3 (SCC1). The UE is only monitoring the PCC and the frequency of PSCell. The UE shall be continuously scheduled in the PCell and PSCell throughout the whole test.

At the beginning of T1 the UE receives an RRC message by which the SCell1 becomes configured on SCC1. The UE now starts monitoring also the SCC1. The test equipment sends a MAC message for activation of the SCell1.

The point in time at which a MAC message is received at the UE antenna connector, in a subframe # denoted m , where m is 4 or 9, defines the start of time period T2. The UE shall be able to report valid CSI for the activated SCell1 at latest in a subframe $(m+24)$. The UE shall start reporting CSI for SCell1 in subframe $(m+8)$ and shall report CQI index 0 (out-of-range) until the SCell activation has been completed. Any PCell and PSCell interruption due to activation of the SCell shall not occur outside subframes $(m+5)$ to $(m+11)$.

Time period T3 starts when a MAC message for deactivation of SCell1, sent from the test equipment to the UE in a subframe # denoted n , is received at the UE antenna connector. The UE shall carry out deactivation of the SCell1 at latest in subframe $(n+8)$, and any PCell and PSCell interruption due to the deactivation of the SCell shall not occur outside subframes $(n+5)$ to $(n+11)$.

The test equipment verifies that potential interruption is carried out in the correct time span by monitoring ACK/NACK sent in PCell and PSCell during activation and deactivation of SCell1, respectively.

The test equipment verifies the activation time by counting the subframes from the time when the SCell1 activation command is sent until a CSI report with other than CQI index 0 is received.

The test equipment verifies the deactivation time by counting the subframes from the time when the SCell1 deactivation command is sent until CQI reporting for SCell1 is discontinued.

Table A.8.23.26-1: General test parameters for E-UTRAN TDD-TDD DC activation and deactivation of known SCell in non-DRX

Parameter	Unit	Value	Comment
E-UTRA RF Channel Number		1, 2, 3	Three radio channels are used for this test
Active PCell		Cell 1	PCell on RF channel number 1.
Configured PSCell		Cell 2	PSCell on RF channel number 2.
Deconfigured SCell in MCG		Cell 3	Deconfigured SCell in MCG on RF channel number 3.
CP length		Normal	
DRX		OFF	Continuous monitoring of primary cell
CQI/PMI periodicity and offset configuration index		0	CQI reporting for SCells every second subframe
Cell-individual offset for cells on RF channel number 1	dB	0	Individual offset for cells on PCC.
Cell-individual offset for cells on RF channel number 2	dB	0	Individual offset for cells on the frequency of PSCell.
Cell-individual offset for cells on RF channel number 3	dB	0	Individual offset for cells on SCC1.
Filter coefficient		0	L3 filtering is not used
SCell measurement cycle (measCycleSCell)	ms	320	
T1	s	7	During this time the PCell and PSCell shall be known and the SCell1 configured and detected.
T2	s	1	During this time the UE shall activate the SCell1.
T3	s	1	During this time the UE shall deactivate the SCell1.

Table A.8.23.26-2: Cell specific test parameters for E-UTRAN TDD-TDD DC activation and deactivation of known SCell in non-DRX

Parameter	Unit	Cell 1			Cell 2			Cell 3		
		T1	T2	T3	T1	T2	T3	T1	T2	T3
E-UTRA RF Channel Number		1			2			3		
BW _{channel}		5MHz: N _{RB,c} = 25 10MHz: N _{RB,c} = 50 20MHz: N _{RB,c} = 100			5MHz: N _{RB,c} = 25 10MHz: N _{RB,c} = 50 20MHz: N _{RB,c} = 100			5MHz: N _{RB,c} = 25 10MHz: N _{RB,c} = 50 20MHz: N _{RB,c} = 100		
PDSCH parameters: DL Reference Measurement Channel		5MHz: R.4 TDD 10MHz: R.0 TDD 20MHz: R.3 TDD			5MHz: R.4 TDD 10MHz: R.0 TDD 20MHz: R.3 TDD			N/A		
PCFICH/PDCCH/PHICH parameters: DL Reference Measurement Channel		5MHz: R.11 TDD 10MHz: R.6 TDD 20MHz: R.10 TDD			5MHz: R.11 TDD 10MHz: R.6 TDD 20MHz: R.10 TDD			5MHz: R.11 TDD 10MHz: R.6 TDD 20MHz: R.10 TDD		

OCNG Patterns		5MHz: OP.9 TDD 10MHz: OP.1 TDD 20MHz: OP. 7 TDD	5MHz: OP.9 TDD 10MHz: OP.1 TDD 20MHz: OP. 7 TDD	5MHz: OP.10 TDD 10MHz: OP.2 TDD 20MHz: OP. 8 TDD
PBCH_RA	dB	0	0	0
PBCH_RB	dB			
PSS_RA	dB			
SSS_RA	dB			
PCFICH_RB	dB			
PHICH_RA	dB			
PHICH_RB	dB			
PDCCH_RA	dB			
PDCCH_RB	dB			
PDSCH_RA	dB			
PDSCH_RB	dB			
OCNG_RA ^{Note 1}	dB			
OCNG_RB ^{Note 1}	dB			
N _{oc} ^{Note 2}	dBm/15 kHz			
E _s /N _{oc}	dB	17	17	17
E _s /I _{ot} ^{Note 3}	dB	17	17	17
RSRP ^{Note 3}	dBm/15 kHz	-87	-87	-87
SCH_RP ^{Note 3}	dBm/15 kHz	-87	-87	-87
I _o ^{Note 3}	dBm/Ch BW	-59.13+10log (N _{RB,c} /50)	-59.13+10log (N _{RB,c} /50)	-59.13+10log (N _{RB,c} /50)
Propagation Condition		AWGN	AWGN	AWGN
Antenna Configuration		1x2	1x2	1x2
Receive timing offset to Cell1 ^{Note 5}	μs	-	33	0
Time alignment error relative to cell 1 ^{Note 5}	μs	-	N/A	≤ TAE
<p>Note 1: OCNG shall be used such that all cells are fully allocated and a constant total transmitted power spectral density is achieved for all OFDM symbols.</p> <p>Note 2: Interference from other cells and noise sources not specified in the test is assumed to be constant over subcarriers and time and shall be modelled as AWGN of appropriate power for N_{oc} to be fulfilled.</p> <p>Note 3: E_s/I_{ot}, RSRP, SCH_RP and I_o have been derived from other parameters for information purposes. They are not settable parameters themselves.</p> <p>Note 4: The uplink resources for CSI reporting are assigned to the UE prior to the start of time period T2.</p> <p>Note 5: Time alignment error (TAE) as specified in TS 36.104 [30] clause 6.5.3.1. The TAE value depends upon the type of carrier aggregation.</p>				

A.8.23.26.2 Test Requirements

During T2 the UE shall send the first CSI report for SCell1 in a subframe (m+8), or in a subframe (m+9) if the subframe (m+8) was subject to interruption. Whether CSI report in subframe (m+8) was interrupted or not is checked by monitoring ACK/NACK sent in PCell in subframe (m+8).

During T2 the UE shall start sending CSI reports for SCell1 with non-zero CQI index at latest in a subframe (m+24).

During T3 the UE shall stop sending CSI reports for SCell1 at latest in a subframe (n+8).

During T2 interruption of PCell during the SCell activation shall not happen outside the subframes (m+5) to (m+11).

During T2 interruption of PSCell during the SCell activation shall not happen outside the subframes (m+5) to (m+11).

During T3 interruption of PCell during the SCell deactivation shall not happen outside the subframes (n+5) to (n+11).

During T3 interruption of PSCell during the SCell deactivation shall not happen outside the subframes (n+5) to (n+11).

The interruption of PCell shall not be more than 1ms.

The interruption of PSCell shall not be more than 1ms.

All of the above test requirements shall be fulfilled in order for the observed SCell1 activation delay and SCell1 deactivation delay to be counted as correct. The rate of correct observed SCell1 activation delay and SCell1 deactivation delay during repeated tests shall be at least 90%.

NOTE: During T2 if there are no uplink resources for reporting the valid CSI in a subframe (m+24) then the UE shall use the next available uplink resource for reporting the corresponding valid CSI.

A.8.23.27 E-UTRAN FDD-FDD DC event triggered reporting under deactivated SCell with PCell and PSCell interruption in non-DRX in synchronous DC

A.8.23.27.1 Test Purpose and Environment

The purpose of this test is to verify that in FDD-FDD DC the UE correctly detects event A6 (Neighbour becomes better than SCell) defined in TS 36.331 [2] within the requirements stated in clause 8.8.8 while at the same time fulfilling the requirement on interruption rate stated in clause 7.12.

In this test case there are three cells: Cell1, Cell2, Cell3 and Cell4. Cell 1 is the PCell on the FDD primary component carrier, Cell 2 is the configured PSCell on the FDD carrier 2, Cell 3 is the configured deactivated SCell on the FDD carrier 3 in MCG, and Cell 4 is the neighbour cell on carrier 3. It is indicated to the UE in the measurement control information that event-triggered reporting with Event A6 is used. The test consists of two successive time periods, with duration of T1 and T2, respectively. During T1 the UE shall not have any information of Cell 4. Immediately at beginning of T2 the transmission power of cell 4 is increased to same level as for cell 3, and due to usage of an offset this shall result in reporting of Event A6. PDCCH indicating a new transmission on the PCell and PSCell shall be sent continuously to ensure that the UE sends ACK/NACKs throughout the test.

The test parameters are given in Table A.8.23.27.1-1 and Table A.8.23.27.1-2 below.

Table A.8.23.27.1-1: General test parameters for E-UTRAN FDD-FDD CA Event triggered reporting on configured but deactivated SCell with PCell interruption in non-DRX with PCell in FDD

Parameter		Unit	Value	Comment
E-UTRA RF Channel Number			1, 2, 3	Three radio channels are used for this test
Active PCell			Cell 1	Primary cell on RF channel number 1.
Configured PSCell			Cell 2	Configured PSCell on RF channel number 2.
Configured deactivated SCell			Cell 3	Configured deactivated secondary cell on RF channel number 3
Neighbour cell			Cell 4	Neighbor cell to be identified on RF channel number 3.
CP length			Normal	
DRX			OFF	Continuous monitoring of primary cell
A6	Hysteresis	dB	0	Hysteresis for evaluation of event A6.
	Offset	dB	-3	Offset parameter for evaluation of event A6. Needs to take relative accuracy tolerance in clause 9.1.11.2 into account plus margin.
	Report on leave		False	
	Time To Trigger	s	0	
Cell-individual offset for cells on RF channel number 1		dB	0	Individual offset for cells on primary component carrier.
Cell-individual offset for cells on RF channel number 2		dB	0	Individual offset for cells on secondary component carrier.
Filter coefficient			0	L3 filtering is not used
SCell measurement cycle (measCycleSCell)		ms	1280	
T1		s	5	During this time the UE shall be aware of cells 1, 2 and 3 but not cell 4.
T2		s	≤30	UE shall report Event A6 within 25.6s (20×scellMeasCycle)

Table A.8.23.27.1-2: Cell specific test parameters for E-UTRAN FDD-FDD CA Event triggered reporting on configured but deactivated SCell with PCell interruption in non-DRX with PCell in FDD

Parameter	Unit	Cell 1		Cell 2		Cell 3		Cell 4	
		T1	T2	T1	T2	T1	T2	T1	T2
E-UTRA RF Channel Number		1		2		3			
BW _{channel}		5MHz: N _{RB,c} = 25 10MHz: N _{RB,c} = 50 20MHz: N _{RB,c} = 100		5MHz: N _{RB,c} = 25 10MHz: N _{RB,c} = 50 20MHz: N _{RB,c} = 100		5MHz: N _{RB,c} = 25 10MHz: N _{RB,c} = 50 20MHz: N _{RB,c} = 100		5MHz: N _{RB,c} = 25 10MHz: N _{RB,c} = 50 20MHz: N _{RB,c} = 100	

PDSCH parameters: DL Reference Measurement Channel		5MHz: R.7 FDD 10MHz: R.3 FDD 20MHz: R.6 FDD	5MHz: R.7 FDD 10MHz: R.3 FDD 20MHz: R.6 FDD	-		-	
PCFICH/PDCCH/PHICH parameters: DL Reference Measurement Channel		5MHz: R.11 FDD 10MHz: R.6 FDD 20MHz: R.10 FDD	5MHz: R.11 FDD 10MHz: R.6 FDD 20MHz: R.10 FDD	5MHz: R.11 FDD 10MHz: R.6 FDD 20MHz: R.10 FDD		5MHz: R.11 FDD 10MHz: R.6 FDD 20MHz: R.10 FDD	
OCNG Patterns defined		5MHz: OP.20 FDD 10MHz: OP.10 FDD 20MHz: OP.17 FDD	5MHz: OP.20 FDD 10MHz: OP.10 FDD 20MHz: OP.17 FDD	5MHz: OP.16 FDD 10MHz: OP.2 FDD 20MHz: OP.12 FDD		5MHz: OP.16 FDD 10MHz: OP.2 FDD 20MHz: OP.12 FDD	
PBCH_RA	dB	0	0	0	0	0	0
PBCH_RB	dB						
PSS_RA	dB						
SSS_RA	dB						
PCFICH_RB	dB						
PHICH_RA	dB						
PHICH_RB	dB						
PDCCH_RA	dB						
PDCCH_RB	dB						
PDSCH_RA	dB						
PDSCH_RB	dB						
OCNG_RA ^{Note 1}	dB						
OCNG_RB ^{Note 1}	dB						
N_{oc} ^{Note 2}	dBm/15 kHz						
\bar{E}_s/N_{oc}	dB	16	16	16	16	-infinity	16
\bar{E}_s/I_{ot} ^{Note 3}	dB	16	16	16	-0.11	-infinity	-0.11
RSRP ^{Note 3}	dBm/15 kHz	-85	-85	-85	-85	-infinity	-85
SCH_RP ^{Note 3}	dBm/15 kHz	-85	-85	-85	-85	-infinity	-85
I_o ^{Note 3}	dBm/Ch BW	-57.11 +10log ($N_{RB,c}/50$)	-57.11 +10log ($N_{RB,c}/50$)	-57.11 +10log ($N_{RB,c}/50$)	-54.15 +10log ($N_{RB,c}/50$)	Specified in columns for Cell 3	
Propagation Condition		ETU70	ETU70	ETU70		ETU70	
Correlation Matrix and Antenna Configuration		1x2 Low	1x2 Low	1x2 Low		1x2 Low	
Timing offset to Cell 1	μ s	-	33	0		3	
Time alignment error relative to cell 1 ^{Note 5}	μ s	-	N/A	\leq TAE		N/A	
<p>Note 1: OCNG shall be used such that all cells are fully allocated and a constant total transmitted power spectral density is achieved for all OFDM symbols.</p> <p>Note 2: Interference from other cells and noise sources not specified in the test is assumed to be constant over subcarriers and time and shall be modelled as AWGN of appropriate power for N_{oc} to be fulfilled.</p> <p>Note 3: E_s/I_{ot}, RSRP, SCH_RP and I_o levels have been derived from other parameters for information purposes. They are not settable parameters themselves.</p> <p>Note 4: The resources for uplink transmission are assigned to the UE prior to the start of time period T2.</p> <p>Note 5: Time alignment error (TAE) as specified in TS 36.104 [30] clause 6.5.3.1. The TAE value depends upon the type of carrier aggregation.</p>							

A.8.23.27.2 Test Requirements

The UE shall send one Event A6 triggered measurement report for cell 3, with a measurement reporting delay less than 25.6s from the beginning of time period T2.

The UE shall not send event triggered measurement reports, as long as the reporting criteria are not fulfilled.

The UE shall be scheduled on PCell and PSCell continuously throughout the test. From the start of T1 until the measurement report is received during T2, at least 99.5% of all expected ACK/NACKs on the PCell and at least 99.5% of all expected ACK/NACKs on the PSCell shall be transmitted by the UE. Each interruption length shall not exceed 1 subframe.

For a test to be considered successful requirements on both event detection and percentage of transmitted ACK/NACKs have to be fulfilled simultaneously.

The rate of correct events observed during repeated tests shall be at least 90%.

NOTE: The actual overall delays measured in the test may be up to $2 \times T_{TTIDCCH}$ higher than the measurement reporting delays above because of TTI insertion uncertainty of the measurement report in DCCH.

A.8.23.28 E-UTRAN FDD-FDD DC event triggered reporting under deactivated SCell with PCell and PSCell interruption in non-DRX in asynchronous DC

A.8.23.28.1 Test Purpose and Environment

The purpose of this test is to verify that in FDD-FDD DC the UE correctly detects event A6 (Neighbour becomes better than SCell) defined in TS 36.331 [2] within the requirements stated in clause 8.8.8 while at the same time fulfilling the requirement on interruption rate stated in clause 7.12.

In this test case there are three cells: Cell1, Cell2, Cell3 and Cell4. Cell 1 is the PCell on the FDD primary component carrier, Cell 2 is the configured PSCell on the FDD carrier 2, Cell 3 is the configured deactivated SCell on the FDD carrier 3 in MCG, and Cell 4 is the neighbour cell on carrier 3. It is indicated to the UE in the measurement control information that event-triggered reporting with Event A6 is used. The test consists of two successive time periods, with duration of T1 and T2, respectively. During T1 the UE shall not have any information of Cell 4. Immediately at beginning of T2 the transmission power of cell 4 is increased to same level as for cell 3, and due to usage of an offset this shall result in reporting of Event A6. PDCCH indicating a new transmission on the PCell and PSCell shall be sent continuously to ensure that the UE sends ACK/NACKs throughout the test.

The test parameters are given in Table A.8.23.28.1-1 and Table A.8.23.28.1-2 below.

Table A.8.23.28.1-1: General test parameters for E-UTRAN FDD-FDD CA Event triggered reporting on configured but deactivated SCell with PCell interruption in non-DRX with PCell in FDD

Parameter		Unit	Value	Comment
E-UTRA RF Channel Number			1, 2, 3	Three radio channels are used for this test
Active PCell			Cell 1	Primary cell on RF channel number 1.
Configured PSCell			Cell 2	Configured PSCell on RF channel number 2.
Configured deactivated SCell			Cell 3	Configured deactivated secondary cell on RF channel number 3
Neighbour cell			Cell 4	Neighbor cell to be identified on RF channel number 3.
CP length			Normal	
DRX			OFF	Continuous monitoring of primary cell
A6	Hysteresis	dB	0	Hysteresis for evaluation of event A6.
	Offset	dB	-3	Offset parameter for evaluation of event A6. Needs to take relative accuracy tolerance in clause 9.1.11.2 into account plus margin.
	Report on leave		False	
	Time To Trigger	s	0	
Cell-individual offset for cells on RF channel number 1		dB	0	Individual offset for cells on primary component carrier.
Cell-individual offset for cells on RF channel number 2		dB	0	Individual offset for cells on secondary component carrier.
Filter coefficient			0	L3 filtering is not used
SCell measurement cycle (measCycleSCell)		ms	1280	
T1		s	5	During this time the UE shall be aware of cells 1, 2 and 3 but not cell 4.
T2		s	≤ 30	UE shall report Event A6 within 25.6s ($20 \times \text{measCycle}$)

Table A.8.23.28.1-2: Cell specific test parameters for E-UTRAN FDD-FDD CA Event triggered reporting on configured but deactivated SCell with PCell interruption in non-DRX with PCell in FDD

Parameter	Unit	Cell 1		Cell 2		Cell 3		Cell 4	
		T1	T2	T1	T2	T1	T2	T1	T2
E-UTRA RF Channel Number		1		2		3			

BW _{channel}		5MHz: N _{RB,c} = 25 10MHz: N _{RB,c} = 50 20MHz: N _{RB,c} = 100	5MHz: N _{RB,c} = 25 10MHz: N _{RB,c} = 50 20MHz: N _{RB,c} = 100	5MHz: N _{RB,c} = 25 10MHz: N _{RB,c} = 50 20MHz: N _{RB,c} = 100	5MHz: N _{RB,c} = 25 10MHz: N _{RB,c} = 50 20MHz: N _{RB,c} = 100		
PDSCH parameters: DL Reference Measurement Channel		5MHz: R.7 FDD 10MHz: R.3 FDD 20MHz: R.6 FDD	5MHz: R.7 FDD 10MHz: R.3 FDD 20MHz: R.6 FDD	-	-		
PCFICH/PDCCH/PHICH parameters: DL Reference Measurement Channel		5MHz: R.11 FDD 10MHz: R.6 FDD 20MHz: R.10 FDD	5MHz: R.11 FDD 10MHz: R.6 FDD 20MHz: R.10 FDD	5MHz: R.11 FDD 10MHz: R.6 FDD 20MHz: R.10 FDD	5MHz: R.11 FDD 10MHz: R.6 FDD 20MHz: R.10 FDD		
OCNG Patterns defined		5MHz: OP.20 FDD 10MHz: OP.10 FDD 20MHz: OP.17 FDD	5MHz: OP.20 FDD 10MHz: OP.10 FDD 20MHz: OP.17 FDD	5MHz: OP.16 FDD 10MHz: OP.2 FDD 20MHz: OP.12 FDD	5MHz: OP.16 FDD 10MHz: OP.2 FDD 20MHz: OP.12 FDD		
PBCH_RA	dB	0	0	0	0		
PBCH_RB	dB						
PSS_RA	dB						
SSS_RA	dB						
PCFICH_RB	dB						
PHICH_RA	dB						
PHICH_RB	dB						
PDCCH_RA	dB						
PDCCH_RB	dB						
PDSCH_RA	dB						
PDSCH_RB	dB						
OCNG_RA ^{Note 1}	dB						
OCNG_RB ^{Note 1}	dB						
N _{oc} ^{Note 2}	dBm/15 kHz	-101	-101	-101			
\bar{E}_s/N_{oc}	dB	16	16	16	16	-infinity	16
\bar{E}_s/I_{ot} ^{Note 3}	dB	16	16	16	-0.11	-infinity	-0.11
RSRP ^{Note 3}	dBm/15 kHz	-85	-85	-85	-85	-infinity	-85
SCH_RP ^{Note 3}	dBm/15 kHz	-85	-85	-85	-85	-infinity	-85
I _o ^{Note 3}	dBm/Ch BW	-57.11 +10log (N _{RB,c} /50)	-57.11 +10log (N _{RB,c} /50)	-57.11 +10log (N _{RB,c} /50)	-54.15 +10log (N _{RB,c} /50)	Specified in columns for Cell 3	
Propagation Condition		ETU70	ETU70	ETU70		ETU70	
Correlation Matrix and Antenna Configuration		1x2 Low	1x2 Low	1x2 Low		1x2 Low	
Timing offset to Cell 1	μs	-	500	0		3	
Time alignment error relative to cell 1 ^{Note 5}	μs	-	N/A	≤ TAE		N/A	
Note 1:	OCNG shall be used such that all cells are fully allocated and a constant total transmitted power spectral density is achieved for all OFDM symbols.						
Note 2:	Interference from other cells and noise sources not specified in the test is assumed to be constant over subcarriers and time and shall be modelled as AWGN of appropriate power for N _{oc} to be fulfilled.						
Note 3:	Es/I _{ot} , RSRP, SCH_RP and I _o levels have been derived from other parameters for information purposes. They are not settable parameters themselves.						
Note 4:	The resources for uplink transmission are assigned to the UE prior to the start of time period T2.						
Note 5:	Time alignment error (TAE) as specified in TS 36.104 [30] clause 6.5.3.1. The TAE value depends upon the type of carrier aggregation.						

A.8.23.28.2 Test Requirements

The UE shall send one Event A6 triggered measurement report for cell 3, with a measurement reporting delay less than 25.6s from the beginning of time period T2.

The UE shall not send event triggered measurement reports, as long as the reporting criteria are not fulfilled.

The UE shall be scheduled on PCell and PSCell continuously throughout the test. From the start of T1 until the measurement report is received during T2, at least 99.5% of all expected ACK/NACKs on the PCell and at least 99.5% of all expected ACK/NACKs on the PSCell shall be transmitted by the UE. Each interruption length shall not exceed 1 subframes on PCell and 2 subframes on PSCell, respectively.

For a test to be considered successful requirements on both event detection and percentage of transmitted ACK/NACKs have to be fulfilled simultaneously.

The rate of correct events observed during repeated tests shall be at least 90%.

NOTE: The actual overall delays measured in the test may be up to $2 \times \text{TTIDCCH}$ higher than the measurement reporting delays above because of TTI insertion uncertainty of the measurement report in DCCH.

A.8.23.29 E-UTRAN TDD-TDD DC event triggered reporting under deactivated SCell with PCell and PSCell interruption in non-DRX in synchronous DC

A.8.23.29.1 Test Purpose and Environment

The purpose of this test is to verify that in TDD-TDD DC the UE correctly detects event A6 (Neighbour becomes better than SCell) defined in TS 36.331 [2] within the requirements stated in clause 8.8.8 while at the same time fulfilling the requirement on interruption rate stated in clause 7.12.

In this test case there are three cells: Cell1, Cell2, Cell3 and Cell4. Cell 1 is the PCell on the TDD primary component carrier, Cell 2 is the configured PSCell on the TDD carrier 2, Cell 3 is the configured deactivated SCell on the TDD carrier 3 in MCG, and Cell 4 is the neighbour cell on carrier 3. It is indicated to the UE in the measurement control information that event-triggered reporting with Event A6 is used. The test consists of two successive time periods, with duration of T1 and T2, respectively. During T1 the UE shall not have any information of Cell 4. Immediately at beginning of T2 the transmission power of cell 4 is increased to same level as for cell 3, and due to usage of an offset this shall result in reporting of Event A6. PDCCH indicating a new transmission on the PCell and PSCell shall be sent continuously to ensure that the UE sends ACK/NACKs throughout the test.

The test parameters are given in Table A.8.23.29.1-1 and Table A.8.23.29.1-2 below.

Table A.8.23.29.1-1: General test parameters for E-UTRAN TDD-TDD CA Event triggered reporting on configured but deactivated SCell with PCell interruption in non-DRX with PCell in FDD

Parameter	Unit	Value	Comment	
E-UTRA RF Channel Number		1, 2, 3	Three radio channels are used for this test	
Active PCell		Cell 1	Primary cell on RF channel number 1.	
Configured PSCell		Cell 2	Configured PSCell on RF channel number 2.	
Configured deactivated SCell		Cell 3	Configured deactivated secondary cell on RF channel number 3	
Neighbour cell		Cell 4	Neighbor cell to be identified on RF channel number 3.	
CP length		Normal		
Special subframe configuration		6	As specified in table 4.2-1 in TS 36.211. The same configuration in TDD cells	
Uplink-downlink configuration		1	As specified in table 4.2-2 in TS 36.211. The same configuration in TDD cells	
DRX		OFF	Continuous monitoring of primary cell	
A6	Hysteresis	dB	0	Hysteresis for evaluation of event A6.
	Offset	dB	-3	Offset parameter for evaluation of event A6. Needs to take relative accuracy tolerance in clause 9.1.11.2 into account plus margin.
	Report on leave		False	
	Time To Trigger	s	0	
Cell-individual offset for cells on RF channel number 1	dB	0	Individual offset for cells on primary component carrier.	
Cell-individual offset for cells on RF channel number 2	dB	0	Individual offset for cells on secondary component carrier.	
Filter coefficient		0	L3 filtering is not used	
SCell measurement cycle (measCycleSCell)	ms	1280		

T1	s	5	During this time the UE shall be aware of cells 1, 2 and 3 but not cell 4.
T2	s	≤30	UE shall report Event A6 within 25.6s (20xscellMeasCycle)

Table A.8.23.29.1-2: Cell specific test parameters for E-UTRAN TDD-TDD CA Event triggered reporting on configured but deactivated SCell with PCell interruption in non-DRX with PCell in FDD

Parameter	Unit	Cell 1		Cell 2		Cell 3		Cell 4	
		T1	T2	T1	T2	T1	T2	T1	T2
E-UTRA RF Channel Number		1		2		3			
BW _{channel}		5MHz: N _{RB,c} = 25 10MHz: N _{RB,c} = 50 20MHz: N _{RB,c} = 100		5MHz: N _{RB,c} = 25 10MHz: N _{RB,c} = 50 20MHz: N _{RB,c} = 100		5MHz: N _{RB,c} = 25 10MHz: N _{RB,c} = 50 20MHz: N _{RB,c} = 100		5MHz: N _{RB,c} = 25 10MHz: N _{RB,c} = 50 20MHz: N _{RB,c} = 100	
PDSCH parameters: DL Reference Measurement Channel		5MHz: R.4 TDD 10MHz: R.0 TDD 20MHz: R.3 TDD		5MHz: R.4 TDD 10MHz: R.0 TDD 20MHz: R.3 TDD		-		-	
PCFICH/PDCCH/PHICH parameters: DL Reference Measurement Channel		5MHz: R.11 TDD 10MHz: R.6 TDD 20MHz: R.10 TDD		5MHz: R.11 TDD 10MHz: R.6 TDD 20MHz: R.10 TDD		5MHz: R.11 TDD 10MHz: R.6 TDD 20MHz: R.10 TDD		5MHz: R.11 TDD 10MHz: R.6 TDD 20MHz: R.10 TDD	
OCNG Patterns defined		5MHz: OP.9 TDD 10MHz: OP.1 TDD 20MHz: OP.7 TDD		5MHz: OP.9 TDD 10MHz: OP.1 TDD 20MHz: OP.7 TDD		5MHz: OP.10 TDD 10MHz: OP.2 TDD 20MHz: OP.8 TDD		5MHz: OP.10 TDD 10MHz: OP.2 TDD 20MHz: OP.8 TDD	
PBCH_RA	dB								
PBCH_RB	dB								
PSS_RA	dB								
SSS_RA	dB								
PCFICH_RB	dB								
PHICH_RA	dB								
PHICH_RB	dB	0		0		0		0	
PDCCH_RA	dB								
PDCCH_RB	dB								
PDSCH_RA	dB								
PDSCH_RB	dB								
OCNG_RA ^{Note 1}	dB								
OCNG_RB ^{Note 1}	dB								
N _{oc} ^{Note 2}	dBm/15 kHz	-101		-101		-101			
E _s /N _{oc}	dB	16		16		16		-infinity	
E _s /I _{ot} ^{Note 3}	dB	16		16		16		-infinity	
RSRP ^{Note 3}	dBm/15 kHz	-85		-85		-85		-infinity	
SCH_RP ^{Note 3}	dBm/15 kHz	-85		-85		-85		-infinity	
I _o ^{Note 3}	dBm/Ch BW	-57.11 +10log(N _{RB,c} /50)		-57.11 +10log(N _{RB,c} /50)		-57.11 +10log(N _{RB,c} /50)		-54.15 +10log(N _{RB,c} /50)	
Propagation Condition		ETU70		ETU70		ETU70		ETU70	
Correlation Matrix and Antenna Configuration		1x2 Low		1x2 Low		1x2 Low		1x2 Low	
Timing offset to Cell 1	μs	-		33		0		3	
Time alignment error relative to cell 1 ^{Note 5}	μs	-		N/A		≤ TAE		N/A	

Note 1:	OCNG shall be used such that all cells are fully allocated and a constant total transmitted power spectral density is achieved for all OFDM symbols.
Note 2:	Interference from other cells and noise sources not specified in the test is assumed to be constant over subcarriers and time and shall be modelled as AWGN of appropriate power for N_{oc} to be fulfilled.
Note 3:	E_s/lot , RSRP, SCH_RP and I_o levels have been derived from other parameters for information purposes. They are not settable parameters themselves.
Note 4:	The resources for uplink transmission are assigned to the UE prior to the start of time period T2.
Note 5:	Time alignment error (TAE) as specified in TS 36.104 [30] clause 6.5.3.1. The TAE value depends upon the type of carrier aggregation.

A.8.23.29.2 Test Requirements

The UE shall send one Event A6 triggered measurement report for cell 3, with a measurement reporting delay less than 25.6s from the beginning of time period T2.

The UE shall not send event triggered measurement reports, as long as the reporting criteria are not fulfilled.

The UE shall be scheduled on PCell and PSCell continuously throughout the test. From the start of T1 until the measurement report is received during T2, at least 99.5% of all expected ACK/NACKs on the PCell and at least 99.5% of all expected ACK/NACKs on the PSCell shall be transmitted by the UE. Each interruption length shall not exceed 1 subframe.

For a test to be considered successful requirements on both event detection and percentage of transmitted ACK/NACKs have to be fulfilled simultaneously.

The rate of correct events observed during repeated tests shall be at least 90%.

NOTE: The actual overall delays measured in the test may be up to $2 \times T_{TTIDCCH}$ higher than the measurement reporting delays above because of TTI insertion uncertainty of the measurement report in DCCH.

A.8.24 Proximity-based Services

A.8.24.1 E-UTRAN FDD - Initiation/Cease of SLSS Transmission with ProSe Direct Discovery

The purpose of this test is to verify the requirements related to the maximum evaluation time allowed to initiate and cease SLSS transmissions defined in clause 8.10.2.1. In the test the UE under test is configured for ProSe operation only on PCell and also the UE is configured only for PCell for WAN. This test is applicable for a UE capable of ProSe Direct Discovery and also SLSS transmission and reception (indicated using *disc-SLSS*).

For this test, the UE is triggered by the test loop function or the upper layers to announce ProSe Direct Discovery.

The test parameters are given in Table A.8.24.1.1-1, Table A.8.24.1.1-2 and Table A.8.24.1.1-3 below. There is one active cell (PCell) in this test. The test consists of three successive time periods, with time duration of T1, T2 and T3 respectively. During T1, the RSRP of the PCell is above *syncTxThreshIC* and the UE is not expected to be transmitting SLSS. During T2, the RSRP of the PCell is lowered below *syncTxThreshIC* and the UE is expected to initiate SLSS transmissions. During T3, the RSRP of the PCell is increased back to be above *syncTxThreshIC* and the UE is expected to cease SLSS transmissions.

A.8.24.1.1 Test Purpose and Environment

Table A.8.24.1.1-1: Test parameters for initiation/cease of SLSS transmissions test for E-UTRAN FDD

Parameter	Unit	Value	Comment
E-UTRA RF Channel Number		1	Only one FDD carrier frequency is used.
Channel Bandwidth ($BW_{channel}$)	MHz	5	
Active cell		Cell 1	E-UTRA FDD Cell1 on RF channel number 1
CP length of Cell 1		Normal	
Layer 3 filtering		Disabled	L3 filtering is not used
drx-Configuration		DRX_P1	As specified in Table A.3.12.2-1
T1	s	3	
T2	s	5.24	
T3	s	5.24	

Table A.8.24.1.1-2: ProSe Direct Discovery configuration for initiation/cease of SLSS transmissions test for E-UTRAN FDD

Parameter	Unit	Value	Comment
E-UTRA RF Channel Number		1	UL carrier frequency
Channel Bandwidth (BW_{channel})	MHz	5	
ProSe Direct Discovery resource pool configuration		As specified in Table A.3.12.4-1 (Configuration #1)	IE values unless specified otherwise in this test.
networkControlledSyncTx		Not configured	
syncTxThreshIC	dBm/15 kHz	-95	In SIB19

Table A.8.24.1.1-3: Cell specific test parameters for initiation/cease of SLSS transmissions test for E-UTRAN FDD

Parameter	Unit	Cell 1		
		T1	T2	T3
E-UTRA RF Channel Number		1		
BW_{channel}	MHz	5		
OCNG Pattern (defined in clause A.3.2)		OP.16 FDD		
PBCH_RA	dB	0		
PBCH_RB				
PSS_RA				
SSS_RA				
PCFICH_RB				
PHICH_RA				
PHICH_RB				
PDCCH_RA				
PDCCH_RB				
PDSCH_RA				
PDSCH_RB				
OCNG_RA ^{Note 1}				
OCNG_RB ^{Note 1}				
N_{oc} ^{Note 2}	dBm/15 kHz	-95		
\hat{E}_s / N_{oc}	dB	4.5	-4.5	4.5
RSRP ^{Note 3}	dBm/15 kHz	-90.5	-99.5	-90.5
SCH_RP ^{Note 3}	dBm/15 kHz	-90.5	-99.5	-90.5
Propagation Condition		AWGN		
<p>Note 1: OCNG shall be used such that cell is fully allocated and a constant total transmitted power spectral density is achieved for all OFDM symbols.</p> <p>Note 2: Interference from other cells and noise sources not specified in the test is assumed to be constant over subcarriers and time and shall be modelled as AWGN of appropriate power for N_{oc} to be fulfilled.</p> <p>Note 3: RSRP levels have been derived from other parameters for information purposes. They are not settable parameters themselves.</p>				

A.8.24.1.2 Test Requirements

The SLSS transmission initiation delay is defined as the time from the beginning of time period T2 up to the moment when the UE initiates the SLSS transmission.

The SLSS transmission initiation delay shall be less than 2.24 s.

The SLSS transmission cease delay is defined as the time from the beginning of time period T3 up to the moment when the UE ceases the SLSS transmission.

The SLSS transmission cease delay shall be less than 2.24 s.

The rate of correct initiation/cease delay of SLSS transmissions observed during repeated tests shall be at least 90%.

NOTE: The initiation/cease delay of SLSS transmissions can be expressed as: $T_{\text{evaluate,SLSS}} + \text{discPeriod}$,

Where:

$T_{\text{evaluate,SLSS}}$ is the evaluation time for initiate/cease of SLSS, and is 1.92 sec (see Table 8.10.2.1-1 in clause 8.10.2.1) for the parameters in this test;

$discPeriod$ is the discovery period (set as 320ms in this test).

A.8.24.2 E-UTRAN TDD - Initiation/Cease of SLSS Transmission with ProSe Direct Discovery

The purpose of this test is to verify the requirements related to the maximum evaluation time allowed to initiate and cease SLSS transmissions defined in clause 8.10.2.1. In the test the UE under test is configured for ProSe operation only on PCell and also the UE is configured only for PCell for WAN. This test is applicable for a UE capable of ProSe Direct Discovery and also SLSS transmission and reception (indicated using $disc\text{-}SLSS$).

For this test, the UE is triggered by the test loop function or the upper layers to announce ProSe Direct Discovery.

The test parameters are given in Table A.8.24.2.1-1, Table A.8.24.2.1-2 and Table A.8.24.2.1-3 below. There is one active cell (PCell) in this test. The test consists of three successive time periods, with time duration of T1, T2 and T3 respectively. During T1, the RSRP of the PCell is above $syncTxThreshIC$ and the UE is not expected to be transmitting SLSS. During T2, the RSRP of the PCell is lowered below $syncTxThreshIC$ and the UE is expected to initiate SLSS transmissions. During T3, the RSRP of the PCell is increased back to be above $syncTxThreshIC$ and the UE is expected to cease SLSS transmissions.

A.8.24.2.1 Test Purpose and Environment

Table A.8.24.2.1-1: Test parameters for initiation/cease of SLSS transmissions test for E-UTRAN TDD

Parameter	Unit	Value	Comment
E-UTRA RF Channel Number		1	Only one TDD carrier frequency is used.
Channel Bandwidth (BW_{channel})	MHz	5	
Active cell		Cell 1	E-UTRA TDD Cell1 on RF channel number 1
Uplink/Downlink Configuration		Config 0	
Special Subframe Configuration		6	
CP length of Cell 1		Normal	
Layer 3 filtering		Disabled	L3 filtering is not used
drx-Configuration		DRX_P1	As specified in Table A.3.12.2-1
T1	s	3	
T2	s	5.24	
T3	s	5.24	

Table A.8.24.1.1-2: ProSe Direct Discovery configuration for initiation/cease of SLSS transmissions test for E-UTRAN TDD

Parameter	Unit	Value	Comment
E-UTRA RF Channel Number		1	
Channel Bandwidth (BW_{channel})	MHz	5	
ProSe Direct Discovery resource pool configuration		As specified in Table A.3.12.4-3 (Configuration #3)	IE values unless specified otherwise in this test.
networkControlledSyncTx		Not configured	
syncTxThreshIC	dBm/15 kHz	-95	In SIB19

Table A.8.24.2.1-3: Cell specific test parameters for initiation/cease of SLSS transmissions test for E-UTRAN TDD

Parameter	Unit	Cell 1		
		T1	T2	T3
E-UTRA RF Channel Number		1		
BW_{channel}	MHz	5		
OCNG Pattern (defined in clause A.3.2)		OP.10 TDD		
PBCH_RA	dB	0		
PBCH_RB				

PSS_RA				
SSS_RA				
PCFICH_RB				
PHICH_RA				
PHICH_RB				
PDCCH_RA				
PDCCH_RB				
PDSCH_RA				
PDSCH_RB				
OCNG_RA ^{Note 1}				
OCNG_RB ^{Note 1}				
N_{oc} ^{Note 2}	dBm/15 kHz		-95	
\hat{E}_s / N_{oc}	dB	4.5	-4.5	4.5
RSRP ^{Note 3}	dBm/15 kHz	-90.5	-99.5	-90.5
SCH_RP ^{Note 3}	dBm/15 kHz	-90.5	-99.5	-90.5
Propagation Condition		AWGN		
Note 1:	OCNG shall be used such that cell is fully allocated and a constant total transmitted power spectral density is achieved for all OFDM symbols.			
Note 2:	Interference from other cells and noise sources not specified in the test is assumed to be constant over subcarriers and time and shall be modelled as AWGN of appropriate power for N_{oc} to be fulfilled.			
Note 3:	RSRP levels have been derived from other parameters for information purposes. They are not settable parameters themselves.			

A.8.24.2.2 Test Requirements

The SLSS transmission initiation delay is defined as the time from the beginning of time period T2 up to the moment when the UE initiates the SLSS transmission.

The SLSS transmission initiation delay shall be less than 2.24 s.

The SLSS transmission cease delay is defined as the time from the beginning of time period T3 up to the moment when the UE ceases the SLSS transmission.

The SLSS transmission cease delay shall be less than 2.24 s.

The rate of correct initiation/cease delay of SLSS transmissions observed during repeated tests shall be at least 90%.

NOTE: The initiation/cease delay of SLSS transmissions can be expressed as: $T_{\text{evaluate,SLSS}} + \text{discPeriod}$,

Where:

$T_{\text{evaluate,SLSS}}$ is the evaluation time for initiate/cease of SLSS, and is 1.92 sec (see Table 8.10.2.1-1 in clause 8.10.2.1) for the parameters in this test;

discPeriod is the discovery period (set as 320ms in this test).

A.8.24.3 E-UTRAN FDD - Initiation/Cease of SLSS Transmission with ProSe Direct Communication

The purpose of this test is to verify that the ProSe UE meets the requirements related to the maximum evaluation time allowed to initiate and cease SLSS transmissions defined in clause 8.10.2.2. This test is applicable for a UE capable of ProSe Direct Communication. In the test the UE under test is configured for ProSe operation only on PCell and also the UE is configured only for PCell for WAN.

For this test, the UE is triggered by the test loop function or the upper layers to transmit for ProSe Direct Communication.

The test parameters are given in Table A.8.24.3.1-1, Table A.8.24.3.1-2 and Table A.8.24.3.1-3 below. There is one active cell (PCell) in this test. The test consists of three successive time periods, with time duration of T1, T2 and T3 respectively. During T1, the RSRP of the PCell is above syncTxThreshIC and the UE is not expected to be transmitting SLSS. During T2, the RSRP of the PCell is lowered below syncTxThreshIC and the UE is expected to initiate SLSS transmissions. During T3, the RSRP of the PCell is increased back to be above syncTxThreshIC and the UE is expected to cease SLSS transmissions.

A.8.24.3.1 Test Purpose and Environment

Table A.8.24.3.1-1: Test parameters for initiation/cease of SLSS transmissions test for E-UTRAN FDD

Parameter	Unit	Value	Comment
E-UTRA RF Channel Number		1	Only one FDD carrier frequency is used.
Channel Bandwidth (BW_{channel})	MHz	5 or 10	According to principle defined in clause A.3.12.3
Active cell		Cell 1	E-UTRA FDD Cell1 on RF channel number 1
CP length of Cell 1		Normal	
Layer 3 filtering		Disabled	L3 filtering is not used
drx-Configuration		DRX_P1	As specified in Table A.3.12.2-1
T1	s	3	
T2	s	5.24	
T3	s	5.24	

Table A.8.24.3.1-2: ProSe Direct Communication configuration for initiation/cease of SLSS transmissions test for E-UTRAN FDD

Parameter	Unit	Value	Comment
E-UTRA RF Channel Number		1	UL carrier frequency
Channel Bandwidth (BW_{channel})	MHz	5 or 10	According to principle defined in clause A.3.12.3
ProSe Direct Communication configuration		As specified in Table A.3.12.5-1 (Configuration #1)	IE values unless specified otherwise in this test.
networkControlledSyncTx		Not configured	
syncTxThreshIC	dBm/15 kHz	-95	In SIB18

Table A.8.24.3.1-3: Cell specific test parameters for initiation/cease of SLSS transmissions test for E-UTRAN FDD

Parameter	Unit	Cell 1		
		T1	T2	T3
E-UTRA RF Channel Number		1		
BW_{channel} ^{Note 4}	MHz	5 or 10		
OCNG Patterns defined in A.3.2.1.2 ^{Note 4}		5MHz: OP.16 FDD 10 MHz: OP.2 FDD		
PBCH_RA	dB	0		
PBCH_RB				
PSS_RA				
SSS_RA				
PCFICH_RB				
PHICH_RA				
PHICH_RB				
PDCCH_RA				
PDCCH_RB				
PDSCH_RA				
PDSCH_RB				
OCNG_RA ^{Note 1}				
OCNG_RB ^{Note 1}				
N_{oc} ^{Note 2}	dBm/15 kHz	-95		
\hat{E}_s / N_{oc}	dB	4.5	-4.5	4.5
RSRP ^{Note 3}	dBm/15 kHz	-90.5	-99.5	-90.5
SCH_RP ^{Note 3}	dBm/15 kHz	-90.5	-99.5	-90.5
Propagation Condition		AWGN		

Note 1:	OCNG shall be used such that cell is fully allocated and a constant total transmitted power spectral density is achieved for all OFDM symbols.
Note 2:	Interference from other cells and noise sources not specified in the test is assumed to be constant over subcarriers and time and shall be modelled as AWGN of appropriate power for N_{oc} to be fulfilled.
Note 3:	RSRP levels have been derived from other parameters for information purposes. They are not settable parameters themselves.
Note 4:	This test is according to the principle defined in section A.3.12.3.

A.8.24.3.2 Test Requirements

The SLSS transmission initiation delay is defined as the time from the beginning of time period T2 up to the moment when the UE initiates the SLSS transmission.

The SLSS transmission initiation delay shall be less than 1.96 s.

The SLSS transmission cease delay is defined as the time from the beginning of time period T3 up to the moment when the UE ceases the SLSS transmission.

The SLSS transmission cease delay shall be less than 1.96 s.

The rate of correct initiation/cease delay of SLSS transmissions observed during repeated tests shall be at least 90%.

NOTE: The initiation/cease delay of SLSS transmissions can be expressed as: $T_{\text{evaluate,SLSS}} + \text{SLSS period}$,

Where:

$T_{\text{evaluate,SLSS}}$ is the evaluation time for initiate/cease of SLSS, and is 1.92 sec (see Table 8.10.2.1-1 in clause 8.10.2.1) for the parameters in this test;

SLSS period is set to 40ms.

A.8.25 E-UTRAN-WLAN Measurements

A.8.25.1 E-UTRAN FDD-WLAN Event Triggered Reporting in non-DRX under AWGN

A.8.25.1.1 Test Purpose and Environment

The purpose of this test is to verify that the UE correctly detects event W1 (WLAN becomes better than a threshold) for unknown cell (unknown neighbour AP) and event W3 (All WLAN inside WLAN mobility set becomes worse than a threshold) for known cell (serving AP) defined in TS 36.331 [2] within the requirements stated in clause 8.1.2.4.19.

The test parameters are given in Tables A.8.25.1.1-1 and A.8.25.1.1-2 below. In the tests there are two cells, cell1 (E-UTRAN FDD) and cell2 (WLAN AP). It is indicated to the UE in the measurement control information that event-triggered reporting with Events W1 (for cell2) and W3 (for cell2) are used. The test consists of three successive time periods, with duration of T1, T2 and T3, respectively. During T1 the UE shall not have any information on cell1. At the beginning of T2 the transmission power of cell 2 is increased to a level, which shall result in reporting of Event W1. At the beginning of T3 the transmission power of cell 2 is decreased to a level, which shall result in reporting of Event W3.

Table A.8.25.1.1-1: General test parameters for E-UTRAN FDD-WLAN event triggered reporting under AWGN in non-DRX

Parameter	Unit	Value	Comment
Active cell		Cell 1	Cell 1 is on E-UTRA RF channel number 1.
Neighbour cell		Cell 2 (AP)	Cell 2 (WLAN AP) is on WLAN RF channel number 1.
CP length		Normal	Applicable to cell 1
E-UTRA RF Channel Number		1	One E-UTRA FDD carrier frequency is used.
WLAN Channel Number		1	One WLAN carrier frequency is used.
WLAN measurement quantity		WLAN RSSI	
WLAN beacon frame transmission period	ms	102.5	
DRX		OFF	
W1 Hysteresis	dB	0	Hysteresis for evaluation of event W1.

	Threshold WLAN RSSI	dBm	-70	Actual WLAN RSSI threshold for event W1. Needs to take absolute accuracy tolerance in section 9.7.1 into account plus margin.
	Time To Trigger	s	0	
W3	Hysteresis	dB	0	Hysteresis for evaluation of event W3.
	Threshold WLAN RSSI	dBm	-65	Actual WLAN RSSI threshold for event W3. Needs to take absolute accuracy tolerance in section 9.7.1 into account plus margin.
	Time To Trigger	s	0	
T1		s	5	During this time the cell1 shall be known to the UE; but cell2 shall be unknown to the UE.
T2		s	≤ 40	UE should report Event W1 for cell2 within 30 s.
T3		s	3	UE should report Event W3 for cell2 within 0.5 s.

Table A.8.25.1.1-2: Cell specific test parameters for E-UTRAN FDD-WLAN event triggered reporting under AWGN in non-DRX

Parameter	Unit	Cell 1			Cell 2 (WLAN AP)		
		T1	T2	T3	T1	T2	T3
E-UTRA RF Channel Number		1			N/A		
WLAN RF channel Number		N/A			1		
$BW_{channel}$		10MHz			20 MHz		
PDSCH parameters: DL Reference Measurement Channel		R.0 FDD			N/A		
PCFICH/PDCCH/PHICH parameters: DL Reference Measurement Channel		R.6 FDD			N/A		
OCNG Patterns		OP.1 FDD			N/A		
PBCH_RA	dB	0			N/A		
PBCH_RB	dB						
PSS_RA	dB						
SSS_RA	dB						
PCFICH_RB	dB						
PHICH_RA	dB						
PHICH_RB	dB						
PDCCH_RA	dB						
PDCCH_RB	dB						
PDSCH_RA	dB						
PDSCH_RB	dB						
OCNG_RA ^{Note 1}	dB						
OCNG_RB ^{Note 1}	dB						
N_{oc1} ^{Note 2}	dBm/15 KHz						
N_{oc2} ^{Note 3}	dBm/20 MHz	N/A			-75		
\hat{E}_s/N_{oc1}	dB	3	3	3	N/A		
\hat{E}_s/I_{ot} ^{Note 4}	dB	3	3	3			
RSRP ^{Note 4}	dBm/15 kHz	-95	-95	-95			
SCH_RP ^{Note 4}	dBm/15 kHz	-95	-95	-95			
I_o ^{Note 3}	dBm/Ch BW	-65.5	-65.5	-65.5			
WLAN RSSI ^{Note 4}	dBm/20 MHz				-infinity	-65	-70
WLAN SNR	dB				-infinity	9.54	3.35
Propagation Condition		AWGN			AWGN		
Antenna Configuration		1x2			-		
Timing offset to Cell 1	ms	0			3		
<p>Note 1: OCNG shall be used such that all cells are fully allocated and a constant total transmitted power spectral density is achieved for all OFDM symbols.</p> <p>Note 2: Interference from other cells and noise sources not specified in the test is assumed to be constant over subcarriers and time and shall be modelled as AWGN of appropriate power for N_{oc1} to be fulfilled.</p> <p>Note 3: Interference from other cells and noise sources not specified in the test is assumed to be constant over the bandwidth and time and shall be modelled as AWGN of appropriate power for N_{oc2} to be fulfilled.</p> <p>Note 4: \hat{E}_s/I_{ot}, RSRP, SCH_RP, I_o and WLAN RSSI have been derived from other parameters for information purposes. They are not settable parameters themselves.</p> <p>Note 5: The resources for uplink transmission are assigned to the UE prior to the start of time period T2.</p>							

A.8.25.1.2 Test Requirements

The UE shall send one Event W1 triggered measurement report, with a measurement reporting delay less than 30 seconds from the beginning of time period T2.

The UE shall send one Event W3 triggered measurement report, with a measurement reporting delay less than 500 ms from the beginning of time period T3.

The UE shall not send event triggered measurement reports as long as the reporting criteria are not fulfilled.

The rate of correct events observed during repeated tests shall be at least 90% for each of the events.

NOTE: The actual overall delays measured in the tests may be up to $2 \times TTI_{DCCH}$ higher than the measurement reporting delays above because of TTI insertion uncertainty of the measurement report in DCCH.

A.8.25.2 E-UTRAN TDD-WLAN Event Triggered Reporting in non-DRX under AWGN

A.8.25.2.1 Test Purpose and Environment

The purpose of this test is to verify that the UE correctly detects event W1 (WLAN becomes better than a threshold) for unknown cell (unknown neighbour AP) and event W3 (All WLAN inside WLAN mobility set becomes worse than a threshold) for known cell (serving AP) defined in TS 36.331 [2] within the requirements stated in clause 8.1.2.4.19.

The test parameters are given in Tables A.8.25.2.1-1 and A.8.25.2.1-2 below. In the tests there are two cells, cell1 (E-UTRAN TDD) and cell2 (WLAN AP). It is indicated to the UE in the measurement control information that event-triggered reporting with Events W1 (for cell2) and W3 (for cell2) are used. The test consists of three successive time periods, with duration of T1, T2 and T3, respectively. During T1 the UE shall not have any information on cell1. At the beginning of T2 the transmission power of cell 2 is increased to a level, which shall result in reporting of Event W1. At the beginning of T3 the transmission power of cell 2 is decreased to a level, which shall result in reporting of Event W3.

Table A.8.25.2.1-1: General test parameters for E-UTRAN TDD-WLAN event triggered reporting under AWGN in non-DRX

Parameter		Unit	Value	Comment
Active cell			Cell 1	Cell 1 is on E-UTRA RF channel number 1.
Neighbour cell			Cell 2 (AP)	Cell 2 (WLAN AP) is on WLAN RF channel number 1.
CP length			Normal	Applicable to cell 1
E-UTRA RF Channel Number			1	One E-UTRA TDD carrier frequency is used.
WLAN Channel Number			1	One WLAN carrier frequency is used.
WLAN measurement quantity			WLAN RSSI	
WLAN beacon frame transmission period		ms	102.5	
DRX			OFF	
Special subframe configuration			6	As specified in table 4.2-1 in TS 36.211 [16]. The same configuration applies to all cells.
Uplink-downlink configuration			1	As specified in table 4.2-2 in TS 36.211 [16]. The same configuration applies to all cells
W1	Hysteresis	dB	0	Hysteresis for evaluation of event W1.
	Threshold WLAN RSSI	dBm	-70	Actual WLAN RSSI threshold for event W1. Needs to take absolute accuracy tolerance in section 9.7.1 into account plus margin.
	Time To Trigger	s	0	
W3	Hysteresis	dB	0	Hysteresis for evaluation of event W3.
	Threshold WLAN RSSI	dBm	-65	Actual WLAN RSSI threshold for event W3. Needs to take absolute accuracy tolerance in section 9.7.1 into account plus margin.
	Time To Trigger	s	0	
T1		s	5	During this time the cell1 shall be known to the UE; but cell2 shall be unknown to the UE.
T2		s	≤ 40	UE should report Event W1 for cell2 within 30 s.
T3		s	3	UE should report Event W3 for cell2 within 0.5 s.

Table A.8.25.2.1-2: Cell specific test parameters for E-UTRAN TDD-WLAN event triggered reporting under AWGN in non-DRX

Parameter	Unit	Cell 1			Cell 2 (WLAN AP)		
		T1	T2	T3	T1	T2	T3
E-UTRA RF Channel Number		1			N/A		
WLAN RF channel Number		N/A			1		
$BW_{channel}$		10MHz			20 MHz		
PDSCH parameters: DL Reference Measurement Channel		R.0 TDD			N/A		
PCFICH/PDCCH/PHICH parameters: DL Reference Measurement Channel		R.6 TDD			N/A		
OCNG Patterns		OP.1 TDD			N/A		
PBCH_RA	dB	0			N/A		
PBCH_RB	dB						
PSS_RA	dB						
SSS_RA	dB						
PCFICH_RB	dB						
PHICH_RA	dB						
PHICH_RB	dB						
PDCCH_RA	dB						
PDCCH_RB	dB						
PDSCH_RA	dB						
PDSCH_RB	dB						
OCNG_RA ^{Note 1}	dB						
OCNG_RB ^{Note 1}	dB						
N_{oc1} ^{Note 2}	dBm/15 KHz						
N_{oc2} ^{Note 3}	dBm/20 MHz	N/A			-75		
\hat{E}_s/N_{oc1}	dB	3	3	3	N/A		
\hat{E}_s/I_{ot} ^{Note 4}	dB	3	3	3			
RSRP ^{Note 4}	dBm/15 kHz	-95	-95	-95			
SCH_RP ^{Note 4}	dBm/15 kHz	-95	-95	-95			
I_o ^{Note 3}	dBm/Ch BW	-65.5	-65.5	-65.5			
WLAN RSSI ^{Note 4}	dBm/20 MHz	N/A	N/A	N/A	-infinity	-65	-70
WLAN SNR	dB	N/A	N/A	N/A	-infinity	9.54	3.35
Propagation Condition		AWGN			AWGN		
Antenna Configuration		1x2			-		
Timing offset to Cell 1	ms	0			3		
<p>Note 1: OCNG shall be used such that all cells are fully allocated and a constant total transmitted power spectral density is achieved for all OFDM symbols.</p> <p>Note 2: Interference from other cells and noise sources not specified in the test is assumed to be constant over subcarriers and time and shall be modelled as AWGN of appropriate power for N_{oc1} to be fulfilled.</p> <p>Note 3: Interference from other cells and noise sources not specified in the test is assumed to be constant over the bandwidth and time and shall be modelled as AWGN of appropriate power for N_{oc2} to be fulfilled.</p> <p>Note 4: \hat{E}_s/I_{ot}, RSRP, SCH_RP, I_o and WLAN RSSI have been derived from other parameters for information purposes. They are not settable parameters themselves.</p> <p>Note 5: The resources for uplink transmission are assigned to the UE prior to the start of time period T2.</p>							

A.8.25.2.2 Test Requirements

The UE shall send one Event W1 triggered measurement report, with a measurement reporting delay less than 30 seconds from the beginning of time period T2.

The UE shall send one Event W3 triggered measurement report, with a measurement reporting delay less than 500 ms from the beginning of time period T3.

The UE shall not send event triggered measurement reports as long as the reporting criteria are not fulfilled.

The rate of correct events observed during repeated tests shall be at least 90% for each of the events.

NOTE: The actual overall delays measured in the tests may be up to $2 \times TTI_{DCCH}$ higher than the measurement reporting delays above because of TTI insertion uncertainty of the measurement report in DCCH.

A.8.26 Frame Structure 3 (FS3)

A.8.26.1 E-UTRAN FDD-FS3 Activation and deactivation of known FS3 SCell with FDD PCell in non-DRX

A.8.26.1.1 Test Purpose and Environment

The purpose of this test is to verify that the LAA SCell activation and deactivation times are within the requirements stated in section 7.7, when the SCell is known by the UE at the time of activation.

The test parameters are given in Tables A.8.26.1.1-1 and cell-specific parameters in A.8.26.1.1-2 below. In the test there are two cells: Cell1 and Cell2. Cell1 is PCell on the FDD primary component (RF Channel 1), Cell2 is deactivated SCell on the secondary component (RF Channel 2) for frame structure 3. Cell 1 has constant signal levels throughout the test, and Cell 2 transmits discovery signal with LBT model.

The test consists of three successive time periods, with duration of T1, T2 and T3, respectively. Before the test starts the UE is connected to Cell1 on radio channel 1 (PCC) but is not aware of Cell 2 on radio channel 2. The UE is only monitoring the PCC. The UE shall be continuously scheduled in the PCell throughout the whole test.

At the beginning of T1 the UE receives an RRC message by which the SCell (Cell 2) becomes configured on radio channel 2 (SCC). The UE now starts monitoring also the SCC. The test equipment sends a MAC message for activation of the SCell.

The point in time at which the MAC message is received at the UE antenna connector, in a subframe # denoted m which is an even number, defines the start of time period T2. The UE shall be able to report valid CSI for the activated SCell at latest in subframe $m + T_{\text{activate_basic_FS3}}$, where $T_{\text{activate_basic_FS3}}$ is specified in section 7.7.10. The UE shall start reporting CSI in subframe (m+8) and shall report CQI index 0 (out-of-range) until the SCell activation has been completed. Any PCell interruption due to activation of SCell shall occur in the subframes (m+5) to (m+9).

Time period T3 starts when a MAC message for deactivation of SCell, sent from the test equipment to the UE in a subframe # denoted n, is received at the UE antenna connector. The UE shall carry out deactivation of the SCell in a subframe (n+8), and any PCell interruption due to the deactivation shall occur in the subframes (n+5) to (n+9).

The test equipment verifies that potential interruption is carried out in the correct time span by monitoring ACK/NACK sent in PCell during activation and deactivation of SCell, respectively.

The test equipment verifies the activation time by counting the subframes from the time when the SCell activation command is sent until a CSI report with other than CQI index 0 is received.

The test equipment verifies the deactivation time by counting the subframes from the time when the SCell deactivation command is sent until CQI reporting for SCell is discontinued.

Table A.8.26.1.1-1: General test parameters for known LAA SCell activation case

Parameter	Unit	Value	Comment
E-UTRA RF Channel Number		1, 2	Two radio channels are used for this test
Active PCell		Cell 1	Primary cell on RF channel number 1.

Configured deactivated LAA FS3 SCell		Cell 2	Configured deactivated secondary cell on RF channel number 2.
CP length		Normal	
DRX		OFF	Continuous monitoring of primary cell
CQI/PMI periodicity and offset configuration index		0	CQI reporting for SCell every second subframe
Discovery signal occasion duration	ms	1	As specified in IE MeasDS-Config in TS 36.331
SCell measurement cycle (measCycleSCell)	ms	320	
DMTC period	ms	40	As specified in IE MeasDS-Config in TS 36.331
dmtc-PeriodOffset		10	As specified in IE MeasDS-Config in TS 36.331
laa-SCellSubframeConfig		00000000	No MBSFN subframe.
T1	s	7	During this time the PCell shall be known and the SCell configured and detected.
T2	s	> T _{activate_basic_FS3}	During this time the UE shall activate the SCell, T _{activate_basic_FS3} is specified in section 7.7.10.
T3	s	1	During this time the UE shall deactivate the SCell.

Table A.8.26.1.1-2: Cell specific test parameters for E-UTRAN FDD known LAA SCell activation

Parameter	Unit	Cell 1			Cell 2		
		T1	T2	T3	T1	T2	T3
E-UTRA RF Channel Number		1			2		
BW _{channel}	MHz	5MHz: N _{RB,c} = 25 10MHz: N _{RB,c} = 50 20MHz: N _{RB,c} = 100			20		
LBT model		-			A.3.17		
PDSCH parameters defined in A.3.1.1.1		5MHz: R.7 FDD 10MHz: R.3 FDD 20MHz: R.6 FDD			-		
PCFICH/PDCCH/PHICH parameters defined in A.3.1.2.1		5MHz: R.11 FDD 10MHz: R.6 FDD 20MHz: R.10 FDD			-		
OCNG Patterns defined in A.3.2.1		5MHz: OP.20 FDD 10MHz: OP.10 FDD 20MHz: OP.17 FDD			OP.14 FDD		
PBCH_RA	dB	0			0		
PBCH_RB	dB						
PSS_RA	dB						
SSS_RA	dB						
PCFICH_RB	dB						
PHICH_RA	dB						
PHICH_RB	dB						
PDCCH_RA	dB						
PDCCH_RB	dB						
PDSCH_RA	dB						
PDSCH_RB	dB						
OCNG_RA ^{Note 1}	dB						
OCNG_RB ^{Note 1}	dB						
N _{oc} ^{Note 2}	dBm/15 kHz						
E _s /N _{oc}	dB	17			17		
RSRP ^{Note 3}	dBm/15 kHz	-87			-87		
E _s /I _{ot} ^{Note 3}	dB	17			17		
SCH_RP ^{Note 3}	dBm/15 kHz	-87			-87		
I _o ^{Note3}	dBm/Ch BW	-59.1+10log(N _{RB,c} /50)			-56.1		
Propagation Condition		AWGN			AWGN		
Antenna Configuration		1x2			1x2		
timing offset to cell1	µs	-			0		
Time alignment error relative to cell 1 ^{Note 5}	µs	-			≤ TAE		

Note 1:	OCNG shall be used such that cells are fully allocated and a constant total transmitted power spectral density is achieved for all OFDM symbols. For cells with LBT model, OCNG is transmitted only in subframes with downlink transmission bursts, and is not transmitted during muted subframes or during DMTC windows.
Note 2:	Interference from other cells and noise sources not specified in the test is assumed to be constant over subcarriers and time and shall be modelled as AWGN of appropriate power for N_{oc} to be fulfilled.
Note 3:	E_s/I_{ot} , RSRP, SCH_RP and I_o levels have been derived from other parameters for information purposes. They are not settable parameters themselves.
Note 4:	The uplink resources for CSI reporting are assigned to the UE prior to the start of time period T2.
Note 5:	Time alignment error (TAE) as specified in TS 36.104 [30] clause 6.5.3.1.

A.8.26.1.2 Test Requirements

During T2 the UE shall send the first CSI report for SCell in a subframe (m+8), or in a subframe (m+10) if the subframe (m+8) was subject to interruption. Whether CSI report in subframe (m+8) was interrupted or not is checked by monitoring ACK/NACK sent in PCell in subframe (m+8).

During T2 the UE shall start sending CSI reports for SCell with non-zero CQI index at latest in a subframe (m+ $T_{activate_basic_FS3}$) ms, L is the number of times the discovery signal occasion is not available at the UE during the SCell activation time.

During T3 the UE shall stop sending CSI reports for SCell at latest in a subframe (n+8).

During T2 interruption of PCell during SCell activation shall not happen outside the subframes (m+5) to (m+9).

During T3 interruption of PCell during SCell deactivation shall not happen outside the subframes (n+5) to (n+9).

The interruption of PCell shall not be more than the values specified for intra-band CA and inter-band CA in Section 7.8.2.

All of the above test requirements shall be fulfilled in order for the observed SCell activation delay and SCell deactivation delay to be counted as correct. The rate of correct observed SCell activation delay and SCell deactivation delay during repeated tests shall be at least 90%.

NOTE: During T2 if there are no uplink resources for reporting the valid CSI in a subframe (m+ $T_{activate_basic_FS3}$)ms, L is the number of times the discovery signal occasion is not available at the UE during the SCell activation time, then the UE shall use the next available uplink resource for reporting the corresponding valid CSI.

A.8.26.2 E-UTRAN TDD-FS3 Activation and deactivation of known FS3 SCell with TDD PCell in non-DRX

A.8.26.2.1 Test Purpose and Environment

The purpose of this test is to verify that the LAA SCell activation and deactivation times are within the requirements stated in section 7.7, when the SCell is known by the UE at the time of activation.

The test parameters are given in Tables A.8.26.2.1-1 and cell-specific parameters in A.8.26.2.1-2 below. In the test there are two cells: Cell1 and Cell2. Cell1 is PCell on the TDD primary component (RF Channel 1), Cell2 is deactivated SCell on the secondary component (RF Channel 2) for frame structure 3. Cell 1 has constant signal levels throughout the test, and Cell 2 transmits discovery signal with LBT model.

The test consists of three successive time periods, with duration of T1, T2 and T3, respectively. Before the test starts the UE is connected to Cell1 on radio channel 1 (PCC) but is not aware of Cell 2 on radio channel 2. The UE is only monitoring the PCC. The UE shall be continuously scheduled in the PCell throughout the whole test.

At the beginning of T1 the UE receives an RRC message by which the SCell (Cell 2) becomes configured on radio channel 2 (SCC). The UE now starts monitoring also the SCC. The test equipment sends a MAC message for activation of the SCell.

The point in time at which the MAC message is received at the UE antenna connector, in a subframe # denoted m, where m is 4 or 9, defines the start of time period T2. The UE shall be able to report valid CSI for the activated SCell at latest in subframe m+ $T_{activate_basic_FS3}$, where $T_{activate_basic_FS3}$ is specified in section 7.7.10. The UE shall start reporting

CSI in subframe (m+8) and shall report CQI index 0 (out-of-range) until the SCell activation has been completed. Any PCell interruption due to activation of SCell shall occur in the subframes (m+5) to (m+11).

Time period T3 starts when a MAC message for deactivation of SCell, sent from the test equipment to the UE in a subframe # denoted n, is received at the UE antenna connector. The UE shall carry out deactivation of the SCell and any PCell interruption due to the deactivation shall occur in the subframes (n+5) to (n+11).

The test equipment verifies that potential interruption is carried out in the correct time span by monitoring ACK/NACK sent in PCell during activation and deactivation of SCell, respectively.

The test equipment verifies the activation time by counting the subframes from the time when the SCell activation command is sent until a CSI report with other than CQI index 0 is received.

The test equipment verifies the deactivation time by counting the subframes from the time when the SCell deactivation command is sent until CQI reporting for SCell is discontinued.

Table A.8.26.2.1-1: General test parameters for known LAA SCell activation case

Parameter	Unit	Value	Comment
E-UTRA RF Channel Number		1, 2	Two radio channels are used for this test
Active PCell		Cell 1	Primary cell on RF channel number 1.
Configured deactivated LAA FS3 SCell		Cell 2	Configured deactivated secondary cell on RF channel number 2.
CP length		Normal	
DRX		OFF	Continuous monitoring of primary cell
CQI/PMI periodicity and offset configuration index		0	CQI reporting for SCell every UL subframe
Discovery signal occasion duration	ms	1	As specified in IE MeasDS-Config in TS 36.331
SCell measurement cycle (measCycleSCell)	ms	320	
DMTC period	ms	40	As specified in IE MeasDS-Config in TS 36.331
dmtc-PeriodOffset		10	As specified in IE MeasDS-Config in TS 36.331
laa-SCellConfiguration		00000000	No MBSFN subframe.
T1	s	7	During this time the PCell shall be known and the SCell configured and detected.
T2	s	> T _{activate_basic_FS3}	During this time the UE shall activate the SCell.
T3	s	1	During this time the UE shall deactivate the SCell.

Table A.8.26.2.1-2: Cell specific test parameters for E-UTRAN TDD known LAA SCell activation

Parameter	Unit	Cell 1			Cell 2		
		T1	T2	T3	T1	T2	T3
E-UTRA RF Channel Number		1			2		
BW _{channel}	MHz	5MHz: N _{RB,c} = 25 10MHz: N _{RB,c} = 50 20MHz: N _{RB,c} = 100			20		
Uplink-downlink configuration ^{Note1}		1			-		
Special subframe configuration ^{Note2}		6			-		
LBT model		-			A.3.17		
PDSCH parameters defined in A.3.1.1.2		5MHz: R.4 TDD 10MHz: R.0 TDD 20MHz: R.3 TDD			-		
PCFICH/PDCCH/PHICH parameters defined in A.3.1.2.2		5MHz: R.11 TDD 10MHz: R.6 TDD 20MHz: R.10 TDD			-		
OCNG Patterns defined in A.3.2.1 and A.3.2.2.		5MHz: OP.9 TDD 10MHz: OP.1 TDD 20MHz: OP.7 TDD			OP.14 FDD		
PBCH_RA	dB	0			0		
PBCH_RB	dB						
PSS_RA	dB						
SSS_RA	dB						
PCFICH_RB	dB						
PHICH_RA	dB						

PHICH_RB	dB		
PDCCH_RA	dB		
PDCCH_RB	dB		
PDSCH_RA	dB		
PDSCH_RB	dB		
OCNG_RA ^{Note 3}	dB		
OCNG_RB ^{Note 3}	dB		
N_{oc} ^{Note 4}	dBm/15 kHz	-104	-104
\bar{E}_s/N_{oc}	dB	17	17
RSRP ^{Note 5}	dBm/15 kHz	-87	-87
\bar{E}_s/I_{ot} ^{Note 5}	dB	17	17
SCH_RP ^{Note 5}	dBm/15 kHz	-87	-87
I_o ^{Note 5}	dBm/Ch BW	$-59.1+10\log(N_{RB,c}/50)$	-56.1
Propagation Condition		AWGN	AWGN
Antenna Configuration		1x2	1x2
timing offset to cell1	μ s	-	0
Time alignment error relative to cell 1 ^{Note 7}	μ s	-	\leq TAE
<p>Note 1: For the uplink-downlink configuration see table 4.2-2 in TS 36.211.</p> <p>Note 2: For the special subframe configuration see table 4.2-1 in TS 36.211.</p> <p>Note 3: OCNG shall be used such that cells are fully allocated and a constant total transmitted power spectral density is achieved for all OFDM symbols. For cells with LBT model, OCNG is transmitted only in subframes with downlink transmission bursts, and is not transmitted during muted subframes or during DMTC windows.</p> <p>Note 4: Interference from other cells and noise sources not specified in the test is assumed to be constant over subcarriers and time and shall be modelled as AWGN of appropriate power for N_{oc} to be fulfilled.</p> <p>Note 5: \bar{E}_s/I_{ot}, RSRP, SCH_RP and I_o levels have been derived from other parameters for information purposes. They are not settable parameters themselves.</p> <p>Note 6: The uplink resources for CSI reporting are assigned to the UE prior to the start of time period T2.</p> <p>Note 7: Time alignment error (TAE) as specified in TS 36.104 [30] clause 6.5.3.1.</p>			

A.8.26.2.2 Test Requirements

During T2 the UE shall send the first CSI report for SCell in a subframe (m+8), or in a subframe (m+9) if the subframe (m+8) was subject to interruption, or in a subframe (m+13) if the subframes (m+8) and (m+9) were subject to interruption when an intra-band SCell is activated. Whether first CSI report was interrupted or not is checked by monitoring ACK/NACK sent in PCell at the same time as the first CSI report.

During T2 the UE shall start sending CSI reports for SCell with non-zero CQI index at latest in a subframe (m+ $T_{activate_basic_FS3}$)ms, L is the number of times the discovery signal occasion is not available at the UE during the SCell activation time.

During T3 the UE shall stop sending CSI reports for SCell at latest in a subframe (m+8).

During T2 interruption of PCell during SCell activation shall not happen outside the subframes (m+5) to (m+11).

During T3 interruption of PCell during SCell deactivation shall not happen outside the subframes (n+5) to (n+11).

The interruption of PCell shall not be more than the values specified for intra-band CA and inter-band CA in Section 7.8.2.

All of the above test requirements shall be fulfilled in order for the observed SCell activation delay and SCell deactivation delay to be counted as correct. The rate of correct observed SCell activation delay and SCell deactivation delay during repeated tests shall be at least 90%.

NOTE: During T2 if there are no uplink resources for reporting the valid CSI in a subframe (m+ $T_{activate_basic_FS3}$)ms, L is the number of times the discovery signal occasion is not available at the UE during the SCell activation time, then the UE shall use the next available uplink resource for reporting the corresponding valid CSI.

A.8.26.3 E-UTRAN FDD-FS3 Event triggered reporting on deactivated FS3 SCell and FDD PCell interruption in non-DRX

A.8.26.3.1 Test Purpose and Environment

The purpose of this test is to verify that the UE correctly detects event A6 (Neighbour becomes better than SCell) defined in TS 36.331 [2] within the requirements stated in clause 8.12.2.4 while at the same time fulfilling the requirement on interruption rate. This test is applicable to UEs that support a maximum of 1 FS3 SCell, ie UEs that support a maximum of 2, 3, or 4 FS3 SCells are not required to pass this test.

The test parameters are given in Table A.8.26.3.1-1 and A.8.26.3.1-2. It is indicated to the UE in the measurement control information that event-triggered reporting with Event A6 is used.

In the test there are three synchronous cells: Cell1, Cell2 and Cell3. Cell1 is PCell on the FDD primary component (RF Channel 1), Cell2 is deactivated SCell on the secondary component (RF Channel 2) for frame structure 3, and Cell3 is the neighbour cell on the secondary component (RF Channel 3) for frame structure 3. Cell 2 and Cell 3 transmit discovery signal in every discovery signal occasion.

The test consists of two successive time periods, with duration of T1 and T2, respectively. During T1 the UE shall not have any information of cell 3. Immediately at beginning of T2 the transmission power of cell 3 is increased to same level as for cell 2, and due to usage of an offset this shall result in reporting of Event A6. PCell is indicated by the network using IE allowInterruptions and PDCCH indicating a new transmission on the PCell shall be sent continuously to ensure that the UE sends ACK/ NACKs throughout the test.

Table A.8.26.3.1-1: General test parameters for Event triggered reporting on LAA deactivated SCell with E-UTRAN FDD PCell interruption in non-DRX

Parameter		Unit	Value	Comment
E-UTRA RF Channel Number			1, 2	Two radio channels are used for this test
Active PCell			Cell 1	Primary cell on RF channel number 1.
Configured deactivated SCell			Cell 2	Configured deactivated secondary cell on RF channel number 2 for frame structure 3.
Neighbour cell			Cell 3	Neighbor cell to be identified on RF channel number 2 for frame structure 3.
CP length			Normal	
DRX			OFF	Continuous monitoring of primary cell
A6	Hysteresis	dB	0	Hysteresis for evaluation of event A6.
	Offset	dB	-3	Offset parameter for evaluation of event A6. Needs to take relative accuracy tolerance in clause 9.1.18.2 into account plus margin.
	Report on leave		False	
	Time To Trigger	s	0	
Discovery signal occasion duration		ms	1	As specified in IE MeasDS-Config in TS 36.331
Filter coefficient			0	L3 filtering is not used
SCell measurement cycle		ms	160	<i>measCycleSCell</i> as specified in TS 36.331
DMTC period		ms	40	As specified in IE MeasDS-Config in TS 36.331
dmtc-PeriodOffset			10	As specified in IE MeasDS-Config in TS 36.331
subframeStartPosition			s0	Discovery signal starts from subframe #0
laa-SCellSubframeConfig			00000000	No MBSFN subframe.
T1		s	5	During this time the UE shall be aware of cells 1 and 2 but not cell 3.
T2		s	≤5	UE should report Event A6 within 4 s (25×measCycleSCell)

Table A.8.26.3.1-2: Cell specific test parameters for Event triggered reporting on LAA deactivated SCell with E-UTRAN FDD PCell interruption in non-DRX

Parameter	Unit	Cell 1		Cell 2		Cell 3	
		T1	T2	T1	T2	T1	T2
E-UTRA RF Channel Number		1		2		2	
BW _{channel}	MHz	5MHz: N _{RB,c} = 25 10MHz: N _{RB,c} = 50		20		20	

		20MHz: $N_{RB,c} = 100$					
Measurement bandwidth	n_{PRB}	5MHz: 10-15 10MHz: 22-27 20MHz: 47-52		47-52		47-52	
PDSCH parameters defined in A.3.1.1.1		5MHz: R.7 FDD 10MHz: R.3 FDD 20MHz: R.6 FDD		-		-	
PCFICH/PDCCH/PHICH parameters defined in A.3.1.2.1		5MHz: R.11 FDD 10MHz: R.6 FDD 20MHz: R.10 FDD		-		-	
OCNG Patterns defined in A.3.2.1		5MHz: OP.20 FDD 10MHz: OP.10 FDD 20MHz: OP.17 FDD		OP.14 FDD		OP.14 FDD	
IE allowInterruptions		True		-		-	
PBCH_RA	dB	0		0		0	
PBCH_RB	dB						
PSS_RA	dB						
SSS_RA	dB						
PCFICH_RB	dB						
PHICH_RA	dB						
PHICH_RB	dB						
PDCCH_RA	dB						
PDCCH_RB	dB						
PDSCH_RA	dB						
PDSCH_RB	dB						
OCNG_RA ^{Note 1}	dB						
OCNG_RB ^{Note 1}	dB						
N_{oc} ^{Note 3}	dBm/15 kHz	-98		-98			
\hat{E}_s / N_{oc}	dB	13	13	13	13	-Infinity	13
RSRP ^{Note 4}	dBm/15 kHz	-85	-85	-85	-85	-Infinity	-85
\hat{E}_s / I_{ot} ^{Note 4}	dB	13	13	13	-0.21	-Infinity	-0.21
SCH_RP ^{Note 4}	dBm/15 kHz	-85	-85	-85	-85	-Infinity	-85
I_o ^{Note 4}	dBm/Ch BW	$-57.01 + 10 \log(N_{RB,c} / 50)$		-54.00	-51.09	Specified in columns for Cell 2	
Propagation Condition		AWGN		AWGN		AWGN	
Antenna Configuration		1x2		1x2		1x2	
timing offset to cell1	μ s	-		0		0	
timing offset to cell2	μ s	-		-		0	
Time alignment error relative to cell 1 ^{Note 5}	μ s	-		\leq TAE		\leq TAE	
Time alignment error relative to cell 2 ^{Note 5}	μ s	-		-		\leq TAE	
<p>Note 1: OCNG shall be used such that all cells are fully allocated and a constant total transmitted power spectral density is achieved for all OFDM symbols.</p> <p>Note 2: The resources for uplink transmission are assigned to the UE prior to the start of time period T2.</p> <p>Note 3: Interference from other cells and noise sources not specified in the test is assumed to be constant over subcarriers and time and shall be modelled as AWGN of appropriate power for N_{oc} to be fulfilled.</p> <p>Note 4: E_s/I_{ot}, RSRP, SCH_RP and I_o levels have been derived from other parameters for information purposes. They are not settable parameters themselves.</p> <p>Note 5: Time alignment error (TAE) as specified in TS 36.104 [30] clause 6.5.3.1.</p>							

A.8.26.3.2 Test Requirements

The UE shall send one Event A6 triggered measurement report, with a measurement reporting delay less than 4s from the beginning of time period T2.

The UE shall not send event triggered measurement reports, as long as the reporting criteria are not fulfilled.

The UE shall be scheduled on PCell continuously throughout the test. From the start of T1 until the measurement report is received during T2, at least 99.5% of all expected ACK/NACKs shall be transmitted by the UE.

For a test to be considered successful requirements on both event detection and percentage of transmitted ACK/NACKs have to be fulfilled simultaneously.

The rate of correct events observed during repeated tests shall be at least 90%.

NOTE: The actual overall delays measured in the test may be up to $2 \times TTI_{DCCH}$ higher than the measurement reporting delays above because of TTI insertion uncertainty of the measurement report in DCCH.

A.8.26.3A E-UTRAN FDD-TDD 3DL Event triggered reporting on deactivated FS3 SCell and FDD PCell interruption in non-DRX

A.8.26.3A.1 Test Purpose and Environment

The purpose of this test is to verify that the UE correctly detects event A6 (Neighbour becomes better than SCell) defined in TS 36.331 [2] within the requirements stated in clause 8.12.2.4 while at the same time fulfilling the requirement on interruption rate. This test is applicable to UEs that support a 2, 3 or 4 FS3 SCells, ie UEs that support a maximum of 1 FS3 SCell are not required to pass this test.

The test parameters are given in Table A.8.26.3A.1-1 and A.8.26.3A.1-2. It is indicated to the UE in the measurement control information that event-triggered reporting with Event A6 is used.

In the test there are three synchronous cells: Cell1, Cell2, Cell3 and Cell4. Cell1 is PCell on the FDD primary component (RF Channel 1), Cell2 is activated SCell on the secondary component (RF Channel 2) for frame structure 3, Cell3 is deactivated SCell on the secondary component (RF Channel 3) for frame structure 3, and Cell4 is the neighbour cell on the secondary component (RF Channel 3) for frame structure 3. Cell 2, Cell 3 and Cell 4 transmit discovery signal in every discovery signal occasion.

The test consists of two successive time periods, with duration of T1 and T2, respectively. During T1 the UE shall not have any information of cell 4. Immediately at beginning of T2 the transmission power of cell 4 is increased to same level as for cell 3, and due to usage of an offset this shall result in reporting of Event A6. PCell is indicated by the network using IE allowInterruptions and PDCCH indicating a new transmission on the PCell shall be sent continuously to ensure that the UE sends ACK/ NACKs throughout the test.

Table A.8.26.3A.1-1: General test parameters for FDD-TDD 3DL Event triggered reporting on LAA deactivated SCell with E-UTRAN FDD PCell interruption in non-DRX

Parameter		Unit	Value	Comment
E-UTRA RF Channel Number			1, 2,3	Three radio channels are used for this test
Active PCell			Cell 1	Primary cell on RF channel number 1.
Active SCell			Cell 2	Primary cell on RF channel number 2.
Configured deactivated SCell			Cell 3	Configured deactivated secondary cell on RF channel number 3 for frame structure 3.
Neighbour cell			Cell 4	Neighbor cell to be identified on RF channel number 3 for frame structure 3.
CP length			Normal	
DRX			OFF	Continuous monitoring of primary cell
A6	Hysteresis	dB	0	Hysteresis for evaluation of event A6.
	Offset	dB	-3	Offset parameter for evaluation of event A6. Needs to take relative accuracy tolerance in clause 9.1.18.2 into account plus margin.
	Report on leave		False	
	Time To Trigger	s	0	
Discovery signal occasion duration		ms	1	As specified in IE MeasDS-Config in TS 36.331
Filter coefficient			0	L3 filtering is not used
SCell measurement cycle		ms	160	<i>measCycleSCell</i> as specified in TS 36.331
DMTC period		ms	40	As specified in IE MeasDS-Config in TS 36.331
dmtc-PeriodOffset			10	As specified in IE MeasDS-Config in TS 36.331
subframeStartPosition			s0	Discovery signal starts from subframe #0
laa-SCellSubframeConfig			00000000	No MBSFN subframe.
T1		s	5	During this time the UE shall be aware of cells 1 and 2 but not cell 3.
T2		s	≤10	UE should report Event A6 within 8s

Table A.8.26.3A.1-2: Cell specific test parameters for FDD-TDD 3DL Event triggered reporting on LAA deactivated SCell with E-UTRAN FDD PCell interruption in non-DRX

Parameter	Unit	Cell 1		Cell 2		Cell 3		Cell 4	
		T1	T2	T1	T2	T1	T2	T1	T2
E-UTRA RF Channel Number		1		2		3		3	
$BW_{channel}$	MHz	5MHz: $N_{RB,c} = 25$ 10MHz: $N_{RB,c} = 50$ 20MHz: $N_{RB,c} = 100$		20		20		20	
Measurement bandwidth	n_{PRB}	5MHz: 10-15 10MHz: 22-27 20MHz: 47-52		47-52		47-52		47-52	
PDSCH parameters defined in A.3.1.1.1		5MHz: R.7 FDD 10MHz: R.3 FDD 20MHz: R.6 FDD		5MHz: R.4 TDD 10MHz: R.0 TDD 20MHz: R.3 TDD		-		-	
PCFICH/PDCCH/PHICH parameters defined in A.3.1.2.1		5MHz: R.11 FDD 10MHz: R.6 FDD 20MHz: R.10 FDD		5MHz: R.11 TDD 10MHz: R.6 TDD 20MHz: R.10 TDD		-		-	
OCNG Patterns defined in A.3.2.1		5MHz: OP.20 FDD 10MHz: OP.10 FDD 20MHz: OP.17 FDD		OP.8 TDD		OP.7 TDD		OP.7 TDD	
IE allowInterruptions		True		-		-		-	
PBCH_RA	dB	0		0		0		0	
PBCH_RB	dB								
PSS_RA	dB								
SSS_RA	dB								
PCFICH_RB	dB								
PHICH_RA	dB								
PHICH_RB	dB								
PDCCH_RA	dB								
PDCCH_RB	dB								
PDSCH_RA	dB								
PDSCH_RB	dB								
OCNG_RA ^{Note 1}	dB								
OCNG_RB ^{Note 1}	dB								
N_{oc} ^{Note 3}	dBm/15 kHz								
\hat{E}_s/N_{oc}	dB	13	13	13	13	13	13	-Infinity	13
RSRP ^{Note 4}	dBm/15 kHz	-85	-85	-85	-85	-85	-85	-Infinity	-85
\hat{E}_s/I_{ot} ^{Note 4}	dB	13	13	13	13	13	-0.21	-Infinity	-0.21
SCH_RP ^{Note 4}	dBm/15 kHz	-85	-85	-85	-85	-85	-85	-Infinity	-85
I_o ^{Note 4}	dBm/Ch BW	$-57.01+10\log(N_{RB,c}/50)$		$57.01+10\log(N_{RB,c}/50)$		-54.00	-51.09	Specified in columns for Cell 2	
Propagation Condition		AWGN		AWGN		AWGN		AWGN	
Antenna Configuration		1x2		1x2		1x2		1x2	
timing offset to cell1	μs	-	-	0	0	0	0	-	3
Time alignment error relative to cell 1 ^{Note 5}	μs	-	-	$\leq TAE$	$\leq TAE$	$\leq TAE$	$\leq TAE$	N/A	N/A
<p>Note 1: OCNG shall be used such that all cells are fully allocated and a constant total transmitted power spectral density is achieved for all OFDM symbols.</p> <p>Note 2: The resources for uplink transmission are assigned to the UE prior to the start of time period T2.</p> <p>Note 3: Interference from other cells and noise sources not specified in the test is assumed to be constant over subcarriers and time and shall be modelled as AWGN of appropriate power for N_{oc} to be fulfilled.</p> <p>Note 4: E_s/I_{ot}, RSRP, SCH_RP and I_o levels have been derived from other parameters for information purposes. They are not settable parameters themselves.</p> <p>Note 5: Time alignment error (TAE) as specified in TS 36.104 [30] clause 6.5.3.1.</p>									

A.8.26.3A.2 Test Requirements

The UE shall send one Event A6 triggered measurement report, with a measurement reporting delay less than 8s from the beginning of time period T2.

The UE shall not send event triggered measurement reports, as long as the reporting criteria are not fulfilled.

The UE shall be scheduled on PCell continuously throughout the test. From the start of T1 until the measurement report is received during T2, at least 99.5% of all expected ACK/NACKs shall be transmitted by the UE.

For a test to be considered successful requirements on both event detection and percentage of transmitted ACK/NACKs have to be fulfilled simultaneously.

The rate of correct events observed during repeated tests shall be at least 90%.

NOTE: The actual overall delays measured in the test may be up to $2 \times TTI_{DCCCH}$ higher than the measurement reporting delays above because of TTI insertion uncertainty of the measurement report in DCCCH.

A.8.26.4 E-UTRAN TDD-FS3 Event triggered reporting on deactivated FS3 SCell and TDD PCell interruption in non-DRX

A.8.26.4.1 Test Purpose and Environment

The purpose of this test is to verify that the UE correctly detects event A6 (Neighbour becomes better than SCell) defined in TS 36.331 [2] within the requirements stated in clause 8.12.2.4 while at the same time fulfilling the requirement on interruption rate. This test is applicable to UEs that support a maximum of 1 FS3 SCell, ie UEs that support a maximum of 2, 3, or 4 FS3 Scells are not required to pass this test.

The test parameters are given in Table A.8.26.4.1-1 and A.8.26.4.1-2. It is indicated to the UE in the measurement control information that event-triggered reporting with Event A6 is used.

In the test there are three synchronous cells: Cell1, Cell2 and Cell3. Cell1 is PCell on the TDD primary component (RF Channel 1), Cell2 is deactivated SCell on the secondary component (RF Channel 2) for frame structure 3, and Cell3 is the neighbour cell on the secondary component (RF Channel 3) for frame structure 3. Cell 2 and Cell 3 transmit discovery signal in every discovery signal occasion.

The test consists of two successive time periods, with duration of T1 and T2, respectively. During T1 the UE shall not have any information of cell 3. Immediately at beginning of T2 the transmission power of cell 3 is increased to same level as for cell 2, and due to usage of an offset this shall result in reporting of Event A6. PCell is indicated by the network using IE allowInterruptions and PDCCH indicating a new transmission on the PCell shall be sent continuously to ensure that the UE sends ACK/ NACKs throughout the test.

Table A.8.26.4.1-1: General test parameters for Event triggered reporting on LAA deactivated SCell with E-UTRAN TDD PCell interruption in non-DRX

Parameter		Unit	Value	Comment
E-UTRA RF Channel Number			1, 2	Two radio channels are used for this test
Active PCell			Cell 1	Primary cell on RF channel number 1.
Configured deactivated SCell			Cell 2	Configured deactivated secondary cell on RF channel number 2 for frame structure 3.
Neighbour cell			Cell 3	Neighbor cell to be identified on RF channel number 2 for frame structure 3.
CP length			Normal	
DRX			OFF	Continuous monitoring of primary cell
A6	Hysteresis	dB	0	Hysteresis for evaluation of event A6.
	Offset	dB	-3	Offset parameter for evaluation of event A6. Needs to take relative accuracy tolerance in clause 9.1.18.2 into account plus margin.
	Report on leave		False	
	Time To Trigger	s	0	
Discovery signal occasion duration		ms	1	As specified in IE MeasDS-Config in TS 36.331
Filter coefficient			0	L3 filtering is not used

SCell measurement cycle	ms	160	<i>measCycleSCell</i> as specified in TS 36.331
DMTC period	ms	40	As specified in IE MeasDS-Config in TS 36.331
dmtc-PeriodOffset		10	As specified in IE MeasDS-Config in TS 36.331
subframeStartPosition		s0	Discovery signal starts from subframe #0
laa-SCellSubframeConfig		00000000	No MBSFN subframe.
T1	s	5	During this time the UE shall be aware of cells 1 and 2 but not cell 3.
T2	s	≤5	UE should report Event A6 within 4 s (25xscellMeasCycle)

Table A.8.26.4.1-2: Cell specific test parameters for E-UTRAN TDD-TDD Event triggered reporting on configured but deactivated SCell with PCell interruption in non-DRX

Parameter	Unit	Cell 1		Cell 2		Cell 3	
		T1	T2	T1	T2	T1	T2
E-UTRA RF Channel Number		1		2		2	
BW _{channel}	MHz	5MHz: N _{RB,c} = 25 10MHz: N _{RB,c} = 50 20MHz: N _{RB,c} = 100		20		20	
Uplink-downlink configuration ^{Note1}		1		-		-	
Special subframe configuration ^{Note2}		6		-		-	
Measurement bandwidth	<i>n_{PRB}</i>	5MHz: 10-15 10MHz: 22-27 20MHz: 47-52		47-52		47-52	
PDSCH parameters defined in A.3.1.1.2		5MHz: R.4 TDD 10MHz: R.0 TDD 20MHz: R.3 TDD		-		-	
PCFICH/PDCCH/PHICH parameters defined in A.3.1.2.2		5MHz: R.11 TDD 10MHz: R.6 TDD 20MHz: R.10 TDD		-		-	
OCNG Patterns defined in A.3.2.1 and A.3.2.2		5MHz: OP.9 TDD 10MHz: OP.1 TDD 20MHz: OP.7 TDD		OP.14 FDD		OP.14 FDD	
IE allowInterruptions		True		-		-	
PBCH_RA	dB	0		0		0	
PBCH_RB	dB						
PSS_RA	dB						
SSS_RA	dB						
PCFICH_RB	dB						
PHICH_RA	dB						
PHICH_RB	dB						
PDCCH_RA	dB						
PDCCH_RB	dB						
PDSCH_RA	dB						
PDSCH_RB	dB						
OCNG_RA ^{Note 3}	dB						
OCNG_RB ^{Note 3}	dB						
<i>N_{oc}</i> ^{Note 5}	dBm/15 kHz						
\hat{E}_s/N_{oc}	dB	13	13	13	13	-Infinity	13
RSRP ^{Note 6}	dBm/15 kHz	-85	-85	-85	-85	-Infinity	-85
\hat{E}_s/I_{ot} ^{Note 6}	dB	13	13	13	-0.21	-Infinity	-0.21
SCH _{RP} ^{Note 6}	dBm/15 kHz	-85	-85	-85	-85	-Infinity	-85
<i>I_o</i> ^{Note6}	dBm/Ch BW	-57.01+10log(N _{RB,c} /50)		-54.00	-51.09	Specified in columns for Cell 2	
Propagation Condition		AWGN		AWGN		AWGN	
Antenna Configuration		1x2		1x2		1x2	
timing offset to cell1	μs	-		0		0	
timing offset to cell2	μs	-		-		0	

Time alignment error relative to cell 1 ^{Note 7}	μs	-	$\leq \text{TAE}$	$\leq \text{TAE}$
Time alignment error relative to cell 2 ^{Note 7}	μs	-	-	$\leq \text{TAE}$
<p>Note 1: For the uplink-downlink configuration see table 4.2-2 in TS 36.211.</p> <p>Note 2: For the special subframe configuration see table 4.2-1 in TS 36.211.</p> <p>Note 3: OCNG shall be used such that all cells are fully allocated and a constant total transmitted power spectral density is achieved for all OFDM symbols.</p> <p>Note 4: The resources for uplink transmission are assigned to the UE prior to the start of time period T2.</p> <p>Note 5: Interference from other cells and noise sources not specified in the test is assumed to be constant over subcarriers and time and shall be modelled as AWGN of appropriate power for N_{oc} to be fulfilled.</p> <p>Note 6: Es/lot, RSRP, SCH_RP and Io levels have been derived from other parameters for information purposes. They are not settable parameters themselves.</p> <p>Note 7: Time alignment error (TAE) as specified in TS 36.104 [30] clause 6.5.3.1.</p>				

A.8.26.4.2 Test Requirements

The UE shall send one Event A6 triggered measurement report, with a measurement reporting delay less than 4s from the beginning of time period T2.

The UE shall not send event triggered measurement reports, as long as the reporting criteria are not fulfilled.

The UE shall be scheduled on PCell continuously throughout the test. From the start of T1 until the measurement report is received during T2, at least 99.5% of all expected ACK/NACKs shall be transmitted by the UE.

For a test to be considered successful requirements on both event detection and percentage of transmitted ACK/NACKs have to be fulfilled simultaneously.

The rate of correct events observed during repeated tests shall be at least 90%.

NOTE: The actual overall delays measured in the test may be up to $2 \times \text{TTI}_{\text{DCCH}}$ higher than the measurement reporting delays above because of TTI insertion uncertainty of the measurement report in DCCH.

A.8.26.4A E-UTRAN TDD-TDD 3DL Event triggered reporting on deactivated FS3 SCell and FDD PCell interruption in non-DRX

A.8.26.4A.1 Test Purpose and Environment

The purpose of this test is to verify that the UE correctly detects event A6 (Neighbour becomes better than SCell) defined in TS 36.331 [2] within the requirements stated in clause 8.12.2.4 while at the same time fulfilling the requirement on interruption rate. This test is applicable to UEs that support a maximum of 1 FS3 SCell, ie UEs that support a maximum of 2, 3, or 4 FS3 Scells are not required to pass this test.

The test parameters are given in Table A.8.26.4A.1-1 and A.8.26.4A.1-2. It is indicated to the UE in the measurement control information that event-triggered reporting with Event A6 is used.

In the test there are three synchronous cells: Cell1, Cell2, Cell3 and Cell4. Cell1 is PCell on the TDD primary component (RF Channel 1), Cell2 is activated SCell on the secondary component (RF Channel 2) for frame structure 3, Cell3 is deactivated SCell on the secondary component (RF Channel 3) for frame structure 3, and Cell4 is the neighbour cell on the secondary component (RF Channel 3) for frame structure 3. Cell 2, Cell 3 and Cell 4 transmit discovery signal in every discovery signal occasion.

The test consists of two successive time periods, with duration of T1 and T2, respectively. During T1 the UE shall not have any information of cell 4. Immediately at beginning of T2 the transmission power of cell 4 is increased to same level as for cell 3, and due to usage of an offset this shall result in reporting of Event A6. PCell is indicated by the network using IE allowInterruptions and PDCCH indicating a new transmission on the PCell shall be sent continuously to ensure that the UE sends ACK/ NACKs throughout the test.

Table A.8.26.4A.1-1: General test parameters for TDD-TDD 3DL Event triggered reporting on LAA deactivated SCell with E-UTRAN FDD PCell interruption in non-DRX

Parameter	Unit	Value	Comment
E-UTRA RF Channel Number		1, 2,3	Three radio channels are used for this test

Active PCell			Cell 1	Primary cell on RF channel number 1.
Active SCell			Cell 2	Primary cell on RF channel number 2.
Configured deactivated SCell			Cell 3	Configured deactivated secondary cell on RF channel number 3 for frame structure 3.
Neighbour cell			Cell 4	Neighbor cell to be identified on RF channel number 3 for frame structure 3.
CP length			Normal	
DRX			OFF	Continuous monitoring of primary cell
A6	Hysteresis	dB	0	Hysteresis for evaluation of event A6.
	Offset	dB	-3	Offset parameter for evaluation of event A6. Needs to take relative accuracy tolerance in clause 9.1.18.2 into account plus margin.
	Report on leave		False	
	Time To Trigger	s	0	
Discovery signal occasion duration		ms	1	As specified in IE MeasDS-Config in TS 36.331
Filter coefficient			0	L3 filtering is not used
SCell measurement cycle		ms	160	<i>measCycleSCell</i> as specified in TS 36.331
DMTC period		ms	40	As specified in IE MeasDS-Config in TS 36.331
dmtc-PeriodOffset			10	As specified in IE MeasDS-Config in TS 36.331
subframeStartPosition			s0	Discovery signal starts from subframe #0
laa-SCellSubframeConfig			00000000	No MBSFN subframe.
T1		s	5	During this time the UE shall be aware of cells 1 and 2 but not cell 3.
T2		s	≤10	UE should report Event A6 within 8 s

Table A.8.26.4A.1-2: Cell specific test parameters for TDD-TDD 3DL Event triggered reporting on LAA deactivated SCell with E-UTRAN FDD PCell interruption in non-DRX

Parameter	Unit	Cell 1		Cell 2		Cell 3		Cell 4	
		T1	T2	T1	T2	T1	T2	T1	T2
E-UTRA RF Channel Number		1		2		3		3	
BW _{channel}	MHz	5MHz: N _{RB,c} = 25 10MHz: N _{RB,c} = 50 20MHz: N _{RB,c} = 100		20		20		20	
Uplink-downlink configuration ^{Note1}		1		1		-		-	
Special subframe configuration ^{Note2}		6		6		-		-	
Measurement bandwidth	<i>n_{PRB}</i>	5MHz: 10-15 10MHz: 22-27 20MHz: 47-52		47-52		47-52		47-52	
PDSCH parameters defined in A.3.1.1.1		5MHz: R.4 TDD 10MHz: R.0 TDD 20MHz: R.3 TDD		5MHz: R.4 TDD 10MHz: R.0 TDD 20MHz: R.3 TDD		-		-	
PCFICH/PDCCH/PHICH parameters defined in A.3.1.2.1		5MHz: R.11 TDD 10MHz: R.6 TDD 20MHz: R.10 TDD		5MHz: R.11 TDD 10MHz: R.6 TDD 20MHz: R.10 TDD		-		-	
OCNG Patterns defined in A.3.2.1		5MHz: OP.9 TDD 10MHz: OP.1 TDD 20MHz: OP.7 TDD		OP.8 TDD		OP.7 TDD		OP.7 TDD	
IE allowInterruptions		True		-		-		-	
PBCH_RA	dB	0		0		0		0	
PBCH_RB	dB								
PSS_RA	dB								
SSS_RA	dB								
PCFICH_RB	dB								
PHICH_RA	dB								
PHICH_RB	dB								
PDCCH_RA	dB								
PDCCH_RB	dB								
PDSCH_RA	dB								

PDSCH_RB	dB								
OCNG_RA ^{Note 1}	dB								
OCNG_RB ^{Note 1}	dB								
N_{oc} ^{Note 3}	dBm/15 kHz	-98		-98				-98	
\hat{E}_s / N_{oc}	dB	13	13	13	13	13	13	-Infinity	13
RSRP ^{Note 4}	dBm/15 kHz	-85	-85	-85	-85	-85	-85	-Infinity	-85
\hat{E}_s / I_{ot} ^{Note 4}	dB	13	13	13	13	13	-0.21	-Infinity	-0.21
SCH_RP ^{Note 4}	dBm/15 kHz	-85	-85	-85	-85	-85	-85	-Infinity	-85
I_o ^{Note 4}	dBm/Ch BW	$-57.01+10\log(N_{RB,c}/50)$		$-57.01+10\log(N_{RB,c}/50)$		-54.00	-51.09	Specified in columns for Cell 2	
Propagation Condition		AWGN		AWGN		AWGN		AWGN	
Antenna Configuration		1x2		1x2		1x2		1x2	
timing offset to cell1	μ s	-	-	0	0	0	0	-	3
Time alignment error relative to cell 1 ^{Note 5}	μ s	-	-	\leq TAE	\leq TAE	\leq TAE	\leq TAE	N/A	N/A
<p>Note 1: OCNG shall be used such that all cells are fully allocated and a constant total transmitted power spectral density is achieved for all OFDM symbols.</p> <p>Note 2: The resources for uplink transmission are assigned to the UE prior to the start of time period T2.</p> <p>Note 3: Interference from other cells and noise sources not specified in the test is assumed to be constant over subcarriers and time and shall be modelled as AWGN of appropriate power for N_{oc} to be fulfilled.</p> <p>Note 4: E_s/I_{ot}, RSRP, SCH_RP and I_o levels have been derived from other parameters for information purposes. They are not settable parameters themselves.</p> <p>Note 5: Time alignment error (TAE) as specified in TS 36.104 [30] clause 6.5.3.1.</p>									

A.8.26.4A.2 Test Requirements

The UE shall send one Event A6 triggered measurement report, with a measurement reporting delay less than 8s from the beginning of time period T2.

The UE shall not send event triggered measurement reports, as long as the reporting criteria are not fulfilled.

The UE shall be scheduled on PCell continuously throughout the test. From the start of T1 until the measurement report is received during T2, at least 99.5% of all expected ACK/NACKs shall be transmitted by the UE.

For a test to be considered successful requirements on both event detection and percentage of transmitted ACK/NACKs have to be fulfilled simultaneously.

The rate of correct events observed during repeated tests shall be at least 90%.

NOTE: The actual overall delays measured in the test may be up to $2 \times TTI_{DCC}$ higher than the measurement reporting delays above because of TTI insertion uncertainty of the measurement report in DCC.

A.8.26.5 E-UTRAN FDD-FS3 Intra-frequency event triggered reporting in non-DRX for CRS based discovery signal

A.8.26.5.1 Test Purpose and Environment

The purpose of the test is to verify that the UE makes correct reporting of an event under operation with frame structure 3. The test will partly verify new intra-frequency FS3 cells in non-DRX requirements in clause 8.11.2. This test is applicable to UEs that support a maximum of 1 FS3 SCell, ie UEs that support a maximum of 2, 3, or 4 FS3 Scells are not required to pass this test.

The test parameters are given in Tables A.8.26.5.1-1 and A.8.26.5.1-2. In the measurement control information, it is indicated to the UE performing CRS based discovery signals measurement and event-triggered reporting with Event A6 is configured.

There are three cells: Cell 1, Cell 2, and Cell 3. Cell 1 is PCell on the FDD primary component (RF Channel 1), Cell 2 is activated SCell on the secondary component (RF Channel 2) for Frame Structure 3, and Cell 3 is the neighbour cell on the secondary component (RF Channel 2) frame structure 3. LBT model is applied on cell 3.

The test consists of two successive time periods, with time duration of T1 and T2 respectively. During time duration T1, the UE shall not have any timing information of cell 3. Immediately at beginning of T2 the transmission power of cell 3 is increased, and due to usage of an offset this shall result in reporting of Event A6.

Table A.8.26.5.1-1: General test parameters for E-UTRAN FDD-FS3 intra-frequency event triggered reporting in non-DRX for CRS based discovery signal measurement under Operation with Frame Structure 3

Parameter	Unit	Value	Comment
E-UTRA RF Channel Number		1, 2	Two radio channels are used for this test
Active PCell		Cell 1	Primary cell on RF channel number 1.
Active SCell		Cell 2	Configured activated secondary cell on RF channel number 2.
Neighbour cell		Cell 3	Neighbor cell to be identified on RF channel number 2.
DMTC period	ms	40	As specified in IE MeasDS-Config in TS 36.331
dmtc-PeriodOffset	ms	10	As specified in IE MeasDS-Config in TS 36.331
Discovery signal occasion duration	ms	1	As specified in IE MeasDS-Config in TS 36.331
CP length		Normal	
A6-Offset	dB	-6	
Time To Trigger	s	0	
Filter coefficient		0	L3 filtering is not used
DRX		OFF	
T1	s	5	
T2	s	5	

Table A.8.26.5.1-2: Cell specific test parameters for E-UTRAN FDD-FS3 intra-frequency event triggered reporting in non-DRX for CRS based discovery signal measurement under Operation with Frame Structure 3

Parameter	Unit	Cell1		Cell2		Cell3	
		T1	T2	T1	T2	T1	T2
E-UTRA RF Channel Number		1		2		2	
BW _{channel}	MHz	5MHz: NRB,c = 25 10MHz: NRB,c = 50 20MHz: NRB,c = 100		20		20	
LBT model		-		-		A.3.17	
Measurement bandwidth	n_{PRB}	5MHz: 10-15 10MHz: 22-27 20MHz: 47-52		47-52		47-52	
PDSCH parameters: DL Reference Measurement Channel		5MHz: R.5 FDD 10MHz: R.0 FDD 20MHz: R.4 FDD		R.1 FS3		-	
PCFICH/PDCCH/PHICH parameters: DL Reference Measurement Channel		5MHz: R.11 FDD 10MHz: R.6 FDD 20MHz: R.10 FDD		R.0 FS3		R.0 FS3	
OCNG Patterns		5MHz: OP.15 FDD 10MHz: OP.1 FDD 20MHz: OP.11 FDD		OP.13 FDD		OP.14 FDD	
PBCH_RA	dB	0		0		0	
PBCH_RB	dB						
PSS_RA	dB						
SSS_RA	dB						

PCFICH_RB	dB						
PHICH_RA	dB						
PHICH_RB	dB						
PDCCH_RA	dB						
PDCCH_RB	dB						
PDSCH_RA	dB						
PDSCH_RB	dB						
OCNG_RA ^{Note 1}	dB						
OCNG_RB ^{Note 1}	dB						
N_{oc} ^{Note 2}	dBm/ 15 kHz	-104		-104			
\hat{E}_s / N_{oc}	dB	4	4	4	4	-infinity	4
\hat{E}_s / I_{α}	dB	4	4	4	-1.455	-infinity	-1.455
RSRP ^{Note 3}	dBm/ 15 kHz	-100	-100	-100	-100	-infinity	-100
SCH_RP ^{Note 3}	dBm/ 15 kHz	-100	-100	-100	-100	-infinity	-100
I_o ^{Note 3}	dBm/ Ch BW	-	-	-67.75	-65.41	Specified in columns for Cell 2	
		$70.76+10\log$ ($N_{RB,c}/50$)	$70.76+10\log$ ($N_{RB,c}/50$)				
Propagation Condition		ETU30		ETU30		ETU30	
Correlation Matrix and Antenna Configuration		1x2 Low		1x2 Low		1x2 Low	
Timing offset to Cell 1	μ s	-	-	0	0	-	3
Time alignment error relative to cell 1 ^{Note 5}	μ s	-	-	\leq TAE	\leq TAE	N/A	N/A
<p>Note 1: OCNG shall be used such that cells are fully allocated and a constant total transmitted power spectral density is achieved for all OFDM symbols. For cells with LBT model, OCNG is transmitted only in subframes with downlink transmission bursts, and is not transmitted during muted subframes or during DMTC windows.</p> <p>Note 2: Interference from other cells and noise sources not specified in the test is assumed to be constant over subcarriers and time and shall be modelled as AWGN of appropriate power for N_{oc} to be fulfilled.</p> <p>Note 3: RSRP, SCH_RP, E_s/I_{α} and I_o levels have been derived from other parameters for information purposes. They are not settable parameters themselves.</p> <p>Note 4: The resources for uplink transmission are assigned to the UE prior to the start of time period T2.</p> <p>Note 5: Time alignment error (TAE) as specified in TS 36.104 [30] clause 6.5.3.1.</p>							

A.8.26.5.2 Test Requirements

In the test, the UE shall send one Event A6 triggered measurement report, with a measurement reporting delay less than $(24+L)*40$ ms from the beginning of time period T2, where L is the number of configured discovery signal occasions which are not available due to the absence of the necessary radio signals from cell3.

The measurement reporting delay is defined as the time from the beginning of time period T2 to the moment when the UE send the measurement report on PUSCH.

The UE shall not send event triggered measurement reports, as long as the reporting criteria are not fulfilled.

The rate of correct events observed during repeated tests shall be at least 90%.

NOTE: The actual overall delays measured in the test may be up to $2xTTI_{DCCH}$ higher than the measurement reporting delays above because of TTI insertion uncertainty of the measurement report in DCCH.

A.8.26.5A E-UTRAN FDD-FS3 Intra-frequency event triggered reporting in non-DRX for CRS based discovery signal with 2 SCells

A.8.26.5A.1 Test Purpose and Environment

The purpose of the test is to verify that the UE makes correct reporting of an event under operation with frame structure 3. The test will partly verify new intra-frequency FS3 cells in non-DRX requirements in clause 8.11.2. This test is applicable to UEs that support a 2,3 or 4 FS3 SCells, ie UEs that support a maximum of 1 FS3 Scell are not required to pass this test.

The test parameters are given in Tables A.8.26.5A.1-1 and A.8.26.5A.1-2. In the measurement control information, it is indicated to the UE performing CRS based discovery signals measurement and event-triggered reporting with Event A6 is configured.

There are five cells: Cell 1 is PCell on the FDD primary component (RF Channel 1), Cell 2 is activated SCell on the secondary component (RF Channel 2) for Frame Structure 3, and Cell 3 is the neighbour cell on the secondary component (RF Channel 2) frame structure 3 and Cell 4 is the activated SCell on the secondary component (RF Channel 3) for Frame Structure 3.

The test consists of two successive time periods, with time duration of T1 and T2 respectively. During time duration T1, the UE shall not have any timing information of cell 3 and 5. Immediately at beginning of T2 the transmission power of cell 3 and 5 is increased, and due to usage of an offset this shall result in reporting of Event A6.

Table A.8.26.5A.1-1: General test parameters for E-UTRAN FDD-TDD intra-frequency event triggered reporting in non-DRX for CRS based discovery signal measurement under Operation with Frame Structure 3

Parameter	Unit	Value	Comment
E-UTRA RF Channel Number		1, 2, 3	Three radio channels are used for this test
Active PCell		Cell 1	Primary cell on RF channel number 1.
Active SCell		Cell 2	Configured activated secondary cell on RF channel number 2.
Neighbour cell		Cell 3	Neighbour cell to be identified on RF channel number 2.
Active SCell		Cell 4	Configured activated secondary cell on RF channel number 3.
DMTC period	ms	40	Applies for cell 2,3 and 4 as specified in IE MeasDS-Config in TS 36.331
dmtc-PeriodOffset	ms	10	Applies for cell 2,3 and 4 as specified in IE MeasDS-Config in TS 36.331
Discovery signal occasion duration	ms	1	Applies for cell 2,3, and 4 as specified in IE MeasDS-Config in TS 36.331
LBT modelling			Not applied for any cell in the test
CP length		Normal	
A6-Offset	dB	-6	
Time To Trigger	s	0	
Filter coefficient		0	L3 filtering is not used
DRX		OFF	
T1	s	5	
T2	s	5	

Table A.8.26.5A.1-2: Cell specific test parameters for E-UTRAN FDD-TDD intra-frequency event triggered reporting in non-DRX for CRS based discovery signal measurement under Operation with Frame Structure 3

Parameter	Unit	Cell1		Cell2		Cell3		Cell4	
		T1	T2	T1	T2	T1	T2	T1	T2
E-UTRA RF Channel Number		1		2		2		3	
BW _{channel}	MHz	5MHz: NRB,c = 25 10MHz: NRB,c = 50 20MHz: NRB,c = 100		20		20		20	
Measurement bandwidth	n_{PRB}	5MHz: 18-24 10MHz: 13-37 20MHz: 47-52		47-52		47-52		47-52	
PDSCH parameters: DL Reference Measurement Channel		5MHz: R.7 FDD 10MHz: R.3 FDD 20MHz: R.6 FDD		R.0 FS3		-		R.0 FS3	

PCFICH/PDCCH/PHICH parameters: DL Reference Measurement Channel		5MHz: R.11 FDD 10MHz: R.6 FDD 20MHz: R.10 FDD		R.0 FS3		R.0 FS3		R.0 FS3
OCNG Patterns		5MHz: OP.20 FDD 10MHz: OP.10 FDD 20MHz: OP.17 FDD		OP.13 FDD		OP.14 FDD		OP.13 FDD
PBCH_RA	dB	0		0		0		0
PBCH_RB	dB							
PSS_RA	dB							
SSS_RA	dB							
PCFICH_RB	dB							
PHICH_RA	dB							
PHICH_RB	dB							
PDCCH_RA	dB							
PDCCH_RB	dB							
PDSCH_RA	dB							
PDSCH_RB	dB							
OCNG_RA ^{Note 1}	dB							
OCNG_RB ^{Note 1}	dB							
N_{oc} ^{Note 2}	dBm/ 15 kHz							
\hat{E}_s/N_{oc}	dB	4	4	4	4	-infinity	4	4
\hat{E}_s/I_{ot}	dB	4	4	4	-1.455	-infinity	-1.455	4
RSRP ^{Note 3}	dBm/ 15 kHz	-100	-100	-100	-100	-infinity	-100	-100
SCH_RP ^{Note 3}	dBm/ 15 kHz	-100	-100	-100	-100	-infinity	-100	-100
I_0 ^{Note 3}	dBm/ Ch BW	-	-	-67.75	-65.41	-67.75	-65.41	-67.75
Propagation Condition		ETU30		ETU30		ETU30		ETU30
Correlation Matrix and Antenna Configuration		1x2 Low		1x2 Low		1x2 Low		1x2 Low
Timing offset to Cell 1	μ s	-	-	0	0	-	3	0
Time alignment error relative to cell 1 ^{Note 5}	μ s	-	-	N/A	\leq TAE	N/A	\leq TAE	N/A
<p>Note 1: OCNG shall be used such that cells are fully allocated and a constant total transmitted power spectral density is achieved for all OFDM symbols. For cells with LBT model, OCNG is transmitted only in subframes with downlink transmission bursts, and is not transmitted during muted subframes or during DMTC windows.</p> <p>Note 2: Interference from other cells and noise sources not specified in the test is assumed to be constant over subcarriers and time and shall be modelled as AWGN of appropriate power for N_{oc} to be fulfilled.</p> <p>Note 3: RSRP SCH_RP and E_s/I_{ot} levels have been derived from other parameters for information purposes. They are not settable parameters themselves.</p> <p>Note 4: The resources for uplink transmission are assigned to the UE prior to the start of time period T2.</p> <p>Note 5: Time alignment error (TAE) as specified in TS 36.104 [30] clause 6.5.3.1. The TAE value depends upon the type of carrier aggregation.</p>								

A.8.26.5A.2 Test Requirements

In the test, the UE shall send one Event A6 triggered measurement report for cell 3, with a measurement reporting delay less than 1920ms from the beginning of time period T2.

The measurement reporting delay is defined as the time from the beginning of time period T2 to the moment when the UE send the measurement report on PUSCH.

The UE shall not send event triggered measurement reports, as long as the reporting criteria are not fulfilled.

The rate of correct events observed during repeated tests shall be at least 90%.

NOTE: The actual overall delays measured in the test may be up to $2 \times TTI_{DCC}$ higher than the measurement reporting delays above because of TTI insertion uncertainty of the measurement report in DCC.

A.8.26.6 E-UTRAN TDD-FS3 Intra-frequency event triggered reporting in non-DRX for CRS based discovery signal

A.8.26.6.1 Test Purpose and Environment

The purpose of the test is to verify that the UE makes correct reporting of an event under operation with frame structure 3. The test will partly verify new intra-frequency FS3 cells in non-DRX requirements in clause 8.11.2. This test is applicable to UEs that support a maximum of 1 FS3 SCell, ie UEs that support a maximum of 2, 3, or 4 FS3 Scells are not required to pass this test.

The test parameters are given in Tables A.8.26.6.1-1 and A.8.26.6.1-2. In the measurement control information, it is indicated to the UE performing CRS based discovery signals measurement and event-triggered reporting with Event A6 is configured.

There are three cells: Cell 1, Cell 2, and Cell 3. Cell 1 is PCell on the TDD primary component (RF Channel 1), Cell 2 is activated SCell on the secondary component (RF Channel 2) for Frame Structure 3, and Cell 3 is the neighbour cell on the secondary component (RF Channel 2) frame structure 3. LBT model is applied on cell 3.

The test consists of two successive time periods, with time duration of T1, and T2 respectively. During time duration T1, the UE shall not have any timing information of cell 3. Immediately at beginning of T2 the transmission power of cell 3 is increased, and due to usage of an offset this shall result in reporting of Event A6.

Table A.8.26.6.1-1: General test parameters for E-UTRAN TDD-TDD intra-frequency event triggered reporting in non-DRX for CRS based discovery signal measurement under Operation with Frame Structure 3

Parameter	Unit	Value	Comment
E-UTRA RF Channel Number		1, 2	Two radio channels are used for this test
Active PCell		Cell 1	Primary cell on RF channel number 1.
Active SCell		Cell 2	Configured activated secondary cell on RF channel number 2.
Neighbour cell		Cell 3	Neighbor cell to be identified on RF channel number 2.
DMTC period	ms	40	As specified in IE MeasDS-Config in TS 36.331
dmtc-PeriodOffset	ms	10	As specified in IE MeasDS-Config in TS 36.331
Discovery signal occasion duration	ms	1	As specified in IE MeasDS-Config in TS 36.331
CP length		Normal	
A6-Offset	dB	-6	
Time To Trigger	s	0	
Filter coefficient		0	L3 filtering is not used
DRX		OFF	
T1	s	5	
T2	s	5	

Table A.8.26.6.1-2: Cell specific test parameters for E-UTRAN TDD-TDD intra-frequency event triggered reporting in non-DRX for CRS based discovery signal measurement under Operation with Frame Structure 3

Parameter	Unit	Cell1		Cell2		Cell3	
		T1	T2	T1	T2	T1	T2
E-UTRA RF Channel Number		1		2		2	
Special subframe configuration		6		-		-	

Uplink-downlink configuration		1		-		-	
LBT model		-		-		A.3.17	
BW _{channel}	MHz	5MHz: NRB,c = 25 10MHz: NRB,c = 50 20MHz: NRB,c = 100		20		20	
Measurement bandwidth	n_{PRB}	5MHz: 10-15 10MHz: 22-27 20MHz: 47-52		47-52		47-52	
PDSCH parameters: DL Reference Measurement Channel		5MHz: R.4 TDD 10MHz: R.0 TDD 20MHz: R.3 TDD		R.0 FS3		-	
PCFICH/PDCCH/PHICH parameters: DL Reference Measurement Channel		5MHz: R.11 TDD 10MHz: R.6 TDD 20MHz: R.10 TDD		R.0 FS3		R.0 FS3	
OCNG Patterns		5MHz: OP.15 TDD 10MHz: OP.1 TDD 20MHz: OP.11 TDD		OP.13 FDD		OP.14 FDD	
PBCH_RA	dB	0		0		0	
PBCH_RB	dB						
PSS_RA	dB						
SSS_RA	dB						
PCFICH_RB	dB						
PHICH_RA	dB						
PHICH_RB	dB						
PDCCH_RA	dB						
PDCCH_RB	dB						
PDSCH_RA	dB						
PDSCH_RB	dB						
OCNG_RA ^{Note 1}	dB						
OCNG_RB ^{Note 1}	dB						
N_{oc} ^{Note 2}	dBm/ 15 kHz	-104		-104			
\hat{E}_s / N_{oc}	dB	4	4	4	4	-infinity	4
\hat{E}_s / I_{ot}	dB	4	4	4	-1.46	-infinity	-1.46
RSRP ^{Note 3}	dBm/ 15 kHz	-100	-100	-100	-100	-infinity	-100
SCH_RP ^{Note 3}	dBm/ 15 kHz	-100	-100	-100	-100	-infinity	-100
I_o ^{Note 3}	dBm/ Ch BW	- 70.76+10log ($N_{RB,c} / 50$)	- 70.76+10log ($N_{RB,c} / 50$)	-67.75	-65.41	Specified in columns for Cell 2	
Propagation Condition		ETU30		ETU30		ETU30	
Correlation Matrix and Antenna Configuration		1x2 Low		1x2 Low		1x2 Low	
Timing offset to Cell 1	μs	-	-	0	0	-	3
Time alignment error relative to cell 1 ^{Note 5}	μs	-	-	\leq TAE	\leq TAE	N/A	N/A
<p>Note 1: OCNG shall be used such that cells are fully allocated and a constant total transmitted power spectral density is achieved for all OFDM symbols. For cells with LBT model, OCNG is transmitted only in subframes with downlink transmission bursts, and is not transmitted during muted subframes or during DMTC windows.</p> <p>Note 2: Interference from other cells and noise sources not specified in the test is assumed to be constant over subcarriers and time and shall be modelled as AWGN of appropriate power for N_{oc} to be fulfilled.</p> <p>Note 3: RSRP, SCH_RP, E_s/I_{ot} and I_o levels have been derived from other parameters for information purposes. They are not settable parameters themselves.</p> <p>Note 4: The resources for uplink transmission are assigned to the UE prior to the start of time period T2.</p> <p>Note 5: Time alignment error (TAE) as specified in TS 36.104 [30] clause 6.5.3.1.</p>							

A.8.26.6.2 Test Requirements

In the test, the UE shall send one Event A6 triggered measurement report, with a measurement reporting delay less than $(24+L)*40ms$ from the beginning of time period T2, where L is the number of configured discovery signal occasions which are not available due to the absence of the necessary radio signals from cell3.

The measurement reporting delay is defined as the time from the beginning of time period T2 to the moment when the UE send the measurement report on PUSCH.

The UE shall not send event triggered measurement reports, as long as the reporting criteria are not fulfilled.

The rate of correct events observed during repeated tests shall be at least 90%.

NOTE: The actual overall delays measured in the test may be up to $2 \times TTI_{DCCCH}$ higher than the measurement reporting delays above because of TTI insertion uncertainty of the measurement report in DCCCH.

A.8.26.6A E-UTRAN TDD-FS3 Intra-frequency event triggered reporting in non-DRX for CRS based discovery signal with 2 SCells

A.8.26.6A.1 Test Purpose and Environment

The purpose of the test is to verify that the UE makes correct reporting of an event under operation with frame structure 3. The test will partly verify new intra-frequency FS3 cells in non-DRX requirements in clause 8.11.2. This test is applicable to UEs that support a 2,3 or 4 FS3 SCells, ie UEs that support a maximum of 1 FS3 Scell are not required to pass this test.

The test parameters are given in Tables A.8.26.6A.1-1 and A.8.26.6A.1-2. In the measurement control information, it is indicated to the UE performing CRS based discovery signals measurement and event-triggered reporting with Event A6 is configured.

There are five cells. Cell 1 is PCell on the TDD primary component (RF Channel 1), Cell 2 is activated SCell on the secondary component (RF Channel 2) for Frame Structure 3, and Cell 3 is the neighbour cell on the secondary component (RF Channel 2) frame structure 3. and Cell 4 is activated SCell on the secondary component (RF Channel 3) for Frame Structure 3.

The test consists of two successive time periods, with time duration of T1, and T2 respectively. During time duration T1, the UE shall not have any timing information of cell 3. Immediately at beginning of T2 the transmission power of cell 3 is increased, and due to usage of an offset this shall result in reporting of Event A6.

Table A.8.26.6A.1-1: General test parameters for E-UTRAN TDD-TDD intra-frequency event triggered reporting in non-DRX for CRS based discovery signal measurement under Operation with Frame Structure 3

Parameter	Unit	Value	Comment
E-UTRA RF Channel Number		1, 2, 3	Three radio channels are used for this test
Active PCell		Cell 1	Primary cell on RF channel number 1.
Active SCell		Cell 2	Configured activated secondary cell on RF channel number 2.
Neighbour cell		Cell 3	Neighbor cell to be identified on RF channel number 2.
Active SCell		Cell 4	Configured activated secondary cell on RF channel number 3.
DMTC period	ms	40	Applies for cell 2,3 and 4 as specified in IE MeasDS-Config in TS 36.331
dmtc-PeriodOffset	ms	10	Applies for cell 2,3 and 4 as specified in IE MeasDS-Config in TS 36.331
Discovery signal occasion duration	ms	1	Applies for cell 2,3 and 4 as specified in IE MeasDS-Config in TS 36.331
LBT modelling			Not applied for any cell in the test
CP length		Normal	
A6-Offset	dB	-6	
Time To Trigger	s	0	
Filter coefficient		0	L3 filtering is not used
DRX		OFF	
T1	s	5	
T2	s	5	

Table A.8.26.6A.1-2: Cell specific test parameters for E-UTRAN TDD-TDD intra-frequency event triggered reporting in non-DRX for CRS based discovery signal measurement under Operation with Frame Structure 3

Parameter	Unit	Cell1		Cell2		Cell3		Cell 4	
		T1	T2	T1	T2	T1	T2	T1	T2
E-UTRA RF Channel Number		1		2		2		3	
Special subframe configuration		6		-		-		-	
Uplink-downlink configuration		1		-		-		-	
BW _{channel}	MHz	5MHz: NRB,c = 25 10MHz: NRB,c = 50 20MHz: NRB,c = 100		20		20		20	
Measurement bandwidth	n_{PRB}	5MHz:18-24 10MHz:13-37 20MHz:47-52		38-62		38-62		38-62	
PDSCH parameters: DL Reference Measurement Channel		5MHz: R.5 TDD 10MHz: R.0 TDD 20MHz: R.4 TDD		R.0 FS3		-		R.0 FS3	
PCFICH/PDCCH/PHICH parameters: DL Reference Measurement Channel		5MHz: R.11 TDD 10MHz: R.6 TDD 20MHz: R.10 TDD		R.0 FS3		R.0 FS3		R.0 FS3	
OCNG Patterns		5MHz: OP.15 TDD 10MHz: OP.1 TDD 20MHz: OP.11 TDD		OP.13 FDD		OP.14 FDD		OP.13 FDD	
PBCH_RA	dB	0		0		0		0	
PBCH_RB	dB								
PSS_RA	dB								
SSS_RA	dB								
PCFICH_RB	dB								
PHICH_RA	dB								
PHICH_RB	dB								
PDCCH_RA	dB								
PDCCH_RB	dB								
PDSCH_RA	dB								
PDSCH_RB	dB								
OCNG_RA ^{Note 1}	dB								
OCNG_RB ^{Note 1}	dB								
N_{oc} ^{Note 2}	dBm/ 15 kHz								
\hat{E}_s/N_{oc}	dB	4	4	4	4	-infinity	4	4	
\hat{E}_s/I_{ot}	dB	4	4	4	-1.455	-infinity	-1.455	4	
RSRP ^{Note 3}	dBm/ 15 kHz	-100	-100	-100	-100	-infinity	-100	-100	
SCH_RP ^{Note 3}	dBm/ 15 kHz	-100	-100	-100	-100	-infinity	-100	-100	
I_o ^{Note 3}	dBm/ Ch BW	-	-	-67.75	-65.41	-67.75	-65.41	-67.75	
Propagation Condition		ETU30		ETU30		ETU30		ETU30	
Correlation Matrix and Antenna Configuration		1x2 Low		1x2 Low		1x2 Low		1x2 Low	
Timing offset to Cell 1	μ s	-	-	0	0	-	3	0	
Time alignment error relative to cell 1 ^{Note 5}	μ s	-	-	N/A	\leq TAE	N/A	\leq TAE	N/A	
<p>Note 1: OCNG shall be used such that cells are fully allocated and a constant total transmitted power spectral density is achieved for all OFDM symbols. For cells with LBT model, OCNG is transmitted only in subframes with downlink transmission bursts, and is not transmitted during muted subframes or during DMTC windows.</p> <p>Note 2: Interference from other cells and noise sources not specified in the test is assumed to be constant over subcarriers and time and shall be modelled as AWGN of appropriate power for N_{oc} to be fulfilled.</p>									

Note 3:	RSRP SCH_RP and Es/lot levels have been derived from other parameters for information purposes. They are not settable parameters themselves.
Note 4:	The resources for uplink transmission are assigned to the UE prior to the start of time period T2.
Note 5:	Time alignment error (TAE) as specified in TS 36.104 [30] clause 6.5.3.1. The TAE value depends upon the type of carrier aggregation.

A.8.26.6A.2 Test Requirements

In the test, the UE shall send one Event A6 triggered measurement report for cell 3, with a measurement reporting delay less than 1920ms from the beginning of time period T2.

The measurement reporting delay is defined as the time from the beginning of time period T2 to the moment when the UE send the measurement report on PUSCH.

The UE shall not send event triggered measurement reports, as long as the reporting criteria are not fulfilled.

The rate of correct events observed during repeated tests shall be at least 90%.

NOTE: The actual overall delays measured in the test may be up to $2 \times TTI_{DCCH}$ higher than the measurement reporting delays above because of TTI insertion uncertainty of the measurement report in DCCH.

A.8.26.7 E-UTRAN FDD-FS3 Intra-frequency event triggered reporting in DRX for CRS based discovery signal

A.8.26.7.1 Test Purpose and Environment

The purpose of the test is to verify that the UE makes correct reporting of an event under operation with frame structure 3. The test will partly verify new intra-frequency FS3 cells in DRX requirements in clause 8.11.2.

The test parameters are given in Tables A.8.26.7.1-1 and A.8.26.7.1-2. In the measurement control information, it is indicated to the UE performing CRS based discovery signals measurement and event-triggered reporting with Event A6 is configured.

There are three cells: Cell 1, Cell 2, and Cell 3. Cell 1 is PCell on the FDD primary component (RF Channel 1), Cell 2 is activated SCell on the secondary component (RF Channel 2) for Frame Structure 3, and Cell 3 is the neighbour cell on the secondary component (RF Channel 2) frame structure 3. LBT model is applied on cell 3.

The test consists of two successive time periods, with time duration of T1, and T2 respectively. During time duration T1, the UE shall not have any timing information of cell 2. Immediately at beginning of T2 the transmission power of cell 3 is increased, and due to usage of an offset this shall result in reporting of Event A6.

Table A.8.26.7.1-1: General test parameters for E-UTRAN FDD-FS3 intra-frequency event triggered reporting in DRX for CRS based discovery signal under Operation with Frame Structure 3

Parameter	Unit	Value	Comment
E-UTRA RF Channel Number		1, 2	Two radio channels are used for this test
Active PCell		Cell 1	Primary cell on RF channel number 1.
Active SCell		Cell 2	Configured activated secondary cell on RF channel number 2.
Neighbour cell		Cell 3	Neighbor cell to be identified on RF channel number 2.
DMTC period	ms	40	As specified in IE MeasDS-Config in TS 36.331
dmtc-PeriodOffset	ms	10	As specified in IE MeasDS-Config in TS 36.331
Discovery signal occasion duration	ms	1	As specified in IE MeasDS-Config in TS 36.331
CP length		Normal	
A6-Offset	dB	-6	
Time To Trigger	s	0	
Filter coefficient		0	L3 filtering is not used

DRX		ON	DRX related parameters are defined in Table A.8.26.7.1-3
T1	s	5	
T2	s	15	During this time the UE identify a new detectable FS3 intra-frequency cell. T _{identify_intra_FS3_DRX} is specified in section 8.11.2.1.1.2.

Table A.8.26.7.1-2: Cell specific test parameters for E-UTRAN FDD-FS3 intra-frequency event triggered reporting in DRX for CRS based discovery signal under Operation with Frame Structure 3

Parameter	Unit	Cell1		Cell2		Cell3	
		T1	T2	T1	T2	T1	T2
E-UTRA RF Channel Number		1		2		2	
BW _{channel}	MHz	5MHz: NRB,c = 25 10MHz: NRB,c = 50 20MHz: NRB,c = 100		20		20	
LBT model		-		-		A.3.17	
Measurement bandwidth	<i>n_{PRB}</i>	5MHz: 10-15 10MHz: 22-27 20MHz: 47-52		47-52		47-52	
PDSCH parameters: DL Reference Measurement Channel		5MHz: R.5 FDD 10MHz: R.0 FDD 20MHz: R.4 FDD		R.1 FS3		-	
PCFICH/PDCCH/PHICH parameters: DL Reference Measurement Channel		5MHz: R.11 FDD 10MHz: R.6 FDD 20MHz: R.10 FDD		R.0 FS3		R.0 FS3	
OCNG Patterns defined in A.3.2		5MHz: OP.15 FDD 10MHz: OP.1 FDD 20MHz: OP.11 FDD		OP.13 FDD		OP.14 FDD	
PBCH_RA	dB	0		0		0	
PBCH_RB	dB						
PSS_RA	dB						
SSS_RA	dB						
PCFICH_RB	dB						
PHICH_RA	dB						
PHICH_RB	dB						
PDCCH_RA	dB						
PDCCH_RB	dB						
PDSCH_RA	dB						
PDSCH_RB	dB						
OCNG_RA ^{Note 1}	dB						
OCNG_RB ^{Note 1}	dB						
<i>N_{oc}</i> ^{Note 2}	dBm/ 15 kHz						
\hat{E}_s/N_{oc}	dB	4	4	4	4	-infinity	4
\hat{E}_s/I_{ot}	dB	4	4	4	-1.455	-infinity	-1.455
RSRP ^{Note 3}	dBm/ 15 kHz	-100	-100	-100	-100	-infinity	-100
SCH_RP ^{Note 3}	dBm/ 15 kHz	-100	-100	-100	-100	-infinity	-100
<i>I_o</i> ^{Note 3}	dBm/ Ch BW	- 70.76+10log (N _{RB,c} /50)	- 70.76+10log (N _{RB,c} /50)	-67.76	-65.42	Specified in columns for Cell 2	
Propagation Condition		ETU30		ETU30		ETU30	
Correlation Matrix and Antenna Configuration		1x2 Low		1x2 Low		1x2 Low	
Timing offset to Cell 1	μs	-	-	0	0	-	3
Time alignment error relative to cell 1 ^{Note 5}	μs	-	-	≤ TAE	≤ TAE	N/A	N/A
Note 1: OCNG shall be used such that cells are fully allocated and a constant total transmitted power spectral density is achieved for all OFDM symbols. For cells with LBT model, OCNG is transmitted only in							

	subframes with downlink transmission bursts, and is not transmitted during muted subframes or during DMTC windows.
Note 2:	Interference from other cells and noise sources not specified in the test is assumed to be constant over subcarriers and time and shall be modelled as AWGN of appropriate power for N_{oc} to be fulfilled.
Note 3:	RSRP SCH_RP and Es/lot levels have been derived from other parameters for information purposes. They are not settable parameters themselves.
Note 4:	The resources for uplink transmission are assigned to the UE prior to the start of time period T2.
Note 5:	Time alignment error (TAE) as specified in TS 36.104 [30] clause 6.5.3.1.

Table A.8.26.7.1-3: DRX-Configuration for E-UTRAN FDD-FS3 intra-frequency event triggered reporting in DRX for CRS based discovery signal under Operation with Frame Structure 3

Field	Value	Comment
onDurationTimer	Psf6	As specified in clause 6.3.2 in TS 36.331
drx-InactivityTimer	psf1	
drx-RetransmissionTimer	psf1	
longDRX-CycleStartOffset	sf320 : 10	
shortDRX	disable	

Table A.8.26.7.1-4: TimeAlignmentTimer -Configuration for E-UTRAN FDD-FS3 intra-frequency event triggered reporting in DRX for CRS based discovery signal under Operation with Frame Structure 3

Field	Value	Comment
TimeAlignmentTimer	sf500	As specified in clause 6.3.2 in TS 36.331
sr-ConfigIndex	0	For further information see clause 6.3.2 in TS 36.331 and section 10.1 in TS 36.213.

A.8.26.7.2 Test Requirements

In the test, the UE shall send one Event A6 triggered measurement report, with a measurement reporting delay less than $(24+L)*320ms$ from the beginning of time period T2, where L is the number of configured discovery signal occasions during ON DURATION which are not available due to the absence of the necessary radio signals from cell3.

The measurement reporting delay is defined as the time from the beginning of time period T2 to the moment when the UE send the measurement report on PUSCH.

The UE shall not send event triggered measurement reports, as long as the reporting criteria are not fulfilled.

The rate of correct events observed during repeated tests shall be at least 90%.

NOTE: The actual overall delays measured in the test may be up to $2xTTI_{DCCH}$ higher than the measurement reporting delays above because of TTI insertion uncertainty of the measurement report in DCCH.

A.8.26.8 E-UTRAN TDD-FS3 Intra-frequency event triggered reporting in DRX for CRS based discovery signal

A.8.26.8.1 Test Purpose and Environment

The purpose of the test is to verify that the UE makes correct reporting of an event under operation with frame structure 3. The test will partly verify new intra-frequency FS3 cells in DRX requirements in clause 8.11.2.

The test parameters are given in Tables A.8.26.8.1-1 and A.8.26.8.1-2. In the measurement control information, it is indicated to the UE performing CRS based discovery signals measurement and event-triggered reporting with Event A6 is configured.

There are three cells: Cell 1, Cell 2, and Cell 3. Cell 1 is PCell on the TDD primary component (RF Channel 1), Cell 2 is activated SCell on the secondary component (RF Channel 2) for Frame Structure 3, and Cell 3 is the neighbour cell on the secondary component (RF Channel 2) frame structure 3. LBT model is applied on cell 3.

The test consists of two successive time periods, with time duration of T1, and T2 respectively. During time duration T1, the UE shall not have any timing information of cell 2. Immediately at beginning of T2 the transmission power of cell 3 is increased, and due to usage of an offset this shall result in reporting of Event A6.

Table A.8.26.8.1-1: General test parameters for E-UTRAN TDD-TDD intra-frequency event triggered reporting in DRX for CRS based discovery signal under Operation with Frame Structure 3

Parameter	Unit	Value	Comment
E-UTRA RF Channel Number		1, 2	Two radio channels are used for this test
Active PCell		Cell 1	Primary cell on RF channel number 1.
Active SCell		Cell 2	Configured activated secondary cell on RF channel number 2.
Neighbour cell		Cell 3	Neighbor cell to be identified on RF channel number 2.
DMTC period	ms	40	As specified in IE MeasDS-Config in TS 36.331
dmtc-PeriodOffset	ms	10	As specified in IE MeasDS-Config in TS 36.331
Discovery signal occasion duration	ms	1	As specified in IE MeasDS-Config in TS 36.331
CP length		Normal	
A6-Offset	dB	-6	
Time To Trigger	s	0	
Filter coefficient		0	L3 filtering is not used
DRX		ON	DRX related parameters are defined in Table A.8.26.8.1-3
T1	s	5	
T2	s	15	

Table A.8.26.8.1-2: Cell specific test parameters for E-UTRAN TDD-TDD intra-frequency event triggered reporting in DRX for CRS based discovery signal under Operation with Frame Structure 3

Parameter	Unit	Cell1		Cell2		Cell3	
		T1	T2	T1	T2	T1	T2
E-UTRA RF Channel Number		1		2		2	
Special subframe configuration		6		-		-	
Uplink-downlink configuration		1		-		-	
BW _{channel}	MHz	5MHz: NRB,c = 25 10MHz: NRB,c = 50 20MHz: NRB,c = 100		20		20	
Measurement bandwidth	n_{PRB}	5MHz: 10-15 10MHz: 22-27 20MHz: 47-52		38-62		38-62	
PDSCH parameters: DL Reference Measurement Channel		5MHz: R.4 TDD 10MHz: R.0 TDD 20MHz: R.3 TDD		R.0 FS3		-	
PCFICH/PDCCH/PHICH parameters: DL Reference Measurement Channel		5MHz: R.11 TDD 10MHz: R.6 TDD 20MHz: R.10 TDD		R.0 FS3		R.0 FS3	
OCNG Patterns defined in A.3.2.2		5MHz: OP.15 TDD 10MHz: OP.1 TDD 20MHz: OP.11 TDD		OP.13 FDD		OP.14 FDD	
PBCH_RA	dB	0		0		0	
PBCH_RB	dB						
PSS_RA	dB						
SSS_RA	dB						
PCFICH_RB	dB						
PHICH_RA	dB						
PHICH_RB	dB						

PDCCH_RA	dB						
PDCCH_RB	dB						
PDSCH_RA	dB						
PDSCH_RB	dB						
OCNG_RA ^{Note 1}	dB						
OCNG_RB ^{Note 1}	dB						
N_{oc} ^{Note 2}	dBm/ 15 kHz	-104		-104			
\hat{E}_s / N_{oc}	dB	4	4	4	4	-infinity	4
\hat{E}_s / I_{ot}	dB	4	4	4	-1.46	-infinity	-1.46
RSRP ^{Note 3}	dBm/ 15 kHz	-100	-100	-100	-100	-infinity	-100
SCH_RP ^{Note 3}	dBm/ 15 kHz	-100	-100	-100	-100	-infinity	-100
I_o ^{Note 3}	dBm/ Ch BW	-	-	-67.76	-65.42	Specified in columns for Cell 2	
		$70.76+10\log(N_{RB,c}/50)$	$70.76+10\log(N_{RB,c}/50)$				
Propagation Condition		ETU30		ETU30		ETU30	
Correlation Matrix and Antenna Configuration		1x2 Low		1x2 Low		1x2 Low	
Timing offset to Cell 1	μs	-	-	0	0	-	3
Time alignment error relative to cell 1 ^{Note 5}	μs	-	-	$\leq TAE$	$\leq TAE$	N/A	N/A
<p>Note 1: OCNG shall be used such that cells are fully allocated and a constant total transmitted power spectral density is achieved for all OFDM symbols. For cells with LBT model, OCNG is transmitted only in subframes with downlink transmission bursts, and is not transmitted during muted subframes or during DMTC windows.</p> <p>Note 2: Interference from other cells and noise sources not specified in the test is assumed to be constant over subcarriers and time and shall be modelled as AWGN of appropriate power for N_{oc} to be fulfilled.</p> <p>Note 3: RSRP, SCH_RP, E_s/I_{ot} and I_o levels have been derived from other parameters for information purposes. They are not settable parameters themselves.</p> <p>Note 4: The resources for uplink transmission are assigned to the UE prior to the start of time period T2.</p> <p>Note 5: Time alignment error (TAE) as specified in TS 36.104 [30] clause 6.5.3.1.</p>							

Table A.8.26.8.1-3: DRX-Configuration for E-UTRAN TDD-TDD intra-frequency event triggered reporting in DRX for CRS based discovery signal under Operation with Frame Structure 3

Field	Value	Comment
onDurationTimer	psf1	As specified in clause 6.3.2 in TS 36.331
drx-InactivityTimer	psf1	
drx-RetransmissionTimer	psf1	
longDRX-CycleStartOffset	Sf320	
shortDRX	disable	

Table A.8.26.8.1-4: TimeAlignmentTimer -Configuration for E-UTRAN TDD-TDD intra-frequency event triggered reporting in DRX for CRS based discovery signal under Operation with Frame Structure 3

Field	Value	Comment
TimeAlignmentTimer	sf500	As specified in clause 6.3.2 in TS 36.331
sr-ConfigIndex	0	For further information see clause 6.3.2 in TS 36.331 and section 10.1 in TS 36.213.

A.8.26.8.2 Test Requirements

In the test, the UE shall send one Event A6 triggered measurement report, with a measurement reporting delay less than $(24+L)*320ms$ from the beginning of time period T2, where L is the number of configured discovery signal occasions which are not available due to the absence of the necessary radio signals from cell3.

The measurement reporting delay is defined as the time from the beginning of time period T2 to the moment when the UE send the measurement report on PUSCH.

The UE shall not send event triggered measurement reports, as long as the reporting criteria are not fulfilled.

The rate of correct events observed during repeated tests shall be at least 90%.

NOTE: The actual overall delays measured in the test may be up to $2 \times TTI_{DCCH}$ higher than the measurement reporting delays above because of TTI insertion uncertainty of the measurement report in DCCH.

A.8.26.9 E-UTRAN FDD-FS3 Inter-frequency event triggered reporting under fading propagation conditions in synchronous cells

A.8.26.9.1 Test Purpose and Environment

The purpose of this test is to verify that the UE correctly detects event A4 (Neighbour becomes better than threshold) defined in TS 36.331 [2] within the requirements stated in clause 8.11.2.2.1.1.

The test parameters are given in Tables A.8.26.9.1-1 and A.8.26.9.1-2 below. In this test, there are two cells on different carrier frequencies. Cell 1 is an FDD cell and neighbouring Cell 2 is an FS3 cell.

In the measurement control information it is indicated to the UE that event-triggered reporting with Event A4 is used. The test consists of two successive time periods, with time duration of T1, and T2 respectively. During time duration T1, the UE shall not have any timing information of Cell 2.

Table A.8.26.9.1-1: General test parameters for E-UTRAN FDD-FS3 inter-frequency event triggered reporting in fading propagation conditions

Parameter		Unit	Value	Comment
E-UTRA RF Channel Number			1, 2	One FDD carrier frequency is used for active cell and one FS3 carrier frequency is used for neighbour cell.
Active cell			Cell 1	Cell 1 is on RF channel number 1
Neighbour cell			Cell 2	Cell 2 is on RF channel number 2
DMTC period			40	As specified in IE MeasDS-Config in TS 36.331
dmtc-PeriodOffset			10	As specified in IE MeasDS-Config in TS 36.331
Discovery signal occasion duration			1	As specified in IE MeasDS-Config in TS 36.331
Gap Pattern Id			0	As specified in TS 36.133 clause 8.1.2.1.
Gap Offset			8	As specified in IE MeasGapConfig in TS 36.331
A4	Hysteresis	dB	0	Hysteresis for evaluation of event A4.
	Threshold RSRP	dBm	-105	Actual RSRP threshold for event A4. Needs to take absolute accuracy tolerance in section 9.1.11.1 into account plus margin.
	Time To Trigger	s	0	
CP length			Normal	
TimeToTrigger		s	0	
Filter coefficient			0	L3 filtering is not used
DRX			OFF	OFF
Time offset between cells			0 ms	Synchronous cells
T1		s	5	
T2		s	1	

Table A.8.26.9.1-2: Cell specific test parameters for E-UTRAN FDD-FS3 inter-frequency event triggered reporting under fading propagation conditions in synchronous cells

Parameter	Unit	Cell 1		Cell 2	
		T1	T2	T1	T2
Frame Structure		FDD		FS3	
E-UTRA RF Channel Number		1		2	

BW _{channel}	MHz	5 MHz: N _{RB,c} = 25 10 MHz: N _{RB,c} = 50 20 MHz: N _{RB,c} = 100		20 MHz: N _{RB,c} = 100	
LBT model		-		A.3.17	
Correlation Matrix and Antenna Configuration		1x2 Low		1x2 Low	
Measurement bandwidth	n _{PRB}	5MHz: 10-15 10MHz: 22-27 20MHz: 47-52		47-52	
PDSCH Reference measurement channel defined in A.3.1.1.1 and A.3.1.1.6		5 MHz: R.5 FDD 10 MHz: R.0 FDD 20 MHz: R.4 FDD		-	
PDCCH/PCFICH/PHICH Reference measurement channel defined in A.3.1.2.1 and A.3.1.2.3		5 MHz: R.11 FDD 10 MHz: R.6 FDD 20 MHz: R.10 FDD		R.0 FS3	
OCNG Patterns defined in A.3.2		5 MHz: OP.15 FDD 10 MHz: OP.1 FDD 20 MHz: OP.11 FDD		OP.14 FDD	
PBCH_RA	dB	0		0	
PBCH_RB	dB				
PSS_RA	dB				
SSS_RA	dB				
PCFICH_RB	dB				
PHICH_RA	dB				
PHICH_RB	dB				
PDCCH_RA	dB				
PDCCH_RB	dB				
PDSCH_RA	dB				
PDSCH_RB	dB				
OCNG_RA ^{Note 1}	dB				
OCNG_RB ^{Note 1}	dB				
N _{oc} ^{Note 3}	dBm/15 kHz				
RSRP ^{Note 4}	dBm/15 kHz	-94	-94	-inf	-91
\hat{E}_s/I_{ot}	dB	4	4	-inf	7
SCH_RP ^{Note 4}	dBm/15 kHz	-94	-94	-inf	-91
\hat{E}_s/N_{oc}	dB	4	4	-inf	7
Io	dBm/Ch BW	-64.76 +10log (N _{RB,c} /50)	-64.76 +10log (N _{RB,c} /50)	-70.22	-62.43
Propagation Condition		ETU30		ETU30	
Note 1:	OCNG shall be used such that cells are fully allocated and a constant total transmitted power spectral density is achieved for all OFDM symbols. For cells with LBT model, OCNG is transmitted only in subframes with downlink transmission bursts, and is not transmitted during muted subframes or during DMTC windows.				
Note 2:	The resources for uplink transmission are assigned to the UE prior to the start of time period T2.				
Note 3:	Interference from other cells and noise sources not specified in the test is assumed to be constant over subcarriers and time and shall be modelled as AWGN of appropriate power for N _{oc} to be fulfilled.				
Note 4:	Es/Iot, RSRP, SCH_RP and Io levels have been derived from other parameters for information purposes. They are not settable parameters themselves.				
Note 5:	Void				

A.8.26.9.2 Test Requirements

The UE shall send one Event A4 triggered measurement report, with a measurement reporting delay less than (3 +L)*40 ms from the beginning of time period T2. L is the number of configured discovery signal occasions which are not

available during the time for cell identification at the UE during measurement gaps due to the absence of the necessary radio signals from the measured cell,

The UE shall not send event triggered measurement reports, as long as the reporting criteria are not fulfilled.

The rate of correct events observed during repeated tests shall be at least 90%.

NOTE: The actual overall delays measured in the test may be up to $2 \times TTI_{DCCCH}$ higher than the measurement reporting delays above because of TTI insertion uncertainty of the measurement report in DCCCH.

A.8.26.10 E-UTRAN TDD-FS3 inter-frequency event triggered reporting under fading propagation conditions in synchronous cells

A.8.26.10.1 Test Purpose and Environment

The purpose of this test is to verify that the UE correctly detects event A4 (Neighbour becomes better than threshold) defined in TS 36.331 [2] within the requirements stated in clause 8.11.2.2.2.1.

The test parameters are given in Tables A.8.26.10.1-1 and A.8.26.10.1-2 below. In this test, there are two cells on different carrier frequencies. Cell 1 is an TDD cell and neighbouring Cell 2 is an FS3 cell.

In the measurement control information it is indicated to the UE that event-triggered reporting with Event A4 is used. The test consists of two successive time periods, with time duration of T1, and T2 respectively. During time duration T1, the UE shall not have any timing information of Cell 2.

Table A.8.26.10.1-1: General test parameters for E-UTRAN TDD-FS3 inter-frequency event triggered reporting in fading propagation conditions

Parameter		Unit	Value	Comment
E-UTRA RF Channel Number			1, 2	One TDD carrier frequency is used for active cell and one FS3 carrier frequency is used for neighbour cell.
Active cell			Cell 1	Cell 1 is on RF channel number 1
Neighbour cell			Cell 2	Cell 2 is on RF channel number 2
DMTC period			40	As specified in IE MeasDS-Config in TS 36.331
dmtc-PeriodOffset			10	As specified in IE MeasDS-Config in TS 36.331
Discovery signal occasion duration			1	As specified in IE MeasDS-Config in TS 36.331
Gap Pattern Id			0	As specified in TS 36.133 clause 8.1.2.1.
Gap Offset			8	As specified in IE MeasGapConfig in TS 36.331
A4	Hysteresis	dB	0	Hysteresis for evaluation of event A4.
	Threshold RSRP	dBm	-105	Actual RSRP threshold for event A4. Needs to take absolute accuracy tolerance in section 9.1.11.1 into account plus margin.
	Time To Trigger	s	0	
CP length			Normal	
TimeToTrigger		s	0	
Filter coefficient			0	L3 filtering is not used
DRX			OFF	OFF
Time offset between cells			0 ms	Synchronous cells
T1		s	5	
T2		s	1	

Table A.8.26.10.1-2: Cell specific test parameters for E-UTRAN TDD-FS3 inter-frequency event triggered reporting under fading propagation conditions in synchronous cells

Parameter	Unit	Cell 1		Cell 2	
		T1	T2	T1	T2
Frame Structure		TDD		FS3	

E-UTRA RF Channel Number		1	2		
BW _{channel}	MHz	5 MHz: N _{RB,c} = 25 10 MHz: N _{RB,c} = 50 20 MHz: N _{RB,c} = 100	20 MHz: N _{RB,c} = 100		
Special subframe configuration		6	-		
Uplink-downlink configuration		1	-		
LBT model		-	A.3.17		
Correlation Matrix and Antenna Configuration		1x2 Low	1x2 Low		
Measurement bandwidth	<i>n_{PRB}</i>	5MHz: 10-15 10MHz: 22-27 20MHz: 47-52	47-52		
PDSCH Reference measurement channel defined in A.3.1.1.2 and A.3.1.1.6		5MHz: R.4 TDD 10MHz: R.0 TDD 20MHz: R.3 TDD	-		
PDCCH/PCFICH/PHICH Reference measurement channel defined in A.3.1.2.2 and A.3.1.2.4		5MHz: R.11 TDD 10MHz: R.6 TDD 20MHz: R.10 TDD	R.0 FS3		
OCNG Patterns defined in A.3.2.2.1 (OP.1 TDD) , A.3.2.2.9 (OP.9 TDD) and A.3.2.2.7 (OP.7 TDD)		5MHz: OP.10 TDD 10MHz: OP.2 TDD 20MHz: OP.8 TDD	OP.14 FDD		
PBCH_RA	dB	0	0		
PBCH_RB	dB				
PSS_RA	dB				
SSS_RA	dB				
PCFICH_RB	dB				
PHICH_RA	dB				
PHICH_RB	dB				
PDCCH_RA	dB				
PDCCH_RB	dB				
PDSCH_RA	dB				
PDSCH_RB	dB				
OCNG_RA ^{Note 1}	dB				
OCNG_RB ^{Note 1}	dB				
<i>N_{oc}</i> ^{Note 3}	dBm/15 kHz				
RSRP ^{Note 4}	dBm/15 kHz	-94	-94	-inf	-91
\hat{E}_s/I_{ot}	dB	4	4	-inf	7
SCH_RP ^{Note 4}	dBm/15 kHz	-94	-94	-inf	-91
\hat{E}_s/N_{oc}	dB	4	4	-inf	7
Io	dBm/Ch BW	-64.76 +10log (N _{RB,c} /50)	-64.76 +10log (N _{RB,c} /50)	-70.22	-62.43
Propagation Condition		ETU30		ETU30	
Note 1:	OCNG shall be used such that cells are fully allocated and a constant total transmitted power spectral density is achieved for all OFDM symbols. For cells with LBT model, OCNG is transmitted only in subframes with downlink transmission bursts, and is not transmitted during muted subframes or during DMTC windows.				
Note 2:	The resources for uplink transmission are assigned to the UE prior to the start of time period T2.				
Note 3:	Interference from other cells and noise sources not specified in the test is assumed to be constant over subcarriers and time and shall be modelled as AWGN of appropriate power for <i>N_{oc}</i> to be fulfilled.				
Note 4:	<i>E_s/I_{ot}</i> , RSRP, SCH_RP and Io levels have been derived from other parameters for information purposes. They are not settable parameters themselves.				
Note 5:	Void				

A.8.26.10.2 Test Requirements

The UE shall send one Event A4 triggered measurement report, with a measurement reporting delay less than $(3 + L) \cdot 40 \text{ ms}$ from the beginning of time period T2. L is the number of configured discovery signal occasions which are not available during the time for cell identification at the UE during measurement gaps due to the absence of the necessary radio signals from the measured cell.

The UE shall not send event triggered measurement reports, as long as the reporting criteria are not fulfilled.

The rate of correct events observed during repeated tests shall be at least 90%.

NOTE: The actual overall delays measured in the test may be up to $2 \cdot TTI_{DCCH}$ higher than the measurement reporting delays above because of TTI insertion uncertainty of the measurement report in DCCH.

A.9 Measurement Performance Requirements

Unless explicitly stated otherwise:

- Reported measurements shall be within defined range of accuracy limits defined in Clause 9 for at least 90 % of the reported cases. If multiple measurement performance requirements are verified in the same test, the reported measurements for each requirement shall be within defined range of accuracy limits of the corresponding requirement defined in Clause 9 for at least 90% of the reported cases.
- Cell 1 is the PCell.
- Measurements are performed in RRC_CONNECTED state.
- The reference channels assume transmission of PDSCH with a maximum number of 5 HARQ transmissions unless otherwise specified.

A.9.1 RSRP

A.9.1.1 FDD Intra frequency case

A.9.1.1.1 Test Purpose and Environment

The purpose of this test is to verify that the RSRP measurement accuracy is within the specified limits. This test will verify the requirements in Sections 9.1.2.1 and 9.1.2.2 for FDD intra frequency measurements.

A.9.1.1.2 Test parameters

In this set of test cases all cells are on the same carrier frequency. Both absolute and relative accuracy of RSRP intra frequency measurements are tested by using the parameters in Table A.9.1.1.2-1. In all test cases, Cell 1 is the PCell and Cell 2 the target cell.

Table A.9.1.1.2-1: RSRP FDD Intra frequency test parameters

Parameter	Unit	Test 1		Test 2		Test 3	
		Cell 1	Cell 2	Cell 1	Cell 2	Cell 1	Cell 2
E-UTRA RF Channel Number		1		1		1	
BW _{channel}	MHz	10		10		10	
Measurement bandwidth	<i>n</i> _{PRB}	22—27		22—27		22—27	
PDSCH Reference measurement channel defined in A.3.1.1.1		R.0 FDD	-	R.0 FDD	-	R.0 FDD	-
PDSCH allocation	<i>n</i> _{PRB}	13—36	-	13—36	-	13—36	-
PDCCH/PCFICH/PHICH Reference measurement channel defined in A.3.1.2.1		R.6 FDD		R.6 FDD		R.6 FDD	
OCNG Patterns defined in A.3.2.1.1 (OP.1 FDD) and A.3.2.1.2 (OP.2 FDD)		OP.1 FDD	OP.2 FDD	OP.1 FDD	OP.2 FDD	OP.1 FDD	OP.2 FDD
PBCH_RA	dB	0	0	0	0	0	0
PBCH_RB							
PSS_RA							
SSS_RA							
PCFICH_RB							
PHICH_RA							
PHICH_RB							
PDCCH_RA							
PDCCH_RB							
PDSCH_RA							
PDSCH_RB							
OCNG_RA ^{Note1}							
OCNG_RB ^{Note1}							
<i>N</i> _{oc} ^{Note2}							
	Bands FDD_B1, FDD_B2 ^{Note 9}	-115.5					
	Bands FDD_C	-115					

	Bands FDD_D							-114.5
	Bands FDD_E, FDD_F ^{Note 5}							-114
	Bands FDD_G ^{Note 7}							-113
	Bands FDD_H							-112.5
\hat{E}_s/I_{ot}		dB	2.5	-6	2.5	-6	0.46	-5.76
RSRP ^{Note3}	Bands FDD_A ^{Note 8}	dBm/15 kHz	-100	-105	-82	-87	-113	-117
	Bands FDD_B1, FDD_B2 ^{Note 9}						-112.5	-116.5
	Bands FDD_C						-112	-116
	Bands FDD_D						-111.5	-115.5
	Bands FDD_E, FDD_F ^{Note 5}						-111	-115
	Bands FDD_G ^{Note 7}						-110	-114
	Bands FDD_H						-109.5	-113.5
I _o ^{Note3}	Bands FDD_A ^{Note 8}	dBm/9 MHz	-70.27	-70.27	-52.27	-52.27	-82.43	
	Bands FDD_B1, FDD_B2 ^{Note 9}						-81.93	
	Bands FDD_C						-81.43	
	Bands FDD_D						-80.93	
	Bands FDD_E, FDD_F ^{Note 5}						-80.43	
	Bands FDD_G ^{Note 7}						-79.43	
	Bands FDD_H						-78.93	
\hat{E}_s/N_{oc}		dB	6	1	6	1	3	-1
Propagation condition		-	AWGN		AWGN		AWGN	
<p>Note 1: OCNG shall be used such that both cells are fully allocated and a constant total transmitted power spectral density is achieved for all OFDM symbols.</p> <p>Note 2: Interference from other cells and noise sources not specified in the test is assumed to be constant over subcarriers and time and shall be modelled as AWGN of appropriate power for N_{oc} to be fulfilled.</p> <p>Note 3: RSRP and I_o levels have been derived from other parameters for information purposes. They are not settable parameters themselves.</p> <p>Note 4: RSRP minimum requirements are specified assuming independent interference and noise at each receiver antenna port.</p> <p>Note 5: For Band 26, the tests shall be performed with the carrier frequency of the assigned E-UTRA channel bandwidth within 865-894 MHz.</p> <p>Note 6: E-UTRA operating band groups are as defined in Section 3.5.</p> <p>Note 7: Except Band 29.</p> <p>Note 8: Except Band 32, Band 75, Band 76.</p> <p>Note 9: For Band 74, the tests shall be performed with the carrier frequency of the assigned E-UTRA channel bandwidth within 1475.9-1510.9 MHz.</p>								

A.9.1.1.3 Test Requirements

The RSRP measurement accuracy shall fulfil the requirements in sections 9.1.2.1 and 9.1.2.2. The RSRP measurement accuracy for UE Category 1bis shall fulfil the requirements in sections 9.1.2.7 and 9.1.2.8.

A.9.1.2 TDD Intra frequency case

A.9.1.2.1 Test Purpose and Environment

The purpose of this test is to verify that the RSRP measurement accuracy is within the specified limits. This test will verify the requirements in Sections 9.1.2.1 and 9.1.2.2 for TDD intra frequency measurements.

A.9.1.2.2 Test parameters

In this set of test cases all cells are on the same carrier frequency. Both absolute and relative accuracy of RSRP intra frequency measurements are tested by using the parameters in Table A.9.1.2.2-1. In all test cases, Cell 1 is the PCell and Cell 2 the target cell.

Table A.9.1.2.2-1: RSRP TDD Intra frequency test parameters

Parameter	Unit	Test 1		Test 2		Test 3	
		Cell 1	Cell 2	Cell 1	Cell 2	Cell 1	Cell 2
E-UTRA RF Channel Number		1		1		1	
BW _{channel}	MHz	10		10		10	
Special subframe configuration ^{Note1}		6		6		6	
Uplink/downlink configuration ^{Note1}		1		1		1	
Measurement bandwidth	n_{PRB}	22—27		22—27		22—27	
PDSCH Reference measurement channel defined in A.3.1.1.2		R.0 TDD	-	R.0 TDD	-	R.0 TDD	-
PDSCH allocation	n_{PRB}	13—36	-	13—36	-	13—36	-
PDCCH/PCFICH/PHICH Reference measurement channel defined in A.3.1.2.2		R.6 TDD		R.6 TDD		R.6 TDD	
OCNG Patterns defined in A.3.2.2.1 (OP.1 TDD) and A.3.2.2.2 (OP.2 TDD)		OP.1 TDD	OP.2 TDD	OP.1 TDD	OP.2 TDD	OP.1 TDD	OP.2 TDD
PBCH_RA	dB	0	0	0	0	0	0
PBCH_RB							
PSS_RA							
SSS_RA							
PCFICH_RB							
PHICH_RA							
PHICH_RB							
PDCCH_RA							
PDCCH_RB							
PDSCH_RA							
PDSCH_RB							
OCNG_RA ^{Note2}							
OCNG_RB ^{Note2}							
N_{oc} ^{Note3}							
	Bands TDD_C	-106	-106	-88	-88	-115	
	Bands TDD_E					-114	
\hat{E}_s/I_{ot}	dB	2.5	-6	2.5	-6	0.5	-5.76
RSRP ^{Note4}	Bands TDD_A					-113	-117
	Bands TDD_C	-100	-105	-82	-87	-112	-116
	Bands TDD_E					-111	-115
I_o ^{Note4}	Bands TDD_A					-82.43	
	Bands TDD_C	-70.27	-70.27	-52.27	-52.27	-81.43	
	Bands TDD_E					-80.43	
\hat{E}_s/N_{oc}	dB	6	1	6	1	3	-1
Propagation condition	-	AWGN		AWGN		AWGN	
<p>Note 1: For special subframe and uplink-downlink configurations see Tables 4.2-1 and 4.2-2 in TS 36.211.</p> <p>Note 2: OCNG shall be used such that both cells are fully allocated and a constant total transmitted power spectral density is achieved for all OFDM symbols.</p> <p>Note 3: Interference from other cells and noise sources not specified in the test is assumed to be constant over subcarriers and time and shall be modelled as AWGN of appropriate power for N_{oc} to be fulfilled.</p> <p>Note 4: RSRP and I_o levels have been derived from other parameters for information purposes. They are not settable parameters themselves.</p> <p>Note 5: RSRP minimum requirements are specified assuming independent interference and noise at each receiver antenna port.</p> <p>Note 6: E-UTRA operating band groups are as defined in Section 3.5.</p>							

A.9.1.2.3 Test Requirements

The RSRP measurement accuracy shall fulfil the requirements in sections 9.1.2.1 and 9.1.2.2. The RSRP measurement accuracy for UE Category 1bis shall fulfil the requirements in sections 9.1.2.7 and 9.1.2.8.

A.9.1.3 FDD—FDD Inter frequency case

A.9.1.3.1 Test Purpose and Environment

The purpose of this test is to verify that the RSRP measurement accuracy is within the specified limits. This test will verify the requirements in Sections 9.1.3.1 and 9.1.3.2 for FDD—FDD inter frequency measurements. The RSRP measurement accuracy for UE Category 1bis shall fulfil the requirements in sections 9.1.2.7 and 9.1.2.8.

A.9.1.3.2 Test parameters

In this set of test cases the cells are on different carrier frequencies. Both absolute and relative accuracy of RSRP inter-frequency measurements are tested by using the parameters in Table A.9.1.3.2-1 In all test cases, Cell 1 is the PCell and Cell 2 the target cell. The inter frequency measurements are supported by a measurement gap.

Table A.9.1.3.2-1: RSRP FDD—FDD Inter frequency test parameters

Parameter		Unit	Test 1		Test 2						
			Cell 1	Cell 2	Cell 1	Cell 2					
E-UTRA RF Channel Number			1	2	1	2					
BW _{channel}		MHz	10	10	10	10					
Gap Pattern Id			0	-	0	-					
Measurement bandwidth		n_{PRB}	22—27		22—27						
PDSCH Reference measurement channel defined in A.3.1.1.1			R.0 FDD	-	R.0 FDD	-					
PDSCH allocation		n_{PRB}	13—36	-	13—36	-					
PDCCH/PCFICH/PHICH Reference measurement channel defined in A.3.1.2.1			R.6 FDD		R.6 FDD						
OCNG Patterns defined in A.3.2.1.1 (OP.1 FDD) and A.3.2.1.2 (OP.2 FDD)			OP.1 FDD	OP.2 FDD	OP.1 FDD	OP.2 FDD					
PBCH_RA		dB	0	0	0	0					
PBCH_RB											
PSS_RA											
SSS_RA											
PCFICH_RB											
PHICH_RA											
PHICH_RB											
PDCCH_RA											
PDCCH_RB											
PDSCH_RA											
PDSCH_RB											
OCNG_RANote1											
OCNG_RBNote											
N_{oc} Note2	Bands FDD_A Note 8						dBm/15 kHz	-88.65	-88.65	$(N_{oc}$ for Channel 2 +8dB)	-117
	Bands FDD_B1, FDD_B2 Note 9										-116.5
	Bands FDD_C										-116
	Bands FDD_D	-115.5									
	Bands FDD_E, FDD_F Note 5	-115									
	Bands FDD_G Note 7	-114									
	Bands FDD_H	-113.5									
\hat{E}_s/I_{ot}		dB	10	10	13	-4					
RSRPNote3	Bands FDD_A Note 8	dBm/15 kHz	-78.65	-78.65	(RSRP for Cell 2 +25dB)	-121					
	Bands FDD_B1, FDD_B2 Note 9					-120.5					
	Bands FDD_C					-120					
	Bands FDD_D					-119.5					
	Bands FDD_E, FDD_F Note 5					-119					
	Bands FDD_G Note 7					-118					
	Bands FDD_H					-117.5					
I_o Note3	Bands FDD_A Note 8	dBm/9 MHz	-50.45	-50.45		-87.76					

	Bands FDD_B1, FDD_B2 ^{Note 9}				(I _o for Channel 2 +19.75dB)	-87.26
	Bands FDD_C					-86.76
	Bands FDD_D					-86.26
	Bands FDD_E, FDD_F ^{Note 5}					-85.76
	Bands FDD_G ^{Note 7}					-84.76
	Bands FDD_H					-84.26
\hat{E}_s/N_{oc}		dB	10	10	13	-4
Propagation condition		-	AWGN		AWGN	
<p>Note 1: OCNG shall be used such that both cells are fully allocated and a constant total transmitted power spectral density is achieved for all OFDM symbols.</p> <p>Note 2: Interference from other cells and noise sources not specified in the test is assumed to be constant over subcarriers and time and shall be modelled as AWGN of appropriate power for N_{oc} to be fulfilled.</p> <p>Note 3: RSRP and I_o levels have been derived from other parameters for information purposes. They are not settable parameters themselves.</p> <p>Note 4: RSRP minimum requirements are specified assuming independent interference and noise at each receiver antenna port.</p> <p>Note 5: For Band 26, the tests shall be performed with the carrier frequency of assigned E-UTRA channel bandwidth within 865-894 MHz.</p> <p>Note 6: E-UTRA operating band groups are as defined in Section 3.5.</p> <p>Note 7: Except Band 29.</p> <p>Note 8: Except Band 32, Band 75, Band 76.</p> <p>Note 9: For Band 74, the tests shall be performed with the carrier frequency of the assigned E-UTRA channel bandwidth within 1475.9-1510.9 MHz.</p>						

A.9.1.3.3 Test Requirements

The RSRP measurement accuracy shall fulfil the requirements in sections 9.1.3.1 and 9.1.3.2. The RSRP measurement accuracy for UE Category 1bis shall fulfil the requirements in sections 9.1.3.3 and 9.1.3.4.

A.9.1.4 TDD—TDD Inter frequency case

A.9.1.4.1 Test Purpose and Environment

The purpose of this test is to verify that the RSRP measurement accuracy is within the specified limits. This test will verify the requirements in Sections 9.1.3.1 and 9.1.3.2 for TDD—TDD inter frequency measurements.

A.9.1.4.2 Test parameters

In this set of test cases the cells are on different carrier frequencies. Both absolute and relative accuracy of RSRP inter-frequency measurements are tested by using the parameters in Table A.9.1.4.2-1 for TDD configuration 1 and in Table A.9.1.4.2-2 for TDD configuration 0. In all test cases, Cell 1 is the PCell and Cell 2 the target cell. The inter frequency measurements are supported by a measurement gap.

Table A.9.1.4.2-1: RSRP TDD—TDD Inter frequency test parameters for TDD configuration 1

Parameter	Unit	Test 1		Test 2	
		Cell 1	Cell 2	Cell 1	Cell 2
E-UTRA RF Channel Number		1	2	1	2
$BW_{channel}$	MHz	10	10	10	10
Special subframe configuration ^{Note1}		6		6	
Uplink-downlink configuration ^{Note1}		1		1	
Gap Pattern Id		0	-	0	-
Measurement bandwidth	n_{PRB}	22—27		22—27	
PDSCH Reference measurement channel defined in A.3.1.1.2		R.0 TDD	-	R.0 TDD	-
PDSCH allocation	n_{PRB}	13—36	-	13—36	-
PDCCH/PCFICH/PHICH Reference measurement channel defined in A.3.1.2.2		R.6 TDD		R.6 TDD	

OCNG Patterns defined in A.3.2.2.1 (OP.1 TDD) and A.3.2.2.2 (OP.2 TDD)			OP.1 TDD	OP.2 TDD	OP.1 TDD	OP.2 TDD					
PBCH_RA		dB	0	0	0	0					
PBCH_RB											
PSS_RA											
SSS_RA											
PCFICH_RB											
PHICH_RA											
PHICH_RB											
PDCCH_RA											
PDCCH_RB											
PDSCH_RA											
PDSCH_RB											
OCNG_RA ^{Note2}											
OCNG_RB ^{Note2}											
N_{oc} ^{Note3}	Bands TDD_A						dBm/15 kHz	-88.65	-88.65	$(N_{oc}$ for Channel 2 +8dB)	-117
	Bands TDD_C										-116
	Bands TDD_E	-115									
\hat{E}_s/I_{ot}		dB	10	10	13	-4					
RSRP ^{Note4}	Bands TDD_A	dBm/15 kHz	-78.65	-78.65	(RSRP for Cell 2 +25dB)	-121					
	Bands TDD_C					-120					
	Bands TDD_E					-119					
I_o ^{Note4}	Bands TDD_A	dBm/9 MHz	-50.45	-50.45	(I _o for Channel 2 +19.75dB)	-87.76					
	Bands TDD_C					-86.76					
	Bands TDD_E					-85.76					
\hat{E}_s/N_{oc}		dB	10	10	13	-4					
Propagation condition		-	AWGN		AWGN						
<p>Note 1: For special subframe and uplink-downlink configurations see Tables 4.2-1 and 4.2-2 in TS 36.211.</p> <p>Note 2: OCNG shall be used such that both cells are fully allocated and a constant total transmitted power spectral density is achieved for all OFDM symbols.</p> <p>Note 3: Interference from other cells and noise sources not specified in the test is assumed to be constant over subcarriers and time and shall be modelled as AWGN of appropriate power for N_{oc} to be fulfilled.</p> <p>Note 4: RSRP and I_o levels have been derived from other parameters for information purposes. They are not settable parameters themselves.</p> <p>Note 5: RSRP minimum requirements are specified assuming independent interference and noise at each receiver antenna port.</p> <p>Note 6: E-UTRA operating band groups are as defined in Section 3.5.</p>											

Table A.9.1.4.2-2: RSRP TDD—TDD Inter frequency test parameters for TDD configuration 0

Parameter	Unit	Test 1		Test 2	
		Cell 1	Cell 2	Cell 1	Cell 2
E-UTRA RF Channel Number		1	2	1	2
$BW_{channel}$	MHz	10	10	10	10
Special subframe configuration ^{Note1}		6		6	
Uplink-downlink configuration ^{Note1}		0		0	
Gap Pattern Id		0	-	0	-
Measurement bandwidth	n_{PRB}	22—27		22—27	
PDSCH Reference measurement channel defined in A.3.1.1.2		R.5 TDD	-	R.5 TDD	-
PDSCH allocation	n_{PRB}	13—36	-	13—36	-
PDCCH/PCFICH/PHICH Reference measurement channel defined in A.3.1.2.2		R.6 TDD		R.6 TDD	
OCNG Patterns defined in A.3.2.2.1 (OP.1 TDD) and A.3.2.2.2 (OP.2 TDD)		OP.1 TDD	OP.2 TDD	OP.1 TDD	OP.2 TDD
PBCH_RA	dB	0	0	0	0
PBCH_RB					

PSS_RA						
SSS_RA						
PCFICH_RB						
PHICH_RA						
PHICH_RB						
PDCCH_RA						
PDCCH_RB						
PDSCH_RA						
PDSCH_RB						
OCNG_RA ^{Note2}						
OCNG_RB ^{Note2}						
N_{oc} ^{Note3}	Bands TDD_A	dBm/15 kHz	-88.65	-88.65	$(N_{oc}$ for Channel 2 +8dB)	-117
	Bands TDD_C					-116
	Bands TDD_E					-115
\hat{E}_s/I_{ot}		dB	10	10	13	-4
RSRP ^{Note4}	Bands TDD_A	dBm/15 kHz	-78.65	-78.65	(RSRP for Cell 2 +25dB)	-121
	Bands TDD_C					-120
	Bands TDD_E					-119
I_o ^{Note4}	Bands TDD_A	dBm/9 MHz	-50.45	-50.45	(I _o for Channel 2 +19.75dB)	-87.76
	Bands TDD_C					-86.76
	Bands TDD_E					-85.76
\hat{E}_s/N_{oc}		dB	10	10	13	-4
Propagation condition		-	AWGN		AWGN	
<p>Note 1: For special subframe and uplink-downlink configurations see Tables 4.2-1 and 4.2-2 in TS 36.211.</p> <p>Note 2: OCNG shall be used such that both cells are fully allocated and a constant total transmitted power spectral density is achieved for all OFDM symbols.</p> <p>Note 3: Interference from other cells and noise sources not specified in the test is assumed to be constant over subcarriers and time and shall be modelled as AWGN of appropriate power for N_{oc} to be fulfilled.</p> <p>Note 4: RSRP and I_o levels have been derived from other parameters for information purposes. They are not settable parameters themselves.</p> <p>Note 5: RSRP minimum requirements are specified assuming independent interference and noise at each receiver antenna port.</p> <p>Note 6: E-UTRA operating band groups are as defined in Section 3.5.</p>						

A.9.1.4.3 Test Requirements

The RSRP measurement accuracy shall fulfil the requirements in sections 9.1.3.1 and 9.1.3.2. The RSRP measurement accuracy for UE Category 1bis shall fulfil the requirements in sections 9.1.3.3 and 9.1.3.4.

A.9.1.5 FDD—TDD Inter frequency case

A.9.1.5.1 Test Purpose and Environment

The purpose of this test is to verify that the RSRP measurement accuracy is within the specified limits. This test will verify the requirements in Sections 9.1.3.1 and 9.1.3.2 for FDD—TDD inter frequency measurements.

A.9.1.5.2 Test parameters

In this set of test cases the cells are on different carrier frequencies. Both absolute and relative accuracy of RSRP inter frequency measurements are tested by using the parameters in Table A.9.1.5.2-1 and Table A.9.1.5.2-2. In all test cases, Cell 1 is the serving cell and Cell 2 the target cell. Cell 1 is FDD cell and Cell 2 is TDD cell. The inter frequency measurements are supported by a measurement gap.

Table A.9.1.5.2-1: RSRP FDD—TDD Inter frequency test parameters (FDD Cell1)

Parameter	Unit	Test 1	Test 2
-----------	------	--------	--------

		Cell 1		Cell 1	
E-UTRA RF Channel Number		1		1	
BW _{channel}	MHz	10		10	
Gap Pattern Id		0		0	
Measurement bandwidth	n_{PRB}	22—27		22—27	
PDSCH Reference measurement channel defined in A.3.1.1.1		R.0 FDD		R.0 FDD	
PDSCH allocation	n_{PRB}	13—36		13—36	
PDCCH/PCFICH/PHICH Reference measurement channel defined in A.3.1.2.1		R.6 FDD		R.6 FDD	
OCNG Patterns defined in A.3.2.1.1 (OP.1 FDD) and A.3.2.1.2 (OP.2 FDD)		OP.1 FDD		OP.1 FDD	
PBCH_RA	dB	0	0	0	0
PBCH_RB					
PSS_RA					
SSS_RA					
PCFICH_RB					
PHICH_RA					
PHICH_RB					
PDCCH_RA					
PDCCH_RB					
PDSCH_RA					
PDSCH_RB					
OCNG_RANote1					
OCNG_RBNote					
N_{oc} ^{Note2}					
\hat{E}_s/I_{ot}	dB	10		13	
RSRP ^{Note3}	dBm/15 kHz	-78.65		-91	
I_o ^{Note3}	dBm/9 MHz	-50.45		-63.01	
\hat{E}_s/N_{oc}	dB	10		13	
Propagation condition	-	AWGN		AWGN	
<p>Note 1: OCNG shall be used such that both cells are fully allocated and a constant total transmitted power spectral density is achieved for all OFDM symbols.</p> <p>Note 2: Interference from other cells and noise sources not specified in the test is assumed to be constant over subcarriers and time and shall be modelled as AWGN of appropriate power for N_{oc} to be fulfilled.</p> <p>Note 3: RSRP and I_o levels have been derived from other parameters for information purposes. They are not settable parameters themselves.</p> <p>Note 4: RSRP minimum requirements are specified assuming independent interference and noise at each receiver antenna port.</p>					

Table A.9.1.5.2-2: RSRP FDD—TDD Inter frequency test parameters (TDD cell2)

Parameter	Unit	Test 1	Test 2
		Cell 2	Cell 2
E-UTRA RF Channel Number		2	2
BW _{channel}	MHz	10	10
Special subframe configuration ^{Note1}		6	6
Uplink-downlink configuration ^{Note1}		1	1
Gap Pattern Id		-	-
Measurement bandwidth	n_{PRB}	22—27	22—27
PDSCH Reference measurement channel defined in A.3.1.1.2		-	-
PDSCH allocation	n_{PRB}	-	-

PDCCH/PCFICH/PHICH Reference measurement channel defined in A.3.1.2.2		R.6 TDD	R.6 TDD
OCNG Patterns defined in A.3.2.2.1 (OP.1 TDD) and A.3.2.2.2 (OP.2 TDD)		OP.2 TDD	OP.2 TDD
PBCH_RA	dB	0	0
PBCH_RB			
PSS_RA			
SSS_RA			
PCFICH_RB			
PHICH_RA			
PHICH_RB			
PDCCH_RA			
PDCCH_RB			
PDSCH_RA			
PDSCH_RB			
OCNG_RA ^{Note2}			
OCNG_RB ^{Note2}			
N_{oc} ^{Note3}			
\hat{E}_s/I_{ot}	dB	10	-4
RSRP ^{Note4}	dBm/15 kHz	-78.65	-116
I_o ^{Note4}	dBm/9 MHz	-50.45	-82.76
\hat{E}_s/N_{oc}	dB	10	-4
Propagation condition	-	AWGN	AWGN
<p>Note 1: For special subframe and uplink-downlink configurations see Tables 4.2-1 and 4.2-2 in TS 36.211.</p> <p>Note 2: OCNG shall be used such that both cells are fully allocated and a constant total transmitted power spectral density is achieved for all OFDM symbols.</p> <p>Note 3: Interference from other cells and noise sources not specified in the test is assumed to be constant over subcarriers and time and shall be modelled as AWGN of appropriate power for N_{oc} to be fulfilled.</p> <p>Note 4: RSRP and I_o levels have been derived from other parameters for information purposes. They are not settable parameters themselves.</p> <p>Note 5: RSRP minimum requirements are specified assuming independent interference and noise at each receiver antenna port.</p>			

A.9.1.5.3 Test Requirements

The RSRP measurement accuracy shall fulfil the requirements in sections 9.1.3.1 and 9.1.3.2. The RSRP measurement accuracy for UE Category 1bis shall fulfil the requirements in sections 9.1.3.3 and 9.1.3.4.

A.9.1.6 FDD RSRP for E-UTRAN Carrier Aggregation

A.9.1.6.1 Test Purpose and Environment

The purpose of this test is to verify that the FDD RSRP absolute and relative accuracy requirements in carrier aggregation are within the specified limits. This test will verify the absolute RSRP accuracy requirements of the primary component carrier defined in clause 9.1.11.1, the absolute RSRP accuracy requirements of the secondary component carrier defined in clause 9.1.11.2, and the relative RSRP accuracy requirements of the secondary component carrier defined in clause 9.1.11.2. The test will also verify the primary and secondary component carrier relative RSRP accuracy requirement defined in Clause 9.1.11.3.

A.9.1.6.2 Test parameters

In this set of cases cell1 is PCell on the primary component carrier, cell2 is SCell on the secondary component carrier and activated, and cell3 is the neighboring cell on the secondary component carrier. The test parameters are given in Table A.9.1.6.2-1.

Table A.9.1.6.2-1: RSRP FDD carrier aggregation test parameters

Parameter	Unit	Test 1		
		Cell 1	Cell 2	Cell3
E-UTRA RF Channel Number		1	2	2
BW _{channel}	MHz	10	10	10
Timing offset to cell1	μs	-	0	3
Time alignment error between cell 2 and cell 1		-	≤ Time alignment error as specified in 3GPP TS 36.104 [30] clause 6.5.3.1.	-
Measurement bandwidth	n_{PRB}	22—27		
PDSCH Reference measurement channel defined in A.3.1.1.1		R.0 FDD	R.0 FDD	-
PDSCH allocation	n_{PRB}	13—36	13—36	-
PDCCH/PCFICH/PHICH Reference measurement channel defined in A.3.1.2.1		R.6 FDD		
OCNG Patterns defined in A.3.2.1.1 (OP.1 FDD) and A.3.2.1.2 (OP.2 FDD)		OP.1 FDD	OP.1 FDD	OP.2 FDD
PBCH_RA	dB	0	0	0
PBCH_RB				
PSS_RA				
SSS_RA				
PCFICH_RB				
PHICH_RA				
PHICH_RB				
PDCCH_RA				
PDCCH_RB				
PDSCH_RA				
PDSCH_RB				
OCNG_RANote1				
OCNG_RBNote				
N_{oc} Note2				
	Bands FDD_B1, FDD_B2 Note 9	-116.5		
	Bands FDD_C	-116		
	Bands FDD_D	-115.5		
	Bands FDD_E, FDD_F Note 6	-115		
	Bands FDD_G	-114		
	Bands FDD_H	-113.5		
\hat{E}_s/I_{ot}	dB	-4	0.46	-5.76
RSRPNote3	Bands FDD_A	-121	(RSRP for Cell 1 +8dB)	(RSRP for Cell 1 +4dB)
	Bands FDD_B1, FDD_B2 Note 9	-120.5		
	Bands FDD_C	-120		
	Bands FDD_D	-119.5		
	Bands FDD_E, FDD_F Note 6	-119		
	Bands FDD_G	-118		
	Bands FDD_H	-117.5		
I_o Note3	Bands FDD_A	-87.76	(I _o for Channel 1 +5.33dB)	
	Bands FDD_B1, FDD_B2 Note 9	-87.26		
	Bands FDD_C	-86.76		
	Bands FDD_D	-86.26		
	Bands FDD_E, FDD_F Note 6	-85.76		

	Bands FDD_G		-84.76	
	Bands FDD_H		-84.26	
\hat{E}_s/N_{oc}		dB	-4	3
Propagation condition		-	AWGN	
Note 1:	OCNG shall be used such that both cells are fully allocated and a constant total transmitted power spectral density is achieved for all OFDM symbols.			
Note 2:	Interference from other cells and noise sources not specified in the test is assumed to be constant over subcarriers and time and shall be modelled as AWGN of appropriate power for N_{oc} to be fulfilled.			
Note 3:	RSRP and Io levels have been derived from other parameters for information purposes. They are not settable parameters themselves.			
Note 4:	RSRP minimum requirements are specified assuming independent interference and noise at each receiver antenna port.			
Note 5:	The selection of the bands for testing depends on the configuration of the carrier aggregation supported by the UEs.			
Note 6:	For Band 26, the tests shall be performed with the carrier frequency of the assigned E-UTRA channel bandwidth within 865-894 MHz.			
Note 7:	This test verifies the RRM requirement which is independent of channel bandwidth and is performed according to the principle defined in section A.3.6.1.			
Note 8:	E-UTRA operating band groups are as defined in Section 3.5.			
Note 9:	For Band 74, the tests shall be performed with the carrier frequency of the assigned E-UTRA channel bandwidth within 1475.9-1510.9 MHz.			

A.9.1.6.3 Test Requirements

In the test, the performance of RSRP measurements is verified from following four perspectives:

- The absolute accuracy of intra-frequency RSRP measurements for Cell 1 on the primary component carrier shall fulfil the requirements defined in clause 9.1.11.1.
- The absolute accuracy of intra-frequency RSRP measurements for Cell 2 on the secondary component carrier shall fulfil the requirements defined in clause 9.1.11.2.
- The relative accuracy of intra-frequency RSRP measurements for Cell 3 relative to Cell 2 on the secondary component carrier shall fulfil the requirements defined in clause 9.1.11.2.
- The relative accuracy of inter-frequency RSRP measurements between the primary and secondary component carriers for Cell 2 relative to Cell 1 shall fulfil the requirements defined in clause 9.1.11.3.

A.9.1.7 TDD RSRP for E-UTRAN Carrier Aggregation

The test case in this clause are applicable to carrier aggregation capable UEs which have been configured with a downlink Scell.

A.9.1.7.1 Test Purpose and Environment

The purpose of this test is to verify that the RSRP measurement accuracy is within the specified limits. This test will verify the absolute RSRP accuracy on PCell defined in clause 9.1.11.1, the absolute RSRP accuracy on Scell defined in clause 9.1.11.2, the relative RSRP accuracy between SCell and Cell 3 defined in clause 9.1.11.2, and the relative RSRP accuracy between PCell and SCell defined in clause 9.1.11.3.

A.9.1.7.2 Test parameters

In this set of test cases there are three cells on two carrier frequencies. Cell 1 is PCell on channel 1, Cell 2 is activated SCell on channel 2, and Cell 3 is neighbour cell which is also on channel 2. The parameters for the test are listed in Table A.9.1.7.2-1.

Table A.9.1.7.2-1: Carrier aggregation RSRP test parameters for TDD

Parameter	Unit	Test 1		
		Cell 1	Cell 2	Cell 3
E-UTRA RF Channel Number		1	2	
BW _{channel}	MHz	10		

Special subframe configuration ^{Note1}			6		
Uplink/downlink configuration ^{Note1}			1		
Timing offset to Cell 1		μs	-	0	3
Time alignment error between cell 2 and cell 1			-	\leq Time alignment error as specified in 3GPP TS 36.104 [30] clause 6.5.3.1	-
Measurement bandwidth		n_{PRB}	22—27		
PDSCH Reference measurement channel defined in A.3.1.1.2			R.0 TDD	R.0 TDD	-
PDSCH allocation		n_{PRB}	13—36	13—36	-
PDCCH/PCFICH/PHICH Reference measurement channel defined in A.3.1.2.2			R.6 TDD		
OCNG Patterns defined in A.3.2.2.1 (OP.1 TDD) and A.3.2.2.2 (OP.2 TDD)			OP.1 TDD	OP.1 TDD	OP.2 TDD
PBCH_RA		dB	0	0	0
PBCH_RB					
PSS_RA					
SSS_RA					
PCFICH_RB					
PHICH_RA					
PHICH_RB					
PDCCH_RA					
PDCCH_RB					
PDSCH_RA					
PDSCH_RB					
OCNG_RA ^{Note2}					
OCNG_RB ^{Note2}					
N_{oc} ^{Note3}	Bands TDD_A				
	Bands TDD_C	-116			
	Bands TDD_E	-115			
\hat{E}_s/I_{ot}		dB	-4	0.5	-5.76
RSRP ^{Note4}	Bands TDD_A	dBm/15 kHz	-121	(RSRP for Cell 1 +8dB)	(RSRP for Cell 1 +4dB)
	Bands TDD_C		-120		
	Bands TDD_E		-119		
Io ^{Note4}	Bands TDD_A	dBm/9 MHz	-87.76	(Io for Channel 1 +5.33dB)	
	Bands TDD_C		-86.76		
	Bands TDD_E		-85.76		
\hat{E}_s/N_{oc}		dB	-4	3	-1
Propagation condition		-	AWGN		
<p>Note 1: For special subframe and uplink-downlink configurations see Tables 4.2-1 and 4.2-2 in TS 36.211.</p> <p>Note 2: OCNG shall be used such that both cells are fully allocated and a constant total transmitted power spectral density is achieved for all OFDM symbols.</p> <p>Note 3: Interference from other cells and noise sources not specified in the test is assumed to be constant over subcarriers and time and shall be modelled as AWGN of appropriate power for N_{oc} to be fulfilled.</p> <p>Note 4: RSRP and Io levels have been derived from other parameters for information purposes. They are not settable parameters themselves.</p> <p>Note 5: RSRP minimum requirements are specified assuming independent interference and noise at each receiver antenna port.</p> <p>Note 6: The selection of the bands for testing depends on the configuration of the carrier aggregation supported by the UEs.</p> <p>Note 7: This test verifies the RRM requirement which is independent of channel bandwidth and is performed according to the principle defined in section A.3.6.1.</p> <p>Note 8: E-UTRA operating band groups are as defined in Section 3.5.</p>					

A.9.1.7.3 Test Requirements

In the test, the performance of RSRP measurements is verified from following four perspectives:

- The absolute accuracy of intra-frequency RSRP measurements for Cell 1 on the primary component carrier shall fulfil the requirements defined in clause 9.1.11.1.
- The absolute accuracy of intra-frequency RSRP measurements for Cell 2 on the secondary component carrier shall fulfil the requirements defined in clause 9.1.11.2.
- The relative accuracy of intra-frequency RSRP measurements for Cell 3 relative to Cell 2 on the secondary component carrier shall fulfil the requirements defined in clause 9.1.11.2.
- The relative accuracy of inter-frequency RSRP measurements between the primary and secondary component carriers for Cell 2 relative to Cell 1 shall fulfil the requirements defined in clause 9.1.11.3

A.9.1.8 FDD RSRP under Time-Domain Measurement Resource Restriction with Non-MBSFN ABS

A.9.1.8.1 Test Purpose and Environment

The purpose of this test is to verify that the RSRP measurement accuracy is within the specified limits. This test will verify the requirements in Sections 9.1.2.3 and 9.1.2.4 for FDD intra-frequency RSRP measurements under time-domain measurement resource restriction with non-MBSFN ABS configured in the aggressor cell.

A.9.1.8.2 Test parameters

In this set of test cases all cells are on the same carrier frequency as PCell. Both absolute and relative accuracy of RSRP intra-frequency measurements are tested, with test parameters specified in Tables A.9.1.8.2-1 and A.9.1.8.2-2.

In the tests there are two synchronous cells, Cell 1 and Cell 2, on the same RF channel. In all test cases, Cell 1 is the serving cell (PCell) and also the aggressor cell to Cell 2. Cell 2 is the cell to be measured for RSRP absolute accuracy, whilst both Cell 1 and Cell 2 are measured for RSRP relative accuracy. Non-MBSFN ABS pattern is configured for Cell 1 during the test. The UE is configured by higher layers via Cell 1 with a time-domain measurement resource restriction pattern for performing E-UTRAN FDD intra-frequency measurements on neighbour cells and provided with a neighbour cell list associated with the pattern, where the cell list includes Cell 2. The UE is also configured with a time-domain measurement resource restriction pattern for the serving cell measurements. The information for both patterns shall be provided to the UE before the measurements start.

Table A.9.1.8.2-1: General test parameters for E-UTRAN FDD RSRP intra frequency test parameters under time-domain measurement resource restriction with non-MBSFN ABS

Parameter	Unit	Value	Comment
Serving cell (PCell)		Cell 1	The aggressor cell to Cell 2
Neighbour cell		Cell 2	Cell to be measured
PCell ABS configuration		Non-MBSFN ABS	As defined in Table A.3.4.1.1-1
CP length		Normal	For both cells in the test
DRX			OFF
Time offset between cells		3 μ s	Synchronous cells
Physical cell ID PCI		$(PCI_{cell1} - PCI_{cell2}) \bmod 6 \neq 0$	Cell PCIs for Cell 1 and Cell 2 are selected randomly so that the condition is met
ABS pattern		'1000000010000000100000001000000010000000'	Non-MBSFN ABS. FDD ABS Pattern Info IE, as defined in TS 36.423 [28], clause 9.2.54. Configured in Cell 1. The first/leftmost bit corresponds to the subframe #0 of a radio frame satisfying $SFN \bmod x = 0$, where x is the size of the bit string (40) divided by 10. No MBSFN subframes are configured in the ABS subframes in Cell 1.
Time-domain measurement resource restriction pattern for neighbour cell measurements on RF Channel 1		'1000000010000000100000001000000010000000'	Configured for Cell 2 measurements by measSubframePattern-Neigh IE in measSubframePatternConfig-Neigh, as defined in TS 36.331 [2], clause 6.3.5. measSubframeCellList contains Cell 2.

Time-domain measurement resource restriction pattern for serving cell measurements		'0100000001000000010000001000000001000000'	Configured for measurements on Cell 1.
--	--	--	--

Table A.9.1.8.2-2: Cell-specific test parameters for E-UTRAN FDD RSRP intra-frequency test parameters under time-domain measurement resource restriction with non-MBSFN ABS

Parameter	Unit	Test 1		Test 2		Test 3								
		Cell 1	Cell 2	Cell 1	Cell 2	Cell 1	Cell 2							
E-UTRA RF Channel Number		1		1		1								
BW _{channel}	MHz	10		10		10								
Measurement bandwidth	n_{PRB}	22–27		22–27		22–27								
PDSCH Reference measurement channel defined in A.3.1.1.1		R.0 FDD	-	R.0 FDD	-	R.0 FDD	-							
PDSCH allocation	n_{PRB}	13–36	-	13–36	-	13–36	-							
PDCCH/PCFICH/PHICH Reference measurement channel defined in A.3.1.2.1		R.6 FDD		R.6 FDD		R.6 FDD								
OCNG Patterns defined in A.3.2.1.5 (OP.5 FDD) and A.3.2.1.6 (OP.6 FDD)		OP.5 FDD	OP.6 FDD	OP.5 FDD	OP.6 FDD	OP.5 FDD	OP.6 FDD							
PBCH_RA														
PBCH_RB														
PCFICH_RB														
PHICH_RA														
PHICH_RB														
PDCCH_RA	dB	Note 6	0	Note 6	0	Note 6	0							
PDCCH_RB														
PDSCH_RA														
PDSCH_RB														
OCNG_RA ^{Note1}														
OCNG_RB ^{Note1}														
PSS_RA								dB	-4	0	-4	0	-4	0
SSS_RA								dB	-4	0	-4	0	-4	0
N_{oc} ^{Note2}								Bands FDD_A ^{Note 10}	dBm/15 kHz	-106		-88	-116	
								Bands FDD_B1, FDD_B2 ^{Note 11}					-115.5	
	Bands FDD_C	-115												
	Bands FDD_D	-114.5												
	Bands FDD_E, FDD_F ^{Note 7}	-114												
	Bands FDD_G ^{Note 9}	-113												
	Bands FDD_H	-112.5												
CRS \hat{E}_s / N_{oc}	dB	5	-2	5	-4	5	-4							
CRS $(\hat{E}_s / I_{ot})_{meas}$ ^{Note 5}	dB	2.88	-2	3.54	-4	3.54	-4							
SCH \hat{E}_s / I_{ot}	dB	-1.12	-5.54	-0.46	-7.54	-0.46	-7.54							
RSRP ^{Note3,4,5}	Bands FDD_A ^{Note 10}	dBm/15 kHz	-101	-108	-83	-92	-111	-120						
	Bands FDD_B1, FDD_B2 ^{Note 11}						-110.5	-119.5						
	Bands FDD_C						-110	-119						
	Bands FDD_D						-109.5	-118.5						
	Bands FDD_E, FDD_F ^{Note 7}						-109	-118						
	Bands FDD_G ^{Note 9}						-108	-117						
	Bands FDD_H						-107.5	-116.5						
$(I_o)_{meas}$ ^{Note 3}	Bands FDD_A ^{Note 10}	dBm/9 MHz	-71.41	-74.88	-53.63	-57.37	-81.63	-85.37						
	Bands FDD_B1, FDD_B2 ^{Note 11}						-81.13	-84.87						
	Bands FDD_C						-80.63	-84.37						
	Bands FDD_D						-80.13	-83.87						
	Bands FDD_E, FDD_F ^{Note 7}						-79.63	-83.37						
Bands FDD_G ^{Note 9}	-78.63	-82.37												

	Bands FDD_H					-78.13	-81.87
Propagation condition			AWGN	AWGN		AWGN	
Note 1:	OCNG shall be used such that both cells are fully allocated and a constant total transmitted power spectral density is achieved for all OFDM symbols.						
Note 2:	Interference from other cells and noise sources not specified in the test is assumed to be constant over subcarriers and time and shall be modelled as AWGN of appropriate power for N_{oc} to be fulfilled. Applies to all subframes.						
Note 3:	RSRP and I_o levels have been derived from other parameters for information purposes. They are not settable parameters themselves. I_o levels are calculated in CRS symbols of measurement restricted subframes.						
Note 4:	RSRP minimum requirements are specified assuming independent interference and noise at each receiver antenna port.						
Note 5:	Applies to restricted measurement subframes of the respective cell.						
Note 6:	Non-ABS and ABS subframe channel powers defined in Table A.3.4.1.1-1.						
Note 7:	For Band 26, the tests shall be performed with the carrier frequency of the assigned E-UTRA channel bandwidth within 865-894 MHz.						
Note 8:	E-UTRA operating band groups are as defined in Section 3.5.						
Note 9:	Except Band 29.						
Note 10:	Except Band 32, Band 75, Band 76.						
Note 11:	For Band 74, the tests shall be performed with the carrier frequency of the assigned E-UTRA channel bandwidth within 1475.9-1510.9 MHz.						

A.9.1.8.3 Test Requirements

The absolute RSRP measurement accuracy and relative RSRP measurement accuracy shall fulfill the requirements in Sections 9.1.2.3 and 9.1.2.4, respectively.

A.9.1.9 TDD RSRP under Time-Domain Measurement Resource Restriction with Non-MBSFN ABS

A.9.1.9.1 Test Purpose and Environment

The purpose of this test is to verify that the RSRP measurement accuracy is within the specified limits. This test will verify the requirements in Sections 9.1.2.3 and 9.1.2.4 for TDD intra-frequency RSRP measurements under time-domain measurement resource restriction with non-MBSFN ABS configured in the aggressor cell.

A.9.1.9.2 Test parameters

In this set of test cases all cells are on the same carrier frequency as PCell. Both absolute and relative accuracy of RSRP intra-frequency measurements are tested, with test parameters specified in Tables A.9.1.9.2-1 and A.9.1.9.2-2.

In the tests there are two synchronous cells, Cell 1 and Cell 2, on the same RF channel. In all test cases, Cell 1 is the serving cell (PCell) and also the aggressor cell to Cell 2. Cell 2 is the cell to be measured for RSRP absolute accuracy, whilst both Cell 1 and Cell 2 are measured for RSRP relative accuracy. Non-MBSFN ABS pattern is configured for Cell 1 during the test. The UE is configured by higher layers via Cell 1 with a time-domain measurement resource restriction pattern for performing E-UTRAN TDD intra-frequency measurements on neighbour cells and provided with a neighbour cell list associated with the pattern, where the cell list includes Cell 2. The UE is also configured with a time-domain measurement resource restriction pattern for the serving cell measurements. The information for both patterns shall be provided to the UE before the measurements start.

Table A.9.1.9.2-1: General test parameters for E-UTRAN TDD RSRP intra frequency test parameters under time-domain measurement resource restriction with non-MBSFN ABS

Parameter	Unit	Value	Comment
Serving cell (PCell)		Cell 1	Also the aggressor cell.
Neighbour cell		Cell 2	Cell to be measured
PCell ABS configuration		Non-MBSFN ABS	As defined in Table A.3.4.1.1-1
Special subframe configuration		6	For Cell 1 and Cell 2. For special subframe configurations see Table 4.2-1 in [16].
Uplink/downlink subframe configuration		1	For Cell 1 and Cell 2. For uplink-downlink subframe configurations see Table 4.2-2 in [16].
CP length		Normal	For both cells in the test
DRX			OFF
Time offset between cells		3 μ s	Synchronous cells

Physical cell ID PCI		$(PCI_{cell1} - PCI_{cell2}) \bmod 6 \neq 0$	Cell PCIs for Cell 1 and Cell 2 are randomly selected so that the condition is met
ABS pattern		'00000000010000000001'	Non-MBSFN ABS. TDD ABS Pattern Info IE, as defined in TS 36.423 [28], clause 9.2.54. Configured in Cell 1. The first/leftmost bit corresponds to the subframe #0 of a radio frame satisfying SFN mod x = 0, where x is the size of the bit string (20) divided by 10. No MBSFN subframes are configured in the ABS subframes in Cell 1.
Time-domain measurement resource restriction pattern for neighbour cell measurements on RF Channel 1		'00000000010000000001'	Configured for Cell 2 measurements by measSubframePattern-Neigh IE in measSubframePatternConfig-Neigh, as defined in TS 36.331 [2], clause 6.3.5. measSubframeCellList contains Cell 2.
Time-domain measurement resource restriction pattern for serving cell measurements		'10000000001000000000'	Configured for Cell 1 measurements.

Table A.9.1.9.2-2: Cell-specific test parameters for E-UTRAN TDD RSRP intra-frequency test parameters under time-domain measurement resource restriction with non-MBSFN ABS

Parameter	Unit	Test 1		Test 2		Test 3		
		Cell 1	Cell 2	Cell 1	Cell 2	Cell 1	Cell 2	
E-UTRA RF Channel Number		1		1		1		
BW _{channel}	MHz	10		10		10		
Measurement bandwidth	n_{PRB}	22—27		22—27		22—27		
PDSCH Reference measurement channel defined in A.3.1.1.2		R.0 TDD	-	R.0 TDD	-	R.0 TDD	-	
PDSCH allocation	n_{PRB}	13—36	-	13—36	-	13—36	-	
PDCCH/PCFICH/PHICH Reference measurement channel defined in A.3.1.2.2		R.6 TDD		R.6 TDD		R.6 TDD		
OCNG Patterns defined in A.3.2.2.1 (OP.1 TDD) and A.3.2.2.2 (OP.2 TDD)		OP.1 TDD	OP.2 TDD	OP.1 TDD	OP.2 TDD	OP.1 TDD	OP.2 TDD	
PBCH_RA	dB	Note 6	0	Note 6	0	Note 6	0	
PBCH_RB								
PCFICH_RB								
PHICH_RA								
PHICH_RB								
PDCCH_RA								
PDCCH_RB								
PDSCH_RA								
PDSCH_RB								
OCNG_RA ^{Note1}								
OCNG_RB ^{Note1}								
PSS_RA								dB
SSS_RA	dB	-4	0	-4	0	-4	0	
N_{oc} ^{Note 2}	Bands TDD_A	dBm/15 kHz	-106	-88	-116			
	Bands TDD_C				-115			
	Bands TDD_E				-114			
CRS \hat{E}_s / N_{oc}	dB	5	-2	5	-4	5	-4	
CRS $(\hat{E}_s / I_{ot})_{meas}$ ^{Note 5}	dB	2.88	-2	3.54	-4	5	-4	
SCH \hat{E}_s / I_{ot}	dB	-1.12	-5.54	-0.46	-7.54	-0.46	-7.54	
RSRP ^{Note3,4,5}	Bands TDD_A	dBm/15 kHz	-101	-108	-83	-92	-111	-120
	Bands TDD_C						-110	-119
	Bands TDD_E						-109	-118
$(I_o)_{meas}$ ^{Note 3}	Bands TDD_A	dBm/9 MHz	-71.41	-74.88	-53.63	-57.37	-81.6	-85.4
	Bands TDD_C						-80.6	-84.4
	Bands TDD_E						-79.6	-83.4

Propagation condition		AWGN	AWGN	AWGN
Note 1:	OCNG shall be used such that both cells are fully allocated and a constant total transmitted power spectral density is achieved for all OFDM symbols.			
Note 2:	Interference from other cells and noise sources not specified in the test is assumed to be constant over subcarriers and time and shall be modelled as AWGN of appropriate power for N_{oc} to be fulfilled. Applies to all subframes.			
Note 3:	RSRP and I_0 levels have been derived from other parameters for information purposes. They are not settable parameters themselves. I_0 levels are calculated in CRS symbols of measurement restricted subframes.			
Note 4:	RSRP minimum requirements are specified assuming independent interference and noise at each receiver antenna port.			
Note 5:	Applies to restricted measurement subframes of the respective cell.			
Note 6:	Non-ABS and ABS subframe channel powers defined in Table A.3.4.1.1-1.			
Note 7:	E-UTRA operating band groups are as defined in Section 3.5.			

A.9.1.9.3 Test Requirements

The absolute RSRP measurement accuracy and relative RSRP measurement accuracy shall fulfill the requirements in Sections 9.1.2.3 and 9.1.2.4, respectively.

A.9.1.10 FDD RSRP under Time-Domain Measurement Resource Restriction with MBSFN ABS

A.9.1.10.1 Test Purpose and Environment

The purpose of this test is to verify that the RSRP measurement accuracy is within the specified limits. This test will verify the requirements in Sections 9.1.2.3 and 9.1.2.4 for FDD intra-frequency RSRP measurements under time-domain measurement resource restriction with MBSFN ABS configured in the aggressor cell.

A.9.1.10.2 Test parameters

In this set of test cases all cells are on the same carrier frequency as PCell. Both absolute and relative accuracy of RSRP intra-frequency measurements are tested, with test parameters specified in Tables A.9.1.10.2-1 and A.9.1.10.2-2.

In the tests there are two synchronous cells, Cell 1 and Cell 2, on the same RF channel. In all test cases, Cell 1 is the serving cell (PCell) and also the aggressor cell to Cell 2. Cell 2 is the cell to be measured for RSRP absolute accuracy, whilst both Cell 1 and Cell 2 are measured for RSRP relative accuracy. MBSFN ABS pattern is configured in Cell 1 during the test. The UE is configured by higher layers via Cell 1 with a time-domain measurement resource restriction pattern for performing E-UTRAN FDD intra-frequency measurements on neighbour cells and provided with a neighbour cell list associated with the pattern, where the cell list includes Cell 2. The UE is also configured with a time-domain measurement resource restriction pattern for the serving cell measurements. The information for both patterns shall be provided to the UE before the measurements start.

Table A.9.1.10.2-1: General test parameters for E-UTRAN FDD RSRP intra-frequency test parameters under time-domain measurement resource restriction with MBSFN ABS

Parameter	Unit	Value	Comment
Serving cell (PCell)		Cell 1	The aggressor cell to Cell 2
Neighbour cell		Cell 2	Cell to be measured
PCell ABS configuration		MBSFN ABS	As defined in Table A.3.4.2.1-1
CP length		Normal	For both cells in the test
DRX			OFF
Time offset between cells		3 μ s	Synchronous cells
Physical cell ID PCI		$(PCI_{cell1} - PCI_{cell2}) \bmod 6 = 0$, PCI_{cell1} not equal to PCI_{cell2}	Cell PCIs for Cell 1 and Cell 2 are selected randomly so that the condition is met

ABS pattern		'0100000010000000100000000100000000100000001000000'	MBSFN ABS pattern. FDD ABS Pattern Info IE, as defined in TS 36.423 [28], clause 9.2.54. Configured in Cell 1. The first/leftmost bit corresponds to the subframe #0 of a radio frame satisfying SFN mod x = 0, where x is the size of the bit string (40) divided by 10. All ABS subframes are MBSFN subframes.
Time-domain measurement resource restriction pattern for neighbour cell measurements on RF Channel 1		'0100000010000000100000000100000000100000001000000'	Configured for Cell 2 measurements by measSubframePatternNeigh IE in measSubframePatternConfigNeigh, as defined in TS 36.331 [2], clause 6.3.5. measSubframeCellList contains Cell 2.
Time-domain measurement resource restriction pattern for serving cell measurements		'00010000000010000000010000000010000000100000001000000'	Configured for measurements on Cell 1.

Table A.9.1.10.2-2: Cell-specific test parameters for E-UTRAN FDD RSRP intra-frequency test parameters under time-domain measurement resource restriction with MBSFN ABS

Parameter	Unit	Test 1		Test 2		Test 3							
		Cell 1	Cell 2	Cell 1	Cell 2	Cell 1	Cell 2						
E-UTRA RF Channel Number		1		1		1							
BW _{channel}	MHz	10		10		10							
Measurement bandwidth	<i>n_{PRB}</i>	22—27		22—27		22—27							
PDSCH Reference measurement channel defined in A.3.1.1.1		R.0 FDD	-	R.0 FDD	-	R.0 FDD	-						
PDSCH allocation	<i>n_{PRB}</i>	13—36	-	13—36	-	13—36	-						
PDCCH/PCFICH/PHICH Reference measurement channel defined in A.3.1.2.1		R.6 FDD		R.6 FDD		R.6 FDD							
OCNG Patterns defined in A.3.2.1.8 (OP.8 FDD) and A.3.2.1.6 (OP.6 FDD)		OP.8 FDD	OP.6 FDD	OP.8 FDD	OP.6 FDD	OP.8 FDD	OP.6 FDD						
PBCH_RA	dB	Note 6	0	Note 6	0	Note 6	0						
PBCH_RB													
PCFICH_RB													
PHICH_RA													
PHICH_RB													
PDCCH_RA													
PDCCH_RB													
PDSCH_RA													
PDSCH_RB													
OCNG_RA ^{Note1}													
OCNG_RB ^{Note1}													
PSS_RA								-4	0	-4	0	-4	0
SSS_RA								-4	0	-4	0	-4	0
<i>N_{oc}</i> ^{Note 2}	Bands FDD_A ^{Note 11}	dBm/15 kHz	-106	-88	-116								
	Bands FDD_B1, FDD_B2 ^{Note 12}				-115.5								
	Bands FDD_C				-115								
	Bands FDD_D				-114.5								
	Bands FDD_E, FDD_F ^{Note 8}				-114								
	Bands FDD_G ^{Note 10}				-113								
	Bands FDD_H				-112.5								
CRS \hat{E}_s/N_{oc}	dB	5	-2	5	-4	5	-4						
CRS $(\hat{E}_s/I_{of})_{mea.}$ ^{Note 5, 7} in the 1 st OFDM symbol	dB	2.88	-8.19	3.54	-10.19	3.54	-10.19						

CRS $(\hat{E}_s/I_{ot})_{meas}$ Note 5 in OFDM symbols 4,7,11		dB	2.88	-2	3.54	-4	3.54	-4
SCH \hat{E}_s/I_{ot}		dB	-1.12	-5.54	-0.46	-7.54	-0.46	-7.54
RSRP Note 3,4	Bands FDD_A Note 11	dBm/15 kHz	-101	-108	-83	-92	-111	-120
	Bands FDD_B1, FDD_B2 Note 12						-110.5	-119.5
	Bands FDD_C						-110	-119
	Bands FDD_D						-109.5	-118.5
	Bands FDD_E, FDD_F Note 8						-109	-118
	Bands FDD_G Note 10						-108	-117
	Bands FDD_H						-107.5	-116.5
$(I_o)_{meas}$ Note 3 in the 1 st OFDM symbol	Bands FDD_A Note 11	dBm/9 MHz	-71.41	-74.88	-53.63	-57.37	-81.63	-85.37
	Bands FDD_B1, FDD_B2 Note 12						-81.13	-84.87
	Bands FDD_C						-80.63	-84.37
	Bands FDD_D						-80.13	-83.87
	Bands FDD_E, FDD_F Note 8						-79.63	-83.37
	Bands FDD_G Note 10						-78.63	-82.37
	Bands FDD_H						-78.13	-81.87
$(I_o)_{meas}$ Note 3 in OFDM symbols other than the 1 st one	Bands FDD_A Note 11	dBm/9 MHz	-71.41	-76.09	-53.63	-58.76	-81.63	-86.76
	Bands FDD_B1, FDD_B2 Note 12						-81.13	-86.26
	Bands FDD_C						-80.63	-85.76
	Bands FDD_D						-80.13	-85.26
	Bands FDD_E, FDD_F Note 8						-79.63	-84.76
	Bands FDD_G Note 10						-78.63	-83.76
	Bands FDD_H						-78.13	-83.26
Propagation condition			AWGN		AWGN		AWGN	
<p>Note 1: OCNB shall be used such that both cells are fully allocated and a constant total transmitted power spectral density is achieved for all OFDM symbols.</p> <p>Note 2: Interference from other cells and noise sources not specified in the test is assumed to be constant over subcarriers and time and shall be modelled as AWGN of appropriate power for N_{oc} to be fulfilled. Applies to all subframes.</p> <p>Note 3: RSRP and I_o levels have been derived from other parameters for information purposes. They are not settable parameters themselves. I_o levels are calculated in CRS symbols of measurement restricted subframes.</p> <p>Note 4: RSRP minimum requirements are specified assuming independent interference and noise at each receiver antenna port.</p> <p>Note 5: Applies to restricted measurement subframes of the respective cell.</p> <p>Note 6: Non-ABS and ABS subframe channel powers defined in Table A.3.4.2.1-1.</p> <p>Note 7: In the 1st OFDM symbol, Cell 2 is not expected to meet the E_s/I_{ot} side condition in 9.1.2.3 and 9.1.2.4.</p> <p>Note 8: For Band 26, the tests shall be performed with the carrier frequency of the assigned E-UTRA channel bandwidth within 865-894 MHz.</p> <p>Note 9: E-UTRA operating band groups are as defined in Section 3.5.</p> <p>Note 10: Except Band 29.</p> <p>Note 11: Except Band 32, Band 75, Band 76.</p> <p>Note 12: For Band 74, the tests shall be performed with the carrier frequency of the assigned E-UTRA channel bandwidth within 1475.9-1510.9 MHz.</p>								

A.9.1.10.3 Test Requirements

The absolute RSRP measurement accuracy and relative RSRP measurement accuracy shall fulfill the requirements in Sections 9.1.2.3 and 9.1.2.4, respectively.

A.9.1.11 TDD RSRP under Time-Domain Measurement Resource Restriction with MBSFN ABS

A.9.1.11.1 Test Purpose and Environment

The purpose of this test is to verify that the RSRP measurement accuracy is within the specified limits. This test will verify the requirements in Sections 9.1.2.3 and 9.1.2.4 for TDD intra-frequency RSRP measurements under time-domain measurement resource restriction with MBSFN ABS configured in the aggressor cell.

A.9.1.11.2 Test parameters

In this set of test cases all cells are on the same carrier frequency as PCell. Both absolute and relative accuracy of RSRP intra-frequency measurements are tested, with test parameters specified in Tables A.9.1.11.2-1 and A.9.1.11.2-2.

In the tests there are two synchronous cells, Cell 1 and Cell 2, on the same RF channel. In all test cases, Cell 1 is the serving cell (PCell) and also the aggressor cell to Cell 2. Cell 2 is the cell to be measured for RSRP absolute accuracy, whilst both Cell 1 and Cell 2 are measured for RSRP relative accuracy. MBSFN ABS pattern is configured in Cell 1 during the test. The UE is configured by higher layers via Cell 1 with a time-domain measurement resource restriction pattern for performing E-UTRAN TDD intra-frequency measurements on neighbour cells and provided with a neighbour cell list associated with the pattern, where the cell list includes Cell 2. The UE is also configured with a time-domain measurement resource restriction pattern for the serving cell measurements. The information for both patterns shall be provided to the UE before the measurements start.

Table A.9.1.11.2-1: General test parameters for E-UTRAN TDD RSRP intra-frequency test parameters under time-domain measurement resource restriction with MBSFN ABS

Parameter	Unit	Value	Comment
Serving cell (PCell)		Cell 1	The aggressor cell to Cell 2
Neighbour cell		Cell 2	Cell to be measured
PCell ABS configuration		MBSFN ABS	As defined in Table A.3.4.2.1-1
Special subframe configuration		6	For Cell 1 and Cell 2. For special subframe configurations see Table 4.2-1 in [16].
Uplink/downlink subframe configuration		1	For Cell 1 and Cell 2. For uplink-downlink subframe configurations see Table 4.2-2 in [16].
CP length		Normal	For both cells in the test
DRX			OFF
Time offset between cells		3 μ s	Synchronous cells
Physical cell ID PCI		$(PCI_{cell1} - PCI_{cell2}) \bmod 6 = 0$, PCI_{cell1} not equal to PCI_{cell2}	Cell PCIs for Cell 1 and Cell 2 are selected randomly so that the condition is met
ABS pattern		'00001000000000100000'	MBSFN ABS pattern. TDD ABS Pattern Info IE, as defined in TS 36.423 [28], clause 9.2.54. Configured in Cell 1. The first/leftmost bit corresponds to the subframe #0 of a radio frame satisfying $SFN \bmod x = 0$, where x is the size of the bit string (20) divided by 10. All ABS subframes are MBSFN subframes.
Time-domain measurement resource restriction pattern for neighbour cell measurements on RF Channel 1		'00001000000000100000'	Configured for Cell 2 measurements by measSubframePatternNeigh IE in measSubframePatternConfigNeigh, as defined in TS 36.331 [2], clause 6.3.5. measSubframeCellList contains Cell 2.
Time-domain measurement resource restriction pattern for serving cell measurements		'10000000001000000000'	Configured for measurements on Cell 1.

Table A.9.1.11.2-2: Cell-specific test parameters for E-UTRAN TDD RSRP intra-frequency test parameters under time-domain measurement resource restriction with MBSFN ABS

Parameter	Unit	Test 1		Test 2		Test 3	
		Cell 1	Cell 2	Cell 1	Cell 2	Cell 1	Cell 2
E-UTRA RF Channel Number		1		1		1	
BW _{channel}	MHz	10		10		10	

Measurement bandwidth	n_{PRB}	22—27		22—27		22—27								
PDSCH Reference measurement channel defined in A.3.1.1.2		R.0 TDD	-	R.0 TDD	-	R.0 TDD	-							
PDSCH allocation	n_{PRB}	13—36	-	13—36	-	13—36	-							
PDCCH/PCFICH/PHICH Reference measurement channel defined in A.3.1.2.2		R.6 TDD		R.6 TDD		R.6 TDD								
OCNG Patterns defined in A.3.2.2.5 (OP.5 TDD) and A.3.2.2.2 (OP.2 TDD)		OP.5 TDD	OP.2 TDD	OP.5 TDD	OP.2 TDD	OP.5 TDD	OP.2 TDD							
PBCH_RA	dB	Note 6	0	Note 6	0	Note 6	0							
PBCH_RB														
PCFICH_RB														
PHICH_RA														
PHICH_RB														
PDCCH_RA														
PDCCH_RB														
PDSCH_RA														
PDSCH_RB														
OCNG_RA ^{Note1}														
OCNG_RB ^{Note1}														
PSS_RA								dB	-4	0	-4	0	-4	0
SSS_RA								dB	-4	0	-4	0	-4	0
N_{oc} ^{Note 2}	Bands TDD_A	dBm/15 kHz	-106		-88		-116							
	Bands TDD_C						-115							
	Bands TDD_E						-114							
CRS \hat{E}_s/N_{oc}	dB	5	-2	5	-4	5	-4							
CRS $(\hat{E}_s/I_{ot})_{meas.}$ ^{note 5, note 7} in the 1 st OFDM symbol	dB	2.88	-8.19	3.54	-10.19	3.54	-10.19							
CRS $(\hat{E}_s/I_{ot})_{meas.}$ ^{note 5} in OFDM symbols 4,7,11	dB	2.88	-2	3.54	-4	3.54	-4							
SCH \hat{E}_s/I_{ot}	dB	-1.12	-5.54	-0.46	-7.54	-0.46	-7.54							
RSRP ^{Note 3,4}	Bands TDD_A	dBm/15 kHz	-101	-108	-83	-92	-111							
	Bands TDD_C						-110							
	Bands TDD_E						-109							
$(I_o)_{meas}$ ^{Note 3} in the 1 st OFDM symbol	Bands TDD_A	dBm/9 MHz	-71.41	-74.88	-53.63	-57.37	-81.63							
	Bands TDD_C						-80.63							
	Bands TDD_E						-79.63							
$(I_o)_{meas}$ ^{Note 3} in OFDM symbols other than the 1 st one	Bands TDD_A	dBm/9 MHz	-71.41	-76.09	-53.63	-58.76	-81.63							
	Bands TDD_C						-80.63							
	Bands TDD_E						-79.63							
Propagation condition		AWGN		AWGN		AWGN								
<p>Note 1: OCNG shall be used such that both cells are fully allocated and a constant total transmitted power spectral density is achieved for all OFDM symbols.</p> <p>Note 2: Interference from other cells and noise sources not specified in the test is assumed to be constant over subcarriers and time and shall be modelled as AWGN of appropriate power for N_{oc} to be fulfilled. Applies to all subframes.</p> <p>Note 3: RSRP and I_o levels have been derived from other parameters for information purposes. They are not settable parameters themselves. I_o levels are calculated in CRS symbols of measurement restricted subframes.</p> <p>Note 4: RSRP minimum requirements are specified assuming independent interference and noise at each receiver antenna port</p> <p>Note 5: Applies to restricted measurement subframes of the respective cell.</p> <p>Note 6: Non-ABS and ABS subframe channel powers defined in Table A.3.4.2.1-1.</p> <p>Note 7: In the 1st OFDM symbol, Cell 2 is not expected to meet the E_s/I_{ot} side condition in 9.1.2.3 and 9.1.2.4.</p> <p>Note 8: E-UTRA operating band groups are as defined in Section 3.5.</p>														

A.9.1.11.3 Test Requirements

The absolute RSRP measurement accuracy and relative RSRP measurement accuracy shall fulfill the requirements in Sections 9.1.2.3 and 9.1.2.4, respectively.

A.9.1.12 FDD RSRP for E-UTRAN Carrier Aggregation for 20MHz

The test case in this section are applicable to carrier aggregation capable UEs which have been configured with a downlink Scell.

A.9.1.12.1 Test Purpose and Environment

The purpose of this test case is the same as for the test defined in subclause A.9.1.6.1.

A.9.1.12.2 Test parameters

The test parameters are the same except those described in the following section. The listed parameter values in Tables A.9.1.12.2-1 will replace the values of corresponding parameters in Tables A.9.1.6.2-1.

Table A.9.1.12.2-1: RSRP FDD carrier aggregation test parameters

Parameter		Unit	Test 1		
			Cell 1	Cell 2	Cell 3
BW _{channel} ^{Note 1}		MHz	20	20	20
Measurement bandwidth		n_{PRB}	47–52		
PDSCH Reference measurement channel defined in A.3.1.1.1			R.4 FDD	R.4 FDD	N/A
PDSCH allocation		n_{PRB}	38–61	38–61	N/A
PDCCH/PCFICH/PHICH Reference measurement channel defined in A.3.1.2.1			R.10 FDD		
OCNG Patterns defined in A.3.2.1.11 (OP.11 FDD) and A.3.2.1.12 (OP.12 FDD)			OP.11 FDD	OP.11 FDD	OP.12 FDD
I _o ^{Note2}	Bands FDD_A ^{Note 5}	dBm/18 MHz	-84.75	(I _o for Channel 1 +5.33dB)	
	Bands FDD_B1 ^{Note 5} , FDD_B2 ^{Note 5, Note 6}		-84.25		
	Bands FDD_C ^{Note 5}		-83.75		
	Bands FDD_D ^{Note 5}		-83.25		
	Bands FDD_E ^{Note 5}		-82.75		
	Bands FDD_G ^{Note 5}		-81.75		
	Bands FDD_H ^{Note 5}		-81.25		
<p>Note 1: This test verifies the RRM requirement which is independent of channel bandwidth and is performed according to the principle defined in section A.3.6.1.</p> <p>Note 2: I_o levels have been derived from other parameters for information purposes. They are not settable parameters themselves.</p> <p>Note 3: See Table A.9.1.6.2-1 for the other parameters.</p> <p>Note 4: E-UTRA operating band groups are as defined in Section 3.5.</p> <p>Note 5: The test applies for E-UTRA operating bands in this band group which are supporting 20 MHz channel bandwidth.</p> <p>Note 6: For Band 74, the tests shall be performed with the carrier frequency of the assigned E-UTRA channel bandwidth within 1475.9-1510.9 MHz.</p>					

A.9.1.12.3 Test Requirements

The test requirements defined in section A.9.1.6.3 shall apply to this test case.

A.9.1.13 TDD RSRP for E-UTRAN Carrier Aggregation for 20MHz

The test case in this section are applicable to carrier aggregation capable UEs which have been configured with a downlink Scell.

A.9.1.13.1 Test Purpose and Environment

The purpose of this test case is the same as for the test defined in subclause A.9.1.7.1.

A.9.1.13.2 Test parameters

The test parameters are the same except those described in the following section. The listed parameter values in Tables A.9.1.13.2-1 will replace the values of corresponding parameters in Tables A.9.1.7.2-1.

Table A.9.1.13.2-1: Carrier aggregation RSRP test parameters for TDD

Parameter		Unit	Test 1		
			Cell 1	Cell 2	Cell 3
BW_{channel} ^{Note 1}		MHz	20		
Measurement bandwidth		n_{PRB}	47—52		
PDSCH Reference measurement channel defined in A.3.1.1.2			R.3 TDD	R.3 TDD	N/A
PDSCH allocation		n_{PRB}	38—61	38—61	N/A
PDCCH/PCFICH/PHICH Reference measurement channel defined in A.3.1.2.2			R.10 TDD		
OCNG Patterns defined in A.3.2.2.7 (OP.7 TDD) and A.3.2.2.8 (OP.8 TDD)			OP.7 TDD	OP.7 TDD	OP.8 TDD
I_0 ^{Note 2}	Bands TDD_A ^{Note 5}	dBm/18 MHz	-84.75	(I ₀ for Channel 1 +5.33dB)	
	Bands TDD_C ^{Note 5}		-83.75		
	Bands TDD_E ^{Note 5}		-82.75		
<p>Note 1: This test verifies the RRM requirement which is independent of channel bandwidth and is performed according to the principle defined in section A.3.6.1.</p> <p>Note 2: I₀ levels have been derived from other parameters for information purposes. They are not settable parameters themselves.</p> <p>Note 3: See Table A.9.1.7.2-1 for the other parameters.</p> <p>Note 4: E-UTRA operating band groups are as defined in Section 3.5.</p> <p>Note 5: The test applies for E-UTRA operating bands in this band group which are supporting 20 MHz channel bandwidth.</p>					

A.9.1.13.3 Test Requirements

The test requirements defined in section A.9.1.7.3 shall apply to this test case.

A.9.1.14 FDD RSRP under Time-Domain Measurement Resource Restriction with CRS Assistance Information and Non-MBSFN ABS

A.9.1.14.1 Test Purpose and Environment

The purpose of this test is to verify that the RSRP measurement accuracy is within the specified limits. This test will verify the requirements in Sections 9.1.2.5 and 9.1.2.6 for FDD intra-frequency RSRP measurements under time-domain measurement resource restriction with CRS Assistance Information and non-MBSFN ABS configured in the aggressor cells.

A.9.1.14.2 Test parameters

In this set of test cases all cells are on the same carrier frequency as PCell. Both absolute and relative accuracy of RSRP intra-frequency measurements are tested, with test parameters specified in Tables A.9.1.14.2-1 and A.9.1.14.2-2.

In the tests there are three synchronous cells, Cell 1, Cell2 and Cell 3, on the same RF channel. In all test cases, Cell 1 is the serving cell (PCell) and also the aggressor cell to Cell 3. Cell 2 is the neighbour aggressor cell without CRS colliding to Cell 3. Cell 3 is the cell to be measured for RSRP absolute accuracy, whilst both Cell 1 and Cell 3 are measured for RSRP relative accuracy. Non-MBSFN ABS pattern is configured for Cell 1 and Cell 2 during the test.

The UE is configured by higher layers with a time domain measurement resource restriction pattern for performing E-UTRAN FDD intra-frequency measurements on neighbour cells, namely Cell 3 measurements. The UE is also provided via higher layers with the CRS assistance information for Cell 2. The information for both measurement pattern and the CRS assistance information shall be provided via RRC to the UE before the measurements start.

Note: It's up to eNB's implementation whether the time domain measurement resource restriction pattern for PCell measurements is configured or not.

Table A.9.1.14.2-1: General test parameters for FDD RSRP under Time-Domain Measurement Resource Restriction with CRS Assistance Information and Non-MBSFN ABS

Parameter		Unit	Value	Comment
Serving cell (PCell)			Cell 1	The aggressor cell to Cell 3
Neighbour cell			Cell 2	The aggressor cell to Cell 3
Neighbour cell			Cell 3	Cell to be measured
PCell ABS configuration			Non-MBSFN ABS	As defined in Table A.3.4.1.1-1
CP length			Normal	For three cells in the test
DRX				OFF
Cell 2 time offset with respect to Cell 1			0 μ s	Synchronous cells
Cell 3 time offset with respect to Cell 1			-2.5 μ s	Synchronous cells
Physical cell ID PCI			Colliding CRS: $(PCI_{cell1} - PCI_{cell3}) \bmod 6 = 0$, PCI_{cell1} not equal to PCI_{cell3} Non-colliding CRS: $(PCI_{cell2} - PCI_{cell3}) \bmod 6 \neq 0$	Cell PCIs for three cells are selected randomly so that all conditions are met
ABS pattern			'10000000100000001000 00001000000010000000'	Non-MBSFN ABS. FDD ABS Pattern Info IE, as defined in TS 36.423 [28], clause 9.2.54. Configured in Cell 1. The first/leftmost bit corresponds to the Pcell subframe #0 of a radio frame satisfying $SFN \bmod x = 0$, where x is the size of the bit string (40) divided by 10. No MBSFN subframes are configured in the ABS subframes in Cell 1.
Time-domain measurement resource restriction pattern for neighbour cell measurements on RF Channel 1			'10000000100000001000 00001000000010000000'	Time domain measurement resource restriction pattern for neighbor cell measurement signalled to the UE in measSubframePatternNeigh IE in measSubframePatternConfigNeigh, as defined in TS 36.331, clause 6.3.5. Configured before the measurements start. The cell list in measSubframeCellList IE shall contain Cell 3 but not Cell 2.
Time-domain measurement resource restriction pattern for serving cell measurements			'01000000010000000100 00000100000001000000'	Configured for measurements on Cell 1.
CRS assistance information	physCellId		see PCI conditions above	The CRS assistance information is provided for Cell 2 only in CRS-AssistanceInfo. It includes a single MBSFN-SubframeConfig element with subframe allocation <i>oneFrame</i> ='000000'.
	antennaPortsCount		1	
	mbsfn-SubframeConfigList		<i>oneFrame</i> = '000000'	

Table A.9.1.14.2-2: Cell-specific test parameters for FDD RSRP under Time-Domain Measurement Resource Restriction with CRS Assistance Information and Non-MBSFN ABS

Parameter	Unit	Test 1			Test 2			Test 3		
		Cell 1	Cell 2	Cell 3	Cell 1	Cell 2	Cell 3	Cell 1	Cell 2	Cell 3
E-UTRA RF Channel Number		1			1			1		
BW _{channel}	MHz	10			10			10		
Measurement bandwidth	n_{PRB}	22—27			22—27			22—27		

PDSCH Reference measurement channel defined in A.3.1.1.1			R.0 FDD	-	-	R.0 FDD	-	-	R.0 FDD	-	-
PDSCH allocation		n_{PRB}	13–36	-	-	13–36	-	-	13–36	-	-
PDCCH/PCFICH/PHICH Reference measurement channel defined in A.3.1.2.1			R.6 FDD			R.6 FDD			R.6 FDD		
OCNG Patterns defined in A.3.2.1.5 (OP.5 FDD) and A.3.2.1.6 (OP.6 FDD)			OP.5 FDD	OP.6 FDD	OP.6 FDD	OP.5 FDD	OP.6 FDD	OP.6 FDD	OP.5 FDD	OP.6 FDD	OP.6 FDD
PBCH_RA		dB	Note 6	Note 6	0	Note 6	Note 6	0	Note 6	Note 6	0
PBCH_RB											
PSS_RA											
SSS_RA											
PCFICH_RB											
PHICH_RA											
PHICH_RB											
PDCCH_RA											
PDCCH_RB											
PDSCH_RA											
PDSCH_RB											
OCNG_RA ^{Note1}											
OCNG_RB ^{Note1}											
N_{oc} ^{Note2}	Bands FDD_A ^{Note 10}										
	Bands FDD_B1, FDD_B2 ^{Note 11}	-115.5									
	Bands FDD_C	-115									
	Bands FDD_D	-114.5									
	Bands FDD_E, FDD_F ^{Note 7}	-114									
	Bands FDD_G ^{Note 9}	-113									
	Bands FDD_H	-112.5									
CRS \hat{E}_s / N_{oc}		dB	4	2	-1.5	4	2	-4	4	2	-4
CRS $(\hat{E}_s / I_{ot})_{meas}$ ^{Note 5}		dB	-1.18	-0.32	-6.96	-0.75	0.54	-9.46	-0.75	0.54	-9.46
RSRP ^{Note3,4,5}	Bands FDD_A ^{Note 10}	dBm/15 kHz	-102	-104	-107.5	-84	-86	-92	-112	-114	-120
	Bands FDD_B1, FDD_B2 ^{Note 11}								-111.5	-113.5	119.5
	Bands FDD_C								-111	-113	-119
	Bands FDD_D								-110.5	-112.5	-118.5
	Bands FDD_E, FDD_F ^{Note 7}								-110	-112	-118
	Bands FDD_G ^{Note 9}								-109	-111	-117
	Bands FDD_H								-108.5	-110.5	-116.5
$(I_o)_{meas}$ ^{Note 3,5}	Bands FDD_A ^{Note 10}	dBm/9 MHz	-70.58	-74.43	-52.82	-57.04	-80.82		-85.04		
	Bands FDD_B1, FDD_B2 ^{Note 11}						-80.32		-84.54		
	Bands FDD_C						-79.82		-84.04		
	Bands FDD_D						-79.32		-83.54		
	Bands FDD_E, FDD_F ^{Note 7}						-78.82		-83.04		
	Bands FDD_G ^{Note 9}						-77.82		-82.04		
	Bands FDD_H						-77.32		-81.54		
Propagation condition			AWGN			AWGN			AWGN		

Note 1:	OCNG shall be used such that both cells are fully allocated and a constant total transmitted power spectral density is achieved for all OFDM symbols.
Note 2:	Interference from other cells and noise sources not specified in the test is assumed to be constant over subcarriers and time and shall be modelled as AWGN of appropriate power for N_{oc} to be fulfilled. Applies to all subframes.
Note 3:	RSRP and I_o levels have been derived from other parameters for information purposes. They are not settable parameters themselves. I_o levels are calculated in CRS symbols of measurement restricted subframes.
Note 4:	RSRP minimum requirements are specified assuming independent interference and noise at each receiver antenna port.
Note 5:	Applies to restricted measurement subframes for only Cell 2 and Cell 3. For Cell 1, the corresponding value is derived from the normal subframes other than the subframes indicated in the time domain measurement resource restriction pattern for intra-frequency measurements.
Note 6:	Non-ABS and ABS subframe channel powers defined in Table A.3.4.1.1-1.
Note 7:	For Band 26, the tests shall be performed with the carrier frequency of the assigned E-UTRA channel bandwidth within 865-894 MHz.
Note 8:	E-UTRA operating band groups are as defined in Section 3.5.
Note 9:	Except Band 29.
Note 10:	Except Band 32, Band 75, Band 76.
Note 11:	For Band 74, the tests shall be performed with the carrier frequency of the assigned E-UTRA channel bandwidth within 1475.9-1510.9 MHz.

A.9.1.14.3 Test Requirements

The absolute RSRP measurement accuracy and relative RSRP measurement accuracy shall fulfill the requirements in Sections 9.1.2.5 and 9.1.2.6, respectively.

A.9.1.15 TDD RSRP under Time-Domain Measurement Resource Restriction with CRS Assistance Information and Non-MBSFN ABS

A.9.1.15.1 Test Purpose and Environment

The purpose of this test is to verify that the RSRP measurement accuracy is within the specified limits. This test will verify the requirements in Sections 9.1.2.5 and 9.1.2.6 for TDD intra-frequency RSRP measurements under time-domain measurement resource restriction with CRS Assistance Information and non-MBSFN ABS configured in the aggressor cells.

A.9.1.15.2 Test parameters

In this set of test cases all cells are on the same carrier frequency as PCell. Both absolute and relative accuracy of RSRP intra-frequency measurements are tested, with test parameters specified in Tables A.9.1.15.2-1 and A.9.1.15.2-2.

In the tests there are three synchronous cells, Cell 1, Cell2 and Cell 3, on the same RF channel. In all test cases, Cell 1 is the serving cell (PCell) and also the aggressor cell to Cell 3. Cell 2 is the neighbour aggressor cell without CRS colliding to Cell 3. Cell 3 is the cell to be measured for RSRP absolute accuracy, whilst both Cell 1 and Cell 3 are measured for RSRP relative accuracy. Non-MBSFN ABS pattern is configured for Cell 1 and Cell 2 during the test.

The UE is configured by higher layers with a time domain measurement resource restriction pattern for performing E-UTRAN TDD intra-frequency measurements on neighbour cells, namely Cell 3 measurements. The UE is also provided via higher layers with the CRS assistance information for Cell 2. The information for both measurement pattern and the CRS assistance information shall be provided via RRC to the UE before the measurements start.

Note: It's up to eNB's implementation whether the time domain measurement resource restriction pattern for PCell measurements is configured or not.

Table A.9.1.15.2-1: General test parameters for TDD RSRP under Time-Domain Measurement Resource Restriction with CRS Assistance Information and Non-MBSFN ABS

Parameter	Unit	Value	Comment
Serving cell (PCell)		Cell 1	The aggressor cell to Cell 3
Neighbour cell		Cell 2	The aggressor cell to Cell 3
Neighbour cell		Cell 3	Cell to be measured
PCell ABS configuration		Non-MBSFN ABS	As defined in Table A.3.4.1.1-1
CP length		Normal	For three cells in the test
Special subframe configuration		6	As specified in table 4.2-1 in TS 36.211. The same configuration in both cells

Uplink-downlink configuration		1	As specified in table 4.2-2 in TS 36.211. The same configuration in both cells
DRX			OFF
Cell 2 time offset with respect to Cell 1		0µs	Synchronous cells
Cell 3 time offset with respect to Cell 1		-2.5 µs	Synchronous cells
Physical cell ID PCI		Colliding CRS: $(PCI_{cell1} - PCI_{cell3}) \bmod 6 = 0$, PCI_{cell1} not equal to PCI_{cell3} Non-colliding CRS: $(PCI_{cell2} - PCI_{cell3}) \bmod 6 \neq 0$	Cell PCIs for three cells are selected randomly so that all conditions are met
ABS pattern		'000000001000000001'	TDD ABS Pattern Info IE, as defined in TS 36.423 [28], clause 9.2.54. The first/leftmost bit corresponds to the Pcell subframe #0 of the radio frame satisfying $SFN \bmod x = 0$, where x is the size of the bit string (20) divided by 10. No MBSFN subframes are configured in the ABS subframes. Provided to the UE for Cell 1 and Cell 2 before the measurements start.
Time-domain measurement resource restriction pattern for neighbour cell measurements on RF Channel 1		'000000001000000001'	Time domain measurement resource restriction pattern for neighbor cell measurement signalled to the UE in measSubframePatternNeigh IE in measSubframePatternConfigNeigh, as defined in TS 36.331, clause 6.3.5. Configured before the measurements start. The cell list in measSubframeCellList IE shall contain Cell 3 but not Cell 2.
Time-domain measurement resource restriction pattern for serving cell measurements		'100000000100000000'	Configured for Cell 1 measurements.
CRS assistance information	physCellId	see PCI conditions above	The CRS assistance information is provided for Cell 2 only in CRS-AssistanceInfo. It includes a single MBSFN-SubframeConfig element with subframe allocation <i>one Frame</i> ='000000'.
	antennaPortsCount	1	
	mbsfn-SubframeConfigList	<i>oneFrame</i> = '000000'	

Table A.9.1.15.2-2: Cell-specific test parameters for TDD RSRP under Time-Domain Measurement Resource Restriction with CRS Assistance Information and Non-MBSFN ABS

Parameter	Unit	Test 1			Test 2			Test 3		
		Cell 1	Cell 2	Cell 3	Cell 1	Cell 2	Cell 3	Cell 1	Cell 2	Cell 3
E-UTRA RF Channel Number		1			1			1		
BW _{channel}	MHz	10			10			10		
Measurement bandwidth	n_{PRB}	22–27			22–27			22–27		
PDSCH Reference measurement channel defined in A.3.1.1.2		R.0 TDD	-	-	R.0 TDD	-	-	R.0 TDD	-	-
PDSCH allocation	n_{PRB}	13–36	-	-	13–36	-	-	13–36	-	-
PDCCH/PCFICH/PHICH Reference measurement channel defined in A.3.1.2.2		R.6 TDD			R.6 TDD			R.6 TDD		
OCNG Patterns defined in A.3.2.2		OP.1 TDD	OP.2 TDD	OP.2 TDD	OP.1 TDD	OP.2 TDD	OP.2 TDD	OP.1 TDD	OP.2 TDD	OP.2 TDD
PBCH_RA	dB	Note 6		0	Note 6		0	Note 6		0
PBCH_RB										
PSS_RA										
SSS_RA										
PCFICH_RB										

PHICH_RA											
PHICH_RB											
PDCCH_RA											
PDCCH_RB											
PDSCH_RA											
PDSCH_RB											
OCNG_RA ^{Note1}											
OCNG_RB ^{Note1}											
N_{oc} ^{Note2}	Bands TDD_A	dBm/15 kHz	-106			-88			-116		
	Bands TDD_C								-115		
	Bands TDD_E								-114		
CRS \hat{E}_s / N_{oc}	dB	4	2	-1.5	4	2	-4	4	2	-4	
CRS $(\hat{E}_s / I_{ot})_{meas}$ ^{Note 5}	dB	-1.18	-0.32	-6.96	-0.75	0.54	-9.46	-0.75	0.54	-9.46	
RSRP ^{Note3,4,5}	Bands TDD_A	dBm/15 kHz	-102	-104	-107.5	-84	-86	-92	-112 -114 -120		
	Bands TDD_C								-111 -113 -119		
	Bands TDD_E								-110 -112 -118		
$(I_o)_{meas}$ ^{Note 3, 5}	Bands TDD_A	dBm/9 MHz	-70.58	-74.43		-52.82	-57.04		-80.82 -85.04		
	Bands TDD_C								-79.82 -84.04		
	Bands TDD_E								-78.82 -83.04		
Propagation condition			AWGN			AWGN			AWGN		
<p>Note 1: OCNG shall be used such that both cells are fully allocated and a constant total transmitted power spectral density is achieved for all OFDM symbols.</p> <p>Note 2: Interference from other cells and noise sources not specified in the test is assumed to be constant over subcarriers and time and shall be modelled as AWGN of appropriate power for N_{oc} to be fulfilled. Applies to all subframes.</p> <p>Note 3: RSRP and I_o levels have been derived from other parameters for information purposes. They are not settable parameters themselves. I_o levels are calculated in CRS symbols of measurement restricted subframes.</p> <p>Note 4: RSRP minimum requirements are specified assuming independent interference and noise at each receiver antenna port.</p> <p>Note 5: Applies to restricted measurement subframes for only Cell 2 and Cell 3. For Cell 1, the corresponding value is derived from the normal subframes other than the subframes indicated in the time domain measurement resource restriction pattern for intra-frequency measurements.</p> <p>Note 6: Non-ABS and ABS subframe channel powers defined in Table A.3.4.1.1-1.</p> <p>Note 7: E-UTRA operating band groups are as defined in Section 3.5.</p>											

A.9.1.15.3 Test Requirements

The absolute RSRP measurement accuracy and relative RSRP measurement accuracy shall fulfill the requirements in Sections 9.1.2.5 and 9.1.2.6, respectively.

A.9.1.16 FDD Intra frequency case for 5MHz Bandwidth

A.9.1.16.1 Test Purpose and Environment

The purpose of this test is to verify that the RSRP measurement accuracy is within the specified limits. This test will verify the requirements in Sections 9.1.2.1 and 9.1.2.2 for FDD intra frequency measurements.

A.9.1.16.2 Test parameters

In this set of test cases all cells are on the same carrier frequency. Both absolute and relative accuracy of RSRP intra frequency measurements are tested by using the parameters in Table A.9.1.16.2-1. In all test cases, Cell 1 is the PCell and Cell 2 the target cell.

Table A.9.1.16.2-1: RSRP FDD Intra frequency test parameters for 5MHz Bandwidth

Parameter	Unit	Test 1		Test 2		Test 3	
		Cell 1	Cell 2	Cell 1	Cell 2	Cell 1	Cell 2
E-UTRA RF Channel Number		1		1		1	
BW _{channel}	MHz	5		5		5	
Measurement bandwidth	n_{PRB}	10–15		10–15		10–15	
PDSCH Reference measurement channel defined in A.3.1.1.1-1		R.5 FDD	-	R.5 FDD	-	R.5 FDD	-

PDSCH allocation	n_{PRB}	7—17	-	7-17	-	7-17	-								
PDCCH/PCFICH/PHICH Reference measurement channel defined in A.3.1.2.1-1		R.11 FDD		R.11 FDD		R.11 FDD									
OCNG Patterns defined in A.3.2.1.15 (OP.15 FDD) and A.3.2.1.16 (OP.16 FDD)		OP.15 FDD	OP.16 FDD	OP.15 FDD	OP.16 FDD	OP.15 FDD	OP.16 FDD								
PBCH_RA	dB	0	0	0	0	0	0								
PBCH_RB															
PSS_RA															
SSS_RA															
PCFICH_RB															
PHICH_RA															
PHICH_RB															
PDCCH_RA															
PDCCH_RB															
PDSCH_RA															
PDSCH_RB															
OCNG_RA ^{Note1}															
OCNG_RB ^{Note1}															
N_{oc} ^{Note2}								Bands FDD_N	dBm/15 kHz		-103		-83		-109.5
\hat{E}_s/I_{ot}		dB		2.46		-5.97		2.46		-5.97		0.46		-5.76	
RSRP ^{Note3}	Bands FDD_N	dBm/15 kHz		-97		-102		-77		-82		-106.5		-110.5	
I_o ^{Note3}	Bands FDD_N	dBm/4.5 MHz		-70.28		-50.28		-78.94							
\hat{E}_s/N_{oc}		dB		6		1		6		1		3		-1	
Propagation condition		-		AWGN		AWGN		AWGN							
<p>Note 1: OCNG shall be used such that both cells are fully allocated and a constant total transmitted power spectral density is achieved for all OFDM symbols.</p> <p>Note 2: Interference from other cells and noise sources not specified in the test is assumed to be constant over subcarriers and time and shall be modelled as AWGN of appropriate power for N_{oc} to be fulfilled.</p> <p>Note 3: RSRP and I_o levels have been derived from other parameters for information purposes. They are not settable parameters themselves.</p> <p>Note 4: RSRP minimum requirements are specified assuming independent interference and noise at each receiver antenna port.</p>															

A.9.1.16.3 Test Requirements

The RSRP measurement accuracy shall fulfil the requirements in sections 9.1.2.1 and 9.1.2.2.

A.9.1.17 FDD—FDD Inter frequency case for 5MHz Bandwidth

A.9.1.17.1 Test Purpose and Environment

The purpose of this test is to verify that the RSRP measurement accuracy is within the specified limits. This test will verify the requirements in Sections 9.1.3.1 and 9.1.3.2 for FDD—FDD inter frequency measurements.

A.9.1.17.2 Test parameters

In this set of test cases the cells are on different carrier frequencies. Both absolute and relative accuracy of RSRP inter-frequency measurements are tested by using the parameters in Table A.9.1.17.2-1 In all test cases, Cell 1 is the PCell and Cell 2 the target cell. The inter frequency measurements are supported by a measurement gap.

Table A.9.1.17.2-1: RSRP FDD—FDD Inter frequency test parameters for 5MHz Bandwidth

Parameter	Unit	Test 1		Test 2		
		Cell 1	Cell 2	Cell 1	Cell 2	
E-UTRA RF Channel Number		1	2	1	2	
$BW_{channel}$	MHz	5	5	5	5	
Gap Pattern Id		0	-	0	-	
Measurement bandwidth	n_{PRB}	10—15		10—15		
PDSCH Reference measurement channel defined in A.3.1.1.1		R.5 FDD	-	R.5 FDD	-	
PDSCH allocation	n_{PRB}	7—17	-	7-17	-	
PDCCH/PCFICH/PHICH Reference measurement channel defined in A.3.1.2.1		R.11 FDD		R.11 FDD		
OCNG Patterns defined in A.3.2.1.15 (OP.15 FDD) and A.3.2.1.16 (OP.16 FDD)		OP.15 FDD	OP.16 FDD	OP.15 FDD	OP.16 FDD	
PBCH_RA	dB	0	0	0	0	
PBCH_RB						
PSS_RA						
SSS_RA						
PCFICH_RB						
PHICH_RA						
PHICH_RB						
PDCCH_RA						
PDCCH_RB						
PDSCH_RA						
PDSCH_RB						
OCNG_RA ^{Note1}						
OCNG_RB ^{Note1}						
N_{oc} ^{Note2}						Cell 2: Bands FDD_N
\hat{E}_s/I_{ot}		dB	10	10	13	-4
RSRP ^{Note3}	Cell 2: Bands FDD_N	dBm/15 kHz	-75.65	-75.65	-89.5	-114.5
I_o ^{Note3}	Cell 2: Bands FDD_N	dBm/4.5 MHz	-50.46	-50.46	-64.52	-84.27
\hat{E}_s/N_{oc}		dB	10	10	13	-4
Propagation condition	-	AWGN		AWGN		
<p>Note 1: OCNG shall be used such that both cells are fully allocated and a constant total transmitted power spectral density is achieved for all OFDM symbols.</p> <p>Note 2: Interference from other cells and noise sources not specified in the test is assumed to be constant over subcarriers and time and shall be modelled as AWGN of appropriate power for N_{oc} to be fulfilled.</p> <p>Note 3: RSRP and I_o levels have been derived from other parameters for information purposes. They are not settable parameters themselves.</p> <p>Note 4: RSRP minimum requirements are specified assuming independent interference and noise at each receiver antenna port.</p> <p>Note 5: For Band 26, the tests shall be performed with the assigned E-UTRA channel bandwidth within 865-894 MHz.</p> <p>Note 6: This test is only applicable for testing inter-frequency requirements for Bands FDD_N. Cell 2 is on the Band under test, and Cell 1 is on another band supported by the UE.</p>						

Table A.9.1.17.2-1: Void

A.9.1.17.3 Test Requirements

The RSRP measurement accuracy shall fulfil the requirements in sections 9.1.3.1 and 9.1.3.2.

A.9.1.18 FDD RSRP for E-UTRAN Carrier Aggregation for 10MHz + 5MHz

The test case in this section are applicable to carrier aggregation capable UEs which have been configured with a downlink Scell.

A.9.1.18.1 Test Purpose and Environment

The purpose of this test case is the same as for the test defined in subclause A.9.1.6.1.

A.9.1.18.2 Test parameters

The test parameters are the same except those described in the following section. The listed parameter values in Tables A.9.1.18.2-1 will replace the values of corresponding parameters in Tables A.9.1.6.2-1.

Table A.9.1.18.2-1: RSRP FDD carrier aggregation test parameters

Parameter		Unit	Test 1		
			Cell 1	Cell 2	Cell 3
BW _{channel} ^{Note 1}		MHz	10	5	
Measurement bandwidth		n_{PRB}	22-27	10-15	
PDSCH Reference measurement channel defined in A.3.1.1.1			R.0 FDD	R.5 FDD	N/A
PDSCH allocation		n_{PRB}	13-36	7-17	N/A
PDCCH/PCFICH/PHICH Reference measurement channel defined in A.3.1.2.1			R.6 FDD	R.11 FDD	
OCNG Patterns defined in A.3.2.1 (FDD)			OP.1 FDD	OP.15 FDD	OP.16 FDD
N_{oc} ^{Note2}	Bands FDD_A	dBm/15 kHz	-117	$(N_{oc}$ for Channel 1 +1dB)	
	Bands FDD_B1, FDD_B2 ^{Note 4}		-116.5		
	Bands FDD_C		-116		
	Bands FDD_D		-115.5		
	Bands FDD_E, FDD_F		-115		
	Bands FDD_G		-114		
	Bands FDD_H		-113.5		
	Bands FDD_N		N/A		
RSRP ^{Note2}	Bands FDD_A	dBm/15 kHz	-121	(RSRP for Cell 1 +8dB)	(RSRP for Cell 1 +4dB)
	Bands FDD_B1, FDD_B2 ^{Note 4}		-120.5		
	Bands FDD_C		-120		
	Bands FDD_D		-119.5		
	Bands FDD_E, FDD_F		-119		
	Bands FDD_G		-118		
	Bands FDD_H		-117.5		
	Bands FDD_N		N/A		
I_o ^{Note2}	Bands FDD_A	dBm/9 MHz	-87.76	N/A	
	Bands FDD_B1, FDD_B2 ^{Note 4}		-87.26		
	Bands FDD_C		-86.76		
	Bands FDD_D		-86.26		
	Bands FDD_E, FDD_F		-85.76		
	Bands FDD_G		-84.76		
	Bands FDD_H		-84.26		
	Bands FDD_A	dBm/4.5 MHz	N/A	(Io for Channel 1 +2.32dB)	
	Bands FDD_B1, FDD_B2 ^{Note 4}				
	Bands FDD_C				
	Bands FDD_D				
	Bands FDD_E, FDD_F				
	Bands FDD_G				
	Bands FDD_H				

	Bands FDD_H			
	Bands FDD_N			-80.94
Note 1:	This test verifies the RRM requirement which is independent of channel bandwidth and is performed according to the principle defined in section A.3.6.1.			
Note 2:	RSRP and I_o levels have been derived from other parameters for information purposes. They are not settable parameters themselves.			
Note 3:	See Table A.9.1.6.2-1 for the other parameters.			
Note 4:	For Band 74, the tests shall be performed with the carrier frequency of the assigned E-UTRA channel bandwidth within 1475.9-1510.9 MHz.			

A.9.1.18.3 Test Requirements

The test requirements defined in section A.9.1.6.3 shall apply to this test case.

A.9.1.19 TDD RSRP for E-UTRAN Carrier Aggregation for 10MHz + 5MHz

The test case in this section are applicable to carrier aggregation capable UEs which have been configured with a downlink Scell.

A.9.1.19.1 Test Purpose and Environment

The purpose of this test case is the same as for the test defined in subclause A.9.1.7.1.

A.9.1.19.2 Test parameters

The test parameters are the same except those described in the following section. The listed parameter values in Tables A.9.1.19.2-1 will replace the values of corresponding parameters in Tables A.9.1.7.2-1.

Table A.9.1.19.2-1: Carrier aggregation RSRP test parameters for TDD

Parameter		Unit	Test 1		
			Cell 1	Cell 2	Cell 3
$BW_{channel}$ ^{Note 1}		MHz	10	5	
Measurement bandwidth		n_{PRB}	22-27	10-15	
PDSCH Reference measurement channel defined in A.3.1.1.2			R.0 TDD	R.4 TDD	N/A
PDSCH allocation		n_{PRB}	13-36	7-17	N/A
PDCCH/PCFICH/PHICH Reference measurement channel defined in A.3.1.2.2			R.6 TDD	R.11 TDD	
OCNG Patterns defined in A.3.2.2 (TDD)			OP.1 TDD	OP.9 TDD	OP.10 TDD
I_o ^{Note 2}	Bands TDD_A	dBm/9 MHz	-87.76	N/A	
	Bands TDD_C		-86.76		
	Bands TDD_E		-85.76		
	Bands TDD_A	dBm/4.5MHz	N/A	(I _o for Channel 1 +2.32dB)	
	Bands TDD_C				
Bands TDD_E					
Note 1:	This test verifies the RRM requirement which is independent of channel bandwidth and is performed according to the principle defined in section A.3.6.1.				
Note 2:	I_o levels have been derived from other parameters for information purposes. They are not settable parameters themselves.				
Note 3:	See Table A.9.1.7.2-1 for the other parameters.				

A.9.1.19.3 Test Requirements

The test requirements defined in section A.9.1.7.3 shall apply to this test case.

A.9.1.20 FDD RSRP for E-UTRAN Carrier Aggregation for 5MHz + 5MHz bandwidth

The test case in this section are applicable to carrier aggregation capable UEs which have been configured with a downlink Scell.

A.9.1.20.1 Test Purpose and Environment

The purpose of this test case is the same as for the test defined in subclause A.9.1.6.1.

A.9.1.20.2 Test parameters

The test parameters are the same except those described in the following section. The listed parameter values in Tables A.9.1.20.2-1 will replace the values of corresponding parameters in Tables A.9.1.6.2-1.

Table A.9.1.20.2-1: RSRP FDD carrier aggregation test parameters

Parameter		Unit	Test 1		
			Cell 1	Cell 2	Cell 3
BW _{channel} ^{Note 1}		MHz	5	5	5
Measurement bandwidth		n_{PRB}	10-15	10-15	10-15
PDSCH Reference measurement channel defined in A.3.1.1.1			R.5 FDD	R.5 FDD	N/A
PDSCH allocation		n_{PRB}	7-17	7-17	-
PDCCH/PCFICH/PHICH Reference measurement channel defined in A.3.1.2.1			R.11 FDD	R.11 FDD	R.11 FDD
OCNG Patterns defined in A.3.2.1.15 (OP.15 FDD) and A.3.2.1.26 (OP.16 FDD)			OP.15 FDD	OP.15 FDD	OP.16 FDD
N_{oc} ^{Note2}	Bands FDD_A	dBm/15 kHz	-117	$(N_{oc}$ for Channel 1 +1dB)	
	Bands FDD_B1, FDD_B2 ^{Note 6}		-116.5		
	Bands FDD_C		-116		
	Bands FDD_D		-115.5		
	Bands FDD_E, FDD_F		-115		
	Bands FDD_G		-114		
	Bands FDD_H		-113.5		
	Bands FDD_N		-110.5		
RSRP ^{Note2}	Bands FDD_A	dBm/15 kHz	-121	(RSRP for Cell 1 +8dB)	(RSRP for Cell 1 +4dB)
	Bands FDD_B1, FDD_B2 ^{Note 6}		-120.5		
	Bands FDD_C		-120		
	Bands FDD_D		-119.5		
	Bands FDD_E, FDD_F		-119		
	Bands FDD_G		-118		
	Bands FDD_H		-117.5		
	Bands FDD_N		-114.5		
I_o ^{Note2}	Bands FDD_A ^{Note 5}	dBm/4.5 MHz	-90.76	$(I_o$ for Channel 1 +5.33dB)	
	Bands FDD_B1 ^{Note 5} , FDD_B2 ^{Note 5, Note 6}		-90.26		
	Bands FDD_C ^{Note 5}		-89.76		
	Bands FDD_D ^{Note 5}		-89.26		
	Bands FDD_E, FDD_F ^{Note 5}		-88.76		
	Bands FDD_G ^{Note 5}		-87.76		
	Bands FDD_H ^{Note 5}		-87.26		
	Bands FDD_N ^{Note 5}		-84.26		

Note 1:	This test verifies the RRM requirement which is independent of channel bandwidth and is performed according to the principle defined in section A.3.6.1.
Note 2:	RSRP and I_0 levels have been derived from other parameters for information purposes. They are not settable parameters themselves.
Note 3:	See Table A.9.1.6.2-1 for the other parameters.
Note 4:	E-UTRA operating band groups are as defined in Section 3.5.
Note 5:	The test applies for E-UTRA operating bands in this band group which are supporting 5MHz + 5MHz channel bandwidth.
Note 6:	For Band 74, the tests shall be performed with the carrier frequency of the assigned E-UTRA channel bandwidth within 1475.9-1510.9 MHz.

A.9.1.20.3 Test Requirements

The test requirements defined in section A.9.1.6.3 shall apply to this test case.

A.9.1.21 TDD RSRP for E-UTRAN Carrier Aggregation for 5MHz + 5MHz bandwidth

The test case in this section are applicable to carrier aggregation capable UEs which have been configured with a downlink Scell.

A.9.1.21.1 Test Purpose and Environment

The purpose of this test case is the same as for the test defined in subclause A.9.1.7.1.

A.9.1.21.2 Test parameters

The test parameters are the same except those described in the following section. The listed parameter values in Tables A.9.1.21.2-1 will replace the values of corresponding parameters in Tables A.9.1.7.2-1.

Table A.9.1.21.2-1: Carrier aggregation RSRP test parameters for TDD

Parameter		Unit	Test 1		
			Cell 1	Cell 2	Cell 3
BW _{channel} ^{Note 1}		MHz	5	5	5
Measurement bandwidth		n_{PRB}	10-15	10-15	10-15
PDSCH Reference measurement channel defined in A.3.1.1.2			R.4 TDD	R.4 TDD	N/A
PDSCH allocation		n_{PRB}	7-17	7-17	N/A
PDCCH/PCFICH/PHICH Reference measurement channel defined in A.3.1.2.2			R.11 TDD		
OCNG Patterns defined in A.3.1.2.9 (OP.9 TDD) and A.3.2.2.10 (OP.10 TDD)			OP.9 TDD	OP.9 TDD	OP.10 TDD
I_0 ^{Note 2}	Bands TDD_A ^{Note 5}	dBm/4.5MHz	-90.76	(I ₀ for Channel 1 +5.33dB)	
	Bands TDD_C ^{Note 5}		-89.76		
	Bands TDD_E ^{Note 5}		-88.76		
Note 1:		This test verifies the RRM requirement which is independent of channel bandwidth and is performed according to the principle defined in section A.3.6.1.			
Note 2:		I_0 levels have been derived from other parameters for information purposes. They are not settable parameters themselves.			
Note 3:		See Table A.9.1.7.2-1 for the other parameters.			
Note 4:		E-UTRA operating band groups are as defined in Section 3.5.			
Note 5:		The test applies for E-UTRA operating bands in this band group which are supporting 5MHz + 5MHz channel bandwidth.			

A.9.1.21.3 Test Requirements

The test requirements defined in section A.9.1.7.3 shall apply to this test case.

A.9.1.22 RSRP for E-UTRAN TDD-FDD Carrier Aggregation with PCell in FDD

A.9.1.22.1 Test Purpose and Environment

The test case is applicable for TDD-FDD carrier aggregation capable UEs which have been configured with a downlink PCell in FDD and a downlink SCell in TDD.

The purpose of this test is to verify that the RSRP absolute and relative measurements accuracy in TDD-FDD carrier aggregation is within the specified limits. This test will verify the absolute RSRP accuracy requirements of the primary component carrier defined in clause 9.1.11.1, the absolute RSRP accuracy requirements of the secondary component carrier defined in clause 9.1.11.2, the relative RSRP accuracy requirements of the secondary component carrier defined in clause 9.1.11.2 between the SCell and a neighbour cell, and the relative RSRP accuracy requirements of the PCell compared to the SCell defined in Clause 9.1.11.3.

A.9.1.22.2 Test parameters

In this test case, Cell 1 is the PCell on the FDD primary component carrier, Cell 2 is the configured and activated SCell on the TDD secondary component carrier, and Cell 3 is the neighboring cell on the TDD secondary component carrier. The test parameters are given in Table A.9.1.22.2-1.

Table A.9.1.22.2-1: RSRP TDD-FDD carrier aggregation test parameters

Parameter	Unit	Test 1		
		Cell 1	Cell 2	Cell3
E-UTRA RF Channel Number		1	2	2
BW_{channel}		5MHz: $N_{RB,c} = 25$ 10MHz: $N_{RB,c} = 50$ 20MHz: $N_{RB,c} = 100$	5MHz: $N_{RB,c} = 25$ 10MHz: $N_{RB,c} = 50$ 20MHz: $N_{RB,c} = 100$	5MHz: $N_{RB,c} = 25$ 10MHz: $N_{RB,c} = 50$ 20MHz: $N_{RB,c} = 100$
Special subframe configuration ^{Note9}		-	6	6
Uplink-downlink configuration ^{Note9}		-	1	1
Measurement bandwidth	n_{PRB}	5MHz: 10-15 10MHz: 22-27 20MHz: 47-52	5MHz: 10-15 10MHz: 22-27 20MHz: 47-52	5MHz: 10-15 10MHz: 22-27 20MHz: 47-52
PDSCH Reference measurement channel defined in A.3.1.1.1 and A.3.1.1.2		5MHz: R.5 FDD 10MHz: R.0 FDD 20MHz: R.4 FDD	5MHz: R.4 TDD 10MHz: R.0 TDD 20MHz: R.3 TDD	-
PDSCH allocation	n_{PRB}	5MHz: 7-17 10MHz: 13-36 20MHz: 38-61	5MHz: 7-17 10MHz: 13-36 20MHz: 38-61	-
PDCCH/PCFICH/PHICH Reference measurement channel defined in A.3.1.2.1 and A.3.1.2.2		5MHz: R.11 FDD 10MHz: R.6 FDD 20MHz: R.10 FDD	5MHz: R.11 TDD 10MHz: R.6 TDD 20MHz: R.10 TDD	5MHz: R.11 TDD 10MHz: R.6 TDD 20MHz: R.10 TDD

OCNG Patterns defined in A.3.2.1.1 (OP.1 FDD), A.3.2.2.1 (OP.1 TDD), and A.3.2.2.2 (OP.2 TDD)			5MHz: OP.15 FDD 10MHz: OP.1 FDD 20MHz: OP.11 FDD	5MHz: OP.9 TDD 10MHz: OP.1 TDD 20MHz: OP.7 TDD	5MHz: OP.10 TDD 10MHz: OP.2 TDD 20MHz: OP.8 TDD
PBCH_RA		dB	0	0	0
PBCH_RB					
PSS_RA					
SSS_RA					
PCFICH_RB					
PHICH_RA					
PHICH_RB					
PDCCH_RA					
PDCCH_RB					
PDSCH_RA					
PDSCH_RB					
OCNG_RA ^{Note 2}					
OCNG_RB ^{Note 2}					
N_{oc} ^{Note 2}	Bands FDD_A				
	Bands FDD_B1, FDD_B2 ^{Note 10}	-116.5	-		
	Bands FDD_C	-116	-		
	Bands FDD_D	-115.5	-		
	Bands FDD_E, FDD_F ^{Note 6}	-115	-		
	Bands FDD_G	-114	-		
	Bands FDD_H	-113.5	-		
	Bands TDD_A	-	$(N_{oc}$ for Channel 1 +1dB)		
	Bands TDD_C	-			
	Bands TDD_E	-			
\hat{E}_s / N_{oc}		dB	-4	3	-1
\hat{E}_s / I_{ot}		dB	-4	0.46	-5.76
RSRP ^{Note 3}	Bands FDD_A	dBm/15 kHz	-121	-	-
	Bands FDD_B1, FDD_B2 ^{Note 10}		-120.5	-	-
	Bands FDD_C		-120	-	-
	Bands FDD_D		-119.5	-	-
	Bands FDD_E, FDD_F ^{Note 6}		-119	-	-
	Bands FDD_G		-118	-	-
	Bands FDD_H		-117.5	-	-
	Bands TDD_A		-	(RSRP for Cell 1 +8dB)	(RSRP for Cell 1 +4dB)
	Bands TDD_C		-		
	Bands TDD_E		-		
I_o ^{Note 3}	Bands FDD_A	dBm/ BW _{channel}	-87.76 + 10log(N _{RB} , √50)	-	
	Bands FDD_B1, FDD_B2 ^{Note 10}		-87.26 + 10log(N _{RB} , √50)	-	
	Bands FDD_C		-86.76+ 10log(N _{RB} , √50)	-	
	Bands FDD_D		-86.26+ 10log(N _{RB} , √50)	-	
	Bands FDD_E, FDD_F ^{Note 6}		-85.76+ 10log(N _{RB} , √50)	-	

	Bands FDD_G		$-84.76 + 10\log(N_{RB, \downarrow 50})$	-	
	Bands FDD_H		$-84.26 + 10\log(N_{RB, \downarrow 50})$	-	
	Bands TDD_A		-	(Io for Channel 1 +5.33dB +10log ($N_{RB, \text{channel}2} / N_{RB, \text{channel}1}$))	
	Bands TDD_C		-		
	Bands TDD_E		-		
Propagation condition		-	AWGN	AWGN	AWGN
Antenna Configuration		-	1x2	1x2	1x2
Timing offset to cell 1		μs	-	0	3
Time alignment error relative to cell 1 <small>Note 8</small>		-	-	$\leq \text{TAE}$	-
Note 1:	For special subframe and uplink-downlink configurations see Tables 4.2-1 and 4.2-2 in TS 36.211.				
Note 2:	OCNG shall be used such that all cells are fully allocated and a constant total transmitted power spectral density is achieved for all OFDM symbols.				
Note 3:	Interference from other cells and noise sources not specified in the test is assumed to be constant over subcarriers and time and shall be modelled as AWGN of appropriate power for to be fulfilled.				
Note 4:	Es/Iot, RSRP and Io levels have been derived from other parameters for information purposes. They are not settable parameters themselves.				
Note 5:	RSRP minimum requirements are specified assuming independent interference and noise at each receiver antenna port.				
Note 6:	The selection of the bands for testing depends on the configuration of the carrier aggregation supported by the UEs.				
Note 7:	For Band 26, the tests shall be performed with the carrier frequency of the assigned E-UTRA channel bandwidth within 865-894 MHz.				
Note 8:	Time alignment error (TAE) as specified in TS 36.104 [30] clause 6.5.3.1. The TAE value depends upon the type of carrier aggregation.				
Note 9:	E-UTRA operating band groups are as defined in Section 3.5.				
Note 10:	For Band 74, the tests shall be performed with the carrier frequency of the assigned E-UTRA channel bandwidth within 1475.9-1510.9 MHz.				

A.9.1.22.3 Test Requirements

In the test, the performance of RSRP measurements is verified from following four perspectives:

- The absolute accuracy of intra-frequency RSRP measurements for Cell 1 on the primary component carrier shall fulfil the requirements defined in clause 9.1.11.1.
- The absolute accuracy of intra-frequency RSRP measurements for Cell 2 on the secondary component carrier shall fulfil the requirements defined in clause 9.1.11.2.
- The relative accuracy of intra-frequency RSRP measurements for Cell 3 relative to Cell 2 on the secondary component carrier shall fulfil the requirements defined in clause 9.1.11.2.
- The relative accuracy of inter-frequency RSRP measurements between the primary and secondary component carriers for Cell 2 relative to Cell 1 shall fulfil the requirements defined in clause 9.1.11.3.

A.9.1.23 RSRP for E-UTRAN TDD-FDD Carrier Aggregation with PCell in TDD

A.9.1.23.1 Test Purpose and Environment

The test case is applicable for TDD-FDD carrier aggregation capable UEs which have been configured with a downlink PCell in TDD and a downlink SCell in FDD.

The purpose of this test is to verify that the RSRP absolute and relative measurements accuracy in TDD-FDD carrier aggregation is within the specified limits. This test will verify the absolute RSRP accuracy requirements of the primary component carrier defined in clause 9.1.11.1, the absolute RSRP accuracy requirements of the secondary component carrier defined in clause 9.1.11.2, the relative RSRP accuracy requirements of the secondary component carrier defined

in clause 9.1.11.2 between the SCell and a neighbour cell, and the relative RSRP accuracy requirements of the PCell compared to the SCell defined in Clause 9.1.11.3.

A.9.1.23.2 Test parameters

In this test case, Cell 1 is the PCell on the TDD primary component carrier, Cell 2 is the configured and activated SCell on the FDD secondary component carrier, and Cell 3 is the neighboring cell on the FDD secondary component carrier. The test parameters are given in Table A.9.1.23.2-1.

Table A.9.1.23.2-1: RSRP TDD-FDD carrier aggregation test parameters

Parameter	Unit	Test 1		
		Cell 1	Cell 2	Cell3
E-UTRA RF Channel Number		1	2	2
BW _{channel}		5MHz: N _{RB,c} = 25 10MHz: N _{RB,c} = 50 20MHz: N _{RB,c} = 100	5MHz: N _{RB,c} = 25 10MHz: N _{RB,c} = 50 20MHz: N _{RB,c} = 100	5MHz: N _{RB,c} = 25 10MHz: N _{RB,c} = 50 20MHz: N _{RB,c} = 100
Special subframe configuration ^{Note1}		6	-	-
Uplink-downlink configuration ^{Note1}		1	-	-
Measurement bandwidth	<i>n_{PRB}</i>	5MHz: 10-15 10MHz: 22-27 20MHz: 47-52	5MHz: 10-15 10MHz: 22-27 20MHz: 47-52	5MHz: 10-15 10MHz: 22-27 20MHz: 47-52
PDSCH Reference measurement channel defined in A.3.1.1.1 and A.3.1.1.2		5MHz: R.4 TDD 10MHz: R.0 TDD 20MHz: R.3 TDD	5MHz: R.5 FDD 10MHz: R.0 FDD 20MHz: R.4 FDD	-
PDSCH allocation	<i>n_{PRB}</i>	5MHz: 7-17 10MHz: 13-36 20MHz: 38-61	5MHz: 7-17 10MHz: 13-36 20MHz: 38-61	-
PDCCH/PCFICH/PHICH Reference measurement channel defined in A.3.1.2.1 and A.3.1.2.2		5MHz: R.11 TDD 10MHz: R.6 TDD 20MHz: R.10 TDD	5MHz: R.11 FDD 10MHz: R.6 FDD 20MHz: R.10 FDD	5MHz: R.11 FDD 10MHz: R.6 FDD 20MHz: R.10 FDD
OCNG Patterns defined in A.3.2.1.1 (OP.1 FDD), A.3.2.2.1 (OP.1 TDD), and A.3.2.1.2 (OP.2 FDD)		5MHz: OP.9 TDD 10MHz: OP.1 TDD 20MHz: OP.7 TDD	5MHz: OP.15 FDD 10MHz: OP.1 FDD 20MHz: OP.11 FDD	5MHz: OP.16 FDD 10MHz: OP.2 FDD 20MHz: OP.12 FDD
PBCH_RA	dB	0	0	0
PBCH_RB				
PSS_RA				
SSS_RA				
PCFICH_RB				
PHICH_RA				
PHICH_RB				
PDCCH_RA				
PDCCH_RB				
PDSCH_RA				
PDSCH_RB				

OCNG_RA ^{Note 2}					
OCNG_RB ^{Note 2}					
N_{oc} ^{Note 3}	Bands FDD_A	dBm/15 kHz	-	$(N_{oc}$ for Channel 1 +1dB)	
	Bands FDD_B1, FDD_B2 ^{Note 10}		-		
	Bands FDD_C		-		
	Bands FDD_D		-		
	Bands FDD_E, FDD_F ^{Note 9}		-		
	Bands FDD_G		-		
	Bands FDD_H		-		
	Bands TDD_A		-117		
	Bands TDD_C		-116	-	
	Bands TDD_E		-115	-	
\hat{E}_s / N_{oc}		dB	-4	3	-1
\hat{E}_s / I_{ot}		dB	-4	0.46	-5.76
RSRP ^{Note 4}	Bands FDD_A	dBm/15 kHz	-	(RSRP for Cell 1 +8dB)	(RSRP for Cell 1 +4dB)
	Bands FDD_B1, FDD_B2 ^{Note 10}		-		
	Bands FDD_C		-		
	Bands FDD_D		-		
	Bands FDD_E, FDD_F ^{Note 9}		-		
	Bands FDD_G		-		
	Bands FDD_H		-		
	Bands TDD_A		-121		
	Bands TDD_C		-120	-	
	Bands TDD_E		-119	-	
I_o ^{Note 4}	Bands FDD_A	dBm/ BW _{channel}	-	$(I_o$ for Channel 1 +5.33dB+10log(N _{RB channel2} / N _{RB channel 1}))	
	Bands FDD_B1, FDD_B2 ^{Note 10}		-		
	Bands FDD_C		-		
	Bands FDD_D		-		
	Bands FDD_E, FDD_F ^{Note 9}		-		
	Bands FDD_G		-		
	Bands FDD_H		-		
	Bands TDD_A		-87.76 + 10log(N _{RB, d} /50)		
	Bands TDD_C		-86.76 + 10log(N _{RB, d} /50)	-	
	Bands TDD_E		-85.76 + 10log(N _{RB, d} /50)	-	
Propagation condition		-	AWGN	AWGN	AWGN
Antenna Configuration		-	1x2	1x2	1x2
Timing offset to cell 1		μs	-	0	3
Time alignment error relative to cell 1 ^{Note 8}		-	-	≤ TAE	-
<p>Note 1: For special subframe and uplink-downlink configurations see Tables 4.2-1 and 4.2-2 in TS 36.211.</p> <p>Note 2: OCNG shall be used such that all cells are fully allocated and a constant total transmitted power spectral density is achieved for all OFDM symbols.</p> <p>Note 3: Interference from other cells and noise sources not specified in the test is assumed to be constant over subcarriers and time and shall be modelled as AWGN of appropriate power for N_{oc} to be fulfilled.</p> <p>Note 4: Es/Iot, RSRP and Io levels have been derived from other parameters for information purposes. They are not settable parameters themselves.</p> <p>Note 5: RSRP minimum requirements are specified assuming independent interference and noise at each receiver antenna port.</p>					

Note 6:	The selection of the bands for testing depends on the configuration of the carrier aggregation supported by the UEs.
Note 7:	For Band 26, the tests shall be performed with the carrier frequency of the assigned E-UTRA channel bandwidth within 865-894 MHz.
Note 8:	Time alignment error (TAE) as specified in TS 36.104 [30] clause 6.5.3.1. The TAE value depends upon the type of carrier aggregation.
Note 9:	E-UTRA operating band groups are as defined in Section 3.5.
Note 10:	For Band 74, the tests shall be performed with the carrier frequency of the assigned E-UTRA channel bandwidth within 1475.9-1510.9 MHz.

A.9.1.23.3 Test Requirements

In the test, the performance of RSRP measurements is verified from following four perspectives:

- The absolute accuracy of intra-frequency RSRP measurements for Cell 1 on the primary component carrier shall fulfil the requirements defined in clause 9.1.11.1.
- The absolute accuracy of intra-frequency RSRP measurements for Cell 2 on the secondary component carrier shall fulfil the requirements defined in clause 9.1.11.2.
- The relative accuracy of intra-frequency RSRP measurements for Cell 3 relative to Cell 2 on the secondary component carrier shall fulfil the requirements defined in clause 9.1.11.2.
- The relative accuracy of inter-frequency RSRP measurements between the primary and secondary component carriers for Cell 2 relative to Cell 1 shall fulfil the requirements defined in clause 9.1.11.3.

A.9.1.24 TDD RSRP for E-UTRAN Carrier Aggregation for 20MHz + 10MHz

The test case in this section are applicable to carrier aggregation capable UEs which have been configured with a downlink Scell.

A.9.1.24.1 Test Purpose and Environment

The purpose of this test case is the same as for the test defined in subclause A.9.1.7.1.

A.9.1.24.2 Test parameters

The test parameters are the same except those described in the following section. The listed parameter values in Tables A.9.1.24.2-1 will replace the values of corresponding parameters in Tables A.9.1.7.2-1.

Table A.9.1.24.2-1: Carrier aggregation RSRP test parameters for TDD

Parameter	Unit	Combination	Test 1		
			Cell 1	Cell 2	Cell 3
BW _{channel} ^{Note 1}	MHz	20MHz+10MHz	20MHz: N _{RB,c} = 100	10MHz: N _{RB,c} = 50	
		10MHz+20MHz	10MHz: N _{RB,c} = 50	20MHz: N _{RB,c} = 100	
Measurement bandwidth	n _{PRB}	20MHz+10MHz	47-52	22-27	
		10MHz+20MHz	22-27	47-52	
PDSCH Reference measurement channel defined in A.3.1.1.2		20MHz+10MHz	R.3 TDD	R.0 TDD	N/A
		10MHz+20MHz	R.0 TDD	R3.TDD	
PDSCH allocation	n _{PRB}	20MHz+10MHz	38-61	13-36	N/A
		10MHz+20MHz	13-36	38-61	
PDCCH/PCFICH/PHICH Reference measurement channel defined in A.3.1.2.2		20MHz+10MHz	R.10 TDD	R.6 TDD	
		10MHz+20MHz	R.6 TDD	R.10 TDD	
OCNG Patterns defined in A.3.2.2 (TDD)		20MHz+10MHz	OP.7 TDD	OP.1 TDD	OP.2 TDD
		10MHz+20MHz	OP.1 TDD	OP.7 TDD	OP.8 TDD
I _o ^{Note2}	Bands TDD_A	dBm/BW _{channel}	All	N/A	
	Bands TDD_C				

	Bands TDD_E			-85.76 + 10log(N _{RB,c} /50)	
	Bands TDD_A	dBm/ BW _{channel}	All	N/A	(I _o for Channel 1 +5.33dB) +10log (N _{RB channel2} / N _{RB channel 1})
	Bands TDD_C				
	Bands TDD_E				
Note 1:	This test verifies the RRM requirement which is independent of channel bandwidth and is performed according to the principle defined in section A.3.6.1.				
Note 2:	I _o levels have been derived from other parameters for information purposes. They are not settable parameters themselves.				
Note 3:	See Table A.9.1.7.2-1 for the other parameters.				
Note 4:	For each parameter, the allowed combinations are shown in separate rows.				

A.9.1.24.3 Test Requirements

The test requirements defined in section A.9.1.7.3 shall apply to this test case.

A.9.1.25 FDD intra-frequency absolute and relative RSRP accuracies in CRS based discovery signal

A.9.1.25.1 Test Purpose and Environment

The purpose of this test is to verify that the FDD RSRP absolute and relative measurement accuracies in CRS based discovery signal are within the specified limits. This test will verify the requirements in Sections 9.1.14.2.

A.9.1.25.2 Test parameters

In this test case, all cells are on the same carrier frequency. Both absolute and relative accuracies of RSRP intra frequency measurements are tested by using the parameters in Table A.9.1.25.2-1. In this test case, Cell 1 is the PCell and Cell 2 is the target cell. The Cell 2 DMTC configuration is provided to the UE in the *measDS-Config* before the start of the test.

Table A.9.1.25.2-1: RSRP FDD Intra frequency test parameters

Parameter	Unit	Test 1	
		Cell 1	Cell 2
E-UTRA RF Channel Number		1	
BW _{channel}	MHz	10	
Measurement bandwidth	n _{PRB}	22—27	
DTMC period	ms	N/A	160
DTMC period offset		N/A	10
Discovery signal occasion duration	ms	N/A	1
Time offset between cells	µs	2.3	
PDSCH Reference measurement channel defined in A.3.1.1.1		R.0 FDD	-
PDSCH allocation	n _{PRB}	13—36	-
PDCCH/PCFICH/PHICH Reference measurement channel defined in A.3.1.2.1		R.6 FDD	
OCNG Patterns defined in A.3.2.1.1 (OP.1 FDD) and A.3.2.1.2 (OP.2 FDD)		OP.1 FDD	OP.2 FDD
PBCH_RA	dB	0	0
PBCH_RB			
PSS_RA			
SSS_RA			
PCFICH_RB			
PHICH_RA			
PHICH_RB			
PDCCH_RA			
PDCCH_RB			
PDSCH_RA			
PDSCH_RB			
OCNG_RA ^{Note1}			

OCNG_RB ^{Note1}				
N_{oc} ^{Note2}	Bands FDD_A ^{Note 8}	dBm/15 kHz	-106	-106
	Bands FDD_B1, FDD_B2 ^{Note 9}			
	Bands FDD_C			
	Bands FDD_D			
	Bands FDD_E, FDD_F ^{Note 5}			
	Bands FDD_G ^{Note 7}			
	Bands FDD_H			
\hat{E}_s/I_{ot}		dB	2.5	-6
RSRP ^{Note3}	Bands FDD_A ^{Note 8}	dBm/15 kHz	-100	-105
	Bands FDD_B1, FDD_B2 ^{Note 9}			
	Bands FDD_C			
	Bands FDD_D			
	Bands FDD_E, FDD_F ^{Note 5}			
	Bands FDD_G ^{Note 7}			
	Bands FDD_H			
I_o ^{Note3}	Bands FDD_A ^{Note 8}	dBm/9 MHz	-70.27	-70.27
	Bands FDD_B1, FDD_B2 ^{Note 9}			
	Bands FDD_C			
	Bands FDD_D			
	Bands FDD_E, FDD_F ^{Note 5}			
	Bands FDD_G ^{Note 7}			
	Bands FDD_H			
\hat{E}_s/N_{oc}		dB	6	1
Propagation condition		-	AWGN	
<p>Note 1: OCNG shall be used such that both cells are fully allocated and a constant total transmitted power spectral density is achieved for all OFDM symbols.</p> <p>Note 2: Interference from other cells and noise sources not specified in the test is assumed to be constant over subcarriers and time and shall be modelled as AWGN of appropriate power for N_{oc} to be fulfilled.</p> <p>Note 3: RSRP and I_o levels have been derived from other parameters for information purposes. They are not settable parameters themselves.</p> <p>Note 4: RSRP minimum requirements are specified assuming independent interference and noise at each receiver antenna port.</p> <p>Note 5: For Band 26, the tests shall be performed with the carrier frequency of the assigned E-UTRA channel bandwidth within 865-894 MHz.</p> <p>Note 6: E-UTRA operating band groups are as defined in Section 3.5.</p> <p>Note 7: Except Band 29.</p> <p>Note 8: Except Band 32, Band 75, Band 76.</p> <p>Note 9: For Band 74, the tests shall be performed with the carrier frequency of the assigned E-UTRA channel bandwidth within 1475.9-1510.9 MHz.</p>				

A.9.1.25.3 Test Requirements

The RSRP measurement accuracy shall fulfil the requirements in sections 9.1.14.2.

A.9.1.26 TDD intra-frequency absolute and relative RSRP accuracies in CRS based discovery signal

A.9.1.26.1 Test Purpose and Environment

The purpose of this test is to verify that the RSRP absolute and relative measurement accuracies in CRS based discovery signal are within the specified limits. This test will verify the requirements in Sections 9.1.14.2.

A.9.1.26.2 Test parameters

In this test case all cells are on the same carrier frequency. Both absolute and relative accuracies of RSRP intra frequency measurements are tested by using the parameters in Table A.9.1.26.2-1. In this test case, Cell 1 is the PCell and Cell 2 is the target cell. The Cell 2 DMTC configuration is provided to the UE in the *measDS-Config* before the start of the test.

Table A.9.1.26.2-1: RSRP TDD Intra frequency test parameters

Parameter	Unit	Test 1				
		Cell 1	Cell 2			
E-UTRA RF Channel Number		1				
BW _{channel}	MHz	10				
Special subframe configuration ^{Note1}		6				
Uplink/downlink configuration ^{Note1}		1				
Measurement bandwidth	n_{PRB}	22—27				
DTMC period	ms	N/A	160			
DTMC period offset		N/A	10			
Discovery signal occasion duration	ms	N/A	2			
Time offset between cells	μ s	2.3				
PDSCH Reference measurement channel defined in A.3.1.1.2		R.0 TDD	-			
PDSCH allocation	n_{PRB}	13—36	-			
PDCCH/PCFICH/PHICH Reference measurement channel defined in A.3.1.2.2		R.6 TDD				
OCNG Patterns defined in A.3.2.2.1 (OP.1 TDD) and A.3.2.2.2 (OP.2 TDD)		OP.1 TDD	OP.2 TDD			
PBCH_RA	dB	0	0			
PBCH_RB						
PSS_RA						
SSS_RA						
PCFICH_RB						
PHICH_RA						
PHICH_RB						
PDCCH_RA						
PDCCH_RB						
PDSCH_RA						
PDSCH_RB						
OCNG_RA ^{Note2}						
OCNG_RB ^{Note2}						
N_{oc} ^{Note3}				Bands TDD_A	-106	-106
				Bands TDD_C		
	Bands TDD_E					
\hat{E}_s/I_{ot}	dB	2.5	-6			
RSRP ^{Note4}	Bands TDD_A	-100	-105			
	Bands TDD_C					
	Bands TDD_E					
I_o ^{Note4}	Bands TDD_A	-70.27	-70.27			
	Bands TDD_C					
	Bands TDD_E					

\hat{E}_s / N_{oc}	dB	6	1
Propagation condition	-	AWGN	
Note 1:	For special subframe and uplink-downlink configurations see Tables 4.2-1 and 4.2-2 in TS 36.211.		
Note 2:	OCNG shall be used such that both cells are fully allocated and a constant total transmitted power spectral density is achieved for all OFDM symbols.		
Note 3:	Interference from other cells and noise sources not specified in the test is assumed to be constant over subcarriers and time and shall be modelled as AWGN of appropriate power for N_{oc} to be fulfilled.		
Note 4:	RSRP and I_0 levels have been derived from other parameters for information purposes. They are not settable parameters themselves.		
Note 5:	RSRP minimum requirements are specified assuming independent interference and noise at each receiver antenna port.		
Note 6:	E-UTRA operating band groups are as defined in Section 3.5.		

A.9.1.26.3 Test Requirements

The RSRP measurement accuracy shall fulfil the requirements in sections 9.1.14. 2.

A.9.1.27 FDD—FDD inter-frequency absolute and relative RSRP accuracies in CRS based discovery signal

A.9.1.27.1 Test Purpose and Environment

The purpose of this test is to verify that the CRS RSRP measurement accuracy is within the specified limits. This test will verify the requirements in Sections 9.1.14.2 for FDD—FDD inter frequency measurements.

A.9.1.27.2 Test parameters

In this set of test case the cells are on different carrier frequencies. Both absolute and relative accuracy of CRS RSRP inter-frequency measurements are tested by using the parameters in Table A.9.1.27.2-1. In this test case, Cell 1 is the PCell and Cell 2 the target cell. The inter frequency measurements are supported by a measurement gap and a DMTC configuration.

Table A.9.1.27.2-1: CRS RSRP FDD—FDD Inter frequency test parameters

Parameter	Unit	Test 1	
		Cell 1	Cell 2
E-UTRA RF Channel Number		1	2
$BW_{channel}$	MHz	10	10
Gap Pattern Id		0	-
gapOffset	ms	9	
DMTC period	ms	-	160
DMTC period offset	ms	-	10
Discovery signal occasion duration	ms	-	1
Time offset between cells	μ s	-	3
Measurement bandwidth	n_{PRB}	22—27	
PDSCH Reference measurement channel defined in A.3.1.1.1		R.0 FDD	-
PDSCH allocation	n_{PRB}	13—36	-
PDCCH/PCFICH/PHICH Reference measurement channel defined in A.3.1.2.1		R.6 FDD	
OCNG Patterns defined in A.3.2.1.1 (OP.1 FDD) and A.3.2.1.2 (OP.2 FDD)		OP.1 FDD	OP.2 FDD
PBCH_RA	dB	0	0

PBCH_RB				
PSS_RA				
SSS_RA				
PCFICH_RB				
PHICH_RA				
PHICH_RB				
PDCCH_RA				
PDCCH_RB				
PDSCH_RA				
PDSCH_RB				
OCNG_RA ^{Note1}				
OCNG_RB ^{Note1}				
N_{oc} ^{Note2}	Bands FDD_A ^{Note 9}	dBm/15 kHz	$(N_{oc}$ for Channel 2 +6dB)	-115
	Bands FDD_B1, FDD_B2 ^{Note 10}			-114.5
	Bands FDD_C			-114
	Bands FDD_D			-113.5
	Bands FDD_E, FDD_F ^{Note 5}			-113
	Bands FDD_G ^{Note 7}			-112
	Bands FDD_H			-111.5
\hat{E}_s/I_{ot}		dB	13	-6
RSRP ^{Note3}	Bands FDD_A ^{Note 9}	dBm/15 kHz	(RSRP for Cell 2 +25dB)	-121
	Bands FDD_B1, FDD_B2 ^{Note 10}			-120.5
	Bands FDD_C			-120
	Bands FDD_D			-119.5
	Bands FDD_E, FDD_F ^{Note 5}			-119
	Bands FDD_G ^{Note 7}			-118
	Bands FDD_H			-117.5
I_o ^{Note3}	Bands FDD_A ^{Note 9}	dBm/9 MHz	(I _o for Channel 2 +18.24dB)	-86.25
	Bands FDD_B1, FDD_B2 ^{Note 10}			-85.75
	Bands FDD_C			-85.25
	Bands FDD_D			-84.75
	Bands FDD_E, FDD_F ^{Note 5}			-84.25
	Bands FDD_G ^{Note 7}			-83.25
	Bands FDD_H			-82.75
\hat{E}_s/N_{oc}		dB	13	-6
Propagation condition		-	AWGN	
<p>Note 1: OCNG shall be used such that both cells are fully allocated and a constant total transmitted power spectral density is achieved for all OFDM symbols.</p> <p>Note 2: Interference from other cells and noise sources not specified in the test is assumed to be constant over subcarriers and time and shall be modelled as AWGN of appropriate power for N_{oc} to be fulfilled.</p> <p>Note 3: RSRP and I_o levels have been derived from other parameters for information purposes. They are not settable parameters themselves.</p> <p>Note 4: RSRP minimum requirements are specified assuming independent interference and noise at each receiver antenna port.</p>				

Note 5:	For Band 26, the tests shall be performed with the carrier frequency of assigned E-UTRA channel bandwidth within 865-894 MHz.
Note 6:	E-UTRA operating band groups are as defined in Section 3.5.
Note 7:	Except Band 29.
Note 8:	DMTC is provided to the UE in the <i>measDS-Config</i> (in TS36.331) before the beginning of the test.
Note 9:	Except Band 32, Band 75, Band 76.
Note 10:	For Band 74, the tests shall be performed with the carrier frequency of the assigned E-UTRA channel bandwidth within 1475.9-1510.9 MHz.

A.9.1.27.3 Test Requirements

The CRS RSRP measurement accuracy shall fulfil the requirements in sections 9.1.14.2.

A.9.1.28 TDD—TDD inter-frequency absolute and relative RSRP accuracies in CRS based discovery signal

A.9.1.28.1 Test Purpose and Environment

The purpose of this test is to verify that the CRS RSRP measurement accuracy is within the specified limits. This test will verify the requirements in Sections 9.1.14.2 for TDD—TDD inter frequency measurements.

A.9.1.28.2 Test parameters

In this set of test case the cells are on different carrier frequencies. Both absolute and relative accuracy of CRS RSRP inter-frequency measurements are tested by using the parameters in Table A.9.1.28.2-1. In this test case, Cell 1 is the PCell and Cell 2 the target cell. The inter frequency measurements are supported by a measurement gap and a DMTC configuration.

Table A.9.1.28.2-1: CRS RSRP TDD—TDD Inter frequency test parameters

Parameter	Unit	Test 1	
		Cell 1	Cell 2
E-UTRA RF Channel Number		1	2
BW_{channel}	MHz	10	10
Special subframe configuration ^{Note1}		6	
Uplink-downlink configuration ^{Note1}		1	
Gap Pattern Id		0	-
gapOffset	ms	9	
DMTC period	ms	-	160
DMTC period offset	ms	-	10
Discovery signal occasion duration	ms	-	2
Time offset between cells	μs	-	3
Measurement bandwidth	n_{PRB}	22—27	
PDSCH Reference measurement channel defined in A.3.1.1.2		R.0 TDD	-
PDSCH allocation	n_{PRB}	13—36	-
PDCCH/PCFICH/PHICH Reference measurement channel defined in A.3.1.2.2		R.6 TDD	
OCNG Patterns defined in A.3.2.2.1 (OP.1 TDD) and A.3.2.2.2 (OP.2 TDD)		OP.1 TDD	OP.2 TDD
PBCH_RA	dB	0	0
PBCH_RB			
PSS_RA			
SSS_RA			
PCFICH_RB			
PHICH_RA			
PHICH_RB			
PDCCH_RA			

PDCCH_RB				
PDSCH_RA				
PDSCH_RB				
OCNG_RA ^{Note2}				
OCNG_RB ^{Note2}				
N_{oc} ^{Note3}	Bands TDD_A	dBm/15 kHz	$(N_{oc}$ for Channel 2 +6dB)	-115
	Bands TDD_C			-114
	Bands TDD_E			-113
\hat{E}_s/I_{ot}		dB	13	-6
RSRP ^{Note4}	Bands TDD_A	dBm/15 kHz	(RSRP for Cell 2 +25dB)	-121
	Bands TDD_C			-120
	Bands TDD_E			-119
I_o ^{Note4}	Bands TDD_A	dBm/9 MHz	$(I_o$ for Channel 2 +18.24dB)	-86.25
	Bands TDD_C			-85.25
	Bands TDD_E			-84.25
\hat{E}_s/N_{oc}		dB	13	-6
Propagation condition		-	AWGN	
<p>Note 1: For special subframe and uplink-downlink configurations see Tables 4.2-1 and 4.2-2 in TS 36.211.</p> <p>Note 2: OCNG shall be used such that both cells are fully allocated and a constant total transmitted power spectral density is achieved for all OFDM symbols.</p> <p>Note 3: Interference from other cells and noise sources not specified in the test is assumed to be constant over subcarriers and time and shall be modelled as AWGN of appropriate power for N_{oc} to be fulfilled.</p> <p>Note 4: RSRP and I_o levels have been derived from other parameters for information purposes. They are not settable parameters themselves.</p> <p>Note 5: RSRP minimum requirements are specified assuming independent interference and noise at each receiver antenna port.</p> <p>Note 6: E-UTRA operating band groups are as defined in Section 3.5.</p> <p>Note 7: DMTC is provided to the UE in the measDS-Config (in TS36.331) before the beginning of test</p>				

A.9.1.28.3 Test Requirements

The CRS RSRP measurement accuracy shall fulfil the requirements in sections 9.1.14.2.

A.9.1.29 FDD intra frequency absolute and relative CSI-RSRP accuracies in CSI-RS based discovery signal

A.9.1.29.1 Test Purpose and Environment

The purpose of this test is to verify that the CSI- RSRP measurement accuracy is within the specified limits. This test will verify the requirements in Sections 9.1.14.3 for FDD intra frequency measurements.

A.9.1.29.2 Test parameters

In this set of test case all cells are on the same carrier frequencies. Both absolute and relative accuracy of CSI- RSRP intra frequency measurements are tested by using the parameters in Table A.9.1.29.2-1. In this test case, Cell 1 is the PCell and Cell 2 the target cell. The intra frequency measurements are supported by a DMTC configuration.

Table A.9.1.29.2-1: CSI-RSRP FDD Intra frequency test parameters

Parameter	Unit	Test 1	
		Cell 1	Cell 2

E-UTRA RF Channel Number			1	
BW _{channel}		MHz	10	
DMTC period		ms	160	
DMTC period offset		ms	10	
Discovery signal occasion duration		ms	1	
CSI-RS resource configuration			2	4
CSI-RS periodicity		ms	10	
CSI-RS subframe offset		ms	0	
CSI-RS individual offset[2]		dB	0	0
CSI-RS muting			Enable	Enable
Time offset between cells		μs	-	2.3
Measurement bandwidth		n_{PRB}	22—27	
PDSCH Reference measurement channel defined in A.3.1.1.1			R.0 FDD	-
PDSCH allocation		n_{PRB}	13—36	-
PDCCH/PCFICH/PHICH Reference measurement channel defined in A.3.1.2.1			R.6 FDD	
OCNG Patterns defined in A.3.2.1.1 (OP.1 FDD) and A.3.2.1.2 (OP.2 FDD)			OP.1 FDD	OP.2 FDD
PBCH_RA		dB	0	0
PBCH_RB				
PSS_RA				
SSS_RA				
PCFICH_RB				
PHICH_RA				
PHICH_RB				
PDCCH_RA				
PDCCH_RB				
PDSCH_RA				
PDSCH_RB				
OCNG_RA ^{Note1}				
OCNG_RB ^{Note1}				
p-C-r10[2]				
N_{oc} ^{Note2}	Bands FDD_A ^{Note 9}	dBm/15 kHz	-116	
	Bands FDD_B1, FDD_B2 ^{Note 10}		-115.5	
	Bands FDD_C		-115	
	Bands FDD_D		-114.5	
	Bands FDD_E, FDD_F ^{Note 5}		-114	
	Bands FDD_G ^{Note 7}		-113	
	Bands FDD_H		-112.5	
CRS \hat{E}_s/I_{ot}		dB	0.46	-5.76
CSI-RS \hat{E}_s/I_{ot}		dB	6.46	0.24
RSRP ^{Note3}	Bands FDD_A ^{Note 9}	dBm/15 kHz	-113	-117
	Bands FDD_B1, FDD_B2 ^{Note 10}		-112.5	-116.5
	Bands FDD_C		-112	-116
	Bands FDD_D		-111.5	-115.5
	Bands FDD_E, FDD_F ^{Note 5}		-111	-115
	Bands FDD_G ^{Note 7}		-110	-114
	Bands FDD_H		-109.5	-113.5
CSI-RSRP ^{Note3}	Bands FDD_A ^{Note 9}	dBm/15 kHz	(RSRP for Cell 1 +6dB)	(RSRP for Cell 2 +6dB)
	Bands FDD_B1, FDD_B2 ^{Note 10}			

	Bands FDD_C			
	Bands FDD_D			
	Bands FDD_E, FDD_F ^{Note 5}			
	Bands FDD_G ^{Note 7}			
	Bands FDD_H			
I _o ^{Note3}	Bands FDD_A ^{Note 9}	dBm/9 MHz	-82.43	
	Bands FDD_B1, FDD_B2 ^{Note 10}		-81.93	
	Bands FDD_C		-81.43	
	Bands FDD_D		-80.93	
	Bands FDD_E, FDD_F ^{Note 5}		-80.43	
	Bands FDD_G ^{Note 7}		-79.43	
	Bands FDD_H		-78.93	
CRS \hat{E}_s/N_{oc}		dB	3	-1
CSI-RS \hat{E}_s/N_{oc}		dB	9	5
Propagation condition		-	AWGN	
<p>Note 1: OCNG shall be used such that both cells are fully allocated and a constant total transmitted power spectral density is achieved for all OFDM symbols.</p> <p>Note 2: Interference from other cells and noise sources not specified in the test is assumed to be constant over subcarriers and time and shall be modelled as AWGN of appropriate power for N_{oc} to be fulfilled.</p> <p>Note 3: RSRP, CSI-RSRP and I_o levels have been derived from other parameters for information purposes. They are not settable parameters themselves. I_o levels are calculated in CRS symbols of measurement subframe.</p> <p>Note 4: RSRP minimum requirements are specified assuming independent interference and noise at each receiver antenna port.</p> <p>Note 5: For Band 26, the tests shall be performed with the carrier frequency of assigned E-UTRA channel bandwidth within 865-894 MHz.</p> <p>Note 6: E-UTRA operating band groups are as defined in Section 3.5.</p> <p>Note 7: Except Band 29.</p> <p>Note 8: DMTC is provided to the UE in the <i>measDS-Config</i> (in TS36.331) before the beginning of the test.</p> <p>Note 9: Except Band 32, Band 75, Band 76.</p> <p>Note 10: For Band 74, the tests shall be performed with the carrier frequency of the assigned E-UTRA channel bandwidth within 1475.9-1510.9 MHz.</p>				

A.9.1.29.3 Test Requirements

The CSI- RSRP measurement accuracy shall fulfil the requirements in sections 9.1.14.3.

A.9.1.30 TDD intra frequency absolute and relative CSI-RSRP accuracies in CSI-RS based discovery signal

A.9.1.30.1 Test Purpose and Environment

The purpose of this test is to verify that the CSI- RSRP measurement accuracy is within the specified limits. This test will verify the requirements in Sections 9.1.14.3 for TDD intra frequency measurements.

A.9.1.30.2 Test parameters

In this set of test case all cells are on the same carrier frequencies. Both absolute and relative accuracy of CSI- RSRP intra frequency measurements are tested by using the parameters in Table A.9.1.30.2-1. In this test case, Cell 1 is the PCell and Cell 2 the target cell. The intra frequency measurements are supported by a DMTC configuration.

Table A.9.1.30.2-1: CSI-RSRP TDD Intra frequency test parameters

Parameter	Unit	Test 1	
		Cell 1	Cell 2
E-UTRA RF Channel Number		1	
BW_{channel}	MHz	10	
Special subframe configuration ^{Note1}		6	
Uplink-downlink configuration ^{Note1}		1	
DMTC period	ms	160	
DMTC period offset	ms	10	
Discovery signal occasion duration	ms	2	
CSI-RS resource configuration		2	4
CSI-RS periodicity	ms	10	
CSI-RS subframe offset	ms	0	
CSI-RS individual offset[2]	dB	0	0
CSI-RS muting		Enable	Enable
Time offset between cells	μs	-	2.3
Measurement bandwidth	n_{PRB}	22—27	
PDSCH Reference measurement channel defined in A.3.1.1.1		R.0 TDD	-
PDSCH allocation	n_{PRB}	13—36	-
PDCCH/PCFICH/PHICH Reference measurement channel defined in A.3.1.2.1		R.6 TDD	
OCNG Patterns defined in A.3.2.2.1 (OP.1 TDD) and A.3.2.2.2 (OP.2 TDD)		OP.1 TDD	OP.2 TDD
PBCH_RA	dB	0	0
PBCH_RB			
PSS_RA			
SSS_RA			
PCFICH_RB			
PHICH_RA			
PHICH_RB			
PDCCH_RA			
PDCCH_RB			
PDSCH_RA			
PDSCH_RB			
OCNG_RA ^{Note1}			
OCNG_RB ^{Note1}			
p-C-r10[2]			
N_{oc} ^{Note3}	Bands TDD_A	-116	
	Bands TDD_C	-115	
	Bands TDD_E	-114	
$\text{CRS } \hat{E}_s / I_{ot}$	dB	0.46	-5.76
$\text{CSI-RS } \hat{E}_s / I_{ot}$	dB	6.46	0.24
RSRP ^{Note4}	Bands TDD_A	-113	-117
	Bands TDD_C	-112	-116
	Bands TDD_E	-111	-115
CSI-RSRP ^{Note4}	Bands TDD_A	(RSRP for Cell 1 +6dB)	(RSRP for Cell 2 +6dB)
	Bands TDD_C		
	Bands TDD_E		
I_o ^{Note4}	Bands TDD_A	-82.43	
	Bands TDD_C	-81.43	
	Bands TDD_E	-80.43	
$\text{CRS } \hat{E}_s / N_{oc}$	dB	3	-1

CSI-RS \hat{E}_s / N_{oc}	dB	9	5
Propagation condition	-	AWGN	
Note 1:	For special subframe and uplink-downlink configurations see Tables 4.2-1 and 4.2-2 in TS 36.211.		
Note 2:	OCNG shall be used such that both cells are fully allocated and a constant total transmitted power spectral density is achieved for all OFDM symbols.		
Note 3:	Interference from other cells and noise sources not specified in the test is assumed to be constant over subcarriers and time and shall be modelled as AWGN of appropriate power for N_{oc} to be fulfilled.		
Note 4:	RSRP, CSI-RSRP and I_o levels have been derived from other parameters for information purposes. They are not settable parameters themselves. I_o levels are calculated in CRS symbols of measurement subframe.		
Note 5:	RSRP minimum requirements are specified assuming independent interference and noise at each receiver antenna port.		
Note 6:	E-UTRA operating band groups are as defined in Section 3.5.		
Note 7:	DMTC is provided to the UE in the <i>measDS-Config</i> (in TS36.331) before the beginning of the test.		

A.9.1.30.3 Test Requirements

The CSI- RSRP measurement accuracy shall fulfil the requirements in sections 9.1.14.3.

A.9.1.31 FDD—FDD inter-frequency absolute and relative CSI-RSRP accuracies in CSI-RS based discovery signal

A.9.1.31.1 Test Purpose and Environment

The purpose of this test is to verify that the CSI-RSRP measurement accuracy is within the specified limits. This test will verify the requirements in Sections 9.1.14.3 for FDD—FDD inter frequency measurements.

A.9.1.31.2 Test parameters

In this set of test case the cells are on different carrier frequencies. Both absolute and relative accuracy of CSI-RSRP inter-frequency measurements are tested by using the parameters in Table A.9.1.31.2-1. In this test case, Cell 1 is the PCell and Cell 2 the target cell. The inter frequency measurements are supported by a measurement gap and two DMTC configurations which one is for cell1 and the other is for cell2.

Table A.9.1.31.2-1: CSI-RSRP FDD—FDD Inter frequency test parameters

Parameter	Unit	Test 1	
		Cell 1	Cell 2
E-UTRA RF Channel Number		1	2
$BW_{channel}$	MHz	10	10
Gap Pattern Id		0	-
gapOffset	ms	9	
DMTC period	ms	160	160
DMTC period offset	ms	0	10
Discovery signal occasion duration	ms	1	1
CSI-RS resource configuration		2	4
CSI-RS periodicity	ms	10	
CSI-RS subframe offset	ms	0	
CSI-RS individual offset[2]	dB	0	0
CSI-RS muting		Enable	Enable
Time offset between cells	μ s	-	3
Measurement bandwidth	n_{PRB}	22—27	
PDSCH Reference measurement channel defined in A.3.1.1.1		R.0 FDD	-

PDSCH allocation		n_{PRB}	13—36	-
PDCCH/PCFICH/PHICH Reference measurement channel defined in A.3.1.2.1			R.6 FDD	
OCNG Patterns defined in A.3.2.1.1 (OP.1 FDD) and A.3.2.1.2 (OP.2 FDD)			OP.1 FDD	OP.2 FDD
PBCH_RA		dB	0	0
PBCH_RB				
PSS_RA				
SSS_RA				
PCFICH_RB				
PHICH_RA				
PHICH_RB				
PDCCH_RA				
PDCCH_RB				
PDSCH_RA				
PDSCH_RB				
OCNG_RA ^{Note1}				
OCNG_RB ^{Note1}				
p-C-r10[2]				
N_{oc} ^{Note2}	Bands FDD_A <small>Note 9</small>	dBm/15 kHz	$(N_{oc}$ for Channel 2 +6dB)	-115
	Bands FDD_B1, FDD_B2 ^{Note 10}			-114.5
	Bands FDD_C			-114
	Bands FDD_D			-113.5
	Bands FDD_E, FDD_F ^{Note 5}			-113
	Bands FDD_G <small>Note 7</small>			-112
	Bands FDD_H			-111.5
$CRS \hat{E}_s / I_{ot}$		dB	13	-6
$CSI-RS \hat{E}_s / I_{ot}$		dB	13	0
RSRP ^{Note3}	Bands FDD_A <small>Note 9</small>	dBm/15 kHz	(RSRP for Cell 2 +25dB)	-121
	Bands FDD_B1, FDD_B2 ^{Note 10}			-120.5
	Bands FDD_C			-120
	Bands FDD_D			-119.5
	Bands FDD_E, FDD_F ^{Note 5}			-119
	Bands FDD_G <small>Note 7</small>			-118
	Bands FDD_H			-117.5
CSI-RSRP ^{Note3}	Bands FDD_A <small>Note 9</small>	dBm/15 kHz	(RSRP for Cell 1 +0dB)	(RSRP for Cell 2 +6dB)
	Bands FDD_B1, FDD_B2 ^{Note 10}			
	Bands FDD_C			
	Bands FDD_D			
	Bands FDD_E, FDD_F ^{Note 5}			
	Bands FDD_G <small>Note 7</small>			
	Bands FDD_H			
I_o ^{Note3}	Bands FDD_A <small>Note 9</small>	dBm/9 MHz	(I _o for Channel 2 +18.24dB)	-86.25
	Bands FDD_B1, FDD_B2 ^{Note 10}			-85.75
	Bands FDD_C			-85.25
	Bands FDD_D			-84.75

	Bands FDD_E, FDD_F ^{Note 5}			-84.25
	Bands FDD_G ^{Note 7}			-83.25
	Bands FDD_H			-82.75
CRS \hat{E}_s/N_{oc}		dB	13	-6
CSI-RS \hat{E}_s/N_{oc}		dB	13	0
Propagation condition		-	AWGN	
Note 1:	OCNG shall be used such that both cells are fully allocated and a constant total transmitted power spectral density is achieved for all OFDM symbols.			
Note 2:	Interference from other cells and noise sources not specified in the test is assumed to be constant over subcarriers and time and shall be modelled as AWGN of appropriate power for N_{oc} to be fulfilled.			
Note 3:	RSRP, CSI-RSRP and I_0 levels have been derived from other parameters for information purposes. They are not settable parameters themselves. I_0 levels are calculated in CRS symbols of measurement subframe.			
Note 4:	RSRP minimum requirements are specified assuming independent interference and noise at each receiver antenna port.			
Note 5:	For Band 26, the tests shall be performed with the carrier frequency of assigned E-UTRA channel bandwidth within 865-894 MHz.			
Note 6:	E-UTRA operating band groups are as defined in Section 3.5.			
Note 7:	Except Band 29.			
Note 8:	DMTC is provided to the UE in the <i>measDS-Config</i> (in TS36.331) before the beginning of the test.			
Note 9:	Except Band 32, Band 75, Band 76.			
Note 10:	For Band 74, the tests shall be performed with the carrier frequency of the assigned E-UTRA channel bandwidth within 1475.9-1510.9 MHz.			

A.9.1.31.3 Test Requirements

The CSI-RSRP measurement accuracy shall fulfil the requirements in sections 9.1.14.3.

A.9.1.32 TDD—TDD inter-frequency absolute and relative CSI-RSRP accuracies in CSI-RS based discovery signal

A.9.1.32.1 Test Purpose and Environment

The purpose of this test is to verify that the CSI-RSRP measurement accuracy is within the specified limits. This test will verify the requirements in Sections 9.1.14.3 for TDD—TDD inter frequency measurements.

A.9.1.32.2 Test parameters

In this set of test case the cells are on different carrier frequencies. Both absolute and relative accuracy of CSI-RSRP inter-frequency measurements are tested by using the parameters in Table A.9.1.32.2-1. In this test case, Cell 1 is the PCell and Cell 2 the target cell. The inter frequency measurements are supported by a measurement gap and two DMTC configurations which one is for cell 1 and the other is for cell2.

Table A.9.1.32.2-1: CSI-RSRP TDD—TDD Inter frequency test parameters

Parameter	Unit	Test 1	
		Cell 1	Cell 2
E-UTRA RF Channel Number		1	2
$BW_{channel}$	MHz	10	10
Special subframe configuration ^{Note1}		6	

Uplink-downlink configuration ^{Note1}			1	
Gap Pattern Id			0	-
gapOffset		ms	9	
DMTC period		ms	160	160
DMTC period offset		ms	0	10
Discovery signal occasion duration		ms	2	2
CSI-RS resource configuration			2	4
CSI-RS periodicity		ms	10	
CSI-RS subframe offset		ms	0	
CSI-RS individual offset[2]		dB	0	0
CSI-RS muting			Enable	Enable
Time offset between cells		μs	-	3
Measurement bandwidth		n_{PRB}	22–27	
PDSCH Reference measurement channel defined in A.3.1.1.2			R.0 TDD	-
PDSCH allocation		n_{PRB}	13–36	-
PDCCH/PCFICH/PHICH Reference measurement channel defined in A.3.1.2.2			R.6 TDD	
OCNG Patterns defined in A.3.2.2.1 (OP.1 TDD) and A.3.2.2.2 (OP.2 TDD)			OP.1 TDD	OP.2 TDD
PBCH_RA		dB	0	0
PBCH_RB				
PSS_RA				
SSS_RA				
PCFICH_RB				
PHICH_RA				
PHICH_RB				
PDCCH_RA				
PDCCH_RB				
PDSCH_RA				
PDSCH_RB				
OCNG_RA ^{Note2}				
OCNG_RB ^{Note2}				
p-C-r10[2]				
N_{oc} ^{Note3}	Bands TDD_A	dBm/15 kHz	$(N_{oc}$ for Channel 2 +6dB)	-115
	Bands TDD_C			-114
	Bands TDD_E			-113
$CRS \hat{E}_s / I_{ot}$		dB	13	-6
CSI-RS \hat{E}_s / I_{ot}		dB	13	0
RSRP ^{Note4}	Bands TDD_A	dBm/15 kHz	(RSRP for Cell 2 +25dB)	-121
	Bands TDD_C			-120
	Bands TDD_E			-119
CSI-RSRP ^{Note4}	Bands TDD_A	dBm/15 kHz	(RSRP for Cell 1 +0dB)	(RSRP for Cell 2 +6dB)
	Bands TDD_C			
	Bands TDD_E			
I_o ^{Note4}	Bands TDD_A	dBm/9 MHz	$(I_o$ for Channel 2 +18.24dB)	-86.25
	Bands TDD_C			-85.25
	Bands TDD_E			-84.25
$CRS \hat{E}_s / N_{oc}$		dB	13	-6
CSI-RS \hat{E}_s / N_{oc}		dB	13	0
Propagation condition		-	AWGN	
Note 1: For special subframe and uplink-downlink configurations see Tables 4.2-1 and 4.2-2 in TS 36.211.				

Note 2:	OCNG shall be used such that both cells are fully allocated and a constant total transmitted power spectral density is achieved for all OFDM symbols.
Note 3:	Interference from other cells and noise sources not specified in the test is assumed to be constant over subcarriers and time and shall be modelled as AWGN of appropriate power for N_{oc} to be fulfilled.
Note 4:	RSRP, CSI-RSRP and I_0 levels have been derived from other parameters for information purposes. They are not settable parameters themselves. I_0 levels are calculated in CRS symbols of measurement subframe.
Note 5:	RSRP minimum requirements are specified assuming independent interference and noise at each receiver antenna port.
Note 6:	E-UTRA operating band groups are as defined in Section 3.5.
Note 7:	DMTC is provided to the UE in the measDS-Config (in TS36.331) before the beginning of test.

A.9.1.32.3 Test Requirements

The CSI-RSRP measurement accuracy shall fulfil the requirements in sections 9.1.14.3.

A.9.1.33 FDD absolute and relative RSRP accuracies for E-UTRAN Carrier Aggregation in CRS based discovery signal

A.9.1.33.1 Test Purpose and Environment

The purpose of this test is to verify that the FDD RSRP absolute and relative measurement accuracies in carrier aggregation in CRS based discovery signal are within the specified limits. This test will verify the absolute RSRP accuracy requirement of the secondary component carrier defined in clause 9.1.15.1.2, and the relative RSRP accuracy requirement of the secondary component carrier defined in clause 9.1.15.1.2. The test will also verify the primary and secondary component carrier relative RSRP accuracy requirement defined in Clause 9.1.15.1.3.

A.9.1.33.2 Test parameters

In this test case, Cell1 is PCell on the primary component carrier, Cell2 is SCell on the secondary component carrier and activated, and Cell3 is the neighboring cell on the secondary component carrier. The test parameters are given in Table A.9.1.33.2-1. The Cell 3 DMTC configuration is provided to the UE in the *measDS-Config* before the start of the test.

Table A.9.1.33.2-1: RSRP FDD carrier aggregation test parameters

Parameter	Unit	Test 1		
		Cell 1	Cell 2	Cell3
E-UTRA RF Channel Number		1	2	2
BW _{channel}	MHz	10	10	10
DMTC period	ms	N/A	N/A	160
DMTC period offset		N/A	N/A	10
Discovery signal occasion duration	ms	N/A	N/A	1
Timing offset to cell1	μs	-	0	3
Time alignment error between cell 2 and cell 1		-	≤ Time alignment error as specified in 3GPP TS 36.104 [30] clause 6.5.3.1.	-
Measurement bandwidth	n_{PRB}	22—27		
PDSCH Reference measurement channel defined in A.3.1.1.1		R.0 FDD	R.0 FDD	-
PDSCH allocation	n_{PRB}	13—36	13—36	-

PDCCH/PCFICH/PHICH Reference measurement channel defined in A.3.1.2.1			R.6 FDD		
OCNG Patterns defined in A.3.2.1.1 (OP.1 FDD) and A.3.2.1.2 (OP.2 FDD)			OP.1 FDD	OP.1 FDD	OP.2 FDD
PBCH_RA		dB	0	0	0
PBCH_RB					
PSS_RA					
SSS_RA					
PCFICH_RB					
PHICH_RA					
PHICH_RB					
PDCCH_RA					
PDCCH_RB					
PDSCH_RA					
PDSCH_RB					
OCNG_RANote1					
OCNG_RBNote					
N_{oc} Note2	Bands FDD_A				
	Bands FDD_B1, FDD_B2 Note 9	-116.5			
	Bands FDD_C	-116			
	Bands FDD_D	-115.5			
	Bands FDD_E, FDD_F Note 6	-115			
	Bands FDD_G	-114			
	Bands FDD_H	-113.5			
\hat{E}_s/I_{ot}		dB	-4	0.46	-5.76
RSRPNote3	Bands FDD_A	dBm/15 kHz	-121	(RSRP for Cell 1 +8dB)	(RSRP for Cell 1 +4dB)
	Bands FDD_B1, FDD_B2 Note 9		-120.5		
	Bands FDD_C		-120		
	Bands FDD_D		-119.5		
	Bands FDD_E, FDD_F Note 6		-119		
	Bands FDD_G		-118		
	Bands FDD_H		-117.5		
I_o Note3	Bands FDD_A	dBm/9 MHz	-87.76	$(I_o$ for Channel 1 +5.33dB)	
	Bands FDD_B1, FDD_B2 Note 9		-87.26		
	Bands FDD_C		-86.76		
	Bands FDD_D		-86.26		
	Bands FDD_E, FDD_F Note 6		-85.76		
	Bands FDD_G		-84.76		
	Bands FDD_H		-84.26		
\hat{E}_s/N_{oc}		dB	-4	3	-1
Propagation condition		-	AWGN		
<p>Note 1: OCNG shall be used such that both cells are fully allocated and a constant total transmitted power spectral density is achieved for all OFDM symbols.</p> <p>Note 2: Interference from other cells and noise sources not specified in the test is assumed to be constant over subcarriers and time and shall be modelled as AWGN of appropriate power for N_{oc} to be fulfilled.</p> <p>Note 3: RSRP and I_o levels have been derived from other parameters for information purposes. They are not settable parameters themselves.</p> <p>Note 4: RSRP minimum requirements are specified assuming independent interference and noise at each receiver antenna port.</p> <p>Note 5: The selection of the bands for testing depends on the configuration of the carrier aggregation supported by the UEs.</p> <p>Note 6: For Band 26, the tests shall be performed with the carrier frequency of the assigned E-UTRA channel bandwidth within 865-894 MHz.</p>					

Note 7:	This test verifies the RRM requirement which is independent of channel bandwidth and is performed according to the principle defined in section A.3.6.1.
Note 8:	E-UTRA operating band groups are as defined in Section 3.5.
Note 9:	For Band 74, the tests shall be performed with the carrier frequency of the assigned E-UTRA channel bandwidth within 1475.9-1510.9 MHz.

A.9.1.33.3 Test Requirements

In the test, the performance of RSRP measurements is verified from following three perspectives:

- The absolute accuracy of intra-frequency RSRP measurements for Cell 3 on the secondary component carrier shall fulfil the requirements defined in clause 9.1.15.1.2.
- The relative accuracy of intra-frequency RSRP measurements for Cell 3 relative to Cell 2 on the secondary component carrier shall fulfil the requirements defined in clause 9.1.15.1.2
- The relative accuracy of inter-frequency RSRP measurements between the primary and secondary component carriers for Cell 3 relative to Cell 1 shall fulfil the requirements defined in clause 9.1.15.1.3.

A.9.1.34 TDD absolute and relative RSRP accuracies for E-UTRAN Carrier Aggregation in CRS based discovery signal

A.9.1.34.1 Test Purpose and Environment

The purpose of this test is to verify that the TDD RSRP absolute and relative measurement accuracies in carrier aggregation in CRS based discovery signal are within the specified limits. This test will verify the absolute RSRP accuracy requirement of the secondary component carrier defined in clause 9.1.15.1.2, and the relative RSRP accuracy requirement of the secondary component carrier defined in clause 9.1.15.1.2. The test will also verify the primary and secondary component carrier relative RSRP accuracy requirement defined in Clause 9.1.15.1.3.

A.9.1.34.2 Test parameters

In this test case, Cell1 is PCell on the primary component carrier, Cell2 is SCell on the secondary component carrier and activated, and Cell3 is the neighboring cell on the secondary component carrier. The test parameters are given in Table A.9.1.34.2-1. The Cell 3 DMTC configuration is provided to the UE in the *measDS-Config* before the start of the test.

Table A.9.1.34.2-1: Carrier aggregation RSRP test parameters for TDD

Parameter	Unit	Test 1		
		Cell 1	Cell 2	Cell 3
E-UTRA RF Channel Number		1	2	2
BW _{channel}	MHz	10	10	10
DMTC period	ms	N/A	N/A	160
DMTC period offset		N/A	N/A	10
Discovery signal occasion duration	ms	N/A	N/A	2
Special subframe configuration ^{Note1}		6		
Uplink/downlink configuration ^{Note1}		1		
Timing offset to Cell 1	μs	-	0	3
Time alignment error between cell 2 and cell 1		-	≤ Time alignment error as specified in 3GPP TS 36.104 [30] clause 6.5.3.1	-
Measurement bandwidth	n_{PRB}	22—27		
PDSCH Reference measurement channel defined in A.3.1.1.2		R.0 TDD	R.0 TDD	-
PDSCH allocation	n_{PRB}	13—36	13—36	-

PDCCH/PCFICH/PHICH Reference measurement channel defined in A.3.1.2.2		R.6 TDD			
OCNG Patterns defined in A.3.2.2.1 (OP.1 TDD) and A.3.2.2.2 (OP.2 TDD)		OP.1 TDD	OP.1 TDD	OP.2 TDD	
PBCH_RA					
PBCH_RB					
PSS_RA					
SSS_RA					
PCFICH_RB					
PHICH_RA					
PHICH_RB					
PDCCH_RA					
PDCCH_RB					
PDSCH_RA					
PDSCH_RB					
OCNG_RA ^{Note2}					
OCNG_RB ^{Note2}					
N_{oc} ^{Note3}	Bands TDD_A	dBm/15 kHz	-117	$(N_{oc}$ for Channel 1 +1dB)	
	Bands TDD_C		-116		
	Bands TDD_E		-115		
\hat{E}_s/I_{ot}		dB	-4	0.46	-5.76
RSRP ^{Note4}	Bands TDD_A	dBm/15 kHz	-121	(RSRP for Cell 1 +8dB)	(RSRP for Cell 1 +4dB)
	Bands TDD_C		-120		
	Bands TDD_E		-119		
I_o ^{Note4}	Bands TDD_A	dBm/9 MHz	-87.76	$(I_o$ for Channel 1 +5.33dB)	
	Bands TDD_C		-86.76		
	Bands TDD_E		-85.76		
\hat{E}_s/N_{oc}		dB	-4	3	-1
Propagation condition		-	AWGN		
<p>Note 1: For special subframe and uplink-downlink configurations see Tables 4.2-1 and 4.2-2 in TS 36.211.</p> <p>Note 2: OCNG shall be used such that both cells are fully allocated and a constant total transmitted power spectral density is achieved for all OFDM symbols.</p> <p>Note 3: Interference from other cells and noise sources not specified in the test is assumed to be constant over subcarriers and time and shall be modelled as AWGN of appropriate power for N_{oc} to be fulfilled.</p> <p>Note 4: RSRP and I_o levels have been derived from other parameters for information purposes. They are not settable parameters themselves.</p> <p>Note 5: RSRP minimum requirements are specified assuming independent interference and noise at each receiver antenna port.</p> <p>Note 6: The selection of the bands for testing depends on the configuration of the carrier aggregation supported by the UEs.</p> <p>Note 7: This test verifies the RRM requirement which is independent of channel bandwidth and is performed according to the principle defined in section A.3.6.1.</p> <p>Note 8: E-UTRA operating band groups are as defined in Section 3.5.</p>					

A.9.1.34.3 Test Requirements

In the test, the performance of RSRP measurements is verified from following three perspectives:

- The absolute accuracy of intra-frequency RSRP measurements for Cell 3 on the secondary component carrier shall fulfil the requirements defined in clause 9.1.15.1.2.
- The relative accuracy of intra-frequency RSRP measurements for Cell 3 relative to Cell 2 on the secondary component carrier shall fulfil the requirements defined in clause 9.1.15.1.2
- The relative accuracy of inter-frequency RSRP measurements between the primary and secondary component carriers for Cell 3 relative to Cell 1 shall fulfil the requirements defined in clause 9.1.15.1.3.

A.9.1.35 FDD absolute and relative CSI-RSRP accuracies for E-UTRAN Carrier Aggregation in CSI-RS based discovery signal

A.9.1.35.1 Test Purpose and Environment

The purpose of this test is to verify that the FDD CSI-RSRP absolute and relative accuracy requirements in carrier aggregation are within the specified limits. This test will verify the absolute CSI-RSRP accuracy requirements of the primary component carrier defined in clause 9.1.15.2.1, the absolute CSI-RSRP accuracy requirements of the secondary component carrier defined in clause 9.1.15.2.2, and the relative CSI-RSRP accuracy requirements of the secondary component carrier defined in clause 9.1.15.2.2. The test will also verify the primary and secondary component carrier relative CSI-RSRP accuracy requirement defined in Clause 9.1.15.2.3.

A.9.1.35.2 Test parameters

In this set of cases cell1 is PCell on the primary component carrier, cell2 is SCell on the secondary component carrier and activated, and cell3 is the neighboring cell on the secondary component carrier. The test parameters are given in Table A.9.1.35.2-1. This set is supported by two DMTC configurations which one is for cell1 and the other is for cell2 and cell3.

Table A.9.1.35.2-1: CSI-RSRP FDD carrier aggregation test parameters

Parameter	Unit	Test 1		
		Cell 1	Cell 2	Cell3
E-UTRA RF Channel Number		1	2	2
BW _{channel}	MHz	10	10	10
Timing offset to cell1	μs	-	0	3
Time alignment error between cell 2 and cell 1		-	≤ Time alignment error as specified in 3GPP TS 36.104 [30] clause 6.5.3.1.	-
DMTC period	ms	160	160	
DMTC period offset	ms	0	10	
Discovery signal occasion duration	ms	1	1	
CSI-RS resource configuration		2	4	6
CSI-RS periodicity	ms	10	10	10
CSI-RS subframe offset	ms	0	0	0
CSI-RS individual offset[2]	dB	0	0	0
CSI-RS muting		Enable	Enable	Enable
Measurement bandwidth	n_{PRB}	22—27		
PDSCH Reference measurement channel defined in A.3.1.1.1		R.0 FDD	R.0 FDD	-
PDSCH allocation	n_{PRB}	13—36	13—36	-
PDCCH/PCFICH/PHICH Reference measurement channel defined in A.3.1.2.1		R.6 FDD		
OCNG Patterns defined in A.3.2.1.1 (OP.1 FDD) and A.3.2.1.2 (OP.2 FDD)		OP.1 FDD	OP.1 FDD	OP.2 FDD
PBCH_RA	dB	0	0	0
PBCH_RB				
PSS_RA				
SSS_RA				
PCFICH_RB				
PHICH_RA				
PHICH_RB				
PDCCH_RA				
PDCCH_RB				
PDSCH_RA				
PDSCH_RB				
OCNG_RANote1				

OCNG_RB>Note					
p-C-r10[2]		dB	-6	-6	-6
N_{oc} Note2	Bands FDD_A	dBm/15 kHz	-117	$(N_{oc}$ for Channel 1 +1dB)	
	Bands FDD_B1, FDD_B2 Note 10		-116.5		
	Bands FDD_C		-116		
	Bands FDD_D		-115.5		
	Bands FDD_E, FDD_F Note 6		-115		
	Bands FDD_G		-114		
	Bands FDD_H		-113.5		
CRS \hat{E}_s/I_{ot}		dB	-4	0.46	-5.76
CSI-RS \hat{E}_s/I_{ot}		dB	2	6.46	0.24
RSRP>Note3	Bands FDD_A	dBm/15 kHz	-121	(RSRP for Cell 1 +8dB)	(RSRP for Cell 1 +4dB)
	Bands FDD_B1, FDD_B2 Note 10		-120.5		
	Bands FDD_C		-120		
	Bands FDD_D		-119.5		
	Bands FDD_E, FDD_F Note 6		-119		
	Bands FDD_G		-118		
	Bands FDD_H		-117.5		
CSI-RSRP>Note3	Bands FDD_A	dBm/15 kHz	-115	(CSI-RSRP for Cell 1 +8dB)	(CSI-RSRP for Cell 1 +4dB)
	Bands FDD_B1, FDD_B2 Note 10		-114.5		
	Bands FDD_C		-114		
	Bands FDD_D		-113.5		
	Bands FDD_E, FDD_F Note 6		-113		
	Bands FDD_G		-112		
	Bands FDD_H		-111.5		
I_o Note3	Bands FDD_A	dBm/9 MHz	-87.76	$(I_o$ for Channel 1 +5.33dB)	
	Bands FDD_B1, FDD_B2 Note 10		-87.26		
	Bands FDD_C		-86.76		
	Bands FDD_D		-86.26		
	Bands FDD_E, FDD_F Note 6		-85.76		
	Bands FDD_G		-84.76		
	Bands FDD_H		-84.26		
CRS \hat{E}_s/N_{oc}		dB	-4	3	-1
CSI-RS \hat{E}_s/N_{oc}		dB	2	9	5
Propagation condition		-	AWGN		
<p>Note 1: OCNG shall be used such that both cells are fully allocated and a constant total transmitted power spectral density is achieved for all OFDM symbols.</p> <p>Note 2: Interference from other cells and noise sources not specified in the test is assumed to be constant over subcarriers and time and shall be modelled as AWGN of appropriate power for N_{oc} to be fulfilled.</p> <p>Note 3: RSRP, CSI-RSRP and I_o levels have been derived from other parameters for information purposes. They are not settable parameters themselves. I_o levels are calculated in CRS symbols of measurement subframe.</p> <p>Note 4: RSRP minimum requirements are specified assuming independent interference and noise at each receiver antenna port.</p> <p>Note 5: The selection of the bands for testing depends on the configuration of the carrier aggregation supported by the UEs.</p> <p>Note 6: For Band 26, the tests shall be performed with the carrier frequency of the assigned E-UTRA channel bandwidth within 865-894 MHz.</p> <p>Note 7: This test verifies the RRM requirement which is independent of channel bandwidth and is performed according to the principle defined in section A.3.6.1.</p> <p>Note 8: E-UTRA operating band groups are as defined in Section 3.5.</p>					

Note9:	DMTC configurations are provided to the UE in the <i>measDS-Config</i> (in TS36.331) before the beginning of the test.
Note 10:	For Band 74, the tests shall be performed with the carrier frequency of the assigned E-UTRA channel bandwidth within 1475.9-1510.9 MHz.

A.9.1.35.3 Test Requirements

In the test, the performance of CSI-RSRP measurements is verified from following four perspectives:

- The absolute accuracy of intra-frequency CSI-RSRP measurements for Cell 1 on the primary component carrier shall fulfil the requirements defined in clause 9.1.15.2.1.
- The absolute accuracy of intra-frequency CSI-RSRP measurements for Cell 2 on the secondary component carrier shall fulfil the requirements defined in clause 9.1.15.2.2.
- The relative accuracy of intra-frequency CSI-RSRP measurements for Cell 3 relative to Cell 2 on the secondary component carrier shall fulfil the requirements defined in clause 9.1.15.2.2.
- The relative accuracy of inter-frequency CSI-RSRP measurements between the primary and secondary component carriers for Cell 2 relative to Cell 1 shall fulfil the requirements defined in clause 9.1.15.2.3.

A.9.1.36 TDD absolute and relative CSI-RSRP accuracies for E-UTRAN Carrier Aggregation in CSI-RS based discovery signal

A.9.1.36.1 Test Purpose and Environment

The purpose of this test is to verify that the TDD CSI-RSRP absolute and relative accuracy requirements in carrier aggregation are within the specified limits. This test will verify the absolute CSI-RSRP accuracy requirements of the primary component carrier defined in clause 9.1.15.2.1, the absolute CSI-RSRP accuracy requirements of the secondary component carrier defined in clause 9.1.15.2.2, and the relative CSI-RSRP accuracy requirements of the secondary component carrier defined in clause 9.1.15.2.2. The test will also verify the primary and secondary component carrier relative CSI-RSRP accuracy requirement defined in Clause 9.1.15.2.3.

A.9.1.36.2 Test parameters

In this set of cases cell1 is PCell on the primary component carrier, cell2 is SCell on the secondary component carrier and activated, and cell3 is the neighboring cell on the secondary component carrier. The test parameters are given in Table A.9.1.36.2-1. This set is supported by two DMTC configurations which one is for cell1 and the other is for cell2 and cell3.

Table A.9.1.36.2-1: CSI-RSRP TDD carrier aggregation test parameters

Parameter	Unit	Test 1		
		Cell 1	Cell 2	Cell 3
E-UTRA RF Channel Number		1	2	
BW _{channel}	MHz	10		
Special subframe configuration ^{Note1}		6		
Uplink/downlink configuration ^{Note1}		1		
Timing offset to Cell 1	μs	-	0	3
Time alignment error between cell 2 and cell 1		-	≤ Time alignment error as specified in 3GPP TS 36.104 [30] clause 6.5.3.1	-
DMTC period	ms	160	160	
DMTC period offset	ms	0	10	
Discovery signal occasion duration	ms	2	2	
CSI-RS resource configuration		2	4	6
CSI-RS periodicity	ms	10	10	10
CSI-RS subframe offset	ms	0	0	0

CSI-RS individual offset[2]		dB	0	0	0
CSI-RS muting			Enable	Enable	Enable
Measurement bandwidth		n_{PRB}	22—27		
PDSCH Reference measurement channel defined in A.3.1.1.2			R.0 TDD	R.0 TDD	-
PDSCH allocation		n_{PRB}	13—36	13—36	-
PDCCH/PCFICH/PHICH Reference measurement channel defined in A.3.1.2.2			R.6 TDD		
OCNG Patterns defined in A.3.2.2.1 (OP.1 TDD) and A.3.2.2.2 (OP.2 TDD)			OP.1 TDD	OP.1 TDD	OP.2 TDD
PBCH_RA		dB	0	0	0
PBCH_RB					
PSS_RA					
SSS_RA					
PCFICH_RB					
PHICH_RA					
PHICH_RB					
PDCCH_RA					
PDCCH_RB					
PDSCH_RA					
PDSCH_RB					
OCNG_RA ^{Note2}					
OCNG_RB ^{Note2}					
p-C-r10[2]					
N_{oc} ^{Note3}	Bands TDD_A	dBm/15 kHz	-117	$(N_{oc}$ for Channel 1 +1dB)	
	Bands TDD_C		-116		
	Bands TDD_E		-115		
CRS \hat{E}_s/I_{ot}		dB	-4	0.46	-5.76
CSI-RS \hat{E}_s/I_{ot}		dB	2	6.46	0.24
RSRP ^{Note4}	Bands TDD_A	dBm/15 kHz	-121	(RSRP for Cell 1 +8dB)	(RSRP for Cell 1 +4dB)
	Bands TDD_C		-120		
	Bands TDD_E		-119		
CSI-RSRP ^{Note4}	Bands TDD_A	dBm/15 kHz	-115	(CSI-RSRP for Cell 1 +8dB)	(CSI-RSRP for Cell 1 +4dB)
	Bands TDD_C		-114		
	Bands TDD_E		-113		
I_o ^{Note4}	Bands TDD_A	dBm/9 MHz	-87.76	$(I_o$ for Channel 1 +5.33dB)	
	Bands TDD_C		-86.76		
	Bands TDD_E		-85.76		
CRS \hat{E}_s/N_{oc}		dB	-4	3	-1
CSI-RS \hat{E}_s/N_{oc}		dB	2	9	5
Propagation condition		-	AWGN		
<p>Note 1: For special subframe and uplink-downlink configurations see Tables 4.2-1 and 4.2-2 in TS 36.211.</p> <p>Note 2: OCNG shall be used such that both cells are fully allocated and a constant total transmitted power spectral density is achieved for all OFDM symbols.</p> <p>Note 3: Interference from other cells and noise sources not specified in the test is assumed to be constant over subcarriers and time and shall be modelled as AWGN of appropriate power for N_{oc} to be fulfilled.</p> <p>Note 4: RSRP, CSI-RSRP and I_o levels have been derived from other parameters for information purposes. They are not settable parameters themselves. I_o levels are calculated in CRS symbols of measurement subframe.</p> <p>Note 5: RSRP minimum requirements are specified assuming independent interference and noise at each receiver antenna port.</p> <p>Note 6: The selection of the bands for testing depends on the configuration of the carrier aggregation supported by the UEs.</p> <p>Note 7: This test verifies the RRM requirement which is independent of channel bandwidth and is performed according to the principle defined in section A.3.6.1.</p> <p>Note 8: E-UTRA operating band groups are as defined in Section 3.5.</p>					

Note 9: DMTC configurations are provided to the UE in the *measDS-Config* (in TS36.331) before the beginning of the test

A.9.1.36.3 Test Requirements

In the test, the performance of CSI-RSRP measurements is verified from following four perspectives:

- The absolute accuracy of intra-frequency CSI-RSRP measurements for Cell 1 on the primary component carrier shall fulfil the requirements defined in clause 9.1.15.2.1.
- The absolute accuracy of intra-frequency CSI-RSRP measurements for Cell 2 on the secondary component carrier shall fulfil the requirements defined in clause 9.1.15.2.2.
- The relative accuracy of intra-frequency CSI-RSRP measurements for Cell 3 relative to Cell 2 on the secondary component carrier shall fulfil the requirements defined in clause 9.1.15.2.2.
- The relative accuracy of inter-frequency CSI-RSRP measurements between the primary and secondary component carriers for Cell 2 relative to Cell 1 shall fulfil the requirements defined in clause 9.1.15.2.3.

A.9.1.37 3 DL PCell in FDD RSRP for E-UTRAN in Carrier Aggregation

A.9.1.37.1 Test Purpose and Environment

The purpose of this test is to verify that the TDD-FDD RSRP absolute and relative accuracy requirements in carrier aggregation with PCell in FDD are within the specified limits. This test will verify the absolute RSRP accuracy requirements of the primary component carrier defined in clause 9.1.11.1, the absolute RSRP accuracy requirements of the secondary component carriers defined in clause 9.1.11.2, and the relative RSRP accuracy requirements of the secondary component carriers defined in clause 9.1.11.2. The test will also verify the primary and secondary component carriers' relative RSRP accuracy requirement defined in Clause 9.1.11.3.

A.9.1.37.2 Test parameters

In this set of cases cell 1 is PCell on the primary component carrier, and cell 2 and cell 4 are activated SCells on secondary component carriers SCC1 and SCC2 respectively. Cell 3 and cell 5 are neighbouring cells on secondary component carriers SCC1 and SCC2 respectively. The test parameters are given in Table A.9.1.37.2-1.

Table A.9.1.37.2-1: 3 Downlink PCell in FDD RSRP carrier aggregation test parameters

Parameter	Unit	Cell 1	Cell 2	Cell 3	Cell 4	Cell 5
E-UTRA RF Channel Number		1	2		3	
$BW_{channel}$	MHz	5MHz: $N_{RB,c} = 25$ 10MHz: $N_{RB,c} = 50$ 20MHz: $N_{RB,c} = 100$	5MHz: $N_{RB,c} = 25$ 10MHz: $N_{RB,c} = 50$ 20MHz: $N_{RB,c} = 100$		5MHz: $N_{RB,c} = 25$ 10MHz: $N_{RB,c} = 50$ 20MHz: $N_{RB,c} = 100$	
Special subframe configuration ^{Note1}		-	6		6	
Uplink/downlink configuration ^{Note1}		-	1		1	
Measurement bandwidth	n_{PRB}	5MHz: 10-15 10MHz: 22-27 20MHz: 47-52	5MHz: 10-15 10MHz: 22-27 20MHz: 47-52		5MHz: 10-15 10MHz: 22-27 20MHz: 47-52	
PDSCH Reference measurement channel defined in A.3.1.1.		5MHz: R.5 FDD 10MHz: R.0 FDD 20MHz: R.4 FDD	5MHz: R.4 TDD 10MHz: R.0 TDD 20MHz: R.3 TDD	-	5MHz: R.4 TDD 10MHz: R.0 TDD 20MHz: R.3 TDD	-
PDSCH allocation	n_{PRB}	5MHz: 7-17 10MHz: 13-36 20MHz: 38-61	5MHz: 7-17 10MHz: 13-36 20MHz: 38-61	-	5MHz: 7-17 10MHz: 13-36 20MHz: 38-61	-
PDCCH/PCFICH/PHICH Reference measurement channel defined in A.3.1.2.		5MHz: R.11 FDD 10MHz:	5MHz: R.11 TDD 10MHz:	5MHz: R.11 TDD 10MHz:	5MHz: R.11 TDD 10MHz:	5MHz: R.11 TDD 10MHz:

		R.6 FDD 20MHz: R.10 FDD	R.6 TDD 20MHz: R.10 TDD	R.6 TDD 20MHz: R.10 TDD	R.6 TDD 20MHz: R.10 TDD	R.6 TDD 20MHz: R.10 TDD
OCNG Patterns defined in A.3.2.		5MHz: OP.15 FDD 10MHz: OP.1 FDD 20MHz: OP.11 FDD	5MHz: OP.9 TDD 10MHz: OP.1 TDD 20MHz: OP.7 TDD	5MHz: OP.10 TDD 10MHz: OP.2 TDD 20MHz: OP.8 TDD	5MHz: OP.9 TDD 10MHz: OP.1 TDD 20MHz: OP.7 TDD	5MHz: OP.10 TDD 10MHz: OP.2 TDD 20MHz: OP.8 TDD
PBCH_RA	dB	0	0	0	0	0
PBCH_RB						
PSS_RA						
SSS_RA						
PCFICH_RB						
PHICH_RA						
PHICH_RB						
PDCCH_RA						
PDCCH_RB						
PDSCH_RA						
PDSCH_RB						
OCNG_RA ^{Note2}						
OCNG_RB ^{Note2}						
N_{oc} ^{Note3}						
	-117	-		-		
	-116.5					
	-116					
	-115.5					
	-115					
	-114					
	-113.5					
	\hat{E}_s/N_{oc}					dB
\hat{E}_s/I_{ot}	dB	-4	0.46	-5.76	0.46	-5.76
RSRP ^{Note4}	dBm/15 kHz	-	(RSRP for Cell 1 +8dB)	(RSRP for Cell 1 +4dB)	(RSRP for Cell 1 +8dB)	(RSRP for Cell 1 +4dB)
		-121	-		-	
		-120.5				
		-120				
		-119.5				
		-119				
		-118				
		-117.5				
		I_o ^{Note4}				
$-87.76+10\log(N_{RB,c}/50)$	-		-			
$-87.26+10\log(N_{RB,c}/50)$						
$-86.76+10\log(N_{RB,c}/50)$						
$-86.26+10\log(N_{RB,c}/50)$						
$-85.76 +10\log(N_{RB,c}/50)$						
$-84.76 +10\log(N_{RB,c}/50)$						
$-84.26 +10\log(N_{RB,c}/50)$						
Propagation condition					-	AWGN
Antenna Configuration	-	1x2	1x2	1x2	1x2	1x2

Timing offset to cell 1	μs	-	0	3	0	3
Time alignment error relative to cell 1 ^{Note 8}		-	$\leq \text{TAE}$	-	$\leq \text{TAE}$	-
Time alignment error relative to cell 2 ^{Note 8}		-	-	-	$\leq \text{TAE}$	-
Note 1:	For special subframe and uplink-downlink configurations see Tables 4.2-1 and 4.2-2 in TS 36.211.					
Note 2:	OCNG shall be used such that all cells are fully allocated and a constant total transmitted power spectral density is achieved for all OFDM symbols.					
Note 3:	Interference from other cells and noise sources not specified in the test is assumed to be constant over subcarriers and time and shall be modelled as AWGN of appropriate power for N_{oc} to be fulfilled.					
Note 4:	RSRP and I_0 levels have been derived from other parameters for information purposes. They are not settable parameters themselves.					
Note 5:	RSRP minimum requirements are specified assuming independent interference and noise at each receiver antenna port.					
Note 6:	The selection of the bands for testing depends on the configuration of the carrier aggregation supported by the UEs.					
Note 7:	For Band 26, the tests shall be performed with the carrier frequency of the assigned E-UTRA channel bandwidth within 865-894 MHz.					
Note 8:	Time alignment error (TAE) as specified in TS 36.104 [30] clause 6.5.3.1. The TAE value depends upon the type of carrier aggregation.					
Note 9:	E-UTRA operating band groups are as defined in Section 3.5.					
Note 10:	For Band 74, the tests shall be performed with the carrier frequency of the assigned E-UTRA channel bandwidth within 1475.9-1510.9 MHz.					

A.9.1.37.3 Test Requirements

In the test, the performance of RSRP measurements is verified from the following 7 perspectives:

- The absolute accuracy of intra-frequency RSRP measurements for Cell 1 on the primary component carrier shall fulfil the requirements defined in clause 9.1.11.1.
- The absolute accuracy of intra-frequency RSRP measurements for Cell 2 on SCC1 shall fulfil the requirements defined in clause 9.1.11.2.
- The absolute accuracy of intra-frequency RSRP measurements for Cell 4 on SCC2 shall fulfil the requirements defined in clause 9.1.11.2.
- The relative accuracy of intra-frequency RSRP measurements for Cell 3 relative to Cell 2 on SCC1 shall fulfil the requirements defined in clause 9.1.11.2.
- The relative accuracy of intra-frequency RSRP measurements for Cell 5 relative to Cell 4 on SCC2 shall fulfil the requirements defined in clause 9.1.11.2.
- The relative accuracy of inter-frequency RSRP measurements between SCC1 and the primary component carriers for Cell 2 relative to Cell 1 shall fulfil the requirements defined in clause 9.1.11.3.
- The relative accuracy of inter-frequency RSRP measurements between SCC2 and the primary component carriers for Cell 4 relative to Cell 1 shall fulfil the requirements defined in clause 9.1.11.3.

A.9.1.38 3 DL PCell in TDD RSRP for E-UTRAN in Carrier Aggregation

A.9.1.38.1 Test Purpose and Environment

The purpose of this test is to verify that the TDD-FDD RSRP absolute and relative accuracy requirements in carrier aggregation with PCell in TDD are within the specified limits. This test will verify the absolute RSRP accuracy requirements of the primary component carrier defined in clause 9.1.11.1, the absolute RSRP accuracy requirements of the secondary component carriers defined in clause 9.1.11.2, and the relative RSRP accuracy requirements of the secondary component carriers defined in clause 9.1.11.2. The test will also verify the primary and secondary component carriers' relative RSRP accuracy requirement defined in Clause 9.1.11.3.

A.9.1.38.2 Test parameters

In this set of cases cell 1 is PCell on the primary component carrier, and cell 2 and cell 4 are activated SCells on secondary component carriers SCC1 and SCC2 respectively. Cell 3 and cell 5 are neighbouring cells on secondary component carriers SCC1 and SCC2 respectively. The test parameters are given in Table A.9.1.38.2-1.

Table A.9.1.38.2-1: 3 Downlink PCell in TDD RSRP carrier aggregation test parameters

Parameter		Unit	Cell 1	Cell 2	Cell 3	Cell 4	Cell 5						
E-UTRA RF Channel Number			1	2		3							
BW _{channel}		MHz	5MHz: N _{RB,c} = 25 10MHz: N _{RB,c} = 50 20MHz: N _{RB,c} = 100	5MHz: N _{RB,c} = 25 10MHz: N _{RB,c} = 50 20MHz: N _{RB,c} = 100		5MHz: N _{RB,c} = 25 10MHz: N _{RB,c} = 50 20MHz: N _{RB,c} = 100							
Special subframe configuration ^{Note1}			6	-		-							
Uplink/downlink configuration ^{Note1}			1	-		-							
Measurement bandwidth		n _{PRB}	5MHz: 10-15 10MHz: 22-27 20MHz: 47-52	5MHz: 10-15 10MHz: 22-27 20MHz: 47-52		5MHz: 10-15 10MHz: 22-27 20MHz: 47-52							
PDSCH Reference measurement channel defined in A.3.1.1.			5MHz: R.4 TDD 10MHz: R.0 TDD 20MHz: R.3 TDD	5MHz: R.5 FDD 10MHz: R.0 FDD 20MHz: R.4 FDD	-	5MHz: R.5 FDD 10MHz: R.0 FDD 20MHz: R.4 FDD	-						
PDSCH allocation		n _{PRB}	5MHz: 7-17 10MHz: 13-36 20MHz: 38-61	5MHz: 7-17 10MHz: 13-36 20MHz: 38-61	-	5MHz: 7-17 10MHz: 13-36 20MHz: 38-61	-						
PDCCH/PCFICH/PHICH Reference measurement channel defined in A.3.1.2.			5MHz: R.11 TDD 10MHz: R.6 TDD 20MHz: R.10 TDD	5MHz: R.11 FDD 10MHz: R.6 FDD 20MHz: R.10 FDD	5MHz: R.11 FDD 10MHz: R.6 FDD 20MHz: R.10 FDD	5MHz: R.11 FDD 10MHz: R.6 FDD 20MHz: R.10 FDD	5MHz: R.11 FDD 10MHz: R.6 FDD 20MHz: R.10 FDD						
OCNG Patterns defined in A.3.2.			5MHz: OP.9 TDD 10MHz: OP.1 TDD 20MHz: OP.7 TDD	5MHz: OP.15 FDD 10MHz: OP.1 FDD 20MHz: OP.11 FDD	5MHz: OP.16 FDD 10MHz: OP.2 FDD 20MHz: OP.12 FDD	5MHz: OP.15 FDD 10MHz: OP.1 FDD 20MHz: OP.11 FDD	5MHz: OP.16 FDD 10MHz: OP.2 FDD 20MHz: OP.12 FDD						
PBCH_RA		dB	0	0	0	0	0						
PBCH_RB													
PSS_RA													
SSS_RA													
PCFICH_RB													
PHICH_RA													
PHICH_RB													
PDCCH_RA													
PDCCH_RB													
PDSCH_RA													
PDSCH_RB													
OCNG_RA ^{Note1}													
OCNG_RB ^{Note1}													
N _{oc} ^{Note3}	Bands FDD_A							dBm/15 kHz	-	(N _{oc} for Channel 1 +1dB)	(N _{oc} for Channel 1 +1dB)	(N _{oc} for Channel 1 +1dB)	(N _{oc} for Channel 1 +1dB)
	Bands FDD_B1, FDD_B2 ^{Note 10}												
	Bands FDD_C												
	Bands FDD_D												
	Bands FDD_E, FDD_F ^{Note 7}												
	Bands FDD_G												
	Bands FDD_H												
	Bands TDD_A	-117	-	-									
	Bands TDD_C	-116											
	Bands TDD_E	-115											

\hat{E}_s / N_{oc}	dB	-4	3	-1	3	-1					
\hat{E}_s / I_{ot}	dB	-4	0.46	-5.76	0.46	-5.76					
RSRP ^{Note4}	Bands FDD_A	dBm/15 kHz	-	(RSRP for Cell 1 +8dB)	(RSRP for Cell 1 +4dB)	(RSRP for Cell 1 +8dB)	(RSRP for Cell 1 +4dB)				
	Bands FDD_B1, FDD_B2 ^{Note 10}										
	Bands FDD_C										
	Bands FDD_D										
	Bands FDD_E, FDD_F ^{Note 7}										
	Bands FDD_G										
	Bands FDD_H										
	Bands TDD_A							-121	-	-	-
	Bands TDD_C							-120	-	-	-
	Bands TDD_E							-119	-	-	-
I _o ^{Note4}	Bands FDD_A	dBm/BW _{channel}	-	(I _o for Channel 1 +5.33dB +10log (N _{RB channel2} / N _{RB channel 1}))	(I _o for Channel 1 +5.33dB +10log (N _{RB channel3} / N _{RB channel 1}))						
	Bands FDD_B1, FDD_B2 ^{Note 10}										
	Bands FDD_C										
	Bands FDD_D										
	Bands FDD_E, FDD_F ^{Note 7}										
	Bands FDD_G										
	Bands FDD_H										
	Bands TDD_A							-87.76+10log(N _{RB,c} /50)	-	-	-
	Bands TDD_C							-86.76+10log(N _{RB,c} /50)	-	-	-
	Bands TDD_E							-85.76+10log(N _{RB,c} /50)	-	-	-
Propagation condition	-	AWGN	AWGN	AWGN	AWGN	AWGN					
Antenna Configuration	-	1x2	1x2	1x2	1x2	1x2					
Timing offset to cell 1	μs	-	0	3	0	3					
Time alignment error relative to cell 1 ^{Note 8}		-	≤ TAE	-	≤ TAE	-					
Time alignment error relative to cell 2 ^{Note8}		-	-	-	≤ TAE	-					
<p>Note 1: For special subframe and uplink-downlink configurations see Tables 4.2-1 and 4.2-2 in TS 36.211.</p> <p>Note 2: OCNB shall be used such that all cells are fully allocated and a constant total transmitted power spectral density is achieved for all OFDM symbols.</p> <p>Note 3: Interference from other cells and noise sources not specified in the test is assumed to be constant over subcarriers and time and shall be modelled as AWGN of appropriate power for N_{oc} to be fulfilled.</p> <p>Note 4: RSRP and I_o levels have been derived from other parameters for information purposes. They are not settable parameters themselves.</p> <p>Note 5: RSRP minimum requirements are specified assuming independent interference and noise at each receiver antenna port.</p> <p>Note 6: The selection of the bands for testing depends on the configuration of the carrier aggregation supported by the UEs.</p> <p>Note 7: For Band 26, the tests shall be performed with the carrier frequency of the assigned E-UTRA channel bandwidth within 865-894 MHz.</p> <p>Note 8: Time alignment error (TAE) as specified in TS 36.104 [30] clause 6.5.3.1. The TAE value depends upon the type of carrier aggregation.</p> <p>Note 9: E-UTRA operating band groups are as defined in Section 3.5.</p> <p>Note 10: For Band 74, the tests shall be performed with the carrier frequency of the assigned E-UTRA channel bandwidth within 1475.9-1510.9 MHz.</p>											

A.9.1.38.3 Test Requirements

In the test, the performance of RSRP measurements is verified from the following 7 perspectives:

- The absolute accuracy of intra-frequency RSRP measurements for Cell 1 on the primary component carrier shall fulfil the requirements defined in clause 9.1.11.1.
- The absolute accuracy of intra-frequency RSRP measurements for Cell 2 on SCC1 shall fulfil the requirements defined in clause 9.1.11.2.
- The absolute accuracy of intra-frequency RSRP measurements for Cell 4 on SCC2 shall fulfil the requirements defined in clause 9.1.11.2.

- The relative accuracy of intra-frequency RSRP measurements for Cell 3 relative to Cell 2 on SCC1 shall fulfil the requirements defined in clause 9.1.11.2.
- The relative accuracy of intra-frequency RSRP measurements for Cell 5 relative to Cell 4 on SCC2 shall fulfil the requirements defined in clause 9.1.11.2.
- The relative accuracy of inter-frequency RSRP measurements between SCC1 and the primary component carriers for Cell 2 relative to Cell 1 shall fulfil the requirements defined in clause 9.1.11.3. The relative accuracy of inter-frequency RSRP measurements between SCC2 and the primary component carriers for Cell 4 relative to Cell 1 shall fulfil the requirements defined in clause 9.1.11.3.

A.9.1.39 3 DL FDD RSRP for E-UTRAN in Carrier Aggregation

A.9.1.39.1 Test Purpose and Environment

The purpose of this test is to verify that the FDD RSRP absolute and relative accuracy requirements in carrier aggregation are within the specified limits. This test will verify the absolute RSRP accuracy requirements of the primary component carrier defined in clause 9.1.11.1, the absolute RSRP accuracy requirements of the secondary component carriers defined in clause 9.1.11.2, and the relative RSRP accuracy requirements of the secondary component carriers defined in clause 9.1.11.2. The test will also verify the primary and secondary component carriers' relative RSRP accuracy requirement defined in Clause 9.1.11.3.

A.9.1.39.2 Test parameters

In this set of test cases there are five cells on three carrier frequencies. Cell 1 is PCell on channel 1, and cell 2 and cell 4 are activated SCells on secondary component carriers SCC1 and SCC2 respectively. Cell 3 and cell 5 are neighbouring cells on secondary component carriers SCC1 and SCC2 respectively. The parameters for the test are listed in Table A.9.1.39.2-1.

Table A.9.1.39.2-1: 3 DL FDD RSRP test parameters for E-UTRAN Carrier aggregation (cell #1, cell #2 and cell #3)

Parameter	Unit	Cell 1	Cell 2	Cell 3
E-UTRA RF Channel Number		1	2	
BW _{channel}	MHz	5MHz: N _{RB,c} = 25 10MHz: N _{RB,c} = 50 20MHz: N _{RB,c} = 100	5MHz: N _{RB,c} = 25 10MHz: N _{RB,c} = 50 20MHz: N _{RB,c} = 100	
Measurement bandwidth	<i>n</i> _{PRB}	5MHz: 10-15 10MHz: 22-27 20MHz: 47-52	5MHz: 10-15 10MHz: 22-27 20MHz: 47-52	
PDSCH Reference measurement channel defined in A.3.1.1.1		5MHz: R.5 FDD 10MHz: R.0 FDD 20MHz: R.4 FDD	5MHz: R.5 FDD 10MHz: R.0 FDD 20MHz: R.4 FDD	-
PDSCH allocation	<i>n</i> _{PRB}	5MHz: 7-17 10MHz: 13-36 20MHz: 38-61	5MHz: 7-17 10MHz: 13-36 20MHz: 38-61	-
PDCCH/PCFICH/PHICH Reference measurement channel defined in A.3.1.2.1		5MHz: R.11 FDD 10MHz: R.6 FDD 20MHz: R.10 FDD	5MHz: R.11 FDD 10MHz: R.6 FDD 20MHz: R.10 FDD	5MHz: R.11 FDD 10MHz: R.6 FDD 20MHz: R.10 FDD
OCNG Patterns defined in A.3.2.1		5MHz: OP.15 FDD 10MHz: OP.1 FDD 20MHz: OP.11 FDD	5MHz: OP.15 FDD 10MHz: OP.1 FDD 20MHz: OP.11 FDD	5MHz: OP.16 FDD 10MHz: OP.2 FDD 20MHz: OP.12 FDD
PBCH_RA	dB	0	0	0
PBCH_RB				
PSS_RA				
SSS_RA				
PCFICH_RB				
PHICH_RA				
PHICH_RB				
PDCCH_RA				
PDCCH_RB				
PDSCH_RA				
PDSCH_RB				

OCNG_RA ^{Note1}					
OCNG_RB ^{Note1}					
N_{oc} ^{Note2}	Bands FDD_A	dBm/ 15kHz	-117	$(N_{oc}$ for Channel 1 +1dB)	
	Bands FDD_B1, FDD_B2 ^{Note 9}		-116.5		
	Bands FDD_C		-116		
	Bands FDD_D		-115.5		
	Bands FDD_E, FDD_F ^{Note 6}		-115		
	Bands FDD_G		-114		
	Bands FDD_H		-113.5		
\hat{E}_s/N_{oc}		dB	-4	3	-1
\hat{E}_s/I_{ot}		dB	-4	0.46	-5.76
RSRP ^{Note3}	Bands FDD_A	dBm/ 15kHz	-121	(RSRP for Cell 1 +8dB)	(RSRP for Cell 1 +4dB)
	Bands FDD_B1, FDD_B2 ^{Note 9}		-120.5		
	Bands FDD_C		-120		
	Bands FDD_D		-119.5		
	Bands FDD_E, FDD_F ^{Note 6}		-119		
	Bands FDD_G		-118		
	Bands FDD_H		-117.5		
I_o ^{Note3}	Bands FDD_A	dBm/ $BW_{channel}$	-87.76 +10log($N_{RB,c}/50$)	$(I_o$ for Channel 1 +5.33dB +10log($N_{RB channel2} / N_{RB channel 1}$))	
	Bands FDD_B1, FDD_B2 ^{Note 9}		-87.26 +10log($N_{RB,c}/50$)		
	Bands FDD_C		-86.76 +10log($N_{RB,c}/50$)		
	Bands FDD_D		-86.26 +10log($N_{RB,c}/50$)		
	Bands FDD_E, FDD_F ^{Note 6}		-85.76 +10log($N_{RB,c}/50$)		
	Bands FDD_G		-84.76 +10log($N_{RB,c}/50$)		
	Bands FDD_H		-84.26 +10log($N_{RB,c}/50$)		
Propagation Condition			AWGN	AWGN	AWGN
Antenna Configuration			1x2	1x2	1x2
Timing offset to Cell 1		μs	-	0	3
Time alignment error relative to cell 1 ^{Note 7}			-	$\leq TAE$	
<p>Note 1: OCNG shall be used such that both cells are fully allocated and a constant total transmitted power spectral density is achieved for all OFDM symbols.</p> <p>Note 2: Interference from other cells and noise sources not specified in the test is assumed to be constant over subcarriers and time and shall be modelled as AWGN of appropriate power for N_{oc} to be fulfilled.</p> <p>Note 3: RSRP and I_o levels have been derived from other parameters for information purposes. They are not settable parameters themselves.</p> <p>Note 4: RSRP minimum requirements are specified assuming independent interference and noise at each receiver antenna port.</p> <p>Note 5: The selection of the bands for testing depends on the configuration of the carrier aggregation supported by the UEs.</p> <p>Note 6: For Band 26, the tests shall be performed with the carrier frequency of the assigned E-UTRA channel bandwidth within 865-894 MHz.</p> <p>Note 7: Time alignment error (TAE) as specified in TS 36.104 [30] clause 6.5.3.1. The TAE value depends upon the type of carrier aggregation.</p> <p>Note 8: E-UTRA operating band groups are as defined in Section 3.5.</p> <p>Note 9: For Band 74, the tests shall be performed with the carrier frequency of the assigned E-UTRA channel bandwidth within 1475.9-1510.9 MHz.</p>					

Table A.9.1.39.2-2: 3 DL FDD RSRP test parameters for E-UTRAN Carrier aggregation (cell #4 and cell #5)

Parameter		Unit	Cell 4	Cell 5
E-UTRA RF Channel Number			3	
BW _{channel}		MHz	5MHz: N _{RB,c} = 25 10MHz: N _{RB,c} = 50 20MHz: N _{RB,c} = 100	
Measurement bandwidth		<i>n_{PRB}</i>	5MHz: 10-15 10MHz: 22-27 20MHz: 47-52	
PDSCH Reference measurement channel defined in A.3.1.1.1			5MHz: R.5 FDD 10MHz: R.0 FDD 20MHz: R.4 FDD	-
PDSCH allocation		<i>n_{PRB}</i>	5MHz: 7-17 10MHz: 13-36 20MHz: 38-61	-
PDCCH/PCFICH/PHICH Reference measurement channel defined in A.3.1.2.1			5MHz: R.11 FDD 10MHz: R.6 FDD 20MHz: R.10 FDD	5MHz: R.11 FDD 10MHz: R.6 FDD 20MHz: R.10 FDD
OCNG Patterns defined in A.3.2.1			5MHz: OP.15 FDD 10MHz: OP.1 FDD 20MHz: OP.11 FDD	5MHz: OP.16 FDD 10MHz: OP.2 FDD 20MHz: OP.12 FDD
PBCH_RA		dB	0	0
PBCH_RB				
PSS_RA				
SSS_RA				
PCFICH_RB				
PHICH_RA				
PHICH_RB				
PDCCH_RA				
PDCCH_RB				
PDSCH_RA				
PDSCH_RB				
OCNG_RA ^{Note1}				
OCNG_RB ^{Note1}				
<i>N_{oc}</i> ^{Note2}	Bands FDD_A			
	Bands FDD_B1, FDD_B2 ^{Note 9}			
	Bands FDD_C			
	Bands FDD_D			
	Bands FDD_E, FDD_F ^{Note 6}			
	Bands FDD_G			
	Bands FDD_H			
\hat{E}_s / N_{oc}		dB	3	-1
\hat{E}_s / I_{ot}		dB	0.46	-5.76
RSRP ^{Note3}	Bands FDD_A	dBm/ 15kHz	(RSRP for Cell 1 +8dB)	(RSRP for Cell 1 +4dB)
	Bands FDD_B1, FDD_B2 ^{Note 9}			
	Bands FDD_C			
	Bands FDD_D			
	Bands FDD_E, FDD_F ^{Note 6}			
	Bands FDD_G			
	Bands FDD_H			
<i>I_o</i> ^{Note3}	Bands FDD_A	dBm/ BW _{channel}	<i>(I_o for Channel 1 +5.33dB +10log (N_{RB channel3} / N_{RB channel 1}))</i>	
	Bands FDD_B1, FDD_B2 ^{Note 9}			

	Bands FDD_C		
	Bands FDD_D		
	Bands FDD_E, FDD_F ^{Note 6}		
	Bands FDD_G		
	Bands FDD_H		
Propagation Condition		AWGN	AWGN
Antenna Configuration		1x2	1x2
Timing offset to Cell 1	μs	0	3
Time alignment error relative to cell 1 ^{Note 7}		≤ TAE	-
Time alignment error relative to cell 2 ^{Note 7}		≤ TAE	-
Note 1:	OCNG shall be used such that both cells are fully allocated and a constant total transmitted power spectral density is achieved for all OFDM symbols.		
Note 2:	Interference from other cells and noise sources not specified in the test is assumed to be constant over subcarriers and time and shall be modelled as AWGN of appropriate power for N_{oc} to be fulfilled.		
Note 3:	RSRP and I_0 levels have been derived from other parameters for information purposes. They are not settable parameters themselves.		
Note 4:	RSRP minimum requirements are specified assuming independent interference and noise at each receiver antenna port.		
Note 5:	The selection of the bands for testing depends on the configuration of the carrier aggregation supported by the UEs.		
Note 6:	For Band 26, the tests shall be performed with the carrier frequency of the assigned E-UTRA channel bandwidth within 865-894 MHz.		
Note 7:	Time alignment error (TAE) as specified in TS 36.104 [30] clause 6.5.3.1. The TAE value depends upon the type of carrier aggregation.		
Note 8:	E-UTRA operating band groups are as defined in Section 3.5.		
Note 9:	For Band 74, the tests shall be performed with the carrier frequency of the assigned E-UTRA channel bandwidth within 1475.9-1510.9 MHz.		

A.9.1.39.3 Test Requirements

In the test, the performance of RSRP measurements is verified from following four perspectives:

- The absolute accuracy of intra-frequency RSRP measurements for Cell 1 on the primary component carrier shall fulfil the requirements defined in clause 9.1.11.1.
- The absolute accuracy of intra-frequency RSRP measurements for Cell 2 on SCC1 shall fulfil the requirements defined in clause 9.1.11.2.
- The absolute accuracy of intra-frequency RSRP measurements for Cell 4 on SCC2 shall fulfil the requirements defined in clause 9.1.11.2.
- The relative accuracy of intra-frequency RSRP measurements for Cell 3 relative to Cell 2 on SCC1 shall fulfil the requirements defined in clause 9.1.11.2.
- The relative accuracy of intra-frequency RSRP measurements for Cell 5 relative to Cell 4 on SCC2 shall fulfil the requirements defined in clause 9.1.11.2.
- The relative accuracy of inter-frequency RSRP measurements between SCC1 and the primary component carriers for Cell 2 relative to Cell 1 shall fulfil the requirements defined in clause 9.1.11.3.
- The relative accuracy of inter-frequency RSRP measurements between SCC2 and the primary component carriers for Cell 4 relative to Cell 1 shall fulfil the requirements defined in clause 9.1.11.3.

A.9.1.40 3 DL TDD RSRP for E-UTRAN in Carrier Aggregation

A.9.1.40.1 Test Purpose and Environment

The purpose of this test is to verify that the FDD RSRP absolute and relative accuracy requirements in carrier aggregation are within the specified limits. This test will verify the absolute RSRP accuracy requirements of the

primary component carrier defined in clause 9.1.11.1, the absolute RSRP accuracy requirements of the secondary component carriers defined in clause 9.1.11.2, and the relative RSRP accuracy requirements of the secondary component carriers defined in clause 9.1.11.2. The test will also verify the primary and secondary component carriers' relative RSRP accuracy requirement defined in Clause 9.1.11.3.

A.9.1.40.2 Test parameters

In this set of test cases there are five cells on three carrier frequencies. Cell 1 is PCell on channel 1, and cell 2 and cell 4 are activated SCells on secondary component carriers SCC1 and SCC2 respectively. Cell 3 and cell 5 are neighbouring cells on secondary component carriers SCC1 and SCC2 respectively. The parameters for the test are listed in Table A.9.1.40.2-1.

Table A.9.1.40.2-1: 3 DL TDD RSRP test parameters for E-UTRAN Carrier aggregation (cell #1, cell #2 and cell #3)

Parameter	Unit	Cell 1	Cell 2	Cell 3
E-UTRA RF Channel Number		1	2	
BW _{channel}		5MHz: N _{RB,c} = 25 10MHz: N _{RB,c} = 50 20MHz: N _{RB,c} = 100	5MHz: N _{RB,c} = 25 10MHz: N _{RB,c} = 50 20MHz: N _{RB,c} = 100	
Special subframe configuration ^{Note1}		6		
Uplink/downlink configuration ^{Note1}		1		
Measurement bandwidth	<i>n_{PRB}</i>	5MHz: 10-15 10MHz: 22-27 20MHz: 47-52	5MHz: 10-15 10MHz: 22-27 20MHz: 47-52	
PDSCH Reference measurement channel defined in A.3.1.1.2		5MHz: R.4 TDD 10MHz: R.0 TDD 20MHz: R.3 TDD	5MHz: R.4 TDD 10MHz: R.0 TDD 20MHz: R.3 TDD	-
PDSCH allocation	<i>n_{PRB}</i>	5MHz: 7-17 10MHz: 13-36 20MHz: 38-61	5MHz: 7-17 10MHz: 13-36 20MHz: 38-61	-
PDCCH/PCFICH/PHICH Reference measurement channel defined in A.3.1.2.2		5MHz: R.11 TDD 10MHz: R.6 TDD 20MHz: R.10 TDD	5MHz: R.11 TDD 10MHz: R.6 TDD 20MHz: R.10 TDD	5MHz: R.11 TDD 10MHz: R.6 TDD 20MHz: R.10 TDD
OCNG Patterns defined in A.3.2.2		5MHz: OP.9 TDD 10MHz: OP.1 TDD 20MHz: OP.7 TDD	5MHz: OP.9 TDD 10MHz: OP.1 TDD 20MHz: OP.7 TDD	5MHz: OP.10 TDD 10MHz: OP.2 TDD 20MHz: OP.8 TDD
PBCH_RA	dB	0	0	0
PBCH_RB				
PSS_RA				
SSS_RA				
PCFICH_RB				
PHICH_RA				
PHICH_RB				
PDCCH_RA				
PDCCH_RB				
PDSCH_RA				
PDSCH_RB				
OCNG_RA ^{Note2}				
OCNG_RB ^{Note2}				
<i>N_{oc}</i> ^{Note3}				
	Bands TDD_C	-116		
	Bands TDD_E	-115		
\hat{E}_s / N_{oc}	dB	-4	3	-1
\hat{E}_s / I_{ot}	dB	-4	0.46	-5.76
RSRP ^{Note4}	Bands TDD_A	-121	<i>(RSRP for Cell 1 +8dB)</i>	<i>(RSRP for Cell 1 +4dB)</i>
	Bands TDD_C	-120		
	Bands TDD_E	-119		
<i>I_o</i> ^{Note4}	dBm/ BW _{channel}	-87.76 + 10log(N _{RB,c} /50)	<i>(I_o for Channel 1 +5.33dB +10log (N_{RB channel2} / N_{RB channel 1}))</i>	

	Bands TDD_C		-86.76 + 10log(N _{RB,c} /50)		
	Bands TDD_E		-85.76 + 10log(N _{RB,c} /50)		
Propagation Condition			AWGN	AWGN	AWGN
Antenna Configuration			1x2	1x2	1x2
Timing offset to Cell 1		μs	-	0	3
Time alignment error relative to cell 1 ^{Note 7}			-	≤ TAE	-
<p>Note 1: For special subframe and uplink-downlink configurations see Tables 4.2-1 and 4.2-2 in TS 36.211.</p> <p>Note 2: OCNG shall be used such that both cells are fully allocated and a constant total transmitted power spectral density is achieved for all OFDM symbols.</p> <p>Note 3: Interference from other cells and noise sources not specified in the test is assumed to be constant over subcarriers and time and shall be modelled as AWGN of appropriate power for N_{oc} to be fulfilled.</p> <p>Note 4: RSRP and Io levels have been derived from other parameters for information purposes. They are not settable parameters themselves.</p> <p>Note 5: RSRP minimum requirements are specified assuming independent interference and noise at each receiver antenna port.</p> <p>Note 6: The selection of the bands for testing depends on the configuration of the carrier aggregation supported by the UEs.</p> <p>Note 7: Time alignment error (TAE) as specified in TS 36.104 [30] clause 6.5.3.1. The TAE value depends upon the type of carrier aggregation.</p> <p>Note 8: E-UTRA operating band groups are as defined in Section 3.5.</p>					

Table A.9.1.40.2-2: 3 DL TDD RSRP test parameters for E-UTRAN Carrier aggregation (cell #4 and cell #5)

Parameter	Unit	Cell 4	Cell 5
E-UTRA RF Channel Number		3	
BW _{channel}	MHz	5MHz: N _{RB,c} = 25 10MHz: N _{RB,c} = 50 20MHz: N _{RB,c} = 100	
Special subframe configuration ^{Note1}		6	
Uplink/downlink configuration ^{Note1}		1	
Measurement bandwidth	n_{PRB}	5MHz: 10-15 10MHz: 22-27 20MHz: 47-52	
PDSCH Reference measurement channel defined in A.3.1.1.2		5MHz: R.4 TDD 10MHz: R.0 TDD 20MHz: R.3 TDD	N/A
PDSCH allocation	n_{PRB}	5MHz: 7-17 10MHz: 13-36 20MHz: 38-61	N/A
PDCCH/PCFICH/PHICH Reference measurement channel defined in A.3.1.2.2		5MHz: R.11 TDD 10MHz: R.6 TDD 20MHz: R.10 TDD	5MHz: R.11 TDD 10MHz: R.6 TDD 20MHz: R.10 TDD
OCNG Patterns defined in A.3.2.2		5MHz: OP.9 TDD 10MHz: OP.1 TDD 20MHz: OP.7 TDD	5MHz: OP.10 TDD 10MHz: OP.2 TDD 20MHz: OP.8 TDD
PBCH_RA	dB	0	0
PBCH_RB			
PSS_RA			
SSS_RA			
PCFICH_RB			
PHICH_RA			
PHICH_RB			
PDCCH_RA			
PDCCH_RB			
PDSCH_RA			
PDSCH_RB			

OCNG_RA ^{Note2}				
OCNG_RB ^{Note2}				
N_{oc} ^{Note3}	Bands TDD_A	dBm/ 15kHz	$(N_{oc}$ for Channel 1 +1dB)	
	Bands TDD_C			
	Bands TDD_E			
\hat{E}_s/N_{oc}		dB	3	-1
\hat{E}_s/I_{ot}		dB	0.46	-5.76
RSRP ^{Note4}	Bands TDD_A	dBm/ 15kHz	(RSRP for Cell 1 +8dB)	(RSRP for Cell 1 +4dB)
	Bands TDD_C			
	Bands TDD_E			
I _o ^{Note4}	Bands TDD_A	dBm/ BW _{channel}	(I _o for Channel 1 +5.33dB +10log (N _{RB channel3} / N _{RB channel 1}))	
	Bands TDD_C			
	Bands TDD_E			
Propagation Condition			AWGN	AWGN
Antenna Configuration			1x2	1x2
Timing offset to Cell 1		μs	0	3
Time alignment error relative to cell 1 ^{Note 7}			≤ TAE	-
Time alignment error relative to cell 2 ^{Note 7}			≤ TAE	
<p>Note 1: For special subframe and uplink-downlink configurations see Tables 4.2-1 and 4.2-2 in TS 36.211.</p> <p>Note 2: OCNG shall be used such that both cells are fully allocated and a constant total transmitted power spectral density is achieved for all OFDM symbols.</p> <p>Note 3: Interference from other cells and noise sources not specified in the test is assumed to be constant over subcarriers and time and shall be modelled as AWGN of appropriate power for N_{oc} to be fulfilled.</p> <p>Note 4: RSRP and I_o levels have been derived from other parameters for information purposes. They are not settable parameters themselves.</p> <p>Note 5: RSRP minimum requirements are specified assuming independent interference and noise at each receiver antenna port.</p> <p>Note 6: The selection of the bands for testing depends on the configuration of the carrier aggregation supported by the UEs.</p> <p>Note 7: Time alignment error (TAE) as specified in TS 36.104 [30] clause 6.5.3.1. The TAE value depends upon the type of carrier aggregation.</p> <p>Note 8: E-UTRA operating band groups are as defined in Section 3.5.</p>				

A.9.1.40.3 Test Requirements

In the test, the performance of RSRP measurements is verified from following four perspectives:

- The absolute accuracy of intra-frequency RSRP measurements for Cell 1 on the primary component carrier shall fulfil the requirements defined in clause 9.1.11.1.
- The absolute accuracy of intra-frequency RSRP measurements for Cell 2 on SCC1 shall fulfil the requirements defined in clause 9.1.11.2.
- The absolute accuracy of intra-frequency RSRP measurements for Cell 4 on SCC2 shall fulfil the requirements defined in clause 9.1.11.2.
- The relative accuracy of intra-frequency RSRP measurements for Cell 3 relative to Cell 2 on SCC1 shall fulfil the requirements defined in clause 9.1.11.2.
- The relative accuracy of intra-frequency RSRP measurements for Cell 5 relative to Cell 4 on SCC2 shall fulfil the requirements defined in clause 9.1.11.2.
- The relative accuracy of inter-frequency RSRP measurements between SCC1 and the primary component carriers for Cell 2 relative to Cell 1 shall fulfil the requirements defined in clause 9.1.11.3.
- The relative accuracy of inter-frequency RSRP measurements between SCC2 and the primary component carriers for Cell 4 relative to Cell 1 shall fulfil the requirements defined in clause 9.1.11.3.

A.9.1.41 FD-FDD RSRP Intra frequency case for UE category 0

A.9.1.41.1 Test Purpose and Environment

The purpose of this test is to verify that the RSRP measurement accuracy is within the specified limits. This test will verify the requirements in Sections 9.1.13.1 and 9.1.13.2 for FD-FDD intra frequency RSRP measurements for UE category 0.

A.9.1.41.2 Test parameters

In this set of test cases all cells are on the same carrier frequency. Both absolute and relative accuracy of RSRP intra frequency measurements are tested by using the parameters in Table A.9.1.41.2-1. In all test cases, Cell 1 is the PCell and Cell 2 the target cell.

Table A.9.1.41.2-1: FD-FDD RSRP Intra frequency test parameters for UE category 0

Parameter		Unit	Test 1		Test 2		Test 3								
			Cell 1	Cell 2	Cell 1	Cell 2	Cell 1	Cell 2							
E-UTRA RF Channel Number			1		1		1								
BW _{channel}		MHz	10		10		10								
Measurement bandwidth		n_{PRB}	22—27		22—27		22—27								
PDSCH Reference measurement channel defined in A.3.1.1.3			R.13 FDD	-	R.13 FDD	-	R.13 FDD	-							
PDSCH allocation		n_{PRB}	13—36	-	13—36	-	13—36	-							
PDCCH/PCFICH/PHICH Reference measurement channel defined in A.3.1.2.1			R.6 FDD		R.6 FDD		R.6 FDD								
OCNG Patterns defined in A.3.2.1			OP.1 FDD	OP.2 FDD	OP.1 FDD	OP.2 FDD	OP.1 FDD	OP.2 FDD							
PBCH_RA		dB	0	0	0	0	0	0							
PBCH_RB															
PSS_RA															
SSS_RA															
PCFICH_RB															
PHICH_RA															
PHICH_RB															
PDCCH_RA															
PDCCH_RB															
PDSCH_RA															
PDSCH_RB															
OCNG_RA ^{Note1}															
OCNG_RB ^{Note1}															
N_{oc} ^{Note2}	Bands FDD-0_A ^{Note 7}								dBm/15 kHz	-106		-86		-116	
	Bands FDD-0_B													-115.5	
	Bands FDD-0_C													-115	
	Bands FDD-0_D	-114.5													
	Bands FDD-0_E, FDD-0_F ^{Note 4}	-114													
	Bands FDD-0_G ^{Note 6}	-113													
	Bands FDD-0_H	-112.5													
\hat{E}_s/N_{oc}		dB	6	1	6	1	3	-1							
\hat{E}_s/I_{ot} ^{Note3}		dB	2.5	-6	2.5	-6	0.46	-5.76							
RSRP ^{Note3}	Bands FDD-0_A ^{Note 7}	dBm/15 kHz	-100	-105	-80	-85	-113	-117							
	Bands FDD-0_B						-112.5	-116.5							
	Bands FDD-0_C						-112	-116							
	Bands FDD-0_D						-111.5	-115.5							
	Bands FDD-0_E, FDD-0_F ^{Note 4}						-111	-115							

	Bands FDD-0_G Note 6					-110	-114
	Bands FDD-0_H					-109.5	-113.5
I _o Note3	Bands FDD-0_A Note 7	dBm/9 MHz	-70.27	-50.27		-82.43	
	Bands FDD-0_B					-81.93	
	Bands FDD-0_C					-81.43	
	Bands FDD-0_D					-80.93	
	Bands FDD-0_E, FDD-0_F Note 4					-80.43	
	Bands FDD-0_G Note 6					-79.43	
	Bands FDD-0_H					-78.93	
	Propagation condition					-	AWGN
Correlation Matrix and Antenna Configuration			1x1	1x1	1x1		
<p>Note 1: OCNB shall be used such that both cells are fully allocated and a constant total transmitted power spectral density is achieved for all OFDM symbols.</p> <p>Note 2: Interference from other cells and noise sources not specified in the test is assumed to be constant over subcarriers and time and shall be modelled as AWGN of appropriate power for N_{oc} to be fulfilled.</p> <p>Note 3: Es/Iot, RSRP and I_o levels have been derived from other parameters for information purposes. They are not settable parameters themselves.</p> <p>Note 4: For Band 26, the tests shall be performed with the carrier frequency of the assigned E-UTRA channel bandwidth within 865-894 MHz.</p> <p>Note 5: E-UTRA operating band groups are as defined in Section 3.5.</p> <p>Note 6: Except Band 29.</p> <p>Note 7: Except Band 32, Band 75, Band 76.</p>							

A.9.1.41.3 Test Requirements

The RSRP measurement accuracy shall fulfil the requirements in sections 9.1.13.1 and 9.1.13.2.

A.9.1.42 HD-FDD RSRP Intra frequency case for UE category 0

A.9.1.42.1 Test Purpose and Environment

The purpose of this test is to verify that the RSRP measurement accuracy is within the specified limits. This test will verify the requirements in Sections 9.1.13.1 and 9.1.13.2 for HD-FDD intra frequency RSRP measurements for UE category 0.

A.9.1.42.2 Test parameters

In this set of test cases all cells are on the same carrier frequency. Both absolute and relative accuracy of RSRP intra frequency measurements are tested by using the parameters in Table A.9.1.42.2-1. In all test cases, Cell 1 is the PCell and Cell 2 the target cell.

Table A.9.1.42.2-1: HD-FDD RSRP Intra frequency test parameters for UE category 0

Parameter	Unit	Test 1		Test 2		Test 3	
		Cell 1	Cell 2	Cell 1	Cell 2	Cell 1	Cell 2
E-UTRA RF Channel Number		1		1		1	
BW _{channel}	MHz	10		10		10	
Measurement bandwidth	n_{PRB}	22—27		22—27		22—27	
PDSCH Reference measurement channel defined in A.3.1.1.4		R.1 HD-FDD	-	R.1 HD-FDD	-	R.1 HD-FDD	-
PDSCH allocation	n_{PRB}	13—36	-	13—36	-	13—36	-
PDCCH/PCFICH/PHICH Reference measurement channel defined in A.3.1.2.3		R.3 HD-FDD		R.3 HD-FDD		R.3 HD-FDD	
OCNB Patterns defined in A.3.2.1		OP.1 FDD	OP.2 FDD	OP.1 FDD	OP.2 FDD	OP.1 FDD	OP.2 FDD
PBCH_RA	dB	0	0	0	0	0	0

PBCH_RB								
PSS_RA								
SSS_RA								
PCFICH_RB								
PHICH_RA								
PHICH_RB								
PDCCH_RA								
PDCCH_RB								
PDSCH_RA								
PDSCH_RB								
OCNG_RA ^{Note1}								
OCNG_RB ^{Note1}								
N_{oc} ^{Note2}	Bands FDD-0_A <small>Note 7</small>	dBm/15 kHz	-106	-86				-116
	Bands FDD-0_B							-115.5
	Bands FDD-0_C							-115
	Bands FDD-0_D							-114.5
	Bands FDD-0_E, FDD-0_F ^{Note 5}							-114
	Bands FDD-0_G <small>Note 6</small>							-113
	Bands FDD-0_H							-112.5
\hat{E}_s/N_{oc}	dB	6	1	6	1	3	-1	
\hat{E}_s/I_{ot} ^{Note3}	dB	2.5	-6	2.5	-6	0.46	-5.76	
RSRP ^{Note3}	Bands FDD-0_A <small>Note 7</small>	dBm/15 kHz	-100	-105	-80	-85	-113	-117
	Bands FDD-0_B						-112.5	-116.5
	Bands FDD-0_C						-112	-116
	Bands FDD-0_D						-111.5	-115.5
	Bands FDD-0_E, FDD-0_F ^{Note 4}						-111	-115
	Bands FDD-0_G <small>Note 6</small>						-110	-114
	Bands FDD-0_H						-109.5	-113.5
I_o ^{Note3}	Bands FDD-0_A <small>Note 7</small>	dBm/9 MHz	-70.27	-50.27				-82.43
	Bands FDD-0_B							-81.93
	Bands FDD-0_C							-81.43
	Bands FDD-0_D							-80.93
	Bands FDD-0_E, FDD-0_F ^{Note 4}							-80.43
	Bands FDD-0_G <small>Note 6</small>							-79.43
	Bands FDD-0_H							-78.93
Propagation condition	-	AWGN		AWGN		AWGN		
Correlation Matrix and Antenna Configuration		1x1		1x1		1x1		
<p>Note 1: OCNG shall be used such that both cells are fully allocated and a constant total transmitted power spectral density is achieved for all OFDM symbols.</p> <p>Note 2: Interference from other cells and noise sources not specified in the test is assumed to be constant over subcarriers and time and shall be modelled as AWGN of appropriate power for N_{oc} to be fulfilled.</p> <p>Note 3: E_s/I_{ot}, RSRP and I_o levels have been derived from other parameters for information purposes. They are not settable parameters themselves.</p> <p>Note 4: For Band 26, the tests shall be performed with the carrier frequency of the assigned E-UTRA channel bandwidth within 865-894 MHz.</p> <p>Note 5: E-UTRA operating band groups are as defined in Section 3.5.</p> <p>Note 6: Except Band 29.</p> <p>Note 7: Except Band 32, Band 75, Band 76.</p>								

A.9.1.42.3 Test Requirements

The RSRP measurement accuracy shall fulfil the requirements in sections 9.1.13.1 and 9.1.13.2.

A.9.1.43 TDD RSRP Intra frequency case for UE category 0

A.9.1.43.1 Test Purpose and Environment

The purpose of this test is to verify that the RSRP measurement accuracy is within the specified limits. This test will verify the requirements in Sections 9.1.13.1 and 9.1.13.2 for TDD intra frequency RSRP measurements for UE category 0.

A.9.1.43.2 Test parameters

In this set of test cases all cells are on the same carrier frequency. Both absolute and relative accuracy of RSRP intra frequency measurements are tested by using the parameters in Table A.9.1.43.2-1. In all test cases, Cell 1 is the PCell and Cell 2 the target cell.

Table A.9.1.43.2-1: TDD RSRP Intra frequency test parameters for UE category 0

Parameter	Unit	Test 1		Test 2		Test 3								
		Cell 1	Cell 2	Cell 1	Cell 2	Cell 1	Cell 2							
E-UTRA RF Channel Number		1		1		1								
BW_{channel}	MHz	10		10		10								
Special subframe configuration ^{Note1}		6		6		6								
Uplink/downlink configuration ^{Note1}		1		1		1								
Measurement bandwidth	n_{PRB}	22—27		22—27		22—27								
PDSCH Reference measurement channel defined in A.3.1.1.5		R.12 TDD	-	R.12 TDD	-	R.12 TDD	-							
PDSCH allocation	n_{PRB}	13—36	-	13—36	-	13—36	-							
PDCCH/PCFICH/PHICH Reference measurement channel defined in A.3.1.2.2		R.6 TDD		R.6 TDD		R.6 TDD								
OCNG Patterns defined in A.3.2.2.1 (OP.1 TDD) and A.3.2.2.2 (OP.2 TDD)		OP.1 TDD	OP.2 TDD	OP.1 TDD	OP.2 TDD	OP.1 TDD	OP.2 TDD							
PBCH_RA	dB	0	0	0	0	0	0							
PBCH_RB														
PSS_RA														
SSS_RA														
PCFICH_RB														
PHICH_RA														
PHICH_RB														
PDCCH_RA														
PDCCH_RB														
PDSCH_RA														
PDSCH_RB														
OCNG_RA ^{Note2}														
OCNG_RB ^{Note2}														
N_{oc} ^{Note3}								Bands TDD-0_A	-106		-86		-116	
								Bands TDD-0_C					-115	
	Bands TDD-0_E	-114												
\hat{E}_s/N_{oc}	dB	6	1	6	1	3	-1							
\hat{E}_s/I_{ot} ^{Note4}	dB	2.5	-6	2.5	-6	0.5	-5.76							
RSRP ^{Note4}	Bands TDD-0_A	-100		-80		-113								
	Bands TDD-0_C					-112								
	Bands TDD-0_E					-111								
I_o ^{Note4}	Bands TDD-0_A	-70.27		-50.27		-82.43								
	Bands TDD-0_C					-81.43								
	Bands TDD-0_E					-80.43								
Propagation condition	-	AWGN		AWGN		AWGN								
Correlation Matrix and Antenna Configuration		1x1		1x1		1x1								

Note 1:	For special subframe and uplink-downlink configurations see Tables 4.2-1 and 4.2-2 in TS 36.211.
Note 2:	OCNG shall be used such that both cells are fully allocated and a constant total transmitted power spectral density is achieved for all OFDM symbols.
Note 3:	Interference from other cells and noise sources not specified in the test is assumed to be constant over subcarriers and time and shall be modelled as AWGN of appropriate power for N_{oc} to be fulfilled.
Note 4:	Es/lot, RSRP and lo levels have been derived from other parameters for information purposes. They are not settable parameters themselves.
Note 5:	E-UTRA operating band groups are as defined in Section 3.5.

A.9.1.43.3 Test Requirements

The RSRP measurement accuracy shall fulfil the requirements in sections 9.1.13.1 and 9.1.13.2.

A.9.1.44 4 DL CA PCell in FDD FDD-TDD RSRP for E-UTRAN in Carrier Aggregation

A.9.1.44.1 Test Purpose and Environment

The purpose of this test is to verify that the FDD-TDD RSRP absolute and relative accuracy requirements in carrier aggregation with PCell in FDD are within the specified limits. This test will verify the absolute RSRP accuracy requirements of the primary component carrier defined in clause 9.1.11.1, the absolute RSRP accuracy requirements of the secondary component carriers defined in clause 9.1.11.2, and the relative RSRP accuracy requirements of the secondary component carriers defined in clause 9.1.11.2. The test will also verify the primary and secondary component carriers' relative RSRP accuracy requirement defined in Clause 9.1.11.3.

A.9.1.44.2 Test parameters

In this set of cases cell 1 is PCell on the primary component carrier, and cell 2, cell 4 and cell 6 are activated SCells on secondary component carriers SCC1, SCC2 and SCC3 respectively. Cell 3, cell 5 and cell 7 are neighbouring cells on secondary component carriers SCC1, SCC2 and SCC3 respectively. The test parameters are given in Table A.9.1.44.2-1.

Table A.9.1.44.2-1: 4 Downlink PCell in FDD-TDD RSRP carrier aggregation test parameters

Parameter	Unit	Cell 1	Cell 2	Cell 3	Cell 4	Cell 5	Cell 6	Cell 7
E-UTRA RF Channel Number		1	2	3	3	4	4	4
BW _{channel}	MHz	5MHz: N _{RB,c} = 25 10MHz: N _{RB,c} = 50 20MHz: N _{RB,c} = 100	5MHz: N _{RB,c} = 25 10MHz: N _{RB,c} = 50 20MHz: N _{RB,c} = 100		5MHz: N _{RB,c} = 25 10MHz: N _{RB,c} = 50 20MHz: N _{RB,c} = 100		5MHz: N _{RB,c} = 25 10MHz: N _{RB,c} = 50 20MHz: N _{RB,c} = 100	
Special subframe configuration ^{Note1}		-	6		6		6	
Uplink/downlink configuration ^{Note1}		-	1		1		1	
Measurement bandwidth	n _{PRB}	5MHz: 10-15 10MHz: 22-27 20MHz: 47-52	5MHz: 10-15 10MHz: 22-27 20MHz: 47-52		5MHz: 10-15 10MHz: 22-27 20MHz: 47-52		5MHz: 10-15 10MHz: 22-27 20MHz: 47-52	
PDSCH Reference measurement channel		5MHz: R.5 FDD 10MHz: R.0 FDD 20MHz: R.4 FDD	5MHz: R.4 TDD 10MHz: R.0 TDD 20MHz: R.3 TDD	-	5MHz: R.4 TDD 10MHz: R.0 TDD 20MHz: R.3 TDD	-	5MHz: R.4 TDD 10MHz: R.0 TDD 20MHz: R.3 TDD	-
PDSCH allocation	n _{PRB}	5MHz: 7-17 10MHz: 13-36 20MHz: 38-61	5MHz: 7-17 10MHz: 13-36 20MHz: 38-61	-	5MHz: 7-17 10MHz: 13-36 20MHz: 38-61	-	5MHz: 7-17 10MHz: 13-36 20MHz: 38-61	-
PDCCH/PCFICH/PHICH Reference measurement channel		5MHz: R.11 FDD 10MHz: R.6 FDD 20MHz: R.10 FDD	5MHz: R.11 TDD 10MHz: R.6 TDD 20MHz: R.10 TDD	5MHz: R.11 TDD 10MHz: R.6 TDD 20MHz: R.10 TDD	5MHz: R.11 TDD 10MHz: R.6 TDD 20MHz: R.10 TDD	5MHz: R.11 TDD 10MHz: R.6 TDD 20MHz: R.10 TDD	5MHz: R.11 TDD 10MHz: R.6 TDD 20MHz: R.10 TDD	5MHz: R.11 TDD 10MHz: R.6 TDD 20MHz: R.10 TDD
OCNG Patterns		5MHz: OP.15 FDD 10MHz: OP.1 FDD 20MHz: OP.11 FDD	5MHz: OP.9 TDD 10MHz: OP.1 TDD 20MHz: OP.7 TDD	5MHz: OP.10 TDD 10MHz: OP.2 TDD 20MHz: OP.8 TDD	5MHz: OP.9 TDD 10MHz: OP.1 TDD 20MHz: OP.7 TDD	5MHz: OP.10 TDD 10MHz: OP.2 TDD 20MHz: OP.8 TDD	5MHz: OP.9 TDD 10MHz: OP.1 TDD 20MHz: OP.7 TDD	5MHz: OP.10 TDD 10MHz: OP.2 TDD 20MHz: OP.8 TDD
PBCH_RA	dB	0	0	0	0	0	0	0
PBCH_RB								
PSS_RA								
SSS_RA								
PCFICH_RB								
PHICH_RA								
PHICH_RB								
PDCCH_RA								
PDCCH_RB								
PDSCH_RA								
PDSCH_RB								

OCNG_RA ^{Note2}									
OCNG_RB ^{Note2}									
N_{oc} ^{Note3}	Bands TDD_A	dBm/15 kHz	-	$(N_{oc}$ for Channel 1 +1dB)		$(N_{oc}$ for Channel 1 +1dB)		$(N_{oc}$ for Channel 1 +1dB)	
	Bands TDD_C								
	Bands TDD_E								
	Bands FDD_A		-117						
	Bands FDD_B1, FDD_B2 <small>Note 10</small>		-116.5						
	Bands FDD_C		-116						
	Bands FDD_D		-115.5						
	Bands FDD_E, FDD_F ^{Note 7}		-115						
	Bands FDD_G		-114						
Bands FDD_H	-113.5								
\hat{E}_s/N_{oc}		dB	-4	3	-1	3	-1	3	-1
\hat{E}_s/I_{ot}		dB	-4	0.46	-5.76	0.46	-5.76	0.46	-5.76
RSRP ^{Note4}	Bands TDD_A	dBm/15 kHz	-	(RSRP for Cell 1 +8dB)	(RSRP for Cell 1 +4dB)	(RSRP for Cell 1 +8dB)	(RSRP for Cell 1 +4dB)	(RSRP for Cell 1 +8dB)	(RSRP for Cell 1 +4dB)
	Bands TDD_C								
	Bands TDD_E								
	Bands FDD_A		-121						
	Bands FDD_B1, FDD_B2 <small>Note 10</small>		-120.5						
	Bands FDD_C		-120						
	Bands FDD_D		-119.5						
	Bands FDD_E, FDD_F ^{Note 7}		-119						
	Bands FDD_G		-118						
Bands FDD_H	-117.5								
I_o ^{Note4}	Bands TDD_A	dBm/ BW _{channel}	-	$(I_o$ for Channel 1 +5.33dB +10log $(N_{RB\ channel2} / N_{RB\ channel\ 1}))$		$(I_o$ for Channel 1 +5.33dB +10log $(N_{RB\ channel3} / N_{RB\ channel\ 1}))$		$(I_o$ for Channel 1 +5.33dB +10log $(N_{RB\ channel4} / N_{RB\ channel\ 1}))$	
	Bands TDD_C								
	Bands TDD_E								
	Bands FDD_A		$87.76+10\log(N_{RB,c}/50)$						
	Bands FDD_B1, FDD_B2 <small>Note 10</small>		$87.26+10\log(N_{RB,c}/50)$						
	Bands FDD_C		$86.76+10\log(N_{RB,c}/50)$						
	Bands FDD_D		$86.26+10\log(N_{RB,c}/50)$						
	Bands FDD_E, FDD_F ^{Note 7}		-85.76 $+10\log(N_{RB,c}/50)$						
	Bands FDD_G		-84.76 $+10\log(N_{RB,c}/50)$						
Bands FDD_H	-84.26 $+10\log(N_{RB,c}/50)$								
Propagation condition		-	AWGN	AWGN	AWGN	AWGN	AWGN	AWGN	AWGN
Antenna Configuration		-	1x2	1x2	1x2	1x2	1x2	1x2	1x2

Timing offset to cell 1	μs	-	0	3	0	3	0	3
Time alignment error relative to cell 1 ^{Note 8}		-	≤ TAE	-	≤ TAE	-	≤ TAE	-
Time alignment error relative to cell 2 ^{Note 8}		-	-	-	≤ TAE	-	≤ TAE	-
Time alignment error relative to cell 4 ^{Note 8}		-	-	-	-	-	≤ TAE	-

Note 1: For special subframe and uplink-downlink configurations see Tables 4.2-1 and 4.2-2 in TS 36.211.

Note 2: OCNG shall be used such that all cells are fully allocated and a constant total transmitted power spectral density is achieved for all OFDM symbols.

Note 3: Interference from other cells and noise sources not specified in the test is assumed to be constant over subcarriers and time and shall be modelled as AWGN of appropriate power for N_{oc} to be fulfilled.

Note 4: RSRP and Io levels have been derived from other parameters for information purposes. They are not settable parameters themselves.

Note 5: RSRP minimum requirements are specified assuming independent interference and noise at each receiver antenna port.

Note 6: The selection of the bands for testing depends on the configuration of the carrier aggregation supported by the UEs.

Note 7: For Band 26, the tests shall be performed with the carrier frequency of the assigned E-UTRA channel bandwidth within 865-894 MHz.

Note 8: Time alignment error (TAE) as specified in TS 36.104 [30] clause 6.5.3.1. The TAE value depends upon the type of carrier aggregation.

Note 9: E-UTRA operating band groups are as defined in Section 3.5.

Note 10: For Band 74, the tests shall be performed with the carrier frequency of the assigned E-UTRA channel bandwidth within 1475.9-1510.9 MHz.

A.9.1.44.3 Test Requirements

In the test, the performance of RSRP measurements is verified from the following 10 perspectives:

- The absolute accuracy of intra-frequency RSRP measurements for Cell 1 on the primary component carrier shall fulfil the requirements defined in clause 9.1.11.1.
- The absolute accuracy of intra-frequency RSRP measurements for Cell 2 on SCC1 shall fulfil the requirements defined in clause 9.1.11.2.
- The absolute accuracy of intra-frequency RSRP measurements for Cell 4 on SCC2 shall fulfil the requirements defined in clause 9.1.11.2.
- The absolute accuracy of intra-frequency RSRP measurements for Cell 6 on SCC3 shall fulfil the requirements defined in clause 9.1.11.2.
- The relative accuracy of intra-frequency RSRP measurements for Cell 3 relative to Cell 2 on SCC1 shall fulfil the requirements defined in clause 9.1.11.2.
- The relative accuracy of intra-frequency RSRP measurements for Cell 5 relative to Cell 4 on SCC2 shall fulfil the requirements defined in clause 9.1.11.2.
- The relative accuracy of intra-frequency RSRP measurements for Cell 7 relative to Cell 6 on SCC3 shall fulfil the requirements defined in clause 9.1.11.2.
- The relative accuracy of inter-frequency RSRP measurements between SCC1 and the primary component carriers for Cell 2 relative to Cell 1 shall fulfil the requirements defined in clause 9.1.11.3.
- The relative accuracy of inter-frequency RSRP measurements between SCC2 and the primary component carriers for Cell 4 relative to Cell 1 shall fulfil the requirements defined in clause 9.1.11.3.
- The relative accuracy of inter-frequency RSRP measurements between SCC3 and the primary component carriers for Cell 6 relative to Cell 1 shall fulfil the requirements defined in clause 9.1.11.3.

A.9.1.45 4 DL CA PCell in TDD FDD-TDD RSRP for E-UTRAN in Carrier Aggregation

A.9.1.45.1 Test Purpose and Environment

The purpose of this test is to verify that the TDD-FDD RSRP absolute and relative accuracy requirements in carrier aggregation with PCell in TDD are within the specified limits. This test will verify the absolute RSRP accuracy requirements of the primary component carrier defined in clause 9.1.11.1, the absolute RSRP accuracy requirements of the secondary component carriers defined in clause 9.1.11.2, and the relative RSRP accuracy requirements of the secondary component carriers defined in clause 9.1.11.2. The test will also verify the primary and secondary component carriers' relative RSRP accuracy requirement defined in Clause 9.1.11.3.

A.9.1.45.2 Test parameters

In this set of cases cell 1 is PCell on the primary component carrier, and cell 2, cell 4 and cell 6 are activated SCells on secondary component carriers SCC1, SCC2 and SCC3 respectively. Cell 3, cell 5 and cell 7 are neighbouring cells on secondary component carriers SCC1, SCC2 and SCC3 respectively. The test parameters are given in Table A.9.1.45.2-1.

Table A.9.1.45.2-1: 4 Downlink PCell in TDD-FDD RSRP carrier aggregation test parameters

Parameter	Unit	Cell 1	Cell 2	Cell 3	Cell 4	Cell 5	Cell 6	Cell 7
E-UTRA RF Channel Number		1	2	3	3	4	4	4
BW _{channel}	MHz	5MHz: N _{RB,c} = 25 10MHz: N _{RB,c} = 50 20MHz: N _{RB,c} = 100	5MHz: N _{RB,c} = 25 10MHz: N _{RB,c} = 50 20MHz: N _{RB,c} = 100	5MHz: N _{RB,c} = 25 10MHz: N _{RB,c} = 50 20MHz: N _{RB,c} = 100	5MHz: N _{RB,c} = 25 10MHz: N _{RB,c} = 50 20MHz: N _{RB,c} = 100	5MHz: N _{RB,c} = 25 10MHz: N _{RB,c} = 50 20MHz: N _{RB,c} = 100	5MHz: N _{RB,c} = 25 10MHz: N _{RB,c} = 50 20MHz: N _{RB,c} = 100	5MHz: N _{RB,c} = 25 10MHz: N _{RB,c} = 50 20MHz: N _{RB,c} = 100
Special subframe configuration ^{Note1}		6	-	-	-	-	-	-
Uplink/downlink configuration ^{Note1}		1	-	-	-	-	-	-
Measurement bandwidth	n _{PRB}	5MHz: 10-15 10MHz: 22-27 20MHz: 47-52	5MHz: 10-15 10MHz: 22-27 20MHz: 47-52	5MHz: 10-15 10MHz: 22-27 20MHz: 47-52	5MHz: 10-15 10MHz: 22-27 20MHz: 47-52	5MHz: 10-15 10MHz: 22-27 20MHz: 47-52	5MHz: 10-15 10MHz: 22-27 20MHz: 47-52	5MHz: 10-15 10MHz: 22-27 20MHz: 47-52
PDSCH Reference measurement channel defined in A.3.1.1.		5MHz: R.4 TDD 10MHz: R.0 TDD 20MHz: R.3 TDD	5MHz: R.5 FDD 10MHz: R.0 FDD 20MHz: R.4 FDD	-	5MHz: R.5 FDD 10MHz: R.0 FDD 20MHz: R.4 FDD	-	5MHz: R.5 FDD 10MHz: R.0 FDD 20MHz: R.4 FDD	-
PDSCH allocation	n _{PRB}	5MHz: 7-17 10MHz: 13-36 20MHz: 38-61	5MHz: 7-17 10MHz: 13-36 20MHz: 38-61	-	5MHz: 7-17 10MHz: 13-36 20MHz: 38-61	-	5MHz: 7-17 10MHz: 13-36 20MHz: 38-61	-
PDCCH/PCFICH/PHICH Reference measurement channel defined in A.3.1.2.		5MHz: R.11 TDD 10MHz: R.6 TDD 20MHz: R.10 TDD	5MHz: R.11 FDD 10MHz: R.6 FDD 20MHz: R.10 FDD	5MHz: R.11 FDD 10MHz: R.6 FDD 20MHz: R.10 FDD	5MHz: R.11 FDD 10MHz: R.6 FDD 20MHz: R.10 FDD	5MHz: R.11 FDD 10MHz: R.6 FDD 20MHz: R.10 FDD	5MHz: R.11 FDD 10MHz: R.6 FDD 20MHz: R.10 FDD	5MHz: R.11 FDD 10MHz: R.6 FDD 20MHz: R.10 FDD
OCNG Patterns defined in A.3.2.		5MHz: OP.9 TDD 10MHz: OP.1 TDD 20MHz: OP.7 TDD	5MHz: OP.15 FDD 10MHz: OP.1 FDD 20MHz: OP.11 FDD	5MHz: OP.16 FDD 10MHz: OP.2 FDD 20MHz: OP.12 FDD	5MHz: OP.15 FDD 10MHz: OP.1 FDD 20MHz: OP.11 FDD	5MHz: OP.16 FDD 10MHz: OP.2 FDD 20MHz: OP.12 FDD	5MHz: OP.15 FDD 10MHz: OP.1 FDD 20MHz: OP.11 FDD	5MHz: OP.16 FDD 10MHz: OP.2 FDD 20MHz: OP.12 FDD
PBCH_RA	dB	0	0	0	0	0	0	0
PBCH_RB								
PSS_RA								
SSS_RA								
PCFICH_RB								
PHICH_RA								
PHICH_RB								
PDCCH_RA								
PDCCH_RB								

PDSCH_RA									
PDSCH_RB									
OCNG_RA ^{Note1}									
OCNG_RB ^{Note1}									
N_{oc} ^{Note3}	Bands FDD_A	dBm/15 kHz	-	$(N_{oc}$ for Channel 1 +1dB)		$(N_{oc}$ for Channel 1 +1dB)		$(N_{oc}$ for Channel 1 +1dB)	$(N_{oc}$ for Channel 1 +1dB)
	Bands FDD_B1, FDD_B2 ^{Note 10}								
	Bands FDD_C								
	Bands FDD_D								
	Bands FDD_E, FDD_F ^{Note 7}								
	Bands FDD_G								
	Bands FDD_H								
	Bands TDD_A								
Bands TDD_C	-117								
Bands TDD_E	-116								
	-115								
\hat{E}_s/N_{oc}		dB	-4	3	-1	3	-1	3	-1
\hat{E}_s/I_{ot}		dB	-4	0.46	-5.76	0.46	-5.76	0.46	-5.76
RSRP ^{Note4}	Bands FDD_A	dBm/15 kHz	-	(RSRP for Cell 1 +8dB)	(RSRP for Cell 1 +4dB)	(RSRP for Cell 1 +8dB)	(RSRP for Cell 1 +4dB)	(RSRP for Cell 1 +8dB)	(RSRP for Cell 1 +4dB)
	Bands FDD_B1, FDD_B2 ^{Note 10}								
	Bands FDD_C								
	Bands FDD_D								
	Bands FDD_E, FDD_F ^{Note 7}								
	Bands FDD_G								
	Bands FDD_H								
	Bands TDD_A								
Bands TDD_C	-121								
Bands TDD_E	-120								
	-119								
I_o ^{Note4}	Bands FDD_A	dBm/ BW _{channel}	-	$(I_o$ for Channel 1 +5.33dB +10log $(N_{RB\ channel2} / N_{RB\ channel\ 1})$)		$(I_o$ for Channel 1 +5.33dB +10log $(N_{RB\ channel3} / N_{RB\ channel\ 1})$)		$(I_o$ for Channel 1 +5.33dB +10log $(N_{RB\ channel4} / N_{RB\ channel\ 1})$)	
	Bands FDD_B1, FDD_B2 ^{Note 10}								
	Bands FDD_C								
	Bands FDD_D								
	Bands FDD_E, FDD_F ^{Note 7}								
	Bands FDD_G								
	Bands FDD_H								
	Bands TDD_A								
Bands TDD_C	87.76+10log($N_{RB,c}/50$)								
Bands TDD_E	-								
	86.76+10log($N_{RB,c}/50$)								
	85.76+10log($N_{RB,c}/50$)								
Propagation condition		-	AWGN	AWGN	AWGN	AWGN	AWGN	AWGN	AWGN
Antenna Configuration		-	1x2	1x2	1x2	1x2	1x2	1x2	1x2
Timing offset to cell 1		μ s	-	0	3	0	3	0	3
Time alignment error relative to cell 1 ^{Note 8}		-	-	\leq TAE	-	\leq TAE	-	\leq TAE	-
Time alignment error relative to cell 2 ^{Note8}		-	-	-	-	\leq TAE	-	\leq TAE	-
Time alignment error relative to cell 4 ^{Note8}		-	-	-	-	-	-	\leq TAE	-

- Note 1: For special subframe and uplink-downlink configurations see Tables 4.2-1 and 4.2-2 in TS 36.211.
- Note 2: OCNG shall be used such that all cells are fully allocated and a constant total transmitted power spectral density is achieved for all OFDM symbols.
- Note 3: Interference from other cells and noise sources not specified in the test is assumed to be constant over subcarriers and time and shall be modelled as AWGN of appropriate power for N_{oc} to be fulfilled.
- Note 4: RSRP and I_o levels have been derived from other parameters for information purposes. They are not settable parameters themselves.
- Note 5: RSRP minimum requirements are specified assuming independent interference and noise at each receiver antenna port.
- Note 6: The selection of the bands for testing depends on the configuration of the carrier aggregation supported by the UEs.
- Note 7: For Band 26, the tests shall be performed with the carrier frequency of the assigned E-UTRA channel bandwidth within 865-894 MHz.
- Note 8: Time alignment error (TAE) as specified in TS 36.104 [30] clause 6.5.3.1. The TAE value depends upon the type of carrier aggregation.
- Note 9: E-UTRA operating band groups are as defined in Section 3.5.
- Note 10: For Band 74, the tests shall be performed with the carrier frequency of the assigned E-UTRA channel bandwidth within 1475.9-1510.9 MHz.

A.9.1.45.3 Test Requirements

In the test, the performance of RSRP measurements is verified from the following perspectives:

- The absolute accuracy of intra-frequency RSRP measurements for Cell 1 on the primary component carrier shall fulfil the requirements defined in clause 9.1.11.1.
- The absolute accuracy of intra-frequency RSRP measurements for Cell 2 on SCC1 shall fulfil the requirements defined in clause 9.1.11.2.
- The absolute accuracy of intra-frequency RSRP measurements for Cell 4 on SCC2 shall fulfil the requirements defined in clause 9.1.11.2.
- The absolute accuracy of intra-frequency RSRP measurements for Cell 6 on SCC3 shall fulfil the requirements defined in clause 9.1.11.2.
- The relative accuracy of intra-frequency RSRP measurements for Cell 3 relative to Cell 2 on SCC1 shall fulfil the requirements defined in clause 9.1.11.2.
- The relative accuracy of intra-frequency RSRP measurements for Cell 5 relative to Cell 4 on SCC2 shall fulfil the requirements defined in clause 9.1.11.2.
- The relative accuracy of intra-frequency RSRP measurements for Cell 7 relative to Cell 6 on SCC3 shall fulfil the requirements defined in clause 9.1.11.2.
- The relative accuracy of inter-frequency RSRP measurements between SCC1 and the primary component carriers for Cell 2 relative to Cell 1 shall fulfil the requirements defined in clause 9.1.11.3.
- The relative accuracy of inter-frequency RSRP measurements between SCC2 and the primary component carriers for Cell 4 relative to Cell 1 shall fulfil the requirements defined in clause 9.1.11.3.
- The relative accuracy of inter-frequency RSRP measurements between SCC3 and the primary component carriers for Cell 6 relative to Cell 1 shall fulfil the requirements defined in clause 9.1.11.3.

A.9.1.46 4 DL FDD RSRP for E-UTRAN in Carrier Aggregation

A.9.1.46.1 Test Purpose and Environment

The purpose of this test is to verify that the RSRP absolute and relative accuracy requirements in FDD-FDD carrier aggregation are within the specified limits. This test will verify the absolute RSRP accuracy requirements of the primary component carrier defined in clause 9.1.11.1, the absolute RSRP accuracy requirements of the secondary component carriers defined in clause 9.1.11.2, and the relative RSRP accuracy requirements of the secondary component carriers defined in clause 9.1.11.2. The test will also verify the primary and secondary component carriers' relative RSRP accuracy requirement defined in Clause 9.1.11.3.

A.9.1.46.2 Test parameters

In this set of test cases cell 1 is PCell on the primary component carrier, and cell 2, cell 4 and cell 6 are activated SCells on secondary component carriers SCC1, SCC2 and SCC3 respectively. Cell 3, cell 5 and cell 7 are neighbouring cells on secondary component carriers SCC1, SCC2 and SCC3 respectively. The test parameters are given in Table A.9.1.46.2-1, Table A.9.1.46.2-2 and Table A.9.1.46.2-3.

Table A.9.1.46.2-1: 4 DL FDD RSRP carrier aggregation test parameters for cell 1, cell 2 and cell 3

Parameter	Unit	Cell 1	Cell 2	Cell 3
E-UTRA RF Channel Number		1	2	
BW_{channel}	MHz	5MHz: $N_{RB,c} = 25$ 10MHz: $N_{RB,c} = 50$ 20MHz: $N_{RB,c} = 100$	5MHz: $N_{RB,c} = 25$ 10MHz: $N_{RB,c} = 50$ 20MHz: $N_{RB,c} = 100$	
Measurement bandwidth	n_{PRB}	5MHz: 10-15 10MHz: 22-27 20MHz: 47-52	5MHz: 10-15 10MHz: 22-27 20MHz: 47-52	

PDSCH Reference measurement channel defined in A.3.1.1.1			5MHz: R.5 FDD 10MHz: R.0 FDD 20MHz: R.4 FDD	5MHz: R.5 FDD 10MHz: R.0 FDD 20MHz: R.4 FDD	-
PDSCH allocation		n_{PRB}	5MHz: 7-17 10MHz: 13-36 20MHz: 38-61	5MHz: 7-17 10MHz: 13-36 20MHz: 38-61	-
PDCCH/PCFICH/PHICH Reference measurement channel defined in A.3.1.2.1			5MHz: R.11 FDD 10MHz: R.6 FDD 20MHz: R.10 FDD	5MHz: R.11 FDD 10MHz: R.6 FDD 20MHz: R.10 FDD	5MHz: R.11 FDD 10MHz: R.6 FDD 20MHz: R.10 FDD
OCNG Patterns defined in A.3.2.1			5MHz: OP.15 FDD 10MHz: OP.1 FDD 20MHz: OP.11 FDD	5MHz: OP.15 FDD 10MHz: OP.1 FDD 20MHz: OP.11 FDD	5MHz: OP.16 FDD 10MHz: OP.2 FDD 20MHz: OP.12 FDD
PBCH_RA		dB	0	0	0
PBCH_RB					
PSS_RA					
SSS_RA					
PCFICH_RB					
PHICH_RA					
PHICH_RB					
PDCCH_RA					
PDCCH_RB					
PDSCH_RA					
PDSCH_RB					
OCNG_RA ^{Note1}					
OCNG_RB ^{Note1}					
N_{oc} ^{Note2}	Bands FDD_A				
	Bands FDD_B1, FDD_B2 ^{Note 9}	-116.5			
	Bands FDD_C	-116			
	Bands FDD_D	-115.5			
	Bands FDD_E, FDD_F ^{Note 6}	-115			
	Bands FDD_G	-114			
	Bands FDD_H	-113.5			
\hat{E}_s/N_{oc}		dB	-4	3	-1
\hat{E}_s/I_{ot}		dB	-4	0.46	-5.76
RSRP ^{Note3}	Bands FDD_A	dBm/ 15kHz	-121	(RSRP for Cell 1 +8dB)	(RSRP for Cell 1 +4dB)
	Bands FDD_B1, FDD_B2 ^{Note 9}		-120.5		
	Bands FDD_C		-120		
	Bands FDD_D		-119.5		
	Bands FDD_E, FDD_F ^{Note 6}		-119		
	Bands FDD_G		-118		
	Bands FDD_H		-117.5		
I_o ^{Note3}	Bands FDD_A	dBm/ BW _{channel}	-87.76 +10log($N_{RB,c}/50$)	$(I_o$ for Channel 1 +5.33dB +10log($N_{RB,channel2} / N_{RB,channel1}$))	
	Bands FDD_B1, FDD_B2 ^{Note 9}		-87.26 +10log($N_{RB,c}/50$)		
	Bands FDD_C		-86.76 +10log($N_{RB,c}/50$)		
	Bands FDD_D		-86.26 +10log($N_{RB,c}/50$)		
	Bands FDD_E, FDD_F ^{Note 6}		-85.76 +10log($N_{RB,c}/50$)		
	Bands FDD_G		-84.76 +10log($N_{RB,c}/50$)		
	Bands FDD_H		-84.26 +10log($N_{RB,c}/50$)		
Propagation Condition			AWGN	AWGN	AWGN

Antenna Configuration		1x2	1x2	1x2
Timing offset to Cell 1	μs	-	0	3
Time alignment error relative to cell 1 ^{Note 7}		-	≤ TAE	
Note 1:	OCNG shall be used such that both cells are fully allocated and a constant total transmitted power spectral density is achieved for all OFDM symbols.			
Note 2:	Interference from other cells and noise sources not specified in the test is assumed to be constant over subcarriers and time and shall be modelled as AWGN of appropriate power for N_{oc} to be fulfilled.			
Note 3:	RSRP and Io levels have been derived from other parameters for information purposes. They are not settable parameters themselves.			
Note 4:	RSRP minimum requirements are specified assuming independent interference and noise at each receiver antenna port.			
Note 5:	The selection of the bands for testing depends on the configuration of the carrier aggregation supported by the UEs.			
Note 6:	For Band 26, the tests shall be performed with the carrier frequency of the assigned E-UTRA channel bandwidth within 865-894 MHz.			
Note 7:	Time alignment error (TAE) as specified in TS 36.104 [30] clause 6.5.3.1. The TAE value depends upon the type of carrier aggregation.			
Note 8:	E-UTRA operating band groups are as defined in Section 3.5.			
Note 9:	For Band 74, the tests shall be performed with the carrier frequency of the assigned E-UTRA channel bandwidth within 1475.9-1510.9 MHz.			

Table A.9.1.46.2-2: 4 DL FDD RSRP carrier aggregation test parameters for cell 4 and cell 5

Parameter	Unit	Cell 4	Cell 5
E-UTRA RF Channel Number		3	
BW _{channel}	MHz	5MHz: N _{RB,c} = 25 10MHz: N _{RB,c} = 50 20MHz: N _{RB,c} = 100	
Measurement bandwidth	n_{PRB}	5MHz: 10-15 10MHz: 22-27 20MHz: 47-52	
PDSCH Reference measurement channel defined in A.3.1.1.1		5MHz: R.5 FDD 10MHz: R.0 FDD 20MHz: R.4 FDD	-
PDSCH allocation	n_{PRB}	5MHz: 7-17 10MHz: 13-36 20MHz: 38-61	-
PDCCH/PCFICH/PHICH Reference measurement channel defined in A.3.1.2.1		5MHz: R.11 FDD 10MHz: R.6 FDD 20MHz: R.10 FDD	5MHz: R.11 FDD 10MHz: R.6 FDD 20MHz: R.10 FDD
OCNG Patterns defined in A.3.2.1		5MHz: OP.15 FDD 10MHz: OP.1 FDD 20MHz: OP.11 FDD	5MHz: OP.16 FDD 10MHz: OP.2 FDD 20MHz: OP.12 FDD
PBCH_RA	dB	0	0
PBCH_RB			
PSS_RA			
SSS_RA			
PCFICH_RB			
PHICH_RA			
PHICH_RB			
PDCCH_RA			
PDCCH_RB			
PDSCH_RA			
PDSCH_RB			
OCNG_RA ^{Note1}			
OCNG_RB ^{Note1}			
N_{oc} ^{Note2}			
	Bands FDD_B1, FDD_B2 ^{Note 9}		
	Bands FDD_C		

	Bands FDD_D			
	Bands FDD_E, FDD_F ^{Note 6}			
	Bands FDD_G			
	Bands FDD_H			
\hat{E}_s / N_{oc}		dB	3	-1
\hat{E}_s / I_{ot}		dB	0.46	-5.76
RSRP ^{Note3}	Bands FDD_A	dBm/ 15kHz	(RSRP for Cell 1 +8dB)	(RSRP for Cell 1 +4dB)
	Bands FDD_B1, FDD_B2 ^{Note 9}			
	Bands FDD_C			
	Bands FDD_D			
	Bands FDD_E, FDD_F ^{Note 6}			
	Bands FDD_G			
	Bands FDD_H			
I _o ^{Note3}	Bands FDD_A	dBm/ BW _{channel}	(I _o for Channel 1 +5.33dB +10log (N _{RB channel3} / N _{RB channel 1}))	
	Bands FDD_B1, FDD_B2 ^{Note 9}			
	Bands FDD_C			
	Bands FDD_D			
	Bands FDD_E, FDD_F ^{Note 6}			
	Bands FDD_G			
	Bands FDD_H			
Propagation Condition			AWGN	AWGN
Antenna Configuration			1x2	1x2
Timing offset to Cell 1		μs	0	3
Time alignment error relative to cell 1 ^{Note 7}			≤ TAE	-
Time alignment error relative to cell 2 ^{Note 7}			≤ TAE	-
<p>Note 1: OCNG shall be used such that both cells are fully allocated and a constant total transmitted power spectral density is achieved for all OFDM symbols.</p> <p>Note 2: Interference from other cells and noise sources not specified in the test is assumed to be constant over subcarriers and time and shall be modelled as AWGN of appropriate power for N_{oc} to be fulfilled.</p> <p>Note 3: RSRP and I_o levels have been derived from other parameters for information purposes. They are not settable parameters themselves.</p> <p>Note 4: RSRP minimum requirements are specified assuming independent interference and noise at each receiver antenna port.</p> <p>Note 5: The selection of the bands for testing depends on the configuration of the carrier aggregation supported by the UEs.</p> <p>Note 6: For Band 26, the tests shall be performed with the carrier frequency of the assigned E-UTRA channel bandwidth within 865-894 MHz.</p> <p>Note 7: Time alignment error (TAE) as specified in TS 36.104 [30] clause 6.5.3.1. The TAE value depends upon the type of carrier aggregation.</p> <p>Note 8: E-UTRA operating band groups are as defined in Section 3.5.</p> <p>Note 9: For Band 74, the tests shall be performed with the carrier frequency of the assigned E-UTRA channel bandwidth within 1475.9-1510.9 MHz.</p>				

Table A.9.1.46.2-3: 4 DL FDD RSRP carrier aggregation test parameters for cell 6 and cell 7

Parameter	Unit	Cell 6	Cell 7
E-UTRA RF Channel Number		4	
BW _{channel}	MHz	5MHz: N _{RB,c} = 25 10MHz: N _{RB,c} = 50 20MHz: N _{RB,c} = 100	

Measurement bandwidth	n_{PRB}	5MHz: 10-15 10MHz: 22-27 20MHz: 47-52		
PDSCH Reference measurement channel defined in A.3.1.1.1		5MHz: R.5 FDD 10MHz: R.0 FDD 20MHz: R.4 FDD	-	
PDSCH allocation	n_{PRB}	5MHz: 7-17 10MHz: 13-36 20MHz: 38-61	-	
PDCCH/PCFICH/PHICH Reference measurement channel defined in A.3.1.2.1		5MHz: R.11 FDD 10MHz: R.6 FDD 20MHz: R.10 FDD	5MHz: R.11 FDD 10MHz: R.6 FDD 20MHz: R.10 FDD	
OCNG Patterns defined in A.3.2.1		5MHz: OP.15 FDD 10MHz: OP.1 FDD 20MHz: OP.11 FDD	5MHz: OP.16 FDD 10MHz: OP.2 FDD 20MHz: OP.12 FDD	
PBCH_RA	dB	0	0	
PBCH_RB				
PSS_RA				
SSS_RA				
PCFICH_RB				
PHICH_RA				
PHICH_RB				
PDCCH_RA				
PDCCH_RB				
PDSCH_RA				
PDSCH_RB				
OCNG_RA ^{Note1}				
OCNG_RB ^{Note1}				
N_{oc} ^{Note2}				Bands FDD_A
	Bands FDD_B1, FDD_B2 ^{Note 9}			
	Bands FDD_C			
	Bands FDD_D			
	Bands FDD_E, FDD_F ^{Note 6}			
	Bands FDD_G			
	Bands FDD_H			
\hat{E}_s / N_{oc}	dB	3	-1	
\hat{E}_s / I_{ot}	dB	0.46	-5.76	
RSRP ^{Note3}	Bands FDD_A	dBm/ 15kHz	(RSRP for Cell 1 +8dB)	(RSRP for Cell 1 +4dB)
	Bands FDD_B1, FDD_B2 ^{Note 9}			
	Bands FDD_C			
	Bands FDD_D			
	Bands FDD_E, FDD_F ^{Note 6}			
	Bands FDD_G			
	Bands FDD_H			
I_o ^{Note3}	Bands FDD_A	dBm/ BW _{channel}	$(I_o$ for Channel 1 +5.33dB +10log($N_{RB channel3} / N_{RB channel1}$))	
	Bands FDD_B1, FDD_B2 ^{Note 9}			
	Bands FDD_C			
	Bands FDD_D			
	Bands FDD_E, FDD_F ^{Note 6}			
	Bands FDD_G			
	Bands FDD_H			
Propagation Condition		AWGN	AWGN	
Antenna Configuration		1x2	1x2	
Timing offset to Cell 1	μ s	0	3	

Time alignment error relative to cell 1 ^{Note 7}		≤ TAE	-
Time alignment error relative to cell 2 ^{Note 7}		≤ TAE	-
Time alignment error relative to cell 4 ^{Note 7}		≤ TAE	-
<p>Note 1: OCNG shall be used such that both cells are fully allocated and a constant total transmitted power spectral density is achieved for all OFDM symbols.</p> <p>Note 2: Interference from other cells and noise sources not specified in the test is assumed to be constant over subcarriers and time and shall be modelled as AWGN of appropriate power for N_{oc} to be fulfilled.</p> <p>Note 3: RSRP and I_0 levels have been derived from other parameters for information purposes. They are not settable parameters themselves.</p> <p>Note 4: RSRP minimum requirements are specified assuming independent interference and noise at each receiver antenna port.</p> <p>Note 5: The selection of the bands for testing depends on the configuration of the carrier aggregation supported by the UEs.</p> <p>Note 6: For Band 26, the tests shall be performed with the carrier frequency of the assigned E-UTRA channel bandwidth within 865-894 MHz.</p> <p>Note 7: Time alignment error (TAE) as specified in TS 36.104 [30] clause 6.5.3.1. The TAE value depends upon the type of carrier aggregation.</p> <p>Note 8: E-UTRA operating band groups are as defined in Section 3.5.</p> <p>Note 9: For Band 74, the tests shall be performed with the carrier frequency of the assigned E-UTRA channel bandwidth within 1475.9-1510.9 MHz.</p>			

A.9.1.46.3 Test Requirements

In the test, the performance of RSRP measurements is verified from the following 10 perspectives:

- The absolute accuracy of intra-frequency RSRP measurements for Cell 1 on the primary component carrier shall fulfil the requirements defined in clause 9.1.11.1.
- The absolute accuracy of intra-frequency RSRP measurements for Cell 2 on SCC1 shall fulfil the requirements defined in clause 9.1.11.2.
- The absolute accuracy of intra-frequency RSRP measurements for Cell 4 on SCC2 shall fulfil the requirements defined in clause 9.1.11.2.
- The absolute accuracy of intra-frequency RSRP measurements for Cell 6 on SCC3 shall fulfil the requirements defined in clause 9.1.11.2.
- The relative accuracy of intra-frequency RSRP measurements for Cell 3 relative to Cell 2 on SCC1 shall fulfil the requirements defined in clause 9.1.11.2.
- The relative accuracy of intra-frequency RSRP measurements for Cell 5 relative to Cell 4 on SCC2 shall fulfil the requirements defined in clause 9.1.11.2.
- The relative accuracy of intra-frequency RSRP measurements for Cell 7 relative to Cell 6 on SCC3 shall fulfil the requirements defined in clause 9.1.11.2.
- The relative accuracy of inter-frequency RSRP measurements between SCC1 and the primary component carriers for Cell 2 relative to Cell 1 shall fulfil the requirements defined in clause 9.1.11.3.
- The relative accuracy of inter-frequency RSRP measurements between SCC2 and the primary component carriers for Cell 4 relative to Cell 1 shall fulfil the requirements defined in clause 9.1.11.3.
- The relative accuracy of inter-frequency RSRP measurements between SCC3 and the primary component carriers for Cell 6 relative to Cell 1 shall fulfil the requirements defined in clause 9.1.11.3.

A.9.1.47 4 DL TDD RSRP for E-UTRAN in Carrier Aggregation

A.9.1.47.1 Test Purpose and Environment

The purpose of this test is to verify that the RSRP absolute and relative accuracy requirements in TDD-TDD carrier aggregation are within the specified limits. This test will verify the absolute RSRP accuracy requirements of the primary component carrier defined in clause 9.1.11.1, the absolute RSRP accuracy requirements of the secondary component carriers defined in clause 9.1.11.2, and the relative RSRP accuracy requirements of the secondary component carriers defined in clause 9.1.11.2. The test will also verify the primary and secondary component carriers' relative RSRP accuracy requirement defined in Clause 9.1.11.3.

A.9.1.47.2 Test parameters

In this set of test cases cell 1 is PCell on the primary component carrier, and cell 2, cell 4 and cell 6 are activated SCells on secondary component carriers SCC1, SCC2 and SCC3 respectively. Cell 3, cell 5 and cell 7 are neighbouring cells on secondary component carriers SCC1, SCC2 and SCC3 respectively. The test parameters are given in Table A.9.1.47.2-1, Table A.9.1.47.2-2 and Table A.9.1.47.2-3.

Table A.9.1.47.2-1: 4 DL TDD RSRP carrier aggregation test parameters for cell 1, cell 2 and cell 3

Parameter	Unit	Cell 1	Cell 2	Cell 3
E-UTRA RF Channel Number		1	2	
BW _{channel}		5MHz: N _{RB,c} = 25 10MHz: N _{RB,c} = 50 20MHz: N _{RB,c} = 100	5MHz: N _{RB,c} = 25 10MHz: N _{RB,c} = 50 20MHz: N _{RB,c} = 100	
Special subframe configuration ^{Note1}		6		
Uplink/downlink configuration ^{Note1}		1		
Measurement bandwidth	n_{PRB}	5MHz: 10-15 10MHz: 22-27 20MHz: 47-52	5MHz: 10-15 10MHz: 22-27 20MHz: 47-52	
PDSCH Reference measurement channel defined in A.3.1.1.2		5MHz: R.4 TDD 10MHz: R.0 TDD 20MHz: R.3 TDD	5MHz: R.4 TDD 10MHz: R.0 TDD 20MHz: R.3 TDD	-
PDSCH allocation	n_{PRB}	5MHz: 7-17 10MHz: 13-36 20MHz: 38-61	5MHz: 7-17 10MHz: 13-36 20MHz: 38-61	-
PDCCH/PCFICH/PHICH Reference measurement channel defined in A.3.1.2.2		5MHz: R.11 TDD 10MHz: R.6 TDD 20MHz: R.10 TDD	5MHz: R.11 TDD 10MHz: R.6 TDD 20MHz: R.10 TDD	5MHz: R.11 TDD 10MHz: R.6 TDD 20MHz: R.10 TDD
OCNG Patterns defined in A.3.2.2		5MHz: OP.9 TDD 10MHz: OP.1 TDD 20MHz: OP.7 TDD	5MHz: OP.9 TDD 10MHz: OP.1 TDD 20MHz: OP.7 TDD	5MHz: OP.10 TDD 10MHz: OP.2 TDD 20MHz: OP.8 TDD
PBCH_RA	dB	0	0	0
PBCH_RB				
PSS_RA				
SSS_RA				
PCFICH_RB				
PHICH_RA				
PHICH_RB				
PDCCH_RA				
PDCCH_RB				
PDSCH_RA				
PDSCH_RB				
OCNG_RA ^{Note2}				
OCNG_RB ^{Note2}				
N_{oc} ^{Note3}				
	Bands TDD_C	-116		
	Bands TDD_E	-115		
\hat{E}_s/N_{oc}	dB	-4	3	-1
\hat{E}_s/I_{ot}	dB	-4	0.46	-5.76

RSRP ^{Note4}	Bands TDD_A	dBm/ 15kHz	-121	(RSRP for Cell 1 +8dB)	(RSRP for Cell 1 +4dB)
	Bands TDD_C		-120		
	Bands TDD_E		-119		
I _o ^{Note4}	Bands TDD_A	dBm/ BW _{channel}	-87.76 + 10log(N _{RB,c} /50)	(I _o for Channel 1 +5.33dB +10log (N _{RB channel2} / N _{RB channel 1}))	
	Bands TDD_C		-86.76 + 10log(N _{RB,c} /50)		
	Bands TDD_E		-85.76 + 10log(N _{RB,c} /50)		
Propagation Condition			AWGN	AWGN	AWGN
Antenna Configuration			1x2	1x2	1x2
Timing offset to Cell 1		μs	-	0	3
Time alignment error relative to cell 1 ^{Note 7}			-	≤ TAE	-
<p>Note 1: For special subframe and uplink-downlink configurations see Tables 4.2-1 and 4.2-2 in TS 36.211.</p> <p>Note 2: OCNB shall be used such that both cells are fully allocated and a constant total transmitted power spectral density is achieved for all OFDM symbols.</p> <p>Note 3: Interference from other cells and noise sources not specified in the test is assumed to be constant over subcarriers and time and shall be modelled as AWGN of appropriate power for N_{oc} to be fulfilled.</p> <p>Note 4: RSRP and I_o levels have been derived from other parameters for information purposes. They are not settable parameters themselves.</p> <p>Note 5: RSRP minimum requirements are specified assuming independent interference and noise at each receiver antenna port.</p> <p>Note 6: The selection of the bands for testing depends on the configuration of the carrier aggregation supported by the UEs.</p> <p>Note 7: Time alignment error (TAE) as specified in TS 36.104 [30] clause 6.5.3.1. The TAE value depends upon the type of carrier aggregation.</p> <p>Note 8: E-UTRA operating band groups are as defined in Section 3.5.</p>					

Table A.9.1.47.2-2: 4 DL TDD RSRP carrier aggregation test parameters for cell 4 and cell 5

Parameter	Unit	Cell 4	Cell 5
E-UTRA RF Channel Number		3	
BW _{channel}	MHz	5MHz: N _{RB,c} = 25 10MHz: N _{RB,c} = 50 20MHz: N _{RB,c} = 100	
Special subframe configuration ^{Note1}		6	
Uplink/downlink configuration ^{Note1}		1	
Measurement bandwidth	n_{PRB}	5MHz: 10-15 10MHz: 22-27 20MHz: 47-52	
PDSCH Reference measurement channel defined in A.3.1.1.2		5MHz: R.4 TDD 10MHz: R.0 TDD 20MHz: R.3 TDD	N/A
PDSCH allocation	n_{PRB}	5MHz: 7-17 10MHz: 13-36 20MHz: 38-61	N/A
PDCCH/PCFICH/PHICH Reference measurement channel defined in A.3.1.2.2		5MHz: R.11 TDD 10MHz: R.6 TDD 20MHz: R.10 TDD	5MHz: R.11 TDD 10MHz: R.6 TDD 20MHz: R.10 TDD
OCNB Patterns defined in A.3.2.2		5MHz: OP.9 TDD 10MHz: OP.1 TDD 20MHz: OP.7 TDD	5MHz: OP.10 TDD 10MHz: OP.2 TDD 20MHz: OP.8 TDD
PBCH_RA	dB	0	0
PBCH_RB			
PSS_RA			
SSS_RA			

PCFICH_RB				
PHICH_RA				
PHICH_RB				
PDCCH_RA				
PDCCH_RB				
PDSCH_RA				
PDSCH_RB				
OCNG_RA ^{Note2}				
OCNG_RB ^{Note2}				
N_{oc} ^{Note3}	Bands TDD_A	dBm/ 15kHz	$(N_{oc}$ for Channel 1 +1dB)	
	Bands TDD_C			
	Bands TDD_E			
\hat{E}_s / N_{oc}		dB	3	-1
\hat{E}_s / I_{ot}		dB	0.46	-5.76
RSRP ^{Note4}	Bands TDD_A	dBm/ 15kHz	(RSRP for Cell 1 +8dB)	(RSRP for Cell 1 +4dB)
	Bands TDD_C			
	Bands TDD_E			
I _o ^{Note4}	Bands TDD_A	dBm/ BW _{channel}	(I _o for Channel 1 +5.33dB +10log (N _{RB channel3} / N _{RB channel 1}))	
	Bands TDD_C			
	Bands TDD_E			
Propagation Condition			AWGN	AWGN
Antenna Configuration			1x2	1x2
Timing offset to Cell 1		μs	0	3
Time alignment error relative to cell 1 ^{Note 7}			≤ TAE	-
Time alignment error relative to cell 2 ^{Note 7}			≤ TAE	
<p>Note 1: For special subframe and uplink-downlink configurations see Tables 4.2-1 and 4.2-2 in TS 36.211.</p> <p>Note 2: OCNG shall be used such that both cells are fully allocated and a constant total transmitted power spectral density is achieved for all OFDM symbols.</p> <p>Note 3: Interference from other cells and noise sources not specified in the test is assumed to be constant over subcarriers and time and shall be modelled as AWGN of appropriate power for N_{oc} to be fulfilled.</p> <p>Note 4: RSRP and I_o levels have been derived from other parameters for information purposes. They are not settable parameters themselves.</p> <p>Note 5: RSRP minimum requirements are specified assuming independent interference and noise at each receiver antenna port.</p> <p>Note 6: The selection of the bands for testing depends on the configuration of the carrier aggregation supported by the UEs.</p> <p>Note 7: Time alignment error (TAE) as specified in TS 36.104 [30] clause 6.5.3.1. The TAE value depends upon the type of carrier aggregation.</p> <p>Note 8: E-UTRA operating band groups are as defined in Section 3.5.</p>				

Table A.9.1.47.2-3: 4 DL TDD RSRP carrier aggregation test parameters for cell 6 and cell 7

Parameter	Unit	Cell 6	Cell 7
E-UTRA RF Channel Number		4	
BW _{channel}	MHz	5MHz: N _{RB,c} = 25 10MHz: N _{RB,c} = 50 20MHz: N _{RB,c} = 100	
Special subframe configuration ^{Note1}		6	
Uplink/downlink configuration ^{Note1}		1	
Measurement bandwidth	n_{PRB}	5MHz: 10-15 10MHz: 22-27 20MHz: 47-52	
PDSCH Reference measurement channel defined in A.3.1.1.2		5MHz: R.4 TDD 10MHz: R.0 TDD	N/A

		20MHz: R.3 TDD	
PDSCH allocation	n_{PRB}	5MHz: 7-17 10MHz: 13-36 20MHz: 38-61	N/A
PDCCH/PCFICH/PHICH Reference measurement channel defined in A.3.1.2.2		5MHz: R.11 TDD 10MHz: R.6 TDD 20MHz: R.10 TDD	5MHz: R.11 TDD 10MHz: R.6 TDD 20MHz: R.10 TDD
OCNG Patterns defined in A.3.2.2		5MHz: OP.9 TDD 10MHz: OP.1 TDD 20MHz: OP.7 TDD	5MHz: OP.10 TDD 10MHz: OP.2 TDD 20MHz: OP.8 TDD
PBCH_RA	dB	0	0
PBCH_RB			
PSS_RA			
SSS_RA			
PCFICH_RB			
PHICH_RA			
PHICH_RB			
PDCCH_RA			
PDCCH_RB			
PDSCH_RA			
PDSCH_RB			
OCNG_RA ^{Note2}			
OCNG_RB ^{Note2}			
N_{oc} ^{Note3}			
\hat{E}_s / N_{oc}		dB	3 -1
\hat{E}_s / I_{ot}		dB	0.46 -5.76
RSRP ^{Note4}	Bands TDD_A Bands TDD_C Bands TDD_E	dBm/ 15kHz	(RSRP for Cell 1 +8dB) (RSRP for Cell 1 +4dB)
I_o ^{Note4}	Bands TDD_A Bands TDD_C Bands TDD_E	dBm/ BW _{channel}	(I_o for Channel 1 +5.33dB +10log ($N_{RB \text{ channel}3} / N_{RB \text{ channel}1}$))
Propagation Condition			AWGN AWGN
Antenna Configuration			1x2 1x2
Timing offset to Cell 1	μ s		0 3
Time alignment error relative to cell 1 ^{Note 7}			\leq TAE -
Time alignment error relative to cell 2 ^{Note 7}			\leq TAE
Time alignment error relative to cell 4 ^{Note 7}			\leq TAE
<p>Note 1: For special subframe and uplink-downlink configurations see Tables 4.2-1 and 4.2-2 in TS 36.211.</p> <p>Note 2: OCNG shall be used such that both cells are fully allocated and a constant total transmitted power spectral density is achieved for all OFDM symbols.</p> <p>Note 3: Interference from other cells and noise sources not specified in the test is assumed to be constant over subcarriers and time and shall be modelled as AWGN of appropriate power for N_{oc} to be fulfilled.</p> <p>Note 4: RSRP and I_o levels have been derived from other parameters for information purposes. They are not settable parameters themselves.</p> <p>Note 5: RSRP minimum requirements are specified assuming independent interference and noise at each receiver antenna port.</p>			

Note 6:	The selection of the bands for testing depends on the configuration of the carrier aggregation supported by the UEs.
Note 7:	Time alignment error (TAE) as specified in TS 36.104 [30] clause 6.5.3.1. The TAE value depends upon the type of carrier aggregation.
Note 8:	E-UTRA operating band groups are as defined in Section 3.5.

A.9.1.47.3 Test Requirements

In the test, the performance of RSRP measurements is verified from the following 10 perspectives:

- The absolute accuracy of intra-frequency RSRP measurements for Cell 1 on the primary component carrier shall fulfil the requirements defined in clause 9.1.11.1.
- The absolute accuracy of intra-frequency RSRP measurements for Cell 2 on SCC1 shall fulfil the requirements defined in clause 9.1.11.2.
- The absolute accuracy of intra-frequency RSRP measurements for Cell 4 on SCC2 shall fulfil the requirements defined in clause 9.1.11.2.
- The absolute accuracy of intra-frequency RSRP measurements for Cell 6 on SCC3 shall fulfil the requirements defined in clause 9.1.11.2.
- The relative accuracy of intra-frequency RSRP measurements for Cell 3 relative to Cell 2 on SCC1 shall fulfil the requirements defined in clause 9.1.11.2.
- The relative accuracy of intra-frequency RSRP measurements for Cell 5 relative to Cell 4 on SCC2 shall fulfil the requirements defined in clause 9.1.11.2.
- The relative accuracy of intra-frequency RSRP measurements for Cell 7 relative to Cell 6 on SCC3 shall fulfil the requirements defined in clause 9.1.11.2.
- The relative accuracy of inter-frequency RSRP measurements between SCC1 and the primary component carriers for Cell 2 relative to Cell 1 shall fulfil the requirements defined in clause 9.1.11.3.
- The relative accuracy of inter-frequency RSRP measurements between SCC2 and the primary component carriers for Cell 4 relative to Cell 1 shall fulfil the requirements defined in clause 9.1.11.3.
- The relative accuracy of inter-frequency RSRP measurements between SCC3 and the primary component carriers for Cell 6 relative to Cell 1 shall fulfil the requirements defined in clause 9.1.11.3.

A.9.1.48 5 DL FDD-TDD with PCell in FDD RSRP for E-UTRAN in Carrier Aggregation

A.9.1.48.1 Test Purpose and Environment

The purpose of this test is to verify that the TDD-FDD RSRP absolute and relative accuracy requirements in carrier aggregation with PCell in FDD are within the specified limits. This test will verify the absolute RSRP accuracy requirements of the primary component carrier defined in clause 9.1.11.1, the absolute RSRP accuracy requirements of the secondary component carriers defined in clause 9.1.11.2, and the relative RSRP accuracy requirements of the secondary component carriers defined in clause 9.1.11.2. The test will also verify the primary and secondary component carriers' relative RSRP accuracy requirement defined in Clause 9.1.11.3.

A.9.1.48.2 Test parameters

In this set of test cases cell 1 is PCell on the primary component carrier, and cell 2, cell 4, cell 6 and cell 8 are activated SCells on secondary component carriers SCC1, SCC2, SCC3 and SCC4 respectively. Cell 3, cell 5, cell 7 and cell 9 are neighbouring cells on secondary component carriers SCC1, SCC2, SCC3 and SCC4 respectively. The test parameters are given in Table A.9.1.48.2-1, Table A.9.1.48.2-2 and Table A.9.1.48.2-3.

Table A.9.1.48.2-1: 5 Downlink PCell in FDD RSRP carrier aggregation test parameters for cell 1, cell 2, cell 3, cell 4 and cell 5

Parameter	Unit	Cell 1	Cell 2	Cell 3	Cell 4	Cell 5
-----------	------	--------	--------	--------	--------	--------

E-UTRA RF Channel Number			1	2		3	
$BW_{channel}$	MHz		5MHz: $N_{RB,c} = 25$ 10MHz: $N_{RB,c} = 50$ 20MHz: $N_{RB,c} = 100$	5MHz: $N_{RB,c} = 25$ 10MHz: $N_{RB,c} = 50$ 20MHz: $N_{RB,c} = 100$		5MHz: $N_{RB,c} = 25$ 10MHz: $N_{RB,c} = 50$ 20MHz: $N_{RB,c} = 100$	
Special subframe configuration ^{Note1}			-	6		6	
Uplink/downlink configuration ^{Note1}			-	1		1	
Measurement bandwidth	n_{PRB}		5MHz: 10-15 10MHz: 22-27 20MHz: 47-52	5MHz: 10-15 10MHz: 22-27 20MHz: 47-52		5MHz: 10-15 10MHz: 22-27 20MHz: 47-52	
PDSCH Reference measurement channel defined in A.3.1.1.			5MHz: R.5 FDD 10MHz: R.0 FDD 20MHz: R.4 FDD	5MHz: R.4 TDD 10MHz: R.0 TDD 20MHz: R.3 TDD	-	5MHz: R.4 TDD 10MHz: R.0 TDD 20MHz: R.3 TDD	-
PDSCH allocation	n_{PRB}		5MHz: 7-17 10MHz: 13-36 20MHz: 38-61	5MHz: 7-17 10MHz: 13-36 20MHz: 38-61	-	5MHz: 7-17 10MHz: 13-36 20MHz: 38-61	-
PDCCH/PCFICH/PHICH Reference measurement channel defined in A.3.1.2.			5MHz: R.11 FDD 10MHz: R.6 FDD 20MHz: R.10 FDD	5MHz: R.11 TDD 10MHz: R.6 TDD 20MHz: R.10 TDD	5MHz: R.11 TDD 10MHz: R.6 TDD 20MHz: R.10 TDD	5MHz: R.11 TDD 10MHz: R.6 TDD 20MHz: R.10 TDD	5MHz: R.11 TDD 10MHz: R.6 TDD 20MHz: R.10 TDD
OCNG Patterns defined in A.3.2.			5MHz: OP.15 FDD 10MHz: OP.1 FDD 20MHz: OP.11 FDD	5MHz: OP.9 TDD 10MHz: OP.1 TDD 20MHz: OP.7 TDD	5MHz: OP.10 TDD 10MHz: OP.2 TDD 20MHz: OP.8 TDD	5MHz: OP.7 TDD 10MHz: OP.1 TDD 20MHz: OP.7 TDD	5MHz: OP.10 TDD 10MHz: OP.2 TDD 20MHz: OP.8 TDD
PBCH_RA	dB	0	0	0	0	0	0
PBCH_RB							
PSS_RA							
SSS_RA							
PCFICH_RB							
PHICH_RA							
PHICH_RB							
PDCCH_RA							
PDCCH_RB							
PDSCH_RA							
PDSCH_RB							
OCNG_RA ^{Note2}							
OCNG_RB ^{Note2}							
N_{oc} ^{Note3}							
	Bands TDD_C						
	Bands TDD_E						
	Bands FDD_A						
			-117	-	-	-	

	Bands FDD_B1, FDD_B2 ^{Note 10}		-116.5				
	Bands FDD_C		-116				
	Bands FDD_D		-115.5				
	Bands FDD_E, FDD_F ^{Note 7}		-115				
	Bands FDD_G		-114				
	Bands FDD_H		-113.5				
\hat{E}_s/N_{oc}		dB	-4	3	-1	3	-1
\hat{E}_s/I_{ot}		dB	-4	0.46	-5.76	0.46	-5.76
RSRP ^{Note 4}	Bands TDD_A	dBm/15 kHz	-	(RSRP for Cell 1 +8dB)	(RSRP for Cell 1 +4dB)	(RSRP for Cell 1 +8dB)	(RSRP for Cell 1 +4dB)
	Bands TDD_C						
	Bands TDD_E						
	Bands FDD_A			-121			
	Bands FDD_B1, FDD_B2 ^{Note 10}			-120.5			
	Bands FDD_C			-120			
	Bands FDD_D			-119.5			
	Bands FDD_E, FDD_F ^{Note 7}			-119			
	Bands FDD_G			-118			
	Bands FDD_H			-117.5			
I_o ^{Note 4}	Bands TDD_A	dBm/ BW _{channel}	-	(I _o for Channel 1 +5.33dB +10log (N _{RB channel2} / N _{RB channel 1}))		(I _o for Channel 1 +5.33dB +10log (N _{RB channel3} / N _{RB channel 1}))	
	Bands TDD_C						
	Bands TDD_E						
	Bands FDD_A			87.76+10log(N _{RB,c} /50)			
	Bands FDD_B1, FDD_B2 ^{Note 10}			87.26+10log(N _{RB,c} /50)			
	Bands FDD_C			86.76+10log(N _{RB,c} /50)			
	Bands FDD_D			86.26+10log(N _{RB,c} /50)			
	Bands FDD_E, FDD_F ^{Note 7}			-85.76 +10log(N _{RB,c} /50)			
	Bands FDD_G			-84.76 +10log(N _{RB,c} /50)			
	Bands FDD_H			-84.26 +10log(N _{RB,c} /50)			
Propagation condition		-	AWGN	AWGN	AWGN	AWGN	AWGN
Antenna Configuration		-	1x2	1x2	1x2	1x2	1x2

Timing offset to cell 1	μs	-	0	3	0	3
Time alignment error relative to cell 1 ^{Note 8}		-	$\leq \text{TAE}$	-	$\leq \text{TAE}$	-
Time alignment error relative to cell 2 ^{Note 8}		-	-	-	$\leq \text{TAE}$	-
<p>Note 1: For special subframe and uplink-downlink configurations see Tables 4.2-1 and 4.2-2 in TS 36.211.</p> <p>Note 2: OCNG shall be used such that all cells are fully allocated and a constant total transmitted power spectral density is achieved for all OFDM symbols.</p> <p>Note 3: Interference from other cells and noise sources not specified in the test is assumed to be constant over subcarriers and time and shall be modelled as AWGN of appropriate power for N_{oc} to be fulfilled.</p> <p>Note 4: RSRP and Io levels have been derived from other parameters for information purposes. They are not settable parameters themselves.</p> <p>Note 5: RSRP minimum requirements are specified assuming independent interference and noise at each receiver antenna port.</p> <p>Note 6: The selection of the bands for testing depends on the configuration of the carrier aggregation supported by the UEs.</p> <p>Note 7: For Band 26, the tests shall be performed with the carrier frequency of the assigned E-UTRA channel bandwidth within 865-894 MHz.</p> <p>Note 8: Time alignment error (TAE) as specified in TS 36.104 [30] clause 6.5.3.1. The TAE value depends upon the type of carrier aggregation.</p> <p>Note 9: E-UTRA operating band groups are as defined in Section 3.5.</p> <p>Note 10: For Band 74, the tests shall be performed with the carrier frequency of the assigned E-UTRA channel bandwidth within 1475.9-1510.9 MHz.</p>						

Table A.9.1.48.2-2: 5 Downlink PCell in FDD RSRP carrier aggregation test parameters for cell 6 and cell 7

Parameter	Unit	Cell 6	Cell 7
E-UTRA RF Channel Number		4	
BW _{channel}	MHz	5MHz: N _{RB,c} = 25 10MHz: N _{RB,c} = 50 20MHz: N _{RB,c} = 100	
Special subframe configuration ^{Note 1}		6	
Uplink/downlink configuration ^{Note 1}		1	
Measurement bandwidth	n_{PRB}	5MHz: 10-15 10MHz: 22-27 20MHz: 47-52	
PDSCH Reference measurement channel defined in A.3.1.1.2		5MHz: R.4 TDD 10MHz: R.0 TDD 20MHz: R.3 TDD	N/A
PDSCH allocation	n_{PRB}	5MHz: 7-17 10MHz: 13-36 20MHz: 38-61	
PDCCH/PCFICH/PHICH Reference measurement channel defined in A.3.1.2.2		5MHz: R.11 TDD 10MHz: R.6 TDD 20MHz: R.10 TDD	5MHz: R.11 TDD 10MHz: R.6 TDD 20MHz: R.10 TDD
OCNG Patterns defined in A.3.2.2		5MHz: OP.9 TDD 10MHz: OP.1 TDD 20MHz: OP.7 TDD	5MHz: OP.10 TDD 10MHz: OP.2 TDD 20MHz: OP.8 TDD
PBCH_RA	dB	0	0
PBCH_RB			
PSS_RA			
SSS_RA			
PCFICH_RB			
PHICH_RA			

PHICH_RB				
PDCCH_RA				
PDCCH_RB				
PDSCH_RA				
PDSCH_RB				
OCNG_RA ^{Note2}				
OCNG_RB ^{Note2}				
N_{oc} ^{Note3}	Bands TDD_A	dBm/ 15kHz	$(N_{oc}$ for Channel 1 +1dB)	
	Bands TDD_C			
	Bands TDD_E			
\hat{E}_s/N_{oc}		dB	3	-1
\hat{E}_s/I_{ot}		dB	0.46	-5.76
RSRP ^{Note4}	Bands TDD_A	dBm/ 15kHz	(RSRP for Cell 1 +8dB)	(RSRP for Cell 1 +4dB)
	Bands TDD_C			
	Bands TDD_E			
I_o ^{Note4}	Bands TDD_A	dBm/ $BW_{channel}$	$(I_o$ for Channel 1 +5.33dB +10log ($N_{RB,channel3} / N_{RB,channel1}$))	
	Bands TDD_C			
	Bands TDD_E			
Propagation Condition			AWGN	AWGN
Antenna Configuration			1x2	1x2
Timing offset to Cell 1		μ s	0	3
Time alignment error relative to cell 1 ^{Note 7}			\leq TAE	-
Time alignment error relative to cell 2 ^{Note 7}			\leq TAE	
Time alignment error relative to cell 4 ^{Note 7}			\leq TAE	
<p>Note 1: For special subframe and uplink-downlink configurations see Tables 4.2-1 and 4.2-2 in TS 36.211.</p> <p>Note 2: OCNG shall be used such that both cells are fully allocated and a constant total transmitted power spectral density is achieved for all OFDM symbols.</p> <p>Note 3: Interference from other cells and noise sources not specified in the test is assumed to be constant over subcarriers and time and shall be modelled as AWGN of appropriate power for N_{oc} to be fulfilled.</p> <p>Note 4: RSRP and I_o levels have been derived from other parameters for information purposes. They are not settable parameters themselves.</p> <p>Note 5: RSRP minimum requirements are specified assuming independent interference and noise at each receiver antenna port.</p> <p>Note 6: The selection of the bands for testing depends on the configuration of the carrier aggregation supported by the UEs.</p> <p>Note 7: Time alignment error (TAE) as specified in TS 36.104 [30] clause 6.5.3.1. The TAE value depends upon the type of carrier aggregation.</p> <p>Note 8: E-UTRA operating band groups are as defined in Section 3.5.</p>				

Table A.9.1.48.2-3: 5 Downlink PCell in FDD RSRP carrier aggregation test parameters for cell 8 and cell 9

Parameter	Unit	Cell 8	Cell 9
E-UTRA RF Channel Number		5	
$BW_{channel}$	MHz	5MHz: $N_{RB,c} = 25$ 10MHz: $N_{RB,c} = 50$ 20MHz: $N_{RB,c} = 100$	
Special subframe configuration ^{Note1}		6	
Uplink/downlink configuration ^{Note1}		1	
Measurement bandwidth	n_{PRB}	5MHz: 10-15 10MHz: 22-27 20MHz: 47-52	

PDSCH Reference measurement channel defined in A.3.1.1.2		5MHz: R.4 TDD 10MHz: R.0 TDD 20MHz: R.3 TDD	N/A
PDSCH allocation	n_{PRB}	5MHz: 7-17 10MHz: 13-36 20MHz: 38-61	N/A
PDCCH/PCFICH/PHICH Reference measurement channel defined in A.3.1.2.2		5MHz: R.11 TDD 10MHz: R.6 TDD 20MHz: R.10 TDD	5MHz: R.11 TDD 10MHz: R.6 TDD 20MHz: R.10 TDD
OCNG Patterns defined in A.3.2.2		5MHz: OP.9 TDD 10MHz: OP.1 TDD 20MHz: OP.7 TDD	5MHz: OP.10 TDD 10MHz: OP.2 TDD 20MHz: OP.8 TDD
PBCH_RA	dB	0	0
PBCH_RB			
PSS_RA			
SSS_RA			
PCFICH_RB			
PHICH_RA			
PHICH_RB			
PDCCH_RA			
PDCCH_RB			
PDSCH_RA			
PDSCH_RB			
OCNG_RA ^{Note2}			
OCNG_RB ^{Note2}			
N_{oc} ^{Note3}	Bands TDD_A Bands TDD_C Bands TDD_E	dBm/ 15kHz	(N_{oc} for Channel 1 +1dB)
\hat{E}_s / N_{oc}		dB	3 -1
\hat{E}_s / I_{ot}		dB	0.46 -5.76
RSRP ^{Note4}	Bands TDD_A Bands TDD_C Bands TDD_E	dBm/ 15kHz	(RSRP for Cell 1 +8dB) (RSRP for Cell 1 +4dB)
I_o ^{Note4}	Bands TDD_A Bands TDD_C Bands TDD_E	dBm/ BW _{channel}	(I_o for Channel 1 +5.33dB +10log(N_{RB} channel3 / N_{RB} channel 1))
Propagation Condition		AWGN	AWGN
Antenna Configuration		1x2	1x2
Timing offset to Cell 1	μ s	0	3
Time alignment error relative to cell 1 ^{Note 7}		\leq TAE	-
Time alignment error relative to cell 2 ^{Note 7}		\leq TAE	
Time alignment error relative to cell 4 ^{Note 7}		\leq TAE	
Time alignment error relative to cell 6 ^{Note 7}		\leq TAE	
<p>Note 1: For special subframe and uplink-downlink configurations see Tables 4.2-1 and 4.2-2 in TS 36.211.</p> <p>Note 2: OCNG shall be used such that both cells are fully allocated and a constant total transmitted power spectral density is achieved for all OFDM symbols.</p> <p>Note 3: Interference from other cells and noise sources not specified in the test is assumed to be constant over subcarriers and time and shall be modelled as AWGN of appropriate power for N_{oc} to be fulfilled.</p>			

Note 4:	RSRP and Io levels have been derived from other parameters for information purposes. They are not settable parameters themselves.
Note 5:	RSRP minimum requirements are specified assuming independent interference and noise at each receiver antenna port.
Note 6:	The selection of the bands for testing depends on the configuration of the carrier aggregation supported by the UEs.
Note 7:	Time alignment error (TAE) as specified in TS 36.104 [30] clause 6.5.3.1. The TAE value depends upon the type of carrier aggregation.
Note 8:	E-UTRA operating band groups are as defined in Section 3.5.

A.9.1.48.3 Test Requirements

In the test, the performance of RSRP measurements is verified from the following 13 perspectives:

- The absolute accuracy of intra-frequency RSRP measurements for Cell 1 on the primary component carrier shall fulfil the requirements defined in clause 9.1.11.1.
- The absolute accuracy of intra-frequency RSRP measurements for Cell 2 on SCC1 shall fulfil the requirements defined in clause 9.1.11.2.
- The absolute accuracy of intra-frequency RSRP measurements for Cell 4 on SCC2 shall fulfil the requirements defined in clause 9.1.11.2.
- The absolute accuracy of intra-frequency RSRP measurements for Cell 6 on SCC3 shall fulfil the requirements defined in clause 9.1.11.2.
- The absolute accuracy of intra-frequency RSRP measurements for Cell 8 on SCC4 shall fulfil the requirements defined in clause 9.1.11.2.
- The relative accuracy of intra-frequency RSRP measurements for Cell 3 relative to Cell 2 on SCC1 shall fulfil the requirements defined in clause 9.1.11.2.
- The relative accuracy of intra-frequency RSRP measurements for Cell 5 relative to Cell 4 on SCC2 shall fulfil the requirements defined in clause 9.1.11.2.
- The relative accuracy of intra-frequency RSRP measurements for Cell 7 relative to Cell 6 on SCC3 shall fulfil the requirements defined in clause 9.1.11.2.
- The relative accuracy of intra-frequency RSRP measurements for Cell 9 relative to Cell 8 on SCC3 shall fulfil the requirements defined in clause 9.1.11.2.
- The relative accuracy of inter-frequency RSRP measurements between SCC1 and the primary component carriers for Cell 2 relative to Cell 1 shall fulfil the requirements defined in clause 9.1.11.3.
- The relative accuracy of inter-frequency RSRP measurements between SCC2 and the primary component carriers for Cell 4 relative to Cell 1 shall fulfil the requirements defined in clause 9.1.11.3.
- The relative accuracy of inter-frequency RSRP measurements between SCC3 and the primary component carriers for Cell 6 relative to Cell 1 shall fulfil the requirements defined in clause 9.1.11.3.
- The relative accuracy of inter-frequency RSRP measurements between SCC4 and the primary component carriers for Cell 8 relative to Cell 1 shall fulfil the requirements defined in clause 9.1.11.3.

A.9.1.49 5 DL FDD-TDD with PCell in TDD RSRP for E-UTRAN in Carrier Aggregation

A.9.1.49.1 Test Purpose and Environment

The purpose of this test is to verify that the TDD-FDD RSRP absolute and relative accuracy requirements in carrier aggregation with PCell in TDD are within the specified limits. This test will verify the absolute RSRP accuracy requirements of the primary component carrier defined in clause 9.1.11.1, the absolute RSRP accuracy requirements of the secondary component carriers defined in clause 9.1.11.2, and the relative RSRP accuracy requirements of the secondary component carriers defined in clause 9.1.11.2. The test will also verify the primary and secondary component carriers' relative RSRP accuracy requirement defined in Clause 9.1.11.3.

A.9.1.49.2 Test parameters

In this set of test cases cell 1 is PCell on the primary component carrier, and cell 2, cell 4, cell 6 and cell 8 are activated SCells on secondary component carriers SCC1, SCC2, SCC3 and SCC4 respectively. Cell 3, cell 5, cell 7 and cell 9 are neighbouring cells on secondary component carriers SCC1, SCC2, SCC3 and SCC4 respectively. The test parameters are given in Table A.9.1.49.2-1, Table A.9.1.49.2-2 and Table A.9.1.49.2-3.

Table A.9.1.49.2-1: 5 Downlink PCell in TDD RSRP carrier aggregation test parameters for cell 1, cell 2, cell 3, cell 4 and cell 5

Parameter	Unit	Cell 1	Cell 2	Cell 3	Cell 4	Cell 5
E-UTRA RF Channel Number		1	2		3	
$BW_{channel}$	MHz	5MHz: $N_{RB,c} = 25$ 10MHz: $N_{RB,c} = 50$ 20MHz: $N_{RB,c} = 100$	5MHz: $N_{RB,c} = 25$ 10MHz: $N_{RB,c} = 50$ 20MHz: $N_{RB,c} = 100$		5MHz: $N_{RB,c} = 25$ 10MHz: $N_{RB,c} = 50$ 20MHz: $N_{RB,c} = 100$	
Special subframe configuration ^{Note1}		6	-		-	
Uplink/downlink configuration ^{Note1}		1	-		-	
Measurement bandwidth	n_{PRB}	5MHz: 10-15 10MHz: 22-27 20MHz: 47-52	5MHz: 10-15 10MHz: 22-27 20MHz: 47-52		5MHz: 10-15 10MHz: 22-27 20MHz: 47-52	
PDSCH Reference measurement channel defined in A.3.1.1.		5MHz: R.4 TDD 10MHz: R.0 TDD 20MHz: R.3 TDD	5MHz: R.5 FDD 10MHz: R.0 FDD 20MHz: R.4 FDD	-	5MHz: R.5 FDD 10MHz: R.0 FDD 20MHz: R.4 FDD	-
PDSCH allocation	n_{PRB}	5MHz: 7-17 10MHz: 13-36 20MHz: 38-61	5MHz: 7-17 10MHz: 13-36 20MHz: 38-61	-	5MHz: 7-17 10MHz: 13-36 20MHz: 38-61	-
PDCCH/PCFICH/PHICH Reference measurement channel defined in A.3.1.2.		5MHz: R.11 TDD 10MHz: R.6 TDD 20MHz: R.10 TDD	5MHz: R.11 FDD 10MHz: R.6 FDD 20MHz: R.10 FDD	5MHz: R.11 FDD 10MHz: R.6 FDD 20MHz: R.10 FDD	5MHz: R.11 FDD 10MHz: R.6 FDD 20MHz: R.10 FDD	5MHz: R.11 FDD 10MHz: R.6 FDD 20MHz: R.10 FDD
OCNG Patterns defined in A.3.2.		5MHz: OP.9 TDD 10MHz: OP.1 TDD 20MHz: OP.7 TDD	5MHz: OP.15 FDD 10MHz: OP.1 FDD 20MHz: OP.11 FDD	5MHz: OP.16 FDD 10MHz: OP.2 FDD 20MHz: OP.12 FDD	5MHz: OP.15 FDD 10MHz: OP.1 FDD 20MHz: OP.11 FDD	5MHz: OP.16 FDD 10MHz: OP.2 FDD 20MHz: OP.12 FDD
PBCH_RA	dB	0	0	0	0	0
PBCH_RB						
PSS_RA						
SSS_RA						
PCFICH_RB						
PHICH_RA						
PHICH_RB						
PDCCH_RA						
PDCCH_RB						
PDSCH_RA						

PDSCH_RB										
OCNG_RA ^{Note1}										
OCNG_RB ^{Note1}										
N_{oc} ^{Note3}	Bands FDD_A	dBm/15 kHz	-	$(N_{oc}$ for Channel 1 +1dB)		$(N_{oc}$ for Channel 1 +1dB)				
	Bands FDD_B1, FDD_B2 ^{Note 10}									
	Bands FDD_C									
	Bands FDD_D									
	Bands FDD_E, FDD_F ^{Note 7}									
	Bands FDD_G									
	Bands FDD_H									
	Bands TDD_A							-117	-	-
	Bands TDD_C							-116		
	Bands TDD_E							-115		
\hat{E}_s/N_{oc}		dB	-4	3	-1	3	-1			
\hat{E}_s/I_{ot}		dB	-4	0.46	-5.76	0.46	-5.76			
RSRP ^{Note4}	Bands FDD_A	dBm/15 kHz	-	(RSRP for Cell 1 +8dB)	(RSRP for Cell 1 +4dB)	(RSRP for Cell 1 +8dB)	(RSRP for Cell 1 +4dB)			
	Bands FDD_B1, FDD_B2 ^{Note 10}									
	Bands FDD_C									
	Bands FDD_D									
	Bands FDD_E, FDD_F ^{Note 7}									
	Bands FDD_G									
	Bands FDD_H									
	Bands TDD_A							-121	-	-
	Bands TDD_C							-120		
	Bands TDD_E							-119		
I_o ^{Note4}	Bands FDD_A	dBm/ BW _{channel} el	-	$(I_o$ for Channel 1 +5.33dB +10log (NRB channel2 / NRB channel 1))		$(I_o$ for Channel 1 +5.33dB +10log (NRB channel3 / NRB channel 1))				
	Bands FDD_B1, FDD_B2 ^{Note 10}									
	Bands FDD_C									
	Bands FDD_D									
	Bands FDD_E, FDD_F ^{Note 7}									

	Bands FDD_G					
	Bands FDD_H					
	Bands TDD_A		$87.76+10\log(N_{RB,c}/50)$			
	Bands TDD_C		$86.76+10\log(N_{RB,c}/50)$	-		-
	Bands TDD_E		$85.76+10\log(N_{RB,c}/50)$			
Propagation condition	-	AWGN	AWGN	AWGN	AWGN	AWGN
Antenna Configuration	-	1x2	1x2	1x2	1x2	1x2
Timing offset to cell 1	μs	-	0	3	0	3
Time alignment error relative to cell 1 ^{Note 8}		-	≤ TAE	-	≤ TAE	-
Time alignment error relative to cell 2 ^{Note 8}		-	-	-	≤ TAE	-
<p>Note 1: For special subframe and uplink-downlink configurations see Tables 4.2-1 and 4.2-2 in TS 36.211.</p> <p>Note 2: OCNG shall be used such that all cells are fully allocated and a constant total transmitted power spectral density is achieved for all OFDM symbols.</p> <p>Note 3: Interference from other cells and noise sources not specified in the test is assumed to be constant over subcarriers and time and shall be modelled as AWGN of appropriate power for N_{oc} to be fulfilled.</p> <p>Note 4: RSRP and Io levels have been derived from other parameters for information purposes. They are not settable parameters themselves.</p> <p>Note 5: RSRP minimum requirements are specified assuming independent interference and noise at each receiver antenna port.</p> <p>Note 6: The selection of the bands for testing depends on the configuration of the carrier aggregation supported by the UEs.</p> <p>Note 7: For Band 26, the tests shall be performed with the carrier frequency of the assigned E-UTRA channel bandwidth within 865-894 MHz.</p> <p>Note 8: Time alignment error (TAE) as specified in TS 36.104 [30] clause 6.5.3.1. The TAE value depends upon the type of carrier aggregation.</p> <p>Note 9: E-UTRA operating band groups are as defined in Section 3.5.</p> <p>Note 10: For Band 74, the tests shall be performed with the carrier frequency of the assigned E-UTRA channel bandwidth within 1475.9-1510.9 MHz.</p>						

Table A.9.1.49.2-2: 5 Downlink PCell in TDD RSRP carrier aggregation test parameters for cell 6 and cell 7

Parameter	Unit	Cell 6	Cell 7
E-UTRA RF Channel Number		4	
BW _{channel}	MHz	5MHz: N _{RB,c} = 25 10MHz: N _{RB,c} = 50 20MHz: N _{RB,c} = 100	
Measurement bandwidth	n _{PRB}	5MHz: 10-15 10MHz: 22-27 20MHz: 47-52	
PDSCH Reference measurement channel defined in A.3.1.1.1		5MHz: R.5 FDD 10MHz: R.0 FDD 20MHz: R.4 FDD	-
PDSCH allocation	n _{PRB}	5MHz: 7-17 10MHz: 13-36 20MHz: 38-61	-
PDCCH/PCFICH/PHICH Reference measurement channel defined in A.3.1.2.1		5MHz: R.11 FDD 10MHz: R.6 FDD 20MHz: R.10 FDD	5MHz: R.11 FDD 10MHz: R.6 FDD 20MHz: R.10 FDD
OCNG Patterns defined in A.3.2.1		5MHz: OP.15 FDD 10MHz: OP.1 FDD 20MHz: OP.11 FDD	5MHz: OP.16 FDD 10MHz: OP.2 FDD 20MHz: OP.12 FDD
PBCH_RA	dB	0	0

PBCH_RB				
PSS_RA				
SSS_RA				
PCFICH_RB				
PHICH_RA				
PHICH_RB				
PDCCH_RA				
PDCCH_RB				
PDSCH_RA				
PDSCH_RB				
OCNG_RA ^{Note1}				
OCNG_RB ^{Note1}				
N_{oc} ^{Note2}	Bands FDD_A	dBm/ 15kHz	$(N_{oc}$ for Channel 1 +1dB)	
	Bands FDD_B1, FDD_B2 ^{Note 9}			
	Bands FDD_C			
	Bands FDD_D			
	Bands FDD_E, FDD_F ^{Note 6}			
	Bands FDD_G			
	Bands FDD_H			
\hat{E}_s / N_{oc}		dB	3	-1
\hat{E}_s / I_{ot}		dB	0.46	-5.76
RSRP ^{Note3}	Bands FDD_A	dBm/ 15kHz	(RSRP for Cell 1 +8dB)	(RSRP for Cell 1 +4dB)
	Bands FDD_B1, FDD_B2 ^{Note 9}			
	Bands FDD_C			
	Bands FDD_D			
	Bands FDD_E, FDD_F ^{Note 6}			
	Bands FDD_G			
	Bands FDD_H			
I_o ^{Note3}	Bands FDD_A	dBm/ BW _{channel}	$(I_o$ for Channel 1 +5.33dB +10log (N_{RB} channel3 / N_{RB} channel 1))	
	Bands FDD_B1, FDD_B2 ^{Note 9}			
	Bands FDD_C			
	Bands FDD_D			
	Bands FDD_E, FDD_F ^{Note 6}			
	Bands FDD_G			
	Bands FDD_H			
Propagation Condition			AWGN	AWGN
Antenna Configuration			1x2	1x2
Timing offset to Cell 1		μ s	0	3
Time alignment error relative to cell 1 ^{Note 7}			\leq TAE	-
Time alignment error relative to cell 2 ^{Note 7}			\leq TAE	-
Time alignment error relative to cell 4 ^{Note 7}			\leq TAE	-
<p>Note 1: OCNG shall be used such that both cells are fully allocated and a constant total transmitted power spectral density is achieved for all OFDM symbols.</p> <p>Note 2: Interference from other cells and noise sources not specified in the test is assumed to be constant over subcarriers and time and shall be modelled as AWGN of appropriate power for N_{oc} to be fulfilled.</p> <p>Note 3: RSRP and I_o levels have been derived from other parameters for information purposes. They are not settable parameters themselves.</p> <p>Note 4: RSRP minimum requirements are specified assuming independent interference and noise at each receiver antenna port.</p>				

Note 5:	The selection of the bands for testing depends on the configuration of the carrier aggregation supported by the UEs.
Note 6:	For Band 26, the tests shall be performed with the carrier frequency of the assigned E-UTRA channel bandwidth within 865-894 MHz.
Note 7:	Time alignment error (TAE) as specified in TS 36.104 [30] clause 6.5.3.1. The TAE value depends upon the type of carrier aggregation.
Note 8:	E-UTRA operating band groups are as defined in Section 3.5.
Note 9:	For Band 74, the tests shall be performed with the carrier frequency of the assigned E-UTRA channel bandwidth within 1475.9-1510.9 MHz.

Table A.9.1.49.2-3: 5 Downlink PCell in TDD RSRP carrier aggregation test parameters for cell 8 and cell 9

Parameter	Unit	Cell 8	Cell 9
E-UTRA RF Channel Number		5	
BW _{channel}	MHz	5MHz: N _{RB,c} = 25 10MHz: N _{RB,c} = 50 20MHz: N _{RB,c} = 100	
Measurement bandwidth	<i>n_{PRB}</i>	5MHz: 10-15 10MHz: 22-27 20MHz: 47-52	
PDSCH Reference measurement channel defined in A.3.1.1.1		5MHz: R.5 FDD 10MHz: R.0 FDD 20MHz: R.4 FDD	-
PDSCH allocation	<i>n_{PRB}</i>	5MHz: 7-17 10MHz: 13-36 20MHz: 38-61	-
PDCCH/PCFICH/PHICH Reference measurement channel defined in A.3.1.2.1		5MHz: R.11 FDD 10MHz: R.6 FDD 20MHz: R.10 FDD	5MHz: R.11 FDD 10MHz: R.6 FDD 20MHz: R.10 FDD
OCNG Patterns defined in A.3.2.1		5MHz: OP.15 FDD 10MHz: OP.1 FDD 20MHz: OP.11 FDD	5MHz: OP.16 FDD 10MHz: OP.2 FDD 20MHz: OP.12 FDD
PBCH_RA	dB	0	0
PBCH_RB			
PSS_RA			
SSS_RA			
PCFICH_RB			
PHICH_RA			
PHICH_RB			
PDCCH_RA			
PDCCH_RB			
PDSCH_RA			
PDSCH_RB			
OCNG_RA ^{Note1}			
OCNG_RB ^{Note1}			
<i>N_{oc}</i> ^{Note2}			
	Bands FDD_B1, FDD_B2 ^{Note 9}		
	Bands FDD_C		
	Bands FDD_D		
	Bands FDD_E, FDD_F ^{Note 6}		
	Bands FDD_G		
	Bands FDD_H		
\hat{E}_s / N_{oc}	dB	3	-1
\hat{E}_s / I_{ot}	dB	0.46	-5.76
RSRP ^{Note3}	Bands FDD_A		

	Bands FDD_B1, FDD_B2 ^{Note 9}	dBm/15kHz	(RSRP for Cell 1 +8dB)	(RSRP for Cell 1 +4dB)
	Bands FDD_C			
	Bands FDD_D			
	Bands FDD_E, FDD_F ^{Note 6}			
	Bands FDD_G			
	Bands FDD_H			
I_o ^{Note 3}	Bands FDD_A	dBm/ $BW_{channel}$	$(I_o \text{ for Channel 1 } +5.33\text{dB} +10\log(N_{RB \text{ channel}3} / N_{RB \text{ channel}1}))$	
	Bands FDD_B1, FDD_B2 ^{Note 9}			
	Bands FDD_C			
	Bands FDD_D			
	Bands FDD_E, FDD_F ^{Note 6}			
	Bands FDD_G			
	Bands FDD_H			
Propagation Condition			AWGN	AWGN
Antenna Configuration			1x2	1x2
Timing offset to Cell 1		μs	0	3
Time alignment error relative to cell 1 ^{Note 7}			$\leq \text{TAE}$	-
Time alignment error relative to cell 2 ^{Note 7}			$\leq \text{TAE}$	-
Time alignment error relative to cell 4 ^{Note 7}			$\leq \text{TAE}$	-
Time alignment error relative to cell 6 ^{Note 7}			$\leq \text{TAE}$	-
<p>Note 1: OCNG shall be used such that both cells are fully allocated and a constant total transmitted power spectral density is achieved for all OFDM symbols.</p> <p>Note 2: Interference from other cells and noise sources not specified in the test is assumed to be constant over subcarriers and time and shall be modelled as AWGN of appropriate power for N_{oc} to be fulfilled.</p> <p>Note 3: RSRP and I_o levels have been derived from other parameters for information purposes. They are not settable parameters themselves.</p> <p>Note 4: RSRP minimum requirements are specified assuming independent interference and noise at each receiver antenna port.</p> <p>Note 5: The selection of the bands for testing depends on the configuration of the carrier aggregation supported by the UEs.</p> <p>Note 6: For Band 26, the tests shall be performed with the carrier frequency of the assigned E-UTRA channel bandwidth within 865-894 MHz.</p> <p>Note 7: Time alignment error (TAE) as specified in TS 36.104 [30] clause 6.5.3.1. The TAE value depends upon the type of carrier aggregation.</p> <p>Note 8: E-UTRA operating band groups are as defined in Section 3.5.</p> <p>Note 9: For Band 74, the tests shall be performed with the carrier frequency of the assigned E-UTRA channel bandwidth within 1475.9-1510.9 MHz.</p>				

A.9.1.49.3 Test Requirements

In the test, the performance of RSRP measurements is verified from the following 13 perspectives:

- The absolute accuracy of intra-frequency RSRP measurements for Cell 1 on the primary component carrier shall fulfil the requirements defined in clause 9.1.11.1.
- The absolute accuracy of intra-frequency RSRP measurements for Cell 2 on SCC1 shall fulfil the requirements defined in clause 9.1.11.2.
- The absolute accuracy of intra-frequency RSRP measurements for Cell 4 on SCC2 shall fulfil the requirements defined in clause 9.1.11.2.

- The absolute accuracy of intra-frequency RSRP measurements for Cell 6 on SCC3 shall fulfil the requirements defined in clause 9.1.11.2.
- The absolute accuracy of intra-frequency RSRP measurements for Cell 8 on SCC4 shall fulfil the requirements defined in clause 9.1.11.2.
- The relative accuracy of intra-frequency RSRP measurements for Cell 3 relative to Cell 2 on SCC1 shall fulfil the requirements defined in clause 9.1.11.2.
- The relative accuracy of intra-frequency RSRP measurements for Cell 5 relative to Cell 4 on SCC2 shall fulfil the requirements defined in clause 9.1.11.2.
- The relative accuracy of intra-frequency RSRP measurements for Cell 7 relative to Cell 6 on SCC3 shall fulfil the requirements defined in clause 9.1.11.2.
- The relative accuracy of intra-frequency RSRP measurements for Cell 9 relative to Cell 8 on SCC3 shall fulfil the requirements defined in clause 9.1.11.2.
- The relative accuracy of inter-frequency RSRP measurements between SCC1 and the primary component carriers for Cell 2 relative to Cell 1 shall fulfil the requirements defined in clause 9.1.11.3.
- The relative accuracy of inter-frequency RSRP measurements between SCC2 and the primary component carriers for Cell 4 relative to Cell 1 shall fulfil the requirements defined in clause 9.1.11.3.
- The relative accuracy of inter-frequency RSRP measurements between SCC3 and the primary component carriers for Cell 6 relative to Cell 1 shall fulfil the requirements defined in clause 9.1.11.3.
- The relative accuracy of inter-frequency RSRP measurements between SCC4 and the primary component carriers for Cell 8 relative to Cell 1 shall fulfil the requirements defined in clause 9.1.11.3.

A.9.1.50 5 DL FDD RSRP for E-UTRAN in Carrier Aggregation

A.9.1.50.1 Test Purpose and Environment

The purpose of this test is to verify that the FDD-FDD RSRP absolute and relative accuracy requirements in carrier aggregation with PCell in FDD are within the specified limits. This test will verify the absolute RSRP accuracy requirements of the primary component carrier defined in clause 9.1.11.1, the absolute RSRP accuracy requirements of the secondary component carriers defined in clause 9.1.11.2, and the relative RSRP accuracy requirements of the secondary component carriers defined in clause 9.1.11.2. The test will also verify the primary and secondary component carriers' relative RSRP accuracy requirement defined in Clause 9.1.11.3.

A.9.1.50.2 Test parameters

In this set of cases cell 1 is PCell on the primary component carrier, and cell 2, cell 4, cell6 and cell8 are activated SCCells on secondary component carriers SCC1, SCC2, SCC3 and SCC4 respectively. Cell 3, cell 5, cell7 and cell9 are neighbouring cells on secondary component carriers SCC1, SCC2, SCC3 and SCC4 respectively. The test parameters are given in Table A.9.1.50.2-1.

Table A.9.1.50.2-1: 5 DL FDD RSRP test parameters for E-UTRAN Carrier aggregation (cell #1, cell #2 and cell #3)

Parameter	Unit	Cell 1	Cell 2	Cell 3
E-UTRA RF Channel Number		1	2	
BW _{channel}	MHz	5MHz: N _{RB,c} = 25 10MHz: N _{RB,c} = 50 20MHz: N _{RB,c} = 100	5MHz: N _{RB,c} = 25 10MHz: N _{RB,c} = 50 20MHz: N _{RB,c} = 100	
Measurement bandwidth	<i>n_{PRB}</i>	5MHz: 10-15 10MHz: 22-27 20MHz: 47-52	5MHz: 10-15 10MHz: 22-27 20MHz: 47-52	
PDSCH Reference measurement channel defined in A.3.1.1.1		5MHz: R.5 FDD 10MHz: R.0 FDD 20MHz: R.4 FDD	5MHz: R.5 FDD 10MHz: R.0 FDD 20MHz: R.4 FDD	-
PDSCH allocation	<i>n_{PRB}</i>	5MHz: 7-17 10MHz: 13-36	5MHz: 7-17 10MHz: 13-36	-

			20MHz: 38-61	20MHz: 38-61	
PDCCH/PCFICH/PHICH Reference measurement channel defined in A.3.1.2.1			5MHz: R.11 FDD 10MHz: R.6 FDD 20MHz: R.10 FDD	5MHz: R.11 FDD 10MHz: R.6 FDD 20MHz: R.10 FDD	5MHz: R.11 FDD 10MHz: R.6 FDD 20MHz: R.10 FDD
OCNG Patterns defined in A.3.2.1			5MHz: OP.15 FDD 10MHz: OP.1 FDD 20MHz: OP.11 FDD	5MHz: OP.15 FDD 10MHz: OP.1 FDD 20MHz: OP.11 FDD	5MHz: OP.16 FDD 10MHz: OP.2 FDD 20MHz: OP.12 FDD
PBCH_RA	dB		0	0	0
PBCH_RB					
PSS_RA					
SSS_RA					
PCFICH_RB					
PHICH_RA					
PHICH_RB					
PDCCH_RA					
PDCCH_RB					
PDSCH_RA					
PDSCH_RB					
OCNG_RA ^{Note1}					
OCNG_RB ^{Note1}					
N_{oc} ^{Note2}					
	Bands FDD_B1, FDD_B2 ^{Note 9}	-116.5			
	Bands FDD_C	-116			
	Bands FDD_D	-115.5			
	Bands FDD_E, FDD_F ^{Note 6}	-115			
	Bands FDD_G	-114			
	Bands FDD_H	-113.5			
\hat{E}_s/N_{oc}	dB		-4	3	-1
\hat{E}_s/I_{ot}	dB		-4	0.46	-5.76
RSRP ^{Note3}	Bands FDD_A	dBm/ 15kHz	-121	(RSRP for Cell 1 +8dB) (RSRP for Cell 1 +4dB)	
	Bands FDD_B1, FDD_B2 ^{Note 9}		-120.5		
	Bands FDD_C		-120		
	Bands FDD_D		-119.5		
	Bands FDD_E, FDD_F ^{Note 6}		-119		
	Bands FDD_G		-118		
	Bands FDD_H		-117.5		
I_o ^{Note3}	Bands FDD_A	dBm/ $BW_{channel}$	-87.76 $+10\log(N_{RB,c}/50)$	$(I_o$ for Channel 1 +5.33dB +10log($N_{RB channel2} / N_{RB channel 1}$))	
	Bands FDD_B1, FDD_B2 ^{Note 9}		-87.26 $+10\log(N_{RB,c}/50)$		
	Bands FDD_C		-86.76 $+10\log(N_{RB,c}/50)$		
	Bands FDD_D		-86.26 $+10\log(N_{RB,c}/50)$		
	Bands FDD_E, FDD_F ^{Note 6}		-85.76 $+10\log(N_{RB,c}/50)$		
	Bands FDD_G		-84.76 $+10\log(N_{RB,c}/50)$		
	Bands FDD_H		-84.26 $+10\log(N_{RB,c}/50)$		
Propagation Condition			AWGN	AWGN	AWGN
Antenna Configuration			1x2	1x2	1x2
Timing offset to Cell 1	μs		-	0	3
Time alignment error relative to cell 1 ^{Note 7}			-	$\leq TAE$	-

Time alignment error relative to cell 2 ^{Note 7}		-	-	-
Time alignment error relative to cell 4 ^{Note 7}		-	-	-
Time alignment error relative to cell 6 ^{Note 7}		-	-	-
<p>Note 1: OCNG shall be used such that both cells are fully allocated and a constant total transmitted power spectral density is achieved for all OFDM symbols.</p> <p>Note 2: Interference from other cells and noise sources not specified in the test is assumed to be constant over subcarriers and time and shall be modelled as AWGN of appropriate power for N_{oc} to be fulfilled.</p> <p>Note 3: RSRP and Io levels have been derived from other parameters for information purposes. They are not settable parameters themselves.</p> <p>Note 4: RSRP minimum requirements are specified assuming independent interference and noise at each receiver antenna port.</p> <p>Note 5: The selection of the bands for testing depends on the configuration of the carrier aggregation supported by the UEs.</p> <p>Note 6: For Band 26, the tests shall be performed with the carrier frequency of the assigned E-UTRA channel bandwidth within 865-894 MHz.</p> <p>Note 7: Time alignment error (TAE) as specified in TS 36.104 [30] clause 6.5.3.1. The TAE value depends upon the type of carrier aggregation.</p> <p>Note 8: E-UTRA operating band groups are as defined in Section 3.5.</p> <p>Note 9: For Band 74, the tests shall be performed with the carrier frequency of the assigned E-UTRA channel bandwidth within 1475.9-1510.9 MHz.</p>				

Table A.9.1.50.2-2: 5 DL FDD RSRP test parameters for E-UTRAN Carrier aggregation (cell #4 – cell #9)

Parameter	Unit	Cell 4	Cell 5	Cell 6	Cell 7	Cell 8	Cell 9
E-UTRA RF Channel Number		3		4		5	
BW _{channel}	MHz	5MHz: N _{RB,c} = 25 10MHz: N _{RB,c} = 50 20MHz: N _{RB,c} = 100		5MHz: N _{RB,c} = 25 10MHz: N _{RB,c} = 50 20MHz: N _{RB,c} = 100		5MHz: N _{RB,c} = 25 10MHz: N _{RB,c} = 50 20MHz: N _{RB,c} = 100	
Measurement bandwidth	n_{PRB}	5MHz: 10-15 10MHz: 22-27 20MHz: 47-52		5MHz: 10-15 10MHz: 22-27 20MHz: 47-52		5MHz: 10-15 10MHz: 22-27 20MHz: 47-52	
PDSCH Reference measurement channel defined in A.3.1.1.1		5MHz: R.5 FDD 10MHz: R.0 FDD 20MHz: R.4 FDD	-	5MHz: R.5 FDD 10MHz: R.0 FDD 20MHz: R.4 FDD	-	5MHz: R.5 FDD 10MHz: R.0 FDD 20MHz: R.4 FDD	-
PDSCH allocation	n_{PRB}	5MHz: 7-17 10MHz: 13-36 20MHz: 38-61	-	5MHz: 7-17 10MHz: 13-36 20MHz: 38-61	-	5MHz: 7-17 10MHz: 13-36 20MHz: 38-61	-
PDCCH/PCFICH/PHICH Reference measurement channel defined in A.3.1.2.1		5MHz: R.11 FDD 10MHz: R.6 FDD 20MHz: R.10 FDD	5MHz: R.11 FDD 10MHz: R.6 FDD 20MHz: R.10 FDD	5MHz: R.11 FDD 10MHz: R.6 FDD 20MHz: R.10 FDD	5MHz: R.11 FDD 10MHz: R.6 FDD 20MHz: R.10 FDD	5MHz: R.11 FDD 10MHz: R.6 FDD 20MHz: R.10 FDD	5MHz: R.11 FDD 10MHz: R.6 FDD 20MHz: R.10 FDD
OCNG Patterns defined in A.3.2.1		5MHz: OP.15 FDD 10MHz: OP.1 FDD 20MHz: OP.11 FDD	5MHz: OP.16 FDD 10MHz: OP.2 FDD 20MHz: OP.12 FDD	5MHz: OP.15 FDD 10MHz: OP.1 FDD	5MHz: OP.16 FDD 10MHz: OP.2 FDD	5MHz: OP.15 FDD 10MHz: OP.1 FDD	5MHz: OP.16 FDD 10MHz: OP.2 FDD

				20MHz: OP.11 FDD	20MHz: OP.12 FDD	20MHz: OP.11 FDD	20MHz: OP.12 FDD	
PBCH_RA	dB	0	0	0	0	0	0	
PBCH_RB								
PSS_RA								
SSS_RA								
PCFICH_RB								
PHICH_RA								
PHICH_RB								
PDCCH_RA								
PDCCH_RB								
PDSCH_RA								
PDSCH_RB								
OCNG_RA ^{Note1}								
OCNG_RB ^{Note1}								
N_{oc} ^{Note2}								Bands FDD_A
	Bands FDD_B1, FDD_B2 <small>Note 9</small>							
	Bands FDD_C							
	Bands FDD_D							
	Bands FDD_E, FDD_F <small>Note 6</small>							
	Bands FDD_G							
	Bands FDD_H							
\hat{E}_s/N_{oc}	dB	3	-1	3	-1	3	-1	
\hat{E}_s/I_{ot}	dB	0.46	-5.76	0.46	-5.76	0.46	-5.76	
RSRP ^{Note3}	Bands FDD_A	dBm/ 15kHz	(RSRP for Cell 1 +8dB)	(RSRP for Cell 1 +4dB)	(RSRP for Cell 1 +8dB)	(RSRP for Cell 1 +4dB)	(RSRP for Cell 1 +8dB)	(RSRP for Cell 1 +4dB)
	Bands FDD_B1, FDD_B2 <small>Note 9</small>							
	Bands FDD_C							
	Bands FDD_D							
	Bands FDD_E, FDD_F <small>Note 6</small>							
	Bands FDD_G							
	Bands FDD_H							
I_o ^{Note3}	Bands FDD_A	dBm/ BW _{channel}	$(I_o$ for Channel 1 +5.33dB +10log (NRB channel3 / NRB channel 1))	$(I_o$ for Channel 1 +5.33dB +10log (NRB channel4 / NRB channel 1))	$(I_o$ for Channel 1 +5.33dB +10log (NRB channel5 / NRB channel 1))			
	Bands FDD_B1, FDD_B2 <small>Note 9</small>							
	Bands FDD_C							
	Bands FDD_D							

	Bands FDD_E, FDD_F ^{Note 6}						
	Bands FDD_G						
	Bands FDD_H						
Propagation Condition		AWGN	AWGN	AWGN	AWGN	AWGN	AWGN
Antenna Configuration		1x2	1x2	1x2	1x2	1x2	1x2
Timing offset to Cell 1	μs	0	3	0	3	0	3
Time alignment error relative to cell 1 ^{Note 7}		$\leq \text{TAE}$	-	$\leq \text{TAE}$	-	$\leq \text{TAE}$	-
Time alignment error relative to cell 2 ^{Note 7}		$\leq \text{TAE}$	-	$\leq \text{TAE}$	-	$\leq \text{TAE}$	-
Time alignment error relative to cell 4 ^{Note 7}		-	-	$\leq \text{TAE}$	-	$\leq \text{TAE}$	-
Time alignment error relative to cell 6 ^{Note 7}		-	-		-	$\leq \text{TAE}$	-
Note 1:	OCNG shall be used such that both cells are fully allocated and a constant total transmitted power spectral density is achieved for all OFDM symbols.						
Note 2:	Interference from other cells and noise sources not specified in the test is assumed to be constant over						
Note 3:	subcarriers and time and shall be modelled as AWGN of appropriate power for N_{oc} to be fulfilled.						
Note 4:	RSRP and I_o levels have been derived from other parameters for information purposes. They are not settable parameters themselves.						
Note 5:	RSRP minimum requirements are specified assuming independent interference and noise at each receiver antenna port.						
Note 6:	The selection of the bands for testing depends on the configuration of the carrier aggregation supported by the UEs.						
Note 7:	For Band 26, the tests shall be performed with the carrier frequency of the assigned E-UTRA channel bandwidth within 865-894 MHz.						
Note 8:	Time alignment error (TAE) as specified in TS 36.104 [30] clause 6.5.3.1. The TAE value depends upon the type of carrier aggregation.						
Note 9:	E-UTRA operating band groups are as defined in Section 3.5.						
Note 10:	For Band 74, the tests shall be performed with the carrier frequency of the assigned E-UTRA channel bandwidth within 1475.9-1510.9 MHz.						

A.9.1.50.3 Test Requirements

In the test, the performance of RSRP measurements is verified from following perspectives:

- The absolute accuracy of intra-frequency RSRP measurements for Cell 1 on the primary component carrier shall fulfil the requirements defined in clause 9.1.11.1.
- The absolute accuracy of intra-frequency RSRP measurements for Cell 2 on SCC1 shall fulfil the requirements defined in clause 9.1.11.2.
- The absolute accuracy of intra-frequency RSRP measurements for Cell 4 on SCC2 shall fulfil the requirements defined in clause 9.1.11.2.
- The absolute accuracy of intra-frequency RSRP measurements for Cell 6 on SCC3 shall fulfil the requirements defined in clause 9.1.11.2.
- The absolute accuracy of intra-frequency RSRP measurements for Cell 8 on SCC4 shall fulfil the requirements defined in clause 9.1.11.2.
- The relative accuracy of intra-frequency RSRP measurements for Cell 3 relative to Cell 2 on SCC1 shall fulfil the requirements defined in clause 9.1.11.2.
- The relative accuracy of intra-frequency RSRP measurements for Cell 5 relative to Cell 4 on SCC2 shall fulfil the requirements defined in clause 9.1.11.2.
- The relative accuracy of intra-frequency RSRP measurements for Cell 7 relative to Cell 6 on SCC3 shall fulfil the requirements defined in clause 9.1.11.2.

- The relative accuracy of intra-frequency RSRP measurements for Cell 9 relative to Cell 8 on SCC4 shall fulfil the requirements defined in clause 9.1.11.2.
- The relative accuracy of inter-frequency RSRP measurements between SCC1 and the primary component carriers for Cell 2 relative to Cell 1 shall fulfil the requirements defined in clause 9.1.11.3.
- The relative accuracy of inter-frequency RSRP measurements between SCC2 and the primary component carriers for Cell 4 relative to Cell 1 shall fulfil the requirements defined in clause 9.1.11.3.
- The relative accuracy of inter-frequency RSRP measurements between SCC3 and the primary component carriers for Cell 6 relative to Cell 1 shall fulfil the requirements defined in clause 9.1.11.3.
- The relative accuracy of inter-frequency RSRP measurements between SCC4 and the primary component carriers for Cell 8 relative to Cell 1 shall fulfil the requirements defined in clause 9.1.11.3.

A.9.1.51 5 DL TDD RSRP for E-UTRAN in Carrier Aggregation

A.9.1.51.1 Test Purpose and Environment

The purpose of this test is to verify that the TDD RSRP absolute and relative accuracy requirements in carrier aggregation with PCell in TDD are within the specified limits. This test will verify the absolute RSRP accuracy requirements of the primary component carrier defined in clause 9.1.11.1, the absolute RSRP accuracy requirements of the secondary component carriers defined in clause 9.1.11.2, and the relative RSRP accuracy requirements of the secondary component carriers defined in clause 9.1.11.2. The test will also verify the primary and secondary component carriers' relative RSRP accuracy requirement defined in Clause 9.1.11.3.

A.9.1.51.2 Test parameters

In this set of cases cell 1 is PCell on the primary component carrier, and cell 2, cell 4, cell 6 and cell 8 are activated SCells on secondary component carriers SCC1, SCC2, SCC3 and SCC4 respectively. Cell 3, cell 5, cell 7 and cell 9 are neighbouring cells on secondary component carriers SCC1, SCC2, SCC3 and SCC4 respectively. The test parameters are given in Table A.9.1.51.2-1.

Table A.9.1.51.2-1: 5 DL TDD RSRP test parameters for E-UTRAN Carrier aggregation (cell #1, cell #2 and cell #3)

Parameter	Unit	Cell 1	Cell 2	Cell 3
E-UTRA RF Channel Number		1	2	
BW _{channel}		5MHz: N _{RB,c} = 25 10MHz: N _{RB,c} = 50 20MHz: N _{RB,c} = 100	5MHz: N _{RB,c} = 25 10MHz: N _{RB,c} = 50 20MHz: N _{RB,c} = 100	
Special subframe configuration ^{Note1}		6		
Uplink/downlink configuration ^{Note1}		1		
Measurement bandwidth	n_{PRB}	5MHz: 10-15 10MHz: 22-27 20MHz: 47-52	5MHz: 10-15 10MHz: 22-27 20MHz: 47-52	
PDSCH Reference measurement channel defined in A.3.1.1.2		5MHz: R.4 TDD 10MHz: R.0 TDD 20MHz: R.3 TDD	5MHz: R.4 TDD 10MHz: R.0 TDD 20MHz: R.3 TDD	-
PDSCH allocation	n_{PRB}	5MHz: 7-17 10MHz: 13-36 20MHz: 38-61	5MHz: 7-17 10MHz: 13-36 20MHz: 38-61	-
PDCCH/PCFICH/PHICH Reference measurement channel defined in A.3.1.2.2		5MHz: R.11 TDD 10MHz: R.6 TDD 20MHz: R.10 TDD	5MHz: R.11 TDD 10MHz: R.6 TDD 20MHz: R.10 TDD	5MHz: R.11 TDD 10MHz: R.6 TDD 20MHz: R.10 TDD
OCNG Patterns defined in A.3.2.2		5MHz: OP.9 TDD 10MHz: OP.1 TDD 20MHz: OP.7 TDD	5MHz: OP.9 TDD 10MHz: OP.1 TDD 20MHz: OP.7 TDD	5MHz: OP.10 TDD 10MHz: OP.2 TDD 20MHz: OP.8 TDD
PBCH_RA	dB	0	0	0
PBCH_RB				
PSS_RA				
SSS_RA				
PCFICH_RB				

PHICH_RA					
PHICH_RB					
PDCCH_RA					
PDCCH_RB					
PDSCH_RA					
PDSCH_RB					
OCNG_RA ^{Note2}					
OCNG_RB ^{Note2}					
N_{oc} ^{Note3}	Bands TDD_A	dBm/ 15kHz	-117	$(N_{oc}$ for Channel 1 +1dB)	
	Bands TDD_C		-116		
	Bands TDD_E		-115		
\hat{E}_s/N_{oc}		dB	-4	3	-1
\hat{E}_s/I_{ot}		dB	-4	0.46	-5.76
RSRP ^{Note4}	Bands TDD_A	dBm/ 15kHz	-121	(RSRP for Cell 1 +8dB)	(RSRP for Cell 1 +4dB)
	Bands TDD_C		-120		
	Bands TDD_E		-119		
I_o ^{Note4}	Bands TDD_A	dBm/ BW _{channel}	-87.76 + 10log($N_{RB,c}/50$)	$(I_o$ for Channel 1 +5.33dB +10log ($N_{RB,channel2} / N_{RB,channel1}$))	
	Bands TDD_C		-86.76 + 10log($N_{RB,c}/50$)		
	Bands TDD_E		-85.76 + 10log($N_{RB,c}/50$)		
Propagation Condition			AWGN	AWGN	AWGN
Antenna Configuration			1x2	1x2	1x2
Timing offset to Cell 1		μ s	-	0	3
Time alignment error relative to cell 1 ^{Note 7}			-	\leq TAE	-
<p>Note 1: For special subframe and uplink-downlink configurations see Tables 4.2-1 and 4.2-2 in TS 36.211.</p> <p>Note 2: OCNG shall be used such that both cells are fully allocated and a constant total transmitted power spectral density is achieved for all OFDM symbols.</p> <p>Note 3: Interference from other cells and noise sources not specified in the test is assumed to be constant over subcarriers and time and shall be modelled as AWGN of appropriate power for N_{oc} to be fulfilled.</p> <p>Note 4: RSRP and I_o levels have been derived from other parameters for information purposes. They are not settable parameters themselves.</p> <p>Note 5: RSRP minimum requirements are specified assuming independent interference and noise at each receiver antenna port.</p> <p>Note 6: The selection of the bands for testing depends on the configuration of the carrier aggregation supported by the UEs.</p> <p>Note 7: Time alignment error (TAE) as specified in TS 36.104 [30] clause 6.5.3.1. The TAE value depends upon the type of carrier aggregation.</p> <p>Note 8: E-UTRA operating band groups are as defined in Section 3.5.</p>					

Table A.9.1.51.2-2: 5 DL TDD RSRP test parameters for E-UTRAN Carrier aggregation (cell #4 – cell #9)

Parameter	Unit	Cell 4	Cell 5	Cell 6	Cell 7	Cell 8	Cell 9
E-UTRA RF Channel Number		3		4		5	
BW _{channel}	MHz	5MHz: $N_{RB,c} = 25$ 10MHz: $N_{RB,c} = 50$ 20MHz: $N_{RB,c} = 100$		5MHz: $N_{RB,c} = 25$ 10MHz: $N_{RB,c} = 50$ 20MHz: $N_{RB,c} = 100$		5MHz: $N_{RB,c} = 25$ 10MHz: $N_{RB,c} = 50$ 20MHz: $N_{RB,c} = 100$	
Special subframe configuration ^{Note1}		6					
Uplink/downlink configuration ^{Note1}		1					
Measurement bandwidth	n_{PRB}	5MHz: 10-15 10MHz: 22-27 20MHz: 47-52		5MHz: 10-15 10MHz: 22-27 20MHz: 47-52		5MHz: 10-15 10MHz: 22-27 20MHz: 47-52	

PDSCH Reference measurement channel defined in A.3.1.1.2			5MHz: R.4 TDD 10MHz: R.0 TDD 20MHz: R.3 TDD	-	5MHz: R.4 TDD 10MHz: R.0 TDD 20MHz: R.3 TDD	-	5MHz: R.4 TDD 10MHz: R.0 TDD 20MHz: R.3 TDD	-							
PDSCH allocation		n_{PRB}	5MHz: 7-17 10MHz: 13-36 20MHz: 38-61	-	5MHz: 7-17 10MHz: 13-36 20MHz: 38-61	-	5MHz: 7-17 10MHz: 13-36 20MHz: 38-61	-							
PDCCH/PCFICH/PHICH Reference measurement channel defined in A.3.1.2.2			5MHz: R.11 TDD 10MHz: R.6 TDD 20MHz: R.10 TDD	5MHz: R.11 TDD 10MHz: R.6 TDD 20MHz: R.10 TDD	5MHz: R.11 TDD 10MHz: R.6 TDD 20MHz: R.10 TDD	5MHz: R.11 TDD 10MHz: R.6 TDD 20MHz: R.10 TDD	5MHz: R.11 TDD 10MHz: R.6 TDD 20MHz: R.10 TDD	5MHz: R.11 TDD 10MHz: R.6 TDD 20MHz: R.10 TDD							
OCNG Patterns defined in A.3.2.2			5MHz: OP.9 TDD 10MHz: OP.1 TDD 20MHz: OP.7 TDD	5MHz: OP.10 TDD 10MHz: OP.2 TDD 20MHz: OP.8 TDD	5MHz: OP.9 TDD 10MHz: OP.1 TDD 20MHz: OP.7 TDD	5MHz: OP.10 TDD 10MHz: OP.2 TDD 20MHz: OP.8 TDD	5MHz: OP.9 TDD 10MHz: OP.1 TDD 20MHz: OP.7 TDD	5MHz: OP.10 TDD 10MHz: OP.2 TDD 20MHz: OP.8 TDD							
PBCH_RA		dB	0	0	0	0	0	0							
PBCH_RB															
PSS_RA															
SSS_RA															
PCFICH_RB															
PHICH_RA															
PHICH_RB															
PDCCH_RA															
PDCCH_RB															
PDSCH_RA															
PDSCH_RB															
OCNG_RA ^{Note2}															
OCNG_RB ^{Note2}															
N_{oc} ^{Note3}	Bands TDD_A								dBm/ 15kHz	$(N_{oc}$ for Channel 1 +1dB)		$(N_{oc}$ for Channel 1 +1dB)		$(N_{oc}$ for Channel 1 +1dB)	
	Bands TDD_C														
	Bands TDD_E														
\hat{E}_s/N_{oc}		dB	3	-1	3	-1	3	-1							
\hat{E}_s/I_{ot}		dB	0.46	-5.76	0.46	-5.76	0.46	-5.76							
RSRP ^{Note4}	Bands TDD_A	dBm/ 15kHz	(RSRP1 +8dB for Cell)	(RSRP for Cell 1 +4dB)	(RSRP for Cell 1 +8dB)	(RSRP for Cell 1 +4dB)	(RSRP for Cell 1 +8dB)	(RSRP for Cell 1 +4dB)							
	Bands TDD_C														
	Bands TDD_E														
I_o ^{Note4}	Bands TDD_A	dBm/ BW _{channel}	(I _o for Channel 1 +5.33dB +10log (N _{RB channel3} / N _{RB channel 1}))		(I _o for Channel 1 +5.33dB +10log (N _{RB channel4} / N _{RB channel 1}))		(I _o for Channel 1 +5.33dB +10log (N _{RB channel5} / N _{RB channel 1}))								
	Bands TDD_C														
	Bands TDD_E														
Propagation Condition			AWGN	AWGN	AWGN	AWGN	AWGN	AWGN							
Antenna Configuration			1x2	1x2	1x2	1x2	1x2	1x2							
Timing offset to Cell 1		μs	0	3	0	3	0	3							

Time alignment error relative to cell 1 ^{Note 7}		≤ TAE	-	≤ TAE	-	≤ TAE	-
Time alignment error relative to cell 2 ^{Note 7}		≤ TAE	-	≤ TAE	-	≤ TAE	-
Time alignment error relative to cell 4 ^{Note 7}		-	-	≤ TAE	-	≤ TAE	-
Time alignment error relative to cell 6 ^{Note 7}		-	-		-	≤ TAE	-
Note 1:	For special subframe and uplink-downlink configurations see Tables 4.2-1 and 4.2-2 in TS 36.211.						
Note 2:	OCNG shall be used such that both cells are fully allocated and a constant total transmitted power spectral density is achieved for all OFDM symbols.						
Note 3:	Interference from other cells and noise sources not specified in the test is assumed to be constant over subcarriers and time and shall be modelled as AWGN of appropriate power for N_{oc} to be fulfilled.						
Note 4:	RSRP and I_0 levels have been derived from other parameters for information purposes. They are not settable parameters themselves.						
Note 5:	RSRP minimum requirements are specified assuming independent interference and noise at each receiver antenna port.						
Note 6:	The selection of the bands for testing depends on the configuration of the carrier aggregation supported by the UEs.						
Note 7:	Time alignment error (TAE) as specified in TS 36.104 [30] clause 6.5.3.1. The TAE value depends upon the type of carrier aggregation.						
Note 8:	E-UTRA operating band groups are as defined in Section 3.5.						

A.9.1.51.3 Test Requirements

In the test, the performance of RSRP measurements is verified from following perspectives:

- The absolute accuracy of intra-frequency RSRP measurements for Cell 1 on the primary component carrier shall fulfil the requirements defined in clause 9.1.11.1.
- The absolute accuracy of intra-frequency RSRP measurements for Cell 2 on SCC1 shall fulfil the requirements defined in clause 9.1.11.2.
- The absolute accuracy of intra-frequency RSRP measurements for Cell 4 on SCC2 shall fulfil the requirements defined in clause 9.1.11.2.
- The absolute accuracy of intra-frequency RSRP measurements for Cell 6 on SCC3 shall fulfil the requirements defined in clause 9.1.11.2.
- The absolute accuracy of intra-frequency RSRP measurements for Cell 8 on SCC4 shall fulfil the requirements defined in clause 9.1.11.2.
- The relative accuracy of intra-frequency RSRP measurements for Cell 3 relative to Cell 2 on SCC1 shall fulfil the requirements defined in clause 9.1.11.2.
- The relative accuracy of intra-frequency RSRP measurements for Cell 5 relative to Cell 4 on SCC2 shall fulfil the requirements defined in clause 9.1.11.2.
- The relative accuracy of intra-frequency RSRP measurements for Cell 7 relative to Cell 6 on SCC3 shall fulfil the requirements defined in clause 9.1.11.2.
- The relative accuracy of intra-frequency RSRP measurements for Cell 9 relative to Cell 8 on SCC4 shall fulfil the requirements defined in clause 9.1.11.2.
- The relative accuracy of inter-frequency RSRP measurements between SCC1 and the primary component carriers for Cell 2 relative to Cell 1 shall fulfil the requirements defined in clause 9.1.11.3.
- The relative accuracy of inter-frequency RSRP measurements between SCC2 and the primary component carriers for Cell 4 relative to Cell 1 shall fulfil the requirements defined in clause 9.1.11.3.
- The relative accuracy of inter-frequency RSRP measurements between SCC3 and the primary component carriers for Cell 6 relative to Cell 1 shall fulfil the requirements defined in clause 9.1.11.3.
- The relative accuracy of inter-frequency RSRP measurements between SCC4 and the primary component carriers for Cell 8 relative to Cell 1 shall fulfil the requirements defined in clause 9.1.11.3.

A.9.1.52 FD-FDD RSRP Intra frequency case for Cat-M1 UE in CEModeA

A.9.1.52.1 Test Purpose and Environment

The purpose of this test is to verify that the RSRP measurement accuracy is within the specified limits. This test will verify the requirements in Sections 9.1.21.1 and 9.1.21.2 for FD-FDD intra frequency RSRP measurements for Cat-M1 UE in CEModeA.

A.9.1.52.2 Test parameters

In this set of test cases all cells are on the same carrier frequency. Both absolute and relative accuracy of RSRP intra frequency measurements are tested by using the parameters in Table A.9.1.52.2-1. In all test cases, Cell 1 is the PCell and Cell 2 the target cell.

Table A.9.1.52.2-1: FD-FDD RSRP Intra frequency test parameters for Cat-M1 UE in CEModeA

Parameter	Unit	Test 1		Test 2		Test 3							
		Cell 1	Cell 2	Cell 1	Cell 2	Cell 1	Cell 2						
E-UTRA RF Channel Number		1		1		1							
$BW_{channel}$	MHz	10		10		10							
Measurement bandwidth	n_{PRB}	22—27		22—27		22—27							
PDSCH Reference measurement channel		R.20 FDD	-	R.20 FDD	-	R.20 FDD	-						
PDSCH allocation	n_{PRB}	Follows R.20 FDD	-	Follows R.20 FDD	-	Follows R.20 FDD	-						
MPDCCH Reference measurement channel		R.16 FDD		R.16 FDD		R.16 FDD							
OCNG Patterns		OP.21 FDD	OP.6 FDD	OP.21 FDD	OP.6 FDD	OP.21 FDD	OP.6 FDD						
PBCH_RA	dB	0	0	0	0	0	0						
PBCH_RB													
PSS_RA													
SSS_RA													
PCFICH_RB													
PHICH_RA													
PHICH_RB													
MPDCCH_RA													
MPDCCH_RB													
PDSCH_RA													
PDSCH_RB													
OCNG_RA ^{Note1}													
OCNG_RB ^{Note1}													
N_{oc} ^{Note2}								Bands FDD-M1_A	dBm/15 kHz	-106	-86	-116	
								Bands FDD-M1_B ^{Note 6}				-115.5	
	Bands FDD-M1_C	-115											
	Bands FDD-M1_D	-114.5											
	Bands FDD-M1_E, FDD-M1_F ^{Note 4}	-114											
	Bands FDD-M1_G	-113											
	Bands FDD-M1_H	-112.5											
\hat{E}_s / N_{oc}	dB	6	1	6	1	3	-1						
\hat{E}_s / I_{ot}	dB	2.5	-6	2.5	-6	0.46	-5.76						
RSRP ^{Note3}	Bands FDD-M1_A	dBm/15 kHz	-100	-105	-80	-85	-113	-117					
	Bands FDD-M1_B ^{Note 6}						-112.5	-116.5					
	Bands FDD-M1_C						-112	-116					
	Bands FDD-M1_D						-111.5	-115.5					
	Bands FDD-M1_E, FDD-M1_F ^{Note 4}						-111	-115					
	Bands FDD-M1_G						-110	-114					
	Bands FDD-M1_H						-109.5	-113.5					

I _o ^{Note3}	Bands FDD-M1_A	dBm/9 MHz	-70.27	-50.27	-82.43	
	Bands FDD-M1_B Note 6				-81.93	
	Bands FDD-M1_C				-81.43	
	Bands FDD-M1_D				-80.93	
	Bands FDD-M1_E, FDD-M1_F Note 4				-80.43	
	Bands FDD-M1_G				-79.43	
	Bands FDD-M1_H				-78.93	
Propagation condition		-	AWGN	AWGN	AWGN	
Antenna Configuration			1x1	1x1	1x1	
Timing offset to Cell 1		ms	-	3	-	3
<p>Note 1: OCNG shall be used such that both cells are fully allocated and a constant total transmitted power spectral density is achieved for all OFDM symbols.</p> <p>Note 2: Interference from other cells and noise sources not specified in the test is assumed to be constant over subcarriers and time and shall be modelled as AWGN of appropriate power for N_{oc} to be fulfilled.</p> <p>Note 3: Es/I_{ot}, RSRP and I_o levels have been derived from other parameters for information purposes. They are not settable parameters themselves.</p> <p>Note 4: For Band 26, the tests shall be performed with the carrier frequency of the assigned E-UTRA channel bandwidth within 865-894 MHz.</p> <p>Note 5: E-UTRA operating band groups are as defined in Section 3.5.</p> <p>Note 6: For Band 74, the tests shall be performed with the carrier frequency of the assigned E-UTRA channel bandwidth within 1475.9-1510.9 MHz.</p>						

A.9.1.52.3 Test Requirements

The RSRP measurement accuracy shall fulfil the requirements in sections 9.1.21.1 and 9.1.21.2.

A.9.1.52A FD-FDD RSRP Intra frequency case for Cat-M1 UE for 5MHz Bandwidth in CEModeA

A.9.1.52A.1 Test Purpose and Environment

The purpose of this test is to verify that the RSRP measurement accuracy is within the specified limits. This test will verify the requirements in Sections 9.1.21.1 and 9.1.21.2 for FD-FDD intra frequency RSRP measurements for Cat-M1 UE in CEModeA.

A.9.1.52A.2 Test parameters

In this set of test cases all cells are on the same carrier frequency. Both absolute and relative accuracy of RSRP intra frequency measurements are tested by using the parameters in Table A.9.1.52A.2-1. In all test cases, Cell 1 is the PCell and Cell 2 the target cell.

Table A.9.1.52A.2-1: FD-FDD RSRP Intra frequency case for Cat-M1 UE for 5MHz Bandwidth in CEModeA

Parameter	Unit	Test 1		Test 2		Test 3	
		Cell 1	Cell 2	Cell 1	Cell 2	Cell 1	Cell 2
E-UTRA RF Channel Number		1		1		1	
BW _{channel}	MHz	5		5		5	
Measurement bandwidth	n_{PRB}	10—15		10—15		10—15	
PDSCH Reference measurement channel		R.28 FDD	-	R.28 FDD	-	R.28 FDD	-
PDSCH allocation	n_{PRB}	Follows R.28 FDD	-	Follows R.28 FDD	-	Follows R.28 FDD	-
MPDCCH Reference measurement channel		R.24 FDD		R.24 FDD		R.24 FDD	
OCNG Patterns		OP.22 FDD	OP.19 FDD	OP.22 FDD	OP.19 FDD	OP.22 FDD	OP.19 FDD
PBCH_RA	dB	0	0	0	0	0	0
PBCH_RB							
PSS_RA							

SSS_RA								
PCFICH_RB								
PHICH_RA								
PHICH_RB								
MPDCCH_RA								
MPDCCH_RB								
PDSCH_RA								
PDSCH_RB								
OCNG_RA ^{Note1}								
OCNG_RB ^{Note1}								
N_{oc} ^{Note2}	Bands FDD-M1_N	dBm/15 kHz	-103		-83		-109.5	
\hat{E}_s/N_{oc}		dB	6	1	6	1	3	-1
\hat{E}_s/I_{ot} ^{Note3}		dB	2.46	-5.97	2.46	-5.97	0.46	-5.76
RSRP ^{Note3}	Bands FDD-M1_N	dBm/15 kHz	-97	-102	-77	-82	-106.5	-110.5
I_o ^{Note3}	Bands FDD-M1_N	dBm/4.5 MHz	-70.28		-50.28		-78.94	
Propagation condition		-	AWGN		AWGN		AWGN	
Antenna Configuration			1x1		1x1		1x1	
Timing offset to Cell 1		ms	-	3	-	3	-	3
<p>Note 1: OCNG shall be used such that both cells are fully allocated and a constant total transmitted power spectral density is achieved for all OFDM symbols.</p> <p>Note 2: Interference from other cells and noise sources not specified in the test is assumed to be constant over subcarriers and time and shall be modelled as AWGN of appropriate power for N_{oc} to be fulfilled.</p> <p>Note 3: E_s/I_{ot}, RSRP and I_o levels have been derived from other parameters for information purposes. They are not settable parameters themselves.</p> <p>Note 4: For Band 26, the tests shall be performed with the carrier frequency of the assigned E-UTRA channel bandwidth within 865-894 MHz.</p> <p>Note 5: E-UTRA operating band groups are as defined in Section 3.5.</p>								

A.9.1.52A.3 Test Requirements

The RSRP measurement accuracy shall fulfil the requirements in sections 9.1.21.1 and 9.1.21.2.

A.9.1.53 HD-FDD RSRP Intra frequency case for Cat-M1 UE in CEModeA

A.9.1.53.1 Test Purpose and Environment

The purpose of this test is to verify that the RSRP measurement accuracy is within the specified limits. This test will verify the requirements in Sections 9.1.21.1 and 9.1.21.2 for HD-FDD intra frequency RSRP measurements for Cat-M1 UE in CEModeA.

A.9.1.53.2 Test parameters

In this set of test cases all cells are on the same carrier frequency. Both absolute and relative accuracy of RSRP intra frequency measurements are tested by using the parameters in Table A.9.1.53.2-1. In all test cases, Cell 1 is the PCell and Cell 2 the target cell.

Table A.9.1.53.2-1: HD-FDD RSRP Intra frequency test parameters for Cat-M1 UE in CEModeA

Parameter	Unit	Test 1		Test 2		Test 3	
		Cell 1	Cell 2	Cell 1	Cell 2	Cell 1	Cell 2
E-UTRA RF Channel Number		1		1		1	
$BW_{channel}$	MHz	10		10		10	
Measurement bandwidth	n_{PRB}	22—27		22—27		22—27	
PDSCH Reference measurement channel		R.10 HD-FDD	-	R.10 HD-FDD	-	R.10 HD-FDD	-
PDSCH allocation	n_{PRB}	Follows R.10	-	Follows R.10	-	Follows R.10	-

			HD-FDD		HD-FDD		HD-FDD	
MPDCCH Reference measurement channel			R.6 HD-FDD		R.6 HD-FDD		R.6 HD-FDD	
OCNG Patterns			OP.21 FDD	OP.6 FDD	OP.21 FDD	OP.6 FDD	OP.21 FDD	OP.6 FDD
PBCH_RA		dB	0	0	0	0	0	0
PBCH_RB								
PSS_RA								
SSS_RA								
PCFICH_RB								
PHICH_RA								
PHICH_RB								
MPDCCH_RA								
MPDCCH_RB								
PDSCH_RA								
PDSCH_RB								
OCNG_RA ^{Note1}								
OCNG_RB ^{Note1}								
N_{oc} ^{Note2}	Bands FDD-M1_A							
	Bands FDD-M1_B	-115.5						
	Bands FDD-M1_C	-115						
	Bands FDD-M1_D	-114.5						
	Bands FDD-M1_E, FDD-M1_F ^{Note 4}	-114						
	Bands FDD-M1_G	-113						
	Bands FDD-M1_H	-112.5						
\hat{E}_s/N_{oc}		dB	6	1	6	1	3	-1
\hat{E}_s/I_{ot} ^{Note3}		dB	2.5	-6	2.5	-6	0.46	-5.76
RSRP ^{Note3}	Bands FDD-M1_A	dBm/15 kHz	-100	-105	-80	-85	-113	-117
	Bands FDD-M1_B						-112.5	-116.5
	Bands FDD-M1_C						-112	-116
	Bands FDD-M1_D						-111.5	-115.5
	Bands FDD-M1_E, FDD-M1_F ^{Note 4}						-111	-115
	Bands FDD-M1_G						-110	-114
	Bands FDD-M1_H						-109.5	-113.5
I_o ^{Note3}	Bands FDD-M1_A	dBm/9 MHz	-70.27		-50.27		-82.43	
	Bands FDD-M1_B						-81.93	
	Bands FDD-M1_C						-81.43	
	Bands FDD-M1_D						-80.93	
	Bands FDD-M1_E, FDD-M1_F ^{Note 4}						-80.43	
	Bands FDD-M1_G						-79.43	
	Bands FDD-M1_H						-78.93	
Propagation condition		-	AWGN		AWGN		AWGN	
Antenna Configuration			1x1		1x1		1x1	
Timing offset to Cell 1		ms	-	3	-	3	-	3
<p>Note 1: OCNG shall be used such that both cells are fully allocated and a constant total transmitted power spectral density is achieved for all OFDM symbols.</p> <p>Note 2: Interference from other cells and noise sources not specified in the test is assumed to be constant over subcarriers and time and shall be modelled as AWGN of appropriate power for N_{oc} to be fulfilled.</p> <p>Note 3: E_s/I_{ot}, RSRP and I_o levels have been derived from other parameters for information purposes. They are not settable parameters themselves.</p> <p>Note 4: For Band 26, the tests shall be performed with the carrier frequency of the assigned E-UTRA channel bandwidth within 865-894 MHz.</p> <p>Note 5: E-UTRA operating band groups are as defined in Section 3.5.</p>								

A.9.1.53.3 Test Requirements

The RSRP measurement accuracy shall fulfil the requirements in sections 9.1.21.1 and 9.1.21.2.

A.9.1.53A HD-FDD RSRP Intra frequency case for Cat-M1 UE for 5MHz Bandwidth in CEModeA

A.9.1.53A.1 Test Purpose and Environment

The purpose of this test is to verify that the RSRP measurement accuracy is within the specified limits. This test will verify the requirements in Sections 9.1.21.1 and 9.1.21.2 for HD-FDD intra frequency RSRP measurements for Cat-M1 UE in CEModeA.

A.9.1.53A.2 Test parameters

In this set of test cases all cells are on the same carrier frequency. Both absolute and relative accuracy of RSRP intra frequency measurements are tested by using the parameters in Table A.9.1.53A.2-1. In all test cases, Cell 1 is the PCell and Cell 2 the target cell.

Table A.9.1.53A.2-1: HD-FDD RSRP Intra frequency case for Cat-M1 UE for 5MHz Bandwidth in CEModeA

Parameter	Unit	Test 1		Test 2		Test 3									
		Cell 1	Cell 2	Cell 1	Cell 2	Cell 1	Cell 2								
E-UTRA RF Channel Number		1		1		1									
BW _{channel}	MHz	5		5		5									
Measurement bandwidth	n_{PRB}	10—15		10—15		10—15									
PDSCH Reference measurement channel		R.18 HD-FDD	-	R.18 HD-FDD	-	R.18 HD-FDD	-								
PDSCH allocation	n_{PRB}	Follows R.18 HD-FDD	-	Follows R.18 HD-FDD	-	Follows R.18 HD-FDD	-								
MPDCCH Reference measurement channel		R.14 HD-FDD		R.14 HD-FDD		R.14 HD-FDD									
OCNG Patterns		OP.22 FDD	OP.19 FDD	OP.22 FDD	OP.19 FDD	OP.22 FDD	OP.19 FDD								
PBCH_RA	dB	0	0	0	0	0	0								
PBCH_RB															
PSS_RA															
SSS_RA															
PCFICH_RB															
PHICH_RA															
PHICH_RB															
MPDCCH_RA															
MPDCCH_RB															
PDSCH_RA															
PDSCH_RB															
OCNG_RA ^{Note1}															
OCNG_RB ^{Note1}															
N_{oc} ^{Note2}								Bands FDD-M1_N	dBm/15 kHz		-103		-83		-109.5
\hat{E}_s/N_{oc}		6	1	6	1	3	-1								
\hat{E}_s/I_{ot} ^{Note3}		2.46	-5.97	2.46	-5.97	0.46	-5.76								
RSRP ^{Note3}	Bands FDD-M1_N	dBm/15 kHz		-97		-102		-77		-82		-106.5		-110.5	
I_o ^{Note3}	Bands FDD-M1_N	dBm/4.5 MHz		-70.28		-50.27		-78.94							
Propagation condition		AWGN				AWGN									
Antenna Configuration		1x1				1x1									
Timing offset to Cell 1	ms	-	3	-	3	-	3								
<p>Note 1: OCNG shall be used such that both cells are fully allocated and a constant total transmitted power spectral density is achieved for all OFDM symbols.</p> <p>Note 2: Interference from other cells and noise sources not specified in the test is assumed to be constant over subcarriers and time and shall be modelled as AWGN of appropriate power for N_{oc} to be fulfilled.</p>															

Note 3:	Es/lot, RSRP and lo levels have been derived from other parameters for information purposes. They are not settable parameters themselves.
Note 4:	For Band 26, the tests shall be performed with the carrier frequency of the assigned E-UTRA channel bandwidth within 865-894 MHz.
Note 5:	E-UTRA operating band groups are as defined in Section 3.5.

A.9.1.53A.3 Test Requirements

The RSRP measurement accuracy shall fulfil the requirements in sections 9.1.21.1 and 9.1.21.2.

A.9.1.54 TDD RSRP Intra frequency case for Cat-M1 UE in CEModeA

A.9.1.54.1 Test Purpose and Environment

The purpose of this test is to verify that the RSRP measurement accuracy is within the specified limits. This test will verify the requirements in Sections 9.1.21.1 and 9.1.21.2 for TDD intra frequency RSRP measurements for Cat-M1 UE in CEModeA.

A.9.1.54.2 Test parameters

In this set of test cases all cells are on the same carrier frequency. Both absolute and relative accuracy of RSRP intra frequency measurements are tested by using the parameters in Table A.9.1.54.2-1. In all test cases, Cell 1 is the PCell and Cell 2 the target cell.

Table A.9.1.54.2-1: TDD RSRP Intra frequency test parameters for Cat-M1 UE in CEModeA

Parameter	Unit	Test 1		Test 2		Test 3								
		Cell 1	Cell 2	Cell 1	Cell 2	Cell 1	Cell 2							
E-UTRA RF Channel Number		1		1		1								
BW _{channel}	MHz	10		10		10								
Special subframe configuration ^{Note1}		6		6		6								
Uplink/downlink configuration ^{Note1}		1		1		1								
Measurement bandwidth	<i>n_{PRB}</i>	22—27		22—27		22—27								
PDSCH Reference measurement channel		R.16 TDD	-	R.16 TDD	-	R.16 TDD	-							
PDSCH allocation	<i>n_{PRB}</i>	Follows R.16 TDD	-	Follows R.16 TDD	-	Follows R.16 TDD	-							
MPDCCH Reference measurement channel		R.14 TDD		R.14 TDD		R.14 TDD								
OCNG Patterns		OP.11 TDD	OP.2 TDD	OP.11 TDD	OP.2 TDD	OP.11 TDD	OP.2 TDD							
PBCH_RA	dB	0	0	0	0	0	0							
PBCH_RB														
PSS_RA														
SSS_RA														
PCFICH_RB														
PHICH_RA														
PHICH_RB														
MPDCCH_RA														
MPDCCH_RB														
PDSCH_RA														
PDSCH_RB														
OCNG_RA ^{Note2}														
OCNG_RB ^{Note2}														
<i>N_{oc}</i> ^{Note3}								Bands TDD-M1_A	-106		-86		-116	
								Bands TDD-M1_C					-115	
	Bands TDD-M1_E	-114												
\hat{E}_s / N_{oc}	dB	6	1	6	1	3	-1							

\hat{E}_s/I_{ot}		dB	2.5	-6	2.5	-6	0.5	-5.76
RSRP ^{Note4}	Bands TDD-M1_A	dBm/15 kHz	-100	-105	-80	-85	-113	-117
	Bands TDD-M1_C						-112	-116
	Bands TDD-M1_E						-111	-115
I _o ^{Note4}	Bands TDD-M1_A	dBm/9 MHz	-70.27		-50.27		-82.43	
	Bands TDD-M1_C						-81.43	
	Bands TDD-M1_E						-80.43	
Propagation condition		-	AWGN		AWGN		AWGN	
Correlation Matrix and Antenna Configuration			1x1		1x1		1x1	
Timing offset to Cell 1		μs	-	3	-	3	-	3
<p>Note 1: For special subframe and uplink-downlink configurations see Tables 4.2-1 and 4.2-2 in TS 36.211.</p> <p>Note 2: OCNB shall be used such that both cells are fully allocated and a constant total transmitted power spectral density is achieved for all OFDM symbols.</p> <p>Note 3: Interference from other cells and noise sources not specified in the test is assumed to be constant over subcarriers and time and shall be modelled as AWGN of appropriate power for N_{oc} to be fulfilled.</p> <p>Note 4: E_s/I_{ot}, RSRP and I_o levels have been derived from other parameters for information purposes. They are not settable parameters themselves.</p> <p>Note 5: E-UTRA operating band groups are as defined in Section 3.5.</p>								

A.9.1.54.3 Test Requirements

The RSRP measurement accuracy shall fulfil the requirements in sections 9.1.21.1 and 9.1.21.2.

A.9.1.55 FS3 Intra frequency absolute and relative RSRP accuracies with FDD PCell

A.9.1.55.1 Test Purpose and Environment

The purpose of this test is to verify that the FDD intra frequency RSRP absolute and relative measurement accuracies in carrier aggregation with frame structure 3 in the configured DMTC occasion are within the specified limits. This test will verify the absolute RSRP accuracy requirement of the secondary component carrier defined in clause 9.1.19.2, and the relative RSRP accuracy requirement of the secondary component carrier defined in clause 9.1.19.2. The test will also verify the primary and secondary component carrier relative RSRP accuracy requirement defined in Clause 9.1.19.4.

A.9.1.55.2 Test parameters

In this test case, Cell1 is PCell on the primary component carrier, Cell2 is SCell on the secondary component carrier with frame structure 3 and activated, and Cell3 is the neighboring cell on the same secondary component carrier of Cell2. The test parameters are given in Table A.9.1.55.2-1. The DMTC configuration for Cell2 and Cell3 is provided to the UE in the *measDS-Config* before the start of the test.

Table A.9.1.55.2-1: Test parameters for FDD RSRP accuracies of SCell with FS3

Parameter	Unit	Test 1		
		Cell 1	Cell 2	Cell3
E-UTRA RF Channel Number		1	2	2
BW _{channel}	MHz	5MHz: N _{RB,c} = 25 10MHz: N _{RB,c} = 50 20MHz: N _{RB,c} = 100	20	20
DMTC period	ms	N/A	40	40

DMTC period offset			N/A	10	10
Discovery signal occasion duration		ms	N/A	1	1
LBT model			N/A	N/A	[A.3.17]
Timing offset to cell1		µs	-	0	3
Time alignment error between cell 2 and cell 1			-	≤ Time alignment error as specified in 3GPP TS 36.104 [30] clause 6.5.3.1.	-
Measurement bandwidth		n_{PRB}	5MHz: 10-15 10MHz: 22-27 20MHz: 47-52	47-52	47-52
PDSCH Reference measurement channel defined in A.3.1.1 and A.3.1.1.6(R.0 FS3)			5MHz: R.5 FDD 10MHz: R.0 FDD 20MHz: R.4 FDD	R.0 FS3	-
PDSCH allocation		n_{PRB}	5MHz: 7-17 10MHz: 13-36 20MHz: 38-61	38-61	-
PDCCH/PCFICH/PHICH Reference measurement channel defined in A.3.1.2			5MHz: R.11 FDD 10MHz: R.6 FDD 20MHz: R.10 FDD	R.0 FS3	R.0 FS3
OCNG Patterns defined in A.3.2			5MHz: OP.15 FDD 10MHz: OP.1 FDD 20MHz: OP.11 FDD	OP.13 FDD	OP.14 FDD
PBCH_RA		dB	0	0	0
PBCH_RB					
PSS_RA					
SSS_RA					
PCFICH_RB					
PHICH_RA					
PHICH_RB					
PDCCH_RA					
PDCCH_RB					
PDSCH_RA					
PDSCH_RB					
OCNG_RA ^{Note1}					
OCNG_RB ^{Note1}					
N_{oc} ^{Note2}	Bands FDD_A				
	Bands FDD_B1, FDD_B2 ^{Note 10}	-116.5			
	Bands FDD_C	-116			
	Bands FDD_D	-115.5			
	Bands FDD_E, FDD_F ^{Note 6}	-115			
	Bands FDD_G	-114			
	Bands FDD_H	-113.5			

	Bands FS3_G		-	$(N_{oc}$ for Channel 1 +1dB)	
\hat{E}_s / I_{ot}		dB	-4	0.46 ^{Note9}	-5.76
RSRP ^{Note3}	Bands FDD_A	dBm/15 kHz	-121	-	
	Bands FDD_B1, FDD_B2 ^{Note 10}		-120.5		
	Bands FDD_C		-120		
	Bands FDD_D		-119.5		
	Bands FDD_E, FDD_F ^{Note 6}		-119		
	Bands FDD_G		-118		
	Bands FDD_H		-117.5		
	Bands FS3_G	-	(RSRP for Cell 1 +8dB)	(RSRP for Cell 1 +4dB)	
I_o ^{Note3}	Bands FDD_A	5MHz: dBm/4.5MHz	-87.76 $+10\log(N_{RB} / 50)$	-	
	Bands FDD_B1, FDD_B2 ^{Note 10}		-86.26 $+10\log(N_{RB} / 50)$		
	Bands FDD_C		-86.76 $+10\log(N_{RB} / 50)$		
	Bands FDD_D		-86.26 $+10\log(N_{RB} / 50)$		
	Bands FDD_E, FDD_F ^{Note 6}	10MHz: dBm/9MHz	-85.76 $+10\log(N_{RB} / 50)$		
	Bands FDD_G	20MHz: dBm/18MHz	-84.76 $+10\log(N_{RB} / 50)$		
	Bands FDD_H	-84.26 $+10\log(N_{RB} / 50)$			
	Bands FS3_G	-	(I_o for Channel 1 +5.33dB ^{Note9} + $10\log(N_{RB\ channel2} / N_{RB\ channel\ 1})$)	(I_o for Channel 1 +5.33dB + $10\log(N_{RB\ channel2} / N_{RB\ channel\ 1})$)	
\hat{E}_s / N_{oc}		dB	-4	3	-1
Propagation condition		-	AWGN		
<p>Note 1: OCNG shall be used such that cells are fully allocated and a constant total transmitted power spectral density is achieved for all OFDM symbols. For cells with LBT model, OCNG is transmitted only in subframes with downlink transmission bursts, and is not transmitted during muted subframes or during DMTC windows.</p> <p>Note 2: Interference from other cells and noise sources not specified in the test is assumed to be constant over subcarriers and time and shall be modelled as AWGN of appropriate power for N_{oc} to be fulfilled.</p> <p>Note 3: RSRP and I_o levels have been derived from other parameters for information purposes. They are not settable parameters themselves.</p> <p>Note 4: RSRP minimum requirements are specified assuming independent interference and noise at each receiver antenna port.</p> <p>Note 5: The selection of the bands for testing depends on the configuration of the carrier aggregation supported by the UEs.</p> <p>Note 6: For Band 26, the tests shall be performed with the carrier frequency of the assigned E-UTRA channel bandwidth within 865-894 MHz.</p> <p>Note 7: This test verifies the RRM requirement which is independent of channel bandwidth and is performed according to the principle defined in section A.3.6.1.</p> <p>Note 8: E-UTRA operating band groups are as defined in Section 3.5.</p> <p>Note 9: The value is corresponding to DRS transmission through LBT operation in Cell3.</p>					

Note 10: For Band 74, the tests shall be performed with the carrier frequency of the assigned E-UTRA channel bandwidth within 1475.9-1510.9 MHz.

A.9.1.55.3 Test Requirements

In the test, the performance of RSRP measurements is verified from following three perspectives:

- The absolute accuracy of intra-frequency RSRP measurements for Cell 3 on the secondary component carrier with frame structure 3 shall fulfil the requirements defined in clause 9.1.19.2.
- The relative accuracy of intra-frequency RSRP measurements for Cell 3 relative to Cell 2 on the secondary component carrier with frame structure 3 shall fulfil the requirements defined in clause 9.1.19.2
- The relative accuracy of inter-frequency RSRP measurements between the primary and secondary component carriers for Cell 3 relative to Cell 1 shall fulfil the requirements defined in clause 9.1.19.4.

A.9.1.56 FS3 Intra frequency absolute and relative RSRP accuracies with TDD PCell

A.9.1.56.1 Test Purpose and Environment

The purpose of this test is to verify that the TDD intra frequency RSRP absolute and relative measurement accuracies in carrier aggregation with frame structure 3 in the configured DMTC occasion are within the specified limits. This test will verify the absolute RSRP accuracy requirement of the secondary component carrier defined in clause 9.1.19.2, and the relative RSRP accuracy requirement of the secondary component carrier defined in clause 9.1.19.2. The test will also verify the primary and secondary component carrier relative RSRP accuracy requirement defined in Clause 9.1.19.4.

A.9.1.56.2 Test parameters

In this test case, Cell1 is PCell on the primary component carrier, Cell2 is SCell on the secondary component carrier with frame structure 3 and activated, and Cell3 is the neighboring cell on the same secondary component carrier of Cell2. The test parameters are given in Table A.9.1.56.2-1. The DMTC configuration for Cell2 and Cell3 is provided to the UE in the *measDS-Config* before the start of the test.

Table A.9.1.56.2-1: Test parameters for TDD RSRP accuracies of SCell with FS3

Parameter	Unit	Test 1		
		Cell 1	Cell 2	Cell3
E-UTRA RF Channel Number		1	2	2
BW _{channel}	MHz	5MHz: N _{RB,c} = 25 10MHz: N _{RB,c} = 50 20MHz: N _{RB,c} = 100	20	20
DMTC period	ms	N/A	40	40
DMTC period offset		N/A	10	10
Discovery signal occasion duration	ms	N/A	1	1
LBT model		N/A	N/A	A.3.17
Special subframe configuration ^{Note1}		6	N/A	N/A
Uplink/downlink configuration ^{Note1}		1	N/A	N/A
Timing offset to cell1	μs	-	0	3
Time alignment error between cell 2 and cell 1		-	≤ Time alignment error as specified in 3GPP TS 36.104 [30] clause 6.5.3.1.	-

Measurement bandwidth	n_{PRB}	5MHz: 10-15 10MHz: 22-27 20MHz: 47-52	47-52	47-52
PDSCH Reference measurement channel defined in A.3.1.1		5MHz: R.4 TDD 10MHz: R.0 TDD 20MHz: R.3 TDD	R.0 FS3	-
PDSCH allocation	n_{PRB}	5MHz: 7-17 10MHz: 13-36 20MHz: 38-61	38-61	-
PDCCH/PCFICH/PHICH Reference measurement channel defined in A.3.1.2		5MHz: R.11 TDD 10MHz: R.6 TDD 20MHz: R.10 TDD	R.0 FS3	R.0 FS3
OCNG Patterns defined in A.3.2		5MHz: OP.9 TDD 10MHz: OP.1 TDD 20MHz: OP.7 TDD	OP.13 FDD	OP.14 FDD
PBCH_RA	dB	0	0	0
PBCH_RB				
PSS_RA				
SSS_RA				
PCFICH_RB				
PHICH_RA				
PHICH_RB				
PDCCH_RA				
PDCCH_RB				
PDSCH_RA				
PDSCH_RB				
OCNG_RA ^{Note2}				
OCNG_RB ^{Note2}				
N_{oc} ^{Note3}				
	Bands TDD_C	-116		
	Bands TDD_E	-115		
	Bands FS3_G	-		
\hat{E}_s/I_{ot}				
RSRP ^{Note4}	Bands TDD_A	-121	-	(RSRP for Cell 1 +8dB)
	Bands TDD_C	-120		
	Bands TDD_E	-119		
	Bands FS3_G	-	(RSRP for Cell 1 +4dB)	
I_o ^{Note4}	Bands TDD_A	5MHz: dBm/4.5MHz $+10\log(N_{RB}/50)$	-87.76	-
	Bands TDD_C	10MHz: dBm/9MHz $+10\log(N_{RB}/50)$	-86.76	
	Bands TDD_E	20MHz: dBm/18MHz $+10\log(N_{RB}/50)$	-85.76	

	Bands FS3_G		-	(lo for Channel 1 +5.33dB ^{Note9} +10log(N _{RB channel2} / N _{RB channel 1}))	(lo for Channel 1 +5.33dB +10log(N _{RB channel2} / N _{RB channel 1}))
\hat{E}_s / N_{oc}		dB	-4	3	-1
Propagation condition		-	AWGN		
<p>Note 1: For special subframe and uplink-downlink configurations see Tables 4.2-1 and 4.2-2 in TS 36.211.</p> <p>Note 2: OCNG shall be used such that cells are fully allocated and a constant total transmitted power spectral density is achieved for all OFDM symbols. For cells with LBT model, OCNG is transmitted only in subframes with downlink transmission bursts, and is not transmitted during muted subframes or during DMTC windows.</p> <p>Note 3: Interference from other cells and noise sources not specified in the test is assumed to be constant over subcarriers and time and shall be modelled as AWGN of appropriate power for N_{oc} to be fulfilled.</p> <p>Note 4: RSRP and lo levels have been derived from other parameters for information purposes. They are not settable parameters themselves.</p> <p>Note 5: RSRP minimum requirements are specified assuming independent interference and noise at each receiver antenna port.</p> <p>Note 6: The selection of the bands for testing depends on the configuration of the carrier aggregation supported by the UEs.</p> <p>Note 7: This test verifies the RRM requirement which is independent of channel bandwidth and is performed according to the principle defined in section A.3.6.1.</p> <p>Note 8: E-UTRA operating band groups are as defined in Section 3.5.</p> <p>Note 9: The value is corresponding to DRS transmission through LBT operation in Cell3.</p>					

A.9.1.56.3 Test Requirements

In the test, the performance of RSRP measurements is verified from following three perspectives:

- The absolute accuracy of intra-frequency RSRP measurements for Cell 3 on the secondary component carrier with frame structure 3 shall fulfil the requirements defined in clause 9.1.19.2.
- The relative accuracy of intra-frequency RSRP measurements for Cell 3 relative to Cell 2 on the secondary component carrier with frame structure 3 shall fulfil the requirements defined in clause 9.1.19.2
- The relative accuracy of inter-frequency RSRP measurements between the primary and secondary component carriers for Cell 3 relative to Cell 1 shall fulfil the requirements defined in clause 9.1.19.4.

A.9.1.57 FD-FDD RSRP Intra frequency case for Cat-M1 UE in CEModeB

A.9.1.57.1 Test Purpose and Environment

The purpose of this test is to verify that the RSRP measurement accuracy is within the specified limits. This test will verify the requirements in Sections 9.1.21.3 and 9.1.21.4 for FD-FDD intra frequency RSRP measurements for Cat-M1 UE in CEModeB.

A.9.1.57.2 Test parameters

In this set of test cases all cells are on the same carrier frequency. Both absolute and relative accuracy of RSRP intra frequency measurements are tested by using the parameters in Table A.9.1.57.2-1. In all test cases, Cell 1 is the PCell and Cell 2 the target cell. All the tests contain MPDCCH for UL grant for reporting RSRP.

Table A.9.1.57.2-1: FD-FDD RSRP Intra frequency test parameters for Cat-M1 UE in CEModeB

Parameter	Unit	Test 1		Test 2		Test 3	
		Cell 1	Cell 2	Cell 1	Cell 2	Cell 1	Cell 2
E-UTRA RF Channel Number		1		1		1	
BW _{channel}	MHz	10		10		10	
Measurement bandwidth	n_{PRB}	22—27		22—27		22—27	

PDSCH Reference measurement channel		R.22 FDD	-	R.22 FDD	-	R.22 FDD	-	
PDSCH allocation	n_{PRB}	Follows R.22 FDD	-	Follows R.22 FDD	-	Follows R.22 FDD	-	
MPDCCH Reference measurement channel		R.18 FDD		R.18 FDD		R.18 FDD		
OCNG Patterns		OP.21 FDD	OP.6 FDD	OP.21 FDD	OP.6 FDD	OP.21 FDD	OP.6 FDD	
PBCH_RA	dB	0	0	0	0	0	0	
PBCH_RB								
PSS_RA								
SSS_RA								
PCFICH_RB								
PHICH_RA								
PHICH_RB								
MPDCCH_RA								
MPDCCH_RB								
PDSCH_RA								
PDSCH_RB								
OCNG_RA ^{Note1}								
OCNG_RB ^{Note1}								
$b N_{oc}$ ^{Note2}								Bands FDD-M1_A
	Bands FDD-M1_B ^{Note 6}	-106.5						
	Bands FDD-M1_C	-106						
	Bands FDD-M1_D	-105.5						
	Bands FDD-M1_E, FDD-M1_F ^{Note 4}	-105						
	Bands FDD-M1_G	-104						
Bands FDD-M1_H	-103.5							
\hat{E}_s / N_{oc}	dB	-12	-14	-12	-14	-12	-14	
\hat{E}_s / I_{ot} ^{Note3}	dB	-12.17	-14.27	-12.17	-14.27	-12.17	-14.27	
RSRP ^{Note3}	Bands FDD-M1_A	dBm/15 kHz	-111	-113	-91	-93	-119	-121
	Bands FDD-M1_B ^{Note 6}						-118.5	-120.5
	Bands FDD-M1_C						-118	-120
	Bands FDD-M1_D						-117.5	-119.5
	Bands FDD-M1_E, FDD-M1_F ^{Note 4}						-117	-119
	Bands FDD-M1_G						-116	-118
Bands FDD-M1_H	-115.5	-117.5						
I_o ^{Note3}	Bands FDD-M1_A	dBm/9 MHz	-70.79	-50.79	-78.79			
	Bands FDD-M1_B ^{Note 6}				-78.29			
	Bands FDD-M1_C				-77.79			
	Bands FDD-M1_D				-77.29			
	Bands FDD-M1_E, FDD-M1_F ^{Note 4}				-76.79			
	Bands FDD-M1_G				-75.79			
Bands FDD-M1_H	-75.29							
Propagation condition	-	AWGN		AWGN		AWGN		
Antenna Configuration		1x1		1x1		1x1		
<p>Note 1: OCNG shall be used such that both cells are fully allocated and a constant total transmitted power spectral density is achieved for all OFDM symbols.</p> <p>Note 2: Interference from other cells and noise sources not specified in the test is assumed to be constant over subcarriers and time and shall be modelled as AWGN of appropriate power for N_{oc} to be fulfilled.</p> <p>Note 3: E_s/I_{ot}, RSRP and I_o levels have been derived from other parameters for information purposes. They are not settable parameters themselves.</p> <p>Note 4: For Band 26, the tests shall be performed with the carrier frequency of the assigned E-UTRA channel bandwidth within 865-894 MHz.</p> <p>Note 5: E-UTRA operating band groups are as defined in Section 3.5.</p> <p>Note 6: For Band 74, the tests shall be performed with the carrier frequency of the assigned E-UTRA channel bandwidth within 1475.9-1510.9 MHz.</p>								

A.9.1.57.3 Test Requirements

The RSRP measurement accuracy shall fulfil the requirements in sections 9.1.21.3 and 9.1.21.4.

A.9.1.57A FD-FDD RSRP Intra frequency case for Cat-M1 UE for 5MHz Bandwidth in CEModeB

A.9.1.57A.1 Test Purpose and Environment

The purpose of this test is to verify that the RSRP measurement accuracy is within the specified limits. This test will verify the requirements in Sections 9.1.21.3 and 9.1.21.4 for FD-FDD intra frequency RSRP measurements for Cat-M1 UE in CEModeB.

A.9.1.57A.2 Test parameters

In this set of test cases all cells are on the same carrier frequency. Both absolute and relative accuracy of RSRP intra frequency measurements are tested by using the parameters in Table A.9.1.57A.2-1. In all test cases, Cell 1 is the PCell and Cell 2 the target cell. All the tests contain MPDCCH for UL grant for reporting RSRP.

Table A.9.1.57A.2-1: FD-FDD RSRP Intra frequency case for Cat-M1 UE for 5MHz Bandwidth in CEModeB

Parameter	Unit	Test 1		Test 2		Test 3									
		Cell 1	Cell 2	Cell 1	Cell 2	Cell 1	Cell 2								
E-UTRA RF Channel Number		1		1		1									
BW _{channel}	MHz	5		5		5									
Measurement bandwidth	n_{PRB}	10—15		10—15		10—15									
PDSCH Reference measurement channel		R.30 FDD	-	R.30 FDD	-	R.30 FDD	-								
PDSCH allocation	n_{PRB}	Follows R.30 FDD	-	Follows R.30 FDD	-	Follows R.30 FDD	-								
MPDCCH Reference measurement channel		R.26 FDD		R.26 FDD		R.26 FDD									
OCNG Patterns		OP.22 FDD	OP.19 FDD	OP.22 FDD	OP.19 FDD	OP.22 FDD	OP.19 FDD								
PBCH_RA	dB	0	0	0	0	0	0								
PBCH_RB															
PSS_RA															
SSS_RA															
PCFICH_RB															
PHICH_RA															
PHICH_RB															
MPDCCH_RA															
MPDCCH_RB															
PDSCH_RA															
PDSCH_RB															
OCNG_RA ^{Note1}															
OCNG_RB ^{Note1}															
N_{oc} ^{Note2}								Bands FDD-M1_N	dBm/15 kHz		-96		-79		-97.5
\hat{E}_s / N_{oc}		dB		-12		-14		-12		-14					
\hat{E}_s / I_{ot} ^{Note3}		dB		-12.17		-14.27		-12.17		-14.27					
RSRP ^{Note3}	Bands FDD-M1_N	dBm/15 kHz		-108		-110		-88		-90		-112.5		-114.5	
I_o ^{Note3}	Bands FDD-M1_N	dBm/4.5 MHz		-70.80		-50.80		-72.30							
Propagation condition		-		AWGN		AWGN		AWGN							
Antenna Configuration		1x1		1x1		1x1									
Note 1: OCNG shall be used such that both cells are fully allocated and a constant total transmitted power spectral density is achieved for all OFDM symbols.															

Note 2:	Interference from other cells and noise sources not specified in the test is assumed to be constant over subcarriers and time and shall be modelled as AWGN of appropriate power for N_{oc} to be fulfilled.
Note 3:	Es/lot, RSRP and Io levels have been derived from other parameters for information purposes. They are not settable parameters themselves.
Note 4:	For Band 26, the tests shall be performed with the carrier frequency of the assigned E-UTRA channel bandwidth within 865-894 MHz.
Note 5:	E-UTRA operating band groups are as defined in Section 3.5.

A.9.1.57A.3 Test Requirements

The RSRP measurement accuracy shall fulfil the requirements in sections 9.1.21.3 and 9.1.21.4.

A.9.1.58 HD-FDD RSRP Intra frequency case for Cat-M1 UE in CEModeB

A.9.1.58.1 Test Purpose and Environment

The purpose of this test is to verify that the RSRP measurement accuracy is within the specified limits. This test will verify the requirements in Sections 9.1.21.3 and 9.1.21.4 for HD-FDD intra frequency RSRP measurements for Cat-M1 UE in CEModeB.

A.9.1.58.2 Test parameters

In this set of test cases all cells are on the same carrier frequency. Both absolute and relative accuracy of RSRP intra frequency measurements are tested by using the parameters in Table A.9.1.58.2-1. In all test cases, Cell 1 is the PCell and Cell 2 the target cell. All the tests contain MPDCCH for UL grant for reporting RSRP.

Table A.9.1.58.2-1: HD-FDD RSRP Intra frequency test parameters for Cat-M1 UE in CEModeB

Parameter	Unit	Test 1		Test 2		Test 3	
		Cell 1	Cell 2	Cell 1	Cell 2	Cell 1	Cell 2
E-UTRA RF Channel Number		1		1		1	
BW _{channel}	MHz	10		10		10	
Measurement bandwidth	n_{PRB}	22–27		22–27		22–27	
PDSCH Reference measurement channel		R.12 HD-FDD	-	R.12 HD-FDD	-	R.12 HD-FDD	-
PDSCH allocation	n_{PRB}	Follows R.12 HD-FDD	-	Follows R.12 HD-FDD	-	Follows R.12 HD-FDD	-
MPDCCH Reference measurement channel		R.8 HD-FDD		R.8 HD-FDD		R.8 HD-FDD	
OCNG Patterns		OP.21 FDD	OP.6 FDD	OP.21 FDD	OP.6 FDD	OP.21 FDD	OP.6 FDD
PBCH_RA	dB	0	0	0	0	0	0
PBCH_RB							
PSS_RA							
SSS_RA							
PCFICH_RB							
PHICH_RA							
PHICH_RB							
MPDCCH_RA							
MPDCCH_RB							
PDSCH_RA							
PDSCH_RB							
OCNG_RA ^{Note1}							
OCNG_RB ^{Note1}							
N_{oc} ^{Note2}							
	Bands FDD-M1_B	-106.5					
	Bands FDD-M1_C	-106					
	Bands FDD-M1_D	-105.5					
	Bands FDD-M1_E, FDD-M1_F ^{Note 4}	-105					

	Bands FDD-M1_G							-104
	Bands FDD-M1_H							-103.5
\hat{E}_s / N_{oc}		dB	-12	-14	-12	-14	-12	-14
\hat{E}_s / I_{ot} ^{Note3}		dB	-12.17	-14.27	-12.17	-14.27	-12.17	-14.27
RSRP ^{Note3}	Bands FDD-M1_A	dBm/15 kHz	-111	-113	-91	-93	-119	-121
	Bands FDD-M1_B						-118.5	-120.5
	Bands FDD-M1_C						-118	-120
	Bands FDD-M1_D						-117.5	-119.5
	Bands FDD-M1_E, FDD-M1_F ^{Note 4}						-117	-119
	Bands FDD-M1_G						-116	-118
	Bands FDD-M1_H						-115.5	-117.5
I _o ^{Note3}	Bands FDD-M1_A	dBm/9 MHz	-70.79		-50.79		-78.79	
	Bands FDD-M1_B						-78.29	
	Bands FDD-M1_C						-77.79	
	Bands FDD-M1_D						-77.29	
	Bands FDD-M1_E, FDD-M1_F ^{Note 4}						-76.79	
	Bands FDD-M1_G						-75.79	
	Bands FDD-M1_H						-75.29	
Propagation condition		-	AWGN		AWGN		AWGN	
Antenna Configuration			1x1		1x1		1x1	
<p>Note 1: OCNG shall be used such that both cells are fully allocated and a constant total transmitted power spectral density is achieved for all OFDM symbols.</p> <p>Note 2: Interference from other cells and noise sources not specified in the test is assumed to be constant over subcarriers and time and shall be modelled as AWGN of appropriate power for N_{oc} to be fulfilled.</p> <p>Note 3: Es/lot, RSRP and I_o levels have been derived from other parameters for information purposes. They are not settable parameters themselves.</p> <p>Note 4: For Band 26, the tests shall be performed with the carrier frequency of the assigned E-UTRA channel bandwidth within 865-894 MHz.</p> <p>Note 5: E-UTRA operating band groups are as defined in Section 3.5.</p>								

A.9.1.58.3 Test Requirements

The RSRP measurement accuracy shall fulfil the requirements in sections 9.1.21.3 and 9.1.21.4.

A.9.1.58A HD-FDD RSRP Intra frequency case for Cat-M1 UE for 5MHz Bandwidth in CEModeB

A.9.1.58A.1 Test Purpose and Environment

The purpose of this test is to verify that the RSRP measurement accuracy is within the specified limits. This test will verify the requirements in Sections 9.1.21.3 and 9.1.21.4 for HD-FDD intra frequency RSRP measurements for Cat-M1 UE in CEModeB.

A.9.1.58A.2 Test parameters

In this set of test cases all cells are on the same carrier frequency. Both absolute and relative accuracy of RSRP intra frequency measurements are tested by using the parameters in Table A.9.1.58A.2-1. In all test cases, Cell 1 is the PCell and Cell 2 the target cell. All the tests contain MPDCCH for UL grant for reporting RSRP.

Table A.9.1.58.2-1: HD-FDD RSRP Intra frequency case for Cat-M1 UE for 5MHz Bandwidth in CEModeB

Parameter	Unit	Test 1		Test 2		Test 3	
		Cell 1	Cell 2	Cell 1	Cell 2	Cell 1	Cell 2
E-UTRA RF Channel Number		1		1		1	
BW _{channel}	MHz	5		5		5	
Measurement bandwidth	n_{PRB}	10—15		10—15		10—15	

PDSCH Reference measurement channel		R.20 HD-FDD	-	R.20 HD-FDD	-	R.20 HD-FDD	-	
PDSCH allocation	n_{PRB}	Follows R.20 HD-FDD	-	Follows R.20 HD-FDD	-	Follows R.20 HD-FDD	-	
MPDCCH Reference measurement channel		R.16 HD-FDD		R.16 HD-FDD		R.16 HD-FDD		
OCNG Patterns		OP.22 FDD	OP.19 FDD	OP.22 FDD	OP.19 FDD	OP.22 FDD	OP.19 FDD	
PBCH_RA	dB	0	0	0	0	0	0	
PBCH_RB								
PSS_RA								
SSS_RA								
PCFICH_RB								
PHICH_RA								
PHICH_RB								
MPDCCH_RA								
MPDCCH_RB								
PDSCH_RA								
PDSCH_RB								
OCNG_RA ^{Note1}								
OCNG_RB ^{Note1}								
N_{oc} ^{Note2}								Bands FDD-M1_N
\hat{E}_s / N_{oc}		dB	-12	-12	-14	-12	-12	-14
\hat{E}_s / I_{ot} ^{Note3}		dB	-12.17	-12.17	-14.27	-12.17	-12.17	-14.27
RSRP ^{Note3}	Bands FDD-M1_N	dBm/15 kHz	-108	-110	-88	-108	-110	-88
I_o ^{Note3}	Bands FDD-M1_N	dBm/4.5 MHz	-70.80		-50.80		-72.30	
Propagation condition		-	AWGN		AWGN		AWGN	
Antenna Configuration			1x1		1x1		1x1	
<p>Note 1: OCNG shall be used such that both cells are fully allocated and a constant total transmitted power spectral density is achieved for all OFDM symbols.</p> <p>Note 2: Interference from other cells and noise sources not specified in the test is assumed to be constant over subcarriers and time and shall be modelled as AWGN of appropriate power for N_{oc} to be fulfilled.</p> <p>Note 3: E_s/I_{ot}, RSRP and I_o levels have been derived from other parameters for information purposes. They are not settable parameters themselves.</p> <p>Note 4: For Band 26, the tests shall be performed with the carrier frequency of the assigned E-UTRA channel bandwidth within 865-894 MHz.</p> <p>Note 5: E-UTRA operating band groups are as defined in Section 3.5.</p>								

A.9.1.58A.3 Test Requirements

The RSRP measurement accuracy shall fulfil the requirements in sections 9.1.21.3 and 9.1.21.4.

A.9.1.59 TDD RSRP Intra frequency case for Cat-M1 UE in CEModeB

A.9.1.59.1 Test Purpose and Environment

The purpose of this test is to verify that the RSRP measurement accuracy is within the specified limits. This test will verify the requirements in Sections 9.1.21.3 and 9.1.21.4 for TDD intra frequency RSRP measurements for Cat-M1 UE in CEModeB.

A.9.1.59.2 Test parameters

In this set of test cases all cells are on the same carrier frequency. Both absolute and relative accuracy of RSRP intra frequency measurements are tested by using the parameters in Table A.9.1.59.2-1. In all test cases, Cell 1 is the PCell and Cell 2 the target cell. All the tests contain MPDCCH for UL grant for reporting RSRP.

Table A.9.1.59.2-1: TDD RSRP Intra frequency test parameters for Cat-M1 UE in CEModeB

Parameter		Unit	Test 1		Test 2		Test 3								
			Cell 1	Cell 2	Cell 1	Cell 2	Cell 1	Cell 2							
E-UTRA RF Channel Number			1		1		1								
BW _{channel}		MHz	10		10		10								
Special subframe configuration ^{Note1}			6		6		6								
Uplink/downlink configuration ^{Note1}			1		1		1								
Measurement bandwidth		n_{PRB}	22—27		22—27		22—27								
PDSCH Reference measurement channel			R.18 TDD	-	R.18 TDD	-	R.18 TDD	-							
PDSCH allocation		n_{PRB}	Follows R.18 TDD	-	Follows R.18 TDD	-	Follows R.18 TDD	-							
MPDCCH Reference measurement channel			R.16 TDD		R.16 TDD		R.16 TDD								
OCNG Patterns			OP.11 TDD	OP.2 TDD	OP.11 TDD	OP.2 TDD	OP.11 TDD	OP.2 TDD							
PBCH_RA		dB	0	0	0	0	0	0							
PBCH_RB															
PSS_RA															
SSS_RA															
PCFICH_RB															
PHICH_RA															
PHICH_RB															
MPDCCH_RA															
MPDCCH_RB															
PDSCH_RA															
PDSCH_RB															
OCNG_RA ^{Note2}															
OCNG_RB ^{Note2}															
N_{oc} ^{Note3}	Bands TDD-M1_A								dBm/15 kHz	-99		-79		-107	
	Bands TDD-M1_C													-106	
	Bands TDD-M1_E	-105													
\hat{E}_s / N_{oc}		dB	-12	-14	-12	-14	-12	-14							
\hat{E}_s / I_{ot} ^{Note4}		dB	-12.17	-14.27	-12.17	-14.27	-12.17	-14.27							
RSRP ^{Note4}	Bands TDD-M1_A	dBm/15 kHz	-111	-113	-91	-93	-119	-121							
	Bands TDD-M1_C						-118	-120							
	Bands TDD-M1_E						-117	-119							
I_o ^{Note4}	Bands TDD-M1_A	dBm/9 MHz	-70.79		-50.79		-78.79								
	Bands TDD-M1_C						-77.79								
	Bands TDD-M1_E						-76.79								
Propagation condition		-	AWGN		AWGN		AWGN								
Correlation Matrix and Antenna Configuration			1x1		1x1		1x1								
<p>Note 1: For special subframe and uplink-downlink configurations see Tables 4.2-1 and 4.2-2 in TS 36.211.</p> <p>Note 2: OCNG shall be used such that both cells are fully allocated and a constant total transmitted power spectral density is achieved for all OFDM symbols.</p> <p>Note 3: Interference from other cells and noise sources not specified in the test is assumed to be constant over subcarriers and time and shall be modelled as AWGN of appropriate power for N_{oc} to be fulfilled.</p> <p>Note 4: E_s/I_{ot}, RSRP and I_o levels have been derived from other parameters for information purposes. They are not settable parameters themselves.</p> <p>Note 5: E-UTRA operating band groups are as defined in Section 3.5.</p>															

A.9.1.59.3 Test Requirements

The RSRP measurement accuracy shall fulfil the requirements in sections 9.1.21.3 and 9.1.21.4.

A.9.1.60 FS3 Absolute and relative CSI-RSRP accuracies in CSI-RS based discovery signal with FDD PCell

A.9.1.60.1 Test Purpose and Environment

The purpose of this test is to verify that CSI-RSRP measurement accuracy is within the specified limits. This test will verify the absolute intra-frequency CSI-RSRP accuracy requirements of the SCells defined in Section 9.1.18.4.4 for intra-frequency measurements under FS3, and the relative intra-frequency CSI-RSRP accuracy requirements between SCells defined in Section 9.1.18.4.5.

A.9.1.60.2 Test parameters

In this set of cases Cell 1 is PCell on the primary component carrier, Cell 2 using FS3 is SCell on the secondary component carrier and activated, and Cell 3 using FS3 is the neighbouring cell on the secondary component carrier. The test parameters are given in Table A.9.1.60.2-1. Intra-frequency measurements are supported by a DMTC configuration.

A.9.1.60.2-1: CSI-RSRP carrier aggregation test parameters with FDD PCell and FS3 SCells

Parameter	Unit	Test 1		
		Cell 1	Cell 2	Cell3
Frame structure		FDD	FS3	FS3
E-UTRA RF Channel Number		1	2	2
BW_{channel}	MHz	5 MHz: $N_{RB,c} = 25$ 10 MHz: $N_{RB,c} = 50$ 20 MHz: $N_{RB,c} = 100$	20 MHz: $N_{RB,c} = 100$	20 MHz: $N_{RB,c} = 100$
Timing offset to Cell 1	μs	-	0	3
Uplink/downlink configuration		-	Note10	Note10
Time alignment error relative to cell 1 <small>Note 11</small>		-	$\leq \text{TAE}$	-
DMTC period	ms	-	40	40
DMTC period offset	ms	-	10	10
Discovery signal occasion duration	ms	-	1	1
CSI-RS resource configuration		-	1	6
CSI-RS subframe offset	ms	-	0	0
CSI-RS individual offset[2]	dB	-	0	0
LBT model		-	-	A.3.17
Measurement bandwidth	n_{PRB}	5 MHz: 10—15 10 MHz: 22—27 20 MHz: 47—52	47—52	47—52
PDSCH Reference measurement channel defined in A.3.1.1		5 MHz: R.5 FDD 10 MHz: R.0 FDD 20 MHz: R.4 FDD	R.0 FS3	-
PDSCH allocation	n_{PRB}	5 MHz: 7-17 10 MHz: 13-36 20 MHz: 38-61	38—61	-
PDCCH/PCFICH/PHICH Reference measurement channel defined in A.3.1.2		5 MHz: R.11 FDD 10 MHz: R.6 FDD 20 MHz: R.10 FDD	R.0 FS3	R.0 FS3
OCNG Patterns defined in A.3.2		5 MHz: OP.15 FDD 10 MHz: OP.1 FDD 20 MHz: OP.11 FDD	OP.13 FDD	OP.14 FDD
PBCH_RA	dB	0	0	0
PBCH_RB				
PSS_RA				
SSS_RA				
PCFICH_RB				

PHICH_RA					
PHICH_RB					
PDCCH_RA					
PDCCH_RB					
PDSCH_RA					
PDSCH_RB					
OCNG_RANote1					
OCNG_RBNote					
N_{oc} Note2	Bands FDD_A	dBm/1 5 kHz	-117	-	-
	Bands FDD_B1, FDD_B2 Note 12		-116.5		
	Bands FDD_C		-116		
	Bands FDD_D		-115.5		
	Bands FDD_E, FDD_F Note 6		-115		
	Bands FDD_G		-114		
	Bands FDD_H		-113.5		
	Bands FS3_G		-		
$CRS \hat{E}_s / I_{ot}$		dB	-4	0.46	-5.76
$CSI-RS \hat{E}_s / I_{ot}$ Note3		dB	-	6.46	0.24
RSRPNote3	Bands FDD_A	dBm/1 5 kHz	-121	-	-
	Bands FDD_B1, FDD_B2 Note 12		-120.5		
	Bands FDD_C		-120		
	Bands FDD_D		-119.5		
	Bands FDD_E, FDD_F Note 6		-119		
	Bands FDD_G		-118		
	Bands FDD_H		-117.5		
	Bands FS3_G		-		
CSI- RSRPNote3	Bands FS3_G	dBm/1 5 kHz	-	RSRP for Cell 2 + 6 dB)	RSRP for Cell 3 + 6 dB)
I_o Note3	Bands FDD_A	dBm/ BW _{chan} nel	$-87.76+10\log(N_{RB,c}/50)$	-	-
	Bands FDD_B1, FDD_B2 Note 12		$-87.26+10\log(N_{RB,c}/50)$		
	Bands FDD_C		$-86.76+10\log(N_{RB,c}/50)$		
	Bands FDD_D		$-86.26+10\log(N_{RB,c}/50)$		
	Bands FDD_E, FDD_F Note 6		$-85.76 +10\log(N_{RB,c}/50)$		
	Bands FDD_G		$-84.76 +10\log(N_{RB,c}/50)$		
	Bands FDD_H		$-84.26 +10\log(N_{RB,c}/50)$		
	Bands FS3_G		-		
$CRS \hat{E}_s / N_{oc}$		dB	-4	3	-1
$CSI-RS \hat{E}_s / N_{oc}$		dB	-	9	5
Propagation condition		-	AWGN	AWGN	AWGN
Antenna Configuration		-	1x2	1x2	1x2
<p>Note 1: OCNG shall be used such that cells are fully allocated and a constant total transmitted power spectral density is achieved for all OFDM symbols. For cells with LBT model, OCNG is transmitted only in subframes with downlink transmission bursts, and is not transmitted during muted subframes or during DMTC windows.</p> <p>Note 2: Interference from other cells and noise sources not specified in the test is assumed to be constant over subcarriers and time and shall be modelled as AWGN of appropriate power for N_{oc} to be fulfilled.</p>					

Note 3:	CSI-RS Es/lot, RSRP, CSI-RSRP and Io levels have been derived from other parameters for information purposes. They are not settable parameters themselves. Io levels are calculated in CRS symbols of measurement subframe.
Note 4:	RSRP minimum requirements are specified assuming independent interference and noise at each receiver antenna port.
Note 5:	The selection of the bands for testing depends on the configuration of the carrier aggregation supported by the UEs.
Note 6:	For Band 26, the tests shall be performed with the carrier frequency of the assigned E-UTRA channel bandwidth within 865-894 MHz.
Note 7:	Void
Note 8:	E-UTRA operating band groups are as defined in Section 3.5.
Note 9:	DMTC configurations are provided to the UE in the <i>measDS-Config</i> (in TS36.331) before the beginning of the test.
Note 10:	Downlink only configuration.
Note 11:	Time alignment error (TAE) as specified in TS 36.104 [30] clause 6.5.3.1. The TAE value depends upon the type of carrier aggregation.
Note 12:	For Band 74, the tests shall be performed with the carrier frequency of the assigned E-UTRA channel bandwidth within 1475.9-1510.9 MHz.

A.9.1.60.3 Test Requirements

In the test, the performance of CSI-RSRP measurements is verified from following three perspectives:

- The absolute accuracy of intra-frequency CSI-RSRP measurements for Cell 2 on the secondary component carrier shall fulfil the requirements defined in clause 9.1.18.4.4.
- The absolute accuracy of intra-frequency CSI-RSRP measurements for Cell 3 on the secondary component carrier shall fulfil the requirements defined in clause 9.1.18.4.4.
- The relative accuracy of intra-frequency CSI-RSRP measurements for Cell 3 relative to Cell 2 on the secondary component carrier shall fulfil the requirements defined in clause 9.1.18.4.5.

A.9.1.61 FS3 Absolute and relative CSI-RSRP accuracies in CSI-RS based discovery signal with TDD PCell

A.9.1.61.1 Test Purpose and Environment

The purpose of this test is to verify that CSI- RSRP measurement accuracy is within the specified limits. This test will verify the absolute intra-frequency CSI-RSRP accuracy requirements of the SCells defined in Section 9.1.18.4.4 for intra-frequency measurements under FS3, and the relative intra-frequency CSI-RSRP accuracy requirements between SCells defined in Section 9.1.18.4.5.

A.9.1.61.2 Test parameters

In this set of cases Cell 1 is PCell on the primary component carrier, Cell 2 using FS3 is SCell on the secondary component carrier and activated, and Cell 3 using FS3 is the neighboring cell on the secondary component carrier. The test parameters are given in Table A.9.1.61.2-1. The intra-frequency measurements are supported by a DMTC configuration.

A.9.1.61.2-1: CSI-RSRP carrier aggregation test parameters with TDD PCell and FS3 SCells

Parameter	Unit	Test 1		
		Cell 1	Cell 2	Cell3
Frame structure		TDD	FS3	FS3
E-UTRA RF Channel Number		1	2	2
BW _{channel}	MHz	5MHz: N _{RB,c} = 25 10MHz: N _{RB,c} = 50 20MHz: N _{RB,c} = 100	20 MHz: N _{RB,c} = 100	20 MHz: N _{RB,c} = 100
Timing offset to cell1	μs	-	0	3
Special subframe configuration ^{Note1}		6	Note10	Note10
Uplink/downlink configuration ^{Note1}		1	Note10	Note10

Time alignment error relative to cell 1 <small>Note 11</small>		-	≤ TAE	-	
DMTC period	ms	-	40	40	
DMTC period offset	ms	-	10	10	
Discovery signal occasion duration	ms	-	1	1	
CSI-RS resource configuration		-	1	6	
CSI-RS subframe offset	ms	-	0	0	
CSI-RS individual offset[2]	dB	-	0	0	
LBT model		-	-	A.3.17	
Measurement bandwidth	n_{PRB}	5 MHz: 10—15 10 MHz: 22—27 20 MHz: 47—52	47—52	47—52	
PDSCH Reference measurement channel defined in A.3.1.1		5 MHz: R.4 TDD 10 MHz: R.0 TDD 20 MHz: R.3 TDD	R.0 FS3	-	
PDSCH allocation	n_{PRB}	5 MHz: 7-17 10 MHz: 13-36 20 MHz: 38-61	38—61	-	
PDCCH/PCFICH/PHICH Reference measurement channel defined in A.3.1.2		5 MHz: R.11 TDD 10 MHz: R.6 TDD 20 MHz: R.10 TDD	R.0 FS3	R.0 FS3	
OCNG Patterns defined in A.3.2.2		5 MHz: OP.9 TDD 10 MHz: OP.1 TDD 20 MHz: OP.7 TDD	OP.13 FDD	OP.14 FDD	
PBCH_RA	dB	0	0	0	
PBCH_RB					
PSS_RA					
SSS_RA					
PCFICH_RB					
PHICH_RA					
PHICH_RB					
PDCCH_RA					
PDCCH_RB					
PDSCH_RA					
PDSCH_RB					
OCNG_RANote1					
OCNG_RBNote					
N_{oc} <small>Note2</small>					Bands TDD_A
	Bands TDD_C	-116			
	Bands TDD_E	-115			
	Bands FS3_G	-	(N_{oc} for Channel 1 + 1 dB)		
$CRS \hat{E}_s / I_{ot}$	dB	-4	0.46	-5.76	
CSI-RS \hat{E}_s / I_{ot} <small>Note3</small>	dB	-	6.46	0.24	
RSRP <small>Note3</small>	Bands TDD_A	-121	-	-	
	Bands TDD_C	-120			
	Bands TDD_E	-119			
	Bands FS3_G	-	RSRP for Cell 1 + 8 dB)	RSRP for Cell 1 + 4 dB)	
CSI-RSRP <small>Note3</small>	Bands FS3_G	dBm/15 kHz	-	RSRP for Cell 2 + 6 dB)	RSRP for Cell 3 + 6 dB)
I_o <small>Note3</small>	Bands TDD_A	dBm/ BW _{channel}	-87.76+10log($N_{RB,c}/50$)	-	-
	Bands TDD_C		-86.76+10log($N_{RB,c}/50$)		
	Bands TDD_E		-85.76+10log($N_{RB,c}/50$)		
	Bands FS3_G		-	(I _o for Channel 1 + 5.33 dB +10log ($N_{RB,channel2} / N_{RB,channel1}$))	
$CRS \hat{E}_s / N_{oc}$	dB	-4	3	-1	
CSI-RS \hat{E}_s / N_{oc}	dB	-	9	5	
Propagation condition	-	AWGN	AWGN	AWGN	
Antenna Configuration	-	1x2	1x2	1x2	

Note 1:	OCNG shall be used such that cells are fully allocated and a constant total transmitted power spectral density is achieved for all OFDM symbols. For cells with LBT model, OCNG is transmitted only in subframes with downlink transmission bursts, and is not transmitted during muted subframes or during DMTC windows.
Note 2:	Interference from other cells and noise sources not specified in the test is assumed to be constant over subcarriers and time and shall be modelled as AWGN of appropriate power for N_{oc} to be fulfilled.
Note 3:	CSI-RS Es/Iot, RSRP, CSI-RSRP and I _o levels have been derived from other parameters for information purposes. They are not settable parameters themselves. I _o levels are calculated in CRS symbols of measurement subframe.
Note 4:	RSRP minimum requirements are specified assuming independent interference and noise at each receiver antenna port.
Note 5:	The selection of the bands for testing depends on the configuration of the carrier aggregation supported by the UEs.
Note 6:	Void
Note 7:	Void
Note 8:	E-UTRA operating band groups are as defined in Section 3.5.
Note 9:	DMTC configurations are provided to the UE in the <i>measDS-Config</i> (in TS36.331) before the beginning of the test.
Note 10:	Downlink only configuration.
Note 11:	Time alignment error (TAE) as specified in TS 36.104 [30] clause 6.5.3.1. The TAE value depends upon the type of carrier aggregation.

A.9.1.61.3 Test Requirements

In the test, the performance of CSI-RSRP measurements is verified from following three perspectives:

- The absolute accuracy of intra-frequency CSI-RSRP measurements for Cell 2 on the secondary component carrier shall fulfil the requirements defined in clause 9.1.18.4.4.
- The absolute accuracy of intra-frequency CSI-RSRP measurements for Cell 3 on the secondary component carrier shall fulfil the requirements defined in clause 9.1.18.4.4.
- The relative accuracy of intra-frequency CSI-RSRP measurements for Cell 3 relative to Cell 2 on the secondary component carrier shall fulfil the requirements defined in clause 9.1.18.4.5.

A.9.1.62 FD-FDD RSRP Inter frequency case for Cat-M1 UE in CEModeA

A.9.1.62.1 Test Purpose and Environment

The purpose of this test is to verify that the RSRP measurement accuracy is within the specified limits. This test will verify the requirements in Sections 9.1.21.9 and 9.1.21.10 for FD-FDD inter frequency RSRP measurements for Cat-M1 UE in CEModeA.

A.9.1.62.2 Test parameters

In this set of test cases all cells are on the same carrier frequency. Both absolute and relative accuracy of RSRP inter frequency measurements are tested by using the parameters in Table A.9.1.62.2-1. In all test cases, Cell 1 is the PCell and Cell 2 the target cell.

Table A.9.1.62.2-1: FD-FDD RSRP Inter frequency test parameters for Cat-M1 UE in CEModeA

Parameter	Unit	Test 1		Test 2	
		Cell 1	Cell 2	Cell 1	Cell 2
E-UTRA RF Channel Number		1	2	1	2
BW _{channel}	MHz	10	10	10	10
Gap Pattern Id		0	-	0	-
Measurement bandwidth	n_{PRB}	22—27	22—27	22—27	22—27
PDSCH Reference measurement channel		R.20 FDD	-	R.20 FDD	-
PDSCH allocation	n_{PRB}	Follows R.20 FDD	-	Follows R.20 FDD	-

MPDCCH Reference measurement channel			R.16 FDD	R.16 FDD	R.16 FDD	R.16 FDD
OCNG Patterns			OP.21 FDD	OP.6 FDD	OP.21 FDD	OP.6 FDD
PBCH_RA		dB	0	0	0	0
PBCH_RB						
PSS_RA						
SSS_RA						
PCFICH_RB						
PHICH_RA						
PHICH_RB						
MPDCCH_RA						
MPDCCH_RB						
PDSCH_RA						
PDSCH_RB						
OCNG_RA ^{Note1}						
OCNG_RB ^{Note1}						
N_{oc} ^{Note2}	Bands FDD-M1_A					
	Bands FDD-M1_B	-115.5				
	Bands FDD-M1_C	-115				
	Bands FDD-M1_D	-114.5				
	Bands FDD-M1_E, FDD-M1_F ^{Note 4}	-114				
	Bands FDD-M1_G	-113				
	Bands FDD-M1_H	-112.5				
\hat{E}_s/I_{ot}		dB	10	10	13	-4
RSRP ^{Note3}	Bands FDD-M1_A	dBm/15 kHz	-78.65	-78.65	(RSRP for Cell 2 +25dB)	-120
	Bands FDD-M1_B					-119.5
	Bands FDD-M1_C					-119
	Bands FDD-M1_D					-118.5
	Bands FDD-M1_E, FDD-M1_F ^{Note 4}					-118
	Bands FDD-M1_G					-117
	Bands FDD-M1_H					-116.5
I_o ^{Note3}	Bands FDD-M1_A	dBm/9 MHz	-50.45	-50.45	(I _o for Channel 2 +19.75d B)	-86.76
	Bands FDD-M1_B					-86.26
	Bands FDD-M1_C					-85.76
	Bands FDD-M1_D					-85.26
	Bands FDD-M1_E, FDD-M1_F ^{Note 4}					-84.76
	Bands FDD-M1_G					-83.76
	Bands FDD-M1_H					-83.26
\hat{E}_s/N_{oc}		dB	10	10	13	-4
Propagation condition		-	AWGN	AWGN	AWGN	AWGN
Antenna Configuration			1x1	1x1	1x1	1x1
<p>Note 1: OCNG shall be used such that both cells are fully allocated and a constant total transmitted power spectral density is achieved for all OFDM symbols.</p> <p>Note 2: Interference from other cells and noise sources not specified in the test is assumed to be constant over subcarriers and time and shall be modelled as AWGN of appropriate power for N_{oc} to be fulfilled.</p> <p>Note 3: RSRP and I_o levels have been derived from other parameters for information purposes. They are not settable parameters themselves.</p> <p>Note 4: For Band 26, the tests shall be performed with the carrier frequency of assigned E-UTRA channel bandwidth within 865-894 MHz.</p> <p>Note 5: E-UTRA operating band groups are as defined in Section 3.5.</p>						

A.9.1.62.3 Test Requirements

The RSRP measurement accuracy shall fulfil the requirements in sections 9.1.21.9 and 9.1.21.10.

A.9.1.63 HD-FDD RSRP Inter frequency case for Cat-M1 UE in CEModeA

A.9.1.53.1 Test Purpose and Environment

The purpose of this test is to verify that the RSRP measurement accuracy is within the specified limits. This test will verify the requirements in section 9.1.21.9 and 9.1.21.10 for HD-FDD inter frequency RSRP measurements for Cat-M1 UE in CEModeA.

A.9.1.53.2 Test parameters

In this set of test cases all cells are on the same carrier frequency. Both absolute and relative accuracy of RSRP inter frequency measurements are tested by using the parameters in Table A.9.1.63.2-1. In all test cases, Cell 1 is the PCell and Cell 2 the target cell.

Table A.9.1.63.2-1: HD-FDD RSRP Inter frequency test parameters for Cat-M1 UE in CEModeA

Parameter	Unit	Test 1		Test 2						
		Cell 1	Cell 2	Cell 1	Cell 2					
E-UTRA RF Channel Number		1	2	1	2					
$BW_{channel}$	MHz	10	10	10	10					
Gap Pattern Id		0	-	0	-					
Measurement bandwidth	n_{PRB}	22—27	22—27	22—27	22—27					
PDSCH Reference measurement channel		R.10 HD-FDD	-	R.10 HD-FDD	-					
PDSCH allocation	n_{PRB}	Follows R.10 HD-FDD	-	Follows R.10 HD-FDD	-					
MPDCCH Reference measurement channel		R.6 HD-FDD	R.6 HD-FDD	R.6 HD-FDD	R.6 HD-FDD					
OCNG Patterns		OP.21 FDD	OP.6 FDD	OP.21 FDD	OP.6 FDD					
PBCH_RA	dB	0	0	0	0					
PBCH_RB										
PSS_RA										
SSS_RA										
PCFICH_RB										
PHICH_RA										
PHICH_RB										
MPDCCH_RA										
MPDCCH_RB										
PDSCH_RA										
PDSCH_RB										
OCNG_RA ^{Note1}										
OCNG_RB ^{Note1}										
N_{oc} ^{Note2}						Bands FDD-M1_A	-88.65	-88.65	$(N_{oc}$ for Channel 2 +8dB)	-116
						Bands FDD-M1_B				-115.5
	Bands FDD-M1_C	-115								
	Bands FDD-M1_D	-114.5								
	Bands FDD-M1_E, FDD-M1_F ^{Note 4}	-114								
	Bands FDD-M1_G	-113								
	Bands FDD-M1_H	-112.5								
\hat{E}_s / I_{ot}	dB	10	10	13	-4					
RSRP ^{Note3}	Bands FDD-M1_A	-78.65	-78.65	(RSRP for Cell 2 +25dB)	-120					
	Bands FDD-M1_B				-119.5					
	Bands FDD-M1_C				-119					
	Bands FDD-M1_D				-118.5					
	Bands FDD-M1_E, FDD-M1_F ^{Note 4}				-118					
	Bands FDD-M1_G				-117					
	Bands FDD-M1_H				-116.5					

I_o ^{Note3}	Bands FDD-M1_A	dBm/9 MHz	-50.45	-50.45	(I _o for Channel 2 +19.75dB)	-86.76
	Bands FDD-M1_B					-86.26
	Bands FDD-M1_C					-85.76
	Bands FDD-M1_D					-85.26
	Bands FDD-M1_E, FDD-M1_F ^{Note 4}					-84.76
	Bands FDD-M1_G					-83.76
	Bands FDD-M1_H					-83.26
\hat{E}_s / N_{oc}		dB	10	10	13	-4
Propagation condition		-	AWGN	AWGN	AWGN	AWGN
Antenna Configuration			1x1	1x1	1x1	1x1
<p>Note 1: OCNG shall be used such that both cells are fully allocated and a constant total transmitted power spectral density is achieved for all OFDM symbols.</p> <p>Note 2: Interference from other cells and noise sources not specified in the test is assumed to be constant over subcarriers and time and shall be modelled as AWGN of appropriate power for N_{oc} to be fulfilled.</p> <p>Note 3: RSRP and I_o levels have been derived from other parameters for information purposes. They are not settable parameters themselves.</p> <p>Note 4: For Band 26, the tests shall be performed with the carrier frequency of assigned E-UTRA channel bandwidth within 865-894 MHz.</p> <p>Note 5: E-UTRA operating band groups are as defined in Section 3.5.</p>						

A.9.1.63.3 Test Requirements

The RSRP measurement accuracy shall fulfil the requirements in sections 9.1.21.1 and 9.1.21.2.

A.9.1.64 TDD RSRP Inter frequency case for Cat-M1 UE in CEModeA

A.9.1.64.1 Test Purpose and Environment

The purpose of this test is to verify that the RSRP measurement accuracy is within the specified limits. This test will verify the requirements in Sections 9.1.21.9 and 9.1.21.10 for TDD inter frequency RSRP measurements for Cat-M1 UE in CEModeA.

A.9.1.64.2 Test parameters

In this set of test cases all cells are on the same carrier frequency. Both absolute and relative accuracy of RSRP inter frequency measurements are tested by using the parameters in Table A.9.1.64.2-1. In all test cases, Cell 1 is the PCell and Cell 2 the target cell.

Table A.9.1.64.2-1: TDD RSRP Inter frequency test parameters for Cat-M1 UE in CEModeA

Parameter	Unit	Test 1		Test 2	
		Cell 1	Cell 2	Cell 1	Cell 2
E-UTRA RF Channel Number		1	2	1	2
$BW_{channel}$	MHz	10	10	10	10
Gap Pattern Id		0	-	0	-
Special subframe configuration		6	6	6	6
Uplink/downlink configuration		1	1	1	1
Measurement bandwidth	n_{PRB}	22—27	22—27	22—27	22—27
PDSCH Reference measurement channel		R.16 TDD	-	R.16 TDD	-
PDSCH allocation	n_{PRB}	Follows R.16 TDD	-	Follows R.16 TDD	-
MPDCCH Reference measurement channel		R.14 TDD	R.14 TDD	R.14 TDD	R.14 TDD
OCNG Patterns		OP.11 TDD	OP.2 TDD	OP.11 TDD	OP.2 TDD
PBCH_RA	dB	0	0	0	0
PBCH_RB					
PSS_RA					

SSS_RA						
PCFICH_RB						
PHICH_RA						
PHICH_RB						
MPDCCH_RA						
MPDCCH_RB						
PDSCH_RA						
PDSCH_RB						
OCNG_RA ^{Note1}						
OCNG_RB ^{Note1}						
N_{oc} ^{Note2}	Bands TDD-M1_A	dBm/15 kHz	-88.65	-88.65	$(N_{oc}$ for Channel 2 +8dB)	-116
	Bands TDD-M1_C					-115
	Bands TDD-M1_E					-114
\hat{E}_s / I_{ot}		dB	10	10	13	-4
RSRP ^{Note3}	Bands TDD-M1_A	dBm/15 kHz	-78.65	-78.65	(RSRP for Cell 2 +25dB)	-120
	Bands TDD-M1_C					-119
	Bands TDD-M1_E					-118
I_o ^{Note3}	Bands TDD-M1_A	dBm/9 MHz	-50.45	-50.45	(I _o for Channel 2 +19.75dB)	-86.76
	Bands TDD-M1_C					-85.76
	Bands TDD-M1_E					-84.76
\hat{E}_s / N_{oc}		dB	10	10	13	-4
Propagation condition		-	AWGN	AWGN	AWGN	AWGN
Antenna Configuration			1x1	1x1	1x1	1x1
<p>Note 1: OCNG shall be used such that both cells are fully allocated and a constant total transmitted power spectral density is achieved for all OFDM symbols.</p> <p>Note 2: Interference from other cells and noise sources not specified in the test is assumed to be constant over subcarriers and time and shall be modelled as AWGN of appropriate power for N_{oc} to be fulfilled.</p> <p>Note 3: RSRP and I_o levels have been derived from other parameters for information purposes. They are not settable parameters themselves.</p> <p>Note 4: E-UTRA operating band groups are as defined in Section 3.5.</p>						

A.9.1.64.3 Test Requirements

The RSRP measurement accuracy shall fulfil the requirements in sections 9.1.21.9 and 9.1.21.10.

A.9.1.65 FD-FDD RSRP Inter frequency case for Cat-M1 UE in CEModeB

A.9.1.65.1 Test Purpose and Environment

The purpose of this test is to verify that the RSRP measurement accuracy is within the specified limits. This test will verify the requirements in Sections 9.1.21.11 and 9.1.21.12 for FD-FDD intra frequency RSRP measurements for Cat-M1 UE in CEModeB.

A.9.1.65.2 Test parameters

Both absolute and relative accuracy of RSRP inter frequency measurements are tested by using the parameters in Table A.9.1.65.2-1 and A.9.1.65.2-2. In all test cases, Cell 1 is the PCell and Cell 2 the target cell. All the tests contain MPDCCH for UL grant for reporting RSRP.

Table A.9.1.65.2-1: FD-FDD RSRP Inter frequency test parameters for Cat-M1 UE in CEModeB for 10MHz cell BW

Parameter	Unit	Test 1		Test 2	
		Cell 1	Cell 2	Cell 1	Cell 2
E-UTRA RF Channel Number		1	2	1	2
BW _{channel}	MHz	10	10	10	10
Gap Pattern Id		0	-	0	-

Measurement bandwidth		n_{PRB}	22—27	22—27	22—27	22—27					
PDSCH Reference measurement channel			R.22 FDD	-	R.22 FDD	-					
PDSCH allocation		n_{PRB}	Follows R.22 FDD	-	Follows R.22 FDD	-					
MPDCCH Reference measurement channel			R.18 FDD	R.18 FDD	R.18 FDD	R.18 FDD					
OCNG Patterns			OP.21 FDD	OP.6 FDD	OP.21 FDD	OP.6 FDD					
PBCH_RA		dB	0	0	0	0					
PBCH_RB											
PSS_RA											
SSS_RA											
PCFICH_RB											
PHICH_RA											
PHICH_RB											
MPDCCH_RA											
MPDCCH_RB											
PDSCH_RA											
PDSCH_RB											
OCNG_RA ^{Note1}											
OCNG_RB ^{Note1}											
N_{oc} ^{Note2}	Bands FDD-M1_A						dBm/15 kHz	-78.5	-78.5	-98.5	-108
	Bands FDD-M1_B										-107.5
	Bands FDD-M1_C										-107
	Bands FDD-M1_D	-106.5									
	Bands FDD-M1_E, FDD-M1_F ^{Note 4}	-106									
	Bands FDD-M1_G	-105									
	Bands FDD-M1_H	-104.5									
\hat{E}_s / I_{ot}		dB	-12	-12	-12	-12					
RSRP ^{Note3}	Bands FDD-M1_A	dBm/15 kHz	-90.5	-90.5	-110.5	-120					
	Bands FDD-M1_B					-119.5					
	Bands FDD-M1_C					-119					
	Bands FDD-M1_D					-118.5					
	Bands FDD-M1_E, FDD-M1_F ^{Note 4}					-118					
	Bands FDD-M1_G					-117					
	Bands FDD-M1_H					-116.5					
I_o ^{Note3}	Bands FDD-M1_A	dBm/9 MHz	-50.45	-50.45	-70.45	-86.76					
	Bands FDD-M1_B					-86.26					
	Bands FDD-M1_C					-85.76					
	Bands FDD-M1_D					-85.26					
	Bands FDD-M1_E, FDD-M1_F ^{Note 4}					-84.76					
	Bands FDD-M1_G					-83.76					
	Bands FDD-M1_H					-83.26					
\hat{E}_s / N_{oc}		dB	-12	-12	-12	-12					
Propagation condition		-	AWGN	AWGN	AWGN	AWGN					
Antenna Configuration			1x1	1x1	1x1	1x1					
<p>Note 1: OCNG shall be used such that both cells are fully allocated and a constant total transmitted power spectral density is achieved for all OFDM symbols.</p> <p>Note 2: Interference from other cells and noise sources not specified in the test is assumed to be constant over subcarriers and time and shall be modelled as AWGN of appropriate power for N_{oc} to be fulfilled.</p> <p>Note 3: RSRP and I_o levels have been derived from other parameters for information purposes. They are not settable parameters themselves.</p> <p>Note 4: For Band 26, the tests shall be performed with the carrier frequency of assigned E-UTRA channel bandwidth within 865-894 MHz.</p> <p>Note 5: E-UTRA operating band groups are as defined in Section 3.5.</p>											

Table A.9.1.65.2-2: FD-FDD RSRP Inter frequency test parameters for Cat-M1 UE in CEModeB for 5MHz cell BW

Parameter		Unit	Test 1		Test 2	
			Cell 1	Cell 2	Cell 1	Cell 2
E-UTRA RF Channel Number			1	2	1	2
BW _{channel}		MHz	5	5	5	5
Gap Pattern Id			0	-	0	-
Measurement bandwidth		n_{PRB}	22–27	22–27	22–27	22–27
PDSCH Reference measurement channel			R.30 FDD	-	R.30 FDD z	-
PDSCH allocation		n_{PRB}	Follow R.30 FDD	-	Follow R.30 FDD	-
MPDCCH Reference measurement channel			R.26 FDD	R.26 FDD	R.26 FDD	R.26 FDD
OCNG Patterns			OP.22 FDD	OP.19 FDD	OP.22 FDD	OP.19 FDD
PBCH_RA						
PBCH_RB						
PSS_RA						
SSS_RA						
PCFICH_RB						
PHICH_RA						
PHICH_RB		dB	0	0	0	0
MPDCCH_RA						
MPDCCH_RB						
PDSCH_RA						
PDSCH_RB						
OCNG_RA ^{Note1}						
OCNG_RB ^{Note1}						
N_{oc} ^{Note2}	Bands FDD-M1_A	dBm/15 kHz	-75.5	-75.5	-95.5	-105
	Bands FDD-M1_B					-104.5
	Bands FDD-M1_C					-104
	Bands FDD-M1_D					-103.5
	Bands FDD-M1_E, FDD-M1_F ^{Note 4}					-103
	Bands FDD-M1_G					-102
	Bands FDD-M1_H					-101.5
\hat{E}_s/I_{ot}		dB	-12	-12	-12	-12
RSRP ^{Note3}	Bands FDD-M1_A	dBm/15 kHz	-87.5	-87.5	-107.5	-117
	Bands FDD-M1_B					-116.5
	Bands FDD-M1_C					-116
	Bands FDD-M1_D					-115.5
	Bands FDD-M1_E, FDD-M1_F ^{Note 4}					-115
	Bands FDD-M1_G					-114
I_o ^{Note3}	Bands FDD-M1_A	dBm/4.5 MHz	-50.45	-50.45	-70.45	-86.76
	Bands FDD-M1_B					-86.26
	Bands FDD-M1_C					-85.76
	Bands FDD-M1_D					-85.26
	Bands FDD-M1_E, FDD-M1_F ^{Note 4}					-84.76
	Bands FDD-M1_G					-83.76
	Bands FDD-M1_H					-83.26
\hat{E}_s/N_{oc}		dB	-12	-12	-12	-12
Propagation condition		-	AWGN	AWGN	AWGN	AWGN
Antenna Configuration			1x1	1x1	1x1	1x1
<p>Note 1: OCNG shall be used such that both cells are fully allocated and a constant total transmitted power spectral density is achieved for all OFDM symbols.</p> <p>Note 2: Interference from other cells and noise sources not specified in the test is assumed to be constant over subcarriers and time and shall be modelled as AWGN of appropriate power for N_{oc} to be fulfilled.</p>						

Note 3:	RSRP and Io levels have been derived from other parameters for information purposes. They are not settable parameters themselves.
Note 4:	For Band 26, the tests shall be performed with the carrier frequency of assigned E-UTRA channel bandwidth within 865-894 MHz.
Note 5:	E-UTRA operating band groups are as defined in Section 3.5.

A.9.1.65.3 Test Requirements

The RSRP measurement accuracy shall fulfil the requirements in sections 9.1.21.11 and 9.1.21.12.

A.9.1.66 HD-FDD RSRP Inter frequency case for Cat-M1 UE in CEModeB

A.9.1.66.1 Test Purpose and Environment

The purpose of this test is to verify that the RSRP measurement accuracy is within the specified limits. This test will verify the requirements in Sections 9.1.21.11 and 9.1.21.12 for HD-FDD inter frequency RSRP measurements for Cat-M1 UE in CEModeB.

A.9.1.66.2 Test parameters

Both absolute and relative accuracy of RSRP inter frequency measurements are tested by using the parameters in Table A.9.1.66.2-1 and A.9.1.66.2-2. In all test cases, Cell 1 is the PCell and Cell 2 the target cell. All the tests contain MPDCCH for UL grant for reporting RSRP.

Table A.9.1.66.2-1: HD-FDD RSRP Inter frequency test parameters for Cat-M1 UE in CEModeB for 10Mhz Cell BW

Parameter	Unit	Test 1		Test 2	
		Cell 1	Cell 2	Cell 1	Cell 2
E-UTRA RF Channel Number		1	2	1	2
BW _{channel}	MHz	10	10	10	10
Gap Pattern Id		0	-	0	-
Measurement bandwidth	n_{PRB}	22—27	22—27	22—27	22—27
PDSCH Reference measurement channel		R.12 HD-FDD	-	R.12 HD-FDD	-
PDSCH allocation	n_{PRB}	Follows R.12 HD-FDD	-	Follows R.12 HD-FDD	-
MPDCCH Reference measurement channel		R.8 HD-FDD	R.8 HD-FDD	R.8 HD-FDD	R.8 HD-FDD
OCNG Patterns		OP.21 FDD	OP.6 FDD	OP.21 FDD	OP.6 FDD
PBCH_RA	dB	0	0	0	0
PBCH_RB					
PSS_RA					
SSS_RA					
PCFICH_RB					
PHICH_RA					
PHICH_RB					
MPDCCH_RA					
MPDCCH_RB					
PDSCH_RA					
PDSCH_RB					
OCNG_RA ^{Note1}					
OCNG_RB ^{Note1}					
N_{oc} ^{Note2}					
	Bands FDD-M1_B	-107.5			
	Bands FDD-M1_C	-107			
	Bands FDD-M1_D	-106.5			
	Bands FDD-M1_E, FDD-M1_F ^{Note 4}	-106			

	Bands FDD-M1_G					-105
	Bands FDD-M1_H					-104.5
\hat{E}_s / I_{ot}		dB	-12	-12	-12	-12
RSRP ^{Note3}	Bands FDD-M1_A	dBm/15 kHz	-90.5	-90.5	-110.5	-120
	Bands FDD-M1_B					-119.5
	Bands FDD-M1_C					-119
	Bands FDD-M1_D					-118.5
	Bands FDD-M1_E, FDD-M1_F ^{Note 4}					-118
	Bands FDD-M1_G					-117
	Bands FDD-M1_H					-116.5
I _o ^{Note3}	Bands FDD-M1_A	dBm/9 MHz	-50.45	-50.45	-70.45	-86.76
	Bands FDD-M1_B					-86.26
	Bands FDD-M1_C					-85.76
	Bands FDD-M1_D					-85.26
	Bands FDD-M1_E, FDD-M1_F ^{Note 4}					-84.76
	Bands FDD-M1_G					-83.76
	Bands FDD-M1_H					-83.26
\hat{E}_s / N_{oc}		dB	-12	-12	-12	-12
Propagation condition		-	AWGN	AWGN	AWGN	AWGN
Antenna Configuration			1x1	1x1	1x1	1x1
<p>Note 1: OCNG shall be used such that both cells are fully allocated and a constant total transmitted power spectral density is achieved for all OFDM symbols.</p> <p>Note 2: Interference from other cells and noise sources not specified in the test is assumed to be constant over subcarriers and time and shall be modelled as AWGN of appropriate power for N_{oc} to be fulfilled.</p> <p>Note 3: RSRP and I_o levels have been derived from other parameters for information purposes. They are not settable parameters themselves.</p> <p>Note 4: For Band 26, the tests shall be performed with the carrier frequency of assigned E-UTRA channel bandwidth within 865-894 MHz.</p> <p>Note 5: E-UTRA operating band groups are as defined in Section 3.5.</p>						

Table A.9.1.66.2-2: HD-FDD RSRP Inter frequency test parameters for Cat-M1 UE in CEModeB for 5MHz Cell BW

Parameter	Unit	Test 1		Test 2	
		Cell 1	Cell 2	Cell 1	Cell 2
E-UTRA RF Channel Number		1	2	1	2
BW _{channel}	MHz	5	5	5	5
Gap Pattern Id		0	-	0	-
Measurement bandwidth	n_{PRB}	22—27	22—27	22—27	22—27
PDSCH Reference measurement channel		R.13 HD- FDD	-	R.13 HD- FDD	-
PDSCH allocation	n_{PRB}	Follows R.13 HD- FDD	-	Follows R.13 HD- FDD	-
MPDCCH Reference measurement channel		R.9 HD- FDD D	R.9 HD- FDD	R.9 HD- FDD	R.9 HD- FDD
OCNG Patterns		OP.22 FDD	OP.19 FDD	OP.22 FDD	OP.19 FDD
PBCH_RA	dB	0	0	0	0
PBCH_RB					
PSS_RA					
SSS_RA					
PCFICH_RB					
PHICH_RA					
PHICH_RB					
MPDCCH_RA					

MPDCCH_RB						
PDSCH_RA						
PDSCH_RB						
OCNG_RA ^{Note1}						
OCNG_RB ^{Note1}						
N_{oc} ^{Note2}	Bands FDD-M1_A	dBm/15 kHz	-75.5	-75.5	-95.5	-105
	Bands FDD-M1_B					-104.5
	Bands FDD-M1_C					-104
	Bands FDD-M1_D					-103.5
	Bands FDD-M1_E, FDD-M1_F ^{Note 4}					-103
	Bands FDD-M1_G					-102
	Bands FDD-M1_H					-101.5
\hat{E}_s/I_{ot}		dB	-12	-12	-12	-12
RSRP ^{Note3}	Bands FDD-M1_A	dBm/15 kHz	-87.5	-87.5	-107.5	-117
	Bands FDD-M1_B					-116.5
	Bands FDD-M1_C					-116
	Bands FDD-M1_D					-115.5
	Bands FDD-M1_E, FDD-M1_F ^{Note 4}					-115
	Bands FDD-M1_G					-114
	Bands FDD-M1_H					-113.5
I_o ^{Note3}	Bands FDD-M1_A	dBm/4.5 MHz	-50.45	-50.45	-70.45	-86.76
	Bands FDD-M1_B					-86.26
	Bands FDD-M1_C					-85.76
	Bands FDD-M1_D					-85.26
	Bands FDD-M1_E, FDD-M1_F ^{Note 4}					-84.76
	Bands FDD-M1_G					-83.76
	Bands FDD-M1_H					-83.26
\hat{E}_s/N_{oc}		dB	-12	-12	-12	-12
Propagation condition		-	AWGN	AWGN	AWGN	AWGN
Antenna Configuration			1x1	1x1	1x1	1x1
Note 1: OCNG shall be used such that both cells are fully allocated and a constant total transmitted power spectral density is achieved for all OFDM symbols.						
Note 2: Interference from other cells and noise sources not specified in the test is assumed to be constant over subcarriers and time and shall be modelled as AWGN of appropriate power for N_{oc} to be fulfilled.						
Note 3: RSRP and I_o levels have been derived from other parameters for information purposes. They are not settable parameters themselves.						
Note 4: For Band 26, the tests shall be performed with the carrier frequency of assigned E-UTRA channel bandwidth within 865-894 MHz.						
Note 5: E-UTRA operating band groups are as defined in Section 3.5.						

A.9.1.66.3 Test Requirements

The RSRP measurement accuracy shall fulfil the requirements in sections 9.1.21.11 and 9.1.21.12.

A.9.1.67 TDD RSRP Inter frequency case for Cat-M1 UE in CEModeB

A.9.1.67.1 Test Purpose and Environment

The purpose of this test is to verify that the RSRP measurement accuracy is within the specified limits. This test will verify the requirements in Sections 9.1.21.11 and 9.1.21.12 for TDD inter frequency RSRP measurements for Cat-M1 UE in CEModeB.

A.9.1.67.2 Test parameters

Both absolute and relative accuracy of RSRP inter frequency measurements are tested by using the parameters in Table A.9.1.67.2-1. In all test cases, Cell 1 is the PCell and Cell 2 the target cell. All the tests contain MPDCCH for UL grant for reporting RSRP.

Table A.9.1.67.2-1: TDD RSRP Inter frequency test parameters for Cat-M1 UE in CEModeB

Parameter	Unit	Test 1		Test 2		
		Cell 1	Cell 2	Cell 1	Cell 2	
E-UTRA RF Channel Number		1	2	1	2	
$BW_{channel}$	MHz	10	10	10	10	
Gap Pattern Id		0	-	0	-	
Special subframe configuration		6	6	6	6	
Uplink/downlink configuration		1	1	1	1	
Measurement bandwidth	n_{PRB}	22–27	22–27	22–27	22–27	
PDSCH Reference measurement channel		R.18 TDD	-	R.18 TDD	-	
PDSCH allocation	n_{PRB}	Follows R.18 TDD	-	Follows R.18 TDD	-	
MPDCCH Reference measurement channel		R.16 TDD	R.16 TDD	R.16 TDD	R.16 TDD	
OCNG Patterns		OP.11 TDD	OP.2 TDD	OP.11 TDD	OP.2 TDD	
PBCH_RA	dB	0	0	0	0	
PBCH_RB						
PSS_RA						
SSS_RA						
PCFICH_RB						
PHICH_RA						
PHICH_RB						
MPDCCH_RA						
MPDCCH_RB						
PDSCH_RA						
PDSCH_RB						
OCNG_RA ^{Note1}						
OCNG_RB ^{Note1}						
N_{oc} ^{Note2}						Bands TDD-M1_A
	Bands TDD-M1_C	-107				
	Bands TDD-M1_E	-106				
\hat{E}_s/I_{ot}	dB	-12	12	-12	-12	
RSRP ^{Note3}	Bands TDD-M1_A	dBm/15 kHz	-90.5	-90.5	-110.5	-120
	Bands TDD-M1_C					-119
	Bands TDD-M1_E					-118
I_o ^{Note3}	Bands TDD-M1_A	dBm/9 MHz	-50.45	-50.45	-70.45	-86.76
	Bands TDD-M1_C					-85.76
	Bands TDD-M1_E					-84.76
\hat{E}_s/N_{oc}	dB	-12	-12	-12	-12	
Propagation condition	-	AWGN	AWGN	AWGN	AWGN	
Antenna Configuration		1x1	1x1	1x1	1x1	
<p>Note 1: OCNG shall be used such that both cells are fully allocated and a constant total transmitted power spectral density is achieved for all OFDM symbols.</p> <p>Note 2: Interference from other cells and noise sources not specified in the test is assumed to be constant over subcarriers and time and shall be modelled as AWGN of appropriate power for N_{oc} to be fulfilled.</p> <p>Note 3: RSRP and I_o levels have been derived from other parameters for information purposes. They are not settable parameters themselves.</p> <p>Note 4: E-UTRA operating band groups are as defined in Section 3.5.</p>						

A.9.1.67.3 Test Requirements

The RSRP measurement accuracy shall fulfil the requirements in sections 9.1.21.11 and 9.1.21.12.

A.9.1.68 3 DL RSRP for E-UTRAN in Carrier Aggregation with generic duplex modes

A.9.1.68.1 Test Purpose and Environment

The purpose of this test is to verify that the RSRP absolute and relative accuracy requirements in carrier aggregation are within the specified limits. This test will verify the absolute RSRP accuracy requirements of the primary component carrier defined in clause 9.1.11.1, the absolute RSRP accuracy requirements of the secondary component carriers defined in clause 9.1.11.2, and the relative RSRP accuracy requirements of the secondary component carriers defined in clause 9.1.11.2. The test will also verify the primary and secondary component carriers' relative RSRP accuracy requirement defined in Clause 9.1.11.3.

Note on the applicability: the requirement tested in the specific duplex-mode test cases A.9.1.37, A.9.1.38, A.9.1.39, A.9.1.40, does not need to be tested in the generic duplex-mode test case A.9.1.68.

A.9.1.68.2 Test parameters

In this set of cases cell 1 is PCell on the primary component carrier, and cell 2 and cell 4 are activated SCells on secondary component carriers SCC1 and SCC2 respectively. Cell 3 and cell 5 are neighbouring cells on secondary component carriers SCC1 and SCC2 respectively. The test parameters are given in Table A.9.1.68.2-1.

Table A.9.1.68.2-1: 3 Downlink RSRP carrier aggregation test parameters

Parameter	Unit	Cell 1	Cell 2	Cell 3	Cell 4	Cell 5
E-UTRA RF Channel Number		1	2		3	
Duplex mode		FDD or TDD	FDD or TDD		FDD or TDD	
BW_{channel}	MHz	5MHz: $N_{RB,c} = 25$ 10MHz: $N_{RB,c} = 50$ 20MHz: $N_{RB,c} = 100$	5MHz: $N_{RB,c} = 25$ 10MHz: $N_{RB,c} = 50$ 20MHz: $N_{RB,c} = 100$		5MHz: $N_{RB,c} = 25$ 10MHz: $N_{RB,c} = 50$ 20MHz: $N_{RB,c} = 100$	
TDD Special subframe configuration ^{Note1}		6	6		6	
TDD Uplink/downlink configuration ^{Note1}		1	1		1	
Measurement bandwidth	n_{PRB}	5MHz: 10-15 10MHz: 22-27 20MHz: 47-52	5MHz: 10-15 10MHz: 22-27 20MHz: 47-52		5MHz: 10-15 10MHz: 22-27 20MHz: 47-52	
PDSCH Reference measurement channel defined in A.3.1.1.		5MHz FDD: R.5 FDD 10MHz FDD: R.0 FDD 20MHz FDD: R.4 FDD 5MHz TDD: R.4 TDD 10MHz TDD: R.0 TDD 20MHz TDD: R.3 TDD	5MHz FDD: R.5 FDD 10MHz FDD: R.0 FDD 20MHz FDD: R.4 FDD 5MHz TDD: R.4 TDD 10MHz TDD: R.0 TDD 20MHz TDD: R.3 TDD	-	5MHz FDD: R.5 FDD 10MHz FDD: R.0 FDD 20MHz FDD: R.4 FDD 5MHz TDD: R.4 TDD 10MHz TDD: R.0 TDD 20MHz TDD: R.3 TDD	-
PDSCH allocation	n_{PRB}	5MHz: 7-17 10MHz: 13-36 20MHz: 38-61	5MHz: 7-17 10MHz: 13-36 20MHz: 38-61	-	5MHz: 7-17 10MHz: 13-36 20MHz: 38-61	-
PDCCH/PCFICH/PHICH Reference measurement channel defined in A.3.1.2.		5MHz FDD: R.11 FDD 10MHz FDD: R.6 FDD 20MHz FDD: R.10 FDD 5MHz TDD: R.11 TDD 10MHz TDD: R.6 TDD 20MHz TDD: R.10 TDD	5MHz FDD: R.11 FDD 10MHz FDD: R.6 FDD 20MHz FDD: R.10 FDD 5MHz TDD: R.11 TDD 10MHz TDD: R.6 TDD 20MHz TDD: R.10 TDD	5MHz FDD: R.11 FDD 10MHz FDD: R.6 FDD 20MHz FDD: R.10 FDD 5MHz TDD: R.11 TDD 10MHz TDD: R.6 TDD 20MHz TDD: R.10 TDD	5MHz FDD: R.11 FDD 10MHz FDD: R.6 FDD 20MHz FDD: R.10 FDD 5MHz TDD: R.11 TDD 10MHz TDD: R.6 TDD 20MHz TDD: R.10 TDD	5MHz FDD: R.11 FDD 10MHz FDD: R.6 FDD 20MHz FDD: R.10 FDD 5MHz TDD: R.11 TDD 10MHz TDD: R.6 TDD 20MHz TDD: R.10 TDD
OCNG Patterns defined in A.3.2.		5MHz FDD: OP.15 FDD 10MHz FDD:	5MHz FDD: OP.15 FDD 10MHz FDD:	5MHz FDD: OP.16 FDD 10MHz FDD:	5MHz FDD: OP.15 FDD 10MHz FDD:	5MHz FDD: OP.16 FDD 10MHz FDD:

			OP.1 FDD 20MHz FDD: OP.11 FDD	OP.1 FDD 20MHz FDD: OP.11 FDD	OP.2 FDD 20MHz FDD: OP.12 FDD	OP.1 FDD 20MHz FDD: OP.11 FDD	OP.2 FDD 20MHz FDD: OP.12 FDD
			5MHz TDD: OP.9 TDD 10MHz TDD: OP.1 TDD 20MHz TDD: OP.7 TDD	5MHz TDD: OP.9 TDD 10MHz TDD: OP.1 TDD 20MHz TDD: OP.7 TDD	5MHz TDD: OP.10 TDD 10MHz TDD: OP.2 TDD 20MHz TDD: OP.8 TDD	5MHz TDD: OP.9 TDD 10MHz TDD: OP.1 TDD 20MHz TDD: OP.7 TDD	5MHz TDD: OP.10 TDD 10MHz TDD: OP.2 TDD 20MHz TDD: OP.8 TDD
PBCH_RA	dB	0	0	0	0	0	0
PBCH_RB							
PSS_RA							
SSS_RA							
PCFICH_RB							
PHICH_RA							
PHICH_RB							
PDCCH_RA							
PDCCH_RB							
PDSCH_RA							
PDSCH_RB							
OCNG_RA ^{Note2}							
OCNG_RB ^{Note2}							
N_{oc} ^{Note3}							
	Bands TDD_C	-116					
	Bands TDD_E	-115					
	Bands FDD_A	-117					
	Bands FDD_B1, FDD_B2 ^{Note 10}	-116.5					
	Bands FDD_C	-116					
	Bands FDD_D	-115.5					
	Bands FDD_E, FDD_F ^{Note 7}	-115					
	Bands FDD_G	-114					
Bands FDD_H	-113.5						
\hat{E}_s / N_{oc}	dB	-4	3	-1	3	-1	
\hat{E}_s / I_{ot}	dB	-4	0.46	-5.76	0.46	-5.76	
RSRP ^{Note4}	Bands TDD_A	-121	(RSRP for Cell 1 +8dB)	(RSRP for Cell 1 +4dB)	(RSRP for Cell 1 +8dB)	(RSRP for Cell 1 +4dB)	
	Bands TDD_C	-120					
	Bands TDD_E	-119					
	Bands FDD_A	-121					
	Bands FDD_B1, FDD_B2 ^{Note 10}	-120.5					
	Bands FDD_C	-120					
	Bands FDD_D	-119.5					
	Bands FDD_E, FDD_F ^{Note 7}	-119					
	Bands FDD_G	-118					
Bands FDD_H	-117.5						
I_o ^{Note4}	Bands TDD_A	$87.76+10\log(N_{RB,c}/50)$	$(I_o$ for Channel 1+5.33dB+10log($N_{RB,channel2} / N_{RB,channel 1}$))	$(I_o$ for Channel 1+5.33dB+10log($N_{RB,channel3} / N_{RB,channel 1}$))			
	Bands TDD_C	$86.76+10\log(N_{RB,c}/50)$					
	Bands TDD_E	$85.76+10\log(N_{RB,c}/50)$					
	Bands FDD_A	$87.76+10\log(N_{RB,c}/50)$					
	Bands FDD_B1, FDD_B2 ^{Note 10}	$87.26+10\log(N_{RB,c}/50)$					

	Bands FDD_C	-	$86.76+10\log(N_{RB,c}/50)$				
	Bands FDD_D	-	$86.26+10\log(N_{RB,c}/50)$				
	Bands FDD_E, FDD_F ^{Note 7}	-	$85.76+10\log(N_{RB,c}/50)$				
	Bands FDD_G	-	$84.76+10\log(N_{RB,c}/50)$				
	Bands FDD_H	-	$84.26+10\log(N_{RB,c}/50)$				
Propagation condition	-	-	AWGN	AWGN	AWGN	AWGN	AWGN
Antenna Configuration	-	-	1x2	1x2	1x2	1x2	1x2
Timing offset to cell 1	μs	-	0	3	0	3	
Time alignment error relative to cell 1 ^{Note 8}		-	≤ TAE	-	≤ TAE	-	
Time alignment error relative to cell 2 ^{Note 8}		-	-	-	≤ TAE	-	
Note 1:	For special subframe and uplink-downlink configurations see Tables 4.2-1 and 4.2-2 in TS 36.211.						
Note 2:	OCNG shall be used such that all cells are fully allocated and a constant total transmitted power spectral density is achieved for all OFDM symbols.						
Note 3:	Interference from other cells and noise sources not specified in the test is assumed to be constant over subcarriers and time and shall be modelled as AWGN of appropriate power for N_{oc} to be fulfilled.						
Note 4:	RSRP and I _o levels have been derived from other parameters for information purposes. They are not settable parameters themselves.						
Note 5:	RSRP minimum requirements are specified assuming independent interference and noise at each receiver antenna port.						
Note 6:	The selection of the bands for testing depends on the configuration of the carrier aggregation supported by the UEs.						
Note 7:	For Band 26, the tests shall be performed with the carrier frequency of the assigned E-UTRA channel bandwidth within 865-894 MHz.						
Note 8:	Time alignment error (TAE) as specified in TS 36.104 [30] clause 6.5.3.1. The TAE value depends upon the type of carrier aggregation.						
Note 9:	E-UTRA operating band groups are as defined in Section 3.5.						
Note 10:	For Band 74, the tests shall be performed with the carrier frequency of the assigned E-UTRA channel bandwidth within 1475.9-1510.9 MHz.						

A.9.1.68.3 Test Requirements

In the test, the performance of RSRP measurements is verified from the following 7 perspectives:

- The absolute accuracy of intra-frequency RSRP measurements for Cell 1 on the primary component carrier shall fulfil the requirements defined in clause 9.1.11.1.
- The absolute accuracy of intra-frequency RSRP measurements for Cell 2 on SCC1 shall fulfil the requirements defined in clause 9.1.11.2.
- The absolute accuracy of intra-frequency RSRP measurements for Cell 4 on SCC2 shall fulfil the requirements defined in clause 9.1.11.2.
- The relative accuracy of intra-frequency RSRP measurements for Cell 3 relative to Cell 2 on SCC1 shall fulfil the requirements defined in clause 9.1.11.2.
- The relative accuracy of intra-frequency RSRP measurements for Cell 5 relative to Cell 4 on SCC2 shall fulfil the requirements defined in clause 9.1.11.2.
- The relative accuracy of inter-frequency RSRP measurements between SCC1 and the primary component carriers for Cell 2 relative to Cell 1 shall fulfil the requirements defined in clause 9.1.11.3.
- The relative accuracy of inter-frequency RSRP measurements between SCC2 and the primary component carriers for Cell 4 relative to Cell 1 shall fulfil the requirements defined in clause 9.1.11.3.

A.9.1.69 4 DL RSRP for E-UTRAN in Carrier Aggregation with generic duplex modes

A.9.1.69.1 Test Purpose and Environment

The purpose of this test is to verify that the RSRP absolute and relative accuracy requirements in carrier aggregation are within the specified limits. This test will verify the absolute RSRP accuracy requirements of the primary component carrier defined in clause 9.1.11.1, the absolute RSRP accuracy requirements of the secondary component carriers defined in clause 9.1.11.2, and the relative RSRP accuracy requirements of the secondary component carriers defined in clause 9.1.11.2. The test will also verify the primary and secondary component carriers' relative RSRP accuracy requirement defined in Clause 9.1.11.3.

Note on the applicability: the requirement tested in the specific duplex-mode test cases A.9.1.44, A.9.1.45, A.9.1.46, A.9.1.47, does not need to be tested in the generic duplex-mode test case A.9.1.69.

A.9.1.69.2 Test parameters

In this set of cases cell 1 is PCell on the primary component carrier, and cell 2, cell 4 and cell 6 are activated SCells on secondary component carriers SCC1, SCC2 and SCC3 respectively. Cell 3, cell 5 and cell 7 are neighbouring cells on secondary component carriers SCC1, SCC2 and SCC3 respectively. The test parameters are given in Table A.9.1.44.2-1.

Table A.9.1.69.2-1: 4 Downlink RSRP carrier aggregation test parameters

Parameter	Unit	Cell 1	Cell 2	Cell 3	Cell 4	Cell 5	Cell 6	Cell 7
E-UTRA RF Channel Number		1	2		3		4	
Duplex mode		FDD or TDD	FDD or TDD		FDD or TDD		FDD or TDD	
$BW_{channel}$	MHz	5MHz: $N_{RB,c} = 25$ 10MHz: $N_{RB,c} = 50$ 20MHz: $N_{RB,c} = 100$	5MHz: $N_{RB,c} = 25$ 10MHz: $N_{RB,c} = 50$ 20MHz: $N_{RB,c} = 100$		5MHz: $N_{RB,c} = 25$ 10MHz: $N_{RB,c} = 50$ 20MHz: $N_{RB,c} = 100$		5MHz: $N_{RB,c} = 25$ 10MHz: $N_{RB,c} = 50$ 20MHz: $N_{RB,c} = 100$	
TDD Special subframe configuration ^{Note1}		6	6		6		6	
TDD Uplink/downlink configuration ^{Note1}		1	1		1		1	
Measurement bandwidth	n_{PRB}	5MHz: 10-15 10MHz: 22-27 20MHz: 47-52	5MHz: 10-15 10MHz: 22-27 20MHz: 47-52		5MHz: 10-15 10MHz: 22-27 20MHz: 47-52		5MHz: 10-15 10MHz: 22-27 20MHz: 47-52	
PDSCH Reference measurement channel		5MHz FDD: R.5 FDD 10MHz FDD: R.0 FDD 20MHz FDD: R.4 FDD 5MHz TDD: R.4 TDD 10MHz TDD: R.0 TDD 20MHz TDD: R.3 TDD	5MHz FDD: R.5 FDD 10MHz FDD: R.0 FDD 20MHz FDD: R.4 FDD 5MHz TDD: R.4 TDD 10MHz TDD: R.0 TDD 20MHz TDD: R.3 TDD	-	5MHz FDD: R.5 FDD 10MHz FDD: R.0 FDD 20MHz FDD: R.4 FDD 5MHz TDD: R.4 TDD 10MHz TDD: R.0 TDD 20MHz TDD: R.3 TDD	-	5MHz FDD: R.5 FDD 10MHz FDD: R.0 FDD 20MHz FDD: R.4 FDD 5MHz TDD: R.4 TDD 10MHz TDD: R.0 TDD 20MHz TDD: R.3 TDD	-
PDSCH allocation	n_{PRB}	5MHz: 7-17 10MHz: 13-36 20MHz: 38-61	5MHz: 7-17 10MHz: 13-36 20MHz: 38-61	-	5MHz: 7-17 10MHz: 13-36 20MHz: 38-61	-	5MHz: 7-17 10MHz: 13-36 20MHz: 38-61	-
PDCCH/PCFICH/PHICH Reference measurement channel		5MHz FDD: R.11 FDD 10MHz FDD: R.6 FDD 20MHz FDD: R.10 FDD 5MHz TDD: R.11 TDD 10MHz TDD: R.6 TDD 20MHz TDD: R.10 TDD	5MHz FDD: R.11 FDD 10MHz FDD: R.6 FDD 20MHz FDD: R.10 FDD 5MHz TDD: R.11 TDD 10MHz TDD: R.6 TDD 20MHz TDD: R.10 TDD	5MHz FDD: R.11 FDD 10MHz FDD: R.6 FDD 20MHz FDD: R.10 FDD 5MHz TDD: R.11 TDD 10MHz TDD: R.6 TDD 20MHz TDD: R.10 TDD	5MHz FDD: R.11 FDD 10MHz FDD: R.6 FDD 20MHz FDD: R.10 FDD 5MHz TDD: R.11 TDD 10MHz TDD: R.6 TDD 20MHz TDD: R.10 TDD	5MHz FDD: R.11 FDD 10MHz FDD: R.6 FDD 20MHz FDD: R.10 FDD 5MHz TDD: R.11 TDD 10MHz TDD: R.6 TDD 20MHz TDD: R.10 TDD	5MHz FDD: R.11 FDD 10MHz FDD: R.6 FDD 20MHz FDD: R.10 FDD 5MHz TDD: R.11 TDD 10MHz TDD: R.6 TDD 20MHz TDD: R.10 TDD	5MHz FDD: R.11 FDD 10MHz FDD: R.6 FDD 20MHz FDD: R.10 FDD 5MHz TDD: R.11 TDD 10MHz TDD: R.6 TDD 20MHz TDD: R.10 TDD

OCNG Patterns			5MHz FDD: OP.15 FDD 10MHz FDD: OP.1 FDD 20MHz FDD: OP.11 FDD	5MHz FDD: OP.15 FDD 10MHz FDD: OP.1 FDD 20MHz FDD: OP.11 FDD	5MHz FDD: OP.16 FDD 10MHz FDD: OP.2 FDD 20MHz FDD: OP.12 FDD	5MHz FDD: OP.16 FDD 10MHz FDD: OP.2 FDD 20MHz FDD: OP.12 FDD	5MHz FDD: OP.15 FDD 10MHz FDD: OP.1 FDD 20MHz FDD: OP.11 FDD	5MHz FDD: OP.16 FDD 10MHz FDD: OP.2 FDD 20MHz FDD: OP.12 FDD	5MHz FDD: OP.16 FDD 10MHz FDD: OP.2 FDD 20MHz FDD: OP.12 FDD
5MHz TDD: OP.9 TDD 10MHz TDD: OP.1 TDD 20MHz TDD: OP.7 TDD			5MHz TDD: OP.9 TDD 10MHz TDD: OP.1 TDD 20MHz TDD: OP.7 TDD	5MHz TDD: OP.9 TDD 10MHz TDD: OP.1 TDD 20MHz TDD: OP.7 TDD	5MHz TDD: OP.10 TDD 10MHz TDD: OP.1 TDD 20MHz TDD: OP.8 TDD	5MHz TDD: OP.10 TDD 10MHz TDD: OP.1 TDD 20MHz TDD: OP.8 TDD	5MHz TDD: OP.9 TDD 10MHz TDD: OP.1 TDD 20MHz TDD: OP.7 TDD	5MHz TDD: OP.10 TDD 10MHz TDD: OP.1 TDD 20MHz TDD: OP.8 TDD	5MHz TDD: OP.10 TDD 10MHz TDD: OP.1 TDD 20MHz TDD: OP.8 TDD
PBCH_RA		dB	0	0	0	0	0	0	0
PBCH_RB									
PSS_RA									
SSS_RA									
PCFICH_RB									
PHICH_RA									
PHICH_RB									
PDCCH_RA									
PDCCH_RB									
PDSCH_RA									
PDSCH_RB									
OCNG_RA ^{Note2}									
OCNG_RB ^{Note2}									
N_{oc} ^{Note3}	Bands TDD_A								
	Bands TDD_C								
	Bands TDD_E								
	Bands FDD_A								
	Bands FDD_B1, FDD_B2 ^{Note 10}								
	Bands FDD_C								
	Bands FDD_D								
	Bands FDD_E, FDD_F ^{Note 7}								
	Bands FDD_G								
	Bands FDD_H								
\hat{E}_s / N_{oc}		dB	-4	3	-1	3	-1	3	-1
\hat{E}_s / I_{ot}		dB	-4	0.46	-5.76	0.46	-5.76	0.46	-5.76
RSRP ^{Note4}	Bands TDD_A	dBm/15 kHz	-121	(RSRP for Cell 1 +8dB)	(RSRP for Cell 1 +4dB)	(RSRP for Cell 1 +8dB)	(RSRP for Cell 1 +4dB)	(RSRP for Cell 1 +8dB)	(RSRP for Cell 1 +4dB)
	Bands TDD_C								
	Bands TDD_E								

	Bands FDD_A		-121						
	Bands FDD_B1, FDD_B2 ^{Note 10}		-120.5						
	Bands FDD_C		-120						
	Bands FDD_D		-119.5						
	Bands FDD_E, FDD_F ^{Note 7}		-119						
	Bands FDD_G		-118						
	Bands FDD_H		-117.5						
Io ^{Note 4}	Bands TDD_A	dBm/ BW _{channel}	- 87.76+10log(N _{RB,c} /50)	(Io for Channel 1 +5.33dB +10log (N _{RB channel2} / N _{RB channel 1}))	(Io for Channel 1 +5.33dB +10log (N _{RB channel3} / N _{RB channel 1}))	(Io for Channel 1 +5.33dB +10log (N _{RB channel4} / N _{RB channel 1}))			
	Bands TDD_C		- 86.76+10log(N _{RB,c} /50)						
	Bands TDD_E		- 85.76+10log(N _{RB,c} /50)						
	Bands FDD_A		- 87.76+10log(N _{RB,c} /50)						
	Bands FDD_B1, FDD_B2 ^{Note 10}		- 87.26+10log(N _{RB,c} /50)						
	Bands FDD_C		- 86.76+10log(N _{RB,c} /50)						
	Bands FDD_D		- 86.26+10log(N _{RB,c} /50)						
	Bands FDD_E, FDD_F ^{Note 7}		-85.76 +10log(N _{RB,c} /50)						
	Bands FDD_G		-84.76 +10log(N _{RB,c} /50)						
	Bands FDD_H		-84.26 +10log(N _{RB,c} /50)						
Propagation condition	-	AWGN	AWGN	AWGN	AWGN	AWGN	AWGN	AWGN	AWGN
Antenna Configuration	-	1x2	1x2	1x2	1x2	1x2	1x2	1x2	1x2
Timing offset to cell 1	μs	-	0	3	0	3	0	3	3
Time alignment error relative to cell 1 ^{Note 8}		-	≤ TAE	-	≤ TAE	-	≤ TAE	-	-
Time alignment error relative to cell 2 ^{Note 8}		-	-	-	≤ TAE	-	≤ TAE	-	-
Time alignment error relative to cell 4 ^{Note 8}		-	-	-	-	-	≤ TAE	-	-
Note 1:	For special subframe and uplink-downlink configurations see Tables 4.2-1 and 4.2-2 in TS 36.211.								
Note 2:	OCNG shall be used such that all cells are fully allocated and a constant total transmitted power spectral density is achieved for all OFDM symbols.								
Note 3:	Interference from other cells and noise sources not specified in the test is assumed to be constant over subcarriers and time and shall be modelled as AWGN of appropriate power for N_{oc} to be fulfilled.								
Note 4:	RSRP and Io levels have been derived from other parameters for information purposes. They are not settable parameters themselves.								
Note 5:	RSRP minimum requirements are specified assuming independent interference and noise at each receiver antenna port.								
Note 6:	The selection of the bands for testing depends on the configuration of the carrier aggregation supported by the UEs.								
Note 7:	For Band 26, the tests shall be performed with the carrier frequency of the assigned E-UTRA channel bandwidth within 865-894 MHz.								
Note 8:	Time alignment error (TAE) as specified in TS 36.104 [30] clause 6.5.3.1. The TAE value depends upon the type of carrier aggregation.								
Note 9:	E-UTRA operating band groups are as defined in Section 3.5.								
Note 10:	For Band 74, the tests shall be performed with the carrier frequency of the assigned E-UTRA channel bandwidth within 1475.9-1510.9 MHz.								

A.9.1.69.3 Test Requirements

In the test, the performance of RSRP measurements is verified from the following 10 perspectives:

- The absolute accuracy of intra-frequency RSRP measurements for Cell 1 on the primary component carrier shall fulfil the requirements defined in clause 9.1.11.1.
- The absolute accuracy of intra-frequency RSRP measurements for Cell 2 on SCC1 shall fulfil the requirements defined in clause 9.1.11.2.
- The absolute accuracy of intra-frequency RSRP measurements for Cell 4 on SCC2 shall fulfil the requirements defined in clause 9.1.11.2.
- The absolute accuracy of intra-frequency RSRP measurements for Cell 6 on SCC3 shall fulfil the requirements defined in clause 9.1.11.2.
- The relative accuracy of intra-frequency RSRP measurements for Cell 3 relative to Cell 2 on SCC1 shall fulfil the requirements defined in clause 9.1.11.2.
- The relative accuracy of intra-frequency RSRP measurements for Cell 5 relative to Cell 4 on SCC2 shall fulfil the requirements defined in clause 9.1.11.2.
- The relative accuracy of intra-frequency RSRP measurements for Cell 7 relative to Cell 6 on SCC3 shall fulfil the requirements defined in clause 9.1.11.2.
- The relative accuracy of inter-frequency RSRP measurements between SCC1 and the primary component carriers for Cell 2 relative to Cell 1 shall fulfil the requirements defined in clause 9.1.11.3.
- The relative accuracy of inter-frequency RSRP measurements between SCC2 and the primary component carriers for Cell 4 relative to Cell 1 shall fulfil the requirements defined in clause 9.1.11.3.
- The relative accuracy of inter-frequency RSRP measurements between SCC3 and the primary component carriers for Cell 6 relative to Cell 1 shall fulfil the requirements defined in clause 9.1.11.3.

A.9.1.70 5 DL RSRP for E-UTRAN in Carrier Aggregation with generic duplex modes

A.9.1.70.1 Test Purpose and Environment

The purpose of this test is to verify that the RSRP absolute and relative accuracy requirements in carrier aggregation are within the specified limits. This test will verify the absolute RSRP accuracy requirements of the primary component carrier defined in clause 9.1.11.1, the absolute RSRP accuracy requirements of the secondary component carriers defined in clause 9.1.11.2, and the relative RSRP accuracy requirements of the secondary component carriers defined in clause 9.1.11.2. The test will also verify the primary and secondary component carriers' relative RSRP accuracy requirement defined in Clause 9.1.11.3.

Note on the applicability: the requirement tested in the specific duplex-mode test cases A.9.1.48, A.9.1.49, A.9.1.50, A.9.1.51, does not need to be tested in the generic duplex-mode test case A.9.1.70.

A.9.1.70.2 Test parameters

In this set of test cases cell 1 is PCell on the primary component carrier, and cell 2, cell 4, cell 6 and cell 8 are activated SCells on secondary component carriers SCC1, SCC2, SCC3 and SCC4 respectively. Cell 3, cell 5, cell 7 and cell 9 are neighbouring cells on secondary component carriers SCC1, SCC2, SCC3 and SCC4 respectively. The test parameters are given in Table A.9.1.70.2-1, Table A.9.1.70.2-2 and Table A.9.1.70.2-3.

Table A.9.1.70.2-1: 5 Downlink RSRP carrier aggregation test parameters for cell 1, cell 2, cell 3, cell 4 and cell 5

Parameter	Unit	Cell 1	Cell 2	Cell 3	Cell 4	Cell 5
E-UTRA RF Channel Number		1	2		3	
Duplex mode		FDD or TDD	FDD or TDD		FDD or TDD	
BW _{channel}	MHz	5MHz: N _{RB,c} = 25 10MHz: N _{RB,c} = 50 20MHz: N _{RB,c} = 100	5MHz: N _{RB,c} = 25 10MHz: N _{RB,c} = 50 20MHz: N _{RB,c} = 100		5MHz: N _{RB,c} = 25 10MHz: N _{RB,c} = 50 20MHz: N _{RB,c} = 100	

TDD Special subframe configuration ^{Note1}		6	6		6	
TDD Uplink/downlink configuration ^{Note1}		1	1		1	
Measurement bandwidth	n_{PRB}	5MHz: 10-15 10MHz: 22-27 20MHz: 47-52	5MHz: 10-15 10MHz: 22-27 20MHz: 47-52		5MHz: 10-15 10MHz: 22-27 20MHz: 47-52	
PDSCH Reference measurement channel defined in A.3.1.1.		5MHz FDD: R.5 FDD 10MHz FDD: R.0 FDD 20MHz FDD: R.4 FDD 5MHz TDD: R.4 TDD 10MHz TDD: R.0 TDD 20MHz TDD: R.3 TDD	5MHz FDD: R.5 FDD 10MHz FDD: R.0 FDD 20MHz FDD: R.4 FDD 5MHz TDD: R.4 TDD 10MHz TDD: R.0 TDD 20MHz TDD: R.3 TDD	-	5MHz FDD: R.5 FDD 10MHz FDD: R.0 FDD 20MHz FDD: R.4 FDD 5MHz TDD: R.4 TDD 10MHz TDD: R.0 TDD 20MHz TDD: R.3 TDD	-
PDSCH allocation	n_{PRB}	5MHz: 7-17 10MHz: 13-36 20MHz: 38-61	5MHz: 7-17 10MHz: 13-36 20MHz: 38-61	-	5MHz: 7-17 10MHz: 13-36 20MHz: 38-61	-
PDCCH/PCFICH/PHICH Reference measurement channel defined in A.3.1.2.		5MHz FDD: R.11 FDD 10MHz FDD: R.6 FDD 20MHz FDD: R.10 FDD 5MHz TDD: R.11 TDD 10MHz TDD: R.6 TDD 20MHz TDD: R.10 TDD	5MHz FDD: R.11 FDD 10MHz FDD: R.6 FDD 20MHz FDD: R.10 FDD 5MHz TDD: R.11 TDD 10MHz TDD: R.6 TDD 20MHz TDD: R.10 TDD	5MHz FDD: R.11 FDD 10MHz FDD: R.6 FDD 20MHz FDD: R.10 FDD 5MHz TDD: R.11 TDD 10MHz TDD: R.6 TDD 20MHz TDD: R.10 TDD	5MHz FDD: R.11 FDD 10MHz FDD: R.6 FDD 20MHz FDD: R.10 FDD 5MHz TDD: R.11 TDD 10MHz TDD: R.6 TDD 20MHz TDD: R.10 TDD	5MHz FDD: R.11 FDD 10MHz FDD: R.6 FDD 20MHz FDD: R.10 FDD 5MHz TDD: R.11 TDD 10MHz TDD: R.6 TDD 20MHz TDD: R.10 TDD
OCNG Patterns defined in A.3.2.		5MHz FDD: OP.15 FDD 10MHz FDD: OP.1 FDD 20MHz FDD: OP.11 FDD 5MHz TDD: OP.9 TDD 10MHz TDD: OP.1 TDD 20MHz TDD: OP.7 TDD	5MHz FDD: OP.15 FDD 10MHz FDD: OP.1 FDD 20MHz FDD: OP.11 FDD 5MHz TDD: OP.9 TDD 10MHz TDD: OP.1 TDD 20MHz TDD: OP.7 TDD	5MHz FDD: OP.16 FDD 10MHz FDD: OP.2 FDD 20MHz FDD: OP.12 FDD 5MHz TDD: OP.10 TDD 10MHz TDD: OP.2 TDD 20MHz TDD: OP.8 TDD	5MHz FDD: OP.15 FDD 10MHz FDD: OP.1 FDD 20MHz FDD: OP.11 FDD 5MHz TDD: OP.9 TDD 10MHz TDD: OP.1 TDD 20MHz TDD: OP.7 TDD	5MHz FDD: OP.16 FDD 10MHz FDD: OP.2 FDD 20MHz FDD: OP.12 FDD 5MHz TDD: OP.10 TDD 10MHz TDD: OP.2 TDD 20MHz TDD: OP.8 TDD
PBCH_RA	dB	0	0	0	0	0
PBCH_RB						
PSS_RA						
SSS_RA						
PCFICH_RB						
PHICH_RA						
PHICH_RB						
PDCCH_RA						
PDCCH_RB						
PDSCH_RA						
PDSCH_RB						
OCNG_RA ^{Note2}						
OCNG_RB ^{Note2}						
Bands TDD_A						

N_{oc} Note3	Bands TDD_C	dBm/ 15 kHz	-116	$(N_{oc}$ for Channel 1 +1dB)	$(N_{oc}$ for Channel 1 +1dB)		
	Bands TDD_E		-115				
	Bands FDD_A		-117				
	Bands FDD_B1, FDD_B2 Note 10		-116.5				
	Bands FDD_C		-116				
	Bands FDD_D		-115.5				
	Bands FDD_E, FDD_F Note 7		-115				
	Bands FDD_G		-114				
	Bands FDD_H		-113.5				
\hat{E}_s/N_{oc}		dB	-4	3	-1	3	-1
\hat{E}_s/I_{ot}		dB	-4	0.46	-5.76	0.46	-5.76
RSRP Note4	Bands TDD_A	dBm/ 15 kHz	-121	(RSRP for Cell 1 +8dB)	(RSRP for Cell 1 +4dB)	(RSRP for Cell 1 +8dB)	(RSRP for Cell 1 +4dB)
	Bands TDD_C		-120				
	Bands TDD_E		-119				
	Bands FDD_A		-121				
	Bands FDD_B1, FDD_B2 Note 10		-120.5				
	Bands FDD_C		-120				
	Bands FDD_D		-119.5				
	Bands FDD_E, FDD_F Note 7		-119				
	Bands FDD_G		-118				
	Bands FDD_H		-117.5				
I_o Note4	Bands TDD_A	dBm/ BW _{cha} nnel	- 87.76+10log(N _R B,c/50)	(I _o for Channel 1 +5.33dB +10log (N _{RB} channel2 / N _{RB} channel 1))	(I _o for Channel 1 +5.33dB +10log (N _{RB} channel3 / N _{RB} channel 1))		
	Bands TDD_C		- 86.76+10log(N _R B,c/50)				
	Bands TDD_E		- 85.76+10log(N _R B,c/50)				
	Bands FDD_A		- 87.76+10log(N _R B,c/50)				
	Bands FDD_B1, FDD_B2 Note 10		- 87.26+10log(N _R B,c/50)				
	Bands FDD_C		- 86.76+10log(N _R B,c/50)				

	Bands FDD_D		- 86.26+10log(N _{R_{B,c}/50})			
	Bands FDD_E, FDD_F <small>Note 7</small>		-85.76 +10log(N _{R_{B,c}/50})			
	Bands FDD_G		-84.76 +10log(N _{R_{B,c}/50})			
	Bands FDD_H		-84.26 +10log(N _{R_{B,c}/50})			
Propagation condition	-	AWGN	AWGN	AWGN	AWGN	AWGN
Antenna Configuration	-	1x2	1x2	1x2	1x2	1x2
Timing offset to cell 1	μs	-	0	3	0	3
Time alignment error relative to cell 1 <small>Note 8</small>		-	≤ TAE	-	≤ TAE	-
Time alignment error relative to cell 2 <small>Note 8</small>		-	-	-	≤ TAE	-
<p>Note 1: For special subframe and uplink-downlink configurations see Tables 4.2-1 and 4.2-2 in TS 36.211.</p> <p>Note 2: OCNG shall be used such that all cells are fully allocated and a constant total transmitted power spectral density is achieved for all OFDM symbols.</p> <p>Note 3: Interference from other cells and noise sources not specified in the test is assumed to be constant over subcarriers and time and shall be modelled as AWGN of appropriate power for N_{oc} to be fulfilled.</p> <p>Note 4: RSRP and Io levels have been derived from other parameters for information purposes. They are not settable parameters themselves.</p> <p>Note 5: RSRP minimum requirements are specified assuming independent interference and noise at each receiver antenna port.</p> <p>Note 6: The selection of the bands for testing depends on the configuration of the carrier aggregation supported by the UEs.</p> <p>Note 7: For Band 26, the tests shall be performed with the carrier frequency of the assigned E-UTRA channel bandwidth within 865-894 MHz.</p> <p>Note 8: Time alignment error (TAE) as specified in TS 36.104 [30] clause 6.5.3.1. The TAE value depends upon the type of carrier aggregation.</p> <p>Note 9: E-UTRA operating band groups are as defined in Section 3.5.</p> <p>Note 10: For Band 74, the tests shall be performed with the carrier frequency of the assigned E-UTRA channel bandwidth within 1475.9-1510.9 MHz.</p>						

Table A.9.1.70.2-2: 5 Downlink RSRP carrier aggregation test parameters for cell 6 and cell 7

Parameter	Unit	Cell 6	Cell 7
E-UTRA RF Channel Number		4	
Duplex mode		FDD or TDD	
BW _{channel}	MHz	5MHz: N _{RB,c} = 25 10MHz: N _{RB,c} = 50 20MHz: N _{RB,c} = 100	
TDD Special subframe configuration <small>Note 1</small>		6	
TDD Uplink/downlink configuration <small>Note 1</small>		1	
Measurement bandwidth	n_{PRE}	5MHz: 10-15 10MHz: 22-27 20MHz: 47-52	
PDSCH Reference measurement channel defined in A.3.1.1.2		5MHz FDD: R.5 FDD 10MHz FDD: R.0 FDD 20MHz FDD: R.4 FDD 5MHz TDD: R.4 TDD 10MHz TDD: R.0 TDD 20MHz TDD: R.3 TDD	-
PDSCH allocation	n_{PRE}	5MHz: 7-17 10MHz: 13-36	-

		20MHz: 38-61		
PDCCH/PCFICH/PHICH Reference measurement channel defined in A.3.1.2.2		5MHz FDD: R.11 FDD 10MHz FDD: R.6 FDD 20MHz FDD: R.10 FDD 5MHz TDD: R.11 TDD 10MHz TDD: R.6 TDD 20MHz TDD: R.10 TDD	5MHz FDD: R.11 FDD 10MHz FDD: R.6 FDD 20MHz FDD: R.10 FDD 5MHz TDD: R.11 TDD 10MHz TDD: R.6 TDD 20MHz TDD: R.10 TDD	
OCNG Patterns defined in A.3.2.2		5MHz FDD: OP.15 FDD 10MHz FDD: OP.1 FDD 20MHz FDD: OP.11 FDD 5MHz TDD: OP.9 TDD 10MHz TDD: OP.1 TDD 20MHz TDD: OP.7 TDD	5MHz FDD: OP.16 FDD 10MHz FDD: OP.2 FDD 20MHz FDD: OP.12 FDD 5MHz TDD: OP.10 TDD 10MHz TDD: OP.2 TDD 20MHz TDD: OP.8 TDD	
PBCH_RA	dB	0	0	
PBCH_RB				
PSS_RA				
SSS_RA				
PCFICH_RB				
PHICH_RA				
PHICH_RB				
PDCCH_RA				
PDCCH_RB				
PDSCH_RA				
PDSCH_RB				
OCNG_RA ^{Note2}				
OCNG_RB ^{Note2}				
N_{oc} ^{Note3}				Bands TDD_A
	Bands TDD_C			
	Bands TDD_E			
	Bands FDD_A			
	Bands FDD_B1, FDD_B2 ^{Note 10}			
	Bands FDD_C			
	Bands FDD_D			
	Bands FDD_E, FDD_F ^{Note 7}			
	Bands FDD_G			
	Bands FDD_H			
\hat{E}_s / N_{oc}	dB	3	-1	
\hat{E}_s / I_{ot}	dB	0.46	-5.76	
RSRP ^{Note4}	Bands TDD_A	dBm/ 15kHz	(RSRP for Cell 1 +8dB)	(RSRP for Cell 1 +4dB)
	Bands TDD_C			
	Bands TDD_E			
	Bands FDD_A			
	Bands FDD_B1, FDD_B2 ^{Note 10}			
	Bands FDD_C			
	Bands FDD_D			
	Bands FDD_E, FDD_F ^{Note 7}			
	Bands FDD_G			

Io ^{Note4}	Bands FDD_H	dBm/ BW _{channel}	(Io for Channel 1 +5.33dB +10log (N _{RB channel3} / N _{RB channel 1}))	
	Bands TDD_A			
	Bands TDD_C			
	Bands TDD_E			
	Bands FDD_A			
	Bands FDD_B1, FDD_B2 ^{Note 10}			
	Bands FDD_C			
	Bands FDD_D			
	Bands FDD_E, FDD_F ^{Note 7}			
	Bands FDD_G			
Bands FDD_H				
Propagation Condition			AWGN	AWGN
Antenna Configuration			1x2	1x2
Timing offset to Cell 1		μs	0	3
Time alignment error relative to cell 1 ^{Note 8}			≤ TAE	-
Time alignment error relative to cell 2 ^{Note 8}			≤ TAE	
Time alignment error relative to cell 4 ^{Note 8}			≤ TAE	
<p>Note 1: For special subframe and uplink-downlink configurations see Tables 4.2-1 and 4.2-2 in TS 36.211.</p> <p>Note 2: OCNG shall be used such that all cells are fully allocated and a constant total transmitted power spectral density is achieved for all OFDM symbols.</p> <p>Note 3: Interference from other cells and noise sources not specified in the test is assumed to be constant over subcarriers and time and shall be modelled as AWGN of appropriate power for N_{oc} to be fulfilled.</p> <p>Note 4: RSRP and Io levels have been derived from other parameters for information purposes. They are not settable parameters themselves.</p> <p>Note 5: RSRP minimum requirements are specified assuming independent interference and noise at each receiver antenna port.</p> <p>Note 6: The selection of the bands for testing depends on the configuration of the carrier aggregation supported by the UEs.</p> <p>Note 7: For Band 26, the tests shall be performed with the carrier frequency of the assigned E-UTRA channel bandwidth within 865-894 MHz.</p> <p>Note 8: Time alignment error (TAE) as specified in TS 36.104 [30] clause 6.5.3.1. The TAE value depends upon the type of carrier aggregation.</p> <p>Note 9: E-UTRA operating band groups are as defined in Section 3.5.</p> <p>Note 10: For Band 74, the tests shall be performed with the carrier frequency of the assigned E-UTRA channel bandwidth within 1475.9-1510.9 MHz.</p>				

Table A.9.1.70.2-3: 5 Downlink PCell in FDD RSRP carrier aggregation test parameters for cell 8 and cell 9

Parameter	Unit	Cell 8	Cell 9
E-UTRA RF Channel Number		5	
Duplex mode		FDD or TDD	
BW _{channel}	MHz	5MHz: N _{RB,c} = 25 10MHz: N _{RB,c} = 50 20MHz: N _{RB,c} = 100	
TDD Special subframe configuration ^{Note1}		6	
TDD Uplink/downlink configuration ^{Note1}		1	
Measurement bandwidth	N_{PRB}	5MHz: 10-15 10MHz: 22-27 20MHz: 47-52	
PDSCH Reference measurement channel defined in A.3.1.1.2		5MHz FDD: R.5 FDD 10MHz FDD: R.0 FDD 20MHz FDD:	-

		R.4 FDD 5MHz TDD: R.4 TDD 10MHz TDD: R.0 TDD 20MHz TDD: R.3 TDD	
PDSCH allocation	n_{PRB}	5MHz: 7-17 10MHz: 13-36 20MHz: 38-61	-
PDCCH/PCFICH/PHICH Reference measurement channel defined in A.3.1.2.2		5MHz FDD: R.11 FDD 10MHz FDD: R.6 FDD 20MHz FDD: R.10 FDD 5MHz TDD: R.11 TDD 10MHz TDD: R.6 TDD 20MHz TDD: R.10 TDD	5MHz FDD: R.11 FDD 10MHz FDD: R.6 FDD 20MHz FDD: R.10 FDD 5MHz TDD: R.11 TDD 10MHz TDD: R.6 TDD 20MHz TDD: R.10 TDD
OCNG Patterns defined in A.3.2.2		5MHz FDD: OP.15 FDD 10MHz FDD: OP.1 FDD 20MHz FDD: OP.11 FDD 5MHz TDD: OP.9 TDD 10MHz TDD: OP.1 TDD 20MHz TDD: OP.7 TDD	5MHz FDD: OP.16 FDD 10MHz FDD: OP.2 FDD 20MHz FDD: OP.12 FDD 5MHz TDD: OP.10 TDD 10MHz TDD: OP.2 TDD 20MHz TDD: OP.8 TDD
PBCH_RA	dB	0	0
PBCH_RB			
PSS_RA			
SSS_RA			
PCFICH_RB			
PHICH_RA			
PHICH_RB			
PDCCH_RA			
PDCCH_RB			
PDSCH_RA			
PDSCH_RB			
OCNG_RA ^{Note2}			
OCNG_RB ^{Note2}			
N_{oc} ^{Note3}			
	Bands TDD_C		
	Bands TDD_E		
	Bands FDD_A		
	Bands FDD_B1, FDD_B2 ^{Note 10}		
	Bands FDD_C		
	Bands FDD_D		
	Bands FDD_E, FDD_F ^{Note 7}		
	Bands FDD_G		
	Bands FDD_H		
\hat{E}_s / N_{oc}	dB	3	-1
\hat{E}_s / I_{ot}	dB	0.46	-5.76
RSRP ^{Note4}	Bands TDD_A		

	Bands TDD_C	dBm/ 15kHz	(RSRP for Cell 1 +8dB)	(RSRP for Cell 1 +4dB)
	Bands TDD_E			
	Bands FDD_A			
	Bands FDD_B1, FDD_B2 ^{Note 10}			
	Bands FDD_C			
	Bands FDD_D			
	Bands FDD_E, FDD_F ^{Note 7}			
	Bands FDD_G			
	Bands FDD_H			
I_o ^{Note 4}	Bands TDD_A	dBm/ $BW_{channel}$	(I_o for Channel 1 +5.33dB +10log ($N_{RB channel3} / N_{RB channel 1}$))	
	Bands TDD_C			
	Bands TDD_E			
	Bands FDD_A			
	Bands FDD_B1, FDD_B2 ^{Note 10}			
	Bands FDD_C			
	Bands FDD_D			
	Bands FDD_E, FDD_F ^{Note 7}			
	Bands FDD_G			
	Bands FDD_H			
Propagation Condition			AWGN	AWGN
Antenna Configuration			1x2	1x2
Timing offset to Cell 1		μ s	0	3
Time alignment error relative to cell 1 ^{Note 8}			\leq TAE	-
Time alignment error relative to cell 2 ^{Note 8}			\leq TAE	
Time alignment error relative to cell 4 ^{Note 8}			\leq TAE	
Time alignment error relative to cell 6 ^{Note 8}			\leq TAE	
<p>Note 1: For special subframe and uplink-downlink configurations see Tables 4.2-1 and 4.2-2 in TS 36.211.</p> <p>Note 2: OCNG shall be used such that all cells are fully allocated and a constant total transmitted power spectral density is achieved for all OFDM symbols.</p> <p>Note 3: Interference from other cells and noise sources not specified in the test is assumed to be constant over subcarriers and time and shall be modelled as AWGN of appropriate power for N_{oc} to be fulfilled.</p> <p>Note 4: RSRP and I_o levels have been derived from other parameters for information purposes. They are not settable parameters themselves.</p> <p>Note 5: RSRP minimum requirements are specified assuming independent interference and noise at each receiver antenna port.</p> <p>Note 6: The selection of the bands for testing depends on the configuration of the carrier aggregation supported by the UEs.</p> <p>Note 7: For Band 26, the tests shall be performed with the carrier frequency of the assigned E-UTRA channel bandwidth within 865-894 MHz.</p> <p>Note 8: Time alignment error (TAE) as specified in TS 36.104 [30] clause 6.5.3.1. The TAE value depends upon the type of carrier aggregation.</p> <p>Note 9: E-UTRA operating band groups are as defined in Section 3.5.</p> <p>Note 10: For Band 74, the tests shall be performed with the carrier frequency of the assigned E-UTRA channel bandwidth within 1475.9-1510.9 MHz.</p>				

A.9.1.70.3 Test Requirements

In the test, the performance of RSRP measurements is verified from the following 13 perspectives:

- The absolute accuracy of intra-frequency RSRP measurements for Cell 1 on the primary component carrier shall fulfil the requirements defined in clause 9.1.11.1.
- The absolute accuracy of intra-frequency RSRP measurements for Cell 2 on SCC1 shall fulfil the requirements defined in clause 9.1.11.2.

- The absolute accuracy of intra-frequency RSRP measurements for Cell 4 on SCC2 shall fulfil the requirements defined in clause 9.1.11.2.
- The absolute accuracy of intra-frequency RSRP measurements for Cell 6 on SCC3 shall fulfil the requirements defined in clause 9.1.11.2.
- The absolute accuracy of intra-frequency RSRP measurements for Cell 8 on SCC4 shall fulfil the requirements defined in clause 9.1.11.2.
- The relative accuracy of intra-frequency RSRP measurements for Cell 3 relative to Cell 2 on SCC1 shall fulfil the requirements defined in clause 9.1.11.2.
- The relative accuracy of intra-frequency RSRP measurements for Cell 5 relative to Cell 4 on SCC2 shall fulfil the requirements defined in clause 9.1.11.2.
- The relative accuracy of intra-frequency RSRP measurements for Cell 7 relative to Cell 6 on SCC3 shall fulfil the requirements defined in clause 9.1.11.2.
- The relative accuracy of intra-frequency RSRP measurements for Cell 9 relative to Cell 8 on SCC3 shall fulfil the requirements defined in clause 9.1.11.2.
- The relative accuracy of inter-frequency RSRP measurements between SCC1 and the primary component carriers for Cell 2 relative to Cell 1 shall fulfil the requirements defined in clause 9.1.11.3.
- The relative accuracy of inter-frequency RSRP measurements between SCC2 and the primary component carriers for Cell 4 relative to Cell 1 shall fulfil the requirements defined in clause 9.1.11.3.
- The relative accuracy of inter-frequency RSRP measurements between SCC3 and the primary component carriers for Cell 6 relative to Cell 1 shall fulfil the requirements defined in clause 9.1.11.3.
- The relative accuracy of inter-frequency RSRP measurements between SCC4 and the primary component carriers for Cell 8 relative to Cell 1 shall fulfil the requirements defined in clause 9.1.11.3.

A.9.1.71 6 DL RSRP for E-UTRAN in Carrier Aggregation with generic duplex modes

A.9.1.71.1 Test Purpose and Environment

The purpose of this test is to verify that the RSRP absolute and relative accuracy requirements in carrier aggregation are within the specified limits. This test will verify the absolute RSRP accuracy requirements of the primary component carrier defined in clause 9.1.11.1, the absolute RSRP accuracy requirements of the secondary component carriers defined in clause 9.1.11.2, and the relative RSRP accuracy requirements of the secondary component carriers defined in clause 9.1.11.2. The test will also verify the primary and secondary component carriers' relative RSRP accuracy requirement defined in Clause 9.1.11.3.

A.9.1.71.2 Test parameters

In this set of test cases cell 1 is PCell on the primary component carrier, and cell 2, cell 4, cell 6, cell 8 and cell 10 are activated SCells on secondary component carriers SCC1, SCC2, SCC3, SCC4 and SCC5 respectively. Cell 3, cell 5, cell 7, cell 9 and cell 11 are neighbouring cells on secondary component carriers SCC1, SCC2, SCC3, SCC4 and SCC5 respectively. For testing the requirement related to a given SCell, the presence of at least the respective intra-frequency neighbouring cell (i.e. on the same secondary component carrier) is required. The test parameters are given in Table A.9.1.71.2-1, Table A.9.1.71.2-2 and Table A.9.1.71.2-3.

Table A.9.1.71.2-1: 6 Downlink RSRP carrier aggregation test parameters for cell 1, cell 2, cell 3, cell 4 and cell 5

Parameter	Unit	Cell 1	Cell 2	Cell 3	Cell 4	Cell 5
E-UTRA RF Channel Number		1	2		3	
Duplex mode		FDD or TDD	FDD or TDD		FDD or TDD	
BW _{channel}	MHz	5MHz: N _{RB,c} = 25 10MHz: N _{RB,c} = 50	5MHz: N _{RB,c} = 25 10MHz: N _{RB,c} = 50 20MHz: N _{RB,c} = 100		5MHz: N _{RB,c} = 25 10MHz: N _{RB,c} = 50 20MHz: N _{RB,c} = 100	

		20MHz: N _{RB,c} = 100				
TDD Special subframe configuration ^{Note1}		6	6	6	6	6
TDD Uplink/downlink configuration ^{Note1}		1	1	1	1	1
Measurement bandwidth		5MHz: 10-15 10MHz: 22-27 20MHz: 47-52	5MHz: 10-15 10MHz: 22-27 20MHz: 47-52	5MHz: 10-15 10MHz: 22-27 20MHz: 47-52	5MHz: 10-15 10MHz: 22-27 20MHz: 47-52	5MHz: 10-15 10MHz: 22-27 20MHz: 47-52
PDSCH Reference measurement channel defined in A.3.1.1.		5MHz FDD: R.5 FDD 10MHz FDD: R.0 FDD 20MHz FDD: R.4 FDD 5MHz TDD: R.4 TDD 10MHz TDD: R.0 TDD 20MHz TDD: R.3 TDD	5MHz FDD: R.5 FDD 10MHz FDD: R.0 FDD 20MHz FDD: R.4 FDD 5MHz TDD: R.4 TDD 10MHz TDD: R.0 TDD 20MHz TDD: R.3 TDD	-	5MHz FDD: R.5 FDD 10MHz FDD: R.0 FDD 20MHz FDD: R.4 FDD 5MHz TDD: R.4 TDD 10MHz TDD: R.0 TDD 20MHz TDD: R.3 TDD	-
PDSCH allocation		5MHz: 7-17 10MHz: 13-36 20MHz: 38-61	5MHz: 7-17 10MHz: 13-36 20MHz: 38-61	-	5MHz: 7-17 10MHz: 13-36 20MHz: 38-61	-
PDCCH/PCFICH/PHICH Reference measurement channel defined in A.3.1.2.		5MHz FDD: R.11 FDD 10MHz FDD: R.6 FDD 20MHz FDD: R.10 FDD 5MHz TDD: R.11 TDD 10MHz TDD: R.6 TDD 20MHz TDD: R.10 TDD	5MHz FDD: R.11 FDD 10MHz FDD: R.6 FDD 20MHz FDD: R.10 FDD 5MHz TDD: R.11 TDD 10MHz TDD: R.6 TDD 20MHz TDD: R.10 TDD	5MHz FDD: R.11 FDD 10MHz FDD: R.6 FDD 20MHz FDD: R.10 FDD 5MHz TDD: R.11 TDD 10MHz TDD: R.6 TDD 20MHz TDD: R.10 TDD	5MHz FDD: R.11 FDD 10MHz FDD: R.6 FDD 20MHz FDD: R.10 FDD 5MHz TDD: R.11 TDD 10MHz TDD: R.6 TDD 20MHz TDD: R.10 TDD	5MHz FDD: R.11 FDD 10MHz FDD: R.6 FDD 20MHz FDD: R.10 FDD 5MHz TDD: R.11 TDD 10MHz TDD: R.6 TDD 20MHz TDD: R.10 TDD
OCNG Patterns defined in A.3.2.		5MHz FDD: OP.15 FDD 10MHz FDD: OP.1 FDD 20MHz FDD: OP.11 FDD 5MHz TDD: OP.9 TDD 10MHz TDD: OP.1 TDD 20MHz TDD: OP.7 TDD	5MHz FDD: OP.15 FDD 10MHz FDD: OP.1 FDD 20MHz FDD: OP.11 FDD 5MHz TDD: OP.9 TDD 10MHz TDD: OP.1 TDD 20MHz TDD: OP.7 TDD	5MHz FDD: OP.16 FDD 10MHz FDD: OP.2 FDD 20MHz FDD: OP.12 FDD 5MHz TDD: OP.10 TDD 10MHz TDD: OP.2 TDD 20MHz TDD: OP.8 TDD	5MHz FDD: OP.15 FDD 10MHz FDD: OP.1 FDD 20MHz FDD: OP.11 FDD 5MHz TDD: OP.9 TDD 10MHz TDD: OP.1 TDD 20MHz TDD: OP.7 TDD	5MHz FDD: OP.16 FDD 10MHz FDD: OP.2 FDD 20MHz FDD: OP.12 FDD 5MHz TDD: OP.10 TDD 10MHz TDD: OP.2 TDD 20MHz TDD: OP.8 TDD
PBCH_RA	dB	0	0	0	0	0
PBCH_RB						
PSS_RA						
SSS_RA						
PCFICH_RB						
PHICH_RA						
PHICH_RB						
PDCCH_RA						
PDCCH_RB						
PDSCH_RA						
PDSCH_RB						
OCNG_RA ^{Note2}						
OCNG_RB ^{Note2}						

N_{oc} ^{Note3}	Bands TDD_A	dBm/ 15 kHz	-117	$(N_{oc}$ for Channel 1 +1dB)		$(N_{oc}$ for Channel 1 +1dB)	
	Bands TDD_C		-116				
	Bands TDD_E		-115				
	Bands FDD_A		-117				
	Bands FDD_B1, FDD_B2 <small>Note 10</small>		-116.5				
	Bands FDD_C		-116				
	Bands FDD_D		-115.5				
	Bands FDD_E, FDD_F ^{Note 7}		-115				
	Bands FDD_G		-114				
	Bands FDD_H		-113.5				
			dB				
\hat{E}_s/I_{ot}	dB	-4	0.46	-5.76	0.46	-5.76	
RSRP ^{Note4}	Bands TDD_A	dBm/ 15 kHz	-121	(RSRP for Cell 1 +8dB)		(RSRP for Cell 1 +8dB)	
	Bands TDD_C		-120				
	Bands TDD_E		-119				
	Bands FDD_A		-121				
	Bands FDD_B1, FDD_B2 <small>Note 10</small>		-120.5				
	Bands FDD_C		-120				
	Bands FDD_D		-119.5				
	Bands FDD_E, FDD_F ^{Note 7}		-119				
	Bands FDD_G		-118				
	Bands FDD_H		-117.5				
	I_o ^{Note4}		Bands TDD_A				
Bands TDD_C		- 86.76+10log($N_{R_{B,c}/50}$)					
Bands TDD_E		- 85.76+10log($N_{R_{B,c}/50}$)					
Bands FDD_A		- 87.76+10log($N_{R_{B,c}/50}$)					
Bands FDD_B1, FDD_B2 <small>Note 10</small>		- 87.26+10log($N_{R_{B,c}/50}$)					

	Bands FDD_C		$86.76+10\log(N_{R_{B,c}/50})$				
	Bands FDD_D		$86.26+10\log(N_{R_{B,c}/50})$				
	Bands FDD_E, FDD_F ^{Note 7}		$-85.76+10\log(N_{R_{B,c}/50})$				
	Bands FDD_G		$-84.76+10\log(N_{R_{B,c}/50})$				
	Bands FDD_H		$-84.26+10\log(N_{R_{B,c}/50})$				
Propagation condition	-	AWGN	AWGN	AWGN	AWGN	AWGN	AWGN
Antenna Configuration	-	1x2	1x2	1x2	1x2	1x2	1x2
Timing offset to cell 1	μs	-	0	3	0	3	
Time alignment error relative to cell 1 ^{Note 8}		-	≤ TAE	-	≤ TAE	-	
Time alignment error relative to cell 2 ^{Note 8}		-	-	-	≤ TAE	-	
<p>Note 1: For special subframe and uplink-downlink configurations see Tables 4.2-1 and 4.2-2 in TS 36.211.</p> <p>Note 2: OCNG shall be used such that all cells are fully allocated and a constant total transmitted power spectral density is achieved for all OFDM symbols.</p> <p>Note 3: Interference from other cells and noise sources not specified in the test is assumed to be constant over subcarriers and time and shall be modelled as AWGN of appropriate power for to be fulfilled.</p> <p>Note 4: RSRP and I_o levels have been derived from other parameters for information purposes. They are not settable parameters themselves.</p> <p>Note 5: RSRP minimum requirements are specified assuming independent interference and noise at each receiver antenna port.</p> <p>Note 6: The selection of the bands for testing depends on the configuration of the carrier aggregation supported by the UEs.</p> <p>Note 7: For Band 26, the tests shall be performed with the carrier frequency of the assigned E-UTRA channel bandwidth within 865-894 MHz.</p> <p>Note 8: Time alignment error (TAE) as specified in TS 36.104 [30] clause 6.5.3.1. The TAE value depends upon the type of carrier aggregation.</p> <p>Note 9: E-UTRA operating band groups are as defined in Section 3.5.</p> <p>Note 10: For Band 74, the tests shall be performed with the carrier frequency of the assigned E-UTRA channel bandwidth within 1475.9-1510.9 MHz.</p>							

Table A.9.1.71.2-2: 6 Downlink RSRP carrier aggregation test parameters for cell 6, cell 7, cell 8 and cell 9

Parameter	Unit	Cell 6	Cell 7	Cell 8	Cell 9
E-UTRA RF Channel Number		4		5	
Duplex mode		FDD or TDD		FDD or TDD	
BW _{channel}	MHz	5MHz: N _{RB,c} = 25 10MHz: N _{RB,c} = 50 20MHz: N _{RB,c} = 100		5MHz: N _{RB,c} = 25 10MHz: N _{RB,c} = 50 20MHz: N _{RB,c} = 100	
TDD Special subframe configuration ^{Note1}		6		6	
TDD Uplink/downlink configuration ^{Note1}		1		1	
Measurement bandwidth	n _{PRB}	5MHz: 10-15 10MHz: 22-27 20MHz: 47-52		5MHz: 10-15 10MHz: 22-27 20MHz: 47-52	
PDSCH Reference measurement channel defined in A.3.1.1.2		5MHz FDD: R.5 FDD 10MHz FDD: R.0 FDD 20MHz FDD: R.4 FDD 5MHz TDD: R.4 TDD 10MHz TDD:	-	5MHz FDD: R.5 FDD 10MHz FDD: R.0 FDD 20MHz FDD: R.4 FDD 5MHz TDD: R.4 TDD 10MHz TDD:	-

		R.0 TDD 20MHz TDD: R.3 TDD		R.0 TDD 20MHz TDD: R.3 TDD		
PDSCH allocation	n_{PRB}	5MHz: 7-17 10MHz: 13-36 20MHz: 38-61	-	5MHz: 7-17 10MHz: 13-36 20MHz: 38-61	-	
PDCCH/PCFICH/PHICH Reference measurement channel defined in A.3.1.2.2		5MHz FDD: R.11 FDD 10MHz FDD: R.6 FDD 20MHz FDD: R.10 FDD 5MHz TDD: R.11 TDD 10MHz TDD: R.6 TDD 20MHz TDD: R.10 TDD	5MHz FDD: R.11 FDD 10MHz FDD: R.6 FDD 20MHz FDD: R.10 FDD 5MHz TDD: R.11 TDD 10MHz TDD: R.6 TDD 20MHz TDD: R.10 TDD	5MHz FDD: R.11 FDD 10MHz FDD: R.6 FDD 20MHz FDD: R.10 FDD 5MHz TDD: R.11 TDD 10MHz TDD: R.6 TDD 20MHz TDD: R.10 TDD	5MHz FDD: R.11 FDD 10MHz FDD: R.6 FDD 20MHz FDD: R.10 FDD 5MHz TDD: R.11 TDD 10MHz TDD: R.6 TDD 20MHz TDD: R.10 TDD	
OCNG Patterns defined in A.3.2.2		5MHz FDD: OP.15 FDD 10MHz FDD: OP.1 FDD 20MHz FDD: OP.11 FDD 5MHz TDD: OP.9 TDD 10MHz TDD: OP.1 TDD 20MHz TDD: OP.7 TDD	5MHz FDD: OP.16 FDD 10MHz FDD: OP.2 FDD 20MHz FDD: OP.12 FDD 5MHz TDD: OP.10 TDD 10MHz TDD: OP.2 TDD 20MHz TDD: OP.8 TDD	5MHz FDD: OP.15 FDD 10MHz FDD: OP.1 FDD 20MHz FDD: OP.11 FDD 5MHz TDD: OP.9 TDD 10MHz TDD: OP.1 TDD 20MHz TDD: OP.7 TDD	5MHz FDD: OP.16 FDD 10MHz FDD: OP.2 FDD 20MHz FDD: OP.12 FDD 5MHz TDD: OP.10 TDD 10MHz TDD: OP.2 TDD 20MHz TDD: OP.8 TDD	
PBCH_RA	dB	0	0	0	0	
PBCH_RB						
PSS_RA						
SSS_RA						
PCFICH_RB						
PHICH_RA						
PHICH_RB						
PDCCH_RA						
PDCCH_RB						
PDSCH_RA						
PDSCH_RB						
OCNG_RA ^{Note2}						
OCNG_RB ^{Note2}						
Note3						Bands TDD_A
	Bands TDD_C					
	Bands TDD_E					
	Bands FDD_A					
	Bands FDD_B1, FDD_B2 ^{Note 10}					
	Bands FDD_C					
	Bands FDD_D					
	Bands FDD_E, FDD_F ^{Note 7}					
	Bands FDD_G					
Bands FDD_H						
\hat{E}_s / N_{oc}	dB	3	-1	3	-1	
	dB	0.46	-5.76	0.46	-5.76	
RSRP ^{Note4}	Bands TDD_A	dBm/ 15kHz	(RSRP for Cell 1 +8dB)	(RSRP for Cell 1 +4dB)	(RSRP for Cell 1 +8dB)	(RSRP for Cell 1 +4dB)
	Bands TDD_C					
	Bands TDD_E					
	Bands FDD_A					
	Bands FDD_B1, FDD_B2 ^{Note 10}					
Bands FDD_C						

	Bands FDD_D				
	Bands FDD_E, FDD_F ^{Note 7}				
	Bands FDD_G				
	Bands FDD_H				
Io ^{Note4}	Bands TDD_A	dBm/ BW _{channel}	(Io for Channel 1 +5.33dB +10log (N _{RB channel3} / N _{RB channel 1}))	Io for Channel 1 +5.33dB +10log (N _{RB channel3} / N _{RB channel 1})	
	Bands TDD_C				
	Bands TDD_E				
	Bands FDD_A				
	Bands FDD_B1, FDD_B2 ^{Note 10}				
	Bands FDD_C				
	Bands FDD_D				
	Bands FDD_E, FDD_F ^{Note 7}				
	Bands FDD_G				
	Bands FDD_H				
Propagation Condition			AWGN	AWGN	AWGN
Antenna Configuration			1x2	1x2	1x2
Timing offset to Cell 1		μs	0	3	0
Time alignment error relative to cell 1 ^{Note 8}			≤ TAE	-	≤ TAE
Time alignment error relative to cell 2 ^{Note 8}			≤ TAE		≤ TAE
Time alignment error relative to cell 4 ^{Note 8}			≤ TAE		≤ TAE
<p>Note 1: For special subframe and uplink-downlink configurations see Tables 4.2-1 and 4.2-2 in TS 36.211.</p> <p>Note 2: OCNG shall be used such that all cells are fully allocated and a constant total transmitted power spectral density is achieved for all OFDM symbols.</p> <p>Note 3: Interference from other cells and noise sources not specified in the test is assumed to be constant over subcarriers and time and shall be modelled as AWGN of appropriate power for to be fulfilled.</p> <p>Note 4: RSRP and Io levels have been derived from other parameters for information purposes. They are not settable parameters themselves.</p> <p>Note 5: RSRP minimum requirements are specified assuming independent interference and noise at each receiver antenna port.</p> <p>Note 6: The selection of the bands for testing depends on the configuration of the carrier aggregation supported by the UEs.</p> <p>Note 7: For Band 26, the tests shall be performed with the carrier frequency of the assigned E-UTRA channel bandwidth within 865-894 MHz.</p> <p>Note 8: Time alignment error (TAE) as specified in TS 36.104 [30] clause 6.5.3.1. The TAE value depends upon the type of carrier aggregation.</p> <p>Note 9: E-UTRA operating band groups are as defined in Section 3.5.</p> <p>Note 10: For Band 74, the tests shall be performed with the carrier frequency of the assigned E-UTRA channel bandwidth within 1475.9-1510.9 MHz</p>					

Table A.9.1.71.2-3: 6 Downlink RSRP carrier aggregation test parameters for cell 10 and cell 11

Parameter	Unit	Cell 10	Cell 11
E-UTRA RF Channel Number		6	
Duplex mode		FDD or TDD	
BW _{channel}	MHz	5MHz: N _{RB,c} = 25 10MHz: N _{RB,c} = 50 20MHz: N _{RB,c} = 100	
TDD Special subframe configuration ^{Note1}		6	
TDD Uplink/downlink configuration ^{Note1}		1	
Measurement bandwidth	<i>n_{PRB}</i>	5MHz: 10-15 10MHz: 22-27 20MHz: 47-52	
PDSCH Reference measurement channel defined in A.3.1.1.2		5MHz FDD: R.5 FDD 10MHz FDD: R.0 FDD 20MHz FDD: R.4 FDD	-

		5MHz TDD: R.4 TDD 10MHz TDD: R.0 TDD 20MHz TDD: R.3 TDD	
PDSCH allocation	N_{PRB}	5MHz: 7-17 10MHz: 13-36 20MHz: 38-61	-
PDCCH/PCFICH/PHICH Reference measurement channel defined in A.3.1.2.2		5MHz FDD: R.11 FDD 10MHz FDD: R.6 FDD 20MHz FDD: R.10 FDD 5MHz TDD: R.11 TDD 10MHz TDD: R.6 TDD 20MHz TDD: R.10 TDD	5MHz FDD: R.11 FDD 10MHz FDD: R.6 FDD 20MHz FDD: R.10 FDD 5MHz TDD: R.11 TDD 10MHz TDD: R.6 TDD 20MHz TDD: R.10 TDD
OCNG Patterns defined in A.3.2.2		5MHz FDD: OP.15 FDD 10MHz FDD: OP.1 FDD 20MHz FDD: OP.11 FDD 5MHz TDD: OP.9 TDD 10MHz TDD: OP.1 TDD 20MHz TDD: OP.7 TDD	5MHz FDD: OP.16 FDD 10MHz FDD: OP.2 FDD 20MHz FDD: OP.12 FDD 5MHz TDD: OP.10 TDD 10MHz TDD: OP.2 TDD 20MHz TDD: OP.8 TDD
PBCH_RA	dB	0	0
PBCH_RB			
PSS_RA			
SSS_RA			
PCFICH_RB			
PHICH_RA			
PHICH_RB			
PDCCH_RA			
PDCCH_RB			
PDSCH_RA			
PDSCH_RB			
OCNG_RA ^{Note2}			
OCNG_RB ^{Note2}			
Note3			
	Bands TDD_C		
	Bands TDD_E		
	Bands FDD_A		
	Bands FDD_B1, FDD_B2 ^{Note 10}		
	Bands FDD_C		
	Bands FDD_D		
	Bands FDD_E, FDD_F ^{Note 7}		
	Bands FDD_G		
Bands FDD_H			
\hat{E}_s / N_{oc}	dB	3	-1
	dB	0.46	-5.76
RSRP ^{Note4}	Bands TDD_A	dBm/ 15kHz	(RSRP for Cell 1 +8dB)
	Bands TDD_C		
	Bands TDD_E		

	Bands FDD_A			
	Bands FDD_B1, FDD_B2 ^{Note 10}			
	Bands FDD_C			
	Bands FDD_D			
	Bands FDD_E, FDD_F ^{Note 7}			
	Bands FDD_G			
	Bands FDD_H			
I _o ^{Note 4}	Bands TDD_A	dBm/ BW _{channel}	(I _o for Channel 1 +5.33dB +10log (N _{RB channel3} / N _{RB channel 1}))	
	Bands TDD_C			
	Bands TDD_E			
	Bands FDD_A			
	Bands FDD_B1, FDD_B2 ^{Note 10}			
	Bands FDD_C			
	Bands FDD_D			
	Bands FDD_E, FDD_F ^{Note 7}			
	Bands FDD_G			
	Bands FDD_H			
Propagation Condition			AWGN	AWGN
Antenna Configuration			1x2	1x2
Timing offset to Cell 1		μs	0	3
Time alignment error relative to cell 1 ^{Note 8}			≤ TAE	-
Time alignment error relative to cell 2 ^{Note 8}			≤ TAE	
Time alignment error relative to cell 4 ^{Note 8}			≤ TAE	
Time alignment error relative to cell 6 ^{Note 8}			≤ TAE	
Time alignment error relative to cell 8 ^{Note 8}			≤ TAE	
<p>Note 1: For special subframe and uplink-downlink configurations see Tables 4.2-1 and 4.2-2 in TS 36.211.</p> <p>Note 2: OCNG shall be used such that all cells are fully allocated and a constant total transmitted power spectral density is achieved for all OFDM symbols.</p> <p>Note 3: Interference from other cells and noise sources not specified in the test is assumed to be constant over subcarriers and time and shall be modelled as AWGN of appropriate power for to be fulfilled.</p> <p>Note 4: RSRP and I_o levels have been derived from other parameters for information purposes. They are not settable parameters themselves.</p> <p>Note 5: RSRP minimum requirements are specified assuming independent interference and noise at each receiver antenna port.</p> <p>Note 6: The selection of the bands for testing depends on the configuration of the carrier aggregation supported by the UEs.</p> <p>Note 7: For Band 26, the tests shall be performed with the carrier frequency of the assigned E-UTRA channel bandwidth within 865-894 MHz.</p> <p>Note 8: Time alignment error (TAE) as specified in TS 36.104 [30] clause 6.5.3.1. The TAE value depends upon the type of carrier aggregation.</p> <p>Note 9: E-UTRA operating band groups are as defined in Section 3.5.</p> <p>Note 10: For Band 74, the tests shall be performed with the carrier frequency of the assigned E-UTRA channel bandwidth within 1475.9-1510.9 MHz.</p>				

A.9.1.71.3 Test Requirements

In the test, the performance of RSRP measurements is verified from the following 13 perspectives:

- The absolute accuracy of intra-frequency RSRP measurements for Cell 1 on the primary component carrier shall fulfil the requirements defined in clause 9.1.11.1.
- The absolute accuracy of intra-frequency RSRP measurements for Cell 2 on SCC1 shall fulfil the requirements defined in clause 9.1.11.2.

- The absolute accuracy of intra-frequency RSRP measurements for Cell 4 on SCC2 shall fulfil the requirements defined in clause 9.1.11.2.
- The absolute accuracy of intra-frequency RSRP measurements for Cell 6 on SCC3 shall fulfil the requirements defined in clause 9.1.11.2.
- The absolute accuracy of intra-frequency RSRP measurements for Cell 8 on SCC4 shall fulfil the requirements defined in clause 9.1.11.2.
- The absolute accuracy of intra-frequency RSRP measurements for Cell 10 on SCC5 shall fulfil the requirements defined in clause 9.1.11.2.
- The relative accuracy of intra-frequency RSRP measurements for Cell 3 relative to Cell 2 on SCC1 shall fulfil the requirements defined in clause 9.1.11.2.
- The relative accuracy of intra-frequency RSRP measurements for Cell 5 relative to Cell 4 on SCC2 shall fulfil the requirements defined in clause 9.1.11.2.
- The relative accuracy of intra-frequency RSRP measurements for Cell 7 relative to Cell 6 on SCC3 shall fulfil the requirements defined in clause 9.1.11.2.
- The relative accuracy of intra-frequency RSRP measurements for Cell 9 relative to Cell 8 on SCC4 shall fulfil the requirements defined in clause 9.1.11.2.
- The relative accuracy of intra-frequency RSRP measurements for Cell 11 relative to Cell 10 on SCC5 shall fulfil the requirements defined in clause 9.1.11.2.
- The relative accuracy of inter-frequency RSRP measurements between SCC1 and the primary component carriers for Cell 2 relative to Cell 1 shall fulfil the requirements defined in clause 9.1.11.3.
- The relative accuracy of inter-frequency RSRP measurements between SCC2 and the primary component carriers for Cell 4 relative to Cell 1 shall fulfil the requirements defined in clause 9.1.11.3.
- The relative accuracy of inter-frequency RSRP measurements between SCC3 and the primary component carriers for Cell 6 relative to Cell 1 shall fulfil the requirements defined in clause 9.1.11.3.
- The relative accuracy of inter-frequency RSRP measurements between SCC4 and the primary component carriers for Cell 8 relative to Cell 1 shall fulfil the requirements defined in clause 9.1.11.3.
- The relative accuracy of inter-frequency RSRP measurements between SCC5 and the primary component carriers for Cell 10 relative to Cell 1 shall fulfil the requirements defined in clause 9.1.11.3.

A.9.1.72 7 DL RSRP for E-UTRAN in Carrier Aggregation with generic duplex modes

A.9.1.72.1 Test Purpose and Environment

The purpose of this test is to verify that the RSRP absolute and relative accuracy requirements in carrier aggregation are within the specified limits. This test will verify the absolute RSRP accuracy requirements of the primary component carrier defined in clause 9.1.11.1, the absolute RSRP accuracy requirements of the secondary component carriers defined in clause 9.1.11.2, and the relative RSRP accuracy requirements of the secondary component carriers defined in clause 9.1.11.2. The test will also verify the primary and secondary component carriers' relative RSRP accuracy requirement defined in Clause 9.1.11.3.

A.9.1.72.2 Test parameters

In this set of test cases cell 1 is PCell on the primary component carrier, and cell 2, cell 4, cell 6, cell 8, cell 10 and cell 12 are activated SCells on secondary component carriers SCC1, SCC2, SCC3, SCC4, SCC5 and SCC6 respectively. Cell 3, cell 5, cell 7, cell 9, cell 11 and cell 13 are neighbouring cells on secondary component carriers SCC1, SCC2, SCC3, SCC4, SCC5 and SCC6 respectively. For testing the requirement related to a given SCell, the presence of at least the respective intra-frequency neighbouring cell (i.e. on the same secondary component carrier) is required. The test parameters are given in Table A.9.1.72.2-1, Table A.9.1.72.2-2 and Table A.9.1.72.2-3.

Table A.9.1.72.2-1: 7 Downlink RSRP carrier aggregation test parameters for cell 1, cell 2, cell 3, cell 4 and cell 5

Parameter	Unit	Cell 1	Cell 2	Cell 3	Cell 4	Cell 5
E-UTRA RF Channel Number		1	2		3	
Duplex mode		FDD or TDD	FDD or TDD		FDD or TDD	
BW _{channel}	MHz	5MHz: N _{RB,c} = 25 10MHz: N _{RB,c} = 50 20MHz: N _{RB,c} = 100	5MHz: N _{RB,c} = 25 10MHz: N _{RB,c} = 50 20MHz: N _{RB,c} = 100		5MHz: N _{RB,c} = 25 10MHz: N _{RB,c} = 50 20MHz: N _{RB,c} = 100	
TDD Special subframe configuration ^{Note1}		6	6		6	
TDD Uplink/downlink configuration ^{Note1}		1	1		1	
Measurement bandwidth		5MHz: 10-15 10MHz: 22-27 20MHz: 47-52	5MHz: 10-15 10MHz: 22-27 20MHz: 47-52		5MHz: 10-15 10MHz: 22-27 20MHz: 47-52	
PDSCH Reference measurement channel defined in A.3.1.1.		5MHz FDD: R.5 FDD 10MHz FDD: R.0 FDD 20MHz FDD: R.4 FDD 5MHz TDD: R.4 TDD 10MHz TDD: R.0 TDD 20MHz TDD: R.3 TDD	5MHz FDD: R.5 FDD 10MHz FDD: R.0 FDD 20MHz FDD: R.4 FDD 5MHz TDD: R.4 TDD 10MHz TDD: R.0 TDD 20MHz TDD: R.3 TDD	-	5MHz FDD: R.5 FDD 10MHz FDD: R.0 FDD 20MHz FDD: R.4 FDD 5MHz TDD: R.4 TDD 10MHz TDD: R.0 TDD 20MHz TDD: R.3 TDD	-
PDSCH allocation		5MHz: 7-17 10MHz: 13-36 20MHz: 38-61	5MHz: 7-17 10MHz: 13-36 20MHz: 38-61	-	5MHz: 7-17 10MHz: 13-36 20MHz: 38-61	-
PDCCH/PCFICH/PHICH Reference measurement channel defined in A.3.1.2.		5MHz FDD: R.11 FDD 10MHz FDD: R.6 FDD 20MHz FDD: R.10 FDD 5MHz TDD: R.11 TDD 10MHz TDD: R.6 TDD 20MHz TDD: R.10 TDD	5MHz FDD: R.11 FDD 10MHz FDD: R.6 FDD 20MHz FDD: R.10 FDD 5MHz TDD: R.11 TDD 10MHz TDD: R.6 TDD 20MHz TDD: R.10 TDD	5MHz FDD: R.11 FDD 10MHz FDD: R.6 FDD 20MHz FDD: R.10 FDD 5MHz TDD: R.11 TDD 10MHz TDD: R.6 TDD 20MHz TDD: R.10 TDD	5MHz FDD: R.11 FDD 10MHz FDD: R.6 FDD 20MHz FDD: R.10 FDD 5MHz TDD: R.11 TDD 10MHz TDD: R.6 TDD 20MHz TDD: R.10 TDD	5MHz FDD: R.11 FDD 10MHz FDD: R.6 FDD 20MHz FDD: R.10 FDD 5MHz TDD: R.11 TDD 10MHz TDD: R.6 TDD 20MHz TDD: R.10 TDD
OCNG Patterns defined in A.3.2.		5MHz FDD: OP.15 FDD 10MHz FDD: OP.1 FDD 20MHz FDD: OP.11 FDD 5MHz TDD: OP.9 TDD 10MHz TDD: OP.1 TDD 20MHz TDD: OP.7 TDD	5MHz FDD: OP.15 FDD 10MHz FDD: OP.1 FDD 20MHz FDD: OP.11 FDD 5MHz TDD: OP.9 TDD 10MHz TDD: OP.1 TDD 20MHz TDD: OP.7 TDD	5MHz FDD: OP.16 FDD 10MHz FDD: OP.2 FDD 20MHz FDD: OP.12 FDD 5MHz TDD: OP.10 TDD 10MHz TDD: OP.2 TDD 20MHz TDD: OP.8 TDD	5MHz FDD: OP.15 FDD 10MHz FDD: OP.1 FDD 20MHz FDD: OP.11 FDD 5MHz TDD: OP.9 TDD 10MHz TDD: OP.1 TDD 20MHz TDD: OP.7 TDD	5MHz FDD: OP.16 FDD 10MHz FDD: OP.2 FDD 20MHz FDD: OP.12 FDD 5MHz TDD: OP.10 TDD 10MHz TDD: OP.2 TDD 20MHz TDD: OP.8 TDD
PBCH_RA	dB	0	0	0	0	0
PBCH_RB						
PSS_RA						
SSS_RA						
PCFICH_RB						

PHICH_RA							
PHICH_RB							
PDCCH_RA							
PDCCH_RB							
PDSCH_RA							
PDSCH_RB							
OCNG_RA ^{Note2}							
OCNG_RB ^{Note2}							
N_{oc} ^{Note3}	Bands TDD_A	dBm/ 15 kHz	-117	$(N_{oc}$ for Channel 1 +1dB)	$(N_{oc}$ for Channel 1 +1dB)		
	Bands TDD_C		-116				
	Bands TDD_E		-115				
	Bands FDD_A		-117				
	Bands FDD_B1, FDD_B2 ^{Note 10}		-116.5				
	Bands FDD_C		-116				
	Bands FDD_D		-115.5				
	Bands FDD_E, FDD_F ^{Note 7}		-115				
	Bands FDD_G		-114				
	Bands FDD_H		-113.5				
		dB	-4	3	-1	3	-1
\hat{E}_s/I_{ot}		dB	-4	0.46	-5.76	0.46	-5.76
RSRP ^{Note4}	Bands TDD_A	dBm/ 15 kHz	-121	(RSRP for Cell 1 +8dB)	(RSRP for Cell 1 +4dB)	(RSRP for Cell 1 +8dB)	(RSRP for Cell 1 +4dB)
	Bands TDD_C		-120				
	Bands TDD_E		-119				
	Bands FDD_A		-121				
	Bands FDD_B1, FDD_B2 ^{Note 10}		-120.5				
	Bands FDD_C		-120				
	Bands FDD_D		-119.5				
	Bands FDD_E, FDD_F ^{Note 7}		-119				
	Bands FDD_G		-118				
	Bands FDD_H		-117.5				
I_o ^{Note4}	Bands TDD_A	dBm/ BW _{cha} nnel	$87.76+10\log(N_{R_{B,c}}/50)$	$(I_o$ for Channel 1 +5.33dB +10log (N_{RB} channel2 / N_{RB} channel 1))	$(I_o$ for Channel 1 +5.33dB +10log (N_{RB} channel3 / N_{RB} channel 1))		
	Bands TDD_C		$86.76+10\log(N_{R_{B,c}}/50)$				

	Bands TDD_E		- 85.76+10log(N _R _{B,c} /50)				
	Bands FDD_A		- 87.76+10log(N _R _{B,c} /50)				
	Bands FDD_B1, FDD_B2 Note 10		- 87.26+10log(N _R _{B,c} /50)				
	Bands FDD_C		- 86.76+10log(N _R _{B,c} /50)				
	Bands FDD_D		- 86.26+10log(N _R _{B,c} /50)				
	Bands FDD_E, FDD_F Note 7		-85.76 +10log(N _{RB,c} /50)				
	Bands FDD_G		-84.76 +10log(N _{RB,c} /50)				
	Bands FDD_H		-84.26 +10log(N _{RB,c} /50)				
Propagation condition	-	-	AWGN	AWGN	AWGN	AWGN	AWGN
Antenna Configuration	-	-	1x2	1x2	1x2	1x2	1x2
Timing offset to cell 1	μs	-	-	0	3	0	3
Time alignment error relative to cell 1 Note 8		-	-	≤ TAE	-	≤ TAE	-
Time alignment error relative to cell 2 Note 8		-	-	-	-	≤ TAE	-
Note 1:	For special subframe and uplink-downlink configurations see Tables 4.2-1 and 4.2-2 in TS 36.211.						
Note 2:	OCNG shall be used such that all cells are fully allocated and a constant total transmitted power spectral density is achieved for all OFDM symbols.						
Note 3:	Interference from other cells and noise sources not specified in the test is assumed to be constant over subcarriers and time and shall be modelled as AWGN of appropriate power for to be fulfilled.						
Note 4:	RSRP and I _o levels have been derived from other parameters for information purposes. They are not settable parameters themselves.						
Note 5:	RSRP minimum requirements are specified assuming independent interference and noise at each receiver antenna port.						
Note 6:	The selection of the bands for testing depends on the configuration of the carrier aggregation supported by the UEs.						
Note 7:	For Band 26, the tests shall be performed with the carrier frequency of the assigned E-UTRA channel bandwidth within 865-894 MHz.						
Note 8:	Time alignment error (TAE) as specified in TS 36.104 [30] clause 6.5.3.1. The TAE value depends upon the type of carrier aggregation.						
Note 9:	E-UTRA operating band groups are as defined in Section 3.5.						
Note 10:	For Band 74, the tests shall be performed with the carrier frequency of the assigned E-UTRA channel bandwidth within 1475.9-1510.9 MHz.						

Table A.9.1.72.2-2: 7 Downlink RSRP carrier aggregation test parameters for cell 6, cell 7, cell8 and cell 9

E-UTRA RF Channel Number		4		5	
Duplex mode		FDD or TDD		FDD or TDD	
3GPP TS 36.133 version 15.2.1 Release 15 ETSI TS 136 133 V15.2.1 (2024-03)		5MHz: $N_{RB,c} = 25$ 10MHz: $N_{RB,c} = 50$ 20MHz: $N_{RB,c} = 100$		5MHz: $N_{RB,c} = 25$ 10MHz: $N_{RB,c} = 50$ 20MHz: $N_{RB,c} = 100$	
TDD Special subframe configuration ^{Note1}		6		6	
TDD Uplink/downlink configuration ^{Note1}		1		1	
Measurement bandwidth	n_{PRB}	5MHz: 10-15 10MHz: 22-27 20MHz: 47-52		5MHz: 10-15 10MHz: 22-27 20MHz: 47-52	
PDSCH Reference measurement channel defined in A.3.1.1.2		5MHz FDD: R.5 FDD 10MHz FDD: R.0 FDD 20MHz FDD: R.4 FDD	-	5MHz FDD: R.5 FDD 10MHz FDD: R.0 FDD 20MHz FDD: R.4 FDD	-
PDSCH allocation	n_{PRB}	5MHz: 7-17 10MHz: 13-36 20MHz: 38-61	-	5MHz: 7-17 10MHz: 13-36 20MHz: 38-61	-
PDCCH/PCFICH/PHICH Reference measurement channel defined in A.3.1.2.2		5MHz FDD: R.11 FDD 10MHz FDD: R.6 FDD 20MHz FDD: R.10 FDD	5MHz FDD: R.11 FDD 10MHz FDD: R.6 FDD 20MHz FDD: R.10 FDD	5MHz FDD: R.11 FDD 10MHz FDD: R.6 FDD 20MHz FDD: R.10 FDD	5MHz FDD: R.11 FDD 10MHz FDD: R.6 FDD 20MHz FDD: R.10 FDD
OCNG Patterns defined in A.3.2.2		5MHz FDD: OP.15 FDD 10MHz FDD: OP.1 FDD 20MHz FDD: OP.11 FDD	5MHz FDD: OP.16 FDD 10MHz FDD: OP.2 FDD 20MHz FDD: OP.12 FDD	5MHz FDD: OP.15 FDD 10MHz FDD: OP.1 FDD 20MHz FDD: OP.11 FDD	5MHz FDD: OP.16 FDD 10MHz FDD: OP.2 FDD 20MHz FDD: OP.12 FDD
PBCH_RA	dB	0	0	0	0
PBCH_RB					
PSS_RA					
SSS_RA					
PCFICH_RB					
PHICH_RA					
PHICH_RB					
PDCCH_RA					
PDCCH_RB					
PDSCH_RA					
PDSCH_RB					
OCNG_RA ^{Note2}					

OCNG_RB ^{Note2}						
Note3	Bands TDD_A	dBm/ 15kHz	$(N_{oc}$ for Channel 1 +1dB)		$(N_{oc}$ for Channel 1 +1dB)	
	Bands TDD_C					
	Bands TDD_E					
	Bands FDD_A					
	Bands FDD_B1, FDD_B2 ^{Note 10}					
	Bands FDD_C					
	Bands FDD_D					
	Bands FDD_E, FDD_F ^{Note 7}					
	Bands FDD_G					
Bands FDD_H						
\hat{E}_s / N_{oc}		dB	3	-1	3	-1
		dB	0.46	-5.76	0.46	-5.76
RSRP ^{Note4}	Bands TDD_A	dBm/ 15kHz	(RSRP for Cell 1 +8dB)	(RSRP for Cell 1 +4dB)	(RSRP for Cell 1 +8dB)	(RSRP for Cell 1 +4dB)
	Bands TDD_C					
	Bands TDD_E					
	Bands FDD_A					
	Bands FDD_B1, FDD_B2 ^{Note 10}					
	Bands FDD_C					
	Bands FDD_D					
	Bands FDD_E, FDD_F ^{Note 7}					
	Bands FDD_G					
Bands FDD_H						
Io ^{Note4}	Bands TDD_A	dBm/ BW _{channel}	$(I_o$ for Channel 1 +5.33dB +10log ($N_{RB\ channel3} / N_{RB\ channel\ 1}$))		$(I_o$ for Channel 1 +5.33dB +10log ($N_{RB\ channel3} / N_{RB\ channel\ 1}$))	
	Bands TDD_C					
	Bands TDD_E					
	Bands FDD_A					
	Bands FDD_B1, FDD_B2 ^{Note 10}					
	Bands FDD_C					
	Bands FDD_D					
	Bands FDD_E, FDD_F ^{Note 7}					
	Bands FDD_G					
Bands FDD_H						
Propagation Condition			AWGN	AWGN	AWGN	AWGN
Antenna Configuration			1x2	1x2	1x2	1x2
Timing offset to Cell 1		μ s	0	3	0	3
Time alignment error relative to cell 1 ^{Note 8}			\leq TAE	-	\leq TAE	-
Time alignment error relative to cell 2 ^{Note 8}			\leq TAE		\leq TAE	
Time alignment error relative to cell 4 ^{Note 8}			\leq TAE		\leq TAE	
<p>Note 1: For special subframe and uplink-downlink configurations see Tables 4.2-1 and 4.2-2 in TS 36.211.</p> <p>Note 2: OCNG shall be used such that all cells are fully allocated and a constant total transmitted power spectral density is achieved for all OFDM symbols.</p> <p>Note 3: Interference from other cells and noise sources not specified in the test is assumed to be constant over subcarriers and time and shall be modelled as AWGN of appropriate power for to be fulfilled.</p> <p>Note 4: RSRP and Io levels have been derived from other parameters for information purposes. They are not settable parameters themselves.</p> <p>Note 5: RSRP minimum requirements are specified assuming independent interference and noise at each receiver antenna port.</p> <p>Note 6: The selection of the bands for testing depends on the configuration of the carrier aggregation supported by the UEs.</p> <p>Note 7: For Band 26, the tests shall be performed with the carrier frequency of the assigned E-UTRA channel bandwidth within 865-894 MHz.</p> <p>Note 8: Time alignment error (TAE) as specified in TS 36.104 [30] clause 6.5.3.1. The TAE value depends upon the type of carrier aggregation.</p> <p>Note 9: E-UTRA operating band groups are as defined in Section 3.5.</p> <p>Note 10: For Band 74, the tests shall be performed with the carrier frequency of the assigned E-UTRA channel bandwidth within 1475.9-1510.9 MHz.</p>						

Table A.9.1.72.2-3: 7 Downlink RSRP carrier aggregation test parameters for cell 10, cell 11, cell 12 and cell 13

Parameter	Unit	Cell 10	Cell 11	Cell 12	Cell 13
E-UTRA RF Channel Number		6		7	
Duplex mode		FDD or TDD		FDD or TDD	
BW _{channel}	MHz	5MHz: N _{RB,c} = 25 10MHz: N _{RB,c} = 50 20MHz: N _{RB,c} = 100		5MHz: N _{RB,c} = 25 10MHz: N _{RB,c} = 50 20MHz: N _{RB,c} = 100	
TDD Special subframe configuration ^{Note1}		6		6	
TDD Uplink/downlink configuration ^{Note1}		1		1	
Measurement bandwidth	<i>n</i> _{PRB}	5MHz: 10-15 10MHz: 22-27 20MHz: 47-52		5MHz: 10-15 10MHz: 22-27 20MHz: 47-52	
PDSCH Reference measurement channel defined in A.3.1.1.2		5MHz FDD: R.5 FDD 10MHz FDD: R.0 FDD 20MHz FDD: R.4 FDD 5MHz TDD: R.4 TDD 10MHz TDD: R.0 TDD 20MHz TDD: R.3 TDD	-	5MHz FDD: R.5 FDD 10MHz FDD: R.0 FDD 20MHz FDD: R.4 FDD 5MHz TDD: R.4 TDD 10MHz TDD: R.0 TDD 20MHz TDD: R.3 TDD	-
PDSCH allocation	<i>n</i> _{PRB}	5MHz: 7-17 10MHz: 13-36 20MHz: 38-61	-	5MHz: 7-17 10MHz: 13-36 20MHz: 38-61	-
PDCCH/PCFICH/PHICH Reference measurement channel defined in A.3.1.2.2		5MHz FDD: R.11 FDD 10MHz FDD: R.6 FDD 20MHz FDD: R.10 FDD 5MHz TDD: R.11 TDD 10MHz TDD: R.6 TDD 20MHz TDD: R.10 TDD	5MHz FDD: R.11 FDD 10MHz FDD: R.6 FDD 20MHz FDD: R.10 FDD 5MHz TDD: R.11 TDD 10MHz TDD: R.6 TDD 20MHz TDD: R.10 TDD	5MHz FDD: R.11 FDD 10MHz FDD: R.6 FDD 20MHz FDD: R.10 FDD 5MHz TDD: R.11 TDD 10MHz TDD: R.6 TDD 20MHz TDD: R.10 TDD	5MHz FDD: R.11 FDD 10MHz FDD: R.6 FDD 20MHz FDD: R.10 FDD 5MHz TDD: R.11 TDD 10MHz TDD: R.6 TDD 20MHz TDD: R.10 TDD
OCNG Patterns defined in A.3.2.2		5MHz FDD: OP.15 FDD 10MHz FDD: OP.1 FDD 20MHz FDD: OP.11 FDD 5MHz TDD: OP.9 TDD 10MHz TDD: OP.1 TDD 20MHz TDD: OP.7 TDD	5MHz FDD: OP.16 FDD 10MHz FDD: OP.2 FDD 20MHz FDD: OP.12 FDD 5MHz TDD: OP.10 TDD 10MHz TDD: OP.2 TDD 20MHz TDD: OP.8 TDD	5MHz FDD: OP.15 FDD 10MHz FDD: OP.1 FDD 20MHz FDD: OP.11 FDD 5MHz TDD: OP.9 TDD 10MHz TDD: OP.1 TDD 20MHz TDD: OP.7 TDD	5MHz FDD: OP.16 FDD 10MHz FDD: OP.2 FDD 20MHz FDD: OP.12 FDD 5MHz TDD: OP.10 TDD 10MHz TDD: OP.2 TDD 20MHz TDD: OP.8 TDD
PBCH_RA	dB	0	0	0	0
PBCH_RB					
PSS_RA					
SSS_RA					
PCFICH_RB					
PHICH_RA					
PHICH_RB					

PDCCH_RA						
PDCCH_RB						
PDSCH_RA						
PDSCH_RB						
OCNG_RA ^{Note2}						
OCNG_RB ^{Note2}						
Note3	Bands TDD_A	dBm/ 15kHz	$(N_{oc}$ for Channel 1 +1dB)		$(N_{oc}$ for Channel 1 +1dB)	
	Bands TDD_C					
	Bands TDD_E					
	Bands FDD_A					
	Bands FDD_B1, FDD_B2 ^{Note 10}					
	Bands FDD_C					
	Bands FDD_D					
	Bands FDD_E, FDD_F ^{Note 7}					
	Bands FDD_G					
Bands FDD_H						
\hat{E}_s / N_{oc}		dB	3	-1	3	-1
		dB	0.46	-5.76	0.46	-5.76
RSRP ^{Note4}	Bands TDD_A	dBm/ 15kHz	(RSRP for Cell 1 +8dB)	(RSRP for Cell 1 +4dB)	(RSRP for Cell 1 +8dB)	(RSRP for Cell 1 +4dB)
	Bands TDD_C					
	Bands TDD_E					
	Bands FDD_A					
	Bands FDD_B1, FDD_B2 ^{Note 10}					
	Bands FDD_C					
	Bands FDD_D					
	Bands FDD_E, FDD_F ^{Note 7}					
	Bands FDD_G					
Bands FDD_H						
Io ^{Note4}	Bands TDD_A	dBm/ BW _{channel}	$(I_o$ for Channel 1 +5.33dB +10log ($N_{RB \text{ channel}3} / N_{RB \text{ channel}1}$))		$(I_o$ for Channel 1 +5.33dB +10log ($N_{RB \text{ channel}3} / N_{RB \text{ channel}1}$))	
	Bands TDD_C					
	Bands TDD_E					
	Bands FDD_A					
	Bands FDD_B1, FDD_B2 ^{Note 10}					
	Bands FDD_C					
	Bands FDD_D					
	Bands FDD_E, FDD_F ^{Note 7}					
	Bands FDD_G					
Bands FDD_H						
Propagation Condition			AWGN	AWGN	AWGN	AWGN
Antenna Configuration			1x2	1x2	1x2	1x2
Timing offset to Cell 1		μ s	0	3	0	3
Time alignment error relative to cell 1 ^{Note 8}			\leq TAE	-	\leq TAE	-
Time alignment error relative to cell 2 ^{Note 8}			\leq TAE		\leq TAE	
Time alignment error relative to cell 4 ^{Note 8}			\leq TAE		\leq TAE	
Time alignment error relative to cell 6 ^{Note 8}			\leq TAE		\leq TAE	
Time alignment error relative to cell 8 ^{Note 8}			\leq TAE		\leq TAE	
<p>Note 1: For special subframe and uplink-downlink configurations see Tables 4.2-1 and 4.2-2 in TS 36.211.</p> <p>Note 2: OCNG shall be used such that all cells are fully allocated and a constant total transmitted power spectral density is achieved for all OFDM symbols.</p> <p>Note 3: Interference from other cells and noise sources not specified in the test is assumed to be constant over subcarriers and time and shall be modelled as AWGN of appropriate power for to be fulfilled.</p> <p>Note 4: RSRP and I_o levels have been derived from other parameters for information purposes. They are not settable parameters themselves.</p>						

Note 5:	RSRP minimum requirements are specified assuming independent interference and noise at each receiver antenna port.
Note 6:	The selection of the bands for testing depends on the configuration of the carrier aggregation supported by the UEs.
Note 7:	For Band 26, the tests shall be performed with the carrier frequency of the assigned E-UTRA channel bandwidth within 865-894 MHz.
Note 8:	Time alignment error (TAE) as specified in TS 36.104 [30] clause 6.5.3.1. The TAE value depends upon the type of carrier aggregation.
Note 9:	E-UTRA operating band groups are as defined in Section 3.5.
Note 10:	For Band 74, the tests shall be performed with the carrier frequency of the assigned E-UTRA channel bandwidth within 1475.9-1510.9 MHz.

A.9.1.72.3 Test Requirements

In the test, the performance of RSRP measurements is verified from the following 13 perspectives:

- The absolute accuracy of intra-frequency RSRP measurements for Cell 1 on the primary component carrier shall fulfil the requirements defined in clause 9.1.11.1.
- The absolute accuracy of intra-frequency RSRP measurements for Cell 2 on SCC1 shall fulfil the requirements defined in clause 9.1.11.2.
- The absolute accuracy of intra-frequency RSRP measurements for Cell 4 on SCC2 shall fulfil the requirements defined in clause 9.1.11.2.
- The absolute accuracy of intra-frequency RSRP measurements for Cell 6 on SCC3 shall fulfil the requirements defined in clause 9.1.11.2.
- The absolute accuracy of intra-frequency RSRP measurements for Cell 8 on SCC4 shall fulfil the requirements defined in clause 9.1.11.2.
- The absolute accuracy of intra-frequency RSRP measurements for Cell 10 on SCC5 shall fulfil the requirements defined in clause 9.1.11.2.
- The absolute accuracy of intra-frequency RSRP measurements for Cell 12 on SCC6 shall fulfil the requirements defined in clause 9.1.11.2.
- The relative accuracy of intra-frequency RSRP measurements for Cell 3 relative to Cell 2 on SCC1 shall fulfil the requirements defined in clause 9.1.11.2.
- The relative accuracy of intra-frequency RSRP measurements for Cell 5 relative to Cell 4 on SCC2 shall fulfil the requirements defined in clause 9.1.11.2.
- The relative accuracy of intra-frequency RSRP measurements for Cell 7 relative to Cell 6 on SCC3 shall fulfil the requirements defined in clause 9.1.11.2.
- The relative accuracy of intra-frequency RSRP measurements for Cell 9 relative to Cell 8 on SCC4 shall fulfil the requirements defined in clause 9.1.11.2.
- The relative accuracy of intra-frequency RSRP measurements for Cell 11 relative to Cell 10 on SCC5 shall fulfil the requirements defined in clause 9.1.11.2.
- The relative accuracy of intra-frequency RSRP measurements for Cell 13 relative to Cell 12 on SCC6 shall fulfil the requirements defined in clause 9.1.11.2.
- The relative accuracy of inter-frequency RSRP measurements between SCC1 and the primary component carriers for Cell 2 relative to Cell 1 shall fulfil the requirements defined in clause 9.1.11.3.
- The relative accuracy of inter-frequency RSRP measurements between SCC2 and the primary component carriers for Cell 4 relative to Cell 1 shall fulfil the requirements defined in clause 9.1.11.3.
- The relative accuracy of inter-frequency RSRP measurements between SCC3 and the primary component carriers for Cell 6 relative to Cell 1 shall fulfil the requirements defined in clause 9.1.11.3.
- The relative accuracy of inter-frequency RSRP measurements between SCC4 and the primary component carriers for Cell 8 relative to Cell 1 shall fulfil the requirements defined in clause 9.1.11.3.

- The relative accuracy of inter-frequency RSRP measurements between SCC5 and the primary component carriers for Cell 10 relative to Cell 1 shall fulfil the requirements defined in clause 9.1.11.3.
- The relative accuracy of inter-frequency RSRP measurements between SCC5 and the primary component carriers for Cell 12 relative to Cell 1 shall fulfil the requirements defined in clause 9.1.11.3.

A.9.2 RSRQ

A.9.2.1 FDD Intra frequency case

A.9.2.1.1 Test Purpose and Environment

The purpose of this test is to verify that the RSRQ measurement accuracy is within the specified limits. This test will verify the requirements in Clause 9.1.5.1.

A.9.2.1.2 Test parameters

In this test case all cells are on the same carrier frequency. The absolute accuracy of RSRQ intra frequency measurement is tested by using the parameters in Table A.9.2.1.2-1. In all test cases, Cell 1 is the PCell and Cell 2 the target cell.

Table A.9.2.1.2-1: RSRQ FDD Intra frequency test parameters

Parameter	Unit	Test 1		Test 2		Test 3								
		Cell 1	Cell 2	Cell 1	Cell 2	Cell 1	Cell 2							
E-UTRA RF Channel Number		1		1		1								
BW _{channel}	MHz	10		10		10								
Measurement bandwidth	n_{PRB}	22—27		22—27		22—27								
PDSCH Reference measurement channel defined in A.3.1.1.1		R.0 FDD	-	R.0 FDD	-	R.0 FDD	-							
PDSCH allocation	n_{PRB}	13—36	-	13—36	-	13—36	-							
PDCCH/PCFICH/PHICH Reference measurement channel defined in A.3.1.2.1		R.6 FDD		R.6 FDD		R.6 FDD								
OCNG Patterns defined in A.3.2.1.1 (OP.1 FDD) and A.3.2.1.2 (OP.2 FDD)		OP.1 FDD	OP.2 FDD	OP.1 FDD	OP.2 FDD	OP.1 FDD	OP.2 FDD							
PBCH_RA	dB	0	0	0	0	0	0							
PBCH_RB														
PSS_RA														
SSS_RA														
PCFICH_RB														
PHICH_RA														
PHICH_RB														
PDCCH_RA														
PDCCH_RB														
PDSCH_RA														
PDSCH_RB														
OCNG_RA ^{Note1}														
OCNG_RB ^{Note1}														
N_{oc} ^{Note2}								Bands FDD_A ^{Note 8}	dBm/15 kHz	-84.76	-84.76	-103.85	-103.85	-116
								Bands FDD_B1, FDD_B2 ^{Note 9}						-115.5
	Bands FDD_C	-115												
	Bands FDD_D	-114.5												
	Bands FDD_E, FDD_F ^{Note 5}	-114												
	Bands FDD_G ^{Note 7}	-113												
	Bands FDD_H	-112.5												
\hat{E}_s/I_{ot}	dB	-1.76	-1.76	-4.7	-4.7	-5.46	-5.46							

RSRP ^{Note3}	Bands FDD_A <small>Note 8</small>	dBm/15 kHz	-81.76	-81.76	-106.75	-106.75	-120	-120
	Bands FDD_B1, FDD_B2 <small>Note 9</small>						-119.5	-119.5
	Bands FDD_C						-119	-119
	Bands FDD_D						-118.5	-118.5
	Bands FDD_E, FDD_F <small>Note 5</small>						-118	-118
	Bands FDD_G <small>Note 7</small>						-117	-117
	Bands FDD_H						-116.5	-116.5
RSRQ ^{Note3}	Bands FDD_A <small>Note 8</small>	dB	-14.77	-14.77	-16.76	-16.76	-17.34	-17.34
	Bands FDD_B1, FDD_B2 <small>Note 9</small>							
	Bands FDD_C							
	Bands FDD_D							
	Bands FDD_E, FDD_F <small>Note 5</small>							
	Bands FDD_G <small>Note 7</small>							
	Bands FDD_H							
I _o ^{Note3}	Bands FDD_A <small>Note 8</small>	dBm/9 MHz	-50	-50	-73	-73	-85.67	
	Bands FDD_B1, FDD_B2 <small>Note 9</small>						-85.17	
	Bands FDD_C						-84.67	
	Bands FDD_D						-84.17	
	Bands FDD_E, FDD_F <small>Note 5</small>						-83.67	
	Bands FDD_G <small>Note 7</small>						-82.67	
	Bands FDD_H						-82.17	
\hat{E}_s / N_{oc}		dB	3	3	-2.9	-2.9	-4	-4
Propagation condition		-	AWGN		AWGN		AWGN	
<p>Note 1: OCNG shall be used such that both cells are fully allocated and a constant total transmitted power spectral density is achieved for all OFDM symbols.</p> <p>Note 2: Interference from other cells and noise sources not specified in the test is assumed to be constant over subcarriers and time and shall be modelled as AWGN of appropriate power for N_{oc} to be fulfilled.</p> <p>Note 3: RSRQ, RSRP and I_o levels have been derived from other parameters for information purposes. They are not settable parameters themselves.</p> <p>Note 4: RSRP and RSRQ minimum requirements are specified assuming independent interference and noise at each receiver antenna port.</p> <p>Note 5: For Band 26, the tests shall be performed with the carrier frequency of the assigned E-UTRA channel bandwidth within 865-894 MHz.</p> <p>Note 6: E-UTRA operating band groups are as defined in Section 3.5.</p> <p>Note 7: Except Band 29.</p> <p>Note 8: Except Band 32, Band 75, Band 76.</p> <p>Note 9: For Band 74, the tests shall be performed with the carrier frequency of the assigned E-UTRA channel bandwidth within 1475.9-1510.9 MHz.</p>								

A.9.2.1.3 Test Requirements

The RSRQ measurement accuracy shall fulfil the requirements in section 9.1.5.1. The RSRQ measurement accuracy for UE Category 1bis shall fulfil the requirements in section 9.1.5.5.

A.9.2.2 TDD Intra frequency case

A.9.2.2.1 Test Purpose and Environment

The purpose of this test is to verify that the RSRQ measurement accuracy is within the specified limits. This test will verify the requirements in Clause 9.1.5.1.

A.9.2.2.2 Test parameters

In this test case all cells are on the same carrier frequency. The absolute accuracy of RSRQ intra frequency measurement is tested by using the parameters in Table A.9.2.2.2-1. In all test cases, Cell 1 is the PCell and Cell 2 the target cell.

Table A.9.2.2-1: RSRQ TDD Intra frequency test parameters

Parameter	Unit	Test 1		Test 2		Test 3								
		Cell 1	Cell 2	Cell 1	Cell 2	Cell 1	Cell 2							
E-UTRA RF Channel Number		1		1		1								
$BW_{channel}$	MHz	10		10		10								
Special subframe configuration ^{Note1}		6		6		6								
Uplink-downlink configuration ^{Note1}		1		1		1								
Measurement bandwidth	n_{PRB}	22–27		22–27		22–27								
PDSCH Reference measurement channel defined in A.3.1.1.2		R.0 TDD	-	R.0 TDD	-	R.0 TDD	-							
PDSCH allocation	n_{PRB}	13–36	-	13–36	-	13–36	-							
PDCCH/PCFICH/PHICH Reference measurement channel defined in A.3.1.2.2		R.6 TDD		R.6 TDD		R.6 TDD								
OCNG Patterns defined in A.3.2.2.1 (OP.1 TDD) and A.3.2.2.2 (OP.2 TDD)		OP.1 TDD	OP.2 TDD	OP.1 TDD	OP.2 TDD	OP.1 TDD	OP.2 TDD							
PBCH_RA	dB	0	0	0	0	0	0							
PBCH_RB														
PSS_RA														
SSS_RA														
PCFICH_RB														
PHICH_RA														
PHICH_RB														
PDCCH_RA														
PDCCH_RB														
PDSCH_RA														
PDSCH_RB														
OCNG_RA ^{Note2}														
OCNG_RB ^{Note2}														
N_{oc} ^{Note3}								Bands TDD_A					-116	
								Bands TDD_C	-84.76	-84.76	-103.85	-103.85	-115	
	Bands TDD_E					-114								
\hat{E}_s / I_{ot}	dB	-1.76	-1.76	-4.7	-4.7	-5.46	-5.46							
RSRP ^{Note4}	Bands TDD_A					-120								
	Bands TDD_C	-81.76	-81.76	-106.75	-106.75	-119								
	Bands TDD_E					-118								
RSRQ ^{Note4}	Bands TDD_A, TDD_C, TDD_E	dB	-14.77	-14.77	-16.76	-16.76	-17.34	-17.34						
I_o ^{Note4}	Bands TDD_A					-85.67								
	Bands TDD_C	-50	-50	-73	-73	-84.67								
	Bands TDD_E					-83.67								
\hat{E}_s / N_{oc}	dB	3	3	-2.9	-2.9	-4	-4							
Propagation condition	-	AWGN		AWGN		AWGN								
<p>Note 1: For special subframe and uplink-downlink configurations see Tables 4.2-1 and 4.2-2 in TS 36.211.</p> <p>Note 2: OCNG shall be used such that both cells are fully allocated and a constant total transmitted power spectral density is achieved for all OFDM symbols.</p> <p>Note 3: Interference from other cells and noise sources not specified in the test is assumed to be constant over subcarriers and time and shall be modelled as AWGN of appropriate power for N_{oc} to be fulfilled.</p> <p>Note 4: RSRQ, RSRP and I_o levels have been derived from other parameters for information purposes. They are not settable parameters themselves.</p> <p>Note 5: RSRP and RSRQ minimum requirements are specified assuming independent interference and noise at each receiver antenna port.</p> <p>Note 6: E-UTRA operating band groups are as defined in Section 3.5.</p>														

A.9.2.2.3 Test Requirements

The RSRQ measurement accuracy shall fulfil the requirements in section 9.1.5.1. The RSRQ measurement accuracy for UE Category 1bis shall fulfil the requirements in section 9.1.5.5.

A.9.2.3 FDD—FDD Inter frequency case

A.9.2.3.1 Test Purpose and Environment

The purpose of this test is to verify that the RSRQ measurement accuracy is within the specified limits. This test will verify the requirements in Sections 9.1.6.1 and 9.1.6.2.

A.9.2.3.2 Test parameters

In this test case the two cells are on different carrier frequencies and measurement gaps are provided. Both RSRQ inter frequency absolute and relative accuracy requirements are tested by using test parameters in Table A.9.2.3.2-1. In all tests, Cell 1 is the PCell and Cell 2 the target cell.

Table A.9.2.3.2-1: RSRQ FDD—FDD Inter frequency test parameters

Parameter	Unit	Test 1		Test 2		Test 3		
		Cell 1	Cell 2	Cell 1	Cell 2	Cell 1	Cell 2	
E-UTRA RF Channel Number		1	2	1	2	1	2	
BW _{channel}	MHz	10	10	10	10	10	10	
Gap Pattern Id		0	-	0	-	0	-	
Measurement bandwidth	n_{PRB}	22—27		22—27		22—27		
PDSCH Reference measurement channel defined in A.3.1.1.1		R.0 FDD	-	R.0 FDD	-	R.0 FDD	-	
PDSCH allocation	n_{PRB}	13—36	-	13—36	-	13—36	-	
PDCCH/PCFICH/PHICH Reference measurement channel defined in A.3.1.2.1		R.6 FDD		R.6 FDD		R.6 FDD		
OCNG Patterns defined in A.3.2.1.1 (OP.1 FDD) and A.3.2.1.2 (OP.2 FDD)		OP.1 FDD	OP.2 FDD	OP.1 FDD	OP.2 FDD	OP.1 FDD	OP.2 FDD	
PBCH_RA	dB	0	0	0	0	0	0	
PBCH_RB								
PSS_RA								
SSS_RA								
PCFICH_RB								
PHICH_RA								
PHICH_RB								
PDCCH_RA								
PDCCH_RB								
PDSCH_RA								
PDSCH_RB								
OCNG_RA ^{Note1}								
OCNG_RB ^{Note1}								
N_{oc} ^{Note2}	Bands FDD_A ^{Note 8}	dBm/15 kHz	-80	-80	-104.70	-104.70	-119.5	-119.5
	Bands FDD_B1, FDD_B2 ^{Note 9}						-119	-119
	Bands FDD_C						-118.5	-118.5
	Bands FDD_D						-118	-118
	Bands FDD_E, FDD_F ^{Note 5}						-117.5	-117.5
	Bands FDD_G ^{Note 7}						-116.5	-116.5
Bands FDD_H	-116	-116						
\hat{E}_s/I_{ot}	dB	-1.75	-1.75	-4.0	-4.0	-4.0	-4.0	
RSRP ^{Note3}	Bands FDD_A ^{Note 8}	dBm/15 kHz	-81.75	-81.75	-108.70	-108.70	-123.5	-123.5

	Bands FDD_B1, FDD_B2 ^{Note 9}						-123	-123
	Bands FDD_C						-122.5	-122.5
	Bands FDD_D						-122	-122
	Bands FDD_E, FDD_F ^{Note 5}						-121.5	-121.5
	Bands FDD_G ^{Note 7}						-120.5	-120.5
	Bands FDD_H						-120	-120
RSRQ ^{Note 3}	Bands FDD_A ^{Note 8}							
	Bands FDD_B1, FDD_B2 ^{Note 9}							
	Bands FDD_C	dB	-14.76	-14.76	-16.25	-16.25	-16.25	-16.25
	Bands FDD_D							
	Bands FDD_E, FDD_F ^{Note 5}							
	Bands FDD_G ^{Note 7}							
	Bands FDD_H							
I _o ^{Note 3}	Bands FDD_A ^{Note 8}						-90.26	-90.26
	Bands FDD_B1, FDD_B2 ^{Note 9}						-89.76	-89.76
	Bands FDD_C	dBm/9 MHz	-50	-50	-75.46	-75.46	-89.26	-89.26
	Bands FDD_D						-88.76	-88.76
	Bands FDD_E, FDD_F ^{Note 5}						-88.26	-88.26
	Bands FDD_G ^{Note 7}						-87.26	-87.26
	Bands FDD_H						-86.76	-86.76
\hat{E}_s / N_{oc}		dB	-1.75	-1.75	-4.0	-4.0	-4.0	-4.0
Propagation condition		-	AWGN		AWGN		AWGN	
<p>Note 1: OCNG shall be used such that both cells are fully allocated and a constant total transmitted power spectral density is achieved for all OFDM symbols.</p> <p>Note 2: Interference from other cells and noise sources not specified in the test is assumed to be constant over subcarriers and time and shall be modelled as AWGN of appropriate power for N_{oc} to be fulfilled.</p> <p>Note 3: RSRQ, RSRP and I_o levels have been derived from other parameters for information purposes. They are not settable parameters themselves.</p> <p>Note 4: RSRP and RSRQ minimum requirements are specified assuming independent interference and noise at each receiver antenna port.</p> <p>Note 5: For Band 26, the tests shall be performed with the carrier frequency of the assigned E-UTRA channel bandwidth within 865-894 MHz.</p> <p>Note 6: E-UTRA operating band groups are as defined in Section 3.5.</p> <p>Note 7: Except Band 29.</p> <p>Note 8: Except Band 32, Band 75, Band 76.</p> <p>Note 9: For Band 74, the tests shall be performed with the carrier frequency of the assigned E-UTRA channel bandwidth within 1475.9-1510.9 MHz.</p>								

A.9.2.3.3 Test Requirements

The RSRQ measurement accuracy shall fulfil the requirements in sections 9.1.6.1 and 9.1.6.2. The RSRQ measurement accuracy for UE Category 1bis shall fulfil the requirements in sections 9.1.6.5 and 9.1.6.6.

A.9.2.4 TDD—TDD Inter frequency case

A.9.2.4.1 Test Purpose and Environment

The purpose of this test is to verify that the RSRQ measurement accuracy is within the specified limits. This test will verify the requirements in Sections 9.1.6.1 and 9.1.6.2.

A.9.2.4.2 Test parameters

In this test case the two cells are on different carrier frequencies and measurement gaps are provided. Both RSRQ inter frequency absolute and relative accuracy requirements are tested by using test parameters in Table A.9.2.4.2-1 for TDD configuration 1 and in Table A.9.2.4.2-2 for TDD configuration 0. In all tests, Cell 1 is the PCell and Cell 2 the target cell.

Table A 9.2.4.2-1: RSRQ TDD—TDD Inter frequency test parameters for TDD configuration 1

Parameter	Unit	Test 1		Test 2		Test 3								
		Cell 1	Cell 2	Cell 1	Cell 2	Cell 1	Cell 2							
E-UTRA RF Channel Number		1	2	1	2	1	2							
BW _{channel}	MHz	10	10	10	10	10	10							
Gap Pattern Id		0	-	0	-	0	-							
Special subframe configuration ^{Note1}		6		6		6								
Uplink-downlink configuration ^{Note1}		1		1		1								
Measurement bandwidth	n_{PRB}	22—27		22—27		22—27								
PDSCH Reference measurement channel defined in A.3.1.1.2		R.0 TDD	-	R.0 TDD	-	R.0 TDD	-							
PDSCH allocation	n_{PRB}	13—36	-	13—36	-	13—36	-							
PDCCH/PCFICH/PHICH Reference measurement channel defined in A.3.1.2.2		R.6 TDD		R.6 TDD		R.6 TDD								
OCNG Patterns defined in A.3.2.2.1 (OP.1 TDD) and A.3.2.2.2 (OP.2 TDD)		OP.1 TDD	OP.2 TDD	OP.1 TDD	OP.2 TDD	OP.1 TDD	OP.2 TDD							
PBCH_RA	dB	0	0	0	0	0	0							
PBCH_RB														
PSS_RA														
SSS_RA														
PCFICH_RB														
PHICH_RA														
PHICH_RB														
PDCCH_RA														
PDCCH_RB														
PDSCH_RA														
PDSCH_RB														
OCNG_RA ^{Note2}														
OCNG_RB ^{Note2}														
N_{oc} ^{Note3}								Bands TDD_A	-80	-80	-104.70	-	-119.50	-119.50
								Bands TDD_C	-80	-80	-104.70	104.70	-118.50	-118.50
	Bands TDD_E	-80	-80	-104.70	104.70	-117.50	-117.50							
\hat{E}_s/I_{ot}	dB	-1.75	-1.75	-4.0	-4.0	-4.0	-4.0							
RSRP ^{Note4}	Bands TDD_A	-81.75	-81.75	-108.70	-	-123.50	-123.50							
	Bands TDD_C	-81.75	-81.75	-108.70	108.70	-122.50	-122.50							
	Bands TDD_E	-81.75	-81.75	-108.70	108.70	-121.50	-121.50							
RSRQ ^{Note4}	Bands TDD_A, TDD_C, TDD_E	-14.76	-14.76	-16.25	-16.25	-16.25	-16.25							
I _o ^{Note4}	Bands TDD_A	-50	-50	-75.46	-75.46	-90.26	-90.26							
	Bands TDD_C	-50	-50	-75.46	-75.46	-89.26	-89.26							
	Bands TDD_E	-50	-50	-75.46	-75.46	-88.26	-88.26							
\hat{E}_s/N_{oc}	dB	-1.75	-1.75	-4.0	-4.0	-4.0	-4.0							
Propagation condition	-	AWGN		AWGN		AWGN								
<p>Note 1: For special subframe and uplink-downlink configurations see Tables 4.2-1 and 4.2-2 in TS 36.211.</p> <p>Note 2: OCNG shall be used such that both cells are fully allocated and a constant total transmitted power spectral density is achieved for all OFDM symbols.</p> <p>Note 3: Interference from other cells and noise sources not specified in the test is assumed to be constant over subcarriers and time and shall be modelled as AWGN of appropriate power for N_{oc} to be fulfilled.</p> <p>Note 4: RSRQ, RSRP and I_o levels have been derived from other parameters for information purposes. They are not settable parameters themselves.</p> <p>Note 5: RSRP and RSRQ minimum requirements are specified assuming independent interference and noise at each receiver antenna port.</p> <p>Note 6: E-UTRA operating band groups are as defined in Section 3.5.</p>														

Table A 9.2.4.2-2: RSRQ TDD—TDD Inter frequency test parameters for TDD configuration 0

Parameter	Unit	Test 1	Test 2	Test 3
-----------	------	--------	--------	--------

		Cell 1	Cell 2	Cell 1	Cell 2	Cell 1	Cell 2	
E-UTRA RF Channel Number		1	2	1	2	1	2	
$BW_{channel}$	MHz	10	10	10	10	10	10	
Gap Pattern Id		0	-	0	-	0	-	
Special subframe configuration ^{Note1}		6		6		6		
Uplink-downlink configuration ^{Note1}		0		0		0		
Measurement bandwidth		n_{PRB} 22—27		22—27		22—27		
PDSCH Reference measurement channel defined in A.3.1.1.2		R.5 TDD	-	R.5 TDD	-	R.5 TDD	-	
PDSCH allocation		n_{PRB} 13—36		13—36		13—36		
PDCCH/PCFICH/PHICH Reference measurement channel defined in A.3.1.2.2		R.6 TDD		R.6 TDD		R.6 TDD		
OCNG Patterns defined in A.3.2.2.1 (OP.1 TDD) and A.3.2.2.2 (OP.2 TDD)		OP.1 TDD	OP.2 TDD	OP.1 TDD	OP.2 TDD	OP.1 TDD	OP.2 TDD	
PBCH_RA		dB	0	0	0	0	0	
PBCH_RB								
PSS_RA								
SSS_RA								
PCFICH_RB								
PHICH_RA								
PHICH_RB								
PDCCH_RA								
PDCCH_RB								
PDSCH_RA								
PDSCH_RB								
OCNG_RA ^{Note2}								
OCNG_RB ^{Note2}								
N_{oc} ^{Note3}	Bands TDD_A							dBm/15 kHz
	Bands TDD_C	-118.50	-118.50					
	Bands TDD_E	-117.50	-117.50					
\hat{E}_s / I_{ot}		dB	-1.75	-1.75	-4.0	-4.0	-4.0	-4.0
RSRP ^{Note4}	Bands TDD_A	dBm/15 kHz	-81.75	-81.75	-108.70	108.70	-123.50	-123.50
	Bands TDD_C						-122.50	-122.50
	Bands TDD_E						-121.50	-121.50
RSRQ ^{Note4}	Bands TDD_A, TDD_C, TDD_E	dB	-14.76	-14.76	-16.25	-16.25	-16.25	-16.25
I_o ^{Note4}	Bands TDD_A	dBm/9 MHz	-50	-50	-75.46	-75.46	-90.26	-90.26
	Bands TDD_C						-89.26	-89.26
	Bands TDD_E						-88.26	-88.26
\hat{E}_s / N_{oc}		dB	-1.75	-1.75	-4.0	-4.0	-4.0	-4.0
Propagation condition		-	AWGN		AWGN		AWGN	
<p>Note 1: For special subframe and uplink-downlink configurations see Tables 4.2-1 and 4.2-2 in TS 36.211.</p> <p>Note 2: OCNG shall be used such that both cells are fully allocated and a constant total transmitted power spectral density is achieved for all OFDM symbols.</p> <p>Note 3: Interference from other cells and noise sources not specified in the test is assumed to be constant over subcarriers and time and shall be modelled as AWGN of appropriate power for N_{oc} to be fulfilled.</p> <p>Note 4: RSRQ, RSRP and I_o levels have been derived from other parameters for information purposes. They are not settable parameters themselves.</p> <p>Note 5: RSRP and RSRQ minimum requirements are specified assuming independent interference and noise at each receiver antenna port.</p> <p>Note 6: E-UTRA operating band groups are as defined in Section 3.5.</p>								

A.9.2.4.3 Test Requirements

The RSRQ measurement accuracy shall fulfil the requirements in sections 9.1.6.1 and 9.1.6.2. The RSRQ measurement accuracy for UE Category 1bis shall fulfil the requirements in sections 9.1.6.5 and 9.1.6.6.

A.9.2.4A FDD—TDD Inter frequency case

A.9.2.4A.1 Test Purpose and Environment

The purpose of this test is to verify that the RSRQ measurement accuracy is within the specified limits. This test will verify the requirements in Sections 9.1.6.1 and 9.1.6.2 for FDD—TDD inter frequency measurements.

A.9.2.4A.2 Test parameters

In this set of test cases the two cells are on different carrier frequencies. Both absolute and relative accuracy of RSRQ inter frequency measurements are tested by using the parameters in Table A.9.2.4A.2-1 and Table A.9.2.4A.2-2. In all test cases, Cell 1 is the PCell and Cell 2 the target cell. Cell 1 is FDD cell and Cell 2 is TDD cell. The inter frequency measurements are supported by a measurement gap.

Table A.9.2.4A.2-1: RSRQ FDD—TDD Inter frequency test parameters (FDD Cell1)

Parameter	Unit	Test 1	Test 2	Test 3
		Cell 1	Cell 1	Cell 1
E-UTRA RF Channel Number		1	1	1
BW_{channel}	MHz	10	10	10
Gap Pattern Id		0	0	0
Measurement bandwidth	n_{PRB}	22—27	22—27	22—27
PDSCH Reference measurement channel defined in A.3.1.1.1		R.0 FDD	R.0 FDD	R.0 FDD
PDSCH allocation	n_{PRB}	13—36	13—36	13—36
PDCCH/PCFICH/PHICH Reference measurement channel defined in A.3.1.2.1		R.6 FDD	R.6 FDD	R.6 FDD
OCNG Patterns defined in A.3.2.1.1 (OP.1 FDD)		OP.1 FDD	OP.1 FDD	OP.1 FDD
PBCH_RA	dB	0	0	0
PBCH_RB				
PSS_RA				
SSS_RA				
PCFICH_RB				
PHICH_RA				
PHICH_RB				
PDCCH_RA				
PDCCH_RB				
PDSCH_RA				
PDSCH_RB				
OCNG_RA ^{Note1}				
OCNG_RB ^{Note1}				
N_{oc} ^{Note2}				
\hat{E}_s/I_{ot}	dB	-1.75	-4.0	-4.0
RSRP ^{Note3}	dBm/15 kHz	-81.75	-108.70	-118.5
RSRQ ^{Note3}	dB	-14.76	-16.25	-16.25
I_o ^{Note3}	dBm/9 MHz	-50	-75.46	-85.26
\hat{E}_s/N_{oc}	dB	-1.75	-4.0	-4.0
Propagation condition	-	AWGN	AWGN	AWGN
Note 1:	OCNG shall be used such that both cells are fully allocated and a constant total transmitted power spectral density is achieved for all OFDM symbols.			
Note 2:	Interference from other cells and noise sources not specified in the test is assumed to be constant over subcarriers and time and shall be modelled as AWGN of appropriate power for N_{oc} to be fulfilled.			
Note 3:	RSRQ, RSRP and I_o levels have been derived from other parameters for information purposes. They are not settable parameters themselves.			
Note 4:	RSRP and RSRQ minimum requirements are specified assuming independent interference and noise at each receiver antenna port.			

Table A.9.2.4A.2-2: RSRQ FDD—TDD Inter frequency test parameters (TDD cell2)

Parameter	Unit	Test 1	Test 2	Test 3
		Cell 2	Cell 2	Cell 2
E-UTRA RF Channel Number		2	2	2
BW _{channel}	MHz	10	10	10
Gap Pattern Id		-	-	-
Special subframe configuration Note1		6	6	6
Uplink-downlink configuration Note1		1	1	1
Measurement bandwidth	n_{PRB}	22—27	22—27	22—27
PDSCH Reference measurement channel		-	-	-
PDSCH allocation	n_{PRB}	-	-	-
PDCCH/PCFICH/PHICH Reference measurement channel defined in A.3.1.2.2		R.6 TDD	R.6 TDD	R.6 TDD
OCNG Patterns defined in A.3.2.2.2 (OP.2 TDD)		OP.2 TDD	OP.2 TDD	OP.2 TDD
PBCH_RA	dB	0	0	0
PBCH_RB				
PSS_RA				
SSS_RA				
PCFICH_RB				
PHICH_RA				
PHICH_RB				
PDCCH_RA				
PDCCH_RB				
PDSCH_RA				
PDSCH_RB				
OCNG_RA Note2				
OCNG_RB Note2				
N_{oc} Note3				
\hat{E}_s / I_{ot}	dB	-1.75	-4.0	-4.0
RSRP Note4	dBm/15 kHz	-81.75	-108.70	-118.50
RSRQ Note4	dB	-14.76	-16.25	-16.25
I_o Note4	dBm/9 MHz	-50	-75.46	-85.26
\hat{E}_s / N_{oc}	dB	-1.75	-4.0	-4.0
Propagation condition	-	AWGN	AWGN	AWGN
<p>Note 1: For special subframe and uplink-downlink configurations see Tables 4.2-1 and 4.2-2 in TS 36.211.</p> <p>Note 2: OCNG shall be used such that both cells are fully allocated and a constant total transmitted power spectral density is achieved for all OFDM symbols.</p> <p>Note 3: Interference from other cells and noise sources not specified in the test is assumed to be constant over subcarriers and time and shall be modelled as AWGN of appropriate power for N_{oc} to be fulfilled.</p> <p>Note 4: RSRQ, RSRP and I_o levels have been derived from other parameters for information purposes. They are not settable parameters themselves.</p> <p>Note 5: RSRP and RSRQ minimum requirements are specified assuming independent interference and noise at each receiver antenna port.</p>				

A.9.2.4A.3 Test Requirements

The RSRQ measurement accuracy shall fulfil the requirements in sections 9.1.6.1 and 9.1.6.2. The RSRQ measurement accuracy for UE Category 1bis shall fulfil the requirements in sections 9.1.6.5 and 9.1.6.6.

A.9.2.5 FDD RSRQ for E-UTRA Carrier Aggregation

A.9.2.5.1 Test Purpose and Environment

The purpose of this test is to verify that the FDD RSRQ measurement accuracy in carrier aggregation is within the specified limits under AWGN propagation conditions. This test will verify the absolute accuracy of intra-frequency RSRQ measurements for the primary component carrier specified in clause 9.1.11.1, the absolute accuracy of intra-frequency RSRQ measurements for the secondary component carrier specified in clause 9.1.11.2 and also the relative inter-frequency RSRQ accuracy requirement between primary and secondary component carriers specified in clause 9.1.11.3.

A.9.2.5.2 Test parameters

In this test case the PCell and the SCell are on different carrier frequencies. There are three cells used in this test case. Both RSRQ absolute and relative accuracy requirements of the primary and secondary component carrier are tested by using test parameters specified in Table A.9.2.5.2-1. In the test, Cell 1 is the PCell, Cell 2 is the SCell on the Secondary Component Carrier (SCC) and Cell 3 is the neighbouring cell on the SCC. The SCC is configured and activated.

Table A.9.2.5.2-1: FDD RSRQ Carrier Aggregation test parameters

Parameters		Test 1			
		Units	Cell 1	Cell 2	Cell 3
E-UTRA RF Channel Number			1	2	2
BW _{channel_CA}		MHz	10	10	10
Timing offset to Cell 1		µs	-	0	3
Time alignment error between cell 2 and cell 1			-	≤ Time alignment error as specified in 3GPP TS 36.104 [30] clause 6.5.3.1	-
Measurement bandwidth		<i>n_{PRB}</i>	22—27	22—27	22—27
PDSCH Reference measurement channel defined in A.3.1.1.1			R.0 FDD	R.0 FDD	-
PDSCH allocation		<i>n_{PRB}</i>	13—36	13—36	-
PDCCH/PCFICH/PHICH Reference measurement channel defined in A.3.1.2.1			R.6 FDD	R.6FDD	R.6 FDD
OCNG Patterns defined in A.3.2.1.1 (OP.1 FDD) and A.3.2.1.2 (OP.2 FDD)			OP.1 FDD	OP.1 FDD	OP.2 FDD
PBCH_RA		dB	0	0	0
PBCH_RB					
PSS_RA					
SSS_RA					
PCFICH_RB					
PHICH_RA					
PHICH_RB					
PDCCH_RA					
PDCCH_RB					
PDSCH_RA					
PDSCH_RB					
OCNG_RA ^{Note1}					
OCNG_RB ^{Note1}					
<i>N_{oc}</i> ^{Note2}	Bands FDD_A	dBm/15 kHz	-119.5	-116	-116
	Bands FDD_B1, FDD_B2 ^{Note 9}		-119	-115.5	-115.5
	Bands FDD_C		-118.5	-115	-115
	Bands FDD_D		-118	-114.5	-114.5
	Bands FDD_E, FDD_F ^{Note 6}		-117.5	-114	-114
	Bands FDD_G		-116.5	-113	-113

	Bands FDD_H		-116	-112.5	-112.5
\hat{E}_s / I_{ot}		dB	-4.0	-5.46	-5.46
RSRP ^{Note3}	Bands FDD_A	dBm/15 kHz	-123.5	-120	-120
	Bands FDD_B1, FDD_B2 ^{Note 9}		-123	-119.5	-119.5
	Bands FDD_C		-122.5	-119	-119
	Bands FDD_D		-122	-118.5	-118.5
	Bands FDD_E, FDD_F ^{Note 6}		-121.5	-118	-118
	Bands FDD_G		-120.5	-117	-117
	Bands FDD_H		-120	-116.5	-116.5
RSRQ ^{Note3}	Bands FDD_A	dB	-16.25	-17.34	-17.34
	Bands FDD_B1, FDD_B2 ^{Note 9}				
	Bands FDD_C				
	Bands FDD_D				
	Bands FDD_E, FDD_F ^{Note 6}				
	Bands FDD_G				
	Bands FDD_H				
I _o ^{Note3}	Bands FDD_A	dBm/9 MHz	-90.26	-85.67	-85.67
	Bands FDD_B1, FDD_B2 ^{Note 9}		-89.76	-85.17	-85.17
	Bands FDD_C		-89.26	-84.67	-84.67
	Bands FDD_D		-88.76	-84.17	-84.17
	Bands FDD_E, FDD_F ^{Note 6}		-88.26	-83.67	-83.67
	Bands FDD_G		-87.26	-82.67	-82.67
	Bands FDD_H		-86.76	-82.17	-82.17
\hat{E}_s / N_{oc}		dB	-4.0	-4.0	-4.0
Propagation condition		-	AWGN		
<p>Note 1: OCNG shall be used such that both cells are fully allocated and a constant total transmitted power spectral density is achieved for all OFDM symbols.</p> <p>Note 2: Interference from other cells and noise sources not specified in the test is assumed to be constant over subcarriers and time and shall be modelled as AWGN of appropriate power for N_{oc} to be fulfilled.</p> <p>Note 3: RSRQ, RSRP and I_o levels have been derived from other parameters for information purposes. They are not settable parameters themselves.</p> <p>Note 4: RSRP and RSRQ minimum requirements are specified assuming independent interference and noise at each receiver antenna port.</p> <p>Note 5: The selection of the bands for testing depends on the configuration of the carrier aggregation supported by the UEs</p> <p>Note 6: For Band 26, the tests shall be performed with the carrier frequency of the assigned E-UTRA channel bandwidth within 865-894 MHz.</p> <p>Note 7: This test verifies the RRM requirement which is independent of channel bandwidth and is performed according to the principle defined in section A.3.6.1.</p> <p>Note 8: E-UTRA operating band groups are as defined in Section 3.5.</p> <p>Note 9: For Band 74, the tests shall be performed with the carrier frequency of the assigned E-UTRA channel bandwidth within 1475.9-1510.9 MHz.</p>					

A.9.2.5.3 Test Requirements

In the test, the RSRQ measurement accuracy in carrier aggregation shall fulfil the requirements in clause 9.1.11.1, 9.1.11.2, and 9.1.11.3.

- The absolute accuracy of intra-frequency RSRQ measurements of Cell 1 on the primary component carrier shall fulfil the requirements specified in clause 9.1.11.1.
- The absolute accuracy of intra-frequency RSRQ measurements of Cell 2 on the secondary component carrier shall fulfil the requirements specified in clause 9.1.11.2
- The relative accuracy of inter-frequency RSRQ measurements between the primary and secondary component carriers for Cell 2 relative to Cell 1 shall fulfil the requirements specified in clause 9.1.11.3.

A.9.2.6 TDD RSRQ for E-UTRA Carrier Aggregation

The test case in this clause are applicable to carrier aggregation capable UEs which have been configured with a downlink Scell.

A.9.2.6.1 Test Purpose and Environment

The purpose of this test is to verify that the TDD RSRQ measurement accuracy in carrier aggregation is within the specified limits in a synchronized network environment with AWGN propagation conditions. This test will verify the absolute accuracy of intra-frequency RSRQ measurements for the primary component carrier defined in Clause 9.1.11.1, the absolute accuracy of intra-frequency RSRQ measurements for the secondary component carrier defined in Clause 9.1.11.2, and also the relative inter-frequency RSRQ accuracy requirement between primary and secondary component carriers defined in Clause 9.1.11.3.

A.9.2.6.2 Test parameters

In the test there are three synchronous cells: Cell 1, Cell 2 and Cell 3. Cell 1 is PCell, Cell 2 is SCell, and Cell 3 is the target cell. PCell and SCell are in different RF channels. Cell 3 is in the same RF channel as Cell 2. The parameters for the test are listed in Table A.9.2.6.2-1.

Table A.9.2.6.2-1: TDD RSRQ test parameters

Parameter	Unit	Test 1		
		Cell 1	Cell 2	Cell 3
E-UTRA RF Channel Number		1	2	2
BW _{channel}	MHz	10		
Timing offset to cell 1	μs	-	0	3
Time alignment error between cell 2 and cell 1		-	≤ Time alignment error as specified in 3GPP TS 36.104 [30] clause 6.5.3.1	-
Special subframe configuration ^{Note1}		6		
Uplink-downlink configuration ^{Note1}		1		
Measurement bandwidth	n_{PRB}	22–27		
PDSCH Reference measurement channel defined in A.3.1.1.2		R.0 TDD	R.0 TDD	-
PDSCH allocation	n_{PRB}	13–36	13–36	-
PDCCH/PCFICH/PHICH Reference measurement channel defined in A.3.1.2.2		R.6 TDD	R.6 TDD	R.6 TDD
OCNG Patterns defined in A.3.2.2.1 (OP.1 TDD) and A.3.2.2.2 (OP.2 TDD)		OP.1 TDD	OP.1 TDD	OP.2 TDD
PBCH_RA			0	0
PBCH_RB				
PSS_RA				
SSS_RA				
PCFICH_RB				
PHICH_RA				
PHICH_RB				
PDCCH_RA				
PDCCH_RB				
PDSCH_RA				
PDSCH_RB				
OCNG_RA ^{Note2}				
OCNG_RB ^{Note2}				
N_{oc} ^{Note3}	Bands TDD_A	dBm/15 kHz	-119.5	-116
	Bands TDD_C		-118.5	-115

	Bands TDD_E		-117.5	-114	
\hat{E}_s / I_{ot}		dB	-4.0	-5.46	-5.46
RSRP ^{Note4}	Bands TDD_A	dBm/15 kHz	-123.50	-120	-120
	Bands TDD_C		-122.50	-119	-119
	Bands TDD_E		-121.50	-118	-118
RSRQ ^{Note4}	Bands TDD_A, TDD_C, TDD_E	dB	-16.25	-17.34	
I _o ^{Note4}	Bands TDD_A	dBm/9 MHz	-90.26	-85.67	
	Bands TDD_C		-89.26	-84.67	
	Bands TDD_E		-88.26	-83.67	
\hat{E}_s / N_{oc}		dB	-4.0	-4.0	-4.0
Propagation condition		-	AWGN		
Note 1:	For special subframe and uplink-downlink configurations see Tables 4.2-1 and 4.2-2 in TS 36.211.				
Note 2:	OCNG shall be used such that both cells are fully allocated and a constant total transmitted power spectral density is achieved for all OFDM symbols.				
Note 3:	Interference from other cells and noise sources not specified in the test is assumed to be constant over subcarriers and time and shall be modelled as AWGN of appropriate power for N_{oc} to be fulfilled.				
Note 4:	RSRQ, RSRP and I _o levels have been derived from other parameters for information purposes. They are not settable parameters themselves.				
Note 5:	RSRP and RSRQ minimum requirements are specified assuming independent interference and noise at each receiver antenna port.				
Note 6:	The selection of the bands for testing depends on the configuration of the carrier aggregation supported by the UEs.				
Note 7:	This test verifies the RRM requirement which is independent of channel bandwidth and is performed according to the principle defined in section A.3.6.1.				
Note 8:	E-UTRA operating band groups are as defined in Section 3.5.				

A.9.2.6.3 Test Requirements

In the test, the RSRQ measurement accuracy in carrier aggregation shall fulfil the requirements in section 9.1.11.1, 9.1.11.2, and 9.1.11.3.

- The absolute accuracy of intra-frequency RSRQ measurements of Cell 1 on the primary component carrier shall fulfil the requirements defined in clause 9.1.11.1.
- The absolute accuracy of intra-frequency RSRQ measurements of Cell 2 on the secondary component carrier shall fulfil the requirements defined in clause 9.1.11.2.
- The relative accuracy of inter-frequency RSRQ measurements between the primary and secondary component carriers for Cell 2 relative to Cell 1 shall fulfil the requirements defined in clause 9.1.11.3.

A.9.2.7 FDD RSRQ under Time Domain Measurement Resource Restriction with Non-MBSFN ABS

A.9.2.7.1 Test Purpose and Environment

The purpose of this test is to verify that the RSRQ measurement accuracy under time domain measurement resource restriction is within the specified limits. This test will verify the requirements in Clause 9.1.5.2 for FDD intra frequency measurements under time domain measurement resource restriction.

A.9.2.7.2 Test parameters

In this test case all cells are on the same carrier frequency. The absolute accuracy of RSRQ intra frequency measurements under time domain measurement resource restriction is tested by using the parameters in Table A.9.2.7.2-1 and Table A.9.2.7.2-2 for non-MBSFN ABS with non-colliding CRS. In all test cases, Cell 1 is the serving cell and also the aggressor cell to Cell 2. Cell 2 is the target cell to be measured for RSRQ.

The UE is configured by higher layers via Cell 1 with a time-domain measurement resource restriction pattern for performing E-UTRAN FDD intra-frequency measurements on neighbour cells and provided with a neighbour cell list associated with the pattern, where the cell list includes Cell 2. The UE is also configured with a time-domain measurement resource restriction pattern for the serving cell measurements. The information for both patterns shall be provided to the UE before the measurements start.

Table A.9.2.7.2-1: General test parameters for E-UTRAN FDD RSRQ intra frequency test parameters under time-domain measurement resource restriction with non-MBSFN ABS

Parameter	Unit	Value	Comment
Serving cell (PCell)		Cell 1	The aggressor cell to Cell 2
Neighbour cell		Cell 2	Cell to be measured
PCell ABS configuration		Non-MBSFN ABS	As defined in Table A.3.4.1.1-1
CP length		Normal	For both cells in the test
DRX			OFF
Time offset between cells		3 μ s	Synchronous cells
Physical cell ID PCI		$(PCI_{cell1} - PCI_{cell2}) \bmod 6 \neq 0$	Cell PCIs for Cell 1 and Cell 2 are selected randomly so that the condition is met.
ABS pattern		'10000000100000001000 00001000000010000000'	Non-MBSFN ABS. FDD ABS Pattern Info IE, as defined in TS 36.423 [28], clause 9.2.54. Configured in Cell 1. The first/leftmost bit corresponds to the subframe #0 of a radio frame satisfying SFN mod x = 0, where x is the size of the bit string (40) divided by 10. No MBSFN subframes are configured in the ABS subframes in Cell 1.
Time-domain measurement resource restriction pattern for neighbour cell measurements on RF Channel 1		'10000000100000001000 00001000000010000000'	Configured for Cell 2 measurements by measSubframePattern-Neigh IE in measSubframePatternConfig-Neigh, as defined in TS 36.331 [2], clause 6.3.5. measSubframeCellList contains Cell 2.
Time-domain measurement resource restriction pattern for serving cell measurements		'01000000010000000100 00000100000001000000'	Configured for measurements on Cell 1.

Table A.9.2.7.2-2: Cell-specific test parameters for E-UTRAN FDD RSRQ intra frequency test parameters under time domain measurement resource restriction with non-MBSFN ABS

Parameter	Unit	Test 1		Test 2		Test 3							
		Cell 1	Cell 2	Cell 1	Cell 2	Cell 1	Cell 2						
E-UTRA RF Channel Number		1		1		1							
BW _{channel}	MHz	10		10		10							
Measurement bandwidth	n_{PRB}	22–27		22–27		22–27							
PDSCH Reference measurement channel defined in A.3.1.1.1		R.0 FDD	-	R.0 FDD	-	R.0 FDD	-						
PDSCH allocation	n_{PRB}	13–36	-	13–36	-	13–36	-						
PDCCH/PCFICH/PHICH Reference measurement channel defined in A.3.1.2.1		R.6 FDD		R.6 FDD		R.6 FDD							
OCNG Patterns defined in A.3.2.1.5 (OP.5 FDD) and A.3.2.1.6 (OP.6 FDD)		OP.5 FDD	OP.6 FDD	OP.5 FDD	OP.6 FDD	OP.5 FDD	OP.6 FDD						
PBCH_RA	dB	Note 6	0	Note 6	0	Note 6	0						
PBCH_RB													
PCFICH_RB													
PHICH_RA													
PHICH_RB													
PDCCH_RA													
PDCCH_RB													
PDSCH_RA													
PDSCH_RB													
OCNG_RA ^{Note1}													
OCNG_RB ^{Note1}													
PSS_RA								-4	0	-4	0	-4	0

SSS_RA		dB	-4	0	-4	0	-4	0
N_{oc} Note2	Bands FDD_A Note 10	dBm/15 kHz	-84.76		-103.85		-116	
	Bands FDD_B1, FDD_B2 Note 11						-115.5	
	Bands FDD_C						-115	
	Bands FDD_D						-114.5	
	Bands FDD_E, FDD_F Note 7						-114	
	Bands FDD_G Note 9						-113	
	Bands FDD_H						-112.5	
$CRS \hat{E}_s / N_{oc}$		dB	5	-2	5	-2	5	-4
$CRS (\hat{E}_s / I_{ot})_{meas}$ Note 5		dB	2.88	-2.00	2.88	-2.00	3.54	-4.00
$SCH \hat{E}_s / I_{ot}$		dB	-1.12	-5.54	-1.12	-5.54	-0.46	-7.54
RSRP Note3,4,5	Bands FDD_A Note 10	dBm/15 kHz	-79.76	-86.76	-98.85	-105.85	-111	-120
	Bands FDD_B1, FDD_B2 Note 11						-110.5	-119.5
	Bands FDD_C						-110	-119
	Bands FDD_D						-109.5	-118.5
	Bands FDD_E, FDD_F Note 7						-109	-118
	Bands FDD_G Note 9						-108	-117
	Bands FDD_H						-107.5	-116.5
$(RSRQ)_{meas}$ Note3,4,5	Bands FDD_A Note 10, FDD_B1, FDD_B2 Note 11, FDD_C, FDD_E, FDD_F Note 7, FDD_G Note 9, FDD_H	dB	-12.60	-15.30	-12.60	-15.30	-12.38	-16.69
$(I_o)_{meas}$ Note3	Bands FDD_A Note 10	dBm/9 MHz	-50.17	-53.64	-69.26	-72.73	-81.63	-85.37
	Bands FDD_B1, FDD_B2 Note 11						-81.13	-84.87
	Bands FDD_C						-80.63	-84.37
	Bands FDD_D						-80.13	-83.87
	Bands FDD_E, FDD_F Note 7						-79.63	-83.37
	Bands FDD_G Note 9						-78.63	-82.37
	Bands FDD_H						-78.13	-81.87
Propagation condition		-	AWGN		AWGN		AWGN	

Note 1:	OCNG shall be used such that both cells are fully allocated and a constant total transmitted power spectral density is achieved for all OFDM symbols.
Note 2:	Interference from other cells and noise sources not specified in the test is assumed to be constant over subcarriers and time and shall be modelled as AWGN of appropriate power for N_{oc} to be fulfilled. Applies to all subframes.
Note 3:	RSRQ, RSRP and Io levels have been derived from other parameters for information purposes. They are not settable parameters themselves. Io levels are calculated in CRS symbols of measurement restricted subframes.
Note 4:	RSRP and RSRQ minimum requirements are specified assuming independent interference and noise at each receiver antenna port.
Note 5:	Applies to restricted measurement subframes of the respective cell.
Note 6:	Non-ABS and ABS subframe channel powers defined in Table A.3.4.1.1-1.
Note 7:	For Band 26, the tests shall be performed with the carrier frequency of the assigned E-UTRA channel bandwidth within 865-894 MHz.
Note 8:	E-UTRA operating band groups are as defined in Section 3.5.
Note 9:	Except Band 29.
Note 10:	Except Band 32, Band 75, Band 76.
Note 11:	For Band 74, the tests shall be performed with the carrier frequency of the assigned E-UTRA channel bandwidth within 1475.9-1510.9 MHz.

A.9.2.7.3 Test Requirements

The RSRQ measurement accuracy shall fulfil the requirements in Clause 9.1.5.2.

A.9.2.8 TDD RSRQ under Time Domain Measurement Resource Restriction with Non-MBSFN ABS

A.9.2.8.1 Test Purpose and Environment

The purpose of this test is to verify that the RSRQ measurement accuracy under time domain measurement resource restriction is within the specified limits. This test will verify the requirements in Clause 9.1.5.2 for TDD intra frequency measurements under time domain measurement resource restriction.

A.9.2.8.2 Test parameters

In this test case all cells are on the same carrier frequency. The absolute accuracy of RSRQ intra frequency measurements under time domain measurement resource restriction is tested by using the parameters in Table A.9.2.8.2-1 and Table A.9.2.8.2-2 for non-MBSFN ABS with non-colliding CRS. In all test cases, Cell 1 is the serving cell and also the aggressor cell to Cell 2. Cell 2 is the target cell to be measured for RSRQ.

The UE is configured by higher layers via Cell 1 with a time-domain measurement resource restriction pattern for performing E-UTRAN TDD intra-frequency measurements on neighbour cells and provided with a neighbour cell list associated with the pattern, where the cell list includes Cell 2. The UE is also configured with a time-domain measurement resource restriction pattern for the serving cell measurements. The information for both patterns shall be provided to the UE before the measurements start.

Table A.9.2.8.2-1: General test parameters for E-UTRAN TDD RSRQ intra frequency test parameters under time domain measurement resource restriction with non-MBSFN ABS

Parameter	Unit	Value	Comment
Serving cell (PCell)		Cell 1	Also the aggressor cell.
Neighbour cell		Cell 2	Cell to be measured
PCell ABS configuration		Non-MBSFN ABS	As defined in Table A.3.4.1.1-1
Special subframe configuration		6	For Cell 1 and Cell 2. For special subframe configurations see Table 4.2-1 in [16].
Uplink/downlink subframe configuration		1	For Cell 1 and Cell 2. For uplink-downlink subframe configurations see Table 4.2-2 in [16].
CP length		Normal	For both cells in the test
DRX			OFF
Time offset between cells		3 μ s	Synchronous cells
Physical cell ID PCI		$(PCI_{cell1} - PCI_{cell2}) \bmod 6 \neq 0$	Cell PCIs for Cell 1 and Cell 2 are randomly selected so that the condition is met

ABS pattern		'00000000010000000001'	Non-MBSFN ABS. TDD ABS Pattern Info IE, as defined in TS 36.423 [28], clause 9.2.54. Configured in Cell 1. The first/leftmost bit corresponds to the subframe #0 of a radio frame satisfying SFN mod x = 0, where x is the size of the bit string (20) divided by 10. No MBSFN subframes are configured in the ABS subframes in Cell 1.
Time-domain measurement resource restriction pattern for neighbour cell measurements on RF Channel 1		'00000000010000000001'	Configured for Cell 2 measurements by measSubframePattern-Neigh IE in measSubframePatternConfig-Neigh, as defined in TS 36.331 [2], clause 6.3.5. measSubframeCellList contains Cell 2.
Time-domain measurement resource restriction pattern for serving cell measurements		'10000000001000000000'	Configured for Cell 1 measurements.

Table A.9.2.8.2-2: Cell-specific test parameters for E-UTRAN TDD RSRQ intra frequency test parameters under time domain measurement resource restriction with non-MBSFN ABS

Parameter	Unit	Test 1		Test 2		Test 3		
		Cell 1	Cell 2	Cell 1	Cell 2	Cell 1	Cell 2	
E-UTRA RF Channel Number		1		1		1		
BW _{channel}	MHz	10		10		10		
Measurement bandwidth	n_{PRB}	22—27		22—27		22—27		
PDSCH Reference measurement channel defined in A.3.1.1.2		R.0 TDD	-	R.0 TDD	-	R.0 TDD	-	
PDSCH allocation	n_{PRB}	13—36	-	13—36	-	13—36	-	
PDCCH/PCFICH/PHICH Reference measurement channel defined in A.3.1.2.2		R.6 TDD		R.6 TDD		R.6 TDD		
OCNG Patterns defined in A.3.2.2.1 (OP.1 TDD) and A.3.2.2.2 (OP.2 TDD)		OP.1 TDD	OP.2 TDD	OP.1 TDD	OP.2 TDD	OP.1 TDD	OP.2 TDD	
PBCH_RA	dB	Note 6	0	Note 6	0	Note 6	0	
PBCH_RB								
PCFICH_RB								
PHICH_RA								
PHICH_RB								
PDCCH_RA								
PDCCH_RB								
PDSCH_RA								
PDSCH_RB								
OCNG_RA ^{Note1}								
OCNG_RB ^{Note1}								
PSS_RA								dB
SSS_RA	dB	-4	0	-4	0	-4	0	
N_{oc} ^{Note2}	Bands TDD_A	dBm/15 kHz	-84.76	-103.85	-116			
	Bands TDD_C				-115			
	Bands TDD_E				-114			
CRS \hat{E}_s / N_{oc}	dB	5	-2	5	-2	5	-4	
CRS $(\hat{E}_s / I_{ot})_{meas}$ ^{Note 5}	dB	2.88	-2.00	2.88	-2.00	3.54	-4.00	
SCH \hat{E}_s / I_{ot}	dB	-1.12	-5.54	-1.12	-5.54	-0.46	-7.54	
RSRP ^{Note3,4,5}	Bands TDD_A	dBm/15 kHz	-79.76	-86.76	-98.85	-105.85	-111	-120
	Bands TDD_C						-110	-119
	Bands TDD_E						-109	-118
$(RSRQ)_{meas}$ ^{Note3,4,5}	Bands TDD_A, TDD_C, TDD_E	dB	-12.60	-15.30	-12.60	-15.30	-12.38	-16.70

$(I_o)_{meas}$ <small>Note3</small>	Bands TDD_A	dBm/9 MHz	-50.17	-53.64	-69.26	-72.73	-81.63	-85.37
	Bands TDD_C						-80.63	-84.37
	Bands TDD_E						-79.63	-83.37
Propagation condition		-	AWGN		AWGN		AWGN	
<p>Note 1: OCNB shall be used such that both cells are fully allocated and a constant total transmitted power spectral density is achieved for all OFDM symbols.</p> <p>Note 2: Interference from other cells and noise sources not specified in the test is assumed to be constant over subcarriers and time and shall be modelled as AWGN of appropriate power for N_{oc} to be fulfilled. Applies to all subframes.</p> <p>Note 3: RSRQ, RSRP and I_o levels have been derived from other parameters for information purposes. They are not settable parameters themselves. I_o levels are calculated in CRS symbols of measurement restricted subframes.</p> <p>Note 4: RSRP and RSRQ minimum requirements are specified assuming independent interference and noise at each receiver antenna port.</p> <p>Note 5: Applies to restricted measurement subframes of the respective cell.</p> <p>Note 6: Non-ABS and ABS subframe channel powers defined in Table A.3.4.1.1-1.</p> <p>Note 7: E-UTRA operating band groups are as defined in Section 3.5.</p>								

A.9.2.8.3 Test Requirements

The RSRQ measurement accuracy shall fulfil the requirements in Clause 9.1.5.2.

A.9.2.9 FDD RSRQ under Time Domain Measurement Resource Restriction with MBSFN ABS

A.9.2.9.1 Test Purpose and Environment

The purpose of this test is to verify that the RSRQ measurement accuracy under time domain measurement resource restriction is within the specified limits under AWGN propagation conditions. This test will verify the absolute FDD RSRQ accuracy under time domain measurement resource restriction specified in Clause 9.1.5.2.

A.9.2.9.2 Test parameters

The test parameters are given in Tables A.9.2.9.2-1 and A.9.2.9.2-2 below. In this test case there are two cells on the same frequency used in this test case. In the test, Cell 1 is the serving cell and also the aggressor cell to Cell 2. Cell 2 is the target cell to be measured for RSRQ.

The UE is configured by higher layers via Cell 1 with a time-domain measurement resource restriction pattern for performing E-UTRAN FDD intra-frequency measurements on neighbour cells and provided with a neighbour cell list associated with the pattern, where the cell list includes Cell 2. The UE is also configured by higher layers with a time domain measurement restriction pattern for the serving cell measurements. The information for both patterns shall be provided to the UE before the measurements start.

Table A.9.2.9.2-1: General test parameters for FDD RSRQ under time domain measurement resource restriction with MBSFN ABS

Parameter	Unit	Value	Comment
PDSCH parameters		DL Reference Measurement Channel R.0 FDD	As specified in clause A.3.1.1.1
PCFICH/PDCCH/PHICH parameters		DL Reference Measurement Channel R.6 FDD	As specified in clause A.3.1.2.1
Serving cell (PCell)		Cell 1	Also the aggressor cell on E-UTRA RF channel number 1
Neighbour cell		Cell 2	Cell to be identified on E-UTRA RF channel number 1
PCell ABS configuration		MBSFN ABS	As defined in Table A.3.4.2.1-1
CP length		Normal	
DRX		OFF	
Time offset between cells		3 μ s	Synchronous cells

Physical cell ID PCI		$(PCI_{cell1} - PCI_{cell2}) \bmod 6 = 0, PCI_{cell1}$ not equal to PCI_{cell2}	Cell PCIs are selected so that the condition is met (colliding CRS)
Cell 1 MBSFN ABS pattern		'0100000010000000100000000000000010000000'	ABS subframe is only MBSFN subframe. FDD ABS Pattern Info IE, as defined in TS 36.423 [28], clause 9.2.54. The first/leftmost bit corresponds to the subframe #0 of the radio frame satisfying $SFN \bmod x = 0$, where x is the size of the bit string (40) divided by 10. Configured in Cell 1.
Time domain measurement resource restriction pattern for PCell (Cell 1) measurements on RF Channel 1		'0001000000010000000100000000'	Time domain measurement resource restriction pattern for PCell measurement signalled to the UE in measSubframePatternPCell. The IE MeasSubframePattern is used to specify the time domain measurement resource restriction as defined in TS 36.331 [2], clause 6.3.6. Configured for Cell 1 measurements.
Time domain measurement resource restriction pattern for neighbour cell (Cell 2) measurements on RF Channel 1		'01000000100000001000000000000000'	Time domain measurement resource restriction pattern for neighbour cell measurement signalled to the UE in measSubframePatternNeigh. The IE MeasSubframePattern is used to specify the time domain measurement resource restriction as defined in TS 36.331 [2], clause 6.3.6. Configured for Cell 2 measurements.

Table A.9.2.9.2-2: Cell specific test parameters for FDD RSRQ under time domain measurement resource restriction with MBSFN ABS

Parameter	Unit	Test 1		Test 2		Test 3	
		Cell 1	Cell 2	Cell 1	Cell 2	Cell 1	Cell 2
E-UTRA RF Channel Number		1		1		1	
$BW_{channel}$	MHz	10		10		10	
OCNG Patterns defined in A.3.2.1.8 (OP.8 FDD) and A.3.2.1.6 (OP.6 FDD) ^{Note5}		OP.8 FDD	OP.6 FDD	OP.8 FDD	OP.6 FDD	OP.8 FDD	OP.6 FDD
Measurement bandwidth	n_{PRB}	22—27		22—27		22—27	
PDSCH allocation	n_{PRB}	13—36	-	13—36	-	13—36	-
PBCH_RA	dB	Note 6	0	Note 6	0	Note 6	0
PBCH_RB							
PCFICH_RB							
PHICH_RA							
PHICH_RB							
PDCCH_RA							
PDCCH_RB							
PDSCH_RA							
PDSCH_RB							
OCNG_RA ^{Note1}							
OCNG_RB ^{Note1}							
PSS_RA							
SSS_RA							
N_{oc} ^{Note2}	Bands FDD_A ^{Note 11}	dBm/15 kHz	-84.76		-103.85		-116
	Bands FDD_B1, FDD_B2 ^{Note 12}						-115.5
	Bands FDD_C						-115
	Bands FDD_D						-114.5
	Bands FDD_E, FDD_F ^{Note 8}						-114
	Bands FDD_G ^{Note 10}						-113
Bands FDD_H		-112.5					
CRS \hat{E}_s / N_{oc}	dB	5	-2	5	-2	5	-4

CRS $(\hat{E}_s/I_{ot})_{meas}$ Note 5, 7 in the 1 st OFDM symbol		dB	2.88	-8.19	2.88	-8.19	3.54	-10.19
CRS $(\hat{E}_s/I_{ot})_{meas}$ note 5 in OFDM symbols 4,7,11		dB	2.88	-2	2.88	-2	3.54	-4
SCH \hat{E}_s/I_{ot}		dB	-1.12	-5.54	-1.12	-5.54	-0.46	-7.54
RSRP Note 3,4,5	Bands FDD_A Note 11	dBm/15 kHz	-79.76	-86.76	-98.85	-105.85	-111	-120
	Bands FDD_B1, FDD_B2 Note 12						-110.5	-119.5
	Bands FDD_C						-110	-119
	Bands FDD_D						-109.5	-118.5
	Bands FDD_E, FDD_F Note 8						-109	-118
	Bands FDD_G Note 10						-108	-117
	Bands FDD_H						-107.5	-116.5
(RSRQ) $_{meas}$ Note 3,4,5	Bands FDD_A Note 11	dB	-12.60	-15.02	-12.60	-15.02	-12.38	-16.36
	Bands FDD_B1, FDD_B2 Note 12							
	Bands FDD_C							
	Bands FDD_D							
	Bands FDD_E, FDD_F Note 8							
	Bands FDD_G Note 10							
	Bands FDD_H							
(I _o) $_{meas}$ Note 3 1 st OFDM symbol	Bands FDD_A Note 11	dBm/9 MHz	-50.17	-53.64	-69.26	-72.73	-81.63	-85.37
	Bands FDD_B1, FDD_B2 Note 12						-81.13	-84.87
	Bands FDD_C						-80.63	-84.37
	Bands FDD_D						-80.13	-83.87
	Bands FDD_E, FDD_F Note 8						-79.63	-83.37
	Bands FDD_G Note 10						-78.63	-82.37
	Bands FDD_H						-78.13	-81.87
(I _o) $_{meas}$ Note 3 OFDM symbols other than the 1 st one	Bands FDD_A Note 11	dBm/9 MHz	-50.17	-54.85	-69.26	-73.94	-81.63	-86.76
	Bands FDD_B1, FDD_B2 Note 12						-81.13	-86.26
	Bands FDD_C						-80.63	-85.76
	Bands FDD_D						-80.13	-85.26
	Bands FDD_E, FDD_F Note 8						-79.63	-84.76
	Bands FDD_G Note 10						-78.63	-83.76
	Bands FDD_H						-78.13	-83.26
Propagation condition		-	AWGN		AWGN		AWGN	

Note 1:	OCNG shall be used such that both cells are fully allocated and a constant total transmitted power spectral density is achieved for all OFDM symbols.
Note 2:	Interference from other cells and noise sources not specified in the test is assumed to be constant over subcarriers and time and shall be modelled as AWGN of appropriate power for N_{oc} to be fulfilled. Applies to all subframes.
Note 3:	RSRQ, RSRP and Io levels have been derived from other parameters for information purposes. They are not settable parameters themselves. Io levels are calculated in CRS symbols of measurement restricted subframes
Note 4:	RSRP and RSRQ minimum requirements are specified assuming independent interference and noise at each receiver antenna port.
Note 5:	Applies to restricted measurement subframes of the respective cell.
Note 6:	Non-ABS and ABS subframe channel powers defined in Table A.3.4.2.1-1.
Note 7:	In the 1 st OFDM symbol, Cell 2 is not expected to meet the Es/Iot side condition in 9.1.5.2.
Note 8:	For Band 26, the tests shall be performed with the carrier frequency of the assigned E-UTRA channel bandwidth within 865-894 MHz.
Note 9:	E-UTRA operating band groups are as defined in Section 3.5.
Note 10:	Except Band 29.
Note 11:	Except Band 32, Band 75, Band 76.
Note 12:	For Band 74, the tests shall be performed with the carrier frequency of the assigned E-UTRA channel bandwidth within 1475.9-1510.9 MHz.

A.9.2.9.3 Test Requirements

In the test, the RSRQ measurement accuracy under time domain measurement resource restriction shall fulfil the requirements in Clause 9.1.5.2

A.9.2.10 TDD Intra frequency case under time domain measurement resource restriction with MBSFN ABS

A.9.2.10.1 Test Purpose and Environment

The purpose of this test is to verify that the RSRQ measurement accuracy under time domain measurement resource restriction is within the specified limits. This test will verify the requirements in Clause 9.1.5.2 for TDD intra frequency measurements under time domain measurement resource restriction.

A.9.2.10.2 Test parameters

In this test case all cells are on the same carrier frequency. The absolute accuracy of RSRQ intra frequency measurements under time domain measurement resource restriction is tested by using the parameters in Table A.9.2.10.2-1 and Table A.9.2.10.2-2 for MBSFN ABS with colliding CRS. In all test cases, Cell 1 is the serving cell and also the aggressor cell to Cell 2. Cell 2 is the target cell to be measured for RSRQ.

The UE is configured by higher layers via Cell 1 with a time-domain measurement resource restriction pattern for performing E-UTRAN TDD intra-frequency measurements on neighbour cells and provided with a neighbour cell list associated with the pattern, where the cell list includes Cell 2. The UE is also configured with a time-domain measurement resource restriction pattern for the serving cell measurements. The information for both patterns shall be provided to the UE before the measurements start.

Table A.9.2.10.2-1: General test parameters for E-UTRAN TDD RSRQ intra frequency test parameters under time-domain measurement resource restriction with MBSFN ABS

Parameter	Unit	Value	Comment
Serving cell (PCell)		Cell 1	The aggressor cell to Cell 2
Neighbour cell		Cell 2	Cell to be measured
PCell ABS configuration		MBSFN ABS	As defined in Table A.3.4.2.1-1
Special subframe configuration		6	For Cell 1 and Cell 2. For special subframe configurations see Table 4.2-1 in [16].
Uplink/downlink subframe configuration		1	For Cell 1 and Cell 2. For uplink-downlink subframe configurations see Table 4.2-2 in [16].
CP length		Normal	For both cells in the test
DRX			OFF
Time offset between cells		3 μ s	Synchronous cells

Physical cell ID PCI		$(PCI_{cell1} - PCI_{cell2}) \bmod 6 \neq 0$ PCI _{cell1} not equal to PCI _{cell2}	Cell PCIs for Cell 1 and Cell 2 are selected randomly so that the condition is met
ABS pattern		'00001000000000100000'	MBSFN ABS pattern. TDD ABS Pattern Info IE, as defined in TS 36.423 [28], clause 9.2.54. Configured in Cell 1. The first/leftmost bit corresponds to the subframe #0 of a radio frame satisfying SFN mod x = 0, where x is the size of the bit string (20) divided by 10. All ABS subframes are MBSFN subframes.
Time-domain measurement resource restriction pattern for neighbour cell measurements on RF Channel 1		'00001000000000100000'	Configured for Cell 2 measurements by measSubframePattern-Neigh IE in measSubframePatternConfig-Neigh, as defined in TS 36.331 [2], clause 6.3.5. measSubframeCellList contains Cell 2.
Time-domain measurement resource restriction pattern for serving cell measurements		'10000000001000000000'	Configured for measurements on Cell 1.

Table A.9.2.10.2-2: Cell-specific test parameters for E-UTRAN TDD RSRQ intra frequency test parameters under time domain measurement resource restriction with MBSFN ABS

Parameter	Unit	Test 1		Test 2		Test 3	
		Cell 1	Cell 2	Cell 1	Cell 2	Cell 1	Cell 2
E-UTRA RF Channel Number		1		1		1	
BW _{channel}	MHz	10		10		10	
Measurement bandwidth	n_{PRB}	22—27		22—27		22—27	
PDSCH Reference measurement channel defined in A.3.1.1.2		R.0 TDD	-	R.0 TDD	-	R.0 TDD	-
PDSCH allocation	n_{PRB}	13—36	-	13—36	-	13—36	-
PDCCH/PCFICH/PHICH Reference measurement channel defined in A.3.1.2.2		R.6 TDD		R.6 TDD		R.6 TDD	
OCNG Patterns defined in A.3.2.2.5 (OP.5 TDD) and A.3.2.2.2 (OP.2 TDD)		OP.5 TDD	OP.2 TDD	OP.5 TDD	OP.2 TDD	OP.5 TDD	OP.2 TDD
PBCH_RA	dB	Note 6	0	Note 6	0	Note 6	0
PBCH_RB							
PCFICH_RB							
PHICH_RA							
PHICH_RB							
PDCCH_RA							
PDCCH_RB							
PDSCH_RA							
PDSCH_RB							
OCNG_RA ^{Note1}							
OCNG_RB ^{Note1}							
PSS_RA							
SSS_RA	dB	-4	0	-4	0	-4	0
N_{oc} ^{Note2}	Bands TDD_A	dBm/15 kHz	-84.76	-103.85		-116	
	Bands TDD_C					-115	
	Bands TDD_E					-114	
CRS \hat{E}_s / N_{oc}	dB	5	-2	5	-2	5	-4
CRS $(\hat{E}_s / I_{ot})_{meas}$ ^{Note 5, 7} In the 1 st OFDM symbol	dB	2.88	-8.19	2.88	-8.19	3.54	-10.19
CRS $(\hat{E}_s / I_{ot})_{meas}$ ^{Note 5} in OFDM symbols 4,7,11	dB	2.88	-2	2.88	-2	3.54	-4
SCH \hat{E}_s / I_{ot}	dB	-1.12	-5.54	-1.12	-5.54	-0.46	-7.54

RSRP <small>Note 3,4,5</small>	Bands TDD_A	dBm/15 kHz	-79.76	-86.76	-98.85	-105.85	-111	-120
	Bands TDD_C						-110	-119
	Bands TDD_E						-109	-118
$(RSRQ)_{meas}$ <small>Note 3,4,5</small>	Bands TDD_A, TDD_C, TDD_E	dB	-12.60	-15.02	-12.60	-15.02	-12.38	-16.36
$(Io)_{meas}$ <small>Note 3</small> in the 1 st OFDM symbol	Bands TDD_A	dBm/9 MHz	-50.17	-53.64	-69.26	-72.73	-81.63	-85.37
	Bands TDD_C						-80.63	-84.37
	Bands TDD_E						-79.63	-83.37
$(Io)_{meas}$ <small>Note 3</small> in OFDM symbols other than the 1 st one	Bands TDD_A	dBm/9 MHz	-50.17	-54.85	-69.26	-73.94	-81.63	-86.76
	Bands TDD_C						-80.63	-85.76
	Bands TDD_E						-79.63	-84.76
Propagation condition		-	AWGN		AWGN		AWGN	
<p>Note 1: OCNG shall be used such that both cells are fully allocated and a constant total transmitted power spectral density is achieved for all OFDM symbols.</p> <p>Note 2: Interference from other cells and noise sources not specified in the test is assumed to be constant over subcarriers and time and shall be modelled as AWGN of appropriate power for N_{oc} to be fulfilled. Applies to all subframes.</p> <p>Note 3: RSRQ, RSRP and I_o levels have been derived from other parameters for information purposes. They are not settable parameters themselves. I_o levels are calculated in CRS symbols of measurement restricted subframes.</p> <p>Note 4: RSRP and RSRQ minimum requirements are specified assuming independent interference and noise at each receiver antenna port.</p> <p>Note 5: Applies to restricted measurement subframes of the respective cell.</p> <p>Note 6: Non-ABS and ABS subframe channel powers defined in Table A.3.4.2.1-1.</p> <p>Note 7: In the 1st OFDM symbol, Cell 2 is not expected to meet the E_s/I_{ot} side condition in 9.1.5.2.</p> <p>Note 8: E-UTRA operating band groups are as defined in Section 3.5.</p>								

A.9.2.10.3 Test Requirements

The RSRQ measurement accuracy shall fulfil the requirements in clause 9.1.5.2.

A.9.2.11 FDD RSRQ for E-UTRA Carrier Aggregation (20MHz bandwidth)

The test case in this section are applicable to carrier aggregation capable UEs which have been configured with a downlink SCell.

A.9.2.11.1 Test Purpose and Environment

The purpose of this test is the same as defined in Subclause A.9.2.5.1.

A.9.2.11.2 Test parameters

The parameters of this test are the same as defined in Subclause A.9.2.5.2 except that the values of the parameters in the Table A.9.2.11.2-1 will replace the values of the corresponding parameters in A.9.2.5.2-1.

Table A.9.2.11.2-1: FDD RSRQ Carrier Aggregation test parameters

Parameters	Test 1			
	Units	Cell 1	Cell 2	Cell 3
BW _{channel_CA} <small>Note 1</small>	MHz	20	20	20
Measurement bandwidth	n_{PRB}	47-52	47-52	47-52
PDSCH Reference measurement channel defined in A.3.1.1.1		R.4 FDD	R.4 FDD	-
PDSCH allocation	n_{PRB}	38-61	38-61	-

PDCCH/PCFICH/PHICH Reference measurement channel defined in A.3.1.2.1			R.10 FDD	R.10 FDD	R.10 FDD
OCNG Patterns defined in A.3.2.1.11 (OP.11 FDD) and A.3.2.1.12 (OP.12 FDD)			OP.11 FDD	OP.11 FDD	OP.12 FDD
I _o Note2	Bands FDD_A Note 5	dBm/18 MHz	-87.26	-82.67	
	Bands FDD_B1 Note 5 , FDD_B2 Note 5 Note 6		-86.76	-82.17	
	Bands FDD_C Note 5		-86.26	-81.67	
	Bands FDD_D Note 5		-85.76	-81.17	
	Bands FDD_E Note 5		-85.26	-80.67	
	Bands FDD_G Note 5		-84.26	-79.67	
	Bands FDD_H Note 5		-83.76	-79.17	
<p>Note 1: This test verifies the RRM requirement which is independent of channel bandwidth and is performed according to the principle defined in section A.3.6.1.</p> <p>Note 2: I_o levels have been derived from other parameters for information purposes. They are not settable parameters themselves</p> <p>Note 3: See Table A.9.2.5.2-1 for the other parameters</p> <p>Note 4: E-UTRA operating band groups are as defined in Section 3.5.</p> <p>Note 5: The test applies for E-UTRA operating bands in this band group which are supporting 20 MHz channel bandwidth.</p> <p>Note 6: For Band 74, the tests shall be performed with the carrier frequency of the assigned E-UTRA channel bandwidth within 1475.9-1510.9 MHz.</p>					

A.9.2.11.3 Test Requirements

The test requirements defined in section A.9.2.5.3 shall apply in this test case.

A.9.2.12 TDD RSRQ for E-UTRA Carrier Aggregation (20MHz bandwidth)

The test case in this section are applicable to carrier aggregation capable UEs which have been configured with a downlink SCell.

A.9.2.12.1 Test Purpose and Environment

The purpose of this test is the same as defined in Subclause A.9.2.6.1.

A.9.2.12.2 Test parameters

The parameters of this test are the same as defined in Subclause A.9.2.6.2 except that the values of the parameters in the Table A.9.2.12.2-1 will replace the values of the corresponding parameters in A.9.2.6.2-1.

Table A.9.2.12.2-1: TDD RSRQ Carrier Aggregation test parameters

Parameters	Test 1			
	Units	Cell 1	Cell 2	Cell 3
BW _{channel_CA} Note1	MHz	20	20	20
Measurement bandwidth	n _{PRB}	47-52	47-52	47-52

PDSCH Reference measurement channel defined in A.3.1.1.2			R.3 TDD	R.3 TDD	-
PDSCH allocation		n_{PRB}	38-61	38-61	-
PDCCH/PCFICH/PHICH Reference measurement channel defined in A.3.1.2.2			R.10 TDD	R.10 TDD	R.10 TDD
OCNG Patterns defined in A.3.2.2.7 (OP.7 TDD) and A.3.2.2.8 (OP.8 TDD)			OP.7 TDD	OP.7 TDD	OP.8 TDD
I_o ^{Note2}	Bands TDD_A ^{Note 5}	dBm/18 MHz	-87.26	-82.67	
	Bands TDD_C ^{Note 5}		-86.26	-81.67	
	Bands TDD_E ^{Note 5}		-85.26	-80.67	
Note 1:	This test verifies the RRM requirement which is independent of channel bandwidth and is performed according to the principle defined in section A.3.6.1.				
Note 2:	I_o levels have been derived from other parameters for information purposes. They are not settable parameters themselves				
Note 3:	See Table A.9.2.6.2-1 for the other parameters.				
Note 4:	E-UTRA operating band groups are as defined in Section 3.5.				
Note 5:	The test applies for E-UTRA operating bands in this band group which are supporting 20 MHz channel bandwidth.				

A.9.2.12.3 Test Requirements

The test requirements defined in section A.9.2.6.3 shall apply in this test case.

A.9.2.13 Void

A.9.2.13.1 Void

A.9.2.13.2 Void

Table A.9.2.13.2-1: Void

A.9.2.13.3 Void

A.9.2.14 Void

A.9.2.14.1 Void

A.9.2.14.2 Void

Table A.9.2.14.2-1: Void

A.9.2.14.3 Void

A.9.2.15 FDD RSRQ under Time Domain Measurement Resource Restriction with CRS Assistance Information and Non-MBSFN ABS

A.9.2.15.1 Test Purpose and Environment

The purpose of this test is to verify that the RSRQ measurement accuracy under time domain measurement resource restriction with CRS assistance information is within the specified limits. This test will verify the requirements in

Clause 9.1.5.3 for FDD intra frequency measurements under time domain measurement resource restriction with CRS assistance information.

A.9.2.15.2 Test parameters

In this test case all cells are on the same carrier frequency. The absolute accuracy of RSRQ intra frequency measurements under time domain measurement resource restriction with CRS assistance information is tested by using the parameters in Table A.9.2.15.2-1 and Table A.9.2.15.2-2 for non-MBSFN ABS with colliding CRS between Cell1 and Cell3 and non-colliding CRS between Cell1 and Cell2. In all test cases, Cell 1 is the serving/aggressor cell, Cell2 is the neighbour/aggressor cell and Cell3 is the target cell to be measured for RSRQ.

The UE is configured by higher layers via Cell 1 with a time domain measurement resource restriction pattern for performing E-UTRAN FDD intra-frequency measurements on neighbour cells, namely Cell 3 measurements with a neighbour cell list, where the cell list includes Cell 3. The UE is also provided via higher layers with the CRS assistance information of Cell 2. The information for both measurement pattern and the CRS assistance information shall be provided to the UE before the measurements start.

Note: It's up to eNB's implementation whether the time domain measurement resource restriction pattern for PCell measurements is configured or not.

Table A.9.2.15.2-1: General test parameters for E-UTRAN FDD RSRQ intra frequency test parameters under time-domain measurement resource restriction with CRS assistance information and non-MBSFN ABS

Parameter	Unit	Value	Comment
PCell		Cell 1	Serving/aggressor cell
Neighbour cells		Cell 2	Neighbour/aggressor cell
		Cell3	Cell to be measured
ABS transmission configuration		Non-MBSFN ABS	As defined in Table A.3.4.1.1-1
CP length		Normal	For all cells in the test
DRX			OFF
Time offset between cells	μ s	Cell 2 offset with respect to Cell 1: 0 Cell 3 offset with respect to Cell 1: -2.5	Three synchronous cells
Physical cell IDs		$(PCI_{cell1} - PCI_{cell3}) \bmod 6 = 0$ $(PCI_{cell2} - PCI_{cell3}) \bmod 6 \neq 0$ PCI_{cell1} not equal to PCI_{cell3}	Cell PCIs are selected so that all conditions are met
ABS pattern		'1000000010000000100000 001000000010000000'	FDD ABS Pattern Info IE, as defined in TS 36.423[28], clause 9.2.54. The first/leftmost bit corresponds to the Pcell subframe #0 of the radio frame satisfying $SFN \bmod x = 0$, where x is the size of the bit string (40) divided by 10. No MBSFN subframes are configured in the ABS subframes. Configured in Cell 1 and Cell 2.
Time domain measurement resource restriction pattern for neighbour cell measurements on RF Channel 1		'1000000010000000100000 001000000010000000'	Time domain measurement resource restriction pattern for neighbor cell measurement signalled to the UE in measSubframePatternNeigh IE in measSubframePatternConfigNeigh, as defined in TS 36.331, clause 6.3.5. Configured for Cell 3 measurements. The cell list in measSubframeCellList IE shall contain Cell 3 but not Cell 2.
Time-domain measurement resource restriction pattern for serving cell measurements		'0100000001000000010000 000100000001000000'	Configured for measurements on Cell 1.
CRS assistance information	physCellId		Only the CRS information of cell 2 is provided in CRS-AssistanceInfo. It includes a single MBSFN-SubframeConfig element
	antennaPortsCount	1	

	mbsfn-SubframeConfigList		$oneFrame = '000000'$	with subframe allocation $oneFrame = '000000'$.
--	--------------------------	--	-----------------------	--

Table A.9.2.15.2-2: Cell-specific test parameters for E-UTRAN FDD RSRQ intra frequency test parameters under time domain measurement resource restriction with CRS assistance information and non-MBSFN ABS

Parameter	Unit	Test 1			Test 2			Test 3					
		Cell 1	Cell 2	Cell 3	Cell 1	Cell 2	Cell 3	Cell 1	Cell 2	Cell 3			
E-UTRA RF Channel Number		1			1			1					
$BW_{channel}$	MHZ	10			10			10					
Measurement bandwidth	n_{PRB}	22–27			22–27			22–27					
PDSCH Reference measurement channel defined in A.3.1.1.1		R.0 FDD	-		R.0 FDD	-		R.0 FDD	-				
PDSCH allocation	n_{PRB}	13–36	-		13–36	-		13–36	-				
PDCCH/PCFICH/PHICH Reference measurement channel defined in A.3.1.2.1		R.6 FDD			R.6 FDD			R.6 FDD					
OCNG Patterns defined in A.3.2.1.5 (OP.5 FDD) and A.3.2.1.6 (OP.6 FDD)		OP.5 FDD	OP.6 FDD	OP.6 FDD	OP.5 FDD	OP.6 FDD	OP.6 FDD	OP.5 FDD	OP.6 FDD	OP.6 FDD			
PBCH_RA	dB	Note 6	0		Note 6	0		Note 6	0				
PBCH_RB													
PSS_RA													
SSS_RA													
PCFICH_RB													
PHICH_RA													
PHICH_RB													
PDCCH_RA													
PDCCH_RB													
PDSCH_RA													
PDSCH_RB													
OCNG_RA <small>Note 1</small>													
OCNG_RB <small>Note 1</small>													
N_{oc} <small>Note 2</small>											Bands FDD_A <small>Note 10</small>	dBm/15 kHz	-84.76
	Bands FDD_B1, FDD_B2 <small>Note 11</small>	-115.5											
	Bands FDD_C	-115											
	Bands FDD_D	-114.5											
	Bands FDD_E, FDD_F <small>Note 7</small>	-114											
	Bands FDD_G <small>Note 9</small>	-113											
Bands FDD_H	-112.5												
$CRS \hat{E}_s / N_{oc}$	dB	4	2	-1.5	4	2	-1.5	4	2	-4			
$CRS (\hat{E}_s / I_{ot})_{meas}$ <small>Note 5</small>	dB	-1.18	0.32	-6.96	-1.18	0.32	-6.96	-0.75	0.54	-9.46			
RSRP <small>Note 3,4,5</small>	Bands FDD_A <small>Note 10</small>	dBm/15 kHz	80.76	82.76	86.26	99.85	101.85	105.35			-112	-114	-120
	Bands FDD_B1, FDD_B2 <small>Note 11</small>										111.5	113.5	119.5
	Bands FDD_C										-111	-113	-119
	Bands FDD_D										110.5	112.5	118.5
	Bands FDD_E, FDD_F <small>Note 7</small>										-110	-112	-118
	Bands FDD_G <small>Note 9</small>										-109	-111	-117
Bands FDD_H	108.5	110.5	116.5										

$(RSRQ)_{meas}$ Note 3,4,5	Bands FDD_A ^{Note 10} , FDD_B1, FDD_B2 ^{Note 11} , FDD_C, FDD_D, FDD_E, FDD_F ^{Note 7} , FDD_G ^{Note 9} , FDD_H	dB	-14.4 3	-11.5 9	-15.09	-14.4 3	-11.5 9	-15.09	-14.1 9	-10.8 1	-16.81
	$(Io)_{meas}$ ^{Note 3}	dBm/ 9 MHz	-49.3 4	-53.19	-68.4 3	-72.28	-72.28	-80.8 2	-85.03		
Bands FDD_B1, FDD_B2 ^{Note 11}	-80.3 2							-84.54			
Bands FDD_C	-79.8 2							-84.04			
Bands FDD_D	-79.3 2							-83.54			
Bands FDD_E, FDD_F ^{Note 7}	-78.8 2							-83.04			
Bands FDD_G ^{Note 9}	-77.8 2							-82.04			
Bands FDD_H	-77.3 2							-81.54			
Propagation condition	-	AWGN		AWGN		AWGN					
<p>Note 1: OCNG shall be used such that all cells are fully allocated and a constant total transmitted power spectral density is achieved for all OFDM symbols.</p> <p>Note 2: Interference from other cells and noise sources not specified in the test is assumed to be constant over subcarriers and time and shall be modelled as AWGN of appropriate power for N_{oc} to be fulfilled. Applies to all subframes.</p> <p>Note 3: RSRQ, RSRP and I_o levels have been derived from other parameters for information purposes. They are not settable parameters themselves. I_o levels are calculated in CRS symbols of measurement restricted subframes.</p> <p>Note 4: RSRP and RSRQ minimum requirements are specified assuming independent interference and noise at each receiver antenna port.</p> <p>Note 5: Applies to restricted measurement subframes for only Cell 2 and Cell 3. For Cell 1, the corresponding value is derived from the normal subframes other than the subframes indicated in the time domain measurement resource restriction pattern for intra-frequency measurements.</p> <p>Note 6: Non-ABS and ABS subframe channel powers defined in Table A.3.4.1.1-1.</p> <p>Note 7: For Band 26, the tests shall be performed with the carrier frequency of the assigned E-UTRA channel bandwidth within 865-894 MHz.</p> <p>Note 8: E-UTRA operating band groups are as defined in Section 3.5.</p> <p>Note 9: Except Band 29.</p> <p>Note 10: Except Band 32, Band 75, Band 76.</p> <p>Note 11: For Band 74, the tests shall be performed with the carrier frequency of the assigned E-UTRA channel bandwidth within 1475.9-1510.9 MHz.</p>											

A.9.2.15.3 Test Requirements

The RSRQ measurement accuracy shall fulfil the requirements in Clause 9.1.5.3.

A.9.2.16 TDD RSRQ under Time Domain Measurement Resource Restriction with CRS Assistance Information and Non-MBSFN ABS

A.9.2.16.1 Test Purpose and Environment

The purpose of this test is to verify that the RSRQ measurement accuracy under time domain measurement resource restriction with CRS assistance information is within the specified limits. This test will verify the requirements in Clause 9.1.5.3 for TDD intra frequency measurements under time domain measurement resource restriction with CRS assistance information.

A.9.2.16.2 Test parameters

In this test case all cells are on the same carrier frequency. The absolute accuracy of RSRQ intra frequency measurements under time domain measurement resource restriction with CRS assistance information is tested by using the parameters in Table A.9.2.16.2-1 and Table A.9.2.16.2-2 for non-MBSFN ABS with colliding CRS between Cell1 and Cell3 and non-colliding CRS between Cell1 and Cell2. In all test cases, Cell 1 is the serving/aggressor cell, Cell2 is the neighbour/aggressor cell and Cell3 is the target cell to be measured for RSRQ.

The UE is configured by higher layers via Cell1 with a time domain measurement resource restriction pattern for performing E-UTRAN TDD intra-frequency measurements on neighbour cells, namely Cell 3 measurements with a neighbour cell list, where the cell list includes Cell 3. The UE is also provided via higher layers with the CRS assistance information of Cell 2. The information for both measurement pattern and the CRS assistance information shall be provided to the UE before the measurements start.

Note: It's up to eNB's implementation whether the time domain measurement resource restriction pattern for PCell measurements is configured or not.

Table A.9.2.16.2-1: General test parameters for E-UTRAN TDD RSRQ intra frequency test parameters under time-domain measurement resource restriction with CRS assistance information and non-MBSFN ABS

Parameter	Unit	Value	Comment
PCell		Cell 1	Serving/aggressor cell
Neighbour cells		Cell 2	Neighbour/aggressor cell
		Cell3	Cell to be measured
Special subframe configuration		6	For Cell 1, Cell 2 and Cell 3. For special subframe configurations see Table 4.2-1 in [16].
Uplink/downlink subframe configuration		1	For Cell 1, Cell 2 and Cell 2. For uplink-downlink subframe configurations see Table 4.2-2 in [16].
ABS transmission configuration		Non-MBSFN ABS	As defined in Table A.3.4.1.1-1
CP length		Normal	For all cells in the test
DRX			OFF
Time offset between cells	μs	Cell 2 offset with respect to Cell 1: 0 Cell 3 offset with respect to Cell 1: -2.5	Three synchronous cells
Physical cell IDs		$(PCI_{cell1} - PCI_{cell3}) \bmod 6 = 0$ $(PCI_{cell2} - PCI_{cell3}) \bmod 6 \neq 0$ PCI_{cell1} not equal to PCI_{cell3}	Cell PCIs are selected so that all conditions are met
ABS pattern		'00000000010000000001'	TDD ABS Pattern Info IE, as defined in TS 36.423 [28], clause 9.2.54. The first/leftmost bit corresponds to the Pcell subframe #0 of the radio frame satisfying $SFN \bmod x = 0$, where x is the size of the bit string (20) divided by 10. No MBSFN subframes are configured in the ABS subframes. Provided to the UE for Cell 1 and Cell 2.
Time domain measurement resource restriction pattern for neighbour cell measurements on RF Channel 1		'00000000010000000001'	Time domain measurement resource restriction pattern for neighbor cell measurement signalled to the UE in measSubframePatternNeigh IE in measSubframePatternConfigNeigh, as defined in TS 36.331, clause 6.3.5. Provided to the UE for Cell 3 measurements. The cell list in measSubframeCellList IE shall contain Cell 3 but not Cell 2.
Time-domain measurement resource restriction pattern for serving cell measurements		'10000000001000000000'	Configured for Cell 1 measurements.

CRS assistance information	physCellId		see PCI conditions above	Only the CRS assistance information of cell 2 is provided for Cell 2 only in CRS-AssistanceInfo. It includes a single MBSFN-SubframeConfigList element with subframe allocation <i>oneFrame</i> ='000000'.
	antennaPortsCount		1	
	mbsfn-SubframeConfigList		<i>oneFrame</i> = '000000'	

Table A.9.2.16.2-2: Cell-specific test parameters for E-UTRAN TDD RSRQ intra frequency test parameters under time domain measurement resource restriction with CRS assistance information and non-MBSFN ABS

Parameter	Unit	Test 1			Test 2			Test 3			
		Cell 1	Cell 2	Cell 3	Cell 1	Cell 2	Cell 3	Cell 1	Cell 2	Cell 3	
E-UTRA RF Channel Number		1			1			1			
BW _{channel}	MHz	10			10			10			
Measurement bandwidth	<i>n_{PRB}</i>	22–27			22–27			22–27			
PDSCH Reference measurement channel defined in A.3.1.1.2		R.0 TDD	-		R.0 TDD	-		R.0 TDD	-		
PDSCH allocation	<i>n_{PRB}</i>	13–36	-		13–36	-		13–36	-		
PDCCH/PCFICH/PHICH Reference measurement channel defined in A.3.1.2.2		R.6 TDD			R.6 TDD			R.6 TDD			
OCNG Patterns defined in A.3.2.2.1 (OP.1 TDD) and A.3.2.2.2 (OP.2 TDD)		OP.1 TDD	OP.2 TDD	OP.2 TDD	OP.1 TDD	OP.2 TDD	OP.2 TDD	OP.1 TDD	OP.2 TDD	OP.2 TDD	
PBCH_RA	dB	Note 6	0		Note 6	0		Note 6	0		
PBCH_RB											
PSS_RA											
SSS_RA											
PCFICH_RB											
PHICH_RA											
PHICH_RB											
PDCCH_RA											
PDCCH_RB											
PDSCH_RA											
PDSCH_RB											
OCNG_RA ^{Note1}											
OCNG_RB ^{Note1}											
<i>N_{oc}</i> ^{Note2}	Bands TDD_A							-116			
	Bands TDD_C	-84.76			-103.85			-115			
	Bands TDD_E							-114			
CRS \hat{E}_s/N_{oc}	dB	4	2	-1.5	4	2	-1.5	4	2	-4	
CRS $(\hat{E}_s/I_{ot})_{meas}$ ^{Note 5}	dB	-1.18	0.32	-6.96	-1.18	0.32	-6.96	-0.75	0.54	-9.46	
RSRP ^{Note3,4,5}	Bands TDD_A							-112			
	Bands TDD_C	-80.7			-82.7			-86.2			
	Bands TDD_E	80.7			82.7			86.2			
		6	6	6	5	85	35	-110	-112	-118	
(RSRQ) _{meas} ^{Note3,4,5}	Bands TDD_A, TDD_C, TDD_E	dB	14.4	11.5	15.0	14.4	11.5	15.0	14.1	10.8	16.8
			3	9	9	3	9	9	9	1	1
(I _o) _{meas} ^{Note3}	Bands TDD_A	dBm/9 MHz	-49.3	-53.19		-68.4	-72.28		-80.8	-85.03	
			4			3		2			

	Bands TDD_C						- 79.8 2	-84.03
	Bands TDD_E						- 78.8 2	-83.04
Propagation condition		-	AWGN		AWGN		AWGN	
Note 1:	OCNG shall be used such that both cells are fully allocated and a constant total transmitted power spectral density is achieved for all OFDM symbols.							
Note 2:	Interference from other cells and noise sources not specified in the test is assumed to be constant over subcarriers and time and shall be modelled as AWGN of appropriate power for N_{oc} to be fulfilled. Applies to all subframes.							
Note 3:	RSRQ, RSRP and I_o levels have been derived from other parameters for information purposes. They are not settable parameters themselves. I_o levels are calculated in CRS symbols of measurement restricted subframes.							
Note 4:	RSRP and RSRQ minimum requirements are specified assuming independent interference and noise at each receiver antenna port.							
Note 5:	Applies to restricted measurement subframes for only Cell 2 and Cell 3. For Cell 1, the corresponding value is derived from the normal subframes other than the subframes indicated in the time domain measurement resource restriction pattern for intra-frequency measurements.							
Note 6:	Non-ABS and ABS subframe channel powers defined in Table A.3.4.1.1-1.							
Note 7:	E-UTRA operating band groups are as defined in Section 3.5.							

A.9.2.16.3 Test Requirements

The RSRQ measurement accuracy shall fulfil the requirements in Clause 9.1.5.3.

A.9.2.17 FDD Intra frequency case for 5 MHz bandwidth

A.9.2.17.1 Test Purpose and Environment

The purpose of this test is to verify that the RSRQ measurement accuracy is within the specified limits. This test will verify the requirements in Clause 9.1.5.1.

A.9.2.17.2 Test parameters

In this test case all cells are on the same carrier frequency. The absolute accuracy of RSRQ intra frequency measurement is tested by using the parameters in Table A.9.2.17.2-1. In all test cases, Cell 1 is the PCell and Cell 2 the target cell.

Table A.9.2.17.2-1: RSRQ FDD Intra frequency test parameters, 5MHz

Parameter	Unit	Test 1		Test 2		Test 3	
		Cell 1	Cell 2	Cell 1	Cell 2	Cell 1	Cell 2
E-UTRA RF Channel Number		1		1		1	
$BW_{channel}$	MHz	5		5		5	
Measurement bandwidth	n_{PRB}	10–15		10–15		10–15	
PDSCH Reference measurement channel defined in A.3.1.1.1		R.5 FDD	-	R.5 FDD	-	R.5 FDD	-
PDSCH allocation	n_{PRB}	7–17	-	7–17	-	7–17	-
PDCCH/PCFICH/PHICH Reference measurement channel defined in A.3.1.2.1		R.11 FDD		R.11 FDD		R.11 FDD	
OCNG Patterns defined in A.3.2.1.15 (OP.15 FDD) and A.3.2.1.16 (OP.16 FDD)		OP.15 FDD	OP.16 FDD	OP.15 FDD	OP.16 FDD	OP.15 FDD	OP.16 FDD
PBCH_RA	dB	0	0	0	0	0	0
PBCH_RB							
PSS_RA							
SSS_RA							
PCFICH_RB							
PHICH_RA							
PHICH_RB							
PDCCH_RA							
PDCCH_RB							

PDSCH_RA								
PDSCH_RB								
OCNG_RA ^{Note1}								
OCNG_RB ^{Note1}								
N_{oc} ^{Note2}	Bands FDD_N	dBm/15 kHz	-81.76		-100.85		-109.5	
\hat{E}_s/I_{ot}		dB	-1.76	-1.76	-4.70	-4.70	-5.46	-5.46
RSRP ^{Note3}	Bands FDD_N	dBm/15 kHz	-78.76	-78.76	-103.75	-103.75	-113.50	-113.50
RSRQ ^{Note3}	Bands FDD_N	dB	-14.77	-14.77	-16.76	-16.76	-17.34	-17.34
I_o ^{Note3}	Bands FDD_N	dBm/4.5 MHz	-50.01		-73.01		-82.19	
\hat{E}_s/N_{oc}		dB	3	3	-2.9	-2.9	-4	-4
Propagation condition		-	AWGN		AWGN		AWGN	
<p>Note 1: OCNG shall be used such that both cells are fully allocated and a constant total transmitted power spectral density is achieved for all OFDM symbols.</p> <p>Note 2: Interference from other cells and noise sources not specified in the test is assumed to be constant over subcarriers and time and shall be modelled as AWGN of appropriate power for N_{oc} to be fulfilled.</p> <p>Note 3: RSRQ, RSRP and I_o levels have been derived from other parameters for information purposes. They are not settable parameters themselves.</p> <p>Note 4: RSRP and RSRQ minimum requirements are specified assuming independent interference and noise at each receiver antenna port.</p>								

A.9.2.17.3 Test Requirements

The RSRQ measurement accuracy shall fulfil the requirements in Clause 9.1.5.1.

A.9.2.18 FDD—FDD Inter frequency case for 5MHz bandwidth

A.9.2.18.1 Test Purpose and Environment

The purpose of this test is to verify that the RSRQ measurement accuracy is within the specified limits. This test will verify the requirements in Sections 9.1.6.1 and 9.1.6.2.

A.9.2.18.2 Test parameters

In this test case the two cells are on different carrier frequencies and measurement gaps are provided. Both RSRQ inter frequency absolute and relative accuracy requirements are tested by using test parameters in Table A.9.2.18.2-1. In all tests, Cell 1 is the PCell and Cell 2 the target cell.

Table A.9.2.18.2-1: RSRQ FDD—FDD Inter frequency test parameters, 5MHz

Parameter	Unit	Test 1		Test 2		Test 3	
		Cell 1	Cell 2	Cell 1	Cell 2	Cell 1	Cell 2
E-UTRA RF Channel Number		1	2	1	2	1	2
BW _{channel}	MHz	5	5	5	5	5	5
Gap Pattern Id		0	-	0	-	0	-
Measurement bandwidth	n_{PRB}	10—15		10—15		10—15	

PDSCH Reference measurement channel defined in A.3.1.1.1			R.5 FDD	-	R.5 FDD	-	R.6 FDD	-							
PDSCH allocation		n_{PRB}	7—17	-	7—17	-	7—17	-							
PDCCH/PCFICH/PHICH Reference measurement channel defined in A.3.1.2.1			R.11 FDD		R.11 FDD		R.11 FDD								
OCNG Patterns defined in A.3.2.1.15 (OP.15 FDD) and A.3.2.1.16 (OP.16 FDD)			OP.15 FDD	OP.16 FDD	OP.15 FDD	OP.16 FDD	OP.15 FDD	OP.16 FDD							
PBCH_RA		dB	0	0	0	0	0	0							
PBCH_RB															
PSS_RA															
SSS_RA															
PCFICH_RB															
PHICH_RA															
PHICH_RB															
PDCCH_RA															
PDCCH_RB															
PDSCH_RA															
PDSCH_RB															
OCNG_RA ^{Note1}															
OCNG_RB ^{Note1}															
N_{oc} ^{Note2}	Bands FDD_A								dBm/15 kHz	-77	-77	-101.70	-101.70	-119.5	N/A
	Bands FDD_B1, FDD_B2 ^{Note 8}													-119	N/A
	Bands FDD_C													-118.5	N/A
	Bands FDD_D	-118	N/A												
	Bands FDD_E, FDD_F ^{Note 5}	-117.5	N/A												
	Bands FDD_G	-116.5	N/A												
	Bands FDD_H	-116	N/A												
	Bands FDD_N	-N/A	-113												
\hat{E}_s/I_{ot}		dB	-1.75	-1.75	-4.00	-4.00	-4.00	-4.00							
RSRP ^{Note3}	Bands FDD_A	dBm/15 kHz	-78.75	-78.75	-105.70	-105.70	-123.5	N/A							
	Bands FDD_B1, FDD_B2 ^{Note 8}						-123	N/A							
	Bands FDD_C						-122.5	N/A							
	Bands FDD_D						-122	N/A							
	Bands FDD_E, FDD_F ^{Note 5}						-121.5	N/A							
	Bands FDD_G						-120.5	N/A							
	Bands FDD_H						-120	N/A							
	Bands FDD_N						N/A	-117							
RSRQ ^{Note3}	Bands FDD_A	dB	-14.76	-14.76	-16.25	-16.25	-16.25	-16.25							
	Bands FDD_B1, FDD_B2 ^{Note 8}														
	Bands FDD_C														
	Bands FDD_D														
	Bands FDD_E, FDD_F ^{Note 5}														
	Bands FDD_G														
	Bands FDD_H														
	Bands FDD_N														
I_o ^{Note3}	Bands FDD_A	dBm/4.5 MHz	-50.01	-50.01	-75.47	-75.47	-93.27	N/A							
	Bands FDD_B1, FDD_B2 ^{Note 8}						-92.77	N/A							
	Bands FDD_C						-92.27	N/A							
	Bands FDD_D						-91.77	N/A							
	Bands FDD_E, FDD_F ^{Note 5}						-91.27	N/A							
	Bands FDD_G						-90.27	N/A							
	Bands FDD_H						-89.77	N/A							
	Bands FDD_N						N/A	-86.77							

\hat{E}_s/N_{oc}	dB	-1.75	-1.75	-4.0	-4.0	-4.0	-4.0
Propagation condition	-	AWGN		AWGN		AWGN	
Note 1:	OCNG shall be used such that both cells are fully allocated and a constant total transmitted power spectral density is achieved for all OFDM symbols.						
Note 2:	Interference from other cells and noise sources not specified in the test is assumed to be constant over subcarriers and time and shall be modelled as AWGN of appropriate power for N_{oc} to be fulfilled.						
Note 3:	RSRQ, RSRP and I_o levels have been derived from other parameters for information purposes. They are not settable parameters themselves.						
Note 4:	RSRP and RSRQ minimum requirements are specified assuming independent interference and noise at each receiver antenna port.						
Note 5:	For Band 26, the tests shall be performed with the assigned E-UTRA channel bandwidth within 865-894 MHz.						
Note 6:	This test is only applicable for testing inter-frequency requirements for Bands FDD_N. Cell 2 is on the Band under test, and Cell 1 is on another band supported by the UE.						
Note 7:	E-UTRA operating band groups are as defined in Section 3.5.						
Note 8:	For Band 74, the tests shall be performed with the carrier frequency of the assigned E-UTRA channel bandwidth within 1475.9-1510.9 MHz.						

A.9.2.18.3 Test Requirements

The RSRQ measurement accuracy shall fulfil the requirements in Sections 9.1.6.1 and 9.1.6.2.

A.9.2.19 FDD-FDD Inter Frequency WB-RSRQ

A.9.2.19.1 Test Purpose and Environment

The purpose of this test is to verify that the RSRQ measurement accuracy is within the specified limits when the measurement configuration message received by the UE contains *widebandRSRQ-Meas* parameter in TS 36.331 [2]. In the test the UE shall also be configured with the *AllowedMeasBandwidth* parameter defined in TS 36.331 [2]. The test shall verify the WB-RSRQ inter frequency absolute accuracy requirements defined in Section 9.1.6.3.

A.9.2.19.2 Test parameters

In this test case the two cells are on two different carrier frequencies and measurement gaps are provided. The WB-RSRQ inter frequency absolute accuracy requirement is tested by using test parameters in Table A.9.2.19.2-1. In the test, Cell 1 is the PCell and Cell 2 the target cell on which the UE shall be ordered to measure WB-RSRQ.

Table A.9.2.19.2-1: WB-RSRQ FDD-FDD Inter frequency test parameters

Parameter	Unit	Test 1			
		Cell 1	Cell 2		
E-UTRA RF Channel Number		1	2		
BW _{channel}	MHz	10	10		
Antenna Configuration		1x2	1x2		
Gap Pattern Id		0	-		
PBCH_RA	dB	0	0		
PBCH_RB			0		
PSS_RA			0		
SSS_RA			0		
PCFICH_RB			-∞		
PHICH_RA			-∞		
PHICH_RB			-∞		
PDCCH_RA			-∞		
PDCCH_RB			-∞		
PDSCH_RA			-∞		
PDSCH_RB			-∞		
OCNG_RA ^{Note1}			-∞		
OCNG_RB ^{Note1}			-∞		
<i>AllowedMeasBandwidth</i> in TS 36.331 [2]			RB	6	50
PDSCH Reference measurement channel defined in A.3.1.1.1				R.0 FDD	-

PDSCH allocation		n_{PRB}	13-36	-	
PDCCH/PCFICH/PHICH Reference measurement channel defined in A.3.1.2.1			R.6 FDD	-	
OCNG Patterns defined in A.3.2.1.1 (OP.1 FDD)			OP.1 FDD	-	
I_{ot} Note2	bandwidth	n_{PRB}	0-49	0-21 28-49	22-27
		dBm/15 kHz	-94	-87	-110
\hat{E}_s / I_{ot}	bandwidth	n_{PRB}	0-49	0-21 28-49	22-27
		dB	-4	-3	20
RSRP ^{Note3}		dBm/15 kHz	-98	-90	
RSRQ ^{Note3}		dB	-16.25	-	
WB-RSRQ ₀ ^{Note3} in subframe 0		dB	-	-13.68	
WB-RSRQ ₁ ^{Note3} in subframe $\neq 0$		dB	-	-13.63	
I_o ^{Note3}		dBm/ 9 MHz	-64.76	-	
I_o ^{Note3} in symbol 0, 4, 11 of subframe 0		dBm/ 9 MHz	-	-82.38	
I_o ^{Note3} in symbol 7 of subframe 0		dBm/ 9 MHz	-	-82.20	
I_o ^{Note3} in symbol 0, 4, 7, 11 of subframes $\neq 0$		dBm/ 9 MHz	-	-82.38	
Propagation condition		-	AWGN	AWGN	
<p>Note 1: OCNG shall be used such that Cell 1 is fully allocated and a constant total transmitted power spectral density is achieved for all OFDM symbols.</p> <p>Note 2: Interference from other cells not specified in the test, assumed to be constant over time and modelled as noise.</p> <p>Note 3: RSRQ, RSRP, WB-RSRQ and I_o levels have been derived from other parameters for information purposes. They are not settable parameters themselves. The stated values represent the weighted average over the allowed measurement bandwidth, and the WB-RSRQ values assume averaging over symbols 0, 4, 7 and 11 of the subframe.</p> <p>Note 4: RSRP and RSRQ minimum requirements are specified assuming independent interference and noise at each receiver antenna port.</p> <p>Note 5: This test case is applicable to all FDD frequency bands except bands within band group FDD_N.</p>					

A.9.2.19.3 Test Requirements

The WB-RSRQ measurement accuracy for cell 2 shall fulfil the requirements in Section 9.1.6.3, compared with WB-RSRQ₀ or WB-RSRQ₁.

A.9.2.20 TDD—TDD Inter Frequency WB-RSRQ

A.9.2.20.1 Test Purpose and Environment

The purpose of this test is to verify that the RSRQ measurement accuracy is within the specified limits when the measurement configuration message received by the UE contains *widebandRSRQ-Meas* parameter in TS 36.331 [2]. In the test the UE shall also be configured with the *AllowedMeasBandwidth* parameter defined in TS 36.331 [2]. The test shall verify the WB-RSRQ inter frequency absolute accuracy requirements defined in Section 9.1.6.3.

A.9.2.20.2 Test parameters

In this test case the two cells are on two different carrier frequencies and measurement gaps are provided. The WB-RSRQ inter frequency absolute accuracy requirement is tested by using test parameters in Table A.9.2.20.2-1. In the test, Cell 1 is the PCell and Cell 2 the target cell on which the UE shall be ordered to measure WB-RSRQ.

Table A.9.2.20.2-1: WB-RSRQ TDD-TDD Inter frequency test parameters

Parameter		Unit	Test 1		
			Cell 1	Cell 2	
E-UTRA RF Channel Number			1	2	
BW _{channel}		MHz	10	10	
Special subframe configuration ^{Note1}			6	6	
Uplink-downlink configuration ^{Note1}			1	1	
Antenna Configuration			1x2	1x2	
Gap Pattern Id			0	-	
PBCH_RA		dB	0	0	
PBCH_RB				0	
PSS_RA				0	
SSS_RA				0	
PCFICH_RB				-∞	
PHICH_RA				-∞	
PHICH_RB				-∞	
PDCCH_RA				-∞	
PDCCH_RB				-∞	
PDSCH_RA				-∞	
PDSCH_RB				-∞	
OCNG_RA ^{Note2}				-∞	
OCNG_RB ^{Note2}				-∞	
Allowed Meas Bandwidth in TS 36.331 [2]				RB	6
PDSCH Reference measurement channel defined in A.3.1.1.2			R.0 TDD	-	
PDSCH allocation		n_{PRB}	13-36	-	
PDCCH/PCFICH/PHICH Reference measurement channel defined in A.3.1.2.2			R.6 TDD	-	
OCNG Patterns defined in A.3.2.2.1 (OP.1 TDD)			OP.1 TDD	-	
I_{ot} ^{Note3}	bandwidth	n_{PRB}	0-49	0-21 28-49	22-27
		dBm/15 kHz	-94	-87	-110
\hat{E}_s / I_{ot}	bandwidth	n_{PRB}	0-49	0-21 28-49	22-27
		dB	-4	-3	20
RSRP ^{Note4}		dBm/15 kHz	-98	-90	
RSRQ ^{Note4}		dB	-16.25	-	
WB-RSRQ ₀ ^{Note4} in subframe 0		dB	-	-13.68	
WB-RSRQ ₁ ^{Note4} in subframe ≠ 0		dB	-	-13.63	
I _o ^{Note4}		dBm/ 9 MHz	-64.76	-	
I _o ^{Note4} in symbol 0, 4, 11 of subframe 0		dBm/ 9 MHz	-	-82.38	
I _o ^{Note4} in symbol 7 of subframe 0		dBm/ 9 MHz	-	-82.20	
I _o ^{Note4} in symbol 0, 4, 7, 11 of subframes ≠ 0		dBm/ 9 MHz	-	-82.38	
Propagation condition		-	AWGN	AWGN	
<p>Note 1: For special subframe and uplink-downlink configurations see Tables 4.2-1 and 4.2-2 in TS 36.211.</p> <p>Note 2: OCNG shall be used such that Cell 1 is fully allocated and a constant total transmitted power spectral density is achieved for all OFDM symbols.</p> <p>Note 3: Interference from other cells not specified in the test, assumed to be constant over time and modelled as noise.</p> <p>Note 4: RSRP, RSRQ, WB-RSRQ and I_o levels have been derived from other parameters for information purposes. They are not settable parameters themselves. The stated values represent the weighted average over the allowed measurement bandwidth, and the WB-RSRQ values assume averaging over symbols 0, 4, 7 and 11 of the subframe.</p>					

Note 5: RSRP and RSRQ minimum requirements are specified assuming independent interference and noise at each receiver antenna port.

A.9.2.20.3 Test Requirements

The WB-RSRQ measurement accuracy for cell 2 shall fulfil the requirements in Section 9.1.6.3, compared with WB-RSRQ₀ or WB-RSRQ₁.

A.9.2.21 FDD RSRQ for E-UTRAN Carrier Aggregation for 10MHz+5MHz

The test case in this section are applicable to carrier aggregation capable UEs which have been configured with a downlink SCell.

A.9.2.21.1 Test Purpose and Environment

The purpose of this test is the same as defined in Subclause A.9.2.5.1.

A.9.2.21.2 Test parameters

The parameters of this test are the same as defined in Subclause A.9.2.5.2 except that the values of the parameters in the Table A.9.2.21.2-1 will replace the values of the corresponding parameters in A.9.2.5.2-1.

Table A.9.2.21.2-1: FDD RSRQ Carrier Aggregation test parameters

Parameters		Test 1			
		Units	Cell 1	Cell 2	Cell 3
BW _{channel_CA} ^{Note 1}		MHz	10	5	
Measurement bandwidth		n_{PRB}	22-27	10-15	
PDSCH Reference measurement channel defined in A.3.1.1.1			R.0 FDD	R.5 FDD	-
PDSCH allocation		n_{PRB}	13-36	7-17	-
PDCCH/PCFICH/PHICH Reference measurement channel defined in A.3.1.2.1			R.6 FDD	R.11 FDD	
OCNG Patterns defined in A.3.2.1.1 (OP.1 FDD), A.3.2.1.15 (OP.15 FDD) and A.3.2.1.16 (OP.16 FDD)			OP.1 FDD	OP.15 FDD	OP.16 FDD
N_{oc} ^{Note2}	Bands FDD_A	dBm/15 kHz	-119.5	-116	-116
	Bands FDD_B1, FDD_B2 ^{Note 4}		-119	-115.5	-115.5
	Bands FDD_C		-118.5	-115	-115
	Bands FDD_D		-118	-114.5	-114.5
	Bands FDD_E, FDD_F		-117.5	-114	-114
	Bands FDD_G		-116.5	-113	-113
	Bands FDD_H		-116	-112.5	-112.5
	Bands FDD_N		N/A	-109.5	-109.5
RSRP ^{Note2}	Bands FDD_A	dBm/15 kHz	-123.5	-120	-120

	Bands FDD_B1, FDD_B2 ^{Note 4}		-123	-119.5	-119.5
	Bands FDD_C		-122.5	-119	-119
	Bands FDD_D		-122	-118.5	-118.5
	Bands FDD_E, FDD_F		-121.5	-118	-118
	Bands FDD_G		-120.5	-117	-117
	Bands FDD_H		-120	-116.5	-116.5
	Bands FDD_N		N/A	-113.5	-113.5
RSRQ ^{Note2}	Bands FDD_A	dB	-16.25	-17.34	-17.34
	Bands FDD_B1, FDD_B2 ^{Note 4}				
	Bands FDD_C				
	Bands FDD_D				
	Bands FDD_E, FDD_F				
	Bands FDD_G				
	Bands FDD_H				
	Bands FDD_N				
I _o ^{Note2}	Bands FDD_A	dBm/9MHz	-90.26	N/A	
	Bands FDD_B1, FDD_B2 ^{Note 4}		-89.76		
	Bands FDD_C		-89.26		
	Bands FDD_D		-88.76		
	Bands FDD_E, FDD_F		-88.26		
	Bands FDD_G		-87.26		
	Bands FDD_H		-86.76		
	Bands FDD_A	dBm/4.5MHz	N/A	-88.67	
	Bands FDD_B1, FDD_B2 ^{Note 4}			-88.17	
	Bands FDD_C			-87.67	
	Bands FDD_D			-87.17	
	Bands FDD_E, FDD_F			-86.67	

	Bands FDD_G			-85.67
	Bands FDD_H			-85.17
	Bands FDD_N			-82.17
Note 1:	This test verifies the RRM requirement which is independent of channel bandwidth and is performed according to the principle defined in section A.3.6.1.			
Note 2:	RSRQ, RSRP and Io levels have been derived from other parameters for information purposes. They are not settable parameters themselves.			
Note 3:	See Table A.9.2.5.2-1 for the other parameters			
Note 4:	For Band 74, the tests shall be performed with the carrier frequency of the assigned E-UTRA channel bandwidth within 1475.9-1510.9 MHz.			

A.9.2.21.3 Test Requirements

The test requirements defined in section A.9.2.5.3 shall apply in this test case.

A.9.2.22 TDD RSRQ for E-UTRAN Carrier Aggregation for 10MHz+5MHz

The test case in this section are applicable to carrier aggregation capable UEs which have been configured with a downlink SCell.

A.9.2.22.1 Test Purpose and Environment

The purpose of this test is the same as defined in Subclause A.9.2.6.1.

A.9.2.22.2 Test parameters

The parameters of this test are the same as defined in Subclause A.9.2.6.2 except that the values of the parameters in the Table A.9.2.22.2-1 will replace the values of the corresponding parameters in A.9.2.6.2-1.

Table A.9.2.22.2-1: TDD RSRQ Carrier Aggregation test parameters

Parameters		Test 1			
		Units	Cell 1	Cell 2	Cell 3
BW _{channel_CA} ^{Note1}		MHz	10	5	
Measurement bandwidth		n_{PRB}	22-27	10-15	
PDSCH Reference measurement channel defined in A.3.1.1.2			R.0 TDD	R.4TDD	-
PDSCH allocation		n_{PRB}	13-36	7-17	-
PDCCH/PCFICH/PHICH Reference measurement channel defined in A.3.1.2.2			R.6 TDD	R.11 TDD	
OCNG Patterns defined in A.3.2.2.1 (OP.1 TDD), A.3.2.2.9 (OP.9 TDD) and A.3.2.2.10 (OP.10 TDD)			OP.1 TDD	OP.9 TDD	OP.10 TDD
Io ^{Note2}	Bands TDD_A	dBm/9MHz	-90.26	N/A	
	Bands TDD_C		-89.26		
	Bands TDD_E		-88.26		
	Bands TDD_A	dBm/4.5MHz	N/A	-88.67	
	Bands TDD_C			-87.67	
	Bands TDD_E			-86.67	
Note 1:		This test verifies the RRM requirement which is independent of channel bandwidth and is performed according to the principle defined in section A.3.6.1.			

Note 2: Io levels have been derived from other parameters for information purposes. They are not settable parameters themselves
 Note 3: See Table A.9.2.6.2-1 for the other parameters

A.9.2.22.3 Test Requirements

The test requirements defined in section A.9.2.6.3 shall apply in this test case.

A.9.2.23 FDD RSRQ for E-UTRA Carrier Aggregation (5MHz + 5MHz bandwidth)

The test case in this section are applicable to carrier aggregation capable UEs which have been configured with a downlink SCell.

A.9.2.23.1 Test Purpose and Environment

The purpose of this test is the same as defined in Subclause A.9.2.5.1.

A.9.2.23.2 Test parameters

The parameters of this test are the same as defined in Subclause A.9.2.5.2 except that the values of the parameters in the Table A.9.2.23.2-1 will replace the values of the corresponding parameters in A.9.2.5.2-1.

Table A.9.2.23.2-1: FDD RSRQ Carrier Aggregation test parameters

Parameters		Test 1			
		Units	Cell 1	Cell 2	Cell 3
$BW_{\text{channel_CA}}$ ^{Note 1}		MHz	5	5	5
Measurement bandwidth		n_{PRB}	10-15	10-15	10-15
PDSCH Reference measurement channel defined in A.3.1.1.1			R.5 FDD	R.5 FDD	N/A
PDSCH allocation		n_{PRB}	7-17	7-17	-
PDCCH/PCFICH/PHICH Reference measurement channel defined in A.3.1.2.1			R.11 FDD	R.11 FDD	R.11 FDD
OCNG Patterns defined in A.3.2.1.15 (OP.15 FDD) and A.3.2.1.16 (OP.16 FDD)			OP.15 FDD	OP.15 FDD	OP.16FDD
N_{oc} ^{Note2}	Bands FDD_A	dBm/15 kHz	-119.5	-116	-116
	Bands FDD_B1, FDD_B2 ^{Note 6}		-119	-115.5	-115.5
	Bands FDD_C		-118.5	-115	-115
	Bands FDD_D		-118	-114.5	-114.5
	Bands FDD_E, FDD_F		-117.5	-114	-114
	Bands FDD_G		-116.5	-113	-113
	Bands FDD_H		-116	-112.5	-112.5
	Bands FDD_N		-113	-109.5	-109.5
RSRP ^{Note2}	Bands FDD_A	dBm/15 kHz	-123.5	-120	-120
	Bands FDD_B1, FDD_B2 ^{Note 6}		-123	-119.5	-119.5
	Bands FDD_C		-122.5	-119	-119
	Bands FDD_D		-122	-118.5	-118.5
	Bands FDD_E, FDD_F		-121.5	-118	-118
	Bands FDD_G		-120.5	-117	-117
	Bands FDD_H		-120	-116.5	-116.5

	Bands FDD_N		-117	-113.5	-113.5	
RSRQ ^{Note2}	Bands FDD_A	dB	-16.25	-17.34	-17.34	
	Bands FDD_B1, FDD_B2 ^{Note 6}					
	Bands FDD_C					
	Bands FDD_D					
	Bands FDD_E, FDD_F					
	Bands FDD_G					
	Bands FDD_H					
	Bands FDD_N					
Io ^{Note2}	Bands FDD_A ^{Note 5}	dBm/4.5MHz			-93.26	-88.67
	Bands FDD_B1 ^{Note 5} , FDD_B2 ^{Note 5}				-92.76	-88.17
	Bands FDD_C ^{Note 5}				-92.26	-87.67
	Bands FDD_D				-91.76	-87.17
	Bands FDD_E, FDD_F ^{Note 5}				-91.26	-86.67
	Bands FDD_G ^{Note 5}				-90.26	-85.67
	Bands FDD_H ^{Note 5}				-89.76	-85.17
	Bands FDD_N ^{Note 5}				-86.76	-82.76
<p>Note 1: This test verifies the RRM requirement which is independent of channel bandwidth and is performed according to the principle defined in section A.3.6.1.</p> <p>Note 2: RSRQ, RSRP and Io levels have been derived from other parameters for information purposes. They are not settable parameters themselves.</p> <p>Note 3: See Table A.9.2.5.2-1 for the other parameters</p> <p>Note 4: E-UTRA operating band groups are as defined in Section 3.5.</p> <p>Note 5: The test applies for E-UTRA operating bands in this band group which are supporting 5MHz + 5MHz channel bandwidth.</p> <p>Note 6: For Band 74, the tests shall be performed with the carrier frequency of the assigned E-UTRA channel bandwidth within 1475.9-1510.9 MHz.</p>						

A.9.2.23.3 Test Requirements

The test requirements defined in section A.9.2.5.3 shall apply in this test case.

A.9.2.24 TDD RSRQ for E-UTRA Carrier Aggregation (5MHz + 5MHz bandwidth)

The test case in this section are applicable to carrier aggregation capable UEs which have been configured with a downlink SCell.

A.9.2.24.1 Test Purpose and Environment

The purpose of this test is the same as defined in Subclause A.9.2.6.1.

A.9.2.24.2 Test parameters

The parameters of this test are the same as defined in Subclause A.9.2.6.2 except that the values of the parameters in the Table A.9.2.24.2-1 will replace the values of the corresponding parameters in A.9.2.6.2-1.

Table A.9.2.24.2-1: TDD RSRQ Carrier Aggregation test parameters

Parameters		Test 1			
		Units	Cell 1	Cell 2	Cell 3
BW _{channel_CA} ^{Note1}		MHz	10	5	5
Measurement bandwidth		n_{PRB}	10-15	10-15	10-15
PDSCH Reference measurement channel defined in A.3.1.1.1			R.0 TDD	R.4 TDD	N/A
PDSCH allocation		n_{PRB}	13-36	7-17	N/A
PDCCH/PCFICH/PHICH Reference measurement channel defined in A.3.1.2.2			R.6 TDD	R.11 TDD	R.11 TDD
OCNG Patterns defined in A.3.2.2.9 (OP.9 TDD) and A.3.2.2.10 (OP.10 TDD)			OP.1 TDD	OP.9 TDD	OP.10 TDD
Io ^{Note2}	Bands TDD_A ^{Note 5}	dBm4.5MHz	-93.26	-88.67	
	Bands TDD_C ^{Note 5}		-92.26	-87.67	
	Bands TDD_E ^{Note 5}		-91.26	-86.67	
Note 1:		This test verifies the RRM requirement which is independent of channel bandwidth and is performed according to the principle defined in section A.3.6.1.			
Note 2:		Io levels have been derived from other parameters for information purposes. They are not settable parameters themselves.			
Note 3:		See Table A.9.2.6.2-1 for the other parameters			
Note 4:		E-UTRA operating band groups are as defined in Section 3.5.			
Note 5:		The test applies for E-UTRA operating bands in this band group which are supporting 5MHz + 5MHz channel bandwidth.			

A.9.2.24.3 Test Requirements

The test requirements defined in section A.9.2.6.3 shall apply in this test case.

A.9.2.25 RSRQ for E-UTRAN TDD-FDD Carrier Aggregation with PCell in FDD

The test case in this section are applicable to TDD-FDD carrier aggregation capable UEs which have been configured with a downlink SCell.

A.9.2.25.1 Test Purpose and Environment

The purpose of this test is to verify that the RSRQ for E-UTRAN TDD-FDD Carrier Aggregation with PCell in FDD measurement accuracy in carrier aggregation is within the specified limits under AWGN propagation conditions. This test will verify the absolute accuracy of RSRQ measurements for the primary component carrier defined in clause 9.1.11.1, the absolute accuracy of RSRQ measurements for the secondary component carrier defined in clause 9.1.11.2, and also the relative RSRQ accuracy requirement between primary and secondary component carriers defined in clause 9.1.11.3.

A.9.2.25.2 Test parameters

In this test case the PCell is FDD and SCell is TDD. Both RSRQ absolute and relative accuracy requirements of the primary and secondary component carrier are tested by using test parameters specified in Table A.9.2.25.2-1. In the test, Cell 1 is the PCell, Cell 2 is the SCell on the Secondary Component Carrier (SCC). The SCC is configured and activated.

The parameters of this test are given in Table A.9.2.25.2-1.

Table A.9.2.25.2-1: RSRQ for E-UTRAN TDD-FDD Carrier Aggregation with PCell in FDD test parameters

Parameter		Unit	Cell 1	Cell 2			
E-UTRA RF Channel Number			1	2			
$BW_{channel}$			5MHz: $N_{RB,c} = 25$ 10MHz: $N_{RB,c} = 50$ 20MHz: $N_{RB,c} = 100$	5MHz: $N_{RB,c} = 25$ 10MHz: $N_{RB,c} = 50$ 20MHz: $N_{RB,c} = 100$			
Special subframe configuration ^{Note1}			-	6			
Uplink-downlink configuration ^{Note1}			-	1			
Measurement bandwidth		n_{PRB}	5MHz: 10-15 10MHz: 22-27 20MHz: 47-52	5MHz: 10-15 10MHz: 22-27 20MHz: 47-52			
PDSCH Reference measurement channel defined in A.3.1.1			5MHz: R.5 FDD 10MHz: R.0 FDD 20MHz: R.4 FDD	5MHz: R.4 TDD 10MHz: R.0 TDD 20MHz: R.3 TDD			
PDSCH allocation		n_{PRB}	5MHz: 7-17 10MHz: 13-36 20MHz: 38-61	5MHz: 7-17 10MHz: 13-36 20MHz: 38-61			
PDCCH/PCFICH/PHICH Reference measurement channel defined in A.3.1.2			5MHz: R.11 FDD 10MHz: R.6 FDD 20MHz: R.10 FDD	5MHz: R.11 TDD 10MHz: R.6 TDD 20MHz: R.10 TDD			
OCNG Patterns defined in A.3.2			5MHz: OP.15 FDD 10MHz: OP.1 FDD 20MHz: OP.11 FDD	5MHz: OP.9 TDD 10MHz: OP.1 TDD 20MHz: OP.7 TDD			
PBCH_RA		dB	0	0			
PBCH_RB							
PSS_RA							
SSS_RA							
PCFICH_RB							
PHICH_RA							
PHICH_RB							
PDCCH_RA							
PDCCH_RB							
PDSCH_RA							
PDSCH_RB							
OCNG_RA ^{Note2}							
OCNG_RB ^{Note2}							
N_{oc} ^{Note3}	Bands TDD_A				dBm/15 kHz	-	-116
	Bands TDD_C					-	-115
	Bands TDD_E	-	-114				
	Bands FDD_A	-119.5	-				
	Bands FDD_B1, FDD_B2 ^{Note 11}	-119	-				
	Bands FDD_C	-118.5	-				
	Bands FDD_D	-118	-				
	Bands FDD_E, Bands FDD_F ^{Note 6}	-117.5	-				
	Bands FDD_G	-116.5	-				
Bands FDD_H	-116	-					
\hat{E}_s / N_{oc}		dB	-6.0	-6.0			
\hat{E}_s / I_{ot}		dB	-6.0	-6.0			
RSRP ^{Note4}	Bands TDD_A	dBm/15 kHz	-	-122			
	Bands TDD_C		-	-121			
	Bands TDD_E		-	-120			
	Bands FDD_A		-125.5	-			

	Bands FDD_B1, FDD_B2 ^{Note 11}		-123	-
	Bands FDD_C		-124.5	-
	Bands FDD_D		-124	-
	Bands FDD_E, Bands FDD_F ^{Note 6}		-123.5	-
	Bands FDD_G		-122.5	-
	Bands FDD_H		-122	-
RSRQ ^{Note 4}	Bands TDD_A	dB	-	-17.77
	Bands TDD_C			
	Bands TDD_E			
	Bands FDD_A			
	Bands FDD_B1, FDD_B2 ^{Note 11}			
	Bands FDD_C		-17.77	-
	Bands FDD_D			
	Bands FDD_E, Bands FDD_F ^{Note 6}			
Bands FDD_G				
Bands FDD_H				
Io ^{Note 4}	Bands TDD_A	dBm/BW _{channel}	-	-87.25 + 10log(N _{RB,c} /50)
	Bands TDD_C		-	-86.25 + 10log(N _{RB,c} /50)
	Bands TDD_E		-	-85.25 + 10log(N _{RB,c} /50)
	Bands FDD_A		-90.75 + 10log(N _{RB,c} /50)	-
	Bands FDD_B1, FDD_B2 ^{Note 11}		89.76	-
	Bands FDD_C		-89.75 + 10log(N _{RB,c} /50)	-
	Bands FDD_D		-89.25 + 10log(N _{RB,c} /50)	-
	Bands FDD_E, Bands FDD_F ^{Note 6}		-88.75 + 10log(N _{RB,c} /50)	-
	Bands FDD_G		-87.75 + 10log(N _{RB,c} /50)	-
	Bands FDD_H		-87.25 + 10log(N _{RB,c} /50)	-
Propagation Condition			AWGN	AWGN
Antenna Configuration			1x2	1x2
Timing offset to Cell 1		µs	-	0
Time alignment error relative to cell 1 ^{Note 10}			-	≤ TAE
<p>Note 1: For special subframe and uplink-downlink configurations see Tables 4.2-1 and 4.2-2 in TS 36.211.</p> <p>Note 2: OCNG shall be used such that both cells are fully allocated and a constant total transmitted power spectral density is achieved for all OFDM symbols.</p> <p>Note 3: Interference from other cells and noise sources not specified in the test is assumed to be constant over subcarriers and time and shall be modelled as AWGN of appropriate power for N_{oc} to be fulfilled.</p> <p>Note 4: Es/Iot, RSRP, RSRQ and Io levels have been derived from other parameters for information purposes. They are not settable parameters themselves.</p> <p>Note 5: RSRP and RSRQ minimum requirements are specified assuming independent interference and noise at each receiver antenna port.</p> <p>Note 6: For Band 26, the tests shall be performed with the carrier frequency of the assigned E-UTRA channel bandwidth within 865-894 MHz.</p> <p>Note 7: The selection of the bands for testing depends on the configuration of the carrier aggregation supported by the UEs.</p>				

Note 8:	This test verifies the RRM requirement which is independent of channel bandwidth and is performed according to the principle defined in section A.3.6.1.
Note 9:	E-UTRA operating band groups are as defined in Section 3.5.
Note 10:	Time alignment error (TAE) as specified in TS 36.104 [30] clause 6.5.3.1. The TAE value depends upon the type of carrier aggregation.
Note 11:	For Band 74, the tests shall be performed with the carrier frequency of the assigned E-UTRA channel bandwidth within 1475.9-1510.9 MHz.

A.9.2.25.3 Test Requirements

In the test, the RSRQ measurement accuracy in carrier aggregation shall fulfil the requirements in clause 9.1.11.1, 9.1.11.2, and 9.1.11.3.

- The absolute accuracy of intra-frequency RSRQ measurements of Cell 1 on the primary component carrier shall fulfil the requirements specified in clause 9.1.11.1.
- The absolute accuracy of intra-frequency RSRQ measurements of Cell 2 on the secondary component carrier shall fulfil the requirements specified in clause 9.1.11.2.
- The relative accuracy of inter-frequency RSRQ measurements between the primary and secondary component carriers for Cell 2 relative to Cell 1 shall fulfil the requirements specified in clause 9.1.11.3.

A.9.2.26 RSRQ for E-UTRAN TDD-FDD Carrier Aggregation with PCell in TDD

The test case in this section are applicable to TDD-FDD carrier aggregation capable UEs which have been configured with a downlink SCell.

A.9.2.26.1 Test Purpose and Environment

The purpose of this test is to verify that the RSRQ for E-UTRAN TDD-FDD Carrier Aggregation with PCell in TDD measurement accuracy in carrier aggregation is within the specified limits. This test will verify the absolute accuracy of RSRQ measurements for the primary component carrier defined in Clause 9.1.11.1, the absolute accuracy of RSRQ measurements for the secondary component carrier defined in Clause 9.1.11.2, and also the relative RSRQ accuracy requirement between primary and secondary component carriers defined in Clause 9.1.11.3.

A.9.2.26.2 Test parameters

In this test case the PCell is TDD and SCell is FDD. Both RSRQ absolute and relative accuracy requirements of the primary and secondary component carrier are tested by using test parameters specified in Table A.9.2.26.2-1. In the test, Cell 1 is the PCell, Cell 2 is the SCell on the Secondary Component Carrier (SCC). The SCC is configured and activated.

The parameters of this test are given in Table A.9.2.26.2-1.

Table A.9.2.26.2-1: RSRQ for E-UTRAN TDD-FDD Carrier Aggregation with PCell in TDD test parameters

Parameter	Unit	Cell 1	Cell 2
E-UTRA RF Channel Number		1	2
BW_{channel}		5MHz: $N_{RB,c} = 25$ 10MHz: $N_{RB,c} = 50$ 20MHz: $N_{RB,c} = 100$	5MHz: $N_{RB,c} = 25$ 10MHz: $N_{RB,c} = 50$ 20MHz: $N_{RB,c} = 100$
Special subframe configuration ^{Note1}		6	-
Uplink-downlink configuration ^{Note1}		1	-
Measurement bandwidth	n_{PRB}	5MHz: 10-15 10MHz: 22-27 20MHz: 47-52	5MHz: 10-15 10MHz: 22-27 20MHz: 47-52
PDSCH Reference measurement channel defined in A.3.1.1		5MHz: R.4 TDD 10MHz: R.0 TDD 20MHz: R.3 TDD	5MHz: R.5 FDD 10MHz: R.0 FDD 20MHz: R.4 FDD

PDSCH allocation		n_{PRB}	5MHz: 7-17 10MHz: 13-36 20MHz: 38-61	5MHz: 7-17 10MHz: 13-36 20MHz: 38-61
PDCCH/PCFICH/PHICH Reference measurement channel defined in A.3.1.2			5MHz: R.11 TDD 10MHz: R.6 TDD 20MHz: R.10 TDD	5MHz: R.11 FDD 10MHz: R.6 FDD 20MHz: R.10 FDD
OCNG Patterns defined in A.3.2			5MHz: OP.9 TDD 10MHz: OP.1 TDD 20MHz: OP.7 TDD	5MHz: OP.15 FDD 10MHz: OP.1 FDD 20MHz: OP.11 FDD
PBCH_RA		dB	0	0
PBCH_RB				
PSS_RA				
SSS_RA				
PCFICH_RB				
PHICH_RA				
PHICH_RB				
PDCCH_RA				
PDCCH_RB				
PDSCH_RA				
PDSCH_RB				
OCNG_RA ^{Note2}				
OCNG_RB ^{Note2}				
N_{oc} ^{Note3}	Bands TDD_A			
	Bands TDD_C	-118.5	-	
	Bands TDD_E	-117.5	-	
	Bands FDD_A	-	-116	
	Bands FDD_B1, FDD_B2 ^{Note 11}	-	-115.5	
	Bands FDD_C	-	-115	
	Bands FDD_D	-	-114.5	
	Bands FDD_E, Bands FDD_F ^{Note 6}	-	-114	
	Bands FDD_G	-	-113	
Bands FDD_H	-	-112.5		
\hat{E}_s / N_{oc}		dB	-6.0	-6.0
\hat{E}_s / I_{ot}		dB	-6.0	-6.0
RSRP ^{Note4}	Bands TDD_A	dBm/15 kHz	-125.50	-
	Bands TDD_C		-124.50	-
	Bands TDD_E		-123.50	-
	Bands FDD_A		-	-122
	Bands FDD_B1, FDD_B2 ^{Note 11}		-	-119.5
	Bands FDD_C		-	-121
	Bands FDD_D		-	-120.5
	Bands FDD_E, Bands FDD_F ^{Note 6}		-	-120
	Bands FDD_G		-	-119
Bands FDD_H	-	-118.5		
RSRQ ^{Note4}	Bands TDD_A	dB	-17.77	-
	Bands TDD_C			
	Bands TDD_E			
	Bands FDD_A			
	Bands FDD_B1, FDD_B2 ^{Note 11}			
	Bands FDD_C			
	Bands FDD_D			
Bands FDD_E, Bands FDD_F ^{Note 6}	-	-17.77		

	Bands FDD_G			
	Bands FDD_H			
I _o ^{Note4}	Bands TDD_A	dBm/BW _{channel}	-90.75 + 10log(N _{RB,c} /50)	-
	Bands TDD_C		-89.75 + 10log(N _{RB,c} /50)	-
	Bands TDD_E		-88.75 + 10log(N _{RB,c} /50)	-
	Bands FDD_A		-	-87.25 + 10log(N _{RB,c} /50)
	Bands FDD_B1, FDD_B2 ^{Note 11}		-	-85.17
	Bands FDD_C		-	-86.25 + 10log(N _{RB,c} /50)
	Bands FDD_D		-	-85.75 + 10log(N _{RB,c} /50)
	Bands FDD_E, Bands FDD_F ^{Note 6}		-	-85.25 + 10log(N _{RB,c} /50)
	Bands FDD_G		-	-84.25 + 10log(N _{RB,c} /50)
	Bands FDD_H		-	-83.75 + 10log(N _{RB,c} /50)
Propagation Condition			AWGN	AWGN
Antenna Configuration			1x2	1x2
Timing offset to Cell 1		μs	-	0
Time alignment error relative to cell 1 ^{Note 10}			-	≤ TAE
<p>Note 1: For special subframe and uplink-downlink configurations see Tables 4.2-1 and 4.2-2 in TS 36.211.</p> <p>Note 2: OCNG shall be used such that both cells are fully allocated and a constant total transmitted power spectral density is achieved for all OFDM symbols.</p> <p>Note 3: Interference from other cells and noise sources not specified in the test is assumed to be constant over subcarriers and time and shall be modelled as AWGN of appropriate power for N_{oc} to be fulfilled.</p> <p>Note 4: Es/lot, RSRP, RSRQ and I_o levels have been derived from other parameters for information purposes. They are not settable parameters themselves.</p> <p>Note 5: RSRP and RSRQ minimum requirements are specified assuming independent interference and noise at each receiver antenna port.</p> <p>Note 6: For Band 26, the tests shall be performed with the carrier frequency of the assigned E-UTRA channel bandwidth within 865-894 MHz.</p> <p>Note 7: The selection of the bands for testing depends on the configuration of the carrier aggregation supported by the UEs.</p> <p>Note 8: This test verifies the RRM requirement which is independent of channel bandwidth and is performed according to the principle defined in section A.3.6.1.</p> <p>Note 9: E-UTRA operating band groups are as defined in Section 3.5.</p> <p>Note 10: Time alignment error (TAE) as specified in TS 36.104 [30] clause 6.5.3.1. The TAE value depends upon the type of carrier aggregation.</p> <p>Note 11: For Band 74, the tests shall be performed with the carrier frequency of the assigned E-UTRA channel bandwidth within 1475.9-1510.9 MHz.</p>				

A.9.2.26.3 Test Requirements

In the test, the RSRQ measurement accuracy in carrier aggregation shall fulfil the requirements in section 9.1.11.1, 9.1.11.2, and 9.1.11.3.

- The absolute accuracy of intra-frequency RSRQ measurements of Cell 1 on the primary component carrier shall fulfil the requirements defined in clause 9.1.11.1.
- The absolute accuracy of intra-frequency RSRQ measurements of Cell 2 on the secondary component carrier shall fulfil the requirements defined in clause 9.1.11.2.
- The relative accuracy of inter-frequency RSRQ measurements between the primary and secondary component carriers for Cell 2 relative to Cell 1 shall fulfil the requirements defined in clause 9.1.11.3.

A.9.2.27 TDD RSRQ for E-UTRAN Carrier Aggregation for 20MHz+10MHz

The test case in this section are applicable to carrier aggregation capable UEs which have been configured with a downlink SCell.

A.9.2.27.1 Test Purpose and Environment

The purpose of this test is the same as defined in Subclause A.9.2.6.1.

A.9.2.27.2 Test parameters

The parameters of this test are the same as defined in Subclause A.9.2.6.2 except that the values of the parameters in the Table A.9.2.27.2-1 will replace the values of the corresponding parameters in A.9.2.6.2-1.

Table A.9.2.27.2-1: TDD RSRQ Carrier Aggregation test parameters

Parameters		Units	Combination	Test 1		
				Cell 1	Cell 2	Cell 3
BW _{channel_CA} ^{Note1}		MHz	20MHz+10MHz	20MHz: N _{RB,c} = 100	10MHz: N _{RB,c} = 50	
			10MHz+20MHz	10MHz: N _{RB,c} = 50	20MHz: N _{RB,c} = 100	
Measurement bandwidth		n_{PRB}	20MHz+10MHz	47-52	22-27	
			10MHz+20MHz	22-27	47-52	
PDSCH Reference measurement channel defined in A.3.1.1.2			20MHz+10MHz	R.3 TDD	R.0 TDD	N/A
			10MHz+20MHz	R.0 TDD	R.3 TDD	
PDSCH allocation		n_{PRB}	20MHz+10MHz	38-61	13-36	N/A
			10MHz+20MHz	13-36	38-61	
PDCCH/PCFICH/PHICH Reference measurement channel defined in A.3.1.2.2			20MHz+10MHz	R.10 TDD	R.6 TDD	R.6 TDD
			10MHz+20MHz	R.6 TDD	R.10 TDD	R.10 TDD
OCNG Patterns defined in A.3.2.2 (TDD)			20MHz+10MHz	OP.7 TDD	OP.1 TDD	OP.2 TDD
			10MHz+20MHz	OP.1 TDD	OP.7 TDD	OP.8 TDD
I _o ^{Note2}	Bands TDD_A	dBm/BW _{channel}	All	-90.26 + 10log(N _{RB,c} /50)	N/A	
	Bands TDD_C			-89.26 + 10log(N _{RB,c} /50)		
	Bands TDD_E			-88.26 + 10log(N _{RB,c} /50)		
	Bands TDD_A	dBm/BW _{channel}	All	N/A	-85.67 + 10log(N _{RB,c} /50)	
	Bands TDD_C				-84.67 + 10log(N _{RB,c} /50)	
	Bands TDD_E				-83.67 + 10log(N _{RB,c} /50)	
<p>Note 1: This test verifies the RRM requirement which is independent of channel bandwidth and is performed according to the principle defined in section A.3.6.1.</p> <p>Note 2: I_o levels have been derived from other parameters for information purposes. They are not settable parameters themselves.</p> <p>Note 3: See Table A.9.2.6.2-1 for the other parameters.</p>						

A.9.2.27.3 Test Requirements

The test requirements defined in section A.9.2.6.3 shall apply in this test case.

A.9.2.28 FDD intra-frequency absolute RSRQ accuracy with CRS based discovery signal

A.9.2.28.1 Test Purpose and Environment

The purpose of this test is to verify that the RSRQ measurement accuracy is within the specified limits. This test will verify the requirements in Clause 9.1.14.4.

A.9.2.28.2 Test parameters

In this test case all cells are on the same carrier frequency. The absolute accuracy of RSRQ intra frequency measurement for Cell 2 is tested by using the parameters in Table A.9.2.28.2-1. In all test cases, Cell 1 is the PCell and Cell 2 the target cell. Cell 2 DMTC configuration is provided to the UE in the *measDS-Config* before the start of the test.

Table A.9.2.28.2-1: RSRQ FDD Intra frequency test parameters

Parameter		Unit	Test 1				
			Cell 1	Cell 2			
E-UTRA RF Channel Number			1				
BW _{channel}		MHz	10				
Measurement bandwidth		<i>n</i> _{PRB}	22–27				
DMTC period		ms	N/A	160			
DMTC period offset		ms	N/A	10			
Discovery signal occasion duration		ms	N/A	1			
Time offset between cell 1 and cell 2		μs	0	2.3			
PDSCH Reference measurement channel defined in A.3.1.1.1			R.0 FDD	-			
<i>PDSCH allocation</i>		<i>n</i> _{PRB}	13–36	-			
PDCCH/PCFICH/PHICH Reference measurement channel defined in A.3.1.2.1			R.6 FDD				
OCNG Patterns defined in A.3.2.1.1 (OP.1 FDD) and A.3.2.1.2 (OP.2 FDD)			OP.1 FDD	OP.2 FDD			
PBCH_RA		dB	0	0			
PBCH_RB							
PSS_RA							
SSS_RA							
PCFICH_RB							
PHICH_RA							
PHICH_RB							
PDCCH_RA							
PDCCH_RB							
PDSCH_RA							
PDSCH_RB							
OCNG_RA ^{Note1}							
OCNG_RB ^{Note1}							
<i>N</i> _{oc} ^{Note2}	Bands FDD_A ^{Note 8}					-116	
	Bands FDD_B1, FDD_B2 ^{Note 9}				dBm/15 kHz	-115.5	
	Bands FDD_C	-115					
	Bands FDD_D	-114.5					
	Bands FDD_E, FDD_F ^{Note 5}	-114					
	Bands FDD_G ^{Note 7}	-113					
	Bands FDD_H	-112.5					
\hat{E}_s / I_{ot}		dB	-5.46	-5.46			
RSRP ^{Note3}	Bands FDD_A ^{Note 8}	dBm/15 kHz	-120	-120			
	Bands FDD_B1, FDD_B2 ^{Note 9}		-119.5	-119.5			
	Bands FDD_C		-119	-119			
	Bands FDD_D		-118.5	-118.5			
	Bands FDD_E, FDD_F ^{Note 5}		-118	-118			
	Bands FDD_G ^{Note 7}		-117	-117			

	Bands FDD_H		-116.5	-116.5
RSRQ ^{Note3}	Bands FDD_A ^{Note 8}	dB	-17.34	-17.34
	Bands FDD_B1, FDD_B2 ^{Note 9}			
	Bands FDD_C			
	Bands FDD_D			
	Bands FDD_E, FDD_F ^{Note 5}			
	Bands FDD_G ^{Note 7}			
	Bands FDD_H			
I _o ^{Note3}	Bands FDD_A ^{Note 8}	dBm/9 MHz	-85.67	
	Bands FDD_B1, FDD_B2 ^{Note 9}		-85.17	
	Bands FDD_C		-84.67	
	Bands FDD_D		-84.17	
	Bands FDD_E, FDD_F ^{Note 5}		-83.67	
	Bands FDD_G ^{Note 7}		-82.67	
	Bands FDD_H		-82.17	
\hat{E}_s / N_{oc}		dB	-4	-4
Propagation condition		-	AWGN	
<p>Note 1: OCNG shall be used such that both cells are fully allocated and a constant total transmitted power spectral density is achieved for all OFDM symbols.</p> <p>Note 2: Interference from other cells and noise sources not specified in the test is assumed to be constant over subcarriers and time and shall be modelled as AWGN of appropriate power for N_{oc} to be fulfilled.</p> <p>Note 3: RSRQ, RSRP and I_o levels have been derived from other parameters for information purposes. They are not settable parameters themselves.</p> <p>Note 4: RSRP and RSRQ minimum requirements are specified assuming independent interference and noise at each receiver antenna port.</p> <p>Note 5: For Band 26, the tests shall be performed with the carrier frequency of the assigned E-UTRA channel bandwidth within 865-894 MHz.</p> <p>Note 6: E-UTRA operating band groups are as defined in Section 3.5.</p> <p>Note 7: Except Band 29.</p> <p>Note 8: Except Band 32, Band 75, Band 76.</p> <p>Note 9: For Band 74, the tests shall be performed with the carrier frequency of the assigned E-UTRA channel bandwidth within 1475.9-1510.9 MHz.</p>				

A.9.2.28.3 Test Requirements

The absolute accuracy of RSRQ intra frequency measurement for Cell 2 shall fulfil the requirements in Clause 9.1.14.4.

A.9.2.29 TDD intra-frequency absolute RSRQ accuracy with CRS based discovery signal

A.9.2.29.1 Test Purpose and Environment

The purpose of this test is to verify that the RSRQ measurement accuracy is within the specified limits. This test will verify the requirements in Clause 9.1.14.4.

A.9.2.29.2 Test parameters

In this test case all cells are on the same carrier frequency. The absolute accuracy of RSRQ intra frequency measurement for Cell 2 is tested by using the parameters in Table A.9.2.29.2-1. In all test cases, Cell 1 is the PCell and Cell 2 the target cell. Cell 2 DMTC configuration is provided to the UE in the *measDS-Config* before the start of the test.

Table A.9.2.29.2-1: RSRQ TDD Intra frequency test parameters

Parameter	Unit	Test 1	
		Cell 1	Cell 2
E-UTRA RF Channel Number		1	
BW _{channel}	MHz	10	
Special subframe configuration ^{Note1}		6	
Uplink-downlink configuration ^{Note1}		1	
Measurement bandwidth	n_{PRB}	22–27	

DMTC period	ms	N/A	160	
DMTC period offset	ms	N/A	10	
Discovery signal occasion duration	ms	N/A	2	
Time offset between cell 1 and cell 2	μs	0	2.3	
PDSCH Reference measurement channel defined in A.3.1.1.2		R.0 TDD	-	
PDSCH allocation	n_{PRB}	13–36	-	
PDCCH/PCFICH/PHICH Reference measurement channel defined in A.3.1.2.2		R.6 TDD		
OCNG Patterns defined in A.3.2.2.1 (OP.1 TDD) and A.3.2.2.2 (OP.2 TDD)		OP.1 TDD	OP.2 TDD	
PBCH_RA	dB	0	0	
PBCH_RB				
PSS_RA				
SSS_RA				
PCFICH_RB				
PHICH_RA				
PHICH_RB				
PDCCH_RA				
PDCCH_RB				
PDSCH_RA				
PDSCH_RB				
OCNG_RA ^{Note1}				
OCNG_RB ^{Note1}				
N_{oc} ^{Note2}				Bands TDD_A
	Bands TDD_C	-115		
	Bands TDD_E	-114		
\hat{E}_s / I_{ot}	dB	-5.46	-5.46	
RSRP ^{Note3}	Bands TDD_A	dBm/15 kHz	-120	-120
	Bands TDD_C		-119	-119
	Bands TDD_E		-118	-118
RSRQ ^{Note3}	Bands TDD_A	dB	-17.34	-17.34
	Bands TDD_C			
	Bands TDD_E			
I _o ^{Note3}	Bands TDD_A	dBm/9 MHz	-85.67	
	Bands TDD_C		-84.67	
	Bands TDD_E		-83.67	
\hat{E}_s / N_{oc}	dB	-4	-4	
Propagation condition	-	AWGN		
<p>Note 1: For special subframe and uplink-downlink configurations see Tables 4.2-1 and 4.2-2 in TS 36.211.</p> <p>Note 2: OCNG shall be used such that both cells are fully allocated and a constant total transmitted power spectral density is achieved for all OFDM symbols.</p> <p>Note 3: Interference from other cells and noise sources not specified in the test is assumed to be constant over subcarriers and time and shall be modelled as AWGN of appropriate power for N_{oc} to be fulfilled.</p> <p>Note 4: RSRQ, RSRP and I_o levels have been derived from other parameters for information purposes. They are not settable parameters themselves.</p> <p>Note 5: RSRP and RSRQ minimum requirements are specified assuming independent interference and noise at each receiver antenna port.</p> <p>Note 6: E-UTRA operating band groups are as defined in Section 3.5.</p>				

A.9.2.29.3 Test Requirements

The absolute accuracy of RSRQ intra frequency measurement for Cell 2 shall fulfil the requirements in Clause 9.1.14.4.

A.9.2.30 FDD-FDD inter-frequency absolute and relative RSRQ accuracies with CRS based discovery signal

A.9.2.30.1 Test Purpose and Environment

The purpose of this test is to verify that the absolute and relative accuracy of RSRQ measurement in discovery signal occasions is within the specified limits. This test will verify the requirements in Sections 9.1.14.4.

A.9.2.30.2 Test parameters

In this test case the two cells are on different carrier frequencies and measurement gaps are provided. Both RSRQ inter frequency absolute and relative accuracy requirements are tested by using test parameters in Table A.9.2.30.2-1. In all tests, Cell 1 is the PCell and Cell 2 the target cell. For measurement of the carrier frequency of Cell 2, DMTC configuration is provided to the UE in the *measDS-Config* before the start of the test.

Table A.9.2.30.2-1: RSRQ in discovery signal occasions FDD—FDD Inter frequency test parameters

Parameter	Unit	Test 1	
		Cell 1	Cell 2
E-UTRA RF Channel Number		1	2
BW _{channel}	MHz	10	10
Gap Pattern Id		0	-
Gap Offset	ms	9	-
DMTC period	ms	-	160
DMTC period offset	ms	-	10
Discovery signal occasion duration	ms	-	1
Time offset between cell 2 and cell 1	μs	3	
Measurement bandwidth	n_{PRB}	22-27	
PDSCH Reference measurement channel defined in A.3.1.1.1		R.0 FDD	-
PDSCH allocation	n_{PRB}	13-36	-
PDCCH/PCFICH/PHICH Reference measurement channel defined in A.3.1.2.1		R.6 FDD	
OCNG Patterns defined in A.3.2.1.1 (OP.1 FDD) and A.3.2.1.2 (OP.2 FDD)		OP.1 FDD	OP.2 FDD
PBCH_RA	dB	0	0
PBCH_RB			
PSS_RA			
SSS_RA			
PCFICH_RB			
PHICH_RA			
PHICH_RB			
PDCCH_RA			
PDCCH_RB			
PDSCH_RA			
PDSCH_RB			
OCNG_RA ^{Note1}			
OCNG_RB ^{Note1}			
N_{oc} ^{Note2}			
	Bands FDD_B1, FDD_B2 ^{Note 9}	-117	-117
	Bands FDD_C	-116.5	-116.5
	Bands FDD_D	-116	-116
	Bands FDD_E, FDD_F ^{Note 5}	-115.5	-115.5
	Bands FDD_G ^{Note 7}	-114.5	-114.5
	Bands FDD_H	-114	-114
\hat{E}_s/I_{ot}	dB	-6	-6
RSRP ^{Note3}	Bands FDD_A ^{Note 8}	-123.5	-123.5
	Bands FDD_B1, FDD_B2 ^{Note 9}	-123	-123
	Bands FDD_C	-122.5	-122.5

	Bands FDD_D		-122	-122
	Bands FDD_E, FDD_F ^{Note 5}		-121.5	-121.5
	Bands FDD_G ^{Note 7}		-120.5	-120.5
	Bands FDD_H		-120	-120
RSRQ ^{Note3}	Bands FDD_A ^{Note 8}	dB	-17.77	-17.77
	Bands FDD_B1, FDD_B2 ^{Note 9}			
	Bands FDD_C			
	Bands FDD_D			
	Bands FDD_E, FDD_F ^{Note 5}			
	Bands FDD_G ^{Note 7}			
	Bands FDD_H			
Io ^{Note3}	Bands FDD_A ^{Note 8}	dBm/ 9 MHz	-88.75	-88.75
	Bands FDD_B1, FDD_B2 ^{Note 9}		-88.25	-88.25
	Bands FDD_C		-87.75	-87.75
	Bands FDD_D		-87.25	-87.25
	Bands FDD_E, FDD_F ^{Note 5}		-86.75	-86.75
	Bands FDD_G ^{Note 7}		-85.75	-85.75
	Bands FDD_H		-85.25	-85.25
\hat{E}_s / N_{oc}		dB	-6	-6
Propagation condition		-	AWGN	
Note 1:	OCNG shall be used such that both cells are fully allocated and a constant total transmitted power spectral density is achieved for all OFDM symbols.			
Note 2:	Interference from other cells and noise sources not specified in the test is assumed to be constant over subcarriers and time and shall be modelled as AWGN of appropriate power for N_{oc} to be fulfilled.			
Note 3:	RSRQ, RSRP and Io levels have been derived from other parameters for information purposes. They are not settable parameters themselves.			
Note 4:	RSRP and RSRQ minimum requirements are specified assuming independent interference and noise at each receiver antenna port.			
Note 5:	For Band 26, the tests shall be performed with the carrier frequency of the assigned E-UTRA channel bandwidth within 865-894 MHz.			
Note 6:	E-UTRA operating band groups are as defined in Section 3.5.			
Note 7:	Except Band 29.			
Note 8:	Except Band 32, Band 75, Band 76.			
Note 9:	For Band 74, the tests shall be performed with the carrier frequency of the assigned E-UTRA channel bandwidth within 1475.9-1510.9 MHz.			

A.9.2.30.3 Test Requirements

The RSRQ measurement accuracy shall fulfil the requirements in Sections 9.1.14.4.

A.9.2.31 TDD-TDD inter-frequency absolute and relative RSRQ accuracies with CRS based discovery signal

A.9.2.31.1 Test Purpose and Environment

The purpose of this test is to verify that the RSRQ measurement accuracy in discovery signal occasions is within the specified limits. This test will verify the requirements in Sections 9.1.14.4.

A.9.2.31.2 Test parameters

In this test case the two cells are on different carrier frequencies and measurement gaps are provided. Both RSRQ inter frequency absolute and relative accuracy requirements are tested by using test parameters in Table A.9.2.31.2-1 for TDD configuration 1. In all tests, Cell 1 is the PCell and Cell 2 the target cell. DMTC configuration for Cell 2 is provided to UE in the *measDS-Config* before the start of the test.

Table A 9.2.31.2-1: RSRQ TDD—TDD Inter frequency test parameters for TDD configuration 1

Parameter		Unit	Test 1				
			Cell 1	Cell 2			
E-UTRA RF Channel Number			1	2			
BW _{channel}		MHz	10	10			
Gap Pattern Id			0	-			
Gap Offset			9	-			
DMTC period		ms	-	160			
DMTC period offset		ms	-	10			
Discovery signal occasion duration		ms	-	2			
Time offset between cells		μs	0	3			
Special subframe configuration ^{Note1}			6				
Uplink-downlink configuration ^{Note1}			1				
Measurement bandwidth		n_{PRB}	22-27				
PDSCH Reference measurement channel defined in A.3.1.1.2			R.0 TDD	-			
PDSCH allocation		n_{PRB}	13—36	-			
PDCCH/PCFICH/PHICH Reference measurement channel defined in A.3.1.2.2			R.6 TDD				
OCNG Patterns defined in A.3.2.2.1 (OP.1 TDD) and A.3.2.2.2 (OP.2 TDD)			OP.1 TDD	OP.2 TDD			
PBCH_RA		dB	0	0			
PBCH_RB							
PSS_RA							
SSS_RA							
PCFICH_RB							
PHICH_RA							
PHICH_RB							
PDCCH_RA							
PDCCH_RB							
PDSCH_RA							
PDSCH_RB							
OCNG_RA ^{Note2}							
OCNG_RB ^{Note2}							
N_{oc} ^{Note3}	Bands TDD_A				dBm/15 kHz	-117.50	-117.50
	Bands TDD_C					-116.50	-116.50
	Bands TDD_E	-115.50	-115.50				
\hat{E}_s/I_{ot}		dB	-6.0	-6.0			
RSRP ^{Note4}	Bands TDD_A	dBm/15 kHz	-123.50	-123.50			
	Bands TDD_C		-122.50	-122.50			
	Bands TDD_E		-121.50	-121.50			
RSRQ ^{Note4}	Bands TDD_A, TDD_C, TDD_E	dB	-17.77	-17.77			
I _o ^{Note4}	Bands TDD_A	dBm/9 MHz	-88.75	-88.75			
	Bands TDD_C		-87.75	-87.75			
	Bands TDD_E		-86.75	-86.75			
\hat{E}_s/N_{oc}		dB	-6.0	-6.0			
Propagation condition		-	AWGN				
<p>Note 1: For special subframe and uplink-downlink configurations see Tables 4.2-1 and 4.2-2 in TS 36.211.</p> <p>Note 2: OCNG shall be used such that both cells are fully allocated and a constant total transmitted power spectral density is achieved for all OFDM symbols.</p> <p>Note 3: Interference from other cells and noise sources not specified in the test is assumed to be constant over subcarriers and time and shall be modelled as AWGN of appropriate power for N_{oc} to be fulfilled.</p> <p>Note 4: RSRP and I_o levels have been derived from other parameters for information purposes. They are not settable parameters themselves.</p>							

Note 5:	RSRP minimum requirements are specified assuming independent interference and noise at each receiver antenna port.
Note 6:	E-UTRA operating band groups are as defined in Section 3.5.

A.9.2.31.3 Test Requirements

The RSRQ measurement accuracy shall fulfil the requirements in Sections 9.1.14.4.

A.9.2.32 FDD absolute and relative RSRQ accuracy for E-UTRAN Carrier Aggregation in CRS based discovery signal

A.9.2.32.1 Test Purpose and Environment

The purpose of this test is to verify that the FDD RSRQ measurement accuracy for carrier aggregation in CRS based discovery signal is within the specified limits under AWGN propagation conditions. This test will verify the absolute accuracy of intra-frequency RSRQ measurements for the secondary component carrier specified in clause 9.1.15.1.2, and also the relative inter-frequency RSRQ accuracy requirement between primary and secondary component carriers specified in clause 9.1.15.1.3.

A.9.2.32.2 Test parameters

In this test case the PCell and the SCell are on different carrier frequencies. There are three cells used in this test case. RSRQ absolute and relative accuracy requirements of the primary and secondary component carrier are tested by using test parameters specified in Table A.9.2.32.2-1. In the test, Cell 1 is the PCell, Cell 2 is the SCell on the Secondary Component Carrier (SCC) and Cell 3 is the neighbouring cell on the SCC. Cell 2 on SCC is configured and activated. Cell 3 DMTC configuration is provided to the UE in the *measDS-Config* before the start of the test.

Table A.9.2.32.2-1: FDD RSRQ Carrier Aggregation Test Parameters

Parameters	Test 1			
	Units	Cell 1	Cell 2	Cell 3
E-UTRA RF Channel Number		1	2	2
BW _{channel_CA}	MHz	10	10	10
DMTC period		N/A	N/A	160
DMTC period offset		N/A	N/A	10
Discovery signal occasion duration		N/A	N/A	1
Timing offset to Cell 1	μs	-	0	3
Time alignment error between cell 2 and cell 1		-	≤ Time alignment error as specified in 3GPP TS 36.104 [30] clause 6.5.3.1	-
Measurement bandwidth	n_{PRB}	22—27	22—27	22—27
PDSCH Reference measurement channel defined in A.3.1.1.1		R.0 FDD	R.0 FDD	-
PDSCH allocation	n_{PRB}	13—36	13—36	-
PDCCH/PCFICH/PHICH Reference measurement channel defined in A.3.1.2.1		R.6 FDD	R.6FDD	R.6 FDD
OCNG Patterns defined in A.3.2.1.1 (OP.1 FDD) and A.3.2.1.2 (OP.2 FDD)		OP.1 FDD	OP.1 FDD	OP.2 FDD
PBCH_RA	dB	0	0	0
PBCH_RB				
PSS_RA				
SSS_RA				
PCFICH_RB				
PHICH_RA				
PHICH_RB				
PDCCH_RA				

PDCCH_RB					
PDSCH_RA					
PDSCH_RB					
OCNG_RA ^{Note1}					
OCNG_RB ^{Note1}					
N_{oc} ^{Note2}	Bands FDD_A	dBm/15 kHz	-119.5	-116	-116
	Bands FDD_B1, FDD_B2 ^{Note 9}		-119	-115.5	-115.5
	Bands FDD_C		-118.5	-115	-115
	Bands FDD_D		-118	-114.5	-114.5
	Bands FDD_E, FDD_F ^{Note 6}		-117.5	-114	-114
	Bands FDD_G		-116.5	-113	-113
	Bands FDD_H		-116	-112.5	-112.5
\hat{E}_s/I_{ot}		dB	-4.0	-5.46	-5.46
RSRP ^{Note3}	Bands FDD_A	dBm/15 kHz	-123.5	-120	-120
	Bands FDD_B1, FDD_B2 ^{Note 9}		-123	-119.5	-119.5
	Bands FDD_C		-122.5	-119	-119
	Bands FDD_D		-122	-118.5	-118.5
	Bands FDD_E, FDD_F ^{Note 6}		-121.5	-118	-118
	Bands FDD_G		-120.5	-117	-117
	Bands FDD_H		-120	-116.5	-116.5
RSRQ ^{Note3}	Bands FDD_A	dB	-16.25	-17.34	-17.34
	Bands FDD_B1, FDD_B2 ^{Note 9}				
	Bands FDD_C				
	Bands FDD_D				
	Bands FDD_E, FDD_F ^{Note 6}				
	Bands FDD_G				
	Bands FDD_H				
I_o ^{Note3}	Bands FDD_A	dBm/9 MHz	-90.26	-85.67	-85.67
	Bands FDD_B1, FDD_B2 ^{Note 9}		-89.76	-85.17	-85.17
	Bands FDD_C		-89.26	-84.67	-84.67
	Bands FDD_D		-88.76	-84.17	-84.17
	Bands FDD_E, FDD_F ^{Note 6}		-88.26	-83.67	-83.67
	Bands FDD_G		-87.26	-82.67	-82.67
	Bands FDD_H		-86.76	-82.17	-82.17
\hat{E}_s/N_{oc}		dB	-4.0	-4.0	-4.0
Propagation condition		-	AWGN		
<p>Note 1: OCNG shall be used such that both cells are fully allocated and a constant total transmitted power spectral density is achieved for all OFDM symbols.</p> <p>Note 2: Interference from other cells and noise sources not specified in the test is assumed to be constant over subcarriers and time and shall be modelled as AWGN of appropriate power for N_{oc} to be fulfilled.</p> <p>Note 3: RSRQ, RSRP and I_o levels have been derived from other parameters for information purposes. They are not settable parameters themselves.</p> <p>Note 4: RSRP and RSRQ minimum requirements are specified assuming independent interference and noise at each receiver antenna port.</p> <p>Note 5: The selection of the bands for testing depends on the configuration of the carrier aggregation supported by the UEs</p> <p>Note 6: For Band 26, the tests shall be performed with the carrier frequency of the assigned E-UTRA channel bandwidth within 865-894 MHz.</p> <p>Note 7: This test verifies the RRM requirement which is independent of channel bandwidth and is performed according to the principle defined in section A.3.6.1.</p> <p>Note 8: E-UTRA operating band groups are as defined in Section 3.5.</p> <p>Note 9: For Band 74, the tests shall be performed with the carrier frequency of the assigned E-UTRA channel bandwidth within 1475.9-1510.9 MHz.</p>					

A.9.2.32.3 Test Requirements

In the test, the RSRQ measurement accuracy in carrier aggregation shall fulfil the requirements in clause 9.1.15.1.1, 9.1.15.1.2, and 9.1.15.1.3.

- The absolute accuracy of intra-frequency RSRQ measurements of Cell 3 on the secondary component carrier shall fulfil the requirements specified in clause 9.1.15.1.2.
- The relative accuracy of inter-frequency RSRQ measurements between Cell 1 on primary component carriers and Cell 3 on the secondary component carrier shall fulfil the requirements specified in clause 9.1.15.1.3.

A.9.2.33 TDD absolute and relative RSRQ accuracy for E-UTRAN Carrier Aggregation in CRS based discovery signal

A.9.2.33.1 Test Purpose and Environment

The purpose of this test is to verify that the TDD RSRQ measurement accuracy for carrier aggregation in CRS based discovery signal is within the specified limits under AWGN propagation conditions. This test will verify the absolute accuracy of intra-frequency RSRQ measurements for the secondary component carrier specified in clause 9.1.15.1.2, and also the relative inter-frequency RSRQ accuracy requirement between primary and secondary component carriers specified in clause 9.1.15.1.3.

A.9.2.33.2 Test parameters

In this test case the PCell and the SCell are on different carrier frequencies. There are three cells used in this test case. RSRQ absolute and relative accuracy requirements of the primary and secondary component carrier are tested by using test parameters specified in Table A.9.2.33.2-1. In the test, Cell 1 is the PCell, Cell 2 is the SCell on the Secondary Component Carrier (SCC) and Cell 3 is the neighbouring cell on the SCC. Cell 2 on SCC is configured and activated. Cell 3 DMTC configuration is provided to the UE in the *measDS-Config* before the start of the test.

Table A.9.2.33.2-1: TDD RSRQ Carrier Aggregation Test Parameters

Parameter	Unit	Test 1		
		Cell 1	Cell 2	Cell 3
E-UTRA RF Channel Number		1	2	2
BW _{channel}	MHz	10		
DMTC period		N/A	N/A	160
DMTC period offset		N/A	N/A	10
Discovery signal occasion duration		N/A	N/A	2
Timing offset to cell 1	μs	-	0	3
Time alignment error between cell 2 and cell 1		-	≤ Time alignment error as specified in 3GPP TS 36.104 [30] clause 6.5.3.1	-
Special subframe configuration ^{Note1}		6		
Uplink-downlink configuration ^{Note1}		1		
Measurement bandwidth	n_{PRB}	22—27		
PDSCH Reference measurement channel defined in A.3.1.1.2		R.0 TDD	R.0 TDD	-
PDSCH allocation	n_{PRB}	13—36	13—36	-
PDCCH/PCFICH/PHICH Reference measurement channel defined in A.3.1.2.2		R.6 TDD	R.6 TDD	R.6 TDD
OCNG Patterns defined in A.3.2.2.1 (OP.1 TDD) and A.3.2.2.2 (OP.2 TDD)		OP.1 TDD	OP.1 TDD	OP.2 TDD
PBCH_RA	dB	0	0	0
PBCH_RB				
PSS_RA				

SSS_RA					
PCFICH_RB					
PHICH_RA					
PHICH_RB					
PDCCH_RA					
PDCCH_RB					
PDSCH_RA					
PDSCH_RB					
OCNG_RA ^{Note2}					
OCNG_RB ^{Note2}					
N_{oc} ^{Note3}	Bands TDD_A	dBm/15 kHz	-119.5	-116	
	Bands TDD_C		-118.5	-115	
	Bands TDD_E		-117.5	-114	
\hat{E}_s/I_{ot}		dB	-4.0	-5.46	-5.46
RSRP ^{Note4}	Bands TDD_A	dBm/15 kHz	-123.50	-120	-120
	Bands TDD_C		-122.50	-119	-119
	Bands TDD_E		-121.50	-118	-118
RSRQ ^{Note4}	Bands TDD_A, TDD_C, TDD_E	dB	-16.25	-17.34	
I_o ^{Note4}	Bands TDD_A	dBm/9 MHz	-90.26	-85.67	
	Bands TDD_C		-89.26	-84.67	
	Bands TDD_E		-88.26	-83.67	
\hat{E}_s/N_{oc}		dB	-4.0	-4.0	-4.0
Propagation condition		-	AWGN		
Note 1:	For special subframe and uplink-downlink configurations see Tables 4.2-1 and 4.2-2 in TS 36.211.				
Note 2:	OCNG shall be used such that both cells are fully allocated and a constant total transmitted power spectral density is achieved for all OFDM symbols.				
Note 3:	Interference from other cells and noise sources not specified in the test is assumed to be constant over subcarriers and time and shall be modelled as AWGN of appropriate power for N_{oc} to be fulfilled.				
Note 4:	RSRQ, RSRP and I_o levels have been derived from other parameters for information purposes. They are not settable parameters themselves.				
Note 5:	RSRP and RSRQ minimum requirements are specified assuming independent interference and noise at each receiver antenna port.				
Note 6:	The selection of the bands for testing depends on the configuration of the carrier aggregation supported by the UEs.				
Note 7:	This test verifies the RRM requirement which is independent of channel bandwidth and is performed according to the principle defined in section A.3.6.1.				
Note 8:	E-UTRA operating band groups are as defined in Section 3.5.				

A.9.2.33.3 Test Requirements

In the test, the RSRQ measurement accuracy in carrier aggregation shall fulfil the requirements in clause 9.1.15.1.1, 9.1.15.1.2, and 9.1.15.1.3.

- The absolute accuracy of intra-frequency RSRQ measurements of Cell 3 on the secondary component carrier shall fulfil the requirements specified in clause 9.1.15.1.2.
- The relative accuracy of inter-frequency RSRQ measurements between Cell 1 on primary component carriers and Cell 3 on the secondary component carrier shall fulfil the requirements specified in clause 9.1.15.1.3.

A.9.2.34 FDD—FDD Inter frequency new RSRQ

A.9.2.34.1 Test Purpose and Environment

The purpose of this test is to verify that the absolute accuracy of RSRQ measurement is within the specified limits when measurement configuration message received by the UE contains *measRSRQ-OnAllSymbols-r12* parameter in TS 36.331 [2]. This test will verify the requirements in Sections 9.1.16.

A.9.2.34.2 Test parameters

In this test case the two cells are on different carrier frequencies and measurement gaps are provided. The new RSRQ inter frequency absolute accuracy requirement is tested by using test parameters in Table A.9.2.34.2-1. In the test, Cell 1 is the PCell and Cell 2 the target cell.

Table A.9.2.34.2-1: New RSRQ FDD—FDD Inter frequency test parameters

Parameter		Unit	Test 1			
			Cell 1	Cell 2		
E-UTRA RF Channel Number			1	2		
BW_{channel}		MHz	10	10		
Gap Pattern Id			0	-		
Antenna Configuration			1x2	1x2		
Time offset between cell 2 and cell 1		μs	3			
Measurement bandwidth		n_{PRB}	22-27			
PDSCH Reference measurement channel defined in A.3.1.1.1			R.0 FDD	-		
PDSCH allocation		n_{PRB}	-	-		
PDCCH/PCFICH/PHICH Reference measurement channel defined in A.3.1.2.1			R.6 FDD	-		
OCNG Patterns defined in A.3.2.1.1 (OP.1 FDD)			OP.1 FDD	-		
PBCH_RA		dB	0	0		
PBCH_RB				0		
PSS_RA				0		
SSS_RA				0		
PCFICH_RB				$-\infty$		
PHICH_RA				$-\infty$		
PHICH_RB				$-\infty$		
PDCCH_RA				$-\infty$		
PDCCH_RB				$-\infty$		
PDSCH_RA				$-\infty$		
PDSCH_RB				$-\infty$		
OCNG_RA ^{Note1}				$-\infty$		
OCNG_RB ^{Note1}				$-\infty$		
I_{ot} ^{Note2}	Symbols with CRS, PSS, SSS or PBCH			dBm/15 kHz	-103.85	-103.85
	All the other symbols				-94.75	-94.75
\hat{E}_s/I_{ot}				dB	-3	-3
RSRP ^{Note3}		dBm/15 kHz	-106.85	-106.85		
RSRQ ^{Note3}	Subframe 0	dB	-14.54	-14.54		
	Subframes other than 0		-14.14	-14.14		
New RSRQ ^{Note3}	Subframe 0	dB	-19.57	-19.57		
	Subframe 5		-20.93	-20.93		
	Subframe other than 0 or 5		-21.66	-21.66		
I_0 in subframe 0 ^{Note3}	Symbol 0/4/11	dBm/ 9 MHz	-75.72	-75.72		
	Symbol 1/2/3/12/13		-66.97	-66.97		
	Symbol 5/6/8/9/10		-75.81	-75.81		
	Symbol 7		-75.52	-75.52		
Symbol 0/4/7/11			-75.72	-75.72		

Io in subframe 5 ^{Note3}	Symbol 1/2/3/8/9/10/12/13	dBm/ 9 MHz	-66.97	-66.97
	Symbol 5/6		-75.81	-75.81
Io in subframes other than 0 or 5 ^{Note3}	Symbol 0/4/7/11	dBm/ 9 MHz	-75.72	-75.72
	Symbol 1/2/3/5/6/8/9/10/12/13		-66.97	-66.97
Propagation condition		-	AWGN	
Note 1:	OCNG shall be used such that both cells are fully allocated and a constant total transmitted power spectral density is achieved for all OFDM symbols.			
Note 2:	Interference from other cells and noise sources not specified in the test is assumed to be constant over subcarriers and time and shall be modelled as AWGN of appropriate power for N_{oc} to be fulfilled.			
Note 3:	RSRQ, RSRP, new RSRQ and Io levels have been derived from other parameters for information purposes. They are not settable parameters themselves. The new RSRQ values assume RSSI averaging over all OFDM symbols of the subframe.			
Note 4:	RSRP and RSRQ minimum requirements are specified assuming independent interference and noise at each receiver antenna port.			

A.9.2.34.3 Test Requirements

The new RSRQ measurement accuracy for cell 2 shall fulfil the requirements in Section 9.1.16, compared with any nominal new RSRQ value in subframe 0, 5 or others.

A.9.2.35 TDD—TDD Inter frequency new RSRQ

A.9.2.35.1 Test Purpose and Environment

The purpose of this test is to verify that the absolute accuracy of RSRQ measurement is within the specified limits when measurement configuration message received by the UE contains *measRSRQ-OnAllSymbols-r12* parameter in TS 36.331 [2]. This test will verify the requirements in Sections 9.1.16.

A.9.2.35.2 Test parameters

In this test case the two cells are on different carrier frequencies and measurement gaps are provided. The new RSRQ inter frequency absolute accuracy requirement is tested by using test parameters in Table A.9.2.35.2-1. In the test, Cell 1 is the PCell and Cell 2 the target cell.

Table A.9.2.35.2-1: New RSRQ TDD—TDD Inter frequency test parameters

Parameter	Unit	Test 1	
		Cell 1	Cell 2
E-UTRA RF Channel Number		1	2
BW _{channel}	MHz	10	10
Special subframe configuration ^{Note1}		6	6
Uplink-downlink configuration ^{Note1}		1	1
Gap Pattern Id		0	-
Antenna Configuration		1x2	1x2
Time offset between cell 2 and cell 1	μs	3	
Measurement bandwidth	n_{PRB}	22-27	
PDSCH Reference measurement channel defined in A.3.1.1.2		R.0 TDD	-
PDSCH allocation	n_{PRB}	-	-
PDCCH/PCFICH/PHICH Reference measurement channel defined in A.3.1.2.2		R.6 TDD	-
OCNG Patterns defined in A.3.2.2.1 (OP.1 TDD)		OP.1 TDD	-
PBCH_RA	dB	0	0
PBCH_RB			0
PSS_RA			0
SSS_RA			0
PCFICH_RB			-∞

PHICH_RA				$-\infty$
PHICH_RB				$-\infty$
PDCCH_RA				$-\infty$
PDCCH_RB				$-\infty$
PDSCH_RA				$-\infty$
PDSCH_RB				$-\infty$
OCNG_RA ^{Note1}				$-\infty$
OCNG_RB ^{Note1}				$-\infty$
I_{ot} ^{Note2}	Symbols with CRS, PSS, SSS or PBCH	dBm/15 kHz	-103.85	-103.85
	All the other symbols		-94.75	-94.75
\hat{E}_s/I_{ot}		dB	-3	-3
RSRP ^{Note3}		dBm/15 kHz	-106.85	-106.85
RSRQ ^{Note3}	Subframe 0	dB	-14.54	-14.54
	Subframes other than 0		-14.14	-14.14
New RSRQ ^{Note3}	Subframe 0	dB	-20.08	-20.08
	Subframe 5		-21.31	-21.31
	Subframe 1 or 6		-20.82	-20.82
	Subframe other than 0, 1, 5 or 6		-21.66	-21.66
Io in subframe 0 ^{Note3}	Symbol 0/4/11	dBm/ 9 MHz	-75.72	-75.72
	Symbol 1/2/3/5/6/12		-66.97	-66.97
	Symbol 8/9/10/13		-75.81	-75.81
	Symbol 7		-75.52	-75.52
Io in subframe 5 ^{Note3}	Symbol 0/4/7/11	dBm/ 9 MHz	-75.72	-75.72
	Symbol 1/2/3/5/6/8/9/10/12		-66.97	-66.97
	Symbol 13		-75.81	-75.81
Io in subframe 1 or 6 ^{Note3}	Symbol 0/4/7	dBm/ 9 MHz	-75.72	-75.72
	Symbol 1/3/5/6/8		-66.97	-66.97
	Symbol 2		-75.81	-75.81
Io in subframes other than 0, 1, 5 or 6 ^{Note3}	Symbol 0/4/7/11	dBm/ 9 MHz	-75.72	-75.72
	Symbol 1/2/3/5/6/8/9/10/12/13		-66.97	-66.97
Propagation condition		-	AWGN	
<p>Note 1: For special subframe and uplink-downlink configurations see Tables 4.2-1 and 4.2-2 in TS 36.211.</p> <p>Note 2: OCNG shall be used such that both cells are fully allocated and a constant total transmitted power spectral density is achieved for all OFDM symbols.</p> <p>Note 3: Interference from other cells and noise sources not specified in the test is assumed to be constant over subcarriers and time and shall be modelled as AWGN of appropriate power for N_{oc} to be fulfilled.</p> <p>Note 4: RSRQ, RSRP, new RSRQ and Io levels have been derived from other parameters for information purposes. They are not settable parameters themselves. The new RSRQ values assume RSSI averaging over all OFDM symbols of the subframe.</p> <p>Note 5: RSRP and RSRQ minimum requirements are specified assuming independent interference and noise at each receiver antenna port.</p>				

A.9.2.35.3 Test Requirements

The new RSRQ measurement accuracy for cell 2 shall fulfil the requirements in Section 9.1.16, compared with any nominal new RSRQ value in subframe 0, 5, 1, 6 or others.

A.9.2.36 FDD—FDD Inter frequency RSRQ measured on all OFDM symbols

A.9.2.36.1 Test Purpose and Environment

The purpose of this test is to verify that the absolute accuracy of RSRQ measurement is within the specified limits when measurement configuration message received by the UE contains *measRSRQ-OnAllSymbols-r12* parameter in TS 36.331 [2]. This test will verify the requirements in Section 9.1.16.

A.9.2.3 is also conducted even if UE is capable of measuring RSRQ on all OFDM symbols.

A.9.2.36.2 Test parameters

In this test case the two cells are on different carrier frequencies and measurement gaps are provided. Both RSRQ measured on all OFDM symbols inter frequency absolute and relative accuracy requirements are tested by using test parameters in Table A.9.2.36.2-1. In all tests, Cell 1 is the PCell and Cell 2 the target cell.

Table A.9.2.36.2-1: FDD—FDD Inter frequency test parameters

Parameter	Unit	Test 1	
		Cell 1	Cell 2
E-UTRA RF Channel Number		1	2
BW_{channel}	MHz	10	10
Gap Pattern Id		0	-
Antenna Configuration		1x2	1x2
Time offset between cell 2 and cell 1	μs	3	
Measurement bandwidth	n_{PRB}	22-27	
PDSCH Reference measurement channel defined in A.3.1.1.1		R.0 FDD	-
PDSCH allocation	n_{PRB}	13—36	-
PDCCH/PCFICH/PHICH Reference measurement channel defined in A.3.1.2.1		R.6 FDD	
OCNG Patterns defined in A.3.2.1.1 (OP.1 FDD) and A.3.2.1.2 (OP.2 FDD)		OP.1 FDD	OP.2 FDD
PBCH_RA	dB	0	0
PBCH_RB			
PSS_RA			
SSS_RA			
PCFICH_RB			
PHICH_RA			
PHICH_RB			
PDCCH_RA			
PDCCH_RB			
PDSCH_RA			
PDSCH_RB			
OCNG_RA ^{Note1}			
OCNG_RB ^{Note1}			
N_{oc} ^{Note2}			
\hat{E}_s/I_{ot}	dB	-1.75	-1.75
RSRP ^{Note3}	dBm/15 kHz	-81.75	-81.75
RSRQ ^{Note3}	dB	-14.76	-14.76
I_o ^{Note3}	dBm/ 9 MHz	-50	-50
\hat{E}_s/N_{oc}	dBm/ 9 MHz	-1.75	-1.75

Propagation condition	-	AWGN
Note 1:	OCNG shall be used such that both cells are fully allocated and a constant total transmitted power spectral density is achieved for all OFDM symbols.	
Note 2:	Interference from other cells and noise sources not specified in the test is assumed to be constant over subcarriers and time and shall be modelled as AWGN of appropriate power for N_{oc} to be fulfilled.	
Note 3:	RSRP, RSRQ and I_0 levels have been derived from other parameters for information purposes. They are not settable parameters themselves. The RSRQ values assume RSSI averaging over all OFDM symbols of the subframe.	
Note 4:	RSRP and RSRQ minimum requirements are specified assuming independent interference and noise at each receiver antenna port.	

A.9.2.36.3 Test Requirements

The RSRQ measurement accuracy shall fulfil the requirements in Section 9.1.16.

A.9.2.37 TDD—TDD Inter frequency RSRQ measurement on all OFDM symbols

A.9.2.37.1 Test Purpose and Environment

The purpose of this test is to verify that the absolute accuracy of RSRQ measurement is within the specified limits when measurement configuration message received by the UE contains *measRSRQ-OnAllSymbols-r12* parameter in TS 36.331 [2]. This test will verify the requirements in Section 9.1.16.

A.9.2.4 is also conducted even if UE is capable of measuring RSRQ on all OFDM symbols..

A.9.2.37.2 Test parameters

In this test case the two cells are on different carrier frequencies and measurement gaps are provided. Both RSRQ measured on all OFDM symbols inter frequency absolute and relative accuracy requirements are tested by using test parameters in Table A.9.2.37.2-1. In all tests, Cell 1 is the PCell and Cell 2 the target cell.

Table A.9.2.37.2-1: TDD-TDD Inter frequency test parameters

Parameter	Unit	Test 1	
		Cell 1	Cell 2
E-UTRA RF Channel Number		1	2
BW _{channel}	MHz	10	10
Special subframe configuration ^{Note1}		6	6
Uplink-downlink configuration ^{Note1}		1	1
Gap Pattern Id		0	-
Antenna Configuration		1x2	1x2
Time offset between cell 2 and cell 1	μs	3	
Measurement bandwidth	n_{PRB}	22-27	
PDSCH Reference measurement channel defined in A.3.1.1.2		R.0 TDD	-
PDSCH allocation	n_{PRB}	13–36	-
PDCCH/PCFICH/PHICH Reference measurement channel defined in A.3.1.2.2		R.6 TDD	
OCNG Patterns defined in A.3.2.2.1 (OP.1 TDD)		OP.1 TDD	OP.2 TDD
PBCH_RA	dB	0	0
PBCH_RB			
PSS_RA			
SSS_RA			
PCFICH_RB			
PHICH_RA			
PHICH_RB			
PDCCH_RA			
PDCCH_RB			
PDSCH_RA			
PDSCH_RB			
OCNG_RA ^{Note1}			
OCNG_RB ^{Note1}			
N_{oc} ^{Note2}	dBm/15 kHz	-80	-80
\hat{E}_s/I_{ot}	dB	-1.75	-1.75
RSRP ^{Note3}	dBm/15 kHz	-81.75	-81.75
RSRQ ^{Note3}	dB	-14.76	-14.76
I_o ^{Note3}	dBm/ 9 MHz	-50	-50
\hat{E}_s/N_{oc}	dBm/ 9 MHz	-1.75	-1.75
Propagation condition	-	AWGN	
Note 1:	For special subframe and uplink-downlink configurations see Tables 4.2-1 and 4.2-2 in TS 36.211.		
Note 2:	OCNG shall be used such that both cells are fully allocated and a constant total transmitted power spectral density is achieved for all OFDM symbols.		
Note 3:	Interference from other cells and noise sources not specified in the test is assumed to be constant over subcarriers and time and shall be modelled as AWGN of appropriate power for N_{oc} to be fulfilled.		
Note 4:	RSRP, RSRQ and I_o levels have been derived from other parameters for information purposes. They are not settable parameters themselves. The RSRQ values assume RSSI averaging over all OFDM symbols of the subframe.		
Note 5:	RSRP and RSRQ minimum requirements are specified assuming independent interference and noise at each receiver antenna port.		

A.9.2.37.3 Test Requirements

The RSRQ measurement accuracy shall fulfil the requirements in Section 9.1.16.

A.9.2.38 3 DL PCell in FDD RSRQ for E-UTRAN in Carrier Aggregation

The test case in this clause is applicable to carrier aggregation capable UEs which have been configured with two downlink SCells.

A.9.2.38.1 Test Purpose and Environment

The purpose of this test is to verify that the RSRQ measurement accuracy in carrier aggregation is within the specified limits under AWGN propagation conditions. This test will verify the absolute accuracy of intra-frequency RSRQ measurements for the primary component carrier specified in clause 9.1.11.1, the absolute accuracy of intra-frequency RSRQ measurements for the secondary component carrier specified in clause 9.1.11.2 and also the relative inter-frequency RSRQ accuracy requirement between primary and secondary component carriers specified in clause 9.1.11.3.

A.9.2.38.2 Test parameters

In this set of test cases there are three cells on three carrier frequencies. Cell 1 is PCell on channel 1, Cell 2 is activated SCell on channel 2, and Cell 3 is activated SCell on channel 3. The parameters for the test are listed in Table A.9.2.38.2-1.

Table A.9.2.38.2-1: 3 DL PCell in FDD RSRQ for E-UTRAN in Carrier Aggregation test parameters (cell #1, cell #2 and cell #3)

Parameter	Unit	Cell 1	Cell 2	Cell 3
E-UTRA RF Channel Number		1	2	3
BW _{channel}		5MHz: N _{RB,c} = 25 10MHz: N _{RB,c} = 50 20MHz: N _{RB,c} = 100	5MHz: N _{RB,c} = 25 10MHz: N _{RB,c} = 50 20MHz: N _{RB,c} = 100	5MHz: N _{RB,c} = 25 10MHz: N _{RB,c} = 50 20MHz: N _{RB,c} = 100
Special subframe configuration ^{Note1}		-	6	6
Uplink/downlink configuration ^{Note1}		-	1	1
Measurement bandwidth	<i>n_{PRB}</i>	5MHz: 10-15 10MHz: 22-27 20MHz: 47-52	5MHz: 10-15 10MHz: 22-27 20MHz: 47-52	5MHz: 10-15 10MHz: 22-27 20MHz: 47-52
PDSCH Reference measurement channel defined in A.3.1.1		5MHz: R.5 FDD 10MHz: R.0 FDD 20MHz: R.4 FDD	5MHz: R.4 TDD 10MHz: R.0 TDD 20MHz: R.3 TDD	5MHz: R.4 TDD 10MHz: R.0 TDD 20MHz: R.3 TDD
PDSCH allocation	<i>n_{PRB}</i>	5MHz: 7-17 10MHz: 13-36 20MHz: 38-61	5MHz: 7-17 10MHz: 13-36 20MHz: 38-61	5MHz: 7-17 10MHz: 13-36 20MHz: 38-61
PDCCH/PCFICH/PHICH Reference measurement channel defined in A.3.1.2		5MHz: R.11 FDD 10MHz: R.6 FDD 20MHz: R.10 FDD	5MHz: R.11 TDD 10MHz: R.6 TDD 20MHz: R.10 TDD	5MHz: R.11 TDD 10MHz: R.6 TDD 20MHz: R.10 TDD
OCNG Patterns defined in A.3.2		5MHz: OP.15 FDD 10MHz: OP.1 FDD 20MHz: OP.11 FDD	5MHz: OP.9 TDD 10MHz: OP.1 TDD 20MHz: OP.7 TDD	5MHz: OP.9 TDD 10MHz: OP.1 TDD 20MHz: OP.7 TDD
PBCH_RA	dB	0	0	0
PBCH_RB				
PSS_RA				
SSS_RA				
PCFICH_RB				
PHICH_RA				
PHICH_RB				
PDCCH_RA				
PDCCH_RB				
PDSCH_RA				
PDSCH_RB				
OCNG_RA ^{Note2}				
OCNG_RB ^{Note2}				
Bands TDD_A				

N_{oc} ^{Note3}	Bands TDD_C	dBm/ 15kHz	-	-115	-115
	Bands TDD_E		-	-114	-114
	Bands FDD_A		-119.5	-	-
	Bands FDD_B1, FDD_B2 ^{Note 11}		-119	-	-
	Bands FDD_C		-118.5	-	-
	Bands FDD_D		-118	-	-
	Bands FDD_E, Bands FDD_F ^{Note 6}		-117.5	-	-
	Bands FDD_G		-116.5	-	-
	Bands FDD_H		-116	-	-
\hat{E}_s/N_{oc}		dB	-6.0	-6.0	-6.0
\hat{E}_s/I_{ot}		dB	-6.0	-6.0	-6.0
RSRP ^{Note4}	Bands TDD_A	dBm/ 15kHz	-	-122	-122
	Bands TDD_C		-	-121	-121
	Bands TDD_E		-	-120	-120
	Bands FDD_A		-125.5	-	-
	Bands FDD_B1, FDD_B2 ^{Note 11}		-125	-	-
	Bands FDD_C		-124.5	-	-
	Bands FDD_D		-124	-	-
	Bands FDD_E, Bands FDD_F ^{Note 6}		-123.5	-	-
	Bands FDD_G		-122.5	-	-
	Bands FDD_H		-122	-	-
RSRQ ^{Note4}	Bands TDD_A	dB	-	-17.77	-17.77
	Bands TDD_C		-	-17.77	-17.77
	Bands TDD_E		-	-17.77	-17.77
	Bands FDD_A		-	-17.77	-17.77
	Bands FDD_B1, FDD_B2 ^{Note 11}		-	-17.77	-17.77
	Bands FDD_C		-	-17.77	-17.77
	Bands FDD_D		-	-17.77	-17.77
	Bands FDD_E, Bands FDD_F ^{Note 6}		-	-17.77	-17.77
	Bands FDD_G		-	-17.77	-17.77
Bands FDD_H	-	-17.77	-17.77		
I_o ^{Note4}	Bands TDD_A	dBm/ BW _{channel}	-	-87.25 + 10log(N _{RB,c} /50)	-87.25 + 10log(N _{RB,c} /50)
	Bands TDD_C		-	-86.25 + 10log(N _{RB,c} /50)	-86.25 + 10log(N _{RB,c} /50)

	Bands TDD_E		-	-85.25 + 10log(N _{RB,c} /50)	-85.25 + 10log(N _{RB,c} /50)
	Bands FDD_A		-90.75 + 10log(N _{RB,c} /50)	-	-
	Bands FDD_B1, FDD_B2 <small>Note 11</small>		-90.25 + 10log(N _{RB,c} /50)	-	-
	Bands FDD_C		-89.75 + 10log(N _{RB,c} /50)	-	-
	Bands FDD_D		-89.25 + 10log(N _{RB,c} /50)	-	-
	Bands FDD_E, Bands FDD_F <small>Note 6</small>		-88.75 + 10log(N _{RB,c} /50)	-	-
	Bands FDD_G		-87.75 + 10log(N _{RB,c} /50)	-	-
	Bands FDD_H		-87.25 + 10log(N _{RB,c} /50)	-	-
Propagation Condition			AWGN	AWGN	AWGN
Antenna Configuration			1x2	1x2	1x2
Timing offset to Cell 1		μs	-	0	0
Time alignment error relative to cell 1 <small>Note 10</small>			-	≤ TAE	≤ TAE
Time alignment error relative to cell 2 <small>Note 10</small>			≤ TAE	-	≤ TAE
<p>Note 1: For special subframe and uplink-downlink configurations see Tables 4.2-1 and 4.2-2 in TS 36.211.</p> <p>Note 2: OCNG shall be used such that both cells are fully allocated and a constant total transmitted power spectral density is achieved for all OFDM symbols.</p> <p>Note 3: Interference from other cells and noise sources not specified in the test is assumed to be constant over subcarriers and time and shall be modelled as AWGN of appropriate power for N_{oc} to be fulfilled.</p> <p>Note 4: RSRP, RSRQ and Io levels have been derived from other parameters for information purposes. They are not settable parameters themselves.</p> <p>Note 5: RSRP and RSRQ minimum requirements are specified assuming independent interference and noise at each receiver antenna port.</p> <p>Note 6: For Band 26, the tests shall be performed with the carrier frequency of the assigned E-UTRA channel bandwidth within 865-894 MHz.</p> <p>Note 7: The selection of the bands for testing depends on the configuration of the carrier aggregation supported by the UEs.</p> <p>Note 8: This test verifies the RRM requirement which is independent of channel bandwidth and is performed according to the principle defined in section A.3.6.1.</p> <p>Note 9: E-UTRA operating band groups are as defined in Section 3.5.</p> <p>Note 10: Time alignment error (TAE) as specified in TS 36.104 [30] clause 6.5.3.1. The TAE value depends upon the type of carrier aggregation.</p> <p>Note 11: For Band 74, the tests shall be performed with the carrier frequency of the assigned E-UTRA channel bandwidth within 1475.9-1510.9 MHz.</p>					

A.9.2.38.3 Test Requirements

In the test, the RSRQ measurement accuracy in carrier aggregation shall fulfil the requirements in clause 9.1.11.1, 9.1.11.2, and 9.1.11.3.

- The absolute accuracy of intra-frequency RSRQ measurements of Cell 1 on the primary component carrier shall fulfil the requirements specified in clause 9.1.11.1.
- The absolute accuracy of intra-frequency RSRQ measurements of Cell 2 on the secondary component carrier shall fulfil the requirements specified in clause 9.1.11.2
- The absolute accuracy of intra-frequency RSRQ measurements of Cell 3 on the secondary component carrier shall fulfil the requirements specified in clause 9.1.11.2
- The relative accuracy of inter-frequency RSRQ measurements between the primary and secondary component carriers for Cell 2 relative to Cell 1 shall fulfil the requirements specified in clause 9.1.11.3.

- The relative accuracy of inter-frequency RSRQ measurements between the primary and secondary component carriers for Cell 3 relative to Cell 1 shall fulfil the requirements specified in clause 9.1.11.3.

A.9.2.39 3 DL PCell in TDD RSRQ for E-UTRAN in Carrier Aggregation

The test case in this clause is applicable to carrier aggregation capable UEs which have been configured with two downlink SCells.

A.9.2.39.1 Test Purpose and Environment

The purpose of this test is to verify that the TDD-FDD RSRQ measurement accuracy in carrier aggregation is within the specified limits under AWGN propagation conditions. This test will verify the absolute accuracy of intra-frequency RSRQ measurements for the primary component carrier defined in Clause 9.1.11.1, the absolute accuracy of intra-frequency RSRQ measurements for the secondary component carrier defined in Clause 9.1.11.2, and also the relative inter-frequency RSRQ accuracy requirement between primary and secondary component carriers defined in Clause 9.1.11.3.

A.9.2.39.2 Test parameters

In this set of cases cell 1 is PCell on the primary component carrier, and cell 2 and cell 3 are activated SCells on secondary component carriers SCC1 and SCC2 respectively. The test parameters for the test are listed in Table A.9.2.39.2-1.

Table A.9.2.39.2-1: 3 Downlink TDD-FDD RSRQ carrier aggregation test parameters with PCell in TDD (cell #1, cell #2 and cell #3)

Parameter	Unit	Cell 1	Cell 2	Cell 3
E-UTRA RF Channel Number		1	2	3
BW _{channel}		5MHz: N _{RB,c} = 25 10MHz: N _{RB,c} = 50 20MHz: N _{RB,c} = 100	5MHz: N _{RB,c} = 25 10MHz: N _{RB,c} = 50 20MHz: N _{RB,c} = 100	5MHz: N _{RB,c} = 25 10MHz: N _{RB,c} = 50 20MHz: N _{RB,c} = 100
Special subframe configuration ^{Note1}		6	-	-
Uplink/downlink configuration ^{Note1}		1	-	-
Measurement bandwidth	<i>n_{PRB}</i>	5MHz: 10-15 10MHz: 22-27 20MHz: 47-52	5MHz: 10-15 10MHz: 22-27 20MHz: 47-52	5MHz: 10-15 10MHz: 22-27 20MHz: 47-52
PDSCH Reference measurement channel defined in A.3.1.1.1 and A.3.1.1.2		5MHz: R.4 TDD 10MHz: R.0 TDD 20MHz: R.3 TDD	5MHz: R.5 FDD 10MHz: R.0 FDD 20MHz: R.4 FDD	5MHz: R.5 FDD 10MHz: R.0 FDD 20MHz: R.4 FDD
PDSCH allocation	<i>n_{PRB}</i>	5MHz: 7-17 10MHz: 13-36 20MHz: 38-61	5MHz: 7-17 10MHz: 13-36 20MHz: 38-61	5MHz: 7-17 10MHz: 13-36 20MHz: 38-61
PDCCH/PCFICH/PHICH Reference measurement channel defined in A.3.1.2.1 and A.3.1.2.2		5MHz: R.11 TDD 10MHz: R.6 TDD 20MHz: R.10 TDD	5MHz: R.11 FDD 10MHz: R.6 FDD 20MHz: R.10 FDD	5MHz: R.11 FDD 10MHz: R.6 FDD 20MHz: R.10 FDD
OCNG Patterns defined in A.3.2.1 and A.3.2.2		5MHz: OP.9 TDD 10MHz: OP.1 TDD 20MHz: OP.7 TDD	5MHz: OP.15 FDD 10MHz: OP.1 FDD 20MHz: OP.11 FDD	5MHz: OP.15 FDD 10MHz: OP.1 FDD 20MHz: OP.11 FDD
PBCH_RA	dB	0	0	0
PBCH_RB				
PSS_RA				
SSS_RA				
PCFICH_RB				
PHICH_RA				
PHICH_RB				
PDCCH_RA				
PDCCH_RB				
PDSCH_RA				

PDSCH_RB					
OCNG_RA ^{Note2}					
OCNG_RB ^{Note2}					
N_{oc} ^{Note3}	Bands TDD_A	dBm/ 15kHz	-119.5	-	-
	Bands TDD_C		-118.5	-	-
	Bands TDD_E		-117.5	-	-
	Bands FDD_A		-	-116	-116
	Bands FDD_B1, FDD_B2 ^{Note 11}		-	-115.5	-115.5
	Bands FDD_C		-	-115	-115
	Bands FDD_D		-	-114.5	-114.5
	Bands FDD_E, Bands FDD_F ^{Note 6}		-	-114	-114
	Bands FDD_G		-	-113	-113
Bands FDD_H	-	-112.5	-112.5		
\hat{E}_s / N_{oc}		dB	-6.0	-6.0	-6.0
\hat{E}_s / I_{ot}		dB	-6.0	-6.00	-6.00
RSRP ^{Note4}	Bands TDD_A	dBm/ 15kHz	-125.50	-	-
	Bands TDD_C		-124.50	-	-
	Bands TDD_E		-123.50	-	-
	Bands FDD_A		-	-122	-122
	Bands FDD_B1, FDD_B2 ^{Note 11}		-	-121.5	-121.5
	Bands FDD_C		-	-121	-121
	Bands FDD_D		-	-120.5	-120.5
	Bands FDD_E, Bands FDD_F ^{Note 6}		-	-120	-120
	Bands FDD_G		-	-119	-119
Bands FDD_H	-	-118.5	-118.5		
RSRQ ^{Note4}	Bands TDD_A	dB	-17.77	-	-
	Bands TDD_C		-	-	-
	Bands TDD_E		-	-	-
	Bands FDD_A		-	-17.77	-17.77
	Bands FDD_B1, FDD_B2 ^{Note 11}		-	-	-
	Bands FDD_C		-	-	-
	Bands FDD_D		-	-	-
	Bands FDD_E, Bands FDD_F ^{Note 6}		-	-	-
	Bands FDD_G		-	-	-
Bands FDD_H	-	-	-		
I_o ^{Note4}	Bands TDD_A	dBm/ BW _{channel}	-90.75 + 10log(N _{RB,c} /50)	-	-
	Bands TDD_C		-89.75 + 10log(N _{RB,c} /50)	-	-
	Bands TDD_E		-88.75 + 10log(N _{RB,c} /50)	-	-
	Bands FDD_A		-	-87.25 + 10log(N _{RB,c} /50)	-87.25 + 10log(N _{RB,c} /50)
	Bands FDD_B1, FDD_B2 ^{Note 11}		-	-86.75 + 10log(N _{RB,c} /50)	-86.75 + 10log(N _{RB,c} /50)
	Bands FDD_C		-	-86.25 + 10log(N _{RB,c} /50)	-86.25 + 10log(N _{RB,c} /50)
	Bands FDD_D		-	-85.75 + 10log(N _{RB,c} /50)	-85.75 + 10log(N _{RB,c} /50)

	Bands FDD_E, Bands FDD_F Note 6		-	-85.25 + 10log(N _{RB,c} /50)	-85.25 + 10log(N _{RB,c} /50)
	Bands FDD_G		-	-84.25 + 10log(N _{RB,c} /50)	-84.25 + 10log(N _{RB,c} /50)
	Bands FDD_H		-	-83.75 + 10log(N _{RB,c} /50)	-83.75 + 10log(N _{RB,c} /50)
Propagation Condition			AWGN	AWGN	AWGN
Antenna Configuration			1x2	1x2	1x2
Timing offset to Cell 1		μs	-	0	0
Time alignment error relative to cell 1 Note 10			-	≤ TAE	≤ TAE
Time alignment error relative to cell 2 Note 10			≤ TAE	-	≤ TAE
<p>Note 1: For special subframe and uplink-downlink configurations see Tables 4.2-1 and 4.2-2 in TS 36.211.</p> <p>Note 2: OCNG shall be used such that both cells are fully allocated and a constant total transmitted power spectral density is achieved for all OFDM symbols.</p> <p>Note 3: Interference from other cells and noise sources not specified in the test is assumed to be constant over subcarriers and time and shall be modelled as AWGN of appropriate power for N_{oc} to be fulfilled.</p> <p>Note 4: RSRP, RSRQ and I_o levels have been derived from other parameters for information purposes. They are not settable parameters themselves.</p> <p>Note 5: RSRP and RSRQ minimum requirements are specified assuming independent interference and noise at each receiver antenna port.</p> <p>Note 6: For Band 26, the tests shall be performed with the carrier frequency of the assigned E-UTRA channel bandwidth within 865-894 MHz.</p> <p>Note 7: The selection of the bands for testing depends on the configuration of the carrier aggregation supported by the UEs.</p> <p>Note 8: This test verifies the RRM requirement which is independent of channel bandwidth and is performed according to the principle defined in section A.3.6.1.</p> <p>Note 9: E-UTRA operating band groups are as defined in Section 3.5.</p> <p>Note 10: Time alignment error (TAE) as specified in TS 36.104 [30] clause 6.5.3.1. The TAE value depends upon the type of carrier aggregation.</p> <p>Note 11: For Band 74, the tests shall be performed with the carrier frequency of the assigned E-UTRA channel bandwidth within 1475.9-1510.9 MHz.</p>					

A.9.2.39.3 Test Requirements

In the test, the RSRQ measurement accuracy in carrier aggregation shall fulfil the requirements in clause 9.1.11.1, 9.1.11.2, and 9.1.11.3.

- The absolute accuracy of intra-frequency RSRQ measurements of Cell 1 on the primary component carrier shall fulfil the requirements specified in clause 9.1.11.1.
- The absolute accuracy of intra-frequency RSRQ measurements of Cell 2 on the secondary component carrier shall fulfil the requirements specified in clause 9.1.11.2
- The absolute accuracy of intra-frequency RSRQ measurements of Cell 3 on the secondary component carrier shall fulfil the requirements specified in clause 9.1.11.2
- The relative accuracy of inter-frequency RSRQ measurements between the primary and secondary component carriers for Cell 2 relative to Cell 1 shall fulfil the requirements specified in clause 9.1.11.3.
- The relative accuracy of inter-frequency RSRQ measurements between the primary and secondary component carriers for Cell 3 relative to Cell 1 shall fulfil the requirements specified in clause 9.1.11.3.

A.9.2.40 3 DL FDD RSRQ for E-UTRAN in Carrier Aggregation

A.9.2.40.1 Test Purpose and Environment

The purpose of this test is to verify that the FDD RSRQ measurement accuracy in carrier aggregation is within the specified limits under AWGN propagation conditions. This test will verify the absolute accuracy of intra-frequency

RSRQ measurements for the primary component carrier specified in clause 9.1.11.1, the absolute accuracy of intra-frequency RSRQ measurements for the secondary component carriers specified in clause 9.1.11.2 and also the relative inter-frequency RSRQ accuracy requirement between primary and secondary component carriers specified in clause 9.1.11.3.

A.9.2.40.2 Test parameters

In this test case the PCell and the SCells are on different carrier frequencies. There are three cells used in this test case. Both RSRQ absolute and relative accuracy requirements of the primary and secondary component carriers are tested by using test parameters specified in Table A.9.2.40.2-1. In the test, Cell 1 is the PCell, Cell 2 and Cell 3 are the SCells on secondary component carrier SCC1 and SCC2 respectively. The SCC1 and SCC2 are configured and activated.

Table A.9.2.40.2-1: 3 DL FDD RSRQ carrier aggregation test parameters

Parameter	Unit	Cell 1	Cell 2	Cell 3	
E-UTRA RF Channel Number		1	2	3	
BW _{channel}	MHz	5MHz: N _{RB,c} = 25 10MHz: N _{RB,c} = 50 20MHz: N _{RB,c} = 100	5MHz: N _{RB,c} = 25 10MHz: N _{RB,c} = 50 20MHz: N _{RB,c} = 100	5MHz: N _{RB,c} = 25 10MHz: N _{RB,c} = 50 20MHz: N _{RB,c} = 100	
Measurement bandwidth	<i>n</i> _{PRB}	5MHz:10-15 10MHz:22-27 20MHz:47-52	5MHz: 10-15 10MHz: 22-27 20MHz: 47-52	5MHz: 10-15 10MHz: 22-27 20MHz: 47-52	
PDSCH Reference measurement channel defined in A.3.1.1.1		5MHz:R.5 FDD 10MHz:R.0 FDD 20MHz:R.4 FDD	5MHz:R.5 FDD 10MHz:R.0 FDD 20MHz:R.4 FDD	5MHz:R.5 FDD 10MHz:R.0 FDD 20MHz:R.4 FDD	
PDSCH allocation	<i>n</i> _{PRB}	5MHz:7-17 10MHz:13-36 20MHz:38-61	5MHz:7-17 10MHz:13-36 20MHz:38-61	5MHz:7-17 10MHz:13-36 20MHz:38-61	
PDCCH/PCFICH/PHICH Reference measurement channel defined in A.3.1.2.1		5MHz:R.11 FDD 10MHz:R.6 FDD 20MHz:R.10 FDD	5MHz:R.11 FDD 10MHz:R.6 FDD 20MHz:R.10 FDD	5MHz:R.11 FDD 10MHz:R.6 FDD 20MHz:R.10 FDD	
OCNG Patterns defined in A.3.2.1		5MHz:OP.15 FDD 10MHz:OP.1 FDD 20MHz:OP.11 FDD	5MHz:OP.15 FDD 10MHz:OP.1 FDD 20MHz:OP.11 FDD	5MHz:OP.15 FDD 10MHz:OP.1 FDD 20MHz:OP.11 FDD	
PBCH_RA	dB	0	0	0	
PBCH_RB					
PSS_RA					
SSS_RA					
PCFICH_RB					
PHICH_RA					
PHICH_RB					
PDCCH_RA					
PDCCH_RB					
PDSCH_RA					
PDSCH_RB					
OCNG_RA ^{Note1}					
OCNG_RB ^{Note1}					
<i>N</i> _{oc} ^{Note2}					dBm/15 kHz
	Bands FDD_B1, FDD_B2 ^{Note 9}	-119	-115.5	-115.5	
	Bands FDD_C	-118.5	-115	-115	
	Bands FDD_D	-118	-114.5	-114.5	
	Bands FDD_E, FDD_F ^{Note 6}	-117.5	-114	-114	
	Bands FDD_G	-116.5	-113	-113	
	Bands FDD_H	-116	-112.5	-112.5	
\hat{E}_s / N_{oc}	dB	-6.0	-6.0	-6.0	
\hat{E}_s / I_{ot} ^{Note3}	dB	-6.0	-6.0	-6.0	
RSRP ^{Note3}	dBm/15 kHz	Bands FDD_A	-125.5	-122	-122
		Bands FDD_B1, FDD_B2 ^{Note 9}	-125	-121.5	-121.5

	Bands FDD_C		-124.5	-121	-121
	Bands FDD_D		-124	-120.5	-120.5
	Bands FDD_E, FDD_F ^{Note 6}		-123.5	-120	-120
	Bands FDD_G		-122.5	-119	-119
	Bands FDD_H		-122	-118.5	-118.5
RSRQ ^{Note3}	Bands FDD_A	dB	-17.77	-17.77	-17.77
	Bands FDD_B1, FDD_B2 ^{Note 9}				
	Bands FDD_C				
	Bands FDD_D				
	Bands FDD_E, FDD_F ^{Note 6}				
	Bands FDD_G Bands FDD_H				
I _o ^{Note3}	Bands FDD_A	dBm/ BW _{channel}	-90.75+ 10log(N _{RB,c} /50)	-87.25+ 10log(N _{RB,c} /50)	-87.25+ 10log(N _{RB,c} /50)
	Bands FDD_B1, FDD_B2 ^{Note 9}		-90.25+ 10log(N _{RB,c} /50)	-86.75+ 10log(N _{RB,c} /50)	-86.75+ 10log(N _{RB,c} /50)
	Bands FDD_C		-89.75+ 10log(N _{RB,c} /50)	-86.25+ 10log(N _{RB,c} /50)	-86.25+ 10log(N _{RB,c} /50)
	Bands FDD_D		-89.25+ 10log(N _{RB,c} /50)	-85.75+ 10log(N _{RB,c} /50)	-85.75+ 10log(N _{RB,c} /50)
	Bands FDD_E, FDD_F ^{Note 6}		-88.75+ 10log(N _{RB,c} /50)	-85.25+ 10log(N _{RB,c} /50)	-85.25+ 10log(N _{RB,c} /50)
	Bands FDD_G		-87.75+ 10log(N _{RB,c} /50)	-84.25+ 10log(N _{RB,c} /50)	-84.25+ 10log(N _{RB,c} /50)
	Bands FDD_H		-87.25+ 10log(N _{RB,c} /50)	-83.75+ 10log(N _{RB,c} /50)	-83.75+ 10log(N _{RB,c} /50)
Propagation condition	-	AWGN	AWGN	AWGN	
Antenna Configuration	-	1x2	1x2	1x2	
Timing offset to Cell 1	μs	-	0	0	
Time alignment error relative to cell 1 ^{Note 7}			≤ TAE	≤ TAE	
Time alignment error relative to cell 2 ^{Note 7}			-	≤ TAE	
<p>Note 1: OCNG shall be used such that all cells are fully allocated and a constant total transmitted power spectral density is achieved for all OFDM symbols.</p> <p>Note 2: Interference from other cells and noise sources not specified in the test is assumed to be constant over subcarriers and time and shall be modelled as AWGN of appropriate power for N_{oc} to be fulfilled.</p> <p>Note 3: Es/I_{ot}, RSRQ, RSRP and I_o levels have been derived from other parameters for information purposes. They are not settable parameters themselves.</p> <p>Note 4: RSRP and RSRQ minimum requirements are specified assuming independent interference and noise at each receiver antenna port.</p> <p>Note 5: The selection of the bands for testing depends on the configuration of the carrier aggregation supported by the UEs.</p> <p>Note 6: For Band 26, the tests shall be performed with the carrier frequency of the assigned E-UTRA channel bandwidth within 865-894 MHz.</p> <p>Note 7: Time alignment error (TAE) as specified in TS 36.104 [30] clause 6.5.3.1. The TAE value depends upon the type of carrier aggregation.</p> <p>Note 8: E-UTRA operating band groups are as defined in Section 3.5.</p> <p>Note 9: For Band 74, the tests shall be performed with the carrier frequency of the assigned E-UTRA channel bandwidth within 1475.9-1510.9 MHz.</p>					

A.9.2.40.3 Test Requirements

In the test, the RSRQ measurement accuracy in carrier aggregation shall fulfil the requirements in clause 9.1.11.1, 9.1.11.2, and 9.1.11.3.

- The absolute accuracy of intra-frequency RSRQ measurements of Cell 1 on the primary component carrier shall fulfil the requirements defined in clause 9.1.11.1.
- The absolute accuracy of intra-frequency RSRQ measurements of Cell 2 on SCC1 shall fulfil the requirements defined in clause 9.1.11.2.

- The absolute accuracy of intra-frequency RSRQ measurements of Cell 3 on SCC2 shall fulfil the requirements defined in clause 9.1.11.2.
- The relative accuracy of inter-frequency RSRQ measurements between the primary component carrier and SCC1 for Cell 2 relative to Cell 1 shall fulfil the requirements defined in clause 9.1.11.3.
- The relative accuracy of inter-frequency RSRQ measurements between the primary component carrier and SCC2 for Cell 3 relative to Cell 1 shall fulfil the requirements defined in clause 9.1.11.3.

A.9.2.41 3 DL TDD RSRQ for E-UTRAN in Carrier Aggregation

A.9.2.41.1 Test Purpose and Environment

The purpose of this test is to verify that the TDD RSRQ measurement accuracy in carrier aggregation is within the specified limits in a synchronized network environment with AWGN propagation conditions. This test will verify the absolute accuracy of intra-frequency RSRQ measurements for the primary component carrier defined in Clause 9.1.11.1, the absolute accuracy of intra-frequency RSRQ measurements for the secondary component carriers defined in Clause 9.1.11.2, and also the relative inter-frequency RSRQ accuracy requirement between primary and secondary component carriers defined in Clause 9.1.11.3.

A.9.2.41.2 Test parameters

In the test there are three synchronous cells: Cell 1, Cell 2 and Cell 3. Cell 1 is PCell, Cell 2 and Cell 3 are the SCells on secondary component carrier SCC1 and SCC2 respectively. PCell and SCells are in different RF channels. The parameters for the test are listed in Table A.9.2.41.2-1.

Table A.9.2.41.2-1: 3 DL TDD RSRQ carrier aggregation test parameters

Parameter	Unit	Cell 1	Cell2	Cell3
E-UTRA RF Channel Number		1	2	3
BW _{channel}	MHz	5MHz: N _{RB,c} = 25 10MHz: N _{RB,c} = 50 20MHz: N _{RB,c} = 100	5MHz: N _{RB,c} = 25 10MHz: N _{RB,c} = 50 20MHz: N _{RB,c} = 100	5MHz: N _{RB,c} = 25 10MHz: N _{RB,c} = 50 20MHz: N _{RB,c} = 100
Special subframe configuration ^{Note1}		6		
Uplink-downlink configuration ^{Note1}		1		
Measurement bandwidth	<i>n_{PRB}</i>	5MHz: 10-15 10MHz: 22-27 20MHz: 47-52	5MHz: 10-15 10MHz: 22-27 20MHz: 47-52	5MHz: 10-15 10MHz: 22-27 20MHz: 47-52
PDSCH Reference measurement channel defined in A.3.1.1.1		5MHz: R.4 TDD 10MHz: R.0 TDD 20MHz: R.3 TDD	5MHz: R.4 TDD 10MHz: R.0 TDD 20MHz: R.3 TDD	5MHz: R.4 TDD 10MHz: R.0 TDD 20MHz: R.3 TDD
PDSCH allocation	<i>n_{PRB}</i>	5MHz: 7-17 10MHz: 13-36 20MHz: 38-61	5MHz: 7-17 10MHz: 13-36 20MHz: 38-61	5MHz: 7-17 10MHz: 13-36 20MHz: 38-61
PDCCH/PCFICH/PHICH Reference measurement channel defined in A.3.1.2.1		5MHz: R.11 TDD 10MHz: R.6 TDD 20MHz: R.10 TDD	5MHz:R.11 TDD 10MHz:R.6 TDD 20MHz:R.10 TDD	5MHz:R.11 TDD 10MHz:R.6 TDD 20MHz:R.10 TDD
OCNG Patterns defined in A.3.2.1		5MHz: OP.9 TDD 10MHz: OP.1 TDD 20MHz: OP.7 TDD	5MHz: OP.9 TDD 10MHz: OP.1 TDD 20MHz: OP.7 TDD	5MHz: OP.9 TDD 10MHz: OP.1 TDD 20MHz: OP.7 TDD
PBCH_RA	dB	0	0	0
PBCH_RB				
PSS_RA				
SSS_RA				
PCFICH_RB				
PHICH_RA				
PHICH_RB				
PDCCH_RA				
PDCCH_RB				
PDSCH_RA				
PDSCH_RB				
OCNG_RA ^{Note2}				
OCNG_RB ^{Note2}				

N_{oc} ^{Note3}	Bands TDD_A	dBm/15 kHz	-119.5	-116	-116
	Bands TDD_C		-118.5	-115	-115
	Bands TDD_E		-117.5	-114	-114
\hat{E}_s/N_{oc}		dB	-6.0	-6.0	-6.0
\hat{E}_s/I_{ot} ^{Note4}		dB	-6.0	-6.0	-6.0
RSRP ^{Note4}	Bands TDD_A	dBm/15 kHz	-125.5	-122	-122
	Bands TDD_C		-124.5	-121	-121
	Bands TDD_E		-123.5	-120	-120
RSRQ ^{Note4}	Bands TDD_A, TDD_C, TDD_E	dB	-17.77	-17.77	-17.77
I_o ^{Note4}	Bands TDD_A	dBm/ BW _{channel}	-90.75+ 10log(N _{RB,c} /50)	-87.25+ 10log(N _{RB,c} /50)	-87.25+ 10log(N _{RB,c} /50)
	Bands TDD_C		-89.75+ 10log(N _{RB,c} /50)	-86.25+ 10log(N _{RB,c} /50)	-86.25+ 10log(N _{RB,c} /50)
	Bands TDD_E		-88.75+ 10log(N _{RB,c} /50)	-85.25+ 10log(N _{RB,c} /50)	-85.25+ 10log(N _{RB,c} /50)
Propagation condition		-	AWGN	AWGN	AWGN
Antenna Configuration		-	1x2	1x2	1x2
Timing offset to Cell 1		μs	-	0	0
Time alignment error relative to cell 1 ^{Note 7}			-	≤ TAE	≤ TAE
Time alignment error relative to cell 2 ^{Note 7}			-	-	≤ TAE
<p>Note 1: For special subframe and uplink-downlink configurations see Tables 4.2-1 and 4.2-2 in TS 36.211.</p> <p>Note 2: OCNG shall be used such that all cells are fully allocated and a constant total transmitted power spectral density is achieved for all OFDM symbols.</p> <p>Note 3: Interference from other cells and noise sources not specified in the test is assumed to be constant over subcarriers and time and shall be modelled as AWGN of appropriate power for N_{oc} to be fulfilled.</p> <p>Note 4: E_s/I_{ot}, RSRQ, RSRP and I_o levels have been derived from other parameters for information purposes. They are not settable parameters themselves.</p> <p>Note 5: RSRP and RSRQ minimum requirements are specified assuming independent interference and noise at each receiver antenna port.</p> <p>Note 6: The selection of the bands for testing depends on the configuration of the carrier aggregation supported by the UEs.</p> <p>Note 7: Time alignment error (TAE) as specified in TS 36.104 [30] clause 6.5.3.1. The TAE value depends upon the type of carrier aggregation.</p> <p>Note 8: E-UTRA operating band groups are as defined in Section 3.5.</p>					

A.9.2.41.3 Test Requirements

In the test, the RSRQ measurement accuracy in carrier aggregation shall fulfil the requirements in section 9.1.11.1, 9.1.11.2, and 9.1.11.3.

- The absolute accuracy of intra-frequency RSRQ measurements of Cell 1 on the primary component carrier shall fulfil the requirements defined in clause 9.1.11.1.
- The absolute accuracy of intra-frequency RSRQ measurements of Cell 2 on SCC1 shall fulfil the requirements defined in clause 9.1.11.2.
- The absolute accuracy of intra-frequency RSRQ measurements of Cell 3 on SCC2 shall fulfil the requirements defined in clause 9.1.11.2.
- The relative accuracy of inter-frequency RSRQ measurements between the primary component carrier and SCC1 for Cell 2 relative to Cell 1 shall fulfil the requirements defined in clause 9.1.11.3.

- The relative accuracy of inter-frequency RSRQ measurements between the primary component carrier and SCC2 for Cell 3 relative to Cell 1 shall fulfil the requirements defined in clause 9.1.11.3.

A.9.2.42 FD-FDD RSRQ Intra frequency case for UE category 0

A.9.2.42.1 Test Purpose and Environment

The purpose of this test is to verify that the RSRQ measurement accuracy is within the specified limits. This test will verify the requirements in Clause 9.1.13.3 for FD-FDD intra frequency RSRQ measurements for UE category 0.

A.9.2.42.2 Test parameters

In this test case all cells are on the same carrier frequency. The absolute accuracy of RSRQ intra frequency measurement is tested by using the parameters in Table A.9.2.42.2-1. In all test cases, Cell 1 is the PCell and Cell 2 the target cell.

Table A.9.2.42.2-1: FD-FDD RSRQ Intra frequency test parameters for UE category 0

Parameter	Unit	Test 1		Test 2		Test 3								
		Cell 1	Cell 2	Cell 1	Cell 2	Cell 1	Cell 2							
E-UTRA RF Channel Number		1		1		1								
BW _{channel}	MHz	10		10		10								
Measurement bandwidth	n_{PRB}	22—27		22—27		22—27								
PDSCH Reference measurement channel defined in A.3.1.1.3		R.13 FDD	-	R.13 FDD	-	R.13 FDD	-							
PDSCH allocation	n_{PRB}	13—36	-	13—36	-	13—36	-							
PDCCH/PCFICH/PHICH Reference measurement channel defined in A.3.1.2.1		R.6 FDD		R.6 FDD		R.6 FDD								
OCNG Patterns defined in A.3.2.1.1 (OP.1 FDD) and A.3.2.1.2 (OP.2 FDD)		OP.1 FDD	OP.2 FDD	OP.1 FDD	OP.2 FDD	OP.1 FDD	OP.2 FDD							
PBCH_RA	dB	0	0	0	0	0	0							
PBCH_RB														
PSS_RA														
SSS_RA														
PCFICH_RB														
PHICH_RA														
PHICH_RB														
PDCCH_RA														
PDCCH_RB														
PDSCH_RA														
PDSCH_RB														
OCNG_RA ^{Note1}														
OCNG_RB ^{Note1}														
N_{oc} ^{Note2}								Bands FDD-0_A ^{Note 7}	dBm/15 kHz	-84.76	-103.85			-116
								Bands FDD-0_B						-115.5
	Bands FDD-0_C	-115												
	Bands FDD-0_D	-114.5												
	Bands FDD-0_E, FDD-0_F ^{Note 5}	-114												
	Bands FDD-0_G ^{Note 7}	-113												
	Bands FDD-0_H	-112.5												
\hat{E}_s / N_{oc}	dB	3	3	-2.9	-2.9	-4	-4							
\hat{E}_s / I_{ot} ^{Note3}	dB	-1.76	-1.76	-4.7	-4.7	-5.46	-5.46							
RSRP ^{Note3}	Bands FDD-0_A ^{Note 7}	dBm/15 kHz	-81.76	-81.76	-106.75	-106.75	-120							
	Bands FDD-0_B						-119.5							
	Bands FDD-0_C						-119							
	Bands FDD-0_D						-118.5							

	Bands FDD-0_E, FDD-0_F ^{Note 4}						-118	-118
	Bands FDD-0_G ^{Note 6}						-117	-117
	Bands FDD-0_H						-116.5	-116.5
RSRQ ^{Note3}	Bands FDD-0_A ^{Note 7}	dB	-14.77	-14.77	-16.76	-16.76	-17.34	-17.34
	Bands FDD-0_B							
	Bands FDD-0_C							
	Bands FDD-0_D							
	Bands FDD-0_E, FDD-0_F ^{Note 45}							
	Bands FDD-0_G ^{Note 6}							
Bands FDD-0_H								
I _o ^{Note3}	Bands FDD-0_A ^{Note 7}	dBm/9 MHz	-50			-73	-85.67	
	Bands FDD-0_B						-85.17	
	Bands FDD-0_C						-84.67	
	Bands FDD-0_D						-84.17	
	Bands FDD-0_E, FDD-0_F ^{Note 4}						-83.67	
	Bands FDD-0_G ^{Note 6}						-82.67	
	Bands FDD-0_H						-82.17	
Propagation condition		-	AWGN		AWGN		AWGN	
Correlation Matrix and Antenna Configuration			1x1		1x1		1x1	
<p>Note 1: OCNG shall be used such that both cells are fully allocated and a constant total transmitted power spectral density is achieved for all OFDM symbols.</p> <p>Note 2: Interference from other cells and noise sources not specified in the test is assumed to be constant over subcarriers and time and shall be modelled as AWGN of appropriate power for N_{oc} to be fulfilled.</p> <p>Note 3: Es/lot, RSRQ, RSRP and I_o levels have been derived from other parameters for information purposes. They are not settable parameters themselves.</p> <p>Note 4: For Band 26, the tests shall be performed with the carrier frequency of the assigned E-UTRA channel bandwidth within 865-894 MHz.</p> <p>Note 5: E-UTRA operating band groups are as defined in Section 3.5.</p> <p>Note 6: Except Band 29.</p> <p>Note 7: Except Band 32, Band 75, Band 76.</p>								

A.9.2.42.3 Test Requirements

The RSRQ measurement accuracy shall fulfil the requirements in Clause 9.1.13.3.

A.9.2.43 HD-FDD RSRQ Intra frequency case for UE category 0

A.9.2.43.1 Test Purpose and Environment

The purpose of this test is to verify that the RSRQ measurement accuracy is within the specified limits. This test will verify the requirements in Clause 9.1.13.3 for HD-FDD intra frequency RSRQ measurements for UE category 0.

A.9.2.43.2 Test parameters

In this test case all cells are on the same carrier frequency. The absolute accuracy of RSRQ intra frequency measurement is tested by using the parameters in Table A.9.2.43.2-1. In all test cases, Cell 1 is the PCell and Cell 2 the target cell.

Table A.9.2.43.2-1: HD-FDD RSRQ Intra frequency test parameters for UE category 0

Parameter	Unit	Test 1		Test 2		Test 3	
		Cell 1	Cell 2	Cell 1	Cell 2	Cell 1	Cell 2
E-UTRA RF Channel Number		1		1		1	
BW _{channel}	MHz	10		10		10	
Measurement bandwidth	n_{PRB}	22—27		22—27		22—27	

PDSCH Reference measurement channel defined in A.3.1.1.4			R.1 HD-FDD	-	R.1 HD-FDD	-	R.1 HD-FDD	-							
PDSCH allocation		n_{PRB}	13–36	-	13–36	-	13–36	-							
PDCCH/PCFICH/PHICH Reference measurement channel defined in A.3.1.2.3			R.3 HD-FDD		R.3 HD-FDD		R.3 HD-FDD								
OCNG Patterns defined in A.3.2.1.1 (OP.1 FDD) and A.3.2.1.2 (OP.2 FDD)			OP.1 FDD	OP.2 FDD	OP.1 FDD	OP.2 FDD	OP.1 FDD	OP.2 FDD							
PBCH_RA		dB	0	0	0	0	0	0							
PBCH_RB															
PSS_RA															
SSS_RA															
PCFICH_RB															
PHICH_RA															
PHICH_RB															
PDCCH_RA															
PDCCH_RB															
PDSCH_RA															
PDSCH_RB															
OCNG_RA ^{Note1}															
OCNG_RB ^{Note1}															
N_{oc} ^{Note2}	Bands FDD-0_A ^{Note 7}								dBm/15 kHz	-84.76		-103.85			-116
	Bands FDD-0_B														-115.5
	Bands FDD-0_C	-115													
	Bands FDD-0_D	-114.5													
	Bands FDD-0_E, FDD-0_F ^{Note 4}	-114													
	Bands FDD-0_G ^{Note 7}	-113													
	Bands FDD-0_H	-112.5													
\hat{E}_s / N_{oc}		dB	3	3	-2.9	-2.9	-4	-4							
\hat{E}_s / I_{ot} ^{Note3}		dB	-1.76	-1.76	-4.7	-4.7	-5.46	-5.46							
RSRP ^{Note3}	Bands FDD-0_A ^{Note 7}	dBm/15 kHz	-81.76	-81.76	-106.75	-106.75			-120	-120					
	Bands FDD-0_B								-119.5	-119.5					
	Bands FDD-0_C								-119	-119					
	Bands FDD-0_D								-118.5	-118.5					
	Bands FDD-0_E, FDD-0_F ^{Note 4}								-118	-118					
	Bands FDD-0_G ^{Note 6}								-117	-117					
	Bands FDD-0_H								-116.5	-116.5					
RSRQ ^{Note3}	Bands FDD-0_A ^{Note 7}	dB	-14.77	-14.77	-16.76	-16.76			-17.34	-17.34					
	Bands FDD-0_B														
	Bands FDD-0_C														
	Bands FDD-0_D														
	Bands FDD-0_E, FDD-0_F ^{Note 4}														
	Bands FDD-0_G ^{Note 6}														
	Bands FDD-0_H														
I_o ^{Note3}	Bands FDD-0_A ^{Note 7}	dBm/9 MHz	-50		-73					-85.67					
	Bands FDD-0_B									-85.17					
	Bands FDD-0_C									-84.67					
	Bands FDD-0_D									-84.17					
	Bands FDD-0_E, FDD-0_F ^{Note 4}									-83.67					
	Bands FDD-0_G ^{Note 6}									-82.67					
	Bands FDD-0_H									-82.17					

Propagation condition	-	AWGN	AWGN	AWGN
Correlation Matrix and Antenna Configuration		1x1	1x1	1x1
Note 1:	OCNG shall be used such that both cells are fully allocated and a constant total transmitted power spectral density is achieved for all OFDM symbols.			
Note 2:	Interference from other cells and noise sources not specified in the test is assumed to be constant over subcarriers and time and shall be modelled as AWGN of appropriate power for N_{oc} to be fulfilled.			
Note 3:	Es/lot, RSRQ, RSRP and Io levels have been derived from other parameters for information purposes. They are not settable parameters themselves.			
Note 4:	For Band 26, the tests shall be performed with the carrier frequency of the assigned E-UTRA channel bandwidth within 865-894 MHz.			
Note 5:	E-UTRA operating band groups are as defined in Section 3.5.			
Note 6:	Except Band 29.			
Note 7:	Except Band 32, Band 75, Band 76.			

A.9.2.43.3 Test Requirements

The RSRQ measurement accuracy shall fulfil the requirements in Clause 9.1.13.3.

A.9.2.44 TDD RSRQ Intra frequency case for UE category 0

A.9.2.44.1 Test Purpose and Environment

The purpose of this test is to verify that the RSRQ measurement accuracy is within the specified limits. This test will verify the requirements in Clause 9.1.13.3 for TDD intra frequency RSRQ measurements for UE category 0.

A.9.2.44.2 Test parameters

In this test case all cells are on the same carrier frequency. The absolute accuracy of RSRQ intra frequency measurement is tested by using the parameters in Table A.9.2.44.2-1. In all test cases, Cell 1 is the PCell and Cell 2 the target cell.

Table A.9.2.44.2-1: TDD RSRQ Intra frequency test parameters for UE category 0

Parameter	Unit	Test 1		Test 2		Test 3	
		Cell 1	Cell 2	Cell 1	Cell 2	Cell 1	Cell 2
E-UTRA RF Channel Number		1		1		1	
BW _{channel}	MHz	10		10		10	
Special subframe configuration ^{Note1}		6		6		6	
Uplink-downlink configuration ^{Note1}		1		1		1	
Measurement bandwidth	n_{PRB}	22—27		22—27		22—27	
PDSCH Reference measurement channel defined in A.3.1.1.5		R.12 TDD	-	R.12 TDD	-	R.12 TDD	-
PDSCH allocation	n_{PRB}	13—36	-	13—36	-	13—36	-
PDCCH/PCFICH/PHICH Reference measurement channel defined in A.3.1.2.2		R.6 TDD		R.6 TDD		R.6 TDD	
OCNG Patterns defined in A.3.2.2.1 (OP.1 TDD) and A.3.2.2.2 (OP.2 TDD)		OP.1 TDD	OP.2 TDD	OP.1 TDD	OP.2 TDD	OP.1 TDD	OP.2 TDD
PBCH_RA	dB	0	0	0	0	0	0
PBCH_RB							
PSS_RA							
SSS_RA							
PCFICH_RB							
PHICH_RA							
PHICH_RB							
PDCCH_RA							
PDCCH_RB							
PDSCH_RA							

PDSCH_RB								
OCNG_RA ^{Note2}								
OCNG_RB ^{Note2}								
N_{oc} ^{Note3}	Bands TDD-0_A	dBm/15 kHz	-84.76		-103.85		-116	
	Bands TDD-0_C						-115	
	Bands TDD-0_E						-114	
\hat{E}_s / N_{oc}		dB	3	3	-2.9	-2.9	-4	-4
\hat{E}_s / I_{ot}		dB	-1.76	-1.76	-4.7	-4.7	-5.46	-5.46
RSRP ^{Note4}	Bands TDD-0_A	dBm/15 kHz	-81.76	-81.76	-106.75	-106.75	-120	
	Bands TDD-0_C						-119	
	Bands TDD-0_E						-118	
RSRQ ^{Note4}	Bands TDD-0_A, TDD-0_C, TDD-0_E	dB	-14.77	-14.77	-16.76	-16.76	-17.34	-17.34
Io ^{Note4}	Bands TDD-0_A	dBm/9 MHz	-50		-73		-85.67	
	Bands TDD-0_C						-84.67	
	Bands TDD-0_E						-83.67	
Propagation condition		-	AWGN		AWGN		AWGN	
Correlation Matrix and Antenna Configuration			1x1		1x1		1x1	
<p>Note 1: For special subframe and uplink-downlink configurations see Tables 4.2-1 and 4.2-2 in TS 36.211.</p> <p>Note 2: OCNG shall be used such that both cells are fully allocated and a constant total transmitted power spectral density is achieved for all OFDM symbols.</p> <p>Note 3: Interference from other cells and noise sources not specified in the test is assumed to be constant over subcarriers and time and shall be modelled as AWGN of appropriate power for N_{oc} to be fulfilled.</p> <p>Note 4: RSRQ, RSRP and Io levels have been derived from other parameters for information purposes. They are not settable parameters themselves.</p> <p>Note 5: RSRP and RSRQ minimum requirements are specified assuming independent interference and noise at each receiver antenna port.</p> <p>Note 6: E-UTRA operating band groups are as defined in Section 3.5.</p>								

A.9.2.44.3 Test Requirements

The RSRQ measurement accuracy shall fulfil the requirements in Clause 9.1.13.3.

A.9.2.45 4 DL CA PCell in FDD FDD-TDD RSRQ for E-UTRAN in Carrier Aggregation

The test case in this clause is applicable to carrier aggregation capable UEs which have been configured with three downlink SCells.

A.9.2.45.1 Test Purpose and Environment

The purpose of this test is to verify that the RSRQ measurement accuracy in carrier aggregation is within the specified limits under AWGN propagation conditions. This test will verify the absolute accuracy of intra-frequency RSRQ measurements for the primary component carrier specified in clause 9.1.11.1, the absolute accuracy of intra-frequency RSRQ measurements for the secondary component carriers specified in clause 9.1.11.2 and also the relative inter-frequency RSRQ accuracy requirement between primary and secondary component carriers specified in clause 9.1.11.3.

A.9.2.45.2 Test parameters

In this set of test cases there are four cells on four carrier frequencies. Cell 1 is PCell on channel 1, Cell 2 is activated SCell on channel 2, Cell 3 is activated SCell on channel 3, and Cell 4 is activated SCell on channel 4. The parameters for the test are listed in Table A.9.2.45.2-1.

Table A.9.2.45.2-1: 4 DL PCell in FDD RSRQ for E-UTRAN in Carrier Aggregation test parameters (cell #1, cell #2, cell #3 and cell #4)

Parameter	Unit	Cell 1	Cell 2	Cell 3	Cell 4
-----------	------	--------	--------	--------	--------

E-UTRA RF Channel Number			1	2	3	4
BW _{channel}			5MHz: N _{RB,c} = 25 10MHz: N _{RB,c} = 50 20MHz: N _{RB,c} = 100	5MHz: N _{RB,c} = 25 10MHz: N _{RB,c} = 50 20MHz: N _{RB,c} = 100	5MHz: N _{RB,c} = 25 10MHz: N _{RB,c} = 50 20MHz: N _{RB,c} = 100	5MHz: N _{RB,c} = 25 10MHz: N _{RB,c} = 50 20MHz: N _{RB,c} = 100
Special subframe configuration ^{Note1}			-	6	6	6
Uplink/downlink configuration ^{Note1}			-	1	1	1
Measurement bandwidth		<i>n_{PRB}</i>	5MHz: 10-15 10MHz: 22-27 20MHz: 47-52	5MHz: 10-15 10MHz: 22-27 20MHz: 47-52	5MHz: 10-15 10MHz: 22-27 20MHz: 47-52	5MHz: 10-15 10MHz: 22-27 20MHz: 47-52
PDSCH Reference measurement channel defined in A.3.1.1			5MHz: R.5 FDD 10MHz: R.0 FDD 20MHz: R.4 FDD	5MHz: R.4 TDD 10MHz: R.0 TDD 20MHz: R.3 TDD	5MHz: R.4 TDD 10MHz: R.0 TDD 20MHz: R.3 TDD	5MHz: R.4 TDD 10MHz: R.0 TDD 20MHz: R.3 TDD
PDSCH allocation		<i>n_{PRB}</i>	5MHz: 7-17 10MHz: 13-36 20MHz: 38-61	5MHz: 7-17 10MHz: 13-36 20MHz: 38-61	5MHz: 7-17 10MHz: 13-36 20MHz: 38-61	5MHz: 7-17 10MHz: 13-36 20MHz: 38-61
PDCCH/PCFICH/PHICH Reference measurement channel defined in A.3.1.2			5MHz: R.11 FDD 10MHz: R.6 FDD 20MHz: R.10 FDD	5MHz: R.11 TDD 10MHz: R.6 TDD 20MHz: R.10 TDD	5MHz: R.11 TDD 10MHz: R.6 TDD 20MHz: R.10 TDD	5MHz: R.11 TDD 10MHz: R.6 TDD 20MHz: R.10 TDD
OCNG Patterns defined in A.3.2			5MHz: OP.15 FDD 10MHz: OP.1 FDD 20MHz: OP.11 FDD	5MHz: OP.9 TDD 10MHz: OP.1 TDD 20MHz: OP.7 TDD	5MHz: OP.9 TDD 10MHz: OP.1 TDD 20MHz: OP.7 TDD	5MHz: OP.9 TDD 10MHz: OP.1 TDD 20MHz: OP.7 TDD
PBCH_RA		dB	0	0	0	0
PBCH_RB						
PSS_RA						
SSS_RA						
PCFICH_RB						
PHICH_RA						
PHICH_RB						
PDCCH_RA						
PDCCH_RB						
PDSCH_RA						
PDSCH_RB						
OCNG_RA ^{Note2}						
OCNG_RB ^{Note2}						
<i>N_{oc}</i> ^{Note3}	Bands TDD_A					
	Bands TDD_C	-	-115	-115	-115	
	Bands TDD_E	-	-114	-114	-114	
	Bands FDD_A	-119.5	-	-	-	
	Bands FDD_B1, FDD_B2 ^{Note 11}	-119	-	-	-	
	Bands FDD_C	-118.5	-	-	-	
	Bands FDD_D	-118	-	-	-	
	Bands FDD_E, Bands FDD_F ^{Note 6}	-117.5	-	-	-	
	Bands FDD_G	-116.5	-	-	-	
	Bands FDD_H	-116	-	-	-	

\hat{E}_s / N_{oc}		dB	-6.0	-6.0	-6.0	-6.0
\hat{E}_s / I_{ot}		dB	-6.0	-6.0	-6.0	-6.0
RSRP ^{Note4}	Bands TDD_A	dBm/ 15kHz	-	-122	-122	-122
	Bands TDD_C		-	-121	-121	-121
	Bands TDD_E		-	-120	-120	-120
	Bands FDD_A		-125.5	-	-	-
	Bands FDD_B1, FDD_B2 ^{Note 11}		-125	-	-	-
	Bands FDD_C		-124.5	-	-	-
	Bands FDD_D		-124	-	-	-
	Bands FDD_E, Bands FDD_F ^{Note 6}		-123.5	-	-	-
	Bands FDD_G		-122.5	-	-	-
	Bands FDD_H		-122	-	-	-
RSRQ ^{Note4}	Bands TDD_A	dB	-	-17.77	-17.77	-17.77
	Bands TDD_C		-	-17.77	-17.77	-17.77
	Bands TDD_E		-	-17.77	-17.77	-17.77
	Bands FDD_A		-17.77	-	-	-
	Bands FDD_B1, FDD_B2 ^{Note 11}		-17.77	-	-	-
	Bands FDD_C		-17.77	-	-	-
	Bands FDD_D		-17.77	-	-	-
	Bands FDD_E, Bands FDD_F ^{Note 6}		-17.77	-	-	-
	Bands FDD_G		-17.77	-	-	-
	Bands FDD_H		-17.77	-	-	-
I _o ^{Note4}	Bands TDD_A	dBm/ BW _{channel}	-	-87.25 + 10log(N _{RB,c} /50)	-87.25 + 10log(N _{RB,c} /50)	-87.25 + 10log(N _{RB,c} /50)
	Bands TDD_C		-	-86.25 + 10log(N _{RB,c} /50)	-86.25 + 10log(N _{RB,c} /50)	-86.25 + 10log(N _{RB,c} /50)
	Bands TDD_E		-	-85.25 + 10log(N _{RB,c} /50)	-85.25 + 10log(N _{RB,c} /50)	-85.25 + 10log(N _{RB,c} /50)
	Bands FDD_A		-90.75 + 10log(N _{RB,c} /50)	-	-	-
	Bands FDD_B1, FDD_B2 ^{Note 11}		-90.25 + 10log(N _{RB,c} /50)	-	-	-
	Bands FDD_C		-89.75 + 10log(N _{RB,c} /50)	-	-	-

	Bands FDD_D		-89.25 + 10log(N _{RB,c} /50)	-	-	-
	Bands FDD_E, Bands FDD_F ^{Note 6}		-88.75 + 10log(N _{RB,c} /50)	-	-	-
	Bands FDD_G		-87.75 + 10log(N _{RB,c} /50)	-	-	-
	Bands FDD_H		-87.25 + 10log(N _{RB,c} /50)	-	-	-
Propagation Condition			AWGN	AWGN	AWGN	AWGN
Antenna Configuration			1x2	1x2	1x2	1x2
Timing offset to Cell 1		μs	-	0	0	0
Time alignment error relative to cell 1 ^{Note 10}			-	≤ TAE	≤ TAE	≤ TAE
Time alignment error relative to cell 2 ^{Note 10}			-	-	≤ TAE	≤ TAE
Time alignment error relative to cell 3 ^{Note 10}			-	-	-	≤ TAE
<p>Note 1: For special subframe and uplink-downlink configurations see Tables 4.2-1 and 4.2-2 in TS 36.211.</p> <p>Note 2: OCNB shall be used such that both cells are fully allocated and a constant total transmitted power spectral density is achieved for all OFDM symbols.</p> <p>Note 3: Interference from other cells and noise sources not specified in the test is assumed to be constant over subcarriers and time and shall be modelled as AWGN of appropriate power for N_{oc} to be fulfilled.</p> <p>Note 4: RSRP, RSRQ and Io levels have been derived from other parameters for information purposes. They are not settable parameters themselves.</p> <p>Note 5: RSRP and RSRQ minimum requirements are specified assuming independent interference and noise at each receiver antenna port.</p> <p>Note 6: For Band 26, the tests shall be performed with the carrier frequency of the assigned E-UTRA channel bandwidth within 865-894 MHz.</p> <p>Note 7: The selection of the bands for testing depends on the configuration of the carrier aggregation supported by the UEs.</p> <p>Note 8: Void.</p> <p>Note 9: E-UTRA operating band groups are as defined in Section 3.5.</p> <p>Note 10: Time alignment error (TAE) as specified in TS 36.104 [30] clause 6.5.3.1. The TAE value depends upon the type of carrier aggregation.</p> <p>Note 11: For Band 74, the tests shall be performed with the carrier frequency of the assigned E-UTRA channel bandwidth within 1475.9-1510.9 MHz.</p>						

A.9.2.45.3 Test Requirements

In the test, the RSRQ measurement accuracy in carrier aggregation shall fulfil the requirements in clause 9.1.11.1, 9.1.11.2, and 9.1.11.3.

- The absolute accuracy of intra-frequency RSRQ measurements of Cell 1 on the primary component carrier shall fulfil the requirements specified in clause 9.1.11.1.
- The absolute accuracy of intra-frequency RSRQ measurements of Cell 2 on the secondary component carrier shall fulfil the requirements specified in clause 9.1.11.2
- The absolute accuracy of intra-frequency RSRQ measurements of Cell 3 on the secondary component carrier shall fulfil the requirements specified in clause 9.1.11.2
- The absolute accuracy of intra-frequency RSRQ measurements of Cell 4 on the secondary component carrier shall fulfil the requirements specified in clause 9.1.11.2
- The relative accuracy of inter-frequency RSRQ measurements between the primary and secondary component carriers for Cell 2 relative to Cell 1 shall fulfil the requirements specified in clause 9.1.11.3.
- The relative accuracy of inter-frequency RSRQ measurements between the primary and secondary component carriers for Cell 3 relative to Cell 1 shall fulfil the requirements specified in clause 9.1.11.3.
- The relative accuracy of inter-frequency RSRQ measurements between the primary and secondary component carriers for Cell 4 relative to Cell 1 shall fulfil the requirements specified in clause 9.1.11.3.

A.9.2.46 4 DL CA PCell in TDD TDD-FDD RSRQ for E-UTRAN in Carrier Aggregation

The test case in this clause is applicable to carrier aggregation capable UEs which have been configured with three downlink SCells.

A.9.2.46.1 Test Purpose and Environment

The purpose of this test is to verify that the RSRQ measurement accuracy in carrier aggregation is within the specified limits under AWGN propagation conditions. This test will verify the absolute accuracy of intra-frequency RSRQ measurements for the primary component carrier specified in clause 9.1.11.1, the absolute accuracy of intra-frequency RSRQ measurements for the secondary component carriers specified in clause 9.1.11.2 and also the relative inter-frequency RSRQ accuracy requirement between primary and secondary component carriers specified in clause 9.1.11.3.

A.9.2.46.2 Test parameters

In this set of test cases there are four cells on four carrier frequencies. Cell 1 is PCell on channel 1, Cell 2 is activated SCell on channel 2, Cell 3 is activated SCell on channel 3, and Cell 4 is activated SCell on channel 4. The parameters for the test are listed in Table A.9.2.45.2-1.

Table A.9.2.46.2-1: 4 DL PCell in TDD RSRQ for E-UTRAN in Carrier Aggregation test parameters (cell #1, cell #2, cell #3 and cell #4)

Parameter	Unit	Cell 1	Cell 2	Cell 3	Cell 4
E-UTRA RF Channel Number		1	2	3	4
$BW_{channel}$		5MHz: $N_{RB,c} = 25$ 10MHz: $N_{RB,c} = 50$ 20MHz: $N_{RB,c} = 100$	5MHz: $N_{RB,c} = 25$ 10MHz: $N_{RB,c} = 50$ 20MHz: $N_{RB,c} = 100$	5MHz: $N_{RB,c} = 25$ 10MHz: $N_{RB,c} = 50$ 20MHz: $N_{RB,c} = 100$	5MHz: $N_{RB,c} = 25$ 10MHz: $N_{RB,c} = 50$ 20MHz: $N_{RB,c} = 100$
Special subframe configuration ^{Note1}		6	-	-	-
Uplink/downlink configuration ^{Note1}		1	-	-	-
Measurement bandwidth	n_{PRB}	5MHz: 10-15 10MHz: 22-27 20MHz: 47-52	5MHz: 10-15 10MHz: 22-27 20MHz: 47-52	5MHz: 10-15 10MHz: 22-27 20MHz: 47-52	5MHz: 10-15 10MHz: 22-27 20MHz: 47-52
PDSCH Reference measurement channel defined in A.3.1.1		5MHz: R.4 TDD 10MHz: R.0 TDD 20MHz: R.3 TDD	5MHz: R.5 FDD 10MHz: R.0 FDD 20MHz: R.4 FDD	5MHz: R.5 FDD 10MHz: R.0 FDD 20MHz: R.4	5MHz: R.5 FDD 10MHz: R.0 FDD 20MHz: R.4
PDSCH allocation	n_{PRB}	5MHz: 7-17 10MHz: 13-36 20MHz: 38-61	5MHz: 7-17 10MHz: 13-36 20MHz: 38-61	5MHz: 7-17 10MHz: 13-36 20MHz: 38-61	5MHz: 7-17 10MHz: 13-36 20MHz: 38-61
PDCCH/PCFICH/PHICH Reference measurement channel defined in A.3.1.2		5MHz: R.11 TDD 10MHz: R.6 TDD 20MHz: R.10 TDD	5MHz: R.11 FDD 10MHz: R.6 FDD 20MHz: R.10 FDD	5MHz: R.11 FDD 10MHz: R.6 FDD 20MHz: R.10	5MHz: R.11 FDD 10MHz: R.6 FDD 20MHz: R.10
OCNG Patterns defined in A.3.2		5MHz: OP.9 TDD 10MHz: OP.1 TDD 20MHz: OP.7 TDD	5MHz: OP.15 FDD 10MHz: OP.1 FDD 20MHz: OP.11 FDD	5MHz: OP.15 FDD 10MHz: OP.1 FDD 20MHz: OP.11	5MHz: OP.15 FDD 10MHz: OP.1 FDD 20MHz: OP.11
PBCH_RA	dB	0	0	0	0
PBCH_RB					
PSS_RA					
SSS_RA					
PCFICH_RB					
PHICH_RA					
PHICH_RB					
PDCCH_RA					
PDCCH_RB					
PDSCH_RA					

PDSCH_RB						
OCNG_RA ^{Note2}						
OCNG_RB ^{Note2}						
N_{oc} ^{Note3}	Bands TDD_A	dBm/ 15kHz	-119.5	-	-	-
	Bands TDD_C		-118.5	-	-	-
	Bands TDD_E		-117.5	-	-	-
	Bands FDD_A		-	-116	-116	-116
	Bands FDD_B1, FDD_B2 ^{Note 11}		-	-115.5	-115.5	-115.5
	Bands FDD_C		-	-115	-115	-115
	Bands FDD_D		-	-114.5	-114.5	-114.5
	Bands FDD_E, Bands FDD_F ^{Note 6}		-	-114	-114	-114
	Bands FDD_G		-	-113	-113	-113
	Bands FDD_H		-	-112.5	-112.5	-112.5
\hat{E}_s/N_{oc}		dB	-6.0	-6.0	-6.0	-6.0
\hat{E}_s/I_{ot}		dB	-6.0	-6.0	-6.0	-6.0
RSRP ^{Note4}	Bands TDD_A	dBm/ 15kHz	-125.5	-	-	-
	Bands TDD_C		-124.5	-	-	-
	Bands TDD_E		-123.5	-	-	-
	Bands FDD_A		-	-122	-122	-122
	Bands FDD_B1, FDD_B2 ^{Note 11}		-	-121.5	-121.5	-121.5
	Bands FDD_C		-	-121	-121	-121
	Bands FDD_D		-	-120.5	-120.5	-120.5
	Bands FDD_E, Bands FDD_F ^{Note 6}		-	-120	-120	-120
	Bands FDD_G		-	-119	-119	-119
	Bands FDD_H		-	-118.5	-118.5	-118.5
RSRQ ^{Note4}	Bands TDD_A	dB	-17.77	-	-	-
	Bands TDD_C					
	Bands TDD_E		-	-17.77	-17.77	-17.77
	Bands FDD_A					
	Bands FDD_B1, FDD_B2 ^{Note 11}					

	Bands FDD_C					
	Bands FDD_D					
	Bands FDD_E, Bands FDD_F ^{Note 6}					
	Bands FDD_G					
	Bands FDD_H					
I _o ^{Note 4}	Bands TDD_A	dBm/ BW _{channel}	-90.75 + 10log(N _{RB,c} /50)	-	-	-
	Bands TDD_C		-89.75 + 10log(N _{RB,c} /50)	-	-	-
	Bands TDD_E		-88.75 + 10log(N _{RB,c} /50)	-	-	-
	Bands FDD_A		-	-87.25 + 10log(N _{RB,c} /50)	-87.25 + 10log(N _{RB,c} /50)	-87.25 + 10log(N _{RB,c} /50)
	Bands FDD_B1, FDD_B2 ^{Note 11}		-	-86.75 + 10log(N _{RB,c} /50)	-86.75 + 10log(N _{RB,c} /50)	-86.75 + 10log(N _{RB,c} /50)
	Bands FDD_C		-	-86.25 + 10log(N _{RB,c} /50)	-86.25 + 10log(N _{RB,c} /50)	-86.25 + 10log(N _{RB,c} /50)
	Bands FDD_D		-	-85.75 + 10log(N _{RB,c} /50)	-85.75 + 10log(N _{RB,c} /50)	-85.75 + 10log(N _{RB,c} /50)
	Bands FDD_E, Bands FDD_F ^{Note 6}		-	-85.25 + 10log(N _{RB,c} /50)	-85.25 + 10log(N _{RB,c} /50)	-85.25 + 10log(N _{RB,c} /50)
	Bands FDD_G		-	-84.25 + 10log(N _{RB,c} /50)	-84.25 + 10log(N _{RB,c} /50)	-84.25 + 10log(N _{RB,c} /50)
	Bands FDD_H		-	-83.75 + 10log(N _{RB,c} /50)	-83.75 + 10log(N _{RB,c} /50)	-83.75 + 10log(N _{RB,c} /50)
Propagation Condition		AWGN	AWGN	AWGN	AWGN	
Antenna Configuration		1x2	1x2	1x2	1x2	
Timing offset to Cell 1	μs	-	0	0	0	
Time alignment error relative to cell 1 ^{Note 10}		-	≤ TAE	≤ TAE	≤ TAE	
Time alignment error relative to cell 2 ^{Note 10}		-	-	≤ TAE	≤ TAE	
Time alignment error relative to cell 3 ^{Note 10}		-	-	-	≤ TAE	
<p>Note 1: For special subframe and uplink-downlink configurations see Tables 4.2-1 and 4.2-2 in TS 36.211.</p> <p>Note 2: OCNG shall be used such that both cells are fully allocated and a constant total transmitted power spectral density is achieved for all OFDM symbols.</p> <p>Note 3: Interference from other cells and noise sources not specified in the test is assumed to be constant over subcarriers and time and shall be modelled as AWGN of appropriate power for N_{oc} to be fulfilled.</p> <p>Note 4: RSRP, RSRQ and I_o levels have been derived from other parameters for information purposes. They are not settable parameters themselves.</p> <p>Note 5: RSRP and RSRQ minimum requirements are specified assuming independent interference and noise at each receiver antenna port.</p> <p>Note 6: For Band 26, the tests shall be performed with the carrier frequency of the assigned E-UTRA channel bandwidth within 865-894 MHz.</p> <p>Note 7: The selection of the bands for testing depends on the configuration of the carrier aggregation supported by the UEs.</p> <p>Note 8: Void.</p> <p>Note 9: E-UTRA operating band groups are as defined in Section 3.5.</p> <p>Note 10: Time alignment error (TAE) as specified in TS 36.104 [30] clause 6.5.3.1. The TAE value depends upon the type of carrier aggregation.</p> <p>Note 11: For Band 74, the tests shall be performed with the carrier frequency of the assigned E-UTRA channel bandwidth within 1475.9-1510.9 MHz.</p>						

A.9.2.46.3 Test Requirements

In the test, the RSRQ measurement accuracy in carrier aggregation shall fulfil the requirements in clause 9.1.11.1, 9.1.11.2, and 9.1.11.3.

- The absolute accuracy of intra-frequency RSRQ measurements of Cell 1 on the primary component carrier shall fulfil the requirements specified in clause 9.1.11.1.
- The absolute accuracy of intra-frequency RSRQ measurements of Cell 2 on the secondary component carrier shall fulfil the requirements specified in clause 9.1.11.2
- The absolute accuracy of intra-frequency RSRQ measurements of Cell 3 on the secondary component carrier shall fulfil the requirements specified in clause 9.1.11.2
- The absolute accuracy of intra-frequency RSRQ measurements of Cell 4 on the secondary component carrier shall fulfil the requirements specified in clause 9.1.11.2
- The relative accuracy of inter-frequency RSRQ measurements between the primary and secondary component carriers for Cell 2 relative to Cell 1 shall fulfil the requirements specified in clause 9.1.11.3.
- The relative accuracy of inter-frequency RSRQ measurements between the primary and secondary component carriers for Cell 3 relative to Cell 1 shall fulfil the requirements specified in clause 9.1.11.3.
- The relative accuracy of inter-frequency RSRQ measurements between the primary and secondary component carriers for Cell 4 relative to Cell 1 shall fulfil the requirements specified in clause 9.1.11.3.

A.9.2.47 5 DL FDD-TDD with PCell in FDD RSRQ for E-UTRAN in Carrier Aggregation

The test case in this clause is applicable to carrier aggregation capable UEs which have been configured with four downlink SCells.

A.9.2.47.1 Test Purpose and Environment

The purpose of this test is to verify that the RSRQ measurement accuracy in carrier aggregation is within the specified limits under AWGN propagation conditions. This test will verify the absolute accuracy of intra-frequency RSRQ measurements for the primary component carrier specified in clause 9.1.11.1, the absolute accuracy of intra-frequency RSRQ measurements for the secondary component carriers specified in clause 9.1.11.2 and also the relative inter-frequency RSRQ accuracy requirement between primary and secondary component carriers specified in clause 9.1.11.3.

A.9.2.47.2 Test parameters

In this set of test cases there are five cells on five carrier frequencies. Cell 1 is PCell on channel 1, Cell 2 is activated SCell on channel 2, Cell 3 is activated SCell on channel 3, Cell 4 is activated SCell on channel 4, and Cell 5 is activated SCell on channel 5. The parameters for the test are listed in Table A.9.2.45.2-1.

Table A.9.2.47.2-1: 5 DL PCell in FDD RSRQ for E-UTRAN in Carrier Aggregation test parameters (cell #1, cell #2, cell #3, cell #4 and cell#5)

Parameter	Unit	Cell 1	Cells			
			2	3	4	5
E-UTRA RF Channel Number		1	2	3	4	5
BW_{channel}		5MHz: $N_{RB,c} = 25$ 10MHz: $N_{RB,c} = 50$ 20MHz: $N_{RB,c} = 100$	5MHz: $N_{RB,c} = 25$ 10MHz: $N_{RB,c} = 50$ 20MHz: $N_{RB,c} = 100$			
Special subframe configuration ^{Note1}		-	6			
Uplink/downlink configuration ^{Note1}		-	1			
Measurement bandwidth	n_{PRB}	5MHz: 10-15 10MHz: 22-27 20MHz: 47-52	5MHz: 10-15 10MHz: 22-27 20MHz: 47-52			
PDSCH Reference measurement channel defined in A.3.1.1		5MHz: R.5 FDD 10MHz: R.0 FDD 20MHz: R.4 FDD	5MHz: R.4 TDD 10MHz: R.0 TDD 20MHz: R.3 TDD			

PDSCH allocation	n_{PRB}	5MHz: 7-17 10MHz: 13-36 20MHz: 38-61	5MHz: 7-17 10MHz: 13-36 20MHz: 38-61
PDCCH/PCFICH/PHICH Reference measurement channel defined in A.3.1.2		5MHz: R.11 FDD 10MHz: R.6 FDD 20MHz: R.10 FDD	5MHz: R.11 TDD 10MHz: R.6 TDD 20MHz: R.10 TDD
OCNG Patterns defined in A.3.2		5MHz: OP.15 FDD 10MHz: OP.1 FDD 20MHz: OP.11 FDD	5MHz: OP.9 TDD 10MHz: OP.1 TDD 20MHz: OP.7 TDD
PBCH_RA	dB	0	0
PBCH_RB			
PSS_RA			
SSS_RA			
PCFICH_RB			
PHICH_RA			
PHICH_RB			
PDCCH_RA			
PDCCH_RB			
PDSCH_RA			
PDSCH_RB			
OCNG_RA ^{Note2}			
OCNG_RB ^{Note2}			
N_{oc} ^{Note3}			
	Bands TDD_C	-	-115
	Bands TDD_E	-	-114
	Bands FDD_A	-119.5	-
	Bands FDD_B1, FDD_B2 ^{Note 11}	-119	-
	Bands FDD_C	-118.5	-
	Bands FDD_D	-118	-
	Bands FDD_E, Bands FDD_F ^{Note 6}	-117.5	-
	Bands FDD_G	-116.5	-
Bands FDD_H	-116	-	
\hat{E}_s/N_{oc}	dB	-6.0	-6.0
\hat{E}_s/I_{ot}	dB	-6.0	-6.0
RSRP ^{Note4}	Bands TDD_A	-	-122
	Bands TDD_C	-	-121
	Bands TDD_E	-	-120
	Bands FDD_A	-125.5	-
	Bands FDD_B, FDD_B2 ^{Note 11}	-125	-
	Bands FDD_C	-124.5	-
	Bands FDD_D	-124	-
	Bands FDD_E, Bands FDD_F ^{Note 6}	-123.5	-
	Bands FDD_G	-122.5	-
Bands FDD_H	-122	-	
RSRQ ^{Note4}	Bands TDD_A	-	-17.77
	Bands TDD_C	-	-17.77
	Bands TDD_E	-	-17.77
	Bands FDD_A	-17.77	-
	Bands FDD_B, FDD_B2 ^{Note 11}	-17.77	-
Bands FDD_C	-	-	

	Bands FDD_D					
	Bands FDD_E, Bands FDD_F <small>Note 6</small>					
	Bands FDD_G					
	Bands FDD_H					
Io ^{Note4}	Bands TDD_A	dBm/ BW _{channel}	-	-87.25 + 10log(N _{RB,c} /50)		
	Bands TDD_C		-	-86.25 + 10log(N _{RB,c} /50)		
	Bands TDD_E		-	-85.25 + 10log(N _{RB,c} /50)		
	Bands FDD_A		-90.75 + 10log(N _{RB,c} /50)	-		
	Bands FDD_B, FDD_B2 <small>Note 11</small>		-90.25 + 10log(N _{RB,c} /50)	-		
	Bands FDD_C		-89.75 + 10log(N _{RB,c} /50)	-		
	Bands FDD_D		-89.25 + 10log(N _{RB,c} /50)	-		
	Bands FDD_E, Bands FDD_F <small>Note 6</small>		-88.75 + 10log(N _{RB,c} /50)	-		
	Bands FDD_G		-87.75 + 10log(N _{RB,c} /50)	-		
	Bands FDD_H		-87.25 + 10log(N _{RB,c} /50)	-		
Propagation Condition			AWGN		AWGN	
Antenna Configuration			1x2		1x2	
Timing offset to Cell 1		µs	-		0	
Time alignment error relative to cell 1 <small>Note 10</small>			-	≤ TAE	≤ TAE	≤ TAE
Time alignment error relative to cell 2 <small>Note 10</small>			-	-	≤ TAE	≤ TAE
Time alignment error relative to cell 3 <small>Note 10</small>			-	-	≤ TAE	≤ TAE
Time alignment error relative to cell 4 <small>Note 10</small>			-	-	-	≤ TAE
<p>Note 1: For special subframe and uplink-downlink configurations see Tables 4.2-1 and 4.2-2 in TS 36.211.</p> <p>Note 2: OCNG shall be used such that both cells are fully allocated and a constant total transmitted power spectral density is achieved for all OFDM symbols.</p> <p>Note 3: Interference from other cells and noise sources not specified in the test is assumed to be constant over subcarriers and time and shall be modelled as AWGN of appropriate power for N_{oc} to be fulfilled.</p> <p>Note 4: RSRP, RSRQ and Io levels have been derived from other parameters for information purposes. They are not settable parameters themselves.</p> <p>Note 5: RSRP and RSRQ minimum requirements are specified assuming independent interference and noise at each receiver antenna port.</p> <p>Note 6: For Band 26, the tests shall be performed with the carrier frequency of the assigned E-UTRA channel bandwidth within 865-894 MHz.</p> <p>Note 7: The selection of the bands for testing depends on the configuration of the carrier aggregation supported by the UEs.</p> <p>Note 8: Void</p> <p>Note 9: E-UTRA operating band groups are as defined in Section 3.5.</p> <p>Note 10: Time alignment error (TAE) as specified in TS 36.104 [30] clause 6.5.3.1. The TAE value depends upon the type of carrier aggregation.</p> <p>Note 11: For Band 74, the tests shall be performed with the carrier frequency of the assigned E-UTRA channel bandwidth within 1475.9-1510.9 MHz.</p>						

A.9.2.47.3 Test Requirements

In the test, the RSRQ measurement accuracy in carrier aggregation shall fulfil the requirements in clause 9.1.11.1, 9.1.11.2, and 9.1.11.3.

- The absolute accuracy of intra-frequency RSRQ measurements of Cell 1 on the primary component carrier shall fulfil the requirements specified in clause 9.1.11.1.
- The absolute accuracy of intra-frequency RSRQ measurements of Cell 2 on the secondary component carrier shall fulfil the requirements specified in clause 9.1.11.2
- The absolute accuracy of intra-frequency RSRQ measurements of Cell 3 on the secondary component carrier shall fulfil the requirements specified in clause 9.1.11.2
- The absolute accuracy of intra-frequency RSRQ measurements of Cell 4 on the secondary component carrier shall fulfil the requirements specified in clause 9.1.11.2
- The absolute accuracy of intra-frequency RSRQ measurements of Cell 5 on the secondary component carrier shall fulfil the requirements specified in clause 9.1.11.2
- The relative accuracy of inter-frequency RSRQ measurements between the primary and secondary component carriers for Cell 2 relative to Cell 1 shall fulfil the requirements specified in clause 9.1.11.3.
- The relative accuracy of inter-frequency RSRQ measurements between the primary and secondary component carriers for Cell 3 relative to Cell 1 shall fulfil the requirements specified in clause 9.1.11.3.
- The relative accuracy of inter-frequency RSRQ measurements between the primary and secondary component carriers for Cell 4 relative to Cell 1 shall fulfil the requirements specified in clause 9.1.11.3.
- The relative accuracy of inter-frequency RSRQ measurements between the primary and secondary component carriers for Cell 5 relative to Cell 1 shall fulfil the requirements specified in clause 9.1.11.3.

A.9.2.48 5 DL FDD-TDD with PCell in TDD RSRQ for E-UTRAN in Carrier Aggregation

The test case in this clause is applicable to carrier aggregation capable UEs which have been configured with four downlink SCells.

A.9.2.48.1 Test Purpose and Environment

The purpose of this test is to verify that the RSRQ measurement accuracy in carrier aggregation is within the specified limits under AWGN propagation conditions. This test will verify the absolute accuracy of intra-frequency RSRQ measurements for the primary component carrier specified in clause 9.1.11.1, the absolute accuracy of intra-frequency RSRQ measurements for the secondary component carriers specified in clause 9.1.11.2 and also the relative inter-frequency RSRQ accuracy requirement between primary and secondary component carriers specified in clause 9.1.11.3.

A.9.2.48.2 Test parameters

In this set of test cases there are five cells on five carrier frequencies. Cell 1 is PCell on channel 1, Cell 2 is activated SCell on channel 2, Cell 3 is activated SCell on channel 3, Cell 4 is activated SCell on channel 4, and Cell 5 is activated SCell on channel 5. The parameters for the test are listed in Table A.9.2.45.2-1.

Table A.9.2.48.2-1: 5 DL PCell in FDD RSRQ for E-UTRAN in Carrier Aggregation test parameters (cell #1, cell #2, cell #3, cell #4 and cell#5)

Parameter	Unit	Cell 1	Cells			
			2	3	4	5
E-UTRA RF Channel Number		1	2	3	4	5
BW _{channel}		5MHz: N _{RB,c} = 25 10MHz: N _{RB,c} = 50 20MHz: N _{RB,c} = 100	5MHz: N _{RB,c} = 25 10MHz: N _{RB,c} = 50 20MHz: N _{RB,c} = 100			
Special subframe configuration ^{Note1}		6	-			
Uplink/downlink configuration ^{Note1}		1	-			
Measurement bandwidth	<i>n</i> _{PRB}	5MHz: 10-15 10MHz: 22-27 20MHz: 47-52	5MHz: 10-15 10MHz: 22-27 20MHz: 47-52			

PDSCH Reference measurement channel defined in A.3.1.1			5MHz: R.4 TDD 10MHz: R.0 TDD 20MHz: R.3 TDD	5MHz: R.5 FDD 10MHz: R.0 FDD 20MHz: R.4 FDD
PDSCH allocation		n_{PRB}	5MHz: 7-17 10MHz: 13-36 20MHz: 38-61	5MHz: 7-17 10MHz: 13-36 20MHz: 38-61
PDCCH/PCFICH/PHICH Reference measurement channel defined in A.3.1.2			5MHz: R.11 TDD 10MHz: R.6 TDD 20MHz: R.10 TDD	5MHz: R.11 FDD 10MHz: R.6 FDD 20MHz: R.10 FDD
OCNG Patterns defined in A.3.2			5MHz: OP.9 TDD 10MHz: OP.1 TDD 20MHz: OP.7 TDD	5MHz: OP.15 FDD 10MHz: OP.1 FDD 20MHz: OP.11 FDD
PBCH_RA		dB	0	0
PBCH_RB				
PSS_RA				
SSS_RA				
PCFICH_RB				
PHICH_RA				
PHICH_RB				
PDCCH_RA				
PDCCH_RB				
PDSCH_RA				
PDSCH_RB				
OCNG_RA ^{Note2}				
OCNG_RB ^{Note2}				
N_{oc} ^{Note3}	Bands TDD_A			
	Bands TDD_C	-115	-	
	Bands TDD_E	-114	-	
	Bands FDD_A	-	-119.5	
	Bands FDD_B1, FDD_B2 ^{Note 11}	-	-119	
	Bands FDD_C	-	-118.5	
	Bands FDD_D	-	-118	
	Bands FDD_E, Bands FDD_F ^{Note 6}	-	-117.5	
	Bands FDD_G	-	-116.5	
	Bands FDD_H	-	-116	
\hat{E}_s / N_{oc}		dB	-6.0	-6.0
\hat{E}_s / I_{ot}		dB	-6.0	-6.0
RSRP ^{Note4}	Bands TDD_A	dBm/ 15kHz	-122	-
	Bands TDD_C		-121	-
	Bands TDD_E		-120	-
	Bands FDD_A		-	-125.5
	Bands FDD_B1, FDD_B2 ^{Note 11}		-	-125
	Bands FDD_C		-	-124.5

	Bands FDD_D		-	-124			
	Bands FDD_E, Bands FDD_F Note 6		-	-123.5			
	Bands FDD_G		-	-122.5			
	Bands FDD_H		-	-122			
RSRQ ^{Note4}	Bands TDD_A	dB	-17.77	-			
	Bands TDD_C						
	Bands TDD_E						
	Bands FDD_A		-	-17.77			
	Bands FDD_B1, FDD_B2 Note 11						
	Bands FDD_C						
	Bands FDD_D						
	Bands FDD_E, Bands FDD_F Note 6						
	Bands FDD_G						
	Bands FDD_H						
Io ^{Note4}	Bands TDD_A	dBm/ BW _{channel}	$-87.25 + 10\log(N_{RB,c}/50)$	-			
	Bands TDD_C		$-86.25 + 10\log(N_{RB,c}/50)$	-			
	Bands TDD_E		$-85.25 + 10\log(N_{RB,c}/50)$	-			
	Bands FDD_A		-	$-90.75 + 10\log(N_{RB,c}/50)$			
	Bands FDD_B1, FDD_B2 Note 11		-	$-90.25 + 10\log(N_{RB,c}/50)$			
	Bands FDD_C		-	$-89.75 + 10\log(N_{RB,c}/50)$			
	Bands FDD_D		-	$-89.25 + 10\log(N_{RB,c}/50)$			
	Bands FDD_E, Bands FDD_F Note 6		-	$-88.75 + 10\log(N_{RB,c}/50)$			
	Bands FDD_G		-	$-87.75 + 10\log(N_{RB,c}/50)$			
	Bands FDD_H		-	$-87.25 + 10\log(N_{RB,c}/50)$			
Propagation Condition			AWGN		AWGN		
Antenna Configuration			1x2		1x2		
Timing offset to Cell 1		μs	0		-		
Time alignment error relative to cell 1 Note 10			-	≤ TAE	≤ TAE	≤ TAE	≤ TAE
Time alignment error relative to cell 2 Note 10			-	-	≤ TAE	≤ TAE	≤ TAE
Time alignment error relative to cell 3 Note 10			-	-	-	≤ TAE	≤ TAE

Time alignment error relative to cell 4 ^{Note 10}		-	-	-	-	≤ TAE
Time alignment error relative to cell 4 ^{Note 10}		-	-	-	-	-
Note 1:	For special subframe and uplink-downlink configurations see Tables 4.2-1 and 4.2-2 in TS 36.211.					
Note 2:	OCNG shall be used such that both cells are fully allocated and a constant total transmitted power spectral density is achieved for all OFDM symbols.					
Note 3:	Interference from other cells and noise sources not specified in the test is assumed to be constant over subcarriers and time and shall be modelled as AWGN of appropriate power for N_{oc} to be fulfilled.					
Note 4:	RSRP, RSRQ and I_0 levels have been derived from other parameters for information purposes. They are not settable parameters themselves.					
Note 5:	RSRP and RSRQ minimum requirements are specified assuming independent interference and noise at each receiver antenna port.					
Note 6:	For Band 26, the tests shall be performed with the carrier frequency of the assigned E-UTRA channel bandwidth within 865-894 MHz.					
Note 7:	The selection of the bands for testing depends on the configuration of the carrier aggregation supported by the UEs.					
Note 8:	Void.					
Note 9:	E-UTRA operating band groups are as defined in Section 3.5.					
Note 10:	Time alignment error (TAE) as specified in TS 36.104 [30] clause 6.5.3.1. The TAE value depends upon the type of carrier aggregation.					
Note 11:	For Band 74, the tests shall be performed with the carrier frequency of the assigned E-UTRA channel bandwidth within 1475.9-1510.9 MHz.					

A.9.2.48.3 Test Requirements

In the test, the RSRQ measurement accuracy in carrier aggregation shall fulfil the requirements in clause 9.1.11.1, 9.1.11.2, and 9.1.11.3.

- The absolute accuracy of intra-frequency RSRQ measurements of Cell 1 on the primary component carrier shall fulfil the requirements specified in clause 9.1.11.1.
- The absolute accuracy of intra-frequency RSRQ measurements of Cell 2 on the secondary component carrier shall fulfil the requirements specified in clause 9.1.11.2
- The absolute accuracy of intra-frequency RSRQ measurements of Cell 3 on the secondary component carrier shall fulfil the requirements specified in clause 9.1.11.2
- The absolute accuracy of intra-frequency RSRQ measurements of Cell 4 on the secondary component carrier shall fulfil the requirements specified in clause 9.1.11.2
- The absolute accuracy of intra-frequency RSRQ measurements of Cell 5 on the secondary component carrier shall fulfil the requirements specified in clause 9.1.11.2
- The relative accuracy of inter-frequency RSRQ measurements between the primary and secondary component carriers for Cell 2 relative to Cell 1 shall fulfil the requirements specified in clause 9.1.11.3.
- The relative accuracy of inter-frequency RSRQ measurements between the primary and secondary component carriers for Cell 3 relative to Cell 1 shall fulfil the requirements specified in clause 9.1.11.3.
- The relative accuracy of inter-frequency RSRQ measurements between the primary and secondary component carriers for Cell 4 relative to Cell 1 shall fulfil the requirements specified in clause 9.1.11.3.
- The relative accuracy of inter-frequency RSRQ measurements between the primary and secondary component carriers for Cell 5 relative to Cell 1 shall fulfil the requirements specified in clause 9.1.11.3.

A.9.2.49 5 DL FDD RSRQ for E-UTRAN in Carrier Aggregation

A.9.2.49.1 Test Purpose and Environment

The purpose of this test is to verify that the FDD RSRQ measurement accuracy in carrier aggregation is within the specified limits under AWGN propagation conditions. This test will verify the absolute accuracy of intra-frequency

RSRQ measurements for the primary component carrier specified in clause 9.1.11.1, the absolute accuracy of intra-frequency RSRQ measurements for the secondary component carriers specified in clause 9.1.11.2 and also the relative inter-frequency RSRQ accuracy requirement between primary and secondary component carriers specified in clause 9.1.11.3.

A.9.2.49.2 Test parameters

In this set of test cases the PCell and the SCells are on different carrier frequencies. There are five cells used in this test case. Both RSRQ absolute and relative accuracy requirements of the primary and secondary component carriers are tested by using test parameters specified in Table A.9.2.49.2-1 and Table A.9.2.49.2-2. In the test, Cell 1 is the PCell, Cell 2, Cell 3, Cell 4 and Cell 5 are the SCells on secondary component carrier SCC1, SCC2, SCC3 and SCC4 respectively. The SCC1, SCC2, SCC3 and SCC4 are configured and activated.

Table A.9.2.49.2-1: 5 DL FDD RSRQ carrier aggregation test parameters for cell 1, cell 2 and cell 3

Parameter	Unit	Cell 1	Cell 2	Cell 3
E-UTRA RF Channel Number		1	2	3
BW _{channel}	MHz	5MHz: N _{RB,c} = 25 10MHz: N _{RB,c} = 50 20MHz: N _{RB,c} = 100	5MHz: N _{RB,c} = 25 10MHz: N _{RB,c} = 50 20MHz: N _{RB,c} = 100	5MHz: N _{RB,c} = 25 10MHz: N _{RB,c} = 50 20MHz: N _{RB,c} = 100
Measurement bandwidth	<i>n</i> _{PRB}	5MHz:10-15 10MHz:22-27 20MHz:47-52	5MHz: 10-15 10MHz: 22-27 20MHz: 47-52	5MHz: 10-15 10MHz: 22-27 20MHz: 47-52
PDSCH Reference measurement channel defined in A.3.1.1.1		5MHz:R.5 FDD 10MHz:R.0 FDD 20MHz:R.4 FDD	5MHz:R.5 FDD 10MHz:R.0 FDD 20MHz:R.4 FDD	5MHz:R.5 FDD 10MHz:R.0 FDD 20MHz:R.4 FDD
PDSCH allocation	<i>n</i> _{PRB}	5MHz:7-17 10MHz:13-36 20MHz:38-61	5MHz:7-17 10MHz:13-36 20MHz:38-61	5MHz:7-17 10MHz:13-36 20MHz:38-61
PDCCH/PCFICH/PHICH Reference measurement channel defined in A.3.1.2.1		5MHz:R.11 FDD 10MHz:R.6 FDD 20MHz:R.10 FDD	5MHz:R.11 FDD 10MHz:R.6 FDD 20MHz:R.10 FDD	5MHz:R.11 FDD 10MHz:R.6 FDD 20MHz:R.10 FDD
OCNG Patterns defined in A.3.2.1		5MHz:OP.15 FDD 10MHz:OP.1 FDD 20MHz:OP.11 FDD	5MHz:OP.15 FDD 10MHz:OP.1 FDD 20MHz:OP.11 FDD	5MHz:OP.15 FDD 10MHz:OP.1 FDD 20MHz:OP.11 FDD
PBCH_RA				
PBCH_RB				
PSS_RA				
SSS_RA				
PCFICH_RB				
PHICH_RA				
PHICH_RB				
PDCCH_RA				
PDCCH_RB				
PDSCH_RA				
PDSCH_RB				
OCNG_RA ^{Note1}				
OCNG_RB ^{Note1}				
<i>N</i> _{oc} ^{Note2}	Bands FDD_A	-119.5	-116	-116
	Bands FDD_B1, FDD_B2 ^{Note9}	-119	-115.5	-115.5
	Bands FDD_C	-118.5	-115	-115
	Bands FDD_D	-118	-114.5	-114.5
	Bands FDD_E, FDD_F ^{Note6}	-117.5	-114	-114
	Bands FDD_G	-116.5	-113	-113
	Bands FDD_H	-116	-112.5	-112.5
\hat{E}_s/N_{oc}	dB	-6.0	-6.0	-6.0
\hat{E}_s/I_{ot} ^{Note3}	dB	-6.0	-6.0	-6.0
RSRP ^{Note3}	Bands FDD_A	-125.5	-122	-122

	Bands FDD_B1, FDD_B2 ^{Note 9}	dBm/15 kHz	-125	-121.5	-121.5
	Bands FDD_C		-124.5	-121	-121
	Bands FDD_D		-124	-120.5	-120.5
	Bands FDD_E, FDD_F ^{Note 6}		-123.5	-120	-120
	Bands FDD_G		-122.5	-119	-119
	Bands FDD_H		-122	-118.5	-118.5
RSRQ ^{Note3}	Bands FDD_A	dB	-17.77	-17.77	-17.77
	Bands FDD_B1, FDD_B2 ^{Note 9}				
	Bands FDD_C				
	Bands FDD_D				
	Bands FDD_E, FDD_F ^{Note 6}				
	Bands FDD_H				
Io ^{Note3}	Bands FDD_A	dBm/ BW _{channel}	-90.75+ 10log(N _{RB,c} /50)	-87.25+ 10log(N _{RB,c} /50)	-87.25+ 10log(N _{RB,c} /50)
	Bands FDD_B1, FDD_B2 ^{Note 9}		-90.25+ 10log(N _{RB,c} /50)	-86.75+ 10log(N _{RB,c} /50)	-86.75+ 10log(N _{RB,c} /50)
	Bands FDD_C		-89.75+ 10log(N _{RB,c} /50)	-86.25+ 10log(N _{RB,c} /50)	-86.25+ 10log(N _{RB,c} /50)
	Bands FDD_D		-89.25+ 10log(N _{RB,c} /50)	-85.75+ 10log(N _{RB,c} /50)	-85.75+ 10log(N _{RB,c} /50)
	Bands FDD_E, FDD_F ^{Note 6}		-88.75+ 10log(N _{RB,c} /50)	-85.25+ 10log(N _{RB,c} /50)	-85.25+ 10log(N _{RB,c} /50)
	Bands FDD_G		-87.75+ 10log(N _{RB,c} /50)	-84.25+ 10log(N _{RB,c} /50)	-84.25+ 10log(N _{RB,c} /50)
	Bands FDD_H		-87.25+ 10log(N _{RB,c} /50)	-83.75+ 10log(N _{RB,c} /50)	-83.75+ 10log(N _{RB,c} /50)
Propagation condition	-	AWGN	AWGN	AWGN	
Antenna Configuration	-	1x2	1x2	1x2	
Timing offset to Cell 1	μs	-	0	0	
Time alignment error relative to cell 1 ^{Note 7}		-	≤ TAE	≤ TAE	
Time alignment error relative to cell 2 ^{Note 7}		-	-	≤ TAE	
<p>Note 1: OCNG shall be used such that all cells are fully allocated and a constant total transmitted power spectral density is achieved for all OFDM symbols.</p> <p>Note 2: Interference from other cells and noise sources not specified in the test is assumed to be constant over subcarriers and time and shall be modelled as AWGN of appropriate power for N_{oc} to be fulfilled.</p> <p>Note 3: Es/lot, RSRQ, RSRP and Io levels have been derived from other parameters for information purposes. They are not settable parameters themselves.</p> <p>Note 4: RSRP and RSRQ minimum requirements are specified assuming independent interference and noise at each receiver antenna port.</p> <p>Note 5: The selection of the bands for testing depends on the configuration of the carrier aggregation supported by the UEs.</p> <p>Note 6: For Band 26, the tests shall be performed with the carrier frequency of the assigned E-UTRA channel bandwidth within 865-894 MHz.</p> <p>Note 7: Time alignment error (TAE) as specified in TS 36.104 [30] clause 6.5.3.1. The TAE value depends upon the type of carrier aggregation.</p> <p>Note 8: E-UTRA operating band groups are as defined in Section 3.5.</p> <p>Note 9: For Band 74, the tests shall be performed with the carrier frequency of the assigned E-UTRA channel bandwidth within 1475.9-1510.9 MHz.</p>					

Table A.9.2.49.2-2: 5 DL FDD RSRQ carrier aggregation test parameters for cell 4 and cell 5

Parameter	Unit	Cell 4	Cell 5
E-UTRA RF Channel Number		2	3
BW _{channel}	MHz	5MHz: N _{RB,c} = 25 10MHz: N _{RB,c} = 50 20MHz: N _{RB,c} = 100	5MHz: N _{RB,c} = 25 10MHz: N _{RB,c} = 50 20MHz: N _{RB,c} = 100
Measurement bandwidth	n_{PRB}	5MHz: 10-15 10MHz: 22-27	5MHz: 10-15 10MHz: 22-27

			20MHz: 47-52	20MHz: 47-52
PDSCH Reference measurement channel defined in A.3.1.1.1			5MHz:R.5 FDD 10MHz:R.0 FDD 20MHz:R.4 FDD	5MHz:R.5 FDD 10MHz:R.0 FDD 20MHz:R.4 FDD
PDSCH allocation	n_{PRB}		5MHz:7-17 10MHz:13-36 20MHz:38-61	5MHz:7-17 10MHz:13-36 20MHz:38-61
PDCCH/PCFICH/PHICH Reference measurement channel defined in A.3.1.2.1			5MHz:R.11 FDD 10MHz:R.6 FDD 20MHz:R.10 FDD	5MHz:R.11 FDD 10MHz:R.6 FDD 20MHz:R.10 FDD
OCNG Patterns defined in A.3.2.1			5MHz:OP.15 FDD 10MHz:OP.1 FDD 20MHz:OP.11 FDD	5MHz:OP.15 FDD 10MHz:OP.1 FDD 20MHz:OP.11 FDD
PBCH_RA	dB		0	0
PBCH_RB				
PSS_RA				
SSS_RA				
PCFICH_RB				
PHICH_RA				
PHICH_RB				
PDCCH_RA				
PDCCH_RB				
PDSCH_RA				
PDSCH_RB				
OCNG_RA ^{Note1}				
OCNG_RB ^{Note1}				
N_{oc} ^{Note2}				
	Bands FDD_B1, FDD_B2 ^{Note 9}	-115.5	-115.5	
	Bands FDD_C	-115	-115	
	Bands FDD_D	-114.5	-114.5	
	Bands FDD_E, FDD_F ^{Note 6}	-114	-114	
	Bands FDD_G	-113	-113	
Bands FDD_H	-112.5	-112.5		
\hat{E}_s/N_{oc}	dB		-6.0	-6.0
\hat{E}_s/I_{ot} ^{Note3}	dB		-6.0	-6.0
RSRP ^{Note3}	Bands FDD_A	dBm/15 kHz	-122	-122
	Bands FDD_B1, FDD_B2 ^{Note 9}		-121.5	-121.5
	Bands FDD_C		-121	-121
	Bands FDD_D		-120.5	-120.5
	Bands FDD_E, FDD_F ^{Note 6}		-120	-120
	Bands FDD_G		-119	-119
Bands FDD_H	-118.5	-118.5		
RSRQ ^{Note3}	Bands FDD_A	dB	-17.77	-17.77
	Bands FDD_B1, FDD_B2 ^{Note 9}		-17.77	-17.77
	Bands FDD_C		-17.77	-17.77
	Bands FDD_D		-17.77	-17.77
	Bands FDD_E, FDD_F ^{Note 6}		-17.77	-17.77
	Bands FDD_G		-17.77	-17.77
Bands FDD_H	-17.77	-17.77		
I_o ^{Note3}	Bands FDD_A	dBm/ BW _{channel}	-87.25+ 10log(N _{RB,c} /50)	-87.25+ 10log(N _{RB,c} /50)
	Bands FDD_B1, FDD_B2 ^{Note 9}		-86.75+ 10log(N _{RB,c} /50)	-86.75+ 10log(N _{RB,c} /50)
	Bands FDD_C		-86.25+ 10log(N _{RB,c} /50)	-86.25+ 10log(N _{RB,c} /50)
	Bands FDD_D		-85.75+ 10log(N _{RB,c} /50)	-85.75+ 10log(N _{RB,c} /50)

			$10\log(N_{RB,c}/50)$	$10\log(N_{RB,c}/50)$
	Bands FDD_E, FDD_F ^{Note 6}		-85.25+ $10\log(N_{RB,c}/50)$	-85.25+ $10\log(N_{RB,c}/50)$
	Bands FDD_G		-84.25+ $10\log(N_{RB,c}/50)$	-84.25+ $10\log(N_{RB,c}/50)$
	Bands FDD_H		-83.75+ $10\log(N_{RB,c}/50)$	-83.75+ $10\log(N_{RB,c}/50)$
Propagation condition		-	AWGN	AWGN
Antenna Configuration		-	1x2	1x2
Timing offset to Cell 1		μs	0	0
Time alignment error relative to cell 1 ^{Note 7}			$\leq \text{TAE}$	$\leq \text{TAE}$
Time alignment error relative to cell 2 ^{Note 7}			$\leq \text{TAE}$	$\leq \text{TAE}$
Time alignment error relative to cell 3 ^{Note 7}			$\leq \text{TAE}$	$\leq \text{TAE}$
Time alignment error relative to cell 4 ^{Note 7}			-	$\leq \text{TAE}$
<p>Note 1: OCNG shall be used such that all cells are fully allocated and a constant total transmitted power spectral density is achieved for all OFDM symbols.</p> <p>Note 2: Interference from other cells and noise sources not specified in the test is assumed to be constant over subcarriers and time and shall be modelled as AWGN of appropriate power for N_{oc} to be fulfilled.</p> <p>Note 3: Es/lot, RSRQ, RSRP and Io levels have been derived from other parameters for information purposes. They are not settable parameters themselves.</p> <p>Note 4: RSRP and RSRQ minimum requirements are specified assuming independent interference and noise at each receiver antenna port.</p> <p>Note 5: The selection of the bands for testing depends on the configuration of the carrier aggregation supported by the UEs.</p> <p>Note 6: For Band 26, the tests shall be performed with the carrier frequency of the assigned E-UTRA channel bandwidth within 865-894 MHz.</p> <p>Note 7: Time alignment error (TAE) as specified in TS 36.104 [30] clause 6.5.3.1. The TAE value depends upon the type of carrier aggregation.</p> <p>Note 8: E-UTRA operating band groups are as defined in Section 3.5.</p> <p>Note 9: For Band 74, the tests shall be performed with the carrier frequency of the assigned E-UTRA channel bandwidth within 1475.9-1510.9 MHz.</p>				

A.9.2.49.3 Test Requirements

In the test, the RSRQ measurement accuracy in carrier aggregation shall fulfil the requirements in clause 9.1.11.1, 9.1.11.2, and 9.1.11.3.

- The absolute accuracy of intra-frequency RSRQ measurements of Cell 1 on the primary component carrier shall fulfil the requirements defined in clause 9.1.11.1.
- The absolute accuracy of intra-frequency RSRQ measurements of Cell 2 on SCC1 shall fulfil the requirements defined in clause 9.1.11.2.
- The absolute accuracy of intra-frequency RSRQ measurements of Cell 3 on SCC2 shall fulfil the requirements defined in clause 9.1.11.2.
- The absolute accuracy of intra-frequency RSRQ measurements of Cell 4 on SCC3 shall fulfil the requirements defined in clause 9.1.11.2.
- The absolute accuracy of intra-frequency RSRQ measurements of Cell 5 on SCC4 shall fulfil the requirements defined in clause 9.1.11.2.
- The relative accuracy of inter-frequency RSRQ measurements between the primary component carrier and SCC1 for Cell 2 relative to Cell 1 shall fulfil the requirements defined in clause 9.1.11.3.
- The relative accuracy of inter-frequency RSRQ measurements between the primary component carrier and SCC2 for Cell 3 relative to Cell 1 shall fulfil the requirements defined in clause 9.1.11.3.
- The relative accuracy of inter-frequency RSRQ measurements between the primary component carrier and SCC3 for Cell 4 relative to Cell 1 shall fulfil the requirements defined in clause 9.1.11.3.
- The relative accuracy of inter-frequency RSRQ measurements between the primary component carrier and SCC4 for Cell 5 relative to Cell 1 shall fulfil the requirements defined in clause 9.1.11.3.

A.9.2.50 5 DL TDD RSRQ for E-UTRAN in Carrier Aggregation

A.9.2.50.1 Test Purpose and Environment

The purpose of this test is to verify that the TDD RSRQ measurement accuracy in carrier aggregation is within the specified limits under AWGN propagation conditions. This test will verify the absolute accuracy of intra-frequency RSRQ measurements for the primary component carrier specified in clause 9.1.11.1, the absolute accuracy of intra-frequency RSRQ measurements for the secondary component carriers specified in clause 9.1.11.2 and also the relative inter-frequency RSRQ accuracy requirement between primary and secondary component carriers specified in clause 9.1.11.3.

A.9.2.50.2 Test parameters

In this set of test cases the PCell and the SCells are on different carrier frequencies. There are five cells used in this test case. Both RSRQ absolute and relative accuracy requirements of the primary and secondary component carriers are tested by using test parameters specified in Table A.9.2.50.2-1 and Table A.9.2.50.2-2. In the test, Cell 1 is the PCell, Cell 2, Cell 3, Cell 4 and Cell 5 are the SCells on secondary component carrier SCC1, SCC2, SCC3 and SCC4 respectively. The SCC1, SCC2, SCC3 and SCC4 are configured and activated.

Table A.9.2.50.2-1: 5 DL TDD RSRQ carrier aggregation test parameters for cell 1, cell 2 and cell 3

Parameter	Unit	Cell 1	Cell 2	Cell 3
E-UTRA RF Channel Number		1	2	3
BW _{channel}	MHz	5MHz: N _{RB,c} = 25 10MHz: N _{RB,c} = 50 20MHz: N _{RB,c} = 100	5MHz: N _{RB,c} = 25 10MHz: N _{RB,c} = 50 20MHz: N _{RB,c} = 100	5MHz: N _{RB,c} = 25 10MHz: N _{RB,c} = 50 20MHz: N _{RB,c} = 100
Special subframe configuration ^{Note1}		6		
Uplink-downlink configuration ^{Note1}		1		
Measurement bandwidth	<i>n</i> _{PRB}	5MHz: 10-15 10MHz: 22-27 20MHz: 47-52	5MHz: 10-15 10MHz: 22-27 20MHz: 47-52	5MHz: 10-15 10MHz: 22-27 20MHz: 47-52
PDSCH Reference measurement channel defined in A.3.1.1.1		5MHz: R.4 TDD 10MHz: R.0 TDD 20MHz: R.3 TDD	5MHz: R.4 TDD 10MHz: R.0 TDD 20MHz: R.3 TDD	5MHz: R.4 TDD 10MHz: R.0 TDD 20MHz: R.3 TDD
PDSCH allocation	<i>n</i> _{PRB}	5MHz: 7-17 10MHz: 13-36 20MHz: 38-61	5MHz: 7-17 10MHz: 13-36 20MHz: 38-61	5MHz: 7-17 10MHz: 13-36 20MHz: 38-61
PDCCH/PCFICH/PHICH Reference measurement channel defined in A.3.1.2.1		5MHz: R.11 TDD 10MHz: R.6 TDD 20MHz: R.10 TDD	5MHz: R.11 TDD 10MHz: R.6 TDD 20MHz: R.10 TDD	5MHz: R.11 TDD 10MHz: R.6 TDD 20MHz: R.10 TDD
OCNG Patterns defined in A.3.2.1		5MHz: OP.9 TDD 10MHz: OP.1 TDD 20MHz: OP.7 TDD	5MHz: OP.9 TDD 10MHz: OP.1 TDD 20MHz: OP.7 TDD	5MHz: OP.9 TDD 10MHz: OP.1 TDD 20MHz: OP.7 TDD
PBCH_RA				
PBCH_RB				
PSS_RA				
SSS_RA				
PCFICH_RB				
PHICH_RA				
PHICH_RB	dB	0	0	0
PDCCH_RA				
PDCCH_RB				
PDSCH_RA				
PDSCH_RB				
OCNG_RA ^{Note2}				
OCNG_RB ^{Note2}				
<i>N</i> _{oc} ^{Note3}	Bands TDD_A	-119.5	-116	-116
	Bands TDD_C	-118.5	-115	-115
	Bands TDD_E	-117.5	-114	-114
\hat{E}_s / N_{oc}	dB	-6.0	-6.0	-6.0
\hat{E}_s / I_{ot} ^{Note4}	dB	-6.0	-6.0	-6.0

RSRP ^{Note4}	Bands TDD_A	dBm/15 kHz	-125.5	-122	-122
	Bands TDD_C		-124.5	-121	-121
	Bands TDD_E		-123.5	-120	-120
RSRQ ^{Note4}	Bands TDD_A, TDD_C, TDD_E	dB	-17.77	-17.77	-17.77
I _o ^{Note4}	Bands TDD_A	dBm/ BW _{channel}	-90.75+ 10log(N _{RB,c} /50)	-87.25+ 10log(N _{RB,c} /50)	-87.25+ 10log(N _{RB,c} /50)
	Bands TDD_C		-89.75+ 10log(N _{RB,c} /50)	-86.25+ 10log(N _{RB,c} /50)	-86.25+ 10log(N _{RB,c} /50)
	Bands TDD_E		-88.75+ 10log(N _{RB,c} /50)	-85.25+ 10log(N _{RB,c} /50)	-85.25+ 10log(N _{RB,c} /50)
Propagation condition		-	AWGN	AWGN	AWGN
Antenna Configuration		-	1x2	1x2	1x2
Timing offset to Cell 1		μs	-	0	0
Time alignment error relative to cell 1 ^{Note 7}			-	≤ TAE	≤ TAE
Time alignment error relative to cell 2 ^{Note 7}			-	-	≤ TAE
<p>Note 1: For special subframe and uplink-downlink configurations see Tables 4.2-1 and 4.2-2 in TS 36.211.</p> <p>Note 2: OCNG shall be used such that all cells are fully allocated and a constant total transmitted power spectral density is achieved for all OFDM symbols.</p> <p>Note 3: Interference from other cells and noise sources not specified in the test is assumed to be constant over subcarriers and time and shall be modelled as AWGN of appropriate power for N_{oc} to be fulfilled.</p> <p>Note 4: Es/lot, RSRQ, RSRP and I_o levels have been derived from other parameters for information purposes. They are not settable parameters themselves.</p> <p>Note 5: RSRP and RSRQ minimum requirements are specified assuming independent interference and noise at each receiver antenna port.</p> <p>Note 6: The selection of the bands for testing depends on the configuration of the carrier aggregation supported by the UEs.</p> <p>Note 7: Time alignment error (TAE) as specified in TS 36.104 [30] clause 6.5.3.1. The TAE value depends upon the type of carrier aggregation.</p> <p>Note 8: E-UTRA operating band groups are as defined in Section 3.5.</p>					

Table A.9.2.50.2-2: 5 DL TDD RSRQ carrier aggregation test parameters for cell 4 and cell 5

Parameter	Unit	Cell 4	Cell 5
E-UTRA RF Channel Number		4	5
BW _{channel}	MHz	5MHz: N _{RB,c} = 25 10MHz: N _{RB,c} = 50 20MHz: N _{RB,c} = 100	5MHz: N _{RB,c} = 25 10MHz: N _{RB,c} = 50 20MHz: N _{RB,c} = 100
Special subframe configuration ^{Note1}		6	6
Uplink-downlink configuration ^{Note1}		1	1
Measurement bandwidth	n_{PRB}	5MHz: 10-15 10MHz: 22-27 20MHz: 47-52	5MHz: 10-15 10MHz: 22-27 20MHz: 47-52
PDSCH Reference measurement channel defined in A.3.1.1.1		5MHz: R.4 TDD 10MHz: R.0 TDD 20MHz: R.3 TDD	5MHz: R.4 TDD 10MHz: R.0 TDD 20MHz: R.3 TDD
PDSCH allocation	n_{PRB}	5MHz: 7-17 10MHz: 13-36 20MHz: 38-61	5MHz: 7-17 10MHz: 13-36 20MHz: 38-61
PDCCH/PCFICH/PHICH Reference measurement channel defined in A.3.1.2.1		5MHz: R.11 TDD 10MHz: R.6 TDD 20MHz: R.10 TDD	5MHz: R.11 TDD 10MHz: R.6 TDD 20MHz: R.10 TDD
OCNG Patterns defined in A.3.2.1		5MHz: OP.9 TDD 10MHz: OP.1 TDD 20MHz: OP.7 TDD	5MHz: OP.9 TDD 10MHz: OP.1 TDD 20MHz: OP.7 TDD
PBCH_RA	dB	0	0

PBCH_RB				
PSS_RA				
SSS_RA				
PCFICH_RB				
PHICH_RA				
PHICH_RB				
PDCCH_RA				
PDCCH_RB				
PDSCH_RA				
PDSCH_RB				
OCNG_RA ^{Note2}				
OCNG_RB ^{Note2}				
N_{oc} ^{Note3}	Bands TDD_A	dBm/15 kHz	-116	-116
	Bands TDD_C		-115	-115
	Bands TDD_E		-114	-114
\hat{E}_s / N_{oc}		dB	-6.0	-6.0
\hat{E}_s / I_{ot} ^{Note4}		dB	-6.0	-6.0
RSRP ^{Note4}	Bands TDD_A	dBm/15 kHz	-122	-122
	Bands TDD_C		-121	-121
	Bands TDD_E		-120	-120
RSRQ ^{Note4}	Bands TDD_A, TDD_C, TDD_E	dB	-17.77	-17.77
I_o ^{Note4}	Bands TDD_A	dBm/ BW _{channel}	-87.25+ 10log(N _{RB,c} /50)	-87.25+ 10log(N _{RB,c} /50)
	Bands TDD_C		-86.25+ 10log(N _{RB,c} /50)	-86.25+ 10log(N _{RB,c} /50)
	Bands TDD_E		-85.25+ 10log(N _{RB,c} /50)	-85.25+ 10log(N _{RB,c} /50)
Propagation condition		-	AWGN	AWGN
Antenna Configuration		-	1x2	1x2
Timing offset to Cell 1		μs	0	0
Time alignment error relative to cell 1 ^{Note 7}			≤ TAE	≤ TAE
Time alignment error relative to cell 2 ^{Note 7}			≤ TAE	≤ TAE
Time alignment error relative to cell 3 ^{Note 7}			≤ TAE	≤ TAE
Time alignment error relative to cell 4 ^{Note 7}			-	≤ TAE
<p>Note 1: For special subframe and uplink-downlink configurations see Tables 4.2-1 and 4.2-2 in TS 36.211.</p> <p>Note 2: OCNG shall be used such that all cells are fully allocated and a constant total transmitted power spectral density is achieved for all OFDM symbols.</p> <p>Note 3: Interference from other cells and noise sources not specified in the test is assumed to be constant over subcarriers and time and shall be modelled as AWGN of appropriate power for N_{oc} to be fulfilled.</p> <p>Note 4: E_s/I_{ot}, RSRQ, RSRP and I_o levels have been derived from other parameters for information purposes. They are not settable parameters themselves.</p> <p>Note 5: RSRP and RSRQ minimum requirements are specified assuming independent interference and noise at each receiver antenna port.</p> <p>Note 6: The selection of the bands for testing depends on the configuration of the carrier aggregation supported by the UEs.</p> <p>Note 7: Time alignment error (TAE) as specified in TS 36.104 [30] clause 6.5.3.1. The TAE value depends upon the type of carrier aggregation.</p> <p>Note 8: E-UTRA operating band groups are as defined in Section 3.5.</p>				

A.9.2.50.3 Test Requirements

In the test, the RSRQ measurement accuracy in carrier aggregation shall fulfil the requirements in clause 9.1.11.1, 9.1.11.2, and 9.1.11.3.

- The absolute accuracy of intra-frequency RSRQ measurements of Cell 1 on the primary component carrier shall fulfil the requirements defined in clause 9.1.11.1.
- The absolute accuracy of intra-frequency RSRQ measurements of Cell 2 on SCC1 shall fulfil the requirements defined in clause 9.1.11.2.
- The absolute accuracy of intra-frequency RSRQ measurements of Cell 3 on SCC2 shall fulfil the requirements defined in clause 9.1.11.2.
- The absolute accuracy of intra-frequency RSRQ measurements of Cell 4 on SCC3 shall fulfil the requirements defined in clause 9.1.11.2.
- The absolute accuracy of intra-frequency RSRQ measurements of Cell 5 on SCC4 shall fulfil the requirements defined in clause 9.1.11.2.
- The relative accuracy of inter-frequency RSRQ measurements between the primary component carrier and SCC1 for Cell 2 relative to Cell 1 shall fulfil the requirements defined in clause 9.1.11.3.
- The relative accuracy of inter-frequency RSRQ measurements between the primary component carrier and SCC2 for Cell 3 relative to Cell 1 shall fulfil the requirements defined in clause 9.1.11.3.
- The relative accuracy of inter-frequency RSRQ measurements between the primary component carrier and SCC3 for Cell 4 relative to Cell 1 shall fulfil the requirements defined in clause 9.1.11.3.
- The relative accuracy of inter-frequency RSRQ measurements between the primary component carrier and SCC4 for Cell 5 relative to Cell 1 shall fulfil the requirements defined in clause 9.1.11.3.

A.9.2.51 FS3 Intra frequency absolute and relative RSRQ accuracies with FDD PCell

A.9.2.51.1 Test Purpose and Environment

The purpose of this test is to verify that the FDD intra frequency RSRQ absolute and relative measurement accuracies in carrier aggregation with frame structure 3 in the configured DMTC occasion are within the specified limits. This test will verify the absolute RSRQ accuracy requirement of the secondary component carrier defined in clause 9.1.19.2. The test will also verify the primary and secondary component carrier relative RSRQ accuracy requirement defined in Clause 9.1.19.4.

A.9.2.51.2 Test parameters

In this test case, Cell1 is PCell on the primary component carrier, Cell2 is SCell on the secondary component carrier with frame structure 3 and activated, and Cell3 is the neighboring cell on the same secondary component carrier of Cell2. The test parameters are given in Table A.9.2.51.2-1. The DMTC configuration for Cell2 and Cell3 is provided to the UE in the *measDS-Config* before the start of the test.

Table A.9.2.51.2-1: Test parameters for FDD RSRQ accuracies of SCell with FS3

Parameter	Unit	Test 1		
		Cell 1	Cell 2	Cell3
E-UTRA RF Channel Number		1	2	2
BW _{channel}	MHz	5MHz: N _{RB,c} = 25 10MHz: N _{RB,c} = 50 20MHz: N _{RB,c} = 100	20	20
DMTC period	ms	N/A	40	40
DMTC period offset		N/A	10	10
Discovery signal occasion duration	ms	N/A	1	1

LBT model		N/A	N/A	A.3.17				
Timing offset to cell1	μs	-	0	3				
Time alignment error between cell 2 and cell 1		-	\leq Time alignment error as specified in 3GPP TS 36.104 [30] clause 6.5.3.1.	-				
Measurement bandwidth	n_{PRB}	5MHz: 10-15 10MHz: 22-27 20MHz: 47-52	47-52	47-52				
PDSCH Reference measurement channel defined in A.3.1.1		5MHz: R.5 FDD 10MHz: R.0 FDD 20MHz: R.4 FDD	R.0 FS3	-				
PDSCH allocation	n_{PRB}	5MHz: 7-17 10MHz: 13-36 20MHz: 38-61	38-61	-				
PDCCH/PCFICH/PHICH Reference measurement channel defined in A.3.1.2		5MHz: R.11 FDD 10MHz: R.6 FDD 20MHz: R.10 FDD	R.0 FS3	R.0 FS3				
OCNG Patterns defined in A.3.2		5MHz: OP.15 FDD 10MHz: OP.1 FDD 20MHz: OP.11 FDD	OP.13 FDD	OP.14 FDD				
PBCH_RA	dB	0	0	0				
PBCH_RB								
PSS_RA								
SSS_RA								
PCFICH_RB								
PHICH_RA								
PHICH_RB								
PDCCH_RA								
PDCCH_RB								
PDSCH_RA								
PDSCH_RB								
OCNG_RA ^{Note1}								
OCNG_RB ^{Note1}								
N_{oc} ^{Note2}					Bands FDD_A	-119.5	-	
					Bands FDD_B1, FDD_B2 ^{Note 10}	-119		
	Bands FDD_C	-118.5						
	Bands FDD_D	-118						
	Bands FDD_E, FDD_F ^{Note 6}	-117.5						
	Bands FDD_G	-116.5						
	Bands FDD_H	-116						
	Bands FS3_G	-	(N_{oc} for Channel 1 +3.5dB)					

\hat{E}_s / I_{ot}		dB	-4	-5.46 ^{Note9}	-5.46
RSRP ^{Note3}	Bands FDD_A	dBm/15 kHz	-123.5	-	
	Bands FDD_B1, FDD_B2 ^{Note 10}		-123		
	Bands FDD_C		-122.5		
	Bands FDD_D		-122		
	Bands FDD_E, FDD_F ^{Note 6}		-121.5		
	Bands FDD_G		-120.5		
	Bands FDD_H		-120		
	Bands FS3_G		-	(RSRP for Cell 1 +3.5dB)	(RSRP for Cell 1 +3.5dB)
RSRQ ^{Note3}	Bands FDD_A	dBm/15 kHz	-16.25	-	
	Bands FDD_B1, FDD_B2 ^{Note 10}				
	Bands FDD_C				
	Bands FDD_D				
	Bands FDD_E, FDD_F ^{Note 6}				
	Bands FDD_G				
	Bands FDD_H				
	Bands FS3_G		-	-17.34 ^{Note9}	-17.34
I _o ^{Note3}	Bands FDD_A	5MHz: dBm/4.5MHz 10MHz: dBm/9MHz 20MHz: dBm/18MHz	-90.26 +10log(N _{RB} , √50)	-	
	Bands FDD_B1, FDD_B2 ^{Note 10}		-89.76 +10log(N _{RB} , √50)		
	Bands FDD_C		-89.26 +10log(N _{RB} , √50)		
	Bands FDD_D		-88.76 +10log(N _{RB} , √50)		
	Bands FDD_E, FDD_F ^{Note 6}		-88.26 +10log(N _{RB} , √50)		
	Bands FDD_G		-87.26 +10log(N _{RB} , √50)		
	Bands FDD_H		-86.76 +10log(N _{RB} , √50)		
	Bands FS3_G		-	(I _o for Channel 1 +4.59dB ^{Note9})	(I _o for Channel 1 +4.59dB)
\hat{E}_s / N_{oc}		dB	-4	-4	-4
Propagation condition		-	AWGN		
<p>Note 1: OCNG shall be used such that cells are fully allocated and a constant total transmitted power spectral density is achieved for all OFDM symbols. For cells with LBT model, OCNG is transmitted only in subframes with downlink transmission bursts, and is not transmitted during muted subframes or during DMTC windows.</p> <p>Note 2: Interference from other cells and noise sources not specified in the test is assumed to be constant over subcarriers and time and shall be modelled as AWGN of appropriate power for N_{oc} to be fulfilled.</p> <p>Note 3: RSRP, RSRQ and I_o levels have been derived from other parameters for information purposes. They are not settable parameters themselves.</p> <p>Note 4: RSRP and RSRQ minimum requirements are specified assuming independent interference and noise at each receiver antenna port.</p> <p>Note 5: The selection of the bands for testing depends on the configuration of the carrier aggregation supported by the UEs.</p> <p>Note 6: For Band 26, the tests shall be performed with the carrier frequency of the assigned E-UTRA channel bandwidth within 865-894 MHz</p>					

Note 7:	This test verifies the RRM requirement which is independent of channel bandwidth and is performed according to the principle defined in section A.3.6.1.
Note 8:	E-UTRA operating band groups are as defined in Section 3.5.
Note 9:	The value is corresponding to DRS transmission through LBT operation in Cell3.
Note 10:	For Band 74, the tests shall be performed with the carrier frequency of the assigned E-UTRA channel bandwidth within 1475.9-1510.9 MHz.

A.9.2.51.3 Test Requirements

In the test, the performance of RSRQ measurements is verified from following three perspectives:

- The absolute accuracy of intra-frequency RSRQ measurements for Cell 3 on the secondary component carrier with frame structure 3 shall fulfil the requirements defined in clause 9.1.19.2.
- The relative accuracy of inter-frequency RSRQ measurements between the primary and secondary component carriers for Cell 3 relative to Cell 1 shall fulfil the requirements defined in clause 9.1.19.4.

A.9.2.52 FS3 Intra frequency absolute and relative RSRQ accuracies with TDD PCell

A.9.2.52.1 Test Purpose and Environment

The purpose of this test is to verify that the TDD intra frequency RSRQ absolute and relative measurement accuracies in carrier aggregation with frame structure 3 in the configured DMTC occasion are within the specified limits. This test will verify the absolute RSRQ accuracy requirement of the secondary component carrier defined in clause 9.1.19.2. The test will also verify the primary and secondary component carrier relative RSRQ accuracy requirement defined in Clause 9.1.19.4.

A.9.2.52.2 Test parameters

In this test case, Cell1 is PCell on the primary component carrier, Cell2 is SCell on the secondary component carrier with frame structure 3 and activated, and Cell3 is the neighboring cell on the same secondary component carrier of Cell2. The test parameters are given in Table A.9.2.52.2-1. The DMTC configuration for Cell2 and Cell3 is provided to the UE in the *measDS-Config* before the start of the test.

Table A.9.2.52.2-1: Test parameters for FDD RSRQ accuracies of Scell with FS3

Parameter	Unit	Test 1		
		Cell 1	Cell 2	Cell3
E-UTRA RF Channel Number		1	2	2
BW _{channel}	MHz	5MHz: N _{RB,c} = 25 10MHz: N _{RB,c} = 50 20MHz: N _{RB,c} = 100	20	20
DMTC period	ms	N/A	40	40
DMTC period offset		N/A	10	10
Discovery signal occasion duration	ms	N/A	1	1
LBT model		N/A	N/A	A.3.17
Special subframe configuration ^{Note1}		6	N/A	N/A
Uplink/downlink configuration ^{Note1}		1	N/A	N/A
Timing offset to cell1	μs	-	0	3
Time alignment error between cell 2 and cell 1		-	≤ Time alignment error as specified in 3GPP TS 36.104 [30] clause 6.5.3.1.	-

Measurement bandwidth	n_{PRB}	5MHz: 10-15 10MHz: 22-27 20MHz: 47-52	47-52	47-52
PDSCH Reference measurement channel defined in A.3.1.1		5MHz: R.4 TDD 10MHz: R.0 TDD 20MHz: R.3 TDD	R.0 FS3	-
PDSCH allocation	n_{PRB}	5MHz: 7-17 10MHz: 13-36 20MHz: 38-61	38-61	-
PDCCH/PCFICH/PHICH Reference measurement channel defined in A.3.1.2		5MHz: R.11 TDD 10MHz: R.6 TDD 20MHz: R.10 TDD	R.0 FS3	R.0 FS3
OCNG Patterns defined in A.3.2		5MHz: OP.9 TDD 10MHz: OP.1 TDD 20MHz: OP.7 TDD	OP.13 FDD	OP.14 FDD
PBCH_RA	dB	0	0	0
PBCH_RB				
PSS_RA				
SSS_RA				
PCFICH_RB				
PHICH_RA				
PHICH_RB				
PDCCH_RA				
PDCCH_RB				
PDSCH_RA				
PDSCH_RB				
OCNG_RA ^{Note2}				
OCNG_RB ^{Note2}				
N_{oc} ^{Note3}				
	Bands TDD_C	-118.5		
	Bands TDD_E	-117.5		
	Bands FS3_G	-	(N_{oc} for Channel 1 +3.5dB)	
\hat{E}_s/I_{ot}		-4	-5.52 ^{Note9}	-5.52
RSRP ^{Note4}	Bands TDD_A	-123.5	-	
	Bands TDD_C	-122.5		
	Bands TDD_E	-121.5		
	Bands FS3_G	-	(RSRP for Cell 1 +3.5dB)	(RSRP for Cell 1 +3.5dB)
RSRQ ^{Note4}	Bands TDD_A	-16.25	-	
	Bands TDD_C			
	Bands TDD_E			
	Bands FS3_G		-	-17.34 ^{Note9}
I_o ^{Note4}	Bands TDD_A	5MHz: -90.26 +10log(N_{RB} , √50)	-	

	Bands TDD_C	10MHz: dBm/9MHz	-89.26 +10log(N_{RB} , /50)		
	Bands TDD_E	20MHz: dBm/18MHz	-88.26 +10log(N_{RB} , /50)		
	Bands FS3_G		-	(lo for Channel 1 +4.59dB ^{Note9})	(lo for Channel 1 +4.59dB)
\hat{E}_s / N_{oc}		dB	-4	-4	-4
Propagation condition		-	AWGN		
<p>Note 1: For special subframe and uplink-downlink configurations see Tables 4.2-1 and 4.2-2 in TS 36.211.</p> <p>Note 2: OCNG shall be used such that cells are fully allocated and a constant total transmitted power spectral density is achieved for all OFDM symbols. For cells with LBT model, OCNG is transmitted only in subframes with downlink transmission bursts, and is not transmitted during muted subframes or during DMTC windows.</p> <p>Note 3: Interference from other cells and noise sources not specified in the test is assumed to be constant over subcarriers and time and shall be modelled as AWGN of appropriate power for N_{oc} to be fulfilled.</p> <p>Note 4: RSRQ, RSRP and lo levels have been derived from other parameters for information purposes. They are not settable parameters themselves.</p> <p>Note 5: RSRP and RSRQ minimum requirements are specified assuming independent interference and noise at each receiver antenna port.</p> <p>Note 6: The selection of the bands for testing depends on the configuration of the carrier aggregation supported by the UEs.</p> <p>Note 7: This test verifies the RRM requirement which is independent of channel bandwidth and is performed according to the principle defined in section A.3.6.1.</p> <p>Note 8: E-UTRA operating band groups are as defined in Section 3.5.</p> <p>Note 9: The value is corresponding to DRS transmission through LBT operation in Cell3.</p>					

A.9.2.52.3 Test Requirements

In the test, the performance of RSRQ measurements is verified from following three perspectives:

- The absolute accuracy of intra-frequency RSRQ measurements for Cell 3 on the secondary component carrier with frame structure 3 shall fulfil the requirements defined in clause 9.1.19.2.
- The relative accuracy of inter-frequency RSRQ measurements between the primary and secondary component carriers for Cell 3 relative to Cell 1 shall fulfil the requirements defined in clause 9.1.19.4.

A.9.2.53 4DL FDD RSRQ for E-UTRAN in Carrier Aggregation

A.9.2.53.1 Test Purpose and Environment

The purpose of this test is to verify that the FDD RSRQ measurement accuracy in carrier aggregation is within the specified limits under AWGN propagation conditions. This test will verify the absolute accuracy of intra-frequency RSRQ measurements for the primary component carrier specified in clause 9.1.11.1, the absolute accuracy of intra-frequency RSRQ measurements for the secondary component carriers specified in clause 9.1.11.2 and also the relative inter-frequency RSRQ accuracy requirement between primary and secondary component carriers specified in clause 9.1.11.3.

A.9.2.53.2 Test parameters

In this set of test cases the PCell and the SCells are on different carrier frequencies. There are five cells used in this test case. Both RSRQ absolute and relative accuracy requirements of the primary and secondary component carriers are tested by using test parameters specified in Table A.9.2.53.2-1 and Table A.9.2.53.2-2. In the test, Cell 1 is the PCell, Cell 2, Cell 3 and Cell 4 are the SCells on secondary component carrier SCC1, SCC2 and SCC3 respectively. The SCC1, SCC2 and SCC3 are configured and activated.

Table A.9.2.53.2-1: 4 DL FDD RSRQ carrier aggregation test parameters for cell 1, cell 2 and cell 3

Parameter	Unit	Cell 1	Cell 2	Cell 3
-----------	------	--------	--------	--------

E-UTRA RF Channel Number			1	2	3
BW _{channel}	MHz		5MHz: N _{RB,c} = 25 10MHz: N _{RB,c} = 50 20MHz: N _{RB,c} = 100	5MHz: N _{RB,c} = 25 10MHz: N _{RB,c} = 50 20MHz: N _{RB,c} = 100	5MHz: N _{RB,c} = 25 10MHz: N _{RB,c} = 50 20MHz: N _{RB,c} = 100
Measurement bandwidth	n _{PRB}		5MHz: 10-15 10MHz: 22-27 20MHz: 47-52	5MHz: 10-15 10MHz: 22-27 20MHz: 47-52	5MHz: 10-15 10MHz: 22-27 20MHz: 47-52
PDSCH Reference measurement channel defined in A.3.1.1.1			5MHz: R.5 FDD 10MHz: R.0 FDD 20MHz: R.4 FDD	5MHz: R.5 FDD 10MHz: R.0 FDD 20MHz: R.4 FDD	5MHz: R.5 FDD 10MHz: R.0 FDD 20MHz: R.4 FDD
PDSCH allocation	n _{PRB}		5MHz: 7-17 10MHz: 13-36 20MHz: 38-61	5MHz: 7-17 10MHz: 13-36 20MHz: 38-61	5MHz: 7-17 10MHz: 13-36 20MHz: 38-61
PDCCH/PCFICH/PHICH Reference measurement channel defined in A.3.1.2.1			5MHz: R.11 FDD 10MHz: R.6 FDD 20MHz: R.10 FDD	5MHz: R.11 FDD 10MHz: R.6 FDD 20MHz: R.10 FDD	5MHz: R.11 FDD 10MHz: R.6 FDD 20MHz: R.10 FDD
OCNG Patterns defined in A.3.2.1			5MHz: OP.15 FDD 10MHz: OP.1 FDD 20MHz: OP.11 FDD	5MHz: OP.15 FDD 10MHz: OP.1 FDD 20MHz: OP.11 FDD	5MHz: OP.15 FDD 10MHz: OP.1 FDD 20MHz: OP.11 FDD
PBCH_RA	dB		0	0	0
PBCH_RB					
PSS_RA					
SSS_RA					
PCFICH_RB					
PHICH_RA					
PHICH_RB					
PDCCH_RA					
PDCCH_RB					
PDSCH_RA					
PDSCH_RB					
OCNG_RA ^{Note1}					
OCNG_RB ^{Note1}					
N _{oc} ^{Note2}					
	Bands FDD_B1, FDD_B2 ^{Note 9}	-119	-115.5	-115.5	
	Bands FDD_C	-118.5	-115	-115	
	Bands FDD_D	-118	-114.5	-114.5	
	Bands FDD_E, FDD_F ^{Note 6}	-117.5	-114	-114	
	Bands FDD_G	-116.5	-113	-113	
	Bands FDD_H	-116	-112.5	-112.5	
\hat{E}_s/N_{oc}	dB		-6.0	-6.0	-6.0
\hat{E}_s/I_{ot} ^{Note3}	dB		-6.0	-6.0	-6.0
RSRP ^{Note3}	Bands FDD_A	dBm/15 kHz	-125.5	-122	-122
	Bands FDD_B1, FDD_B2 ^{Note 9}		-125	-121.5	-121.5
	Bands FDD_C		-124.5	-121	-121
	Bands FDD_D		-124	-120.5	-120.5
	Bands FDD_E, FDD_F ^{Note 6}		-123.5	-120	-120
	Bands FDD_G		-122.5	-119	-119
	Bands FDD_H		-122	-118.5	-118.5
RSRQ ^{Note3}	Bands FDD_A	dB	-17.77	-17.77	-17.77
	Bands FDD_B1, FDD_B2 ^{Note 9}				
	Bands FDD_C				
	Bands FDD_D				
	Bands FDD_E, FDD_F ^{Note 6}				
	Bands FDD_G				
	Bands FDD_H				
I _o ^{Note3}	Bands FDD_A		-90.75+	-87.25+	-87.25+

			$10\log(N_{RB,c}/50)$	$10\log(N_{RB,c}/50)$	$10\log(N_{RB,c}/50)$
	Bands FDD_B1, FDD_B2 ^{Note 9}	dBm/ BW _{channel}	-90.25+	-86.75+	-86.75+
	Bands FDD_C		$10\log(N_{RB,c}/50)$	$10\log(N_{RB,c}/50)$	$10\log(N_{RB,c}/50)$
	Bands FDD_D		-89.75+	-86.25+	-86.25+
	Bands FDD_E, FDD_F ^{Note 6}		$10\log(N_{RB,c}/50)$	$10\log(N_{RB,c}/50)$	$10\log(N_{RB,c}/50)$
	Bands FDD_G		-89.25+	-85.75+	-85.75+
	Bands FDD_H		-88.75+	-85.25+	-85.25+
			$10\log(N_{RB,c}/50)$	$10\log(N_{RB,c}/50)$	$10\log(N_{RB,c}/50)$
Propagation condition	-		AWGN	AWGN	AWGN
Antenna Configuration	-		1x2	1x2	1x2
Timing offset to Cell 1	μs		-	0	0
Time alignment error relative to cell 1 ^{Note 7}			-	≤ TAE	≤ TAE
Time alignment error relative to cell 2 ^{Note 7}			-	-	≤ TAE
<p>Note 1: OCNG shall be used such that all cells are fully allocated and a constant total transmitted power spectral density is achieved for all OFDM symbols.</p> <p>Note 2: Interference from other cells and noise sources not specified in the test is assumed to be constant over subcarriers and time and shall be modelled as AWGN of appropriate power for N_{oc} to be fulfilled.</p> <p>Note 3: Es/lot, RSRQ, RSRP and Io levels have been derived from other parameters for information purposes. They are not settable parameters themselves.</p> <p>Note 4: RSRP and RSRQ minimum requirements are specified assuming independent interference and noise at each receiver antenna port.</p> <p>Note 5: The selection of the bands for testing depends on the configuration of the carrier aggregation supported by the UEs.</p> <p>Note 6: For Band 26, the tests shall be performed with the carrier frequency of the assigned E-UTRA channel bandwidth within 865-894 MHz.</p> <p>Note 7: Time alignment error (TAE) as specified in TS 36.104 [30] clause 6.5.3.1. The TAE value depends upon the type of carrier aggregation.</p> <p>Note 8: E-UTRA operating band groups are as defined in Section 3.5.</p> <p>Note 9: For Band 74, the tests shall be performed with the carrier frequency of the assigned E-UTRA channel bandwidth within 1475.9-1510.9 MHz.</p>					

Table A.9.2.53.2-2: 4 DL FDD RSRQ carrier aggregation test parameters for cell 4

Parameter	Unit	Cell 4
E-UTRA RF Channel Number		2
BW _{channel}	MHz	5MHz: N _{RB,c} = 25 10MHz: N _{RB,c} = 50 20MHz: N _{RB,c} = 100
Measurement bandwidth	n_{PRB}	5MHz: 10-15 10MHz: 22-27 20MHz: 47-52
PDSCH Reference measurement channel defined in A.3.1.1.1		5MHz:R.5 FDD 10MHz:R.0 FDD 20MHz:R.4 FDD
PDSCH allocation	n_{PRB}	5MHz:7-17 10MHz:13-36 20MHz:38-61
PDCCH/PCFICH/PHICH Reference measurement channel defined in A.3.1.2.1		5MHz:R.11 FDD 10MHz:R.6 FDD 20MHz:R.10 FDD
OCNG Patterns defined in A.3.2.1		5MHz:OP.15 FDD 10MHz:OP.1 FDD 20MHz:OP.11 FDD
PBCH_RA	dB	0
PBCH_RB		
PSS_RA		
SSS_RA		
PCFICH_RB		

PHICH_RA			
PHICH_RB			
PDCCH_RA			
PDCCH_RB			
PDSCH_RA			
PDSCH_RB			
OCNG_RA ^{Note1}			
OCNG_RB ^{Note1}			
N_{oc} ^{Note2}	Bands FDD_A	dBm/15 kHz	-116
	Bands FDD_B1, FDD_B2 ^{Note 9}		-115.5
	Bands FDD_C		-115
	Bands FDD_D		-114.5
	Bands FDD_E, FDD_F ^{Note 6}		-114
	Bands FDD_G		-113
	Bands FDD_H		-112.5
\hat{E}_s/N_{oc}		dB	-6.0
\hat{E}_s/I_{ot} ^{Note3}		dB	-6.0
RSRP ^{Note3}	Bands FDD_A	dBm/15 kHz	-122
	Bands FDD_B1, FDD_B2 ^{Note 9}		-121.5
	Bands FDD_C		-121
	Bands FDD_D		-120.5
	Bands FDD_E, FDD_F ^{Note 6}		-120
	Bands FDD_G		-119
	Bands FDD_H		-118.5
RSRQ ^{Note3}	Bands FDD_A	dB	-17.77
	Bands FDD_B1, FDD_B2 ^{Note 9}		-17.77
	Bands FDD_C		-17.77
	Bands FDD_D		-17.77
	Bands FDD_E, FDD_F ^{Note 6}		-17.77
	Bands FDD_G		-17.77
	Bands FDD_H		-17.77
I_o ^{Note3}	Bands FDD_A	dBm/ BW _{channel}	-87.25+ 10log(N _{RB,c} /50)
	Bands FDD_B1, FDD_B2 ^{Note 9}		-86.75+ 10log(N _{RB,c} /50)
	Bands FDD_C		-86.25+ 10log(N _{RB,c} /50)
	Bands FDD_D		-85.75+ 10log(N _{RB,c} /50)
	Bands FDD_E, FDD_F ^{Note 6}		-85.25+ 10log(N _{RB,c} /50)
	Bands FDD_G		-84.25+ 10log(N _{RB,c} /50)
	Bands FDD_H		-83.75+ 10log(N _{RB,c} /50)
Propagation condition		-	AWGN
Antenna Configuration		-	1x2
Timing offset to Cell 1		μs	0
Time alignment error relative to cell 1 ^{Note 7}			≤ TAE
Time alignment error relative to cell 2 ^{Note 7}			≤ TAE
Time alignment error relative to cell 3 ^{Note 7}			≤ TAE
Time alignment error relative to cell 4 ^{Note 7}			-
Note 1: OCNG shall be used such that all cells are fully allocated and a constant total transmitted power spectral density is achieved for all OFDM symbols.			

Note 2:	Interference from other cells and noise sources not specified in the test is assumed to be constant over subcarriers and time and shall be modelled as AWGN of appropriate power for N_{oc} to be fulfilled.
Note 3:	Es/Iot, RSRQ, RSRP and Io levels have been derived from other parameters for information purposes. They are not settable parameters themselves.
Note 4:	RSRP and RSRQ minimum requirements are specified assuming independent interference and noise at each receiver antenna port.
Note 5:	The selection of the bands for testing depends on the configuration of the carrier aggregation supported by the UEs.
Note 6:	For Band 26, the tests shall be performed with the carrier frequency of the assigned E-UTRA channel bandwidth within 865-894 MHz.
Note 7:	Time alignment error (TAE) as specified in TS 36.104 [30] clause 6.5.3.1. The TAE value depends upon the type of carrier aggregation.
Note 8:	E-UTRA operating band groups are as defined in Section 3.5.
Note 9:	For Band 74, the tests shall be performed with the carrier frequency of the assigned E-UTRA channel bandwidth within 1475.9-1510.9 MHz.

A.9.2.53.3 Test Requirements

In the test, the RSRQ measurement accuracy in carrier aggregation shall fulfil the requirements in clause 9.1.11.1, 9.1.11.2, and 9.1.11.3.

- The absolute accuracy of intra-frequency RSRQ measurements of Cell 1 on the primary component carrier shall fulfil the requirements defined in clause 9.1.11.1.
- The absolute accuracy of intra-frequency RSRQ measurements of Cell 2 on SCC1 shall fulfil the requirements defined in clause 9.1.11.2.
- The absolute accuracy of intra-frequency RSRQ measurements of Cell 3 on SCC2 shall fulfil the requirements defined in clause 9.1.11.2.
- The absolute accuracy of intra-frequency RSRQ measurements of Cell 4 on SCC3 shall fulfil the requirements defined in clause 9.1.11.2.
- The relative accuracy of inter-frequency RSRQ measurements between the primary component carrier and SCC1 for Cell 2 relative to Cell 1 shall fulfil the requirements defined in clause 9.1.11.3.
- The relative accuracy of inter-frequency RSRQ measurements between the primary component carrier and SCC2 for Cell 3 relative to Cell 1 shall fulfil the requirements defined in clause 9.1.11.3.
- The relative accuracy of inter-frequency RSRQ measurements between the primary component carrier and SCC3 for Cell 4 relative to Cell 1 shall fulfil the requirements defined in clause 9.1.11.3.

A.9.2.54 4DL TDD RSRQ for E-UTRAN in Carrier Aggregation

A.9.2.54.1 Test Purpose and Environment

The purpose of this test is to verify that the TDD RSRQ measurement accuracy in carrier aggregation is within the specified limits under AWGN propagation conditions. This test will verify the absolute accuracy of intra-frequency RSRQ measurements for the primary component carrier specified in clause 9.1.11.1, the absolute accuracy of intra-frequency RSRQ measurements for the secondary component carriers specified in clause 9.1.11.2 and also the relative inter-frequency RSRQ accuracy requirement between primary and secondary component carriers specified in clause 9.1.11.3.

A.9.2.54.2 Test parameters

In this set of test cases the PCell and the SCells are on different carrier frequencies. There are five cells used in this test case. Both RSRQ absolute and relative accuracy requirements of the primary and secondary component carriers are tested by using test parameters specified in Table A.9.2.54.2-1 and Table A.9.2.54.2-2. In the test, Cell 1 is the PCell, Cell 2, Cell 3 and Cell 4 are the SCells on secondary component carrier SCC1, SCC2 and SCC3 respectively. The SCC1, SCC2 and SCC3 are configured and activated.

Table A.9.2.54.2-1: 4 DL TDD RSRQ carrier aggregation test parameters for cell 1, cell 2 and cell 3

Parameter		Unit	Cell 1	Cell 2	Cell 3					
E-UTRA RF Channel Number			1	2	3					
BW _{channel}	MHz		5MHz: N _{RB,c} = 25 10MHz: N _{RB,c} = 54 20MHz: N _{RB,c} = 100	5MHz: N _{RB,c} = 25 10MHz: N _{RB,c} = 54 20MHz: N _{RB,c} = 100	5MHz: N _{RB,c} = 25 10MHz: N _{RB,c} = 54 20MHz: N _{RB,c} = 100					
Special subframe configuration ^{Note1}			6							
Uplink-downlink configuration ^{Note1}			1							
Measurement bandwidth	<i>n</i> _{PRB}		5MHz: 10-15 10MHz: 22-27 20MHz: 47-52	5MHz: 10-15 10MHz: 22-27 20MHz: 47-52	5MHz: 10-15 10MHz: 22-27 20MHz: 47-52					
PDSCH Reference measurement channel defined in A.3.1.1.1			5MHz: R.4 TDD 10MHz: R.0 TDD 20MHz: R.3 TDD	5MHz: R.4 TDD 10MHz: R.0 TDD 20MHz: R.3 TDD	5MHz: R.4 TDD 10MHz: R.0 TDD 20MHz: R.3 TDD					
PDSCH allocation	<i>n</i> _{PRB}		5MHz: 7-17 10MHz: 13-36 20MHz: 38-61	5MHz: 7-17 10MHz: 13-36 20MHz: 38-61	5MHz: 7-17 10MHz: 13-36 20MHz: 38-61					
PDCCH/PCFICH/PHICH Reference measurement channel defined in A.3.1.2.1			5MHz: R.11 TDD 10MHz: R.6 TDD 20MHz: R.10 TDD	5MHz: R.11 TDD 10MHz: R.6 TDD 20MHz: R.10 TDD	5MHz: R.11 TDD 10MHz: R.6 TDD 20MHz: R.10 TDD					
OCNG Patterns defined in A.3.2.1			5MHz: OP.9 TDD 10MHz: OP.1 TDD 20MHz: OP.7 TDD	5MHz: OP.9 TDD 10MHz: OP.1 TDD 20MHz: OP.7 TDD	5MHz: OP.9 TDD 10MHz: OP.1 TDD 20MHz: OP.7 TDD					
PBCH_RA	dB		0	0	0					
PBCH_RB										
PSS_RA										
SSS_RA										
PCFICH_RB										
PHICH_RA										
PHICH_RB										
PDCCH_RA										
PDCCH_RB										
PDSCH_RA										
PDSCH_RB										
OCNG_RA ^{Note2}										
OCNG_RB ^{Note2}										
<i>N</i> _{oc} ^{Note3}						Bands TDD_A	dBm/15 kHz	-119.5	-116	-116
						Bands TDD_C		-118.5	-115	-115
	Bands TDD_E	-117.5	-114	-114						
\hat{E}_s / N_{oc}			-6.0	-6.0	-6.0					
\hat{E}_s / I_{ot} ^{Note4}			-6.0	-6.0	-6.0					
RSRP ^{Note4}	Bands TDD_A	dBm/15 kHz	-125.5	-122	-122					
	Bands TDD_C		-124.5	-121	-121					
	Bands TDD_E		-123.5	-120	-120					
RSRQ ^{Note4}	Bands TDD_A, TDD_C, TDD_E		-17.77	-17.77	-17.77					
<i>I</i> _o ^{Note4}	Bands TDD_A	dBm/ BW _{channel}	-90.75+ 10log(N _{RB,c} /54)	-87.25+ 10log(N _{RB,c} /54)	-87.25+ 10log(N _{RB,c} /54)					
	Bands TDD_C		-89.75+ 10log(N _{RB,c} /54)	-86.25+ 10log(N _{RB,c} /54)	-86.25+ 10log(N _{RB,c} /54)					
	Bands TDD_E		-88.75+ 10log(N _{RB,c} /54)	-85.25+ 10log(N _{RB,c} /54)	-85.25+ 10log(N _{RB,c} /54)					
Propagation condition		-	AWGN	AWGN	AWGN					
Antenna Configuration		-	1x2	1x2	1x2					

Timing offset to Cell 1	μs	-	0	0
Time alignment error relative to cell 1 ^{Note 7}		-	$\leq \text{TAE}$	$\leq \text{TAE}$
Time alignment error relative to cell 2 ^{Note 7}		-	-	$\leq \text{TAE}$
<p>Note 1: For special subframe and uplink-downlink configurations see Tables 4.2-1 and 4.2-2 in TS 36.211.</p> <p>Note 2: OCNG shall be used such that all cells are fully allocated and a constant total transmitted power spectral density is achieved for all OFDM symbols.</p> <p>Note 3: Interference from other cells and noise sources not specified in the test is assumed to be constant over subcarriers and time and shall be modelled as AWGN of appropriate power for N_{oc} to be fulfilled.</p> <p>Note 4: Es/lot, RSRQ, RSRP and Io levels have been derived from other parameters for information purposes. They are not settable parameters themselves.</p> <p>Note 5: RSRP and RSRQ minimum requirements are specified assuming independent interference and noise at each receiver antenna port.</p> <p>Note 6: The selection of the bands for testing depends on the configuration of the carrier aggregation supported by the UEs.</p> <p>Note 7: Time alignment error (TAE) as specified in TS 36.104 [30] clause 6.5.3.1. The TAE value depends upon the type of carrier aggregation.</p> <p>Note 8: E-UTRA operating band groups are as defined in Section 3.5.</p>				

Table A.9.2.54.2-2: 4 DL TDD RSRQ carrier aggregation test parameters for cell 4

Parameter	Unit	Cell 4
E-UTRA RF Channel Number		4
BW _{channel}	MHz	5MHz: $N_{RB,c} = 25$ 10MHz: $N_{RB,c} = 54$ 20MHz: $N_{RB,c} = 100$
Special subframe configuration ^{Note1}		6
Uplink-downlink configuration ^{Note1}		1
Measurement bandwidth	n_{PRB}	5MHz: 10-15 10MHz: 22-27 20MHz: 47-52
PDSCH Reference measurement channel defined in A.3.1.1.1		5MHz: R.4 TDD 10MHz: R.0 TDD 20MHz: R.3 TDD
PDSCH allocation	n_{PRB}	5MHz: 7-17 10MHz: 13-36 20MHz: 38-61
PDCCH/PCFICH/PHICH Reference measurement channel defined in A.3.1.2.1		5MHz: R.11 TDD 10MHz: R.6 TDD 20MHz: R.10 TDD
OCNG Patterns defined in A.3.2.1		5MHz: OP.9 TDD 10MHz: OP.1 TDD 20MHz: OP.7 TDD
PBCH_RA	dB	0
PBCH_RB		
PSS_RA		
SSS_RA		
PCFICH_RB		
PHICH_RA		
PHICH_RB		
PDCCH_RA		
PDCCH_RB		
PDSCH_RA		
PDSCH_RB		
OCNG_RA ^{Note2}		
OCNG_RB ^{Note2}		
N_{oc} ^{Note3}		
	Bands TDD_C	-115
	Bands TDD_E	-114
\hat{E}_s / N_{oc}	dB	-6.0

\hat{E}_s/I_{ot} ^{Note4}		dB	-6.0
RSRP ^{Note4}	Bands TDD_A	dBm/15 kHz	-122
	Bands TDD_C		-121
	Bands TDD_E		-120
RSRQ ^{Note4}	Bands TDD_A, TDD_C, TDD_E	dB	-17.77
I _o ^{Note4}	Bands TDD_A	dBm/ BW _{channel}	-87.25+ 10log(N _{RB,c} /54)
	Bands TDD_C		-86.25+ 10log(N _{RB,c} /54)
	Bands TDD_E		-85.25+ 10log(N _{RB,c} /54)
Propagation condition		-	AWGN
Antenna Configuration		-	1x2
Timing offset to Cell 1		μs	0
Time alignment error relative to cell 1 ^{Note 7}			≤ TAE
Time alignment error relative to cell 2 ^{Note 7}			≤ TAE
Time alignment error relative to cell 3 ^{Note 7}			≤ TAE
Time alignment error relative to cell 4 ^{Note 7}			-
<p>Note 1: For special subframe and uplink-downlink configurations see Tables 4.2-1 and 4.2-2 in TS 36.211.</p> <p>Note 2: OCNG shall be used such that all cells are fully allocated and a constant total transmitted power spectral density is achieved for all OFDM symbols.</p> <p>Note 3: Interference from other cells and noise sources not specified in the test is assumed to be constant over subcarriers and time and shall be modelled as AWGN of appropriate power for N_{oc} to be fulfilled.</p> <p>Note 4: E_s/I_{ot}, RSRQ, RSRP and I_o levels have been derived from other parameters for information purposes. They are not settable parameters themselves.</p> <p>Note 5: RSRP and RSRQ minimum requirements are specified assuming independent interference and noise at each receiver antenna port.</p> <p>Note 6: The selection of the bands for testing depends on the configuration of the carrier aggregation supported by the UEs.</p> <p>Note 7: Time alignment error (TAE) as specified in TS 36.104 [30] clause 6.5.3.1. The TAE value depends upon the type of carrier aggregation.</p> <p>Note 8: E-UTRA operating band groups are as defined in Section 3.5.</p>			

A.9.2.54.3 Test Requirements

In the test, the RSRQ measurement accuracy in carrier aggregation shall fulfil the requirements in clause 9.1.11.1, 9.1.11.2, and 9.1.11.3.

- The absolute accuracy of intra-frequency RSRQ measurements of Cell 1 on the primary component carrier shall fulfil the requirements defined in clause 9.1.11.1.
- The absolute accuracy of intra-frequency RSRQ measurements of Cell 2 on SCC1 shall fulfil the requirements defined in clause 9.1.11.2.
- The absolute accuracy of intra-frequency RSRQ measurements of Cell 3 on SCC2 shall fulfil the requirements defined in clause 9.1.11.2.
- The absolute accuracy of intra-frequency RSRQ measurements of Cell 4 on SCC3 shall fulfil the requirements defined in clause 9.1.11.2.
- The relative accuracy of inter-frequency RSRQ measurements between the primary component carrier and SCC1 for Cell 2 relative to Cell 1 shall fulfil the requirements defined in clause 9.1.11.3.
- The relative accuracy of inter-frequency RSRQ measurements between the primary component carrier and SCC2 for Cell 3 relative to Cell 1 shall fulfil the requirements defined in clause 9.1.11.3.

- The relative accuracy of inter-frequency RSRQ measurements between the primary component carrier and SCC3 for Cell 4 relative to Cell 1 shall fulfil the requirements defined in clause 9.1.11.3.

A.9.2.55 3 DL RSRQ for E-UTRAN in Carrier Aggregation with generic duplex modes

A.9.2.55.1 Test Purpose and Environment

The purpose of this test is to verify that the RSRQ measurement accuracy in carrier aggregation is within the specified limits under AWGN propagation conditions. This test will verify the absolute accuracy of intra-frequency RSRQ measurements for the primary component carrier specified in clause 9.1.11.1, the absolute accuracy of intra-frequency RSRQ measurements for the secondary component carrier specified in clause 9.1.11.2 and also the relative inter-frequency RSRQ accuracy requirement between primary and secondary component carriers specified in clause 9.1.11.3.

Note on the applicability: the requirement tested in the specific duplex-mode test cases A.9.2.38, A.9.2.39, A.9.2.40, A.9.2.41, does not need to be tested in the generic duplex-mode test case A.9.2.55.

A.9.2.55.2 Test parameters

In this set of test cases there are three cells on three carrier frequencies. Cell 1 is PCell on channel 1, Cell 2 is activated SCell on channel 2, and Cell 3 is activated SCell on channel 3. The parameters for the test are listed in Table A.9.2.55.2-1.

Table A.9.2.55.2-1: 3 DL RSRQ for E-UTRAN in Carrier Aggregation test parameters

Parameter	Unit	Cell 1	Cell 2	Cell 3
E-UTRA RF Channel Number		1	2	3
Duplex mode		FDD or TDD	FDD or TDD	FDD or TDD
BW _{channel}		5MHz: N _{RB,c} = 25 10MHz: N _{RB,c} = 50 20MHz: N _{RB,c} = 100	5MHz: N _{RB,c} = 25 10MHz: N _{RB,c} = 50 20MHz: N _{RB,c} = 100	5MHz: N _{RB,c} = 25 10MHz: N _{RB,c} = 50 20MHz: N _{RB,c} = 100
TDD Special subframe configuration ^{Note1}		6	6	6
TDD Uplink/downlink configuration ^{Note1}		1	1	1
Measurement bandwidth	n_{PRB}	5MHz: 10-15 10MHz: 22-27 20MHz: 47-52	5MHz: 10-15 10MHz: 22-27 20MHz: 47-52	5MHz: 10-15 10MHz: 22-27 20MHz: 47-52
PDSCH Reference measurement channel defined in A.3.1.1		5MHz FDD: R.5 FDD 10MHz FDD: R.0 FDD 20MHz FDD: R.4 FDD 5MHz TDD: R.4 TDD 10MHz TDD: R.0 TDD 20MHz TDD: R.3 TDD	5MHz FDD: R.5 FDD 10MHz FDD: R.0 FDD 20MHz FDD: R.4 FDD 5MHz TDD: R.4 TDD 10MHz TDD: R.0 TDD 20MHz TDD: R.3 TDD	5MHz FDD: R.5 FDD 10MHz FDD: R.0 FDD 20MHz FDD: R.4 FDD 5MHz TDD: R.4 TDD 10MHz TDD: R.0 TDD 20MHz TDD: R.3 TDD
PDSCH allocation	n_{PRB}	5MHz: 7-17 10MHz: 13-36 20MHz: 38-61	5MHz: 7-17 10MHz: 13-36 20MHz: 38-61	5MHz: 7-17 10MHz: 13-36 20MHz: 38-61
PDCCH/PCFICH/PHICH Reference measurement channel defined in A.3.1.2		5MHz FDD: R.11 FDD 10MHz FDD: R.6 FDD 20MHz FDD: R.10 FDD 5MHz TDD: R.11 TDD	5MHz FDD: R.11 FDD 10MHz FDD: R.6 FDD 20MHz FDD: R.10 FDD 5MHz TDD: R.11 TDD	5MHz FDD: R.11 FDD 10MHz FDD: R.6 FDD 20MHz FDD: R.10 FDD 5MHz TDD: R.11 TDD

			10MHz TDD: R.6 TDD 20MHz TDD: R.10 TDD	10MHz TDD: R.6 TDD 20MHz TDD: R.10 TDD	10MHz TDD: R.6 TDD 20MHz TDD: R.10 TDD
OCNG Patterns defined in A.3.2			5MHz FDD: OP.15 FDD 10MHz FDD: OP.1 FDD 20MHz FDD: OP.11 FDD 5MHz TDD: OP.9 TDD 10MHz TDD: OP.1 TDD 20MHz TDD: OP.7 TDD	5MHz FDD: OP.15 FDD 10MHz FDD: OP.1 FDD 20MHz FDD: OP.11 FDD 5MHz TDD: OP.9 TDD 10MHz TDD: OP.1 TDD 20MHz TDD: OP.7 TDD	5MHz FDD: OP.15 FDD 10MHz FDD: OP.1 FDD 20MHz FDD: OP.11 FDD 5MHz TDD: OP.9 TDD 10MHz TDD: OP.1 TDD 20MHz TDD: OP.7 TDD
PBCH_RA	dB		0	0	0
PBCH_RB					
PSS_RA					
SSS_RA					
PCFICH_RB					
PHICH_RA					
PHICH_RB					
PDCCH_RA					
PDCCH_RB					
PDSCH_RA					
PDSCH_RB					
OCNG_RA ^{Note2}					
OCNG_RB ^{Note2}					
N_{oc} ^{Note3}	Bands TDD_A	dBm/ 15kHz	-116	-116	-116
	Bands TDD_C		-115	-115	-115
	Bands TDD_E		-114	-114	-114
	Bands FDD_A		-119.5	-119.5	-119.5
	Bands FDD_B1, FDD_B2 ^{Note 11}		-119	-119	-119
	Bands FDD_C		-118.5	-118.5	-118.5
	Bands FDD_D		-118	-118	-118
	Bands FDD_E, Bands FDD_F ^{Note 6}		-117.5	-117.5	-117.5
	Bands FDD_G		-116.5	-116.5	-116.5
	Bands FDD_H		-116	-116	-116
\hat{E}_s / N_{oc}	dB	-6.0	-6.0	-6.0	
\hat{E}_s / I_{ot}	dB	-6.0	-6.0	-6.0	
RSRP ^{Note4}	Bands TDD_A	dBm/ 15kHz	-122	-122	-122
	Bands TDD_C		-121	-121	-121
	Bands TDD_E		-120	-120	-120
	Bands FDD_A		-125.5	-125.5	-125.5

	Bands FDD_B1, FDD_B2 ^{Note 11}		-125	-125	-125
	Bands FDD_C		-124.5	-124.5	-124.5
	Bands FDD_D		-124	-124	-124
	Bands FDD_E, Bands FDD_F ^{Note 6}		-123.5	-123.5	-123.5
	Bands FDD_G		-122.5	-122.5	-122.5
	Bands FDD_H		-122	-122	-122
RSRQ ^{Note4}	Bands TDD_A	dB	-17.77	-17.77	-17.77
	Bands TDD_C				
	Bands TDD_E				
	Bands FDD_A		-17.77	-17.77	-17.77
	Bands FDD_B1, FDD_B2 ^{Note 11}				
	Bands FDD_C				
	Bands FDD_D				
	Bands FDD_E, Bands FDD_F ^{Note 6}				
	Bands FDD_G				
	Bands FDD_H				
Io ^{Note4}	Bands TDD_A	dBm/ BW _{channel}	-87.25 + 10log(N _{RB,c} /50)	-87.25 + 10log(N _{RB,c} /50)	-87.25 + 10log(N _{RB,c} /50)
	Bands TDD_C		-86.25 + 10log(N _{RB,c} /50)	-86.25 + 10log(N _{RB,c} /50)	-86.25 + 10log(N _{RB,c} /50)
	Bands TDD_E		-85.25 + 10log(N _{RB,c} /50)	-85.25 + 10log(N _{RB,c} /50)	-85.25 + 10log(N _{RB,c} /50)
	Bands FDD_A		-90.75 + 10log(N _{RB,c} /50)	-90.75 + 10log(N _{RB,c} /50)	s
	Bands FDD_B1, FDD_B2 ^{Note 11}		-90.25 + 10log(N _{RB,c} /50)	-90.25 + 10log(N _{RB,c} /50)	-90.25 + 10log(N _{RB,c} /50)
	Bands FDD_C		-89.75 + 10log(N _{RB,c} /50)	-89.75 + 10log(N _{RB,c} /50)	-89.75 + 10log(N _{RB,c} /50)
	Bands FDD_D		-89.25 + 10log(N _{RB,c} /50)	-89.25 + 10log(N _{RB,c} /50)	-89.25 + 10log(N _{RB,c} /50)
	Bands FDD_E, Bands FDD_F ^{Note 6}		-88.75 + 10log(N _{RB,c} /50)	-88.75 + 10log(N _{RB,c} /50)	-88.75 + 10log(N _{RB,c} /50)
	Bands FDD_G		-87.75 + 10log(N _{RB,c} /50)	-87.75 + 10log(N _{RB,c} /50)	-87.75 + 10log(N _{RB,c} /50)
	Bands FDD_H		-87.25 + 10log(N _{RB,c} /50)	-87.25 + 10log(N _{RB,c} /50)	-87.25 + 10log(N _{RB,c} /50)
Propagation Condition			AWGN	AWGN	AWGN
Antenna Configuration			1x2	1x2	1x2
Timing offset to Cell 1		μs	-	0	0

Time alignment error relative to cell 1 ^{Note 10}		-	≤ TAE	≤ TAE
Time alignment error relative to cell 2 ^{Note 10}		-	-	≤ TAE
Note 1:	For special subframe and uplink-downlink configurations see Tables 4.2-1 and 4.2-2 in TS 36.211.			
Note 2:	OCNG shall be used such that both cells are fully allocated and a constant total transmitted power spectral density is achieved for all OFDM symbols.			
Note 3:	Interference from other cells and noise sources not specified in the test is assumed to be constant over subcarriers and time and shall be modelled as AWGN of appropriate power for N_{oc} to be fulfilled.			
Note 4:	RSRP, RSRQ and Io levels have been derived from other parameters for information purposes. They are not settable parameters themselves.			
Note 5:	RSRP and RSRQ minimum requirements are specified assuming independent interference and noise at each receiver antenna port.			
Note 6:	For Band 26, the tests shall be performed with the carrier frequency of the assigned E-UTRA channel bandwidth within 865-894 MHz.			
Note 7:	The selection of the bands for testing depends on the configuration of the carrier aggregation supported by the UEs.			
Note 8:	This test verifies the RRM requirement which is independent of channel bandwidth and is performed according to the principle defined in section A.3.6.1.			
Note 9:	E-UTRA operating band groups are as defined in Section 3.5.			
Note 10:	Time alignment error (TAE) as specified in TS 36.104 [30] clause 6.5.3.1. The TAE value depends upon the type of carrier aggregation.			
Note 11:	For Band 74, the tests shall be performed with the carrier frequency of the assigned E-UTRA channel bandwidth within 1475.9-1510.9 MHz.			

A.9.2.55.3 Test Requirements

In the test, the RSRQ measurement accuracy in carrier aggregation shall fulfil the requirements in clause 9.1.11.1, 9.1.11.2, and 9.1.11.3.

- The absolute accuracy of intra-frequency RSRQ measurements of Cell 1 on the primary component carrier shall fulfil the requirements specified in clause 9.1.11.1.
- The absolute accuracy of intra-frequency RSRQ measurements of Cell 2 on the secondary component carrier shall fulfil the requirements specified in clause 9.1.11.2
- The absolute accuracy of intra-frequency RSRQ measurements of Cell 3 on the secondary component carrier shall fulfil the requirements specified in clause 9.1.11.2
- The relative accuracy of inter-frequency RSRQ measurements between the primary and secondary component carriers for Cell 2 relative to Cell 1 shall fulfil the requirements specified in clause 9.1.11.3.
- The relative accuracy of inter-frequency RSRQ measurements between the primary and secondary component carriers for Cell 3 relative to Cell 1 shall fulfil the requirements specified in clause 9.1.11.3.

A.9.2.56 4 DL RSRQ for E-UTRAN in Carrier Aggregation with generic duplex modes

A.9.2.56.1 Test Purpose and Environment

The purpose of this test is to verify that the RSRQ measurement accuracy in carrier aggregation is within the specified limits under AWGN propagation conditions. This test will verify the absolute accuracy of intra-frequency RSRQ measurements for the primary component carrier specified in clause 9.1.11.1, the absolute accuracy of intra-frequency RSRQ measurements for the secondary component carriers specified in clause 9.1.11.2 and also the relative inter-frequency RSRQ accuracy requirement between primary and secondary component carriers specified in clause 9.1.11.3.

Note on the applicability: the requirement tested in the specific duplex-mode test cases A.9.2.45, A.9.2.46, A.9.2.53 A.9.2.54, does not need to be tested in the generic duplex-mode test case A.9.2.56.

A.9.2.56.2 Test parameters

In this set of test cases there are four cells on four carrier frequencies. Cell 1 is PCell on channel 1, Cell 2 is activated SCell on channel 2, Cell 3 is activated SCell on channel 3, and Cell 4 is activated SCell on channel 4. The parameters for the test are listed in Table A.9.2.56.2-1.

Table A.9.2.56.2-1: 4 DL PCell in FDD RSRQ for E-UTRAN in Carrier Aggregation test parameters

Parameter	Unit	Cell 1	Cell 2	Cell 3	Cell 4
E-UTRA RF Channel Number		1	2	3	4
Duplex mode		FDD or TDD	FDD or TDD	FDD or TDD	FDD or TDD
BW _{channel}		5MHz: N _{RB,c} = 25 10MHz: N _{RB,c} = 50 20MHz: N _{RB,c} = 100	5MHz: N _{RB,c} = 25 10MHz: N _{RB,c} = 50 20MHz: N _{RB,c} = 100	5MHz: N _{RB,c} = 25 10MHz: N _{RB,c} = 50 20MHz: N _{RB,c} = 100	5MHz: N _{RB,c} = 25 10MHz: N _{RB,c} = 50 20MHz: N _{RB,c} = 100
TDD Special subframe configuration ^{Note1}		6	6	6	6
TDD Uplink/downlink configuration ^{Note1}		1	1	1	1
Measurement bandwidth	n_{PRB}	5MHz: 10-15 10MHz: 22-27 20MHz: 47-52	5MHz: 10-15 10MHz: 22-27 20MHz: 47-52	5MHz: 10-15 10MHz: 22-27 20MHz: 47-52	5MHz: 10-15 10MHz: 22-27 20MHz: 47-52
PDSCH Reference measurement channel defined in A.3.1.1		5MHz FDD: R.5 FDD 10MHz FDD: R.0 FDD 20MHz FDD: R.4 FDD 5MHz TDD: R.4 TDD 10MHz TDD: R.0 TDD 20MHz TDD: R.3 TDD	5MHz FDD: R.5 FDD 10MHz FDD: R.0 FDD 20MHz FDD: R.4 FDD 5MHz TDD: R.4 TDD 10MHz TDD: R.0 TDD 20MHz TDD: R.3 TDD	5MHz FDD: R.5 FDD 10MHz FDD: R.0 FDD 20MHz FDD: R.4 FDD 5MHz TDD: R.4 TDD 10MHz TDD: R.0 TDD 20MHz TDD: R.3 TDD	5MHz FDD: R.5 FDD 10MHz FDD: R.0 FDD 20MHz FDD: R.4 FDD 5MHz TDD: R.4 TDD 10MHz TDD: R.0 TDD 20MHz TDD: R.3 TDD
PDSCH allocation	n_{PRB}	5MHz: 7-17 10MHz: 13-36 20MHz: 38-61	5MHz: 7-17 10MHz: 13-36 20MHz: 38-61	5MHz: 7-17 10MHz: 13-36 20MHz: 38-61	5MHz: 7-17 10MHz: 13-36 20MHz: 38-61
PDCCH/PCFICH/PHICH Reference measurement channel defined in A.3.1.2		5MHz FDD: R.11 FDD 10MHz FDD: R.6 FDD 20MHz FDD: R.10 FDD 5MHz TDD: R.11 TDD 10MHz TDD: R.6 TDD 20MHz TDD: R.10 TDD	5MHz FDD: R.11 FDD 10MHz FDD: R.6 FDD 20MHz FDD: R.10 FDD 5MHz TDD: R.11 TDD 10MHz TDD: R.6 TDD 20MHz TDD: R.10 TDD	5MHz FDD: R.11 FDD 10MHz FDD: R.6 FDD 20MHz FDD: R.10 FDD 5MHz TDD: R.11 TDD 10MHz TDD: R.6 TDD 20MHz TDD: R.10 TDD	5MHz FDD: R.11 FDD 10MHz FDD: R.6 FDD 20MHz FDD: R.10 FDD 5MHz TDD: R.11 TDD 10MHz TDD: R.6 TDD 20MHz TDD: R.10 TDD
OCNG Patterns defined in A.3.2		5MHz FDD: OP.15 FDD 10MHz FDD: OP.1 FDD 20MHz FDD: OP.11 FDD 5MHz TDD: OP.9 TDD 10MHz TDD: OP.1 TDD 20MHz TDD: OP.7 TDD	5MHz FDD: OP.15 FDD 10MHz FDD: OP.1 FDD 20MHz FDD: OP.11 FDD 5MHz TDD: OP.9 TDD 10MHz TDD: OP.1 TDD 20MHz TDD: OP.7 TDD	5MHz FDD: OP.15 FDD 10MHz FDD: OP.1 FDD 20MHz FDD: OP.11 FDD 5MHz TDD: OP.9 TDD 10MHz TDD: OP.1 TDD 20MHz TDD: OP.7 TDD	5MHz FDD: OP.15 FDD 10MHz FDD: OP.1 FDD 20MHz FDD: OP.11 FDD 5MHz TDD: OP.9 TDD 10MHz TDD: OP.1 TDD 20MHz TDD: OP.7 TDD

PBCH_RA		dB	0	0	0	0
PBCH_RB						
PSS_RA						
SSS_RA						
PCFICH_RB						
PHICH_RA						
PHICH_RB						
PDCCH_RA						
PDCCH_RB						
PDSCH_RA						
PDSCH_RB						
OCNG_RA ^{Note2}						
OCNG_RB ^{Note2}						
N_{oc} ^{Note3}	Bands TDD_A					
	Bands TDD_C	-115	-115	-115	-115	
	Bands TDD_E	-114	-114	-114	-114	
	Bands FDD_A	-119.5	-119.5	-119.5	-119.5	
	Bands FDD_B1, FDD_B2 ^{Note 11}	-119	-119	-119	-119	
	Bands FDD_C	-118.5	-118.5	-118.5	-118.5	
	Bands FDD_D	-118	-118	-118	-118	
	Bands FDD_E, Bands FDD_F ^{Note 6}	-117.5	-117.5	-117.5	-117.5	
	Bands FDD_G	-116.5	-116.5	-116.5	-116.5	
	Bands FDD_H	-116	-116	-116	-116	
	\hat{E}_s/N_{oc}		dB	-6.0	-6.0	-6.0
\hat{E}_s/I_{ot}		dB	-6.0	-6.0	-6.0	-6.0
RSRP ^{Note4}	Bands TDD_A	dBm/ 15kHz	-122	-122	-122	-122
	Bands TDD_C		-121	-121	-121	-121
	Bands TDD_E		-120	-120	-120	-120
	Bands FDD_A		-125.5	-125.5	-125.5	-125.5
	Bands FDD_B1, FDD_B2 ^{Note 11}		-125	-125	-125	-125
	Bands FDD_C		-124.5	-124.5	-124.5	-124.5
	Bands FDD_D		-124	-124	-124	-124
	Bands FDD_E, Bands FDD_F ^{Note 6}		-123.5	-123.5	-123.5	-123.5
	Bands FDD_G		-122.5	-122.5	-122.5	-122.5
	Bands FDD_H		-122	-122	-122	-122
	RSRQ ^{Note4}		Bands TDD_A	dB	-17.77	-17.77

	Bands TDD_C						
	Bands TDD_E						
	Bands FDD_A						
	Bands FDD_B1, FDD_B2 ^{Note 11}						
	Bands FDD_C						
	Bands FDD_D						
	Bands FDD_E, Bands FDD_F ^{Note 6}						
	Bands FDD_G						
	Bands FDD_H						
Io ^{Note4}	Bands TDD_A	dBm/ BW _{channel}	-87.25 + 10log(N _{RB,c} /50)	-87.25 + 10log(N _{RB,c} /50)	-87.25 + 10log(N _{RB,c} /50)	-87.25 + 10log(N _{RB,c} /50)	
	Bands TDD_C		-86.25 + 10log(N _{RB,c} /50)	-86.25 + 10log(N _{RB,c} /50)	-86.25 + 10log(N _{RB,c} /50)	-86.25 + 10log(N _{RB,c} /50)	
	Bands TDD_E		-85.25 + 10log(N _{RB,c} /50)	-85.25 + 10log(N _{RB,c} /50)	-85.25 + 10log(N _{RB,c} /50)	-85.25 + 10log(N _{RB,c} /50)	
	Bands FDD_A		-90.75 + 10log(N _{RB,c} /50)	-90.75 + 10log(N _{RB,c} /50)	-90.75 + 10log(N _{RB,c} /50)	-90.75 + 10log(N _{RB,c} /50)	
	Bands FDD_B1, FDD_B2 ^{Note 11}		-90.25 + 10log(N _{RB,c} /50)	-90.25 + 10log(N _{RB,c} /50)	-90.25 + 10log(N _{RB,c} /50)	-90.25 + 10log(N _{RB,c} /50)	
	Bands FDD_C		-89.75 + 10log(N _{RB,c} /50)	-89.75 + 10log(N _{RB,c} /50)	-89.75 + 10log(N _{RB,c} /50)	-89.75 + 10log(N _{RB,c} /50)	
	Bands FDD_D		-89.25 + 10log(N _{RB,c} /50)	-89.25 + 10log(N _{RB,c} /50)	-89.25 + 10log(N _{RB,c} /50)	-89.25 + 10log(N _{RB,c} /50)	
	Bands FDD_E, Bands FDD_F ^{Note 6}		-88.75 + 10log(N _{RB,c} /50)	-88.75 + 10log(N _{RB,c} /50)	-88.75 + 10log(N _{RB,c} /50)	-88.75 + 10log(N _{RB,c} /50)	
	Bands FDD_G		-87.75 + 10log(N _{RB,c} /50)	-87.75 + 10log(N _{RB,c} /50)	-87.75 + 10log(N _{RB,c} /50)	-87.75 + 10log(N _{RB,c} /50)	
	Bands FDD_H		-87.25 + 10log(N _{RB,c} /50)	-87.25 + 10log(N _{RB,c} /50)	-87.25 + 10log(N _{RB,c} /50)	-87.25 + 10log(N _{RB,c} /50)	
	Propagation Condition			AWGN	AWGN	AWGN	AWGN
	Antenna Configuration			1x2	1x2	1x2	1x2
Timing offset to Cell 1	μs	-	0	0	0		
Time alignment error relative to cell 1 ^{Note 10}		-	≤ TAE	≤ TAE	≤ TAE		
Time alignment error relative to cell 2 ^{Note 10}		-	-	≤ TAE	≤ TAE		
Time alignment error relative to cell 3 ^{Note 10}		-	-	-	≤ TAE		
<p>Note 1: For special subframe and uplink-downlink configurations see Tables 4.2-1 and 4.2-2 in TS 36.211.</p> <p>Note 2: OCNB shall be used such that both cells are fully allocated and a constant total transmitted power spectral density is achieved for all OFDM symbols.</p> <p>Note 3: Interference from other cells and noise sources not specified in the test is assumed to be constant over subcarriers and time and shall be modelled as AWGN of appropriate power for N_{oc} to be fulfilled.</p> <p>Note 4: RSRP, RSRQ and Io levels have been derived from other parameters for information purposes. They are not settable parameters themselves.</p> <p>Note 5: RSRP and RSRQ minimum requirements are specified assuming independent interference and noise at each receiver antenna port.</p> <p>Note 6: For Band 26, the tests shall be performed with the carrier frequency of the assigned E-UTRA channel bandwidth within 865-894 MHz.</p>							

Note 7:	The selection of the bands for testing depends on the configuration of the carrier aggregation supported by the UEs.
Note 8:	Void.
Note 9:	E-UTRA operating band groups are as defined in Section 3.5.
Note 10:	Time alignment error (TAE) as specified in TS 36.104 [30] clause 6.5.3.1. The TAE value depends upon the type of carrier aggregation.
Note 11:	For Band 74, the tests shall be performed with the carrier frequency of the assigned E-UTRA channel bandwidth within 1475.9-1510.9 MHz.

A.9.2.56.3 Test Requirements

In the test, the RSRQ measurement accuracy in carrier aggregation shall fulfil the requirements in clause 9.1.11.1, 9.1.11.2, and 9.1.11.3.

- The absolute accuracy of intra-frequency RSRQ measurements of Cell 1 on the primary component carrier shall fulfil the requirements specified in clause 9.1.11.1.
- The absolute accuracy of intra-frequency RSRQ measurements of Cell 2 on the secondary component carrier shall fulfil the requirements specified in clause 9.1.11.2
- The absolute accuracy of intra-frequency RSRQ measurements of Cell 3 on the secondary component carrier shall fulfil the requirements specified in clause 9.1.11.2
- The absolute accuracy of intra-frequency RSRQ measurements of Cell 4 on the secondary component carrier shall fulfil the requirements specified in clause 9.1.11.2
- The relative accuracy of inter-frequency RSRQ measurements between the primary and secondary component carriers for Cell 2 relative to Cell 1 shall fulfil the requirements specified in clause 9.1.11.3.
- The relative accuracy of inter-frequency RSRQ measurements between the primary and secondary component carriers for Cell 3 relative to Cell 1 shall fulfil the requirements specified in clause 9.1.11.3.
- The relative accuracy of inter-frequency RSRQ measurements between the primary and secondary component carriers for Cell 4 relative to Cell 1 shall fulfil the requirements specified in clause 9.1.11.3.

A.9.2.57 5 DL RSRQ for E-UTRAN in Carrier Aggregation with generic duplex modes

A.9.2.57.1 Test Purpose and Environment

The purpose of this test is to verify that the RSRQ measurement accuracy in carrier aggregation is within the specified limits under AWGN propagation conditions. This test will verify the absolute accuracy of intra-frequency RSRQ measurements for the primary component carrier specified in clause 9.1.11.1, the absolute accuracy of intra-frequency RSRQ measurements for the secondary component carriers specified in clause 9.1.11.2 and also the relative inter-frequency RSRQ accuracy requirement between primary and secondary component carriers specified in clause 9.1.11.3.

Note on the applicability: the requirement tested in the specific duplex-mode test cases A.9.2.47, A.9.2.48, A.9.2.49 A.9.2.50, does not need to be tested in the generic duplex-mode test case A.9.2.57.

A.9.2.57.2 Test parameters

In this set of test cases there are five cells on five carrier frequencies. Cell 1 is PCell on channel 1, Cell 2 is activated SCell on channel 2, Cell 3 is activated SCell on channel 3, Cell 4 is activated SCell on channel 4, and Cell 5 is activated SCell on channel 5. The parameters for the test are listed in Table A.9.2.57.2-1.

Table A.9.2.57.2-1: 5 DL PCell in FDD RSRQ for E-UTRAN in Carrier Aggregation test parameters

Parameter	Unit	Cell 1	Cells			
			2	3	4	5
E-UTRA RF Channel Number		1	2	3	4	5
Duplex mode		FDD or TDD	FDD or TDD			
BW _{channel}		5MHz: N _{RB,c} = 25 10MHz: N _{RB,c} = 50 20MHz: N _{RB,c} = 100	5MHz: N _{RB,c} = 25 10MHz: N _{RB,c} = 50 20MHz: N _{RB,c} = 100			

TDD Special subframe configuration ^{Note1}			6	6
TDD Uplink/downlink configuration ^{Note1}			1	1
Measurement bandwidth		n_{PRB}	5MHz: 10-15 10MHz: 22-27 20MHz: 47-52	5MHz: 10-15 10MHz: 22-27 20MHz: 47-52
PDSCH Reference measurement channel defined in A.3.1.1			5MHz FDD: R.5 FDD 10MHz FDD: R.0 FDD 20MHz FDD: R.4 FDD 5MHz TDD: R.4 TDD 10MHz TDD: R.0 TDD 20MHz TDD: R.3 TDD	5MHz FDD: R.5 FDD 10MHz FDD: R.0 FDD 20MHz FDD: R.4 FDD 5MHz TDD: R.4 TDD 10MHz TDD: R.0 TDD 20MHz TDD: R.3 TDD
PDSCH allocation		n_{PRB}	5MHz: 7-17 10MHz: 13-36 20MHz: 38-61	5MHz: 7-17 10MHz: 13-36 20MHz: 38-61
PDCCH/PCFICH/PHICH Reference measurement channel defined in A.3.1.2			5MHz FDD: R.11 FDD 10MHz FDD: R.6 FDD 20MHz FDD: R.10 FDD 5MHz TDD: R.11 TDD 10MHz TDD: R.6 TDD 20MHz TDD: R.10 TDD	5MHz FDD: R.11 FDD 10MHz FDD: R.6 FDD 20MHz FDD: R.10 FDD 5MHz TDD: R.11 TDD 10MHz TDD: R.6 TDD 20MHz TDD: R.10 TDD
OCNG Patterns defined in A.3.2			5MHz FDD: OP.15 FDD 10MHz FDD: OP.1 FDD 20MHz FDD: OP.11 FDD 5MHz TDD: OP.9 TDD 10MHz TDD: OP.1 TDD 20MHz TDD: OP.7 TDD	5MHz FDD: OP.15 FDD 10MHz FDD: OP.1 FDD 20MHz FDD: OP.11 FDD 5MHz TDD: OP.9 TDD 10MHz TDD: OP.1 TDD 20MHz TDD: OP.7 TDD
PBCH_RA		dB	0	0
PBCH_RB				
PSS_RA				
SSS_RA				
PCFICH_RB				
PHICH_RA				
PHICH_RB				
PDCCH_RA				
PDCCH_RB				
PDSCH_RA				
PDSCH_RB				
OCNG_RA ^{Note2}				
OCNG_RB ^{Note2}				
N_{oc} ^{Note3}	Bands TDD_A	dBm/ 15kHz	-116	-116
	Bands TDD_C		-115	-115
	Bands TDD_E		-114	-114
	Bands FDD_A		-119.5	-119.5

	Bands FDD_B1, FDD_B2 ^{Note 11}		-119	-119
	Bands FDD_C		-118.5	-118.5
	Bands FDD_D		-118	-118
	Bands FDD_E, Bands FDD_F ^{Note 6}		-117.5	-117.5
	Bands FDD_G		-116.5	-116.5
	Bands FDD_H		-116	-116
\hat{E}_s / N_{oc}		dB	-6.0	-6.0
\hat{E}_s / I_{ot}		dB	-6.0	-6.0
RSRP ^{Note4}	Bands TDD_A	dBm/ 15kHz	-122	-122
	Bands TDD_C		-121	-121
	Bands TDD_E		-120	-120
	Bands FDD_A		-125.5	-125.5
	Bands FDD_B, FDD_B2 ^{Note 11}		-125	-125
	Bands FDD_C		-124.5	-124.5
	Bands FDD_D		-124	-124
	Bands FDD_E, Bands FDD_F ^{Note 6}		-123.5	-123.5
	Bands FDD_G		-122.5	-122.5
	Bands FDD_H		-122	-122
	RSRQ ^{Note4}		Bands TDD_A	dB
Bands TDD_C				
Bands TDD_E				
Bands FDD_A				
Bands FDD_B, FDD_B2 ^{Note 11}		-17.77	-17.77	
Bands FDD_C				
Bands FDD_D				
Bands FDD_E, Bands FDD_F ^{Note 6}				
Bands FDD_G				
Bands FDD_H				
I _o ^{Note4}	Bands TDD_A	dBm/ BW _{channel}	-87.25 + 10log(N _{RB,c} /50)	-87.25 + 10log(N _{RB,c} /50)
	Bands TDD_C		-86.25 + 10log(N _{RB,c} /50)	-86.25 + 10log(N _{RB,c} /50)
	Bands TDD_E		-85.25 + 10log(N _{RB,c} /50)	-85.25 + 10log(N _{RB,c} /50)
	Bands FDD_A		-90.75 + 10log(N _{RB,c} /50)	-90.75 + 10log(N _{RB,c} /50)

	Bands FDD_B, FDD_B2 ^{Note 11}		-90.25 + 10log(N _{RB,c} /50)	-90.25 + 10log(N _{RB,c} /50)			
	Bands FDD_C		-89.75 + 10log(N _{RB,c} /50)	-89.75 + 10log(N _{RB,c} /50)			
	Bands FDD_D		-89.25 + 10log(N _{RB,c} /50)	-89.25 + 10log(N _{RB,c} /50)			
	Bands FDD_E, Bands FDD_F ^{Note 6}		-88.75 + 10log(N _{RB,c} /50)	-88.75 + 10log(N _{RB,c} /50)			
	Bands FDD_G		-87.75 + 10log(N _{RB,c} /50)	-87.75 + 10log(N _{RB,c} /50)			
	Bands FDD_H		-87.25 + 10log(N _{RB,c} /50)	-87.25 + 10log(N _{RB,c} /50)			
Propagation Condition			AWGN		AWGN		
Antenna Configuration			1x2		1x2		
Timing offset to Cell 1		μs	-		0		
Time alignment error relative to cell 1 ^{Note 10}			-	≤ TAE	≤ TAE	≤ TAE	≤ TAE
Time alignment error relative to cell 2 ^{Note 10}			-	-	≤ TAE	≤ TAE	≤ TAE
Time alignment error relative to cell 3 ^{Note 10}			-	-	-	≤ TAE	≤ TAE
Time alignment error relative to cell 4 ^{Note 10}			-	-	-	-	≤ TAE
<p>Note 1: For special subframe and uplink-downlink configurations see Tables 4.2-1 and 4.2-2 in TS 36.211.</p> <p>Note 2: OCNG shall be used such that both cells are fully allocated and a constant total transmitted power spectral density is achieved for all OFDM symbols.</p> <p>Note 3: Interference from other cells and noise sources not specified in the test is assumed to be constant over subcarriers and time and shall be modelled as AWGN of appropriate power for N_{oc} to be fulfilled.</p> <p>Note 4: RSRP, RSRQ and I_o levels have been derived from other parameters for information purposes. They are not settable parameters themselves.</p> <p>Note 5: RSRP and RSRQ minimum requirements are specified assuming independent interference and noise at each receiver antenna port.</p> <p>Note 6: For Band 26, the tests shall be performed with the carrier frequency of the assigned E-UTRA channel bandwidth within 865-894 MHz.</p> <p>Note 7: The selection of the bands for testing depends on the configuration of the carrier aggregation supported by the UEs.</p> <p>Note 8: Void</p> <p>Note 9: E-UTRA operating band groups are as defined in Section 3.5.</p> <p>Note 10: Time alignment error (TAE) as specified in TS 36.104 [30] clause 6.5.3.1. The TAE value depends upon the type of carrier aggregation.</p> <p>Note 11: For Band 74, the tests shall be performed with the carrier frequency of the assigned E-UTRA channel bandwidth within 1475.9-1510.9 MHz.</p>							

A.9.2.57.3 Test Requirements

In the test, the RSRQ measurement accuracy in carrier aggregation shall fulfil the requirements in clause 9.1.11.1, 9.1.11.2, and 9.1.11.3.

- The absolute accuracy of intra-frequency RSRQ measurements of Cell 1 on the primary component carrier shall fulfil the requirements specified in clause 9.1.11.1.
- The absolute accuracy of intra-frequency RSRQ measurements of Cell 2 on the secondary component carrier shall fulfil the requirements specified in clause 9.1.11.2
- The absolute accuracy of intra-frequency RSRQ measurements of Cell 3 on the secondary component carrier shall fulfil the requirements specified in clause 9.1.11.2
- The absolute accuracy of intra-frequency RSRQ measurements of Cell 4 on the secondary component carrier shall fulfil the requirements specified in clause 9.1.11.2

- The absolute accuracy of intra-frequency RSRQ measurements of Cell 5 on the secondary component carrier shall fulfil the requirements specified in clause 9.1.11.2
- The relative accuracy of inter-frequency RSRQ measurements between the primary and secondary component carriers for Cell 2 relative to Cell 1 shall fulfil the requirements specified in clause 9.1.11.3.
- The relative accuracy of inter-frequency RSRQ measurements between the primary and secondary component carriers for Cell 3 relative to Cell 1 shall fulfil the requirements specified in clause 9.1.11.3.
- The relative accuracy of inter-frequency RSRQ measurements between the primary and secondary component carriers for Cell 4 relative to Cell 1 shall fulfil the requirements specified in clause 9.1.11.3.
- The relative accuracy of inter-frequency RSRQ measurements between the primary and secondary component carriers for Cell 5 relative to Cell 1 shall fulfil the requirements specified in clause 9.1.11.3.

A.9.2.58 6 DL RSRQ for E-UTRAN in Carrier Aggregation with generic duplex modes

A.9.2.58.1 Test Purpose and Environment

The purpose of this test is to verify that the RSRQ measurement accuracy in carrier aggregation is within the specified limits under AWGN propagation conditions. This test will verify the absolute accuracy of intra-frequency RSRQ measurements for the primary component carrier specified in clause 9.1.11.1, the absolute accuracy of intra-frequency RSRQ measurements for the secondary component carriers specified in clause 9.1.11.2 and also the relative inter-frequency RSRQ accuracy requirement between primary and secondary component carriers specified in clause 9.1.11.3.

A.9.2.58.2 Test parameters

In this set of test cases there are six cells on six carrier frequencies. Cell 1 is PCell on channel 1, Cell 2 is activated SCell on channel 2, Cell 3 is activated SCell on channel 3, Cell 4 is activated SCell on channel 4, Cell 5 is activated SCell on channel 5 and Cell 6 is activated SCell on channel 6. The parameters for the test are listed in Table A.9.2.58.2-1.

Table A.9.2.58.2-1: 6 DL RSRQ for E-UTRAN in Carrier Aggregation test parameters

Parameter	Unit	Cell 1	Cells				
			2	3	4	5	6
E-UTRA RF Channel Number		1	2	3	4	5	6
Duplex mode		FDD or TDD	FDD or TDD				
BW _{channel}		5MHz: N _{RB,c} = 25 10MHz: N _{RB,c} = 50 20MHz: N _{RB,c} = 100	5MHz: N _{RB,c} = 25 10MHz: N _{RB,c} = 50 20MHz: N _{RB,c} = 100				
TDD Special subframe configuration ^{Note1}		-	6				
TDD uplink/downlink configuration ^{Note1}		-	1				
Measurement bandwidth	n_{PRB}	5MHz: 10-15 10MHz: 22-27 20MHz: 47-52	5MHz: 10-15 10MHz: 22-27 20MHz: 47-52				
PDSCH Reference measurement channel defined in A.3.1.1		5MHz FDD: R.5 FDD 10MHz FDD: R.0 FDD 20MHz FDD: R.4 FDD 5MHz TDD: R.4 TDD 10MHz TDD: R.0 TDD 20MHz TDD: R.3 TDD	5MHz FDD: R.5 FDD 10MHz FDD: R.0 FDD 20MHz FDD: R.4 FDD 5MHz TDD: R.4 TDD 10MHz TDD: R.0 TDD 20MHz TDD: R.3 TDD				
PDSCH allocation	n_{PRB}	5MHz: 7-17 10MHz: 13-36 20MHz: 38-61	5MHz: 7-17 10MHz: 13-36 20MHz: 38-61				

PDCCH/PCFICH/PHICH Reference measurement channel defined in A.3.1.2			5MHz FDD: R.11 FDD 10MHz FDD: R.6 FDD 20MHz FDD: R.10 FDD 5MHz TDD: R.11 TDD 10MHz TDD: R.6 TDD 20MHz TDD: R.10 TDD	5MHz FDD: R.11 FDD 10MHz FDD: R.6 FDD 20MHz FDD: R.10 FDD 5MHz TDD: R.11 TDD 10MHz TDD: R.6 TDD 20MHz TDD: R.10 TDD
OCNG Patterns defined in A.3.2			5MHz FDD: OP.15 FDD 10MHz FDD: OP.1 FDD 20MHz FDD: OP.11 FDD 5MHz TDD: OP.9 TDD 10MHz TDD: OP.1 TDD 20MHz TDD: OP.7 TDD	5MHz FDD: OP.15 FDD 10MHz FDD: OP.1 FDD 20MHz FDD: OP.11 FDD 5MHz TDD: OP.9 TDD 10MHz TDD: OP.1 TDD 20MHz TDD: OP.7 TDD
PBCH_RA		dB	0	0
PBCH_RB				
PSS_RA				
SSS_RA				
PCFICH_RB				
PHICH_RA				
PHICH_RB				
PDCCH_RA				
PDCCH_RB				
PDSCH_RA				
PDSCH_RB				
OCNG_RA ^{Note2}				
OCNG_RB ^{Note2}				
N_{oc} ^{Note3}	Bands TDD_A	dBm/ 15kHz	-116	-116
	Bands TDD_C		-115	-115
	Bands TDD_E		-114	-114
	Bands FDD_A		-119.5	-119.5
	Bands FDD_B1, FDD_B2 ^{Note 11}		-119	-119
	Bands FDD_C		-118.5	-118.5
	Bands FDD_D		-118	-118
	Bands FDD_E, Bands FDD_F ^{Note 6}		-117.5	-117.5
	Bands FDD_G		-116.5	-116.5
Bands FDD_H	-116	-116		
\hat{E}_s/N_{oc}		dB	-6.0	-6.0
\hat{E}_s/I_{ot}		dB	-6.0	-6.0
RSRP ^{Note4}	Bands TDD_A	dBm/ 15kHz	-122	-122
	Bands TDD_C		-121	-121
	Bands TDD_E		-120	-120
	Bands FDD_A		-125.5	-125.5
	Bands FDD_B, FDD_B2 ^{Note 11}		-125	-125
	Bands FDD_C		-124.5	-124.5

	Bands FDD_D		-124	-124				
	Bands FDD_E, Bands FDD_F <small>Note 6</small>		-123.5	-123.5				
	Bands FDD_G		-122.5	-122.5				
	Bands FDD_H		-122	-122				
RSRQ ^{Note4}	Bands TDD_A	dB	-17.77					
	Bands TDD_C							
	Bands TDD_E							
	Bands FDD_A							
	Bands FDD_B, FDD_B2 <small>Note 11</small>							
	Bands FDD_C							
	Bands FDD_D		-17.77	-17.77				
	Bands FDD_E, Bands FDD_F <small>Note 6</small>							
	Bands FDD_G							
Bands FDD_H								
I _o ^{Note4}	Bands TDD_A	dBm/ BW _{channel}	-87.25 + 10log(N _{RB,c} /50)	-87.25 + 10log(N _{RB,c} /50)				
	Bands TDD_C		-86.25 + 10log(N _{RB,c} /50)	-86.25 + 10log(N _{RB,c} /50)				
	Bands TDD_E		-85.25 + 10log(N _{RB,c} /50)	-85.25 + 10log(N _{RB,c} /50)				
	Bands FDD_A		-90.75 + 10log(N _{RB,c} /50)	-90.75 + 10log(N _{RB,c} /50)				
	Bands FDD_B, FDD_B2 <small>Note 11</small>		-90.25 + 10log(N _{RB,c} /50)	-90.25 + 10log(N _{RB,c} /50)				
	Bands FDD_C		-89.75 + 10log(N _{RB,c} /50)	-89.75 + 10log(N _{RB,c} /50)				
	Bands FDD_D		-89.25 + 10log(N _{RB,c} /50)	-89.25 + 10log(N _{RB,c} /50)				
	Bands FDD_E, Bands FDD_F <small>Note 6</small>		-88.75 + 10log(N _{RB,c} /50)	-88.75 + 10log(N _{RB,c} /50)				
	Bands FDD_G		-87.75 + 10log(N _{RB,c} /50)	-87.75 + 10log(N _{RB,c} /50)				
	Bands FDD_H		-87.25 + 10log(N _{RB,c} /50)	-87.25 + 10log(N _{RB,c} /50)				
Propagation Condition			AWGN		AWGN			
Antenna Configuration			1x2		1x2			
Timing offset to Cell 1		μs	-		0			
Time alignment error relative to cell 1 <small>Note 10</small>			-	≤ TAE	≤ TAE	≤ TAE	≤ TAE	≤ TAE
Time alignment error relative to cell 2 <small>Note 10</small>			-	-	≤ TAE	≤ TAE	≤ TAE	≤ TAE
Time alignment error relative to cell 3 <small>Note 10</small>			-	-	-	≤ TAE	≤ TAE	≤ TAE
Time alignment error relative to cell 4 <small>Note 10</small>			-	-	-	-	≤ TAE	≤ TAE
Time alignment error relative to cell 5 <small>Note 10</small>			-	-	-	-	-	≤ TAE
<p>Note 1: For special subframe and uplink-downlink configurations see Tables 4.2-1 and 4.2-2 in TS 36.211.</p> <p>Note 2: OCNG shall be used such that both cells are fully allocated and a constant total transmitted power spectral density is achieved for all OFDM symbols.</p>								

Note 3:	Interference from other cells and noise sources not specified in the test is assumed to be constant over subcarriers and time and shall be modelled as AWGN of appropriate power for N_{oc} to be fulfilled.	
Note 4:	RSRP, RSRQ and Io levels have been derived from other parameters for information purposes. They are not settable parameters themselves.	
Note 5:	RSRP and RSRQ minimum requirements are specified assuming independent interference and noise at each receiver antenna port.	
Note 6:	For Band 26, the tests shall be performed with the carrier frequency of the assigned E-UTRA channel bandwidth within 865-894 MHz.	
Note 7:	The selection of the bands for testing depends on the configuration of the carrier aggregation supported by the UEs.	
Note 8:	Void	
Note 9:	E-UTRA operating band groups are as defined in Section 3.5.	
Note 10:	Time alignment error (TAE) as specified in TS 36.104 [30] clause 6.5.3.1. The TAE value depends upon the type of carrier aggregation.	
Note 11:	For Band 74, the tests shall be performed with the carrier frequency of the assigned E-UTRA channel bandwidth within 1475.9-1510.9 MHz.	

A.9.2.58.3 Test Requirements

In the test, the RSRQ measurement accuracy in carrier aggregation shall fulfil the requirements in clause 9.1.11.1, 9.1.11.2, and 9.1.11.3.

- The absolute accuracy of intra-frequency RSRQ measurements of Cell 1 on the primary component carrier shall fulfil the requirements specified in clause 9.1.11.1.
- The absolute accuracy of intra-frequency RSRQ measurements of Cell 2 on the secondary component carrier shall fulfil the requirements specified in clause 9.1.11.2
- The absolute accuracy of intra-frequency RSRQ measurements of Cell 3 on the secondary component carrier shall fulfil the requirements specified in clause 9.1.11.2
- The absolute accuracy of intra-frequency RSRQ measurements of Cell 4 on the secondary component carrier shall fulfil the requirements specified in clause 9.1.11.2
- The absolute accuracy of intra-frequency RSRQ measurements of Cell 5 on the secondary component carrier shall fulfil the requirements specified in clause 9.1.11.2
- The absolute accuracy of intra-frequency RSRQ measurements of Cell 6 on the secondary component carrier shall fulfil the requirements specified in clause 9.1.11.2
- The relative accuracy of inter-frequency RSRQ measurements between the primary and secondary component carriers for Cell 2 relative to Cell 1 shall fulfil the requirements specified in clause 9.1.11.3.
- The relative accuracy of inter-frequency RSRQ measurements between the primary and secondary component carriers for Cell 3 relative to Cell 1 shall fulfil the requirements specified in clause 9.1.11.3.
- The relative accuracy of inter-frequency RSRQ measurements between the primary and secondary component carriers for Cell 4 relative to Cell 1 shall fulfil the requirements specified in clause 9.1.11.3.
- The relative accuracy of inter-frequency RSRQ measurements between the primary and secondary component carriers for Cell 5 relative to Cell 1 shall fulfil the requirements specified in clause 9.1.11.3.
- The relative accuracy of inter-frequency RSRQ measurements between the primary and secondary component carriers for Cell 6 relative to Cell 1 shall fulfil the requirements specified in clause 9.1.11.3.

A.9.2.59 7 DL RSRQ for E-UTRAN in Carrier Aggregation with generic duplex modes

A.9.2.59.1 Test Purpose and Environment

The purpose of this test is to verify that the RSRQ measurement accuracy in carrier aggregation is within the specified limits under AWGN propagation conditions. This test will verify the absolute accuracy of intra-frequency RSRQ measurements for the primary component carrier specified in clause 9.1.11.1, the absolute accuracy of intra-frequency

RSRQ measurements for the secondary component carriers specified in clause 9.1.11.2 and also the relative inter-frequency RSRQ accuracy requirement between primary and secondary component carriers specified in clause 9.1.11.3.

A.9.2.59.2 Test parameters

In this set of test cases there are seven cells on seven carrier frequencies. Cell 1 is PCell on channel 1, Cell 2 is activated SCell on channel 2, Cell 3 is activated SCell on channel 3, Cell 4 is activated SCell on channel 4, Cell 5 is activated SCell on channel 5, Cell 6 is activated SCell on channel 6 and Cell 7 is activated SCell on channel 7. The parameters for the test are listed in Table A.9.2.59.2-1.

Table A.9.2.59.2-1: 7 DL RSRQ for E-UTRAN in Carrier Aggregation test parameters

Parameter	Unit	Cell 1	Cells						
			2	3	4	5	6	7	
E-UTRA RF Channel Number		1	2	3	4	5	6	7	
Duplex mode		FDD or TDD	FDD or TDD						
BW _{channel}		5MHz: N _{RB,c} = 25 10MHz: N _{RB,c} = 50 20MHz: N _{RB,c} = 100	5MHz: N _{RB,c} = 25 10MHz: N _{RB,c} = 50 20MHz: N _{RB,c} = 100						
TDD Special subframe configuration ^{Note1}		-	6						
TDD uplink/downlink configuration ^{Note1}		-	1						
Measurement bandwidth	<i>n_{PRB}</i>	5MHz: 10-15 10MHz: 22-27 20MHz: 47-52	5MHz: 10-15 10MHz: 22-27 20MHz: 47-52						
PDSCH Reference measurement channel defined in A.3.1.1		5MHz FDD: R.5 FDD 10MHz FDD: R.0 FDD 20MHz FDD: R.4 FDD 5MHz TDD: R.4 TDD 10MHz TDD: R.0 TDD 20MHz TDD: R.3 TDD	5MHz FDD: R.5 FDD 10MHz FDD: R.0 FDD 20MHz FDD: R.4 FDD 5MHz TDD: R.4 TDD 10MHz TDD: R.0 TDD 20MHz TDD: R.3 TDD						
PDSCH allocation	<i>n_{PRB}</i>	5MHz: 7-17 10MHz: 13-36 20MHz: 38-61	5MHz: 7-17 10MHz: 13-36 20MHz: 38-61						
PDCCH/PCFICH/PHICH Reference measurement channel defined in A.3.1.2		5MHz FDD: R.11 FDD 10MHz FDD: R.6 FDD 20MHz FDD: R.10 FDD 5MHz TDD: R.11 TDD 10MHz TDD: R.6 TDD 20MHz TDD: R.10 TDD	5MHz FDD: R.11 FDD 10MHz FDD: R.6 FDD 20MHz FDD: R.10 FDD 5MHz TDD: R.11 TDD 10MHz TDD: R.6 TDD 20MHz TDD: R.10 TDD						
OCNG Patterns defined in A.3.2		5MHz FDD: OP.15 FDD 10MHz FDD: OP.1 FDD 20MHz FDD: OP.11 FDD 5MHz TDD: OP.9 TDD 10MHz TDD: OP.1 TDD	5MHz FDD: OP.15 FDD 10MHz FDD: OP.1 FDD 20MHz FDD: OP.11 FDD 5MHz TDD: OP.9 TDD 10MHz TDD: OP.1 TDD						

			20MHz TDD: OP.7 TDD	20MHz TDD: OP.7 TDD
PBCH_RA		dB	0	0
PBCH_RB				
PSS_RA				
SSS_RA				
PCFICH_RB				
PHICH_RA				
PHICH_RB				
PDCCH_RA				
PDCCH_RB				
PDSCH_RA				
PDSCH_RB				
OCNG_RA ^{Note2}				
OCNG_RB ^{Note2}				
N_{oc} ^{Note3}	Bands TDD_A			
	Bands TDD_C	-115	-115	
	Bands TDD_E	-114	-114	
	Bands FDD_A	-119.5	-119.5	
	Bands FDD_B1, FDD_B2 ^{Note 11}	-119	-119	
	Bands FDD_C	-118.5	-118.5	
	Bands FDD_D	-118	-118	
	Bands FDD_E, Bands FDD_F ^{Note 6}	-117.5	-117.5	
	Bands FDD_G	-116.5	-116.5	
	Bands FDD_H	-116	-116	
\hat{E}_s / N_{oc}		dB	-6.0	-6.0
\hat{E}_s / I_{ot}		dB	-6.0	-6.0
RSRP ^{Note4}	Bands TDD_A	dBm/ 15kHz	-122	-122
	Bands TDD_C		-121	-121
	Bands TDD_E		-120	-120
	Bands FDD_A		-125.5	-125.5
	Bands FDD_B, FDD_B2 ^{Note 11}		-125	-125
	Bands FDD_C		-124.5	-124.5
	Bands FDD_D		-124	-124
	Bands FDD_E, Bands FDD_F ^{Note 6}		-123.5	-123.5
	Bands FDD_G		-122.5	-122.5
	Bands FDD_H		-122	-122

RSRQ ^{Note 4}	Bands TDD_A	dB	-17.77	-17.77					
	Bands TDD_C								
	Bands TDD_E								
	Bands FDD_A		-17.77	-17.77					
	Bands FDD_B, FDD_B2 ^{Note 11}								
	Bands FDD_C								
	Bands FDD_D								
	Bands FDD_E, Bands FDD_F ^{Note 6}								
	Bands FDD_G								
	Bands FDD_H								
I _o ^{Note 4}	Bands TDD_A	dBm/ BW _{channel}	-87.25 + 10log(N _{RB,c} /50)	-87.25 + 10log(N _{RB,c} /50)					
	Bands TDD_C		-86.25 + 10log(N _{RB,c} /50)	-86.25 + 10log(N _{RB,c} /50)					
	Bands TDD_E		-85.25 + 10log(N _{RB,c} /50)	-85.25 + 10log(N _{RB,c} /50)					
	Bands FDD_A		-90.75 + 10log(N _{RB,c} /50)	-90.75 + 10log(N _{RB,c} /50)					
	Bands FDD_B, FDD_B2 ^{Note 11}		-90.25 + 10log(N _{RB,c} /50)	-90.25 + 10log(N _{RB,c} /50)					
	Bands FDD_C		-89.75 + 10log(N _{RB,c} /50)	-89.75 + 10log(N _{RB,c} /50)					
	Bands FDD_D		-89.25 + 10log(N _{RB,c} /50)	-89.25 + 10log(N _{RB,c} /50)					
	Bands FDD_E, Bands FDD_F ^{Note 6}		-88.75 + 10log(N _{RB,c} /50)	-88.75 + 10log(N _{RB,c} /50)					
	Bands FDD_G		-87.75 + 10log(N _{RB,c} /50)	-87.75 + 10log(N _{RB,c} /50)					
	Bands FDD_H		-87.25 + 10log(N _{RB,c} /50)	-87.25 + 10log(N _{RB,c} /50)					
Propagation Condition			AWGN			AWGN			
Antenna Configuration			1x2			1x2			
Timing offset to Cell 1		μs	-			0			
Time alignment error relative to cell 1 ^{Note 10}			-	≤ TAE	≤ TAE	≤ TAE	≤ TAE	≤ TAE	≤ TAE
Time alignment error relative to cell 2 ^{Note 10}			-	-	≤ TAE	≤ TAE	≤ TAE	≤ TAE	≤ TAE
Time alignment error relative to cell 3 ^{Note 10}			-	-	-	≤ TAE	≤ TAE	≤ TAE	≤ TAE
Time alignment error relative to cell 4 ^{Note 10}			-	-	-	-	≤ TAE	≤ TAE	≤ TAE
Time alignment error relative to cell 5 ^{Note 10}			-	-	-	-	-	≤ TAE	≤ TAE
Time alignment error relative to cell 6 ^{Note 10}			-	-	-	-	-	-	≤ TAE
Note 1: For special subframe and uplink-downlink configurations see Tables 4.2-1 and 4.2-2 in TS 36.211. Note 2: OCNG shall be used such that both cells are fully allocated and a constant total transmitted power spectral density is achieved for all OFDM symbols.									

Note 3:	Interference from other cells and noise sources not specified in the test is assumed to be constant over subcarriers and time and shall be modelled as AWGN of appropriate power for N_{oc} to be fulfilled.
Note 4:	RSRP, RSRQ and I_0 levels have been derived from other parameters for information purposes. They are not settable parameters themselves.
Note 5:	RSRP and RSRQ minimum requirements are specified assuming independent interference and noise at each receiver antenna port.
Note 6:	For Band 26, the tests shall be performed with the carrier frequency of the assigned E-UTRA channel bandwidth within 865-894 MHz.
Note 7:	The selection of the bands for testing depends on the configuration of the carrier aggregation supported by the UEs.
Note 8:	Void
Note 9:	E-UTRA operating band groups are as defined in Section 3.5.
Note 10:	Time alignment error (TAE) as specified in TS 36.104 [30] clause 6.5.3.1. The TAE value depends upon the type of carrier aggregation.
Note 11:	For Band 74, the tests shall be performed with the carrier frequency of the assigned E-UTRA channel bandwidth within 1475.9-1510.9 MHz.

A.9.2.59.3 Test Requirements

In the test, the RSRQ measurement accuracy in carrier aggregation shall fulfil the requirements in clause 9.1.11.1, 9.1.11.2, and 9.1.11.3.

- The absolute accuracy of intra-frequency RSRQ measurements of Cell 1 on the primary component carrier shall fulfil the requirements specified in clause 9.1.11.1.
- The absolute accuracy of intra-frequency RSRQ measurements of Cell 2 on the secondary component carrier shall fulfil the requirements specified in clause 9.1.11.2
- The absolute accuracy of intra-frequency RSRQ measurements of Cell 3 on the secondary component carrier shall fulfil the requirements specified in clause 9.1.11.2
- The absolute accuracy of intra-frequency RSRQ measurements of Cell 4 on the secondary component carrier shall fulfil the requirements specified in clause 9.1.11.2
- The absolute accuracy of intra-frequency RSRQ measurements of Cell 5 on the secondary component carrier shall fulfil the requirements specified in clause 9.1.11.2
- The absolute accuracy of intra-frequency RSRQ measurements of Cell 6 on the secondary component carrier shall fulfil the requirements specified in clause 9.1.11.2
- The absolute accuracy of intra-frequency RSRQ measurements of Cell 7 on the secondary component carrier shall fulfil the requirements specified in clause 9.1.11.2
- The relative accuracy of inter-frequency RSRQ measurements between the primary and secondary component carriers for Cell 2 relative to Cell 1 shall fulfil the requirements specified in clause 9.1.11.3.
- The relative accuracy of inter-frequency RSRQ measurements between the primary and secondary component carriers for Cell 3 relative to Cell 1 shall fulfil the requirements specified in clause 9.1.11.3.
- The relative accuracy of inter-frequency RSRQ measurements between the primary and secondary component carriers for Cell 4 relative to Cell 1 shall fulfil the requirements specified in clause 9.1.11.3.
- The relative accuracy of inter-frequency RSRQ measurements between the primary and secondary component carriers for Cell 5 relative to Cell 1 shall fulfil the requirements specified in clause 9.1.11.3.
- The relative accuracy of inter-frequency RSRQ measurements between the primary and secondary component carriers for Cell 6 relative to Cell 1 shall fulfil the requirements specified in clause 9.1.11.3.
- The relative accuracy of inter-frequency RSRQ measurements between the primary and secondary component carriers for Cell 7 relative to Cell 1 shall fulfil the requirements specified in clause 9.1.11.3.

A.9.3 UTRAN FDD CPICH RSCP

A.9.3.1 E-UTRAN FDD

A.9.3.1.1 Test Purpose and Environment

The purpose of this test is to verify that the CPICH RSCP absolute measurement accuracy is within the specified limits. This test will verify the requirements in Clause 9.2.1. There are two different test setups with different UTRAN parameters.

A.9.3.1.2 Parameters

The test parameters are given in Tables A.9.3.1.2-1, A.9.3.1.2-2 and A.9.3.1.2-3 below.

Table A.9.3.1.2-1: General test parameters for UTRAN FDD CPICH RSCP absolute measurement accuracy test in E-UTRAN FDD

Parameter	Unit	Value	Comment
PDSCH parameters		DL Reference Measurement Channel R.0 FDD	As specified in clause A.3.1.1.1
PCFICH/PDCCH/PHICH parameters		DL Reference Measurement Channel R.6 FDD	As specified in clause A.3.1.2.1
E-UTRAN RF Channel Number		1	One E-UTRAN FDD carrier frequency is used.
UTRAN RF Channel Number		1	One UTRAN FDD carrier frequency is used.
E-UTRAN Channel Bandwidth (BW_{channel})	MHz	10	
Active cell		Cell 1	E-UTRAN cell 1 on RF channel number 1
Neighbor cells		Cell 2	UTRAN cell 2 on RF channel number 1
Gap Pattern Id		0	As specified in TS 36.133 clause 8.1.2.1.
Inter-RAT (UTRAN FDD) measurement quantity		CPICH RSCP	
Monitored UTRA FDD cell list size		12	UTRA cells on UTRA RF channel 1 provided in the cell list.
CP length		Normal	
Filter coefficient		0	L3 filtering is not used
DRX		OFF	OFF

Table A.9.3.1.2-2: E-UTRAN FDD cell specific test parameters for UTRAN FDD CPICH RSCP absolute measurement accuracy test in E-UTRAN FDD

Parameter	Unit	Test 1	Test 2
E-UTRAN RF Channel Number			1
BW_{channel}	MHz		10
OCNG Patterns defined in A.3.2.1.1 (OP.1 FDD)			OP.1 FDD
PBCH_RA	dB		0
PBCH_RB	dB		
PSS_RA	dB		
SSS_RA	dB		
PCFICH_RB	dB		
PHICH_RA	dB		
PHICH_RB	dB		
PDCCH_RA	dB		
PDCCH_RB	dB		
PDSCH_RA	dB		
PDSCH_RB	dB		
OCNG_RA ^{Note 1}	dB		
OCNG_RB ^{Note 1}	dB		
N_{oc} ^{Note 2}	dBm/15 kHz		

RSRP ^{Note 3}	dBm/15 kHz	-94
\hat{E}_s/I_{ot}	dB	4
SCH_RP ^{Note 3}	dBm/15 kHz	-94
\hat{E}_s/N_{oc}	dB	4
Propagation Condition		AWGN
<p>Note 1: OCNG shall be used such that all cells are fully allocated and a constant total transmitted power spectral density is achieved for all OFDM symbols.</p> <p>Note 2: Interference from other cells and noise sources not specified in the test is assumed to be constant over subcarriers and time and shall be modeled as AWGN of appropriate power for N_{oc} to be fulfilled.</p> <p>Note 3: RSRP and SCH_RP levels have been derived from other parameters for information purposes. They are not settable parameters themselves.</p>		

Table A.9.3.1.2-3: UTRAN FDD cell specific test parameters for UTRAN FDD CPICH RSCP absolute measurement accuracy test in E-UTRAN FDD

Parameter		Unit	Test 1	Test 2
			Cell 2	Cell 2
	CPICH_Ec/lor	dB	-10	-10
	PCCPCH_Ec/lor	dB	-12	-12
	SCH_Ec/lor	dB	-12	-12
	PICH_Ec/lor	dB	-15	-15
	DPCH_Ec/lor	dB	-	-
	OCNS_Ec/lor	dB	-0.94	-0.94
loc	Band I, IV, VI, X, XI, XIX, XXI	dBm/3.84 MHz	-60.00	-94.46
	Band II, V, VII			-92.46
	Band XXV, XXVI			-90.96 (Note 3)
	Band III, VIII, XII, XIII, XIV, XX, XXII			-91.46
	Band IX (Note 2)			-93.46
	lor/loc	dB	9.54	-9.54
CPICH RSCP, Note 1	Band I, IV, VI, X, XI, XIX, XXI	dBm	-60.46	-114.0
	Band II, V, VII			-112.0
	Band XXV, XXVI			-110.5 (Note 3)
	Band III, VIII, XII, XIII, XIV, XX, XXII			-111.0
	Band IX (Note 2)			-113.0
lo, Note 1	Band I, IV, VI, X, XI, XIX, XXI	dBm/3.84 MHz	-50.00	-94.0
	Band II, V, VII			-92.0
	Band XXV, XXVI			-90.5 (Note 3)
	Band III, VIII, XII, XIII, XIV, XX, XXII			-91.0
	Band IX (Note 2)			-93.0
Propagation condition		-	AWGN	AWGN
<p>NOTE 1: CPICH RSCP and lo levels have been calculated from other parameters for information purposes. They are not settable parameters themselves.</p> <p>NOTE 2: For the UE which supports both Band III and Band IX operating frequencies, the measurement performance requirements for Band III shall apply to the multi-band UE.</p> <p>NOTE 3: The test parameter is modified by -1.5 dB when the carrier frequency of the assigned UTRA channel is within 869-894 MHz for the UE which supports both Band V and Band XXVI operating frequencies.</p>				
<p>Tests shall be done sequentially. Test 1 shall be done first. After test 1 has been executed test parameters for test 2 shall be set within 5 seconds so that UE does not loose the Cell 2 in between the tests.</p>				

A.9.3.1.3 Test Requirements

The CPICH RSCP measurement absolute accuracy shall meet the requirements in Clause 9.2.1.

A.9.3.2 E-UTRAN TDD

A.9.3.2.1 Test Purpose and Environment

The purpose of this test is to verify that the CPICH RSCP absolute measurement accuracy is within the specified limits. This test will verify the requirements in Clause 9.2.1. There are three different test setups with different UTRAN parameters.

A.9.3.2.2 Parameters

The test parameters are given in Tables A.9.3.2.2-1, A.9.3.2.2-2 and A.9.3.2.2-3 below.

Table A.9.3.2.2-1: General test parameters for UTRAN FDD CPICH RSCP absolute measurement accuracy test in E-UTRAN TDD

Parameter	Unit	Value	Comment
PDSCH parameters		DL Reference Measurement Channel R.0 TDD	As specified in clause A.3.1.1.2
PCFICH/PDCCH/PHICH parameters		DL Reference Measurement Channel R.6 TDD	As specified in clause A.3.1.2.2
E-UTRAN RF Channel Number		1	One E-UTRAN TDD carrier frequency is used.
UTRAN RF Channel Number		1	One UTRAN FDD carrier frequency is used.
E-UTRAN Channel Bandwidth ($BW_{channel}$)	MHz	10	
Active cell		Cell 1	E-UTRAN cell 1 on RF channel number 1
Neighbor cells		Cell 2	UTRAN cell 2 on RF channel number 1
Gap Pattern Id		1	As specified in TS 36.133 clause 8.1.2.1.
Inter-RAT (UTRAN FDD) measurement quantity		CPICH RSCP	
Monitored UTRA FDD cell list size		12	UTRA cells on UTRA RF channel 1 provided in the cell list.
CP length		Normal	
Filter coefficient		0	L3 filtering is not used
DRX		OFF	OFF

Table A.9.3.2.2-2: E-UTRAN TDD cell specific test parameters for UTRAN FDD CPICH RSCP absolute measurement accuracy test in E-UTRAN TDD

Parameter	Unit	Test 1	Test 2
E-UTRAN RF Channel Number			1
$BW_{channel}$	MHz		10
Special subframe configuration ^{Note 1}			6
Uplink-downlink configuration ^{Note 1}			1
OCNG Patterns defined in A.3.2.2.1 (OP.1 TDD)			OP.1 TDD
PBCH_RA	dB		0
PBCH_RB	dB		
PSS_RA	dB		
SSS_RA	dB		
PCFICH_RB	dB		
PHICH_RA	dB		
PHICH_RB	dB		
PDCCH_RA	dB		
PDCCH_RB	dB		
PDSCH_RA	dB		
PDSCH_RB	dB		
OCNG_RA ^{Note 2}	dB		
OCNG_RB ^{Note 2}	dB		
N_{oc} ^{Note 3}	dBm/15 kHz		
RSRP ^{Note 4}	dBm/15 kHz		-94

\hat{E}_s/I_{ot}	dB	4
SCH_RP <small>Note 4</small>	dBm/15 kHz	-94
\hat{E}_s/N_{oc}	dB	4
Propagation Condition		AWGN
<p>Note 1: For special subframe and uplink-downlink configurations see Tables 4.2-1 and 4.2-2 in TS 36.211.</p> <p>Note 2: OCNG shall be used such that all cells are fully allocated and a constant total transmitted power spectral density is achieved for all OFDM symbols.</p> <p>Note 3: Interference from other cells and noise sources not specified in the test is assumed to be constant over subcarriers and time and shall be modeled as AWGN of appropriate power for N_{oc} to be fulfilled.</p> <p>Note 4: RSRP and SCH_RP levels have been derived from other parameters for information purposes. They are not settable parameters themselves.</p>		

Table A.9.3.2.2-3: UTRAN FDD cell specific test parameters for UTRAN FDD CPICH RSCP absolute measurement accuracy test in E-UTRAN TDD

Parameter		Unit	Test 1	Test 2
			Cell 2	Cell 2
CPICH_Ec/lor		dB	-10	-10
PCCPCH_Ec/lor		dB	-12	-12
SCH_Ec/lor		dB	-12	-12
PICH_Ec/lor		dB	-15	-15
DPCH_Ec/lor		dB	-	-
OCNS_Ec/lor		dB	-0.94	-0.94
loc	Band I, IV, VI, X, XI, XIX, XXI	dBm/3.84 MHz	-60.00	-94.46
	Band II, V, VII			-92.46
	Band XXV, XXVI			-90.96 (Note 3)
	Band III, VIII, XII, XIII, XIV, XX, XXII			-91.46
	Band IX (Note 2)			-93.46
lor/loc		dB	9.54	-9.54
CPICH RSCP, Note 1	Band I, IV, VI, X, XI, XIX, XXI	dBm	-60.46	-114.0
	Band II, V, VII			-112.0
	Band XXV, XXVI			-110.5 (Note 3)
	Band III, VIII, XII, XIII, XIV, XX, XXII			-111.0
	Band IX (Note 2)			-113.0
Io, Note 1	Band I, IV, VI, X, XI, XIX, XXI	dBm/3.84 MHz	-50.00	-94.0
	Band II, V, VII			-92.0
	Band XXV, XXVI			-90.5 (Note 3)
	Band III, VIII, XII, XIII, XIV, XX, XXII			-91.0
	Band IX (Note 2)			-93.0
Propagation condition		-	AWGN	AWGN
<p>NOTE 1: CPICH RSCP and Io levels have been calculated from other parameters for information purposes. They are not settable parameters themselves.</p> <p>NOTE 2: For the UE which supports both Band III and Band IX operating frequencies, the measurement performance requirements for Band III shall apply to the multi-band UE.</p> <p>NOTE 3: The test parameter is modified by -1.5 dB when the carrier frequency of the assigned UTRA channel is within 869-894 MHz for the UE which supports both Band V and Band XXVI operating frequencies.</p>				
<p>Tests shall be done sequentially. Test 1 shall be done first. After test 1 has been executed test parameters for test 2 shall be set within 5 seconds so that UE does not loose the Cell 2 in between the tests.</p>				

A.9.3.2.3 Test Requirements

The CPICH RSCP measurement absolute accuracy shall meet the requirements in Clause 9.2.1.

A.9.3.3 E-UTRAN FDD for 5MHz Bandwidth

A.9.3.3.1 Test Purpose and Environment

The purpose of this test case is the same as for the test defined in subclause A.9.3.1.1.

A.9.3.3.2 Parameters

The parameters of this test are the same as defined in Subclause A.9.3.1.2 except that the values of the parameters in the Table A.9.3.3.2-1 will replace the values of the corresponding parameters in A.9.3.1.2-1, and the values of E-UTRAN FDD cell specific parameters in the Table A.9.3.3.2-2 shall be adopted, and the values of UTRA FDD cell specific parameters shall be reused as defined in Table A.9.3.1.2-3 of Subclause A.9.3.1.2.

Table A.9.3.3.2-1: General test parameters for UTRAN FDD CPICH RSCP absolute measurement accuracy test in E-UTRAN FDD for 5MHz bandwidth

Parameter	Unit	Value	Comment
PDSCH parameters		DL Reference Measurement Channel R.5 FDD	As specified in clause A.3.1.1.1
PCFICH/PDCCH/PHICH parameters		DL Reference Measurement Channel R.11 FDD	As specified in clause A.3.1.2.1
E-UTRAN Channel Bandwidth (BW_{channel})	MHz	5	

Note 1: See Table A.9.3.1.2-1 for other general test parameters.

Table A.9.3.3.2-2: E-UTRAN FDD cell specific test parameters for UTRAN FDD CPICH RSCP absolute measurement accuracy test in E-UTRAN FDD for 5MHz bandwidth

Parameter	Unit	Test 1	Test 2
E-UTRAN RF Channel Number		1	
BW_{channel}	MHz	5	
OCNG Patterns defined in A.3.2.1.15 (OP.15 FDD)		OP.15 FDD	
PBCH_RA	dB	0	
PBCH_RB	dB		
PSS_RA	dB		
SSS_RA	dB		
PCFICH_RB	dB		
PHICH_RA	dB		
PHICH_RB	dB		
PDCCH_RA	dB		
PDCCH_RB	dB		
PDSCH_RA	dB		
PDSCH_RB	dB		
OCNG_RA ^{Note 1}	dB		
OCNG_RB ^{Note 1}	dB		
N_{oc} ^{Note 2}	FDD_N		
RSRP ^{Note 3}	FDD_N	dBm/15 kHz	-94
\hat{E}_s / I_{ot}	dB	4	
SCH_RP ^{Note 3}	FDD_N	dBm/15 kHz	-94
\hat{E}_s / N_{oc}	dB	4	
I_o ^{Note 3}	FDD_N	dBm/4.5 MHz	-67.8
Propagation Condition		AWGN	
<p>Note 1: OCNG shall be used such that all cells are fully allocated and a constant total transmitted power spectral density is achieved for all OFDM symbols.</p> <p>Note 2: Interference from other cells and noise sources not specified in the test is assumed to be constant over subcarriers and time and shall be modeled as AWGN of appropriate power for N_{oc} to be fulfilled.</p>			

Note 3: RSRP, SCH_RP and Io levels have been derived from other parameters for information purposes. They are not settable parameters themselves.

A.9.3.3.3 Test Requirements

The test requirements defined in section A.9.3.1.3 shall apply to this test case.

A.9.4 UTRAN FDD CPICH E_c/N_0

A.9.4.1 E-UTRAN FDD

A.9.4.1.1 Test Purpose and Environment

The purpose of this test is to verify that the CPICH E_c/N_0 absolute measurement accuracy is within the specified limits. This test will verify the requirements in Clause 9.2.3. There are three different test setups with different UTRAN parameters.

A.9.4.1.2 Parameters

The test parameters are given in Tables A.9.4.1.2-1, A.9.4.1.2-2 and A.9.4.1.2-3 below.

Table A.9.4.1.2-1: General test parameters for UTRAN FDD CPICH E_c/N_0 absolute measurement accuracy test in E-UTRAN FDD

Parameter	Unit	Value	Comment
PDSCH parameters		DL Reference Measurement Channel R.0 FDD	As specified in clause A.3.1.1.1
PCFICH/PDCCH/PHICH parameters		DL Reference Measurement Channel R.6 FDD	As specified in clause A.3.1.2.1
E-UTRAN RF Channel Number		1	One E-UTRAN FDD carrier frequency is used.
UTRAN RF Channel Number		1	One UTRAN FDD carrier frequency is used.
E-UTRAN Channel Bandwidth ($BW_{channel}$)	MHz	10	
Active cell		Cell 1	E-UTRAN cell 1 on RF channel number 1
Neighbor cells		Cell 2	UTRAN cell 2 on RF channel number 1
Gap Pattern Id		0	As specified in TS 36.133 clause 8.1.2.1.
Inter-RAT (UTRAN FDD) measurement quantity		CPICH E_c/N_0	
Monitored UTRA FDD cell list size		12	UTRA cells on UTRA RF channel 1 provided in the cell list.
CP length		Normal	
Filter coefficient		0	L3 filtering is not used
DRX		OFF	OFF

Table A.9.4.1.2-2: E-UTRAN FDD cell specific test parameters for UTRAN FDD CPICH E_c/N_0 absolute measurement accuracy test in E-UTRAN FDD

Parameter	Unit	Test 1	Test 2	Test 3
E-UTRAN RF Channel Number			1	
$BW_{channel}$	MHz		10	
OCNG Patterns defined in A.3.2.1.1 (OP.1 FDD)			OP.1 FDD	
PBCH_RA	dB		0	
PBCH_RB	dB			
PSS_RA	dB			
SSS_RA	dB			
PCFICH_RB	dB			
PHICH_RA	dB			
PHICH_RB	dB			

PDCCH_RA	dB	
PDCCH_RB	dB	
PDSCH_RA	dB	
PDSCH_RB	dB	
OCNG_RA ^{Note 1}	dB	
OCNG_RB ^{Note 1}	dB	
N_{oc} ^{Note 2}	dBm/15 kHz	-98
RSRP ^{Note 3}	dBm/15 kHz	-94
\hat{E}_s/I_{ot}	dB	4
SCH_RP ^{Note 3}	dBm/15 kHz	-94
\hat{E}_s/N_{oc}	dB	4
Propagation Condition		AWGN
<p>Note 1: OCNG shall be used such that all cells are fully allocated and a constant total transmitted power spectral density is achieved for all OFDM symbols.</p> <p>Note 2: Interference from other cells and noise sources not specified in the test is assumed to be constant over subcarriers and time and shall be modeled as AWGN of appropriate power for N_{oc} to be fulfilled.</p> <p>Note 3: RSRP and SCH_RP levels have been derived from other parameters for information purposes. They are not settable parameters themselves.</p>		

Table A.9.4.1.2-3: UTRAN FDD cell specific test parameters for UTRAN FDD CPICH Ec/No absolute measurement accuracy test in E-UTRAN FDD

Parameter		Unit	Test 1 Cell 2	Test 2 Cell 2	Test 3 Cell 2
CPICH_Ec/Ior		dB	-10	-10	-10
PCCPCH_Ec/Ior		dB	-12	-12	-12
SCH_Ec/Ior		dB	-12	-12	-12
PICH_Ec/Ior		dB	-15	-15	-15
DPCH_Ec/Ior		dB	-	-	-
OCNS_Ec/Ior		dB	-0.94	-0.94	-0.94
Ioc	Band I, IV, VI, X, XI, XIX, XXI	dBm/ 3.84 MHz	-52.22	-87.27	-94.46
	Band II, V, VII				-92.46
	Band XXV, XXVI				-90.96 (Note 3)
	Band III, VIII, XII, XIII, XIV, XX, XXII				-91.46
	Band IX (Note 2)				-93.46
Ior/Ioc		dB	-1.75	-4.7	-9.54
CPICH Ec/Io, Note 1		dBm	-14.0	-16.0	-20.0
Io, Note 1	Band I, IV, VI, X, XI, XIX, XXI	dBm/ 3.84 MHz	-50	-86	-94
	Band II, V, VII				-92.0
	Band XXV, XXVI				-90.5 (Note 3)
	Band III, VIII, XII, XIII, XIV, XX, XXII				-91.0
	Band IX (Note 2)				-93
Propagation condition		-	AWGN	AWGN	AWGN
<p>NOTE 1: CPICH Ec/Io and Io levels have been calculated from other parameters for information purposes. They are not settable parameters themselves.</p> <p>NOTE 2: For the UE which supports both Band III and Band IX operating frequencies, the measurement performance requirements for Band III shall apply to the multi-band UE.</p> <p>NOTE 3: The test parameter is modified by -1.5 dB when the carrier frequency of the assigned UTRA channel is within 869-894 MHz for the UE which supports both Band V and Band XXVI operating frequencies.</p> <p>Tests shall be done sequentially. Test 1 shall be done first. After test 1 has been executed test parameters for tests 2 and 3 shall be set within 5 seconds so that UE does not loose the Cell 2 in between the tests.</p>					

A.9.4.1.3 Test Requirements

The CPICH Ec/No measurement absolute accuracy shall meet the requirements in Clause 9.2.3.

The effect of assumed thermal noise and noise generated in the receiver (-99 dBm for frequency bands I, IV, VI, X, XI, XIX and XXI; -98 dBm for frequency band IX, -97dBm for frequency bands II, V and VII; -95.5dBm for frequency band XXV and XXVI; and -96dBm for frequency band III) shall be added into the required accuracy. The test requirements for the absolute CPICH_Ec/Io measurement are shown in Table A.9.4.1.3-1.

Table A.9.4.1.3-1: CPICH_Ec/Io absolute accuracy

Parameter	Unit	Accuracy [dB]		Conditions
		Normal condition	Extreme condition	Io [dBm/3,84 MHz]
CPICH_Ec/Io	dB	-2.7...1.5 for $-14 \leq \text{CPICH Ec/Io}$ -3.2...2 for $-16 \leq \text{CPICH Ec/Io} < -14$ -4.2...3 for $-20 \leq \text{CPICH Ec/Io} < -16$	-4.2...3	-94...-87(Band I, IV, VI, X, XI, XIX, XXI) -92...-85 (Band II, V, VII) -90.5...-83.5 (Band XXV, XXVI (Note 2)) -91...-84 (Band III, VIII, XII, XIII, XIV, XX, XXII) 93...-86 (Band IX (Note 1))
		± 1.5 for $-14 \leq \text{CPICH Ec/Io}$ ± 2 for $-16 \leq \text{CPICH Ec/Io} < -14$ ± 3 for $-20 \leq \text{CPICH Ec/Io} < -16$	± 3	-87...-50(Band I, IV, VI, X, XI, XIX, XXI) -85...-50 (Band II, V, VII) -83.5...-50 (Band XXV, XXVI (Note 2)) -84...-50 (Band III, VIII, XII, XIII, XIV, XX, XXII) -86...-50 (Band IX (Note 1))
NOTE1: For the UE which supports both Band III and Band IX operating frequencies, the measurement performance requirements for Band III shall apply to the multi-band UE.				
NOTE 2: The test parameter is modified by -1.5 dB when the carrier frequency of the assigned UTRA channel is within 869-894 MHz for the UE which supports both Band V and Band XXVI operating frequencies.				

A.9.4.2 E-UTRAN TDD

A.9.4.2.1 Test Purpose and Environment

The purpose of this test is to verify that the CPICH Ec/No absolute measurement accuracy is within the specified limits. This test will verify the requirements in Clause 9.2.3. There are three different test setups with different UTRAN parameters.

A.9.4.2.2 Parameters

The test parameters are given in Tables A.9.4.2.2-1, A.9.4.2.2-2 and A.9.4.2.2-3 below.

Table A.9.4.2.2-1: General test parameters for UTRAN FDD CPICH Ec/No absolute measurement accuracy test in E-UTRAN TDD

Parameter	Unit	Value	Comment
PDSCH parameters		DL Reference Measurement Channel R.0 TDD	As specified in clause A.3.1.1.2
PCFICH/PDCCH/PHICH parameters		DL Reference Measurement Channel R.6 TDD	As specified in clause A.3.1.2.2
E-UTRAN RF Channel Number		1	One E-UTRAN TDD carrier frequency is used.
UTRAN RF Channel Number		1	One UTRAN FDD carrier frequency is used.
E-UTRAN Channel Bandwidth (BW_{channel})	MHz	10	
Active cell		Cell 1	E-UTRAN cell 1 on RF channel number 1
Neighbor cells		Cell 2	UTRAN cell 2 on RF channel number 1
Gap Pattern Id		0	As specified in TS 36.133 clause 8.1.2.1.
Inter-RAT (UTRAN FDD) measurement quantity		CPICH Ec/No	
Monitored UTRA FDD cell list size		12	UTRA cells on UTRA RF channel 1 provided in the cell list.

CP length		Normal	
Filter coefficient		0	L3 filtering is not used
DRX		OFF	OFF

Table A.9.4.2.2-2: E-UTRAN TDD cell specific test parameters for UTRAN FDD CPICH Ec/No absolute measurement accuracy test in E-UTRAN TDD

Parameter	Unit	Test 1	Test 2	Test 3
E-UTRAN RF Channel Number			1	
BW _{channel}	MHz		10	
Special subframe configuration ^{Note1}			6	
Uplink-downlink configuration ^{Note1}			1	
OCNG Patterns defined in A.3.2.2.1 (OP.1 TDD)			OP.1 TDD	
PBCH_RA	dB			
PBCH_RB	dB			
PSS_RA	dB			
SSS_RA	dB			
PCFICH_RB	dB			
PHICH_RA	dB			
PHICH_RB	dB		0	
PDCCH_RA	dB			
PDCCH_RB	dB			
PDSCH_RA	dB			
PDSCH_RB	dB			
OCNG_RA ^{Note 2}	dB			
OCNG_RB ^{Note 2}	dB			
N_{oc} ^{Note 3}	dBm/15 kHz		-98	
RSRP ^{Note 4}	dBm/15 kHz		-94	
\hat{E}_s/I_{ot}	dB		4	
SCH_RP ^{Note 4}	dBm/15 kHz		-94	
\hat{E}_s/N_{oc}	dB		4	
Propagation Condition			AWGN	
Note 1: For special subframe and uplink-downlink configurations see Tables 4.2-1 and 4.2-2 in TS 36.211. Note 2: OCNG shall be used such that all cells are fully allocated and a constant total transmitted power spectral density is achieved for all OFDM symbols. Note 3: Interference from other cells and noise sources not specified in the test is assumed to be constant over subcarriers and time and shall be modeled as AWGN of appropriate power for N_{oc} to be fulfilled. Note 4: RSRP and SCH_RP levels have been derived from other parameters for information purposes. They are not settable parameters themselves.				

Table A.9.4.2.2-3: UTRAN FDD cell specific test parameters for UTRAN FDD CPICH Ec/No absolute measurement accuracy test in E-UTRAN TDD

Parameter	Unit	Test 1	Test 2	Test 3	
		Cell 2	Cell 2	Cell 2	
CPICH_Ec/Ior	dB	-10	-10	-10	
PCCPCH_Ec/Ior	dB	-12	-12	-12	
SCH_Ec/Ior	dB	-12	-12	-12	
PICH_Ec/Ior	dB	-15	-15	-15	
DPCH_Ec/Ior	dB	-	-	-	
OCNS_Ec/Ior	dB	-0.94	-0.94	-0.94	
loc	Band I, IV, VI, X, XI, XIX, XXI	dBm/3.84 MHz	-52.22	-87.27	-94.46
	Band II, V, VII				-92.46

	Band XXV, XXVI				-90.96 (Note 3)
	Band III, VIII, XII, XIII, XIV, XX, XXII				-91.46
	Band IX (Note 2)				-93.46
	$\bar{I}or/loc$	dB	-1.75	-4.7	-9.54
	CPICH Ec/Io, Note 1	dBm	-14.0	-16.0	-20.0
I _o , Note 1	Band I, IV, VI, X, XI, XIX, XXI	dBm/ 3.84 MHz	-50	-86	-94
	Band II, V, VII				-92.0
	Band XXV, XXVI				-90.5 (Note 3)
	Band III, VIII, XII, XIII, XIV, XX, XXII				-91.0
	Band IX (Note 2)				-93
Propagation condition		-	AWGN	AWGN	AWGN
NOTE 1: CPICH Ec/Io and I _o levels have been calculated from other parameters for information purposes. They are not settable parameters themselves.					
NOTE 2: For the UE which supports both Band III and Band IX operating frequencies, the measurement performance requirements for Band III shall apply to the multi-band UE.					
NOTE 3: The test parameter is modified by -1.5 dB when the carrier frequency of the assigned UTRA channel is within 869-894 MHz for the UE which supports both Band V and Band XXVI operating frequencies.					
Tests shall be done sequentially. Test 1 shall be done first. After test 1 has been executed test parameters for tests 2 and 3 shall be set within 5 seconds so that UE does not loose the Cell 2 in between the tests.					

A.9.4.2.3 Test Requirements

The CPICH Ec/No measurement absolute accuracy shall meet the requirements in Clause 9.2.3.

The effect of assumed thermal noise and noise generated in the receiver (-99 dBm for frequency bands I, IV, VI, X, XI, XIX and XXI; -98 dBm for frequency band IX, -97dBm for frequency bands II, V and VII; -95.5dBm for frequency band XXV and XXVI; and -96dBm for frequency band III) shall be added into the required accuracy. The test requirements for the absolute CPICH_Ec/Io measurement are shown in Table A.9.4.2.3-1.

Table A.9.4.2.3-1: CPICH_Ec/Io absolute accuracy

Parameter	Unit	Accuracy [dB]		Conditions
		Normal condition	Extreme condition	I _o [dBm/3,84 MHz]
CPICH_Ec/Io	dB	-2.7...1.5 for -14 ≤ CPICH Ec/Io -3.2...2 for -16 ≤ CPICH Ec/Io < -14 -4.2...3 for -20 ≤ CPICH Ec/Io < -16	-4.2...3	-94...-87(Band I, IV, VI, X, XI, XIX, XXI) -92...-85 (Band II, V, VII) -90.5...-83.5 (Band XXV, XXVI (Note 2)) -91...-84 (Band III, VIII, XII, XIII, XIV, XX, XXII) 93...-86 (Band IX (Note 1))
		± 1.5 for -14 ≤ CPICH Ec/Io ± 2 for -16 ≤ CPICH Ec/Io < -14 ± 3 for -20 ≤ CPICH Ec/Io < -16	± 3	-87...-50(Band I, IV, VI, X, XI, XIX, XXI) -85...-50 (Band II, V, VII) -83.5...-50 (Band XXV, XXVI (Note 2)) -84...-50 (Band III, VIII, XII, XIII, XIV, XX, XXII) -86...-50 (Band IX (Note 1))
NOTE1: For the UE which supports both Band III and Band IX operating frequencies, the measurement performance requirements for Band III shall apply to the multi-band UE.				
NOTE 2: The test parameter is modified by -1.5 dB when the carrier frequency of the assigned UTRA channel is within 869-894 MHz for the UE which supports both Band V and Band XXVI operating frequencies.				

A.9.4.3 E-UTRAN FDD for 5MHz Bandwidth

A.9.4.3.1 Test Purpose and Environment

The purpose of this test case is the same as for the test defined in subclause A.9.4.1.1.

A.9.4.3.2 Parameters

The parameters of this test are the same as defined in Subclause A.9.4.1.2 except that the values of the parameters in the Table A.9.4.3.2-1 will replace the values of the corresponding parameters in A.9.4.1.2-1, and the values of E-UTRAN FDD cell specific parameters in the Table A.9.4.3.2-2 shall be adopted, and the values of UTRA FDD cell specific parameters shall be reused as defined in Table A.9.4.1.2-3 of Subclause A.9.4.1.2.

Table A.9.4.3.2-1: General test parameters for UTRAN FDD CPICH Ec/No absolute measurement accuracy test in E-UTRAN FDD for 5MHz bandwidth

Parameter	Unit	Value	Comment
PDSCH parameters		DL Reference Measurement Channel R.5 FDD	As specified in clause A.3.1.1.1
PCFICH/PDCCH/PHICH parameters		DL Reference Measurement Channel R.11 FDD	As specified in clause A.3.1.2.1
E-UTRAN Channel Bandwidth (BW_{channel})	MHz	5	
Note 1: See Table A.9.4.1.2-1 for other general test parameters.			

Table A.9.4.3.2-2: E-UTRAN FDD cell specific test parameters for UTRAN FDD CPICH Ec/No absolute measurement accuracy test in E-UTRAN FDD for 5MHz bandwidth

Parameter	Unit	Test 1	Test 2	Test 3
E-UTRAN RF Channel Number			1	
BW_{channel}	MHz		5	
OCNG Patterns defined in A.3.2.1.15 (OP.15 FDD)			OP.15 FDD	
PBCH_RA	dB			
PBCH_RB	dB			
PSS_RA	dB			
SSS_RA	dB			
PCFICH_RB	dB			
PHICH_RA	dB			
PHICH_RB	dB		0	
PDCCH_RA	dB			
PDCCH_RB	dB			
PDSCH_RA	dB			
PDSCH_RB	dB			
OCNG_RA ^{Note 1}	dB			
OCNG_RB ^{Note 1}	dB			
N_{oc} ^{Note 2}	FDD_N	dBm/15 kHz	-98	
RSRP ^{Note 3}	FDD_N	dBm/15 kHz	-94	
\hat{E}_s/I_{ot}	dB		4	
SCH_RP ^{Note 3}	FDD_N	dBm/15 kHz	-94	
\hat{E}_s/N_{oc}	dB		4	
I_o ^{Note 3}	FDD_N	dBm/4.5 MHz	-67.8	
Propagation Condition			AWGN	
Note 1: OCNG shall be used such that all cells are fully allocated and a constant total transmitted power spectral density is achieved for all OFDM symbols.				
Note 2: Interference from other cells and noise sources not specified in the test is assumed to be constant over subcarriers and time and shall be modeled as AWGN of appropriate power for N_{oc} to be fulfilled.				
Note 3: RSRP and SCH_RP levels have been derived from other parameters for information purposes. They are not settable parameters themselves.				

A.9.4.3.3 Test Requirements

The test requirements defined in section A.9.4.1.3 shall apply to this test case.

A.9.5 UTRAN TDD measurement

A.9.5.1 P-CCPCH RSCP absolute accuracy for E-UTRAN FDD

A.9.5.1.1 Test Purpose and Environment

The purpose of this test is to verify that the UTRAN TDD P-CCPCH RSCP measurement absolute accuracy is within the specified limits. This test will verify the requirements in clause 9.3.1 and applies to UE supporting this capability.

Gap pattern configuration with id #1 as specified in Table 8.1.2.1-1 is provided. In the measurement control information it is indicated to the UE that periodic reporting of the UTRA TDD P-CCPCH RSRP measurement is used.

A.9.5.1.2 Test parameters

In this set of test cases there are two cells. Cell 1 is a E-UTRA FDD cell and cell 2 is a UTRA TDD cell. The absolute accuracy of P-CCPCH RSCP measurements are tested by using test parameters in Table A.9.5.1-1, Table A.9.5.1-2, and Table A.9.5.1-3. In all test cases, Cell 1 is the PCell and Cell 2 is the target cell.

Table A.9.5.1-1: General test parameters for UTRA TDD P-CCPCH RSCP measurement absolute accuracy in E-UTRAN FDD

Parameter	Unit	Value	Comment
PDSCH parameters		DL Reference Measurement Channel R.0 FDD	As specified in clause A.3.1.1.1
PCFICH/PDCCH/PHICH parameters		DL Reference Measurement Channel R.6 FDD	As specified in clause A.3.1.2.1
E-UTRAN RF Channel Number		1	One E-UTRAN FDD carrier frequency is used.
UTRAN RF Channel Number		2	One UTRAN TDD carrier frequency is used.
E-UTRAN Channel Bandwidth (BWchannel)	MHz	10	
Active cell		Cell 1	E-UTRAN FDD cell 1 on RF channel number 1
Neighbor cells		Cell 2	1.28Mcps UTRA TDD cell 2 on RF channel number 2
Gap Pattern Id		1	As specified in TS 36.133 clause 8.1.2.1.
CP length of cell 1		Normal	
Filter coefficient		0	L3 filtering is not used
DRX		OFF	OFF
Inter-RAT (UTRAN TDD) measurement quantity		P-CCPCH RSRP	

Table A.9.5.1-2: UTRA TDD P-CCPCH RSCP measurement tests parameters (cell 1)

Parameter	Unit	Test 1	Test 2	Test 3
E-UTRA RF Channel Number			1	
BWchannel	MHz		10	
OCNG Patterns defined in A.3.2.1.1 (OP.1 FDD)			OP.1 FDD	
PBCH_RA				
PBCH_RB				
PSS_RA				
SSS_RA				
PCFICH_RB				
PHICH_RA				
PHICH_RB	dB		0	
PDCCH_RA				
PDCCH_RB				
PDSCH_RA				
PDSCH_RB				
OCNG_RA ^{Note1}				
OCNG_RB ^{Note1}				

N_{oc} ^{Note2}	dBm/15 kHz	-98
\hat{E}_s / I_{ot}	dB	4
RSRP ^{Note3}	dBm/15 kHz	-94
I_o ^{Note3}	dBm/9 MHz	-64.76
\hat{E}_s / N_{oc}	dB	4
Propagation condition	-	AWGN
<p>Note 1: OCNG shall be used such that both cells are fully allocated and a constant total transmitted power spectral density is achieved for all OFDM symbols.</p> <p>Note 2: Interference from other cells and noise sources not specified in the test is assumed to be constant over subcarriers and time and shall be modelled as AWGN of appropriate power for N_{oc} to be fulfilled.</p> <p>Note 3: RSRP and I_o levels have been derived from other parameters for information purposes. They are not settable parameters themselves.</p> <p>Note 4: RSRP minimum requirements are specified assuming independent interference and noise at each receiver antenna port.</p>		

Table A.9.5.1-3: UTRA TDD P-CCPCH RSCP measurement tests parameters (cell 2)

Parameter	Unit	Test 1		Test 2		Test 3	
DL timeslot number		0		DwPTS		0	DwPTS
UTRA RF Channel number ^{Note2}		Channel 2		Channel 2		Channel 2	
PCCPCH E_c/I_{or}	dB	-3		-3		-3	
DwPCH E_c/I_{or}	dB		0		0		0
OCNS E_c/I_{or}	dB	-3		-3		-3	
I_{oc}	dBm/1.28MHz	-54.1		-75.2		-97	
I_{or}/I_{oc}	dB	2		5		0	
PCCPCH RSCP ^{Note1}	dBm	-55.1		-73.2		-100	
I_o ^{Note1}	dBm/1.28MHz	-50		-69		-94	
Propagation condition		AWGN					
<p>Note 1: PCCPCH RSCP and I_o levels have been calculated from other parameters for information purposes. They are not settable parameters themselves.</p> <p>Note 2: In the case of multi-frequency network of 1.28 Mcps TDD, the UTRA RF Channel Number can be set for the primary frequency in this test.</p>							

A.9.5.1.3 Test Requirements

The UTRA TDD P-CCPCH RSCP measurement accuracy shall meet the requirements in clause 9.3.1.

A.9.5.2 P-CCPCH RSCP absolute accuracy for E-UTRAN TDD

A.9.5.2.1 Test Purpose and Environment

The purpose of this test is to verify that the UTRAN TDD P-CCPCH RSCP measurement accuracy is within the specified limits. This test will verify the requirements in clause 9.3.1 and applies to UE supporting this capability.

Gap pattern configuration with id #1 as specified in Table 8.1.2.1-1 is provided. In the measurement control information it is indicated to the UE that periodic reporting of the UTRA TDD P-CCPCH RSCP measurement is used.

A.9.5.2.2 Test parameters

In this set of test cases there are two cells. Cell 1 is a E-UTRA TDD cell and cell 2 is a UTRA TDD cell. The absolute accuracy of P-CCPCH RSCP measurements are tested by using test parameters in Table A.9.5.2-1, Table A.9.5.2-2, and Table A.9.5.2-3. In all test cases, Cell 1 is the PCell and Cell 2 is the target cell.

Table A.9.5.2-1: General test parameters for UTRA TDD P-CCPCH RSCP measurement

Parameter	Unit	Value	Comment
PDSCH parameters		DL Reference Measurement Channel R.0 TDD	As specified in clause A.3.1.1.2

PCFICH/PDCCH/PHICH parameters		DL Reference Measurement Channel R.6 TDD	As specified in clause A.3.1.2.2
E-UTRAN RF Channel Number		1	One E-UTRAN TDD carrier frequency is used.
UTRAN RF Channel Number		2	One UTRAN TDD carrier frequency is used.
E-UTRAN Channel Bandwidth (BWchannel)	MHz	10	
Active cell		Cell 1	E-UTRA TDD cell1 on RF channel number 1
Neighbour cell		Cell 2	1.28Mcps UTRA TDD Cell2 on RF channel number 2
Gap Pattern Id		1	As specified in TS 36.133 clause 8.1.2.1.
Uplink-downlink configuration of cell 1		1	As specified in table 4.2.2 in TS 36.211
Special subframe configuration of cell 1		6	As specified in table 4.2.1 in TS 36.211
CP length of cell 1		Normal	
Filter coefficient		0	L3 filtering is not used
DRX		OFF	
Time offset between cells	ms	3	Asynchronous cells
Inter-RAT (UTRAN TDD) measurement quantity		P-CCPCH RSCP	

Table A.9.5.2-2: UTRA TDD P-CCPCH RSCP measurement tests parameters (cell 1)

Parameter	Unit	Test 1	Test 2	Test 3
E-UTRA RF Channel Number			1	
BWchannel	MHz		10	
OCNG Patterns defined in A.3.2.2.1 (OP.1 TDD)			OP.1 TDD	
PBCH_RA	dB		0	
PBCH_RB				
PSS_RA				
SSS_RA				
PCFICH_RB				
PHICH_RA				
PHICH_RB				
PDCCH_RA				
PDCCH_RB				
PDSCH_RA				
PDSCH_RB				
OCNG_RA ^{Note1}				
OCNG_RB ^{Note1}				
N_{oc} ^{Note2}				
\hat{E}_s / I_{ot}	dB		4	
RSRP ^{Note3}	dBm/15 kHz		-94	
I_o ^{Note3}	dBm/9 MHz		-64.76	
\hat{E}_s / N_{oc}	dB		4	
Propagation condition	-		AWGN	
<p>Note 1: OCNG shall be used such that both cells are fully allocated and a constant total transmitted power spectral density is achieved for all OFDM symbols.</p> <p>Note 2: Interference from other cells and noise sources not specified in the test is assumed to be constant over subcarriers and time and shall be modelled as AWGN of appropriate power for N_{oc} to be fulfilled.</p> <p>Note 3: RSRP and I_o levels have been derived from other parameters for information purposes. They are not settable parameters themselves.</p> <p>Note 4: RSRP minimum requirements are specified assuming independent interference and noise at each receiver antenna port.</p>				

Table A.9.5.2-3: UTRA TDD P-CCPCH RSCP measurement tests parameters (cell 2)

Parameter	Unit	Test 1		Test 2		Test 3	
DL timeslot number		0		DwPTS		0	DwPTS
UTRA RF Channel number ^{Note2}		Channel 2		Channel 2		Channel 2	
PCCPCH_Ec/Ior	dB	-3		-3		-3	
DwPCH_Ec/Ior	dB		0		0		0
OCNS_Ec/Ior	dB	-3		-3		-3	
Ioc	dBm/1.28MHz	-54.1		-75.2		-97	
Ior/Ioc	dB	2		5		0	
PCCPCH RSCP ^{Note1}	dBm	-55.1		-73.2		-100	
Io ^{Note1}	dBm/1.28MHz	-50		-69		-94	
Propagation condition		AWGN					
Note 1:	PCCPCH RSCP and Io levels have been calculated from other parameters for information purposes. They are not settable parameters themselves.						
Note 2:	In the case of multi-frequency network of 1.28 Mcps TDD, the UTRA RF Channel Number can be set for the primary frequency in this test.						

A.9.5.2.3 Test Requirements

The UTRA TDD P-CCPCH RSCP measurement accuracy shall meet the requirements in clause 9.3.1.

A.9.6 GSM Carrier RSSI

A.9.6.1 E-UTRAN FDD

A.9.6.1.1 Test Purpose and Environment

The purpose of this test is to verify that the GSM Carrier RSSI measurement accuracy is within the specified limits when the active cell is E-UTRAN FDD. This test will verify the requirements in clause 9.4.1. There are 12 different test setups with different signal levels for the GSM cells.

Measurement gaps are configured to measure on the GSM cells. Table A.9.6.1.1-2 defines the cell specific test parameters for the E-UTRAN FDD cell. In the measurement control information it is indicated to the UE that periodic reporting of the GSM RSSI measurement is used. The limits of the GSM test parameters in terms of GSM BCCH received level at the receiver inputs are defined in Table A.9.6.1.1-3.

Table A.9.6.1.1-1: General GSM Carrier RSSI test parameters

Parameter	Unit	Value	Comment
PDSCH parameters (E-UTRAN FDD)		DL Reference Measurement Channel R.0 FDD	As specified in clause A.3.1.1.1.
PCFICH/PDCCH/PHICH parameters (E-UTRAN FDD)		DL Reference Measurement Channel R.6 FDD	As specified in clause A.3.1.2.1.
Active cell	-	Cell 1	
DRX	-	OFF	
Gap pattern Id		1	As specified in TS 36.133 clause 8.1.2.1.
Filtering coefficient	-	0	L3 filtering is not used.
Inter-RAT measurement quantity		GSM Carrier RSSI	
Monitored cell list size		6 GSM neighbours including ARFCN 1	Included in the Measurement control information

Table A.9.6.1.1-2: E-UTRAN FDD Cell specific test parameters for GSM Carrier RSSI accuracy test in E-UTRAN FDD

Parameter	Unit	Tests 1-12
E-UTRAN RF Channel Number		1

BW _{channel}	MHz	10
OCNG Patterns defined in A.3.2.1.1 (OP.1 FDD)		OP.1 FDD
PBCH_RA	dB	0
PBCH_RB	dB	
PSS_RA	dB	
SSS_RA	dB	
PCFICH_RB	dB	
PHICH_RA	dB	
PHICH_RB	dB	
PDCCH_RA	dB	
PDCCH_RB	dB	
PDSCH_RA	dB	
PDSCH_RB	dB	
OCNG_RA ^{Note 1}	dB	
OCNG_RB ^{Note 1}	dB	
N_{oc} ^{Note 2}	dBm/15 kHz	
RSRP ^{Note 3}	dBm/15 kHz	-94
\hat{E}_s / I_{ot}	dB	4
SCH_RP ^{Note 3}	dBm/15 kHz	-94
\hat{E}_s / N_{oc}	dB	4
Propagation Condition		AWGN
<p>Note 1: OCNG shall be used such that all cells are fully allocated and a constant total transmitted power spectral density is achieved for all OFDM symbols.</p> <p>Note 2: Interference from other cells and noise sources not specified in the test is assumed to be constant over subcarriers and time and shall be modeled as AWGN of appropriate power for N_{oc} to be fulfilled.</p> <p>Note 3: RSRP and SCH_RP levels have been derived from other parameters for information purposes. They are not settable parameters themselves.</p>		

Table A.9.6.1.1-3: BCCH signal levels at receiver input in dBm

Step	BCCH1	BCCH2	BCCH3	BCCH4	BCCH5	BCCH6
1	-38.5	-38.5	NA	NA	NA	NA
2	-48.5	-48.5	NA	NA	NA	NA
3	-70.5	-70.5	NA	NA	NA	NA
4	-109.5	-109.5	NA	NA	NA	NA
5	-57.5	NA	-54.5	NA	NA	NA
6	-64.5	NA	-59.5	NA	NA	NA
7	-71.5	NA	NA	-64.5	NA	NA
8	-78.5	NA	NA	-69.5	NA	NA
9	-85.5	NA	NA	NA	-74.5	NA
10	-92.5	NA	NA	NA	-79.5	NA
11	-99.5	NA	NA	NA	NA	-84.5
12	-106.5	NA	NA	NA	NA	-89.5

A.9.6.1.2 Test Requirements

The GSM Carrier RSSI measurement accuracy shall meet the requirements in clause 9.4.1.

A.9.6.2 E-UTRAN TDD

A.9.6.2.1 Test Purpose and Environment

The purpose of this test is to verify that the GSM Carrier RSSI measurement accuracy is within the specified limits when the active cell is E-UTRAN TDD. This test will verify the requirements in clause 9.4.1. There are 12 different test setups with different signal levels for the GSM cells.

Measurement gaps are configured to measure on the GSM cells. Table A.9.6.2.1-2 defines the cell specific test parameters for the E-UTRAN TDD cell. In the measurement control information it is indicated to the UE that periodic reporting of the GSM RSSI measurement is used. The limits of the GSM test parameters in terms of GSM BCCH received level at the receiver inputs are defined in Table A.9.6.2.1-3.

Table A.9.6.2.1-1: General GSM Carrier RSSI test parameters

Parameter	Unit	Value	Comment
PDSCH parameters (E-UTRAN TDD)		DL Reference Measurement Channel R.0 TDD	As specified in clause A.3.1.1.2.
PCFICH/PDCCH/PHICH parameters (E-UTRAN TDD)		DL Reference Measurement Channel R.6 TDD	As specified in clause A.3.1.2.2.
Active cell	-	Cell 1	
DRX	-	OFF	
Uplink-downlink configuration of cell 1		1	As specified in table 4.2.2 in TS 36.211
Special subframe configuration of cell 1		6	As specified in table 4.2.1 in TS 36.211
Gap pattern Id		1	As specified in TS 36.133 clause 8.1.2.1.
Filtering coefficient	-	0	L3 filtering is not used.
Inter-RAT measurement quantity		GSM Carrier RSSI	
Monitored cell list size		6 GSM neighbours including ARFCN 1	Included in the Measurement control information

Table A.9.6.2.1-2: E-UTRAN TDD Cell specific test parameters for GSM Carrier RSSI accuracy test in E-UTRAN TDD

Parameter	Unit	Tests 1 - 12
E-UTRAN RF Channel Number		1
BW _{channel}	MHz	10
OCNG Patterns defined in A.3.2.2.1 (OP.1 TDD)		OP.1 TDD
PBCH_RA	dB	0
PBCH_RB	dB	
PSS_RA	dB	
SSS_RA	dB	
PCFICH_RB	dB	
PHICH_RA	dB	
PHICH_RB	dB	
PDCCH_RA	dB	
PDCCH_RB	dB	
PDSCH_RA	dB	
PDSCH_RB	dB	
OCNG_RA ^{Note 1}	dB	
OCNG_RB ^{Note 1}	dB	
N_{oc} ^{Note 2}	dBm/15 kHz	-98
RSRP ^{Note 3}	dBm/15 kHz	-94
\hat{E}_s/I_{ot}	dB	4
SCH_RP ^{Note 3}	dBm/15 kHz	-94
\hat{E}_s/N_{oc}	dB	4
Propagation Condition		AWGN
Note 1: OCNG shall be used such that all cells are fully allocated and a constant total transmitted power spectral density is achieved for all OFDM symbols.		

Note 2: Interference from other cells and noise sources not specified in the test is assumed to be constant over subcarriers and time and shall be modeled as AWGN of appropriate power

for N_{oc} to be fulfilled.

Note 3: RSRP and SCH_RP levels have been derived from other parameters for information purposes. They are not settable parameters themselves.

Table A.9.6.2.1-3: BCCH signal levels at receiver input in dBm

Step	BCCH1	BCCH2	BCCH3	BCCH4	BCCH5	BCCH6
1	-38.5	-38.5	NA	NA	NA	NA
2	-48.5	-48.5	NA	NA	NA	NA
3	-70.5	-70.5	NA	NA	NA	NA
4	-109.5	-109.5	NA	NA	NA	NA
5	-57.5	NA	-54.5	NA	NA	NA
6	-64.5	NA	-59.5	NA	NA	NA
7	-71.5	NA	NA	-64.5	NA	NA
8	-78.5	NA	NA	-69.5	NA	NA
9	-85.5	NA	NA	NA	-74.5	NA
10	-92.5	NA	NA	NA	-79.5	NA
11	-99.5	NA	NA	NA	NA	-84.5
12	-106.5	NA	NA	NA	NA	-89.5

A.9.6.2.2 Test Requirements

The GSM Carrier RSSI measurement accuracy shall meet the requirements in clause 9.4.1.

A.9.7 UE Rx – Tx Time Difference

A.9.7.1 E-UTRAN FDD UE Rx – Tx time difference case

A.9.7.1.1 Test Purpose and Environment

The purpose of this test is to verify that the E-UTRAN FDD UE Rx – Tx time difference measurement accuracy is within the specified limits in Clause 9.1.9.

There is only one active cell in the test. The tested UE is connected with the PCell, configured to transmit SRS signals periodically, and signaled to report UE Rx – Tx time difference measurement. The test equipment measures the transmit timing of the UE using the transmitted SRS, and measures the receive timing using the downlink CRS. The test equipment then compares the difference of these two timings to the UE Rx-Tx measurement reported by the UE.

A.9.7.1.2 Test parameters

The parameters for this test case are defined in Table A.9.7.1.2-1, and the SRS configuration used is defined in Table A.9.7.1.2-2.

Table A.9.7.1.2-1: FDD UE Rx – Tx time difference test parameters

Parameter	Unit	Test 1	Test 2
E-UTRAN RF Channel Number		1	1
BW _{channel}	MHz	1.4	10
DRX		OFF	
PDSCH Reference measurement channel defined in A.3.1.1.1		R.2 FDD	R.0 FDD
PDSCH allocation	n_{PRB}	2–3	13–36
PDCCH/PCFICH/PHICH Reference measurement channel defined in A.3.1.2.1		R.8 FDD	R.6 FDD
OCNG Patterns defined in A.3.2.1.3 (OP.3 FDD) and A.3.2.1.1 (OP.1 FDD)		OP.3 FDD	OP.1 FDD
PBCH_RA	dB	0	0
PBCH_RB	dB		
PSS_RA	dB		

SSS_RA	dB		
PCFICH_RB	dB		
PHICH_RA	dB		
PHICH_RB	dB		
PDCCH_RA	dB		
PDCCH_RB	dB		
PDSCH_RA	dB		
PDSCH_RB	dB		
OCNG_RA ^{Note1}	dB		
OCNG_RB ^{Note1}	dB		
N_{oc} ^{Note2}	dBm/15 kHz	-98	-98
RSRP ^{Note3}	dBm/15 kHz	-101	-101
\hat{E}_s / N_{oc}	dB	-3	-3
I_o ^{Note3}	dBm/1.08 MHz	-77.66	N/A
	dBm/9 MHz	N/A	-68.45
\hat{E}_s / I_{ot}	dB	-3	-3
Propagation Condition		AWGN	
Note 1: OCNG shall be used such that the resources in the active cell are fully allocated and a constant total transmitted power spectral density is achieved for all OFDM symbols.			
Note 2: Interference from other cells and noise sources not specified in the test is assumed to be constant over subcarriers and time and shall be modeled as AWGN of appropriate power for N_{oc} to be fulfilled.			
Note 3: RSRP and I_o levels have been derived from other parameters for information purposes. They are not settable parameters themselves.			

Table A.9.7.1.2-2: Sounding Reference Symbol Configuration to be used in FDD UE Rx – Tx time difference test

Field	Test 1	Test 2	Comment
	Value		
srsBandwidthConfiguration	bw7	bw5	
srsSubframeConfiguration	sc1		
ackNackSrsSimultaneousTransmission	FALSE		
srsMaxUpPTS	N/A		Not applicable for FDD
srsBandwidth	0		No hopping
srsHoppingBandwidth	hbw0		
frequencyDomainPosition	0		
Duration	TRUE		Indefinite duration
Srs-ConfigurationIndex	0		SRS periodicity of 2ms for all Tests.
transmissionComb	0		
cyclicShift	cs0		No cyclic shift
SRS-AntennaPort	an1		Number of antenna ports used for SRS transmission
Note:	For further information see clause 6.3.2 in TS 36.331.		

A.9.7.1.3 Test Requirements

The UE Rx – Tx time difference measurement accuracy shall fulfill the requirements in Clause 9.1.9.1.

A.9.7.2 E-UTRA TDD UE Rx – Tx time difference case

A.9.7.2.1 Test Purpose and Environment

The purpose of this test is to verify that the E-UTRAN TDD UE Rx-Tx time difference measurement accuracy is within the specified limits in clause 9.1.9.

There is only one cell in the test. The tested UE is connected with the PCell, configured to transmit SRS signals periodically, and signaled to report UE Rx – Tx time difference measurement. The test equipment measures the transmit

timing of the UE using the transmitted SRS, and measures the receive timing using the downlink CRS. The test equipment then compares the difference of these two timings to the UE Rx – Tx measurement reported by the UE.

A.9.7.2.2 Test parameters

The parameters for this test case are defined in Table A.9.7.2.2-1, and the SRS configuration used is defined in Table A.9.7.2.2-2.

Table A.9.7.2.2-1: Cell specific test parameters for UE Rx-Tx time difference measurement

Parameter	Unit	Tests 1	Tests 2
E-UTRAN RF Channel Number	-	1	1
BW _{channel}	MHz	1.4	10
Uplink-downlink configuration of cell ^{Note1}		1	1
Special subframe configuration of cell ^{Note1}		6	6
PDSCH Reference measurement channel defined in A.3.1.1.2	-	R.2 TDD	R.0 TDD
PDSCH allocation	n_{PRB}	2-3	13-36
PDCCH/PCFICH/PHICH Reference measurement channel defined in A.3.1.2.2	-	R.8 TDD	R.6 TDD
OCNG Patterns defined in A.3.2.2.3 (OP.3 TDD) and A.3.2.2.1 (OP.1 TDD)	-	OP.3 TDD	OP.1 TDD
PBCH_RA	dB	0	0
PBCH_RB	dB		
PSS_RA	dB		
SSS_RA	dB		
PCFICH_RB	dB		
PHICH_RA	dB		
PHICH_RB	dB		
PDCCH_RA	dB		
PDCCH_RB	dB		
PDSCH_RA	dB		
PDSCH_RB	dB		
OCNG_RA ^{Note2}	dB		
OCNG_RB ^{Note2}	dB		
N_{oc} ^{Note 3}	dBm/15 kHz		
RSRP ^{Note 4}	dBm/15 kHz	-101	-101
\hat{E}_s/N_{oc}	dB	-3	-3
I_o ^{Note 4}	dBm/1.08 MHz	-77.66	N/A
	dBm/9 MHz	N/A	-68.45
\hat{E}_s/I_{ot}	dB	-3	-3
Propagation Condition		AWGN	
Note 1: For special subframe and uplink-downlink configurations see Tables 4.2-1 and 4.2-2 in TS 36.211. Note 2: OCNG shall be used such that the cell is fully allocated and a constant total transmitted power spectral density is achieved for all OFDM symbols. Note 3: Interference from other cells and noise sources not specified in the test is assumed to be constant over subcarriers and time and shall be modeled as AWGN of appropriate power for N_{oc} to be fulfilled. Note 4: RSRP and I_o levels have been derived from other parameters for information purposes. They are not settable parameters themselves.			

Table A.9.7.2.2-2: Sounding Reference Symbol Configuration to be used in TDD UE Rx – Tx time difference test

Field	Test 1	Test 2	Comment
	Value		
srsBandwidthConfiguration	bw7	bw5	
srsSubframeConfiguration	sc1		
ackNackSrsSimultaneousTransmission	FALSE		
srsMaxUpPTS	TRUE		
srsBandwidth	0		No hopping
srsHoppingBandwidth	hbw0		

frequencyDomainPosition	0	
Duration	TRUE	Indefinite duration
Srs-ConfigurationIndex	10	SRS periodicity of 10ms for all Tests.
transmissionComb	0	
cyclicShift	cs0	No cyclic shift
SRS-AntennaPort	an1	Number of antenna ports used for SRS transmission
Note:	For further information see clause 6.3.2 in TS 36.331.	

A.9.7.2.3 Test Requirements

The UE Rx – Tx time difference measurement accuracy shall fulfill the requirements in clause 9.1.9.1.

A.9.7.3 E-UTRAN FDD UE Rx–Tx Time Difference under Time-Domain Measurement Resource Restriction with Non-MBSFN ABS

A.9.7.3.1 Test Purpose and Environment

The purpose of this test is to verify that the E-UTRAN FDD UE Rx–Tx time difference measurement accuracy is within the specified limits. This test will verify the requirements in Section 9.1.9.3 when time-domain measurement resource restriction is configured for PCell measurements via higher-layer signalling [2] and non-MBSFN ABS are configured in the interfering cell.

A.9.7.3.2 Test parameters

In this test case, there are two synchronous cells, Cell 1 and Cell 2, on the same RF channel. Cell 1 is the PCell on which UE Rx-Tx is measured, and Cell 2 is the interfering cell. Non-MBSFN ABS pattern is configured in Cell 2 during the entire test.

The tested UE is connected to the PCell and configured to transmit SRS signals periodically. The SRS configuration is provided to the UE before the measurement starts. The UE is configured to report UE Rx–Tx time difference measurement. The test equipment measures the transmit timing of the UE using the transmitted SRS, and measures the receive timing using the downlink CRS. The test equipment then compares the difference of these two timings to the UE Rx-Tx measurement reported by the UE. The UE is configured by higher layers via Cell 1 with a time-domain measurement resource restriction pattern for performing E-UTRAN FDD intra-frequency measurements on PCell. The information for both patterns shall be provided to the UE before the measurement starts.

The general and cell-specific parameters for this test case are defined in Table A.9.7.3.2-1 and Table A.9.7.3.2-2, respectively, and the SRS configuration used is specified in Table A.9.7.3.2-3.

Table A.9.7.3.2-1: General test parameters for FDD UE Rx–Tx time difference measurement under time-domain measurement resource restriction with non-MBSFN ABS

Parameter	Unit	Value	Comment
Serving cell (PCell)		Cell 1	The measured cell
Neighbour cell		Cell 2	The cell interfering to Cell 1
PCell ABS configuration		Non-MBSFN ABS	As defined in Table A.3.4.1.1-1
E-UTRA RF Channel Number		1	One FDD carrier frequency is used
Downlink Channel Bandwidth (BW _{channel})	MHz	10	For both cells in the test
CP length		Normal	For both cells in the test
DRX			OFF
Time offset between cells	µs	3	Synchronous cells
Physical cell ID PCI		$(PCI_{cell1} - PCI_{cell2}) \bmod 6 \neq 0$	Cell PCIs for Cell 1 and Cell 2 are selected randomly so that the condition is met
ABS pattern		'10000000100000001000000000001000000010000000'	Non-MBSFN ABS. FDD ABS Pattern Info IE, as defined in TS 36.423 [28], clause 9.2.54. Configured in Cell 2. The first/leftmost bit corresponds to the subframe #0 of a radio frame satisfying SFN mod 40 = 0. No MBSFN subframes are configured in Cell 1 or Cell 2 during the ABS subframes of Cell 2.

Time-domain measurement resource restriction pattern for serving cell measurements		'10000000100000001000 00001000000010000000'	Configured for measurements on Cell 1.
--	--	--	--

Table A.9.7.3.2-2: Cell-specific test parameters for FDD UE Rx–Tx time difference measurement under time-domain measurement resource restriction with non-MBSFN ABS

Parameter	Unit	Cell 1	Cell 2
E-UTRAN RF Channel Number		1	1
Channel bandwidth ($BW_{channel}$)	MHz	10	10
PDSCH Reference measurement channel defined in A.3.1.1.1		R.0 FDD	N/A
PDSCH allocation	n_{PRB}	13–36	N/A
PDCCH/PCFICH/PHICH Reference measurement channel defined in A.3.1.2.1		R.6 FDD	N/A
OCNG Patterns defined in A.3.2.1.1 (OP.1 FDD) and in A.3.2.1.6 (OP.6 FDD)		OP.5 FDD	OP.6 FDD
PBCH_RA	dB	0	Non-ABS and ABS subframe channel powers defined in Table A.3.4.1.1-1.
PBCH_RB	dB		
PSS_RA	dB		
SSS_RA	dB		
PCFICH_RB	dB		
PHICH_RA	dB		
PHICH_RB	dB		
PDCCH_RA	dB		
PDCCH_RB	dB		
PDSCH_RA	dB		
PDSCH_RB	dB		
OCNG_RA ^{Note 1}	dB		
OCNG_RB ^{Note 1}	dB		
N_{oc} ^{Note 2}	dBm/15 kHz		
CRS \hat{E}_s/N_{oc}	dB	-3	1
CRS $(\hat{E}_s/I_{ot})_{meas}$ ^{Note 3}	dB	-3	-0.76
CRS $(\hat{E}_s/I_{ot})_{nonABS}$ ^{Note 3}	dB	-6.54	-0.76
RSRP ^{Note 4}	dBm/15 kHz	-101	-97
$(I_o)_{meas}$ ^{Note 4}	dBm/9 MHz	-67.89	-67.89
$(I_o)_{nonABS}$ ^{Note 4}	dBm/9 MHz	-65.81	-65.81
Propagation condition		AWGN	
<p>NOTE 1: OCNG shall be used such that the resources in the active cell are fully allocated and a constant total transmitted power spectral density is achieved for all OFDM symbols.</p> <p>NOTE 2: Interference from other cells and noise sources not specified in the test is assumed to be constant over subcarriers and time and shall be modelled as AWGN of appropriate power for N_{oc} to be fulfilled. Applies to all subframes.</p> <p>Note 3: $(\hat{E}_s/I_{ot})_{meas}$ is calculated in CRS REs in the subframes indicated for PCell measurements by measurement resource restriction pattern, whilst $(\hat{E}_s/I_{ot})_{nonABS}$ is calculated in CRS REs in the subframes not indicated for PCell measurements by measurement resource restriction pattern.</p> <p>Note 4: RSRP and I_o levels have been derived from other parameters for information purposes. They are not settable parameters themselves. $(I_o)_{meas}$ is calculated in CRS symbols in the subframes indicated for PCell measurements by measurement resource restriction pattern, whilst $(I_o)_{nonABS}$ is calculated in</p>			

CRS symbols in the subframes not indicated for PCell measurements by measurement resource restriction pattern.
--

Table A.9.7.3.2-3: Sounding Reference Symbol Configuration to be used in FDD UE Rx–Tx time difference test

Field	Value	Comment
UL bandwidth	50 RBs	Same as the DL bandwidth
srsBandwidthConfiguration	bw5	
srsSubframeConfiguration	sc1	
ackNackSrsSimultaneousTransmission	FALSE	
srsMaxUpPTS	N/A	Not applicable for FDD
srsBandwidth	0	No hopping
srsHoppingBandwidth	hbw0	
frequencyDomainPosition	0	
Duration	TRUE	Indefinite duration
srs-ConfigIndex	0	SRS periodicity of 2ms
transmissionComb	0	
cyclicShift	cs0	No cyclic shift
srsAntennaPort	an1	Number of SRS antenna ports
Note:	For further information see clause 6.3.2 in TS 36.331.	

A.9.7.3.3 Test Requirements

The UE Rx–Tx time difference measurement accuracy shall fulfill the requirements in Section 9.1.9.3.

A.9.7.4 E-UTRAN TDD UE Rx-Tx Time Difference under Time-Domain Measurement Resource Restriction with Non-MBSFN ABS

A.9.7.4.1 Test Purpose and Environment

The purpose of this test is to verify that the TDD UE Rx-Tx time difference measurement accuracy is within the specified limits. This test will verify the requirements in Section 9.1.9.3 when time-domain measurement resource restriction is configured for PCell measurements via higher-layer signalling [2] and non-MBSFN ABS are configured in the interfering cell.

A.9.7.4.2 Test Parameters

In the test, there are two synchronous cells, Cell 1 and Cell 2, on the same RF channel. Cell 1 is the PCell on which UE Rx-Tx is measured, and Cell 2 is the interfering cell. Non-MBSFN ABS pattern is configured in Cell 2 during the entire test.

The tested UE is connected to the PCell and configured to transmit SRS signals periodically. The SRS configuration is provided to the UE before the measurement starts. The UE is configured to report UE Rx–Tx time difference measurement. The test equipment measures the transmit timing of the UE using the transmitted SRS, and measures the receive timing using the downlink CRS. The test equipment then compares the difference of these two timings to the UE Rx-Tx measurement reported by the UE. The UE is configured by higher layers via Cell 1 with a time-domain measurement resource restriction pattern for performing E-UTRAN TDD UE Rx-Tx time difference measurements on PCell. The information for both patterns shall be provided to the UE before the measurement starts.

The general and cell-specific parameters for this test case are defined in Table A.9.7.4.2-1 and Table A.9.7.4.2-2, respectively, and the SRS configuration used is defined in Table A.9.7.4.2-3.

Table A.9.7.4.2-1: General test parameters for E-UTRAN TDD UE Rx-Tx time difference measurement under time-domain measurement resource restriction with non-MBSFN ABS

Parameter	Unit	Value	Comment
Serving cell (PCell)		Cell 1	Cell to be measured
Neighbour cell		Cell 2	The cell interfering to Cell 1
PCell ABS configuration		Non-MBSFN ABS	As defined in Table A.3.4.1.1-1
E-UTRA RF Channel Number		1	One TDD carrier frequency is used

Downlink Channel Bandwidth (BW _{channel})	MHz	10	For both cells in the test
CP length		Normal	For both cells in the test
Special subframe configuration		6	For Cell 1 and Cell 2. For special subframe configurations see Table 4.2-1 in [16].
Uplink/downlink subframe configuration		1	For Cell 1 and Cell 2. For uplink-downlink subframe configurations see Table 4.2-2 in [16].
DRX			OFF
Time offset between cells	μs	3	Synchronous cells
Physical cell ID PCI		(PCI _{cell1} - PCI _{cell2}) mod6 !=0	Cell PCIs for Cell 1 and Cell 2 are selected randomly so that the condition is met.
ABS pattern		'00000000010000000001'	Non-MBSFN ABS. TDD ABS Pattern Info IE, as defined in TS 36.423 [28], clause 9.2.54. Configured in Cell 2. The first/leftmost bit corresponds to the subframe #0 of a radio frame satisfying SFN mod 20 = 0. No MBSFN subframes are configured in the ABS subframes in Cell 2.
Time-domain measurement resource restriction pattern for serving cell measurements		'00000000010000000001'	Configured for measurements on Cell 1.

Table A.9.7.4.2-2: Cell-specific test parameters for E-UTRAN TDD UE Rx-Tx time difference measurement under time-domain measurement resource restriction with non-MBSFN ABS

Parameter	Unit	Cell 1	Cell 2
PDSCH Reference measurement channel defined in A.3.1.1.2		R.0 TDD	N/A
PDSCH allocation	n_{PRB}	13—36	N/A
PDCCH/PCFICH/PHICH Reference measurement channel defined in A.3.1.2.2		R.6 TDD	R.6 TDD
OCNG Patterns defined in A.3.2.2.1 (OP.1 TDD) and A.3.2.2.2 (OP.2 TDD)		OP.1 TDD	OP.2 TDD
PBCH_RA	dB	0	Non-ABS and ABS subframe channel powers defined in Table A.3.4.1.1-1.
PBCH_RB	dB		
PSS_RA	dB		
SSS_RA	dB		
PCFICH_RB	dB		
PHICH_RA	dB		
PHICH_RB	dB		
PDCCH_RA	dB		
PDCCH_RB	dB		
PDSCH_RA	dB		
PDSCH_RB	dB		
OCNG_RA ^{Note1}	dB		
OCNG_RB ^{Note1}	dB		
N_{oc} ^{Note2}	dBm/15 kHz		
CRS \hat{E}_s/N_{oc}	dB	-3	1
CRS $(\hat{E}_s/I_{ot})_{meas}$ ^{Note 3}	dB	-3	-0.76
CRS $(\hat{E}_s/I_{ot})_{nonABS}$ ^{Note 3}	dB	-6.54	-0.76
RSRP ^{Note 4}	dBm/15 kHz	-101	-97
$(I_o)_{meas}$ ^{Note 4}	dBm/9 MHz	-67.89	-67.89
$(I_o)_{nonABS}$ ^{Note 4}	dBm/9 MHz	-65.81	-65.81
Propagation Condition		AWGN	

Note 1:	OCNG shall be used such that the resources in the active cell are fully allocated and a constant total transmitted power spectral density is achieved for all OFDM symbols.
Note 2:	Interference from other cells and noise sources not specified in the test is assumed to be constant over subcarriers and time and shall be modeled as AWGN of appropriate power for N_{oc} to be fulfilled.
Note 3:	$(\hat{E}_s/I_{ot})_{meas}$ is calculated in CRS REs in the subframes indicated for PCell measurements by measurement resource restriction pattern, whilst $(\hat{E}_s/I_{ot})_{nonABS}$ is calculated in CRS REs in the subframes not indicated for PCell measurements by measurement resource restriction pattern.
Note 4:	RSRP and I _o levels have been derived from other parameters for information purposes. They are not settable parameters themselves. $(I_o)_{meas}$ is calculated in CRS symbols in the subframes indicated for PCell measurements by measurement resource restriction pattern, whilst $(I_o)_{nonABS}$ is calculated in CRS symbols

Table A.9.7.4.2-3: Sounding Reference Symbol Configuration to be used in TDD UE Rx–Tx time difference test

Field	Value	Comment
UL bandwidth	50 RBs	Same as the DL bandwidth
srsBandwidthConfiguration	bw5	
srsSubframeConfiguration	sc1	
ackNackSrsSimultaneousTransmission	FALSE	
srsMaxUpPTS	TRUE	
srsBandwidth	0	No hopping
srsHoppingBandwidth	hbw0	
frequencyDomainPosition	0	
Duration	TRUE	Indefinite duration
Srs-ConfigurationIndex	10	SRS periodicity of 10ms for all Tests.
transmissionComb	0	
cyclicShift	cs0	No cyclic shift
SRS-AntennaPort	an1	Number of antenna ports used for SRS transmission
Note:	For further information see clause 6.3.2 in TS 36.331.	

A.9.7.4.3 Test Requirements

The UE Rx–Tx time difference measurement accuracy shall fulfill the requirements in Section 9.1.9.3.

A.9.7.5 E-UTRAN FDD UE Rx–Tx time difference under Time Domain Measurement Resource Restriction with CRS Assistance Information and Non-MBSFN ABS

A.9.7.5.1 Test Purpose and Environment

The purpose of this test is to verify that the E-UTRAN FDD UE Rx–Tx time difference measurement accuracy is within the specified limits. This test will verify the requirements in Section 9.1.9.4 when the UE is provided with a time-domain measurement resource restriction pattern and CRS assistance information, and when non-MBSFN ABS configured in the interfering cells.

A.9.7.5.2 Test parameters

In this test case, there are three synchronous cells, Cell 1, Cell 2 and Cell 3, on the same RF channel. Cell 1 is the PCell on which UE Rx–Tx is measured. Cell 2 and Cell 3 are the interfering cells. A non-MBSFN ABS pattern is configured in each of the Cell 2 and Cell 3 during the entire test.

The tested UE is connected to the PCell and configured to transmit SRS signals periodically. The SRS configuration is provided to the UE before the measurement starts. The UE is configured to report UE Rx–Tx time difference measurement. The test equipment measures the transmit timing of the UE using the transmitted SRS, and measures the receive timing using the downlink CRS. The test equipment then compares the difference of these two timings to the

UE Rx-Tx measurement reported by the UE. The UE is configured by higher layers via Cell 1 with a time-domain measurement resource restriction pattern for performing E-UTRAN FDD intra-frequency measurements on PCell. The UE is also provided via higher layers with the CRS assistance information for Cell 2. The information for both measurement patterns and the CRS assistance information shall be provided via RRC to the UE before the measurement starts.

The general and cell-specific parameters for this test case are defined in Table A.9.7.5.2-1 and Table A.9.7.5.2-2, respectively, and the SRS configuration used is specified in Table A.9.7.5.2-3.

Table A.9.7.5.2-1: General test parameters for FDD UE Rx–Tx time difference measurement under time-domain measurement resource restriction with CRS assistance information and non-MBSFN ABS

Parameter	Unit	Value	Comment
Serving cell (PCell)		Cell 1	The measured cell
Neighbour cell		Cell 2 and Cell 3	Cell 2 is the first interfering cell to Cell 1, whilst Cell 3 is the second interfering cell to Cell 1.
ABS transmission configuration		Non-MBSFN ABS	As defined in Table A.3.4.1.1-1
E-UTRA RF Channel Number		1	One FDD carrier frequency is used
Downlink Channel Bandwidth ($BW_{channel}$)	MHz	10	For all cells in the test
CP length		Normal	For all cells in the test
DRX			OFF
Time offset between cells	μ s	Cell 2 offset with respect to Cell 1: 3 Cell 3 offset with respect to Cell 1: 2	Three synchronous cells
Physical cell ID PCI		$(PCI_{cell1} - PCI_{cell2}) \bmod 6 = 0$ $(PCI_{cell1} - PCI_{cell3}) \bmod 6 \neq 0$	Cell PCIs are selected so that both conditions are met
ABS pattern		'10000000100000001000 00001000000010000000'	Non-MBSFN ABS. FDD ABS Pattern Info IE, as defined in TS 36.423 [28], clause 9.2.54. The first/leftmost bit corresponds to the Pcell subframe #0 of a radio frame satisfying $SFN \bmod x = 0$, where x is the size of the bit string (40) divided by 10. No MBSFN subframes are configured in the ABS subframes. Configured in Cell 2 and Cell 3 during the testing.
Time-domain measurement resource restriction pattern for PCell measurements		'10000000100000001000 00001000000010000000'	Configured for measurements on Cell 1.
CRS assistance information	physCellId	see PCI conditions above	The CRS assistance information is provided for Cell 2 and Cell 3 in CRS-AssistanceInfo. It includes a single MBSFN-SubframeConfig element with subframe allocation one Frame='000000'.
	antennaPortsCount	1	
	mbsfn-SubframeConfigList	oneFrame = '000000'	

Table A.9.7.5.2-2: Cell-specific test parameters for FDD UE Rx–Tx time difference measurement under time-domain measurement resource restriction with CRS assistance information and non-MBSFN ABS

Parameter	Unit	Cell 1	Cell 2	Cell 3
E-UTRAN RF Channel Number		1	1	1
PDSCH Reference measurement channel defined in A.3.1.1.1		R.0 FDD	N/A	N/A
PDSCH allocation	n_{PRB}	13–36	N/A	N/A
PDCCH/PCFICH/PHICH Reference measurement channel defined in A.3.1.2.1		R.6 FDD	N/A	N/A
OCNG Patterns defined in A.3.2.1.5 (OP.5 FDD) and in A.3.2.1.6 (OP.6 FDD)		OP.5 FDD	OP.6 FDD	OP.6 FDD
PBCH_RA	dB	0		

PBCH_RB	dB	Non-ABS and ABS subframe channel powers defined in Table A.3.4.1.1-1.		
PSS_RA	dB			
SSS_RA	dB			
PCFICH_RB	dB			
PHICH_RA	dB			
PHICH_RB	dB			
PDCCH_RA	dB			
PDCCH_RB	dB			
PDSCH_RA	dB			
PDSCH_RB	dB			
OCNG_RA ^{Note1}	dB			
OCNG_RB ^{Note1}	dB			
N_{oc} ^{Note 2}	dBm/15 kHz			
$CRS \hat{E}_s / N_{oc}$	dB	-3	3	1
$CRS \left(\hat{E}_s / I_{ot} \right)_{meas}$ ^{Note 3}	dB	-7.76	1.24	-0.76
$CRS \left(\hat{E}_s / I_{ot} \right)_{nonABS}$ ^{Note 3}	dB	-9.29	-1.41	-4.44
RSRP ^{Note 4}	dBm/15 kHz	-101	-95	-97
$(I_o)_{meas}$ ^{Note 4}	dBm/9 MHz	-67.11	-67.11	-67.11
$(I_o)_{nonABS}$ ^{Note 4}	dBm/9 MHz	-63.45	-63.45	-63.45
Propagation condition		AWGN		
<p>NOTE 1: OCNG shall be used such that the resources in the active cell are fully allocated and a constant total transmitted power spectral density is achieved for all OFDM symbols.</p> <p>NOTE 2: Interference from other cells and noise sources not specified in the test is assumed to be constant over subcarriers and time and shall be modelled as AWGN of appropriate power for N_{oc} to be fulfilled. Applies to all subframes.</p> <p>Note 3: $\left(\hat{E}_s / I_{ot} \right)_{meas}$ is calculated in CRS REs in the subframes indicated for PCell measurements by measurement resource restriction pattern, whilst $\left(\hat{E}_s / I_{ot} \right)_{nonABS}$ is calculated in CRS REs in the subframes not indicated for PCell measurements by measurement resource restriction pattern.</p> <p>Note 4: RSRP and I_o levels have been derived from other parameters for information purposes. They are not settable parameters themselves. $(I_o)_{meas}$ is calculated in CRS symbols in the subframes indicated for PCell measurements by measurement resource restriction pattern, whilst $(I_o)_{nonABS}$ is calculated in CRS symbols in the subframes not indicated for PCell measurements by measurement resource restriction pattern.</p>				

Table A.9.7.5.2-3: Sounding Reference Symbol Configuration to be used in FDD UE Rx-Tx time difference test

Field	Value	Comment
UL bandwidth	50 RBs	Same as the DL bandwidth
srsBandwidthConfiguration	bw5	
srsSubframeConfiguration	sc1	
ackNackSrsSimultaneousTransmission	FALSE	
srsMaxUpPTS	N/A	Not applicable for FDD
srsBandwidth	0	No hopping
srsHoppingBandwidth	hbw0	
frequencyDomainPosition	0	
Duration	TRUE	Indefinite duration
srs-ConfigIndex	0	SRS periodicity of 2ms
transmissionComb	0	
cyclicShift	cs0	No cyclic shift
srsAntennaPort	an1	Number of SRS antenna ports
Note: For further information see clause 6.3.2 in TS 36.331.		

A.9.7.5.3 Test Requirements

The UE Rx–Tx time difference measurement accuracy shall fulfill the requirements in Section 9.1.9.4.

A.9.7.6 E-UTRAN TDD UE Rx-Tx Time Difference under Time-Domain Measurement Resource Restriction with CRS Assistance Information and Non-MBSFN ABS

A.9.7.6.1 Test Purpose and Environment

The purpose of this test is to verify that the E-UTRAN TDD UE Rx–Tx time difference measurement accuracy is within the specified limits. This test will verify the requirements in Section 9.1.9.4 when the UE is provided with a time-domain measurement resource restriction pattern and CRS assistance information, and when non-MBSFN ABS configured in the interfering cells.

A.9.7.6.2 Test Parameters

In this test case, there are three synchronous cells, Cell 1, Cell 2 and Cell 3, on the same RF channel. Cell 1 is the PCell on which UE Rx-Tx is measured. Cell 2 and Cell 3 are the interfering cells. A non-MBSFN ABS pattern is configured in each of the Cell 2 and Cell 3 during the entire test.

The tested UE is connected to the PCell and configured to transmit SRS signals periodically. The SRS configuration is provided to the UE before the measurement starts. The UE is configured to report UE Rx–Tx time difference measurement. The test equipment measures the transmit timing of the UE using the transmitted SRS, and measures the receive timing using the downlink CRS. The test equipment then compares the difference of these two timings to the UE Rx-Tx measurement reported by the UE. The UE is configured by higher layers via Cell 1 with a time-domain measurement resource restriction pattern for performing E-UTRAN TDD intra-frequency measurements on PCell. The UE is also provided via higher layers with the CRS assistance information for Cell 2. The information for both measurement patterns and the CRS assistance information shall be provided via RRC to the UE before the measurement starts.

The general and cell-specific parameters for this test case are defined in Table A.9.7.6.2-1 and Table A.9.7.6.2-2, respectively, and the SRS configuration used is specified in Table A.9.7.6.2-3.

Table A.9.7.6.2-1: General test parameters for E-UTRAN TDD UE Rx-Tx time difference measurement under time-domain measurement resource restriction with CRS assistance information and non-MBSFN ABS

Parameter	Unit	Value	Comment
Serving cell (PCell)		Cell 1	Cell to be measured
Neighbour cell		Cell 2 and Cell 3	Cell 2 is the first interfering cell to Cell 1, whilst Cell 3 is the second interfering cell to Cell 1.
ABS transmission configuration		Non-MBSFN ABS	As defined in Table A.3.4.1.1-1
E-UTRA RF Channel Number		1	One TDD carrier frequency is used
Downlink Channel Bandwidth (BW_{channel})	MHz	10	For all cells in the test
CP length		Normal	For all cells in the test
Special subframe configuration		6	For all cells in the test. For special subframe configurations see Table 4.2-1 in [16].
Uplink/downlink subframe configuration		1	For all cells in the test. For uplink-downlink subframe configurations see Table 4.2-2 in [16].
DRX			OFF
Time offset between cells	μs	Cell 2 offset with respect to Cell 1: 3 Cell 3 offset with respect to Cell 1: 2	Three synchronous cells
Physical cell ID PCI		$(\text{PCI}_{\text{cell1}} - \text{PCI}_{\text{cell2}}) \bmod 6 = 0$ $(\text{PCI}_{\text{cell1}} - \text{PCI}_{\text{cell3}}) \bmod 6 \neq 0$	Cell PCIs are selected so that both conditions are met

ABS pattern			'00000000010000000001'	Non-MBSFN ABS. TDD ABS Pattern Info IE, as defined in TS 36.423 [28], clause 9.2.54. The first/leftmost bit corresponds to the Pcell subframe #0 of a radio frame satisfying SFN mod x = 0, where x is the size of the bit string (20) divided by 10. No MBSFN subframes are configured in the ABS subframes. Configured in Cell 2 and Cell 3 during the testing.
Time-domain measurement resource restriction pattern for serving cell measurements			'00000000010000000001'	Configured for measurements on Cell 1.
CRS assistance information	physCellId		see PCI conditions above	The CRS assistance information is provided for Cell 2 and Cell 3 in CRS-AssistanceInfo. It includes a single MBSFN-SubframeConfig element with subframe allocation one Frame='000000'.
	antennaPortsCount		1	
	mbsfn-SubframeConfigList		oneFrame = '000000'	

Table A.9.7.6.2-2: Cell-specific test parameters for E-UTRAN TDD UE Rx-Tx time difference measurement under time-domain measurement resource restriction with CRS assistance information and non-MBSFN ABS

Parameter	Unit	Cell 1	Cell 2	Cell 3
E-UTRAN RF Channel Number		1	1	1
PDSCH Reference measurement channel defined in A.3.1.1.2		R.0 TDD	N/A	N/A
PDSCH allocation	n_{PRB}	13–36	N/A	N/A
PDCCH/PCFICH/PHICH Reference measurement channel defined in A.3.1.2.2		R.6 TDD	N/A	N/A
OCNG Patterns defined in A.3.2.2.1 (OP.1 TDD) and A.3.2.2.2 (OP.2 TDD)		OP.1 TDD	OP.2 TDD	OP.2 TDD
PBCH_RA	dB	0	Non-ABS and ABS subframe channel powers defined in Table A.3.4.1.1-1.	
PBCH_RB	dB			
PSS_RA	dB			
SSS_RA	dB			
PCFICH_RB	dB			
PHICH_RA	dB			
PHICH_RB	dB			
PDCCH_RA	dB			
PDCCH_RB	dB			
PDSCH_RA	dB			
PDSCH_RB	dB			
OCNG_RA ^{Note1}	dB			
OCNG_RB ^{Note1}	dB			
N_{oc} ^{Note2}	dBm/15 kHz	-98	-98	-98
CRS \hat{E}_s / N_{oc}	dB	-3	3	1
CRS $(\hat{E}_s / I_{ot})_{meas}$ ^{Note 3}	dB	-7.76	1.24	-0.76
CRS $(\hat{E}_s / I_{ot})_{nonABS}$ ^{Note 3}	dB	-9.29	-1.41	-4.44
RSRP ^{Note 4}	dBm/15 kHz	-101	-95	-97
$(I_o)_{meas}$ ^{Note 4}	dBm/9 MHz	-67.11	-67.11	-67.11
$(I_o)_{nonABS}$ ^{Note 4}	dBm/9 MHz	-63.45	-63.45	-63.45
Propagation Condition		AWGN		
Note 1: OCNG shall be used such that the resources in the active cell are fully allocated and a constant total transmitted power spectral density is achieved for all OFDM symbols. Note 2: Interference from other cells and noise sources not specified in the test is assumed to be constant over subcarriers and time and shall be modeled as AWGN of appropriate power for N_{oc} to be fulfilled.				

Note 3: $(\hat{E}_s/I_{ot})_{meas}$ is calculated in CRS REs in the subframes indicated for PCell measurements by measurement resource restriction pattern, whilst $(\hat{E}_s/I_{ot})_{nonABS}$ is calculated in CRS REs in the subframes not indicated for PCell measurements by measurement resource restriction pattern.

Note 4: RSRP and I_o levels have been derived from other parameters for information purposes. They are not settable parameters themselves. $(I_o)_{meas}$ is calculated in CRS symbols in the subframes indicated for PCell measurements by measurement resource restriction pattern, whilst $(I_o)_{nonABS}$ is calculated in CRS symbols

Table A.9.7.6.2-3: Sounding Reference Symbol Configuration to be used in TDD UE Rx–Tx time difference test

Field	Value	Comment
UL bandwidth	50 RBs	Same as the DL bandwidth
srsBandwidthConfiguration	bw5	
srsSubframeConfiguration	sc1	
ackNackSrsSimultaneousTransmission	FALSE	
srsMaxUpPTS	TRUE	
srsBandwidth	0	No hopping
srsHoppingBandwidth	hbw0	
frequencyDomainPosition	0	
Duration	TRUE	Indefinite duration
Srs-ConfigurationIndex	10	SRS periodicity of 10ms for all Tests.
transmissionComb	0	
cyclicShift	cs0	No cyclic shift
SRS-AntennaPort	an1	Number of antenna ports used for SRS transmission
Note:	For further information see clause 6.3.2 in TS 36.331.	

A.9.7.6.3 Test Requirements

The UE Rx–Tx time difference measurement accuracy shall fulfill the requirements in Section 9.1.9.4.

A.9.7.7 E-UTRAN FDD UE Rx-Tx time difference case for Cat-M1/M2 UE in CEModeA

A.9.7.7.1 Test Purpose and Environment

The purpose of this test is to verify that Cat-M1 and Cat-M2 UE can meet the E-UTRAN FDD UE Rx-Tx time difference measurement accuracy requirements. Requirements for Cat-M1 UE is specified in Clause 9.1.21.21 and requirements for Cat-M2 UE is specified in Clause 9.1.25.25.

There is only one active cell in the test. The tested UE is connected with the PCell, configured to transmit SRS signals periodically, and signaled to report UE Rx-Tx time difference measurement. The test equipment measures the transmit timing of the UE using the transmitted SRS, and measures the receive timing using the downlink CRS. The test equipment then compares the difference of these two timings to the UE Rx-Tx measurement reported by the UE.

A.9.7.7.2 Test parameters

The parameters for this test case are defined in Table A.9.7.7.2-1, and the SRS configuration used is defined in Table A.9.7.7.2-2.

Table A.9.7.7.2-1: FDD UE Rx-Tx time difference test parameters for Cat-M1/M2 UE in CEModeA

Parameter	Unit	Test 1
E-UTRAN RF Channel Number		1
Channel Bandwidth ($BW_{channel}$)	MHz	10

DRX		OFF
PRACH Configuration		PRACH_4CE As specified in A.3.16
MPDCCH Reference measurement channel ^{Note1}		R.16 FDD
OCNG Pattern ^{Note2}		OP.21 FDD
PBCH_RA	dB	0
PBCH_RB	dB	
PSS_RA	dB	
SSS_RA	dB	
PHICH_RA	dB	
PHICH_RB	dB	
MPDCCH_RA	dB	
MPDCCH_RB	dB	
OCNG_RA ^{Note3}	dB	
OCNG_RB ^{Note3}	dB	
N_{oc}	dBm/15 kHz	-98
\hat{E}_s/N_{oc}	dB	3
\hat{E}_s/I_{ot}	dB	3
I_o ^{Note4}	dBm/9 MHz	-65.5
Propagation Condition		AWGN
<p>Note 1: For the reference measurement channels, see clause A.3.1.</p> <p>Note 2: For the OCNG pattern, see clause A.3.2.</p> <p>Note 3: OCNG shall be used such that both cells are fully allocated and a constant total transmitted power spectral density is achieved for all OFDM symbols.</p> <p>Note 4: I_o level has been derived from other parameters for information purpose. It is not a settable parameter.</p>		

Table A.9.7.7.2-2: Sounding Reference Symbol Configuration to be used in FDD UE Rx-Tx time difference test for Cat-M1/M2 UE in CEModeA

Field	Test 1	Comment
srsBandwidthConfiguration	bw5	
srsSubframeConfiguration	sc1	
ackNackSrsSimultaneousTransmission	FALSE	
srsMaxUpPTS	N/A	Not applicable for FDD
srsBandwidth	0	No hopping
srsHoppingBandwidth	hbw0	
frequencyDomainPosition	0	
Duration	TRUE	Indefinite duration
Srs-ConfigurationIndex	0	SRS periodicity of 2ms for all Tests.
transmissionComb	0	
cyclicShift	cs0	No cyclic shift
SRS-AntennaPort	an1	Number of antenna ports used for SRS transmission
Note: For further information see clause 6.3.2 in TS 36.331.		

A.9.7.7.3 Test Requirements

For Cat-M1 UE, the UE Rx-Tx time difference measurement accuracy shall fulfill the requirements in Clause 9.1.21.21.

For Cat-M2 UE, the UE Rx-Tx time difference measurement accuracy shall fulfill the requirements in Clause 9.1.25.25.

A.9.7.8 E-UTRAN HD-FDD UE Rx-Tx time difference case for Cat-M1/M2 UE in CEModeA

A.9.7.8.1 Test Purpose and Environment

The purpose of this test is to verify that Cat-M1 and Cat-M2 UE can meet the E-UTRAN HD-FDD UE Rx-Tx time difference measurement accuracy requirements. Requirements for Cat-M1 UE is specified in Clause 9.1.21.21 and requirements for Cat-M2 UE is specified in Clause 9.1.25.25.

There is only one active cell in the test. The tested UE is connected with the PCell, configured to transmit SRS signals periodically, and signaled to report UE Rx-Tx time difference measurement. The test equipment measures the transmit timing of the UE using the transmitted SRS, and measures the receive timing using the downlink CRS. The test equipment then compares the difference of these two timings to the UE Rx-Tx measurement reported by the UE.

A.9.7.8.2 Test parameters

The parameters for this test case are defined in Table A.9.7.8.2-1, and the SRS configuration used is defined in Table A.9.7.8.2-2.

Table A.9.7.8.2-1: HD-FDD UE Rx-Tx time difference test parameters for Cat-M1/M2 UE in CEModeA

Parameter	Unit	Test 1
E-UTRAN RF Channel Number		1
Channel Bandwidth ($BW_{channel}$)	MHz	10
DRX		OFF
PRACH Configuration		PRACH_4CE As specified in A.3.16
MPDCCH Reference measurement channel ^{Note1}		R.6 HD FDD
OCNG Pattern ^{Note2}		OP.21 FDD
PBCH_RA	dB	0
PBCH_RB	dB	
PSS_RA	dB	
SSS_RA	dB	
PHICH_RA	dB	
PHICH_RB	dB	
MPDCCH_RA	dB	
MPDCCH_RB	dB	
OCNG_RA ^{Note3}	dB	
OCNG_RB ^{Note3}	dB	
N_{oc}	dBm/15 kHz	-98
\hat{E}_s / N_{oc}	dB	3
\hat{E}_s / I_{ot}	dB	3
I_o ^{Note4}	dBm/9 MHz	-65.5
Propagation Condition		AWGN
Note 1: For the reference measurement channels, see clause A.3.1.		
Note 2: For the OCNG pattern, see clause A.3.2.		
Note 3: OCNG shall be used such that both cells are fully allocated and a constant total transmitted power spectral density is achieved for all OFDM symbols.		
Note 4: I_o level has been derived from other parameters for information purpose. It is not a settable parameter.		

Table A.9.7.8.2-2: Sounding Reference Symbol Configuration to be used in HD-FDD UE Rx-Tx time difference test for Cat-M1/M2 UE in CEModeA

Field	Test 1	Comment
srsBandwidthConfiguration	bw5	
srsSubframeConfiguration	sc1	
ackNackSrsSimultaneousTransmission	FALSE	
srsMaxUpPTS	N/A	Not applicable for FDD
srsBandwidth	0	No hopping

srsHoppingBandwidth	hbw0	
frequencyDomainPosition	0	
Duration	TRUE	Indefinite duration
Srs-ConfigurationIndex	0	SRS periodicity of 2ms for all Tests.
transmissionComb	0	
cyclicShift	cs0	No cyclic shift
SRS-AntennaPort	an1	Number of antenna ports used for SRS transmission
Note: For further information see clause 6.3.2 in TS 36.331.		

A.9.7.8.3 Test Requirements

For Cat-M1 UE, the UE Rx-Tx time difference measurement accuracy shall fulfill the requirements in Clause 9.1.21.21.

For Cat-M2 UE, the UE Rx-Tx time difference measurement accuracy shall fulfill the requirements in Clause 9.1.25.25.

A.9.7.9 E-UTRAN TDD UE Rx-Tx time difference case for Cat-M1/M2 UE in CEModeA

A.9.7.9.1 Test Purpose and Environment

The purpose of this test is to verify that Cat-M1 and Cat-M2 UE can meet the E-UTRAN TDD UE Rx-Tx time difference measurement accuracy requirements. Requirements for Cat-M1 UE is specified in Clause 9.1.21.21 and requirements for Cat-M2 UE is specified in Clause 9.1.25.25.

There is only one active cell in the test. The tested UE is connected with the PCell, configured to transmit SRS signals periodically, and signaled to report UE Rx-Tx time difference measurement. The test equipment measures the transmit timing of the UE using the transmitted SRS, and measures the receive timing using the downlink CRS. The test equipment then compares the difference of these two timings to the UE Rx-Tx measurement reported by the UE.

A.9.7.9.2 Test parameters

The parameters for this test case are defined in Table A.9.7.9.2-1, and the SRS configuration used is defined in Table A.9.7.9.2-2.

Table A.9.7.9.2-1: TDD UE Rx-Tx time difference test parameters for Cat-M1/M2 UE in CEModeA

Parameter	Unit	Test 1
E-UTRAN RF Channel Number		1
Channel Bandwidth ($BW_{channel}$)	MHz	10
Special subframe configuration ^{Note1}		6
Uplink-downlink configuration ^{Note2}		1
DRX		OFF
PRACH Configuration		PRACH_4CE As specified in A.3.16
MPDCCH Reference measurement channel ^{Note3}		R.14 TDD
OCNG Pattern ^{Note4}		OP.11 TDD
PBCH_RA	dB	0
PBCH_RB	dB	
PSS_RA	dB	
SSS_RA	dB	
PHICH_RA	dB	
PHICH_RB	dB	
MPDCCH_RA	dB	
MPDCCH_RB	dB	
OCNG_RA ^{Note5}	dB	
OCNG_RB ^{Note5}	dB	
N_{oc}	dBm/15 kHz	-98
\hat{E}_s / N_{oc}	dB	3

\hat{E}_s / I_{ot}	dB	3
I_o ^{Note6}	dBm/9 MHz	-65.5
Propagation Condition		AWGN
<p>Note 1: For the special subframe configuration see table 4.2-1 in TS 36.211.</p> <p>Note 2: For the uplink-downlink configuration see table 4.2-2 in TS 36.211.</p> <p>Note 3: For the reference measurement channels, see clause A.3.1.</p> <p>Note 4: For the OCNG pattern, see clause A.3.2.</p> <p>Note 5: OCNG shall be used such that both cells are fully allocated and a constant total transmitted power spectral density is achieved for all OFDM symbols.</p> <p>Note 6: I_o level has been derived from other parameters for information purpose. It is not a settable parameter.</p>		

Table A.9.7.9.2-2: Sounding Reference Symbol Configuration to be used in TDD UE Rx-Tx time difference test for Cat-M1/M2 UE in CEModeA

Field	Test 1	Comment
srsBandwidthConfiguration	bw5	
srsSubframeConfiguration	sc3	Once every 5 subframes
ackNackSrsSimultaneousTransmission	FALSE	
srsMaxUpPTS	FALSE	
srsBandwidth	0	No hopping
srsHoppingBandwidth	hbw0	
frequencyDomainPosition	0	
Duration	TRUE	Indefinite duration
Srs-ConfigurationIndex	15	SRS periodicity of 10ms
transmissionComb	0	
cyclicShift	cs0	No cyclic shift
SRS-AntennaPort	an1	Number of antenna ports used for SRS transmission
Note: For further information see clause 6.3.2 in TS 36.331.		

A.9.7.9.3 Test Requirements

For Cat-M1 UE, the UE Rx-Tx time difference measurement accuracy shall fulfill the requirements in Clause 9.1.21.21.

For Cat-M2 UE, the UE Rx-Tx time difference measurement accuracy shall fulfill the requirements in Clause 9.1.25.25.

A.9.8 RSTD

A.9.8.1 E-UTRAN FDD RSTD intra frequency case

A.9.8.1.1 Test Purpose and Environment

The purpose of this test is to verify that the RSTD intra-frequency measurement accuracy is within the specified limits in clause 9.1.10.1 in AWGN channels.

In the test, there are two synchronous cells, Cell 1 as the reference cell and Cell 2 as the neighbour cell on the same frequency.

The OTDOA assistance data as defined in TS 36.355, Clause 6.5.1, shall be provided to the UE before the measurement period. The last TTI containing the OTDOA assistance data shall be provided to the UE ΔT ms before the start of measurement period, where $\Delta T = 150$ ms is the maximum processing time of the OTDOA assistance data.

A time span of $T_{RSTD \text{ IntraFreqFDD, E-UTRAN}}$ is provided for the measurement period, and PRS are configured according to I_{PRS} in Tables A.9.8.1.1-1 and A.9.8.1.1-2 during this time.

The test parameters are given in Table A.9.8.1.1-1 and Table A.9.8.1.1-2.

Table A.9.8.1.1-1: General Test Parameters for intra frequency RSTD Tests for E-UTRAN FDD

Parameter	Unit	Value	Comment
-----------	------	-------	---------

		Test1	Test2	Test3	Test4	
PCFICH/PDCCH/PHICH parameters		R.14 FDD		R.6 FDD		As specified in clause A.3.1.2.1
OCNG Patterns defined in A.3.2.1		OP.7 FDD		OP.6 FDD		OCNG shall be used such that both cells are fully allocated and a constant total transmitted power spectral density is achieved for all OFDM symbols (other than those in the PRS subframes).
Reference cell		Cell 1				
Neighbour cell		Cell 2				
E-UTRA RF Channel Number		1				One FDD carrier frequency is used.
Channel Bandwidth (BW _{channel})	MHz	1.4		10		
PRS Bandwidth	RB	6		50		PRS bandwidth is as indicated in <i>prs-Bandwidth</i> in the OTDOA assistance data defined in [24].
PRS configuration Index I_{PRS}		12		2		As defined in TS 36.211
Number of consecutive positioning downlink subframes N_{PRS}		6		1		As defined in TS 36.211
prs-MutingInfo		Cell 1: '11110000' Cell 2: '11110000'				See clause 6.5.1.2 in TS 36.355 for more information
Cell ID		(Cell ID of cell 1 – Cell ID of cell 2) mod 6 = 0	(Cell ID of cell 1 – Cell ID of cell 2) mod 6 = 1	(Cell ID of cell 1 – Cell ID of cell 2) mod 6 = 0	(Cell ID of cell 1 – Cell ID of cell 2) mod 6 = 3	
expectedRSTD	us	Cell 2: 1 Other neighbour cells: randomly between -3 and 3	Cell 2: -1 Other neighbour cells: randomly between -3 and 3	Cell 2: -1 Other neighbour cells: randomly between -3 and 3	Cell 2: 1 Other neighbour cells: randomly between -3 and 3	
expectedRSTDUncertainty for all neighbour cells	us	5	5	5	5	
CP length		Normal				
DRX		OFF				
Radio frame receive time offset between the cells at the UE antenna connector	us	Cell 2 to Cell 1: -3	Cell 2 to Cell 1: 3	Cell 2 to Cell 1: 3	Cell 2 to Cell 1: -3	PRS are transmitted from synchronous cells
Number of cells provided in OTDOA assistance data		16				The number of cells includes the reference cell
T_{RSTD} IntraFreqFDD, E-UTRAN	ms	2560				Derived according to the RSTD measurement requirements specified in Clause 8.1.2.5.1

Table A.9.8.1.1-2: Cell Specific Test Parameters for intra frequency RSTD Tests for E-UTRAN FDD

Parameter	Unit	Test1		Test2		Test3		Test4	
		Cell1	Cell2	Cell1	Cell2	Cell1	Cell2	Cell1	Cell2

E-UTRA RF Channel Number		1							
PBCH_RA									
PBCH_RB									
PSS_RA									
SSS_RA									
PCFICH_RB									
PHICH_RA	dB	0	0	0	0	0	0	0	0
PHICH_RB									
PDCCH_RA									
PDCCH_RB									
OCNG_RA ^{Note1}									
OCNG_RB ^{Note1}									
PRS_RA	dB	0	0	-3	0	0	0	-3	0
N_{oc} ^{Note2}	dBm/15 kHz	-98	-98	-98	-98	-98	-98	-98	-98
PRS \hat{E}_s/N_{oc}	dB	-2.37	-8.02	-6	-13	-2.37	-8.02	-6	-13
PRS \hat{E}_s/I_{ot} ^{Note3}	dB	-3	-10	-6	-13	-3	-10	-6	-13
I_o ^{Note3}	dBm/1.08 MHz	-78.92	-78.92	-79.21	-79.21	N/A	N/A	N/A	N/A
	dBm/9 MHz	N/A	N/A	N/A	N/A	-69.72	-69.72	-70	-70
PRP ^{Note3}	dBm/15kHz	-100.37	-106.02	-104	-111	-100.37	-106.02	-104	-111
\hat{E}_s/N_{oc} ^{Note 3}	dB	-2.37	-8.02	-3	-13	-2.37	-8.02	-3	-13
RSRP ^{Note 3}	dBm/15kHz	-100.37	-106.02	-101	-111	-100.37	-106.02	-101	-111
Propagation condition		AWGN							
<p>Note 1: OCNG shall be used such that both cells are fully allocated and a constant total transmitted power spectral density is achieved for all OFDM symbols (other than those in the PRS subframes).</p> <p>Note 2: Interference from other cells and noise sources not specified in the test is assumed to be constant over subcarriers and time and shall be modelled as AWGN of appropriate power for N_{oc} to be fulfilled.</p> <p>Note 3: \hat{E}_s/N_{oc}, PRS \hat{E}_s/I_{ot}, I_o, RSRP and PRP levels have been derived from other parameters for information purposes. They are not settable parameters themselves. I_o values are derived in the case that there is no PBCH, PSS or SSS in the OFDM symbols carrying PRS</p>									

A.9.8.1.2 Test Requirements

The RSTD measurement accuracy shall fulfill the requirements in clause 9.1.10.1.

A.9.8.1.2A Test Requirements for UE Category 1bis

The RSTD measurement accuracy shall fulfill the requirements in clause 9.1.10.5. The test parameters given in Table A.9.8.1.1-1 and Table A.9.8.1.1-2 shall be applied with the exceptions given in Table A.9.8.1.2A-1.

Table A.9.8.1.2A-1: Specific test parameters for UE Category for 1Bis intra frequency RSTD Tests for E-UTRAN FDD

Parameter	Unit	Value	Comment
PRS muting info		Cell 1: '1111111100000000' Cell 2: '1111111100000000'	Corresponds to prs-MutingInfo defined in TS 36.355 [24]
T_{RSTD} IntraFreqFDD, E-UTRAN	s	5.12	Derived according to the RSTD measurement requirements specified in Clause 8.1.2.5.3

A.9.8.2 E-UTRAN TDD RSTD intra frequency case

A.9.8.2.1 Test Purpose and Environment

The purpose of this test is to verify that the RSTD intra-frequency measurement accuracy is within the specified limits in clause 9.1.10.1 in AWGN channels.

In the test, there are two synchronous cells, Cell 1 as the reference cell and Cell 2 as the neighbour cell on the same frequency.

The OTDOA assistance data as defined in TS 36.355, Clause 6.5.1, shall be provided to the UE before the measurement period. The last TTI containing the OTDOA assistance data shall be provided to the UE ΔT ms before the start of measurement period, where $\Delta T = 150$ ms is the maximum processing time of the OTDOA assistance data.

A time span of $T_{\text{RSTD IntraFreqTDD, E-UTRAN}}$ is provided for the measurement period, and PRS are configured according to I_{PRS} in Tables A.9.8.2.1-1 and A.9.8.2.1-2 during this time.

The test parameters are given in Table A.9.8.2.1-1 and Table A.9.8.2.1-2.

Table A.9.8.2.1-1: General Test Parameters for intra frequency RSTD Tests for E-UTRAN TDD

Parameter	Unit	Value				Comment
		Test1	Test2	Test3	Test4	
PCFICH/PDCCH/PHICH parameters		R.14 TDD		R.6 TDD		As specified in clause A.3.1.2.2
OCNG Patterns defined in A.3.2.2		OP.4 TDD		OP.2 TDD		OCNG shall be used such that both cells are fully allocated and a constant total transmitted power spectral density is achieved for all OFDM symbols (other than those in the PRS subframes).
Reference cell		Cell 1				
Neighbour cell		Cell 2				
E-UTRA RF Channel Number		1				One TDD carrier frequency is used.
Channel Bandwidth (BW_{channel})	MHz	1.4		10		
PRS Bandwidth	RB	6		50		PRS bandwidth is as indicated in <i>prs-Bandwidth</i> in the OTDOA assistance data defined in [24].
Special subframe configuration		6		6		As specified in table 4.2-1 in TS 36.211. The same configuration in both cells.
Uplink-downlink configuration		3		1		As specified in table 4.2-2 in TS 36.211 and table 8.1.2.5.2-2. The same configuration in both cells.
PRS configuration Index I_{PRS}		9		14		As defined in TS 36.211
Number of consecutive positioning downlink subframes N_{PRS}		6		1		As defined in TS 36.211
prs-MutingInfo		Cell 1: '11110000' Cell 2: '11110000'				See clause 6.5.1.2 in TS 36.355 for more information
Cell ID		(Cell ID of cell 1 – Cell ID of cell 2) mod 6 = 0	(Cell ID of cell 1 – Cell ID of cell 2) mod 6 = 1	(Cell ID of cell 1 – Cell ID of cell 2) mod 6 = 0	(Cell ID of cell 1 – Cell ID of cell 2) mod 6 = 3	

expectedRSTD	us	Cell 2: 1 Other neighbour cells: randomly between -3 and 3	Cell 2: -1 Other neighbour cells: randomly between -3 and 3	Cell 2: -1 Other neighbour cells: randomly between -3 and 3	Cell 2: 1 Other neighbour cells: randomly between -3 and 3	
expectedRSTDUncertainty for all neighbour cells	us	5	5	5	5	
CP length		Normal				
DRX		OFF				
Radio frame receive time offset between the cells at the UE antenna connector	us	Cell 2 to Cell 1: -3	Cell 2 to Cell 1: 3	Cell 2 to Cell 1: 3	Cell 2 to Cell 1: -3	PRS are transmitted from synchronous cells
Number of cells provided in OTDOA assistance data		16				The number of cells includes the reference cell
T_{RSTD} IntraFreqTDD, E-UTRAN	ms	2560				Derived according to the RSTD measurement requirements specified in Clause 8.1.2.5.2

Table A.9.8.2.1-2: Cell Specific Test Parameters for intra frequency RSTD Tests for E-UTRAN TDD

Parameter	Unit	Test1		Test2		Test3		Test4	
		Cell1	Cell2	Cell1	Cell2	Cell1	Cell2	Cell1	Cell2
E-UTRA RF Channel Number		1							
PBCH_RA	dB	0	0	0	0	0	0	0	0
PBCH_RB									
PSS_RA									
SSS_RA									
PCFICH_RB									
PHICH_RA									
PHICH_RB									
PDCCH_RA									
PDCCH_RB									
OCNG_RA ^{Note1}									
OCNG_RB ^{Note1}									
PRS_RA	dB	0	0	-3	0	0	0	-3	0
N_{oc} ^{Note2}	dBm/15 kHz	-98	-98	-98	-98	-98	-98	-98	-98
$PRS \hat{E}_s / N_{oc}$	dB	-2.37	-8.02	-6	-13	-2.37	-8.02	-6	-13
$PRS \hat{E}_s / I_{ot}$ ^{Note3}	dB	-3	-10	-6	-13	-3	-10	-6	-13
I_o ^{Note3}	dBm/1.08 MHz	-78.92	-78.92	-79.21	-79.21	N/A	N/A	N/A	N/A
	dBm/9 MHz	N/A	N/A	N/A	N/A	-69.72	-69.72	-70	-70
PRP ^{Note3}	dBm/15kHz	-100.37	-106.02	-104	-111	-100.37	-106.02	-104	-111
\hat{E}_s / N_{oc} ^{Note 3}	dB	-2.37	-8.02	-3	-13	-2.37	-8.02	-3	-13
RSRP ^{Note 3}	dBm/15kHz	-100.37	-106.02	-101	-111	-100.37	-106.02	-101	-111
Propagation condition		AWGN							
Note 1:	OCNG shall be used such that both cells are fully allocated and a constant total transmitted power spectral density is achieved for all OFDM symbols (other than those in the PRS subframes).								
Note 2:	Interference from other cells and noise sources not specified in the test is assumed to be constant over subcarriers and time and shall be modelled as AWGN of appropriate power for N_{oc} to be fulfilled.								
Note 3:	\hat{E}_s / N_{oc} , $PRS \hat{E}_s / I_{ot}$, I_o , RSRP and PRP levels have been derived from other parameters for information purposes. They are not settable parameters themselves. I_o values are derived in the case that there is no PBCH, PSS or SSS in the OFDM symbols carrying PRS.								

A.9.8.2.2 Test Requirements

The RSTD measurement accuracy shall fulfill the requirements in clause 9.1.10.1.

A.9.8.2.2A Test Requirements for UE Category 1bis

The RSTD measurement accuracy shall fulfill the requirements in clause 9.1.10.5. The test parameters given in Table A.9.8.2.1-1 and Table A.9.8.2.1-2 shall be applied with the exceptions given in Table A.9.8.2.2A-1.

Table A.9.8.2.2A-1: Specific test parameters for UE Category for 1Bis intra frequency RSTD Tests for E-UTRAN TDD

Parameter	Unit	Value	Comment
PRS muting info		Cell 1: '1111111100000000' Cell 2: '1111111100000000'	Corresponds to prs-MutingInfo defined in TS 36.355 [24]
$T_{\text{RSTD IntraFreqFDD, E-UTRAN}}$	s	5.12	Derived according to the RSTD measurement requirements specified in Clause 8.1.2.5.4

A.9.8.3 E-UTRAN FDD-FDD RSTD inter frequency case

A.9.8.3.1 Test Purpose and Environment

The purpose of these tests is to verify that the RSTD inter-frequency measurement accuracy is within the specified limits in clause 9.1.10.2 in AWGN channels.

There are two synchronous cells on different carrier frequencies in the test. In all test cases, Cell 1 is the reference cell as well as the PCell and Cell 2 the neighbor cell. The inter frequency measurements on Cell 2 are supported by measurement gaps. PCIs of the two cells are selected randomly.

The OTDOA assistance data as defined in TS 36.355, Clause 6.5.1, shall be provided to the UE before the measurement period. The last TTI containing the OTDOA assistance data shall be provided to the UE ΔT ms before the start of measurement period, where $\Delta T = 150$ ms is the maximum processing time of the OTDOA assistance data. The measurement gap configuration is known and configured in the UE before the measurements start.

There is no PDSCH allocated in the subframe transmitting PRS. A time span of $T_{\text{RSTD InterFreqFDD, E-UTRAN}}$ is provided for the measurement period, and PRS are configured according to I_{PRS} in Table A.9.8.3.1-1 and Table A.9.8.3.1-2 for each of the two cells during this time.

The test parameters are given in Table A.9.8.3.1-1 and Table A.9.8.3.1-2.

Table A.9.8.3.1-1: General Test Parameters for inter frequency RSTD Tests for E-UTRAN FDD

Parameter	Unit	Value		Comment
		Test1	Test2	
PCFICH/PDCCH/PHICH parameters		R.14 FDD	R.6 FDD	As specified in clause A.3.1.2.1
OCNG Patterns defined in A.3.2.1		OP.7 FDD	OP.6 FDD	OCNG shall be used such that both cells are fully allocated and a constant total transmitted power spectral density is achieved for all OFDM symbols (other than those in the PRS subframes).
Reference cell		Cell 1		Cell 1 on RF channel number 1
Neighbour cell		Cell 2		Cell 2 on RF channel number 2
E-UTRA RF Channel Number		1,2		Two FDD carrier frequencies are used.
Channel Bandwidth (BW_{channel})	MHz	1.4	10	
PRS Bandwidth	RB	6	50	PRS bandwidth is as indicated in <i>prs-Bandwidth</i> in the OTDOA assistance data defined in [24].
Number of consecutive positioning downlink subframes N_{PRS}		6	1	As defined in TS 36.211

prs-MutingInfo		Cell1:'11110000' Cell2:'11110000'	See clause 6.5.1.2 in TS 36.355 for more information
expectedRSTD	μs	Cell 2:1 Other neighbour cells: randomly between -3 and 3	The expected RSTD is what is expected at the receiver. The corresponding parameter in the OTDOA assistance data specified in TS 36.355 [24] is the expectedRSTD indicator
expectedRSTDUncertainty for all neighbour cells	μs	5	The corresponding parameter in the OTDOA assistance data specified in TS 36.355 [24] is the expectedRSTD-Uncertainty index
CP length		Normal	
DRX		OFF	
Radio frame transmit time offset between the cells at the UE antenna connector	μs	Cell 2 to Cell 1: 3	Cell 1: -3 Synchronous cells
Number of cells provided in OTDOA assistance data		16	The list includes the reference cell (received in <i>OTDOA-ReferenceCellInfo</i> [24]) on RF channel 1 and 15 other cells on RF channel 2, all received in <i>OTDOA-ProvideAssistanceData</i> [24].
T_{RSTD} InterFreqFDD, E-UTRAN	ms	5120	Derived according to the RSTD measurement requirements specified in Clause 8.1.2.6.1

Table A.9.8.3.1-2: Cell Specific Test Parameters for inter frequency RSTD Tests for E-UTRAN FDD

Parameter	Unit	Test1		Test2					
		Cell1	Cell2	Cell1	Cell2				
E-UTRA RF Channel Number		1	2	1	2				
GapOffset		18	N/A	11	N/A				
Gap Pattern ID		0	N/A	0	N/A				
PRS configuration Index I_{PRS}		12	19	2	12				
PRS subframe offset		N/A	7	N/A	10				
PBCH_RA	dB	0	0	0	0				
PBCH_RB									
PSS_RA									
SSS_RA									
PCFICH_RB									
PHICH_RA									
PHICH_RB									
PDCCH_RA									
PDCCH_RB									
OCNG_RA ^{Note1}									
OCNG_RB ^{Note1}									
PRS_RA						-3	0	-3	0
N_{oc} ^{Note2}						dBm/15 kHz		-98	
PRS \hat{E}_s/N_{oc}	dB		-6	-13	-6	-13			
PRS \hat{E}_s/I_{ot} ^{Note3}	dB		-6	-13	-6	-13			
I_o ^{Note3}	dBm/1.08 MHz		-79.25	-79.39	N/A	N/A			
	dBm/9 MHz		N/A	N/A	-70.04	-70.18			
PRP ^{Note3}	dBm/15kHz		-104	-111	-104	-111			
\hat{E}_s/N_{oc} ^{Note 3}	dB		-3	-13	-3	-13			
RSRP ^{Note 3}	dBm/15kHz		-101	-111	-101	-111			
Propagation condition	AWGN								
<p>Note 1: OCNG shall be used such that both cells are fully allocated and a constant total transmitted power spectral density is achieved for all OFDM symbols (other than those in the PRS subframes).</p> <p>Note 2: Interference from other cells and noise sources not specified in the test is assumed to be constant over subcarriers and time and shall be modelled as AWGN of appropriate power for N_{oc} to be fulfilled.</p> <p>Note 3: \hat{E}_s/N_{oc}, PRS \hat{E}_s/I_{ot}, I_o, RSRP and PRP levels have been derived from other parameters for information purposes. They are not settable parameters themselves. I_o values are derived in the case that there is no PBCH, PSS or SSS in the OFDM symbols carrying PRS.</p>									

A.9.8.3.2 Test Requirements

The RSTD measurement accuracy shall fulfill the requirements in clause 9.1.10.2.

A.9.8.3.2A Test Requirements for UE Category 1bis

The RSTD measurement accuracy shall fulfill the requirements in clause 9.1.10.6. The test parameters given in Table A.9.8.3.1-1 and Table A.9.8.3.1-2 shall be applied with the exceptions given in Table A.9.8.3.2A-1.

Table A.9.8.3.2A-1: Specific test parameters for UE Category for 1Bis inter frequency RSTD Tests for E-UTRAN FDD-FDD

Parameter	Unit	Value	Comment
PRS muting info		Cell 1: '1111111100000000' Cell 2: '1111111100000000'	Correponds to prs-MutingInfo defined in TS 36.355 [24]
$T_{\text{RSTD IntraFreqFDD, E-UTRAN}}$	s	10.24	Derived according to the RSTD measurement requirements specified in Clause 8.1.2.5.5

A.9.8.4 E-UTRAN TDD-TDD RSTD inter frequency case

A.9.8.4.1 Test Purpose and Environment

The purpose of this test is to verify that the RSTD inter-frequency measurement accuracy is within the specified limits in clause 9.1.10.2 in AWGN channels.

There are two synchronous cells on different carrier frequencies in the test. In all test cases, Cell 1 is the reference cell as well as the PCell and Cell 2 is the neighbour cell. The inter frequency measurements on Cell 2 are supported by a measurement gap. PCIs of the two cells are selected randomly.

The OTDOA assistance data as defined in TS 36.355, Clause 6.5.1, shall be provided to the UE before the measurement period. The last TTI containing the OTDOA assistance data shall be provided to the UE ΔT ms before the start of measurement period, where $\Delta T = 150$ ms is the maximum processing time of the OTDOA assistance data. The measurement gap configuration is known and configured in the UE before the measurements start.

There is no PDSCH allocated in the subframe transmitting PRS. A time span of $T_{\text{RSTD InterFreqTDD, E-UTRAN}}$ is provided for the measurement period, and PRS are configured according to I_{PRS} in Table A.9.8.4.1-1 and Table A.9.8.4.1-2 for each of the two cells during this time.

The test parameters are given in Table A.9.8.4.1-1 and Table A.9.8.4.1-2.

Table A.9.8.4.1-1: General Test Parameters for inter frequency RSTD Tests for E-UTRAN TDD

Parameter	Unit	Value		Comment
		Test1	Test2	
PCFICH/PDCCH/PHICH parameters		R.14 TDD	R.6 TDD	As specified in clause A.3.1.2.2
OCNG Patterns defined in A.3.2.2		OP.4 TDD	OP.2 TDD	OCNG shall be used such that both cells are fully allocated and a constant total transmitted power spectral density is achieved for all OFDM symbols (other than those in the PRS subframes).
Reference cell		Cell 1		Cell 1 on RF channel number 1
Neighbour cell		Cell 2		Cell 2 on RF channel number 2
E-UTRA RF Channel Number		1,2		Two TDD carrier frequencies are used.
Channel Bandwidth (BW_{channel})	MHz	1.4	10	
PRS Bandwidth	RB	6	50	PRS bandwidth is as indicated in <i>prs-Bandwidth</i> in the OTDOA assistance data defined in [24].
Special subframe configuration		6		As specified in table 4.2-1 in TS 36.211. The same configuration in both cells.

Uplink-downlink configuration		3	1	As specified in table 4.2-2 in TS 36.211 and table 8.1.2.5.2-2.
Number of consecutive positioning downlink subframes N_{PRS}		6	1	As defined in TS 36.211
prs-MutingInfo		Cell1:'11110000' Cell2:'11110000'		PRS muting is not used. See clause 6.5.1.2 in TS 36.355 for more information
expectedRSTD	μs	Cell 2: 1 Other neighbour cells: randomly between -3 and 3		The expected RSTD is what is expected at the receiver. The corresponding parameter in the OTDOA assistance data specified in TS 36.355 [24] is the expectedRSTD indicator
expectedRSTDUncertainty for all neighbour cells	μs	5	5	The corresponding parameter in the OTDOA assistance data specified in TS 36.355 [24] is the expectedRSTD-Uncertainty index
CP length		Normal		
DRX		OFF		
Radio frame receive time offset between the cells at the UE antenna connector	μs	Cell 2 to Cell 1: 3	Cell 2 to Cell 1: -3	PRS are transmitted from synchronous cells
Number of cells provided in OTDOA assistance data		16		The list includes the reference cell (received in <i>OTDOA-ReferenceCellInfo</i> [24]) on RF channel 1 and 15 other cells on RF channel 2, all received in <i>OTDOA-ProvideAssistanceData</i> [24].
T_{RSTD} InterFreqTDD, E-UTRAN	ms	5120		Derived according to the RSTD measurement requirements specified in Clause 8.1.2.6.3

Table A.9.8.4.1-2: Cell Specific Test Parameters for inter frequency RSTD Tests for E-UTRAN TDD

Parameter	Unit	Test1		Test2	
		Cell1	Cell2	Cell1	Cell2
E-UTRA RF Channel Number		1	2	1	2
Gap pattern ID		0	N/A	0	N/A
Gapoffset		34	N/A	13	N/A
PRS configuration Index I_{PRS}		15	35	4	14
PRS subframe offset		N/A	20	N/A	10
PBCH_RA	dB	0			
PBCH_RB					
PSS_RA					
SSS_RA					
PCFICH_RB					
PHICH_RA					
PHICH_RB					
PDCCH_RA					
PDCCH_RB					
OCNG_RA ^{Note1}					
OCNG_RB ^{Note1}					
PRS_RA					
N_{oc} ^{Note2}	dBm/15 kHz	-98			
PRS \hat{E}_s/N_{oc}	dB	-6	-13	-6	-13
PRS \hat{E}_s/I_{ot} ^{Note3}	dB	-6	-13	-6	-13
I_o ^{Note3}	dBm/1.08 MHz	-79.25	-79.39	N/A	N/A
	dBm/9 MHz	N/A	N/A	-70.04	-70.18
PRP ^{Note3}	dBm/15kHz	-104	-111	-104	-111
\hat{E}_s/N_{oc} ^{Note 3}	dB	-3	-13	-3	-13
RSRP ^{Note 3}	dBm/15kHz	-101	-111	-101	-111
Propagation condition		AWGN			
Note 1:	OCNG shall be used such that both cells are fully allocated and a constant total transmitted power spectral density is achieved for all OFDM symbols (other than those in the PRS subframes).				
Note 2:	Interference from other cells and noise sources not specified in the test is assumed to be constant over subcarriers and time and shall be modelled as AWGN of appropriate power for N_{oc} to be fulfilled.				

Note 3: \hat{E}_s/N_{oc} , PRS \hat{E}_s/I_{ot} , I_0 , RSRP and PRP levels have been derived from other parameters for information purposes. They are not settable parameters themselves. I_0 values are derived in the case that there is no PBCH, PSS or SSS in the OFDM symbols carrying PRS.

A.9.8.4.2 Test Requirements

The RSTD measurement accuracy shall fulfill the requirements in clause 9.1.10.2.

A.9.8.4.2A Test Requirements for UE Category 1bis

The RSTD measurement accuracy shall fulfill the requirements in clause 9.1.10.6. The test parameters given in Table A.9.8.4.1-1 and Table A.9.8.4.1-2 shall be applied with the exceptions given in Table A.9.8.4.2A-1.

Table A.9.8.4.2A-1: Specific test parameters for UE Category for 1Bis inter frequency RSTD Tests for E-UTRAN TDD-TDD

Parameter	Unit	Value	Comment
PRS muting info		Cell 1: '1111111100000000' Cell 2: '1111111100000000'	Corresponds to prs-MutingInfo defined in TS 36.355 [24]
$T_{\text{RSTD IntraFreqFDD, E-UTRAN}}$	s	10.24	Derived according to the RSTD measurement requirements specified in Clause 8.1.2.5.7

A.9.8.5 E-UTRAN FDD RSTD Measurement Accuracy in Carrier Aggregation

A.9.8.5.1 Test Purpose and Environment

The purpose of these tests is to verify that the E-UTRAN FDD RSTD measurement accuracy in carrier aggregation is within the specified limits in clause 9.1.12.

There are three synchronous cells on two different carrier frequencies in the test. Cell 1 is the PCell on primary component carrier F1 (RF channel number 1), Cell 2 is the SCell and reference cell on secondary component carrier F2 (RF channel number 2), and Cell 3 is the neighbor cell on F2.

Cell2 and Cell3 are included in the OTDOA assistance data, whilst Cell1 is not included in the OTDOA assistance data. The RSTD measurements are performed between Cell 2 and Cell 3 to verify that when both the reference cell and neighbouring cell belong to the secondary component carrier the RSTD measurement accuracy can meet the intra-frequency RSTD accuracy requirements defined in clause 9.1.10.1.

The OTDOA assistance data as defined in TS 36.355, Clause 6.5.1.1, shall be provided to the UE before the measurement period. The last TTI containing the OTDOA assistance data shall be provided to the UE ΔT ms before the start of measurement period, where $\Delta T = 150$ ms is the maximum processing time of the OTDOA assistance data. The measurement gap is not configured in the test because of UE carrier aggregation capability.

There is no PDSCH allocated in the subframe transmitting PRS. A time span of $T_{\text{RSTD IntraFreqFDD, E-UTRAN}}$ is provided for the measurement period, and PRS are configured according to I_{PRS} in Table A.9.8.5.1-1 and Table A.9.8.5.1-2 for each of the three cells during this time.

The test parameters are given in Table A.9.8.5.1-1 and Table A.9.8.5.1-2.

Table A.9.8.5.1-1: General Test Parameters for RSTD Tests for E-UTRAN FDD for Carrier Aggregation

Parameter	Unit	Value	Comment
PCFICH/PDCCH/PHICH parameters		R.6 FDD	As specified in clause A.3.1.2.1

OCNG Patterns defined in A.3.2.1		OP.6 FDD	OCNG shall be used such that both cells are fully allocated and a constant total transmitted power spectral density is achieved for all OFDM symbols (other than those in the PRS subframes). There is no PDSCH allocated in the subframe transmitting PRS.
Assistance data reference cell		Cell 2	Cell 2 is the SCell on RF channel number 2
PCell		Cell 1	Cell 1 on RF channel number 1
Neighbour cell		Cell 3	Cell 3 on RF channel number 2
E-UTRA RF Channel Number		1,2	Two FDD carrier frequencies are used.
Channel Bandwidth ($BW_{channel}$)	MHz	10	
PRS Bandwidth	RB	50	PRS Bandwidth bandwidth is as indicated in <i>prs-Bandwidth</i> in the OTDOA assistance data defined in [24].
Number of consecutive positioning downlink subframes N_{PRS}		1	As defined in TS 36.211
prs-MutingInfo		Cell1:'11110000' Cell2:'11110000' Cell3:'11110000'	See clause 6.5.1.2 in TS 36.355 for more information
Cell ID		(Cell ID of cell 2 – Cell ID of cell 3) mod 6 = 3	PCI of cell 1 is selected randomly.
expectedRSTD	μs	Cell 3:-2 Other neighbour cells: randomly between -3 and 3	The expected RSTD is what is expected at the receiver. The corresponding parameter in the OTDOA assistance data specified in TS 36.355 [24] is the expectedRSTD indicator
expectedRSTDUncertainty for all neighbour cells	μs	5	The corresponding parameter in the OTDOA assistance data specified in TS 36.355 [24] is the expectedRSTD-Uncertainty index
CP length		Normal	
DRX		OFF	
Radio frame receive time offset between the cells at the UE antenna connector	μs	Cell 1 to Cell 2: -1 Cell 3 to Cell 2:1	PRS are transmitted from synchronous cells
Time alignment error between cell2 and cell1	μs	\leq Time alignment error as specified in 3GPP TS 36.104 [30] clause 6.5.3.1.	The value of time alignment error depends upon the type of carrier aggregation.
Number of cells provided in OTDOA assistance data		16	The list includes the assistance-data-reference cell (received in <i>OTDOA-ReferenceCellInfo</i> [24]) and 15 other cells, all received in <i>OTDOA-ProvideAssistanceData</i> [24]. All cells provided in OTDOA assistance data are on RF channel 2.
T_{RSTD} IntraFreqFDD, E-UTRAN	ms	2560	Derived according to the RSTD measurement requirements specified in Clause 8.1.2.5.1

Table A.9.8.5.1-2: Cell Specific Test Parameters for RSTD Tests for E-UTRAN FDD for Carrier Aggregation

Parameter	Unit	Cell1	Cell2	Cell3
E-UTRA RF Channel Number		1	2	2
PRS configuration Index I_{PRS}		2	2	2
PBCH_RA	dB	0	0	0
PBCH_RB				
PSS_RA				
SSS_RA				

PCFICH_RB				
PHICH_RA				
PHICH_RB				
PDCCH_RA				
PDCCH_RB				
OCNG_RA ^{Note1}				
OCNG_RB ^{Note1}				
PRS_RA	dB	-3	0	0
N_{oc} ^{Note2}	dBm/15 kHz	-98		
PRS \hat{E}_s/N_{oc}	dB	-6	-6	-13
PRS \hat{E}_s/I_{ot}	dB	-6	-6	-13
I_o ^{Note3}	dBm/9 MHz	-70.04	-70.01	-70.01
PRP ^{Note3}	dBm/15kHz	-104	-104	-111
RSRP ^{Note3}	dBm/15kHz	-101	-104	-111
\hat{E}_s/N_{oc} ^{Note3}	dB	-3	-6	-13
Propagation condition		AWGN		
<p>Note 1: OCNG shall be used such that both cells are fully allocated and a constant total transmitted power spectral density is achieved for all OFDM symbols (other than those in the PRS subframes).</p> <p>Note 2: Interference from other cells and noise sources not specified in the test is assumed to be constant over subcarriers and time and shall be modelled as AWGN of appropriate power for N_{oc} to be fulfilled.</p> <p>Note 3: \hat{E}_s/N_{oc}, PRS \hat{E}_s/I_{ot}, RSRP, I_o and PRP levels have been derived from other parameters for information purposes. They are not settable parameters themselves. I_o values are derived in the case that there is no PBCH, PSS or SSS in the OFDM symbols carrying PRS.</p>				

A.9.8.5.2 Test Requirements

The measurement accuracy of RSTD between Cell2 and Cell3 shall fulfill the requirements in clause 9.1.12.

A.9.8.6 E-UTRAN TDD RSTD Measurement Accuracy in Carrier Aggregation

A.9.8.6.1 Test Purpose and Environment

The purpose of these tests is to verify that the E-UTRAN TDD RSTD measurement accuracy in carrier aggregation is within the specified limits in clause 9.1.12.

There are three synchronous cells on two different carrier frequencies in the test. Cell 1 is the PCell on primary component carrier F1 (RF channel number 1), Cell 2 is the SCell and reference cell on secondary component carrier F2 (RF channel number 2), and Cell 3 is the neighbor cell on F2.

Cell2 and Cell3 are included in the OTDOA assistance data, whilst Cell1 is not included in the OTDOA assistance data. The RSTD measurements are performed between Cell 2 and Cell 3 to verify that when both the reference cell and neighbouring cell belong to the secondary component carrier the RSTD measurement accuracy can meet the intra-frequency RSTD accuracy requirements defined in clause 9.1.10.1.

The OTDOA assistance data as defined in TS 36.355, Clause 6.5.1.1, shall be provided to the UE before the measurement period. The last TTI containing the OTDOA assistance data shall be provided to the UE ΔT ms before the start of measurement period, where $\Delta T = 150$ ms is the maximum processing time of the OTDOA assistance data. The measurement gap is not configured in the test because of UE carrier aggregation capability.

There is no PDSCH allocated in the subframe transmitting PRS. A time span of $T_{RSTD \text{ IntraFreqTDD, E-UTRAN}}$ is provided for the measurement period, and PRS are configured according to I_{PRS} in Table A.9.8.6.1-1 and Table A.9.8.6.1-2 for each of the three cells during this time.

The test parameters are given in Table A.9.8.6.1-1 and Table A.9.8.6.1-2.

Table A.9.8.6.1-1: General Test Parameters for RSTD Tests for E-UTRAN TDD for Carrier Aggregation

Parameter	Unit	Value	Comment
PCFICH/PDCCH/PHICH parameters		R.6 TDD	As specified in clause A.3.1.2.2
OCNG Patterns defined in A.3.2.2		OP.2 TDD	OCNG shall be used such that both cells are fully allocated and a constant total transmitted power spectral density is achieved for all OFDM symbols (other than those in the PRS subframes). There is no PDSCH allocated in the subframe transmitting PRS.
Assistance data reference cell		Cell 2	Cell 2 is the SCell on RF channel number 2
PCell		Cell 1	Cell 1 on RF channel number 1
Neighbour cell		Cell 3	Cell 3 on RF channel number 2
E-UTRA RF Channel Number		1,2	Two TDD carrier frequencies are used.
Channel Bandwidth ($BW_{channel}$)	MHz	10	
PRS Bandwidth	RB	50	PRS Bandwidth bandwidth is as indicated in <i>prs-Bandwidth</i> in the OTDOA assistance data defined in [24].
Number of consecutive positioning downlink subframes N_{PRS}		1	As defined in TS 36.211
Special subframe configuration		6	As specified in table 4.2-1 in TS 36.211. The same configuration in both cells.
Uplink-downlink configuration		1	As specified in table 4.2-2 in TS 36.211 and table 8.1.2.5.2-2. The same configuration in both cells.
prs-MutingInfo		Cell1:'11110000' Cell2:'11110000' Cell3:'11110000'	See clause 6.5.1.2 in TS 36.355 for more information
Cell ID		(Cell ID of cell 2 – Cell ID of cell 3) mod 6 = 3	PCI of cell 1 is selected randomly.
expectedRSTD	μ s	Cell 3:-2 Other neighbour cells: randomly between -3 and 3	The expected RSTD is what is expected at the receiver. The corresponding parameter in the OTDOA assistance data specified in TS 36.355 [24] is the expectedRSTD indicator
expectedRSTDUncertainty for all neighbour cells	μ s	5	The corresponding parameter in the OTDOA assistance data specified in TS 36.355 [24] is the expectedRSTD-Uncertainty index
CP length		Normal	
DRX		OFF	
Radio frame receive time offset between the cells at the UE antenna connector	μ s	Cell 1 to Cell 2: -1 Cell 3 to Cell 2:1	PRS are transmitted from synchronous cells
Time alignment error between cell2 and cell1	μ s	\leq Time alignment error as specified in 3GPP TS 36.104 [30] clause 6.5.3.1.	The value of time alignment error depends upon the type of carrier aggregation.
Number of cells provided in OTDOA assistance data		16	The list includes the assistance-data-reference cell (received in <i>OTDOA-ReferenceCellInfo</i> [24]) and 15 other cells, all received in <i>OTDOA-ProvideAssistanceData</i> [24]. All cells provided in OTDOA assistance data are on RF channel 2.
T_{RSTD} IntraFreqTDD, E-UTRAN	ms	2560	Derived according to the RSTD measurement requirements specified in Clause 8.1.2.5.2

Table A.9.8.6.1-2: Cell Specific Test Parameters for RSTD Tests for E-UTRAN TDD for Carrier Aggregation

Parameter	Unit	Cell1	Cell2	Cell3
E-UTRA RF Channel Number		1	2	2
PRS configuration Index I_{PRS}		14	14	14
PBCH_RA	dB	0	0	0
PBCH_RB				
PSS_RA				
SSS_RA				
PCFICH_RB				
PHICH_RA				
PHICH_RB				
PDCCH_RA				
PDCCH_RB				
OCNG_RA ^{Note1}				
OCNG_RB ^{Note1}				
PRS_RA				
N_{oc} ^{Note2}	dBm/15 kHz	-98		
PRS \hat{E}_s/N_{oc}	dB	-6	-6	-13
PRS \hat{E}_s/I_{ot}	dB	-6	-6	-13
I_o ^{Note3}	dBm/9 MHz	-70.04	-70.01	-70.01
PRP ^{Note3}	dBm/15kHz	-104	-104	-111
RSRP ^{Note3}	dBm/15kHz	-101	-104	-111
\hat{E}_s/N_{oc} ^{Note3}	dB	-3	-6	-13
Propagation condition		AWGN		
<p>Note 1: OCNG shall be used such that both cells are fully allocated and a constant total transmitted power spectral density is achieved for all OFDM symbols (other than those in the PRS subframes).</p> <p>Note 2: Interference from other cells and noise sources not specified in the test is assumed to be constant over subcarriers and time and shall be modelled as AWGN of appropriate power for N_{oc} to be fulfilled.</p> <p>Note 3: \hat{E}_s/N_{oc}, PRS \hat{E}_s/I_{ot}, RSRP, I_o and PRP levels have been derived from other parameters for information purposes. They are not settable parameters themselves. I_o values are derived in the case that there is no PBCH, PSS or SSS in the OFDM symbols carrying PRS.</p>				

A.9.8.6.2 Test Requirements

The measurement accuracy of RSTD between Cell2 and Cell3 shall fulfill the requirements in clause 9.1.12.

A.9.8.7 E-UTRAN FDD RSTD Measurement Accuracy in Carrier Aggregation for 20MHz bandwidth

A.9.8.7.1 Test Purpose and Environment

The purpose of this test case is the same as for the test defined in subclause A.9.8.5.1. The test parameters are the same except those described in the following section. The listed parameter values in Tables A.9.8.7.1-1 and A.9.8.7.1-2 will replace the values of corresponding parameters in Tables A.9.8.5.1-1 and A.9.8.5.1-2.

Table A.9.8.7.1-1: General Test Parameters for RSTD Tests for E-UTRAN FDD for Carrier Aggregation for 20MHz bandwidth

Parameter	Unit	Value	Comment
PCFICH/PDCCH/PHICH parameters		R.10 FDD	As specified in clause A.3.1.2.1

OCNG Patterns defined in A.3.2.1.14		OP.14 FDD	OCNG shall be used such that both cells are fully allocated and a constant total transmitted power spectral density is achieved for all OFDM symbols (other than those in the PRS subframes). There is no PDSCH allocated in the subframe transmitting PRS.
Channel Bandwidth ($BW_{channel}$)	MHz	20	
PRS Bandwidth	RB	100	PRS Bandwidth bandwidth is as indicated in <i>prs-Bandwidth</i> in the OTDOA assistance data defined in [24].
Note 1: See Table A.9.8.5.1-1 for other general test parameters. Note 2: N/A			

Table A.9.8.7.1-2: Cell Specific Test Parameters for RSTD Tests for E-UTRAN FDD for Carrier Aggregation for 20MHz bandwidth

Parameter	Unit	Cell1	Cell2	Cell3
I_0 ^{Note1}	dBm/18 MHz	-67.03	-67.00	-67.00
Note 1: I_0 level has been derived from other parameters for information purposes. It is not settable parameter itself. I_0 values are derived in the case that there is no PBCH, PSS or SSS in the OFDM symbols carrying PRS				
Note 2: See Table A.9.8.5.1-2 for other cell specific test parameters.				

A.9.8.7.2 Test Requirements

The test requirements defined in section A.9.8.5.2 shall apply to this test case.

A.9.8.8 E-UTRAN TDD RSTD Measurement Accuracy in Carrier Aggregation for 20MHz bandwidth

A.9.8.8.1 Test Purpose and Environment

The purpose of this test case is the same as for the test defined in subclause A.9.8.6.1. The test parameters are the same except those described in the following section. The listed parameter values in Tables A.9.8.8.1-1 and A.9.8.8.1-2 will replace the values of corresponding parameters in Tables A.9.8.6.1-1 and A.9.8.6.1-2.

Table A.9.8.8.1-1: General Test Parameters for RSTD Tests for E-UTRAN TDD for Carrier Aggregation for 20MHz bandwidth

Parameter	Unit	Value	Comment
PCFICH/PDCCH/PHICH parameters		R.10 TDD	As specified in clause A.3.1.2.2
OCNG Patterns defined in A.3.2.2.8		OP.8 TDD	OCNG shall be used such that both cells are fully allocated and a constant total transmitted power spectral density is achieved for all OFDM symbols (other than those in the PRS subframes). There is no PDSCH allocated in the subframe transmitting PRS.
Channel Bandwidth ($BW_{channel}$)	MHz	20	
PRS Bandwidth	RB	100	PRS Bandwidth bandwidth is as indicated in <i>prs-Bandwidth</i> in the OTDOA assistance data defined in [24].
Note 1: See Table A.9.8.6.1-1 for other general test parameters. Note 2: N/A			

Table A.9.8.8.1-2: Cell Specific Test Parameters for RSTD Tests for E-UTRAN TDD for Carrier Aggregation for 20MHz bandwidth

Parameter	Unit	Cell1	Cell2	Cell3
I_0 ^{Note1}	dBm/18 MHz	-67.03	-67.00	-67.00
Note 1: I_0 level has been derived from other parameters for information purposes. It is not settable parameter itself. I_0 values are derived in the case that there is no PBCH, PSS or SSS in the OFDM symbols carrying PRS				
Note 2: See Table A.9.8.6.1-2 for other cell specific test parameters.				

A.9.8.8.2 Test Requirements

The test requirements defined in section A.9.8.6.2 shall apply to this test case.

A.9.8.9 E-UTRAN FDD RSTD Measurement Accuracy in Carrier Aggregation for 10MHz+5MHz

A.9.8.9.1 Test Purpose and Environment

The purpose of this test case is the same as for the test defined in subclause A.9.8.5.1. The test parameters are the same except those described in the following section. The listed parameter values in Tables A.9.8.9.1-1 and A.9.8.9.1-2 will replace the values of corresponding parameters in Tables A.9.8.5.1-1 and A.9.8.5.1-2.

Table A.9.8.9.1-1: General Test Parameters for RSTD Tests for E-UTRAN FDD for Carrier Aggregation for 10MHz+5MHz

Parameter	Unit	Value	Comment
PCFICH/PDCCH/PHICH parameters		Cell1: R.6 FDD Cell2: R.11 FDD Cell3: R.11 FDD	As specified in clause A.3.1.2.1
OCNG Patterns defined in A.3.2.1		Cell1: OP.6 FDD Cell2: OP.19 FDD Cell3: OP.19 FDD	OCNG shall be used such that both cells are fully allocated and a constant total transmitted power spectral density is achieved for all OFDM symbols (other than those in the PRS subframes). There is no PDSCH allocated in the subframe transmitting PRS.
Channel Bandwidth ($BW_{channel}$)	MHz	Cell1: 10 Cell2: 5 Cell3: 5	
PRS Bandwidth	RB	Cell1: 50 Cell2: 25 Cell3: 25	PRS Bandwidth bandwidth is as indicated in <i>prs-Bandwidth</i> in the OTDOA assistance data defined in [24].
Number of consecutive positioning downlink subframes N_{PRS}		2	As defined in TS 36.211
Note 1: See Table A.9.8.5.1-1 for other general test parameters.			
Note 2: N/A			

Table A.9.8.9.1-2: Cell Specific Test Parameters for RSTD Tests for E-UTRAN FDD for Carrier Aggregation for 10MHz+5MHz

Parameter	Unit	Cell1	Cell2	Cell3
I_0 ^{Note1}	dBm/9 MHz	-70.04	N/A	N/A
	dBm/4.5 MHz	N/A	-73.02	-73.02
Note 1: I_0 level has been derived from other parameters for information purposes. It is not settable parameter itself. I_0 values are derived in the case that there is no PBCH, PSS or SSS in the OFDM symbols carrying PRS				
Note 2: See Table A.9.8.5.1-2 for other cell specific test parameters.				

A.9.8.9.2 Test Requirements

The test requirements defined in section A.9.8.5.2 shall apply to this test case.

A.9.8.10 E-UTRAN TDD RSTD Measurement Accuracy in Carrier Aggregation for 10MHz+5MHz

A.9.8.10.1 Test Purpose and Environment

The purpose of this test case is the same as for the test defined in subclause A.9.8.6.1. The test parameters are the same except those described in the following section. The listed parameter values in Tables A.9.8.10.1-1 and A.9.8.10.1-2 will replace the values of corresponding parameters in Tables A.9.8.6.1-1 and A.9.8.6.1-2.

Table A.9.8.10.1-1: General Test Parameters for RSTD Tests for E-UTRAN TDD for Carrier Aggregation for 10MHz+5MHz

Parameter	Unit	Value	Comment
PCFICH/PDCCH/PHICH parameters		Cell1: R.6 TDD Cell2: R.11 TDD Cell3: R.11 TDD	As specified in clause A.3.1.2.2
OCNG Patterns defined in A.3.2.2		Cell1: OP.2 TDD Cell2: OP.10 TDD Cell3: OP.10 TDD	OCNG shall be used such that both cells are fully allocated and a constant total transmitted power spectral density is achieved for all OFDM symbols (other than those in the PRS subframes). There is no PDSCH allocated in the subframe transmitting PRS.
Channel Bandwidth (BW _{channel})	MHz	Cell1: 10 Cell2: 5 Cell3: 5	
PRS Bandwidth	RB	Cell1: 50 Cell2: 25 Cell3: 25	PRS Bandwidth bandwidth is as indicated in <i>prs-Bandwidth</i> in the OTDOA assistance data defined in [24].
Number of consecutive positioning downlink subframes N_{PRS}		2	As defined in TS 36.211
Note 1: See Table A.9.8.6.1-1 for other general test parameters.			
Note 2: N/A			

Table A.9.8.10.1-2: Cell Specific Test Parameters for RSTD Tests for E-UTRAN TDD for Carrier Aggregation for 10MHz+5MHz

Parameter	Unit	Cell1	Cell2	Cell3
I_0 ^{Note1}	dBm/9 MHz	-70.04	N/A	N/A
	dBm/4.5 MHz	N/A	-73.02	-73.02
Note 1: I_0 level has been derived from other parameters for information purposes. It is not settable parameter itself. I_0 values are derived in the case that there is no PBCH, PSS or SSS in the OFDM symbols carrying PRS				
Note 2: See Table A.9.8.6.1-2 for other cell specific test parameters.				

A.9.8.10.2 Test Requirements

The test requirements defined in section A.9.8.6.2 shall apply to this test case.

A.9.8.11 E-UTRAN FDD RSTD Measurement Accuracy in Carrier Aggregation for 5 + 5MHz bandwidth

A.9.8.11.1 Test Purpose and Environment

The purpose of this test case is the same as for the test defined in subclause A.9.8.5.1. The test parameters are the same except those described in the following section. The listed parameter values in Tables A.9.8.11.1-1 and A.9.8.11.1-2 will replace the values of corresponding parameters in Tables A.9.8.5.1-1 and A.9.8.5.1-2.

Table A.9.8.11.1-1: General Test Parameters for RSTD Tests for E-UTRAN FDD for Carrier Aggregation for 5+5MHz bandwidth

Parameter	Unit	Value	Comment
PCFICH/PDCCH/PHICH parameters		R.11 FDD	As specified in clause A.3.1.2.1
OCNG Patterns defined in A.3.2.1.19		OP.19 FDD	OCNG shall be used such that both cells are fully allocated and a constant total transmitted power spectral density is achieved for all OFDM symbols (other than those in the PRS subframes). There is no PDSCH allocated in the subframe transmitting PRS.
Channel Bandwidth (BW_{channel})	MHz	5	
PRS Bandwidth	RB	25	PRS Bandwidth bandwidth is as indicated in <i>prs-Bandwidth</i> in the OTDOA assistance data defined in [24].
Number of consecutive positioning downlink subframes N_{PRS}		2	As defined in TS 36.211
Note 1: See Table A.9.8.5.1-1 for other general test parameters.			
Note 2: N/A			

Table A.9.8.11.1-2: Cell Specific Test Parameters for RSTD Tests for E-UTRAN FDD for Carrier Aggregation for 5+5MHz bandwidth

Parameter	Unit	Cell1	Cell2	Cell3
I_0 ^{Note1}	dBm/4.5 MHz	-73.05	-73.02	-73.02
Note 1: I_0 level has been derived from other parameters for information purposes. It is not settable parameter itself. I_0 values are derived in the case that there is no PBCH, PSS or SSS in the OFDM symbols carrying PRS				
Note 2: See Table A.9.8.5.1-2 for other cell specific test parameters.				

A.9.8.11.2 Test Requirements

The test requirements defined in section A.9.8.5.2 shall apply to this test case.

A.9.8.12 E-UTRAN TDD RSTD Measurement Accuracy in Carrier Aggregation for 5+5MHz bandwidth

A.9.8.12.1 Test Purpose and Environment

The purpose of this test case is the same as for the test defined in subclause A.9.8.6.1. The test parameters are the same except those described in the following section. The listed parameter values in Tables A.9.8.12.1-1 and A.9.8.12.1-2 will replace the values of corresponding parameters in Tables A.9.8.6.1-1 and A.9.8.6.1-2.

Table A.9.8.12.1-1: General Test Parameters for RSTD Tests for E-UTRAN TDD for Carrier Aggregation for 5+5MHz bandwidth

Parameter	Unit	Value	Comment
PCFICH/PDCCH/PHICH parameters		R.11 TDD	As specified in clause A.3.1.2.2
OCNG Patterns defined in A.3.2.2.10		OP.10 TDD	OCNG shall be used such that both cells are fully allocated and a constant total transmitted power spectral density is achieved for all OFDM symbols (other than those in the PRS subframes). There is no PDSCH allocated in the subframe transmitting PRS.
Channel Bandwidth (BW_{channel})	MHz	5	
PRS Bandwidth	RB	25	PRS Bandwidth bandwidth is as indicated in <i>prs-Bandwidth</i> in the OTDOA assistance data defined in [24].
Number of consecutive positioning downlink subframes N_{PRS}		2	As defined in TS 36.211

Note 1: See Table A.9.8.6.1-1 for other general test parameters.
 Note 2: N/A

Table A.9.8.12.1-2: Cell Specific Test Parameters for RSTD Tests for E-UTRAN TDD for Carrier Aggregation for 5+5MHz bandwidth

Parameter	Unit	Cell1	Cell2	Cell3
I_{O} ^{Note1}	dBm/4.5 MHz	-73.05	-73.02	-73.02
Note 1: I_{O} level has been derived from other parameters for information purposes. It is not settable parameter itself. I_{O} values are derived in the case that there is no PBCH, PSS or SSS in the OFDM symbols carrying PRS				
Note 2: See Table A.9.8.6.1-2 for other cell specific test parameters.				

A.9.8.12.2 Test Requirements

The test requirements defined in section A.9.8.6.2 shall apply to this test case.

A.9.8.13 E-UTRAN TDD RSTD Measurement Accuracy in Carrier Aggregation for 20MHz+10MHz

A.9.8.13.1 Test Purpose and Environment

The purpose of this test case is the same as for the test defined in subclause A.9.8.6.1. The test parameters are the same except those described in the following section. The listed parameter values in Tables A.9.8.13.1-1 and A.9.8.13.1-2 will replace the values of corresponding parameters in Tables A.9.8.6.1-1 and A.9.8.6.1-2.

Table A.9.8.13.1-1: General Test Parameters for RSTD Tests for E-UTRAN TDD for Carrier Aggregation for 20MHz+10MHz

Parameter	Unit	Value	Comment
PCFICH/PDCCH/PHICH parameters		Cell1: R.10 TDD Cell2: R.6 TDD Cell3: R.6 TDD	As specified in clause A.3.1.2.2
OCNG Patterns defined in A.3.2.2		Cell1: OP.8 TDD Cell2: OP.2 TDD Cell3: OP.2 TDD	OCNG shall be used such that both cells are fully allocated and a constant total transmitted power spectral density is achieved for all OFDM symbols (other than those in the PRS subframes). There is no PDSCH allocated in the subframe transmitting PRS.
Channel Bandwidth ($BW_{channel}$)	MHz	Cell1: 20 Cell2: 10 Cell3: 10	
PRS Bandwidth	RB	Cell1: 100 Cell2: 50 Cell3: 50	PRS Bandwidth bandwidth is as indicated in <i>prs-Bandwidth</i> in the OTDOA assistance data defined in [24].
Note 1: See Table A.9.8.6.1-1 for other general test parameters.			
Note 2: N/A			

Table A.9.8.13.1-2: Cell Specific Test Parameters for RSTD Tests for E-UTRAN TDD for Carrier Aggregation for 20MHz+10MHz

Parameter	Unit	Cell1	Cell2	Cell3
I_{O} ^{Note1}	dBm/ 18MHz	-67.03	N/A	N/A
	dBm/ 9MHz	N/A	-70.01	-70.01
Note 1: I_{O} level has been derived from other parameters for information purposes. It is not settable parameter itself. I_{O} values are derived in the case that there is no PBCH, PSS or SSS in the OFDM symbols carrying PRS				
Note 2: See Table A.9.8.6.1-2 for other cell specific test parameters.				

A.9.8.13.2 Test Requirements

The test requirements defined in section A.9.8.6.2 shall apply to this test case.

A.9.8.14 E-UTRAN FDD RSTD Measurement Accuracy in 3DL Carrier Aggregation

A.9.8.14.1 Test Purpose and Environment

The purpose of these tests is to verify that the E-UTRAN FDD RSTD measurement accuracy in carrier aggregation is within the specified limits in clause 9.1.12.

There are four synchronous cells on three different carrier frequencies in the test. Cell 1 is the PCell on primary component carrier F1 (RF channel number 1), Cell 2 is an SCell on secondary component carrier F2 (RF channel number 2), Cell 3 is an SCell and reference cell on secondary component carrier F3 (RF channel number 3), and Cell 4 is the neighbor cell on F3.

Cell 1, Cell2, Cell3, and Cell 4 are included in the OTDOA assistance data. The RSTD measurements are performed

- between Cell 4 and Cell 3 to verify the accuracy of RSTD measurement when the reference cell and neighbouring cell belong to the same secondary component carrier can meet the intra-frequency RSTD accuracy requirements defined in clause 9.1.10.1.
- between Cell 1 and Cell 3 to verify the accuracy of RSTD measurement between the PCell and an SCell can meet the inter-frequency RSTD accuracy requirements defined in clause 9.1.10.2.
- between Cell 2 and Cell 3 to verify the accuracy of RSTD measurement between two SCells can meet the inter-frequency RSTD accuracy requirements defined in clause 9.1.10.2.

The OTDOA assistance data as defined in TS 36.355, Clause 6.5.1.1, shall be provided to the UE before the measurement period. The last TTI containing the OTDOA assistance data shall be provided to the UE ΔT ms before the start of measurement period, where $\Delta T = 150$ ms is the maximum processing time of the OTDOA assistance data. The measurement gap is not configured in the test because of UE carrier aggregation capability.

There is no PDSCH allocated in the subframe transmitting PRS. A time span of $T_{\text{RSTD InterFreqFDD, E-UTRAN}}$ is provided for the measurement period, and PRS are configured according to I_{PRS} in Table A.9.8.14.1-1 and Table A.9.8.14.1-2 for each of the three cells during this time.

The test parameters are given in Table A.9.8.14.1-1 and Table A.9.8.14.1-2.

Table A.9.8.14.1-1: General Test Parameters for RSTD Tests for E-UTRAN FDD for 3DL Carrier Aggregation

Parameter	Unit	Value	Comment
PCell		Cell 1	Cell 1 on RF channel number 1
SCell 1		Cell 2	Cell 2 is an SCell on RF channel number 2
SCell 2 (Assistance data reference cell)		Cell 3	Cell 3 is an SCell on RF channel number 3
Neighbour cell		Cell 4	Cell 4 on RF channel number 3
PRS configuration index I_{PRS}		171 for all cells on PCC 181 for all cells on SCC1 191 for all cells on SCC2	This corresponds to periodicity of 320 ms and PRS subframe offset of $I_{\text{PRS}} - 160$ DL subframes, as defined in TS 36.211 [16], Table 6.10.4.3-1

prs-MutingInfo		Cell1:'11110000' Cell2:'11110000' Cell3:'11110000' Cell4:'11110000'	See clause 6.5.1.2 in TS 36.355 for more information
prs-SubframeOffset		Cells on PCC: 300 Cells on SCC1: 310 Cells on SCC2, except reference cell: 0	Subframe offset, counted in full subframes. The corresponding parameter in the OTDOA assistance data is prs-SubframeOffset specified in TS 36.355 [24]
slotNumberOffset		Cells on PCC: 0 Cells on SCC1: 0 Cells on SCC2, except reference cell: 0	The slot number offset at the transmitter between a neighbour cell and the assistance data reference cell. The corresponding parameter in the OTDOA assistance data is slotNumberOffset specified in TS 36.355 [24].
Cell ID		(Cell ID of cell 4 – Cell ID of cell 3) mod 6 = 3	PCIs of cell 1 and cell 2 are selected randomly.
expectedRSTD	μs	Cell 1: -2 Cell 2: 0 Cell 4: 2 Other neighbour cells: randomly between -3 and 3	The expected RSTD is what is expected at the receiver. The corresponding parameter in the OTDOA assistance data specified in TS 36.355 [24] is the expectedRSTD indicator
expectedRSTDUncertainty for all neighbour cells	μs	5	The corresponding parameter in the OTDOA assistance data specified in TS 36.355 [24] is the expectedRSTD-Uncertainty index
CP length		Normal	
DRX		OFF	
Radio frame receive time offset between the cells at the UE antenna connector	μs	Cell 1 to Cell 3: 1 Cell 2 to Cell 3: -1 Cell 4 to Cell 3: 3	PRS are transmitted from synchronous cells
Time alignment errors between Cell 1, Cell 2, and Cell 3	μs	≤ Time alignment error as specified in 3GPP TS 36.104 [30] clause 6.5.3.1.	The value of time alignment error depends upon the type of carrier aggregation.
Number of cells provided in OTDOA assistance data		16	The list includes the assistance-data-reference cell (received in <i>OTDOA-ReferenceCellInfo</i> [24]) and 15 other cells, all received in <i>OTDOA-ProvideAssistanceData</i> [24]. Cell 1 and Cell 2 appears at random places in the first half of the neighbour cell list in the OTDOA assistance data. Cell 4 always appears at random places in the second half of the list.
$T_{\text{RSTD InterFreqFDD, E-UTRAN}}$	ms	4960	Derived according to the RSTD measurement requirements specified in Clause 8.1.2.6.1

Table A.9.8.14.1-2: Cell Specific Test Parameters for RSTD Tests for E-UTRAN FDD for Carrier Aggregation

Parameter	Unit	Cell1	Cell2	Cell3	Cell 4
E-UTRA RF Channel Number		1	2	3	3
Channel Bandwidth ($BW_{channel}$)	MHz	5,10,20	5,10,20	5,10,20	5,10,20
PCFICH/PDCCH/PHICH parameters as specified in clause A.3.1.2.1		5MHz: R.11 FDD 10MHz: R.6 FDD 20MHz: R.10 FDD	5MHz: R.11 FDD 10MHz: R.6 FDD 20MHz: R.10 FDD	5MHz: R.11 FDD 10MHz: R.6 FDD 20MHz: R.10 FDD	5MHz: R.11 FDD 10MHz: R.6 FDD 20MHz: R.10 FDD
OCNG Patterns defined in A.3.2.1		5MHz: OP.18 FDD 10MHz: OP.5 FDD 20MHz: OP.13 FDD	5MHz: OP.18 FDD 10MHz: OP.5 FDD 20MHz: OP.13 FDD	5MHz: OP.18 FDD 10MHz: OP.5 FDD 20MHz: OP.13 FDD	5MHz: OP.18 FDD 10MHz: OP.5 FDD 20MHz: OP.13 FDD
PRS Transmission Bandwidth (PRS transmission bandwidth depends on selected channel bandwidth. PRS are transmitted over the system bandwidth)	RB	5MHz: 25 10MHz: 50 20MHz:100	5MHz: 25 10MHz: 50 20MHz:100	5MHz: 25 10MHz: 50 20MHz:100	5MHz: 25 10MHz: 50 20MHz:100
Number of consecutive downlink positioning subframes N_{PRS} . N_{PRS} also depends on selected channel bandwidth. As defined in TS 36.211 [16]. The number of subframes in a positioning occasion		5MHz: 2 10MHz: 1 20MHz:1	5MHz: 2 10MHz: 1 20MHz:1	5MHz: 2 10MHz: 1 20MHz:1	5MHz: 2 10MHz: 1 20MHz:1
PBCH_RA	dB	0	0	0	0
PBCH_RB					
PSS_RA					
SSS_RA					
PCFICH_RB					
PHICH_RA					
PHICH_RB					
PDCCH_RA					
PDCCH_RB					
OCNG_RA ^{Note1}					
OCNG_RB ^{Note1}					
PRS_RA	dB	-3	0	0	0
N_{oc} ^{Note2}	dBm/15 kHz	-98			
PRS \hat{E}_s/N_{oc}	dB	-6	-6	-6	-13
PRS \hat{E}_s/I_{ot}	dB	-6	-6	-6	-13
I_o ^{Note3}	dBm/9 MHz	-70.04 +10log ($N_{RB,c}/50$)	-70.04 +10log ($N_{RB,c}/50$)	-70.01 +10log ($N_{RB,c}/50$)	-70.01 +10log ($N_{RB,c}/50$)
PRP ^{Note3}	dBm/15kHz	-104	-104	-104	-111
RSRP ^{Note3}	dBm/15kHz	-101	-104	-104	-111
\hat{E}_s/N_{oc} ^{Note3}	dB	-3	-6	-6	-13
Propagation condition	AWGN				
Note 1: OCNG shall be used such that both cells are fully allocated and a constant total transmitted power spectral density is achieved for all OFDM symbols (other than those in the PRS subframes).					

Note 2: Interference from other cells and noise sources not specified in the test is assumed to be constant over subcarriers and time and shall be modelled as AWGN of appropriate power for N_{oc} to be fulfilled.

Note 3: \hat{E}_s/N_{oc} , PRS \hat{E}_s/I_{ot} , RSRP, Io and PRP levels have been derived from other parameters for information purposes. They are not settable parameters themselves. Io values are derived in the case that there is no PBCH, PSS or SSS in the OFDM symbols carrying PRS.

A.9.8.14.2 Test Requirements

The measurement accuracy of RSTD between Cell1 and Cell3 shall fulfill the requirements in clause 9.1.12.2

The measurement accuracy of RSTD between Cell2 and Cell3 shall fulfill the requirements in clause 9.1.12.2

The measurement accuracy of RSTD between Cell4 and Cell3 shall fulfill the requirements in clause 9.1.12.1.

A.9.8.15 E-UTRAN TDD RSTD Measurement Accuracy in 3DL Carrier Aggregation

A.9.8.15.1 Test Purpose and Environment

The purpose of these tests is to verify that the E-UTRAN TDD RSTD measurement accuracy in carrier aggregation is within the specified limits in clause 9.1.12.

There are four synchronous cells on three different carrier frequencies in the test. Cell 1 is the PCell on primary component carrier F1 (RF channel number 1), Cell 2 is an SCell on secondary component carrier F2 (RF channel number 2), Cell 3 is an SCell and reference cell on secondary component carrier F3 (RF channel number 3), and Cell 4 is the neighbor cell on F3.

Cell 1, Cell2, Cell3, and Cell 4 are included in the OTDOA assistance data. The RSTD measurements are performed

- between Cell 4 and Cell 3 to verify the accuracy of RSTD measurement when the reference cell and neighbouring cell belong to the same secondary component carrier can meet the intra-frequency RSTD accuracy requirements defined in clause 9.1.10.1.
- between Cell 1 and Cell 3 to verify the accuracy of RSTD measurement between the PCell and an SCell can meet the inter-frequency RSTD accuracy requirements defined in clause 9.1.10.2.
- between Cell 2 and Cell 3 to verify the accuracy of RSTD measurement between two SCells can meet the inter-frequency RSTD accuracy requirements defined in clause 9.1.10.2.

The OTDOA assistance data as defined in TS 36.355, Clause 6.5.1.1, shall be provided to the UE before the measurement period. The last TTI containing the OTDOA assistance data shall be provided to the UE ΔT ms before the start of measurement period, where $\Delta T = 150$ ms is the maximum processing time of the OTDOA assistance data. The measurement gap is not configured in the test because of UE carrier aggregation capability.

There is no PDSCH allocated in the subframe transmitting PRS. A time span of $T_{\text{RSTD InterFreqTDD, E-UTRAN}}$ is provided for the measurement period, and PRS are configured according to I_{PRS} in Table A.9.8.15.1-1 and Table A.9.8.15.1-2 for each of the three cells during this time.

The test parameters are given in Table A.9.8.15.1-1 and Table A.9.8.15.1-2.

Table A.9.8.15.1-1: General Test Parameters for RSTD Tests for E-UTRAN TDD for 3DL Carrier Aggregation

Parameter	Unit	Value	Comment
PCell		Cell 1	Cell 1 on RF channel number 1
SCell 1		Cell 2	Cell 2 is an SCell on RF channel number 2
SCell 2 (Assistance data reference cell)		Cell 3	Cell 3 is an SCell on RF channel number 3

Neighbour cell		Cell 4	Cell 4 on RF channel number 3
E-UTRA RF Channel Number		1,2,3	Three TDD carrier frequencies are used.
PRS configuration index I_{PRS}		171 for all cells on PCC 181 for all cells on SCC1 191 for all cells on SCC2	This corresponds to periodicity of 320 ms and PRS subframe offset of $I_{PRS} - 160$ DL subframes, as defined in TS 36.211 [16], Table 6.10.4.3-1
prs-MutingInfo		Cell1:'11110000' Cell2:'11110000' Cell3:'11110000' Cell4:'11110000'	See clause 6.5.1.2 in TS 36.355 for more information
prs-SubframeOffset		Cells on PCC: 300 Cells on SCC1: 310 Cells on SCC2, except reference cell: 0	Subframe offset, counted in full subframes. The corresponding parameter in the OTDOA assistance data is prs-SubframeOffset specified in TS 36.355 [24]
slotNumberOffset		Cells on PCC: 0 Cells on SCC1: 0 Cells on SCC2, except reference cell: 0	The slot number offset at the transmitter between a neighbour cell and the assistance data reference cell. The corresponding parameter in the OTDOA assistance data is slotNumberOffset specified in TS 36.355 [24].
Special subframe configuration		6	As specified in table 4.2-1 in TS 36.211. The same configuration in both cells.
Uplink-downlink configuration		1	As specified in table 4.2-2 in TS 36.211 and table 8.1.2.5.2-2. The same configuration in both cells.
Cell ID		(Cell ID of cell 4 – Cell ID of cell 3) mod 6 = 3	PCIs of cell 1 and cell 2 are selected randomly.
expectedRSTD	μs	Cell 1: -2 Cell 2: 0 Cell 4: 2 Other neighbour cells: randomly between -3 and 3	The expected RSTD is what is expected at the receiver. The corresponding parameter in the OTDOA assistance data specified in TS 36.355 [24] is the expectedRSTD indicator
expectedRSTDUncertainty for all neighbour cells	μs	5	The corresponding parameter in the OTDOA assistance data specified in TS 36.355 [24] is the expectedRSTD-Uncertainty index
CP length		Normal	
DRX		OFF	
Radio frame receive time offset between the cells at the UE antenna connector	μs	Cell 1 to Cell 3: 1 Cell 2 to Cell 3: -1 Cell 4 to Cell 3: 3	PRS are transmitted from synchronous cells
Time alignment errors between Cell 1, Cell 2, and Cell 3	μs	\leq Time alignment error as specified in 3GPP TS 36.104 [30] clause 6.5.3.1.	The value of time alignment error depends upon the type of carrier aggregation.

Number of cells provided in OTDOA assistance data		16	The list includes the assistance-data-reference cell (received in <i>OTDOA-ReferenceCellInfo</i> [24]) and 15 other cells, all received in <i>OTDOA-ProvideAssistanceData</i> [24]. Cell 1 and Cell 2 appears at random places in the first half of the neighbour cell list in the OTDOA assistance data. Cell 4 always appears at random places in the second half of the list.
T_{RSTD} InterFreqTDD, E-UTRAN	ms	4960	Derived according to the RSTD measurement requirements specified in Clause 8.1.2.6.3

Table A.9.8.15.1-2: Cell Specific Test Parameters for RSTD Tests for E-UTRAN TDD for Carrier Aggregation

Parameter	Unit	Cell1	Cell2	Cell3	Cell 4
E-UTRA RF Channel Number		1	2	3	3
Channel Bandwidth ($BW_{channel}$)	MHz	5,10,20	5,10,20	5,10,20	5,10,20
PCFICH/PDCCH/PHICH parameters as specified in clause A.3.1.2.2		5MHz: R11 TDD 10MHz: R6 TDD 20MHz: R10 TDD	5MHz: R11 TDD 10MHz: R6 TDD 20MHz: R10 TDD	5MHz: R11 TDD 10MHz: R6 TDD 20MHz: R10 TDD	5MHz: R11 TDD 10MHz: R6 TDD 20MHz: R10 TDD
OCNG Patterns defined in A.3.2.2 (There is no PDSCH allocated in the subframe transmitting PRS)		5MHz: OP.10 TDD 10MHz: OP.2 TDD 20MHz: OP.8 TDD	5MHz: OP.10 TDD 10MHz: OP.2 TDD 20MHz: OP.8 TDD	5MHz: OP.10 TDD 10MHz: OP.2 TDD 20MHz: OP.8 TDD	5MHz: OP.10 TDD 10MHz: OP.2 TDD 20MHz: OP.8 TDD
PRS Transmission Bandwidth (PRS transmission bandwidth depends on selected channel bandwidth. PRS are transmitted over the system bandwidth)	RB	5MHz: 25 10MHz: 50 20MHz:100	5MHz: 25 10MHz: 50 20MHz:100	5MHz: 25 10MHz: 50 20MHz:100	5MHz: 25 10MHz: 50 20MHz:100
Number of consecutive downlink positioning subframes N_{PRS} , N_{PRS} also depends on selected channel bandwidth. As defined in TS 36.211 [16]. The number of subframes in a positioning occasion		5MHz: 2 10MHz: 1 20MHz:1	5MHz: 2 10MHz: 1 20MHz:1	5MHz: 2 10MHz: 1 20MHz:1	5MHz: 2 10MHz: 1 20MHz:1
PBCH_RA	dB	0	0	0	0
PBCH_RB					
PSS_RA					
SSS_RA					
PCFICH_RB					
PHICH_RA					
PHICH_RB					
PDCCH_RA					
PDCCH_RB					

OCNG_RA ^{Note1}					
OCNG_RB ^{Note1}					
PRS_RA	dB	-3	0	0	0
N_{oc} ^{Note2}	dBm/15 kHz	-98			
PRS \hat{E}_s/N_{oc}	dB	-6	-6	-6	-13
PRS \hat{E}_s/I_{ot}	dB	-6	-6	-6	-13
I_o ^{Note3}	dBm/9 MHz	-70.04 +10log ($N_{RB,c}/50$)	-70.04 +10log ($N_{RB,c}/50$)	-70.01 +10log ($N_{RB,c}/50$)	-70.01 +10log ($N_{RB,c}/50$)
PRP ^{Note3}	dBm/15kHz	-104	-104	-104	-111
RSRP ^{Note3}	dBm/15kHz	-101	-104	-104	-111
\hat{E}_s/N_{oc} ^{Note3}	dB	-3	-6	-6	-13
Propagation condition		AWGN			
<p>Note 1: OCNG shall be used such that both cells are fully allocated and a constant total transmitted power spectral density is achieved for all OFDM symbols (other than those in the PRS subframes).</p> <p>Note 2: Interference from other cells and noise sources not specified in the test is assumed to be constant over subcarriers and time and shall be modelled as AWGN of appropriate power for N_{oc} to be fulfilled.</p> <p>Note 3: \hat{E}_s/N_{oc}, PRS \hat{E}_s/I_{ot}, RSRP, I_o and PRP levels have been derived from other parameters for information purposes. They are not settable parameters themselves. I_o values are derived in the case that there is no PBCH, PSS or SSS in the OFDM symbols carrying PRS.</p>					

A.9.8.15.2 Test Requirements

The measurement accuracy of RSTD between Cell1 and Cell3 shall fulfill the requirements in clause 9.1.12.2

The measurement accuracy of RSTD between Cell2 and Cell3 shall fulfill the requirements in clause 9.1.12.2

The measurement accuracy of RSTD between Cell4 and Cell3 shall fulfill the requirements in clause 9.1.12.1.

A.9.8.16 HD – FDD Intra frequency case for UE Category NB1 inband mode in normal coverage

A.9.8.16.1 Test Purpose and Environment

The purpose of the tests is to verify that the intra frequency RSTD measurement for HD-FDD category NB1 UE meets the accuracy requirements specified in Clause 9.1.22.10. Test 1 is applicable for UE supporting NPRS Type 1 and Test 2 is applicable for UE supporting NPRS Type 2.

In the tests there are three synchronous cells: nCell 1, nCell 2, eCell1 and eCell 2. nCell 1 is the reference as well as the PCell. nCell 2, eCell1 and eCell12 are the neighbour cells.

The OTDOA assistance data and *OTDOA-RequestLocationInformation* as defined in TS 36.355, shall be provided to the UE. After the receipt of the OTDOA assistance data and *OTDOA-RequestLocationInformation* has been successfully acknowledged, the UE is provided with a RRC connection release command. The UE is expected to enter RRC_IDLE before the measurement period.

The test parameters are given in Tables A.9.8.16.1-1, A.9.8.16.1-2 and A.9.8.16.1-3.

Table A.9.8.16.1-1: General test parameters

Parameter	Unit	Value	Comment
NB-LoT operational mode		Inband	
Reference cell		nCell 1	
Neighbor cells		nCell 2, eCell 2 and eCell 1	
NPDCCH parameters		R.26 HD-FDD	As defined in section A.3.1.6.1

nprsID		Test1: (nprsID of Cell 1 – nprsID of Cell 2)mod6=1 Test2: (nprsID of Cell 1 – nprsID of Cell2)mod6=0	As defined in TS36.366 [24]
NPRS Type		Test1: Type 1 Test2: Type 2	As defined in TS36.211
nprs-period	ms	1280	As defined in TS36.355 [24]
nprs-startSF		sf0	Subframe offset of the NPRS positioning occasion as defined in TS36.355 [24]
Number of consecutive downlink positioning subframes nprs-NumSF		640	As defined in TS36.355 [24]
NPRS muting info		nCell 1: '11110000' nCell 2: '11110000'	Correponds to nprs-MutingInfoB defined in TS 36.355 [24]
PartA Configuration		as in the following 2 rows:	
subframePattern10		'0111001110'	Correponds to subframePattern10-r14 defined in TS 36.355 [24]
nprsSequenceInfo		BW _{channel} 5MHz: 54 BW _{channel} 10MHz: 130	Correponds to nprsSequenceInfo defined in TS 36.355 [24]
CP length		Normal	
NPRACH Configuration		NPRACH.R-1	Refer to A.3.18
DRX cycle length		1.28	The value shall be used for all cells in the test.
Expected RSTD	μs	nCell 2: 3 Other neighbour cells: randomly between -3 and 3	The expected RSTD is what is expected at the receiver. The corresponding parameter in the OTDOA assistance data specified in TS 36.355 [24] is the expectedRSTD indicator
Expected RSTD uncertainty for all neighbour cells	μs	5	The corresponding parameter in the OTDOA assistance data specified in TS 36.355 [24] is the expectedRSTD-Uncertainty index
Number of cells provided in OTDOA assistance data		16	Including the reference cell
Measurement period	s	[11.52]	Derived according to the RSTD measurement period in clause 4.8.1

Table A.9.8.16.1-2: nCell1 and nCell2 specific test parameters

Parameter	Unit	Test1		Test2	
		nCell 1	nCell 2	nCell 1	nCell 2
BW _{channel}	kHz	180	180	180	180
PRB location within eCell		eCell 1 BW _{channel} 5MHz: 17 eCell 1 BW _{channel} 10MHz: 30	eCell 2 BW _{channel} 5MHz: 17 eCell 2 BW _{channel} 10MHz: 30	eCell 1 BW _{channel} 5MHz: 17 eCell 1 BW _{channel} 10MHz: 30	eCell 2 BW _{channel} 5MHz: 17 eCell 2 BW _{channel} 10MHz: 30
NPBCH_RA	dB	0	0	0	0
NPBCH_RB					
NPSS_RA					
NSSS_RA					
NPDCCH_RA					
NPDCCH_RB					
NPDSCH_RA					
NPDSCH_RB					
OCNG_RA ^{Note 1}					
OCNG_RB ^{Note 1}					
NPRS_RA	dB	-7.5	-9	0	0
N_{oc} ^{Note 2}	dBm/ 15 kHz	-98	-98	-98	-98
$NPRS \hat{E}_s / N_{oc}$	dB	-0.5	-5	-2.37	-8.02

NPRS \hat{E}_s/I_{ot} ^{Note 3}	dB	-5.96	-12.79	-3.01	-10.01
I_o ^{Note 3}	dBm/ 180kHz	-78.40	-78.40	-85.60	-85.60
NPRP ^{Note 3}	dBm/ 15 kHz	-98.5	-103	-100.37	-106.02
NRSRP ^{Note 3}	dBm/ 15 kHz	-91	-94	-100.37	-106.02
\hat{E}_s/N_{oc} ^{Note 3}	dB	7	4	-2.37	-8.02
Propagation Condition		AWGN	AWGN	AWGN	AWGN
Antenna Configuration		1x1	1x1	1x1	1x1
Timing offset to nCell 1	us	N/A	3	N/A	3
<p>Note 1: OCNG shall be used such that active cells are fully allocated and a constant total transmitted power spectral density is achieved for all OFDM symbols other than those in the subframes with transmitted NPRS.</p> <p>Note 2: Interference from other cells and noise sources not specified in the test are assumed to be constant over subcarriers and time and shall be modelled as AWGN of appropriate power for N_{oc} to be fulfilled.</p> <p>Note 3: If NPRS_RA is not "N/A", \hat{E}_s/N_{oc}, NPRS \hat{E}_s/I_{ot}, I_o, NRSRP and NPRP levels have been derived from other parameters and are given for information purpose. If NPRS_RA is "N/A", I_o and NRSRP levels have been derived from other parameters and are given for information purpose. These are not settable test parameters. Interference conditions shall be applied to all PRS symbols of DL positioning subframes.</p>					

Table A.9.8.16.1-3: eCell 1 and eCell 2 specific test parameters

Parameter	Unit	Test1						Test2					
		eCell 1			eCell 2			eCell 1			eCell 2		
		T1	T2	T3	T1	T2	T3	T1	T2	T3	T1	T2	T3
BW _{channel}	MHz	5 or 10			5 or 10			5 or 10			5 or 10		
NOCNG Pattern defined in clause D.3	-	BW _{channel} 5MHz: NOP.4 FDD BW _{channel} 10MHz: NOP.1 FDD			BW _{channel} 5MHz: NOP.4 FDD BW _{channel} 10MHz: NOP.1 FDD			BW _{channel} 5MHz: NOP.4 FDD BW _{channel} 10MHz: NOP.1 FDD			BW _{channel} 5MHz: NOP.4 FDD BW _{channel} 10MHz: NOP.1 FDD		
PBCH_RA	dB	-3			-3			-3			-3		
PBCH_RB	dB												
PSS_RA	dB												
SSS_RA	dB												
PDCCH_RA	dB												
PDCCH_RB	dB												
PDSCH_RA	dB												
PDSCH_RB	dB												
OCNG_RA ^{Note 1}	dB												
OCNG_RB ^{Note 1}	dB												
N_{oc} ^{Note2}	dBm/15 kHz	-98			-98			-98			-98		
\hat{E}_s/N_{oc} ^{Note2}	dBm	7	7	7	4	4	4	0	0	0	-7	-7	-7
Propagation Condition		AWGN			AWGN			AWGN			AWGN		
Antenna Configuration		1x1			1x1			1x1			1x1		
Timing offset to eCell 1	ms	-			3			-			3		
<p>Note 1: OCNG shall be used such that the Cell is fully allocated and a constant total transmitted power spectral density is achieved for all OFDM symbols.</p> <p>Note 2: Interference from other cells and noise sources not specified in the test is assumed to be constant over subcarriers and time and shall be modelled as AWGN of appropriate power N_{oc}.</p>													

A.9.8.16.2 Test Requirements

The RSTD measurement accuracy shall fulfill the requirements in clause 9.1.22.10.

A.9.8.17 HD – FDD Inter frequency case for UE Category NB1 inband mode in normal coverage

A.9.8.17.1 Test Purpose and Environment

The purpose of the tests is to verify that the intra frequency RSTD measurement for HD-FDD category NB1 UE meets the accuracy requirements specified in Clause 9.1.22.11. Test 1 is applicable for UE supporting NPRS Type 1 and Test 2 is applicable for UE supporting NPRS Type 2.

In the tests there are three synchronous cells: nCell 1, nCell 2, eCell1 and eCell 2. nCell 1 is the reference as well as the PCell. nCell 2, eCell1 and eCell2 are the neighbour cells.

The OTDOA assistance data and *OTDOA-RequestLocationInformation* as defined in TS 36.355, shall be provided to the UE. After the receipt of the OTDOA assistance data and *OTDOA-RequestLocationInformation* has been successfully acknowledged, the UE is provided with a RRC connection release command. The UE is expected to enter RRC_IDLE before the measurement period.

The test parameters are given in Tables A.9.8.17.1-1, A.9.8.17.1-2 and A.9.8.17.1-3.

Table A.9.8.17.1-1: General test parameters

Parameter	Unit	Value	Comment
NB-IoT operational mode		Inband	
Reference cell		nCell 1	
Neighbor cells		nCell 2, eCell 1 and eCell 2	
NPDCCH parameters		R.26 HD-FDD	As defined in section A.3.1.6.1
nprsID		Test1: (nprsID of Cell 1 – nprsID of Cell 2)mod6=1 Test2: (nprsID of Cell 1 – nprsID of Cell 2)mod6=0	As defined in TS36.355 [24]
NPRS Type		Test1: Type 1 Test2: Type 2	As defined in TS36.211
nprs-period	ms	1280	As defined in TS36.355 [24]
nprs-startSF		sf0	Subframe offset of the NPRS positioning occasion as defined in TS36.355 [24]
nprs-slotNumberOffset		0	As defined in TS36.355 [24]
nprs-SubframeOffset		640	As defined in TS36.355 [24]
Number of consecutive downlink positioning subframes nprs-NumSF		640	As defined in TS36.355 [24]
NPRS muting info		nCell 1: '1111111100000000' nCell 2: '1111111100000000'	Correponds to nprs-MutingInfoB defined in TS 36.355 [24]
PartA Configuration		as in the following 3 rows:	
subframePattern10		'0111001110'	Correponds to subframePattern10-r14 defined in TS 36.355 [24]
nprsSequenceInfo nCell1		BW _{channel} 5MHz: 54 BW _{channel} 10MHz: 130	Correponds to nprsSequenceInfo defined in TS 36.355 [24]
nprsSequenceInfo nCell2		BW _{channel} 5MHz: 59 BW _{channel} 10MHz: 135	Correponds to nprsSequenceInfo defined in TS 36.355 [24]
CP length		Normal	
NPRACH Configuration		NPRACH.R-1	Refer to A.3.18
DRX cycle length		1.28	The value shall be used for all cells in the test.
Expected RSTD	μs	nCell 2: 3 Other neighbour cells: randomly between -3 and 3	The expected RSTD is what is expected at the receiver. The corresponding parameter in the OTDOA assistance data specified in TS 36.355 [24] is the expectedRSTD indicator

Expected RSTD uncertainty for all neighbour cells	μs	5	The corresponding parameter in the OTDOA assistance data specified in TS 36.355 [24] is the expectedRSTD-Uncertainty index
Number of cells provided in OTDOA assistance data		16	Including the reference cell
Measurement period	s	[20..48]	Derived according to the RSTD measurement period in clause 4.8.3

Table A.9.8.17.1-2: nCell1 and nCell2 specific test parameters

Parameter	Unit	Test1		Test2	
		nCell 1	nCell 2	nCell 1	nCell 2
BW _{channel}	kHz	180	180	180	180
PRB location within eCell		eCell 1 BW _{channel} 5MHz: 17 eCell 1 BW _{channel} 10MHz: 30	eCell 2 BW _{channel} 5MHz: 22 eCell 2 BW _{channel} 10MHz: 35	eCell 1 BW _{channel} 5MHz: 17 eCell 1 BW _{channel} 10MHz: 30	eCell 2 BW _{channel} 5MHz: 22 eCell 2 BW _{channel} 10MHz: 35
NPBCH_RA	dB	0	0	0	0
NPBCH_RB					
NPSS_RA					
NSSS_RA					
NPDCCH_RA					
NPDCCH_RB					
NPDSCH_RA					
NPDSCH_RB					
OCNG_RA ^{Note 1}					
OCNG_RB ^{Note 1}					
NPRS_RA	dB	-13	-17	0	0
N_{oc} ^{Note 2}	dBm/ 15 kHz	-98	-98	-98	-98
$NPRS \hat{E}_s / N_{oc}$	dB	-6	-13	-2.37	-8.02
$NPRS \hat{E}_s / I_{ot}$ ^{Note 3}	dB	-6	-13	-3.01	-10.01
I_o ^{Note 3}	dBm/ 180 kHz	-80.20	-83.20	-85.60	-85.60
NPRP ^{Note 3}	dBm/ 15 kHz	-104	-111	-100.37	-106.02
NRSRP ^{Note 3}	dBm/ 15 kHz	-91	-94	-100.37	-106.02
\hat{E}_s / N_{oc} ^{Note 3}	dB	7	4	-2.37	-8.02
Propagation Condition		AWGN	AWGN	AWGN	AWGN
Antenna Configuration		1x1	1x1	1x1	1x1
Timing offset to nCell 1	us	N/A	3	N/A	3
<p>Note 1: OCNG shall be used such that active cells are fully allocated and a constant total transmitted power spectral density is achieved for all OFDM symbols other than those in the subframes with transmitted NPRS.</p> <p>Note 2: Interference from other cells and noise sources not specified in the test are assumed to be constant over subcarriers and time and shall be modelled as AWGN of appropriate power for N_{oc} to be fulfilled.</p> <p>Note 3: If NPRS_RA is not "N/A", \hat{E}_s / N_{oc}, $NPRS \hat{E}_s / I_{ot}$, I_o, NRSRP and NPRP levels have been derived from other parameters and are given for information purpose. If NPRS_RA is "N/A", I_o and NRSRP levels have been derived from other parameters and are given for information purpose. These are not settable test parameters. Interference conditions shall be applied to all PRS symbols of DL positioning subframes.</p>					

Table A.9.8.17.1-3: eCell 1 and eCell2 specific test parameters

Parameter	Unit	Test1						Test2					
		eCell 1			eCell 2			eCell 1			eCell 2		
		T1	T2	T3	T1	T2	T3	T1	T2	T3	T1	T2	T3
$BW_{channel}$	MHz	5 or 10			5 or 10			5 or 10			5 or 10		
NOCNG Pattern defined in clause D.3	-	$BW_{channel}$ 5MHz: NOP.4 FDD $BW_{channel}$ 10MHz: NOP.1 FDD			$BW_{channel}$ 5MHz: NOP.4 FDD $BW_{channel}$ 10MHz: NOP.1 FDD			$BW_{channel}$ 5MHz: NOP.4 FDD $BW_{channel}$ 10MHz: NOP.1 FDD			$BW_{channel}$ 5MHz: NOP.4 FDD $BW_{channel}$ 10MHz: NOP.1 FDD		
PBCH_RA	dB	-3			-3			-3			-3		
PBCH_RB	dB												
PSS_RA	dB												
SSS_RA	dB												
PDCCH_RA	dB												
PDCCH_RB	dB												
PDSCH_RA	dB												
PDSCH_RB	dB												
OCNG_RA ^{Note 1}	dB												
OCNG_RB ^{Note 1}	dB												
N_{oc} ^{Note2}	dBm/15 kHz	-98			-98			-98			-98		
\hat{E}_s / N_{oc} ^{Note2}	dBm	7	7	7	4	4	4	0	0	0	-7	-7	-7
Propagation Condition		AWGN			AWGN			AWGN			AWGN		
Antenna Configuration		1x1			1x1			1x1			1x1		
Timing offset to eCell 1	ms	-			3			-			3		
Note 1: OCNG shall be used such that the Cell is fully allocated and a constant total transmitted power spectral density is achieved for all OFDM symbols. Note 2: Interference from other cells and noise sources not specified in the test is assumed to be constant over subcarriers and time and shall be modelled as AWGN of appropriate power N_{oc} .													

A.9.8.17.2 Test Requirements

The RSTD measurement accuracy shall fulfill the requirements in clause 9.1.22.11.

A.9.8.18 HD – FDD Intra frequency case for UE Category NB1 inband mode in enhanced coverage

A.9.8.18.1 Test Purpose and Environment

The purpose of the tests is to verify that the intra frequency RSTD measurement for HD-FDD category NB1 UE meets the accuracy requirements specified in Clause 9.1.22.12. Test 1 is applicable for UE supporting NPRS Type 1 and Test 2 is applicable for UE supporting NPRS Type 2.

In the tests there are three synchronous cells: nCell 1, nCell 2, eCell1 and eCell 2. nCell 1 is the reference as well as the PCell. nCell 2, eCell1 and eCell2 are the neighbour cells.

The OTDOA assistance data and *OTDOA-RequestLocationInformation* as defined in TS 36.355, shall be provided to the UE. After the receipt of the OTDOA assistance data and *OTDOA-RequestLocationInformation* has been successfully acknowledged, the UE is provided with a RRC connection release command. The UE is expected to enter RRC_IDLE before the measurement period.

The test parameters are given in Tables A.9.8.18.1-1, A.9.8.18.1-2 and A.9.8.18.1-3.

Table A.9.8.18.1-1: General test parameters

Parameter	Unit	Value	Comment
NB-IoT operational mode		Inband	
Reference cell		nCell 1	
Neighbor cells		nCell 2, eCell 1 and eCell 2	

NPDCCH parameters		R.26 HD-FDD	As defined in section A.3.1.6.1
nprSID		Test1: (nprSID of Cell 1 – nprSID of Cell 2)mod6=1 Test2: (nprSID of Cell 1 – nprSID of Cell 2)mod6 = 0	As defined in TS36.355 [24]
NPRS Type		Test1: Type 1 Test2: Type 2	As defined in TS36.211
nprs-period	ms	1280	As defined in TS36.355 [24]
nprs-startSF		sf0	Subframe offset of the NPRS positioning occasion as defined in TS36.355 [24]
Number of consecutive downlink positioning subframes nprs-NumSF		640	As defined in TS36.355 [24]
NPRS muting info		nCell 1: '11110000' nCell 2: '11110000'	Corresponds to nprs-MutingInfoB defined in TS 36.355 [24]
PartA Configuration		as in the following 2 rows:	
subframePattern10		'0111001110'	Corresponds to subframePattern10-r14 defined in TS 36.355 [24]
nprsSequenceInfo		BW _{channel} 5MHz: 54 BW _{channel} 10MHz: 130	Corresponds to nprsSequenceInfo defined in TS 36.355 [24]
CP length		Normal	
NPRACH Configuration		NPRACH.R-1	Refer to A.3.18
DRX cycle length		1.28	The value shall be used for all cells in the test.
Expected RSTD	µs	nCell 2: 3 Other neighbour cells: randomly between -3 and 3	The expected RSTD is what is expected at the receiver. The corresponding parameter in the OTDOA assistance data specified in TS 36.355 [24] is the expectedRSTD indicator
Expected RSTD uncertainty for all neighbour cells	µs	5	The corresponding parameter in the OTDOA assistance data specified in TS 36.355 [24] is the expectedRSTD-Uncertainty index
Number of cells provided in OTDOA assistance data		16	Including the reference cell
Measurement period	s	[11.52]	Derived according to the RSTD measurement period in clause 4.8.2

Table A.9.8.18.1-2: nCell1 and nCell2 specific test parameters

Parameter	Unit	Test1		Test2	
		nCell 1	nCell 2	nCell 1	nCell 2
BW _{channel}	kHz	180	180	180	180
PRB location within eCell		eCell 1 BW _{channel} 5MHz: 17 eCell 1 BW _{channel} 10MHz: 30	eCell 2 BW _{channel} 5MHz: 17 eCell 2 BW _{channel} 10MHz: 30	eCell 1 BW _{channel} 5MHz: 17 eCell 1 BW _{channel} 10MHz: 30	eCell 2 BW _{channel} 5MHz: 17 eCell 2 BW _{channel} 10MHz: 30
NPBCH_RA	dB	0	0	0	0
NPBCH_RB					
NPSS_RA					
NSSS_RA					
NPDCCH_RA					
NPDCCH_RB					
NPDSCH_RA					
NPDSCH_RB					
OCNG_RA ^{Note 1}					
OCNG_RB ^{Note 1}					
NPRS_RA	dB	-12.7	-0.7	0	0
N _{oc} ^{Note 2}	dBm/ 15 kHz	-110	-110	-98	-98

$NPRS \hat{E}_s / N_{oc}$	dB	-14.7	-12.7	-5	-13
$NPRS \hat{E}_s / I_{ot}$ <small>Note 3</small>	dB	-14.97	-14.82	-5.21	-14.19
I_o <small>Note 3</small>	dBm/ 180kHz	-100.8	-100.8	-87.08	-87.08
$NPRP$ <small>Note 3</small>	dBm/ 15 kHz	-124.7	-122.7	-103	-111
$NRSRP$ <small>Note 3</small>	dBm/ 15 kHz	-112	-122	-103	-111
\hat{E}_s / N_{oc} <small>Note 3</small>	dB	-2	-12	-5	-13
Propagation Condition		AWGN	AWGN	AWGN	AWGN
Antenna Configuration		1x1	1x1	1x1	1x1
Timing offset to nCell 1	us	N/A	3	N/A	3
<p>Note 1: OCNG shall be used such that active cells are fully allocated and a constant total transmitted power spectral density is achieved for all OFDM symbols other than those in the subframes with transmitted NPRS.</p> <p>Note 2: Interference from other cells and noise sources not specified in the test are assumed to be constant over subcarriers and time and shall be modelled as AWGN of appropriate power for N_{oc} to be fulfilled.</p> <p>Note 3: If NPRS_RA is not "N/A", \hat{E}_s / N_{oc}, $NPRS \hat{E}_s / I_{ot}$, I_o, NRSRP and NPRP levels have been derived from other parameters and are given for information purpose. If NPRS_RA is "N/A", I_o and NRSRP levels have been derived from other parameters and are given for information purpose. These are not settable test parameters. Interference conditions shall be applied to all PRS symbols of DL positioning subframes.</p>					

Table A.9.8.18.1-3: eCell 1 and eCell 2 specific test parameters

Parameter	Unit	Test1						Test2					
		eCell 1			eCell 2			eCell 1			eCell 2		
		T1	T2	T1	T2	T1	T2	T1	T2	T1	T2		
$BW_{channel}$	MHz	5 or 10			5 or 10			5 or 10			5 or 10		
NOCNG Pattern defined in clause D.3	-	$BW_{channel}$ 5MHz: NOP.4 FDD $BW_{channel}$ 10MHz: NOP.1 FDD			$BW_{channel}$ 5MHz: NOP.4 FDD $BW_{channel}$ 10MHz: NOP.1 FDD			$BW_{channel}$ 5MHz: NOP.4 FDD $BW_{channel}$ 10MHz: NOP.1 FDD			$BW_{channel}$ 5MHz: NOP.4 FDD $BW_{channel}$ 10MHz: NOP.1 FDD		
PBCH_RA	dB	-3			-3			-3			-3		
PBCH_RB	dB												
PSS_RA	dB												
SSS_RA	dB												
PDCCH_RA	dB												
PDCCH_RB	dB												
PDSCH_RA	dB												
PDSCH_RB	dB												
OCNG_RA <small>Note 1</small>	dB												
OCNG_RB <small>Note 1</small>	dB												
N_{oc} <small>Note 2</small>	dBm/15 kHz	-110			-110			-98			-98		
\hat{E}_s / N_{oc} <small>Note 2</small>	dBm	-2	-2	-2	-12	-12	-12	-9	-9	-9	-9	-9	-9
Propagation Condition		AWGN			AWGN			AWGN			AWGN		
Antenna Configuration		1x1			1x1			1x1			1x1		
Timing offset to eCell 1	ms	-			3			-			3		
<p>Note 1: OCNG shall be used such that the Cell is fully allocated and a constant total transmitted power spectral density is achieved for all OFDM symbols.</p> <p>Note 2: Interference from other cells and noise sources not specified in the test is assumed to be constant over subcarriers and time and shall be modelled as AWGN of appropriate power N_{oc}.</p>													

A.9.8.18.2 Test Requirements

The RSTD measurement accuracy shall fulfill the requirements in clause 9.1.22.12.

A.9.8.19 HD – FDD Inter frequency case for UE Category NB1 inband mode in enhanced coverage

A.9.8.19.1 Test Purpose and Environment

The purpose of the tests is to verify that the intra frequency RSTD measurement for HD-FDD category NB1 UE meets the accuracy requirements specified in Clause 9.1.22.13. Test 1 is applicable for UE supporting NPRS Type 1 and Test 2 is applicable for UE supporting NPRS Type 2.

In the tests there are three synchronous cells: nCell 1, nCell 2, eCell1 and eCell 2. nCell 1 is the reference as well as the PCell. nCell 2, eCell1 and eCell2 are the neighbour cells.

The OTDOA assistance data and *OTDOA-RequestLocationInformation* as defined in TS 36.355, shall be provided to the UE. After the receipt of the OTDOA assistance data and *OTDOA-RequestLocationInformation* has been successfully acknowledged, the UE is provided with a RRC connection release command. The UE is expected to enter RRC_IDLE before the measurement period.

The test parameters are given in Tables A.9.8.19.1-1, A.9.8.19.1-2 and A.9.8.19.1-3.

Table A.9.8.19.1-1: General test parameters

Parameter	Unit	Value	Comment
NB-IoT operational mode		Inband	
Reference cell		nCell 1	
Neighbor cells		nCell 2, eCell 1 and eCell 2	
NPDCCH parameters		R.26 HD-FDD	As defined in section A.3.1.6.1
nprsID		Test1: (nprsID of Cell 1 – nprsID of Cell 2)mod6=1 Test2: (nprsID of Cell 1 – nprsID of Cell 2)mod6 = 0	As defined in TS36.355 [24]
NPRS Type		Test1: Type 1 Test2: Type 2	As defined in TS36.211
nprs-period	ms	1280	As defined in TS36.355 [24]
nprs-startSF		sf0	Subframe offset of the NPRS positioning occasion as defined in TS36.355 [24]
Number of consecutive downlink positioning subframes nprs-NumSF		640	As defined in TS36.355 [24]
nprs-slotNumberOffset		0	As defined in TS36.355 [24]
nprs-SubframeOffset		640	As defined in TS36.355 [24]
NPRS muting info		nCell 1: '1111111100000000' nCell 2: '1111111100000000'	Correponds to nprs-MutingInfoB defined in TS 36.355 [24]
PartA Configuration		as in the following 3 rows:	
subframePattern10		'0111001110'	Correponds to subframePattern10-r14 defined in TS 36.355 [24]
nprsSequenceInfo nCell1		BW _{channel} 5MHz: 54 BW _{channel} 10MHz: 130	Correponds to nprsSequenceInfo defined in TS 36.355 [24]
nprsSequenceInfo nCell2		BW _{channel} 5MHz: 59 BW _{channel} 10MHz: 135	Correponds to nprsSequenceInfo defined in TS 36.355 [24]
CP length		Normal	
NPRACH Configuration		NPRACH.R-1	Refer to A.3.18
DRX cycle length		1.28	The value shall be used for all cells in the test.
Expected RSTD	µs	nCell 2: 3 Other neighbour cells: randomly between -3 and 3	The expected RSTD is what is expected at the receiver. The corresponding parameter in the OTDOA assistance data specified in TS 36.355 [24] is the expectedRSTD indicator

Expected RSTD uncertainty for all neighbour cells	μs	5	The corresponding parameter in the OTDOA assistance data specified in TS 36.355 [24] is the expectedRSTD-Uncertainty index
Number of cells provided in OTDOA assistance data		16	Including the reference cell
Measurement period	s	[20..48]	Derived according to the RSTD measurement period in clause 4.8.4

Table A.9.8.19.1-2: nCell1 and nCell2 specific test parameters

Parameter	Unit	Test1		Test2	
		nCell 1	nCell 2	nCell 1	nCell 2
BW _{channel}	kHz	180	180	180	180
PRB location within eCell		eCell 1 BW _{channel} 5MHz: 17 eCell 1 BW _{channel} 10MHz: 30	eCell 2 BW _{channel} 5MHz: 22 eCell 2 BW _{channel} 10MHz: 35	eCell 1 BW _{channel} 5MHz: 17 eCell 1 BW _{channel} 10MHz: 30	eCell 2 BW _{channel} 5MHz: 22 eCell 2 BW _{channel} 10MHz: 35
NPBCH_RA	dB	0	0	0	0
NPBCH_RB					
NPSS_RA					
NSSS_RA					
NPDCCH_RA					
NPDCCH_RB					
NPDSCH_RA					
NPDSCH_RB					
OCNG_RA ^{Note 1}					
OCNG_RB ^{Note 1}					
NPRS_RA	dB	-13	-3	0	0
N_{oc} ^{Note 2}	dBm/ 15 kHz	-110	-110	-98	-98
$NPRS \hat{E}_s / N_{oc}$	dB	-15	-15	-5	-13
$NPRS \hat{E}_s / I_{ot}$ ^{Note 3}	dB	-15	-15	-5.21	-14.19
I_o ^{Note 3}	dBm/ 180 kHz	-101.20	-111.20	-87.08	-87.08
NPRP ^{Note 3}	dBm/ 15 kHz	-125	-125	-103	-111
NRSRP ^{Note 3}	dBm/ 15 kHz	-112	-122	-103	-111
\hat{E}_s / N_{oc} ^{Note 3}	dB	-2	-12	-5	-13
Propagation Condition		AWGN	AWGN	AWGN	AWGN
Antenna Configuration		1x1	1x1	1x1	1x1
Timing offset to nCell 1	us	N/A	3	N/A	3
<p>Note 1: OCNG shall be used such that active cells are fully allocated and a constant total transmitted power spectral density is achieved for all OFDM symbols other than those in the subframes with transmitted NPRS.</p> <p>Note 2: Interference from other cells and noise sources not specified in the test are assumed to be constant over subcarriers and time and shall be modelled as AWGN of appropriate power for N_{oc} to be fulfilled.</p> <p>Note 3: If NPRS_RA is not "N/A", \hat{E}_s / N_{oc}, $NPRS \hat{E}_s / I_{ot}$, I_o, NRSRP and NPRP levels have been derived from other parameters and are given for information purpose. If NPRS_RA is "N/A", I_o and NRSRP levels have been derived from other parameters and are given for information purpose. These are not settable test parameters. Interference conditions shall be applied to all PRS symbols of DL positioning subframes.</p>					

Table A.9.8.19.1-3: eCell 1 and eCell2 specific test parameters

Parameter	Unit	Test1						Test2					
		eCell 1			eCell 2			eCell 1			eCell 2		
		T1	T2	T1	T2	T1	T2	T1	T2	T1	T2	T1	T2
$BW_{channel}$	MHz	5 or 10			5 or 10			5 or 10			5 or 10		
NOCNG Pattern defined in clause D.3	-	$BW_{channel}$ 5MHz: NOP.4 FDD $BW_{channel}$ 10MHz: NOP.1 FDD			$BW_{channel}$ 5MHz: NOP.4 FDD $BW_{channel}$ 10MHz: NOP.1 FDD			$BW_{channel}$ 5MHz: NOP.4 FDD $BW_{channel}$ 10MHz: NOP.1 FDD			$BW_{channel}$ 5MHz: NOP.4 FDD $BW_{channel}$ 10MHz: NOP.1 FDD		
PBCH_RA	dB	-3			-3			-3			-3		
PBCH_RB	dB												
PSS_RA	dB												
SSS_RA	dB												
PDCCH_RA	dB												
PDCCH_RB	dB												
PDSCH_RA	dB												
PDSCH_RB	dB												
OCNG_RA ^{Note 1}	dB												
OCNG_RB ^{Note 1}	dB												
N_{oc} ^{Note2}	dBm/15 kHz	-110			-110			-98			-98		
\hat{E}_s / N_{oc} ^{Note2}	dBm	-2	-2	-2	-12	-12	-12	-9	-9	-9	-9	-9	-9
Propagation Condition		AWGN			AWGN			AWGN			AWGN		
Antenna Configuration		1x1			1x1			1x1			1x1		
Timing offset to eCell 1	ms	-			3			-			3		
Note 1: OCNG shall be used such that the Cell is fully allocated and a constant total transmitted power spectral density is achieved for all OFDM symbols. Note 2: Interference from other cells and noise sources not specified in the test is assumed to be constant over subcarriers and time and shall be modelled as AWGN of appropriate power N_{oc} .													

A.9.8.19.2 Test Requirements

The RSTD measurement accuracy shall fulfill the requirements in clause 9.1.22.13.

A.9.8.20 E-UTRAN FDD RSTD intra-frequency measurement accuracy in CE Mode A

A.9.8.20.1 Test Purpose and Environment

The purpose of the test is to verify for Cat-M1 and Cat-M2 UE in CE ModeA that the RSTD intra-frequency measurement accuracy is within the specified limits in sections 9.1.21.20 and 9.1.25.4, respectively, in AWGN channels.

In the test, there are two synchronous cells, Cell 1 as the reference cell and Cell 2 as the neighbour cell on the same frequency. Tests 1 and 2 are applicable for Cat-M1 and Cat-M2 supporting 1.4 MHz UE RF bandwidth, while Tests 3 and 4 are applicable for Cat-M2 supporting 5 MHz UE RF bandwidth.

The OTDOA assistance data as defined in TS 36.355, Clause 6.5.1, shall be provided to the UE before the measurement period. The last TTI containing the OTDOA assistance data shall be provided to the UE ΔT ms before the start of measurement period, where $\Delta T = 150$ ms is the maximum processing time of the OTDOA assistance data.

A time span of $T_{RSTD\ IntraFreqFDD, E-UTRAN}$ is provided for the measurement period, and PRS are configured according to I_{PRS} in Tables A.9.8.20.1-1 and A.9.8.20.1-2 during this time.

The test parameters are given in Table A.9.8.20.1-1 and Table A.9.8.20.1-2.

Table A.9.8.20.1-1: General Test Parameters for intra frequency RSTD Tests for E-UTRAN FDD

Parameter	Unit	Value				Comment
		Test1	Test2	Test3	Test4	
M-PDCCH parameters		R.16 FDD		R.16 FDD		As specified in clause A.3.1.3.1
<i>mPDCCH-startSF-UeSS</i>		10		10		Parameter G in $T = r_{\max} \cdot G$ which determines subframe $k0$ in which MPDCCH starts
OCNG Patterns defined in A.3.2.1		OP.21 FDD		OP.21 FDD		OCNG shall be used such that both cells are fully allocated and a constant total transmitted power spectral density is achieved for all OFDM symbols (other than those in the PRS subframes).
Reference cell		Cell 1				
Neighbour cell		Cell 2				
E-UTRA RF Channel Number		1				One FDD carrier frequency is used.
System channel Bandwidth (BW_{channel})	MHz	10		10		
PRS Bandwidth	RB	50 ^{Note 1}		50 ^{Note 1}		PRS bandwidth is as indicated in <i>prs-Bandwidth</i> in the OTDOA assistance data defined in [24].
PRS configuration Index I_{PRS}		151		151		As defined in TS 36.211
Number of consecutive positioning downlink subframes N_{PRS}		6		2		As defined in TS 36.211
prs-MutingInfo		Cell 1: '11110000' Cell 2: '11110000'				See clause 6.5.1.2 in TS 36.355 for more information
Cell ID		(Cell ID of cell 1 – Cell ID of cell 2) mod 6 = 0	(Cell ID of cell 1 – Cell ID of cell 2) mod 6 = 1	(Cell ID of cell 1 – Cell ID of cell 2) mod 6 = 0	(Cell ID of cell 1 – Cell ID of cell 2) mod 6 = 3	
expectedRSTD	μs	Cell 2: 1 Other neighbour cells: randomly between -3 and 3	Cell 2: -1 Other neighbour cells: randomly between -3 and 3	Cell 2: -1 Other neighbour cells: randomly between -3 and 3	Cell 2: 1 Other neighbour cells: randomly between -3 and 3	
expectedRSTDUncertainty for all neighbour cells	μs	5	5	5	5	
CP length		Normal				
DRX		OFF				
Radio frame receive time offset between the cells at the UE antenna connector	μs	Cell 2 to Cell 1: -3	Cell 2 to Cell 1: 3	Cell 2 to Cell 1: 3	Cell 2 to Cell 1: -3	PRS are transmitted from synchronous cells
Number of cells provided in OTDOA assistance data		16				The number of cells includes the reference cell

T_{RSTD} IntraFreqFDD, E-UTRAN	ms	5120	Derived according to the RSTD measurement requirements specified in Clause 8.13.2.3.1 (for Cat-M1) and Clause 8.16.2.3.1 (Cat-M2).
NOTE 1: If the PRS transmission bandwidth is larger than the UE RF bandwidth, the UE is measuring RSTD within its RF bandwidth.			

Table A.9.8.20.1-2: Cell Specific Test Parameters for intra frequency RSTD Tests for E-UTRAN FDD

Parameter	Unit	Test1		Test2		Test3		Test4	
		Cell1	Cell2	Cell1	Cell2	Cell1	Cell2	Cell1	Cell2
E-UTRA RF Channel Number		1							
PBCH_RA	dB	0	0	0	0	0	0	0	0
PBCH_RB									
PSS_RA									
SSS_RA									
MPDCCH_RA									
MPDCCH_RB									
OCNG_RA ^{Note1}									
OCNG_RB ^{Note1}									
PRS_RA	dB	0	0	-3	0	0	0	-3	0
N_{oc} ^{Note2}	dBm/15 kHz	-98	-98	-98	-98	-98	-98	-98	-98
PRS \hat{E}_s/N_{oc}	dB	-2.37	-8.02	-6	-13	-2.37	-8.02	-6	-13
PRS \hat{E}_s/I_{ot} ^{Note3}	dB	-3.01	-10.01	-6	-13	-3.01	-10.01	-6	-13
I_o ^{Note3}	dBm/9 MHz	-69.23	-69.23	-70	-70	-69.23	-69.23	-70	-70
PRP ^{Note3}	dBm/15kHz	-100.37	-106.02	-104	-111	-100.37	-106.02	-104	-111
\hat{E}_s/N_{oc} ^{Note 3}	dB	-2.37	-8.02	-3	-13	-2.37	-8.02	-3	-13
RSRP ^{Note 3}	dBm/15kHz	-100.37	-106.02	-101	-111	-100.37	-106.02	-101	-111
Propagation condition		AWGN							
<p>Note 1: OCNG shall be used such that both cells are fully allocated and a constant total transmitted power spectral density is achieved for all OFDM symbols (other than those in the PRS subframes).</p> <p>Note 2: Interference from other cells and noise sources not specified in the test is assumed to be constant over subcarriers and time and shall be modelled as AWGN of appropriate power for N_{oc} to be fulfilled.</p> <p>Note 3: \hat{E}_s/N_{oc}, PRS \hat{E}_s/I_{ot}, I_o, RSRP and PRP levels have been derived from other parameters for information purposes. They are not settable parameters themselves. I_o values are derived in the case that there is no PBCH, PSS or SSS in the OFDM symbols carrying PRS</p>									

A.9.8.20.2 Test Requirements

For Cat-M1 UE in CE Mode A, the RSTD measurement accuracy shall fulfill the requirements in clause 9.1.21.20.

For Cat-M2 UE in CE Mode A, the RSTD measurement accuracy shall fulfill the requirements in clause 9.1.25.4.

A.9.8.21 E-UTRAN HD-FDD RSTD intra-frequency measurement accuracy in CEModeA

A.9.8.21.1 Test Purpose and Environment

The purpose of the test is to verify for Cat-M1 and Cat-M2 UE in CEModeA that the RSTD intra-frequency measurement accuracy is within the specified limits in sections 9.1.21.20 and 9.1.25.4, respectively, in AWGN channels.

In the test, there are two synchronous cells, Cell 1 as the reference cell and Cell 2 as the neighbour cell on the same frequency. Tests 1 and 2 are applicable for Cat-M1 and Cat-M2 supporting 1.4 MHz UE RF bandwidth, while Tests 3 and 4 are applicable for Cat-M2 supporting 5 MHz UE RF bandwidth.

The OTDOA assistance data as defined in TS 36.355, Clause 6.5.1, shall be provided to the UE before the measurement period. The last TTI containing the OTDOA assistance data shall be provided to the UE ΔT ms before the start of measurement period, where $\Delta T = 150$ ms is the maximum processing time of the OTDOA assistance data.

A time span of $T_{\text{RSTDIntraFreqHD-FDD,E-UTRAN}}$ is provided for the measurement period, and PRS are configured according to I_{PRS} in Tables A.9.8.21.1-1 and A.9.8.21.1-2 during this time.

The test parameters are given in Table A.9.8.21.1-1 and Table A.9.8.21.1-2.

Table A.9.8.21.1-1: General Test Parameters for intra frequency RSTD Tests for E-UTRAN HD-FDD

Parameter	Unit	Value				Comment
		Test1	Test2	Test3	Test4	
M-PDCCH parameters		R.6 HD-FDD		R.6 HD-FDD		As specified in clause A.3.1.3.1
<i>mPDCCH-startSF-UESS</i>		10		10		Parameter <i>G</i> in $T = r_{\text{max}} \cdot G$ which determines subframe <i>k0</i> in which MPDCCH starts
OCNG Patterns defined in A.3.2.1		OP.21 FDD		OP.21 FDD		OCNG shall be used such that both cells are fully allocated and a constant total transmitted power spectral density is achieved for all OFDM symbols (other than those in the PRS subframes).
Reference cell		Cell 1				
Neighbour cell		Cell 2				
E-UTRA RF Channel Number		1				One FDD carrier frequency is used.
System Channel Bandwidth (BW_{channel})	MHz	10		10		
PRS Bandwidth	RB	50 ^{Note 1}		50 ^{Note 1}		PRS bandwidth is as indicated in <i>prs-Bandwidth</i> in the OTDOA assistance data defined in [24].
PRS configuration Index I_{PRS}		151		151		As defined in TS 36.211
Number of consecutive positioning downlink subframes N_{PRS}		6		2		As defined in TS 36.211
prs-MutingInfo		Cell 1: '11110000' Cell 2: '11110000'				See clause 6.5.1.2 in TS 36.355 for more information

Cell ID		(Cell ID of cell 1 – Cell ID of cell 2) mod 6 = 0	(Cell ID of cell 1 – Cell ID of cell 2) mod 6 = 1	(Cell ID of cell 1 – Cell ID of cell 2) mod 6 = 0	(Cell ID of cell 1 – Cell ID of cell 2) mod 6 = 3	
expectedRSTD	μs	Cell 2: 1 Other neighbour cells: randomly between -3 and 3	Cell 2: -1 Other neighbour cells: randomly between -3 and 3	Cell 2: -1 Other neighbour cells: randomly between -3 and 3	Cell 2: 1 Other neighbour cells: randomly between -3 and 3	
expectedRSTDUncertainty for all neighbour cells	μs	5	5	5	5	
CP length		Normal				
DRX		OFF				
Radio frame receive time offset between the cells at the UE antenna connector	μs	Cell 2 to Cell 1: -3	Cell 2 to Cell 1: 3	Cell 2 to Cell 1: 3	Cell 2 to Cell 1: -3	PRS are transmitted from synchronous cells
Number of cells provided in OTDOA assistance data		16				The number of cells includes the reference cell
$T_{RSTD\ IntraFreqHD-FDD, E-UTRAN}$	ms	5120				Derived according to the RSTD measurement requirements specified in Clause 8.13.2.3.3 (for Cat-M1) and Clause 8.16.2.3.3 (Cat-M2).
NOTE 1: If the PRS transmission bandwidth is larger than the UE RF bandwidth, the UE is measuring RSTD within its RF bandwidth.						

Table A.9.8.21.1-2: Cell Specific Test Parameters for intra frequency RSTD Tests for E-UTRAN HD-FDD

Parameter	Unit	Test1		Test2		Test3		Test4	
		Cell1	Cell2	Cell1	Cell2	Cell1	Cell2	Cell1	Cell2
E-UTRA RF Channel Number		1							
PBCH_RA	dB	0	0	0	0	0	0	0	0
PBCH_RB									
PSS_RA									
SSS_RA									
MPDCCH_RA									
MPDCCH_RB									
OCNG_RA ^{Note1}									
OCNG_RB ^{Note1}									
PRS_RA	dB	0	0	-3	0	0	0	-3	0
N_{oc} ^{Note2}	dBm/15 kHz	-98	-98	-98	-98	-98	-98	-98	-98
$PRS \hat{E}_s / N_{oc}$	dB	-2.37	-8.02	-6	-13	-2.37	-8.02	-6	-13
$PRS \hat{E}_s / I_{ot}$ ^{Note3}	dB	-3.01	-10.01	-6	-13	-3.01	-10.01	-6	-13
I_o ^{Note3}	dBm/9 MHz	-69.23	-69.23	-70	-70	-69.23	-69.23	-70	-70
PRP ^{Note3}	dBm/15kHz	-100.37	-106.02	-104	-111	-100.37	-106.02	-104	-111
\hat{E}_s / N_{oc} ^{Note 3}	dB	-2.37	-8.02	-3	-13	-2.37	-8.02	-3	-13
RSRP ^{Note 3}	dBm/15kHz	-100.37	-106.02	-101	-111	-100.37	-106.02	-101	-111
Propagation condition		AWGN							
Note 1: OCNG shall be used such that both cells are fully allocated and a constant total transmitted power spectral density is achieved for all OFDM symbols (other than those in the PRS subframes).									

Note 2:	Interference from other cells and noise sources not specified in the test is assumed to be constant over subcarriers and time and shall be modelled as AWGN of appropriate power for N_{oc} to be fulfilled.
Note 3:	\hat{E}_s/N_{oc} , PRS \hat{E}_s/I_{ot} , I_o , RSRP and PRP levels have been derived from other parameters for information purposes. They are not settable parameters themselves. I_o values are derived in the case that there is no PBCH, PSS or SSS in the OFDM symbols carrying PRS

A.9.8.21.2 Test Requirements

For Cat-M1 UE in CE Mode A, the RSTD measurement accuracy shall fulfill the requirements in clause 9.1.21.20.

For Cat-M2 UE in CE Mode A, the RSTD measurement accuracy shall fulfill the requirements in clause 9.1.25.4.

A.9.8.22 E-UTRAN TDD RSTD intra-frequency measurement accuracy in CE Mode A

A.9.8.22.1 Test Purpose and Environment

The purpose of the test is to verify for Cat-M1 and Cat-M2 UE in CE Mode A that the RSTD intra-frequency measurement accuracy is within the specified limits in sections 9.1.21.20 and 9.1.25.4, respectively, in AWGN channels.

In the test, there are two synchronous cells, Cell 1 as the reference cell and Cell 2 as the neighbour cell on the same frequency. Tests 1 and 2 are applicable for Cat-M1 and Cat-M2 supporting 1.4 MHz UE RF bandwidth, while Tests 3 and 4 are applicable for Cat-M2 supporting 5 MHz UE RF bandwidth.

The OTDOA assistance data as defined in TS 36.355, Clause 6.5.1, shall be provided to the UE before the measurement period. The last TTI containing the OTDOA assistance data shall be provided to the UE ΔT ms before the start of measurement period, where $\Delta T = 150$ ms is the maximum processing time of the OTDOA assistance data.

A time span of $T_{\text{RSTD IntraFreqTDD, E-UTRAN}}$ is provided for the measurement period, and PRS are configured according to I_{PRS} in Tables A.9.8.22.1-1 and A.9.8.22.1-2 during this time.

The test parameters are given in Table A.9.8.22.1-1 and Table A.9.8.22.1-2.

Table A.9.8.22.1-1: General Test Parameters for intra frequency RSTD Tests for E-UTRAN TDD

Parameter	Unit	Value				Comment
		Test1	Test2	Test3	Test4	
M-PDCCH parameters		R.14 TDD		R.14 TDD		As specified in clause A.3.1.3.1
<i>mPDCCH-startSF-UESS</i>		10		10		Parameter G in $T = r_{\max} \cdot G$ which determines subframe $k0$ in which MPDCCH starts
OCNG Patterns defined in A.3.2.1		OP.11 TDD		OP.11 TDD		OCNG shall be used such that both cells are fully allocated and a constant total transmitted power spectral density is achieved for all OFDM symbols (other than those in the PRS subframes).
Reference cell		Cell 1				
Neighbour cell		Cell 2				
E-UTRA RF Channel Number		1				One FDD carrier frequency is used.
System Channel Bandwidth (BW_{channel})	MHz	10		10		

Special subframe configuration		6				As specified in table 4.2-1 in TS 36.211. The same configuration in both cells.
Uplink-downlink configuration		1				As specified in table 4.2-2 in TS 36.211 and table 8.1.2.5.2-2. The same configuration in both cells.
PRS Bandwidth	RB	50 ^{Note 1}	50 ^{Note 1}			PRS bandwidth is as indicated in <i>prs-Bandwidth</i> in the OTDOA assistance data defined in [24].
PRS configuration Index I_{PRS}		154	154			As defined in TS 36.211
Number of consecutive positioning downlink subframes N_{PRS}		6	2			As defined in TS 36.211
prs-MutingInfo		Cell 1: '11110000' Cell 2: '11110000'				See clause 6.5.1.2 in TS 36.355 for more information
Cell ID		(Cell ID of cell 1 – Cell ID of cell 2) mod 6 = 0	(Cell ID of cell 1 – Cell ID of cell 2) mod 6 = 1	(Cell ID of cell 1 – Cell ID of cell 2) mod 6 = 0	(Cell ID of cell 1 – Cell ID of cell 2) mod 6 = 3	
expectedRSTD	μs	Cell 2: 1 Other neighbour cells: randomly between -3 and 3	Cell 2: -1 Other neighbour cells: randomly between -3 and 3	Cell 2: -1 Other neighbour cells: randomly between -3 and 3	Cell 2: 1 Other neighbour cells: randomly between -3 and 3	
expectedRSTDUncertainty for all neighbour cells	μs	5	5	5	5	
CP length		Normal				
DRX		OFF				
Radio frame receive time offset between the cells at the UE antenna connector	μs	Cell 2 to Cell 1: -3	Cell 2 to Cell 1: 3	Cell 2 to Cell 1: 3	Cell 2 to Cell 1: -3	PRS are transmitted from synchronous cells
Number of cells provided in OTDOA assistance data		16				The number of cells includes the reference cell
T_{RSTD} IntraFreqTDD, E-UTRAN	ms	5120				Derived according to the RSTD measurement requirements specified in Clause 8.13.2.3.2 (for Cat-M1) and Clause 8.16.2.3.2 (Cat-M2)
NOTE 1: If the PRS transmission bandwidth is larger than the UE RF bandwidth, the UE is measuring RSTD within its RF bandwidth.						

Table A.9.8.22.1-2: Cell Specific Test Parameters for intra frequency RSTD Tests for E-UTRAN TDD

Parameter	Unit	Test1		Test2		Test3		Test4	
		Cell1	Cell2	Cell1	Cell2	Cell1	Cell2	Cell1	Cell2
E-UTRA RF Channel Number		1							
PBCH_RA	dB	0	0	0	0	0	0	0	0
PBCH_RB									
PSS_RA									

SSS_RA									
MPDCCH_RA									
MPDCCH_RB									
OCNG_RA ^{Note1}									
OCNG_RB ^{Note1}									
PRS_RA	dB	0	0	-3	0	0	0	-3	0
N_{oc} ^{Note2}	dBm/15 kHz	-98	-98	-98	-98	-98	-98	-98	-98
PRS \hat{E}_s/N_{oc}	dB	-2.37	-8.02	-6	-13	-2.37	-8.02	-6	-13
PRS \hat{E}_s/I_{ot} ^{Note3}	dB	-3.01	-10.01	-6	-13	-3.01	-10.01	-6	-13
I_o ^{Note3}	dBm/9 MHz	-69.23	-69.23	-70	-70	-69.23	-69.23	-70	-70
PRP ^{Note3}	dBm/15kHz	-100.37	-106.02	-104	-111	-100.37	-106.02	-104	-111
\hat{E}_s/N_{oc} ^{Note 3}	dB	-2.37	-8.02	-3	-13	-2.37	-8.02	-3	-13
RSRP ^{Note 3}	dBm/15kHz	-100.37	-106.02	-101	-111	-100.37	-106.02	-101	-111
Propagation condition		AWGN							
Note 1:	OCNG shall be used such that both cells are fully allocated and a constant total transmitted power spectral density is achieved for all OFDM symbols (other than those in the PRS subframes).								
Note 2:	Interference from other cells and noise sources not specified in the test is assumed to be constant over subcarriers and time and shall be modelled as AWGN of appropriate power for N_{oc} to be fulfilled.								
Note 3:	\hat{E}_s/N_{oc} , PRS \hat{E}_s/I_{ot} , I_o , RSRP and PRP levels have been derived from other parameters for information purposes. They are not settable parameters themselves. I_o values are derived in the case that there is no PBCH, PSS or SSS in the OFDM symbols carrying PRS								

A.9.8.22.2 Test Requirements

For Cat-M1 UE in CE Mode A, the RSTD measurement accuracy shall fulfill the requirements in clause 9.1.21.20.

For Cat-M2 UE in CE Mode A, the RSTD measurement accuracy shall fulfill the requirements in clause 9.1.25.4.

A.9.8.23 E-UTRAN FDD RSTD intra-frequency measurement accuracy in CE Mode B

A.9.8.23.1 Test Purpose and Environment

The purpose of the test is to verify for Cat-M1 and Cat-M2 UE in CE Mode B that the RSTD intra-frequency measurement accuracy is within the specified limits in sections 9.1.21.21 and 9.1.25.5, respectively, in AWGN channels.

In the test, there are two synchronous cells, Cell 1 as the reference cell and Cell 2 as the neighbour cell on the same frequency. Tests 1 and 2 are applicable for Cat-M1 and Cat-M2 supporting 1.4 MHz UE RF bandwidth, while Tests 3 and 4 are applicable for Cat-M2 supporting 5 MHz UE RF bandwidth.

The OTDOA assistance data as defined in TS 36.355, Clause 6.5.1, shall be provided to the UE before the measurement period. The last TTI containing the OTDOA assistance data shall be provided to the UE ΔT ms before the start of measurement period, where $\Delta T = 150$ ms is the maximum processing time of the OTDOA assistance data.

A time span of $T_{RSTD \text{ IntraFreqFDD, E-UTRAN}}$ is provided for the measurement period, and PRS are configured according to I_{PRC} in Tables A.9.8.23.1-1 and A.9.8.23.1-2 during this time.

The test parameters are given in Table A.9.8.23.1-1 and Table A.9.8.23.1-2.

Table A.9.8.23.1-1: General Test Parameters for intra frequency RSTD Tests for E-UTRAN FDD

Parameter	Unit	Value				Comment
		Test1	Test2	Test3	Test4	
M-PDCCH parameters		R.18 FDD		R.18 FDD		As specified in clause A.3.1.3.1

<i>mPDCCH-startSF-U ESS</i>		10		10		Parameter G in $T = r_{max} \cdot G$ which determines subframe $k0$ in which MPDCCH starts
OCNG Patterns defined in A.3.2.1		OP.21 FDD		OP.21 FDD		OCNG shall be used such that both cells are fully allocated and a constant total transmitted power spectral density is achieved for all OFDM symbols (other than those in the PRS subframes).
Reference cell		Cell 1				
Neighbour cell		Cell 2				
E-UTRA RF Channel Number		1				One FDD carrier frequency is used.
System channel bandwidth ($BW_{channel}$)	MHz	10		10		
PRS Bandwidth	RB	50 ^{Note 1}		50 ^{Note 1}		PRS bandwidth is as indicated in <i>prs-Bandwidth</i> in the OTDOA assistance data defined in [24].
PRS configuration Index I_{PRS}		151		151		As defined in TS 36.211
Number of consecutive positioning downlink subframes N_{PRS}		6		4		As defined in TS 36.211
prs-MutingInfo		Cell 1: '11110000' Cell 2: '11110000'				See clause 6.5.1.2 in TS 36.355 for more information
Cell ID		(Cell ID of cell 1 – Cell ID of cell 2) mod 6 = 0	(Cell ID of cell 1 – Cell ID of cell 2) mod 6 = 1	(Cell ID of cell 1 – Cell ID of cell 2) mod 6 = 0	(Cell ID of cell 1 – Cell ID of cell 2) mod 6 = 3	
expectedRSTD	μs	Cell 2: 1 Other neighbour cells: randomly between -3 and 3	Cell 2: -1 Other neighbour cells: randomly between -3 and 3	Cell 2: -1 Other neighbour cells: randomly between -3 and 3	Cell 2: 1 Other neighbour cells: randomly between -3 and 3	
expectedRSTDUncertainty for all neighbour cells	μs	5	5	5	5	
CP length		Normal				
DRX		OFF				
Radio frame receive time offset between the cells at the UE antenna connector	μs	Cell 2 to Cell 1: -3	Cell 2 to Cell 1: 3	Cell 2 to Cell 1: 3	Cell 2 to Cell 1: -3	PRS are transmitted from synchronous cells
Number of cells provided in OTDOA assistance data		16				The number of cells includes the reference cell
T_{RSTD} IntraFreqFDD, E-UTRAN	ms	12800		5120		Derived according to the RSTD measurement requirements specified in Clause 8.13.3.3.1 (for Cat-M1) and Clause 8.16.1.1.1 (Cat-M2).

NOTE 1: If the PRS transmission bandwidth is larger than the UE RF bandwidth, the UE is measuring RSTD within its RF bandwidth.

Table A.9.8.23.1-2: Cell Specific Test Parameters for intra frequency RSTD Tests for E-UTRAN FDD

Parameter	Unit	Test1		Test2		Test3		Test4	
		Cell1	Cell2	Cell1	Cell2	Cell1	Cell2	Cell1	Cell2
E-UTRA RF Channel Number		1							
PBCH_RA									
PBCH_RB									
PSS_RA									
SSS_RA									
MPDCCH_RA									
MPDCCH_RB									
OCNG_RA ^{Note1}									
OCNG_RB ^{Note1}									
PRS_RA	dB	0	0	-3	0	0	0	-3	0
N_{oc} ^{Note 2}	dBm/15 kHz	-98	-98	-98	-98	-98	-98	-98	-98
PRS \hat{E}_s/N_{oc}	dB	-5	-13	-15	-15	-5	-13	-15	-15
PRS \hat{E}_s/I_{ot} ^{Note 3}	dB	-5.21	-14.19	-15	-15	-5.21	-14.19	-15	-15
I_o ^{Note 3}	dBm/9 MHz	-69.79	-69.79	-70.06	-70.06	-69.79	-69.79	-70.06	-70.06
PRP ^{Note 3}	dBm/15kHz	-103	-111	-113	-113	-103	-111	-113	-113
\hat{E}_s/N_{oc} ^{Note 3}	dB	-5	-13	-12	-15	-5	-13	-12	-15
RSRP ^{Note 3}	dBm/15kHz	-103	-111	-110	-113	-103	-111	-110	-113
Propagation condition		AWGN							
Note 1:	OCNG shall be used such that both cells are fully allocated and a constant total transmitted power spectral density is achieved for all OFDM symbols (other than those in the PRS subframes).								
Note 2:	Interference from other cells and noise sources not specified in the test is assumed to be constant over subcarriers and time and shall be modelled as AWGN of appropriate power for N_{oc} to be fulfilled.								
Note 3:	\hat{E}_s/N_{oc} , PRS \hat{E}_s/I_{ot} , I_o , RSRP and PRP levels have been derived from other parameters for information purposes. They are not settable parameters themselves. I_o values are derived in the case that there is no PBCH, PSS or SSS in the OFDM symbols carrying PRS								

A.9.8.23.2 Test Requirements

For Cat-M1 UE in CE Mode B, the RSTD measurement accuracy shall fulfill the requirements in clause 9.1.21.21.

For Cat-M2 UE in CE Mode B, the RSTD measurement accuracy shall fulfill the requirements in clause 9.1.25.5.

A.9.8.24 E-UTRAN HD-FDD RSTD intra-frequency measurement accuracy in CE Mode B

A.9.8.24.1 Test Purpose and Environment

The purpose of the test is to verify for Cat-M1 and Cat-M2 UE in CE Mode B that the RSTD intra-frequency measurement accuracy is within the specified limits in sections 9.1.21.21 and 9.1.25.5, respectively, in AWGN channels.

In the test, there are two synchronous cells, Cell 1 as the reference cell and Cell 2 as the neighbour cell on the same frequency. Tests 1 and 2 are applicable for Cat-M1 and Cat-M2 supporting 1.4 MHz UE RF bandwidth, while Tests 3 and 4 are applicable for Cat-M2 supporting 5 MHz UE RF bandwidth.

The OTDOA assistance data as defined in TS 36.355, Clause 6.5.1, shall be provided to the UE before the measurement period. The last TTI containing the OTDOA assistance data shall be provided to the UE ΔT ms before the start of measurement period, where $\Delta T = 150$ ms is the maximum processing time of the OTDOA assistance data.

A time span of $T_{RSTD\text{IntraFreqHD-FDD,E-UTRAN}}$ is provided for the measurement period, and PRS are configured according to I_{PRS} in Tables A.9.8.24.1-1 and A.9.8.24.1-2 during this time.

The test parameters are given in Table A.9.8.24.1-1 and Table A.9.8.24.1-2.

Table A.9.8.24.1-1: General Test Parameters for intra frequency RSTD Tests for E-UTRAN HD-FDD

Parameter	Unit	Value				Comment
		Test1	Test2	Test3	Test4	
M-PDCCH parameters		R.8 HD-FDD		R.86 HD-FDD		As specified in clause A.3.1.3.1
<i>mPDCCH-startSF-U ESS</i>		10		10		Parameter <i>G</i> in $T = r_{max} \cdot G$ which determines subframe <i>k0</i> in which MPDCCH starts
OCNG Patterns defined in A.3.2.1		OP.21 FDD		OP.21 FDD		OCNG shall be used such that both cells are fully allocated and a constant total transmitted power spectral density is achieved for all OFDM symbols (other than those in the PRS subframes).
Reference cell		Cell 1				
Neighbour cell		Cell 2				
E-UTRA RF Channel Number		1				One FDD carrier frequency is used.
System channel bandwidth ($BW_{channel}$)	MHz	10		10		
PRS Bandwidth	RB	50 ^{Note 1}		50 ^{Note 1}		PRS bandwidth is as indicated in <i>prs-Bandwidth</i> in the OTDOA assistance data defined in [24].
PRS configuration Index I_{PRS}		151		151		As defined in TS 36.211
Number of consecutive positioning downlink subframes N_{PRS}		6		4		As defined in TS 36.211
prs-MutingInfo		Cell 1: '11110000' Cell 2: '11110000'				See clause 6.5.1.2 in TS 36.355 for more information
Cell ID		(Cell ID of cell 1 – Cell ID of cell 2) mod 6 = 0	(Cell ID of cell 1 – Cell ID of cell 2) mod 6 = 1	(Cell ID of cell 1 – Cell ID of cell 2) mod 6 = 0	(Cell ID of cell 1 – Cell ID of cell 2) mod 6 = 3	
expectedRSTD	μs	Cell 2: 1 Other neighbour cells: randomly between -3 and 3	Cell 2: -1 Other neighbour cells: randomly between -3 and 3	Cell 2: -1 Other neighbour cells: randomly between -3 and 3	Cell 2: 1 Other neighbour cells: randomly between -3 and 3	
expectedRSTDUncertainty for all neighbour cells	μs	5	5	5	5	
CP length		Normal				
DRX		OFF				
Radio frame receive time offset between the cells at the UE antenna connector	μs	Cell 2 to Cell 1: -3	Cell 2 to Cell 1: 3	Cell 2 to Cell 1: 3	Cell 2 to Cell 1: -3	PRS are transmitted from synchronous cells

Number of cells provided in OTDOA assistance data		16		The number of cells includes the reference cell
$T_{RSTD, IntraFreq, HD-FDD, E-UTRAN}$	ms	12800	5120	Derived according to the RSTD measurement requirements specified in Clause 8.13.3.3.3 (for Cat-M1) and Clause 8.16.3.1.3 (Cat-M2).
NOTE 1: If the PRS transmission bandwidth is larger than the UE RF bandwidth, the UE is measuring RSTD within its RF bandwidth.				

Table A.9.8.24.1-2: Cell Specific Test Parameters for intra frequency RSTD Tests for E-UTRAN HD-FDD

Parameter	Unit	Test1		Test2		Test3		Test4	
		Cell1	Cell2	Cell1	Cell2	Cell1	Cell2	Cell1	Cell2
E-UTRA RF Channel Number		1							
PBCH_RA	dB	0	0	0	0	0	0	0	0
PBCH_RB									
PSS_RA									
SSS_RA									
MPDCCH_RA									
MPDCCH_RB									
OCNG_RA ^{Note1}									
OCNG_RB ^{Note1}									
PRS_RA	dB	0	0	-3	0	0	0	-3	0
N_{oc} ^{Note 2}	dBm/15 kHz	-98	-98	-98	-98	-98	-98	-98	-98
$PRS \hat{E}_s / N_{oc}$	dB	-5	-13	-15	-15	-5	-13	-15	-15
$PRS \hat{E}_s / I_{ot}$ ^{Note 3}	dB	-5.21	-14.19	-15	-15	-5.21	-14.19	-15	-15
I_o ^{Note 3}	dBm/9 MHz	-69.79	-69.79	-70.06	-70.06	-69.79	-69.79	-70.06	-70.06
PRP ^{Note 3}	dBm/15kHz	-103	-111	-113	-113	-103	-111	-113	-113
\hat{E}_s / N_{oc} ^{Note 3}	dB	-5	-13	-12	-15	-5	-13	-12	-15
RSRP ^{Note 3}	dBm/15kHz	-103	-111	-110	-113	-103	-111	-110	-113
Propagation condition		AWGN							
<p>Note 1: OCNG shall be used such that both cells are fully allocated and a constant total transmitted power spectral density is achieved for all OFDM symbols (other than those in the PRS subframes).</p> <p>Note 2: Interference from other cells and noise sources not specified in the test is assumed to be constant over subcarriers and time and shall be modelled as AWGN of appropriate power for N_{oc} to be fulfilled.</p> <p>Note 3: \hat{E}_s / N_{oc}, $PRS \hat{E}_s / I_{ot}$, I_o, RSRP and PRP levels have been derived from other parameters for information purposes. They are not settable parameters themselves. I_o values are derived in the case that there is no PBCH, PSS or SSS in the OFDM symbols carrying PRS</p>									

A.9.8.24.2 Test Requirements

For Cat-M1 UE in CE Mode B, the RSTD measurement accuracy shall fulfill the requirements in clause 9.1.21.21.

For Cat-M2 UE in CE Mode B, the RSTD measurement accuracy shall fulfill the requirements in clause 9.1.25.5.

A.9.8.25 E-UTRAN TDD RSTD intra-frequency measurement accuracy in CE Mode B

A.9.8.25.1 Test Purpose and Environment

The purpose of the test is to verify for Cat-M1 and Cat-M2 UE in CE Mode B that the RSTD intra-frequency measurement accuracy is within the specified limits in sections 9.1.21.21 and 9.1.25.5, respectively, in AWGN channels.

In the test, there are two synchronous cells, Cell 1 as the reference cell and Cell 2 as the neighbour cell on the same frequency. Tests 1 and 2 are applicable for Cat-M1 and Cat-M2 supporting 1.4 MHz UE RF bandwidth, while Tests 3 and 4 are applicable for Cat-M2 supporting 5 MHz UE RF bandwidth.

The OTDOA assistance data as defined in TS 36.355, Clause 6.5.1, shall be provided to the UE before the measurement period. The last TTI containing the OTDOA assistance data shall be provided to the UE ΔT ms before the start of measurement period, where $\Delta T = 150$ ms is the maximum processing time of the OTDOA assistance data.

A time span of $T_{\text{RSTD IntraFreqHD-FDD,E-UTRAN}}$ is provided for the measurement period, and PRS are configured according to I_{PRS} in Tables A.9.8.25.1-1 and A.9.8.25.1-2 during this time.

The test parameters are given in Table A.9.8.25.1-1 and Table A.9.8.25.1-2.

Table A.9.8.25.1-1: General Test Parameters for intra frequency RSTD Tests for E-UTRAN TDD

Parameter	Unit	Value				Comment
		Test1	Test2	Test3	Test4	
M-PDCCH parameters		R.16 TDD		R.16 TDD		As specified in clause A.3.1.3.1
<i>mPDCCH-startSF-UESS</i>		10		10		Parameter G in $T = r_{\text{max}} \cdot G$ which determines subframe $k0$ in which MPDCCH starts
OCNG Patterns defined in A.3.2.1		OP.11 TDD		OP.11 TDD		OCNG shall be used such that both cells are fully allocated and a constant total transmitted power spectral density is achieved for all OFDM symbols (other than those in the PRS subframes).
Reference cell		Cell 1				
Neighbour cell		Cell 2				
E-UTRA RF Channel Number		1				One FDD carrier frequency is used.
System channel bandwidth (BW_{channel})	MHz	10		10		
Special subframe configuration		6				As specified in table 4.2-1 in TS 36.211. The same configuration in both cells.
Uplink-downlink configuration		1				As specified in table 4.2-2 in TS 36.211 and table 8.1.2.5.2-2. The same configuration in both cells.
PRS Bandwidth	RB	50 ^{Note 1}		50 ^{Note 1}		PRS bandwidth is as indicated in <i>prs-Bandwidth</i> in the OTDOA assistance data defined in [24].

PRS configuration Index I_{PRS}		154		154		As defined in TS 36.211
Number of consecutive positioning downlink subframes N_{PRS}		6		4		As defined in TS 36.211
prs-MutingInfo		Cell 1: '11110000' Cell 2: '11110000'				See clause 6.5.1.2 in TS 36.355 for more information
Cell ID		(Cell ID of cell 1 – Cell ID of cell 2) mod 6 = 0	(Cell ID of cell 1 – Cell ID of cell 2) mod 6 = 1	(Cell ID of cell 1 – Cell ID of cell 2) mod 6 = 0	(Cell ID of cell 1 – Cell ID of cell 2) mod 6 = 3	
expectedRSTD	μ s	Cell 2: 1 Other neighbour cells: randomly between -3 and 3	Cell 2: -1 Other neighbour cells: randomly between -3 and 3	Cell 2: -1 Other neighbour cells: randomly between -3 and 3	Cell 2: 1 Other neighbour cells: randomly between -3 and 3	
expectedRSTDUncertainty for all neighbour cells	μ s	5	5	5	5	
CP length		Normal				
DRX		OFF				
Radio frame receive time offset between the cells at the UE antenna connector	μ s	Cell 2 to Cell 1: -3	Cell 2 to Cell 1: 3	Cell 2 to Cell 1: 3	Cell 2 to Cell 1: -3	PRS are transmitted from synchronous cells
Number of cells provided in OTDOA assistance data		16				The number of cells includes the reference cell
T_{RSTD} IntraFreqTDD, E-UTRAN	Ms	12800		5120		Derived according to the RSTD measurement requirements specified in Clause 8.13.3.3.2 (for Cat-M1) and Clause 8.16.3.1.2 (Cat-M2).
NOTE 1: If the PRS transmission bandwidth is larger than the UE RF bandwidth, the UE is measuring RSTD within its RF bandwidth.						

Table A.9.8.25.1-2: Cell Specific Test Parameters for intra frequency RSTD Tests for E-UTRAN TDD

Parameter	Unit	Test1		Test2		Test3		Test4	
		Cell1	Cell2	Cell1	Cell2	Cell1	Cell2	Cell1	Cell2
E-UTRA RF Channel Number		1							
PBCH_RA	dB	0	0	0	0	0	0	0	0
PBCH_RB									
PSS_RA									
SSS_RA									
MPDCCH_RA									
MPDCCH_RB									
OCNG_RA ^{Note1}									
OCNG_RB ^{Note1}									
PRS_RA	dB	0	0	-3	0	0	0	-3	0
N_{oc} ^{Note 2}	dBm/15 kHz	-98	-98	-98	-98	-98	-98	-98	-98
PRS \hat{E}_s/N_{oc}	dB	-5	-13	-15	-15	-5	-13	-15	-15
PRS \hat{E}_s/I_{ot} ^{Note 3}	dB	-5.21	-14.19	-15	-15	-5.21	-14.19	-15	-15
I_o ^{Note 3}	dBm/9 MHz	-69.79	-69.79	-70.06	-70.06	-69.79	-69.79	-70.06	-70.06
PRP ^{Note 3}	dBm/15kHz	-103	-111	-113	-113	-103	-111	-113	-113

\hat{E}_s/N_{oc} Note 3	dB	-5	-13	-12	-15	-5	-13	-12	-15
RSRP Note 3	dBm/15kHz	-103	-111	-110	-113	-103	-111	-110	-113
Propagation condition	AWGN								
Note 1:	OCNG shall be used such that both cells are fully allocated and a constant total transmitted power spectral density is achieved for all OFDM symbols (other than those in the PRS subframes).								
Note 2:	Interference from other cells and noise sources not specified in the test is assumed to be constant over subcarriers and time and shall be modelled as AWGN of appropriate power for N_{oc} to be fulfilled.								
Note 3:	\hat{E}_s/N_{oc} , PRS \hat{E}_s/I_{ot} , I_0 , RSRP and PRP levels have been derived from other parameters for information purposes. They are not settable parameters themselves. I_0 values are derived in the case that there is no PBCH, PSS or SSS in the OFDM symbols carrying PRS								

A.9.8.25.2 Test Requirements

For Cat-M1 UE in CE Mode B, the RSTD measurement accuracy shall fulfill the requirements in clause 9.1.21.21.

For Cat-M2 UE in CE Mode B, the RSTD measurement accuracy shall fulfill the requirements in clause 9.1.25.5.

A.9.8.26 E-UTRAN FDD-FDD RSTD inter-frequency measurement accuracy in CE Mode A

A.9.8.26.1 Test Purpose and Environment

The purpose of the test is to verify for Cat-M1 and Cat-M2 UE in CE ModeA that the RSTD inter-frequency measurement accuracy is within the specified limits in sections 9.1.21.17 and 9.1.25.1, respectively, in AWGN channels.

In the test, there are two synchronous cells, Cell 1 as the reference cell and Cell 2 as the neighbour cell. Cell 1 is on FDD RF channel 1 and Cell 2 is on FDD RF channel 2.

The UE requires measurement gaps to perform inter-frequency measurements. Gap pattern configuration # 0 as defined in Table 8.1.2.1-1 is provided and configured not to overlap with PRS subframes of Cell 1. Test 1 is applicable for Cat-M1 and Cat-M2 supporting 1.4 MHz UE RF bandwidth, while Test 2 is applicable for Cat-M2 supporting 5 MHz UE RF bandwidth.

The OTDOA assistance data as defined in TS 36.355, Clause 6.5.1, shall be provided to the UE before the measurement period. The last TTI containing the OTDOA assistance data shall be provided to the UE ΔT ms before the start of measurement period, where $\Delta T = 150$ ms is the maximum processing time of the OTDOA assistance data. The measurement gap configuration is known and configured in the UE before the measurements start.

There is no PDSCH allocated in the subframe transmitting PRS. A time span of $T_{RSTD\ InterFreqFDD-FDD, E-UTRAN}$ is provided for the measurement period, and PRS are configured according to I_{PRC} in Tables A.9.8.26.1-1 and A.9.8.26.1-2 during this time.

The test parameters are given in Table A.9.8.26.1-1 and Table A.9.8.26.1-2.

Table A.9.8.26.1-1: General Test Parameters for E-UTRAN FDD-FDD inter-frequency RSTD Tests

Parameter	Unit	Value		Comment
		Test1	Test2	
MPDCCH parameters		R.16 FDD	R.16 FDD	As specified in clause A.3.1.3.1
<i>mPDCCH-startSF-U ESS</i>		10	10	Parameter G in $T = r_{max} \cdot G$ which determines subframe $k0$ in which MPDCCH starts in the serving cell
Reference cell		Cell 1		
Neighbour cell		Cell 2		
E-UTRA RF Channel Number		Cell 1: 1 Cell 2: 2		The two cells are on different frequencies.

System Channel Bandwidth (BW _{channel})	MHz	10	10	
PRS Bandwidth	RB	50 ^{Note 1}	50 ^{Note 1}	PRS bandwidth is as indicated in <i>prs-Bandwidth</i> in the OTDOA assistance data defined in [24].
Number of consecutive positioning downlink subframes N_{PRS}		4	2	As defined in TS 36.211
prs-MutingInfo		Cell 1: '11110000' Cell 2: '11110000'		See clause 6.5.1.2 in TS 36.355 for more information
Cell ID		(Cell ID of cell 1 – Cell ID of cell 2) mod 6 = 0	(Cell ID of cell 1 – Cell ID of cell 2) mod 6 = 0	
prs-SubframeOffset		10	10	Number of subframes rounded to the closest integer. The corresponding parameter in the OTDOA assistance data is prs-SubframeOffset specified in TS 36.355 [24]
slotNumberOffset		0	0	The slot number offset at the transmitter between a neighbour cell and the assistance data reference cell specified in TS 36.355 [24]
expectedRSTD	μs	Cell 2: 1 Other neighbour cells: randomly between -3 and 3	Cell 2: -1 Other neighbour cells: randomly between -3 and 3	
expectedRSTDUncertainty for all neighbour cells	μs	5	5	
CP length		Normal		
DRX		OFF		
Radio frame receive time offset between the cells at the UE antenna connector	μs	Cell 2 to Cell 1: -3	Cell 2 to Cell 1: 3	PRS are transmitted from synchronous cells
Number of cells provided in OTDOA assistance data		16		The number of cells includes the reference cell
T_{RSTD} InterFreqFDD-FDD, E-UTRAN	ms	15360	10240	Derived according to the RSTD measurement requirements specified in Clause 8.13.2.4.1 (for Cat-M1) and Clause 8.16.2.4.1 (Cat-M2).
NOTE 1: If the PRS transmission bandwidth is larger than the UE RF bandwidth, the UE is measuring RSTD within its RF bandwidth.				

Table A.9.8.26.1-2: Cell Specific Test Parameters for E-UTRAN FDD-FDD inter-frequency RSTD Tests

Parameter	Unit	Test1		Test2	
		Cell1	Cell2	Cell1	Cell2
E-UTRA RF Channel Number		1	2	1	2
Gap offset		9	N/A	9	N/A
Gap pattern		#0	N/A	#0	N/A
OCNG Patterns defined in A.3.2.1		OP.21 FDD	OP.6 FDD	OP.21 FDD	OP.6 FDD
PRS configuration Index I_{PRS} as defined in TS 36.211		142	152	142	152
PBCH_RA	dB	0	0	0	0
PBCH_RB					
PSS_RA					
SSS_RA					
MPDCCH_RA					
MPDCCH_RB					
OCNG_RA ^{Note1}					

OCNG_RB ^{Note1}					
PRS_RA	dB	0	0	0	0
N_{oc} ^{Note2}	dBm/15 kHz	-98	-98	-98	-98
PRS \hat{E}_s/N_{oc}	dB	-1	-11	-1	-11
PRS \hat{E}_s/I_{ot} ^{Note3}	dB	-1	-11	-1	-11
I_o ^{Note3}	dBm/9 MHz	-69.68	-70.16	-69.68	-70.16
PRP ^{Note3}	dBm/15kHz	-99	-109	-99	-109
\hat{E}_s/N_{oc} ^{Note 3}	dB	-1	-11	-1	-11
RSRP ^{Note 3}	dBm/15kHz	-99	-109	-99	-109
Propagation condition		AWGN			
<p>Note 1: OCNG shall be used such that both cells are fully allocated and a constant total transmitted power spectral density is achieved for all OFDM symbols (other than those in the PRS subframes).</p> <p>Note 2: Interference from other cells and noise sources not specified in the test is assumed to be constant over subcarriers and time and shall be modelled as AWGN of appropriate power for N_{oc} to be fulfilled.</p> <p>Note 3: \hat{E}_s/N_{oc}, PRS \hat{E}_s/I_{ot}, I_o, RSRP and PRP levels have been derived from other parameters for information purposes. They are not settable parameters themselves. I_o values are derived in the case that there is no PBCH, PSS or SSS in the OFDM symbols carrying PRS</p>					

A.9.8.26.2 Test Requirements

For Cat-M1 UE in CE Mode A, the RSTD measurement accuracy shall fulfill the requirements in clause 9.1.21.17.

For Cat-M2 UE in CE Mode A, the RSTD measurement accuracy shall fulfill the requirements in clause 9.1.25.1.

A.9.8.27 E-UTRAN HD-FDD RSTD inter-frequency measurement accuracy in CE Mode A

A.9.8.27.1 Test Purpose and Environment

The purpose of the test is to verify for Cat-M1 and Cat-M2 UE in CE ModeA that the RSTD inter-frequency measurement accuracy is within the specified limits in sections 9.1.21.17 and 9.1.25.1, respectively, in AWGN channels.

In the test, there are two synchronous cells, Cell 1 as the reference cell and Cell 2 as the neighbour cell. Cell 1 is on FDD RF channel 1 and Cell 2 is on FDD RF channel 2.

The UE requires measurement gaps to perform inter-frequency measurements. Gap pattern configuration # 0 as defined in Table 8.1.2.1-1 is provided and configured not to overlap with PRS subframes of Cell 1. Test 1 is applicable for Cat-M1 and Cat-M2 supporting 1.4 MHz UE RF bandwidth, while Test 2 is applicable for Cat-M2 supporting 5 MHz UE RF bandwidth.

The OTDOA assistance data as defined in TS 36.355, Clause 6.5.1, shall be provided to the UE before the measurement period. The last TTI containing the OTDOA assistance data shall be provided to the UE ΔT ms before the start of measurement period, where $\Delta T = 150$ ms is the maximum processing time of the OTDOA assistance data. The measurement gap configuration is known and configured in the UE before the measurements start.

There is no PDSCH allocated in the subframe transmitting PRS. A time span of $T_{\text{RSTDInterFreqHD-FDD,E-UTRAN}}$ is provided for the measurement period, and PRS are configured according to I_{PRC} in Tables A.9.8.27.1-1 and A.9.8.27.1-2 during this time.

The test parameters are given in Table A.9.8.27.1-1 and Table A.9.8.27.1-2.

Table A.9.8.27.1-1: General Test Parameters for E-UTRAN HD-FDD inter-frequency RSTD Tests

Parameter	Unit	Value		Comment
		Test1	Test2	
MPDCCH parameters		R.6 HD-FDD	R.6 HD-FDD	As specified in clause A.3.1.3.1

<i>mPDCCH-startSF-U ESS</i>		10	10	Parameter G in $T = r_{\max} \cdot G$ which determines subframe kO in which MPDCCH starts in the serving cell
Reference cell		Cell 1		
Neighbour cell		Cell 2		
E-UTRA RF Channel Number		Cell 1: 1 Cell 2: 2		The two cells are on different frequencies.
System Channel Bandwidth (BW_{channel})	MHz	10	10	
PRS Bandwidth	RB	50 ^{Note 1}	50 ^{Note 1}	PRS bandwidth is as indicated in <i>prs-Bandwidth</i> in the OTDOA assistance data defined in [24].
Number of consecutive positioning downlink subframes N_{PRS}		4	2	As defined in TS 36.211
prs-MutingInfo		Cell 1: '11110000' Cell 2: '11110000'		See clause 6.5.1.2 in TS 36.355 for more information
Cell ID		(Cell ID of cell 1 – Cell ID of cell 2) mod 6 = 0	(Cell ID of cell 1 – Cell ID of cell 2) mod 6 = 0	
prs-SubframeOffset		10	10	Number of subframes rounded to the closest integer. The corresponding parameter in the OTDOA assistance data is prs-SubframeOffset specified in TS 36.355 [24]
slotNumberOffset		0	0	The slot number offset at the transmitter between a neighbour cell and the assistance data reference cell specified in TS 36.355 [24]
expectedRSTD	μs	Cell 2: 1 Other neighbour cells: randomly between -3 and 3	Cell 2: -1 Other neighbour cells: randomly between -3 and 3	
expectedRSTDUncertainty for all neighbour cells	μs	5	5	
CP length		Normal		
DRX		OFF		
Radio frame receive time offset between the cells at the UE antenna connector	μs	Cell 2 to Cell 1: -3	Cell 2 to Cell 1: 3	PRS are transmitted from synchronous cells
Number of cells provided in OTDOA assistance data		16		The number of cells includes the reference cell
$T_{\text{RSTD InterFreqHD-FDD, E-UTRAN}}$	ms	15360	10240	Derived according to the RSTD measurement requirements specified in Clause 8.13.2.4.1 (for Cat-M1) and Clause 8.16.2.4.1 (Cat-M2).
NOTE 1: If the PRS transmission bandwidth is larger than the UE RF bandwidth, the UE is measuring RSTD within its RF bandwidth.				

Table A.9.8.27.1-2: Cell Specific Test Parameters for E-UTRAN HD-FDD inter-frequency RSTD Tests

Parameter	Unit	Test1		Test2	
		Cell1	Cell2	Cell1	Cell2
E-UTRA RF Channel Number		1	2	1	2
Gap offset		9	N/A	9	N/A
Gap pattern		#0	N/A	#0	N/A
OCNG Patterns defined in A.3.2.1		OP.21 FDD	OP.6 FDD	OP.21 FDD	OP.6 FDD
PRS configuration Index I_{PRS} as defined in TS 36.211		142	152	142	152
PBCH_RA	dB	0	0	0	0
PBCH_RB					

PSS_RA					
SSS_RA					
MPDCCH_RA					
MPDCCH_RB					
OCNG_RA ^{Note1}					
OCNG_RB ^{Note1}					
PRS_RA	dB	0	0	0	0
N_{oc} ^{Note2}	dBm/15 kHz	-98	-98	-98	-98
PRS \hat{E}_s/N_{oc}	dB	-1	-11	-1	-11
PRS \hat{E}_s/I_{ot} ^{Note3}	dB	-1	-11	-1	-11
I_o ^{Note3}	dBm/9 MHz	-69.68	-70.16	-69.68	-70.16
PRP ^{Note3}	dBm/15kHz	-99	-109	-99	-109
\hat{E}_s/N_{oc} ^{Note 3}	dB	-1	-11	-1	-11
RSRP ^{Note 3}	dBm/15kHz	-99	-109	-99	-109
Propagation condition		AWGN			
Note 1:	OCNG shall be used such that both cells are fully allocated and a constant total transmitted power spectral density is achieved for all OFDM symbols (other than those in the PRS subframes).				
Note 2:	Interference from other cells and noise sources not specified in the test is assumed to be constant over subcarriers and time and shall be modelled as AWGN of appropriate power for N_{oc} to be fulfilled.				
Note 3:	\hat{E}_s/N_{oc} , PRS \hat{E}_s/I_{ot} , I_o , RSRP and PRP levels have been derived from other parameters for information purposes. They are not settable parameters themselves. I_o values are derived in the case that there is no PBCH, PSS or SSS in the OFDM symbols carrying PRS				

A.9.8.27.2 Test Requirements

For Cat-M1 UE in CE Mode A, the RSTD measurement accuracy shall fulfill the requirements in clause 9.1.21.17.

For Cat-M2 UE in CE Mode A, the RSTD measurement accuracy shall fulfill the requirements in clause 9.1.25.1.

A.9.8.28 E-UTRAN TDD RSTD inter-frequency measurement accuracy in CE Mode A

A.9.8.28.1 Test Purpose and Environment

The purpose of the test is to verify for Cat-M1 and Cat-M2 UE in CE ModeA that the RSTD inter-frequency measurement accuracy is within the specified limits in sections 9.1.21.17 and 9.1.25.1, respectively, in AWGN channels.

In the test, there are two synchronous cells, Cell 1 as the reference cell and Cell 2 as the neighbour cell. Cell 1 is on TDD RF channel 1 and Cell 2 is on TDD RF channel 2.

The UE requires measurement gaps to perform inter-frequency measurements. Gap pattern configuration # 0 as defined in Table 8.1.2.1-1 is provided and configured not to overlap with PRS subframes of Cell 1. Test 1 is applicable for Cat-M1 and Cat-M2 supporting 1.4 MHz UE RF bandwidth, while Test 2 is applicable for Cat-M2 supporting 5 MHz UE RF bandwidth.

The OTDOA assistance data as defined in TS 36.355, Clause 6.5.1, shall be provided to the UE before the measurement period. The last TTI containing the OTDOA assistance data shall be provided to the UE ΔT ms before the start of measurement period, where $\Delta T = 150$ ms is the maximum processing time of the OTDOA assistance data. The measurement gap configuration is known and configured in the UE before the measurements start.

There is no PDSCH allocated in the subframe transmitting PRS. A time span of $T_{\text{RSTDInterFreqDD,E-UTRAN}}$ is provided for the measurement period, and PRS are configured according to I_{PRC} in Tables A.9.8.28.1-1 and A.9.8.28.1-2 during this time.

The test parameters are given in Table A.9.8.28.1-1 and Table A.9.8.28.1-2.

Table A.9.8.28.1-1: General Test Parameters for E-UTRAN TDD inter-frequency RSTD Tests

Parameter	Unit	Value		Comment
		Test1	Test2	
MPDCCH parameters		R.14 TDD	R.14 TDD	As specified in clause A.3.1.3.1
$mPDCCH\text{-startSF}\text{-UESS}$		10	10	Parameter G in $T = r_{\max} \cdot G$ which determines subframe $k0$ in which MPDCCH starts in the serving cell
Reference cell		Cell 1		
Neighbour cell		Cell 2		
E-UTRA RF Channel Number		Cell 1: 1 Cell 2: 2		The two cells are on different frequencies.
System Channel Bandwidth (BW_{channel})	MHz	10	10	
PRS Bandwidth	RB	50 ^{Note 1}	50 ^{Note 1}	PRS bandwidth is as indicated in <i>prs-Bandwidth</i> in the OTDOA assistance data defined in [24].
Number of consecutive positioning downlink subframes N_{PRS}		4	2	As defined in TS 36.211
prs-MutingInfo		Cell 1: '11110000' Cell 2: '11110000'		See clause 6.5.1.2 in TS 36.355 for more information
Cell ID		(Cell ID of cell 1 – Cell ID of cell 2) mod 6 = 0	(Cell ID of cell 1 – Cell ID of cell 2) mod 6 = 0	
prs-SubframeOffset		10	10	Number of subframes rounded to the closest integer. The corresponding parameter in the OTDOA assistance data is prs-SubframeOffset specified in TS 36.355 [24]
slotNumberOffset		0	0	The slot number offset at the transmitter between a neighbour cell and the assistance data reference cell specified in TS 36.355 [24]
expectedRSTD	μs	Cell 2: 1 Other neighbour cells: randomly between -3 and 3	Cell 2: -1 Other neighbour cells: randomly between -3 and 3	
expectedRSTDUncertainty for all neighbour cells	μs	5	5	
TDD uplink-downlink configuration		1		As specified in TS 36.211 [16], Clause 4.2; corresponds to a configuration with 5 ms switch-point periodicity and two downlink consecutive subframes
TDD special subframe configuration		6		As specified in TS 36.211 [16], Clause 4.2; corresponds to DwPTS of $19760 \cdot T_s$ and UpPTS of $4384 \cdot T_s$
CP length		Normal		
DRX		OFF		
Radio frame receive time offset between the cells at the UE antenna connector	μs	Cell 2 to Cell 1: -3	Cell 2 to Cell 1: 3	PRS are transmitted from synchronous cells
Number of cells provided in OTDOA assistance data		16		The number of cells includes the reference cell
$T_{\text{RSTD}}^{\text{InterFreqTDD, E-UTRAN}}$	ms	15360	10240	Derived according to the RSTD measurement requirements specified in Clause 8.13.2.4.2 (for Cat-M1) and Clause 8.16.2.4.2 (Cat-M2).
NOTE 1: If the PRS transmission bandwidth is larger than the UE RF bandwidth, the UE is measuring RSTD within its RF bandwidth.				

Table A.9.8.28.1-2: Cell Specific Test Parameters for E-UTRAN TDD inter-frequency RSTD Tests

Parameter	Unit	Test1		Test2	
		Cell1	Cell2	Cell1	Cell2
E-UTRA RF Channel Number		1	2	1	2
Gap offset		9	N/A	9	N/A
Gap pattern		#0	N/A	#0	N/A
OCNG Patterns defined in A.3.2.1		OP.11 TDD	OP.2 TDD	OP.11 TDD	OP.2 TDD
PRS configuration Index I_{PRS} as defined in TS 36.211		140	150	140	150
PBCH_RA	dB	0	0	0	0
PBCH_RB					
PSS_RA					
SSS_RA					
MPDCCH_RA					
MPDCCH_RB					
OCNG_RA ^{Note1}					
OCNG_RB ^{Note1}					
PRS_RA					
N_{oc} ^{Note2}	dBm/15 kHz	-98	-98	-98	-98
PRS \hat{E}_s/N_{oc}	dB	-1	-11	-1	-11
PRS \hat{E}_s/I_{ot} ^{Note3}	dB	-1	-11	-1	-11
I_o ^{Note3}	dBm/9 MHz	-69.68	-70.16	-69.68	-70.16
PRP ^{Note3}	dBm/15kHz	-99	-109	-99	-109
\hat{E}_s/N_{oc} ^{Note 3}	dB	-1	-11	-1	-11
RSRP ^{Note 3}	dBm/15kHz	-99	-109	-99	-109
Propagation condition		AWGN			
Note 1:	OCNG shall be used such that both cells are fully allocated and a constant total transmitted power spectral density is achieved for all OFDM symbols (other than those in the PRS subframes).				
Note 2:	Interference from other cells and noise sources not specified in the test is assumed to be constant over subcarriers and time and shall be modelled as AWGN of appropriate power for N_{oc} to be fulfilled.				
Note 3:	\hat{E}_s/N_{oc} , PRS \hat{E}_s/I_{ot} , I_o , RSRP and PRP levels have been derived from other parameters for information purposes. They are not settable parameters themselves. I_o values are derived in the case that there is no PBCH, PSS or SSS in the OFDM symbols carrying PRS				

A.9.8.28.2 Test Requirements

For Cat-M1 UE in CE Mode A, the RSTD measurement accuracy shall fulfill the requirements in clause 9.1.21.17.

For Cat-M2 UE in CE Mode A, the RSTD measurement accuracy shall fulfill the requirements in clause 9.1.25.1.

A.9.8.29 E-UTRAN FDD-FDD RSTD inter-frequency measurement accuracy in CE Mode B

A.9.8.29.1 Test Purpose and Environment

The purpose of the test is to verify for Cat-M1 and Cat-M2 UE in CE Mode B that the RSTD inter-frequency measurement accuracy is within the specified limits in sections 9.1.21.18 and 9.1.25.2, respectively, in AWGN channels.

In the test, there are two synchronous cells, Cell 1 as the reference cell and Cell 2 as the neighbour cell. Cell 1 is on FDD RF channel 1 and Cell 2 is on FDD RF channel 2.

The UE requires measurement gaps to perform inter-frequency measurements. Gap pattern configuration # 0 as defined in Table 8.1.2.1-1 is provided and configured not to overlap with PRS subframes of Cell 1. Test 1 is applicable for Cat-M1 and Cat-M2 supporting 1.4 MHz UE RF bandwidth, while Test 2 is applicable for Cat-M2 supporting 5 MHz UE RF bandwidth.

The OTDOA assistance data as defined in TS 36.355, Clause 6.5.1, shall be provided to the UE before the measurement period. The last TTI containing the OTDOA assistance data shall be provided to the UE ΔT ms before the start of measurement period, where $\Delta T = 150$ ms is the maximum processing time of the OTDOA assistance data. The measurement gap configuration is known and configured in the UE before the measurements start.

There is no PDSCH allocated in the subframe transmitting PRS. A time span of $T_{\text{RSTD, InterFreqFDD, E-UTRAN}}$ is provided for the measurement period, and PRS are configured according to I_{PRs} in Tables A.9.8.29.1-1 and A.9.8.29.1-2 during this time.

The test parameters are given in Table A.9.8.29.1-1 and Table A.9.8.29.1-2.

Table A.9.8.29.1-1: General Test Parameters for E-UTRAN FDD-FDD inter-frequency RSTD Tests

Parameter	Unit	Value		Comment
		Test1	Test2	
MPDCCH parameters		R.18 FDD	R.18 FDD	As specified in clause A.3.1.3.1
<i>mPDCCH-startSF-UESS</i>		10	10	Parameter G in $T = r_{\text{max}} \cdot G$ which determines subframe $k0$ in which MPDCCH starts in the serving cell.
Reference cell		Cell 1		
Neighbour cell		Cell 2		
E-UTRA RF Channel Number		Cell 1: 1 Cell 2: 2		The two cells are on different frequencies.
System Channel Bandwidth (BW_{channel})	MHz	10	10	
PRS Bandwidth	RB	50 ^{Note 1}	50 ^{Note 1}	PRS bandwidth is as indicated in <i>prs-Bandwidth</i> in the OTDOA assistance data defined in [24].
Number of consecutive positioning downlink subframes N_{PRS}		4	4	As defined in TS 36.211
prs-MutingInfo		Cell 1: '11110000' Cell 2: '11110000'		See clause 6.5.1.2 in TS 36.355 for more information
Cell ID		(Cell ID of cell 1 – Cell ID of cell 2) mod 6 = 0	(Cell ID of cell 1 – Cell ID of cell 2) mod 6 = 0	
prs-SubframeOffset		10	10	Number of subframes rounded to the closest integer. The corresponding parameter in the OTDOA assistance data is <i>prs-SubframeOffset</i> specified in TS 36.355 [24]

slotNumberOffset		0	0	The slot number offset at the transmitter between a neighbour cell and the assistance data reference cell specified in TS 36.355 [24]
expectedRSTD	μs	Cell 2: 1 Other neighbour cells: randomly between -3 and 3	Cell 2: -1 Other neighbour cells: randomly between -3 and 3	
expectedRSTDUncertainty for all neighbour cells	μs	5	5	
CP length		Normal		
DRX		OFF		
Radio frame receive time offset between the cells at the UE antenna connector	μs	Cell 2 to Cell 1: -3	Cell 2 to Cell 1: 3	PRS are transmitted from synchronous cells
Number of cells provided in OTDOA assistance data		16		The number of cells includes the reference cell
$T_{RSTD}^{InterFreqFDD, E-UTRAN}$	ms	40.96	10.24	Derived according to the RSTD measurement requirements specified in Clause 8.13.3.7.1 (for Cat-M1) and Clause 8.16.3.2.1 (Cat-M2).
NOTE 1: If the PRS transmission bandwidth is larger than the UE RF bandwidth, the UE is measuring RSTD within its RF bandwidth.				

Table A.9.8.29.1-2: Cell Specific Test Parameters for E-UTRAN FDD-FDD inter-frequency RSTD Tests

Parameter	Unit	Test1		Test2	
		Cell1	Cell2	Cell1	Cell2
E-UTRA RF Channel Number		1	2	1	2
Gap offset		9	N/A	9	N/A
Gap pattern		#0	N/A	#0	N/A
OCNG Patterns defined in A.3.2.1		OP.21 FDD	OP.6 FDD	OP.21 FDD	OP.6 FDD
PRS configuration Index I_{PRS} as defined in TS 36.211		142	152	142	152
PBCH_RA	dB	0	0	0	0
PBCH_RB					
PSS_RA					
SSS_RA					
MPDCCH_RA					
MPDCCH_RB					
OCNG_RA ^{Note1}					
OCNG_RB ^{Note1}					
PRS_RA	dB	0	0	0	0
N_{oc} ^{Note2}	dBm/15 kHz	-98	-98	-98	-98
PRS \hat{E}_s/N_{oc}	dB	-11	-14	-11	-14
PRS \hat{E}_s/I_{at} ^{Note3}	dB	-11	-14	-11	-14
I_o ^{Note3}	dBm/9 MHz	-70.16	-70.19	-70.16	-70.19
PRP ^{Note3}	dBm/15kHz	-109	-112	-109	-112

\hat{E}_s/N_{oc} ^{Note 3}	dB	-11	-14	-11	-14
RSRP ^{Note 3}	dBm/15kHz	-109	-112	-109	-112
Propagation condition	AWGN				
Note 1:	OCNG shall be used such that both cells are fully allocated and a constant total transmitted power spectral density is achieved for all OFDM symbols (other than those in the PRS subframes).				
Note 2:	Interference from other cells and noise sources not specified in the test is assumed to be constant over subcarriers and time and shall be modelled as AWGN of appropriate power for N_{oc} to be fulfilled.				
Note 3:	\hat{E}_s/N_{oc} , PRS \hat{E}_s/I_{ot} , I_o , RSRP and PRP levels have been derived from other parameters for information purposes. They are not settable parameters themselves. I_o values are derived in the case that there is no PBCH, PSS or SSS in the OFDM symbols carrying PRS				

A.9.8.29.2 Test Requirements

For Cat-M1 UE in CE Mode B, the RSTD measurement accuracy shall fulfill the requirements in clause 9.1.21.18.

For Cat-M2 UE in CE Mode B, the RSTD measurement accuracy shall fulfill the requirements in clause 9.1.25.2.

A.9.8.30 E-UTRAN HD-FDD RSTD inter-frequency measurement accuracy in CE Mode B

A.9.8.30.1 Test Purpose and Environment

The purpose of the test is to verify for Cat-M1 and Cat-M2 UE in CE Mode B that the RSTD inter-frequency measurement accuracy is within the specified limits in sections 9.1.21.18 and 9.1.25.2, respectively, in AWGN channels.

In the test, there are two synchronous cells, Cell 1 as the reference cell and Cell 2 as the neighbour cell. Cell 1 is on FDD RF channel 1 and Cell 2 is on FDD RF channel 2.

The UE requires measurement gaps to perform inter-frequency measurements. Gap pattern configuration # 0 as defined in Table 8.1.2.1-1 is provided and configured not to overlap with PRS subframes of Cell 1. Test 1 is applicable for Cat-M1 and Cat-M2 supporting 1.4 MHz UE RF bandwidth, while Test 2 is applicable for Cat-M2 supporting 5 MHz UE RF bandwidth.

The OTDOA assistance data as defined in TS 36.355, Clause 6.5.1, shall be provided to the UE before the measurement period. The last TTI containing the OTDOA assistance data shall be provided to the UE ΔT ms before the start of measurement period, where $\Delta T = 150$ ms is the maximum processing time of the OTDOA assistance data. The measurement gap configuration is known and configured in the UE before the measurements start.

There is no PDSCH allocated in the subframe transmitting PRS. A time span of $T_{\text{RSTD InterFreqH D-FDD, E-UTRAN}}$ is provided for the measurement period, and PRS are configured according to I_{PRC} in Tables A.9.8.30.1-1 and A.9.8.30.1-2 during this time.

The test parameters are given in Table A.9.8.30.1-1 and Table A.9.8.30.1-2.

Table A.9.8.30.1-1: General Test Parameters for E-UTRAN HD-FDD inter-frequency RSTD Tests

Parameter	Unit	Value		Comment
		Test1	Test2	
MPDCCH parameters		R.8 HD-FDD	R.8 HD-FDD	As specified in clause A.3.1.3.1
$m\text{PDCCH-startSF-UeSS}$		10	10	Parameter G in $T = r_{\text{max}} \cdot G$ which determines subframe $k0$ in which MPDCCH starts in the serving cell.
Reference cell		Cell 1		
Neighbour cell		Cell 2		

E-UTRA RF Channel Number		Cell 1: 1 Cell 2: 2		The two cells are on different frequencies.
System Channel Bandwidth ($BW_{channel}$)	MHz	10	10	
PRS Bandwidth	RB	50 ^{Note 1}	50 ^{Note 1}	PRS bandwidth is as indicated in <i>prs-Bandwidth</i> in the OTDOA assistance data defined in [24].
Number of consecutive positioning downlink subframes N_{PRS}		4	4	As defined in TS 36.211
prs-MutingInfo		Cell 1: '11110000' Cell 2: '11110000'		See clause 6.5.1.2 in TS 36.355 for more information
Cell ID		(Cell ID of cell 1 – Cell ID of cell 2) mod 6 = 0	(Cell ID of cell 1 – Cell ID of cell 2) mod 6 = 0	
prs-SubframeOffset		10	10	Number of subframes rounded to the closest integer. The corresponding parameter in the OTDOA assistance data is prs-SubframeOffset specified in TS 36.355 [24]
slotNumberOffset		0	0	The slot number offset at the transmitter between a neighbour cell and the assistance data reference cell specified in TS 36.355 [24]
expectedRSTD	μs	Cell 2: 1 Other neighbour cells: randomly between -3 and 3	Cell 2: -1 Other neighbour cells: randomly between -3 and 3	
expectedRSTDUncertainty for all neighbour cells	μs	5	5	
CP length		Normal		
DRX		OFF		
Radio frame receive time offset between the cells at the UE antenna connector	μs	Cell 2 to Cell 1: -3	Cell 2 to Cell 1: 3	PRS are transmitted from synchronous cells
Number of cells provided in OTDOA assistance data		16		The number of cells includes the reference cell

T_{RSTD} InterFreqH D-FDD, E-UTRAN	ms	40.96	10.24	Derived according to the RSTD measurement requirements specified in Clause 8.13.2.4.1 (for Cat-M1) and Clause 8.16.2.4.1 (Cat-M2).
NOTE 1: If the PRS transmission bandwidth is larger than the UE RF bandwidth, the UE is measuring RSTD within its RF bandwidth.				

Table A.9.8.30.1-2: Cell Specific Test Parameters for E-UTRAN HD-FDD inter-frequency RSTD Tests

Parameter	Unit	Test1		Test2	
		Cell1	Cell2	Cell1	Cell2
E-UTRA RF Channel Number		1	2	1	2
Gap offset		9	N/A	9	N/A
Gap pattern		#0	N/A	#0	N/A
OCNG Patterns defined in A.3.2.1		OP.21 FDD	OP.6 FDD	OP.21 FDD	OP.6 FDD
PRS configuration Index I_{PRS} as defined in TS 36.211		142	152	142	152
PBCH_RA	dB	0	0	0	0
PBCH_RB					
PSS_RA					
SSS_RA					
MPDCCH_RA					
MPDCCH_RB					
OCNG_RA ^{Note1}					
OCNG_RB ^{Note1}					
PRS_RA	dB	0	0	0	0
N_{oc} ^{Note2}	dBm/15 kHz	-98	-98	-98	-98
PRS \hat{E}_s/N_{oc}	dB	-11	-14	-11	-14
PRS \hat{E}_s/I_{ot} ^{Note3}	dB	-11	-14	-11	-14
I_o ^{Note3}	dBm/9 MHz	-70.16	-70.19	-70.16	-70.19
PRP ^{Note3}	dBm/15kHz	-109	-112	-109	-112
\hat{E}_s/N_{oc} ^{Note 3}	dB	-11	-14	-11	-14
RSRP ^{Note 3}	dBm/15kHz	-109	-112	-109	-112
Propagation condition		AWGN			
<p>Note 1: OCNG shall be used such that both cells are fully allocated and a constant total transmitted power spectral density is achieved for all OFDM symbols (other than those in the PRS subframes).</p> <p>Note 2: Interference from other cells and noise sources not specified in the test is assumed to be constant over subcarriers and time and shall be modelled as AWGN of appropriate power for N_{oc} to be fulfilled.</p> <p>Note 3: \hat{E}_s/N_{oc}, PRS \hat{E}_s/I_{ot}, I_o, RSRP and PRP levels have been derived from other parameters for information purposes. They are not settable parameters themselves. I_o values are derived in the case that there is no PBCH, PSS or SSS in the OFDM symbols carrying PRS</p>					

A.9.8.30.2 Test Requirements

For Cat-M1 UE in CE Mode B, the RSTD measurement accuracy shall fulfill the requirements in clause 9.1.21.18.

For Cat-M2 UE in CE Mode B, the RSTD measurement accuracy shall fulfill the requirements in clause 9.1.25.2.

A.9.8.31 E-UTRAN TDD RSTD inter-frequency measurement accuracy in CE Mode B

A.9.8.31.1 Test Purpose and Environment

The purpose of the test is to verify for Cat-M1 and Cat-M2 UE in CE Mode B that the RSTD inter-frequency measurement accuracy is within the specified limits in sections 9.1.21.18 and 9.1.25.2, respectively, in AWGN channels.

In the test, there are two synchronous cells, Cell 1 as the reference cell and Cell 2 as the neighbour cell. Cell 1 is on TDD RF channel 1 and Cell 2 is on TDD RF channel 2.

The UE requires measurement gaps to perform inter-frequency measurements. Gap pattern configuration # 0 as defined in Table 8.1.2.1-1 is provided and configured not to overlap with PRS subframes of Cell 1. Test 1 is applicable for Cat-M1 and Cat-M2 supporting 1.4 MHz UE RF bandwidth, while Test 2 is applicable for Cat-M2 supporting 5 MHz UE RF bandwidth.

The OTDOA assistance data as defined in TS 36.355, Clause 6.5.1, shall be provided to the UE before the measurement period. The last TTI containing the OTDOA assistance data shall be provided to the UE ΔT ms before the start of measurement period, where $\Delta T = 150$ ms is the maximum processing time of the OTDOA assistance data. The measurement gap configuration is known and configured in the UE before the measurements start.

There is no PDSCH allocated in the subframe transmitting PRS. A time span of $T_{\text{RSTD InterFreqTDD, E-UTRAN}}$ is provided for the measurement period, and PRS are configured according to I_{PRS} in Tables A.9.8.31.1-1 and A.9.8.31.1-2 during this time.

The test parameters are given in Table A.9.8.31.1-1 and Table A.9.8.31.1-2.

Table A.9.8.31.1-1: General Test Parameters for E-UTRAN TDD inter-frequency RSTD Tests

Parameter	Unit	Value		Comment
		Test1	Test2	
MPDCCH parameters		R.16 TDD	R.16 TDD	As specified in clause A.3.1.3.1
<i>mPDCCH-startSF-UESS</i>		10	10	Parameter G in $T = r_{\text{max}} \cdot G$ which determines subframe $k0$ in which MPDCCH starts in the serving cell.
Reference cell		Cell 1		
Neighbour cell		Cell 2		
E-UTRA RF Channel Number		Cell 1: 1 Cell 2: 2		The two cells are on different frequencies.
System Channel Bandwidth (BW_{channel})	MHz	10	10	
PRS Bandwidth	RB	50 ^{Note 1}	50 ^{Note 1}	PRS bandwidth is as indicated in <i>prs-Bandwidth</i> in the OTDOA assistance data defined in [24].
Number of consecutive positioning downlink subframes N_{PRS}		4	4	As defined in TS 36.211
prs-MutingInfo		Cell 1: '11110000' Cell 2: '11110000'		See clause 6.5.1.2 in TS 36.355 for more information
Cell ID		(Cell ID of cell 1 – Cell ID of cell 2) mod 6 = 0	(Cell ID of cell 1 – Cell ID of cell 2) mod 6 = 0	

prs-SubframeOffset		10	10	Number of subframes rounded to the closest integer. The corresponding parameter in the OTDOA assistance data is prs-SubframeOffset specified in TS 36.355 [24]
slotNumberOffset		0	0	The slot number offset at the transmitter between a neighbour cell and the assistance data reference cell specified in TS 36.355 [24]
expectedRSTD	μs	Cell 2: 1 Other neighbour cells: randomly between -3 and 3	Cell 2: -1 Other neighbour cells: randomly between -3 and 3	
expectedRSTDUncertainty for all neighbour cells	μs	5	5	
TDD uplink-downlink configuration		1		As specified in TS 36.211 [16], Clause 4.2; corresponds to a configuration with 5 ms switch-point periodicity and two downlink consecutive subframes
TDD special subframe configuration		6		As specified in TS 36.211 [16], Clause 4.2; corresponds to DwPTS of $19760 \cdot T_s$ and UpPTS of $4384 \cdot T_s$
CP length		Normal		
DRX		OFF		
Radio frame receive time offset between the cells at the UE antenna connector	μs	Cell 2 to Cell 1: -3	Cell 2 to Cell 1: 3	PRS are transmitted from synchronous cells
Number of cells provided in OTDOA assistance data		16		The number of cells includes the reference cell
$T_{\text{RSTD}}^{\text{InterFreqTDD, E-UTRAN}}$	ms	40.96	10.24	Derived according to the RSTD measurement requirements specified in Clause 8.13.3.7.2 (for Cat-M1) and Clause 8.16.3.2.2 (Cat-M2).

NOTE 1: If the PRS transmission bandwidth is larger than the UE RF bandwidth, the UE is measuring RSTD within its RF bandwidth.

Table A.9.8.31.1-2: Cell Specific Test Parameters for E-UTRAN TDD inter-frequency RSTD Tests

Parameter	Unit	Test1		Test2	
		Cell1	Cell2	Cell1	Cell2
E-UTRA RF Channel Number		1	2	1	2
Gap offset		9	N/A	9	N/A
Gap pattern		#0	N/A	#0	N/A
OCNG Patterns defined in A.3.2.1		OP.11 TDD	OP.2 TDD	OP.11 TDD	OP.2 TDD
PRS configuration Index I_{PRS} as defined in TS 36.211		140	150	140	150
PBCH_RA	dB	0	0	0	0
PBCH_RB					
PSS_RA					
SSS_RA					
MPDCCH_RA					
MPDCCH_RB					
OCNG_RA ^{Note1}					
OCNG_RB ^{Note1}					
PRS_RA	dB	0	0	0	0
N_{oc} ^{Note2}	dBm/15 kHz	-98	-98	-98	-98
PRS \hat{E}_s/N_{oc}	dB	-11	-14	-11	-14
PRS \hat{E}_s/I_{ot} ^{Note3}	dB	-11	-14	-11	-14
I_o ^{Note3}	dBm/9 MHz	-70.16	-70.19	-70.16	-70.19
PRP ^{Note3}	dBm/15kHz	-109	-112	-109	-112
\hat{E}_s/N_{oc} ^{Note 3}	dB	-11	-14	-11	-14
RSRP ^{Note 3}	dBm/15kHz	-109	-112	-109	-112
Propagation condition		AWGN			
<p>Note 1: OCNG shall be used such that both cells are fully allocated and a constant total transmitted power spectral density is achieved for all OFDM symbols (other than those in the PRS subframes).</p> <p>Note 2: Interference from other cells and noise sources not specified in the test is assumed to be constant over subcarriers and time and shall be modelled as AWGN of appropriate power for N_{oc} to be fulfilled.</p> <p>Note 3: \hat{E}_s/N_{oc}, PRS \hat{E}_s/I_{ot}, I_o, RSRP and PRP levels have been derived from other parameters for information purposes. They are not settable parameters themselves. I_o values are derived in the case that there is no PBCH, PSS or SSS in the OFDM symbols carrying PRS</p>					

A.9.8.31.2 Test Requirements

For Cat-M1 UE in CE Mode B, the RSTD measurement accuracy shall fulfill the requirements in clause 9.1.21.18.

For Cat-M2 UE in CE Mode B, the RSTD measurement accuracy shall fulfill the requirements in clause 9.1.25.2.

A.9.8.32 TDD Intra frequency case for UE Category NB1 inband mode in normal coverage

A.9.8.32.1 Test Purpose and Environment

The purpose of the test is to verify that the intra frequency RSTD measurement for TDD category NB1 UE meets the accuracy requirements specified in Clause 9.1.22.10.

In the test there are four synchronous cells: nCell 1, nCell 2, eCell1 and eCell 2. nCell 1 is the reference as well as the PCell. nCell 2, eCell1 and eCell12 are the neighbour cells.

The OTDOA assistance data and *OTDOA-RequestLocationInformation* as defined in TS 36.355 [24], shall be provided to the UE. After the receipt of the OTDOA assistance data and *OTDOA-RequestLocationInformation* has been

successfully acknowledged, the UE is provided with a RRC connection release command. The UE is expected to enter RRC_IDLE before the measurement period.

The test parameters are given in Tables A.9.8.32.1-1, A.9.8.32.1-2 and A.9.8.32.1-3.

Table A.9.8.32.1-1: General test parameters

Parameter	Unit	Value	Comment
NB-IoT operational mode		Inband	
Reference cell		nCell 1	
Neighbor cells		nCell 2, eCell 2 and eCell 1	
NPDCCH parameters		R.26 NB-TDD	Specified in section A.3.1.6.1
nprsID		Test1: (nprsID of Cell 1 – nprsID of Cell 2)mod6=1	As defined in TS 36.355 [24]
nprs-period	ms	1280	As defined in TS 36.355 [24]
nprs-startSF		sf0	Subframe offset of the NPRS positioning occasion as defined in TS 36.355 [24]
Number of consecutive downlink positioning subframes nprs-NumSF		640	As defined in TS 36.355 [24]
NPRS muting info		nCell 1: '11110000' nCell 2: '11110000'	Correponds to nprs-MutingInfoB defined in TS 36.355 [24]
PartA Configuration: subframePattern10-TDD		'01100011'	Correponds to subframePattern10-TDD-r15 defined in TS 36.355 [24]
nprsSequenceInfo		BW _{channel} 10MHz: 130	Correponds to nprsSequenceInfo defined in TS 36.355 [24]
CP length		Normal	
NPRACH Configuration		NPRACH.R-2	Specified in section A.3.18
DRX cycle length		1.28	The value shall be used for all cells in the test.
Expected RSTD	μs	nCell 2: 3 Other neighbour cells: randomly between -3 and 3	The expected RSTD is what is expected at the receiver. The corresponding parameter in the OTDOA assistance data specified in TS 36.355 [24] is the expectedRSTD indicator
Expected RSTD uncertainty for all neighbour cells	μs	5	The corresponding parameter in the OTDOA assistance data specified in TS 36.355 [24] is the expectedRSTD-Uncertainty index
Number of cells provided in OTDOA assistance data		16	Including the reference cell
Special subframe configuration		6	As specified in table 4.2-1 in TS 36.211 [16]
Uplink-downlink configuration		2	As specified in table 4.2-2 in TS 36.211 [16]
Measurement period	s	11.52	Derived according to the RSTD measurement period in clause 4.8.1

Table A.9.8.32.1-2: nCell1 and nCell2 specific test parameters

Parameter	Unit	Test1	
		nCell 1	nCell 2
BW _{channel}	kHz	180	180
PRB location within eCell		eCell 1 BW _{channel} 10MHz: 30	eCell 2 BW _{channel} 10MHz: 30
NPBCH_RA	dB	0	0
NPBCH_RB			
NPSS_RA			
NSSS_RA			
NPDCCH_RA			
NPDCCH_RB			

NPDSCH_RA			
NPDSCH_RB			
OCNG_RA ^{Note 1}			
OCNG_RB ^{Note 1}			
NPRS_RA	dB		
N_{oc} ^{Note 2}	dBm/ 15 kHz	-98	-98
$NPRS \hat{E}_s/N_{oc}$	dB	-6	-13
$NPRS \hat{E}_s/I_{ot}$ ^{Note 3}	dB	-6	-13
I_o ^{Note 3}	dBm/ 180kHz	-86.89	-86.89
NPRP ^{Note 3}	dBm/ 15 kHz	-104	-111
NRSRP ^{Note 3}	dBm/ 15 kHz	-104	-111
\hat{E}_s/N_{oc} ^{Note 3}	dB	-6	-13
Propagation Condition		AWGN	AWGN
Antenna Configuration		1x1	1x1
Timing offset to nCell 1	us	N/A	3
<p>Note 1: OCNG shall be used such that active cells are fully allocated and a constant total transmitted power spectral density is achieved for all OFDM symbols other than those in the subframes with transmitted NPRS.</p> <p>Note 2: Interference from other cells and noise sources not specified in the test are assumed to be constant over subcarriers and time and shall be modelled as AWGN of appropriate power for N_{oc} to be fulfilled.</p> <p>Note 3: If NPRS_RA is not "N/A", \hat{E}_s/N_{oc}, $NPRS \hat{E}_s/I_{ot}$, I_o, NRSRP and NPRP levels have been derived from other parameters and are given for information purpose. If NPRS_RA is "N/A", I_o and NRSRP levels have been derived from other parameters and are given for information purpose. These are not settable test parameters. Interference conditions shall be applied to all PRS symbols of DL positioning subframes.</p>			

Table A.9.8.32.1-3: eCell 1 and eCell2 specific test parameters

Parameter	Unit	eCell 1			eCell 2		
		T1	T2	T3	T1	T2	T3
BW _{channel}	MHz	10			10		
NOCNG Pattern	-	NOP.1 TDD			NOP.1 TDD		
PBCH_RA	dB	-3			-3		
PBCH_RB	dB						
PSS_RA	dB						
SSS_RA	dB						
PDCCH_RA	dB						
PDCCH_RB	dB						
PDSCH_RA	dB						
PDSCH_RB	dB						
OCNG_RA ^{Note 1}	dB						
OCNG_RB ^{Note 1}	dB						
N_{oc} ^{Note 2}	dBm/15 kHz	-98			-98		
\hat{E}_s/N_{oc} ^{Note 2}	dBm	0	0	0	-7	-7	-7
Propagation Condition		AWGN			AWGN		
Antenna Configuration		1x1			1x1		
Timing offset to eCell 1	us	-			3		
<p>Note 1: OCNG shall be used such that the Cell is fully allocated and a constant total transmitted power spectral density is achieved for all OFDM symbols.</p> <p>Note 2: Interference from other cells and noise sources not specified in the test is assumed to be constant over subcarriers and time and shall be modelled as AWGN of appropriate power N_{oc}.</p>							

A.9.8.32.2 Test Requirements

The RSTD measurement accuracy shall fulfill the requirements in clause 9.1.22.10.

A.9.8.33 TDD Inter frequency case for UE Category NB1 inband mode in normal coverage

A.9.8.33.1 Test Purpose and Environment

The purpose of the test is to verify that the inter frequency RSTD measurement for TDD category NB1 UE meets the accuracy requirements specified in Clause 9.1.22.11.

In the test there are four synchronous cells: nCell 1, nCell 2, eCell1 and eCell 2. nCell 1 is the reference as well as the PCell. nCell 2, eCell1 and eCell2 are the neighbour cells.

The OTDOA assistance data and *OTDOA-RequestLocationInformation* as defined in TS 36.355 [24], shall be provided to the UE. After the receipt of the OTDOA assistance data and *OTDOA-RequestLocationInformation* has been successfully acknowledged, the UE is provided with a RRC connection release command. The UE is expected to enter RRC_IDLE before the measurement period.

The test parameters are given in Tables A.9.8.33.1-1, A.9.8.33.1-2 and A.9.8.33.1-3.

Table A.9.8.33.1-1: General test parameters

Parameter	Unit	Value	Comment
NB-IoT operational mode		Inband	
Reference cell		nCell 1	
Neighbor cells		nCell 2, eCell 1 and eCell 2	
NPDCCH parameters		R.26 NB-TDD	Specified in section A.3.1.6.1
nprsID		Test1: (nprsID of Cell 1 – nprsID of Cell 2)mod6=1	As defined in TS 36.355 [24]
nprs-period	ms	1280	As defined in TS 36.355 [24]
nprs-startSF		sf0	Subframe offset of the NPRS positioning occasion as defined in TS 36.355 [24]
nprs-slotNumberOffset		0	As defined in TS 36.355 [24]
nprs-SubframeOffset		640	As defined in TS 36.355 [24]
Number of consecutive downlink positioning subframes nprs-NumSF		640	As defined in TS 36.355 [24]
NPRS muting info		nCell 1: '1111111100000000' nCell 2: '1111111100000000'	Correponds to nprs-MutingInfoB defined in TS 36.355 [24]
PartA Configuration: subframePattern10-TDD		'01100011'	Correponds to subframePattern10-TDD-r15 defined in TS 36.355 [24]
nprsSequenceInfo nCell1		BW _{channel} 10MHz: 130	Correponds to nprsSequenceInfo defined in TS 36.355 [24]
nprsSequenceInfo nCell2		BW _{channel} 10MHz: 135	Correponds to nprsSequenceInfo defined in TS36.355 [24]
CP length		Normal	
NPRACH Configuration		NPRACH.R-2	Specified in section A.3.18
DRX cycle length		1.28	The value shall be used for all cells in the test.
Expected RSTD	μs	nCell 2: 3 Other neighbour cells: randomly between -3 and 3	The expected RSTD is what is expected at the receiver. The corresponding parameter in the OTDOA assistance data specified in TS 36.355 [24] is the expectedRSTD indicator
Expected RSTD uncertainty for all neighbour cells	μs	5	The corresponding parameter in the OTDOA assistance data specified in TS 36.355 [24] is the expectedRSTD-Uncertainty index

Number of cells provided in OTDOA assistance data		16	Including the reference cell
Special subframe configuration		6	As specified in table 4.2-1 in TS 36.211 [16]
Uplink-downlink configuration		2	As specified in table 4.2-2 in TS 36.211 [16]
Measurement period	s	20.48	Derived according to the RSTD measurement period in clause 4.8.3

Table A.9.8.33.1-2: nCell1 and nCell2 specific test parameters

Parameter	Unit	Test1	
		nCell 1	nCell 2
$BW_{channel}$	kHz	180	180
PRB location within eCell		eCell 1 $BW_{channel}$ 10MHz: 30	eCell 2 $BW_{channel}$ 10MHz: 35
NPBCH_RA	dB	0	0
NPBCH_RB			
NPSS_RA			
NSSS_RA			
NPDCCH_RA			
NPDCCH_RB			
NPDSCH_RA			
NPDSCH_RB			
OCNG_RA <small>Note 1</small>			
OCNG_RB <small>Note 1</small>			
NPRS_RA			
N_{oc} <small>Note 2</small>	dBm/15 kHz	-98	-98
$NPRS \hat{E}_s/N_{oc}$	dB	-6	-13
$NPRS \hat{E}_s/I_{ot}$ <small>Note 3</small>	dB	-6	-13
I_o <small>Note 3</small>	dBm/15kHz	-86.93	-86.93
NPRP <small>Note 3</small>	dBm/15 kHz	-104	-111
NRSRP <small>Note 3</small>	dBm/15 kHz	-104	-111
\hat{E}_s/N_{oc} <small>Note 3</small>	dB	-6	-13
Propagation Condition		AWGN	AWGN
Antenna Configuration		1x1	1x1
Timing offset to nCell 1	us	N/A	3
<p>Note 1: OCNG shall be used such that active cells are fully allocated and a constant total transmitted power spectral density is achieved for all OFDM symbols other than those in the subframes with transmitted NPRS.</p> <p>Note 2: Interference from other cells and noise sources not specified in the test are assumed to be constant over subcarriers and time and shall be modelled as AWGN of appropriate power for N_{oc} to be fulfilled.</p> <p>Note 3: If NPRS_RA is not "N/A", \hat{E}_s/N_{oc}, $NPRS \hat{E}_s/I_{ot}$, I_o, NRSRP and NPRP levels have been derived from other parameters and are given for information purpose. If NPRS_RA is "N/A", I_o and NRSRP levels have been derived from other parameters and are given for information purpose. These are not settable test parameters. Interference conditions shall be applied to all PRS symbols of DL positioning subframes.</p>			

Table A.9.8.33.1-3: eCell 1 and eCell2 specific test parameters

Parameter	Unit	eCell 1			eCell 2		
		T1	T2	T3	T1	T2	T3
$BW_{channel}$	MHz	10			10		
NOCNG Pattern	-	NOP.1 TDD			NOP.1 TDD		
PBCH_RA	dB	-3			-3		
PBCH_RB	dB						
PSS_RA	dB						

SSS_RA	dB						
PDCCH_RA	dB						
PDCCH_RB	dB						
PDSCH_RA	dB						
PDSCH_RB	dB						
OCNG_RA ^{Note 1}	dB						
OCNG_RB ^{Note 1}	dB						
N_{oc} ^{Note 2}	dBm/15 kHz	-98			-98		
\hat{E}_s/N_{oc} ^{Note 2}	dBm	3	3	3	3	3	3
Propagation Condition		AWGN			AWGN		
Antenna Configuration		1x1			1x1		
Timing offset to eCell 1	us	-			3		
<p>Note 1: OCNG shall be used such that the Cell is fully allocated and a constant total transmitted power spectral density is achieved for all OFDM symbols.</p> <p>Note 2: Interference from other cells and noise sources not specified in the test is assumed to be constant over subcarriers and time and shall be modelled as AWGN of appropriate power N_{oc}.</p>							

A.9.8.33.2 Test Requirements

The RSTD measurement accuracy shall fulfill the requirements in clause 9.1.22.11.

A.9.8.34 TDD Intra frequency case for UE Category NB1 inband mode in enhanced coverage

A.9.8.34.1 Test Purpose and Environment

The purpose of the test is to verify that the intra frequency RSTD measurement for TDD category NB1 UE meets the accuracy requirements specified in Clause 9.1.22.12.

In the test there are four synchronous cells: nCell 1, nCell 2, eCell1 and eCell 2. nCell 1 is the reference as well as the PCell. nCell 2, eCell1 and eCell12 are the neighbour cells.

The OTDOA assistance data and *OTDOA-RequestLocationInformation* as defined in TS 36.355 [24], shall be provided to the UE. After the receipt of the OTDOA assistance data and *OTDOA-RequestLocationInformation* has been successfully acknowledged, the UE is provided with a RRC connection release command. The UE is expected to enter RRC_IDLE before the measurement period.

The test parameters are given in Tables A.9.8.34.1-1, A.9.8.34.1-2 and A.9.8.34.1-3.

Table A.9.8.34.1-1: General test parameters

Parameter	Unit	Value	Comment
NB-IoT operational mode		Inband	
Reference cell		nCell 1	
Neighbor cells		nCell 2, eCell 2 and eCell 1	
NPDCCH parameters		R.26 NB-TDD	Specified in section A.3.1.6.1
nprsID		Test1: (nprsID of Cell 1 – nprsID of Cell 2)mod6=1	As defined in TS 36.355 [24]
nprs-period	ms	1280	As defined in TS 36.355 [24]
nprs-startSF		sf0	Subframe offset of the NPRS positioning occasion as defined in TS 36.355 [24]
Number of consecutive downlink positioning subframes nprs-NumSF		640	As defined in TS 36.355 [24]
NPRS muting info		nCell 1: '11110000' nCell 2: '11110000'	Correponds to nprs-MutingInfoB defined in TS 36.355 [24]
PartA Configuration: subframePattern-TDD		'01100011'	Correponds to subframePattern10-TDD-r15 defined in TS 36.355 [24]

nprsSequenceInfo		BW _{channel} 10MHz: 130	Corresponds to nprsSequenceInfo defined in TS 36.355 [24]
CP length		Normal	
NPRACH Configuration		NPRACH.R-2	Specified in section A.3.18
DRX cycle length		1.28	The value shall be used for all cells in the test.
Expected RSTD	μs	nCell 2: 3 Other neighbour cells: randomly between -3 and 3	The expected RSTD is what is expected at the receiver. The corresponding parameter in the OTDOA assistance data specified in TS 36.355 [24] is the expectedRSTD indicator
Expected RSTD uncertainty for all neighbour cells	μs	5	The corresponding parameter in the OTDOA assistance data specified in TS 36.355 [24] is the expectedRSTD-Uncertainty index
Number of cells provided in OTDOA assistance data		16	Including the reference cell
Special subframe configuration		6	As specified in table 4.2-1 in TS 36.211 [16]
Uplink-downlink configuration		2	As specified in table 4.2-2 in TS 36.211 [16]
Measurement period	s	11.52	Derived according to the RSTD measurement period in clause 4.8.1

Table A.9.8.34.1-2: nCell1 and nCell2 specific test parameters

Parameter	Unit	Test1	
		nCell 1	nCell 2
BW _{channel}	kHz	180	180
PRB location within eCell		eCell 1 BW _{channel} 10MHz: 30	eCell 2 BW _{channel} 10MHz: 30
NPBCH_RA	dB	0	0
NPBCH_RB			
NPSS_RA			
NSSS_RA			
NPDCCH_RA			
NPDCCH_RB			
NPDSCH_RA			
NPDSCH_RB			
OCNG_RA <small>Note 1</small>			
OCNG_RB <small>Note 1</small>			
NPRS_RA	dB		
N_{oc} <small>Note 2</small>	dBm/ 15 kHz	-98	-98
$NPRS \hat{E}_s / N_{oc}$	dB	-15	-15
$NPRS \hat{E}_s / I_{ot}$ <small>Note 3</small>	dB	-15	-15
I_o <small>Note 3</small>	dBm/ 180kHz	-87.14	-87.14
NPRP <small>Note 3</small>	dBm/ 15 kHz	-113	-113
NRSRP <small>Note 3</small>	dBm/ 15 kHz	-113	-113
\hat{E}_s / N_{oc} <small>Note 3</small>	dB	-15	-15
Propagation Condition		AWGN	AWGN
Antenna Configuration		1x1	1x1
Timing offset to nCell 1	us	N/A	3

Note 1:	OCNG shall be used such that active cells are fully allocated and a constant total transmitted power spectral density is achieved for all OFDM symbols other than those in the subframes with transmitted NPRS.
Note 2:	Interference from other cells and noise sources not specified in the test are assumed to be constant over subcarriers and time and shall be modelled as AWGN of appropriate power for N_{oc} to be fulfilled.
Note 3:	If NPRS_RA is not "N/A", \hat{E}_s/N_{oc} , NPRS \hat{E}_s/I_{α} , I_{α} , NRSRP and NPRP levels have been derived from other parameters and are given for information purpose. If NPRS_RA is "N/A", I_{α} and NRSRP levels have been derived from other parameters and are given for information purpose. These are not settable test parameters. Interference conditions shall be applied to all PRS symbols of DL positioning subframes.

Table A.9.8.34.1-3: eCell 1 and eCell2 specific test parameters

Parameter	Unit	eCell 1			eCell 2		
		T1	T2	T3	T1	T2	T3
$BW_{channel}$	MHz	10			10		
NOCNG Pattern	-	NOP.1 TDD			NOP.1 TDD		
PBCH_RA	dB	-3			-3		
PBCH_RB	dB						
PSS_RA	dB						
SSS_RA	dB						
PDCCH_RA	dB						
PDCCH_RB	dB						
PDSCH_RA	dB						
PDSCH_RB	dB						
OCNG_RA ^{Note 1}	dB						
OCNG_RB ^{Note 1}	dB						
N_{oc} ^{Note 2}	dBm/15 kHz	-98			-98		
\hat{E}_s/N_{oc} ^{Note 2}	dBm	-9	-9	-9	-9	-9	-9
Propagation Condition		AWGN			AWGN		
Antenna Configuration		1x1			1x1		
Timing offset to eCell 1	us	-			3		
Note 1:	OCNG shall be used such that the Cell is fully allocated and a constant total transmitted power spectral density is achieved for all OFDM symbols.						
Note 2:	Interference from other cells and noise sources not specified in the test is assumed to be constant over subcarriers and time and shall be modelled as AWGN of appropriate power N_{oc} .						

A.9.8.34.2 Test Requirements

The RSTD measurement accuracy shall fulfill the requirements in clause 9.1.22.12.

A.9.8.35 TDD Inter frequency case for UE Category NB1 inband mode in enhanced coverage

A.9.8.35.1 Test Purpose and Environment

The purpose of the test is to verify that the inter frequency RSTD measurement for TDD category NB1 UE meets the accuracy requirements specified in Clause 9.1.22.13.

In the test there are four synchronous cells: nCell 1, nCell 2, eCell1 and eCell 2. nCell 1 is the reference as well as the PCell. nCell 2, eCell1 and eCell12 are the neighbour cells.

The OTDOA assistance data and *OTDOA-RequestLocationInformation* as defined in TS 36.355 [24], shall be provided to the UE. After the receipt of the OTDOA assistance data and *OTDOA-RequestLocationInformation* has been successfully acknowledged, the UE is provided with a RRC connection release command. The UE is expected to enter RRC_IDLE before the measurement period.

The test parameters are given in Tables A.9.8.35.1-1, A.9.8.35.1-2 and A.9.8.35.1-3.

Table A.9.8.35.1-1: General test parameters

Parameter	Unit	Value	Comment
NB-IoT operational mode		Inband	
Reference cell		nCell 1	
Neighbor cells		nCell 2, eCell 2 and eCell 1	
NPDCCH parameters		R.26 NB-TDD	Specified in section A.3.1.6.1
nprsID		Test1: (nprsID of Cell 1 – nprsID of Cell 2)mod6=1	As defined in TS 36.355 [24]
nprs-period	ms	1280	As defined in TS 36.355 [24]
nprs-startSF		sf0	Subframe offset of the NPRS positioning occasion as defined in TS 36.355 [24]
Number of consecutive downlink positioning subframes nprs-NumSF		640	As defined in TS 36.355 [24]
NPRS muting info		nCell 1: '1111111100000000' nCell 2: '1111111100000000'	Correponds to nprs-MutingInfoB defined in TS 36.355 [24]
PartA Configuration : subframePattern10		'01100011'	Correponds to subframePattern10-r14 defined in TS 36.355 [24]
nprsSequenceInfo nCell1		BW _{channel} 10MHz: 130	Correponds to nprsSequenceInfo defined in TS 36.355 [24]
nprsSequenceInfo nCell2		BW _{channel} 10MHz: 135	Correponds to nprsSequenceInfo defined in TS 36.355 [24]
CP length		Normal	
NPRACH Configuration		NPRACH.R-2	Specified in section A.3.18
DRX cycle length		1.28	The value shall be used for all cells in the test.
Expected RSTD	μs	nCell 2: 3 Other neighbour cells: randomly between -3 and 3	The expected RSTD is what is expected at the receiver. The corresponding parameter in the OTDOA assistance data specified in TS 36.355 [24] is the expectedRSTD indicator
Expected RSTD uncertainty for all neighbour cells	μs	5	The corresponding parameter in the OTDOA assistance data specified in TS 36.355 [24] is the expectedRSTD-Uncertainty index
Number of cells provided in OTDOA assistance data		16	Including the reference cell
Special subframe configuration		6	As specified in table 4.2-1 in TS 36.211 [16]
Uplink-downlink configuration		2	As specified in table 4.2-2 in TS 36.211 [16]
Measurement period	s	20.48	Derived according to the RSTD measurement period in clause 4.8.1

Table A.9.8.35.1-2: nCell1 and nCell2 specific test parameters

Parameter	Unit	Test1	
		nCell 1	nCell 2
BW _{channel}	kHz	180	180
PRB location within eCell		eCell 1 BW _{channel} 10MHz: 30	eCell 2 BW _{channel} 10MHz: 30
NPBCH_RA	dB	0	0
NPBCH_RB			
NPSS_RA			
NSSS_RA			
NPDCCH_RA			
NPDCCH_RB			
NPDSCH_RA			
NPDSCH_RB			
OCNG_RA ^{Note 1}			
OCNG_RB ^{Note 1}			

NPRS_RA	dB		
N_{oc} <small>Note 2</small>	dBm/ 15 kHz	-98	-98
NPRS \hat{E}_s/N_{oc}	dB	-15	-15
NPRS \hat{E}_s/I_{ot} <small>Note 3</small>	dB	-15	-15
I_o <small>Note 3</small>	dBm/ 180kHz	-87.14	-87.14
NPRP <small>Note 3</small>	dBm/ 15 kHz	-113	-113
NRSRP <small>Note 3</small>	dBm/ 15 kHz	-113	-113
\hat{E}_s/N_{oc} <small>Note 3</small>	dB	-15	-15
Propagation Condition		AWGN	AWGN
Antenna Configuration		1x1	1x1
Timing offset to nCell 1	us	N/A	3
<p>Note 1: OCNG shall be used such that active cells are fully allocated and a constant total transmitted power spectral density is achieved for all OFDM symbols other than those in the subframes with transmitted NPRS.</p> <p>Note 2: Interference from other cells and noise sources not specified in the test are assumed to be constant over subcarriers and time and shall be modelled as AWGN of appropriate power for N_{oc} to be fulfilled.</p> <p>Note 3: If NPRS_RA is not "N/A", \hat{E}_s/N_{oc}, NPRS \hat{E}_s/I_{ot}, I_o, NRSRP and NPRP levels have been derived from other parameters and are given for information purpose. If NPRS_RA is "N/A", I_o and NRSRP levels have been derived from other parameters and are given for information purpose. These are not settable test parameters. Interference conditions shall be applied to all PRS symbols of DL positioning subframes.</p>			

Table A.9.8.35.1-3: eCell 1 and eCell2 specific test parameters

Parameter	Unit	eCell 1			eCell 2		
		T1	T2	T3	T1	T2	T3
BW _{channel}	MHz	10			10		
NOCNG Pattern	-	NOP.1 TDD			NOP.1 TDD		
PBCH_RA	dB	-3			-3		
PBCH_RB	dB						
PSS_RA	dB						
SSS_RA	dB						
PDCCH_RA	dB						
PDCCH_RB	dB						
PDSCH_RA	dB						
PDSCH_RB	dB						
OCNG_RA <small>Note 1</small>	dB						
OCNG_RB <small>Note 1</small>	dB						
N_{oc} <small>Note 2</small>	dBm/15 kHz	-98			-98		
\hat{E}_s/N_{oc} <small>Note 2</small>	dBm	-9	-9	-9	-9	-9	-9
Propagation Condition		AWGN			AWGN		
Antenna Configuration		1x1			1x1		
Timing offset to eCell 1	us	-			3		
<p>Note 1: OCNG shall be used such that the Cell is fully allocated and a constant total transmitted power spectral density is achieved for all OFDM symbols.</p> <p>Note 2: Interference from other cells and noise sources not specified in the test is assumed to be constant over subcarriers and time and shall be modelled as AWGN of appropriate power N_{oc}.</p>							

A.9.8.35.2 Test Requirements

The RSTD measurement accuracy shall fulfill the requirements in clause 9.1.22.13.

A.9.9 RSRP and RSRQ on the serving cell

A.9.9.1 FDD Intra frequency serving cell case

A.9.9.1.1 Test Purpose and Environment

The purpose of this test is to verify that the RSRP/RSRQ absolute measurement accuracy is within the specified limits. This test will verify the requirements in Clause 9.1.2.1 and 9.1.5.1 for FDD intra frequency measurements.

A.9.9.1.2 Test parameters

In this set of test case there is only the serving cell. Absolute accuracy of RSRP/RSRQ intra frequency measurements for the serving cell is tested by using the parameters in Table A.9.9.1.2-1. In the test case, Cell 1 is the serving cell.

Table A.9.9.1.2-1: RSRP FDD Intra frequency test parameters

Parameter	Unit	Test		
		Cell 1		
E-UTRA RF Channel Number		1		
BW_{channel}	MHz	10		
Measurement bandwidth	n_{PRI}	22—27		
PDSCH Reference measurement channel defined in A.3.1.1.1		R.0 FDD		
PDSCH allocation	n_{PRI}	13—36		
PDCCH/PCFICH/PHICH Reference measurement channel defined in A.3.1.2.1		R.6 FDD		
OCNG Patterns defined in A.3.2.1.1 (OP.1 FDD)		OP.1 FDD		
PBCH_RA	dB	0		
PBCH_RB				
PSS_RA				
SSS_RA				
PCFICH_RB				
PHICH_RA				
PHICH_RB				
PDCCH_RA				
PDCCH_RB				
PDSCH_RA				
PDSCH_RB				
OCNG_RA ^{Note1}				
OCNG_RB ^{Note1}				
N_{OC} ^{Note2}			Bands FDD_A ^{Note 8}	-122
			Bands FDD_B1, FDD_B2 ^{Note 9}	-121.5
	Bands FDD_C	-121		
	Bands FDD_D	-120.5		
	Bands FDD_E, FDD_F ^{Note 5}	-120		
	Bands FDD_G ^{Note 7}	-119		
	Bands FDD_H	-118.5		
\hat{E}_s/I_{ot}	dB	-4		
RSRP ^{Note3}	Bands FDD_A ^{Note 8}	-126		
	Bands FDD_B1, FDD_B2 ^{Note 9}	-125.5		
	Bands FDD_C	-125		
	Bands FDD_D	-124.5		
	Bands FDD_E, FDD_F ^{Note 5}	-124		
	Bands FDD_G ^{Note 7}	-123		

	Bands FDD_H		-122.5
RSRQ ^{Note3}	Bands FDD_A ^{Note 8}	dB	-16.25
	Bands FDD_B1, FDD_B2 ^{Note 9}		
	Bands FDD_C		
	Bands FDD_D		
	Bands FDD_E, FDD_F ^{Note 5}		
	Bands FDD_G ^{Note 7}		
	Bands FDD_H		
I _o ^{Note3}	Bands FDD_A ^{Note 8}	dBm/9 MHz	-92.76
	Bands FDD_B1, FDD_B2 ^{Note 9}		-92.26
	Bands FDD_C		-91.76
	Bands FDD_D		-91.26
	Bands FDD_E, FDD_F ^{Note 5}		-90.76
	Bands FDD_G ^{Note 7}		-89.76
	Bands FDD_H		-89.26
\hat{E}_s / N_{oc}		dB	-4
Propagation condition		-	AWGN
<p>Note 1: OCNG shall be used such that both cells are fully allocated and a constant total transmitted power spectral density is achieved for all OFDM symbols.</p> <p>Note 2: Interference from other cells and noise sources not specified in the test is assumed to be constant over subcarriers and time and shall be modelled as AWGN of appropriate power for N_{oc} to be fulfilled.</p> <p>Note 3: RSRP, RSRQ and I_o levels have been derived from other parameters for information purposes. They are not settable parameters themselves.</p> <p>Note 4: RSRP minimum requirements are specified assuming independent interference and noise at each receiver antenna port.</p> <p>Note 5: For Band 26, the tests shall be performed with the carrier frequency of the assigned E-UTRA channel bandwidth within 865-894 MHz.</p> <p>Note 6: E-UTRA operating band groups are as defined in Section 3.5.</p> <p>Note 7: Except Band 29.</p> <p>Note 8: Except Band 32, Band 75, Band 76.</p> <p>Note 9: For Band 74, the tests shall be performed with the carrier frequency of the assigned E-UTRA channel bandwidth within 1475.9-1510.9 MHz.</p>			

A.9.9.1.3 Test Requirements

The absolute RSRP and RSRQ measurement accuracy shall fulfil the requirements in clause 9.1.2.1 and 9.1.5.1 respectively.

A.9.9.2 TDD Intra frequency serving cell case

A.9.9.2.1 Test Purpose and Environment

The purpose of this test is to verify that the RSRP/ RSRQ absolute measurement accuracy is within the specified limits. This test will verify the requirements in Section 9.1.2.1 and 9.1.5.1 for TDD intra frequency measurements.

A.9.9.2.2 Test parameters

In this set of test case there is only the serving cell. Absolute accuracy of RSRP/ RSRQ intra frequency measurements for the serving cell is tested by using the parameters in Table A.9.9.2.2-1. In the test case, Cell 1 is the serving cell.

Table A.9.9.2.2-1: RSRP TDD Intra frequency test parameters

Parameter	Unit	Test		
		Cell 1		
E-UTRA RF Channel Number		1		
$BW_{channel}$	MHz	10		
Special subframe configuration ^{Note1}		6		
Uplink/downlink configuration ^{Note1}		1		
Measurement bandwidth	n_{PRL}	22—27		
PDSCH Reference measurement channel defined in A.3.1.1.2		R.0 TDD		
PDSCH allocation	n_{PRL}	13—36		
PDCCH/PCFICH/PHICH Reference measurement channel defined in A.3.1.2.2		R.6 TDD		
OCNG Patterns defined in A.3.2.2.1 (OP.1 TDD)		OP.1 TDD		
PBCH_RA	dB	0		
PBCH_RB				
PSS_RA				
SSS_RA				
PCFICH_RB				
PHICH_RA				
PHICH_RB				
PDCCH_RA				
PDCCH_RB				
PDSCH_RA				
PDSCH_RB				
OCNG_RA ^{Note2}				
OCNG_RB ^{Note2}				
N_{oc} ^{Note3}			Bands TDD_A	-122
			Bands TDD_C	-121
	Bands TDD_E	-120		
\hat{E}_s / I_{ot}	dB	-4		
RSRP ^{Note4}	Bands TDD_A	-126		
	Bands TDD_C	-125		
	Bands TDD_E	-124		
RSRQ ^{Note4}	Bands TDD_A	-16.25		
	Bands TDD_C			
	Bands TDD_E			
I_o ^{Note4}	Bands TDD_A	-92.76		
	Bands TDD_C	-91.76		
	Bands TDD_E	-90.76		
\hat{E}_s / N_{oc}	dB	-4		
Propagation condition	-	AWGN		
<p>Note 1: For special subframe and uplink-downlink configurations see Tables 4.2-1 and 4.2-2 in TS 36.211.</p> <p>Note 2: OCNG shall be used such that both cells are fully allocated and a constant total transmitted power spectral density is achieved for all OFDM symbols.</p> <p>Note 3: Interference from other cells and noise sources not specified in the test is assumed to be constant over subcarriers and time and shall be modelled as AWGN of appropriate power for N_{oc} to be fulfilled.</p> <p>Note 4: RSRP, RSRQ and I_o levels have been derived from other parameters for information purposes. They are not settable parameters themselves.</p> <p>Note 5: RSRP minimum requirements are specified assuming independent interference and noise at each receiver antenna port.</p> <p>Note 6: E-UTRA operating band groups are as defined in Section 3.5.</p>				

A.9.9.2.3 Test Requirements

The absolute RSRP and RSRQ measurement accuracy shall fulfil the requirements in section 9.1.2.1 and 9.1.5.1 respectively.

A.9.10 SSTD

A.9.10.1 EUTRAN FDD-FDD SSTD accuracy in asynchronous DC

A.9.10.1.1 Test Purpose and Environment

The purpose of this test is to verify that the SSTD measurement accuracy is within the specified limits. This test will verify the requirements in Section 9.1.20 for FDD SSTD measurements.

A.9.10.1.2 Test parameters

The test parameters are given in Tables A.9.10.1.2-1 and A.9.10.1.2-2. In this test there are 2 cells. Cell 1 is the PCell and cell 2 is the PScell. Cell 1 and cell 2 are on different frequencies. The SSTD time difference between PCell and PScell reported by the UE is compared to the actual SSTD. The SSTD time difference between PCell and PScell shall be set by the test equipment to one of the time differences in table A.9.10.1.2-3.

Table A.9.10.1.2-1: EUTRAN FDD-FDD SSTD accuracy in asynchronous DC

Parameter	Unit	Value	Comment
E-UTRA RF Channel Number		1, 2	Two radio channels are used for this test.
Active PCell		Cell1	PCell on RF channel number 1.
Configured PScell		Cell2	PScell on RF channel number 2.
CP length		Normal	
DRX		OFF	
Note 1: This test verifies the RRM requirement which is independent of channel bandwidth and is performed according to the principle defined in section A.3.6.1.			

Table A.9.10.1.2-2: EUTRAN FDD-FDD SSTD accuracy in asynchronous DC

Parameter	Unit	Cell 1	Cell 2
E-UTRA RF Channel Number		1	2
BW _{channel}	MHz	5MHz: N _{RB,c} = 25 10MHz: N _{RB,c} = 50 20MHz: N _{RB,c} = 100	5MHz: N _{RB,c} = 25 10MHz: N _{RB,c} = 50 20MHz: N _{RB,c} = 100
PDSCH parameters: DL Reference Measurement Channel		5MHz: R.5 FDD 10MHz: R.0 FDD 20MHz: R.4 FDD	5MHz: R.5 FDD 10MHz: R.0 FDD 20MHz: R.4 FDD
PCFICH/PDCCH/PHICH parameters: DL Reference Measurement Channel		5MHz: R.11 FDD 10MHz: R.6 FDD 20MHz: R.10 FDD	5MHz: R.11 FDD 10MHz: R.6 FDD 20MHz: R.10 FDD
OCNG Patterns		5MHz: OP.15 FDD 10MHz: OP.1 FDD 20MHz: OP.11 FDD	5MHz: OP.15 FDD 10MHz: OP.1 FDD 20MHz: OP.11 FDD
PBCH_RA	dB	0	0
PBCH_RB	dB		
PSS_RA	dB		
SSS_RA	dB		
PCFICH_RB	dB		
PHICH_RA	dB		
PHICH_PB	dB		
PDCCH_RA	dB		
PDCCH_PB	dB		
PDSCH_RA	dB		

PDSCH_RB	dB		
OCNG_RA ^{Note 1}	dB		
OCNG_RB ^{Note 1}	dB		
N_{oc} ^{Note 2}	dBm/15 KHz	-104	-104
\hat{E}_s/N_{oc}	dB	-3	-3
\hat{E}_s/I_{ot}	dB	-3	-3
RSRP ^{Note 3}	dBm/15 KHz	-107	-107
SCH_RP ^{Note 3}	dBm/15 KHz	-107	-107
I_o ^{Note 3}	dBm/Ch BW	-74.45 +10log ($N_{RB,c}/50$)	-74.45 +10log ($N_{RB,c}/50$)
Propagation Condition		AWGN	AWGN
Correlation Matrix and Antenna Configuration		1x2 Low	1x2 Low
Receive Time offset to cell1 ^{Note 4}	μ s	-	Between 22.8 and 42.9
<p>Note 1: OCNG shall be used such that both cells are fully allocated and a constant total transmitted power spectral density is achieved for all OFDM symbols.</p> <p>Note 2: Interference from other cells and noise sources not specified in the test is assumed to be constant over subcarriers and time and shall be modelled as AWGN of appropriate power for N_{oc} to be fulfilled.</p> <p>Note 3: RSRP, SCH_RP and I_o levels have been derived from other parameters for information purposes. They are not settable parameters themselves.</p> <p>Note 4: Offset shall be chosen by the test equipment. Test equipment may also select any SFN and frame offset between cell 1 and cell 2</p>			

Table A.9.10.1.2-3: EUTRAN FDD-FDD SSTD accuracy in asynchronous DC timing offsets

Configuration	SFN offset between MeNB and SeNB (ΔX)	Frame boundary offset between MeNB and SeNB (ΔY)	Subframe boundary offset between MeNB and SeNB (ΔZ).
1	100	-4	800
2	300	-2	900
3	500	0	1000
4	700	3	1100
5	900	5	1200

A.9.10.1.3 Test Requirements

The SSTD reported by the UE consists of 3 elements, SFN offset between MeNB and SeNB (ΔX), frame boundary offset between MeNB and SeNB (ΔY) and subframe boundary offset between MeNB and SeNB (ΔZ).

The reported ΔX , ΔY and ΔZ shall meet the accuracy requirements in section 9.1.20.

A.9.10.2 Void

A.9.10.3 Void

A.9.10.4 Void

A.9.11 RSSI

A.9.11.1 FS3 average RSSI accuracy case (PCell using FDD)

A.9.11.1.1 Test Purpose and Environment

The purpose of this test is to verify that the average RSSI measurement accuracy is within the specified limits. This test will partially verify the requirements in Section 9.1.18.5.2.

A.9.11.1.2 Test parameters

In all test cases, Cell 1 is the PCell and Cell 2 the FS3 Scell. RSSI is measured on channel number 2.

Table A.9.11.1.2-1: Average RSSI test parameters

Parameter	Unit	Test 1	
		Cell 1	Cell 2
E-UTRA RF Channel Number		1	2
BW_{channel}	MHz	5 10 20	20
Listen before talk model		Not applicable	Not used
Measurement bandwidth	n_{PRB}	6	
PDSCH Reference measurement channel defined in A.3.1.1.1		5MHz: R.5 FDD 10MHz: R.0 FDD 20MHz: R.4 FDD	R0.FS3
PDCCH/PCFICH/PHICH Reference measurement channel defined in A.3.1.2.1		5MHz: R.11 FDD 10MHz: R.6 FDD 20MHz: R.10 FDD	R0.FS3
OCNG Patterns defined in A.3.2.1.1 (OP.1 FDD) and A.3.2.1.2 (OP.2 FDD)		5MHz: OP.15 FDD 10MHz: OP.1 FDD 20MHz: OP.11 FDD	OP.14 FDD
PBCH_RA	dB	0	0
PBCH_RB			
PSS_RA			
SSS_RA			
PCFICH_RB			
PHICH_RA			
PHICH_RB			
PDCCH_RA			
PDCCH_RB			
PDSCH_RA			
PDSCH_RB			
OCNG_RA ^{Note1}			
OCNG_RB ^{Note1}			
N_{oc} in subframes not corresponding to RSSI measurement time configuration (RMTC)	dBm/15 kHz	-106	-106
N_{oc} in subframes corresponding to RSSI measurement time configuration (RMTC)	dBm/15 kHz	-106	-83
\hat{E}_s/I_{ot} in subframes not corresponding to RSSI measurement time configuration (RMTC)	dB	2.5	2.5
\hat{E}_s/I_{ot} in subframes corresponding to RSSI measurement time configuration (RMTC)	dB	2.5	-Infinity
RSRP in subframes not corresponding to RSSI measurement time configuration (RMTC)	dBm/15 kHz	-103.5	-103.5
RSRP in subframes corresponding to RSSI measurement time configuration (RMTC)		-103.5	-Infinity
Io within measurement bandwidth in subframes corresponding to RSSI	dBm/1.08 MHz	-83	-64.43

measurement time configuration (RMTC)			
lo within measurement bandwidth in subframes not corresponding to RSSI measurement time configuration (RMTC)	dBm/1.08 MHz	-83	-83
Propagation condition	-	AWGN	

Table A.9.11.1.2-2: Average RSSI RMTC and DMTC parameters

measDuration-r13	sym14
rmtc-Period-r13	ms40
rmtc-SubframeOffset-r13	20
ReportInterval	ms120
dmtd-PeriodOffset-r12	ms40-r12 value 0

A.9.11.1.3 Test Requirements

The average RSSI measurement accuracy shall fulfil the requirements in sections 9.1.18.5.2. The nominal RSSI used to evaluate the requirement shall be based on lo in subframes corresponding to RSSI measurement time configuration (RMTC).

A.9.11.2 FS3 average RSSI accuracy case (PCell using TDD)

A.9.11.2.1 Test Purpose and Environment

The purpose of this test is to verify that the average RSSI measurement accuracy is within the specified limits. This test will partially verify the requirements in Section 9.1.18.5.2.

A.9.11.2.2 Test parameters

In all test cases, Cell 1 is the PCell and Cell 2 the FS3 Scell. RSSI is measured on channel number 2.

Table A.9.11.2.2-1: Average RSSI test parameters

Parameter	Unit	Test 1	
		Cell 1	Cell 2
E-UTRA RF Channel Number		1	2
BW _{channel}	MHz	5 10 20	20
Listen before talk model		Not applicable	Not used
Measurement bandwidth	N_{PRB}	6	
PDSCH Reference measurement channel defined in A.3.1.1.1		5MHz: R.4 TDD 10MHz: R.0 TDD 20MHz: R.3 TDD	R0.FS3
PDCCH/PCFICH/PHICH Reference measurement channel defined in A.3.1.2.1		5MHz: R.11 TDD 10MHz: R.6 TDD 20MHz: R.10 TDD	R0.FS3
OCNG Patterns defined in A.3.2.1.1 (OP.1 FDD) and A.3.2.1.2 (OP.2 FDD)		5MHz: OP.9 TDD 10MHz: OP.1 TDD 20MHz: OP.7 TDD	OP.14 FDD
PBCH_RA	dB	0	0
PBCH_RB			
PSS_RA			
SSS_RA			
PCFICH_RB			
PHICH_RA			
PHICH_RB			
PDCCH_RA			
PDCCH_RB			

PDSCH_RA			
PDSCH_RB			
OCNG_RA ^{Note1}			
OCNG_RB ^{Note1}			
N_{oc} in subframes not corresponding to RSSI measurement time configuration (RMTC)	dBm/15 kHz	-106	-106
N_{oc} in subframes corresponding to RSSI measurement time configuration (RMTC)	dBm/15 kHz	-106	-83
\hat{E}_s/I_{ot} in subframes not corresponding to RSSI measurement time configuration (RMTC)	dB	2.5	2.5
\hat{E}_s/I_{ot} in subframes corresponding to RSSI measurement time configuration (RMTC)	dB	2.5	-Infinity
RSRP in subframes not corresponding to RSSI measurement time configuration (RMTC)	dBm/15 kHz	-103.5	-103.5
RSRP in subframes corresponding to RSSI measurement time configuration (RMTC)		-103.5	-Infinity
Io within measurement bandwidth in subframes corresponding to RSSI measurement time configuration (RMTC)	dBm/1.08 MHz	-83	-64.43
Io within measurement bandwidth in subframes not corresponding to RSSI measurement time configuration (RMTC)	dBm/1.08 MHz	-83	-83
Propagation condition	-	AWGN	

Table A.9.11.2.2-2: Average RSSI RMTC and DMTC parameters

measDuration-r13	sym14
rmtc-Period-r13	ms40
rmtc-SubframeOffset-r13	20
ReportInterval	ms120
dmtc-PeriodOffset-r12	ms40-r12 value 0

A.9.11.2.3 Test Requirements

The average RSSI measurement accuracy shall fulfil the requirements in sections 9.1.18.5.2. The nominal RSSI used to evaluate the requirement shall be based on Io in subframes corresponding to RSSI measurement time configuration (RMTC).

A.9.12 Channel occupancy

A.9.12.1 FS3 channel occupancy test (PCell using FDD)

A.9.12.1.1 Test Purpose and Environment

The purpose of this test is to verify that the channel occupancy is within the specified limits. This test will partially verify the requirements in Section 9.1.18.6.1.

A.9.12.1.2 Test parameters

In all test cases, Cell 1 is the PCell and Cell 2 the FS3 Scell. Channel occupancy is measured on channel number 2.

Table A.9.12.1.2-1: Channel occupancy test parameters

Parameter	Unit	Test 1	
		Cell 1	Cell 2
E-UTRA RF Channel Number		1	2
BW_{channel}	MHz	5 10 20	20
Listen before talk model		Not applicable	Not used
Measurement bandwidth	n_{PRB}	6	
PDSCH Reference measurement channel defined in A.3.1.1.1		5MHz: R.5 FDD 10MHz: R.0 FDD 20MHz: R.4 FDD	R0.FS3
PDCCH/PCFICH/PHICH Reference measurement channel defined in A.3.1.2.1		5MHz: R.11 FDD 10MHz: R.6 FDD 20MHz: R.10 FDD	R0.FS3
OCNG Patterns defined in A.3.2.1.1 (OP.1 FDD) and A.3.2.1.2 (OP.2 FDD)		5MHz: OP.15 FDD 10MHz: OP.1 FDD 20MHz: OP.11 FDD	OP.14 FDD
PBCH_RA	dB	0	0
PBCH_RB			
PSS_RA			
SSS_RA			
PCFICH_RB			
PHICH_RA			
PHICH_RB			
PDCCH_RA			
PDCCH_RB			
PDSCH_RA			
PDSCH_RB			
OCNG_RA ^{Note1}			
OCNG_RB ^{Note1}			
N_{oc} in subframes not corresponding to RSSI measurement time configuration (RMTC)	dBm/15 kHz	-106	-106
N_{oc} in subframes corresponding to RSSI measurement time configuration (RMTC) where system frame number mod 12 = 2 (Note 1)	dBm/15 kHz	-106	-90.28
N_{oc} in subframes corresponding to RSSI measurement time configuration (RMTC) where system frame number mod 12 is not equal to 2 (Note 1)	dBm/15 kHz	-106	-97.28
\hat{E}_s/I_{ot} in subframes not corresponding to RSSI measurement time configuration (RMTC)	dB	2.5	2.5
\hat{E}_s/I_{ot} in subframes corresponding to RSSI measurement time configuration (RMTC)	dB	2.5	-Infinity
RSRP in subframes not corresponding to RSSI	dBm/15 kHz	-103.5	-103.5

measurement time configuration (RMTC)			
RSRP in subframes corresponding to RSSI measurement time configuration (RMTC)		-103.5	-Infinity
Io within measurement bandwidth in subframes corresponding to RSSI measurement time configuration (RMTC) where system frame number mod 12 = 2 (Note 1)	dBm/1.08 MHz	-83	-71.73
Io within measurement bandwidth in subframes corresponding to RSSI measurement time configuration (RMTC) where system frame number mod 12 is not equal to 2 (Note 1)	dBm/1.08 MHz	-83	-78.73
Io within measurement bandwidth in subframes not corresponding to RSSI measurement time configuration (RMTC)	dBm/1.08 MHz	-83	-83
Propagation condition	-	AWGN	
channelOccupancyThreshold	dBm	-75.2	
Note 1: Accumulated system frame number is used to avoid a configuration not matching the test purpose at the boundary of hyper frame numbers.			

Table A.9.12.1.2-2: Channel occupancy RMTC and DMTC parameters

measDuration-r13	sym14
rmtc-Period-r13	ms40
rmtc-SubframeOffset-r13	20
ReportInterval	ms120
dmtd-PeriodOffset-r12	ms40-r12 value 0

A.9.12.1.3 Test Requirements

The nominal reported *channelOccupancy* shall be 33. At least 90% of channel occupancy reports made by the UE shall indicate this value.

A.9.12.2 FS3 channel occupancy test (PCell using TDD)

A.9.12.2.1 Test Purpose and Environment

The purpose of this test is to verify that the channel occupancy is within the specified limits. This test will partially verify the requirements in Section 9.1.18.6.1.

A.9.12.2.2 Test parameters

In all test cases, Cell 1 is the PCell and Cell 2 the FS3 Scell. Channel occupancy is measured on channel number 2.

Table A.9.12.2.2-1: Channel occupancy test parameters

Parameter	Unit	Test 1	
		Cell 1	Cell 2
E-UTRA RF Channel Number		1	2
BW _{channel}	MHz	5 10 20	20
Listen before talk model		Not applicable	Not used
Measurement bandwidth	n_{PRB}	6	
PDSCH Reference measurement channel defined in A.3.1.1.1		5MHz: R.4 TDD 10MHz: R.0 TDD 20MHz: R.3 TDD	R0.FS3

PDCCH/PCFICH/PHICH Reference measurement channel defined in A.3.1.2.1		5MHz: R.11 TDD 10MHz: R.6 TDD 20MHz: R.10 TDD	R0.FS3
OCNG Patterns defined in A.3.2.1.1 (OP.1 FDD) and A.3.2.1.2 (OP.2 FDD)		5MHz: OP.9 TDD 10MHz: OP.1 TDD 20MHz: OP.7 TDD	OP.14 FDD
PBCH_RA	dB	0	0
PBCH_RB			
PSS_RA			
SSS_RA			
PCFICH_RB			
PHICH_RA			
PHICH_RB			
PDCCH_RA			
PDCCH_RB			
PDSCH_RA			
PDSCH_RB			
OCNG_RA ^{Note1}			
OCNG_RB ^{Note1}			
N_{oc} in subframes not corresponding to RSSI measurement time configuration (RMTC)	dBm/15 kHz	-106	-106
N_{oc} in subframes corresponding to RSSI measurement time configuration (RMTC) where system frame number mod 12 = 2 (Note 1)	dBm/15 kHz	-106	-90.28
N_{oc} in subframes corresponding to RSSI measurement time configuration (RMTC) where system frame number mod 12 is not equal to 2 (Note 1)	dBm/15 kHz	-106	-97.28
\hat{E}_s/I_{ot} in subframes not corresponding to RSSI measurement time configuration (RMT)	dB	2.5	2.5
\hat{E}_s/I_{ot} in subframes corresponding to RSSI measurement time configuration (RMTC)	dB	2.5	-Infinity
RSRP in subframes not corresponding to RSSI measurement time configuration (RMTC)	dBm/15 kHz	-103.5	-103.5
RSRP in subframes corresponding to RSSI measurement time configuration (RMTC)		-103.5	-Infinity
Io within measurement bandwidth in subframes corresponding to RSSI measurement time configuration (RMTC) where system frame number mod 12 = 2 (Note 1)	dBm/1.08 MHz	-83	-71.73
Io within measurement bandwidth in subframes corresponding to RSSI measurement time configuration (RMTC) where system frame number mod 12 is not equal to 2 (Note 1)	dBm/1.08 MHz	-83	-78.73
Io within measurement bandwidth in subframes not corresponding to RSSI measurement time configuration (RMTC)	dBm/1.08 MHz	-83	-83

Propagation condition	-	AWGN
channelOccupancyThreshold	dBm	-75.2
Note 1: Accumulated system frame number is used to avoid a configuration not matching the test purpose at the boundary of hyper frame numbers.		

Table A.9.12.2.2-2: Channel occupancy RMTC and DMTC parameters

measDuration-r13	sym14
rmtc-Period-r13	ms40
rmtc-SubframeOffset-r13	20
ReportInterval	ms120
dmtc-PeriodOffset-r12	ms40-r12 value 0

A.9.12.2.3 Test Requirements

The nominal reported *channelOccupancy* in this test is 33. At least 90% of channel occupancy reports made by the UE shall indicate this value.

A.9.13 RS-SINR

A.9.13.1 FDD Intra-Frequency Case

A.9.13.1.1 Test Purpose and Environment

The purpose of this test is to verify that the RS-SINR measurement accuracy is within the specified limits. This test will verify the requirements in Section 9.1.17.2.1.

A.9.13.1.2 Test parameters

In this test case all cells are on the same carrier frequency. The absolute accuracy of RS-SINR intra-frequency measurement is tested by using the parameters in Table A.9.13.1.2-1. In all test cases, Cell 1 is the PCell and Cell 2 the target cell.

Table A.9.13.1.2-1: RS-SINR FDD intra-frequency test parameters

Parameter	Unit	Test 1		Test 2	
		Cell 1	Cell 2	Cell 1	Cell 2
E-UTRA RF Channel Number		1		1	
Cell Ids		(Cell ID of cell 1 – Cell ID of cell 2) mod 3 ≠ 0		(Cell ID of cell 1 – Cell ID of cell 2) mod 6 = 0	
BW _{channel}	MHz	10		10	
Measurement bandwidth	N_{PRI}	22–27		22–27	
PDSCH Reference measurement channel defined in A.3.1.1.1		R.0 FDD	-	R.0 FDD	-
PDSCH allocation	N_{PRI}	13–36	-	13–36	-
PDCCH/PCFICH/PHICH Reference measurement channel defined in A.3.1.2.1		R.6 FDD	-	R.6 FDD	-
OCNG Patterns defined in A.3.2.1.1 (OP.1 FDD) and A.3.2.1.2 (OP.2 FDD)		OP.1 FDD	-	OP.1 FDD	-
PBCH_RA	dB	0	0	0	0
PBCH_RB			0		0
PSS_RA			0		0
SSS_RA			0		0
PCFICH_RB			-∞		-∞
PHICH_RA			-∞		-∞
PHICH_RB			-∞		-∞
PDCCH_RA			-∞		-∞
PDCCH_RB			-∞		-∞

PDSCH_RA				-∞		-∞
PDSCH_RB				-∞		-∞
OCNG_RA ^{Note1}				-∞		-∞
OCNG_RB ^{Note1}				-∞		-∞
N_{oc} ^{Note2}	Bands FDD_A <small>Note 8</small>	dBm/15 kHz	-90	-90	-116	
	Bands FDD_B1, FDD_B2 ^{Note 9}				-115.5	
	Bands FDD_C				-115	
	Bands FDD_D				-114.5	
	Bands FDD_E, FDD_F ^{Note 5}				-114	
	Bands FDD_G <small>Note 7</small>				-113	
	Bands FDD_H				-112.5	
CRS \hat{E}_s/I_{ot}		dB	5	-3.19	-5.46	-5.46
RSRP ^{Note3}	Bands FDD_A <small>Note 8</small>	dBm/15 kHz	-85.00	-87.00	-120	-120
	Bands FDD_B1, FDD_B2 ^{Note 9}				-119.5	-119.5
	Bands FDD_C				-119	-119
	Bands FDD_D				-118.5	-118.5
	Bands FDD_E, FDD_F ^{Note 5}				-118	-118
	Bands FDD_G <small>Note 7</small>				-117	-117
	Bands FDD_H				-116.5	-116.5
RS-SINR ^{Note3}	Bands FDD_A <small>Note 8</small>	dB	5	-3.19	-5.46	-5.46
	Bands FDD_B1, FDD_B2 ^{Note 9}					
	Bands FDD_C					
	Bands FDD_D					
	Bands FDD_E, FDD_F ^{Note 5}					
	Bands FDD_G <small>Note 7</small>					
Bands FDD_H						
I_o ^{Note3}	Bands FDD_A <small>Note 8</small>	dBm/9 MHz	-55.69	-55.69	-86.56	
	Bands FDD_B1, FDD_B2 ^{Note 9}				-86.06	
	Bands FDD_C				-85.56	
	Bands FDD_D				-85.06	
	Bands FDD_E, FDD_F ^{Note 5}				-84.56	
	Bands FDD_G <small>Note 7</small>				-83.56	
	Bands FDD_H				-83.06	
CRS \hat{E}_s/N_{oc}		dB	5	3	-4	-4
Propagation condition		-	AWGN		AWGN	
<p>Note 1: OCNG shall be used such that both cells are fully allocated and a constant total transmitted power spectral density is achieved for all OFDM symbols.</p> <p>Note 2: Interference from other cells and noise sources not specified in the test is assumed to be constant over subcarriers and time and shall be modelled as AWGN of appropriate power for N_{oc} to be fulfilled.</p> <p>Note 3: RS-SINR, RSRP and I_o levels have been derived from other parameters for information purposes. They are not settable parameters themselves.</p> <p>Note 4: RSRP and RS-SINR minimum requirements are specified assuming independent interference and noise at each receiver antenna port.</p> <p>Note 5: For Band 26, the tests shall be performed with the carrier frequency of the assigned E-UTRA channel bandwidth within 865-894 MHz.</p> <p>Note 6: E-UTRA operating band groups are as defined in Section 3.5.</p> <p>Note 7: Except Band 29</p> <p>Note 8: Except Band 32, Band 75, Band 76.</p>						

Note 9: For Band 74, the tests shall be performed with the carrier frequency of the assigned E-UTRA channel bandwidth within 1475.9-1510.9 MHz.

A.9.13.1.3 Test Requirements

The RS-SINR measurement accuracy for Cell 2 shall fulfil the requirements in Section 9.1.17.2.1.

A.9.13.2 TDD Intra-Frequency Case

A.9.13.2.1 Test Purpose and Environment

The purpose of this test is to verify that the RS-SINR measurement accuracy is within the specified limits. This test will verify the requirements in Section 9.1.17.2.1.

A.9.13.2.2 Test parameters

In this test case all cells are on the same carrier frequency. The absolute accuracy of RS-SINR intra-frequency measurement is tested by using the parameters in Table A.9.13.2.2-1. In all test cases, Cell 1 is the PCell and Cell 2 the target cell.

Table A.9.13.2.2-1: RS-SINR TDD intra-frequency test parameters

Parameter		Unit	Test 1		Test 2						
			Cell 1	Cell 2	Cell 1	Cell 2					
E-UTRA RF Channel Number			1		1						
Cell Ids			(Cell ID of cell 1 – Cell ID of cell 2) mod 3 ≠ 0		(Cell ID of cell 1 – Cell ID of cell 2) mod 6 = 0						
BW _{channel}		MHz	10		10						
Special subframe configuration ^{Note1}			6		6						
Uplink-downlink configuration ^{Note1}			1		1						
Measurement bandwidth		n_{PRL}	22–27		22–27						
PDSCH Reference measurement channel defined in A.3.1.1.2			R.0 TDD	-	R.0 TDD	-					
PDSCH allocation		n_{PRL}	13–36	-	13–36	-					
PDCCH/PCFICH/PHICH Reference measurement channel defined in A.3.1.2.2			R.6 TDD	-	R.6 TDD	-					
OCNG Patterns defined in A.3.2.2.1 (OP.1 TDD) and A.3.2.2.2 (OP.2 TDD)			OP.1 TDD	-	OP.1 TDD	-					
PBCH_RA		dB	0	0	0	0					
PBCH_RB							0				
PSS_RA							0				
SSS_RA							0				
PCFICH_RB							-∞				
PHICH_RA							-∞				
PHICH_RB							-∞				
PDCCH_RA							-∞				
PDCCH_RB							-∞				
PDSCH_RA							-∞				
PDSCH_RB							-∞				
OCNG_RA ^{Note2}							-∞				
OCNG_RB ^{Note2}							-∞				
N_{oc} ^{Note3}	Bands TDD_A						dBm/15 kHz	-90.00	-90.00	-116	
	Bands TDD_C									-115	
	Bands TDD_E	-114									
\hat{E}_s / I_{ot}		dB	5	-3.19	-5.46	-5.46					
RSRP ^{Note4}	Bands TDD_A	dBm/15 kHz	-85	-87	-120	-120					
	Bands TDD_C				-119	-119					
	Bands TDD_E				-118	-118					
RS-SINR ^{Note4}		dB	5	-3.19	-5.46	-5.46					
I_o ^{Note4}	Bands TDD_A	dBm/9 MHz	-55.69	-55.69	-86.56						
	Bands TDD_C				-85.56						
	Bands TDD_E				-84.56						
\hat{E}_s / N_{oc}		dB	5	3	-4	-4					
Propagation condition		-	AWGN		AWGN						
<p>Note 1: For special subframe and uplink-downlink configurations see Tables 4.2-1 and 4.2-2 in TS 36.211.</p> <p>Note 2: OCNG shall be used such that both cells are fully allocated and a constant total transmitted power spectral density is achieved for all OFDM symbols.</p> <p>Note 3: Interference from other cells and noise sources not specified in the test is assumed to be constant over subcarriers and time and shall be modelled as AWGN of appropriate power for N_{oc} to be fulfilled.</p>											

Note 4:	RS-SINR, RSRP and Io levels have been derived from other parameters for information purposes. They are not settable parameters themselves.
Note 5:	RSRP and RS-SINR minimum requirements are specified assuming independent interference and noise at each receiver antenna port.
Note 6:	E-UTRA operating band groups are as defined in Section 3.5.

A.9.13.2.3 Test Requirements

The RS-SINR measurement accuracy for Cell 2 shall fulfil the requirements in Section 9.1.17.2.1.

A.9.13.3 FDD—FDD Inter frequency case

A.9.13.3.1 Test Purpose and Environment

The purpose of this test is to verify that the RS-SINR measurement accuracy is within the specified limits. This test will verify the requirements in Sections 9.1.17.3.

A.9.13.3.2 Test parameters

In this test case the two cells are on different carrier frequencies and measurement gaps are provided. Both RS-SINR inter-frequency absolute and relative accuracy requirements are tested by using test parameters in Table A.9.13.3.2-1 and Table A.9.13.3.2-2. In all tests, Cell 1 is the PCell and Cell 2 the target cell.

Table A.9.13.3.2-1: RS-SINR FDD—FDD Inter frequency test parameters (Cell 1)

Parameter		Unit	Test 1	Test 2	Test 3				
			Cell 1	Cell 1	Cell 1				
E-UTRA RF Channel Number			2	2	2				
BW _{channel}		MHz	10	10	10				
Gap Pattern Id			0	0	0				
Measurement bandwidth			22—27	22—27	22—27				
PDSCH Reference measurement channel defined in A.3.1.1.1			R.0 FDD	R.0 FDD	R.0 FDD				
PDSCH allocation			13—36	13—36	13—36				
PDCCH/PCFICH/PHICH Reference measurement channel defined in A.3.1.2.1			R.6 FDD	R.6 FDD	R.6 FDD				
OCNG Patterns defined in A.3.2.1.1			OP.1 FDD	OP.1 FDD	OP.1 FDD				
PBCH_RA		dB	0	0	0				
PBCH_RB									
PSS_RA									
SSS_RA									
PCFICH_RB									
PHICH_RA									
PHICH_RB									
PDCCH_RA									
PDCCH_RB									
PDSCH_RA									
PDSCH_RB									
OCNG_RA ^{Note1}									
OCNG_RB ^{Note1}									
Note2	Bands FDD_A Note 8					dBm/15 kHz	-80	-108.50	-119.5
	Bands FDD_B								-119
	Bands FDD_C	-118.5							
	Bands FDD_D	-118							
	Bands FDD_E, FDD_F ^{Note 5}	-117.5							
	Bands FDD_G Note 7	-116.5							
	Bands FDD_H	-116							
CRS		dB	-1.75	20	-4.0				

RSRP ^{Note3}	Bands FDD_A <small>Note 8</small>	dBm/15 kHz	-81.75	-88.50	-123.5
	Bands FDD_B				-123
	Bands FDD_C				-122.5
	Bands FDD_D				-122
	Bands FDD_E, FDD_F <small>Note 5</small>				-121.5
	Bands FDD_G <small>Note 7</small>				-120.5
	Bands FDD_H				-120
RS-SINR ^{Note3}	Bands FDD_A <small>Note 8</small>	dB	-1.75	20	-4.0
	Bands FDD_B				
	Bands FDD_C				
	Bands FDD_D				
	Bands FDD_E, FDD_F <small>Note 5</small>				
	Bands FDD_G <small>Note 7</small>				
	Bands FDD_H				
Io ^{Note3}	Bands FDD_A <small>Note 8</small>	dBm/9 MHz	-50	-60.68	-90.26
	Bands FDD_B				-89.76
	Bands FDD_C				-89.26
	Bands FDD_D				-88.76
	Bands FDD_E, FDD_F <small>Note 5</small>				-88.26
	Bands FDD_G <small>Note 7</small>				-87.26
	Bands FDD_H				-86.76
Propagation condition		-	AWGN	AWGN	AWGN
Antenna Configuration		-	1x2	1x2	1x2
<p>Note 1: OCNG shall be used such that both cells are fully allocated and a constant total transmitted power spectral density is achieved for all OFDM symbols.</p> <p>Note 2: Interference from other cells and noise sources not specified in the test is assumed to be constant over subcarriers and time and shall be modelled as AWGN of appropriate power for to be fulfilled.</p> <p>Note 3: RSRP, RS-SINR and Io levels have been derived from other parameters for information purposes. They are not settable parameters themselves.</p> <p>Note 4: RSRP and RS-SINR minimum requirements are specified assuming independent interference and noise at each receiver antenna port.</p> <p>Note 5: For Band 26, the tests shall be performed with the carrier frequency of the assigned E-UTRA channel bandwidth within 865-894 MHz.</p> <p>Note 6: E-UTRA operating band groups are as defined in Section 3.5.</p> <p>Note 7: Except Band 29.</p> <p>Note 8: Except Band 32.</p>					

Table A.9.13.3.2-2: RS-SINR FDD—FDD Inter frequency test parameters (Cell 2)

Parameter	Unit	Test 1	Test 2	Test 3
		Cell 1	Cell 1	Cell 1
E-UTRA RF Channel Number		2	2	2
BW _{channel}	MHz	10	10	10
Gap Pattern Id		-	-	-
Measurement bandwidth		22—27	22—27	22—27
PDSCH Reference measurement channel defined in A.3.1.1.1		-	-	-
PDSCH allocation		-	-	-
PDCCH/PCFICH/PHICH Reference measurement channel defined in A.3.1.2.1		R.6 FDD	R.6 FDD	R.6 FDD
OCNG Patterns defined in A.3.2.1.1 (OP.1 FDD)		OP.1 FDD	OP.1 FDD	OP.1 FDD
PBCH_RA	dB	0	0	0
PBCH_RB				
PSS_RA				

SSS_RA					
PCFICH_RB					
PHICH_RA					
PHICH_RB					
PDCCH_RA					
PDCCH_RB					
PDSCH_RA					
PDSCH_RB					
OCNG_RA ^{Note1}					
OCNG_RB ^{Note1}					
Note2	Bands FDD_A Note 8	dBm/15 kHz	-85	-108.5	-119.5
	Bands FDD_B				-119
	Bands FDD_C				-118.5
	Bands FDD_D				-118
	Bands FDD_E, FDD_F ^{Note 5}				-117.5
	Bands FDD_G Note 7				-116.5
	Bands FDD_H				-116
Note2a	Bands FDD_A Note 8	dBm/15 kHz	-79	-114.5	-113.5
	Bands FDD_B				-113
	Bands FDD_C				-112.5
	Bands FDD_D				-112
	Bands FDD_E, FDD_F ^{Note 5}				-111.5
	Bands FDD_G Note 7				-110.5
	Bands FDD_H				-110
CRS		dB	-1.75	20	-4.0
RSRP ^{Note3}	Bands FDD_A Note 8	dBm/15 kHz	-86.75	-88.50	-123.5
	Bands FDD_B				-123
	Bands FDD_C				-122.5
	Bands FDD_D				-122
	Bands FDD_E, FDD_F ^{Note 5}				-121.5
	Bands FDD_G Note 7				-120.5
	Bands FDD_H				-120
RS-SINR ^{Note3}		dB	-1.75	20	-4.0
I _o ^{Note3}	Bands FDD_A Note 8	dBm/9 MHz	-50.68	-60.71	-85.45
	Bands FDD_B				-84.95
	Bands FDD_C				-84.45
	Bands FDD_D				-83.95
	Bands FDD_E, FDD_F ^{Note 5}				-83.45
	Bands FDD_G Note 7				-82.45
	Bands FDD_H				-81.95
Propagation condition		-	AWGN	AWGN	AWGN
Antenna Configuration		-	1x2	1x2	1x2
<p>Note 1: OCNG shall be used such that both cells are fully allocated and a constant total transmitted power spectral density is achieved for all OFDM symbols.</p> <p>Note 2: Interference from other cells and noise sources not specified in the test is assumed to be constant over CRS subcarriers and time and shall be modelled as AWGN of appropriate power for to be fulfilled.</p> <p>Note 2a: Interference from other cells and noise sources not specified in the test is assumed to be constant over subcarriers other than CRS subcarriers and time and shall be modelled as AWGN of appropriate power for to be fulfilled.</p> <p>Note 3: RSRP, RS-SINR and I_o levels have been derived from other parameters for information purposes. They are not settable parameters themselves.</p> <p>Note 4: RSRP and RS-SINR minimum requirements are specified assuming independent interference and noise at each receiver antenna port.</p>					

Note 5:	For Band 26, the tests shall be performed with the carrier frequency of the assigned E-UTRA channel bandwidth within 865-894 MHz.
Note 6:	E-UTRA operating band groups are as defined in Section 3.5.
Note 7:	Except Band 29.
Note 8:	Except Band 32.

A.9.13.3.3 Test Requirements

The RS-SINR measurement accuracy shall fulfil the requirements in Sections 9.1.17.3.

A.9.13.4 TDD—TDD Inter frequency case

A.9.13.4.1 Test Purpose and Environment

The purpose of this test is to verify that the RS-SINR measurement accuracy is within the specified limits. This test will verify the requirements in Sections 9.1.17.3.

A.9.13.4.2 Test parameters

In this test case the two cells are on different carrier frequencies and measurement gaps are provided. Both RS-SINR inter-frequency absolute and relative accuracy requirements are tested by using test parameters in Table A.9.13.4.2-1 and Table A.9.13.4.2-2 for TDD configuration 1 and in Table A.9.13.4.2-3 and Table A.9.13.4.2-4 for TDD configuration 0. In all tests, Cell 1 is the PCell and Cell 2 the target cell.

Table A.9.13.4.2-1: RS-SINR TDD—TDD Inter frequency test parameters for TDD configuration 1 (Cell 1)

Parameter	Unit	Test 1	Test 2	Test 3				
		Cell 2	Cell 2	Cell 2				
E-UTRA RF Channel Number		2	2	2				
BW _{channel}	MHz	10	10	10				
Gap Pattern Id		0	0	0				
Special subframe configuration <small>Note1</small>		6	6	6				
Uplink-downlink configuration <small>Note1</small>		1	1	1				
Measurement bandwidth		22—27	22—27	22—27				
PDSCH Reference measurement channel defined in A.3.1.1.2		R.0 TDD	R.0 TDD	R.0 TDD				
PDSCH allocation		13—36	13—36	13—36				
PDCCH/PCFICH/PHICH Reference measurement channel defined in A.3.1.2.2		R.6 TDD	R.6 TDD	R.6 TDD				
OCNG Patterns defined in A.3.2.2.1		OP.1 TDD	OP.1 TDD	OP.1 TDD				
PBCH_RA	dB	0	0	0				
PBCH_RB								
PSS_RA								
SSS_RA								
PCFICH_RB								
PHICH_RA								
PHICH_RB								
PDCCH_RA								
PDCCH_RB								
PDSCH_RA								
PDSCH_RB								
OCNG_RA <small>Note2</small>								
OCNG_RB <small>Note2</small>								
<small>Note3</small> Bands TDD_A					dBm/15 kHz	-80	-108.50	-119.50
Bands TDD_C								-118.50
Bands TDD_E	-117.50							
CRS	dB	-1.75	20	-4.0				
<small>Note4</small> RSRP	dBm/15 kHz	-81.75	-88.50	-123.50				
Bands TDD_C				-122.50				
Bands TDD_E				-121.50				
<small>Note4</small> RS-SINR	dB	-1.75	20	-4.0				
<small>Note4</small> I _o	dBm/9 MHz	-50	-60.68	-90.26				
Bands TDD_C				-89.26				
Bands TDD_E				-88.26				
Propagation condition	-	AWGN	AWGN	AWGN				
Antenna Configuration	-	1x2	1x2	1x2				
<p>Note 1: For special subframe and uplink-downlink configurations see Tables 4.2-1 and 4.2-2 in TS 36.211.</p> <p>Note 2: OCNG shall be used such that both cells are fully allocated and a constant total transmitted power spectral density is achieved for all OFDM symbols.</p> <p>Note 3: Interference from other cells and noise sources not specified in the test is assumed to be constant over subcarriers and time and shall be modelled as AWGN of appropriate power for to be fulfilled.</p> <p>Note 4: RSRP, RS-SINR and I_o levels have been derived from other parameters for information purposes. They are not settable parameters themselves.</p> <p>Note 5: RSRP and RS-SINR minimum requirements are specified assuming independent interference and noise at each receiver antenna port.</p> <p>Note 6: E-UTRA operating band groups are as defined in Section 3.5.</p>								

Table A.9.13.4.2-2: RS-SINR TDD—TDD Inter frequency test parameters for TDD configuration 1 (Cell 2)

Parameter	Unit	Test 1	Test 2	Test 3
		Cell 2	Cell 2	Cell 2
E-UTRA RF Channel Number		2	2	2
BW _{channel}	MHz	10	10	10
Gap Pattern Id		-	-	-

Special subframe configuration <small>Note1</small>			6	6	6
Uplink-downlink configuration <small>Note1</small>			1	1	1
Measurement bandwidth			22–27	22–27	22–27
PDSCH Reference measurement channel			-	-	-
PDSCH allocation			-	-	-
PDCCH/PCFICH/PHICH Reference measurement channel defined in A.3.1.2.2			R.6 TDD	R.6 TDD	R.6 TDD
OCNG Patterns defined in A.3.2.2.2			OP.2 TDD	OP.2 TDD	OP.2 TDD
PBCH_RA		dB	0	0	0
PBCH_RB					
PSS_RA					
SSS_RA					
PCFICH_RB					
PHICH_RA					
PHICH_RB					
PDCCH_RA					
PDCCH_RB					
PDSCH_RA					
PDSCH_RB					
OCNG_RA <small>Note2</small>					
OCNG_RB <small>Note2</small>					
<small>Note3</small>	Bands TDD_A				
	Bands TDD_C	-118.50			
	Bands TDD_E	-117.50			
<small>Note3a</small>	Bands TDD_A	dBm/15 kHz	-79	-114.50	-113.50
	Bands TDD_C				-112.50
	Bands TDD_E				-111.50
CRS		dB	-1.75	20	-4.0
RSRP <small>Note4</small>	Bands TDD_A	dBm/15 kHz	-81.75	-88.50	-123.50
	Bands TDD_C				-122.50
	Bands TDD_E				-121.50
RS-SINR <small>Note4</small>		dB	-1.75	20	-4.0
I _o <small>Note4</small>	Bands TDD_A	dBm/9 MHz	-50.68	-60.71	-85.45
	Bands TDD_C				-84.45
	Bands TDD_E				-83.45
Propagation condition		-	AWGN	AWGN	AWGN
Antenna Configuration		-	1x2	1x2	1x2
<p><small>Note 1:</small> For special subframe and uplink-downlink configurations see Tables 4.2-1 and 4.2-2 in TS 36.211.</p> <p><small>Note 2:</small> OCNG shall be used such that both cells are fully allocated and a constant total transmitted power spectral density is achieved for all OFDM symbols.</p> <p><small>Note 3:</small> Interference from other cells and noise sources not specified in the test is assumed to be constant over CRS subcarriers and time and shall be modelled as AWGN of appropriate power for CRS to be fulfilled.</p> <p><small>Note 3a:</small> Interference from other cells and noise sources not specified in the test is assumed to be constant over Non-CRS subcarriers and time and shall be modelled as AWGN of appropriate power for Non-CRS to be fulfilled.</p> <p><small>Note 4:</small> RSRP, RS-SINR and I_o levels have been derived from other parameters for information purposes. They are not settable parameters themselves.</p> <p><small>Note 5:</small> RSRP and RS-SINR minimum requirements are specified assuming independent interference and noise at each receiver antenna port.</p> <p><small>Note 6:</small> E-UTRA operating band groups are as defined in Section 3.5.</p>					

Table A.9.13.4.2-3: RS-SINR TDD—TDD Inter frequency test parameters for TDD configuration 0 (Cell 1)

Parameter	Unit	Test 1	Test 2	Test 3
		Cell 2	Cell 2	Cell 2
E-UTRA RF Channel Number		2	2	2
BW _{channel}	MHz	10	10	10
Gap Pattern Id		0	0	0

Special subframe configuration <small>Note1</small>		6	6	6	
Uplink-downlink configuration <small>Note1</small>		0	0	0	
Measurement bandwidth		22—27	22—27	22—27	
PDSCH Reference measurement channel defined in A.3.1.1.2		R.0 TDD	R.0 TDD	R.0 TDD	
PDSCH allocation		13—36	13—36	13—36	
PDCCH/PCFICH/PHICH Reference measurement channel defined in A.3.1.2.2		R.6 TDD	R.6 TDD	R.6 TDD	
OCNG Patterns defined in A.3.2.2.1		OP.1 TDD	OP.1 TDD	OP.1 TDD	
PBCH_RA	dB	0	0	0	
PBCH_RB					
PSS_RA					
SSS_RA					
PCFICH_RB					
PHICH_RA					
PHICH_RB					
PDCCH_RA					
PDCCH_RB					
PDSCH_RA					
PDSCH_RB					
OCNG_RA <small>Note2</small>					
OCNG_RB <small>Note2</small>					
<small>Note3</small>					Bands TDD_A
	Bands TDD_C	-118.50			
	Bands TDD_E	-117.50			
CRS		dB	-1.75	20	-4.0
<small>Note4</small>	Bands TDD_A	dBm/15 kHz	-81.75	-88.50	-123.50
	Bands TDD_C				-122.50
	Bands TDD_E				-121.50
RS-SINR <small>Note4</small>		dB	-1.75	20	-4.0
<small>Note4</small>	Bands TDD_A	dBm/9 MHz	-50	-60.68	-90.26
	Bands TDD_C				-89.26
	Bands TDD_E				-88.26
Propagation condition		-	AWGN	AWGN	AWGN
Antenna Configuration		-	1x2	1x2	1x2
<p><small>Note 1:</small> For special subframe and uplink-downlink configurations see Tables 4.2-1 and 4.2-2 in TS 36.211.</p> <p><small>Note 2:</small> OCNG shall be used such that both cells are fully allocated and a constant total transmitted power spectral density is achieved for all OFDM symbols.</p> <p><small>Note 3:</small> Interference from other cells and noise sources not specified in the test is assumed to be constant over subcarriers and time and shall be modelled as AWGN of appropriate power for to be fulfilled.</p> <p><small>Note 4:</small> RSRP, RS-SINR and Io levels have been derived from other parameters for information purposes. They are not settable parameters themselves.</p> <p><small>Note 5:</small> RSRP and RS-SINR minimum requirements are specified assuming independent interference and noise at each receiver antenna port.</p> <p><small>Note 6:</small> E-UTRA operating band groups are as defined in Section 3.5.</p>					

Table A.9.13.4.2-4: RS-SINR TDD—TDD Inter frequency test parameters for TDD configuration 0 (Cell 2)

Parameter	Unit	Test 1	Test 2	Test 3
		Cell 2	Cell 2	Cell 2
E-UTRA RF Channel Number		2	2	2
BW _{channel}	MHz	10	10	10
Gap Pattern Id		-	-	-
Special subframe configuration <small>Note1</small>		6	6	6
Uplink-downlink configuration <small>Note1</small>		0	0	0
Measurement bandwidth		22—27	22—27	22—27
PDSCH Reference measurement channel		-	-	-
PDSCH allocation		-	-	-

PDCCH/PCFICH/PHICH Reference measurement channel defined in A.3.1.2.2			R.6 TDD	R.6 TDD	R.6 TDD
OCNG Patterns defined in A.3.2.2.2			OP.2 TDD	OP.2 TDD	OP.2 TDD
PBCH_RA		dB	0	0	0
PBCH_RB					
PSS_RA					
SSS_RA					
PCFICH_RB					
PHICH_RA					
PHICH_RB					
PDCCH_RA					
PDCCH_RB					
PDSCH_RA					
PDSCH_RB					
OCNG_RA ^{Note2}					
OCNG_RB ^{Note2}					
CRS ^{Note3}	Bands TDD_A				
	Bands TDD_C	-118.50			
	Bands TDD_E	-117.50			
Non-CRS ^{Note3a}	Bands TDD_A	dBm/15 kHz	-79	-114.50	-113.50
	Bands TDD_C				-112.50
	Bands TDD_E				-111.50
CRS		dB	-1.75	20	-4.0
RSRP ^{Note4}	Bands TDD_A	dBm/15 kHz	-81.75	-88.50	-123.50
	Bands TDD_C				-122.50
	Bands TDD_E				-121.50
RS-SINR ^{Note4}		dB	-1.75	20	-4.0
I _o ^{Note4}	Bands TDD_A	dBm/9 MHz	-50.68	-60.71	-85.45
	Bands TDD_C				-84.45
	Bands TDD_E				-83.45
Propagation condition		-	AWGN	AWGN	AWGN
Antenna Configuration		-	1x2	1x2	1x2
<p>Note 1: For special subframe and uplink-downlink configurations see Tables 4.2-1 and 4.2-2 in TS 36.211.</p> <p>Note 2: OCNG shall be used such that both cells are fully allocated and a constant total transmitted power spectral density is achieved for all OFDM symbols.</p> <p>Note 3: Interference from other cells and noise sources not specified in the test is assumed to be constant over CRS subcarriers and time and shall be modelled as AWGN of appropriate power for to be fulfilled.</p> <p>Note 3a: Interference from other cells and noise sources not specified in the test is assumed to be constant over subcarriers other than CRS subcarriers and time and shall be modelled as AWGN of appropriate power for to be fulfilled.</p> <p>Note 4: RSRP, RS-SINR and I_o levels have been derived from other parameters for information purposes. They are not settable parameters themselves.</p> <p>Note 5: RSRP and RS-SINR minimum requirements are specified assuming independent interference and noise at each receiver antenna port.</p> <p>Note 6: E-UTRA operating band groups are as defined in Section 3.5.</p>					

A.9.13.4.3 Test Requirements

The RS-SINR measurement accuracy shall fulfil the requirements in Sections 9.1.17.3.

A.9.13.5 FDD—TDD Inter frequency case

A.9.13.5.1 Test Purpose and Environment

The purpose of this test is to verify that the RS-SINR measurement accuracy is within the specified limits. This test will verify the requirements in Sections 9.1.17.3.

A.9.13.5.2 Test parameters

In this set of test cases the two cells are on different carrier frequencies. Both absolute and relative accuracy of RS-SINR inter frequency measurements are tested by using the parameters in Table A.9.13.5.2-1. In all test cases, Cell 1 is

the PCell and Cell 2 is the target cell. Cell 1 is FDD cell and Cell 2 is TDD cell. The inter frequency measurements are supported by a measurement gap.

Table A.9.13.5.2-1: RS-SINR FDD—TDD Inter frequency test parameters (FDD Cell1)

Parameter	Unit	Test 1	Test 2	Test 2				
		Cell 1	Cell 1	Cell 1				
E-UTRA RF Channel Number		2	2	2				
BW _{channel}	MHz	10	10	10				
Gap Pattern Id		0	0	0				
Measurement bandwidth	n_{PRI}	22—27	22—27	22—27				
PDSCH Reference measurement channel defined in A.3.1.1.1		R.0 FDD	R.0 FDD	R.0 FDD				
PDSCH allocation	n_{PRI}	13—36	13—36	13—36				
PDCCH/PCFICH/PHICH Reference measurement channel defined in A.3.1.2.1		R.6 FDD	R.6 FDD	R.6 FDD				
OCNG Patterns defined in A.3.2.1.1 (OP.1 FDD)		OP.1 FDD	OP.1 FDD	OP.1 FDD				
PBCH_RA	dB	0	0	0				
PBCH_RB								
PSS_RA								
SSS_RA								
PCFICH_RB								
PHICH_RA								
PHICH_RB								
PDCCH_RA								
PDCCH_RB								
PDSCH_RA								
PDSCH_RB								
OCNG_RA ^{Note1}								
OCNG_RB ^{Note1}								
N_{oc} ^{Note2}					Bands FDD_A ^{Note 8}	-80	-108.50	-119.5
					Bands FDD_B1, FDD_B2 ^{Note 9}			-119
	Bands FDD_C	-118.5						
	Bands FDD_D	-118						
	Bands FDD_E, FDD_F ^{Note 5}	-117.5						
	Bands FDD_G ^{Note 7}	-116.5						
	Bands FDD_H	-116						
CRS \hat{E}_s/I_{ot}	dB	-1.75	20	-4.0				
RSRP ^{Note3}	Bands FDD_A ^{Note 8}	-81.75	-88.50	-123.5				
	Bands FDD_B1, FDD_B2 ^{Note 9}			-123				
	Bands FDD_C			-122.5				
	Bands FDD_D			-122				
	Bands FDD_E, FDD_F ^{Note 5}			-121.5				
	Bands FDD_G ^{Note 7}			-120.5				
	Bands FDD_H			-120				
RS-SINR ^{Note3}	Bands FDD_A ^{Note 8}	-1.75	20	-4.0				
	Bands FDD_B1, FDD_B2 ^{Note 9}							
	Bands FDD_C							

	Bands FDD_D				
	Bands FDD_E, FDD_F ^{Note 5}				
	Bands FDD_G ^{Note 7}				
	Bands FDD_H				
I _o ^{Note3}	Bands FDD_A ^{Note 8}	dBm/9 MHz	-50	-60.68	-90.26
	Bands FDD_B1, FDD_B2 ^{Note 9}				-89.76
	Bands FDD_C				-89.26
	Bands FDD_D				-88.76
	Bands FDD_E, FDD_F ^{Note 5}				-88.26
	Bands FDD_G ^{Note 7}				-87.26
	Bands FDD_H				-86.76
CRS \hat{E}_s / N_{oc}	dB	-1.75	20	-4.0	
Propagation condition	-		AWGN	AWGN	
<p>Note 1: OCNB shall be used such that both cells are fully allocated and a constant total transmitted power spectral density is achieved for all OFDM symbols.</p> <p>Note 2: Interference from other cells and noise sources not specified in the test is assumed to be constant over subcarriers and time and shall be modelled as AWGN of appropriate power for N_{oc} to be fulfilled.</p> <p>Note 3: RS-SINR, RSRP and I_o levels have been derived from other parameters for information purposes. They are not settable parameters themselves.</p> <p>Note 4: RSRP and RS-SINR minimum requirements are specified assuming independent interference and noise at each receiver antenna port.</p> <p>Note 5: For Band 26, the tests shall be performed with the carrier frequency of the assigned E-UTRA channel bandwidth within 865-894 MHz.</p> <p>Note 6: E-UTRA operating band groups are as defined in Section 3.5.</p> <p>Note 7: Except Band 29.</p> <p>Note 8: Except Band 32, Band 75, Band 76.</p> <p>Note 9: For Band 74, the tests shall be performed with the carrier frequency of the assigned E-UTRA channel bandwidth within 1475.9-1510.9 MHz.</p>					

Table A.9.13.5.2-2: RS-SINR FDD—TDD Inter frequency test parameters (TDD cell2)

Parameter	Unit	Test 1	Test 2	Test 3
		Cell 2	Cell 2	Cell 2
E-UTRA RF Channel Number		2	2	2
BW _{channel}	MHz	10	10	10
Gap Pattern Id		-	-	-
Special subframe configuration ^{Note1}		6	6	6
Uplink-downlink configuration ^{Note1}		1	1	1
Measurement bandwidth	n_{PR1}	22—27	22—27	22—27
PDSCH Reference measurement channel		-	-	-
PDSCH allocation	n_{PR1}	-	-	-
PDCCH/PCFICH/PHICH Reference measurement channel defined in A.3.1.2.2		R.6 TDD	R.6 TDD	R.6 TDD
OCNB Patterns defined in A.3.2.2.2 (OP.2 TDD)		OP.2 TDD	OP.2 TDD	OP.2 TDD
PBCH_RA	dB	0	0	0
PBCH_RB				
PSS_RA				
SSS_RA				
PCFICH_RB				
PHICH_RA				

PHICH_RB					
PDCCH_RA					
PDCCH_RB					
PDSCH_RA					
PDSCH_RB					
OCNG_RA ^{Note2}					
OCNG_RB ^{Note2}					
N_{od} ^{Note3}	Bands TDD_A	dBm/15 kHz	-85	-108.50	-119.50
	Bands TDD_C				-118.50
	Bands TDD_E				-117.50
N_{oc2} ^{Note3a}	Bands TDD_A	dBm/15 kHz	-79	-114.50	-113.50
	Bands TDD_C				-112.50
	Bands TDD_E				-111.50
CRS \hat{E}_s / I_{ot}		dB	-1.75	20	-4.0
RSRP ^{Note4}	Bands TDD_A	dBm/15 kHz	-81.75	-88.50	-123.50
	Bands TDD_C				-122.50
	Bands TDD_E				-121.50
RS-SINR ^{Note4}	Bands TDD_A	dB	-1.75	20	-4.0
	Bands TDD_C				
	Bands TDD_E				
Io ^{Note4}	Bands TDD_A	dBm/9 MHz	-50.79	-60.56	-93.48
	Bands TDD_C				-92.48
	Bands TDD_E				-91.48
CRS \hat{E}_s / N_{oc}		dB	-1.75	20	-4.0
Propagation condition		-	AWGN	AWGN	AWGN
<p>Note 1: For special subframe and uplink-downlink configurations see Tables 4.2-1 and 4.2-2 in TS 36.211.</p> <p>Note 2: OCNG shall be used such that both cells are fully allocated and a constant total transmitted power spectral density is achieved for all OFDM symbols.</p> <p>Note 3: Interference from other cells and noise sources not specified in the test is assumed to be constant over CRS subcarriers and time and shall be modelled as AWGN of appropriate power for N_{od} to be fulfilled.</p> <p>Note 3a: Interference from other cells and noise sources not specified in the test is assumed to be constant over subcarriers other than CRS subcarriers and time and shall be modelled as AWGN of appropriate power for N_{oc2} to be fulfilled.</p> <p>Note 4: RS-SINR, RSRP and Io levels have been derived from other parameters for information purposes. They are not settable parameters themselves.</p> <p>Note 5: RSRP and RS-SINR minimum requirements are specified assuming independent interference and noise at each receiver antenna port.</p> <p>Note 6: E-UTRA operating band groups are as defined in Section 3.5.</p>					

A.9.13.5.3 Test Requirements

The RS-SINR measurement accuracy shall fulfil the requirements in Sections 9.1.17.3.

A.9.13.6 TDD—FDD Inter frequency case

A.9.13.6.1 Test Purpose and Environment

The purpose of this test is to verify that the RS-SINR measurement accuracy is within the specified limits. This test will verify the requirements in Sections 9.1.17.3.

A.9.13.6.2 Test parameters

In this set of test cases the two cells are on different carrier frequencies. Both absolute and relative accuracy of RS-SINR inter frequency measurements are tested by using the parameters in Table A.9.13.6.2-1. In all test cases, Cell 1 is the PCell and Cell 2 is the target cell. Cell 1 is TDD cell and Cell 2 is FDD cell. The inter frequency measurements are supported by a measurement gap.

Table A.9.13.6.2-1: RS-SINR TDD—FDD Inter frequency test parameters (TDD cell1)

Parameter	Unit	Test 1	Test 2	Test 3
		Cell 2	Cell 2	Cell 2

E-UTRA RF Channel Number		2	2	2	
BW _{channel}	MHz	10	10	10	
Gap Pattern Id		-	-	-	
Special subframe configuration Note1		6	6	6	
Uplink-downlink configuration ^{Note1}		1	1	1	
Measurement bandwidth	n_{PRI}	22–27	22–27	22–27	
PDSCH Reference measurement channel		-	-	-	
PDSCH allocation	n_{PRI}	-	-	-	
PDCCH/PCFICH/PHICH Reference measurement channel defined in A.3.1.2.2		R.6 TDD	R.6 TDD	R.6 TDD	
OCNG Patterns defined in A.3.2.2.2 (OP.2 TDD)		OP.2 TDD	OP.2 TDD	OP.2 TDD	
PBCH_RA					
PBCH_RB					
PSS_RA					
SSS_RA					
PCFICH_RB					
PHICH_RA					
PHICH_RB					
PDCCH_RA					
PDCCH_RB					
PDSCH_RA					
PDSCH_RB					
OCNG_RA ^{Note2}					
OCNG_RB ^{Note2}					
N_{oc} ^{Note3}	Bands TDD_A	dBm/15 kHz	-80	-108.50	-119.50
	Bands TDD_C				-118.50
	Bands TDD_E				-117.50
CRS \hat{E}_s/I_{ot}	dB	-1.75	20	-4.0	
RSRP ^{Note4}	Bands TDD_A	dBm/15 kHz	-81.75	-88.50	-123.50
	Bands TDD_C				-122.50
	Bands TDD_E				-121.50
RS-SINR ^{Note4}	Bands TDD_A	dB	-1.75	20	-4.0
	Bands TDD_C				
	Bands TDD_E				
I _o ^{Note4}	Bands TDD_A	dBm/9 MHz	-50	-60.68	-90.26
	Bands TDD_C				-89.26
	Bands TDD_E				-88.26
CRS \hat{E}_s/N_{oc}	dB	-1.75	20	-4.0	
Propagation condition	-	AWGN	AWGN	AWGN	
<p>Note 1: For special subframe and uplink-downlink configurations see Tables 4.2-1 and 4.2-2 in TS 36.211.</p> <p>Note 2: OCNG shall be used such that both cells are fully allocated and a constant total transmitted power spectral density is achieved for all OFDM symbols.</p> <p>Note 3: Interference from other cells and noise sources not specified in the test is assumed to be constant over subcarriers and time and shall be modelled as AWGN of appropriate power for N_{oc} to be fulfilled.</p> <p>Note 4: RS-SINR, RSRP and I_o levels have been derived from other parameters for information purposes. They are not settable parameters themselves.</p> <p>Note 5: RSRP and RS-SINR minimum requirements are specified assuming independent interference and noise at each receiver antenna port.</p> <p>Note 6: E-UTRA operating band groups are as defined in Section 3.5.</p>					

Table A.9.13.6.2-2: RS-SINR TDD—FDD Inter frequency test parameters (FDD Cell2)

Parameter	Unit	Test 1	Test 2	Test 2
		Cell 1	Cell 1	Cell 1
E-UTRA RF Channel Number		2	2	2
BW _{channel}	MHz	10	10	10

Gap Pattern Id		0	0	0	
Measurement bandwidth	n_{PRI}	22—27	22—27	22—27	
PDSCH Reference measurement channel defined in A.3.1.1.1		R.0 FDD	R.0 FDD	R.0 FDD	
PDSCH allocation	n_{PRI}	13—36	13—36	13—36	
PDCCH/PCFICH/PHICH Reference measurement channel defined in A.3.1.2.1		R.6 FDD	R.6 FDD	R.6 FDD	
OCNG Patterns defined in A.3.2.1.1 (OP.1 FDD)		OP.1 FDD	OP.1 FDD	OP.1 FDD	
PBCH_RA	dB	0	0	0	
PBCH_RB					
PSS_RA					
SSS_RA					
PCFICH_RB					
PHICH_RA					
PHICH_RB					
PDCCH_RA					
PDCCH_RB					
PDSCH_RA					
PDSCH_RB					
OCNG_RA ^{Note1}					
OCNG_RB ^{Note1}					
N_{oc1} ^{Note2}					Bands FDD_A ^{Note 8}
	Bands FDD_B1, FDD_B2 ^{Note 9}	-119			
	Bands FDD_C	-118.5			
	Bands FDD_D	-118			
	Bands FDD_E, FDD_F ^{Note 5}	-117.5			
	Bands FDD_G ^{Note 7}	-116.5			
	Bands FDD_H	-116			
N_{oc2} ^{Note2a}	Bands FDD_A ^{Note 8}	dBm/15 kHz	-79	-114.5	-113.5
	Bands FDD_B1, FDD_B2 ^{Note 9}				-113
	Bands FDD_C				-112.5
	Bands FDD_D				-112
	Bands FDD_E, FDD_F ^{Note 5}				-111.5
	Bands FDD_G ^{Note 7}				-110.5
	Bands FDD_H				-110
CRS \hat{E}_s/I_{ot}	dB	-1.75	20	-4.0	
RSRP ^{Note3}	Bands FDD_A ^{Note 8}	dBm/15 kHz	-86.75	-88.50	-123.5
	Bands FDD_B1, FDD_B2 ^{Note 9}				-123
	Bands FDD_C				-122.5
	Bands FDD_D				-122
	Bands FDD_E, FDD_F ^{Note 5}				-121.5
	Bands FDD_G ^{Note 7}				-120.5
	Bands FDD_H				-120
RS-SINR ^{Note3}	Bands FDD_A ^{Note 8}	dB	-1.75	20	-4.0

	Bands FDD_B1, FDD_B2 ^{Note 9}				
	Bands FDD_C				
	Bands FDD_D				
	Bands FDD_E, FDD_F ^{Note 5}				
	Bands FDD_G ^{Note 7}				
	Bands FDD_H				
I_o ^{Note 3}	Bands FDD_A ^{Note 8}	dBm/9 MHz	-50.79	-60.56	-93.48
	Bands FDD_B1, FDD_B2 ^{Note 9}				-92.98
	Bands FDD_C				-92.48
	Bands FDD_D				-91.98
	Bands FDD_E, FDD_F ^{Note 5}				-91.48
	Bands FDD_G ^{Note 7}				-90.48
	Bands FDD_H				-89.98
$CRS \hat{E}_s / N_{oc1}$	dB	-1.75	20	-4.0	
Propagation condition	-	AWGN	AWGN	AWGN	
<p>Note 1: OCNG shall be used such that both cells are fully allocated and a constant total transmitted power spectral density is achieved for all OFDM symbols.</p> <p>Note 2: Interference from other cells and noise sources not specified in the test is assumed to be constant over CRS subcarriers and time and shall be modelled as AWGN of appropriate power for N_{oc1} to be fulfilled.</p> <p>Note 2a: Interference from other cells and noise sources not specified in the test is assumed to be constant over subcarriers other than CRS subcarriers and time and shall be modelled as AWGN of appropriate power for N_{oc2} to be fulfilled.</p> <p>Note 3: RS-SINR, RSRP and I_o levels have been derived from other parameters for information purposes. They are not settable parameters themselves.</p> <p>Note 4: RSRP and RS-SINR minimum requirements are specified assuming independent interference and noise at each receiver antenna port.</p> <p>Note 5: For Band 26, the tests shall be performed with the carrier frequency of the assigned E-UTRA channel bandwidth within 865-894 MHz.</p> <p>Note 6: E-UTRA operating band groups are as defined in Section 3.5.</p> <p>Note 7: Except Band 29.</p> <p>Note 8: Except Band 32, Band 75, Band 76.</p> <p>Note 9: For Band 74, the tests shall be performed with the carrier frequency of the assigned E-UTRA channel bandwidth within 1475.9-1510.9 MHz.</p>					

A.9.13.6.3 Test Requirements

The RS-SINR measurement accuracy shall fulfil the requirements in Sections 9.1.17.3.

A.9.14 Channel quality reporting accuracy

A.9.14.1 E-UTRAN HD-FDD Downlink channel quality reporting accuracy for UE Category NB1 Standalone mode under normal coverage

A.9.14.1.1 Test Purpose and Environment

The purpose of this test is to verify that the downlink channel quality reporting accuracy is within the specified limits. This test will verify the requirements in Section 9.1.22.16.

A.9.14.1.2 Test parameters

In this set of test cases all cells are on the same carrier frequency. The MSG3-based downlink channel quality reporting accuracy is tested by using the parameters in Tables A.9.14.1.2-1 and A.9.14.1.2-2.

Table A.9.14.1.2-1: General Test Parameters for Downlink channel quality reporting accuracy test for E-UTRAN HD-FDD Category NB1 UE in Standalone mode under normal coverage

Parameter	Unit	Value
NB-IoT operational mode		Standalone
CP Length		Normal
DRX		OFF
NPRACH configuration		As specified in A.3.18
NPUSCH repetition level		1

Table A.9.14.1.2-2: nCell specific Test Parameters for Downlink channel quality reporting accuracy test for E-UTRAN HD-FDD Category NB1 UE in Standalone mode under normal coverage

Parameter	Unit	Test 1
BW_{channel}	kHz	200
NPDCCH parameter		R.31 HD-FDD
NPDCCH repetition level for RAR		4
NPBCH_RB	dB	0
NPSS_RA	dB	
NSSS_RA	dB	
NPDCCH_RA	dB	
NPDCCH_RB	dB	
NPDSCH_RA	dB	
NPDSCH_RB	dB	
OCNG_RA ^{Note1}	dB	
OCNG_RB ^{Note1}	dB	
N_{oc} ^{Note2}	dBm/15 kHz	
$NRS \hat{E}_s / N_{oc}$	dB	-6
Propagation condition		AWGN
Antenna Configuration		2x1
Scheduling delay in RAR (I_{Delay}) ^{Note3}		0
Channel quality IE ^{Note4}		CQI-NPDCCH-NB
<p>Note 1: OCNG shall be used such that active cells are fully allocated and a constant total transmitted power spectral density is achieved for all OFDM symbols.</p> <p>Note 2: Interference from other cells and noise sources not specified in the test are assumed to be constant over subcarriers and time and shall be modelled as AWGN of appropriate power for N_{oc} to be fulfilled.</p> <p>Note 3: See section 16.3.3 in TS 36.213 [23].</p> <p>Note 4: See TS 36.331 [2].</p>		

A.9.14.1.3 Test Requirements

The downlink channel quality reporting accuracy shall fulfil the requirements in section 9.1.22.16.

A.9.14.2 E-UTRAN HD-FDD Downlink channel quality reporting accuracy for UE Category NB1 Standalone mode under enhanced coverage

A.9.14.2.1 Test Purpose and Environment

The purpose of this test is to verify that the downlink channel quality reporting accuracy is within the specified limits. This test will verify the requirements in Section 9.1.22.16.

A.9.14.2.2 Test parameters

In this set of test cases all cells are on the same carrier frequency. The MSG3-based downlink channel quality reporting accuracy is tested by using the parameters in Tables A.9.14.2.2-1 and A.9.14.2.2-2.

Table A.9.14.2.2-1: General Test Parameters for Downlink channel quality reporting accuracy test for E-UTRAN HD-FDD Category NB1 UE in Standalone mode under enhanced coverage

Parameter	Unit	Value
NB-IoT operational mode		Standalone
CP Length		Normal
DRX		OFF
NPRACH configuration		As specified in A.3.18
NPUSCH repetition level		1

Table A.9.14.2.2-2: nCell specific Test Parameters for Downlink channel quality reporting accuracy test for E-UTRAN HD-FDD Category NB1 UE in Standalone mode under enhanced coverage

Parameter	Unit	Test 1
$BW_{channel}$	kHz	200
NPDCCH parameter		R.31 HD-FDD
NPDCCH repetition level for RAR		16
NPBCH_RB	dB	0
NPSS_RA	dB	
NSSS_RA	dB	
NPDCCH_RA	dB	
NPDCCH_RB	dB	
NPDSCH_RA	dB	
NPDSCH_RB	dB	
OCNG_RA ^{Note1}	dB	
OCNG_RB ^{Note1}	dB	
N_{oc} ^{Note2}	dBm/15 kHz	-98
$NRS \hat{E}_s / N_{oc}$	dB	-12
Propagation condition		AWGN
Antenna Configuration		2x1
Scheduling delay in RAR (I_{Delay}) ^{Note3}		0
Channel quality IE ^{Note4}		CQI-NPDCCH-NB
<p>Note 1: OCNG shall be used such that active cells are fully allocated and a constant total transmitted power spectral density is achieved for all OFDM symbols.</p> <p>Note 2: Interference from other cells and noise sources not specified in the test are assumed to be constant over subcarriers and time and shall be modelled as AWGN of appropriate power for N_{oc} to be fulfilled.</p> <p>Note 3: See section 16.3.3 in TS 36.213 [23].</p> <p>Note 4: See TS 36.331 [2].</p>		

A.9.14.2.3 Test Requirements

The downlink channel quality reporting accuracy shall fulfil the requirements in section 9.1.22.16.

A.10 Proximity-based Services in Any Cell Selection State

A.10.1 E-UTRAN FDD – UE ProSe Direct Communication Transmission Timing Accuracy Test

A.10.1.1 Test Purpose and Environment

The purpose of this test is to verify the timing requirements for ProSe Direct Communication transmissions in Any Cell Selection state defined in clause 11.2.

For this test, the UE is triggered by the test loop function or the upper layers to transmit for ProSe Direct Communication.

The test parameters are given in Table A.10.1.1-1 below. There is no serving cell and one active SyncRef UE in this test. The test system shall emulate the SyncRef UE to transmit SLSS and MIB-SL every synchronization period.

The test system will configure the ProSe UE to transmit SLSS in each period (40ms) by configuring *syncTxThreshOoC* as +infinity in the pre-configured parameters. The ProSe UE is expected to synchronize to the SyncRef UE and transmit its own SLSS and SL-MIB in accordance to the procedure specified in clause 5.10.7.3 of TS 36.331.

The transmit timing is verified using the transmission timing of SLSS transmissions.

Table A.10.1.1-1: Test parameters for ProSe Transmission Timig Accuracy test for E-UTRAN FDD

Parameter	Unit	Value	Comment
E-UTRA RF Channel Number		1	
Channel Bandwidth (BW _{channel})	MHz	5 or 10	According to principle defined in clause A.3.12.3
Active cell		None	
Active SyncRef UE		SyncRef UE 1	Transmitting SLSS+MIB-SL on uplink of RF channel number 1
ProSe Direct Communication preconfiguration		As specified in Table A.3.12.5-2 (Configuration #2)	IE values unless specified otherwise in this test.
syncTxThreshOoC		11 (+infinity)	
N_{oc}	dBm/15 kHz	-98	
SyncRef UE 1	syncCP-Len	Normal	
	syncOffsetIndicator	Set same as <i>syncOffsetIndicator1</i> in ProSe Direct Communication preconfiguration	
	slssid	30	
	inCoverage	TRUE	In MIB-SL
	networkControlledSyncTx	ON	
	ProSe Direct Communication resource pool configuration	As specified in Table A.3.12.5-1 (Configuration #1)	IE values unless specified otherwise in this test; Note resource pool is same as Configuration #2 used by ProSe UE.
	\hat{E}_s/N_{oc}		3
S-RSRP <small>Note1, Note 2</small>		-95	
Propagation condition		AWGN	
Note 1: RSRP levels have been derived from other parameters for information purposes. They are not settable parameters themselves.			
Note 2: SSSS Es/lot is set the same as PSSS/PSBCH Es/lot.			

A.10.1.2 Test Requirements

For parameters specified in Tables A.10.1.1-1, the timing accuracy for ProSe Direct Communication transmissions shall be within the limits defined in clause 11.2.2. The timing accuracy is verified using SLSS transmissions.

Prior to start of test, test system is required to ensure that the ProSe UE is synchronornized to the SyncRef UE 1 and is transmitting SLSS + MIB-SL as derived from the SLSS + MIB-SL of SyncRef UE 1 as per clause 5.10.7.3 of TS 36.331. For the test configuration, the SLSSID used by the ProSe UE shall be 30 with *inCoverage* IE in MIB-SL set as FALSE.

The following sequence of events shall be used to verify that the requirements are met.

For 5MHz or 10MHz channel bandwidth, the test sequence shall be carried out in Any Cell Selection state.

- a) After the ProSe UE is synchronized to SyncRef UE 1, the test system shall verify that the ProSe UE SLSS transmission timing offset is within $\pm 24 \times T_s$ with respect to the first detected path (in time) of the corresponding frame of SyncRef UE 1.
- b) The test system adjusts the transmit timing of SyncRef UE 1 by $+24 \times T_s$ compared to that in (a). The test system shall wait for at least one SLSS period (40ms) before verifying the requirement again in (c).
- c) The test system shall verify that the UE SLSS transmission timing offset stays within $\pm 24 \times T_s$ with respect to the first detected path (in time) of the corresponding frame of SyncRef UE 1.

A.10.2 E-UTRAN FDD – Initiation/Cease of SLSS Transmission with ProSe Direct Communication

A.10.2.1 Test Purpose and Environment

The purpose of this test is to verify the requirements related to the evaluation time allowed to initiate and cease SLSS transmissions in Any Cell Selection state defined in clause 11.3.

For this test, the UE is triggered by the test loop function or the upper layers to transmit for ProSe Direct Communication.

The test parameters are given in Table A. X.2.1-1 and Table A.10.2.1-2 below. There are no active cells in this test. There is one active SyncRef UE (SyncRef UE 1) in this test. The test system shall emulate SyncRef UE 1 to transmit SLSS and MIB-SL every synchronization period.

Prior to start of test, test system is required to ensure that the ProSe UE is synchronornized to the SyncRef UE 1 and is transmitting SLSS + MIB-SL as derived from the SLSS + MIB-SL of SyncRef UE 1 as per clause 5.10.7.3 of TS 36.331. For the test configuration, the SLSSID used by the ProSe UE shall be 30 with *inCoverage* IE in MIB-SL set as FALSE.

The test consists of three successive time periods, with time duration of T1, T2 and T3 respectively. During T1, the S-RSRP of SyncRef UE 1 is above *syncTxThreshOOC* and the UE is not expected to be transmitting SLSS. During T2, the S-RSRP of SyncRef UE 1 is lowered below *syncTxThreshOOC* and the UE is expected to initiate SLSS transmissions. During T3, the S-RSRP of SyncRef UE 1 is increased back to be above *syncTxThreshOOC* and the UE is expected to cease SLSS transmissions.

Table A.10.2.1-1: Test parameters for initiation/cease of SLSS transmissions test for E-UTRAN FDD

Parameter	Unit	Value	Comment
E-UTRA RF Channel Number		1	
Channel Bandwidth (BW _{channel})	MHz	5 or 10	According to principle defined in clause A.3.12.3
Active cell		None	
Active SyncRef UE		SyncRef UE 1	Transmitting SLSS+MIB-SL on uplink of RF channel number 1
ProSe Direct Communication preconfiguration		As specified in Table A.3.12.5-2	IE values unless specified otherwise in this test.

		(Configuration #2)	
syncTxThreshOoC	dBm/15 kHz	-95	
T1	s	3	
T2	s	5.24	
T3	s	5.24	

Table A.10.2.1-2: SyncRef UE specific test parameters for initiation/cease of SLSS transmissions test for E-UTRAN FDD

Parameter	Unit	SyncRef UE 1		
		T1	T2	T3
E-UTRA RF Channel Number		1		
$BW_{channel}$ ^{Note 4}	MHz	5 or 10		
ProSe Direct Communication resource pool configuration		As specified in Table A.3.12.5-1 (Configuration #1) Note resource pool is same as Configuration #2 used by ProSe UE.		
syncOffsetIndicator		Set same as <i>syncOffsetIndicator1</i> in ProSe Direct Communication preconfiguration		
slssid		30		
inCoverage		TRUE		
networkControlledSyncTx		ON		
N_{oc} ^{Note1}	dBm/15 kHz	-96		
\hat{E}_s / N_{oc}	dB	5.5	-3.5	5.5
S-RSRP ^{Note2, Note3}	dBm/15 kHz	-90.5	-99.5	-90.5
Propagation Condition		AWGN		
<p>Note 1: Interference from other cells and noise sources not specified in the test is assumed to be constant over subcarriers and time and shall be modelled as AWGN of appropriate power for N_{oc} to be fulfilled.</p> <p>Note 2: RSRP levels have been derived from other parameters for information purposes. They are not settable parameters themselves.</p> <p>Note 3: SSSS Es/lot is set the same as PSSS/PSBCH Es/lot.</p> <p>Note 4: This test is according to the principle defined in section A.3.12.3.</p>				

A.10.2.2 Test Requirements

The SLSS transmission initiation delay is defined as the time from the beginning of time period T2 up to the moment when the UE initiates the SLSS transmission.

The SLSS transmission initiation delay shall be less than 0.84 s.

The SLSS transmission cease delay is defined as the time from the beginning of time period T3 up to the moment when the UE ceases the SLSS transmission.

The SLSS transmission cease delay shall be less than 0.84 s.

The rate of correct initiation/cease delay of SLSS transmissions observed during repeated tests shall be at least 90%.

NOTE: The initiation/cease delay of SLSS transmissions can be expressed as: $T_{evaluate,SLSS} + \text{SLSS period}$,

Where:

$T_{evaluate,SLSS}$ is the evaluation time for initiate/cease of SLSS, and is 0.8 sec (clause 11.3.2) for the parameters in this test;

SLSS period is set as 40ms in this test.

A.10.3 E-UTRAN FDD – SyncRef UE Selection / Reselection Test

A.10.3.1 Test Purpose and Environment

The purpose of this test is to verify the requirements related to SyncRef UE selection / reselection in Any Cell Selection state defined in clause 11.5.

For this test, the UE is triggered by the test loop function or the upper layers to transmit for ProSe Direct Communication.

The test parameters are given in Table A. X.3.1-1 and Table A.10.3.1-2 below. There are no active cells in this test. There are two active SyncRef UEs (SyncRef UE 1 and SyncRef UE 2) in this test. The test system shall emulate SyncRef UE 1 and SyncRef UE 2 to transmit SLSS and MIB-SL every SLSS period (40ms).

The test system can verify the selection / reselection of SyncRef UE by monitoring the SLSS ID used by the ProSe UE for its SLSS+MIB-SL transmissions. When the ProSe UE is not synchronized to any SyncRef UE, then the ProSe UE shall use the SLSS ID pre-configured in the ProSe UE. When the ProSe UE is synchronized to a SyncRef UE, the ProSe UE shall derive its SLSS ID from the SLSS ID of the SyncRef UE as per clause 5.10.7.3 of TS 36.331.

The test consists of three successive time periods, with time duration of T1, T2 and T3 respectively. During T1, both SyncRef UE 1 and SyncRef UE 2 are powered off and the ProSe UE is expected to transmit SLSS as an independent synchronization source. During T1, SyncRef UE 1 is powered ON and the ProSe UE will select SyncRef UE 1 as the synchronization source. During T2, a higher priority SyncRef UE 2 is additionally powered ON and the ProSe UE will reselect to the higher priority SyncRef UE 2 as the synchronization source.

Table A.10.3.1-1: Test parameters for SyncRef UE selection/reselection test for E-UTRAN FDD

Parameter		Unit	Value	Comment
Initial condition	Active synchronization source		Independent synchronization source	UE transmits for ProSe Direct Communication and SLSS+MIB-SL with some random SLSS ID and in-coverage set as FALSE in MIB-SL.
T2 end condition	Active synchronization source		Sync Ref UE 1	UE transmits for ProSe Direct Communication and SLSS+MIB-SL with SLSS ID = 168+59 and in-coverage set as FALSE in MIB-SL.
Final condition	Active synchronization source		Sync Ref UE 2	UE transmits for ProSe Direct Communication and SLSS+MIB-SL with SLSS ID = 30 and in-coverage set as FALSE in MIB-SL.
E-UTRA RF Channel Number			1	
Channel Bandwidth (BW _{channel})		MHz	5 or 10	According to principle defined in clause A.3.12.3
Active cell			None	
Active SyncRef UEs			SyncRef UE 1 SyncRef UE 2	Transmitting SLSS+MIB-SL on uplink of RF channel number 1
Timing offset between SyncRef UE 1 and SyncRef UE 2		ms	3	Asynchronous
Frequency offset of SyncRef UE 1		ppm	0	
Frequency offset of SyncRef UE 2		ppm	5	
ProSe Direct Communication preconfiguration			As specified in Table A.3.12.5-2 (Configuration #2)	IE values unless specified otherwise in this test.
syncTxThreshOoC			11 (+infinity)	
T1		s	24	
T2		s	24	
T3		s	24	

Table A.10.3.1-2: SyncRef UE specific test parameters for SyncRef UE selection/reselection test for E-UTRAN FDD

Parameter	Unit	SyncRef UE 1	SyncRef UE 2
-----------	------	--------------	--------------

		T1	T2	T3	T1	T2	T3
E-UTRA RF Channel Number		1					
BW _{channel} ^{Note 4}	MHz	5 or 10					
ProSe Direct Communication resource pool configuration		As specified in Table A.3.12.5-2 (Configuration #2)			As specified in Table A.3.12.5-1 (Configuration #1)		
networkControlledSyncTx		N/A			ON		
syncTxThreshOoC	dBm/15 kHz	+infinity			N/A		
slssid		59			30		
inCoverage (in MIB-SL)		FALSE			TRUE		
syncOffsetIndicator		syncOffsetIndicator2			syncOffsetIndicator1		
N_{oc} ^{Note 1}	dBm/15 kHz	-98					
\hat{E}_s / N_{oc}	dB	-infinity	16	16	-infinity	-infinity	13
\hat{E}_s / I_{ot}	dB	-infinity	16	2.79	-infinity	-infinity	-3.11
S-RSRP ^{Note 2, Note 3}	dBm/15 kHz	-infinity	-82	-82	-infinity	-infinity	-85
Propagation Condition		AWGN					
<p>Note 1: Interference from other cells and noise sources not specified in the test is assumed to be constant over subcarriers and time and shall be modelled as AWGN of appropriate power for N_{oc} to be fulfilled.</p> <p>Note 2: RSRP levels have been derived from other parameters for information purposes. They are not settable parameters themselves.</p> <p>Note 3: SSSS Es/lot is set the same as PSSS/PSBCH Es/lot.</p> <p>Note 4: This test is according to the principle defined in section A.3.12.3.</p>							

A.10.3.2 Test Requirements

SyncRef UE selection delay is defined as the time from the beginning of T2 to the time UE is synchronized to SyncRef UE 1 and changes its SLSS transmissions timing and SLSS ID to follow SyncRef UE 1 as the synchronization source. For the test configuration, the SLSS ID will be changed to 168+59 (with in-coverage IE in MIB-SL set to FALSE) after SyncRef UE selection delay from start of T2.

The SyncRef UE selection delay shall be less than 20.84sec.

SyncRef UE reselection delay is defined as the time from the beginning of T3 to the time UE changes its synchronization source from SyncRef UE 1 to SyncRef UE 2, and changes its SLSS transmissions timing and SLSS ID to follow SyncRef UE 2 as the synchronization source. For the test configuration, the SLSS ID will be changed to 30 (with in-coverage IE in MIB-SL set to FALSE) after SyncRef UE selection delay from start of T3.

The SyncRef UE reselection delay shall be less than 20.84sec.

The rate of correct SyncRef UE selection / reselection observed during repeated tests shall be at least 90%.

The test system will verify that the ProSe UE does not drop or delay more than 2% of its SLSS transmissions during the duration of T1, T2, and T3.

The SyncRef UE selection/reselection delay can be expressed as:

$$\text{SyncRef UE selection/reselection delay} = T_{\text{detect, SyncRef UE}} + T_{\text{evaluate, SLSS}} + \text{SLSS period}$$

Where

- $T_{\text{detect, SyncRef UE}} = 20\text{sec}$ (as specified in sub-clause 11.5.2.2)
- $T_{\text{evaluate, SLSS}} = 0.8$ (as specified in sub-clause 11.3.2)
- SLSS period = 40ms

This gives a total of 20.84 seconds.

A.10.4 E-UTRAN FDD – Cell Identification on downlink frequency associated with ProSe frequency (when UE is transmitting for ProSe)

A.10.4.1 Test Purpose and Environment

The purpose of this test is to verify cell identification delay requirement for a newly detectable cell on the downlink frequency associated with the pre-configured ProSe carrier frequency in Any Cell Selection state. This test will verify the requirements in clause 11.4 when the UE is transmitting for ProSe.

For this test, the UE is triggered by the test loop function or the upper layers to transmit for ProSe Direct Communication.

The test parameters are given in Table A. 10.4.1-1, Table A. 10.4.1-2, and Table A.10.4.1-3 below. There is one active cell (Cell 1) and active SyncRef UE (SyncRef UE 1) in this test. The test system shall emulate SyncRef UE 1 to transmit SLSS and MIB-SL every SLSS period (40ms).

The test consists of two successive time periods, with time duration of T1 and T2 respectively. During T1, the cell is powered OFF and the ProSe UE is synchronized to SyncRef UE 1. During T2, the cell is powered ON and the ProSe UE will detect the cell and attempt to camp on the cell.

Prior to start of test, test system is required to ensure that the ProSe UE is synchronized to the SyncRef UE 1 and is transmitting SLSS + MIB-SL as derived from the SLSS + MIB-SL of SyncRef UE 1 as per clause 5.10.7.3 of TS 36.331. For the test configuration, the SLSSID used by the ProSe UE shall be 30 with *inCoverage* IE in MIB-SL set as FALSE.

Table A.10.4.1-1: Test parameters for cell identification test on on downlink frequency associated with ProSe frequency for E-UTRAN FDD (when UE is transmitting for ProSe)

Parameter		Unit	Value	Comment
Initial condition	Active synchronization source		Sync Ref UE 1	
Final condition	Active synchronization source		Cell1	
E-UTRA RF Channel Number			1	
Channel Bandwidth (BW _{channel})		MHz	5 or 10	According to principle defined in clause A.3.12.3
Active cell			Cell1	
Active SyncRef UEs			SyncRef UE 1	Transmitting SLSS+MIB-SL on uplink of RF channel number 1
ProSe Direct Communication preconfiguration			As specified in Table A.3.12.5-2 (Configuration #2)	IE values unless specified otherwise in this test.
syncTxThreshOoC			11 (+infinity)	
T1		s	2	
T2		s	30	

Table A.10.4.1-2: Cell specific test parameters for cell identification test on on downlink frequency associated with ProSe frequency for E-UTRAN FDD (when UE is transmitting for ProSe)

Parameter	Unit	Cell 1	
		T1	T2
E-UTRA RF Channel Number		1	
BW _{channel} ^{Note 4}	MHz	5 or 10	
OCNG Patterns defined in A.3.2.1.2 ^{Note 4}		5 MHz: OP.16 FDD 10 MHz: OP.2 FDD	
PBCH_RA	dB	0	
PBCH_RB			
PSS_RA			
SSS_RA			
PCFICH_RB			
PHICH_RA			
PHICH_RB			

PDCCH_RA		
PDCCH_RB		
PDSCH_RA		
PDSCH_RB		
OCNG_RA ^{Note 1}		
OCNG_RB ^{Note 1}		
N_{oc} ^{Note2}	dBm/15 kHz	-98
\hat{E}_s/N_{oc}	dB	-infinity -3
RSRP ^{Note3}	dBm/15 kHz	-infinity -101
SCH_RP ^{Note3}	dBm/15 kHz	-infinity -101
Propagation Condition		AWGN
Note 1:	OCNG shall be used such that cell is fully allocated and a constant total transmitted power spectral density is achieved for all OFDM symbols.	
Note 2:	Interference from other cells and noise sources not specified in the test is assumed to be constant over subcarriers and time and shall be modelled as AWGN of appropriate power for N_{oc} to be fulfilled.	
Note 3:	RSRP levels have been derived from other parameters for information purposes. They are not settable parameters themselves.	
Note 4:	This test is according to the principle defined in section A.3.12.3.	

Table A.10.4.1-3: SyncRef UE specific test parameters for cell identification test on on downlink frequency associated with ProSe frequency for E-UTRAN FDD

Parameter	Unit	SyncRef UE 1	
		T1	T2
E-UTRA RF Channel Number		1 (Uplink)	
BW _{channel} ^{Note 4}	MHz	5 or 10	
ProSe Direct Communication resource pool configuration		As specified in Table A.3.12.5-1 (Configuration #1)	
networkControlledSyncTx		ON	
slssid		30	
inCoverage (in MIB-SL)		TRUE	
syncOffsetIndicator		syncOffsetIndicator1	
N_{oc} ^{Note1}	dBm/15 kHz	-98	
\hat{E}_s/N_{oc}	dB	13	
S-RSRP ^{Note2, Note3}	dBm/15 kHz	-85	
Propagation Condition		AWGN	
Note 1:	Interference from other cells and noise sources not specified in the test is assumed to be constant over subcarriers and time and shall be modelled as AWGN of appropriate power for N_{oc} to be fulfilled.		
Note 2:	RSRP levels have been derived from other parameters for information purposes. They are not settable parameters themselves.		
Note 3:	SSSS Es/lot is set the same as PSSS/PSBCH Es/lot.		
Note 4:	This test is according to the principle defined in section A.3.12.3.		

A.10.4.2 Test Requirements

The cell selection delay to a newly detectable cell on the downlink associated with the preconfigured ProSe carrier is defined as the time from the beginning of T2 to the time UE camps on the cell and starts to send preambles on the PRACH for sending the RRC CONNECTION REQUEST.

The cell selection delay to a newly detectable cell on the downlink associated with the preconfigured ProSe carrier shall be less than 7.68 s.

The cell selection delay can be expressed as $T_{\text{basic_identify_OoC_ProSe Tx_ON}} + T_{\text{SI}}$, where

- $T_{\text{basic_identify_OoC_ProSe Tx_ON}} = 6.4\text{sec}$ as specified in sub-clause 11.4.2.2

- T_{SI} = Maximum repetition period of relevant system info blocks that needs to be received by the UE to camp on a cell; 1280 ms is assumed in this test case

This gives a total of 7.68 sec.

A.11 V2V Sidelink Communication for V2V Operation on Dedicated V2V Carrier

A.11.1 V2V UE Transmission Timing Accuracy Test

A.11.1.1 Test Purpose and Environment

The purpose of this test is to verify the timing requirements for V2V sidelink transmissions specified in clause 12.2.

For this test, the UE is triggered by the test loop function to transmit for V2V sidelink Communication.

Table A.11.1.1-1 defines test parameters for UE transmit timing accuracy tests for V2V. There is one GNSS based synchronization source during the test. The test system can emulate and send the GNSS signal to the test UE. The test parameters for GNSS signals are defined in B.6.1.

The transmit timing accuracy is verified by the UE transmitting PSSCH and PSCCH.

UE is not expected to receive any configuration related to V2V sidelink communication from the serving cell.

The test parameters of pre-configuration for V2V sidelink communication is defined in Table A.3.21.2-1.

Table A.11.1.1-1: Test Parameters for UE Transmit Timing Accuracy Tests for V2V

Parameter	Unit	Value	Comment
RF Channel Number		1	
Channel Bandwidth (BW_{channel})	MHz	10	Band 47 TDD
V2V SL Communication preconfiguration		Defined in Table A.3.21.2-1	
PSCCH Reference Measurement Channel		Defined in Table A.3.21.3-1	
PSSCH Reference Measurement Channel		Defined in Table A.3.21.3-2	
Propagation condition		AWGN	

A.11.1.2 Test requirements

For parameters specified in Tables A.11.1.1-1, the timing accuracy for V2V sidelink transmission shall be within the limits defined in clause 12.2.1. The timing accuracy is verified by using PSSCH and PSCCH transmissions.

The following sequence of events shall be used to verify that the requirements are met:

- After the UE is synchronized to the GNSS synchronization source, the test system shall verify that the UE PSSCH and PSCCH transmission timing offset is within $\pm 12 \times T_s$ with respect to the GNSS reference time.

A.11.2 Interruptions due to V2V sidelink communication

A.11.2.1 Test Purpose and Environment

The purpose of this test is to verify the requirements as defined in clause 12.3, related to interruptions due to V2V sidelink communication under the following additional conditions:

- the UE is pre-configured with parameters for enabling the UE to acquire timing synchronization
- the UE has dedicated transmitter chain and dedicated receiver chain for the V2V operation.

This test is applicable for V2V sidelink communication capable UEs that performs independent concurrent E-UTRAN operation in an E-UTRA band and stand-alone V2V sidelink operation in Band 47. If UE supports multiple bands, the UE needs to be tested only with the band with highest frequency.

In the test, the UE under test is configured with PCell on a serving frequency in the E-UTRA band, and is pre-configured with V2V sidelink communication resources for a non-serving frequency in Band 47. The test consists of one active serving cell (cell 1) on the serving RF channel 1, and there is no active cell on RF channel 2. There is no other UE in the test.

UE is not expected to receive any configuration related to V2V sidelink communication from the serving cell. Prior to the start of the test, UE is already synchronized to a GNSS source for V2V sidelink communication. The test system can emulate and send the GNSS signal to the test UE. The test parameters for GNSS signals are defined in B.6.1.

At the beginning of the test, UE is triggered by the test loop function or the upper layers to receive and transmit V2V sidelink communication. The UE is continuously scheduled with PDSCH traffic on PCell downlink in RF channel 1 for a duration of 1s. The UE is then triggered by the test loop function or the upper layers to stop receiving and transmitting V2V sidelink communication before the end of the test.

The test parameters are given in Table A.11.2.1-1, Table A.11.2.1-2, and Table A.11.2.1-3 below.

Table A.11.2.1-1: Test parameters for interruptions due to V2V sidelink communication

Parameter	Unit	Value	Comment
E-UTRA RF Channel Number		1, 2	RF channel 1 is serving RF channel 2 is non-serving
Channel Bandwidth ($BW_{channel}$)	MHz	10	On both Band 47 and E-UTRA band
Active cell		Cell 1	Serving cell on RF channel number 1

Table A.11.2.1-2: Sidelink communication configuration for interruptions due to V2V

Parameter	Unit	Value	Comment
RF Channel Number		2	Band 47
Channel Bandwidth ($BW_{channel}$)	MHz	10	According to principle defined in clause A.3.21
V2V sidelink communication resource pool configuration		As specified in Table A.3.21.2-1	IE values unless specified otherwise in this test. (Preconfigured)
PSCCH Reference Measurement Channel		CC.1	As specified in Table A.3.21.3-1
PSSCH Reference Measurement Channel		CD.1	As specified in Table A.3.21.3-2

Table A.11.2.1-3: Cell specific test parameters for interruptions due to V2V sidelink communication

Parameter	Unit	Cell1
RF Channel Number		1
Serving/Non-serving		Serving
$BW_{channel}$ ^{Note 5}	MHz	10
Correlation Matrix and Antenna Configuration		1x2 Low
drx-Configuration		None
PDCCH/PCFICH/PHICH Reference measurement channel ^{Note1, Note 5}		R.6 FDD
PDSCH Reference measurement channel defined in A.3.1.1.1 ^{Note1, Note 5}		R.3 FDD
OCNG Pattern defined in A.3.2.1		OP.10 FDD
PCFICH_RB	dB	0
PDCCH_RA	dB	
PDCCH_RB	dB	
PBCH_RA	dB	
PBCH_RB	dB	
PSS_RA	dB	

SSS_RA	dB	
PHICH_RA	dB	
PHICH_RB	dB	
PDSCH_RA	dB	
PDSCH_RB	dB	
OCNG_RA ^{Note1}	dB	
OCNG_RB ^{Note1}	dB	
\hat{E}_s/N_{oc}	dB	16
N_{oc}	dBm/15 kHz	-98
RSRP ^{Note4}	dBm/15 kHz	-82
SCH_RP ^{Note 4}	dBm/15 kHz	-82
Propagation condition		AWGN
Note 1: For the reference measurement channels, see clause A.3.1.		
Note 2: For the OCNG pattern, see clause A.3.2.		
Note 3: OCNG shall be used such that cell is fully allocated and a constant total transmitted power spectral density is achieved for all OFDM symbols.		
Note 4: RSRP levels have been derived from other parameters for information purposes. They are not settable parameters themselves.		
Note 5: This test is according to the principle defined in section A.3.21.		

A.11.2.2 Test Requirements

The test system shall verify that no interruption is caused to the ACK/NACKs on the serving cell on RF channel 1 during the test.

A.12

A.12.1 V2X UE Transmission Timing Accuracy Test

A.12.1.1 V2X UE Transmission Timing Accuracy Test for eNB as Timing Reference

A.12.1.1.1 Test Purpose and Environment

The purpose of this test is to verify the timing requirements for V2X sidelink transmissions specified in clause 13.2.2, when the downlink timing of the serving cell (RRC_IDLE) or PCell (RRC_CONNECTED) on a non-V2X sidelink carrier is used as timing reference. For this test, the UE is triggered by the test loop function or the upper layers to transmit for V2X sidelink communication.

Table A.12.1.1.1-1 and A.12.1.1.1-2 define test parameters for UE transmit timing accuracy tests for V2X sidelink Communication. There is one active cell (PCell) in this test. The transmit timing accuracy is verified by using the transmission timing of PSSCH transmissions.

Table A.12.1.1.1-1: V2XSidelink Test Parameters for V2X UE Transmit Timing Accuracy Test for eNB as Timing Reference

Parameter	Unit	Value	Comment
E-UTRA RF Channel Number		1	Band 47 TDD
Channel Bandwidth (BW _{channel})	MHz	10	
V2X sidelink communication configuration		As specified in Table A.3.22.2-2 (Configuration #2)	IE values unless specified otherwise in this test.
PSCCH Reference Measurement Channel		CC.1A	Defined in Table A.3.22.3-1
PSSCH Reference Measurement Channel		CD.1A	Defined in Table A.3.22.3-2
Propagation condition		AWGN	

Table A.12.1.1.1-2: Cell Test parameters for V2X UE Transmit Timing Accuracy Test for eNB as Timing Reference

Parameter	Unit	Value	Comment			
E-UTRA RF Channel Number		2	FDD band			
Channel Bandwidth (BW_{channel})	MHz	10				
Active cell		Cell 1	E-UTRA FDD Cell1 on RF channel number 2			
CP length of Cell 1		Normal				
PDCCH/PCFICH/PHICH Reference measurement channel ^{Note1}		R.6 FDD				
OCNG Pattern ^{Note2}		OP.2 FDD				
PBCH_RA	dB	0				
PBCH_RB						
PSS_RA						
SSS_RA						
PCFICH_RB						
PHICH_RA						
PHICH_RB						
PDCCH_RA						
PDCCH_RB						
OCNG_RA ^{Note3}						
OCNG_RB ^{Note3}						
N_{oc}				dBm/15 kHz	-98	
\hat{E}_s/N_{oc}				dB	3	
RSRP ^{Note4}	dBm/15 kHz	-95				
SCH_RP ^{Note 4}	dBm/15 kHz	-95				
Propagation condition		AWGN				
Note 1: For the reference measurement channels, see clause A.3.1. Note 2: For the OCNG pattern, see clause A.3.2. Note 3: OCNG shall be used such that Cell 1 is fully allocated and a constant total transmitted power spectral density is achieved for all OFDM symbols. Note 4: RSRP and SCH_RP levels have been derived from other parameters for information purposes. They are not settable parameters themselves.						

A.12.1.1.2 Test requirements

For parameters specified in Tables A.12.1.1.1-1 and A.12.1.1.1-2, the timing accuracy for V2X sidelink transmission shall be within the limits defined in clause 13.2.2. The timing accuracy is verified by using PSSCH transmissions.

A.12.1.2 V2X UE Transmission Timing Accuracy Test for SyncRef UE as Timing Reference

A.12.1.2.1 Test Purpose and Environment

The purpose of this test is to verify the timing requirements for V2X sidelink transmissions specified in clause 13.2.3, when SyncRef UE is used as timing reference. For this test, the UE is triggered by the test loop function to transmit for V2X sidelink communication.

Table A.12.1.2.1-1 defines test parameters for UE transmit timing accuracy tests for V2X sidelink Communication. There is one active SyncRef UE in this test without either serving cell and or GNSS signals. Before the test starts, the UE has been synchronized to the SyncRef UE. The transmit timing accuracy is verified by using the transmission timing of PSSCH transmissions.

Table A.12.1.2.1-1: Test parameters for V2X UE Transmit Timing Accuracy Test for SyncRef UE as Timing Reference

Parameter	Unit	Value	Comment
E-UTRA RF Channel Number		1	Band 47 TDD
Channel Bandwidth (BW_{channel})	MHz	10	

Active cell			None	
Active SyncRef UE			SyncRef UE 1	Transmitting SLSS+MIB-SL on uplink of RF channel number 1
V2X sidelink communication configuration			As specified in Table A.3.22.2-2 (Configuration #1)	IE values unless specified otherwise in this test.
PSCCH Reference Measurement Channel			CC.1A	Defined in Table A.3.22.3-1
PSSCH Reference Measurement Channel			CD.1A	Defined in Table A.3.22.3-2
N_{oc}		dBm/15 kHz	-98	
SyncRef UE 1	syncCP-Len		Normal	
	syncOffsetIndicator		3	
	slssid		30	
	inCoverage		TRUE	In MIB-SL
	networkControlledSyncTx		ON	
	V2X sidelink communication resource pool configuration		As specified in Table A.3.22.2-2 (Configuration #2)	IE values unless specified otherwise in this test; Note resource pool is same as Configuration #1 used by V2X UE.
	\hat{E}_s/N_{oc}		3	
S-RSRP <small>Note1, Note 2</small>			-95	
Propagation condition			AWGN	
Note 1: S-RSRP levels have been derived from other parameters for information purposes. They are not settable parameters themselves.				
Note 2: SSSS Es/lot is set the same as PSSS/PSBCH Es/lot.				

A.12.1.2.2 Test Requirements

For parameters specified in Tables A.12.1.2.1-1, the timing accuracy for V2X sidelink transmission shall be within the limits defined in clause 13.2.3. The timing accuracy is verified by using PSSCH transmissions.

A.12.2 Initiation/Cease of SLSS Transmission with V2X Sidelink Communication

A.12.2.1 Initiation/Cease of SLSS Transmission with V2X Sidelink Communication for eNB as Timing Reference

A.12.2.1.1 Test Purpose and Environment

The purpose of this test is to verify that the V2X UE meets the requirements related to the maximum evaluation time allowed to initiate and cease SLSS transmissions defined in clause 13.3.1.1, when the downlink timing of the serving cell (RRC_IDLE) or PCell (RRC_CONNECTED) on a non-V2X sidelink carrier is used as timing reference. For this test, the UE is triggered by the test loop function or the upper layers to transmit for V2X sidelink Communication.

The test parameters are given in Table A.12.2.1.1-1 and Table A.12.2.1.1-2 below. There is one active cell in this test. The test consists of three successive time periods, with time duration of T1, T2 and T3 respectively. During T1, the RSRP of the PCell is above *syncTxThreshIC* and the UE is not expected to be transmitting SLSS. During T2, the RSRP of the PCell is lowered below *syncTxThreshIC* and the UE is expected to initiate SLSS transmissions. During T3, the RSRP of the PCell is increased back to be above *syncTxThreshIC* and the UE is expected to cease SLSS transmissions.

Table A.12.2.1.1-1: Test Parameters for Initiation/Cease of SLSS Transmissions Test for eNB as Timing Reference

Parameter	Unit	Value	Comment
Active cell		Cell 1	Serving cell on RF channel number 1

Active SyncRef UE		SyncRef UE 1	Transmitting SLSS+MIB-SL on RF channel number 2 (TDD carrier in Band 47)
V2X sidelink Communication configuration		As specified in Table A.3.24.2-2 (Configuration #2)	IE values unless specified otherwise in this test.
networkControlledSyncTx		Not configured	
syncTxThreshIC	dBm/15 kHz	-110	In SIB21
DRX		OFF	
T1	s	3	
T2	s	5.24	
T3	s	5.24	

Table A.12.2.1.1-2: Cell Test Parameters for Initiation/Cease of SLSS Transmissions Test for eNB as Timing Reference

Parameter	Unit	Cell 1		
		T1	T2	T3
E-UTRA RF Channel Number		1		
$BW_{channel}$	MHz	10		
PDCCH/PCFICH/PHICH Reference measurement channel defined in A.3.1.2.1		R.6 FDD		
OCNG Patterns defined in A.3.2.1.2		OP.2 FDD		
PBCH_RA	dB	0		
PBCH_RB				
PSS_RA				
SSS_RA				
PCFICH_RB				
PHICH_RA				
PHICH_RB				
PDCCH_RA				
PDCCH_RB				
PDSCH_RA				
PDSCH_RB				
OCNG_RA ^{Note 1}				
OCNG_RB ^{Note 1}				
N_{oc} ^{Note 2}				
\hat{E}_s / N_{oc}	dB	4.5	-4.5	4.5
RSRP ^{Note 3}	dBm/15 kHz	-105.5	-114.5	-105.5
SCH_RP ^{Note 3}	dBm/15 kHz	-105.5	-114.5	-105.5
I_o ^{Note 3}	dBm/9 MHz	-76.4	-80.9	-76.4
Propagation Condition		AWGN		
Note 1:	OCNG shall be used such that cell is fully allocated and a constant total transmitted power spectral density is achieved for all OFDM symbols.			
Note 2:	Interference from other cells and noise sources not specified in the test is assumed to be constant over subcarriers and time and shall be modelled as AWGN of appropriate power for N_{oc} to be fulfilled.			
Note 3:	RSRP and SCH_RP levels have been derived from other parameters for information purposes. They are not settable parameters themselves.			

A.12.2.1.2 Test Requirements

The SLSS transmission initiation delay is defined as the time from the beginning of time period T2 up to the moment when the UE initiates the SLSS transmission.

The SLSS transmission initiation delay shall be less than 0.56 s.

The SLSS transmission cease delay is defined as the time from the beginning of time period T3 up to the moment when the UE ceases the SLSS transmission.

The SLSS transmission cease delay shall be less than 0.56 s.

The rate of correct initiation/cease delay of SLSS transmissions observed during repeated tests shall be at least 90%.

NOTE: The initiation/cease delay of SLSS transmissions can be expressed as: $T_{\text{evaluate,SLSS}} + \text{SLSS period}$,

Where:

$T_{\text{evaluate,SLSS}}$ is the evaluation time for initiate/cease of SLSS, and is 0.4 sec (clause 13.3.1.1) for the parameters in this test;

SLSS period is set as 160ms in this test.

A.12.2.2 Initiation/Cease of SLSS Transmission with V2X Sidelink Communication for SyncRef UE as Timing Reference

A.12.2.2.1 Test Purpose and Environment

The purpose of this test is to verify the requirements related to the evaluation time allowed to initiate and cease SLSS transmissions defined in clause 13.3.1.3, when SyncRef UE is used as timing reference. For this test, the UE is triggered by the test loop function or the upper layers to transmit for V2X sidelink Communication.

The test parameters are given in Table A.12.2.2.1-1 and Table A.12.2.2.1-2 below. There are neither active cells and nor GNSS signals in this test. There is one active SyncRef UE (SyncRef UE 1) in this test. The test system shall emulate SyncRef UE 1 to transmit SLSS and MIB-SL every synchronization period.

Prior to start of test, test system is required to ensure that the V2X UE is synchronised to the SyncRef UE 1 and is transmitting SLSS + MIB-SL as derived from the SLSS + MIB-SL of SyncRef UE 1 as per clause 5.10.7.3 of TS 36.331. For the test configuration, the SLSSID used by the V2X UE shall be 30 with *inCoverage* IE in MIB-SL set as FALSE. The test consists of three successive time periods, with time duration of T1, T2 and T3 respectively. During T1, the S-RSRP of SyncRef UE 1 is above *syncTxThreshOOC* and the UE is not expected to be transmitting SLSS. During T2, the S-RSRP of SyncRef UE 1 is lowered below *syncTxThreshOOC* and the UE is expected to initiate SLSS transmissions. During T3, the S-RSRP of SyncRef UE 1 is increased back to be above *syncTxThreshOOC* and the UE is expected to cease SLSS transmissions.

Table A.12.2.2.1-1: Test Parameters for Initiation/Cease of SLSS Transmissions Test for SyncRef UE as Timing Reference

Parameter	Unit	Value	Comment
E-UTRA RF Channel Number		1	TDD carrier in Band 47 is used.
Channel Bandwidth (BW_{channel})	MHz	10	
Active cell		None	
Active SyncRef UE		SyncRef UE 1	Transmitting SLSS+MIB-SL on RF channel number 1
V2X sidelink Communication preconfiguration		As specified in Table A.3.24.2-1 (Configuration #1)	IE values unless specified otherwise in this test.
<i>syncTxThreshOoC</i>	dBm/15 kHz	-100	
T1	s	3	
T2	s	5.24	
T3	s	5.24	

Table A.12.2.2.1-2: SyncRef UE Specific Test Parameters for Initiation/Cease of SLSS Transmissions Test for SyncRef UE as Timing Reference

Parameter	Unit	SyncRef UE 1		
		T1	T2	T3
E-UTRA RF Channel Number		1		
BW_{channel}	MHz	10		
V2X sidelink Communication resource pool configuration		As specified in Table A.3.24.2-1 (Configuration #1) Note resource pool is same as Configuration #1 used by V2X UE.		

syncOffsetIndicator		Set same as <i>syncOffsetIndicator1</i> in V2X sidelink Communication preconfiguration		
slssid		30		
inCoverage		TRUE		
networkControlledSyncTx		ON		
N_{oc} ^{Note1}	dBm/15 kHz	-101		
PSBCH \hat{E}_s / N_{oc}	dB	5.5	-3.5	5.5
S-RSRP ^{Note2, Note3}	dBm/15 kHz	-95.5	-104.5	-95.5
lo	dBm/9MHz	-75.85	-80.82	-75.85
Propagation Condition		AWGN		
<p>Note 1: Interference from other cells and noise sources not specified in the test is assumed to be constant over subcarriers and time and shall be modelled as AWGN of appropriate power for N_{oc} to be fulfilled.</p> <p>Note 2: S-RSRP levels have been derived from other parameters for information purposes. They are not settable parameters themselves.</p> <p>Note 3: SSSS E_s/N_{oc} and PSSS E_s/N_{oc} are set the same as PSBCH E_s/N_{oc}.</p>				

A.12.2.2.2 Test Requirements

The SLSS transmission initiation delay is defined as the time from the beginning of time period T2 up to the moment when the UE initiates the SLSS transmission.

The SLSS transmission initiation delay shall be less than 0.8 s.

The SLSS transmission cease delay is defined as the time from the beginning of time period T3 up to the moment when the UE ceases the SLSS transmission.

The SLSS transmission cease delay shall be less than 0.8 s.

The rate of correct initiation/cease delay of SLSS transmissions observed during repeated tests shall be at least 90%.

NOTE: The initiation/cease delay of SLSS transmissions can be expressed as: $T_{\text{evaluate,SLSS}} + \text{SLSS period}$,

Where:

$T_{\text{evaluate,SLSS}}$ is the evaluation time for initiate/cease of SLSS, and is 0.64 sec (clause 13.3.1.3) for the parameters in this test;

SLSS period is set as 160ms in this test.

A.12.3 V2X Synchronization Reference Selection/Reselection Tests

A.12.3.1 V2X Synchronization Reference Selection/Reselection Tests for GNSS configured as the highest priority

A.12.3.1.1 Test Purpose and Environment

The purpose of this test is to verify the requirements related to SyncRef UE selection / reselection defined in clause 13.4, when GNSS is configured as the highest priority. For this test, the UE is triggered by the test loop function or the upper layers to transmit for V2X Sidelink Communication.

The test parameters are given in Table A.12.3.1.1-1 and A.12.3.1.1-2 below. There are no GNSS signals in this test. There are one active cell (PCell) and two active SyncRef UEs (SyncRef UE 1 and SyncRef UE 2) in this test. The test system shall emulate SyncRef UE 1 and SyncRef UE 2 to transmit SLSS and MIB-SL every SLSS period.

The test system can verify the selection / reselection of SyncRef UE by monitoring the SLSS ID used by the V2X UE for its SLSS+MIB-SL transmissions. When the V2X UE is not synchronized to any SyncRef UE, then the V2X UE shall use the SLSS ID pre-configured in the V2X UE. When the V2X UE is synchronized to a SyncRef UE, the V2X UE shall derive its SLSS ID from the SLSS ID of the SyncRef UE as per clause 5.10.7.3 of TS 36.331.

The test consists of three successive time periods, with time duration of T1, T2 and T3 respectively. During T1, both SyncRef UE 1 and SyncRef UE 2 are powered off and the V2X UE will select PCell as synchronization source. During T2, SyncRef UE 1 is powered ON and the V2X UE will select SyncRef UE 1 as the synchronization source. During T3, a higher priority SyncRef UE 2 is additionally powered ON and the V2X UE will reselect to the higher priority SyncRef UE 2 as the synchronization source.

Table A.12.3.1.1-1: Test Parameters for V2X Synchronization Reference Selection/Reselection Tests for GNSS configured as the highest priority

Parameter		Unit	Value	Comment
Initial condition	Active synchronization source		Cell 1	UE transmits for V2X Sidelink Communication and SLSS+MIB-SL with SLSS ID = 30 and in-coverage set as TRUE in MIB-SL.
T2 end condition	Active synchronization source		Sync Ref UE 1	UE transmits for V2X Sidelink Communication and SLSS+MIB-SL with SLSS ID = 168 and in-coverage set as FALSE in MIB-SL.
Final condition	Active synchronization source		Sync Ref UE 2	UE transmits for V2X Sidelink Communication and SLSS+MIB-SL with SLSS ID = 0 and in-coverage set as FALSE in MIB-SL.
Active SyncRef UEs			SyncRef UE 1 SyncRef UE 2	Transmitting SLSS+MIB-SL on RF channel number 1 (TDD carrier in Band 47)
Active cell			Cell 1	E-UTRA FDD Cell 1 on RF channel number 2
Timing offset between SyncRef UE 1 and SyncRef UE 2		µs	3	Synchronous
Frequency offset of SyncRef UE 1		ppm	0	
Frequency offset of SyncRef UE 2		ppm	0	
V2X sidelink Communication configuration			As specified in Table A.3.24.2-2 (Configuration #2)	IE values unless specified otherwise in this test.
typeTxSync			<i>gnss</i>	
slssid			30	
syncTxThreshIC			+infinity	
T1		s	24	
T2		s	16	
T3		s	3.2	

Table A.12.3.1.1-2: SyncRef UE Specific Test Parameters for V2X Synchronization Reference Selection/Reselection Tests for GNSS configured as the highest priority

Parameter	Unit	SyncRef UE 1			SyncRef UE 2		
		T1	T2	T3	T1	T2	T3
E-UTRA RF Channel Number		1					
BW _{channel} ^{Note 4}	MHz	5 or 10					
V2X Sidelink Communication resource pool configuration		As specified in Table A.3.24.2-1 (Configuration #1)			As specified in Table A.3.24.2-2 (Configuration #2)		
networkControlledSyncTx		N/A			ON		
syncTxThreshOoC	dBm/15 kHz	+infinity			N/A		
slssid		0			0		
inCoverage (in MIB-SL)		FALSE			TRUE		
syncOffsetIndicator		syncOffsetIndicator2			syncOffsetIndicator1		
N_{oc} ^{Note1}	dBm/15 kHz	-95					
\hat{E}_s / N_{oc}	dB	-infinity	0	0	-infinity	-infinity	3
\hat{E}_s / I_{ot}	dB	-infinity	0	0	-infinity	-infinity	3
S-RSRP ^{Note2, Note 3}	dBm/15 kHz	-infinity	-95	-95	-infinity	-infinity	-92

Propagation Condition		AWGN
Note 1:	Interference from other cells and noise sources not specified in the test is assumed to be constant over subcarriers and time and shall be modelled as AWGN of appropriate power for N_{oc} to be fulfilled.	
Note 2:	S-RSRP levels have been derived from other parameters for information purposes. They are not settable parameters themselves.	
Note 3:	SSSS Es/lot is set the same as PSSS/PSBCH Es/lot.	

Table A.12.3.1.1-3: Cell Test Parameters for V2X Synchronization Reference Selection/Reselection Tests for GNSS configured as the highest priority

Parameter	Unit	Cell 1		
		T1	T2	T3
E-UTRA RF Channel Number		2		
BW _{channel}	MHz	10		
PDCCH/PCFICH/PHICH Reference measurement channel defined in A.3.1.2.1		R.6 FDD		
OCNG Patterns defined in A.3.2.1.2		OP.2 FDD		
PBCH_RA	dB	0		
PBCH_RB				
PSS_RA				
SSS_RA				
PCFICH_RB				
PHICH_RA				
PHICH_RB				
PDCCH_RA				
PDCCH_RB				
PDSCH_RA				
PDSCH_RB				
OCNG_RA ^{Note 1}				
OCNG_RB ^{Note 1}				
N_{oc} ^{Note2}				
\hat{E}_s / N_{oc}	dB	4.5	4.5	4.5
RSRP ^{Note3}	dBm/15 kHz	-90.5	-90.5	-90.5
SCH_RP ^{Note 3}	dBm/15 kHz	-90.5	-90.5	-90.5
Propagation Condition		AWGN		
Note 1:	OCNG shall be used such that cell is fully allocated and a constant total transmitted power spectral density is achieved for all OFDM symbols.			
Note 2:	Interference from other cells and noise sources not specified in the test is assumed to be constant over subcarriers and time and shall be modelled as AWGN of appropriate power for N_{oc} to be fulfilled.			
Note 3:	RSRP and SCH_RP levels have been derived from other parameters for information purposes. They are not settable parameters themselves.			

A.12.3.1.2 Test Requirements

1) During T2, SyncRef UE selection delay is defined as the time from the beginning of T2 to the time UE is synchronized to SyncRef UE 1 and changes its SLSS transmissions timing and SLSS ID to follow SyncRef UE 1 as the synchronization source. For the test configuration, the SLSS ID will be changed to 168 (with in-coverage IE in MIB-SL set to FALSE) after SyncRef UE selection delay from start of T2.

The SyncRef UE selection delay shall be less than 8.8sec. The SyncRef UE selection/reselection delay can be expressed as:

$$\text{SyncRef UE selection/reselection delay} = T_{\text{detect,SyncRef UE}} + T_{\text{evaluate,SLSS}} + \text{SLSS period}$$

Where

- $T_{\text{detect,SyncRef UE}} = 8\text{sec}$ (as specified in sub-clause 13.4)
- $T_{\text{evaluate,SLSS}} = 0.64$ (as specified in sub-clause 13.3.1.3)

- SLSS period = 160ms

This gives a total of 8.8seconds.

2) During T3, SyncRef UE reselection delay is defined as the time from the beginning of T3 to the time UE changes its synchronization source from SyncRef UE 1 to SyncRef UE 2, and changes its SLSS transmissions timing and SLSS ID to follow SyncRef UE 2 as the synchronization source. For the test configuration, the SLSS ID will still be 0 (with in-coverage IE in MIB-SL set to FALSE) after SyncRef UE selection delay from start of T3.

The SyncRef UE reselection delay shall be less than 2.4sec. The SyncRef UE selection/reselection delay can be expressed as:

$$\text{SyncRef UE selection/reselection delay} = T_{\text{detect,SyncRef UE}} + T_{\text{evaluate,SLSS}} + \text{SLSS period}$$

Where

- $T_{\text{detect,SyncRef UE}} = 1.6\text{sec}$ (as specified in sub-clause 13.4)
- $T_{\text{evaluate,SLSS}} = 0.64$ (as specified in sub-clause 13.3.1.3)
- SLSS period = 160ms

This gives a total of 2.4seconds.

The test system will verify that the V2X UE does not drop or delay more than 6% of its V2X data and SLSS transmissions during the duration of T2, and does not drop or delay more than 30% of its SLSS transmissions during the duration of T3.

The rate of correct SyncRef UE selection / reselection observed during repeated tests shall be at least 90%.

A.12.3.2 V2X Synchronization Reference Selection/Reselection Tests for eNB configured as the highest priority

A.12.3.2.1 Test Purpose and Environment

The purpose of this test is to verify the requirements related to SyncRef UE selection / reselection defined in clause 13.4, when eNB is configured as the highest priority. For this test, the UE is triggered by the test loop function or the upper layers to transmit for V2X Sidelink Communication.

The test parameters are given in Table A.12.3.2.1-1 and A.12.3.2.1-2 below. There are no active cells and GNSS is reliable during the whole test. The test system can emulate and send the GNSS signal to the test UE. The test parameters for GNSS signals are defined in B.6.1. There are two active SyncRef UEs (SyncRef UE 1 and SyncRef UE 2) in this test. The test system shall emulate SyncRef UE 1 and SyncRef UE 2 to transmit SLSS and MIB-SL every SLSS period.

The test system can verify the selection / reselection of SyncRef UE by monitoring the SLSS ID used by the V2X UE for its SLSS+MIB-SL transmissions. When the V2X UE is not synchronized to any SyncRef UE, then the V2X UE shall use the SLSS ID pre-configured in the V2X UE. When the V2X UE is synchronized to a SyncRef UE, the V2X UE shall derive its SLSS ID from the SLSS ID of the SyncRef UE as per clause 5.10.7.3 of TS 36.331.

The test consists of three successive time periods, with time duration of T1, T2 and T3 respectively. During T1, both SyncRef UE 1 and SyncRef UE 2 are powered off and the V2X UE will select GNSS as synchronization source. During T2, SyncRef UE 1 is powered ON and the V2X UE will select SyncRef UE 1 as the synchronization source. During T3, a higher priority SyncRef UE 2 is additionally powered ON and the V2X UE will reselect to the higher priority SyncRef UE 2 as the synchronization source.

Table A.12.3.2.1-1: Test Parameters for V2X Synchronization Reference Selection/Reselection Tests for eNB configured as the highest priority

Parameter		Unit	Value	Comment
Initial condition	Active synchronization source		GNSS	UE transmits for V2X Sidelink Communication and SLSS+MIB-SL with SLSS ID = 0 and in-coverage set as TRUE in MIB-SL.
T2 end condition	Active synchronization source		Sync Ref UE 1	UE transmits for V2X Sidelink Communication and SLSS+MIB-SL with SLSS ID = 168+59 and in-

				coverage set as FALSE in MIB-SL.
Final condition	Active synchronization source		Sync Ref UE 2	UE transmits for V2X Sidelink Communication and SLSS+MIB-SL with SLSS ID = 30 and in-coverage set as FALSE in MIB-SL.
Active cell			None	
Active SyncRef UEs			SyncRef UE 1 SyncRef UE 2	Transmitting SLSS+MIB-SL on RF channel number 1
Timing offset between SyncRef UE 1 and SyncRef UE 2	ms		3	Asynchronous
Frequency offset of SyncRef UE 1	ppm		0	
Frequency offset of SyncRef UE 2	ppm		5	
V2X sidelink Communication preconfiguration			As specified in Table A.3.24.2-1 (Configuration #1)	IE values unless specified otherwise in this test.
syncPriority			<i>enb</i>	
syncTxThreshOoC			11 (+infinity)	
T1	s		24	
T2	s		16	
T3	s		16	

Table A.12.3.2.1-2: SyncRef UE Specific Test Parameters for V2X Synchronization Reference Selection/Reselection Tests for eNB configured as the highest priority

Parameter	Unit	SyncRef UE 1			SyncRef UE 2		
		T1	T2	T3	T1	T2	T3
E-UTRA RF Channel Number		1					
BW _{channel}	MHz	5 or 10					
V2X Sidelink Communication resource pool configuration		As specified in Table A.3.24.2-1 (Configuration #1)			As specified in Table A.3.24.2-2 (Configuration #2)		
networkControlledSyncTx		N/A			ON		
syncTxThreshOoC	dBm/15 kHz	+infinity			N/A		
slssid		59			30		
inCoverage (in MIB-SL)		FALSE			TRUE		
syncOffsetIndicator		syncOffsetIndicator2			syncOffsetIndicator1		
N_{oc} <small>Note1</small>	dBm/15 kHz	-95					
\hat{E}_s/N_{oc}	dB	-infinity	0	0	-infinity	-infinity	3
\hat{E}_s/I_{ot}	dB	-infinity	0	0	-infinity	-infinity	3
S-RSRP <small>Note2, Note3</small>	dBm/15 kHz	-infinity	-95	-95	-infinity	-infinity	-92
Propagation Condition		AWGN					
<p>Note 1: Interference from other cells and noise sources not specified in the test is assumed to be constant over subcarriers and time and shall be modelled as AWGN of appropriate power for N_{oc} to be fulfilled.</p> <p>Note 2: S-RSRP levels have been derived from other parameters for information purposes. They are not settable parameters themselves.</p> <p>Note 3: SSSS Es/lot is set the same as PSSS/PSBCH Es/lot.</p>							

A.12.3.1.2 Test Requirements

1) During T2, SyncRef UE selection delay is defined as the time from the beginning of T2 to the time UE is synchronized to SyncRef UE 1 and changes its SLSS transmissions timing and SLSS ID to follow SyncRef UE 1 as the synchronization source. For the test configuration, the SLSS ID will be changed to 168+59 (with in-coverage IE in MIB-SL set to FALSE) after SyncRef UE selection delay from start of T2.

The SyncRef UE selection delay shall be less than 8.8sec. The SyncRef UE selection/reselection delay can be expressed as:

$$\text{SyncRef UE selection/reselection delay} = T_{\text{detect, SyncRef UE}} + T_{\text{evaluate, SLSS}} + \text{SLSS period}$$

Where

- $T_{\text{detect,SyncRef UE}} = 8\text{sec}$ (as specified in sub-clause 11.4)
- $T_{\text{evaluate,SLSS}} = 0.64$ (as specified in sub-clause 13.3.1.3)
- SLSS period = 160ms

This gives a total of 8.8 seconds.

2) During T3, SyncRef UE reselection delay is defined as the time from the beginning of T3 to the time UE changes its synchronization source from SyncRef UE 1 to SyncRef UE 2, and changes its SLSS transmissions timing and SLSS ID to follow SyncRef UE 2 as the synchronization source. For the test configuration, the SLSS ID will be changed o 30 (with in-coverage IE in MIB-SL set to FALSE) after SyncRef UE selection delay from start of T3.

The SyncRef UE reselection delay shall be less than 8.8sec. The SyncRef UE selection/reselection delay can be expressed as:

$$\text{SyncRef UE selection/reselection delay} = T_{\text{detect,SyncRef UE}} + T_{\text{evaluate,SLSS}} + \text{SLSS period}$$

Where

- $T_{\text{detect,SyncRef UE}} = 8\text{sec}$ (as specified in sub-clause 11.4)
- $T_{\text{evaluate,SLSS}} = 0.64$ (as specified in sub-clause 13.3.1.3)
- SLSS period = 160ms

This gives a total of 8.8 seconds.

The test system will verify that the V2X UE does not drop or delay more than 6% of its V2X data and SLSS transmissions during the duration of T2 and T3.

The rate of correct SyncRef UE selection / reselection observed during repeated tests shall be at least 90%.

A.12.4 Congestion Control Measurement Test for V2X UE

A.12.4.1 Test Purpose and Environment

The purpose of this test is to verify that the V2X UE makes correct reporting of an event. This test will verify the congestion control measurement requirements in section 13.6.

The test parameters are given in Table A.12.4.1-1 and A.12.4.1-2 below. In the measurement control information it is indicated to the V2X UE that event-triggered reporting with Event V1 is used. There are 4 active sidelink UEs in this test. The test system shall emulate the active sidelink UE to transmit PSCCH/PSSCH every 100ms. The test consists of two successive time periods, with time duration of T1, and T2 respectively. During T1, all of active sidelink UEs are powered off. During T2, all of active sidelink UEs are powered on and transmit PSCCH/PSSCH every 100ms.

Table A.12.4.1-1: General test parameters for Congestion Control Measurement Test for V2X UE

Parameter	Unit	Value	Comment
E-UTRA RF Channel Number		1	TDD carrier in Band 47
Channel Bandwidth (BW_{channel})	MHz	10	
V2X sidelink communication configuration		As specified in Table A.3.24.2-2 (Configuration #2)	IE values unless specified otherwise in this test.
sl-Subframe-r14 included in SL-configV2X-TxPoolList		11111111111111111111 11111111111111111111 11111111111111111111 11111111111111111111 11111111111111111111	Indicates the bitmap of the TX resource pool, which is defined by repeating the bitmap within a SFN cycle (see TS 36.213 [23])
numSubchannel-r14 included in SL-configV2X-TxPoolList		1	ENUMERATED {n1}
<i>threshS-RSSI-CBR</i>		21	Corresponding -70dBm as defined in Section 6.3.8 in TS36.331

Number of Active Sidelink UEs every 100ms			4	Active Sidelink UE i , where $i = 0, 1, 2, 3$
Active Sidelink UEs	V2X sidelink Communication configuration		As specified in Table A.3.24.2-2 (Configuration #2)	IE values unless specified otherwise in this test.
	sl-Subframe-r14 included in SL-configV2X-TxPoolList		10000000000000000000 00000000000000000000 00000000000000000000 00000000000000000000 00000000000000000000	Indicates the bitmap of the TX resource pool, which is defined by repeating the bitmap within a SFN cycle (see TS 36.213 [23])
	numSubchannel-r14 included in SL-configV2X-TxPoolList		1	ENUMERATED {n1}
	sl-OffsetIndicator-r14		i	For Active Sidelink UE i , where $i = 0, 1, 2, 3$
Timing offset between V2X UE and Active Sidelink UEs	μs		3	Synchronous
v1-Threshold			2	Corresponding 0.02 as defined in Section 6.3.8 in TS36.331
Hysteresis			0	
Time To Trigger	s		0	
Filter coefficient			0	L3 filtering is not used
T1	s		5	
T2	s		5	

Table A.12.4.1-2: Active sidelink UE specific test parameters for Congestion Control Measurement Test for V2X UE

Parameter	Unit	Active Sidelink UE i ($i = 0, 1, 2, 3$)	
		T1	T2
E-UTRA RF Channel Number		1	
BW_{channel}	MHz	10	
PSCCH RMC (defined in A.3.24.3)		CC.1A TDD	
PSSCH RMC (defined in A.3.24.3)		CD.1A TDD	
N_{oc} Note1	dBm/15 KHz	-106	
PSCCH \hat{E}_s/N_{oc}	dB	7.19	13.19
PSSCH \hat{E}_s/N_{oc}	dB	4.19	10.19
PSSCH-RSRP Note 2	dBm/15 KHz	-101.81	-95.81
S-RSSI1 Note 2 Note3	dBm/9 MHz	-72.5	-67.5
S-RSSI2 Note 2 Note4	dBm/9 MHz	-78.22	-78.22
Io1 Note 2 Note4	dBm/9 MHz	-72.5	-67.5
Io2 Note 2 Note6	dBm/9 MHz	-78.22	-78.22
Propagation Condition	-	AWGN	
<p>Note 1: Interference from other UEs and noise sources not specified in the test is assumed to be constant over subcarriers and time and shall be modelled as AWGN of appropriate power for N_{oc} to be fulfilled.</p> <p>Note 2: PSSCH E_s/N_{oc}, PSSCH-RSRP, S-RSSI1, S-RSSI2, Io1 and Io2 levels have been derived from other parameters for information purposes. They are not settable parameters themselves.</p> <p>Note 3: S-RSSI1 is the S-RSSI level measured on the subframe# 0 - 3 with "SFN mod 10 = 0".</p> <p>Note 4: S-RSSI2 is the S-RSSI level measured on the subframe# 4-9 with "SFN mod 10 = 0" and the subframe# 0-9 with "SFN mod 10 = 1, ..., 9".</p> <p>Note 5: Io1 is the Io level measured on the subframe# 0 - 3 with "SFN mod 10 = 0".</p> <p>Note 6: Io2 is the Io level measured on the subframe# 4-9 with "SFN mod 10 = 0" and the subframe# 0-9 with "SFN mod 10 = 1, ..., 9".</p>			

A.12.4.2 Test Requirements

The UE shall not send event V1 triggered measurement reports during T1 and shall send event V1 triggered measurement reports during T2.

The rate of correct events observed during repeated tests shall be at least 98%.

A.12.5 Interruptions due to V2X Sidelink Communication

A.12.5.1 Test Purpose and Environment

The purpose of this test is to verify the requirements related to interruptions due to V2X sidelink communication defined in clause 13.7.1 under the following additional conditions:

- The UE is out of coverage on the V2X sidelink carrier and is associated with a serving cell on a non-V2X sidelink carrier

This test is applicable for V2X sidelink communication capable UEs that support concurrent inter-band E-UTRAN and V2X sidelink operation.

For this test, the UE is triggered by the test loop function or the upper layers to monitor V2X sidelink communication.

The test parameters are given in Table A.12.5.1-1, Table A.12.5.1-2, and Table A.12.5.1-3. The test consists of one active cell (PCell) on the serving RF channel 1, and there are no active cells on RF channel 2. On RF channel 2, the test consists of 8 active Sidelink UEs in this test transmitting V2X sidelink communication.

The test consists of three successive time periods, with time duration of T1, T2 and T3 respectively.

During T1, the UE is in RRC_IDLE and monitoring the V2X sidelink communication transmission from other active Sidelink UEs on the V2X sidelink communication resources.

During T2, the test system establishes a RRC connection with the UE. No PDSCH traffic is scheduled for UE during T2, and the UE is expected to transmit *SidelinkUEInformation* indicating *v2x-CommRxInterestedFreqList* during T2. On reception of *SidelinkUEInformation*, the test system shall send RRC reconfiguration message to the UE and wait for the UE to repond with RRC reconfiguration complete message before transitioning to T3. If the UE does not transmit *SidelinkUEInformation* for up to 2 second, the test system shall transition to T3.

During T3, the UE is scheduled with PDSCH traffic on PCell downlink. The test system will count the missed ACK/NACKs during T3 to verify the allowed interruptions during V2X sidelink communication (no missed ACK/NACKs are allowed).

Table A.12.5.1-1: Test Parameters for Interruptions due to V2X Sidelink Communication

Parameter	Unit	Value	Comment
E-UTRA RF Channel Number	-	1, 2	RF channel 1 is non-V2X sidelink carrier RF channel 2 is V2X sidelink carrier
Channel Bandwidth ($BW_{channel}$)	MHz	10	
Active cell	-	Cell 1	PCell on RF channel number 1
CP length of Cell 1	-	Normal	
T1	s	5.12	
T2	s	Up to receiving RRC reconfiguration setup complete from the UE, or up to 2 second if UE does not transmit <i>SidelinkUEInformation</i> during this period.	
T3	s	10	

Table A.12.5.1-2: Sidelink Communication Configuration for Interruptions due to V2X Sidelink Communication

Parameter	Unit	Value	Comment
-----------	------	-------	---------

E-UTRA RF Channel Number		-	2	TDD carrier in Band 47
Channel Bandwidth ($BW_{channel}$)		MHz	10	
V2X sidelink Communication configuration		-	As specified in Table A.3.24.2-2 (Configuration #2)	IE values unless specified otherwise in this test.
Number of Active Sidelink UEs per sc-period		-	8	Sidelink UE $i = 0, \dots, 7$
Active Sidelink UEs	V2X sidelink Communication configuration	-	As specified in Table A.3.24.2-2 (Configuration #2)	IE values unless specified otherwise in this test.
	PSCCH Reference Measurement Channel	-	CC.1A TDD	As specified in Table A.3.24.3.1-1
	PSSCH Reference Measurement Channel	-	CD.1A TDD	As specified in Table A.3.24.3.1-2
	numSubchannel-r14 included in v2x-CommTxPoolNormal-r14	-	1	ENUMERATED {n1}
	startRB-Subchannel-r14 included in v2x-CommTxPoolNormal-r14	-	i	For Sidelink UE $i = 0, \dots, 7$
	RSRP	dBm/15kHz	-98	

Table A.12.5.1-3: Cell specific test parameters for interruptions due to V2X sidelink communication

Parameter		Unit	Cell 1		
			T1	T2	T3
E-UTRA RF Channel Number		-	1		
$BW_{channel}$		MHz	10		
UE RRC state		-	IDLE	CONNECTED	
Paging configuration	defaultPagingCycle	-	rf256	N/A	
	nB	-	T/32		
DRX		-	N/A	OFF	
PDSCH Reference measurement channel defined in A.3.1.1.1 ^{Note1, Note 4}		-	N/A	None	R.3 FDD
PDCCH/PCFICH/PHICH Reference measurement channel defined in A.3.1.2.1 ^{Note1}		-	R.6 FDD		
OCNG Pattern		-	OP.6 FDD		OP.10 FDD
PBCH_RA		dB	0		
PBCH_RB					
PSS_RA					
SSS_RA					
PCFICH_RB					
PHICH_RA					
PHICH_RB					
PDCCH_RA					
PDCCH_RB					
PDSCH_RA					
PDSCH_RB					
OCNG_RA ^{Note 1}					
OCNG_RB ^{Note 1}					
N_{oc} ^{Note2}					
\hat{E}_s / N_{oc}		dB	16		
RSRP ^{Note3}		dBm/15 kHz	-82		
SCH_RP ^{Note 3}		dBm/15 kHz	-82		
Propagation Condition		-	AWGN		
Correlation Matrix and Antenna Configuration		-	1x2 Low		
<p>Note 1: OCNG shall be used such that cell is fully allocated and a constant total transmitted power spectral density is achieved for all OFDM symbols.</p> <p>Note 2: Interference from other cells and noise sources not specified in the test is assumed to be constant over subcarriers and time and shall be modelled as AWGN of appropriate power for N_{oc} to be fulfilled.</p> <p>Note 3: RSRP levels have been derived from other parameters for information purposes. They are not settable parameters themselves.</p>					

A.12.5.2 Test Requirements

The UE shall be continuously scheduled on PCell on RF channel 1 during T3. During T3, 100% of all expected ACK/NACKs shall be transmitted by the V2X UE.

A.12.6 V2X UE Autonomous Resource Selection/Reselection Measurement Test

A.12.6.1 V2X UE Autonomous Resource Selection/Reselection Tests for PSSCH-RSRP measurements

A.12.6.1.1 Test Purpose and Environment

The purpose of this test is to verify the requirements related to autonomous resource selection / reselection for V2X UE in mode 4 defined in clause 13.5. For this test, the UE is triggered by the test loop function or the upper layers to transmit for V2X Sidelink Communication.

The test parameters are given in Table A.12.6.1.1-1 and A.12.6.1.1-2 below. There are 20 active V2X sidelink UEs in this test. Both the UE under test and active V2X sidelink UEs select GNSS as synchronization reference source. The test system can emulate and send the GNSS signal to the test UE and active V2X sidelink UEs. The test parameters for GNSS signals are defined in B.6.1. The test system shall emulate the active V2X sidelink UEs to transmit PSCCH/PSSCH every 20ms. At the beginning of whole test, the test equipment shall send one message with a SL-SCH MAC PDU as specified in Clause 6.1.6 in TS 36.321, in order to make sure that the UE under test needs continuously transmit PSCCH/PSSCH.

The test consists of two duration T1 and T2. During T1, the signal from Test Equipment are configured such that the measured PSSCH-RSRP is above the measurement threshold, and the resource occupied by the active V2X sidelink UEs is expected to be excluded in the resource selection procedure. During T2, the signal from Test Equipment are configured such that the measured PSSCH-RSRP is below the measurement threshold, and the resource occupied by the active V2X sidelink UEs is expected to be included in the resource selection procedure.

Table A.12.6.1.1-1: Test Parameters for V2X UE Autonomous Resource Selection/Reselection Tests for PSSCH-RSRP measurements

Parameter	Unit	Value	Comment
E-UTRA RF Channel Number		1	TDD carrier in Band 47
Channel Bandwidth ($BW_{channel}$)	MHz	10	
V2X sidelink communication pre-configuration		As specified in Table A.3.24.2-1 (Configuration #1)	IE values unless specified otherwise in this test.
sl-Subframe-r14 included in SL-PreconfigV2X-TxPoolList		11111111111111111111	Indicates the bitmap of the TX resource pool, which is defined by repeating the bitmap within a SFN cycle (see TS 36.213 [23])
numSubchannel-r14 included in SL-PreconfigV2X-TxPoolList		5	Indicates the number of sub-channels for TX resource pool
minSubChannel-NumberPSSCH-r14 included in v2x-ResourceSelectionConfig-r14		1	Indicates the minimum number of sub-channels which may be used for transmissions on PSSCH
maxSubchannel-NumberPSSCH-r14 included in v2x-ResourceSelectionConfig-r14		1	Indicates the maximum number of sub-channels which may be used for transmissions on PSSCH
Number of Active Sidelink UEs		20	Active Sidelink UE $i = 0, \dots, 19$
<i>SL-ThresPSSCH-RSRP</i>		12	Corresponding -106 dBm as defined in Section 6.3.8 in TS36.331

Active Sidelink UEs	V2X sidelink Communication preconfiguration		As specified in Table A.3.24.2-1 (Configuration #1)	IE values unless specified otherwise in this test.
	sl-Subframe-r14 included in SL-PreconfigV2X-TxPoolList		10000000000000000000	Indicates the bitmap of the TX resource pool, which is defined by repeating the bitmap within a SFN cycle (see TS 36.213 [23])
	numSubchannel-r14 included in SL-PreconfigV2X-TxPoolList		1	Indicates the number of sub-channels for TX resource pool
	startRB-Subchannel-r14 included in SL-PreconfigV2X-TxPoolList		5	Indicates the lowest RB index of the subchannel with the lowest index.
	startRB-PSCCH-Pool-r14 included in SL-PreconfigV2X-TxPoolList		5	Indicates the lowest RB index of the PSCCH pool.
	sl-OffsetIndicator-r14		$i \bmod 20$	For Active Sidelink UE i , where $i = 0, \dots, 19$
Timing offset among Active Sidelink UEs	μs	≤ 3	Synchronous	

Table A.12.6.1.1-2: Active Sidelink UE Specific Test Parameters for V2X UE Autonomous Resource Selection/Reselection Tests for PSSCH-RSRP measurements

Parameter	Unit	Active Sidelink UE i ($i = 0, \dots, 19$)	
		T1	T2
E-UTRA RF Channel Number	-	1	
BW_{channel} ^{Note 4}	MHz	10	
PSCCH RMC (defined in A.3.24.3)	-	CC.1A HD	
PSSCH RMC (defined in A.3.24.3)	-	CD.1B HD	
OCNG pattern defined in A.3.2.4	-	VOP.1 HD	
N_{oc} ^{Note1}	dBm/15 kHz	-103	-113
PSCCH \hat{E}_s/N_{oc}	dB	5	
PSSCH \hat{E}_s/N_{oc}	dB	2	
PSCCH \hat{E}_s/I_{ot} ^{Note2}	dB	5	
PSSCH \hat{E}_s/I_{ot} ^{Note2}	dB	2	
S-RSRP ^{Note 2}	dB	-101	-111
S-RSSI1 ^{Note 2 Note3}	dBm/0.9 MHz	-80.15	-90.15
S-RSSI2 ^{Note 2 Note4}	dBm/0.9 MHz	-80.15	-90.15
S-RSSI3 ^{Note 2 Note5}	dBm/0.9 MHz	-65.18	-75.18
Antenna Configuration	-	1x2	
Propagation Condition	-	AWGN	
<p>Note 1: Interference from other UEs and noise sources not specified in the test is assumed to be constant over subcarriers and time and shall be modelled as AWGN of appropriate power for N_{oc} to be fulfilled.</p> <p>Note 2: E_s/I_{ot}, S-RSRP and S-RSSI levels have been derived from other parameters for information purposes. They are not settable parameters themselves.</p> <p>Note 3: S-RSSI1 is the S-RSSI level measured on subchannel #1.</p> <p>Note 4: S-RSSI2 is the S-RSSI level measured on subchannel #3.</p> <p>Note 5: S-RSSI3 is the S-RSSI level measured on subchannel #0/2/4.</p>			

A.12.6.1.2 Test Requirements

The test time T1 and T2 should be long enough. The rate of PSSCH transmissions on the resources on subchannel #1 or #3 shall be less than 10% during T1. The rate of PSSCH transmissions on the resources on subchannel #1 or #3 shall be more than 90% during T2.

A.12.6.2 V2X UE Autonomous Resource Selection/Reselection Tests for S-RSSI measurements

A.12.6.2.1 Test Purpose and Environment

The purpose of this test is to verify the requirements related to autonomous resource selection / reselection for V2X UE in mode 4 defined in clause 13.5. For this test, the UE is triggered by the test loop function or the upper layers to transmit for V2X Sidelink Communication.

The test parameters are given in Table A.12.6.2.1-1 and A.12.6.2.1-2 below. There are 20 active V2X sidelink UEs in this test. Both the UE under test and active V2X sidelink UEs select GNSS as synchronization reference source. The test system can emulate and send the GNSS signal to the test UE and active V2X sidelink UEs. The test parameters for GNSS signals are defined in B.6.1. The test system shall emulate the active sidelink UE to transmit PSCCH/PSSCH every 20ms. At the beginning of whole test, the test equipment shall send one message with a SL-SCH MAC PDU as specified in Clause 6.1.6 in TS 36.321, in order to make sure that the UE under test needs continually transmit PSCCH/PSSCH.

Table A.12.6.2.1-1: Test Parameters for V2X UE Autonomous Resource Selection/Reselection Tests for S-RSSI measurements

Parameter	Unit	Value	Comment
E-UTRA RF Channel Number		1	TDD carrier in Band 47
Channel Bandwidth (BW _{channel})	MHz	10	
V2X sidelink communication pre-configuration		As specified in Table A.3.24.2-1 (Configuration #1)	IE values unless specified otherwise in this test.
sl-Subframe-r14 included in SL-PreconfigV2X-TxPoolList		11111111111111111111	Indicates the bitmap of the TX resource pool, which is defined by repeating the bitmap within a SFN cycle (see TS 36.213 [23])
numSubchannel-r14 included in SL-PreconfigV2X-TxPoolList		5	Indicates the number of sub-channels for TX resource pool
minSubChannel-NumberPSSCH-r14 included in v2x-ResourceSelectionConfig-r14		1	Indicates the minimum number of sub-channels which may be used for transmissions on PSSCH
maxSubchannel-NumberPSSCH-r14 included in v2x-ResourceSelectionConfig-r14		1	Indicates the maximum number of sub-channels which may be used for transmissions on PSSCH
Number of Active Sidelink UEs		20	Sidelink UE $i = 0, \dots, 19$
SL-ThresPSSCH-RSRP		66	Corresponding infinity dBm as defined in Section 6.3.8 in TS36.331
Active Sidelink UEs	V2X sidelink communication preconfiguration	As specified in Table A.3.24.2-1 (Configuration #1)	IE values unless specified otherwise in this test.
	sl-Subframe-r14 included in SL-PreconfigV2X-TxPoolList	10000000000000000000	Indicates the bitmap of the TX resource pool, which is defined by repeating the bitmap within a SFN cycle (see TS 36.213 [23])
	numSubchannel-r14 included in SL-PreconfigV2X-TxPoolList	1	Indicates the number of sub-channels for TX resource pool
	startRB-Subchannel-r14 included in SL-PreconfigV2X-TxPoolList	5	Indicates the lowest RB index of the subchannel with the lowest index.

	startRB-PSCCH-Pool-r14 included in SL- PreconfigV2X-TxPoolList		5	Indicates the lowest RB index of the PSCCH pool.
	sl-OffsetIndicator-r14		$i \bmod 20$	For Sidelink UE i , where $i = 0, \dots, 19$
Timing offset among Active Sidelink UEs		μs	≤ 3	Synchronous

Table A.12.6.2.1-2: Active Sidelink UE Specific Test Parameters for V2X UE Autonomous Resource Selection/Reselection Tests for S-RSSI measurements

Parameter	Unit	Active Sidelink UE i ($i = 0, \dots, 19$)
E-UTRA RF Channel Number	-	1
BW_{channel} ^{Note 4}	MHz	10
PSCCH RMC (defined in A.3.24.3)	-	CC.1A HD
PSSCH RMC (defined in A.3.24.3)	-	CD.1B HD
OCNG pattern defined in A.3.2.4	-	VOP.2 TDD
N_{oc} ^{Note1}	dBm/15 kHz	-105
PSCCH \hat{E}_s / N_{oc}	dB	5
PSSCH \hat{E}_s / N_{oc}	dB	2
PSCCH \hat{E}_s / I_{ot} ^{Note2}	dB	5
PSSCH \hat{E}_s / I_{ot} ^{Note2}	dB	2
S-RSRP ^{Note 2}	dB	-103
S-RSSI1 ^{Note 2 Note3}	dBm/0.9 MHz	-82.15
S-RSSI2 ^{Note 2 Note4}	dBm/0.9 MHz	-76.71
S-RSSI3 ^{Note 2 Note5}	dBm/0.9 MHz	-67.18
Antenna Configuration	-	1x2
Propagation Condition	-	AWGN
<p>Note 1: Interference from other UEs and noise sources not specified in the test is assumed to be constant over subcarriers and time and shall be modelled as AWGN of appropriate power for N_{oc} to be fulfilled.</p> <p>Note 2: E_s/I_{ot}, S-RSRP and S-RSSI levels have been derived from other parameters for information purposes. They are not settable parameters themselves.</p> <p>Note 3: S-RSSI1 is the S-RSSI level measured on subchannel #1.</p> <p>Note 4: S-RSSI2 is the S-RSSI level measured on subchannel #3.</p> <p>Note 5: S-RSSI3 is the S-RSSI level measured on subchannel #0/2/4.</p>		

A.12.6.1.2 Test Requirements

The test shall be run for a long enough amount of time. The rate of PSSCH transmissions on the resources on subchannel #1 shall be more than 80%.

A.12.7 V2X Synchronization Reference Selection/Reselection Tests for V2X Carrier Aggregation

A.12.7.1 Test Purpose and Environment

The purpose of this test is to verify the requirements related to SyncRef UE selection / reselection defined in clause 13.10, when GNSS is configured as the highest priority.

The test parameters are given in Table A.12.7.1-1 and A.12.7.1-2 below. GNSS is configured as the highest priority, and there are no GNSS signals in this test. There are one active cell (PCell) and one active SyncRef UE (SyncRef UE 1) in this test. The test system shall emulate SyncRef UE 1 to transmit SLSS and MIB-SL every SLSS period. SyncRef UE 1 is operating on a PC5-based V2X channel (RF channel 1), and no active SyncRef UE is operating on another PC5-based V2X channel (RF channel 2). PCell is operating on an E-UTRAN channel (RF channel 3).

For this test, the UE is triggered by the test loop function or the upper layers to transmit for V2X sidelink communication both on RF channel 1 and on RF channel 2. RF channel 1 and on RF channel 2 are both included in *syncFreqList*.

The test system can verify the selection/reselection of SyncRef UE by monitoring the SLSS ID used by the V2X UE for its SLSS+MIB-SL transmissions. When the V2X UE is synchronized to a SyncRef UE, the V2X UE shall derive its SLSS ID from the SLSS ID of the selected SyncRef UE as defined in clause 5.10.7.3 of TS 36.331 [2].

The test consists of three successive time periods, with time duration of T1, T2 and T3 respectively. PCell is only powered on during T1. SyncRef UE 1 is only powered on during T3.

During T1, the V2X UE will select PCell as synchronization source. During T3, the V2X UE will select SyncRef UE 1 as the synchronization source and select RF channel 1 as synchronization carrier.

Table A.12.7.1-1: Test Parameters for V2X Synchronization Reference Selection/Reselection Tests

Parameter		Unit	Value	Comment
Initial condition	Active synchronization source		Cell 1	UE transmits for V2X Sidelink Communication and SLSS+MIB-SL with SLSS ID = 30 and in-coverage set as TRUE in MIB-SL.
T3 end condition	Active synchronization source		Sync Ref UE 1	UE transmits for V2X Sidelink Communication and SLSS+MIB-SL with SLSS ID = 168 and in-coverage set as FALSE in MIB-SL.
Active SyncRef UEs			SyncRef UE 1	Transmitting SLSS+MIB-SL on RF channel number 1 (TDD carrier in Band 47)
Active cell			Cell 1	E-UTRA FDD Cell 1 on RF channel number 3
Timing offset between SyncRef UE 1 and Cell 1		µs	3	Synchronous
Frequency offset of SyncRef UE 1		ppm	0	
V2X sidelink Communication configuration			As specified in Table A.3.24.2-2 (Configuration #2)	IE values unless specified otherwise in this test.
typeTxSync			<i>gnss</i>	
slssid			30	
syncTxThreshIC			+infinity	
T1		s	24	
T2		s	0.8	
T3		s	24	

Table A.12.7.1-2: SyncRef UE 1 Test Parameters for V2X Synchronization Reference Selection/Reselection Tests

Parameter	Unit	T1	T2	T3
E-UTRA RF Channel Number			1	
BW _{channel}	MHz		10	
V2X Sidelink Communication resource pool configuration		As specified in Table A.3.24.2-1 (Configuration #1)		
networkControlledSyncTx			N/A	
syncTxThreshOoC	dBm/15 kHz		+infinity	
slssid			0	

inCoverage (in MIB-SL)		FALSE		
syncOffsetIndicator		syncOffsetIndicator2		
N_{oc} <small>Note1</small>	dBm/15kHz	-95		
\hat{E}_s/N_{oc}	dB	-inf	-inf	0
\hat{E}_s/I_{ot} <small>Note 3</small>	dB	-inf	-inf	0
S-RSRP <small>Note2,</small>	dBm/15kHz	-inf	-inf	-95
Propagation Condition		AWGN		
<p>Note 1: Interference from other cells and noise sources not specified in the test is assumed to be constant over subcarriers and time and shall be modelled as AWGN of appropriate power for N_{oc} to be fulfilled.</p> <p>Note 2: S-RSRP levels have been derived from other parameters for information purposes. They are not settable parameters themselves.</p> <p>Note 3: SSSS E_s/I_{ot} is set the same as PSSS/PSBCH E_s/I_{ot}.</p>				

Table A.12.7.1-3: Cell Test Parameters for V2X Synchronization Reference Selection/Reselection Tests

Parameter	Unit	Cell 1		
		T1	T2	T3
E-UTRA RF Channel Number		3		
$BW_{channel}$	MHz	10		
PDCCH/PCFICH/PHICH Reference measurement channel defined in A.3.1.2.1		R.6 FDD		
OCNG Patterns defined in A.3.2.1.2		OP.2 FDD		
PBCH_RA	dB	0		
PBCH_RB				
PSS_RA				
SSS_RA				
PCFICH_RB				
PHICH_RA				
PHICH_RB				
PDCCH_RA				
PDCCH_RB				
PDSCH_RA				
PDSCH_RB				
OCNG_RA <small>Note 1</small>				
OCNG_RB <small>Note 1</small>				
N_{oc} <small>Note2</small>	dBm/15 kHz	-95		
\hat{E}_s/N_{oc}	dB	4.5	-inf	-inf
RSRP <small>Note3</small>	dBm/15 kHz	-90.5	-inf	-inf
SCH_RP <small>Note 3</small>	dBm/15 kHz	-90.5	-inf	-inf
Propagation Condition		AWGN		
<p>Note 1: OCNG shall be used such that cell is fully allocated and a constant total transmitted power spectral density is achieved for all OFDM symbols.</p> <p>Note 2: Interference from other cells and noise sources not specified in the test is assumed to be constant over subcarriers and time and shall be modelled as AWGN of appropriate power for N_{oc} to be fulfilled.</p> <p>Note 3: RSRP and SCH_RP levels have been derived from other parameters for information purposes. They are not settable parameters themselves.</p>				

A.12.7.2 Test Requirements

1) During T3, SyncRef UE selection delay is defined as the time from the beginning of T3 to the time UE is synchronized to SyncRef UE 1 and changes its SLSS transmissions timing and SLSS ID to follow SyncRef UE 1 as the synchronization source. For the test configuration, the SLSS ID will be changed to 168 (with in-coverage IE in MIB-SL set to FALSE) after SyncRef UE selection delay from start of T3.

The SyncRef UE selection delay shall be less than 17.44sec. The SyncRef UE selection/reselection delay can be expressed as:

$$\text{SyncRef UE selection/reselection delay} = T_{\text{detect,SyncRef UE}} + T_{\text{evaluate,SLSS}} + \text{SLSS period}$$

Where

- $T_{\text{detect,SyncRef UE}} = 16\text{sec}$ (as specified in subclause 13.10)
- $T_{\text{evaluate,SLSS}} = 1.28\text{sec}$ (as specified in subclause 13.10)
- SLSS period = 160ms

This gives a total of 17.44 seconds.

The test system will verify that the V2X UE does not drop or delay more than 6% of its V2X data and SLSS transmissions during the duration of T3, and does not drop or delay more than 30% of its SLSS transmissions during the duration of T3.

The rate of correct SyncRef UE selection / reselection observed during repeated tests shall be at least 90%.

A.12.8 Interruptions due to V2X Carrier Aggregation

A.12.8.1 Interruptions on a FDD PCell

A.12.8.1.1 Test Purpose and Environment

The purpose of this test is to verify the requirements related to interruptions due to V2X carrier aggregation defined in clause 13.7.3, under the following additional conditions:

- The UE is out of coverage on the V2X sidelink carriers and is associated with the PCell on a non-V2X sidelink carrier

For this test, the UE is triggered by the test loop function or the upper layers to monitor and transmit V2X sidelink communication. There are three carriers, including two V2X sidelink carriers (CC2 and CC3) and one E-UTRAN carrier (CC1). Before the test starts the UE is connected to PCell on CC1. The UE uses PCell as synchronization reference for V2X sidelink communication and shall be continuously scheduled in the PCell throughout the whole test.

The test consists of two consecutive time periods, with time duration of T1 and T2, respectively.

At the beginning of T1, the UE receives an *RRCCONNECTIONRECONFIGURATION* message by which the UE is configured only to monitor and transmit V2X sidelink communication on CC2.

An *RRCCONNECTIONRECONFIGURATION* message including *sl-V2X-ConfigDedicated*, by which the UE is configured to monitor and transmit V2X sidelink communication on CC2 and CC3, is sent by the test equipment in subframe #*n*. The point in time at which the *sl-V2X-ConfigDedicated* message for adding CC3 for V2X sidelink communication is received at the UE antenna connector defines the start of time period T2.

During T2, the test system will count the missed ACK/NACKs during T2 to verify the allowed interruptions due to V2X CC addition/release.

The test parameters are given in Table A.12.8.1.1-1, Table A.12.8.1.1-2, and Table A.12.8.1.1-3.

Table A.12.8.1.1-1: Test Parameters for Interruptions due to V2X Carrier Aggregation

Parameter	Unit	Value	Comment
E-UTRA RF Channel Number	-	1, 2, 3	RF channel 1 is non-V2X sidelink carrier

			RF channel 2 and 3 are V2X sidelink carrier
Channel Bandwidth ($BW_{channel}$)	MHz	10	
Active cell	-	Cell 1	PCell on RF channel number 1
CP length of Cell 1	-	Normal	
T1	s	5	
T2	s	5	

Table A.12.8.1.1-2: Slidelink Communication Configuration for Interruptions due to V2X Carrier Aggregation

Parameter	Unit	Value	Comment
E-UTRA RF Channel Number	-	2, 3	TDD carrier in Band 47
Channel Bandwidth ($BW_{channel}$)	MHz	10	
V2X sidelink Communication configuration	-	As specified in Table A.3.24.2-2 (Configuration #2)	IE values unless specified otherwise in this test.

Table A.12.8.1.1-3: Cell Specific Test Parameters for Interruptions due to V2X Carrier Aggregation

Parameter	Unit	Cell 1	
		T1	T2
E-UTRA RF Channel Number	-	1	
$BW_{channel}$	MHz	10	
PDSCH Reference measurement channel defined in A.3.1.1.1		R.3 FDD	
PDCCH/PCFICH/PHICH Reference measurement channel defined in A.3.1.2.1	-	R.6 FDD	
OCNG Pattern	-	OP.10 FDD	
PBCH_RA	dB	0	
PBCH_RB			
PSS_RA			
SSS_RA			
PCFICH_RB			
PHICH_RA			
PHICH_RB			
PDCCH_RA			
PDCCH_RB			
PDSCH_RA			
PDSCH_RB			
OCNG_RA ^{Note 1}			
OCNG_RB ^{Note 1}			
N_{oc} ^{Note 2}			
\hat{E}_s/N_{oc}	dB	16	
RSRP ^{Note 3}	dBm/15 kHz	-82	
SCH_RP ^{Note 3}	dBm/15 kHz	-82	
Propagation Condition	-	AWGN	
Correlation Matrix and Antenna Configuration	-	1x2 Low	
<p>Note 1: OCNG shall be used such that cell is fully allocated and a constant total transmitted power spectral density is achieved for all OFDM symbols.</p> <p>Note 2: Interference from other cells and noise sources not specified in the test is assumed to be constant over subcarriers and time and shall be modelled as AWGN of appropriate power for N_{oc} to be fulfilled.</p> <p>Note 3: RSRP levels have been derived from other parameters for information purposes. They are not settable parameters themselves.</p>			

A.12.8.1.2 Test Requirements

During T2, an interruption on PCell shall occur no earlier than in subframe ($n+5$) and no later than in subframe ($n + 22$), and the total number of missed ACK/NACKs is no more than 4. The ACK/NACK missing shall occur no earlier than in subframe ($n+5$) and no later than in subframe ($n +26$).

All of the above test requirements shall be fulfilled in order for the observed CC3 addition delay and PCell interruptions to be counted as correct. The rate of correct observed CC3 addition delay and PCell interruptions during repeated tests shall be at least 90%.

A.12.8.2 Interruptions on a TDD PCell

A.12.8.2.1 Test Purpose and Environment

The purpose of this test is to verify the requirements related to interruptions due to V2X carrier aggregation defined in clause 13.7.3, under the following additional conditions:

- The UE is out of coverage on the V2X sidelink carriers and is associated with the PCell on a non-V2X sidelink carrier

For this test, the UE is triggered by the test loop function or the upper layers to monitor and transmit V2X sidelink communication. There are three carriers, including two V2X sidelink carriers (CC2 and CC3) and one E-UTRAN carrier (CC1). Before the test starts the UE is connected to PCell on CC1. The UE uses PCell as synchronization reference for V2X sidelink communication and shall be continuously scheduled in the PCell throughout the whole test.

The test consists of two consecutive time periods, with time duration of T1 and T2, respectively.

At the beginning of T1, the UE receives an *RRCConnectionReconfiguration* message by which the UE is configured only to monitor and transmit V2X sidelink communication on CC2.

An *RRCConnectionReconfiguration* message including *sl-V2X-ConfigDedicated*, by which the UE is configured to monitor and transmit V2X sidelink communication on CC2 and CC3, is sent by the test equipment in subframe $\#n$. The point in time at which the *sl-V2X-ConfigDedicated* message for adding CC3 for V2X sidelink communication is received at the UE antenna connector defines the start of time period T2.

During T2, the test system will count the missed ACK/NACKs during T2 to verify the allowed interruptions due to V2X CC addition/release.

The test parameters are given in Table A.12.8.2.1-1, Table A.12.8.2.1-2, and Table A.12.8.2.1-3.

Table A.12.8.2.1-1: Test Parameters for Interruptions due to V2X Carrier Aggregation

Parameter	Unit	Value	Comment
E-UTRA RF Channel Number	-	1, 2, 3	RF channel 1 is non-V2X sidelink carrier RF channel 2 and 3 are V2X sidelink carrier
Channel Bandwidth (BW_{channel})	MHz	10	
Active cell	-	Cell 1	PCell on RF channel number 1
CP length of Cell 1	-	Normal	
T1	s	5	
T2	s	5	

Table A.12.8.2.1-2: Sidelink Communication Configuration for Interruptions due to V2X Carrier Aggregation

Parameter	Unit	Value	Comment
E-UTRA RF Channel Number	-	2, 3	TDD carrier in Band 47
Channel Bandwidth (BW_{channel})	MHz	10	
V2X sidelink Communication configuration	-	As specified in Table A.3.24.2-2 (Configuration #2)	IE values unless specified otherwise in this test.

Table A.12.8.2.1-3: Cell Specific Test Parameters for Interruptions due to V2X Carrier Aggregation

Parameter	Unit	Cell 1	
		T1	T2
E-UTRA RF Channel Number	-		1
BW_{channel}	MHz		10
Special subframe configuration ^{Note1}			6
Uplink/downlink configuration ^{Note1}			1
PDSCH Reference measurement channel defined in A.3.1.1.2			R.0 TDD
PDCCH/PCFICH/PHICH Reference measurement channel defined in A.3.1.2.2	-		R.6 TDD
OCNG Pattern	-		OP.1 TDD
PBCH_RA	dB		0
PBCH_RB			
PSS_RA			
SSS_RA			
PCFICH_RB			
PHICH_RA			
PHICH_RB			
PDCCH_RA			
PDCCH_RB			
PDSCH_RA			
PDSCH_RB			
OCNG_RA ^{Note 2}			
OCNG_RB ^{Note 2}			
N_{oc} ^{Note3}			
\hat{E}_s/N_{oc}	dB		16
RSRP ^{Note4}	dBm/15 kHz		-82
SCH_RP ^{Note 4}	dBm/15 kHz		-82
Propagation Condition	-		AWGN
Correlation Matrix and Antenna Configuration	-		1x2 Low
Note 1:	For special subframe and uplink-downlink configurations see Tables 4.2-1 and 4.2-2 in TS 36.211 [16].		
Note 2:	OCNG shall be used such that cell is fully allocated and a constant total transmitted power spectral density is achieved for all OFDM symbols.		
Note 3:	Interference from other cells and noise sources not specified in the test is assumed to be constant over subcarriers and time and shall be modelled as AWGN of appropriate power for N_{oc} to be fulfilled.		
Note 4:	RSRP levels have been derived from other parameters for information purposes. They are not settable parameters themselves.		

A.12.8.2.2 Test Requirements

During T2, an interruption on PCell shall occur no earlier than in subframe ($n+5$) and no later than in subframe ($n + 22$), and the total number of missed ACK/NACKs is no more than 2. The ACK/NACK missing shall occur no earlier than in subframe ($n+5$) and no later than in subframe ($n + 29$).

All of the above test requirements shall be fulfilled in order for the observed CC3 addition delay and PCell interruptions to be counted as correct. The rate of correct observed CC3 addition delay and PCell interruptions during repeated tests shall be at least 90%.

Annex B (normative): Conditions for RRM requirements applicability for operating bands

B.1 Conditions for E-UTRAN RRC_IDLE state mobility

B.1.1 Conditions for measurements of intra-frequency E-UTRAN cells for cell re-selection

This clause defines the E-UTRAN intra-frequency RSRP, RSRP \hat{E}_s/I_{ot} , SCH_RP and SCH \hat{E}_s/I_{ot} applicable for a corresponding operating band.

The conditions for measurements of intra-frequency E-UTRAN cells for cell re-selection are defined in Table B.1.1-1.

Table B.1.1-1: Conditions for measurements of intra-frequency E-UTRAN cells for cell re-selection

Parameter	E-UTRA operating band groups ^{Note 3}	Minimum RSRP ^{Note 1}	Minimum SCH_RP ^{Note 1}	RSRP \hat{E}_s/I_{ot}	SCH \hat{E}_s/I_{ot}
		dBm/15kHz	dBm/15kHz	dB	dB
Conditions	FDD_A, TDD_A	-124	-124	≥ -4	≥ -4
	FDD_B1, FDD_B2	-123.5	-123.5		
	FDD_C, TDD_C	-123	-123		
	FDD_D	-122.5	-122.5		
	FDD_E, TDD_E	-122	-122		
	FDD_F	-121.5 ^{Note 2}	-121.5 ^{Note 2}		
	FDD_G	-121	-121		
	FDD_H, FDD_N	-120.5	-120.5		
		-117.5	-117.5		

NOTE 1: This condition level is increased by $\Delta > 0$, when applicable, as described in Section B.4.2.
NOTE 2: The condition is -122 dBm/15kHz when the carrier frequency of the assigned E-UTRA channel bandwidth is within 865-894 MHz.
NOTE 3: E-UTRA operating band groups are as defined in Section 3.5.

B.1.2 Conditions for measurements of inter-frequency E-UTRAN cells for cell re-selection

This clause defines the E-UTRAN inter-frequency RSRP, RSRP \hat{E}_s/I_{ot} , SCH_RP and SCH \hat{E}_s/I_{ot} applicable for a corresponding operating band.

The conditions for measurements of intra-frequency E-UTRAN cells for cell re-selection defined in Table B.1.1-1 also apply for inter-frequency E-UTRAN cells in this section.

B.1.3 Conditions for measurements of intra-frequency E-UTRAN cells for cell re-selection for UE Category M1

This clause defines the E-UTRAN intra-frequency RSRP, RSRP \hat{E}_s/I_{ot} , SCH_RP and SCH \hat{E}_s/I_{ot} applicable for a corresponding operating band. The UE category M1 applicability of the conditions in Appendix B.1.3 is defined in Section 3.1.

The conditions for normal coverage measurements of FDD and TDD intra-frequency E-UTRAN cells for cell re-selection are defined in Table B.1.3-1 and for E-UTRAN HD-FDD are defined in Table B.1.3-2.

The conditions for enhanced coverage measurements of FDD and TDD intra-frequency E-UTRAN cells for cell re-selection are defined in Table B.1.3-3 and for E-UTRAN HD-FDD are defined in Table B.1.3-4.

Table B.1.3-1: E-UTRAN intra-frequency measurements for FDD and TDD for normal coverage

Parameter	E-UTRA operating band groups <small>Note 3</small>	Minimum RSRP <small>Note 1</small>	Minimum SCH_RP <small>Note 1</small>	RSRP \hat{E} s/lot	SCH \hat{E} s/lot
		dBm/15kHz	dBm/15kHz	dB	dB
Conditions	FDD-M1_A, TDD-M1_A	-125	-125	≥ -6	≥ -6
	FDD-M1_B	-123.5	-123.5		
	FDD-M1_D	-123.5	-123.5		
	FDD-M1_E, TDD-M1_E	-123	-123		
	FDD-M1_F	-122.5 <small>Note 2</small>	-122.5 <small>Note 2</small>		
	FDD-M1_G	-122	-122		
	FDD-M1_N	-118.5	-118.5		

NOTE 1: This condition level is increased by $\Delta > 0$, when applicable, as described in Sections B.4.2.
 NOTE 2: The condition is -125 dBm/15kHz when the carrier frequency of the assigned E-UTRA channel bandwidth is within 865-894 MHz.
 NOTE 3: E-UTRA operating band groups are as defined in Section 3.5.

Table B.1.3-2: E-UTRAN intra-frequency measurements for HD-FDD for normal coverage

Parameter	E-UTRA operating band groups <small>Note 3</small>	Minimum RSRP <small>Note 1</small>	Minimum SCH_RP <small>Note 1</small>	RSRP \hat{E} s/lot	SCH \hat{E} s/lot
		dBm/15kHz	dBm/15kHz	dB	dB
Conditions	FDD-M1_A	-125	-125	≥ -6	≥ -6
	FDD-M1_B	-123.5	-123.5		
	FDD-M1_D	-123.5	-123.5		
	FDD-M1_E	-123	-123		
	FDD-M1_F	-122.5 <small>Note 2</small>	-122.5 <small>Note 2</small>		
	FDD-M1_G	-122	-122		
	FDD-M1_N	-118.5	-118.5		

NOTE 1: This condition level is increased by $\Delta > 0$, when applicable, as described in Sections B.4.2.
 NOTE 2: The condition is -125 dBm/15kHz when the carrier frequency of the assigned E-UTRA channel bandwidth is within 865-894 MHz.
 NOTE 3: E-UTRA operating band groups are as defined in Section 3.5.

Table B.1.3-3: E-UTRAN intra-frequency measurements for FDD and TDD for enhanced coverage

Parameter	E-UTRA operating band groups <small>Note 3</small>	Minimum RSRP <small>Note 1</small>	Minimum SCH_RP <small>Note 1</small>	RSRP \hat{E} s/lot	SCH \hat{E} s/lot
		dBm/15kHz	dBm/15kHz	dB	dB
Conditions	FDD-M1_A, TDD-M1_A	-135	-135	≥ -15	≥ -15
	FDD-M1_B	-123.5	-123.5		
	FDD-M1_D	-133.5	-133.5		
	FDD-M1_E, TDD-M1_E	-133	-133		
	FDD-M1_F	-132.5 <small>Note 2</small>	-132.5 <small>Note 2</small>		
	FDD-M1_G	-132	-132		
	FDD-M1_N	-128.5	-128.5		

NOTE 1: This condition level is increased by $\Delta > 0$, when applicable, as described in Sections B.4.2.
 NOTE 2: The condition is -125 dBm/15kHz when the carrier frequency of the assigned E-UTRA channel bandwidth is within 865-894 MHz.
 NOTE 3: E-UTRA operating band groups are as defined in Section 3.5.

Table B.1.3-4: E-UTRAN intra-frequency measurements for HD-FDD for enhanced coverage

Parameter	E-UTRA operating band groups <small>Note 3</small>	Minimum RSRP <small>Note 1</small>	Minimum SCH_RP <small>Note 1</small>	RSRP \hat{E} s/lot	SCH \hat{E} s/lot
		dBm/15kHz	dBm/15kHz	dB	dB
Conditions	FDD-M1_A	-135	-135	≥ -15	≥ -15
	FDD-M1_B	-123.5	-123.5		
	FDD-M1_D	-133.5	-133.5		
	FDD-M1_E	-133	-133		
	FDD-M1_F	-132.5 <small>Note 2</small>	-132.5 <small>Note 2</small>		
	FDD-M1_G	-132	-132		

	FDD-M1_N	-128.5	-128.5	
NOTE 1: This condition level is increased by $\Delta > 0$, when applicable, as described in Sections B.4.2.				
NOTE 2: The condition is -125 dBm/15kHz when the carrier frequency of the assigned E-UTRA channel bandwidth is within 865-894 MHz.				
NOTE 3: E-UTRA operating band groups are as defined in Section 3.5.				

B.1.4 Conditions for measurements of intra-frequency NB-IoT cells for cell re-selection for UE Category NB1

This clause defines the NB-IoT intra-frequency NRSRP, $\text{NRSRP } \hat{E}_s/\text{lot}$, NSCH_RP and $\text{NSCH } \hat{E}_s/\text{lot}$ applicable for a corresponding operating band. The UE category NB1 applicability of the conditions in Appendix B.1.4 is defined in Section 3.6.

The conditions for measurements of intra-frequency NB-IoT cells in normal coverage for cell re-selection are defined in Table B.1.4-1 and B.1.4-3.

The conditions for measurements of intra-frequency NB-IoT cells in enhanced coverage for cell re-selection are defined in Table B.1.4-2 and B.1.4-4.

Table B.1.4-1: NB-IoT intra-frequency measurements for HD-FDD in normal coverage

Parameter	E-UTRA operating band groups ^{Note 1}	Minimum NRSRP	Minimum NSCH_RP	NRS \hat{E}_s/lot	NSCH \hat{E}_s/lot
		dBm/15kHz	dBm/15kHz	dB	dB
Conditions	NFDD_G	-129	-129	≥ -6	≥ -6

NOTE 1: E-UTRA operating band groups are as defined in Section 3.5.

Table B.1.4-2: NB-IoT intra-frequency measurements for HD-FDD in enhanced coverage

Parameter	E-UTRA operating band groups ^{Note 1}	Minimum NRSRP	Minimum NSCH_RP	NRS \hat{E}_s/lot	NSCH \hat{E}_s/lot
		dBm/15kHz	dBm/15kHz	dB	dB
Conditions	NFDD_G	-138	-138	≥ -15	≥ -15

NOTE 1: E-UTRA operating band groups are as defined in Section 3.5.

Table B.1.4-3: NB-IoT intra-frequency measurements for TDD in normal coverage

Parameter	E-UTRA operating band groups ^{Note 1}	Minimum NRSRP	Minimum NSCH_RP	NRS \hat{E}_s/lot	NSCH \hat{E}_s/lot
		dBm/15kHz	dBm/15kHz	dB	dB
Conditions	NTDD_G	-129	-129	≥ -6	≥ -6

NOTE 1: E-UTRA operating band groups are as defined in Section 3.5.

Table B.1.4-4: NB-IoT intra-frequency measurements for TDD in enhanced coverage

Parameter	E-UTRA operating band groups ^{Note 1}	Minimum NRSRP	Minimum NSCH_RP	NRS \hat{E}_s/lot	NSCH \hat{E}_s/lot
		dBm/15kHz	dBm/15kHz	dB	dB
Conditions	NTDD_G	-138	-138	≥ -15	≥ -15

NOTE 1: E-UTRA operating band groups are as defined in Section 3.5.

B.1.5 Conditions for measurements of inter-frequency NB-IoT cells for cell re-selection for UE Category NB1

This clause defines the NB-IoT inter-frequency NRSRP, $\text{NRSRP } \hat{E}_s/\text{lot}$, NSCH_RP and $\text{NSCH } \hat{E}_s/\text{lot}$ applicable for a corresponding operating band. The UE category NB1 applicability of the conditions in Appendix B.1.5 is defined in Section 3.6.

The conditions for measurements of intra-frequency NB-IoT cells in normal coverage for cell re-selection defined in Table B.1.4-1 and B.1.4-3 also apply for inter-frequency NB-IoT cells in normal coverage in this section.

The conditions for measurements of intra-frequency NB-IoT cells in enhanced coverage for cell re-selection defined in Table B.1.4-2 and B.1.4-4 also apply for inter-frequency NB-IoT cells in enhanced coverage in this section.

B.1.6 Conditions for measurements of intra-frequency E-UTRAN cells for cell re-selection for UE Category 1bis

This clause defines the E-UTRAN intra-frequency RSRP, RSRP \hat{E}_s/lot , SCH_RP and SCH \hat{E}_s/lot applicable for a corresponding operating band.

The conditions for measurements of intra-frequency E-UTRAN cells for cell re-selection are defined in Table B.1.6-1.

Table B.1.6-1: Conditions for measurements of intra-frequency E-UTRAN cells for cell re-selection

Parameter	E-UTRA operating band groups ^{Note 3}	Minimum RSRP ^{Note 1}	Minimum SCH_RP ^{Note 1}	RSRP \hat{E}_s/lot	SCH \hat{E}_s/lot
		dBm/15kHz	dBm/15kHz	dB	dB
Conditions	FDD_A, TDD_A	-124	-124	≥ -5	≥ -5
	FDD_B1	-123.5	-123.5		
	FDD_C, TDD_C	-123	-123		
	FDD_D	-122.5	-122.5		
	FDD_E, TDD_E	-122	-122		
	FDD_F	-121.5 ^{Note 2}	-121.5 ^{Note 2}		
	FDD_G	-121	-121		
	FDD_H, FDD_N	-120.5	-120.5		
NOTE 1: This condition level is increased by $\Delta > 0$, when applicable, as described in Section B.4.2.					
NOTE 2: The condition is -122 dBm/15kHz when the carrier frequency of the assigned E-UTRA channel bandwidth is within 865-894 MHz.					
NOTE 3: E-UTRA operating band groups are as defined in Section 3.5.					

B.1.7 Conditions for measurements of E-UTRAN cells for cell re-selection for UE Category M2

B.1.7.1 Conditions for measurements of intra-frequency E-UTRAN cells for cell selection

This clause defines the E-UTRAN intra-frequency RSRP, RSRP \hat{E}_s/lot , SCH_RP and SCH \hat{E}_s/lot applicable for a corresponding operating band. The UE category M2 applicability of the conditions in Appendix B.1.7 is defined in Section 3.1.

The conditions for CE mode A measurements of FDD and TDD intra-frequency E-UTRAN cells for cell re-selection are defined in Table B.1.7.1-1 and for E-UTRAN HD-FDD are defined in Table B.1.7.1-2.

The conditions for CE mode B measurements of FDD and TDD intra-frequency E-UTRAN cells for cell re-selection are defined in Table B.1.7.1-3 and for E-UTRAN HD-FDD are defined in Table B.1.7.1-4.

Table B.1.7.1-1: E-UTRAN intra-frequency measurements for FDD and TDD for normal coverage

Parameter	E-UTRA operating band groups ^{Note 3}	Minimum RSRP ^{Note 1}	Minimum SCH_RP ^{Note 1}	RSRP \hat{E}_s/lot	SCH \hat{E}_s/lot
		dBm/15kHz	dBm/15kHz	dB	dB
Conditions	FDD_M2_A, TDD_M2_A	-125	-125	≥ -4	≥ -4
	FDD_M2_D	-123.5	-123.5		
	FDD_M2_E, TDD_M2_E	-123	-123		
	FDD_M2_F	-122.5 ^{Note 2}	-122.5 ^{Note 2}		
	FDD_M2_G	-122	-122		
	FDD_M2_N	-118.5	-118.5		
NOTE 1: This condition level is increased by $\Delta > 0$, when applicable, as described in Sections B.4.2.					

NOTE 2: The condition is -125 dBm/15kHz when the carrier frequency of the assigned E-UTRA channel bandwidth is within 865-894 MHz.
 NOTE 3: E-UTRA operating band groups are as defined in Section 3.5.

Table B.1.7.1-2: E-UTRAN intra-frequency measurements for HD-FDD for normal coverage

Parameter	E-UTRA operating band groups Note 3	Minimum RSRP Note 1	Minimum SCH_RP Note 1	RSRP Ês/lot	SCH Ês/lot
		dBm/15kHz	dBm/15kHz	dB	dB
Conditions	FDD_M2_A	-125	-125	≥ -4	≥ -4
	FDD_M2_D	-123.5	-123.5		
	FDD_M2_E	-123	-123		
	FDD_M2_F	-122.5 ^{Note 2}	-122.5 ^{Note 2}		
	FDD_M2_G	-122	-122		
	FDD_M2_N	-118.5	-118.5		

NOTE 1: This condition level is increased by $\Delta > 0$, when applicable, as described in Sections B.4.2.
 NOTE 2: The condition is -125 dBm/15kHz when the carrier frequency of the assigned E-UTRA channel bandwidth is within 865-894 MHz.
 NOTE 3: E-UTRA operating band groups are as defined in Section 3.5.

Table B.1.7.1-3: E-UTRAN intra-frequency measurements for FDD and TDD for enhanced coverage

Parameter	E-UTRA operating band groups Note 3	Minimum RSRP Note 1	Minimum SCH_RP Note 1	RSRP Ês/lot	SCH Ês/lot
		dBm/15kHz	dBm/15kHz	dB	dB
Conditions	FDD_M2_A, TDD_M2_A	-136	-136	≥ -15	≥ -15
	FDD_M2_D	-134.5	-134.5		
	FDD_M2_E, TDD_M2_E	-134	-134		
	FDD_M2_F	-133.5 ^{Note 1}	-133.5 ^{Note 1}		
	FDD_M2_G	-133	-133		
	FDD_M2_N	-129.5	-129.5		

NOTE 1: This condition level is increased by $\Delta > 0$, when applicable, as described in Sections B.4.2.
 NOTE 2: The condition is -125 dBm/15kHz when the carrier frequency of the assigned E-UTRA channel bandwidth is within 865-894 MHz.
 NOTE 3: E-UTRA operating band groups are as defined in Section 3.5.

Table B.1.7.1-4: E-UTRAN intra-frequency measurements for HD-FDD for enhanced coverage

Parameter	E-UTRA operating band groups Note 3	Minimum RSRP Note 1	Minimum SCH_RP Note 1	RSRP Ês/lot	SCH Ês/lot
		dBm/15kHz	dBm/15kHz	dB	dB
Conditions	FDD_M2_A	-136	-136	≥ -15	≥ -15
	FDD_M2_D	-134.5	-134.5		
	FDD_M2_E	-134	-134		
	FDD_M2_F	-133.5 ^{Note 1}	-133.5 ^{Note 1}		
	FDD_M2_G	-133	-133		
	FDD_M2_N	-129.5	-129.5		

NOTE 1: This condition level is increased by $\Delta > 0$, when applicable, as described in Sections B.4.2.
 NOTE 2: The condition is -125 dBm/15kHz when the carrier frequency of the assigned E-UTRA channel bandwidth is within 865-894 MHz.
 NOTE 3: E-UTRA operating band groups are as defined in Section 3.5.

B.1.7.2 Condition for measurements of inter-frequency E-UTRAN cells for cell selection

This clause defines the E-UTRAN inter-frequency RSRP, RSRP Ês/lot, SCH_RP and SCH Ês/lot applicable for a corresponding operating band. The UE category M2 applicability of the conditions in Appendix B.1.7 is defined in Section 3.1.

The conditions for CE mode A measurements of FDD and TDD inter-frequency E-UTRAN cells for cell re-selection are defined in Table B.1.7.2-1 and for E-UTRAN HD-FDD are defined in Table B.1.7.2-2.

The conditions for CE mode B measurements of FDD and TDD inter-frequency E-UTRAN cells for cell re-selection are defined in Table B.1.7.2-3 and for E-UTRAN HD-FDD are defined in Table B.1.7.2-4.

Table B.1.7.2-1: E-UTRAN inter-frequency measurements for FDD and TDD for normal coverage

Parameter	E-UTRA operating band groups Note 3	Minimum RSRP Note 1	Minimum SCH_RP Note 1	RSRP Ês/lot	SCH Ês/lot
		dBm/15kHz	dBm/15kHz	dB	dB
Conditions	FDD_M2_A, TDD_M2_A	-125	-125	≥ -4	≥ -4
	FDD_M2_D	-123.5	-123.5		
	FDD_M2_E, TDD_M2_E	-123	-123		
	FDD_M2_F	-122.5 ^{Note 2}	-122.5 ^{Note 2}		
	FDD_M2_G	-122	-122		
	FDD_M2_N	-118.5	-118.5		

NOTE 1: This condition level is increased by $\Delta > 0$, when applicable, as described in Sections B.4.2.
NOTE 2: The condition is -125 dBm/15kHz when the carrier frequency of the assigned E-UTRA channel bandwidth is within 865-894 MHz.
NOTE 3: E-UTRA operating band groups are as defined in Section 3.5.

Table B.1.7.2-2: E-UTRAN inter-frequency measurements for HD-FDD for normal coverage

Parameter	E-UTRA operating band groups Note 3	Minimum SCH_RP Note 1	Minimum SCH_RP Note 1	RSRP Ês/lot	SCH Ês/lot
		dBm/15kHz	dBm/15kHz	dB	dB
Conditions	FDD_M2_A	-125	-124	≥ -4	≥ -4
	FDD_M2_D	-123.5	-122.5		
	FDD_M2_E	-123	-122		
	FDD_M2_F	-122.5 ^{Note 2}	-121.5 ^{Note 2}		
	FDD_M2_G	-122	-121		
	FDD_M2_N	-118.5	-117.5		

NOTE 1: This condition level is increased by $\Delta > 0$, when applicable, as described in Sections B.4.2.
NOTE 2: The condition is -125 dBm/15kHz when the carrier frequency of the assigned E-UTRA channel bandwidth is within 865-894 MHz.
NOTE 3: E-UTRA operating band groups are as defined in Section 3.5.

Table B.1.7.2-3: E-UTRAN inter-frequency measurements for FDD and TDD for enhanced coverage

Parameter	E-UTRA operating band groups Note 3	Minimum RSRP Note 1	Minimum SCH_RP Note 1	RSRP Ês/lot	SCH Ês/lot
		dBm/15kHz	dBm/15kHz	dB	dB
Conditions	FDD_M2_A, TDD_M2_A	-136	-136	≥ -15	≥ -15
	FDD_M2_D	-134.5	-134.5		
	FDD_M2_E, TDD_M2_E	-134	-134		
	FDD_M2_F	-133.5 ^{Note 1}	-133.5 ^{Note 1}		
	FDD_M2_G	-133	-133		
	FDD_M2_N	-129.5	-129.5		

NOTE 1: This condition level is increased by $\Delta > 0$, when applicable, as described in Sections B.4.2.
NOTE 2: The condition is -125 dBm/15kHz when the carrier frequency of the assigned E-UTRA channel bandwidth is within 865-894 MHz.
NOTE 3: E-UTRA operating band groups are as defined in Section 3.5.

Table B.1.7.2-4: E-UTRAN inter-frequency measurements for HD-FDD for enhanced coverage

Parameter	E-UTRA operating band groups Note 3	Minimum RSRP Note 1	Minimum SCH_RP Note 1	RSRP Ês/lot	SCH Ês/lot
		dBm/15kHz	dBm/15kHz	dB	dB
Conditions	FDD_M2_A	-136	-136	≥ -15	≥ -15
	FDD_M2_D	-134.5	-134.5		
	FDD_M2_E	-134	-134		

FDD_M2_F	-133.5 ^{Note 1}	-133.5 ^{Note 1}	
FDD_M2_G	-133	-133	
FDD_M2_N	-129.5	-129.5	

NOTE 1: This condition level is increased by $\Delta > 0$, when applicable, as described in Sections B.4.2.
NOTE 2: The condition is -125 dBm/15kHz when the carrier frequency of the assigned E-UTRA channel bandwidth is within 865-894 MHz.
NOTE 3: E-UTRA operating band groups are as defined in Section 3.5.

B.1.8 Conditions for measurements of inter-frequency E-UTRAN cells for cell re-selection for UE Category M1

This clause defines the E-UTRAN inter-frequency RSRP, RSRP \hat{E}_s/I_{ot} , SCH_RP and SCH \hat{E}_s/I_{ot} applicable for a corresponding operating band. The UE category M1 applicability of the conditions in Appendix B.1.3 is defined in Section 3.1.

The conditions for normal coverage measurements of FDD and TDD intra-frequency E-UTRAN cells for cell re-selection defined in Table B.1.3-1 and for E-UTRAN HD-FDD defined in Table B.1.3-2 also apply for E-UTRAN FDD, TDD and HD-FDD inter-frequency E-UTRAN cells for cell reselection.

The conditions for enhanced coverage measurements of FDD and TDD intra-frequency E-UTRAN cells for cell re-selection defined in Table B.1.3-3 and for E-UTRAN HD-FDD defined in Table B.1.3-4 also apply for E-UTRAN FDD, TDD, and HD-FDD inter-frequency E-UTRAN cells for re-selection.

B.2 Conditions for UE Measurements Procedures in RRC_CONNECTED State

B.2.1 Conditions for E-UTRAN intra-frequency measurements

This clause defines the E-UTRAN intra-frequency SCH_RP and SCH \hat{E}_s/I_{ot} applicable for a corresponding operating band.

The conditions for intra-frequency E-UTRAN measurements are defined in Table B.2.1-1.

Table B.2.1-1: E-UTRAN intra-frequency measurements

Parameter	E-UTRA operating band groups ^{Note 3}	Minimum SCH_RP ^{Note 1}	SCH \hat{E}_s/I_{ot}
		dBm/15kHz	dB
Conditions	FDD_A, TDD_A	-127	≥ -6
	FDD_B1, FDD_B2	-126.5	
	FDD_C, TDD_C	-126	
	FDD_D	-125.5	
	FDD_E, TDD_E	-125	
	FDD_F	-124.5 ^{Note 2}	
	FDD_G	-124	
	FDD_H	-123.5	
	FDD_N	-120.5	

NOTE 1: This condition level is increased by $\Delta > 0$, when applicable, as described in Sections B.4.2.
NOTE 2: The condition is -125 dBm/15kHz when the carrier frequency of the assigned E-UTRA channel bandwidth is within 865-894 MHz.
NOTE 3: E-UTRA operating band groups are as defined in Section 3.5.

B.2.2 Conditions for E-UTRAN intra-frequency measurements with autonomous gaps

This clause defines the E-UTRAN intra-frequency SCH_RP and SCH \hat{E}_s/I_{ot} applicable for a corresponding operating band.

The conditions for intra-frequency E-UTRAN measurements with autonomous gap are as in Table B.2.1-1.

Table B.2.2-1: Void

B.2.3 Conditions for E-UTRAN inter-frequency measurements

This clause defines the E-UTRAN inter-frequency SCH_{RP}, SCH Ês/Iot, RSRP and RSRP Ês/Iot applicable for a corresponding operating band.

The conditions for inter-frequency E-UTRAN measurements with autonomous gap are defined in Table B.2.3-1.

Table B.2.3-1: E-UTRAN inter-frequency measurements

Parameter	E-UTRA operating band groups ^{Note 3}	Minimum RSRP ^{Note 1}	Minimum SCH _{RP} ^{Note 1}	RSRP Ês/Iot	SCH Ês/Iot
		dBm/15kHz	dBm/15kHz	dB	dB
Conditions	FDD_A, TDD_A	-125	-125	≥ -4	≥ -4
	FDD_B1, FDD_B2	-124.5	-124.5		
	FDD_C, TDD_C	-124	-124		
	FDD_D	-123.5	-123.5		
	FDD_E, TDD_E	-123	-123		
	FDD_F	-122.5 ^{Note 2}	-122.5 ^{Note 2}		
	FDD_G	-122	-122		
	FDD_H	-121.5	-121.5		
FDD_N	-118.5	-118.5			

NOTE 1: This condition level is increased by $\Delta > 0$, when applicable, as described in Sections B.4.2 and B.4.3.
NOTE 2: The condition is -123 dBm/15kHz when the carrier frequency of the assigned E-UTRA channel bandwidth is within 865-894 MHz.
NOTE 3: E-UTRA operating band groups are as defined in Section 3.5.

B.2.4 Conditions for E-UTRAN inter-frequency measurements with autonomous gaps

This clause defines the E-UTRAN inter-frequency SCH_{RP} and SCH Ês/Iot applicable for a corresponding operating band.

The conditions for inter-frequency E-UTRAN measurements with autonomous gap are defined in Table B.2.4-1.

Table B.2.4-1: E-UTRAN inter-frequency measurements with autonomous gaps

Parameter	E-UTRA operating band groups ^{Note 3}	Minimum SCH _{RP} ^{Note 1}	SCH Ês/Iot
		dBm/15kHz	dB
Conditions	FDD_A, TDD_A	-125	≥ -4
	FDD_B1, FDD_B2	-124.5	
	FDD_C, TDD_C	-124	
	FDD_D	-123.5	
	FDD_E, TDD_E	-123	
	FDD_F	-122.5 ^{Note 2}	
	FDD_G	-122	
	FDD_H	-121.5	
FDD_N	-118.5		

NOTE 1: This condition level is increased by $\Delta > 0$, when applicable, as described in Sections B.4.2 and B.4.3.
NOTE 2: The condition is -123 dBm/15kHz when the carrier frequency of the assigned E-UTRA channel bandwidth is within 865-894 MHz.
NOTE 3: E-UTRA operating band groups are as defined in Section 3.5.

B.2.5 Conditions for E-UTRAN OTDOA intra-frequency RSTD Measurements

This clause defines the E-UTRAN intra-frequency PRP1,2 applicable for a corresponding operating band

The conditions for E-UTRAN OTDOA intra-frequency RSTD measurements are defined in Table B.2.5-1

Table B.2.5-1: E-UTRAN OTDOA intra-frequency RSTD measurements

Parameter	E-UTRA operating band groups ^{Note 3}	Minimum PRP1,2 ^{Note 1}
		dBm/15kHz
Conditions	FDD_A, TDD_A	-127
	FDD_B1, FDD_B2	-126.5
	FDD_C, TDD_C	-126
	FDD_D	-125.5
	FDD_E, TDD_E	-125
	FDD_F	-124.5 ^{Note 2}
	FDD_G	-124
	FDD_H	-123.5
	FDD_N	-120.5

NOTE 1: This condition level is increased by $\Delta > 0$, when applicable, as described in Sections B.4.2 and B.4.3.
NOTE 2: The condition is -125 dBm/15kHz when the carrier frequency of the assigned E-UTRA channel bandwidth is within 865-894 MHz.
NOTE 3: E-UTRA operating band groups are as defined in Section 3.5.

B.2.6 Conditions for E-UTRAN OTDOA inter-frequency RSTD Measurements

This clause defines the E-UTRAN inter-frequency PRP1,2 applicable for a corresponding operating band.

The conditions for E-UTRAN OTDOA inter-frequency RSTD measurements are defined in Table B.2.5-1.

B.2.7 Conditions for Measurements of the secondary component carrier with deactivated SCell

This clause defines the SCH_{RP} and SCH Ês/lot for measurements in the secondary component carrier applicable for a corresponding operating band.

The conditions for measurements of the secondary component carrier with deactivated SCell are defined in Table B.2.7-1.

Table B.2.7-1: Measurements of the secondary component carrier with deactivated SCell

Parameter	E-UTRA operating band groups ^{Note 3}	Minimum SCH _{RP} ^{Note 1}	SCH Ês/lot
		dBm/15kHz	dB
Conditions	FDD_A, TDD_A	-127	≥ -6
	FDD_B1, FDD_B2	-126.5	
	FDD_C, TDD_C	-126	
	FDD_D	-125.5	
	FDD_E, TDD_E	-125	
	FDD_F	-124.5 ^{Note 2}	
	FDD_G	-124	
	FDD_H	-123.5	
	FDD_N	-120.5	

NOTE 1: This condition level is increased by $\Delta > 0$, when applicable, as described in Sections B.4.2 and B.4.3.
NOTE 2: The condition is -125 dBm/15kHz when the carrier frequency of the assigned E-UTRA channel bandwidth is within 865-894 MHz.
NOTE 3: E-UTRA operating band groups are as defined in Section 3.5.

B.2.8 Conditions for E-UTRAN Intra-Frequency Measurements under Time Domain Measurement Resource Restriction

This clause defines the E-UTRAN intra-frequency SCH_{RP} and SCH Ês/Iot applicable for a corresponding operating band.

The conditions for intra-frequency E-UTRAN measurements under time domain measurement resource restriction are defined in Table B.2.8-1.

Table B.2.8-1: E-UTRAN intra-frequency measurements under time domain measurement resource restriction

Parameter	E-UTRA operating band groups ^{Note 3}	Minimum SCH _{RP} ^{Note 1}	SCH Ês/Iot
		dBm/15kHz	dB
Conditions	FDD_A, TDD_A	-127	≥ -7.5
	FDD_B1, FDD_B2	-126.5	
	FDD_C, TDD_C	-126	
	FDD_D	-125.5	
	FDD_E, TDD_E	-125	
	FDD_F	-124.5 ^{Note 2}	
	FDD_G	-124	
	FDD_H	-123.5	
	FDD_N	-120.5	
NOTE 1: This condition level is increased by $\Delta > 0$, when applicable, as described in Sections B.4.2 and B.4.3.			
NOTE 2: The condition is -125 dBm/15kHz when the carrier frequency of the assigned E-UTRA channel bandwidth is within 865-894 MHz.			
NOTE 3: E-UTRA operating band groups are as defined in Section 3.5.			

B.2.9 Conditions for E-UTRAN Intra-Frequency Measurements under Time Domain Measurement Resource Restriction with CRS Assistance Information

This clause defines the E-UTRAN intra-frequency SCH_{RP} and SCH Ês/Iot applicable for a corresponding operating band.

The conditions for intra-frequency E-UTRAN measurements under time domain measurement resource restriction with CRS assistance information are defined in Table B.2.9-1.

Table B.2.9-1: E-UTRAN intra-frequency measurements under time domain measurement resource restriction with CRS assistance information

Parameter	E-UTRA operating band groups ^{Note 3}	Minimum SCH _{RP} ^{Note 1}	SCH Ês/Iot
		dBm/15kHz	dB
Conditions	FDD_A, TDD_A	-127	≥ -11.07
	FDD_B1, FDD_B2	-126.5	
	FDD_C, TDD_C	-126	
	FDD_D	-125.5	
	FDD_E, TDD_E	-125	
	FDD_F	-124.5 ^{Note 2}	
	FDD_G	-124	
	FDD_H	-123.5	
	FDD_N	-120.5	
NOTE 1: This condition level is increased by $\Delta > 0$, when applicable, as described in Sections B.4.2 and B.4.3.			
NOTE 2: The condition is -125 dBm/15kHz when the carrier frequency of the assigned E-UTRA channel bandwidth is within 865-894 MHz.			
NOTE 3: E-UTRA operating band groups are as defined in Section 3.5.			

B.2.10 Conditions for E-UTRAN intra-frequency discovery signal measurements

B.2.10.1 Conditions for E-UTRAN intra-frequency CRS-based measurements

This clause defines the E-UTRAN intra-frequency SCH_{RP}, SCH \hat{E}_s/I_{ot} in discovery signal occasions [16], applicable for a corresponding operating band for CRS based discovery signal measurements

The conditions for E-UTRAN intra-frequency CRS based discovery signal measurements are as in Table B.2.1-1.

B.2.10.2 Conditions for E-UTRAN intra-frequency CSI-RS based measurements

This clause defines the E-UTRAN intra-frequency SCH_{RP}, SCH \hat{E}_s/I_{ot} , CSI-RSRP, and CSI-RS \hat{E}_s/I_{ot} in discovery signal occasions [16], applicable for a corresponding operating band for CSI-RS based discovery signal measurements.

The conditions for E-UTRAN intra-frequency CSI-RS based discovery signal measurements in discovery signal occasions are specified in Table B.2.10.2-1.

Table B.2.10.2-1: E-UTRAN intra-frequency discovery signal measurements

Parameter	E-UTRA operating band groups ^{Note 3}	Minimum CSI-RSRP ^{Note 1}	Minimum SCH _{RP} ^{Note 1}	CSI-RS \hat{E}_s/I_{ot}	SCH \hat{E}_s/I_{ot}
		dBm/15kHz	dBm/15kHz	dB	dB
Conditions	FDD_A, TDD_A	-121	-127	≥ 0	≥ -6
	FDD_B1, FDD_B2	-120.5	-126.5		
	FDD_C, TDD_C	-120	-126		
	FDD_D	-119.5	-125.5		
	FDD_E, TDD_E	-119	-125		
	FDD_F	-118.5 ^{Note 2}	-124.5 ^{Note 2}		
	FDD_G	-118	-124		
	FDD_H	-117.5	-123.5		
	FDD_N	-114.5	-120.5		

NOTE 1: This condition level is increased by $\Delta > 0$, when applicable, as described in Sections B.4.2 and B.4.3.
NOTE 2: The condition is -123 dBm/15kHz when the carrier frequency of the assigned E-UTRA channel bandwidth is within 865-894 MHz.
NOTE 3: E-UTRA operating band groups are as defined in Section 3.5.

B.2.11 Conditions for E-UTRAN inter-frequency discovery signal measurements

B.2.11.1 Conditions for E-UTRAN inter-frequency CRS-based measurements

This clause defines the E-UTRAN inter-frequency SCH_{RP}, SCH \hat{E}_s/I_{ot} , RSRP, and \hat{E}_s/I_{ot} in discovery signal occasions [16], applicable for a corresponding operating band for CRS based discovery signal measurements.

The conditions for E-UTRAN inter-frequency CRS-based discovery signal measurements in discovery signal occasions are specified in Table B.2.11.1-1.

Table B.2.11.1-1: E-UTRAN inter-frequency discovery signal measurements

Parameter	E-UTRA operating band groups ^{Note 3}	Minimum RSRP ^{Note 1}	Minimum SCH _{RP} ^{Note 1}	RSRP \hat{E}_s/I_{ot}	SCH \hat{E}_s/I_{ot}
		dBm/15kHz	dBm/15kHz	dB	dB
Conditions	FDD_A, TDD_A	-125	-125	≥ -6	≥ -6
	FDD_B1, FDD_B2	-124.5	-124.5		
	FDD_C, TDD_C	-124	-124		
	FDD_D	-123.5	-123.5		
	FDD_E, TDD_E	-123	-123		
	FDD_F	-122.5 ^{Note 2}	-122.5 ^{Note 2}		
	FDD_G	-122	-122		

	FDD_H	-121.5	-121.5	
	FDD_N	-118.5	-118.5	

NOTE 1: This condition level is increased by $\Delta > 0$, when applicable, as described in Sections B.4.2 and B.4.3.
NOTE 2: The condition is -123 dBm/15kHz when the carrier frequency of the assigned E-UTRA channel bandwidth is within 865-894 MHz.
NOTE 3: E-UTRA operating band groups are as defined in Section 3.5.

B.2.11.2 Conditions for E-UTRAN inter-frequency CSI-RS based measurements

This clause defines the E-UTRAN inter-frequency SCH_RP, SCH \hat{E}_s/I_{ot} , CSI-RSRP, and CSI-RS \hat{E}_s/I_{ot} in discovery signal occasions [16], applicable for a corresponding operating band for CSI-RS based discovery signal measurements.

The conditions for E-UTRAN inter-frequency CRS-based discovery signal measurements in discovery signal occasions are specified in Table B.2.11.2-1.

Table B.2.11.2-1: E-UTRAN inter-frequency discovery signal measurements

Parameter	E-UTRA operating band groups ^{Note 3}	Minimum CSI-RSRP ^{Note 1}	Minimum SCH_RP ^{Note 1}	CSI-RS \hat{E}_s/I_{ot}	SCH \hat{E}_s/I_{ot}
		dBm/15kHz	dBm/15kHz	dB	dB
Conditions	FDD_A, TDD_A	-119	-125	≥ 0	≥ -6
	FDD_B1, FDD_B2	-118.5	-124.5		
	FDD_C, TDD_C	-118	-124		
	FDD_D	-117.5	-123.5		
	FDD_E, TDD_E	-117	-123		
	FDD_F	-116.5 ^{Note 2}	-122.5 ^{Note 2}		
	FDD_G	-116	-122		
	FDD_N	-112.5	-118.5		

NOTE 1: This condition level is increased by $\Delta > 0$, when applicable, as described in Sections B.4.2 and B.4.3.
NOTE 2: The condition is -123 dBm/15kHz when the carrier frequency of the assigned E-UTRA channel bandwidth is within 865-894 MHz.
NOTE 3: E-UTRA operating band groups are as defined in Section 3.5.

B.2.12 Conditions for E-UTRAN intra-frequency discovery signal measurements under operation with frame structure 3

This section defines the E-UTRAN intra-frequency SCH_RP in discovery signal occasions [16], applicable for a corresponding operating band for discovery signal measurements under frame structure type 3.

The conditions for E-UTRAN intra-frequency discovery signal measurements are defined in Table B.2.12-1.

Table B.2.12-1: E-UTRAN intra-frequency measurements under operation with frame structure 3

Parameter	E-UTRA operating band groups ^{Note 2}	Minimum SCH_RP ^{Note 1}
		dBm/15kHz
Conditions	FS3_G	-124

NOTE 1: This condition level is increased by $\Delta > 0$, when applicable, as described in Sections B.4.2.
NOTE 2: E-UTRA operating band groups are as defined in Section 3.5.

B.2.13 Conditions for E-UTRAN inter-frequency discovery signal measurements under operation with frame structure 3

B.2.13.1 Conditions for E-UTRAN inter-frequency CRS-based measurements

This section defines the E-UTRAN inter-frequency SCH_RP in discovery signal occasions [16], applicable for a corresponding operating band for CRS based discovery signal measurements under frame structure 3.

The conditions for E-UTRAN inter-frequency CRS-based discovery signal measurements in discovery signal occasions are specified in Table B.2.13.1-1.

Table B.2.13.1-1: E-UTRAN inter-frequency discovery signal measurements

Parameter	E-UTRA operating band groups ^{Note 2}	Minimum SCH_RP ^{Note 1}
		dBm/15kHz
Conditions	FS3_G	-124
NOTE 1: This condition level is increased by $\Delta > 0$, when applicable, as described in Sections B.4.2.		
NOTE 2: E-UTRA operating band groups are as defined in Section 3.5.		

B.2.13.2 Conditions for E-UTRAN inter-frequency CSI-RS based measurements

This section defines the E-UTRAN inter-frequency SCH_RP in discovery signal occasions [16], applicable for a corresponding operating band for CSI-RS based discovery signal measurements.

The conditions for E-UTRAN inter-frequency CSI-RS based discovery signal measurements in discovery signal occasions under frame structure 3 are specified in Table B.2.13.2-1.

Table B.2.13.2-1: E-UTRAN inter-frequency discovery signal measurements

Parameter	E-UTRA operating band groups ^{Note 2}	Minimum SCH_RP ^{Note 1}
		dBm/15kHz
Conditions	FS3_G	-124
NOTE 1: This condition level is increased by $\Delta > 0$, when applicable, as described in Sections B.4.2.		
NOTE 2: E-UTRA operating band groups are as defined in Section 3.5.		

B.2.14 Conditions for E-UTRAN intra-frequency measurements by UE Category M1

This clause defines the E-UTRAN intra-frequency SCH_RP and SCH \hat{E}_s/I_{ot} applicable for a corresponding operating band. The UE category M1 applicability of the conditions in Appendix B.2.14 is defined in Section 3.1.

The conditions for CE mode A intra-frequency E-UTRAN FDD and TDD measurements are defined in Table B.2.14-1 and for E-UTRAN HD-FDD measurements are defined in Table B.2.14-2.

The conditions for CE mode B for intra-frequency E-UTRAN FDD and TDD measurements are defined in Table B.2.14-3 and for E-UTRAN HD-FDD measurements are defined in Table B.2.14-4.

Table B.2.14-1: E-UTRAN intra-frequency measurements for FDD and TDD for CE mode A

Parameter	E-UTRA operating band groups ^{Note 3}	Minimum SCH_RP ^{Note 1}	SCH \hat{E}_s/I_{ot}
		dBm/15kHz	dB
Conditions	FDD-M1_A, TDD-M1_A	-127	≥ -6
	FDD-M1_B	-126.5	
	FDD-M1_D	-125.5	
	FDD-M1_E, TDD-M1_E	-125	
	FDD-M1_F	-124.5 ^{Note 2}	
	FDD-M1_G	-124	
	FDD-M1_N	-120.5	
NOTE 1: This condition level is increased by $\Delta > 0$, when applicable, as described in Sections B.4.2.			
NOTE 2: The condition is -125 dBm/15kHz when the carrier frequency of the assigned E-UTRA channel bandwidth is within 865-894 MHz.			
NOTE 3: E-UTRA operating band groups are as defined in Section 3.5.			

Table B.2.14-2: E-UTRAN intra-frequency measurements for HD-FDD for CEModeA

Parameter	E-UTRA operating band groups ^{Note 3}	Minimum SCH_RP ^{Note 1}	SCH Ês/lot
		dBm/15kHz	dB
Conditions	FDD-M1_A,	-127	≥ -6
	FDD-M1_B	-126.5	
	FDD-M1_D	-125.5	
	FDD-M1_E	-125	
	FDD-M1_F	-124.5 ^{Note 2}	
	FDD-M1_G	-124	
	FDD-M1_N	-120.5	

NOTE 1: This condition level is increased by $\Delta > 0$, when applicable, as described in Sections B.4.2.
NOTE 2: The condition is -125 dBm/15kHz when the carrier frequency of the assigned E-UTRA channel bandwidth is within 865-894 MHz.
NOTE 3: E-UTRA operating band groups are as defined in Section 3.5.

Table B.2.14-3: E-UTRAN intra-frequency measurements for FDD and TDD for CEModeB

Parameter	E-UTRA operating band groups ^{Note 3}	Minimum SCH_RP ^{Note 1}	SCH Ês/lot
		dBm/15kHz	dB
Conditions	FDD-M1_A, TDD-M1_A	-136	≥ -15
	FDD-M1_B	-126.5	
	FDD-M1_D	-134.5	
	FDD-M1_E, TDD-M1_E	-134	
	FDD-M1_F	-133.5 ^{Note 2}	
	FDD-M1_G	-133	
	FDD-M1_N	-129.5	

NOTE 1: This condition level is increased by $\Delta > 0$, when applicable, as described in Sections B.4.2.
NOTE 2: The condition is -125 dBm/15kHz when the carrier frequency of the assigned E-UTRA channel bandwidth is within 865-894 MHz.
NOTE 3: E-UTRA operating band groups are as defined in Section 3.5.

Table B.2.14-4: E-UTRAN intra-frequency measurements for HD-FDD for CE mode B

Parameter	E-UTRA operating band groups ^{Note 3}	Minimum SCH_RP ^{Note 1}	SCH Ês/lot
		dBm/15kHz	dB
Conditions	FDD-M1_A,	-136	≥ -15
	FDD-M1_B	-126.5	
	FDD-M1_D	-134.5	
	FDD-M1_E	-134	
	FDD-M1_F	-133.5 ^{Note 2}	
	FDD-M1_G	-133	
	FDD-M1_N	-129.5	

NOTE 1: This condition level is increased by $\Delta > 0$, when applicable, as described in Sections B.4.2.
NOTE 2: The condition is -125 dBm/15kHz when the carrier frequency of the assigned E-UTRA channel bandwidth is within 865-894 MHz.
NOTE 3: E-UTRA operating band groups are as defined in Section 3.5.

B.2.15 Conditions for NB-IoT intra-frequency measurements by UE Category NB1

This clause defines the NB-IoT intra-frequency NSCH_RP and NSCH Ês/lot applicable for a corresponding operating band. The UE category NB1 applicability of the conditions in Appendix B.2.15 is defined in Section 3.6.

The conditions for intra-frequency measurements in normal coverage are defined in Table B.2.15-1 and B.2.15-3.

The conditions for intra-frequency measurements in denhanced coverage are defined in Table B.2.15-2 and B.2.15-4.

Table B.2.15-1: NB-IoT intra-frequency measurements for HD-FDD in normal coverage

Parameter	E-UTRA operating band groups ^{Note 1}	Minimum NSCH_RP	NSCH Ês/lot
		dBm/15kHz	dB
Conditions	NFDD_G	-129	≥ -6
NOTE 1: E-UTRA operating band groups are as defined in Section 3.5.			

Table B.2.15-2: NB-IoT intra-frequency measurements for HD-FDD in enhanced coverage

Parameter	E-UTRA operating band groups ^{Note 1}	Minimum NSCH_RP	SCH Ês/lot
		dBm/15kHz	dB
Conditions	NFDD_G	-138	≥ -15
NOTE 1: E-UTRA operating band groups are as defined in Section 3.5.			

Table B.2.15-3: NB-IoT intra-frequency measurements for TDD in normal coverage

Parameter	E-UTRA operating band groups ^{Note 1}	Minimum NSCH_RP	NSCH Ês/lot
		dBm/15kHz	dB
Conditions	NTDD_G	-129	≥ -6
NOTE 1: E-UTRA operating band groups are as defined in Section 3.5.			

Table B.2.15-4: NB-IoT intra-frequency measurements for TDD in enhanced coverage

Parameter	E-UTRA operating band groups ^{Note 1}	Minimum NSCH_RP	SCH Ês/lot
		dBm/15kHz	dB
Conditions	NTDD_G	-138	≥ -15
NOTE 1: E-UTRA operating band groups are as defined in Section 3.5.			

B.2.16 Conditions for NB-IoT intra-frequency RSTD measurements by UE Category NB1

This clause defines the NB-IoT intra-frequency PRP_{1,2} applicable for a corresponding operating band. The UE category NB1 applicability of the conditions in Appendix B.2.16 is defined in Section 3.1.

The conditions for intra-frequency RSTD measurements in normal coverage are defined in Table B.2.16-1 and B.2.16-3.

The conditions for intra-frequency RSTD measurements in enhanced coverage are defined in Table B.2.16-2 and B.2.16-4.

Table B.2.16-1: NB-IoT intra-frequency RSTD measurements for HD-FDD in normal coverage

Parameter	E-UTRA operating band groups ^{Note 1}	Minimum PRP _{1,2} ^{Note 1}
		dBm/15kHz
Conditions	NFDD_G	-129
NOTE 1: E-UTRA operating band groups are as defined in Section 3.5		

Table B.2.16-2: NB-IoT intra-frequency RSTD measurements for HD-FDD in enhanced coverage

Parameter	E-UTRA operating band groups ^{Note 1}	Minimum PRP _{1,2} ^{Note 1}
		dBm/15kHz
Conditions	NFDD_G	-135
NOTE 1: E-UTRA operating band groups are as defined in Section 3.5		

Table B.2.16-3: NB-IoT intra-frequency RSTD measurements for TDD in normal coverage

Parameter	E-UTRA operating band groups ^{Note 1}	Minimum PRP1,2 ^{Note 1}
		dBm/15kHz
Conditions	NTDD_G	-129
NOTE 1: E-UTRA operating band groups are as defined in Section 3.5		

Table B.2.16-4: NB-IoT intra-frequency RSTD measurements for TDD in enhanced coverage

Parameter	E-UTRA operating band groups ^{Note 1}	Minimum PRP1,2 ^{Note 1}
		dBm/15kHz
Conditions	NTDD_G	-135
NOTE 1: E-UTRA operating band groups are as defined in Section 3.5		

B.2.17 Conditions for NB-IoT inter-frequency RSTD measurements by UE Category NB1

This clause defines the NB-IoT inter-frequency PRP1,2 applicable for a corresponding operating band. The UE category NB1 applicability of the conditions in Appendix B.2.17 is defined in Section 3.1.

The conditions for intra-frequency RSTD measurements in normal coverage are defined in Table B.2.17-1 and B.2.17-3.

The conditions for intra-frequency RSTD measurements in enhanced coverage are defined in Table B.2.17-2 and B.2.17-4.

Table B.2.17-1: NB-IoT inter-frequency RSTD measurements for HD-FDD in normal coverage

Parameter	E-UTRA operating band groups ^{Note 1}	Minimum PRP1,2 ^{Note 1}
		dBm/15kHz
Conditions	NFDD_G	-129
NOTE 1: E-UTRA operating band groups are as defined in Section 3.5		

Table B.2.17-2: NB-IoT inter-frequency RSTD measurements for HD-FDD in enhanced coverage

Parameter	E-UTRA operating band groups ^{Note 1}	Minimum PRP1,2 ^{Note 1}
		dBm/15kHz
Conditions	NFDD_G	-135
NOTE 1: E-UTRA operating band groups are as defined in Section 3.5		

Table B.2.17-3: NB-IoT inter-frequency RSTD measurements for TDD in normal coverage

Parameter	E-UTRA operating band groups ^{Note 1}	Minimum PRP1,2 ^{Note 1}
		dBm/15kHz
Conditions	NTDD_G	-129
NOTE 1: E-UTRA operating band groups are as defined in Section 3.5		

Table B.2.17-4: NB-IoT inter-frequency RSTD measurements for TDD in enhanced coverage

Parameter	E-UTRA operating band groups ^{Note 1}	Minimum PRP1,2 ^{Note 1}
		dBm/15kHz
Conditions	NTDD_G	-135
NOTE 1: E-UTRA operating band groups are as defined in Section 3.5		

B.2.18 Conditions for E-UTRAN inter-frequency measurements by UE Category M1

This clause defines the E-UTRAN inter-frequency SCH_{RP} and SCH Ês/lot applicable for a corresponding operating band. The UE category M1 applicability of the conditions in Appendix B.2.18 is defined in Section 3.1.

The conditions for CE mode A inter-frequency E-UTRAN FDD and TDD measurements are defined in Table B.2.18-1 and for E-UTRAN HD-FDD measurements are defined in Table B.2.18-2.

The conditions for CE mode B for inter-frequency E-UTRAN FDD and TDD measurements are defined in Table B.2.18-3 and for E-UTRAN HD-FDD measurements are defined in Table B.2.18-4.

Table B.2.18-1: E-UTRAN inter-frequency measurements for FDD and TDD for CEModeA

Parameter	E-UTRA operating band groups ^{Note 3}	Minimum SCH _{RP} ^{Note 1}	SCH Ês/lot
		dBm/15kHz	dB
Conditions	FDD-M1_A, TDD-M1_A	-127	≥ -6
	FDD-M1_D	-125.5	
	FDD-M1_E, TDD-M1_E	-125	
	FDD-M1_F	-124.5 ^{Note 2}	
	FDD-M1_G	-124	
	FDD-M1_N	-120.5	
NOTE 1: This condition level is increased by $\Delta > 0$, when applicable, as described in Sections B.4.2.			
NOTE 2: The condition is -125 dBm/15kHz when the carrier frequency of the assigned E-UTRA channel bandwidth is within 865-894 MHz.			
NOTE 3: E-UTRA operating band groups are as defined in Section 3.5.			

Table B.2.18-2: E-UTRAN inter-frequency measurements for HD-FDD for CEModeA

Parameter	E-UTRA operating band groups ^{Note 3}	Minimum SCH _{RP} ^{Note 1}	SCH Ês/lot
		dBm/15kHz	dB
Conditions	FDD-M1_A,	-127	≥ -6
	FDD-M1_D	-125.5	
	FDD-M1_E	-125	
	FDD-M1_F	-124.5 ^{Note 2}	
	FDD-M1_G	-124	
	FDD-M1_N	-120.5	
NOTE 1: This condition level is increased by $\Delta > 0$, when applicable, as described in Sections B.4.2.			
NOTE 2: The condition is -125 dBm/15kHz when the carrier frequency of the assigned E-UTRA channel bandwidth is within 865-894 MHz.			
NOTE 3: E-UTRA operating band groups are as defined in Section 3.5.			

Table B.2.18-3: E-UTRAN inter-frequency measurements for FDD and TDD for CEModeB

Parameter	E-UTRA operating band groups ^{Note 3}	Minimum SCH _{RP} ^{Note 1}	SCH Ês/lot
		dBm/15kHz	dB
Conditions	FDD-M1_A, TDD-M1_A	-136	≥ -15
	FDD-M1_D	-134.5	
	FDD-M1_E, TDD-M1_E	-134	
	FDD-M1_F	-133.5 ^{Note 1}	
	FDD-M1_G	-133	
	FDD-M1_N	-129.5	
NOTE 1: This condition level is increased by $\Delta > 0$, when applicable, as described in Sections B.4.2.			
NOTE 2: The condition is -125 dBm/15kHz when the carrier frequency of the assigned E-UTRA channel bandwidth is within 865-894 MHz.			
NOTE 3: E-UTRA operating band groups are as defined in Section 3.5.			

Table B.2.18-4: E-UTRAN inter-frequency measurements for HD-FDD for CEModeB

Parameter	E-UTRA operating band groups ^{Note 3}	Minimum SCH_RP ^{Note 1}	SCH Ês/lot
		dBm/15kHz	dB
Conditions	FDD-M1_A,	-136	≥ -15
	FDD-M1_D	-134.5	
	FDD-M1_E	-134	
	FDD-M1_F	-133.5 ^{Note 1}	
	FDD-M1_G	-133	
	FDD-M1_N	-129.5	
NOTE 1: This condition level is increased by $\Delta > 0$, when applicable, as described in Sections B.4.2.			
NOTE 2: The condition is -125 dBm/15kHz when the carrier frequency of the assigned E-UTRA channel bandwidth is within 865-894 MHz.			
NOTE 3: E-UTRA operating band groups are as defined in Section 3.5.			

B.2.19 Conditions for E-UTRAN measurements by UE Category M2

B.2.19.1 Conditions for E-UTRAN intra-frequency measurements

This clause defines the E-UTRAN intra-frequency SCH_RP and SCH Ês/lot applicable for a corresponding operating band.

The conditions for intra-frequency measurements are defined in sub-section B.2.14.

B.2.19.2 Conditions for E-UTRAN inter-frequency measurements

This clause defines the E-UTRAN inter-frequency SCH_RP and SCH Ês/lot applicable for a corresponding operating band.

The conditions for inter-frequency measurements are defined in sub-section B.2.18.

B.2.20 Conditions for E-UTRAN inter-frequency RSTD measurements by UE Category M1

This clause defines the E-UTRAN inter-frequency PRP1,2 applicable for a corresponding operating band. The UE category M1 applicability of the conditions in Appendix B.2.20 is defined in Section 3.1.

The conditions for CE mode A inter-frequency E-UTRAN FDD and TDD measurements are defined in Table B.2.20-1 and for E-UTRAN HD-FDD measurements are defined in Table B.2.20-2.

The conditions for CE mode B for inter-frequency E-UTRAN FDD and TDD measurements are defined in Table B.2.20-3 and for E-UTRAN HD-FDD measurements are defined in Table B.2.20-4.

Table B.2.20-1: E-UTRAN inter-frequency measurements for FDD and TDD for CE mode A

Parameter	E-UTRA operating band groups ^{Note 2}	Minimum PRP1,2
		dBm/15kHz
Conditions	FDD_A, TDD_A	-127
	FDD_D	-125.5
	FDD_E, TDD_E	-125
	FDD_F	-124.5 ^{Note 1}
	FDD_G	-124
	FDD_N	-120.5
NOTE 1: The condition is -125 dBm/15kHz when the carrier frequency of the assigned E-UTRA channel bandwidth is within 865-894 MHz.		
NOTE 2: E-UTRA operating band groups are as defined in Section 3.5.		

Table B.2.20-2: E-UTRAN inter-frequency measurements for HD-FDD for CE mode A

Parameter	E-UTRA operating band groups ^{Note 2}	Minimum PRP1,2 dBm/15kHz
Conditions	FDD_A,	-127
	FDD_D	-125.5
	FDD_E	-125
	FDD_F	-124.5 ^{Note 1}
	FDD_G	-124
	FDD_N	-120.5

NOTE 1: The condition is -125 dBm/15kHz when the carrier frequency of the assigned E-UTRA channel bandwidth is within 865-894 MHz.
NOTE 2: E-UTRA operating band groups are as defined in Section 3.5.

Table B.2.20-3: E-UTRAN inter-frequency measurements for FDD and TDD for CE mode B

Parameter	E-UTRA operating band groups ^{Note 2}	Minimum PRP1,2 dBm/15kHz
Conditions	FDD_A, TDD_A	-136
	FDD_D	-134.5
	FDD_E, TDD_E	-134
	FDD_F	-133.5 ^{Note 1}
	FDD_G	-133
	FDD_N	-129.5

NOTE 1: The condition is -125 dBm/15kHz when the carrier frequency of the assigned E-UTRA channel bandwidth is within 865-894 MHz.
NOTE 2: E-UTRA operating band groups are as defined in Section 3.5.

Table B.2.20-4: E-UTRAN inter-frequency measurements for HD-FDD for CE mode B

Parameter	E-UTRA operating band groups ^{Note 2}	Minimum PRP1,2 dBm/15kHz
Conditions	FDD_A,	-136
	FDD_D	-134.5
	FDD_E	-134
	FDD_F	-133.5 ^{Note 1}
	FDD_G	-133
	FDD_N	-129.5

NOTE 1: The condition is -125 dBm/15kHz when the carrier frequency of the assigned E-UTRA channel bandwidth is within 865-894 MHz.
NOTE 2: E-UTRA operating band groups are as defined in Section 3.5.

B.2.21 Conditions for E-UTRAN inter-frequency RSTD measurements by UE Category M2

This section defines the inter-frequency PRP applicable for a corresponding operating band for Cat-M2.

The conditions for inter-frequency RSTD measurements are defined in sub-section B.2.20.

B.2.22 Conditions for E-UTRAN intra-frequency RSTD measurements by UE Category M1

This clause defines the E-UTRAN intra-frequency PRP1,2 applicable for a corresponding operating band. The UE category M1 applicability of the conditions in Appendix B.2.22 is defined in Section 3.1.

The conditions for CE mode A intra-frequency E-UTRAN FDD and TDD measurements are defined in Table B.2.22-1 and for E-UTRAN HD-FDD measurements are defined in Table B.2.22-2.

The conditions for CE mode B for intra-frequency E-UTRAN FDD and TDD measurements are defined in Table B.2.22-3 and for E-UTRAN HD-FDD measurements are defined in Table B.2.22-4.

Table B.2.22-1: E-UTRAN intra-frequency measurements for FDD and TDD for CE mode A

Parameter	E-UTRA operating band groups ^{Note 2}	Minimum PRP1,2
		dBm/15kHz
Conditions	FDD_A, TDD_A	-127
	FDD_D	-125.5
	FDD_E, TDD_E	-125
	FDD_F	-124.5 ^{Note 1}
	FDD_G	-124
	FDD_N	-120.5
NOTE 1: The condition is -125 dBm/15kHz when the carrier frequency of the assigned E-UTRA channel bandwidth is within 865-894 MHz.		
NOTE 2: E-UTRA operating band groups are as defined in Section 3.5.		

Table B.2.22-2: E-UTRAN intra-frequency measurements for HD-FDD for CE mode A

Parameter	E-UTRA operating band groups ^{Note 2}	Minimum PRP1,2
		dBm/15kHz
Conditions	FDD_A,	-127
	FDD_D	-125.5
	FDD_E	-125
	FDD_F	-124.5 ^{Note 1}
	FDD_G	-124
	FDD_N	-120.5
NOTE 1: The condition is -125 dBm/15kHz when the carrier frequency of the assigned E-UTRA channel bandwidth is within 865-894 MHz.		
NOTE 2: E-UTRA operating band groups are as defined in Section 3.5.		

Table B.2.22-3: E-UTRAN intra-frequency measurements for FDD and TDD for CE mode B

Parameter	E-UTRA operating band groups ^{Note 2}	Minimum PRP1,2
		dBm/15kHz
Conditions	FDD_A, TDD_A	-136
	FDD_D	-134.5
	FDD_E, TDD_E	-134
	FDD_F	-133.5 ^{Note 1}
	FDD_G	-133
	FDD_N	-129.5
NOTE 1: The condition is -125 dBm/15kHz when the carrier frequency of the assigned E-UTRA channel bandwidth is within 865-894 MHz.		
NOTE 2: E-UTRA operating band groups are as defined in Section 3.5.		

Table B.2.22-4: E-UTRAN intra-frequency measurements for HD-FDD for CE mode B

Parameter	E-UTRA operating band groups ^{Note 2}	Minimum PRP1,2
		dBm/15kHz
Conditions	FDD_A,	-136
	FDD_D	-134.5
	FDD_E	-134
	FDD_F	-133.5 ^{Note 1}
	FDD_G	-133
	FDD_N	-129.5
NOTE 1: The condition is -125 dBm/15kHz when the carrier frequency of the assigned E-UTRA channel bandwidth is within 865-894 MHz.		
NOTE 2: E-UTRA operating band groups are as defined in Section 3.5.		

B.2.23 Conditions for E-UTRAN intra-frequency RSTD measurements by UE Category M2

This section defines the intra-frequency PRP applicable for a corresponding operating band for Cat-M2.

The conditions for intra-frequency RSTD measurements are defined in sub-section B.2.22.

B.3 Conditions for measurements performance requirements for UE

B.3.1 Conditions for intra-frequency RSRP and RSRQ Accuracy Requirements

This clause defines the E-UTRAN intra-frequency RSRP applicable for a corresponding operating band.

The conditions for intra-frequency absolute RSRP and RSRQ accuracy requirements are defined in Table B.3.1-1.

Table B.3.1-1: Intra-frequency absolute RSRP and RSRQ Accuracy Requirements

Parameter	E-UTRA operating band groups ^{Note 3}	Minimum RSRP ^{Note 1}
		dBm/15kHz
Conditions	FDD_A, TDD_A	-127
	FDD_B1, FDD_B2	-126.5
	FDD_C, TDD_C	-126
	FDD_D	-125.5
	FDD_E, TDD_E	-125
	FDD_F	-124.5 ^{Note 2}
	FDD_G	-124
	FDD_H	-123.5
	FDD_N	-120.5

NOTE 1: This condition level is increased by $\Delta > 0$, when applicable, as described in Sections B.4.2 and B.4.3.
NOTE 2: The condition is -125 dBm/15kHz when the carrier frequency of the assigned E-UTRA channel bandwidth is within 865-894 MHz.
NOTE 3: E-UTRA operating band groups are as defined in Section 3.5.

B.3.2 Void

B.3.3 Conditions for inter-frequency RSRP and RSRQ Accuracy Requirements

This clause defines the E-UTRAN inter-frequency RSRP applicable for a corresponding operating band.

The conditions for inter-frequency absolute RSRP and RSRQ accuracy requirements are defined in Table B.3.1-1.

B.3.4 Conditions for inter-frequency relative RSRP and RSRQ Accuracy Requirements

This clause defines the E-UTRAN inter-frequency RSRP_{1,2} applicable for a corresponding operating band.

The conditions for inter-frequency relative RSRP and RSRQ accuracy requirements are defined in Table B.3.8-1.

B.3.5 Conditions for UE Rx – Tx time difference

This clause defines the E-UTRAN RSRP applicable for a corresponding operating band.

The conditions for UE Rx-Tx time difference are defined in Table B.3.1-1.

B.3.6 Conditions for intra-frequency Reference Signal Time Difference (RSTD) measurements

This sections defines the E-UTRAN intra-frequency PRP applicable for a corresponding operating band.

The conditions for intra-frequency RSTD measurements are defined in Table B.2.5-1.

B.3.7 Conditions for inter-frequency RSTD measurements

This sections defines the E-UTRAN inter-frequency PRP applicable for a corresponding operating band.

The conditions for inter-frequency RSTD measurements are defined in Table B.2.5-1.

B.3.8 Conditions for Intra-Frequency Relative RSRP Accuracy Requirements

This clause defines the E-UTRAN intra-frequency RSRP_{1,2} applicable for a corresponding operating band.

The conditions for intra-frequency relative RSRP accuracy requirements are specified in Table B.3.8-1.

Table B.3.8-1: Intra-frequency relative RSRP accuracy requirements

Parameter	E-UTRA operating band groups ^{Note 3}	Minimum RSRP _{1,2} ^{Note 1}
		dBm/15kHz
Conditions	FDD_A, TDD_A	-127
	FDD_B1, FDD_B2	-126.5
	FDD_C, TDD_C	-126
	FDD_D	-125.5
	FDD_E, TDD_E	-125
	FDD_F	-124.5 ^{Note 2}
	FDD_G	-124
	FDD_H	-123.5
	FDD_N	-120.5
NOTE 1: This condition level is increased by $\Delta > 0$, when applicable, as described in Sections B.4.2 and B.4.3.		
NOTE 2: The condition is -125 dBm/15kHz when the carrier frequency of the assigned E-UTRA channel bandwidth is within 865-894 MHz.		
NOTE 3: E-UTRA operating band groups are as defined in Section 3.5.		

B.3.9 Conditions for Intra-Frequency Absolute RSRP and RSRQ Accuracy Requirements under Time Domain Measurement Resource Restriction

This clause defines the E-UTRAN intra-frequency RSRP applicable for a corresponding operating band.

The conditions for intra-frequency absolute RSRP and RSRQ accuracy requirements under time domain measurement resource restriction are as specified in Table B.3.1-1.

B.3.10 Conditions for Intra-Frequency Relative RSRP Accuracy Requirements under Time Domain Measurement Resource Restriction

This clause defines the E-UTRAN intra-frequency RSRP_{1,2} applicable for a corresponding operating band.

The conditions for intra-frequency relative RSRP accuracy requirements under time domain measurement resource restriction are defined in Table B.3.8-1.

B.3.11 Conditions for Intra-Frequency Absolute RSRP and RSRQ Accuracy Requirements under Time Domain Measurement Resource Restriction with CRS Assistance Information

This clause defines the E-UTRAN intra-frequency RSRP applicable for a corresponding operating band.

The conditions for intra-frequency absolute RSRP and RSRQ accuracy requirements under time domain measurement resource restriction with CRS assistance information are as specified in Table B.3.1-1.

B.3.12 Conditions for Intra-Frequency Relative RSRP Accuracy Requirements under Time Domain Measurement Resource Restriction with CRS Assistance Information

This clause defines the E-UTRAN intra-frequency RSRP_{1,2} applicable for a corresponding operating band.

The conditions for intra-frequency relative RSRP accuracy requirements under time domain measurement resource restriction with CRS assistance information are as specified in Table B.3.8-1.

B.3.13 Conditions for UE Rx–Tx Time Difference Measurement under Time Domain Measurement Resource Restriction with CRS Assistance Information

This clause defines the E-UTRAN RSRP applicable for a corresponding operating band.

The conditions for UE Rx-Tx time difference measurements, when time domain measurement resource restriction pattern and CRS assistance information are provided, are as defined in Table B.3.1-1.

B.3.14 Conditions for Intra-Frequency Absolute Discovery Signal Measurement Accuracy Requirements

B.3.14.1 Conditions for Intra-frequency CRS-based measurements

This clause defines the intra-frequency RSRP in discovery signal occasions [16], applicable for a corresponding operating band for CRS based discovery signal measurements.

The conditions for intra-frequency absolute RSRP and RSRQ accuracy requirements for CRS-based discovery signal measurements in discovery signal occasions are as in Table B.3.1-1

B.3.14.2 Conditions for Intra-frequency CSI-RS-based measurements

This clause defines the intra-frequency CSI-RSRP in discovery signal occasions [16], applicable for a corresponding operating band for CSI-RS based discovery signal measurements.

The conditions for intra-frequency absolute CSI-RSRP accuracy requirements for CSI-RS-based discovery signal measurements in discovery signal occasions are specified in Table B.3.14.2-1

Table B.3.14.2-1: Intra-frequency Absolute CSI-RSRP Accuracy Requirements

Parameter	E-UTRA operating band groups ^{Note 3}	Minimum CSI-RSRP ^{Note 1}
		dBm/15kHz
Conditions	FDD_A, TDD_A	-127
	FDD_B1, FDD_B2	-126.5
	FDD_C, TDD_C	-126
	FDD_D	-125.5
	FDD_E, TDD_E	-125
	FDD_F	-124.5 ^{Note 2}
	FDD_G	-124

	FDD_H	-123.5
	FDD_N	-120.5
NOTE 1: This condition level is increased by $\Delta > 0$, when applicable, as described in Sections B.4.2 and B.4.3.		
NOTE 2: The condition is -125 dBm/15kHz when the carrier frequency of the assigned E-UTRA channel bandwidth is within 865-894 MHz.		
NOTE 3: E-UTRA operating band groups are as defined in Section 3.5.		

B.3.15 Conditions for Intra-Frequency Relative Discovery Signal Measurement Accuracy Requirements

B.3.15.1 Conditions for Intra-frequency CRS-based measurements

This clause defines the intra-frequency RSRP in discovery signal occasions [16], applicable for a corresponding operating band for CRS based discovery signal measurements.

The conditions for intra-frequency relative RSRP accuracy requirements for CRS-based discovery signal measurements in discovery signal occasions are as in Table B.3.8-1

B.3.15.2 Conditions for Intra-frequency CSI-RS-based measurements

This clause defines the intra-frequency CSI-RSRP in discovery signal occasions [16], applicable for a corresponding operating band for CSI-RS based discovery signal measurements.

The conditions for intra-frequency relative CSI-RSRP accuracy requirements for CSI-RS-based discovery signal measurements in discovery signal occasions are specified in Table B.3.15.2-1

Table B.3.15.2-1: Intra-frequency Relative CSI-RSRP Accuracy Requirements

Parameter	E-UTRA operating band groups ^{Note 3}	Minimum CSI-RSRP _{1,2} ^{Note 1}
		dBm/15kHz
Conditions	FDD_A, TDD_A	-127
	FDD_B1, FDD_B2	-126.5
	FDD_C, TDD_C	-126
	FDD_D	-125.5
	FDD_E, TDD_E	-125
	FDD_F	-124.5 ^{Note 2}
	FDD_G	-124
	FDD_H	-123.5
	FDD_N	-120.5
NOTE 1: This condition level is increased by $\Delta > 0$, when applicable, as described in Sections B.4.2 and B.4.3.		
NOTE 2: The condition is -125 dBm/15kHz when the carrier frequency of the assigned E-UTRA channel bandwidth is within 865-894 MHz.		
NOTE 3: E-UTRA operating band groups are as defined in Section 3.5.		

B.3.16 Conditions for Inter-Frequency Absolute Discovery Signal Measurement Accuracy Requirements

B.3.16.1 Conditions for Inter-frequency CRS-based measurements

This clause defines the inter-frequency RSRP in discovery signal occasions [16], applicable for a corresponding operating band for CRS based discovery signal measurements.

The conditions for inter-frequency absolute RSRP and RSRQ accuracy requirements for CRS-based discovery signal measurements in discovery signal occasions are as in Table B.3.1-1

B.3.16.2 Conditions for Inter-frequency CSI-RS-based measurements

This clause defines the inter-frequency CSI-RSRP in discovery signal occasions [16], applicable for a corresponding operating band for CSI-RS based discovery signal measurements.

The conditions for inter-frequency absolute CSI-RSRP accuracy requirements for CSI-RS-based discovery signal measurements in discovery signal occasions are as in Table B.3.14.2-1.

B.3.17 Conditions for Inter-Frequency Relative Discovery Signal Measurement Accuracy Requirements

B.3.17.1 Conditions for Inter-frequency CRS-based measurements

This clause defines the inter-frequency RSRP in discovery signal occasions [16], applicable for a corresponding operating band for CRS based discovery signal measurements.

The conditions for inter-frequency relative RSRP and RSRQ accuracy requirements for CRS-based discovery signal measurements in discovery signal occasions are as in Table B.3.8-1

B.3.17.2 Conditions for Inter-frequency CSI-RS-based measurements

This clause defines the inter-frequency CSI-RSRP in discovery signal occasions [16], applicable for a corresponding operating band for CSI-RS based discovery signal measurements.

The conditions for inter-frequency relative CSI-RSRP accuracy requirements for CSI-RS-based discovery signal measurements in discovery signal occasions are as in Table B.3.15.2-1.

B.3.18 Conditions for Intra-frequency Absolute RS-SINR Accuracy Requirements

This clause defines the E-UTRAN intra-frequency RSRP applicable for a corresponding operating band.

The conditions for intra-frequency absolute RS-SINR accuracy requirements are the same as defined in Table B.3.1-1.

B.3.19 Conditions for Inter-frequency Absolute RS-SINR Accuracy Requirements

This clause defines the E-UTRAN inter-frequency RSRP applicable for a corresponding operating band.

The conditions for inter-frequency absolute RS-SINR accuracy requirements are the same as defined in Table B.3.1-1.

B.3.20 Conditions for Inter-frequency Relative RS-SINR Accuracy Requirements

This clause defines the E-UTRAN inter-frequency RSRP_{1,2} applicable for a corresponding operating band.

The conditions for inter-frequency relative RS-SINR accuracy requirements are the same as defined in Table B.3.8-1.

B.3.21 Conditions for Intra-Frequency Absolute Accuracy Requirements for Measurements under Operation with Frame Structure 3

B.3.21.1 Conditions for RSRP measurements

This clause defines the intra-frequency absolute RSRP during the configured DMTC occasion [2] under operation with frame structure 3 [16], applicable for a corresponding operating band.

The conditions for intra-frequency absolute RSRP accuracy requirements are defined in Table B.3.21.1-1.

Table B.3.21.1-1: Intra-frequency absolute RSRP requirements

Parameter	E-UTRA operating band groups ^{Note 2}	Minimum RSRP ^{Note 1}
		dBm/15kHz

Conditions	FS3_G	-124
NOTE 1: This condition level is increased by $\Delta > 0$, when applicable, as described in Sections B.4.2 and B.4.3.		
NOTE 2: E-UTRA operating band groups are as defined in Section 3.5.		

B.3.21.2 Conditions for RSRQ measurements

This clause defines the intra-frequency absolute RSRQ during the configured DMTC occasion [2] under operation with frame structure 3 [16], applicable for a corresponding operating band.

The conditions for intra-frequency absolute RSRQ accuracy requirements are the same as defined in Table B.3.21.1-1.

B.3.21.3 Conditions for CSI-RSRP measurements

This clause defines the intra-frequency absolute CSI-RSRP during the configured DMTC occasion [2] under operation with frame structure 3 [16], applicable for a corresponding operating band.

The conditions for intra-frequency absolute RSRP accuracy requirements are defined in Table B.3.21.3-1.

Table B.3.21.3-1: Intra-frequency absolute CSI-RSRP requirements

Parameter	E-UTRA operating band groups ^{Note 2}	Minimum CSI-RSRP ^{Note 1}
		dBm/15kHz
Conditions	FS3_G	-124
NOTE 1: This condition level is increased by $\Delta > 0$, when applicable, as described in Sections B.4.2 and B.4.3.		
NOTE 2: E-UTRA operating band groups are as defined in Section 3.5.		

B.3.22 Conditions for Intra-Frequency Relative Accuracy Requirements for Measurements under Operation with Frame Structure 3

B.3.22.1 Conditions for RSRP measurements

This clause defines the intra-frequency relative RSRP during the configured DMTC occasion [2] under operation with frame structure 3 [16], applicable for a corresponding operating band.

The conditions for intra-frequency relative RSRP accuracy requirements are as defined in Table B.3.22.1-1.

Table B.3.22.1-1: Intra-frequency relative RSRP requirements

Parameter	E-UTRA operating band groups ^{Note 2}	Minimum RSRP _{1,2} ^{Note 1}
		dBm/15kHz
Conditions	FS3_G	-124
NOTE 1: This condition level is increased by $\Delta > 0$, when applicable, as described in Sections B.4.2 and B.4.3.		
NOTE 2: E-UTRA operating band groups are as defined in Section 3.5.		

B.3.22.2 Void

B.3.22.3 Conditions for CSI-RSRP measurements

This clause defines the intra-frequency relative CSI-RSRP during the configured DMTC occasion [2] under operation with frame structure 3 [16], applicable for a corresponding operating band.

The conditions for intra-frequency relative CSI-RSRP accuracy requirements are as defined in Table B.3.22.3-1.

Table B.3.22.3-1: Intra-frequency relative CSI-RSRP requirements

Parameter	E-UTRA operating band groups ^{Note 2}	Minimum CSI-RSRP _{1,2} ^{Note 1}
-----------	--	---

		dBm/15kHz
Conditions	FS3_G	-124
NOTE 1: This condition level is increased by $\Delta > 0$, when applicable, as described in Sections B.4.2 and B.4.3.		
NOTE 2: E-UTRA operating band groups are as defined in Section 3.5.		

B.3.23 Conditions for Inter-Frequency Absolute Accuracy Requirements for Measurements under Operation with Frame Structure 3

B.3.23.1 Conditions for RSRP measurements

This clause defines the inter-frequency absolute RSRP during the configured DMTC occasion [2] under operation with frame structure 3 [16], applicable for a corresponding operating band.

The conditions for inter-frequency absolute RSRP accuracy requirements are the same as defined in Table B.3.21.1-1.

B.3.23.2 Conditions for RSRQ measurements

This clause defines the inter-frequency absolute RSRQ during the configured DMTC occasion [2] under operation with frame structure 3 [16], applicable for a corresponding operating band.

The conditions for inter-frequency absolute RSRQ accuracy requirements are the same as defined in Table B.3.21.1-1.

B.3.23.3 Conditions for CSI-RSRP measurements

This clause defines the inter-frequency absolute CSI-RSRP during the configured DMTC occasion [2] under operation with frame structure 3 [16], applicable for a corresponding operating band.

The conditions for inter-frequency absolute CSI-RSRP accuracy requirements are the same as defined in Table B.3.21.3-1.

B.3.24 Conditions for Inter-Frequency Relative Accuracy Requirements for Measurements under Operation with Frame Structure 3

B.3.24.1 Conditions for RSRP measurements

This clause defines the inter-frequency relative RSRP during the configured DMTC occasion [2] under operation with frame structure 3 [16], applicable for a corresponding operating band.

The conditions for inter-frequency relative RSRP accuracy requirements are the same as defined in Table B.3.22.1-1.

B.3.24.2 Conditions for RSRQ measurements

This clause defines the inter-frequency relative RSRQ during the configured DMTC occasion [2] under operation with frame structure 3 [16], applicable for a corresponding operating band.

The conditions for inter-frequency relative RSRP accuracy requirements are the same as defined in Table B.3.22.1-1.

B.3.24.3 Conditions for CSI-RSRP measurements

This clause defines the inter-frequency relative CSI-RSRP during the configured DMTC occasion [2] under operation with frame structure 3 [16], applicable for a corresponding operating band.

The conditions for inter-frequency relative CSI-RSRP accuracy requirements are the same as defined in Table B.3.22.3-1.

B.3.25 Conditions for NB-IoT intra-frequency Absolute NRSRP and NRSRQ Accuracy Requirements for UE Category NB1

This clause defines the NB-IoT intra-frequency NRSRP applicable for a corresponding operating band. The UE category NB1 applicability of the conditions in Appendix B.3.25 is defined in Section 3.6.

The conditions for intra-frequency absolute NRSRP and NRSRQ accuracy requirements are defined in Table B.3.25-1.

Table B.3.25-1: NB-IoT intra-frequency absolute NRSRP and NRSRQ Accuracy Requirements

Parameter	E-UTRA operating band groups ^{Note 1}	Minimum NRSRP
		dBm/15kHz
Conditions	NFDD_G, NTDD_G	-139.8
NOTE 1: E-UTRA operating band groups are as defined in Section 3.5.		

B.3.26 Conditions for NB-IoT inter-frequency Absolute NRSRP and NRSRQ Accuracy Requirements for UE Category NB1

This clause defines the NB-IoT inter-frequency NRSRP applicable for a corresponding operating band. The UE category NB1 applicability of the conditions in Appendix B.3.26 is defined in Section 3.6.

The conditions for inter-frequency absolute NRSRP and NRSRQ accuracy requirements are defined in Table B.3.25-1.

B.3.27 Conditions for intra-frequency RSRP and RSRQ Accuracy Requirements for Category 0

This clause defines the E-UTRAN intra-frequency RSRP applicable for a corresponding operating band. The UE category 0 applicability of the conditions in Appendix B.3.27 is defined in Section 3.1.

The conditions for intra-frequency absolute RSRP and RSRQ accuracy requirements are defined in Table B.3.27-1.

Table B.3.27-1: Intra-frequency absolute RSRP and RSRQ Accuracy Requirements

Parameter	E-UTRA operating band groups ^{Note 3}	Minimum RSRP ^{Note 1}
		dBm/15kHz
Conditions	FDD-0_A, TDD-0_A	-127
	FDD-0_E, TDD-0_E	-125
	FDD-0_G	-124

B.3.28 Conditions for Intra-Frequency Relative RSRP Accuracy Requirements for Category 0

This clause defines the E-UTRAN intra-frequency RSRP_{1,2} applicable for a corresponding operating band. The UE category 0 applicability of the conditions in Appendix B.3.28 is defined in Section 3.1.

The conditions for intra-frequency relative RSRP accuracy requirements are specified in Table B.3.28-1.

Table B.3.28-1: Intra-frequency relative RSRP accuracy requirements

Parameter	E-UTRA operating band groups ^{Note 3}	Minimum RSRP _{1,2} ^{Note 1}
		dBm/15kHz
Conditions	FDD-0_A, TDD-0_A	-127
	FDD-0_E, TDD-0_E	-125
	FDD-0_G	-124

B.3.29 Conditions for intra-frequency Reference Signal Time Difference (RSTD) measurements for NB1

This sections defines the intra-frequency PRP applicable for a corresponding operating band for NB1.

The conditions for intra-frequency RSTD measurements are defined in Table B.2.16-1 and Table B.2.16-2

B.3.30 Conditions for inter-frequency Reference Signal Time Difference (RSTD) measurements for NB1

This sections defines the inter-frequency PRP applicable for a corresponding operating band for NB1.

The conditions for inter-frequency RSTD measurements are defined in Table B.2.17-1 and Table B.2.17-2.

B.3.31 Conditions for inter-frequency Reference Signal Time Difference (RSTD) measurements for Cat M1

This sections defines the inter-frequency PRP applicable for a corresponding operating band for Cat-M1.

The conditions for inter-frequency RSTD measurements are defined in sub-section B.2.20.

B.3.32 Conditions for inter-frequency Reference Signal Time Difference (RSTD) measurements for Cat M2

This sections defines the inter-frequency PRP applicable for a corresponding operating band for Cat-M2.

The conditions for inter-frequency RSTD measurements are defined in sub-section B.2.21.

B.3.33 Conditions for intra-frequency Reference Signal Time Difference (RSTD) measurements for Cat M1

This section defines the intra-frequency PRP applicable for a corresponding operating band for Cat-M1.

The conditions for intra-frequency RSTD measurements are defined in sub-section B.2.22.

B.3.34 Conditions for intra-frequency Reference Signal Time Difference (RSTD) measurements for Cat M2

This section defines the intra-frequency PRP applicable for a corresponding operating band for Cat-M2.

The conditions for intra-frequency RSTD measurements are defined in sub-section B.2.23.

B.4 RRM Requirements Exceptions

B.4.1 General

B.4.2 Receiver sensitivity relaxation for UE supporting CA

For a UE supporting inter-band carrier aggregation configuration with uplink in one E-UTRA band, if there is a relaxation of receiver sensitivity $\Delta R_{IB,c} > 0$ dB as defined in TS 36.101 [5], Table 7.3.1-1A, the relevant side conditions specifying received power levels (E-UTRA RSRP, SCH_RP, PRP, CSI-RSRP, and I_o) shall be increased by the amount $\Delta = \Delta R_{IB,c}$ defined for each of the downlink E-UTRA bands.

NOTE: This side condition adjustment applies only for a UE supporting a single inter-band LTE CA band combination. For a UE supporting additional inter-band LTE CA band combinations, the $\Delta R_{IB,c}$ for all bands supported by the UE, need to be studied [5].

B.4.3 Receiver sensitivity relaxation for UE configured with CA

B.4.3.1 Inter-band carrier aggregation

In this section, requirements exceptions are described for the UE configured with inter-band carrier aggregation with one uplink active in low operating band.

A relevant side condition (e.g., E-UTRA RSRP, SCH_RP, PRP, CSI-RSRP, and Io) in a requirement shall be increased by the amount $\Delta=L2-L1$, where L1 is the reference sensitivity level specified in 36.101, Table 7.3.1-1, and L2 is the reference sensitivity level specified in 36.101, Table 7.3.1A-0a, when the following conditions are fulfilled,

- both downlink component carriers on different bands are configured with CA and active,
- the single uplink is active in the low operating band,
- the exception requirements specified in TS36.101, Table 7.3.1A-0a, apply.

If the relaxation Δ specified in this section applies, then the relaxation specified in Section B.4.2 should not be applied.

B.4.3.2 Intra-band non-contiguous carrier aggregation

For a UE configured with intra-band non-contiguous carrier aggregation configuration with uplink in one E-UTRA band, if there is a relaxation of receiver sensitivity $\Delta R_{IBNC}>0$ as defined in TS 36.101 [5], Table 7.3.1A-3, the relevant side conditions specifying received power levels (E-UTRA RSRP, SCH_RP, PRP, CSI-RSRP, and Io) shall be increased by the amount $\Delta=\Delta R_{IBNC}$ defined for the downlink SCC, when the following conditions are fulfilled,

- both downlink component carriers are configured with CA and active,
- one uplink carrier is active,
- the exception requirements specified in TS36.101, Table 7.3.1A-3, apply.

If the relaxation Δ specified in this section applies, then the relaxation specified in Section B.4.2 should not be applied.

B.4.3.3 Inter-band carrier aggregation with operating bands without uplink band

In this section, requirements are described for the UE configured with inter-band carrier aggregation involving one operating band without uplink band.

There is no relaxation in relevant side condition (e.g., E-UTRA RSRP, SCH_RP, PRP, CSI-RSRP, and Io) in a requirement, i.e., $\Delta=0$, when the following conditions are fulfilled,

- both downlink component carriers on different bands are configured with CA and active,
- the single uplink is active in the high operating band,
- conditions specified in TS36.101, Table 7.3.1A-0d, apply.

If Δ specified in this section applies, then no other additional relaxation to REFSSENS shall be applied.

B.5 Conditions for Measurement Performance Requirements for ProSe UE

B.5.1 Conditions for S-RSRP Accuracy Requirements

This clause defines the S-RSRP applicable for a corresponding operating band.

The conditions for absolute S-RSRP accuracy requirements are defined in Table B.5.1-1.

Table B.5.1-1: Absolute S-RSRP Requirements

Parameter	E-UTRA ProSe operating band groups ^{Note 3}	Minimum S-RSRP ^{Note 1}
		dBm/15kHz
	FDD_D	-125.5
	FDD_E	-125
	FDD_F	-124.5 ^{Note 2}
	FDD_G	-124
	FDD_N	-120.5

NOTE 1: This condition level is increased by $\Delta > 0$, when applicable, as described in Sections B.4.2 and B.4.3.
NOTE 2: The condition is -125 dBm/15kHz when the carrier frequency of the assigned E-UTRA channel bandwidth is within 865-894 MHz.
NOTE 3: E-UTRA ProSe operating band groups are as defined in Section 3.5 for the corresponding E-UTRA operating bands.

B.5.2 Conditions for Relative S-RSRP Accuracy Requirements

This clause defines the S-RSRP_{1,2} applicable for a corresponding operating band.

The conditions for relative S-RSRP accuracy requirements are specified in Table B.5.2-1.

Table B.5.2-1: Relative S-RSRP accuracy requirements

Parameter	E-UTRA ProSe operating band groups ^{Note 3}	Minimum S-RSRP _{1,2} ^{Note 1}
		dBm/15kHz
	FDD_D	-125.5
	FDD_E	-125
	FDD_F	-124.5 ^{Note 2}
	FDD_G	-124
	FDD_N	-120.5

NOTE 1: This condition level is increased by $\Delta > 0$, when applicable, as described in Sections B.4.2 and B.4.3.
NOTE 2: The condition is -125 dBm/15kHz when the carrier frequency of the assigned E-UTRA channel bandwidth is within 865-894 MHz.
NOTE 3: E-UTRA ProSe operating band groups are as defined in Section 3.5 for the corresponding E-UTRA operating bands.

B.5.3 Conditions for Selection/Reselection to Intra-frequency SyncRef UE

This clause defines the ProSe SCH_{RP} and SCH_{Es/lot} applicable for a corresponding operating band.

The conditions for selection/reselection to intra-frequency SyncRef UE are defined in Table B.5.3-1.

Table B.5.3-1: ProSe synchronization measurements

Parameter	E-UTRA ProSe operating band groups ^{Note 3}	Minimum ProSe SCH _{RP} ^{Note 1}	ProSe SCH _{Es/lot} ^{Note 4}
		dBm/15kHz	dB
	FDD_D	-125.5	≥ -4
	FDD_E	-125	
	FDD_F	-124.5	
	FDD_G	-124	
	FDD_N	-120.5	

NOTE 1: This condition level is increased by $\Delta > 0$, when applicable, as described in Sections B.4.2 and B.4.3.
NOTE 2: Void
NOTE 3: E-UTRA ProSe operating band groups are as defined in Section 3.5 for the corresponding E-UTRA operating bands.
NOTE 4: ProSe SCH_{Es/lot} for a SyncRef UE is the minimum of the \hat{E}_s/lot of PSSS/PSBCH and the \hat{E}_s/lot of SSSS

B.5.4 Conditions for SD-RSRP Accuracy Requirements

This clause defines the intra-frequency SD-RSRP applicable for a corresponding operating band.

The conditions for intra-frequency absolute SD-RSRP accuracy requirements are defined in Table B.5.4-1.

Table B.5.4-1: Absolute SD-RSRP Requirements

Parameter	E-UTRA ProSe operating band groups ^{Note 3}	Minimum SD-RSRP ^{Note 1} dBm/15kHz
		FDD_D
	FDD_E	-125
	FDD_F	-124.5
	FDD_G	-124
	FDD_N	-120.5

NOTE 1: This condition level is increased by $\Delta > 0$, when applicable, as described in Sections B.4.2 and B.4.3.
NOTE 2: Void
NOTE 3: E-UTRA ProSe operating band groups are as defined in Section 3.5 for the corresponding E-UTRA operating bands.

B.5.5 Conditions for Relative SD-RSRP Accuracy Requirements

This clause defines the intra-frequency SD-RSRP applicable for a corresponding operating band.

The conditions for intra-frequency relative S-RSRP accuracy requirements are specified in Table B.5.5-1.

Table B.5.5-1: Relative S-RSRP accuracy requirements

Parameter	E-UTRA ProSe operating band groups ^{Note 3}	Minimum SD-RSRP _{1,2} ^{Note 1} dBm/15kHz
		FDD_D
	FDD_E	-125
	FDD_F	-124.5
	FDD_G	-124
	FDD_N	-120.5

NOTE 1: This condition level is increased by $\Delta > 0$, when applicable, as described in Sections B.4.2 and B.4.3.
NOTE 2: Void
NOTE 3: E-UTRA ProSe operating band groups are as defined in Section 3.5 for the corresponding E-UTRA operating bands.

B.6 Conditions for V2X

B.6.1 Test parameters for GNSS signals

This clause defines the reference signal power levels of generated satellites for a corresponding GNSS, which will be used in V2V and V2X test cases.

Table B.6.1-1: GNSS Reference Signal Power Parameters

System	Parameters	Unit	Value
	Number of generated satellites per system	-	6
GPS ⁽¹⁾	Reference signal power level for all satellites	dBm	-128.5
Galileo	Reference signal power level for all satellites	dBm	-127
GLONASS	Reference signal power level for all satellites	dBm	-131
BDS	Reference signal power level for all satellites	dBm	-133

NOTE 1: "GPS" here means GPS L1 C/A, Modernized GPS, or both, dependent on UE capabilities.
NOTE 2: The DUT UE does not need to support all systems. The DUT UE shall support at least one system and will be test for the supported systems.

B.6.2 Conditions for Absolute S-RSRP Accuracy Requirements

This clause defines the S-RSRP applicable for a corresponding operating band.

The conditions for absolute S-RSRP accuracy requirements are defined in Table B.6.2-1.

Table B.6.2-1: Absolute S-RSRP Requirements

Parameter	E-UTRA V2X operating band groups ^{Note 2}	Minimum S-RSRP ^{Note 1}
		dBm/15kHz
	TDD_G	-124
NOTE 1: This condition level is increased by $\Delta > 0$, when applicable, as described in Sections B.4.2 and B.4.3.		
NOTE 2: E-UTRA V2X operating band groups are as defined in Section 3.5 for the corresponding E-UTRA operating bands.		

B.6.3 Conditions for Relative S-RSRP Accuracy Requirements

This clause defines the S-RSRP_{1,2} applicable for a corresponding operating band.

The conditions for relative S-RSRP accuracy requirements are specified in Table B.6.3-1.

Table B.6.3-1: Relative S-RSRP accuracy requirements

Parameter	E-UTRA V2X operating band groups ^{Note 2}	Minimum S-RSRP _{1,2} ^{Note 1}
		dBm/15kHz
	TDD_G	-124
NOTE 1: This condition level is increased by $\Delta > 0$, when applicable, as described in Sections B.4.2 and B.4.3.		
NOTE 2: E-UTRA V2X operating band groups are as defined in Section 3.5 for the corresponding E-UTRA operating bands.		

B.6.4 Conditions for Selection/Reselection to Intra-frequency SyncRef UE

This clause defines the V2X SCH_{RP} and SCH_{Ês/lot} applicable for a corresponding operating band.

The conditions for selection/reselection to intra-frequency SyncRef UE are defined in Table B.6.4-1.

Table B.6.4-1: V2X synchronization measurements

Parameter	E-UTRA V2X operating band groups ^{Note 2}	Minimum V2X SCH _{RP} ^{Note 1}	V2X SCH _{Ês/lot} ^{Note 3}
		dBm/15kHz	dB
	TDD_G	120	≥ 0
NOTE 1: This condition level is increased by $\Delta > 0$, when applicable, as described in Sections B.4.2 and B.4.3.			
NOTE 2: E-UTRA V2X operating band groups are as defined in Section 3.5 for the corresponding E-UTRA operating bands.			
NOTE 3: V2X SCH _{Ês/lot} for a SyncRef UE is the minimum of the Ês/lot of PSSS/PSBCH and the Ês/lot of SSSS			
NOTE 4: The SyncRef UE transmission frequency shall be accurate to within ± 5 PPM compared to the absolute frequency.			

B.6.5 Conditions for Absolute PSSCH-RSRP Accuracy Requirements

This clause defines the PSSCH-RSRP applicable for a corresponding operating band.

The conditions for absolute PSSCH-RSRP accuracy requirements are defined in Table B.6.5-1.

Table B.6.5-1: Absolute PSSCH-RSRP Requirements

Parameter	E-UTRA V2X operating band groups ^{Note2}	Minimum PSSCH-RSRP ^{Note 1}
	TDD_G	-124
NOTE 1: This condition level is increased by $\Delta > 0$, when applicable, as described in Sections B.4.2 and B.4.3.		
NOTE 2: E-UTRA V2X operating band groups are as defined in Section 3.5 for the corresponding E-UTRA operating bands.		

B.7 Conditions for sTTI and 1ms-TTI with 3 Subframe HARQ Processing

B.7.1 Conditions for Maximum Timing Difference Between Uplink and Downlink Carriers in Carrier Aggregation

This clause defines the condition on the maximum timing difference between the earliest uplink carrier and the latest downlink carrier in carrier aggregation when a UE is configured with at least one serving cell that is configured with *dl-STTI-Length-r15* or *ShortProcessingTime = TRUE*.

The timing difference between the earliest uplink carrier and the latest downlink carrier among all the serving cells configured to the UE is no larger than

$\max Td_1$ when any of the serving cells is configured with *dl-STTI-Length-r15*=subslot and *proc-Timeline-r15*=nplus4set1,

$\max Td_2$ when any of the serving cells is configured with *dl-STTI-Length-r15* =subslot and *proc-Timeline-r15*=nplus6set2,

$\max Td_3$ when any of the serving cells is configured with *ShortProcessingTime = TRUE*,

$\max Td_4$ when any of the serving cells is configured with *dl-STTI-Length-r15*=slot,

$\max Td_5$ when any of the serving cells is configured with *dl-STTI-Length-r15*=subslot and *proc-Timeline-r15*=nplus6set1,

$\max Td_6$ when any of the serving cells is configured with *dl-STTI-Length-r15*=subslot and *proc-Timeline-r15*=nplus8set2.

The values of the parameters $\max Td_i$ for $i=1, \dots, 6$ are as specified in Table B.7.2-1.

Table B.7.2-1: Maximum Subframe Timing Boundary Difference Between Earliest Uplink Carrier and Latest Downlink Carrier

Parameter	Value
$\max Td_1$	66.67 μ s (Note 1)
$\max Td_2$	166.67 μ s (Note 2)
$\max Td_3$	200.00 μ s (Note 3)
$\max Td_4$	309.90 μ s (Note 4)
$\max Td_5$	352.08 μ s (Note 5)
$\max Td_6$	452.08 μ s (Note 6)

- | | |
|---------|---|
| Note 1: | Maximum timing advance with $dl-STTI-Length-r15=$ subslot and $proc-Timeline-r15=nplus4set1$ [16] |
| Note 2: | Maximum timing advance with $dl-STTI-Length-r15=$ subslot and $proc-Timeline-r15=nplus6set2$ [16] |
| Note 3: | Maximum timing advance with $ShortProcessingTime = TRUE$ [16] |
| Note 4: | Maximum timing advance with $dl-STTI-Length-r15=$ slot [16] |
| Note 5: | Maximum timing advance with $dl-STTI-Length-r15=$ subslot and $proc-Timeline-r15=nplus6set1$ [16] |
| Note 6: | Maximum timing advance with $dl-STTI-Length-r15=$ subslot and $proc-Timeline-r15=nplus8set2$ [16] |

Annex C (informative): Change history:

Date	Meeting	TDoc	CR	Rev	Cat	Subject/Comment	New version
2007-12	RP#38	RP-071037				Approved version in TSG RAN#38	8.0.0
2008-03	RP#39	RP-080123	2			Updates of TS36.133	8.1.0
2008-05	RP#40	RP-080325	3			Updates of TS36.133	8.2.0
2008-09	RP#41	RP-080644	006	1		E-UTRAN TDD intra frequency measurements when DRX is used	8.3.0
2008-09	RP#41	RP-080644	008	1		E-UTRAN TDD - UTRAN TDD measurements	8.3.0
2008-09	RP#41	RP-080644	012			RSRQ reporting Range	8.3.0
2008-09	RP#41	RP-080644	018	1		Interfrequency and UTRA interRAT DRX performance requirements	8.3.0
2008-09	RP#41	RP-080644	020	1		Additions to UE transmit timing requirements	8.3.0
2008-09	RP#41	RP-080644	043			Received interference power measurement performance requirement	8.3.0
2008-09	RP#41	RP-080644	044			Cell Synchronization requirement for E-UTRA TDD	8.3.0
2008-09	RP#41	RP-080644	047			Power Headroom Requirements	8.3.0
2008-09	RP#41	RP-080644	048			Event Triggering and Reporting Criteria Capability Requirements	8.3.0
2008-09	RP#41	RP-080642	004			Correction of E-UTRAN to UTRAN TDD handover	8.3.0
2008-09	RP#41	RP-080642	016	1		Definition of Symbols	8.3.0
2008-09	RP#41	RP-080642	019	1		Idle mode requirements updates	8.3.0
2008-09	RP#41	RP-080642	021	1		General updates to 36.133	8.3.0
2008-09	RP#41	RP-080642	023	1		Handover requirements for E-UTRAN to cdma200 HRPD/1x	8.3.0
2008-09	RP#41	RP-080642	024			Inter-frequency and inter-RAT measurement requirements for multiple layer monitoring	8.3.0
2008-09	RP#41	RP-080642	025			Side conditions for UE measurement procedures and measurement performance requirements	8.3.0
2008-09	RP#41	RP-080642	026			Correction to cell reselection Requirement from E-UTRAN to HRPD/cdma200 1x	8.3.0
2008-09	RP#41	RP-080642	027			IRAT Measurement requirements in TS 36.133	8.3.0
2008-09	RP#41	RP-080713	022	1		Corrections to Handover requirements	8.3.0
2008-09	RP#41	RP-080713	028			Measurement reporting requirements	8.3.0
2008-09	RP#41	RP-080713	029	2		RRC re-establishment requirements	8.3.0
2008-09	RP#41	RP-080713	032			Correction to UE measurement requirements	8.3.0
2008-09	RP#41	RP-080713	033			Correction for the definition of interruption time	8.3.0
2008-09	RP#41	RP-080713	040	1		Correction to idle mode higher priority search requirements	8.3.0
2008-09	RP#41	RP-080713	045			E-UTRAN TDD inter frequency measurement requirements	8.3.0
2008-09	RP#41	RP-080713	046			Updates of the Measurement procedures in RRC_Connected state from RAN 4#47bis and RAN 4#48	8.3.0
2008-12	RP#42	RP-080919	53			Introduction of 700MHz Bands 12, 14 and 17	8.4.0
2008-12	RP#42	RP-080928	88	1		CR to 36.133 on Radio Link Failure Monitoring	8.4.0
2008-12	RP#42	RP-080929	51			Correction to idle mode requirements	8.4.0
2008-12	RP#42	RP-080929	52			Definition of out of service area	8.4.0
2008-12	RP#42	RP-080929	54			Measurement requirements for UTRAN TDD cells in idle state	8.4.0
2008-12	RP#42	RP-080929	69	2		Correction of Inter-RAT UTRA cell reselection requirement	8.4.0
2008-12	RP#42	RP-080929	55			Correction of E-UTRAN cell measurement requirements in idle state	8.4.0
2008-12	RP#42	RP-080930	76			Correction to HO Requirements	8.4.0
2008-12	RP#42	RP-080931	71			Random access requirements	8.4.0
2008-12	RP#42	RP-080932	85			Cell phase synchronization error for large cell	8.4.0
2008-12	RP#42	RP-080932	63	4		Synchronization Requirements for E-UTRAN to 1xRTT and HRPD Handovers	8.4.0
2008-12	RP#42	RP-080933	49			E-UTRAN TDD-TDD intra/inter frequency measurement reporting requirements	8.4.0
2008-12	RP#42	RP-080933	50			E-UTRAN FDD – UTRAN FDD Measurement reporting requirements	8.4.0
2008-12	RP#42	RP-080933	58			Measurement requirement for E-UTRAN TDD to UTRAN TDD/FDD when DRX is used	8.4.0

2008-12	RP#42	RP-080933	60			Interfrequency and GSM measurement performance requirements in large DRX	8.4.0
2008-12	RP#42	RP-080933	62			Correction of implementation margin for transmission gap.	8.4.0
2008-12	RP#42	RP-080933	72			Alignment of DRX cycle dependent requirements	8.4.0
2008-12	RP#42	RP-080933	73	1		Alignment of side conditions for mobility measurements	8.4.0
2008-12	RP#42	RP-080933	66	1		Measurement models in RRC_CONNECTED	8.4.0
2008-12	RP#42	RP-080933	78	1		Limitation of maximum number of layers for multiple monitoring	8.4.0
2008-12	RP#42	RP-080933	83	1		GSM Cell identification requirements for parallel monitoring	8.4.0
2008-12	RP#42	RP-080933	87			UE transmit timing requirement	8.4.0
2008-12	RP#42	RP-080933	56			Correction of TS 36.133 clause 8.1.2.1.1.	8.4.0
2008-12	RP#42	RP-080934	77			Correction to RSRQ Report Mapping	8.4.0
2008-12	RP#42		86			Missing side conditions for RSRP and RSRQ	8.4.0
2008-12	RP#42	RP-080935	81	1		Phase I RRM Test Cases	8.4.0
2008-12	RP#42		80	1		Test Configuration for RRM Tests: Measurement Reference Channels and OCNG	8.4.0
2008-12	RP#42	RP-080936	75			Cdma200 1xRTT Measurement Requirements	8.4.0
2008-12	RP#42	RP-080937	74	1		E-UTRA to UTRA cell search requirements for SON	8.4.0
2009-03	RP#43	RP-090182	101	1		Correction of A3-offset parameter in RRM test case	8.5.0
2009-03	RP#43	RP-090182	105			Some Editorial Corrections	8.5.0
2009-03	RP#43	RP-090182	145			Clarifications for the DRX state	8.5.0
2009-03	RP#43	RP-090183	89			Modification on measurements of UTRAN TDD cells	8.5.0
2009-03	RP#43	RP-090183	91			Clarification of the correct behavior when Treselection is not a multiple of idle mode reselection evaluation period	8.5.0
2009-03	RP#43	RP-090183	98			Clarification of 'Out of Service Area' Concept and Definition	8.5.0
2009-03	RP#43	RP-090183	118			Radio link monitoring	8.5.0
2009-03	RP#43	RP-090183	142	1		Update of RRC_IDLE state mobility side conditions	8.5.0
2009-03	RP#43	RP-090183	150			UE measurement capability in Idle mode	8.5.0
2009-03	RP#43	RP-090184	133			Removal of RRC re-establishment procedure delay	8.5.0
2009-03	RP#43	RP-090184	138	1		Correction for the UE Re-establishment delay requirement	8.5.0
2009-03	RP#43	RP-090185	92	2		Cell phase synchronization accuracy	8.5.0
2009-03	RP#43	RP-090185	97			Radio link monitoring in DRX	8.5.0
2009-03	RP#43	RP-090185	120			UE Transmit Timing	8.5.0
2009-03	RP#43	RP-090185	137	1		Clarification of the reference point for the UE initial transmission timing control requirement	8.5.0
2009-03	RP#43	RP-090186	90			Correction of clause 8.1.2.2.2.2 in TS36.133	8.5.0
2009-03	RP#43	RP-090186	93	1		cdma2000 1xRTT and HRPD Measurement Requirements	8.5.0
2009-03	RP#43	RP-090186	94			Event Triggered Periodic Reporting Requirements for IRAT Measurements	8.5.0
2009-03	RP#43	RP-090186	95			Measurement Reporting Requirements for E-UTRAN TDD – UTRAN TDD Measurements	8.5.0
2009-03	RP#43	RP-090186	99	1		Clarification of UE behavior when measurement gap is used	8.5.0
2009-03	RP#43	RP-090186	100			E-UTRA to UTRA cell search requirements in DRX for SON	8.5.0
2009-03	RP#43	RP-090186	110	1		Correction to GSM BSIC Requirements for Parallel Monitoring	8.5.0
2009-03	RP#43	RP-090186	117			Alignment of terminology for GAP	8.5.0
2009-03	RP#43	RP-090186	134			Inter frequency and Inter RAT cell search requirement when DRX is used	8.5.0
2009-03	RP#43	RP-090186	139			Correction of E-UTRAN FDD – UTRAN FDD measurements when no DRX	8.5.0
2009-03	RP#43	RP-090186	146			Addition of the definition of "when DRX is used"	8.5.0
2009-03	RP#43	RP-090186	147	1		Corrections to E-UTRAN inter-frequency side conditions	8.5.0
2009-03	RP#43	RP-090187	96			Correction to Intra-frequency RSRP Accuracy Requirements	8.5.0
2009-03	RP#43	RP-090187	136	1		Power Headroom reporting delay	8.5.0
2009-03	RP#43	RP-090370	103	1		E-UTRAN -GSM Handover Test Case	8.5.0
2009-03	RP#43	RP-090370	104	1		E-UTRAN FDD - UTRAN TDD Cell Search Test Cases in Fading	8.5.0
2009-03	RP#43	RP-090370	106	1		E-UTRA FDD to UTRA FDD Handover Test Case	8.5.0

2009-03	RP#43	RP-090370	107	1		Correction of E-UTRA FDD-FDD Intra-frequency cell reselection test case	8.5.0
2009-03	RP#43	RP-090370	108	1		Correction of E-UTRA FDD-FDD priority based Inter-frequency cell reselection test case	8.5.0
2009-03	RP#43	RP-090370	111			E-UTRAN TDD - UTRAN FDD Handover Test Case	8.5.0
2009-03	RP#43	RP-090370	112	1		E-UTRAN FDD - GSM Cell Search Test Case in AWGN	8.5.0
2009-03	RP#43	RP-090370	113			E-UTRAN - UTRAN FDD Cell Search Test Cases in Fading	8.5.0
2009-03	RP#43	RP-090370	114	1		E-UTRAN UE Timing Accuracy Related Test Cases	8.5.0
2009-03	RP#43	RP-090370	115	1		Inclusion of MBSFN Configurations for RRM Test Cases	8.5.0
2009-03	RP#43	RP-090370	116			E-UTRAN FDD HRPD Cell Reselection Test Case; HRPD of Low Priority	8.5.0
2009-03	RP#43	RP-090370	122	1		Clarification on Annex A.9: Measurement performance requirements	8.5.0
2009-03	RP#43	RP-090370	125			E-UTRA TDD – UTRA TDD cell reselection: UTRA is of higher priority	8.5.0
2009-03	RP#43	RP-090370	126			E-UTRA TDD – UTRA TDD cell reselection: UTRA is of lower priority	8.5.0
2009-03	RP#43	RP-090370	127			E-UTRA FDD – UTRA TDD cell reselection	8.5.0
2009-03	RP#43	RP-090370	128	1		E-UTRA TDD-UTRA TDD cell search (fading)	8.5.0
2009-03	RP#43	RP-090370	129	1		E-UTRA TDD-UTRA TDD handover	8.5.0
2009-03	RP#43	RP-090370	132	1		Addition of E-UTRA FDD to UTRA FDD reselection test cases	8.5.0
2009-03	RP#43	RP-090370	141	1		Correction and introduction of some test related parameters	8.5.0
2009-03	RP#43	RP-090370	143			Description of Annex A in TS 36.133	8.5.0
2009-03	RP#43	RP-090370	148			Reselection from E-UTRA to GSM cell test case	8.5.0
2009-03	RP#43	RP-090370	149			Radio Link Monitoring Test Cases	8.5.0
2009-05	RP#44	RP-090546	151			E-UTRA FDD UTRA TDD HO delay test case	8.6.0
2009-05	RP#44	RP-090546	153			Correction of CQI reporting periodicity for TDD RLM test cases	8.6.0
2009-05	RP#44	RP-090546	157			Correction to inter RAT reselection requirements to exclude equal priority. (Technically Endorsed CR in R4-50bis - R4-091092)	8.6.0
2009-05	RP#44	RP-090546	167			Clarification of the number of monitoring carriers in idle mode. (Technically Endorsed CR in R4-50bis - R4-091394)	8.6.0
2009-05	RP#44	RP-090546	180			Correction of Core spec references in A.9 Measurements performance test cases	8.6.0
2009-05	RP#44	RP-090546	984			UTRA FDD-E-UTRA FDD/ TDD handover test cases	8.6.0
2009-05	RP#44	RP-090546	184			SON ANR UTRAN FDD Cell Search Test Case	8.6.0
2009-05	RP#44	RP-090546	187			E-UTRAN FDD cdma2000 1x RTT Cell Reselection Test Case; Cdma2000 1X of Low Priority	8.6.0
2009-05	RP#44	RP-090546	188			E-UTRAN FDD cdma2000 HO Test cases	8.6.0
2009-05	RP#44	RP-090546	190			E-UTRAN Random Access Test Cases	8.6.0
2009-05	RP#44	RP-090546	191			E-UTRAN RRC Re-establishment Test Cases	8.6.0
2009-05	RP#44	RP-090546	192			E-UTRAN TDD - GSM Cell Search Test Case in AWGN	8.6.0
2009-05	RP#44	RP-090546	197			Correction to E-UTRAN FDD - GSM Handover Test case	8.6.0
2009-05	RP#44	RP-090546	173	1		Correction of cell reselection test cases	8.6.0
2009-05	RP#44	RP-090546	179	1		Test cases of E-UTRA TDD intra-frequency cell search in fading environment when DRX is used	8.6.0
2009-05	RP#44	RP-090546	152	1		E-UTRA TDD GSM handover test case	8.6.0
2009-05	RP#44	RP-090546	178	1		Test cases of E-UTRA FDD intra-frequency cell search in fading environment when DRX is used	8.6.0
2009-05	RP#44	RP-090546	201	1		Test case for E-UTRA FDD E-UTRA FDD inter frequency cell search when DRX is used in fading conditions	8.6.0
2009-05	RP#44	RP-090546	185	1		Correction to Radio Link Monitoring Tests	8.6.0
2009-05	RP#44	RP-090546	203			Correction to E-UTRAN FDD to HRPD Cell Reselection Test Case	8.6.0
2009-05	RP#44	RP-090546	177	1		Introduction of New Reference Channels and OCNG Patterns for 1.4MHz Bandwidth	8.6.0
2009-05	RP#44	RP-090546	200	2		Test case for E-UTRA TDD E-UTRA TDD inter frequency cell search when DRX is used in fading conditions	8.6.0
2009-05	RP#44	RP-090547	158			Alignment of inter frequency and inter RAT RRM reselection testcases with core requirements. (Technically Endorsed CR in R4-50bis - R4-091094)	8.6.0

2009-05	RP#44	RP-090547	160			Correction relating E-UTRAN TDD - UE Transmit Timing Accuracy Tests. (Technically Endorsed CR in R4-50bis - R4-091198)	8.6.0
2009-05	RP#44	RP-090547	165			Modifications of T3 and the verification point for in-sync test cases. (Technically Endorsed CR in R4-50bis - R4-091386)	8.6.0
2009-05	RP#44	RP-090547	172			E-UTRAN UE Timing Accuracy Related Test Cases. (Technically Endorsed CR in R4-50bis - R4-091517)	8.6.0
2009-05	RP#44	RP-090547	171	1		Reference measurement Channels for Radio Link Monitoring Tests with 2 Antennas. (Technically Endorsed CR in R4-50bis - R4-091508)	8.6.0
2009-05	RP#44	RP-090548	170			Misalignment between TS36.133 and TS36.321. (Technically Endorsed CR in R4-50bis - R4-091457)	8.6.0
2009-05	RP#44	RP-090548	193			Correction to Inter-RAT HO Interruption Time Definition	8.6.0
2009-05	RP#44	RP-090548	195			CR c2k RRC delay	8.6.0
2009-05	RP#44	RP-090548	196			CR c2k interruption time	8.6.0
2009-05	RP#44	RP-090548	162			Clarifications to UE UL timing requirements. (Technically Endorsed CR in R4-50bis - R4-091357)	8.6.0
2009-05	RP#44	RP-090548	176			Corrections of Random Access Requirements	8.6.0
2009-05	RP#44	RP-090548	154			Correction of TGRP in clause 8.1.2.1.1	8.6.0
2009-05	RP#44	RP-090548	168			Clarifications for the Relative RSRP and RSRQ measurement requirements. (Technically Endorsed CR in R4-50bis - R4-091407)	8.6.0
2009-05	RP#44	RP-090549	161			E-UTRAN UTRAN HO Command Processing Delay. (Technically Endorsed CR in R4-50bis - R4-091291)	8.6.0
2009-05	RP#44	RP-090549	175			Corrections of Cell Reselection Requirements in Idle Mode	8.6.0
2009-05	RP#44	RP-090549	181	2		Removal of [] from ranking criteria in Idle mode cell reselection	8.6.0
2009-05	RP#44	RP-090550	156			Correction on the TDD-TDD inter frequency measurements. (Technically Endorsed CR in R4-50bis - R4-091071)	8.6.0
2009-05	RP#44	RP-090550	159			Correction to the Referenced Clause Number for Tinter1. (Technically Endorsed CR in R4-50bis - R4-091153)	8.6.0
2009-05	RP#44	RP-090551	166			Further clarification of DRX/Non-DRX state. (Technically Endorsed CR in R4-50bis - R4-091389)	8.6.0
2009-05	RP#44	RP-090551	202			Correction on reference to 3GPP2 specification	8.6.0
2009-05	RP#44	RP-090551	169			OCNG simplification. (Technically Endorsed CR in R4-50bis - R4-091410)	8.6.0
2009-05	RP#44	RP-090559	155			Introduction of Extended LTE800 requirements. (Technically Endorsed CR in R4-50bis - R4-091063)	9.0.0
2009-05	RP#45	RP-090817	211			Correction to TDD RMC references in RLM test cases	9.1.0
2009-05	RP#45	RP-090880	205			Introduction of Reference DRX configurations	9.1.0
2009-05	RP#45	RP-090880	207			Addition of DRX configurations into non DRX test cases	9.1.0
2009-05	RP#45	RP-090880	225			Correction to HO Test Cases	9.1.0
2009-05	RP#45	RP-090880	227			Correction to E-UTRAN GSM BSIC Identification Requirements with DRX	9.1.0
2009-05	RP#45	RP-090880	259			Corrections of Test Cases	9.1.0
2009-05	RP#45	RP-090880	314			E-UTRA FDD - E-UTRA FDD and UTRA FDD cell search test cases	9.1.0
2009-05	RP#45	RP-090880	315			E-UTRAN Radio Link Monitoring Test Cases in DRX	9.1.0
2009-05	RP#45	RP-090880	316			Inter-frequency E-UTRA - E-UTRA HO test cases: unknown target cell	9.1.0
2009-05	RP#45	RP-090880	263	2		E-UTRA FDD UTRA FDD Blind Handover test case: unknown target cell	9.1.0
2009-05	RP#45	RP-090836	321	1		Small corrections to Measurements performance tests parameters	9.1.0
2009-05	RP#45	RP-090836	285	1		E-UTRAN GSM Cell Search in DRX Test Cases	9.1.0
2009-05	RP#45	RP-090836	267			Set 3.2. E-UTRA TDD to UTRA TDD cell search in DRX under fading	9.1.0
2009-05	RP#45	RP-090836	269			Set 3.6. Test case of E-UTRA TDD to E-UTRA TDD and UTRA TDD combined cell search under fading	9.1.0
2009-05	RP#45	RP-090836	271			Set 3.12. E-UTRA TDD to UTRA TDD blind handover test	9.1.0
2009-05	RP#45	RP-090836	279			E-UTRAN FDD - UTRAN FDD Cell Search in DRX Test Cases	9.1.0
2009-05	RP#45	RP-090836	281			E-UTRAN TDD- E-UTRAN TDD and E-UTRAN TDD Inter-frequency Cell Search Test Case	9.1.0
2009-05	RP#45	RP-090836	283			E-UTRAN GSM Blind Handover Test Cases	9.1.0

2009-05	RP#45	RP-090836	287			E-UTRAN FDD cdma2000 Blind HO Test cases	9.1.0
2009-05	RP#45	RP-090836	302			RRM Test case for multiple E-UTRAN FDD-FDD Inter-frequency event triggered reporting under fading propagation conditions	9.1.0
2009-05	RP#45	RP-090836	304			Fading reselection test case between E-UTRA and UTRA (UTRA of lower priority)	9.1.0
2009-05	RP#45	RP-090828	233			CR SI HRPD correction	9.1.0
2009-05	RP#45	RP-090879	215	1		Corrections to Measurements of HRPD cells and cdma2000 1X	9.1.0
2009-05	RP#45	RP-090879	231			CR reference correction	9.1.0
2009-05	RP#45	RP-090879	235	1		Corrections to Measurements of GSM cells in RRC_IDLE	9.1.0
2009-05	RP#45	RP-090879	247			Range of Idle Mode Es/lot side conditions	9.1.0
2009-05	RP#45	RP-090879	249			Removal of [] from Tdetect, Tmeasure and Tevaluate	9.1.0
2009-05	RP#45	RP-090879	245	1		Clarification to applicability of RSRP side conditions in Idle mode	9.1.0
2009-05	RP#45	RP-090879	317			CR Idle mode IF measurement condition	9.1.0
2009-05	RP#45	RP-090879	318			CR Idle mode IF measurement period	9.1.0
2009-05	RP#45	RP-090879	217	2		Corrections to E-UTRAN RRC_IDLE state mobility requirements	9.1.0
2009-05	RP#45	RP-090814	265	1		Correction to Random Access	9.1.0
2009-05	RP#45	RP-090816	221			E-UTRAN TDD-TDD inter frequency cell search/measurement requirements when DRX is used	9.1.0
2009-05	RP#45	RP-090816	223			E-UTRAN inter RAT measurement requirements	9.1.0
2009-05	RP#45	RP-090816	229			Correction to Monitoring of Multiple Layers Using Gaps	9.1.0
2009-05	RP#45	RP-090816	219	1		E-UTRAN FDD-FDD inter frequency measurements when DRX is used	9.1.0
2009-05	RP#45	RP-090816	322			CR GSM measurement period	9.1.0
2009-05	RP#45	RP-090816	323			CR cdma2000 1x and HRPD number of carriers	9.1.0
2009-05	RP#45	RP-090816	213	1		Editorial correction on E-UTRAN inter frequency measurements	9.1.0
2009-05	RP#45	RP-090816	261	1		E-UTRAN TDD intra frequency measurements	9.1.0
2009-05	RP#45	RP-090816	319	1		Clarification of the number of monitoring cells for intra frequency measurements	9.1.0
2009-05	RP#45	RP-090815	237			Correction of timing advance adjustment accuracy test case	9.1.0
2009-05	RP#45	RP-090815	291			Correction to UE Transmit Timing Requirements	9.1.0
2009-12	RP-46	RP-091275	329			Defining requirements for UTRA TDD measurements for SON (Technically endorsed at RAN 4 52bis in R4-093512)	9.2.0
2009-12	RP-46	RP-091272	332			Modification of test case of E-UTRA TDD intra frequency cell reselection (Technically endorsed at RAN 4 52bis in R4-093552)	9.2.0
2009-12	RP-46	RP-091272	333			Modification of test case of E-UTRA TDD inter frequency cell reselection (Technically endorsed at RAN 4 52bis in R4-093553)	9.2.0
2009-12	RP-46	RP-091286	334			Introduction of Extended LTE1500 requirements for TS36.133 (Technically endorsed at RAN 4 52bis in R4-093636)	9.2.0
2009-12	RP-46	RP-091272	336			Addition of E-UTRA TDD to UTRA FDD reselection test cases (Technically endorsed at RAN 4 52bis in R4-093686)	9.2.0
2009-12	RP-46	RP-091271	338			Correction of missing accuracy requirements for UTRAN FDD (Technically endorsed at RAN 4 52bis in R4-093689)	9.2.0
2009-12	RP-46	RP-091275	340			CR cdma2000 HRPD measurement period (Technically endorsed at RAN 4 52bis in R4-093720)	9.2.0
2009-12	RP-46	RP-091275	342			CR cdma2000 1x measurement period (Technically endorsed at RAN 4 52bis in R4-093721)	9.2.0
2009-12	RP-46	RP-091272	344			Correction for E-UTRAN FDD - UTRAN FDD Cell Search in DRX Test Cases (Technically endorsed at RAN 4 52bis in R4-093890)	9.2.0
2009-12	RP-46	RP-091272	346			Revise geometry factors for Intra freq Reselection Test Cases	9.2.0
2009-12	RP-46	RP-091271	348			Corrections on RRM parameters for Bands 12, 14, 17	9.2.0
2009-12	RP-46	RP-091271	351	1		Corrections to PDSCH RMC-s	9.2.0
2009-12	RP-46	RP-091271	353			Corrections of TS36.133	9.2.0
2009-12	RP-46	RP-091275	356	1		UTRA TDD P-CCPCH RSCP absolute accuracy measurement in E-UTRAN	9.2.0
2009-12	RP-46	RP-091275	358	1		E-UTRAN TDD - UTRAN TDD cell search for SON	9.2.0

2009-12	RP-46	RP-091275	361			Cell Search Requirements for Intra-LTE Handover to Unknown Target Cell	9.2.0
2009-12	RP-46	RP-091273	365			Combined E-UTRAN interfrequency and GSM cell search test cases (Scenario set 3.2)	9.2.0
2009-12	RP-46	RP-091271	367	1		Correction in UE UTRA TDD P-CCPCH RSCP measurement capability for R9	9.2.0
2009-12	RP-46	RP-091273	374			E-UTRAN GSM RSSI Measurement Accuracy Tests	9.2.0
2009-12	RP-46	RP-091273	375			E-UTRAN UTRAN FDD CPICH RSCP Measurement Accuracy Tests	9.2.0
2009-12	RP-46	RP-091273	376			E-UTRAN UTRAN FDD CPICH Ec/No Measurement Accuracy Tests	9.2.0
2009-12	RP-46	RP-091275	378			Cell Timing Change Requirements for Event Triggered Reporting	9.2.0
2009-12	RP-46	RP-091271	380			Correction to Power Headroom Requirements	9.2.0
2009-12	RP-46	RP-091271	382			Editorial corrections to 36.133	9.2.0
2009-12	RP-46	RP-091271	387			Editorial corrections to the time units for RRC Re-establishment test cases	9.2.0
2009-12	RP-46	RP-091272	389	1		Introduction of cell search test case in DRX to verify L3 filtering	9.2.0
2009-12	RP-46	RP-091271	391			Correction to ONCG Patterns	9.2.0
2009-12	RP-46	RP-091275	329			Defining requirements for UTRA TDD measurements for SON (Technically endorsed at RAN 4 52bis in R4-093512)	9.2.0
2009-12	RP-46	RP-091272	332			Modification of test case of E-UTRA TDD intra frequency cell reselection (Technically endorsed at RAN 4 52bis in R4-093552)	9.2.0
2009-12	RP-46	RP-091272	333			Modification of test case of E-UTRA TDD inter frequency cell reselection (Technically endorsed at RAN 4 52bis in R4-093553)	9.2.0
2010-03	RP-47	RP-100254	410			Idle mode corrections	9.3.0
2010-03	RP-47	RP-100254	405	1		UE measurement capability requirements in Idle and Connected	9.3.0
2010-03	RP-47	RP-100254	423			Correction to UE Measurement Capability Requirements in Idle Mode	9.3.0
2010-03	RP-47	RP-100254	412			Removal of activation time from interRAT handover requirements	9.3.0
2010-03	RP-47	RP-100254	417	1		Correction to UE Transmit Timing Requirements	9.3.0
2010-03	RP-47	RP-100254	402			Correction of E-UTRAN TDD inter frequency measurements_R9	9.3.0
2010-03	RP-47	RP-100254	414	1		Enhanced GSM Requirements for CSFB	9.3.0
2010-03	RP-47	RP-100254	415	1		Enhanced UTRA FDD Requirements for CSFB	9.3.0
2010-03	RP-47	RP-100255	399			Correction of RSRP value in E-UTRAN FDD Inter frequency reselection test	9.3.0
2010-03	RP-47	RP-100255	397			Addition of missing Es/Noc parameters in RRM test cases	9.3.0
2010-03	RP-47	RP-100255	421			Correction to RRC Re-establishment Test Case	9.3.0
2010-03	RP-47	RP-100255	427	1		Correction of UE transmit timing test case	9.3.0
2010-03	RP-47	RP-100255	419	1		Correction to RLM Test Cases	9.3.0
2010-03	RP-47	RP-100262	407			Editorial Corrections in TS36.133(Rel-9)	9.3.0
2010-03	RP-47	RP-100263	413			Introduction of LTE in 800 MHz for Europe requirements in TS 36.133	9.3.0
2010-03	RP-47	RP-100264	395			Corrections for Extended UMTS1500 in TS36.133(Rel-9)	9.3.0
2010-03	RP-47	RP-100269	393			AOA and TA measurement report mappings	9.3.0
2010-03	RP-47	RP-100269	403	2		Mapping of UE RxTx time difference measurement	9.3.0
2010-03	RP-47	RP-100266	425	2		Home eNode B synchronization requirement	9.3.0
2010-03	RP-47	RP-100266	424	2		Minimum requirements on SI reading for HeNB inbound mobility	9.3.0
2010-06	RP-48	RP-100622	473			Clarification on radio link monitoring	9.4.0
2010-06						Corrections of clause numbering on the test case of E-UTRAN FDD-FDD inter-frequency cell search requirements for L3 filtering	9.4.0
2010-06	RP-48	RP-100622	472				
2010-06	RP-48	RP-100622	466	1		Correction to RRM Test Cases	9.4.0
2010-06	RP-48	RP-100622	464			Correction to RRM Requirements	9.4.0
2010-06	RP-48	RP-100622	462	1		Correction to Absolute RSRP/RSRQ Definitions	9.4.0
2010-06						UE Measurement Capability Requirements for CDMA2000	9.4.0
2010-06	RP-48	RP-100622	457				
2010-06						Correction of E-UTRAN Inter-frequency Cell Re-selection Requirements	9.4.0
2010-06	RP-48	RP-100622	455	1			
2010-06	RP-48	RP-100622	451	1		Correction to idle mode requirements(Rel-9)	9.4.0
2010-06	RP-48	RP-100622	449	1		Editorial corrections to 36.133(Rel-9)	9.4.0
2010-06	RP-48	RP-100622	447			Correction to TDD intrafrequency accuracy test case	9.4.0

2010-06	RP-48	RP-100622	441	1	Correction of Io value in E-UTRAN FDD and TDD Inter frequency RSRP tests	9.4.0
2010-06	RP-48	RP-100627	444	2	Corrections to CSG SI reading core requirement	9.4.0
2010-06	RP-48	RP-100627	445	1	RSRQ idle mode requirements	9.4.0
2010-06	RP-48	RP-100630	470	1	Test cases for R9 cell reselection enhancements	9.4.0
2010-06	RP-48	RP-100630	460		Missing E-UTRA - UTRA FDD DRX Requirements	9.4.0
2010-06	RP-48	RP-100631	442	2	Corrections to enhanced cell identification core requirement	9.4.0
2010-06	RP-48	RP-100632	469		Applicability of mobility requirements with inter-frequency RSTD measurements	9.4.0
2010-06	RP-48	RP-100632	439		UE Rx-Tx Time Difference Measurement Requirements for E-CID	9.4.0
2010-06	RP-48	RP-100632	438	2	CR UE RX-TX time-difference measurement requirement	9.4.0
2010-06	RP-48	RP-100632	433	5	RSTD Measurement Requirements for OTDOA	9.4.0
2010-06	RP-48	RP-100632	432	5	RSTD Accuracy Requirements for OTDOA	9.4.0
2010-09	RP-49	RP-100914	477	1	Cell identity change time in RRM Test cases	9.5.0
2010-09	RP-49	RP-100919	537		A clarification text in the RSTD intra-frequency accuracy requirements	9.5.0
2010-09	RP-49	RP-100920	506		Correction of drx-RetransmissionTimer parameters	9.5.0
2010-09	RP-49	RP-100915	508		Correction of Io value in RSRP FDD and TDD Intra frequency test	9.5.0
2010-09	RP-49	RP-100920	521	1	Editorial corrections to 36.133 (R9)	9.5.0
2010-09	RP-49	RP-100914	523		Alignment of REFSENS between 36.101 and 36.133(R9)	9.5.0
2010-09	RP-49	RP-100920	525	1	Correction of Time to Trigger unit for 36.133(R9)	9.5.0
2010-09	RP-49	RP-100915	505	1	Corrections to 36.133(R9)	9.5.0
2010-09	RP-49	RP-100920	528	1	E-UTRAN FDD Intra Frequency RSTD Measurement Accuracy test case	9.5.0
2010-09	RP-49	RP-100919	538	1	Correction to Enhanced BSIC Verification Requirements	9.5.0
2010-09	RP-49	RP-100919	539		Enhanced CSFB Requirements with DRX	9.5.0
2010-09	RP-49	RP-100919	540		Correction to E-CID Requirements	9.5.0
2010-09	RP-49	RP-100920	544	1	Addition of UTRA and GSM enhanced cell identification test cases	9.5.0
2010-09	RP-49	RP-100920	547	1	E-UTRAN FDD UE Rx – Tx Time Difference Measurement Accuracy test case	9.5.0
2010-09	RP-49	RP-100914	479	1	Scrambling code change time in RRM Test cases	9.5.0
2010-09	RP-49	RP-100914	549		Introduction of CSG cell reselection requirements	9.5.0
2010-09	RP-49	RP-100920	527		correction of redundant Hysteresis(Hys) for 36.133(R9)	9.5.0
2010-09	RP-49	RP-100920	488	2	Test case for TDD UE Rx-Tx time difference measurement	9.5.0
2010-09	RP-49	RP-100914	483		Clarification of Radio link monitoring test cases	9.5.0
2010-09	RP-49	RP-100915	485		Test case for E-UTRA TDD event triggered reporting when L3 filtering is used in R9	9.5.0
2010-09	RP-49	RP-100915	487		E-UTRA TDD - UTRA TDD cell reselection in fading propagation conditions: UTRA TDD is of lower priority in R9	9.5.0
2010-09	RP-49	RP-100924	492		Test case for E-UTRAN TDD in the existence of non-allowed CSG cell	9.5.0
2010-09	RP-49	RP-100915	494		PDCCCH Aggregation level for RRM tests	9.5.0
2010-09	RP-49	RP-100915	503		Correction of ES/lot value in E-UTRAN RSRQ FDD intra frequency test	9.5.0
2010-09	RP-49	RP-100915	496		Corrections to RRM OCNG Patterns	9.5.0
2010-09	RP-49	RP-100919	498		RRC timer accuracy requirement	9.5.0
2010-09	RP-49	RP-100915	501		Correction of OCNG	9.5.0
2010-09	RP-49	RP-100914	477	1	Cell identity change time in RRM Test cases	9.5.0
2010-09	RP-49	RP-100919	537		A clarification text in the RSTD intra-frequency accuracy requirements	9.5.0
2010-09	RP-49	RP-100920	506		Correction of drx-RetransmissionTimer parameters	9.5.0
2010-09	RP-49	RP-100915	508		Correction of Io value in RSRP FDD and TDD Intra frequency test	9.5.0
2010-09	RP-49	RP-100920	521	1	Editorial corrections to 36.133 (R9)	9.5.0
2010-09	RP-49	RP-100914	523		Alignment of REFSENS between 36.101 and 36.133(R9)	9.5.0
2010-09	RP-49	RP-100920	525	1	Correction of Time to Trigger unit for 36.133(R9)	9.5.0
2010-09	RP-49	RP-100915	505	1	Corrections to 36.133(R9)	9.5.0
2010-09	RP-49	RP-100920	528	1	E-UTRAN FDD Intra Frequency RSTD Measurement Accuracy test case	9.5.0
2010-09	RP-49	RP-100919	538	1	Correction to Enhanced BSIC Verification Requirements	9.5.0

2010-09	RP-49	RP-100919	539		Enhanced CSFB Requirements with DRX	9.5.0
2010-09	RP-49	RP-100919	540		Correction to E-CID Requirements	9.5.0
2010-09	RP-49	RP-100920	544	1	Addition of UTRA and GSM enhanced cell identification test cases	9.5.0
2010-09	RP-49	RP-100920	547	1	E-UTRAN FDD UE Rx – Tx Time Difference Measurement Accuracy test case	9.5.0
2010-09	RP-49	RP-100914	479	1	Scrambling code change time in RRM Test cases	9.5.0
2010-09	RP-49	RP-100914	549		Introduction of CSG cell reselection requirements	9.5.0
2010-09	RP-49	RP-100920	527		correction of redundant Hysteresis(Hys) for 36.133(R9)	9.5.0
2010-09	RP-49	RP-100920	488	2	Test case for TDD UE Rx-Tx time difference measurement	9.5.0
2010-09	RP-49	RP-100914	483		Clarification of Radio link monitoring test cases	9.5.0
2010-09	RP-49	RP-100915	485		Test case for E-UTRA TDD event triggered reporting when L3 filtering is used in R9	9.5.0
2010-09	RP-49	RP-100915	487		E-UTRA TDD - UTRA TDD cell reselection in fading propagation conditions: UTRA TDD is of lower priority in R9	9.5.0
2010-09	RP-49	RP-100924	492		Test case for E-UTRAN TDD in the existence of non-allowed CSG cell	9.5.0
2010-09	RP-49	RP-100915	494		PDCCH Aggregation level for RRM tests	9.5.0
2010-09	RP-49	RP-100915	503		Correction of ES/lot value in E-UTRAN RSRQ FDD intra frequency test	9.5.0
2010-09	RP-49	RP-100915	496		Corrections to RRM OCNG Patterns	9.5.0
2010-09	RP-49	RP-100919	498		RRC timer accuracy requirement	9.5.0
2010-09	RP-49	RP-100915	501		Correction of OCNG	9.5.0
2010-09	RP-49	RP-100927	497		CR LTE_TDD_2600_US spectrum band definition additions to TS 36.133	10.0.0
2010-12	RP-50	RP-101331	635		Corrections to 36.133 performance requirements	10.1.0
2010-12	RP-50	RP-101331	638		Correction to intra frequency cell identification time for FDD and TDD	10.1.0
2010-12	RP-50	RP-101331	566	1	Corrections and Clarifications to TS36.133	10.1.0
2010-12	RP-50	RP-101331	592	2	Correction to Radio link monitoring test cases	10.1.0
2010-12	RP-50	RP-101332	563		PDCCH Aggregation Level for RRM Tests	10.1.0
2010-12	RP-50	RP-101332	571		MIMO correlation scenario for RLM test cases	10.1.0
2010-12	RP-50	RP-101332	580		Removal of [] from PDSCH and PCFICH/PDCCH/PHICH Measurement Channel references in Annex A.	10.1.0
2010-12	RP-50	RP-101332	585		Enabling HARQ for RRM Tests	10.1.0
2010-12	RP-50	RP-101335	643	1	Completion of CSG cell reselection requirements	10.1.0
2010-12	RP-50	RP-101343	568		Clarification of measurements requirements for HRPD and cdma2000 1x	10.1.0
2010-12	RP-50	RP-101343	589		Addition of Band 18, 19 and 21 into UE Rx - Tx time difference requirements	10.1.0
2010-12	RP-50	RP-101343	604		Correction to Enhanced GSM Cell Identification Requirement	10.1.0
2010-12	RP-50	RP-101343	632		Correction of reselection requirement for UTRAN FDD cells	10.1.0
2010-12	RP-50	RP-101343	640		Correction to Enhanced UTRA FDD Cell Identification Requirements	10.1.0
2010-12	RP-50	RP-101343	645		E-UTRAN TDD Intra Frequency RSTD Measurement Accuracy test case	10.1.0
2010-12	RP-50	RP-101343	621	1	Correction for Measurements of inter-RAT cells	10.1.0
2010-12	RP-50	RP-101343	598	2	E-UTRAN FDD intra-frequency RSTD measurement reporting delay test case	10.1.0
2010-12	RP-50	RP-101343	600	2	E-UTRAN TDD intra-frequency RSTD measurement reporting delay test case	10.1.0
2010-12	RP-50	RP-101356	644		Band 42 and 43 parameters for UMTS/LTE 3500 (TDD) for TS 36.133	10.1.0
2010-12	RP-50	RP-101361	552		Introduction of L-band in TS36.133	10.1.0
2010-12	RP-50	RP-101388	648		Removal of square brackets from scope of TS36.133	10.1.0
2011-04	RP-51	RP-110359	0658	-	Addition of UE RRM capabilities for CA	10.2.0
2011-04	RP-51	RP-110340	0663	-	Correction to E-UTRAN TDD in-sync test requirements	10.2.0
2011-04	RP-51	RP-110348	0665	1	RSTD requirements, RMC and OCNG patterns	10.2.0
2011-04	RP-51	RP-110350	0669	-	CR to 36.133: Aligning relevant RRM requirements for Band 41 with the reference sensitivity values in 36.101	10.2.0
2011-04	RP-51	RP-110339	0676	-	Modification on test case of E-UTRA TDD to UTRA TDD cell reselection(R10)	10.2.0
2011-04	RP-51	RP-110339	0681	1	Value of MS_TXPWR_MAX_CCH for EUTRA-GSM reselection test cases A.4.4.x	10.2.0

2011-04	RP-51	RP-110339	0687	1		Rearrangement of Time periods for EUTRA-UTRA reselection test case A.4.3.1.1	10.2.0
2011-04	RP-51	RP-110339	0690	1		Removal of "Force to Cell 2" during initialisation for EUTRA-UTRA reselection test case A.4.3.1.2	10.2.0
2011-04	RP-51	RP-110340	0693	1		SNR for RRM A.8.x test cases using ETU70	10.2.0
2011-04	RP-51	RP-110408	0697	1		Requirements for Minimaztion of Drive Tests (MDT) in LTE	
2011-04	RP-51	RP-110339	0703	-		Correction to test cases of E-UTRA to UTRA cell reselection when UE is in idle state	10.2.0
2011-04	RP-51	RP-110359	0706	2		Introduction of measurement requirements for carrier aggregation	10.2.0
2011-04	RP-51	RP-110347	0709	1		Addition of test cases for FDD intra-frequency SI reading using autonomous gaps with both non DRX and DRX for Rel-10	10.2.0
2011-04	RP-51	RP-110347	0711	1		Addition of test cases for FDD inter-frequency SI reading using autonomous gaps with both non DRX and DRX for Rel-10	10.2.0
2011-04	RP-51	RP-110359	0713	1		Introduction of core requirements of radio link monitoring in CA	10.2.0
2011-04	RP-51	RP-110339	0719	1		Modification on Test Requirements in E-UTRA - UTRA TDD SON Test Case (A.8.7.3) (R10)	10.2.0
2011-04	RP-51	RP-110348	0727	2		Requirements for reporting criteria with positioning measurements	10.2.0
2011-04	RP-51	RP-110340	0736	-		Correction of RLM evaluation period in DRX	10.2.0
2011-04	RP-51	RP-110340	0739	-		Correction of inter-frequency measurement accuracy test cases	10.2.0
2011-04	RP-51	RP-110339	0744	-		Modification on Test Requirements in E-UTRA GSM cell reselection Test Case (A.4.4) (R10)	10.2.0
2011-04	RP-51	RP-110348	0747	1		Corrections to RSTD measurement for Rel-9	10.2.0
2011-04	RP-51	RP-110348	0748	-		Correction on FDD Intra Frequency RSTD Measurement Accuracy test case	10.2.0
2011-04	RP-51	RP-110348	0751	1		RSTD test case corrections	10.2.0
2011-04	RP-51	RP-110344	0753	-		Correction of serving cell performance requirements for autonomous SI acquisition	10.2.0
2011-06	RP-52	RP-110753	0785	1		Simplification of frequency dependent requirements in 36.133 (Table B.2.2-1 contains erroneous values. These wrong values will be corrected in the RAN#53 meeting.)	10.3.0
2011-06	RP-52	RP-110793	754			E-UTRAN FDD-FDD inter-frequency RSTD measurement reporting delay test case with the reference cell on the serving carrier frequency	10.3.0
2011-06	RP-52	RP-110793	755			E-UTRAN TDD-TDD inter-frequency RSTD measurement reporting delay test case with the reference cell on the serving carrier frequency	10.3.0
2011-06	RP-52	RP-110807	757			Core requirements on RRC connection mobility control in CA	10.3.0
2011-06	RP-52	RP-110807	758			Timing core requirements in CA	10.3.0
2011-06	RP-52	RP-110807	759			Introduction of Handover Requirements for Carrier Aggregation	10.3.0
2011-06	RP-52	RP-110793	760			E-UTRAN FDD Inter Frequency RSTD Measurement Accuracy test case	10.3.0
2011-06	RP-52	RP-110793	761			E-UTRAN TDD Inter Frequency RSTD Measurement Accuracy test case	10.3.0
2011-06	RP-52	RP-110786	765			Rearrangement of Time periods for EUTRA-UTRA reselection test case A.4.3.4.1	10.3.0
2011-06	RP-52	RP-110786	768			Removal of "Force to Cell 2" during initialisation for EUTRA -UTRA reselection test cases	10.3.0
2011-06	RP-52	RP-110807	776			Introduction of UE interruption requirements in SCC measurements with de-activated SCell	10.3.0
2011-06	RP-52	RP-110794	797			Editorial Correction to Cell Re-selection Requirements	10.3.0
2011-06	RP-52	RP-110789	808			Correction to side conditions for TDD inter-frequency CGI identification for Rel-10	10.3.0
2011-06	RP-52	RP-110786	814			Correction to inter-RAT cell identificiation time in DRX for Rel-10	10.3.0
2011-06	RP-52	RP-110787	817			Correction to identification time of UTRA FDD cell for SON in DRX for Rel-10	10.3.0
2011-06	RP-52	RP-110787	822			Correction to requirements of E-UTRAN TDDUTRAN TDD measurements for SON when DRX is used for Rel-10	10.3.0
2011-06	RP-52	RP-110807	829			Correction to the side condition for measurements for E-UTRA carrier aggregation	10.3.0
2011-06	RP-52	RP-110803	850			CR Timestamp accuracy requirements for MDT	10.3.0
2011-06	RP-52	RP-110812	778	1		Add 2GHz S-Band (Band 23) in 36.133	10.3.0

2011-06	RP-52	RP-110796	787	1		Clarification on inter-frequency layers for RSTD	10.3.0
2011-06	RP-52	RP-110794	780	1		Correction to RSTD measurement for Rel-10	10.3.0
2011-06	RP-52	RP-110807	852	1		Pcmax,c mapping	10.3.0
2011-06	RP-52	RP-110787	771	1		Clarification of Radio link monitoring test requirements (The CR was not implemented as it is not based on the latest version of the specification)	10.3.0
2011-06	RP-52	RP-110807	793	1		E-CID Measurement Requirements under Pcell Switching	10.3.0
2011-06	RP-52	RP-110807	775	1		Removal of undefined intra-freq RSRQ relative accuracy requirements in CA	10.3.0
2011-06	RP-52	RP-110789	856			Correction on E-UTRAN FDD RSTD intra frequency case	10.3.0
2011-06	RP-52	RP-110796	800	1		Addition of E-UTRAN FDD/TDD cdma2000 1xRTT measurements requirement for SON for Rel-10	10.3.0
2011-06	RP-52	RP-110790	804	1		Addition of test cases for TDD intra-frequency SI reading using autonomous gaps with both non DRX and DRX for Rel-10	10.3.0
2011-06	RP-52	RP-110790	806	1		Addition of test cases for TDD inter-frequency SI reading using autonomous gaps with both non DRX and DRX for Rel-10	10.3.0
2011-06	RP-52	RP-110787	828	1		Addition of missing EsNoc parameters in E-UTRAN TDD UTRAN TDD Measurements test cases for Rel-10	10.3.0
2011-06	RP-52	RP-110807	835	1		Clarification of UE Rx-Tx time difference measurement requirement for carrier aggregation	10.3.0
2011-06	RP-52	RP-110804	859			Expanded 1900 MHz addition to 36.133	10.3.0
2011-06	RP-52	RP-110811	860			Introduction of RLM requirement for eCIC	10.3.0
2011-06	RP-52	RP-110796	794	1		E-CID Measurement Requirements under Handover	10.3.0
2011-06	RP-52	RP-110811	762	1		CR on RLM requirements for eCIC	10.3.0
2011-06	RP-52	RP-110811	788	2		RSRP and RSRQ measurement requirements for eCIC	10.3.0
2011-06	RP-52	RP-110811	851	1		CR on RSRP and RSRQ measurement accuracy requirements for eCIC	10.3.0
2011-06	RP-52	RP-110807	802	2		Addition of OTDOA measurement requirement for E-UTRAN carrier aggregation	10.3.0
2011-09	RP-53	RP-111246	863			Thresholds and margins for reporting of neighbour cells in RRM test A.8.9.1	10.4.0
2011-09	RP-53	RP-111246	902			Thresholds and margins for RRM tests A.5.2.1 and A.5.2.2	10.4.0
2011-09	RP-53	RP-111246	905			Thresholds and margins for RRM tests A.5.2.4 and A.5.2.5	10.4.0
2011-09	RP-53	RP-111247	889			Removing [] in clause 8.1.2.2.2 for Rel-10	10.4.0
2011-09	RP-53	RP-111247	915			Adding condition of UTRA TDD measurement report delay requirements applied	10.4.0
2011-09	RP-53	RP-111247	930			Clarify time points and time duration for RLM tests A.7.3.x	10.4.0
2011-09	RP-53	RP-111251	926	1		Adding enhanced UTRA TDD cell identification requirements for Rel-10	10.4.0
2011-09	RP-53	RP-111251	969			CR for E-UTRAN FDD GSM event triggered reporting in AWGN with enhanced BSIC identification in R10	10.4.0
2011-09	RP-53	RP-111252	894			Requirements for RRC Connection Release with Redirection	10.4.0
2011-09	RP-53	RP-111252	960			Missing RSRQ in Intra-frequency measurement requirements	10.4.0
2011-09	RP-53	RP-111252	965	1		Requirements for RRC Connection Release with Redirection for TDD in R10	10.4.0
2011-09	RP-53	RP-111255	946			Introduction of Band 22	10.4.0
2011-09	RP-53	RP-111255	979	1		Modifications of Band 42 and 43	10.4.0
2011-09	RP-53	RP-111263	879	1		Correction to RRC connection mobility control in CA	10.4.0
2011-09	RP-53	RP-111263	895	2		RSTD Measurement Requirements under Handover	10.4.0
2011-09	RP-53	RP-111263	896	2		RSTD Measurement Requirements under Pcell Switching	10.4.0
2011-09	RP-53	RP-111263	920	1		Editorial corrections for 36.133 (Rel-10)	10.4.0
2011-09	RP-53	RP-111263	924	1		Correction to RRC connection mobility control in CA	10.4.0
2011-09	RP-53	RP-111263	927			Modifications on TDD inter frequency measurements with autonomous gaps	10.4.0
2011-09	RP-53	RP-111263	945	1		Frequency band related requirements to 36.133	10.4.0
2011-09	RP-53	RP-111263	949	1		Correction of references	10.4.0
2011-09	RP-53	RP-111263	950			Alignment of the carrier aggregation terminology	10.4.0
2011-09	RP-53	RP-111263	951			Band simplification for core requirements	10.4.0
2011-09	RP-53	RP-111263	952			Clarification in inter-frequency RSTD accuracy tests	10.4.0
2011-09	RP-53	RP-111263	953	1		Editorial corrections for RRM requirements	10.4.0

2011-09	RP-53	RP-111263	961			Missing RSRQ in E-UTRA carrier aggregation measurement requirements	10.4.0
2011-09	RP-53	RP-111265	874	1		Clarification of TDD uplink-downlink subframe configurations applicability for RSTD measurement in CA	10.4.0
2011-09	RP-53	RP-111265	875	3		CR on UE interruption requirements in SCC measurements with de-activated SCell when common DRX is used	10.4.0
2011-09	RP-53	RP-111265	883	1		Alignment of terminology for SCell measurement cycle	10.4.0
2011-09	RP-53	RP-111265	921	1		Introduction of P _{max,c} reporting requirements for carrier aggregation	10.4.0
2011-09	RP-53	RP-111266	849	3		RSTD Accuracy Requirements for Carrier Aggregation	10.4.0
2011-09	RP-53	RP-111266	898	1		Introduction of power headroom reporting requirement for carrier aggregation	10.4.0
2011-09	RP-53	RP-111308	891	1		RSRP and RSRQ measurement requirements for eICIC	10.4.0
2011-12	RP-54	RP-111681	982			Corrections of inter-frequency measurement accuracy RSRP and RSRQ test cases	10.5.0
2011-12	RP-54	RP-111682	984			Removing [] in CSFB requirement for Rel-10	10.5.0
2011-12	RP-54	RP-111693	985			Reference channel for RLM testing with eICIC	10.5.0
2011-12	RP-54	RP-111683	987			Clarification on RSTD test cases	10.5.0
2011-12	RP-54	RP-111690	988			RSRP Measurement performance lo corrections	10.5.0
2011-12	RP-54	RP-111686	989			RLM measurement requirements for eICIC	10.5.0
2011-12	RP-54	RP-111693	990			PDCCCH/PCFICH transmission parameters for RLM	10.5.0
2011-12	RP-54	RP-111683	992			Clarification on PRS bandwidth	10.5.0
2011-12	RP-54	RP-111735	993			Missing RSRQ in intra-frequency measurement requirements for eICIC	10.5.0
2011-12	RP-54	RP-111686	994	1		Test case for TDD RSRQ Accuracy for Carrier Aggregation	10.5.0
2011-12	RP-54	RP-111686	995			Cell identification requirements without DRX	10.5.0
2011-12	RP-54	RP-111693	997	1		Test case for cell identification with eICIC in E-UTRAN FDD	10.5.0
2011-12	RP-54	RP-111693	998	1		Test case for cell identification with eICIC in E-UTRAN TDD	10.5.0
2011-12	RP-54	RP-111691	999	1		Carrier aggregation RSRP measurement test case for TDD	10.5.0
2011-12	RP-54	RP-111690	1001			Test case for enhanced UTRA TDD cell identification for R10	10.5.0
2011-12	RP-54	RP-111690	1003			Test case for RRC connection release redirection to UTRA TDD for R10	10.5.0
2011-12	RP-54	RP-111735	1005			Clarification of the Successful Percentage for Measurement Performance Requirements	10.5.0
2011-12	RP-54	RP-111691	1007	2		FDD Absolute and Relative RSRQ Accuracy test in CA	10.5.0
2011-12	RP-54	RP-111691	1011	1		FDD absolute and relative RSRP accuracies test in CA	10.5.0
2011-12	RP-54	RP-111693	1014	1		E-UTRAN TDD Radio Link Monitoring Test for Out-of-sync under time domain measurement resource restriction	10.5.0
2011-12	RP-54	RP-111735	1016			E-UTRAN FDD - UTRAN TDD enhanced cell identification test under AWGN propagation conditions in R10	10.5.0
2011-12	RP-54	RP-111735	1018	1		E-UTRAN FDD RRC connection release with redirection to UTRAN TDD in R10	10.5.0
2011-12	RP-54	RP-111735	1021	1		CR for Inter-RAT SI reading	10.5.0
2011-12	RP-54	RP-111687	1022			Addition of E-UTRAN FDD - TDD Inter frequency cell reselection test case	10.5.0
2011-12	RP-54	RP-111687	1023			Addition of E-UTRAN TDD - FDD Inter frequency cell reselection test case	10.5.0
2011-12	RP-54	RP-111687	1024			Addition of E-UTRAN FDD - TDD Inter frequency handover test case	10.5.0
2011-12	RP-54	RP-111687	1025			Addition of E-UTRAN TDD - FDD Inter frequency handover test case	10.5.0
2011-12	RP-54	RP-111687	1026			Addition of E-UTRAN TDD-FDD Inter-frequency event triggered reporting under fading propagation conditions in asynchronous cells test case	10.5.0
2011-12	RP-54	RP-111687	1027	1		Addition of E-UTRAN FDD-TDD Inter-frequency event triggered reporting under fading propagation conditions in asynchronous cells test case	10.5.0
2011-12	RP-54	RP-111687	1028			Addition of E-UTRAN FDD - TDD inter frequency measurement accuracy test case	10.5.0
2011-12	RP-54	RP-111681	1031			Correction for the identification time in DRX for UTRA TDD in R10	10.5.0
2011-12	RP-54	RP-111735	1032			Correction the side condition for SCH in R10	10.5.0

2011-12	RP-54	RP-111735	1033	1		Correction to event triggered reporting for TS 36.133 in R10	10.5.0
2011-12	RP-54	RP-111681	1039	1		Correction of E-UTRAN TDD-TDD inter frequency handover test case in R10	10.5.0
2011-12	RP-54	RP-111735	1041			Clarification of Expected RSTD and Expected RSTD uncertainty in RSTD test cases in R10	10.5.0
2011-12	RP-54	RP-111680	1043			Thresholds and margins for RRM tests A.8.11.3 and A.8.11.4	10.5.0
2011-12	RP-54	RP-111683	1046			Thresholds and margins for RRM tests A.8.11.5 and A.8.11.6	10.5.0
2011-12	RP-54	RP-111693	1047	2		RLM Out of Sync Detection Test for eICIC	10.5.0
2011-12	RP-54	RP-111683	1049			RRC Connection Release with Redirection from E-UTRAN FDD to GERAN	10.5.0
2011-12	RP-54	RP-111693	1051			Colliding CRS in non-MBSFN ABS	10.5.0
2011-12	RP-54	RP-111683	1052			RRC Connection Release with Redirection from E-UTRAN TDD to GERAN	10.5.0
2011-12	RP-54	RP-111693	1053	1		RLM In Sync Detection Test for FDD eICIC	10.5.0
2011-12	RP-54	RP-111693	1054	1		RLM In Sync Detection Test for FDD eICIC	10.5.0
2011-12	RP-54	RP-111691	1055	1		FDD Event triggered reporting on deactivated Scell in non-DRX	10.5.0
2011-12	RP-54	RP-111691	1056	1		TDD Event triggered reporting on deactivated Scell in non-DRX	10.5.0
2011-12	RP-54	RP-111683	1058			Adding Band XX	10.5.0
2011-12	RP-54	RP-111690	1061	1		Optional faster higher priority reselection	10.5.0
2011-12	RP-54	RP-111735	1064	1		Addition of a test case at lower RSRP level for the serving cell measurement accuracy	10.5.0
2011-12	RP-54	RP-111683	1066			Test cases for RRC connection release with redirection to UTRAN FDD	10.5.0
2011-12	RP-54	RP-111735	1072			CA definition alignment in test cases	10.5.0
2011-12	RP-54	RP-111683	1074			Applicable PRS BW for RSTD accuracy requirements	10.5.0
2012-03	RP-55	RP-120304	1077	1		RSTD signalling modifications	10.6.0
2012-03	RP-55	RP-120294	1079	1		Test case for E-UTRA TDD RRC connection release redirection to UTRA TDD without SI provided for R10	10.6.0
2012-03	RP-55	RP-120294	1081	1		Test case for E-UTRA FDD RRC connection release redirection to UTRA TDD without SI provided for R10	10.6.0
2012-03	RP-55	RP-120291	1084			Thresholds and margins for E-UTRAN to C2K RRM reselection test cases (Rel-10)	10.6.0
2012-03	RP-55	RP-120294	1087			Addition of E-UTRAN TDD-HRPD Cell Reselection: HRPD is of Lower Priority test case R10	10.6.0
2012-03	RP-55	RP-120293	1089			Addition of E-UTRAN TDD-cdma2000 1X Cell Reselection: cdma2000 1X is of Lower Priority test case R10	10.6.0
2012-03	RP-55	RP-120293	1091			Addition of E-UTRAN TDD-HRPD Handover test case R10	10.6.0
2012-03	RP-55	RP-120294	1093			Addition of E-UTRAN TDD-cdma2000 1X Handover test case R10	10.6.01 0.6.0
2012-03	RP-55	RP-120294	1099			Addition of E-UTRAN FDD-TDD inter frequency RSRQ measurement accuracy test case R10	10.6.0
2012-03	RP-55	RP-120300	1112	1		RLM test cases with SNRs for OOS and INS for E-UTRAN TDD in eICIC	10.6.0
2012-03	RP-55	RP-120304	1115			lo difference band-independent in Inter-frequency RSRP TDD TC A.9.1.4	10.6.0
2012-03	RP-55	RP-120292	1118	1		Thresholds and margins in RRM test case A.8.11.4	10.6.0
2012-03	RP-55	RP-120292	1121			TDD PRACH Test cases value of PRACH Configuration Index and first preamble power	10.6.0
2012-03	RP-55	RP-120292	1124	1		PDSCH and OCNG pattern in PRACH Test cases A.6.2.1 and A.6.2.3	10.6.0
2012-03	RP-55	RP-120300	1134	1		Clarification of colliding CRS in MBSFN ABS	10.6.0
2012-03	RP-55	RP-120304	1135			Editorial corrections on the test cases of RRC connection release with redirection to UTRAN FDD	10.6.0
2012-03	RP-55	RP-120304	1139	1		Corrections on test case of Event triggered reporting on deactivated Scell in non-DRX CR not implemented as it is based on the wrong version of the spec	10.6.0
2012-03	RP-55	RP-120304	1140			Core requirements for E-UTRAN TDD inter-RAT UTRAN FDD SI acquisition using autonomous gaps	10.6.0
2012-03	RP-55	RP-120304	1143	1		Editorial corrections	10.6.0
2012-03	RP-55	RP-120300	1145	1		Side condition clarification for eICIC with MBSFN	10.6.0
2012-03	RP-55	RP-120300	1146			Clarification on reported cells with eICIC	10.6.0
2012-03	RP-55	RP-120294	1148			Correction of RSTD accuracy test cases for TDD	10.6.0
2012-03	RP-55	RP-120300	1151	2		RLM requirements with autonomous gaps	10.6.0
2012-03	RP-55	RP-120300	1152	1		SNR levels in out-of-sync RLM test cases for eICIC	10.6.0
2012-03	RP-55	RP-120303	1156	1		CR for 36.133: B41 REFSENS and MOP changes to accommodate single filter architecture	10.6.0

2012-03	RP-55	RP-120300	1157			eICIC measurement accuracy	10.6.0
2012-03	RP-55	RP-120307	1154	1		Introduction of Band 26/XXVI to TS 36.133	11.0.0
2012-06	RP-56	RP-120782	1162			Resolve Band 41 omission between R4-120125 and R4-121106	11.1.0
2012-06	RP-56	RP-120770	1165	1		Corrections to FDD-TDD Inter-freq RSRP measurement accuracy test case parameters	11.1.0
2012-06	RP-56	RP-120771	1168			OCNG and PDSCH for FDD-TDD event triggered reporting test cases	11.1.0
2012-06	RP-56	RP-120771	1171			RRC Connection Release with Redirection from E-UTRAN FDD to GERAN without System Information	11.1.0
2012-06	RP-56	RP-120771	1174			RRC Connection Release with Redirection from E-UTRAN TDD to GERAN without System Information	11.1.0
2012-06	RP-56	RP-120784	1176			OCNG Patterns for MBSFN ABS	11.1.0
2012-06	RP-56	RP-120769	1183			Addition of E-UTRAN TDD-FDD Inter-frequency event triggered reporting when DRX is used under fading propagation conditions in asynchronous cells test case R11	11.1.0
2012-06	RP-56	RP-120769	1186			Addition of E-UTRAN TDD - FDD Inter-frequency identification of a new CGI of E-UTRA cell using autonomous gaps test case R11	11.1.0
2012-06	RP-56	RP-120769	1189			Addition of E-UTRAN FDD-TDD Inter-frequency event triggered reporting when DRX is used under fading propagation conditions in asynchronous cells R11	11.1.0
2012-06	RP-56	RP-120769	1192			Addition of E-UTRAN FDD - TDD Inter-frequency identification of a new CGI of E-UTRA cell using autonomous gaps test case R11	11.1.0
2012-06	RP-56	RP-120777	1195	1		Addition of E-UTRAN TDD-HRPD event triggered reporting under fading propagation conditions test case R11	11.1.0
2012-06	RP-56	RP-120769	1198			Addition of E-UTRAN TDD-CDMA2000 1X event triggered reporting under fading propagation conditions test case R11	11.1.0
2012-06	RP-56	RP-120770	1201			E-UTRA TDD RRC connection release redirection to UTRA FDD test without SI provided R11	11.1.0
2012-06	RP-56	RP-120784	1205	1		FDD RSRQ under Time Domain Measurement Resource Restriction with Non-MBSFN ABS R11	11.1.0
2012-06	RP-56	RP-120784	1207	1		TDD RSRQ under Time Domain Measurement Resource Restriction with Non-MBSFN ABS R11	11.1.0
2012-06	RP-56	RP-120780	1213			CR to TS36.133 Corrections on RRC signalling in RLM test cases for eICIC	11.1.0
2012-06	RP-56	RP-120773	1223			Test case for event-triggered reporting on deactivated SCell with PCell interruption	11.1.0
2012-06	RP-56	RP-120770	1227	1		Finalization of Rel.9 cell reselection enhancement related test cases	11.1.0
2012-06	RP-56	RP-120770	1231			E-UTRAN FDD to UTRAN FDD RRC connection release with redirection test case when SI is not provided	11.1.0
2012-06	RP-56	RP-120781	1233			No interruptions on PCell at SCell activation/deactivation when measCycleSCell is smaller than 640 ms	11.1.0
2012-06	RP-56	RP-120780	1235			Editorial corrections	11.1.0
2012-06	RP-56	RP-120782	1237	1		Reporting criteria requirements for carrier aggregation	11.1.0
2012-06	RP-56	RP-120784	1239			Cell identification requirements with DRX	11.1.0
2012-06	RP-56	RP-120784	1241	1		Phase II eICIC FDD: absolute and relative RSRP accuracies in non-MBSFN ABS	11.1.0
2012-06	RP-56	RP-120784	1243	1		Phase II eICIC TDD: absolute and relative RSRP accuracies in non-MBSFN ABS	11.1.0
2012-06	RP-56	RP-120784	1249			RLM requirements with autonomous gaps for DRX	11.1.0
2012-06	RP-56	RP-120779	1251			CR for 36.133: Aligning RSRQ measurement requirements in TS 36.133 with TS 36.101 regarding the modification of B41 REFSENS	11.1.0
2012-06	RP-56	RP-120777	1260			Bands 22, 23, 42 and 43 side conditions for inter-frequency measurements with autonomous gaps	11.1.0
2012-06	RP-56	RP-120772	1261			Clarification on UE Rx-Tx with eICIC	11.1.0
2012-06	RP-56	RP-120767	1271			sr-ConfigIndex in TDD DRX test cases	11.1.0
2012-06	RP-56	RP-120782	1273			Remove [] from eICIC RSRP, RSRQ Es/lot side conditions	11.1.0
2012-06	RP-56	RP-120764	1277	1		RRM: Clarifications to the OCNG patterns	11.1.0
2012-06	RP-56	RP-120784	1279	2		Intra-Frequency FDD RSRQ Accuracy under Time Domain Measurement Resource Restriction with MBSFN ABS	11.1.0
2012-06	RP-56	RP-120784	1286	1		eICIC FDD out-of-sync RLM test case in MBSFN ABS	11.1.0
2012-06	RP-56	RP-120784	1288	1		eICIC TDD out-of-sync RLM test case in MBSFN ABS	11.1.0

2012-06	RP-56	RP-120781	1289	1		On UE behavior in the uplink subframe after measurement GAP	11.1.0
2012-06	RP-56	RP-120773	1293	1		Clarification on the number of monitoring layers for CA UEs	11.1.0
2012-06	RP-56	RP-120784	1299	2		CR on TDD RSRQ test case under Time Domain Measurement Resource Restriction with MBSFN ABS Rel11	11.1.0
2012-06	RP-56	RP-120784	1303	1		In-Sync RLM test case in MBSFN ABS for E-UTRAN FDD R11	11.1.0
2012-06	RP-56	RP-120784	1306	1		In-Sync RLM test case in MBSFN ABS for E-UTRAN TDD R11	11.1.0
2012-06	RP-56	RP-120781	1310			Inter-frequency and Inter-RAT Requirements for Measurements without Measurement Gaps	11.1.0
2012-06	RP-56	RP-120788	1318	1		The introduction of Multi-TA timing requirements R11	11.1.0
2012-06	RP-56	RP-120777	1320	1		Addition of E-UTRAN FDD RSTD measurement accuracy test case in carrier aggregation R11	11.1.0
2012-06	RP-56	RP-120777	1322			Addition of E-UTRAN TDD RSTD measurement accuracy test case in carrier aggregation R11	11.1.0
2012-06	RP-56	RP-120779	1328			Correction to RLM requirements in eICIC with Autonomous gaps R11	11.1.0
2012-06	RP-56	RP-120769	1331	1		Correction to E-UTRAN FDD/TDD - UTRAN FDD /TDD enhanced cell identification test case R11	11.1.0
2012-06	RP-56	RP-120770	1336			Correction to E-UTRAN TDD redirection to UTRAN FDD test configuration R11	11.1.0
2012-06	RP-56	RP-120780	1337	1		FDD CA RSTD Measurement Reporting Delay Test Case (Rel-11)	11.1.0
2012-06	RP-56	RP-120782	1338	1		TDD CA RSTD Measurement Reporting Delay Test Case (Rel-11)	11.1.0
2012-06	RP-56	RP-120779	1342			Correction to RSTD measurement reporting delay requirement in CA R11	11.1.0
2012-06	RP-56	RP-120795	1345	1		Add Band 25 lo values R11	11.1.0
2012-06	RP-56	RP-120777	1347	1		Clarification for cell identification condition in inter-RAT SI reading requirement R11	11.1.0
2012-06	RP-56	RP-120793	1349			Introduction of Band 28	11.1.0
2012-06	RP-56	RP-120794	1350	1		Introduction of Band 44	11.1.0
2012-06	RP-56	RP-120780	1355			Editorial corrections	11.1.0
2012-06	RP-56	RP-120766	1361	2		Correction of a timer period in inter-frequency measurement tests	11.1.0
2012-06	RP-56	RP-120764	1363	1		UL Transmit Timing Requirements	11.1.0
2012-06	RP-56	RP-120784	1364	2		Phase IIbis eICIC FDD absolute and relative RSRP accuracy with MBSFN ABS	11.1.0
2012-06	RP-56	RP-120784	1366	2		Phase IIbis eICIC TDD absolute and relative RSRP accuracy with MBSFN ABS	11.1.0
2012-06	RP-56	RP-120784	1368			OCNG correction in Phase I eICIC test cases	11.1.0
2012-06	RP-56	RP-120792	1379			Introduction of e850_LB (Band 27) to TS 36.133	11.1.0
2012-09	RP-57	RP-121301	1385			Identification of Cell 3 in RRM Test cases A.4.2.7 and A.4.2.8	11.2.0
2012-09	RP-57	RP-121301	1390			Making FDD-TDD Inter-freq RSRQ measurement accuracy test case band-agnostic	11.2.0
2012-09	RP-57	RP-121304	1392			Thresholds and margins in RRM test cases A.8.16.1 and A.8.16.2	11.2.0
2012-09	RP-57	RP-121295	1398	1		Modification of Handover Delay Requirement and Test Cases from E-UTRAN to cdma2000 1x (Rel-11)	11.2.0
2012-09	RP-57	RP-121302	1400			Correction to RSRP/RSRQ measurement accuracy tests in MBSFN R11	11.2.0
2012-09	RP-57	RP-121304	1403			Activation/ deactivation core requirement for carrier aggregation R11	11.2.0
2012-09	RP-57	RP-121313	1405			Minor corrections for E-UTRAN â€ GSM measurements without Measurement Gaps and Rx-Tx measurements when PCell is changed	11.2.0
2012-09	RP-57	RP-121304	1407	3		RRM requirements for CA REFSENSE (Rel-11)	11.2.0
2012-09	RP-57	RP-121304	1409			Square Bracket Removal for RSTD measurement requirement in Pcell changing and Handover R11	11.2.0
2012-09	RP-57	RP-121304	1411			Correction to the E-UTRAN secondary component carrier measurements when common DRX is used R11	11.2.0
2012-09	RP-57	RP-121304	1413			Requirements for Inter-frequency Measurements without Gaps when DRX is used R11	11.2.0
2012-09	RP-57	RP-121304	1415			Clarification on TDD UL-DL subframe configurations in inter-frequency RSTD measurement without gaps R11	11.2.0
2012-09	RP-57	RP-121301	1418			Correction for E-UTRA TDD RRC connection release redirection to UTRA TDD test case R11	11.2.0

2012-09	RP-57	RP-121340	1419			Addition of E-UTRAN FDD - UTRAN FDD identification of a new CGI of UTRAN cell using autonomous gaps	11.2.0
2012-09	RP-57	RP-121340	1420			Addition of E-UTRAN TDD - UTRAN FDD identification of a new CGI of UTRAN cell using autonomous gaps	11.2.0
2012-09	RP-57	RP-121301	1423			Correction to E-UTRAN TDD-FDD Inter-frequency event triggered reporting test case R11	11.2.0
2012-09	RP-57	RP-121302	1432			Alignment for ABS configurations in RRM Tests R11	11.2.0
2012-09	RP-57	RP-121294	1433	1		Correction to RSRQ accuracy test cases R11	11.2.0
2012-09	RP-57	RP-121297	1438			Radio conditions for PBCH reading in E-UTRA	11.2.0
2012-09	RP-57	RP-121305	1444			Introduction of inter-frequency/ RAT measurements in CA	11.2.0
2012-09	RP-57	RP-121302	1449			ABS signal transmission configuration for RRM tests	11.2.0
2012-09	RP-57	RP-121340	1450	1		Table format update for adding new bands	11.2.0
2012-09	RP-57	RP-121301	1454			Editorial correction RRM	11.2.0
2012-12	RP-58	RP-121899	1458	-		Random Access requirements for SCell	11.3.0
2012-12	RP-58	RP-121861	1459	-		Correction on CA TDD RSTD measurement accuracy test cases R11	11.3.0
2012-12	RP-58	RP-121849	1461	-		Correction to high priority cell measurement of UTRA TDD R11	11.3.0
2012-12	RP-58	RP-121861	1467	-		Clarification of Test Requirements for CA RSRP, RSRQ Test Cases	11.3.0
2012-12	RP-58	RP-121850	1470	-		Remove [] from 10% requirement in RRM Test cases A.4.2.7 and A.4.2.8	11.3.0
2012-12	RP-58	RP-121861	1486	1		Clean up for CA	11.3.0
2012-12	RP-58	RP-121911	1487	-		Clarification of CPICH RSCP side conditions	11.3.0
2012-12	RP-58	RP-121867	1489	-		Editorial corrections	11.3.0
2012-12	RP-58	RP-121867	1497	-		Band correction in RRM requirements	11.3.0
2012-12	RP-58	RP-121861	1499	-		Correction to RSTD Measurement Reporting Delay for Carrier Aggregation Test Cases	11.3.0
2012-12	RP-58	RP-121861	1506	-		Band-dependent RRM requirements for CA	11.3.0
2012-12	RP-58	RP-121872	1507	1		CR on RLM Requirements for FeICIC	11.3.0
2012-12	RP-58	RP-121854	1516	-		Correction of OCNG Patterns for UE Rx - Tx Time Difference Test Cases	11.3.0
2012-12	RP-58	RP-121872	1517	1		Cell identification requirements in FeICIC	11.3.0
2012-12	RP-58	RP-121851	1522	-		Time offset correction in CA test cases R11	11.3.0
2012-12	RP-58	RP-121854	1529	1		Clarification on RSTD measurement requirement under HO and Pcell changing	11.3.0
2012-12	RP-58	RP-121910	1530	2		Introduction the IDC requirements in 36.133 Rel-11	11.3.0
2012-12	RP-58	RP-121849	1537	-		Correction on test cases for handover to UTRAN TDD for Rel-11	11.3.0
2012-12	RP-58	RP-121910	1542	-		Updating RRM requirements in 36.133	11.3.0
2012-12	RP-58	RP-121867	1545	-		Editorial corrections RRM	11.3.0
2012-12	RP-58	RP-121852	1549	-		Conditions in CSG reselection requirements	11.3.0
2012-12	RP-58	RP-121852	1553	-		Correcting inconsistency between inter-RAT UTRA measurements and requirements	11.3.0
2012-12	RP-58	RP-121861	1555	-		Refsens requirements for CA capable UE	11.3.0
2012-12	RP-58	RP-121854	1558	1		Intra-frequency RSTD accuracy requirements account for serving cell bandwidth	11.3.0
2012-12	RP-58	RP-121854	1559	1		Clarification on the total number of cells for RSTD inter-frequency measurement	11.3.0
2012-12	RP-58	RP-121860	1561	1		Clarification of the TDM pattern conditions	11.3.0
2012-12	RP-58	RP-121873	1562	1		MDT requirements in Rel-11	11.3.0
2012-12	RP-58	RP-121901	1563	-		Introduction of Band 29	11.3.0
2012-12						Editorial Correction	11.3.1
2013-03	RP-59	RP-130268	1477	1		Correction to Inter-frequency Measurements in CA mode test case R11	11.4.0
2013-03	RP-59	RP-130287	1480	1		Requirements for RSRP and RSRQ for E-CID Positioning	11.4.0
2013-03	RP-59	RP-130263	1566			Secondary Component carrier levels for CA RSRP Test cases A.9.1.6 and A.9.1.7	11.4.0
2013-03	RP-59	RP-130263	1568			Remove intra-frequency relative Requirement for CA RSRQ Test Cases	11.4.0
2013-03	RP-59	RP-130263	1572			Cell timing for CA RSRP and RSRQ Test cases	11.4.0
2013-03	RP-59	RP-130277	1573	1		Editorial correction for introduction of Band 29	11.4.0
2013-03	RP-59	RP-130263	1576			Clarification of retuning interruption in single carrier operation	11.4.0
2013-03	RP-59	RP-130260	1579			RRM: RMC and OCNG pattern for FDD CGI test with autonomous gaps (Rel-11)	11.4.0
2013-03	RP-59	RP-130268	1582			Correction to CSG proximity requirement	11.4.0
2013-03	RP-59	RP-130268	1584			E-UTRAN FDD Proximity Indication RRM Requirements (Rel-11)	11.4.0

2013-03	RP-59	RP-130275	1589	1		Clarification of Cell Identification core requirement in FeICIC	11.4.0
2013-03	RP-59	RP-130283	1591	1		RSRP/RSRQ measurement accuracy requirements in FeICIC	11.4.0
2013-03	RP-59	RP-130263	1598			UE interruption requirements in SCC RSTD measurements with de-activated Scell R11	11.4.0
2013-03	RP-59	RP-130287	1602			Timing offset correction in CA RSTD test cases	11.4.0
2013-03	RP-59	RP-130280	1616			Editorial corrections for IDC	11.4.0
2013-03	RP-59	RP-130262	1618			Editorial corrections for eICIC	11.4.0
2013-03	RP-59	RP-130258	1622			Editorial corrections RRM	11.4.0
2013-03	RP-59	RP-130259	1627			A clarification on measurement gap pattern in RSTD requirements	11.4.0
2013-03	RP-59	RP-130268	1642	1		Modification of PRS configuration for RSTD measurement reporting delay test cases(Rel-11)	11.4.0
2013-03	RP-59	RP-130261	1644			E-UTRAN FDD Proximity Indication Test Case (Rel-11)	11.4.0
2013-06	RP-60	RP-130763	1648			Correction to test parameters for combined E-UTRA - E-UTRA and GSM cell search - Rel 11	11.5.0
2013-06	RP-60	RP-130770	1649			Remove the Brackets in cell identification of FeICIC	11.5.0
2013-06	RP-60	RP-130763	1657			Clarification on inter-frequency RSTD measurement accuracy requirement R11	11.5.0
2013-06	RP-60	RP-130765	1659	1		RRM test configurations for 20MHz R11	11.5.0
2013-06	RP-60	RP-130763	1668	1		Corrections on RSTD measurement test cases (Rel-11)	11.5.0
2013-06	RP-60	RP-130763	1673			Remove [] from GCI identification Test cases A.8.4.4 and A.8.4.5	11.5.0
2013-06	RP-60	RP-130761	1677			Cell 1 levels for RSRP Test cases A.9.1.3 and A.9.1.4	11.5.0
2013-06	RP-60	RP-130765	1679	1		RSRP, RSRQ RRM eICIC Test case cleanup	11.5.0
2013-06	RP-60	RP-130761	1683			Update on the GSM carrier RSSI measurement period when DRX is used	11.5.0
2013-06	RP-60	RP-130763	1692			sr-ConfigIndex in TDD-FDD Inter-frequency event triggered DRX Test case A.8.14.2	11.5.0
2013-06	RP-60	RP-130767	1694			Testing of CA tests with multiple BW combinations	11.5.0
2013-06	RP-60	RP-130767	1696			Reference measurement channels for 20 MHz Tests	11.5.0
2013-06	RP-60	RP-130765	1702			Editorial corrections RRM	11.5.0
2013-06	RP-60	RP-130761	1706			Section numbering correction	11.5.0
2013-06	RP-60	RP-130770	1708	1		Editorial corrections for FeICIC	11.5.0
2013-06	RP-60	RP-130770	1709	1		Removing an eICIC note on measurements	11.5.0
2013-06	RP-60	RP-130770	1713			Clean up for CA	11.5.0
2013-06	RP-60	RP-130763	1716			Editorial corrections in RSTD requirements	11.5.0
2013-06	RP-60	RP-130766	1719			SCell Activation Delay Requirements in CA	11.5.0
2013-06	RP-60	RP-130765	1721			Clarification on supported bandwidth combinations in RSTD requirements with CA	11.5.0
2013-06	RP-60	RP-130770	1723	1		Impact of REFSENS requirements on the core specification	11.5.0
2013-06	RP-60	RP-130770	1724			Correction of the total number of reporting criteria	11.5.0
2013-06	RP-60	RP-130769	1728	1		Condition clarification in MDT requirements	11.5.0
2013-06	RP-60	RP-130769	1732			Band 26 test cases corrections	11.5.0
2013-06	RP-60	RP-130770	1739			CR on Interruptions for Intra-band Non-contiguous Carrier Aggregation	11.5.0
2013-06	RP-60	RP-130763	1744			Time Alignment Timer in Test Case A.8.2.4	11.5.0
2013-06	RP-60	RP-130763	1745			RRM: Adding required measurement gap	11.5.0
2013-06	RP-60	RP-130761	1749			TDD PRACH configuration index for Test Cases A.8.7.2, A.8.15.2	11.5.0
2013-06	RP-60	RP-130763	1752			GSM cell list size for Test Cases A.6.3.10, A.6.3.11	11.5.0
2013-06	RP-60	RP-130763	1755			Neighbour list for Test cases A.8.5.4, A.8.7.4, A.8.9.2	11.5.0
2013-06	RP-60	RP-130763	1758			Additional corrections on intra-frequency RSTD test parameters (Rel-11)	11.5.0
2013-06	RP-60	RP-130763	1760			Additional corrections on inter-frequency RSTD test parameters (Rel-11)	11.5.0
2013-06	RP-60	RP-130767	1762			Phase I CA 20 MHz Tests: Event triggered reporting on deactivating Scells in non-DRX	11.5.0
2013-06	RP-60	RP-130763	1767			Corrections of E-UTRAN FDD CSG Proximity Indication Test Case (Rel-11)	11.5.0
2013-06	RP-60	RP-130770	1770	1		In sync detection with CRS assistance information with non-MBSFN ABS in FDD	11.5.0
2013-06	RP-60	RP-130770	1771	1		In sync detection with CRS assistance information with non-MBSFN ABS in TDD	11.5.0
2013-06	RP-60	RP-130770	1772	1		E-UTRAN FDD RLM Out-of-sync Test of FeICIC	11.5.0
2013-06	RP-60	RP-130770	1773	1		E-UTRAN TDD RLM Out-of-sync Test of FeICIC	11.5.0
2013-06	RP-60	RP-130767	1776			E-UTRAN FDD absolute and relative RSRP accuracies for 20MHz in CA R11	11.5.0

2013-06	RP-60	RP-130767	1778			E-UTRAN TDD absolute and relative RSRP accuracies for 20MHz in CA R11	11.5.0
2013-06	RP-60	RP-130765	1780			Modification of OCNG patterns of RRM test configuration for 20MHz R11	11.5.0
2013-06	RP-60	RP-130761	1782			Clarification of Pcell in 36.133 R11	11.5.0
2013-06	RP-60	RP-130767	1784			FDD Absolute and relative RSRQ accuracies for CA with 20MHz BW (Rel-11)	11.5.0
2013-06	RP-60	RP-130767	1786			TDD Absolute and relative RSRQ accuracies for CA with 20MHz BW (Rel-11)	11.5.0
2013-06	RP-60	RP-130761	1790			Correction on fading propagation condition for CA inter-RAT test cases R11	11.5.0
2013-06	RP-60	RP-130770	1791			Clean up for band 44	11.5.0
2013-06	RP-60	RP-130765	1793	1		E-UTRAN TDD UE Rx-Tx time difference test case in eCIC	11.5.0
2013-06	RP-60	RP-130770	1799	1		Test case for UE Transmit Timing Accuracy for SCell	11.5.0
2013-06	RP-60	RP-130767	1801			CR on measurements without gaps	11.5.0
2013-06	RP-60	RP-130770	1804	1		Editorial corrections RRM	11.5.0
2013-06	RP-60	RP-130765	1806	1		Clarification for UE Rx-Tx with eCIC	11.5.0
2013-06	RP-60	RP-130770	1807	2		Capturing RF requirements in the core specification	11.5.0
2013-06	RP-60	RP-130765	1808	1		Test case for UE Rx-Tx accuracy with eCIC in FDD	11.5.0
2013-06	RP-60	RP-130770	1812	1		RSRP and RSRQ relative accuracy requirements for FeCIC	11.5.0
2013-06	RP-60	RP-130765	1814	1		Adding clarification for begin and end of measurement GAP for Rel-11	11.5.0
2013-06	RP-60	RP-130770	1821			Measurement requirements with interruptions due to CA	11.5.0
2013-06	RP-60	RP-130770	1822			Clarification on antenna ports in the measured and aggressor cells with FeCIC	11.5.0
2013-06	RP-60	RP-130770	1825	1		UE Rx-Tx accuracy requirements with FeCIC	11.5.0
2013-06	RP-60	RP-130770	1826			UE Rx-Tx measurement requirements with FeCIC	11.5.0
2013-06	RP-60	RP-130770	1827	2		Test case for cell identification with FeCIC in FDD	11.5.0
2013-06	RP-60	RP-130770	1828	2		Test case for cell identification with FeCIC in TDD	11.5.0
2013-06	RP-60	RP-130770	1829	1		Corrections on Wideband RSRQ inter-frequency accuracy requirements	11.5.0
2013-06	RP-60	RP-130791	1769	1		Introduction of Band 30	12.0.0
09-2013	RP-61	RP-131303	1830	1		UTRAN FDD CPICH Ec/No measurement accuracy test for 5MHz bandwidth	12.1.0
09-2013	RP-61	RP-131291	1832			Correction on the test cases for UE Transmit Timing Accuracy for SCell (Rel-12)	12.1.0
09-2013	RP-61	RP-131282	1836			Corrections on RSTD CA test parameters (Rel-12)	12.1.0
09-2013	RP-61	RP-131282	1839			FDD: RSTD measurement reporting test cases for CA with 20MHz BW (Rel-12)	12.1.0
09-2013	RP-61	RP-131282	1842			TDD: RSTD measurement reporting test cases for CA with 20MHz BW (Rel-12)	12.1.0
09-2013	RP-61	RP-131285	1844			Timing and RSRP value corrections in Test cases A.9.2.6 and A.9.2.9	12.1.0
09-2013	RP-61	RP-131285	1846			Corrections to Bands for 20MHz CA Test cases	12.1.0
09-2013	RP-61	RP-131279	1854			Cell time offset in TDD Inter-RAT test cases	12.1.0
09-2013	RP-61	RP-131303	1855			EUTRA FDD-UTRA FDD cell reselection: UTRA FDD is of lower priority	12.1.0
09-2013	RP-61	RP-131282	1860			Rel-12 CRs on synchronization requirements for E-UTRA to CDMA 2000 handover	12.1.0
09-2013	RP-61	RP-131290	1866	1		Correct the SNR values for RLM tests with non-MBSFN ABS in FeCIC R12	12.1.0
09-2013	RP-61	RP-131290	1869	1		E-UTRAN FDD RSRP Measurement Accuracy Test in FeCIC R12	12.1.0
09-2013	RP-61	RP-131290	1871	1		E-UTRAN TDD RSRP Measurement Accuracy Test in FeCIC R12	12.1.0
09-2013	RP-61	RP-131284	1873			E-UTRAN FDD UE Rx-Tx Time difference test in FeCIC R12	12.1.0
09-2013	RP-61	RP-131284	1875			E-UTRAN TDD UE Rx-Tx Time difference test in FeCIC R12	12.1.0
09-2013	RP-61	RP-131284	1881			Clarification on UE Rx-Tx accuracy requirements in FeCIC R12	12.1.0
09-2013	RP-61	RP-131284	1883			Clarification on UE Rx-Tx measurement requirements in FeCIC R12	12.1.0
09-2013	RP-61	RP-131282	1886			Clarification on antenna port for timing and eCID test cases R12	12.1.0
09-2013	RP-61	RP-131282	1889	1		Addition of TDD serving cell measurement accuracy tests R12	12.1.0
09-2013	RP-61	RP-131303	1890			Introduction of Band 31 in 36.133	12.1.0
09-2013	RP-61	RP-131303	1891			Addition of New OCNG Pattern for 5MHz	12.1.0
09-2013	RP-61	RP-131303	1892			E-UTRAN FDD intra-frequency RSRP measurement accuracy for 5MHz bandwidth	12.1.0

09-2013	RP-61	RP-131303	1893			E-UTRAN FDD-FDD inter-frequency RSRP measurement accuracy for 5MHz bandwidth	12.1.0
09-2013	RP-61	RP-131303	1894			E-UTRAN FDD Radio Link Monitoring Test for Out-of-sync for 5MHz Bandwidth	12.1.0
09-2013	RP-61	RP-131303	1895			E-UTRAN FDD-FDD intra-frequency event triggered reporting under fading propagation conditions in asynchronous cells for 5MHz bandwidth	12.1.0
09-2013	RP-61	RP-131303	1896			E-UTRAN FDD-FDD intra-frequency Cell Re-selection case for 5MHz bandwidth	12.1.0
09-2013	RP-61	RP-131303	1897			E-UTRAN FDD intra-frequency RRC re-establishment for 5MHz bandwidth	12.1.0
09-2013	RP-61	RP-131303	1898			E-UTRAN FDD - Contention Based Random Access Test for 5MHz bandwidth	12.1.0
09-2013	RP-61	RP-131303	1899	1		E-UTRAN FDD - UE Transmit Timing Accuracy Tests for 5MHz bandwidth	12.1.0
09-2013	RP-61	RP-131303	1900			E-UTRA FDD- UTRA FDD inter-RAT handover case for 5MHz bandwidth	12.1.0
09-2013	RP-61	RP-131303	1901	1		E-UTRA FDD- UTRA FDD CPICH RSCP measurement accuracy issues	12.1.0
09-2013	RP-61	RP-131285	1903			Clarification of Refesens in WB-RSRQ sections of 36.133 R12	12.1.0
09-2013	RP-61	RP-131290	1905			Remove the brackets of FelCIC side conditions R12	12.1.0
09-2013	RP-61	RP-131282	1908	1		Test cases of E-UTRAN FDD RSTD Measurement Accuracy for Carrier Aggregation for 20MHz R12	12.1.0
09-2013	RP-61	RP-131282	1913	1		Test cases of E-UTRAN TDD RSTD Measurement Accuracy for Carrier Aggregation for 20MHz R12	12.1.0
09-2013	RP-61	RP-131284	1916			Correction to SCH Es/lot side condition for intra-frequency measurements under time domain measurement resource restriction with CRS assistance information	12.1.0
09-2013	RP-61	RP-131303	1919			E-UTRAN FDD " Non-contention Based Random Access Test for 5MHz bandwidth	12.1.0
09-2013	RP-61	RP-131282	1921			Modification on the requirement for PCell interruption for Rel-12	12.1.0
09-2013	RP-61	RP-131303	1922			E-UTRAN FDD " Timing Advance Accuracy Test for 5MHz bandwidth	12.1.0
09-2013	RP-61	RP-131282	1928			Phase II CA 20 MHz Tests: Event triggered reporting on deactivating SCell and and interruption probability without DRX	12.1.0
09-2013	RP-61	RP-131303	1945	1		CR on Applicability of 5MHz Test Cases	12.1.0
09-2013	RP-61	RP-131303	1946	1		E-UTRAN FDD Radio Link Monitoring Test for In-Sync for 5MHz	12.1.0
09-2013	RP-61	RP-131303	1947			E-UTRAN FDD Intra-frequency handover test for 5MHz Channel Bandwidth	12.1.0
09-2013	RP-61	RP-131303	1948			E-UTRAN FDD Intra-frequency RSRQ Accuracy Test for 5MHz Channel Bandwidth	12.1.0
09-2013	RP-61	RP-131293	1952			Editorial corrections RRM	12.1.0
09-2013	RP-61	RP-131303	1954			E-UTRAN FDD Inter-frequency RSRQ Accuracy Test for 5MHz Channel Bandwidth	12.1.0
09-2013	RP-61	RP-131293	1955			Clarification of CGI reading requirements	12.1.0
09-2013	RP-61	RP-131303	1958	2		E-UTRAN FDD Radio Link Monitoring Test for In-Sync for 5MHz with DRX	12.1.0
09-2013	RP-61	RP-131285	1961			Editorial corrections in capturing RF requirements	12.1.0
09-2013	RP-61	RP-131282	1964			Clarification on tests for multiple bandwidths	12.1.0
09-2013	RP-61	RP-131282	1969			CR on PCell interruptions	12.1.0
09-2013	RP-61	RP-131283	1970			Time stamp accuracy for RLF and handover failure reporting with eMDT	12.1.0
09-2013	RP-61	RP-131303	1971			FDD reference measurement channels for 5 MHz tests	12.1.0
09-2013	RP-61	RP-131303	1972			Part II RRM tests: UE intra-frequency measurements with synchronous cells in DRX FDD	12.1.0
09-2013	RP-61	RP-131303	1973			Part II RRM tests: E-UTRAN FDD - UTRAN FDD event triggered reporting under fading propagation conditions	12.1.0
09-2013	RP-61	RP-131284	1978			Correction of cell identification test case with FelCIC	12.1.0
09-2013	RP-61	RP-131284	1984			RLM requirements correction	12.1.0
09-2013	RP-61	RP-131284	1988			Clarification on antenna ports in the measured and aggressor cells for UE Rx-Tx with FelCIC	12.1.0
09-2013	RP-61	RP-131290	1990			FelCIC FDD Test for In-sync With MBSFN ABS for Rel. 12	12.1.0
09-2013	RP-61	RP-131290	1992			FelCIC TDD Test for In-sync With MBSFN ABS for Rel. 12	12.1.0
09-2013	RP-61	RP-131303	1993			Correction of the SNR value of Out of sync RLM test for 5MHz	12.1.0

12-2013	RP-62	RP-131927	1996			Corrections to CA event triggered tests on deactivated SCell with PCell interruption in non-DRX (Rel-12)	12.2.0
12-2013	RP-62	RP-131928	2003			Corrections to CA Interruption Requirements	12.2.0
12-2013	RP-62	RP-131926	2009			CRS Es/lot for eICIC RSRP, RSRQ with MBSFN ABS Test Cases	12.2.0
12-2013	RP-62	RP-131941	2010			Correction to RSTD measurement accuracy side condition for Band 31	12.2.0
12-2013	RP-62	RP-131928	2013			Amendment on SCell Activation Delay Requirements for other activation actions	12.2.0
12-2013	RP-62	RP-131928	2016			Amendment on SCell Activation Delay Requirements in case no RS for measurement	12.2.0
12-2013	RP-62	RP-131936	2019			Correction to the SNR values for RLM tests with MBSFN ABS in FeICIC R12	12.2.0
12-2013	RP-62	RP-131936	2023			Correction for the RSRP/RSRQ test cases in FeICIC R12	12.2.0
12-2013	RP-62	RP-131928	2031	1		CR on PCell Interruptions For Inter-band CA During Measurements	12.2.0
12-2013	RP-62	RP-131939	2039			Introduction of E-UTRAN TDD WB-RSRQ test case R12	12.2.0
12-2013	RP-62	RP-131925	2044			Correction of Proximity Indication Test Case Not implemented as it is not based on the latest version of the spec	12.2.0
12-2013	RP-62	RP-131939	2053			Clarifications for intra-band non-contiguous CA R12	12.2.0
12-2013	RP-62	RP-131939	2058			Inter-frequency WB-RSRQ FDD test case	12.2.0
12-2013	RP-62	RP-131928	2071			Clarification on Pcell Interruption shall not occur before SF n+5	12.2.0
12-2013	RP-62	RP-131925	2078			Correction in RSTD requirements	12.2.0
12-2013	RP-62	RP-131939	2080			Editorial corrections RRM	12.2.0
12-2013	RP-62	RP-131939	2084	1		Band simplification	12.2.0
12-2013	RP-62	RP-131931	2091			Requirements clarification under different BWs in FeICIC	12.2.0
12-2013	RP-62	RP-131931	2095			Correction in cell search FeICIC test cases	12.2.0
12-2013	RP-62	RP-131936	2097	1		Correct ABS pattern for FeICIC for In-sync with MBSFN ABS for Rel. 12	12.2.0
12-2013	RP-62	RP-131926	2104			Correction to Test cases A.9.2.9 and A.9.2.10	12.2.0
12-2013	RP-62	RP-131942	2106	1		Bands applicability in RSRP, RSRQ FDD-FDD Inter frequency tests for 5MHz Bandwidth	12.2.0
12-2013	RP-62	RP-131925	2111			Corrections to CGI Reading in Autonomous Gap	12.2.0
12-2013	RP-62	RP-131936	2123			Remove the brackets of SNR values in RLM test cases in FeICIC R12	12.2.0
12-2013	RP-62	RP-131967	2129			Correction on RMC pattern for 5MHz UE Transmit Timing Accuracy Tests	12.2.0
12-2013	RP-62	RP-131928	2135			CSI Reporting in SCell Activation Requirements	12.2.0
12-2013	RP-62	RP-131927	2143			Editorial corrections RRM	12.2.0
12-2013	RP-62	RP-131939	2145			Applying band simplification	12.2.0
12-2013	RP-62	RP-131939	2151			Correction to MTA requirements	12.2.0
12-2013	RP-62	RP-131925	2155			Correction in RSTD test cases	12.2.0
12-2013	RP-62	RP-131931	2157			Correction to interference clarification in FeICIC requirements	12.2.0
03-2014	RP-63	RP-140389	2236			Band simplification clean up	12.3.0
03-2014	RP-63	RP-140368	2234			Missing condition in CGI identification requirements	12.3.0
03-2014	RP-63	RP-140368	2224			CSI Reporting in SCell Activation Requirements	12.3.0
03-2014	RP-63	RP-140368	2258			Alignment between interruption requirements for RSTD and mobility measurements for SCell	12.3.0
03-2014	RP-63	RP-140367	2263			Correction of Proximity Indication Test Case	12.3.0
03-2014	RP-63	RP-140380	2259			Addition of new OCNG pattern for E-UTRA TDD with 5MHz bandwidth	12.3.0
03-2014	RP-63	RP-140380	2260			Addition of new RMC for E-UTRA TDD with 5MHz bandwidth	12.3.0
03-2014	RP-63	RP-140380	2261			Addition of OCNG pattern for E-UTRA FDD with 5MHz bandwidth without MBSFN	12.3.0
03-2014	RP-63	RP-140381	2169			Updates on test case A.9.1.17 FDD—FDD Inter frequency case for 5MHz Bandwidth for R12	12.3.0
03-2014	RP-63	RP-140389	2170			Correction on the SNR values of in-sync RLM test for 5MHz	12.3.0
03-2014	RP-63	RP-140371	2200	1		Clarification of BW applicability in Rx-Tx Time Difference measurement R12	12.3.0
03-2014	RP-63	RP-140389	2182			Clarification on FDD reference measurement channels for 5 MHz tests	12.3.0
03-2014	RP-63	RP-140368	2181			Correction on PDSCH allocation in PRS subframe r12	12.3.0
03-2014	RP-63	RP-140367	2192			PRS_RA corrections	12.3.0
06-2014	RP-64	RP-140650	2331	3		Introduction of test cases for 5MHz +5MHz : absolute and relative RSRQ accuracies in CA for FDD and TDD	12.4.0

						The CR was not implemented as it contained the wrong content.	
06-2014	RP-64	RP-140743	2366	1		SCell activation and deactivation delay test case for known SCell	12.4.0
06-2014	RP-64	RP-140910	2312			Clarification on UE Transmit Timing Accuracy test cases in DRX mode R12	12.4.0
06-2014	RP-64	RP-140910	2267			RRM: Clean-up of time offset between cells in RSTD tests (Rel-12)	12.4.0
06-2014	RP-64	RP-140910	2354			RSTD inter-frequency requirements applicability	12.4.0
06-2014	RP-64	RP-140911	2382			RRM: Remove square brackets from eICIC RLM test requirement (Rel-12)	12.4.0
06-2014	RP-64	RP-140911	2379			Correction to periodicity of ABS pattern in eICIC RRM test cases	12.4.0
06-2014	RP-64	RP-140911	2315			Correction for OCNB pattern number in RRM tests R12	12.4.0
06-2014	RP-64	RP-140911	2302			Introduce the CGI reading requirements in CA R12	12.4.0
06-2014	RP-64	RP-140911	2360	1		Test case corrections for eICIC	12.4.0
06-2014	RP-64	RP-140911	2278			Removing DPCH for handover from E-UTRAN to UTRA TDD for Rel-12	12.4.0
06-2014	RP-64	RP-140911	2422			Clean up the correction on PDSCH allocation in PRS subframe R12	12.4.0
06-2014	RP-64	RP-140911	2319			Clarification on E-UTRAN TDD - UE Timing Advance Adjustment Accuracy Test R12	12.4.0
06-2014	RP-64	RP-140914	2416			Correction to PCI configuration conditions in FeICIC tests R12	12.4.0
06-2014	RP-64	RP-140914	2338			CQI feedback periodicity correction for RLM in eICIC/FeICIC test setup	12.4.0
06-2014	RP-64	RP-140916	2307			E-UTRAN TDD - UE Timing Advance Adjustment Accuracy Test for SCell in sTAG	12.4.0
06-2014	RP-64	RP-140916	2340	1		Test case for RACH on SCell	12.4.0
06-2014	RP-64	RP-140916	2306			E-UTRAN FDD - UE Timing Advance Adjustment Accuracy Test for SCell in sTAG	12.4.0
06-2014	RP-64	RP-140918	2357			Editorial corrections RRM	12.4.0
06-2014	RP-64	RP-140918	2364			Clean up for Band 29	12.4.0
06-2014	RP-64	RP-140918	2445			Removing square brackets in FeICIC test cases	12.4.0
06-2014	RP-64	RP-140923	2387			E-UTRAN FDD RSTD measurement reporting in carrier aggregation for 10MHz+5MHz	12.4.0
06-2014	RP-64	RP-140923	2388			E-UTRAN TDD RSTD measurement reporting in carrier aggregation for 10MHz+5MHz	12.4.0
06-2014	RP-64	RP-140923	2389			E-UTRAN FDD RSTD measurement accuracy in CA for 10MHz+5MHz	12.4.0
06-2014	RP-64	RP-140923	2390			E-UTRAN TDD RSTD measurement accuracy in CA for 10MHz+5MHz	12.4.0
06-2014	RP-64	RP-140923	2290			E-UTRAN FDD absolute and relative RSRP accuracies in CA for 10MHz+5MHz	12.4.0
06-2014	RP-64	RP-140923	2291			E-UTRAN TDD absolute and relative RSRP accuracies in CA for 10MHz+5MHz	12.4.0
06-2014	RP-64	RP-140926	2339			Introduction of Band 32/XXXII	12.4.0
06-2014	RP-64	RP-140928	2394	1		Introduce RRM measurement requirements for eIMTA	12.4.0
06-2014	RP-64	RP-140928	2396	1		Inter frequency measurements using autonomous gaps	12.4.0
06-2014	RP-64	RP-140930	2374	1		RRM requirements for TDD-FDD CA	12.4.0
06-2014	RP-64	RP-140937	2412	1		Introduction of test cases for 5MHz +5MHz : RSTD Measurement Accuracy in Carrier Aggregation for 5 + 5MHz bandwidth	12.4.0
06-2014	RP-64	RP-140937	2330	1		Introduction of test cases for 5MHz +5MHz : absolute and relative RSRP accuracies in CA for FDD and TDD	12.4.0
06-2014	RP-64	RP-140937	2410	1		Introduction of test cases for 5MHz +5MHz : RSTD Measurement Reporting Test Case	12.4.0
06-2014	RP-64	RP-140937	2332	2		Introduction of test cases for 5MHz +5MHz : Event triggered reporting on deactivating Scells in non-DRX FDD and TDD	12.4.0
06-2014	RP-64	RP-140937	2415	1		Introduction of test cases for 5MHz +5MHz : E-UTRA event triggered reporting on deactivated SCell with PCell interruption in non-DRX	12.4.0
06-2014	RP-64	RP-140939	2294			E-UTRAN TDD absolute and relative RSRQ accuracies in CA for 10MHz+5MHz	12.4.0
06-2014	RP-64	RP-140939	2385			E-UTRAN FDD Event triggered reporting on deactivating Scells and interruption probability (0.5%) without DRX for 10MHz+5MHz	12.4.0
06-2014	RP-64	RP-140939	2386			E-UTRAN TDD Event triggered reporting on deactivating Scells and interruption probability (0.5%) without DRX for 10MHz+5MHz	12.4.0

06-2014	RP-64	RP-140939	2292			E-UTRAN FDD absolute and relative RSRQ accuracies in CA for 5MHz+10MHz	12.4.0
06-2014	RP-64	RP-140939	2289			E-UTRAN TDD Event triggered reporting under deactivated SCell in non-DRX for 10MHz+5MHz	12.4.0
06-2014	RP-64	RP-140939	2288			E-UTRAN FDD Event triggered reporting under deactivated SCell in non-DRX for 10MHz+5MHz	12.4.0
06-2014	RP-64	RP-140945	2384			Correct Correlation Matrix and Antenna Configuration for RRM test cases A.8	12.4.0
06-2014	RP-64	RP-140945	2346	1		E-UTRAN TDD - UE Transmit Timing Accuracy Tests for SCell in sTAG	12.4.0
06-2014	RP-64	RP-140945	2383			Correct Correlation Matrix and Antenna Configuration for RRM test cases A.4, A.7	12.4.0
06-2014	RP-64	RP-140945	2336	2		New Test Case for UE Transmit Timing Accuracy requirements in DRX	12.4.0
06-2014	RP-64	RP-140945	2268	1		UE Behaviour after Measurement Gap	12.4.0
06-2014	RP-64	RP-140945	2345	1		E-UTRAN FDD - UE Transmit Timing Accuracy Tests for SCell in sTAG	12.4.0
06-2014	RP-64	RP-140945	2419			Editorial correction for band 31 in 36.133	12.4.0
06-2014	RP-64	RP-140959	2395	2		Introduce RSRP/RSRQ measurement accuracy requirements for 3DL CA	12.4.0
06-2014	RP-64	RP-140959	2376	3		Introduce the support of 3DL CA to TS 36.133 Section 7.8 "Interruptions with Carrier Aggregation"	12.4.0
06-2014	RP-64	RP-140959	2375	2		Introduce the support of 3DL CA to TS 36.133 Section 7.1 "UE transmit timing"	12.4.0
06-2014	RP-64	RP-140959	2373	2		SCell activation and deactivation delay requirements for 3 DL CA	12.4.0
09-2014	RP-65	RP-141526	2527			Tolerance levels for measurements on UTRAN	12.5.0
09-2014	RP-65	RP-141530	2474			Correction to periodicity of ABS pattern in felCIC RRM test cases	12.5.0
09-2014	RP-65	RP-141531	2515	1		Maximum transmission timing difference	12.5.0
09-2014	RP-65	RP-141536	2502			Introduction of test cases for 5MHz +5MHz : absolute and relative RSRQ accuracies in CA for FDD and TDD	12.5.0
09-2014	RP-65	RP-141539	2481			Modification on E-UTRAN event triggered reporting under deactivated SCell for 20 MHz bandwidth	12.5.0
09-2014	RP-65	RP-141545	2523	2		Introduction of BeaconRSSI measurements for WLAN/3GPP Radio Interworking	12.5.0
09-2014	RP-65	RP-141554	2492			Interruptions on Activated Serving Cells for 3DL CA	12.5.0
09-2014	RP-65	RP-141554	2495			Requirements for UE Measurements Procedures in RRC_CONNECTED State for 3DL CA	12.5.0
09-2014	RP-65	RP-141562	2454	1		Correction of values in RSTD tests	12.5.0
09-2014	RP-65	RP-141562	2457			Clarification to RSTD CA Reporting Delay tests	12.5.0
09-2014	RP-65	RP-141562	2480	1		Clarification on UE behavior considering max transmit timing difference between TAGs R12	12.5.0
09-2014	RP-65	RP-141562	2496	1		Applicability of requirements	12.5.0
09-2014	RP-65	RP-141562	2510			Note to clarify that certain requirements do not apply to band 32	12.5.0
09-2014	RP-65	RP-141700	2471	3		Clarification for ACK/NACK feedback of CGI measurement	12.5.0
12-2014	RP-66	RP-142176	2484	2		Introducing measurement accuracy requirements for UE category 0 in TS36.133 Clause 9	12.6.0
12-2014	RP-66	RP-142176	2506	3		Measurements requirements for UE category 0 with 1 Rx	12.6.0
12-2014	RP-66	RP-142143	2534	-		Correction of PRS Signal Levels in RSTD Reporting Tests	12.6.0
12-2014	RP-66	RP-142144	2538	-		Correction of Es/Noc values in inter-frequency RSTD tests	12.6.0
12-2014	RP-66	RP-142174	2547	1		Introduction of PDSCH FRC for TDD UL-DL configuration 0	12.6.0
12-2014	RP-66	RP-142144	2553	1		Clarification on time to identify the target UTRA TDD cell for blind redirection from E-UTRA to UTRA TDD	12.6.0
12-2014	RP-66	RP-142174	2555	1		CR on inter frequency RSRP test case for eIMTA	12.6.0
12-2014	RP-66	RP-142174	2556	1		CR on inter frequency RSRQ test case for eIMTA	12.6.0
12-2014	RP-66	RP-142147	2566	-		Correction to ABS pattern and CRS Es/lot in felCIC RRM test cases	12.6.0
12-2014	RP-66	RP-142144	2569	-		SCell activation and deactivation delay test case for unknown SCell R12	12.6.0
12-2014	RP-66	RP-142157	2573	2		Clarification on cell identification for TDD config 0	12.6.0
12-2014	RP-66	RP-142177	2585	1		RSRQ accuracy test case in TDD-FDD CA when Pcell is FDD R12	12.6.0
12-2014	RP-66	RP-142177	2586	1		RSRQ accuracy test case in TDD-FDD CA when Pcell is TDD R12	12.6.0
12-2014	RP-66	RP-142147	2597	-		Correction on Io value in CA 20MHz RSRQ test case R12	12.6.0

12-2014	RP-66	RP-142163	2598	-		Correction on Io value in CA 10MHz+5MHz RSRQ test case R12	12.6.0
12-2014	RP-66	RP-142188	2599	-		Range increase for RSRQ	12.6.0
12-2014	RP-66	RP-142188	2606	1		Clarification of parallel reporting criteria (E-UTRA)	12.6.0
12-2014	RP-66	RP-142164	2611	1		Interruptions with RSTD Measurements for 3DL CA	12.6.0
12-2014	RP-66	RP-142164	2614	-		RRM requirements for RSTD in 3 DL CA	12.6.0
12-2014	RP-66	RP-142177	2619	1		RSRP accuracy test cases for TDD-FDD CA	12.6.0
12-2014	RP-66	RP-142176	2630	-		SI reading requirements for UE category 0 with 1 Rx in FDD, TDD and HD-FDD	12.6.0
12-2014	RP-66	RP-142144	2639	-		Changes to RSTD CA Reporting Delay tests	12.6.0
12-2014	RP-66	RP-142188	2640	-		Revision of RSRP absolute accuracy requirements in Rel-12	12.6.0
12-2014	RP-66	RP-142144	2644	-		Clarifications to RSTD values	12.6.0
12-2014	RP-66	RP-142144	2656	-		Correction to RSTD Intra Frequency Delay Test Case	12.6.0
12-2014	RP-66	RP-142144	2665	-		Correction on autonomous time adjustment in MTAG case	12.6.0
12-2014	RP-66	RP-142176	2666	-		Introduce RLM requirements for LC-MTC in TS36.133	12.6.0
12-2014	RP-66	RP-142174	2669	1		Introducing test case for TDD-TDD Inter-frequency event triggered reporting for TDD UL/DL configuration 0	12.6.0
12-2014	RP-66	RP-142179	2670	1		Introducing requirements for small cell enhancement in TS36.133	12.6.0
12-2014	RP-66	RP-142180	2671	2		Introducing interruption requirements for dual connectivity into TS36.133	12.6.0
12-2014	RP-66	RP-142162	2674	-		E-UTRAN TDD event triggered reporting under deactivated SCell in non-DRX for 20MHz+10MHz	12.6.0
12-2014	RP-66	RP-142162	2675	-		E-UTRAN TDD event triggered reporting on deactivating SCell with PCell interruption in non-DRX for 20MHz+10MHz	12.6.0
12-2014	RP-66	RP-142162	2676	-		E-UTRAN TDD RSTD Measurement Reporting Test Case for 20MHz+10MHz	12.6.0
12-2014	RP-66	RP-142162	2677	-		TDD RSRP for E-UTRAN Carrier Aggregation for 20MHz+10MHz	12.6.0
12-2014	RP-66	RP-142162	2678	1		TDD RSRP for E-UTRAN Carrier Aggregation for 20MHz+10MHz	12.6.0
12-2014	RP-66	RP-142162	2679	-		E-UTRAN TDD RSTD Measurement Accuracy in Carrier Aggregation for 20MHz+10MHz	12.6.0
12-2014	RP-66	RP-142143	2682	1		Introducing positioning enhancement requirement for UE Rx-Tx accuracy	12.6.0
12-2014	RP-66	RP-142144	2686	-		Correction on CA test cases in R12	12.6.0
12-2014	RP-66	RP-142188	2687	-		Correction on E-UTRAN TDD – Non-Contention Based Random Access Test For Scell	12.6.0
12-2014	RP-66	RP-142179	2688	1		Introduction of RSRP measurement accuracy requirement for DRS based measurement	12.6.0
12-2014	RP-66	RP-142188	2690	1		Ecat clarification for iRAT	12.6.0
12-2014	RP-66	RP-142180	2694	-		CR for TS36.133 on Cell phase accuracy for Dual Connectivity	12.6.0
12-2014	RP-66	RP-142180	2695	1		Introduction of RRM requirements for Dual Connectivity	12.6.0
12-2014	RP-66	RP-142180	2696	1		Introduction of measurement requirements for Dual Connectivity	12.6.0
12-2014	RP-66	RP-142178	2697	1		Measurement and reporting of BLER in section 9	12.6.0
12-2014	RP-66	RP-142177	2698	1		Introduction of TDD-FDD CA test cases	12.6.0
12-2014	RP-66	RP-142178	2699	1		CR on measurement for MBSFN MDT	12.6.0
12-2014	RP-66	RP-142188	2707	1		PCell Interruption in Rel-12 CA	12.6.0
12-2014	RP-66	RP-142158	2708	1		UE Behaviour after Measurement Gap in CA	12.6.0
12-2014	RP-66	RP-142177	2709	1		CA RRM Testing for Multiple Duplex Modes	12.6.0
12-2014	RP-66	RP-142177	2710	1		CA RRM Testing for Fall back CA Configuration	12.6.0
12-2014	RP-66	RP-142188	2712	1		Introduction of High Doppler measurement accuracy requirements	12.6.0
12-2014	RP-66	RP-142172	2714	1		Requirements for increased carrier monitoring for idle mode 36.133	12.6.0
12-2014	RP-66	RP-142172	2715	1		Requirements for increased carrier monitoring in RRC connected state 36.133	12.6.0
12-2014	RP-66	RP-142161	2716	1		Different TDD configurations in CA	12.6.0
12-2014	RP-66	RP-142178	2722	1		MBMS requirements in section 9	12.6.0
12-2014	RP-66	RP-142179	2725	1		Intra-frequency and inter-frequency measurement accuracy requirements with DMTC	12.6.0
12-2014	RP-66	RP-142188	2727	-		RSTD accuracy requirements for smaller and larger bandwidths	12.6.0
12-2014	RP-66	RP-142149	2736	-		Corrections to E-UTRAN TDD RLM In-sync under Time Domain Measurement Resource Restriction with CRS assistance information	12.6.0

12-2014	RP-66	RP-142149	2738	-		Corrections to E-UTRAN TDD RLM Out-of-sync under Time Domain Measurement Resource Restriction with CRS Assistance Information	12.6.0
12-2014	RP-66	RP-142149	2740	-		Test case for inter-RAT HO to multicarrier UTRA	12.6.0
12-2014	RP-66	RP-142178	2741	-		CR on parallel reporting criteria for eMBMS	12.6.0
12-2014	RP-66	RP-142186	2742	-		Introduction of 2UL non-contiguous intra-band CA	12.6.0
12-2014	RP-66	RP-142021	2743	-		Introduction of 2UL inter-band CA	12.6.0
12-2014	RP-66	RP-142150	2745	-		Requirements for multicarrier handover from EUTRA to UTRA	12.6.0
03-2015	RP-77	RP-150387	2747	-		CR to Correct Implementation Error in FDD RSTD Measurement Reporting Delay Test Case and to Update Io Levels for Certain RSTD Test Cases	12.7.0
03-2015	RP-77	RP-150382	2750	-		Remove incorrect note from CA RSTD Accuracy tests	12.7.0
03-2015	RP-77	RP-150387	2751	-		Change Nprs value for 5MHz CA RSTD Accuracy tests	12.7.0
03-2015	RP-77	RP-150066	2754	1		Maximum allowed layers for multiple monitoring for CA	12.7.0
03-2015	RP-77	RP-150387	2756	-		DRX correction for interruption with dual connectivity	12.7.0
03-2015	RP-77	RP-150388	2757	-		Correction of Interruptions with RSTD Measurements for 3DL CA	12.7.0
03-2015	RP-77	RP-150387	2761	1		RRM requirements for ProSe	12.7.0
03-2015	RP-77	RP-150396	2763	1		Updating the requirements applicability for TDD config 0	12.7.0
03-2015	RP-77	RP-150394	2764	1		Cleanup for RSRQ measurement requirement for SCE	12.7.0
03-2015	RP-77	RP-150394	2774	1		Clean up the correction on discovery signal measurements	12.7.0
03-2015	RP-77	RP-150387	2775	1		Correction on MBSFN measurements	12.7.0
03-2015	RP-77	RP-150394	2776	-		Introduce CA measurement accuracy requirements for SCE	12.7.0
03-2015	RP-77	RP-150382	2777	-		Correction on Io in carrier aggregation test cases	12.7.0
03-2015	RP-77	RP-150387	2783	-		Introducing accuracy requirement for new RSRQ	12.7.0
03-2015	RP-77	RP-150384	2785	-		Time-domain measurement resource restriction pattern for serving cell in fclCIC RSRP and RSRQ test cases	12.7.0
03-2015	RP-77	RP-150384	2791	-		CR on typo of referencing section name in CA measurements	12.7.0
03-2015	RP-77	RP-150393	2797	1		Clarification including PSCell in Note 1 for Ecat	12.7.0
03-2015	RP-77	RP-150386	2798	1		Clarification of IncMon requirements for E-UTRA idle state	12.7.0
03-2015	RP-77	RP-150386	2799	1		Clarification of IncMon requirements for E-UTRA connected state	12.7.0
03-2015	RP-77	RP-150386	2800	1		Clarification concerning IncMon scaling for non-gap-assisted measurements	12.7.0
03-2015	RP-77	RP-150382	2803	-		Correction of RMC and OCNG pattern in event triggered tests without measurement gap	12.7.0
03-2015	RP-77	RP-150394	2804	-		CR on RSRQ requirements for CRS based discovery signal	12.7.0
03-2015	RP-77	RP-150387	2808	-		Correction to RRM test cases	12.7.0
03-2015	RP-77	RP-150388	2809	-		Correction to CA Testing with Different CA Configurations	12.7.0
03-2015	RP-77	RP-150393	2811	-		Principle to test synchronous and asynchronous DC requirements	12.7.0
03-2015	RP-77	RP-150387	2814	-		Further revision of RSRP requirement for 36.133 release 12	12.7.0
03-2015	RP-77	RP-150387	2815	-		Additional bandwidths for EUTRAN activation and deactivation of known and unknown SCell in non-DRX	12.7.0
03-2015	RP-77	RP-150387	2816	1		High Doppler measurement accuracy requirements	12.7.0
03-2015	RP-77	RP-150384	2817	1		36.133 CR to change CPICH Ec/No to CPICH Ec/Io in EUTRA FDD to UTRA FDD HO test cases	12.7.0
03-2015	RP-77	RP-150388	2822	-		Maximum Transmission Timing Difference in 3DL CA	12.7.0
03-2015	RP-77	RP-150053	2824	-		Correction to the implementation of CR 2471r3 (Clarification for ACK/NACK feedback of CGI measurement)	12.7.0
06-2015	RP-68	RP-150972	2825			3 DL CA Phase I tests # 1-2: Event triggered reporting tests with deactivated SCells in non-DRX for TDD-FDD CA	12.8.0
06-2015	RP-68	RP-150961	2828			RMC for 10 MHz for UE category 0 RRM tests	12.8.0
06-2015	RP-68	RP-150957	2829			Correction to measurement scaling factor for incmon	12.8.0
06-2015	RP-68	RP-150957	2832			RSRP requirement for SCE	12.8.0
06-2015	RP-68	RP-150962	2833r1	1		CR on FDD-FDD inter-frequency absolute and relative CRS RSRP accuracy test case	12.8.0
06-2015	RP-68	RP-150962	2834r1	1		CR on TDD-TDD inter-frequency absolute and relative CRS RSRP accuracy test case	12.8.0
06-2015	RP-68	RP-150962	2835r1	1		CR on FDD absolute and relative CSI-RSRP accuracy test case for E-UTRAN Carrier Aggregation	12.8.0

06-2015	RP-68	RP-150962	2836r 1	1		CR on TDD absolute and relative CSI-RSRP accuracy test case for E-UTRAN Carrier Aggregation	12.8.0
06-2015	RP-68	RP-150962	2837r 1	1		CR on FDD-FDD inter-frequency absolute and relative CSI-RSRP accuracy test case	12.8.0
06-2015	RP-68	RP-150962	2838r 1	1		CR on TDD-TDD inter-frequency absolute and relative CSI-RSRP accuracy test case	12.8.0
06-2015	RP-68	RP-150962	2839r 1	1		CR on FDD intra frequency absolute and relative CSI-RSRP accuracy test case	12.8.0
06-2015	RP-68	RP-150962	2840r 1	1		CR on TDD intra frequency absolute and relative CSI-RSRP accuracy test case	12.8.0
06-2015	RP-68	RP-150962	2842r 1	1		Intra-frequency absolute and relative RSRP accuracies in CRS based discovery signal	12.8.0
06-2015	RP-68	RP-150962	2843r 1	1		Absolute and relative RSRP accuracies for E-UTRAN Carrier Aggregation in CRS based discovery signal	12.8.0
06-2015	RP-68	RP-150962	2845r 1	1		SCE FDD intra-frequency absolute RSRQ accuracy	12.8.0
06-2015	RP-68	RP-150962	2846r 1	1		SCE TDD intra-frequency absolute RSRQ accuracy	12.8.0
06-2015	RP-68	RP-150962	2847			SCE FDD absolute RSRQ accuracy for CA	12.8.0
06-2015	RP-68	RP-150962	2848			SCE TDD absolute RSRQ accuracy for CA	12.8.0
06-2015	RP-68	RP-150961	2849r 1	1		Test for CGI acquisition requirements for UE category 0	12.8.0
06-2015	RP-68	RP-150961	2850r 1	1		Test for cell identification for UE category 0	12.8.0
06-2015	RP-68	RP-150961	2851			Test for handover requirements for UE category 0	12.8.0
06-2015	RP-68	RP-150961	2852			Test for RRC re-establishment requirements for UE category 0	12.8.0
06-2015	RP-68	RP-150961	2853r 1	1		HD-FDD handover requirements for UE category 0	12.8.0
06-2015	RP-68	RP-150957	2855r 1	1		Correction of requirements for ProSe in DRX	12.8.0
06-2015	RP-68	RP-150962	2857r 1	1		E-UTRAN FDD intra frequency CRS based discovery signal measurements when DRX is used	12.8.0
06-2015	RP-68	RP-150962	2858r 1	1		E-UTRAN TDD intra frequency CRS based discovery signal measurements when DRX is used	12.8.0
06-2015	RP-68	RP-150962	2859r 1	1		E-UTRAN FDD-FDD inter-frequency event triggered reporting under fading propagation conditions in DRX based on CRS based discovery signal	12.8.0
06-2015	RP-68	RP-150962	2860r 1	1		E-UTRAN TDD-TDD inter-frequency event triggered reporting under fading propagation conditions in DRX based on CRS based discovery signal	12.8.0
06-2015	RP-68	RP-150962	2861r 1	1		E-UTRAN FDD event triggered reporting under deactivated SCell in non-DRX based on CRS based discovery signal	12.8.0
06-2015	RP-68	RP-150962	2862r 1	1		E-UTRAN TDD event triggered reporting under deactivated SCell in non-DRX based on CRS based discovery signal	12.8.0
06-2015	RP-68	RP-150961	2866r 1	1		RSRP accuracy FD-FDD Intra frequency case for UE category 0	12.8.0
06-2015	RP-68	RP-150961	2867r 1	1		RSRP accuracy HD-FDD Intra frequency case for UE category 0	12.8.0
06-2015	RP-68	RP-150961	2868r 1	1		RSRP accuracy TDD Intra frequency case for UE category 0	12.8.0
06-2015	RP-68	RP-150961	2869r 1	1		RSRQ accuracy FD-FDD Intra frequency case for UE category 0	12.8.0
06-2015	RP-68	RP-150961	2870r 1	1		RSRQ accuracy HD-FDD Intra frequency case for UE category 0	12.8.0
06-2015	RP-68	RP-150961	2871r 1	1		RSRQ accuracy TDD Intra frequency case for UE category 0	12.8.0
06-2015	RP-68	RP-150972	2872r 1	1		Test case for 3DL CA: PCell in FDD: Event triggered reporting on deactivated SCells and interruption probability (0.5%) without DRX (TDD-FDD CA)	12.8.0
06-2015	RP-68	RP-150972	2873r 1	1		Test case for 3DL CA: PCell in TDD: Event triggered reporting on deactivated SCells and interruption probability (0.5%) without DRX (TDD-FDD CA)	12.8.0
06-2015	RP-68	RP-150958	2874r 1	1		Test case for 3DL CA: Event triggered reporting on deactivated SCells and interruption probability (0.5%) without DRX (FDD CA)	12.8.0
06-2015	RP-68	RP-150968	2875r 1	1		Test case for 3DL CA: Event triggered reporting on deactivated SCells and interruption probability (0.5%) without DRX (TDD 3 DL CA)	12.8.0
06-2015	RP-68	RP-150965	2880			OTDOA RSTD Measurements on different secondary component carriers	12.8.0

06-2015	RP-68	RP-150955	2884			E-UTRAN TDD-TDD Inter-frequency event triggered reporting under fading propagation conditions in synchronous cells for 20 MHz +20 MHz bandwidth R12	12.8.0
06-2015	RP-68	RP-150958	2885			E-UTRAN TDD-TDD Inter-frequency event triggered reporting under fading propagation conditions in synchronous cells for 20 MHz +10 MHz bandwidth R12	12.8.0
06-2015	RP-68	RP-150955	2886			E-UTRAN TDD with 20 MHz +20 MHz bandwidth to UTRAN TDD cell search under fading propagation conditions R12	12.8.0
06-2015	RP-68	RP-150958	2887			E-UTRAN TDD with 20 MHz +10 MHz bandwidth to UTRAN TDD cell search under fading propagation conditions R12	12.8.0
06-2015	RP-68	RP-150957	2897			Further clarification of MBMSBLER reporting in section 9	12.8.0
06-2015	RP-68	RP-150962	2903r 1	1		Test case of FDD-FDD inter-frequency RSRQ measurement accuracy in discovery signal occasions	12.8.0
06-2015	RP-68	RP-150962	2904			CR on side conditions for inter-frequency measurement for SCE	12.8.0
06-2015	RP-68	RP-150962	2905			CR on test case for RSRQ TDD-TDD inter frequency measurement accuracy requirement for SCE	12.8.0
06-2015	RP-68	RP-150955	2906r 1	1		Maximum Rx difference between Pcell and Scell in section 7.9	12.8.0
06-2015	RP-68	RP-150962	2908r 1	1		FDD-FDD intra frequency event triggered reporting in DRX based on CSI-RS based discovery signal	12.8.0
06-2015	RP-68	RP-150962	2909r 1	1		TDD-TDD intra frequency event triggered reporting in DRX based on CSI-RS based discovery signal	12.8.0
06-2015	RP-68	RP-150962	2910r 1	1		FDD-FDD inter frequency event triggered reporting in DRX based on CSI-RS based discovery signal	12.8.0
06-2015	RP-68	RP-150962	2911r 1	1		TDD-TDD inter frequency event triggered reporting in DRX based on CSI-RS based discovery signal	12.8.0
06-2015	RP-68	RP-150962	2912r 1	1		FDD event triggered reporting under deactivated SCell in non-DRX based on CSI-RS based discovery signal	12.8.0
06-2015	RP-68	RP-150962	2913r 1	1		TDD event triggered reporting under deactivated SCell in non-DRX based on CSI-RS based discovery signal	12.8.0
06-2015	RP-68	RP-150957	2915r 2	2		CR of DC interruption requirements	12.8.0
06-2015	RP-68	RP-150965	2916r 1	1		Event triggered reporting on deactivated SCCells in non-DRX (FDD CA)	12.8.0
06-2015	RP-68	RP-150965	2917r 1	1		Event triggered reporting on deactivated SCCells in non-DRX (TDD CA)	12.8.0
06-2015	RP-68	RP-150972	2919r 1	1		Introduction of RRM test case for E-UTRAN TDD-FDD 3 DL CA activation and deactivation of known SCell in non-DRX with PCell in FDD	12.8.0
06-2015	RP-68	RP-150972	2920r 1	1		Introduction of RRM test case for E-UTRAN TDD-FDD 3 DL CA activation and deactivation of known SCell in non-DRX with PCell in TDD	12.8.0
06-2015	RP-68	RP-150972	2921			3DL CA Phase I tests #11_3DL FDD CA SCell activation and deactivation for known SCCells without DRX	12.8.0
06-2015	RP-68	RP-150965	2921a			Correction of implementation of CR 2644 in Table A.9.8.1.1-1	12.8.0
06-2015	RP-68	RP-150972	2922			3DL CA Phase I tests #12_3DL TDD CA SCell activation and deactivation for known SCCells without DRX	12.8.0
06-2015	RP-68	RP-150959	2922a r2	2		Incmon CR for FDD-FDD Interfrequency correct reporting of measurement events without reduced performance group configured, non DRX	12.8.0
06-2015	RP-68	RP-150959	2923r 2	2		Incmon CR for TDD-TDD Interfrequency correct reporting of measurement events without reduced performance group configured, non DRX	12.8.0
06-2015	RP-68	RP-150963	2928r 1	1		FDD RLM Test Case for Out-of-sync in DRX for PSCell in asynchronous DC	12.8.0
06-2015	RP-68	RP-150963	2929r 1	1		FDD RLM Test Case for In-sync in DRX for PSCell in asynchronous DC	12.8.0
06-2015	RP-68	RP-150954	2932			Correction of Cell Time offset in RSTD CA Test cases (Rel-12)	12.8.0
06-2015	RP-68	RP-150963	2933r 1	1		Introduction of DC intra-frequency event triggered reporting with DRX in synchronous FDD DC	12.8.0
06-2015	RP-68	RP-150963	2934r 1	1		Introduction of DC intra-frequency event triggered reporting with DRX in synchronous TDD DC	12.8.0
06-2015	RP-68	RP-150963	2935r 1	1		Introduction of DC intra-frequency event triggered reporting with DRX in asynchronous FDD DC	12.8.0

06-2015	RP-68	RP-150963	2936r 1	1		Introduction of DC inter-frequency event triggered reporting with DRX in synchronous FDD DC	12.8.0
06-2015	RP-68	RP-150963	2937r 1	1		Introduction of DC inter-frequency event triggered reporting with DRX in synchronous TDD DC	12.8.0
06-2015	RP-68	RP-150959	2938r 1	1		Testcases for E-UTRA Incmon idle interfrequency reselection	12.8.0
06-2015	RP-68	RP-150962	2940r 2	2		CR on minimum number of subframes for discovery-based measurements	12.8.0
06-2015	RP-68	RP-150961	2941r 1	1		E-UTRAN FD-FDD Radio Link Monitoring Tests for UE category 0	12.8.0
06-2015	RP-68	RP-150961	2942r 1	1		E-UTRAN HD-FDD Radio Link Monitoring Tests for UE category 0	12.8.0
06-2015	RP-68	RP-150961	2943r 1	1		E-UTRAN TDD Radio Link Monitoring Tests for UE category 0	12.8.0
06-2015	RP-68	RP-150958	2944r 1	1		Absolute and relative RSRP accuracies in FDD 3 DL CA	12.8.0
06-2015	RP-68	RP-150968	2945r 1	1		Absolute and relative RSRP accuracies in TDD 3 DL CA	12.8.0
06-2015	RP-68	RP-150972	2946r 1	1		PCell in FDD: absolute and relative RSRQ accuracies in TDD-FDD 3 DL CA	12.8.0
06-2015	RP-68	RP-150972	2947r 1	1		PCell in TDD: absolute and relative RSRQ accuracies in TDD-FDD 3 DL CA	12.8.0
06-2015	RP-68	RP-150959	2950			FDD-FDD Interfrequency correct reporting of measurement events with reduced performance group configured for non DRX IncMon	12.8.0
06-2015	RP-68	RP-150959	2951			TDD-TDD Interfrequency correct reporting of measurement events with reduced performance group configured for non DRX IncMon	12.8.0
06-2015	RP-68	RP-150963	2952r 1	1		E-UTRAN FDD Radio Link Monitoring Test for In-sync in DRX for PSCell in synchronous dual connectivity	12.8.0
06-2015	RP-68	RP-150963	2953r 1	1		E-UTRAN TDD Radio Link Monitoring Test for In-sync in DRX for PSCell in synchronous dual connectivity	12.8.0
06-2015	RP-68	RP-150961	2954r 1	1		E-UTRAN FDD PCell interruption at transitions between active and non-active when DRX is used in PSCell in asynchronous dual connectivity	12.8.0
06-2015	RP-68	RP-150958	2955			E-UTRAN TDD - UE Transmit Timing Accuracy Tests for SCell for 20 MHz +10 MHz bandwidth R12	12.8.0
06-2015	RP-68	RP-150955	2956			E-UTRAN TDD - UE Transmit Timing Accuracy Tests for SCell in sTAG for 20 MHz +20 MHz bandwidth R12	12.8.0
06-2015	RP-68	RP-150958	2957			E-UTRAN TDD - UE Transmit Timing Accuracy Tests for SCell in sTAG for 20 MHz +10 MHz bandwidth R12	12.8.0
06-2015	RP-68	RP-150955	2958			E-UTRAN TDD - UE Timing Advance Adjustment Accuracy Test for Scell in sTAG for 20 MHz +20 MHz bandwidth R12	12.8.0
06-2015	RP-68	RP-150958	2959			E-UTRAN TDD - UE Timing Advance Adjustment Accuracy Test for Scell in sTAG for 20 MHz +10 MHz bandwidth R12	12.8.0
06-2015	RP-68	RP-150965	2962			Addition PDSCH RMC for 5MHz with user data	12.8.0
06-2015	RP-68	RP-150972	2967r 1	1		3 DL CA Phase II tests # 1-2: RSRP measurement accuracies for TDD-FDD CA	12.8.0
06-2015	RP-68	RP-150963	2971r 1	1		PSCell Add and Release Delay Tests for Synchronous DC	12.8.0
06-2015	RP-68	RP-150963	2972r 1	1		PSCell Add and Release Delay Tests for Asynchronous DC	12.8.0
06-2015	RP-68	RP-150959	2975r 1	1		Idle mode FDD to UTRA FDD interRAT reselection	12.8.0
06-2015	RP-68	RP-150959	2976r 1	1		Idle mode TDD to UTRA FDD interRAT reselection	12.8.0
06-2015	RP-68	RP-150959	2977			E-UTRA FDD InterRAT UTRA FDD correct reporting of measurement events with reduced performance group configured, non DRX	12.8.0
06-2015	RP-68	RP-150959	2978			E-UTRA TDD InterRAT UTRA FDD correct reporting of measurement events with reduced performance group configured, non DRX	12.8.0
06-2015	RP-68	RP-150963	2979r 1	1		E-UTRAN FDD PCell interruption at transitions between active and non-active when DRX is used in PSCell in synchronous dual connectivity	12.8.0
06-2015	RP-68	RP-150963	2980r 1	1		E-UTRAN TDD PCell interruption at transitions between active and non-active when DRX is used in PSCell in synchronous dual connectivity	12.8.0
06-2015	RP-68	RP-150963	2981r 1	1		E-UTRAN FDD inter-frequency event triggered reporting in asynchronous dual connectivity	12.8.0
06-2015	RP-68	RP-150958	2984r 1	1		Modification for interruption period for SCell (de-)activation with 3DL	12.8.0

06-2015	RP-68	RP-150959	2987r 1	1		Test cases of Idle mode E-UTRA to UTRA TDD interRAT cell reselection for IncMon	12.8.0
06-2015	RP-68	RP-150959	2988r 1	1		Test cases of Interfrequency correct reporting of measurement events with reduced performance group configured, DRX	12.8.0
06-2015	RP-68	RP-150963	2989r 2	2		E-UTRAN FDD Radio Link Monitoring Test for Out-of-sync in DRX for PSCell in synchronous dual connectivity	12.8.0
06-2015	RP-68	RP-150963	2990r 2	2		E-UTRAN TDD Radio Link Monitoring Test for Out-of-sync in DRX for PSCell in synchronous dual connectivity	12.8.0
06-2015	RP-68	RP-150957	2992			CR on interruption during D2D discovery for D2D single RF chain	12.8.0
06-2015	RP-68	RP-150965	2993			CR on E-UTRAN TDD-TDD inter frequency measurements when DRX is used	12.8.0
06-2015	RP-68	RP-150965	2998			Test case of FDD-FDD inter-frequency new RSRQ measurement accuracy	12.8.0
06-2015	RP-68	RP-150965	2999			Test case of TDD-TDD inter-frequency new RSRQ measurement accuracy	12.8.0
06-2015	RP-68	RP-150955	3001			Correction to felCIC cell configurations in RLM	12.8.0
06-2015	RP-68	RP-150955	3003			Correction to A.8.1.8	12.8.0
06-2015	RP-68	RP-150972	3004r 1	1		CR on absolute and relative RSRQ accuracies in TDD 3DL CA	12.8.0
06-2015	RP-68	RP-150972	3005r 1	1		CR on absolute and relative RSRQ accuracies in FDD 3DL CA	12.8.0
06-2015	RP-68	RP-150965	3006			CR for test case of new RSRQ measurement accuracy in FDD	12.8.0
06-2015	RP-68	RP-150965	3007			CR for test case of new RSRQ measurement accuracy in TDD	12.8.0
06-2015	RP-68	RP-150972	3008r 1	1		RSTD measurement reporting in FDD 3 DL CA	12.8.0
06-2015	RP-68	RP-150972	3009r 1	1		RSTD measurement reporting in TDD 3 DL CA	12.8.0
06-2015	RP-68	RP-150972	3010r 1	1		RSTD measurement accuracy in FDD 3 DL CA	12.8.0
06-2015	RP-68	RP-150972	3011r 1	1		RSTD measurement accuracy in TDD 3 DL CA	12.8.0
06-2015	RP-68	RP-150964	3012r 2	2		Clarification of ProSe requirements in ONC	12.8.0
06-2015	RP-68	RP-150957	3013			Correction to Asynchronous Requirements for DC for only FDD-FDD	12.8.0
06-2015	RP-68	RP-150959	3014			E-UTRA TDD InterRAT UTRA TDD correct reporting of measurement events with reduced performance group configured non DRX IncMon	12.8.0
06-2015	RP-68	RP-150959	3015			E-UTRA FDD InterRAT UTRA TDD correct reporting of measurement events with reduced performance group configured non DRX for IncMon	12.8.0
06-2015	RP-68	RP-150958	3016			Correction to E-UTRA TDD event triggered reporting under deactivated SCell in non-DRX for 20 MHz + 10 MHz	12.8.0
06-2015	RP-68	RP-150969	2893			Carrier aggregation test cases for band 31	13.0.0
06-2015	RP-68	RP-150974	2966			4DL CA RRM requirements for "UE Measurements Procedures in RRC_CONNECTED State"	13.0.0
06-2015	RP-68	RP-150974	2970	1		RRM Requirements in Section 7 for 4 DL CA	13.0.0
09-2015	RP-69	RP-151475	3020	-		Correction of lor/loc value in RRM Test case A.4.3.1.1	13.1.0
09-2015	RP-69	RP-151479	3022	-		Cleanup of 3DL CA RRM Test cases	13.1.0
09-2015	RP-69	RP-151483	3031	-		Time offset between cells	13.1.0
09-2015	RP-69	RP-151497	3032	-		Requirements for DC on ACK/NACK reporting for measurements using autonomous gaps	13.1.0
09-2015	RP-69	RP-151475	3034	-		Interruptions at overlapping addition/release/activation/deactivation of SCells	13.1.0
09-2015	RP-69	RP-151504	3035	-		RRM Requirements for 3 DL/2UL Inter-band CA	13.1.0
09-2015	RP-69	RP-151483	3037	-		CR on editorial corrections in TS36133 in Rel-13	13.1.0
09-2015	RP-69	RP-151478	3039	-		CR on item title of table in clause 8.1.2.4.5.1 in TS36133 in Rel-13	13.1.0
09-2015	RP-69	RP-151500	3041	-		3DL CA Phase II tests #15_ SCell activation and deactivation for unknown SCells without DRX (FDD 3 DL CA) in Rel-13	13.1.0
09-2015	RP-69	RP-151500	3043	-		3DL CA Phase II tests #16_ SCell activation and deactivation for unknown SCells without DRX (TDD 3 DL CA) in Rel-13	13.1.0
09-2015	RP-69	RP-151475	3045	-		Modifying test case of E-UTRAN 2DL TDD CA activation of unknown SCell in non-DRX in Rel-13	13.1.0

09-2015	RP-69	RP-151480	3047	-		CR on delete note in table 8.5.2.1.6.1-1 in TS36133 in Rel-13	13.1.0
09-2015	RP-69	RP-151479	3052	-		Correction of inconsistency in 3 DL CA Event Triggered Reporting under Deactivated SCells in Non-DRX	13.1.0
09-2015	RP-69	RP-151479	3054	-		CR on Interruptions at PSCell Addition/release	13.1.0
09-2015	RP-69	RP-151483	3062	-		Corrections to the RMC configurations in 36.133 R13	13.1.0
09-2015	RP-69	RP-151479	3064	-		Remove the Brackets in RLM Tests for UE category 0 R13	13.1.0
09-2015	RP-69	RP-151474	3066	1		Adding SNR values to DC RLM test cases R13	13.1.0
09-2015	RP-69	RP-151486	3068	-		Correction on Band 31 test cases R13	13.1.0
09-2015	RP-69	RP-151483	3070	-		Correction to UE transmit timing accuracy tests R13	13.1.0
09-2015	RP-69	RP-151500	3078	-		Introduction of RRM test case for E-UTRAN TDD-FDD 3DL CA activation and deactivation of unknown SCell in non-DRX with PCell in TDD	13.1.0
09-2015	RP-69	RP-151483	3079	-		Modifying test case of E-UTRAN 2DL FDD CA activation of unknown SCell in non-DRX	13.1.0
09-2015	RP-69	RP-151500	3080	-		Introduction of RRM test case for E-UTRAN TDD-FDD 3DL CA activation and deactivation of unknown SCell in non-DRX with PCell in FDD	13.1.0
12-2015	RP-70	RP-152131	3086	-		Correction of RSRQ value in RRM Serving Cell Test cases A.9.9.1, A.9.9.2	13.2.0
12-2015	RP-70	RP-152136	3088	-		Remove brackets in RSTD measurement accuracy R13	13.2.0
12-2015	RP-70	RP-152133	3090	-		Remove bracket for CSI-RSRP measurement R13	13.2.0
12-2015	RP-70	RP-152133	3094	-		Correction to E-UTRAN TDD-FDD CA Event Triggered Reporting Under Deactivated SCell in Non-DRX with PCell in FDD R13	13.2.0
12-2015	RP-70	RP-152133	3096	-		Correction to E-UTRAN TDD-FDD CA Event Triggered Reporting Under Deactivated SCell in Non-DRX with PCell in TDD R13	13.2.0
12-2015	RP-70	RP-152133	3098	-		Correction to E-UTRAN TDD-FDD CA Event triggered reporting on deactivated SCell with PCell interruption in non-DRX with PCell in FDD R13	13.2.0
12-2015	RP-70	RP-152133	3100	-		Correction to E-UTRAN TDD-FDD CA Event triggered reporting on deactivated SCell with PCell interruption in non-DRX with PCell in TDD R13	13.2.0
12-2015	RP-70	RP-152133	3102	-		Correction to RSRP for E-UTRAN TDD-FDD Carrier Aggregation with PCell in FDD R13	13.2.0
12-2015	RP-70	RP-152133	3104	-		Correction to RSRP for E-UTRAN TDD-FDD Carrier Aggregation with PCell in TDD R13	13.2.0
12-2015	RP-70	RP-152133	3106	-		Correction to RSRQ for E-UTRAN TDD-FDD Carrier Aggregation with PCell in FDD R13	13.2.0
12-2015	RP-70	RP-152133	3108	-		Correction to RSRQ for E-UTRAN TDD-FDD Carrier Aggregation with PCell in TDD R13	13.2.0
12-2015	RP-70	RP-152136	3114	-		Alignment of UE reporting criteria requirements	13.2.0
12-2015	RP-70	RP-152131	3116	-		Removal of square brackets for some CA requirements	13.2.0
12-2015	RP-70	RP-152133	3118	-		Cleanup of 3DL CA RRM Test cases	13.2.0
12-2015	RP-70	RP-152134	3121	-		Correction of definition of antenna connection in some RSTD tests	13.2.0
12-2015	RP-70	RP-152133	3129	-		Different TDD configurations for OTDOA in CA in release 12	13.2.0
12-2015	RP-70	RP-152157	3131	-		Introduction of Band 67	13.2.0
12-2015	RP-70	RP-152133	3136	-		Correction of definition of pTAG and psTAG	13.2.0
12-2015	RP-70	RP-152133	3145	-		Title of new section A.7.4 in TS36.133 for Rel-13	13.2.0
12-2015	RP-70	RP-152133	3146	-		SNR levels and Reference channels for DC RLM test cases for Rel-13	13.2.0
12-2015	RP-70	RP-152131	3150	-		Correction on measurement category for reporting criteria	13.2.0
12-2015	RP-70	RP-152133	3167	-		Alignment of dB values for 2DL CA activation and deactivation Test cases	13.2.0
12-2015	RP-70	RP-152135	3173	-		CR on editorial cleanup for D2D RRM requirements	13.2.0
12-2015	RP-70	RP-152136	3178	-		Correction to Trstd values in 3DL RSTD Measurement Accuracy test cases	13.2.0
12-2015	RP-70	RP-152133	3183	-		Update of 2DL CA activation and deactivation of unknown SCell Test cases A.8.16.19+A.8.16.20	13.2.0
12-2015	RP-70	RP-152133	3185	-		Update of 3DL CA activation and deactivation of unknown SCell Test cases A.8.16.41+A.8.16.42	13.2.0
12-2015	RP-70	RP-152133	3187	-		Update to RRM test case for E-UTRAN TDD-FDD 3DL CA activation and deactivation of unknown SCell in non-DRX with PCell in FDD	13.2.0

12-2015	RP-70	RP-152133	3189	-		Update to RRM test case for E-UTRAN TDD-FDD 3DL CA activation and deactivation of unknown SCell in non-DRX with PCell in TDD	13.2.0
12-2015	RP-70	RP-152136	3191	-		Correction to Cells in OTDOA assistance data in 3DL RSTD Measurement Reporting Delay test cases	13.2.0
12-2015	RP-70	RP-152153	3192	2		CR on RS-SINR accuracy in 36.133	13.2.0
12-2015	RP-70	RP-152136	3195	1		Correction on RSRQ measurement report mapping R13	13.2.0
12-2015	RP-70	RP-152173	3196	-		Introduction of Band 45 into TS36.133	13.2.0
12-2015	RP-70	RP-152131	3211	-		Further Correction of Cell Time offset in RSTD CA test cases (Rel-13)	13.2.0
12-2015	RP-70	RP-152155	3213	1		CR for clarification of band combination in 36133	13.2.0
12-2015	RP-70	RP-152166	3214	1		CR for RRM requirement up to 3UL CA in 36133	13.2.0
12-2015	RP-70	RP-152152	3216	1		CR on measurement performance requirements for UE reporting SSTD between MeNB and SeNB for dual connectivity enhancements	13.2.0
12-2015	RP-70	RP-152133	3223	-		Adding the title of A.8.22 in TS 36.133 R13	13.2.0
12-2015	RP-70	RP-152133	3227	-		Correction on A.8.16.17 E-UTRAN FDD activation and deactivation of known SCell in non-DRX	13.2.0
12-2015	RP-70	RP-152133	3229	-		Correction on A.8.16.18 E-UTRAN TDD activation and deactivation of known SCell in non-DRX	13.2.0
12-2015	RP-70	RP-152133	3231	-		Correction on A.8.16.35 3 DL PCell in FDD CA Activation and Deactivation of Known SCell in Non-DRX	13.2.0
12-2015	RP-70	RP-152133	3233	-		Correction on A.8.16.36 3 DL PCell in TDD CA Activation and Deactivation of Known SCell in Non-DRX	13.2.0
12-2015	RP-70	RP-152133	3235	-		Correction on A.8.16.37 3DL FDD CA activation and deactivation of known SCell in non-DRX	13.2.0
12-2015	RP-70	RP-152133	3237	-		Correction on A.8.16.38 3DL TDD CA activation and deactivation of known SCell in non-DRX	13.2.0
12-2015	RP-70	RP-152152	3238	1		CR on RRM requirements for SSTD reporting for Dual Connectivity	13.2.0
12-2015	RP-70	RP-152152	3239	1		CR on maximum uplink timing difference for Dual Connectivity	13.2.0
12-2015	RP-70	RP-152152	3240	1		CR on RRM requirements for 3 DL CC Dual connectivity	13.2.0
12-2015	RP-70	RP-152152	3241	1		CR on requirements of interruption for 3 DL CC Dual connectivity	13.2.0
12-2015	RP-70	RP-152163	3243	1		CR on RRM requirements for 5DL CC CA	13.2.0
12-2015	RP-70	RP-152171	3250	-		Introduction of Band 65	13.2.0
12-2015	RP-70	RP-152172	3251	-		Introduction of Band 66	13.2.0
12-2015	RP-70	RP-152149	3253	2		SCell activation/deactivation delay for PUCCH SCell	13.2.0
12-2015	RP-70	RP-152146	3256	1		Beacon RSSI Reporting Requirements	13.2.0
12-2015	RP-70	RP-152148	3260	1		Core RRM requirements for LAA	13.2.0
12-2015	RP-70	RP-152148	3262	1		LAA measurement requirements	13.2.0
12-2015	RP-70	RP-152148	3263	1		LAA measurement accuracy requirements and measurement report mapping	13.2.0
12-2015	RP-70	RP-152153	3265	-		RS-SINR measurement requirements	13.2.0
12-2015	RP-70	RP-152153	3268	1		RS-SINR measurement report mapping	13.2.0
12-2015	RP-70	RP-152154	3269	1		Extended DRX requirements in RRC_CONNECTED state	13.2.0
12-2015	RP-70	RP-152135	3275	-		CR on ProSe UE transmission timing in Any Cell Selection State	13.2.0
12-2015	RP-70	RP-152133	3279	-		Alignment of time when UE starts CSI reporting for activated SCell	13.2.0
03/2016	RP-71	RP-160472	3317		B	RRM requirements for eMTC in IDLE mode in section 4	13.3.0
03/2016	RP-71	RP-160472	3355		B	Reference configuration for Rel-13 MTC	13.3.0
03/2016	RP-71	RP-160472	3346	1	B	CR on eMTC positioning	13.3.0
03/2016	RP-71	RP-160472	3369	1	B	Random access requirements for eMTC UEs	13.3.0
03/2016	RP-71	RP-160472	3331	1	F	CR on CGI reading of eMTC	13.3.0
03/2016	RP-71	RP-160472	3354	1	B	Radio link monitoring for Rel-13 MTC UE	13.3.0
03/2016	RP-71	RP-160472	3353	1	B	Measurement accuracy requirements for Rel-13 MTC UE	13.3.0
03/2016	RP-71	RP-160472	3352	1	B	Measurement requirements for Rel-13 MTC UE under normal coverage	13.3.0
03/2016	RP-71	RP-160472	3356	1	B	Measurement requirements for Rel-13 MTC UE under enhanced coverage	13.3.0
03/2016	RP-71	RP-160473	3285	1	B	CR on eD2D RRM requirements: Inter-freq discovery and multicarrier D2D	13.3.0
03/2016	RP-71	RP-160473	3286	1	B	CR on eD2D RRM requirements: UE-NW relays	13.3.0
03/2016	RP-71	RP-160473	3284	1	B	CR on eD2D RRM requirements: OOC Discovery	13.3.0

03/2016	RP-71	RP-160473	3310	2	F	CR of measurement performance on eD2D	13.3.0
03/2016	RP-71	RP-160475	3347	1	B	Correction to SSTD measurement accuracy and reporting range	13.3.0
03/2016	RP-71	RP-160476	3366	1	B	Measurement requirements in RRC CONNECTED state	13.3.0
03/2016	RP-71	RP-160476	3367	2	B	Measurement requirements in RRC IDLE state	13.3.0
03/2016	RP-71	RP-160477	3341	1	F	CR on RSSI measurement	13.3.0
03/2016	RP-71	RP-160477	3351	1	B	RSSI Report Mapping Requirements	13.3.0
03/2016	RP-71	RP-160478	3362	1	F	Corrections in measurement accuracy requirements for LAA	13.3.0
03/2016	RP-71	RP-160488	3321		A	Correction to felCIC TDD RSRP accuracy OCNG in TS 36.133	13.3.0
03/2016	RP-71	RP-160489	3283		A	CR for correction to syncOffsetIndicator parameter in D2D resource pool configuration	13.3.0
03/2016	RP-71	RP-160489	3288		A	Change OGNNG for 3DL CA Event Triggered Reporting on Deactivated SCell with PCell and SCell Interruptions, A.8.16.32+A.8.16.33	13.3.0
03/2016	RP-71	RP-160489	3293		F	Correction of errors in Annex A Activation/Deactivation Test cases	13.3.0
03/2016	RP-71	RP-160489	3323		A	CR on E-UTRAN TDD-FDD CA activation and deactivation of known SCell in non-DRX with PCell in FDD for Rel-13	13.3.0
03/2016	RP-71	RP-160489	3326		A	CR on E-UTRAN TDD-FDD CA activation and deactivation of unknown SCell in non-DRX with PCell in FDD for Rel-13	13.3.0
03/2016	RP-71	RP-160489	3344		A	Correction on SCE requirements and test cases R13	13.3.0
03/2016	RP-71	RP-160489	3349		A	Correction to antenna configuration principle	13.3.0
03/2016	RP-71	RP-160489	3372		A	CR for IncMon requirements alignment 36.133 Rel-13	13.3.0
03/2016	RP-71	RP-160489	3373		A	Editorial corrections	13.3.0
03/2016	RP-71	RP-160489	3295	1	F	Modification for MBSFN measurements for R13	13.3.0
03/2016	RP-71	RP-160490	3290		F	Correction to RS-SINR measurement accuracy requirements	13.3.0
03/2016	RP-71	RP-160490	3297		F	Modification for interruptions with Carrier Aggregation	13.3.0
03/2016	RP-71	RP-160490	3305		F	Clarification on timing of interruption for PUCCH SCell activation/deactivation	13.3.0
03/2016	RP-71	RP-160490	3316		F	Activation and deactivation delay requirements for PUCCH SCell with four downlink SCells	13.3.0
03/2016	RP-71	RP-160490	3339		F	CR on maximum UL transmission time difference for R13 DC	13.3.0
03/2016	RP-71	RP-160490	3357		F	Interruptions on RSTD in CA	13.3.0
03/2016	RP-71	RP-160490	3303	1	F	Clarification of SSTD measurement requirements	13.3.0
03/2016	RP-71	RP-160490	3361	1	F	Corrections for intra-frequency measurement requirements for LAA	13.3.0
03/2016	RP-71	RP-160490	3312	1	F	CR on measurement and measurement accuracy for LAA	13.3.0
03/2016	RP-71	RP-160490	3330	2	F	Correction on LAA measurement conditions	13.3.0
03/2016	RP-71	RP-160490	3363	2	F	Reporting criteria for RS-SINR	13.3.0
03/2016	RP-71	RP-160490	3327	2	F	Modification on the SCell activation delay requirement for deactivated SCell under Frame Structure 3	13.3.0
2016/06	RP-72	RP-161128	3374	1	B	CR: MPDCCH RMCs for Cat-M1 RRM Tests	13.4.0
2016/06	RP-72	RP-161128	3375	1	B	CR: PDSCH RMCs for Cat-M1 RRM Tests	13.4.0
2016/06	RP-72	RP-161142	3377	3	F	CR: Intra-frequency handover requirements for Cat-M1 UEs in CEModeA	13.4.0
2016/06	RP-72	RP-161142	3379	1	F	CR: UE transmit timing Requirements for Cat-M1 UEs	13.4.0
2016/06	RP-72	RP-161142	3384		F	Removal of conditions for intra-frequency relative RSRQ measurement accuracy requirements under operation with frame structure 3	13.4.0
2016/06	RP-72	RP-161141	3385		F	Radio Link Monitoring Test for In-sync in DRX for PSCell	13.4.0
2016/06	RP-72	RP-161141	3393		F	Introduction of test cases for E-UTRAN FDD-TDD and TDD-FDD DC interruption at transitions between active and non-active during DRX in synchronous DC	13.4.0
2016/06	RP-72	RP-161142	3394		F	CR: Correction to Band 66 notes in E-UTRA band groups	13.4.0
2016/06	RP-72	RP-161141	3395		F	New test cases: E-UTRAN TDD-FDD DC intra-frequency event triggered reporting with DRX in synchronous DC with PCell in FDD/PCell in TDD	13.4.0
2016/06	RP-72	RP-161142	3396	1	F	New test cases: Event triggered reporting on deactivated SCells and interruption probability (0.5%) without DRX (FDD 4 DL CA and TDD 4 DL CA)	13.4.0
2016/06	RP-72	RP-161142	3397	1	F	New test cases: Event triggered reporting on deactivated SCells and interruption probability (0.5%) without DRX (FDD 5 DL CA and TDD 5 DL CA)	13.4.0

2016/06	RP-72	RP-161134	3402	1	F	CR on measurement reference channel and OCNB with FS3	13.4.0
2016/06	RP-72	RP-161141	3404		A	CR on minimum ProSe SCH_RP condition on FDD_F	13.4.0
2016/06	RP-72	RP-161130	3405		F	CR on minimum ProSe SCH_RP condition on FDD_F	13.4.0
2016/06	RP-72	RP-161142	3406		F	CR of typo in interruption requirements	13.4.0
2016/06	RP-72	RP-161141	3408		A	Editorial CR in RSRQ test case for CA in CRS based discovery signal	13.4.0
2016/06	RP-72	RP-161141	3411		F	CR on TDD-FDD DC Radio Link Monitoring Test for Out-of-sync	13.4.0
2016/06	RP-72	RP-161142	3418		F	Editorial correction in RRM requirements	13.4.0
2016/06	RP-72	RP-161142	3421	1	F	Reporting criteria for LAA	13.4.0
2016/06	RP-72	RP-161142	3423		F	Channel occupancy measurement requirements	13.4.0
2016/06	RP-72	RP-161142	3428		F	Inter-frequency RSSI measurement requirements	13.4.0
2016/06	RP-72	RP-161134	3429	1	B	RSRP and RSRQ accuracy requirements	13.4.0
2016/06	RP-72	RP-161142	3430		F	Editorial correction in LAA requirements	13.4.0
2016/06	RP-72	RP-161142	3432		F	RS-SINR accuracy requirements with CA	13.4.0
2016/06	RP-72	RP-161142	3433	1	F	RS-SINR measurement requirements with CA	13.4.0
2016/06	RP-72	RP-161142	3434		F	4 DL PCell in FDD Event triggered reporting on deactivated SCells in non-DRX # 3	13.4.0
2016/06	RP-72	RP-161142	3435		F	4 DL PCell in TDD Event triggered reporting on deactivated SCells in non-DRX # 4	13.4.0
2016/06	RP-72	RP-161142	3436		F	5 DL PCell in FDD Event triggered reporting on deactivated SCells in non-DRX # 1	13.4.0
2016/06	RP-72	RP-161142	3437		F	5 DL PCell in TDD Event triggered reporting on deactivated SCells in non-DRX # 2	13.4.0
2016/06	RP-72	RP-161141	3439		A	Correction on E-UTRAN TDD-FDD CA activation and deactivation of known/unknown SCell in non-DRX with PCell in FDD for Rel-13	13.4.0
2016/06	RP-72	RP-161141	3442		A	CR on E-UTRAN TDD-FDD CA activation and deactivation of known SCell in non-DRX with PCell in TDD for Rel-13	13.4.0
2016/06	RP-72	RP-161141	3444		A	CR on E-UTRAN TDD-FDD CA activation and deactivation of unknown SCell in non-DRX with PCell in TDD for Rel-13	13.4.0
2016/06	RP-72	RP-161141	3446		A	Corrections on PDSCH RMC for UE category 0 R13	13.4.0
2016/06	RP-72	RP-161142	3450	1	F	5 DL FDD CA Event Triggered Reporting with Deactivated SCells in Non-DRX	13.4.0
2016/06	RP-72	RP-161142	3451	1	F	5 DL TDD CA Event Triggered Reporting with Deactivated SCells in Non-DRX	13.4.0
2016/06	RP-72	RP-161142	3452	1	F	4 DL FDD CA Event Triggered Reporting with 3 deactivated SCells in Non-DRX	13.4.0
2016/06	RP-72	RP-161142	3453	1	F	4 DL TDD CA Event Triggered Reporting with 3 deactivated SCells in Non-DRX	13.4.0
2016/06	RP-72	RP-161142	3455		F	RSTD CA interruption on SCC in release 13	13.4.0
2016/06	RP-72	RP-161134	3460	1	B	CR on testing principle of Carrier Aggregation under operation with Frame 3 with Different Duplex Modes	13.4.0
2016/06	RP-72	RP-161132	3466	1	F	E-UTRAN TDD-FDD Addition and Release Delay of known PSCell in Synchronous DC with PCell in FDD	13.4.0
2016/06	RP-72	RP-161132	3467	1	F	E-UTRAN TDD-FDD Addition and Release Delay of known PSCell in Synchronous DC with PCell in TDD	13.4.0
2016/06	RP-72	RP-161142	3474	2	F	maintenance on radio link monitoring for Rel-13 MTC UE	13.4.0
2016/06	RP-72	RP-161142	3475	2	F	Maintenance on measurement requirements for Rel-13 MTC UE under normal coverage	13.4.0
2016/06	RP-72	RP-161142	3476	2	F	Maintenance on measurement requirements for Rel-13 MTC UE under CEModeB	13.4.0
2016/06	RP-72	RP-161142	3478	1	F	CR for eMTC RLM	13.4.0
2016/06	RP-72	RP-161141	3479		F	New Test cases: E-UTRAN TDD-FDD DC inter-frequency event triggered reporting with DRX in synchronous DC with PCell in FDD/PCell in TDD	13.4.0
2016/06	RP-72	RP-161142	3483		B	Measurement accuracy requirements for Rel-13 MTC UE	13.4.0
2016/06	RP-72	RP-161142	3484	1	F	Timing requirements for eMTC	13.4.0
2016/06	RP-72	RP-161141	3487		A	Physical channels undefined in RRM Test cases A.9.1.22, A.9.1.23	13.4.0
2016/06	RP-72	RP-161141	3489		A	Cleanup of Dual Connectivity RRM Test cases	13.4.0
2016/06	RP-72	RP-161141	3494	-	A	Corrections to values for 3DL RSTD test cases	13.4.0
2016/06	RP-72	RP-161141	3497	-	A	Removal of duplicated parameter from 3DL RSTD reporting delay test cases	13.4.0
2016/06	RP-72	RP-161129	3498	2	B	2DL/2UL FDD CA activation and deactivation of known PUCCH SCell without valid TA in non-DRX	13.4.0

2016/06	RP-72	RP-161142	3502	1	F	Rx-Tx time difference reporting CR not implemented: Not based on the latest version of the spec.	13.4.0
2016/06	RP-72	RP-161141	3506	-	A	Corrections in A.8.16.12, A.8.16.21, A.8.16.22, A.8.16.30, A.9.1.15 and A.9.1.37	13.4.0
2016/06	RP-72	RP-161141	3510	-	A	Editorial corrections	13.4.0
2016/06	RP-72	RP-161134	3512	-	B	CSI-RSRP measurement accuracy requirements	13.4.0
2016/06	RP-72	RP-161142	3515	-	F	A clarification on LAA band	13.4.0
2016/06	RP-72	RP-161142	3516	-	F	Editorial corrections for LAA	13.4.0
2016/06	RP-72	RP-161142	3519	1	F	Inter-frequency measurement requirements	13.4.0
2016/06	RP-72	RP-161128	3521	2	F	eMTC requirements with eDRX in RRC_CONNECTED	13.4.0
2016/06	RP-72	RP-161141	3526	-	F	CR on correction for section number of A.7.3.29	13.4.0
2016/06	RP-72	RP-161139	3528	-	A	CR on correction for test cases in A.8.16.17x Rel-13	13.4.0
2016/06	RP-72	RP-161142	3530	-	F	Editorial correction for title in section A.8 and A.9 Rel-13	13.4.0
2016/06	RP-72	RP-161141	3533	-	F	3DL/3UL TDD CA - UE Transmit Timing Accuracy Tests for 2SCells	13.4.0
2016/06	RP-72	RP-161142	3534	1	F	Test cases for E-UTRAN DC Inter-frequency identification of a new CGI of E-UTRA cell using autonomous gaps	13.4.0
2016/06	RP-72	RP-161128	3535	1	B	UE Timing Advance Adjustment Accuracy Test for Cat-M1 UE in CEModeA	13.4.0
2016/06	RP-72	RP-161168	3536	-	F	E-UTRAN 4DL CA activation and deactivation of know SCell in non-DRX	13.4.0
2016/06	RP-72	RP-161168	3537	-	F	E-UTRAN 5DL CA activation and deactivation of know SCell in non-DRX	13.4.0
2016/06	RP-72	RP-161141	3539	-	A	PCC and SCC assignment in 20MHz+10MHz test case A.9.1.24	13.4.0
2016/06	RP-72	RP-161142	3541	1	F	Modifications on LAA SCell activation delay requirements	13.4.0
2016/06	RP-72	RP-161133	3544	1	B	Antenna connection method for RLM and RRM tests with 4RX	13.4.0
2016/06	RP-72	RP-161132	3548	1	B	Dual connectivity enhancements test case : SSTD accuracy	13.4.0
2016/06	RP-72	RP-161132	3549	-	B	Dual connectivity enhancements test case : SSTD delay with DRX	13.4.0
2016/06	RP-72	RP-161132	3550	-	B	Dual connectivity enhancements test case : SSTD delay in non DRX	13.4.0
2016/06	RP-72	RP-161142	3553	-	F	Absolute and relative RSRP accuracies in FDD 4DL CA# 3	13.4.0
2016/06	RP-72	RP-161142	3554	-	F	Absolute and relative RSRP accuracies in TDD 4DL CA# 4	13.4.0
2016/06	RP-72	RP-161142	3555	1	F	PCell in FDD: absolute and relative RSRP accuracies in TDD-FDD 5 DL CA # 1	13.4.0
2016/06	RP-72	RP-161142	3556	1	F	PCell in TDD: absolute and relative RSRP accuracies in TDD-FDD 5 DL CA # 2	13.4.0
2016/06	RP-72	RP-161142	3557	-	F	Absolute and relative RSRQ accuracies in 5 DL FDD CA # 7	13.4.0
2016/06	RP-72	RP-161142	3558	-	F	Absolute and relative RSRQ accuracies in 5 DL TDD CA # 8	13.4.0
2016/06	RP-72	RP-161141	3559	-	F	Test Case on Random Acces for 3 DL/3UL TDD CA	13.4.0
2016/06	RP-72	RP-161129	3560	1	B	SCell activation and deactivation of known PUCCH SCell in TDD CA without valid TA	13.4.0
2016/06	RP-72	RP-161142	3562	-	F	E-UTRAN-WLAN RSSI event triggered reporting in non-DRX	13.4.0
2016/06	RP-72	RP-161128	3563	1	B	CR for Cat-M1 CEMode A RLM test cases: DRX FDD	13.4.0
2016/06	RP-72	RP-161128	3564	1	B	CR for Cat-M1 CEMode A RLM test cases: DRX HD-FDD	13.4.0
2016/06	RP-72	RP-161128	3565	1	B	CR for Cat-M1 CEMode A RLM test cases: DRX TDD	13.4.0
2016/06	RP-72	RP-161132	3567	-	B	CR on activation and deactivation of known SCell for 3DL CC DC	13.4.0
2016/06	RP-72	RP-161132	3568	-	B	CR on additional test requirements for Maximum transmission timing difference for DC	13.4.0
2016/06	RP-72	RP-161142	3569	-	F	CR on TDD-FDD 4DL CA activation and deactivation of known SCell in non-DRX	13.4.0
2016/06	RP-72	RP-161142	3570	1	F	CR on TDD-FDD 5DL CA activation and deactivation of known SCell in non-DRX	13.4.0
2016/06	RP-72	RP-161142	3571	-	F	CR on TDD-FDD 4DL CA activation and deactivation of unknown SCell in non-DRX	13.4.0
2016/06	RP-72	RP-161142	3572	1	F	CR on TDD-FDD 5DL CA activation and deactivation of unknown SCell in non-DRX	13.4.0
2016/06	RP-72	RP-161126	3573	1	B	CR on RRM requirements in Section 3 for NB-IoT	13.4.0
2016/06	RP-72	RP-161126	3574	1	B	Draft CR on RRM requirements in Annex B for NB-IoT	13.4.0

2016/06	RP-72	RP-161142	3578	1	F	Editorial corrections of an incorrect note for Band 32	13.4.0
2016/06	RP-72	RP-161142	3587	1	F	Modification on intra-frequency discovery signal measurement requirements in LAA	13.4.0
2016/06	RP-72	RP-161142	3591	2	F	Modification on CA requirements in LAA	13.4.0
2016/06	RP-72	RP-161141	3596	-	A	Correction of SCE event triggered reporting test cases for CSI-RS based discovery signal R13	13.4.0
2016/06	RP-72	RP-161129	3602	1	B	2DL/2UL TDD-FDD CA (TDD PCell) activation and deactivation of known PUCCH SCell without valid TA in non-DRX	13.4.0
2016/06	RP-72	RP-161132	3603	-	B	CR: Introduction of testing principle for different combination of duplex modes DC	13.4.0
2016/06	RP-72	RP-161141	3605	-	A	CR of RLM requirement for PSCell in dual connectivity R12	13.4.0
2016/06	RP-72	RP-161132	3606	-	B	E-UTRAN FDD - FDD DC intra-frequency identification of a new CGI of E-UTRA cell using autonomous gaps in synchronous DC	13.4.0
2016/06	RP-72	RP-161132	3607	-	B	E-UTRAN FDD - FDD DC intra-frequency identification of a new CGI of E-UTRA cell using autonomous gaps in asynchronous DC	13.4.0
2016/06	RP-72	RP-161132	3608	-	B	E-UTRAN TDD - TDD DC intra-frequency identification of a new CGI of E-UTRA cell using autonomous gaps in synchronous DC	13.4.0
2016/06	RP-72	RP-161142	3609	1	F	CR on UE transmit timing requirement	13.4.0
2016/06	RP-72	RP-161142	3612	-	F	PCell in FDD: absolute and relative RSRP accuracies in FDD-TDD 4DL CA	13.4.0
2016/06	RP-72	RP-161142	3613	-	F	PCell in TDD: absolute and relative RSRP accuracies in TDD-FDD 4DL CA.	13.4.0
2016/06	RP-72	RP-161142	3614	-	F	absolute and relative RSRP accuracies in FDD 5 DL CA	13.4.0
2016/06	RP-72	RP-161142	3615	-	F	absolute and relative RSRP accuracies in TDD 5 DL CA	13.4.0
2016/06	RP-72	RP-161128	3616	1	B	E-UTRAN Intra frequency case for Cat-M1 UE in normal coverage	13.4.0
2016/06	RP-72	RP-161128	3617	1	B	E-UTRAN FDD-FDD intra-frequency event triggered reporting under fading propagation conditions for Cat-M1 UE in CEModeA	13.4.0
2016/06	RP-72	RP-161128	3618	1	B	E-UTRAN HD-FDD intra-frequency event triggered reporting under fading propagation conditions for Cat-M1 UE in CEModeA	13.4.0
2016/06	RP-72	RP-161128	3619	1	B	E-UTRAN TDD-TDD intra-frequency event triggered reporting under fading propagation conditions for Cat-M1 UE in CEModeA	13.4.0
2016/06	RP-72	RP-161128	3620	1	B	CR on RSRP Intra frequency test cases for Cat-M1 UE in CEModeA	13.4.0
2016/06	RP-72	RP-161128	3621	-	B	PRACH configuration for eMTC	13.4.0
2016/06	RP-72	RP-161142	3622	2	F	CR on eMTC eDRX	13.4.0
2016/06	RP-72	RP-161128	3629	3	B	FD-FDD Radio Link Monitoring Test for Out-of-sync for Cat-M1 UE in CEModeA	13.4.0
2016/06	RP-72	RP-161128	3630	3	B	FD-FDD Radio Link Monitoring Test for In-sync for Cat-M1 UE in CEModeA	13.4.0
2016/06	RP-72	RP-161128	3631	3	B	HD-FDD Radio Link Monitoring Test for Out-of-sync for Cat-M1 UE in CEModeA: CR Not implemented as there are no track changes	13.4.0
2016/06	RP-72	RP-161128	3632	3	B	HD-FDD Radio Link Monitoring Test for In-sync for Cat-M1 UE in CEModeA	13.4.0
2016/06	RP-72	RP-161128	3633	3	B	TDD Radio Link Monitoring Test for Out-of-sync for Cat-M1 UE in CEModeA	13.4.0
2016/06	RP-72	RP-161128	3634	3	B	TDD Radio Link Monitoring Test for In-sync for Cat-M1 UE in CEModeA	13.4.0
2016/06	RP-72	RP-161132	3636	1	B	E-UTRAN FDD-FDD DC event triggered reporting under deactivated SCell with PCell and PSCell interruption in non-DRX in synchronous DC	13.4.0
2016/06	RP-72	RP-161132	3637	1	B	E-UTRAN FDD-FDD DC event triggered reporting under deactivated SCell with PCell and PSCell interruption in non-DRX in asynchronous DC	13.4.0
2016/06	RP-72	RP-161126	3638	1	B	Uplink transmit timing adjustments in HD-FDD operation	13.4.0
2016/06	RP-72	RP-161132	3639	1	B	E-UTRAN TDD-TDD DC event triggered reporting under deactivated SCell with PCell and PSCell interruption in non-DRX in synchronous DC	13.4.0
2016/06	RP-72	RP-161142	3640	1	F	4 DL CA PCell in FDD FDD-TDD RSRQ for E-UTRAN in Carrier Aggregation	13.4.0
2016/06	RP-72	RP-161142	3641	2	F	4 DL CA PCell in TDD TDD-FDD RSRQ for E-UTRAN in Carrier Aggregation	13.4.0

2016/06	RP-72	RP-161142	3642	2	F	5 DL PCell in FDD RSRQ for E-UTRAN in Carrier Aggregation	13.4.0
2016/06	RP-72	RP-161142	3643	2	F	5 DL PCell in TDD RSRQ for E-UTRAN in Carrier Aggregation	13.4.0
2016/06	RP-72	RP-161129	3644	1	B	2DL/2UL TDD-FDD CA (FDD PCell) activation and deactivation of known PUCCH SCell without valid TA in non-DRX	13.4.0
2016/06	RP-72	RP-161142	3647	2	F	CR: RRC re-establishment requirements for Cat-M1 UEs	13.4.0
2016/06	RP-72	RP-161128	3648	1	B	CR: Cat-M1 PRACH test cases for FDD in CEModeA	13.4.0
2016/06	RP-72	RP-161128	3649	1	B	CR: Cat-M1 PRACH test cases for HD-FDD in CEModeA	13.4.0
2016/06	RP-72	RP-161128	3650	1	B	CR: Cat-M1 PRACH test cases for TDD in CEModeA	13.4.0
2016/06	RP-72	RP-161128	3651	1	B	CR: Cat-M1 Intra-frequency handover test cases for CEModeA	13.4.0
2016/06	RP-72	RP-161142	3653	1	B	UE transmit timing test for eMTC UEs in CEModeA	13.4.0
2016/06	RP-72	RP-161128	3654	1	B	RRC Re-establishment test for eMTC UEs in CEModeA	13.4.0
2016/06	RP-72	RP-161142	3655	1	F	Defining of ProSe periodicity for ProSe inter-frequency and CA operation	13.4.0
2016/06	RP-72	RP-161141	3657	-	F	Editorial corrections in Rel-12 Cat-0 requirements	13.4.0
2016/06	RP-72	RP-161126	3659	2	B	Draft CR on RRC_IDLE state requirements for NB-IOT	13.4.0
2016/06	RP-72	RP-161168	3664	-	F	E-UTRAN 4DL CA activation and deactivation for unknown SCells without DRX	13.4.0
2016/06	RP-72	RP-161168	3665	-	F	E-UTRAN 5DL CA activation and deactivation of unknown SCell in non-DRX	13.4.0
2016/06	RP-72	RP-161142	3666	1	F	CR: Intra-frequency handover requirements for Cat-M1 UEs in CEModeB	13.4.0
2016/06	RP-72	RP-161126	3667	-	B	Modification on RRC re-establishment requirement for NB-IoT	13.4.0
2016/06	RP-72	RP-161126	3668	-	B	Modification for random access requirement for NB-IoT	13.4.0
2016/06	RP-72	RP-161126	3669	-	B	Intra-frequency Absolute NRSRP Accuracy for UE Category NB1 in Normal Mode	13.4.0
2016/06	RP-72	RP-161126	3670	-	B	Intra-frequency Absolute NRSRP Accuracy for UE Category NB1 in Enhanced Mode	13.4.0
2016/06	RP-72	RP-161126	3671	-	B	Intra-frequency Absolute NRSRQ Accuracy for UE Category NB1 in Normal Mode	13.4.0
2016/06	RP-72	RP-161126	3672	-	B	Intra-frequency Absolute NRSRQ Accuracy for UE Category NB1 in Enhanced Mode	13.4.0
2016/06	RP-72	RP-161126	3673	-	B	Inter-frequency Absolute NRSRP Accuracy for UE Category NB1 in Normal Mode	13.4.0
2016/06	RP-72	RP-161126	3674	-	B	Inter-frequency Absolute NRSRP Accuracy for UE Category NB1 in Enhanced Mode	13.4.0
2016/06	RP-72	RP-161126	3675	1	B	CR on measurement requirement in RRC_CONNECTED state for NB-IoT	13.4.0
2016/06	RP-72	RP-161126	3676	-	B	CR on Radio Link Monitoring for NB-IoT	13.4.0
2016/06	RP-72	RP-161125	3495	-	B	Introduction of Band 70 to 36.133	14.0.0
2016/06	RP-72	RP-161124	3579	1	B	Introduction of 2.6GHz SDL	14.0.0
2016/09	RP-73	RP-161634	3679	-	A	Duration of T3 in RRM 3DL Test cases A.8.16.31, A.8.16.32, A.8.16.33, A.8.16.34.	14.1.0
2016/09	RP-73	RP-161640	3681	-	A	Duration of T3 in RRM 4DL/5DL Test cases A.8.16.55, A.8.16.56, A.8.16.73, A.8.16.74.	14.1.0
2016/09	RP-73	RP-161613	3683	-	A	Square bracket removal for RLM antenna connection for 4 Rx capable UEs	14.1.0
2016/09	RP-73	RP-161614	3685	-	A	LAA channel occupancy test	14.1.0
2016/09	RP-73	RP-161783	3687	-	A	LBT model for LAA RRM tests	14.1.0
2016/09	RP-73	RP-161614	3689	-	A	LAA Average RSSI accuracy test	14.1.0
2016/09	RP-73	RP-161619	3690	1	B	Higher resolution RSTD measurement report mapping	14.1.0
2016/09	RP-73	RP-161616	3691	2	B	eLAA RRM requirements	14.1.0
2016/09	RP-73	RP-161612	3695	-	A	Intra-frequency FDD test cases for RS-SINR	14.1.0
2016/09	RP-73	RP-161612	3697	-	A	Intra-frequency TDD test cases for RS-SINR	14.1.0
2016/09	RP-73	RP-161638	3699	-	A	Applicability of intra-frequency maximum measurement time requirements	14.1.0
2016/09	RP-73	RP-161638	3703	-	A	Known cell requirements	14.1.0
2016/09	RP-73	RP-161783	3705	-	A	Channel occupancy accuracy requirements	14.1.0
2016/09	RP-73	RP-161780	3707	-	A	CR: Reference NPRACH Configuration for NB-IoT RRM test cases	14.1.0
2016/09	RP-73	RP-161637	3709	-	A	CR: Corrections on Section 4.6 "Cell Selection and Re-selection Requirements for UE category NB1	14.1.0
2016/09	RP-73	RP-161639	3715	-	A	CR: Correction of E-CID RSRP measurement requirements for Cat-M1 UEs	14.1.0
2016/09	RP-73	RP-161610	3717	-	A	CR: OCN patterns for Cat-M1 RRM Tests	14.1.0

2016/09	RP-73	RP-161610	3719	-	A	CR: Correction of Cat-M1 Intra-frequency handover test cases for CEModeA	14.1.0
2016/09	RP-73	RP-161610	3721	-	A	CR: Correction of Transmit Timing Accuracy Tests for Cat-M1 UE in CEModeA	14.1.0
2016/09	RP-73	RP-161782	3725	-	A	CR: Cat-M1 PRACH test cases for FDD in Enhanced Coverage	14.1.0
2016/09	RP-73	RP-161782	3727	-	A	CR: Cat-M1 PRACH test cases for HD-FDD in Enhanced Coverage	14.1.0
2016/09	RP-73	RP-161782	3729	-	A	CR: Cat-M1 PRACH test cases for TDD in Enhanced Coverage	14.1.0
2016/09	RP-73	RP-161612	3740	-	A	CR on RS-SINR TDD-FDD inter-frequency accuracy test case	14.1.0
2016/09	RP-73	RP-161612	3741	-	A	CR on RS-SINR FDD-TDD inter-frequency accuracy test case	14.1.0
2016/09	RP-73	RP-161612	3743	-	A	CR on RS-SINR measurement accuracy requirements	14.1.0
2016/09	RP-73	RP-161617	3744	1	B	CR of core requirements for V2V service	14.1.0
2016/09	RP-73	RP-161783	3751	-	A	CR of FDD intrafrequency absolute and relative RSRP accuracy test for SCell with FS3	14.1.0
2016/09	RP-73	RP-161783	3752	-	A	CR of TDD intrafrequency absolute and relative RSRP accuracy test for SCell with FS3	14.1.0
2016/09	RP-73	RP-161783	3753	-	A	CR of FDD intrafrequency RSRQ measurement accuracy test for SCell with FS3	14.1.0
2016/09	RP-73	RP-161783	3754	-	A	CR of TDD intrafrequency RSRQ measurement accuracy test for SCell with FS3	14.1.0
2016/09	RP-73	RP-161627	3755	-	F	CR of Applicability of requirements for xDL2UL CA	14.1.0
2016/09	RP-73	RP-161781	3757	-	A	CR for Cat-M1 CEMode A RLM test cases: DRX FDD	14.1.0
2016/09	RP-73	RP-161781	3759	-	A	CR for Cat-M1 CEMode A RLM test cases: DRX HD-FDD	14.1.0
2016/09	RP-73	RP-161781	3761	-	A	CR for Cat-M1 CEMode A RLM test cases: DRX TDD	14.1.0
2016/09	RP-73	RP-161640	3767	-	A	CR on modification on report mapping of TADV measurement in TS36.133 for Rel-14	14.1.0
2016/09	RP-73	RP-161636	3769	-	A	Editing change in TS36.133 for Rel-14	14.1.0
2016/09	RP-73	RP-161614	3771	-	A	LAA SCell activation and deactivation for known SCells without DRX	14.1.0
2016/09	RP-73	RP-161783	3773	-	A	Event triggered reporting on LAA deactivated SCells and interruption probability (0.5%) without DRX	14.1.0
2016/09	RP-73	RP-161631	3785	-	A	Correction to RSTD Test Cases for 1.4 MHz	14.1.0
2016/09	RP-73	RP-161635	3787	-	F	Correction to Band 66 notes in E-UTRA band groups in Rel-14	14.1.0
2016/09	RP-73	RP-161609	3791	-	A	RMCs for NPDSCH and NPDCCH for in-band for NB-IoT test cases	14.1.0
2016/09	RP-73	RP-161634	3804	-	A	Resolving TBDs in HD-FDD RLM test-cases for Rel-12 category 0 UEs	14.1.0
2016/09	RP-73	RP-161610	3806	-	A	E-UTRAN UE Transmit Timing Accuracy Tests for Cat-M1 UE in CEModeB	14.1.0
2016/09	RP-73	RP-161610	3811	-	A	RRC Re-establishment test for eMTC UEs in CEModeB	14.1.0
2016/09	RP-73	RP-161635	3828	-	A	Correction to DL RMCs for Cell1 in A 8.16.25	14.1.0
2016/09	RP-73	RP-161612	3832	-	A	CR on FDD-FDD inter-frequency RS-SINR accuracy test case R14	14.1.0
2016/09	RP-73	RP-161612	3834	-	A	CR on TDD-TDD inter-frequency RS-SINR accuracy test case R14	14.1.0
2016/09	RP-73	RP-161638	3838	-	A	Definition and abbreviation of frame structure 3	14.1.0
2016/09	RP-73	RP-161638	3840	-	A	Editorial correction on LAA measurement requirements	14.1.0
2016/09	RP-73	RP-161614	3842	-	A	Intra-frequency event triggered reporting under fading propagation conditions in synchronous cells in non-DRX based on CRS under Operation with Frame Structure 3	14.1.0
2016/09	RP-73	RP-161614	3844	-	A	Intra-frequency event triggered reporting under fading propagation conditions in synchronous cells in DRX based on CRS under Operation with Frame Structure 3	14.1.0
2016/09	RP-73	RP-161638	3846	-	A	CR on inter-frequency infinite measurement in LAA R14	14.1.0
2016/09	RP-73	RP-161638	3848	-	A	Correction on discovery signal conditions in LAA R14	14.1.0
2016/09	RP-73	RP-161616	3849	1	B	CR on RACH in eLAA	14.1.0
2016/09	RP-73	RP-161785	3854	-	A	Modification on inter-frequency CSI-RS related test cases R14	14.1.0
2016/09	RP-73	RP-161785	3857	-	A	Modification on CSI-RS related CA test cases R14	14.1.0
2016/09	RP-73	RP-161785	3860	-	A	Correction on discovery signal conditions for SCE R14	14.1.0
2016/09	RP-73	RP-161785	3863	-	A	Correction of Band group for TDD SCE test R14	14.1.0
2016/09	RP-73	RP-161785	3866	-	A	Correction on accuracy test cases for CRS based measurement R14	14.1.0

2016/09	RP-73	RP-161610	3868	-	A	E-UTRAN Intra frequency case for Cat-M1 UE in enhanced coverage R14	14.1.0
2016/09	RP-73	RP-161610	3870	-	A	E-UTRAN FDD-FDD intra-frequency event triggered reporting under fading propagation conditions for Cat-M1 UE in CEModeB R14	14.1.0
2016/09	RP-73	RP-161610	3872	-	A	E-UTRAN HD-FDD intra-frequency event triggered reporting under fading propagation conditions for Cat-M1 UE in CEModeB R14	14.1.0
2016/09	RP-73	RP-161610	3874	-	A	E-UTRAN TDD-TDD intra-frequency event triggered reporting under fading propagation conditions for Cat-M1 UE in CEModeB R14	14.1.0
2016/09	RP-73	RP-161610	3876	-	A	RSRP Intra frequency case for Cat-M1 UE in CEModeB R14	14.1.0
2016/09	RP-73	RP-161782	3878	-	A	CR on PRACH configuration reference R14	14.1.0
2016/09	RP-73	RP-161639	3884	-	A	CR on eMTC maintenance R14	14.1.0
2016/09	RP-73	RP-161639	3886	-	A	CGI requirement for eMTC R14	14.1.0
2016/09	RP-73	RP-161639	3890	-	A	Correction on UE Category M1 measurement requirement R14	14.1.0
2016/09	RP-73	RP-161637	3892	-	A	CR for NB-IoT RRC re-establishment R14	14.1.0
2016/09	RP-73	RP-161637	3900	-	A	Modification on requirement of measurement in RRC_CONNECTED for NB-IoT R14	14.1.0
2016/09	RP-73	RP-161637	3904	-	A	CR for Conditions on NSCH \bar{E}_s /lot of identified and of the neighbour cell R14	14.1.0
2016/09	RP-73	RP-161780	3906	-	A	CR for OCNG pattern for NB-IoT standalone operation R14	14.1.0
2016/09	RP-73	RP-161609	3908	1	A	HD-FDD Intra-frequency RRC Re-establishment for UE category NB1 under normal coverage R14	14.1.0
2016/09	RP-73	RP-161609	3910	1	A	HD-FDD Inter-frequency RRC Re-establishment for UE category NB1 under enhanced coverage R14	14.1.0
2016/09	RP-73	RP-161609	3914	-	A	CR: RMCs for NPDCCH RMCs for standalone and guard band NB-IoT test cases R14	14.1.0
2016/09	RP-73	RP-161609	3915	-	A	CR: RMCs for NPDCCH RMCs for standalone and guard band NB-IoT test cases R14	14.1.0
2016/09	RP-73	RP-161780	3916	-	A	CR of OCNG pattern for guard band for NB-IoT test cases R14	14.1.0
2016/09	RP-73	RP-161609	3918	-	A	Introduce inter-frequency NRSRQ measurement accuracy requirement R14	14.1.0
2016/09	RP-73	RP-161609	3920	-	A	Modification on Conditions for NB-IoT inter-frequency Accuracy Requirements for UE Category NB1 R14	14.1.0
2016/09	RP-73	RP-161784	3923	-	A	CR of test principle for DC test cases with different bandwidth combinations R14	14.1.0
2016/09	RP-73	RP-161780	3926	1	A	CR OCNG pattern for in-band RRM tests	14.1.0
2016/09	RP-73	RP-161634	3930	-	A	CR for correction to some parameters in D2D RRM tests	14.1.0
2016/09	RP-73	RP-161614	3934	-	A	Inter-frequency event triggered reporting	14.1.0
2016/09	RP-73	RP-161614	3935	1	A	Intra-frequency absolute and relative CSI-RSRP accuracies for SCell with FS3	14.1.0
2016/09	RP-73	RP-161616	3937	1	B	Clarification for TAGs with FS3 cells	14.1.0
2016/09	RP-73	RP-161609	3945	-	A	E-UTRAN UE Timing Advance Adjustment Accuracy Test for NB-IoT UE in Enhanced Coverage	14.1.0
2016/09	RP-73	RP-161781	3947	-	A	HD-FDD Radio Link Monitoring Test for Out-of-sync for Cat-M1 UE in CEModeA	14.1.0
2016/09	RP-73	RP-161781	3858	-	A	Corrections on FD-FDD Radio Link Monitoring Test for Out-of-sync for Cat-M1 UE in CEModeA	14.1.0
2016/09	RP-73	RP-161781	3960	-	A	Corrections on FD-FDD Radio Link Monitoring Test for In-sync for Cat-M1 UE in CEModeA	14.1.0
2016/09	RP-73	RP-161781	3962	-	A	Corrections on HD-FDD Radio Link Monitoring Test for In-sync for Cat-M1 UE in CEModeA	14.1.0
2016/09	RP-73	RP-161781	3964	-	A	Corrections on TDD Radio Link Monitoring Test for Out-of-sync for Cat-M1 UE in CEModeA	14.1.0
2016/09	RP-73	RP-161781	3966	-	A	Corrections on TDD Radio Link Monitoring Test for In-sync for Cat-M1 UE in CEModeA	14.1.0
2016/09	RP-73	RP-161637	3969	-	A	Correction CR on UE Measurement Capability for NB-IOT	14.1.0
2016/09	RP-73	RP-161637	3972	-	A	Correction to Radio Link Monitoring Requirements for NB-IoT	14.1.0
2016/09	RP-73	RP-161609	3973	-	A	Power headroom reporting requirements	14.1.0
2016/09	RP-73	RP-161611	3974	-	A	CR on eD2D RRM tests	14.1.0
2016/12	RP-74	RP-162430	3979	-	A	Correction of RRC re-establishment delay for eMTC	14.2.0
2016/12	RP-74	RP-162430	3980	2	A	Correction of transmit timing for category M1	14.2.0
2016/12	RP-74	RP-162384	3990	-	A	UE Timing Advance Adjustment Accuracy Test for Cat-M1 UE in CEModeB	14.2.0
2016/12	RP-74	RP-162423	3997	1	A	Corrections to Antenna connection for 4 Rx capable UEs	14.2.0

2016/12	RP-74	RP-162458	4001	-	A	Corrections on inter-frequency measurement test cases for IncMon in R14	14.2.0
2016/12	RP-74	RP-162424	4006	-	A	Corrections on DC measurements test cases R14	14.2.0
2016/12	RP-74	RP-162424	4008	-	A	Corrections on DC test cases for measurements with autonomous gaps R14	14.2.0
2016/12	RP-74	RP-162385	4010	1	A	Corrections on RLM test cases for Cat-M1 UE in R14	14.2.0
2016/12	RP-74	RP-162433	4017	-	A	CR on RRC re-establishment RRM requirement R14	14.2.0
2016/12	RP-74	RP-162435	4015	-	A	Introduce test requirements for E-UTRAN TDD - TDD Intra frequency handover for UE category 0 R14	14.2.0
2016/12	RP-74	RP-162426	4027	-	A	CR on eDRX maintenance R14	14.2.0
2016/12	RP-74	RP-162431	4029	-	A	CR on TDD CEModeB measurement requirement R14	14.2.0
2016/12	RP-74	RP-162431	4031	-	A	CR on eMTC maintenance R14	14.2.0
2016/12	RP-74	RP-162459	4043	-	A	Correction on the test cases of autonomous gaps in R14	14.2.0
2016/12	RP-74	RP-162387	4071	1	B	eLAA RRM requirements	14.2.0
2016/12	RP-74	RP-162384	4083	-	A	CR: Cat-M1 Editorial Corrections	14.2.0
2016/12	RP-74	RP-162385	4098	1	F	Correction to RRC reestablishment test case in CE mode A	14.2.0
2016/12	RP-74	RP-162385	4102	1	F	Correction to transmit timing accuracy test case in CE mode A	14.2.0
2016/12	RP-74	RP-162430	4104	2	A	Modification to Handover Delay in CE ModeA	14.2.0
2016/12	RP-74	RP-162430	4108	1	A	Modification to Handover Delay in CE ModeB	14.2.0
2016/12	RP-74	RP-162434	4112	1	F	Corrections on NPDCCH transmission parameters	14.2.0
2016/12	RP-74	RP-162429	4116	-	A	CR on finalization of RS-SINR measurement accuracy requirements	14.2.0
2016/12	RP-74	RP-162428	4123	-	A	Correction on the discovery signal measurements under FS3 R14	14.2.0
2016/12	RP-74	RP-162428	4125	-	A	Editorial correction on the measurement applicability in LAA R14	14.2.0
2016/12	RP-74	RP-162416	4128	-	A	Corrections to 3DL CA Event triggered reporting Test cases A.8.16.29, A.8.16.30	14.2.0
2016/12	RP-74	RP-162459	4134	-	A	CR on CSI-RS based measurement conditions R14	14.2.0
2016/12	RP-74	RP-162432	4144	-	A	Correction to levels in LTE-WLAN RRM test	14.2.0
2016/12	RP-74	RP-162431	4148	-	A	Correction to RRC re-establishment requirements in eMTC	14.2.0
2016/12	RP-74	RP-162431	4150	-	A	Requirements for RRC Connection Release with Redirection in eMTC	14.2.0
2016/12	RP-74	RP-162434	4152	-	A	Requirements for redirection to non-anchor carrier	14.2.0
2016/12	RP-74	RP-162434	4158	-	A	CR on PTW length in cell reselection requirement for NB-IoT	14.2.0
2016/12	RP-74	RP-162385	4160	-	A	CR for Cat-M1 CEMode A RLM DRX test cases	14.2.0
2016/12	RP-74	RP-162424	4161	-	A	Modifications on SSTD measurement reporting	14.2.0
2016/12	RP-74	RP-162384	4163	1	A	CR on cell re-selection test case for Cat-M1 in normal coverage	14.2.0
2016/12	RP-74	RP-162382	4167	1	A	CR on RRC re-establishment test case for Cat-M1 in CE Mode A	14.2.0
2016/12	RP-74	RP-162382	4169	-	A	CR on RRC re-establishment test case for Cat-M1 in CE Mode B	14.2.0
2016/12	RP-74	RP-162433	4170	-	A	Correction of transmit timing for NB-IoT	14.2.0
2016/12	RP-74	RP-162415	4175	-	A	PCC and SCC assignment in 20MHz+10MHz test case A.8.20.2B and A.9.2.27	14.2.0
2016/12	RP-74	RP-162418	4178	-	A	Remove redundant requirement for Intra-frequency relative CSI-RSRP	14.2.0
2016/12	RP-74	RP-162420	4181	-	A	Correct InformationBitPayload for Sub-Frame 1, 6 and Max T-put of TDD PDSCH RMC	14.2.0
2016/12	RP-74	RP-162382	4185	-	A	Correction to Es/Noc, Es/Iot and RSRP values in Idle mode re-selection test in normal coverage	14.2.0
2016/12	RP-74	RP-162382	4187	-	A	Corrections to rsrp-ThresholdsPrach and test requirement in Random Access Test in enhanced coverage	14.2.0
2016/12	RP-74	RP-162405	4194	-	B	Introduction of Band 48 to 36.133	14.2.0
2016/12	RP-74	RP-162435	4198	-	A	4 DL CA PCell in FDD FDD-TDD RSRQ for E-UTRAN in Carrier Aggregation	14.2.0
2016/12	RP-74	RP-162435	4200	-	A	4 DL CA PCell in TDD TDD-FDD RSRQ for E-UTRAN in Carrier Aggregation	14.2.0
2016/12	RP-74	RP-162435	4204	-	A	5 DL PCell in TDD RSRQ for E-UTRAN in Carrier Aggregation	14.2.0
2016/12	RP-74	RP-162379	4206	-	A	Clarification to applicability of NRSRQ for UE category NB1	14.2.0
2016/12	RP-74	RP-162433	4208	-	A	Introducing agreed measurement period for NB IoT connected mode	14.2.0
2016/12	RP-74	RP-162456	4210	2	A	Introducing agreed measurement accuracy for NB IoT	14.2.0

2016/12	RP-74	RP-162388	4217	2	B	CR for RRM requirements in idle mode for high speed conditions	14.2.0
2016/12	RP-74	RP-162382	4221	-	A	CR: E-UTRAN FDD-FDD Intra frequency handover for Cat-M1 UEs in CEModeB (Rel-14)	14.2.0
2016/12	RP-74	RP-162382	4223	-	A	CR: E-UTRAN HD-FDD Intra frequency handover for Cat-M1 UEs in CEModeB (Rel-14)	14.2.0
2016/12	RP-74	RP-162382	4225	-	A	CR: E-UTRAN TDD-TDD Intra frequency handover for Cat-M1 UEs in CEModeB (Rel-14)	14.2.0
2016/12	RP-74	RP-162391	4228	2	B	CR to introduce handover requirements for mobility enhancement	14.2.0
2016/12	RP-74	RP-162409	4229	1	F	CR on reliability of GNSS	14.2.0
2016/12	RP-74	RP-162386	4232	1	A	CR for Inter-frequency event triggered reporting	14.2.0
2016/12	RP-74	RP-162379	4237	-	A	CR on UE Transmit Timing Accuracy Tests for NB-IoT UE	14.2.0
2016/12	RP-74	RP-162379	4239	-	A	CR for PHR requirement for NB-IoT R14	14.2.0
2016/12	RP-74	RP-162379	4241	-	A	CR for NPDCCH RMC R14	14.2.0
2016/12	RP-74	RP-162380	4243	-	A	CR for NPDSCH RMC R14	14.2.0
2016/12	RP-74	RP-162456	4245	1	F	CR on test parameter for RRC re-establishment R14	14.2.0
2016/12	RP-74	RP-162380	4246	-	F	CR on NB-IoT measurement conditions R14	14.2.0
2016/12	RP-74	RP-162380	4248	-	A	HD-FDD radio Link Monitoring Test for Out-of-sync in DRX for UE category NB1 under normal coverage R14	14.2.0
2016/12	RP-74	RP-162380	4250	-	A	HD-FDD radio Link Monitoring Test for Out-of-sync in DRX for UE category NB1 under enhanced coverage R14	14.2.0
2016/12	RP-74	RP-162382	4252	-	A	Correction on test parameter in RSRP Intra frequency case for Cat-M1 UE in CE mode A R14	14.2.0
2016/12	RP-74	RP-162382	4254	-	A	Correction on test parameter in RSRP Intra frequency case for Cat-M1 UE in CE mode B R14	14.2.0
2016/12	RP-74	RP-162382	4256	-	A	Introduce RSRP accuracy test case for Band 31 for Cat-M1 UE R14	14.2.0
2016/12	RP-74	RP-162383	4258	-	A	Introduce 5MHz Bandwidth MPDCCH Reference Channel for Cat-M1 UE R14	14.2.0
2016/12	RP-74	RP-162383	4260	-	A	Introduce 5MHz Bandwidth MPDSCH Reference Channel for Cat-M1 UE R14	14.2.0
2016/12	RP-74	RP-162383	4262	-	A	Introduce 5MHz Bandwidth OCNG for Cat-M1 UE R14	14.2.0
2016/12	RP-74	RP-162433	4264	-	A	CR on RRC re-establishment RRM requirement R14	14.2.0
2016/12	RP-74	RP-162433	4266	-	A	CR on paging interruption for NB-IoT R14	14.2.0
2016/12	RP-74	RP-162430	4270	-	A	CR on CGI reading of eMTC R14	14.2.0
2016/12	RP-74	RP-162430	4272	-	A	CR on handover of eMTC R14	14.2.0
2016/12	RP-74	RP-162383	4280	-	A	CR on modification of cell reselection test case R14	14.2.0
2016/12	RP-74	RP-162420	4288	-	A	Corrections on DC interruption test cases R14	14.2.0
2016/12	RP-74	RP-162388	4291	1	B	CR on the enhanced RRM requirements in connected mode under high speed scenario	14.2.0
2016/12	RP-74	RP-162392	4293	3	B	CR on interruption requirements in SRS switching	14.2.0
2016/12	RP-74	RP-162418	4299	-	A	Correction on SCE test cases R14	14.2.0
2016/12	RP-74	RP-162420	4302	-	A	Correction on the test cases of RSTD Measurement in R14	14.2.0
2016/12	RP-74	RP-162420	4305	-	A	Corrections on the test cases of UE measurement procedures and measurement performance requirements in R14	14.2.0
2016/12	RP-74	RP-162383	4309	1	A	SI reading tests for eMTC UEs in CEModeB	14.2.0
2016/12	RP-74	RP-162456	4315	1	A	RLM in-sync test DRX under enhanced coverage	14.2.0
2016/12	RP-74	RP-162456	4316	1	A	RLM in-sync test with DRX under normal coverage	14.2.0
2016/12	RP-74	RP-162456	4319	1	A	Intra-frequency cell reselection under normal coverage for NB-IOT	14.2.0
2016/12	RP-74	RP-162383	4321	1	A	Applicability rule for eMTC test cases in CEModeA and CEModeB	14.2.0
2016/12	RP-74	RP-162387	4343	1	F	eLAA requirements corrections	14.2.0
2016/12	RP-74	RP-162420	4348	-	A	RRM: Correction to TCs A.7.1.7A and A.7.1.7B (Rel-14)	14.2.0
2016/12	RP-74	RP-162383	4352	-	A	Correction to the handover test case in CE mode A	14.2.0
2016/12	RP-74	RP-162414	4354	-	A	PCFICH/PDCCH/PHICH Reference channel in UE Cat 0 new CGI RRM test cases	14.2.0
2016/12	RP-74	RP-162392	4355	1	B	Requirements with SRS carrier based switching	14.2.0
2016/12	RP-74	RP-162417	4358	-	A	Correction to RRM tests on dual connectivity	14.2.0
2016/12	RP-74	RP-162430	4361	-	A	Correction of paging interruption for eMTC	14.2.0
2016/12	RP-74	RP-162380	4362	1	A	CR on RLM in-sync test without DRX under normal coverage	14.2.0
2016/12	RP-74	RP-162380	4364	1	A	CR on RLM in-sync test without DRX under enhanced coverage	14.2.0

2016/12	RP-74	RP-162392	4365	1	F	Correction on random access requirement for SRS switching	14.2.0
2016/12	RP-74	RP-162407	4366	-	B	Introduction of new bands for NB-IoT in 36.133	14.2.0
2017/03	RP-75	RP-170595	4368		A	Correction to transmit timing accuracy test case in Cat-m1 CE mode B	14.3.0
2017/03	RP-75	RP-170596	4372		A	Correction to the intra-frequency reselection requirements in Cat-m1 enhanced coverage	14.3.0
2017/03	RP-75	RP-170595	4374		A	Correction to intra-frequency handover test case in CE mode B	14.3.0
2017/03	RP-75	RP-170595	4376		A	Correction to intra-frequency handover test case in CE mode A	14.3.0
2017/03	RP-75	RP-170597	4378		A	Modification the intra-frequency event triggered reporting test cases in Cat-m1 CE mode B	14.3.0
2017/03	RP-75	RP-170596	4380		A	Correction to the CGI requirement test case in Cat-M1	14.3.0
2017/03	RP-75	RP-170597	4382		A	Editorial correction to the CGI requirements	14.3.0
2017/03	RP-75	RP-170596	4384		A	Correction to payload sizes in reference channels for Cat-m1	14.3.0
2017/03	RP-75	RP-170598	4388	1	F	CR Update to Radio Link Monitoring Requirements for NB-IoT	14.3.0
2017/03	RP-75	RP-170598	4390		A	Correction CR on RRC_IDLE state requirements for NB-IOT	14.3.0
2017/03	RP-75	RP-170563	4391	2	B	CR for RRM core requirement for Cat.1 UE with single receiver chain (Part 1)	14.3.0
2017/03	RP-75	RP-170563	4392	1	B	CR for RRM core requirement for Cat.1 UE with single receiver chain (Part 2)	14.3.0
2017/03	RP-75	RP-170596	4395		A	Correction to prach-ConfigIndex for TDD Random Access Test for Cat-M1	14.3.0
2017/03	RP-75	RP-170596	4399		A	Corrections to UE Cat M1 Intra-frequency Event triggered Reporting CE Mode A Test Cases	14.3.0
2017/03	RP-75	RP-170588	4401		A	Correct 4DL Act-deact Unknown SCell Test Cases A.8.16.63 and A.8.16.64	14.3.0
2017/03	RP-75	RP-170600	4403		A	Correct parameters for UE Category NB1 Reselection Test Case A.4.2.18	14.3.0
2017/03	RP-75	RP-170595	4405		A	Correct Frequency hopping parameters for UE Cat M1 PDSCH Reference channel	14.3.0
2017/03	RP-75	RP-170596	4407		A	Correction to OCNG pattern for CatM1 FD-FDD and HD-FDD re-establishment TCs	14.3.0
2017/03	RP-75	RP-170596	4420		A	Corrections to UE Cat M1 Intra-frequency Event triggered Reporting CE Mode B Test Cases	14.3.0
2017/03	RP-75	RP-170597	4424		A	RRM: Corrections to eMTC PRACH TC A.6.2.10 and A.6.2.11 (Rel-14)	14.3.0
2017/03	RP-75	RP-170559	4428	1	B	CR on Initiation/Cease of SLSS Transmissions	14.3.0
2017/03	RP-75	RP-170559	4430	2	B	CR on Autonomous Resource Selection/Reselection measurements	14.3.0
2017/03	RP-75	RP-170559	4431	1	B	CR on PSSCH-RSRP measurement accuracy requirement	14.3.0
2017/03	RP-75	RP-170559	4432	1	B	CR on Intra-Frequency S-RSRP Measurement Accuracy Requirements	14.3.0
2017/03	RP-75	RP-170559	4433	1	B	CR on Side conditions for V2X measurements	14.3.0
2017/03	RP-75	RP-170596	4437		A	CR on initial PRACH transmit power in RA test for Cat-M1 CEMode B R14	14.3.0
2017/03	RP-75	RP-170554	4438	2	B	CR to introduce test case for V2V interruption	14.3.0
2017/03	RP-75	RP-170560	4439	1	B	CR on feMTC measurement requirements section 4	14.3.0
2017/03	RP-75	RP-170579	4443		F	CR on HST connected mode measurement requirement	14.3.0
2017/03	RP-75	RP-170557	4444		F	CR to finalize handover requirements for further mobility enhancement	14.3.0
2017/03	RP-75	RP-170594	4448		A	Correction to core requirement of RRC re-establishment in Cat-m1	14.3.0
2017/03	RP-75	RP-170594	4450		A	Correction to core requirement of Handover in Cat-m1	14.3.0
2017/03	RP-75	RP-170597	4452	1	A	Removing square brackets from RLM test case in Cat-m1	14.3.0
2017/03	RP-75	RP-170554	4459	1	B	CR on UE transmission timing accuracy test for V2V	14.3.0
2017/03	RP-75	RP-170559	4460	2	B	CR on interruption requirements for V2X	14.3.0
2017/03	RP-75	RP-170559	4461	2	B	CR on Selection / Reselection of Synchronization Reference for V2X	14.3.0
2017/03	RP-75	RP-170559	4462	1	B	CR on S-RSSI measurement accuracy requirement for V2X	14.3.0
2017/03	RP-75	RP-170559	4463	1	B	CR on Congestion Control Measurements Requirements for V2X	14.3.0
2017/03	RP-75	RP-170577	4464	1	B	CR on Introducing inter-cell synchronization requirements for MBMS R14	14.3.0
2017/03	RP-75	RP-170600	4466		A	CR on RRC re-establishment test case R14	14.3.0

2017/03	RP-75	RP-170601	4472		A	Remove square brackets in NB-IoT performance requirement R14	14.3.0
2017/03	RP-75	RP-170581	4477		A	Correction on test parameter in RSRP Intra frequency case for UE category 0 R14	14.3.0
2017/03	RP-75	RP-170595	4480		A	Correction on RSRP level in RSRP Intra frequency case for Cat-M1 UE in CEModeB R14	14.3.0
2017/03	RP-75	RP-170595	4482		A	Correction of 8.13 Measurements for UE Category M1 R14	14.3.0
2017/03	RP-75	RP-170564	4484	1	A	CR on WLAN RSSI R14	14.3.0
2017/03	RP-75	RP-170594	4489	1	A	Not implement CRs for eMTC R14	14.3.0
2017/03	RP-75	RP-170560	4502	1	B	CR on E-CID RSRP RSRQ measurement requirement for FeMTC	14.3.0
2017/03	RP-75	RP-170600	4508		A	CR for the correction on the testcases of HD-FDD Radio Link Monitoring for UE category NB1 in R14	14.3.0
2017/03	RP-75	RP-170603	4510	1	A	Correction on measurement performance requirements for UE category M1 in R14	14.3.0
2017/03	RP-75	RP-170585	4513		A	CR for the correction on the testcases of Proximity-based Services and measurement performance requirement in R14	14.3.0
2017/03	RP-75	RP-170555	4514	1	B	CR on measurement accuracy requirements under high speed scenarios	14.3.0
2017/03	RP-75	RP-170591	4518	1	F	Remove the bracket in LAA requirements R14	14.3.0
2017/03	RP-75	RP-170592	4520		A	Correction on LAA test cases R14	14.3.0
2017/03	RP-75	RP-170592	4522		A	Correction on p-C-r10 value for LAA test cases R14	14.3.0
2017/03	RP-75	RP-170584	4525		A	Correction on SCE event triggered reporting for CSI-RS based test cases R14	14.3.0
2017/03	RP-75	RP-170559	4529	1	B	CR on UE transmission timing requirements for V2X	14.3.0
2017/03	RP-75	RP-170601	4543	1	A	Test on Intra-frequency cell reselection in enhanced coverage	14.3.0
2017/03	RP-75	RP-170595	4545		A	Correction to Cat-M1 UE RRC re-establishment tests	14.3.0
2017/03	RP-75	RP-170581	4550		A	Correction of RMC reference in the cat-0 HD-FDD intra-frequency test case	14.3.0
2017/03	RP-75	RP-170594	4552		A	Clarification on measurement reporting delay for eMTC	14.3.0
2017/03	RP-75	RP-170560	4554	3	B	Introducing intra-frequency measurement requirements for UE category M2 in normal coverage/CEModeA	14.3.0
2017/03	RP-75	RP-170560	4555	1	B	Introducing intra-frequency measurement requirements for UE category M2 in enhanced coverage/CEModeB	14.3.0
2017/03	RP-75	RP-170560	4556	2	B	Introducing inter-frequency measurement requirements for UE category M2 in normal coverage/CEModeA	14.3.0
2017/03	RP-75	RP-170560	4557	3	B	Introducing inter-frequency measurement requirements for UE category M2 in enhanced coverage/CEModeB	14.3.0
2017/03	RP-75	RP-170598	4565		A	Correction to redirection to NB-IoT non-anchor carrier	14.3.0
2017/03	RP-75	RP-170594	4567		A	Correction to RRC release with redirection in eMTC	14.3.0
2017/03	RP-75	RP-170582	4575	1	A	PCC and SCC assignment in 20MHz+10MHz test case A.8.16.21 and A.8.20.4B	14.3.0
2017/03	RP-75	RP-170603	4578	1	A	5 DL PCell in FDD RSRQ for E-UTRAN in Carrier Aggregation	14.3.0
2017/03	RP-75	RP-170598	4582	1	A	Capturing agreements for NB-IoT	14.3.0
2017/03	RP-75	RP-170591	4598	3	F	LAA SCC requirements with multiple SCCs	14.3.0
2017/03	RP-75	RP-170553	4599	1	F	Correction in UE transmit Timing Requirements with eLAA SCell	14.3.0
2017/03	RP-75	RP-170592	4601		A	Correction of LAA RRM test cases	14.3.0
2017/06	RP-76	RP-171309	4603		A	PDSCH allocation parameters for UE Cat M1 RSRP Test Cases	14.4.0
2017/06	RP-76	RP-171303	4605		F	Cat NB1 RRM Test Case A.4.2.18/19 update for 5MHz Ch BW	14.4.0
2017/06	RP-76	RP-171278	4606		F	CR on applicability of requirements for CA	14.4.0
2017/06	RP-76	RP-171264	4608	1	B	Introduction of non-uniform gap pattern	14.4.0
2017/06	RP-76	RP-171301	4612		A	CR: NB-IoT Radio Link Monitoring Performance Test for Out-of-Sync in Normal Coverage	14.4.0
2017/06	RP-76	RP-171307	4619		A	LAA RRM: Correction to test case titles (Rel-14)	14.4.0
2017/06	RP-76	RP-171309	4621		A	eMTC RRM: Correction to prach test cases (Rel-14)	14.4.0
2017/06	RP-76	RP-171309	4623		A	eMTC RRM: Alignment of used OCN patterns (Rel-14)	14.4.0
2017/06	RP-76	RP-171301	4625		A	NB-IoT RRM: Correction to NOCN definition (Rel-14)	14.4.0
2017/06	RP-76	RP-171311	4627		A	CA RRM: 5DL CA test case titles for inter-mode (FDD-TDD) scenarios (Rel-14)	14.4.0
2017/06	RP-76	RP-171264	4629		B	RSTD requirements for short MGL	14.4.0

2017/06	RP-76	RP-171283	4633	1	F	Correction to RRC connected state requirements for CA	14.4.0
2017/06	RP-76	RP-171284	4636	1	F	CR on CGI reading requirement with SRS switching	14.4.0
2017/06	RP-76	RP-171308	4650	1	A	CR on measurement condition in B.1.3 R14	14.4.0
2017/06	RP-76	RP-171279	4655	1	B	Introduction of new bands for NB-IoT in 36.133	14.4.0
2017/06	RP-76	RP-171296	4686	1	A	Band groups for category 0 operation	14.4.0
2017/06	RP-76	RP-171308	4688		A	Band groups for category 0 operation	14.4.0
2017/06	RP-76	RP-171298	4692	1	A	Prose Operation during CA	14.4.0
2017/06	RP-76	RP-171267	4695	3	F	PHR reporting for NB-IOT low-power class UEs	14.4.0
2017/06	RP-76	RP-171309	4698		A	Correction to Cat-M1 UE RRC re-establishment tests	14.4.0
2017/06	RP-76	RP-171266	4701	3	B	Timing requirements for Cat-M2	14.4.0
2017/06	RP-76	RP-171264	4703	1	B	CR on NCSG configuration	14.4.0
2017/06	RP-76	RP-171264	4704	2	B	CR on per-CC based measurement gap configuration	14.4.0
2017/06	RP-76	RP-171269	4706	3	F	CR for correction for RRM core requirement for Cat.1bis UE	14.4.0
2017/06	RP-76	RP-171269	4707	1	B	CR for RRM measurement requirement for Cat.1bis UE	14.4.0
2017/06	RP-76	RP-171269	4708	3	B	CR for RRM tests for Cat.1 UE with single receiver chain	14.4.0
2017/06	RP-76	RP-171309	4714		A	Correction to event triggered reporting test cases in eMTC	14.4.0
2017/06	RP-76	RP-171299	4716		A	Correction to inter-frequency requirements in NB-IOT	14.4.0
2017/06	RP-76	RP-171288	4719	1	F	Clarification on requirements for RSTD based on CRS and PRS	14.4.0
2017/06	RP-76	RP-171284	4721	1	F	SRS switching and SI reading	14.4.0
2017/06	RP-76	RP-171267	4728	1	B	Requirements on NPRACH Transmission in Enhanced NB-IoT	14.4.0
2017/06	RP-76	RP-171299	4760		A	Maintenance of core requirements for UE Cat.NB1 R14	14.4.0
2017/06	RP-76	RP-171267	4761	3	B	Applicability of requirements for UE Cat.NB2	14.4.0
2017/06	RP-76	RP-171267	4762		B	RRM tests for UE Cat.NB2	14.4.0
2017/06	RP-76	RP-171301	4764		A	CR on test parameters for UE transmit timing for UE Cat.NB1 R14	14.4.0
2017/06	RP-76	RP-171301	4766		A	CR for PHR requirement for NB-IoT R14	14.4.0
2017/06	RP-76	RP-171301	4770		A	CR on conditions for NRSRP and NRSRQ accuracy R14	14.4.0
2017/06	RP-76	RP-171301	4772		A	CR on lo range for NB-IoT measurement accuracy R14	14.4.0
2017/06	RP-76	RP-171301	4776		A	CR for cell reselection test parameter for NB-IoT R14	14.4.0
2017/06	RP-76	RP-171302	4778	1	F	Correction on T2 time duration for RLM in-sync test R14	14.4.0
2017/06	RP-76	RP-171266	4797	3	B	CR on UE Rx-Tx measurement requirement for FeMTC	14.4.0
2017/06	RP-76	RP-171266	4798	1	B	CR on UE Rx-Tx accuracy requirement for FeMTC	14.4.0
2017/06	RP-76	RP-171262	4808		B	Test case for CA interruption at SRS carrier based switching	14.4.0
2017/06	RP-76	RP-171262	4809	1	B	Test case for DC interruption at SRS carrier based switching	14.4.0
2017/06	RP-76	RP-171257	4812	1	B	CR on measurement accuracy requirements under high speed scenarios	14.4.0
2017/06	RP-76	RP-171257	4813	5	B	Test case for cell reselection on idle mode under high speed scenario	14.4.0
2017/06	RP-76	RP-171257	4814	3	B	Test case for measurement reporting on connected mode under high speed scenario	14.4.0
2017/06	RP-76	RP-171283	4815	1	F	Remove bracket in measurement core requirements in high speed	14.4.0
2017/06	RP-76	RP-171296	4816		F	Correction on lo for SCE test case A.8.22.8	14.4.0
2017/06	RP-76	RP-171309	4819		A	CR on RA test for Cat-M1 normal coverage R14	14.4.0
2017/06	RP-76	RP-171266	4821	3	F	Refinement of idle mode requirements for feMTC in R14	14.4.0
2017/06	RP-76	RP-171267	4823	1	B	CR on NRSRP mapping table	14.4.0
2017/06	RP-76	RP-171267	4824		B	CR on NRSRQ mapping table	14.4.0
2017/06	RP-76	RP-171256	4829		F	CR on V2V RRM performance requirements corrections	14.4.0
2017/06	RP-76	RP-171282	4830	1	F	CR on V2X RRM core requirements corrections	14.4.0
2017/06	RP-76	RP-171307	4834		A	LAA RRM: Correction to test case A.9.11.x and A.9.12.x (Rel-14)	14.4.0
2017/06	RP-76	RP-171309	4836		A	eMTC RRM: Correction to MPDCCH and PDSCH Reference Measurement Channels (Rel-14)	14.4.0
2017/06	RP-76	RP-171281	4837		F	CR on side condition for reliability of GNSS	14.4.0
2017/06	RP-76	RP-171298	4839	1	A	Correction to RRM 4DL FDD CA test cases	14.4.0
2017/06	RP-76	RP-171307	4841		A	Corrections to LAA Event-triggered reporting Test Cases A.8.26	14.4.0

2017/06	RP-76	RP-171299	4843		A	Rel-14 CR on the applicability of RRC procedures	14.4.0
2017/06	RP-76	RP-171259	4844	1	B	E-UTRAN FDD - FDD Intra frequency RACH-less handover	14.4.0
2017/06	RP-76	RP-171259	4845	1	B	E-UTRAN FDD - FDD Inter frequency RACH-less handover	14.4.0
2017/06	RP-76	RP-171259	4846	1	B	E-UTRAN TDD - TDD Intra frequency RACH-less handover	14.4.0
2017/06	RP-76	RP-171259	4847	1	B	E-UTRAN TDD - TDD Inter frequency RACH-less handover	14.4.0
2017/06	RP-76	RP-171264	4853	1	B	E-UTRAN FDD-FDD Inter-frequency event triggered reporting with MGL=3ms under fading propagation conditions in synchronous cells	14.4.0
2017/06	RP-76	RP-171264	4854	1	B	E-UTRAN TDD-TDD Inter-frequency event triggered reporting with MGL=3ms under fading propagation conditions in synchronous cells	14.4.0
2017/06	RP-76	RP-171298	4860		A	CA RRM: 4DL CA test parameter correction for A.8.16.51 and A.8.16.52 (Rel-14)	14.4.0
2017/06	RP-76	RP-171296	4863		A	PCC and SCC assignment in 20MHz+10MHz test case A.8.16.22	14.4.0
2017/06	RP-76	RP-171264	4864	1	B	Introduction of additional gap patterns and measurement capabilities for measurement gap enhancement	14.4.0
2017/06	RP-76	RP-171265	4867	1	B	CR on reference configurations for V2X RRM	14.4.0
2017/06	RP-76	RP-171281	4868	1	B	Correction on reliability of GNSS signal for V2V	14.4.0
2017/06	RP-76	RP-171282	4869	1	B	CR on reliability of GNSS signal for V2X	14.4.0
2017/06	RP-76	RP-171301	4873		A	CR on T311 timer in RRC re-establishment test case R14	14.4.0
2017/06	RP-76	RP-171300	4875		A	Introduce NPDCCH RMC with DCI format N0 R14	14.4.0
2017/06	RP-76	RP-171302	4877		A	Correction on UE transmit timing test for NB-IoT R14	14.4.0
2017/06	RP-76	RP-171303	4879		A	Correction on timing advance test for NB-IoT R14	14.4.0
2017/06	RP-76	RP-171299	4881		A	Maintenance CR on NB-IoT core requirements R14	14.4.0
2017/06	RP-76	RP-171302	4883		A	Correction on side condition for RRC re-establishment test cases R14	14.4.0
2017/06	RP-76	RP-171259	4885		B	E-UTRAN FDD - UE Transmit Timing Accuracy Test for RACH-less Handover	14.4.0
2017/06	RP-76	RP-171259	4886		B	E-UTRAN TDD - UE Transmit Timing Accuracy Test for RACH-less Handover	14.4.0
2017/06	RP-76	RP-171310	4888		A	Correction on transmit timing requirement R14	14.4.0
2017/06	RP-76	RP-171267	4889	1	B	CR on intra frequency RSTD measurement requirement for eNB-IOT	14.4.0
2017/06	RP-76	RP-171267	4890	1	B	CR on inter frequency RSTD measurement requirement for eNB-IOT	14.4.0
2017/06	RP-76	RP-171267	4891	1	B	CR on intra frequency RSTD accuracy requirement for eNB-IOT	14.4.0
2017/06	RP-76	RP-171267	4892	1	B	CR on inter frequency RSTD accuracy requirement for eNB-IOT	14.4.0
2017/06	RP-76	RP-171266	4893	1	B	CR on intra frequency RSTD measurement requirement for FeMTC	14.4.0
2017/06	RP-76	RP-171266	4894	1	B	CR on inter frequency RSTD measurement requirement for FeMTC	14.4.0
2017/06	RP-76	RP-171266	4906	1	B	CR on applicability rule for FeMTC in R14	14.4.0
2017/06	RP-76	RP-171266	4909	1	A	CR on UE timer accuracy for FeMTC in R14	14.4.0
2017/06	RP-76	RP-171311	4911	1	A	4DL FDD RSRQ for E-UTRAN in Carrier Aggregation in R14	14.4.0
2017/06	RP-76	RP-171311	4913	1	A	4DL TDD RSRQ for E-UTRAN in Carrier Aggregation in R14	14.4.0
2017/06	RP-76	RP-171311	4915	1	A	Correction on the test cases of RLM for Cat-M1 UE in R14	14.4.0
2017/06	RP-76	RP-171282	4917	1	F	CR on Modification of Selection/Reselection of V2X Synchronization Reference	14.4.0
2017/06	RP-76	RP-171265	4918		B	CR on UE Transmission Timing Accuracy Tests for V2X	14.4.0
2017/06	RP-76	RP-171285	4926		F	Modification on LAA measurement considering Inter-frequency RSSI measurement R14	14.4.0
2017/06	RP-76	RP-171307	4928		A	Corrections on the LAA test cases R14	14.4.0
2017/06	RP-76	RP-171297	4931		A	Update of some SCE test case	14.4.0
2017/06	RP-76	RP-171311	4933		A	Event triggered reporting on deactivated SCells and interruption probability (0.5%) without DRX (FDD-TDD 4DL CA) R14	14.4.0
2017/06	RP-76	RP-171311	4935		A	Event triggered reporting on deactivated SCells and interruption probability (0.5%) without DRX (TDD-FDD 4 DL CA) R14	14.4.0
2017/06	RP-76	RP-171303	4937		A	Inter-frequency cell reselection under enhanced coverage for NB-IOT	14.4.0

2017/06	RP-76	RP-171266	4938	3	B	CONNECTED mode requirements for feMTC UEs in CEModeA	14.4.0
2017/06	RP-76	RP-171266	4939	3	B	CONNECTED mode requirements for feMTC UEs in CEModeB	14.4.0
2017/06	RP-76	RP-171308	4941	1	A	Timing advance requirements for Cat M1 UEs	14.4.0
2017/06	RP-76	RP-171266	4942	1	B	Introduction of enhanced RLM requirements for feMTC	14.4.0
2017/06	RP-76	RP-171303	4953		A	Contention Based Random Access Test for UE category NB1 UEs in Normal Coverage	14.4.0
2017/06	RP-76	RP-171303	4955		A	Contention Based Random Access Test for UE category NB1 UEs in Enhanced Coverage	14.4.0
2017/06	RP-76	RP-171302	4956		A	CR: NB-IoT Radio Link Monitoring Performance Test for Out-of-Sync in Enhanced Coverage	14.4.0
2017/06	RP-76	RP-171297	4959	1	A	Correction to RSTD test cases for carrier aggregation (R14)	14.4.0
2017/06	RP-76	RP-171269	4960	1	B	CR for RSTD measurement requirement for Cat.1bis UE	14.4.0
2017/06	RP-76	RP-171302	4963		A	Correction to inter-frequency RRC re-establishment test case in NB-IOT	14.4.0
2017/06	RP-76	RP-171259	4968		B	CR for E-UTRAN TDD intra-frequency MBB handover test cases	14.4.0
2017/06	RP-76	RP-171259	4969		B	CR for E-UTRAN FDD intra-frequency MBB handover test cases	14.4.0
2017/06	RP-76	RP-171259	4970		F	CR for correction of handover test cases	14.4.0
2017/06	RP-76	RP-171286	4971		F	CR for correction of handover requirements for mobility enhancement	14.4.0
2017/06	RP-76	RP-171266	4972	1	B	Enhanced Handover Requirement for FeMTC	14.4.0
2017/06	RP-76	RP-171266	4974		F	CR on 36.133: Intra and inter-frequency RSRP and RSRQ measurement accuracies for UE cat M1	14.4.0
2017/06	RP-76	RP-171285	4982	1	F	Requirements applicability for eLAA	14.4.0
2017/06	RP-76	RP-171307	4984		A	Corrections in LAA requirements	14.4.0
2017/06	RP-76	RP-171261	4985	4	B	RRM requirements with eMBMS enhancements	14.4.0
2017/06	RP-76	RP-171266	4986	1	F	Measurement requirements under discontinuous MPDCCH monitoring	14.4.0
2017/06	RP-76	RP-171266	4990	1	F	Introducing gapless measurement requirement for eMTC R14	14.4.0
2017/06	RP-76	RP-171264	4997	1	B	Introduction of test cases for burst gap	14.4.0
2017/06	RP-76	RP-171264	4998	1	B	Introduction of test cases for NCSG	14.4.0
2017/09	RP-77	RP-171933	5004	2	B	Introduction of event triggered reporting LAA test cases for multiple Scells	14.5.0
2017/09	RP-77	RP-171967	5007		A	Updates to Intra-freq Event-triggered reporting Test cases for UE Cat 0	14.5.0
2017/09	RP-77	RP-171971	5009		A	Reference Channels in UE Cat M1 RRC Re-establishment test cases	14.5.0
2017/09	RP-77	RP-171971	5011		A	OCNG and RMCs in UE Cat M1 Handover TCs	14.5.0
2017/09	RP-77	RP-171971	5015		A	Es/lot and RSRP values in UE Cat M1 Re-selection test cases	14.5.0
2017/09	RP-77	RP-171971	5017		A	Reference PRACH Configurations for Cat M1 test cases	14.5.0
2017/09	RP-77	RP-171971	5019		A	PRACH Configurations and parameters for Cat M1 test cases A.6.2.10/11/12	14.5.0
2017/09	RP-77	RP-171971	5021		A	PRACH Configuration for Cat M1 test case A.6.2.15 This CR was NOT implemented as it didn't use revision marks	14.5.0
2017/09	RP-77	RP-171972	5025		A	Correction to RLM test cases Category NB1.	14.5.0
2017/09	RP-77	RP-171973	5028		A	CA RRM: Correction of Cell 3 Es/lot for T2 and T4 for TC A.8.16.55 and 56 (Rel-14)	14.5.0
2017/09	RP-77	RP-171967	5031		A	CA RRM: Correction of PRS Subframe Offset for TC A.8.17.10 and A.8.17.11 (Rel-14)	14.5.0
2017/09	RP-77	RP-171971	5033		A	eMTC RRM: Corrections to Timing Advance Adjustment Accuracy test for Cat-M1 UE (Rel-14)	14.5.0
2017/09	RP-77	RP-171972	5035		A	NB-IoT RRM: Correction of antenna configuration of LTE and NB-IoT cells in Inband RRM scenarios (Rel-14)	14.5.0
2017/09	RP-77	RP-171972	5037		A	NB-IoT RRM: Corrections to the NOCNG definition (Rel-14)	14.5.0
2017/09	RP-77	RP-171943	5042		F	Update applicability of V2V Interruption requirement	14.5.0
2017/09	RP-77	RP-171943	5043		F	Correction to V2X requirements for Initiation/Cease of SLSS transmissions	14.5.0
2017/09	RP-77	RP-171942	5044	1	B	CR on measurement performance scaling with MPDCCH monitoring CEModeA	14.5.0
2017/09	RP-77	RP-171942	5045	1	B	CR on measurement performance scaling with MPDCCH monitoring CEModeB	14.5.0
2017/09	RP-77	RP-171943	5055	1	F	Remove bracket in V2X core requirements	14.5.0

2017/09	RP-77	RP-171969	5058		A	Correction CR on adding band group to RS-SINR measurement conditions	14.5.0
2017/09	RP-77	RP-171932	5061	2	B	RRM requirements with FeMBMS	14.5.0
2017/09	RP-77	RP-171941	5062	1	F	CR for correcting transmit timing requirement of eLAA	14.5.0
2017/09	RP-77	RP-171943	5066		F	Clarification on V2X requirements for V2X UEs in RRC_CONNECTED state	14.5.0
2017/09	RP-77	RP-171942	5068	1	F	Gapsharing due to RSTD measurements for Rel-14 MTC in CEModeA	14.5.0
2017/09	RP-77	RP-171942	5070	1	F	Gap sharing due to RSTD measurements for Rel-14 MTC in CEModeB	14.5.0
2017/09	RP-77	RP-171935	5073		F	CR on evaluation time of GNSS synchronization source reliability	14.5.0
2017/09	RP-77	RP-171943	5076		F	Completing V2V Interruption test case	14.5.0
2017/09	RP-77	RP-171972	5078		A	NB-IoT RRM: Corrections to invalid configuration for In-band Intra-frequency scenarios (Rel-14)	14.5.0
2017/09	RP-77	RP-171968	5080		A	LAA RRM: Remove Square brackets from TCs A.9.1.60 and A.9.1.61 (Rel-14)	14.5.0
2017/09	RP-77	RP-171971	5082		A	eMTC RRM: MPDSCH Repetitions in CEModeA test cases with DRX (Rel-14)	14.5.0
2017/09	RP-77	RP-171932	5083	1	B	RRM performance requirements with FeMBMS	14.5.0
2017/09	RP-77	RP-171940	5084		F	CR on BS synchronization requirements for eMBMS enhancements	14.5.0
2017/09	RP-77	RP-171935	5085		B	CR on Initiation/Cease of SLSS Transmissions Tests for V2X	14.5.0
2017/09	RP-77	RP-171935	5086		B	CR on Synchronization Reference Selection / Reselection Tests for V2X	14.5.0
2017/09	RP-77	RP-171935	5088	1	B	CR on Congestion Control Measurement Tests for V2X	14.5.0
2017/09	RP-77	RP-171935	5089	1	B	CR on Interruptions Tests for V2X	14.5.0
2017/09	RP-77	RP-171972	5095		A	Correction on RLM core requirements for NB-IoT	14.5.0
2017/09	RP-77	RP-171972	5097	1	F	Correction on cell reselection test case for NB-IoT	14.5.0
2017/09	RP-77	RP-171937	5099	1	B	Introduce 5MHz NPDSCH RMC pattern for NB-IoT	14.5.0
2017/09	RP-77	RP-171937	5100		B	Introduce 5MHz NPDCCH RMC pattern for NB-IoT	14.5.0
2017/09	RP-77	RP-171937	5101		B	Correction on RRC re-establishment test case for NB-IoT	14.5.0
2017/09	RP-77	RP-171973	5103		A	Event triggered reporting on deactivated SCells and interruption probability (0.5%) without DRX (FDD-TDD 5DL CA)	14.5.0
2017/09	RP-77	RP-171973	5105		A	Event triggered reporting on deactivated SCells and interruption probability (0.5%) without DRX (TDD-FDD 5DL CA)	14.5.0
2017/09	RP-77	RP-171936	5106		F	Correction on the applicability rules for FeMTC in R14	14.5.0
2017/09	RP-77	RP-171942	5107	1	F	Correction on the measurement requirement for FeMTC in R14	14.5.0
2017/09	RP-77	RP-171936	5108	1	B	CR on conditions for E-UTRAN inter-frequency measurements by UE cat M1 in RRC_CONNECTED State in R14	14.5.0
2017/09	RP-77	RP-171936	5109	2	B	CR on conditions for measurements procedures in RRC_CONNECTED State for cat M2 in R14	14.5.0
2017/09	RP-77	RP-171936	5110	1	B	CR on conditions for measurements procedures in RRC_IDLE State for cat M2 in R14	14.5.0
2017/09	RP-77	RP-171940	5112	1	F	CR on correction on the band groups in R14	14.5.0
2017/09	RP-77	RP-171933	5116	1	B	FDD-TDD 3DL Event triggered reporting on deactivated FS3 SCell and FDD PCell interruption in non-DRX	14.5.0
2017/09	RP-77	RP-171933	5117	1	B	TDD-TDD 3DL Event triggered reporting on deactivated FS3 SCell and FDD PCell interruption in non-DRX	14.5.0
2017/09	RP-77	RP-171969	5119		A	CR on RSRP range of eMTC Rel-14	14.5.0
2017/09	RP-77	RP-171942	5120	1	F	CR on intra frequency RSTD measurement requirement for FeMTC	14.5.0
2017/09	RP-77	RP-171942	5121	1	F	CR on inter frequency RSTD measurement requirement for FeMTC	14.5.0
2017/09	RP-77	RP-171936	5127	1	F	CR on 36.133 Intra and inter-frequency RSRP and RSRQ measurement accuracies for UE cat M1	14.5.0
2017/09	RP-77	RP-171972	5129	1	F	CR for NB-IoT Transmit Timing Test	14.5.0
2017/09	RP-77	RP-171969	5133	1	A	Restructuring of Handover Requirements in FeMTC	14.5.0
2017/09	RP-77	RP-171942	5134		F	Corrections to enhanced RLM core requirements	14.5.0
2017/09	RP-77	RP-171942	5135		F	Corrections to E-CID UE Rx-Tx requirements	14.5.0
2017/09	RP-77	RP-171973	5139		F	Correction to LAA RRM measurement requirement R14	14.5.0
2017/09	RP-77	RP-171932	5141	2	B	Inter-frequency measurement requirement for FeMBMS unicast mixed cell	14.5.0

2017/09	RP-77	RP-171936	5143	2	B	CR on inter frequency RSTD accuracy requirement for FeMTC	14.5.0
2017/09	RP-77	RP-171936	5145	1	B	CR on UE Rx-Tx accuracy requirement for FeMTC	14.5.0
2017/09	RP-77	RP-171973	5146		A	Correction to LAA RRM test cases	14.5.0
2017/09	RP-77	RP-171942	5147		F	CR on UE Rx - Tx measurement requirement for Cat-M1	14.5.0
2017/09	RP-77	RP-171942	5148		F	CR on UE Rx - Tx measurement requirement for Cat-M2	14.5.0
2017/09	RP-77	RP-171948	5056	1	B	Introduction of the FDD L-band (Band 74) into 36.133	15.0.0
2017/09	RP-77	RP-171946	5059		B	Introduction of Band 72 in TS36.133	15.0.0
2017/09	RP-77	RP-171952	5072		B	CR to 36.133: Introduction of Band 71	15.0.0
2017/09	RP-77	RP-171950	5074	1	B	Introduction of Extended 1.5 GHz SDL bands 75 and 76	15.0.0
2017/09	RP-77	RP-171949	5136	1	B	Introduction of TDD L-band into TS 36.133	15.0.0
2017-12	RAN#78	RP-172607	5162		A	Correction of test requirement for LAA Test cases A.8.26.x	15.1.0
2017-12	RAN#78	RP-172593	5163	1	B	Introduction of Band 73 into TS 36.133	15.1.0
2017-12	RAN#78	RP-172580	5174		A	Introduction of NB-IoT RSTD measurement requirement	15.1.0
2017-12	RAN#78	RP-172609	5175		A	Clarification on the SNR transition in NB-IoT RLM test for in-sync	15.1.0
2017-12	RAN#78	RP-172574	5192		A	cell identification test case for FeMTC in CEModeA with discontinuous MPDCCH monitoring	15.1.0
2017-12	RAN#78	RP-172574	5194		A	cell identification test case for FeMTC in CEModeA in DRX	15.1.0
2017-12	RAN#78	RP-172574	5196		A	cell identification test case for serving cell without gap for FeMTC	15.1.0
2017-12	RAN#78	RP-172579	5197		A	RSRP accuracy test case for FeMTC in CEModeA	15.1.0
2017-12	RAN#78	RP-172574	5210		A	CR for MPDCCH RMCs for Category M2 UE RRM tests (R15)	15.1.0
2017-12	RAN#78	RP-172574	5212		A	CR for Rx-Tx time difference tests for UE category M1/M2 (R15)	15.1.0
2017-12	RAN#78	RP-172574	5214		A	CR for transmit timing accuracy tests for UE category M2 (R15)	15.1.0
2017-12	RAN#78	RP-172575	5222		A	CR for feMTC inter-frequency HO test cases CEModeA R15	15.1.0
2017-12	RAN#78	RP-172575	5224		A	CR for feMTC inter-frequency HO test cases CEModeB R15	15.1.0
2017-12	RAN#78	RP-172575	5226		A	CR for feMTC intra-frequency HO test cases CEModeA without SFN acquisition R15	15.1.0
2017-12	RAN#78	RP-172575	5228		A	CR for feMTC intra-frequency HO test cases CEModeB without SFN acquisition R15	15.1.0
2017-12	RAN#78	RP-172581	5230		A	CR on measurement gap enhancement	15.1.0
2017-12	RAN#78	RP-172575	5231		A	CR on absolute RSRP accuracy for R15 non-BL/CE UE (The CR was not implemented as it is replaced by CR 5472)	15.1.0
2017-12	RAN#78	RP-172607	5236	1	A	Correction on coverage enhancement level for cat-M1 in IDLE state	15.1.0
2017-12	RAN#78	RP-172607	5238	1	A	Correction of cell reselection margin for Cat-M1	15.1.0
2017-12	RAN#78	RP-172607	5240	1	A	Removal of squarebrackets from the cat-M2 timing requirements	15.1.0
2017-12	RAN#78	RP-172583	5243	1	A	Correction on coverage enhancement level for cat-M1 in IDLE state for Rel-15 MTC	15.1.0
2017-12	RAN#78	RP-172574	5246	1	A	Correction to Rel-15 cat-M1 cell re-selection and RRC re-establishment test cases	15.1.0
2017-12	RAN#78	RP-172578	5250		A	FD-FDD Inter-frequency cell re-selection test for cat-M1	15.1.0
2017-12	RAN#78	RP-172578	5251		A	HD-FDD Inter-frequency cell re-selection test for cat-M1 UEs in normal coverage	15.1.0
2017-12	RAN#78	RP-172579	5252		A	TDD-TDD Inter-frequency cell re-selection test for cat-M1 UEs in normal coverage	15.1.0
2017-12	RAN#78	RP-172578	5256		A	FD-FDD Inter-frequency RRC re-establishment est for cat-M1 UEs in CEModeA	15.1.0
2017-12	RAN#78	RP-172578	5257		A	HD-FDD Inter-frequency RRC re-establishment est for cat-M1 UEs in CEModeA	15.1.0
2017-12	RAN#78	RP-172579	5258		A	TDD-TDD Inter-frequency RRC re-establishment est for cat-M1 UEs in CEModeA	15.1.0
2017-12	RAN#78	RP-172576	5265		A	E-UTRAN FD-FDD Early Out-of-sync reporting Test for Cat-M1 UE in CEModeA	15.1.0
2017-12	RAN#78	RP-172576	5266		A	E-UTRAN HD-FDD Early Out-of-sync reporting Test for Cat-M1 UE in CEModeA	15.1.0
2017-12	RAN#78	RP-172577	5267		A	E-UTRAN TDD Early Out-of-sync reporting Test for Cat-M1 UE in CEModeA	15.1.0

2017-12	RAN#78	RP-172576	5268		A	E-UTRAN FD-FDD Early In-Sync reporting Test for Cat-M1 UE in CEModeA	15.1.0
2017-12	RAN#78	RP-172576	5269		A	E-UTRAN HD-FDD Early In-Sync reporting Test for Cat-M1 UE in CEModeA	15.1.0
2017-12	RAN#78	RP-172577	5270		A	E-UTRAN TDD Early In-Sync reporting Test for Cat-M1 UE in CEModeA	15.1.0
2017-12	RAN#78	RP-172571	5295	3	B	Clarification of LTE requirements applicability for NSA NR	15.1.0
2017-12	RAN#78	RP-172571	5305	2	B	CR on NR PSCell Addition and Release Delay	15.1.0
2017-12	RAN#78	RP-172575	5307		A	CR on 36.133 Intra and inter-frequency RSRP and RSRQ measurement accuracies for UE cat M1 CE Mode B	15.1.0
2017-12	RAN#78	RP-172585	5308		A	CR to Correct Pool Configuration and FRC for CBR test	15.1.0
2017-12	RAN#78	RP-172607	5313		A	Correction of OCNG for LAA Test cases A.8.26.x, A.9.1.x, A.9.2.x	15.1.0
2017-12	RAN#78	RP-172609	5318		A	Add 5MHz eCell Channel BW scenario in NB-IoT Random Access Test cases	15.1.0
2017-12	RAN#78	RP-172609	5320		A	Add 5MHz eCell Channel BW scenario in NB-IoT Transmit Timing Accuracy Test case	15.1.0
2017-12	RAN#78	RP-172609	5322		A	Add 5MHz eCell Channel BW scenario in NB-IoT RLM In-sync Test cases	15.1.0
2017-12	RAN#78	RP-172609	5325		A	Clarification on the SNR transition in NB-IoT RLM test for out-of-sync	15.1.0
2017-12	RAN#78	RP-172607	5328		A	Correction to Test Parameters for FS3 Channel Occupancy tests	15.1.0
2017-12	RAN#78	RP-172586	5333		A	CR on V2X requirements for asynchronous SyncRef UE Selection / Reselection (Rel-15)	15.1.0
2017-12	RAN#78	RP-172587	5335	1	B	CR on Clarification for MTTD and MTRD for shortened TTI	15.1.0
2017-12	RAN#78	RP-172583	5337		A	CR on requirement applicability for R15 non-BL/CE UE	15.1.0
2017-12	RAN#78	RP-172571	5339	2	B	CR on TS36.133 on interruptions for NSA LTE NR EN-DC	15.1.0
2017-12	RAN#78	RP-172571	5340	1	B	Introduction of NR references, definitions and abbreviations in 36.133	15.1.0
2017-12	RAN#78	RP-172587	5341	1	B	TX timing requirements for sTTI and reduced processing time	15.1.0
2017-12	RAN#78	RP-172587	5342		B	CGI interruption requirements for sTTI and processing time reduction	15.1.0
2017-12	RAN#78	RP-172587	5343		B	ProSe interruption requirements for sTTI and processing time reduction	15.1.0
2017-12	RAN#78	RP-172587	5344	1	B	Transmit timing adjustment delay	15.1.0
2017-12	RAN#78	RP-172587	5345	1	B	STTI definition for 36.133	15.1.0
2017-12	RAN#78	RP-172594	5346		B	CR to 36.133: Introduction of Band 49	15.1.0
2017-12	RAN#78	RP-172585	5348		A	Clarification on UE synchronization behaviour during the evaluation of GNSS reliability	15.1.0
2017-12	RAN#78	RP-172611	5358		A	RRM NB-IoT: Correction to transmit timing accuracy test under enhanced coverage (Rel-15)	15.1.0
2017-12	RAN#78	RP-172613	5361		A	RRM 4DL: Correction of cell powers for TC A.9.2.46 (Rel-15)	15.1.0
2017-12	RAN#78	RP-172608	5366		A	CR for RLM tests for non-BL/CE UE (R15)	15.1.0
2017-12	RAN#78	RP-172587	5367	1	B	Introduction of MRTD/MTTD requirement for sTTI	15.1.0
2017-12	RAN#78	RP-172608	5370	1	A	Introducing PBCH repetition for eMTC RRM test case	15.1.0
2017-12	RAN#78	RP-172583	5378		A	Clarification on measurement reporting delay for FeMTC	15.1.0
2017-12	RAN#78	RP-172578	5380		A	Inter-frequency cell re-selection test for cat-M1 in enhanced coverage	15.1.0
2017-12	RAN#78	RP-172578	5382		B	Inter-frequency RRC re-establishment est for cat-M1 UEs in CEModeB	15.1.0
2017-12	RAN#78	RP-172576	5386		B	E-UTRAN FD-FDD Enhanced RLM Tests for Cat-M1 UE in CEModeB	15.1.0
2017-12	RAN#78	RP-172576	5387		B	E-UTRAN HD-FDD Enhanced RLM Tests for Cat-M1 UE in CEModeB	15.1.0
2017-12	RAN#78	RP-172577	5388		B	E-UTRAN TDD Enhanced RLM Tests for Cat-M1 UE in CEModeB	15.1.0
2017-12	RAN#78	RP-172585	5390		A	CR on Autonomous Resource Selection/Reselection Measurement Tests for V2X R15	15.1.0
2017-12	RAN#78	RP-172610	5393		A	Correctoin on cell reselectoin test case	15.1.0
2017-12	RAN#78	RP-172610	5396		A	Correctoin on random access test case	15.1.0
2017-12	RAN#78	RP-172610	5399		A	Correction on NPRACH configuration in RRC re-establishment test cases	15.1.0
2017-12	RAN#78	RP-172580	5401		A	Test case for random access on non-anchor carrier	15.1.0

2017-12	RAN#78	RP-172585	5403		A	Update the maximum DRX cycle length in connected mode	15.1.0
2017-12	RAN#78	RP-172606	5407		A	Correct the core requirements referred in multiple TDD-TDD inter-frequency measurements test cases.	15.1.0
2017-12	RAN#78	RP-172575	5432		A	FDD cell identification test case for FeMTC in CEModeB with discontinuous MPDCCH monitoring R15	15.1.0
2017-12	RAN#78	RP-172578	5433		A	HD-FDD cell identification test case for FeMTC in CEModeB with discontinuous MPDCCH monitoring R15	15.1.0
2017-12	RAN#78	RP-172579	5434		A	TDD cell identification test case for FeMTC in CEModeB with discontinuous MPDCCH monitoring R15	15.1.0
2017-12	RAN#78	RP-172575	5435		A	FDD cell identification test case for FeMTC in CEModeB in DRX R15	15.1.0
2017-12	RAN#78	RP-172578	5436		A	HD-FDD cell identification test case for FeMTC in CEModeB in DRX R15	15.1.0
2017-12	RAN#78	RP-172579	5437		A	TDD cell identification test case for FeMTC in CEModeB in DRX R15	15.1.0
2017-12	RAN#78	RP-172578	5438		A	FDD RSRP accuracy test case for FeMTC in CEModeB R15	15.1.0
2017-12	RAN#78	RP-172578	5439		A	HD-FDD RSRP accuracy test case for FeMTC in CEModeB R15	15.1.0
2017-12	RAN#78	RP-172579	5440		A	TDD RSRP accuracy test case for FeMTC in CEModeB R15	15.1.0
2017-12	RAN#78	RP-172585	5444		A	CR on E-CID for eNB-IOT normal coverage R15	15.1.0
2017-12	RAN#78	RP-172585	5445		A	CR on E-CID for eNB-IOT enhanced coverage R15	15.1.0
2017-12	RAN#78	RP-172580	5448		A	CR for intra RSTD accuracy test case for eNB-IOT positioning in normal coverage R15	15.1.0
2017-12	RAN#78	RP-172580	5449		A	CR for intra RSTD accuracy test case for eNB-IOT positioning in enhanced coverage R15	15.1.0
2017-12	RAN#78	RP-172580	5450		A	CR for inter RSTD accuracy test case for eNB-IOT positioning in normal coverage R15	15.1.0
2017-12	RAN#78	RP-172580	5451		A	CR for inter RSTD accuracy test case for eNB-IOT positioning in enhanced coverage R15	15.1.0
2017-12	RAN#78	RP-172585	5452		A	CR on NB-IOT RSTD requirement R15	15.1.0
2017-12	RAN#78	RP-172583	5455		A	CR on HD-FDD requirement for FeMTC R15	15.1.0
2017-12	RAN#78	RP-172587	5456		B	CR on sTTI related definitions	15.1.0
2017-12	RAN#78	RP-172587	5458	1	B	CR on SCell activation and deactivation for sTTI and Spt	15.1.0
2017-12	RAN#78	RP-172587	5459	1	B	CR on Measurement reporting delay for shorten TTI and reduced processing time	15.1.0
2017-12	RAN#78	RP-172587	5460		B	Power headroom with shorten TTI and reduced processing time	15.1.0
2017-12	RAN#78	RP-172587	5461		B	CR on DRX state for sTTI	15.1.0
2017-12	RAN#78	RP-172571	5463	2	B	CR for TS36.133 on inter-RAT measurement requirement for NR	15.1.0
2017-12	RAN#78	RP-172571	5467	1	B	CR on measurement gap patterns in TS 36.133	15.1.0
2017-12	RAN#78	RP-172571	5468	3	B	CR on event triggering and reporting criteria for NR	15.1.0
2017-12	RAN#78	RP-172580	5470		A	Correction of placement of NRSRQ mapping table	15.1.0
2017-12	RAN#78	RP-172575	5472		A	CR on introduction of measurement requirements for non-BL CE UE	15.1.0
2017-12	RAN#78	RP-172575	5474		A	CR on introduction of remaining measurement requirements for non-BL CE UE in CE Mode B	15.1.0
2017-12	RAN#78	RP-172571	5475	3	B	Introduction of requirement on EN-DC SSTD measurements	15.1.0
2017-12	RAN#78	RP-172574	5477		A	Applicability of FeMTC RRM Test Cases	15.1.0
2017-12	RAN#78	RP-172571	5478	1	B	E-UTRA Inter-frequency Measurement Requirements for NSA Operation	15.1.0
2017-12	RAN#78	RP-172571	5479	1	B	LTE and NR cell naming convention in 36.133	15.1.0
2017-12	RAN#78	RP-172571	5480	1	B	CR for 36.133 on Number of carriers being monitored	15.1.0
2017-12	RAN#78	RP-172571	5483	2	B	Endorsed CR on NR PSCell Addition and Release Delay with modifications	15.1.0
2017-12	RAN#78	RP-172576	5496		A	E-UTRAN FD-FDD intra-frequency RSTD measurement period for FeMTC	15.1.0
2017-12	RAN#78	RP-172577	5497		A	E-UTRAN HD-FDD intra-frequency RSTD measurement period for FeMTC	15.1.0
2017-12	RAN#78	RP-172577	5498		A	E-UTRAN TDD intra-frequency RSTD measurement period for FeMTC	15.1.0
2017-12	RAN#78	RP-172576	5499		A	E-UTRAN FD-FDD intra-frequency RSTD measurement accuracy for FeMTC	15.1.0
2017-12	RAN#78	RP-172577	5500		A	E-UTRAN HD-FDD intra-frequency RSTD measurement accuracy for FeMTC	15.1.0

2017-12	RAN#78	RP-172577	5501		A	E-UTRAN TDD intra-frequency RSTD measurement accuracy for FeMTC	15.1.0
2017-12	RAN#78	RP-172576	5502		A	E-UTRAN FD-FDD inter-frequency RSTD measurement period for FeMTC	15.1.0
2017-12	RAN#78	RP-172577	5503		A	E-UTRAN HD-FDD inter-frequency RSTD measurement period for FeMTC	15.1.0
2017-12	RAN#78	RP-172577	5504		A	E-UTRAN TDD inter-frequency RSTD measurement period for FeMTC	15.1.0
2017-12	RAN#78	RP-172576	5505		A	E-UTRAN FD-FDD inter-frequency RSTD measurement accuracy for FeMTC	15.1.0
2017-12	RAN#78	RP-172577	5506		A	E-UTRAN HD-FDD inter-frequency RSTD measurement accuracy for FeMTC	15.1.0
2017-12	RAN#78	RP-172577	5507		A	E-UTRAN TDD inter-frequency RSTD measurement accuracy for FeMTC	15.1.0
2017-12	RAN#78	RP-172579	5510	1	A	Reference correction	15.1.0
2017-12	RAN#78	RP-172583	5514		A	CR on inter frequency measurement requirement R15	15.1.0
2017-12	RAN#78	RP-172583	5516		A	CR on UE Rx-Tx measurement requirement R15	15.1.0
2018-03	RAN#79	RP-180264	5518	4	F	CR on TS36.133 on interruptions for NSA EN-DC	15.2.0
2018-03	RAN#79	RP-180264	5521	2	F	Number of carriers	15.2.0
2018-03	RAN#79	RP-180264	5524	1	F	Editorial corrections for NSA NR	15.2.0
2018-03	RAN#79	RP-180264	5526	1	F	CR on NR PSCell addition and release delay	15.2.0
2018-03	RAN#79	RP-180296	5528		A	Remove [] from UE Cat 1bis RRM requirements (Rel-15)	15.2.0
2018-03	RAN#79	RP-180291	5530		A	Correction of test requirement for LAA Test cases A.8.26.x	15.2.0
2018-03	RAN#79	RP-180293	5536		A	Correction to Reference NPRACH Configurations	15.2.0
2018-03	RAN#79	RP-180293	5539		A	Finalising NB-IoT NPRACH Test cases A.6.2.16 and A.6.2.17	15.2.0
2018-03	RAN#79	RP-180293	5542		A	Correction to NB-IoT UE Transmit Timing Accuracy Test cases	15.2.0
2018-03	RAN#79	RP-180291	5545	1	A	Correction to successful report rate threshold for FS3 channel occupancy tests	15.2.0
2018-03	RAN#79	RP-180291	5548		A	Correction to incorrect reference for A8.26.9 and A8.26.10	15.2.0
2018-03	RAN#79	RP-180291	5551		A	Correction to OCNG pattern for FS3 RSSI and channel occupancy tests	15.2.0
2018-03	RAN#79	RP-180297	5553	1	A	CR for applicability correction for non-BLCE UE R15	15.2.0
2018-03	RAN#79	RP-180299	5555		A	Correction of test requirements for RSTD intra-frequency reporting delay for Cat1Bis (Rel-15)	15.2.0
2018-03	RAN#79	RP-180299	5557		A	Correction of test requirements for RSTD inter-frequency reporting delay for Cat1Bis (Rel-15)	15.2.0
2018-03	RAN#79	RP-180299	5559		A	Correction of test requirements for RSTD measurement performance for Cat1Bis (Rel-15)	15.2.0
2018-03	RAN#79	RP-180299	5561		A	RRM-Cat1Bis: Missing references to the core requirements (Rel-15)	15.2.0
2018-03	RAN#79	RP-180298	5563		A	Corrections on enhanced RLM tests in CEModeA (R15) The CR was partially implemented as it was not based on the latest version of the spec	15.2.0
2018-03	RAN#79	RP-180281	5566		A	Correction for LAA channel occupancy test (R15)	15.2.0
2018-03	RAN#79	RP-180294	5569		A	Correction for LAA RSSI measurement accuracy requirement (R15)	15.2.0
2018-03	RAN#79	RP-180264	5571	1	F	Requirements for LTE incmon with NR	15.2.0
2018-03	RAN#79	RP-180296	5573		A	Changes to conditions for V2X GNSS reliability requirements	15.2.0
2018-03	RAN#79	RP-180279	5575		B	CR to 36.133: Introduction of Band 85 (B12-extended)	15.2.0
2018-03	RAN#79	RP-180297	5577		A	Updating HO requirement without SFN acquisition for feMTC R15	15.2.0
2018-03	RAN#79	RP-180298	5579		A	Updating HO test cases without SFN acquisition for feMTC CEModeA R15	15.2.0
2018-03	RAN#79	RP-180298	5581		A	Updating HO test cases without SFN acquisition for feMTC CEModeB R15	15.2.0
2018-03	RAN#79	RP-180264	5582	1	F	Interruption time for MG in EN-DC	15.2.0
2018-03	RAN#79	RP-180297	5591		A	CR on RRM measurement requirements for UE cat M1 R15	15.2.0
2018-03	RAN#79	RP-180298	5593	1	A	CR on intra RSTD accuracy requirement for FeMTC R15	15.2.0
2018-03	RAN#79	RP-180295	5595	1	A	CR on non-uniform gap inter frequency requirements when DRX is used R15	15.2.0
2018-03	RAN#79	RP-180264	5596		F	CR on TS36133 for event triggering and reporting criteria	15.2.0
2018-03	RAN#79	RP-180295	5598		A	Correction on interruption test cases for SRS switching in CA R15	15.2.0

2018-03	RAN#79	RP-180295	5600		A	Correction on interruption test cases for SRS switching in DC R15	15.2.0
2018-03	RAN#79	RP-180264	5601		F	CR on measurement gap patterns in TS 36.133	15.2.0
2018-03	RAN#79	RP-180295	5603	1	A	Clean-up for high speed performance enhancement	15.2.0
2018-03	RAN#79	RP-180296	5605		A	CR on introducing PSSCH RMC configuration for V2X UE autonomous resource selection/reselection measurement tests R15	15.2.0
2018-03	RAN#79	RP-180293	5613		A	Editorial change on RLM requirement	15.2.0
2018-03	RAN#79	RP-180296	5618		A	CR for intra frequency RSTD reporting delay test case for eNB-IOT positioning R15	15.2.0
2018-03	RAN#79	RP-180296	5619		A	CR for inter frequency RSTD reporting delay test case for eNB-IOT positioning R15	15.2.0
2018-03	RAN#79	RP-180264	5622	1	B	CR on TS36.133 for UE capability in idle mode	15.2.0
2018-03	RAN#79	RP-180264	5624		F	CR on TS36.133 for NR RRM measurement in EN-DC	15.2.0
2018-03	RAN#79	RP-180264	5625	1	F	CR on TS36.133 for inter-frequency E-UTRAN RRM measurement in EN-DC	15.2.0
2018-03	RAN#79	RP-180264	5628	2	B	CR on TS36.133 for inter-RAT handover from E-UTRAN to NR	15.2.0
2018-03	RAN#79	RP-180264	5631	1	F	CR on TS36.133 for UE measurement capability related to EN-DC operation	15.2.0
2018-03	RAN#79	RP-180264	5632	1	F	CR on TS36.133 for EN-DC SSTD measurement	15.2.0
2018-03	RAN#79	RP-180294	5642		A	CR for 36.133 introducing band 68	15.2.0
2018-03	RAN#79	RP-180293	5645		A	Clarification on coverage enhancement level for cat-NB1 in IDLE state	15.2.0
2018-03	RAN#79	RP-180297	5647		A	Clarification on enhanced RLM requirements for FeMTC	15.2.0
2018-03	RAN#79	RP-180298	5649	1	A	Editorial correction to test cases on SI reading test in DRX for cat-M1 in CEModeB	15.2.0
2018-03	RAN#79	RP-180296	5656		A	Editorial correction in RSTD requirements for UE category 1bis	15.2.0
2018-03	RAN#79	RP-180296	5658		A	OTDOA NB-IoT: Corrections to core and test requirements for NB-IOT Positioning tests (Rel-15)	15.2.0
2018-03	RAN#79	RP-180298	5660		A	OTDOA eMTC: Corrections to core and test requirements for eMTC Positioning tests (Rel-15)	15.2.0
2018-03	RAN#79	RP-180278	5661		B	Introduction of TDD 3.3-3.4GHz band (band 52)	15.2.0
2018-06	RAN#80	RP-181075	5687		B	CR for 36.133 on UE measurement capability for NR SA UE without NR PCell	15.3.0
2018-06	RAN#80	RP-181075	5782		B	On TDD inter-RAT SFTD measurement requirements	15.3.0
2018-06	RAN#80	RP-181075	5831	1	B	CR for 36.133 Clarification on the total number of carrier frequency layers	15.3.0
2018-06	RAN#80	RP-181075	5735	4	B	Introduction of inter-RAT SFTD measurement requirement	15.3.0
2018-06	RAN#80	RP-181075	5783	1	B	On inter-RAT SFTD interruption requirements	15.3.0
2018-06	RAN#80	RP-181076	5719		F	CR on TS36.133 for NR RRM measurement in EN-DC	15.3.0
2018-06	RAN#80	RP-181076	5666	1	F	Applicability of EN-DC requirements in 36.133	15.3.0
2018-06	RAN#80	RP-181076	5761		F	CR on short gap for LTE measurement in TS36.133	15.3.0
2018-06	RAN#80	RP-181076	5790		F	CR on inter-frequency measurement in EN-DC for 36.133	15.3.0
2018-06	RAN#80	RP-181076	5800	1	F	CR on TS36.133 for NR PSCell addition delay	15.3.0
2018-06	RAN#80	RP-181076	5799	2	F	CR on TS36.133 for inter-RAT 3G measurement in EN-DC	15.3.0
2018-06	RAN#80	RP-181076	5759	2	F	CR on TS36.133 on interruptions for NSA EN-DC	15.3.0
2018-06	RAN#80	RP-181076	5760	2	F	CR on TS36.133 for inter-RAT handover from E-UTRAN to NR	15.3.0
2018-06	RAN#80	RP-181077	5772	1	F	CR on interruption for SCell activation and deactivation with sTTI	15.3.0
2018-06	RAN#80	RP-181077	5757	1	D	Editorial corrections to STTI and short processing time requirements	15.3.0
2018-06	RAN#80	RP-181077	5758	2	B	ONCG and RMC definitions for slot and subslot RRM testing in LTE	15.3.0
2018-06	RAN#80	RP-181077	5791	2	B	Test case principle for sTTI	15.3.0
2018-06	RAN#80	RP-181077	5792	2	B	E-UTRAN FDD – UE Timing Advance Adjustment Delay Test for sTTI and processing time reduction	15.3.0
2018-06	RAN#80	RP-181077	5833		B	E-UTRAN TDD – UE Timing Advance Adjustment Delay Test for sTTI and processing time reduction	15.3.0
2018-06	RAN#80	RP-181079	5665	1	B	CR on interruption and addition/release requirement for V2X carrier aggregation	15.3.0
2018-06	RAN#80	RP-181079	5788	2	B	CR on Synchronization Reference Source Selection/Reselection requirements for V2X CA	15.3.0
2018-06	RAN#80	RP-181079	5769	2	F	CR on V2X CA requirements corrections	15.3.0
2018-06	RAN#80	RP-181082	5817	3	B	Introducing RRC_INACTIVE mode mobility requirements for 36133	15.3.0
2018-06	RAN#80	RP-181083	5754		B	RSTD measurement requirements with new gaps	15.3.0

2018-06	RAN#80	RP-181083	5826		B	Introduction of High-velocity support for muting for Rel-15 MTC	15.3.0
2018-06	RAN#80	RP-181083	5803	1	F	CR on CGI requirements for CEmodeB	15.3.0
2018-06	RAN#80	RP-181083	5805	1	F	CR on new gap impact on intra-frequency RSTD requirements for M1	15.3.0
2018-06	RAN#80	RP-181083	5806	1	F	CR on new gap impact on intra-frequency RSTD requirements for M2	15.3.0
2018-06	RAN#80	RP-181083	5753	2	B	Introduction of measurement gaps for dense PRS	15.3.0
2018-06	RAN#80	RP-181083	5825	3	B	Introduction of CRS muting requirements for Rel-15 MTC	15.3.0
2018-06	RAN#80	RP-181084	5717	1	B	CR for relaxed monitoring of cell reselection	15.3.0
2018-06	RAN#80	RP-181084	5796		B	CR for TDD NB-IoT RRM requirement	15.3.0
2018-06	RAN#80	RP-181084	5827		B	Side conditions for supporting TDD NB-IOT	15.3.0
2018-06	RAN#80	RP-181084	5797	1	B	CR for serving cell measurement relaxation for WUS-capable UE	15.3.0
2018-06	RAN#80	RP-181085	5765	4	B	Introduction of network-based CRS interference mitigation	15.3.0
2018-06	RAN#80	RP-181093	5736		B	Introduction of 1UL and more than 5DL CA into 36.133	15.3.0
2018-06	RAN#80	RP-181100	5756	1	F	Introduction of generic duplex modes test cases for 3/4/5DL CA	15.3.0
2018-06	RAN#80	RP-181100	5762	1	F	Introduction of generic duplex modes test cases on RSRP and RSRQ accuracy for 3/4/5DL CA	15.3.0
2018-06	RAN#80	RP-181100	5743	1	F	New generic TC: 4DL CA Activation and Deactivation	15.3.0
2018-06	RAN#80	RP-181100	5744	1	F	New generic TC: 5DL CA Activation and Deactivation	15.3.0
2018-06	RAN#80	RP-181100	5742	2	F	New generic TC: 3DL CA Activation and Deactivation	15.3.0
2018-06	RAN#80	RP-181110	5673		A	Correction of test parameters for LAA Test cases A.9.1.60 and A.9.1.61	15.3.0
2018-06	RAN#80	RP-181110	5679		A	Specify Measurement BW for LAA Test cases A.8.26.3/4 and A.8.26.9/10	15.3.0
2018-06	RAN#80	RP-181110	5750		A	Correction to Test Parameters for FS3 Channel Occupancy tests	15.3.0
2018-06	RAN#80	RP-181111	5775		A	Correction to eMTC CGI reading delay requirement R15	15.3.0
2018-06	RAN#80	RP-181112	5670		A	Remove [] from Physical channels for NB-IoT Test case A.6.1.16	15.3.0
2018-06	RAN#80	RP-181112	5676		A	Update parameters for NB-IoT Tx Timing Test case A.7.1.18	15.3.0
2018-06	RAN#80	RP-181112	5778		A	Correction to the delay requirement for RRC connection redirection to non-anchor carrier for NB-IoT R15	15.3.0
2018-06	RAN#80	RP-181113	5664		A	Editorial changes to single carrier RLM test case for 4 Rx capable Ues R15	15.3.0
2018-06	RAN#80	RP-181113	5747		A	Corrections to CA activation and deactivation test cases (Rel-15)	15.3.0
2018-06	RAN#80	RP-181114	5691		A	Intra-frequency RSTD measurement period requirements with gaps for Cat M1 UE	15.3.0
2018-06	RAN#80	RP-181114	5693		A	Intra-frequency RSTD measurement period requirements with gaps for Cat M2 UE	15.3.0
2018-06	RAN#80	RP-181114	5695		A	Correction for intra-frequency RSTD accuracy requirements with gaps for Cat M1 UE	15.3.0
2018-06	RAN#80	RP-181114	5697		A	Correction for intra-frequency RSTD accuracy requirements with gaps for Cat M2 UE	15.3.0
2018-06	RAN#80	RP-181114	5709	1	A	CR on intra-frequency RSTD measurement requirements for UE cat M1 in CE mode B	15.3.0
2018-06	RAN#80	RP-181114	5711	1	A	CR on intra-frequency RSTD measurement requirements for UE cat M2	15.3.0
2018-06	RAN#80	RP-181115	5725		A	OTDOA NB-IoT: Corrections to test requirements for NB-IOT Positioning tests (Rel-15)	15.3.0
2018-06	RAN#80	RP-181115	5699	1	A	Correction in SRS switching requirements	15.3.0
2018-06	RAN#80	RP-181115	5752		A	Remaining square brackets in eNB-IoT RSTD requirements (Rel-15)	15.3.0
2018-06	RAN#80	RP-181115	5787		A	CR on modification of GNSS reliability requirements for V2X R15	15.3.0
2018-06	RAN#80	RP-181115	5795		A	CR on NB-IoT test case Random Access on Non-anchor Carrier (A.6.2.18) R15	15.3.0
2018-06	RAN#80	RP-181116	5768	1	A	Correction to Category 1bis test case and requirement R15	15.3.0
2018-06	RAN#80	RP-181116	5785	1	A	CR on modification of interruption requirement for V2V R15	15.3.0
2018-09	RAN#81	RP-181897	5840		F	Number of frequency layers for inter-frequency RSTD in NSA NR in 36.133	15.4.0
2018-09	RAN#81	RP-181897	5843		F	Correcting inactive state requirements in 36133	15.4.0
2018-09	RAN#81	RP-181897	5842	1	F	Correcting UE measurement capability with same MO configured by MN and SN on TS36.133	15.4.0

						(The CR was not implemented as it is replaced by CR 5897r1)	
2018-09	RAN#81	RP-181897	5837	2	F	CR 36.133 Correction of EN-DC SFTD core requirement in DRX	15.4.0
2018-09	RAN#81	RP-181897	5835	1	F	Interruption requirements for EN-DC in 36.133	15.4.0
2018-09	RAN#81	RP-181897	5841	2	F	CR on inter-RAT NR measurements in idle in 36.133	15.4.0
2018-09	RAN#81	RP-181897	5848	2	B	Interruption Requirements on LTE Serving Cells due to BWP Switching	15.4.0
2018-09	RAN#81	RP-181897	5856		F	Interruption requirements for EN-DC in 36.133	15.4.0
2018-09	RAN#81	RP-181897	5866		F	CR to TS36.133 for editorial correction of NR NSA measurement capability	15.4.0
2018-09	RAN#81	RP-181897	5868		F	Introduction on Gap sharing for EN-DC in TS36.133	15.4.0
2018-09	RAN#81	RP-181897	5886		F	Correction of EN-DC SFTD core requirement	15.4.0
2018-09	RAN#81	RP-181897	5885	1	F	Clarification of inter-RAT SFTD core requirement	15.4.0
2018-09	RAN#81	RP-181897	5897	1	F	Correcting UE measurement capability with same MO configured by MN and SN on TS36.133	15.4.0
2018-09	RAN#81	RP-181897	5940	2	F	CR on NR PScell addition	15.4.0
2018-09	RAN#81	RP-181897	5857	1	F	CR on TS36.133 for handover from E-UTRAN to NR	15.4.0
2018-09	RAN#81	RP-181897	5909	1	B	CR to 36.133 on introduction of SFTD measurement accuracy requirements	15.4.0
2018-09	RAN#81	RP-181897	5867	3	F	CR on TS36.133 for inter-RAT NR measurements in idle	15.4.0
2018-09	RAN#81	RP-181899	5913		F	Indicator for high-speed operation for Rel-15 cat-M1/M2	15.4.0
2018-09	RAN#81	RP-181899	5879	1	B	Clarification of the requirement for dense PRS gap in eFeMTC UE R15	15.4.0
2018-09	RAN#81	RP-181899	5891	1	F	CR on RLM requirements for UE configured with dense PRS gaps	15.4.0
2018-09	RAN#81	RP-181899	5936	1	F	Updated requirements for measurement gaps for dense PRS	15.4.0
2018-09	RAN#81	RP-181899	5916	1	F	Remaining work on CRS muting for Cat-M1/M2	15.4.0
2018-09	RAN#81	RP-181900	5930	1	B	Addition of NSSS-based RRM measurement accuracy requirement	15.4.0
2018-09	RAN#81	RP-181900	5892	1	F	CR on WUS RRM requirements	15.4.0
2018-09	RAN#81	RP-181903	5858	1	F	CR on Interruption and Delay of CC addition/release	15.4.0
2018-09	RAN#81	RP-181904	5895		F	Correcting UE measurement capability in Inactive state for 36133	15.4.0
2018-09	RAN#81	RP-181905	5876	1	B	Addition of SCell activation/interruption requirement for dormant SCell	15.4.0
2018-09	RAN#81	RP-181905	5944	2	B	CR introducing enhanced utilization of CA and direct activation	15.4.0
2018-09	RAN#81	RP-181905	5942	2	B	CR introducing enhanced utilization of CA and idle mode measurements for early reporting	15.4.0
2018-09	RAN#81	RP-181906	5931	1	F	Applicability requirement for network-based CRS-IM	15.4.0
2018-09	RAN#81	RP-181911	5861		A	Correction of test parameters for LAA Test cases A.9.1.60 and A.9.1.61	15.4.0
2018-09	RAN#81	RP-181911	5872		A	Clarification of the measurement gap offset in LAA inter-frequency measurement test R15	15.4.0
2018-09	RAN#81	RP-181912	5917		A	Correction to category M1 PDSCH RMCs	15.4.0
2018-09	RAN#81	RP-181913	5914		A	Correction on gap ID usage for UE category M1/M2	15.4.0
2018-09	RAN#81	RP-181913	5935		A	Correction in inter-frequency RSTD measurement period requirements in FeMTC	15.4.0
2018-09	RAN#81	RP-181914	5901		A	CR on modification of V2X initiation/cease of SLSS transmission test for eNB as Timing Reference R15	15.4.0
2018-09	RAN#81	RP-181914	5903		A	CR on modification of V2X initiation/cease of SLSS transmission test for SyncRef UE as Timing Reference R15	15.4.0
2018-09	RAN#81	RP-181914	5905		A	CR on modification of V2X congestion control measurement test R15	15.4.0
2018-09	RAN#81	RP-181915	5853		A	Corrections to NB-IoT RSTD test cases (Rel-15)	15.4.0
2018-09	RAN#81	RP-181915	5855		A	Correct 5MHz eCell PRB# for Cat NB1 Test Case A.4.2.18	15.4.0
2018-09	RAN#81	RP-181915	5874		A	Introduction of MSG3-based channel quality report for NB-IoT	15.4.0
2018-09	RAN#81	RP-181917	5925		B	Introduction of Event Triggered Reporting test cases with generic duplex modes for 6DL/7DL CA	15.4.0
2018-09	RAN#81	RP-181917	5926		B	Introduction of Activation and Deactivation test cases with generic duplex modes for 6DL/7DL CA	15.4.0
2018-09	RAN#81	RP-181917	5927		B	Introduction of generic duplex modes test cases on RSRP accuracy for 6DL/7DL CA	15.4.0
2018-09	RAN#81	RP-181917	5928		B	Introduction of generic duplex modes test cases on RSRQ accuracy for 6DL/7DL CA	15.4.0
2018-09	RAN#81	RP-181917	5851	1	F	Corrections to generic CA RRM test cases (Rel-15)	15.4.0

2018-12	RAN#82	RP-182360	5946		F	Interruption requirements correction for EN-DC in 36.133	15.5.0
2018-12	RAN#82	RP-182360	5948		F	CR on UE measurement capability with MOs configured by MN and SN in TS36.133	15.5.0
2018-12	RAN#82	RP-182366	5954		A	Finalize MSG3-based channel quality report for NB-IoT	15.5.0
2018-12	RAN#82	RP-182366	5955	1	B	RMC for NB-IoT TDD RRM test cases	15.5.0
2018-12	RAN#82	RP-182365	5956	1	F	Addition of side condition for CGI reading delay for Rel-15 eFeMTC UE	15.5.0
2018-12	RAN#82	RP-182365	5959	1	F	Applicability rules for UE supporting new gaps	15.5.0
2018-12	RAN#82	RP-182365	5960	2	B	Intra-frequency FDD test cases for RSTD measurement period under new measurement gaps for CE Mode A	15.5.0
2018-12	RAN#82	RP-182365	5961	1	B	Intra-frequency HD-FDD test cases for RSTD measurement period under new measurement gaps for CE Mode A	15.5.0
2018-12	RAN#82	RP-182365	5962	1	B	Intra-frequency TDD test cases for RSTD measurement period under new measurement gaps for CE Mode A	15.5.0
2018-12	RAN#82	RP-182365	5964	1	B	Inter-frequency HD-FDD test cases for RSTD measurement period under new measurement gaps for CE Mode A	15.5.0
2018-12	RAN#82	RP-182365	5965	1	B	Inter-frequency TDD test cases for RSTD measurement period under new measurement gaps for CE Mode A	15.5.0
2018-12	RAN#82	RP-182383	5967	1	A	Correction in RSTD measurement requirements	15.5.0
2018-12	RAN#82	RP-182360	5968	2	F	CR to 36.133 on SFTD measurement requirements (Section 8.17.2, 8.1.2.4.25)	15.5.0
2018-12	RAN#82	RP-182365	5983	3	F	Requirements for high velocity measurement for eFeMTC	15.5.0
2018-12	RAN#82	RP-182361	5987		F	CR on interruption during DRX operation in TS 36.133	15.5.0
2018-12	RAN#82	RP-182383	6001		A	Correction to inter-frequency handover test case for UE category M1/M2 in CEModeB	15.5.0
2018-12	RAN#82	RP-182361	6017	1	F	CR 36.133 Inter-RAT and EN-DC SFTD measurement accuracy for FR2	15.5.0
2018-12	RAN#82	RP-182379	6024		A	CR 36.133 Correction of references in OCNG patterns Rel-15	15.5.0
2018-12	RAN#82	RP-182366	6026		A	CR 36.133 Correction of NB-IoT OCNG patterns Rel-15	15.5.0
2018-12	RAN#82	RP-182366	6027	1	B	Introduction of OCNG patterns for NB-IoT TDD	15.5.0
2018-12	RAN#82	RP-182386	6028	1	F	UE known dormant SCell condition and activation delay requirements for unknown dormant SCell	15.5.0
2018-12	RAN#82	RP-182384	6030		A	Correction to downlink channel quality reporting R15	15.5.0
2018-12	RAN#82	RP-182371	6032	1	B	RRM test for dormant SCell	15.5.0
2018-12	RAN#82	RP-182384	6035		A	Correction to RSTD measurement accuracy requirement in NB-IoT R15	15.5.0
2018-12	RAN#82	RP-182362	6038	4	B	CR for 36.133 on E-UTRAN measurement to support gap pattern 4, 6,7,8,10 (section 8.1.2.1, 8.1.2.3.1.2, 8.1.2.3.2.2, 8.17.3)	15.5.0
2018-12	RAN#82	RP-182365	6039		B	Inter-frequency FDD test cases for RSTD measurement period under new measurement gaps for CE Mode A	15.5.0
2018-12	RAN#82	RP-182361	6040		F	CR for correction on measurement gap sharing in EN-DC	15.5.0
2018-12	RAN#82	RP-182381	6043		A	Correction to FDD-FS3 Intra-frequency event triggered reporting in DRX	15.5.0
2018-12	RAN#82	RP-182388	6044		F	Correction to DL CA Activation and Deactivation Test cases	15.5.0
2018-12	RAN#82	RP-182384	6051	1	A	NB-IoT RSTD accuracy tests using Type 2 NPRS - Rel15	15.5.0
2018-12	RAN#82	RP-182360	6052	2	F	CR on updating requirement for BWP switching interruption in TS36.133 (Section 7.32.2.7)	15.5.0
2018-12	RAN#82	RP-182382	6058		A	Corrections to feMTC RRM test case A.8.1.28 (Rel-15)	15.5.0
2018-12	RAN#82	RP-182388	6061		F	Corrections to generic CA RRM test cases up to 5 DL CCs (Rel-15)	15.5.0
2018-12	RAN#82	RP-182388	6062		F	Corrections to generic CA RRM test cases for 6 and 7 DL CCs (Rel-15)	15.5.0
2018-12	RAN#82	RP-182366	6065		B	Introducing TDD NPRACH configuration for NB test cases	15.5.0
2018-12	RAN#82	RP-182366	6066	1	B	TDD contention based random access test case under normal coverage	15.5.0
2018-12	RAN#82	RP-182366	6067	1	B	TDD contention based random access test case under enhanced coverage	15.5.0

2018-12	RAN#82	RP-182366	6068	1	B	TDD contention based random access test case on non-anchor carriers	15.5.0
2018-12	RAN#82	RP-182367	6069	1	B	TDD intra-frequency RSTD measurement accuracy test case under normal coverage	15.5.0
2018-12	RAN#82	RP-182367	6070	1	B	TDD inter-frequency RSTD measurement accuracy test case under normal coverage	15.5.0
2018-12	RAN#82	RP-182367	6071	1	B	TDD intra-frequency RSTD measurement accuracy test case under enhanced coverage	15.5.0
2018-12	RAN#82	RP-182367	6072	1	B	TDD inter-frequency RSTD measurement accuracy test case under enhanced coverage	15.5.0
2018-12	RAN#82	RP-182367	6073	2	B	TDD idle intra-frequency RSTD measurement test case under enhanced coverage	15.5.0
2018-12	RAN#82	RP-182367	6074	2	B	TDD idle inter-frequency RSTD measurement test case under enhanced coverage	15.5.0
2018-12	RAN#82	RP-182366	6075		F	CR on TDD support in conditions for NB-IoT measurements	15.5.0
2018-12	RAN#82	RP-182367	6076	2	F	CR on TDD support in measurement accuracy requirements for NB-IoT	15.5.0
2018-12	RAN#82	RP-182366	6079	1	A	CR on NRSRP accuracy applicability for UE Category NB1 and NB2 R15	15.5.0
2018-12	RAN#82	RP-182367	6087		A	CR on NB random access test cases R15	15.5.0
2018-12	RAN#82	RP-182370	6089	1	B	Introducing principle for LTE UE connected to 5GC test cases	15.5.0
2018-12	RAN#82	RP-182361	6092	1	F	CR on PSCell addition delay in TS36.133 (The CR was not implemented as it is not based on the latest version of the specification)	15.5.0
2018-12	RAN#82	RP-182361	6093		F	Defining MG starting point in 36.133	15.5.0
2018-12	RAN#82	RP-182367	6095		A	Introduction of MSG3-based channel quality reporting test	15.5.0
2018-12	RAN#82	RP-182367	6097	1	B	CR introducing out-of-sync RLM test for NB-IoT TDD in normal coverage with DRX	15.5.0
2018-12	RAN#82	RP-182367	6098	1	B	CR introducing out-of-sync RLM test for NB-IoT TDD in enhanced coverage with DRX	15.5.0
2018-12	RAN#82	RP-182367	6099	1	B	CR introducing in-sync RLM test for NB-IoT TDD in normal coverage with DRX	15.5.0
2018-12	RAN#82	RP-182367	6100	1	B	CR introducing in-sync RLM test for NB-IoT TDD in enhanced coverage with DRX	15.5.0
2018-12	RAN#82	RP-182367	6101	1	B	CR introducing in-sync RLM test for NB-IoT TDD in normal coverage without DRX	15.5.0
2018-12	RAN#82	RP-182367	6102	1	B	CR introducing in-sync RLM test for NB-IoT TDD in enhanced coverage without DRX	15.5.0
2018-12	RAN#82	RP-182367	6103	1	B	CR introducing Out-of-sync RLM test for NB-IoT TDD in normal coverage without DRX in stand alone mode	15.5.0
2018-12	RAN#82	RP-182367	6104	1	B	CR introducing Out-of-sync RLM test for NB-IoT TDD in enhanced coverage without DRX in guard band	15.5.0
2018-12	RAN#82	RP-182386	6105	1	F	UE known dormant SCell condition	15.5.0
2018-12	RAN#82	RP-182386	6108	1	F	Introducing enhanced utilization of CA and direct activation in HO	15.5.0
2018-12	RAN#82	RP-182366	6113	1	B	Cell re-selection test case for TDD Intra frequency case for UE category NB1 in in-band mode in normal coverage	15.5.0
2018-12	RAN#82	RP-182366	6114	1	B	TDD Inter-frequency RRC Re-establishment for UE category NB1 in In-Band mode under normal coverage	15.5.0
2018-12	RAN#82	RP-182366	6115	1	B	UE Transmit Timing Accuracy Test for category NB1 UE In-Band in Normal coverage	15.5.0
2018-12	RAN#82	RP-182367	6118	1	B	UE Transmit Timing Accuracy Test for category NB1 UE In-Band in Enhanced coverage	15.5.0
2018-12	RAN#82	RP-182367	6119	1	B	UE Timing advance adjustment test Test for category NB1 UE standalone under Enhanced coverage	15.5.0
2018-12	RAN#82	RP-182366	6120	1	B	TDD Intra-frequency RRC Re-establishment for UE category NB1 in In-Band mode under enhanced coverage	15.5.0
2018-12	RAN#82	RP-182366	6121	1	B	Cell re-selection test case for TDD Inter- frequency case for UE category NB1 in in-band mode in enhanced coverage	15.5.0
2018-12	RAN#82	RP-182366	6122	1	B	Cell re-selection test case for TDD Intra frequency case for UE category NB1 in in-band mode in enhanced coverage	15.5.0
2018-12	RAN#82	RP-182365	6124	2	F	Correction of references in CONNECTED mode requirements for category M1	15.5.0
2018-12	RAN#82	RP-182366	6127	1	B	Introduction of enhanced PHR for category NB1	15.5.0
2018-12	RAN#82	RP-182366	6128		B	Remaining work on minimum WUS reception requirements for NB-IoT	15.5.0

2018-12	RAN#82	RP-182365	6129		B	Introduction of WUS requirements for efeMTC	15.5.0
2018-12	RAN#82	RP-182386	6132	1	F	Addition of missing Band 71 in 36.133 NB-IoT bands	15.5.0
2018-12	RAN#82	RP-182385	6134		A	Corrections on V2X core requirements in TS36.133 R15	15.5.0
2018-12	RAN#82	RP-182385	6136		A	Corrections on Conditions for Selection/Reselection to Intra-frequency SyncRef UE R15	15.5.0
2018-12	RAN#82	RP-182382	6149		A	Clarification on the applicability of side condition for CE UE R15	15.5.0
2018-12	RAN#82	RP-182383	6153		A	Applicability of non-BL CE requirements for Cat-1bis (The CR was partially implemented as it is not based on the latest version of the specification)	15.5.0
2018-12	RAN#82	RP-182365	6155	1	F	Correction to CRS muting applicability in efeMTC	15.5.0
2018-12	RAN#82	RP-182360	6156	1	F	Introduction of search window for 4ms MGL in LTE interfrequency requirements (The CR was partially implemented as this CR is clashes with CR#6038r4)	15.5.0
2018-12	RAN#82	RP-182360	6157	2	F	Corrections to DRX cycle for EN-DC operation	15.5.0
2018-12	RAN#82	RP-182360	6158	2	F	Correction of side condition in FR2 handover in section 6.1.1	15.5.0
2018-12	RAN#82	RP-182386	6160	2	F	SIB5 reporting corrections for Idle Mode CA Measurement	15.5.0
2018-12	RAN#82	RP-182386	6167	1	F	Corrections in network-based CRS interference mitigation requirements	15.5.0
2018-12	RAN#82	RP-182365	6168	2	B	Intra-frequency FDD test cases for RSTD measurement period under new measurement gaps for CE Mode B	15.5.0
2018-12	RAN#82	RP-182365	6169	2	B	Intra-frequency HD-FDD test cases for RSTD measurement period under new measurement gaps for CE Mode B	15.5.0
2018-12	RAN#82	RP-182365	6170	2	B	Intra-frequency TDD test cases for RSTD measurement period under new measurement gaps for CE Mode B	15.5.0
2018-12	RAN#82	RP-182365	6171	1	B	Inter-frequency FDD test cases for RSTD measurement period under new measurement gaps for CE Mode B	15.5.0
2018-12	RAN#82	RP-182365	6172	1	B	Inter-frequency HD-FDD test cases for RSTD measurement period under new measurement gaps for CE Mode B	15.5.0
2018-12	RAN#82	RP-182365	6173	2	B	Inter-frequency TDD test cases for RSTD measurement period under new measurement gaps for CE Mode B	15.5.0
2018-12	RAN#82	RP-182383	6175		A	Correction in FeMTC RSTD test cases	15.5.0
2018-12	RAN#82	RP-182362	6176		B	Inter-RAT NR measurement accuracy requirements	15.5.0
2018-12	RAN#82	RP-182360	6177		F	Side conditions for inter-RAT NR measurements in EN-DC case	15.5.0
2018-12	RAN#82	RP-182360	6178		F	Side conditions for inter-RAT NR measurements in non-EN-DC case	15.5.0
2018-12	RAN#82	RP-182379	6186		A	Corrections to incmon testcases	15.5.0
2018-12	RAN#82	RP-182369	6187		B	CR on introducing test cases of Synchronization Reference Source Selection/Reselection requirements for V2X CA	15.5.0
2018-12	RAN#82	RP-182369	6188		B	CR on introducing test cases of interruptions due to V2X CA	15.5.0
2019-03	RAN#83	RP-190414	6191		A	Correction to FDD-FS3 Intra-frequency event triggered reporting in DRX	15.6.0
2019-03	RAN#83	RP-190413	6196		A	Clarifications on HD-FDD NB-IoT Out-of-sync RLM test cases	15.6.0
2019-03	RAN#83	RP-190413	6200		A	Corrections to HD-FDD NB-IoT In-Sync RLM tests	15.6.0
2019-03	RAN#83	RP-190413	6204		A	Clarification on test requirements for transmit timing accuracy for HD-FDD Category NB1 UE	15.6.0
2019-03	RAN#83	RP-190406	6206		F	Clarification on test requirements for transmit timing accuracy for TDD Category NB1 UE	15.6.0
2019-03	RAN#83	RP-190416	6209		A	Clarifications to HD-FDD Idle State Positioning Measurement test for NB1	15.6.0
2019-03	RAN#83	RP-190406	6211	1	F	Clarifications to TDD Idle State Positioning Measurement test for NB1	15.6.0
2019-03	RAN#83	RP-190399	6222		F	Corrections on SFTD R15 (8.1.2.4.26.1)	15.6.0
2019-03	RAN#83	RP-190411	6229		A	Correction to Incmon test cases for reselection from E-UTRA FDD/TDD to UTRA	15.6.0
2019-03	RAN#83	RP-190399	6233	1	F	Inter-RAT NR measurements in 36.133 for SA	15.6.0
2019-03	RAN#83	RP-190414	6239	1	A	CR to 36.133 for corrections on section A.9.10 and section A.9.13	15.6.0
2019-03	RAN#83	RP-190400	6240	1	F	Corrections on SFTD measurement requirements for EN-DC	15.6.0

2019-03	RAN#83	RP-190399	6241		F	CR for MO merging in 36.133	15.6.0
2019-03	RAN#83	RP-190400	6242	1	F	CR for SFTD in 36.133	15.6.0
2019-03	RAN#83	RP-190413	6245	1	A	CR on NB random access test cases R15	15.6.0
2019-03	RAN#83	RP-190416	6248	1	A	CR on MSG3 based channel quality report requirements R15	15.6.0
2019-03	RAN#83	RP-190406	6257		F	CR on Cat NB2 UE test cases applicability R15	15.6.0
2019-03	RAN#83	RP-190399	6259	1	F	CR on BWP switch interruptions on LTE PCell in EN-DC R15	15.6.0
2019-03	RAN#83	RP-190421	6261	1	F	Adding section 8.18 in 36.133	15.6.0
2019-03	RAN#83	RP-190417	6264		A	Correction to the non-BL UE applicability	15.6.0
2019-03	RAN#83	RP-190417	6267		A	Correction of reference number in Cat-M HO requirements	15.6.0
2019-03	RAN#83	RP-190421	6269	1	F	Finalizing efeMTC CRS muting applicability	15.6.0
2019-03	RAN#83	RP-190399	6273		B	Measurement requirements for NE-DC	15.6.0
2019-03	RAN#83	RP-190399	6275	2	B	CR for measurement gap applicability for NE-DC	15.6.0
2019-03	RAN#83	RP-190399	6279	1	F	CR on E-UTRAN E-UTRAN inter-frequency and inter-RAT measurements with EN-DC in TS36.133 R15	15.6.0
2019-03	RAN#83	RP-190402	6281	2	F	CR on corrections on SFTD measurements accuracy in TS36.133 R15	15.6.0
2019-03	RAN#83	RP-190399	6283	1	F	CR on gap sharing and CSSF definition in TS36.133	15.6.0
2019-03	RAN#83	RP-190408	6287	1	B	Applicability rule for 8Rx RLM	15.6.0
2019-03	RAN#83	RP-190416	6290		A	Correction of NB-IoT MSG3-based channel quality report test case	15.6.0
2019-03	RAN#83	RP-190399	6292	2	F	CR on E-UTRA SCell (de)activation interruptions for EN-DC (36.133, Rel-15)	15.6.0
2019-03	RAN#83	RP-190399	6294		B	CR on interruption requirements for NE-DC (36.133, Rel-15)	15.6.0
2019-03	RAN#83	RP-190400	6296		B	CR on E-UTRA SCell (de)activation applicability for NE-DC (36.133)	15.6.0
2019-03	RAN#83	RP-190416	6303		A	Corrections to NB-IOT RSTD reporting delay core requirements (Rel-15)	15.6.0
2019-03	RAN#83	RP-190416	6306		A	Corrections to NB-IOT RSTD reporting accuracy test requirements for normal coverage (Rel-15)	15.6.0
2019-03	RAN#83	RP-190416	6309		A	Corrections to NB-IOT RSTD reporting accuracy test requirements for enhanced coverage (Rel-15)	15.6.0
2019-03	RAN#83	RP-190400	6311		F	Corrections on SFTD accuracy requirements	15.6.0
2019-03	RAN#83	RP-190417	6315	1	A	Correction to side conditions for cat-M	15.6.0
2019-03	RAN#83	RP-190421	6319	1	F	Maintenance CR on WUS requirements for cat-M Ues	15.6.0
2019-03	RAN#83	RP-190420	6321	2	F	Maintenance CR on WUS requirements for Rel-15 NB-IoT	15.6.0
2019-03	RAN#83	RP-190400	6323	1	B	Requirements for RRC connection release with redirection delay from LTE to NR	15.6.0
2019-03	RAN#83	RP-190422	6325	1	B	IDLE mode measurement requirements for euCA	15.6.0
2019-03	RAN#83	RP-190407	6327	1	B	Introduction of IDLE mode measurement accuracy requirements	15.6.0
2019-03	RAN#83	RP-190407	6329	1	B	CR introducing test case for enhanced utilization of CA and idle mode measurements for early reporting	15.6.0
2019-03	RAN#83	RP-190400	6332	1	F	CR on inter-RAT NR measurements (36.133-rel15)	15.6.0
2019-03	RAN#83	RP-190400	6334	1	F	CR on NR PSCell addition delay in EN-DC (36.133-rel15)	15.6.0
2019-03	RAN#83	RP-190420	6336		F	Clean-up in network-based CRS interference mitigation requirements	15.6.0
2019-03	RAN#83	RP-190400	6342	1	F	UE measurements capability in RRC_IDLE for EN-DC capable UE	15.6.0
2019-03	RAN#83	RP-190400	6344	1	F	Introduction of NE-DC in 36.133	15.6.0
2019-03	RAN#83	RP-190400	6346		F	Requirements for NGEN-DC	15.6.0
2019-06	RAN#84	RP-191265	6359		F	Corrections to TDD in-sync RLM test cases for NB-IoT	15.7.0
2019-06	RAN#84	RP-191265	6361		F	Corrections to TDD inter-frequency idle state positioning measurement test in NB1	15.7.0
2019-06	RAN#84	RP-191265	6372	1	F	CR on Cat NB2 UE test cases applicability R15	15.7.0
2019-06	RAN#84	RP-191265	6378	3	F	Maintenance on TDD inter-frequency re-establishment test cases R15	15.7.0
2019-06	RAN#84	RP-191265	6380		F	Maintenance on side conditions for NSSS measurement accuracy requirements R15	15.7.0
2019-06	RAN#84	RP-191265	6382		F	CR on TDD intra frequency idle RSTD accuracy test cases R15	15.7.0
2019-06	RAN#84	RP-191266	6384		F	CR on serving cell measurement relaxation for NB-IoT R15	15.7.0
2019-06	RAN#84	RP-191238	6386	2	F	Maintenance CR on event triggering and reporting criteria R15	15.7.0
2019-06	RAN#84	RP-191238	6396	1	F	Introduction of UE measurement capability for NE-DC in 36.133	15.7.0

2019-06	RAN#84	RP-191238	6403		F	CR for starting point of measurement gap in LTE, ENDC and NEDC in TS 36.133	15.7.0
2019-06	RAN#84	RP-191239	6409	3	F	CR on PSCell addition delay R15	15.7.0
2019-06	RAN#84	RP-191239	6419		F	Side condition for NR handover	15.7.0
2019-06	RAN#84	RP-191238	6427	1	F	Interruption Requirement for RRC based BWP Switching on LTE Serving Cells	15.7.0
2019-06	RAN#84	RP-191238	6430		F	CR on TS36.133 for UE behavior after MG (Section 8.1.2)	15.7.0
2019-06	RAN#84	RP-191264	6437		F	Correction to side conditions for cat-M	15.7.0
2019-06	RAN#84	RP-191267	6448		F	Correction to event triggered reporting on Deactivated SCell	15.7.0
2019-06	RAN#84	RP-191258	6452		A	Correction to timing advance adjustment accuracy test for Cat-M1 UE	15.7.0
2019-06	RAN#84	RP-191239	6457		F	maintenance CR on redirection requirements R15	15.7.0
2019-06	RAN#84	RP-191238	6459		F	CR for NE-DC interruptions due to BWP switch R15	15.7.0
2019-06	RAN#84	RP-191260	6464		A	Maintenance on HD-FDD inter-frequency re-establishment test cases R15	15.7.0
2019-06	RAN#84	RP-191265	6466	1	F	CR on TDD inter frequency idle RSTD accuracy test cases R15	15.7.0
2019-06	RAN#84	RP-191265	6468	1	F	endorsed CR for serving cell RRM measurement relaxation test case R15	15.7.0
2019-06	RAN#84	RP-191239	6474		F	Requirements for RRC connection release with redirection delay from LTE to NR	15.7.0
2019-06	RAN#84	RP-191264	6477	2	F	CR introducing test cases for direct activation of Scell	15.7.0
2019-06	RAN#84	RP-191239	6479	2	F	PSCell addition delay in FR2 36.133 rel-15	15.7.0
2019-06	RAN#84	RP-191264	6482		F	Corrections to idle mode CA measurement accuracy test	15.7.0
2019-06	RAN#84	RP-191264	6484		F	Clarification on WUS EPRE in requirements for WUS reception for UE category M1	15.7.0
2019-06	RAN#84	RP-191238	6486	1	F	Correction CR for inter-RAT NR measurement before EN-DC in 36.133	15.7.0
2019-06	RAN#84	RP-191260	6490		A	CR on threshold for FS3 RSSI and channel occupancy tests R15	15.7.0
2019-06	RAN#84	RP-191238	6492		F	CR on reselection criterion in inter-RAT NR measurements (36.133-rel15)	15.7.0
2019-06	RAN#84	RP-191238	6494	1	F	CR to 36.133 on SFTD accuracy	15.7.0
2019-06	RAN#84	RP-191238	6504		F	Correction on the Tiu in handover in TS36.133 R15	15.7.0
2019-06	RAN#84	RP-191260	6511		A	Corrections on inter-frequency RS-SINR measurement accuracy test in TS36.133 R15	15.7.0
2019-06	RAN#84	RP-191261	6517		A	CR for eMTC re-establishment test case	15.7.0
2019-06	RAN#84	RP-191261	6520		A	CR for eMTC RSTD test cases	15.7.0
2019-06	RAN#84	RP-191239	6531		F	CR 36.133 Correction to SFTD interruption requirements (Rel-15)	15.7.0
2019-06	RAN#84	RP-191260	6535		A	Corrections to NB-IoT PRACH test cases (Rel-15)	15.7.0
2019-06	RAN#84	RP-191267	6537		F	Adding missing bands in the bands grouping	15.7.0
2019-06	RAN#84	RP-191239	6539		F	RSTD requirements for NE-DC	15.7.0
2019-06	RAN#84	RP-191260	6542		A	Adding missing UE Rx-Tx time difference measurement mapping for TDD	15.7.0
2019-06	RAN#84	RP-191239	6544		F	Reporting criteria for NE-DC and EN-DC	15.7.0
2019-09	RAN#85	RP-192052	6551		A	Correction to NB-IoT RSTD delay test case (Rel 15)	15.8.0
2019-09	RAN#85	RP-192051	6561		A	Corrections to test case for HD – FDD Inter frequency reselection case for UE Category NB1 In-Band mode in enhanced coverage	15.8.0
2019-09	RAN#85	RP-192055	6564		F	CR on Cat NB2 UE test cases applicability R15	15.8.0
2019-09	RAN#85	RP-192055	6566		F	maintenance CR on synchronized TDD NB test cases R15	15.8.0
2019-09	RAN#85	RP-192055	6568		F	CR on NB1 timing test cases R15	15.8.0
2019-09	RAN#85	RP-192047	6576	1	F	CR on interruptions due to RRC based BWP switch for EN-DC R15	15.8.0
2019-09	RAN#85	RP-192047	6578	1	F	CR on BWP switch interruptions for NE-DC R15	15.8.0
2019-09	RAN#85	RP-192052	6583		A	Clarification of Rmax for NB-IoT MSG3-based channel quality report	15.8.0
2019-09	RAN#85	RP-192047	6585	1	F	CR on applicability of gap in LTE, ENDC and NEDC in 36.133 R15	15.8.0
2019-09	RAN#85	RP-192047	6587		F	CR on default gap sharing scheme in 36.133 R15	15.8.0
2019-09	RAN#85	RP-192047	6589		F	CR on handover requirements in 36.133 R15	15.8.0
2019-09	RAN#85	RP-192047	6591	1	F	CR on PSCell addition in ENDC R15	15.8.0
2019-09	RAN#85	RP-192047	6600		F	Editorial corrections in 36.133	15.8.0
2019-09	RAN#85	RP-192055	6603	1	F	Applicability of non-BL CE UE requirements in release 15	15.8.0
2019-09	RAN#85	RP-192052	6605		A	Correction of section numbering in handover requirements	15.8.0

2019-09	RAN#85	RP-192055	6609	1	F	Clarification of normal and enhanced coverage UE requirements in IDLE mode for Rel-15	15.8.0
2019-09	RAN#85	RP-192047	6617		F	Correction of interruption requirements for EN-DC in 36.133 R15	15.8.0
2019-09	RAN#85	RP-192047	6621		F	Correction of interruption requirements for NE-DC in 36.133 R15	15.8.0
2019-09	RAN#85	RP-192047	6623		F	Correction to MG interruption due to NE-DC in 36.133 R15	15.8.0
2019-12	RAN#86	RP-193043	6676		A	Correction to misused variables in intra-frequency cell identification requirements	15.9.0
2019-12	RAN#86	RP-193038	6679		F	CR on handover requirements in 36.133 R15	15.9.0
2019-12	RAN#86	RP-193043	6684		A	CR on clarification on RSSI measurement requirement R15	15.9.0
2019-12	RAN#86	RP-193038	6690	1	F	CR on E-UTRA Inter-frequency Measurements when Configured with E-UTRA-NR Dual Connectivity Operation in TS36.133 (section 8.17.3)	15.9.0
2019-12	RAN#86	RP-193047	6700		F	Correction RAN4 requirements for a Dormant Scell	15.9.0
2019-12	RAN#86	RP-193047	6702		F	Measurements interruption requirements for an SCell in Dormant state	15.9.0
2019-12	RAN#86	RP-193047	6704		F	Correction to interruption requirement introduction to include dormant Scell	15.9.0
2019-12	RAN#86	RP-193047	6706		F	Removal of brackets from euCA performance requirements	15.9.0
2019-12	RAN#86	RP-193047	6708		F	Correction to test case A.8.16.104	15.9.0
2019-12	RAN#86	RP-193047	6710	1	F	Correction to S-measure threshold applicability in IDLE mode measurements	15.9.0
2019-12	RAN#86	RP-193038	6714	1	F	CR for 36133 editorial for section 7.6 and 7.31 in Rel-15	15.9.0
2019-12	RAN#86	RP-193038	6715	1	F	CR for 36133 editorial for section 8.1.2.4 and 8.17.4 in Rel-15	15.9.0
2019-12	RAN#86	RP-193049	6721	1	F	Applicability of relaxed neighbour cell monitoring for category M1/M2	15.9.0
2019-12	RAN#86	RP-193046	6725	1	F	Cat-1bis clarification to RSRQ measurements	15.9.0
2019-12	RAN#86	RP-193046	6730		A	CR on maintaining core requirements and tests for V3X synchronization reference source selection/reselection R15	15.9.0
2019-12	RAN#86	RP-193046	6733		A	CR on maintaining interruption tests due to V2X sidelink communication R15	15.9.0
2019-12	RAN#86	RP-193047	6745		F	Correction to direct Scell activation requirements R15	15.9.0
2019-12	RAN#86	RP-193047	6747		F	Correction to direct Scell activation during HO requirements R15	15.9.0
2019-12	RAN#86	RP-193047	6749		F	Adding interruption length requirements for direct Scell activation R15	15.9.0
2019-12	RAN#86	RP-193047	6751		F	Update to interruption requirements due to measurement on dormant Scell R15	15.9.0
2019-12	RAN#86	RP-193047	6753		F	Adding interruption length requirements for dormant state transition R15	15.9.0
2019-12	RAN#86	RP-193038	6755		F	Correction on inter-frequency RSTD measurement requirements	15.9.0
2019-12	RAN#86	RP-193043	6772		A	Clarifications on RSSI and Channel Occupancy measurement requirements in LTE LAA	15.9.0
2019-12	RAN#86	RP-193043	6780		A	Correction of reference in subclause 5.3.2	15.9.0
2019-12	RAN#86	RP-193038	6782		F	Editorial updates (36.133, section 8.19)	15.9.0
2019-12	RAN#86	RP-193049	6789		F	Correction of feMTC test cases	15.9.0
2020-06	RAN#88	RP-200983	6825		F	[CR] RRC release with redirection 36.133 R15	15.10.0
2020-06	RAN#88	RP-200990	6835		A	CR to RRM MPDSCH Repetitions in CE ModeA test case	15.10.0
2020-06	RAN#88	RP-200988	6841	1	F	Finalisation of requirements in 36.133 R15	15.10.0
2020-06	RAN#88	RP-200992	6843		F	Editorial correction of E-UTRAN FDD	15.10.0
2020-06	RAN#88	RP-200988	6850		F	CR on Number of carriers to monitor for IDLE mode measurements	15.10.0
2020-06	RAN#88	RP-200990	6860		A	CR to TS 36.133: Change of SR-ConfigIndex in eMTC RLM DRX test cases (Rel-15)	15.10.0
2020-06	RAN#88	RP-200983	6862	1	F	CR to 36.133 on NR reporting criteria	15.10.0
2020-06	RAN#88	RP-200988	6873		A	CR on NB-IoT cell reselection margin in enhanced coverage in Rel-15 (Cat A)	15.10.0
2020-06	RAN#88	RP-200983	6879		F	Correction on gap pattern applicability in TS 36.133 R15	15.10.0
2020-06	RAN#88	RP-200983	6881		F	CR to remove RSTD requirements for NE-DC in 36.133 R15	15.10.0
2020-06	RAN#88	RP-200989	6892		A	Correction to eMTC inter-frequency reselection margin R15	15.10.0
2020-06	RAN#88	RP-200983	6905		F	Correction to RRC release with redirection requirements in 36.133 Rel-15	15.10.0

2020-09	RAN#89	RP-201512	6915		A	Correction to intra-frequency event triggered reporting test case in CEModeA	15.11.0
2020-09	RAN#89	RP-201512	6935	1	F	CR on NB-IoT Intra frequency with serving cell measurement relaxation test case 4.2.38 R15	15.11.0
2020-09	RAN#89	RP-201512	6940		F	Correction on UE measurement capability in NR idle mode R15	15.11.0
2020-09	RAN#89	RP-201512	6942		F	CR to measurement capability for NE-DC in 36133 R15	15.11.0
2020-12	RAN#90	RP-202512	6966		A	CR on maintaining V2X test cases in TS36.133 R15	15.12.0
2020-12	RAN#90	RP-202491	6986		F	CR 36.133 Corrections to test cases for SCell Hibernation	15.12.0
2020-12	RAN#90	RP-202486	6989		F	CR 36.133 Removal of brackets for SFTD measurements	15.12.0
2020-12	RAN#90	RP-202513	7004		A	Correction to test parameters for FDD and TDD intra-frequency RSRP for Cat-M1 UE in CEModeA	15.12.0
2021-03	RAN#91	RP-210120	7020	1	F	CR: Correction of eMTC RLM test cases	15.13.0
2021-03	RAN#91	RP-210115	7038		F	CR 36.133 (A.8.16.106) Correction of test case for direct Scell activation at addition	15.13.0
2021-03	RAN#91	RP-210121	7051	1	F	Correction to applicability of E-UTRAN E-CID measurements requirements for NE-DC	15.13.0
2021-03	RAN#91	RP-210119	7055		A	Correction to requirements for NCSG patterns	15.13.0
2021-03	RAN#91	RP-210117	7058	1	F	CR to remove intra-frequency ECID requirements for NE-DC 36.133 R15	15.13.0
2021-03	RAN#91	RP-210117	7061		F	CR to idle more requirements in 36.133 R15	15.13.0
2021-03	RAN#91	RP-210113	7074	2	F	CR on TC for eMTC RSTD measurement R15	15.13.0
2021-03	RAN#91	RP-210112	7077	1	F	CR on CRS muting for eMTC R15	15.13.0
2021-06	RAN#92	RP-211107	7098		A	CR on requirements of cell reselection for NB-IoT R15	15.14.0
2021-06	RAN#92	RP-211089	7108		F	Correction to interruption to LTE serving cells for measurements on deactivated NR SCell_ R15	15.14.0
2021-06	RAN#92	RP-211080	7120	1	F	CR on applicability of requirements for NE-DC operation and SMTC determination 36133	15.14.0
2021-09	RAN#93	RP-211923	7132		F	Big CR to TS 36.133: LTE RRM maintenance (Rel-15)	15.15.0
2022-03	RAN#95	RP-220336	7145		F	Big CR to TS 36.133: LTE RRM maintenance (Rel-15)	15.16.0
2022-06	RAN#96	RP-221655	7164		A	Big CR on TS 36.133 Maintenance (Rel-15)	15.17.0
2022-09	RAN#97	RP-222054	7167		A	Correction of Configuration Parameters for Test 1 in Test Case A.7.1.11	15.18.0
2022-09	RAN#97	RP-222026	7178		F	Big CR for 36.133 maintenance (Rel-15)	15.18.0
2023-03	RAN#99	RP-230500	7194	1	F	Editorial corrections in TS 36.133	15.19.0
2023-06	RAN#100	RP-231356	7211	1	F	Correction to inter-RAT NR measurement requirements_R15	15.20.0
2023-12	RAN#101	RP-233336	7269		F	[NB_IOTenh2-Perf] CR to 36.133 for correcting errors on the PHR table for NB1 UEs	15.21.0
2024-03						Editorial Update	15.21.1

History

Document history		
V15.3.0	October 2018	Publication
V15.4.0	January 2019	Publication
V15.5.0	July 2019	Publication
V15.6.0	July 2019	Publication
V15.7.0	July 2019	Publication
V15.8.0	October 2019	Publication
V15.9.0	February 2020	Publication
V15.10.0	September 2020	Publication
V15.11.0	December 2020	Publication
V15.12.0	February 2021	Publication
V15.13.0	June 2021	Publication
V15.14.0	September 2021	Publication
V15.15.0	November 2021	Publication
V15.16.0	May 2022	Publication
V15.17.0	August 2022	Publication
V15.18.0	January 2023	Publication
V15.19.0	May 2023	Publication
V15.20.0	July 2023	Publication
V15.21.1	March 2024	Publication