

# ETSI TS 136 211 V13.2.0 (2016-08)



TECHNICAL SPECIFICATION

**LTE;  
Evolved Universal Terrestrial Radio Access (E-UTRA);  
Physical channels and modulation  
(3GPP TS 36.211 version 13.2.0 Release 13)**



---

**Reference**

RTS/TSGR-0136211vd20

---

**Keywords**

LTE

**ETSI**

---

650 Route des Lucioles  
F-06921 Sophia Antipolis Cedex - FRANCE

Tel.: +33 4 92 94 42 00 Fax: +33 4 93 65 47 16

Siret N° 348 623 562 00017 - NAF 742 C  
Association à but non lucratif enregistrée à la  
Sous-Préfecture de Grasse (06) N° 7803/88

---

**Important notice**

The present document can be downloaded from:  
<http://www.etsi.org/standards-search>

The present document may be made available in electronic versions and/or in print. The content of any electronic and/or print versions of the present document shall not be modified without the prior written authorization of ETSI. In case of any existing or perceived difference in contents between such versions and/or in print, the only prevailing document is the print of the Portable Document Format (PDF) version kept on a specific network drive within ETSI Secretariat.

Users of the present document should be aware that the document may be subject to revision or change of status. Information on the current status of this and other ETSI documents is available at  
<https://portal.etsi.org/TB/ETSIDeliverableStatus.aspx>

If you find errors in the present document, please send your comment to one of the following services:  
<https://portal.etsi.org/People/CommiteeSupportStaff.aspx>

---

**Copyright Notification**

No part may be reproduced or utilized in any form or by any means, electronic or mechanical, including photocopying and microfilm except as authorized by written permission of ETSI.

The content of the PDF version shall not be modified without the written authorization of ETSI.  
The copyright and the foregoing restriction extend to reproduction in all media.

© European Telecommunications Standards Institute 2016.  
All rights reserved.

**DECT™**, **PLUGTESTS™**, **UMTS™** and the ETSI logo are Trade Marks of ETSI registered for the benefit of its Members.  
**3GPP™** and **LTE™** are Trade Marks of ETSI registered for the benefit of its Members and of the 3GPP Organizational Partners.  
**GSM®** and the GSM logo are Trade Marks registered and owned by the GSM Association.

---

## Intellectual Property Rights

IPRs essential or potentially essential to the present document may have been declared to ETSI. The information pertaining to these essential IPRs, if any, is publicly available for **ETSI members and non-members**, and can be found in ETSI SR 000 314: *"Intellectual Property Rights (IPRs); Essential, or potentially Essential, IPRs notified to ETSI in respect of ETSI standards"*, which is available from the ETSI Secretariat. Latest updates are available on the ETSI Web server (<https://ipr.etsi.org>).

Pursuant to the ETSI IPR Policy, no investigation, including IPR searches, has been carried out by ETSI. No guarantee can be given as to the existence of other IPRs not referenced in ETSI SR 000 314 (or the updates on the ETSI Web server) which are, or may be, or may become, essential to the present document.

---

## Foreword

This Technical Specification (TS) has been produced by ETSI 3rd Generation Partnership Project (3GPP).

The present document may refer to technical specifications or reports using their 3GPP identities, UMTS identities or GSM identities. These should be interpreted as being references to the corresponding ETSI deliverables.

The cross reference between GSM, UMTS, 3GPP and ETSI identities can be found under <http://webapp.etsi.org/key/queryform.asp>.

---

## Modal verbs terminology

In the present document "**shall**", "**shall not**", "**should**", "**should not**", "**may**", "**need not**", "**will**", "**will not**", "**can**" and "**cannot**" are to be interpreted as described in clause 3.2 of the [ETSI Drafting Rules](#) (Verbal forms for the expression of provisions).

"**must**" and "**must not**" are **NOT** allowed in ETSI deliverables except when used in direct citation.

# Contents

Intellectual Property Rights .....	2
Foreword.....	2
Modal verbs terminology.....	2
Foreword.....	8
1 Scope .....	9
2 References .....	9
3 Symbols and abbreviations.....	9
3.1 Symbols.....	9
3.2 Abbreviations .....	13
4 Frame structure.....	14
4.1 Frame structure type 1 .....	14
4.2 Frame structure type 2 .....	15
4.3 Frame structure type 3 .....	16
5 Uplink.....	18
5.1 Overview .....	18
5.1.1 Physical channels.....	18
5.1.2 Physical signals.....	18
5.2 Slot structure and physical resources.....	18
5.2.1 Resource grid .....	18
5.2.2 Resource elements .....	20
5.2.3 Resource blocks .....	20
5.2.4 Narrowbands.....	20
5.2.5 Guard period for narrowband retuning .....	21
5.3 Physical uplink shared channel .....	22
5.3.1 Scrambling .....	22
5.3.2 Modulation.....	23
5.3.2A Layer mapping.....	24
5.3.2A.1 Layer mapping for transmission on a single antenna port.....	24
5.3.2A.2 Layer mapping for spatial multiplexing .....	24
5.3.3 Transform precoding.....	25
5.3.3A Precoding .....	25
5.3.3A.1 Precoding for transmission on a single antenna port.....	25
5.3.3A.2 Precoding for spatial multiplexing .....	25
5.3.4 Mapping to physical resources.....	28
5.4 Physical uplink control channel.....	30
5.4.1 PUCCH formats 1, 1a and 1b .....	30
5.4.2 PUCCH formats 2, 2a and 2b .....	34
5.4.2A PUCCH format 3 .....	35
5.4.2B PUCCH format 4 .....	37
5.4.2C PUCCH format 5 .....	37
5.4.3 Mapping to physical resources.....	38
5.5 Reference signals.....	41
5.5.1 Generation of the reference signal sequence.....	41
5.5.1.1 Base sequences of length $3N_{sc}^{RB}$ or larger .....	41
5.5.1.2 Base sequences of length less than $3N_{sc}^{RB}$ .....	42
5.5.1.3 Group hopping .....	44
5.5.1.4 Sequence hopping .....	45
5.5.1.5 Determining virtual cell identity for sequence generation .....	45
5.5.2 Demodulation reference signal .....	46
5.5.2.1 Demodulation reference signal for PUSCH .....	46
5.5.2.1.1 Reference signal sequence.....	46

5.5.2.1.2	Mapping to physical resources .....	48
5.5.2.2	Demodulation reference signal for PUCCH.....	48
5.5.2.2.1	Reference signal sequence.....	48
5.5.2.2.2	Mapping to physical resources .....	50
5.5.3	Sounding reference signal.....	51
5.5.3.1	Sequence generation.....	51
5.5.3.2	Mapping to physical resources .....	51
5.5.3.3	Sounding reference signal subframe configuration .....	54
5.6	SC-FDMA baseband signal generation .....	55
5.7	Physical random access channel.....	56
5.7.1	Time and frequency structure .....	56
5.7.2	Preamble sequence generation.....	62
5.7.3	Baseband signal generation.....	65
5.8	Modulation and upconversion .....	66
6	Downlink.....	66
6.1	Overview .....	66
6.1.1	Physical channels.....	66
6.1.2	Physical signals.....	67
6.2	Slot structure and physical resource elements .....	67
6.2.1	Resource grid.....	67
6.2.2	Resource elements .....	68
6.2.3	Resource blocks .....	69
6.2.3.1	Virtual resource blocks of localized type .....	70
6.2.3.2	Virtual resource blocks of distributed type .....	70
6.2.4	Resource-element groups.....	71
6.2.4A	Enhanced Resource-Element Groups (EREGs).....	72
6.2.5	Guard period for half-duplex FDD operation .....	72
6.2.6	Guard Period for TDD Operation .....	72
6.2.7	Narrowbands.....	73
6.2.8	Guard period for narrowband retuning .....	73
6.3	General structure for downlink physical channels.....	73
6.3.1	Scrambling .....	74
6.3.2	Modulation.....	75
6.3.3	Layer mapping .....	75
6.3.3.1	Layer mapping for transmission on a single antenna port.....	75
6.3.3.2	Layer mapping for spatial multiplexing .....	76
6.3.3.3	Layer mapping for transmit diversity .....	77
6.3.4	Precoding .....	77
6.3.4.1	Precoding for transmission on a single antenna port.....	77
6.3.4.2	Precoding for spatial multiplexing using antenna ports with cell-specific reference signals .....	77
6.3.4.2.1	Precoding without CDD .....	78
6.3.4.2.2	Precoding for large delay CDD .....	78
6.3.4.2.3	Codebook for precoding and CSI reporting.....	79
6.3.4.3	Precoding for transmit diversity .....	80
6.3.4.4	Precoding for spatial multiplexing using antenna ports with UE-specific reference signals.....	81
6.3.5	Mapping to resource elements .....	81
6.4	Physical downlink shared channel.....	82
6.4.1	Physical downlink shared channel for BL/CE UEs .....	83
6.5	Physical multicast channel .....	85
6.6	Physical broadcast channel.....	85
6.6.1	Scrambling .....	85
6.6.2	Modulation.....	85
6.6.3	Layer mapping and precoding .....	85
6.6.4	Mapping to resource elements .....	86
6.7	Physical control format indicator channel.....	87
6.7.1	Scrambling .....	87
6.7.2	Modulation.....	87
6.7.3	Layer mapping and precoding .....	88
6.7.4	Mapping to resource elements .....	88
6.8	Physical downlink control channel.....	88
6.8.1	PDCCH formats.....	88

6.8.2	PDCCH multiplexing and scrambling .....	89
6.8.3	Modulation.....	89
6.8.4	Layer mapping and precoding .....	89
6.8.5	Mapping to resource elements .....	89
6.8A	Enhanced physical downlink control channel .....	90
6.8A.1	EPDCCH formats .....	90
6.8A.2	Scrambling.....	92
6.8A.3	Modulation.....	92
6.8A.4	Layer mapping and precoding .....	92
6.8A.5	Mapping to resource elements .....	92
6.8B	MTC physical downlink control channel .....	93
6.8B.1	MPDCCH formats .....	93
6.8B.2	Scrambling.....	94
6.8B.3	Modulation.....	95
6.8B.4	Layer mapping and precoding .....	95
6.8B.5	Mapping to resource elements .....	95
6.9	Physical hybrid ARQ indicator channel .....	97
6.9.1	Modulation.....	98
6.9.2	Resource group alignment, layer mapping and precoding .....	98
6.9.3	Mapping to resource elements .....	100
6.10	Reference signals.....	102
6.10.1	Cell-specific Reference Signal (CRS).....	102
6.10.1.1	Sequence generation.....	102
6.10.1.2	Mapping to resource elements.....	103
6.10.2	MBSFN reference signals.....	105
6.10.2.1	Sequence generation.....	105
6.10.2.2	Mapping to resource elements.....	105
6.10.3	UE-specific reference signals associated with PDSCH .....	107
6.10.3.1	Sequence generation.....	108
6.10.3.2	Mapping to resource elements.....	109
6.10.3A	Demodulation reference signals associated with EPDCCH or MPDCCH.....	114
6.10.3A.1	Sequence generation.....	114
6.10.3A.2	Mapping to resource elements.....	115
6.10.4	Positioning reference signals .....	116
6.10.4.1	Sequence generation.....	116
6.10.4.2	Mapping to resource elements.....	117
6.10.4.3	Positioning reference signal subframe configuration .....	118
6.10.5	CSI reference signals .....	118
6.10.5.1	Sequence generation.....	119
6.10.5.2	Mapping to resource elements.....	119
6.10.5.3	CSI reference signal subframe configuration .....	125
6.11	Synchronization signals.....	125
6.11.1	Primary synchronization signal (PSS) .....	125
6.11.1.1	Sequence generation.....	125
6.11.1.2	Mapping to resource elements.....	126
6.11.2	Secondary synchronization signal (SSS) .....	126
6.11.2.1	Sequence generation.....	126
6.11.2.2	Mapping to resource elements.....	128
6.11A	Discovery signal .....	129
6.12	OFDM baseband signal generation .....	129
6.13	Modulation and upconversion .....	130
7	Generic functions .....	131
7.1	Modulation mapper .....	131
7.1.1	BPSK .....	131
7.1.2	QPSK .....	131
7.1.3	16QAM.....	131
7.1.4	64QAM.....	132
7.1.5	256QAM.....	133
7.2	Pseudo-random sequence generation.....	135
8	Timing .....	135

8.1	Uplink-downlink frame timing.....	135
9	Sidelink.....	136
9.1	Overview .....	136
9.1.1	Physical channels.....	136
9.1.2	Physical signals.....	136
9.1.3	Handling of simultaneous sidelink and uplink/downlink transmissions .....	136
9.2	Slot structure and physical resources.....	137
9.2.1	Resource grid.....	137
9.2.2	Resource elements .....	137
9.2.3	Resource blocks .....	138
9.2.4	Resource pool .....	138
9.2.5	Guard period.....	138
9.3	Physical Sidelink Shared Channel.....	138
9.3.1	Scrambling.....	138
9.3.2	Modulation.....	138
9.3.3	Layer mapping.....	139
9.3.4	Transform precoding.....	139
9.3.5	Precoding .....	139
9.3.6	Mapping to physical resources.....	139
9.4	Physical Sidelink Control Channel.....	140
9.4.1	Scrambling.....	140
9.4.2	Modulation.....	140
9.4.3	Layer mapping.....	140
9.4.4	Transform precoding.....	140
9.4.5	Precoding.....	140
9.4.6	Mapping to physical resources.....	140
9.5	Physical Sidelink Discovery Channel.....	141
9.5.1	Scrambling.....	141
9.5.2	Modulation.....	141
9.5.3	Layer mapping .....	141
9.5.4	Transform precoding.....	141
9.5.5	Precoding .....	141
9.5.6	Mapping to physical resources.....	141
9.6	Physical Sidelink Broadcast Channel.....	141
9.6.1	Scrambling.....	141
9.6.2	Modulation.....	142
9.6.3	Layer mapping.....	142
9.6.4	Transform precoding.....	142
9.6.5	Precoding .....	142
9.6.6	Mapping to physical resources.....	142
9.7	Sidelink Synchronization Signals.....	142
9.7.1	Primary sidelink synchronization signal .....	142
9.7.1.1	Sequence generation.....	142
9.7.1.2	Mapping to resource elements.....	143
9.7.2	Secondary sidelink synchronization signal .....	143
9.7.2.1	Sequence generation.....	143
9.7.2.2	Mapping to resource elements.....	143
9.8	Demodulation reference signals .....	143
9.9	SC-FDMA baseband signal generation .....	144
9.10	Timing .....	144
10	Narrowband IoT .....	145
10.1	Uplink.....	145
10.1.1	Overview .....	145
10.1.1.1	Physical channels .....	145
10.1.1.2	Physical signals .....	145
10.1.2	Slot structure and physical resources .....	146
10.1.2.1	Resource grid .....	146
10.1.2.2	Resource elements.....	146
10.1.2.3	Resource unit.....	147
10.1.3	Narrowband physical uplink shared channel .....	147

10.1.3.1	Scrambling .....	147
10.1.3.2	Modulation .....	147
10.1.3.3	Layer mapping .....	147
10.1.3.4	Transform precoding .....	147
10.1.3.5	Precoding .....	148
10.1.3.6	Mapping to physical resources .....	148
10.1.4	Demodulation reference signal .....	148
10.1.4.1	Reference signal sequence .....	148
10.1.4.1.1	Reference signal sequence for $N_{sc}^{RU} = 1$ .....	148
10.1.4.1.2	Reference signal sequence for $N_{sc}^{RU} > 1$ .....	149
10.1.4.1.3	Group hopping .....	150
10.1.4.2	Mapping to physical resources .....	151
10.1.5	SC-FDMA baseband signal generation .....	151
10.1.6	Narrowband physical random access channel .....	152
10.1.6.1	Time and frequency structure .....	152
10.1.6.2	Baseband signal generation .....	154
10.1.7	Modulation and upconversion .....	154
10.2	Downlink .....	154
10.2.1	Overview .....	154
10.2.1.1	Physical channels .....	154
10.2.1.2	Physical signals .....	154
10.2.2	Slot structure and physical resource elements .....	155
10.2.2.1	Resource grid .....	155
10.2.2.2	Resource elements .....	155
10.2.2.3	Guard period for half-duplex FDD operation .....	155
10.2.3	Narrowband physical downlink shared channel .....	155
10.2.3.1	Scrambling .....	155
10.2.3.2	Modulation .....	155
10.2.3.3	Layer mapping and precoding .....	155
10.2.3.4	Mapping to resource elements .....	155
10.2.4	Narrowband physical broadcast channel .....	156
10.2.4.1	Scrambling .....	156
10.2.4.2	Modulation .....	156
10.2.4.3	Layer mapping and precoding .....	156
10.2.4.4	Mapping to resource elements .....	157
10.2.5	Narrowband physical downlink control channel .....	157
10.2.5.1	NPDCCH formats .....	157
10.2.5.2	Scrambling .....	157
10.2.5.3	Modulation .....	157
10.2.5.4	Layer mapping and precoding .....	157
10.2.5.5	Mapping to resource elements .....	158
10.2.6	Narrowband reference signal (NRS) .....	158
10.2.6.1	Sequence generation .....	158
10.2.6.2	Mapping to resource elements .....	158
10.2.7	Synchronization signals .....	160
10.2.7.1	Narrowband primary synchronization signal (NPSS) .....	160
10.2.7.1.1	Sequence generation .....	160
10.2.7.1.2	Mapping to resource elements .....	160
10.2.7.2	Narrowband secondary synchronization signal (NSSS) .....	160
10.2.7.2.1	Sequence generation .....	160
10.2.7.2.2	Mapping to resource elements .....	161
10.2.8	OFDM baseband signal generation .....	161
10.2.9	Modulation and upconversion .....	162
<b>Annex A (informative):</b>	<b>Change history .....</b>	<b>163</b>
History .....		169



---

## Foreword

This Technical Specification has been produced by the 3<sup>rd</sup> Generation Partnership Project (3GPP).

The contents of the present document are subject to continuing work within the TSG and may change following formal TSG approval. Should the TSG modify the contents of the present document, it will be re-released by the TSG with an identifying change of release date and an increase in version number as follows:

Version x.y.z

where:

- x the first digit:
  - 1 presented to TSG for information;
  - 2 presented to TSG for approval;
  - 3 or greater indicates TSG approved document under change control.
- y the second digit is incremented for all changes of substance, i.e. technical enhancements, corrections, updates, etc.
- z the third digit is incremented when editorial only changes have been incorporated in the document.

---

# 1 Scope

The present document describes the physical channels for evolved UTRA.

---

## 2 References

The following documents contain provisions which, through reference in this text, constitute provisions of the present document.

- References are either specific (identified by date of publication, edition number, version number, etc.) or non-specific.
- For a specific reference, subsequent revisions do not apply.
- For a non-specific reference, the latest version applies. In the case of a reference to a 3GPP document (including a GSM document), a non-specific reference implicitly refers to the latest version of that document *in the same Release as the present document*.

- [1] 3GPP TR 21.905: "Vocabulary for 3GPP Specifications".
- [2] 3GPP TS 36.201: "Evolved Universal Terrestrial Radio Access (E-UTRA); LTE physical layer; General description".
- [3] 3GPP TS 36.212: "Evolved Universal Terrestrial Radio Access (E-UTRA); Multiplexing and channel coding".
- [4] 3GPP TS 36.213: "Evolved Universal Terrestrial Radio Access (E-UTRA); Physical layer procedures".
- [5] 3GPP TS 36.214: "Evolved Universal Terrestrial Radio Access (E-UTRA); Physical layer; Measurements".
- [6] 3GPP TS 36.104: "Evolved Universal Terrestrial Radio Access (E-UTRA); Base Station (BS) radio transmission and reception".
- [7] 3GPP TS 36.101: "Evolved Universal Terrestrial Radio Access (E-UTRA); User Equipment (UE) radio transmission and reception".
- [8] 3GPP TS 36.321, "Evolved Universal Terrestrial Radio Access (E-UTRA); Medium Access Control (MAC) protocol specification".
- [9] 3GPP TS 36.331, 'Evolved Universal Terrestrial Radio Access (E-UTRA); Radio Resource Control (RRC) Protocol specification'
- [10] 3GPP TS 36.304, 'Evolved Universal Terrestrial Radio Access (E-UTRA); User Equipment (UE) procedures in idle mode'

---

## 3 Symbols and abbreviations

### 3.1 Symbols

For the purposes of the present document, the following symbols apply:

- ( $k, l$ ) Resource element with frequency-domain index  $k$  and time-domain index  $l$

$a_{k,l}^{(p)}$	Value of resource element $(k,l)$ [for antenna port $p$ ]
$D$	Matrix for supporting cyclic delay diversity
$D_{RA}$	Density of random access opportunities per radio frame
$f_0$	Carrier frequency
$f_{RA}$	PRACH resource frequency index within the considered time-domain location
$f_{PRB,hop}^{PRACH}$	PRACH frequency hopping offset, expressed as a number of resource blocks
$l_{NPDCCHstart}$	Start symbol in slot 0 for NPDCCH
$l_{NPDSCHstart}$	Start symbol in slot 0 for NPDSCH
$M_{sc}^{PSBCH}$	Bandwidth for PSBCH transmission, expressed as a number of subcarriers
$M_{RB}^{PSBCH}$	Bandwidth for PSBCH transmission, expressed as a number of resource blocks
$M_{sc}^{PSCCH}$	Bandwidth for PSCCH transmission, expressed as a number of subcarriers
$M_{RB}^{PSCCH}$	Bandwidth for PSCCH transmission, expressed as a number of resource blocks
$M_{sc}^{PSDCH}$	Bandwidth for PSDCH transmission, expressed as a number of subcarriers
$M_{RB}^{PSDCH}$	Bandwidth for PSDCH transmission, expressed as a number of resource blocks
$M_{sc}^{PSSCH}$	Scheduled bandwidth for PSSCH transmission, expressed as a number of subcarriers
$M_{RB}^{PSSCH}$	Scheduled bandwidth for PSSCH transmission, expressed as a number of resource blocks
$M_{sc}^{PUSCH}$	Scheduled bandwidth for uplink transmission, expressed as a number of subcarriers
$M_{RB}^{PUSCH}$	Scheduled bandwidth for uplink transmission, expressed as a number of resource blocks
$M_{rep}^{NPDSCH}$	Scheduled number of repetitions of a NPDSCH transmission
$M_{sc}^{NPUSCH}$	Scheduled bandwidth for uplink NPUSCH transmission, expressed as a number of subcarriers
$M_{identical}^{NPUSCH}$	Number of repetitions of identical slots for NPUSCH
$M_{bit}^{(q)}$	Number of coded bits to transmit on a physical channel [for codeword $q$ ]
$M_{symb}^{(q)}$	Number of modulation symbols to transmit on a physical channel [for codeword $q$ ]
$M_{symb}^{layer}$	Number of modulation symbols to transmit per layer for a physical channel
$M_{symb}^{ap}$	Number of modulation symbols to transmit per antenna port for a physical channel
$N$	A constant equal to 2048 for $\Delta f = 15$ kHz, 4096 for $\Delta f = 7.5$ kHz and 8192 for $\Delta f = 3.75$ kHz
$N_{CP,l}$	Downlink cyclic prefix length for OFDM symbol $l$ in a slot
$N_{CS}$	Cyclic shift value used for random access preamble generation
$N_{cs}^{(1)}$	Number of cyclic shifts used for PUCCH formats 1/1a/1b in a resource block with a mix of formats 1/1a/1b and 2/2a/2b
$N_{RB}^{(2)}$	Bandwidth available for use by PUCCH formats 2/2a/2b, expressed in multiples of $N_{sc}^{RB}$
$N_{RB}^{HO}$	The offset used for PUSCH frequency hopping, expressed in number of resource blocks (set by higher layers)
$N_{ID}^{cell}$	Physical layer cell identity
$N_{ID}^{Ncell}$	Narrowband physical layer cell identity
$N_{ID}^{MBSFN}$	MBSFN area identity
$N_{ID}^{SL}$	Physical layer sidelink synchronization identity
$N_{RB}^{DL}$	Downlink bandwidth configuration, expressed in multiples of $N_{sc}^{RB}$
$N_{RB}^{min,DL}$	Smallest downlink bandwidth configuration, expressed in multiples of $N_{sc}^{RB}$
$N_{RB}^{max,DL}$	Largest downlink bandwidth configuration, expressed in multiples of $N_{sc}^{RB}$
$N_{RB}^{UL}$	Uplink bandwidth configuration, expressed in multiples of $N_{sc}^{RB}$
$N_{RB}^{min,UL}$	Smallest uplink bandwidth configuration, expressed in multiples of $N_{sc}^{RB}$

$N_{RB}^{\max, UL}$	Largest uplink bandwidth configuration, expressed in multiples of $N_{sc}^{RB}$
$N_{RB}^{SL}$	Sidelink bandwidth configuration, expressed in multiples of $N_{sc}^{RB}$
$N_{SF}$	Number of scheduled subframes for NPDSCH transmission
$N_{symb}^{NPSS}$	Number of symbols for NPSS in a subframe
$N_{symb}^{NSSS}$	Number of symbols for NSSS in a subframe
$N_{sc}^{RU}$	Number of consecutive subcarriers in an UL resource unit for NB-IoT
$N_{seq}^{RU}$	Number of reference signal sequences available for the UL resource unit size
$N_{RU}$	Number of scheduled UL resource units for NB-IoT
$N_{NB}^{UL}$	Total number of uplink narrowbands
$N_{sc}^{UL}$	Number of subcarriers in the frequency domain for NB-IoT
$N_{acc}$	Number of consecutive absolute subframes over which the scrambling sequence stays the same
$N_{abs}^{PUSCH}$	Total number of absolute subframes a PUSCH with repetition spans , expressed as a number of absolute subframes
$N_{rep}^{PUSCH}$	Number of repetitions of a PUSCH transmission
$N_{NB}^{ch, UL}$	Number of consecutive absolute subframes over which PUCCH or PUSCH stays at the same narrowband before hopping to another narrowband, expressed as a number of absolute subframes
$f_{NB, hop}^{PUSCH}$	Narrowband offset between one narrowband and the next narrowband a PUSCH hops to, expressed as a number of uplink narrowbands
$N_{abs}^{PUCCH}$	Total number of absolute subframes a PUCCH with repetition spans, expressed as a number of absolute subframes
$N_{rep}^{PUCCH}$	Number of repetitions of a PUCCH transmission
$N_{rep}^{PRACH}$	Number of PRACH repetitions per preamble transmission attempt
$N_{sf}^{RA}$	Number of subframes allowed for preamble transmission within a 1024-frame interval
$N_{start}^{PRACH}$	PRACH starting subframe periodicity
$N_{rep}^{NPRACH}$	Number of NPRACH repetitions per preamble transmission attempt
$N_{period}^{NPRACH}$	NPRACH resource periodicity
$N_{scoffset}^{NPRACH}$	Frequency location of the first sub-carrier allocated to NPRACH
$N_{sc}^{NPRACH}$	Number of sub-carriers allocated to NPRACH
$N_{start}^{NPRACH}$	NPRACH starting subframe
$N_{MSG3}^{NPRACH}$	Fraction for starting subcarrier index for UE support for multi-tone msg3 transmission
$N_{gap, period}$	Periodicity for NPDSCH/NPDCCH gaps
$N_{gap, duration}$	Duration for NPDSCH/NPDCCH gaps
$N_{gap, threshold}$	Threshold for applying NPDDCH/NPDCCH gaps
$N_{NB}^{DL}$	Total number of downlink narrowbands
$N_{abs}^{PDSCH}$	Total number of absolute subframes a PDSCH with repetition spans, expressed as a number of absolute subframes
$N_{rep}^{PDSCH}$	Number of repetitions of a PDSCH transmission
$N_{NB}^{ch, DL}$	Number of consecutive absolute subframes over which MPDCCH or PDSCH stays at the same narrowband before hopping to another narrowband, expressed as a number of absolute subframes
$N_{NB, hop}^{ch, DL}$	Number of narrowbands over which MPDCCH or PDSCH frequency hops
$f_{NB, hop}^{DL}$	Narrowband offset between one narrowband and the next narrowband an MPDCCH or PDSCH hops to, expressed as a number of downlink narrowbands

$N_{\text{PDSCH}}^{\text{SIB1-BR}}$	Number of times a PDSCH carrying SIB1-BR is transmitted over 8 radio frames
$N_{\text{abs}}^{\text{MPDCCH}}$	Total number of absolute subframes a MPDCCH with repetition spans , expressed as a number of absolute subframes
$N_{\text{rep}}^{\text{MPDCCH}}$	Number of repetitions of a MPDCCH transmission
$N_{\text{ECCE}}^{\text{MPDCCH}}$	Number of ECCEs in a subframe for one MPDCCH
$N_{\text{symb}}^{\text{DL}}$	Number of OFDM symbols in a downlink slot
$N_{\text{symb}}^{\text{UL}}$	Number of SC-FDMA symbols in an uplink slot
$N_{\text{slots}}^{\text{UL}}$	Number of consecutive slots in an UL resource unit for NB-IoT
$N_{\text{symb}}^{\text{SL}}$	Number of SC-FDMA symbols in a sidelink slot
$N_{\text{sc}}^{\text{RB}}$	Resource block size in the frequency domain, expressed as a number of subcarriers
$N_{\text{sb}}$	Number of sub-bands for PUSCH frequency-hopping with predefined hopping pattern
$N_{\text{RB}}^{\text{sb}}$	Size of each sub-band for PUSCH frequency-hopping with predefined hopping pattern, expressed as a number of resource blocks
$N_{\text{sc}}^{\text{RA}}$	Size of narrow-band random-access resource in number of subcarriers
$N_{\text{SP}}$	Number of downlink to uplink switch points within the radio frame
$N_{\text{RS}}^{\text{PUCCH}}$	Number of reference symbols per slot for PUCCH
$N_{\text{TA}}$	Timing offset between uplink and downlink radio frames at the UE, expressed in units of $T_s$
$N_{\text{TA offset}}$	Fixed timing advance offset, expressed in units of $T_s$
$N_{\text{TA,SL}}$	Timing offset between sidelink and timing reference frames at the UE, expressed in units of $T_s$
$n_{\text{PUCCH}}^{(1,\tilde{p})}$	Resource index for PUCCH formats 1/1a/1b
$n_{\text{PUCCH}}^{(2,\tilde{p})}$	Resource index for PUCCH formats 2/2a/2b
$n_{\text{PUCCH}}^{(3,\tilde{p})}$	Resource index for PUCCH formats 3
$n_{\text{PDCCH}}$	Number of PDCCHs present in a subframe
$n_{\text{PRB}}$	Physical resource block number
$n_{\text{PRB}}^{\text{RA}}$	First physical resource block occupied by PRACH resource considered
$n_{\text{PRB offset}}^{\text{RA}}$	First physical resource block available for PRACH
$n_{\text{sc}}^{\text{RA}}$	Subcarrier occupied by NPRACH resource considered
$n_{\text{VRB}}$	Virtual resource block number
$n_{\text{RNTI}}$	Radio network temporary identifier
$n_{\text{ID}}^{\text{SA}}$	Sidelink group destination identity
$n_{\text{f}}$	System frame number
$n_{\text{s}}$	Slot number within a radio frame
$n_{\text{sf}}^{\text{abs}}$	Absolute subframe number
$n_{\text{sf}}^{\text{RA}}$	Index for subframes allowed for preamble transmission
$P$	Number of antenna ports used for transmission of a channel
$p$	Antenna port number
$q$	Codeword number
$r_{\text{RA}}$	Index for PRACH versions with same preamble format and PRACH density
$Q_m$	Modulation order: 2 for QPSK, 4 for 16QAM, 6 for 64QAM and 8 for 256QAM transmissions
$s_l^{(p)}(t)$	Time-continuous baseband signal for antenna port $p$ and OFDM symbol $l$ in a slot
$t_{\text{RA}}^{(0)}$	Radio frame indicator index of PRACH opportunity
$t_{\text{RA}}^{(1)}$	Half frame index of PRACH opportunity within the radio frame
$t_{\text{RA}}^{(2)}$	Uplink subframe number for start of PRACH opportunity within the half frame
$T_{\text{f}}$	Radio frame duration

$T_s$	Basic time unit
$T_{\text{slot}}$	Slot duration
$W$	Precoding matrix for downlink spatial multiplexing
$\beta_{\text{PRACH}}$	Amplitude scaling for PRACH
$\beta_{\text{NPRACH}}$	Amplitude scaling for NPRACH
$\beta_{\text{PUCCH}}$	Amplitude scaling for PUCCH
$\beta_{\text{PUSCH}}$	Amplitude scaling for PUSCH
$\beta_{\text{NPUSCH}}$	Amplitude scaling for NPUSCH
$\beta_{\text{SRS}}$	Amplitude scaling for sounding reference symbols
$\Delta f$	Subcarrier spacing
$\Delta f_{\text{RA}}$	Subcarrier spacing for the random access preamble
$v$	Number of transmission layers

## 3.2 Abbreviations

For the purposes of the present document, the abbreviations given in TR 21.905 [1] and the following apply. An abbreviation defined in the present document takes precedence over the definition of the same abbreviation, if any, in TR 21.905 [1].

CCE	Control Channel Element
CDD	Cyclic Delay Diversity
CRS	Cell-specific Reference Signal
CSI	Channel-State Information
DCI	Downlink Control Information
DM-RS	Demodulation Reference Signal
ECCE	Enhanced Control Channel Element
EPDCCH	Enhanced Physical Downlink Control CHannel
EREG	Enhanced Resource-Element Group
MPDCCH	MTC Physical Downlink Control Channel
NCCE	Narrowband Control Channel Element
NPBCH	Narrowband Physical Broadcast CHannel
NPDCCH	Narrowband Physical Downlink Control CHannel
NPDSCH	Narrowband Physical Downlink Shared CHannel
NPRACH	Narrowband Physical Random Access CHannel
NPUSCH	Narrowband Physical Uplink Shared CHannel
NPSS	Narrowband Primary Synchronization Signal
NSSS	Narrowband Secondary Synchronization Signal
NRS	Narrowband Reference Signal PBCH Physical Broadcast CHannel
PCFICH	Physical Control Format Indicator CHannel
PDCCH	Physical Downlink Control CHannel
PDSCH	Physical Downlink Shared CHannel
PHICH	Physical Hybrid-ARQ Indicator CHannel
PMCH	Physical Multicast CHannel
PRACH	Physical Random Access CHannel
PRB	Physical Resource Block
PRS	Positioning Reference Signal
PSBCH	Physical Sidelink Broadcast CHannel
PSCCH	Physical Sidelink Control CHannel
PSDCH	Physical Sidelink Discovery CHannel
PSSCH	Physical Sidelink Shared CHannel
PUCCH	Physical Uplink Control CHannel
PUSCH	Physical Uplink Shared CHannel
REG	Resource-Element Group
SCG	Secondary Cell Group
SRS	Sounding Reference Signal
VRB	Virtual Resource Block

# 4 Frame structure

Throughout this specification, unless otherwise noted, the size of various fields in the time domain is expressed as a number of time units  $T_s = 1/(15000 \times 2048)$  seconds.

Downlink, uplink and sidelink transmissions are organized into radio frames with  $T_f = 307200 \times T_s = 10$  ms duration. Three radio frame structures are supported:

- Type 1, applicable to FDD only,
- Type 2, applicable to TDD only,
- Type 3, applicable to LAA secondary cell operation only.

NOTE: LAA secondary cell operation only applies to frame structure type 3.

Transmissions in multiple cells can be aggregated where up to 31 secondary cells can be used in addition to the primary cell. Unless otherwise noted, the description in this specification applies to each of the up to 32 serving cells. In case of multi-cell aggregation, different frame structures can be used in the different serving cells.

## 4.1 Frame structure type 1

Frame structure type 1 is applicable to both full duplex and half duplex FDD only. Each radio frame is  $T_f = 307200 \cdot T_s = 10$  ms long and consists of 20 slots of length  $T_{slot} = 15360 \cdot T_s = 0.5$  ms, numbered from 0 to 19. A subframe is defined as two consecutive slots where subframe  $i$  consists of slots  $2i$  and  $2i+1$ . Subframe  $i$  in frame  $n_f$  has an absolute subframe number  $n_{sf}^{abs} = 10n_f + i$  where  $n_f$  is the system frame number.

For FDD, 10 subframes are available for downlink transmission and 10 subframes are available for uplink transmissions in each 10 ms interval. Uplink and downlink transmissions are separated in the frequency domain. In half-duplex FDD operation, the UE cannot transmit and receive at the same time while there are no such restrictions in full-duplex FDD.

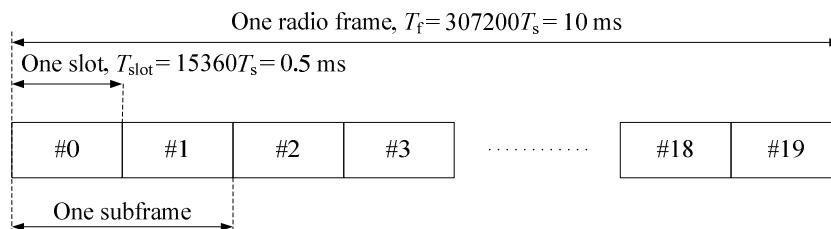

Figure 4.1-1: Frame structure type 1

## 4.2 Frame structure type 2

Frame structure type 2 is applicable to TDD only. Each radio frame of length  $T_f = 307200 \cdot T_s = 10$  ms consists of two half-frames of length  $153600 \cdot T_s = 5$  ms each. Each half-frame consists of five subframes of length  $30720 \cdot T_s = 1$  ms. Each subframe  $i$  is defined as two slots,  $2i$  and  $2i+1$ , of length  $T_{\text{slot}} = 15360 \cdot T_s = 0.5$  ms each. Subframe  $i$  in frame  $n_f$  has an absolute subframe number  $n_{\text{sf}}^{\text{abs}} = 10n_f + i$  where  $n_f$  is the system frame number.

The uplink-downlink configuration in a cell may vary between frames and controls in which subframes uplink or downlink transmissions may take place in the current frame. The uplink-downlink configuration in the current frame is obtained according to Section 13 in [4].

The supported uplink-downlink configurations are listed in Table 4.2-2 where, for each subframe in a radio frame, "D" denotes a downlink subframe reserved for downlink transmissions, "U" denotes an uplink subframe reserved for uplink transmissions and "S" denotes a special subframe with the three fields DwPTS, GP and UpPTS. The length of DwPTS and UpPTS is given by Table 4.2-1 subject to the total length of DwPTS, GP and UpPTS being equal to  $30720 \cdot T_s = 1$  ms where X is the number of additional SC-FDMA symbols in UpPTS provided by the higher layer parameter *srs-UpPtsAdd* if configured otherwise X is equal to 0. The UE is not expected to be configured with 2 additional UpPTS SC-FDMA symbols for special subframe configurations {3, 4, 7, 8} for normal cyclic prefix in downlink and special subframe configurations {2, 3, 5, 6} for extended cyclic prefix in downlink and 4 additional UpPTS SC-FDMA symbols for special subframe configurations {1, 2, 3, 4, 6, 7, 8} for normal cyclic prefix in downlink and special subframe configurations {1, 2, 3, 5, 6} for extended cyclic prefix in downlink.

Uplink-downlink configurations with both 5 ms and 10 ms downlink-to-uplink switch-point periodicity are supported.

- In case of 5 ms downlink-to-uplink switch-point periodicity, the special subframe exists in both half-frames.
- In case of 10 ms downlink-to-uplink switch-point periodicity, the special subframe exists in the first half-frame only.

Subframes 0 and 5 and DwPTS are always reserved for downlink transmission. UpPTS and the subframe immediately following the special subframe are always reserved for uplink transmission.

In case multiple cells are aggregated, the UE may assume that the guard period of the special subframe in the cells using frame structure type 2 have an overlap of at least  $1456 \cdot T_s$ .

In case multiple cells with different uplink-downlink configurations in the current radio frame are aggregated and the UE is not capable of simultaneous reception and transmission in the aggregated cells, the following constraints apply:

- if the subframe in the primary cell is a downlink subframe, the UE shall not transmit any signal or channel on a secondary cell in the same subframe
- if the subframe in the primary cell is an uplink subframe, the UE is not expected to receive any downlink transmissions on a secondary cell in the same subframe
- if the subframe in the primary cell is a special subframe and the same subframe in a secondary cell is a downlink subframe, the UE is not expected to receive PDSCH/EPDCCH/PMCH/PRS transmissions in the secondary cell in the same subframe, and the UE is not expected to receive any other signals on the secondary cell in OFDM symbols that overlaps with the guard period or UpPTS in the primary cell.



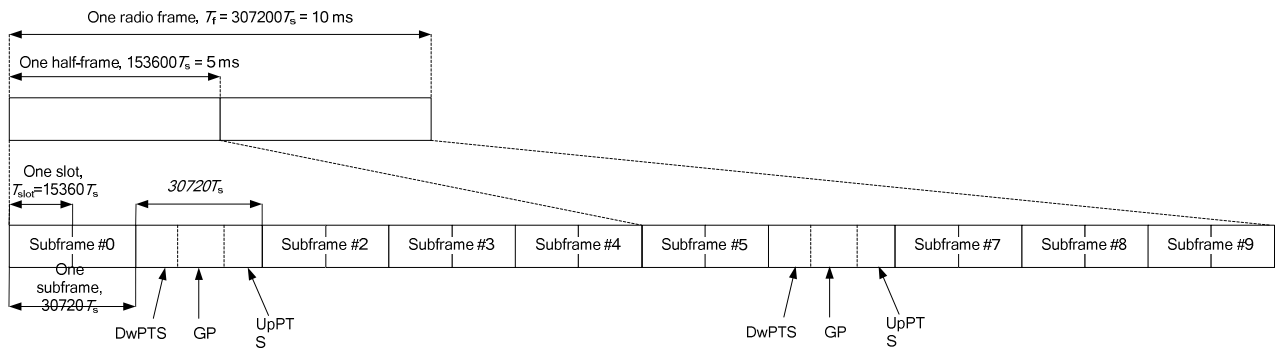

Figure 4.2-1: Frame structure type 2 (for 5 ms switch-point periodicity)

Table 4.2-1: Configuration of special subframe (lengths of DwPTS/GP/UpPTS)

Special subframe configuration	Normal cyclic prefix in downlink			Extended cyclic prefix in downlink		
	DwPTS	UpPTS		DwPTS	UpPTS	
		Normal cyclic prefix in uplink	Extended cyclic prefix in uplink		Normal cyclic prefix in uplink	Extended cyclic prefix in uplink
0	$6592 \cdot T_s$	$(1+X) \cdot 2192 \cdot T_s$	$(1+X) \cdot 2560 \cdot T_s$	$7680 \cdot T_s$	$(1+X) \cdot 2192 \cdot T_s$	$(1+X) \cdot 2560 \cdot T_s$
1	$19760 \cdot T_s$			$20480 \cdot T_s$		
2	$21952 \cdot T_s$			$23040 \cdot T_s$		
3	$24144 \cdot T_s$			$25600 \cdot T_s$		
4	$26336 \cdot T_s$	$(2+X) \cdot 2192 \cdot T_s$	$(2+X) \cdot 2560 \cdot T_s$	$7680 \cdot T_s$	$(2+X) \cdot 2192 \cdot T_s$	$(2+X) \cdot 2560 \cdot T_s$
5	$6592 \cdot T_s$			$20480 \cdot T_s$		
6	$19760 \cdot T_s$			$23040 \cdot T_s$		
7	$21952 \cdot T_s$	$(2+X) \cdot 2192 \cdot T_s$	$(2+X) \cdot 2560 \cdot T_s$	$12800 \cdot T_s$	-	-
8	$24144 \cdot T_s$			-		
9	$13168 \cdot T_s$	-	-	-	-	-

Table 4.2-2: Uplink-downlink configurations

Uplink-downlink configuration	Downlink-to-Uplink Switch-point periodicity	Subframe number									
		0	1	2	3	4	5	6	7	8	9
0	5 ms	D	S	U	U	U	D	S	U	U	U
1	5 ms	D	S	U	U	D	D	S	U	U	D
2	5 ms	D	S	U	D	D	D	S	U	D	D
3	10 ms	D	S	U	U	U	D	D	D	D	D
4	10 ms	D	S	U	U	D	D	D	D	D	D
5	10 ms	D	S	U	D	D	D	D	D	D	D
6	5 ms	D	S	U	U	U	D	S	U	U	D

### 4.3 Frame structure type 3

Frame structure type 3 is applicable to LAA secondary cell operation with normal cyclic prefix only. Each radio frame is  $T_f = 307200 \cdot T_s = 10$  ms long and consists of 20 slots of length  $T_{slot} = 15360 \cdot T_s = 0.5$  ms, numbered from 0 to 19. A subframe is defined as two consecutive slots where subframe  $i$  consists of slots  $2i$  and  $2i+1$ .

The 10 subframes within a radio frame are available for downlink transmissions. Downlink transmissions occupy one or more consecutive subframes, starting anywhere within a subframe and ending with the last subframe either fully occupied or following one of the DwPTS durations in Table 4.2-1.



## 5 Uplink

### 5.1 Overview

The smallest resource unit for uplink transmissions is denoted a resource element and is defined in clause 5.2.2.

#### 5.1.1 Physical channels

An uplink physical channel corresponds to a set of resource elements carrying information originating from higher layers and is the interface defined between 3GPP TS 36.212 [3] and the present document 3GPP TS 36.211. The following uplink physical channels are defined:

- Physical Uplink Shared Channel, PUSCH
- Physical Uplink Control Channel, PUCCH
- Physical Random Access Channel, PRACH

#### 5.1.2 Physical signals

An uplink physical signal is used by the physical layer but does not carry information originating from higher layers. The following uplink physical signals are defined:

- Reference signal

## 5.2 Slot structure and physical resources

### 5.2.1 Resource grid

The transmitted signal in each slot is described by one or several resource grids of  $N_{RB}^{UL} N_{sc}^{RB}$  subcarriers and  $N_{symb}^{UL}$  SC-FDMA symbols. The resource grid is illustrated in Figure 5.2.1-1. The quantity  $N_{RB}^{UL}$  depends on the uplink transmission bandwidth configured in the cell and shall fulfil

$$N_{RB}^{min,UL} \leq N_{RB}^{UL} \leq N_{RB}^{max,UL}$$

where  $N_{RB}^{min,UL} = 6$  and  $N_{RB}^{max,UL} = 110$  are the smallest and largest uplink bandwidths, respectively, supported by the current version of this specification. The set of allowed values for  $N_{RB}^{UL}$  is given by 3GPP TS 36.101 [7].

The number of SC-FDMA symbols in a slot depends on the cyclic prefix length configured by the higher layer parameter *UL-CyclicPrefixLength* and is given in Table 5.2.3-1.

An antenna port is defined such that the channel over which a symbol on the antenna port is conveyed can be inferred from the channel over which another symbol on the same antenna port is conveyed. There is one resource grid per antenna port. The antenna ports used for transmission of a physical channel or signal depends on the number of antenna ports configured for the physical channel or signal as shown in Table 5.2.1-1. The index  $\tilde{p}$  is used throughout clause 5 when a sequential numbering of the antenna ports is necessary.

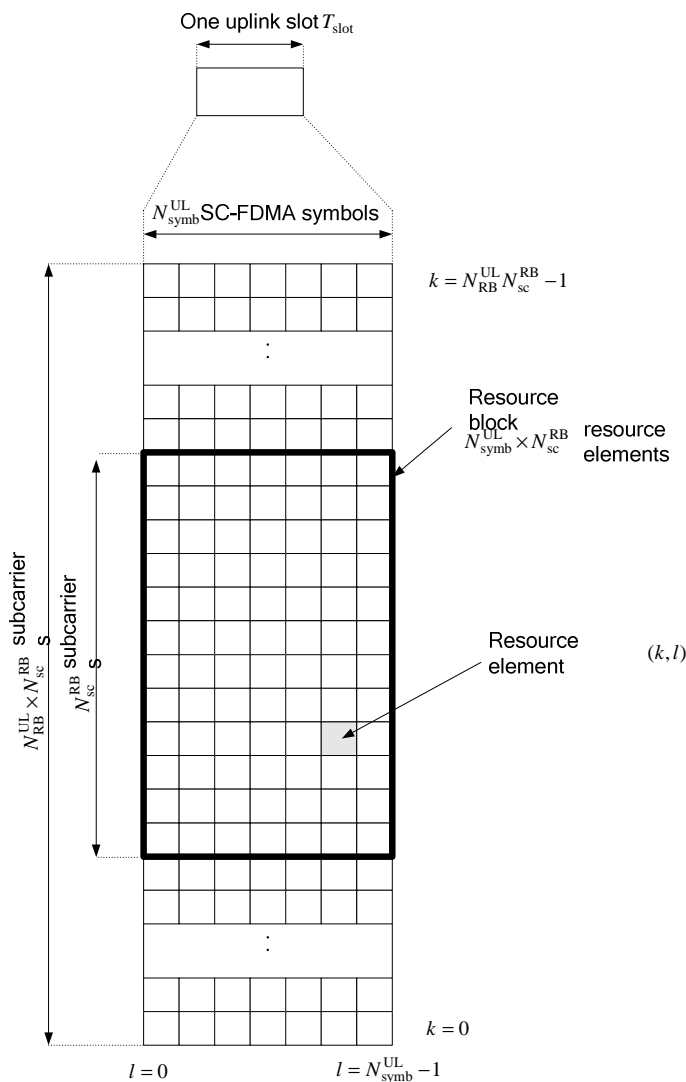

Figure 5.2.1-1: Uplink resource grid

Table 5.2.1-1: Antenna ports used for different physical channels and signals

Physical channel or signal	Index $\tilde{p}$	Antenna port number $p$ as a function of the number of antenna ports configured for the respective physical channel/signal		
		1	2	4
PUSCH	0	10	20	40
	1	-	21	41
	2	-	-	42
	3	-	-	43
SRS	0	10	20	40
	1	-	21	41
	2	-	-	42
	3	-	-	43
PUCCH	0	100	200	-
	1	-	201	-

## 5.2.2 Resource elements

Each element in the resource grid is called a resource element and is uniquely defined by the index pair  $(k, l)$  in a slot where  $k = 0, \dots, N_{\text{RB}}^{\text{UL}} N_{\text{sc}}^{\text{RB}} - 1$  and  $l = 0, \dots, N_{\text{symb}}^{\text{UL}} - 1$  are the indices in the frequency and time domains, respectively.

Resource element  $(k, l)$  on antenna port  $p$  corresponds to the complex value  $a_{k,l}^{(p)}$ .

When there is no risk for confusion, or no particular antenna port is specified, the index  $p$  may be dropped.

Quantities  $a_{k,l}^{(p)}$  corresponding to resource elements not used for transmission of a physical channel or a physical signal in a slot shall be set to zero.

## 5.2.3 Resource blocks

A physical resource block is defined as  $N_{\text{symb}}^{\text{UL}}$  consecutive SC-FDMA symbols in the time domain and  $N_{\text{sc}}^{\text{RB}}$  consecutive subcarriers in the frequency domain, where  $N_{\text{symb}}^{\text{UL}}$  and  $N_{\text{sc}}^{\text{RB}}$  are given by Table 5.2.3-1.

A physical resource block in the uplink thus consists of  $N_{\text{symb}}^{\text{UL}} \times N_{\text{sc}}^{\text{RB}}$  resource elements, corresponding to one slot in the time domain and 180 kHz in the frequency domain.

**Table 5.2.3-1: Resource block parameters**

Configuration	$N_{\text{sc}}^{\text{RB}}$	$N_{\text{symb}}^{\text{UL}}$
Normal cyclic prefix	12	7
Extended cyclic prefix	12	6

The relation between the physical resource block number  $n_{\text{PRB}}$  in the frequency domain and resource elements  $(k, l)$  in a slot is given by

$$n_{\text{PRB}} = \left\lfloor \frac{k}{N_{\text{sc}}^{\text{RB}}} \right\rfloor$$

## 5.2.4 Narrowbands

A narrowband is defined as six non-overlapping consecutive physical resource blocks in the frequency domain. The total number of uplink narrowbands in the uplink transmission bandwidth configured in the cell is given by

$$N_{\text{NB}}^{\text{UL}} = \left\lfloor \frac{N_{\text{RB}}^{\text{UL}}}{6} \right\rfloor$$

The narrowbands are numbered  $n_{\text{NB}} = 0, \dots, N_{\text{NB}}^{\text{UL}} - 1$  in order of increasing physical resource-block number where narrowband  $n_{\text{NB}}$  is composed of physical resource-block indices

$$\begin{cases} 6n_{\text{NB}} + i_0 + i & \text{if } N_{\text{RB}}^{\text{UL}} \bmod 2 = 0 \\ 6n_{\text{NB}} + i_0 + i & \text{if } N_{\text{RB}}^{\text{UL}} \bmod 2 = 1 \text{ and } n_{\text{NB}} < N_{\text{NB}}^{\text{UL}}/2 \\ 6n_{\text{NB}} + i_0 + i + 1 & \text{if } N_{\text{RB}}^{\text{UL}} \bmod 2 = 1 \text{ and } n_{\text{NB}} \geq N_{\text{NB}}^{\text{UL}}/2 \end{cases}$$

where

$$i = 0, 1, \dots, 5$$

$$i_0 = \left\lfloor \frac{N_{\text{RB}}^{\text{UL}}}{2} \right\rfloor - \frac{6N_{\text{NB}}^{\text{UL}}}{2}$$

## 5.2.5 Guard period for narrowband retuning

For BL/CE UEs, a guard period is created for Tx-to-Tx frequency retuning between two consecutive subframes.

- If the UE retunes from a first narrowband carrying PUSCH to a second narrowband carrying PUSCH, or if the UE retunes from a first narrowband carrying PUCCH to a second narrowband carrying PUCCH,
  - a guard period is created by the UE not transmitting the last SC-FDMA symbol in the first subframe and the first SC-FDMA symbol in the second subframe.
- If the UE retunes from a first narrowband carrying PUCCH to a second narrowband carrying PUSCH,
  - if the PUCCH uses a shortened PUCCH format, a guard period is created by the UE not transmitting the first SC-FDMA symbol in the second subframe,
  - otherwise a guard period is created by the UE not transmitting the first two SC-FDMA symbols in the second subframe.
- If the UE retunes from a first narrowband carrying PUSCH to a second narrowband carrying PUCCH,
  - a guard period is created by the UE not transmitting the last two SC-FDMA symbols in the first subframe.

## 5.3 Physical uplink shared channel

The baseband signal representing the physical uplink shared channel is defined in terms of the following steps:

- scrambling
- modulation of scrambled bits to generate complex-valued symbols
- mapping of the complex-valued modulation symbols onto one or several transmission layers
- transform precoding to generate complex-valued symbols
- precoding of the complex-valued symbols
- mapping of precoded complex-valued symbols to resource elements
- generation of complex-valued time-domain SC-FDMA signal for each antenna port

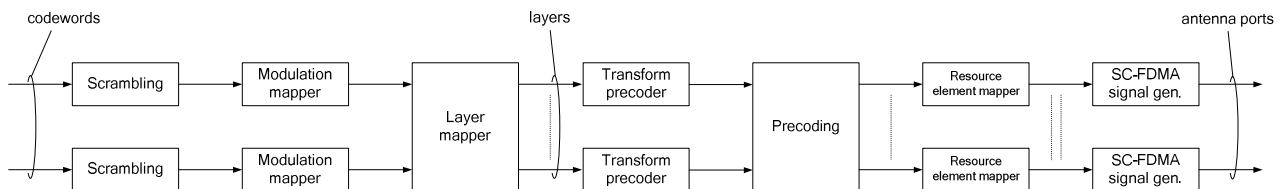

Figure 5.3-1: Overview of uplink physical channel processing

### 5.3.1 Scrambling

For each codeword  $q$ , the block of bits  $b^{(q)}(0), \dots, b^{(q)}(M_{\text{bit}}^{(q)} - 1)$ , where  $M_{\text{bit}}^{(q)}$  is the number of bits transmitted in codeword  $q$  on the physical uplink shared channel in one subframe, shall be scrambled with a UE-specific scrambling sequence prior to modulation, resulting in a block of scrambled bits  $\tilde{b}^{(q)}(0), \dots, \tilde{b}^{(q)}(M_{\text{bit}}^{(q)} - 1)$  according to the following pseudo code

Set  $i = 0$

while  $i < M_{\text{bit}}^{(q)}$

if  $b^{(q)}(i) = x$  // ACK/NACK or Rank Indication placeholder bits

$$\tilde{b}^{(q)}(i) = 1$$

else

if  $b^{(q)}(i) = y$  // ACK/NACK or Rank Indication repetition placeholder bits

$$\tilde{b}^{(q)}(i) = \tilde{b}^{(q)}(i-1)$$

else // Data or channel quality coded bits, Rank Indication coded bits or ACK/NACK coded bits

$$\tilde{b}^{(q)}(i) = (b^{(q)}(i) + c^{(q)}(i)) \bmod 2$$

end if

end if

$i = i + 1$

end while

where  $x$  and  $y$  are tags defined in 3GPP TS 36.212 [3] clause 5.2.2.6 and where the scrambling sequence  $c^{(q)}(i)$  is given by clause 7.2. The scrambling sequence generator shall be initialised with

$c_{\text{init}} = n_{\text{RNTI}} \cdot 2^{14} + q \cdot 2^{13} + \lfloor n_s/2 \rfloor \cdot 2^9 + N_{\text{ID}}^{\text{cell}}$  at the start of each subframe where  $n_{\text{RNTI}}$  corresponds to the RNTI associated with the PUSCH transmission as described in clause 8 in 3GPP TS 36.213 [4].

For BL/CE UEs, the same scrambling sequence is applied per subframe to PUSCH for a given block of  $N_{\text{acc}}$  subframes. For the  $j^{\text{th}}$  block of  $N_{\text{acc}}$  subframes, the scrambling sequence generator shall be initialised with

$$c_{\text{init}} = n_{\text{RNTI}} \cdot 2^{14} + q \cdot 2^{13} + [(j_0 + j)N_{\text{acc}} \bmod 10] \cdot 2^9 + N_{\text{ID}}^{\text{cell}}$$

where

$$j = 0, 1, \dots, \left\lfloor \frac{i_0 + N_{\text{abs}}^{\text{PUSCH}} - 1}{N_{\text{acc}}} \right\rfloor - j_0$$

$$j_0 = \lfloor i_0 / N_{\text{acc}} \rfloor$$

and  $i_0$  is the absolute subframe number of the first uplink subframe intended for PUSCH. The PUSCH transmission spans  $N_{\text{abs}}^{\text{PUSCH}}$  consecutive subframes including invalid subframes where the UE postpones the PUSCH transmission. For a BL/CE UE configured in CEModeA,  $N_{\text{acc}} = 1$ . For a BL/CE UE configured with CEModeB,  $N_{\text{acc}} = 4$  for frame structure type 1 and  $N_{\text{acc}} = 5$  for frame structure type 2.

Up to two codewords can be transmitted in one subframe, i.e.,  $q \in \{0, 1\}$ . In the case of single-codeword transmission,  $q = 0$ .

### 5.3.2 Modulation

For each codeword  $q$ , the block of scrambled bits  $\tilde{b}^{(q)}(0), \dots, \tilde{b}^{(q)}(M_{\text{bit}}^{(q)} - 1)$  shall be modulated as described in clause 7.1, resulting in a block of complex-valued symbols  $d^{(q)}(0), \dots, d^{(q)}(M_{\text{symp}}^{(q)} - 1)$ . Table 5.3.2-1 specifies the modulation mappings applicable for the physical uplink shared channel.

**Table 5.3.2-1: Uplink modulation schemes**

Physical channel	Modulation schemes
PUSCH	QPSK, 16QAM, 64QAM



### 5.3.2A Layer mapping

The complex-valued modulation symbols for each of the codewords to be transmitted are mapped onto one or two layers. Complex-valued modulation symbols  $d^{(q)}(0), \dots, d^{(q)}(M_{\text{symp}}^{(q)} - 1)$  for codeword  $q$  shall be mapped onto the layers  $x(i) = [x^{(0)}(i) \ \dots \ x^{(v-1)}(i)]^T$ ,  $i = 0, 1, \dots, M_{\text{symp}}^{\text{layer}} - 1$  where  $v$  is the number of layers and  $M_{\text{symp}}^{\text{layer}}$  is the number of modulation symbols per layer.

#### 5.3.2A.1 Layer mapping for transmission on a single antenna port

For transmission on a single antenna port, a single layer is used,  $v = 1$ , and the mapping is defined by

$$x^{(0)}(i) = d^{(0)}(i)$$

with  $M_{\text{symp}}^{\text{layer}} = M_{\text{symp}}^{(0)}$ .

#### 5.3.2A.2 Layer mapping for spatial multiplexing

For spatial multiplexing, the layer mapping shall be done according to Table 5.3.2A.2-1. The number of layers  $v$  is less than or equal to the number of antenna ports  $P$  used for transmission of the physical uplink shared channel. The case of a single codeword mapped to multiple layers is only applicable when the number of antenna ports used for PUSCH is four.

**Table 5.3.2A.2-1: Codeword-to-layer mapping for spatial multiplexing**

Number of layers	Number of codewords	Codeword-to-layer mapping $i = 0, 1, \dots, M_{\text{symp}}^{\text{layer}} - 1$
1	1	$x^{(0)}(i) = d^{(0)}(i)$ $M_{\text{symp}}^{\text{layer}} = M_{\text{symp}}^{(0)}$
2	1	$x^{(0)}(i) = d^{(0)}(2i)$ $x^{(1)}(i) = d^{(0)}(2i+1)$ $M_{\text{symp}}^{\text{layer}} = M_{\text{symp}}^{(0)} / 2$
2	2	$x^{(0)}(i) = d^{(0)}(i)$ $x^{(1)}(i) = d^{(1)}(i)$ $M_{\text{symp}}^{\text{layer}} = M_{\text{symp}}^{(0)} = M_{\text{symp}}^{(1)}$
3	2	$x^{(0)}(i) = d^{(0)}(i)$ $x^{(1)}(i) = d^{(1)}(2i)$ $x^{(2)}(i) = d^{(1)}(2i+1)$ $M_{\text{symp}}^{\text{layer}} = M_{\text{symp}}^{(0)} = M_{\text{symp}}^{(1)} / 2$
4	2	$x^{(0)}(i) = d^{(0)}(2i)$ $x^{(1)}(i) = d^{(0)}(2i+1)$ $x^{(2)}(i) = d^{(1)}(2i)$ $x^{(3)}(i) = d^{(1)}(2i+1)$ $M_{\text{symp}}^{\text{layer}} = M_{\text{symp}}^{(0)} / 2 = M_{\text{symp}}^{(1)} / 2$

### 5.3.3 Transform precoding

For each layer  $\lambda = 0, 1, \dots, \nu - 1$  the block of complex-valued symbols  $x^{(\lambda)}(0), \dots, x^{(\lambda)}(M_{\text{symb}}^{\text{layer}} - 1)$  is divided into  $M_{\text{symb}}^{\text{layer}} / M_{\text{sc}}^{\text{PUSCH}}$  sets, each corresponding to one SC-FDMA symbol. Transform precoding shall be applied according to

$$y^{(\lambda)}(l \cdot M_{\text{sc}}^{\text{PUSCH}} + k) = \frac{1}{\sqrt{M_{\text{sc}}^{\text{PUSCH}}}} \sum_{i=0}^{M_{\text{sc}}^{\text{PUSCH}} - 1} x^{(\lambda)}(l \cdot M_{\text{sc}}^{\text{PUSCH}} + i) e^{-j \frac{2\pi i k}{M_{\text{sc}}^{\text{PUSCH}}}}$$

$$k = 0, \dots, M_{\text{sc}}^{\text{PUSCH}} - 1$$

$$l = 0, \dots, M_{\text{symb}}^{\text{layer}} / M_{\text{sc}}^{\text{PUSCH}} - 1$$

resulting in a block of complex-valued symbols  $y^{(\lambda)}(0), \dots, y^{(\lambda)}(M_{\text{symb}}^{\text{layer}} - 1)$ . The variable  $M_{\text{sc}}^{\text{PUSCH}} = M_{\text{RB}}^{\text{PUSCH}} \cdot N_{\text{sc}}^{\text{RB}}$ , where  $M_{\text{RB}}^{\text{PUSCH}}$  represents the bandwidth of the PUSCH in terms of resource blocks, and shall fulfil

$$M_{\text{RB}}^{\text{PUSCH}} = 2^{\alpha_2} \cdot 3^{\alpha_3} \cdot 5^{\alpha_5} \leq N_{\text{RB}}^{\text{UL}}$$

where  $\alpha_2, \alpha_3, \alpha_5$  is a set of non-negative integers.

#### 5.3.3A Precoding

The precoder takes as input a block of vectors  $[y^{(0)}(i) \ \dots \ y^{(\nu-1)}(i)]^T$ ,  $i = 0, 1, \dots, M_{\text{symb}}^{\text{layer}} - 1$  from the transform precoder and generates a block of vectors  $[z^{(0)}(i) \ \dots \ z^{(P-1)}(i)]^T$ ,  $i = 0, 1, \dots, M_{\text{symb}}^{\text{ap}} - 1$  to be mapped onto resource elements.

##### 5.3.3A.1 Precoding for transmission on a single antenna port

For transmission on a single antenna port, precoding is defined by

$$z^{(0)}(i) = y^{(0)}(i)$$

where  $i = 0, 1, \dots, M_{\text{symb}}^{\text{ap}} - 1$ ,  $M_{\text{symb}}^{\text{ap}} = M_{\text{symb}}^{\text{layer}}$ .

##### 5.3.3A.2 Precoding for spatial multiplexing

Precoding for spatial multiplexing is only used in combination with layer mapping for spatial multiplexing as described in clause 5.3.2A.2. Spatial multiplexing supports  $P = 2$  or  $P = 4$  antenna ports where the set of antenna ports used for spatial multiplexing is  $p \in \{20, 21\}$  and  $p \in \{40, 41, 42, 43\}$ , respectively.

Precoding for spatial multiplexing is defined by

$$\begin{bmatrix} z^{(0)}(i) \\ \vdots \\ z^{(P-1)}(i) \end{bmatrix} = W \begin{bmatrix} y^{(0)}(i) \\ \vdots \\ y^{(\nu-1)}(i) \end{bmatrix}$$

where  $i = 0, 1, \dots, M_{\text{symb}}^{\text{ap}} - 1$ ,  $M_{\text{symb}}^{\text{ap}} = M_{\text{symb}}^{\text{layer}}$ .

The precoding matrix  $W$  of size  $P \times \nu$  is given by one of the entries in Table 5.3.3A.2-1 for  $P = 2$  and by Tables 5.3.3A.2-2 through 5.3.3A.2-5 for  $P = 4$  where the entries in each row are ordered from left to right in increasing order of codebook indices.

**Table 5.3.3A.2-1: Codebook for transmission on antenna ports {20,21}**

Codebook index	Number of layers	
	$v=1$	$v=2$
0	$\frac{1}{\sqrt{2}} \begin{bmatrix} 1 \\ 1 \end{bmatrix}$	$\frac{1}{\sqrt{2}} \begin{bmatrix} 1 & 0 \\ 0 & 1 \end{bmatrix}$
1	$\frac{1}{\sqrt{2}} \begin{bmatrix} 1 \\ -1 \end{bmatrix}$	-
2	$\frac{1}{\sqrt{2}} \begin{bmatrix} 1 \\ j \end{bmatrix}$	-
3	$\frac{1}{\sqrt{2}} \begin{bmatrix} 1 \\ -j \end{bmatrix}$	-
4	$\frac{1}{\sqrt{2}} \begin{bmatrix} 1 \\ 0 \end{bmatrix}$	-
5	$\frac{1}{\sqrt{2}} \begin{bmatrix} 0 \\ 1 \end{bmatrix}$	-

**Table 5.3.3A.2-2: Codebook for transmission on antenna ports {40,41,42,43} with  $v=1$**

Codebook index	Number of layers $v=1$							
0 – 7	$\frac{1}{2} \begin{bmatrix} 1 \\ 1 \\ 1 \\ -1 \end{bmatrix}$	$\frac{1}{2} \begin{bmatrix} 1 \\ 1 \\ j \\ j \end{bmatrix}$	$\frac{1}{2} \begin{bmatrix} 1 \\ 1 \\ -1 \\ 1 \end{bmatrix}$	$\frac{1}{2} \begin{bmatrix} 1 \\ 1 \\ -j \\ -j \end{bmatrix}$	$\frac{1}{2} \begin{bmatrix} 1 \\ j \\ 1 \\ j \end{bmatrix}$	$\frac{1}{2} \begin{bmatrix} 1 \\ j \\ j \\ 1 \end{bmatrix}$	$\frac{1}{2} \begin{bmatrix} 1 \\ j \\ -1 \\ -j \end{bmatrix}$	$\frac{1}{2} \begin{bmatrix} 1 \\ j \\ -j \\ -1 \end{bmatrix}$
8 – 15	$\frac{1}{2} \begin{bmatrix} 1 \\ -1 \\ 1 \\ 1 \end{bmatrix}$	$\frac{1}{2} \begin{bmatrix} 1 \\ -1 \\ j \\ -j \end{bmatrix}$	$\frac{1}{2} \begin{bmatrix} 1 \\ -1 \\ -1 \\ -1 \end{bmatrix}$	$\frac{1}{2} \begin{bmatrix} 1 \\ -1 \\ -j \\ j \end{bmatrix}$	$\frac{1}{2} \begin{bmatrix} 1 \\ -j \\ 1 \\ -j \end{bmatrix}$	$\frac{1}{2} \begin{bmatrix} 1 \\ -j \\ j \\ -1 \end{bmatrix}$	$\frac{1}{2} \begin{bmatrix} 1 \\ -j \\ -1 \\ j \end{bmatrix}$	$\frac{1}{2} \begin{bmatrix} 1 \\ -j \\ -j \\ 1 \end{bmatrix}$
16 – 23	$\frac{1}{2} \begin{bmatrix} 1 \\ 0 \\ 1 \\ 0 \end{bmatrix}$	$\frac{1}{2} \begin{bmatrix} 1 \\ 0 \\ -1 \\ 0 \end{bmatrix}$	$\frac{1}{2} \begin{bmatrix} 1 \\ 0 \\ j \\ 0 \end{bmatrix}$	$\frac{1}{2} \begin{bmatrix} 1 \\ 0 \\ -j \\ 0 \end{bmatrix}$	$\frac{1}{2} \begin{bmatrix} 0 \\ 1 \\ 0 \\ 1 \end{bmatrix}$	$\frac{1}{2} \begin{bmatrix} 0 \\ 1 \\ 0 \\ -1 \end{bmatrix}$	$\frac{1}{2} \begin{bmatrix} 0 \\ 1 \\ 0 \\ j \end{bmatrix}$	$\frac{1}{2} \begin{bmatrix} 0 \\ 1 \\ 0 \\ -j \end{bmatrix}$

**Table 5.3.3A.2-3: Codebook for transmission on antenna ports {40,41,42,43} with  $v = 2$**

Codebook index	Number of layers $v = 2$			
0-3	$\frac{1}{2} \begin{bmatrix} 1 & 0 \\ 1 & 0 \\ 0 & 1 \\ 0 & -j \end{bmatrix}$	$\frac{1}{2} \begin{bmatrix} 1 & 0 \\ 1 & 0 \\ 0 & 1 \\ 0 & j \end{bmatrix}$	$\frac{1}{2} \begin{bmatrix} 1 & 0 \\ -j & 0 \\ 0 & 1 \\ 0 & 1 \end{bmatrix}$	$\frac{1}{2} \begin{bmatrix} 1 & 0 \\ -j & 0 \\ 0 & 1 \\ 0 & -1 \end{bmatrix}$
4-7	$\frac{1}{2} \begin{bmatrix} 1 & 0 \\ -1 & 0 \\ 0 & 1 \\ 0 & -j \end{bmatrix}$	$\frac{1}{2} \begin{bmatrix} 1 & 0 \\ -1 & 0 \\ 0 & 1 \\ 0 & j \end{bmatrix}$	$\frac{1}{2} \begin{bmatrix} 1 & 0 \\ j & 0 \\ 0 & 1 \\ 0 & 1 \end{bmatrix}$	$\frac{1}{2} \begin{bmatrix} 1 & 0 \\ j & 0 \\ 0 & 1 \\ 0 & -1 \end{bmatrix}$
8-11	$\frac{1}{2} \begin{bmatrix} 1 & 0 \\ 0 & 1 \\ 1 & 0 \\ 0 & 1 \end{bmatrix}$	$\frac{1}{2} \begin{bmatrix} 1 & 0 \\ 0 & 1 \\ 1 & 0 \\ 0 & -1 \end{bmatrix}$	$\frac{1}{2} \begin{bmatrix} 1 & 0 \\ 0 & 1 \\ -1 & 0 \\ 0 & 1 \end{bmatrix}$	$\frac{1}{2} \begin{bmatrix} 1 & 0 \\ 0 & 1 \\ -1 & 0 \\ 0 & -1 \end{bmatrix}$
12-15	$\frac{1}{2} \begin{bmatrix} 1 & 0 \\ 0 & 1 \\ 0 & 1 \\ 1 & 0 \end{bmatrix}$	$\frac{1}{2} \begin{bmatrix} 1 & 0 \\ 0 & 1 \\ 0 & -1 \\ 1 & 0 \end{bmatrix}$	$\frac{1}{2} \begin{bmatrix} 1 & 0 \\ 0 & 1 \\ 0 & 1 \\ -1 & 0 \end{bmatrix}$	$\frac{1}{2} \begin{bmatrix} 1 & 0 \\ 0 & 1 \\ 0 & -1 \\ -1 & 0 \end{bmatrix}$

**Table 5.3.3A.2-4: Codebook for transmission on antenna ports {40,41,42,43} with  $v = 3$**

Codebook index	Number of layers $v = 3$			
0-3	$\frac{1}{2} \begin{bmatrix} 1 & 0 & 0 \\ 1 & 0 & 0 \\ 0 & 1 & 0 \\ 0 & 0 & 1 \end{bmatrix}$	$\frac{1}{2} \begin{bmatrix} 1 & 0 & 0 \\ -1 & 0 & 0 \\ 0 & 1 & 0 \\ 0 & 0 & 1 \end{bmatrix}$	$\frac{1}{2} \begin{bmatrix} 1 & 0 & 0 \\ 0 & 1 & 0 \\ 1 & 0 & 0 \\ 0 & 0 & 1 \end{bmatrix}$	$\frac{1}{2} \begin{bmatrix} 1 & 0 & 0 \\ 0 & 1 & 0 \\ -1 & 0 & 0 \\ 0 & 0 & 1 \end{bmatrix}$
4-7	$\frac{1}{2} \begin{bmatrix} 1 & 0 & 0 \\ 0 & 1 & 0 \\ 0 & 0 & 1 \\ 1 & 0 & 0 \end{bmatrix}$	$\frac{1}{2} \begin{bmatrix} 1 & 0 & 0 \\ 0 & 1 & 0 \\ 0 & 0 & 1 \\ -1 & 0 & 0 \end{bmatrix}$	$\frac{1}{2} \begin{bmatrix} 0 & 1 & 0 \\ 1 & 0 & 0 \\ 1 & 0 & 0 \\ 0 & 0 & 1 \end{bmatrix}$	$\frac{1}{2} \begin{bmatrix} 0 & 1 & 0 \\ 1 & 0 & 0 \\ -1 & 0 & 0 \\ 0 & 0 & 1 \end{bmatrix}$
8-11	$\frac{1}{2} \begin{bmatrix} 0 & 1 & 0 \\ 1 & 0 & 0 \\ 0 & 0 & 1 \\ 1 & 0 & 0 \end{bmatrix}$	$\frac{1}{2} \begin{bmatrix} 0 & 1 & 0 \\ 1 & 0 & 0 \\ 0 & 0 & 1 \\ -1 & 0 & 0 \end{bmatrix}$	$\frac{1}{2} \begin{bmatrix} 0 & 1 & 0 \\ 0 & 0 & 1 \\ 1 & 0 & 0 \\ 1 & 0 & 0 \end{bmatrix}$	$\frac{1}{2} \begin{bmatrix} 0 & 1 & 0 \\ 0 & 0 & 1 \\ 1 & 0 & 0 \\ -1 & 0 & 0 \end{bmatrix}$

**Table 5.3.3A.2-5: Codebook for transmission on antenna ports {40,41,42,43} with  $v = 4$**

Codebook index	Number of layers $v = 4$
0	$\frac{1}{2} \begin{bmatrix} 1 & 0 & 0 & 0 \\ 0 & 1 & 0 & 0 \\ 0 & 0 & 1 & 0 \\ 0 & 0 & 0 & 1 \end{bmatrix}$

### 5.3.4 Mapping to physical resources

For each antenna port  $p$  used for transmission of the PUSCH in a subframe the block of complex-valued symbols  $z^{(\tilde{p})}(0), \dots, z^{(\tilde{p})}(M_{\text{symb}}^{\text{ap}} - 1)$  shall be multiplied with the amplitude scaling factor  $\beta_{\text{PUSCH}}$  in order to conform to the transmit power  $P_{\text{PUSCH}}$  specified in clause 5.1.1.1 in 3GPP TS 36.213 [4], and mapped in sequence starting with  $z^{(\tilde{p})}(0)$  to physical resource blocks on antenna port  $p$  and assigned for transmission of PUSCH. The relation between the index  $\tilde{p}$  and the antenna port number  $p$  is given by Table 5.2.1-1. The mapping to resource elements  $(k, l)$  corresponding to the physical resource blocks assigned for transmission and

- not used for transmission of reference signals, and
- not part of the last SC-FDMA symbol in a subframe, if the UE transmits SRS in the same subframe in the same serving cell, and
- not part of the last SC-FDMA symbol in a subframe configured with cell-specific SRS for non-BL/CE UEs and BL/CE UEs in CEModeA, if the PUSCH transmission partly or fully overlaps with the cell-specific SRS bandwidth, and
- not part of an SC-FDMA symbol reserved for possible SRS transmission in a UE-specific aperiodic SRS subframe in the same serving cell, and
- not part of an SC-FDMA symbol reserved for possible SRS transmission in a UE-specific periodic SRS subframe in the same serving cell when the UE is configured with multiple TAGs

shall be in increasing order of first the index  $k$ , then the index  $l$ , starting with the first slot in the subframe.

For BL/CE UEs in CEModeB, resource elements in the last SC-FDMA symbol in a subframe configured with cell-specific SRS shall be counted in the PUSCH mapping but not used for transmission of the PUSCH.

For BL/CE UEs, if one or more SC-FDMA symbol(s) are left empty due to guard period for narrowband retuning, the affected SC-FDMA symbol(s) shall be counted in the PUSCH mapping but not used for transmission of the PUSCH.

If uplink frequency-hopping is disabled or the resource blocks allocated for PUSCH transmission are not contiguous in frequency, the set of physical resource blocks to be used for transmission is given by  $n_{\text{PRB}} = n_{\text{VRB}}$  where  $n_{\text{VRB}}$  is obtained from the uplink scheduling grant as described in clause 8.1 in 3GPP TS 36.213 [4].

If uplink frequency-hopping with type 1 PUSCH hopping is enabled, the set of physical resource blocks to be used for transmission is given by clause 8.4.1 in 3GPP TS 36.213 [4].

If uplink frequency-hopping with predefined hopping pattern is enabled, the set of physical resource blocks to be used for transmission in slot  $n_s$  is given by the scheduling grant together with a predefined pattern according to

$$\begin{aligned} \tilde{n}_{\text{PRB}}(n_s) &= \left( \tilde{n}_{\text{VRB}} + f_{\text{hop}}(i) \cdot N_{\text{RB}}^{\text{sb}} + \left( (N_{\text{RB}}^{\text{sb}} - 1) - 2(\tilde{n}_{\text{VRB}} \bmod N_{\text{RB}}^{\text{sb}}) \right) \cdot f_m(i) \right) \bmod (N_{\text{RB}}^{\text{sb}} \cdot N_{\text{sb}}) \\ i &= \begin{cases} \lfloor n_s/2 \rfloor & \text{inter - subframe hopping} \\ n_s & \text{intra and inter - subframe hopping} \end{cases} \\ n_{\text{PRB}}(n_s) &= \begin{cases} \tilde{n}_{\text{PRB}}(n_s) & N_{\text{sb}} = 1 \\ \tilde{n}_{\text{PRB}}(n_s) + \lceil N_{\text{RB}}^{\text{HO}}/2 \rceil & N_{\text{sb}} > 1 \end{cases} \\ \tilde{n}_{\text{VRB}} &= \begin{cases} n_{\text{VRB}} & N_{\text{sb}} = 1 \\ n_{\text{VRB}} - \lceil N_{\text{RB}}^{\text{HO}}/2 \rceil & N_{\text{sb}} > 1 \end{cases} \end{aligned}$$

where  $n_{\text{VRB}}$  is obtained from the scheduling grant as described in clause 8.1 in 3GPP TS 36.213 [4]. The parameter *pusch-HoppingOffset*,  $N_{\text{RB}}^{\text{HO}}$ , is provided by higher layers. The size  $N_{\text{RB}}^{\text{sb}}$  of each sub-band is given by,

$$N_{\text{RB}}^{\text{sb}} = \begin{cases} N_{\text{RB}}^{\text{UL}} & N_{\text{sb}} = 1 \\ \left\lfloor \left( N_{\text{RB}}^{\text{UL}} - N_{\text{RB}}^{\text{HO}} - N_{\text{RB}}^{\text{HO}} \bmod 2 \right) / N_{\text{sb}} \right\rfloor & N_{\text{sb}} > 1 \end{cases}$$

where the number of sub-bands  $N_{\text{sb}}$  is given by higher layers. The function  $f_m(i) \in \{0,1\}$  determines whether mirroring is used or not. The parameter *Hopping-mode* provided by higher layers determines if hopping is "inter-subframe" or "intra and inter-subframe".

The hopping function  $f_{\text{hop}}(i)$  and the function  $f_m(i)$  are given by

$$f_{\text{hop}}(i) = \begin{cases} 0 & N_{\text{sb}} = 1 \\ (f_{\text{hop}}(i-1) + \sum_{k=i-10+1}^{i-10+9} c(k) \times 2^{k-(i-10+1)}) \bmod N_{\text{sb}} & N_{\text{sb}} = 2 \\ (f_{\text{hop}}(i-1) + \left( \sum_{k=i-10+1}^{i-10+9} c(k) \times 2^{k-(i-10+1)} \right) \bmod (N_{\text{sb}} - 1) + 1) \bmod N_{\text{sb}} & N_{\text{sb}} > 2 \end{cases}$$

$$f_m(i) = \begin{cases} i \bmod 2 & N_{\text{sb}} = 1 \text{ and intra and inter - subframe hopping} \\ \text{CURRENT\_TX\_NB} \bmod 2 & N_{\text{sb}} = 1 \text{ and inter - subframe hopping} \\ c(i \cdot 10) & N_{\text{sb}} > 1 \end{cases}$$

where  $f_{\text{hop}}(-1) = 0$  and the pseudo-random sequence  $c(i)$  is given by clause 7.2 and CURRENT\_TX\_NB indicates the transmission number for the transport block transmitted in slot  $n_s$  as defined in [8]. The pseudo-random sequence generator shall be initialised with  $c_{\text{init}} = N_{\text{ID}}^{\text{cell}}$  for frame structure type 1 and  $c_{\text{init}} = 2^9 \cdot (n_f \bmod 4) + N_{\text{ID}}^{\text{cell}}$  for frame structure type 2 at the start of each frame.

For BL/CE UEs, the PRB resources within the narrowband  $n_{\text{NB}}^{(i_0)}$  for PUSCH transmission in the first subframe are obtained from the DCI as described in clauses 5.3.3.1.10 and 5.3.3.1.11 in [3]. The PUSCH is transmitted with  $N_{\text{rep}}^{\text{PUSCH}} \geq 1$  repetitions. The PUSCH transmission spans  $N_{\text{abs}}^{\text{PUSCH}} \geq N_{\text{rep}}^{\text{PUSCH}}$  consecutive subframes, including invalid subframes where the UE postpones the PUSCH transmission if  $N_{\text{rep}}^{\text{PUSCH}} > 1$ . For BL/CE UE in CEModeA, PUSCH frequency hopping is enabled when the higher-layer parameter *pusch-HoppingConfig* is set and the frequency hopping flag in DCI format 6-0A indicates frequency hopping, otherwise frequency hopping is disabled. If frequency hopping is not enabled for PUSCH, the PUSCH repetitions are located at the same PRB resources at the same narrowband  $n_{\text{NB}}^{(i_0)}$ . If frequency hopping is enabled for PUSCH, PUSCH is transmitted in subframe  $i$  within the  $N_{\text{abs}}^{\text{PUSCH}}$  consecutive uplink subframes using the same PRB resources within narrowband

$$n_{\text{NB}}^{(i)} = \begin{cases} n_{\text{NB}}^{(i_0)} & \text{if } \left\lfloor i / N_{\text{NB}}^{\text{ch,UL}} - j_0 \right\rfloor \bmod 2 = 0 \\ \left( n_{\text{NB}}^{(i_0)} + f_{\text{NB,hop}}^{\text{PUSCH}} \right) \bmod N_{\text{NB}}^{\text{UL}} & \text{if } \left\lfloor i / N_{\text{NB}}^{\text{ch,UL}} - j_0 \right\rfloor \bmod 2 = 1 \end{cases}$$

$$j_0 = \left\lfloor i_0 / N_{\text{NB}}^{\text{ch,UL}} \right\rfloor$$

$$i_0 \leq i \leq i_0 + N_{\text{abs}}^{\text{PUSCH}} - 1$$

where  $i_0$  is the absolute subframe number of the first UL subframe intended for carrying the PUSCH and  $N_{\text{NB}}^{\text{ch,UL}}$  and  $f_{\text{NB,hop}}^{\text{PUSCH}}$  are cell-specific higher-layer parameters. For the  $N_{\text{abs}}^{\text{PUSCH}}$  consecutive subframes, the UE shall not transmit PUSCH in subframe  $i$  if it is not a valid uplink subframe.

For BL/CE UEs, PUSCH transmission associated with Temporary C-RNTI, frequency hopping of the PUSCH is enabled when higher layer parameter *rar-HoppingConfig* is set. Further

- if PRACH CE level 0 or 1 is used for the last PRACH attempt,  $N_{\text{NB}}^{\text{ch,UL}}$  is set to the higher layer parameter *interval-ULHoppingConfigCommonModeA*;

- if PRACH CE level 2 or 3 is used for the last PRACH attempt,  $N_{\text{NB}}^{\text{ch,UL}}$  is set to the higher layer parameter *interval-ULHoppingConfigCommonModeB*.

## 5.4 Physical uplink control channel

The physical uplink control channel, PUCCH, carries uplink control information. Simultaneous transmission of PUCCH and PUSCH from the same UE is supported if enabled by higher layers. For frame structure type 2, the PUCCH is not transmitted in the UpPTS field.

The physical uplink control channel supports multiple formats as shown in Table 5.4-1 with different number of bits per subframe, where  $M_{\text{RB}}^{\text{PUCCH4}}$  represents the bandwidth of the PUCCH format 4 as defined by clause 5.4.2B, and  $N_0^{\text{PUCCH}}$  and  $N_1^{\text{PUCCH}}$  are defined in Table 5.4.2C-1.

Formats 2a and 2b are supported for normal cyclic prefix only.

**Table 5.4-1: Supported PUCCH formats**

PUCCH format	Modulation scheme	Number of bits per subframe, $M_{\text{bit}}$
1	N/A	N/A
1a	BPSK	1
1b	QPSK	2
2	QPSK	20
2a	QPSK+BPSK	21
2b	QPSK+QPSK	22
3	QPSK	48
4	QPSK	$M_{\text{RB}}^{\text{PUCCH4}} \cdot N_{\text{sc}}^{\text{RB}} \cdot (N_0^{\text{PUCCH}} + N_1^{\text{PUCCH}}) \cdot 2$
5	QPSK	$N_{\text{sc}}^{\text{RB}} \cdot (N_0^{\text{PUCCH}} + N_1^{\text{PUCCH}})$

All PUCCH formats use a cyclic shift,  $n_{\text{cs}}^{\text{cell}}(n_s, l)$ , which varies with the symbol number  $l$  and the slot number  $n_s$  according to

$$n_{\text{cs}}^{\text{cell}}(n_s, l) = \sum_{i=0}^7 c(8N_{\text{symb}}^{\text{UL}} \cdot n_s + 8l + i) \cdot 2^i$$

where the pseudo-random sequence  $c(i)$  is defined by clause 7.2. The pseudo-random sequence generator shall be initialized with  $c_{\text{init}} = n_{\text{ID}}^{\text{RS}}$ , where  $n_{\text{ID}}^{\text{RS}}$  is given by clause 5.5.1.5 with  $N_{\text{ID}}^{\text{cell}}$  corresponding to the primary cell, at the beginning of each radio frame.

The physical resources used for PUCCH depends on two parameters,  $N_{\text{RB}}^{(2)}$  and  $N_{\text{cs}}^{(1)}$ , given by higher layers.

The variable  $N_{\text{RB}}^{(2)} \geq 0$  denotes the bandwidth in terms of resource blocks that are available for use by PUCCH formats 2/2a/2b transmission in each slot. The variable  $N_{\text{cs}}^{(1)}$  denotes the number of cyclic shift used for PUCCH formats 1/1a/1b in a resource block used for a mix of formats 1/1a/1b and 2/2a/2b. The value of  $N_{\text{cs}}^{(1)}$  is an integer multiple of  $\Delta_{\text{shift}}^{\text{PUCCH}}$  within the range of  $\{0, 1, \dots, 7\}$ , where  $\Delta_{\text{shift}}^{\text{PUCCH}}$  is provided by higher layers. No mixed resource block is present if  $N_{\text{cs}}^{(1)} = 0$ . At most one resource block in each slot supports a mix of formats 1/1a/1b and 2/2a/2b.

Resources used for transmission of PUCCH formats 1/1a/1b, 2/2a/2b, 3, 4, and 5 are represented by the non-negative

indices  $n_{\text{PUCCH}}^{(1, \tilde{p})}$ ,  $n_{\text{PUCCH}}^{(2, \tilde{p})} < N_{\text{RB}}^{(2)} N_{\text{sc}}^{\text{RB}} + \left\lceil \frac{N_{\text{cs}}^{(1)}}{8} \right\rceil \cdot (N_{\text{sc}}^{\text{RB}} - N_{\text{cs}}^{(1)} - 2)$ ,  $n_{\text{PUCCH}}^{(3, \tilde{p})}$ ,  $n_{\text{PUCCH}}^{(4)}$  and  $n_{\text{PUCCH}}^{(5)}$ , respectively.

### 5.4.1 PUCCH formats 1, 1a and 1b

For PUCCH format 1, information is carried by the presence/absence of transmission of PUCCH from the UE. In the remainder of this clause,  $d(0) = 1$  shall be assumed for PUCCH format 1.

For PUCCH formats 1a and 1b, one or two explicit bits are transmitted, respectively. The block of bits  $b(0), \dots, b(M_{\text{bit}} - 1)$  shall be modulated as described in Table 5.4.1-1, resulting in a complex-valued symbol  $d(0)$ . The modulation schemes for the different PUCCH formats are given by Table 5.4-1.

The complex-valued symbol  $d(0)$  shall be multiplied with a cyclically shifted length  $N_{\text{seq}}^{\text{PUCCH}} = 12$  sequence  $r_{u,v}^{(\alpha_{\tilde{p}})}(n)$  for each of the  $P$  antenna ports used for PUCCH transmission according to

$$y^{(\tilde{p})}(n) = \frac{1}{\sqrt{P}} d(0) \cdot r_{u,v}^{(\alpha_{\tilde{p}})}(n), \quad n = 0, 1, \dots, N_{\text{seq}}^{\text{PUCCH}} - 1$$

where  $r_{u,v}^{(\alpha_{\tilde{p}})}(n)$  is defined by clause 5.5.1 with  $M_{\text{sc}}^{\text{RS}} = N_{\text{seq}}^{\text{PUCCH}}$ . The antenna-port specific cyclic shift  $\alpha_{\tilde{p}}$  varies between symbols and slots as defined below.

The block of complex-valued symbols  $y^{(\tilde{p})}(0), \dots, y^{(\tilde{p})}(N_{\text{seq}}^{\text{PUCCH}} - 1)$  shall be scrambled by  $S(n_s)$  and block-wise spread with the antenna-port specific orthogonal sequence  $w_{n_{\text{oc}}^{(\tilde{p})}}(i)$  according to

$$z^{(\tilde{p})}(m' \cdot N_{\text{SF}}^{\text{PUCCH}} \cdot N_{\text{seq}}^{\text{PUCCH}} + m \cdot N_{\text{seq}}^{\text{PUCCH}} + n) = S(n_s) \cdot w_{n_{\text{oc}}^{(\tilde{p})}}(m) \cdot y^{(\tilde{p})}(n)$$

where

$$\begin{aligned} m &= 0, \dots, N_{\text{SF}}^{\text{PUCCH}} - 1 \\ n &= 0, \dots, N_{\text{seq}}^{\text{PUCCH}} - 1 \\ m' &= 0, 1 \end{aligned}$$

and

$$S(n_s) = \begin{cases} 1 & \text{if } n_{\tilde{p}}'(n_s) \bmod 2 = 0 \\ e^{j\pi/2} & \text{otherwise} \end{cases}$$

with  $N_{\text{SF}}^{\text{PUCCH}}$  for the two slots in a subframe given by Table 5.4.1-1a. The sequence  $w_{n_{\text{oc}}^{(\tilde{p})}}(i)$  is given by Table 5.4.1-2 and Table 5.4.1-3 and  $n_{\tilde{p}}'(n_s)$  is defined below.

Resources used for transmission of PUCCH format 1, 1a and 1b are identified by a resource index  $n_{\text{PUCCH}}^{(1, \tilde{p})}$  from which the orthogonal sequence index  $n_{\text{oc}}^{(\tilde{p})}(n_s)$  and the cyclic shift  $\alpha_{\tilde{p}}(n_s, l)$  are determined according to

$$n_{\text{oc}}^{(\tilde{p})}(n_s) = \begin{cases} \lfloor n_{\tilde{p}}'(n_s) \cdot \Delta_{\text{shift}}^{\text{PUCCH}} / N' \rfloor & \text{for normal cyclic prefix} \\ 2 \cdot \lfloor n_{\tilde{p}}'(n_s) \cdot \Delta_{\text{shift}}^{\text{PUCCH}} / N' \rfloor & \text{for extended cyclic prefix} \end{cases}$$

$$\alpha_{\tilde{p}}(n_s, l) = 2\pi \cdot n_{\text{cs}}^{(\tilde{p})}(n_s, l) / N_{\text{sc}}^{\text{RB}}$$

$$n_{\text{cs}}^{(\tilde{p})}(n_s, l) = \begin{cases} \left[ \left[ n_{\text{cs}}^{\text{cell}}(n_s, l) + \left( n_{\tilde{p}}'(n_s) \cdot \Delta_{\text{shift}}^{\text{PUCCH}} + \left( n_{\text{oc}}^{(\tilde{p})}(n_s) \bmod \Delta_{\text{shift}}^{\text{PUCCH}} \right) \right) \bmod N' \right] \bmod N_{\text{sc}}^{\text{RB}} \right] & \text{for normal cyclic prefix} \\ \left[ \left[ n_{\text{cs}}^{\text{cell}}(n_s, l) + \left( n_{\tilde{p}}'(n_s) \cdot \Delta_{\text{shift}}^{\text{PUCCH}} + n_{\text{oc}}^{(\tilde{p})}(n_s) / 2 \right) \bmod N' \right] \bmod N_{\text{sc}}^{\text{RB}} \right] & \text{for extended cyclic prefix} \end{cases}$$

where

$$\begin{aligned} N' &= \begin{cases} N_{\text{cs}}^{(1)} & \text{if } n_{\text{PUCCH}}^{(1, \tilde{p})} < c \cdot N_{\text{cs}}^{(1)} / \Delta_{\text{shift}}^{\text{PUCCH}} \\ N_{\text{sc}}^{\text{RB}} & \text{otherwise} \end{cases} \\ c &= \begin{cases} 3 & \text{normal cyclic prefix} \\ 2 & \text{extended cyclic prefix} \end{cases} \end{aligned}$$



The resource indices within the two resource blocks in the two slots of a subframe to which the PUCCH is mapped are given by

$$n'_{\tilde{p}}(n_s) = \begin{cases} n_{\text{PUCCH}}^{(1,\tilde{p})} & \text{if } n_{\text{PUCCH}}^{(1,\tilde{p})} < c \cdot N_{\text{cs}}^{(1)} / \Delta_{\text{shift}}^{\text{PUCCH}} \\ (n_{\text{PUCCH}}^{(1,\tilde{p})} - c \cdot N_{\text{cs}}^{(1)} / \Delta_{\text{shift}}^{\text{PUCCH}}) \bmod (c \cdot N_{\text{sc}}^{\text{RB}} / \Delta_{\text{shift}}^{\text{PUCCH}}) & \text{otherwise} \end{cases}$$

for  $n_s \bmod 2 = 0$  and by

$$n'_{\tilde{p}}(n_s) = \begin{cases} \left[ \left[ c(n'_{\tilde{p}}(n_s - 1) + 1) \right] \bmod (cN_{\text{sc}}^{\text{RB}} / \Delta_{\text{shift}}^{\text{PUCCH}} + 1) - 1 \right] & n_{\text{PUCCH}}^{(1,\tilde{p})} \geq c \cdot N_{\text{cs}}^{(1)} / \Delta_{\text{shift}}^{\text{PUCCH}} \\ \left[ h_{\tilde{p}} / c \right] + (h_{\tilde{p}} \bmod c) N' / \Delta_{\text{shift}}^{\text{PUCCH}} & \text{otherwise} \end{cases}$$

for  $n_s \bmod 2 = 1$ , where  $h_{\tilde{p}} = (n'_{\tilde{p}}(n_s - 1) + d) \bmod (cN' / \Delta_{\text{shift}}^{\text{PUCCH}})$ , with  $d = 2$  for normal CP and  $d = 0$  for extended CP.

The parameter *deltaPUCCH-Shift*  $\Delta_{\text{shift}}^{\text{PUCCH}}$  is provided by higher layers.

**Table 5.4.1-1: Modulation symbol  $d(0)$  for PUCCH formats 1a and 1b**

PUCCH format	$b(0), \dots, b(M_{\text{bit}} - 1)$	$d(0)$
1a	0	1
	1	-1
1b	00	1
	01	-j
	10	j
	11	-1

**Table 5.4.1-1a: The quantity  $N_{\text{SF}}^{\text{PUCCH}}$  for PUCCH formats 1a and 1b**

PUCCH format	$N_{\text{SF}}^{\text{PUCCH}}$	
	first slot	second slot
normal 1/1a/1b	4	4
type-0 shortened 1/1a/1b	4	3
type-1 shortened 1/1a/1b	3	4
type-2 shortened 1/1a/1b	3	3

**Table 5.4.1-2: Orthogonal sequences  $[w(0) \dots w(N_{\text{SF}}^{\text{PUCCH}} - 1)]$  for  $N_{\text{SF}}^{\text{PUCCH}} = 4$**

Sequence index $n_{\text{oc}}^{(\tilde{p})}(n_s)$	Orthogonal sequences $[w(0) \dots w(N_{\text{SF}}^{\text{PUCCH}} - 1)]$
0	[+1 +1 +1 +1]
1	[+1 -1 +1 -1]
2	[+1 -1 -1 +1]

**Table 5.4.1-3: Orthogonal sequences  $[w(0) \dots w(N_{SF}^{PUCCH} - 1)]$  for  $N_{SF}^{PUCCH} = 3$**

Sequence index $n_{oc}^{(\tilde{p})}(n_s)$	Orthogonal sequences $[w(0) \dots w(N_{SF}^{PUCCH} - 1)]$
<b>0</b>	$[1 \ 1 \ 1]$
<b>1</b>	$[1 \ e^{j2\pi/3} \ e^{j4\pi/3}]$
<b>2</b>	$[1 \ e^{j4\pi/3} \ e^{j2\pi/3}]$

## 5.4.2 PUCCH formats 2, 2a and 2b

The block of bits  $b(0), \dots, b(19)$  shall be scrambled with a UE-specific scrambling sequence, resulting in a block of scrambled bits  $\tilde{b}(0), \dots, \tilde{b}(19)$  according to

$$\tilde{b}(i) = (b(i) + c(i)) \bmod 2$$

where the scrambling sequence  $c(i)$  is given by clause 7.2. The scrambling sequence generator shall be initialised with  $c_{\text{init}} = (\lfloor n_s/2 \rfloor + 1) \cdot (2N_{\text{ID}}^{\text{cell}} + 1) \cdot 2^{16} + n_{\text{RNTI}}$  at the start of each subframe where  $n_{\text{RNTI}}$  is C-RNTI.

The block of scrambled bits  $\tilde{b}(0), \dots, \tilde{b}(19)$  shall be QPSK modulated as described in clause 7.1, resulting in a block of complex-valued modulation symbols  $d(0), \dots, d(9)$ .

Each complex-valued symbol  $d(0), \dots, d(9)$  shall be multiplied with a cyclically shifted length  $N_{\text{seq}}^{\text{PUCCH}} = 12$  sequence  $r_{u,v}^{(\alpha_{\tilde{p}})}(n)$  for each of the  $P$  antenna ports used for PUCCH transmission according to

$$z^{(\tilde{p})}(N_{\text{seq}}^{\text{PUCCH}} \cdot n + i) = \frac{1}{\sqrt{P}} d(n) \cdot r_{u,v}^{(\alpha_{\tilde{p}})}(i)$$

$$n = 0, 1, \dots, 9$$

$$i = 0, 1, \dots, N_{\text{sc}}^{\text{RB}} - 1$$

where  $r_{u,v}^{(\alpha_{\tilde{p}})}(i)$  is defined by clause 5.5.1 with  $M_{\text{sc}}^{\text{RS}} = N_{\text{seq}}^{\text{PUCCH}}$ .

Resources used for transmission of PUCCH formats 2/2a/2b are identified by a resource index  $n_{\text{PUCCH}}^{(2,\tilde{p})}$  from which the cyclic shift  $\alpha_{\tilde{p}}(n_s, l)$  is determined according to

$$\alpha_{\tilde{p}}(n_s, l) = 2\pi \cdot n_{\text{cs}}^{(\tilde{p})}(n_s, l) / N_{\text{sc}}^{\text{RB}}$$

where

$$n_{\text{cs}}^{(\tilde{p})}(n_s, l) = (n_{\text{cs}}^{\text{cell}}(n_s, l) + n'_{\tilde{p}}(n_s)) \bmod N_{\text{sc}}^{\text{RB}}$$

and

$$n'_{\tilde{p}}(n_s) = \begin{cases} n_{\text{PUCCH}}^{(2,\tilde{p})} \bmod N_{\text{sc}}^{\text{RB}} & \text{if } n_{\text{PUCCH}}^{(2,\tilde{p})} < N_{\text{sc}}^{\text{RB}} N_{\text{RB}}^{(2)} \\ (n_{\text{PUCCH}}^{(2,\tilde{p})} + N_{\text{cs}}^{(1)} + 1) \bmod N_{\text{sc}}^{\text{RB}} & \text{otherwise} \end{cases}$$

for  $n_s \bmod 2 = 0$  and by

$$n'_{\tilde{p}}(n_s) = \begin{cases} \left[ N_{\text{sc}}^{\text{RB}} (n'_{\tilde{p}}(n_s - 1) + 1) \right] \bmod (N_{\text{sc}}^{\text{RB}} + 1) - 1 & \text{if } n_{\text{PUCCH}}^{(2,\tilde{p})} < N_{\text{sc}}^{\text{RB}} N_{\text{RB}}^{(2)} \\ (N_{\text{sc}}^{\text{RB}} - 2 - n_{\text{PUCCH}}^{(2,\tilde{p})}) \bmod N_{\text{sc}}^{\text{RB}} & \text{otherwise} \end{cases}$$

for  $n_s \bmod 2 = 1$ .

For PUCCH formats 2a and 2b, supported for normal cyclic prefix only, the bit(s)  $b(20), \dots, b(M_{\text{bit}} - 1)$  shall be modulated as described in Table 5.4.2-1 resulting in a single modulation symbol  $d(10)$  used in the generation of the reference-signal for PUCCH format 2a and 2b as described in clause 5.5.2.2.1.

**Table 5.4.2-1: Modulation symbol  $d(10)$  for PUCCH formats 2a and 2b**

PUCCH format	$b(20), \dots, b(M_{\text{bit}} - 1)$	$d(10)$
2a	0	1
	1	-1
2b	00	1
	01	$-j$
	10	$j$
	11	-1

### 5.4.2A PUCCH format 3

The block of bits  $b(0), \dots, b(M_{\text{bit}} - 1)$  shall be scrambled with a UE-specific scrambling sequence, resulting in a block of scrambled bits  $\tilde{b}(0), \dots, \tilde{b}(M_{\text{bit}} - 1)$  according to

$$\tilde{b}(i) = (b(i) + c(i)) \bmod 2$$

where the scrambling sequence  $c(i)$  is given by clause 7.2. The scrambling sequence generator shall be initialised with  $c_{\text{init}} = (\lfloor n_s/2 \rfloor + 1) \cdot (2N_{\text{ID}}^{\text{cell}} + 1) \cdot 2^{16} + n_{\text{RNTI}}$  at the start of each subframe where  $n_{\text{RNTI}}$  is the C-RNTI.

The block of scrambled bits  $\tilde{b}(0), \dots, \tilde{b}(M_{\text{bit}} - 1)$  shall be QPSK modulated as described in Subclause 7.1, resulting in a block of complex-valued modulation symbols  $d(0), \dots, d(M_{\text{symb}} - 1)$  where  $M_{\text{symb}} = M_{\text{bit}}/2 = 2N_{\text{sc}}^{\text{RB}}$ .

The complex-valued symbols  $d(0), \dots, d(M_{\text{symb}} - 1)$  shall be block-wise spread with the orthogonal sequences  $w_{n_{\text{oc},0}}^{(\tilde{p})}(i)$  and  $w_{n_{\text{oc},1}}^{(\tilde{p})}(i)$  resulting in  $N_{\text{SF},0}^{\text{PUCCH}} + N_{\text{SF},1}^{\text{PUCCH}}$  sets of  $N_{\text{sc}}^{\text{RB}}$  values each according to

$$y_n^{(\tilde{p})}(i) = \begin{cases} w_{n_{\text{oc},0}}^{(\tilde{p})}(\bar{n}) \cdot e^{j\pi \lfloor n_{\text{cs}}^{\text{cell}}(n_s, l)/64 \rfloor / 2} \cdot d(i) & n < N_{\text{SF},0}^{\text{PUCCH}} \\ w_{n_{\text{oc},1}}^{(\tilde{p})}(\bar{n}) \cdot e^{j\pi \lfloor n_{\text{cs}}^{\text{cell}}(n_s, l)/64 \rfloor / 2} \cdot d(N_{\text{sc}}^{\text{RB}} + i) & \text{otherwise} \end{cases}$$

$$\bar{n} = n \bmod N_{\text{SF},0}^{\text{PUCCH}}$$

$$n = 0, \dots, N_{\text{SF},0}^{\text{PUCCH}} + N_{\text{SF},1}^{\text{PUCCH}} - 1$$

$$i = 0, 1, \dots, N_{\text{sc}}^{\text{RB}} - 1$$

where  $N_{\text{SF},0}^{\text{PUCCH}} = N_{\text{SF},1}^{\text{PUCCH}} = 5$  for both slots in a subframe using normal PUCCH format 3 and  $N_{\text{SF},0}^{\text{PUCCH}} = 5$ ,  $N_{\text{SF},1}^{\text{PUCCH}} = 4$  holds for the first and second slot, respectively, in a subframe using shortened PUCCH format 3. The orthogonal sequences  $w_{n_{\text{oc},0}}^{(\tilde{p})}(i)$  and  $w_{n_{\text{oc},1}}^{(\tilde{p})}(i)$  are given by Table 5.4.2A-1. Resources used for transmission of PUCCH formats 3 are identified by a resource index  $n_{\text{PUCCH}}^{(3, \tilde{p})}$  from which the quantities  $n_{\text{oc},0}^{(\tilde{p})}$  and  $n_{\text{oc},1}^{(\tilde{p})}$  are derived according to

$$n_{\text{oc},0}^{(\tilde{p})} = n_{\text{PUCCH}}^{(3, \tilde{p})} \bmod N_{\text{SF},1}^{\text{PUCCH}}$$

$$n_{\text{oc},1}^{(\tilde{p})} = \begin{cases} (3n_{\text{oc},0}^{(\tilde{p})}) \bmod N_{\text{SF},1}^{\text{PUCCH}} & \text{if } N_{\text{SF},1}^{\text{PUCCH}} = 5 \\ n_{\text{oc},0}^{(\tilde{p})} \bmod N_{\text{SF},1}^{\text{PUCCH}} & \text{otherwise} \end{cases}$$

Each set of complex-valued symbols shall be cyclically shifted according to

$$\tilde{y}_n^{(\tilde{p})}(i) = y_n^{(\tilde{p})} \left( (i + n_{\text{cs}}^{\text{cell}}(n_s, l)) \bmod N_{\text{sc}}^{\text{RB}} \right)$$

where  $n_{\text{cs}}^{\text{cell}}(n_s, l)$  is given by Subclause 5.4,  $n_s$  is the slot number within a radio frame and  $l$  is the SC-FDMA symbol number within a slot.

The shifted sets of complex-valued symbols shall be transform precoded according to

$$z^{(\tilde{p})}(n \cdot N_{sc}^{RB} + k) = \frac{1}{\sqrt{P}} \frac{1}{\sqrt{N_{sc}^{RB}}} \sum_{i=0}^{N_{sc}^{RB}-1} \tilde{y}_n^{(\tilde{p})}(i) e^{-j \frac{2\pi k i}{N_{sc}^{RB}}}$$

$$k = 0, \dots, N_{sc}^{RB} - 1$$

$$n = 0, \dots, N_{SF,0}^{PUCCH} + N_{SF,1}^{PUCCH} - 1$$

where  $P$  is the number of antenna ports used for PUCCH transmission, resulting in a block of complex-valued symbols  $z^{(\tilde{p})}(0), \dots, z^{(\tilde{p})}((N_{SF,0}^{PUCCH} + N_{SF,1}^{PUCCH})N_{sc}^{RB} - 1)$ .

**Table 5.4.2A-1: The orthogonal sequence  $w_{n_{oc}}(i)$**

Sequence index $n_{oc}$	Orthogonal sequence $[w_{n_{oc}}(0) \ \dots \ w_{n_{oc}}(N_{SF}^{PUCCH} - 1)]$	
	$N_{SF}^{PUCCH} = 5$	$N_{SF}^{PUCCH} = 4$
0	[1 1 1 1 1]	[+1 +1 +1 +1]
1	[1 $e^{j2\pi/5}$ $e^{j4\pi/5}$ $e^{j6\pi/5}$ $e^{j8\pi/5}$ ]	[+1 -1 +1 -1]
2	[1 $e^{j4\pi/5}$ $e^{j8\pi/5}$ $e^{j2\pi/5}$ $e^{j6\pi/5}$ ]	[+1 +1 -1 -1]
3	[1 $e^{j6\pi/5}$ $e^{j2\pi/5}$ $e^{j8\pi/5}$ $e^{j4\pi/5}$ ]	[+1 -1 -1 +1]
4	[1 $e^{j8\pi/5}$ $e^{j6\pi/5}$ $e^{j4\pi/5}$ $e^{j2\pi/5}$ ]	-

## 5.4.2B PUCCH format 4

The block of bits  $b(0), \dots, b(M_{\text{bit}} - 1)$  shall be scrambled with a UE-specific scrambling sequence, resulting in a block of scrambled bits  $\tilde{b}(0), \dots, \tilde{b}(M_{\text{bit}} - 1)$  according to

$$\tilde{b}(i) = (b(i) + c(i)) \bmod 2$$

where the scrambling sequence  $c(i)$  is given by clause 7.2. The scrambling sequence generator shall be initialised with  $c_{\text{init}} = (\lfloor n_s/2 \rfloor + 1) \cdot (2N_{\text{ID}}^{\text{cell}} + 1) \cdot 2^{16} + n_{\text{RNTI}}$  at the start of each subframe where  $n_{\text{RNTI}}$  is the C-RNTI.

The block of scrambled bits  $\tilde{b}(0), \dots, \tilde{b}(M_{\text{bit}} - 1)$  shall be QPSK modulated as described in Subclause 7.1, resulting in a block of complex-valued modulation symbols  $d(0), \dots, d(M_{\text{symb}} - 1)$  where  $M_{\text{symb}} = M_{\text{bit}}/2$ .

The block of complex-valued symbols  $d(0), \dots, d(M_{\text{symb}} - 1)$  is divided into  $N_0^{\text{PUCCH}} + N_1^{\text{PUCCH}}$  sets, each corresponding to one SC-FDMA symbol. Transform precoding shall be applied according to

$$z^{(\tilde{p})}(l \cdot M_{\text{sc}}^{\text{PUCCH4}} + k) = \frac{1}{\sqrt{M_{\text{sc}}^{\text{PUCCH4}}}} \sum_{i=0}^{M_{\text{sc}}^{\text{PUCCH4}} - 1} d(l \cdot M_{\text{sc}}^{\text{PUCCH4}} + i) e^{-j \frac{2\pi i k}{M_{\text{sc}}^{\text{PUCCH4}}}}$$

$$k = 0, \dots, M_{\text{sc}}^{\text{PUCCH4}} - 1$$

$$l = 0, \dots, N_0^{\text{PUCCH}} + N_1^{\text{PUCCH}} - 1$$

where  $\tilde{p} = 0$ ,  $N_0^{\text{PUCCH}}$  and  $N_1^{\text{PUCCH}}$  are given by Table 5.4.2C-1 for normal PUCCH format 4 and shortened PUCCH format 4, resulting in a block of complex-valued symbols  $z^{(\tilde{p})}(0), \dots, z^{(\tilde{p})}(M_{\text{symb}} - 1)$ . The variable

$M_{\text{sc}}^{\text{PUCCH4}} = M_{\text{RB}}^{\text{PUCCH4}} \cdot N_{\text{sc}}^{\text{RB}}$ , where  $M_{\text{RB}}^{\text{PUCCH4}}$  represents the bandwidth of the PUCCH format 4 in terms of resource blocks, shall fulfil

$$M_{\text{RB}}^{\text{PUCCH4}} = 2^{\alpha_2} \cdot 3^{\alpha_3} \cdot 5^{\alpha_5} \leq N_{\text{RB}}^{\text{UL}}$$

where  $\alpha_2, \alpha_3, \alpha_5$  is a set of non-negative integers.

## 5.4.2C PUCCH format 5

The block of bits  $b(0), \dots, b(M_{\text{bit}} - 1)$  shall be scrambled with a UE-specific scrambling sequence, resulting in a block of scrambled bits  $\tilde{b}(0), \dots, \tilde{b}(M_{\text{bit}} - 1)$  according to

$$\tilde{b}(i) = (b(i) + c(i)) \bmod 2$$

where the scrambling sequence  $c(i)$  is given by clause 7.2. The scrambling sequence generator shall be initialised with  $c_{\text{init}} = (\lfloor n_s/2 \rfloor + 1) \cdot (2N_{\text{ID}}^{\text{cell}} + 1) \cdot 2^{16} + n_{\text{RNTI}}$  at the start of each subframe where  $n_{\text{RNTI}}$  is the C-RNTI.

The block of scrambled bits  $\tilde{b}(0), \dots, \tilde{b}(M_{\text{bit}} - 1)$  shall be QPSK modulated as described in Subclause 7.1, resulting in a block of complex-valued modulation symbols  $d(0), \dots, d(M_{\text{symb}} - 1)$  where  $M_{\text{symb}} = M_{\text{bit}}/2$ .

The complex-valued symbols  $d(0), \dots, d(M_{\text{symb}} - 1)$  shall be divided into  $N_0^{\text{PUCCH}} + N_1^{\text{PUCCH}}$  sets, each corresponding to one SC-FDMA symbol. Block-wise spreading shall be applied according to

$$y_n(i) = w_{n_{\text{oc}}}(i) \cdot d(i \bmod N_{\text{sc}}^{\text{RB}} / N_{\text{SF}}^{\text{PUCCH}} + n \cdot N_{\text{sc}}^{\text{RB}} / N_{\text{SF}}^{\text{PUCCH}})$$

$$n = 0, \dots, N_0^{\text{PUCCH}} + N_1^{\text{PUCCH}} - 1$$

$$i = 0, 1, \dots, N_{\text{sc}}^{\text{RB}} - 1$$

where  $N_{SF}^{PUCCH} = 2$ ,  $N_0^{PUCCH}$  and  $N_1^{PUCCH}$  are given by Table 5.4.2C-1 for normal PUCCH format 5 and shortened PUCCH format 5, and  $w_{n_{oc}}(i)$  is given by Table 5.4.2C-2 with  $n_{oc}$  provided by higher layers.

The block-wise spread complex-valued symbols shall be transform precoded according to

$$z^{(\tilde{p})}(n \cdot N_{sc}^{RB} + k) = \frac{1}{\sqrt{N_{sc}^{RB}}} \sum_{i=0}^{N_{sc}^{RB}-1} y_n(i) e^{-j \frac{2\pi i k}{N_{sc}^{RB}}}$$

$$k = 0, \dots, N_{sc}^{RB} - 1$$

$$n = 0, \dots, N_0^{PUCCH} + N_1^{PUCCH} - 1$$

where  $\tilde{p} = 0$ , resulting in a block of complex-valued symbols  $z^{(\tilde{p})}(0), \dots, z^{(\tilde{p})}((N_0^{PUCCH} + N_1^{PUCCH})N_{sc}^{RB} - 1)$ .

**Table 5.4.2C-1: The quantities  $N_0^{PUCCH}$  and  $N_1^{PUCCH}$**

PUCCH format type	Normal cyclic prefix		Extended cyclic prefix	
	$N_0^{PUCCH}$	$N_1^{PUCCH}$	$N_0^{PUCCH}$	$N_1^{PUCCH}$
Normal PUCCH format	6	6	5	5
Shortened PUCCH format	6	5	5	4

**Table 5.4.2C-2: Orthogonal sequences  $w_{n_{oc}}(i)$**

$n_{oc}$	Orthogonal sequences $[w_{n_{CDM}}(0) \dots w_{n_{CDM}}(N_{sc}^{RB} - 1)]$
0	[+1 +1 +1 +1 +1 +1 +1 +1 +1 +1 +1 +1]
1	[+1 +1 +1 +1 +1 +1 -1 -1 -1 -1 -1 -1]

### 5.4.3 Mapping to physical resources

The block of complex-valued symbols  $z^{(\tilde{p})}(i)$  shall be multiplied with the amplitude scaling factor  $\beta_{PUCCH}$  in order to conform to the transmit power  $P_{PUCCH}$  specified in Subclause 5.1.2.1 in 3GPP TS 36.213 [4], and mapped in sequence starting with  $z^{(\tilde{p})}(0)$  to resource elements. PUCCH uses one or more resource block in each of the two slots in a subframe. Within the physical resource block(s) used for transmission, the mapping of  $z^{(\tilde{p})}(i)$  to resource elements  $(k, l)$  on antenna port  $p$  and not used for transmission of reference signals shall be in increasing order of first  $k$ , then  $l$  and finally the slot number, starting with the first slot in the subframe. The relation between the index  $\tilde{p}$  and the antenna port number  $p$  is given by Table 5.2.1-1.

For non-BL/CE UEs, except for PUCCH format 4, the physical resource blocks to be used for transmission of PUCCH in slot  $n_s$  are given by

$$n_{PRB} = \begin{cases} \left\lfloor \frac{m}{2} \right\rfloor & \text{if } (m + n_s \bmod 2) \bmod 2 = 0 \\ N_{RB}^{UL} - 1 - \left\lfloor \frac{m}{2} \right\rfloor & \text{if } (m + n_s \bmod 2) \bmod 2 = 1 \end{cases}$$

For BL/CE UEs, PUCCH is transmitted with  $N_{rep}^{PUCCH} \geq 1$  repetitions. The PUCCH transmission spans

$N_{abs}^{PUCCH} \geq N_{rep}^{PUCCH}$  consecutive subframes, including invalid subframes where the UE postpones the PUCCH

transmission if  $N_{rep}^{PUCCH} > 1$ . The quantity  $N_{rep}^{PUCCH}$  is given by the higher-layer parameter *pucch-NumRepetitionCE-*

*Msg4* for transmission of *Msg4* in the random-access procedure [8], otherwise by *pucch-NumRepetitionCE-Format1* for PUCCH format 1/1a and *pucch-NumRepetitionCE-Format2* for PUCCH format 2/2a/2b,

The physical resource blocks to be used for transmission of PUCCH in subframe  $i$  within the  $N_{\text{abs}}^{\text{PUCCH}}$  consecutive subframes are given by

$$n_{\text{PRB}}(i) = \begin{cases} m'(j)/2 & \text{if } m'(j) \bmod 2 = 0 \\ N_{\text{RB}}^{\text{UL}} - 1 - \lfloor m'(j)/2 \rfloor & \text{if } m'(j) \bmod 2 = 1 \end{cases}$$

$$m'(j) = \begin{cases} m & \text{if } j \bmod 2 = 0 \\ m+1 & \text{if } j \bmod 2 = 1 \text{ and } m \bmod 2 = 0 \\ m-1 & \text{if } j \bmod 2 = 1 \text{ and } m \bmod 2 = 1 \end{cases}$$

$$j = \left\lfloor \frac{i}{N_{\text{NB}}^{\text{ch,UL}}} \right\rfloor$$

$$i_0 \leq i \leq i_0 + N_{\text{abs}}^{\text{PUCCH}} - 1$$

where  $i_0$  is the absolute subframe number of the first uplink subframe intended for PUCCH.

The variable  $m$  depends on the PUCCH format.

- Formats 1, 1a and 1b:

$$m = \begin{cases} N_{\text{RB}}^{(2)} & \text{if } n_{\text{PUCCH}}^{(1,\tilde{p})} < c \cdot N_{\text{cs}}^{(1)} / \Delta_{\text{shift}}^{\text{PUCCH}} \\ \left\lfloor \frac{n_{\text{PUCCH}}^{(1,\tilde{p})} - c \cdot N_{\text{cs}}^{(1)} / \Delta_{\text{shift}}^{\text{PUCCH}}}{c \cdot N_{\text{sc}}^{\text{RB}} / \Delta_{\text{shift}}^{\text{PUCCH}}} \right\rfloor + N_{\text{RB}}^{(2)} + \left\lfloor \frac{N_{\text{cs}}^{(1)}}{8} \right\rfloor & \text{otherwise} \end{cases}$$

$$c = \begin{cases} 3 & \text{normal cyclic prefix} \\ 2 & \text{extended cyclic prefix} \end{cases}$$

- Formats 2, 2a and 2b:

$$m = \left\lfloor n_{\text{PUCCH}}^{(2,\tilde{p})} / N_{\text{sc}}^{\text{RB}} \right\rfloor$$

- Format 3:

$$m = \left\lfloor n_{\text{PUCCH}}^{(3,\tilde{p})} / N_{\text{SF},0}^{\text{PUCCH}} \right\rfloor$$

- Format 5 (non-BL/CE UEs only):

$$m = n_{\text{PUCCH}}^{(5)}$$

For non-BL/CE UEs, for PUCCH format 4, the physical resource blocks to be used for transmission of PUCCH in slot  $n_s$  are given by

$$n_{\text{PRB}} = \begin{cases} m & \text{if } n_s \bmod 2 = 0 \\ N_{\text{RB}}^{\text{UL}} - 1 - m & \text{if } n_s \bmod 2 = 1 \end{cases}$$

$$m = n_{\text{PUCCH}}^{(4)}, n_{\text{PUCCH}}^{(4)} + 1, \dots, n_{\text{PUCCH}}^{(4)} + M_{\text{RB}}^{\text{PUCCH4}} - 1$$

where  $M_{\text{RB}}^{\text{PUCCH4}}$  is obtained from [4].

Mapping of modulation symbols for the physical uplink control channel for PUCCH formats 1 – 3 is illustrated in Figure 5.4.3-1.

In case of simultaneous transmission of sounding reference signal and PUCCH format 1, 1a, 1b, 3, 4 or 5 when there is one serving cell configured, a type-0 shortened PUCCH format shall be used where the last SC-FDMA symbol in the second slot of a subframe shall be left empty.



In case of guard period for narrowband retuning for BL/CE UEs,

- For PUCCH format 1, 1a,
  - if the only SC-FDMA symbol affected by the guard period is the last SC-FDMA symbol in the second slot, a type-0 shortened PUCCH format shall be used.
  - if the first SC-FDMA symbol in the first slot of a subframe is left empty due to guard period, while the last SC-FDMA symbol is available for PUCCH transmission, a type-1 shortened PUCCH format shall be used.
  - if the first SC-FDMA symbol in the first slot of a subframe is left empty due to guard period, and the last SC-FDMA symbol in the second slot of a subframe is left empty due to either guard period or sounding reference signal, a type-2 shortened PUCCH format shall be used.
- For PUCCH format 2, 2a, if an SC-FDMA symbol is left empty due to guard period, the SC-FDMA symbol shall be counted in the PUCCH mapping but not used for transmission of the PUCCH. The SC-FDMA symbol affected by the guard period can be the first SC-FDMA symbol in the first slot of a subframe and/or the last SC-FDMA symbol in the second slot of a subframe.

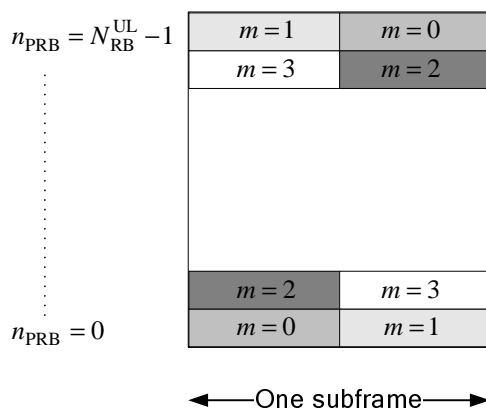

Figure 5.4.3-1: Mapping to physical resource blocks for PUCCH formats 1 – 3 for non-BL/CE UEs.

## 5.5 Reference signals

Two types of uplink reference signals are supported:

- Demodulation reference signal, associated with transmission of PUSCH or PUCCH
- Sounding reference signal, not associated with transmission of PUSCH or PUCCH

The same set of base sequences is used for demodulation and sounding reference signals.

### 5.5.1 Generation of the reference signal sequence

Reference signal sequence  $r_{u,v}^{(\alpha)}(n)$  is defined by a cyclic shift  $\alpha$  of a base sequence  $\bar{r}_{u,v}(n)$  according to

$$r_{u,v}^{(\alpha)}(n) = e^{j\alpha n} \bar{r}_{u,v}(n), \quad 0 \leq n < M_{sc}^{RS}$$

where  $M_{sc}^{RS} = mN_{sc}^{RB}$  is the length of the reference signal sequence and  $1 \leq m \leq N_{RB}^{\max,UL}$ . Multiple reference signal sequences are defined from a single base sequence through different values of  $\alpha$ .

Base sequences  $\bar{r}_{u,v}(n)$  are divided into groups, where  $u \in \{0,1,\dots,29\}$  is the group number and  $v$  is the base sequence number within the group, such that each group contains one base sequence ( $v=0$ ) of each length  $M_{sc}^{RS} = mN_{sc}^{RB}$ ,  $1 \leq m \leq 5$  and two base sequences ( $v=0,1$ ) of each length  $M_{sc}^{RS} = mN_{sc}^{RB}$ ,  $6 \leq m \leq N_{RB}^{\max,UL}$ . The sequence group number  $u$  and the number  $v$  within the group may vary in time as described in clauses 5.5.1.3 and 5.5.1.4, respectively. The definition of the base sequence  $\bar{r}_{u,v}(0), \dots, \bar{r}_{u,v}(M_{sc}^{RS} - 1)$  depends on the sequence length  $M_{sc}^{RS}$ .

#### 5.5.1.1 Base sequences of length $3N_{sc}^{RB}$ or larger

For  $M_{sc}^{RS} \geq 3N_{sc}^{RB}$ , the base sequence  $\bar{r}_{u,v}(0), \dots, \bar{r}_{u,v}(M_{sc}^{RS} - 1)$  is given by

$$\bar{r}_{u,v}(n) = x_q(n \bmod N_{ZC}^{RS}), \quad 0 \leq n < M_{sc}^{RS}$$

where the  $q^{\text{th}}$  root Zadoff-Chu sequence is defined by

$$x_q(m) = e^{-j \frac{\pi q m(m+1)}{N_{ZC}^{RS}}}, \quad 0 \leq m \leq N_{ZC}^{RS} - 1$$

with  $q$  given by

$$q = \lfloor \bar{q} + 1/2 \rfloor + v \cdot (-1)^{\lfloor 2\bar{q} \rfloor}$$

$$\bar{q} = N_{ZC}^{RS} \cdot (u+1)/31$$

The length  $N_{ZC}^{RS}$  of the Zadoff-Chu sequence is given by the largest prime number such that  $N_{ZC}^{RS} < M_{sc}^{RS}$ .

5.5.1.2 Base sequences of length less than  $3N_{sc}^{RB}$

For  $M_{sc}^{RS} = N_{sc}^{RB}$  and  $M_{sc}^{RS} = 2N_{sc}^{RB}$ , base sequence is given by

$$\bar{r}_{u,v}(n) = e^{j\varphi(n)\pi/4}, \quad 0 \leq n \leq M_{sc}^{RS} - 1$$

where the value of  $\varphi(n)$  is given by Table 5.5.1.2-1 and Table 5.5.1.2-2 for  $M_{sc}^{RS} = N_{sc}^{RB}$  and  $M_{sc}^{RS} = 2N_{sc}^{RB}$ , respectively.

**Table 5.5.1.2-1: Definition of  $\varphi(n)$  for  $M_{sc}^{RS} = N_{sc}^{RB}$ .**

$u$	$\varphi(0), \dots, \varphi(11)$											
0	-1	1	3	-3	3	3	1	1	3	1	-3	3
1	1	1	3	3	3	-1	1	-3	-3	1	-3	3
2	1	1	-3	-3	-3	-1	-3	-3	1	-3	1	-1
3	-1	1	1	1	1	-1	-3	-3	1	-3	3	-1
4	-1	3	1	-1	1	-1	-3	-1	1	-1	1	3
5	1	-3	3	-1	-1	1	1	-1	-1	3	-3	1
6	-1	3	-3	-3	-3	3	1	-1	3	3	-3	1
7	-3	-1	-1	-1	1	-3	3	-1	1	-3	3	1
8	1	-3	3	1	-1	-1	-1	1	1	3	-1	1
9	1	-3	-1	3	3	-1	-3	1	1	1	1	1
10	-1	3	-1	1	1	-3	-3	-1	-3	-3	3	-1
11	3	1	-1	-1	3	3	-3	1	3	1	3	3
12	1	-3	1	1	-3	1	1	1	-3	-3	-3	1
13	3	3	-3	3	-3	1	1	3	-1	-3	3	3
14	-3	1	-1	-3	-1	3	1	3	3	3	-1	1
15	3	-1	1	-3	-1	-1	1	1	3	1	-1	-3
16	1	3	1	-1	1	3	3	3	-1	-1	3	-1
17	-3	1	1	3	-3	3	-3	-3	3	1	3	-1
18	-3	3	1	1	-3	1	-3	-3	-1	-1	1	-3
19	-1	3	1	3	1	-1	-1	3	-3	-1	-3	-1
20	-1	-3	1	1	1	1	3	1	-1	1	-3	-1
21	-1	3	-1	1	-3	-3	-3	-3	-3	1	-1	-3
22	1	1	-3	-3	-3	-3	-1	3	-3	1	-3	3
23	1	1	-1	-3	-1	-3	1	-1	1	3	-1	1
24	1	1	3	1	3	3	-1	1	-1	-3	-3	1
25	1	-3	3	3	1	3	3	1	-3	-1	-1	3
26	1	3	-3	-3	3	-3	1	-1	-1	3	-1	-3
27	-3	-1	-3	-1	-3	3	1	-1	1	3	-3	-3
28	-1	3	-3	3	-1	3	3	-3	3	3	-1	-1
29	3	-3	-3	-1	-1	-3	-1	3	-3	3	1	-1

**Table 5.5.1.2-2: Definition of  $\varphi(n)$  for  $M_{sc}^{RS} = 2N_{sc}^{RB}$**

$u$	$\varphi(0), \dots, \varphi(23)$																							
0	-1	3	1	-3	3	-1	1	3	-3	3	1	3	-3	3	1	1	-1	1	3	-3	3	-3	-1	-3
1	-3	3	-3	-3	-3	1	-3	-3	3	-1	1	1	1	3	1	-1	3	-3	-3	1	3	1	1	-3
2	3	-1	3	3	1	1	-3	3	3	3	3	1	-1	3	-1	1	1	-1	-3	-1	-1	1	3	3
3	-1	-3	1	1	3	-3	1	1	-3	-1	-1	1	3	1	3	1	-1	3	1	1	-3	-1	-3	-1
4	-1	-1	-1	-3	-3	-1	1	1	3	3	-1	3	-1	1	-1	-3	1	-1	-3	-3	1	-3	-1	-1
5	-3	1	1	3	-1	1	3	1	-3	1	-3	1	1	-1	-1	3	-1	-3	3	-3	-3	-3	1	1
6	1	1	-1	-1	3	-3	-3	3	-3	1	-1	-1	1	-1	1	1	-1	-3	-1	1	-1	3	-1	-3
7	-3	3	3	-1	-1	-3	-1	3	1	3	1	3	1	1	-1	3	1	-1	1	3	-3	-1	-1	1
8	-3	1	3	-3	1	-1	-3	3	-3	3	-1	-1	-1	-1	1	-3	-3	-3	1	-3	-3	-3	1	-3
9	1	1	-3	3	3	-1	-3	-1	3	-3	3	3	3	-1	1	1	-3	1	-1	1	1	-3	1	1
10	-1	1	-3	-3	3	-1	3	-1	-1	-3	-3	-3	-1	-3	-3	1	-1	1	3	3	-1	1	-1	3
11	1	3	3	-3	-3	1	3	1	-1	-3	-3	-3	3	3	-3	3	3	-1	-3	3	-1	1	-3	1
12	1	3	3	1	1	1	-1	-1	1	-3	3	-1	1	1	-3	3	3	-1	-3	3	-3	-1	-3	-1
13	3	-1	-1	-1	-1	-3	-1	3	3	1	-1	1	3	3	3	-1	1	1	-3	1	3	-1	-3	3
14	-3	-3	3	1	3	1	-3	3	1	3	1	1	3	3	-1	-1	-3	1	-3	-1	3	1	1	3
15	-1	-1	1	-3	1	3	-3	1	-1	-3	-1	3	1	3	1	-1	-3	-3	-1	-1	-3	-3	-3	-1
16	-1	-3	3	-1	-1	-1	-1	1	1	-3	3	1	3	3	1	-1	1	-3	1	-3	1	1	-3	-1
17	1	3	-1	3	3	-1	-3	1	-1	-3	3	3	3	-1	1	1	3	-1	-3	-1	3	-1	-1	-1
18	1	1	1	1	1	-1	3	-1	-3	1	1	3	-3	1	-3	-1	1	1	-3	-3	3	1	1	-3
19	1	3	3	1	-1	-3	3	-1	3	3	3	-3	1	-1	1	-1	-3	-1	1	3	-1	3	-3	-3
20	-1	-3	3	-3	-3	-3	-1	-1	-3	-1	-3	3	1	3	-3	-1	3	-1	1	-1	3	-3	1	-1
21	-3	-3	1	1	-1	1	-1	1	-1	3	1	-3	-1	1	-1	1	-1	-1	3	3	-3	-1	1	-3
22	-3	-1	-3	3	1	-1	-3	-1	-3	-3	3	-3	3	-3	-1	1	3	1	-3	1	3	3	-1	-3
23	-1	-1	-1	-1	3	3	3	1	3	3	-3	1	3	-1	3	-1	3	3	-3	3	1	-1	3	3
24	1	-1	3	3	-1	-3	3	-3	-1	-1	3	-1	3	-1	-1	1	1	1	1	-1	-1	-3	-1	3
25	1	-1	1	-1	3	-1	3	1	1	-1	-1	-3	1	1	-3	1	3	-3	1	1	-3	-3	-1	-1
26	-3	-1	1	3	1	1	-3	-1	-1	-3	3	-3	3	1	-3	3	-3	1	-1	1	-3	1	1	1
27	-1	-3	3	3	1	1	3	-1	-3	-1	-1	-1	3	1	-3	-3	-1	3	-3	-1	-3	-1	-3	-1
28	-1	-3	-1	-1	1	-3	-1	-1	1	-1	-3	1	1	-3	1	-3	-3	3	1	1	-1	3	-1	-1
29	1	1	-1	-1	-3	-1	3	-1	3	-1	1	3	1	-1	3	1	3	-3	-3	1	-1	-1	1	3

### 5.5.1.3 Group hopping

The sequence-group number  $u$  in slot  $n_s$  is defined by a group hopping pattern  $f_{gh}(n_s)$  and a sequence-shift pattern  $f_{ss}$  according to

$$u = (f_{gh}(n_s) + f_{ss}) \bmod 30$$

There are 17 different hopping patterns and 30 different sequence-shift patterns. Sequence-group hopping can be enabled or disabled by means of the cell-specific parameter *Group-hopping-enabled* provided by higher layers. Sequence-group hopping for PUSCH can be disabled for a certain UE through the higher-layer parameter *Disable-sequence-group-hopping* despite being enabled on a cell basis unless the PUSCH transmission corresponds to a Random Access Response Grant or a retransmission of the same transport block as part of the contention based random access procedure.

The group-hopping pattern  $f_{gh}(n_s)$  may be different for PUSCH, PUCCH and SRS and is given by

$$f_{gh}(n_s) = \begin{cases} 0 & \text{if group hopping is disabled} \\ \left( \sum_{i=0}^7 c(8n_s + i) \cdot 2^i \right) \bmod 30 & \text{if group hopping is enabled} \end{cases}$$

where the pseudo-random sequence  $c(i)$  is defined by clause 7.2. The pseudo-random sequence generator shall be

initialized with  $c_{\text{init}} = \left\lfloor \frac{n_{\text{ID}}^{\text{RS}}}{30} \right\rfloor$  at the beginning of each radio frame where  $n_{\text{ID}}^{\text{RS}}$  is given by clause 5.5.1.5.

The sequence-shift pattern  $f_{ss}$  definition differs between PUCCH, PUSCH and SRS.

For PUCCH, the sequence-shift pattern  $f_{ss}^{\text{PUCCH}}$  is given by  $f_{ss}^{\text{PUCCH}} = n_{\text{ID}}^{\text{RS}} \bmod 30$  where  $n_{\text{ID}}^{\text{RS}}$  is given by clause 5.5.1.5.

For PUSCH, the sequence-shift pattern  $f_{ss}^{\text{PUSCH}}$  is given by  $f_{ss}^{\text{PUSCH}} = (N_{\text{ID}}^{\text{cell}} + \Delta_{ss}) \bmod 30$ , where  $\Delta_{ss} \in \{0, 1, \dots, 29\}$  is configured by higher layers, if no value for  $n_{\text{ID}}^{\text{PUSCH}}$  is provided by higher layers or if the PUSCH transmission corresponds to a Random Access Response Grant or a retransmission of the same transport block as part of the contention based random access procedure, otherwise it is given by  $f_{ss}^{\text{PUSCH}} = n_{\text{ID}}^{\text{RS}} \bmod 30$  with  $n_{\text{ID}}^{\text{RS}}$  given by clause 5.5.1.5.

For SRS, the sequence-shift pattern  $f_{ss}^{\text{SRS}}$  is given by  $f_{ss}^{\text{SRS}} = n_{\text{ID}}^{\text{RS}} \bmod 30$  where  $n_{\text{ID}}^{\text{RS}}$  is given by clause 5.5.1.5.

### 5.5.1.4 Sequence hopping

Sequence hopping only applies for reference-signals of length  $M_{sc}^{RS} \geq 6N_{sc}^{RB}$ .

For reference-signals of length  $M_{sc}^{RS} < 6N_{sc}^{RB}$ , the base sequence number  $v$  within the base sequence group is given by  $v = 0$ .

For reference-signals of length  $M_{sc}^{RS} \geq 6N_{sc}^{RB}$ , the base sequence number  $v$  within the base sequence group in slot  $n_s$  is defined by

$$v = \begin{cases} c(n_s) & \text{if group hopping is disabled and sequence hopping is enabled} \\ 0 & \text{otherwise} \end{cases}$$

where the pseudo-random sequence  $c(i)$  is given by clause 7.2. The parameter *Sequence-hopping-enabled* provided by higher layers determines if sequence hopping is enabled or not. Sequence hopping for PUSCH can be disabled for a certain UE through the higher-layer parameter *Disable-sequence-group-hopping* despite being enabled on a cell basis unless the PUSCH transmission corresponds to a Random Access Response Grant or a retransmission of the same transport block as part of the contention based random access procedure.

For PUSCH, the pseudo-random sequence generator shall be initialized with  $c_{init} = \left\lfloor \frac{n_{ID}^{RS}}{30} \right\rfloor \cdot 2^5 + f_{ss}^{PUSCH}$  at the beginning of each radio frame where  $n_{ID}^{RS}$  is given by clause 5.5.1.5.

For SRS, the pseudo-random sequence generator shall be initialized with  $c_{init} = \left\lfloor \frac{n_{ID}^{RS}}{30} \right\rfloor \cdot 2^5 + (n_{ID}^{RS} + \Delta_{ss}) \bmod 30$  at the beginning of each radio frame where  $n_{ID}^{RS}$  is given by clause 5.5.1.5 and  $\Delta_{ss}$  is given by clause 5.5.1.3.

### 5.5.1.5 Determining virtual cell identity for sequence generation

The definition of  $n_{ID}^{RS}$  depends on the type of transmission.

Transmissions associated with PUSCH:

- $n_{ID}^{RS} = N_{ID}^{cell}$  if no value for  $n_{ID}^{PUSCH}$  is configured by higher layers or if the PUSCH transmission corresponds to a Random Access Response Grant or a retransmission of the same transport block as part of the contention based random access procedure,
- $n_{ID}^{RS} = n_{ID}^{PUSCH}$  otherwise.

Transmissions associated with PUCCH:

- $n_{ID}^{RS} = N_{ID}^{cell}$  if no value for  $n_{ID}^{PUCCH}$  is configured by higher layers,
- $n_{ID}^{RS} = n_{ID}^{PUCCH}$  otherwise.

Sounding reference signals:

- $n_{ID}^{RS} = N_{ID}^{cell}$ .

## 5.5.2 Demodulation reference signal

### 5.5.2.1 Demodulation reference signal for PUSCH

#### 5.5.2.1.1 Reference signal sequence

The PUSCH demodulation reference signal sequence  $r_{\text{PUSCH}}^{(\lambda)}(\cdot)$  associated with layer  $\lambda \in \{0,1,\dots,v-1\}$  is defined by

$$r_{\text{PUSCH}}^{(\lambda)}(m \cdot M_{\text{sc}}^{\text{RS}} + n) = w^{(\lambda)}(m) r_{u,v}^{(\alpha_\lambda)}(n)$$

where

$$\begin{aligned} m &= 0,1 \\ n &= 0,\dots,M_{\text{sc}}^{\text{RS}} - 1 \end{aligned}$$

and

$$M_{\text{sc}}^{\text{RS}} = M_{\text{sc}}^{\text{PUSCH}}$$

Subclause 5.5.1 defines the sequence  $r_{u,v}^{(\alpha_\lambda)}(0), \dots, r_{u,v}^{(\alpha_\lambda)}(M_{\text{sc}}^{\text{RS}} - 1)$ . The orthogonal sequence  $w^{(\lambda)}(m)$  is given by

$\begin{bmatrix} w^{(\lambda)}(0) & w^{(\lambda)}(1) \end{bmatrix} = \begin{bmatrix} 1 & 1 \end{bmatrix}$  for DCI format 0 if the higher-layer parameter *Activate-DMRS-with OCC* is not set or if the temporary C-RNTI was used to transmit the most recent uplink-related DCI for the transport block associated with the corresponding PUSCH transmission, otherwise it is given by Table 5.5.2.1.1-1 using the cyclic shift field in most recent uplink-related DCI 3GPP TS 36.212 [3] for the transport block associated with the corresponding PUSCH transmission.

The cyclic shift  $\alpha_\lambda$  in a slot  $n_s$  is given as  $\alpha_\lambda = 2m_{\text{cs},\lambda}/12$  with

$$n_{\text{cs},\lambda} = (n_{\text{DMRS}}^{(1)} + n_{\text{DMRS},\lambda}^{(2)} + n_{\text{PN}}(n_s)) \bmod 12$$

where the value of  $n_{\text{DMRS}}^{(1)}$  is given by Table 5.5.2.1.1-2 according to the parameter *cyclicShift* provided by higher layers, for non-BL/CE UEs  $n_{\text{DMRS},\lambda}^{(2)}$  is given by the cyclic shift for DMRS field in most recent uplink-related DCI 3GPP TS 36.212 [3] for the transport block associated with the corresponding PUSCH transmission where the value of  $n_{\text{DMRS},\lambda}^{(2)}$  is given in Table 5.5.2.1.1-1. For BL/CE UEs, a cyclic shift field of "000" shall be assumed when determining  $n_{\text{DMRS},\lambda}^{(2)}$  from Table 5.5.2.1.1-1.

The first row of Table 5.5.2.1.1-1 shall be used to obtain  $n_{\text{DMRS},0}^{(2)}$  and  $w^{(\lambda)}(m)$  if there is no uplink-related DCI for the same transport block associated with the corresponding PUSCH transmission, and

- if the initial PUSCH for the same transport block is semi-persistently scheduled, or
- if the initial PUSCH for the same transport block is scheduled by the random access response grant.

The quantity  $n_{\text{PN}}(n_s)$  is given by

$$n_{\text{PN}}(n_s) = \sum_{i=0}^7 c(8N_{\text{symb}}^{\text{UL}} \cdot n_s + i) \cdot 2^i$$

where the pseudo-random sequence  $c(i)$  is defined by clause 7.2. The application of  $c(i)$  is cell-specific. The pseudo-random sequence generator shall be initialized with  $c_{\text{init}}$  at the beginning of each radio frame. The quantity  $c_{\text{init}}$  is

given by  $c_{\text{init}} = \left\lfloor \frac{N_{\text{ID}}^{\text{cell}}}{30} \right\rfloor \cdot 2^5 + ((N_{\text{ID}}^{\text{cell}} + \Delta_{\text{ss}}) \bmod 30)$  if no value for  $N_{\text{ID}}^{\text{csh-DMRS}}$  is configured by higher layers or the

PUSCH transmission corresponds to a Random Access Response Grant or a retransmission of the same transport block

as part of the contention based random access procedure, otherwise it is given by

$$c_{\text{init}} = \left\lfloor \frac{N_{\text{ID}}^{\text{csh\_DMRS}}}{30} \right\rfloor \cdot 2^5 + (N_{\text{ID}}^{\text{csh\_DMRS}} \bmod 30).$$

The vector of reference signals shall be precoded according to

$$\begin{bmatrix} \tilde{r}_{\text{PUSCH}}^{(0)} \\ \vdots \\ \tilde{r}_{\text{PUSCH}}^{(P-1)} \end{bmatrix} = W \begin{bmatrix} r_{\text{PUSCH}}^{(0)} \\ \vdots \\ r_{\text{PUSCH}}^{(v-1)} \end{bmatrix}$$

where  $P$  is the number of antenna ports used for PUSCH transmission.

For PUSCH transmission using a single antenna port,  $P = 1$ ,  $W = 1$  and  $v = 1$ .

For spatial multiplexing,  $P = 2$  or  $P = 4$  and the precoding matrix  $W$  shall be identical to the precoding matrix used in clause 5.3.3A.2 for precoding of the PUSCH in the same subframe.

**Table 5.5.2.1.1-1: Mapping of Cyclic Shift Field in uplink-related DCI format to  $n_{\text{DMRS},\lambda}^{(2)}$  and**

$$\begin{bmatrix} w^{(\lambda)}(0) & w^{(\lambda)}(1) \end{bmatrix}$$

Cyclic Shift Field in uplink-related DCI format [3]	$n_{\text{DMRS},\lambda}^{(2)}$				$\begin{bmatrix} w^{(\lambda)}(0) & w^{(\lambda)}(1) \end{bmatrix}$			
	$\lambda = 0$	$\lambda = 1$	$\lambda = 2$	$\lambda = 3$	$\lambda = 0$	$\lambda = 1$	$\lambda = 2$	$\lambda = 3$
000	0	6	3	9	$\begin{bmatrix} 1 & 1 \end{bmatrix}$	$\begin{bmatrix} 1 & 1 \end{bmatrix}$	$\begin{bmatrix} 1 & -1 \end{bmatrix}$	$\begin{bmatrix} 1 & -1 \end{bmatrix}$
001	6	0	9	3	$\begin{bmatrix} 1 & -1 \end{bmatrix}$	$\begin{bmatrix} 1 & -1 \end{bmatrix}$	$\begin{bmatrix} 1 & 1 \end{bmatrix}$	$\begin{bmatrix} 1 & 1 \end{bmatrix}$
010	3	9	6	0	$\begin{bmatrix} 1 & -1 \end{bmatrix}$	$\begin{bmatrix} 1 & -1 \end{bmatrix}$	$\begin{bmatrix} 1 & 1 \end{bmatrix}$	$\begin{bmatrix} 1 & 1 \end{bmatrix}$
011	4	10	7	1	$\begin{bmatrix} 1 & 1 \end{bmatrix}$	$\begin{bmatrix} 1 & 1 \end{bmatrix}$	$\begin{bmatrix} 1 & 1 \end{bmatrix}$	$\begin{bmatrix} 1 & 1 \end{bmatrix}$
100	2	8	5	11	$\begin{bmatrix} 1 & 1 \end{bmatrix}$	$\begin{bmatrix} 1 & 1 \end{bmatrix}$	$\begin{bmatrix} 1 & 1 \end{bmatrix}$	$\begin{bmatrix} 1 & 1 \end{bmatrix}$
101	8	2	11	5	$\begin{bmatrix} 1 & -1 \end{bmatrix}$	$\begin{bmatrix} 1 & -1 \end{bmatrix}$	$\begin{bmatrix} 1 & -1 \end{bmatrix}$	$\begin{bmatrix} 1 & -1 \end{bmatrix}$
110	10	4	1	7	$\begin{bmatrix} 1 & -1 \end{bmatrix}$	$\begin{bmatrix} 1 & -1 \end{bmatrix}$	$\begin{bmatrix} 1 & -1 \end{bmatrix}$	$\begin{bmatrix} 1 & -1 \end{bmatrix}$
111	9	3	0	6	$\begin{bmatrix} 1 & 1 \end{bmatrix}$	$\begin{bmatrix} 1 & 1 \end{bmatrix}$	$\begin{bmatrix} 1 & -1 \end{bmatrix}$	$\begin{bmatrix} 1 & -1 \end{bmatrix}$

**Table 5.5.2.1.1-2: Mapping of *cyclicShift* to  $n_{\text{DMRS}}^{(1)}$  values**

<i>cyclicShift</i>	$n_{\text{DMRS}}^{(1)}$
0	0
1	2
2	3
3	4
4	6
5	8
6	9
7	10



### 5.5.2.1.2 Mapping to physical resources

For each antenna port used for transmission of the PUSCH, the sequence  $\tilde{r}_{\text{PUSCH}}^{(\tilde{p})}(\cdot)$  shall be multiplied with the amplitude scaling factor  $\beta_{\text{PUSCH}}$  and mapped in sequence starting with  $\tilde{r}_{\text{PUSCH}}^{(\tilde{p})}(0)$  to the resource blocks.

The set of physical resource blocks used in the mapping process and the relation between the index  $\tilde{p}$  and the antenna port number  $p$  shall be identical to the corresponding PUSCH transmission as defined in clause 5.3.4.

The mapping to resource elements  $(k, l)$ , with  $l = 3$  for normal cyclic prefix and  $l = 2$  for extended cyclic prefix, in the subframe shall be in increasing order of first  $k$ , then the slot number.

### 5.5.2.2 Demodulation reference signal for PUCCH

#### 5.5.2.2.1 Reference signal sequence

The PUCCH demodulation reference signal sequence  $r_{\text{PUCCH}}^{(\tilde{p})}(\cdot)$  for PUCCH formats 1, 1a, 1b, 2, 2a, 2b, and 3 is defined by

$$r_{\text{PUCCH}}^{(\tilde{p})}(m'N_{\text{RS}}^{\text{PUCCH}}M_{\text{sc}}^{\text{RS}} + mM_{\text{sc}}^{\text{RS}} + n) = \frac{1}{\sqrt{P}} \bar{w}^{(\tilde{p})}(m) z(m) r_{u,v}^{(\alpha_{\tilde{p}})}(n)$$

where

$$\begin{aligned} m &= 0, \dots, N_{\text{RS}}^{\text{PUCCH}} - 1 \\ n &= 0, \dots, M_{\text{sc}}^{\text{RS}} - 1 \\ m' &= 0, 1 \end{aligned}$$

and  $P$  is the number of antenna ports used for PUCCH transmission. For PUCCH formats 2a and 2b,  $z(m)$  equals  $d(10)$  for  $m = 1$ , where  $d(10)$  is defined in clause 5.4.2. For all other cases,  $z(m) = 1$ .

The sequence  $r_{u,v}^{(\alpha_{\tilde{p}})}(n)$  is given by clause 5.5.1 with  $M_{\text{sc}}^{\text{RS}} = 12$  where the expression for the cyclic shift  $\alpha_{\tilde{p}}$  is determined by the PUCCH format.

For PUCCH formats 1, 1a and 1b,  $\alpha_{\tilde{p}}(n_s, l)$  is given by

$$\begin{aligned} \bar{n}_{\text{oc}}^{(\tilde{p})}(n_s) &= \left\lfloor n'_{\tilde{p}}(n_s) \cdot \Delta_{\text{shift}}^{\text{PUCCH}} / N' \right\rfloor \\ \alpha_{\tilde{p}}(n_s, l) &= 2\pi \cdot \bar{n}_{\text{cs}}^{(\tilde{p})}(n_s, l) / N_{\text{sc}}^{\text{RB}} \\ \bar{n}_{\text{cs}}^{(\tilde{p})}(n_s, l) &= \begin{cases} \left[ n_{\text{cs}}^{\text{cell}}(n_s, l) + \left( n'_{\tilde{p}}(n_s) \cdot \Delta_{\text{shift}}^{\text{PUCCH}} + \left( \bar{n}_{\text{oc}}^{(\tilde{p})}(n_s) \bmod \Delta_{\text{shift}}^{\text{PUCCH}} \right) \right) \bmod N' \right] \bmod N_{\text{sc}}^{\text{RB}} & \text{for normal cyclic prefix} \\ \left[ n_{\text{cs}}^{\text{cell}}(n_s, l) + \left( n'_{\tilde{p}}(n_s) \cdot \Delta_{\text{shift}}^{\text{PUCCH}} + \bar{n}_{\text{oc}}^{(\tilde{p})}(n_s) \right) \bmod N' \right] \bmod N_{\text{sc}}^{\text{RB}} & \text{for extended cyclic prefix} \end{cases} \end{aligned}$$

where  $n'_{\tilde{p}}(n_s)$ ,  $N'$ ,  $\Delta_{\text{shift}}^{\text{PUCCH}}$  and  $n_{\text{cs}}^{\text{cell}}(n_s, l)$  are defined by clause 5.4.1. The number of reference symbols per slot  $N_{\text{RS}}^{\text{PUCCH}}$  and the sequence  $\bar{w}(n)$  are given by Table 5.5.2.2.1-1 and 5.5.2.2.1-2, respectively.

For PUCCH formats 2, 2a and 2b,  $\alpha_{\tilde{p}}(n_s, l)$  is defined by clause 5.4.2. The number of reference symbols per slot  $N_{\text{RS}}^{\text{PUCCH}}$  and the sequence  $\bar{w}^{(\tilde{p})}(n)$  are given by Table 5.5.2.2.1-1 and 5.5.2.2.1-3, respectively.

For PUCCH format 3,  $\alpha_{\tilde{p}}(n_s, l)$  is given by

$$\begin{aligned} \alpha_{\tilde{p}}(n_s, l) &= 2\pi \cdot \bar{n}_{\text{cs}}^{(\tilde{p})}(n_s, l) / N_{\text{sc}}^{\text{RB}} \\ \bar{n}_{\text{cs}}^{(\tilde{p})}(n_s, l) &= \left( n_{\text{cs}}^{\text{cell}}(n_s, l) + n'_{\tilde{p}}(n_s) \right) \bmod N_{\text{sc}}^{\text{RB}} \end{aligned}$$

where  $n'_p(n_s)$  is given by Table 5.5.2.2.1-4 and  $n_{oc,0}^{(\tilde{p})}$  and  $n_{oc,1}^{(\tilde{p})}$  for the first and second slot in a subframe, respectively, are obtained from clause 5.4.2A. The number of reference symbols per slot  $N_{RS}^{PUCCH}$  and the sequence  $\bar{w}(n)$  are given by Table 5.5.2.2.1-1 and 5.5.2.2.1-3, respectively.

**Table 5.5.2.2.1-1: Number of PUCCH demodulation reference symbols per slot  $N_{RS}^{PUCCH}$**

PUCCH format	Normal cyclic prefix	Extended cyclic prefix
1, 1a, 1b	3	2
2, 3	2	1
2a, 2b	2	N/A

**Table 5.5.2.2.1-2: Orthogonal sequences  $[\bar{w}^{(\tilde{p})}(0) \dots \bar{w}^{(\tilde{p})}(N_{RS}^{PUCCH} - 1)]$  for PUCCH formats 1, 1a and 1b**

Sequence index $\bar{n}_{oc}^{(\tilde{p})}(n_s)$	Normal cyclic prefix	Extended cyclic prefix
0	[1 1 1]	[1 1]
1	[1 $e^{j2\pi/3}$ $e^{j4\pi/3}$ ]	[1 -1]
2	[1 $e^{j4\pi/3}$ $e^{j2\pi/3}$ ]	N/A

**Table 5.5.2.2.1-3: Orthogonal sequences  $[\bar{w}^{(\tilde{p})}(0) \dots \bar{w}^{(\tilde{p})}(N_{RS}^{PUCCH} - 1)]$  for PUCCH formats 2, 2a, 2b and 3.**

Normal cyclic prefix	Extended cyclic prefix
[1 1]	[1]

**Table 5.5.2.2.1-4: Relation between  $n_{oc}^{(\tilde{p})}$  and  $n'_p(n_s)$  for PUCCH format 3.**

$n_{oc}^{(\tilde{p})}$	$n'_p(n_s)$	
	$N_{SF,1} = 5$	$N_{SF,1} = 4$
0	0	0
1	3	3
2	6	6
3	8	9
4	10	N/A

The PUCCH demodulation reference signal sequence  $r_{PUCCH}^{(\tilde{p})}(\cdot)$  for PUCCH formats 4 and 5 is defined by

$$r_{PUCCH}^{(\tilde{p})}(m \cdot M_{sc}^{RS} + n) = r_{u,v}^{(\alpha)}(n)$$

where

$$\begin{aligned} \tilde{p} &= 0 \\ m &= 0,1 \\ n &= 0, \dots, M_{sc}^{RS} - 1 \end{aligned}$$

and

$$M_{sc}^{RS} = \begin{cases} M_{sc}^{PUCCH4} & \text{for PUCCH format 4} \\ N_{sc}^{RB} & \text{for PUCCH format 5} \end{cases}$$

Subclause 5.5.1 defines the sequence  $r_{u,v}^{(\alpha_\lambda)}(0), \dots, r_{u,v}^{(\alpha_\lambda)}(M_{sc}^{RS} - 1)$ .

The cyclic shift  $\alpha_\lambda$  in a slot  $n_s$  is given as  $\alpha_\lambda = 2\pi n_{cs,\lambda}/12$  with

$$n_{cs,\lambda} = (n_{DMRS}^{(1)} + n_{DMRS}^{(2)} + n_{PN}(n_s)) \bmod 12$$

where the values of  $n_{DMRS}^{(1)}$  and  $n_{PN}(n_s)$  are given by Subclause 5.5.2.1.1 and

$$n_{DMRS}^{(2)} = \begin{cases} 0 & \text{PUCCH format 4} \\ 0 & \text{PUCCH format 5 with } n_{oc} = 0 \\ 6 & \text{PUCCH format 5 with } n_{oc} = 1 \end{cases}$$

with  $n_{oc}$  obtained as described in clause 5.4.2C.

#### 5.5.2.2.2 Mapping to physical resources

The sequence  $r_{PUCCH}^{(\tilde{p})}(\cdot)$  shall be multiplied with the amplitude scaling factor  $\beta_{PUCCH}$  and mapped in sequence starting with  $r_{PUCCH}^{(\tilde{p})}(0)$  to resource elements  $(k, l)$  on antenna port  $p$ . The mapping shall be in increasing order of first  $k$ , then  $l$  and finally the slot number. The set of values for  $k$  and the relation between the index  $\tilde{p}$  and the antenna port number  $p$  shall be identical to the values used for the corresponding PUCCH transmission. The values of the symbol index  $l$  in a slot are given by Table 5.5.2.2.2-1.

**Table 5.5.2.2.2-1: Demodulation reference signal location for different PUCCH formats.**

PUCCH format	Set of values for $l$	
	Normal cyclic prefix	Extended cyclic prefix
1, 1a, 1b	2, 3, 4	2, 3
2, 3	1, 5	3
2a, 2b	1, 5	N/A
4, 5	3	2

## 5.5.3 Sounding reference signal

### 5.5.3.1 Sequence generation

The sounding reference signal sequence  $r_{\text{SRS}}^{(\tilde{p})}(n) = r_{u,\nu}^{(\alpha_{\tilde{p}})}(n)$  is defined by clause 5.5.1, where  $u$  is the sequence-group number defined in clause 5.5.1.3 and  $\nu$  is the base sequence number defined in clause 5.5.1.4. The cyclic shift  $\alpha_{\tilde{p}}$  of the sounding reference signal is given as

$$\alpha_{\tilde{p}} = 2\pi \frac{n_{\text{SRS}}^{\text{cs},\tilde{p}}}{n_{\text{SRS}}^{\text{cs,max}}}$$

$$n_{\text{SRS}}^{\text{cs},\tilde{p}} = \left( n_{\text{SRS}}^{\text{cs}} + \frac{n_{\text{SRS}}^{\text{cs,max}} \tilde{p}}{N_{\text{ap}}} \right) \bmod n_{\text{SRS}}^{\text{cs,max}},$$

$$\tilde{p} \in \{0, 1, \dots, N_{\text{ap}} - 1\}$$

where  $n_{\text{SRS}}^{\text{cs}} = \{0, 1, \dots, n_{\text{SRS}}^{\text{cs,max}} - 1\}$  is configured separately for periodic and each configuration of aperiodic sounding by the higher-layer parameters *cyclicShift* and *cyclicShift-ap*, respectively, for each UE and  $N_{\text{ap}}$  is the number of antenna ports used for sounding reference signal transmission. The parameter  $n_{\text{SRS}}^{\text{cs,max}} = 8$  if  $K_{\text{TC}} = 2$ , otherwise  $n_{\text{SRS}}^{\text{cs,max}} = 12$ . The parameter  $K_{\text{TC}}$  is given by the higher layer parameter *transmissionCombNum* if configured, otherwise  $K_{\text{TC}} = 2$ .

### 5.5.3.2 Mapping to physical resources

The sequence shall be multiplied with the amplitude scaling factor  $\beta_{\text{SRS}}$  in order to conform to the transmit power  $P_{\text{SRS}}$  specified in clause 5.1.3.1 in 3GPP TS 36.213 [4], and mapped in sequence starting with  $r_{\text{SRS}}^{(\tilde{p})}(0)$  to resource elements  $(k, l)$  on antenna port  $p$  according to

$$a_{K_{\text{TC}}k'+k_0^{(p)},l}^{(p)} = \begin{cases} \frac{1}{\sqrt{N_{\text{ap}}}} \beta_{\text{SRS}} r_{\text{SRS}}^{(\tilde{p})}(k') & k' = 0, 1, \dots, M_{\text{sc},b}^{\text{RS}} - 1 \\ 0 & \text{otherwise} \end{cases}$$

where  $N_{\text{ap}}$  is the number of antenna ports used for sounding reference signal transmission and the relation between the index  $\tilde{p}$  and the antenna port  $p$  is given by Table 5.2.1-1. The set of antenna ports used for sounding reference signal transmission is configured independently for periodic and each configuration of aperiodic sounding. The quantity  $k_0^{(p)}$  is the frequency-domain starting position of the sounding reference signal and for  $b = B_{\text{SRS}}$  and  $M_{\text{sc},b}^{\text{RS}}$  is the length of the sounding reference signal sequence defined as

$$M_{\text{sc},b}^{\text{RS}} = m_{\text{SRS},b} N_{\text{sc}}^{\text{RB}} / K_{\text{TC}}$$

where  $m_{\text{SRS},b}$  is given by Table 5.5.3.2-1 through Table 5.5.3.2-4 for each uplink bandwidth  $N_{\text{RB}}^{\text{UL}}$ . The cell-specific parameter *srs-BandwidthConfig*,  $C_{\text{SRS}} \in \{0, 1, 2, 3, 4, 5, 6, 7\}$  and the UE-specific parameter *srs-Bandwidth*,  $B_{\text{SRS}} \in \{0, 1, 2, 3\}$  are given by higher layers. For UpPTS,  $m_{\text{SRS},0}$  shall be reconfigured to  $m_{\text{SRS},0}^{\text{max}} = \max_{c \in C_{\text{SRS}}} \{m_{\text{SRS},0}^c\} \leq (N_{\text{RB}}^{\text{UL}} - 6N_{\text{RA}})$  if this reconfiguration is enabled by the cell-specific parameter *srsMaxUpPts* given by higher layers, otherwise if the reconfiguration is disabled  $m_{\text{SRS},0}^{\text{max}} = m_{\text{SRS},0}$ , where  $c$  is a SRS BW configuration and  $C_{\text{SRS}}$  is the set of SRS BW configurations from the Tables 5.5.3.2-1 to 5.5.3.2-4 for each uplink bandwidth  $N_{\text{RB}}^{\text{UL}}$ ,  $N_{\text{RA}}$  is the number of format 4 PRACH in the addressed UpPTS and derived from Table 5.7.1-4.

The frequency-domain starting position  $k_0^{(p)}$  is defined by

$$k_0^{(p)} = \bar{k}_0^{(p)} + \sum_{b=0}^{B_{\text{SRS}}} K_{\text{TC}} M_{\text{sc},b}^{\text{RS}} n_b$$

where for normal uplink subframes  $\bar{k}_0^{(p)}$  is defined by

$$\bar{k}_0^{(p)} = \left( \lfloor N_{\text{RB}}^{\text{UL}} / 2 \rfloor - m_{\text{SRS},0} / 2 \right) N_{\text{SC}}^{\text{RB}} + k_{\text{TC}}^{(p)}$$

and for UpPTS by

$$\bar{k}_0^{(p)} = \begin{cases} (N_{\text{RB}}^{\text{UL}} - m_{\text{SRS},0}^{\text{max}}) N_{\text{SC}}^{\text{RB}} + k_{\text{TC}}^{(p)} & \text{if } ((n_f \bmod 2) \cdot (2 - N_{\text{SP}}) + n_{\text{hf}}) \bmod 2 = 0 \\ k_{\text{TC}}^{(p)} & \text{otherwise} \end{cases}$$

The quantity  $k_{\text{TC}}^{(p)} \in \{0, 1, \dots, K_{\text{TC}} - 1\}$  is given by

$$k_{\text{TC}}^{(p)} = \begin{cases} 1 - \bar{k}_{\text{TC}} & \text{if } n_{\text{SRS}}^{\text{cs}} \in \{4, 5, 6, 7\} \text{ and } \tilde{p} \in \{1, 3\} \text{ and } N_{\text{ap}} = 4 \\ \bar{k}_{\text{TC}} & \text{otherwise} \end{cases}$$

where the relation between the index  $\tilde{p}$  and the antenna port  $p$  is given by Table 5.2.1-1,  $\bar{k}_{\text{TC}} \in \{0, 1, \dots, K_{\text{TC}} - 1\}$  is given by the UE-specific parameter *transmissionComb* or *transmissionComb-ap* for periodic and each configuration of aperiodic transmission, respectively, provided by higher layers for the UE, and  $n_b$  is frequency position index. The variable  $n_{\text{hf}}$  is equal to 0 for UpPTS in the first half frame and equal to 1 for UpPTS in the second half frame of a radio frame.

The frequency hopping of the sounding reference signal is configured by the parameter  $b_{\text{hop}} \in \{0, 1, 2, 3\}$ , provided by higher-layer parameter *srs-HoppingBandwidth*. Frequency hopping is not supported for aperiodic transmission. If frequency hopping of the sounding reference signal is not enabled (i.e.,  $b_{\text{hop}} \geq B_{\text{SRS}}$ ), the frequency position index  $n_b$  remains constant (unless re-configured) and is defined by  $n_b = \lfloor 4n_{\text{RRC}} / m_{\text{SRS},b} \rfloor \bmod N_b$  where the parameter  $n_{\text{RRC}}$  is given by higher-layer parameters *freqDomainPosition* and *freqDomainPosition-ap* for periodic and each configuration of aperiodic transmission, respectively. If frequency hopping of the sounding reference signal is enabled (i.e.,  $b_{\text{hop}} < B_{\text{SRS}}$ ), the frequency position indexes  $n_b$  are defined by

$$n_b = \begin{cases} \lfloor 4n_{\text{RRC}} / m_{\text{SRS},b} \rfloor \bmod N_b & b \leq b_{\text{hop}} \\ \{F_b(n_{\text{SRS}}) + \lfloor 4n_{\text{RRC}} / m_{\text{SRS},b} \rfloor\} \bmod N_b & \text{otherwise} \end{cases}$$

where  $N_b$  is given by Table 5.5.3.2-1 through Table 5.5.3.2-4 for each uplink bandwidth  $N_{\text{RB}}^{\text{UL}}$ ,

$$F_b(n_{\text{SRS}}) = \begin{cases} (N_b / 2) \left[ \frac{n_{\text{SRS}} \bmod \prod_{b'=b_{\text{hop}}}^b N_{b'}}{\prod_{b'=b_{\text{hop}}}^{b-1} N_{b'}} \right] + \left[ \frac{n_{\text{SRS}} \bmod \prod_{b'=b_{\text{hop}}}^b N_{b'}}{2 \prod_{b'=b_{\text{hop}}}^{b-1} N_{b'}} \right] & \text{if } N_b \text{ even} \\ \lfloor N_b / 2 \rfloor \lfloor n_{\text{SRS}} / \prod_{b'=b_{\text{hop}}}^{b-1} N_{b'} \rfloor & \text{if } N_b \text{ odd} \end{cases}$$

where  $N_{b_{\text{hop}}} = 1$  regardless of the  $N_b$  value on Table 5.5.3.2-1 through Table 5.5.3.2-4, and

$$n_{\text{SRS}} = \begin{cases} \left\lfloor \frac{2N_{\text{SP}}n_f + 2(N_{\text{SP}} - 1) \left\lfloor \frac{n_s}{10} \right\rfloor + \left\lfloor \frac{T_{\text{offset}}}{T_{\text{offset\_max}}} \right\rfloor}{T_{\text{SRS}}} \right\rfloor & \text{for 2 ms SRS periodicity of frame structure type 2} \\ \lfloor (n_f \times 10 + \lfloor n_s / 2 \rfloor) / T_{\text{SRS}} \rfloor & \text{otherwise} \end{cases}$$

counts the number of UE-specific SRS transmissions, where  $T_{\text{SRS}}$  is UE-specific periodicity of SRS transmission defined in clause 8.2 of 3GPP TS 36.213 [4],  $T_{\text{offset}}$  is SRS subframe offset defined in Table 8.2-2 of 3GPP TS 36.213 [4] and  $T_{\text{offset\_max}}$  is the maximum value of  $T_{\text{offset}}$  for a certain configuration of SRS subframe offset.

The sounding reference signal shall be transmitted in the last symbol of the uplink subframe.

**Table 5.5.3.2-1:  $m_{\text{SRS},b}$  and  $N_b$ ,  $b = 0,1,2,3$ , values for the uplink bandwidth of  $6 \leq N_{\text{RB}}^{\text{UL}} \leq 40$** 

SRS bandwidth configuration $C_{\text{SRS}}$	SRS-Bandwidth $B_{\text{SRS}} = 0$		SRS-Bandwidth $B_{\text{SRS}} = 1$		SRS-Bandwidth $B_{\text{SRS}} = 2$		SRS-Bandwidth $B_{\text{SRS}} = 3$	
	$m_{\text{SRS},0}$	$N_0$	$m_{\text{SRS},1}$	$N_1$	$m_{\text{SRS},2}$	$N_2$	$m_{\text{SRS},3}$	$N_3$
0	36	1	12	3	4	3	4	1
1	32	1	16	2	8	2	4	2
2	24	1	4	6	4	1	4	1
3	20	1	4	5	4	1	4	1
4	16	1	4	4	4	1	4	1
5	12	1	4	3	4	1	4	1
6	8	1	4	2	4	1	4	1
7	4	1	4	1	4	1	4	1

**Table 5.5.3.2-2:  $m_{\text{SRS},b}$  and  $N_b$ ,  $b = 0,1,2,3$ , values for the uplink bandwidth of  $40 < N_{\text{RB}}^{\text{UL}} \leq 60$** 

SRS bandwidth configuration $C_{\text{SRS}}$	SRS-Bandwidth $B_{\text{SRS}} = 0$		SRS-Bandwidth $B_{\text{SRS}} = 1$		SRS-Bandwidth $B_{\text{SRS}} = 2$		SRS-Bandwidth $B_{\text{SRS}} = 3$	
	$m_{\text{SRS},0}$	$N_0$	$m_{\text{SRS},1}$	$N_1$	$m_{\text{SRS},2}$	$N_2$	$m_{\text{SRS},3}$	$N_3$
0	48	1	24	2	12	2	4	3
1	48	1	16	3	8	2	4	2
2	40	1	20	2	4	5	4	1
3	36	1	12	3	4	3	4	1
4	32	1	16	2	8	2	4	2
5	24	1	4	6	4	1	4	1
6	20	1	4	5	4	1	4	1
7	16	1	4	4	4	1	4	1

**Table 5.5.3.2-3:  $m_{\text{SRS},b}$  and  $N_b$ ,  $b = 0,1,2,3$ , values for the uplink bandwidth of  $60 < N_{\text{RB}}^{\text{UL}} \leq 80$** 

SRS bandwidth configuration $C_{\text{SRS}}$	SRS-Bandwidth $B_{\text{SRS}} = 0$		SRS-Bandwidth $B_{\text{SRS}} = 1$		SRS-Bandwidth $B_{\text{SRS}} = 2$		SRS-Bandwidth $B_{\text{SRS}} = 3$	
	$m_{\text{SRS},0}$	$N_0$	$m_{\text{SRS},1}$	$N_1$	$m_{\text{SRS},2}$	$N_2$	$m_{\text{SRS},3}$	$N_3$
0	72	1	24	3	12	2	4	3
1	64	1	32	2	16	2	4	4
2	60	1	20	3	4	5	4	1
3	48	1	24	2	12	2	4	3
4	48	1	16	3	8	2	4	2
5	40	1	20	2	4	5	4	1
6	36	1	12	3	4	3	4	1
7	32	1	16	2	8	2	4	2

**Table 5.5.3.2-4:  $m_{\text{SRS},b}$  and  $N_b$ ,  $b = 0,1,2,3$ , values for the uplink bandwidth of  $80 < N_{\text{RB}}^{\text{UL}} \leq 110$** 

SRS bandwidth configuration $C_{\text{SRS}}$	SRS-Bandwidth $B_{\text{SRS}} = 0$		SRS-Bandwidth $B_{\text{SRS}} = 1$		SRS-Bandwidth $B_{\text{SRS}} = 2$		SRS-Bandwidth $B_{\text{SRS}} = 3$	
	$m_{\text{SRS},0}$	$N_0$	$m_{\text{SRS},1}$	$N_1$	$m_{\text{SRS},2}$	$N_2$	$m_{\text{SRS},3}$	$N_3$
0	96	1	48	2	24	2	4	6
1	96	1	32	3	16	2	4	4
2	80	1	40	2	20	2	4	5
3	72	1	24	3	12	2	4	3
4	64	1	32	2	16	2	4	4
5	60	1	20	3	4	5	4	1
6	48	1	24	2	12	2	4	3
7	48	1	16	3	8	2	4	2

### 5.5.3.3 Sounding reference signal subframe configuration

The cell-specific subframe configuration period  $T_{\text{SFC}}$  and the cell-specific subframe offset  $\Delta_{\text{SFC}}$  for the transmission of sounding reference signals are listed in Tables 5.5.3.3-1 and 5.5.3.3-2, for frame structures type 1 and 2 respectively, where the parameter *srs-SubframeConfig* is provided by higher layers. Sounding reference signal subframes are the subframes satisfying  $\lfloor n_s / 2 \rfloor \bmod T_{\text{SFC}} \in \Delta_{\text{SFC}}$ . For frame structure type 2, a sounding reference signal is transmitted only in uplink subframes or UpPTS.

**Table 5.5.3.3-1: Frame structure type 1 sounding reference signal subframe configuration**

srs-SubframeConfig	Binary	Configuration Period $T_{\text{SFC}}$ (subframes)	Transmission offset $\Delta_{\text{SFC}}$ (subframes)
0	0000	1	{0}
1	0001	2	{0}
2	0010	2	{1}
3	0011	5	{0}
4	0100	5	{1}
5	0101	5	{2}
6	0110	5	{3}
7	0111	5	{0,1}
8	1000	5	{2,3}
9	1001	10	{0}
10	1010	10	{1}
11	1011	10	{2}
12	1100	10	{3}
13	1101	10	{0,1,2,3,4,6,8}
14	1110	10	{0,1,2,3,4,5,6,8}
15	1111	reserved	reserved

**Table 5.5.3.3-2: Frame structure type 2 sounding reference signal subframe configuration**

srs-SubframeConfig	Binary	Configuration Period $T_{\text{SFC}}$ (subframes)	Transmission offset $\Delta_{\text{SFC}}$ (subframes)
0	0000	5	{1}
1	0001	5	{1, 2}
2	0010	5	{1, 3}
3	0011	5	{1, 4}
4	0100	5	{1, 2, 3}
5	0101	5	{1, 2, 4}
6	0110	5	{1, 3, 4}
7	0111	5	{1, 2, 3, 4}
8	1000	10	{1, 2, 6}
9	1001	10	{1, 3, 6}
10	1010	10	{1, 6, 7}
11	1011	10	{1, 2, 6, 8}
12	1100	10	{1, 3, 6, 9}
13	1101	10	{1, 4, 6, 7}
14	1110	reserved	reserved
15	1111	reserved	reserved

## 5.6 SC-FDMA baseband signal generation

This clause applies to all uplink physical signals and uplink physical channels except the physical random access channel.

The time-continuous signal  $s_l^{(p)}(t)$  for antenna port  $p$  in SC-FDMA symbol  $l$  in an uplink slot is defined by

$$s_l^{(p)}(t) = \sum_{k=-\lfloor N_{RB}^{UL} N_{sc}^{RB} / 2 \rfloor}^{\lfloor N_{RB}^{UL} N_{sc}^{RB} / 2 \rfloor - 1} a_{k^{(-)},l}^{(p)} \cdot e^{j2\pi(k+1/2)\Delta f(t - N_{CP,l}T_s)}$$

for  $0 \leq t < (N_{CP,l} + N) \times T_s$  where  $k^{(-)} = k + \lfloor N_{RB}^{UL} N_{sc}^{RB} / 2 \rfloor$ ,  $N = 2048$ ,  $\Delta f = 15$  kHz and  $a_{k,l}^{(p)}$  is the content of resource element  $(k,l)$  on antenna port  $p$ .

The SC-FDMA symbols in a slot shall be transmitted in increasing order of  $l$ , starting with  $l = 0$ , where SC-FDMA symbol  $l > 0$  starts at time  $\sum_{l'=0}^{l-1} (N_{CP,l'} + N)T_s$  within the slot.

Table 5.6-1 lists the values of  $N_{CP,l}$  that shall be used.

**Table 5.6-1: SC-FDMA parameters**

Configuration	Cyclic prefix length $N_{CP,l}$
Normal cyclic prefix	160 for $l = 0$
	144 for $l = 1, 2, \dots, 6$
Extended cyclic prefix	512 for $l = 0, 1, \dots, 5$



## 5.7 Physical random access channel

### 5.7.1 Time and frequency structure

The physical layer random access preamble, illustrated in Figure 5.7.1-1, consists of a cyclic prefix of length  $T_{CP}$  and a sequence part of length  $T_{SEQ}$ . The parameter values are listed in Table 5.7.1-1 and depend on the frame structure and the random access configuration. Higher layers control the preamble format.

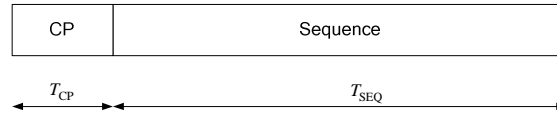

**Figure 5.7.1-1: Random access preamble format**

**Table 5.7.1-1: Random access preamble parameters**

Preamble format	$T_{CP}$	$T_{SEQ}$
0	$3168 \cdot T_s$	$24576 \cdot T_s$
1	$21024 \cdot T_s$	$24576 \cdot T_s$
2	$6240 \cdot T_s$	$2 \cdot 24576 \cdot T_s$
3	$21024 \cdot T_s$	$2 \cdot 24576 \cdot T_s$
4 (see Note)	$448 \cdot T_s$	$4096 \cdot T_s$
NOTE: Frame structure type 2 and special subframe configurations with UpPTS lengths $4384 \cdot T_s$ and $5120 \cdot T_s$ only assuming that the number of additional SC-FDMA symbols in UpPTS X in Table 4.2-1 is 0.		

The transmission of a random access preamble, if triggered by the MAC layer, is restricted to certain time and frequency resources. These resources are enumerated in increasing order of the subframe number within the radio frame and the physical resource blocks in the frequency domain such that index 0 correspond to the lowest numbered physical resource block and subframe within the radio frame. PRACH resources within the radio frame are indicated by a PRACH configuration index, where the indexing is in the order of appearance in Table 5.7.1-2 and Table 5.7.1-4.

For non-BL/CE UEs there is a single PRACH configuration with  $n_{PRB\text{offset}}^{RA}$  given by the higher-layer parameter *prach-FrequencyOffset*.

For BL/CE UEs, for each PRACH coverage enhancement level, there is a PRACH configuration configured by higher layers with a PRACH configuration index (*prach-ConfigurationIndex*), a PRACH frequency offset  $\bar{n}_{PRB\text{offset}}^{RA}$  (*prach-FrequencyOffset*), a number of PRACH repetitions per attempt  $N_{rep}^{PRACH}$  (*numRepetitionPerPreambleAttempt*) and optionally a PRACH starting subframe periodicity  $N_{start}^{PRACH}$  (*prach-StartingSubframe*). PRACH of preamble format 0-3 is transmitted  $N_{rep}^{PRACH} \geq 1$  times, whereas PRACH of preamble format 4 is transmitted one time only.

For BL/CE UEs and for each PRACH coverage enhancement level, if frequency hopping is enabled for a PRACH configuration by the higher-layer parameter *prach-HoppingConfig*, the value of the parameter  $n_{PRB\text{offset}}^{RA}$  depends on the SFN and the PRACH configuration index and is given by

- In case the PRACH configuration index is such that a PRACH resource occurs in every radio frame when calculated as below from Table 5.7.1-2 or Table 5.7.1-4,

$$n_{PRB\text{offset}}^{RA} = \begin{cases} \bar{n}_{PRB\text{offset}}^{RA} & \text{if } n_f \bmod 2 = 0 \\ \left( \bar{n}_{PRB\text{offset}}^{RA} + f_{PRB,hop}^{PRACH} \right) \bmod N_{RB}^{UL} & \text{if } n_f \bmod 2 = 1 \end{cases}$$

- otherwise

$$n_{\text{PRB offset}}^{\text{RA}} = \begin{cases} \bar{n}_{\text{PRB offset}}^{\text{RA}} & \text{if } \left\lfloor \frac{n_f \bmod 4}{2} \right\rfloor = 0 \\ \left( \bar{n}_{\text{PRB offset}}^{\text{RA}} + f_{\text{PRB,hop}}^{\text{PRACH}} \right) \bmod N_{\text{RB}}^{\text{UL}} & \text{if } \left\lfloor \frac{n_f \bmod 4}{2} \right\rfloor = 1 \end{cases}$$

where  $n_f$  is the system frame number,  $f_{\text{PRB,hop}}^{\text{PRACH}}$  corresponds to a cell-specific higher-layer parameter *prach-HoppingOffset*. If frequency hopping is not enabled for the PRACH configuration then  $n_{\text{PRB offset}}^{\text{RA}} = \bar{n}_{\text{PRB offset}}^{\text{RA}}$ .

For frame structure type 1 with preamble format 0-3, for each of the PRACH configurations there is at most one random access resource per subframe.

Table 5.7.1-2 lists the preamble formats according to Table 5.7.1-1 and the subframes in which random access preamble transmission is allowed for a given configuration in frame structure type 1. The start of the random access preamble shall be aligned with the start of the corresponding uplink subframe at the UE assuming  $N_{\text{TA}} = 0$ , where  $N_{\text{TA}}$  is defined in clause 8.1. For PRACH configurations 0, 1, 2, 15, 16, 17, 18, 31, 32, 33, 34, 47, 48, 49, 50 and 63 the UE may for handover purposes assume an absolute value of the relative time difference between radio frame  $i$  in the current cell and the target cell of less than  $153600 \cdot T_s$ .

The first physical resource block  $n_{\text{PRB}}^{\text{RA}}$  allocated to the PRACH opportunity considered for preamble formats 0, 1, 2 and 3 is defined as  $n_{\text{PRB}}^{\text{RA}} = n_{\text{PRB offset}}^{\text{RA}}$ .

**Table 5.7.1-2: Frame structure type 1 random access configuration for preamble formats 0-3**

PRACH Configuration Index	Preamble Format	System frame number	Subframe number	PRACH Configuration Index	Preamble Format	System frame number	Subframe number
0	0	Even	1	32	2	Even	1
1	0	Even	4	33	2	Even	4
2	0	Even	7	34	2	Even	7
3	0	Any	1	35	2	Any	1
4	0	Any	4	36	2	Any	4
5	0	Any	7	37	2	Any	7
6	0	Any	1, 6	38	2	Any	1, 6
7	0	Any	2, 7	39	2	Any	2, 7
8	0	Any	3, 8	40	2	Any	3, 8
9	0	Any	1, 4, 7	41	2	Any	1, 4, 7
10	0	Any	2, 5, 8	42	2	Any	2, 5, 8
11	0	Any	3, 6, 9	43	2	Any	3, 6, 9
12	0	Any	0, 2, 4, 6, 8	44	2	Any	0, 2, 4, 6, 8
13	0	Any	1, 3, 5, 7, 9	45	2	Any	1, 3, 5, 7, 9
14	0	Any	0, 1, 2, 3, 4, 5, 6, 7, 8, 9	46	N/A	N/A	N/A
15	0	Even	9	47	2	Even	9
16	1	Even	1	48	3	Even	1
17	1	Even	4	49	3	Even	4
18	1	Even	7	50	3	Even	7
19	1	Any	1	51	3	Any	1
20	1	Any	4	52	3	Any	4
21	1	Any	7	53	3	Any	7
22	1	Any	1, 6	54	3	Any	1, 6
23	1	Any	2, 7	55	3	Any	2, 7
24	1	Any	3, 8	56	3	Any	3, 8
25	1	Any	1, 4, 7	57	3	Any	1, 4, 7
26	1	Any	2, 5, 8	58	3	Any	2, 5, 8
27	1	Any	3, 6, 9	59	3	Any	3, 6, 9
28	1	Any	0, 2, 4, 6, 8	60	N/A	N/A	N/A
29	1	Any	1, 3, 5, 7, 9	61	N/A	N/A	N/A
30	N/A	N/A	N/A	62	N/A	N/A	N/A
31	1	Even	9	63	3	Even	9

For frame structure type 2 with preamble formats 0-4, for each of the PRACH configurations there might be multiple random access resources in an UL subframe (or UpPTS for preamble format 4) depending on the UL/DL configuration [see table 4.2-2]. Table 5.7.1-3 lists PRACH configurations allowed for frame structure type 2 where the configuration index corresponds to a certain combination of preamble format, PRACH density value,  $D_{RA}$  and version index,  $r_{RA}$ . For frame structure type 2 with PRACH configuration indices 0, 1, 2, 20, 21, 22, 30, 31, 32, 40, 41, 42, 48, 49, 50, or with PRACH configuration indices 51, 53, 54, 55, 56, 57 in UL/DL configuration 3, 4, 5, the UE may for handover purposes assume an absolute value of the relative time difference between radio frame  $i$  in the current cell and the target cell is less than  $153600 \cdot T_s$ .

**Table 5.7.1-3: Frame structure type 2 random access configurations for preamble formats 0-4**

PRACH configuration Index	Preamble Format	Density Per 10 ms $D_{RA}$	Version $r_{RA}$	PRACH configuration Index	Preamble Format	Density Per 10 ms $D_{RA}$	Version $r_{RA}$
0	0	0.5	0	32	2	0.5	2
1	0	0.5	1	33	2	1	0
2	0	0.5	2	34	2	1	1
3	0	1	0	35	2	2	0
4	0	1	1	36	2	3	0
5	0	1	2	37	2	4	0
6	0	2	0	38	2	5	0
7	0	2	1	39	2	6	0
8	0	2	2	40	3	0.5	0
9	0	3	0	41	3	0.5	1
10	0	3	1	42	3	0.5	2
11	0	3	2	43	3	1	0
12	0	4	0	44	3	1	1
13	0	4	1	45	3	2	0
14	0	4	2	46	3	3	0
15	0	5	0	47	3	4	0
16	0	5	1	48	4	0.5	0
17	0	5	2	49	4	0.5	1
18	0	6	0	50	4	0.5	2
19	0	6	1	51	4	1	0
20	1	0.5	0	52	4	1	1
21	1	0.5	1	53	4	2	0
22	1	0.5	2	54	4	3	0
23	1	1	0	55	4	4	0
24	1	1	1	56	4	5	0
25	1	2	0	57	4	6	0
26	1	3	0	58	N/A	N/A	N/A
27	1	4	0	59	N/A	N/A	N/A
28	1	5	0	60	N/A	N/A	N/A
29	1	6	0	61	N/A	N/A	N/A
30	2	0.5	0	62	N/A	N/A	N/A
31	2	0.5	1	63	N/A	N/A	N/A

Table 5.7.1-4 lists the mapping to physical resources for the different random access opportunities needed for a certain PRACH density value,  $D_{RA}$ . Each quadruple of the format  $(f_{RA}, t_{RA}^{(0)}, t_{RA}^{(1)}, t_{RA}^{(2)})$  indicates the location of a specific random access resource, where  $f_{RA}$  is a frequency resource index within the considered time instance,  $t_{RA}^{(0)} = 0,1,2$  indicates whether the resource is reoccurring in all radio frames, in even radio frames, or in odd radio frames, respectively,  $t_{RA}^{(1)} = 0,1$  indicates whether the random access resource is located in first half frame or in second half frame, respectively, and where  $t_{RA}^{(2)}$  is the uplink subframe number where the preamble starts, counting from 0 at the first uplink subframe between 2 consecutive downlink-to-uplink switch points, with the exception of preamble format 4 where  $t_{RA}^{(2)}$  is denoted as (\*). The start of the random access preamble formats 0-3 shall be aligned with the start of the corresponding uplink subframe at the UE assuming  $N_{TA} = 0$  and the random access preamble format 4 shall start  $4832 \cdot T_s$  before the end of the UpPTS at the UE, where the UpPTS is referenced to the UE's uplink frame timing assuming  $N_{TA} = 0$ .

The random access opportunities for each PRACH configuration shall be allocated in time first and then in frequency if and only if time multiplexing is not sufficient to hold all opportunities of a PRACH configuration needed for a certain density value  $D_{RA}$  without overlap in time. For preamble format 0-3, the frequency multiplexing shall be done according to

$$n_{PRB}^{RA} = \begin{cases} n_{PRB\ offset}^{RA} + 6 \left\lfloor \frac{f_{RA}}{2} \right\rfloor, & \text{if } f_{RA} \bmod 2 = 0 \\ N_{RB}^{UL} - 6 - n_{PRB\ offset}^{RA} - 6 \left\lfloor \frac{f_{RA}}{2} \right\rfloor, & \text{otherwise} \end{cases}$$

where  $N_{RB}^{UL}$  is the number of uplink resource blocks,  $n_{PRB}^{RA}$  is the first physical resource block allocated to the PRACH opportunity considered and where  $n_{PRB\ offset}^{RA}$  is the first physical resource block available for PRACH.

For preamble format 4, the frequency multiplexing shall be done according to

$$n_{PRB}^{RA} = \begin{cases} 6f_{RA}, & \text{if } ((n_f \bmod 2) \times (2 - N_{SP}) + t_{RA}^{(1)}) \bmod 2 = 0 \\ N_{RB}^{UL} - 6(f_{RA} + 1), & \text{otherwise} \end{cases}$$

where  $n_f$  is the system frame number and where  $N_{SP}$  is the number of DL to UL switch points within the radio frame.

For BL/CE UEs, only a subset of the subframes allowed for preamble transmission are allowed as starting subframes for the  $N_{rep}^{PRACH}$  repetitions. The allowed starting subframes for a PRACH configuration are determined as follows:

- Enumerate the subframes that are allowed for preamble transmission for the PRACH configuration as  $n_{sf}^{RA} = 0, \dots, N_{sf}^{RA} - 1$  where  $n_{sf}^{RA} = 0$  and  $n_{sf}^{RA} = N_{sf}^{RA} - 1$  correspond to the two subframes allowed for preamble transmission with the smallest and the largest absolute subframe number  $n_{sf}^{abs}$ , respectively.
- If a PRACH starting subframe periodicity  $N_{start}^{PRACH}$  is not provided by higher layers, the periodicity of the allowed starting subframes in terms of subframes allowed for preamble transmission is  $N_{rep}^{PRACH}$ . The allowed starting subframes defined over  $n_{sf}^{RA} = 0, \dots, N_{sf}^{RA} - 1$  are given by  $jN_{rep}^{PRACH}$  where  $j = 0, 1, 2, \dots$
- If a PRACH starting subframe periodicity  $N_{start}^{PRACH}$  is provided by higher layers, it indicates the periodicity of the allowed starting subframes in terms of subframes allowed for preamble transmission. The allowed starting subframes defined over  $n_{sf}^{RA} = 0, \dots, N_{sf}^{RA} - 1$  are given by  $jN_{start}^{PRACH} + N_{rep}^{PRACH}$  where  $j = 0, 1, 2, \dots$
- No starting subframe with absolute subframe number  $n_{sf}^{abs} > 10240 - N_{rep}^{PRACH}$  is allowed.

Each random access preamble occupies a bandwidth corresponding to 6 consecutive resource blocks for both frame structures.

Table 5.7.1-4: Frame structure type 2 random access preamble mapping in time and frequency

PRACH configuration Index (See Table 5.7.1-3)	UL/DL configuration (See Table 4.2-2)						
	0	1	2	3	4	5	6
0	(0,1,0,2)	(0,1,0,1)	(0,1,0,0)	(0,1,0,2)	(0,1,0,1)	(0,1,0,0)	(0,1,0,2)
1	(0,2,0,2)	(0,2,0,1)	(0,2,0,0)	(0,2,0,2)	(0,2,0,1)	(0,2,0,0)	(0,2,0,2)
2	(0,1,1,2)	(0,1,1,1)	(0,1,1,0)	(0,1,0,1)	(0,1,0,0)	N/A	(0,1,1,1)
3	(0,0,0,2)	(0,0,0,1)	(0,0,0,0)	(0,0,0,2)	(0,0,0,1)	(0,0,0,0)	(0,0,0,2)
4	(0,0,1,2)	(0,0,1,1)	(0,0,1,0)	(0,0,0,1)	(0,0,0,0)	N/A	(0,0,1,1)
5	(0,0,0,1)	(0,0,0,0)	N/A	(0,0,0,0)	N/A	N/A	(0,0,0,1)
6	(0,0,0,2)	(0,0,0,1)	(0,0,0,0)	(0,0,0,1)	(0,0,0,0)	(0,0,0,0)	(0,0,0,2)
	(0,0,1,2)	(0,0,1,1)	(0,0,1,0)	(0,0,0,2)	(0,0,0,1)	(1,0,0,0)	(0,0,1,1)
7	(0,0,0,1)	(0,0,0,0)	N/A	(0,0,0,0)	N/A	N/A	(0,0,0,1)
	(0,0,1,1)	(0,0,1,0)	N/A	(0,0,0,2)	N/A	N/A	(0,0,1,0)
8	(0,0,0,0)	N/A	N/A	(0,0,0,0)	N/A	N/A	(0,0,0,0)
	(0,0,1,0)	N/A	N/A	(0,0,0,1)	N/A	N/A	(0,0,1,1)
9	(0,0,0,1)	(0,0,0,0)	(0,0,0,0)	(0,0,0,0)	(0,0,0,0)	(0,0,0,0)	(0,0,0,1)
	(0,0,0,2)	(0,0,0,1)	(0,0,1,0)	(0,0,0,1)	(0,0,0,1)	(1,0,0,0)	(0,0,0,2)
	(0,0,1,2)	(0,0,1,1)	(1,0,0,0)	(0,0,0,2)	(1,0,0,1)	(2,0,0,0)	(0,0,1,1)
10	(0,0,0,0)	(0,0,0,1)	(0,0,0,0)	N/A	(0,0,0,0)	N/A	(0,0,0,0)
	(0,0,1,0)	(0,0,1,0)	(0,0,1,0)	N/A	(0,0,0,1)	N/A	(0,0,0,2)
	(0,0,1,1)	(0,0,1,1)	(1,0,1,0)	N/A	(1,0,0,0)	N/A	(0,0,1,0)
11	N/A	(0,0,0,0)	N/A	N/A	N/A	N/A	(0,0,0,1)
	N/A	(0,0,0,1)	N/A	N/A	N/A	N/A	(0,0,1,0)
	N/A	(0,0,1,0)	N/A	N/A	N/A	N/A	(0,0,1,1)
12	(0,0,0,1)	(0,0,0,0)	(0,0,0,0)	(0,0,0,0)	(0,0,0,0)	(0,0,0,0)	(0,0,0,1)
	(0,0,0,2)	(0,0,0,1)	(0,0,1,0)	(0,0,0,1)	(0,0,0,1)	(1,0,0,0)	(0,0,0,2)
	(0,0,1,1)	(0,0,1,0)	(1,0,0,0)	(0,0,0,2)	(1,0,0,0)	(2,0,0,0)	(0,0,1,0)
	(0,0,1,2)	(0,0,1,1)	(1,0,1,0)	(1,0,0,2)	(1,0,0,1)	(3,0,0,0)	(0,0,1,1)
13	(0,0,0,0)	N/A	N/A	(0,0,0,0)	N/A	N/A	(0,0,0,0)
	(0,0,0,2)	N/A	N/A	(0,0,0,1)	N/A	N/A	(0,0,0,1)
	(0,0,1,0)	N/A	N/A	(0,0,0,2)	N/A	N/A	(0,0,0,2)
	(0,0,1,2)	N/A	N/A	(1,0,0,1)	N/A	N/A	(0,0,1,1)
14	(0,0,0,0)	N/A	N/A	(0,0,0,0)	N/A	N/A	(0,0,0,0)
	(0,0,0,1)	N/A	N/A	(0,0,0,1)	N/A	N/A	(0,0,0,2)
	(0,0,1,0)	N/A	N/A	(0,0,0,2)	N/A	N/A	(0,0,1,0)
	(0,0,1,1)	N/A	N/A	(1,0,0,0)	N/A	N/A	(0,0,1,1)
15	(0,0,0,0)	(0,0,0,0)	(0,0,0,0)	(0,0,0,0)	(0,0,0,0)	(0,0,0,0)	(0,0,0,0)
	(0,0,0,1)	(0,0,0,1)	(0,0,1,0)	(0,0,0,1)	(0,0,0,1)	(1,0,0,0)	(0,0,0,1)
	(0,0,0,2)	(0,0,1,0)	(1,0,0,0)	(0,0,0,2)	(1,0,0,0)	(2,0,0,0)	(0,0,0,2)
	(0,0,1,1)	(0,0,1,1)	(1,0,1,0)	(1,0,0,1)	(1,0,0,1)	(3,0,0,0)	(0,0,1,0)
	(0,0,1,2)	(1,0,0,1)	(2,0,0,0)	(1,0,0,2)	(2,0,0,1)	(4,0,0,0)	(0,0,1,1)
16	(0,0,0,1)	(0,0,0,0)	(0,0,0,0)	(0,0,0,0)	(0,0,0,0)	N/A	N/A
	(0,0,0,2)	(0,0,0,1)	(0,0,1,0)	(0,0,0,1)	(0,0,0,1)	N/A	N/A
	(0,0,1,0)	(0,0,1,0)	(1,0,0,0)	(0,0,0,2)	(1,0,0,0)	N/A	N/A
	(0,0,1,1)	(0,0,1,1)	(1,0,1,0)	(1,0,0,0)	(1,0,0,1)	N/A	N/A
	(0,0,1,2)	(1,0,1,1)	(2,0,1,0)	(1,0,0,2)	(2,0,0,0)	N/A	N/A
17	(0,0,0,0)	(0,0,0,0)	N/A	(0,0,0,0)	N/A	N/A	N/A
	(0,0,0,1)	(0,0,0,1)	N/A	(0,0,0,1)	N/A	N/A	N/A
	(0,0,0,2)	(0,0,1,0)	N/A	(0,0,0,2)	N/A	N/A	N/A
	(0,0,1,0)	(0,0,1,1)	N/A	(1,0,0,0)	N/A	N/A	N/A
	(0,0,1,2)	(1,0,0,0)	N/A	(1,0,0,1)	N/A	N/A	N/A
18	(0,0,0,0)	(0,0,0,0)	(0,0,0,0)	(0,0,0,0)	(0,0,0,0)	(0,0,0,0)	(0,0,0,0)
	(0,0,0,1)	(0,0,0,1)	(0,0,1,0)	(0,0,0,1)	(0,0,0,1)	(1,0,0,0)	(0,0,0,1)
	(0,0,0,2)	(0,0,1,0)	(1,0,0,0)	(0,0,0,2)	(1,0,0,0)	(2,0,0,0)	(0,0,0,2)
	(0,0,1,0)	(0,0,1,1)	(1,0,1,0)	(1,0,0,0)	(1,0,0,1)	(3,0,0,0)	(0,0,1,0)
	(0,0,1,1)	(1,0,0,1)	(2,0,0,0)	(1,0,0,1)	(2,0,0,0)	(4,0,0,0)	(0,0,1,1)
	(0,0,1,2)	(1,0,1,1)	(2,0,1,0)	(1,0,0,2)	(2,0,0,1)	(5,0,0,0)	(1,0,0,2)
19	N/A	(0,0,0,0)	N/A	N/A	N/A	N/A	(0,0,0,0)
	N/A	(0,0,0,1)	N/A	N/A	N/A	N/A	(0,0,0,1)
	N/A	(0,0,1,0)	N/A	N/A	N/A	N/A	(0,0,0,2)
	N/A	(0,0,1,1)	N/A	N/A	N/A	N/A	(0,0,1,0)
	N/A	(1,0,0,0)	N/A	N/A	N/A	N/A	(0,0,1,1)
	N/A	(1,0,1,0)	N/A	N/A	N/A	N/A	(1,0,1,1)
20 / 30	(0,1,0,1)	(0,1,0,0)	N/A	(0,1,0,1)	(0,1,0,0)	N/A	(0,1,0,1)
21 / 31	(0,2,0,1)	(0,2,0,0)	N/A	(0,2,0,1)	(0,2,0,0)	N/A	(0,2,0,1)
22 / 32	(0,1,1,1)	(0,1,1,0)	N/A	N/A	N/A	N/A	(0,1,1,0)
23 / 33	(0,0,0,1)	(0,0,0,0)	N/A	(0,0,0,1)	(0,0,0,0)	N/A	(0,0,0,1)
24 / 34	(0,0,1,1)	(0,0,1,0)	N/A	N/A	N/A	N/A	(0,0,1,0)
25 / 35	(0,0,0,1)	(0,0,0,0)	N/A	(0,0,0,1)	(0,0,0,0)	N/A	(0,0,0,1)
	(0,0,1,1)	(0,0,1,0)	N/A	(1,0,0,1)	(1,0,0,0)	N/A	(0,0,1,0)
26 / 36	(0,0,0,1)	(0,0,0,0)	N/A	(0,0,0,1)	(0,0,0,0)	N/A	(0,0,0,1)
	(0,0,1,1)	(0,0,1,0)	N/A	(1,0,0,1)	(1,0,0,0)	N/A	(0,0,1,0)
	(1,0,0,1)	(1,0,0,0)	N/A	(2,0,0,1)	(2,0,0,0)	N/A	(1,0,0,1)

27 / 37	(0,0,0,1) (0,0,1,1) (1,0,0,1) (1,0,1,1)	(0,0,0,0) (0,0,1,0) (1,0,0,0) (1,0,1,0)	N/A	(0,0,0,1) (1,0,0,1) (2,0,0,1) (3,0,0,1)	(0,0,0,0) (1,0,0,0) (2,0,0,0) (3,0,0,0)	N/A	(0,0,0,1) (0,0,1,0) (1,0,0,1) (1,0,1,0)
28 / 38	(0,0,0,1) (0,0,1,1) (1,0,0,1) (1,0,1,1) (2,0,0,1)	(0,0,0,0) (0,0,1,0) (1,0,0,0) (1,0,1,0) (2,0,0,0)	N/A	(0,0,0,1) (1,0,0,1) (2,0,0,1) (3,0,0,1) (4,0,0,1)	(0,0,0,0) (1,0,0,0) (2,0,0,0) (3,0,0,0) (4,0,0,0)	N/A	(0,0,0,1) (0,0,1,0) (1,0,0,1) (1,0,1,0) (2,0,0,1)
29/39	(0,0,0,1) (0,0,1,1) (1,0,0,1) (1,0,1,1) (2,0,0,1) (2,0,1,1)	(0,0,0,0) (0,0,1,0) (1,0,0,0) (1,0,1,0) (2,0,0,0) (2,0,1,0)	N/A	(0,0,0,1) (1,0,0,1) (2,0,0,1) (3,0,0,1) (4,0,0,1) (5,0,0,1)	(0,0,0,0) (1,0,0,0) (2,0,0,0) (3,0,0,0) (4,0,0,0) (5,0,0,0)	N/A	(0,0,0,1) (0,0,1,0) (1,0,0,1) (1,0,1,0) (2,0,0,1) (2,0,1,0)
40	(0,1,0,0)	N/A	N/A	(0,1,0,0)	N/A	N/A	(0,1,0,0)
41	(0,2,0,0)	N/A	N/A	(0,2,0,0)	N/A	N/A	(0,2,0,0)
42	(0,1,1,0)	N/A	N/A	N/A	N/A	N/A	N/A
43	(0,0,0,0)	N/A	N/A	(0,0,0,0)	N/A	N/A	(0,0,0,0)
44	(0,0,1,0)	N/A	N/A	N/A	N/A	N/A	N/A
45	(0,0,0,0) (0,0,1,0)	N/A	N/A	(0,0,0,0) (1,0,0,0)	N/A	N/A	(0,0,0,0) (1,0,0,0)
46	(0,0,0,0) (0,0,1,0) (1,0,0,0)	N/A	N/A	(0,0,0,0) (1,0,0,0) (2,0,0,0)	N/A	N/A	(0,0,0,0) (1,0,0,0) (2,0,0,0)
47	(0,0,0,0) (0,0,1,0) (1,0,0,0) (1,0,1,0)	N/A	N/A	(0,0,0,0) (1,0,0,0) (2,0,0,0) (3,0,0,0)	N/A	N/A	(0,0,0,0) (1,0,0,0) (2,0,0,0) (3,0,0,0)
48	(0,1,0,*)	(0,1,0,*)	(0,1,0,*)	(0,1,0,*)	(0,1,0,*)	(0,1,0,*)	(0,1,0,*)
49	(0,2,0,*)	(0,2,0,*)	(0,2,0,*)	(0,2,0,*)	(0,2,0,*)	(0,2,0,*)	(0,2,0,*)
50	(0,1,1,*)	(0,1,1,*)	(0,1,1,*)	N/A	N/A	N/A	(0,1,1,*)
51	(0,0,0,*)	(0,0,0,*)	(0,0,0,*)	(0,0,0,*)	(0,0,0,*)	(0,0,0,*)	(0,0,0,*)
52	(0,0,1,*)	(0,0,1,*)	(0,0,1,*)	N/A	N/A	N/A	(0,0,1,*)
53	(0,0,0,*) (0,0,1,*)	(0,0,0,*) (0,0,1,*)	(0,0,0,*) (0,0,1,*)	(0,0,0,*) (1,0,0,*)	(0,0,0,*) (1,0,0,*)	(0,0,0,*) (1,0,0,*)	(0,0,0,*) (0,0,1,*)
54	(0,0,0,*) (0,0,1,*) (1,0,0,*)	(0,0,0,*) (0,0,1,*) (1,0,0,*)	(0,0,0,*) (0,0,1,*) (1,0,0,*)	(0,0,0,*) (1,0,0,*) (2,0,0,*)	(0,0,0,*) (1,0,0,*) (2,0,0,*)	(0,0,0,*) (1,0,0,*) (2,0,0,*)	(0,0,0,*) (0,0,1,*) (1,0,0,*)
55	(0,0,0,*) (0,0,1,*) (1,0,0,*) (1,0,1,*)	(0,0,0,*) (0,0,1,*) (1,0,0,*) (1,0,1,*)	(0,0,0,*) (0,0,1,*) (1,0,0,*) (1,0,1,*)	(0,0,0,*) (1,0,0,*) (2,0,0,*) (3,0,0,*)	(0,0,0,*) (1,0,0,*) (2,0,0,*) (3,0,0,*)	(0,0,0,*) (1,0,0,*) (2,0,0,*) (3,0,0,*)	(0,0,0,*) (0,0,1,*) (1,0,0,*) (1,0,1,*)
56	(0,0,0,*) (0,0,1,*) (1,0,0,*) (1,0,1,*) (2,0,0,*)	(0,0,0,*) (0,0,1,*) (1,0,0,*) (1,0,1,*) (2,0,0,*)	(0,0,0,*) (0,0,1,*) (1,0,0,*) (1,0,1,*) (2,0,0,*)	(0,0,0,*) (1,0,0,*) (2,0,0,*) (3,0,0,*) (4,0,0,*)	(0,0,0,*) (1,0,0,*) (2,0,0,*) (3,0,0,*) (4,0,0,*)	(0,0,0,*) (1,0,0,*) (2,0,0,*) (3,0,0,*) (4,0,0,*)	(0,0,0,*) (0,0,1,*) (1,0,0,*) (1,0,1,*) (2,0,0,*)
57	(0,0,0,*) (0,0,1,*) (1,0,0,*) (1,0,1,*) (2,0,0,*) (2,0,1,*)	(0,0,0,*) (0,0,1,*) (1,0,0,*) (1,0,1,*) (2,0,0,*) (2,0,1,*)	(0,0,0,*) (0,0,1,*) (1,0,0,*) (1,0,1,*) (2,0,0,*) (2,0,1,*)	(0,0,0,*) (1,0,0,*) (2,0,0,*) (3,0,0,*) (4,0,0,*) (5,0,0,*)	(0,0,0,*) (1,0,0,*) (2,0,0,*) (3,0,0,*) (4,0,0,*) (5,0,0,*)	(0,0,0,*) (1,0,0,*) (2,0,0,*) (3,0,0,*) (4,0,0,*) (5,0,0,*)	(0,0,0,*) (0,0,1,*) (1,0,0,*) (1,0,1,*) (2,0,0,*) (2,0,1,*)
58	N/A	N/A	N/A	N/A	N/A	N/A	N/A
59	N/A	N/A	N/A	N/A	N/A	N/A	N/A
60	N/A	N/A	N/A	N/A	N/A	N/A	N/A
61	N/A	N/A	N/A	N/A	N/A	N/A	N/A
62	N/A	N/A	N/A	N/A	N/A	N/A	N/A
63	N/A	N/A	N/A	N/A	N/A	N/A	N/A

NOTE: \* UpPTS

## 5.7.2 Preamble sequence generation

The random access preambles are generated from Zadoff-Chu sequences with zero correlation zone, generated from one or several root Zadoff-Chu sequences. The network configures the set of preamble sequences the UE is allowed to use.

There are 64 preambles available in each cell. The set of 64 preamble sequences in a cell is found by including first, in the order of increasing cyclic shift, all the available cyclic shifts of a root Zadoff-Chu sequence with the logical index RACH\_ROOT\_SEQUENCE, where RACH\_ROOT\_SEQUENCE is broadcasted as part of the System Information. Additional preamble sequences, in case 64 preambles cannot be generated from a single root Zadoff-Chu sequence, are obtained from the root sequences with the consecutive logical indexes until all the 64 sequences are found. The logical root sequence order is cyclic: the logical index 0 is consecutive to 837. The relation between a logical root sequence index and physical root sequence index  $u$  is given by Tables 5.7.2-4 and 5.7.2-5 for preamble formats 0 – 3 and 4, respectively.

The  $u^{\text{th}}$  root Zadoff-Chu sequence is defined by

$$x_u(n) = e^{-j \frac{\pi u n(n+1)}{N_{ZC}}}, \quad 0 \leq n \leq N_{ZC} - 1$$

where the length  $N_{ZC}$  of the Zadoff-Chu sequence is given by Table 5.7.2-1. From the  $u^{\text{th}}$  root Zadoff-Chu sequence, random access preambles with zero correlation zones of length  $N_{CS} - 1$  are defined by cyclic shifts according to

$$x_{u,v}(n) = x_u((n + C_v) \bmod N_{ZC})$$

where the cyclic shift is given by

$$C_v = \begin{cases} vN_{CS} & v = 0, 1, \dots, \lfloor N_{ZC}/N_{CS} \rfloor - 1, N_{CS} \neq 0 & \text{for unrestricted sets} \\ 0 & N_{CS} = 0 & \text{for unrestricted sets} \\ d_{\text{start}} \lfloor v/n_{\text{shift}}^{\text{RA}} \rfloor + (v \bmod n_{\text{shift}}^{\text{RA}})N_{CS} & v = 0, 1, \dots, n_{\text{shift}}^{\text{RA}} n_{\text{group}}^{\text{RA}} + \bar{n}_{\text{shift}}^{\text{RA}} - 1 & \text{for restricted sets} \end{cases}$$

and  $N_{CS}$  is given by Tables 5.7.2-2 and 5.7.2-3 for preamble formats 0-3 and 4, respectively, where the parameter *zeroCorrelationZoneConfig* is provided by higher layers. The parameter *High-speed-flag* provided by higher layers determines if unrestricted set or restricted set shall be used.

The variable  $d_u$  is the cyclic shift corresponding to a Doppler shift of magnitude  $1/T_{\text{SEQ}}$  and is given by

$$d_u = \begin{cases} p & 0 \leq p < N_{ZC}/2 \\ N_{ZC} - p & \text{otherwise} \end{cases}$$

where  $p$  is the smallest non-negative integer that fulfils  $(pu) \bmod N_{ZC} = 1$ . The parameters for restricted sets of cyclic shifts depend on  $d_u$ . For  $N_{CS} \leq d_u < N_{ZC}/3$ , the parameters are given by

$$\begin{aligned} n_{\text{shift}}^{\text{RA}} &= \lfloor d_u / N_{CS} \rfloor \\ d_{\text{start}} &= 2d_u + n_{\text{shift}}^{\text{RA}} N_{CS} \\ n_{\text{group}}^{\text{RA}} &= \lfloor N_{ZC} / d_{\text{start}} \rfloor \\ \bar{n}_{\text{shift}}^{\text{RA}} &= \max\left(\lfloor (N_{ZC} - 2d_u - n_{\text{group}}^{\text{RA}} d_{\text{start}}) / N_{CS} \rfloor, 0\right) \end{aligned}$$

For  $N_{ZC}/3 \leq d_u \leq (N_{ZC} - N_{CS})/2$ , the parameters are given by

$$\begin{aligned} n_{\text{shift}}^{\text{RA}} &= \lfloor (N_{ZC} - 2d_u) / N_{CS} \rfloor \\ d_{\text{start}} &= N_{ZC} - 2d_u + n_{\text{shift}}^{\text{RA}} N_{CS} \\ n_{\text{group}}^{\text{RA}} &= \lfloor d_u / d_{\text{start}} \rfloor \\ \bar{n}_{\text{shift}}^{\text{RA}} &= \min\left(\max\left(\lfloor (d_u - n_{\text{group}}^{\text{RA}} d_{\text{start}}) / N_{CS} \rfloor, 0\right), n_{\text{shift}}^{\text{RA}}\right) \end{aligned}$$

For all other values of  $d_u$ , there are no cyclic shifts in the restricted set.

**Table 5.7.2-1: Random access preamble sequence length**

Preamble format	$N_{ZC}$
0 – 3	839
4	139

**Table 5.7.2-2:  $N_{CS}$  for preamble generation (preamble formats 0-3)**

<i>zeroCorrelationZoneConfig</i>	$N_{CS}$ value	
	Unrestricted set	Restricted set
0	0	15
1	13	18
2	15	22
3	18	26
4	22	32
5	26	38
6	32	46
7	38	55
8	46	68
9	59	82
10	76	100
11	93	128
12	119	158
13	167	202
14	279	237
15	419	-

**Table 5.7.2-3:  $N_{CS}$  for preamble generation (preamble format 4)**

<i>zeroCorrelationZoneConfig</i>	$N_{CS}$ value
0	2
1	4
2	6
3	8
4	10
5	12
6	15
7	N/A
8	N/A
9	N/A
10	N/A
11	N/A
12	N/A
13	N/A
14	N/A
15	N/A



Table 5.7.2-4: Root Zadoff-Chu sequence order for preamble formats 0 – 3

Logical root sequence number	Physical root sequence number $u$ (in increasing order of the corresponding logical sequence number)
0–23	129, 710, 140, 699, 120, 719, 210, 629, 168, 671, 84, 755, 105, 734, 93, 746, 70, 769, 60, 779 2, 837, 1, 838
24–29	56, 783, 112, 727, 148, 691
30–35	80, 759, 42, 797, 40, 799
36–41	35, 804, 73, 766, 146, 693
42–51	31, 808, 28, 811, 30, 809, 27, 812, 29, 810
52–63	24, 815, 48, 791, 68, 771, 74, 765, 178, 661, 136, 703
64–75	86, 753, 78, 761, 43, 796, 39, 800, 20, 819, 21, 818
76–89	95, 744, 202, 637, 190, 649, 181, 658, 137, 702, 125, 714, 151, 688
90–115	217, 622, 128, 711, 142, 697, 122, 717, 203, 636, 118, 721, 110, 729, 89, 750, 103, 736, 61, 778, 55, 784, 15, 824, 14, 825
116–135	12, 827, 23, 816, 34, 805, 37, 802, 46, 793, 207, 632, 179, 660, 145, 694, 130, 709, 223, 616
136–167	228, 611, 227, 612, 132, 707, 133, 706, 143, 696, 135, 704, 161, 678, 201, 638, 173, 666, 106, 733, 83, 756, 91, 748, 66, 773, 53, 786, 10, 829, 9, 830
168–203	7, 832, 8, 831, 16, 823, 47, 792, 64, 775, 57, 782, 104, 735, 101, 738, 108, 731, 208, 631, 184, 655, 197, 642, 191, 648, 121, 718, 141, 698, 149, 690, 216, 623, 218, 621
204–263	152, 687, 144, 695, 134, 705, 138, 701, 199, 640, 162, 677, 176, 663, 119, 720, 158, 681, 164, 675, 174, 665, 171, 668, 170, 669, 87, 752, 169, 670, 88, 751, 107, 732, 81, 758, 82, 757, 100, 739, 98, 741, 71, 768, 59, 780, 65, 774, 50, 789, 49, 790, 26, 813, 17, 822, 13, 826, 6, 833
264–327	5, 834, 33, 806, 51, 788, 75, 764, 99, 740, 96, 743, 97, 742, 166, 673, 172, 667, 175, 664, 187, 652, 163, 676, 185, 654, 200, 639, 114, 725, 189, 650, 115, 724, 194, 645, 195, 644, 192, 647, 182, 657, 157, 682, 156, 683, 211, 628, 154, 685, 123, 716, 139, 700, 212, 627, 153, 686, 213, 626, 215, 624, 150, 689
328–383	225, 614, 224, 615, 221, 618, 220, 619, 127, 712, 147, 692, 124, 715, 193, 646, 205, 634, 206, 633, 116, 723, 160, 679, 186, 653, 167, 672, 79, 760, 85, 754, 77, 762, 92, 747, 58, 781, 62, 777, 69, 770, 54, 785, 36, 803, 32, 807, 25, 814, 18, 821, 11, 828, 4, 835
384–455	3, 836, 19, 820, 22, 817, 41, 798, 38, 801, 44, 795, 52, 787, 45, 794, 63, 776, 67, 772, 72 767, 76, 763, 94, 745, 102, 737, 90, 749, 109, 730, 165, 674, 111, 728, 209, 630, 204, 635, 117, 722, 188, 651, 159, 680, 198, 641, 113, 726, 183, 656, 180, 659, 177, 662, 196, 643, 155, 684, 214, 625, 126, 713, 131, 708, 219, 620, 222, 617, 226, 613
456–513	230, 609, 232, 607, 262, 577, 252, 587, 418, 421, 416, 423, 413, 426, 411, 428, 376, 463, 395, 444, 283, 556, 285, 554, 379, 460, 390, 449, 363, 476, 384, 455, 388, 451, 386, 453, 361, 478, 387, 452, 360, 479, 310, 529, 354, 485, 328, 511, 315, 524, 337, 502, 349, 490, 335, 504, 324, 515
514–561	323, 516, 320, 519, 334, 505, 359, 480, 295, 544, 385, 454, 292, 547, 291, 548, 381, 458, 399, 440, 380, 459, 397, 442, 369, 470, 377, 462, 410, 429, 407, 432, 281, 558, 414, 425, 247, 592, 277, 562, 271, 568, 272, 567, 264, 575, 259, 580
562–629	237, 602, 239, 600, 244, 595, 243, 596, 275, 564, 278, 561, 250, 589, 246, 593, 417, 422, 248, 591, 394, 445, 393, 446, 370, 469, 365, 474, 300, 539, 299, 540, 364, 475, 362, 477, 298, 541, 312, 527, 313, 526, 314, 525, 353, 486, 352, 487, 343, 496, 327, 512, 350, 489, 326, 513, 319, 520, 332, 507, 333, 506, 348, 491, 347, 492, 322, 517
630–659	330, 509, 338, 501, 341, 498, 340, 499, 342, 497, 301, 538, 366, 473, 401, 438, 371, 468, 408, 431, 375, 464, 249, 590, 269, 570, 238, 601, 234, 605
660–707	257, 582, 273, 566, 255, 584, 254, 585, 245, 594, 251, 588, 412, 427, 372, 467, 282, 557, 403, 436, 396, 443, 392, 447, 391, 448, 382, 457, 389, 450, 294, 545, 297, 542, 311, 528, 344, 495, 345, 494, 318, 521, 331, 508, 325, 514, 321, 518
708–729	346, 493, 339, 500, 351, 488, 306, 533, 289, 550, 400, 439, 378, 461, 374, 465, 415, 424, 270, 569, 241, 598
730–751	231, 608, 260, 579, 268, 571, 276, 563, 409, 430, 398, 441, 290, 549, 304, 535, 308, 531, 358, 481, 316, 523
752–765	293, 546, 288, 551, 284, 555, 368, 471, 253, 586, 256, 583, 263, 576
766–777	242, 597, 274, 565, 402, 437, 383, 456, 357, 482, 329, 510
778–789	317, 522, 307, 532, 286, 553, 287, 552, 266, 573, 261, 578
790–795	236, 603, 303, 536, 356, 483
796–803	355, 484, 405, 434, 404, 435, 406, 433
804–809	235, 604, 267, 572, 302, 537
810–815	309, 530, 265, 574, 233, 606
816–819	367, 472, 296, 543
820–837	336, 503, 305, 534, 373, 466, 280, 559, 279, 560, 419, 420, 240, 599, 258, 581, 229, 610

**Table 5.7.2-5: Root Zadoff-Chu sequence order for preamble format 4**

Logical root sequence number	Physical root sequence number $u$ (in increasing order of the corresponding logical sequence number)																			
	0 – 19	1	138	2	137	3	136	4	135	5	134	6	133	7	132	8	131	9	130	10
20 – 39	11	128	12	127	13	126	14	125	15	124	16	123	17	122	18	121	19	120	20	119
40 – 59	21	118	22	117	23	116	24	115	25	114	26	113	27	112	28	111	29	110	30	109
60 – 79	31	108	32	107	33	106	34	105	35	104	36	103	37	102	38	101	39	100	40	99
80 – 99	41	98	42	97	43	96	44	95	45	94	46	93	47	92	48	91	49	90	50	89
100 – 119	51	88	52	87	53	86	54	85	55	84	56	83	57	82	58	81	59	80	60	79
120 – 137	61	78	62	77	63	76	64	75	65	74	66	73	67	72	68	71	69	70	-	-
138 – 837	N/A																			

### 5.7.3 Baseband signal generation

The time-continuous random access signal  $s(t)$  is defined by

$$s(t) = \beta_{\text{PRACH}} \sum_{k=0}^{N_{\text{ZC}}-1} \sum_{n=0}^{N_{\text{ZC}}-1} x_{u,v}(n) \cdot e^{-j \frac{2\pi n k}{N_{\text{ZC}}}} \cdot e^{j 2\pi (k + \varphi + K(k_0 + \frac{1}{2})) \Delta f_{\text{RA}} (t - T_{\text{CP}})}$$

where  $0 \leq t < T_{\text{SEQ}} + T_{\text{CP}}$ ,  $\beta_{\text{PRACH}}$  is an amplitude scaling factor in order to conform to the transmit power  $P_{\text{PRACH}}$  specified in clause 6.1 in 3GPP TS 36.213 [4], and  $k_0 = n_{\text{PRB}}^{\text{RA}} N_{\text{sc}}^{\text{RB}} - N_{\text{RB}}^{\text{UL}} N_{\text{sc}}^{\text{RB}} / 2$ . The location in the frequency domain is controlled by the parameter  $n_{\text{PRB}}^{\text{RA}}$  is derived from clause 5.7.1. The factor  $K = \Delta f / \Delta f_{\text{RA}}$  accounts for the difference in subcarrier spacing between the random access preamble and uplink data transmission. The variable  $\Delta f_{\text{RA}}$ , the subcarrier spacing for the random access preamble, and the variable  $\varphi$ , a fixed offset determining the frequency-domain location of the random access preamble within the physical resource blocks, are both given by Table 5.7.3-1.

**Table 5.7.3-1: Random access baseband parameters**

Preamble format	$\Delta f_{\text{RA}}$	$\varphi$
0 – 3	1250 Hz	7
4	7500 Hz	2

## 5.8 Modulation and upconversion

Modulation and upconversion to the carrier frequency of the complex-valued SC-FDMA baseband signal for each antenna port or the complex-valued PRACH baseband signal is shown in Figure 5.8-1. The filtering required prior to transmission is defined by the requirements in 3GPP TS 36.101 [7].

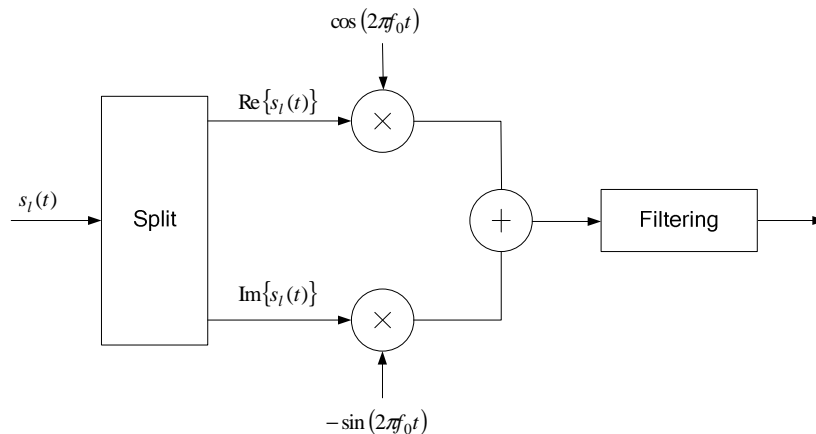

Figure 5.8-1: Uplink modulation

---

## 6 Downlink

### 6.1 Overview

The smallest time-frequency unit for downlink transmission is denoted a resource element and is defined in clause 6.2.2.

A subset of the downlink subframes in a radio frame on a carrier supporting PDSCH transmission can be configured as MBSFN subframes by higher layers. Each MBSFN subframe is divided into a non-MBSFN region and an MBSFN region.

- The non-MBSFN region spans the first one or two OFDM symbols in an MBSFN subframe where the length of the non-MBSFN region is given according to Subclause 6.7.
- The MBSFN region in an MBSFN subframe is defined as the OFDM symbols not used for the non-MBSFN region.

For frame structure type 3, MBSFN configuration shall not be applied to downlink subframes in which at least one OFDM symbol is not occupied or discovery signal is transmitted.

Unless otherwise specified, transmission in each downlink subframe shall use the same cyclic prefix length as used for downlink subframe #0.

#### 6.1.1 Physical channels

A downlink physical channel corresponds to a set of resource elements carrying information originating from higher layers and is the interface defined between 3GPP TS 36.212 [3] and the present document 3GPP TS 36.211.

The following downlink physical channels are defined:

- Physical Downlink Shared Channel, PDSCH

- Physical Broadcast Channel, PBCH
- Physical Multicast Channel, PMCH
- Physical Control Format Indicator Channel, PCFICH
- Physical Downlink Control Channel, PDCCH
- Physical Hybrid ARQ Indicator Channel, PHICH
- Enhanced Physical Downlink Control Channel, EPDCCH
- MTC Physical Downlink Control Channel, MPDCCH

## 6.1.2 Physical signals

A downlink physical signal corresponds to a set of resource elements used by the physical layer but does not carry information originating from higher layers. The following downlink physical signals are defined:

- Reference signal
- Synchronization signal
- Discovery signal

## 6.2 Slot structure and physical resource elements

### 6.2.1 Resource grid

The transmitted signal in each slot is described by one or several resource grids of  $N_{RB}^{DL} N_{sc}^{RB}$  subcarriers and  $N_{symb}^{DL}$  OFDM symbols. The resource grid structure is illustrated in Figure 6.2.2-1. The quantity  $N_{RB}^{DL}$  depends on the downlink transmission bandwidth configured in the cell and shall fulfil

$$N_{RB}^{min,DL} \leq N_{RB}^{DL} \leq N_{RB}^{max,DL}$$

where  $N_{RB}^{min,DL} = 6$  and  $N_{RB}^{max,DL} = 110$  are the smallest and largest downlink bandwidths, respectively, supported by the current version of this specification.

The set of allowed values for  $N_{RB}^{DL}$  is given by 3GPP TS 36.104 [6]. The number of OFDM symbols in a slot depends on the cyclic prefix length and subcarrier spacing configured and is given in Table 6.2.3-1.

An antenna port is defined such that the channel over which a symbol on the antenna port is conveyed can be inferred from the channel over which another symbol on the same antenna port is conveyed. For MBSFN reference signals, positioning reference signals, UE-specific reference signals associated with PDSCH and demodulation reference signals associated with EPDCCH, there are limits given below within which the channel can be inferred from one symbol to another symbol on the same antenna port. There is one resource grid per antenna port. The set of antenna ports supported depends on the reference signal configuration in the cell:

- Cell-specific reference signals support a configuration of one, two, or four antenna ports and are transmitted on antenna ports  $p = 0$ ,  $p \in \{0,1\}$ , and  $p \in \{0,1,2,3\}$ , respectively.
- MBSFN reference signals are transmitted on antenna port  $p = 4$ . The channel over which a symbol on antenna port  $p = 4$  is conveyed can be inferred from the channel over which another symbol on the same antenna port is conveyed only if the two symbols correspond to subframes of the same MBSFN area.
- UE-specific reference signals associated with PDSCH are transmitted on antenna port(s)  $p = 5$ ,  $p = 7$ ,  $p = 8$ , or one or several of  $p \in \{7,8,9,10,11,12,13,14\}$ . The channel over which a symbol on one of these antenna ports is conveyed can be inferred from the channel over which another symbol on the same antenna port is conveyed

only if the two symbols are within the same subframe and in the same PRG when PRB bundling is used or in the same PRB pair when PRB bundling is not used.

- Demodulation reference signals associated with EPDCCH are transmitted on one or several of  $p \in \{107,108,109,110\}$ . The channel over which a symbol on one of these antenna ports is conveyed can be inferred from the channel over which another symbol on the same antenna port is conveyed only if the two symbols are in the same PRB pair.
- Positioning reference signals are transmitted on antenna port  $p = 6$ . The channel over which a symbol on antenna port  $p = 6$  is conveyed can be inferred from the channel over which another symbol on the same antenna port is conveyed only within one positioning reference signal occasion consisting of  $N_{\text{PRS}}$  consecutive downlink subframes, where  $N_{\text{PRS}}$  is configured by higher layers.
- CSI reference signals support a configuration of one, two, four, eight, twelve, or sixteen antenna ports and are transmitted on antenna ports  $p = 15$ ,  $p = 15,16$ ,  $p = 15,\dots,18$ ,  $p = 15,\dots,22$ ,  $p = 15,\dots,26$  and  $p = 15,\dots,30$ , respectively.

Two antenna ports are said to be quasi co-located if the large-scale properties of the channel over which a symbol on one antenna port is conveyed can be inferred from the channel over which a symbol on the other antenna port is conveyed. The large-scale properties include one or more of delay spread, Doppler spread, Doppler shift, average gain, and average delay.

## 6.2.2 Resource elements

Each element in the resource grid for antenna port  $p$  is called a resource element and is uniquely identified by the index pair  $(k, l)$  in a slot where  $k = 0, \dots, N_{\text{RB}}^{\text{DL}} N_{\text{sc}}^{\text{RB}} - 1$  and  $l = 0, \dots, N_{\text{ymb}}^{\text{DL}} - 1$  are the indices in the frequency and time domains, respectively. Resource element  $(k, l)$  on antenna port  $p$  corresponds to the complex value  $a_{k,l}^{(p)}$ .

When there is no risk for confusion, or no particular antenna port is specified, the index  $p$  may be dropped.

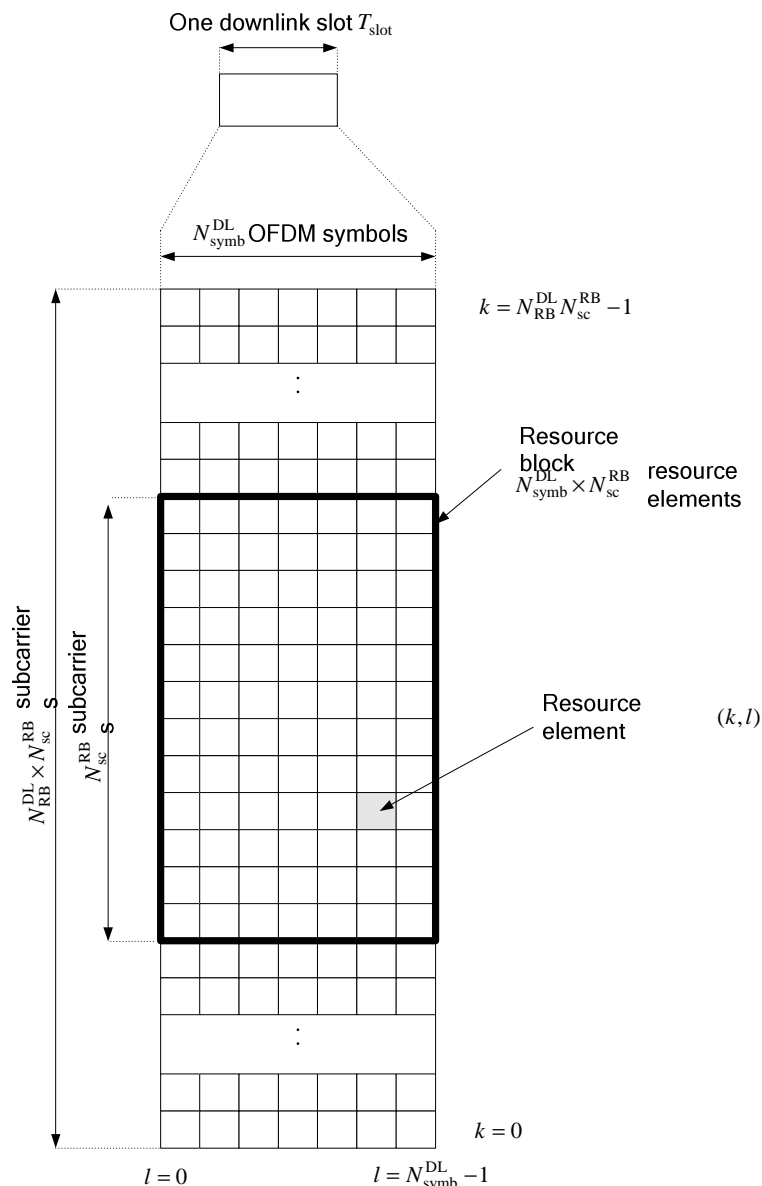

Figure 6.2.2-1: Downlink resource grid

### 6.2.3 Resource blocks

Resource blocks are used to describe the mapping of certain physical channels to resource elements. Physical and virtual resource blocks are defined.

A physical resource block is defined as  $N_{symb}^{DL}$  consecutive OFDM symbols in the time domain and  $N_{sc}^{RB}$  consecutive subcarriers in the frequency domain, where  $N_{symb}^{DL}$  and  $N_{sc}^{RB}$  are given by Table 6.2.3-1. A physical resource block thus consists of  $N_{symb}^{DL} \times N_{sc}^{RB}$  resource elements, corresponding to one slot in the time domain and 180 kHz in the frequency domain.

Physical resource blocks are numbered from 0 to  $N_{RB}^{DL} - 1$  in the frequency domain. The relation between the physical resource block number  $n_{PRB}$  in the frequency domain and resource elements  $(k, l)$  in a slot is given by

$$n_{PRB} = \left\lfloor \frac{k}{N_{sc}^{RB}} \right\rfloor$$

**Table 6.2.3-1: Physical resource blocks parameters**

Configuration		$N_{sc}^{RB}$	$N_{symbol}^{DL}$
Normal cyclic prefix	$\Delta f = 15$ kHz	12	7
Extended cyclic prefix	$\Delta f = 15$ kHz		6
		$\Delta f = 7.5$ kHz	24

A physical resource-block pair is defined as the two physical resource blocks in one subframe having the same physical resource-block number  $n_{PRB}$ .

A virtual resource block is of the same size as a physical resource block. Two types of virtual resource blocks are defined:

- Virtual resource blocks of localized type
- Virtual resource blocks of distributed type

For each type of virtual resource blocks, a pair of virtual resource blocks over two slots in a subframe is assigned together by a single virtual resource block number,  $n_{VRB}$ .

### 6.2.3.1 Virtual resource blocks of localized type

Virtual resource blocks of localized type are mapped directly to physical resource blocks such that virtual resource block  $n_{VRB}$  corresponds to physical resource block  $n_{PRB} = n_{VRB}$ . Virtual resource blocks are numbered from 0 to  $N_{VRB}^{DL} - 1$ , where  $N_{VRB}^{DL} = N_{RB}^{DL}$ .

### 6.2.3.2 Virtual resource blocks of distributed type

Virtual resource blocks of distributed type are mapped to physical resource blocks as described below.

**Table 6.2.3.2-1: RB gap values**

System BW ( $N_{RB}^{DL}$ )	Gap ( $N_{gap}$ )	
	1 <sup>st</sup> Gap ( $N_{gap,1}$ )	2 <sup>nd</sup> Gap ( $N_{gap,2}$ )
6-10	$\lceil N_{RB}^{DL} / 2 \rceil$	N/A
11	4	N/A
12-19	8	N/A
20-26	12	N/A
27-44	18	N/A
45-49	27	N/A
50-63	27	9
64-79	32	16
80-110	48	16

The parameter  $N_{gap}$  is given by Table 6.2.3.2-1. For  $6 \leq N_{RB}^{DL} \leq 49$ , only one gap value  $N_{gap,1}$  is defined and  $N_{gap} = N_{gap,1}$ . For  $50 \leq N_{RB}^{DL} \leq 110$ , two gap values  $N_{gap,1}$  and  $N_{gap,2}$  are defined. Whether  $N_{gap} = N_{gap,1}$  or  $N_{gap} = N_{gap,2}$  is signaled as part of the downlink scheduling assignment as described in 3GPP TS 36.212 [3].

Virtual resource blocks of distributed type are numbered from 0 to  $N_{VRB}^{DL} - 1$ , where

$$N_{VRB}^{DL} = N_{VRB,gap1}^{DL} = 2 \cdot \min(N_{gap}, N_{RB}^{DL} - N_{gap}) \text{ for } N_{gap} = N_{gap,1} \text{ and } N_{VRB}^{DL} = N_{VRB,gap2}^{DL} = \lfloor N_{RB}^{DL} / 2N_{gap} \rfloor \cdot 2N_{gap} \text{ for } N_{gap} = N_{gap,2}.$$

Consecutive  $\tilde{N}_{\text{VRB}}^{\text{DL}}$  VRB numbers compose a unit of VRB number interleaving, where  $\tilde{N}_{\text{VRB}}^{\text{DL}} = N_{\text{VRB}}^{\text{DL}}$  for  $N_{\text{gap}} = N_{\text{gap},1}$  and  $\tilde{N}_{\text{VRB}}^{\text{DL}} = 2N_{\text{gap}}$  for  $N_{\text{gap}} = N_{\text{gap},2}$ . Interleaving of VRB numbers of each interleaving unit is performed with 4 columns and  $N_{\text{row}}$  rows, where  $N_{\text{row}} = \lceil \tilde{N}_{\text{VRB}}^{\text{DL}} / (4P) \rceil \cdot P$ , and  $P$  is RBG size as described in 3GPP TS 36.213 [4]. VRB numbers are written row by row in the rectangular matrix, and read out column by column.  $N_{\text{null}}$  nulls are inserted in the last  $N_{\text{null}} / 2$  rows of the 2<sup>nd</sup> and 4<sup>th</sup> column, where  $N_{\text{null}} = 4N_{\text{row}} - \tilde{N}_{\text{VRB}}^{\text{DL}}$ . Nulls are ignored when reading out. The VRB numbers mapping to PRB numbers including interleaving is derived as follows:

For even slot number  $n_s$  ;

$$\tilde{n}_{\text{PRB}}(n_s) = \begin{cases} \tilde{n}'_{\text{PRB}} - N_{\text{row}} & , N_{\text{null}} \neq 0 \text{ and } \tilde{n}_{\text{VRB}} \geq \tilde{N}_{\text{VRB}}^{\text{DL}} - N_{\text{null}} \text{ and } \tilde{n}_{\text{VRB}} \bmod 2 = 1 \\ \tilde{n}'_{\text{PRB}} - N_{\text{row}} + N_{\text{null}} / 2 & , N_{\text{null}} \neq 0 \text{ and } \tilde{n}_{\text{VRB}} \geq \tilde{N}_{\text{VRB}}^{\text{DL}} - N_{\text{null}} \text{ and } \tilde{n}_{\text{VRB}} \bmod 2 = 0 \\ \tilde{n}''_{\text{PRB}} - N_{\text{null}} / 2 & , N_{\text{null}} \neq 0 \text{ and } \tilde{n}_{\text{VRB}} < \tilde{N}_{\text{VRB}}^{\text{DL}} - N_{\text{null}} \text{ and } \tilde{n}_{\text{VRB}} \bmod 4 \geq 2 \\ \tilde{n}''_{\text{PRB}} & , \text{otherwise} \end{cases}$$

$$\text{where } \tilde{n}'_{\text{PRB}} = 2N_{\text{row}} \cdot (\tilde{n}_{\text{VRB}} \bmod 2) + \lfloor \tilde{n}_{\text{VRB}} / 2 \rfloor + \tilde{N}_{\text{VRB}}^{\text{DL}} \cdot \lfloor n_{\text{VRB}} / \tilde{N}_{\text{VRB}}^{\text{DL}} \rfloor,$$

$$\text{and } \tilde{n}''_{\text{PRB}} = N_{\text{row}} \cdot (\tilde{n}_{\text{VRB}} \bmod 4) + \lfloor \tilde{n}_{\text{VRB}} / 4 \rfloor + \tilde{N}_{\text{VRB}}^{\text{DL}} \cdot \lfloor n_{\text{VRB}} / \tilde{N}_{\text{VRB}}^{\text{DL}} \rfloor,$$

where  $\tilde{n}_{\text{VRB}} = n_{\text{VRB}} \bmod \tilde{N}_{\text{VRB}}^{\text{DL}}$  and  $n_{\text{VRB}}$  is obtained from the downlink scheduling assignment as described in 3GPP TS 36.213 [4].

For odd slot number  $n_s$  ;

$$\tilde{n}_{\text{PRB}}(n_s) = (\tilde{n}_{\text{PRB}}(n_s - 1) + \tilde{N}_{\text{VRB}}^{\text{DL}} / 2) \bmod \tilde{N}_{\text{VRB}}^{\text{DL}} + \tilde{N}_{\text{VRB}}^{\text{DL}} \cdot \lfloor n_{\text{VRB}} / \tilde{N}_{\text{VRB}}^{\text{DL}} \rfloor$$

Then, for all  $n_s$  ;

$$n_{\text{PRB}}(n_s) = \begin{cases} \tilde{n}_{\text{PRB}}(n_s), & \tilde{n}_{\text{PRB}}(n_s) < \tilde{N}_{\text{VRB}}^{\text{DL}} / 2 \\ \tilde{n}_{\text{PRB}}(n_s) + N_{\text{gap}} - \tilde{N}_{\text{VRB}}^{\text{DL}} / 2, & \tilde{n}_{\text{PRB}}(n_s) \geq \tilde{N}_{\text{VRB}}^{\text{DL}} / 2 \end{cases}$$

Virtual resource blocks of distributed type are not applicable to BL/CE UEs.

## 6.2.4 Resource-element groups

Resource-element groups are used for defining the mapping of control channels to resource elements.

A resource-element group is represented by the index pair  $(k', l')$  of the resource element with the lowest index  $k$  in the group with all resource elements in the group having the same value of  $l$ . The set of resource elements  $(k, l)$  in a resource-element group depends on the number of cell-specific reference signals configured as described below with  $k_0 = n_{\text{PRB}} \cdot N_{\text{sc}}^{\text{RB}}$ ,  $0 \leq n_{\text{PRB}} < N_{\text{RB}}^{\text{DL}}$ .

- In the first OFDM symbol of the first slot in a subframe the two resource-element groups in physical resource block  $n_{\text{PRB}}$  consist of resource elements  $(k, l = 0)$  with  $k = k_0 + 0, k_0 + 1, \dots, k_0 + 5$  and  $k = k_0 + 6, k_0 + 7, \dots, k_0 + 11$ , respectively.
- In the second OFDM symbol of the first slot in a subframe in case of one or two cell-specific reference signals configured, the three resource-element groups in physical resource block  $n_{\text{PRB}}$  consist of resource elements  $(k, l = 1)$  with  $k = k_0 + 0, k_0 + 1, \dots, k_0 + 3$ ,  $k = k_0 + 4, k_0 + 5, \dots, k_0 + 7$  and  $k = k_0 + 8, k_0 + 9, \dots, k_0 + 11$ , respectively.
- In the second OFDM symbol of the first slot in a subframe in case of four cell-specific reference signals configured, the two resource-element groups in physical resource block  $n_{\text{PRB}}$  consist of resource elements  $(k, l = 1)$  with  $k = k_0 + 0, k_0 + 1, \dots, k_0 + 5$  and  $k = k_0 + 6, k_0 + 7, \dots, k_0 + 11$ , respectively.



- In the third OFDM symbol of the first slot in a subframe, the three resource-element groups in physical resource block  $n_{\text{PRB}}$  consist of resource elements  $(k, l = 2)$  with  $k = k_0 + 0, k_0 + 1, \dots, k_0 + 3$ ,  $k = k_0 + 4, k_0 + 5, \dots, k_0 + 7$  and  $k = k_0 + 8, k_0 + 9, \dots, k_0 + 11$ , respectively.
- In the fourth OFDM symbol of the first slot in a subframe in case of normal cyclic prefix, the three resource-element groups in physical resource block  $n_{\text{PRB}}$  consist of resource elements  $(k, l = 3)$  with  $k = k_0 + 0, k_0 + 1, \dots, k_0 + 3$ ,  $k = k_0 + 4, k_0 + 5, \dots, k_0 + 7$  and  $k = k_0 + 8, k_0 + 9, \dots, k_0 + 11$ , respectively.
- In the fourth OFDM symbol of the first slot in a subframe in case of extended cyclic prefix, the two resource-element groups in physical resource block  $n_{\text{PRB}}$  consist of resource elements  $(k, l = 3)$  with  $k = k_0 + 0, k_0 + 1, \dots, k_0 + 5$  and  $k = k_0 + 6, k_0 + 7, \dots, k_0 + 11$ , respectively.

Mapping of a symbol-quadruplet  $\langle z(i), z(i+1), z(i+2), z(i+3) \rangle$  onto a resource-element group represented by resource-element  $(k', l')$  is defined such that elements  $z(i)$  are mapped to resource elements  $(k, l)$  of the resource-element group not used for cell-specific reference signals in increasing order of  $i$  and  $k$ . In case a single cell-specific reference signal is configured, cell-specific reference signals shall be assumed to be present on antenna ports 0 and 1 for the purpose of mapping a symbol-quadruplet to a resource-element group, otherwise the number of cell-specific reference signals shall be assumed equal to the actual number of antenna ports used for cell-specific reference signals. The UE shall not make any assumptions about resource elements assumed to be reserved for reference signals but not used for transmission of a reference signal.

For frame structure type 3, if the higher layer parameter *subframeStartPosition* indicates "s07" and the downlink transmission starts in the second slot of a subframe, the above definition applies to the second slot of that subframe instead of the first slot.

## 6.2.4A Enhanced Resource-Element Groups (EREGs)

EREGs are used for defining the mapping of enhanced control channels to resource elements.

There are 16 EREGs, numbered from 0 to 15, per physical resource block pair. Number all resource elements, except resource elements carrying DM-RS for antenna ports  $p = \{107, 108, 109, 110\}$  for normal cyclic prefix or  $p = \{107, 108\}$  for extended cyclic prefix, in a physical resource-block pair cyclically from 0 to 15 in an increasing order of first frequency, then time. All resource elements with number  $i$  in that physical resource-block pair constitutes EREG number  $i$ .

For frame structure type 3, if the higher layer parameter *subframeStartPosition* indicates "s07" and the downlink transmission starts in the second slot of a subframe, the above definition applies to the second slot of that subframe instead of the first slot.

## 6.2.5 Guard period for half-duplex FDD operation

For type A half-duplex FDD operation, a guard period is created by the UE by

- not receiving the last part of a downlink subframe immediately preceding an uplink subframe from the same UE.

For type B half-duplex FDD operation, guard periods, each referred to as a half-duplex guard subframe, are created by the UE by

- not receiving a downlink subframe immediately preceding an uplink subframe from the same UE, and
- not receiving a downlink subframe immediately following an uplink subframe from the same UE.

## 6.2.6 Guard Period for TDD Operation

For frame structure type 2, the GP field in Figure 4.2-1 serves as a guard period.

## 6.2.7 Narrowbands

A narrowband is defined as six non-overlapping consecutive physical resource blocks in the frequency domain. The total number of downlink narrowbands in the downlink transmission bandwidth configured in the cell is given by

$$N_{\text{NB}}^{\text{DL}} = \left\lfloor \frac{N_{\text{RB}}^{\text{DL}}}{6} \right\rfloor$$

The narrowbands are numbered  $n_{\text{NB}} = 0, \dots, N_{\text{NB}}^{\text{DL}} - 1$  in order of increasing physical resource-block number where narrowband  $n_{\text{NB}}$  is composed of physical resource-block indices

$$\begin{cases} 6n_{\text{NB}} + i_0 + i & \text{if } N_{\text{RB}}^{\text{DL}} \bmod 2 = 0 \\ 6n_{\text{NB}} + i_0 + i & \text{if } N_{\text{RB}}^{\text{DL}} \bmod 2 = 1 \text{ and } n_{\text{NB}} < N_{\text{NB}}^{\text{DL}}/2 \\ 6n_{\text{NB}} + i_0 + i + 1 & \text{if } N_{\text{RB}}^{\text{DL}} \bmod 2 = 1 \text{ and } n_{\text{NB}} \geq N_{\text{NB}}^{\text{DL}}/2 \end{cases}$$

where

$$i = 0, 1, \dots, 5$$

$$i_0 = \left\lfloor \frac{N_{\text{RB}}^{\text{DL}}}{2} \right\rfloor - \frac{6N_{\text{NB}}^{\text{DL}}}{2}$$

## 6.2.8 Guard period for narrowband retuning

For BL/CE UEs, a guard period is created by the UE not receiving at most the first two OFDM symbols in the second narrowband when

- the UE retunes from a first downlink narrowband to a second downlink narrowband with a different center frequency, or
- the UE retunes from a first uplink narrowband to a second downlink narrowband with a different center frequency for frame structure type 2.

## 6.3 General structure for downlink physical channels

This clause describes a general structure, applicable to more than one physical channel.

The baseband signal representing a downlink physical channel is defined in terms of the following steps:

- scrambling of coded bits in each of the codewords to be transmitted on a physical channel
- modulation of scrambled bits to generate complex-valued modulation symbols
- mapping of the complex-valued modulation symbols onto one or several transmission layers
- precoding of the complex-valued modulation symbols on each layer for transmission on the antenna ports
- mapping of complex-valued modulation symbols for each antenna port to resource elements
- generation of complex-valued time-domain OFDM signal for each antenna port

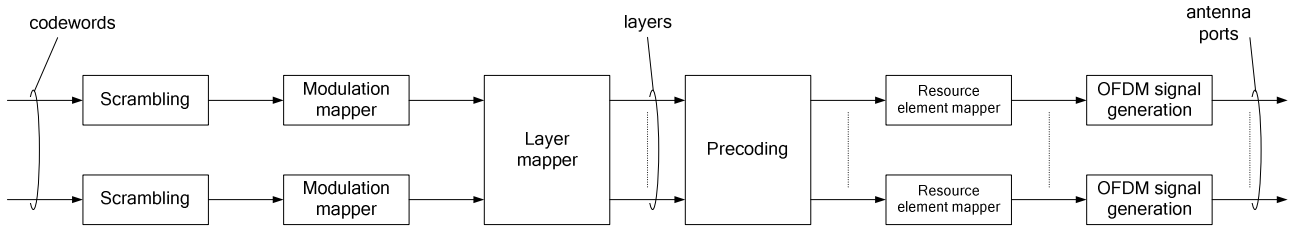

Figure 6.3-1: Overview of physical channel processing

### 6.3.1 Scrambling

For each codeword  $q$ , the block of bits  $b^{(q)}(0), \dots, b^{(q)}(M_{\text{bit}}^{(q)} - 1)$ , where  $M_{\text{bit}}^{(q)}$  is the number of bits in codeword  $q$  transmitted on the physical channel in one subframe, shall be scrambled prior to modulation, resulting in a block of scrambled bits  $\tilde{b}^{(q)}(0), \dots, \tilde{b}^{(q)}(M_{\text{bit}}^{(q)} - 1)$  according to

$$\tilde{b}^{(q)}(i) = (b^{(q)}(i) + c^{(q)}(i)) \bmod 2$$

where the scrambling sequence  $c^{(q)}(i)$  is given by clause 7.2. The scrambling sequence generator shall be initialised at the start of each subframe, where the initialisation value of  $c_{\text{init}}$  depends on the transport channel type according to

$$c_{\text{init}} = \begin{cases} n_{\text{RNTI}} \cdot 2^{14} + q \cdot 2^{13} + \lfloor n_s/2 \rfloor \cdot 2^9 + N_{\text{ID}}^{\text{cell}} & \text{for PDSCH} \\ \lfloor n_s/2 \rfloor \cdot 2^9 + N_{\text{ID}}^{\text{MBSFN}} & \text{for PMCH} \end{cases}$$

where  $n_{\text{RNTI}}$  corresponds to the RNTI associated with the PDSCH transmission as described in clause 7.1 3GPP TS 36.213 [4].

For BL/CE UEs, the same scrambling sequence is applied per subframe to PDSCH for a given block of  $N_{\text{acc}}$  subframes. For the  $j^{\text{th}}$  block of  $N_{\text{acc}}$  subframes, the scrambling sequence generator shall be initialised with

$$c_{\text{init}} = n_{\text{RNTI}} \cdot 2^{14} + q \cdot 2^{13} + [(j_0 + j)N_{\text{acc}} \bmod 10] \cdot 2^9 + N_{\text{ID}}^{\text{cell}}$$

where

$$j = 0, 1, \dots, \left\lfloor \frac{i_0 + N_{\text{abs}}^{\text{PDSCH}} + i_{\Delta} - 1}{N_{\text{acc}}} \right\rfloor - j_0$$

$$j_0 = \lfloor (i_0 + i_{\Delta}) / N_{\text{acc}} \rfloor$$

$$i_{\Delta} = \begin{cases} 0, & \text{for frame structure type 1 or } N_{\text{acc}} = 1 \\ N_{\text{acc}} - 2, & \text{for frame structure type 2 and } N_{\text{acc}} = 10 \end{cases}$$

and  $i_0$  is the absolute subframe number of the first downlink subframe intended for PDSCH. The PDSCH transmission spans  $N_{\text{abs}}^{\text{PDSCH}}$  consecutive subframes including invalid subframes where the PDSCH transmission is postponed.

For BL/CE UEs,

- if the PDSCH is carrying SIB1-BR
  - $N_{\text{acc}} = 1$
- else if the PDSCH is carrying SI message (except for SIB1-BR) or if the PDSCH transmission is associated with P-RNTI:
  - $N_{\text{acc}} = 4$  for frame structure type 1 and  $N_{\text{acc}} = 10$  for frame structure type 2

- otherwise
  - $N_{\text{acc}} = 1$  for UEs assuming CEModeA (according to the definition in section 12 of [4]) or configured with CEModeA
  - $N_{\text{acc}} = 4$  for frame structure type 1 and  $N_{\text{acc}} = 10$  for frame structure type 2 for UEs assuming CEModeB (according to the definition in section 12 of [4]) or configured with CEModeB

Up to two codewords can be transmitted in one subframe, i.e.,  $q \in \{0,1\}$ . In the case of single codeword transmission,  $q$  is equal to zero.

## 6.3.2 Modulation

For each codeword  $q$ , the block of scrambled bits  $\tilde{b}^{(q)}(0), \dots, \tilde{b}^{(q)}(M_{\text{bit}}^{(q)} - 1)$  shall be modulated as described in clause 7.1 using one of the modulation schemes in Table 6.3.2-1, resulting in a block of complex-valued modulation symbols  $d^{(q)}(0), \dots, d^{(q)}(M_{\text{symp}}^{(q)} - 1)$ .

**Table 6.3.2-1: Modulation schemes**

Physical channel	Modulation schemes
PDSCH	QPSK, 16QAM, 64QAM, 256QAM
PMCH	QPSK, 16QAM, 64QAM, 256QAM

## 6.3.3 Layer mapping

The complex-valued modulation symbols for each of the codewords to be transmitted are mapped onto one or several layers. Complex-valued modulation symbols  $d^{(q)}(0), \dots, d^{(q)}(M_{\text{symp}}^{(q)} - 1)$  for codeword  $q$  shall be mapped onto the layers  $x(i) = [x^{(0)}(i) \ \dots \ x^{(v-1)}(i)]^T$ ,  $i = 0, 1, \dots, M_{\text{symp}}^{\text{layer}} - 1$  where  $v$  is the number of layers and  $M_{\text{symp}}^{\text{layer}}$  is the number of modulation symbols per layer.

### 6.3.3.1 Layer mapping for transmission on a single antenna port

For transmission on a single antenna port, a single layer is used,  $v = 1$ , and the mapping is defined by

$$x^{(0)}(i) = d^{(0)}(i)$$

with  $M_{\text{symp}}^{\text{layer}} = M_{\text{symp}}^{(0)}$ .

### 6.3.3.2 Layer mapping for spatial multiplexing

For spatial multiplexing, the layer mapping shall be done according to Table 6.3.3.2-1. The number of layers  $\nu$  is less than or equal to the number of antenna ports  $P$  used for transmission of the physical channel. The case of a single codeword mapped to multiple layers is only applicable when the number of cell-specific reference signals is four or when the number of UE-specific reference signals is two or larger.

**Table 6.3.3.2-1: Codeword-to-layer mapping for spatial multiplexing**

Number of layers	Number of codewords	Codeword-to-layer mapping $i = 0, 1, \dots, M_{\text{symp}}^{\text{layer}} - 1$
1	1	$x^{(0)}(i) = d^{(0)}(i)$ $M_{\text{symp}}^{\text{layer}} = M_{\text{symp}}^{(0)}$
2	1	$x^{(0)}(i) = d^{(0)}(2i)$ $x^{(1)}(i) = d^{(0)}(2i+1)$ $M_{\text{symp}}^{\text{layer}} = M_{\text{symp}}^{(0)} / 2$
2	2	$x^{(0)}(i) = d^{(0)}(i)$ $x^{(1)}(i) = d^{(1)}(i)$ $M_{\text{symp}}^{\text{layer}} = M_{\text{symp}}^{(0)} = M_{\text{symp}}^{(1)}$
3	1	$x^{(0)}(i) = d^{(0)}(3i)$ $x^{(1)}(i) = d^{(0)}(3i+1)$ $x^{(2)}(i) = d^{(0)}(3i+2)$ $M_{\text{symp}}^{\text{layer}} = M_{\text{symp}}^{(0)} / 3$
3	2	$x^{(0)}(i) = d^{(0)}(i)$ $x^{(1)}(i) = d^{(1)}(2i)$ $x^{(2)}(i) = d^{(1)}(2i+1)$ $M_{\text{symp}}^{\text{layer}} = M_{\text{symp}}^{(0)} = M_{\text{symp}}^{(1)} / 2$
4	1	$x^{(0)}(i) = d^{(0)}(4i)$ $x^{(1)}(i) = d^{(0)}(4i+1)$ $x^{(2)}(i) = d^{(0)}(4i+2)$ $x^{(3)}(i) = d^{(0)}(4i+3)$ $M_{\text{symp}}^{\text{layer}} = M_{\text{symp}}^{(0)} / 4$
4	2	$x^{(0)}(i) = d^{(0)}(2i)$ $x^{(1)}(i) = d^{(0)}(2i+1)$ $x^{(2)}(i) = d^{(1)}(2i)$ $x^{(3)}(i) = d^{(1)}(2i+1)$ $M_{\text{symp}}^{\text{layer}} = M_{\text{symp}}^{(0)} / 2 = M_{\text{symp}}^{(1)} / 2$
5	2	$x^{(0)}(i) = d^{(0)}(2i)$ $x^{(1)}(i) = d^{(0)}(2i+1)$ $x^{(2)}(i) = d^{(1)}(3i)$ $x^{(3)}(i) = d^{(1)}(3i+1)$ $x^{(4)}(i) = d^{(1)}(3i+2)$ $M_{\text{symp}}^{\text{layer}} = M_{\text{symp}}^{(0)} / 2 = M_{\text{symp}}^{(1)} / 3$
6	2	$x^{(0)}(i) = d^{(0)}(3i)$ $x^{(1)}(i) = d^{(0)}(3i+1)$ $x^{(2)}(i) = d^{(0)}(3i+2)$ $x^{(3)}(i) = d^{(1)}(3i)$ $x^{(4)}(i) = d^{(1)}(3i+1)$ $x^{(5)}(i) = d^{(1)}(3i+2)$ $M_{\text{symp}}^{\text{layer}} = M_{\text{symp}}^{(0)} / 3 = M_{\text{symp}}^{(1)} / 3$
7	2	$x^{(0)}(i) = d^{(0)}(3i)$ $x^{(1)}(i) = d^{(0)}(3i+1)$ $x^{(2)}(i) = d^{(0)}(3i+2)$ $x^{(3)}(i) = d^{(1)}(4i)$ $x^{(4)}(i) = d^{(1)}(4i+1)$ $x^{(5)}(i) = d^{(1)}(4i+2)$ $x^{(6)}(i) = d^{(1)}(4i+3)$ $M_{\text{symp}}^{\text{layer}} = M_{\text{symp}}^{(0)} / 3 = M_{\text{symp}}^{(1)} / 4$

8	2	$x^{(0)}(i) = d^{(0)}(4i)$ $x^{(1)}(i) = d^{(0)}(4i+1)$ $x^{(2)}(i) = d^{(0)}(4i+2)$ $x^{(3)}(i) = d^{(0)}(4i+3)$ $x^{(4)}(i) = d^{(1)}(4i)$ $x^{(5)}(i) = d^{(1)}(4i+1)$ $x^{(6)}(i) = d^{(1)}(4i+2)$ $x^{(7)}(i) = d^{(1)}(4i+3)$ $M_{\text{sy mb}}^{\text{layer}} = M_{\text{sy mb}}^{(0)} / 4 = M_{\text{sy mb}}^{(1)} / 4$
---	---	---

### 6.3.3.3 Layer mapping for transmit diversity

For transmit diversity, the layer mapping shall be done according to Table 6.3.3.3-1. There is only one codeword and the number of layers  $\nu$  is equal to the number of antenna ports  $P$  used for transmission of the physical channel.

**Table 6.3.3.3-1: Codeword-to-layer mapping for transmit diversity**

Number of layers	Number of codewords	Codeword-to-layer mapping	
		$i = 0, 1, \dots, M_{\text{sy mb}}^{\text{layer}} - 1$	
2	1	$x^{(0)}(i) = d^{(0)}(2i)$ $x^{(1)}(i) = d^{(0)}(2i+1)$	$M_{\text{sy mb}}^{\text{layer}} = M_{\text{sy mb}}^{(0)} / 2$
4	1	$x^{(0)}(i) = d^{(0)}(4i)$ $x^{(1)}(i) = d^{(0)}(4i+1)$ $x^{(2)}(i) = d^{(0)}(4i+2)$ $x^{(3)}(i) = d^{(0)}(4i+3)$	$M_{\text{sy mb}}^{\text{layer}} = \begin{cases} M_{\text{sy mb}}^{(0)} / 4 & \text{if } M_{\text{sy mb}}^{(0)} \bmod 4 = 0 \\ (M_{\text{sy mb}}^{(0)} + 2) / 4 & \text{if } M_{\text{sy mb}}^{(0)} \bmod 4 \neq 0 \end{cases}$ <p>If <math>M_{\text{sy mb}}^{(0)} \bmod 4 \neq 0</math> two null symbols shall be appended to <math>d^{(0)}(M_{\text{sy mb}}^{(0)} - 1)</math></p>

## 6.3.4 Precoding

The precoder takes as input a block of vectors  $x(i) = [x^{(0)}(i) \ \dots \ x^{(\nu-1)}(i)]^T$ ,  $i = 0, 1, \dots, M_{\text{sy mb}}^{\text{layer}} - 1$  from the layer mapping and generates a block of vectors  $y(i) = [\dots \ y^{(p)}(i) \ \dots]^T$ ,  $i = 0, 1, \dots, M_{\text{sy mb}}^{\text{ap}} - 1$  to be mapped onto resources on each of the antenna ports, where  $y^{(p)}(i)$  represents the signal for antenna port  $p$ .

### 6.3.4.1 Precoding for transmission on a single antenna port

For transmission on a single antenna port, precoding is defined by

$$y^{(p)}(i) = x^{(0)}(i)$$

where  $p \in \{0, 4, 5, 7, 8, 11, 13\}$  is the number of the single antenna port used for transmission of the physical channel and  $i = 0, 1, \dots, M_{\text{sy mb}}^{\text{ap}} - 1$ ,  $M_{\text{sy mb}}^{\text{ap}} = M_{\text{sy mb}}^{\text{layer}}$ .

### 6.3.4.2 Precoding for spatial multiplexing using antenna ports with cell-specific reference signals

Precoding for spatial multiplexing using antenna ports with cell-specific reference signals is only used in combination with layer mapping for spatial multiplexing as described in clause 6.3.3.2. Spatial multiplexing supports two or four antenna ports and the set of antenna ports used is  $p \in \{0, 1\}$  or  $p \in \{0, 1, 2, 3\}$ , respectively.

### 6.3.4.2.1 Precoding without CDD

Without Cyclic Delay Diversity (CDD), precoding for spatial multiplexing is defined by

$$\begin{bmatrix} y^{(0)}(i) \\ \vdots \\ y^{(P-1)}(i) \end{bmatrix} = W(i) \begin{bmatrix} x^{(0)}(i) \\ \vdots \\ x^{(v-1)}(i) \end{bmatrix}$$

where the precoding matrix  $W(i)$  is of size  $P \times v$  and  $i = 0, 1, \dots, M_{\text{symb}}^{\text{ap}} - 1$ ,  $M_{\text{symb}}^{\text{ap}} = M_{\text{symb}}^{\text{layer}}$ .

For spatial multiplexing, the values of  $W(i)$  shall be selected among the precoder elements in the codebook configured in the eNodeB and the UE. The eNodeB can further confine the precoder selection in the UE to a subset of the elements in the codebook using codebook subset restrictions. The configured codebook shall be selected from Table 6.3.4.2.3-1 or 6.3.4.2.3-2.

### 6.3.4.2.2 Precoding for large delay CDD

For large-delay CDD, precoding for spatial multiplexing is defined by

$$\begin{bmatrix} y^{(0)}(i) \\ \vdots \\ y^{(P-1)}(i) \end{bmatrix} = W(i) D(i) U \begin{bmatrix} x^{(0)}(i) \\ \vdots \\ x^{(v-1)}(i) \end{bmatrix}$$

where the precoding matrix  $W(i)$  is of size  $P \times v$  and  $i = 0, 1, \dots, M_{\text{symb}}^{\text{ap}} - 1$ ,  $M_{\text{symb}}^{\text{ap}} = M_{\text{symb}}^{\text{layer}}$ . The diagonal size- $v \times v$  matrix  $D(i)$  supporting cyclic delay diversity and the size- $v \times v$  matrix  $U$  are both given by Table 6.3.4.2.2-1 for different numbers of layers  $v$ .

The values of the precoding matrix  $W(i)$  shall be selected among the precoder elements in the codebook configured in the eNodeB and the UE. The eNodeB can further confine the precoder selection in the UE to a subset of the elements in the codebook using codebook subset restriction. The configured codebook shall be selected from Table 6.3.4.2.3-1 or 6.3.4.2.3-2.

For 2 antenna ports, the precoder is selected according to  $W(i) = C_1$  where  $C_1$  denotes the precoding matrix corresponding to precoder index 0 in Table 6.3.4.2.3-1.

For 4 antenna ports, the UE may assume that the eNodeB cyclically assigns different precoders to different vectors  $\begin{bmatrix} x^{(0)}(i) & \dots & x^{(v-1)}(i) \end{bmatrix}^T$  on the physical downlink shared channel as follows. A different precoder is used every  $v$  vectors, where  $v$  denotes the number of transmission layers in the case of spatial multiplexing. In particular, the precoder is selected according to  $W(i) = C_k$ , where  $k$  is the precoder index given by

$k = \left( \left\lfloor \frac{i}{v} \right\rfloor \bmod 4 \right) + 1 \in \{1, 2, 3, 4\}$  and  $C_1, C_2, C_3, C_4$  denote precoder matrices corresponding to precoder indices 12, 13, 14 and 15, respectively, in Table 6.3.4.2.3-2.

**Table 6.3.4.2.2-1: Large-delay cyclic delay diversity**

Number of layers $\nu$	$U$	$D(i)$
2	$\frac{1}{\sqrt{2}} \begin{bmatrix} 1 & 1 \\ 1 & e^{-j2\pi/2} \end{bmatrix}$	$\begin{bmatrix} 1 & 0 \\ 0 & e^{-j2\pi/2} \end{bmatrix}$
3	$\frac{1}{\sqrt{3}} \begin{bmatrix} 1 & 1 & 1 \\ 1 & e^{-j2\pi/3} & e^{-j4\pi/3} \\ 1 & e^{-j4\pi/3} & e^{-j8\pi/3} \end{bmatrix}$	$\begin{bmatrix} 1 & 0 & 0 \\ 0 & e^{-j2\pi/3} & 0 \\ 0 & 0 & e^{-j4\pi/3} \end{bmatrix}$
4	$\frac{1}{2} \begin{bmatrix} 1 & 1 & 1 & 1 \\ 1 & e^{-j2\pi/4} & e^{-j4\pi/4} & e^{-j6\pi/4} \\ 1 & e^{-j4\pi/4} & e^{-j8\pi/4} & e^{-j12\pi/4} \\ 1 & e^{-j6\pi/4} & e^{-j12\pi/4} & e^{-j18\pi/4} \end{bmatrix}$	$\begin{bmatrix} 1 & 0 & 0 & 0 \\ 0 & e^{-j2\pi/4} & 0 & 0 \\ 0 & 0 & e^{-j4\pi/4} & 0 \\ 0 & 0 & 0 & e^{-j6\pi/4} \end{bmatrix}$

### 6.3.4.2.3 Codebook for precoding and CSI reporting

For transmission on two antenna ports,  $p \in \{0,1\}$ , and for the purpose of CSI reporting based on two antenna ports  $p \in \{0,1\}$  or  $p \in \{15,16\}$ , the precoding matrix  $W(i)$  shall be selected from Table 6.3.4.2.3-1 or a subset thereof. For the closed-loop spatial multiplexing transmission mode defined in 3GPP TS 36.213 [4], the codebook index 0 is not used when the number of layers is  $\nu = 2$ .

**Table 6.3.4.2.3-1: Codebook for transmission on antenna ports  $\{0,1\}$  and for CSI reporting based on antenna ports  $\{0,1\}$  or  $\{15,16\}$**

Codebook index	Number of layers $\nu$	
	1	2
0	$\frac{1}{\sqrt{2}} \begin{bmatrix} 1 \\ 1 \end{bmatrix}$	$\frac{1}{\sqrt{2}} \begin{bmatrix} 1 & 0 \\ 0 & 1 \end{bmatrix}$
1	$\frac{1}{\sqrt{2}} \begin{bmatrix} 1 \\ -1 \end{bmatrix}$	$\frac{1}{2} \begin{bmatrix} 1 & 1 \\ 1 & -1 \end{bmatrix}$
2	$\frac{1}{\sqrt{2}} \begin{bmatrix} 1 \\ j \end{bmatrix}$	$\frac{1}{2} \begin{bmatrix} 1 & 1 \\ j & -j \end{bmatrix}$
3	$\frac{1}{\sqrt{2}} \begin{bmatrix} 1 \\ -j \end{bmatrix}$	-

For transmission on four antenna ports,  $p \in \{0,1,2,3\}$ , the precoding matrix  $W$  shall be selected from Table 6.3.4.2.3-2 or a subset thereof. For the purpose of CSI reporting based on four antenna ports  $p \in \{0,1,2,3\}$  or  $p \in \{15,16,17,18\}$ , the precoding matrix  $W$  shall be selected from Table 6.3.4.2.3-2 or a subset thereof except for *alternativeCodeBookEnabledFor4TX-r12 = TRUE* in which case the precoding matrix  $W$  shall be selected from Tables 7.2.4-0A, 7.2.4-0B, 7.2.4-0C, 7.2.4-0D in [4] or a subset thereof. The quantity  $W_n^{\{s\}}$  denotes the matrix defined by the columns given by the set  $\{s\}$  from the expression  $W_n = I - 2u_n u_n^H / u_n^H u_n$  where  $I$  is the  $4 \times 4$  identity matrix and the vector  $u_n$  is given by Table 6.3.4.2.3-2.



**Table 6.3.4.2.3-2: Codebook for transmission on antenna ports {0,1,2,3} and for CSI reporting based on antenna ports {0,1,2,3} or {15,16,17,18}**

Codebook index	$u_n$	Number of layers $\nu$			
		1	2	3	4
0	$u_0 = [1 \ -1 \ -1 \ -1]^T$	$W_0^{(1)}$	$W_0^{(14)}/\sqrt{2}$	$W_0^{(124)}/\sqrt{3}$	$W_0^{(1234)}/2$
1	$u_1 = [1 \ -j \ 1 \ j]^T$	$W_1^{(1)}$	$W_1^{(12)}/\sqrt{2}$	$W_1^{(123)}/\sqrt{3}$	$W_1^{(1234)}/2$
2	$u_2 = [1 \ 1 \ -1 \ 1]^T$	$W_2^{(1)}$	$W_2^{(12)}/\sqrt{2}$	$W_2^{(123)}/\sqrt{3}$	$W_2^{(3214)}/2$
3	$u_3 = [1 \ j \ 1 \ -j]^T$	$W_3^{(1)}$	$W_3^{(12)}/\sqrt{2}$	$W_3^{(123)}/\sqrt{3}$	$W_3^{(3214)}/2$
4	$u_4 = [1 \ (-1-j)/\sqrt{2} \ -j \ (1-j)/\sqrt{2}]^T$	$W_4^{(1)}$	$W_4^{(14)}/\sqrt{2}$	$W_4^{(124)}/\sqrt{3}$	$W_4^{(1234)}/2$
5	$u_5 = [1 \ (1-j)/\sqrt{2} \ j \ (-1-j)/\sqrt{2}]^T$	$W_5^{(1)}$	$W_5^{(14)}/\sqrt{2}$	$W_5^{(124)}/\sqrt{3}$	$W_5^{(1234)}/2$
6	$u_6 = [1 \ (1+j)/\sqrt{2} \ -j \ (-1+j)/\sqrt{2}]^T$	$W_6^{(1)}$	$W_6^{(13)}/\sqrt{2}$	$W_6^{(134)}/\sqrt{3}$	$W_6^{(1324)}/2$
7	$u_7 = [1 \ (-1+j)/\sqrt{2} \ j \ (1+j)/\sqrt{2}]^T$	$W_7^{(1)}$	$W_7^{(13)}/\sqrt{2}$	$W_7^{(134)}/\sqrt{3}$	$W_7^{(1324)}/2$
8	$u_8 = [1 \ -1 \ 1 \ 1]^T$	$W_8^{(1)}$	$W_8^{(12)}/\sqrt{2}$	$W_8^{(124)}/\sqrt{3}$	$W_8^{(1234)}/2$
9	$u_9 = [1 \ -j \ -1 \ -j]^T$	$W_9^{(1)}$	$W_9^{(14)}/\sqrt{2}$	$W_9^{(134)}/\sqrt{3}$	$W_9^{(1234)}/2$
10	$u_{10} = [1 \ 1 \ 1 \ -1]^T$	$W_{10}^{(1)}$	$W_{10}^{(13)}/\sqrt{2}$	$W_{10}^{(123)}/\sqrt{3}$	$W_{10}^{(1324)}/2$
11	$u_{11} = [1 \ j \ -1 \ j]^T$	$W_{11}^{(1)}$	$W_{11}^{(13)}/\sqrt{2}$	$W_{11}^{(134)}/\sqrt{3}$	$W_{11}^{(1324)}/2$
12	$u_{12} = [1 \ -1 \ -1 \ 1]^T$	$W_{12}^{(1)}$	$W_{12}^{(12)}/\sqrt{2}$	$W_{12}^{(123)}/\sqrt{3}$	$W_{12}^{(1234)}/2$
13	$u_{13} = [1 \ -1 \ 1 \ -1]^T$	$W_{13}^{(1)}$	$W_{13}^{(13)}/\sqrt{2}$	$W_{13}^{(123)}/\sqrt{3}$	$W_{13}^{(1324)}/2$
14	$u_{14} = [1 \ 1 \ -1 \ -1]^T$	$W_{14}^{(1)}$	$W_{14}^{(13)}/\sqrt{2}$	$W_{14}^{(123)}/\sqrt{3}$	$W_{14}^{(3214)}/2$
15	$u_{15} = [1 \ 1 \ 1 \ 1]^T$	$W_{15}^{(1)}$	$W_{15}^{(12)}/\sqrt{2}$	$W_{15}^{(123)}/\sqrt{3}$	$W_{15}^{(1234)}/2$

For the purpose of CSI reporting for eight CSI reference signals the codebooks are given in clause 7.2.4 of 3GPP TS 36.213 [4].

### 6.3.4.3 Precoding for transmit diversity

Precoding for transmit diversity is only used in combination with layer mapping for transmit diversity as described in clause 6.3.3.3. The precoding operation for transmit diversity is defined for two and four antenna ports.

For transmission on two antenna ports,  $p \in \{0,1\}$ , the output  $y(i) = [y^{(0)}(i) \ y^{(1)}(i)]^T$ ,  $i = 0,1,\dots,M_{\text{symb}}^{\text{ap}} - 1$  of the precoding operation is defined by

$$\begin{bmatrix} y^{(0)}(2i) \\ y^{(1)}(2i) \\ y^{(0)}(2i+1) \\ y^{(1)}(2i+1) \end{bmatrix} = \frac{1}{\sqrt{2}} \begin{bmatrix} 1 & 0 & j & 0 \\ 0 & -1 & 0 & j \\ 0 & 1 & 0 & j \\ 1 & 0 & -j & 0 \end{bmatrix} \begin{bmatrix} \text{Re}(x^{(0)}(i)) \\ \text{Re}(x^{(1)}(i)) \\ \text{Im}(x^{(0)}(i)) \\ \text{Im}(x^{(1)}(i)) \end{bmatrix}$$

for  $i = 0,1,\dots,M_{\text{symb}}^{\text{layer}} - 1$  with  $M_{\text{symb}}^{\text{ap}} = 2M_{\text{symb}}^{\text{layer}}$ .

For transmission on four antenna ports,  $p \in \{0,1,2,3\}$ , the output  $y(i) = [y^{(0)}(i) \ y^{(1)}(i) \ y^{(2)}(i) \ y^{(3)}(i)]^T$ ,  $i = 0,1,\dots,M_{\text{symb}}^{\text{ap}} - 1$  of the precoding operation is defined by

$$\begin{bmatrix} y^{(0)}(4i) \\ y^{(1)}(4i) \\ y^{(2)}(4i) \\ y^{(3)}(4i) \\ y^{(0)}(4i+1) \\ y^{(1)}(4i+1) \\ y^{(2)}(4i+1) \\ y^{(3)}(4i+1) \\ y^{(0)}(4i+2) \\ y^{(1)}(4i+2) \\ y^{(2)}(4i+2) \\ y^{(3)}(4i+2) \\ y^{(0)}(4i+3) \\ y^{(1)}(4i+3) \\ y^{(2)}(4i+3) \\ y^{(3)}(4i+3) \end{bmatrix} = \frac{1}{\sqrt{2}} \begin{bmatrix} 1 & 0 & 0 & 0 & j & 0 & 0 & 0 \\ 0 & 0 & 0 & 0 & 0 & 0 & 0 & 0 \\ 0 & -1 & 0 & 0 & 0 & j & 0 & 0 \\ 0 & 0 & 0 & 0 & 0 & 0 & 0 & 0 \\ 0 & 1 & 0 & 0 & 0 & j & 0 & 0 \\ 0 & 0 & 0 & 0 & 0 & 0 & 0 & 0 \\ 1 & 0 & 0 & 0 & -j & 0 & 0 & 0 \\ 0 & 0 & 0 & 0 & 0 & 0 & 0 & 0 \\ 0 & 0 & 0 & 0 & 0 & 0 & 0 & 0 \\ 0 & 0 & 1 & 0 & 0 & 0 & j & 0 \\ 0 & 0 & 0 & 0 & 0 & 0 & 0 & 0 \\ 0 & 0 & 0 & 0 & 0 & 0 & 0 & 0 \\ 0 & 0 & 0 & -1 & 0 & 0 & 0 & j \\ 0 & 0 & 0 & 0 & 0 & 0 & 0 & 0 \\ 0 & 0 & 0 & 1 & 0 & 0 & 0 & j \\ 0 & 0 & 0 & 0 & 0 & 0 & 0 & 0 \\ 0 & 0 & 1 & 0 & 0 & 0 & -j & 0 \end{bmatrix} \begin{bmatrix} \text{Re}\{x^{(0)}(i)\} \\ \text{Re}\{x^{(1)}(i)\} \\ \text{Re}\{x^{(2)}(i)\} \\ \text{Re}\{x^{(3)}(i)\} \\ \text{Im}\{x^{(0)}(i)\} \\ \text{Im}\{x^{(1)}(i)\} \\ \text{Im}\{x^{(2)}(i)\} \\ \text{Im}\{x^{(3)}(i)\} \end{bmatrix}$$

for  $i = 0, 1, \dots, M_{\text{symb}}^{\text{layer}} - 1$  with  $M_{\text{symb}}^{\text{ap}} = \begin{cases} 4M_{\text{symb}}^{\text{layer}} & \text{if } M_{\text{symb}}^{(0)} \bmod 4 = 0 \\ (4M_{\text{symb}}^{\text{layer}}) - 2 & \text{if } M_{\text{symb}}^{(0)} \bmod 4 \neq 0 \end{cases}$ .

#### 6.3.4.4 Precoding for spatial multiplexing using antenna ports with UE-specific reference signals

Precoding for spatial multiplexing using antenna ports with UE-specific reference signals is only used in combination with layer mapping for spatial multiplexing as described in clause 6.3.3.2. Spatial multiplexing using antenna ports with UE-specific reference signals supports up to eight antenna ports.

If the higher-layer parameter *dmrs-tableAlt* is set to 1 and the set of antenna ports  $p = \{11, 13\}$  is used for two layers transmission, the precoding operation for transmission on the two antenna ports is defined by

$$\begin{bmatrix} y^{(11)}(i) \\ y^{(13)}(i) \end{bmatrix} = \begin{bmatrix} x^{(0)}(i) \\ x^{(1)}(i) \end{bmatrix}$$

where  $i = 0, 1, \dots, M_{\text{symb}}^{\text{ap}} - 1$ ,  $M_{\text{symb}}^{\text{ap}} = M_{\text{symb}}^{\text{layer}}$ . Otherwise, the set of antenna ports used is  $p = 7, 8, \dots, v+6$  and the precoding operation for transmission on  $v$  antenna ports is defined by

$$\begin{bmatrix} y^{(7)}(i) \\ y^{(8)}(i) \\ \vdots \\ y^{(6+v)}(i) \end{bmatrix} = \begin{bmatrix} x^{(0)}(i) \\ x^{(1)}(i) \\ \vdots \\ x^{(v-1)}(i) \end{bmatrix}$$

where  $i = 0, 1, \dots, M_{\text{symb}}^{\text{ap}} - 1$ ,  $M_{\text{symb}}^{\text{ap}} = M_{\text{symb}}^{\text{layer}}$ .

#### 6.3.5 Mapping to resource elements

For each of the antenna ports used for transmission of the physical channel, the block of complex-valued symbols  $y^{(p)}(0), \dots, y^{(p)}(M_{\text{symb}}^{\text{ap}} - 1)$  shall conform to the downlink power allocation specified in clause 5.2 in

3GPP TS 36.213 [4] and be mapped in sequence starting with  $y^{(p)}(0)$  to resource elements  $(k, l)$  which meet all of the following criteria in the current subframe:

- they are in the physical resource blocks corresponding to the virtual resource blocks assigned for transmission, and
- they are not used for transmission of the core part of PBCH, synchronization signals, and
- they are assumed by the UE not to be used for cell-specific reference signals, where the positions of the cell-specific reference signals are given by clause 6.10.1.2 with the number of antenna ports for and the frequency shift of cell-specific reference signals derived as described in clause 6.10.1.2 4, and

The mapping to resource elements  $(k,l)$  on antenna port  $p$  not reserved for other purposes shall be in increasing order of first the index  $k$  over the assigned physical resource blocks and then the index  $l$ , starting with the first slot in a subframe.

## 6.4 Physical downlink shared channel

The physical downlink shared channel shall be processed and mapped to resource elements as described in clause 6.3 with the following additions and exceptions:

- In resource blocks in which UE-specific reference signals are not transmitted, the PDSCH shall be transmitted on the same set of antenna ports as the PBCH, which is one of  $\{0\}$ ,  $\{0,1\}$ , or  $\{0,1,2,3\}$ .
- In resource blocks in which UE-specific reference signals are transmitted, the PDSCH shall be transmitted on antenna port(s)  $\{5\}$ ,  $\{7\}$ ,  $\{8\}$ , or  $p \in \{7,8,\dots,v+6\}$ , where  $v$  is the number of layers used for transmission of the PDSCH.
- If PDSCH is transmitted in MBSFN subframes as defined in 3GPP TS 36.213 [4], the PDSCH shall be transmitted on one or several of antenna port(s)  $p \in \{7,8,\dots,v+6\}$ , where  $v$  is the number of layers used for transmission of the PDSCH.
- PDSCH is not mapped to resource elements used for UE-specific reference signals associated with PDSCH
- In mapping to resource elements, the positions of the cell-specific reference signals are given by clause 6.10.1.2 with the number of antenna ports and the frequency shift of the cell-specific reference signals derived as described in clause 6.10.1.2, unless other values for these parameters are provided by clause 7.1.9 in 3GPP TS 36.213 [4], in which case these values are used in the resource blocks indicated by the relevant DCI.
- If the DCI associated with the PDSCH uses the C-RNTI or semi-persistent C-RNTI, the PDSCH is not mapped to resource elements assumed by the UE to be used for transmission of:
  - zero-power CSI reference signals, where the positions of the CSI reference signals are given by clause 6.10.5.2. The configuration for zero power CSI reference signals is
    - obtained as described in clause 6.10.5.2, unless other values for these parameters are provided by clause 7.1.9 in 3GPP TS 36.213 [4], in which case these values are used in the resource blocks indicated by the relevant DCI, and
    - obtained by higher-layer configuration of up to five reserved CSI-RS resources as part of the discovery signal configuration following the procedure for zero-power CSI-RS in clause 6.10.5.2.
  - non-zero-power CSI reference signals for CSI reporting, where the positions of the non-zero-power CSI reference signals for CSI reporting are given by clause 6.10.5.2. The configuration for non-zero power CSI reference signals is obtained as described in clause 6.10.5.2.
- PDSCH is not mapped to any physical resource-block pair(s) carrying an EPDCCH associated with the PDSCH.
- PDSCH on antenna port 5, 7, 8, 9, 10, 11, 12, 13 or 14 is not mapped to any physical resource-block pair(s) carrying PBCH or synchronization signals.
- For frame structure type 1 and 2, the index  $l$  in the first slot in a subframe fulfils  $l \geq l_{\text{DataStart}}$  where  $l_{\text{DataStart}}$  is given by clause 7.1.6.4 of 3GPP TS 36.213 [4].
- For frame structure type 3,

- if the higher layer parameter *subframeStartPosition* indicates "s07" and the downlink transmission starts in the second slot of a subframe
  - the index  $l$  in the second slot in a subframe fulfils  $l \geq l_{\text{DataStart}}$  where  $l_{\text{DataStart}}$  is given by clause 7.1.6.4 of 3GPP TS 36.213 [4],
- otherwise
  - the index  $l$  in the first slot in a subframe fulfils  $l \geq l_{\text{DataStart}}$  where  $l_{\text{DataStart}}$  is given by clause 7.6.1.4 of 3GPP TS 36.213 [4],
- In mapping to resource elements, if the DCI associated with the PDSCH uses the C-RNTI or semi-persistent C-RNTI and transmit diversity according to clause 6.3.4.3 is used, resource elements in an OFDM symbol assumed by the UE to contain CSI-RS shall be used in the mapping if and only if all of the following criteria are fulfilled:
  - there is an even number of resource elements for the OFDM symbol in each resource block assigned for transmission, and
  - the complex-valued symbols  $y^{(p)}(i)$  and  $y^{(p)}(i+1)$ , where  $i$  is an even number, can be mapped to resource elements  $(k,l)$  and  $(k+n,l)$  in the same OFDM symbol with  $n < 3$ .

### 6.4.1 Physical downlink shared channel for BL/CE UEs

For BL/CE UEs, the following additions and exceptions hold in addition to those in clause 6.4:

- Resource elements occupied by CSI reference signals shall be counted in the PDSCH mapping but not used for transmission of the PDSCH.
- Resource elements belonging to synchronization signals, the core part of PBCH or PBCH repetitions shall be counted in the PDSCH mapping but not used for transmission of the PDSCH.
- For BL/CE UEs in CEModeB configured in transmission mode 9, in MBSFN subframe(s), resource elements that correspond to the positions of cell-specific reference signals as in subframe #0 shall not be counted in the PDSCH mapping and not used for transmission of the PDSCH.

For BL/CE UEs, if the PDSCH is not carrying SIB1-BR the PRB resources within the narrowband  $n_{\text{NB}}^{(i_0)}$  for PDSCH transmission in the first subframe are obtained from the DCI as described in clauses 5.3.3.1.12, 5.3.3.1.13, and 5.5.1.3.14 in [3], or provided by higher layers. The PDSCH is transmitted with  $N_{\text{rep}}^{\text{PDSCH}} \geq 1$  repetitions, spanning  $N_{\text{abs}}^{\text{PDSCH}} \geq N_{\text{rep}}^{\text{PDSCH}}$  consecutive subframes, including invalid subframes where the the PDSCH transmission is postponed.

- If frequency hopping is not enabled for PDSCH, the PDSCH repetitions are located at the same PRB resources in the same narrowband  $n_{\text{NB}}^{(i_0)}$ , and
- if frequency hopping is enabled for PDSCH, the PDSCH shall be transmitted in subframe  $i$  within the  $N_{\text{abs}}^{\text{PDSCH}}$  consecutive downlink subframes using the same PRB resources within each narrowband

$$n_{\text{NB}}^{(i)} = \left( n_{\text{NB}}^{(i_0)} + \left( \left[ \frac{i + i_{\Delta}}{N_{\text{NB}}^{\text{ch,DL}}} - j_0 \right] \bmod N_{\text{NB,hop}}^{\text{ch,DL}} \right) \cdot f_{\text{NB,hop}}^{\text{DL}} \right) \bmod N_{\text{NB}}^{\text{DL}}$$

$$j_0 = \left\lfloor (i_0 + i_{\Delta}) / N_{\text{NB}}^{\text{ch,DL}} \right\rfloor$$

$$i_0 \leq i \leq i_0 + N_{\text{abs}}^{\text{PDSCH}} - 1$$

$$i_{\Delta} = \begin{cases} 0, & \text{for frame structure type 1} \\ N_{\text{NB}}^{\text{ch,DL}} - 2, & \text{for frame structure type 2} \end{cases}$$

where  $i_0$  is the absolute subframe number of the first downlink subframe intended for PDSCH and  $N_{\text{NB}}^{\text{ch,DL}}$ ,  $N_{\text{NB,hop}}^{\text{ch,DL}}$  and  $f_{\text{NB,hop}}^{\text{DL}}$  are cell-specific higher-layer parameters. For PDSCH carrying SI other than SIB1-BR, If

*interval-DlHoppingConfigCommonModeB* is signalled in SIB1-BR, then the frequency hopping granularity  $N_{NB}^{ch,DL}$  is set to *interval-DlHoppingConfigCommonModeB*; Otherwise,  $N_{NB}^{ch,DL}$  is set to *interval-DlHoppingConfigCommonModeA* signalled in SIB1-BR.

For BL/CE UE in CEModeA, frequency hopping of PDSCH associated with C-RNTI or SPS-RNTI is enabled when higher layer parameter *mpdcch-pdsch-HoppingConfig* is set and the frequency hopping flag in DCI format 6-1A indicates frequency hopping, otherwise, frequency hopping of is not enabled.

The UE shall not expect PDSCH in subframe  $i$  if it is not a valid downlink subframe.

For BL/CE UEs, if the PDSCH carries SIB1-BR, the PDSCH transmission is repeated periodically in every period of 8 radio frames, where a period starts with a radio frame with  $n_f \bmod 8 = 0$  where  $n_f$  is the system frame number. The PDSCH is transmitted  $N_{PDSCH}^{SIB1-BR}$  times in each period of 8 frames, Let  $\{s_j\}$  be the set of narrowbands, excluding narrowbands overlapping with the 72 center subcarriers for  $N_{RB}^{DL} > 15$ , and ordered in increasing order of narrowband index. The PDSCH transmission cycles through the set  $\{s_i\}$  of narrowbands in increasing order of  $i$ , starting with  $i = 0$  for the first subframe, according to

$$n_{NB} = s_j$$

$$j = \left( N_{ID}^{cell} \bmod N_{NB}^S + i \cdot \left\lfloor N_{NB}^S / m \right\rfloor \right) \bmod N_{NB}^S$$

$$i = 0, 1, \dots, m-1$$

$$m = \begin{cases} 1 & N_{RB}^{DL} < 12 \\ 2 & 12 \leq N_{RB}^{DL} \leq 50 \\ 4 & 50 < N_{RB}^{DL} \end{cases}$$

where  $N_{NB}^S$  is the number of narrowbands in the set  $\{s_j\}$ .

The set of frames and subframes used for SIB1-BR transmission in each period are given by Tables 6.4.1-1 and 6.4.1-2.

**Table 6.4.1-1: The set of frames and subframes for SIB1-BR for  $N_{RB}^{DL} \leq 15$ .**

$N_{PDSCH}^{SIB1-BR}$	$N_{ID}^{cell} \bmod 2$	Frame structure type 1		Frame structure type 2	
		$n_f \bmod 2$	$n_{sf}$	$n_f \bmod 2$	$n_{sf}$
4	0	0	4	1	5
	1	1	4	1	5

**Table 6.4.1-2: The set of frames and subframes for SIB1-BR for  $N_{RB}^{DL} > 15$ .**

$N_{PDSCH}^{SIB1-BR}$	$N_{ID}^{cell} \bmod 2$	Frame structure type 1		Frame structure type 2	
		$n_f \bmod 2$	$n_{sf}$	$n_f \bmod 2$	$n_{sf}$
4	0	0	4	1	5
	1	1	4	1	0
8	0	0, 1	4	0, 1	5
	1	0, 1	9	0, 1	0
16	0	0, 1	4, 9	0, 1	0, 5
	1	0, 1	0, 9	0, 1	0, 5

BL/CE UEs may assume the same precoding matrix being used for a PRB across a block of  $N_{NB}^{ch,DL}$  consecutive subframes when UE-specific reference signals are transmitted together with the PDSCH.

For PDSCH transmission associated with RA-RNTI or temporary C-RNTI to BL/CE UEs, frequency hopping of the PDSCH is enabled when higher layer parameter *rar-HoppingConfig* is set. Further

- if PRACH CE level 0 or 1 is used for the last PRACH attempt,  $N_{NB}^{ch,DL}$  is set to the higher layer parameter *interval-DlHoppingConfigCommonModeA*;

- if PRACH CE level 2 or 3 is used for the last PRACH attempt,  $N_{\text{NB}}^{\text{ch,DL}}$  is set to the higher layer parameter *interval-DIHoppingConfigCommonModeB*.

## 6.5 Physical multicast channel

The physical multicast channel shall be processed and mapped to resource elements as described in clause 6.3 with the following exceptions:

- No transmit diversity scheme is specified.
- Layer mapping and precoding shall be done assuming a single antenna port and the transmission shall use antenna port 4.
- The PMCH can only be transmitted in the MBSFN region of an MBSFN subframe. The index  $l$  in the first slot in the MBSFN subframe fulfils  $l \geq l_{\text{PMCHstart}}$  where  $l_{\text{PMCHstart}}$  is equal to the value given by the higher layer parameter *non-MBSFNregionLength* [9].
- The PMCH shall use extended cyclic prefix.
- The PMCH is not mapped to resource elements used for transmission of MBSFN reference signals.

## 6.6 Physical broadcast channel

The PBCH is not transmitted for frame structure type 3.

### 6.6.1 Scrambling

The block of bits  $b(0), \dots, b(M_{\text{bit}} - 1)$ , where  $M_{\text{bit}}$ , the number of bits transmitted on the physical broadcast channel, equals 1920 for normal cyclic prefix and 1728 for extended cyclic prefix, shall be scrambled with a cell-specific sequence prior to modulation, resulting in a block of scrambled bits  $\tilde{b}(0), \dots, \tilde{b}(M_{\text{bit}} - 1)$  according to

$$\tilde{b}(i) = (b(i) + c(i)) \bmod 2$$

where the scrambling sequence  $c(i)$  is given by clause 7.2. The scrambling sequence shall be initialised with  $c_{\text{init}} = N_{\text{ID}}^{\text{cell}}$  in each radio frame fulfilling  $n_f \bmod 4 = 0$ .

### 6.6.2 Modulation

The block of scrambled bits  $\tilde{b}(0), \dots, \tilde{b}(M_{\text{bit}} - 1)$  shall be modulated as described in clause 7.1, resulting in a block of complex-valued modulation symbols  $d(0), \dots, d(M_{\text{symb}} - 1)$ . Table 6.6.2-1 specifies the modulation mappings applicable for the physical broadcast channel.

**Table 6.6.2-1: PBCH modulation schemes.**

Physical channel	Modulation schemes
PBCH	QPSK

### 6.6.3 Layer mapping and precoding

The block of modulation symbols  $d(0), \dots, d(M_{\text{symb}} - 1)$  shall be mapped to layers according to one of clauses 6.3.3.1 or 6.3.3.3 with  $M_{\text{symb}}^{(0)} = M_{\text{symb}}$  and precoded according to one of clauses 6.3.4.1 or 6.3.4.3, resulting in a block of vectors

$y(i) = [y^{(0)}(i) \dots y^{(P-1)}(i)]^T$ ,  $i = 0, \dots, M_{\text{symb}} - 1$ , where  $y^{(p)}(i)$  represents the signal for antenna port  $p$  and where  $p = 0, \dots, P-1$  and the number of antenna ports for cell-specific reference signals  $P \in \{1, 2, 4\}$ .

## 6.6.4 Mapping to resource elements

The block of complex-valued symbols  $y^{(p)}(0), \dots, y^{(p)}(M_{\text{symb}} - 1)$  for each antenna port is transmitted during 4 consecutive radio frames starting in each radio frame fulfilling  $n_f \bmod 4 = 0$  and shall be mapped in sequence starting with  $y(0)$  to resource elements  $(k, l)$  constituting the core set of PBCH resource elements. The mapping to resource elements  $(k, l)$  not reserved for transmission of reference signals shall be in increasing order of first the index  $k$ , then the index  $l$  in slot 1 in subframe 0 and finally the radio frame number. The resource-element indices are given by

$$k = \frac{N_{\text{RB}}^{\text{DL}} N_{\text{sc}}^{\text{RB}}}{2} - 36 + k', \quad k' = 0, 1, \dots, 71$$

$$l = 0, 1, \dots, 3$$

where resource elements reserved for reference signals shall be excluded. The mapping operation shall assume cell-specific reference signals for antenna ports 0-3 being present irrespective of the actual configuration. The UE shall assume that the resource elements assumed to be reserved for reference signals in the mapping operation above but not used for transmission of reference signal are not available for PDSCH or MPDCCH transmission. The UE shall not make any other assumptions about these resource elements.

If a cell is configured with repetition of the physical broadcast channel

- symbols mapped to core resource element  $(k, l)$  in slot 1 in subframe 0 within a radio frame  $n_f$  according to the mapping operation above, and
- cell-specific reference signals in OFDM symbols  $l$  in slot 1 in subframe 0 within a radio frame  $n_f$  with  $l$  according to the mapping operation above

shall additionally be mapped to resource elements  $(k, l')$  in slot number  $n'_s$  within radio frame  $n_f - i$  unless resource element  $(k, l')$  is used by CSI reference signals.

For frame structure type 1,  $l'$ ,  $n'_s$ , and  $i$  are given by Table 6.6.4-1.

For frame structure type 2,

- if  $N_{\text{RB}}^{\text{DL}} > 15$ ,  $l'$  and  $n'_s$  are given by Table 6.6.4-2 and  $i = 0$ ;
- if  $7 \leq N_{\text{RB}}^{\text{DL}} \leq 15$ ,  $l'$  and  $n'_s$  are given by Table 6.6.4-2 and  $i = 0$ , except that repetitions with  $n'_s = 10$  and  $n'_s = 11$  are not applied.

For both frame structure type 1 and frame structure type 2, repetition of the physical broadcast channel is not applicable if  $N_{\text{RB}}^{\text{DL}} = 6$ .

Resource elements already used for transmission of cell-specific reference signals in absence of repetition shall not be used for additional mapping of cell-specific reference signals.

**Table 6.6.4-1: Frame offset, slot and symbol number triplets for repetition of PBCH for frame structure type 1.**

$l$	Frame offset, slot and symbol number triplets $(i, n'_s, l')$	
	Normal cyclic prefix	Extended cyclic prefix
0	(1,18,3), (1,19,0), (1,19,4), (0,0,4)	(1,18,3), (1,19,0), (1,19,5)
1	(1,18,4), (1,19,1), (1,19,5), (0,1,4)	(1,18,4), (1,19,1), (0,0,3)
2	(1,18,5), (1,19,2), (1,19,6), (0,1,5)	(1,18,5), (1,19,2), (0,1,4)
3	(1,18,6), (1,19,3), (0,0,3), (0,1,6)	(1,19,3), (1,19,4), (0,1,5)

**Table 6.6.4-2: Slot and symbol number pairs for repetition of PBCH for frame structure type 2.**

$l$	Slot and symbol number pairs $(n'_s, l')$	
	Normal cyclic prefix	Extended cyclic prefix
0	(0,3), (1,4), (10,3), (11,0), (11,4)	(0,3), (10,3), (11,0)
1	(0,4), (1,5), (10,4), (11,1), (11,5)	(0,4), (10,4), (11,1)
2	(0,5), (10,5), (11,2)	(0,5), (10,5), (11,2)
3	(0,6), (10,6), (11,3)	(1,4), (11,3), (11,4)

## 6.7 Physical control format indicator channel

The physical control format indicator channel carries information about the number of OFDM symbols used for transmission of PDCCHs in a subframe. The set of OFDM symbols possible to use for PDCCH in a subframe is given by Table 6.7-1.

**Table 6.7-1: Number of OFDM symbols used for PDCCH**

Subframe	Number of OFDM symbols for PDCCH when $N_{RB}^{DL} > 10$	Number of OFDM symbols for PDCCH when $N_{RB}^{DL} \leq 10$
Subframe 1 and 6 for frame structure type 2 or a subframe for frame structure type 3 with the same duration as the DwPTS duration of a special subframe configuration	1, 2	2
MBSFN subframes on a carrier supporting PDSCH, configured with 1 or 2 cell-specific antenna ports	1, 2	2
MBSFN subframes on a carrier supporting PDSCH, configured with 4 cell-specific antenna ports	2	2
Subframes on a carrier not supporting PDSCH	0	0
Non-MBSFN subframes (except subframe 6 for frame structure type 2) configured with positioning reference signals	1, 2, 3	2, 3
All other cases	1, 2, 3	2, 3, 4

The UE may assume the PCFICH is transmitted when the number of OFDM symbols for PDCCH is greater than zero unless stated otherwise in [4, clause 12].

### 6.7.1 Scrambling

The block of bits  $b(0), \dots, b(31)$  transmitted in one subframe shall be scrambled with a cell-specific sequence prior to modulation, resulting in a block of scrambled bits  $\tilde{b}(0), \dots, \tilde{b}(31)$  according to

$$\tilde{b}(i) = (b(i) + c(i)) \bmod 2$$

where the scrambling sequence  $c(i)$  is given by clause 7.2. The scrambling sequence generator shall be initialised with  $c_{\text{init}} = (\lfloor n_s/2 \rfloor + 1) \cdot (2N_{ID}^{\text{cell}} + 1) \cdot 2^9 + N_{ID}^{\text{cell}}$  at the start of each subframe.

### 6.7.2 Modulation

The block of scrambled bits  $\tilde{b}(0), \dots, \tilde{b}(31)$  shall be modulated as described in clause 7.1, resulting in a block of complex-valued modulation symbols  $d(0), \dots, d(15)$ . Table 6.7.2-1 specifies the modulation mappings applicable for the physical control format indicator channel.

**Table 6.7.2-1: PCFICH modulation schemes**

Physical channel	Modulation schemes
PCFICH	QPSK



### 6.7.3 Layer mapping and precoding

The block of modulation symbols  $d(0), \dots, d(15)$  shall be mapped to layers according to one of clauses 6.3.3.1 or 6.3.3.3 with  $M_{\text{symp}}^{(0)} = 16$  and precoded according to one of clauses 6.3.4.1 or 6.3.4.3, resulting in a block of vectors

$y(i) = [y^{(0)}(i) \ \dots \ y^{(P-1)}(i)]^T$ ,  $i = 0, \dots, 15$ , where  $y^{(p)}(i)$  represents the signal for antenna port  $p$  and where  $p = 0, \dots, P-1$  and the number of antenna ports for cell-specific reference signals  $P \in \{1, 2, 4\}$ . The PCFICH shall be transmitted on the same set of antenna ports as the PBCH.

### 6.7.4 Mapping to resource elements

The mapping to resource elements is defined in terms of quadruplets of complex-valued symbols. Let

$z^{(p)}(i) = \langle y^{(p)}(4i), y^{(p)}(4i+1), y^{(p)}(4i+2), y^{(p)}(4i+3) \rangle$  denote symbol quadruplet  $i$  for antenna port  $p$ . For each of the antenna ports, symbol quadruplets shall be mapped in increasing order of  $i$  to the four resource-element groups in the first OFDM symbol in a downlink subframe or DwPTS with the representative resource-element as defined in clause 6.2.4 given by

$$\begin{aligned} z^{(p)}(0) & \text{ is mapped to the resource - element group represented by } k = \bar{k} \\ z^{(p)}(1) & \text{ is mapped to the resource - element group represented by } k = \bar{k} + \lfloor N_{\text{RB}}^{\text{DL}}/2 \rfloor \cdot N_{\text{sc}}^{\text{RB}}/2 \\ z^{(p)}(2) & \text{ is mapped to the resource - element group represented by } k = \bar{k} + \lfloor 2N_{\text{RB}}^{\text{DL}}/2 \rfloor \cdot N_{\text{sc}}^{\text{RB}}/2 \\ z^{(p)}(3) & \text{ is mapped to the resource - element group represented by } k = \bar{k} + \lfloor 3N_{\text{RB}}^{\text{DL}}/2 \rfloor \cdot N_{\text{sc}}^{\text{RB}}/2 \end{aligned}$$

where the additions are modulo  $N_{\text{RB}}^{\text{DL}} N_{\text{sc}}^{\text{RB}}$ ,

$$\bar{k} = \left( N_{\text{sc}}^{\text{RB}}/2 \right) \cdot \left( N_{\text{ID}}^{\text{cell}} \bmod 2N_{\text{RB}}^{\text{DL}} \right)$$

and  $N_{\text{ID}}^{\text{cell}}$  is the physical-layer cell identity as given by clause 6.11.

## 6.8 Physical downlink control channel

### 6.8.1 PDCCH formats

The physical downlink control channel carries scheduling assignments and other control information. A physical control channel is transmitted on an aggregation of one or several consecutive control channel elements (CCEs), where a control channel element corresponds to 9 resource element groups. The number of resource-element groups not assigned to PCFICH or PHICH is  $N_{\text{REG}}$ . The CCEs available in the system are numbered from 0 to  $N_{\text{CCE}} - 1$ , where  $N_{\text{CCE}} = \lfloor N_{\text{REG}}/9 \rfloor$ . The PDCCH supports multiple formats as listed in Table 6.8.1-1. A PDCCH consisting of  $n$  consecutive CCEs may only start on a CCE fulfilling  $i \bmod n = 0$ , where  $i$  is the CCE number.

Multiple PDCCHs can be transmitted in a subframe.

**Table 6.8.1-1: Supported PDCCH formats**

PDCCH format	Number of CCEs	Number of resource-element groups	Number of PDCCH bits
0	1	9	72
1	2	18	144
2	4	36	288
3	8	72	576

## 6.8.2 PDCCH multiplexing and scrambling

The block of bits  $b^{(i)}(0), \dots, b^{(i)}(M_{\text{bit}}^{(i)} - 1)$  on each of the control channels to be transmitted in a subframe, where  $M_{\text{bit}}^{(i)}$  is the number of bits in one subframe to be transmitted on physical downlink control channel number  $i$ , shall be multiplexed, resulting in a block of bits

$b^{(0)}(0), \dots, b^{(0)}(M_{\text{bit}}^{(0)} - 1), b^{(1)}(0), \dots, b^{(1)}(M_{\text{bit}}^{(1)} - 1), \dots, b^{(n_{\text{PDCCH}} - 1)}(0), \dots, b^{(n_{\text{PDCCH}} - 1)}(M_{\text{bit}}^{(n_{\text{PDCCH}} - 1)} - 1)$ , where  $n_{\text{PDCCH}}$  is the number of PDCCHs transmitted in the subframe.

The block of bits  $b^{(0)}(0), \dots, b^{(0)}(M_{\text{bit}}^{(0)} - 1), b^{(1)}(0), \dots, b^{(1)}(M_{\text{bit}}^{(1)} - 1), \dots, b^{(n_{\text{PDCCH}} - 1)}(0), \dots, b^{(n_{\text{PDCCH}} - 1)}(M_{\text{bit}}^{(n_{\text{PDCCH}} - 1)} - 1)$  shall be scrambled with a cell-specific sequence prior to modulation, resulting in a block of scrambled bits  $\tilde{b}(0), \dots, \tilde{b}(M_{\text{tot}} - 1)$  according to

$$\tilde{b}(i) = (b(i) + c(i)) \bmod 2$$

where the scrambling sequence  $c(i)$  is given by clause 7.2. The scrambling sequence generator shall be initialised with  $c_{\text{init}} = \lfloor n_s/2 \rfloor 2^9 + N_{\text{ID}}^{\text{cell}}$  at the start of each subframe.

CCE number  $n$  corresponds to bits  $b(72n), b(72n+1), \dots, b(72n+71)$ . If necessary, <NIL> elements shall be inserted in the block of bits prior to scrambling to ensure that the PDCCHs starts at the CCE positions as described in

3GPP TS 36.213 [4] and to ensure that the length  $M_{\text{tot}} = 8N_{\text{REG}} \geq \sum_{i=0}^{n_{\text{PDCCH}} - 1} M_{\text{bit}}^{(i)}$  of the scrambled block of bits matches the amount of resource-element groups not assigned to PCFICH or PHICH.

## 6.8.3 Modulation

The block of scrambled bits  $\tilde{b}(0), \dots, \tilde{b}(M_{\text{tot}} - 1)$  shall be modulated as described in clause 7.1, resulting in a block of complex-valued modulation symbols  $d(0), \dots, d(M_{\text{symb}} - 1)$ . Table 6.8.3-1 specifies the modulation mappings applicable for the physical downlink control channel.

**Table 6.8.3-1: PDCCH modulation schemes**

Physical channel	Modulation schemes
PDCCH	QPSK

## 6.8.4 Layer mapping and precoding

The block of modulation symbols  $d(0), \dots, d(M_{\text{symb}} - 1)$  shall be mapped to layers according to one of clauses 6.3.3.1 or 6.3.3.3 with  $M_{\text{symb}}^{(0)} = M_{\text{symb}}$  and precoded according to one of clauses 6.3.4.1 or 6.3.4.3, resulting in a block of vectors

$y(i) = [y^{(0)}(i) \ \dots \ y^{(P-1)}(i)]^T$ ,  $i = 0, \dots, M_{\text{symb}} - 1$  to be mapped onto resources on the antenna ports used for

transmission, where  $y^{(p)}(i)$  represents the signal for antenna port  $p$ . The PDCCH shall be transmitted on the same set of antenna ports as the PBCH.

## 6.8.5 Mapping to resource elements

The mapping to resource elements is defined by operations on quadruplets of complex-valued symbols. Let  $z^{(p)}(i) = \langle y^{(p)}(4i), y^{(p)}(4i+1), y^{(p)}(4i+2), y^{(p)}(4i+3) \rangle$  denote symbol quadruplet  $i$  for antenna port  $p$ .

The block of quadruplets  $z^{(p)}(0), \dots, z^{(p)}(M_{\text{quad}} - 1)$ , where  $M_{\text{quad}} = M_{\text{symb}}/4$ , shall be permuted resulting in  $w^{(p)}(0), \dots, w^{(p)}(M_{\text{quad}} - 1)$ . The permutation shall be according to the sub-block interleaver in clause 5.1.4.2.1 of 3GPP TS 36.212 [3] with the following exceptions:

- the input and output to the interleaver is defined by symbol quadruplets instead of bits
- interleaving is performed on symbol quadruplets instead of bits by substituting the terms "bit", "bits" and "bit sequence" in clause 5.1.4.2.1 of 3GPP TS 36.212 [3] by "symbol quadruplet", "symbol quadruplets" and "symbol-quadruplet sequence", respectively

<NULL> elements at the output of the interleaver in 3GPP TS 36.212 [3] shall be removed when forming  $w^{(p)}(0), \dots, w^{(p)}(M_{\text{quad}} - 1)$ . Note that the removal of <NULL> elements does not affect any <NIL> elements inserted in clause 6.8.2.

The block of quadruplets  $w^{(p)}(0), \dots, w^{(p)}(M_{\text{quad}} - 1)$  shall be cyclically shifted, resulting in  $\bar{w}^{(p)}(0), \dots, \bar{w}^{(p)}(M_{\text{quad}} - 1)$  where  $\bar{w}^{(p)}(i) = w^{(p)}((i + N_{\text{ID}}^{\text{cell}}) \bmod M_{\text{quad}})$ .

Mapping of the block of quadruplets  $\bar{w}^{(p)}(0), \dots, \bar{w}^{(p)}(M_{\text{quad}} - 1)$  is defined in terms of resource-element groups, specified in clause 6.2.4, according to steps 1–10 below:

- 1) Initialize  $m' = 0$  (resource-element group number)
- 2) Initialize  $k' = 0$
- 3) Initialize  $l' = 0$
- 4) If the resource element  $(k', l')$  represents a resource-element group and the resource-element group is not assigned to PCFICH or PHICH then perform step 5 and 6, else go to step 7
- 5) Map symbol-quadruplet  $\bar{w}^{(p)}(m')$  to the resource-element group represented by  $(k', l')$  for each antenna port  $p$
- 6) Increase  $m'$  by 1
- 7) Increase  $l'$  by 1
- 8) Repeat from step 4 if  $l' < L$ , where  $L$  corresponds to the number of OFDM symbols used for PDCCH transmission as indicated by the sequence transmitted on the PCFICH
- 9) Increase  $k'$  by 1
- 10) Repeat from step 3 if  $k' < N_{\text{RB}}^{\text{DL}} \cdot N_{\text{sc}}^{\text{RB}}$

## 6.8A Enhanced physical downlink control channel

For frame structure type 3, for a subframe with the same duration as the DwPTS duration of a special subframe configuration, the enhanced physical downlink control channel is defined the same as that for the corresponding special subframe configuration.

### 6.8A.1 EPDCCH formats

The enhanced physical downlink control channel (EPDCCH) carries scheduling assignments. An enhanced physical downlink control channel is transmitted using an aggregation of one or several consecutive enhanced control channel elements (ECCEs) where each ECCE consists of multiple enhanced resource element groups (EREGs), defined in clause 6.2.4A. The number of ECCEs used for one EPDCCH depends on the EPDCCH format as given by Table 6.8A.1-2 and the number of EREGs per ECCE is given by Table 6.8A.1-1. Both localized and distributed transmission is supported.

An EPDCCH can use either localized or distributed transmission, differing in the mapping of ECCEs to EREGs and PRB pairs.

A UE shall monitor multiple EPDCCHs as defined in 3GPP TS 36.213 [4]. One or two sets of physical resource-block pairs which a UE shall monitor for EPDCCH transmissions can be configured. All EPDCCH candidates in EPDCCH

set  $X_m$  use either only localized or only distributed transmission as configured by higher layers. Within EPDCCH set  $X_m$  in subframe  $i$ , the ECCEs available for transmission of EPDCCHs are numbered from 0 to  $N_{ECCE,m,i} - 1$  and ECCE number  $n$  corresponds to

- EREGs numbered  $(n \bmod N_{ECCE}^{RB}) + jN_{ECCE}^{RB}$  in PRB index  $\lfloor n / N_{ECCE}^{RB} \rfloor$  for localized mapping, and
- EREGs numbered  $\lfloor n / N_{RB}^{X_m} \rfloor + jN_{ECCE}^{RB}$  in PRB indices  $(n + j \max(1, N_{RB}^{X_m} / N_{EREG}^{ECCE})) \bmod N_{RB}^{X_m}$  for distributed mapping,

where  $j = 0, 1, \dots, N_{EREG}^{ECCE} - 1$ ,  $N_{EREG}^{ECCE}$  is the number of EREGs per ECCE, and  $N_{ECCE}^{RB} = 16 / N_{EREG}^{ECCE}$  is the number of ECCEs per resource-block pair. The physical resource-block pairs constituting EPDCCH set  $X_m$  are in this paragraph assumed to be numbered in ascending order from 0 to  $N_{RB}^{X_m} - 1$ .

**Table 6.8A.1-1: Number of EREGs per ECCE,  $N_{EREG}^{ECCE}$**

Normal cyclic prefix			Extended cyclic prefix	
Normal subframe	Special subframe, configuration 3, 4, 8	Special subframe, configuration 1, 2, 6, 7, 9	Normal subframe	Special subframe, configuration 1, 2, 3, 5, 6
4			8	

**Table 6.8A.1-2: Supported EPDCCH formats**

EPDCCH format	Number of ECCEs for one EPDCCH, $N_{ECCE}^{EPDCCH}$			
	Case A		Case B	
	Localized transmission	Distributed transmission	Localized transmission	Distributed transmission
0	2	2	1	1
1	4	4	2	2
2	8	8	4	4
3	16	16	8	8
4	-	32	-	16

Case A in Table 6.8A.1-2 is used when the conditions corresponding to case 1 in clause 9.1.4 of 3GPP TS 36.213 [4] are satisfied, otherwise case B is used. The quantity  $n_{EPDCCH}$  for a particular UE and referenced in 3GPP TS 36.213 [4] is defined as the number of downlink resource elements  $(k, l)$  available for EPDCCH transmission in a physical resource-block pair configured for possible EPDCCH transmission of EPDCCH set  $X_0$  and fulfilling all of the following criteria:

- they are part of any one of the 16 EREGs in the physical resource-block pair, and
- they are assumed by the UE not to be used for cell-specific reference signals, where the positions of the cell-specific reference signals are given by clause 6.10.1.2 with the number of antenna ports for and the frequency shift of cell-specific reference signals derived as described in clause 6.10.1.2 unless other values for these parameters are provided by clause 9.1.4.3 in 3GPP TS 36.213 [4], and-
- they are assumed by the UE not to be used for transmission of CSI reference signals, where the positions of the CSI reference signals are given by clause 6.10.5.2 with the configuration for zero power CSI reference signals obtained as described in clause 6.10.5.2 unless other values are provided by clause 9.1.4.3 in 3GPP TS 36.213 [4], and with the configuration for non-zero power CSI reference signals obtained as described in clause 6.10.5.2, and
- for frame structure type 1 and 2, the index  $l$  in the first slot in a subframe fulfils  $l \geq l_{EPDCCHstart}$  where  $l_{EPDCCHstart}$  is given by clause 9.1.4.1 of 3GPP TS 36.213 [4], and
- for frame structure type 3,

- if the higher layer parameter *subframeStartPosition* indicates "s07" and if the downlink transmission starts in the second slot of a subframe
  - the index  $l$  in the second slot in the subframe fulfils  $l \geq l_{\text{EPDCCHstart}}$  where  $l_{\text{EPDCCHstart}}$  is given by clause 7.1.6.4 of 3GPP TS 36.213 [4],
- otherwise
  - the index  $l$  in the first slot in the subframe fulfils  $l \geq l_{\text{EPDCCHstart}}$  where  $l_{\text{EPDCCHstart}}$  is given by clause 7.1.6.4 of 3GPP TS 36.213 [4].

## 6.8A.2 Scrambling

The block of bits  $b(0), \dots, b(M_{\text{bit}} - 1)$  to be transmitted on an EPDCCH in a subframe shall be scrambled, resulting in a block of scrambled bits  $\tilde{b}(0), \dots, \tilde{b}(M_{\text{bit}} - 1)$  according to

$$\tilde{b}(i) = (b(i) + c(i)) \bmod 2$$

where the UE-specific scrambling sequence  $c(i)$  is given by clause 7.2. The scrambling sequence generator shall be initialized with  $c_{\text{init}} = \lfloor n_s / 2 \rfloor \cdot 2^9 + n_{\text{ID},m}^{\text{EPDCCH}}$  where  $m$  is the EPDCCH set number.

## 6.8A.3 Modulation

The block of scrambled bits  $\tilde{b}(0), \dots, \tilde{b}(M_{\text{bit}} - 1)$  shall be modulated as described in clause 7.1, resulting in a block of complex-valued modulation symbols  $d(0), \dots, d(M_{\text{symb}} - 1)$ . Table 6.8A.3-1 specifies the modulation mappings applicable for the enhanced physical downlink control channel.

**Table 6.8A.3-1: EPDCCH modulation schemes**

Physical channel	Modulation schemes
EPDCCH	QPSK

## 6.8A.4 Layer mapping and precoding

The block of complex-valued modulation symbols shall be mapped to a single layer and precoded according to  $y(i) = d(i)$ ,  $i = 0, \dots, M_{\text{symb}} - 1$ .

## 6.8A.5 Mapping to resource elements

The block of complex-valued symbols  $y(0), \dots, y(M_{\text{symb}} - 1)$  shall be mapped in sequence starting with  $y(0)$  to resource elements  $(k, l)$  on the associated antenna port which meet all of the following criteria:

- they are part of the EREGs assigned for the EPDCCH transmission, and
- they are assumed by the UE not to be used for cell-specific reference signals, where the positions of the cell-specific reference signals are given by clause 6.10.1.2 with the number of antenna ports for and the frequency shift of cell-specific reference signals derived as described in clause 6.10.1.2 unless other values for these parameters are provided by clause 9.1.4.3 in 3GPP TS 36.213 [4], and
- they are assumed by the UE not to be used for transmission of:
  - zero-power CSI reference signals, where the positions of the CSI reference signals are given by clause 6.10.5.2. The configuration for zero power CSI reference signals is

- obtained as described in clause 6.10.5.2 unless other values are provided by clause 9.1.4.3 in 3GPP TS 36.213 [4], and
- obtained by higher-layer configuration of up to five reserved CSI-RS resources as part of the discovery signal configuration following the procedure for zero-power CSI-RS in clause 6.10.5.2.
- non-zero-power CSI reference signals for CSI reporting with the configuration for non-zero power CSI reference signals for CSI reporting obtained as described in clause 6.10.5.2, and
- for frame structure type 1 and 2, the index  $l$  in the first slot in a subframe fulfils  $l \geq l_{\text{EPDCCHstart}}$  where  $l_{\text{EPDCCHstart}}$  is given by clause 9.1.4.1 of 3GPP TS 36.213 [4], and
- for frame structure type 3,
  - if the higher layer parameter *subframeStartPosition* indicates "s07" and if the downlink transmission starts in the second slot of a subframe
    - the index  $l$  in the second slot in the subframe fulfils  $l \geq l_{\text{EPDCCHstart}}$  where  $l_{\text{EPDCCHstart}}$  is given by clause 7.1.6.4 of 3GPP TS 36.213 [4],
  - otherwise
    - the index  $l$  in the first slot in the subframe fulfils  $l \geq l_{\text{EPDCCHstart}}$  where  $l_{\text{EPDCCHstart}}$  is given by clause 7.6.1.4 of 3GPP TS 36.213 [4].

The mapping to resource elements  $(k, l)$  on antenna port  $p$  meeting the criteria above shall be in increasing order of first the index  $k$  and then the index  $l$ , starting with the first slot and ending with the second slot in a subframe.

For localized transmission, the single antenna port  $p$  to use is given by Table 6.8A.5-1 with

$$n' = n_{\text{ECCE,low}} \bmod N_{\text{ECCE}}^{\text{RB}} + n_{\text{RNTI}} \bmod \min(N_{\text{ECCE}}^{\text{EPDCCH}}, N_{\text{ECCE}}^{\text{RB}})$$

where  $n_{\text{ECCE,low}}$  is the lowest ECCE index used by this EPDCCH transmission in the EPDCCH set,  $n_{\text{RNTI}}$  equals the C-RNTI, and  $N_{\text{ECCE}}^{\text{EPDCCH}}$  is the number of ECCEs used for this EPDCCH.

**Table 6.8A.5-1: Antenna port to use for localized EPDCCH transmission**

$n'$	Normal cyclic prefix		Extended cyclic prefix
	Normal subframes, Special subframes, configurations 3, 4, 8	Special subframes, configurations 1, 2, 6, 7, 9	Any subframe
0	107	107	107
1	108	109	108
2	109	-	-
3	110	-	-

For distributed transmission, each resource element in an EREG is associated with one out of two antenna ports in an alternating manner, starting with antenna port 107, where  $p \in \{107, 109\}$  for normal cyclic prefix and  $p \in \{107, 108\}$  for extended cyclic prefix.

## 6.8B MTC physical downlink control channel

### 6.8B.1 MPDCCH formats

The MPDCCH formats are defined as in Clause 6.8A.1 with the following exceptions:

- The term EPDCCH is replaced by MPDCCH.

- The MTC physical downlink control channel carries downlink control information and is transmitted across  $N_{\text{rep}}^{\text{MPDCCH}} \geq 1$  consecutive valid downlink subframes. Within each of the  $N_{\text{rep}}^{\text{MPDCCH}}$  valid downlink subframes an MPDCCH is transmitted using an aggregation of one or several consecutive enhanced control channel elements (ECCEs) where each ECCE consists of multiple enhanced resource element groups (EREGs), defined in clause 6.2.4A.
- For frame structure type 2,
  - For a UE configured in CEModeA, if repetition is not configured for the MPDCCH, the number of EREGs per ECCE is given by Table 6.8A.1-1. If repetition is configured for the MPDCCH, the number of EREGs per ECCE is given by Table 6.8B.1-1. The MPDCCH is not supported in special subframe with configurations not listed in Table 6.8B.1-1.
  - For a UE configured in CEModeB, MPDCCH is not supported in the special subframe.
  - For both CEModeA and CEModeB, for those special subframes where the MPDCCH is not supported, these special subframes are considered valid downlink subframes for both MPDCCH and PDSCH transmission, only if they are indicated as valid downlink subframe by higher layer signalling.
- For an MPDCCH associated with 2 or 4 PRBs, if repetition is not configured for the MPDCCH, the supported MPDCCH formats are given by Table 6.8A.1-2. Otherwise, the supported MPDCCH formats are given by Table 6.8B.1-2. However, for MPDCCH format 5, the equation defining the relation between ECCE index and EREG index does not apply and the number of ECCEs refers to the MPDCCH mapping to the REs of the 2+4 PRB set as defined in section 6.8B.5.

**Table 6.8B.1-1: Number of EREGs per ECCE,  $N_{\text{EREG}}^{\text{ECCE}}$ , for frame structure type 2.**

Normal cyclic prefix		Extended cyclic prefix	
Normal subframe	Special subframe, configuration 3, 4, 8	Normal subframe	Special subframe, configuration 1, 2, 3, 5, 6
4		8	

**Table 6.8B.1-2: Supported MPDCCH formats**

MPDCCH format	Number of ECCEs in a subframe for one MPDCCH, $N_{\text{ECCE}}^{\text{MPDCCH}}$			
	$N_{\text{EREG}}^{\text{ECCE}} = 4$		$N_{\text{EREG}}^{\text{ECCE}} = 8$	
	Localized transmission	Distributed transmission	Localized transmission	Distributed transmission
0	2	2	1	1
1	4	4	2	2
2	8	8	4	4
3	16	16	8	8
4	-	-	-	-
5	24	24	12	12

## 6.8B.2 Scrambling

Scrambling shall be performed according to Clause 6.8A.2 with EPDCCH replaced by MPDCCH except that the same scrambling sequence is applied per subframe to MPDCCH for a given block of  $N_{\text{acc}}$  subframes and  $m$  is the MPDCCH set number. For MPDCCH format 5,  $m = 0$  is used to generate the scrambling sequence for mapping to REs in 6 PRBs.

For the  $j^{\text{th}}$  block of  $N_{\text{acc}}$  subframes, the scrambling sequence generator shall be initialised with

$$c_{\text{init}} = \begin{cases} [(j_0 + j)N_{\text{acc}} \bmod 10] \cdot 2^9 + N_{\text{ID}}^{\text{cell}} & \text{for P-RNTI, RA-RNTI, temporary C-RNTI} \\ [(j_0 + j)N_{\text{acc}} \bmod 10] \cdot 2^9 + n_{\text{ID},m}^{\text{MPDCCH}} & \text{otherwise} \end{cases}$$

where

$$j = 0, 1, \dots, \left\lfloor \frac{i_0 + N_{\text{abs}}^{\text{MPDCCH}} + i_{\Delta} - 1}{N_{\text{acc}}} \right\rfloor - j_0$$

$$j_0 = \lfloor (i_0 + i_{\Delta}) / N_{\text{acc}} \rfloor$$

$$i_{\Delta} = \begin{cases} 0, & \text{for frame structure type 1 or } N_{\text{acc}} = 1 \\ N_{\text{acc}} - 2, & \text{for frame structure type 2 and } N_{\text{acc}} = 10 \end{cases}$$

and  $i_0$  is the absolute subframe number of the first downlink subframe intended for the MPDCCH. The MPDCCH transmission spans  $N_{\text{abs}}^{\text{MPDCCH}}$  consecutive subframes, including invalid subframes where the MPDCCH transmission is postponed.

For BL/CE UEs,

- if the MPDCCH transmission is associated with P-RNTI:
  - $N_{\text{acc}} = 4$  for frame structure type 1 and  $N_{\text{acc}} = 10$  for frame structure type 2
- otherwise
  - $N_{\text{acc}} = 1$  for UEs assuming CEModeA (according to the definition in section 12 of [4]) or configured with CEModeA:
  - $N_{\text{acc}} = 4$  for frame structure type 1 and  $N_{\text{acc}} = 10$  for frame structure type 2 for UEs assuming CEModeB (according to the definition in section 12 of [4]) or configured with CEModeB.

### 6.8B.3 Modulation

Modulation shall be performed according to 6.8A.3 with EPDCCH replaced by MPDCCH.

### 6.8B.4 Layer mapping and precoding

Layer mapping and precoding shall be done according to Clause 6.8A.4 with EPDCCH replaced by MPDCCH.

### 6.8B.5 Mapping to resource elements

Mapping to resource elements shall be done according to Clause 6.8A.5 with the following exceptions:

- The term EPDCCH shall be replaced by MPDCCH.
- The mapping shall be repeated across each of the  $N_{\text{rep}}^{\text{MPDCCH}}$  valid downlink subframes.
- $N_{\text{ECCE}}^{\text{MPDCCH}}$  is the number of ECCEs used for this MPDCCH in the first of the  $N_{\text{rep}}^{\text{MPDCCH}}$  subframes.
- For an MPDCCH associated with a 2+4 PRB set as defined in [4], the mapping to resource elements  $(k, l)$  on antenna port  $p$  shall be in increasing order of first the index  $k$  and then the index  $l$  over the 6 PRBs for MPDCCH format 5 and over the 2 or 4 PRBs for the other MPDCCH formats.
- For localized transmission and MPDCCH format 5, the single antenna port  $p$  to use is given by Table 6.8A.5-1 with

$$n' = n_{\text{RNTI}} \bmod N_{\text{ECCE}}^{\text{RB}}$$

- Resource elements occupied by CSI reference signals shall be counted in the MPDCCH mapping but not used for transmission of the MPDCCH. The UE may assume there is no MPDCCH transmission which uses



overlapping sets of subframes as PDSCH transmissions to that UE, where the MPDCCH is located at a different narrowband than the PDSCH.

- For BL/CE UEs in CEModeB, in MBSFN subframe(s), resource elements that correspond to the positions of cell-specific reference signals as in subframe #0 shall not be counted in the MPDCCH mapping and not used for transmission of the MPDCCH.
- Resource elements belonging to synchronization signals, the core part of PBCH or PBCH repetitions shall be counted in the MPDCCH mapping but not used for transmission of the MPDCCH.
- In the subframes where an MPDCCH or its associated PDSCH is transmitted in response to a physical random access transmission initiated by a PDCCH order, the UE shall receive the MPDCCH or its associated PDSCH, and assume no other UE-specific reception is needed.
- For MPDCCH transmission associated with C-RNTI or SPS-RNTI, frequency hopping of the MPDCCH is enabled when higher layer parameter *mpdcch-pdsch-HoppingConfig* is set. For MPDCCH transmission associated with RA-RNTI or temporary C-RNTI, frequency hopping of the MPDCCH is enabled when higher layer parameter *rar-HoppingConfig* is set.
- The narrowband  $n_{\text{NB}}^{(i_0)}$  for MPDCCH transmission in the first subframe of MPDCCH monitoring instance is provided by higher layers. Starting subframe configuration of UE-specific search space where UE monitors an MPDCCH is also provided by higher layers. The MPDCCH is transmitted with  $N_{\text{rep}}^{\text{MPDCCH}} \geq 1$  repetitions, spanning  $N_{\text{abs}}^{\text{MPDCCH}} \geq N_{\text{rep}}^{\text{MPDCCH}}$  consecutive subframes, including invalid subframes where the MPDCCH transmission is postponed.
  - If frequency hopping is not enabled for MPDCCH, the repetitions of an MPDCCH candidate are located at the same PRB resources in the same narrowband  $n_{\text{NB}}^{(i_0)}$ , and
  - if frequency hopping is enabled for MPDCCH, an MPDCCH candidate shall be transmitted in subframe  $i$  within the  $N_{\text{abs}}^{\text{MPDCCH}}$  consecutive downlink subframes using the same PRB resources within each narrowband

$$n_{\text{NB}}^{(i)} = \left( n_{\text{NB}}^{(i_0)} + \left( \left\lfloor \frac{i + i_{\Delta}}{N_{\text{NB}}^{\text{ch,DL}}} - j_0 \right\rfloor \bmod N_{\text{NB,hop}}^{\text{ch,DL}} \right) \cdot f_{\text{NB,hop}}^{\text{DL}} \right) \bmod N_{\text{NB}}^{\text{DL}}$$

$$j_0 = \left\lfloor (i_0 + i_{\Delta}) / N_{\text{NB}}^{\text{ch,DL}} \right\rfloor$$

$$i_0 \leq i \leq i_0 + N_{\text{abs}}^{\text{MPDCCH}} - 1$$

$$i_{\Delta} = \begin{cases} 0, & \text{for frame structure type 1} \\ N_{\text{NB}}^{\text{ch,DL}} - 2, & \text{for frame structure type 2} \end{cases}$$

where  $i_0$  is the absolute subframe number of the first downlink subframe of MPDCCH monitoring instance, and  $N_{\text{NB,hop}}^{\text{ch,DL}}$ ,  $N_{\text{NB}}^{\text{ch,DL}}$  and  $f_{\text{NB,hop}}^{\text{DL}}$  are cell-specific higher-layer parameters. The UE shall not expect MPDCCH transmission in subframe  $i$  if it is not a valid downlink subframe.

- The UE may assume the same precoding matrix being used for a PRB across a block of  $N_{\text{NB}}^{\text{ch,DL}}$  consecutive subframes for MPDCCH.

The UE may assume that an MPDCCH associated with the P-RNTI is transmitted on the set  $\{s_j\}$  of narrowbands where  $\{s_j\}$  is defined in section 6.4.1. For a UE monitoring an MPDCCH associated with the P-RNTI, the first MPDCCH narrowband is given by  $s_m$  where  $m = (\tilde{N}_{\text{NB}}^{\text{P}} + N_{\text{ID}}^{\text{cell}}) \bmod N_{\text{NB}}^{\text{S}}$ ,  $\tilde{N}_{\text{NB}}^{\text{P}} \in \{0, 1, \dots, N_{\text{NB}}^{\text{P}} - 1\}$  is the Paging Narrowband (PN) obtained according to [10], and  $N_{\text{NB}}^{\text{P}}$  is the higher-layer parameter *paging-narrowBands*.

- If the higher-layer parameter *Slx-HoppingConfigCommon* disables frequency hopping for an MPDCCH associated with P-RNTI, each MPDCCH candidate shall be located in the same PRB in narrowband  $s_m$  where  $m = (\tilde{N}_{NB}^p + N_{ID}^{cell}) \bmod N_{NB}^S$ .
- If the higher-layer parameter *Slx-HoppingConfigCommon* enables frequency hopping for an MPDCCH with P-RNTI, an MPDCCH candidate shall be located in narrowband  $s_j$  in subframe  $i$  within the  $N_{abs}^{MPDCCH}$  consecutive downlink subframes using the same PRB resources within each narrowband  $s_j$  where

$$j = \left( \left( \tilde{N}_{NB}^p + N_{ID}^{cell} \right) + \left( \left\lfloor \frac{i + i_{\Delta}}{N_{NB}^{ch,DL}} - j_0 \right\rfloor \bmod N_{NB,hop}^{ch,DL} \right) \cdot f_{NB,hop}^{DL} \right) \bmod N_{NB}^S$$

$$j_0 = \left\lfloor (i_0 + i_{\Delta}) / N_{NB}^{ch,DL} \right\rfloor$$

$$i_0 \leq i \leq i_0 + N_{abs}^{MPDCCH} - 1$$

$$i_{\Delta} = \begin{cases} 0 & \text{for frame structure type 1} \\ N_{NB}^{ch,DL} - 2 & \text{for frame structure type 2} \end{cases}$$

where  $i_0$  is the absolute subframe number of the first downlink subframe of MPDCCH monitoring instance according to locations of paging opportunity subframes, and  $N_{NB,hop}^{ch,DL}$ ,  $N_{NB}^{ch,DL}$  and  $f_{NB,hop}^{DL}$  are cell-specific higher-layer parameters. The UE shall not expect MPDCCH transmission in subframe  $i$  if it is not a valid downlink subframe.

## 6.9 Physical hybrid ARQ indicator channel

The PHICH carries the hybrid-ARQ ACK/NACK. Multiple PHICHs mapped to the same set of resource elements constitute a PHICH group, where PHICHs within the same PHICH group are separated through different orthogonal sequences. A PHICH resource is identified by the index pair  $(n_{PHICH}^{group}, n_{PHICH}^{seq})$ , where  $n_{PHICH}^{group}$  is the PHICH group number and  $n_{PHICH}^{seq}$  is the orthogonal sequence index within the group.

For frame structure type 1 and type 3, the number of PHICH groups  $N_{PHICH}^{group}$  is constant in all subframes and given by

$$N_{PHICH}^{group} = \begin{cases} \left\lceil N_g \left( N_{RB}^{DL} / 8 \right) \right\rceil & \text{for normal cyclic prefix} \\ 2 \cdot \left\lceil N_g \left( N_{RB}^{DL} / 8 \right) \right\rceil & \text{for extended cyclic prefix} \end{cases}$$

where  $N_g \in \{1/6, 1/2, 1, 2\}$  is provided by higher layers. The index  $n_{PHICH}^{group}$  ranges from 0 to  $N_{PHICH}^{group} - 1$ .

For frame structure type 2, the number of PHICH groups may vary between subframes and is given by  $m_i \cdot N_{PHICH}^{group}$  where  $N_{PHICH}^{group}$  is given by the expression above and  $m_i$  is given by Table 6.9-1 with the uplink-downlink configuration provided by the higher-layer parameter *subframeAssignment*. The index  $n_{PHICH}^{group}$  in a subframe with non-zero PHICH resources ranges from 0 to  $m_i \cdot N_{PHICH}^{group} - 1$ .

**Table 6.9-1: The factor  $m_i$  for frame structure type 2**

Uplink-downlink configuration	Subframe number $i$									
	0	1	2	3	4	5	6	7	8	9
0	2	1	0	0	0	2	1	0	0	0
1	0	1	0	0	1	0	1	0	0	1
2	0	0	0	1	0	0	0	0	1	0
3	1	0	0	0	0	0	0	0	1	1
4	0	0	0	0	0	0	0	0	1	1
5	0	0	0	0	0	0	0	0	1	0
6	1	1	0	0	0	1	1	0	0	1

## 6.9.1 Modulation

The block of bits  $b(0), \dots, b(M_{\text{bit}} - 1)$  transmitted on one PHICH in one subframe shall be modulated as described in clause 7.1, resulting in a block of complex-valued modulation symbols  $z(0), \dots, z(M_s - 1)$ , where  $M_s = M_{\text{bit}}$ . Table 6.9.1-1 specifies the modulation mappings applicable for the physical hybrid ARQ indicator channel.

**Table 6.9.1-1: PHICH modulation schemes.**

Physical channel	Modulation schemes
PHICH	BPSK

The block of modulation symbols  $z(0), \dots, z(M_s - 1)$  shall be symbol-wise multiplied with an orthogonal sequence and scrambled, resulting in a sequence of modulation symbols  $d(0), \dots, d(M_{\text{symb}} - 1)$  according to

$$d(i) = w(i \bmod N_{\text{SF}}^{\text{PHICH}}) \cdot (1 - 2c(i)) \cdot z(\lfloor i / N_{\text{SF}}^{\text{PHICH}} \rfloor)$$

where

$$i = 0, \dots, M_{\text{symb}} - 1$$

$$M_{\text{symb}} = N_{\text{SF}}^{\text{PHICH}} \cdot M_s$$

$$N_{\text{SF}}^{\text{PHICH}} = \begin{cases} 4 & \text{normal cyclic prefix} \\ 2 & \text{extended cyclic prefix} \end{cases}$$

and  $c(i)$  is a cell-specific scrambling sequence generated according to clause 7.2. The scrambling sequence generator shall be initialised with  $c_{\text{init}} = (\lfloor n_s / 2 \rfloor + 1) \cdot (2N_{\text{ID}}^{\text{cell}} + 1) \cdot 2^9 + N_{\text{ID}}^{\text{cell}}$  at the start of each subframe.

The sequence  $[w(0) \ \dots \ w(N_{\text{SF}}^{\text{PHICH}} - 1)]$  is given by Table 6.9.1-2 where the sequence index  $n_{\text{PHICH}}^{\text{seq}}$  corresponds to the PHICH number within the PHICH group.

**Table 6.9.1-2: Orthogonal sequences  $[w(0) \dots w(N_{SF}^{PHICH} - 1)]$  for PHICH**

Sequence index $n_{PHICH}^{seq}$	Orthogonal sequence	
	Normal cyclic prefix $N_{SF}^{PHICH} = 4$	Extended cyclic prefix $N_{SF}^{PHICH} = 2$
0	[+1 +1 +1 +1]	[+1 +1]
1	[+1 -1 +1 -1]	[+1 -1]
2	[+1 +1 -1 -1]	[+j +j]
3	[+1 -1 -1 +1]	[+j -j]
4	[+j +j +j +j]	-
5	[+j -j +j -j]	-
6	[+j +j -j -j]	-
7	[+j -j -j +j]	-

## 6.9.2 Resource group alignment, layer mapping and precoding

The block of symbols  $d(0), \dots, d(M_{\text{symb}} - 1)$  should be first aligned with resource element group size, resulting in a block of symbols  $d^{(0)}(0), \dots, d^{(0)}(c \cdot M_{\text{symb}} - 1)$ , where  $c = 1$  for normal cyclic prefix; and  $c = 2$  for extended cyclic prefix.

For normal cyclic prefix,  $d^{(0)}(i) = d(i)$ , for  $i = 0, \dots, M_{\text{symb}} - 1$ .

For extended cyclic prefix,

$$\begin{bmatrix} d^{(0)}(4i) & d^{(0)}(4i+1) & d^{(0)}(4i+2) & d^{(0)}(4i+3) \end{bmatrix}^T = \begin{cases} \begin{bmatrix} d(2i) & d(2i+1) & 0 & 0 \end{bmatrix}^T & n_{PHICH}^{\text{group}} \bmod 2 = 0 \\ \begin{bmatrix} 0 & 0 & d(2i) & d(2i+1) \end{bmatrix}^T & n_{PHICH}^{\text{group}} \bmod 2 = 1 \end{cases}$$

for  $i = 0, \dots, (M_{\text{symb}}/2) - 1$ .

The block of symbols  $d^{(0)}(0), \dots, d^{(0)}(c \cdot M_{\text{symb}} - 1)$  shall be mapped to layers and precoded, resulting in a block of vectors  $y(i) = [y^{(0)}(i) \dots y^{(P-1)}(i)]^T$ ,  $i = 0, \dots, c \cdot M_{\text{symb}} - 1$ , where  $y^{(p)}(i)$  represents the signal for antenna port  $p$ ,  $p = 0, \dots, P - 1$  and the number of cell-specific reference signals  $P \in \{1, 2, 4\}$ . The layer mapping and precoding operation depends on the cyclic prefix length and the number of antenna ports used for transmission of the PHICH. The PHICH shall be transmitted on the same set of antenna ports as the PBCH.

For transmission on a single antenna port,  $P = 1$ , layer mapping and precoding are defined by clauses 6.3.3.1 and 6.3.4.1, respectively, with  $M_{\text{symb}}^{(0)} = c \cdot M_{\text{symb}}$ .

For transmission on two antenna ports,  $P = 2$ , layer mapping and precoding are defined by clauses 6.3.3.3 and 6.3.4.3, respectively, with  $M_{\text{symb}}^{(0)} = c \cdot M_{\text{symb}}$ .

For transmission on four antenna ports,  $P = 4$ , layer mapping is defined by clause 6.3.3.3 with  $M_{\text{symb}}^{(0)} = c \cdot M_{\text{symb}}$  and precoding by

$$\begin{bmatrix}
y^{(0)}(4i) \\
y^{(1)}(4i) \\
y^{(2)}(4i) \\
y^{(3)}(4i) \\
y^{(0)}(4i+1) \\
y^{(1)}(4i+1) \\
y^{(2)}(4i+1) \\
y^{(3)}(4i+1) \\
y^{(0)}(4i+2) \\
y^{(1)}(4i+2) \\
y^{(2)}(4i+2) \\
y^{(3)}(4i+2) \\
y^{(0)}(4i+3) \\
y^{(1)}(4i+3) \\
y^{(2)}(4i+3) \\
y^{(3)}(4i+3)
\end{bmatrix}
= \frac{1}{\sqrt{2}}
\begin{bmatrix}
1 & 0 & 0 & 0 & j & 0 & 0 & 0 \\
0 & 0 & 0 & 0 & 0 & 0 & 0 & 0 \\
0 & -1 & 0 & 0 & 0 & j & 0 & 0 \\
0 & 0 & 0 & 0 & 0 & 0 & 0 & 0 \\
0 & 1 & 0 & 0 & 0 & j & 0 & 0 \\
0 & 0 & 0 & 0 & 0 & 0 & 0 & 0 \\
1 & 0 & 0 & 0 & -j & 0 & 0 & 0 \\
0 & 0 & 0 & 0 & 0 & 0 & 0 & 0 \\
0 & 0 & 1 & 0 & 0 & 0 & j & 0 \\
0 & 0 & 0 & 0 & 0 & 0 & 0 & 0 \\
0 & 0 & 0 & -1 & 0 & 0 & 0 & j \\
0 & 0 & 0 & 0 & 0 & 0 & 0 & 0 \\
0 & 0 & 0 & 1 & 0 & 0 & 0 & j \\
0 & 0 & 0 & 0 & 0 & 0 & 0 & 0 \\
0 & 0 & 1 & 0 & 0 & 0 & -j & 0 \\
0 & 0 & 0 & 0 & 0 & 0 & 0 & 0
\end{bmatrix}
\begin{bmatrix}
\text{Re}\{x^{(0)}(i)\} \\
\text{Re}\{x^{(1)}(i)\} \\
\text{Re}\{x^{(2)}(i)\} \\
\text{Re}\{x^{(3)}(i)\} \\
\text{Im}\{x^{(0)}(i)\} \\
\text{Im}\{x^{(1)}(i)\} \\
\text{Im}\{x^{(2)}(i)\} \\
\text{Im}\{x^{(3)}(i)\}
\end{bmatrix}$$

if  $(i + n_{\text{PHICH}}^{\text{group}}) \bmod 2 = 0$  for normal cyclic prefix, or  $(i + \lfloor n_{\text{PHICH}}^{\text{group}}/2 \rfloor) \bmod 2 = 0$  for extended cyclic prefix, where  $n_{\text{PHICH}}^{\text{group}}$  is the PHICH group number and  $i = 0,1,2$ , and by

$$\begin{bmatrix}
y^{(0)}(4i) \\
y^{(1)}(4i) \\
y^{(2)}(4i) \\
y^{(3)}(4i) \\
y^{(0)}(4i+1) \\
y^{(1)}(4i+1) \\
y^{(2)}(4i+1) \\
y^{(3)}(4i+1) \\
y^{(0)}(4i+2) \\
y^{(1)}(4i+2) \\
y^{(2)}(4i+2) \\
y^{(3)}(4i+2) \\
y^{(0)}(4i+3) \\
y^{(1)}(4i+3) \\
y^{(2)}(4i+3) \\
y^{(3)}(4i+3)
\end{bmatrix}
= \frac{1}{\sqrt{2}}
\begin{bmatrix}
0 & 0 & 0 & 0 & 0 & 0 & 0 & 0 \\
1 & 0 & 0 & 0 & j & 0 & 0 & 0 \\
0 & 0 & 0 & 0 & 0 & 0 & 0 & 0 \\
0 & -1 & 0 & 0 & 0 & j & 0 & 0 \\
0 & 0 & 0 & 0 & 0 & 0 & 0 & 0 \\
0 & 1 & 0 & 0 & 0 & j & 0 & 0 \\
0 & 0 & 0 & 0 & 0 & 0 & 0 & 0 \\
1 & 0 & 0 & 0 & -j & 0 & 0 & 0 \\
0 & 0 & 0 & 0 & 0 & 0 & 0 & 0 \\
0 & 0 & 1 & 0 & 0 & 0 & j & 0 \\
0 & 0 & 0 & 0 & 0 & 0 & 0 & 0 \\
0 & 0 & 0 & -1 & 0 & 0 & 0 & j \\
0 & 0 & 0 & 0 & 0 & 0 & 0 & 0 \\
0 & 0 & 0 & 1 & 0 & 0 & 0 & j \\
0 & 0 & 0 & 0 & 0 & 0 & 0 & 0 \\
0 & 0 & 1 & 0 & 0 & 0 & -j & 0
\end{bmatrix}
\begin{bmatrix}
\text{Re}\{x^{(0)}(i)\} \\
\text{Re}\{x^{(1)}(i)\} \\
\text{Re}\{x^{(2)}(i)\} \\
\text{Re}\{x^{(3)}(i)\} \\
\text{Im}\{x^{(0)}(i)\} \\
\text{Im}\{x^{(1)}(i)\} \\
\text{Im}\{x^{(2)}(i)\} \\
\text{Im}\{x^{(3)}(i)\}
\end{bmatrix}$$

otherwise for  $i = 0,1,2$ .

### 6.9.3 Mapping to resource elements

The sequence  $\bar{y}^{(p)}(0), \dots, \bar{y}^{(p)}(M_{\text{sybm}}^{(0)} - 1)$  for each of the PHICH groups is defined by

$$\bar{y}^{(p)}(n) = \sum y_i^{(p)}(n)$$

where the sum is over all PHICHs in the PHICH group and  $y_i^{(p)}(n)$  represents the symbol sequence from the  $i$ :th PHICH in the PHICH group.

PHICH groups are mapped to PHICH mapping units.

For normal cyclic prefix, the mapping of PHICH group  $m$  to PHICH mapping unit  $m'$  is defined by

$$\tilde{y}_{m'}^{(p)}(n) = \bar{y}_m^{(p)}(n)$$

where

$$m' = m = \begin{cases} 0, 1, \dots, N_{\text{PHICH}}^{\text{group}} - 1 & \text{for frame structure type 1} \\ 0, 1, \dots, m_i \cdot N_{\text{PHICH}}^{\text{group}} - 1 & \text{for frame structure type 2} \end{cases},$$

and where  $m_i$  is given by Table 6.9-1.

For extended cyclic prefix, the mapping of PHICH group  $m$  and  $m+1$  to PHICH mapping unit  $m'$  is defined by

$$\tilde{y}_{m'}^{(p)}(n) = \bar{y}_m^{(p)}(n) + \bar{y}_{m+1}^{(p)}(n)$$

where

$$m' = m / 2$$

$$m = \begin{cases} 0, 2, \dots, N_{\text{PHICH}}^{\text{group}} - 2 & \text{for frame structure type 1} \\ 0, 2, \dots, m_i \cdot N_{\text{PHICH}}^{\text{group}} - 2 & \text{for frame structure type 2} \end{cases}$$

and where  $m_i$  is given by Table 6.9-1.

Let  $z^{(p)}(i) = \langle \tilde{y}^{(p)}(4i), \tilde{y}^{(p)}(4i+1), \tilde{y}^{(p)}(4i+2), \tilde{y}^{(p)}(4i+3) \rangle$ ,  $i = 0, 1, 2$  denote symbol quadruplet  $i$  for antenna port  $p$ .

Mapping to resource elements is defined in terms of symbol quadruplets according to steps 1–10 below:

- 1) For each value of  $I'$
- 2) Let  $n_r$  denote the number of resource element groups not assigned to PCFICH in OFDM symbol  $I'$
- 3) Number the resource-element groups not assigned to PCFICH in OFDM symbol  $I'$  from 0 to  $n_r - 1$ , starting from the resource-element group with the lowest frequency-domain index.
- 4) Initialize  $m' = 0$  (PHICH mapping unit number)
- 5) For each value of  $i = 0, 1, 2$
- 6) Symbol-quadruplet  $z^{(p)}(i)$  from PHICH mapping unit  $m'$  is mapped to the resource-element group represented by  $(k', l')_i$  as defined in clause 6.2.4 where the indices  $k'_i$  and  $l'_i$  are given by steps 7 and 8 below:

- 7) The time-domain index  $l'_i$  is given by

$$l'_i = \begin{cases} 0 & \text{normal PHICH duration, all subframes} \\ (\lfloor m'/2 \rfloor + i + 1) \bmod 2 & \text{extended PHICH duration, MBSFN subframes} \\ (\lfloor m'/2 \rfloor + i + 1) \bmod 2 & \text{extended PHICH duration, subframe 1 and 6 in frame structure type 2} \\ i & \text{otherwise} \end{cases}$$

- 8) Set the frequency-domain index  $k'_i$  to the resource-element group assigned the number  $\bar{n}_i$  in step 3 above, where  $\bar{n}_i$  is given by

$$\bar{n}_i = \begin{cases} \left( \left\lfloor N_{\text{ID}}^{\text{cell}} \cdot n_{i'} / n_1 \right\rfloor + m' \right) \bmod n_{i'} & i = 0 \\ \left( \left\lfloor N_{\text{ID}}^{\text{cell}} \cdot n_{i'} / n_1 \right\rfloor + m' + \left\lfloor n_{i'} / 3 \right\rfloor \right) \bmod n_{i'} & i = 1 \\ \left( \left\lfloor N_{\text{ID}}^{\text{cell}} \cdot n_{i'} / n_1 \right\rfloor + m' + \left\lfloor 2n_{i'} / 3 \right\rfloor \right) \bmod n_{i'} & i = 2 \end{cases}$$

in case of extended PHICH duration in MBSFN subframes, or extended PHICH duration in subframes 1 and 6 for frame structure type 2 and by

$$\bar{n}_i = \begin{cases} \left( \left\lfloor N_{\text{ID}}^{\text{cell}} \cdot n_{i'} / n_0 \right\rfloor + m' \right) \bmod n_{i'} & i = 0 \\ \left( \left\lfloor N_{\text{ID}}^{\text{cell}} \cdot n_{i'} / n_0 \right\rfloor + m' + \left\lfloor n_{i'} / 3 \right\rfloor \right) \bmod n_{i'} & i = 1 \\ \left( \left\lfloor N_{\text{ID}}^{\text{cell}} \cdot n_{i'} / n_0 \right\rfloor + m' + \left\lfloor 2n_{i'} / 3 \right\rfloor \right) \bmod n_{i'} & i = 2 \end{cases}$$

otherwise.

9) Increase  $m'$  by 1.

10) Repeat from step 5 until all PHICH mapping units have been assigned.

The PHICH duration is configurable by higher layers according to Table 6.9.3-1.

**Table 6.9.3-1: PHICH duration in MBSFN and non-MBSFN subframes**

PHICH duration	Non-MBSFN subframes		MBSFN subframes on a carrier supporting PDSCH
	Subframes 1 and 6 in case of frame structure type 2	All other cases	
Normal	1	1	1
Extended	2	3	2

## 6.10 Reference signals

Six types of downlink reference signals are defined:

- Cell-specific Reference Signal (CRS)
- MBSFN reference signal
- UE-specific Reference Signal (DM-RS) associated with PDSCH
- DeModulation Reference Signal (DM-RS) associated with EPDCCH or MPDCCH
- Positioning Reference Signal (PRS)
- CSI Reference Signal (CSI-RS)

There is one reference signal transmitted per downlink antenna port.

### 6.10.1 Cell-specific Reference Signal (CRS)

The UE may assume cell-specific reference signals are, unless otherwise stated in [4, clause 12], transmitted in

- all downlink subframes for frame structure type 1,
- all downlink subframes and DwPTS for frame structure type 2,
- non-empty subframes for frame structure type 3

in a cell supporting PDSCH transmission.

Cell-specific reference signals are transmitted on one or several of antenna ports 0 to 3.

Cell-specific reference signals are defined for  $\Delta f = 15$  kHz only.

### 6.10.1.1 Sequence generation

The reference-signal sequence  $r_{l,n_s}(m)$  is defined by

$$r_{l,n_s}(m) = \frac{1}{\sqrt{2}}(1 - 2 \cdot c(2m)) + j \frac{1}{\sqrt{2}}(1 - 2 \cdot c(2m+1)), \quad m = 0, 1, \dots, 2N_{\text{RB}}^{\text{max,DL}} - 1$$

where  $n_s$  is the slot number within a radio frame and  $l$  is the OFDM symbol number within the slot. The pseudo-random sequence  $c(i)$  is defined in clause 7.2. The pseudo-random sequence generator shall be initialised with  $c_{\text{init}} = 2^{10} \cdot (7 \cdot (n'_s + 1) + l + 1) \cdot (2 \cdot N_{\text{ID}}^{\text{cell}} + 1) + 2 \cdot N_{\text{ID}}^{\text{cell}} + N_{\text{CP}}$  at the start of each OFDM symbol where

$$n'_s = \begin{cases} 10 \lfloor n_s / 10 \rfloor + n_s \bmod 2 & \text{for frame structure type 3 when the CRS is part of a DRS} \\ n_s & \text{otherwise} \end{cases}$$

$$N_{\text{CP}} = \begin{cases} 1 & \text{for normal CP} \\ 0 & \text{for extended CP} \end{cases}$$

### 6.10.1.2 Mapping to resource elements

The reference signal sequence  $r_{l,n_s}(m)$  shall be mapped to complex-valued modulation symbols  $a_{k,l}^{(p)}$  used as reference symbols for antenna port  $p$  in slot  $n_s$  according to

$$a_{k,l}^{(p)} = r_{l,n_s}(m')$$

where

$$k = 6m + (v + v_{\text{shift}}) \bmod 6$$

$$l = \begin{cases} 0, N_{\text{symp}}^{\text{DL}} - 3 & \text{if } p \in \{0, 1\} \\ 1 & \text{if } p \in \{2, 3\} \end{cases}$$

$$m = 0, 1, \dots, 2 \cdot N_{\text{RB}}^{\text{DL}} - 1$$

$$m' = m + N_{\text{RB}}^{\text{max,DL}} - N_{\text{RB}}^{\text{DL}}$$

The variables  $v$  and  $v_{\text{shift}}$  define the position in the frequency domain for the different reference signals where  $v$  is given by

$$v = \begin{cases} 0 & \text{if } p = 0 \text{ and } l = 0 \\ 3 & \text{if } p = 0 \text{ and } l \neq 0 \\ 3 & \text{if } p = 1 \text{ and } l = 0 \\ 0 & \text{if } p = 1 \text{ and } l \neq 0 \\ 3(n_s \bmod 2) & \text{if } p = 2 \\ 3 + 3(n_s \bmod 2) & \text{if } p = 3 \end{cases}$$

The cell-specific frequency shift is given by  $v_{\text{shift}} = N_{\text{ID}}^{\text{cell}} \bmod 6$ .

Resource elements  $(k, l)$  used for transmission of cell-specific reference signals on any of the antenna ports in a slot shall not be used for any transmission on any other antenna port in the same slot and set to zero.

In an MBSFN subframe, cell-specific reference signals shall only be transmitted in the non-MBSFN region of the MBSFN subframe.



Figures 6.10.1.2-1 and 6.10.1.2-2 illustrate the resource elements used for reference signal transmission according to the above definition. The notation  $R_p$  is used to denote a resource element used for reference signal transmission on antenna port  $p$ .

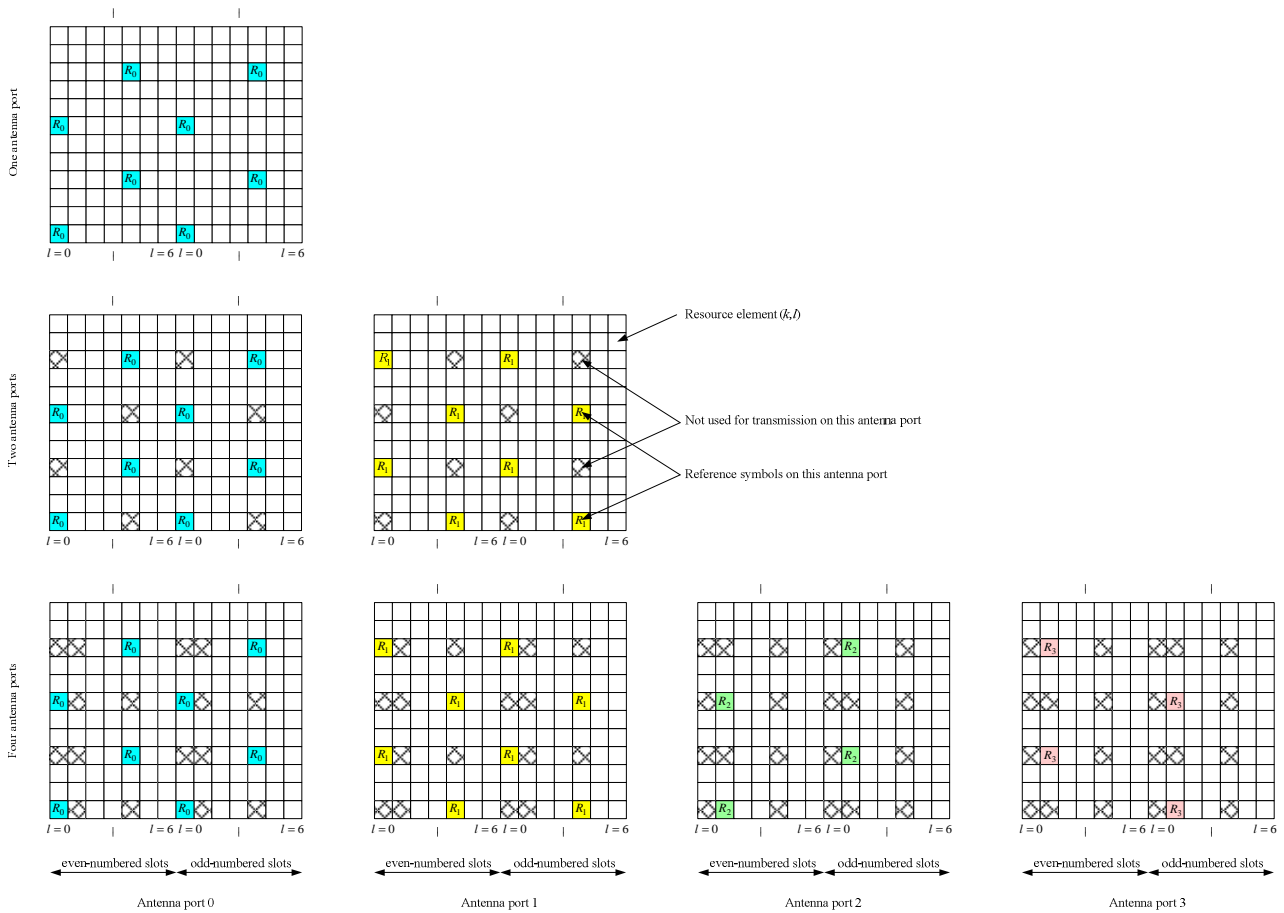

Figure 6.10.1.2-1. Mapping of downlink reference signals (normal cyclic prefix)

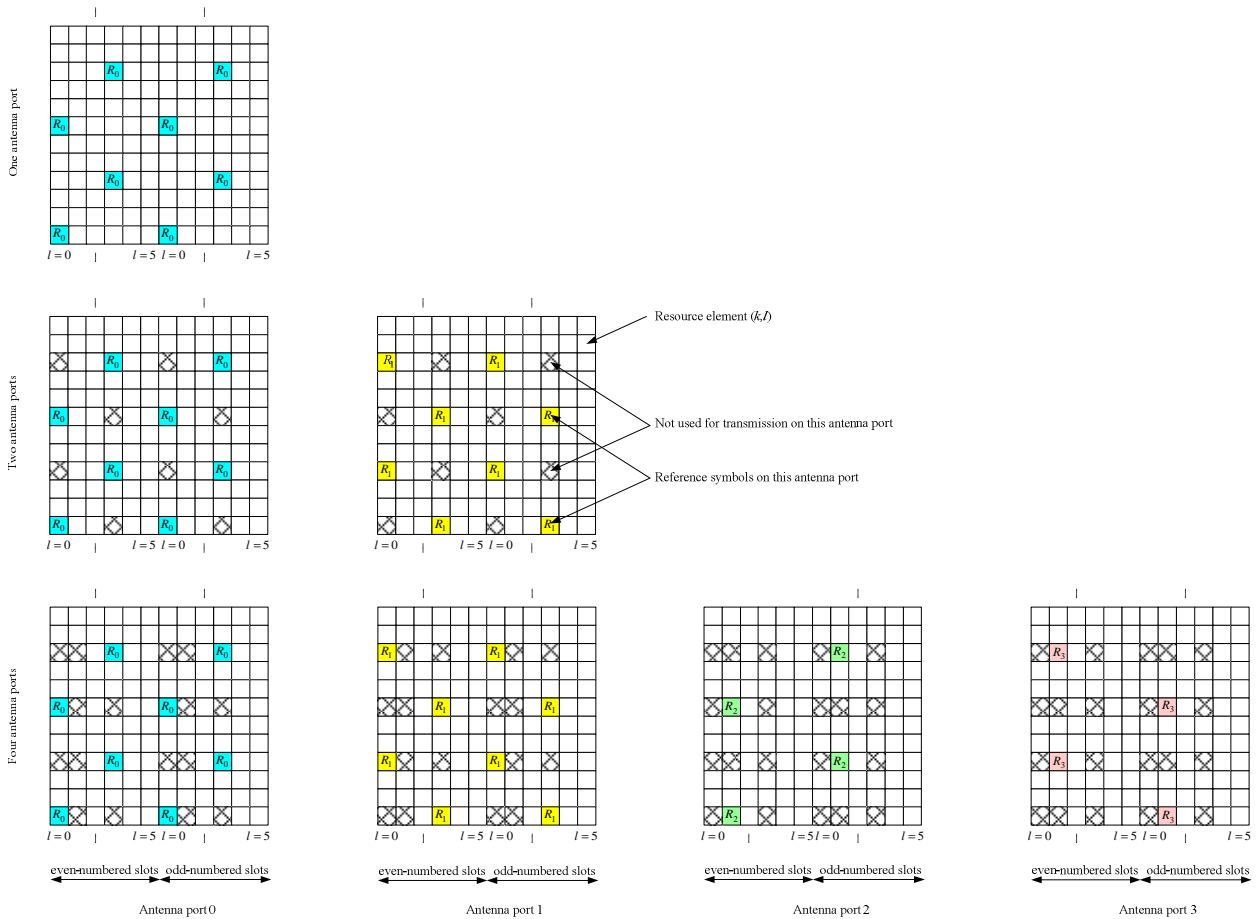

Figure 6.10.1.2-2. Mapping of downlink reference signals (extended cyclic prefix)

## 6.10.2 MBSFN reference signals

MBSFN reference signals shall be transmitted in the MBSFN region of MBSFN subframes only when the PMCH is transmitted. MBSFN reference signals are transmitted on antenna port 4.

MBSFN reference signals are defined for extended cyclic prefix only.

### 6.10.2.1 Sequence generation

The MBSFN reference-signal sequence  $r_{l,n_s}(m)$  is defined by

$$r_{l,n_s}(m) = \frac{1}{\sqrt{2}}(1 - 2 \cdot c(2m)) + j \frac{1}{\sqrt{2}}(1 - 2 \cdot c(2m+1)), \quad m = 0, 1, \dots, 6N_{RB}^{\max,DL} - 1$$

where  $n_s$  is the slot number within a radio frame and  $l$  is the OFDM symbol number within the slot. The pseudo-random sequence  $c(i)$  is defined in clause 7.2. The pseudo-random sequence generator shall be initialised with  $c_{init} = 2^9 \cdot (7 \cdot (n_s + 1) + l + 1) \cdot (2 \cdot N_{ID}^{MBSFN} + 1) + N_{ID}^{MBSFN}$  at the start of each OFDM symbol.

### 6.10.2.2 Mapping to resource elements

The reference-signal sequence  $r_{l,n_s}(m')$  in OFDM symbol  $l$  shall be mapped to complex-valued modulation symbols  $a_{k,l}^{(p)}$  with  $p = 4$  according to

$$a_{k,l}^{(p)} = r_{l,n_s}(m')$$

where

$$k = \begin{cases} 2m & \text{if } l \neq 0 \text{ and } \Delta f = 15 \text{ kHz} \\ 2m + 1 & \text{if } l = 0 \text{ and } \Delta f = 15 \text{ kHz} \\ 4m & \text{if } l \neq 0 \text{ and } \Delta f = 7.5 \text{ kHz} \\ 4m + 2 & \text{if } l = 0 \text{ and } \Delta f = 7.5 \text{ kHz} \end{cases}$$

$$l = \begin{cases} 2 & \text{if } n_s \bmod 2 = 0 \text{ and } \Delta f = 15 \text{ kHz} \\ 0, 4 & \text{if } n_s \bmod 2 = 1 \text{ and } \Delta f = 15 \text{ kHz} \\ 1 & \text{if } n_s \bmod 2 = 0 \text{ and } \Delta f = 7.5 \text{ kHz} \\ 0, 2 & \text{if } n_s \bmod 2 = 1 \text{ and } \Delta f = 7.5 \text{ kHz} \end{cases}$$

$$m = 0, 1, \dots, 6N_{RB}^{DL} - 1$$

$$m' = m + 3(N_{RB}^{max,DL} - N_{RB}^{DL})$$

Figure 6.10.2.2-1 illustrates the resource elements used for MBSFN reference signal transmission in case of  $\Delta f = 15 \text{ kHz}$ . In case of  $\Delta f = 7.5 \text{ kHz}$  for a MBSFN-dedicated cell, the MBSFN reference signal shall be mapped to resource elements according to Figure 6.10.2.2-3. The notation  $R_p$  is used to denote a resource element used for reference signal transmission on antenna port  $p$ .

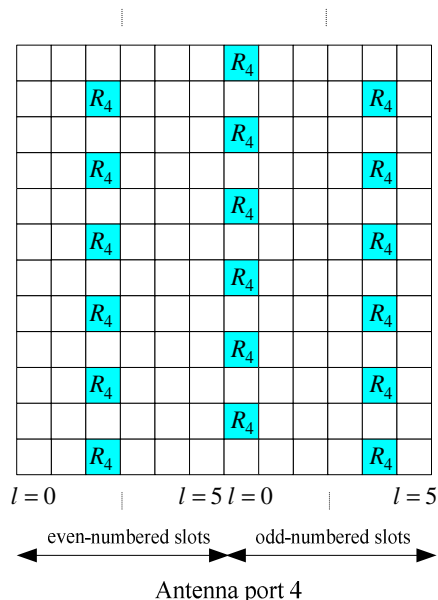

Figure 6.10.2.2-1: Mapping of MBSFN reference signals (extended cyclic prefix,  $\Delta f = 15 \text{ kHz}$ )

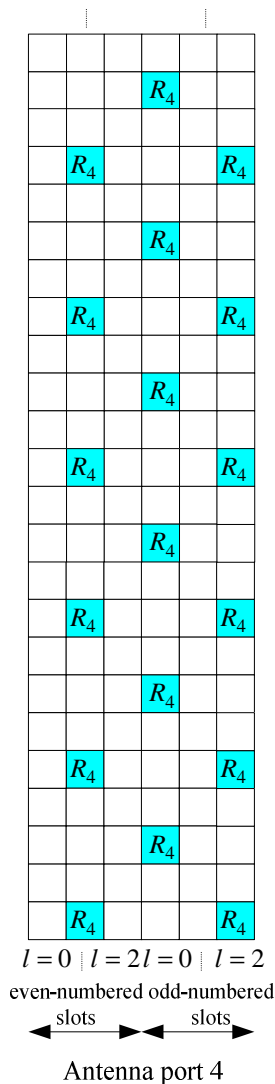

Figure 6.10.2.2-3: Mapping of MBSFN reference signals (extended cyclic prefix,  $\Delta f = 7.5$  kHz)

### 6.10.3 UE-specific reference signals associated with PDSCH

UE-specific reference signals associated with PDSCH

- are transmitted on antenna port(s)  $p = 5, p = 7, p = 8, p = 11, p = 13, p = \{11, 13\}$  or  $p = 7, 8, \dots, v + 6$ , where  $v$  is the number of layers used for transmission of the PDSCH;
- are present and are a valid reference for PDSCH demodulation only if the PDSCH transmission is associated with the corresponding antenna port according to clause 7.1 of 3GPP TS 36.213 [4];
- are transmitted only on the physical resource blocks upon which the corresponding PDSCH is mapped.

A UE-specific reference signal associated with PDSCH is not transmitted in resource elements  $(k, l)$  in which one of the physical channels or physical signals other than the UE-specific reference signals defined in 6.1 are transmitted using resource elements with the same index pair  $(k, l)$  regardless of their antenna port  $p$ .

For frame structure type 3, for PDSCH in a subframe with the same duration as the DwPTS duration of a special subframe configuration, the UE-specific reference signals are defined the same as that for the corresponding special subframe configuration.

### 6.10.3.1 Sequence generation

For antenna port 5, the UE-specific reference-signal sequence  $r_{n_s}(m)$  is defined by

$$r_{n_s}(m) = \frac{1}{\sqrt{2}}(1 - 2 \cdot c(2m)) + j \frac{1}{\sqrt{2}}(1 - 2 \cdot c(2m+1)), \quad m = 0, 1, \dots, 12N_{\text{RB}}^{\text{PDSCH}} - 1$$

where  $N_{\text{RB}}^{\text{PDSCH}}$  denotes the assigned bandwidth in resource blocks of the corresponding PDSCH transmission. The pseudo-random sequence  $c(i)$  is defined in clause 7.2. The pseudo-random sequence generator shall be initialised with  $c_{\text{init}} = (\lfloor n_s/2 \rfloor + 1) \cdot (2N_{\text{ID}}^{\text{cell}} + 1) \cdot 2^{16} + n_{\text{RNTI}}$  at the start of each subframe where  $n_{\text{RNTI}}$  is as described in clause 7.1 3GPP TS 36.213 [4].

For any of the antenna ports  $p \in \{7, 8, \dots, 14\}$ , the reference-signal sequence  $r(m)$  is defined by

$$r(m) = \frac{1}{\sqrt{2}}(1 - 2 \cdot c(2m)) + j \frac{1}{\sqrt{2}}(1 - 2 \cdot c(2m+1)), \quad m = \begin{cases} 0, 1, \dots, 12N_{\text{RB}}^{\text{max,DL}} - 1 & \text{normal cyclic prefix} \\ 0, 1, \dots, 16N_{\text{RB}}^{\text{max,DL}} - 1 & \text{extended cyclic prefix} \end{cases}$$

The pseudo-random sequence  $c(i)$  is defined in clause 7.2. The pseudo-random sequence generator shall be initialised with

$$c_{\text{init}} = (\lfloor n_s/2 \rfloor + 1) \cdot (2n_{\text{ID}}^{(\text{n}_{\text{SCID}})} + 1) \cdot 2^{16} + n_{\text{SCID}}$$

at the start of each subframe.

For BL/CE UEs, the same scrambling sequence is applied per subframe to the UE-specific reference-signal sequence for a given block of  $N_{\text{acc}}$  subframes. For the  $j^{\text{th}}$  block of  $N_{\text{acc}}$  subframes, the scrambling sequence generator shall be initialised with

$$c_{\text{init}} = ((j_0 + j)N_{\text{acc}} \bmod 10 + 1) \cdot (2N_{\text{ID}}^{\text{cell}} + 1) \cdot 2^{16} + n_{\text{SCID}}$$

where

$$j = 0, 1, \dots, \left\lfloor \frac{i_0 + N_{\text{abs}}^{\text{PDSCH}} + i_{\Delta} - 1}{N_{\text{acc}}} \right\rfloor - j_0$$

$$j_0 = \lfloor (i_0 + i_{\Delta}) / N_{\text{acc}} \rfloor$$

$$i_{\Delta} = \begin{cases} 0, & \text{for frame structure type 1} \\ N_{\text{acc}} - 2, & \text{for frame structure type 2} \end{cases}$$

and  $i_0$  is the absolute subframe number of the first downlink subframe intended for PDSCH. The PDSCH transmissions span  $N_{\text{abs}}^{\text{PDSCH}}$  consecutive subframes, including invalid subframes where the PDSCH transmission is postponed. For a BL/CE UE configured in CEModeA,  $N_{\text{acc}} = 1$ . For a BL/CE UE configured with CEModeB,  $N_{\text{acc}} = 4$  for frame structure type 1 and  $N_{\text{acc}} = 10$  for frame structure type 2.

The quantities  $n_{\text{ID}}^{(i)}$ ,  $i = 0, 1$ , are given by

- $n_{\text{ID}}^{(i)} = N_{\text{ID}}^{\text{cell}}$  if no value for  $n_{\text{ID}}^{\text{DMRS},i}$  is provided by higher layers or if DCI format 1A, 2B or 2C is used for the DCI associated with the PDSCH transmission
- $n_{\text{ID}}^{(i)} = n_{\text{ID}}^{\text{DMRS},i}$  otherwise

The value of  $n_{\text{SCID}}$  is zero unless specified otherwise. For a PDSCH transmission on ports 7 or 8,  $n_{\text{SCID}}$  is given by the DCI format 2B, 2C, 2D or 6-1A in 3GPP TS 36.212 [3] associated with the PDSCH transmission. In the case of DCI format 2B,  $n_{\text{SCID}}$  is indicated by the scrambling identity field according to Table 6.10.3.1-1. In the case of DCI format 2C or 2D,  $n_{\text{SCID}}$  is given by Table 5.3.3.1.5C-1 or Table 5.3.3.1.5C-2 in 3GPP TS 36.212 [3]. For a

PDSCH transmission on ports 11 or 13,  $n_{\text{SCID}}$  is given by the DCI format 2C or 2D in 3GPP TS 36.212 [3] associated with the PDSCH transmission where  $n_{\text{SCID}}$  is given by Table 5.3.3.1.5C-2 in 3GPP TS 36.212 [3].

**Table 6.10.3.1-1: Mapping of scrambling identity field in DCI format 2B to  $n_{\text{SCID}}$  values for antenna ports 7 and 8**

Scrambling identity field in DCI format 2B (3GPP TS 36.212 [3])	$n_{\text{SCID}}$
0	0
1	1

### 6.10.3.2 Mapping to resource elements

For antenna port 5, in a physical resource block with frequency-domain index  $n_{\text{PRB}}$  assigned for the corresponding PDSCH transmission, the reference signal sequence  $r_{n_s}(m)$  shall be mapped to complex-valued modulation symbols  $a_{k,l}^{(p)}$  with  $p=5$  in a subframe according to:

Normal cyclic prefix:

$$a_{k,l}^{(p)} = r_{n_s}(3 \cdot l' \cdot N_{\text{RB}}^{\text{PDSCH}} + m')$$

$$k = (k') \bmod N_{\text{sc}}^{\text{RB}} + N_{\text{sc}}^{\text{RB}} \cdot n_{\text{PRB}}$$

$$k' = \begin{cases} 4m' + v_{\text{shift}} & \text{if } l \in \{2,3\} \\ 4m' + (2 + v_{\text{shift}}) \bmod 4 & \text{if } l \in \{5,6\} \end{cases}$$

$$l = \begin{cases} 3 & l' = 0 \\ 6 & l' = 1 \\ 2 & l' = 2 \\ 5 & l' = 3 \end{cases}$$

$$l' = \begin{cases} 0,1 & \text{if } n_s \bmod 2 = 0 \\ 2,3 & \text{if } n_s \bmod 2 = 1 \end{cases}$$

$$m' = 0, 1, \dots, 3N_{\text{RB}}^{\text{PDSCH}} - 1$$

Extended cyclic prefix:

$$a_{k,l}^{(p)} = r_{n_s}(4 \cdot l' \cdot N_{\text{RB}}^{\text{PDSCH}} + m')$$

$$k = (k') \bmod N_{\text{sc}}^{\text{RB}} + N_{\text{sc}}^{\text{RB}} \cdot n_{\text{PRB}}$$

$$k' = \begin{cases} 3m' + v_{\text{shift}} & \text{if } l = 4 \\ 3m' + (2 + v_{\text{shift}}) \bmod 3 & \text{if } l = 1 \end{cases}$$

$$l = \begin{cases} 4 & l' \in \{0,2\} \\ 1 & l' = 1 \end{cases}$$

$$l' = \begin{cases} 0 & \text{if } n_s \bmod 2 = 0 \\ 1,2 & \text{if } n_s \bmod 2 = 1 \end{cases}$$

$$m' = 0, 1, \dots, 4N_{\text{RB}}^{\text{PDSCH}} - 1$$

where  $m'$  is the counter of UE-specific reference signal resource elements within a respective OFDM symbol of the PDSCH transmission.

The cell-specific frequency shift is given by  $v_{\text{shift}} = N_{\text{ID}}^{\text{cell}} \bmod 3$ .

The mapping shall be in increasing order of the frequency-domain index  $n_{PRB}$  of the physical resource blocks assigned for the corresponding PDSCH transmission. The quantity  $N_{RB}^{PDSCH}$  denotes the assigned bandwidth in resource blocks of the corresponding PDSCH transmission.

Figure 6.10.3.2-1 illustrates the resource elements used for UE-specific reference signals for normal cyclic prefix for antenna port 5.

Figure 6.10.3.2-2 illustrates the resource elements used for UE-specific reference signals for extended cyclic prefix for antenna port 5.

The notation  $R_p$  is used to denote a resource element used for reference signal transmission on antenna port  $p$ .

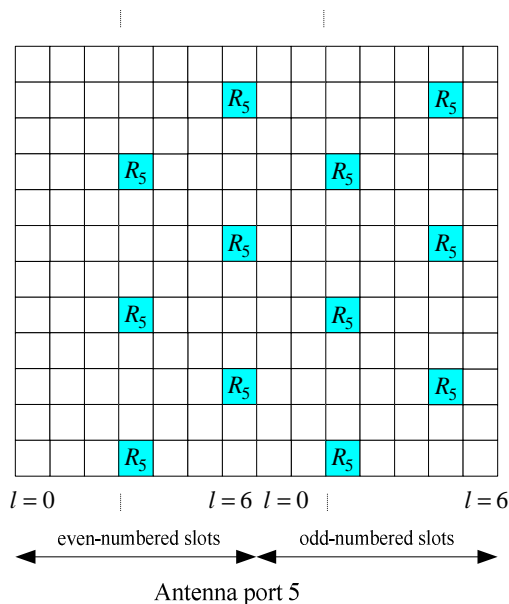

Figure 6.10.3.2-1: Mapping of UE-specific reference signals, antenna port 5 (normal cyclic prefix)

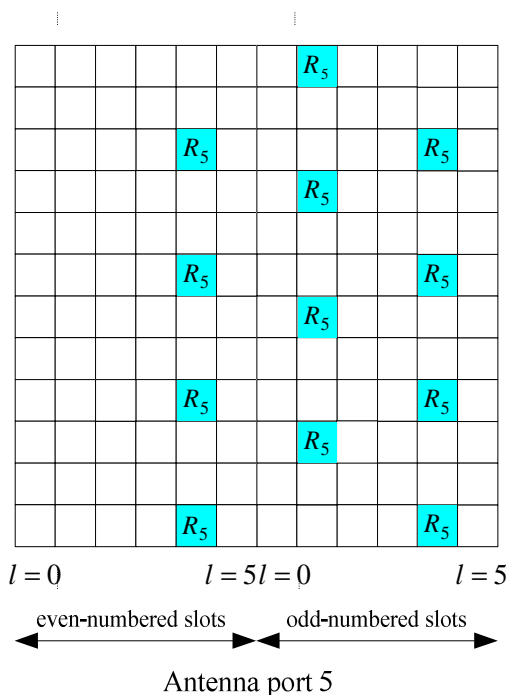

Figure 6.10.3.2-2: Mapping of UE-specific reference signals, antenna port 5 (extended cyclic prefix)

For antenna ports  $p = 7$ ,  $p = 8$ ,  $p = 11$ ,  $p = 13$ ,  $p = \{11, 13\}$  or  $p = 7, 8, \dots, v + 6$ , in a physical resource block with frequency-domain index  $n_{\text{PRB}}$  assigned for the corresponding PDSCH transmission, a part of the reference signal sequence  $r(m)$  shall be mapped to complex-valued modulation symbols  $a_{k,l}^{(p)}$  in a subframe according to

Normal cyclic prefix:

$$a_{k,l}^{(p)} = w_p(l') \cdot r(3 \cdot l' \cdot N_{\text{RB}}^{\text{max,DL}} + 3 \cdot n_{\text{PRB}} + m')$$

where

$$w_p(i) = \begin{cases} \bar{w}_p(i) & (m' + n_{\text{PRB}}) \bmod 2 = 0 \\ \bar{w}_p(3-i) & (m' + n_{\text{PRB}}) \bmod 2 = 1 \end{cases}$$

$$k = 5m' + N_{\text{sc}}^{\text{RB}} n_{\text{PRB}} + k'$$

$$k' = \begin{cases} 1 & p \in \{7, 8, 11, 13\} \\ 0 & p \in \{9, 10, 12, 14\} \end{cases}$$

$$l' = \begin{cases} l' \bmod 2 + 2 & \text{if in a special subframe with configuration 3, 4, 8 or 9 (see Table 4.2-1)} \\ l' \bmod 2 + 2 + 3 \lfloor l'/2 \rfloor & \text{if in a special subframe with configuration 1, 2, 6, or 7 (see Table 4.2-1)} \\ l' \bmod 2 + 5 & \text{if not in a special subframe} \end{cases}$$

$$l' = \begin{cases} 0, 1, 2, 3 & \text{if } n_s \bmod 2 = 0 \text{ and in a special subframe with configuration 1, 2, 6, or 7 (see Table 4.2-1)} \\ 0, 1 & \text{if } n_s \bmod 2 = 0 \text{ and not in special subframe with configuration 1, 2, 6, or 7 (see Table 4.2-1)} \\ 2, 3 & \text{if } n_s \bmod 2 = 1 \text{ and not in special subframe with configuration 1, 2, 6, or 7 (see Table 4.2-1)} \end{cases}$$

$$m' = 0, 1, 2$$

The sequence  $\bar{w}_p(i)$  is given by Table 6.10.3.2-1.

**Table 6.10.3.2-1: The sequence  $\bar{w}_p(i)$  for normal cyclic prefix**

Antenna port $p$	$\begin{bmatrix} \bar{w}_p(0) & \bar{w}_p(1) & \bar{w}_p(2) & \bar{w}_p(3) \end{bmatrix}$
7	$\begin{bmatrix} +1 & +1 & +1 & +1 \end{bmatrix}$
8	$\begin{bmatrix} +1 & -1 & +1 & -1 \end{bmatrix}$
9	$\begin{bmatrix} +1 & +1 & +1 & +1 \end{bmatrix}$
10	$\begin{bmatrix} +1 & -1 & +1 & -1 \end{bmatrix}$
11	$\begin{bmatrix} +1 & +1 & -1 & -1 \end{bmatrix}$
12	$\begin{bmatrix} -1 & -1 & +1 & +1 \end{bmatrix}$
13	$\begin{bmatrix} +1 & -1 & -1 & +1 \end{bmatrix}$
14	$\begin{bmatrix} -1 & +1 & +1 & -1 \end{bmatrix}$

Extended cyclic prefix:

$$a_{k,l}^{(p)} = w_p(l' \bmod 2) \cdot r(4 \cdot l' \cdot N_{\text{RB}}^{\text{max,DL}} + 4 \cdot n_{\text{PRB}} + m')$$

where



$$w_p(i) = \begin{cases} \overline{w}_p(i) & m' \bmod 2 = 0 \\ \overline{w}_p(1-i) & m' \bmod 2 = 1 \end{cases}$$

$$k = 3m' + N_{sc}^{RB} n_{PRB} + k'$$

$$k' = \begin{cases} 1 & \text{if } n_s \bmod 2 = 0 \text{ and } p \in \{7,8\} \\ 2 & \text{if } n_s \bmod 2 = 1 \text{ and } p \in \{7,8\} \end{cases}$$

$$l = l' \bmod 2 + 4$$

$$l' = \begin{cases} 0,1 & \text{if } n_s \bmod 2 = 0 \text{ and in a special subframe with configuration 1, 2, 3, 5 or 6 (see Table 4.2-1)} \\ 0,1 & \text{if } n_s \bmod 2 = 0 \text{ and not in a special subframe} \\ 2,3 & \text{if } n_s \bmod 2 = 1 \text{ and not in a special subframe} \end{cases}$$

$$m' = 0,1,2,3$$

The sequence  $\overline{w}_p(i)$  is given by Table 6.10.3.2-2.

**Table 6.10.3.2-2: The sequence  $\overline{w}_p(i)$  for extended cyclic prefix**

Antenna port $p$	$[\overline{w}_p(0) \quad \overline{w}_p(1)]$
7	$[+1 \quad +1]$
8	$[-1 \quad +1]$

For extended cyclic prefix, UE-specific reference signals are not supported on antenna ports 9 to 14.

Resource elements  $(k, l)$  used for transmission of UE-specific reference signals to one UE on any of the antenna ports in the set  $S$ , where  $S = \{7,8,11,13\}$  or  $S = \{9,10,12,14\}$  shall

- not be used for transmission of PDSCH on any antenna port in the same slot, and
- not be used for UE-specific reference signals to the same UE on any antenna port other than those in  $S$  in the same slot.

Figure 6.10.3.2-3 illustrates the resource elements used for UE-specific reference signals for normal cyclic prefix for antenna ports 7, 8, 9 and 10. Figure 6.10.3.2-4 illustrates the resource elements used for UE-specific reference signals for extended cyclic prefix for antenna ports 7, 8.

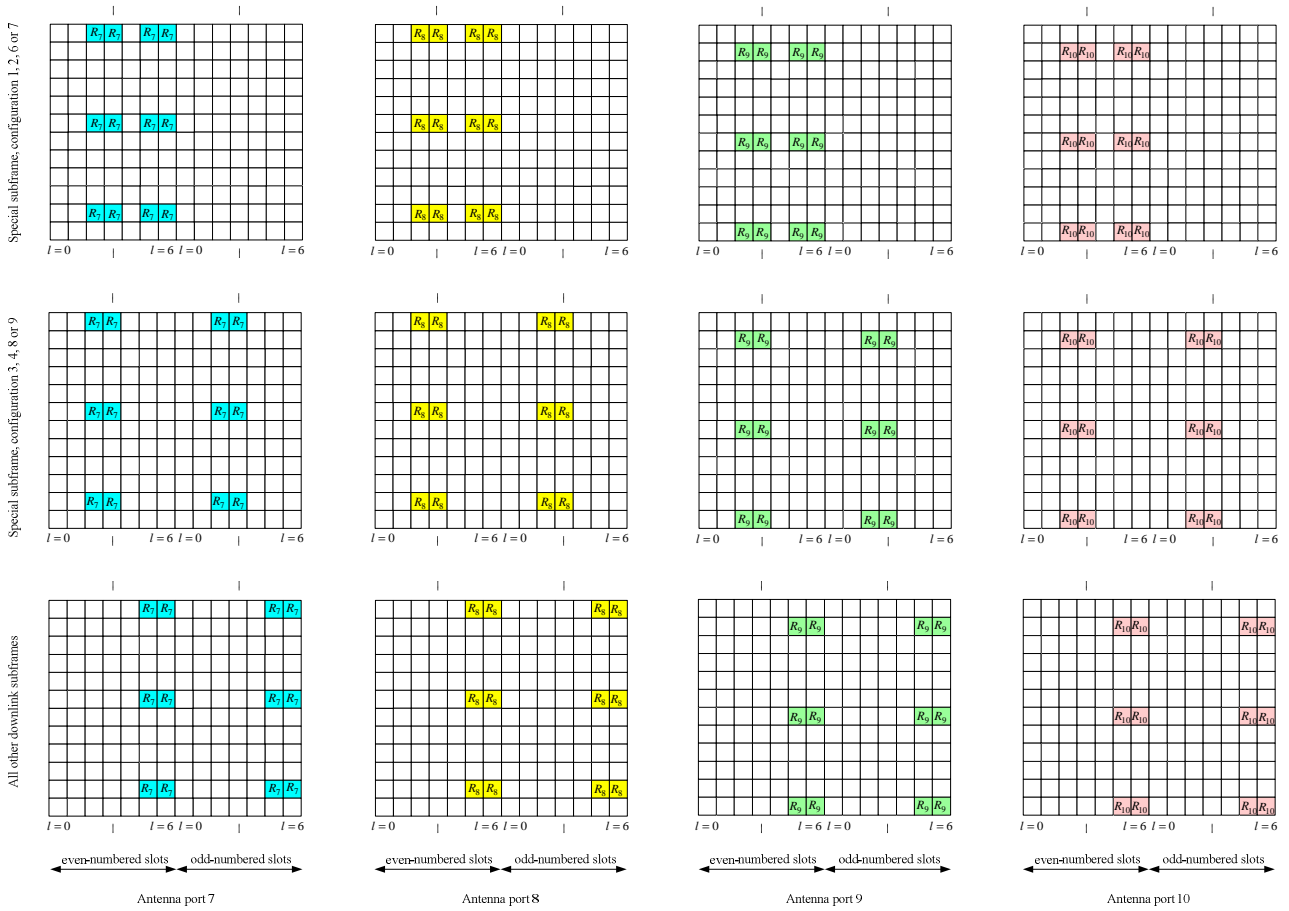

Figure 6.10.3.2-3: Mapping of UE-specific reference signals, antenna ports 7, 8, 9 and 10 (normal cyclic prefix)

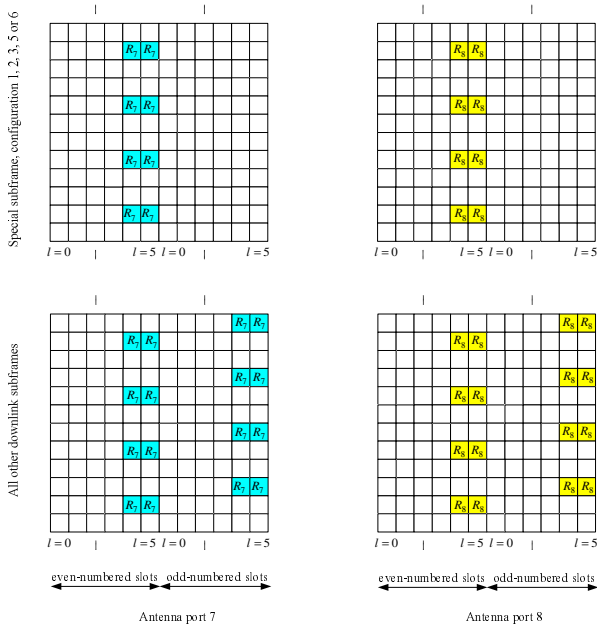

Figure 6.10.3.2-4: Mapping of UE-specific reference signals, antenna ports 7 and 8 (extended cyclic prefix)

## 6.10.3A Demodulation reference signals associated with EPDCCH or MPDCCH

The demodulation reference signal associated with EPDCCH/MPDCCH

- is transmitted on the same antenna port  $p \in \{107,108,109,110\}$  as the associated EPDCCH/MPDCCH physical resource;
- is present and is a valid reference for EPDCCH/MPDCCH demodulation only if the EPDCCH/MPDCCH transmission is associated with the corresponding antenna port;
- is transmitted only on the physical resource blocks upon which the corresponding EPDCCH/MPDCCH is mapped.

A demodulation reference signal associated with EPDCCH/MPDCCH is not transmitted in resource elements  $(k,l)$  in which one of the physical channels or physical signals other than the demodulation reference signals defined in 6.1 are transmitted using resource elements with the same index pair  $(k,l)$  regardless of their antenna port  $p$ .

### 6.10.3A.1 Sequence generation

For any of the antenna ports  $p \in \{107,108,109,110\}$ , the reference-signal sequence  $r(m)$  is defined by

$$r(m) = \frac{1}{\sqrt{2}}(1 - 2 \cdot c(2m)) + j \frac{1}{\sqrt{2}}(1 - 2 \cdot c(2m+1)), \quad m = \begin{cases} 0, 1, \dots, 12N_{\text{RB}}^{\text{max,DL}} - 1 & \text{normal cyclic prefix} \\ 0, 1, \dots, 16N_{\text{RB}}^{\text{max,DL}} - 1 & \text{extended cyclic prefix} \end{cases}$$

For non-BL/CE UEs, the pseudo-random sequence  $c(n)$  is defined in clause 7.2. The pseudo-random sequence generator shall be initialised with

$$c_{\text{init}} = (\lfloor n_s / 2 \rfloor + 1) \cdot (2n_{\text{ID},i}^{\text{EPDCCH}} + 1) \cdot 2^{16} + n_{\text{SCID}}^{\text{EPDCCH}}$$

at the start of each subframe where  $n_{\text{SCID}}^{\text{EPDCCH}} = 2$  and  $n_{\text{ID},i}^{\text{EPDCCH}}$  is configured by higher layers. The EPDCCH set to which the EPDCCH associated with the demodulation reference signal belong is denoted  $i \in \{0,1\}$ .

For BL/CE UEs, the same scrambling sequence is applied per subframe to the demodulation reference signal associated with MPDCCH for a given block of  $N_{\text{acc}}$  subframes. For the  $j^{\text{th}}$  block of  $N_{\text{acc}}$  subframes, the scrambling sequence generator shall be initialised with

$$c_{\text{init}} = \begin{cases} (\lfloor (j_0 + j)N_{\text{acc}} \bmod 10 \rfloor + 1) \cdot (2N_{\text{ID},i}^{\text{MPDCCH}} + 1) \cdot 2^{16} + n_{\text{SCID}}^{\text{MPDCCH}} & \text{otherwise} \\ (\lfloor (j_0 + j)N_{\text{acc}} \bmod 10 \rfloor + 1) \cdot (2N_{\text{ID}}^{\text{cell}} + 1) \cdot 2^{16} + n_{\text{SCID}}^{\text{MPDCCH}} & \text{for P - RNTI, RA - RNTI and temporary C - RNTI} \end{cases} \quad \text{where}$$

$$j = 0, 1, \dots, \left\lfloor \frac{i_0 + N_{\text{abs}}^{\text{MPDCCH}} + i_{\Delta} - 1}{N_{\text{acc}}} \right\rfloor - j_0$$

$$j_0 = \lfloor (i_0 + i_{\Delta}) / N_{\text{acc}} \rfloor$$

$$i_{\Delta} = \begin{cases} 0, & \text{for frame structure type 1} \\ N_{\text{acc}} - 2, & \text{for frame structure type 2} \end{cases}$$

and  $i_0$  is the absolute subframe number of the first downlink subframe intended for MPDCCH. The MPDCCH transmissions span  $N_{\text{abs}}^{\text{MPDCCH}}$  consecutive subframes, including invalid subframes where the MPDCCH transmission is postponed. For a BL/CE UE configured with CEModeA,  $N_{\text{acc}} = 1$ . For a BL/CE UE configured with CEModeB,  $N_{\text{acc}} = 4$  for frame structure type 1 and  $N_{\text{acc}} = 10$  for frame structure type 2. The quantities  $n_{\text{SCID}}^{\text{MPDCCH}} = 2$  and  $n_{\text{ID},i}^{\text{MPDCCH}}$  are configured by higher layers. The MPDCCH set to which the MPDCCH associated with the demodulation reference signal belong is denoted  $i \in \{0,1\}$ . For an MPDCCH associated with a 2+4 PRB set as defined in [4],  $i = 0$  is used to generate the scrambling sequence for the 6 PRBs as well as for the 2 PRBs and 4 PRBs.

### 6.10.3A.2 Mapping to resource elements

For the antenna port  $p \in \{107,108,109,110\}$  in a physical resource block  $n_{\text{PRB}}$  assigned for the associated EPDCCH/MPDCCH, a part of the reference signal sequence  $r(m)$  shall be mapped to complex-valued modulation symbols  $a_{k,l}^{(p)}$  in a subframe according to

Normal cyclic prefix:

$$a_{k,l}^{(p)} = w_p(l') \cdot r(3 \cdot l' \cdot N_{\text{RB}}^{\text{max,DL}} + 3 \cdot n_{\text{PRB}} + m')$$

where

$$w_p(i) = \begin{cases} \bar{w}_p(i) & (m' + n_{\text{PRB}}) \bmod 2 = 0 \\ \bar{w}_p(3-i) & (m' + n_{\text{PRB}}) \bmod 2 = 1 \end{cases}$$

$$k = 5m' + N_{\text{sc}}^{\text{RB}} n_{\text{PRB}} + k'$$

$$k' = \begin{cases} 1 & p \in \{107,108\} \\ 0 & p \in \{109,110\} \end{cases}$$

$$l = \begin{cases} l' \bmod 2 + 2 & \text{if in a special subframe with configuration 3, 4, 8 or 9 (see Table 4.2-1)} \\ l' \bmod 2 + 2 + 3 \lfloor l'/2 \rfloor & \text{if in a special subframe with configuration 1, 2, 6, or 7 (see Table 4.2-1)} \\ l' \bmod 2 + 5 & \text{if not in a special subframe} \end{cases}$$

$$l' = \begin{cases} 0,1,2,3 & \text{if } n_s \bmod 2 = 0 \text{ and in a special subframe with configuration 1, 2, 6, or 7 (see Table 4.2-1)} \\ 0,1 & \text{if } n_s \bmod 2 = 0 \text{ and not in special subframe with configuration 1, 2, 6, or 7 (see Table 4.2-1)} \\ 2,3 & \text{if } n_s \bmod 2 = 1 \text{ and not in special subframe with configuration 1, 2, 6, or 7 (see Table 4.2-1)} \end{cases}$$

$$m' = 0,1,2$$

The sequence  $\bar{w}_p(i)$  is given by Table 6.10.3A.2-1.

**Table 6.10.3A.2-1: The sequence  $\bar{w}_p(i)$  for normal cyclic prefix**

Antenna port $p$	$\begin{bmatrix} \bar{w}_p(0) & \bar{w}_p(1) & \bar{w}_p(2) & \bar{w}_p(3) \end{bmatrix}$
107	$\begin{bmatrix} +1 & +1 & +1 & +1 \end{bmatrix}$
108	$\begin{bmatrix} +1 & -1 & +1 & -1 \end{bmatrix}$
109	$\begin{bmatrix} +1 & +1 & +1 & +1 \end{bmatrix}$
110	$\begin{bmatrix} +1 & -1 & +1 & -1 \end{bmatrix}$

Extended cyclic prefix:

$$a_{k,l}^{(p)} = w_p(l' \bmod 2) \cdot r(4 \cdot l' \cdot N_{\text{RB}}^{\text{max,DL}} + 4 \cdot n_{\text{PRB}} + m')$$

where

$$w_p(i) = \begin{cases} \bar{w}_p(i) & m' \bmod 2 = 0 \\ \bar{w}_p(1-i) & m' \bmod 2 = 1 \end{cases}$$

$$k = 3m' + N_{\text{sc}}^{\text{RB}} n_{\text{PRB}} + k'$$

$$k' = \begin{cases} 1 & \text{if } n_s \bmod 2 = 0 \text{ and } p \in \{107,108\} \\ 2 & \text{if } n_s \bmod 2 = 1 \text{ and } p \in \{107,108\} \end{cases}$$

$$l = l' \bmod 2 + 4$$

$$l' = \begin{cases} 0,1 & \text{if } n_s \bmod 2 = 0 \text{ and in a special subframe with configuration 1, 2, 3, 5 or 6 (see Table 4.2-1)} \\ 0,1 & \text{if } n_s \bmod 2 = 0 \text{ and not in a special subframe} \\ 2,3 & \text{if } n_s \bmod 2 = 1 \text{ and not in a special subframe} \end{cases}$$

$$m' = 0,1,2,3$$

The sequence  $\bar{w}_p(i)$  is given by Table 6.10.3A.2-2.

**Table 6.10.3A.2-2: The sequence  $\overline{w}_p(i)$  for extended cyclic prefix**

Antenna port $p$	$[\overline{w}_p(0) \quad \overline{w}_p(1)]$
107	[+1 +1]
108	[-1 +1]

For extended cyclic prefix, demodulation reference signals are not supported on antenna ports 109 to 110.

Resource elements  $(k, l)$  used for transmission of demodulation reference signals to one UE on any of the antenna ports in the set  $S$ , where  $S = \{107, 108\}$  or  $S = \{109, 110\}$  shall

- not be used for transmission of EPDCCH/MPDCCH on any antenna port in the same slot, and
- not be used for demodulation reference signals to the same UE on any antenna port other than those in  $S$  in the same slot.

Replacing antenna port numbers 7 – 10 by 107 – 110 in Figure 6.10.3.2-3 provides an illustration of the resource elements used for demodulation reference signals associated with EPDCCH/MPDCCH for normal cyclic prefix. Replacing antenna port numbers 7 – 8 by 107 – 108 in Figure 6.10.3.2-4 provides an illustration of the resource elements used for demodulation reference signals associated with EPDCCH/MPDCCH for extended cyclic prefix.

For frame structure type 3, for EPDCCH in a subframe with the same duration as the DwPTS duration of a special subframe configuration, the mapping of the demodulation reference signals to the resource elements is the same as that for the corresponding special subframe configuration.

## 6.10.4 Positioning reference signals

Positioning reference signals shall only be transmitted in resource blocks in downlink subframes configured for positioning reference signal transmission. If both normal and MBSFN subframes are configured as positioning subframes within a cell, the OFDM symbols in a MBSFN subframe configured for positioning reference signal transmission shall use the same cyclic prefix as used for subframe #0. If only MBSFN subframes are configured as positioning subframes within a cell, the OFDM symbols configured for positioning reference signals in the MBSFN region of these subframes shall use extended cyclic prefix length. In a subframe configured for positioning reference signal transmission, the starting positions of the OFDM symbols configured for positioning reference signal transmission shall be identical to those in a subframe in which all OFDM symbols have the same cyclic prefix length as the OFDM symbols configured for positioning reference signal transmission.

Positioning reference signals are transmitted on antenna port 6.

The positioning reference signals shall not be mapped to resource elements  $(k, l)$  allocated to the core part of the PBCH, PSS or SSS regardless of their antenna port  $p$ .

Positioning reference signals are defined for  $\Delta f = 15$  kHz only.

### 6.10.4.1 Sequence generation

The reference-signal sequence  $r_{l, n_s}(m)$  is defined by

$$r_{l, n_s}(m) = \frac{1}{\sqrt{2}}(1 - 2 \cdot c(2m)) + j \frac{1}{\sqrt{2}}(1 - 2 \cdot c(2m+1)), \quad m = 0, 1, \dots, 2N_{\text{RB}}^{\text{max, DL}} - 1$$

where  $n_s$  is the slot number within a radio frame,  $l$  is the OFDM symbol number within the slot. The pseudo-random sequence  $c(i)$  is defined in clause 7.2. The pseudo-random sequence generator shall be initialised with

$c_{\text{init}} = 2^{10} \cdot (7 \cdot (n_s + 1) + l + 1) \cdot (2 \cdot N_{\text{ID}}^{\text{cell}} + 1) + 2 \cdot N_{\text{ID}}^{\text{cell}} + N_{\text{CP}}$  at the start of each OFDM symbol where

$$N_{CP} = \begin{cases} 1 & \text{for normal CP} \\ 0 & \text{for extended CP} \end{cases}$$

### 6.10.4.2 Mapping to resource elements

The reference signal sequence  $r_{l,n_s}(m)$  shall be mapped to complex-valued modulation symbols  $a_{k,l}^{(p)}$  used as reference signal for antenna port  $p = 6$  in slot  $n_s$  according to

$$a_{k,l}^{(p)} = r_{l,n_s}(m')$$

where

Normal cyclic prefix:

$$k = 6 \left( m + N_{RB}^{DL} - N_{RB}^{PRS} \right) + (6 - l + v_{\text{shift}}) \bmod 6$$

$$l = \begin{cases} 3,5,6 & \text{if } n_s \bmod 2 = 0 \\ 1,2,3,5,6 & \text{if } n_s \bmod 2 = 1 \text{ and (1 or 2 PBCH antenna ports)} \\ 2,3,5,6 & \text{if } n_s \bmod 2 = 1 \text{ and (4 PBCH antenna ports)} \end{cases}$$

$$m = 0, 1, \dots, 2 \cdot N_{RB}^{PRS} - 1$$

$$m' = m + N_{RB}^{\text{max,DL}} - N_{RB}^{PRS}$$

Extended cyclic prefix:

$$k = 6 \left( m + N_{RB}^{DL} - N_{RB}^{PRS} \right) + (5 - l + v_{\text{shift}}) \bmod 6$$

$$l = \begin{cases} 4,5 & \text{if } n_s \bmod 2 = 0 \\ 1,2,4,5 & \text{if } n_s \bmod 2 = 1 \text{ and (1 or 2 PBCH antenna ports)} \\ 2,4,5 & \text{if } n_s \bmod 2 = 1 \text{ and (4 PBCH antenna ports)} \end{cases}$$

$$m = 0, 1, \dots, 2 \cdot N_{RB}^{PRS} - 1$$

$$m' = m + N_{RB}^{\text{max,DL}} - N_{RB}^{PRS}$$

The bandwidth for positioning reference signals  $N_{RB}^{PRS}$  is configured by higher layers and the cell-specific frequency shift is given by  $v_{\text{shift}} = N_{ID}^{\text{cell}} \bmod 6$ .

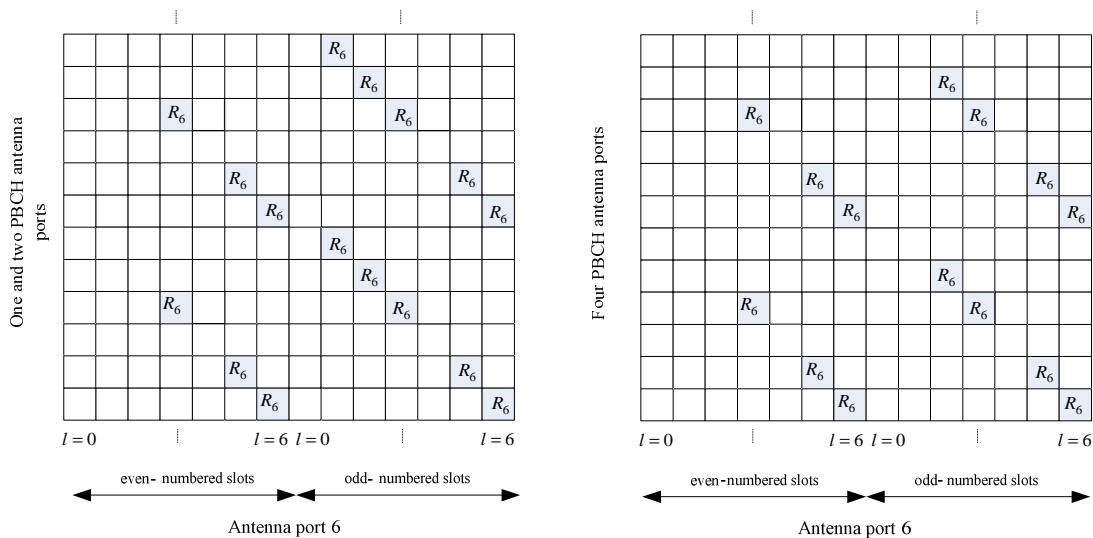

Figure 6.10.4.2-1: Mapping of positioning reference signals (normal cyclic prefix)

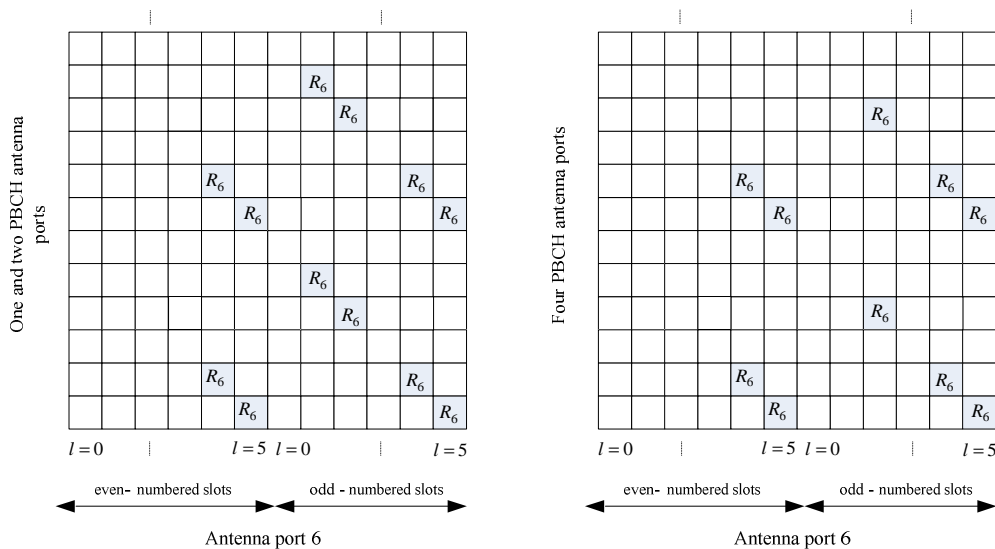

Figure 6.10.4.2-2: Mapping of positioning reference signals (extended cyclic prefix)

### 6.10.4.3 Positioning reference signal subframe configuration

The cell specific subframe configuration period  $T_{PRS}$  and the cell specific subframe offset  $\Delta_{PRS}$  for the transmission of positioning reference signals are listed in Table 6.10.4.3-1. The PRS configuration index  $I_{PRS}$  is configured by higher layers. Positioning reference signals are transmitted only in configured DL subframes. Positioning reference signals shall not be transmitted in DwPTS. Positioning reference signals shall be transmitted in  $N_{PRS}$  consecutive downlink subframes, where  $N_{PRS}$  is configured by higher layers.

The positioning reference signal instances, for the first subframe of the  $N_{PRS}$  downlink subframes, shall satisfy  $(10 \times n_f + \lfloor n_s / 2 \rfloor - \Delta_{PRS}) \bmod T_{PRS} = 0$ .

Table 6.10.4.3-1: Positioning reference signal subframe configuration

PRS configuration Index $I_{PRS}$	PRS periodicity $T_{PRS}$ (subframes)	PRS subframe offset $\Delta_{PRS}$ (subframes)
0 – 159	160	$I_{PRS}$
160 – 479	320	$I_{PRS} - 160$
480 – 1119	640	$I_{PRS} - 480$
1120 – 2399	1280	$I_{PRS} - 1120$
2400-4095	Reserved	

### 6.10.5 CSI reference signals

CSI reference signals are transmitted on one, two, four, eight, twelve, or sixteen antenna ports using  $p = 15$ ,  $p = 15, 16$ ,  $p = 15, \dots, 18$ ,  $p = 15, \dots, 22$ ,  $p = 15, \dots, 26$  and  $p = 15, \dots, 30$ , respectively.

For CSI reference signals using more than eight antenna ports,  $N_{res}^{CSI} > 1$  CSI-RS configurations in the same subframe, numbered from 0 to  $N_{res}^{CSI} - 1$ , are aggregated to obtain  $N_{res}^{CSI} N_{ports}^{CSI}$  antenna ports in total. Each CSI-RS configuration in such an aggregation corresponds to  $N_{ports}^{CSI} \in \{4, 8\}$  antenna ports and one of the configurations in Table 6.10.5.3-1 or 6.10.5.2-1 for normal cyclic prefix, and one of the configurations in Table 6.10.5.3-1 or 6.10.5.2-2 for extended cyclic prefix. The supported configurations of aggregated CSI-RS configurations are shown in Table 6.10.5-1.

CSI reference signals are defined for  $\Delta f = 15$  kHz only.

**Table 6.10.5-1: Aggregation of CSI-RS configurations.**

Total number of antenna ports $N_{\text{res}}^{\text{CSI}} N_{\text{ports}}^{\text{CSI}}$	Number of antenna ports per CSI-RS configuration $N_{\text{ports}}^{\text{CSI}}$	Number of CSI-RS configurations $N_{\text{res}}^{\text{CSI}}$
12	4	3
16	8	2

### 6.10.5.1 Sequence generation

The reference-signal sequence  $r_{l,n_s}(m)$  is defined by

$$r_{l,n_s}(m) = \frac{1}{\sqrt{2}}(1 - 2 \cdot c(2m)) + j \frac{1}{\sqrt{2}}(1 - 2 \cdot c(2m+1)), \quad m = 0, 1, \dots, N_{\text{RB}}^{\text{max,DL}} - 1$$

where  $n_s$  is the slot number within a radio frame and  $l$  is the OFDM symbol number within the slot. The pseudo-random sequence  $c(i)$  is defined in clause 7.2. The pseudo-random sequence generator shall be initialised with  $c_{\text{init}} = 2^{10} \cdot (7 \cdot (n'_s + 1) + l + 1) \cdot (2 \cdot N_{\text{ID}}^{\text{CSI}} + 1) + 2 \cdot N_{\text{ID}}^{\text{CSI}} + N_{\text{CP}}$  at the start of each OFDM symbol where

$$n'_s = \begin{cases} 10 \lfloor n_s / 10 \rfloor + n_s \bmod 2 & \text{for frame structure type 3 when the CSI - RS is part of a DRS} \\ n_s & \text{otherwise} \end{cases}$$

$$N_{\text{CP}} = \begin{cases} 1 & \text{for normal CP} \\ 0 & \text{for extended CP} \end{cases}$$

The quantity  $N_{\text{ID}}^{\text{CSI}}$  equals  $N_{\text{ID}}^{\text{cell}}$  unless configured by higher layers.

### 6.10.5.2 Mapping to resource elements

In subframes configured for CSI reference signal transmission, the reference signal sequence  $r_{l,n_s}(m)$  shall be mapped to complex-valued modulation symbols  $a_{k,l}^{(p)}$  used as reference symbols on antenna port  $p$ . The mapping depends on the higher-layer parameter  $CDMType$ .

For the case of  $CDMType$  not equal to CDM4:

$$a_{k,l}^{(p')} = w_{l^n} \cdot r_{l,n_s}(m')$$

where



$$\begin{aligned}
k &= k'+12m + \begin{cases} -0 & \text{for } p' \in \{15,16\}, \text{ normal cyclic prefix} \\ -6 & \text{for } p' \in \{17,18\}, \text{ normal cyclic prefix} \\ -1 & \text{for } p' \in \{19,20\}, \text{ normal cyclic prefix} \\ -7 & \text{for } p' \in \{21,22\}, \text{ normal cyclic prefix} \\ -0 & \text{for } p' \in \{15,16\}, \text{ extended cyclic prefix} \\ -3 & \text{for } p' \in \{17,18\}, \text{ extended cyclic prefix} \\ -6 & \text{for } p' \in \{19,20\}, \text{ extended cyclic prefix} \\ -9 & \text{for } p' \in \{21,22\}, \text{ extended cyclic prefix} \end{cases} \\
l &= l' + \begin{cases} l'' & \text{CSI reference signal configurations 0 - 19, normal cyclic prefix} \\ 2l'' & \text{CSI reference signal configurations 20 - 31, normal cyclic prefix} \\ l'' & \text{CSI reference signal configurations 0 - 27, extended cyclic prefix} \end{cases} \\
w_{l'} &= \begin{cases} 1 & p' \in \{15,17,19,21\} \\ (-1)^{l''} & p' \in \{16,18,20,22\} \end{cases} \\
l'' &= 0,1 \\
m &= 0,1,\dots, N_{\text{RB}}^{\text{DL}} - 1 \\
m' &= m + \left\lfloor \frac{N_{\text{RB}}^{\text{max,DL}} - N_{\text{RB}}^{\text{DL}}}{2} \right\rfloor
\end{aligned}$$

For the case of *CDMType* equal to *CDM4*:

$$a_{k,l}^{(p')} = w_{p'}(i) \cdot r_{l,n_s}(m')$$

where

$$\begin{aligned}
k &= k'+12m - \begin{cases} k'' & \text{for } p' \in \{15,16,19,20\}, \text{ normal cyclic prefix, } N_{\text{ports}}^{\text{CSI}} = 8 \\ k''+6 & \text{for } p' \in \{17,18,21,22\}, \text{ normal cyclic prefix, } N_{\text{ports}}^{\text{CSI}} = 8 \\ 6k'' & \text{for } p' \in \{15,16,17,18\}, \text{ normal cyclic prefix, } N_{\text{ports}}^{\text{CSI}} = 4 \end{cases} \\
l &= l' + \begin{cases} l'' & \text{CSI reference signal configurations 0 - 19, normal cyclic prefix} \\ 2l'' & \text{CSI reference signal configurations 20 - 31, normal cyclic prefix} \end{cases} \\
l'' &= 0,1 \\
k'' &= 0,1 \\
i &= 2k''+l'' \\
m &= 0,1,\dots, N_{\text{RB}}^{\text{DL}} - 1 \\
m' &= m + \left\lfloor \frac{N_{\text{RB}}^{\text{max,DL}} - N_{\text{RB}}^{\text{DL}}}{2} \right\rfloor
\end{aligned}$$

and where  $w_{p'}(i)$  is given by Table 6.10.5.2-0.

**Table 6.10.5.2-0: The sequence  $w_{p'}(i)$  for CDM4.**

$p'$		$[w_{p'}(0) \ w_{p'}(1) \ w_{p'}(2) \ w_{p'}(3)]$
$N_{\text{ports}}^{\text{CSI}} = 4$	$N_{\text{ports}}^{\text{CSI}} = 8$	
15	15,17	$[1 \ 1 \ 1 \ 1]$
16	16,18	$[1 \ -1 \ 1 \ -1]$
17	19,21	$[1 \ 1 \ -1 \ -1]$
18	20,22	$[1 \ -1 \ -1 \ 1]$

The quantity  $(k', l')$  and the necessary conditions on  $n_s$  are given by Tables 6.10.5.2-1 and 6.10.5.2-2 for normal and extended cyclic prefix, respectively.

The relation between the antenna port number  $p$  and the quantity  $p'$  depends on the number of CSI-RS antenna ports:

- for CSI reference signals using up to eight antenna ports,  $p = p'$
- for CSI reference signals using more than eight antenna ports when the higher-layer parameter  $CDMType$  equals *CDM2*

$$p = \begin{cases} p' + \frac{N_{\text{ports}}^{\text{CSI}}}{2} i & \text{for } p' \in \{15, \dots, 15 + N_{\text{ports}}^{\text{CSI}}/2 - 1\} \\ p' + \frac{N_{\text{ports}}^{\text{CSI}}}{2} (i + N_{\text{res}}^{\text{CSI}} - 1) & \text{for } p' \in \{15 + N_{\text{ports}}^{\text{CSI}}/2, \dots, 15 + N_{\text{ports}}^{\text{CSI}} - 1\} \end{cases}$$

where  $i \in \{0, 1, \dots, N_{\text{res}}^{\text{CSI}} - 1\}$  is the CSI-RS resource number.

- for CSI reference signals using more than eight antenna ports the higher-layer parameter  $CDMType$  equals *CDM4*, antenna port number  $p = iN_{\text{ports}}^{\text{CSI}} + p'$  where  $p' \in \{15, 16, \dots, 15 + N_{\text{ports}}^{\text{CSI}} - 1\}$  for CSI-RS resource number  $i \in \{0, 1, \dots, N_{\text{res}}^{\text{CSI}} - 1\}$ .

Multiple CSI reference signal configurations can be used in a given cell. A UE can be configured with multiple sets of CSI reference signals,

- one or more configurations for CSI reporting for which the UE shall assume non-zero transmission power for the CSI-RS, and
- zero or more configurations for which the UE shall assume zero transmission power, and
- zero or more configurations valid across the system downlink bandwidth as part of the discovery signals for which the UE shall assume non-zero transmission power for the CSI-RS.

The CSI-RS configurations for which the UE shall assume non-zero transmission power are provided by higher layers.

The CSI-RS configurations for which the UE shall assume zero transmission power in a subframe are given by a bitmap derived according to clause 7.2.7 in 3GPP TS 36.213 [4]. For each bit set to one in the 16-bit bitmap, the UE shall assume zero transmission power for the resource elements corresponding to the four CSI reference signal column in Tables 6.10.5.2-1 and 6.10.5.2-2 for normal and extended cyclic prefix, respectively, except for resource elements that overlap with those for which the UE shall assume non-zero transmission power CSI-RS as configured by higher layers. The most significant bit corresponds to the lowest CSI reference signal configuration index and subsequent bits in the bitmap correspond to configurations with indices in increasing order.

CSI reference signals can only occur in

- downlink slots where  $n_s \bmod 2$  fulfils the condition in Tables 6.10.5.2-1 and 6.10.5.2-2 for normal and extended cyclic prefix, respectively, and

- where the subframe number fulfils the conditions in clause 6.10.5.3.

The UE shall assume that CSI reference signals are not transmitted

- in the DwPTS for special subframe configuration 0, 5 and 9 for normal cyclic prefix and special subframe configuration 0, 4 and 7 for extended cyclic prefix, in case of frame structure type 2,
- in subframes where PDSCH/EPDCCH transmission starts in the second slot of a subframe for frame structure type 3,
- in subframes where PDSCH/EPDCCH transmission ends prior to the end of a subframe for frame structure type 3,
- in an empty subframe where there is no PDSCH or discovery signal transmission for frame structure type 3,
- in subframes where transmission of a CSI-RS would collide with *SystemInformationBlockType1* messages,
- in the primary cell in subframes configured for transmission of paging messages in the primary cell for any UE with the cell-specific paging configuration.

For special subframe configuration {1, 2, 6, or 7}, a UE does not expect to be configured with one of CSI-RS configurations {1, 2, 3, 4, 6, 7, 8, 9, 12, 13, 14, 15, 16, 17} in DwPTS for normal CP.

The UE shall assume that none of the CSI reference signals corresponding to a CSI reference signal configuration are transmitted in subframes where transmission of any of those CSI reference signals would collide with transmission of synchronization signals or the core part of PBCH.

Resource elements  $(k, l)$  used for transmission of CSI reference signals on any of the antenna ports in the set  $S$ , where  $S = \{15\}$ ,  $S = \{15,16\}$ ,  $S = \{17,18\}$ ,  $S = \{19,20\}$ ,  $S = \{21,22\}$ ,  $S = \{23,24\}$ ,  $S = \{25,26\}$ ,  $S = \{27,28\}$ , or  $S = \{29,30\}$  shall not be used for transmission of PDSCH on any antenna port in the same slot if higher layer parameter *CDMType* is not configured, or is configured to *CDM2*.

Resource elements  $(k, l)$  used for transmission of CSI reference signals on any of the antenna ports in the set  $S$ , where  $S = \{15,16,17,18\}$ ,  $S = \{19,20,21,22\}$  or  $S = \{23,24,25,26\}$  for CSI reference signals on 12 ports or  $S = \{15,16,19,20\}$ ,  $S = \{17,18,21,22\}$ ,  $S = \{23,24,27,28\}$  or  $S = \{25,26,29,30\}$  for CSI reference signals on 16 ports shall not be used for transmission of PDSCH on any antenna port in the same slot if higher layer parameter *CDMType* is configured to *CDM4*.

The mapping for CSI reference signal configuration 0 is illustrated in Figures 6.10.5.2-1 and 6.10.5.2-2.

Table 6.10.5.2-1: Mapping from CSI reference signal configuration to  $(k', l')$  for normal cyclic prefix

CSI-RS config.	Number of CSI reference signals configured											
	1 or 2				4				8			
	Normal subframe $(k', l')$		Special subframe $(k', l')$		Normal subframe $(k', l')$		Special subframe $(k', l')$		Normal subframe $(k', l')$		Special subframe $(k', l')$	
	$n'_s$		$n'_s$		$n'_s$		$n'_s$		$n'_s$		$n'_s$	
0	(9,5)	0	(9,5)	0	(9,5)	0	(9,5)	0	(9,5)	0	(9,5)	0
1	(11,2)	1	(11,5)	0	(11,2)	1	(11,5)	0	(11,2)	1	(11,5)	0
2	(9,2)	1	(9,2)	1	(9,2)	1	(9,2)	1	(9,2)	1	(9,2)	1
3	(7,2)	1	(7,5)	0	(7,2)	1	(7,5)	0	(7,2)	1	(7,5)	0
4	(9,5)	1			(9,5)	1			(9,5)	1		
5	(8,5)	0	(8,5)	0	(8,5)	0	(8,5)	0				
6	(10,2)	1	(10,5)	0	(10,2)	1	(10,5)	0				
7	(8,2)	1	(8,2)	1	(8,2)	1	(8,2)	1				
8	(6,2)	1	(6,5)	0	(6,2)	1	(6,5)	0				
9	(8,5)	1			(8,5)	1						
10	(3,5)	0	(3,5)	0								
11	(2,5)	0	(2,5)	0								
12	(5,2)	1	(5,5)	0								
13	(4,2)	1	(4,5)	0								
14	(3,2)	1	(3,2)	1								
15	(2,2)	1	(2,2)	1								
16	(1,2)	1	(1,5)	0								
17	(0,2)	1	(0,5)	0								
18	(3,5)	1										
19	(2,5)	1										
20	(11,1)	1			(11,1)	1			(11,1)	1		
21	(9,1)	1			(9,1)	1			(9,1)	1		
22	(7,1)	1			(7,1)	1			(7,1)	1		
23	(10,1)	1			(10,1)	1						
24	(8,1)	1			(8,1)	1						
25	(6,1)	1			(6,1)	1						
26	(5,1)	1										
27	(4,1)	1										
28	(3,1)	1										
29	(2,1)	1										
30	(1,1)	1										
31	(0,1)	1										

Note:  $n'_s = n_s \bmod 2$ . Configurations 0 – 19 for normal subframes are available for frame structure types 1, 2 and 3. Configurations 20 – 31 and configurations for special subframes are available for frame structure type 2 only.

Table 6.10.5.2-2: Mapping from CSI reference signal configuration to  $(k', l')$  for extended cyclic prefix.

CSI-RS config.	Number of CSI reference signals configured											
	1 or 2				4				8			
	Normal subframe $(k', l')$	$n'_s$	Special subframe $(k', l')$	$n'_s$	Normal subframe $(k', l')$	$n'_s$	Special subframe $(k', l')$	$n'_s$	Normal Subframe $(k', l')$	$n'_s$	Special subframe $(k', l')$	$n'_s$
0	(11,4)	0	(11,4)	0	(11,4)	0	(11,4)	0	(11,4)	0	(11,4)	0
1	(9,4)	0	(9,4)	0	(9,4)	0	(9,4)	0	(9,4)	0	(9,4)	0
2	(10,4)	1			(10,4)	1			(10,4)	1		
3	(9,4)	1			(9,4)	1			(9,4)	1		
4	(5,4)	0	(5,4)	0	(5,4)	0	(5,4)	0				
5	(3,4)	0	(3,4)	0	(3,4)	0	(3,4)	0				
6	(4,4)	1			(4,4)	1						
7	(3,4)	1			(3,4)	1						
8	(8,4)	0	(8,4)	0								
9	(6,4)	0	(6,4)	0								
10	(2,4)	0	(2,4)	0								
11	(0,4)	0	(0,4)	0								
12	(7,4)	1										
13	(6,4)	1										
14	(1,4)	1										
15	(0,4)	1										
16	(11,1)	1	(11,1)	1	(11,1)	1	(11,1)	1	(11,1)	1	(11,1)	1
17	(10,1)	1	(10,1)	1	(10,1)	1	(10,1)	1	(10,1)	1	(10,1)	1
18	(9,1)	1	(9,1)	1	(9,1)	1	(9,1)	1	(9,1)	1	(9,1)	1
19	(5,1)	1	(5,1)	1	(5,1)	1	(5,1)	1				
20	(4,1)	1	(4,1)	1	(4,1)	1	(4,1)	1				
21	(3,1)	1	(3,1)	1	(3,1)	1	(3,1)	1				
22	(8,1)	1	(8,1)	1								
23	(7,1)	1	(7,1)	1								
24	(6,1)	1	(6,1)	1								
25	(2,1)	1	(2,1)	1								
26	(1,1)	1	(1,1)	1								
27	(0,1)	1	(0,1)	1								

Note:  $n'_s = n_s \bmod 2$ . Configurations 0 – 15 for normal subframes are available for both frame structure type 1 and type 2. Configurations 16 – 27 and configurations for special subframes are available for frame structure type 2 only.

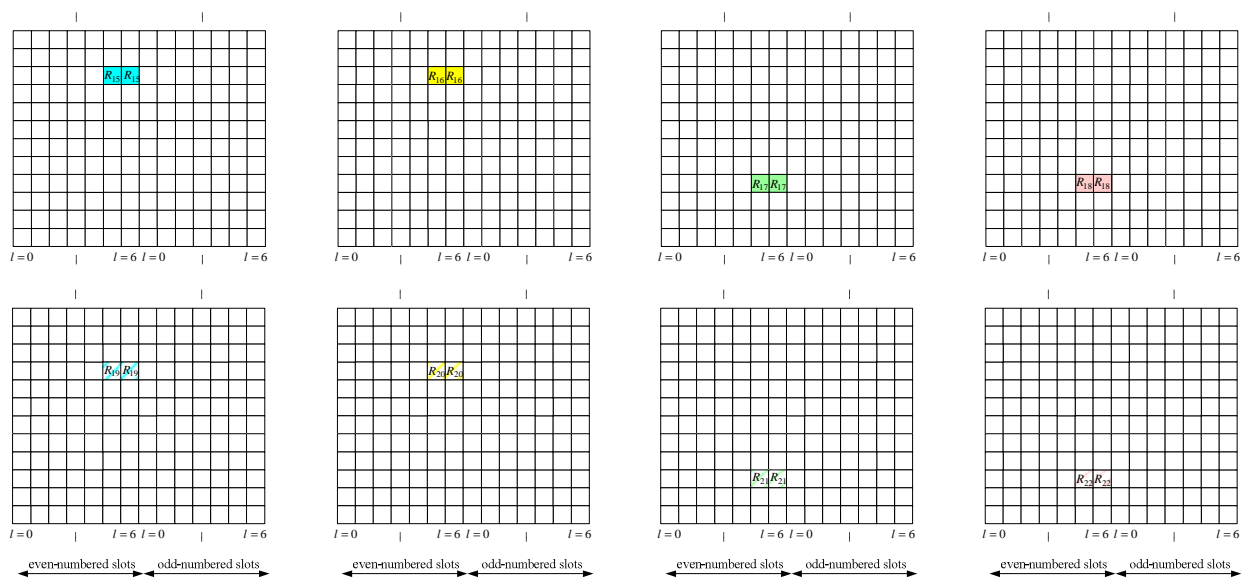

Figure 6.10.5.2-1: Mapping of CSI reference signals (CSI configuration 0, normal cyclic prefix)

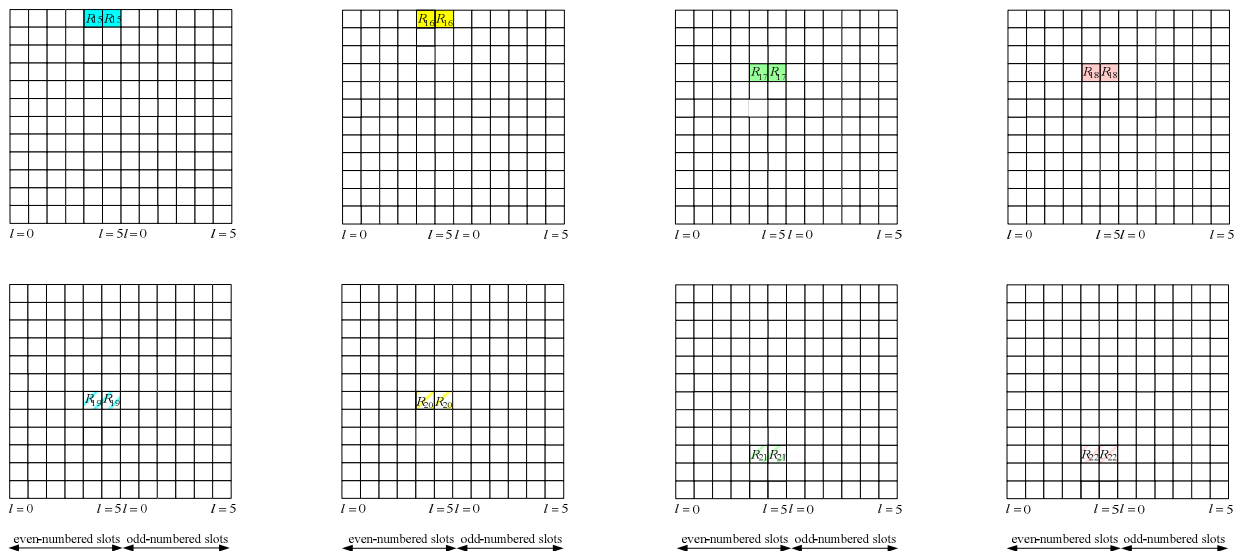

Figure 6.10.5.2-2: Mapping of CSI reference signals (CSI configuration 0, extended cyclic prefix)

### 6.10.5.3 CSI reference signal subframe configuration

The subframe configuration period  $T_{\text{CSI-RS}}$  and the subframe offset  $\Delta_{\text{CSI-RS}}$  for the occurrence of CSI reference signals are listed in Table 6.10.5.3-1. The parameter  $I_{\text{CSI-RS}}$  can be configured separately for CSI reference signals for which the UE shall assume non-zero and zero transmission power. Subframes containing CSI reference signals shall satisfy  $(10n_f + \lfloor n_s/2 \rfloor - \Delta_{\text{CSI-RS}}) \bmod T_{\text{CSI-RS}} = 0$ .

Table 6.10.5.3-1: CSI reference signal subframe configuration

CSI-RS-SubframeConfig $I_{\text{CSI-RS}}$	CSI-RS periodicity $T_{\text{CSI-RS}}$ (subframes)	CSI-RS subframe offset $\Delta_{\text{CSI-RS}}$ (subframes)
0 – 4	5	$I_{\text{CSI-RS}}$
5 – 14	10	$I_{\text{CSI-RS}} - 5$
15 – 34	20	$I_{\text{CSI-RS}} - 15$
35 – 74	40	$I_{\text{CSI-RS}} - 35$
75 – 154	80	$I_{\text{CSI-RS}} - 75$

## 6.11 Synchronization signals

There are 504 unique physical-layer cell identities. The physical-layer cell identities are grouped into 168 unique physical-layer cell-identity groups, each group containing three unique identities. The grouping is such that each physical-layer cell identity is part of one and only one physical-layer cell-identity group. A physical-layer cell identity  $N_{\text{ID}}^{\text{cell}} = 3N_{\text{ID}}^{(1)} + N_{\text{ID}}^{(2)}$  is thus uniquely defined by a number  $N_{\text{ID}}^{(1)}$  in the range of 0 to 167, representing the physical-layer cell-identity group, and a number  $N_{\text{ID}}^{(2)}$  in the range of 0 to 2, representing the physical-layer identity within the physical-layer cell-identity group.

### 6.11.1 Primary synchronization signal (PSS)

#### 6.11.1.1 Sequence generation

The sequence  $d(n)$  used for the primary synchronization signal is generated from a frequency-domain Zadoff-Chu sequence according to

$$d_u(n) = \begin{cases} e^{-j\frac{\pi un(n+1)}{63}} & n = 0,1,\dots,30 \\ e^{-j\frac{\pi u(n+1)(n+2)}{63}} & n = 31,32,\dots,61 \end{cases}$$

where the Zadoff-Chu root sequence index  $u$  is given by Table 6.11.1.1-1.

**Table 6.11.1.1-1: Root indices for the primary synchronization signal**

$N_{\text{ID}}^{(2)}$	Root index $u$
0	25
1	29
2	34

### 6.11.1.2 Mapping to resource elements

The mapping of the sequence to resource elements depends on the frame structure. The UE shall not assume that the primary synchronization signal is transmitted on the same antenna port as any of the downlink reference signals. The UE shall not assume that any transmission instance of the primary synchronization signal is transmitted on the same antenna port, or ports, used for any other transmission instance of the primary synchronization signal.

The sequence  $d(n)$  shall be mapped to the resource elements according to

$$a_{k,l} = d(n), \quad n = 0, \dots, 61$$

$$k = n - 31 + \frac{N_{\text{RB}}^{\text{DL}} N_{\text{sc}}^{\text{RB}}}{2}$$

For frame structure type 1, the primary synchronization signal shall be mapped to the last OFDM symbol in slots 0 and 10.

For frame structure type 2, the primary synchronization signal shall be mapped to the third OFDM symbol in subframes 1 and 6. Resource elements  $(k, l)$  in the OFDM symbols used for transmission of the primary synchronization signal where

$$k = n - 31 + \frac{N_{\text{RB}}^{\text{DL}} N_{\text{sc}}^{\text{RB}}}{2}$$

$$n = -5, -4, \dots, -1, 62, 63, \dots, 66$$

are reserved and not used for transmission of the primary synchronization signal.

For frame structure type 3, the primary synchronization signal shall be mapped according to frame structure type 1 with the following exceptions:

- the primary synchronization signal shall be transmitted only if the corresponding subframe is non-empty and at least 12 OFDM symbols are transmitted,
- a primary synchronization signal being part of a discovery signal shall be transmitted in the last OFDM symbol of the first slot of a discovery signal occasion.

## 6.11.2 Secondary synchronization signal (SSS)

### 6.11.2.1 Sequence generation

The sequence  $d(0), \dots, d(61)$  used for the second synchronization signal is an interleaved concatenation of two length-31 binary sequences. The concatenated sequence is scrambled with a scrambling sequence given by the primary synchronization signal.

The combination of two length-31 sequences defining the secondary synchronization signal differs between subframes according to

$$d(2n) = \begin{cases} s_0^{(m_0)}(n)c_0(n) & \text{in subframes 0, 1, 2, 3, 4} \\ s_1^{(m_1)}(n)c_0(n) & \text{in subframes 5, 6, 7, 8, 9} \end{cases}$$

$$d(2n+1) = \begin{cases} s_1^{(m_1)}(n)c_1(n)z_1^{(m_0)}(n) & \text{in subframes 0, 1, 2, 3, 4} \\ s_0^{(m_0)}(n)c_1(n)z_1^{(m_1)}(n) & \text{in subframes 5, 6, 7, 8, 9} \end{cases}$$

where  $0 \leq n \leq 30$ . The indices  $m_0$  and  $m_1$  are derived from the physical-layer cell-identity group  $N_{\text{ID}}^{(1)}$  according to

$$m_0 = m' \bmod 31$$

$$m_1 = (m_0 + \lfloor m'/31 \rfloor + 1) \bmod 31$$

$$m' = N_{\text{ID}}^{(1)} + q(q+1)/2, \quad q = \left\lfloor \frac{N_{\text{ID}}^{(1)} + q'(q'+1)/2}{30} \right\rfloor, \quad q' = \lfloor N_{\text{ID}}^{(1)}/30 \rfloor$$

where the output of the above expression is listed in Table 6.11.2.1-1.

The two sequences  $s_0^{(m_0)}(n)$  and  $s_1^{(m_1)}(n)$  are defined as two different cyclic shifts of the m-sequence  $\tilde{s}(n)$  according to

$$s_0^{(m_0)}(n) = \tilde{s}((n + m_0) \bmod 31)$$

$$s_1^{(m_1)}(n) = \tilde{s}((n + m_1) \bmod 31)$$

where  $\tilde{s}(i) = 1 - 2x(i)$ ,  $0 \leq i \leq 30$ , is defined by

$$x(\bar{i} + 5) = (x(\bar{i} + 2) + x(\bar{i})) \bmod 2, \quad 0 \leq \bar{i} \leq 25$$

with initial conditions  $x(0) = 0$ ,  $x(1) = 0$ ,  $x(2) = 0$ ,  $x(3) = 0$ ,  $x(4) = 1$ .

The two scrambling sequences  $c_0(n)$  and  $c_1(n)$  depend on the primary synchronization signal and are defined by two different cyclic shifts of the m-sequence  $\tilde{c}(n)$  according to

$$c_0(n) = \tilde{c}((n + N_{\text{ID}}^{(2)}) \bmod 31)$$

$$c_1(n) = \tilde{c}((n + N_{\text{ID}}^{(2)} + 3) \bmod 31)$$

where  $N_{\text{ID}}^{(2)} \in \{0,1,2\}$  is the physical-layer identity within the physical-layer cell identity group  $N_{\text{ID}}^{(1)}$  and  $\tilde{c}(i) = 1 - 2x(i)$ ,  $0 \leq i \leq 30$ , is defined by

$$x(\bar{i} + 5) = (x(\bar{i} + 3) + x(\bar{i})) \bmod 2, \quad 0 \leq \bar{i} \leq 25$$

with initial conditions  $x(0) = 0$ ,  $x(1) = 0$ ,  $x(2) = 0$ ,  $x(3) = 0$ ,  $x(4) = 1$ .

The scrambling sequences  $z_1^{(m_0)}(n)$  and  $z_1^{(m_1)}(n)$  are defined by a cyclic shift of the m-sequence  $\tilde{z}(n)$  according to

$$z_1^{(m_0)}(n) = \tilde{z}((n + (m_0 \bmod 8)) \bmod 31)$$

$$z_1^{(m_1)}(n) = \tilde{z}((n + (m_1 \bmod 8)) \bmod 31)$$

where  $m_0$  and  $m_1$  are obtained from Table 6.11.2.1-1 and  $\tilde{z}(i) = 1 - 2x(i)$ ,  $0 \leq i \leq 30$ , is defined by



$$x(\bar{i} + 5) = (x(\bar{i} + 4) + x(\bar{i} + 2) + x(\bar{i} + 1) + x(\bar{i})) \bmod 2, \quad 0 \leq \bar{i} \leq 25$$

with initial conditions  $x(0) = 0$ ,  $x(1) = 0$ ,  $x(2) = 0$ ,  $x(3) = 0$ ,  $x(4) = 1$ .

**Table 6.11.2.1-1: Mapping between physical-layer cell-identity group  $N_{ID}^{(1)}$  and the indices  $m_0$  and  $m_1$**

$N_{ID}^{(1)}$	$m_0$	$m_1$	$N_{ID}^{(1)}$	$m_0$	$m_1$	$N_{ID}^{(1)}$	$m_0$	$m_1$	$N_{ID}^{(1)}$	$m_0$	$m_1$	$N_{ID}^{(1)}$	$m_0$	$m_1$
0	0	1	34	4	6	68	9	12	102	15	19	136	22	27
1	1	2	35	5	7	69	10	13	103	16	20	137	23	28
2	2	3	36	6	8	70	11	14	104	17	21	138	24	29
3	3	4	37	7	9	71	12	15	105	18	22	139	25	30
4	4	5	38	8	10	72	13	16	106	19	23	140	0	6
5	5	6	39	9	11	73	14	17	107	20	24	141	1	7
6	6	7	40	10	12	74	15	18	108	21	25	142	2	8
7	7	8	41	11	13	75	16	19	109	22	26	143	3	9
8	8	9	42	12	14	76	17	20	110	23	27	144	4	10
9	9	10	43	13	15	77	18	21	111	24	28	145	5	11
10	10	11	44	14	16	78	19	22	112	25	29	146	6	12
11	11	12	45	15	17	79	20	23	113	26	30	147	7	13
12	12	13	46	16	18	80	21	24	114	0	5	148	8	14
13	13	14	47	17	19	81	22	25	115	1	6	149	9	15
14	14	15	48	18	20	82	23	26	116	2	7	150	10	16
15	15	16	49	19	21	83	24	27	117	3	8	151	11	17
16	16	17	50	20	22	84	25	28	118	4	9	152	12	18
17	17	18	51	21	23	85	26	29	119	5	10	153	13	19
18	18	19	52	22	24	86	27	30	120	6	11	154	14	20
19	19	20	53	23	25	87	0	4	121	7	12	155	15	21
20	20	21	54	24	26	88	1	5	122	8	13	156	16	22
21	21	22	55	25	27	89	2	6	123	9	14	157	17	23
22	22	23	56	26	28	90	3	7	124	10	15	158	18	24
23	23	24	57	27	29	91	4	8	125	11	16	159	19	25
24	24	25	58	28	30	92	5	9	126	12	17	160	20	26
25	25	26	59	0	3	93	6	10	127	13	18	161	21	27
26	26	27	60	1	4	94	7	11	128	14	19	162	22	28
27	27	28	61	2	5	95	8	12	129	15	20	163	23	29
28	28	29	62	3	6	96	9	13	130	16	21	164	24	30
29	29	30	63	4	7	97	10	14	131	17	22	165	0	7
30	0	2	64	5	8	98	11	15	132	18	23	166	1	8
31	1	3	65	6	9	99	12	16	133	19	24	167	2	9
32	2	4	66	7	10	100	13	17	134	20	25	-	-	-
33	3	5	67	8	11	101	14	18	135	21	26	-	-	-

### 6.11.2.2 Mapping to resource elements

The mapping of the sequence to resource elements depends on the frame structure. In a subframe for frame structure type 1 and 3 and in a half-frame for frame structure type 2, the same antenna port as for the primary synchronization signal shall be used for the secondary synchronization signal.

The sequence  $d(n)$  shall be mapped to resource elements according to

$$a_{k,l} = d(n), \quad n = 0, \dots, 61$$

$$k = n - 31 + \frac{N_{RB}^{DL} N_{sc}^{RB}}{2}$$

$$l = \begin{cases} N_{symb}^{DL} - 2 & \text{in slots 0 and 10} & \text{for frame structure type 1} \\ N_{symb}^{DL} - 1 & \text{in slots 1 and 11} & \text{for frame structure type 2} \\ N_{symb}^{DL} - 2 & \text{in slots where the PSS is transmitted} & \text{for frame structure type 3} \end{cases}$$

Resource elements  $(k, l)$  where

$$k = n - 31 + \frac{N_{\text{RB}}^{\text{DL}} N_{\text{sc}}^{\text{RB}}}{2}$$

$$l = \begin{cases} N_{\text{symb}}^{\text{DL}} - 2 & \text{in slots 0 and 10} & \text{for frame structure type 1} \\ N_{\text{symb}}^{\text{DL}} - 1 & \text{in slots 1 and 11} & \text{for frame structure type 2} \\ N_{\text{symb}}^{\text{DL}} - 2 & \text{in slots where the PSS is transmitted} & \text{for frame structure type 3} \end{cases}$$

$$n = -5, -4, \dots, -1, 62, 63, \dots, 66$$

are reserved and not used for transmission of the secondary synchronization signal.

## 6.11A Discovery signal

A discovery signal occasion for a cell consists of a period with a duration of

- one to five consecutive subframes for frame structure type 1
- two to five consecutive subframes for frame structure type 2
- 12 OFDM symbols within one non-empty subframe for frame structure type 3

where the UE in the downlink subframes may assume presence of a discovery signal consisting of

- cell-specific reference signals on antenna port 0 in all downlink subframes and in DwPTS of all special subframes in the period for frame structure type 1 and 2
- cell specific reference signals on antenna port 0 when higher layer parameters indicate only one configured antenna port for cell specific reference signals for a serving cell using frame structure type 3
- cell specific reference signals on antenna port 0 and antenna port 1 when higher layer parameters indicate at least two configured antenna ports for cell specific reference signals for a serving cell using frame structure type 3
- cell specific reference signals on antenna port 0 and antenna port 1 when higher layer configured parameter *presenceAntennaPort1* is signalled to be 1, for a neighbour cell when using frame structure type 3
- primary synchronization signal in the first subframe of the period for frame structure types 1 and 3 or the second subframe of the period for frame structure type 2,
- secondary synchronization signal in the first subframe of the period, and
- non-zero-power CSI reference signals in zero or more subframes in the period. The configuration of non-zero-power CSI reference signals part of the discovery signal is obtained as described in clause 6.10.5.2

For frame structures 1 and 2 the UE may assume a discovery signal occasion once every *dmtc-Periodicity*.

For frame structure type 3, the UE may assume a discovery signal occasion may occur in any subframe within the discovery signals measurement timing configuration in clause 5.5.2.10 of [9].

For frame structure type 3, simultaneous transmission of a discovery signal and PDSCH/PDCCH/EPDCCH may occur in subframes 0 and 5 only.

For frame structure type 3, the UE may assume that a discovery signal occasion occurs in the first subframe containing a primary synchronization signal, secondary synchronization signal and cell-specific reference signals within the discovery measurement timing configuration in clause 5.5.2.10 of [9].

## 6.12 OFDM baseband signal generation

The time-continuous signal  $s_l^{(p)}(t)$  on antenna port  $p$  in OFDM symbol  $l$  in a downlink slot is defined by

$$s_l^{(p)}(t) = \sum_{k=-\lfloor N_{RB}^{DL} N_{sc}^{RB} / 2 \rfloor}^{-1} a_{k^{(-)},l}^{(p)} \cdot e^{j2\pi k \Delta f (t - N_{CP,l} T_s)} + \sum_{k=1}^{\lfloor N_{RB}^{DL} N_{sc}^{RB} / 2 \rfloor} a_{k^{(+)},l}^{(p)} \cdot e^{j2\pi k \Delta f (t - N_{CP,l} T_s)}$$

for  $0 \leq t < (N_{CP,l} + N) \times T_s$  where  $k^{(-)} = k + \lfloor N_{RB}^{DL} N_{sc}^{RB} / 2 \rfloor$  and  $k^{(+)} = k + \lfloor N_{RB}^{DL} N_{sc}^{RB} / 2 \rfloor - 1$ . The variable  $N$  equals 2048 for  $\Delta f = 15$  kHz subcarrier spacing and 4096 for  $\Delta f = 7.5$  kHz subcarrier spacing.

The OFDM symbols in a slot shall be transmitted in increasing order of  $l$ , starting with  $l = 0$ , where OFDM symbol  $l > 0$  starts at time  $\sum_{l'=0}^{l-1} (N_{CP,l'} + N) T_s$  within the slot. In case the first OFDM symbol(s) in a slot use normal cyclic prefix and the remaining OFDM symbols use extended cyclic prefix, the starting position the OFDM symbols with extended cyclic prefix shall be identical to those in a slot where all OFDM symbols use extended cyclic prefix. Thus there will be a part of the time slot between the two cyclic prefix regions where the transmitted signal is not specified.

Table 6.12-1 lists the value of  $N_{CP,l}$  that shall be used. Note that different OFDM symbols within a slot in some cases have different cyclic prefix lengths.

**Table 6.12-1: OFDM parameters**

Configuration		Cyclic prefix length $N_{CP,l}$
Normal cyclic prefix	$\Delta f = 15$ kHz	160 for $l = 0$ 144 for $l = 1, 2, \dots, 6$
	$\Delta f = 7.5$ kHz	512 for $l = 0, 1, \dots, 5$
Extended cyclic prefix	$\Delta f = 15$ kHz	512 for $l = 0, 1, \dots, 5$
	$\Delta f = 7.5$ kHz	1024 for $l = 0, 1, 2$

### 6.13 Modulation and upconversion

Modulation and upconversion to the carrier frequency of the complex-valued OFDM baseband signal for each antenna port is shown in Figure 6.13-1. The filtering required prior to transmission is defined by the requirements in 3GPP TS 36.104 [6].

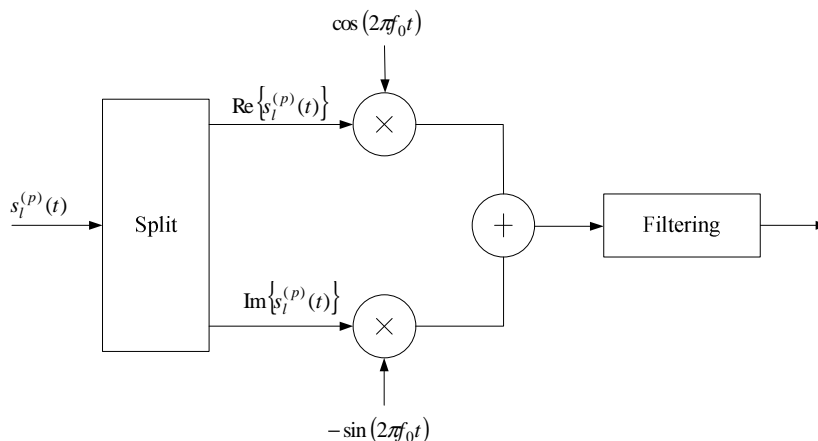

**Figure 6.13-1: Downlink modulation**

## 7 Generic functions

### 7.1 Modulation mapper

The modulation mapper takes binary digits, 0 or 1, as input and produces complex-valued modulation symbols,  $x=I+jQ$ , as output.

#### 7.1.1 BPSK

In case of BPSK modulation, a single bit,  $b(i)$ , is mapped to a complex-valued modulation symbol  $x=I+jQ$  according to Table 7.1.1-1.

**Table 7.1.1-1: BPSK modulation mapping**

$b(i)$	$I$	$Q$
0	$1/\sqrt{2}$	$1/\sqrt{2}$
1	$-1/\sqrt{2}$	$-1/\sqrt{2}$

#### 7.1.2 QPSK

In case of QPSK modulation, pairs of bits,  $b(i), b(i+1)$ , are mapped to complex-valued modulation symbols  $x=I+jQ$  according to Table 7.1.2-1.

**Table 7.1.2-1: QPSK modulation mapping**

$b(i), b(i+1)$	$I$	$Q$
00	$1/\sqrt{2}$	$1/\sqrt{2}$
01	$1/\sqrt{2}$	$-1/\sqrt{2}$
10	$-1/\sqrt{2}$	$1/\sqrt{2}$
11	$-1/\sqrt{2}$	$-1/\sqrt{2}$

#### 7.1.3 16QAM

In case of 16QAM modulation, quadruplets of bits,  $b(i), b(i+1), b(i+2), b(i+3)$ , are mapped to complex-valued modulation symbols  $x=I+jQ$  according to Table 7.1.3-1.

**Table 7.1.3-1: 16QAM modulation mapping**

$b(i), b(i+1), b(i+2), b(i+3)$	$I$	$Q$
0000	$1/\sqrt{10}$	$1/\sqrt{10}$
0001	$1/\sqrt{10}$	$3/\sqrt{10}$
0010	$3/\sqrt{10}$	$1/\sqrt{10}$
0011	$3/\sqrt{10}$	$3/\sqrt{10}$
0100	$1/\sqrt{10}$	$-1/\sqrt{10}$
0101	$1/\sqrt{10}$	$-3/\sqrt{10}$
0110	$3/\sqrt{10}$	$-1/\sqrt{10}$
0111	$3/\sqrt{10}$	$-3/\sqrt{10}$
1000	$-1/\sqrt{10}$	$1/\sqrt{10}$
1001	$-1/\sqrt{10}$	$3/\sqrt{10}$
1010	$-3/\sqrt{10}$	$1/\sqrt{10}$
1011	$-3/\sqrt{10}$	$3/\sqrt{10}$
1100	$-1/\sqrt{10}$	$-1/\sqrt{10}$
1101	$-1/\sqrt{10}$	$-3/\sqrt{10}$
1110	$-3/\sqrt{10}$	$-1/\sqrt{10}$
1111	$-3/\sqrt{10}$	$-3/\sqrt{10}$

#### 7.1.4 64QAM

In case of 64QAM modulation, hexuplets of bits,  $b(i), b(i+1), b(i+2), b(i+3), b(i+4), b(i+5)$ , are mapped to complex-valued modulation symbols  $x=I+jQ$  according to Table 7.1.4-1.

Table 7.1.4-1: 64QAM modulation mapping

$b(i), b(i+1), b(i+2), b(i+3), b(i+4), b(i+5)$	$I$	$Q$	$b(i), b(i+1), b(i+2), b(i+3), b(i+4), b(i+5)$	$I$	$Q$
000000	$3/\sqrt{42}$	$3/\sqrt{42}$	100000	$-3/\sqrt{42}$	$3/\sqrt{42}$
000001	$3/\sqrt{42}$	$1/\sqrt{42}$	100001	$-3/\sqrt{42}$	$1/\sqrt{42}$
000010	$1/\sqrt{42}$	$3/\sqrt{42}$	100010	$-1/\sqrt{42}$	$3/\sqrt{42}$
000011	$1/\sqrt{42}$	$1/\sqrt{42}$	100011	$-1/\sqrt{42}$	$1/\sqrt{42}$
000100	$3/\sqrt{42}$	$5/\sqrt{42}$	100100	$-3/\sqrt{42}$	$5/\sqrt{42}$
000101	$3/\sqrt{42}$	$7/\sqrt{42}$	100101	$-3/\sqrt{42}$	$7/\sqrt{42}$
000110	$1/\sqrt{42}$	$5/\sqrt{42}$	100110	$-1/\sqrt{42}$	$5/\sqrt{42}$
000111	$1/\sqrt{42}$	$7/\sqrt{42}$	100111	$-1/\sqrt{42}$	$7/\sqrt{42}$
001000	$5/\sqrt{42}$	$3/\sqrt{42}$	101000	$-5/\sqrt{42}$	$3/\sqrt{42}$
001001	$5/\sqrt{42}$	$1/\sqrt{42}$	101001	$-5/\sqrt{42}$	$1/\sqrt{42}$
001010	$7/\sqrt{42}$	$3/\sqrt{42}$	101010	$-7/\sqrt{42}$	$3/\sqrt{42}$
001011	$7/\sqrt{42}$	$1/\sqrt{42}$	101011	$-7/\sqrt{42}$	$1/\sqrt{42}$
001100	$5/\sqrt{42}$	$5/\sqrt{42}$	101100	$-5/\sqrt{42}$	$5/\sqrt{42}$
001101	$5/\sqrt{42}$	$7/\sqrt{42}$	101101	$-5/\sqrt{42}$	$7/\sqrt{42}$
001110	$7/\sqrt{42}$	$5/\sqrt{42}$	101110	$-7/\sqrt{42}$	$5/\sqrt{42}$
001111	$7/\sqrt{42}$	$7/\sqrt{42}$	101111	$-7/\sqrt{42}$	$7/\sqrt{42}$
010000	$3/\sqrt{42}$	$-3/\sqrt{42}$	110000	$-3/\sqrt{42}$	$-3/\sqrt{42}$
010001	$3/\sqrt{42}$	$-1/\sqrt{42}$	110001	$-3/\sqrt{42}$	$-1/\sqrt{42}$
010010	$1/\sqrt{42}$	$-3/\sqrt{42}$	110010	$-1/\sqrt{42}$	$-3/\sqrt{42}$
010011	$1/\sqrt{42}$	$-1/\sqrt{42}$	110011	$-1/\sqrt{42}$	$-1/\sqrt{42}$
010100	$3/\sqrt{42}$	$-5/\sqrt{42}$	110100	$-3/\sqrt{42}$	$-5/\sqrt{42}$
010101	$3/\sqrt{42}$	$-7/\sqrt{42}$	110101	$-3/\sqrt{42}$	$-7/\sqrt{42}$
010110	$1/\sqrt{42}$	$-5/\sqrt{42}$	110110	$-1/\sqrt{42}$	$-5/\sqrt{42}$
010111	$1/\sqrt{42}$	$-7/\sqrt{42}$	110111	$-1/\sqrt{42}$	$-7/\sqrt{42}$
011000	$5/\sqrt{42}$	$-3/\sqrt{42}$	111000	$-5/\sqrt{42}$	$-3/\sqrt{42}$
011001	$5/\sqrt{42}$	$-1/\sqrt{42}$	111001	$-5/\sqrt{42}$	$-1/\sqrt{42}$
011010	$7/\sqrt{42}$	$-3/\sqrt{42}$	111010	$-7/\sqrt{42}$	$-3/\sqrt{42}$
011011	$7/\sqrt{42}$	$-1/\sqrt{42}$	111011	$-7/\sqrt{42}$	$-1/\sqrt{42}$
011100	$5/\sqrt{42}$	$-5/\sqrt{42}$	111100	$-5/\sqrt{42}$	$-5/\sqrt{42}$
011101	$5/\sqrt{42}$	$-7/\sqrt{42}$	111101	$-5/\sqrt{42}$	$-7/\sqrt{42}$
011110	$7/\sqrt{42}$	$-5/\sqrt{42}$	111110	$-7/\sqrt{42}$	$-5/\sqrt{42}$
011111	$7/\sqrt{42}$	$-7/\sqrt{42}$	111111	$-7/\sqrt{42}$	$-7/\sqrt{42}$

### 7.1.5 256QAM

In case of 256QAM modulation, octuplets of bits,  $b(i), b(i+1), b(i+2), b(i+3), b(i+4), b(i+5), b(i+6), b(i+7)$ , are mapped to complex-valued modulation symbols  $x = (I + jQ)/\sqrt{170}$  according to Table 7.1.5-1.

Table 7.1.5-1: 256QAM modulation mapping

$b(i), \dots, b(i+7)$	I	Q	$b(i), \dots, b(i+7)$	I	Q	$b(i), \dots, b(i+7)$	I	Q	$b(i), \dots, b(i+7)$	I	Q
00000000	5	5	01000000	5	-5	10000000	-5	5	11000000	-5	-5
00000001	5	7	01000001	5	-7	10000001	-5	7	11000001	-5	-7
00000010	7	5	01000010	7	-5	10000010	-7	5	11000010	-7	-5
00000011	7	7	01000011	7	-7	10000011	-7	7	11000011	-7	-7
00000100	5	3	01000100	5	-3	10000100	-5	3	11000100	-5	-3
00000101	5	1	01000101	5	-1	10000101	-5	1	11000101	-5	-1
00000110	7	3	01000110	7	-3	10000110	-7	3	11000110	-7	-3
00000111	7	1	01000111	7	-1	10000111	-7	1	11000111	-7	-1
00001000	3	5	01001000	3	-5	10001000	-3	5	11001000	-3	-5
00001001	3	7	01001001	3	-7	10001001	-3	7	11001001	-3	-7
00001010	1	5	01001010	1	-5	10001010	-1	5	11001010	-1	-5
00001011	1	7	01001011	1	-7	10001011	-1	7	11001011	-1	-7
00001100	3	3	01001100	3	-3	10001100	-3	3	11001100	-3	-3
00001101	3	1	01001101	3	-1	10001101	-3	1	11001101	-3	-1
00001110	1	3	01001110	1	-3	10001110	-1	3	11001110	-1	-3
00001111	1	1	01001111	1	-1	10001111	-1	1	11001111	-1	-1
00010000	5	11	01010000	5	-11	10010000	-5	11	11010000	-5	-11
00010001	5	9	01010001	5	-9	10010001	-5	9	11010001	-5	-9
00010010	7	11	01010010	7	-11	10010010	-7	11	11010010	-7	-11
00010011	7	9	01010011	7	-9	10010011	-7	9	11010011	-7	-9
00010100	5	13	01010100	5	-13	10010100	-5	13	11010100	-5	-13
00010101	5	15	01010101	5	-15	10010101	-5	15	11010101	-5	-15
00010110	7	13	01010110	7	-13	10010110	-7	13	11010110	-7	-13
00010111	7	15	01010111	7	-15	10010111	-7	15	11010111	-7	-15
00011000	3	11	01011000	3	-11	10011000	-3	11	11011000	-3	-11
00011001	3	9	01011001	3	-9	10011001	-3	9	11011001	-3	-9
00011010	1	11	01011010	1	-11	10011010	-1	11	11011010	-1	-11
00011011	1	9	01011011	1	-9	10011011	-1	9	11011011	-1	-9
00011100	3	13	01011100	3	-13	10011100	-3	13	11011100	-3	-13
00011101	3	15	01011101	3	-15	10011101	-3	15	11011101	-3	-15
00011110	1	13	01011110	1	-13	10011110	-1	13	11011110	-1	-13
00011111	1	15	01011111	1	-15	10011111	-1	15	11011111	-1	-15
00100000	11	5	01100000	11	-5	10100000	-11	5	11100000	-11	-5
00100001	11	7	01100001	11	-7	10100001	-11	7	11100001	-11	-7
00100010	9	5	01100010	9	-5	10100010	-9	5	11100010	-9	-5
00100011	9	7	01100011	9	-7	10100011	-9	7	11100011	-9	-7
00100100	11	3	01100100	11	-3	10100100	-11	3	11100100	-11	-3
00100101	11	1	01100101	11	-1	10100101	-11	1	11100101	-11	-1
00100110	9	3	01100110	9	-3	10100110	-9	3	11100110	-9	-3
00100111	9	1	01100111	9	-1	10100111	-9	1	11100111	-9	-1
00101000	13	5	01101000	13	-5	10101000	-13	5	11101000	-13	-5
00101001	13	7	01101001	13	-7	10101001	-13	7	11101001	-13	-7
00101010	15	5	01101010	15	-5	10101010	-15	5	11101010	-15	-5
00101011	15	7	01101011	15	-7	10101011	-15	7	11101011	-15	-7
00101100	13	3	01101100	13	-3	10101100	-13	3	11101100	-13	-3
00101101	13	1	01101101	13	-1	10101101	-13	1	11101101	-13	-1
00101110	15	3	01101110	15	-3	10101110	-15	3	11101110	-15	-3
00101111	15	1	01101111	15	-1	10101111	-15	1	11101111	-15	-1
00110000	11	11	01110000	11	-11	10110000	-11	11	11110000	-11	-11
00110001	11	9	01110001	11	-9	10110001	-11	9	11110001	-11	-9
00110010	9	11	01110010	9	-11	10110010	-9	11	11110010	-9	-11
00110011	9	9	01110011	9	-9	10110011	-9	9	11110011	-9	-9
00110100	11	13	01110100	11	-13	10110100	-11	13	11110100	-11	-13
00110101	11	15	01110101	11	-15	10110101	-11	15	11110101	-11	-15
00110110	9	13	01110110	9	-13	10110110	-9	13	11110110	-9	-13
00110111	9	15	01110111	9	-15	10110111	-9	15	11110111	-9	-15
00111000	13	11	01111000	13	-11	10111000	-13	11	11111000	-13	-11
00111001	13	9	01111001	13	-9	10111001	-13	9	11111001	-13	-9
00111010	15	11	01111010	15	-11	10111010	-15	11	11111010	-15	-11
00111011	15	9	01111011	15	-9	10111011	-15	9	11111011	-15	-9
00111100	13	13	01111100	13	-13	10111100	-13	13	11111100	-13	-13
00111101	13	15	01111101	13	-15	10111101	-13	15	11111101	-13	-15

00111110	15	13	01111110	15	-13	10111110	-15	13	11111110	-15	-13
00111111	15	15	01111111	15	-15	10111111	-15	15	11111111	-15	-15

## 7.2 Pseudo-random sequence generation

Pseudo-random sequences are defined by a length-31 Gold sequence. The output sequence  $c(n)$  of length  $M_{PN}$ , where  $n = 0, 1, \dots, M_{PN} - 1$ , is defined by

$$\begin{aligned}
 c(n) &= (x_1(n + N_c) + x_2(n + N_c)) \bmod 2 \\
 x_1(n + 31) &= (x_1(n + 3) + x_1(n)) \bmod 2 \\
 x_2(n + 31) &= (x_2(n + 3) + x_2(n + 2) + x_2(n + 1) + x_2(n)) \bmod 2
 \end{aligned}$$

where  $N_c = 1600$  and the first m-sequence shall be initialized with  $x_1(0) = 1, x_1(n) = 0, n = 1, 2, \dots, 30$ . The initialization of the second m-sequence is denoted by  $c_{init} = \sum_{i=0}^{30} x_2(i) \cdot 2^i$  with the value depending on the application of the sequence.

# 8 Timing

## 8.1 Uplink-downlink frame timing

Transmission of the uplink radio frame number  $i$  from the UE shall start  $(N_{TA} + N_{TA\ offset}) \times T_s$  seconds before the start of the corresponding downlink radio frame at the UE, where  $0 \leq N_{TA} \leq 4096$  if the UE is configured with a SCG and  $0 \leq N_{TA} \leq 20512$  otherwise. For frame structure type 1  $N_{TA\ offset} = 0$  and for frame structure type 2  $N_{TA\ offset} = 624$  unless stated otherwise in [4]. Note that not all slots in a radio frame may be transmitted. One example hereof is TDD, where only a subset of the slots in a radio frame is transmitted.

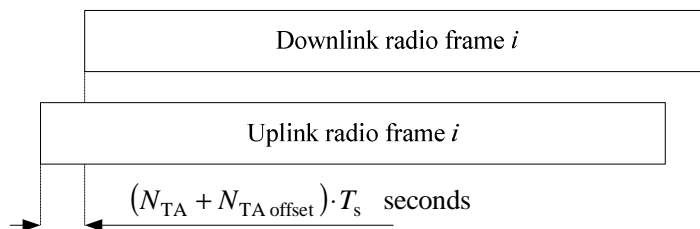

Figure 8.1-1: Uplink-downlink timing relation



## 9 Sidelink

### 9.1 Overview

A sidelink is used for ProSe direct communication and ProSe direct discovery between UEs.

#### 9.1.1 Physical channels

A sidelink physical channel corresponds to a set of resource elements carrying information originating from higher layers and is the interface defined between 3GPP TS 36.212 [3] and the present document 3GPP TS 36.211. The following sidelink physical channels are defined:

- Physical Sidelink Shared Channel, PSSCH
- Physical Sidelink Control Channel, PSCCH
- Physical Sidelink Discovery Channel, PSDCH
- Physical Sidelink Broadcast Channel, PSBCH

Generation of the baseband signal representing the different physical sidelink channels is illustrated in Figure 5.3-1.

#### 9.1.2 Physical signals

A sidelink physical signal is used by the physical layer but does not carry information originating from higher layers. The following sidelink physical signals are defined:

- Demodulation reference signal
- Synchronization signal

#### 9.1.3 Handling of simultaneous sidelink and uplink/downlink transmissions

For a given frequency, on an uplink subframe included in *discTxGapConfig* [9], a UE shall not transmit an uplink transmission that is not a PRACH transmission and that is partly or completely overlapping in time with a PSDCH transmission or a SLSS transmission for PSDCH by the same UE. Else, for a given carrier frequency, a UE shall not transmit a sidelink signal or channel overlapping partly or completely in time with an uplink transmission from the same UE.

For a given carrier frequency, no PSDCH, PSCCH, or PSSCH transmission shall occur from a UE in a sidelink subframe configured for synchronization purposes by the higher-layer parameters

- *syncOffsetIndicator1* or *syncOffsetIndicator2* in [9] if the UE has no serving cell fulfilling the S criterion according to [10, clause 5.2.3.2], or
- *syncOffsetIndicator* in *commSyncConfig* or *discSyncConfig* which includes *txParameters* in [9] if the UE has a serving cell fulfilling the S criterion according to [10, clause 5.2.3.2]. The UE may assume the same configuration in *commSyncConfig* and *discSyncConfig*.

For a given carrier frequency, with the exception of PSSCH transmissions with transmission mode 1 and same sidelink cyclic prefix as PUSCH, no sidelink transmissions shall occur in sidelink subframe  $n$  from a UE if uplink SRS is transmitted from the same UE in uplink subframe  $n$ .

In case of a UE capable of transmission on multiple carriers, sidelink transmission may only occur on a single carrier frequency at a given time.

A UE with limited transmission capabilities, on an uplink subframe included in *discTxGapConfig* [9], shall first prioritize a PSDCH transmission or a SLSS transmission for PSDCH over an uplink transmission that is not a PRACH transmission. Else, a UE with limited transmission capabilities shall at a given time first prioritize uplink transmissions, followed by sidelink transmissions.

A UE with limited transmission capabilities shall at a given time prioritize sidelink communication transmissions (PSSS, SSSS, PSBCH, PSSCH, PSCCH) over sidelink discovery transmissions (PSDCH).

A UE with limited reception capabilities, on a downlink subframe included in *discRxGapConfig* [9], shall first prioritize reception of PSDCH or reception of SLSS for PSDCH over downlink reception. Else, a UE with limited reception capabilities shall at a given time first prioritize downlink reception over sidelink reception.

A UE with limited reception capabilities shall at a given time first prioritize sidelink communication reception, sidelink discovery reception on carriers configured by the eNodeB, and last sidelink discovery reception on carriers not configured by the eNodeB.

## 9.2 Slot structure and physical resources

Sidelink transmissions are organized into radio frames with a duration of  $T_f$ , each consisting of 20 slots of duration  $T_{\text{slot}}$ . A sidelink subframe consists of two consecutive slots, starting with an even-numbered slot.

### 9.2.1 Resource grid

A transmitted physical channel or signal in a slot is described by a resource grid of  $N_{\text{RB}}^{\text{SL}} N_{\text{sc}}^{\text{RB}}$  subcarriers and  $N_{\text{ymb}}^{\text{SL}}$  SC-FDMA symbols. The sidelink bandwidth  $N_{\text{RB}}^{\text{SL}} = N_{\text{RB}}^{\text{UL}}$  if the S criterion according to [10, clause 5.2.3.2] is fulfilled for a serving cell having the same uplink carrier frequency as the sidelink, otherwise a preconfigured value is used [9].

The sidelink cyclic prefix is configured independently for type 1 discovery, type 2B discovery, sidelink transmission mode 1, sidelink transmission mode 2, control signalling, and PSBCH and synchronization signals. Configuration is per resource pool for discovery, sidelink transmission mode 2, and control signalling. The PSBCH and synchronization signals always use the same cyclic prefix.

The resource grid is illustrated in Figure 5.2.1-1.

An antenna port is defined such that the channel over which a symbol on the antenna port is conveyed can be inferred from the channel over which another symbol on the same antenna port is conveyed. There is one resource grid per antenna port. The antenna ports used for transmission of a physical channel or signal are shown in Table 9.2.1-1.

**Table 9.2.1-1: Antenna ports used for different physical channels and signals**

Physical channel or signal	Antenna port number
PSSCH	1000
PSCCH	1000
PSDCH	1000
PSBCH	1010
Synchronization signals	1020

### 9.2.2 Resource elements

Each element in the resource grid is called a resource element and is uniquely defined by the index pair  $(k, l)$  in a slot where  $k = 0, \dots, N_{\text{RB}}^{\text{SL}} N_{\text{sc}}^{\text{RB}} - 1$  and  $l = 0, \dots, N_{\text{ymb}}^{\text{SL}} - 1$  are the indices in the frequency and time domains, respectively.

Resource element  $(k, l)$  on antenna port  $p$  corresponds to the complex value  $a_{k,l}^{(p)}$ . When there is no risk for confusion, or no particular antenna port is specified, the index  $p$  may be dropped.

Quantities  $a_{k,l}^{(p)}$  corresponding to resource elements not used for transmission of a physical channel or a physical signal in a slot shall be set to zero.

### 9.2.3 Resource blocks

A physical resource block is defined as  $N_{\text{symb}}^{\text{SL}}$  consecutive SC-FDMA symbols in the time domain and  $N_{\text{sc}}^{\text{RB}}$  consecutive subcarriers in the frequency domain, where  $N_{\text{symb}}^{\text{SL}}$  and  $N_{\text{sc}}^{\text{RB}}$  are given by Table 9.2.3-1. A physical resource block in the sidelink thus consists of  $N_{\text{symb}}^{\text{SL}} \times N_{\text{sc}}^{\text{RB}}$  resource elements, corresponding to one slot in the time domain and 180 kHz in the frequency domain.

**Table 9.2.3-1: Resource block parameters**

Configuration	$N_{\text{sc}}^{\text{RB}}$	$N_{\text{symb}}^{\text{SL}}$
Normal cyclic prefix	12	7
Extended cyclic prefix	12	6

The relation between the physical resource block number  $n_{\text{PRB}}$  in the frequency domain and resource elements  $(k, l)$  in a slot is given by

$$n_{\text{PRB}} = \left\lfloor \frac{k}{N_{\text{sc}}^{\text{RB}}} \right\rfloor$$

### 9.2.4 Resource pool

The subframe pools and resource block pools are defined in [4].

For PSSCH, the number of the current slot in the subframe pool  $n_{\text{ss}}^{\text{PSSCH}} = 2n_{\text{ssf}}^{\text{PSSCH}} + i$ , where  $i \in \{0,1\}$  is the number of the current slot within the current sidelink subframe  $n_{\text{ssf}}^{\text{PSSCH}} = j \bmod 10$  with  $j$  equal to the subscript of  $l_j^{\text{PSSCH}}$ , defined in clauses 14.1.4 and 14.2.3 of [4] for sidelink transmission modes 1 and 2, respectively

### 9.2.5 Guard period

The last SC-FDMA symbol in a sidelink subframe serves as a guard period and shall not be used for sidelink transmission.

## 9.3 Physical Sidelink Shared Channel

### 9.3.1 Scrambling

The block of bits  $b(0), \dots, b(M_{\text{bit}} - 1)$ , where  $M_{\text{bit}}$  is the number of bits transmitted on the physical sidelink shared channel in one subframe shall be scrambled according to clause 5.3.1.

The scrambling sequence generator shall be initialised with  $c_{\text{init}} = n_{\text{ID}}^{\text{SA}} \cdot 2^{14} + n_{\text{ssf}}^{\text{PSSCH}} \cdot 2^9 + 510$  at the start of every PSSCH subframe where  $n_{\text{ID}}^{\text{SA}}$  is destination identity obtained from the sidelink control channel.

### 9.3.2 Modulation

Modulation shall be done according to clause 5.3.2. Table 9.3.2-1 specifies the modulation mappings applicable for the physical sidelink shared channel.

**Table 9.3.2-1: PSSCH modulation schemes**

Physical channel	Modulation schemes
PSSCH	QPSK, 16QAM

### 9.3.3 Layer mapping

Layer mapping shall be done according to clause 5.3.2A assuming a single antenna port,  $\nu = 1$ .

### 9.3.4 Transform precoding

Transform precoding shall be done according to clause 5.3.3 with  $M_{\text{RB}}^{\text{PUSCH}}$  and  $M_{\text{sc}}^{\text{PUSCH}}$  replaced by  $M_{\text{RB}}^{\text{PSSCH}}$  and  $M_{\text{sc}}^{\text{PSSCH}}$ , respectively.

### 9.3.5 Precoding

Precoding shall be done according to clause 5.3.3A assuming a single antenna port,  $\nu = 1$ .

### 9.3.6 Mapping to physical resources

The block of complex-valued symbols  $z(0), \dots, z(M_{\text{symb}}^{\text{ap}} - 1)$  shall be multiplied with the amplitude scaling factor  $\beta_{\text{PSSCH}}$  in order to conform to the transmit power  $P_{\text{PSSCH}}$  specified in [4], and mapped in sequence starting with  $z(0)$  to physical resource blocks on antenna port  $p$  and assigned for transmission of PSSCH. The mapping to resource elements  $(k, l)$  corresponding to the physical resource blocks assigned for transmission and not used for transmission of reference signals shall be in increasing order of first the index  $k$ , then the index  $l$ , starting with the first slot in the subframe. Resource elements in the last SC-FDFMA symbol within a subframe shall be counted in the mapping process but not transmitted.

If sidelink frequency hopping is disabled the set of physical resource blocks to be used for transmission is given by  $n_{\text{PRB}} = n'_{\text{VRB}}$  where  $n'_{\text{VRB}}$  is obtained from [4, clause 14.1.1.2.1].

If sidelink frequency hopping with type 1 hopping is enabled, the set of physical resource blocks to be used for transmission is given by [4].

If sidelink frequency hopping with predefined hopping pattern is enabled, the set of physical resource blocks to be used for transmission is given by the sidelink control information together with a predefined pattern in clause 5.3.4 with the following exceptions:

- only inter-subframe hopping shall be used
- the number of subbands  $N_{\text{sb}} \in \{1, 2, 4\}$  is given by higher layers as described in [4, clause 14.1.1.2]
- the quantity  $N_{\text{RB}}^{\text{HO}} \in \{0, \dots, 110\}$  is given by higher layers as described in [4, clause 14.1.1.2]
- the quantity  $n_{\text{s}} = n_{\text{ss}}^{\text{PSSCH}}$  where  $n_{\text{ss}}^{\text{PSSCH}}$  is given by clause 9.2.4
- the quantity  $\text{CURRENT\_TX\_NB} = n_{\text{ssf}}^{\text{PSSCH}}$
- the pseudo-random sequence generator is initialized at the start of each slot fulfilling  $n_{\text{ss}}^{\text{PSSCH}} = 0$  with the initialization value  $c_{\text{init}} \in \{0, 1, \dots, 503, 510\}$  given by *hoppingParameter-r12* in [9]
- the quantity  $n_{\text{VRB}}$  shall be replaced by  $n'_{\text{VRB}}$ , given by [4, clause 14.1.1.2.1]
- for sidelink transmission mode 1
  - $N_{\text{RB}}^{\text{UL}} = N_{\text{RB}}^{\text{SL}}$
- for sidelink transmission mode 2
  - $N_{\text{RB}}^{\text{UL}} = M_{\text{RB}}^{\text{PSSCH\_RP}}$  where  $M_{\text{RB}}^{\text{PSSCH\_RP}}$  is given by [4, clause 14.1.3]

- the quantity  $n_{\text{PRB}}$  shall be replaced by  $n'_{\text{PRB}}$ , given by [4, clause 14.1.1.4]
- the physical resource block to use for transmission  $n_{\text{PRB}} = m'_{n_{\text{PRB}}}{}^{\text{PSSCH}}$  with  $m_j{}^{\text{PSSCH}}$  given by [4, clause 14.1.3]

## 9.4 Physical Sidelink Control Channel

### 9.4.1 Scrambling

The block of bits  $b(0), \dots, b(M_{\text{bit}} - 1)$ , where  $M_{\text{bit}}$  is the number of bits transmitted on the physical sidelink control channel in one subframe shall be scrambled according to clause 5.3.1.

The scrambling sequence generator shall be initialised with  $c_{\text{init}} = 510$  at the start of every PSCCH subframe.

### 9.4.2 Modulation

Modulation shall be done according to clause 5.3.2. Table 9.4.2-1 specifies the modulation mappings applicable for the physical sidelink control channel.

**Table 9.4.2-1: PSCCH modulation schemes**

Physical channel	Modulation schemes
PSCCH	QPSK

### 9.4.3 Layer mapping

Layer mapping shall be done according to clause 5.3.2A assuming a single antenna port,  $v = 1$ .

### 9.4.4 Transform precoding

Transform precoding shall be done according to clause 5.3.3 with  $M_{\text{RB}}^{\text{PUSCH}}$  and  $M_{\text{sc}}^{\text{PUSCH}}$  replaced by  $M_{\text{RB}}^{\text{PSCCH}}$  and  $M_{\text{sc}}^{\text{PSCCH}}$ , respectively.

### 9.4.5 Precoding

Precoding shall be done according to clause 5.3.3A assuming a single antenna port,  $v = 1$ .

### 9.4.6 Mapping to physical resources

The block of complex-valued symbols  $z(0), \dots, z(M_{\text{symp}}^{\text{ap}} - 1)$  shall be multiplied with the amplitude scaling factor  $\beta_{\text{PSCCH}}$  in order to conform to the transmit power  $P_{\text{PSCCH}}$  specified in [4], and mapped in sequence starting with  $z(0)$  to physical resource blocks on antenna port  $p$  and assigned for transmission of PSCCH. The mapping to resource elements  $(k, l)$  corresponding to the physical resource blocks assigned for transmission and not used for transmission of reference signals shall be in increasing order of first the index  $k$ , then the index  $l$ , starting with the first slot in the subframe. Resource elements in the last SC-FDFMA symbol within a subframe shall be counted in the mapping process but not transmitted.

## 9.5 Physical Sidelink Discovery Channel

### 9.5.1 Scrambling

The block of bits  $b(0), \dots, b(M_{\text{bit}} - 1)$ , where  $M_{\text{bit}}$  is the number of bits transmitted on the physical sidelink discovery channel in one subframe shall be scrambled according to clause 5.3.1.

The scrambling sequence generator shall be initialised with  $c_{\text{init}} = 510$  at the start of each PSDCH subframe.

### 9.5.2 Modulation

Modulation shall be done according to clause 5.3.2. Table 9.5.2-1 specifies the modulation mappings applicable for the physical sidelink discovery channel.

**Table 9.5.2-1: Sidelink modulation schemes**

Physical channel	Modulation schemes
PSDCH	QPSK

### 9.5.3 Layer mapping

Layer mapping shall be done according to clause 5.3.2A assuming a single antenna port,  $\nu = 1$ .

### 9.5.4 Transform precoding

Transform precoding shall be done according to clause 5.3.3 with  $M_{\text{RB}}^{\text{PUSCH}}$  and  $M_{\text{sc}}^{\text{PUSCH}}$  replaced by  $M_{\text{RB}}^{\text{PSDCH}}$  and  $M_{\text{sc}}^{\text{PSDCH}}$ , respectively.

### 9.5.5 Precoding

Precoding shall be done according to clause 5.3.3A assuming a single antenna port,  $\nu = 1$ .

### 9.5.6 Mapping to physical resources

The block of complex-valued symbols  $z(0), \dots, z(M_{\text{symb}}^{\text{ap}} - 1)$  shall be multiplied with the amplitude scaling factor  $\beta_{\text{PSDCH}}$  in order to conform to the transmit power  $P_{\text{PSDCH}}$  specified in [4], and mapped in sequence starting with  $z(0)$  to physical resource blocks on antenna port  $p$  and assigned for transmission of PSDCH. The mapping to resource elements  $(k, l)$  corresponding to the physical resource blocks assigned for transmission and not used for transmission of reference signals shall be in increasing order of first the index  $k$ , then the index  $l$ , starting with the first slot in the subframe. Resource elements in the last SC-FDFMA symbol within a subframe shall be counted in the mapping process but not transmitted.

The set of physical resource blocks that shall be used are given by [4, clause 14.3.1].

## 9.6 Physical Sidelink Broadcast Channel

### 9.6.1 Scrambling

The block of bits  $b(0), \dots, b(M_{\text{bit}} - 1)$ , where  $M_{\text{bit}}$  is the number of bits transmitted on the physical sidelink broadcast channel in one subframe, shall be scrambled according to clause 5.3.1. The scrambling sequence generator shall be initialised at the start of every PSBCH subframe with  $c_{\text{init}} = N_{\text{ID}}^{\text{SL}}$ .

## 9.6.2 Modulation

Modulation shall be done according to clause 5.3.2. Table 9.6.2-1 specifies the modulation mappings applicable for the physical sidelink broadcast channel.

**Table 9.6.2-1: PSBCH modulation schemes**

Physical channel	Modulation schemes
PSBCH	QPSK

## 9.6.3 Layer mapping

Layer mapping shall be done according to clause 5.3.2A assuming a single antenna port,  $v = 1$ .

## 9.6.4 Transform precoding

Transform precoding shall be done according to clause 5.3.3 with  $M_{RB}^{PUSCH}$  and  $M_{sc}^{PUSCH}$  replaced by  $M_{RB}^{PSBCH}$  and  $M_{sc}^{PSBCH}$ , respectively.

## 9.6.5 Precoding

Precoding shall be done according to clause 5.3.3A assuming a single antenna port,  $v = 1$ .

## 9.6.6 Mapping to physical resources

The block of complex-valued symbols  $z(0), \dots, z(M_{\text{sym}}^{\text{ap}} - 1)$  shall be multiplied with the amplitude scaling factor  $\beta_{\text{PSBCH}}$  in order to conform to the transmit power  $P_{\text{PSBCH}}$  specified in [4], and mapped in sequence starting with  $z(0)$  to physical resource blocks on antenna port  $p$ . The PSBCH shall use the same set of resource blocks as the synchronization signal. The mapping to resource elements  $(k, l)$  corresponding to the physical resource blocks used for the PSBCH and not used for transmission of reference signals or synchronization signals shall be in increasing order of first the index  $k$ , then the index  $l$ , starting with the first slot in the subframe. The resource-element index  $k$  given by

$$k = k' - 36 + \frac{N_{RB}^{\text{SL}} N_{sc}^{\text{RB}}}{2}, \quad k' = 0, 1, \dots, 71$$

Resource elements in the last SC-FDMA symbol within a subframe should be counted in the mapping process but not transmitted.

## 9.7 Sidelink Synchronization Signals

A physical-layer sidelink synchronization identity is represented by  $N_{\text{ID}}^{\text{SL}} \in \{0, 1, \dots, 335\}$ , divided into two sets  $\text{id\_net}$  and  $\text{id\_oon}$  consisting of identities  $\{0, 1, \dots, 167\}$  and  $\{168, 169, \dots, 335\}$ , respectively.

### 9.7.1 Primary sidelink synchronization signal

The primary sidelink synchronization signal is transmitted in two adjacent SC-FDMA symbols in the same subframe.

#### 9.7.1.1 Sequence generation

Each of the two sequences  $d_i(0), \dots, d_i(61), i = 1, 2$  used for the primary sidelink synchronization signal in the two SC-FDMA symbols is given by clause 6.11.1.1 with root index  $u = 26$  if  $N_{\text{ID}}^{\text{SL}} \leq 167$  and  $u = 37$  otherwise.

### 9.7.1.2 Mapping to resource elements

The sequence  $d_i(n)$  shall be multiplied with the amplitude scaling factor  $\sqrt{72/62} \cdot \beta_{\text{PSBCH}}$  and mapped to resource elements on antenna port 1020 in the first slot in the subframe according to

$$a_{k,l} = d_i(n), \quad n = 0, \dots, 61$$

$$k = n - 31 + \frac{N_{\text{RB}}^{\text{SL}} N_{\text{sc}}^{\text{RB}}}{2}$$

$$l = \begin{cases} 1, 2 & \text{normal cyclic prefix} \\ 0, 1 & \text{extended cyclic prefix} \end{cases}$$

## 9.7.2 Secondary sidelink synchronization signal

The secondary sidelink synchronization signal is transmitted in two adjacent SC-FDMA symbols in the same subframe.

### 9.7.2.1 Sequence generation

Each of the two sequences  $d_i(0), \dots, d_i(61), i=1,2$  used for the secondary sidelink synchronization signal is given by clause 6.11.2.1 assuming subframe 0 with  $N_{\text{ID}}^{(1)} = N_{\text{ID}}^{\text{SL}} \bmod 168$  and  $N_{\text{ID}}^{(2)} = \lfloor N_{\text{ID}}^{\text{SL}} / 168 \rfloor$ .

### 9.7.2.2 Mapping to resource elements

The sequence  $d_i(n)$  shall be multiplied with the amplitude scaling factor  $\beta_{\text{SSSS}}$  in order to conform to the transmit power specified in clause 14.4 in 3GPP TS 36.213 [4] and mapped to resource elements on antenna port 1020 in the second slot in the subframe according to

$$a_{k,l} = d_i(n), \quad n = 0, \dots, 61$$

$$k = n - 31 + \frac{N_{\text{RB}}^{\text{SL}} N_{\text{sc}}^{\text{RB}}}{2}$$

$$l = \begin{cases} 4, 5 & \text{normal cyclic prefix} \\ 3, 4 & \text{extended cyclic prefix} \end{cases}$$

## 9.8 Demodulation reference signals

Demodulation reference signals associated with PSSCH, PSCCH, PSDCH, and PSBCH transmission shall be transmitted according to PUSCH in clause 5.5.2.1 with the following exceptions:

- The parameters in Tables 9.8-1 and 9.8-2 shall be used.
- The term PUSCH shall be replaced by PSSCH, PSCCH, PSDCH or PSBCH, depending on the physical channel to which the reference signal is associated.
- Antenna ports are given by Table 9.2-1.
- The set of physical resource blocks used in the mapping process shall be identical to the corresponding PSSCH/PSCCH/PSDCH/PSBCH transmission.
- The index  $k$  in the mapping process in clause 5.5.2.1.2 shall be identical to that for the corresponding PSSCH/PSCCH/PSDCH/PSBCH transmission.
- The pseudo-random sequence generator in clause 5.5.1.3 shall be initialized at the start of each slot fulfilling  $n_{\text{ss}}^{\text{PSSCH}} = 0$



Table 9.8-1: Reference signal parameters for PSSCH and PSCCH.

Parameter in clause 5.5.2.1		PSSCH	PSCCH
Group hopping		enabled	disabled
	$n_{ID}^{RS}$	$n_{ID}^{SA}$	-
	$n_s$	$n_{ss}^{PSSCH}$	-
	$f_{ss}$	$n_{ID}^{SA} \bmod 30$	0
Sequence hopping		disabled	disabled
Cyclic shift	$n_{cs,\lambda}$	$\lfloor n_{ID}^{SA}/2 \rfloor \bmod 8$	0
Orthogonal sequence	$[w^{\lambda}(0) \ w^{\lambda}(1)]$	$\begin{cases} [+1 \ +1] & \text{if } n_{ID}^{SA} \bmod 2 = 0 \\ [+1 \ -1] & \text{if } n_{ID}^{SA} \bmod 2 = 1 \end{cases}$	$[+1 \ +1]$
Reference signal length	$M_{sc}^{RS}$	$M_{sc}^{PSSCH}$	$M_{sc}^{PSCCH}$
Number of layers	$\nu$	1	1
Number of antenna ports	$P$	1	1

Table 9.8-2: Reference signal parameters for PSDCH and PSBCH.

Parameter in clause 5.5.2.1		PSDCH	PSBCH
Group hopping		disabled	disabled
	$f_{ss}$	0	$\lfloor N_{ID}^{SL}/16 \rfloor \bmod 30$
Sequence hopping		disabled	disabled
Cyclic shift	$n_{cs,\lambda}$	0	$\lfloor N_{ID}^{SL}/2 \rfloor \bmod 8$
Orthogonal sequence	$[w^{\lambda}(0) \ w^{\lambda}(1)]$	$[+1 \ +1]$	$\begin{cases} [+1 \ +1] & \text{if } N_{ID}^{SL} \bmod 2 = 0 \\ [+1 \ -1] & \text{if } N_{ID}^{SL} \bmod 2 = 1 \end{cases}$
Reference signal length	$M_{sc}^{RS}$	$M_{sc}^{PSDCH}$	$M_{sc}^{PSBCH}$
Number of layers	$\nu$	1	1
Number of antenna ports	$P$	1	1

## 9.9 SC-FDMA baseband signal generation

The time-continuous signal  $s_l^{(p)}(t)$  for antenna port  $p$  in SC-FDMA symbol  $l$  in a sidelink slot is defined by clause 5.6 with  $N_{RB}^{UL}$  replaced by  $N_{RB}^{SL}$ .

The cyclic prefix length for each sidelink channel or signal may differ from that configured for uplink transmissions.

## 9.10 Timing

Transmission of a sidelink radio frame number  $i$  from the UE shall start  $(N_{TA,SL} + N_{TA,offset}) \cdot T_s$  seconds before the start of the corresponding timing reference frame at the UE. The UE is not required to receive sidelink or downlink transmissions earlier than  $624T_s$  after the end of a sidelink transmission.

For PSDCH transmission and sidelink synchronization signal transmission for PSDCH:

if the UE has a serving cell fulfilling the S criterion according to [10, clause 5.2.3.2]

- the timing of reference radio frame  $i$  equals that of downlink radio frame  $i$  of the cell  $c$  as given in Section 14.3.1 of [4] and
- $N_{TA,offset}$  is given by clause 8.1,

otherwise

- the timing of reference radio frame  $i$  is implicitly obtained from [4] and
- $N_{TA\ offset} = 0$ .

For all other sidelink transmissions:

if the UE has a serving cell fulfilling the S criterion according to [10, clause 5.2.3.2]

- the timing of reference radio frame  $i$  equals that of downlink radio frame  $i$  in the cell with the same uplink carrier frequency as the sidelink and
- $N_{TA\ offset}$  is given by clause 8.1,

otherwise

- the timing of reference radio frame  $i$  is implicitly obtained from [4] and
- $N_{TA\ offset} = 0$ .

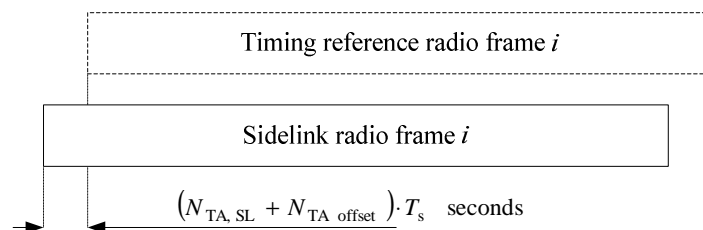

**Figure 9.9-1: Sidelink timing relation.**

The quantity  $N_{TA,SL}$  differs between channels and signals according to

$$N_{TA,SL} = \begin{cases} N_{TA} & \text{for PSSCH in sidelink transmission mode 1} \\ 0 & \text{for all other cases} \end{cases}$$

## 10 Narrowband IoT

### 10.1 Uplink

#### 10.1.1 Overview

##### 10.1.1.1 Physical channels

The following narrowband physical channels are defined:

- Narrowband Physical Uplink Shared Channel, NPUSCH
- Narrowband Physical Random Access Channel, NPRACH

##### 10.1.1.2 Physical signals

The following uplink narrowband physical signals are defined:

- Narrowband demodulation reference signal

## 10.1.2 Slot structure and physical resources

### 10.1.2.1 Resource grid

A transmitted physical channel or signal in a slot is described by one or several resource grids of  $N_{sc}^{UL}$  subcarriers and  $N_{symb}^{UL}$  SC-FDMA symbols. The resource grid is illustrated in Figure 10.1.2.1-1. The slot number within a radio frame is denoted  $n_s$  where  $n_s \in \{0,1,\dots,19\}$  for  $\Delta f = 15$  kHz and  $n_s \in \{0,1,\dots,4\}$  for  $\Delta f = 3.75$  kHz .

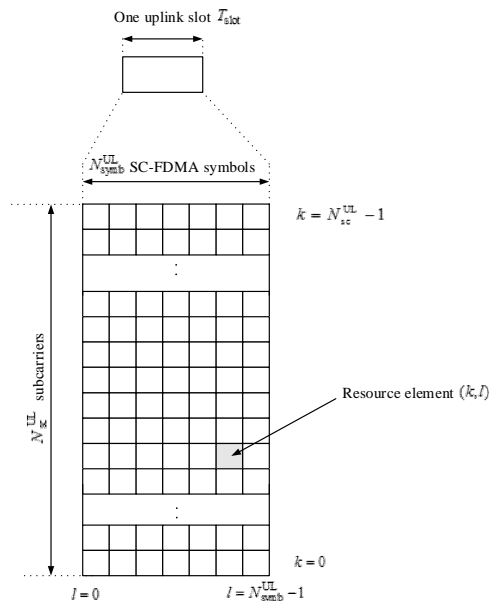

**Figure 10.1.2.1-1: Uplink resource grid for NB-IoT**

The uplink bandwidth in terms of subcarriers  $N_{sc}^{UL}$ , and the slot duration  $T_{slot}$  are given in Table 10.1.2.1-1.

**Table 10.1.2.1-1: NB-IoT parameters.**

Subcarrier spacing	$N_{sc}^{UL}$	$T_{slot}$
$\Delta f = 3.75$ kHz	48	$61440 \cdot T_s$
$\Delta f = 15$ kHz	12	$15360 \cdot T_s$

A single antenna port  $p = 0$  is used for all uplink transmissions.

### 10.1.2.2 Resource elements

Each element in the resource grid is called a resource element and is uniquely defined by the index pair  $(k,l)$  in a slot where  $k = 0, \dots, N_{sc}^{UL} - 1$  and  $l = 0, \dots, N_{symb}^{UL} - 1$  are the indices in the frequency and time domains, respectively.

Resource element  $(k,l)$  corresponds to the complex value  $a_{k,l}$ . Quantities  $a_{k,l}$  corresponding to resource elements not used for transmission of a physical channel or a physical signal in a slot shall be set to zero.

### 10.1.2.3 Resource unit

Resource units are used to describe the mapping of the NPUSCH to resource elements. A resource unit is defined as  $N_{\text{symb}}^{\text{UL}} N_{\text{slots}}^{\text{UL}}$  consecutive SC-FDMA symbols in the time domain and  $N_{\text{sc}}^{\text{RU}}$  consecutive subcarriers in the frequency domain, where  $N_{\text{sc}}^{\text{RU}}$  and  $N_{\text{symb}}^{\text{UL}}$  are given by Table 10.1.2.3-1.

**Table 10.1.2.3-1: Supported combinations of  $N_{\text{sc}}^{\text{RU}}$ ,  $N_{\text{slots}}^{\text{UL}}$ , and  $N_{\text{symb}}^{\text{UL}}$ .**

NPUSCH format	$\Delta f$	$N_{\text{sc}}^{\text{RU}}$	$N_{\text{slots}}^{\text{UL}}$	$N_{\text{symb}}^{\text{UL}}$
1	3.75 kHz	1	16	7
	15 kHz	1	16	
		3	8	
		6	4	
		12	2	
2	3.75 kHz	1	4	
	15 kHz	1	4	

## 10.1.3 Narrowband physical uplink shared channel

The narrowband physical uplink shared channel supports two formats:

- NPUSCH format 1, used to carry the UL-SCH
- NPUSCH format 2, used to carry uplink control information

### 10.1.3.1 Scrambling

Scrambling shall be done according to clause 5.3.1. The scrambling sequence generator shall be initialised with  $c_{\text{init}} = n_{\text{RNTI}} \cdot 2^{14} + n_f \bmod 2 \cdot 2^{13} + \lfloor n_s / 2 \rfloor \cdot 2^9 + N_{\text{ID}}^{\text{Ncell}}$  where  $n_s$  is the first slot of the transmission of the codeword. In case of NPUSCH repetitions, the scrambling sequence reinitialised according to the above formula after every  $M_{\text{identical}}^{\text{NPUSCH}}$  transmissions of the codeword with  $n_s$  and  $n_f$  set to the first slot and the frame, respectively, used for the transmission of the repetition. The quantity  $M_{\text{identical}}^{\text{NPUSCH}}$  is given by clause 10.1.3.6.

### 10.1.3.2 Modulation

Modulation shall be done according to clause 5.3.2. Table 10.1.3.2-1 specifies the modulation mappings applicable for the narrowband physical uplink shared channel.

**Table 10.1.3.2-1: NPUSCH modulation schemes**

NPUSCH format	$N_{\text{sc}}^{\text{RU}}$	Modulation scheme
1	1	BPSK, QPSK
	>1	QPSK
2	1	BPSK

### 10.1.3.3 Layer mapping

Layer mapping shall be done according to clause 5.3.2A with  $v = 1$ .

### 10.1.3.4 Transform precoding

Transform precoding shall be done according to clause 5.3.3 with  $M_{\text{RB}}^{\text{PUSCH}} = 1$  and  $M_{\text{sc}}^{\text{PUSCH}}$  replaced by  $M_{\text{sc}}^{\text{NPUSCH}}$ .

### 10.1.3.5 Precoding

Precoding shall be done according to clause 5.3.3A assuming a single antenna port.

### 10.1.3.6 Mapping to physical resources

NPUSCH can be mapped to one or more than one resource units,  $N_{RU}$ , as given by clause 16.5.1.2 of 3GPP TS 36.213 [4], each of which shall be transmitted  $M_{rep}^{NPUSCH}$  times.

The block of complex-valued symbols  $z(0), \dots, z(M_{symb}^{ap} - 1)$  shall be multiplied with the amplitude scaling factor  $\beta_{NPUSCH}$  in order to conform to the transmit power  $P_{NPUSCH}$  specified in [4], and mapped in sequence starting with  $z(0)$  to subcarriers assigned for transmission of NPUSCH. The mapping to resource elements  $(k, l)$  corresponding to the subcarriers assigned for transmission and not used for transmission of reference signals, shall be in increasing order of first the index  $k$ , then the index  $l$ , starting with the first slot in the assigned resource unit.

After mapping to  $N_{slots}$  slots, the  $N_{slots}$  slots shall be repeated  $M_{identical}^{NPUSCH} - 1$  additional times, before continuing the mapping of  $z(\cdot)$  to the following slot, where

$$M_{identical}^{NPUSCH} = \begin{cases} \min\left(M_{rep}^{NPUSCH} / 2, 4\right) & N_{sc}^{RU} > 1 \\ 1 & N_{sc}^{RU} = 1 \end{cases}$$

$$N_{slots} = \begin{cases} 1 & \Delta f = 3.75 \text{ kHz} \\ 2 & \Delta f = 15 \text{ kHz} \end{cases}$$

The mapping of  $z(0), \dots, z(M_{symb}^{ap} - 1)$  is then repeated until  $M_{rep}^{NPUSCH} N_{RU} N_{slots}^{UL}$  slots have been transmitted. After transmissions of  $256 \cdot 30720T_s$  time units, a gap of  $40 \cdot 30720T_s$  time units shall be inserted where the NPUSCH transmission is postponed.

When higher layer parameter *npusch-AllSymbols* is set to false, resource elements in SC-FDMA symbols overlapping with a symbol configured with SRS according to *srs-SubframeConfig* shall be counted in the NPUSCH mapping but not used for transmission of the NPUSCH. When higher layer parameter *npusch-AllSymbols* is set to true, all symbols are transmitted.

## 10.1.4 Demodulation reference signal

### 10.1.4.1 Reference signal sequence

#### 10.1.4.1.1 Reference signal sequence for $N_{sc}^{RU} = 1$

The reference signal sequence  $\bar{r}_u(n)$  for  $N_{sc}^{RU} = 1$  is defined by

$$\bar{r}_u(n) = \frac{1}{\sqrt{2}}(1 + j)(1 - 2c(n))w(n \bmod 16), \quad 0 \leq n < N_{rep}^{NPUSCH} N_{slots}^{UL} N_{RU} - 1$$

where the binary sequence  $c(n)$  is defined by clause 7.2 and shall be initialised with  $c_{init} = 35$  at the start of the NPUSCH transmission. The quantity  $w(n)$  is given by Table 10.1.4.1.1-1 where  $u = N_{ID}^{Ncell} \bmod 16$  for NPUSCH format 2, and for NPUSCH format 1 if group hopping is not enabled, and by clause 10.1.4.1.3 if group hopping is enabled for NPUSCH format 1.

**Table 10.1.4.1.1-1: Definition of  $w(n)$** 

$u$	$w(0), \dots, w(15)$															
0	1	1	1	1	1	1	1	1	1	1	1	1	1	1	1	1
1	1	-1	1	-1	1	-1	1	-1	1	-1	1	-1	1	-1	1	-1
2	1	1	-1	-1	1	1	-1	-1	1	1	-1	-1	1	1	-1	-1
3	1	-1	-1	1	1	-1	-1	1	1	-1	-1	1	1	-1	-1	1
4	1	1	1	1	-1	-1	-1	-1	1	1	1	1	-1	-1	-1	-1
5	1	-1	1	-1	-1	1	-1	1	1	-1	1	-1	-1	1	-1	1
6	1	1	-1	-1	-1	-1	1	1	1	1	-1	-1	-1	-1	1	1
7	1	-1	-1	1	-1	1	1	-1	1	-1	-1	1	-1	1	1	-1
8	1	1	1	1	1	1	1	1	1	-1	-1	-1	-1	-1	-1	-1
9	1	-1	1	-1	1	-1	1	-1	-1	1	-1	1	-1	1	-1	1
10	1	1	-1	-1	1	1	-1	-1	-1	-1	1	1	-1	-1	1	1
11	1	-1	-1	1	1	-1	-1	1	-1	1	1	-1	-1	1	1	-1
12	1	1	1	1	-1	-1	-1	-1	-1	-1	-1	-1	1	1	1	1
13	1	-1	1	-1	-1	1	-1	1	-1	1	-1	1	1	-1	1	-1
14	1	1	-1	-1	-1	-1	1	1	-1	-1	1	1	1	1	-1	-1
15	1	-1	-1	1	-1	1	1	-1	-1	1	1	-1	1	-1	-1	1

The reference signal sequence for NPUSCH format 1 is given by:

$$r_u(n) = \bar{r}_u(n)$$

The reference signal sequence for NPUSCH format 2 is given by

$$r_u(3n + m) = \bar{w}(m) \bar{r}_u(n), \quad m = 0, 1, 2$$

where  $\bar{w}(m)$  is defined in Table 5.5.2.2.1-2 with the sequence index chosen according to  $\left( \sum_{i=0}^7 c(8n_s + i) 2^i \right) \bmod 3$  with  $c_{\text{init}} = N_{\text{ID}}^{\text{Ncell}}$ .

#### 10.1.4.1.2 Reference signal sequence for $N_{\text{sc}}^{\text{RU}} > 1$

The reference signal sequences  $r_u(n)$  for  $N_{\text{sc}}^{\text{RU}} > 1$  is defined by a cyclic shift  $\alpha$  of a base sequence according to

$$r_u(n) = e^{j\alpha n} e^{j\varphi(n)\pi/4}, \quad 0 \leq n < N_{\text{sc}}^{\text{RU}} - 1,$$

where  $\varphi(n)$  is given by Table 10.1.4.1.2-1 for  $N_{\text{sc}}^{\text{RU}} = 3$ , Table 10.1.4.1.2-2 for  $N_{\text{sc}}^{\text{RU}} = 6$  and Table 5.5.1.2-1 for  $N_{\text{sc}}^{\text{RU}} = 12$ .

If group hopping is not enabled, the base sequence index  $u$  is given by higher layer parameters *threeTone-BaseSequence*, *sixTone-BaseSequence*, and *twelveTone-BaseSequence* for  $N_{\text{sc}}^{\text{RU}} = 3$ ,  $N_{\text{sc}}^{\text{RU}} = 6$ , and  $N_{\text{sc}}^{\text{RU}} = 12$ , respectively. If not signalled by higher layers, the base sequence is given by

$$u = \begin{cases} N_{\text{ID}}^{\text{Ncell}} \bmod 12 & \text{for } N_{\text{sc}}^{\text{RU}} = 3 \\ N_{\text{ID}}^{\text{Ncell}} \bmod 14 & \text{for } N_{\text{sc}}^{\text{RU}} = 6 \\ N_{\text{ID}}^{\text{Ncell}} \bmod 30 & \text{for } N_{\text{sc}}^{\text{RU}} = 12 \end{cases}$$

If group hopping is enabled, the base sequence index  $u$  is given by clause 10.1.4.1.3.

The cyclic shift  $\alpha$  for  $N_{\text{sc}}^{\text{RU}} = 3$  and  $N_{\text{sc}}^{\text{RU}} = 6$  is derived from higher layer parameters *threeTone-CyclicShift* and *sixTone-CyclicShift*, respectively, as defined in Table 10.1.4.1.2-3. For  $N_{\text{sc}}^{\text{RU}} = 12$ ,  $\alpha = 0$ .

**Table 10.1.4.1.2-1: Definition of  $\varphi(n)$  for  $N_{sc}^{RU} = 3$** 

$u$	$\varphi(0), \varphi(1), \varphi(2)$		
0	1	-3	-3
1	1	-3	-1
2	1	-3	3
3	1	-1	-1
4	1	-1	1
5	1	-1	3
6	1	1	-3
7	1	1	-1
8	1	1	3
9	1	3	-1
10	1	3	1
11	1	3	3

**Table 10.1.4.1.2-2: Definition of  $\varphi(n)$  for  $N_{sc}^{RU} = 6$** 

$u$	$\varphi(0), \dots, \varphi(5)$					
0	1	1	1	1	3	-3
1	1	1	3	1	-3	3
2	1	-1	-1	-1	1	-3
3	1	-1	3	-3	-1	-1
4	1	3	1	-1	-1	3
5	1	-3	-3	1	3	1
6	-1	-1	1	-3	-3	-1
7	-1	-1	-1	3	-3	-1
8	3	-1	1	-3	-3	3
9	3	-1	3	-3	-1	1
10	3	-3	3	-1	3	3
11	-3	1	3	1	-3	-1
12	-3	1	-3	3	-3	-1
13	-3	3	-3	1	1	-3

**Table 10.1.4.1.2-3: Definition of  $\alpha$** 

$N_{sc}^{RU} = 3$		$N_{sc}^{RU} = 6$	
<i>threeTone-CyclicShift</i>	$\alpha$	<i>sixTone-CyclicShift</i>	$\alpha$
0	0	0	0
1	$2\pi/3$	1	$2\pi/6$
2	$4\pi/3$	2	$4\pi/6$
		3	$8\pi/6$

### 10.1.4.1.3 Group hopping

For the reference signal for NPUSCH format 1, sequence-group hopping can be enabled where the sequence-group number  $u$  in slot  $n_s$  is defined by a group hopping pattern  $f_{gh}(n_s)$  and a sequence-shift pattern  $f_{ss}$  according to

$$u = (f_{gh}(n_s) + f_{ss}) \bmod N_{seq}^{RU}$$

where the number of reference signal sequences available for each resource unit size,  $N_{seq}^{RU}$  is given by Table 10.1.4.1.3-1.

**Table 10.1.4.1.3-1: Definition of  $N_{\text{seq}}^{\text{RU}}$** 

$N_{\text{sc}}^{\text{RU}}$	$N_{\text{seq}}^{\text{RU}}$
1	16
3	12
6	14
12	30

Sequence-group hopping can be enabled or disabled by means of the cell-specific parameter *groupHoppingEnabled* provided by higher layers. Sequence-group hopping for NPUSCH can be disabled for a certain UE through the higher-layer parameter *groupHoppingDisabled* despite being enabled on a cell basis unless the NPUSCH transmission corresponds to a Random Access Response Grant or a retransmission of the same transport block as part of the contention based random access procedure.

The group-hopping pattern  $f_{\text{gh}}(n_s)$  is given by

$$f_{\text{gh}}(n_s) = \left( \sum_{i=0}^7 c(8n'_s + i) \cdot 2^i \right) \bmod N_{\text{seq}}^{\text{RU}}$$

where  $n'_s = n_s$  for  $N_{\text{sc}}^{\text{RU}} > 1$  and  $n'_s$  is the slot number of the first slot of the resource unit for  $N_{\text{sc}}^{\text{RU}} = 1$ . The pseudo-random sequence  $c(i)$  is defined by clause 7.2. The pseudo-random sequence generator shall be initialized with

$$c_{\text{init}} = \left\lfloor \frac{N_{\text{ID}}^{\text{Ncell}}}{N_{\text{seq}}^{\text{RU}}} \right\rfloor \text{ at the beginning of the resource unit for } N_{\text{sc}}^{\text{RU}} = 1 \text{ and in every even slot for } N_{\text{sc}}^{\text{RU}} > 1.$$

The sequence-shift pattern  $f_{\text{ss}}$  is given by

$$f_{\text{ss}} = (N_{\text{ID}}^{\text{Ncell}} + \Delta_{\text{ss}}) \bmod N_{\text{seq}}^{\text{RU}}$$

where  $\Delta_{\text{ss}} \in \{0,1,\dots,29\}$  is given by higher-layer parameter *groupAssignmentNPUSCH*. If no value is signalled,  $\Delta_{\text{ss}} = 0$ .

### 10.1.4.2 Mapping to physical resources

The sequence  $r(\cdot)$  shall be multiplied with the amplitude scaling factor  $\beta_{\text{NPUSCH}}$  and mapped in sequence starting with  $r(0)$  to the sub-carriers.

The set of sub-carriers used in the mapping process shall be identical to the corresponding NPUSCH transmission as defined in clause 10.1.3.6.

The mapping to resource elements  $(k, l)$  shall be in increasing order of first  $k$ , then  $l$ , and finally the slot number. The values of the symbol index  $l$  in a slot are given in Table 10.1.4.2-1.

**Table 10.1.4.2-1: Demodulation reference signal location for NPUSCH.**

NPUSCH format	Values for $l$	
	$\Delta f = 3.75$ kHz	$\Delta f = 15$ kHz
1	4	3
2	0,1,2	2,3,4

### 10.1.5 SC-FDMA baseband signal generation

For  $N_{\text{sc}}^{\text{RU}} > 1$ , the time-continuous signal  $s_l(t)$  in SC-FDMA symbol  $l$  in a slot is defined by clause 5.6 with the quantity  $N_{\text{RB}}^{\text{UL}} N_{\text{sc}}^{\text{RB}}$  replaced by  $N_{\text{sc}}^{\text{UL}}$ .



For  $N_{sc}^{RU} = 1$ , the time-continuous signal  $s_{k,l}(t)$  for sub-carrier index  $k$  in SC-FDMA symbol  $l$  in an uplink slot is defined by

$$s_{k,l}(t) = a_{k^{(-)},l} \cdot e^{j\varphi_{k,l}} \cdot e^{j2\pi(k+1/2)\Delta f(t - N_{CP,l}T_s)}$$

$$k^{(-)} = k + \lfloor N_{sc}^{RB} / 2 \rfloor$$

For  $0 \leq t < (N_{CP,l} + N)T_s$  where parameters for  $\Delta f = 15$  kHz and  $\Delta f = 3.75$  kHz are given in Table 10.1.5-1,  $a_{k^{(-)},l}$  is the modulation value of symbol  $l$  and the phase rotation  $\varphi_{k,l}$  is defined by

$$\varphi_{k,l} = \rho(\tilde{l} \bmod 2) + \hat{\varphi}_k(\tilde{l})$$

$$\rho = \begin{cases} \frac{\pi}{2} & \text{for BPSK} \\ \frac{\pi}{4} & \text{for QPSK} \end{cases}$$

$$\hat{\varphi}_k(\tilde{l}) = \begin{cases} 0 & \tilde{l} = 0 \\ \hat{\varphi}_k(\tilde{l} - 1) + 2\pi\Delta f(k + 1/2)(N + N_{CP,l})T_s & \tilde{l} > 0 \end{cases}$$

$$\tilde{l} = 0, 1, \dots, M_{rep}^{NPUSCH} N_{RU} N_{slots}^{UL} N_{symb}^{UL} - 1$$

$$l = \tilde{l} \bmod N_{symb}^{UL}$$

where  $\tilde{l}$  is a symbol counter that is reset at the start of a transmission and incremented for each symbol during the transmission.

**Table 10.1.5-1: SC-FDMA parameters for  $N_{sc}^{RU} = 1$**

Parameter	$\Delta f = 3.75$ kHz	$\Delta f = 15$ kHz
$N$	8192	2048
Cyclic prefix length $N_{CP,l}$	256	160 for $l = 0$ 144 for $l = 1, 2, \dots, 6$
Set of values for $k$	-24, -23, ..., 23	-6, -5, ..., 5

The SC-FDMA symbols in a slot shall be transmitted in increasing order of  $l$ , starting with  $l = 0$ , where SC-FDMA symbol  $l > 0$  starts at time  $\sum_{l'=0}^{l-1} (N_{CP,l'} + N)T_s$  within the slot. For  $\Delta f = 3.75$  kHz, the remaining  $2304T_s$  in  $T_{slot}$  are not transmitted and used for guard period.

Only normal CP is supported for Narrowband IoT uplink in this release of the specification.

## 10.1.6 Narrowband physical random access channel

### 10.1.6.1 Time and frequency structure

The physical layer random access preamble is based on single-subcarrier frequency-hopping symbol groups. A symbol group is illustrated in Figure 10.1.6.1-1, consisting of a cyclic prefix of length  $T_{CP}$  and a sequence of 5 identical symbols with total length  $T_{SEQ}$ . The parameter values are listed in Table 10.1.6.1-1.

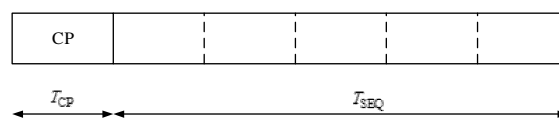

**Figure 10.1.6.1-1: Random access symbol group**

**Table 10.6.1.1-1: Random access preamble parameters**

Preamble format	$T_{CP}$	$T_{SEQ}$
0	$2048T_s$	$5 \cdot 8192T_s$
1	$8192T_s$	$5 \cdot 8192T_s$

The preamble consisting of 4 symbol groups transmitted without gaps shall be transmitted  $N_{rep}^{NPRACH}$  times.

The transmission of a random access preamble, if triggered by the MAC layer, is restricted to certain time and frequency resources.

A NPRACH configuration provided by higher layers contains the following:

- NPRACH resource periodicity  $N_{period}^{NPRACH}$  (*nprach-Periodicity*),
- frequency location of the first sub-carrier allocated to NPRACH  $N_{scoffset}^{NPRACH}$  (*nprach-SubcarrierOffset*),
- number of sub-carriers allocated to NPRACH  $N_{sc}^{NPRACH}$  (*nprach-NumSubcarriers*),
- number of NPRACH repetitions per attempt  $N_{rep}^{NPRACH}$  (*nprach-NumRepetitions*),
- NPRACH starting time  $N_{start}^{NPRACH}$  (*nprach-StartTime*),
- Fraction for calculating starting subcarrier index for the range of NPRACH subcarriers reserved for indication of UE support for multi-tone msg3 transmission  $N_{MSG3}^{NPRACH}$  (*nprach-SubcarrierRangeStart*).

NPRACH transmission can start only  $N_{start}^{NPRACH} \cdot 30720T_s$  time units after the start of a radio frame fulfilling  $n_f \bmod (N_{period}^{NPRACH} / 10) = 0$ . After transmissions of  $4 \cdot 64(T_{CP} + T_{SEQ})$  time units, a gap of  $40 \cdot 30720T_s$  time units shall be inserted.

NPRACH configurations where  $N_{scoffset}^{NPRACH} + N_{sc}^{NPRACH} > N_{sc}^{UL}$  are invalid.

The NPRACH subcarriers are split in two sets of subcarriers,  $\{0, 1, \dots, N_{sc}^{NPRACH} N_{MSG3}^{NPRACH} - 1\}$  and  $\{N_{sc}^{NPRACH} N_{MSG3}^{NPRACH}, \dots, N_{sc}^{NPRACH} - 1\}$ , where the second set, if present, indicate UE support for multi-tone msg3 transmission.

The frequency location of the NPRACH transmission is constrained within  $N_{sc}^{RA} = 12$  sub-carriers. Frequency hopping shall be used within the 12 subcarriers, where the frequency location of the  $i^{th}$  symbol group is given by

$n_{sc}^{RA}(i) = n_{start} + \tilde{n}_{sc}^{RA}(i)$  where  $n_{start} = N_{scoffset}^{NPRACH} + \lfloor n_{init} / N_{sc}^{RA} \rfloor \cdot N_{sc}^{RA}$  and

$$\tilde{n}_{sc}^{RA}(i) = \begin{cases} (\tilde{n}_{sc}^{RA}(0) + f(t)) \bmod N_{sc}^{RA} & i \bmod 4 = 0 \text{ and } i > 0 \text{ and } t = i / 4 \\ \tilde{n}_{sc}^{RA}(i-1) + 1 & i \bmod 4 = 1, 3 \text{ and } \tilde{n}_{sc}^{RA}(i-1) \bmod 2 = 0 \\ \tilde{n}_{sc}^{RA}(i-1) - 1 & i \bmod 4 = 1, 3 \text{ and } \tilde{n}_{sc}^{RA}(i-1) \bmod 2 = 1 \\ \tilde{n}_{sc}^{RA}(i-1) + 6 & i \bmod 4 = 2 \text{ and } \tilde{n}_{sc}^{RA}(i-1) < 6 \\ \tilde{n}_{sc}^{RA}(i-1) - 6 & i \bmod 4 = 2 \text{ and } \tilde{n}_{sc}^{RA}(i-1) \geq 6 \end{cases}$$

$$f(t) = \left( f(t-1) + \left( \sum_{n=10t+1}^{10t+9} c(n) 2^{n-(10t+1)} \right) \bmod (N_{sc}^{RA} - 1) + 1 \right) \bmod N_{sc}^{RA}$$

$$f(-1) = 0$$

where  $\tilde{n}_{SC}^{RA}(0) = n_{init} \bmod N_{sc}^{RA}$  with  $n_{init}$  being the subcarrier selected by the MAC layer from  $\{0, 1, \dots, N_{sc}^{NPRACH} - 1\}$ , and the pseudo random sequence  $c(n)$  is given by clause 7.2. The pseudo random sequence generator shall be initialised with  $c_{init} = N_{ID}^{Ncell}$ .

### 10.1.6.2 Baseband signal generation

The time-continuous random access signal  $s(t)$  is defined by

$$s(t) = \beta_{NPRACH} e^{j2\pi(n_{SC}^{RA} + Kk_0 + 1/2)\Delta f_{RA}(t - T_{CP})}$$

where  $\beta_{NPRACH}$  is an amplitude scaling factor in order to conform to the transmit power  $P_{NPRACH}$  specified in clause 16.3.1 in 3GPP TS 36.213 [4],  $k_0 = -N_{sc}^{UL}/2$ ,  $K = \Delta f / \Delta f_{RA}$ ,  $\Delta f = 15$  kHz accounts for the difference in subcarrier spacing between the random access preamble and uplink data transmission, and the location in the frequency domain controlled by the parameter  $n_{SC}^{RA}$  is derived from clause 10.1.6.1. The variable  $\Delta f_{RA}$  is given by Table 10.1.6.2-1.

**Table 10.1.6.2-1: Random access baseband parameters**

Preamble format	$\Delta f_{RA}$
0, 1	3.75 kHz

### 10.1.7 Modulation and upconversion

Modulation and upconversion to the carrier frequency of the complex-valued baseband signal or the complex-valued NPRACH baseband signal is shown in Figure 5.8-1. The filtering required prior to transmission is defined by the requirements in 3GPP TS 36.101 [7].

## 10.2 Downlink

### 10.2.1 Overview

#### 10.2.1.1 Physical channels

A downlink narrowband physical channel corresponds to a set of resource elements carrying information originating from higher layers and is the interface defined between 3GPP TS 36.212 [3] and the present document 3GPP TS 36.211.

The following downlink physical channels are defined:

- Narrowband Physical Downlink Shared Channel, NPDSCH
- Narrowband Physical Broadcast Channel, NPBCH
- Narrowband Physical Downlink Control Channel, NPDCCH

#### 10.2.1.2 Physical signals

A downlink narrowband physical signal corresponds to a set of resource elements used by the physical layer but does not carry information originating from higher layers. The following downlink physical signals are defined:

- Narrowband reference signal, NRS
- Narrowband synchronization signal

## 10.2.2 Slot structure and physical resource elements

### 10.2.2.1 Resource grid

The transmitted signal on one antenna port in each slot is described by a resource grid of size one resource block as defined in clause 6.2.3.

Only  $\Delta f = 15$  kHz is supported.

### 10.2.2.2 Resource elements

Resource elements are defined according to clause 6.2.2.

### 10.2.2.3 Guard period for half-duplex FDD operation

Only type-B half-duplex FDD operation is supported.

## 10.2.3 Narrowband physical downlink shared channel

### 10.2.3.1 Scrambling

Scrambling shall be done according to clause 6.3.1. The scrambling sequence generator shall be initialised with  $c_{\text{init}} = n_{\text{RNTI}} \cdot 2^{14} + n_f \bmod 2 \cdot 2^{13} + \lfloor n_s / 2 \rfloor \cdot 2^9 + N_{\text{ID}}^{\text{Ncell}}$  where  $n_s$  is the first slot of the transmission of the codeword.

In case of NPDSCH repetitions and the NPDSCH carrying the BCCH, the scrambling sequence generator shall be reinitialized according to the expression above for each repetition.

In case of NPDSCH repetitions and the NPDSCH is not carrying the BCCH, the scrambling sequence generator shall be reinitialized according to the expression above after every  $\min(M_{\text{rep}}^{\text{NPDSCH}}, 4)$  transmission of the codeword with  $n_s$  and  $n_f$  set to the first slot and the frame, respectively, used for the transmission of the repetition.

### 10.2.3.2 Modulation

Modulation shall be done according to clause 6.3.2 using one of the modulation schemes in Table 10.2.3-1

**Table 10.2.3-1: Modulation schemes**

Physical channel	Modulation schemes
NPDSCH	QPSK

### 10.2.3.3 Layer mapping and precoding

Layer mapping and precoding shall be done according to clause 6.6.3 using the same set of antenna ports as the NPBCH.

### 10.2.3.4 Mapping to resource elements

NPDSCH can be mapped to one or more than one subframes,  $N_{\text{SF}}$ , as given by clause 16.4.1.5 of 3GPP TS 36.213 [4], each of which shall be transmitted  $M_{\text{rep}}^{\text{NPDSCH}}$  times.

For each of the antenna ports used for transmission of the physical channel, the block of complex-valued symbols  $y^{(p)}(0), \dots, y^{(p)}(M_{\text{symb}}^{\text{ap}} - 1)$  shall be mapped to resource elements  $(k, l)$  which meet all of the following criteria in the current subframe:

- the subframe is not used for transmission of NPBCH, NPSS, or NSSS, and

- they are assumed by the UE not to be used for NRS, and
- they are not overlapping with resource elements used for CRS as defined in clause 6 (if any), and
- the index  $l$  in the first slot in a subframe fulfils  $l \geq l_{\text{DataStart}}$  where  $l_{\text{DataStart}}$  is given by clause 16.4.1.4 of 3GPP TS 36.213 [4].

The mapping of  $y^{(p)}(0), \dots, y^{(p)}(M_{\text{symb}}^{\text{ap}} - 1)$  in sequence starting with  $y^{(p)}(0)$  to resource elements  $(k, l)$  on antenna port  $p$  meeting the criteria above shall be in increasing order of first the index  $k$  and then the index  $l$ , starting with the first slot and ending with the second slot in a subframe. For NPDSCH not carrying BCCH, after mapping to a subframe, the subframe shall be repeated for  $\min(M_{\text{rep}}^{\text{NPDSCH}}, 4) - 1$  additional subframes, before continuing the mapping of  $y^{(p)}(\cdot)$  to the following subframe. The mapping of  $y^{(p)}(0), \dots, y^{(p)}(M_{\text{symb}}^{\text{ap}} - 1)$  is then repeated until  $M_{\text{rep}}^{\text{NPDSCH}} N_{\text{SF}}$  subframes have been transmitted. For NPDSCH carrying BCCH, the  $y^{(p)}(0), \dots, y^{(p)}(M_{\text{symb}}^{\text{ap}} - 1)$  is mapped to  $N_{\text{SF}}$  subframes in sequence and then repeated until  $M_{\text{rep}}^{\text{NPDSCH}} N_{\text{SF}}$  subframes have been transmitted.

The NPDSCH transmission can be configured by higher layers with transmission gaps where the NPDSCH transmission is postponed. There are no gaps in the NPDSCH transmission if  $R_{\text{max}} < N_{\text{gap,threshold}}$  where  $N_{\text{gap,threshold}}$  is given by the higher layer parameter *dlGap-Threshold* and  $R_{\text{max}}$  is given by [4]. The gap starting frame and subframe is given by  $(10n_f + \lfloor n_s/2 \rfloor) \bmod N_{\text{gap,period}} = 0$  where the gap periodicity,  $N_{\text{gap,period}}$ , is given by the higher layer parameter *dlGap-Periodicity*. The gap duration in number of subframes is given by  $N_{\text{gap,duration}} = N_{\text{gap,coeff}} N_{\text{gap,period}}$ , where  $N_{\text{gap,coeff}}$  is given by the higher layer parameter *dlGap-DurationCoeff*. For NPDSCH carrying the BCCH there are no gaps in the transmission.

The UE shall not expect NPDSCH in subframe  $i$  if it is not a NB-IoT downlink subframe, except for transmissions of NPDSCH carrying *SystemInformationBlockType1-NB* in subframe 4. In case of NPDSCH transmissions, in subframes that are not NB-IoT downlink subframes, the NPDSCH transmission is postponed until the next NB-IoT downlink subframe.

## 10.2.4 Narrowband physical broadcast channel

### 10.2.4.1 Scrambling

Scrambling shall be done according to clause 6.6.1 with  $M_{\text{bit}}$  denoting the number of bits to be transmitted on the NPBCH. The scrambling sequence shall be initialised with  $c_{\text{init}} = N_{\text{ID}}^{\text{Ncell}}$  in radio frames fulfilling  $n_f \bmod 64 = 0$ .

### 10.2.4.2 Modulation

Modulation shall be done according to clause 6.6.2 using the modulation scheme in Table 10.2.4.2-1

**Table 10.2.4.2-1: Modulation schemes for NPBCH**

Physical channel	Modulation schemes
NPBCH	QPSK

### 10.2.4.3 Layer mapping and precoding

Layer mapping and precoding shall be done according to clause 6.6.3 with  $P \in \{1, 2\}$ . The UE shall assume antenna ports  $R_{1000}$  and  $R_{1001}$  are used for the transmission of the narrowband physical broadcast channel.

#### 10.2.4.4 Mapping to resource elements

The block of complex-valued symbols  $y^{(p)}(0), \dots, y^{(p)}(M_{\text{symb}} - 1)$  for each antenna port is transmitted in subframe 0 during 64 consecutive radio frames starting in each radio frame fulfilling  $n_f \bmod 64 = 0$  and shall be mapped in sequence starting with  $y(0)$  to resource elements  $(k, l)$ . The mapping to resource elements  $(k, l)$  not reserved for transmission of reference signals shall be in increasing order of first the index  $k$ , then the index  $l$ . After mapping to a subframe, the subframe shall be repeated in subframe 0 in the 7 following radio frames, before continuing the mapping of  $y^{(p)}(\cdot)$  to subframe 0 in the following radio frame. The first three OFDM symbols in a subframe shall not be used in the mapping process.

For the purpose of the mapping, the UE shall assume cell-specific reference signals for antenna ports 0-3 and narrowband reference signals for antenna ports 0 and 1 being present irrespective of the actual configuration. The frequency shift of the cell-specific reference signals shall be calculated by replacing  $N_{\text{ID}}^{\text{cell}}$  with  $N_{\text{ID}}^{\text{Ncell}}$  in the calculation of  $v_{\text{shift}}$  in clause 6.10.1.2.

### 10.2.5 Narrowband physical downlink control channel

#### 10.2.5.1 NPDCCH formats

The narrowband physical downlink control channel carries control information. A narrowband physical control channel is transmitted on an aggregation of one or two consecutive narrowband control channel elements (NCCEs), where a narrowband control channel element corresponds to 6 consecutive subcarriers in a subframe where NCCE 0 occupies subcarriers 0 through 5 and NCCE 1 occupies subcarriers 6 through 11. The NPDCCH supports multiple formats as listed in Table 10.2.5.1-1. For NPDCCH format 1, both NCCEs belong to the same subframe.

One or two NPDCCHs can be transmitted in a subframe.

**Table 10.2.5.1-1: Supported NPDCCH formats**

NPDCCH format	Number of NCCEs
0	1
1	2

#### 10.2.5.2 Scrambling

Scrambling shall be done according to clause 6.6.1. The scrambling sequence shall be initialised at the start of the search space and after every 4<sup>th</sup> NPDCCH subframe with  $c_{\text{init}} = \lfloor n_s/2 \rfloor 2^9 + N_{\text{ID}}^{\text{Ncell}}$  where  $n_s$  is the first slot for NPDCCH transmission after the initialisation.

#### 10.2.5.3 Modulation

Modulation shall be done according to clause 6.8.3 using the modulation scheme in Table 10.2.5.3-1

**Table 10.2.5.3-1: Modulation schemes**

Physical channel	Modulation schemes
NPDCCH	QPSK

#### 10.2.5.4 Layer mapping and precoding

Layer mapping and precoding shall be done according to clause 6.6.3 using the same set of antenna ports as the NPBCH.

### 10.2.5.5 Mapping to resource elements

The block of complex-valued symbols  $y(0), \dots, y(M_{\text{symb}} - 1)$  shall be mapped in sequence starting with  $y(0)$  to resource elements  $(k, l)$  on the associated antenna port which meet all of the following criteria:

- they are part of the NCCE assigned for the NPDCCH transmission, and
- they are not used for transmission of NPBCH, NPSS, or NSSS, and
- they are assumed by the UE not to be used for NRS, and
- they are not overlapping with resource elements used for PBCH, PSS, SSS, or CRS as defined in clause 6 (if any), and
- the index  $l$  in the first slot in a subframe fulfils  $l \geq l_{\text{NPDCCHstart}}$  where  $l_{\text{NPDCCHstart}}$  is given by clause 16.6.1 of 3GPP TS 36.213 [4].

The mapping to resource elements  $(k, l)$  on antenna port  $p$  meeting the criteria above shall be in increasing order of first the index  $k$  and then the index  $l$ , starting with the first slot and ending with the second slot in a subframe.

The NPDCCH transmission can be configured by higher layers with transmissions gaps where the NPDCCH transmission is postponed. The configuration is the same as described for NPDSCH in clause 10.2.3.4.

The UE shall not expect NPDCCH in subframe  $i$  if it is not a NB-IoT downlink subframe. In case of NPDCCH transmissions, in subframes that are not NB-IoT downlink subframes, the NPDCCH transmission is postponed until the next NB-IoT downlink subframe.

### 10.2.6 Narrowband reference signal (NRS)

The UE may assume narrowband reference signals are transmitted in all NB-IoT downlink subframes in a cell supporting NPDSCH transmission. The UE shall not expect narrowband reference signals in subframes that are not NB-IoT downlink subframes, except if these subframes contain NPBCH or NPDSCH carrying *SystemInformationBlockType1-NB* where narrowband reference signals shall be transmitted.

A UE without a NB-IoT downlink subframes configuration may assume narrowband reference signals are transmitted in subframes #0 and #4 and in subframes #9 not containing NSSS.

#### 10.2.6.1 Sequence generation

The narrowband reference sequence shall be initialised according to clause 6.10.1.1 where  $N_{\text{ID}}^{\text{cell}}$  is replaced with  $N_{\text{ID}}^{\text{Ncell}}$ .

#### 10.2.6.2 Mapping to resource elements

Narrowband reference signals are transmitted on one or two antenna ports.

If the higher layer parameter *operationModeInfo* indicates "00", the number of antenna ports for narrowband reference signals is the same as for the common reference signals as defined in clause 6.10.1, the narrowband reference signals are transmitted on the same antenna ports as the common reference signals, 0 to 1, and the UE may assume the common reference signals are available in all subframes where the narrowband reference signals are available.

If the higher layer parameter *operationModeInfo* does not indicate "00", the narrowband reference signals are transmitted on antenna ports 1000 to 1001.

The reference signal sequence  $r_{l, n_s}(m)$  shall be mapped to complex-valued modulation symbols  $a_{k, l}^{(p)}$  used as reference symbols for antenna port  $p$  in slot  $n_s$  according to

$$a_{k, l}^{(p)} = r_{l, n_s}(m')$$

where

$$\begin{aligned}
 k &= 6m + (v + v_{\text{shift}}) \bmod 6 \\
 l &= N_{\text{syml}}^{\text{DL}} - 2, N_{\text{syml}}^{\text{DL}} - 1 \\
 m &= 0,1 \\
 m' &= m + N_{\text{RB}}^{\text{max,DL}} - 1
 \end{aligned}$$

The variables  $v$  and  $v_{\text{shift}}$  define the position in the frequency domain for the different reference signals where  $v$  is given by

$$v = \begin{cases} 0 & \text{if } p \in \{0, 1000\} \text{ and } l = N_{\text{syml}}^{\text{DL}} - 2 \\ 3 & \text{if } p \in \{0, 1000\} \text{ and } l = N_{\text{syml}}^{\text{DL}} - 1 \\ 3 & \text{if } p \in \{1, 1001\} \text{ and } l = N_{\text{syml}}^{\text{DL}} - 2 \\ 0 & \text{if } p \in \{1, 1001\} \text{ and } l = N_{\text{syml}}^{\text{DL}} - 1 \end{cases}$$

The cell-specific frequency shift is given by  $v_{\text{shift}} = N_{\text{ID}}^{\text{Ncell}} \bmod 6$ .

Resource elements  $(k, l)$  used for transmission of narrowband reference signals on any of the antenna ports in a slot shall not be used for any transmission on any other antenna port in the same slot and set to zero.

Narrowband reference signals shall not be transmitted in subframes containing NPSS or NSSS.

Figure 10.2.6.2-1 illustrates the resource elements used for reference signal transmission according to the above definition. The notation  $R_p$  is used to denote a resource element used for reference signal transmission on antenna port  $p$ .

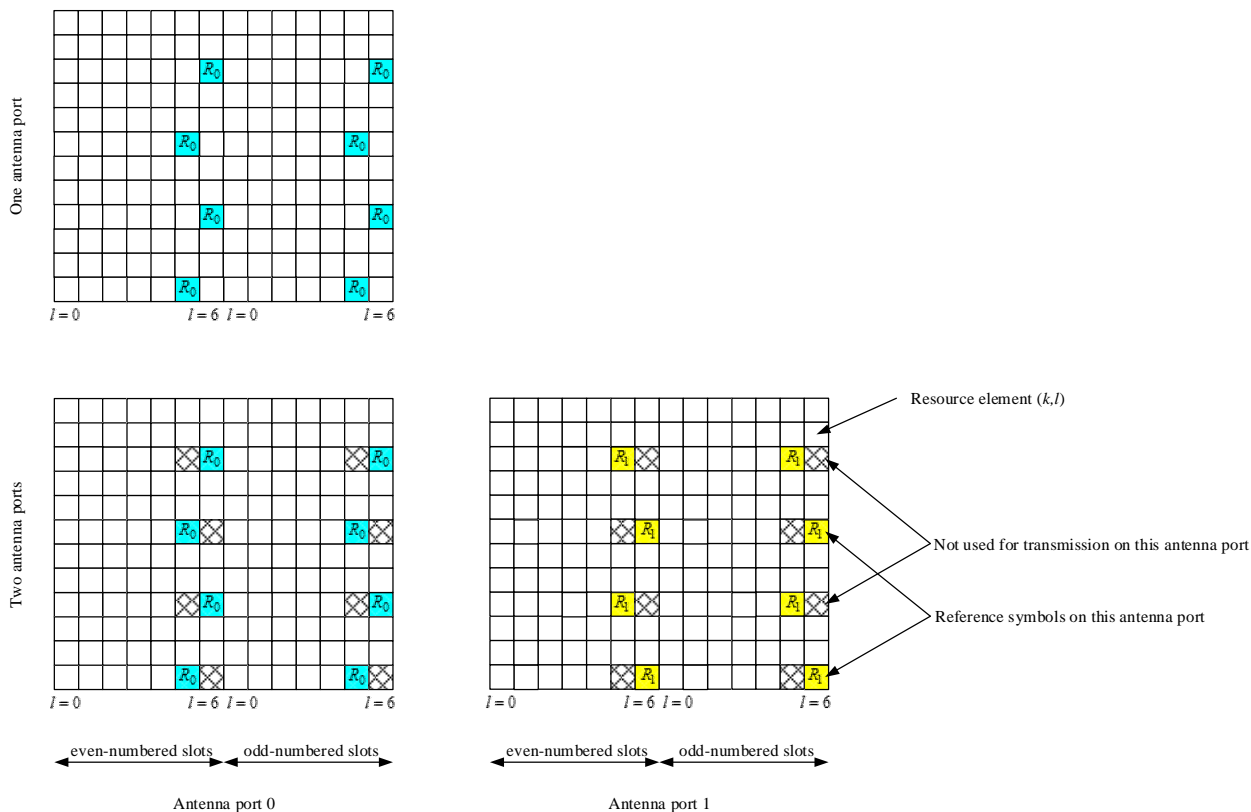

**Figure 10.2.6.2-1. Mapping of downlink narrowband reference signals (normal cyclic prefix, operationModeInfo indicates "00")**



## 10.2.7 Synchronization signals

There are 504 unique physical-layer cell identities indicated by the narrowband secondary synchronization signal.

### 10.2.7.1 Narrowband primary synchronization signal (NPSS)

#### 10.2.7.1.1 Sequence generation

The sequence  $d_l(n)$  used for the narrowband primary synchronization signal is generated from a frequency-domain Zadoff-Chu sequence according to

$$d_l(n) = S(l) \cdot e^{-j \frac{\pi u n(n+1)}{11}}, \quad n = 0, 1, \dots, 10$$

where the Zadoff-Chu root sequence index  $u = 5$  and  $S(l)$  for different symbol indices  $l$  is given by Table 10.2.7.1.1-1.

**Table 10.2.7.1.1-1: Definition of  $S(l)$ .**

Cyclic prefix length	$S(3), \dots, S(13)$										
Normal	1	1	1	1	-1	-1	1	1	1	-1	1

#### 10.2.7.1.2 Mapping to resource elements

The same antenna port shall be used for all symbols of the narrowband primary synchronization signal within a subframe.

UE shall not assume that the narrowband primary synchronization signal is transmitted on the same antenna port as any of the downlink reference signals. The UE shall not assume that the transmissions of the narrowband primary synchronization signal in a given subframe use the same antenna port, or ports, as the narrowband primary synchronization signal in any other subframe.

The sequence  $d_l(n)$  shall be mapped to resource elements  $(k, l)$  in increasing order of first the index  $k = 0, 1, \dots, N_{sc}^{RB} - 2$  and then the index  $l = 3, 4, \dots, N_{symb}^{DL} - 1$  in subframe 5 in every radio frame. For resource elements  $(k, l)$  overlapping with resource elements where cell-specific reference signals according to clause 6.10 are transmitted, the corresponding sequence element  $d(n)$  is not used for the NPSS but counted in the mapping process.

### 10.2.7.2 Narrowband secondary synchronization signal (NSSS)

#### 10.2.7.2.1 Sequence generation

The sequence  $d(n)$  used for the narrowband secondary synchronization signal is generated from a frequency-domain Zadoff-Chu sequence according to

$$d(n) = b_q(m) e^{-j 2\pi \theta_f n} e^{-j \frac{\pi u n'(n'+1)}{131}}$$

where

$$\begin{aligned} n &= 0, 1, \dots, 131 \\ n' &= n \bmod 131 \\ m &= n \bmod 128 \\ u &= N_{ID}^{Ncell} \bmod 126 + 3 \\ q &= \left\lfloor \frac{N_{ID}^{Ncell}}{126} \right\rfloor \end{aligned}$$



for  $0 \leq t < (N_{CP,l} + N) \times T_s$  where  $k^{(-)} = k + \lfloor N_{sc}^{RB} / 2 \rfloor$ ,  $N = 2048$ ,  $\Delta f = 15$  kHz and  $a_{k,l}^{(p)}$  is the content of resource element  $(k,l)$  on antenna port  $p$ .

Only normal CP is supported for Narrowband IoT downlink in this release of the specification.

## 10.2.9 Modulation and upconversion

Modulation and upconversion to the carrier frequency of the complex-valued OFDM baseband signal for each antenna port is shown in Figure 6.13-1. The filtering required prior to transmission is defined by the requirements in 3GPP TS 36.104 [6].

## Annex A (informative): Change history

Change history							
Date	TSG #	TSG Doc.	CR	Rev	Subject/Comment	Old	New
2006-09-24	-	-	-	-	Draft version created	-	0.0.0
2006-10-09	-	-	-	-	Updated skeleton	0.0.0	0.0.1
2006-10-13	-	-	-	-	Endorsed by RAN1	0.0.1	0.1.0
2006-10-23	-	-	-	-	Inclusion of decision from RAN1#46bis	0.1.0	0.1.1
2006-11-06	-	-	-	-	Updated editor's version	0.1.1	0.1.2
2006-11-09	-	-	-	-	Updated editor's version	0.1.2	0.1.3
2006-11-10	-	-	-	-	Endorsed by RAN1#47	0.1.3	0.2.0
2006-11-27	-	-	-	-	Editor's version, including decisions from RAN1#47	0.2.0	0.2.1
2006-12-14	-	-	-	-	Updated editor's version	0.2.1	0.2.2
2007-01-15	-	-	-	-	Updated editor's version	0.2.2	0.2.3
2007-01-19	-	-	-	-	Endorsed by RAN1#47bis	0.2.3	0.3.0
2007-02-01	-	-	-	-	Editor's version, including decisions from RAN1#47bis	0.3.0	0.3.1
2007-02-12	-	-	-	-	Updated editor's version	0.3.1	0.3.2
2007-02-16	-	-	-	-	Endorsed by RAN1#48	0.3.2	0.4.0
2007-02-16	-	-	-	-	Editor's version, including decisions from RAN1#48	0.4.0	0.4.1
2007-02-21	-	-	-	-	Updated editor's version	0.4.1	0.4.2
2007-03-03	RP_35	RP-070169	-	-	For information at RAN#35	0.4.2	1.0.0
2007-04-25	-	-	-	-	Editor's version, including decisions from RAN1#48bis and RAN1 TDD Ad Hoc	1.0.0	1.0.1
2007-05-03	-	-	-	-	Updated editor's version	1.0.1	1.0.2
2007-05-08	-	-	-	-	Updated editor's version	1.0.2	1.0.3
2007-05-11	-	-	-	-	Updated editor's version	1.0.3	1.0.4
2007-05-11	-	-	-	-	Endorsed by RAN1#49	1.0.4	1.1.0
2007-05-15	-	-	-	-	Editor's version, including decisions from RAN1#49	1.1.0	1.1.1
2007-06-05	-	-	-	-	Updated editor's version	1.1.1	1.1.2
2007-06-25	-	-	-	-	Endorsed by RAN1#49bis	1.1.2	1.2.0
2007-07-10	-	-	-	-	Editor's version, including decisions from RAN1#49bis	1.2.0	1.2.1
2007-08-10	-	-	-	-	Updated editor's version	1.2.1	1.2.2
2007-08-20	-	-	-	-	Updated editor's version	1.2.2	1.2.3
2007-08-24	-	-	-	-	Endorsed by RAN1#50	1.2.3	1.3.0
2007-08-27	-	-	-	-	Editor's version, including decisions from RAN1#50	1.3.0	1.3.1
2007-09-05	-	-	-	-	Updated editor's version	1.3.1	1.3.2
2007-09-08	RP_37	RP-070729	-	-	For approval at RAN#37	1.3.2	2.0.0
12/09/07	RP_37	RP-070729	-	-	Approved version	2.0.0	8.0.0
28/11/07	RP_38	RP-070949	0001	-	Introduction of optimized FS2 for TDD	8.0.0	8.1.0
28/11/07	RP_38	RP-070949	0002	-	Introduction of scrambling sequences, uplink reference signal sequences, secondary synchronization sequences and control channel processing	8.0.0	8.1.0
05/03/08	RP_39	RP-080219	0003	1	Update of uplink reference-signal hopping, downlink reference signals, scrambling sequences, DwPTS/UpPTS lengths for TDD and control channel processing	8.1.0	8.2.0
28/05/08	RP_40	RP-080432	0004	-	Correction of the number of subcarriers in PUSCH transform precoding	8.2.0	8.3.0
28/05/08	RP_40	RP-080432	0005	-	Correction of PHICH mapping	8.2.0	8.3.0
28/05/08	RP_40	RP-080432	0006	-	Correction of PUCCH resource index for PUCCH format 2	8.2.0	8.3.0
28/05/08	RP_40	RP-080432	0007	3	Correction of the predefined hopping pattern for PUSCH	8.2.0	8.3.0
28/05/08	RP_40	RP-080432	0008	-	Non-binary hashing functions	8.2.0	8.3.0
28/05/08	RP_40	RP-080432	0009	1	PUCCH format 1	8.2.0	8.3.0
28/05/08	RP_40	RP-080432	0010	1	CR on Uplink DM RS hopping	8.2.0	8.3.0
28/05/08	RP_40	RP-080432	0012	1	Correction to limitation of constellation size of ACK transmission in PUSCH	8.2.0	8.3.0
28/05/08	RP_40	RP-080432	0015	1	PHICH mapping for one and two antenna ports in extended CP	8.2.0	8.3.0
28/05/08	RP_40	RP-080432	0016	1	Correction of PUCCH in absent of mixed format	8.2.0	8.3.0
28/05/08	RP_40	RP-080432	0017	-	Specification of CCE size and PHICH resource indication	8.2.0	8.3.0
28/05/08	RP_40	RP-080432	0018	3	Correction of the description of frame structure type 2	8.2.0	8.3.0
28/05/08	RP_40	RP-080432	0019	-	On Delta <sup>pucch</sup> _shift correction	8.2.0	8.3.0
28/05/08	RP_40	RP-080432	0021	-	Corrections to Secondary Synchronization Signal Mapping	8.2.0	8.3.0
28/05/08	RP_40	RP-080432	0022	-	Downlink VRB mapping to PRB for distributed transmission	8.2.0	8.3.0
28/05/08	RP_40	RP-080432	0023	-	Clarification of modulation symbols to REs mapping for DVRB	8.2.0	8.3.0
28/05/08	RP_40	RP-080432	0024	1	Consideration on the scrambling of PDSCH	8.2.0	8.3.0
28/05/08	RP_40	RP-080432	0025	-	Corrections to Initialization of DL RS Scrambling	8.2.0	8.3.0

Change history							
Date	TSG #	TSG Doc.	CR	Rev	Subject/Comment	Old	New
28/05/08	RP_40	RP-080432	0026	1	CR on Downlink RS	8.2.0	8.3.0
28/05/08	RP_40	RP-080432	0027	-	CR on Uplink RS	8.2.0	8.3.0
28/05/08	RP_40	RP-080432	0028	1	Fixed timing advance offset for LTE TDD and half-duplex FDD	8.2.0	8.3.0
28/05/08	RP_40	RP-080432	0029	1	Timing of random access preamble format 4	8.2.0	8.3.0
28/05/08	RP_40	RP-080432	0030	1	Uplink sounding RS bandwidth configuration	8.2.0	8.3.0
28/05/08	RP_40	RP-080432	0031	-	Use of common RS when UE-specific RS are configured	8.2.0	8.3.0
28/05/08	RP_40	RP-080432	0032	1	Uplink RS Updates	8.2.0	8.3.0
28/05/08	RP_40	RP-080432	0033	-	Orthogonal cover sequence for shortened PUCCH format 1a and 1b	8.2.0	8.3.0
28/05/08	RP_40	RP-080432	0034	-	Clarification of PDCCH mapping	8.2.0	8.3.0
28/05/08	RP_40	RP-080432	0035	-	TDD PRACH time/frequency mapping	8.2.0	8.3.0
28/05/08	RP_40	RP-080432	0036	-	Cell Specific Uplink Sounding RS Subframe Configuration	8.2.0	8.3.0
28/05/08	RP_40	RP-080432	0038	-	PDCCH length for carriers with mixed MBSFN and Unicast Traffic	8.2.0	8.3.0
28/05/08	RP_40	RP-080432	0040	-	Correction to the scrambling sequence generation for PUCCH, PCFICH, PHICH, MBSFN RS and UE specific RS	8.2.0	8.3.0
28/05/08	RP_40	RP-080432	0041	-	PDCCH coverage in narrow bandwidths	8.2.0	8.3.0
28/05/08	RP_40	RP-080432	0042	-	Closed-Loop and Open-Loop Spatial Multiplexing	8.2.0	8.3.0
28/05/08	RP_40	RP-080432	0043	-	Removal of small-delay CDD	8.2.0	8.3.0
09/09/08	RP_41	RP-080668	48	1	Frequency Shifting of UE-specific RS	8.3.0	8.4.0
09/09/08	RP_41	RP-080668	49	1	Correction of PHICH to RE mapping in extended CP subframe	8.3.0	8.4.0
09/09/08	RP_41	RP-080668	50	-	Corrections to for handling remaining Res	8.3.0	8.4.0
09/09/08	RP_41	RP-080668	51	-	PRACH configuration for frame structure type 1	8.3.0	8.4.0
09/09/08	RP_41	RP-080668	52	2	Correction of PUCCH index generation formula	8.3.0	8.4.0
09/09/08	RP_41	RP-080668	53	-	Orthogonal cover sequence for shortened PUCCH format 1a and 1b	8.3.0	8.4.0
09/09/08	RP_41	RP-080668	54	-	Correction of mapping of ACK/NAK to binary bit values	8.3.0	8.4.0
09/09/08	RP_41	RP-080668	56	2	Remaining issues on SRS hopping	8.3.0	8.4.0
09/09/08	RP_41	RP-080668	57	1	Correction of n <sub>cs</sub> (n <sub>s</sub> ) and OC/CS remapping for PUCCH formats 1/1a/1b and 2/2a/2b	8.3.0	8.4.0
09/09/08	RP_41	RP-080668	59	-	Corrections to Rank information scrambling in Uplink Shared Channel	8.3.0	8.4.0
09/09/08	RP_41	RP-080668	60	-	Definition on the slot number for frame structure type 2	8.3.0	8.4.0
09/09/08	RP_41	RP-080668	61	-	Correction of the Npucch sequence upper limit for the formats 1/1a/1b	8.3.0	8.4.0
09/09/08	RP_41	RP-080668	62	1	Clarifications for DMRS parameters	8.3.0	8.4.0
09/09/08	RP_41	RP-080668	63	-	Correction of n <sub>prs</sub>	8.3.0	8.4.0
09/09/08	RP_41	RP-080668	64	1	Introducing missing L1 parameters to 36.211	8.3.0	8.4.0
09/09/08	RP_41	RP-080668	65	3	Clarification on reception of synchronization signals	8.3.0	8.4.0
09/09/08	RP_41	RP-080668	66	-	Correction to the downlink/uplink timing	8.3.0	8.4.0
09/09/08	RP_41	RP-080668	67	-	ACK/NAK Scrambling scheme on PUCCH	8.3.0	8.4.0
09/09/08	RP_41	RP-080668	68	-	DCI format1C	8.3.0	8.4.0
09/09/08	RP_41	RP-080668	69	-	Refinement for REG Definition for n = 4	8.3.0	8.4.0
09/09/08	RP_41	RP-080668	71	-	Correcting Ncs value for PRACH preamble format 0-3	8.3.0	8.4.0
09/09/08	RP_41	RP-080668	73	-	Correction of the half duplex timing advance offset value	8.3.0	8.4.0
09/09/08	RP_41	RP-080668	74	-	Correction to Precoding for Transmit Diversity	8.3.0	8.4.0
09/09/08	RP_41	RP-080668	75	-	Clarification on number of OFDM symbols used for PDCCH	8.3.0	8.4.0
09/09/08	RP_41	RP-080668	77	-	Number of antenna ports for PDSCH	8.3.0	8.4.0
09/09/08	RP_41	RP-080668	78	-	Correction to Type 2 PUSCH predetermined hopping for Nsb=1 operation	8.3.0	8.4.0
09/09/08	RP_41	RP-080668	79	-	PRACH frequency location	8.3.0	8.4.0
03/12/08	RP_42	RP-081074	70	1	Correction for the definition of UE-specific reference signals	8.4.0	8.5.0
03/12/08	RP_42	RP-081074	72	2	Corrections to precoding for large delay CDD	8.4.0	8.5.0
03/12/08	RP_42	RP-081074	80	-	Correction to the definition of nbar <sub>oc</sub> for extended CP	8.4.0	8.5.0
03/12/08	RP_42	RP-081074	81	1	Specification of reserved REs not used for RS	8.4.0	8.5.0
03/12/08	RP_42	RP-081074	82	2	Clarification of the random access preamble transmission timing	8.4.0	8.5.0
03/12/08	RP_42	RP-081074	83	1	Indexing of PRACH resources within the radio frame	8.4.0	8.5.0
03/12/08	RP_42	RP-081074	84	6	Alignment of RAN1/RAN2 specification	8.4.0	8.5.0
03/12/08	RP_42	RP-081074	86	-	Clarification on scrambling of ACK/NAK bits for PUCCH format 2a/2b	8.4.0	8.5.0
03/12/08	RP_42	RP-081074	87	-	Correction of introduction of shortened SR	8.4.0	8.5.0
03/12/08	RP_42	RP-081074	88	-	Corrections to 36.211	8.4.0	8.5.0
03/12/08	RP_42	RP-081074	89	-	Clarification on PUSCH DM RS Cyclic Shift Hopping	8.4.0	8.5.0
03/12/08	RP_42	RP-081074	92	1	Correction to the uplink DM RS assignment	8.4.0	8.5.0
03/12/08	RP_42	RP-081074	93	-	Clarify the RNTI used in scrambling sequence initialization	8.4.0	8.5.0
03/12/08	RP_42	RP-081074	94	1	On linkage Among UL Power Control Parameters	8.4.0	8.5.0
03/12/08	RP_42	RP-081074	95	-	Clarification on PUSCH pre-determined hopping pattern	8.4.0	8.5.0
03/12/08	RP_42	RP-081074	96	-	Clarification of SRS sequence-group and base sequence number	8.4.0	8.5.0
03/12/08	RP_42	RP-081074	97	1	SRS subframe configuration	8.4.0	8.5.0
03/12/08	RP_42	RP-081074	98	-	Remaining SRS details for TDD	8.4.0	8.5.0

Change history							
Date	TSG #	TSG Doc.	CR	Rev	Subject/Comment	Old	New
03/12/08	RP_42	RP-081074	99	-	Clarifying UL VRB Allocation	8.4.0	8.5.0
03/12/08	RP_42	RP-081074	100	-	Clarification on PUCCH resource hopping	8.4.0	8.5.0
03/12/08	RP_42	RP-081074	101	-	Correction for definition of $Q_m$ and a pseudo code syntax error in Scrambling.	8.4.0	8.5.0
03/12/08	RP_42	RP-081074	105	1	Remaining Issues on SRS of TDD	8.4.0	8.5.0
03/12/08	RP_42	RP-081074	106	-	Correction of reference to RAN4 specification of supported uplink bandwidth	8.4.0	8.5.0
03/12/08	RP_42	RP-081074	107	-	General corrections to SRS	8.4.0	8.5.0
03/12/08	RP_42	RP-081074	109	2	Correction to PCFICH specification	8.4.0	8.5.0
03/12/08	RP_42	RP-081074	110	1	Correction to Layer Mapping for Transmit Diversity with Four Antenna Ports	8.4.0	8.5.0
03/12/08	RP_42	RP-081074	111	-	Correction of the mapping of cyclic shift filed in DCI format 0 to the dynamic cyclic shift offset	8.4.0	8.5.0
03/12/08	RP_42	RP-081074	112	-	DRS collision handling	8.4.0	8.5.0
03/12/08	RP_42	RP-081074	113	-	Clarification to enable reuse of non-active PUCCH CQI RBs for PUSCH	8.4.0	8.5.0
03/12/08	RP_42	RP-081074	114	1	PUSCH Mirror Hopping operation	8.4.0	8.5.0
03/12/08	RP_42	RP-081074	108	1	Extended and normal cyclic prefix in DL and UL for LTE TDD	8.4.0	8.5.0
04/03/09	RP_43	RP-090234	115	1	Alignment of PRACH configuration index for FS type 1 and type 2	8.5.0	8.6.0
04/03/09	RP_43	RP-090234	118	1	Clarification for DRS Collision handling	8.5.0	8.6.0
04/03/09	RP_43	RP-090234	121	1	Removing inverse modulo operation	8.5.0	8.6.0
04/03/09	RP_43	RP-090234	123	1	Clarification on the use of preamble format 4	8.5.0	8.6.0
04/03/09	RP_43	RP-090234	124	-	Clarification of RNTI used in scrambling sequence	8.5.0	8.6.0
04/03/09	RP_43	RP-090234	125	1	Clarifying PDCCH RE mapping	8.5.0	8.6.0
04/03/09	RP_43	RP-090234	126	-	Correction of preamble format 4 timing	8.5.0	8.6.0
04/03/09	RP_43	RP-090234	127	2	Corrections to SRS	8.5.0	8.6.0
04/03/09	RP_43	RP-090234	128	2	Clarification of PDSCH Mapping to Resource Elements	8.5.0	8.6.0
04/03/09	RP_43	RP-090234	129	1	Alignment with correct ASN1 parameter names	8.5.0	8.6.0
04/03/09	RP_43	RP-090234	130	-	Correction to PUCCH format 1 mapping to physical resources	8.5.0	8.6.0
04/03/09	RP_43	RP-090234	132	-	Correction to type-2 PUSCH hopping	8.5.0	8.6.0
04/03/09	RP_43	RP-090234	134	-	Alignment of SRS configuration	8.5.0	8.6.0
27/05/09	RP_44	RP-090527	135	-	Correction on UE behavior for PRACH 20ms periodicity	8.6.0	8.7.0
15/09/09	RP_45	RP-090888	137	1	Clarification on DMRS sequence for PUSCH	8.7.0	8.8.0
15/09/09	RP_45	RP-090888	138	1	Correction to PHICH resource mapping for TDD and to PHICH scrambling	8.7.0	8.8.0
01/12/09	RP_46	RP-091168	142	-	Clarification of the transmit condition for UE specific reference signals	8.8.0	8.9.0
01/12/09	RP_46	RP-091172	139	2	Introduction of LTE positioning	8.9.0	9.0.0
01/12/09	RP_46	RP-091177	140	3	Editorial corrections to 36.211	8.9.0	9.0.0
01/12/09	RP_46	RP-091257	141	1	Introduction of enhanced dual layer transmission	8.9.0	9.0.0
16/03/10	RP_47	RP-100209	144	1	Removal of square brackets on positioning subframe periodicities	9.0.0	9.1.0
16/03/10	RP_47	RP-100209	145	-	Clarification of the CP length of empty OFDM symbols in PRS subframes	9.0.0	9.1.0
16/03/10	RP_47	RP-100210	146	-	Clarification of MBSFN subframe definition	9.0.0	9.1.0
07/12/10	RP_50	RP-101320	148	-	Introduction of Rel-10 LTE-Advanced features in 36.211	9.1.0	10.0.0
15/03/11	RP_51	RP-110254	149	1	Correction on UE behavior for PRACH preamble format 4	10.0.0	10.1.0
15/03/11	RP_51	RP-110256	150	-	Corrections to Rel-10 LTE-Advanced features in 36.211	10.0.0	10.1.0
01/06/11	RP_52	RP-110818	153	2	PUSCH interaction with periodic SRS	10.1.0	10.2.0
01/06/11	RP_52	RP-110819	154	1	Correction on describing PUCCH format 3	10.1.0	10.2.0
01/06/11	RP_52	RP-110821	155	3	Correction on codebooks for CSI-RS based feedback for up to 4 CSI-RS ports.	10.1.0	10.2.0
01/06/11	RP_52	RP-110821	156	-	Correction on overlapping non-zero-power and zero-power CSI-RS configurations	10.1.0	10.2.0
01/06/11	RP_52	RP-110821	157	-	Correction on CSI-RS configuration	10.1.0	10.2.0
01/06/11	RP_52	RP-110821	158	-	PDSCH transmission in MBSFN subframes	10.1.0	10.2.0
01/06/11	RP_52	RP-110823	159	-	Correction on implicit derivation of transmission comb per antenna port for SRS	10.1.0	10.2.0
01/06/11	RP_52	RP-110823	160	-	Uplink DMRS sequence in RACH procedure	10.1.0	10.2.0
15/09/11	RP_53	RP-111229	162	-	Corrections on DMRS for Extended CP	10.2.0	10.3.0
15/09/11	RP_53	RP-111228	163	-	Clarification of applicability of precoding power scaling factors for PDSCH	10.2.0	10.3.0
15/09/11	RP_53	RP-111228	164	-	Correction to modulation and upconversion on PRACH	10.2.0	10.3.0
15/09/11	RP_53	RP-111229	165	-	Clarification on cyclic prefix of PDSCH in MBSFN subframes	10.2.0	10.3.0
15/09/11	RP_53	RP-111229	166	3	Corrections on indication in scrambling identity field in DCI format 2B and 2C	10.2.0	10.3.0
05/12/11	RP_54	RP-111668	167	-	A correction to PDSCH precoding for CQI calculation	10.3.0	10.4.0
05/12/11	RP_54	RP-111668	168	-	Correction to figure of CSI-RS pattern in extended-CP subframe	10.3.0	10.4.0
13/06/12	RP_56	RP-120736	169	-	Correction to resource mapping for PDSCH	10.4.0	10.5.0
13/06/12	RP_56	RP-120739	171	-	Correction for DMRS group hopping and sequence hopping	10.4.0	10.5.0
13/06/12	RP_56	RP-120738	172	-	Correction to assumed CSI-RS transmissions in subframes used	10.4.0	10.5.0

Change history							
Date	TSG #	TSG Doc.	CR	Rev	Subject/Comment	Old	New
					for paging		
04/09/12	RP_57	RP-121274	170	4	Introduction of an additional special subframe configuration	10.5.0	11.0.0
04/09/12	RP_57	RP-121272	173	-	Inclusion of Rel-11 features	10.5.0	11.0.0
04/12/12	RP_58	RP-121839	175	-	Correction to assumed CSI-RS transmissions in secondary cells	11.0.0	11.1.0
04/12/12	RP_58	RP-121846	176	-	Correction to assumed CSI-RS transmissions in secondary cells	11.0.0	11.1.0
26/02/13	RP_59	RP-130254	178	-	Clarification of CSI RS mapping to resource elements	11.1.0	11.2.0
26/02/13	RP_59	RP-130254	180	-	Correction to CSI Reference Signals	11.1.0	11.2.0
26/02/13	RP_59	RP-130255	181	-	Additional clarifications/corrections for introducing Rel-11 features	11.1.0	11.2.0
11/06/13	RP_60	RP-130752	182	-	Correction to EPDCCH PRB pair indication	11.2.0	11.3.0
11/06/13	RP_60	RP-130752	183	-	CR on collision between EPDCCH and PSS/SSS/PBCH	11.2.0	11.3.0
03/09/13					MCC clean-up	11.3.0	11.4.0
03/09/13	RP_60	RP-131250	185	-	Correction to QCL behaviour on CRS	11.3.0	11.4.0
03/12/13	RP_62	RP-131894	186	-	Correction on the derivation of the non-MBSFN region by PCFICH	11.4.0	11.5.0
03/12/13	RP_62	RP-131896	184	3	Introduction of Rel 12 feature for Downlink MIMO Enhancement	11.5.0	12.0.0
03/03/14	RP_63	RP-140286	187	-	On PMCH starting symbol in an MBSFN subframe	12.0.0	12.1.0
10/06/14	RP_64	RP-140858	189	-	CR on antenna port definitions	12.1.0	12.2.0
10/06/14	RP_64	RP-140858	190	1	Clarification of downlink subframes	12.1.0	12.2.0
10/06/14	RP_64	RP-140862	191	-	Inclusion of eIMTA, TDD-FDD CA, and coverage enhancements	12.1.0	12.2.0
10/09/14	RP_65	RP-141485	192	-	Inclusion of low-cost MTC and 256QAM	12.2.0	12.3.0
10/09/14	RP_65	RP-141477	194	-	CR on port 5 UE-specific reference signal when PDSCH is overlapped with EPDCCH	12.2.0	12.3.0
08/12/14	RP_66	RP-142098	195	3	Clarification of PUSCH rate matching with SRS	12.3.0	12.4.0
08/12/14	RP_66	RP-142106	197	4	Inclusion of small-cell enhancements	12.3.0	12.4.0
09/03/15	RP_67	RP-150366	196	7	Inclusion of ProSe	12.4.0	12.5.0
09/03/15	RP_67	RP-150364	198	-	Correction on 256QAM applicability to PMCH	12.4.0	12.5.0
09/03/15	RP_67	RP-150364	199	-	Correction of discovery signal transmission	12.4.0	12.5.0
15/06/15	RP_68	RP-150935	201	-	Alignment of ProSe parameters	12.5.0	12.6.0
14/09/15	RP_69	RP-151465	203	-	Clarification on SRS BW configuration	12.6.0	12.7.0
07/12/15	RP_70	RP-152036	209	1	Modify max TA for dual connectivity	12.7.0	12.8.0
07/12/15	RP_70	RP-152025	206	2	Introduction of EB/FD-MIMO	12.8.0	13.0.0
07/12/15	RP_70	RP-152027	208	1	Introduction of Rel-13 eCA	12.8.0	13.0.0
07/12/15	RP_70	RP-152125	204	2	eD2D CR for 36.211	12.8.0	13.0.0
07/12/15	RP_70	RP-152258	205	4	Introduction of LAA	12.8.0	13.0.0

Change history							
Date	Meeting	TDoc	CR	Rev	Cat	Subject/Comment	New version
2016-03	RAN#71	RP-160359	210	-	F	Alignment eD2D CR for 36.211	13.1.0
2016-03	RAN#71	RP-160367	212	-	F	Clarification on PDSCH collision with PSS/SSS/PBCH	13.1.0
2016-03	RAN#71	RP-160357	213	-	F	Correction on support of CA with up to 32 CCs	13.1.0
2016-03	RAN#71	RP-160357	214	-	F	Correction on PUCCH format 4 and 5	13.1.0
2016-03	RAN#71	RP-160360	217	-	F	Correction on DRS subframe in 36.211	13.1.0
2016-03	RAN#71	RP-160360	218	-	F	Correction on EPDCCH start symbol in LAA	13.1.0
2016-03	RAN#71	RP-160360	219	-	F	Correction to MBSFN subframe configuration	13.1.0
2016-03	RAN#71	RP-160358	220	-	F	CR on CSI-RS configuration for more than eight antenna ports in 36.211	13.1.0
2016-03	RAN#71	RP-160358	221	-	F	CR on mismatch between 36.211 and 36.331	13.1.0
2016-03	RAN#71	RP-160358	222	-	F	Clarification on additional SC-FDMA symbols in UpPTS for SRS	13.1.0
2016-03	RAN#71	RP-160358	223	-	F	Correction on Precoding and definition of DMRS ports	13.1.0
2016-03	RAN#71	RP-160361	207	9	B	Introduction of LC/CE MTC	13.1.0
2016-06	RAN#72	RP-161063	216	2	F	CR on CSI-RS transmission in DwPTS	13.2.0
2016-06	RAN#72	RP-161067	224	8	B	Introduction of NB-IoT	13.2.0
2016-06	RAN#72	RP-161066	229	2	F	Collision between PSS/SSS/PBCH and MPDCCH/PDSCH for MTC	13.2.0
2016-06	RAN#72	RP-161066	230	-	F	DMRS initialization of CSS for MTC	13.2.0
2016-06	RAN#72	RP-161066	231	-	F	Missing words in PRACH starting subframe paragraph for MTC	13.2.0
2016-06	RAN#72	RP-161065	232	-	F	Correction to EPDCCH procedures for LAA FS 3	13.2.0
2016-06	RAN#72	RP-161063	233	-	F	Clarification on PDSCH mapping to resource elements	13.2.0
2016-06	RAN#72	RP-161063	234	-	F	CR on CSI-RS description in TS 36.211	13.2.0
2016-06	RAN#72	RP-161065	235	-	F	Corrections on the support of ending partial subframe in LAA	13.2.0
2016-06	RAN#72	RP-161063	236	-	F	Clarification of CSI-RS on extended CP	13.2.0
2016-06	RAN#72	RP-161063	237	-	F	Correction on description about UpPTS length for preamble format 4 for PRACH	13.2.0
2016-06	RAN#72	RP-161066	238	-	F	Correction to TS 36.211 for eMTC	13.2.0
2016-06	RAN#72	RP-161066	239	-	F	Narrow band hopping	13.2.0
2016-06	RAN#72	RP-161066	240	1	F	CR on MPDCCH format for Rmax=1 and 2/4 PRBs	13.2.0
2016-06	RAN#72	RP-161066	241	1	F	Correction on RE mapping in MBSFN subframe for BL/CE UEs in CEModeB	13.2.0
2016-06	RAN#72	RP-161063	242	-	F	Correction on the description about DMRS	13.2.0
2016-06	RAN#72	RP-161066	243	-	F	CR for TS36.211 related to 2+4 PRB set	13.2.0
2016-06	RAN#72	RP-161065	244	-	F	CR on UE assumptions on number of CRS ports in DRS	13.2.0
2016-06	RAN#72	RP-161066	245	-	F	Some corrections for eMTC	13.2.0
2016-06	RAN#72	RP-161066	247	-	F	Clarification of MPDCCH over empty CRS tones in PBCH repetition	13.2.0
2016-06	RAN#72	RP-161066	248	-	F	Scrambling sequence initialization	13.2.0
2016-06	RAN#72	RP-161066	249	-	F	On MPDCCH AL for 8 EREGs per ECCE in TS 36.211	13.2.0



2016-06	RAN#72	RP-161066	250	-	F	Overriding of valid-invalid subframes for R=1	13.2.0
2016-06	RAN#72	RP-161066	251	-	F	Scrambling Sequence for paging MPDCCH and PDSCH	13.2.0
2016-06	RAN#72	RP-161066	252	-	F	Scrambling sequence initialization for PDSCH	13.2.0

---

# History

<b>Document history</b>		
V13.0.0	January 2016	Publication
V13.1.0	April 2016	Publication
V13.2.0	August 2016	Publication