

ETSI TS 136 300 V15.13.0 (2022-05)



**LTE;
Evolved Universal Terrestrial Radio Access (E-UTRA)
and Evolved Universal Terrestrial
Radio Access Network (E-UTRAN);
Overall description;
Stage 2
(3GPP TS 36.300 version 15.13.0 Release 15)**



Reference

RTS/TSGR-0236300vfd0

Keywords

LTE

ETSI

650 Route des Lucioles
F-06921 Sophia Antipolis Cedex - FRANCE

Tel.: +33 4 92 94 42 00 Fax: +33 4 93 65 47 16

Siret N° 348 623 562 00017 - APE 7112B
Association à but non lucratif enregistrée à la
Sous-Préfecture de Grasse (06) N° w061004871

Important notice

The present document can be downloaded from:

<http://www.etsi.org/standards-search>

The present document may be made available in electronic versions and/or in print. The content of any electronic and/or print versions of the present document shall not be modified without the prior written authorization of ETSI. In case of any existing or perceived difference in contents between such versions and/or in print, the prevailing version of an ETSI deliverable is the one made publicly available in PDF format at www.etsi.org/deliver.

Users of the present document should be aware that the document may be subject to revision or change of status.

Information on the current status of this and other ETSI documents is available at

<https://portal.etsi.org/TB/ETSIDeliverableStatus.aspx>

If you find errors in the present document, please send your comment to one of the following services:

<https://portal.etsi.org/People/CommitteeSupportStaff.aspx>

If you find a security vulnerability in the present document, please report it through our
Coordinated Vulnerability Disclosure Program:

<https://www.etsi.org/standards/coordinated-vulnerability-disclosure>

Notice of disclaimer & limitation of liability

The information provided in the present deliverable is directed solely to professionals who have the appropriate degree of experience to understand and interpret its content in accordance with generally accepted engineering or other professional standard and applicable regulations.

No recommendation as to products and services or vendors is made or should be implied.

No representation or warranty is made that this deliverable is technically accurate or sufficient or conforms to any law and/or governmental rule and/or regulation and further, no representation or warranty is made of merchantability or fitness for any particular purpose or against infringement of intellectual property rights.

In no event shall ETSI be held liable for loss of profits or any other incidental or consequential damages.

Any software contained in this deliverable is provided "AS IS" with no warranties, express or implied, including but not limited to, the warranties of merchantability, fitness for a particular purpose and non-infringement of intellectual property rights and ETSI shall not be held liable in any event for any damages whatsoever (including, without limitation, damages for loss of profits, business interruption, loss of information, or any other pecuniary loss) arising out of or related to the use of or inability to use the software.

Copyright Notification

No part may be reproduced or utilized in any form or by any means, electronic or mechanical, including photocopying and microfilm except as authorized by written permission of ETSI.

The content of the PDF version shall not be modified without the written authorization of ETSI.

The copyright and the foregoing restriction extend to reproduction in all media.

© ETSI 2022.
All rights reserved.

Intellectual Property Rights

Essential patents

IPRs essential or potentially essential to normative deliverables may have been declared to ETSI. The declarations pertaining to these essential IPRs, if any, are publicly available for **ETSI members and non-members**, and can be found in ETSI SR 000 314: "*Intellectual Property Rights (IPRs); Essential, or potentially Essential, IPRs notified to ETSI in respect of ETSI standards*", which is available from the ETSI Secretariat. Latest updates are available on the ETSI Web server (<https://ipr.etsi.org/>).

Pursuant to the ETSI Directives including the ETSI IPR Policy, no investigation regarding the essentiality of IPRs, including IPR searches, has been carried out by ETSI. No guarantee can be given as to the existence of other IPRs not referenced in ETSI SR 000 314 (or the updates on the ETSI Web server) which are, or may be, or may become, essential to the present document.

Trademarks

The present document may include trademarks and/or tradenames which are asserted and/or registered by their owners. ETSI claims no ownership of these except for any which are indicated as being the property of ETSI, and conveys no right to use or reproduce any trademark and/or tradename. Mention of those trademarks in the present document does not constitute an endorsement by ETSI of products, services or organizations associated with those trademarks.

DECT™, **PLUGTESTS™**, **UMTS™** and the ETSI logo are trademarks of ETSI registered for the benefit of its Members. **3GPP™** and **LTE™** are trademarks of ETSI registered for the benefit of its Members and of the 3GPP Organizational Partners. **oneM2M™** logo is a trademark of ETSI registered for the benefit of its Members and of the oneM2M Partners. **GSM®** and the GSM logo are trademarks registered and owned by the GSM Association.

Legal Notice

This Technical Specification (TS) has been produced by ETSI 3rd Generation Partnership Project (3GPP).

The present document may refer to technical specifications or reports using their 3GPP identities. These shall be interpreted as being references to the corresponding ETSI deliverables.

The cross reference between 3GPP and ETSI identities can be found under <http://webapp.etsi.org/key/queryform.asp>.

Modal verbs terminology

In the present document "**shall**", "**shall not**", "**should**", "**should not**", "**may**", "**need not**", "**will**", "**will not**", "**can**" and "**cannot**" are to be interpreted as described in clause 3.2 of the [ETSI Drafting Rules](#) (Verbal forms for the expression of provisions).

"**must**" and "**must not**" are **NOT** allowed in ETSI deliverables except when used in direct citation.

Contents

Intellectual Property Rights	2
Legal Notice	2
Modal verbs terminology.....	2
Foreword.....	18
1 Scope	19
2 References	19
3 Definitions, symbols and abbreviations	22
3.1 Definitions	22
3.2 Abbreviations	25
4 Overall architecture	30
4.0 General	30
4.1 Functional Split	31
4.2 Void.....	33
4.2.1 Void	33
4.2.2 Void	33
4.3 Radio Protocol architecture	33
4.3.0 General.....	33
4.3.1 User plane	34
4.3.2 Control plane	34
4.4 Synchronization.....	35
4.5 IP fragmentation	35
4.6 Support of HeNBs	35
4.6.1 Architecture	35
4.6.2 Functional Split.....	37
4.6.3 Interfaces.....	39
4.6.3.1 Protocol Stack for S1 User Plane	39
4.6.3.2 Protocol Stacks for S1 Control Plane	40
4.6.3.3 Protocol Stack for S5 interface.....	41
4.6.3.4 Protocol Stack for SGi interface.....	41
4.6.3.5 Protocol Stack for X2 User Plane and X2 Control Plane	41
4.6.4 Void	41
4.6.5 Support of LIPA with HeNB	41
4.6.6 Support of X2 GW.....	43
4.6.6.1 Enhanced TNL Address Discovery.....	44
4.6.6.2 Routing of X2AP messages	44
4.6.6.3 (H)eNB unavailability	44
4.6.6.4 (H)eNB registration.....	44
4.7 Support for relaying.....	44
4.7.1 General.....	44
4.7.2 Architecture	45
4.7.3 S1 and X2 user plane aspects.....	45
4.7.4 S1 and X2 control plane aspects	46
4.7.5 Radio protocol aspects	47
4.7.6 Signalling procedures	48
4.7.6.1 RN attach procedure.....	48
4.7.6.2 E-RAB activation/modification.....	49
4.7.6.3 RN startup procedure	49
4.7.6.4 RN detach procedure.....	50
4.7.6.5 Neighbouring Information Transfer	51
4.7.6.6 Mobility to or from RN	51
4.7.7 Relay Node OAM Aspects	51
4.7.7.1 Architecture.....	51
4.7.7.2 OAM Traffic QoS Requirements	52
4.7.7.3 Security Aspects.....	52

4.7.7.4	Void.....	52
4.7.7.5	OAM Requirements for Configuration Parameters.....	52
4.7.7.5.1	Parameters Associated with Relay Bearer Mapping.....	52
4.8	Support of SIPTO at the Local Network	52
4.8.1	General.....	52
4.8.2	SIPTO at the Local Network with collocated L-GW.....	53
4.8.3	Support for SIPTO@LN with Stand-Alone Gateway.....	54
4.9	Support for Dual Connectivity	54
4.9.1	General.....	54
4.9.2	Radio Protocol Architecture	54
4.9.3	Network Interfaces.....	55
4.9.3.1	E-UTRAN Control Plane for Dual Connectivity	55
4.9.3.2	E-UTRAN User Plane for Dual Connectivity.....	55
4.9.3.3	Support of HeNBs for Dual Connectivity.....	56
4.9.3.4	Support of SIPTO@LN and LIPA for Dual Connectivity	56
4.10	NB-IoT	58
4.11	Support for UE assistance information for local cache	58
5	Physical Layer for E-UTRA.....	58
5.0	Frame structures and channels.....	58
5.1	Downlink Transmission Scheme.....	61
5.1.1	Basic transmission scheme based on OFDM.....	61
5.1.1a	Basic transmission scheme based on OFDM for NB-IoT.....	62
5.1.2	Physical-layer processing	62
5.1.3	Physical downlink control channels.....	62
5.1.4	Downlink Reference signal and synchronization signals.....	64
5.1.4a	Downlink Reference signal and synchronization signals for NB-IoT	64
5.1.5	Downlink multi-antenna transmission	64
5.1.5a	Downlink multi-antenna transmission for NB-IoT	65
5.1.6	MBSFN transmission.....	65
5.1.7	Physical layer procedure.....	65
5.1.7.1	Link adaptation	65
5.1.7.2	Power Control	65
5.1.7.3	Cell search.....	65
5.1.7.3a	Cell search for NB-IoT.....	65
5.1.8	Physical layer measurements definition.....	65
5.1.9	Coordinated Multi-Point transmission.....	66
5.1.10	Wake-up signal for NB-IoT	66
5.1.11	Wake-up signal for BL UE or UE in enhanced coverage	66
5.2	Uplink Transmission Scheme.....	66
5.2.1	Basic transmission scheme	66
5.2.1a	Basic transmission scheme for NB-IoT	67
5.2.2	Physical-layer processing	67
5.2.3	Physical uplink control channel.....	68
5.2.3a	Uplink control information for NB-IoT.....	68
5.2.4	Uplink Reference signal.....	68
5.2.4a	Uplink Reference signal for NB-IoT	69
5.2.5	Random access preamble.....	69
5.2.5a	Random access preamble for NB-IoT.....	69
5.2.6	Uplink multi-antenna transmission	69
5.2.7	Physical channel procedure.....	70
5.2.7.1	Link adaptation	70
5.2.7.2	Uplink Power control	70
5.2.7.3	Uplink timing control.....	70
5.2.8	Coordinated Multi-Point reception	70
5.3	Transport Channels.....	70
5.3.0	Transport channel types	70
5.3.1	Mapping between transport channels and physical channels.....	72
5.3.1a	Mapping between transport channels and narrowband physical channels.....	73
5.4	E-UTRA physical layer model	73
5.4.1	Void	74
5.4.2	Void	74

5.5	Carrier Aggregation.....	74
5.5.0	General.....	74
5.5.1	SRS switching between component carriers.....	74
5.5a	Multi-carrier operation for NB-IoT.....	75
5.6	Sidelink.....	75
5.6.0	General.....	75
5.6.1	Basic transmission scheme.....	75
5.6.2	Physical-layer processing.....	76
5.6.3	Physical Sidelink control channel.....	76
5.6.4	Sidelink reference signals.....	76
5.6.5	Physical channel procedure.....	76
5.6.5.1	Sidelink power control.....	76
5.6.6	Physical layer measurements definition.....	76
5.7	Licensed-Assisted Access.....	76
5.7.0	General.....	76
5.7.1	Channel Access Priority Classes.....	77
5.7.2	Multiplexing of data.....	77
5.8	Short Processing Time.....	78
5.9	Short Transmission Time Interval.....	78
6	Layer 2.....	78
6.0	Overview.....	78
6.1	MAC Sublayer.....	80
6.1.0	General.....	80
6.1.1	Services and Functions.....	80
6.1.2	Logical Channels.....	81
6.1.2.0	General.....	81
6.1.2.1	Control Channels.....	81
6.1.2.2	Traffic Channels.....	82
6.1.3	Mapping between logical channels and transport channels.....	82
6.1.3.1	Mapping in Uplink.....	82
6.1.3.2	Mapping in Downlink.....	82
6.1.3.3	Mapping in Sidelink.....	83
6.2	RLC Sublayer.....	84
6.2.0	General.....	84
6.2.1	Services and Functions.....	84
6.2.2	PDU Structure.....	84
6.3	PDCP Sublayer.....	85
6.3.0	General.....	85
6.3.1	Services and Functions.....	85
6.3.2	PDU Structure.....	86
6.4	Carrier Aggregation.....	86
6.5	Dual Connectivity.....	87
7	RRC.....	89
7.0	General.....	89
7.1	Services and Functions.....	89
7.2	RRC protocol states & state transitions.....	90
7.3	Transport of NAS messages.....	91
7.3a	CIoT signalling reduction optimizations.....	91
7.3a.1	General.....	91
7.3a.2	Control Plane CIoT EPS optimizations.....	91
7.3a.3	User Plane CIoT EPS optimizations.....	92
7.3b	EDT.....	95
7.3b.1	General.....	95
7.3b.2	EDT for Control Plane CIoT EPS optimizations.....	95
7.3b.3	EDT for User Plane CIoT EPS optimizations.....	96
7.4	System Information.....	99
7.5	Carrier Aggregation.....	101
7.6	Dual Connectivity.....	102
8	E-UTRAN identities.....	103
8.1	E-UTRA related UE identities.....	103

8.2	Network entity related Identities	103
8.3	Sidelink communication and V2X Sidelink Communication related identities	104
8.4	MBMS related identities	105
9	ARQ and HARQ	105
9.0	General	105
9.1	HARQ principles.....	105
9.2	ARQ principles.....	107
9.3	Void.....	107
10	Mobility.....	107
10.0	General	107
10.1	Intra E-UTRAN.....	108
10.1.0	General.....	108
10.1.1	Mobility Management in ECM-IDLE	108
10.1.1.1	Cell selection.....	108
10.1.1.2	Cell reselection.....	108
10.1.1.3	Void.....	109
10.1.1.4	Void.....	109
10.1.1.5	Void.....	109
10.1.2	Mobility Management in ECM-CONNECTED/CM-CONNECTED	109
10.1.2.0	General	109
10.1.2.1	Handover	111
10.1.2.1.0	General	111
10.1.2.1.1	C-plane handling	111
10.1.2.1.2	U-plane handling	114
10.1.2.2	Path Switch	115
10.1.2.2.1	Path Switch upon handover	115
10.1.2.2.2	Path Update upon Dual Connectivity specific activities.....	116
10.1.2.2.3	Path Switch upon UE context resume	116
10.1.2.3	Data forwarding	116
10.1.2.3.1	For RLC-AM DRBs	116
10.1.2.3.2	For RLC-UM DRBs	117
10.1.2.3.3	SRB handling	117
10.1.2.3.4	User data forwarding for Dual Connectivity	117
10.1.2.4	Void.....	118
10.1.2.5	Void.....	118
10.1.2.6	Void.....	118
10.1.2.7	Timing Advance.....	118
10.1.2.8	Dual Connectivity operation	119
10.1.2.8.1	SeNB Addition	119
10.1.2.8.2	SeNB Modification.....	120
10.1.2.8.2.1	Intra-MeNB handover involving SCG change.....	122
10.1.2.8.3	SeNB Release	123
10.1.2.8.4	Change of SeNB	125
10.1.2.8.5	MeNB to eNB Change.....	126
10.1.2.8.6	SCG change	127
10.1.2.8.7	eNB to MeNB change	127
10.1.2.8.8	Inter-MeNB handover without SeNB change.....	128
10.1.2.8.9	Addition of a hybrid HeNB as the SeNB.....	131
10.1.2.9	LWA mobility	132
10.1.2.9.1	Inter-eNB handover without WT change.....	132
10.1.2.10	EN-DC Operation	134
10.1.3	Measurements	134
10.1.3.0	General	134
10.1.3.1	Intra-frequency neighbour (cell) measurements.....	136
10.1.3.2	Inter-frequency neighbour (cell) measurements.....	136
10.1.4	Paging and C-plane establishment	136
10.1.5	Random Access Procedure	138
10.1.5.0	General	138
10.1.5.1	Contention based random access procedure.....	138
10.1.5.2	Non-contention based random access procedure	141

10.1.5.3	Interaction model between L1 and L2/3 for Random Access Procedure	142
10.1.6	Radio Link Failure	142
10.1.7	Radio Access Network Sharing	144
10.1.8	Handling of Roaming and Area Restrictions for UEs in ECM-CONNECTED	144
10.1.8a	Handling of Roaming and Access Restrictions for UEs in ECM-CONNECTED	144
10.1.9	Mobility in RRC_INACTIVE	144
10.1.9.1	Overview	144
10.1.9.2	Cell Reselection	145
10.1.9.3	RAN-Based Notification Area	145
10.1.9.4	State Transitions	145
10.1.9.4.1	UE triggered transition from RRC_INACTIVE to RRC_CONNECTED	145
10.1.9.4.2	Network triggered transition from RRC_INACTIVE to RRC_CONNECTED	145
10.1.9.5	RNA update	145
10.2	Inter RAT	145
10.2.0	General	145
10.2.1	Cell reselection	145
10.2.2	Handover	146
10.2.2a	Inter-RAT cell change order to GERAN with NACC	147
10.2.2b	Inter-RAT handovers from E-UTRAN	147
10.2.2b.1	Data forwarding	147
10.2.2b.1.1	For RLC-AM bearers	147
10.2.2b.1.2	For RLC-UM bearers	147
10.2.2c	Intra-EUTRA inter-system Handover	148
10.2.3	Measurements	148
10.2.3.1	Inter-RAT handovers from E-UTRAN	148
10.2.3.2	Inter-RAT handovers to E-UTRAN	148
10.2.3.3	Inter-RAT cell reselection from E-UTRAN	148
10.2.3.4	Limiting measurement load at UE	148
10.2.4	Network Aspects	149
10.2.5	CS fallback	149
10.3	Mobility between E-UTRAN and Non-3GPP radio technologies	150
10.3.1	UE Capability Configuration	150
10.3.2	Mobility between E-UTRAN and cdma2000 network	150
10.3.2.1	Tunnelling of cdma2000 Messages over E-UTRAN between UE and cdma2000 Access Nodes	151
10.3.2.2	Mobility between E-UTRAN and HRPD	152
10.3.2.2.1	Mobility from E-UTRAN to HRPD	152
10.3.2.2.1.1	HRPD System Information Transmission in E-UTRAN	152
10.3.2.2.1.2	Measuring HRPD from E-UTRAN	152
10.3.2.2.1.2.1	Idle Mode Measurement Control	152
10.3.2.2.1.2.2	Active Mode Measurement Control	152
10.3.2.2.1.2.3	Active Mode Measurement	152
10.3.2.2.1.3	Pre-registration to HRPD Procedure	152
10.3.2.2.1.4	E-UTRAN to HRPD Cell Re-selection	153
10.3.2.2.1.5	E-UTRAN to HRPD Handover	153
10.3.2.2.2	Mobility from HRPD to E-UTRAN	153
10.3.2.3	Mobility between E-UTRAN and cdma2000 1xRTT	153
10.3.2.3.1	Mobility from E-UTRAN to cdma2000 1xRTT	153
10.3.2.3.1.1	cdma2000 1xRTT System Information Transmission in E-UTRAN	153
10.3.2.3.1.2	Measuring cdma2000 1xRTT from E-UTRAN	153
10.3.2.3.1.2.1	Idle Mode Measurement Control	154
10.3.2.3.1.2.2	Active Mode Measurement Control	154
10.3.2.3.1.2.3	Active Mode Measurement	154
10.3.2.3.1.3	E-UTRAN to cdma2000 1xRTT Cell Re-selection	154
10.3.2.3.1.4	E-UTRAN to cdma2000 1xRTT Handover	154
10.3.2.3.2	Mobility from cdma2000 1xRTT to E-UTRAN	154
10.3.2.3.3	1xRTT CS Fallback	155
10.3.3	CDMA2000 interworking in LTE shared networks	156
10.4	Area Restrictions	156
10.4a	Roaming and Access Restrictions	157
10.5	Mobility to and from CSG and Hybrid cells	157
10.5.0	Principles for idle-mode mobility with CSG cells	157
10.5.0.1	Intra-frequency mobility	157

10.5.0.2	Inter-frequency mobility	157
10.5.0.3	Inter-RAT Mobility	158
10.5.1	Inbound mobility to CSG cells	158
10.5.1.1	RRC_IDLE.....	158
10.5.1.2	RRC_CONNECTED.....	158
10.5.2	Outbound mobility from CSG cells	161
10.5.2.1	RRC_IDLE.....	161
10.5.2.2	RRC_CONNECTED.....	161
10.6	Measurement Model.....	161
10.7	Hybrid Cells	162
10.7.0	General.....	162
10.7.1	RRC_IDLE	162
10.7.2	RRC_CONNECTED	162
10.7.2.1	Inbound Mobility	162
10.7.2.2	Outbound Mobility.....	162
11	Scheduling and Rate Control.....	162
11.0	General	162
11.1	Basic Scheduler Operation	162
11.1.1	Downlink Scheduling	163
11.1.2	Uplink Scheduling	164
11.2	Activation/Deactivation Mechanism	165
11.3	Measurements to Support Scheduler Operation	166
11.4	Rate Control of GBR, MBR and UE-AMBR	166
11.4.1	Downlink	166
11.4.2	Uplink	166
11.4.3	UE-AMBR for Dual Connectivity	166
11.5	CQI reporting for Scheduling.....	167
11.6	Explicit Congestion Notification.....	167
11.7	DL channel quality reporting in NB-IoT	167
12	DRX in RRC_CONNECTED	168
13	QoS.....	169
13.0	General	169
13.1	Bearer service architecture	169
13.2	QoS parameters	170
13.3	QoS support in Hybrid Cells	171
14	Security.....	171
14.1	Overview and Principles	171
14.2	Security termination points.....	174
14.3	State Transitions and Mobility	175
14.3.1	RRC_IDLE to RRC_CONNECTED	175
14.3.2	RRC_CONNECTED to RRC_IDLE	175
14.3.3	Intra E-UTRAN Mobility	175
14.3.4	SeNB Removal	175
14.4	AS Key Change in RRC_CONNECTED	176
14.5	Security Interworking.....	176
14.6	RN integrity protection for DRB(s).....	176
15	MBMS.....	176
15.0	MBMS-Specific Definitions.....	176
15.1	General	177
15.1.0	Overview	177
15.1.1	E-MBMS Logical Architecture.....	178
15.1.2	E-MBMS User Plane Protocol Architecture	180
15.1.3	E-MBMS Control Plane Protocol Architecture	180
15.2	MBMS Cells.....	181
15.2.1	MBMS-dedicated cell.....	181
15.2.2	MBMS/Unicast-mixed cell	181
15.2.2.1	FeMBMS/Unicast-mixed cell	181
15.3	MBMS Transmission.....	181
15.3.1	General.....	181

15.3.2	Single-cell transmission	181
15.3.3	Multi-cell transmission	182
15.3.4	MBMS Reception States	184
15.3.5	MCCH Structure	184
15.3.5a	SC-MCCH structure	185
15.3.6	MBMS signalling on BCCH	185
15.3.7	MBMS User Data flow synchronisation	186
15.3.8	Synchronisation of MCCH Update Signalling via M2	187
15.3.9	IP Multicast Distribution	187
15.4	Service Continuity	187
15.5	Network sharing	189
15.6	Network Functions for Support of Multiplexing	189
15.7	Procedures	190
15.7.1	Procedures for Broadcast mode	190
15.7.1.1	Session Start procedure	190
15.7.1.2	Session Stop procedure	191
15.7a	M1 Interface	192
15.7a.1	M1 User Plane	192
15.8	M2 Interface	193
15.8.1	M2 Control Plane	193
15.8.2	M2 Interface Functions	194
15.8.2.1	General	194
15.8.2.2	MBMS Session Handling Function	194
15.8.2.3	MBMS Scheduling Information Provision Function	194
15.8.2.4	M2 Interface Management Function	194
15.8.2.5	M2 Configuration Function	194
15.8.2.6	MBMS Service Counting Function	194
15.8.2.7	MBMS Service Suspension and Resumption Function	194
15.8.2.8	MBMS Overload Notification Function	195
15.8.3	M2 Interface Signalling Procedures	195
15.8.3.1	General	195
15.8.3.2	MBMS Session signalling procedure	195
15.8.3.3	MBMS Scheduling Information procedure	195
15.8.3.4	M2 Interface Management procedures	195
15.8.3.4.1	Reset procedure	195
15.8.3.4.2	Error Indication procedure	195
15.8.3.5	M2 Configuration procedures	195
15.8.3.5.1	M2 Setup procedure	195
15.8.3.5.2	eNB Configuration Update procedure	195
15.8.3.5.3	MCE Configuration Update procedure	196
15.8.3.6	MBMS Service Counting procedures	196
15.8.3.6.1	MBMS Service Counting procedure	196
15.8.3.6.2	MBMS Service Counting Results Report procedure	196
15.8.3.7	MBMS Overload Notification procedure	196
15.9	M3 Interface	196
15.9.1	M3 Control Plane	196
15.9.2	M3 Interface Functions	197
15.9.2.1	General	197
15.9.2.2	MBMS Session Handling Function	197
15.9.2.3	M3 Interface Management Function	197
15.9.2.4	M3 Configuration Function	197
15.9.3	M3 Interface Signalling Procedures	197
15.9.3.1	General	197
15.9.3.2	MBMS Session signalling procedure	197
15.9.3.3	M3 Interface Management procedures	198
15.9.3.3.1	Reset procedure	198
15.9.3.3.2	Error Indication procedure	198
15.9.3.4	M3 Configuration procedures	198
15.9.3.4.1	M3 Setup procedure	198
15.9.3.4.2	MCE Configuration Update procedure	198
15.10	MBMS Counting	198
15.10.1	General	198

15.10.2	Counting Procedure	198
15.11	MBMS service reception using Receive Only Mode	199
16	Radio Resource Management aspects	199
16.0	General	199
16.1	RRM functions	199
16.1.1	Radio Bearer Control (RBC)	199
16.1.2	Radio Admission Control (RAC).....	199
16.1.3	Connection Mobility Control (CMC)	200
16.1.4	Dynamic Resource Allocation (DRA) - Packet Scheduling (PS)	200
16.1.5	Inter-cell Interference Coordination (ICIC).....	200
16.1.5.0	General	200
16.1.5.1	UE configurations for time domain ICIC.....	201
16.1.5.2	OAM requirements for time domain ICIC	201
16.1.5.2.1	Configuration for CSG cell.....	201
16.1.5.2.2	Configuration for interfering non-CSG cell.....	201
16.1.6	Load Balancing (LB)	201
16.1.7	Inter-RAT Radio Resource Management	202
16.1.8	Subscriber Profile ID for RAT/Frequency Priority.....	202
16.1.9	Inter-eNB CoMP.....	202
16.1.10	Cell on/off and cell discovery	202
16.2	RRM architecture	202
16.2.1	Centralised Handling of certain RRM Functions.....	202
16.2.2	De-Centralised RRM	203
16.2.2.1	UE History Information	203
16.2.3	Void	203
16.3	UE assistance information for RRM, and UE power optimisations and UE overheating	203
17	Void.....	204
17.1	Void.....	204
18	UE capabilities	204
19	S1 Interface	205
19.1	S1 User plane	205
19.2	S1 Control Plane.....	206
19.2.0	General.....	206
19.2.1	S1 Interface Functions	207
19.2.1.0	General	207
19.2.1.1	S1 Paging function	208
19.2.1.2	S1 UE Context Management function.....	208
19.2.1.3	Initial Context Setup Function	208
19.2.1.3a	UE Context Modification Function.....	208
19.2.1.3b	UE Context Resume Function.....	208
19.2.1.4	Mobility Functions for UEs in ECM-CONNECTED	208
19.2.1.4.1	Intra-LTE Handover	208
19.2.1.4.2	Inter-3GPP-RAT Handover	209
19.2.1.5	E-RAB Service Management function.....	209
19.2.1.6	NAS Signalling Transport function.....	209
19.2.1.7	NAS Node Selection Function (NNSF)	209
19.2.1.8	S1-interface management functions	209
19.2.1.9	MME Load balancing Function	209
19.2.1.10	Location Reporting Function	210
19.2.1.11	Warning Message Transmission function.....	210
19.2.1.12	Overload Function.....	210
19.2.1.13	RAN Information Management Function	210
19.2.1.14	S1 CDMA2000 Tunnelling function.....	210
19.2.1.15	Configuration Transfer Function.....	210
19.2.1.16	LPPa Signalling Transport function.....	210
19.2.1.17	Trace Function	210
19.2.1.18	UE Radio Capability Match	210
19.2.1.19	Retrieve UE Information Function.....	210
19.2.1.20	UE Information Transfer Function.....	211

19.2.1.21	Report of Secondary RAT data volumes Function.....	211
19.2.2	S1 Interface Signalling Procedures.....	211
19.2.2.0	General.....	211
19.2.2.1	Paging procedure.....	211
19.2.2.2	S1 UE Context Release procedure.....	211
19.2.2.2.0	General.....	211
19.2.2.2.1	S1 UE Context Release (EPC triggered).....	212
19.2.2.2.2	S1 UE Context Release Request (eNB triggered).....	212
19.2.2.3	Initial Context Setup procedure.....	212
19.2.2.3a	UE Context Modification procedure.....	213
19.2.2.4	E-RAB signalling procedures.....	214
19.2.2.4.1	E-RAB Setup procedure.....	214
19.2.2.4.2	E-RAB Modification procedure.....	215
19.2.2.4.3	E-RAB Release procedure.....	216
19.2.2.4.4	E-RAB Release Indication procedure.....	217
19.2.2.4.5	E-RAB Modification Indication procedure.....	217
19.2.2.5	Handover signalling procedures.....	217
19.2.2.5.0	General.....	217
19.2.2.5.1	Handover Preparation procedure.....	218
19.2.2.5.2	Handover Resource Allocation procedure.....	218
19.2.2.5.3	Handover Notification procedure.....	219
19.2.2.5.4	Handover Cancellation.....	219
19.2.2.5.5	Path Switch procedure.....	220
19.2.2.5.6	Message sequence diagrams.....	220
19.2.2.5.7	eNB Status Transfer procedure.....	228
19.2.2.5.8	MME Status Transfer procedure.....	229
19.2.2.6	NAS transport procedures.....	229
19.2.2.7	S1 interface Management procedures.....	232
19.2.2.7.1	Reset procedure.....	232
19.2.2.7.1a	eNB initiated Reset procedure.....	232
19.2.2.7.1b	MME initiated Reset procedure.....	233
19.2.2.7.2	Error Indication functions and procedures.....	233
19.2.2.7.2a	eNB initiated error indication.....	233
19.2.2.7.2b	MME initiated error indication.....	233
19.2.2.8	S1 Setup procedure.....	234
19.2.2.9	eNB Configuration Update procedure.....	234
19.2.2.9a	eNB Configuration Transfer procedure.....	235
19.2.2.10	MME Configuration Update procedure.....	235
19.2.2.10a	MME Configuration Transfer procedure.....	236
19.2.2.11	Location Reporting procedures.....	236
19.2.2.11.0	General.....	236
19.2.2.11.1	Location Reporting Control procedure.....	237
19.2.2.11.2	Location Report procedure.....	237
19.2.2.11.3	Location Report Failure Indication procedure.....	237
19.2.2.12	Overload procedure.....	238
19.2.2.12.1	Overload Start procedure.....	238
19.2.2.12.2	Overload Stop procedure.....	238
19.2.2.13	Write-Replace Warning procedure.....	239
19.2.2.14	eNB Direct Information Transfer procedure.....	239
19.2.2.15	MME Direct Information Transfer procedure.....	240
19.2.2.16	S1 CDMA2000 Tunnelling procedures.....	240
19.2.2.16.1	Downlink S1 CDMA2000 Tunnelling procedure.....	240
19.2.2.16.2	Uplink S1 CDMA2000 Tunnelling procedure.....	240
19.2.2.17	Kill procedure.....	241
19.2.2.18	LPPa Transport procedures.....	241
19.2.2.18.0	General.....	241
19.2.2.18.1	Downlink UE Associated LPPa Transport procedure.....	242
19.2.2.18.2	Uplink UE Associated LPPa Transport procedure.....	242
19.2.2.18.3	Downlink Non UE Associated LPPa Transport procedure.....	242
19.2.2.18.4	Uplink Non UE Associated LPPa Transport procedure.....	243
19.2.2.19	Trace procedures.....	243
19.2.2.19.0	General.....	243

19.2.2.19.1	Trace Start procedure	243
19.2.2.19.2	Trace Failure Indication procedure.....	244
19.2.2.19.3	Deactivate Trace procedure	244
19.2.2.19.4	Cell Traffic Trace procedure	244
19.2.2.20	UE Capability Info Indication procedure	244
19.2.2.21	UE Radio Capability Match procedure	245
19.2.2.22	PWS Restart Indication procedure	245
19.2.2.23	PWS Failure Indication procedure	246
19.2.2.24	UE Context Modification Indication procedure	246
19.2.2.25	Connection Establishment Indication procedure.....	247
19.2.2.26	UE Context Suspend procedure	247
19.2.2.27	UE Context Resume procedure	248
19.2.2.28	Retrieve UE Information procedure.....	248
19.2.2.29	UE Information Transfer procedure.....	249
19.2.2.30	eNB CP Relocation Indication	249
19.2.2.31	MME CP Relocation Indication.....	249
19.2.2.32	Secondary RAT Report	250
20	X2 Interface.....	250
20.1	User Plane	250
20.1.1	Flow Control Functions	251
20.2	Control Plane.....	251
20.2.0	X2-CP Overview	251
20.2.1	X2-CP Functions	252
20.2.2	X2-CP Procedures	253
20.2.2.0	Overview of X2-CP procedures	253
20.2.2.1	Handover Preparation procedure.....	253
20.2.2.2	Handover Cancel procedure	253
20.2.2.2a	SeNB Addition Preparation procedure.....	254
20.2.2.2b	SeNB Reconfiguration Completion procedure.....	254
20.2.2.2c	MeNB initiated SeNB Modification Preparation procedure	254
20.2.2.2d	SeNB initiated SeNB Modification procedure	255
20.2.2.2e	MeNB initiated SeNB Release procedure	255
20.2.2.2f	SeNB initiated SeNB Release procedure	256
20.2.2.2g	SeNB Counter Check procedure	256
20.2.2.3	UE Context Release procedure	256
20.2.2.4	SN Status Transfer procedure	257
20.2.2.5	Error Indication procedure	258
20.2.2.6	Load Indication procedure	259
20.2.2.7	X2 Setup procedure.....	260
20.2.2.8	eNB Configuration Update procedure.....	260
20.2.2.9	Reset procedure.....	261
20.2.2.10	Resource Status Reporting Initiation procedure.....	262
20.2.2.11	Resource Status Reporting procedure	262
20.2.2.12	Radio Link Failure Indication procedure	262
20.2.2.13	Handover Report procedure	263
20.2.2.14	Mobility Settings Change procedure.....	263
20.2.2.15	Cell Activation procedure	264
20.2.2.16	X2 Release procedure	264
20.2.2.17	X2AP Message Transfer procedure	265
20.2.2.18	X2 Removal procedure	265
20.2.2.19	Retrieve UE Context	266
20.2.2.20	SgNB Addition Preparation procedure.....	267
20.2.2.21	SgNB Reconfiguration Completion procedure	268
20.2.2.22	MeNB initiated SgNB Modification Preparation procedure	268
20.2.2.23	SgNB initiated SgNB Modification Preparation procedure	268
20.2.2.24	MeNB initiated SgNB Release procedure.....	269
20.2.2.25	SgNB initiated SgNB Release procedure.....	269
20.2.2.26	SgNB initiated SgNB Change procedure	269
20.2.2.27	SgNB Counter Check procedure	270
20.2.2.28	EN-DC X2 Setup procedure.....	270
20.2.2.29	EN-DC Configuration Update procedure.....	271

20.2.2.30	EN-DC Cell Activation procedure	272
20.2.2.31	E-UTRA - NR Cell Resource Coordination procedure	272
20.2.2.32	Partial Reset procedure for EN-DC	273
20.2.3	Void	274
21	Void	274
21.1	Void	274
21.2	Void	274
21.3	Void	274
22	Support for self-configuration and self-optimisation	274
22.1	Definitions	274
22.2	UE Support for self-configuration and self-optimisation	275
22.3	Self-configuration	275
22.3.1	Dynamic configuration of the S1-MME interface	275
22.3.1.1	Prerequisites	275
22.3.1.2	SCTP initialization	275
22.3.1.3	Application layer initialization	276
22.3.2	Dynamic Configuration of the X2 interface	276
22.3.2.1	Prerequisites	276
22.3.2.2	SCTP initialization	276
22.3.2.3	Application layer initialization	276
22.3.2a	Automatic Neighbour Relation Function	277
22.3.3	Intra-LTE/frequency Automatic Neighbour Relation Function	278
22.3.4	Inter-RAT/Inter-frequency Automatic Neighbour Relation Function	279
22.3.4a	Automatic Neighbour Relation Function towards NR	280
22.3.5	Framework for PCI Selection	280
22.3.6	TNL address discovery	281
22.3.6.1	TNL address discovery of candidate eNB via S1 interface	281
22.3.6.2	TNL address discovery of a candidate en-gNB via the S1 interface	281
22.3.6.3	TNL address discovery of a candidate en-gNB via inter-system signalling	282
22.3.7	Dynamic configuration of the Xw-C interface	282
22.3.7.1	Prerequisites	282
22.3.7.2	SCTP initialization	282
22.3.7.3	Application layer initialization	282
22.4	Self-optimisation	282
22.4.1	Support for Mobility Load Balancing	282
22.4.1.1	General	282
22.4.1.2.1	Load reporting for intra-LTE scenario	283
22.4.1.2.2	Load reporting for inter-RAT scenario	284
22.4.1.3	Load balancing action based on handovers	284
22.4.2	Support for Mobility Robustness Optimisation	284
22.4.2.1	General	284
22.4.2.2	Connection failure due to intra-LTE mobility	284
22.4.2.2a	Connection failure due to inter-RAT mobility	287
22.4.2.3	Unnecessary HO to another RAT	288
22.4.2.4	O&M Requirements	289
22.4.2.5	Inter-RAT ping-pong	289
22.4.2.6	Dynamic coverage configuration changes	290
22.4.3	Support for RACH Optimisation	290
22.4.4	Support for Energy Saving	290
22.4.4.1	General	290
22.4.4.2	Solution description	291
22.4.4.2.1	E-UTRA cell case	291
22.4.4.2.2	EN-DC cell case	291
22.4.4.3	O&M requirements	291
22.4.5	Radio Link Failure report	292
22.5	Void	292
22.6	Void	292
22A	LTE-WLAN Aggregation and RAN Controlled LTE-WLAN Interworking	292
22A.1	LTE-WLAN Aggregation	292
22A.1.1	General	292

22A.1.2	Radio Protocol Architecture	293
22A.1.3	Network Interfaces.....	294
22A.1.3.1	General	294
22A.1.3.2	User Plane	294
22A.1.3.3	Control Plane.....	295
22A.1.4	Mobility	296
22A.1.5	WLAN Measurements	296
22A.1.6	Procedure for WLAN Connection Status Reporting.....	296
22A.1.7	LTE-WLAN Aggregation Operation	297
22A.1.7.1	WT Addition	297
22A.1.7.2	WT Modification.....	298
22A.1.7.3	WT Release	299
22A.1.7.4	Change of WT	301
22A.1.8	WLAN Authentication.....	301
22A.2	RAN Controlled LTE WLAN Interworking.....	301
22A.2.1	General.....	301
22A.2.2	Network Interfaces.....	302
22A.2.2.1	General	302
22A.2.2.2	User Plane	302
22A.2.2.3	Control Plane.....	302
22A.2.3	Mobility	302
22A.2.4	WLAN Measurements	302
22A.2.5	Procedure for WLAN Connection Status Reporting.....	302
22A.2.6	Traffic Steering Operation	302
22A.2.6.1	Traffic Steering from E-UTRAN to WLAN	302
22A.2.6.2	Traffic Steering from WLAN to E-UTRAN	303
22A.3	LTE/WLAN Radio Level Integration with IPsec Tunnel.....	303
22A.3.0	General.....	303
22A.3.1	LWIP Operation.....	306
22A.3.1.1	LWIP Tunnel Setup and Data Bearer Configuration.....	306
22A.3.1.2	Reconfiguration to Remove WLAN Resources from Data Bearer	307
22A.3.1.3	LWIP Tunnel Release	307
22A.3.2	Network Interfaces.....	308
22A.3.2.1	General	308
22A.3.2.2	User Plane	308
22A.3.2.3	Control Plane.....	308
22B	Xw Interface	309
22B.1	User Plane	309
22B.2	Control Plane.....	309
22B.2.0	General.....	309
22B.2.1	Xw-CP Functions.....	310
22B.2.2	Xw-CP Procedures.....	310
22B.2.2.1	WT Addition Preparation procedure	310
22B.2.2.2	WT Association Confirmation procedure	310
22B.2.2.3	eNB initiated WT Modification Preparation procedure	311
22B.2.2.4	WT initiated WT Modification procedure.....	311
22B.2.2.5	eNB initiated WT Release procedure	312
22B.2.2.6	WT initiated WT Release procedure	312
22B.2.2.7	WT Status Reporting Initiation	313
22B.2.2.8	WT Status Reporting	313
22B.2.2.9	Xw Setup procedure	313
22B.2.2.10	WT Configuration Update procedure.....	314
22B.2.2.11	Error Indication procedure	314
22B.2.2.11.0	General	314
22B.2.2.11.1	WT initiated error indication	315
22B.2.2.11.2	eNB initiated error indication	315
22B.2.2.12	Reset procedure	315
22B.2.2.12.0	General	315
22B.2.2.12.1	WT initiated reset	315
22B.2.2.12.2	eNB initiated reset	316
22B.2.2.13	LWIP Addition Preparation procedure.....	316

22B.2.2.14	eNB initiated LWIP Modification Preparation procedure.....	316
22B.2.2.15	eNB initiated LWIP Release procedure	317
22B.2.2.16	LWIP-SeGW initiated LWIP Release procedure	317
23	Others	318
23.1	Support for real time IMS services.....	318
23.1.1	IMS Emergency Call	318
23.2	Subscriber and equipment trace.....	318
23.2.0	General.....	318
23.2.1	Signalling activation	318
23.2.2	Management activation.....	319
23.3	E-UTRAN Support for Warning Systems	319
23.3.0	General.....	319
23.3.1	Earthquake and Tsunami Warning System.....	319
23.3.2	Commercial Mobile Alert System	319
23.3.3	Korean Public Alert System.....	319
23.3.4	EU-Alert	319
23.4	Interference avoidance for in-device coexistence.....	320
23.4.1	Problems	320
23.4.2	Solutions	320
23.5	TDD Enhanced Interference Management and Traffic Adaptation (eIMTA)	322
23.6	RAN assisted WLAN interworking.....	322
23.6.0	General.....	322
23.6.1	General principles.....	322
23.6.2	Access network selection and traffic steering rules	323
23.7	Support of Low Complexity UEs	323
23.7a	Support of Bandwidth Reduced Low Complexity UEs.....	323
23.7b	Support of UEs in Enhanced Coverage	324
23.8	Support for Radio Interface based Synchronization	325
23.9	Network-assisted interference cancellation/suppression	325
23.10	Support for sidelink communication	325
23.10.1	General.....	325
23.10.2	Radio Protocol Architecture	326
23.10.2.0	General	326
23.10.2.1	User plane	326
23.10.2.2	Control plane.....	327
23.10.3	Radio resource allocation.....	327
23.10.3.0	General	327
23.10.3.1	Resource Pool for sidelink control information	329
23.10.3.2	Resource Pool for sidelink data.....	330
23.10.4	Sidelink Communication via ProSe UE-to-Network Relay	330
23.11	Support for sidelink discovery.....	331
23.11.1	General.....	331
23.11.2	Radio Protocol Architecture	332
23.11.3	Radio resource allocation.....	332
23.12	Resource usage reporting for shared networks.....	334
23.13	Optimising signalling load and resource usage for paging.....	335
23.13.1	General paging optimisation	335
23.13.2	Paging optimisation for UEs in enhanced coverage	335
23.14	Support for V2X services	335
23.14.1	General.....	335
23.14.1.0	Overview	335
23.14.1.1	Support for V2X sidelink communication	335
23.14.1.2	Support for V2X communication via Uu	339
23.15	Support for MMTEL voice and video enhancements.....	340
23.15.1	RAN-assisted codec adaptation	340
23.15.2	MMTEL signalling optimization	341
23.15.3	MMTEL voice quality/coverage enhancements	341
23.16	Application Layer Measurement Collection.....	341
23.17	Support for Aerial UE communication.....	342
23.17.1	General.....	342
23.17.2	Subscription based identification of Aerial UE function	342

23.17.3	Height based reporting for Aerial UE communication	342
23.17.4	Interference detection and mitigation for Aerial UE communication.....	342
23.17.5	Flight path information reporting.....	342
23.17.6	Location reporting for Aerial UE communication	342
23.18	PDCP packet duplication.....	343
24	Support for 5GC	343
24.1	General	343
24.2	Radio Protocol Architecture	344
24.2.1	User Plane	344
24.2.2	Control Plane	344
24.3	Layer 2	345
24.4	CN Selection	345
24.5	Mobility.....	345
24.6	Slicing	345
24.7	Access Control	346
24.8	Radio access network sharing	346
Annex A (informative): NAS Overview		347
A.1	Services and Functions.....	347
A.2	NAS protocol states & state transitions.....	347
Annex B (informative): MAC and RRC Control.....		348
B.1	Difference between MAC and RRC control	348
B.2	Void.....	348
Annex C (informative): Void		349
Annex D (informative): Void		349
Annex E (informative): Void		349
Annex F (informative): Void		349
Annex G (informative): Guideline for E-UTRAN UE capabilities		350
Annex H (informative): Void.....		352
Annex I (informative): SPID ranges and mapping of SPID values to cell reselection and inter-RAT/inter frequency handover priorities.....		353
I.2	Reference SPID values.....	353
Annex J (informative): Carrier Aggregation.....		355
J.1	Deployment Scenarios.....	355
J.2	Void.....	356
J.3	Void.....	356
J.4	Void.....	356
J.5	Void.....	356
J.6	Void.....	356
Annex K (informative): Time domain ICIC		357
K.1	Deployment scenarios	357
K.1.1	CSG scenario.....	357
K.1.2	Pico scenario	358
Annex L (informative): Void		358
Annex M (informative): Dual Connectivity		359

M.1	Dual Connectivity operation	359
M.2	Operation Overview	359
Annex N (informative): Sidelink communication.....		361
N.1	Deployment Scenarios.....	361
Annex O (informative): E-UTRAN Architecture for Radio Access Network Sharing with multiple cell ID broadcast		362
Annex P (informative): Change history.....		363
History		377

Foreword

This Technical Specification has been produced by the 3rd Generation Partnership Project (3GPP).

The contents of the present document are subject to continuing work within the TSG and may change following formal TSG approval. Should the TSG modify the contents of the present document, it will be re-released by the TSG with an identifying change of release date and an increase in version number as follows:

Version x.y.z

where:

- x the first digit:
 - 1 presented to TSG for information;
 - 2 presented to TSG for approval;
 - 3 or greater indicates TSG approved document under change control.
- y the second digit is incremented for all changes of substance, i.e. technical enhancements, corrections, updates, etc.
- z the third digit is incremented when editorial only changes have been incorporated in the document.

1 Scope

The present document provides an overview and overall description of the E-UTRAN radio interface protocol architecture. Details of the radio interface protocols are specified in companion specifications of the 36 series. For Multi-Connectivity involving E-URAN, the differences relative to E-UTRA and E-UTRAN are specified in 3GPP TS 37.340 [76].

2 References

The following documents contain provisions which, through reference in this text, constitute provisions of the present document.

- References are either specific (identified by date of publication, edition number, version number, etc.) or non-specific.
- For a specific reference, subsequent revisions do not apply.
- For a non-specific reference, the latest version applies. In the case of a reference to a 3GPP document (including a GSM document), a non-specific reference implicitly refers to the latest version of that document *in the same Release as the present document*.

- [1] 3GPP TR 21.905: "Vocabulary for 3GPP Specifications".
- [2] 3GPP TR 25.913: "Requirements for Evolved UTRA (E-UTRA) and Evolved UTRAN (E-UTRAN)".
- [3] 3GPP TS 36.201: "Evolved Universal Terrestrial Radio Access (E-UTRA); Physical layer; General description".
- [4] 3GPP TS 36.211: "Evolved Universal Terrestrial Radio Access (E-UTRA); Physical Channels and Modulation".
- [5] 3GPP TS 36.212: "Evolved Universal Terrestrial Radio Access (E-UTRA); Multiplexing and channel coding".
- [6] 3GPP TS 36.213: "Evolved Universal Terrestrial Radio Access (E-UTRA); Physical layer procedures".
- [7] 3GPP TS 36.214: "Evolved Universal Terrestrial Radio Access (E-UTRA); Physical layer; Measurements".
- [8] IETF RFC 4960 (09/2007): "Stream Control Transmission Protocol".
- [9] 3GPP TS 36.302: "Evolved Universal Terrestrial Radio Access (E-UTRA); Services provided by the physical layer".
- [10] Void
- [11] 3GPP TS 36.304: "Evolved Universal Terrestrial Radio Access (E-UTRA); User Equipment (UE) procedures in idle mode".
- [12] 3GPP TS 36.306: "Evolved Universal Terrestrial Radio Access (E-UTRA); User Equipment (UE) radio access capabilities".
- [13] 3GPP TS 36.321: "Evolved Universal Terrestrial Radio Access (E-UTRA); Medium Access Control (MAC) protocol specification".
- [14] 3GPP TS 36.322: "Evolved Universal Terrestrial Radio Access (E-UTRA); Radio Link Control (RLC) protocol specification".
- [15] 3GPP TS 36.323: "Evolved Universal Terrestrial Radio Access (E-UTRA); Packet Data Convergence Protocol (PDCP) specification".

- [16] 3GPP TS 36.331: "Evolved Universal Terrestrial Radio Access (E-UTRA); Radio Resource Control (RRC) protocol specification".
- [17] 3GPP TS 23.401: "Technical Specification Group Services and System Aspects; GPRS enhancements for E-UTRAN access".
- [18] 3GPP TR 24.801: "3GPP System Architecture Evolution (SAE); CT WG1 aspects".
- [19] 3GPP TS 23.402: "3GPP System Architecture Evolution: Architecture Enhancements for non-3GPP accesses".
- [20] 3GPP TS 24.301: "Non-Access-Stratum (NAS) protocol for Evolved Packet System (EPS); Stage 3".
- [21] 3GPP TS 36.133: "Evolved Universal Terrestrial Radio Access (E-UTRA); "Requirements for support of radio resource management".
- [22] 3GPP TS 33.401: "3GPP System Architecture Evolution: Security Architecture".
- [23] 3GPP TS 23.272: "Circuit Switched Fallback in Evolved Packet System; Stage 2".
- [24] Void.
- [25] 3GPP TS 36.413: "Evolved Universal Terrestrial Radio Access Network (E-UTRAN); S1 Application Protocol (S1AP)".
- [26] 3GPP TS 23.003: "Numbering, addressing and identification".
- [27] 3GPP TR 25.922: "Radio Resource Management Strategies".
- [28] 3GPP TS 23.216: "Single Radio voice Call continuity (SRVCC); Stage 2".
- [29] 3GPP TS 32.421: "Subscriber and equipment trace: Trace concepts and requirements".
- [30] 3GPP TS 32.422: "Subscriber and equipment trace; Trace control and configuration management".
- [31] 3GPP TS 32.423: "Subscriber and equipment trace: Trace data definition and management".
- [32] Void.
- [33] 3GPP TS 22.220: "Service Requirements for Home NodeBs and Home eNodeBs".
- [34] 3GPP TS 22.268: "Public Warning System (PWS) Requirements".
- [35] IETF RFC 3168 (09/2001): "The Addition of Explicit Congestion Notification (ECN) to IP".
- [36] 3GPP TS 25.446: "MBMS synchronisation protocol (SYNC)".
- [37] 3GPP TS 22.168: "Earthquake and Tsunami Warning System (ETWS) requirements; Stage 1".
- [38] Void.
- [39] Void.
- [40] 3GPP TS 29.274: "Tunnelling Protocol for Control Plane (GTPv2-C); Stage 3".
- [41] 3GPP TS 29.061: "Interworking between the Public Land Mobile Network (PLMN) supporting packet based services and Packet Data Networks (PDN)".
- [42] 3GPP TS 36.423: "Evolved Universal Terrestrial Radio Access Network (E-UTRAN); X2 Application Protocol (X2AP)".
- [43] 3GPP TS 37.320: "Universal Terrestrial Radio Access (UTRA) and Evolved Universal Terrestrial Radio Access (E-UTRA); Radio measurement collection for Minimization of Drive Tests (MDT); Overall description; Stage 2".
- [44] 3GPP TS 36.443: "Evolved Universal Terrestrial Radio Access Network (E-UTRAN); M2 Application Protocol (M2AP)".

- [45] 3GPP TS 36.444: "Evolved Universal Terrestrial Radio Access Network (E-UTRAN); M3 Application Protocol (M3AP)".
- [46] 3GPP TS 36.420: "Evolved Universal Terrestrial Radio Access Network (E-UTRAN); X2 general aspects and principles".
- [47] 3GPP TS 29.281: "General Packet Radio System (GPRS) Tunnelling Protocol User Plane (GTPv1-U)"
- [48] 3GPP TS 23.246: "Multimedia Broadcast/Multicast Service (MBMS); Architecture and functional description"
- [49] 3GPP TS 26.346: "Multimedia Broadcast/Multicast Service (MBMS); Protocols and codecs"
- [50] 3GPP TR 36.816: "Evolved Universal Terrestrial Radio Access (E-UTRA); Study on signalling and procedure for interference avoidance for in-device coexistence".
- [51] 3GPP TS 36.305: "Evolved Universal Terrestrial Radio Access Network (E-UTRAN); Stage 2 functional specifications of User Equipment (UE) positioning in E-UTRAN".
- [52] 3GPP TS 36.101: "Evolved Universal Terrestrial Radio Access (E-UTRA); User Equipment (UE) radio transmission and reception".
- [53] 3GPP TS 33.320: "Security of Home Node B (HNB) / Home evolved Node B (HeNB)".
- [54] 3GPP TS 23.251: "Technical Specification Group Services and System Aspects; Network Sharing; Architecture and functional description".
- [55] 3GPP TS 23.139: "3GPP system – fixed broadband access network interworking".
- [56] 3GPP TS 23.007: "Technical Specification Group Core Network and Terminals; Restoration procedures".
- [57] 3GPP TS 23.682: "Architecture enhancements to facilitate communications with packet data networks and applications".
- [58] 3GPP TS 24.312: "Access Network Discovery and Selection Function (ANDSF) Management Object (MO)".
- [59] 3GPP TR 36.842: "Study on Small Cell enhancements for E-UTRA and E-UTRAN; Higher layer aspects"
- [60] 3GPP TR 36.932: "Scenarios and Requirements for Small Cell Enhancements for E-UTRA and E-UTRAN".
- [61] 3GPP TS 36.425: "Evolved Universal Terrestrial Radio Access Network (E-UTRAN); X2 interface user plane protocol".
- [62] 3GPP TS 23.303: "Technical Specification Group Services and System Aspects; Proximity-based services (ProSe)"
- [63] 3GPP TS 36.314: "Evolved Universal Terrestrial Radio Access (E-UTRA); Layer 2 - Measurements".
- [64] 3GPP TR 36.889: "Study on Licensed-Assisted Access to Unlicensed Spectrum".
- [65] IEEE 802.11, Part 11: "Wireless LAN Medium Access Control (MAC) and Physical Layer (PHY) specifications, IEEE Std.".
- [66] 3GPP TS 36.360: "LTE-WLAN Aggregation Adaptation Protocol (LWAAP) specification".
- [67] 3GPP TS 24.302: "Access to the 3GPP Evolved Packet Core (EPC) via non-3GPP access networks".
- [68] 3GPP TS 36.361: "LTE/WLAN Radio Level Integration Using IPsec Tunnel (LWIP) encapsulation; Protocol specification".

- [69] 3GPP TS 36.463: "Evolved Universal Terrestrial Radio Access Network (E-UTRAN) and Wireless LAN (WLAN); Xw application protocol (XwAP)".
- [70] 3GPP TS 33.402: "3GPP System Architecture Evolution (SAE); Security aspects of non-3GPP accesses".
- [71] 3GPP TS 22.185: "Service requirements for V2X services; Stage 1".
- [72] 3GPP TS 23.285: "Technical Specification Group Services and System Aspects; Architecture enhancements for V2X services".
- [73] IETF RFC 7567 "IETF Recommendations Regarding Active Queue Management".
- [74] 3GPP TS 26.114: "Technical Specification Group Services and System Aspects; IP Multimedia Subsystem (IMS); Multimedia Telephony; Media handling and interaction".
- [75] 3GPP TS 24.386: "User Equipment (UE) to V2X control function; protocol aspects; Stage 3".
- [76] 3GPP TS 37.340: "Evolved Universal Terrestrial Radio Access (E-UTRA) and NR; Multi-connectivity".
- [77] 3GPP TS 23.280: "Common functional architecture to support mission critical services; Stage 2".
- [78] 3GPP TS 36.355: " Evolved Universal Terrestrial Radio Access (E-UTRA);LTE Positioning Protocol (LPP)".
- [79] 3GPP TS 38.300: "NR; NR and NG-RAN Overall Description, Stage 2".
- [80] 3GPP TS 37.324: "NR; Service Data Protocol (SDAP) specification".
- [81] 3GPP TS 38.323: "NR; Packet Data Convergence Protocol (PDCP) specification".
- [82] 3GPP TS 23.501: "System Architecture for the 5G System; Stage 2".
- [83] 3GPP TS 23.502: "Procedures for the 5G System; Stage 2".
- [84] 3GPP TS 29.002: "Mobile Application Part (MAP) specification".
- [85] 3GPP TS 25.412: "UTRAN Iu interface signalling transport".
- [86] 3GPP TS 38.423: "NG-RAN; Xn Application Protocol (XnAP)".
- [87] Void
- [88] 3GPP TS 38.101-1: "NR; User Equipment (UE) radio transmission and reception; Part 1: Range 1 Standalone".
- [89] 3GPP TS 38.306: "NR; User Equipment (UE) radio access capabilities".
- [90] 3GPP TS 37.213: "Physical layer procedures for shared spectrum channel access".

3 Definitions, symbols and abbreviations

3.1 Definitions

For the purposes of the present document, the following terms and definitions apply.

Access Control: the process that checks whether a UE is allowed to access and to be granted services in a closed cell.

Aerial UE communication: functionality enabling Aerial UE function as defined in 23.17.

Anchor carrier: in NB-IoT, a carrier where the UE assumes that NPSS/NSSS/NPBCH/SIB-NB for FDD or NPSS/NSSS/NPBCH for TDD are transmitted.

Carrier frequency: center frequency of the cell.

Cell: combination of downlink and optionally uplink resources. The linking between the carrier frequency of the downlink resources and the carrier frequency of the uplink resources is indicated in the system information transmitted on the downlink resources.

Cell Group: in dual connectivity, a group of serving cells associated with either the MeNB or the SeNB.

Control plane CIoT EPS optimization: Enables support of efficient transport of user data (IP, non-IP or SMS) over control plane via the MME without triggering data radio bearer establishment, as defined in TS 24.301 [20]. In the context of this specification, a NB-IoT UE that only supports Control plane CIoT EPS optimization is a UE that does not support User plane CIoT EPS optimization and S1-U data transfer but may support other CIoT EPS optimizations.

CSG Cell: a cell broadcasting a CSG indicator set to true and a specific CSG identity.

CSG ID Validation: the process that checks whether the CSG ID received via handover messages is the same as the one broadcast by the target E-UTRAN.

CSG member cell: a cell broadcasting the identity of the selected PLMN, registered PLMN or equivalent PLMN and for which the CSG whitelist of the UE includes an entry comprising cell's CSG ID and the respective PLMN identity.

DCN-ID: DCN identity identifies a specific dedicated core network (DCN).

Dual Connectivity: mode of operation of a UE in RRC_CONNECTED, configured with a Master Cell Group and a Secondary Cell Group.

en-gNB: as defined in TS 37.340 [76].

E-RAB: an E-RAB uniquely identifies the concatenation of an S1 Bearer and the corresponding Data Radio Bearer. When an E-RAB exists, there is a one-to-one mapping between this E-RAB and an EPS bearer of the Non Access Stratum as defined in [17].

Frequency layer: set of cells with the same carrier frequency.

FeMBMS: further enhanced multimedia broadcast multicast service.

FeMBMS/Unicast-mixed cell: cell supporting MBMS transmission and unicast transmission as SCell.

Handover: procedure that changes the serving cell of a UE in RRC_CONNECTED.

Hybrid cell: a cell broadcasting a CSG indicator set to false and a specific CSG identity. This cell is accessible as a CSG cell by UEs which are members of the CSG and as a normal cell by all other UEs.

Local Home Network: as defined in TS 23.401 [17].

LTE bearer: in LTE-WLAN Aggregation, a bearer whose radio protocols are located in the eNB only to use eNB radio resources only.

LWA bearer: in LTE-WLAN Aggregation, a bearer whose radio protocols are located in both the eNB and the WLAN to use both eNB and WLAN resources.

LWAAP PDU: in LTE-WLAN Aggregation, a PDU with DRB ID generated by LWAAP entity for transmission over WLAN.

Make-Before-Break HO/SeNB change: maintaining source eNB/SeNB connection after reception of RRC message for handover or change of SeNB before the initial uplink transmission to the target eNB during handover or change of SeNB.

Master Cell Group: in dual connectivity, a group of serving cells associated with the MeNB, comprising of the PCell and optionally one or more SCells.

Master eNB: in dual connectivity, the eNB which terminates at least S1-MME.

MBMS-dedicated cell: cell dedicated to MBMS transmission.

MBMS/Unicast-mixed cell: cell supporting both unicast and MBMS transmissions.

MCG bearer: in dual connectivity, a bearer whose radio protocols are only located in the MeNB to use MeNB resources only.

Membership Verification: the process that checks whether a UE is a member or non-member of a hybrid cell.

Multi-Connectivity: Mode of operation whereby a multiple Rx/Tx UE in the connected mode is configured to utilise radio resources amongst E-UTRA and/or NR provided by multiple distinct schedulers connected via non-ideal backhaul.

NB-IoT: NB-IoT allows access to network services via E-UTRA with a channel bandwidth limited to 200 kHz.

NB-IoT UE: a UE that uses NB-IoT.

ng-eNB: node providing E-UTRA user plane and control plane protocol terminations towards the UE, and connected via the NG interface to the 5GC.

Non-anchor carrier: in NB-IoT, a carrier where the UE does not assume that NPSS/NSSS/NPBCH/SIB-NB for FDD or NPSS/NSSS/NPBCH for TDD are transmitted.

NR: NR radio access

PLMN ID Check: the process that checks whether a PLMN ID is the RPLMN identity or an EPLMN identity of the UE.

Power saving mode: mode configured and controlled by NAS that allows the UE to reduce its power consumption, as defined in TS 24.301 [20], TS 23.401 [17], TS 23.682 [57].

Primary PUCCH group: a group of serving cells including PCell whose PUCCH signalling is associated with the PUCCH on PCell.

Primary Timing Advance Group: Timing Advance Group containing the PCell. In this specification, Primary Timing Advance Group refers also to Timing Advance Group containing the PCell unless explicitly stated otherwise.

ProSe-enabled Public Safety UE: a UE that the HPLMN has configured to be authorized for Public Safety use, and which is ProSe-enabled and supports ProSe procedures and capabilities specific to Public Safety. The UE may, but need not, have a USIM with one of the special access classes {12, 13, 14}.

ProSe Per-Packet Priority: a scalar value associated with a protocol data unit that defines the priority handling to be applied for transmission of that protocol data unit.

ProSe UE-to-Network Relay: a UE that provides functionality to support connectivity to the network for Remote UE(s).

ProSe UE-to-Network Relay Selection: Process of identifying a potential ProSe UE-to Network Relay, which can be used for connectivity services (e.g. to communicate with a PDN).

ProSe UE-to-Network Relay Reselection: process of changing previously selected ProSe UE-to-Network Relay and identifying potential a new ProSe UE-to-Network Relay, which can be used for connectivity services (e.g. to communicate with PDN).

Public Safety ProSe Carrier: carrier frequency for public safety sidelink communication and public safety sidelink discovery.

PUCCH group: either primary PUCCH group or a secondary PUCCH group.

PUCCH SCell: a Secondary Cell configured with PUCCH.

RACH-less HO/SeNB change: skipping random access procedure during handover or change of SeNB.

Receive Only Mode: See TS 23.246 [48].

Remote UE: a ProSe-enabled Public Safety UE, that communicates with a PDN via a ProSe UE-to-Network Relay.

SCG bearer: in dual connectivity, a bearer whose radio protocols are only located in the SeNB to use SeNB resources.

Secondary Cell Group: in dual connectivity, a group of serving cells associated with the SeNB, comprising of PCell and optionally one or more SCells.

Secondary eNB: in dual connectivity, the eNB that is providing additional radio resources for the UE but is not the Master eNB.

Secondary PUCCH group: a group of SCells whose PUCCH signalling is associated with the PUCCH on the PUCCH SCell.

Secondary Timing Advance Group: Timing Advance Group containing neither the PCell nor PSCell.

Short Processing Time: For 1 ms TTI length, the operation with short processing time in UL data transmission and DL data reception.

Short TTI: TTI length based on a slot or a subslot.

Sidelink: UE to UE interface for sidelink communication, V2X sidelink communication and sidelink discovery. The Sidelink corresponds to the PC5 interface as defined in TS 23.303 [62].

Sidelink Control period: period over which resources are allocated in a cell for sidelink control information and sidelink data transmissions. The Sidelink Control period corresponds to the PSCCH period as defined in TS 36.213 [6].

Sidelink communication: AS functionality enabling ProSe Direct Communication as defined in TS 23.303 [62], between two or more nearby UEs, using E-UTRA technology but not traversing any network node. In this version, the terminology "sidelink communication" without "V2X" prefix only concerns PS unless specifically stated otherwise.

Sidelink discovery: AS functionality enabling ProSe Direct Discovery as defined in TS 23.303 [62], using E-UTRA technology but not traversing any network node.

Split bearer: in dual connectivity, a bearer whose radio protocols are located in both the MeNB and the SeNB to use both MeNB and SeNB resources.

Split LWA bearer: in LTE-WLAN Aggregation, a bearer whose radio protocols are located in both the eNB and the WLAN to use both eNB and WLAN radio resources.

Switched LWA bearer: in LTE-WLAN Aggregation, a bearer whose radio protocols are located in both the eNB and the WLAN but uses WLAN radio resources only.

Timing Advance Group: a group of serving cells that is configured by RRC and that, for the cells with an UL configured, use the same timing reference cell and the same Timing Advance value.

User plane CIoT EPS optimization: Enables support for change from EMM-IDLE mode to EMM-CONNECTED mode without the need for using the Service Request procedure, as defined in TS 24.301 [20].

V2X sidelink communication: AS functionality enabling V2X Communication as defined in TS 23.285 [72], between nearby UEs, using E-UTRA technology but not traversing any network node.

WLAN Termination: the logical node that terminates the Xw interface on the WLAN side.

3.2 Abbreviations

For the purposes of the present document, the abbreviations given in TR 21.905 [1] and the following apply. An abbreviation defined in the present document takes precedence over the definition of the same abbreviation, if any, in TR 21.905 [1].

1xCsFB	Circuit Switched Fallback to 1xRTT
5GC	5G Core Network
ABS	Almost Blank Subframe
AC	Access Category
ACK	Acknowledgement
ACLR	Adjacent Channel Leakage Ratio
AM	Acknowledged Mode
AMBR	Aggregate Maximum Bit Rate
ANDSF	Access Network Discovery and Selection Function
ANR	Automatic Neighbour Relation
ARP	Allocation and Retention Priority
ARQ	Automatic Repeat Request

AS	Access Stratum
AUL	Autonomous Uplink
BCCH	Broadcast Control Channel
BCH	Broadcast Channel
BL	Bandwidth reduced Low complexity
BR-BCCH	Bandwidth Reduced Broadcast Control Channel
BSR	Buffer Status Report
C/I	Carrier-to-Interference Power Ratio
CA	Carrier Aggregation
CAZAC	Constant Amplitude Zero Auto-Correlation
CBC	Cell Broadcast Center
CC	Component Carrier
CG	Cell Group
CIF	Carrier Indicator Field
CIoT	Cellular Internet of Things
CMAS	Commercial Mobile Alert Service
CMC	Connection Mobility Control
C-plane	Control Plane
C-RNTI	Cell RNTI
CoMP	Coordinated Multi Point
CP	Cyclic Prefix
CQI	Channel Quality Indicator
CRC	Cyclic Redundancy Check
CRE	Cell Range Extension
CRS	Cell-specific Reference Signal
CSA	Common Subframe Allocation
CSG	Closed Subscriber Group
CSI	Channel State Information
CSI-IM	CSI interference measurement
CSI-RS	CSI reference signal
DC	Dual Connectivity
DCCH	Dedicated Control Channel
DCN	Dedicated Core Network
DeNB	Donor eNB
DFTS	DFT Spread OFDM
DL	Downlink
DMTC	Discovery Signal Measurement Timing Configuration
DRB	Data Radio Bearer
DRS	Discovery Reference Signal
DRX	Discontinuous Reception
DTCH	Dedicated Traffic Channel
DTX	Discontinuous Transmission
DwPTS	Downlink Pilot Time Slot
E-CID	Enhanced Cell-ID (positioning method)
E-RAB	E-UTRAN Radio Access Bearer
E-UTRA	Evolved UTRA
E-UTRAN	Evolved UTRAN
EAB	Extended Access Barring
ECGI	E-UTRAN Cell Global Identifier
ECM	EPS Connection Management
EDT	Early Data Transmission
eHRPD	enhanced High Rate Packet Data
eIMTA	Enhanced Interference Management and Traffic Adaptation
EMM	EPS Mobility Management
eNB	E-UTRAN NodeB
EPC	Evolved Packet Core
EPDCCH	Enhanced Physical Downlink Control Channel
EPS	Evolved Packet System
ETWS	Earthquake and Tsunami Warning System
FDD	Frequency Division Duplex
FDM	Frequency Division Multiplexing
G-RNTI	Group RNTI

GBR	Guaranteed Bit Rate
GERAN	GSM EDGE Radio Access Network
GNSS	Global Navigation Satellite System
GP	Guard Period
GRE	Generic Routing Encapsulation
GSM	Global System for Mobile communication
GUMMEI	Globally Unique MME Identifier
GUTI	Globally Unique Temporary Identifier
GWCN	GateWay Core Network
H-SFN	Hyper System Frame Number
HARQ	Hybrid ARQ
(H)eNB	eNB or HeNB
HO	Handover
HPLMN	Home Public Land Mobile Network
HRPD	High Rate Packet Data
HSDPA	High Speed Downlink Packet Access
ICIC	Inter-Cell Interference Coordination
IDC	In-Device Coexistence
IP	Internet Protocol
ISM	Industrial, Scientific and Medical
KPAS	Korean Public Alert System
L-GW	Local Gateway
LAA	Licensed-Assisted Access
LB	Load Balancing
LBT	Listen Before Talk
LCG	Logical Channel Group
LCR	Low Chip Rate
LCS	LoCation Service
LHN	Local Home Network
LHN ID	Local Home Network ID
LIPA	Local IP Access
LMU	Location Measurement Unit
LPPa	LTE Positioning Protocol Annex
LTE	Long Term Evolution
LWA	LTE-WLAN Aggregation
LWAAP	LTE-WLAN Aggregation Adaptation Protocol
LWIP	LTE WLAN Radio Level Integration with IPsec Tunnel
LWIP-SeGW	LWIP Security Gateway
MAC	Medium Access Control
MBMS	Multimedia Broadcast Multicast Service
MBR	Maximum Bit Rate
MBSFN	Multimedia Broadcast multicast service Single Frequency Network
MCCH	Multicast Control Channel
MCE	Multi-cell/multicast Coordination Entity
MCG	Master Cell Group
MCH	Multicast Channel
MCS	Modulation and Coding Scheme
MDT	Minimization of Drive Tests
MeNB	Master eNB
MGW	Media Gateway
MIB	Master Information Block
MIMO	Multiple Input Multiple Output
MME	Mobility Management Entity
MMTEL	Multimedia telephony
MPDCCH	MTC Physical Downlink Control Channel
MSA	MCH Subframe Allocation
MSI	MCH Scheduling Information
MSP	MCH Scheduling Period
MTC	Machine-Type Communications
MTCH	Multicast Traffic Channel
MTSI	Multimedia Telephony Service for IMS
N2	Reference point between the NG-RAN and the AMF

NACK	Negative Acknowledgement
NAS	Non-Access Stratum
NB-IoT	Narrow Band Internet of Things
NCC	Next Hop Chaining Counter
NCGI	NR Cell Global Identifier
NCR	Neighbour Cell Relation
NG-RAN	NG Radio Access Network
NH	Next Hop key
NNSF	NAS Node Selection Function
NPBCH	Narrowband Physical Broadcast channel
NPDCCH	Narrowband Physical Downlink Control channel
NPDSCH	Narrowband Physical Downlink Shared channel
NPRACH	Narrowband Physical Random Access channel
NPUSCH	Narrowband Physical Uplink Shared channel
NPRS	Narrowband Positioning Reference Signal
NPSS	Narrowband Primary Synchronization Signal
NR	NR Radio Access
NRT	Neighbour Relation Table
NSSS	Narrowband Secondary Synchronization Signal
OFDM	Orthogonal Frequency Division Multiplexing
OFDMA	Orthogonal Frequency Division Multiple Access
OPI	Offload Preference Indicator
OTDOA	Observed Time Difference Of Arrival (positioning method)
P-GW	PDN Gateway
P-RNTI	Paging RNTI
PA	Power Amplifier
PAPR	Peak-to-Average Power Ratio
PBCH	Physical Broadcast CHannel
PBR	Prioritised Bit Rate
PCC	Primary Component Carrier
PCCH	Paging Control Channel
PCell	Primary Cell
PCFICH	Physical Control Format Indicator CHannel
PCH	Paging Channel
PCI	Physical Cell Identifier
PDCCH	Physical Downlink Control CHannel
PDCP	Packet Data Convergence Protocol
PDN	Packet Data Network
PDSCH	Physical Downlink Shared CHannel
PDU	Protocol Data Unit
PHICH	Physical Hybrid ARQ Indicator CHannel
PHY	Physical layer
PLMN	Public Land Mobile Network
PMCH	Physical Multicast CHannel
PMK	Pairwise Master Key
PPPP	ProSe Per-Packet Priority
PPPR	ProSe Per-Packet Reliability
PRACH	Physical Random Access CHannel
PRB	Physical Resource Block
ProSe	Proximity based Services
PSBCH	Physical Sidelink Broadcast CHannel
PSC	Packet Scheduling
PSCCH	Physical Sidelink Control CHannel
PSCell	Primary SCell
PSDCH	Physical Sidelink Discovery CHannel
PSK	Pre-Shared Key
PSM	Power Saving Mode
PSSCH	Physical Sidelink Shared CHannel
pTAG	Primary Timing Advance Group
PTW	Paging Time Window
PUCCH	Physical Uplink Control CHannel
PUSCH	Physical Uplink Shared CHannel

PWS	Public Warning System
QAM	Quadrature Amplitude Modulation
QCI	QoS Class Identifier
QoE	Quality of Experience
QoS	Quality of Service
R-PDCCH	Relay Physical Downlink Control CHannel
RA-RNTI	Random Access RNTI
RAC	Radio Admission Control
RACH	Random Access Channel
RANAC	RAN-based Notification Area code
RAT	Radio Access Technology
RB	Radio Bearer
RBC	Radio Bearer Control
RCLWI	RAN Controlled LTE-WLAN Interworking
RF	Radio Frequency
RIBS	Radio-interface based synchronization
RIM	RAN Information Management
RLC	Radio Link Control
RMTC	RSSI Measurement Timing Configuration
RN	Relay Node
RNA	RAN-based Notification Area
RNAU	RAN-based Notification Area Update
RNC	Radio Network Controller
RNL	Radio Network Layer
RNTI	Radio Network Temporary Identifier
ROHC	Robust Header Compression
ROM	Receive Only Mode
RRC	Radio Resource Control
RRM	Radio Resource Management
RU	Resource Unit
S-GW	Serving Gateway
S-RSRP	Sidelink Reference Signal Received Power
S1-MME	S1 for the control plane
SAE	System Architecture Evolution
SAP	Service Access Point
SBCCH	Sidelink Broadcast Control Channel
SC-FDMA	Single Carrier – Frequency Division Multiple Access
SC-MCCH	Single Cell Multicast Control Channel
SC-MTCH	Single Cell Multicast Transport Channel
SC-N-RNTI	Single Cell Notification RNTI
SC-PTM	Single Cell Point To Multipoint
SC-RNTI	Single Cell RNTI
SCC	Secondary Component Carrier
SCell	Secondary Cell
SCG	Secondary Cell Group
SCH	Synchronization Channel
SCTP	Stream Control Transmission Protocol
SD-RSRP	Sidelink Discovery Reference Signal Received Power
SDAP	Service Data Adaptation Protocol
SDF	Service Data Flow
SDMA	Spatial Division Multiple Access
SDU	Service Data Unit
SeGW	Security Gateway
SeNB	Secondary eNB
SFN	System Frame Number
SI	System Information
SI-RNTI	System Information RNTI
S1-U	S1 for the user plane
SIB	System Information Block
SIPTO	Selected IP Traffic Offload
SIPTO@LN	Selected IP Traffic Offload at the Local Network
SL-BCH	Sidelink Broadcast Channel

SL-DCH	Sidelink Discovery Channel
SL-RNTI	Sidelink RNTI
SL-SCH	Sidelink Shared Channel
SPDCCH	Short PDCCH
SPID	Subscriber Profile ID for RAT/Frequency Priority
SPT	Short Processing Time
SPUCCH	Short PUCCH
SR	Scheduling Request
SRB	Signalling Radio Bearer
sTAG	Secondary Timing Advance Group
STCH	Sidelink Traffic Channel
SU	Scheduling Unit
TA	Tracking Area
TAG	Timing Advance Group
TB	Transport Block
TCP	Transmission Control Protocol
TDD	Time Division Duplex
TDM	Time Division Multiplexing
TEID	Tunnel Endpoint Identifier
TFT	Traffic Flow Template
TM	Transparent Mode
TMGI	Temporary Mobile Group Identity
TNL	Transport Network Layer
TTI	Transmission Time Interval
U-plane	User plane
UAC	Unified Access Control
UDC	Uplink Data Compression
UE	User Equipment
UL	Uplink
UM	Unacknowledged Mode
UMTS	Universal Mobile Telecommunication System
UpPTS	Uplink Pilot Time Slot
UTRA	Universal Terrestrial Radio Access
UTRAN	Universal Terrestrial Radio Access Network
V2I	Vehicle-to-Infrastructure
V2N	Vehicle-to-Network
V2P	Vehicle-to-Pedestrian
V2V	Vehicle-to-Vehicle
V2X	Vehicle-to-Everything
VRB	Virtual Resource Block
WLAN	Wireless Local Area Network
WT	WLAN Termination
WUS	Wake Up Signal
X2-C	X2-Control plane
X2 GW	X2 GateWay
X2-U	X2-User plane
Xw-C	Xw-Control plane
Xw-U	Xw-User plane

4 Overall architecture

4.0 General

The E-UTRAN consists of eNBs, providing the E-UTRA user plane (PDCP/RLC/MAC/PHY) and control plane (RRC) protocol terminations towards the UE. The eNBs are interconnected with each other by means of the X2 interface. The eNBs are also connected by means of the S1 interface to the EPC (Evolved Packet Core), more specifically to the MME (Mobility Management Entity) by means of the S1-MME interface and to the Serving Gateway (S-GW) by means of the S1-U interface. The S1 interface supports a many-to-many relation between MMEs / Serving Gateways and eNBs.

The E-UTRAN architecture is illustrated in Figure 4 below.

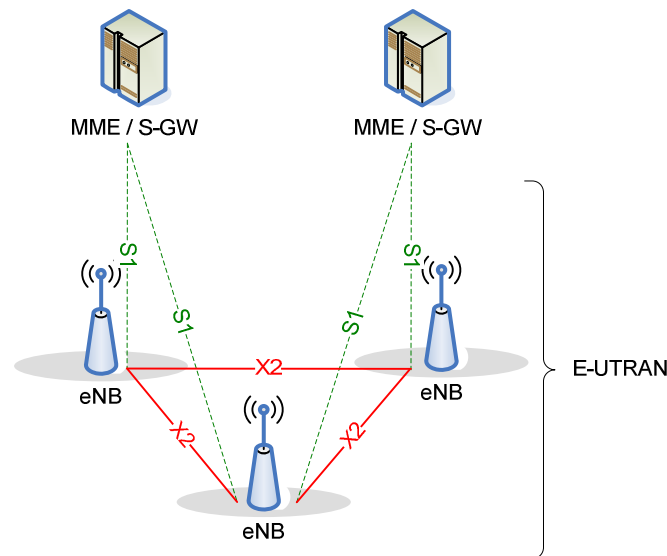

Figure 4-1: Overall Architecture

If the eNB supports SIPTO@LN with collocated L-GW, it shall support an S5 interface towards the S-GW and an SGI interface towards the IP network. See clause 4.8.2 for the details of the architecture and functions in case SIPTO@LN with collocated L-GW is supported.

The E-UTRAN may also comprise LMUs (Location Measurement Unit) (see TS 36.305 [51]) used for Uplink positioning.

For NB-IoT the positioning is supported based on the existing LCS architecture.

4.1 Functional Split

The eNB hosts the following functions:

- Functions for Radio Resource Management: Radio Bearer Control, Radio Admission Control, Connection Mobility Control, Dynamic allocation of resources to UEs in uplink, downlink and sidelink (scheduling);
- IP header compression, uplink data decompression and encryption of user data stream;
- Selection of an MME at UE attachment when no routing to an MME can be determined from the information provided by the UE;
- Routing of User Plane data towards Serving Gateway;
- Scheduling and transmission of paging messages (originated from the MME);
- Scheduling and transmission of broadcast information (originated from the MME or O&M);
- Measurement and measurement reporting configuration for mobility and scheduling;
- Scheduling and transmission of PWS (which includes ETWS and CMAS) messages (originated from the MME);
- CSG handling;
- Transport level packet marking in the uplink;
- S-GW relocation without UE mobility, as defined in TS 23.401 [17];
- SIPTO@LN handling;
- Maintaining security and radio configuration for User Plane CIoT EPS optimizations, as defined in TS 24.301 [20];
- Optionally registering with the X2 GW (if used).

The DeNB hosts the following functions in addition to the eNB functions:

- S1/X2 proxy functionality for supporting RNs;
- S11 termination and S-GW/P-GW functionality for supporting RNs.

The MME hosts the following functions (see TS 23.401 [17]):

- NAS signalling;
- NAS signalling security;
- AS Security control;
- Selection of CIoT EPS optimizations (e.g., Control Plane CIoT EPS optimization, as defined in TS 24.301 [20]);
- Inter CN node signalling for mobility between 3GPP access networks;
- Idle mode UE Reachability (including control and execution of paging retransmission);
- Tracking Area list management (for UE in idle and active mode);
- PDN GW and Serving GW selection;
- MME selection for handovers with MME change;
- SGSN selection for handovers to 2G or 3G 3GPP access networks;
- Roaming;
- Authentication;
- Bearer management functions including dedicated bearer establishment. The MME may include two transport layer addresses of different versions in the Transport Layer Address IE to enable that an en-gNB can select either IPv4 or IPv6 for a bearer;
- Support for PWS (which includes ETWS and CMAS) message transmission;
- Optionally performing paging optimisation;
- S-GW relocation without UE mobility, as defined in TS 23.401 [17].

NOTE 1: The MME should not filter the PAGING message based on the CSG IDs towards macro eNBs.

The Serving Gateway (S-GW) hosts the following functions (see TS 23.401 [17]):

- The local Mobility Anchor point for inter-eNB handover;
- Mobility anchoring for inter-3GPP mobility;
- E-UTRAN idle mode downlink packet buffering and initiation of network triggered service request procedure;
- Lawful Interception;
- Packet routing and forwarding;
- Transport level packet marking in the uplink and the downlink;
- Accounting on user and QCI granularity for inter-operator charging;
- UL and DL charging per UE, PDN, and QCI.

The PDN Gateway (P-GW) hosts the following functions (see TS 23.401 [17]):

- Per-user based packet filtering (by e.g. deep packet inspection);
- Lawful Interception;
- UE IP address allocation;

- Transport level packet marking in the uplink and the downlink;
- UL and DL service level charging, gating and rate enforcement;
- DL rate enforcement based on APN-AMBR;

This is summarized on the figure below where yellow boxes depict the logical nodes, white boxes depict the functional entities of the control plane and blue boxes depict the radio protocol layers.

NOTE 2: There is no logical E-UTRAN node other than the eNB needed for RRM purposes.

NOTE 3: MBMS related functions in E-UTRAN are described separately in clause 15.

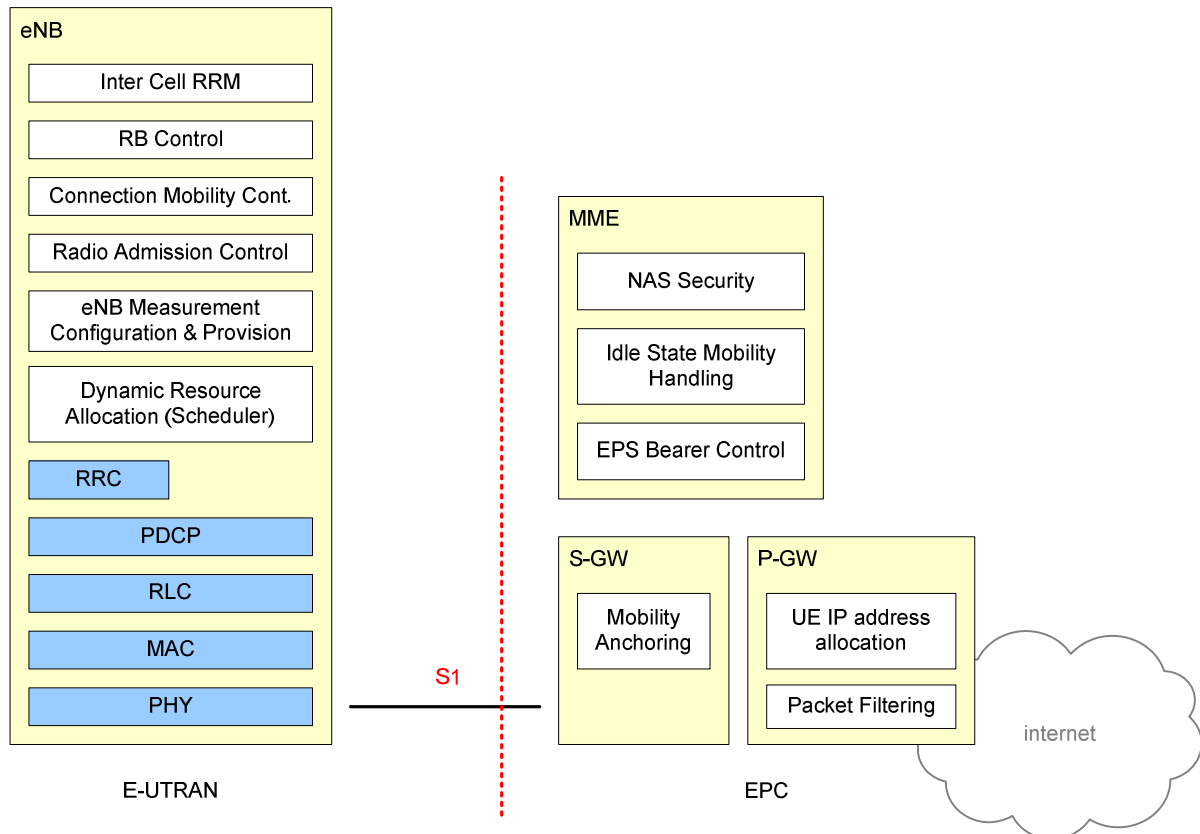

Figure 4.1-1: Functional Split between E-UTRAN and EPC

4.2 Void

4.2.1 Void

4.2.2 Void

4.3 Radio Protocol architecture

4.3.0 General

In this clause, the radio protocol architecture of E-UTRAN is given for the user plane and the control plane.

4.3.1 User plane

The figure below shows the protocol stack for the user-plane, where PDCP, RLC and MAC sublayers (terminated in eNB on the network side) perform the functions listed for the user plane in clause 6, e.g. header compression, ciphering, scheduling, ARQ and HARQ.

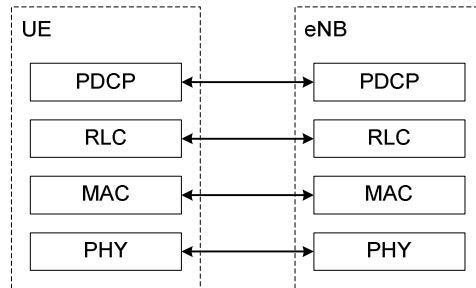

Figure 4.3.1-1: User-plane protocol stack

For NB-IoT, the user plane is not used when transferring data over NAS.

4.3.2 Control plane

The figure below shows the protocol stack for the control-plane, where:

- PDCP sublayer (terminated in eNB on the network side) performs the functions listed for the control plane in clause 6, e.g. ciphering and integrity protection;
- RLC and MAC sublayers (terminated in eNB on the network side) perform the same functions as for the user plane;
- RRC (terminated in eNB on the network side) performs the functions listed in clause 7, e.g.:
 - Broadcast;
 - Paging;
 - RRC connection management;
 - RB control;
 - Mobility functions;
 - UE measurement reporting and control, except for NB-IoT.
- NAS control protocol (terminated in MME on the network side) performs among other things:
 - EPS bearer management;
 - Authentication;
 - ECM-IDLE mobility handling;
 - Paging origination in ECM-IDLE;
 - Security control.

NOTE 1: The NAS control protocol is not covered by the scope of this TS and is only mentioned for information.

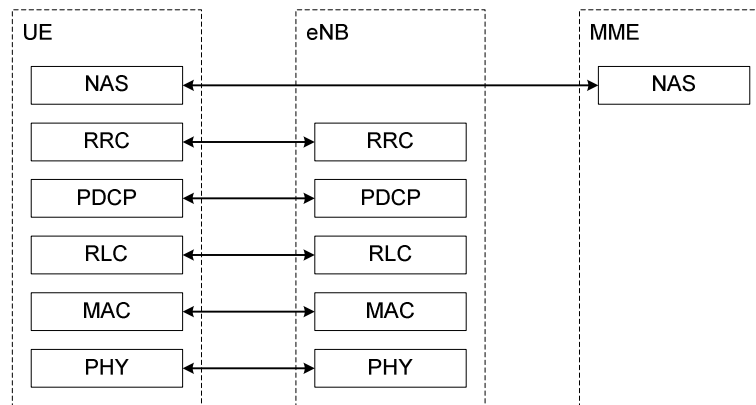

Figure 4.3.2-1: Control-plane protocol stack

NOTE 2: For a NB-IoT UE that only supports Control Plane CIoT EPS optimization, as defined in TS 24.301 [20], PDCP is bypassed. For a NB-IoT UE that supports Control Plane CIoT EPS optimization and S1-U data transfer or User Plane CIoT EPS optimization, as defined in TS 24.301 [20], PDCP is also bypassed (i.e. not used) until AS security is activated.

4.4 Synchronization

Diverse methods and techniques are preferred depending on synchronization requirements. As no single method can cover all E-UTRAN applications a logical port at eNB may be used for reception of timing and/or frequency and/or phase inputs pending to the synchronization method chosen.

4.5 IP fragmentation

Fragmentation function in IP layer on S1 and X2 shall be supported.

Configuration of S1-U (X2-U) link MTU in the eNB according to the MTU of the network domain the node belongs to shall be considered as a choice at network deployment. The network may employ various methods to handle IP fragmentation, but the specific methods to use are implementation dependant.

4.6 Support of HeNBs

4.6.1 Architecture

Figure 4.6.1-1 shows a logical architecture for the HeNB that has a set of S1 interfaces to connect the HeNB to the EPC.

The configuration and authentication entities as shown here should be common to HeNBs and HNBs.

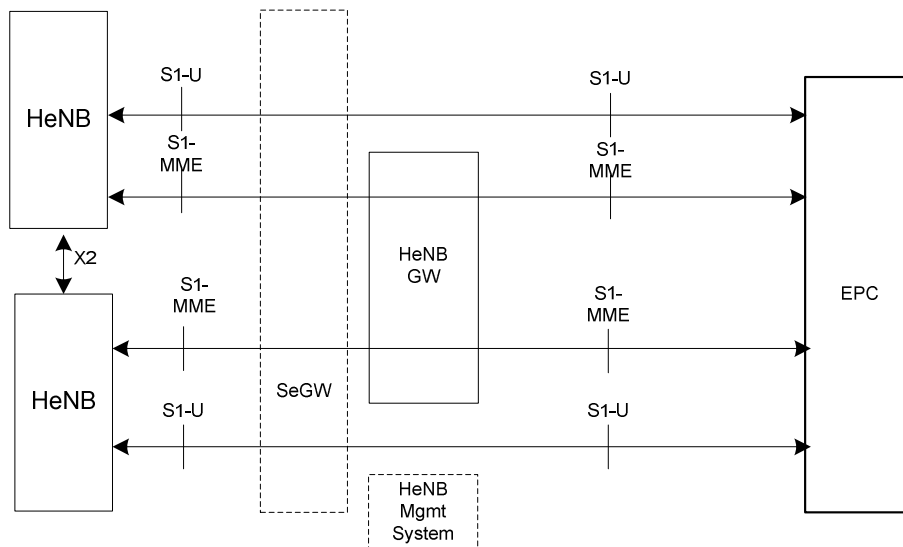

Figure 4.6.1-1: E-UTRAN HeNB Logical Architecture

The E-UTRAN architecture may deploy a Home eNB Gateway (HeNB GW) to allow the S1 interface between the HeNB and the EPC to support a large number of HeNBs in a scalable manner. The HeNB GW serves as a concentrator for the C-Plane, specifically the S1-MME interface. The S1-U interface from the HeNB may be terminated at the HeNB GW, or a direct logical U-Plane connection between HeNB and S-GW may be used (as shown in Figure 4.6.1-1).

The S1 interface is defined as the interface:

- Between the HeNB GW and the Core Network;
- Between the HeNB and the HeNB GW;
- Between the HeNB and the Core Network;
- Between the eNB and the Core Network.

The HeNB GW appears to the MME as an eNB. The HeNB GW appears to the HeNB as an MME. The S1 interface between the HeNB and the EPC is the same, regardless whether the HeNB is connected to the EPC via a HeNB GW or not.

The HeNB GW shall connect to the EPC in a way that inbound and outbound mobility to cells served by the HeNB GW shall not necessarily require inter MME handovers. One HeNB serves only one cell.

The functions supported by the HeNB shall be the same as those supported by an eNB (with possible exceptions e.g. NNSF) and the procedures run between a HeNB and the EPC shall be the same as those between an eNB and the EPC (with possible exceptions e.g. S5 procedures in case of LIPA support).

X2-based HO involving HeNBs is allowed as shown in Table 4.6.1-1.

Table 4.6.1-1: X2-based HO support

Source	Target	Notes
eNB or any HeNB	open access HeNB	
eNB, or any HeNB	hybrid access HeNB	
hybrid access HeNB or closed access HeNB	closed access HeNB	Only applies for same CSG ID and PLMN, and if the UE is a member of the CSG cell.
Any HeNB	eNB	

This version of the specification supports X2-connectivity between HeNBs, independent of whether any of the involved HeNBs is connected to a HeNB GW.

The overall E-UTRAN architecture with deployed HeNB GW and X2 GW is shown below.

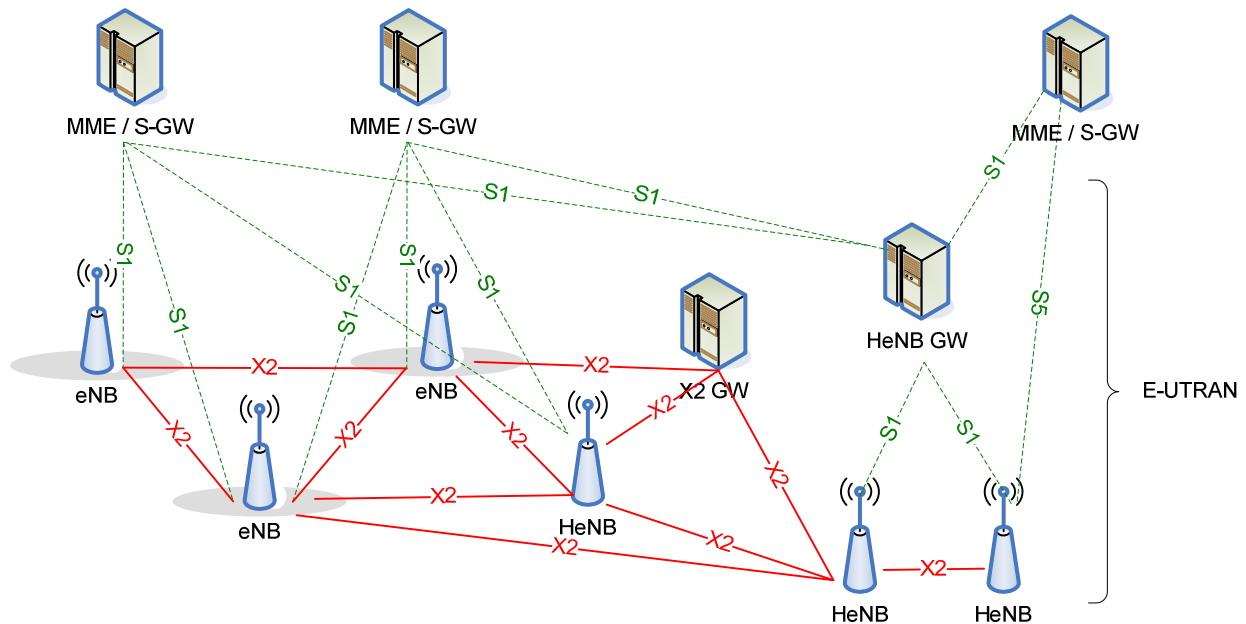

Figure 4.6.1-2: Overall E-UTRAN Architecture with deployed HeNB GW and X2 GW.

NOTE: In the figure above, a HeNB operating in LIPA mode has been represented with its S5 interface. X2-based HO involving HeNBs is supported according to Table 4.6.1-1.

If the HeNB supports the LIPA function, it shall support an S5 interface towards the S-GW and an SGi interface towards the residential/IP network. See clause 4.6.5 for the details of the architecture and functions in case of LIPA support.

If the HeNB supports SIPTO@LN with collocated L-GW, it shall support an S5 interface towards the S-GW and an SGi interface towards the IP network. The S5 interface does not go via the HeNB GW, even when present. All other functions are described in clause 4.8.2.

4.6.2 Functional Split

A HeNB hosts the same functions as an eNB as described in clause 4.1, with the following additional specifics in case of connection to the HeNB GW:

- Discovery of a suitable Serving HeNB GW;
- A HeNB shall only connect to a single HeNB GW at one time, namely no S1 Flex function shall be used at the HeNB:
 - The HeNB will not simultaneously connect to another HeNB GW, or another MME.
- The TAC and PLMN ID used by the HeNB shall also be supported by the HeNB GW;
- Selection of an MME at UE attachment is hosted by the HeNB GW instead of the HeNB. Upon reception of the GUMMEI from a UE, the HeNB shall include it in the INITIAL UE MESSAGE message; upon reception of the GUMMEI Type from the UE, the HeNB shall also include it in the message if supported and supported by the HeNB GW.
- HeNBs may be deployed without network planning. A HeNB may be moved from one geographical area to another and therefore it may need to connect to different HeNB GWs depending on its location;
- Signalling the GUMMEI of the Source MME to the HeNB GW in the S1 PATH SWITCH REQUEST message.

Regardless of HeNB GW connection:

- The HeNB may support the LIPA function. See clause 4.6.5 for details.
- The HeNB may support Fixed Broadband Access network interworking function to signal Tunnel Information to the MME via INITIAL UE MESSAGE message, PATH SWITCH REQUEST message and HANDOVER NOTIFY message as specified in TS 23.139 [55]. The HeNB may also signal Tunnel Information to the MeNB via SENB ADDITION REQUEST ACKNOWLEDGE message when the HeNB provide SeNB function and the MeNB signal to MME via E-RAB MODIFICATION INDICATION message The Tunnel Information includes the HeNB IP address, the UDP port if NAT/NAPT is detected.
- In case an X2 GW is used, the HeNB registers with the X2 GW at power on or after any change of TNL address(es).

The HeNB GW hosts the following functions:

- Relaying UE-associated S1 application part messages between the MME serving the UE and the HeNB serving the UE, except the UE CONTEXT RELEASE REQUEST message received from the HeNB with an explicit GW Context Release Indication. In that case, the HeNB GW terminates the S1 UE Context Release Request procedure and releases the UE context if it determines that the UE identified by the received UE S1AP IDs is no longer served by an HeNB attached to it. Otherwise it ignores the message.
- In case of S1 INITIAL CONTEXT SETUP REQUEST message and S1 HANDOVER REQUEST message, informing the HeNB about any GUMMEI corresponding to the serving MME, the MME UE S1AP ID assigned by the MME and the MME UE S1AP ID assigned by the HeNB GW for the UE. In case of S1 PATH SWITCH REQUEST ACKNOWLEDGE message, informing the HeNB about the MME UE S1AP ID assigned by the MME and the MME UE S1AP ID assigned by the HeNB GW for the UE.
- In case of S1 INITIAL UE MESSAGE message, S1 PATH SWITCH REQUEST and S1 HANDOVER REQUEST ACKNOWLEDGE message, verifying, as defined in TS 33.320 [53], for a closed HeNB, that the indicated cell access mode and CSG ID are valid for that HeNB.
- Terminating non-UE associated S1 application part procedures towards the HeNB and towards the MME. In case of S1 SETUP REQUEST message, verifying, as defined in TS 33.320 [53], that the identity used by the HeNB is valid and determining whether the access mode of the HeNB is closed or not. In case of S1 PWS RESTART INDICATION message and PWS FAILURE INDICATION message, verifying, as defined in TS 33.320 [53], that the indicated cell identity is valid and replacing the HeNB ID by the HeNB GW ID before sending the PWS RESTART INDICATION message (respectively the PWS FAILURE INDICATION message) to the MME.
- Upon receiving an OVERLOAD START/STOP message, the HeNB GW should send the OVERLOAD START/STOP message towards the HeNB(s) including in the message the identities of the affected MME node. The HeNB uses this information received from the OVERLOAD START message to identify to which traffic the above defined rejections shall be applied. The HeNB shall apply the defined rejections until reception of an OVERLOAD STOP message applicable to this traffic, or until the HeNB receives a further OVERLOAD START message applicable to the same traffic, in which case it shall replace the ongoing overload action with the newly requested one.

NOTE: If a HeNB GW is deployed, non-UE associated procedures shall be run between HeNBs and the HeNB GW and between the HeNB GW and the MME.

- Optionally terminating S1-U interface with the HeNB and with the S-GW.
- Supporting TAC and PLMN ID used by the HeNB.
- X2 interfaces shall not be established between the HeNB GW and other nodes.
- Routing the S1 PATH SWITCH REQUEST message towards the MME based on the GUMMEI of the source MME received from the HeNB.
- Selection of an IP version to be used for S1-U, if a requested ERAB configuration contains two transport layer addresses of different versions.

A list of CSG IDs may be included in the PAGING message. If included, the HeNB GW may use the list of CSG IDs for paging optimization.

The X2 GW hosts the following functions:

- routing the X2AP X2 MESSAGE TRANSFER message to target eNB or HeNB based on the routing information received in the X2AP X2 MESSAGE TRANSFER message.
- informing the relevant (H)eNBs upon detecting that the signalling (i.e. SCTP) connection to a (H)eNB is unavailable. The relevant (H)eNBs are the ones which had an "X2AP association" with this (H)eNB via the X2 GW when the signalling connection became unavailable.
- Mapping the TNL address(es) of a (H)eNB to its corresponding Global (H)eNB ID and maintaining the association.

In addition to functions specified in clause 4.1, the MME hosts the following functions:

- Access control for UEs that are members of Closed Subscriber Groups (CSG):
 - In case of handovers to CSG cells, access control is based on the target CSG ID of the selected target PLMN provided to the MME by the serving E-UTRAN (see TS 23.401 [17]).
- Membership Verification for UEs handing over to hybrid cells:
 - In case of handovers to hybrid cells the MME performs Membership Verification based on UE's selected target PLMN, cell access mode related information and the CSG ID of the target cell provided by the source E-UTRAN in S1 handover, or provided by the target E-UTRAN in X2 handover (see TS 23.401 [17]).
- Membership Verification for UEs for which the hybrid cell is served by an SeNB is described in clause 4.9.3.3.
- CSG membership status signalling to the E-UTRAN in case of attachment/handover to hybrid cells and in case of the change of membership status when a UE is served by a CSG cell or a hybrid cell.
- Supervising the E-UTRAN action after the change in the membership status of a UE.
- In case of a HeNB directly connected:
 - verifying as defined in TS 33.320 [53], that the identity used by the HeNB is valid when receiving the S1 SETUP REQUEST message and determining whether the access mode of the HeNB is closed or not;
 - verifying as defined in TS 33.320 [53], for a closed HeNB, that the indicated cell access mode and CSG ID are valid when receiving the S1 INITIAL UE MESSAGE message, the S1 PATH SWITCH REQUEST and the S1 HANDOVER REQUEST ACKNOWLEDGE message;
 - and verifying, as defined in TS 33.320 [53], that the indicated HeNB identity is valid when receiving the S1 PWS RESTART INDICATION message and the S1 PWS FAILURE INDICATION message.
- Routing of handover messages, MME configuration transfer messages and MME Direct Information Transfer messages towards HeNB GWs based on the TAI contained in these messages.

NOTE: If routing ambiguities are to be avoided, a TAI used in a HeNB GW should not be reused in another HeNB GW.

NOTE: The MME or HeNB GW should not include the list of CSG IDs for paging when sending the paging message directly to an un-trusted HeNB or eNB.

- The MME may support the LIPA function with HeNB. See details of this support in clause 4.6.5.
- The MME may support fixed Broadband Access network interworking with HeNB as specified in TS 23.139 [55].
- The MME may send two transport layer addresses of different versions only in case of HeNB GW which does not terminate user plane.

4.6.3 Interfaces

4.6.3.1 Protocol Stack for S1 User Plane

The S1-U data plane is defined between the HeNB, HeNB GW and the S-GW. The figures below show the S1-U protocol stack with and without the HeNB GW.



Figure 4.6.3.1-1: User plane for S1-U interface for HeNB without HeNB GW

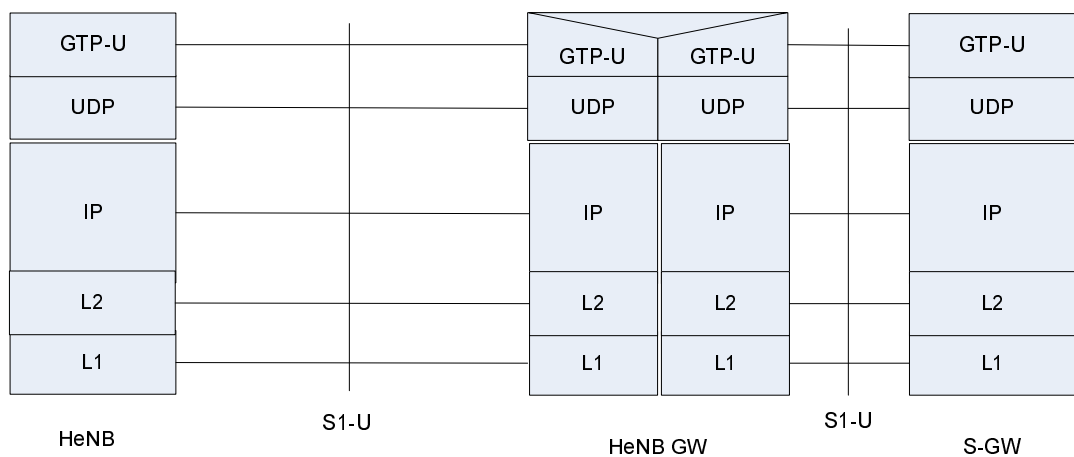

Figure 4.6.3.1-2: User plane for S1-U interface for HeNB with HeNB GW

The HeNB GW may optionally terminate the user plane towards the HeNB and towards the S-GW, and relay User Plane data between the HeNB and the S-GW.

4.6.3.2 Protocol Stacks for S1 Control Plane

The two figures below show the S1-MME protocol stacks with and without the HeNB GW.

When the HeNB GW is not present (Fig. 4.6.3.2-1), all the S1-AP procedures are terminated at the HeNB and the MME.

When present (Fig. 4.6.3.2-2), the HeNB GW shall terminate the non-UE-dedicated procedures – both with the HeNB, and with the MME. The HeNB GW relays Control Plane data between the HeNB and the MME. The scope of any protocol function associated to a non-UE-dedicated procedure shall be between HeNB and HeNB GW and/or between HeNB GW and MME.

Any protocol function associated to an UE-dedicated-procedure shall reside within the HeNB and the MME only.

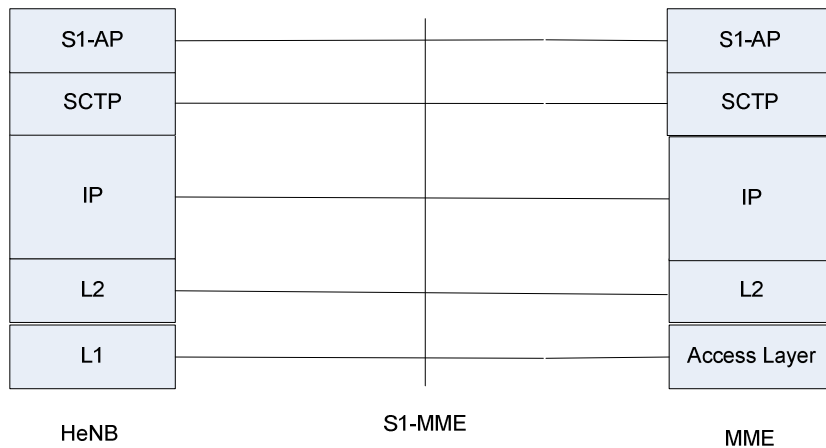

Figure 4.6.3.2-1: Control plane for S1-MME Interface for HeNB to MME without the HeNB GW

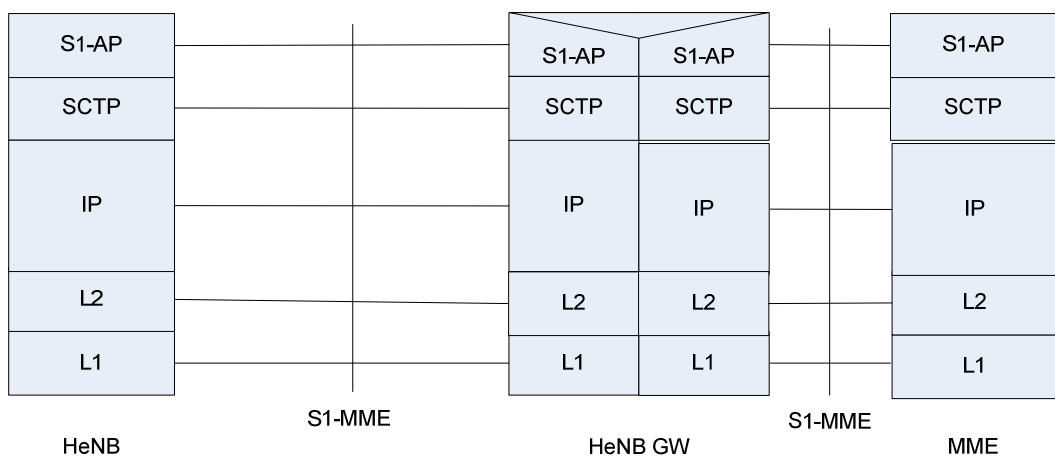

Figure 4.6.3.2-2: Control plane for S1-MME Interface for HeNB to MME with the HeNB GW

4.6.3.3 Protocol Stack for S5 interface

The protocol stack for the S5 interface can be found in TS 29.281 [47] for the user plane and in TS 29.274 [40] for the control plane.

4.6.3.4 Protocol Stack for SGi interface

The protocol stack for the SGi interface can be found in TS 29.061 [41].

4.6.3.5 Protocol Stack for X2 User Plane and X2 Control Plane

The protocol stack for X2 User Plane and X2 Control Plane is reported in clause 6.4 of TS 36.420 [46].

4.6.4 Void

4.6.5 Support of LIPA with HeNB

Figure 4.6.5-1 shows the logical architecture for the HeNB when it supports the LIPA function.

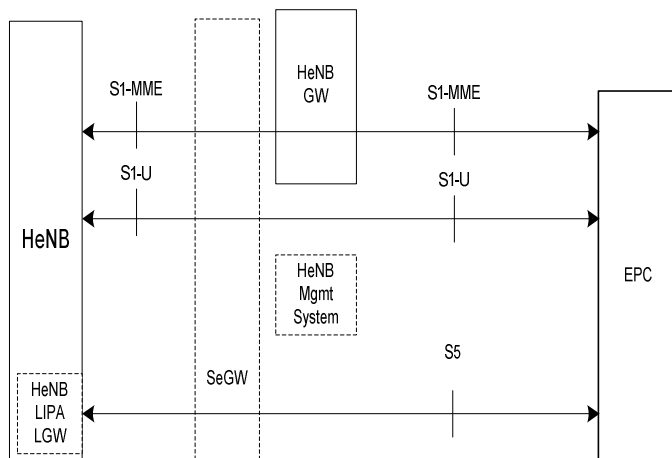

Figure 4.6.5-1: E-UTRAN - HeNB operating in LIPA mode - Logical Architecture

For a LIPA PDN connection, the HeNB sets up and maintains an S5 connection to the EPC.

The S5 interface does not go via the HeNB GW, even when present.

Requirements on the secure backhaul link for the S5 interface are specified in TS 33.320 [53].

The mobility of the LIPA PDN connection is not supported in this release of the specification. The LIPA connection is always released at outgoing handover as described in TS 23.401 [17]. The L-GW function in the HeNB triggers this release over the S5 interface.

In case of LIPA support, the HeNB supports the following additional functions, regardless of the presence of a HeNB GW:

- transfer of the collocated L-GW IP address of the HeNB over S1-MME to the EPC at every idle-active transition;
- transfer of the collocated L-GW IP address of the HeNB over S1-MME to the EPC within every Uplink NAS Transport procedure;
- support of basic P-GW functions in the collocated L-GW function such as support of the SGi interface corresponding to LIPA;
- additional support of first packet sending, buffering of subsequent packets, internal direct L-GW - HeNB user path management and in sequence packet delivery to the UE;
- support of the necessary restricted set of S5 procedures corresponding to the strict support of LIPA function as specified in TS 23.401 [17];
- notification to the EPC of the collocated L-GW uplink TEID(s) or GRE key(s) for the LIPA bearer(s) over S5 interface within the restricted set of procedures to be forwarded over S1-MME and further used by the HeNB as "correlation id" for correlation purposes between the collocated L-GW function and the HeNB;
- in case of outgoing handover triggering the L-GW function to release the LIPA PDN connection and only handing over the non-LIPA E-RABs.

In case of LIPA support, the MME may support the following additional functions:

- verification of UE authorization to request LIPA activation for the requested APN at this CSG and transfer of the received collocated L-GW IP address;
- transfer of the "correlation id" i.e. collocated L-GW uplink TEID or GRE key to the HeNB within the UE context setup procedure and E-RAB setup procedure;
- verification of whether the LIPA PDN connection has been released during the handover procedure, as specified in TS 23.401 [17];
- deactivation of the LIPA PDN connection of an idle-mode UE if it detects that the UE has moved out of the coverage area of the HeNB collocated with L-GW function, as specified in TS 23.401 [17].

4.6.6 Support of X2 GW

Figure 4.6.6-1 shows the logical architecture when X2-connectivity via the X2 GW is supported.

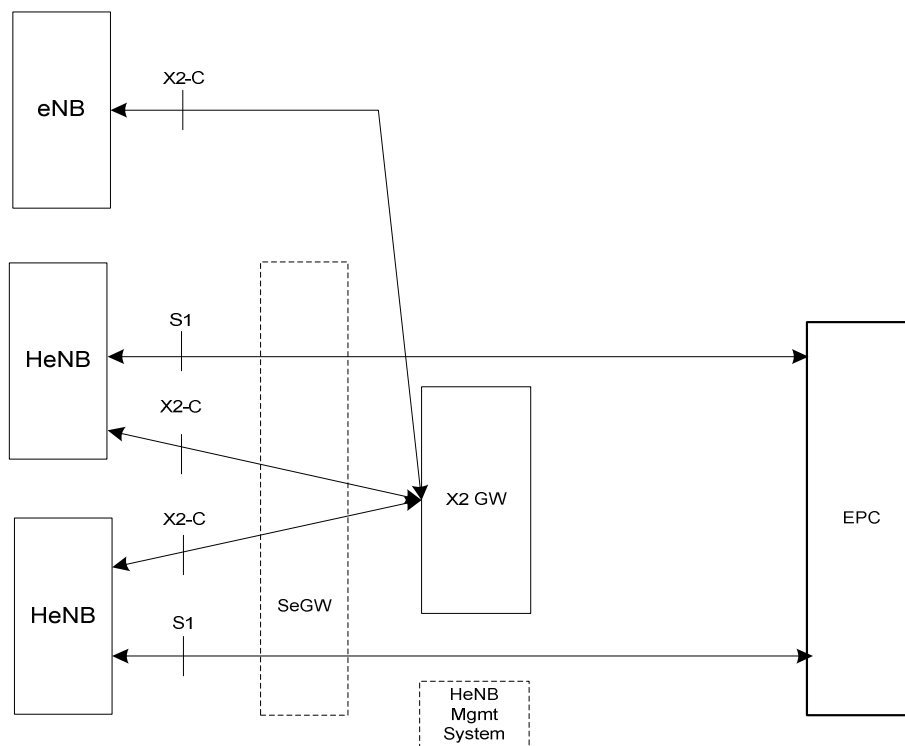

Figure 4.6.6-1: E-UTRAN operating with X2 GW - Logical Architecture

Support for the X2 GW relies on following principles:

- A HeNB connects to a single X2 GW only. Each HeNB is preconfigured with information about which X2 GW it connects to, e.g. an IP address of the X2 GW.
- There is no limitation on the number of X2 GWs an eNB may connect to.
- The X2 GW does not terminate X2AP procedures except for the X2AP Message Transfer procedure, but it initiates the X2 Release procedure and the X2 Error Indication procedure.
- This version of the specification does not support an interface between two X2 GWs. The routing of X2AP messages via more than one X2 GW (i.e. more than two SCTP hops) is not allowed.
- X2AP contexts only exist in the two peer (H)eNBs (same as without X2 GW). The peer X2AP contexts define an "X2AP association" between peer (H)eNBs which spans over two SCTP associations (one per each hop).
- The X2 GW puts no constraints on the X2 user plane interface (X2-U).

- For each (H)eNB connected to the X2 GW, the X2 GW maintains the association information, i.e. the mapping of the Global eNB ID to the TNL address(es). The registration procedure, described in Sec. 4.6.6.4, is used to update the association information in the X2 GW.

4.6.6.1 Enhanced TNL Address Discovery

In case of Enhanced TNL Address Discovery is used with the X2 GW, in addition to the procedures specified in clause 22.3.6.1, the following also applies.

- During HeNB initiated Enhanced TNL address discovery procedure, the HeNB may include the IP address of the X2 GW to which the HeNB connected in the eNB CONFIGURATION TRANSFER message thus indicating its X2 GW support capability. Upon the reception of the IP address of the X2 GW, the candidate eNB may include in its reply the received IP address of the X2 GW thus indicating the support of indirect X2 via the indicated X2 GW.
- During the eNB or HeNB initiated Enhanced TNL address discovery procedure towards an HeNB, the candidate HeNB may include in its reply the IP address of the X2 GW to which the candidate HeNB connected thus indicating the support of indirect X2 via the indicated X2 GW.

4.6.6.2 Routing of X2AP messages

When a (H)eNB sends an X2AP message (except the X2AP X2 MESSAGE TRANSFER message) to a peer node via the X2 GW, the (H)eNB encapsulates the X2AP message in an X2AP X2 MESSAGE TRANSFER message, adds the routing information, then sends the X2AP X2 MESSAGE TRANSFER message to the X2 GW. The routing information includes both Target (H)eNB ID and source (H)eNB ID. The X2 GW routes the message based on the target (H)eNB ID. The source (H)eNB ID is used by the destination (H)eNB node to reply.

4.6.6.3 (H)eNB unavailability

Upon the detection that the signalling (i.e. SCTP) connection to a (H)eNB is unavailable, the X2 GW initiates the X2 Release procedure to inform the relevant (H)eNBs. The relevant (H)eNBs are the ones which had an "X2AP association" with this (H)eNB via the X2 GW when the signalling connection became unavailable.

4.6.6.4 (H)eNB registration

Registration of a (H)eNB is performed by initiating the X2AP Message Transfer procedure towards the X2 GW signalling a Source (H)eNB ID, no Target (H)eNB ID, and no X2AP Message in the X2AP MESSAGE TRANSFER message. Upon receipt of this message, the X2 GW saves the association information, i.e. the mapping of the received Global eNB ID to the TNL address(es) of the originating (H)eNB.

4.7 Support for relaying

4.7.1 General

E-UTRAN supports relaying by having a Relay Node (RN) wirelessly connect to an eNB serving the RN, called Donor eNB (DeNB), via a modified version of the E-UTRA radio interface, the modified version being called the Un interface.

The RN supports the eNB functionality meaning it terminates the radio protocols of the E-UTRA radio interface, and the S1 and X2 interfaces. From a specification point of view, functionality defined for eNBs, e.g. RNL and TNL, also applies to RNs unless explicitly specified. RNs do not support NNSF.

In addition to the eNB functionality, the RN also supports a subset of the UE functionality, e.g. physical layer, layer-2, RRC, and NAS functionality, in order to wirelessly connect to the DeNB.

NOTE: Inter-cell handover of the RN is not supported.

NOTE: It is up to implementation when the RN starts or stops serving UEs.

NOTE: An RN may not use another RN as its DeNB.

4.7.2 Architecture

The architecture for supporting RNs is shown in Figure 4.7.2-1. The RN terminates the S1, X2 and Un interfaces. The DeNB provides S1 and X2 proxy functionality between the RN and other network nodes (other eNBs, MMEs and S-GWs). The S1 and X2 proxy functionality includes passing UE-dedicated S1 and X2 signalling messages as well as GTP data packets between the S1 and X2 interfaces associated with the RN and the S1 and X2 interfaces associated with other network nodes. Due to the proxy functionality, the DeNB appears as an MME (for S1-MME), an eNB (for X2) and an S-GW (for S1-U) to the RN.

In phase II of RN operation (see clause 4.7.6.3), the DeNB also embeds and provides the S-GW/P-GW-like functions needed for the RN operation. This includes creating a session for the RN and managing EPS bearers for the RN, as well as terminating the S11 interface towards the MME serving the RN.

The RN and DeNB also perform mapping of signalling and data packets onto EPS bearers that are setup for the RN. The mapping is based on existing QoS mechanisms defined for the UE and the P-GW.

In phase II of RN operation (see clause 4.7.6.3), the P-GW functions in the DeNB allocate an IP address for the RN for the O&M which may be different than the S1 IP address of the DeNB.

If the RN address is not routable to the RN O&M domain, it shall be reachable from the RN O&M domain (e.g. via NAT).

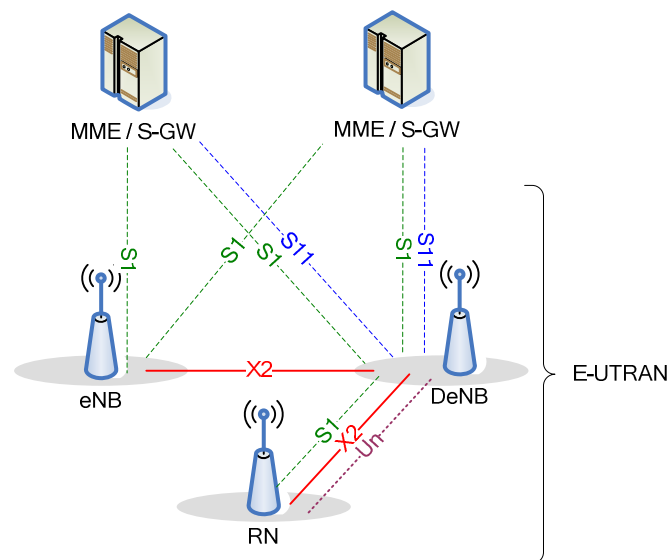

Figure 4.7.2-1: Overall E-UTRAN Architecture supporting RNs

4.7.3 S1 and X2 user plane aspects

The S1 user plane protocol stack for supporting RNs is shown in Figure 4.7.3-1. There is a GTP tunnel associated with each UE EPS bearer, spanning from the S-GW associated with the UE to the DeNB, which is switched to another GTP tunnel in the DeNB, going from the DeNB to the RN (one-to-one mapping).

The X2 user plane protocol stack for supporting RNs is shown in Figure 4.7.3-2. There is a GTP forwarding tunnel associated with each UE EPS bearer subject to forwarding, spanning from the other eNB to the DeNB, which is switched to another GTP tunnel in the DeNB, going from the DeNB to the RN (one-to-one mapping).

The S1 and X2 user plane packets are mapped to radio bearers over the Un interface. The mapping can be based on the QCI associated with the UE EPS bearers. UE EPS bearer with similar QoS can be mapped to the same Un radio bearer.

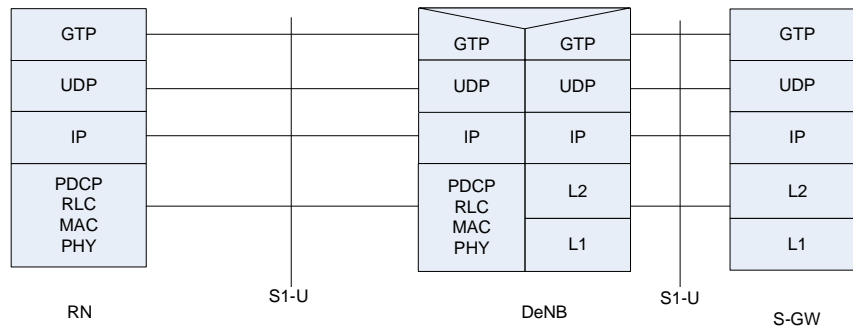

Figure 4.7.3-1: S1 user plane protocol stack for supporting RNs

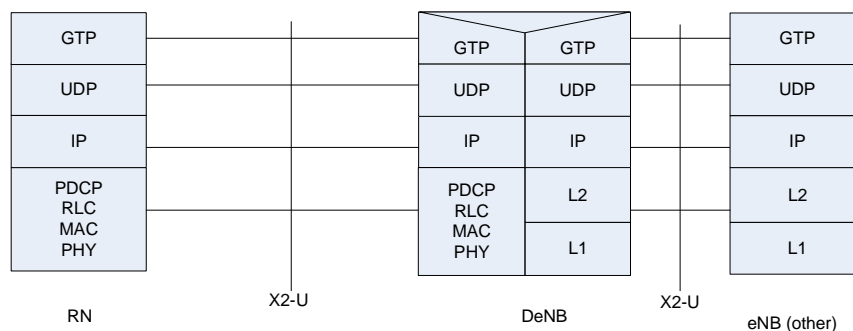

Figure 4.7.3-2: X2 user plane protocol stack for supporting RNs

4.7.4 S1 and X2 control plane aspects

The S1 control plane protocol stack for supporting RNs is shown in Figure 4.7.4-1. There is a single S1 interface relation between each RN and its DeNB, and there is one S1 interface relation between the DeNB and each MME in the MME pool. The DeNB processes and forwards all S1 messages between the RN and the MMEs for all UE-dedicated procedures. The processing of S1-AP messages includes modifying S1-AP UE IDs, Transport Layer address and GTP TEIDs but leaves other parts of the message unchanged.

All non-UE-dedicated S1-AP procedures are terminated at the DeNB, and handled locally between the RN and the DeNB, and between the DeNB and the MME(s). Upon reception of an S1 non-UE-dedicated message from an MME, the DeNB may trigger corresponding S1 non-UE-dedicated procedure(s) to the RN(s). If more than one RN is involved, the DeNB may wait and aggregate the response messages from all involved RNs before responding to the MME. Upon reception of an S1 non-UE-dedicated message from an RN, the DeNB may trigger associated S1 non-UE-dedicated procedure(s) to the MME(s). In case of the RESET procedure, the DeNB does not need to wait for the response message(s) from the MME(s) or RN(s) before responding with the RESET ACKNOWLEDGE message to the originating node. Upon reception of a PAGING message, the DeNB sends the PAGING message toward the RN(s) which support any tracking area(s) indicated in the List of TAIs. Upon reception of an S1 MME overload START/STOP message, the DeNB sends the MME overload START/STOP message towards the RN(s), including in the message the identities of the affected CN node. The RN uses this information received from the OVERLOAD START message to identify to which traffic the above defined rejections shall be applied. The RN shall apply the defined rejections until reception of an OVERLOAD STOP message applicable to this traffic, or until the RN receives a further OVERLOAD START message applicable to the same traffic, in which case it shall replace the ongoing overload action with the newly requested one. Upon reception of the GUMMEI from a UE, the RN shall include it in the INITIAL UE MESSAGE message; upon reception of the GUMMEI Type from the UE, the RN shall also include it in the message.

The X2 control plane protocol stack for supporting RNs is shown in Figure 4.7.4-2. There is a single X2 interface relation between each RN and its DeNB. In addition, the DeNB may have X2 interface relations to neighbouring eNBs. The DeNB processes and forwards all X2 messages between the RN and other eNBs for all UE-dedicated procedures. The processing of X2-AP messages includes modifying S1/X2-AP UE IDs, Transport Layer address and GTP TEIDs but leaves other parts of the message unchanged.

All non-UE-dedicated X2-AP procedures are terminated at the DeNB, and handled locally between the RN and the DeNB, and between the DeNB and other eNBs. Upon reception of an X2 non cell related non-UE-associated message from RN or neighbour eNB, the DeNB may trigger associated non-UE-dedicated X2-AP procedure(s) to the neighbour eNB or RN(s). Upon reception of an X2 cell related non-UE-dedicated message from RN or neighbour eNB, the DeNB may pass associated information to the neighbour eNB or RN(s) based on the included cell information. If one or more RN(s) are involved, the DeNB may wait and aggregate the response messages from all involved nodes to respond to the originating node. Further, parallel Cell Activation procedures are not allowed on each X2 interface instance. The processing of Resource Status Reporting Initiation/ Resource Status Reporting messages includes modification of measurement ID.

The S1 and X2 interface signalling packets are mapped to radio bearers over the Un interface.

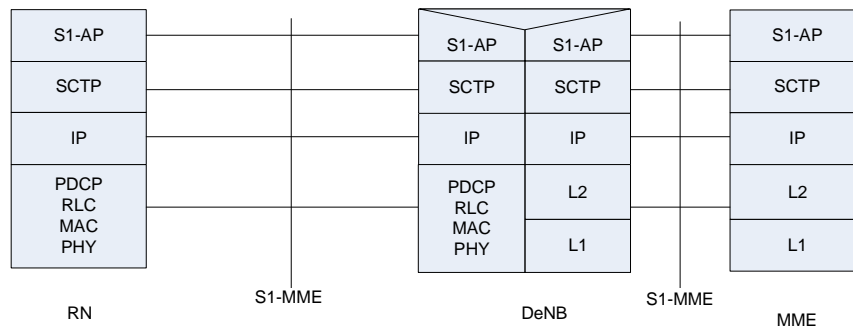

Figure 4.7.4-1: S1 control plane protocol stack for supporting RNs

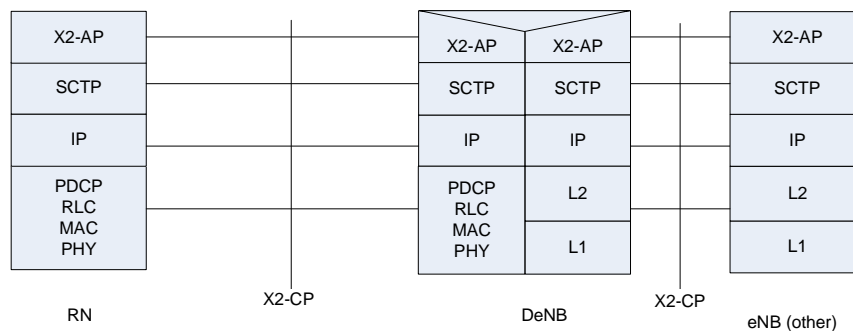

Figure 4.7.4-2: X2 control plane protocol stack for supporting RNs

4.7.5 Radio protocol aspects

The RN connects to the DeNB via the Un interface using the same radio protocols and procedures as a UE connecting to an eNB. The control plane protocol stack is shown in Figure 4.7.5-1 and the user plane protocol stack is shown in Figure 4.7.5-2.

The following relay-specific functionalities are supported:

- the RRC layer of the Un interface has functionality to configure and reconfigure an RN subframe configuration through the RN reconfiguration procedure (e.g. DL subframe configuration and an RN-specific control channel) for transmissions between an RN and a DeNB. The RN may request such a configuration from the DeNB during the RRC connection establishment, and the DeNB may initiate the RRC signalling for such configuration. The RN applies the configuration immediately upon reception;

NOTE: The RN subframe configuration on the Un interface can be temporarily misaligned with the MBSFN subframes configured in the RN cell due to the RN subframe configuration; i.e. a new subframe configuration can be applied earlier by the RN on Un than in the RN cell.

- the RRC layer of the Un interface has functionality to send updated system information in a dedicated message to an RN with an RN subframe configuration. The RN applies the received system information immediately;

- the PDCP layer of the Un interface has functionality to provide integrity protection for the user plane. The integrity protection is configured per DRB.

To support PWS towards UEs, the RN receives the relevant information over S1. The RN should hence ignore DeNB system information relating to PWS.

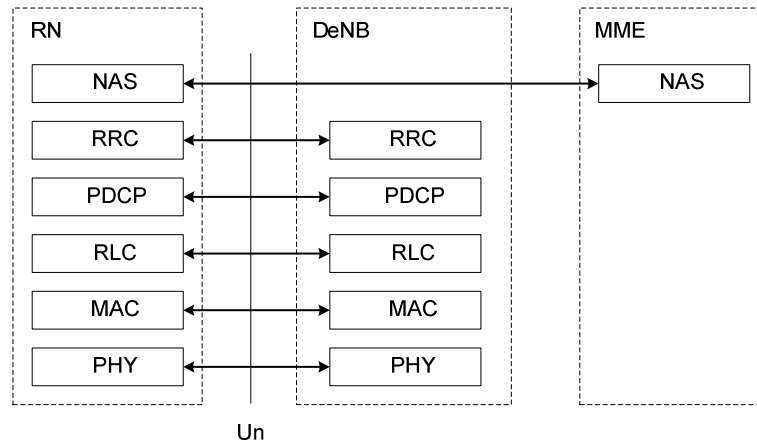

Figure 4.7.5-1: Radio control plane protocol stack for supporting RNs

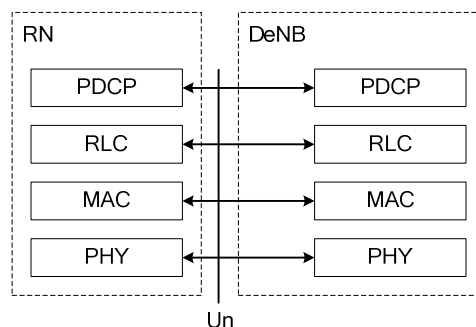

Figure 4.7.5-2: Radio user plane protocol stack for supporting RNs

4.7.6 Signalling procedures

4.7.6.1 RN attach procedure

Figure 4.7.6.1-1 shows a simplified version of the attach procedure for the RN. The procedure is the same as the normal UE attach procedure TS 23.401 [17] with the exception that:

- The DeNB has been made aware of which MMEs support RN functionality via the S1 Setup Response message earlier received from the MMEs;
- The RN sends an RN indication to the DeNB during RRC connection establishment;
- After receiving the RN indication from the RN, the DeNB sends the RN indicator and the IP address of the S-GW/P-GW function embedded in the DeNB, within the Initial UE Message, to an MME supporting RN functionality;
- MME selects S-GW/P-GW for the RN based on the IP address included in the Initial UE Message;
- During the attach procedure, the EPC checks if the RN is authorised for relay operation; only if the RN is authorised, the EPC accepts the attach and sets up a context with the DeNB; otherwise the EPC rejects the attach.

The RN is preconfigured with information about which cells (DeNBs) it is allowed to access.

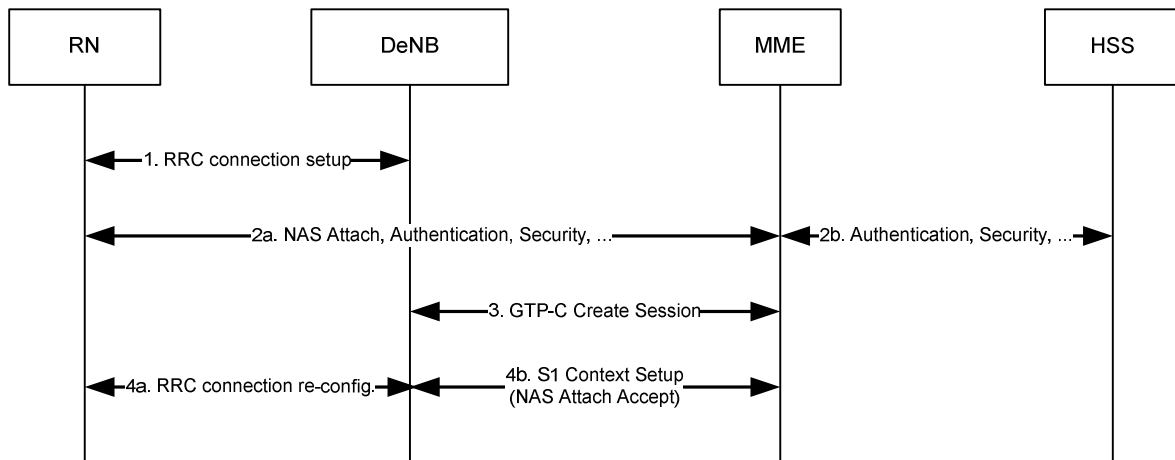

Figure 4.7.6.1-1: RN attach procedure

4.7.6.2 E-RAB activation/modification

Figure 4.7.6.2-1 shows a simplified version of the DeNB-initiated bearer activation/modification procedure. This procedure can be used by the DeNB to change the EPS bearer allocation for the RN. The procedure is the same as the normal network-initiated bearer activation/modification procedure TS 23.401 [17] with the exception that the S-GW/P-GW functionality (steps 1 and 6) is performed by the DeNB.

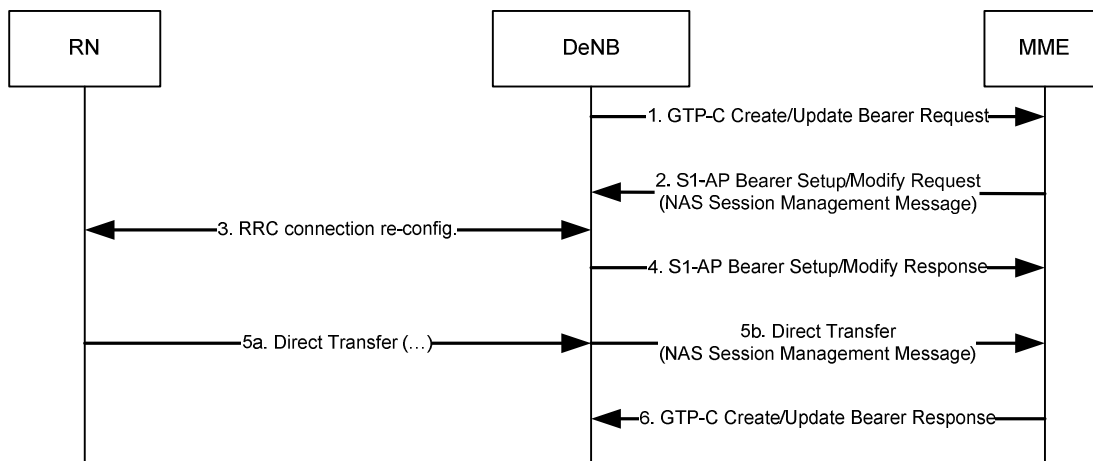

Figure 4.7.6.2-1: DeNB-initiated bearer activation/modification procedure

4.7.6.3 RN startup procedure

Figure 4.7.6.3-1 shows a simplified version of the startup procedure for the RN. The procedure is based on the normal UE attach procedure TS 23.401 [17] and it consists of the following two phases:

I. Phase I: Attach for RN preconfiguration.

The RN attaches to the E-UTRAN/EPC as a UE at power-up and retrieves initial configuration parameters, including the list of DeNB cells, from RN OAM. After this operation is complete, the RN detaches from the network as a UE and triggers Phase II. The MME performs the S-GW and P-GW selection for the RN as a normal UE.

II. Phase II: Attach for RN operation.

The RN connects to a DeNB selected from the list acquired during Phase I to start relay operations. For this purpose, the normal RN attach procedure described in clause 4.7.6.1 is applied. After the DeNB initiates setup of bearer for S1/X2, the RN initiates the setup of S1 and X2 associations with the DeNB (see clause 4.7.4). In addition, the DeNB may initiate an RN reconfiguration procedure via RRC signalling for RN-specific parameters.

After the S1 setup, the DeNB performs the S1 eNB Configuration Update procedure(s), if the configuration data for the DeNB is updated due to the RN attach. After the X2 setup, the DeNB performs the X2 eNB Configuration Update procedure(s) to update the cell information.

In this phase the RN cells' ECGIs are configured by RN OAM.

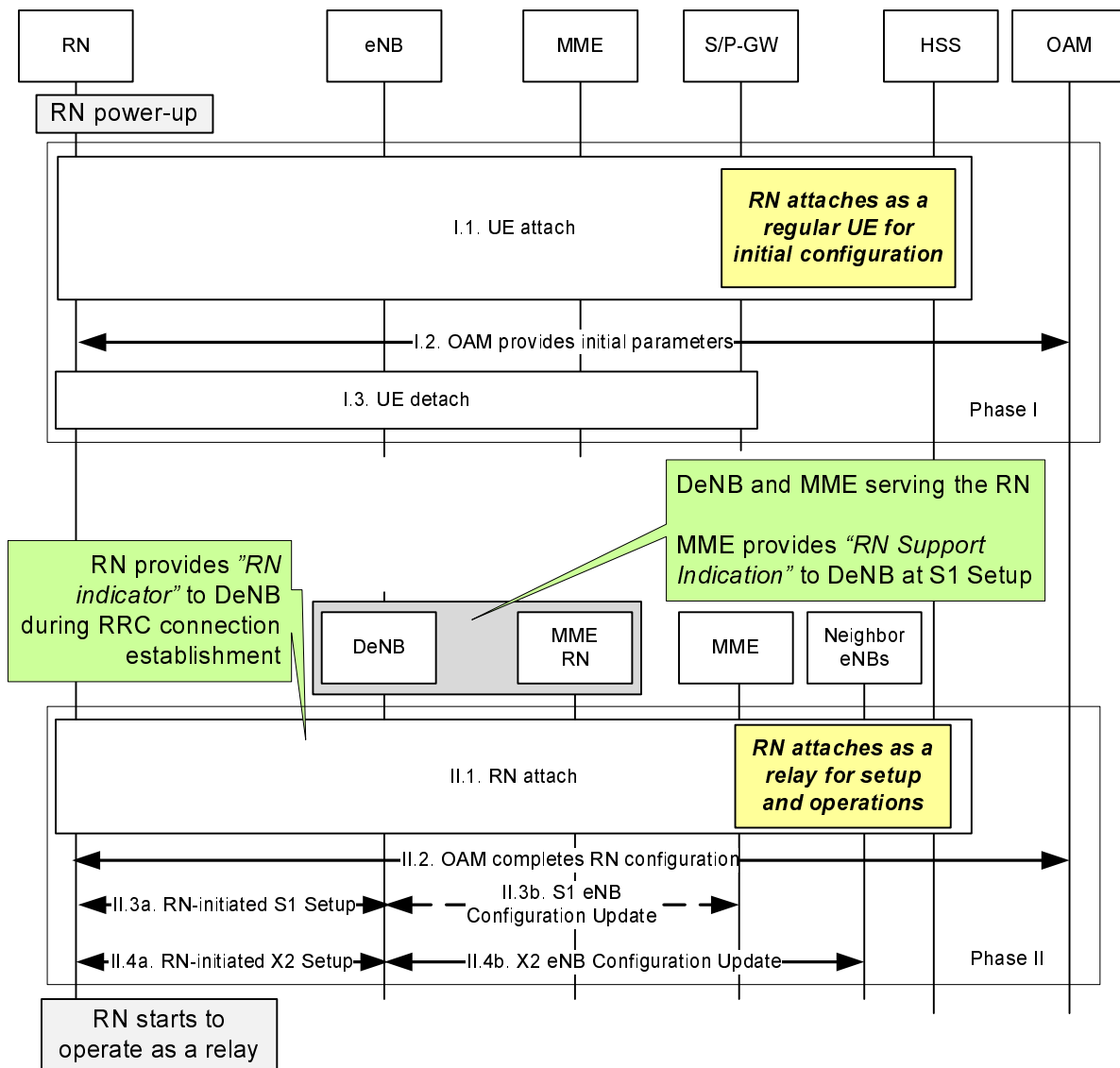

Figure 4.7.6.3-1: RN startup procedure

4.7.6.4 RN detach procedure

Figure 4.7.6.4-1 shows a simplified version of the detach procedure for the RN operation in case no UE is connected to the RN cells.

1. The detach procedure is the same as the normal UE detach procedure TS 23.401 [17].
2. The DeNB performs the X2 eNB Configuration Update procedure(s) to update the cell information.

- 3 The DeNB performs the S1 eNB Configuration Update procedure(s), if the configuration data for the DeNB is updated due to the RN detach.

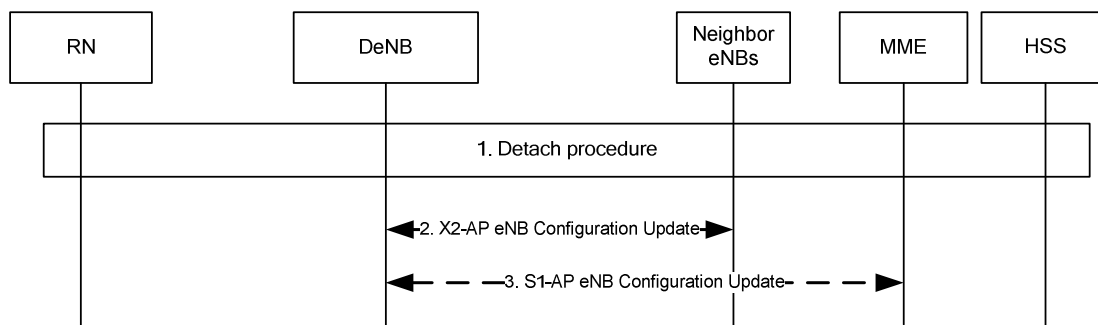

Figure 4.7.6.4-1: RN detach procedure

4.7.6.5 Neighbouring Information Transfer

The X2 eNB Configuration Update procedure (see clause 20.2.2.8) is used by the DeNB to also transfer application level configuration data of a single neighbouring eNB to the RN. Upon reception of an ENB CONFIGURATION UPDATE message, if the served cells contained in the message belong to the neighbour eNB rather than the DeNB, the RN shall regard the X2 interface between DeNB and the neighbour eNB as available. The RN will update the X2 availability, the corresponding GU Group ID and other information of the neighbour eNB according to the message.

4.7.6.6 Mobility to or from RN

In case of Handover between RN and neighbour eNB, in addition to the procedures specified in clause 10.1.2.1.1, the following also applies.

- The DeNB may inform the RN of any GUMMEI of the UE's serving MME in the INITIAL CONTEXT SETUP REQUEST and S1 HANDOVER REQUEST messages. Considering this information as well as the GU Group ID of the neighbour eNB and the X2 interface availability between DeNB and neighbour eNB, the RN initiates either S1 or X2 handover for the UE. In case the GUMMEI information is not available to the RN, the RN attempts X2 handover for the UE (see clause 19.2.2.5); upon X2 handover failure, S1 handover may be initiated.
- The S1/X2 HANDOVER REQUEST is received by the DeNB, which reads the target cell ID from the message, finds the target node corresponding to the target cell ID, and forwards the message toward the target node if appropriate.

4.7.7 Relay Node OAM Aspects

4.7.7.1 Architecture

Each RN sends alarms and traffic counter information to its OAM system, from which it receives commands, configuration data and software downloads (e.g. for equipment software upgrades). This transport connection between each RN and its OAM, using IP, is provided by the DeNB; the reference architecture is shown in Figure 4.7.7.1-1. RN OAM traffic is transported over the Un interface, and it shares resources with the rest of the traffic, including UEs attached to the DeNB. The secure connection between the RN and its OAM may be direct or hop-by-hop, i.e. involving intermediate hops trusted by the operator for this purpose.

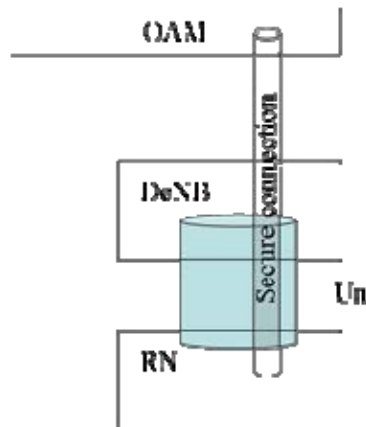

Figure 4.7.7.1-1: Relay OAM architecture.

It has to be noted that Figure 4.7.7.1-1 refers to normal operating conditions for the RN, i.e. after the initial start-up phase has been completed. The case where the secure connection between the RN and the OAM does not go through the DeNB, e.g. during the initial start-up phase, is not precluded.

4.7.7.2 OAM Traffic QoS Requirements

Alarms in the RN generate bursts of high-priority traffic, to be transported in real time. Traffic counters generate bursts of traffic, but their transport need not be real-time. Configuration messages from OAM to the RN will also generate small bursts of traffic, possibly with lower priority than alarms but still delay-sensitive: when a configuration is committed on the OAM, the time interval between the commitment and the effect on the equipment shall be small.

Alarm messages and commands should be transported on a high-priority bearer, while counters may be transported on a lower priority bearer. There is no need to specify a new QCI value other than those already standardized.

Alarm messages and commands may be mapped over a dedicated bearer or over the same bearer that carries S1 and/or X2 messages between the RN and the DeNB.

OAM software download to the RN may generate larger amounts of data, but both the required data rate and the priority of this kind of traffic are much lower than in the case of alarms, commands and counters. OAM software downloads may be mapped to a dedicated, non-GBR bearer, or transported together with the user plane traffic. If a dedicated bearer is used, it is FFS whether it shall be present at all times, or its setup should be event-triggered (software upgrades are triggered by the operator).

4.7.7.3 Security Aspects

Refer to clause D.2.5 of TS 33.401 [22] for details on secure management procedures for RN.

4.7.7.4 Void

4.7.7.5 OAM Requirements for Configuration Parameters

4.7.7.5.1 Parameters Associated with Relay Bearer Mapping

OAM provides the appropriate support to configure a QCI-to-DSCP mapping function at the relay node which is used to control the mapping in uplink of Uu bearer(s) of different QCI(s) to Un bearer(s).

4.8 Support of SIPTO at the Local Network

4.8.1 General

E-UTRAN supports SIPTO at the Local Network with a collocated L-GW in the eNB or a standalone GW (with S-GW and L-GW collocated), as specified in TS 23.401 [17].

4.8.2 SIPTO at the Local Network with collocated L-GW

Figure 4.8.2-1 shows the logical architecture for the eNB when it supports SIPTO@LN with a collocated L-GW.

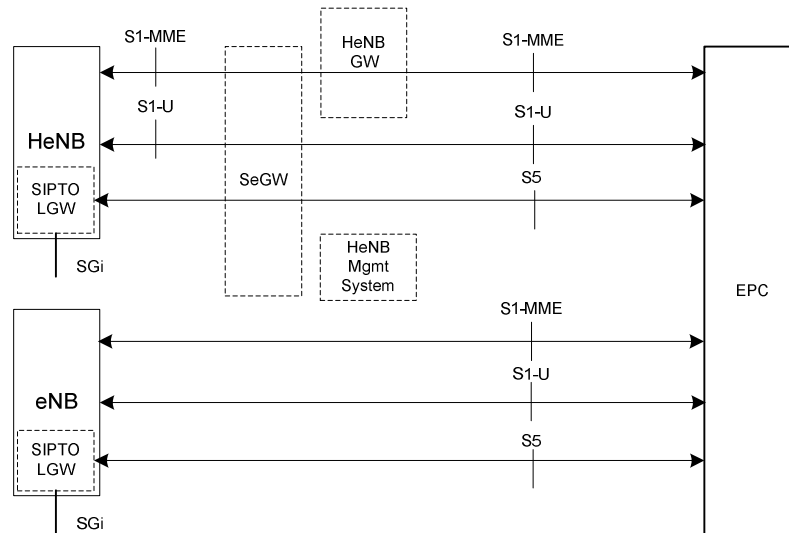

Figure 4.8.2-1: E-UTRAN - SIPTO@LN with collocated L-GW - Logical Architecture

For a SIPTO@LN PDN connection, the eNB sets up and maintains an S5 connection to the EPC.

The mobility of the SIPTO@LN PDN connection is not supported in this release of the specification. The SIPTO@LN PDN connection is released after a handover is performed, and the collocated L-GW in the source eNB triggers the release over the S5 interface, as described in TS 23.401 [17].

In case of SIPTO@LN with collocated L-GW support, the eNB supports the following additional functions:

- transfer of the collocated L-GW IP address of the eNB over S1-MME to the EPC at every idle-active transition;
- transfer of the collocated L-GW IP address of the eNB over S1-MME to the EPC within every Uplink NAS Transport procedure;
- support of basic P-GW functions in the collocated L-GW such as support of the SGi interface corresponding to SIPTO@LN;
- additional support of first packet sending, buffering of subsequent packets, internal direct L-GW-eNB user path management and in sequence packet delivery to the UE;
- support of the necessary restricted set of S5 procedures corresponding to the support of SIPTO@LN function as specified in TS 23.401 [17];
- notification to the EPC of the collocated L-GW uplink TEID(s) or GRE key(s) for the SIPTO@LN bearer(s) over S5 interface within the restricted set of procedures to be forwarded over S1-MME and further used by the eNB as "SIPTO correlation id" for correlation purposes between the collocated L-GW and the eNB;
- triggering SIPTO@LN PDN connection release by the collocated L-GW after a handover is performed, as specified in TS 23.401 [17].

In case of SIPTO@LN with collocated L-GW support, the MME supports the following additional functions:

- SIPTO@LN activation for the requested APN based on SIPTO permissions in the subscription data and received collocated L-GW IP address;
- transfer of the "SIPTO correlation id" to the eNB via the initial context setup procedure and E-RAB setup procedure;

- release of the SIPTO@LN PDN connection of an idle-mode UE when the UE moves away from the coverage area of the eNB, as specified in TS 23.401 [17].

4.8.3 Support for SIPTO@LN with Stand-Alone Gateway

SIPTO@LN is supported using a stand-alone gateway (with co-located S-GW and L-GW) deployed in the local network. The MME may decide to trigger S-GW relocation without UE mobility, as specified in TS 23.401 [17]. Mobility for the SIPTO@LN PDN connection is not supported in this release: the SIPTO@LN PDN connection shall be released after handover, unless the source and target eNBs are in the same LHN (i.e. they have the same LHN ID), as specified in TS 23.401 [17].

In case of SIPTO@LN support with stand-alone gateway, the eNB supports the following additional functions:

- signalling of its LHN ID to the MME in the INITIAL UE MESSAGE, UPLINK NAS TRANSPORT, HANDOVER NOTIFY and PATH SWITCH REQUEST messages;
- support for MME-triggered S-GW relocation without UE mobility through the E-RAB MODIFY REQUEST message.

In case of SIPTO@LN support with stand-alone gateway, the MME supports the following additional functions:

- SIPTO@LN PDN activation for the requested APN based on subscription data and received LHN ID;
- S-GW relocation without UE mobility.

4.9 Support for Dual Connectivity

4.9.1 General

E-UTRAN supports Dual Connectivity (DC) operation whereby a multiple Rx/Tx UE in RRC_CONNECTED is configured to utilise radio resources provided by two distinct schedulers, located in two eNBs connected via a non-ideal backhaul over the X2 interface (see TR 36.842 [59] and TR 36.932 [60]). The overall E-UTRAN architecture as specified in clause 4 and depicted in Figure 4-1 is applicable for DC as well. eNBs involved in DC for a certain UE may assume two different roles: an eNB may either act as an MeNB or as an SeNB. In DC a UE is connected to one MeNB and one SeNB.

NOTE: This clause only concerns intra-E-UTRAN DC. Dual connectivity between E-UTRAN and NR is specified in TS 37.340 [76].

4.9.2 Radio Protocol Architecture

In DC, the radio protocol architecture that a particular bearer uses depends on how the bearer is setup. Three bearer types exist: MCG bearer, SCG bearer and split bearer. Those three bearer types are depicted on Figure 4.9.2-1 below. RRC is located in MeNB and SRBs are always configured as MCG bearer type and therefore only use the radio resources of the MeNB.

NOTE: DC can also be described as having at least one bearer configured to use radio resources provided by the SeNB.

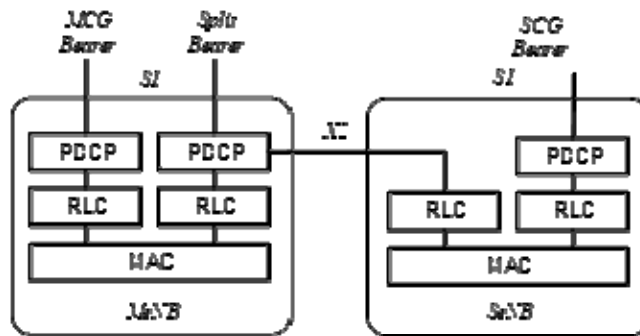

Figure 4.9.2-1: Radio Protocol Architecture for Dual Connectivity

4.9.3 Network Interfaces

4.9.3.1 E-UTRAN Control Plane for Dual Connectivity

Inter-eNB control plane signalling for DC is performed by means of X2 interface signalling. Control plane signalling towards the MME is performed by means of S1 interface signalling.

There is only one S1-MME connection per DC UE between the MeNB and the MME. Each eNB should be able to handle UEs independently, i.e. provide the PCell to some UEs while providing SCell(s) for SCG to others. Each eNB involved in DC for a certain UE controls its radio resources and is primarily responsible for allocating radio resources of its cells. Respective coordination between MeNB and SeNB is performed by means of X2 interface signalling.

Figure 4.9.3.1-1 shows C-plane connectivity of eNBs involved in DC for a certain UE: the S1-MME is terminated in MeNB and the MeNB and the SeNB are interconnected via X2-C.

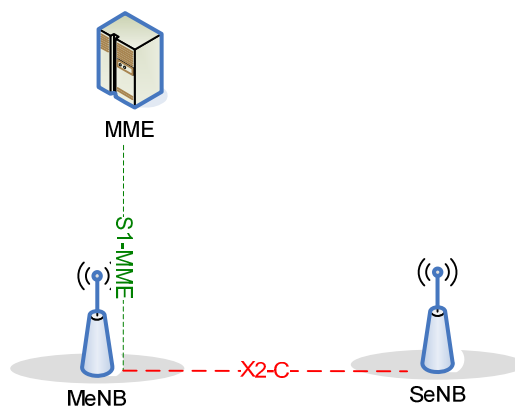

Figure 4.9.3.1-1: C-Plane connectivity of eNBs involved in Dual Connectivity

4.9.3.2 E-UTRAN User Plane for Dual Connectivity

For dual connectivity two different user plane architectures are allowed: one in which the S1-U only terminates in the MeNB and the user plane data is transferred from MeNB to SeNB using the X2-U, and a second architecture where the S1-U can terminate in the SeNB. Figure 4.9.3.2-1 shows different U-plane connectivity options of eNBs involved in DC for a certain UE.

Different bearer options can be configured with different user plane architectures. U-plane connectivity depends on the bearer option configured:

- For MCG bearers, the S1-U connection for the corresponding bearer(s) to the S-GW is terminated in the MeNB. The SeNB is not involved in the transport of user plane data for this type of bearer(s) over the Uu.

- For split bearers, the S1-U connection to the S-GW is terminated in the MeNB. PDCP data is transferred between the MeNB and the SeNB via X2-U. The SeNB and MeNB are involved in transmitting data of this bearer type over the Uu.
- For SCG bearers, the SeNB is directly connected with the S-GW via S1-U. The MeNB is not involved in the transport of user plane data for this type of bearer(s) over the Uu.

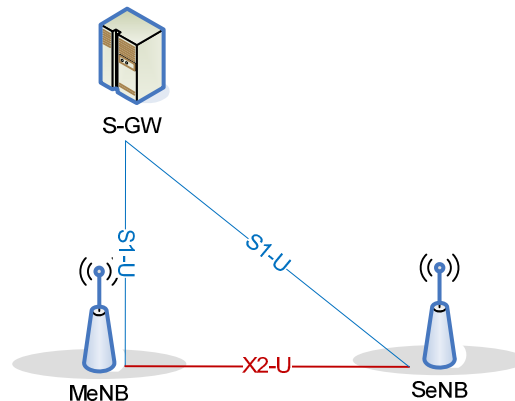

Figure 4.9.3.2-1: U-Plane connectivity of eNBs involved in Dual Connectivity

NOTE: if only MCG and split bearers are configured, there is no S1-U termination in the SeNB.

4.9.3.3 Support of HeNBs for Dual Connectivity

The following scenarios for Dual Connectivity involving HeNBs are supported as listed in Table 4.9.3.3-1.

Table 4.9.3.3-1: Support of HeNBs for Dual Connectivity

MeNB	SeNB
eNB	open access HeNB
eNB	hybrid access HeNB

Membership Verification for the hybrid access HeNB is performed between the MeNB and the MME and is based on membership status information reported by the UE and the CSG ID.

If the cell served by the SeNB is a shared hybrid cell, the UE reports the subset of the broadcasted PLMN identities passing PLMN ID check and the CSG whitelist of the UE includes an entry comprising of the concerned PLMN identity and the CSG ID broadcast by the cell served by the SeNB. The MeNB performs PLMN ID check for the PLMNs reported by the UE and selects one if multiple pass the PLMN ID check. If the cell served by the SeNB belongs to a different PLMN than the PLMN serving for the UE in the MeNB, the information provided to the MME for membership verification needs to contain the PLMN-ID of the hybrid cell served by the SeNB as well. Finally the MME verifies the CSG membership according to the received CSG ID, the selected PLMN ID and stored subscription CSG information of the UE.

In case the UE has been admitted with SCG resources configured with the split bearer option from a hybrid HeNB and a SeNB Change is performed within the coverage area of the MeNB towards another hybrid HeNB which has the same CSG ID as the first one, the MeNB may re-use the result of the membership verification performed for the first HeNB.

4.9.3.4 Support of SIPTO@LN and LIPA for Dual Connectivity

This version of the specification supports SIPTO@LN and LIPA for Dual Connectivity according to the following logical architecture:

- SIPTO@LN with co-located L-GW in the MeNB. The MeNB and the MME support the functions described in clause. 4.8.2 with the following change:

- For SCG bearer option, the MeNB sets GTP TEID and Transport Layer Address in S1 UL GTP Tunnel Endpoint IE in the SENB ADDITION REQUEST message and SENB MODIFICATION REQUEST messages as the correlation ID received from the MME and the IP address of the collocated L-GW respectively.

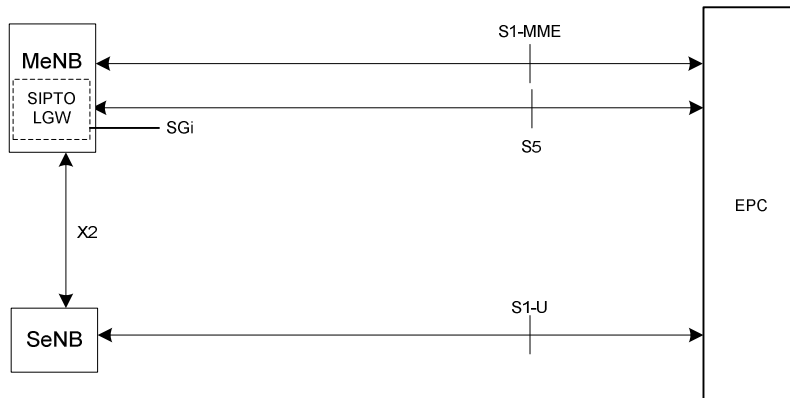

Figure 4.9.3.4-1: SIPTO@LN with co-located L-GW in MeNB – split and SCG bearer options.

- SIPTO@LN with co-located L-GW in the SeNB. For this scenario, only the SCG bearer option is supported for the SIPTO bearer. The SeNB signals its L-GW IP address using the SeNB Addition Preparation procedure, or the MeNB obtains such address via OAM. The MeNB signals the "SIPTO correlation id" to the SeNB using the SeNB Addition Preparation and SeNB Modification Preparation procedures. The functions described in clause 4.8.2 are supported with the following changes:
 - The MeNB supports the transfer of the L-GW IP address of SeNB over S1-MME to the EPC within every Uplink NAS Transport procedure;
 - The SeNB supports basic P-GW functions in the collocated L-GW such as support of the SGi interface corresponding to SIPTO@LN;
 - Additional support by the SeNB of first packet sending, buffering of subsequent packets, internal direct L-GW-eNB user path management and in sequence packet delivery to the UE;
 - The SeNB supports the necessary restricted set of S5 procedures corresponding to the support of SIPTO@LN function as specified in TS 23.401 [17];
 - The MeNB supports the notification to the EPC of the L-GW uplink TEID(s) or GRE key(s) for the SIPTO@LN bearer(s) over S5 interface within the restricted set of procedures to be forwarded over S1-MME and further used as "SIPTO correlation id" for correlation purposes between the L-GW and the SeNB;
 - The SeNB supports triggering SIPTO@LN PDN connection release by the collocated L-GW after an SeNB change or MeNB to eNB handover is performed.

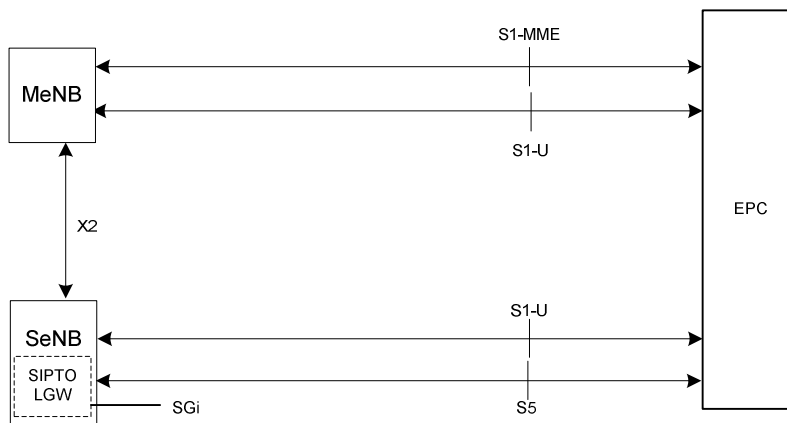

Figure 4.9.3.4-2: SIPTO@LN with co-located L-GW in SeNB

- SIPTO@LN with stand-alone gateway: the MeNB and the SeNB belong to the same LHN (i.e. they have the same LHN ID). The MeNB and the SeNB exchange their LHN ID using the X2 Setup procedure or via OAM. The MeNB initiates the SeNB Modification Preparation procedure in order to support the MME-triggered S-GW relocation without UE mobility. The MeNB and the MME support the functions described in Sec. 4.8.3.
- LIPA: the logical architectures for LIPA correspond to the logical architectures for SIPTO@LN with co-located L-GW in the SeNB.
 - Before handover, the MeNB shall initiate the SeNB Modification Preparation procedure or the UE Context Release procedure to release radio and control plane related resources associated to the LIPA bearer.

4.10 NB-IoT

NB-IoT provides access to network services using physical layer optimized for very low power consumption (e.g. full carrier bandwidth is 180 kHz, subcarrier spacing can be 3.75 kHz or 15 kHz).

As indicated in the relevant clauses in this specification, a number of E-UTRA protocol functions supported by all Rel-8 UEs are not used for NB-IoT and need not be supported by eNBs and UEs only using NB-IoT.

In this version of the specification, a number of functions including inter-RAT mobility, handover, measurement reports, public warning functions, GBR, CSG, support of HeNBs, relaying, carrier aggregation, dual connectivity, NAICS, real-time services, interference avoidance for in-device coexistence, RAN assisted WLAN interworking, sidelink communication/discovery, V2X sidelink communication, MDT, emergency call, CS fallback, self-configuration/self-optimisation, ACB, EAB, ACDC, SSAC, aerial UE Communication, EN-DC and connection to 5GC are not supported for NB-IoT. This is not further stated in the corresponding procedures.

4.11 Support for UE assistance information for local cache

UE assisted local cache is a solution to address long backhaul latency issue. The UE is allowed to transmit assistance information bit to eNB to enable the eNB to identify whether an uplink data needs to be transferred to the local cache entity, which may be co-sited with eNB or has direct connection with eNB, by operator implementation.

UE can report to the network its capability of supporting assistance information bit for local cache. If supported, the UE assisted local cache function can be activated by the eNB. After that, the UE may indicate the assistance information bit in the uplink PDCP PDU. Whether the UE indicates this assistance information bit is based on for instance the service from the application layer the UE requests that support local cache handling.

5 Physical Layer for E-UTRA

5.0 Frame structures and channels

Downlink and uplink transmissions are organized into radio frames with 10 ms duration. Three radio frame structures are supported:

- Type 1, applicable to FDD;
- Type 2, applicable to TDD;
- Type 3, applicable to LAA secondary cell operation only.

Frame structure Type 1 is illustrated in Figure 5.1-1. Each 10 ms radio frame is divided into ten equally sized sub-frames. Each sub-frame consists of two equally sized slots. Each slot can further be divided into three subslots that may have different sizes. For FDD, 10 subframes, 20 slots, or up to 60 subslots are available for downlink and uplink transmission in each 10 ms interval. Uplink and downlink transmissions are separated in the frequency domain.

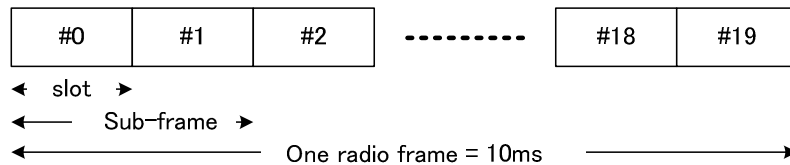

Figure 5.1-1: Frame structure type 1

Frame structure Type 2 is illustrated in Figure 5.1-2. Each 10 ms radio frame consists of two half-frames of 5 ms each. Each half-frame consists of eight slots of length 0.5 ms and three special fields: DwPTS, GP and UpPTS. The length of DwPTS and UpPTS is configurable subject to the total length of DwPTS, GP and UpPTS being equal to 1ms. Both 5ms and 10ms switch-point periodicity are supported. Subframe 1 in all configurations and subframe 6 in configuration with 5ms switch-point periodicity consist of DwPTS, GP and UpPTS. Subframe 6 in configuration with 10ms switch-point periodicity consists of DwPTS only. All other subframes consist of two equally sized slots.

For TDD, GP is reserved for downlink to uplink transition, and UpPTS is reserved in NB-IoT. Other Subframes/Fields are assigned for either downlink or uplink transmission. Uplink and downlink transmissions are separated in the time domain.

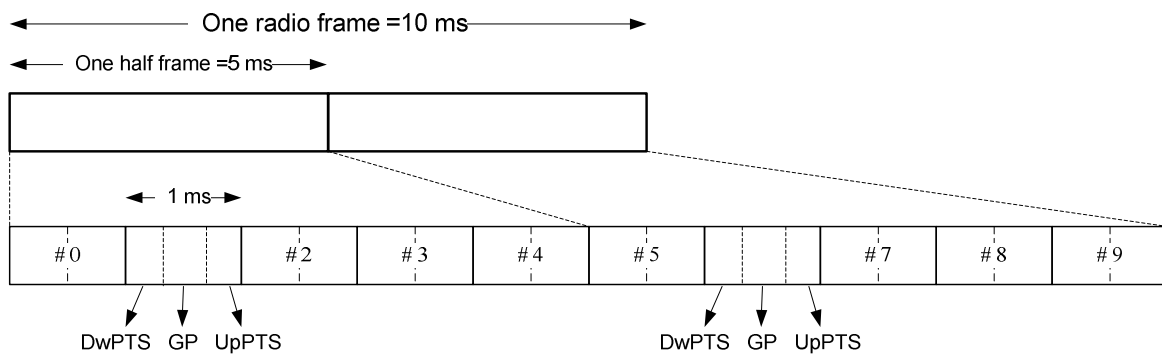

Figure 5.1-2: Frame structure type 2 (for 5ms switch-point periodicity)

Table 5.1-1: Uplink-downlink allocations.

Configuration	Switch-point periodicity	Subframe number									
		0	1	2	3	4	5	6	7	8	9
0	5 ms	D	S	U	U	U	D	S	U	U	U
1	5 ms	D	S	U	U	D	D	S	U	U	D
2	5 ms	D	S	U	D	D	D	S	U	D	D
3	10 ms	D	S	U	U	U	D	D	D	D	D
4	10 ms	D	S	U	U	D	D	D	D	D	D
5	10 ms	D	S	U	D	D	D	D	D	D	D
6	5 ms	D	S	U	U	U	D	S	U	U	D

Frame structure Type 3 is applicable to LAA secondary cell operation with normal cyclic prefix only. Each 10 ms radio frame is divided into ten equally sized sub-frames. Each sub-frame consists of two equally sized slots. The 10 subframes within a radio frame are available for downlink or uplink transmissions.

Sidelink transmissions are defined for sidelink discovery, sidelink communication and V2X sidelink communication between UEs. The sidelink transmissions use the same frame structure as the frame structure that is defined for uplink and downlink when UEs are in network coverage; however, the sidelink transmission are restricted to a sub-set of the uplink resources in time and frequency domain.

For NB-IoT, the frame structure is described in clauses 5.1.1a and 5.2.1a.

The physical channels of E-UTRA are:

Physical broadcast channel (PBCH)

- The coded BCH transport block is mapped to four subframes within a 40 ms interval;

- 40 ms timing is blindly detected, i.e. there is no explicit signalling indicating 40 ms timing;
- Each subframe is assumed to be self-decodable, i.e. the BCH can be decoded from a single reception, assuming sufficiently good channel conditions.

Physical control format indicator channel (PCFICH)

- Informs the UE and the RN about the number of OFDM symbols used for the PDCCHs;
- Transmitted in every downlink or special subframe.

Physical downlink control channel (PDCCH)

- Informs the UE and the RN about the resource allocation of PCH and DL-SCH, and Hybrid ARQ information related to DL-SCH;
- Carries the uplink scheduling grant;
- Carries the sidelink scheduling grant.

Enhanced physical downlink control channel (EPDCCH)

- Informs the UE about the resource allocation of DL-SCH, and Hybrid ARQ information related to DL-SCH;
- Carries the uplink scheduling grant;
- Carries the sidelink scheduling grant.

MTC physical downlink control channel (MPDCCH)

- Informs the UE about the resource allocation of DL-SCH, and Hybrid ARQ information related to DL-SCH;
- Carries Hybrid ARQ ACK in response to uplink transmissions.
- Carries the uplink scheduling grant;
- Carries the direct indication information.

Short physical downlink control channel (SPDCCH)

- Informs the UE about the resource allocation of DL-SCH, and Hybrid ARQ information related to DL-SCH;
- Carries the uplink scheduling grant.

Physical Hybrid ARQ Indicator Channel (PHICH)

- Carries Hybrid ARQ ACK/NAKs in response to uplink transmissions.

Physical downlink shared channel (PDSCH)

- Carries the DL-SCH and PCH.

Physical multicast channel (PMCH)

- Carries the MCH.

Physical uplink control channel (PUCCH)

- Carries Hybrid ARQ ACK/NAKs in response to downlink transmission;
- Carries Scheduling Request (SR);
- Carries CSI reports.

Short physical uplink control channel (SPUCCH)

- Carries Hybrid ARQ ACK/NAKs in response to downlink transmission;
- Carries Scheduling Request (SR).

Physical uplink shared channel (PUSCH)

- Carries the UL-SCH.

Physical random access channel (PRACH)

- Carries the random access preamble.

Relay physical downlink control channel (R-PDCCH)

- Informs the RN about the resource allocation of DL-SCH, and Hybrid ARQ information related to DL-SCH;
- Carries the uplink scheduling grant.

Physical sidelink broadcast channel (PSBCH)

- Carries system and synchronization related information, transmitted from the UE.

Physical sidelink discovery channel (PSDCH)

- Carries sidelink discovery message from the UE.

Physical sidelink control channel (PSCCH)

- Carries control from a UE for sidelink communication and V2X sidelink communication.

Physical sidelink shared channel (PSSCH)

- Carries data from a UE for sidelink communication and V2X sidelink communication.

Narrowband Physical broadcast channel (NPBCH)

- The coded BCH transport block is mapped to sixty four subframes within a 640 ms interval;
- 640 ms timing is blindly detected, i.e. there is no explicit signalling indicating 640 ms timing.

Narrowband Physical downlink shared channel (NPDSCH)

- Carries the DL-SCH and PCH for NB-IoT UEs.

Narrowband Physical downlink control channel (NPDCCH)

- Informs the NB-IoT UE about the resource allocation of PCH and DL-SCH;
- Carries the uplink scheduling grant for the NB-IoT UE;
- Carries the direct indication information.

Narrowband Physical uplink shared channel (NPUSCH)

- Carries the UL-SCH and Hybrid ARQ ACK/NAKs in response to downlink transmission for the NB-IoT UE;
- Carries SR for the NB-IoT UE.

Narrowband Physical random access channel (NPRACH)

- Carries the random access preamble for the NB-IoT UE;
- Carries SR for the NB-IoT UE.

5.1 Downlink Transmission Scheme

5.1.1 Basic transmission scheme based on OFDM

The downlink transmission scheme is based on conventional OFDM using a cyclic prefix. The OFDM sub-carrier spacing is $\Delta f = 15$ kHz. 12 consecutive sub-carriers during one slot correspond to one downlink *resource block*. In the

frequency domain, the number of resource blocks, N_{RB} , can range from $N_{RB-min} = 6$ to $N_{RB-max} = 110$ per CC or per Cell in case of CA or DC.

In addition, there are also two reduced sub-carrier spacings, $\Delta f_{low} = 7.5$ kHz and $\Delta f_{low2} = 1.25$ kHz for both MBMS-dedicated cell and MBMS/Unicast-mixed cell.

In the case of 15 kHz sub-carrier spacing there are two cyclic-prefix lengths, corresponding to seven and six OFDM symbols per slot respectively.

- Normal cyclic prefix: $T_{CP} = 160 \times T_s$ (OFDM symbol #0), $T_{CP} = 144 \times T_s$ (OFDM symbol #1 to #6)
 - Extended cyclic prefix: $T_{CP-e} = 512 \times T_s$ (OFDM symbol #0 to OFDM symbol #5)
- where $T_s = 1 / (2048 \times \Delta f)$

In case of 7.5 kHz sub-carrier spacing, there is only a single cyclic prefix length $T_{CP-low} = 1024 \times T_s$, corresponding to 3 OFDM symbols per slot.

In case of 1.25 kHz sub-carrier spacing, there is only a single cyclic prefix length $T_{CP-low2} = 6144 \times T_s$, corresponding to 1 OFDM symbol per subframe.

In case of FDD, operation with half duplex from UE point of view is supported.

5.1.1a Basic transmission scheme based on OFDM for NB-IoT

The downlink transmission scheme for NB-IoT is as described in clause 5.1.1, with the differences that in the frequency domain, there is one resource block for an NB-IoT carrier, the OFDM sub-carrier spacing $\Delta f = 15$ kHz always, and in case of FDD, only operation with half duplex from NB-IoT UE point of view is supported. There can be more than one NB-IoT carrier configured as described in clause 5.5a.

5.1.2 Physical-layer processing

The downlink physical-layer processing of transport channels consists of the following steps:

- CRC insertion: 24 bit CRC for PDSCH and NPDSCH;
- Channel coding: Turbo coding based on QPP inner interleaving with trellis termination, or Tail Biting Convolutional Coding for NPDSCH;
- Physical-layer hybrid-ARQ processing;
- Channel interleaving;
- Scrambling: transport-channel specific scrambling on DL-SCH, BCH, and PCH. Common MCH scrambling for all cells involved in a specific MBSFN transmission;
- Modulation: QPSK, 16QAM, 64QAM, and 256QAM;
- Layer mapping and pre-coding;
- Mapping to assigned resources and antenna ports.

5.1.3 Physical downlink control channels

The downlink control signalling (PDCCH) is located in the first n OFDM symbols where $n \leq 4$ and consists of:

- Transport format and resource allocation related to DL-SCH and PCH, and hybrid ARQ information related to DL-SCH;
- Transport format, resource allocation, and hybrid-ARQ information related to UL-SCH;
- Resource allocation information related to SL-SCH and PSCCH.

Transmission of control signalling from these groups is mutually independent.

Multiple physical downlink control channels are supported and a UE monitors a set of control channels.

Control channels are formed by aggregation of control channel elements, each control channel element consisting of a set of resource elements. Different code rates for the control channels are realized by aggregating different numbers of control channel elements.

QPSK modulation is used for all control channels.

Each separate control channel has its own set of x-RNTI.

There is an implicit relation between the uplink resources used for dynamically scheduled data transmission, or the DL control channel used for assignment, and the downlink ACK/NAK resource used for feedback.

The physical layer supports R-PDCCH for the relay.

The enhanced physical downlink control channel (EPDCCH) carries UE-specific signalling. It is located in UE-specifically configured physical resource blocks and consists of:

- Transport format, resource allocation, and hybrid ARQ information related to DL-SCH;
- Transport format, resource allocation, and hybrid-ARQ information related to UL-SCH;
- Resource allocation information related to SL-SCH and PSCCH.

Multiple EPDCCHs are supported and a UE monitors a set of EPDCCHs.

EPDCCHs are formed by aggregation of enhanced control channel elements, each enhanced control channel element consisting of a set of resource elements. Different code rates for EPDCCHs are realized by aggregating different numbers of enhanced control channel elements. An EPDCCH can use either localized or distributed transmission, differing in the mapping of enhanced control channel elements to the resource elements in the PRBs.

EPDCCH supports C-RNTI and SPS C-RNTI and UL Semi-Persistent Scheduling V-RNTI and SL-RNTI and SL-V-RNTI and SL Semi-Persistent Scheduling V-RNTI, and AUL C-RNTI, and SRS-TPC-RNTI. If configured, EPDCCH is applicable in the same way as PDCCH unless otherwise specified.

The MTC physical downlink control channel (MPDCCH) is used for bandwidth-reduced operation and carries common and UE-specific signalling.

Multiple MPDCCHs are supported and a UE monitors a set of MPDCCHs.

MPDCCHs are formed by aggregation of enhanced control channel elements, each enhanced control channel element consisting of a set of resource elements. Different code rates for MPDCCHs are realized by aggregating different numbers of enhanced control channel elements. An MPDCCH can use either localized or distributed transmission, differing in the mapping of enhanced control channel elements to the resource elements in the PRBs.

MPDCCH supports RA-RNTI, P-RNTI, C-RNTI, Temporary C-RNTI, SPS C-RNTI, SC-RNTI and G-RNTI.

The short physical downlink control channel (SPDCCH) carries UE-specific signalling. It is located in UE-specifically configured physical resource blocks and consists of:

- Transport format, resource allocation, and hybrid ARQ information related to DL-SCH;
- Transport format, resource allocation, and hybrid-ARQ information related to UL-SCH;

Multiple SPDCCHs are supported and a UE monitors a set of SPDCCHs.

SPDCCHs are formed by aggregation of short control channel elements (SCCEs), each short control channel element consisting of a set of resource elements. Different code rates for SPDCCHs are realized by aggregating different numbers of SCCEs. An SPDCCH can use either localized or distributed transmission, differing in the mapping of SCCEs to the resource elements in the PRBs.

SPDCCH supports C-RNTI and SPS C-RNTI. If configured, SPDCCH is applicable in the same way as PDCCH unless otherwise specified.

For NB-IoT, the narrowband physical downlink control channel (NPDCCH) is located in available symbols of configured subframes. Within a PRB pair, two control channel elements are defined, with each control channel element composed of resources within a subframe. NPDCCH supports aggregations of 1 and 2 control channel elements and

repetition. NPDCCH supports C-RNTI, Temporary C-RNTI, P-RNTI, RA-RNTI, SC-RNTI, G-RNTI, and SPS C-RNTI.

5.1.4 Downlink Reference signal and synchronization signals

The downlink cell-specific reference signals consist of known reference symbols inserted in the first and third last OFDM symbol of each slot for antenna port 0 and 1. There is one cell-specific reference signal transmitted per downlink antenna port. The number of downlink antenna ports for the transmission of cell-specific reference signals equals 1, 2, or 4.

Physical layer provides 504 unique cell identities using Synchronization signals and resynchronization signals.

The downlink MBSFN reference signals consist of known reference symbols inserted every other sub-carrier in the 3rd, 7th and 11th OFDM symbol of sub-frame in case of 15kHz sub-carrier spacing and extended cyclic prefix; every four subcarriers in the 2nd, 4th and 6th symbol of sub-frame in case of 7.5kHz sub-carrier spacing; and every six subcarriers in the single symbol of subframe in case of 1.25kHz sub-carrier spacing.

In addition to cell-specific reference signals and MBSFN reference signals, the physical layer supports UE-specific reference signals, positioning reference signals, CSI reference signals, and discovery signals.

A UE may assume presence of the discovery signals consisting of cell-specific reference signals, primary and secondary synchronization signals, configurable resynchronization signals, and configurable CSI reference signals.

5.1.4a Downlink Reference signal and synchronization signals for NB-IoT

The downlink narrowband reference signal consists of known reference symbols inserted in the last two, or the third and fourth, OFDM symbols of each slot depending on the frame structure Type, for NB-IoT antenna port 0 and 1, except invalid subframes, and subframes transmitting NPSS or NSSS, and certain subframes in frame structure Type 2. There is one narrowband reference signal transmitted per downlink NB-IoT antenna port. The number of downlink NB-IoT antenna ports equals 1 or 2.

In addition to narrowband reference signals, the physical layer supports Narrowband Positioning Reference Signals (NPRS).

Physical layer provides 504 unique cell identities using the narrowband secondary synchronization signal. It is indicated whether or not the UE may assume the cell ID is identical for NB-IoT and LTE. In case the cell IDs are identical, a UE may use the downlink cell-specific reference signals for demodulation and/or measurements when the number of NB-IoT antenna ports is the same as the number of downlink cell-specific reference signal antenna ports.

5.1.5 Downlink multi-antenna transmission

Multi-antenna transmission with up to 8 transmit antennas is supported. The maximum number of codeword is two irrespective to the number of antennas with fixed mapping between code words to layers. For slot/subslot based transmission, multi-antenna transmission with up to 4 transmit antennas is supported. The maximum number of codeword is one irrespective of the number of antennas with fixed mapping between codewords and layers.

Spatial division multiplexing (SDM) of multiple modulation symbol streams to a single UE using the same time-frequency (-code) resource, also referred to as Single-User MIMO (SU-MIMO) is supported. When a MIMO channel is solely assigned to a single UE, it is known as SU-MIMO. Spatial division multiplexing of modulation symbol streams to different UEs using the same time-frequency resource, also referred to as MU-MIMO, is also supported.

In addition, the following techniques are supported:

- Code-book-based pre-coding with a single pre-coding feedback per full system bandwidth when the system bandwidth (or subset of resource blocks) is smaller or equal to 12RB and per 5 adjacent resource blocks or the full system bandwidth (or subset of resource blocks) when the system bandwidth is larger than 12RB.
- Non-code-book-based pre-coding with or without pre-coding feedback.
- Rank adaptation with single rank feedback referring to full system bandwidth. Node B can override rank report.

- Non-precoded CSI-RS operation is supported by CLASS A eMIMO-Type with one CSI-RS resource. This operation comprises schemes where different CSI-RS ports have the same wide beam width and direction and hence generally cell wide coverage.
- Beamformed CSI-RS operation is supported by CLASS B eMIMO-Type with one or more CSI-RS resources. This operation comprises schemes where (at least at a given time/frequency) CSI-RS ports have narrow beam widths and hence not cell wide coverage, and (at least from the eNB perspective) at least some CSI-RS port-resource combinations have different beam directions.

5.1.5a Downlink multi-antenna transmission for NB-IoT

Transmit diversity, specifically space frequency block coding (SFBC), is supported if two NB-IoT antenna ports are used.

5.1.6 MBSFN transmission

MBSFN is supported for the MCH transport channel. Multiplexing of transport channels using MBSFN and non-MBSFN transmission is done on a per-sub-frame basis. Additional reference symbols, transmitted using MBSFN are transmitted within MBSFN subframes.

5.1.7 Physical layer procedure

5.1.7.1 Link adaptation

Link adaptation (AMC: adaptive modulation and coding) with various modulation schemes and channel coding rates is applied to the shared data channel. The same coding and modulation is applied to all groups of resource blocks belonging to the same L2 PDU scheduled to one user within one TTI and within a single stream.

5.1.7.2 Power Control

Downlink power control can be used.

5.1.7.3 Cell search

Cell search is the procedure by which a UE acquires time and frequency synchronization with a cell and detects the Cell ID of that cell. E-UTRA cell search supports a scalable overall transmission bandwidth corresponding to 72 sub-carriers and upwards.

E-UTRA cell search is based on following signals transmitted in the downlink: the primary and secondary synchronization signals. If a resynchronization signal is transmitted in the downlink, it can be used to re-acquire time and frequency synchronization with the cell.

The primary and secondary synchronization signals are transmitted over the centre 72 sub-carriers in the first and sixth subframe of each frame. The resynchronization signals are transmitted over 2 consecutive PRBs. The time and frequency positions of the resynchronization signal (if transmitted) are configurable.

Neighbour-cell search is based on the same downlink signals as initial cell search.

5.1.7.3a Cell search for NB-IoT

NB-IoT is based on following signals transmitted in the downlink: the primary and secondary narrowband synchronization signals. The narrowband primary synchronization sequence is transmitted over 11 sub-carriers from the first subcarrier to the eleventh subcarrier in the sixth subframe of each frame, and the narrowband secondary synchronization sequence is transmitted over 12 sub-carriers in the NB-IoT carrier in the tenth subframe for FDD and the first subframe for TDD of every other frame.

5.1.8 Physical layer measurements definition

The physical layer measurements to support mobility are classified as:

- within E-UTRAN (intra-frequency, inter-frequency);
- between E-UTRAN and GERAN/UTRAN (inter-RAT);
- between E-UTRAN and non-3GPP RAT (Inter 3GPP access system mobility).

For measurements within E-UTRAN two basic UE measurement quantities shall be supported:

- Reference signal received power (RSRP);
- Reference signal received quality (RSRQ).

In addition, the following UE measurement quantity may be supported:

- Received signal strength indicator (RSSI);
- Reference signal signal to noise and interference ratio (RS-SINR).

RSRP measurement is based on the following signals:

- Cell-specific reference signals; or
- CSI reference signals in configured discovery signals; or
- Narrowband secondary synchronization signal for NB-IoT UEs.

5.1.9 Coordinated Multi-Point transmission

For DL CoMP, multiple transmission points are coordinated in their downlink data transmission.

The UE may be configured to measure and report the CSI of a set of non-zero power CSI-RS resources.

The UE may also be configured with one or more interference measurements. Each interference measurement is associated with one CSI-interference measurement (CSI-IM) resource, which is a set of REs on which the UE measures interference.

The UE may also be configured with multiple CSI processes. Each CSI process defines the CSI measurement associated with one non-zero power CSI-RS resource and one CSI-IM resource.

5.1.10 Wake-up signal for NB-IoT

The narrowband wake-up signal is transmitted over 12 sub-carriers in the frequency domain in the NB-IoT carrier in available symbols of configured subframes. It conveys 504 unique cell identities, as per the narrowband secondary synchronization signal.

5.1.11 Wake-up signal for BL UE or UE in enhanced coverage

The wake-up signal is transmitted over 2 physical resource blocks in the frequency domain in available symbols of configured subframes. It conveys 504 unique cell identities, as per the secondary synchronization signal.

5.2 Uplink Transmission Scheme

5.2.1 Basic transmission scheme

For both FDD and TDD, the uplink transmission scheme is based on single-carrier FDMA, more specifically DFTS-OFDM. It also supports multi-cluster assignment of DFTS-OFDM.

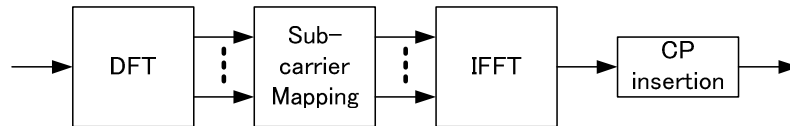

Figure 5.2.1-1: Transmitter scheme of SC-FDMA

The uplink sub-carrier spacing $\Delta f = 15$ kHz. The sub-carriers are grouped into sets of 12 consecutive sub-carriers, corresponding to the uplink resource blocks. 12 consecutive sub-carriers during one slot correspond to one uplink *resource block*. In the frequency domain, the number of resource blocks, N_{RB} , can range from $N_{RB-min} = 6$ to $N_{RB-max} = 110$ per carrier or per CC in case of CA or DC.

There are two cyclic-prefix lengths defined: Normal cyclic prefix and extended cyclic prefix corresponding to seven and six SC-FDMA symbol per slot respectively.

- Normal cyclic prefix: $T_{CP} = 160 \times T_s$ (SC-FDMA symbol #0) , $T_{CP} = 144 \times T_s$ (SC-FDMA symbol #1 to #6)
- Extended cyclic prefix: $T_{CP-e} = 512 \times T_s$ (SC-FDMA symbol #0 to SC-FDMA symbol #5)

5.2.1a Basic transmission scheme for NB-IoT

For NB-IoT uplink transmission, both single-tone transmission and multi-tone transmission are defined.

For single-tone transmission, there are two numerologies defined: 3.75 kHz and 15 kHz subcarrier spacing, based on single-carrier FDMA as described in clause 5.2.1, with the following differences: In the frequency domain, resource blocks are not defined. If the uplink sub-carrier spacing $\Delta f = 15$ kHz, there are 12 consecutive sub-carriers. If the uplink sub-carrier spacing $\Delta f = 3.75$ kHz, there are 48 consecutive sub-carriers.

Single-tone transmission with 3.75 kHz subcarrier spacing is organized into slots with 2ms duration, each of which consists of seven symbols located from beginning of the slot. The slot boundary is aligned with sub-frame boundaries of frame structure Type 1. One symbol of 3.75 kHz subcarrier spacing consists of 8448 T_s of symbol with CP length of 256 T_s . The remaining time (2304 T_s) of the slot is used as a guard period.

Multi-tone transmission is based on single-carrier FDMA as described in clause 5.2.1, with the difference that resource blocks are not defined. There are 12 consecutive uplink sub-carriers with uplink sub-carrier spacing $\Delta f = 15$ kHz. The sub-carriers can be grouped into sets of 3, 6, or 12 consecutive subcarriers.

A resource unit, schedulable for single-tone NPUSCH with UL-SCH transmission, is defined as a single 3.75 kHz sub-carrier for 32 ms or a single 15 kHz sub-carrier for 8 ms. A resource unit, schedulable for multi-tone NPUSCH with UL-SCH transmission is defined as 3 sub-carriers for 4 ms; or 6 sub-carriers for 2 ms; or 12 sub-carriers for 1 ms. A resource unit, schedulable for NPUSCH with ACK/NAK transmission, is defined as a single 3.75 kHz sub-carrier for 8 ms or a single 15 kHz sub-carrier for 2 ms.

A UL-SCH transport block can be scheduled over one or more than one resource unit in time.

5.2.2 Physical-layer processing

The uplink physical layer processing of transport channels consists of the following steps:

- CRC insertion: 24 bit CRC for PUSCH and NPUSCH;
- Channel coding: turbo coding based on QPP inner interleaving with trellis termination;
- Physical-layer hybrid-ARQ processing;
- Scrambling: UE-specific scrambling;
- Modulation: QPSK, 16QAM, 64QAM and 256 QAM (64 QAM and 256 QAM optional in UE) for full-PRB transmission of PUSCH, and $\pi/2$ -BPSK and QPSK for sub-PRB transmission of PUSCH (optional in UE); $\pi/2$ -BPSK and $\pi/4$ -QPSK in single-tone transmission of NPUSCH, and QPSK for multi-tone transmission of NPUSCH;

- Mapping to assigned resources and antennas ports.

5.2.3 Physical uplink control channel

The PUCCH/SPUCCH shall be mapped to a control channel resource in the uplink.

Depending on presence or absence of uplink timing synchronization, the uplink physical control signalling for scheduling request can differ.

In the case of time synchronization being present for the pTAG, the outband control signalling consists of:

- CSI;
- ACK/NAK;
- Scheduling Request (SR).

The CSI informs the scheduler about the current channel conditions as seen by the UE. If MIMO transmission is used, the CSI includes necessary MIMO-related feedback.

The HARQ feedback in response to downlink data transmission consists of a single ACK/NAK bit per transport block in case of non-bundling configuration.

PUCCH/SPUCCH resources for SR, CSI reporting and possibly HARQ feedback are assigned and can be revoked through RRC signalling. An SR is not necessarily assigned to UEs acquiring synchronization through the RACH (i.e. synchronised UEs may or may not have a dedicated SR channel). PUCCH/SPUCCH resources for SR, CSI and HARQ feedback are lost when the UE is no longer synchronized.

PUCCH/SPUCCH is transmitted on PCell, PUCCH SCell (if such is configured in CA) and on PSCell (in DC).

The physical layer supports simultaneous transmission of PUCCH and subframe PUSCH, or of SPUCCH and (sub)slot-PUSCH. In case of SPUCCH and (sub)slot-PUSCH transmission, both the shared channel and the associated control channel shall be of the same transmission duration (slot or subslot).

5.2.3a Uplink control information for NB-IoT

The uplink control information consists of:

- ACK/NAK corresponding to NPDSCH;
- Scheduling Request (SR).

ACK/NAK corresponding to NPDSCH is transmitted with single-tone transmission on NPUSCH, with frequency resource and time resource indicated by downlink grant.

SR may be transmitted with or without Hybrid ARQ ACK/NAKs corresponding to NPDSCH. Resources for SR are assigned and can be revoked through RRC signaling. An SR is not necessarily assigned to NB-IoT UEs acquiring synchronisation through the RACH (i.e. synchronised NB-IoT UEs may or may not have SR resources configured). Resources for SR are lost when the NB-IoT UE is no longer synchronised.

5.2.4 Uplink Reference signal

For PUSCH demodulation, uplink demodulation reference signals are transmitted in the 4-th block of the slot in normal CP. In case of subslot-PUSCH, the presence and position of demodulation reference signals are indicated to the UE. Uplink demodulation reference signals are also transmitted for PUCCH demodulation. The uplink demodulation reference signals sequence length equals the size (number of sub-carriers) of the assigned resource.

The uplink reference signals are based on sequences having constant amplitude and zero autocorrelation.

For full-PRB transmission, multiple reference signals can be created:

- Based on different base sequences;
- Different shifts of the same sequence;

- Different orthogonal sequences (OCC) on DM RS.

For sub-PRB transmission of PUSCH, multiple reference signals can be created:

- Based on different base sequences;
- Different cyclic shifts of the same sequence;
- A common Gold sequence.

In addition to demodulation reference signals, the physical layer supports sounding reference signals (SRS).

5.2.4a Uplink Reference signal for NB-IoT

For single-tone NPUSCH with UL-SCH demodulation, uplink demodulation reference signals are transmitted in the 4-th block of the slot for 15 kHz subcarrier spacing, and in the 5-th block of the slot for 3.75 kHz subcarrier spacing. For multi-tone NPUSCH with UL-SCH demodulation, uplink demodulation reference signals are transmitted in the 4-th block of the slot. The uplink demodulation reference signals sequence length is 16 for single-tone NPUSCH with UL-SCH transmission, and equals the size (number of sub-carriers) of the assigned resource for multi-tone transmission.

For single-tone NPUSCH with UL-SCH transmission, multiple narrow band reference signals can be created:

- Based on different base sequences;
- A common Gold sequence.

For multi-tone NPUSCH with UL-SCH transmission, multiple narrow band reference signals are created:

- Based on different base sequences;
- Different cyclic shifts of the same sequence.

For NPUSCH with ACK/NAK demodulation, uplink demodulation reference signals are transmitted in the 3-rd, 4-th and 5-th block of the slot for 15 kHz subcarrier spacing, and in the 1-st, 2-nd and 3-rd block of the slot for 3.75 kHz subcarrier spacing. Multiple narrow band reference signals can be created:

- Based on different base sequences;
- A common Gold sequence;
- Different orthogonal sequences (OCC).

5.2.5 Random access preamble

The physical layer random access burst consists of a cyclic prefix, a preamble, and a guard time during which nothing is transmitted.

The random access preambles are generated from Zadoff-Chu sequences with zero correlation zone, ZC-ZCZ, generated from one or several root Zadoff-Chu sequences.

5.2.5a Random access preamble for NB-IoT

The physical layer random access transmission uses a 3.75 kHz or 1.25 kHz sub-carrier spacing and consists of symbol groups with frequency hopping between symbol groups. Each symbol group has a cyclic prefix and a preamble. Symbol groups with 3.75 kHz sub-carrier spacing hop by one or six sub-carriers in frequency, and symbol groups with 1.25 kHz subcarrier spacing hop by one, three, or eighteen sub-carriers in frequency. Repetitions of groups of symbol groups hop by a pseudo-random number of sub-carriers in frequency. There are two in FDD, and four in TDD, possible cyclic prefix lengths for the random access transmission symbol groups, suitable for different maximum cell sizes.

5.2.6 Uplink multi-antenna transmission

The antenna configuration for uplink supports both SU-MIMO and MU-MIMO.

Closed loop and open loop types of adaptive antenna selection transmit diversity are supported for both FDD and TDD by physical layer.

The physical layer supports transmit diversity of some control formats.

5.2.7 Physical channel procedure

5.2.7.1 Link adaptation

Uplink link adaptation is used in order to guarantee the required minimum transmission performance of each UE such as the user data rate, packet error rate, and latency, while maximizing the system throughput.

Three types of link adaptation are performed according to the channel conditions, the UE capability such as the maximum transmission power and maximum transmission bandwidth etc., and the required QoS such as the data rate, latency, and packet error rate etc. Three link adaptation methods are as follows.

- Adaptive transmission bandwidth;
- Transmission power control;
- Adaptive modulation and channel coding rate.

5.2.7.2 Uplink Power control

Intra-cell power control: the power spectral density of the uplink transmissions can be influenced by the eNB. For DC, two types of power control modes are defined, mode 1 and mode 2 as specified in TS 36.213 [6]. A UE capable of DC supports at least power control mode 1 and the UE may additionally support power control mode 2. In both modes, the UE is configured with a minimum guaranteed power for each CG, as a ratio of the configured maximum UE output power P_{max} (see TS 36.101 [52]). In power control mode 1, UE allocates up to the minimum guaranteed power to each CG and any remaining power is shared across MCG and SCG on a per transmission basis according to a priority order based on UCI type. In power control mode 2, the UE reserves the minimum guaranteed power to each CG and any remaining power is first made available to the CG where transmission starts the earliest in time.

5.2.7.3 Uplink timing control

The timing advance is derived from the UL received timing and sent by the eNB to the UE which the UE uses to advance/delay its timings of transmissions to the eNB so as to compensate for propagation delay and thus time align the transmissions from different UEs with the receiver window of the eNB.

The timing advance command for each TAG is on a per need basis with a granularity in the step size of $0.52 \mu\text{s}$ ($16 \times T_s$).

5.2.8 Coordinated Multi-Point reception

For UL CoMP, multiple reception points are coordinated in their uplink data reception.

The UE may be configured with UE-specific parameters of PUSCH DMRS sequence and cyclic shift hopping, PUCCH sequence, and PUCCH region for hybrid-ARQ feedback. These UE-specific parameters can be configured independently of the physical cell identity of the UE's serving cell.

5.3 Transport Channels

5.3.0 Transport channel types

The physical layer offers information transfer services to MAC and higher layers. The physical layer transport services are described by *how* and with what characteristics data are transferred over the radio interface. An adequate term for this is "Transport Channel".

NOTE 1: This should be clearly separated from the classification of *what* is transported, which relates to the concept of logical channels at MAC sublayer.

Downlink transport channel types are:

1. **Broadcast Channel (BCH)** characterised by:

- fixed, pre-defined transport format;
- requirement to be broadcast in the entire coverage area of the cell.

2. **Downlink Shared Channel (DL-SCH)** characterised by:

- support for HARQ;
- support for dynamic link adaptation by varying the modulation, coding and transmit power;
- possibility to be broadcast in the entire cell;
- possibility to use beamforming;
- support for both dynamic and semi-static resource allocation;
- support for UE discontinuous reception (DRX) to enable UE power saving;

NOTE 2: the possibility to use slow power control depends on the physical layer.

3. **Paging Channel (PCH)** characterised by:

- support for UE discontinuous reception (DRX) to enable UE power saving (DRX cycle is indicated by the network to the UE);
- requirement to be broadcast in the entire coverage area of the cell;
- mapped to physical resources which can be used dynamically also for traffic/other control channels.

4. **Multicast Channel (MCH)** characterised by:

- requirement to be broadcast in the entire coverage area of the cell;
- support for MBSFN combining of MBMS transmission on multiple cells;
- support for semi-static resource allocation e.g. with a time frame of a long cyclic prefix.

Uplink transport channel types are:

1. **Uplink Shared Channel (UL-SCH)** characterised by:

- possibility to use beamforming; (likely no impact on specifications)
- support for dynamic link adaptation by varying the transmit power and potentially modulation and coding;
- support for HARQ;
- support for both dynamic and semi-static resource allocation.

NOTE 3: the possibility to use uplink synchronisation and timing advance depend on the physical layer.

2. **Random Access Channel(s) (RACH)** characterised by:

- limited control information;
- collision risk.

NOTE 4: The possibility to use open loop power control depends on the physical layer solution.

Sidelink transport channel types are:

1. **Sidelink broadcast channel (SL-BCH)** characterised by:

- pre-defined transport format.

2. **Sidelink discovery channel (SL-DCH)** characterised by:

- fixed size, pre-defined format periodic broadcast transmission;
- support for both UE autonomous resource selection and scheduled resource allocation by eNB;
- collision risk due to support of UE autonomous resource selection; no collision when UE is allocated dedicated resources by the eNB;
- support for HARQ combining, but no support for HARQ feedback.

NOTE 5: the possibility to use uplink synchronisation and timing advance depends on the physical layer.

3. **Sidelink shared channel (SL-SCH)** characterised by:

- support for broadcast transmission;
- support for both UE autonomous resource selection and scheduled resource allocation by eNB;
- collision risk due to support of UE autonomous resource selection; no collision when UE is allocated dedicated resources by the eNB;
- support for HARQ combining, but no support for HARQ feedback;
- support for dynamic link adaptation by varying the transmit power, modulation and coding.

NOTE 6: the possibility to use uplink synchronisation and timing advance depend on the physical layer.

5.3.1 Mapping between transport channels and physical channels

The figures below depict the mapping between transport and physical channels:

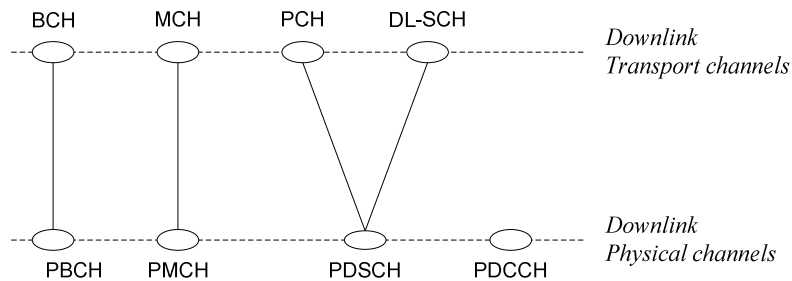

Figure 5.3.1-1: Mapping between downlink transport channels and downlink physical channels

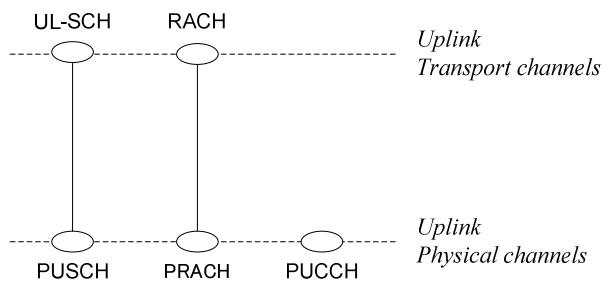

Figure 5.3.1-2: Mapping between uplink transport channels and uplink physical channels

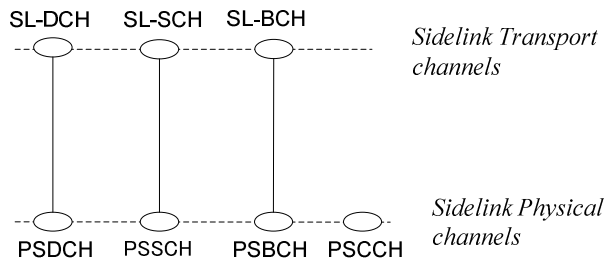

Figure 5.3.1-3: Mapping between sidelink transport channels and sidelink physical channels

5.3.1a Mapping between transport channels and narrowband physical channels

The figures below depict the mapping between transport and narrowband physical channels:

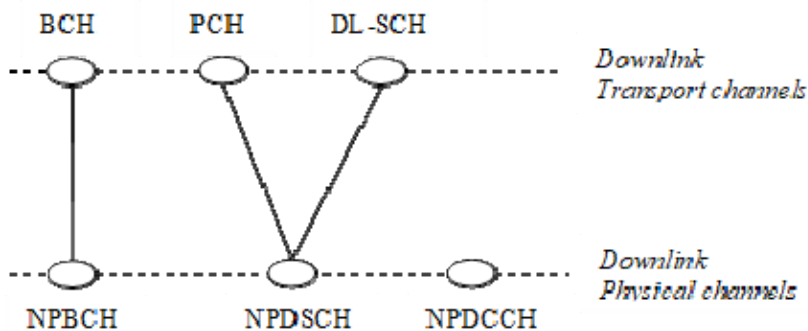

Figure 5.3.1a-1: Mapping between downlink transport channels and downlink narrowband physical channels

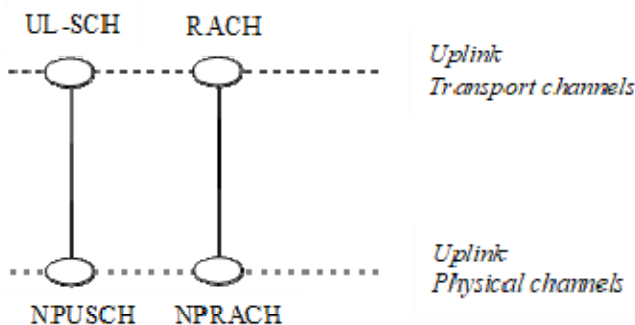

Figure 5.3.1a-2: Mapping between uplink transport channels and uplink narrowband physical channels

5.4 E-UTRA physical layer model

The E-UTRAN physical layer model is captured in TS 36.302 [9].

5.4.1 Void

5.4.2 Void

5.5 Carrier Aggregation

5.5.0 General

In Carrier Aggregation (CA), two or more Component Carriers (CCs) are aggregated in order to support wider transmission bandwidths up to 640MHz. A UE may simultaneously receive or transmit on one or multiple CCs depending on its capabilities:

- A UE with single timing advance capability for CA can simultaneously receive and/or transmit on multiple CCs corresponding to multiple serving cells sharing the same timing advance (multiple serving cells grouped in one TAG);
- A UE with multiple timing advance capability for CA can simultaneously receive and/or transmit on multiple CCs corresponding to multiple serving cells with different timing advances (multiple serving cells grouped in multiple TAGs). E-UTRAN ensures that each TAG contains at least one serving cell;
- A non-CA capable UE can receive on a single CC and transmit on a single CC corresponding to one serving cell only (one serving cell in one TAG).

CA is supported for both contiguous and non-contiguous CCs with each CC limited to a maximum of 110 Resource Blocks in the frequency domain using the Rel-8/9 numerology.

CA is supported both between same and different duplex CCs.

It is possible to configure a UE to aggregate a different number of CCs originating from the same eNB and of possibly different bandwidths in the UL and the DL:

- The number of DL CCs that can be configured depends on the DL aggregation capability of the UE;
- The number of UL CCs that can be configured depends on the UL aggregation capability of the UE;
- It is not possible to configure a UE with more UL CCs than DL CCs;
- In typical TDD deployments, the number of CCs and the bandwidth of each CC in UL and DL is the same.
- The number of TAGs that can be configured depends on the TAG capability of the UE.

CCs originating from the same eNB need not to provide the same coverage.

CCs shall be LTE Rel-8/9 compatible. Nevertheless, existing mechanisms (e.g. barring) may be used to avoid Rel-8/9 UEs to camp on a CC.

The spacing between centre frequencies of contiguously aggregated CCs shall be a multiple of 300 kHz. This is in order to be compatible with the 100 kHz frequency raster of Rel-8/9 and at the same time preserve orthogonality of the subcarriers with 15 kHz spacing. Depending on the aggregation scenario, the $n \times 300$ kHz spacing can be facilitated by insertion of a low number of unused subcarriers between contiguous CCs.

For TDD CA, the downlink/uplink configuration is identical across component carriers in the same band and may be the same or different across component carriers in different bands.

5.5.1 SRS switching between component carriers

A UE supporting CA can be capable of aggregating more downlink CCs than uplink CCs, and hence a TDD CC may operate in downlink without PUCCH/PUSCH. A UE may be configured with SRS switching between CCs so that SRS can be transmitted on a TDD CC configured without PUCCH/PUSCH. When such SRS needs to be transmitted on a TDD CC without PUCCH/PUSCH, the UE may transmit SRS on the TDD CC or skip the SRS transmission on the TDD CC depending on the priority order for the operation of SRS switching between CCs.

5.5a Multi-carrier operation for NB-IoT

For NB-IoT, multi-carrier operation is supported.

The UE in RRC_CONNECTED can be configured, via UE-specific RRC signaling, to a non-anchor carrier, for all unicast transmissions. The UE in RRC_IDLE, based on broadcast/multicast signaling, can use a non-anchor carrier for SC-PTM reception. The UE in RRC_IDLE can, based on broadcast signaling, use a non-anchor carrier for paging reception. The UE in RRC_IDLE or RRC_CONNECTED, based on broadcast signaling, can use a non-anchor carrier for random access. If the non-anchor carrier is not configured for the UE, all transmissions occur on the anchor carrier. The valid anchor and non-anchor carrier combinations are provided in Table 5.5a-1 for FDD and Table 5.5a-2 for TDD.

Table 5.5a-1: Anchor and non-anchor carrier deployment combinations in FDD

	<i>Anchor Carrier</i>			
		<i>In-band</i>	<i>Guard-band</i>	<i>Standalone</i>
Non-Anchor Carrier	In-band	Valid (Note 1)	Valid (Note 1)	Valid (Note 2, Note 3)
	Guard-band	Valid (Note 1)	Valid (Note 1)	Valid (Note 2, Note 3)
	Standalone	Valid (Note 2, Note 3)	Valid (Note 2, Note 3)	Valid (Note 2)

Table 5.5a-2: Anchor and non-anchor carrier deployment combinations in TDD

	<i>Anchor Carrier</i>			
		<i>In-band</i>	<i>Guard-band</i>	<i>Standalone</i>
Non-Anchor Carrier	In-band	Valid (Note 1)	Valid (Note 1)	Invalid
	Guard-band	Valid (Note 1)	Valid (Note 1)	Invalid
	Standalone	Invalid	Invalid	Valid (Note 2)

NOTE 1: Both carriers associated with the same LTE cell.

NOTE 2: Total frequency span to not exceed 20MHz and both anchor and non-anchor carriers synchronised.

NOTE 3: Not applicable to SC-PTM reception.

5.6 Sidelink

5.6.0 General

Sidelink comprises sidelink discovery, sidelink communication and V2X sidelink communication between UEs. Sidelink uses uplink resources and physical channel structure similar to uplink transmissions. However, some changes, noted below, are made to the physical channels.

5.6.1 Basic transmission scheme

Sidelink transmission uses the same basic transmission scheme as the UL transmission scheme. However, sidelink is limited to single cluster transmissions for all the sidelink physical channels. Further, sidelink uses a 1 symbol gap at the

end of each sidelink sub-frame. For V2X sidelink communication, PSCCH and PSSCH are transmitted in the same subframe.

5.6.2 Physical-layer processing

The sidelink physical layer processing of transport channels differs from UL transmission in the following steps:

- Scrambling: for PSDCH and PSCCH, the scrambling is not UE-specific;
- Modulation: 256 QAM is not supported for sidelink. 64 QAM is only supported for V2X sidelink communication.

5.6.3 Physical Sidelink control channel

PSCCH is mapped to the sidelink control resources.

PSCCH indicates resource and other transmission parameters used by a UE for PSSCH.

5.6.4 Sidelink reference signals

For PSDCH, PSCCH and PSSCH demodulation, reference signals similar to uplink demodulation reference signals are transmitted in the 4-th symbol of the slot in normal CP and in the 3rd symbol of the slot in extended cyclic prefix. The sidelink demodulation reference signals sequence length equals the size (number of sub-carriers) of the assigned resource. For V2X sidelink communication, reference signals are transmitted in 3rd and 6th symbols of the first slot and 2nd and 5th symbols of the second slot in normal CP.

For PSDCH and PSCCH, reference signals are created based on a fixed base sequence, cyclic shift and orthogonal cover code. For V2X sidelink communication, cyclic shift for PSCCH is randomly selected in each transmission.

5.6.5 Physical channel procedure

5.6.5.1 Sidelink power control

For in-coverage operation, the power spectral density of the sidelink transmissions can be influenced by the eNB.

5.6.6 Physical layer measurements definition

For measurement on the sidelink, the following basic UE measurement quantities are supported:

- Sidelink reference signal received power (S-RSRP).
- Sidelink discovery reference signal received power (SD-RSRP).
- PSSCH reference signal received power (PSSCH-RSRP).
- Sidelink reference signal strength indicator (S-RSSI).

5.7 Licensed-Assisted Access

5.7.0 General

Carrier aggregation with at least one SCell operating in the unlicensed spectrum is referred to as Licensed-Assisted Access (LAA). In LAA, the configured set of serving cells for a UE therefore always includes at least one SCell operating in the unlicensed spectrum according to Frame structure Type 3, also called LAA SCell. Unless otherwise specified, LAA SCells act as regular SCells.

LAA eNB and UE apply Listen-Before-Talk (LBT) before performing a transmission on LAA SCell. When LBT is applied, the transmitter listens to/senses the channel to determine whether the channel is free or busy. If the channel is determined to be free, the transmitter may perform the transmission; otherwise, it does not perform the transmission. If

an LAA eNB uses channel access signals of other technologies for the purpose of LAA channel access, it shall continue to meet the LAA maximum energy detection threshold requirement.

The combined time of transmissions compliant with the channel access procedure described in clause 4.1.2 of TS 37.213 [90] by an eNB should not exceed 50 ms in any contiguous 1 second period on an LAA SCell.

Which LBT type (i.e. type 1 or type 2 uplink channel access) the UE applies is signalled via uplink grant for uplink PUSCH transmission on LAA SCells, except for Autonomous Uplink (AUL) transmissions.

For type 1 uplink channel access on AUL, E-UTRAN signals the Channel Access Priority Class for each logical channel and UE shall select the lowest Channel Access Priority Class (i.e. with a higher number in the Table 5.7.1-1) of the logical channel(s) with MAC SDU multiplexed into the MAC PDU. The MAC CEs except padding BSR use the highest Channel Access Priority Class (i.e. the lowest number in the Table 5.7.1-1).

For type 2 uplink channel access on AUL, the UE may select logical channels corresponding to any Channel Access Priority Class for UL transmission in the subframes signalled by E-UTRAN in common downlink control signalling.

For uplink LAA operation, the eNB shall not schedule the UE more subframes than the minimum necessary to transmit all the traffic corresponding to the selected Channel Access Priority Class or lower (i.e. with a lower number in the Table 5.7.1-1), than the:

- Channel Access Priority Class signaled in UL grant based on the latest BSR and received uplink traffic from the UE if type 1 uplink channel access procedure (see clause 4.2.1.1 of TS 37.213 [90]) is signalled to the UE;
- Channel Access Priority Class used by the eNB based on the downlink traffic, the latest BSR and received UL traffic from the UE if type 2 uplink channel access procedure (see clause 4.2.1.2 of TS 37.213 [90]) is signalled to the UE.

5.7.1 Channel Access Priority Classes

Four Channel Access Priority Classes (CAPC) are defined in TS 37.213 [90] which can be used when performing uplink and downlink transmissions in LAA carriers. Table 5.7.1-1 shows which Channel Access Priority Class should be used by traffic belonging to the different standardized QCIs. A non-standardized QCI (i.e. Operator specific QCI) should use suitable Channel Access Priority Class based on the below table, i.e. the Channel Access Priority Class used for a non-standardized QCI should be the Channel Access Priority Class of the standardized QCIs which best matches the traffic class of the non-standardized QCI.

For uplink, the eNB selects the Channel Access Priority Class by taking into account the lowest priority QCI in a Logical Channel Group.

Table 5.7.1-1: Mapping between Channel Access Priority Classes and QCI

Channel Access Priority Class (P)	QCI
1	1, 3, 5, 65, 66, 67, 69, 70, 79, 80, 82, 83, 84, 85
2	2, 7
3	4, 6, 8, 9
4	-

5.7.2 Multiplexing of data

Four Channel Access Priority Classes are defined in TS 37.213 [90]. If a DL transmission burst with PDSCH is transmitted, for which channel access has been obtained using Channel Access Priority Class P (1..4), E-UTRAN shall ensure the following where a DL transmission burst refers to the continuous transmission by E-UTRAN after a successful LBT:

- the transmission duration of the DL transmission burst shall not exceed the minimum duration needed to transmit all available buffered traffic corresponding to Channel Access Priority Class(es) $\leq P$;
- the transmission duration of the DL transmission burst shall not exceed the Maximum Channel Occupancy Time ($T_{mco,t,p}$ as defined in Table 4.1.1-1 of TS 37.213 [90]) for Channel Access Priority Class P ;

- additional traffic corresponding to Channel Access Priority Class(s) $> P$ may only be included in the DL transmission burst once no more data corresponding to Channel Access Priority Class $\leq P$ is available for transmission. In such cases, E-UTRAN should maximise occupancy of the remaining transmission resources in the DL transmission burst with this additional traffic.

For uplink PUSCH transmission, there is no additional restriction at the UE (other than the multiplexing rules defined in clause 5.4.3 of TS 36.321 [13]) on the type of the traffic that can be carried in the scheduled subframes.

5.8 Short Processing Time

If Short Processing Time (SPT) for 1 ms TTI length is configured, the minimum timing from UL grant transmission to UL PUSCH transmission, and the timing from DL PDSCH transmission to HARQ feedback transmission is 3 ms.

5.9 Short Transmission Time Interval

Short TTI provides support for TTI length shorter than 1 ms DL-SCH and UL-SCH. To support the short TTI, the associated control channels, SPDCCH and SPUCCH, are also transmitted with duration shorter than 1 ms.

Over the physical layer, DL and UL transmissions use either slots or subslots when short TTI is configured. A subslot is defined to be of either 2 OFDM/SC-FDMA symbol or 3 OFDM/SC-FDMA symbol duration.

Table 5.9-1: Slot/subslot DL and UL transmission availability for different frame structure types

Frame Structure Type	Supported DL and UL transmission
1	slot, subslot
2	slot
3	-

In case of Frame structure Type 1 the DL and UL transmission duration does not have to be the same. Table 5.9-2 shows the allowed DL and UL combinations.

Table 5.9-2: DL and UL combinations for Frame Structure Type 1

DL	UL
Slot	Slot
Subslot	Slot
Subslot	Subslot

When short TTI is configured, extended cyclic prefix is not supported.

6 Layer 2

6.0 Overview

Layer 2 is split into the following sublayers: Medium Access Control (MAC), Radio Link Control (RLC) and Packet Data Convergence Protocol (PDCP).

This clause gives a high level description of the Layer 2 sub-layers in terms of services and functions. The three figures below depict the PDCP/RLC/MAC architecture for downlink, uplink and Sidelink, where:

- Service Access Points (SAP) for peer-to-peer communication are marked with circles at the interface between sublayers. The SAP between the physical layer and the MAC sublayer provides the transport channels. The SAPs between the MAC sublayer and the RLC sublayer provide the logical channels.
- The multiplexing of several logical channels (i.e. radio bearers) on the same transport channel (i.e. transport block) is performed by the MAC sublayer;

- In both uplink and downlink, when neither CA nor DC are configured, only one transport block is generated per TTI in the absence of spatial multiplexing;
- In Sidelink, only one transport block is generated per TTI for each carrier.

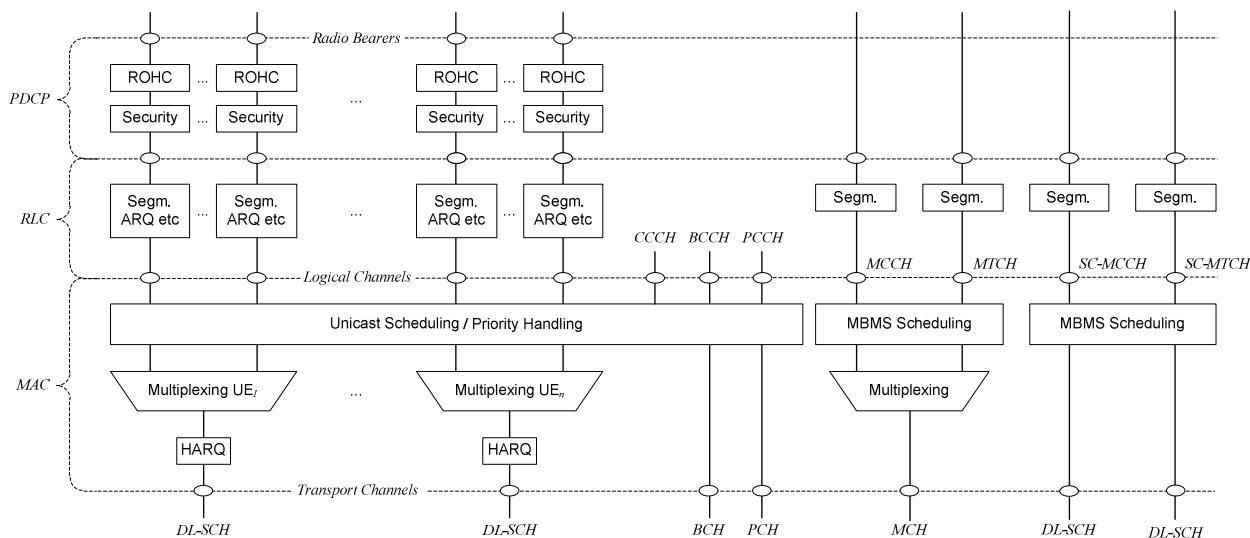

Figure 6-1: Layer 2 Structure for DL

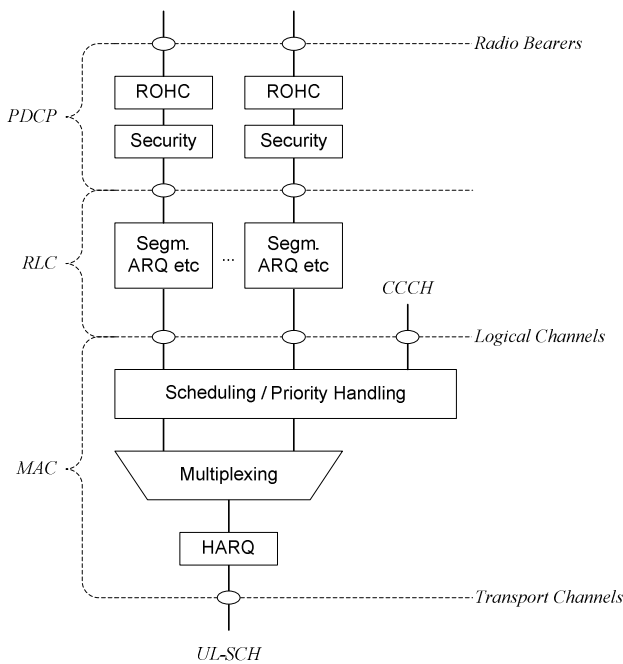

Figure 6-2: Layer 2 Structure for UL

NOTE 1: The eNB may not be able to guarantee that a L2 buffer overflow will never occur. If such overflow occurs, UE may discard packets in the L2 buffer.

NOTE 2: For a NB-IoT UE that only supports Control Plane CIoT EPS optimizations, as defined in TS 24.301 [20], PDCP is bypassed. For a NB-IoT UE that supports Control Plane CIoT EPS optimization and S1-U data transfer or User Plane CIoT EPS optimization, as defined in TS 24.301 [20], PDCP is also bypassed (i.e. not used) until AS security is activated.

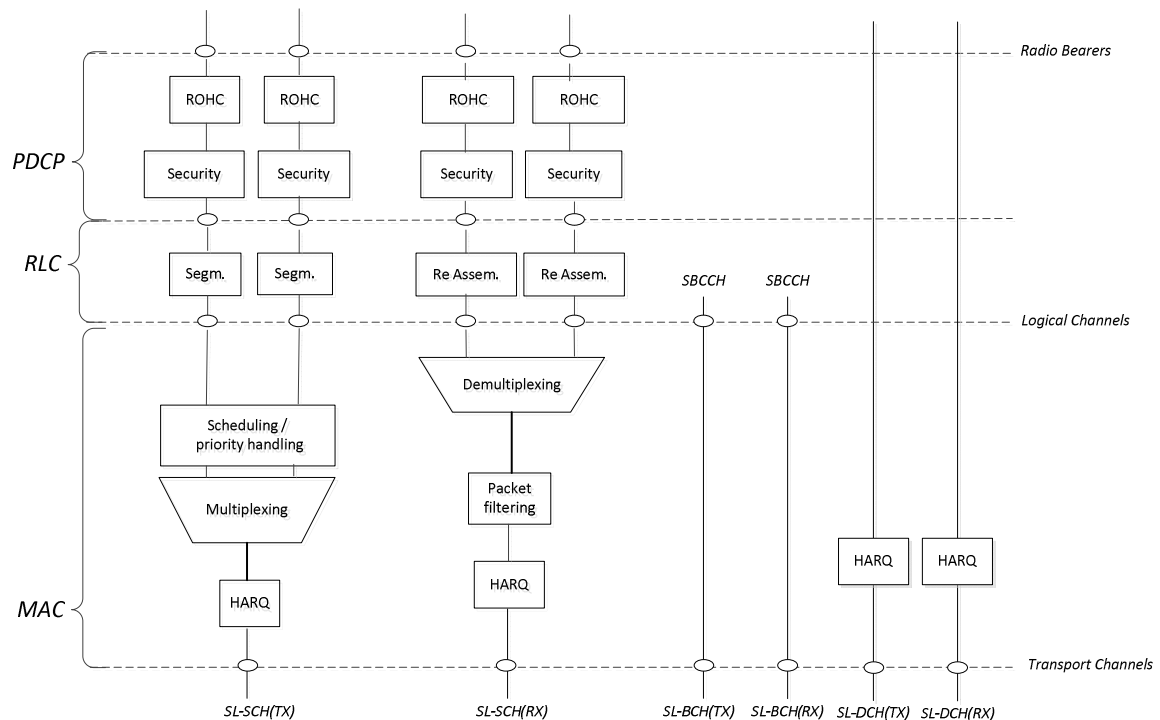

Figure 6-3: Layer 2 Structure for Sidelink

6.1 MAC Sublayer

6.1.0 General

This clause provides an overview on services and functions provided by the MAC sublayer.

6.1.1 Services and Functions

The main services and functions of the MAC sublayer include:

- Mapping between logical channels and transport channels;
- Multiplexing/demultiplexing of MAC SDUs belonging to one or different logical channels into/from transport blocks (TB) delivered to/from the physical layer on transport channels;
- Scheduling information reporting;
- Error correction through HARQ;
- Priority handling between logical channels of one UE;
- Priority handling between UEs by means of dynamic scheduling;
- MBMS service identification;
- Transport format selection;
- Padding.

The sidelink specific services and functions of the MAC sublayer include:

- Radio resource selection;
- Packet filtering for sidelink communication and V2X sidelink communication.
- Transmission carrier selection for V2X sidelink communication.

6.1.2 Logical Channels

6.1.2.0 General

Different kinds of data transfer services as offered by MAC. Each logical channel type is defined by what type of information is transferred.

A general classification of logical channels is into two groups:

- Control Channels (for the transfer of control plane information);
- Traffic Channels (for the transfer of user plane information).

There is one MAC entity per CG. MAC generally consists of several function blocks (transmission scheduling functions, per UE functions, MBMS functions, MAC control functions, transport block generation...). Transparent Mode is only applied to BCCH, BR-BCCH, PCCH and SBCCH.

NOTE: For a NB-IoT UE that only uses Control Plane CIoT EPS optimizations, as defined in TS 24.301 [20], there is only one dedicated logical channel per UE.

6.1.2.1 Control Channels

Control channels are used for transfer of control plane information only. The control channels offered by MAC are:

- **Broadcast Control Channel (BCCH)**
A downlink channel for broadcasting system control information.
- **Bandwidth Reduced Broadcast Control Channel (BR-BCCH)**
A downlink channel for broadcasting system control information.
- **Paging Control Channel (PCCH)**
A downlink channel that transfers paging information and system information change notifications. This channel is used for paging when the network does not know the location cell of the UE.
- **Common Control Channel (CCCH)**
Channel for transmitting control information between UEs and network. This channel is used for UEs having no RRC connection with the network.
- **Multicast Control Channel (MCCH)**
A point-to-multipoint downlink channel used for transmitting MBMS control information from the network to the UE, for one or several MTCHs. This channel is only used by UEs that receive or are interested to receive MBMS.
- **Single-Cell Multicast Control Channel (SC-MCCH)**
A point-to-multipoint downlink channel used for transmitting MBMS control information from the network to the UE, for one or several SC-MTCHs. This channel is only used by UEs that receive or are interested to receive MBMS using SC-PTM.
- **Dedicated Control Channel (DCCH)**
A point-to-point bi-directional channel that transmits dedicated control information between a UE and the network. Used by UEs having an RRC connection.
- **Sidelink Broadcast Control Channel (SBCCH)**
A sidelink channel for broadcasting sidelink system information from one UE to other UE(s).

6.1.2.2 Traffic Channels

Traffic channels are used for the transfer of user plane information only. The traffic channels offered by MAC are:

- **Dedicated Traffic Channel (DTCH)**

A Dedicated Traffic Channel (DTCH) is a point-to-point channel, dedicated to one UE, for the transfer of user information. A DTCH can exist in both uplink and downlink. DTCH is not supported for a NB-IoT UE that only uses Control Plane CIoT EPS optimizations, as defined in TS 24.301 [20].

- **Multicast Traffic Channel (MTCH)**

A point-to-multipoint downlink channel for transmitting traffic data from the network to the UE. This channel is only used by UEs that receive MBMS.

- **Single-Cell Multicast Traffic Channel (SC-MTCH)**

A point-to-multipoint downlink channel for transmitting traffic data from the network to the UE using SC-PTM transmission. This channel is only used by UEs that receive MBMS using SC-PTM.

- **Sidelink Traffic Channel (STCH)**

A Sidelink Traffic Channel (STCH) is a point-to-multipoint channel, for transfer of user information from one UE to other UE(s). This channel is used only by sidelink communication capable UEs and V2X sidelink communication capable UEs. Point-to-point communication between two sidelink communication capable UEs is also realized with an STCH.

6.1.3 Mapping between logical channels and transport channels

6.1.3.1 Mapping in Uplink

The figure below depicts the mapping between uplink logical channels and uplink transport channels:

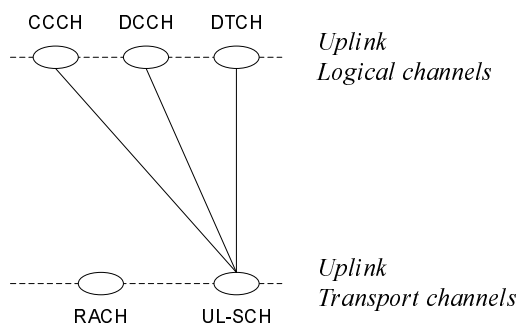

Figure 6.1.3.1-1: Mapping between uplink logical channels and uplink transport channels

In Uplink, the following connections between logical channels and transport channels exist:

- CCCH can be mapped to UL-SCH;
- DCCH can be mapped to UL-SCH;
- DTCH can be mapped to UL-SCH.

6.1.3.2 Mapping in Downlink

The figure below depicts the mapping between downlink logical channels and downlink transport channels:

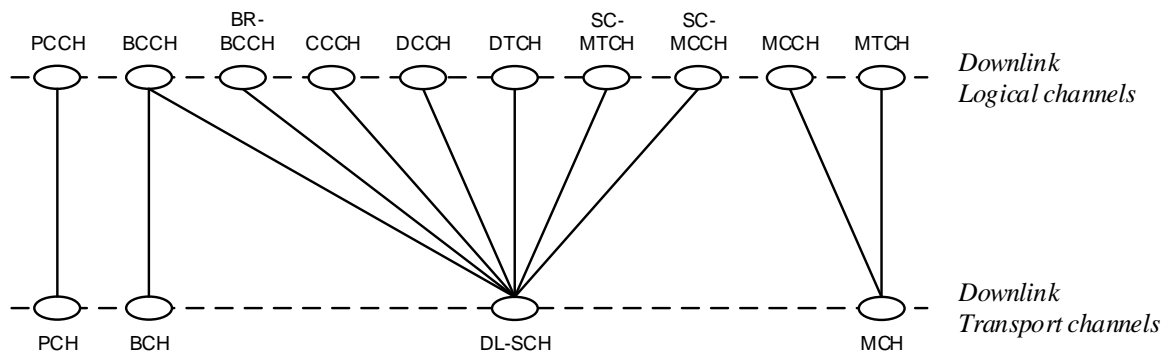

Figure 6.1.3.2-1: Mapping between downlink logical channels and downlink transport channels

In Downlink, the following connections between logical channels and transport channels exist:

- BCCH can be mapped to BCH;
- BCCH can be mapped to DL-SCH;
- BR-BCCH can be mapped to DL-SCH;
- PCCH can be mapped to PCH;
- CCCH can be mapped to DL-SCH;
- DCCH can be mapped to DL-SCH;
- DTCH can be mapped to DL-SCH;
- MTCH can be mapped to MCH;
- MCCH can be mapped to MCH;
- SC-MTCH can be mapped to DL-SCH;
- SC-MCCH can be mapped to DL-SCH.

6.1.3.3 Mapping in Sidelink

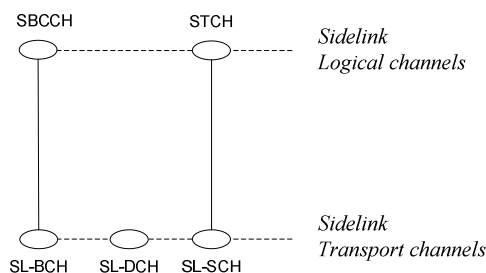

Figure 6.1.3.3-1: Mapping between Sidelink logical channels and Sidelink transport channels

In Sidelink, the following connections between logical channels and transport channels exist:

- STCH can be mapped to SL-SCH;
- SBCCH can be mapped to SL-BCH.

6.2 RLC Sublayer

6.2.0 General

This clause provides an overview on services, functions and PDU structure provided by the RLC sublayer. Note that:

- The reliability of RLC is configurable: some radio bearers may tolerate rare losses (e.g. TCP traffic);
- Radio Bearers are not characterized by a fixed sized data unit (e.g. a fixed sized RLC PDU).

6.2.1 Services and Functions

The main services and functions of the RLC sublayer include:

- Transfer of upper layer PDUs;
- Error Correction through ARQ (only for AM data transfer);
- Concatenation, segmentation and reassembly of RLC SDUs (only for UM and AM data transfer);
- Re-segmentation of RLC data PDUs (only for AM data transfer);
- Reordering of RLC data PDUs (only for UM and AM data transfer);
- Duplicate detection (only for UM and AM data transfer);
- Protocol error detection (only for AM data transfer);
- RLC SDU discard (only for UM and AM data transfer);
- RLC re-establishment, as defined in TS 24.301 [20];

6.2.2 PDU Structure

Figure 6.2.2-1 below depicts the RLC PDU structure where:

- The PDU sequence number carried by the RLC header is independent of the SDU sequence number (i.e. PDCP sequence number);
- A red dotted line indicates the occurrence of segmentation;
- Because segmentation only occurs when needed and concatenation is done in sequence, the content of an RLC PDU can generally be described by the following relations:
 - $\{0; 1\}$ last segment of SDU_i + $[0; n]$ complete SDUs + $\{0; 1\}$ first segment of SDU_{i+n+1} ; or
 - 1 segment of SDU_i .

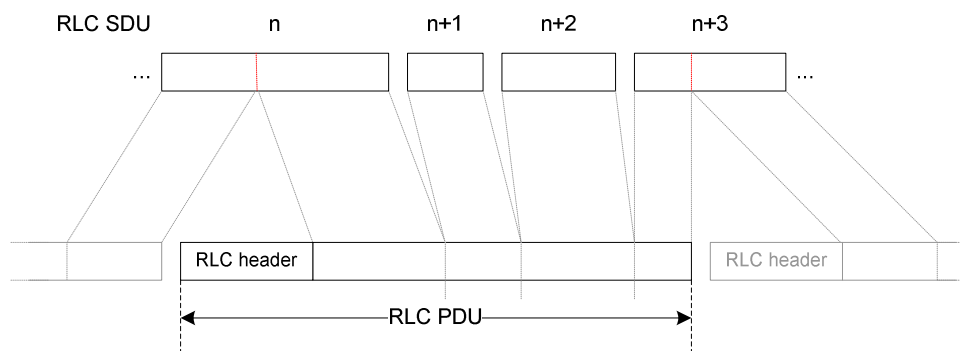

Figure 6.2.2-1: RLC PDU Structure

6.3 PDCP Sublayer

6.3.0 General

This clause provides an overview on services, functions and PDU structure provided by the PDCP sublayer.

6.3.1 Services and Functions

Except for NB-IoT, the main services and functions of the PDCP sublayer for the user plane include:

- Header compression and decompression: ROHC only;
- Compression and decompression of uplink PDCP SDUs: DEFLATE based UDC only;
- Transfer of user data;
- In-sequence delivery of upper layer PDUs at PDCP re-establishment procedure for RLC AM;
- For split bearers in DC (only support for RLC AM) and LWA bearers (only support for RLC AM and RLC UM): PDCP PDU routing for transmission and PDCP PDU reordering for reception;
- Duplicate detection of lower layer SDUs at PDCP re-establishment procedure for RLC AM;
- Retransmission of PDCP SDUs at handover and, for split bearers in DC and LWA, of PDCP PDUs at PDCP data-recovery procedure, for RLC AM;
- Ciphering and deciphering;
- Timer-based SDU discard in uplink;
- Duplication of PDCP PDUs;
- For PDCP duplication, reordering and duplicate detection at the receiver.

For NB-IoT UE when AS security is activated, the main services and functions of the PDCP sublayer for the user plane include:

- Header compression and decompression: ROHC only;
- Transfer of user data;
- In-sequence delivery of upper layer PDUs at PDCP re-establishment procedure for RLC AM;
- Duplicate detection of lower layer SDUs at PDCP re-establishment procedure for RLC AM;
- Ciphering and deciphering;
- Timer-based SDU discard in uplink.

NOTE 1: When compared to UTRAN, the *lossless DL RLC PDU size change* is not required.

The main services and functions of the PDCP for the control plane include:

- Ciphering and Integrity Protection;
- Transfer of control plane data.

Except for NB-IoT, the main services and functions of the PDCP sublayer for the control plane also include:

- Duplication of PDCP PDUs;
- For PDCP duplication, reordering and duplicate detection at the receiver.

NOTE 2: For a NB-IoT UE that only supports Control Plane CIoT EPS optimization, as defined in TS 24.301 [20], PDCP is bypassed. For a NB-IoT UE that supports Control Plane CIoT EPS optimization and S1-U data transfer or User Plane CIoT EPS optimization, as defined in TS 24.301 [20], PDCP is not used until AS security is activated.

6.3.2 PDU Structure

Figure 6.3.2-1 below depicts the PDCP PDU structure for user plane data, where:

- PDCP PDU and PDCP header are octet-aligned;
- PDCP header can be either 1, 2 or 5 bytes long.

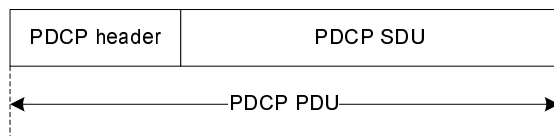

Figure 6.3.2-1: PDCP PDU Structure

The structures for control PDCP PDUs and for control plane PDCP data PDUs are specified in TS 36.323 [15].

6.4 Carrier Aggregation

In case of CA, the multi-carrier nature of the physical layer is only exposed to the MAC layer for which one HARQ entity is required per serving cell;

- In both uplink and downlink, there is one independent hybrid-ARQ entity per serving cell and one transport block is generated per TTI per serving cell in the absence of spatial multiplexing. Each transport block and its potential HARQ retransmissions are mapped to a single serving cell;
- HARQ operation is asynchronous for Licensed-Assisted Access (LAA) SCells.

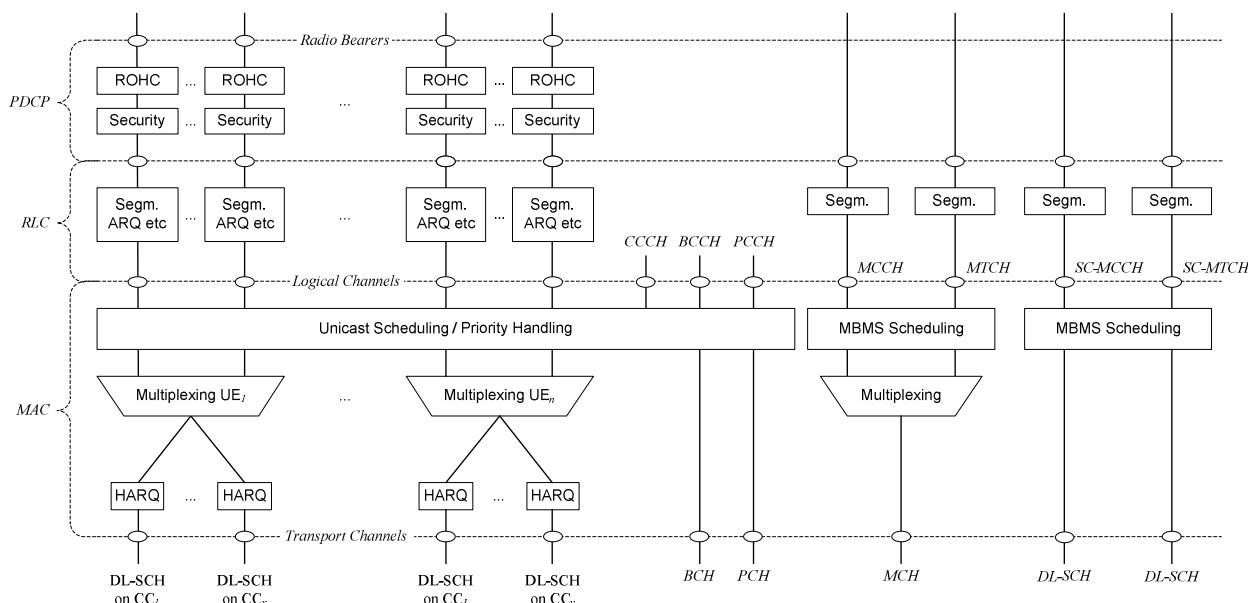

Figure 6.4-1: Layer 2 Structure for DL with CA configured

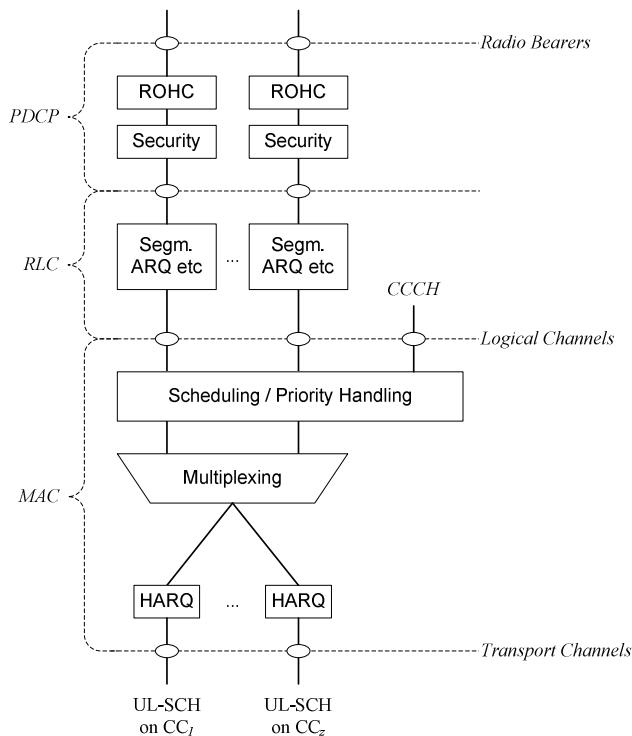

Figure 6.4-2: Layer 2 Structure for UL with CA configured

In case of CA in sidelink, which applies to V2X sidelink communication, there is one independent HARQ entity per carrier used for V2X sidelink communication and one transport block is generated per TTI per carrier. Each transport block and its potential HARQ retransmissions are mapped to a single carrier.

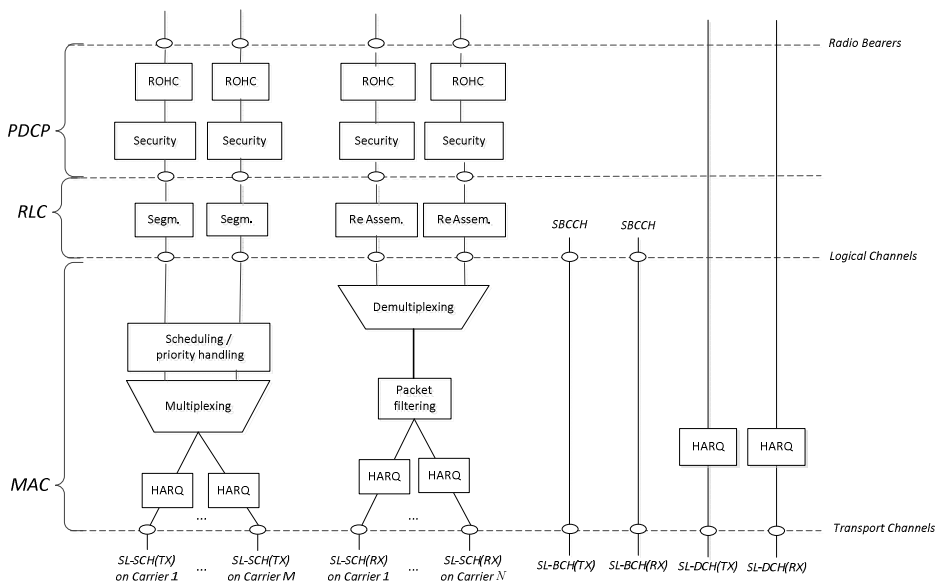

Figure 6.4-3: Layer 2 Structure for Sidelink with CA configured

6.5 Dual Connectivity

In case of DC, the UE is configured with two MAC entities: one MAC entity for MeNB and one MAC entity for SeNB. Figure 6.5-1 below describes the layer 2 structure for the downlink when both CA and DC are configured. In order to simplify the figure, the BCH, PCH, MCH and corresponding logical channels are not included. Also, only UE_n is shown as having DC configured.

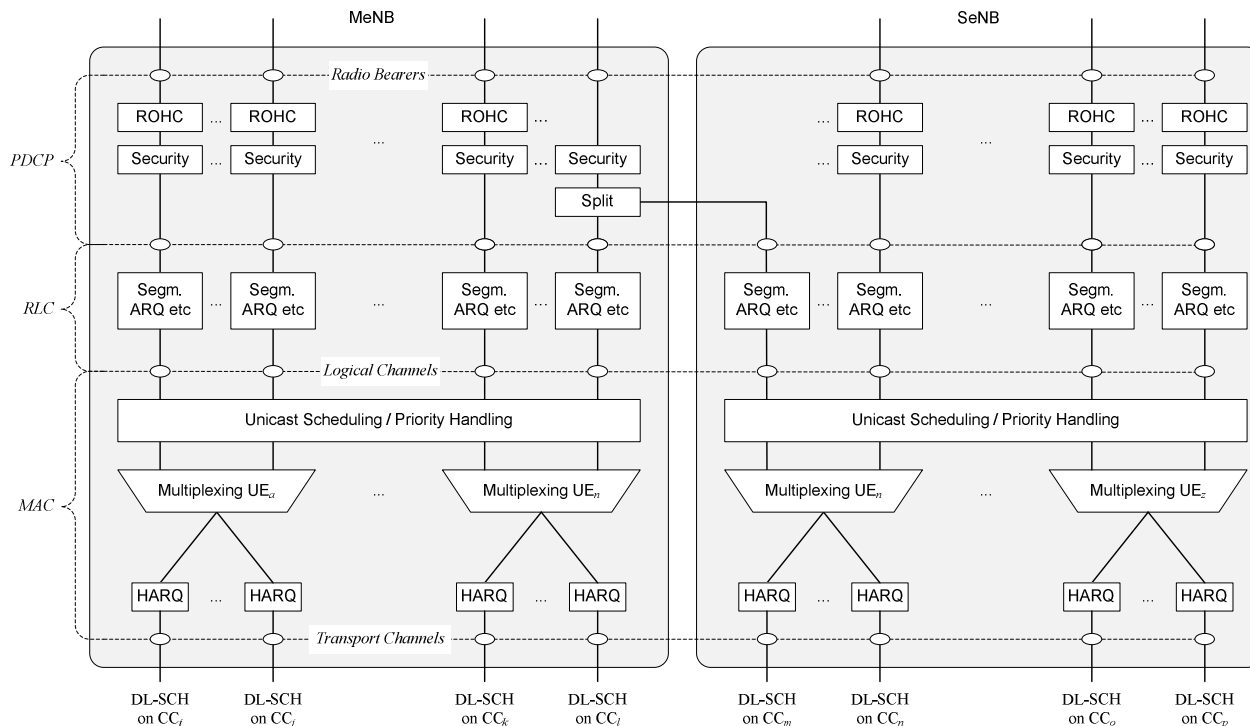

Figure 6.5-1: Layer 2 Structure for DL with CA and DC configured

Figure 6.5-2 below describes the layer 2 structure for the uplink when both CA and DC are configured. As explained in clause 4.9.2, SRBs are always handled by the MeNB and as a result, CCCH is only shown for the MeNB. For a split bearer, UE is configured over which link (or both) the UE transmits UL PDCP PDUs by the MeNB. On the link which is not responsible for UL PDCP PDUs transmission, the RLC layer only transmits corresponding ARQ feedback for the downlink data.

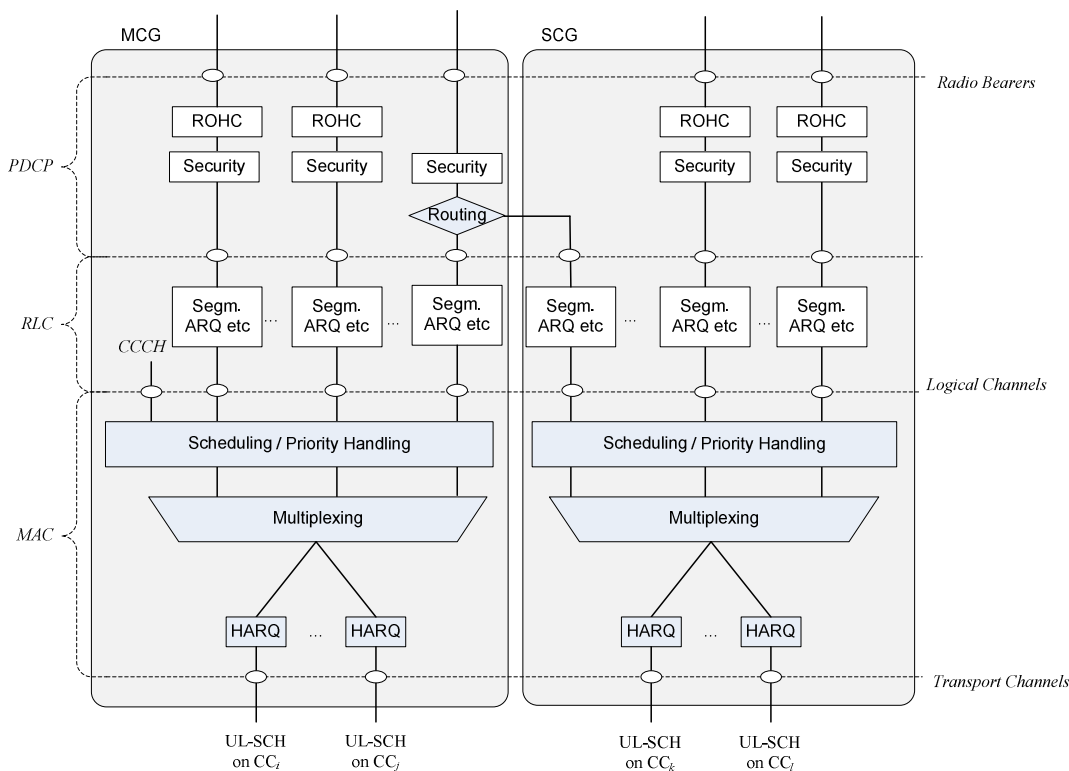

Figure 6.5-2: Layer 2 Structure for UL with CA and DC configured

7 RRC

7.0 General

This clause provides an overview on services and functions provided by the RRC sublayer.

7.1 Services and Functions

The main services and functions of the RRC sublayer include:

- Broadcast of System Information related to the non-access stratum (NAS);
- Broadcast of System Information related to the access stratum (AS);
- Paging;
- Establishment, maintenance and release of an RRC connection between the UE and E-UTRAN including:
 - Allocation of temporary identifiers between UE and E-UTRAN;
 - Configuration of signalling radio bearer(s) for RRC connection:
- Low priority SRB and high priority SRB;
- For NB-IoT, a new UE dedicated SRB is supported before AS security is activated and only one UE dedicated SRB is supported after AS security is activated;
- For a NB-IoT UE that supports S1-U data transfer or User Plane CIoT EPS optimization, as defined in TS 24.301 [20]:
 - One DRB is supported by default and up to two DRBs are supported optionally;
- For a UE that supports User Plane CIoT EPS optimization, as specified in TS 24.301 [20]:
 - Suspension/resuming of the RRC connection;
- Security functions including key management;
- Establishment, configuration, maintenance and release of point to point Radio Bearers;
- Mobility functions including:
 - UE measurement reporting and control of the reporting for inter-cell and inter-RAT mobility;
 - Handover;
 - UE cell selection and reselection and control of cell selection and reselection;
 - Context transfer at handover.
- Notification and counting for MBMS services;
- Establishment, configuration, maintenance and release of Radio Bearers for MBMS services;
- QoS management functions;
- UE measurement reporting and control of the reporting;
- NAS direct message transfer to/from NAS from/to UE.

7.2 RRC protocol states & state transitions

RRC uses the following states:

- **RRC_IDLE:**
 - PLMN selection;
 - DRX configured by NAS;
 - Broadcast of system information;
 - Paging;
 - Cell re-selection mobility;
 - The UE shall have been allocated an id which uniquely identifies the UE in a tracking area;
 - No RRC context stored in the eNB (except for a UE that supports User Plane CIoT EPS optimizations, as specified in TS 24.301 [20], where a context may be stored for the resume procedure);
 - Sidelink communication transmission and reception;
 - Sidelink discovery announcement and monitoring;
 - V2X sidelink communication transmission and reception;
 - EDT.
- **RRC_CONNECTED:**
 - UE has an E-UTRAN-RRC connection;
 - UE has context in E-UTRAN;
 - E-UTRAN knows the cell which the UE belongs to;
 - Network can transmit and/or receive data to/from UE;
 - Network controlled mobility (handover and inter-RAT cell change order to GERAN with NACC);
 - Neighbour cell measurements;
 - Sidelink communication transmission and reception;
 - Sidelink discovery announcement and monitoring;
 - V2X sidelink communication transmission and reception;
 - At PDCP/RLC/MAC level:
 - UE can transmit and/or receive data to/from network;
 - UE monitors control signalling channel for shared data channel to see if any transmission over the shared data channel has been allocated to the UE;
 - UE also reports channel quality information and feedback information to eNB;
 - DRX period can be configured according to UE activity level for UE power saving and efficient resource utilization. This is under control of the eNB.

E-UTRA connected to 5GC additionally supports RRC_INACTIVE state, which has the same characteristics as RRC_INACTIVE of NR connected to 5GC, as specified in TS 38.300 [79].

7.3 Transport of NAS messages

The AS provides reliable in-sequence delivery of NAS messages in a cell. During handover, message loss or duplication of NAS messages can occur.

In E-UTRAN, NAS messages are either concatenated with RRC messages or carried in RRC without concatenation. Upon arrival of concurrent NAS messages for the same UE requiring both concatenation with RRC for the high priority queue and also without concatenation for the lower priority queue, the messages are first queued as necessary to maintain in-sequence delivery.

In downlink, when an EPS bearer (EPC) or PDU Session (5GC) establishment or release procedure is triggered, or for EDT in case of Control Plane CIoT EPS optimization, the NAS message should normally be concatenated with the associated RRC message. When the EPS bearer (EPC) or PDU Session (5GC) is modified and when the modification also depends on a modification of the radio bearer, the NAS message and associated RRC message should normally be concatenated. Concatenation of DL NAS with RRC message is not allowed otherwise. In uplink, concatenation of NAS messages with RRC message is used only for transferring the initial NAS message during connection setup and for EDT in case of Control Plane CIoT EPS optimization. Initial Direct Transfer is not used in E-UTRAN and no NAS message is concatenated with RRC connection request.

Multiple NAS messages can be sent in a single downlink RRC message during EPS bearer (EPC) or PDU Session (5GC) establishment or modification. In this case, the order of the NAS messages in the RRC message shall be kept the same as that in the corresponding S1-AP (EPC) or NG-AP (5GC) message in order to ensure the in-sequence delivery of NAS messages.

NOTE: NAS messages are integrity protected and ciphered by PDCP, in addition to the integrity protection and ciphering performed by NAS.

7.3a CIoT signalling reduction optimizations

7.3a.1 General

Which solution of CIoT signalling reduction optimizations to be used is configured over NAS signalling between the UE and the MME.

For NB-IoT, PDCP is not used while AS security is not activated.

7.3a.2 Control Plane CIoT EPS optimizations

The RRC connection established for Control Plane CIoT EPS optimizations, as defined in TS 24.301 [20] is characterized as below:

- A UL NAS signalling message or UL NAS message carrying data can be transmitted in a UL RRC container message (see Figure 7.3a.2-1). A DL NAS signaling or DL NAS data can be transmitted in a DL RRC container message;
- for NB-IoT:
 - RRC connection reconfiguration is not supported;
 - Data radio bearer (DRB) is not used;
 - AS security is not used;
 - A non-anchor carrier can be configured for all unicast transmissions during RRC connection establishment or re-establishment.
- There is no differentiation between the different data types (i.e. IP, non-IP or SMS) in the AS.

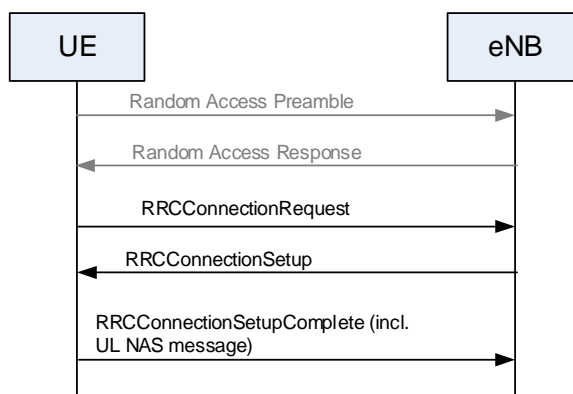

Figure 7.3a.2-1: The RRC connection established for Control Plane Clot EPS Optimizations

7.3a.3 User Plane Clot EPS optimizations

The RRC connection established for User Plane Clot EPS optimization, as defined in TS 24.301 [20], is characterized as below:

- A RRC connection suspend procedure is used at RRC connection release, the eNB may request the UE to retain the UE AS context including UE capability in RRC_IDLE;
- A RRC connection resume procedure is used at transition from RRC_IDLE to RRC_CONNECTED where previously stored information in the UE as well as in the eNB is utilised to resume the RRC connection. In the message to resume, the UE provides a Resume ID to be used by the eNB to access the stored information required to resume the RRC connection;
- At suspend-resume, security is continued. Re-keying is not supported in RRC connection resume procedure. The short MAC-I is reused as the authentication token at RRC connection reestablishment procedure and RRC connection resume procedure by the UE. The eNB provides the NCC in the *RRCCConnectionResume* message as well. And also the UE resets the COUNT;
- Multiplexing of CCCH and DTCH in the transition from RRC_IDLE to RRC_CONNECTED is not supported;
- For NB-IoT, a non-anchor carrier can be configured for all unicast transmissions when an RRC connection is re-established, resumed or reconfigured additionally when an RRC connection is established.

The RRC connection suspend and resume procedures are illustrated in Figures 7.3a.3-1 and 7.3a.3-2, respectively. Note that the description here is only intended as an overview and all parameters are therefore not listed in the message flows.

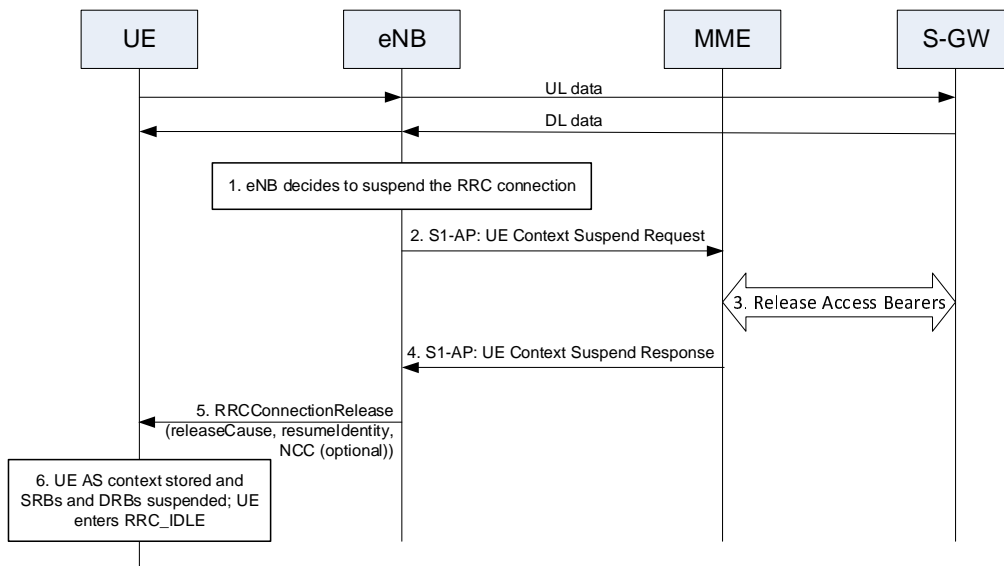

Figure 7.3a.3-1: RRC Connection Suspend procedure

1. Due to some triggers, e.g. the expiry of a UE inactivity timer, the eNB decides to suspend the RRC connection.
2. The eNB initiates the S1-AP UE Context Suspend procedure to inform the MME that the RRC connection is being suspended.
3. The MME requests the S-GW to release all S1-U bearers for the UE.
4. MME Acks step 2.
5. The eNB suspends the RRC connection by sending an *RRCConnectionRelease* message with the *releaseCause* set to *rrc-Suspend*. The message includes the Resume ID which is stored by the UE. Optionally, for EDT, the message also includes the *NextHopChainingCount* which is stored by the UE.
6. The UE stores the AS context, suspends all SRBs and DRBs, and enters RRC_IDLE.

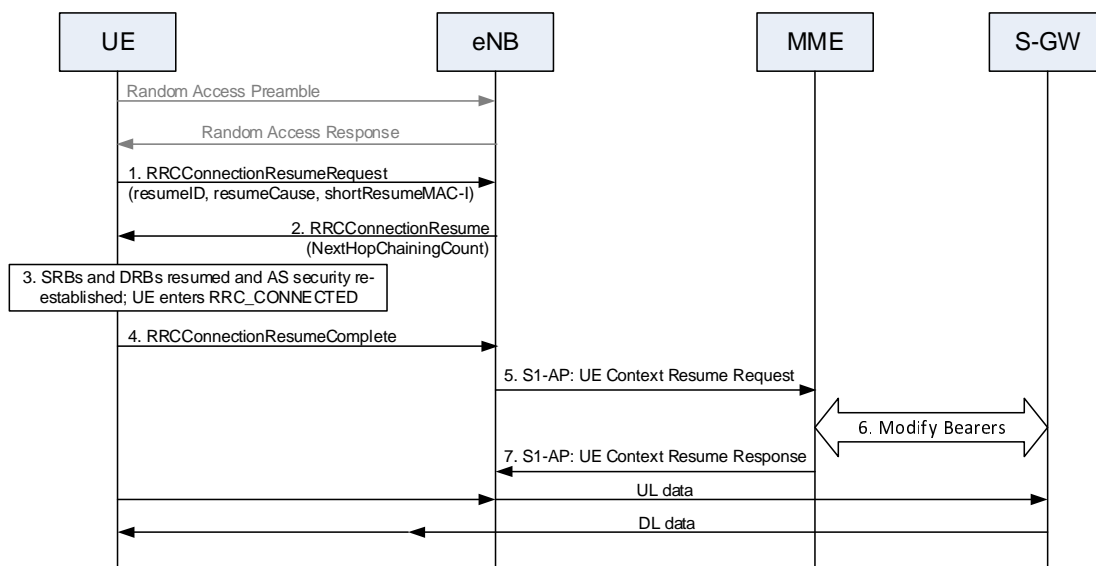

Figure 7.3a.3-2: RRC Connection Resume procedure

1. At some later point in time (e.g. when the UE is being paged or when new data arrives in the uplink buffer) the UE resumes the connection by sending an *RRCConnectionResumeRequest* to the eNB. The UE includes its Resume ID, the establishment cause, and authentication token. The authentication token is calculated in the same way as the short MAC-I used in RRC connection re-establishment and allows the eNB to verify the UE identity.

2. Provided that the Resume ID exists and the authentication token is successfully validated, the eNB responds with an *RRCConnectionResume*. The message includes the Next Hop Chaining Count (NCC) value which is required in order to re-establish the AS security.
3. The UE resumes all SRBs and DRBs and re-establishes the AS security. The UE is now in RRC_CONNECTED.
4. The UE responds with an *RRCConnectionResumeComplete* confirming that the RRC connection was resumed successfully, along with an uplink Buffer Status Report, and/or UL data, whenever possible, to the eNB.
5. The eNB initiates the S1-AP Context Resume procedure to notify the MME about the UE state change.
6. The MME requests the S-GW to activate the S1-U bearers for the UE.
7. MME Acks step 5.

An RRC connection can also be resumed in an eNB (the new eNB) different from the one where the connection was suspended (the old eNB). Inter eNB connection resumption is handled using context fetching, whereby the new eNB retrieves the UE context from the old eNB over the X2 interface. The new eNB provides the Resume ID which is used by the old eNB to identify the UE context. This is illustrated in Figure 7.3a.3-3.

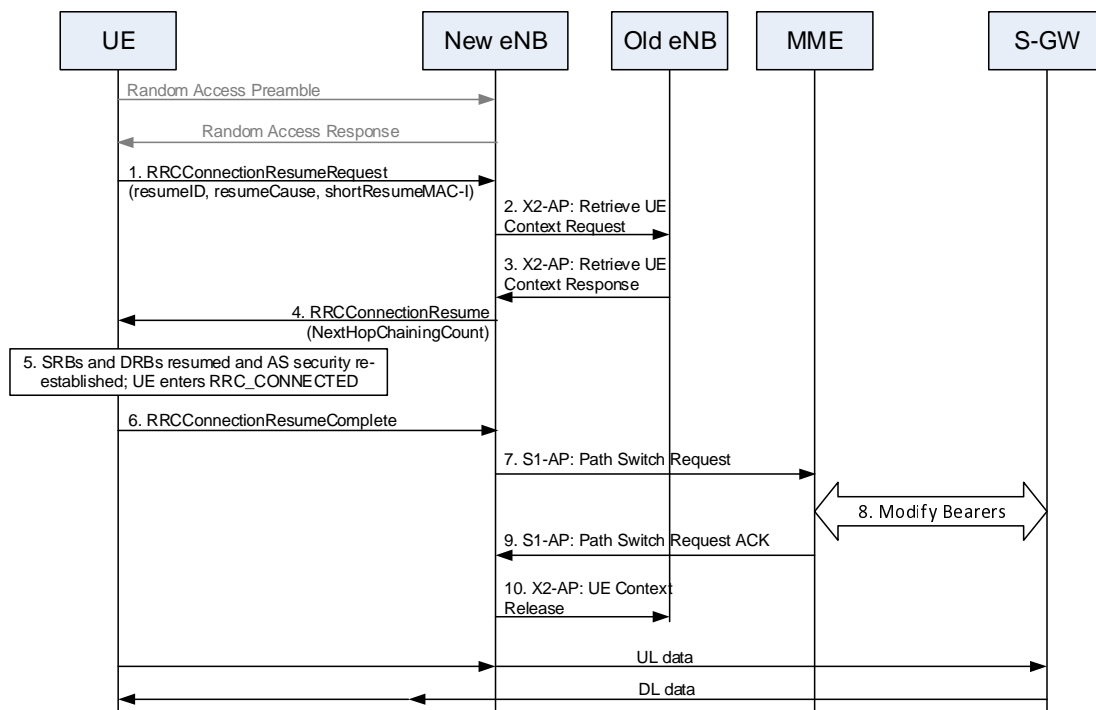

Figure 7.3a.3-3: RRC Connection Resume procedure in different eNB

1. Same as step 1 in the intra eNB connection resumption.
2. The new eNB locates the old eNB using the Resume ID and retrieves the UE context by means of the X2-AP Retrieve UE Context procedure.
3. The old eNB responds with the UE context associated with the Resume ID.
4. Same as step 2 in the intra eNB connection resumption.
5. Same as step 3 in the intra eNB connection resumption.
6. Same as step 4 in the intra eNB connection resumption.
7. The new eNB initiates the S1-AP Path Switch procedure to establish a S1 UE associated signalling connection to the serving MME and to request the MME to resume the UE context.
8. The MME requests the S-GW to activate the S1-U bearers for the UE and updates the downlink path.
9. MME Acks step 7.

10. After the S1-AP Path Switch procedure the new eNB triggers release of the UE context at the old eNB by means of the X2-AP UE Context Release procedure.

For a NB-IoT UE that supports Control Plane CIoT EPS optimization and S1-U data transfer or User Plane CIoT EPS optimization, as defined in TS 24.301 [20], PDCP is not used until AS security is activated.

7.3b EDT

7.3b.1 General

EDT allows one uplink data transmission optionally followed by one downlink data transmission during the random access procedure.

EDT is triggered when the upper layers have requested the establishment or resumption of the RRC Connection for Mobile Originated data (i.e., not signalling or SMS) and the uplink data size is less than or equal to a TB size indicated in the system information. EDT is not used for data over the control plane when using the User Plane CIoT EPS optimizations.

EDT is only applicable to BL UEs, UEs in Enhanced Coverage and NB-IoT UEs.

7.3b.2 EDT for Control Plane CIoT EPS optimizations

EDT for Control Plane CIoT EPS optimizations, as defined in TS 24.301 [20], is characterized as below:

- Uplink user data are transmitted in a NAS message concatenated in UL RRCEarlyDataRequest message on CCCH;
- Downlink user data are optionally transmitted in a NAS message concatenated in DL RRCEarlyDataComplete message on CCCH;
- There is no transition to RRC CONNECTED.

The EDT procedure for Control Plane CIoT EPS optimizations is illustrated in Figure 7.3b-1.

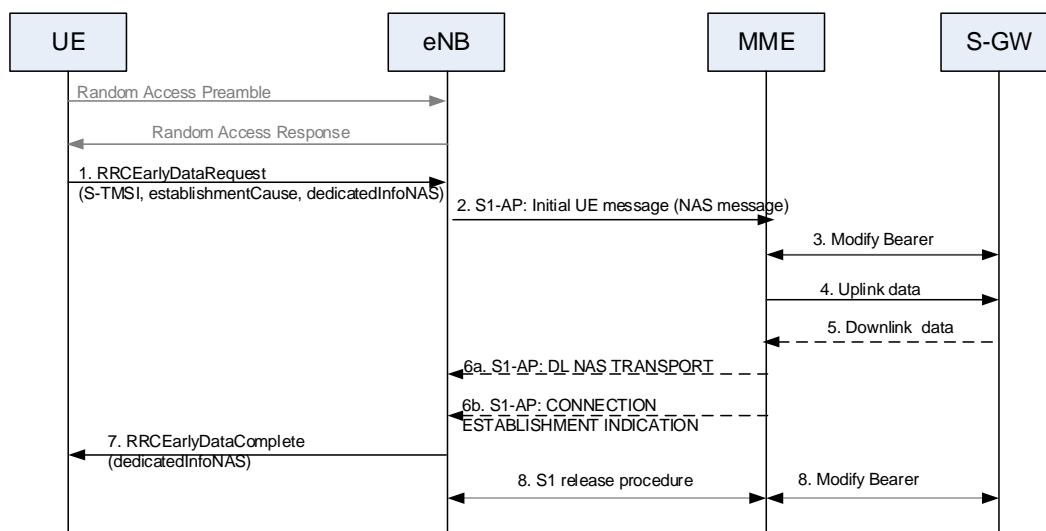

Figure 7.3b-1: EDT for Control Plane CIoT EPS Optimizations

0. Upon connection establishment request for Mobile Originated data from the upper layers, the UE initiates the early data transmission procedure and selects a random access preamble configured for EDT.
1. UE sends *RRCEarlyDataRequest* message concatenating the user data on CCCH.
2. The eNB initiates the S1-AP Initial UE message procedure to forward the NAS message and establish the S1 connection. The eNB may indicate in this procedure that this connection is triggered for EDT.

3. The MME requests the S-GW to re-activate the EPS bearers for the UE.
4. The MME sends the uplink data to the S-GW.
5. If downlink data are available, the S-GW sends the downlink data to the MME.
6. If downlink data are received from the S-GW, the MME forwards the data to the eNB via DL NAS Transport procedure and may also indicate whether further data are expected. Otherwise, the MME may trigger Connection Establishment Indication procedure and also indicate whether further data are expected.
7. If no further data are expected, the eNB can send the *RRCEarlyDataComplete* message on CCCH to keep the UE in RRC_IDLE. If downlink data were received in step 6, they are concatenated in *RRCEarlyDataComplete* message.
8. The S1 connection is released and the EPS bearers are deactivated.

NOTE 1: If the MME or the eNB decides to move the UE in RRC_CONNECTED mode, *RRCConnectionSetup* message is sent in step 7 to fall back to the legacy RRC Connection establishment procedure; the eNB will discard the zero-length NAS PDU received in *RRCConnectionSetupComplete* message.

NOTE 2: If neither *RRCEarlyDataComplete* nor, in case of fallback, *RRCConnectionSetup* is received in response to *RRCEarlyDataRequest*, the UE considers the UL data transmission not successful.

7.3b.3 EDT for User Plane CIoT EPS optimizations

EDT for User Plane CIoT EPS optimizations, as defined in TS 24.301 [20], is characterized as below:

- The UE has been provided with a *NextHopChainingCount* in the *RRCConnectionRelease* message with suspend indication;
- Uplink user data are transmitted on DTCH multiplexed with UL *RRCConnectionResumeRequest* message on CCCH;
- Downlink user data are optionally transmitted on DTCH multiplexed with DL *RRCConnectionRelease* message on DCCH;
- The short resume MAC-I is reused as the authentication token for *RRCConnectionResumeRequest* message and is calculated using the integrity key from the previous connection;
- The user data in uplink and downlink are ciphered. The keys are derived using the *NextHopChainingCount* provided in the *RRCConnectionRelease* message of the previous RRC connection;
- The *RRCConnectionRelease* message is integrity protected and ciphered using the newly derived keys;
- There is no transition to RRC CONNECTED.

The EDT procedure for User Plane CIoT EPS optimizations is illustrated in Figure 7.3b-2.

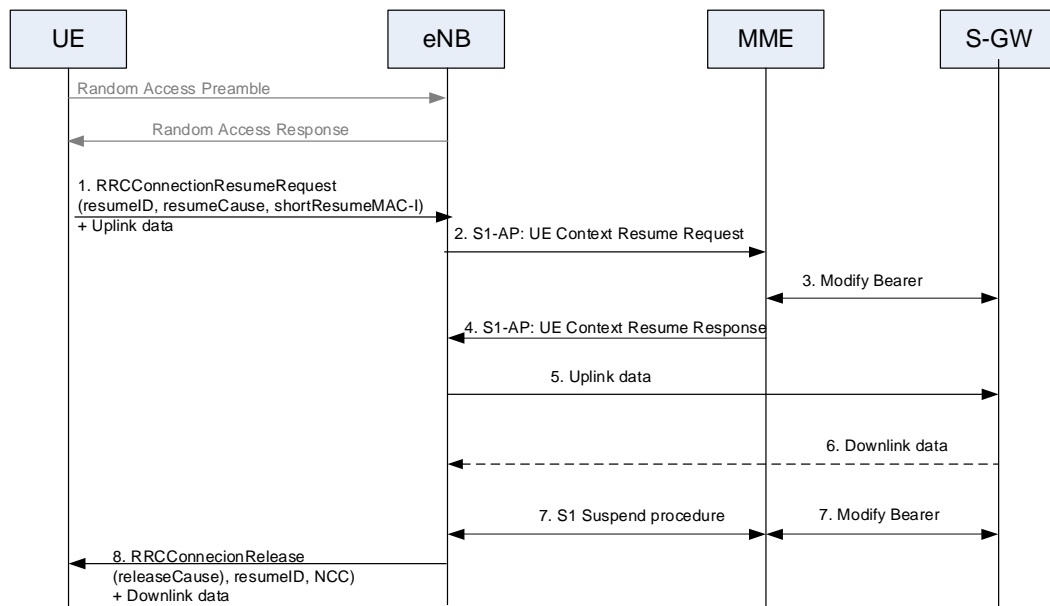

Figure 7.3b-2: EDT for User Plane Clot EPS Optimizations

0. Upon connection resumption request for Mobile Originated data from the upper layers, the UE initiates the early data transmission procedure and selects a random access preamble configured for EDT.
1. The UE sends an *RRCConnectionResumeRequest* to the eNB, including its Resume ID, the establishment cause, and an authentication token. The UE resumes all SRBs and DRBs, derives new security keys using the *NextHopChainingCount* provided in the *RRCConnectionRelease* message of the previous connection and re-establishes the AS security. The user data are ciphered and transmitted on DTCH multiplexed with the *RRCConnectionResumeRequest* message on CCCH.
2. The eNB initiates the S1-AP Context Resume procedure to resume the S1 connection and re-activate the S1-U bearers.
3. The MME requests the S-GW to re-activate the S1-U bearers for the UE.
4. The MME confirms the UE context resumption to the eNB.
5. The uplink data are delivered to the S-GW.
6. If downlink data are available, the S-GW sends the downlink data to the eNB.
7. If no further data are expected from the S-GW, the eNB can initiate the suspension of the S1 connection and the deactivation of the S1-U bearers.
8. The eNB sends the *RRCConnectionRelease* message to keep the UE in RRC_IDLE. The message includes the *releaseCause* set to *rrc-Suspend*, the *resumeID*, the *NextHopChainingCount* and *drb-ContinueROHC* which are stored by the UE. If downlink data were received in step 6, they are sent ciphered on DTCH multiplexed with the *RRCConnectionRelease* message on DCCH. The procedure ends with the reception of the HARQ feedback (ACK) acknowledging the successful DL transmission.

NOTE 1: If the MME or eNB decides the UE to move in RRC_CONNECTED mode, *RRCConnectionResume* message is sent in step 7 to fall back to the RRC Connection resume procedure. In that case, the *RRCConnectionResume* message is integrity protected and ciphered with the keys derived in step 1 and the UE ignores the *NextHopChainingCount* included in the *RRCConnectionResume* message. Downlink data can be transmitted on DTCH multiplexed with the *RRCConnectionResume* message. In addition, an *RRCConnectionSetup* can also be sent in step 7 to fall back to the RRC Connection establishment procedure.

NOTE 2: If neither *RRCConnectionRelease* nor, in case of fallback, *RRCConnectionResume* is received in response to *RRCConnectionResumeRequest* for EDT, the UE considers the UL data transmission not successful.

For EDT for User Plane ClIoT EPS Optimizations, an RRC connection can also be resumed in an eNB (the new eNB) different from the one where the connection was suspended (the old eNB). Inter eNB connection resumption is handled using context fetching, whereby the new eNB retrieves the UE context from the old eNB over the X2 interface. The new eNB provides the Resume ID which is used by the old eNB to identify the UE context. This is illustrated in Figure 7.3b-3.

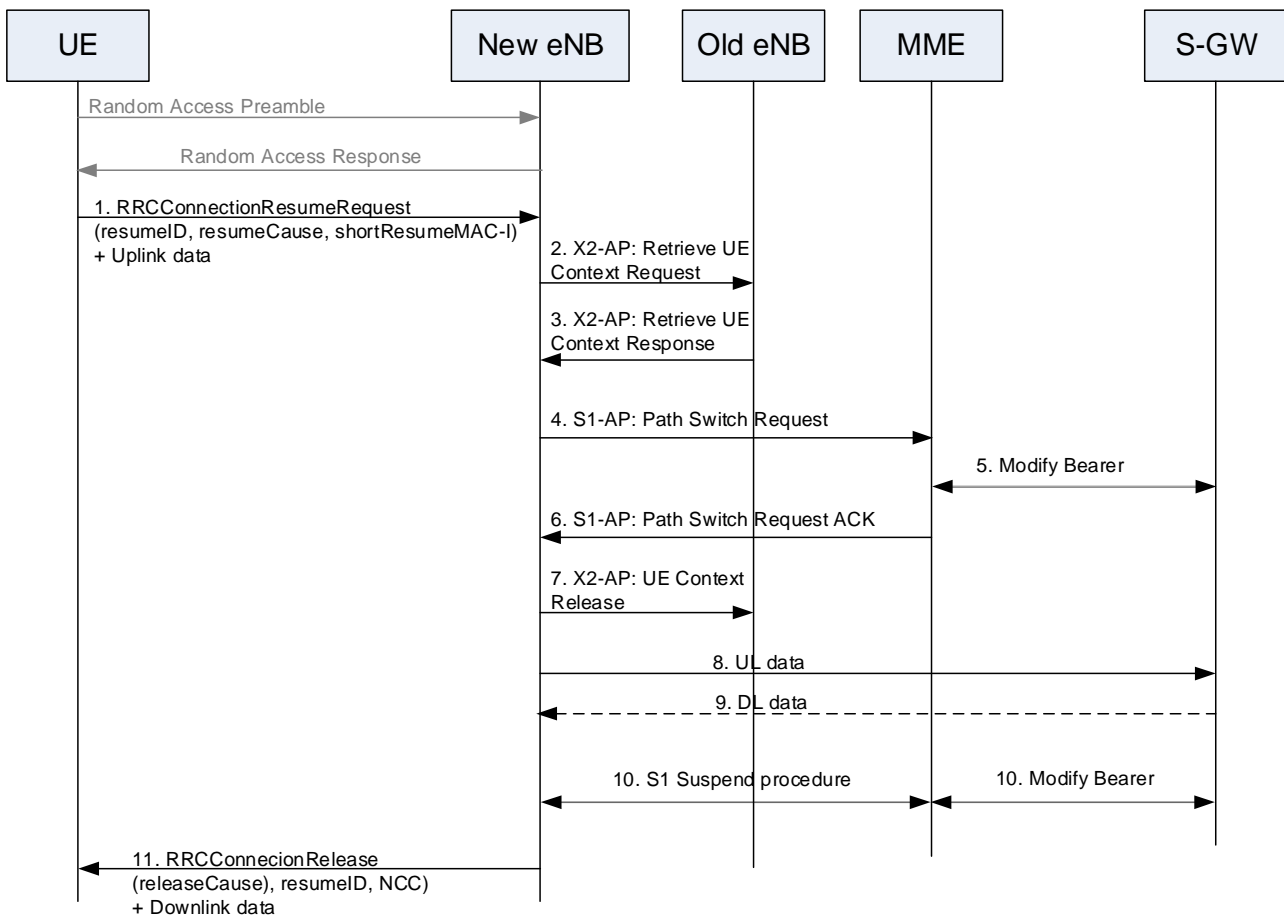

Figure: 7.3b-3: EDT for User Plane ClIoT EPS Optimizations in different eNB

1. Same as step 1 in the intra eNB connection resumption.
2. The new eNB locates the old eNB using the Resume ID and retrieves the UE context by means of the X2-AP Retrieve UE Context procedure.
3. The old eNB responds with the UE context associated with the Resume ID.
4. The new eNB initiates the S1-AP Path Switch procedure to establish a S1 UE associated signalling connection to the serving MME and to request the MME to resume the UE context.
5. The MME requests the S-GW to activate the S1-U bearers for the UE and updates the downlink path.
6. MME Acks step 5.
7. After the S1-AP Path Switch procedure the new eNB triggers release of the UE context at the old eNB by means of the X2-AP UE Context Release procedure.
8. Same as step 5 in the intra eNB connection resumption.
9. Same as step 6 in the intra eNB connection resumption.
10. Same as step 7 in the intra eNB connection resumption.
11. Same as step 8 in the intra eNB connection resumption.

7.4 System Information

System information is divided into the *MasterInformationBlock* (MIB) and a number of *SystemInformationBlocks* (SIBs):

- *MasterInformationBlock* defines the most essential physical layer information of the cell required to receive further system information;
- *SystemInformationBlockPos* contains positioning assistance data;
- *SystemInformationBlockType1* and *SystemInformationBlockType1-BR* (for a BL UE or UE in enhanced coverage) contain information relevant when evaluating if a UE is allowed to access a cell and defines the scheduling of other system information blocks;
- *SystemInformationBlockType2* contains common and shared channel information;
- *SystemInformationBlockType3* contains cell re-selection information, mainly related to the serving cell;
- *SystemInformationBlockType4* contains information about the serving frequency and intra-frequency neighbouring cells relevant for cell re-selection (including cell re-selection parameters common for a frequency as well as cell specific re-selection parameters);
- *SystemInformationBlockType5* contains information about other E-UTRA frequencies and inter-frequency neighbouring cells relevant for cell re-selection (including cell re-selection parameters common for a frequency as well as cell specific re-selection parameters) and information about the idle mode measurement configuration in RRC_IDLE or RRC_INACTIVE;
- *SystemInformationBlockType6* contains information about UTRA frequencies and UTRA neighbouring cells relevant for cell re-selection (including cell re-selection parameters common for a frequency as well as cell specific re-selection parameters);
- *SystemInformationBlockType7* contains information about GERAN frequencies relevant for cell re-selection (including cell re-selection parameters for each frequency);
- *SystemInformationBlockType8* contains information about CDMA2000 frequencies and CDMA2000 neighbouring cells relevant for cell re-selection (including cell re-selection parameters common for a frequency as well as cell specific re-selection parameters);
- *SystemInformationBlockType9* contains a home eNB name (HNB name);
- *SystemInformationBlockType10* contains an ETWS primary notification;
- *SystemInformationBlockType11* contains an ETWS secondary notification;
- *SystemInformationBlockType12* contains a CMAS warning notification;
- *SystemInformationBlockType13* contains MBMS-related information;
- *SystemInformationBlockType14* contains information about Extended Access Barring for access control;
- *SystemInformationBlockType15* contains information related to mobility procedures for MBMS reception;
- *SystemInformationBlockType16* contains information related to GPS time and Coordinated Universal Time (UTC);
- *SystemInformationBlockType17* contains information relevant for traffic steering between E-UTRAN and WLAN;
- *SystemInformationBlockType18* contains information related to sidelink communication;
- *SystemInformationBlockType19* contains information related to sidelink discovery;
- *SystemInformationBlockType20* contains information related to SC-PTM;
- *SystemInformationBlockType21* contains information related to V2X sidelink communication;

- *SystemInformationBlockType24* contains information about NR frequencies and NR neighbouring cells relevant for cell re-selection (including cell re-selection parameters common for a frequency);
- *SystemInformationBlockType25* contains information about UAC parameters;
- *SystemInformationBlockType26* contains additional information related to V2X sidelink communication.

System information for NB-IoT is divided into the *MasterInformationBlock-NB* (MIB-NB) and a number of *SystemInformationBlocks-NB* (SIBs-NB):

- *MasterInformationBlock-NB* defines the most essential information of the cell required to receive further system information;
- *SystemInformationBlockType1-NB* contains information relevant when evaluating if a UE is allowed to access a cell and defines the scheduling of other system information blocks;
- *SystemInformationBlockType2-NB* contains common radio resource configuration information;
- *SystemInformationBlockType3-NB* contains cell re-selection information for intra-frequency, inter-frequency;
- *SystemInformationBlockType4-NB* contains neighboring cell related information relevant for intra-frequency cell re-selection;
- *SystemInformationBlockType5-NB* contains neighboring cell related information relevant for inter-frequency cell re-selection;
- *SystemInformationBlockType14-NB* contains information about access barring;
- *SystemInformationBlockType15-NB* contains information related to mobility procedures for MBMS reception;
- *SystemInformationBlockType16-NB* contains information related to GPS time and Coordinated Universal Time (UTC);
- *SystemInformationBlockType20-NB* contains information related to SC-PTM;
- *SystemInformationBlockType22-NB* contains common radio resource configuration information for paging and random access procedure on non-anchor carriers;
- *SystemInformationBlockType23-NB* contains common additional radio resource configuration information for random access procedure on anchor and non-anchor carriers.

On MBMS-dedicated cell, only system information relevant for receiving MBMS service is broadcasted.

MasterInformationBlock-MBMS (MIB-MBMS) and *SystemInformationBlockType1-MBMS* (SIB1-MBMS) are used instead of MIB and SIB1 respectively:

- *MasterInformationBlock-MBMS* defines the most essential physical layer information of the cell required to receive further system information on MBMS-dedicated cell;
- *SystemInformationBlockType1-MBMS* contains information relevant for receiving MBMS service and defines the scheduling of other system information blocks on MBMS-dedicated cell;

The MIB is mapped on the BCCH and carried on BCH while all other SI messages are mapped on the BCCH and BR-BCCH, and carried on DL-SCH. Except for BL UEs, UEs in enhanced coverage and NB-IoT UEs, all other SI messages than the MIB which are dynamically carried on DL-SCH, can be identified through the SI-RNTI (System Information RNTI). Both the MIB and *SystemInformationBlockType1* (*SystemInformationBlockType1-BR* for BL UEs and UEs in enhanced coverage) use a fixed schedule with a periodicity of 40 and 80 ms respectively. The scheduling of other SI messages is flexible and indicated by *SystemInformationBlockType1* (*SystemInformationBlockType1-BR* for BL UEs and UEs in enhanced coverage, and *SystemInformationBlockType1-NB* for NB-IoT). For NB-IoT, the MIB-NB is mapped on the BCCH and carried on BCH while all other SI messages are mapped on the BCCH and carried on DL-SCH. Both the MIB-NB and *SystemInformationBlockType1-NB* use a fixed schedule with a periodicity of 640 and 2560 ms respectively. The MIB-NB contains all information required to acquire SIB1-NB and SIB1-NB contains all information required to acquire other SI messages.

On MBMS-dedicated cell, the MIB-MBMS and SIB1-MBMS use a fixed schedule with a periodicity of 160 ms. Additionally, SIB1-MBMS may be scheduled in additional non-MBSFN subframes indicated in MIB-MBMS.

For NB-IoT, in TDD mode, the MIB-TDD-NB is transmitted on the same NB-IoT carrier as NPSS/NSSS, *SystemInformationBlockType1-NB* can be transmitted on NB-IoT carrier other than the MIB-NB, and the SI messages can be transmitted on a NB-IoT carrier other than the MIB-NB. At most two NB-IoT carriers are used to transmit the MIB-NB, *SystemInformationBlockType1-NB* and the SI messages.

Except for NB-IoT, the eNB may schedule DL-SCH transmissions concerning logical channels other than BCCH or BR-BCCH in the same subframe as used for BCCH or BR-BCCH. The minimum UE capability restricts the BCCH or BR-BCCH mapped to DL-SCH e.g. regarding the maximum rate.

The Paging message is used to inform UEs in RRC_IDLE and UEs in RRC_CONNECTED about a system information change. For NB-IoT UEs, BL UEs, and UEs in CE, the UE is not required to detect SIB changes when in RRC_CONNECTED, and the network may release the NB-IoT UE, BL UE or UE in CE to RRC_IDLE if it wants the NB-IoT UE, BL UE or UE in CE to acquire changed SIB(s).

Except for NB-IoT, system information may also be provided to the UE by means of dedicated signalling e.g. upon handover.

7.5 Carrier Aggregation

When CA is configured, the UE only has one RRC connection with the network. At RRC connection establishment/re-establishment/handover, one serving cell provides the NAS mobility information (e.g. TAI), and at RRC connection re-establishment/handover, one serving cell provides the security input. This cell is referred to as the Primary Cell (PCell). In the downlink, the carrier corresponding to the PCell is the Downlink Primary Component Carrier (DL PCC) while in the uplink it is the Uplink Primary Component Carrier (UL PCC).

Depending on UE capabilities, Secondary Cells (SCells) can be configured to form together with the PCell a set of serving cells. In the downlink, the carrier corresponding to an SCell is a Downlink Secondary Component Carrier (DL SCC) while in the uplink it is an Uplink Secondary Component Carrier (UL SCC).

The configured set of serving cells for a UE therefore always consists of one PCell and one or more SCells:

- For each SCell the usage of uplink resources by the UE in addition to the downlink ones is configurable (the number of DL SCCs configured is therefore always larger than or equal to the number of UL SCCs and no SCell can be configured for usage of uplink resources only);
- An SCell may be configured to start in either deactivated, dormant or activated mode;
- From a UE viewpoint, each uplink resource only belongs to one serving cell;
- The number of serving cells that can be configured depends on the aggregation capability of the UE (see clause 5.5);
- PCell can only be changed with handover procedure (i.e. with security key change and, unless RACH-less HO is configured, with RACH procedure);
- PCell is used for transmission of PUCCH;
- If DC is not configured one additional PUCCH can be configured on an SCell, the PUCCH SCell;
- Unlike SCells, PCell cannot be de-activated or be in dormant SCell state (see clause 11.2);
- Re-establishment is triggered when PCell experiences RLF, not when SCells experience RLF;
- NAS information is taken from PCell.

The reconfiguration, addition and removal of SCells can be performed by RRC. At intra-LTE handover, RRC can also add, remove, or reconfigure SCells for usage with the target PCell. When adding a new SCell, dedicated RRC signalling is used for sending all required system information of the SCell i.e. while in connected mode, UEs need not acquire broadcasted system information directly from the SCells. A common configuration, applicable for multiple SCells, may be provided in addition to dedicated SCell configuration.

When a PUCCH SCell is configured, RRC configures the mapping of each serving cell to Primary PUCCH group or Secondary PUCCH group, i.e., for each SCell whether the PCell or the PUCCH SCell is used for the transmission of ACK/NAKs and CSI reports. A PUCCH SCell cannot be in dormant state.

For LAA SCell the following additional principles are applied:

- The eNB can configure whether the data of a logical channel can be transferred via LAA SCells.

7.6 Dual Connectivity

In DC, the configured set of serving cells for a UE consists of two subsets: the Master Cell Group (MCG) containing the serving cells of the MeNB, and the Secondary Cell Group (SCG) containing the serving cells of the SeNB.

When a UE is configured with CA in the MCG, the same principles as described in clause 7.5 apply to MCG.

For SCG, the following principles are applied:

- At least one cell in SCG has a configured UL CC and one of them, named PSCell, is configured with PUCCH resources;
- When SCG is configured, there is always at least one SCG bearer or one Split bearer;
- Upon detection of a physical layer problem or a random access problem on PSCell, or the maximum number of RLC retransmissions has been reached associated with the SCG, or upon detection of an access problem on PSCell (T307 expiry) during SCG change, or when exceeding the maximum transmission timing difference between CGs:
 - RRC connection Re-establishment procedure is not triggered;
 - All UL transmissions towards all cells of the SCG are stopped;
 - MeNB is informed by the UE of SCG failure type;
 - For split bearer, the DL data transfer over the MeNB is maintained.
- Only the RLC AM bearer can be configured for the split bearer;
- Like PCell, PSCell cannot be de-activated and cannot be in dormant SCell state (see clause 11.2);
- PSCell can only be changed with SCG change (i.e. with security key change and, unless RACH-less HO is configured, with RACH procedure);
- Neither direct bearer type change between Split bearer and SCG bearer nor simultaneous configuration of SCG and Split bearer are supported.

With respect to the interaction between MeNB and SeNB, the following principles are applied:

- Logical channel identities are independently allocated by the MeNB and the SeNB.
- The MeNB maintains the RRM measurement configuration of the UE and may, e.g. based on received measurement reports or traffic conditions or bearer types, decide to ask a SeNB to provide additional resources (serving cells) for a UE.
- Upon receiving the request from the MeNB, a SeNB may create the container that will result in the configuration of additional serving cells for the UE (or decide that it has no resource available to do so).
- For UE capability coordination, the MeNB provides (part of) the AS configuration and the UE capabilities to the SeNB.
- The MeNB and the SeNB exchange information about UE configuration by means of RRC containers (inter-node messages) carried in X2 messages.
- The SeNB may initiate a reconfiguration of its existing serving cells (e.g., PUCCH towards the SeNB).
- The SeNB decides which cell is the PSCell within the SCG.
- The MeNB does not change the content of the RRC configuration provided by the SeNB.
- In the case of the SCG addition and SCG SCell addition, the MeNB may provide the latest measurement results for the SCG cell(s).

- Both MeNB and SeNB know the SFN and subframe offset of each other by OAM or UE measurement, e.g., for the purpose of DRX alignment and identification of measurement gap.

When adding a new SCG SCell, dedicated RRC signalling is used for sending all required system information of the cell as for CA described in clause 7.5, except for the SFN acquired from MIB of the PSCell of SCG.

8 E-UTRAN identities

8.1 E-UTRA related UE identities

The following E-UTRA related UE identities are used at cell level:

- C-RNTI: unique identification used for identifying RRC Connection and scheduling;
- Semi-Persistent Scheduling C-RNTI: unique identification used for semi-persistent scheduling;
- Temporary C-RNTI: identification used for the random access procedure;
- TPC-PUSCH-RNTI: identification used for the power control of PUSCH;
- TPC-PUCCH-RNTI: identification used for the power control of PUCCH;
- SL-RNTI: identification used for sidelink communication scheduling;
- SL-V-RNTI: identification used for V2X sidelink communication scheduling;
- Random value for contention resolution: during some transient states, the UE is temporarily identified with a random value used for contention resolution purposes;
- SRS-TPC-RNTI: identification used for triggering group SRS and power control of SRS for SRS-only SCells;
- SL Semi-Persistent Scheduling V-RNTI: identification used for semi-persistent scheduling for V2X sidelink communication;
- UL Semi-Persistent Scheduling V-RNTI: identification used for multiple semi-persistent scheduling for UE capable of V2X communication;
- AUL C-RNTI: unique identification used for autonomous uplink scheduling.

In DC, two C-RNTIs are independently allocated to the UE: one for MCG, and one for SCG.

The following UE identity is only used for E-UTRA connected to EPC:

- Resume ID: unique identification used for the RRC connection resume procedure;

The following UE identity is only used for E-UTRA connected to 5GC:

- I-RNTI: unique identification as specified for NR connected to 5GC in TS 38.300 [79];

8.2 Network entity related Identities

The following identities are used in E-UTRAN for identifying a specific network entity TS 36.413 [25]:

- Globally Unique MME Identity (GUMMEI): used to identify MME globally. The GUMMEI is constructed from the PLMN identity the MME belongs to, the group identity of the MME group the MME belongs to and the MME code (MMEC) of the MME within the MME group.

NOTE: GUMMEI or S-TMSI containing the MMEC is provided by the UE to the eNB according to TS 23.401 [17], TS 24.301 [20] and TS 36.331 [16].

- E-UTRAN Cell Global Identifier (ECGI): used to identify cells globally. The ECGI is constructed from the PLMN identity the cell belongs to and the E-UTRA Cell Identifier of the cell. The included PLMN is the one

given by the first PLMN entry in SIB1 associated with the E-UTRA Cell Identifier of the cell, according to TS 36.331 [16].

- eNB Identifier (eNB ID): used to identify eNBs within a PLMN. The eNB ID is contained within the E-UTRA Cell Identifier of its cells.
- Global eNB ID: used to identify eNBs globally. The Global eNB ID is constructed from the PLMN identity the eNB belongs to and the eNB ID. The MCC and MNC are the same as included in the E-UTRAN Cell Global Identifier (ECGI).
- The Global eNB ID of RN is the same as its serving DeNB.
- Tracking Area identity (TAI): used to identify tracking areas allocated by EPC or 5GC. The TAI is constructed from the PLMN identity the tracking area belongs to and the TAC (Tracking Area Code) of the Tracking Area. The TACs allocated to an ng-eNB by EPC and 5GC are separate.
- CSG identity (CSG ID): used to identify a CSG within a PLMN.
- EPS Bearer ID / E-RAB ID:
 - The value of the E-RAB ID used at S1 and X2 interfaces to identify an E-RAB allocated to the UE is the same as the EPS Bearer ID value used at the Uu interface to identify the associated EPS Bearer (and also used at the NAS layer as defined in TS 36.413 [25]).
- NR Cell Global Identifier (NCGI): specified in TS 38.300 [79].
- en-gNB Identifier (en-gNB ID): as specified for the gNB Identifier in TS 38.300 [79].
- Global en-gNB ID: as specified for the Global gNB ID in TS 38.300 [79].

The following identities are broadcast in every E-UTRAN cell (SIB1): CI, TAC, CSG ID (if any) and one or more PLMN identities.

8.3 Sidelink communication and V2X Sidelink Communication related identities

The following identities are used for sidelink communication and V2X sidelink communication:

- Source Layer-2 ID: Identifies the sender of the data in sidelink communication and V2X sidelink communication. The Source Layer-2 ID is 24 bits long and is used together with Destination Layer-2 ID and LCID for identification of the RLC UM entity and PDCP entity in the receiver;
- Destination Layer-2 ID: Identifies the target of the data in sidelink communication and V2X sidelink communication. For sidelink communication, the Destination Layer-2 ID is 24 bits long and is split in the MAC layer into two bit strings:
 - One bit string is the LSB part (8 bits) of Destination Layer-2 ID and forwarded to physical layer as Group Destination ID. This identifies the target of the intended data in sidelink control information and is used for filtering of packets at the physical layer.
 - Second bit string is the MSB part (16 bits) of the Destination Layer-2 ID and is carried within the MAC header. This is used for filtering of packets at the MAC layer.
 - In case of V2X sidelink communication, Destination Layer-2 ID is not split and is carried within the MAC header.

No Access Stratum signalling is required for group formation and to configure Source Layer-2 ID, Destination Layer-2 ID and Group Destination ID in the UE. These identities are either provided by higher layer or derived from identities provided by higher layer. In case of groupcast and broadcast, the ProSe UE ID, as specified in TS 23.303 [62], provided by higher layer is used directly as the Source Layer-2 ID and the ProSe Layer-2 Group ID, as specified in TS 23.303 [62], provided by higher layer is used directly as the Destination Layer-2 ID in the MAC layer. In case of one-to-one communications, the ProSe UE ID, as specified in TS 23.303 [62], provided by higher layer is used directly as the Source Layer-2 ID or the Destination Layer-2 ID in the MAC layer. In case of V2X sidelink communication, higher layer provides Source Layer-2 ID and Destination Layer-2 ID, as specified in TS 23.285 [72].

8.4 MBMS related identities

The following identities are used for SC-PTM transmission:

- SC-RNTI: Identifies transmissions of the SC-MCCH, and for NB-IoT UEs, BL UEs or UEs in enhanced coverage identifies SC-MCCH change notification;
- SC-N-RNTI: Identifies SC-MCCH change notification for UEs other than NB-IoT UEs, BL UEs or UEs in enhanced coverage;
- G-RNTI: Identifies transmissions of a SC-MTCH, and for NB-IoT UEs, BL UEs or UEs in enhanced coverage identifies SC-MCCH change notification.

9 ARQ and HARQ

9.0 General

E-UTRAN provides ARQ and HARQ functionalities. The ARQ functionality provides error correction by retransmissions in acknowledged mode at Layer 2. The HARQ functionality ensures delivery between peer entities at Layer 1.

9.1 HARQ principles

The HARQ within the MAC sublayer has the following characteristics:

- HARQ transmits and retransmits transport blocks;
- In the downlink:
 - N-process Stop-And-Wait;
 - Asynchronous adaptive HARQ;
 - Uplink ACK/NAKs in response to downlink (re)transmissions are sent on PUCCH or PUSCH (except for NB-IoT and short TTI);
 - For BL UEs or UEs in enhanced coverage, uplink ACK/NAKs are sent in response to transmission bundles;
 - For NB-IoT, Uplink ACK/NAKs in response to downlink (re)transmissions are sent on NPUSCH;
 - For short TTI, Uplink ACK/NAKs in response to downlink (re)transmissions are sent on SPUCCH or (sub)slot-PUSCH;
 - PDCCH, MPDCCH, NPDCCH or SPDCCH signals the HARQ process identifier (except for NB-IoT when only one HARQ process is configured) and if it is a transmission or retransmission;
 - Retransmissions are always scheduled through PDCCH, MPDCCH, NPDCCH or SPDCCH.
- In the uplink:
 - N-process Stop-And-Wait;
 - Synchronous HARQ (except for the cases below);
 - Asynchronous adaptive HARQ for NB-IoT, BL UEs, UEs in enhanced coverage, HARQ processes scheduled with (sub)slot based PUSCH, HARQ processes scheduled with SPT, or for HARQ processes not configured with AUL operation for SCells configured with uplink LAA or for SCells configured with PUSCH enhancement mode;

- Autonomous HARQ for HARQ processes configured with AUL operation for SCells configured with uplink LAA;
- Maximum number of retransmissions configured per UE (as opposed to per radio bearer) for synchronous HARQ;
- For asynchronous adaptive HARQ, HARQ process identifier is either signalled by PDCCH, MPDCCH, NPDCCH or SPDCCH, except for NB-IoT when only one HARQ process is configured the HARQ process identifier is fixed (see clause 5.4.2.1 in TS 36.321 [13]);
- For Autonomous HARQ, UE selects HARQ process identifier from a pool of configured HARQ processes;
- Downlink ACK/NAKs in response to uplink (re)transmissions are sent on PHICH except for asynchronous adaptive HARQ and autonomous HARQ;
- For autonomous HARQ, downlink ACK/NAKs in response to uplink (re)transmissions are sent on PDCCH;
- HARQ operation in uplink is governed by the following principles (summarized in Table 9.1-1) except for asynchronous adaptive HARQ:
 - 1) Regardless of the content of the HARQ feedback (ACK or NACK), when a PDCCH for the UE is correctly received, the UE follows what the PDCCH asks the UE to do i.e. perform a transmission or a retransmission (referred to as adaptive retransmission);
 - 2) When no PDCCH addressed to the C-RNTI of the UE is detected, the HARQ feedback dictates how the UE performs retransmissions:
 - NACK: the UE performs a non-adaptive retransmission i.e. a retransmission on the same uplink resource as previously used by the same process;
 - ACK: the UE does not perform any UL (re)transmission and keeps the data in the HARQ buffer. A PDCCH is then required to perform a retransmission i.e. a non-adaptive retransmission cannot follow.
- For asynchronous adaptive HARQ, HARQ feedback is not sent, except for BL UEs and UEs in enhanced coverage. The UE follows what the PDCCH, MPDCCH, NPDCCH or SPDCCH asks the UE to do i.e. perform a transmission or a retransmission. For BL UEs or UEs in enhanced coverage, downlink ACK in response to uplink (re)transmissions may be sent in the DCI with C-RNTI or SPS C-RNTI scheduling MPDCCH.
- In the sidelink:
 - No HARQ feedback;
 - Retransmissions are always performed in a pre-defined/ configured number.
- Measurement gaps and sidelink discovery transmission during a sidelink discovery gap for transmission are of higher priority than HARQ retransmissions: whenever an HARQ retransmission collides with a measurement gap or sidelink discovery transmission during a sideink discovery gap for transmission, the HARQ retransmission does not take place.

Table 9.1-1: UL synchronous HARQ Operation

HARQ feedback seen by the UE	PDCCH seen by the UE	UE behaviour
ACK or NACK	New Transmission	New transmission according to PDCCH
ACK or NACK	Retransmission	Retransmission according to PDCCH (adaptive retransmission)
ACK	None	No (re)transmission, keep data in HARQ buffer and a PDDCH is required to resume retransmissions
NACK	None	Non-adaptive retransmission

9.2 ARQ principles

The ARQ within the RLC sublayer has the following characteristics:

- ARQ retransmits RLC PDUs or RLC PDU segments based on RLC status reports;
- Polling for RLC status report is used when needed by RLC;
- RLC receiver can also trigger RLC status report after detecting a missing RLC PDU or RLC PDU segment.

9.3 Void

10 Mobility

10.0 General

Load balancing is achieved in E-UTRAN with handover, redirection mechanisms upon RRC release, DC and through the usage of inter-frequency and inter-RAT absolute priorities and inter-frequency Qoffset parameters.

Measurements to be performed by a UE for mobility are classified in at least four measurement types:

- Intra-frequency E-UTRAN measurements;
- Inter-frequency E-UTRAN measurements;
- Inter-RAT measurements for UTRAN and GERAN;
- Inter-RAT measurements of CDMA2000 HRPD or 1xRTT frequencies.

For each measurement type one or several measurement objects can be defined (a measurement object defines e.g. the carrier frequency to be monitored).

For each measurement object one or several reporting configurations can be defined (a reporting configuration defines the reporting criteria). Three reporting criteria are used: event triggered reporting, periodic reporting and event triggered periodic reporting.

The association between a measurement object and a reporting configuration is created by a measurement identity (a measurement identity links together one measurement object and one reporting configuration of same RAT). By using several measurement identities (one for each measurement object, reporting configuration pair) it is possible:

- To associate several reporting configurations to one measurement object and;
- To associate one reporting configuration to several measurement objects.

The measurements identity is as well used when reporting results of the measurements.

Measurement quantities are considered separately for each RAT.

Measurement commands are used by E-UTRAN to order the UE to start measurements, modify measurements or stop measurements.

For NB-IoT:

- Handover, measurement reports and inter-RAT mobility are not supported;
- 10.1.1 Mobility Management in ECM-IDLE, 10.1.4 Paging and C-plane establishment, 10.1.5 Random Access Procedure, 10.1.6 Radio Link Failure, 10.1.7 Radio Access Network Sharing and all their clauses are applicable;
- All other subclauses of clause 10 are not applicable.

10.1 Intra E-UTRAN

10.1.0 General

In E-UTRAN RRC_CONNECTED state, network-controlled UE-assisted handovers and DC specific activities are performed, except for NB-IoT, and various DRX cycles are supported.

In E-UTRAN RRC_IDLE state, cell reselections are performed and DRX is supported.

10.1.1 Mobility Management in ECM-IDLE

10.1.1.1 Cell selection

The principles of PLMN selection in E-UTRA are based on the 3GPP PLMN selection principles. Cell selection is required on transition from EMM_DETACHED to EMM-REGISTERED and from ECM-IDLE or ECM-CONNECTED.

Cell selection:

- The UE NAS layer identifies a selected PLMN and equivalent PLMNs;
- The UE searches the E-UTRA frequency bands and for each carrier frequency identifies the strongest cell. It reads cell system information broadcast to identify its PLMN(s):
 - The UE may search each carrier in turn ("initial cell selection") or make use of stored information to shorten the search ("stored information cell selection").
- The UE seeks to identify a suitable cell; if it is not able to identify a suitable cell it seeks to identify an acceptable cell. When a suitable cell is found or if only an acceptable cell is found it camps on that cell and commence the cell reselection procedure:
 - A suitable cell is one for which the measured cell attributes satisfy the cell selection criteria; the cell PLMN is the selected PLMN, registered or an equivalent PLMN; the cell is not barred or reserved and the cell is not part of a tracking area which is in the list of "forbidden tracking areas for roaming";
 - An acceptable cell is one for which the measured cell attributes satisfy the cell selection criteria and the cell is not barred.

Transition to RRC_IDLE:

On transition from RRC_CONNECTED to RRC_IDLE, a UE should camp on the last cell for which it was in RRC_CONNECTED or a cell/any cell of set of cells or frequency be assigned by RRC in the state transition message.

Recovery from out of coverage:

The UE should attempt to find a suitable cell in the manner described for stored information or initial cell selection above. If no suitable cell is found on any frequency or RAT the UE should attempt to find an acceptable cell.

10.1.1.2 Cell reselection

A UE in RRC_IDLE performs cell reselection. The principles of the procedure are the following:

- The UE makes measurements of attributes of the serving and neighbour cells to enable the reselection process:
 - There is no need to indicate neighbouring cells in the serving cell system information to enable the UE to search and measure a cell i.e. E-UTRAN relies on the UE to detect the neighbouring cells;
 - For the search and measurement of inter-frequency neighbouring cells, only the carrier frequencies need to be indicated;
 - Measurements may be omitted if the serving cell attribute fulfils particular search or measurement criteria.

- Cell reselection identifies the cell that the UE should camp on. It is based on cell reselection criteria which involves measurements of the serving and neighbour cells, except for NB-IoT:
 - Intra-frequency reselection is based on ranking of cells;
 - Inter-frequency reselection is based on absolute priorities where a UE tries to camp on the highest priority frequency available. Absolute priorities for reselection are provided only by the RPLMN and are valid only within the RPLMN; priorities are given by the system information and are valid for all UEs in a cell, specific priorities per UE can be signalled in the RRC Connection Release message. A validity time can be associated with UE specific priorities.
 - Inter-frequency E-UTRAN reselection can be also based on redistribution priority. A UE may be redistributed to a redistribution target (frequency or cell) and will consider the redistribution target (frequency or cell) as having the highest priority (i.e. higher than any network configured priority) for a period of time (i.e. validity timer). The redistribution parameters are defined in system information and can be triggered by Paging.
 - For inter-frequency neighbouring cells, it is possible to indicate layer-specific cell reselection parameters (e.g., layer specific offset). These parameters are common to all neighbouring cells on a frequency;
 - An NCL can be provided by the serving cell to handle specific cases for intra- and inter-frequency neighbouring cells. This NCL contains cell specific cell reselection parameters (e.g., cell specific offset) for specific neighbouring cells;
 - Black lists can be provided to prevent the UE from reselecting to specific intra- and inter-frequency neighbouring cells;
 - Cell reselection can be speed dependent (speed detection based on UTRAN solution);
 - Cell reselection parameters are applicable for all UEs in a cell, but it is possible to configure specific reselection parameters per UE group or per UE.

For NB-IoT, cell reselection identifies the cell that the UE should camp on. It is based on cell reselection criteria which involve measurements of the serving and neighbour cells as follows:

- Intra-frequency reselection is based on ranking of cells (potentially with cell specific offsets);
- Inter-frequency reselection is based on ranking of frequencies (potentially with frequency specific offsets);
- Blind redirection supported for load balancing (potentially with a dedicated offset for the frequency where the UE is redirected to).

Cell access restrictions apply as for UTRAN, which consist of access class (AC) barring and cell reservation (e.g. for cells "reserved for operator use") applicable for mobiles in RRC_IDLE mode. For NB-IoT UEs, BL UEs or UEs in enhanced coverage, E-UTRAN can also restrict access to the cell based on the level of coverage enhancements that would be needed by the UE.

10.1.1.3 Void

10.1.1.4 Void

10.1.1.5 Void

10.1.2 Mobility Management in ECM-CONNECTED/CM-CONNECTED

10.1.2.0 General

The Intra-E-UTRAN-Access Mobility Support for UEs in ECM-CONNECTED/CM-CONNECTED handles all necessary steps for

- Handover procedures, like processes that precede the final HO decision on the source network side (control and evaluation of UE and eNB measurements taking into account certain UE specific roaming and access

restrictions), preparation of resources on the target network side, commanding the UE to the new radio resources and finally releasing resources on the (old) source network side. It contains mechanisms to transfer context data between evolved nodes, and to update node relations on C-plane and U-plane.

- DC specific procedures, like processes that precede the final decision for a certain configuration of a SeNB (control and evaluation of UE and network side measurements), preparation of respective resources on the network side of a SeNB, commanding the UE to the new radio resources configuration for a second connection and, if applicable, finally releasing resources of a SeNB. It contains mechanisms to transfer UE- and bearer-context data between involved nodes, and to update node relations on C-plane and U-plane.

In E-UTRAN RRC_CONNECTED state, network-controlled UE-assisted handovers and DC specific activities are performed and various DRX cycles are supported.

The UE makes measurements of attributes of the serving and neighbour cells to enable the process:

- There is no need to indicate neighbouring cells to enable the UE to search and measure a cell i.e. E-UTRAN relies on the UE to detect the neighbouring cells;
- For the search and measurement of inter-frequency neighbouring cells, at least the carrier frequencies need to be indicated;
- The E-UTRAN signals reporting criteria for event-triggered and periodical reporting;
- An NCL can be provided by the serving cell by RRC dedicated signalling to handle specific cases for intra- and inter-frequency neighbouring cells. This NCL contains cell specific measurement parameters (e.g. cell specific offset) for specific neighbouring cells;
- Black lists can be provided to prevent the UE from measuring specific neighbouring cells.

For the UE measuring discovery signals (i.e. CRS and/or CSI-RS) of the serving and neighbour cells, the E-UTRAN indicates the measurement configuration to the UE, including the measurement timing configuration of the discovery signals.

Depending on whether the UE needs transmission/reception gaps to perform the relevant measurements, measurements are classified as gap assisted or non-gap assisted. A non-gap assisted measurement is a measurement on a cell that does not require transmission/reception gaps to allow the measurement to be performed. A gap assisted measurement is a measurement on a cell that does require transmission/reception gaps to allow the measurement to be performed. Gap patterns (as opposed to individual gaps) are configured and activated by RRC.

In the text and figure(s) in the following clauses, intra-E-UTRA HO description is applicable for both intra-EPC and intra-5GC cases. In addition, the following differences are applicable for intra-5GC:

- ng-eNB should be considered instead of eNB;
- 5GC should be considered instead of EPC, and NG interface should be considered instead of S1 interface;
- Xn interface should be considered instead of X2 interface and the messages sent between ng-eNBs over Xn are defined in TS 38.423 [86];
- AMF should be considered instead of MME, and UPF should be considered instead of Serving Gateway;
- PDU session information should be considered instead of E-RAB QoS, and the QoS flow to DRB mapping rules applied to the UE should be forwarded to the target ng-eNB;
- For the messages sent between MME and Serving Gateway, and between MME and eNB, use AMF/UPF/ng-eNB respectively;
- The data forwarding defined in clause 9.2.3.2.3 in TS 38.300 [79] should be applied instead of clause 10.1.2.3;
- The Dual Connectivity operation in clause 10.1.2.8 is not applicable to intra-5GC mobility. The corresponding Dual Connectivity operations for 5GC are described in TS 37.340 [76].

10.1.2.1 Handover

10.1.2.1.0 General

The intra E-UTRAN HO of a UE in RRC_CONNECTED state is a UE-assisted network-controlled HO, with HO preparation signalling in E-UTRAN:

- Part of the HO command comes from the target eNB and is transparently forwarded to the UE by the source eNB;
- To prepare the HO, the source eNB passes all necessary information to the target eNB (e.g. E-RAB attributes and RRC context):
 - When CA is configured and to enable SCell selection in the target eNB, the source eNB can provide in decreasing order of radio quality a list of the best cells and optionally measurement result of the cells.
 - When DC is configured, the source MeNB provides the SCG configuration (in addition to the MCG configuration) to the target MeNB.
- Both the source eNB and UE keep some context (e.g. C-RNTI) to enable the return of the UE in case of HO failure;
- If RACH-less HO is not configured, the UE accesses the target cell via RACH following a contention-free procedure using a dedicated RACH preamble or following a contention-based procedure if dedicated RACH preambles are not available:
 - the UE uses the dedicated preamble until the handover procedure is finished (successfully or unsuccessfully);
- If RACH-less HO is configured, the UE accesses the target cell via the uplink grant preallocated to the UE in the RRC message. If the UE does not receive the preallocated uplink grant in the RRC message from the source eNB, the UE monitors the PDCCH of the target cell;
- If the access towards the target cell (using RACH or RACH-less procedure) is not successful within a certain time, the UE initiates radio link failure recovery using a suitable cell;
- No ROHC context is transferred at handover;
- No UDC context is transferred at handover;
- ROHC context can be kept at handover within the same eNB.

10.1.2.1.1 C-plane handling

The preparation and execution phase of the HO procedure is performed without EPC involvement, i.e. preparation messages are directly exchanged between the eNBs. The release of the resources at the source side during the HO completion phase is triggered by the eNB. In case an RN is involved, its DeNB relays the appropriate S1 messages between the RN and the MME (S1-based handover) and X2 messages between the RN and target eNB (X2-based handover); the DeNB is explicitly aware of a UE attached to the RN due to the S1 proxy and X2 proxy functionality (see clause 4.7.6.6). The figure below depicts the basic handover scenario where neither MME nor Serving Gateway changes:

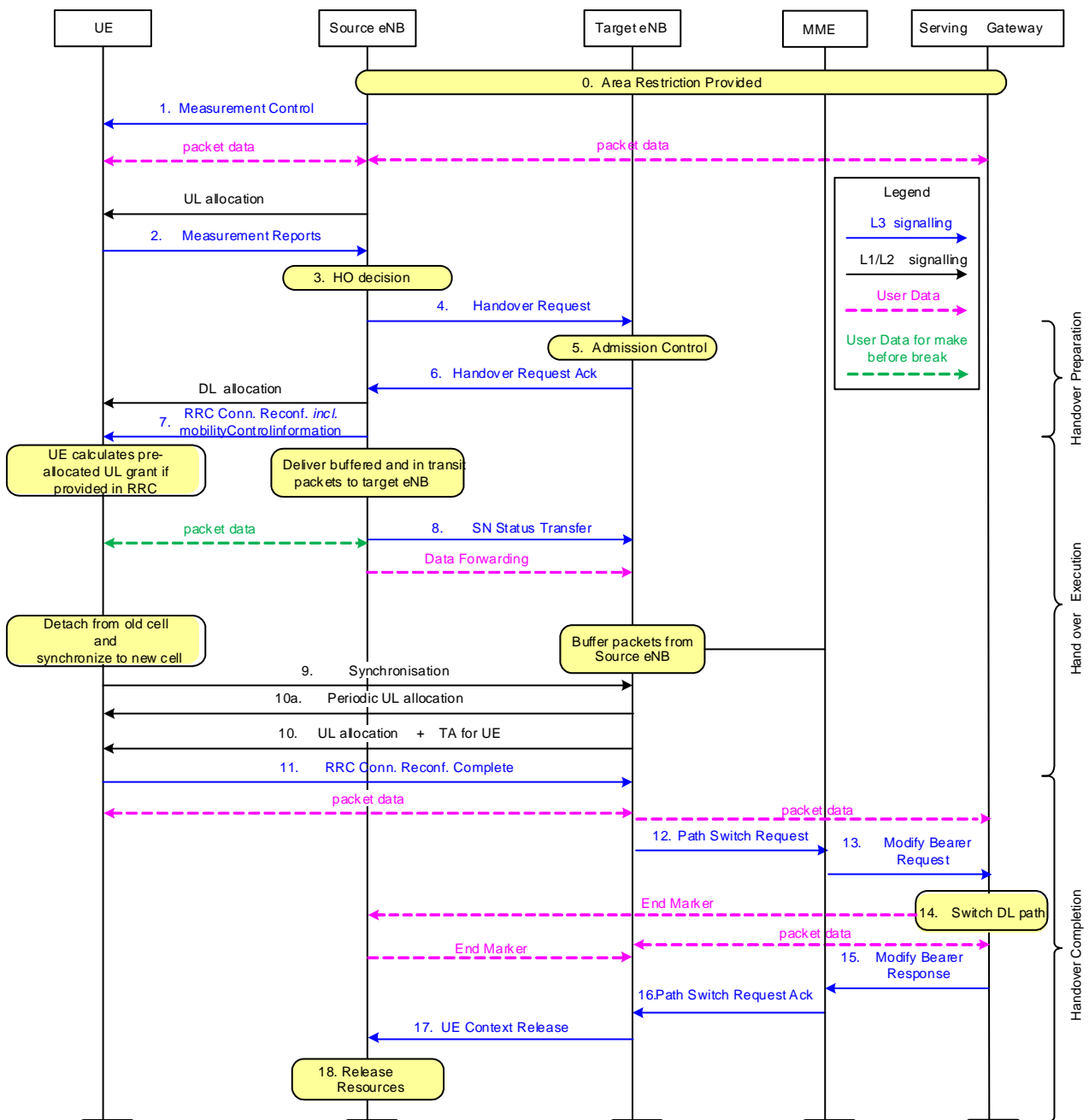

Figure 10.1.2.1.1-1: Intra-MME/Serving Gateway HO

Below is a more detailed description of the intra-MME/Serving Gateway HO procedure:

- 0 The UE context within the source eNB contains information regarding roaming and access restrictions which were provided either at connection establishment or at the last TA update.
- 1 The source eNB configures the UE measurement procedures according to the roaming and access restriction information and e.g. the available multiple frequency band information. Measurements provided by the source eNB may assist the function controlling the UE's connection mobility.
- 2 A MEASUREMENT REPORT is triggered and sent to the eNB.
- 3 The source eNB makes decision based on MEASUREMENT REPORT and RRM information to hand off the UE.

- 4 The source eNB issues a HANDOVER REQUEST message to the target eNB passing necessary information to prepare the HO at the target side (UE X2 signalling context reference at source eNB, UE S1 EPC signalling context reference, target cell ID, K_{eNB^*} , RRC context including the C-RNTI of the UE in the source eNB, AS-configuration, E-RAB context and physical layer ID of the source cell + short MAC-I for possible RLF recovery). UE X2 / UE S1 signalling references enable the target eNB to address the source eNB and the EPC. The E-RAB context includes necessary RNL and TNL addressing information, and QoS profiles of the E-RABs.
- 5 Admission Control may be performed by the target eNB dependent on the received E-RAB QoS information to increase the likelihood of a successful HO, if the resources can be granted by target eNB. The target eNB configures the required resources according to the received E-RAB QoS information and reserves a C-RNTI and optionally a RACH preamble. The AS-configuration to be used in the target cell can either be specified independently (i.e. an "establishment") or as a delta compared to the AS-configuration used in the source cell (i.e. a "reconfiguration").
- 6 The target eNB prepares HO with L1/L2 and sends the HANDOVER REQUEST ACKNOWLEDGE to the source eNB. The HANDOVER REQUEST ACKNOWLEDGE message includes a transparent container to be sent to the UE as an RRC message to perform the handover. The container includes a new C-RNTI, target eNB security algorithm identifiers for the selected security algorithms, may include a dedicated RACH preamble, and possibly some other parameters i.e. access parameters, SIBs, etc. If RACH-less HO is configured, the container includes timing adjustment indication and optionally a preallocated uplink grant. The HANDOVER REQUEST ACKNOWLEDGE message may also include RNL/TNL information for the forwarding tunnels, if necessary.

NOTE 1: As soon as the source eNB receives the HANDOVER REQUEST ACKNOWLEDGE, or as soon as the transmission of the handover command is initiated in the downlink, data forwarding may be initiated.

Steps 7 to 16 provide means to avoid data loss during HO and are further detailed in 10.1.2.1.2 and 10.1.2.3.

- 7 The target eNB generates the RRC message to perform the handover, i.e. *RRConnectionReconfiguration* message including the *mobilityControlInfo*, to be sent by the source eNB towards the UE. The source eNB performs the necessary integrity protection and ciphering of the message.

The UE receives the *RRConnectionReconfiguration* message with necessary parameters (i.e. new C-RNTI, target eNB security algorithm identifiers, and optionally dedicated RACH preamble, target eNB SIBs, etc.) and is commanded by the source eNB to perform the HO. If RACH-less HO is configured, the *RRConnectionReconfiguration* includes timing adjustment indication and optionally preallocated uplink grant for accessing the target eNB. If preallocated uplink grant is not included, the UE should monitor PDCCH of the target eNB to receive an uplink grant. The UE does not need to delay the handover execution for delivering the HARQ/ARQ responses to source eNB.

If Make-Before-Break HO is configured, the connection to the source cell is maintained after the reception of *RRConnectionReconfiguration* message with *mobilityControlInfo* before the UE executes initial uplink transmission to the target cell.

NOTE 2: If Make-Before-Break HO is configured, the source eNB decides when to stop transmitting to the UE.

NOTE 3: The UE can be configured with Make-Before-Break HO and RACH-less HO simultaneously.

- 8 The source eNB sends the SN STATUS TRANSFER message to the target eNB to convey the uplink PDCP SN receiver status and the downlink PDCP SN transmitter status of E-RABs for which PDCP status preservation applies (i.e. for RLC AM). The uplink PDCP SN receiver status includes at least the PDCP SN of the first missing UL SDU and may include a bit map of the receive status of the out of sequence UL SDUs that the UE needs to retransmit in the target cell, if there are any such SDUs. The downlink PDCP SN transmitter status indicates the next PDCP SN that the target eNB shall assign to new SDUs, not having a PDCP SN yet. The source eNB may omit sending this message if none of the E-RABs of the UE shall be treated with PDCP status preservation.
- 9 If RACH-less HO is not configured, after receiving the *RRConnectionReconfiguration* message including the *mobilityControlInfo*, UE performs synchronisation to target eNB and accesses the target cell via RACH, following a contention-free procedure if a dedicated RACH preamble was indicated in the *mobilityControlInfo*, or following a contention-based procedure if no dedicated preamble was indicated. UE derives target eNB specific keys and configures the selected security algorithms to be used in the target cell.

If RACH-less HO is configured, UE performs synchronisation to target eNB. UE derives target eNB specific keys and configures the selected security algorithms to be used in the target cell.

- 10 If RACH-less HO is not configured, the target eNB responds with UL allocation and timing advance.
- 10a If RACH-less HO is configured and the UE did not get the periodic pre-allocated uplink grant in the *RRCConnectionReconfiguration* message including the *mobilityControlInfo*, the UE receives uplink grant via the PDCCH of the target cell. The UE uses the first available uplink grant after synchronization to the target cell.
- 11 When the RACH-less HO is not configured and the UE has successfully accessed the target cell, the UE sends the *RRCConnectionReconfigurationComplete* message (C-RNTI) to confirm the handover, along with an uplink Buffer Status Report, and/or UL data, whenever possible, to the target eNB, which indicates that the handover procedure is completed for the UE. The target eNB verifies the C-RNTI sent in the *RRCConnectionReconfigurationComplete* message. The target eNB can now begin sending data to the UE.
- When the RACH-less HO is configured, after the UE has received uplink grant, the UE sends the *RRCConnectionReconfigurationComplete* message (C-RNTI) to confirm the handover, along with an uplink Buffer Status Report, and/or UL data, whenever possible, to the target eNB. The target eNB verifies the C-RNTI sent in the *RRCConnectionReconfigurationComplete* message. The target eNB can now begin sending data to the UE. The handover procedure is completed for the UE when the UE receives the UE contention resolution identity MAC control element from the target eNB.
- 12 The target eNB sends a PATH SWITCH REQUEST message to MME to inform that the UE has changed cell.
- 13 The MME sends a MODIFY BEARER REQUEST message to the Serving Gateway.
- 14 The Serving Gateway switches the downlink data path to the target side. The Serving gateway sends one or more "end marker" packets on the old path to the source eNB and then can release any U-plane/TNL resources towards the source eNB.
- 15 The Serving Gateway sends a MODIFY BEARER RESPONSE message to MME.
- 16 The MME confirms the PATH SWITCH REQUEST message with the PATH SWITCH REQUEST ACKNOWLEDGE message.
- 17 By sending the UE CONTEXT RELEASE message, the target eNB informs success of HO to source eNB and triggers the release of resources by the source eNB. The target eNB sends this message after the PATH SWITCH REQUEST ACKNOWLEDGE message is received from the MME.
- 18 Upon reception of the UE CONTEXT RELEASE message, the source eNB can release radio and C-plane related resources associated to the UE context. Any ongoing data forwarding may continue.

When an X2 handover is used involving HeNBs and when the source HeNB is connected to a HeNB GW, a UE CONTEXT RELEASE REQUEST message including an explicit GW Context Release Indication is sent by the source HeNB, in order to indicate that the HeNB GW may release of all the resources related to the UE context.

10.1.2.1.2 U-plane handling

The U-plane handling during the Intra-E-UTRAN-Access mobility activity for UEs in ECM-CONNECTED takes the following principles into account to avoid data loss during HO:

- During HO preparation U-plane tunnels can be established between the source eNB and the target eNB. There is one tunnel established for uplink data forwarding and another one for downlink data forwarding for each E-RAB for which data forwarding is applied. In the case of a UE under an RN performing handover, forwarding tunnels can be established between the RN and the target eNB via the DeNB.
- During HO execution, user data can be forwarded from the source eNB to the target eNB. The forwarding may take place in a service and deployment dependent and implementation specific way.
 - Forwarding of downlink user data from the source to the target eNB should take place in order as long as packets are received at the source eNB from the EPC or the source eNB buffer has not been emptied.
- During HO completion:
 - The target eNB sends a PATH SWITCH message to MME to inform that the UE has gained access and MME sends a MODIFY BEARER REQUEST message to the Serving Gateway, the U-plane path is switched by the Serving Gateway from the source eNB to the target eNB.

- The source eNB should continue forwarding of U-plane data as long as packets are received at the source eNB from the Serving Gateway or the source eNB buffer has not been emptied.

For **RLC-AM bearers**:

- During normal HO not involving Full Configuration:
 - For in-sequence delivery and duplication avoidance, PDCP SN is maintained on a bearer basis and the source eNB informs the target eNB about the next DL PDCP SN to allocate to a packet which does not have a PDCP sequence number yet (either from source eNB or from the Serving Gateway).
 - For security synchronisation, HFN is also maintained and the source eNB provides to the target one reference HFN for the UL and one for the DL i.e. HFN and corresponding SN.
 - In both the UE and the target eNB, a window-based mechanism is needed for duplication detection.
 - The occurrence of duplicates over the air interface in the target eNB is minimised by means of PDCP SN based reporting at the target eNB by the UE. In uplink, the reporting is optionally configured on a bearer basis by the eNB and the UE should first start by transmitting those reports when granted resources in the target eNB. In downlink, the eNB is free to decide when and for which bearers a report is sent and the UE does not wait for the report to resume uplink transmission.
 - The target eNB re-transmits and prioritizes all downlink PDCP SDUs forwarded by the source eNB (i.e. the target eNB should send data with PDCP SNs from X2 before sending data from S1), with the exception of PDCP SDUs of which the reception was acknowledged through PDCP SN based reporting by the UE.
 - The UE re-transmits in the target eNB all uplink PDCP SDUs starting from the first PDCP SDU following the last consecutively confirmed PDCP SDU i.e. the oldest PDCP SDU that has not been acknowledged at RLC in the source, excluding the PDCP SDUs of which the reception was acknowledged through PDCP SN based reporting by the target.
- During HO involving Full Configuration:
 - The following description below for RLC-UM bearers also applies for RLC-AM bearers. Data loss may happen.

For **RLC-UM bearers**:

- The PDCP SN and HFN are reset in the target eNB.
- No PDCP SDUs are retransmitted in the target eNB.
- The target eNB prioritizes all downlink PDCP SDUs forwarded by the source eNB if any (i.e. the target eNB should send data with PDCP SNs from X2 before sending data from S1).
- The UE PDCP entity does not attempt to retransmit any PDCP SDU in the target cell for which transmission had been completed in the source cell. Instead UE PDCP entity starts the transmission with other PDCP SDUs.

10.1.2.2 Path Switch

10.1.2.2.1 Path Switch upon handover

After the downlink path is switched at the Serving GW downlink packets on the forwarding path and on the new direct path may arrive interchanged at the target eNB. The target eNodeB should first deliver all forwarded packets to the UE before delivering any of the packets received on the new direct path. The method employed in the target eNB to enforce the correct delivery order of packets is outside the scope of the standard.

In order to assist the reordering function in the target eNB, the Serving GW shall send one or more "end marker" packets on the old path immediately after switching the path for each E-RAB of the UE. The "end marker" packet shall not contain user data. The "end marker" is indicated in the GTP header. After completing the sending of the tagged packets the GW shall not send any further user data packets via the old path.

Upon receiving the "end marker" packets, the source eNB shall, if forwarding is activated for that bearer, forward the packet toward the target eNB.

On detection of an "end marker" the target eNB shall discard the end marker packet and initiate any necessary processing to maintain in sequence delivery of user data forwarded over X2 interface and user data received from the serving GW over S1 as a result of the path switch.

On detection of the "end marker", the target eNB may also initiate the release of the data forwarding resource. However, the release of the data forwarding resource is implementation dependent and could also be based on other mechanisms (e.g. timer-based mechanism).

EPC may change the uplink end-point of the tunnels with Path Switch procedure. However, the EPC should keep the old GTP tunnel end-point(s) sufficiently long time in order to minimise the probability of packet losses and avoid unintentional release of respective E-RAB(s).

10.1.2.2.2 Path Update upon Dual Connectivity specific activities

Upon DC specific activities which involve the transfer of bearer contexts from one eNB to another, if one of the eNBs involved in DC provides radio resources to the UE for one or several E-RABs configured with the SCG bearer option, the update of the downlink path towards the EPC for the relevant E-RABs needs to be communicated by the MeNB to the MME. The functions specified for the path switch for handover as specified in clause 10.1.2.2.1 are applicable for the path update for DC with SCG bearer option as well except that:

- The role of involved eNBs are different: in DC, the "source eNB" as specified for handover, is the eNB from which the bearer context is transferred and the "target eNB" is the eNB to which the bearer context is transferred.
- The EPC does not change the uplink end-point of the tunnels with the Path Update procedure in a way that this would change the Serving GW.

10.1.2.2.3 Path Switch upon UE context resume

Upon resumption of a UE context in an eNB different from the one where the UE context was suspended, the Path Switch procedure is used to request the MME to resume the UE context and related bearer contexts in the EPC and update the downlink path.

10.1.2.3 Data forwarding

10.1.2.3.1 For RLC-AM DRBs

Upon handover, the source eNB may forward in order to the target eNB all downlink PDCP SDUs with their SN that have not been acknowledged by the UE. In addition, the source eNB may also forward without a PDCP SN fresh data arriving over S1 to the target eNB.

NOTE: The target eNB does not have to wait for the completion of forwarding from the source eNB before it begins transmitting packets to the UE.

The source eNB discards any remaining downlink RLC PDUs. Correspondingly, the source eNB does not forward the downlink RLC context to the target eNB.

NOTE: The source eNB does not need to abort ongoing RLC transmissions with the UE as it starts data forwarding to the target eNB.

Upon handover, the source eNB forwards to the Serving Gateway the uplink PDCP SDUs successfully received in-sequence until the sending of the Status Transfer message to the target eNB. Then at that point of time the source eNB stops delivering uplink PDCP SDUs to the S-GW and shall discard any remaining uplink RLC PDUs. Correspondingly, the source eNB does not forward the uplink RLC context to the target eNB.

Then the source eNB shall either:

- discard the uplink PDCP SDUs received out of sequence if the source eNB has not accepted the request from the target eNB for uplink forwarding or if the target eNB has not requested uplink forwarding for the bearer during the Handover Preparation procedure,
- forward to the target eNB the uplink PDCP SDUs received out of sequence if the source eNB has accepted the request from the target eNB for uplink forwarding for the bearer during the Handover Preparation procedure.

The PDCP SN of forwarded SDUs is carried in the "PDCP PDU number" field of the GTP-U extension header. The target eNB shall use the PDCP SN if it is available in the forwarded GTP-U packet.

For normal HO in-sequence delivery of upper layer PDUs during handover is based on a continuous PDCP SN and is provided by the "in-order delivery and duplicate elimination" function at the PDCP layer:

- in the downlink, the "in-order delivery and duplicate elimination" function at the UE PDCP layer guarantees in-sequence delivery of downlink PDCP SDUs;
- in the uplink, the "in-order delivery and duplicate elimination" function at the target eNB PDCP layer guarantees in-sequence delivery of uplink PDCP SDUs.

After a normal handover, when the UE receives a PDCP SDU from the target eNB, it can deliver it to higher layer together with all PDCP SDUs with lower SNs regardless of possible gaps.

For handovers involving Full Configuration, the source eNB behaviour is unchanged from the description above. The target eNB may not send PDCP SDUs for which delivery was attempted by the source eNB. The target eNB identifies these by the presence of the PDCP SN in the forwarded GTP-U packet and discards them.

After a Full Configuration handover, the UE delivers received PDCP SDU from the source cell to the higher layer regardless of possible gaps. UE discards uplink PDCP SDUs for which transmission was attempted and retransmission of these over the target cell is not possible.

10.1.2.3.2 For RLC-UM DRBs

Upon handover, the source eNB does not forward to the target eNB downlink PDCP SDUs for which transmission had been completed in the source cell. PDCP SDUs that have not been transmitted may be forwarded. In addition, the source eNB may forward fresh downlink data arriving over S1 to the target eNB. The source eNB discards any remaining downlink RLC PDUs. Correspondingly, the source eNB does not forward the downlink RLC context to the target eNB.

Upon handover, the source eNB forwards all uplink PDCP SDUs successfully received to the Serving Gateway (i.e. including the ones received out of sequence) and discards any remaining uplink RLC PDUs. Correspondingly, the source eNB does not forward the uplink RLC context to the target eNB.

10.1.2.3.3 SRB handling

With respect to SRBs, the following principles apply at HO:

- No forwarding or retransmissions of RRC messages in the target;
- The PDCP SN and HFN are reset in the target.

10.1.2.3.4 User data forwarding for Dual Connectivity

Upon DC specific activities user data forwarding may be performed for E-RABs configured with the SCG bearer option or with the split bearer option. The behaviour of the eNB from which data is forwarded is the same as specified for the "source eNB" for handover, the behaviour of the eNB to which data is forwarded is the same as specified for the "target eNB" for handover. If data forwarding for split bearer option is applied, the PDCP PDUs which are not acknowledged by the UE are forwarded from the SeNB to the MeNB in the course of procedures involving the release of the SCG part of the split bearer (e.g., SeNB Modification, SeNB Release, Change of SeNB).

10.1.2.4 Void

10.1.2.5 Void

10.1.2.6 Void

10.1.2.7 Timing Advance

In RRC_CONNECTED, the eNB is responsible for maintaining the timing advance. Serving cells having UL to which the same timing advance applies (typically corresponding to the serving cells hosted by the same receiver) and using the same timing reference cell are grouped in a timing advance group (TAG). Each TAG contains at least one serving cell with configured uplink, and the mapping of each serving cell to a TAG is configured by RRC. In case of DC, a TAG only includes cells that are associated to the same CG and the maximum number of TAG is 8.

For the pTAG the UE uses the PCell in MCG and the PSCell in SCG as timing reference. In a sTAG, the UE may use any of the activated SCells of this TAG as a timing reference cell, but should not change it unless necessary.

For NB-IoT, the UE uses the anchor carrier as timing reference no matter if the non-anchor carrier is configured or not.

In some cases (e.g. during DRX), the timing advance is not necessarily always maintained and the MAC sublayer knows if the L1 is synchronised and which procedure to use to start transmitting in the uplink:

- as long as the L1 is non-synchronised, uplink transmission can only take place on PRACH.

For a TAG, cases where the UL synchronisation status moves from "synchronised" to "non-synchronised" include:

- Expiration of a timer specific to the TAG;
- Non-synchronised handover.

The synchronisation status of the UE follows the synchronisation status of the pTAG of MCG. The synchronisation status of the UE w.r.t. SCG follows the synchronisation status of the pTAG of SCG. When the timer associated with pTAG is not running, the timer associated with an sTAG in that CG shall not be running. Expiry of the timers associated with one CG does not affect the operation of the other CG.

The value of the timer associated to the pTAG of MCG is either UE specific and managed through dedicated signalling between the UE and the eNB, or cell specific and indicated via broadcast information. In both cases, the timer is normally restarted whenever a new timing advance is given by the eNB for the pTAG:

- restarted to a UE specific value if any; or
- restarted to a cell specific value otherwise.

The value of the timer associated to a pTAG of SCG and the value of a timer associated to an sTAG of an MCG or an sTAG of SCG are managed through dedicated signalling between the UE and the eNB, and the timers associated to these TAGs can be configured with different values. The timers of these TAGs are normally restarted whenever a new timing advance is given by the eNB for the corresponding TAG.

Upon DL data arrival or for positioning purpose, a dedicated signature on PRACH can be allocated by the eNB to the UE. When a dedicated signature on PRACH is allocated, the UE shall perform the corresponding random access procedure regardless of its L1 synchronisation status.

Timing advance updates are signalled by the eNB to the UE in MAC PDUs.

With RACH-less HO, only timing adjustment indication, $N_{TA}=0$ or reuse N_{TA} from a source eNB, are allowed where N_{TA} denotes a parameter defined in TS36.213 [6] and TS36.211 [4].

10.1.2.8 Dual Connectivity operation

10.1.2.8.1 SeNB Addition

The SeNB Addition procedure is initiated by the MeNB and is used to establish a UE context at the SeNB in order to provide radio resources from the SeNB to the UE. This procedure is used to add at least the first cell (PSCell) of the SCG. Figure 10.1.2.8.1-1 shows the SeNB Addition procedure.

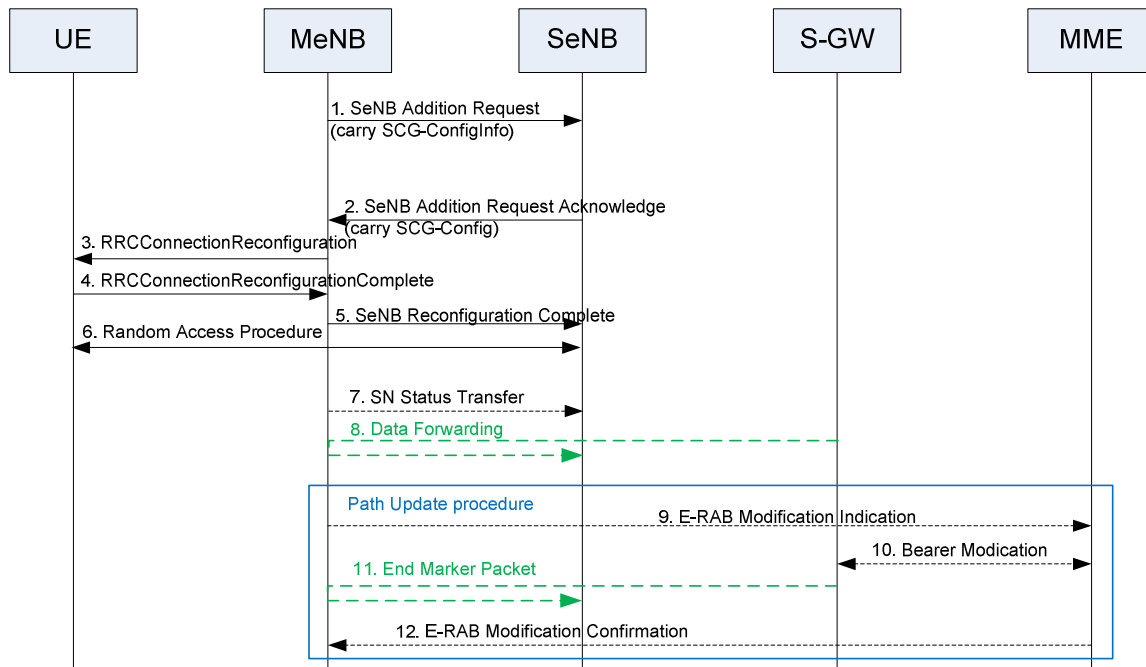

Figure 10.1.2.8.1-1: SeNB Addition procedure

1. The MeNB decides to request the SeNB to allocate radio resources for a specific E-RAB, indicating E-RAB characteristics (E-RAB parameters, TNL address information corresponding to bearer type). In addition, MeNB indicates within *SCG-ConfigInfo* the MCG configuration and the entire UE capabilities for UE capability coordination to be used as basis for the reconfiguration by the SeNB, but does not include SCG configuration. The MeNB can provide the latest measurement results for the SCG cell(s) requested to be added. The SeNB may reject the request.

NOTE: In contrast to SCG bearer, for the split bearer option the MeNB may either decide to request resources from the SeNB of such an amount, that the QoS for the respective E-RAB is guaranteed by the exact sum of resources provided by the MeNB and the SeNB together, or even more. The MeNB's decision may be reflected in step 1 by the E-RAB parameters signalled to the SeNB, which may differ from E-RAB parameters received over S1.

NOTE: For a specific E-RAB, the MeNB may request the direct establishment of an SCG or a Split bearer, i.e., without first having to establish an MCG bearer.

2. If the RRM entity in the SeNB is able to admit the resource request, it allocates respective radio resources and, dependent on the bearer option, respective transport network resources. The SeNB triggers Random Access so that synchronisation of the SeNB radio resource configuration can be performed. The SeNB provides the new radio resource of SCG in *SCG-Config* to the MeNB. For SCG bearers, the SeNB provides the new radio resource of the SCG together with S1 DL TNL address information for the respective E-RAB and security algorithm, for split bearers together with X2 DL TNL address information.

NOTE: In case of split bearers, transmission of user plane data may take place after step 2.

NOTE: In case of SCG bearers, data forwarding and the SN Status Transfer may take place after step 2.

3. If the MeNB endorses the new configuration, the MeNB sends the *RRCConnectionReconfiguration* message to the UE including the new radio resource configuration of SCG according to the *SCG-Config*.

4. The UE applies the new configuration and replies with *RRCCONNECTIONRECONFIGURATIONCOMPLETE* message. In case the UE is unable to comply with (part of) the configuration included in the *RRCCONNECTIONRECONFIGURATION* message, it performs the reconfiguration failure procedure.
5. The MeNB informs the SeNB that the UE has completed the reconfiguration procedure successfully.
6. The UE performs synchronisation towards the PSCell of the SeNB. The order the UE sends the *RRCCONNECTIONRECONFIGURATIONCOMPLETE* message and performs the Random Access procedure towards the SCG is not defined. The successful RA procedure towards the SCG is not required for a successful completion of the RRC Connection Reconfiguration procedure.
- 7./8. In case of SCG bearers, and dependent on the bearer characteristics of the respective E-RAB, the MeNB may take actions to minimise service interruption due to activation of dual connectivity (Data forwarding, SN Status Transfer).
- 9.-12. For SCG bearers, the update of the UP path towards the EPC is performed.

10.1.2.8.2 SeNB Modification

The SeNB Modification procedure may be initiated either by the MeNB or by the SeNB and be used to modify, establish or release bearer contexts, to transfer bearer contexts to and from the SeNB or to modify other properties of the UE context within the same SeNB.

The SeNB modification procedure does not necessarily need to involve signalling towards the UE.

MeNB initiated SeNB Modification

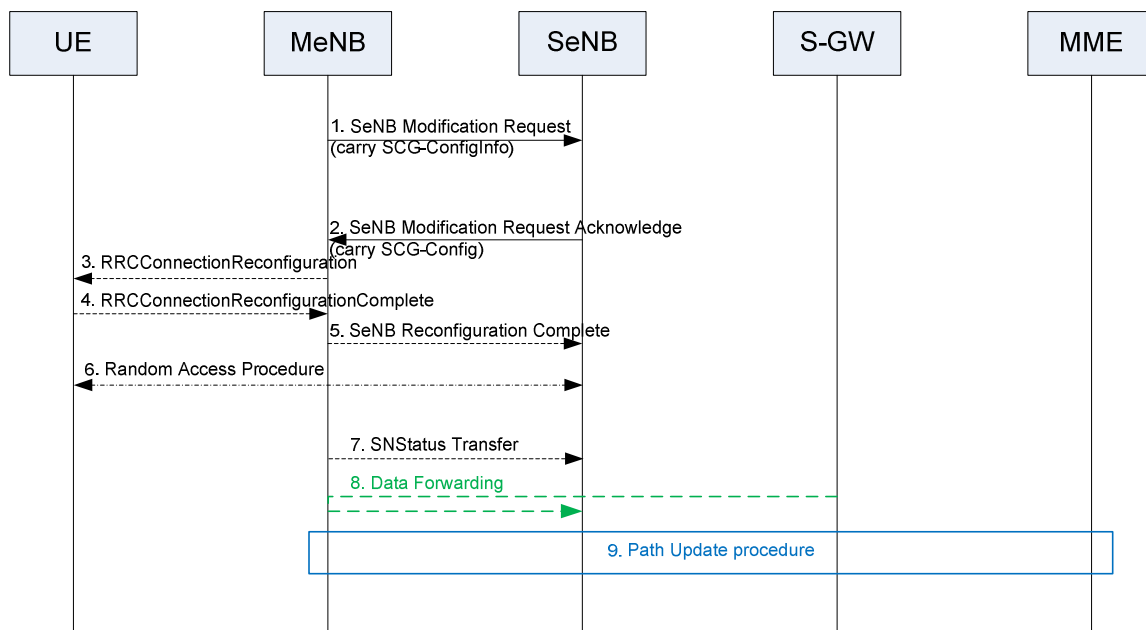

Figure 10.1.2.8.2-1: SeNB Modification procedure - MeNB initiated

The MeNB uses the procedure to initiate configuration changes of the SCG within the same SeNB, e.g. the addition or release of SCG SCells, the addition, modification or release of SCG bearer(s) and the SCG part of split bearer(s) and to trigger PSCell change involving PSCell release. The SeNB may reject the request, except if it concerns the release of SCG cells, of SCG bearer(s) or the SCG part of split bearer(s). Figure 10.1.2.8.2-1 shows an example signalling flow for a MeNB initiated SeNB Modification procedure.

1. The MeNB sends the SeNB Modification Request message, which may contain bearer context related or other UE context related information, data forwarding address information (if applicable) and *SCG-ConfigInfo* which contains the MCG configuration and the entire UE capabilities for UE capability coordination to be used as basis for the reconfiguration by the SeNB. In case of SCG SCell addition request, the MeNB can provide the latest measurement results for the SCG cell(s) requested to be added and SCG serving cell(s). In case of SCG Change, SCG Change Indication is included.

NOTE: MeNB may request the establishment or release of SCG or Split bearer while not reconfiguration to MCG bearer, which can be performed without SCG change.

2. The SeNB responds with the SeNB Modification Request Acknowledge message, which may contain radio configuration information within *SCG-Config* message and data forwarding address information (if applicable). In this step, the SeNB does not initiate an SCG change i.e. the *SCG-Config* message indicates an SCG Change only if the MeNB included the SCG Change Indication in the SeNB Modification Request message (as an SCG change initiated by the SeNB would subsequently require an SCG counter from the MeNB). In case of SCG Change, for E-RABs configured with the split bearer option for which no bearer type change is performed, the SeNB provides a new DL GTP TEID to the MeNB. The MeNB shall continue sending DL PDCP PDUs to the SeNB with the previous DL GTP TEID until it performs PDCP re-establishment or PDCP data recovery, and use the new DL GTP TEID starting with the PDCP re-establishment or data recovery.
- 3/4. The MeNB initiates the RRC connection reconfiguration procedure. The UE applies the new configuration and replies with *RRCConnectionReconfigurationComplete*. In case the UE is unable to comply with (part of) the configuration included in the *RRCConnectionReconfiguration* message, it performs the reconfiguration failure procedure.
5. Upon successful completion of the reconfiguration, the success of the procedure is indicated in the SeNB Reconfiguration Complete message.
6. If instructed, the UE performs synchronisation towards the PSCell of the SeNB as described in SeNB addition procedure. Otherwise, the UE may perform UL transmission after having applied the new configuration.
- 7/8. If applicable, data forwarding between MeNB and the SeNB takes place (Figure 10.1.2.8.2-1 depicts the case where a bearer context is transferred from the MeNB to the SeNB).
9. If applicable, a path update is performed.

SeNB initiated SeNB Modification

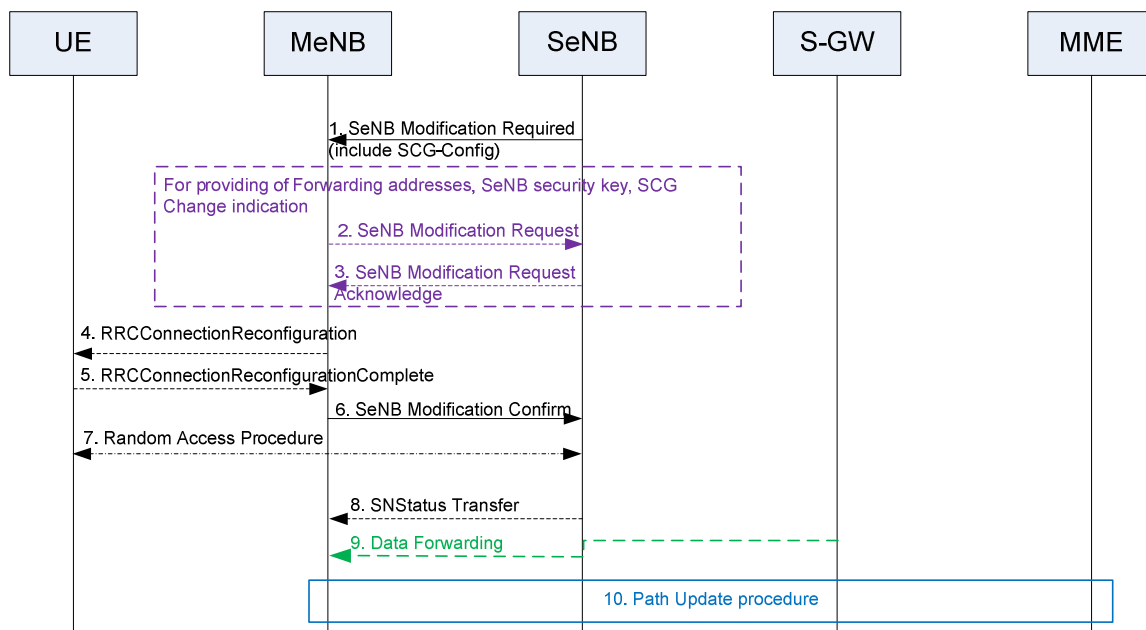

Figure 10.1.2.8.2-2: SeNB Modification procedure - SeNB initiated

The SeNB uses the procedure to perform configuration changes of the SCG within the same SeNB, e.g. to trigger the release of SCG SCell(s) (other than PSCell), SCG bearer(s) and the SCG part of split bearer(s) (upon which the MeNB may release the bearer or reconfigure it to an MCG bearer), and to trigger PSCell change. The MeNB cannot reject the release request of SCG SCells (other than PSCell), SCG bearer and the SCG part of split bearer. The SeNB cannot initiate an SCG SCell addition except for the case of SI update of an SCG SCell. Figure 10.1.2.8.2-2 shows an example signalling flow for an SeNB initiated SeNB Modification procedure.

1. The SeNB sends the SeNB Modification Required message, which may contain bearer context related, other UE context related information and *SCG-Config* which contains the new radio resource configuration of SCG. For

bearer release or modification a corresponding E-RAB list is included in the SeNB Modification Required message. In case of SCG Change, SCG Change Indication together with *SCG-Config* are included. In case of release of bearer served by SeNB, *SCG-Config* is not included.

The SeNB can decide whether the Random Access procedure is required, i.e. SCG change.

2./3. If data forwarding and/or SeNB security key change needs to be applied, the MeNB triggers the preparation of the MeNB initiated SeNB Modification procedure and provides forwarding address and/or a new SeNB security key information within the SeNB Modification Request message, respectively. If the SeNB requested to release a bearer in step 1, and the MeNB decides to reconfigure it to an MCG bearer, the MeNB provides the SCG Change Indication within the SeNB Modification Request message and the SeNB provides respective RRC information in the *SCG-Configuration* within the SeNB Modification Request Acknowledgement message.

NOTE: When the SeNB Modification Required message contains *SCG-Config* in step 1, the following MeNB initiated SeNB Modification procedure triggered by the MeNB in step 2 cannot be used for anything that would require a new SCG configuration (as *SCG-Config* cannot be subsequently signalled by the SeNB).

NOTE: If only SeNB security key (i.e. without SCG Change Indication) is provided in step 2, the MeNB does not need to wait for the reception of step 3 to initiate the RRC connection reconfiguration procedure.

4. If MeNB accepts the SeNB request, the MeNB sends the *RRCCConnectionReconfiguration* message to the UE including the new radio resource configuration of SCG according to the *SCG-Config*.
5. The UE applies the new configuration and replies the *RRCCConnectionReconfigurationComplete* message. In case the UE is unable to comply with (part of) the configuration included in the *RRCCConnectionReconfiguration* message, it performs the reconfiguration failure procedure.
6. Upon successful completion of the reconfiguration, the success of the procedure related to *SCG-Config* is indicated in the SeNB Modification Confirm message.
7. If instructed, the UE performs synchronisation towards the PSCell of the SeNB as described in SeNB addition procedure. Otherwise, the UE may perform UL transmission after having applied the new configuration.
- 8/9. If applicable, data forwarding between MeNB and the SeNB takes place (Figure 10.1.2.8.2-2 depicts the case where a bearer context is transferred from the SeNB to the MeNB).
10. If applicable, a path update is performed.

10.1.2.8.2.1 Intra-MeNB handover involving SCG change

This procedure is used to perform handover within the same MeNB while keeping the SCG in the same SeNB.

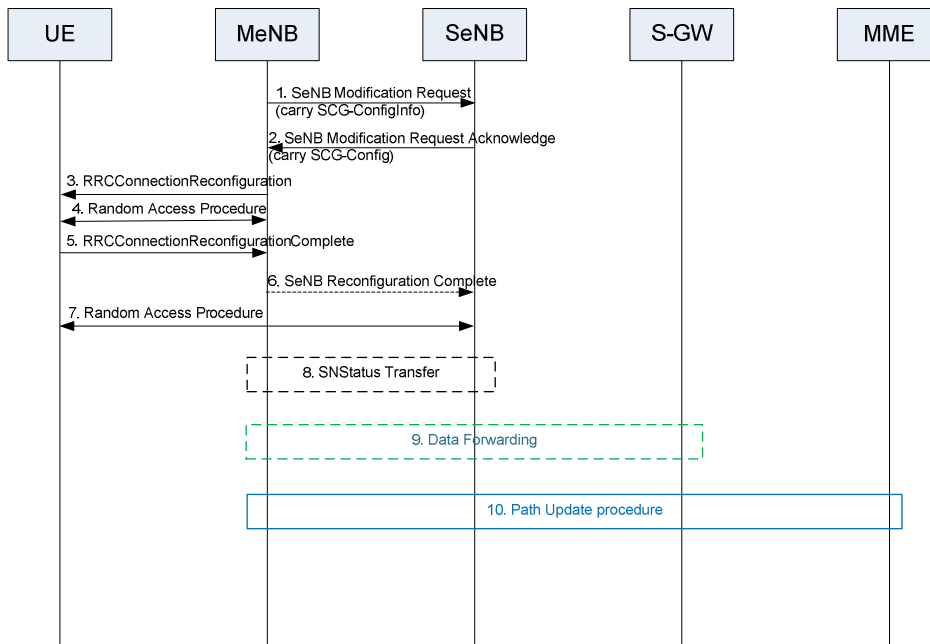

Figure 10.1.2.8.2.1-1: Intra-MeNB handover procedure with SeNB configuration

1. The MeNB sends the SeNB Modification Request message, which may contain bearer context related or other UE context related information, data forwarding address information (if applicable) and *SCG-ConfigInfo* which contains the MCG configuration and the entire UE capabilities for UE capability coordination to be used as basis for the reconfiguration by the SeNB. In case of SCG SCell addition request, the MeNB can provide the latest measurement results for the SCG cell(s) requested to be added and SCG serving cell(s). For E-RABs configured with the split bearer option for which no bearer type change is performed during the SCG Change procedure the MeNB provides a new UL GTP TEID to the SeNB. The SeNB shall continue sending UL PDCP PDUs to the MeNB with the previous UL GTP TEID until it re-establishes the RLC and use the new UL GTP TEID after RLC re-establishment.
2. The SeNB responds with the SeNB Modification Request Acknowledge message, which may contain radio configuration information within *SCG-Config* message and data forwarding address information (if applicable).
3. The MeNB triggers the UE to apply the new configuration including SCG configuration.
- 4/5. The UE synchronizes to the MeNB.
6. Upon successful completion of the reconfiguration, the success of the procedure is indicated in the SeNB Reconfiguration Complete message.
7. The UE performs synchronisation towards the PSCell of the SeNB as described in SeNB addition procedure.
- 8/9. Data forwarding between MeNB and the SeNB may take place.
10. If applicable, a path update is performed.

10.1.2.8.3 SeNB Release

The SeNB Release procedure may be initiated either by the MeNB or by the SeNB and is used to initiate the release of the UE context at the SeNB. The recipient node of this request cannot reject.

It does not necessarily need to involve signalling towards the UE, e.g., RRC connection re-establishment due to Radio Link Failure in MeNB.

MeNB initiated SeNB Release

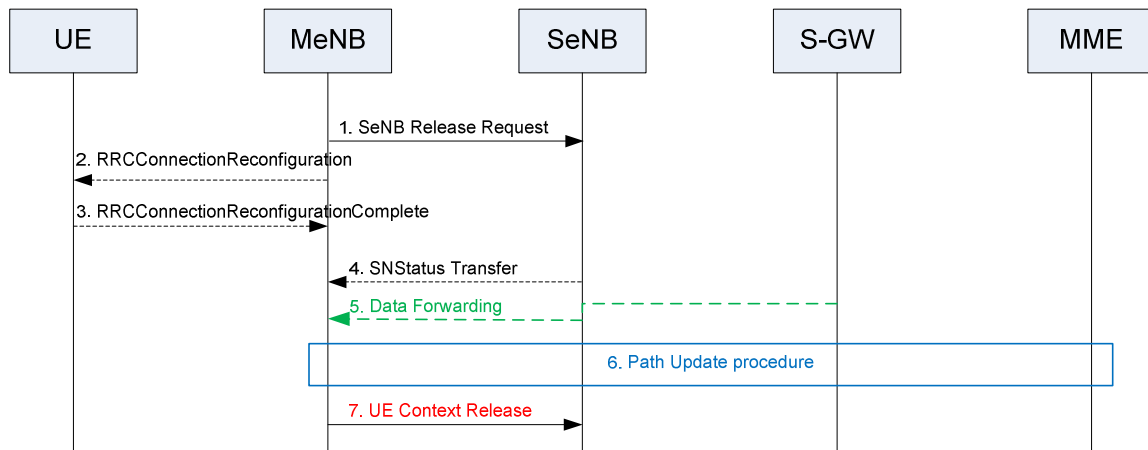

Figure 10.1.2.8.3-1: SeNB Release procedure – MeNB initiated

Figure 10.1.2.8.3-1 shows an example signalling flow for the MeNB initiated SeNB Release procedure.

1. The MeNB initiates the procedure by sending the SeNB Release Request message. If data forwarding is requested, the MeNB provides data forwarding addresses to the SeNB.
 - 2/3. If required, the MeNB indicates in the *RRCConnectionReconfiguration* message towards the UE that the UE shall release the entire SCG configuration. In case the UE is unable to comply with (part of) the configuration included in the *RRCConnectionReconfiguration* message, it performs the reconfiguration failure procedure.
- NOTE: If data forwarding is applied, timely coordination between steps 1 and 2 may minimize gaps in service provision, this is however regarded to be an implementation matter.
- 4/5. Data forwarding from the SeNB to the MeNB takes place.
 6. If applicable, the path update procedure is initiated.
 7. Upon reception of the UE Context Release message, the SeNB can release radio and C-plane related resource associated to the UE context. Any ongoing data forwarding may continue.

SeNB initiated SeNB Release

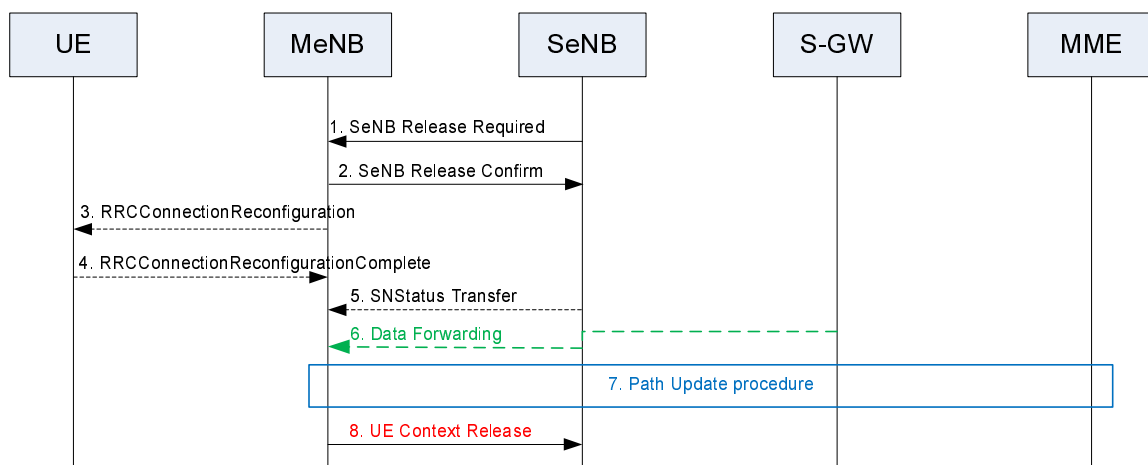

Figure 10.1.2.8.3-2: SeNB Release procedure – SeNB initiated

Figure 10.1.2.8.3-2 shows an example signalling flow for the SeNB initiated SeNB Release procedure.

1. The SeNB initiates the procedure by sending the SeNB Release Required message which does not contain inter-node message.

2. If data forwarding is requested, the MeNB provides data forwarding addresses to the SeNB in the SeNB Release Confirm message. The SeNB may start data forwarding and stop providing user data to the UE as early as it receives the SeNB Release Confirm message.

3/4. If required, the MeNB indicates in the *RRCConnectionReconfiguration* message towards the UE that the UE shall release the entire SCG configuration. In case the UE is unable to comply with (part of) the configuration included in the *RRCConnectionReconfiguration* message, it performs the reconfiguration failure procedure.

NOTE: If data forwarding is applied, timely coordination between steps 2 and 3 may minimize gaps in service provision. This is however regarded to be an implementation matter.

5/6. Data forwarding from the SeNB to the MeNB takes place.

7. If applicable, the path update procedure is initiated.

8. Upon reception of the UE Context Release message, the SeNB can release radio and C-plane related resource associated to the UE context. Any ongoing data forwarding may continue.

10.1.2.8.4 Change of SeNB

The change of SeNB procedure is initiated by MeNB and used to transfer a UE context from a source SeNB to a target SeNB and to change the SCG configuration in UE from one SeNB to another.

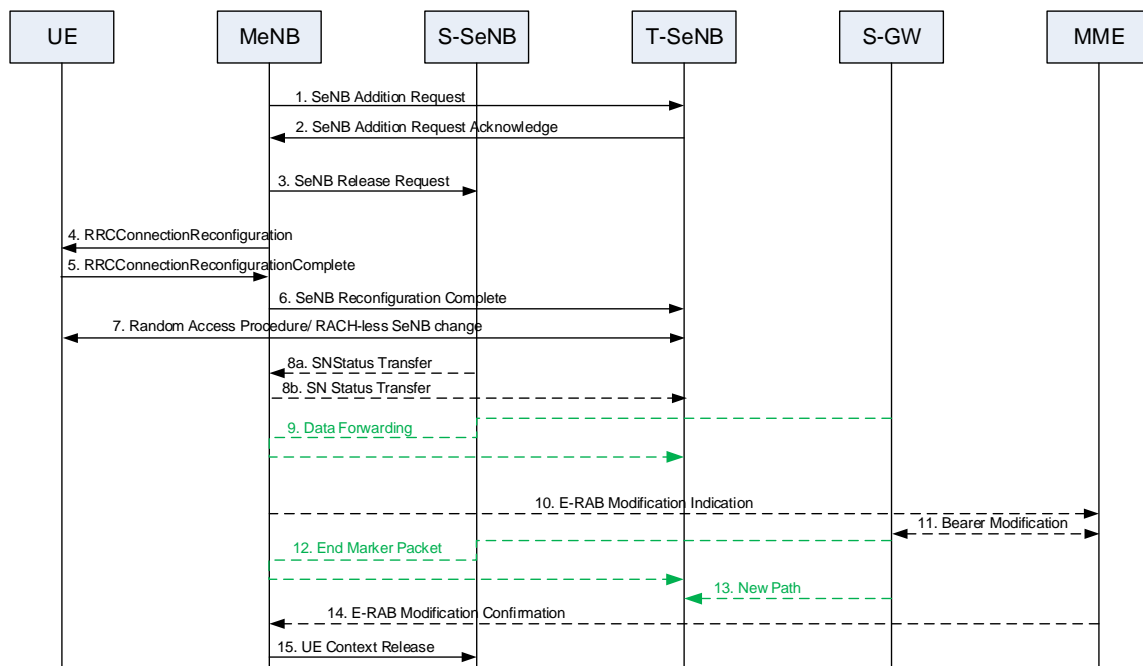

Figure 10.1.2.8.4-1: Change of SeNB

Figure 10.1.2.8.4-1 shows an example signalling flow for the Change of SeNB:

1/2. The MeNB initiates the change of SeNB by requesting the target SeNB to allocate resources for the UE by means of the SeNB Addition Preparation procedure. MeNB includes the SCG configuration of the old SeNB in the SeNB Addition Request. If forwarding is needed, the target SeNB provides forwarding addresses to the MeNB.

If RACH-less SeNB Change is configured, the target SeNB includes timing adjustment indication and optionally a preallocated uplink grant in the container.

3. If the allocation of target SeNB resources was successful, the MeNB initiates the release of the source SeNB resources towards the UE and the source SeNB. In case Make-Before-Break SeNB change is configured, the source SeNB decides when to stop transmitting to the UE. If data forwarding is needed the MeNB provides data forwarding addresses to the source SeNB. Either direct data forwarding or indirect data forwarding is used for SCG bearer. Only indirect data forwarding is used for Split bearer. Reception of the SeNB Release Request

message triggers the source SeNB to stop providing user data to the UE and, if applicable, to start data forwarding.

4/5. The MeNB triggers the UE to apply the new configuration. The MeNB indicates the new configuration in the *RRCCONNECTIONRECONFIGURATION* message towards the UE. In case the UE is unable to comply with (part of) the configuration included in the *RRCCONNECTIONRECONFIGURATION* message, it performs the reconfiguration failure procedure.

If Make-Before-Break SeNB change is configured, the connection to the source SeNB is maintained after the reception of *RRCCONNECTIONRECONFIGURATION* message with *mobilityControlInfoSCG* before the UE executes initial uplink transmission to the target cell.

NOTE: The UE can be configured with Make-Before-Break SeNB change and RACH-less SeNB change simultaneously.

6. If the RRC connection reconfiguration procedure was successful, the MeNB informs the target SeNB.

7. The UE synchronizes to the target SeNB.

If RACH-less SeNB Change is configured, the preallocated uplink grant may be included in the *RRCCONNECTIONRECONFIGURATION* message. If the preallocated uplink grant is not included, the UE should monitor PDCCH of the target SeNB for uplink grant. The SeNB Change procedure is completed for the UE when the UE receives the UE contention resolution identity.

8/9. If applicable, data forwarding from the source SeNB takes place. It may be initiated as early as the source SeNB receives the SeNB Release Request message from the MeNB.

10-14. If one of the bearer contexts was configured with the SCG bearer option at the source SeNB, path update is triggered by the MeNB.

15. Upon reception of the UE Context Release message, the source SeNB can release radio and C-plane related resource associated to the UE context. Any ongoing data forwarding may continue.

10.1.2.8.5 MeNB to eNB Change

The MeNB to eNB Change procedure is used to transfer context data from a source MeNB/SeNB to a target eNB.

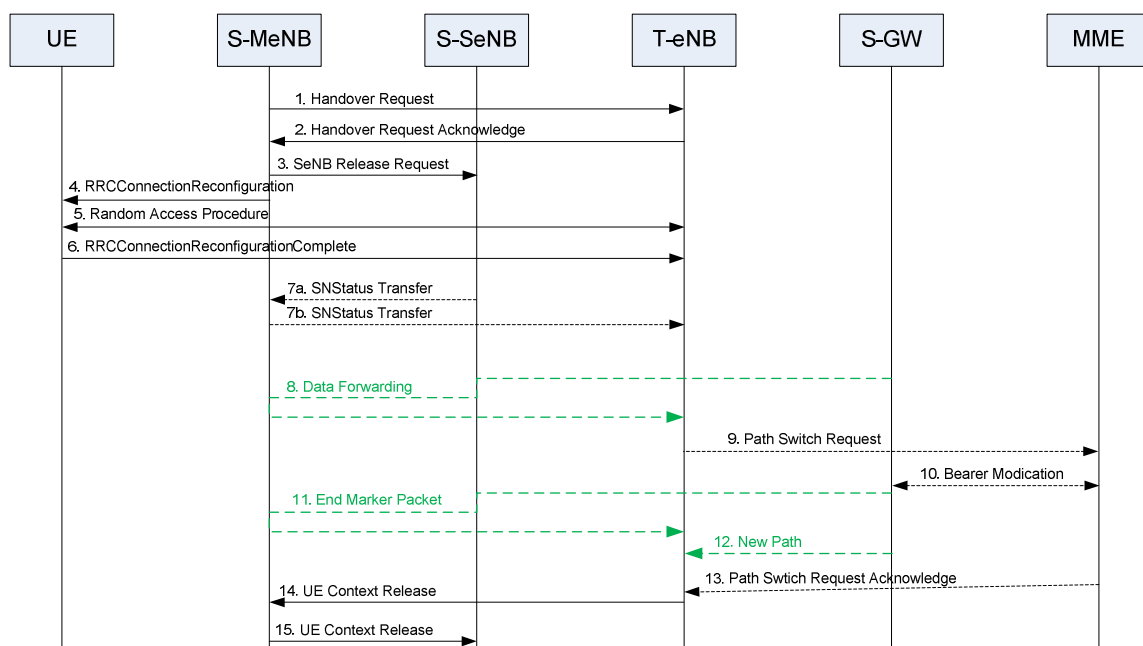

Figure 10.1.2.8.5-1: MeNB to eNB Change procedure

Figure 10.1.2.8.5-1 shows an example signalling flow for the MeNB to eNB Change procedure:

1. The source MeNB starts the MeNB to eNB Change procedure by initiating the X2 Handover Preparation procedure. The source MeNB includes the SCG configuration in the *HandoverPreparationInformation*.
2. The target eNB includes the field in HO command which releases SCG configuration, and may also provide forwarding addresses to the source MeNB. The addition of an SeNB can be initiated only after completing HO.
3. If the allocation of target eNB resources was successful, the MeNB initiates the release of the source SeNB resources towards the source SeNB. If data forwarding is needed, the MeNB provides data forwarding addresses to the source SeNB. Either direct data forwarding or indirect data forwarding is used for SCG bearer. Only indirect data forwarding is used for Split bearer. Reception of the SeNB Release Request message triggers the source SeNB to stop providing user data to the UE and, if applicable, to start data forwarding.
4. The MeNB triggers the UE to apply the new configuration. Upon receiving the new configuration, the UE releases the entire SCG configuration.
- 5/6. The UE synchronizes to the target eNB.
- 7/8. If applicable, data forwarding from the source SeNB takes place. It may start as early as the source SeNB receives the SeNB Release Request message from the MeNB.
- 9-13. The target eNB initiates the S1 Path Switch procedure.
14. The target eNB initiates the UE Context Release procedure towards the source MeNB.
15. Upon reception of the UE CONTEXT RELEASE message, the S-SeNB can release radio and C-plane related resource associated to the UE context. Any ongoing data forwarding may continue.

10.1.2.8.6 SCG change

"SCG change" refers to a synchronous SCG reconfiguration procedure towards the UE involving random access on PSCell. This procedure is used to establish SCG, and can be used to reconfigure the SCG configuration. During SCG change, MAC configured for SCG is reset and RLC configured for SCG is re-established regardless of the bearer type(s) established on SCG. For SCG bearer, PDCP configured for SCG is re-established. In case of reconfiguration from split to MCG bearer, RLC configured for SCG is released. During SCG change, S-KeNB key is refreshed. To perform SCG change within the same SeNB, the SeNB Modification procedure as described in clause 10.1.2.8.2 is used and in this case, the path switch and data forwarding for DRB on SCG may be suppressed. To perform SCG change between different SeNBs, the change of SeNB as described in clause 10.1.2.8.4 is used.

10.1.2.8.7 eNB to MeNB change

The eNB to MeNB change procedure is used to transfer context data from a source eNB to a target MeNB that adds an SeNB during the handover.

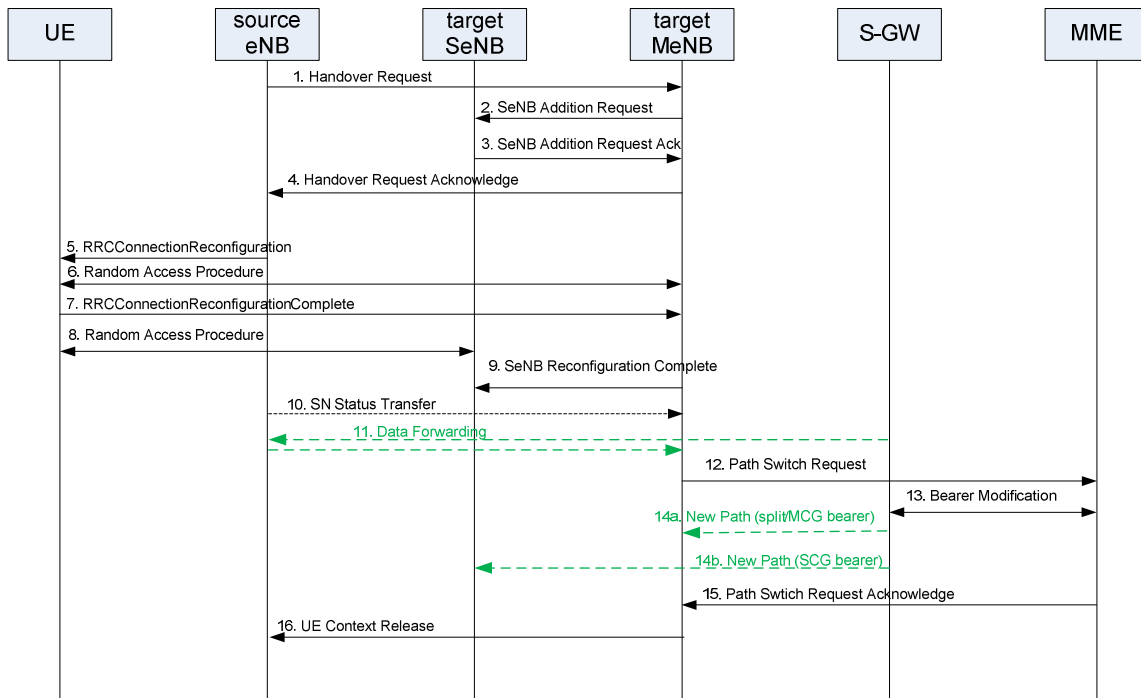

Figure 10.1.2.8.7-1: eNB to MeNB change

Figure 10.1.2.8.7-1 shows an example signaling flow for eNB to MeNB change:

1. The source eNB starts the handover procedure by initiating the X2 Handover Preparation procedure.
 2. The target MeNB sends SeNB Addition Request to the target SeNB.
 3. The target SeNB replies with SeNB Addition Request Acknowledge. If data forwarding is needed, the target SeNB provides forwarding addresses to the target MeNB.
 4. The target MeNB includes within the Handover Request Acknowledge message a transparent container to be sent to the UE as an RRC message to perform the handover which also includes the SCG configuration, and may also provide forwarding addresses to the source eNB. Either direct data forwarding or indirect data forwarding is used for SCG bearer. Only indirect data forwarding is used for split bearer.
 5. The source eNB triggers the UE to apply the new configuration.
 - 6/7. The UE synchronizes to the target MeNB and replies with *RRCConnectionReconfigurationComplete* message.
 8. The UE synchronizes to the target SeNB
 9. If the RRC connection reconfiguration procedure was successful, the target MeNB informs the target SeNB.
 - 10/11. Data forwarding from the source eNB takes place.
 - 12-15. The target MeNB initiates the S1 Path Switch procedure.
- NOTE: If new UL TEIDs of the S-GW are included, the target MeNB performs MeNB initiated SeNB Modification procedure to provide them to the target SeNB.
16. The target MeNB initiates the UE Context Release procedure towards the source eNB.

10.1.2.8.8 Inter-MeNB handover without SeNB change

Inter-MeNB handover without SeNB change is used to transfer context data from a source MeNB to a target MeNB while the context at the SeNB is kept.

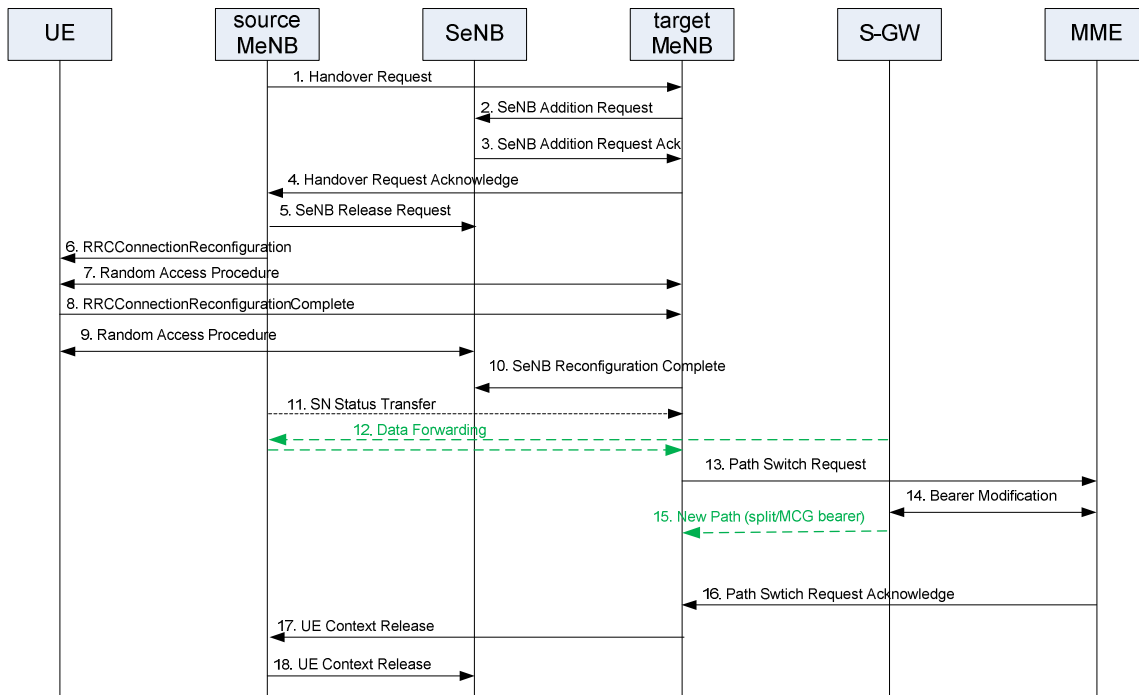

Figure 10.1.2.8.8-1: Inter-MeNB handover without SeNB change

Figure 10.1.2.8.8-1 shows an example signaling flow for inter-MeNB handover without SeNB change:

1. The source MeNB starts the handover procedure by initiating the X2 Handover Preparation procedure. The source MeNB includes the SCG configuration in the *HandoverPreparationInformation*. The source MeNB includes the SeNB UE X2AP ID and SeNB ID as a reference to the UE context in the SeNB that was established by the source MeNB in the Handover Request message.
 2. If the target MeNB decides to keep the SeNB, the target MeNB sends SeNB Addition Request to the SeNB including the SeNB UE X2AP ID as a reference to the UE context in the SeNB that was established by the source MeNB.
 3. The SeNB replies with SeNB Addition Request Acknowledge.
 4. The target MeNB includes within the Handover Request Acknowledge message a transparent container to be sent to the UE as an RRC message to perform the handover which also includes the SCG configuration, and may also provide forwarding addresses to the source MeNB. The target MeNB indicates to the source MeNB that the UE context in the SeNB is kept if the target MeNB and the SeNB decided to keep the UE context in the SeNB in step 2 and step 3.
 5. The source MeNB sends SeNB Release Request to the SeNB. The source MeNB indicates to the SeNB that the UE context in SeNB is kept. If the indication as the UE context kept in SeNB is included, the SeNB keeps the UE context.
 6. The source MeNB triggers the UE to apply the new configuration.
 - 7/8. The UE synchronizes to the target MeNB and replies with *RRCConnectionReconfigurationComplete* message.
 9. The UE synchronizes to the SeNB.
 10. If the RRC connection reconfiguration procedure was successful, the target MeNB informs the SeNB.
 - 11/12. Data forwarding from the source MeNB takes place. Data forwarding may be omitted for SCG bearers. Direct data forwarding from the source MeNB to the SeNB is not possible for split bearers.
- NOTE: Direct data forwarding may occur only for bearer type change.
- 13-16. The target MeNB initiates the S1 Path Switch procedure.

NOTE: If new UL TEIDs of the S-GW are included, the target MeNB performs MeNB initiated SeNB Modification procedure to provide them to the SeNB.

17. The target MeNB initiates the UE Context Release procedure towards the source MeNB.

18. Upon reception of the UE Context Release message, the SeNB can release C-plane related resource associated to the UE context towards the source MeNB. Any ongoing data forwarding may continue. The SeNB shall not release the UE context associated with the target MeNB if the indication was included in the SeNB Release Request in step 5.

10.1.2.8.9 Addition of a hybrid HeNB as the SeNB

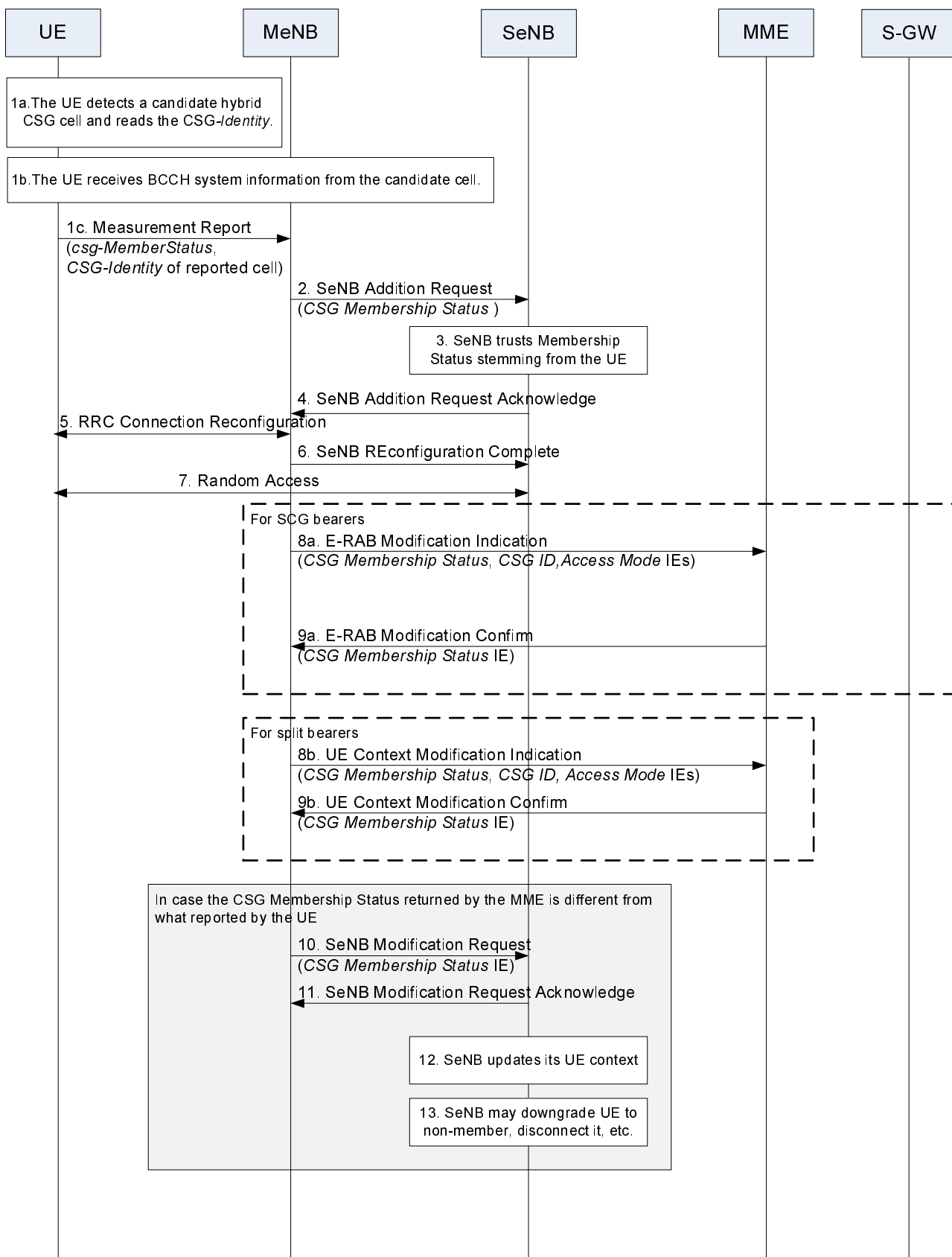

Figure 10.1.2.8.9-1: Addition of a hybrid cell as serving cell of the SeNB

Figure 10.1.2.8.9-1 shows the signalling flow for the addition of the hybrid cell as serving cell of the SeNB procedure:

- 1a. The UE is connected to an MeNB and detects a potential candidate cell for dual connectivity.
- 1b. The UE reads System Information from the candidate cell (*csg-Indication, csg-Identity*).
- 1c. The MeNB receives CSG related information from the UE (*csg-MemberStatus, csg-Identity*).
- 2. The MeNB initiates the SeNB Addition preparation procedure including Membership Status of the UE in the hybrid HeNB.
- 3. The SeNB takes the membership information provided by the MeNB into account (even if this was not yet verified with the MME).
- 4-7. No difference to the SeNB Addition Preparation procedure as described in 10.2.1.1.
- 8/9. The MeNB requests the MME to verify the membership status of the UE for the CSG-ID reported by the UE.
 - For SCG bearer, the MeNB triggers the E-RAB Modification Indication procedure.
 - For split bearer, the MeNB triggers the UE Context Modification Indication procedure.
- 10-13. If the result of the membership verification requires an update of the UE context at the SeNB, the MeNB triggers the MeNB initiated SeNB Modification Preparation procedure. If the membership verification fails, it is up to the SeNB to decide on further actions.

10.1.2.9 LWA mobility

10.1.2.9.1 Inter-eNB handover without WT change

Inter-eNB handover without WT change is used to transfer context data from a source eNB to a target eNB while the LWA connectivity is kept.

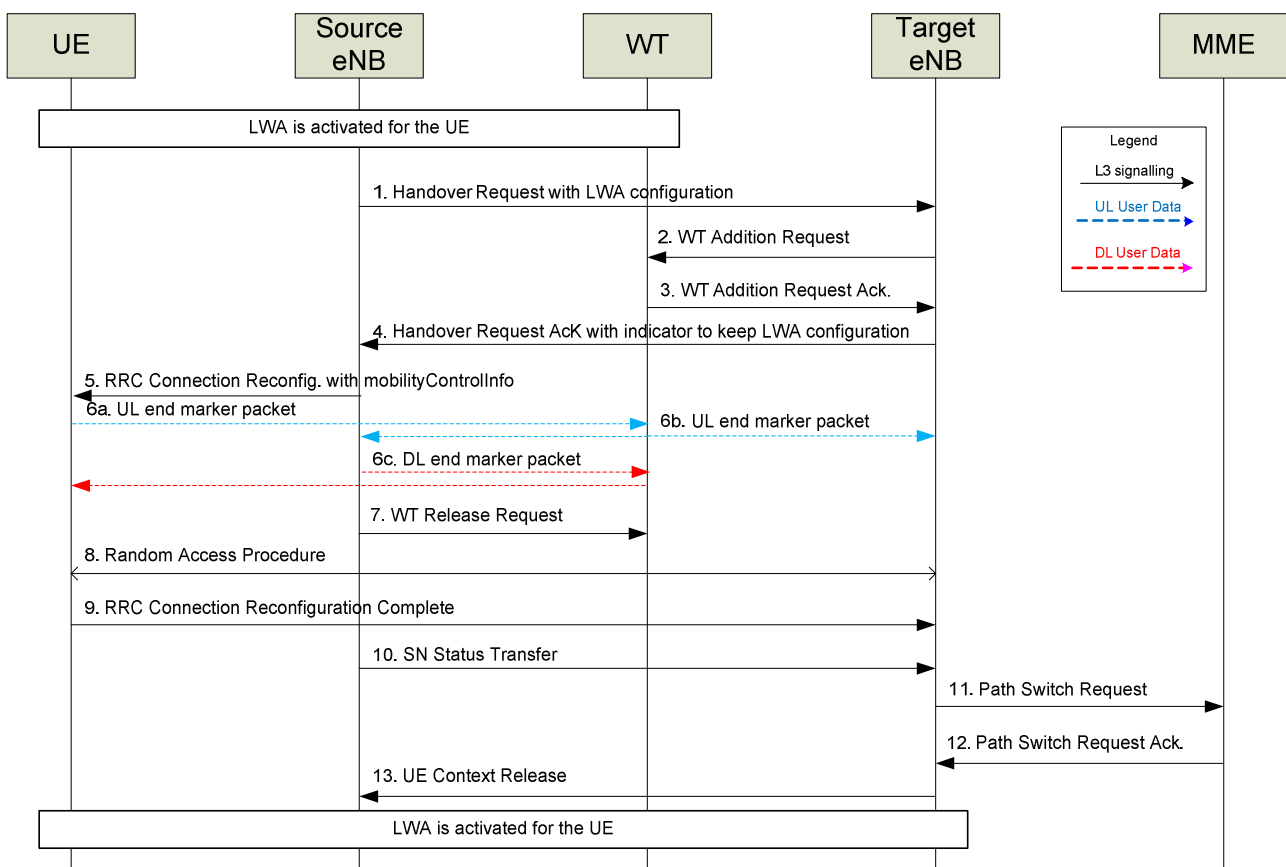

Figure 10.1.2.9-1: Handover without WT change

1. The source eNB starts the handover procedure by initiating the X2 Handover Preparation procedure. The source eNB includes the LWA configuration in the HANDOVER REQUEST: the Mobility Set currently valid for the UE, the WT UE XwAP ID and WT ID as a reference to the UE context in the WT that was established by the source eNB.
2. If the target eNB decides to keep the LWA connection, the target eNB sends WT ADDITION REQUEST to the WT including the WT UE XwAP ID as a reference to the UE context in the WT that was established by the source eNB. The WT shall use this information to check if the UE context is present.
3. If successful, the WT replies with WT ADDITION REQUEST ACKNOWLEDGE.
4. If both, the target eNB and the WT decided to keep the LWA connection in steps 2 and 3 respectively, the target eNB sends the HANDOVER REQUEST ACKNOWLEDGE message, which includes the LWA configuration and the UE LWA Context Kept Indicator, and may also provide forwarding addresses to the source eNB.
5. The source eNB triggers the UE to apply the new configuration.
- 6a. After the UE applies the target eNB PDCP keys contained in the handover command for UL, the UL end marker packet is sent to WT.

NOTE: The UE can change the DL and UL encryption keys at different times since it can receive an end marker packet at a different time than changing the PDCP key for UL.

- 6b. WT forwards the UL end marker packet to the source eNB. If WT is able to distinguish the UL end marker packet, it may also forward the end marker packet to target eNB.
- 6c. When the source eNB has sent the last DL packet to UE, it sends a DL end marker packet to the UE. When UE receives the end marker packet, it starts using the target eNB PDCP keys for decoding of DL packets.

NOTE: The DL end marker packet should be sent before the UE completes the handover, i.e. before step 9.

7. The source eNB sends the WT Release Request to the WT, indicating whether the UE context has been matched at the target. The WT keeps the relevant part of the UE context based on the identification information provided from the target eNB at step 2.

NOTE: The source eNB may postpone sending the WT Release Request until the UE CONTEXT RELEASE is received in step 12.

- 8-9. The UE synchronizes to the target eNB and replies with *RRCConnectionReconfigurationComplete* message.
10. The source eNB forwards the SN status to the target eNB.
- 11-12. The target eNB initiates the S1 Path Switch procedure.
13. The target eNB initiates the UE Context Release procedure towards the source eNB.

NOTE: Some time after the handover without WT change procedure, the target eNB may provide the UE and the WT with new WLAN security information. Based on this information, the UE re-authenticates itself in the WLAN network.

User plane aspects:

Before the source eNB initiates the WT Release Request, the WT is configured with bearer tunnels to both source and target eNB (after WT Addition by the target eNB).

In the downlink, the source eNB forwards end marker packets immediately after the last data packets sent to the WT for a particular bearer, and the WT forwards packets received from either eNB towards the UE. The end marker packets may be used by the UE to switch the PDCP key.

In the uplink, the UE inserts end marker packets to indicate the key switch. The WT may use the end marker packets to infer which packets should be forwarded to source eNB or target eNB. The source eNB may use the end marker packets to infer which packets it should process or discard while the source Xw-u tunnel is operational. The target eNB processes all received packets.

10.1.2.10 EN-DC Operation

Procedures to support EN-DC Operation are described in TS 37.340 [76].

10.1.3 Measurements

10.1.3.0 General

Measurements to be performed by a UE for intra/inter-frequency/inter-RAT mobility can be controlled by E-UTRAN, using broadcast or dedicated control. In RRC_IDLE state, a UE shall follow the measurement parameters defined for cell reselection specified by the E-UTRAN broadcast. The use of dedicated measurement control for RRC_IDLE state is possible through the provision of UE specific priorities (see clause 10.2.4). In RRC_CONNECTED state, a UE shall follow the measurement configurations specified by RRC directed from the E-UTRAN (e.g. as in UTRAN MEASUREMENT_CONTROL).

In RRC_IDLE and RRC_CONNECTED the UE may be configured to monitor some UTRA or E-UTRA carriers according to reduced performance requirements as specified in TS 36.133 [21].

In RRC_IDLE, for NB-IoT UEs, BL UEs or UEs in enhanced coverage, the UE may further limit the intra-frequency and inter-frequency measurements when the relaxed monitoring criterion is fulfilled as specified in TS 36.304 [11].

For CSI-RS based discovery signals measurements, "cell" should be interpreted as "transmission point of the concerned cell" in the following descriptions.

Intra-frequency neighbour (cell) measurements, inter-frequency neighbour (cell) measurements and inter-RAT measurements are defined as follows:

- Intra-frequency neighbour (cell) measurements: Neighbour cell measurements performed by the UE are intra-frequency measurements when the current and target cell operates on the same carrier frequency.
- Inter-frequency neighbour (cell) measurements: Neighbour cell measurements performed by the UE are inter-frequency measurements when the neighbour cell operates on a different carrier frequency, compared to the current cell.
- Inter-RAT neighbour (cell) measurements: Neighbour cell measurements performed by the UE are inter-RAT measurements when the neighbour cell operates on a different RAT, compared to the current cell.

Whether a measurement is non gap assisted or gap assisted depends on the UE's capability and the current operating frequency. In non gap assisted scenarios, the UE shall be able to carry out such measurements without measurement gaps. In gap assisted scenarios, the UE may not be able to perform such measurements without measurement gaps. The UE determines whether a particular cell measurement needs to be performed in a transmission/reception gap and the scheduler needs to know whether gaps are needed:

- Same carrier frequency and cell bandwidths (Scenario A): an intra-frequency scenario; not measurement gap assisted.
- Same carrier frequency, bandwidth of the target cell smaller than the bandwidth of the current cell (Scenario B): an intra-frequency scenario; not measurement gap assisted.
- Same carrier frequency, bandwidth of the target cell larger than the bandwidth of the current cell (Scenario C): an intra-frequency scenario; not measurement gap assisted.
- Different carrier frequencies, bandwidth of the target cell smaller than the bandwidth of the current cell and bandwidth of the target cell within bandwidth of the current cell (Scenario D): an inter-frequency scenario; measurement gap-assisted scenario.
- Different carrier frequencies, bandwidth of the target cell larger than the bandwidth of the current cell and bandwidth of the current cell within bandwidth of the target cell (Scenario E): an inter-frequency scenario; measurement gap-assisted scenario.
- Different carrier frequencies and non-overlapping bandwidth, (Scenario F): an inter-frequency scenario; measurement gap-assisted scenario.

- Same carrier frequency, the operating frequency of the bandwidth reduced low complexity (BL) UE or the UE in Enhanced Coverage is not guaranteed to be aligned with the center frequency of the current cell (Scenario G): an intra-frequency scenario; measurement gap assisted scenario.

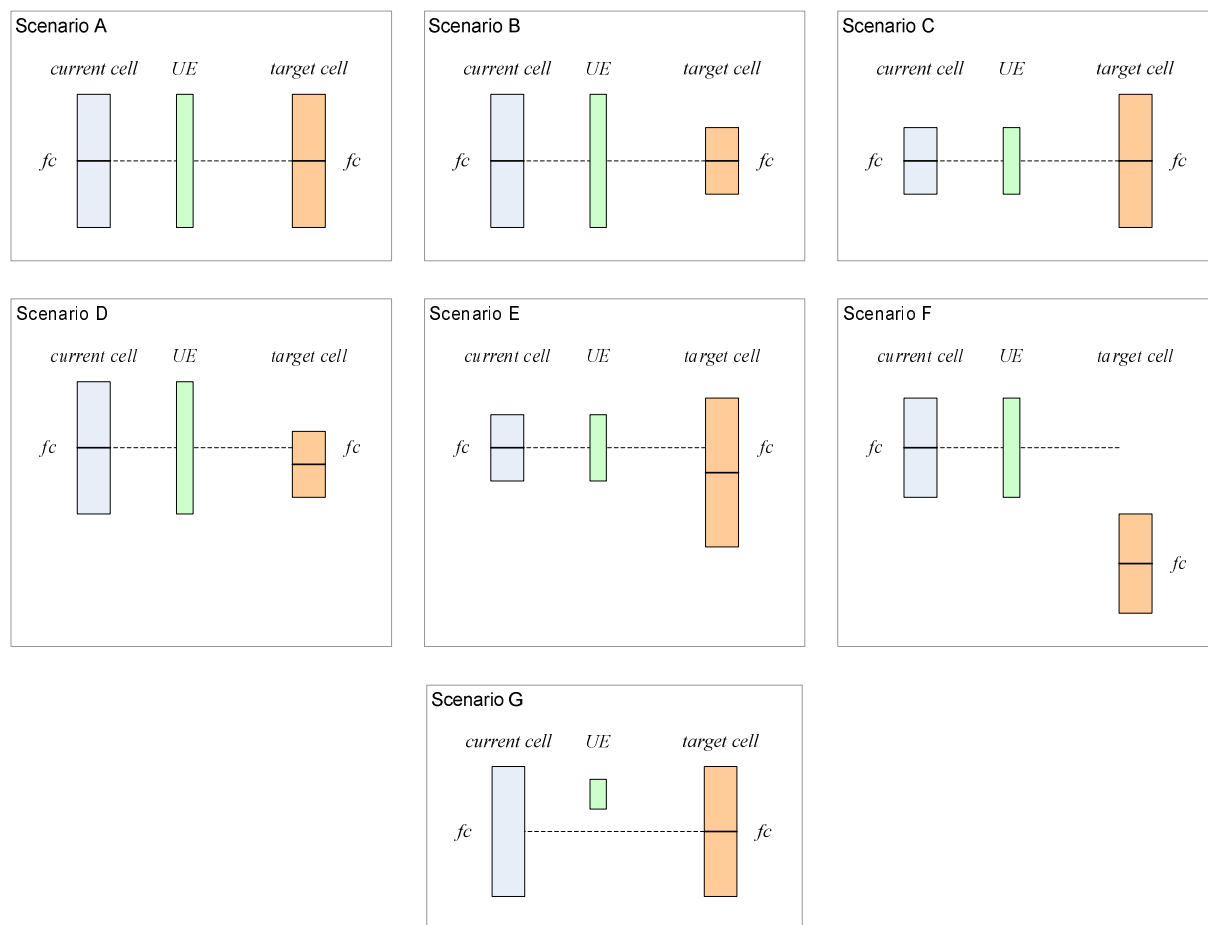

Figure 10.1.3-1: Inter and Intra-frequency measurements scenarios

Measurement gaps may be needed by the UE to carry out inter-RAT measurements on NR frequencies. UE may need measurement gaps to perform inter-RAT measurements on NR frequencies depending on the UE capability to support independent FR measurement as specified in TS 38.306 [89]. The UE may not be able to perform inter-RAT NR measurements without measurement gaps in the following cases:

- If the UE only supports per-UE gaps and the UE is required to measure NR frequencies;
- If the UE supports per-FR gaps and the UE is required to measure at least one NR frequency in FR1;

Measurement gaps patterns are configured and activated by RRC.

When CA is configured, the "current cell" above refers to any serving cell of the configured set of serving cells. For instance, for the definition of intra and inter frequency measurements, this means:

- Intra-frequency neighbour (cell) measurements: Neighbour cell measurements performed by the UE are intra-frequency measurements when one of the serving cells of the configured set and the target cell operates on the same carrier frequency. The UE shall be able to carry out such measurements without measurement gaps.
- Inter-frequency neighbour (cell) measurements: Neighbour cell measurements performed by the UE are inter-frequency measurements when the neighbour cell operates on a different carrier frequency than any serving cell of the configured set. The UE may not be able to perform such measurements without measurement gaps.

When DC is configured, the following principles are applied:

- The configured set of serving cells includes all the cells from MCG and SCG as for CA;

- The measurement procedure of serving cells belonging to the SeNB shall not be impacted due to RLF of SeNB;
- Common gap for the MeNB and the SeNB is applied;
 - There is only a single measurement gap configuration for the UE which is controlled and informed by the MeNB.
- UE determines the starting point of the measurement gap based on the SFN, subframe number and subframe boundaries of the MCG serving cells.

When LAA is configured:

- The eNB configures the UE with one DMTC window for all neighbor cells as well as for the serving cell (if any) on one frequency;
- The UE is only expected to detect and measure cells transmitting DRS during the configured DRS DMTC window;
- For channel selection in an environment where hidden nodes may exist, UE may be configured with one RMTC per a frequency to perform RSSI measurement, and to report average RSSI and channel occupancy (percentage of measurement samples that RSSI value is above a threshold) in a reporting interval.

10.1.3.1 Intra-frequency neighbour (cell) measurements

In a system with frequency reuse = 1, mobility within the same frequency layer (i.e. between cells with the same carrier frequency) is predominant. Good neighbour cell measurements are needed for cells that have the same carrier frequency as the serving cell in order to ensure good mobility support and easy network deployment. Search for neighbour cells with the same carrier frequency as the serving cell, and measurements of the relevant quantities for identified cells are needed.

NOTE: To avoid UE activity outside the DRX cycle, the reporting criteria for neighbour cell measurements should match the used DRX cycle.

10.1.3.2 Inter-frequency neighbour (cell) measurements

Regarding mobility between different frequency layers (i.e. between cells with a different carrier frequency), UE may need to perform neighbour cell measurements during DL/UL idle periods that are provided by DRX or packet scheduling (i.e. gap assisted measurements).

Network may request UE to measure inter-frequency carriers in RRC_IDLE or RRC_INACTIVE mode via system information or via dedicated measurement configuration in RRC Connection Release. The UE performs the requested measurements and provides indication of the availability of measurement report to the eNB during RRC Connection Setup or Resume procedure. The network may request UE to report those measurements after security activation.

10.1.4 Paging and C-plane establishment

Paging groups (where multiple UEs can be addressed) are used on PDCCH:

- Precise UE identity is found on PCH;
- DRX configurable via BCCH and NAS, for NB-IoT DRX configurable via BCCH only;
- Only one subframe allocated per paging interval per UE;
- The network may divide UEs to different paging occasions in time;
- There is no grouping within paging occasion;
- One paging RNTI for PCH.

When extended DRX (eDRX) is used in idle mode, the following are applicable:

- The DRX cycle is extended up to and beyond 10.24s in idle mode, with a maximum value of 2621.44 seconds (43.69 minutes); For NB-IoT, the maximum value of the DRX cycle is 10485.76 seconds (2.91 hours);

- The hyper SFN (H-SFN) is broadcast by the cell and increments by one when the SFN wraps around;
- Paging Hyperframe (PH) refers to the H-SFN in which the UE starts monitoring paging DRX during a Paging Time Window (PTW) used in ECM-IDLE. The PH is determined based on a formula that is known by the MME, UE and eNB as a function of eDRX cycle and UE identity;
- During the PTW, the UE monitors paging for the duration of the PTW (as configured by NAS) or until a paging message is including the UE's NAS identity received for the UE, whichever is earlier. The possible starting offsets for the PTW are uniformly distributed within the PH and defined in TS 36.304 [11];
- MME uses the formulas defined in TS 36.304 [11] to determine the PH as well as the beginning of the PTW and sends the S1 paging request just before the occurrence of the start of PTW or during PTW to avoid storing paging messages in the eNB;
- ETWS, CMAS, PWS requirement may not be met when a UE is in eDRX. For EAB, if the UE supports SIB14, when in extended DRX, it acquires SIB14 before establishing the RRC connection;
- When the eDRX cycle is longer than the system information modification period, the UE verifies that stored system information remains valid before establishing an RRC connection. Paging message can be used for system information change notification, when including *systemInfoModification-eDRX*, for a UE configured with eDRX cycle longer than the system information modification period.

NB-IoT UEs, BL UEs or UEs in enhanced coverage can use WUS, when configured in the cell, to reduce the power consumption related to paging monitoring.

When WUS is used in RRC_IDLE, the following are applicable:

- The UE monitors WUS only in the last used cell as defined in TS 36.304 [11];
- The WUS is used to indicate that the UE shall monitor MPDCCH or NPDCCH to receive paging in that cell;
- For a UE not configured with extended DRX, the WUS is associated to one paging occasion (N = 1);
- For a UE configured with extended DRX, the WUS can be associated to one or multiple paging occasion(s) (N ≥ 1) in a PTW;
- If UE detects the WUS, the UE shall monitor the following N paging occasions unless it has received a paging message;
- The paging operation in the MME is not aware of the use of the WUS in the eNB.
- To reduce WUS use in cells not monitored by the UE, WUS-capable eNBs provide UE's last used cell information to MME in the S1 UE Context Release Complete or UE Context Suspend Request messages for all UEs, as described in TS 23.401[17].

The timing between WUS and the paging occasion (PO) is illustrated in Figure 10.1.4-1. The UE can expect WUS repetitions during "Configured maximum WUS duration" but the actual WUS transmission can be shorter, e.g. for UE in good coverage. The UE does not monitor WUS during the non-zero "Gap".

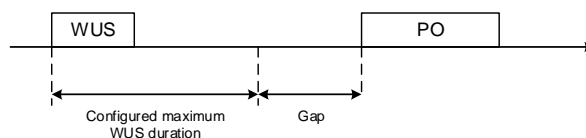

Figure 10.1.4-1: Illustration of WUS timing

For NB-IoT, UE in RRC_IDLE receives paging on the anchor carrier or on a non anchor carrier based on system information.

10.1.5 Random Access Procedure

10.1.5.0 General

The random access procedure is characterized by:

- Common procedure for FDD and TDD;
- One procedure irrespective of cell size and the number of serving cells when CA is configured;

The random access procedure is performed for the following events related to the PCell:

- Initial access from RRC_IDLE;
- RRC Connection Re-establishment procedure, as defined in TS 24.301 [20];
- Handover, except for NB-IoT or when RACH-less HO is configured;
- DL data arrival during RRC_CONNECTED requiring random access procedure:
 - E.g. when UL synchronisation status is "non-synchronised".
- UL data arrival during RRC_CONNECTED requiring random access procedure:
 - E.g. when UL synchronisation status is "non-synchronised" or there are no PUCCH resources for SR available.
- For positioning purpose during RRC_CONNECTED requiring random access procedure:
 - E.g. when timing advance is needed for UE positioning.

The random access procedure is also performed on a SCell to establish time alignment for the corresponding sTAG.

For E-UTRA connected to 5GC, the random access procedure is also performed for the transition from RRC_INACTIVE.

In DC, the random access procedure is also performed on at least PSCell upon SCG addition/modification, if instructed, or upon DL/UL data arrival during RRC_CONNECTED requiring random access procedure. The UE initiated random access procedure is performed only on PSCell for SCG.

Furthermore, the random access procedure takes two distinct forms:

- Contention based (applicable to all six events, but the sixth event for positioning is applicable for NB-IoT only);
- Non-contention based (applicable to only handover, DL data arrival, positioning and obtaining timing advance alignment for a sTAG).

Normal DL/UL transmission can take place after the random access procedure.

An RN supports both contention-based and non-contention-based random access. When an RN performs the random access procedure, it suspends any current RN subframe configuration, meaning it temporarily disregards the RN subframe configuration. The RN subframe configuration is resumed at successful random access procedure completion.

For NB-IoT, the random access procedure is performed on the anchor carrier or on a non anchor carrier based on system information.

10.1.5.1 Contention based random access procedure

The contention based random access procedure is outlined on Figure 10.1.5.1-1 below:

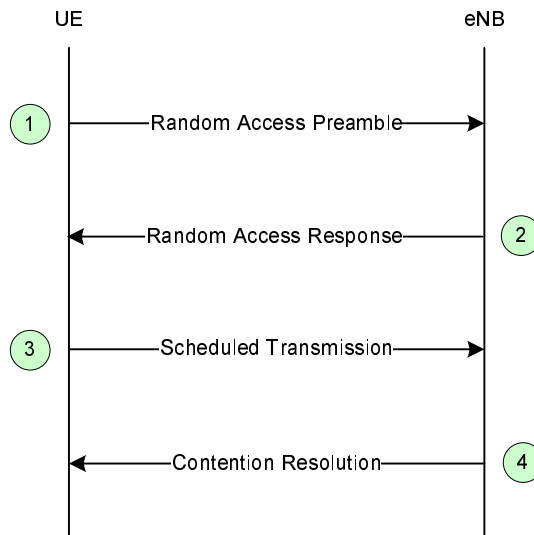

Figure 10.1.5.1-1: Contention based Random Access Procedure

The four steps of the contention based random access procedures are:

1) Random Access Preamble on RACH in uplink:

- There are two possible groups defined and one is optional. If both groups are configured the size of message 3 and the pathloss are used to determine which group a preamble is selected from. The group to which a preamble belongs provides an indication of the size of the message 3 and the radio conditions at the UE. The preamble group information along with the necessary thresholds are broadcast on system information.

2) Random Access Response generated by MAC on DL-SCH:

- Semi-synchronous (within a flexible window of which the size is one or more TTI) with message 1;
- No HARQ;
- Addressed to RA-RNTI on PDCCH;
- Conveys at least RA-preamble identifier, Timing Alignment information for the pTAG, initial UL grant and assignment of Temporary C-RNTI (which may or may not be made permanent upon Contention Resolution);
- Intended for a variable number of UEs in one DL-SCH message.

3) First scheduled UL transmission on UL-SCH:

- Uses HARQ;
- Size of the transport blocks depends on the UL grant conveyed in step 2.
- For initial access:
 - Conveys the RRC Connection Request generated by the RRC layer and transmitted via CCCH;
 - Conveys at least NAS UE identifier but no NAS message;
 - RLC TM: no segmentation.
- For RRC Connection Re-establishment procedure:
 - Conveys the RRC Connection Re-establishment Request generated by the RRC layer and transmitted via CCCH;
 - RLC TM: no segmentation;
 - Does not contain any NAS message.

- After handover, in the target cell:
 - Conveys the ciphered and integrity protected RRC Handover Confirm generated by the RRC layer and transmitted via DCCH;
 - Conveys the C-RNTI of the UE (which was allocated via the Handover Command);
 - Includes an uplink Buffer Status Report when possible.
- For other events:
 - Conveys at least the C-RNTI of the UE;
- In the procedure to resume the RRC connection or in the EDT procedure for User Plane CIoT EPS Optimizations:
 - Conveys the RRC Connection Resume Request generated by the RRC layer and transmitted via CCCH;
 - Conveys a Resume ID to resume the RRC connection;
 - For the EDT procedure for User Plane CIoT EPS Optimizations:
 - Conveys ciphered user data transmitted via DTCH;
 - RLC UM/AM: no segmentation;
 - Does not contain any NAS message.
- For NB-IoT:
 - In the procedure to setup the RRC connection:
 - An indication of the amount of data for subsequent transmission(s) on SRB or DRB can be indicated.
- For EDT for Control Plane CIoT EPS Optimizations:
 - Conveys the RRC Early Data Request generated by the RRC layer and transmitted via CCCH;
 - Conveys NAS UE identifier and user data concatenated in a NAS message;
 - RLC TM: no segmentation.

4) Contention Resolution on DL:

- Early contention resolution shall be used i.e. eNB does not wait for NAS reply before resolving contention;
- For NB-IoT, for initial access, RRC connection resume procedure and RRC Connection Re-establishment procedure, eNB may transmit MAC PDU containing the UE contention resolution identity MAC control element without RRC response message;

NOTE: In Release 13, NB-IoT UEs do not support the MAC PDU containing the UE contention resolution identity MAC control element without RRC response message for initial access, RRC connection resume procedure and RRC Connection Re-establishment procedure.

- Not synchronised with message 3;
- HARQ is supported;
- Addressed to:
 - The Temporary C-RNTI on PDCCH for initial access and after radio link failure;
 - The C-RNTI on PDCCH for UE in RRC_CONNECTED.
- HARQ feedback is transmitted only by the UE which detects its own UE identity, as provided in message 3, echoed in the Contention Resolution message;

- For initial access, RRC Connection Re-establishment procedure and EDT for Control Plane CIoT EPS Optimizations, no segmentation is used (RLC-TM).

The Temporary C-RNTI is promoted to C-RNTI for a UE which detects RA success and does not already have a C-RNTI; it is dropped by others. A UE which detects RA success and already has a C-RNTI, resumes using its C-RNTI.

When CA is configured, the first three steps of the contention based random access procedures occur on the PCell while contention resolution (step 4) can be cross-scheduled by the PCell.

When DC is configured, the first three steps of the contention based random access procedures occur on the PCell in MCG and PSCell in SCG. When CA is configured in SCG, the first three steps of the contention based random access procedures occur on the PSCell while contention resolution (step 4) can be cross-scheduled by the PSCell.

10.1.5.2 Non-contention based random access procedure

The non-contention based random access procedure is outlined on Figure 10.1.5.2-1 below:

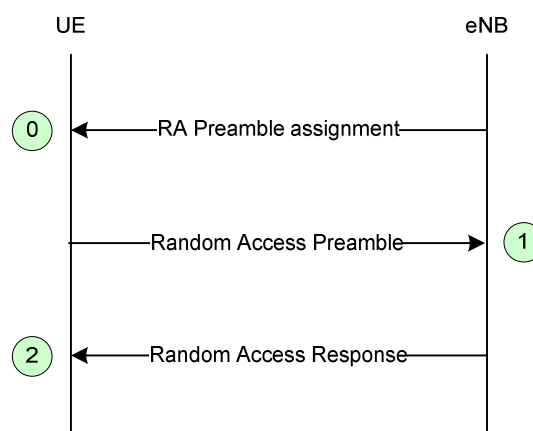

Figure 10.1.5.2-1: Non-contention based Random Access Procedure

The three steps of the non-contention based random access procedures are:

- 0) Random Access Preamble assignment via dedicated signalling in DL:
 - eNB assigns to UE a non-contention Random Access Preamble (a Random Access Preamble not within the set sent in broadcast signalling).
 - Signalled via:
 - HO command generated by target eNB and sent via source eNB for handover;
 - PDCCH in case of DL data arrival or positioning;
 - PDCCH for initial UL time alignment for a sTAG.
- 1) Random Access Preamble on RACH in uplink:
 - UE transmits the assigned non-contention Random Access Preamble.
- 2) Random Access Response on DL-SCH:
 - Semi-synchronous (within a flexible window of which the size is two or more TTIs) with message 1;
 - No HARQ;
 - Addressed to RA-RNTI on PDCCH;
 - Conveys at least:
 - Timing Alignment information and initial UL grant for handover;

- Timing Alignment information for DL data arrival;
- RA-preamble identifier;
- Intended for one or multiple UEs in one DL-SCH message.

When performing non-contention based random access on the PCell while CA is configured, the Random Access Preamble assignment via PDCCH of step 0, step 1 and 2 of the non-contention based random access procedure occur on the PCell. In order to establish timing advance for a sTAG, the eNB may initiate a non-contention based random access procedure with a PDCCH order (step 0) that is sent on a scheduling cell of activated SCell of the sTAG. Preamble transmission (step 1) is on the indicated SCell and Random Access Response (step 2) takes place on PCell.

When performing non-contention based random access on the PCell or PSCell while DC is configured, the Random Access Preamble assignment via PDCCH of step 0, step 1 and 2 of the non-contention based random access procedure occur on the corresponding cell. In order to establish timing advance for a sTAG, the eNB may initiate a non-contention based random access procedure with a PDCCH order (step 0) that is sent on a scheduling cell of activated SCell of the sTAG not including PSCell. Preamble transmission (step 1) is on the indicated SCell and Random Access Response (step 2) takes place on PCell for MCG and PSCell for SCG.

10.1.5.3 Interaction model between L1 and L2/3 for Random Access Procedure

Random access procedure described above is modelled in Figure 10.1.5.3-1 below from L1 and L2/3 interaction point of view. L2/L3 receives indication from L1 whether ACK is received or DTX is detected after indication of Random Access Preamble transmission to L1. L2/3 indicates L1 to transmit first scheduled UL transmission (RRC Connection Request in case of initial access) if necessary or Random Access Preamble based on the indication from L1.

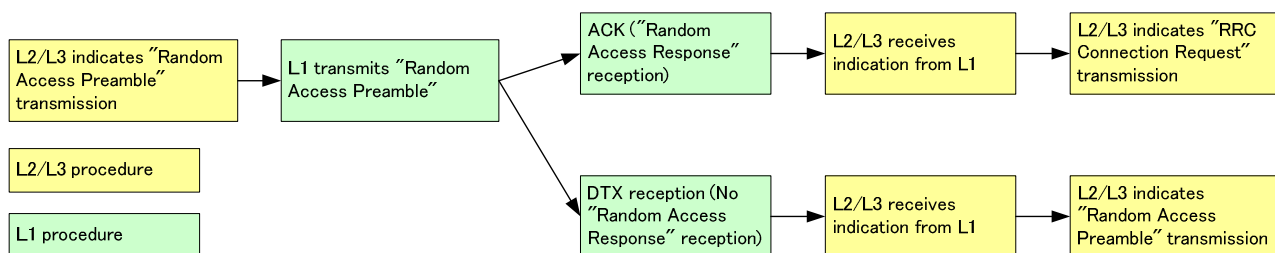

Figure 10.1.5.3-1: Interaction model between L1 and L2/3 for Random Access Procedure

10.1.6 Radio Link Failure

Two phases govern the behaviour associated to radio link failure as shown on Figure 10.1.6-1:

- First phase:
 - started upon radio problem detection;
 - leads to radio link failure detection;
 - no UE-based mobility;
 - based on timer or other (e.g. counting) criteria (T_1).
- Second Phase:
 - started upon radio link failure detection or handover failure;
 - leads to RRC_IDLE;
 - UE-based mobility;
 - Timer based (T_2).

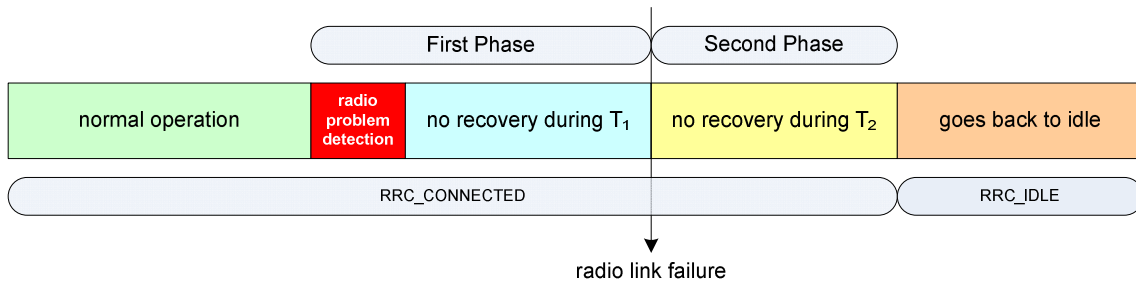

Figure 10.1.6-1: Radio Link Failure

Table 10.1.6-1 below describes how mobility is handled with respect to radio link failure:

Table 10.1.6-1: Mobility and Radio Link Failure

Cases	First Phase	Second Phase	T2 expired
UE returns to the same cell	Continue as if no radio problems occurred	Activity is resumed by means of explicit signalling between UE and eNB	Go via RRC_IDLE
UE selects a different cell from the same eNB	N/A	Activity is resumed by means of explicit signalling between UE and eNB	Go via RRC_IDLE
UE selects a cell of a prepared eNB (NOTE)	N/A	Activity is resumed by means of explicit signalling between UE and eNB	Go via RRC_IDLE
UE selects a cell of a different eNB that is not prepared (NOTE)	N/A	Go via RRC_IDLE	Go via RRC_IDLE
NOTE: a prepared eNB is an eNB which has admitted the UE during an earlier executed HO preparation phase, or obtains the UE context during the Second Phase.			

For a NB-IoT UE that only uses Control Plane CIoT EPS optimizations, as defined in TS 24.301 [20] and does not support RRC Connection re-establishment for the control plane as defined in TS 36.331 [16], at the end of the first phase, the UE enters RRC_IDLE (there is no second phase). In the Second Phase, in order to resume activity and avoid going via RRC_IDLE when the UE returns to the same cell or when the UE selects a different cell from the same eNB, or when the UE selects a cell from a different eNB, the following procedure applies:

- The UE stays in RRC_CONNECTED;
- The UE accesses the cell through the random access procedure;
- Except for a NB-IoT UE using only Control Plane CIoT EPS optimizations, the UE identifier used in the random access procedure for contention resolution (i.e. C-RNTI of the UE in the cell where the RLF occurred + physical layer identity of that cell + short MAC-I based on the keys of that cell) is used by the selected eNB to authenticate the UE and check whether it has a context stored for that UE:
 - If the eNB finds a context that matches the identity of the UE, or obtains this context from the previously serving eNB, it indicates to the UE that its connection can be resumed;
 - If the context is not found, RRC connection is released and UE initiates procedure to establish new RRC connection. In this case UE is required to go via RRC_IDLE.
- For a NB-IoT UE using only Control Plane CIoT EPS optimizations, the UE identifier used in the random access procedure for contention resolution (i.e. S-TMSI of the UE at the time where the RLF occurred + UL NAS MAC + UL NAS COUNT) is used by the selected eNB to request the MME to authenticate the UE's re-establishment request and provide the UE context:
 - If the authentication of the UE is successful and a context is provided, it indicates to the UE that its connection can be resumed;

- If no context is provided, the RRC connection is released and UE initiates procedure to establish new RRC connection. In this case UE is required to go via RRC_IDLE.

The radio link failure procedure applies also for RNs, with the exception that the RN is limited to select a cell from its DeNB cell list. Upon detecting radio link failure, the RN discards any current RN subframe configuration (for communication with its DeNB), enabling the RN to perform normal contention-based RACH as part of the re-establishment. Upon successful re-establishment, an RN subframe configuration can be configured again using the RN reconfiguration procedure.

For DC, PCell supports above phases. In addition, the first phase of the radio link failure procedure is supported for PSCell. However, upon detecting RLF on the PSCell, the re-establishment procedure is not triggered at the end of the first phase. Instead, UE shall inform the radio link failure of PSCell to the MeNB.

NOTE: If the recovery attempt in the second phase fails, the details of the RN behaviour in RRC_IDLE to recover an RRC connection are up to the RN implementation.

10.1.7 Radio Access Network Sharing

E-UTRAN shall support radio access network sharing based on support for multi-to-multi relationship between E-UTRAN nodes and EPC nodes (S1-flex).

If the E-UTRAN is shared by multiple operators, the system information broadcasted in each shared cell contains the PLMN-id of each operator (up to 6).

E-UTRA may provide a single tracking area code (TAC) and Cell Identity valid for all the PLMNs sharing the radio access network resources. Alternatively, E-UTRA may provide TACs and Cell Identities valid only for a subset of the PLMNs sharing the radio network resources. With both alternatives, E-UTRA provides only one TAC and one Cell Identity per cell per PLMN.

The UE shall be able to read up to 6 PLMN-ids, to select one of the PLMN-ids at initial attachment and to indicate this PLMN-id to the E-UTRAN in subsequent instances of the Random Access procedures (e.g. as defined in clause 10.1.5). The E-UTRAN shall select an appropriate MME for the PLMN indicated by the UE. Once attached to an MME, the UE shall be able to indicate the allocated MME in subsequent instances of the Random Access procedures. The indication of the allocated MMEC is contained in the temporary UE identity.

Handling of roaming and access restrictions for UE in ECM-CONNECTED shall follow the principles specified in clause 10.4a.

Each Cell Identity associated with a subset of PLMNs identifies its serving eNB.

10.1.8 Handling of Roaming and Area Restrictions for UEs in ECM-CONNECTED

NOTE: The term Roaming and Area Restrictions is not used in Rel-11 and onwards. It has been replaced by the term Roaming and Access Restrictions, see clause 10.1.8a.

10.1.8a Handling of Roaming and Access Restrictions for UEs in ECM-CONNECTED

Handling of roaming and access restrictions and handling of subscription specific preferences in ECM-CONNECTED is performed in the eNB based on information provided by the EPC over the S1 interface.

10.1.9 Mobility in RRC_INACTIVE

10.1.9.1 Overview

Mobility procedures for the RRC_INACTIVE state as specified in clause 9.2.2.1 of TS 38.300 [79] also apply for EUTRA connected to 5GC with the following differences:

- ng-eNB shall be considered instead of gNB.

10.1.9.2 Cell Reselection

A UE in RRC_INACTIVE performs cell reselection. The principles of the procedure are same as for the RRC_IDLE state (see subclause 10.1.1.2). In addition, for E-UTRA RRC_INACTIVE state:

- Cell reselection from E-UTRA RRC_INACTIVE to NR RRC_IDLE is supported;
- Cell reselection from E-UTRA RRC_INACTIVE to E-UTRA/EPC RRC_IDLE is supported.

10.1.9.3 RAN-Based Notification Area

A UE in the RRC_INACTIVE state can be configured with an RNA as it is specified in clause 9.2.2.3 of TS 38.300 [79].

10.1.9.4 State Transitions

10.1.9.4.1 UE triggered transition from RRC_INACTIVE to RRC_CONNECTED

The UE triggered transition from RRC_INACTIVE to RRC_CONNECTED procedure of clause 9.2.2.4.1 of TS 38.300 [79] is applicable with the following differences:

- ng-eNB shall be considered instead of gNB.

10.1.9.4.2 Network triggered transition from RRC_INACTIVE to RRC_CONNECTED

The Network triggered transition from RRC_INACTIVE to RRC_CONNECTED procedure of clause 9.2.2.4.2 of TS 38.300 [79] is applicable with the following differences:

- ng-eNB shall be considered instead of gNB;
- To resume from RRC_INACTIVE the procedure in clause 10.1.x.4.1 shall be applied.

10.1.9.5 RNA update

The RNA update procedure of clause 9.2.2.5 of TS 38.300 [79] is applicable with the following differences:

- ng-eNB shall be considered instead of gNB.

10.2 Inter RAT

10.2.0 General

Service-based redirection between GERAN / UTRAN and E-UTRAN is supported in both directions. This should not require inter-RAT reporting in RRC CONNECTION REQUEST.

10.2.1 Cell reselection

A UE in RRC_IDLE performs cell reselection. The principles of this procedure are as follows:

- The UE makes **measurements** of attributes of the serving and neighbour cells to enable the reselection process:
 - For a UE to search and measure neighbouring GERAN cells, the ARFCNs of the BCCH carriers need to be indicated in the serving cell system information (i.e., an NCL). The NCL does not contain BSICs or cell specific offsets and Qrxlevmin is given per frequency band.
 - For a UE to search and measure neighbouring UTRAN cells, the serving cell can indicate an NCL containing a list of carrier frequencies and scrambling codes.
 - For a UE to search and measure neighbouring NR cells, the serving cell can indicate the measured RS types and parameters for cell quality derivation.

- Measurements may be omitted if the serving cell attribute fulfils particular search or measurement criteria.
- **Cell reselection** identifies the cell that the UE should camp on. It is based on cell reselection criteria which involves measurements of the serving and neighbour cells:
 - Inter-RAT reselection is based on absolute priorities where UE tries to camp on highest priority RAT available. Absolute priorities for inter-RAT reselection are provided only by the RPLMN and valid only within the RPLMN; priorities are given by the system information and valid for all UEs in a cell, specific priorities per UE can be signalled in the RRC Connection Release message. A validity time can be associated with UE specific priorities.
 - It should be possible to prevent the UE from reselecting to specific detected neighbouring cells;
 - The UE is allowed to "leave" the source E-UTRAN cell to read the target GERAN cell broadcast, in order to determine its "suitability", prior to completing the cell reselection;
 - Cell reselection can be speed dependent (speed detection based on UTRAN solution);

Cell access restrictions apply as for UTRAN, which consist of access class (AC) barring and cell reservation (e.g. for cells "reserved for operator use") applicable for mobiles in RRC_IDLE mode.

When performing cell reselection while the UE is camped on another RAT, the principles of this procedure are as follows:

- The UE measures attributes of the E-UTRA neighbouring cells:
 - Only the carrier frequencies need to be indicated to enable the UE to search and measure E-UTRA neighbouring cells;
- Cell reselection identifies the cell that the UE should camp on. It is based on cell reselection criteria which involves measurements of the serving and neighbour cells:
 - For E-UTRA neighbouring cells, there is no need to indicate cell-specific cell reselection parameters i.e. these parameters are common to all neighbouring cells on an E-UTRA frequency;
- Cell reselection parameters are applicable to all UEs in a cell, but it is possible to configure specific reselection parameters per UE group or per UE.
- It should be possible to prevent the UE from reselecting to specific detected neighbouring cells.

10.2.2 Handover

Inter RAT HO is designed so that changes to GERAN, UTRAN and NR are minimised. This can be done by following the principles specified for GERAN to/from UTRAN intersystem HO. In particular the following principles are applied to E-UTRAN Inter RAT HO design:

1. Inter RAT HO is network controlled through source access system. The source access system decides about starting the preparation and provides the necessary information to the target system in the format required by the target system. That is, the source system adapts to the target system. The actual handover execution is decided in the source system.
2. Inter RAT HO is backwards handover, i.e. radio resources are prepared in the target 3GPP access system before the UE is commanded by the source 3GPP access system to change to the target 3GPP access system.
3. To enable backwards handover, and while RAN level interfaces are not available, a control interface exists in CN level. In Inter RAT HO involving E-UTRAN access, this interface is between:
 - 2G/3G SGSN and corresponding MME/Serving Gateway;
 - AMF/UPF and corresponding MME/Serving Gateway.
4. The target access system will be responsible for giving exact guidance for the UE on how to make the radio access there (this includes radio resource configuration, target cell system information etc.). This information is given during the handover preparation and should be transported completely transparently through the source access system to the UE.

5. Mechanisms for avoiding or mitigating the loss of user data (i.e. forwarding) can be used until the 3GPP Anchor determines that it can send DL U-plane data directly to the target system.
6. The handover procedure should not require any UE to CN signalling in order for data to start to flow in the target system. This requires that the security context, UE capability context and QoS context is transferred (or translated) within the network between source and target system.
7. Similar handover procedure should apply for handovers of both real time and non-real time services.
8. Similar handover procedure should apply for Inter RAT Handover, intra-LTE Handover with EPC node change, and intra-E-UTRA inter-system Handover.
9. Network controlled mobility is supported even if no prior UE measurements have been performed on the target cell and/or frequency i.e. "blind HO" is supported.
10. Inter-RAT HO from E-UTRA with EN-DC configuration to GERAN/UTRAN/NR is supported.
11. Inter-RAT HO from GERAN/UTRAN/NR to E-UTRA with EN-DC configuration is not supported.

10.2.2a Inter-RAT cell change order to GERAN with NACC

For interworking towards GERAN, inter-RAT cell change order with NACC is supported even if no prior UE measurements have been performed on the system i.e. "blind NACC" is supported.

10.2.2b Inter-RAT handovers from E-UTRAN

10.2.2b.1 Data forwarding

10.2.2b.1.1 For RLC-AM bearers

Upon handover, the eNB may forward all downlink PDCP SDUs that have not been acknowledged by the UE, or all downlink PDCP SDUs that have not been transmitted to the UE, to the target node. In addition, the eNB may forward fresh data arriving over S1 to the target node.

NOTE: Any assigned PDCP SNs are not forwarded because of PDCP reset.

NOTE: Target node does not have to wait for the completion of forwarding from the eNB before it begins transmitting packets to the UE.

The eNB discards any remaining downlink RLC PDUs.

Upon handover, all successfully received PDCP SDUs are delivered to the upper layers in the UE.

NOTE: eNB does not need to abort ongoing RLC transmissions with the UE as it starts data forwarding to the target node.

Upon handover, the eNB may forward uplink PDCP SDUs successfully received to the Serving Gateway and shall discard any remaining uplink RLC PDUs.

Correspondingly, the eNB does not forward the downlink and uplink RLC context.

For the uplink, the UE transmits over the target RAT from the first PDCP SDU for which transmission has not been attempted in the source cell.

In-sequence delivery of upper layer PDUs during handover is not guaranteed.

10.2.2b.1.2 For RLC-UM bearers

Upon handover, the eNB does not forward to the target node downlink PDCP SDUs for which transmission had been completed in the source cell. PDCP SDUs that have not been transmitted may be forwarded. In addition, the eNB may forward fresh data arriving over S1 to the target node. The eNB discards any remaining downlink RLC PDUs.

Upon handover, all successfully received PDCP SDUs are delivered to the upper layers in the UE.

Upon handover, the eNB may forward all uplink PDCP SDUs successfully received to the Serving Gateway and discards any remaining uplink RLC PDUs.

For the uplink, the UE transmits over the target RAT from the first PDCP SDU for which transmission has not been attempted in the source cell.

Correspondingly, the eNB does not forward the downlink and uplink RLC context.

10.2.2c Intra-EUTRA inter-system Handover

For intra-EUTRA handover, the source node decides whether to trigger inter-system HO (with CN type change) or intra-system HO (without CN type change). The UE gets the knowledge of the target CN type from handover command during handover procedure.

10.2.3 Measurements

10.2.3.1 Inter-RAT handovers from E-UTRAN

Measurements to be performed by a UE for inter-RAT mobility can be controlled by E-UTRAN, using broadcast or dedicated control. In RRC_CONNECTED state, a UE shall follow the measurement parameters specified by RRC directed from the E-UTRAN (e.g. as in UTRAN MEASUREMENT_CONTROL).

UE performs inter-RAT neighbour cell measurements during DL/UL idle periods that are provided by the network through suitable DRX/DTX period or packet scheduling if necessary.

10.2.3.2 Inter-RAT handovers to E-UTRAN

From UTRAN, UE performs E-UTRAN measurements by using idle periods created by compressed mode (CELL_DCH) or DRX (other states) or measurement occasions (CELL_FACH).

From GERAN, E-UTRAN measurements are performed in the same way as WCDMA measurements for handover to UTRAN: E-UTRAN measurements are performed in GSM idle frames in a time multiplexed manner.

For NR, UE performs E-UTRAN measurements according to the measurement configuration decided by gNB.

10.2.3.3 Inter-RAT cell reselection from E-UTRAN

In RRC_IDLE state, a UE shall follow the measurement parameters specified by the E-UTRAN broadcast (as in UTRAN SIB). The use of dedicated measurement control is possible through the provision of UE specific priorities (see clause 10.2.4).

10.2.3.4 Limiting measurement load at UE

Introduction of E-UTRA implies co-existence of various UE capabilities. Each UE may support different combinations of RATs, e.g., E-UTRA, UTRA, GSM, and non-3GPP RATs, and different combinations of frequency bands, e.g., 800 MHz, 1.7 GHz, 2 GHz, etc. Despite such heterogeneous environment, the measurement load at UE should be minimised. To limit the measurement load and the associated control load:

- E-UTRAN can configure the RATs to be measured by UE;
- The number of measurement criteria (event and periodic reporting criteria) should be limited (as in TS 25.133 [7] clause 8.3.2);
- E-UTRAN should be aware of the UE capabilities for efficient measurement control, to prevent unnecessary waking up of the measurement entity;
- Blind HO (i.e., HO without measurement reports from UE) is possible.

10.2.4 Network Aspects

Inter-frequency/inter-RAT UE based mobility relies on a "priority based scheme", where the network configures a list of RATs/frequencies to be taken as basis for UE's inter-frequency/inter-RAT cell reselection decisions in priority order. E-UTRAN cells can enable inter-frequency/inter-RAT cell reselection by broadcasting a common priority valid for all UEs in a given cell in addition to other inter-frequency/inter-RAT information.

NOTE: The same principles apply in UTRAN.

These common priorities can be overwritten by E-UTRAN through dedicated signalling to individual UEs at RRC_CONNECTED to RRC_IDLE transition.

NOTE: In order to have consistent inter-RAT operation, the same principles apply to inter-RAT reselection to E-UTRAN. For UTRAN this includes also the transitions within RRC_CONNECTED state from CELL_DCH to CELL_PCH and URA_PCH.

Setting dedicated priorities by E-UTRAN can be based on subscription related information provided by the MME.

Based on operator policy the eNBs may be configured to always integrity protect the redirection to GERAN as described in TS 33.401 [22].

10.2.5 CS fallback

CS fallback can be performed via different options. The following table summarize the various CS fallback options per RAT, necessary UE capabilities and FGI index which should be set to '1'. The meaning of FGI index is specified in TS 36.331 [16], Annex B.

Table 10.2.5-1: CS fallback options

Target RAT	Solutions	Release	UE Capability	FGI Index
CS fallback to UMTS	RRC Connection Release with Redirection without Sys Info	Rel-8	(NOTE 1) Mandatory for UEs supporting CS fallback to UMTS	
	RRC Connection Release with Redirection with Sys Info	Rel-9	(NOTE 1) e-RedirectionUTRA	
	PS handover with DRB(s)	Rel-8	(NOTE 1) Mandatory for UEs supporting CS fallback to UMTS	FGI8, FGI22
CS fallback to GSM	RRC Connection Release with Redirection without Sys Info	Rel-8	(NOTE 2) Mandatory for UEs supporting CS fallback to GSM	
	RRC Connection Release with Redirection with Sys Info	Rel-9	(NOTE 2) Mandatory for UEs supporting CS fallback to GSM	
	Cell change order without NACC	Rel-8	(NOTE 2) Mandatory for UEs supporting CS fallback to GSM	FGI10
	Cell change order with NACC	Rel-8	(NOTE 2) Mandatory for UEs supporting CS fallback to GSM	FGI10
	PS handover	Rel-8	(NOTE 2) interRAT-PS-HO-ToGERAN	
NOTE 1: All CS fallback to UMTS capable UE shall indicate that it supports UTRA FDD or TDD and supported band list in the UE capability.				
NOTE 2: All CS fallback to GSM capable UE shall indicate that it supports GERAN and supported band list in the UE capability.				
NOTE 3: The measurement may be performed before any of the above CS fallback solution is triggered to select the target cell or frequency layer more accurately based on eNB decision. eNB may trigger any of above CS fallback solutions blindly.				

10.3 Mobility between E-UTRAN and Non-3GPP radio technologies

10.3.1 UE Capability Configuration

A UE shall be able to communicate with the E-UTRAN about its radio access capability, such as the system (including the release and frequency band) it supports and its receive and transmit capabilities (single/dual radio, dual receiver). UE shall transfer its capability about other radio technologies over E-UTRAN using the same procedure used to carry its E-UTRAN radio capability.

10.3.2 Mobility between E-UTRAN and cdma2000 network

This clause describes the E-UTRAN mechanisms to support idle and active mode mobility between E-UTRAN and cdma2000 HRPD or 1xRTT. The overall system is described in TS 23.401 [17].

10.3.2.1 Tunnelling of cdma2000 Messages over E-UTRAN between UE and cdma2000 Access Nodes

In order to efficiently support handover procedures when on E-UTRAN with a cdma2000 target system, cdma2000 messages are sent transparently to the target system over the E-UTRAN, with the eNB and MME acting as relay points.

To support the MME in its selection of the correct target system node to which it should route an Uplink tunnelled message and to provide the target system with information that is needed to resolve technology-specific measurement information (RouteUpdate and pilot strength measurements) that are delivered to the cdma2000 system, each eNB cell is associated with a cdma2000 HRPD SectorID and/or with a cdma2000 1xRTT SectorID (generically referred to as cdma2000 reference cellid). This cdma2000 reference cellid is provided by the eNB to the MME using the cdma2000 message transfer capability over S1-AP and forwarded to the target system via the S101 interface and corresponding interface to the cdma2000 1xRTT system.

Tunnelling is achieved over the E-UTRAN radio interface by encapsulating tunnelled cdma2000 messages in the UL Information Transfer (for pre-registration signalling) or UL Handover Preparation transfer (for handover signalling) and DL Information Transfer RRC messages (e.g., similar to UMTS Uplink/Downlink Direct Transfer). The reason for using different UL transfer messages is so that the UL Handover Preparation transfer messages can use a higher priority signalling radio bearer. For the UL/DL Information Transfer messages a specific IE in these RRC messages is used to identify the type of information contained in the message (e.g., NAS, TunneledMsg). Additionally if the message is carrying a tunnelled message, an additional IE is included to carry cdma2000 specific RRC Tunnelling Procedure Information (e.g. RAT type).

AS level security will be applied for these UL Information Transfer / UL Handover Preparation Transfer and DL Information Transfer RRC messages as normal but there is no NAS level security for these tunnelled cdma2000 messages.

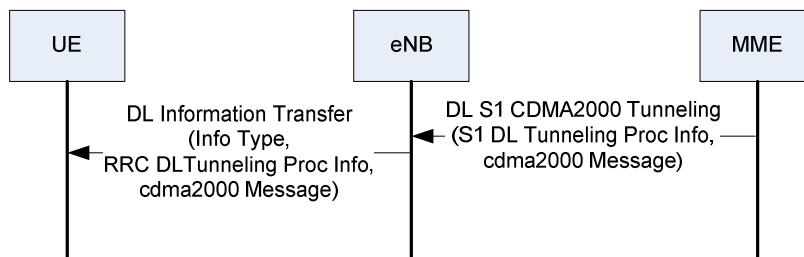

Figure 10.3.2.1-1: Downlink Direct Transfer

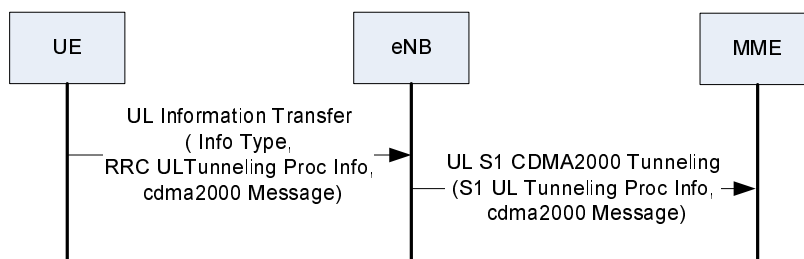

Figure 10.3.2.1-2: Uplink Direct Transfer

Tunnelling to the MME is achieved over the S1-MME interface by encapsulating the tunnelled cdma2000 message in a new S1 CDMA tunnelling messages. These S1 messages carry in addition to the tunnelled message some additional cdma2000 specific IEs (e.g. cdma2000 Reference Cell Id, RAT type, cdma2000 message type).

10.3.2.2 Mobility between E-UTRAN and HRPD

10.3.2.2.1 Mobility from E-UTRAN to HRPD

10.3.2.2.1.1 HRPD System Information Transmission in E-UTRAN

The HRPD system information block (SIB) shall be sent on the E-UTRAN BCCH. The UE shall monitor the E-UTRAN BCCH during the RRC_IDLE and RRC_CONNECTED modes to retrieve the HRPD system information for the preparation of cell reselection or handover from the E-UTRAN to HRPD system. HRPD system information may also be provided to the UE by means of dedicated signalling. The HRPD system information contains HRPD neighbouring cell information, cdma timing information, as well as information controlling the HRPD pre-registration.

10.3.2.2.1.2 Measuring HRPD from E-UTRAN

Measurement events and parameters for HRPD measurements are to be aligned with those defined in clause 10.2.3.

10.3.2.2.1.2.1 Idle Mode Measurement Control

UE shall be able to make measurements on the HRPD cells in RRC_IDLE mode to perform cell re-selection.

The intra-3GPP inter-RAT idle mode measurement control is re-used to control the idle mode measurements on HRPD. The UE performs measurement on HRPD when the signal quality from E-UTRAN serving cell falls below a given threshold.

10.3.2.2.1.2.2 Active Mode Measurement Control

In RRC_CONNECTED mode, the UE shall perform radio measurements on the HRPD network when directed by the E-UTRAN network. The network provides the required HRPD neighbour cell list information and measurement controls to the UE through dedicated RRC signalling. When needed the eNB is responsible for configuring and activating the HRPD measurements on the UE via the dedicated RRC signalling message. Periodic and event-triggered measurements are supported.

For single-radio terminals, measurement gaps are needed to allow the UE to switch into the HRPD network and do radio measurements. These measurement gaps are network-controlled. The eNB is responsible for configuring the gap pattern and providing it to the UE through RRC dedicated signalling. Terminals with a dual receiver perform measurements on HRPD neighbour cells without tuning away from the E-UTRAN network. No DL gap patterns will be required for UEs which are capable of simultaneous reception on the involved frequency bands. No UL gap patterns will be required for UEs which are capable simultaneous transmission in one access and measuring on another access.

10.3.2.2.1.2.3 Active Mode Measurement

In RRC_CONNECTED mode, the UE measures the strengths of each of the HRPD neighbour cells and reports them in an RRC message.

10.3.2.2.1.3 Pre-registration to HRPD Procedure

Pre-registration allows a UE to establish a presence with an HRPD system in advance of a cell re-selection or handover. E-UTRAN network instructs the UE whether the pre-registration is needed over broadcast channel and in a dedicated RRC message.

The signalling procedure is transparent to E-UTRAN network. In the pre-registration to HRPD, messages shall be tunnelled inside RRC and S1-AP messages between the UE and MME and in a generic "transfer" message between source MME and target access network.

The UE is responsible for maintaining the HRPD context e.g. by performing periodic re-registrations if needed. The UE will use pre-registration zone information (including the current HRPD Pre-registration Zone and a list of HRPD Secondary Pre-registration Zone ID) to decide whether a re-registration shall be performed. A dual-receiver UE can ignore the parameter. E-UTRAN will provide the pre-registration zone information on the E-UTRAN system information broadcast channel or dedicated RRC signalling (unless it is determined that the UE will read the E-UTRAN system information broadcast channel in RRC_CONNECTED). Re-registrations are only allowed in areas where pre-registration is requested.

The managing of pre-registration and re-registration is handled by HRPD upper layer. The UE should indicate if it is pre-registered when sending measurement reports on cdma2000 cells.

10.3.2.2.1.4 E-UTRAN to HRPD Cell Re-selection

For the "Optimized Idle-mode Mobility" in TS 23.402 [19], the pre-condition for cell re-selection from E-UTRAN to HRPD is that the UE has previously established a presence in the target HRPD network, either through the pre-registration procedure or previous HRPD attachment.

For the "Non-optimized Handover" in TS 23.402 [19], the above pre-condition does not apply.

The UE performs Cell re-selection to HRPD while in RRC_IDLE.

Cell reselection from E-UTRAN to HRPD should be aligned with 3GPP inter RAT cell reselection mechanism.

10.3.2.2.1.5 E-UTRAN to HRPD Handover

The pre-condition for the E-UTRAN to HRPD Handover procedure is that the UE is attached in the E-UTRAN network in E-UTRAN_ACTIVE state and has pre-registered with the HRPD network. Based on measurement reports received from the UE the eNB initiates a handover by sending an RRC Handover FROM E-UTRA PREPARATION REQUEST message to the UE to indicate to the UE that it should begin the handover procedure. This message shall include the specified target RAT type and any cdma2000 specific HRPD parameters needed by the UE to create the appropriate HRPD messages needed to request a connection. Upon reception of this message the UE should begin handover signalling towards the HRPD access. The HRPD handover signalling is tunnelled through E-UTRAN between the UE and HRPD network. These HRPD parameters and HRPD messages are transparent to E-UTRAN. The set of the required HRPD parameters are out of scope of this specification.

The messages are transferred inside RRC transfer messages and S1 CDMA2000 tunnelling messages. The MME will, based on indication provided by the HRPD network, get information about if the handover succeeded or failed making it possible for the MME set the handover status in the S1 CDMA2000 tunnelling messages (e.g. handover success, handover failure). In case the handover succeeded E-UTRAN will include the tunnelled "CDMA2000 handover command", which will be sent to the UE, inside the RRC MOBILITY from E-UTRA COMMAND message.

The UE can continue to send and receive data on the E-UTRAN radio until it receives the RRC MOBILITY from E-UTRA COMMAND message including a tunnelled "CDMA2000 handover command". After this message is received by the UE, the UE shall leave the E-UTRAN radio and start acquiring the HRPD traffic channel. The HRPD handover signalling is tunnelled between the UE and HRPD network.

10.3.2.2.2 Mobility from HRPD to E-UTRAN

Mobility from HRPD to E-UTRAN has no impact on the E-UTRAN.

10.3.2.3 Mobility between E-UTRAN and cdma2000 1xRTT

10.3.2.3.1 Mobility from E-UTRAN to cdma2000 1xRTT

10.3.2.3.1.1 cdma2000 1xRTT System Information Transmission in E-UTRAN

The cdma2000 1xRTT system information block (SIB) shall be sent on E-UTRAN BCCH. The UE shall monitor the E-UTRAN BCCH during the RRC_IDLE and RRC_CONNECTED modes to retrieve the 1xRTT system information for the preparation of handover from the E-UTRAN to cdma2000 1xRTT system. 1xRTT system information may also be provided to the UE by means of dedicated signalling. The 1xRTT system information contains 1xRTT neighbouring cell information, cdma timing information, and 1xRTT CS Fallback information.

10.3.2.3.1.2 Measuring cdma2000 1xRTT from E-UTRAN

Measurement events and parameters for 1xRTT measurements are to be aligned with those defined in clause 10.2.3.

10.3.2.3.1.2.1 Idle Mode Measurement Control

UE shall be able to make measurements on the 1xRTT system cells in LTE_IDLE mode to perform cell re-selection. UE shall perform cdma2000 1xRTT neighbour cell measurements during DRX periods, between paging occasions.

The intra-3GPP inter-RAT idle mode measurement control is re-used to control the idle mode measurements on cdma2000 1xRTT. The UE performs measurement on cdma2000 1xRTT when the signal quality from E-UTRAN serving cell falls below a given threshold.

10.3.2.3.1.2.2 Active Mode Measurement Control

In the E-UTRAN network, in RRC_CONNECTED mode, the UE shall perform radio measurements on the cdma2000 1xRTT network when directed by the E-UTRAN network. The network provides the required cdma2000 1xRTT neighbour cell list information and measurement controls to the UE through dedicated RRC signalling. When needed the eNB is responsible for configuring and activating the cdma2000 1xRTT measurements on the UE via the dedicated RRC signalling message. As for intra-3GPP inter-RAT measurement reporting, periodic and event-triggered measurements are supported.

For single-radio terminals, measurement gaps are needed to allow the UE to switch into the cdma2000 1xRTT network and do radio measurements. These Measurement gaps are network-controlled. The eNB is responsible for configuring the gap pattern and providing it to the UE through RRC dedicated signalling. Terminals with a dual receiver perform measurements on cdma2000 1xRTT neighbour cells without tuning away from the E-UTRAN network. No DL gap patterns will be required for UEs which are capable of simultaneous reception on the involved frequency bands. No UL gap patterns will be required for UEs which are capable simultaneous transmission in one access and measuring on another access.

10.3.2.3.1.2.3 Active Mode Measurement

In RRC_CONNECTED mode, the UE measures the strengths of each of the cdma2000 1xRTT neighbour cells and reports them in an RRC Message.

10.3.2.3.1.3 E-UTRAN to cdma2000 1xRTT Cell Re-selection

UE performs Cell re-selection to cdma2000 1xRTT while in RRC_IDLE.

Cell reselection from E-UTRAN to 1xRTT should be aligned with 3GPP inter RAT cell reselection mechanism.

10.3.2.3.1.4 E-UTRAN to cdma2000 1xRTT Handover

In the high level procedure for handover from E-UTRAN to cdma2000 1xRTT except 1xRTT CS Fallback, registration and handover is performed directly after the handover decision has been made. Based on measurement reports received from the UE the eNB initiates a handover by sending a RRC Handover FROM E-UTRA PREPARATION REQUEST message to the UE to indicate to the UE that it should begin the handover procedure. This message shall include the specified target RAT type and any cdma2000 specific 1xRTT access parameters needed by the UE to create the appropriate 1xRTT Origination Request message. The 1xRTT handover signalling is tunnelled between the UE and 1xRTT network. The 1xRTT access parameters and 1xRTT messages are transparent to E-UTRAN. The set of the required 1xRTT access parameters are out of scope of this specification.

The messages are transferred inside RRC transfer messages and S1 CDMA2000 tunnelling messages. The MME will, based on indication provided by the 1xRTT network, get information about if the handover succeeded or failed making it possible for the MME set the handover status in the S1 CDMA2000 tunnelling messages (e.g. handover success, handover failure). In case the handover succeeded E-UTRAN will include the tunnelled "CDMA2000 handover command", which will be sent to the UE, inside the RRC MOBILITY FROM E-UTRA COMMAND message.

The UE can continue to send and receive data on the E-UTRAN radio until it receives the RRC MOBILITY FROM E-UTRA COMMAND message including a tunnelled "CDMA2000 handover command". After this message is received by the UE, the UE shall leave the E-UTRAN radio and start acquiring the 1xRTT traffic channel.

10.3.2.3.2 Mobility from cdma2000 1xRTT to E-UTRAN

Mobility from cdma2000 1xRTT has no impact on E-UTRAN.

10.3.2.3.3 1xRTT CS Fallback

CS fallback to 1xRTT enables the delivery of CS-domain services when a UE is being served by the E-UTRAN, as specified in TS 23.272 [23].

The UE initiates 1xCSFB (e.g. to perform a 1xCS call origination or accept a 1xCS call termination) by using NAS signalling to send a CSFB indication to the MME. The MME then indicates to the eNB that 1xCSFB is required, which triggers the eNB to execute one of the following 1xCSFB procedures depending on network support and UE capability:

- Rel-8 1xCSFB, characterized by RRC connection release with redirection to 1xRTT;
- enhanced 1xCSFB, characterized by 1xRTT handover signalling tunnelled between the UE and 1xRTT network;
- dual receiver 1xCSFB, characterized by RRC connection release without redirection information; or
- dual receiver/transmitter enhanced 1xCSFB, characterized by either 1xRTT handover signalling tunnelled between the UE and 1xRTT network, or redirection of the UE's second radio to 1xRTT.

The network advertises its support for Rel-8 1xCSFB by broadcasting 1xRTT pre-registration parameters in system information (SIB8). The Rel-8 1xCSFB procedure is the default procedure, when no other 1xCSFB procedure can be performed. If Rel-8 1xCSFB is to be performed, the eNB optionally solicits 1xRTT measurements from the UE, and then sends an RRC Connection Release message with redirection to 1xRTT. The UE then performs the normal 1xCS call origination or termination procedure in the 1xRTT access network.

A network which advertises support for Rel-8 1xCSFB may also support enhanced 1xCSFB, in which case the eNB determines to perform enhanced 1xCSFB based on UE capability. If enhanced 1xCSFB is to be performed, the eNB optionally solicits 1xRTT measurements from the UE, and then sends it a Handover From EUTRA Preparation Request message. This triggers the UE to send the UL Handover Preparation Transfer message containing 1xRTT dedicated information. The 1xRTT information is contained inside RRC and S1-AP messages between the UE and MME and in a generic "transfer" message between MME and 1xRTT network. The response from the 1xRTT network triggers the eNB to send a Mobility From EUTRA Command message which includes a 1xRTT channel assignment message that causes the UE to acquire a traffic channel in the 1xRTT access network. In addition to enhanced 1xCSFB, the eNB may determine to perform concurrent mobility to HRPD based on UE capability; if so, then two separate UL Handover Preparation Transfer messages are triggered from the UE containing 1xRTT and HRPD dedicated information, respectively. The concurrent HRPD handover procedure is handled independently from the e1xCSFB procedure, except that responses from the 1xRTT and HRPD networks shall be combined by the eNB into a single Mobility From EUTRA Command message.

The network advertises support for dual receiver 1xCSFB by broadcasting the dual receiver 1xCSFB support indicator in system information (SIB8). The eNB determines to perform dual receiver 1xCSFB if the UE has a dual Rx configuration according to UE capability, and enhanced 1xCSFB cannot be performed (i.e. because enhanced 1xCSFB is not supported by both network and UE). If dual receiver 1xCSFB is to be performed, the eNB sends an RRC Connection Release message without including redirection information. The UE then performs the normal 1xCS call origination or termination procedure in the 1xRTT access network. A UE with dual Rx configuration may initiate 1xCSFB to a network broadcasting 1xRTT pre-registration parameters but not broadcasting the dual receiver 1xCSFB support indicator; in this case, the UE may receive an RRC Connection Release message with redirection to 1xRTT.

The network advertises support for dual receiver/transmitter enhanced 1xCSFB (dual Rx/Tx e1xCSFB) by broadcasting the dual Rx/Tx e1xCSFB support indicator in system information (SIB8). The eNB determines to perform dual Rx/Tx e1xCSFB if the UE supports dual Rx/Tx e1xCSFB according to UE capability. If the network does not advertise support for dual Rx/Tx e1xCSFB, UE which have dual Rx/Tx configuration may decide to keep the 1xRTT receiver/transmitter turned on in order to continuously operate in both 1xRTT and E-UTRAN. If dual Rx/Tx e1xCSFB is to be performed, the eNB optionally solicits 1xRTT measurements from the UE, and then sends a Handover From EUTRA Preparation Request message. This triggers the UE to perform one of the following:

- send the UL Handover Preparation Transfer message containing 1xRTT dedicated information. The 1xRTT information is contained inside RRC and S1-AP messages between the UE and MME and in a generic "transfer" message between MME and 1xRTT network. The response from the 1xRTT network triggers the eNB to send a DL Information Transfer message which includes a 1xRTT channel assignment message that causes the UE to acquire a traffic channel in the 1xRTT access network while continuing to be served by the E-UTRAN (for PS-domain services).
- direct its second radio to 1xRTT, where it performs the 1xCS call origination or termination procedure in the 1xRTT access network while continuing to be served by the E-UTRAN (for PS-domain services).

The following table summarizes the various CS fallback options for 1xRTT, necessary UE capabilities and FGI index which should be set to '1'. The meaning of FGI index is specified in TS 36.331 [16], Annex B.

Table 10.3.2.3.3-1: CS fallback options

Target RAT	Solutions	Release	UE Capability	FGI Index
CS fallback to 1xRTT	RRC Connection Release with Redirection	Rel-8	(NOTE 1) Mandatory for UEs supporting CS fallback to 1xRTT	
	enhanced 1xCSFB	Rel-9	(NOTE 1) e-CSFB-1XRTT	
	enhanced 1xCSFB with concurrent HRPD handover	Rel-9	(NOTE 1) e-CSFB-ConcPS-Mob1XRTT, Support of HRPD, supportedBandListHRPD	FGI12, FGI26
	dual receiver 1xCSFB (RRC Connection Release without Redirection)	Rel-9	(NOTE 1) rx-Config1XRTT (set to 'dual')	
	dual receiver/transmitter enhanced 1xCSFB	Rel-10	(NOTE 1) e-CSFB-dual-1XRTT	
NOTE 1: All CS fallback to 1xRTT capable UE shall indicate that it supports 1xRTT and supported band list in the UE capability.				
NOTE 2: The measurement may be performed before any of the above CS fallback solution is triggered to select the target cell or frequency layer more accurately based on eNB decision. eNB may trigger any of above CS fallback solutions blindly.				

10.3.2.3.3.1 Pre-registration Procedure for 1xRTT CSFB

A 1xCSFB capable terminal may pre-register in the 1xRTT network via the E-UTRAN in order to establish CS services (e.g. originating and terminating voice calls) in the 1xRTT network. Pre-registration applies only to Rel-8 1xCSFB, enhanced 1xCSFB and dual receiver/transmitter enhanced 1xCSFB. It does not apply to dual receiver 1xCSFB, since the UE registers directly in the 1xRTT network using the normal 1xCS registration procedure.

The UE determines whether pre-registration is needed based on 1xRTT pre-registration parameters broadcast in system information (SIB8). Before performing a 1xRTT pre-registration, the UE requests from the eNB the necessary information to perform the 1xRTT pre-registration using the CDMA2000 CSFB Parameters Request message. The eNB provides the necessary parameters in the CDMA2000 CSFB Parameters Response message. These necessary parameters are pre-configured in the eNB and are transparent to E-UTRAN.

The UE is responsible for maintaining the 1xRTT context, e.g. by performing re-registrations if needed. The UE will use the 1xRTT pre-registration information to decide whether a re-registration shall be performed. A dual receiver UE which registers directly in the 1xRTT network can ignore these parameters. Re-registrations are only allowed in areas where pre-registration is allowed.

The management of the pre-registration and re-registration is handled by the 1xRTT upper layer in the UE.

10.3.3 CDMA2000 interworking in LTE shared networks

LTE system information (SIB8) can contain parameters for multiple CDMA2000 networks to allow the different PLMNs to inter-work with different CDMA2000 networks. There is a one to one mapping between PLMN and CDMA2000 network in that each LTE PLMN in SIB1 can inter-work with only one CDMA2000 network. Thus the UE, eNB and MME implicitly knows the CDMA2000 network from the UE's RPLMN. All UEs not supporting the per-PLMN signalling inter-work with the same CDMA2000 network independent of their RPLMN.

10.4 Area Restrictions

NOTE: The term Area Restrictions is not used in Rel-11 and onwards. It has been replaced by the term Roaming and Access Restrictions, see clause 10.4a.

10.4a Roaming and Access Restrictions

The roaming and access restriction information for a UE includes information on restrictions to be applied for subsequent mobility action during ECM-CONNECTED state. It includes the Serving PLMN and may include a list of equivalent PLMNs and other information. It may be provided by the MME at context setup over the S1 interface, and may be updated by the MME during S1 Handover, and when sending NAS Downlink messages.

NOTE: In case of GWCN network sharing scenario, the roaming and access restriction information should always be provided by the MME to the eNBs.

Upon receiving the roaming and access restriction information for a UE, the eNB shall store it and thereafter it should use it to determine whether to apply restriction handling for subsequent mobility action for which the eNB provides information about the target of the mobility action towards the UE, e.g., handover and CCO, if applicable as specified in TS 23.401 [17] and TS 23.272 [23]. If the roaming and access restriction information is not available at the eNB, the eNB shall consider that there is no restriction for subsequent mobility actions.

Only if received via S1 signalling or X2 signalling, the roaming and access restriction information for a UE shall be propagated by the source eNB over X2 at intra E-UTRAN handover. For the case when the X2 handover results in a change of serving PLMN (to an equivalent PLMN), the source eNB shall replace the Serving PLMN with the identity of the target PLMN and move the Serving PLMN to the equivalent PLMN list, before propagating the roaming and access restriction information.

SCG selection for DC at the MeNB is based upon roaming and access restriction information. If the roaming and access restriction information is not available at the MeNB, the MeNB shall consider that there is no restriction for the SCG selection. In case of RAN sharing scenarios, the MeNB selects the serving PLMN ID of the SCG and provides it to the SeNB.

SCG (re)selection for EN-DC at the SgNB is based on roaming and access restriction information in SgNB. If roaming and access restriction information is not available at the SgNB, the SgNB shall consider that there is no restriction for SCG (re)selection. Therefore, MeNB needs to convey the up-to-date roaming and access restriction information from MME to SgNB via X2AP messages.

If eNBs with different versions of the X2AP or S1AP protocol are deployed, information provided by the EPC within the S1AP Handover Restriction List may be lost in the course of X2 mobility. In order to avoid such loss of information at X2 handover or UE context retrieval due to a source eNB or an old eNB not able to recognise the entire content, the source eNB or the old eNB may provide an EPC Handover Restriction List Container to the target eNB or the new eNB, containing the Handover Restriction List as received from the EPC. The target eNB or the new eNB shall use the information contained in the EPC Handover Restriction List Container as the Handover Restriction List, except for the Serving PLMN and the Equivalent PLMNs, which the eNB shall use from the X2AP Handover Restriction List. The EPC Handover Restriction List Container may be propagated at future X2 handover and UE context retrieval.

NOTE: Alternatively, the EPC may provide the S1AP Handover Restriction List to the target eNB or new eNB at path switch, either based on knowledge about the eNB's implementation status or always.

10.5 Mobility to and from CSG and Hybrid cells

10.5.0 Principles for idle-mode mobility with CSG cells

10.5.0.1 Intra-frequency mobility

Intra-frequency mobility in idle mode in the presence of CSG member cells is based on cell ranking and reselection using the "best cell principle": For cell ranking and reselection, the UE may ignore all CSG cells that are known by the UE not to be CSG member cells.

10.5.0.2 Inter-frequency mobility

For cell ranking and reselection, the UE should prioritize CSG member cells irrespective of normal network configured frequency priorities.

10.5.0.3 Inter-RAT Mobility

Inter-RAT inbound mobility to E-UTRAN CSG cells is also supported by a UE autonomous search when the UE is camped on a RAT other than E-UTRAN. The UE requirements are defined in the specifications of the concerned RAT.

10.5.1 Inbound mobility to CSG cells

10.5.1.1 RRC_IDLE

Cell selection/reselection to CSG cells is based on a UE autonomous search function. The search function determines itself when/where to search, and need not be assisted by the network with information about frequencies which are dedicated to CSG cells.

To assist the search function on mixed carriers, all CSG cells on mixed carriers broadcast in system information a range of PCI values reserved by the network for use by CSG cells. Optionally also non-CSG cells on the mixed carrier can send this information in system information. The reserved PCI range is only applicable to the frequency of the PLMN where the UE received this information. The UE considers the last received reserved range of PCI values for CSG cells to be valid for a maximum of 24 hours within the entire PLMN. UE's use of the received PCI split information is UE implementation dependent.

NOTE: In shared NW scenario, aligned PCI ranges are beneficial in the shared carrier frequency across the involved PLMNs. Furthermore, in deployments where cells broadcast different primary PLMN (with or without multiple PLMN IDs), it is beneficial that CSG and non-CSG cells will broadcast same PCI ranges.

UE checks the suitability of CSG cells (identified by the 1 bit indicator) based on the CSG whitelist in the UE (provided by upper layers). Only CSG member cells are considered suitable.

The automated searching for the CSG cells by the UE shall be disabled by the search function, if the CSG whitelist configured in the UE is empty.

In addition, manual selection of CSG cells is supported.

Cell selection/reselection to CSG cells does not require the network to provide neighbour cell information to the UE. The neighbour cell information can be provided to help the UE in specific cases, e.g. where the network wishes to trigger the UE to search for CSG cells.

Cell Reselection between CSG member cells is based on normal cell reselection procedure.

10.5.1.2 RRC_CONNECTED

While the UE is in RRC_CONNECTED state, the UE performs normal measurement and mobility procedures based on configuration provided by the network.

The UE is not required to support manual selection of CSG IDs while in RRC_CONNECTED state.

Handover to a HNB/HeNB follows the framework of UE assisted network controlled handover as described in 10.1.2.1. Handover to a HNB/HeNB is different from the normal handover procedure in four aspects:

- 1. Proximity Estimation:** in case the UE is able to determine, using autonomous search procedures, that it is near a CSG member cell, the UE may provide to the source eNB an indication of proximity. The proximity indication may be used as follows:
 - If a measurement configuration is not present for the concerned frequency/RAT, the source eNB may configure the UE to perform measurements and reporting for the concerned frequency/RAT.
 - The source eNB may determine whether to perform other actions related to handover to HNB/HeNBs based on having received a proximity indication (for example, the source eNB may not configure the UE to acquire system information of the HNB/HeNB unless it has received a proximity indication).
- 2. PSC/PCI Confusion:** due to the typical cell size of HNB/HeNBs being much smaller than macro cells, there can be multiple HNBs/HeNBs within the coverage of the source eNB that have the same PSC/PCI. This leads to a condition referred to as PSC/PCI confusion, wherein the source eNB is unable to determine the correct target cell

for handover from the PSC/PCI included in the measurement reports from the UE. PSC/PCI confusion is solved by the UE reporting the global cell identity of the target HNB/HeNB.

- 3. **Access Control:** if the target cell is a hybrid cell, prioritization of allocated resources may be performed based on the UE's membership status. Access control is done by a two step process, where first the UE reports whether the target cell is a CSG member cell based on the UE's CSG whitelist, and then the network verifies the reported status. When the UE has an emergency call the MME allows inbound mobility to CSG cells even if the access control fails as specified in TS 23.401[17].
- 4. **PLMN Selection:** If the target cell is a shared CSG/hybrid cell, the UE reports the subset of the broadcasted PLMN identities passing PLMN ID check and the CSG whitelist of the UE includes an entry comprising of the concerned PLMN identity and the CSG ID broadcast by the target cell. The source eNB performs PLMN ID check for the PLMNs reported by the UE and selects one if multiple pass the PLMN ID check. Finally the MME verifies the CSG membership according to the received CSG ID, the selected PLMN ID and stored subscription CSG information of the UE.

Mobility from eNB/HeNB to a HeNB's CSG/hybrid cell may take place with the S1 Handover procedure. In the following call flow the source cell can be an eNB or a HeNB.

The current version of the specification also supports mobility involving HeNBs by using X2 handover in some cases (see clause 4.6.1). If membership verification is required for X2 mobility, the procedure described in clause 10.1.2.1 applies, with the following additions to the steps described in clause 10.1.2.1.1:

- In Step 4, the source eNB/HeNB includes the CSG membership status reported by the UE handed over in the X2AP HANDOVER REQUEST message to the target HeNB; the target HeNB performs admission control based on the CSG membership status reported by the UE;
- In Step 12, the target HeNB includes the CSG membership status of the UE handed over in the PATH SWITCH REQUEST message to the MME;
- In Step 16, after the MME has performed membership verification for the UE handed over, the MME includes its verified CSG membership status in the PATH SWITCH REQUEST ACKNOWLEDGE message to the target HeNB; the target HeNB updates its membership information if needed.

The procedure below applies to any scenario where the CSG ID is provided by the UE or provided by the source eNB.

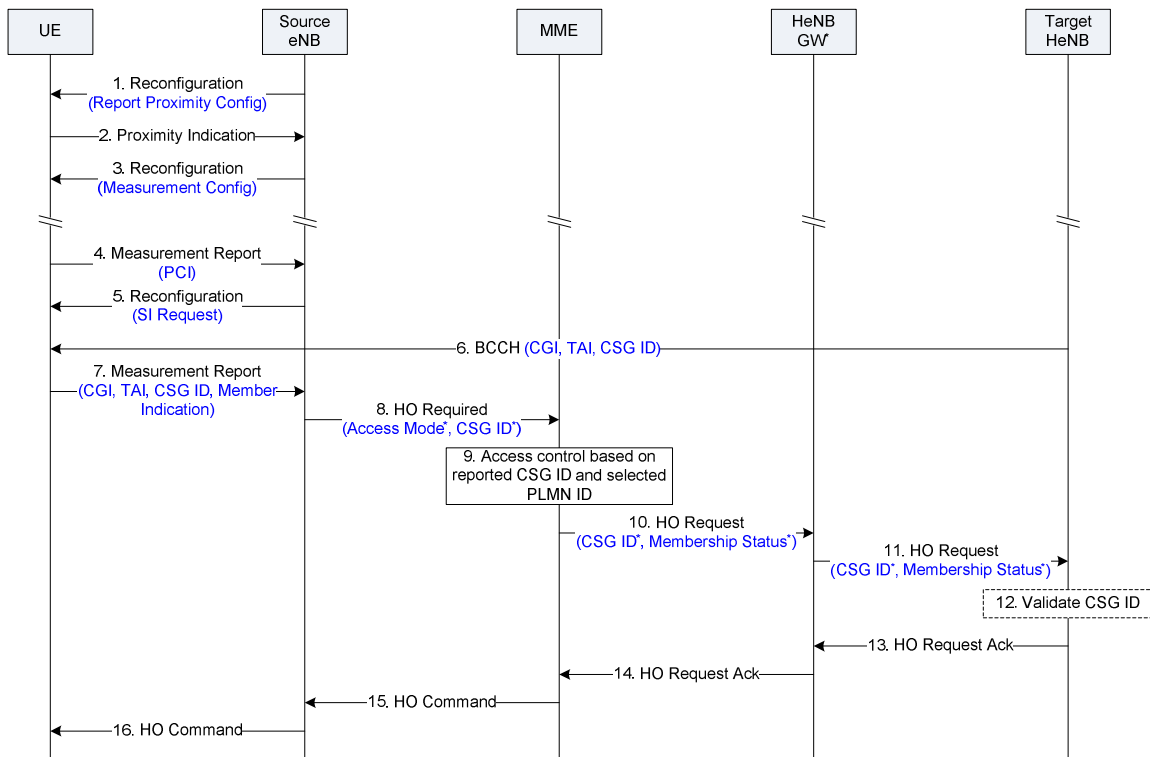

Figure 10.5.1.2-1: Mobility to HeNB's CSG and hybrid cells.

- 1) The source eNB configures the UE with proximity indication control.
- 2) The UE sends an "entering" proximity indication when it determines it may be near a CSG member cell (based on autonomous search procedures). The proximity indication includes the RAT and frequency of the cell.
- 3) If a measurement configuration is not present for the concerned frequency/RAT the source eNB configures the UE with relevant measurement configuration including measurement gaps as needed, so that the UE can perform measurements on the reported RAT and frequency. The network may also use the proximity indication to minimize the requesting of handover preparation information of CSG/hybrid cells by avoiding requesting such information when the UE is not in the geographical area where its CSG member cells are located.
- 4) The UE sends a measurement report including the PCI (e.g., due to triggered event A3).
- 5) The source eNB configures the UE to perform SI acquisition and reporting of a particular PCI.
- 6) The UE performs SI acquisition using autonomous gaps, i.e., the UE may suspend reception and transmission with the source eNB within the limits defined in TS 36.133 [21] to acquire the relevant system information from the target HeNB.
- 7) The UE sends a measurement report including (E-)CGI, TAI, CSG ID and "member/non-member" indication. If the target cell is a shared CSG/hybrid cell, the measurement report also includes the subset of the broadcast PLMN identities that pass PLMN ID check and for which the CSG whitelist of the UE includes an entry comprising the cell's CSG ID and the respective PLMN identity.
- 8) The source eNB includes the target E-CGI and the CSG ID in the Handover Required message sent to the MME. If the target is a hybrid cell the Cell Access Mode of the target is included.
- 9) The MME performs UE access control to the CSG cell based on the CSG ID and the selected target PLMN received in the Handover Required message and the stored CSG subscription data for the UE (see TS 23.401 [17]). If the access control procedure fails, the MME ends the handover procedure by replying with the Handover Preparation Failure message. If the Cell Access Mode is present, the MME determines the CSG Membership Status of the UE handing over to the hybrid cell and includes it in the Handover Request message.
- 10-11) The MME sends the Handover Request message to the target HeNB including the target CSG ID received in the Handover Required message. If the target is a hybrid cell the CSG Membership Status will be included in the Handover Request message.
- 12) The target HeNB verifies that the CSG ID received in the Handover Request message matches the CSG ID broadcast in the target cell and if such validation is successful it allocates appropriate resources. UE prioritisation may also be applied if the CSG Membership Status indicates that the UE is a member.
- 13-14) The target HeNB sends the Handover Request Acknowledge message to the MME via the HeNB GW if present.
- 15) The MME sends the Handover Command message to the source eNB.
- 16) The source eNB transmits the Handover Command (RRC Connection Reconfiguration message including mobility control information) to the UE.

NOTE: Steps 1-9, 15 and 16 also apply to inter-RAT mobility from LTE to HNB.

After sending an "entering" proximity indication (step 2), if the UE determines that it is no longer near a CSG member cell, the UE sends a "leaving" proximity indication to the source eNB. Upon reception of this indication, the source eNB may reconfigure the UE to stop measurements on the reported RAT and frequency.

In the above procedure, steps 2 and 3 may not be performed in case the UE has not previously visited the HeNB, e.g., when the UE first visits a hybrid cell.

The PCI confusion is resolved by steps 5, 6 and 7. The source eNB can request SI acquisition and reporting for any PCI, not limited to PSCs/PCIs of CSG or hybrid cells.

10.5.2 Outbound mobility from CSG cells

10.5.2.1 RRC_IDLE

For a UE leaving a CSG cell in idle mode normal cell reselection based on configuration from the BCCH of the CSG cell applies.

10.5.2.2 RRC_CONNECTED

For a UE leaving a CSG cell in active mode normal network controlled mobility applies.

10.6 Measurement Model

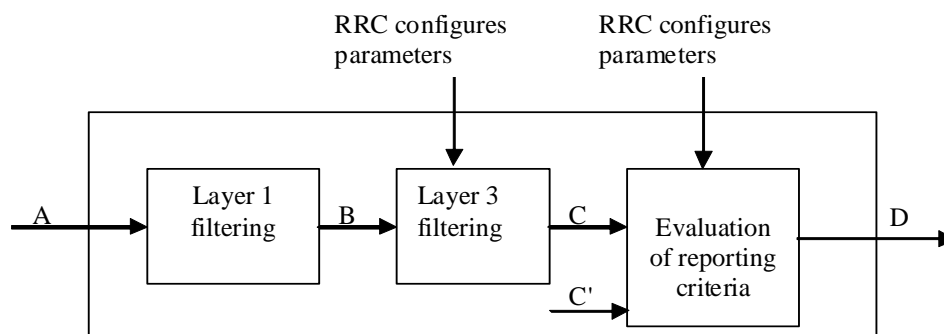

Figure 10.6-1: Measurement model

- **A:** measurements (samples) internal to the physical layer.
- **Layer 1 filtering:** internal layer 1 filtering of the inputs measured at point A. Exact filtering is implementation dependant. How the measurements are actually executed in the physical layer by an implementation (inputs A and Layer 1 filtering) is not constrained by the standard.
- **B:** A measurement reported by layer 1 to layer 3 after layer 1 filtering.
- **Layer 3 filtering:** Filtering performed on the measurements provided at point B. The behaviour of the Layer 3 filters are standardised and the configuration of the layer 3 filters is provided by RRC signalling. Filtering reporting period at C equals one measurement period at B.
- **C:** A measurement after processing in the layer 3 filter. The reporting rate is identical to the reporting rate at point B. This measurement is used as input for one or more evaluation of reporting criteria.
- **Evaluation of reporting criteria:** This checks whether actual measurement reporting is necessary at point D. The evaluation can be based on more than one flow of measurements at reference point C e.g. to compare between different measurements. This is illustrated by input C and C'. The UE shall evaluate the reporting criteria at least every time a new measurement result is reported at point C, C'. The reporting criteria are standardised and the configuration is provided by RRC signalling (UE measurements).
- **D:** Measurement report information (message) sent on the radio interface.

Layer 1 filtering will introduce a certain level of measurement averaging. How and when the UE exactly performs the required measurements will be implementation specific to the point that the output at B fulfils the performance requirements set in TS 36.133 [21]. Layer 3 filtering and parameters used is specified in TS 36.331 [16] and does not introduce any delay in the sample availability between B and C. Measurement at point C, C' is the input used in the event evaluation.

10.7 Hybrid Cells

10.7.0 General

Hybrid Cells have a CSG Indication bit set to FALSE but broadcast a CSG Identity and the PCI values for hybrid cells are not contained within the reserved PCI range for CSG cells. Similar to CSG cells, the network can reserve a PCI list for hybrid cells.

The network shall distinguish whether it is a hybrid cell, e.g. by reserving a PCI list for hybrid cells.

10.7.1 RRC_IDLE

When the CSG ID and associated PLMN ID of the hybrid cell belong to the CSG whitelist of the UE, the hybrid cell is considered by the UE as a CSG cell in idle mode cell selection/reselection procedures.

NOTE: The autonomous search for hybrid cells does not imply that a UE needs to constantly check the CSG ID and associated PLMN ID of all cells it sees.

For all other UEs, normal cell selection/reselection procedures apply with hybrid cells (as for non CSG cells).

Manual selection of CSG IDs of hybrid cells is also supported in the same way as for CSG cells.

10.7.2 RRC_CONNECTED

10.7.2.1 Inbound Mobility

Inbound mobility to hybrid cells is described in clause 10.5.1.2.

10.7.2.2 Outbound Mobility

Procedure for outbound mobility from CSG cells applies (See clause 10.5.2.2).

11 Scheduling and Rate Control

11.0 General

In order to utilise the SCH resources efficiently, a scheduling function is used in MAC. In this clause, an overview of the scheduler is given in terms of scheduler operation, signalling of scheduler decisions, and measurements to support scheduler operation.

For NB-IoT, the Basic Scheduler Operation in 11.1, the uplink buffer status reports part in 11.3 and the DL channel quality reporting in 11.7 are applicable, the UE-AMBR part in 11.4 is applicable only for UE which is enabled to use S1-U data transfer or User Plane CIoT EPS optimization, and all other subclauses of clause 11 are not applicable.

11.1 Basic Scheduler Operation

MAC in eNB includes dynamic resource schedulers that allocate physical layer resources for the DL-SCH, UL-SCH and SL-SCH transport channels. Different schedulers operate for the DL-SCH, UL-SCH and SL-SCH.

The scheduler should take account of the traffic volume and the QoS requirements of each UE and associated radio bearers, when sharing resources between UEs. Only "per UE" grants are used to grant the right to transmit on the UL-SCH and SL-SCH (i.e. there are no "per UE per RB" grants).

Schedulers may assign resources taking account the radio conditions at the UE identified through measurements made at the eNB and/or reported by the UE.

Radio resource allocations can be valid for one or multiple TTIs.

Resource assignment consists of physical resource blocks (PRB) and MCS. Allocations for time periods longer than one TTI might also require additional information (allocation time, allocation repetition factor...).

When CA is configured, a UE may be scheduled over multiple serving cells simultaneously but at most one random access procedure shall be ongoing at any time. Cross-carrier scheduling with the Carrier Indicator Field (CIF) allows the PDCCH of a serving cell to schedule resources on another serving cell but with the following restrictions:

- Cross-carrier scheduling does not apply to PCell i.e. PCell is always scheduled via its PDCCH;
- When the PDCCH of an SCell is configured except for an LAA SCell, cross-carrier scheduling for uplink transmission and downlink transmission does not apply to this SCell i.e. it is always scheduled for uplink transmission and downlink transmission via its PDCCH;
- When the PDCCH of an LAA SCell is configured:
 - If cross-carrier scheduling applies only to uplink transmission, it is scheduled for downlink transmission via its PDCCH and for uplink transmission via the PDCCH of one other serving cell;
 - If self-scheduling applies to both uplink transmission and downlink transmission, it is always scheduled for uplink transmission and downlink transmission via its PDCCH.
- When the PDCCH of an SCell is not configured, cross-carrier scheduling for uplink transmission and downlink transmission applies and this SCell is always scheduled for uplink transmission and downlink transmission via the PDCCH of one other serving cell.

A linking between UL and DL allows identifying the serving cell for which the DL assignment or UL grant applies when the CIF is not present:

- DL assignment received on PCell corresponds to downlink transmission on PCell;
- For DC, DL assignment received on PSCell corresponds to downlink transmission on PSCell;
- UL grant received on PCell corresponds to uplink transmission on PCell, except for the UL grant in Random Access Response from PCell in response to a random access preamble on SCell of MCG for which case the UL grant is for the SCell where the preamble is sent;
- For DC, UL grant received on PSCell corresponds to uplink transmission on PSCell, except for the UL grant in Random Access Response from PSCell in response to a random access preamble on SCell of SCG for which case the UL grant is for the SCell where the preamble is sent.
- DL assignment received on SCell_n corresponds to downlink transmission on SCell_n;
- UL grant received on SCell_n corresponds to uplink transmission on SCell_n. If SCell_n is not configured for uplink usage by the UE, the grant is ignored by the UE.

When DC is configured, cross-carrier scheduling can only be used across serving cells within the same CG. Within a CG, neither PCell of MCG nor PSCell of SCG can be cross-carrier scheduled.

When SPT is configured, cross-carrier scheduling can be used, but is limited to serving cells within the same PUCCH group. In this case, both the scheduling cell and the scheduled cell shall be configured with SPT.

11.1.1 Downlink Scheduling

In the downlink, E-UTRAN can dynamically allocate resources (PRBs and MCS) to UEs at each TTI via the C-RNTI on PDCCH(s). A UE always monitors the PDCCH(s) in order to find possible allocation when its downlink reception is enabled (activity governed by DRX when configured). When CA is configured, the same C-RNTI applies to all serving cells.

In addition, E-UTRAN can allocate semi-persistent downlink resources for the first HARQ transmissions to UEs:

- RRC defines the periodicity of the semi-persistent downlink grant;
- PDCCH indicates whether the downlink grant is a semi-persistent one i.e. whether it can be implicitly reused in the following TTIs according to the periodicity defined by RRC.

When required, retransmissions are explicitly signalled via the PDCCH(s). In the TTIs where the UE has semi-persistent downlink resource, if the UE cannot find its C-RNTI on the PDCCH(s), a downlink transmission according to the semi-persistent allocation that the UE has been assigned in the TTI is assumed. Otherwise, in the sub-TTIs where the UE has semi-persistent downlink resource, if the UE finds its C-RNTI on the PDCCH(s), the PDCCH allocation overrides the semi-persistent allocation for that TTI and the UE does not decode the semi-persistent resources.

Semi-persistent downlink resources can be configured per serving cell with the restriction that multiple DL SPS configurations per serving cell are not supported. SPS configurations can be active simultaneously for different cells. PDCCH allocations made on a given serving cell can only override the semi-persistent allocation for that serving cell.

For NB-IoT:

- Scheduling information for downlink data is transmitted on the downlink physical control channel NPDCCH. The scheduled downlink data is transmitted on the shared data channel NPDSCH;
- Only cross-subframe scheduling is supported, cross-carrier scheduling is not supported. The transmission duration in number of sub-frames for the NPDCCH and the NPDSCH is variable;
- The transmission duration in number of sub-frames is semi-static for the NPDCCH and is indicated for the NPDSCH as part of the scheduling information transmitted on the NPDCCH;
- The start time of the NPDSCH relative to the NPDCCH is signaled as part of the scheduling message.

11.1.2 Uplink Scheduling

In the uplink, E-UTRAN can dynamically allocate resources (PRBs and MCS) to UEs at each TTI via the C-RNTI on PDCCH(s). A UE always monitors the PDCCH(s) in order to find possible allocation for uplink transmission when its downlink reception is enabled (activity governed by DRX when configured). When CA is configured, the same C-RNTI applies to all serving cells.

In addition, E-UTRAN can allocate a semi-persistent uplink resource or autonomous uplink resource for the first HARQ transmissions and potentially retransmissions to UEs:

- RRC defines the periodicity of the semi-persistent uplink grant or the bitmap of the autonomous uplink grant;
- PDCCH indicates whether the uplink grant is a semi-persistent one or an autonomous uplink one i.e. whether it can be implicitly reused in the following TTIs according to the periodicity or the bitmap defined by RRC.

In the TTIs where the UE has semi-persistent uplink resource or autonomous uplink resource, if the UE cannot find its C-RNTI on the PDCCH(s), an uplink transmission according to the semi-persistent allocation or autonomous uplink allocation that the UE has been assigned in the TTI can be made. The network performs decoding of the pre-defined PRBs according to the pre-defined MCS. Otherwise, in the TTIs where the UE has semi-persistent uplink resource or autonomous uplink resource, if the UE finds its C-RNTI on the PDCCH(s), the PDCCH allocation overrides the persistent allocation or autonomous uplink allocation for that TTI and the UE's transmission follows the PDCCH allocation, not the semi-persistent allocation or autonomous uplink. Retransmissions are either implicitly allocated in which case the UE uses the semi-persistent uplink allocation or autonomous uplink allocation, or explicitly allocated via PDCCH(s) in which case the UE does not follow the semi-persistent allocation or autonomous uplink allocation. The UE is not allowed to use autonomous uplink resource for retransmission of dynamically scheduled transmission.

NOTE: there is no blind decoding in uplink and when the UE does not have enough data to fill the allocated resource, padding is used.

When the UE is provided with valid uplink grants in several serving cells in one TTI, the order in which the grants are processed during logical channel prioritisation and whether joint or serial processing is applied are left up to UE implementation, while adhering to transmission restrictions of a logical channel via LAA SCells.

Similar to the downlink, semi-persistent uplink resources can be configured. Multiple UL SPS configurations are supported per Serving Cell. On one Serving Cell, multiple such configurations can be active simultaneously only for the same TTI length. SPS configurations can also be active simultaneously for different cells. PDCCH allocations made on a given serving cell can only override the semi-persistent allocation for that serving cell.

When UL skipping is configured, the UE will not transmit a MAC PDU with only padding BSR and padding if no data is available for transmission in the UE buffer. When UL Skipping and an SPS interval shorter than 10ms is configured,

a retransmission is prioritised over a new transmission on semi-persistent uplink resources if no dynamic grant is allocated for that subframe.

For a UE capable of V2X communication, multiple semi-persistent configurations can be configured in uplink, regardless of the specific services the UE is operating. The uplink resources for each semi-persistent configuration can only be configured for the PCell. When DC is configured, the uplink resources for each semi-persistent configuration can only be configured for the PCell or PSCell.

Autonomous uplink allocation can be configured for LAA SCell(s). The UE will not transmit on autonomous uplink resources if no data is available for transmission.

For NB-IoT:

- Scheduling information for uplink data is transmitted on the downlink physical control channel NPDCCH. The scheduled uplink data is transmitted on the shared data channel NPUSCH;
- The transmission duration in number of sub-frames for the NPUSCH is variable;
- The transmission duration in number of sub-frames is semi-static for the NPDCCH and is indicated for the NPUSCH as part of the scheduling information transmitted on the NPDCCH;
- The start time of the NPUSCH relative to the NPDCCH is signaled as part of the scheduling message;
- E-UTRAN can allocate semi-persistent uplink resource for sending a BSR acting as a Scheduling Request.

11.2 Activation/Deactivation Mechanism

To enable reasonable UE battery consumption when CA is configured, an activation/deactivation mechanism of SCells is supported (i.e. activation/deactivation does not apply to PCell). When an SCell is deactivated, the UE does not need to receive the corresponding PDCCH or PDSCH, cannot transmit in the corresponding uplink, nor is it required to perform CQI measurements. Conversely, when an SCell is active, the UE shall receive PDSCH and PDCCH (if the UE is configured to monitor PDCCH from this SCell), and is expected to be able to perform CQI measurements. To enable faster CQI reporting, a temporary CQI reporting period (called short CQI period) can be supported during SCell activation period. E-UTRAN ensures that while PUCCH SCell is deactivated, SCells of secondary PUCCH group should not be activated or dormant. E-UTRAN ensures that SCells mapped to PUCCH SCell are deactivated before the PUCCH SCell is changed or removed.

To enable faster transition to activated state, a dormant state for SCells (i.e. not PCell or PSCell) is supported. When an SCell is in dormant state, the UE does not need to receive the corresponding PDCCH or PDSCH, cannot transmit in the corresponding uplink, but is required to perform CQI measurements. A PUCCH SCell cannot be in dormant state.

The activation/deactivation mechanism is based on the combination of a MAC control element and deactivation timers. The MAC control element carries a bitmap for the activation and deactivation of SCells: a bit set to 1 denotes activation of the corresponding SCell, while a bit set to 0 denotes deactivation. With the bitmap, SCells can be activated and deactivated individually, and a single activation/deactivation command can activate/deactivate a subset of the SCells. One deactivation timer is maintained per SCell but one common value is configured per UE by RRC.

The state transitions to and from dormant SCell state use MAC control elements.

At reconfiguration without mobility control information:

- SCells added to the set of serving cells are initially "deactivated", "dormant" or "activated";
- SCells which remain in the set of serving cells (either unchanged or reconfigured) do not change their activation status ("activated", "deactivated" or "dormant").

At reconfiguration with mobility control information (i.e. handover):

- SCells are "deactivated", "dormant" or "activated".

In DC, the serving cells of the MCG other than the PCell can only be activated/deactivated by the MAC Control Element received on MCG, and the serving cells of the SCG other than PSCell can only be activated/ deactivated by the MAC Control Element received on SCG. The MAC entity applies the bitmap for the associated cells of either MCG or SCG. PSCell in SCG is always activated like the PCell (i.e. deactivation timer is not applied to PSCell). With the

exception of PUCCH SCell, one deactivation timer is maintained per SCell but one common value is configured per CG by RRC.

11.3 Measurements to Support Scheduler Operation

Measurement reports are required to enable the scheduler to operate in both uplink and downlink. These include transport volume and measurements of a UE's radio environment.

Uplink buffer status reports (BSR) are needed to provide support for QoS-aware packet scheduling. In E-UTRAN uplink buffer status reports refer to the data that is buffered in for a group of logical channel (LCG) in the UE. Four LCGs and two formats are used for reporting in uplink:

- A short format for which only one BSR (of one LCG) is reported;
- A long format for which all four BSRs (of all four LCGs) are reported.

Uplink buffer status reports are transmitted using MAC signalling.

In DC, LCG is configured per CG.

In DC, BSR configuration, triggering and reporting are independently performed per CG. For split bearers, the PDCP data is considered in BSR in the CG(s) configured by RRC. For LWA bearers in the UL, the bearers configured to use WLAN only do not trigger BSR. For bearers configured to use WLAN and LTE, only the data that may be sent over LTE (i.e., excluding UL data already sent or decided to be sent over WLAN) is considered for BSR.

11.4 Rate Control of GBR, MBR and UE-AMBR

11.4.1 Downlink

The eNB guarantees the downlink GBR associated with a GBR bearer, enforces the downlink MBR associated with a GBR bearer and enforces the downlink AMBR associated with a group of Non-GBR bearers.

11.4.2 Uplink

The UE has an uplink rate control function which manages the sharing of uplink resources between radio bearers. RRC controls the uplink rate control function by giving each bearer a priority and a prioritised bit rate (PBR). The values signalled may not be related to the ones signalled via S1 to the eNB.

The uplink rate control function ensures that the UE serves its radio bearer(s) in the following sequence:

1. All the radio bearer(s) in decreasing priority order up to their PBR;
2. All the radio bearer(s) in decreasing priority order for the remaining resources assigned by the grant.

NOTE1: In case the PBRs are all set to zero, the first step is skipped and the radio bearer(s) are served in strict priority order: the UE maximises the transmission of higher priority data.

NOTE2: By limiting the total grant to the UE, the eNB can ensure that the UE-AMBR plus the sum of MBRs is not exceeded.

NOTE3: Provided the higher layers are responsive to congestion indications, the eNB can enforce the MBR of an uplink radio bearer by triggering congestion indications towards higher layers and by shaping the data rate towards the S1 interface.

If more than one radio bearer has the same priority, the UE shall serve these radio bearers equally.

11.4.3 UE-AMBR for Dual Connectivity

In DC, the MeNB ensures that the UE-AMBR is not exceeded by:

- 1) limiting the resources it allocates to the UE in MCG; and

- 2) indicating to the SeNB a limit so that the SeNB can also in turn guarantee that this limit is not exceeded.

For split bearers the SeNB ignores the indicated downlink UE-AMBR. If the SeNB is not configured to serve the uplink for split bearers, the SeNB ignores the indicated uplink UE-AMBR.

11.5 CQI reporting for Scheduling

The time and frequency resources used by the UE to report CQI are under the control of the eNB. CQI reporting can be either periodic or aperiodic. A UE can be configured to have both periodic and aperiodic reporting at the same time. In case both periodic and aperiodic reporting occurs in the same subframe for a particular CG, only the aperiodic report is transmitted in that subframe.

For efficient support of localized, distributed and MIMO transmissions, E-UTRA supports three types of CQI reporting:

- Wideband type: providing channel quality information of entire system bandwidth of the cell;
- Multi-band type: providing channel quality information of some subset(s) of system bandwidth of the cell;
- MIMO type: open loop or closed loop operation (with or without PMI feedback).

Periodic CQI reporting is defined by the following characteristics:

- When the UE is allocated PUSCH resources in a subframe where a periodic CQI report is configured to be sent, the periodic CQI report is transmitted together with uplink data on the PUSCH. Otherwise, the periodic CQI reports are sent on the PUCCH.

Aperiodic CQI reporting is defined by the following characteristics:

- The report is scheduled by the eNB via the PDCCH;
- Transmitted together with uplink data on PUSCH.

When a CQI report is transmitted together with uplink data on PUSCH, it is multiplexed with the transport block by L1 (i.e. the CQI report is not part of the uplink the transport block).

The eNB configures a set of sizes and formats of the reports. Size and format of the report depends on whether it is transmitted over PUCCH or PUSCH and whether it is a periodic or aperiodic CQI report.

11.6 Explicit Congestion Notification

The eNB and the UE support of the Explicit Congestion Notification (ECN) is specified in clause 5 of IETF RFC 3168 [35] (i.e., the normative part of IETF RFC 3168 [35] that applies to the end-to-end flow of IP packets), and below. ECN is beneficial especially for latency sensitive interacted applications such as chat and gaming as well as for real-time voice and video, this because loss as a congestion signal is avoided, losses that would otherwise necessitate retransmission of packets with additional application delay as a result.

The eNB should set the Congestion Experienced (CE) codepoint ('11') in PDCP SDUs in the downlink direction to indicate downlink (radio) congestion if those PDCP SDUs have one of the two ECN-Capable Transport (ECT) codepoints set. The eNB should set the Congestion Experienced (CE) codepoint ('11') in PDCP SDUs in the uplink direction to indicate uplink (radio) congestion if those PDCP SDUs have one of the two ECN-Capable Transport (ECT) codepoints set. ECN marking should be per the recommendations in IETF RFC 7567 [73].

11.7 DL channel quality reporting in NB-IoT

The DL channel quality report in RRC_IDLE is defined by the following characteristics:

- The reporting is configured by eNB via system information;
- The report is related to the DL anchor carrier when used for the initial random access procedure;
- The report is carried in the RRC message during the random access procedure.

12 DRX in RRC_CONNECTED

In order to enable reasonable UE battery consumption, DRX in E-UTRAN is characterised by the following:

- Per UE mechanism (as opposed to per radio bearer);
- No RRC or MAC substate to distinguish between different levels of DRX;
- Available DRX values are controlled by the network and start from non-DRX up to 10.24 seconds;
- Measurement requirement and reporting criteria can differ according to the length of the DRX interval i.e. long DRX intervals may experience more relaxed requirements;
- Irrespective of DRX, UE may use first available RACH opportunity to send an UL measurement report;
- HARQ operation related to data transmission is independent of DRX operation and the UE wakes up to read the PDCCH for possible retransmissions and/or ACK/NAK signalling regardless of DRX. In the downlink, a timer is used to limit the time the UE stays awake awaiting for a retransmission. In the uplink, for asynchronous HARQ, a timer is used to limit the time the UE stays awake awaiting for a retransmission;
- When DRX is configured, the UE may be further configured with an "on-duration" timer during which time the UE monitors the PDCCHs for possible allocations;
- When DRX is configured, periodic CQI reports can only be sent by the UE during the "active-time". RRC can further restrict periodic CQI reports so that they are only sent during the on-duration;
- A timer per TAG in the UE is used to detect need for obtaining timing advance for each TAG.

The following definitions apply to DRX in E-UTRAN, except for NB-IoT:

- **on-duration**: duration in downlink subframes that the UE waits for, after waking up from DRX, to receive PDCCHs. If the UE successfully decodes a PDCCH, the UE stays awake and starts the inactivity timer;
- **inactivity-timer**: duration in downlink subframes that the UE waits to successfully decode a PDCCH, from the last successful decoding of a PDCCH, failing which it re-enters DRX. The UE shall restart the inactivity timer following a single successful decoding of a PDCCH for a first transmission only (i.e. not for retransmissions).
- **active-time**: total duration that the UE is awake. This includes the "on-duration" of the DRX cycle, the time UE is performing continuous reception while the inactivity timer has not expired and the time UE is performing continuous reception while waiting for a DL retransmission after one HARQ RTT or, for asynchronous UL HARQ operation, for an UL retransmission grant after one UL HARQ RTT. Based on the above the minimum active time is of length equal to on-duration, and the maximum is undefined (infinite);

Of the above parameters the on-duration and inactivity-timer are of fixed lengths, while the active-time is of varying lengths based on scheduling decision and UE decoding success. Only on-duration and inactivity-timer duration are signalled to the UE by the eNB:

- There is only one DRX configuration applied in the UE at any time;
- UE shall apply an on-duration on wake-up from DRX sleep;

NOTE: this is also applicable for the case where the UE has only one service (e.g. Real Time) that is being handled through the allocation of predefined resources; this allows for other signalling such as RRC to be sent during the remaining portion of the active time.

- New transmissions can only take place during the active-time (so that when the UE is waiting for one retransmission only, it does not have to be "awake" during the RTT).
- If PDCCH has not been successfully decoded during the on-duration, the UE shall follow the DRX configuration (i.e. the UE can enter DRX sleep if allowed by the DRX configuration):
 - This applies also for the sub-frames where the UE has been allocated predefined resources.
- Except for NB-IoT, if it successfully decodes a PDCCH for a first transmission, the UE shall stay awake and start the inactivity timer (even if a PDCCH is successfully decoded in the sub-frames where the UE has also been

allocated predefined resources) until a MAC control message tells the UE to re-enter DRX, or until the inactivity timer expires. In both cases, the DRX cycle that the UE follows after re-entering DRX is given by the following rules:

- If a short DRX cycle is configured; the UE first follows the short DRX cycle and after a longer period of inactivity the UE follows the long DRX cycle;
- Else the UE follows the long DRX cycle directly.

NOTE: When DRX is configured, the network should detect whether UE remains in EUTRAN coverage by requesting UE to send periodic signals to the network.

In CA, whenever a UE is configured with only one serving cell (i.e. PCell) Rel-8/9 DRX applies. In other cases, the same DRX operation applies to all configured and activated serving cells (i.e. identical active time for PDCCH monitoring).

In DC, separate DRX configurations can be applied to MCG and SCG, and the CG specific DRX operation applies to all configured and activated serving cells in the same CG (i.e. identical active time for PDCCH monitoring).

13 QoS

13.0 General

An EPS bearer/E-RAB is the level of granularity for bearer level QoS control in the EPC/E-UTRAN. That is, SDFs mapped to the same EPS bearer receive the same bearer level packet forwarding treatment (e.g. scheduling policy, queue management policy, rate shaping policy, RLC configuration, etc.), as specified in TS 23.401 [17].

One EPS bearer/E-RAB is established when the UE connects to a PDN, and that remains established throughout the lifetime of the PDN connection to provide the UE with always-on IP connectivity to that PDN. That bearer is referred to as the *default* bearer. Any additional EPS bearer/E-RAB that is established to the same PDN is referred to as a *dedicated* bearer. The initial bearer level QoS parameter values of the default bearer are assigned by the network, based on subscription data. The decision to establish or modify a dedicated bearer can only be taken by the EPC, and the bearer level QoS parameter values are always assigned by the EPC.

An EPS bearer/E-RAB is referred to as a GBR bearer if dedicated network resources related to a Guaranteed Bit Rate (GBR) value that is associated with the EPS bearer/E-RAB are permanently allocated (e.g. by an admission control function in the eNodeB) at bearer establishment/modification. Otherwise, an EPS bearer/E-RAB is referred to as a Non-GBR bearer. A dedicated bearer can either be a GBR or a Non-GBR bearer while a default bearer shall be a Non-GBR bearer.

13.1 Bearer service architecture

The EPS bearer service layered architecture is depicted in Figure 13.1-1 below, where:

- An UL TFT in the UE binds an SDF to an EPS bearer in the uplink direction. Multiple SDFs can be multiplexed onto the same EPS bearer by including multiple uplink packet filters in the UL TFT.
- A DL TFT in the PDN GW binds an SDF to an EPS bearer in the downlink direction. Multiple SDFs can be multiplexed onto the same EPS bearer by including multiple downlink packet filters in the DL TFT.
- An E-RAB transports the packets of an EPS bearer between the UE and the EPC. When an E-RAB exists, there is a one-to-one mapping between this E-RAB and an EPS bearer.
- A data radio bearer transports the packets of an EPS bearer between a UE and one or more eNB(s). When a data radio bearer exists, there is a one-to-one mapping between this data radio bearer and the EPS bearer/E-RAB.
- An S1 bearer transports the packets of an E-RAB between an eNodeB and a Serving GW.
- An S5/S8 bearer transports the packets of an EPS bearer between a Serving GW and a PDN GW.

- A UE stores a mapping between an uplink packet filter and a data radio bearer to create the binding between an SDF and a data radio bearer in the uplink.
- A PDN GW stores a mapping between a downlink packet filter and an S5/S8a bearer to create the binding between an SDF and an S5/S8a bearer in the downlink.
- An eNB stores a one-to-one mapping between a data radio bearer and an S1 bearer to create the binding between a data radio bearer and an S1 bearer in both the uplink and downlink.
- A Serving GW stores a one-to-one mapping between an S1 bearer and an S5/S8a bearer to create the binding between an S1 bearer and an S5/S8a bearer in both the uplink and downlink.

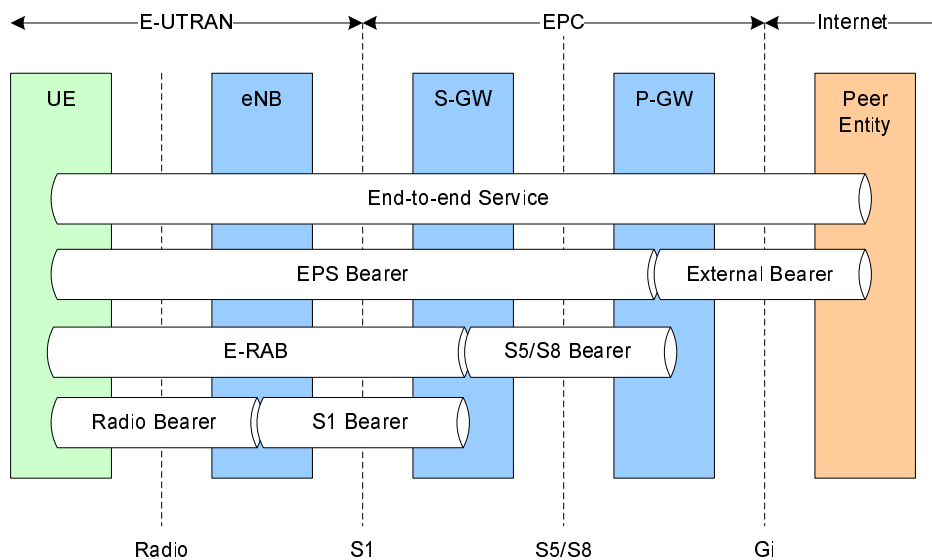

Figure 13.1-1: EPS Bearer Service Architecture

13.2 QoS parameters

The bearer level (i.e. per bearer or per bearer aggregate) QoS parameters are QCI, ARP, GBR, and AMBR, as specified in TS 23.401 [17]. Each EPS bearer/E-RAB (GBR and Non-GBR) is associated with the following bearer level QoS parameters:

- QoS Class Identifier (QCI): scalar that is used as a reference to access node-specific parameters that control bearer level packet forwarding treatment (e.g. scheduling weights, admission thresholds, queue management thresholds, link layer protocol configuration, etc.), and that have been pre-configured by the operator owning the eNodeB. A one-to-one mapping of standardized QCI values to standardized characteristics is captured in TS 23.401 [17].
- Allocation and Retention Priority (ARP): the primary purpose of ARP is to decide whether a bearer establishment / modification request can be accepted or needs to be rejected in case of resource limitations. In addition, the ARP can be used by the eNodeB to decide which bearer(s) to drop during exceptional resource limitations (e.g. at handover).

Each GBR bearer is additionally associated with the following bearer level QoS parameter:

- Guaranteed Bit Rate (GBR): the bit rate that can be expected to be provided by a GBR bearer;
- Maximum Bit Rate (MBR): the maximum bit rate that can be expected to be provided by a GBR bearer. MBR can be greater or equal to the GBR.

Each APN access, by a UE, is associated with the following QoS parameter:

- per APN Aggregate Maximum Bit Rate (APN-AMBR).

Each UE in state EMM-REGISTERED is associated with the following bearer aggregate level QoS parameter:

- per UE Aggregate Maximum Bit Rate (UE-AMBR).

The definitions of APN AMBR and UE-AMBR are captured in TS 23.401 [17].

The GBR and MBR denotes bit rate of traffic per bearer while UE-AMBR/APN-AMBR denote bit rate of traffic per group of bearers. Each of those QoS parameters has an uplink and a downlink component.

13.3 QoS support in Hybrid Cells

The following principles apply to serving non CSG members and CSG members of a Hybrid Cell:

NOTE: The term "eNB" in this clause applies to HeNBs (as described in clause 4.6.1), as well as eNBs (as denoted in the basic E-UTRAN architecture in Figure 4-1).

- When the UE connects to a Hybrid Cell, the MME shall inform the eNB serving this Hybrid Cell whether the UE is a member or not of the CSG associated with this Hybrid Cell;
- Based on CSG membership, the offered QoS for UEs served by this Hybrid Cell may be modified as follows:
 - The eNB serving this Hybrid Cell may distinguish between a CSG member and non-member when determining whether to handover a UE, which GBR bearers to admit and which GBR bearers to deactivate;
 - The eNB serving this Hybrid Cell may distinguish between a CSG member and non-member for handover and packet scheduling on Uu interface (including reduced QoS) of non-GBR bearers.

14 Security

14.1 Overview and Principles

The following principles apply to E-UTRAN security:

- The keys used for NAS and AS protection shall be dependent on the algorithm with which they are used.
- The eNB keys are cryptographically separated from the EPC keys used for NAS protection (making it impossible to use the eNB key to figure out an EPC key).
- For SCG bearers in DC, the SeNB keys are cryptographically separated from the eNB keys.
- The AS (RRC and UP) and NAS keys are derived in the EPC/UE from key material that was generated by a NAS (EPC/UE) level AKA procedure (K_{ASME}) and identified with a key identifier (KSI_{ASME}).
- For SCG bearers in DC, the AS (UP) keys are derived in the SeNB/UE from key material that was generated in the MeNB/UE.
- The eNB key (K_{eNB}) is sent from the EPC to the eNB when the UE is entering ECM-CONNECTED state (i.e. during RRC connection or S1 context setup).
- For SCG bearers in DC, the SeNB key ($S-K_{eNB}$) is sent from the MeNB to the SeNB when adding an SCG.
- For LWA bearers, the WT Counter, if included in LWA Configuration, is used when computing the $S-K_{WT}$ (as specified in TS 33.401 [22], clause G and TS 36.331 [16], clause 5.6.14.2). If WT Counter is not signalled to the UE, the UE uses authentication methods specified in TS 33.402 [70], clause 6, as described in 22A.1.8.
- For LWIP, the LWIP Counter in the LWIP Configuration is used when computing the LWIP-PSK (as specified in TS 33.401 [13], clause A.13, and TS 36.331 [16], subclause 5.6.17.2).
- Separate AS and NAS level security mode command procedures are used. AS level security mode command procedure configures AS security (RRC and user plane) and NAS level security mode command procedure configures NAS security. Both integrity protection and ciphering for RRC are activated within the same AS SMC procedure. User plane ciphering is activated at the same time as RRC ciphering.

- Keys stored inside eNBs shall never leave a secure environment within the eNB (except when done in accordance with this or other 3GPP specifications), and user plane data ciphering/deciphering shall take place inside the secure environment where the related keys are stored.
- Key material for the eNB keys is sent between the eNBs during ECM-CONNECTED intra-E-UTRAN mobility and from the MeNB to the SeNB in DC for SCG bearer during SCG addition and SCG change.
- A sequence number (COUNT) is used as input to the ciphering and integrity protection. A given sequence number must only be used once for a given eNB key (except for identical re-transmission) on the same radio bearer in the same direction. The same sequence number can be used for both ciphering and integrity protection.
- A hyper frame number (HFN) (i.e. an overflow counter mechanism) is used in the eNB and UE in order to limit the actual number of sequence number bits that is needed to be sent over the radio. The HFN needs to be synchronized between the UE and eNB.
- No integrity protection initialisation number (FRESH).
- Since SIM access is not granted in E-UTRAN TS 33.401 [22] except for making IMS Emergency calls, idle mode UE not equipped with USIM shall not attempt to reselect to E-UTRAN unless it is originating an IMS Emergency call. The RNC may try to prevent handover to E-UTRAN for example by identifying a SIM based UE from the security keys provided by the CN.

A simplified key derivation is depicted on Figure 14.1-1 below, where:

- K_{NASint} is a key, which shall only be used for the protection of NAS traffic with a particular integrity algorithm. This key is derived by UE and MME from K_{ASME} , as well as an identifier for the integrity algorithm.
- K_{NASenc} is a key, which shall only be used for the protection of NAS traffic with a particular encryption algorithm. This key is derived by UE and MME from K_{ASME} , as well as an identifier for the encryption algorithm.
- K_{eNB} is a key derived by UE and MME from K_{ASME} . K_{eNB} may also be derived by the target eNB from NH at handover. K_{eNB} shall be used for the derivation of K_{RRCint} , K_{RRCenc} and K_{UPenc} , and for the derivation of K_{eNB*} upon handover.
- K_{eNB*} is a key derived by UE and source eNB from either K_{eNB} or from a fresh NH. K_{eNB*} shall be used by UE and target eNB as a new K_{eNB} for RRC and UP traffic.
- K_{UPenc} is a key, which shall only be used for the protection of UP traffic with a particular encryption algorithm. This key is derived by UE and eNB from K_{eNB} , as well as an identifier for the encryption algorithm.
- K_{RRCint} is a key, which shall only be used for the protection of RRC traffic with a particular integrity algorithm. K_{RRCint} is derived by UE and eNB from K_{eNB} , as well as an identifier for the integrity algorithm.
- K_{RRCenc} is a key, which shall only be used for the protection of RRC traffic with a particular encryption algorithm. K_{RRCenc} is derived by UE and eNB from K_{eNB} as well as an identifier for the encryption algorithm.
- Next Hop (NH) is used by UE and eNB in the derivation of K_{eNB*} for the provision of "forward security", as specified in TS 33.401 [22]. NH is derived by UE and MME from K_{ASME} and K_{eNB} when the security context is established, or from K_{ASME} and previous NH, otherwise.
- Next Hop Chaining Count (NCC) is a counter related to NH (i.e. the amount of Key chaining that has been performed) which allow the UE to be synchronised with the eNB and to determine whether the next K_{eNB*} needs to be based on the current K_{eNB} or a fresh NH.

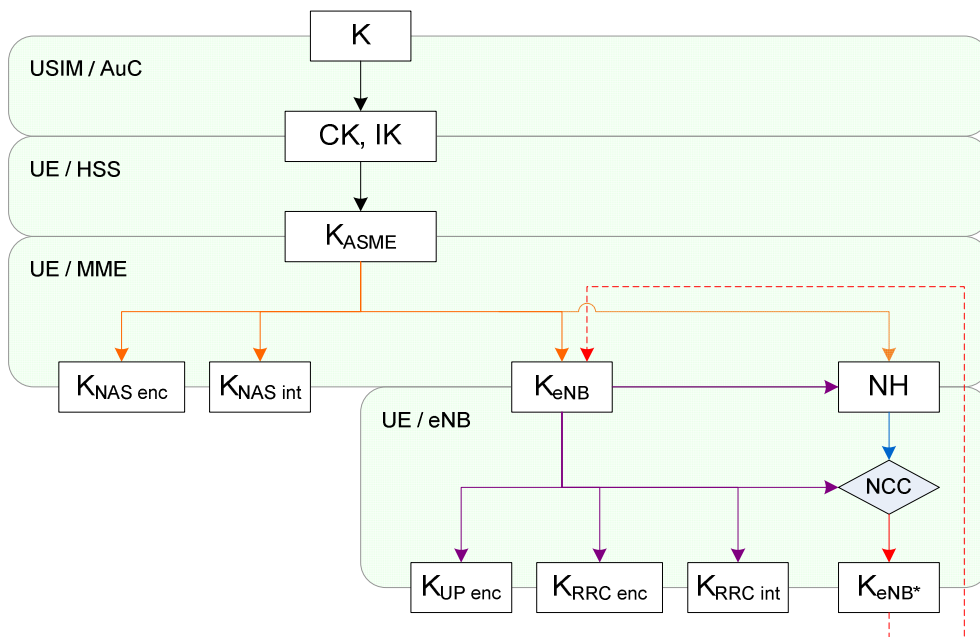

Figure 14.1-1: Key Derivation

Key derivation for SCG bearers in DC is depicted on Figure 14.1-2 below, where:

- SCG Counter is a counter used as freshness input into S- K_{eNB} derivations (see TS 33.401 [22], Annex E.2.4).

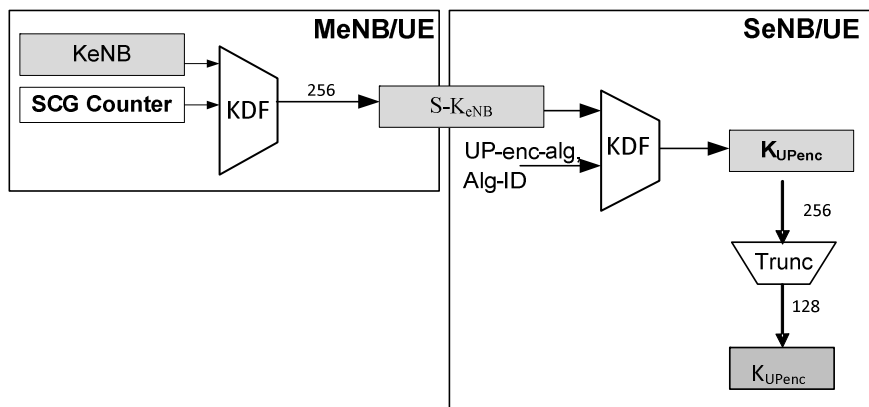

Figure 14.1-2: DC Key Derivation

The MME invokes the AKA procedures by requesting authentication vectors to the HE (Home environment) if no unused EPS authentication vectors have been stored. The HE sends an authentication response back to the MME that contains a fresh authentication vector, including a base-key named K_{ASME} . Thus, as a result of an AKA run, the EPC and the UE share K_{ASME} . From K_{ASME} , the NAS keys, (and indirectly) K_{eNB} keys and NH are derived. The K_{ASME} is never transported to an entity outside of the EPC, but K_{eNB} and NH are transported to the eNB from the EPC when the UE transitions to ECM-CONNECTED. From the K_{eNB} , the eNB and UE can derive the UP and RRC keys.

RRC and UP keys are refreshed at handover. K_{eNB*} is derived by UE and source eNB from target PCI, target frequency and K_{eNB} (this is referred to as a *horizontal* key derivation and is indicated to UE with an NCC that does not increase) or from target PCI, target frequency and NH (this is referred to as a *vertical* key derivation and is indicated to UE with an NCC increase). K_{eNB*} is then used as new K_{eNB} for RRC and UP traffic at the target. When the UE goes into ECM-IDLE all keys are deleted from the eNB except for the UE which was enabled to use User Plane ClIoT EPS Optimization.

For SCG Bearers in DC, UP keys are updated at SCG change by indicating in RRC signalling to the UE the value of the SCG Counter to be used in key derivation. When K_{eNB} is refreshed, SCG Counter shall be reset and $S-K_{eNB}$ shall be newly derived from the K_{eNB} .

COUNT reusing avoidance for the same radio bearer identity in RRC_CONNECTED mode without K_{eNB} change is left to eNB implementation e.g. by using intra-cell handover, smart management of radio bearer identities or triggering a transition to RRC_IDLE.

SCG bearers in DC share a common pool of radio bearer identities (DRB IDs) together with the MCG bearers and when no new DRB ID can be allocated for an SCG bearer without guaranteeing COUNT reuse avoidance, the MeNB shall derive a new $S-K_{eNB}$. SeNB indicates to MeNB when uplink or downlink PDCP COUNTs are about to wrap around and MeNB shall update the $S-K_{eNB}$. To update the $S-K_{eNB}$, the MeNB increases the SCG Counter and uses it to derive a new $S-K_{eNB}$ from the currently active K_{eNB} in the MeNB. The MeNB sends the newly derived $S-K_{eNB}$ to the SeNB. The newly derived $S-K_{eNB}$ is then used by the SeNB in computing a new encryption key K_{UPenc} which is used with all DRBs in the SeNB for this UE. Furthermore, when the SCG Counter approaches its maximum value, the MeNB refreshes the currently active K_{eNB} , before any further $S-K_{eNB}$ is derived.

In case of HFN de-synchronisation in RRC_CONNECTED mode between the UE and eNB, the UE is pushed to IDLE.

14.2 Security termination points

The table below describes the security termination points.

Table 14.2-1 Security Termination Points

	Ciphering	Integrity Protection
NAS Signalling	Required and terminated in MME	Required and terminated in MME
U-Plane Data	Required and terminated in eNB	Not Required (NOTE 1)
RRC Signalling (AS)	Required and terminated in eNB	Required and terminated in eNB
MAC Signalling (AS)	Not required	Not required
NOTE 1: Integrity protection for U-Plane is not required and thus it is not supported between UE and Serving Gateway or for the transport of user plane data between eNB and Serving Gateway on S1 interface.		

The table below describes the security termination points for DC with SCG bearers and split bearers.

Table 14.2-2 Security Termination Points in DC

	Ciphering	Integrity Protection
NAS Signalling	Required and terminated in MME	Required and terminated in MME
U-Plane Data for MCG bearers	Required and terminated in MeNB	Not Required
U-Plane Data for SCG bearers	Required and terminated in SeNB	Not Required
U-Plane Data for split bearers	Required and terminated in MeNB	Not Required
RRC Signalling (AS)	Required and terminated in MeNB	Required and terminated in MeNB

14.3 State Transitions and Mobility

14.3.1 RRC_IDLE to RRC_CONNECTED

As a general principle, on RRC_IDLE to RRC_CONNECTED transitions, RRC protection keys and UP protection keys shall be generated while keys for NAS protection as well as higher layer keys are assumed to be already available in the MME. These higher layer keys may have been established in the MME as a result of an AKA run, or as a result of a transfer from another MME during handover or idle mode mobility, as specified in TS 33.401 [22].

14.3.2 RRC_CONNECTED to RRC_IDLE

Except for the UE which was enabled to use User Plane CIoT EPS Optimization, on RRC_CONNECTED to RRC_IDLE transitions, eNBs shall delete the keys they store such that state for idle mode UEs only has to be maintained in MME. It is also assumed that eNB does no longer store state information about the corresponding UE and deletes the current keys from its memory. In particular, on connected to idle transitions:

- The eNB and UE deletes NH, K_{eNB} , K_{RRCenc} , K_{RRCint} and K_{UPenc} and related NCC.
- MME and UE keeps K_{ASME} , K_{NASint} and K_{NASenc} stored.

On RRC_CONNECTED to RRC_IDLE transitions for the UE which was enabled to use User Plane CIoT EPS Optimization, the eNBs, the UE and MME shall maintain the keys they store.

14.3.3 Intra E-UTRAN Mobility

The key hierarchy does not allow, as is, explicit RRC and UP key updates, but RRC and UP keys are derived based on the algorithm identifiers and K_{eNB} which results with new RRC and UP keys at every handover:

- Source eNB and UE independently create K_{eNB*} with the input parameters as described in TS 33.401 [22];
- K_{eNB*} is given to Target eNB during the HO preparation phase;
- Both Target eNB and UE considers the new K_{eNB} equal to the received K_{eNB*} .

The handling of HFN and PDCP SN at handover depends on the type of radio bearer:

- SRB: HFN and PDCP SN are reset.
- RLC-UM bearers: HFN and PDCP SN are reset.
- RLC-AM bearers: PDCP SN and HFN are maintained (10.1.2.3).

NOTE: COUNT reusing avoidance is left to network implementation.

For LWA, eNB may not trigger the S- K_{WT} update during handover without WT change. In such a case, the eNB sends the WT counter to the UE after handover via a separate RRC reconfiguration procedure. The UE does not need to perform reauthentication with WLAN immediately even though the K_{eNB} is updated but shall use the updated WT counter the next time the UE does re-association with WLAN. As the PDCP PDUs may continue to be transmitted over WLAN during handover without WT change, the transmitter uses an end-marker PDCP control PDU to inform the receiver of the last PDCP PDU encrypted with source K_{eNB} , as described in 10.1.2.9.

14.3.4 SeNB Removal

For SCG bearers in DC, at SeNB removal, the SeNB shall delete the keys it stores. It is also assumed that SeNB does no longer store state information about the corresponding UE and deletes the current keys from its memory. In particular, at SeNB removal:

- The SeNB and UE delete S- K_{eNB} and K_{UPenc} .
- The MeNB and UE keep K_{eNB} .

14.4 AS Key Change in RRC_CONNECTED

If AS Keys (K_{UPenc} , K_{RRCint} and K_{RRCenc}) need to be changed in RRC_CONNECTED, an intra-cell handover shall be used.

For SCG bearers in DC, if AS Key (K_{UPenc}) needs to be changed, the SCG change shall be performed.

14.5 Security Interworking

Inter-RAT handover from UTRAN to E-UTRAN is only supported after activation of integrity protection in UTRAN. Security may be activated in the target RAN using null ciphering algorithms. If ciphering was not running in UTRAN, it will be activated at handover to E-UTRAN. Integrity protection shall be activated in E-UTRAN on handover from UTRAN/GERAN.

For E-UTRAN to UTRAN/GERAN mobility, the MME shall derive and transfer to the SGSN a confidentiality key and an integrity key derived from K_{ASME} and other input parameters as specified in TS 33.401 [22]. Based on this information, the SGSN can in turn derive appropriate keys to be used in the target RAN.

Similarly for UTRAN/GERAN to E-UTRAN mobility, the SGSN shall derive and transfer to the MME a confidentiality key and an integrity key CK and IK. Based on this information and other input parameters as specified in TS 33.401 [22], the MME and UE can in turn derive K_{ASME} .

14.6 RN integrity protection for DRB(s)

Between the DeNB and the RN, integrity protection is required for the DRB(s) carrying S1AP and/or X2AP signalling and optional for other DRB(s).

K_{UPint} , used for the integrity protection of the DRBs, is derived by the RN and the DeNB from K_{eNB} , as well as an identifier for the integrity algorithm used as specified in TS 33.401 [22]. K_{UPint} is generated, changed or deleted when other AS keys are generated, changed or deleted.

15 MBMS

15.0 MBMS-Specific Definitions

For MBMS, the following definitions are introduced:

MBSFN Synchronization Area: an area of the network where all eNodeBs can be synchronized and perform MBSFN transmissions. MBSFN Synchronization Areas are capable of supporting one or more MBSFN Areas. On a given frequency layer, a eNodeB can only belong to one MBSFN Synchronization Area. MBSFN Synchronization Areas are independent from the definition of MBMS Service Areas

MBSFN Transmission or a transmission in MBSFN mode: a simulcast transmission technique realised by transmission of identical waveforms at the same time from multiple cells. An MBSFN Transmission from multiple cells within the MBSFN Area is seen as a single transmission by a UE.

MBSFN Area: an MBSFN Area consists of a group of cells within an MBSFN Synchronization Area of a network, which are co-ordinated to achieve an MBSFN Transmission. Except for the MBSFN Area Reserved Cells, all cells within an MBSFN Area contribute to the MBSFN Transmission and advertise its availability. The UE may only need to consider a subset of the MBSFN areas that are configured, i.e. when it knows which MBSFN area applies for the service(s) it is interested to receive.

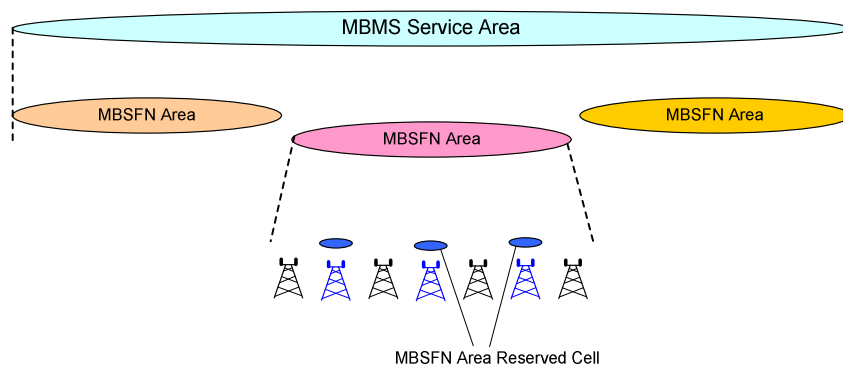

Figure 15-1: MBMS Definitions

MBSFN Area Reserved Cell: A cell within a MBSFN Area which does not contribute to the MBSFN Transmission. The cell may be allowed to transmit for other services but at restricted power on the resource allocated for the MBSFN transmission.

Synchronisation Sequence: Each SYNC PDU contains a time stamp which indicates the start time of the synchronisation sequence. For an MBMS service, each synchronisation sequence has the same duration which is configured in the BM-SC and the MCE.

Synchronisation Period: The synchronisation period provides the time reference for the indication of the start time of each synchronisation sequence. The time stamp which is provided in each SYNC PDU is a relative value which refers to the start time of the synchronisation period. The duration of the synchronisation period is configurable.

15.1 General

15.1.0 Overview

In E-UTRAN, MBMS can be provided with single frequency network mode of operation (MBSFN) either on a frequency layer shared with non-MBMS services (set of cells supporting both unicast and MBMS transmissions i.e. set of "MBMS/Unicast-mixed cells") or on a frequency layer dedicated for MBMS (set of cells supporting MBMS transmission only i.e. set of "MBMS-dedicated cells").

MBMS reception is possible for UEs in RRC_IDLE state, or except for NB- IoT UEs, BL UEs or UEs in enhanced coverage, in RRC_CONNECTED state. Whenever receiving MBMS services, a user shall be notified of an incoming call, and originating calls shall be possible.

ROHC for MBMS is supported by upper layers (outside of Access Stratum) and only for Mission Critical services, as described in TS 23.280 [77].

RNs do not support MBMS.

HeNBs do not support MBMS.

For NB-IoT UEs, BL UEs or UEs in enhanced coverage:

- MBMS is provided in "MBMS/Unicast-mixed cells" with single-cell transmission.
- MBMS reception is possible only for UEs in RRC_IDLE state.
- Whenever receiving MBMS services, a user shall be notified of an incoming call, and originating calls shall be possible:
 - Mobile Terminated call has higher priority than MBMS reception;
 - Mobile Originated signalling has higher priority than MBMS reception;
 - Other cases are left to UE implementation.

15.1.1 E-MBMS Logical Architecture

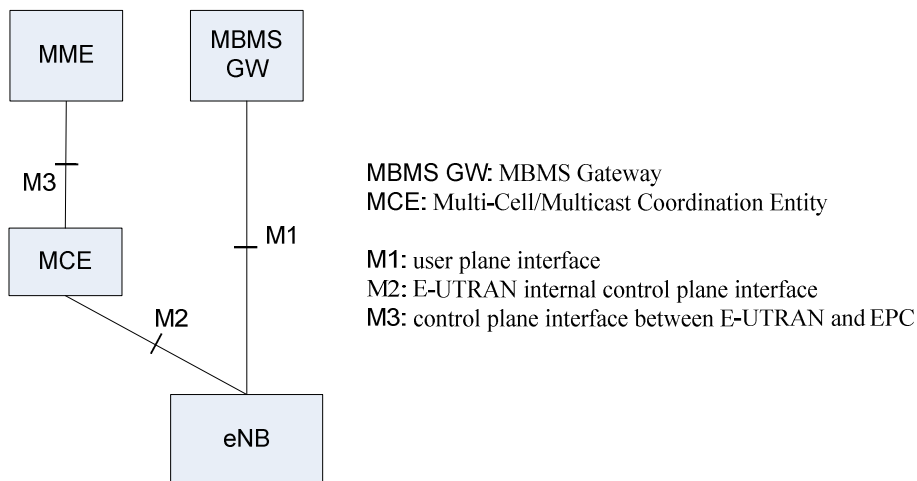

Figure 15.1.1-1: E-MBMS Logical Architecture

Figure 15.1.1-1 depicts the E-MBMS Logical Architecture.

Multi-cell/multicast Coordination Entity (MCE)

The MCE is a logical entity – this does not preclude the possibility that it may be part of another network element – whose functions are:

- the admission control and the allocation of the radio resources used by all eNBs in the MBSFN area for multi-cell MBMS transmissions using MBSFN operation. The MCE decides not to establish the radio bearer(s) of the new MBMS service(s) if the radio resources are not sufficient for the corresponding MBMS service(s) or may pre-empt radio resources from other radio bearer(s) of ongoing MBMS service(s) according to ARP. Besides allocation of the time/ frequency radio resources this also includes deciding the further details of the radio configuration e.g. the modulation and coding scheme.
- deciding on whether to use SC-PTM or MBSFN.
- counting and acquisition of counting results for MBMS service(s).
- resumption of MBMS session(s) within MBSFN area(s) based on e.g. the ARP and/or the counting results for the corresponding MBMS service(s).
- suspension of MBMS session(s) within MBSFN area(s) based e.g. the ARP and/or on the counting results for the corresponding MBMS service(s).

NOTE: In case of distributed MCE architecture, the MCE manages the above functions for a single eNB of a MBSFN. The coordination of the functions between MCEs is provided by OAM, if needed.

The MCE is involved in MBMS Session Control Signalling. The MCE does not perform UE - MCE signalling.

An eNB is served by a single MCE.

E-MBMS Gateway (MBMS GW)

The MBMS GW is a logical entity – this does not preclude the possibility that it may be part of another network element – that is present between the BMSC and eNBs whose principal functions is the sending/broadcasting of MBMS packets to each eNB transmitting the service. The MBMS GW uses IP Multicast as the means of forwarding MBMS user data to the eNB. The MBMS GW performs MBMS Session Control Signalling (Session start/update/stop) towards the E-UTRAN via MME.

Control Plane Interfaces

"M3" Interface: MCE – MME

An Application Part is defined for this interface between MME and MCE. This application part allows for MBMS Session Control Signalling on E-RAB level (i.e. does not convey radio configuration data). The procedures comprise e.g. MBMS Session Start and Stop. SCTP is used as signalling transport i.e. Point-to-Point signalling is applied.

"M2" Interface: MCE – eNB

An Application Part is defined for this interface, which conveys at least radio configuration data for the multi-cell transmission mode eNBs and Session Control Signalling. SCTP is used as signalling transport i.e. Point-to-Point signalling is applied.

User Plane Interface

"M1" Interface: MBMS GW – eNB

This interface is a pure user plane interface. Consequently no Control Plane Application Part is defined for this interface. IP Multicast is used for point-to-multipoint delivery of user packets.

Deployment consideration

The two envisaged alternatives are shown in Figure 15.1.1-2.

The architecture on the right part is defined as the "distributed MCE architecture". In this architecture, a MCE is part of the eNB and the M2 interface should be kept between the MCE and the corresponding eNB.

The architecture on the left part is defined as the "centralized MCE architecture". In this architecture, the MCE is a logical entity which means it can be deployed as a stand-alone physical entity or collocated in another physical entity e.g. eNB. In both cases of the centralized MCE architecture, the M2 interface is kept between the MCE and all eNB(s) belonging to the corresponding MBSFN area.

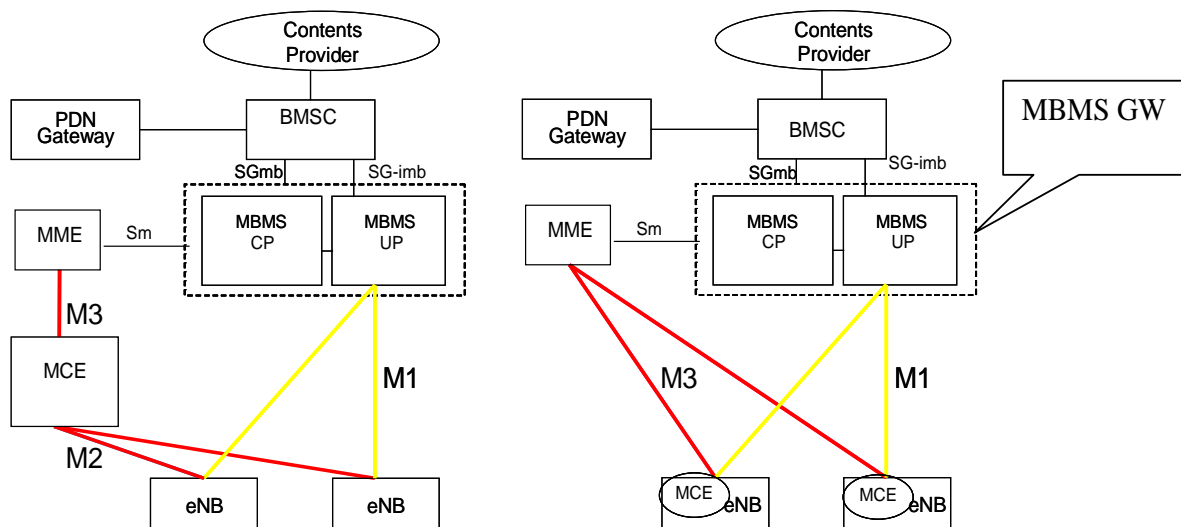

Figure 15.1.1-2: eMBMS Architecture deployment alternatives

MBMS for V2X

When MBMS is used to deliver downlink V2X messages, the localized MBMS specified in TS 23.285 [72] may be used to improve latency if desired.

Single TMGI in non-overlapped MBMS service areas or multiple TMGIs in overlapped MBMS service areas may be used to support small MBMS areas for V2X.

15.1.2 E-MBMS User Plane Protocol Architecture

The overall U-plane architecture of content synchronization is shown in Figure 15.1.2-1. This architecture is based on the functional allocation for Unicast and the SYNC protocol layer is defined additionally on transport network layer to support content synchronization mechanism.

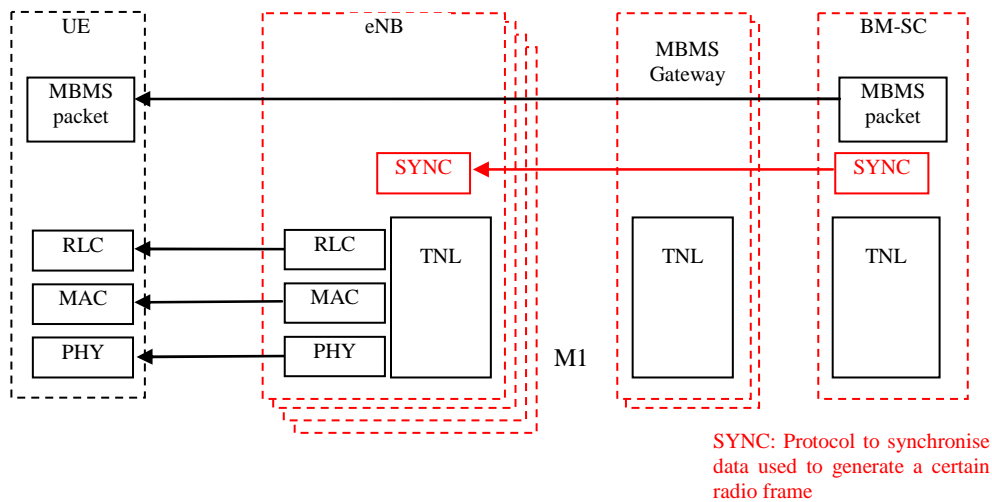

Figure 15.1.2-1: The overall u-plane architecture of the MBMS content synchronization

The SYNC protocol is defined as a protocol to carry additional information that enable eNBs to identify the timing for radio frame transmission and detect packet loss. Every E-MBMS service uses its own SYNC entity. The SYNC protocol is applicable to DL and is terminated in the BM-SC.

15.1.3 E-MBMS Control Plane Protocol Architecture

The E-MBMS C-plane protocol architecture is shown in Figure 15.1.3-1.

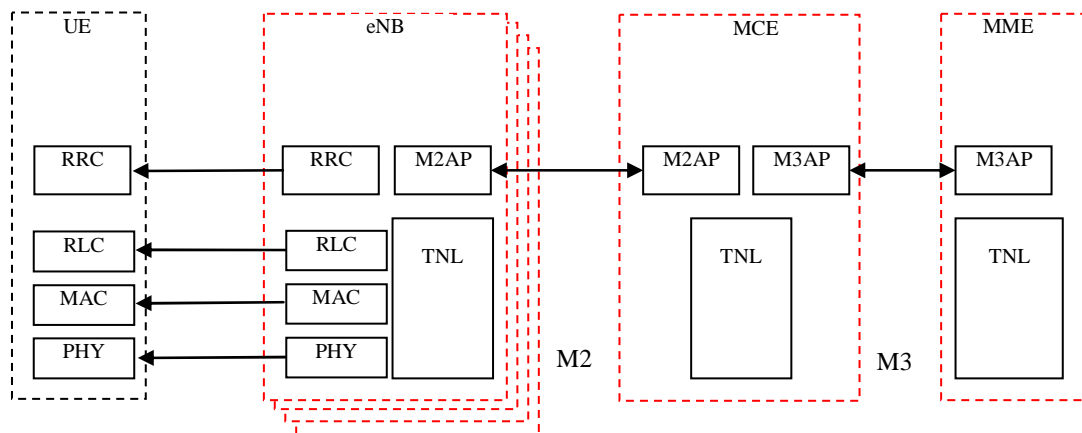

Figure 15.1.3-1: The E-MBMS c-plane architecture

MCCH is terminated in the eNB on the network side. How to achieve the synchronisation of MCCH signalling is described in clause 15.3.8.

15.2 MBMS Cells

15.2.1 MBMS-dedicated cell

Cells performing only MBMS transmissions are referred to as MBMS-dedicated cells. UEs not supporting FeMBMS are not supported on these cells. Paging is not supported on an MBMS-dedicated cell.

For MBMS-dedicated cells:

- MTCH and MCCH are mapped on MCH for MBSFN transmission;

MBMS-dedicated cells do not support unicast traffic in the downlink and these cells cannot be used as PCell or PSCell. System information required to receive MBMS from MBMS-dedicated cells is broadcasted on non-MBSFN subframes. The system information change notification as well as ETWS/CMAS notification are provided via L1 signalling on non-MBSFN subframes. The PBCH of MBMS-dedicated cell, uses a different scrambling sequence initialization than the PBCH of MBMS/Unicast-mixed cell which prevents UEs not supporting FeMBMS from camping on this cell.

15.2.2 MBMS/Unicast-mixed cell

Cells performing both MBMS and unicast transmissions are referred to as MBMS/Unicast-mixed cells.

For MBMS/Unicast mixed cells:

- MTCH and MCCH are mapped on MCH for MBSFN transmission;
- SC-MTCH and SC-MCCH are mapped on DL-SCH for SC-PTM transmission;
- Transmission of both unicast and MBMS in the cell is done in a co-ordinated manner.

15.2.2.1 FeMBMS/Unicast-mixed cell

An FeMBMS/Unicast-mixed cell is an MBMS/Unicast-mixed cell that operates with at least one of the following:

- subframes 4 or 9 or both configured as MBSFN subframes
- subframes that may not contain unicast control region

The FeMBMS/Unicast-mixed cell cannot be used as a PCell or PSCell. To provide unicast traffic on non-MBSFN subframes, such cell needs to be configured as an SCell. UEs not supporting FeMBMS are not supported on these cells and camping of such UEs is prevented by using cell barring mechanism of SIB1. Paging for incoming calls is not supported on such cells and system information change notification as well as ETWS/CMAS notification are provided with L1 signalling.

15.3 MBMS Transmission

15.3.1 General

Transmission of a MBMS in E-UTRAN uses either MBSFN transmission or SC-PTM transmission. The MCE makes the decision on whether to use SC-PTM or MBSFN for each MBMS session.

15.3.2 Single-cell transmission

Single-cell transmission of MBMS is characterized by:

- MBMS is transmitted in the coverage of a single cell;
- One SC-MCCH and one or more SC-MTCH(s) are mapped on DL-SCH;
- Scheduling is done by the eNB;

- SC-MCCH and SC-MTCH transmissions are each indicated by a logical channel specific RNTI on PDCCH (there is a one-to-one mapping between TMGI and G-RNTI used for the reception of the DL-SCH to which a SC-MTCH is mapped);
- A single transmission is used for DL-SCH (i.e. neither blind HARQ repetitions nor RLC quick repeat) on which SC-MCCH or SC-MTCH is mapped;
- SC-MCCH and SC-MTCH use the RLC-UM mode.

For each SC-MTCH, the following scheduling information is provided on SC-MCCH:

- **SC-MTCH scheduling cycle;**
- **SC-MTCH on-duration:** duration in downlink subframes that the UE waits for, after waking up from DRX, to receive PDCCHs. If the UE successfully decodes a PDCCH indicating the DL-SCH to which this SC-MTCH is mapped, the UE stays awake and starts the inactivity timer;
- **SC-MTCH inactivity-timer:** duration in downlink subframes that the UE waits to successfully decode a PDCCH, from the last successful decoding of a PDCCH indicating the DL-SCH to which this SC-MTCH is mapped, failing which it re-enters DRX. The UE shall restart the inactivity timer following a single successful decoding of a PDCCH.

NOTE 1: The SC-PTM reception opportunities are independent of the unicast DRX scheme.

NOTE 2: The SC-MTCH inactivity-timer may be set to 0.

NOTE 3: Although the above parameters are per SC-MTCH (i.e. per MBMS service), the network may configure the same scheduling pattern for multiple SC-MTCHs (i.e. multiple MBMS services).

NOTE 4: For NB-IoT UEs, the definition of the above parameters does not apply.

NOTE 5: For BL UEs and UEs in enhanced coverage, the definition of the above parameters does not apply.

15.3.3 Multi-cell transmission

Multi-cell transmission of MBMS is characterized by:

- Synchronous transmission of MBMS within its MBSFN Area;
- Combining of MBMS transmission from multiple cells is supported;
- Scheduling of each MCH is done by the MCE;
- A single transmission is used for MCH (i.e. neither blind HARQ repetitions nor RLC quick repeat);
- A single Transport Block is used per TTI for MCH transmission, that TB uses all the MBSFN resources in that subframe;
- MTCH and MCCH can be multiplexed on the same MCH and are mapped on MCH for p-t-m transmission;
- MTCH and MCCH use the RLC-UM mode;
- The MAC subheader indicates the LCID for MTCH and MCCH;
- The MBSFN Synchronization Area, the MBSFN Area, and the MBSFN cells are semi-statically configured e.g. by O&M;
- MBSFN areas are static, unless changed by O&M (i.e. no dynamic change of areas);

NOTE: The UE is not required to receive services from more than one MBSFN Area simultaneously and may support only a limited number of MTCHs.

Multiple MBMS services can be mapped to the same MCH and one MCH contains data belonging to only one MBSFN Area. An MBSFN Area contains one or more MCHs. An MCH specific MCS is used for all subframes of the MCH that do not use the MCS indicated in BCCH. All MCHs have the same coverage area.

For MCCH and MTCH, the UE shall not perform RLC re-establishment at cell change between cells of the same MBSFN area. Within the MBSFN subframes, all MCHs within the same MBSFN area occupy a pattern of subframes, not necessarily adjacent in time, that is common for all these MCHs and is therefore called the Common Subframe Allocation (CSA) Pattern. The CSA pattern is periodically repeated with the CSA period. The actual MCH subframe allocation (MSA) for every MCH carrying MTCH is defined by the CSA pattern, the CSA period, and the MSA end, that are all signalled on MCCH. The MSA end indicates the last subframe of the MCH within the CSA period. Consequently, the MCHs are time multiplexed within the CSA period, which finally defines the interleaving degree between the MCHs. It shall be possible for MCHs to not use all MBSFN resources signalled as part of the Rel-8 MBSFN signalling. Further, such MBSFN resource can be shared for more than one purpose (MBMS, Positioning, etc.). During one MCH scheduling period (MSP), which is configurable per MCH, the eNB applies MAC multiplexing of different MTCHs and optionally MCCH to be transmitted on this MCH.

MCH scheduling information (MSI) is provided per MCH to indicate which subframes are used by each MTCH during the MSP, and to indicate whether transmission for an MTCH is going to be, or has been, suspended by the eNode B. The following principles are used for the MSI:

- it is used both when services are multiplexed onto the MCH and when only a single service is transmitted on the MCH;
- it is generated by the eNB and provided once at the beginning of the MSP;
- it has higher scheduling priority than the MCCH and, when needed, it appears first in the PDU;
- it allows the receiver to determine what subframes are used by every MTCH, sessions are scheduled in the order in which they are included in the MCCH session list;
- it is carried in a MAC control element which cannot be segmented;
- it carries the mapping of MTCHs to the subframes of the associated MSP. This mapping is based on the indexing of subframes belonging to one MSP;
- it carries an indication of whether the transmission of an MTCH is to be suspended by the eNode B.

The content synchronization for multi-cell transmission is provided by the following principles:

1. All eNBs in a given MBSFN Synchronization Area have a synchronized radio frame timing such that the radio frames are transmitted at the same time and have the same SFN.
2. All eNBs have the same configuration of RLC/MAC/PHY for each MBMS service, and identical information (e.g. time information, transmission order/priority information) such that synchronized MCH scheduling in the eNBs is ensured. These are indicated in advance by the MCE.
3. An E-MBMS GW sends/broadcasts MBMS packet with the SYNC protocol to each eNB transmitting the service.
4. The SYNC protocol provides additional information so that the eNBs identify the transmission radio frame(s). The E-MBMS GW does not need accurate knowledge of radio resource allocation in terms of exact time division (e.g. exact start time of the radio frame transmission).
5. eNB buffers MBMS packet and waits for the transmission timing indicated in the SYNC protocol.
6. The segmentation/concatenation is needed for MBMS packets and should be totally up to the RLC/MAC layer in eNB.
7. The SYNC protocol provides means to detect packet loss(es) and supports a recovery mechanism robust against loss of consecutive PDU packets (MBMS Packets with SYNC Header).
8. For the packet loss case the transmission of radio blocks potentially impacted by the lost packet should be muted.
9. The mechanism supports indication or detection of MBMS data burst termination (e.g. to identify and alternately use available spare resources related to pauses in the MBMS PDU data flow).
10. If two or more consecutive SYNC SDUs within a SYNC bearer are not received by the eNB, or if no SYNC PDUs of Type 0 or 3 are received for some synchronization sequence, the eNB may mute the exact subframes impacted by lost SYNC PDUs using information provided by SYNC protocol. If not muting only those exact subframes, the eNB stops transmitting the associated MCH from the subframe corresponding to the consecutive

losses until the end of the corresponding MSP and it does not transmit in the subframe corresponding to the MSI of that MSP.

11. The eNB sets VT(US) to zero in the RLC UM entity corresponding to an MCCH at its modification period boundary.
12. The eNB sets VT(US) to zero in each RLC UM entity corresponding to an MTCH at the beginning of its MSP.
13. The eNB sets every bit in the MAC padding on MCH to "0".
14. The eNB's RLC concatenates as many RLC SDUs from the same radio bearer as possible.
15. The eNB's MAC multiplexes as many RLC PDUs as fit in the Transport Block.
16. The eNB sets every padding bit in the RLC UM PDU corresponding to an MTCH or MCCH to "0".
17. A MAC PDU including a MAC subheader for a MTCH MAC SDU always includes non-zero size of MTCH MAC SDU.
18. A MAC PDU including a MAC subheader for a MSI MAC control element always includes non-zero size of MSI MAC control element.

15.3.4 MBMS Reception States

UEs that are receiving MTCH and/or SC-MTCH transmissions can be in RRC_IDLE or except for NB-IoT UEs, BL UEs or UEs in enhanced coverage, in RRC_CONNECTED state.

UEs except for NB-IoT UEs, BL UEs or UEs in enhanced coverage that are receiving MTCH can also be in Receive Only Mode as defined in TS 23.246 [48].

15.3.5 MCCH Structure

The following principles govern the MCCH structure:

- One MBSFN Area is associated with one MCCH and one MCCH corresponds to one MBSFN Area;
- The MCCH is sent on MCH;
- MCCH consists of a single MBSFN Area configuration RRC message which lists all the MBMS services with ongoing sessions and an optional MBMS counting request message which, when present, comes after the former message in the repetition period;
- MCCH is transmitted by all cells within an MBSFN Area, except the MBSFN Area Reserved Cells;
- MCCH is transmitted by RRC every MCCH repetition period;
- MCCH uses a modification period;
- A notification mechanism is used to announce changes of MCCH due to either Session Start or the presence of an MBMS counting request message;
 - The notification is sent periodically throughout the modification period preceding the change of MCCH, in MBSFN subframes configured for notification;
 - The DCI format 1C with M-RNTI is used for notification and includes an 8-bit bitmap to indicate the one or more MBSFN Area(s) in which the MCCH change(s);
 - The UE monitors more than one notification subframe per modification period;
 - When the UE receives a notification, it acquires the MCCH at the next modification period boundary;
- The UE detects changes to MCCH which are not announced by the notification mechanism by MCCH monitoring at the modification period.

15.3.5a SC-MCCH structure

The following principles govern the SC-MCCH structure:

- there is one SC-MCCH per cell;
- the SC-MCCH is sent on DL-SCH;
- the SC-MCCH provides the list of all MBMS services with ongoing sessions transmitted on SC-MTCH(s), including for each MBMS service TMGI and optional session ID, associated G-RNTI and scheduling information;
- SC-MCCH is transmitted by RRC every SC-MCCH repetition period;
- SC-MCCH uses a modification period;
- Except for NB-IoT UEs, BL UEs or UEs in enhanced coverage a notification mechanism is used to announce changes of SC-MCCH due to Session Start:
 - The notification is sent in the first subframe in a repetition period where the SC-MCCH can be scheduled. The notification is sent using the DCI format 1C with SC-N-RNTI and one bit within the 8-bit bitmap;
 - When the UE receives a notification, it acquires the SC-MCCH in the same subframe;
- For NB-IoT UEs, BL UEs or UEs in enhanced coverage:
 - Two notification mechanisms are used to announce changes of SC-MCCH due to Session Start:
 - A notification is sent in the DCI with SC-RNTI scheduling SC-MCCH. When the UE receives the notification, it acquires the SC-MCCH in the same modification period;
 - A notification is sent in the DCI with G-RNTI scheduling SC-MTCH. When the UE receives the notification, it acquires the SC-MCCH in the next modification period;
 - One notification mechanism is used to announce changes of SC-MCCH for the ongoing service:
 - The notification is sent in the DCI with G-RNTI scheduling SC-MTCH. When the UE receives the notification, it acquires the SC-MCCH in the next modification period.
- The UE detects changes to SC-MCCH which are not announced by the notification mechanism by SC-MCCH monitoring at the modification period.

15.3.6 MBMS signalling on BCCH

- BCCH only points to the resources where the MCCH(s)/SC-MCCH can be found i.e. it does not indicate the availability of the services;
- For each MCCH, BCCH indicates independently:
 - the scheduling of the MCCH for multi-cell transmission on MCH;
 - the MCCH modification period, repetition period radio frame offset and subframe allocation;
 - an MCS which applies to the subframes indicated for MCCH scheduling and for the first subframe of all MSPs in that MBSFN Area.
- For the notification commonly used for all MCCH, BCCH:
 - configures the position of the MCCH change notification subframe and the number of occasions monitored by the UE;
 - indicates the mapping between the PDCCH bit(s) carried in the notification and the MCCH(s).
- BCCH indicates the SC-MCCH modification period, SC-MCCH repetition period and SC-MCCH subframe offset.

15.3.7 MBMS User Data flow synchronisation

The synchronised radio interface transmission from the cells controlled by different eNBs requires a SYNC-protocol support between the BM-SC and the eNBs.

As part of the SYNC-protocol procedures the BM-SC shall include within the SYNC PDU packets a time stamp which tells the timing based on which the eNB sends MBMS data over the air interface. This time stamp is based on a common time reference, and common start of the first synchronisation period available at the BM-SC and the concerned eNBs and represents a relative time value which refers to the start time of the synchronisation period.

The BM-SC shall set the timestamp of all SYNC PDU packets in one synchronisation sequence of an MBMS service to the same value. The BM-SC should take into account the following factors for setting the timestamp: arrival time of data, the Maximum Transmission Delay from the BM-SC to the farthest eNB, the length of the synchronisation sequence used for time stamping and other extra delay (e.g. processing delay in the eNB). The MSP length is one or multiple times of the synchronisation sequence length for MBMS services in the MCH.

MBMS user data shall be time-stamped based on separable synchronisation sequences which are tied to multiples of the TTI length. Each synchronisation sequence for each service is denoted by a single timestamp value working in such a manner that an increase of the timestamp value by one or more synchronisation sequence lengths shall be interpreted as an implicit start-of-a-new-synchronisation-sequence-indicator, so that the eNB becomes aware that a new sequence is starting.

The BM-SC does not know the absolute time point at which a TTI starts, but the sequence length for the time stamp is set by O&M like the delay parameters. The BM-SC will use the delay parameters to define the transmission time point of that user data packet and for the following user data packets the sequence length for the time stamp: following user data packets arriving within e.g. 40ms will receive the same time stamp value as the first data packet, if the sequence length is set to be 40ms.

In MBSFN operation, the eNB shall schedule the received data packets in the first MSP following the time point indicated by the timestamp unless the MBMS service is suspended, in which case no packet shall be sent by eNB. When a suspended MBMS service is resumed, the eNB shall enable the transmission from the beginning of the Modification Period indicated by the *MCCH Update Time*.

The elementary procedures related to the SYNC-protocol are defined in TS 25.446 [36].

Based on the parameters in the SYNC Header (e.g. Timestamp, Packet Number, Elapsed Octet Counter), the eNB is able to derive the timing for downlink radio transmission and notice if any SYNC packets are lost during transmission from BM-SC to the eNB. The eNB is also able to know the size of the lost SYNC packet in case a single SYNC packet is lost. Furthermore, the eNB may also be able to know the sizes of each lost SYNC packet if multiple consecutive SYNC packets are lost. Additionally the eNB is able to reorder the PDUs before passing them to RLC processing, if needed.

At the end of each synchronisation sequence the BM-SC shall send to the eNBs a user data frame, which contains counter information including '*Total Number Of Packet Counter*' and '*Total Number Of Octet*' without MBMS payload. This *Total Counter* frame is implicitly marking the end-of-sync.seq. The *Total Counter* frame without payload may be repeated in order to improve the reliability of the delivery to the eNBs.

In MBSFN operation, in case the SYNC protocol delivers more data for an MCH than the air interface can transport in the scheduling period, the following procedure shall be used by the eNB. As long as the eNB must drop a packet because it has too much data for this MCH scheduling period, it does the following,

- select the last bearer according to the order in the MCCH list with a SYNC SDU available for dropping;
- for the selected bearer, drop the available SYNC SDU with the highest Packet Number among the SYNC SDUs with the latest Timestamp.

A SYNC SDU is considered available for dropping when the eNB knows its size and it has not been dropped by the eNB.

In SC-PTM operation, if/how to use the timestamp information is left to eNB implementation.

15.3.8 Synchronisation of MCCH Update Signalling via M2

The synchronised radio interface transmission from the cells controlled by different eNBs require means to ensure that the MCCH content is updated at the same modification period border in each cell belonging to the same MBSFN Area.

The MCE and the concerned eNBs maintain a common time reference which allows each node to be aware of the modification period boundary within an MBSFN Area. In addition, each node maintains a counter of modification periods which is incremented by one at each modification period boundary. This counter which is based on common start of the first MCCH modification period, allows the MCE to indicate to the eNBs at which modification period the MCCH update shall take place. The MCE shall ensure that it starts to inform all eNBs within the MBSFN Area well in advance. In case of the simultaneously change of the MCCH information and the MCCH related BCCH information, the eNB may use this counter to decide after which BCCH modification period the MCCH related BCCH information update takes place.

15.3.9 IP Multicast Distribution

To improve the transport efficiency the IP Multicast shall be used for the MBMS payload distribution in the backbone network between the MBMS-GW and the eNBs that have joined the IP Multicast Group.

The MBMS-GW allocates the Transport Layer Address(es) used for the IP multicast and the DL TEID used for the M1 Transport association. The MBMS-GW sends this information to the MME(s) during the Session Start procedure. The MCE(s) receives these parameters from the MME in the MBMS Session Start Request message. The MCE passes the received parameters including at least one set of the Transport Layer Address to the relevant eNBs.

If the eNB accepts the MBMS Session Start request, or if it is required following the acceptance of the MBMS Session Update request, the eNB joins the channel (IP Multicast and Source address) to the backbone in order to join the bearer service multicast distribution.

The MBMS payload is forwarded by the MBMS-GW towards the IP Multicast address(es). The eNBs having joined that IP Multicast will receive the user data packets (SYNC PDU) together with the synchronisation-related information in header part of SYNC PDU.

15.4 Service Continuity

Mobility procedures for MBMS reception allow the UE to start or continue receiving MBMS service(s) via MBSFN or SC-PTM when changing cell(s). For each MBMS service provided using SC-PTM, E-UTRAN indicates in the SC-MCCH the list of neighbour cells providing this MBMS service so that the UE can request unicast reception of the service before changing to a cell not providing the MBMS service using SC-PTM.

For MBSFN transmission, E-UTRAN procedures provide support for service continuity with respect to mobility within the same MBSFN area. Within the same geographic area, MBMS services can be provided on more than one frequency and the frequencies used to provide MBMS services may change from one geographic area to another within a PLMN.

UEs that are receiving MBMS service(s) in RRC_IDLE state performing cell reselection or are in RRC_CONNECTED state obtain target cell (SC-)MCCH information from the target cell (SC-)MCCH.

To avoid the need to read MBMS related system information and potentially (SC-)MCCH on neighbour frequencies, the UE is made aware of which frequency is providing which MBMS services via MBSFN or SC-PTM through the combination of the following MBMS assistance information:

- user service description (USD): in the USD (see TS 26.346 [49]), the application/service layer provides for each service the TMGI, the session start and end time, the frequencies and the MBMS service area identities (MBMS SAIs, see definition in clause 15.3 of TS 23.003 [26]) belonging to the MBMS service area (see definition in TS 23.246 [48]);
- system information: MBMS and non-MBMS cells indicate in *SystemInformationBlockType15* the MBMS SAIs of the current frequency and of each neighbour frequency.

The MBMS SAIs of the neighbouring cell may be provided by X2 signalling (i.e. X2 Setup and eNB Configuration Update procedures) or/and OAM.

When applying the procedures described below for UEs in RRC_IDLE and RRC_CONNECTED state:

- the UE does not need to verify that a frequency is providing a MBMS service by acquiring (SC-)MCCH and may apply these procedures even though a MBMS service is not provided via MBSFN or SC-PTM;
- the UE may consider that a service is provided if a session of this service is ongoing as derived from the session start and end times indicated for this service in the USD and if a frequency provides this service;
- the UE determines the frequency on which a service is provided according to the following:
 - if the serving cell provides *SystemInformationBlockType15* (*SystemInformationBlockType15-NB* in NB-IoT), the UE considers that a frequency is providing the MBMS service via MBSFN or SC-PTM if and only if one of the MBMS SAI(s) of this frequency as indicated in *SystemInformationBlockType15* of the serving cell is indicated for this MBMS service in the USD;
 - except for NB-IoT UEs, BL UEs or UEs in enhanced coverage, if the serving cell does not provide *SystemInformationBlockType15*, the UE in RRC_IDLE state may consider that a frequency included in the USD for the MBMS service is providing this MBMS service as long as the UE reselects cells where *SystemInformationBlockType13* is provided.

Except for NB-IoT UEs, BL UEs or UEs in enhanced coverage, in RRC_IDLE, the UE applies the normal cell reselection rules with the following modifications:

- the UE which is receiving MBMS service(s) via MBSFN or SC-PTM and can only receive these MBMS service(s) via MBSFN or SC-PTM while camping on the frequency providing these MBMS service(s) is allowed to make this frequency highest priority;
- the UE which is interested in receiving MBMS service(s) via MBSFN or SC-PTM and can only receive these MBMS service(s) via MBSFN or SC-PTM while camping on the frequency providing these MBMS service(s) is allowed to make this frequency highest priority when it intends to receive these MBMS service(s);
- when the MBMS service(s) which the UE is interested in are no longer available (after the end of the session) or the UE is no longer interested in receiving the service(s), the UE no longer prioritises the frequency providing these MBMS service(s);

NOTE 1: In RRC_IDLE, when the above modifications to cell reselection rules are applied, the prioritization between the frequency providing these MBMS service(s) and the frequency of a CSG cell, and the autonomous search are left to UE implementation.

For NB-IoT UEs, BL UEs or UEs in enhanced coverage, the UE applies the normal cell reselection rules with the following modifications:

- the UE which is receiving MBMS service(s) via SC-PTM and can only receive these MBMS service(s) via SC-PTM while camping on the frequency providing these MBMS service(s) applies an offset signalled in *SystemInformationBlockType5-NB* for NB-IoT UEs and *SystemInformationBlockType5* for BL UEs or UEs in CE to this frequency in ranking based cell reselection;
- the UE which is interested in receiving MBMS service(s) via SC-PTM and can only receive these MBMS service(s) via SC-PTM while camping on the frequency providing these MBMS service(s) applies an offset signalled in *SystemInformationBlockType5-NB* for NB-IoT UEs and *SystemInformationBlockType5* for BL UEs or UEs in CE to this frequency in ranking based cell reselection;
- when the MBMS service(s) which the UE is interested in are no longer available (after the end of the session) or the UE is no longer interested in receiving the service(s), the UE no longer apply the offset to the frequency providing these MBMS service(s) in ranking based cell reselection.

Except for NB-IoT UEs, in RRC_CONNECTED, the UE that is receiving or interested to receive MBMS via MBSFN or SC-PTM informs the network about its MBMS interest via a RRC message and the network does its best to ensure that the UE is able to receive MBMS and unicast services subject to the UE's capabilities:

- the UE indicates the frequencies which provide the service(s) that the UE is receiving or is interested to receive simultaneously, and which can be received simultaneously in accordance with the UE capabilities.
- if the PCell broadcasts *SystemInformationBlockType20*, the UE also indicates the list of services that the UE is receiving or is interested to receive on the indicated frequencies.

- the UE indicates its MBMS interest at RRC connection establishment (the UE does not need to wait until AS security is activated), and whenever the set of frequencies on which the UE is interested in receiving MBMS services has changed compared with the last indication sent to the network (e.g. due to a change of user interest or of service availability), and whenever the list of MBMS services that the UE is interested in receiving has changed compared with the last indication sent to the network.
- the UE may only indicate its interest when the PCell provides *SystemInformationBlockType15* and after having acquired *SystemInformationBlockType15* of the current PCell.
- the UE may indicate its MBMS interest even if the current configured serving cell(s) do not prevent it from receiving the MBMS services it is interested in.
- the UE indicates with a single bit whether it prioritises MBMS reception over unicast. This priority indication applies to all unicast bearers and all MBMS frequencies. It is sent whether the MBMS frequencies are congested or not.
- the E-UTRAN reuses the *SupportedBandCombination* IE to derive the UE's MBMS related reception capabilities, i.e. the E-UTRAN tries to ensure that the UE is able to receive MBMS and unicast bearers by providing them on the frequencies indicated in *SupportedBandCombination* IE signalled by the UE. The UE supporting MBMS reception via MBSFN or SC-PTM shall support MBMS reception via MBSFN or SC-PTM respectively, on any serving cell and on any cell that may be additionally configured as serving cell according to the UE capabilities.
- the E-UTRAN tries to ensure that the UE which does not support simultaneous reception of unicast transmission and SC-PTM transmission in one subframe on one carrier is able to receive the indicated MBMS services transmitted via SC-PTM and to receive unicast bearers by scheduling them in different subframes.
- for handover preparation, the source eNB transfers the MBMS interest of the UE, if available, to the target eNB. After handover, the UE reads *SystemInformationBlockType15* before updating its MBMS interest. If *SystemInformationBlockType15* is provided on the target cell but not on the source cell, the UE indicates its MBMS interest after handover.

If MBMS is prioritised and the unicast connection cannot be maintained because of congestion on the MBMS carrier then the E-UTRAN releases unicast bearers. It is left to E-UTRAN implementation whether all bearers or only GBR bearers are released. The E-UTRAN does not trigger re-establishment of the released unicast bearers. For congestion control, the E-UTRAN can rely on existing access control mechanisms.

The E-UTRAN may take into account the UE priority for MBMS or unicast reception when receiving an indication of proximity to a CSG cell from a UE which also indicated interest in MBMS reception (or vice-versa).

15.5 Network sharing

Unicast mobility shall not be affected by the sharing of MBMS resources by operators.

15.6 Network Functions for Support of Multiplexing

Considerable gain in radio resource efficiency can be achieved by multiplexing several E-MBMS services on a single MCH. The services that share the resources are called E-MBMS Service Multiplex. The amount of common radio resources allocated to such an E-MBMS Service Multiplex can be smaller than the sum of radio resources, which would need to be allocated for the individual services without multiplexing. This represents the statistical multiplexing gain.

The MCE manages the E-MBMS Service Multiplex e.g. deciding which services are to be multiplexed on which MCH. The duration of each E-MBMS service may be different, so there is a need to manage the Service Multiplex dynamically, i.e. addition or removal of services into/from the E-MBMS Service Multiplex. The MCE allocates the optimal amount of resources to multiplexed services, using service related information. The MCE selects the CSA pattern for the MCHs and also the order in which the services appear in the MCCH. MBSFN transmission is ensured by identical multiplexing of the services in all cells belonging to the same MBSFN area. The location of the multiplexing function is in the eNB MAC layer.

These functions are supported by respective signalling information on M2 interface. This scheduling information is sent to all eNBs via the M2 interface procedure "MBMS Scheduling Information".

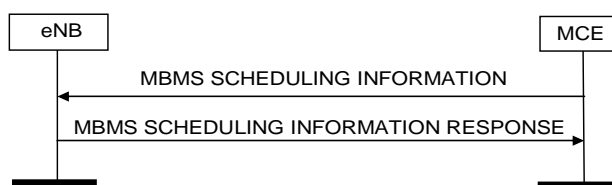

Figure 15.6.1 MBMS Scheduling Information procedure message flow on M2 interface

15.7 Procedures

15.7.1 Procedures for Broadcast mode

15.7.1.1 Session Start procedure

The purpose of the MBMS Session Start procedure is to request the E-UTRAN to notify UEs about an upcoming MBMS Session of a given MBMS Bearer Service and to establish an MBMS E-RAB for this MBMS Session. The MBMS Session Start procedure is triggered by the EPC.

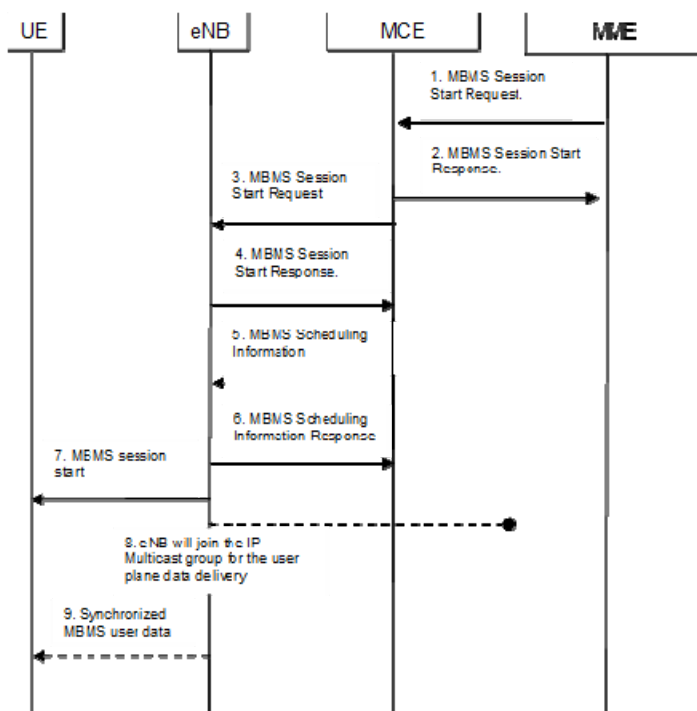

Figure 15.7.1.1-1. Session Start procedure

1. The MME sends MBMS session start request message to the MCE(s) controlling eNBs in the targeted MBMS service area. The message includes the IP multicast address, session attributes and the minimum time to wait before the first data delivery, and includes the list of cell identities if available.

NOTE 1: The MME does not need to check the PLMN ID included in the TMGI

2. The MCE decides whether to use SC-PTM or MBSFN to carry the MBMS bearer over the air interface.

In MBSFN operation, the MCE checks whether the radio resources are sufficient for the establishment of new MBMS service(s) in the area it controls. If not, MCE decides not to establish the radio bearers of the MBMS service(s) and does not forward the MBMS session start request message to the involved eNBs, or may pre-empt radio resources from other radio bearer(s) of ongoing MBMS service(s) according to ARP. The MCE confirms the reception of the MBMS Session Start request to the MME. This message can be transmitted before the step 4. Only in case of distributed MCE architecture radio resource setup is scheduled according to the parameter "time

of MBMS data transfer" which indicates an absolute start time of data delivery, otherwise according to the "minimum time to MBMS data transfer" parameter.

NOTE 2: In MBSFN operation, the MCE may send the MBMS SESSION START RESPONSE message after it receives at least one confirmation from the eNB(s) (i.e. Step 4).

In SC-PTM operation, the MCE only confirms the reception of the MBMS Session Start request to the MME, after the MCE receives at least one confirmation from the eNB(s) (i.e. Step 4).

3. In MBSFN operation, the MCE sends the MBMS Session Start Request message to the relevant eNBs. If the MBMS Session Start message includes the MBMS Service Area Identity with value 0 as defined in TS 23.003 [26], the MCE shall consider that all those eNBs supporting the PLMN as indicated by the received MBMS Session Start Request message are involved. The MCE then determines in which MBSFN area(s) the service should be delivered.

In SC-PTM operation, the MCE includes the SC-PTM information (i.e. list of cell identities and QoS information received from the MME in Step 1) , in the MBMS Session Start Request message to the relevant eNBs.

NOTE 3: The MCE does not need to check the PLMN ID included in the TMGI.

NOTE 4: When to send the MBMS Session Start message from MCE to eNB according to the minimum time to wait indication is an MCE implementation issue.

4. In MBSFN operation, eNB confirms the reception of the MBMS Session Start message.

In SC-PTM operation, the eNB checks whether the radio resources are sufficient for the establishment of new MBMS service(s) in the area it controls. If not, eNB decides not to establish the radio bearers of the MBMS service(s), or may pre-empt radio resources from other radio bearer(s) according to ARP. eNB confirms the reception of the MBMS Session Start message.

Step 5 and 6 are only applicable to MBSFN operation.

5. MCE sends the MBMS Scheduling Information message to the eNB including the updated MCCH information which carries the MBMS service's configuration information. This message can be transmitted before the step 3.
6. eNB confirms the reception of the MBMS Scheduling Information message.
7. eNB indicates MBMS session start to UEs by MCCH change notification and updated MCCH information which carries the MBMS service's configuration information.
8. eNB joins the IP multicast group to receive the MBMS User Plane data.
9. eNB sends the MBMS data to radio interface; In MBSFN operation, the MBMS data is sent at the determined time.

15.7.1.2 Session Stop procedure

The MBMS Session Stop procedure is to request the E-UTRAN to notify UEs about the end of a given MBMS Session and to release the corresponding MBMS E-RAB this MBMS Session. The MBMS Session Stop procedure is triggered by the EPC.

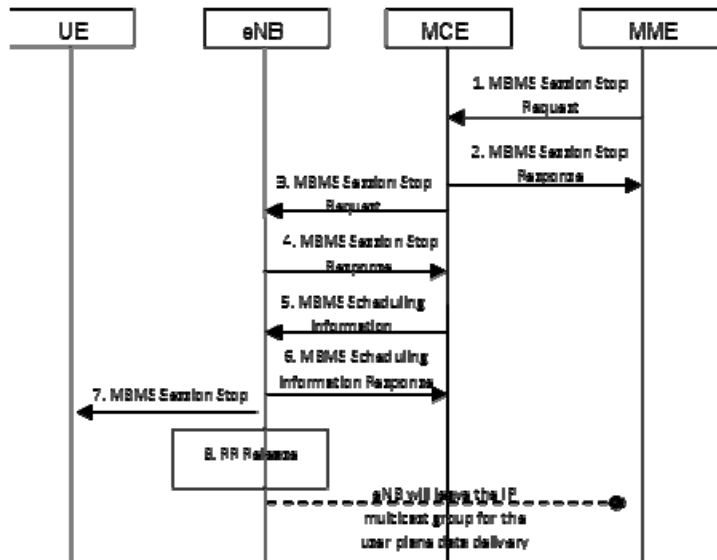

Figure 15.7.1.2-1. Session Stop procedure

1. The MME sends MBMS session stop request message to the MCE(s) controlling eNBs in the targeted MBMS service area.
 2. MCE confirms the reception of the MBMS Session stop request to the MME.
 3. MCE forwards the MBMS Session stop message to the relevant eNBs.
 4. eNB confirms the reception of the MBMS Session stop message.
- Step 5 and 6 are only applicable to MBSFN operation.
5. MCE sends the MBMS Scheduling Information message to the eNB including the updated MCCH information which carries the MBMS service's configuration information. This message can be transmitted before the step 3.
 6. eNB confirms the reception of the MBMS Scheduling Information message.
 7. eNB indicates MBMS session stop to UEs by removing any service configuration associated with the stopped session from the updated MCCH message.
 8. The corresponding E-RAB is released, and eNB leaves the IP multicast group.

15.7a M1 Interface

15.7a.1 M1 User Plane

The M1 user plane interface is defined between the eNB and the MBMS GW. The M1 user plane interface provides non guaranteed delivery of user plane PDUs between the eNB and the MBMS GW. The user plane protocol stack on the M1 interface is shown in Figure 15.7a.1-1. The transport network layer is built on IP transport and GTP-U is used on top of UDP/IP to carry the user plane PDUs between the eNB and the MBMS GW.

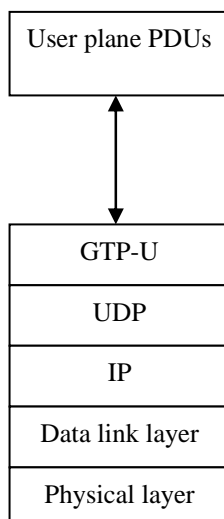

Figure 15.7a.1-1: M1 Interface User Plane (eNB – MBMS GW)

15.8 M2 Interface

15.8.1 M2 Control Plane

The M2 control plane interface is defined between the eNB and the MCE. The control plane protocol stack of the M2 interface is shown on Figure 15.8.1-1. The transport network layer is built on IP transport, for the reliable transport of signalling messages SCTP is added on top of IP. The application layer signalling protocol is referred to as M2AP (M2 Application Protocol).

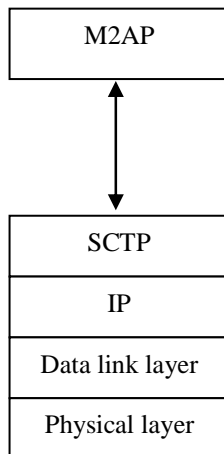

Figure 15.8.1-1: M2 Interface Control Plane (eNB-MCE)

The SCTP layer provides the guaranteed delivery of application layer messages.

In the transport IP layer point-to-point transmission is used to deliver the signalling PDUs.

A single SCTP association per eNB-MCE interface instance shall be used with one pair of stream identifiers for M2 common procedures. Only a few pairs of stream identifiers should be used for M2 MBMS-service-associated procedures. eNB and MCE communication context identifiers that are assigned by the eNB and the MCE for M2 MBMS-service-associated procedures shall be used to distinguish MBMS service specific M2 signalling transport bearers. The communication context identifiers are conveyed in the respective M2AP messages.

15.8.2 M2 Interface Functions

15.8.2.1 General

The M2 interface provides the following functions:

- MBMS Session Handling Function:
 - MBMS Session Start, MBMS Session Stop, MBMS Session Update.
- MBMS Scheduling Information Provision Function.
- M2 Interface Management Function:
 - Reset, Error Indication, Restoration.
- M2 Configuration Function.
- MBMS Service Counting Function.
- MBMS Service Suspension and Resumption Function.

15.8.2.2 MBMS Session Handling Function

The MBMS Session Handling Function enables the MCE to provide Session Start, Session Stop and Session Update messages to the eNBs it is connected to. The MCE provides the information of the MBMS session, e.g., the MBMS Service Area information, and the SC-PTM information to the eNB, where the SC-PTM information is included only in case of SC-PTM operation.

15.8.2.3 MBMS Scheduling Information Provision Function

The MBMS Scheduling Information Provision Function enables the MCE to configure MCCH content according to the expected or ongoing MBMS services, and to configure MCH Scheduling Information for suspension notification.

15.8.2.4 M2 Interface Management Function

The M2 interface management functions provide:

- means to ensure a defined start of the M2 interface operation (reset);
- means to handle different versions of application part implementations and protocol errors (error indication);
- means to restore services following an eNB failure or an M2 path failure (restoration). The Restoration function enables the MCE to restore in the eNB the MBMS sessions. This restoration function is implemented by the MBMS Session Start procedure.

15.8.2.5 M2 Configuration Function

The M2 Configuration Function allows the eNB and MCE to exchange configuration information necessary for the operation of the M2 interface, and MCCH related BCCH content.

15.8.2.6 MBMS Service Counting Function

The MBMS Service Counting Function enables the MCE to perform counting and to receive counting results per MBMS service(s) within MBSFN area(s). MCE can perform counting only for those MBMS service(s) for which access has not been denied by the admission control function for the corresponding MBMS session(s).

15.8.2.7 MBMS Service Suspension and Resumption Function

The MBMS Service Suspension and Resumption Function enables the MCE to request the eNB that it may release the allocated RAN resources, may leave the IP multicast if already joined, shall update the MCCH information and shall suspend the MBSFN transmission while keeping the MBMS context for that service in the eNB. If the MCE

subsequently requests the eNB for resumption, then the eNB shall allocate the RAN resources, shall send the MCCH change notification, shall update the MCCH information, shall resume the MBSFN transmission and shall join IP multicast if previously left. This MBMS Services Suspension and Resumption function is implemented by the MBMS Scheduling Information procedure as described in clause 15.8.3.3.

Suspension/Resumption of MBMS service provision is applied to a whole MBSFN area.

15.8.2.8 MBMS Overload Notification Function

The MBMS Overload Notification Function enables the eNB to notify the MCE about MBMS overload status.

15.8.3 M2 Interface Signalling Procedures

15.8.3.1 General

The elementary procedures supported by the M2AP protocol are listed in Table 2 and Table 3 of TS 36.443 [44].

15.8.3.2 MBMS Session signalling procedure

The MBMS Session signalling procedure enables the MCE to deliver Session Start, Session Stop and Session Update messages to the concerned eNBs. At Session Start and Session Update, the MCE provides the information of the MBMS session, e.g., the MBMS Service Area information, and the SC-PTM information to the eNB, where the SC-PTM information is included only in case of SC-PTM operation.

15.8.3.3 MBMS Scheduling Information procedure

The MBMS Scheduling Information procedure enables the MCE to update MCCH information whenever necessary. Typically, the MCE issues an MBMS Scheduling Information procedure before user data transmission for an announced MBMS service starts or after it has ended.

The MBMS Scheduling Information procedure also enables the MCE to update MCH Scheduling Information for suspension notification.

15.8.3.4 M2 Interface Management procedures

15.8.3.4.1 Reset procedure

The Reset procedure is issued in order to re-initialize the peer entity or part of the peer entity after node setup and after a failure event occurred. This procedure may be initiated by both the eNB and MCE.

15.8.3.4.2 Error Indication procedure

The Error Indication procedure may be initiated by the eNB and the MCE. It is used to report detected errors in one incoming message, if an appropriate failure message cannot be reported to the sending entity.

15.8.3.5 M2 Configuration procedures

15.8.3.5.1 M2 Setup procedure

The M2 Setup procedure allows the exchange of configured data which is required in the MCE and in the eNB respectively to ensure a proper interoperation and MCCH related BCCH content. The M2 Setup procedure is triggered by the eNB. The M2 Setup procedure is the first M2AP procedure executed on an M2 interface instance.

15.8.3.5.2 eNB Configuration Update procedure

The eNB Configuration Update procedure is used to provide updated configured data in the eNB and receive MCCH related BCCH content from MCE. The eNB Configuration Update procedure is triggered by the eNB.

15.8.3.5.3 MCE Configuration Update procedure

The MCE Configuration Update procedure is used to provide updated configured data in the MCE and tell eNB updated MCCCH related BCCH content. The MCE Configuration Update procedure is triggered by the MCE.

15.8.3.6 MBMS Service Counting procedures

15.8.3.6.1 MBMS Service Counting procedure

The MBMS Service Counting procedure is used to trigger the eNB to count the number of connected mode UEs that either are receiving the MBMS service(s) or are interested in the reception of the MBMS service(s).

15.8.3.6.2 MBMS Service Counting Results Report procedure

The MBMS Service Counting Results Report procedure is used by the eNB to provide the MCE with the number of connected mode UEs that either are receiving the MBMS service(s) or are interested in the reception of the MBMS service(s) based on counting performed by the eNB.

15.8.3.7 MBMS Overload Notification procedure

The MBMS Overload Notification procedure enables the eNB to notify the MCE about MBMS overload status.

15.9 M3 Interface

15.9.1 M3 Control Plane

The M3 control plane interface is defined between the MME and the MCE. The control plane protocol stack of the M3 interface is shown on Figure 15.9.1-1. The transport network layer is built on IP transport, for the reliable transport of signalling messages SCTP is added on top of IP. The application layer signalling protocol is referred to as M3AP (M3 Application Protocol).

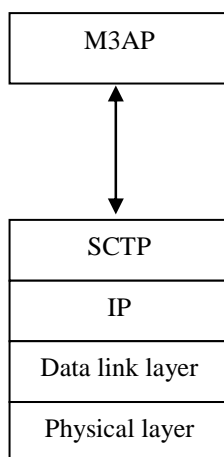

Figure 15.9.1-1: M3 Interface Control Plane (MME-MCE)

The SCTP layer provides the guaranteed delivery of application layer messages.

In the transport IP layer point-to-point transmission is used to deliver the signalling PDUs.

A single SCTP association per MME-MCE interface instance shall be used with one pair of stream identifiers for M3 common procedures. Only a few pairs of stream identifiers should be used for M3 MBMS-service-associated procedures. MME and MCE communication context identifiers that are assigned by the MME and the MCE for M3 MBMS-service-associated procedures shall be used to distinguish MBMS service specific M3 signalling transport bearers. The communication context identifiers are conveyed in the respective M3AP messages.

15.9.2 M3 Interface Functions

15.9.2.1 General

The M3 interface provides the following functions:

- MBMS Session Handling Function:
 - MBMS Session Start, MBMS Session Stop, MBMS Session Update.
- M3 Interface Management Function:
 - Reset, Error Indication, Restoration.
- M3 Configuration Function (distributed MCE architecture only, see clause 15.1.1)
 - M3 Setup, MCE Configuration Update.

15.9.2.2 MBMS Session Handling Function

The MBMS Session Handling Function enables the MME to provide Session Start, Session Stop and Session Update messages to the MCEs it is connected to. The MME provides the information of the MBMS session, e.g., QoS, MBMS Service Area, and the list of cell identities if available, to the MCEs.

In this release the MBMS Session Update procedure only supports the update of MBMS Service Area, the update of the list of cell identities, the update of the allocation and retention priority of the MBMS session and the update of time of MBMS data transfer where the last one is used in the distributed MCE architecture only.

15.9.2.3 M3 Interface Management Function

The M3 interface management functions provide:

- means to ensure a defined start of the M3 interface operation (reset);
- means to handle different versions of application part implementations and protocol errors (error indication);
- means to restore services following an MCE failure or an M3 path failure (restoration). The Restoration function enables the MME to restore in the MCE the MBMS sessions as specified in TS 23.007 [56]. This Restoration function is implemented by the MBMS Session Start procedure.

15.9.2.4 M3 Configuration Function

The M3 Configuration Function allows the MCE to exchange with the MME node configuration information necessary for the operation of the M3 interface such as the supported MBMS Service Area information.

15.9.3 M3 Interface Signalling Procedures

15.9.3.1 General

The elementary procedures supported by the M3AP protocol are listed in Table 8-1 and Table 8-2 of TS 36.444 [45].

15.9.3.2 MBMS Session signalling procedure

The MBMS Session signalling procedure enables the MME to deliver Session Start, Session Stop and Session Update messages to the concerned MCEs. At Session Start and Session Update, the MME provides the information of the MBMS session, e.g., QoS, MBMS Service Area, and the list of cell identities if available, to the MCEs.

In distributed MCE architecture only, the MME may also provide a "time of MBMS data transfer" to indicate the absolute start time of data delivery, and a "time of MBMS data stop" to indicate the absolute end time of data delivery.

In this release the MBMS Session Update procedure only supports the update of MBMS Service Area, the update of the list of cell identities if available, the update of the allocation and retention priority of the MBMS session and the update of time of MBMS data transfer where the last one is used in the distributed MCE architecture only.

15.9.3.3 M3 Interface Management procedures

15.9.3.3.1 Reset procedure

The Reset procedure is issued in order to re-initialize the peer entity or part of the peer entity after node setup and after a failure event occurred. This procedure may be initiated by both the MME and MCE.

15.9.3.3.2 Error Indication procedure

The Error Indication procedure may be initiated by the MME and the MCE. It is used to report detected errors in one incoming message, if an appropriate failure message cannot be reported to the sending entity.

15.9.3.4 M3 Configuration procedures

15.9.3.4.1 M3 Setup procedure

The M3 Setup procedure allows the initial exchange of configured data which is required in the MCE and in the MME such as the supported MBMS Service Area information. The M3 Setup procedure is initiated by the MCE.

15.9.3.4.2 MCE Configuration Update procedure

The MCE Configuration Update procedure is used to provide updated configured data in the MCE to the MME. The MCE Configuration Update procedure is triggered by the MCE.

15.10 MBMS Counting

15.10.1 General

MBMS counting in LTE is used to determine if there are sufficient UEs interested in receiving a service to enable the operator to decide if it is appropriate to deliver the service via MBSFN. It allows the operator to choose between enabling or disabling MBSFN transmission for the service. MBMS counting applies only to connected mode UEs. Enabling and disabling MBSFN transmission is realized by MBMS Service Suspension and Resumption function in clause 15.8.2.7.

The following principles are used for the MBMS counting:

- Counting is supported for both a service already provided by MBSFN in an MBSFN area as well as for a service not yet provided via MBSFN in an MBSFN area. A service not yet provided via MBSFN in an MBSFN area may be:
 - Service provided via unicast bearer.
 - Service not yet provided either by MBSFN or by unicast.
- RAN is not aware of MBMS service provisioning through unicast bearers.

15.10.2 Counting Procedure

The Counting Procedure is initiated by the network. Initiation of the Counting Procedure results in a request to each eNB involved in the providing MBSFN area to send a Counting Request (the Counting Request is included in the directly extended MCCH message), which contains a list of TMGI's requiring UE feedback. The connected mode UEs which are receiving or interested in the indicated services will respond with a RRC Counting Response message, which includes short MBMS service identities (unique within the MBSFN service area) and may optionally include the information to identify the MBSFN Area (if overlapping is configured).

The following principles are used for the Counting Procedure:

- Network has means to disable UE counting per service.
- The UE is able to report on multiple MBMS services via a single Counting Response message.
- It is unnecessary to retransmit the Counting Response when the UE moves within the same MBSFN area.
- The network only gets one response from a UE related to one Counting Request message, which is broadcast for one modification period.
- The UE cannot automatically indicate to network a change of interest in MBMS service(s).
- The network counts UE interest per service.

15.11 MBMS service reception using Receive Only Mode

MBMS service(s) can be received by a UE in ROM as described in TS 23.246 [48], clause D.2.3 and in TS 26.346 [49]. A UE may receive or be interested to receive broadcast MBMS service(s) in ROM from a different eNB while receiving unicast or MBMS service(s) from serving eNB. If UE baseband resources are shared for receiving unicast service and MBMS service(s) in ROM from different eNBs, the UE may use *MBMSInterestIndication* signaling procedure as described in TS 36.331 [16] to inform the unicast serving eNB about the baseband resources used for the purpose of MBMS service(s) in ROM from a different eNB.

16 Radio Resource Management aspects

16.0 General

The purpose of radio resource management (RRM) is to ensure the efficient use of the available radio resources and to provide mechanisms that enable E-UTRAN to meet radio resource related requirements identified in clause 10 of TR 25.913 [2]. In particular, RRM in E-UTRAN provides means to manage (e.g. assign, re-assign and release) radio resources taking into account single and multi-cell aspects.

16.1 RRM functions

16.1.1 Radio Bearer Control (RBC)

The establishment, maintenance and release of Radio Bearers involve the configuration of radio resources associated with them. When setting up a radio bearer for a service, radio bearer control (RBC) takes into account the overall resource situation in E-UTRAN, the QoS requirements of in-progress sessions and the QoS requirement for the new service. RBC is also concerned with the maintenance of radio bearers of in-progress sessions at the change of the radio resource situation due to mobility or other reasons. RBC is involved in the release of radio resources associated with radio bearers at session termination, handover or at other occasions.

RBC is located in the eNB.

16.1.2 Radio Admission Control (RAC)

The task of radio admission control (RAC) is to admit or reject the establishment requests for new radio bearers. In order to do this, RAC takes into account the overall resource situation in E-UTRAN, the QoS requirements, the priority levels and the provided QoS of in-progress sessions and the QoS requirement of the new radio bearer request. The goal of RAC is to ensure high radio resource utilization (by accepting radio bearer requests as long as radio resources are available) and at the same time to ensure proper QoS for in-progress sessions (by rejecting radio bearer requests when they cannot be accommodated).

RAC is located in the eNB.

16.1.3 Connection Mobility Control (CMC)

Connection mobility control (CMC) is concerned with the management of radio resources in connection with idle or connected mode mobility. In idle mode, the cell reselection algorithms are controlled by setting of parameters (thresholds and hysteresis values) that define the best cell and/or determine when the UE should select a new cell. Also, E-UTRAN broadcasts parameters that configure the UE measurement and reporting procedures. In connected mode, the mobility of radio connections has to be supported. Handover decisions may be based on UE and eNB measurements. In addition, handover decisions may take other inputs, such as neighbour cell load, traffic distribution, transport and hardware resources and Operator defined policies into account.

CMC is located in the eNB.

16.1.4 Dynamic Resource Allocation (DRA) - Packet Scheduling (PS)

The task of dynamic resource allocation (DRA) or packet scheduling (PS) is to allocate and de-allocate resources (including buffer and processing resources and resource blocks (i.e. chunks)) to user and control plane packets. DRA involves several sub-tasks, including the selection of radio bearers whose packets are to be scheduled and managing the necessary resources (e.g. the power levels or the specific resource blocks used). PS typically takes into account the QoS requirements associated with the radio bearers, the channel quality information for UEs, buffer status, interference situation, etc. DRA may also take into account restrictions or preferences on some of the available resource blocks or resource block sets due to inter-cell interference coordination considerations.

DRA is located in the eNB.

16.1.5 Inter-cell Interference Coordination (ICIC)

16.1.5.0 General

Inter-cell interference coordination has the task to manage radio resources such that inter-cell interference is kept under control. ICIC mechanism includes a frequency domain component and time domain component. ICIC is inherently a multi-cell RRM function that needs to take into account information (e.g. the resource usage status and traffic load situation) from multiple cells. The preferred ICIC method may be different in the uplink and downlink.

The frequency domain ICIC manages radio resource, notably the radio resource blocks, such that multiple cells coordinate use of frequency domain resources.

In TDD, intended UL-DL configuration may be exchanged through backhaul signalling, and frequency domain ICIC information may be exchanged per subframe set, such that multiple cells may coordinate the usage of frequency domain resources in the subframe sets.

For the time domain ICIC, subframe utilization across different cells are coordinated in time through backhaul signalling or OAM configuration of so called Almost Blank Subframe patterns. The Almost Blank Subframes (ABSs) in an aggressor cell are used to protect resources in subframes in the victim cell receiving strong inter-cell interference. Almost blank subframes are subframes with reduced transmit power (including no transmission) on some physical channels and/or reduced activity. The eNB ensures backwards compatibility towards UEs by transmitting necessary control channels and physical signals as well as System Information. Patterns based on ABSs are signalled to the UE to restrict the UE measurement to specific subframes, called measurement resource restrictions. There are different patterns depending on the type of measured cell (serving or neighbour cell) and measurement type (e.g. RRM, RLM). MBSFN subframes can be used for time domain ICIC when they are also included in ABS patterns. The eNB cannot configure MBSFN subframes, as specified in TS 36.211 [4], as ABSs when these MBSFN subframes are used for other usages (e.g., MBMS, LCS).

Extending the coverage of a cell by means of connecting a UE to cell that is weaker than the strongest detected cell is referred to as cell range extension (CRE). With time domain ICIC, a CRE UE may continue to be served by a victim cell (i.e., the weaker cell) even while under strong interference from aggressor cells (i.e., the stronger cell).

A UE under strong interference from aggressor cells may need to mitigate interference from the aggressor cells on some physical channels and signals in order to receive data from serving cell or to detect the weak cells or to perform measurements on the weak cells.

The network may provide SIB1 to the UE in the CRE region by a dedicated RRC signalling to assist UE system information acquisition.

ICIC is located in the eNB.

16.1.5.1 UE configurations for time domain ICIC

For the UE to measure "protected" resources of the serving cell and/or neighbour cells, RRM/RLM/CSI measurement resource restriction is signalled to the UE. There are three kinds of measurement resource restriction patterns that may be configured for the UE.

- Pattern 1: A single RRM/RLM measurement resource restriction for the PCell.
- Pattern 2: A single RRM measurement resource restriction for indicated list of neighbour cells operating in the same carrier frequency as the PCell.
- Pattern 3: Resource restriction for CSI measurement of the PCell. If configured, two subframe subsets are configured per UE. The UE reports CSI for each configured subframe subset.

For pattern 3, it is up to the network to choose the two subframe subsets but typically the two subframe subsets are chosen with the expectation that CSI measurements using the two configured subframe subsets are subject to different levels of interference (e.g., one subframe subset indicates ABSs while the second subframe subset indicates non-ABSs). For periodic CSI reports, linkage of each CSI report to a configured subset of subframe is defined in TS 36.331 [16]. For aperiodic CSI reports, the UE reports CSI based on the subframe subset containing the CSI reference resource.

In RRC_CONNECTED, the RRM/RLM/CSI measurement resource restrictions are configured by dedicated RRC signalling.

The network may configure the UE with CRS assistance information of the aggressor cells in order to aid the UE to mitigate the interference from CRS of the aggressor cells.

16.1.5.2 OAM requirements for time domain ICIC

16.1.5.2.1 Configuration for CSG cell

When the time-domain inter-cell interference coordination is used for non-members UE in close proximity of a CSG cell, OAM configures a CSG cell not to use a time domain resource set (i.e. a set of subframes), so that a non-member UE in close proximity of the CSG cell can be still served by another cell. OAM also configures a cell neighbour to a CSG cell with the protected time domain resource set not used by the CSG cell, so that the neighbour cell knows which time domain resource can be used for a non-member UE in close proximity of the CSG cell.

16.1.5.2.2 Configuration for interfering non-CSG cell

When the time-domain inter-cell interference coordination is used to mitigate interference between two cells using X2 signalling of ABS patterns from an interfering eNB to an interfered eNB, the following OAM requirements are applied.

- OAM may configure association between eNBs to use the time-domain inter-cell interference coordination.
- For the deployment scenarios where common subset for ABS patterns from multiple interfering cells is desirable, OAM configuration ensures that a 'common subset' exists between the ABS patterns of those interfering cells.

NOTE 1: The possibility of whether the common ABS pattern from multiple eNBs is desirable or not depends on the deployment cases of the time domain solution of inter-cell interference coordination.

NOTE 2: It is up to eNB implementation how a receiving eNB derives the 'usable ABS subset' from the ABS patterns coming from multiple neighbour eNBs.

16.1.6 Load Balancing (LB)

Load balancing has the task to handle uneven distribution of the traffic load over multiple cells. The purpose of LB is thus to influence the load distribution in such a manner that radio resources remain highly utilized and the QoS of in-progress sessions are maintained to the extent possible and call dropping probabilities are kept sufficiently small. LB

algorithms may result in hand-over or cell reselection decisions with the purpose of redistribute traffic from highly loaded cells to underutilized cells.

LB is located in the eNB.

16.1.7 Inter-RAT Radio Resource Management

Inter-RAT RRM is primarily concerned with the management of radio resources in connection with inter-RAT mobility, notably inter-RAT handover. At inter-RAT handover, the handover decision may take into account the involved RATs resource situation as well as UE capabilities and Operator policies. The importance of Inter-RAT RRM may depend on the specific scenario in which E-UTRAN is deployed. Inter-RAT RRM may also include functionality for inter-RAT load balancing for idle and connected mode UEs.

16.1.8 Subscriber Profile ID for RAT/Frequency Priority

The RRM strategy in E-UTRAN may be based on user specific information.

The Subscriber Profile ID for RAT/Frequency Priority (SPID) parameter received by the eNB via the S1 interface or the X2 interface is an index referring to user information (e.g. mobility profile, service usage profile). The information is UE specific and applies to all its Radio Bearers.

This index is mapped by the eNB to locally defined configuration in order to apply specific RRM strategies (e.g. to define RRC_IDLE mode priorities and control inter-RAT/inter frequency handover in RRC_CONNECTED mode).

16.1.9 Inter-eNB CoMP

The task of inter-eNB CoMP is to coordinate multiple eNBs in order that the coverage of high data rates and the cell-edge throughput are improved, and also the system throughput is increased. The coordination of multiple eNBs is achieved by signalling between eNBs of hypothetical resource allocation information, CoMP hypotheses, associated with benefit metrics. Each of the signalled CoMP hypotheses is concerned with a cell belonging to either the receiving eNB, the sending eNB or their neighbour. The benefit metric associated with the CoMP hypotheses quantifies the benefit assuming that the CoMP hypotheses are applied. The receiving eNB of the CoMP hypotheses and the benefit metrics may take them into account for RRM.

RSRP measurement reports and CSI reports may be exploited for inter-eNB CoMP. For example, the RSRP measurement reports and CSI reports can be used to determine and/or validate CoMP hypotheses and benefit metrics.

The enhanced RNTI may be used in inter-eNB CoMP to exchange information between eNBs concerning the adopted power allocation.

Inter-eNB CoMP is located in the eNB.

16.1.10 Cell on/off and cell discovery

The eNB using cell on/off may adaptively turn the downlink transmission of a cell on and off. A cell whose downlink transmission is turned off may be configured as a deactivated SCell for a UE. A cell performing on/off may transmit only periodic discovery signals and UEs may be configured to measure the discovery signals for RRM. Cell on/off may be performed for the purpose of e.g. inter-cell interference coordination and avoidance, load balancing, and energy saving, etc. The criteria used for cell on/off may be e.g. traffic load increase/decrease, UE arrival/departure (i.e. UE-cell association), and packet arrival/completion.

A UE performs RRM measurement and may discover a cell or transmission point of a cell based on discovery signals when the UE is configured with discovery-signal-based measurements.

16.2 RRM architecture

16.2.1 Centralised Handling of certain RRM Functions

Void.

16.2.2 De-Centralised RRM

16.2.2.1 UE History Information

The source eNB collects and stores the UE History Information for as long as the UE stays in one of its cells.

When information needs to be discarded because the list is full, such information will be discarded in order of its position in the list, starting with the oldest cell record. If the list is full, and the UE history information from the UE is available, the UE history information from the UE should also be discarded.

The resulting information is then used in subsequent handover preparations by means of the Handover Preparation procedures over the S1 and X2 interfaces, which provide the target eNB with a list of previously visited cells and associated (per-cell) information elements. The Handover Preparation procedures also trigger the target eNB to start collection and storage of UE history Information and thus to propagate the collected information.

16.2.3 Void

16.3 UE assistance information for RRM, and UE power optimisations and UE overheating

Except for NB-IoT UEs, in order to optimise the user experience and (for instance) to assist the eNB in configuring connected mode parameters and connection release handling, the UE may be configured to send assistance information to the eNB comprising:

- UE preference for power optimised configuration (1 bit):
 - When this bit is sent by the UE, the UE shall set this in accordance with its preference for a configuration that is primarily optimised for power saving (e.g. a long value for the long DRX cycle or RRC connection release) or not;
 - The details regarding how the UE sets the indicator are left to UE implementation.
- UE bandwidth preference on maximum PDSCH/PUSCH bandwidth:
 - When this information is sent by the UE that supports CE mode, the UE shall set this in accordance with its preference on maximum PDSCH/PUSCH bandwidth to assist the eNB for a reconfiguration of the CE mode for the UE in RRC_CONNECTED state;
 - The details regarding how the UE sets the bandwidth preference are left to UE implementation.
- UE indication on detected overheating:
 - When this information is sent by the UE, the UE shall set this information to inform the eNB about UE internal overheating caused by configurations concerning carrier aggregation/dual connectivity, MIMO transmissions, and/or modulation schemes being concurrently configured. The eNB may mitigate the indicated overheating by downgrading the UE configuration. Details regarding how the eNB mitigates the overheating are left to implementation (e.g. the eNB may choose to mitigate overheating by downgrading E-UTRA configuration and/or NR in case of EN-DC taking into account the assistance information provided by the UE). If the eNB does not provide any mitigation, the UE may need to mitigate the indicated overheating based on UE implementation.
 - The details regarding how the UE detects the internal overheating are left to UE implementation.

A NB-IoT UE or BL UE may be configured to send assistance information to the eNB to assist the eNB in connection release handling.

The network response to the UE assistance information is left to network implementation. The eNB ensures that an appropriate QoS level is provided irrespective of received power preference indication or the bandwidth preference.

17 Void

17.1 Void

18 UE capabilities

RRC signalling carries AS capabilities and NAS signalling carries NAS capabilities. The UE capability information is stored in the MME. In the uplink, except of NB-IoT no capability information is sent early in e.g. *RRCConnectionRequest* message. For NB-IoT, early indications for multi-tone support (IOT bit) and multi-carrier support (IOT bit) are sent in *RRCConnectionRequest-NB* message. In the downlink, enquiry procedure of the UE capability is supported.

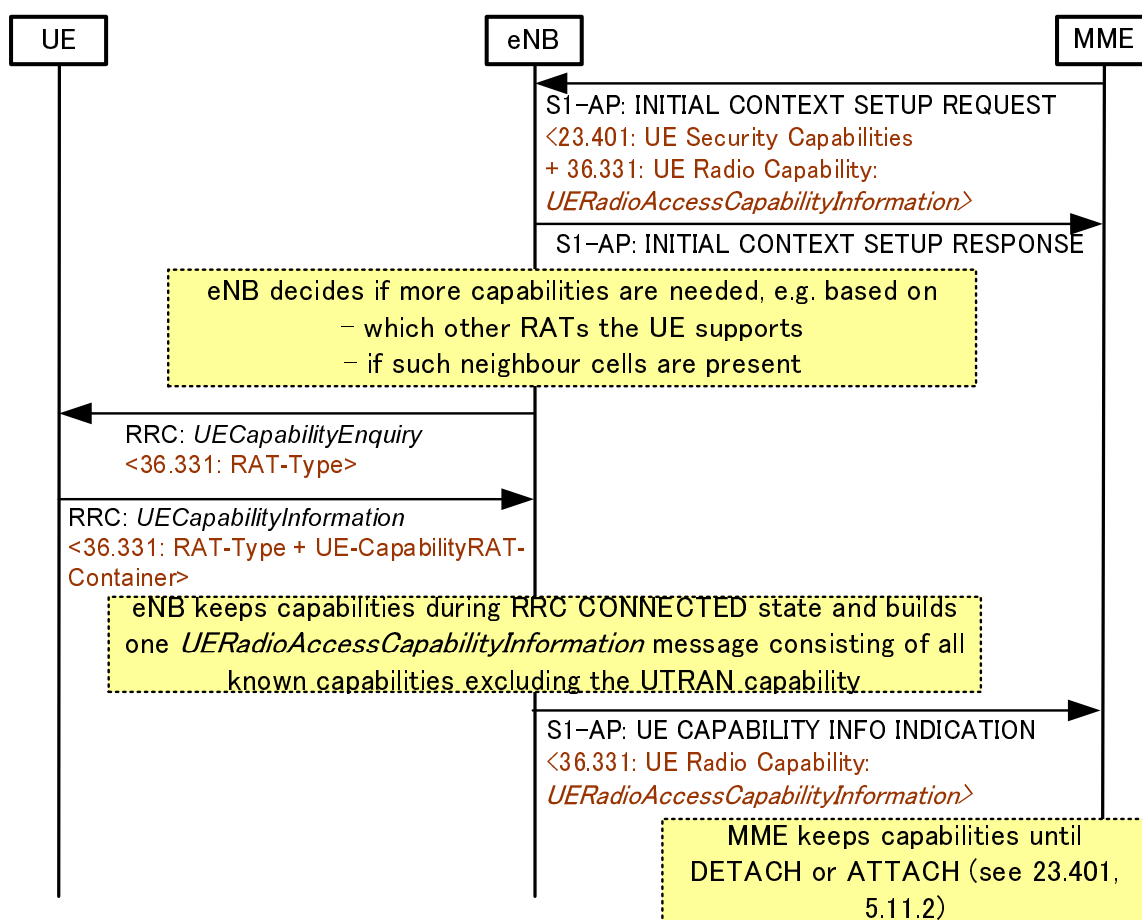

Figure 18-1: Initial UE Capability Handling

The MME stores the UE Radio Capability uploaded in the UE CAPABILITY INFO INDICATION message.

The possible RAT-Types are: EUTRAN, UTRAN, GERAN-PS, GERAN-CS, CDMA2000-1XRTT. The GERAN capability is divided into separate parts. MS Classmark 2 and Classmark 3 are used for CS domain (in both AS and NAS) and MS Radio Access Capability is used for PS domain. The main part of CDMA2000 capabilities is not handled by the eNB or the MME, but is exchanged via tunnelling (see 10.3.2). The small part of CDMA2000 capabilities (for CDMA2000-1XRTT) is needed for the eNB to be able to build messages for the target CDMA2000 RNC (see 10.3.2).

The eNB may acquire the UE capabilities after a Handover completion. The UE capabilities are then uploaded to the MME.

Usually during handover preparation, the source RAN node transfers both the UE source RAT capabilities and the target RAT capabilities to the target RAN node, in order to minimize interruptions and to follow the principles in clause 10.2.2. The source RAN is not mandated to acquire other RAT capabilities (i.e. other than the source and target RAT capabilities) in order to start a handover preparation. This is described in clause 19.2.2.5.6. However, there are exceptions to this principle:

- For handover from GERAN to EUTRAN, due to limitations in GERAN radio interface signalling, source RAT (GERAN) never provides the EUTRA capabilities to the target RAN node.
- At handover from UTRAN to EUTRAN, it is optional to forward the UTRAN capabilities to the target RAN.

The UTRAN capabilities, i.e. the INTER RAT HANDOVER INFO, include START-CS, START-PS and "predefined configurations", which are "dynamic" IEs. In order to avoid the START values desynchronisation and the key replaying issue, the eNB always enquires the UE UTRAN capabilities at transition from RRC_IDLE to RRC_CONNECTED and before Handover to UTRAN. The eNB does not upload the UE UTRAN capabilities to the MME.

Due to limitations in radio interface signalling, transfer of EUTRA capabilities is not supported in GERAN.

For BL UEs, UEs supporting Enhanced Coverage and NB-IoT UEs, the S1 signalling includes the UE Radio Capability for Paging. The eNB uploads the UE Radio Capability for Paging to the MME in the UE CAPABILITY INFO INDICATION message separately from the UE Radio Capability. The MME includes the UE Radio Capability for Paging in the paging request to the eNB. The eNB may use the UE Radio Capability for Paging to determine how to page the UE.

For a NB-IoT UE that supports S1-U data transfer or User Plane CIoT EPS optimizations, as defined in TS 24.301 [20], the procedure in Figure 18-1 is applicable except that RAT-Types and handover are not supported.

If a request to retrieve the UE Radio Capability is included in the DOWNLINK NAS TRANSPORT message, the eNB may request the UE Radio Capability from the UE and provide it to the MME in the UE CAPABILITY INFO INDICATION message. The detailed procedure is defined in TS 36.413 [25].

For a UE that supports Control Plane CIoT EPS optimization, as defined in TS 24.301 [20], the MME may initiate Connection Establishment Indication procedure to provide UE Radio Capability to the eNB after receiving INITIAL UE MESSAGE message. If the UE Radio Capability is not included in the procedure, this may trigger the eNB to request the UE Radio Capability from the UE and to provide it to the MME in the UE CAPABILITY INFO INDICATION message. The detailed procedure is defined in TS 36.413 [25].

In NB-IoT, for a UE that supports Control Plane CIoT EPS optimizations, as defined in TS 24.301 [20], the eNB, based on configuration, may retrieve the UE Radio capability from the MME upon reception of RRC Connection Request as defined in TS 23.401 [17], clauses 5.3.4B.2 and 5.3.4B.3.

19 S1 Interface

19.1 S1 User plane

The S1 user plane interface (S1-U) is defined between the eNB and the S-GW. The S1-U interface provides non guaranteed delivery of user plane PDUs between the eNB and the S-GW. The user plane protocol stack on the S1 interface is shown in Figure 19.1-1. The transport network layer is built on IP transport and GTP-U is used on top of UDP/IP to carry the user plane PDUs between the eNB and the S-GW.

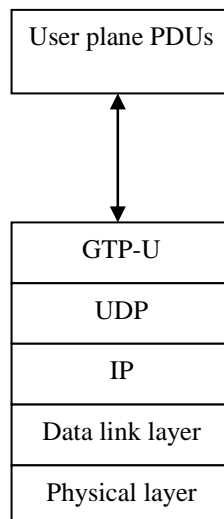

Figure 19.1-1: S1 Interface User Plane (eNB - S-GW)

19.2 S1 Control Plane

19.2.0 General

The S1 control plane interface (S1-MME) is defined between the eNB and the MME. The control plane protocol stack of the S1 interface is shown on Figure 19.2-1. The transport network layer is built on IP transport, similarly to the user plane but for the reliable transport of signalling messages SCTP is added on top of IP. The application layer signalling protocol is referred to as S1-AP (S1 Application Protocol).

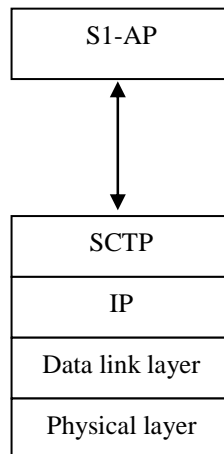

Figure 19.2-1: S1 Interface Control Plane (eNB-MME)

The SCTP layer provides the guaranteed delivery of application layer messages.

In the transport IP layer point-to-point transmission is used to deliver the signalling PDUs.

A single SCTP association per S1-MME interface instance shall be used with one pair of stream identifiers for S1-MME common procedures. Only a few pairs of stream identifiers should be used for S1-MME dedicated procedures. MME communication context identifiers that are assigned by the MME for S1-MME dedicated procedures and eNB communication context identifiers that are assigned by the eNB for S1-MME dedicated procedures shall be used to distinguish UE specific S1-MME signalling transport bearers. The communication context identifiers are conveyed in the respective S1-AP messages.

If the S1 signalling transport layer notifies the S1AP layer that the signalling connection broke:

- the MME

- either locally changes the state of the UEs which used this signalling connection to the ECM-IDLE state as described in TS 23.401 [17] and removes suspended UE Context data for UEs in ECM-IDLE which have used the S1 signalling connection before it was broken; or
- keep those UEs in ECM_CONNECTED and keep the suspended UE Context data for UEs in ECM-IDLE which have used the S1 signalling connection before it was broken;
- the eNB
 - either releases the RRC connection with those UEs and removes suspended UE Context data for UEs in RRC_IDLE which have used the S1 signalling connection before it was broken; or
 - keep those UEs in RRC_CONNECTED and keep the suspended UE Context data for UEs in ECM-IDLE which have used the S1 signalling connection before it was broken.

If the S1 signalling transport layer notifies the S1AP layer that the signalling connection is operational again and the eNB and the MME have decided to keep UEs in ECM-CONNECTED and RRC_CONNECTED respectively and keep the suspended UE Context data for UEs in ECM-IDLE while the signalling connection was broken, handling of the UE-related contexts and related signalling connections during the S1 Setup procedure that attempts to re-establish the broken signalling connection is described in clause 19.2.2.8.

RNs terminate S1-AP. In this case, there is one S1 interface relation between the RN and the DeNB, and one S1 interface relation between the DeNB and each of the MMEs in the MME pool. The S1 interface relation between the RN and the DeNB carries non-UE-associated S1-AP signalling between RN and DeNB and UE-associated S1-AP signalling for UEs connected to the RN. The S1 interface relation between the DeNB and an MME carries non-UE-associated S1-AP signalling between DeNB and MME and UE-associated S1-AP signalling for UEs connected to the RN and for UEs connected to the DeNB.

19.2.1 S1 Interface Functions

19.2.1.0 General

The S1 interface provides the following functions:

- E-RAB Service Management function:
 - Setup, Modify, Release.
- Mobility Functions for UEs in ECM-CONNECTED:
 - Intra-LTE Handover;
 - Inter-3GPP-RAT Handover.
- S1 Paging function;
- NAS Signalling Transport function;
- LPPa Signalling Transport function;
- S1-interface management functions:
 - Error indication;
 - Reset.
- Network Sharing Function;
- Roaming and Access Restriction Support function;
- NAS Node Selection Function;
- Initial Context Setup Function;
- UE Context Modification Function;

- UE Context Resume Function;
- MME Load balancing Function;
- Location Reporting Function;
- PWS (which includes ETWS and CMAS) Message Transmission Function;
- Overload function;
- RAN Information Management Function;
- Configuration Transfer Function;
- S1 CDMA2000 Tunnelling function;
- Trace function;
- UE Radio Capability Match;
- Retrieve UE Information Function;
- UE Information Transfer Function;
- Report of Secondary RAT data volumes Function.

19.2.1.1 S1 Paging function

The paging function supports the sending of paging requests to all cells of the TA(s) the UE is registered.

Paging requests are sent to the relevant eNBs according to the mobility information kept in the UE's MM context in the serving MME.

19.2.1.2 S1 UE Context Management function

In order to support UEs in ECM-CONNECTED, UE contexts need to be managed, i.e. established and released in the eNodeB and in the EPC to support user individual signalling on S1.

19.2.1.3 Initial Context Setup Function

The Initial Context Setup function supports the establishment of the necessary overall initial UE Context including E-RAB context, Security context, roaming and access restrictions, UE capability information, Subscriber Profile ID for RAT/Frequency Priority, UE S1 signalling connection ID, etc. in the eNB to enable fast Idle-to-Active transition.

In addition to the setup of overall initial UE Contexts, Initial Context Setup function also supports the piggy-backing of the corresponding NAS messages. Initial Context Setup is initiated by the MME.

19.2.1.3a UE Context Modification Function

The UE Context Modification function supports the modification of UE Context in eNB for UEs in active state.

19.2.1.3b UE Context Resume Function

The UE Context Resume function supports the suspension and resumption of an established UE Context and allows keeping the UE Context in eNB for UEs that were sent to RRC_IDLE and may resume the RRC connection without the necessity to re-establish the UE Context in the eNB.

19.2.1.4 Mobility Functions for UEs in ECM-CONNECTED

19.2.1.4.1 Intra-LTE Handover

The Intra-LTE-Handover function supports mobility for UEs in ECM-CONNECTED and comprises the preparation, execution and completion of handover via the X2 and S1 interfaces.

19.2.1.4.2 Inter-3GPP-RAT Handover

The Inter-3GPP-RAT Handover function supports mobility to and from other 3GPP-RATs for UEs in ECM-CONNECTED and comprises the preparation, execution and completion of handover via the S1 interface.

19.2.1.5 E-RAB Service Management function

The E-RAB Service management function is responsible for establishing, modifying and releasing E-UTRAN resources for user data transport once a UE context is available in the eNB. The establishment and modification of E-UTRAN resources is triggered by the MME and requires respective QoS information to be provided to the eNB. The release of E-UTRAN resources is triggered by the MME either directly or following a request received from the eNB (optional).

For DC when SCG bearer option is applied, the modification of the E-RAB is triggered by the MeNB towards the MME for the modification of the transport information.

19.2.1.6 NAS Signalling Transport function

The NAS Signalling Transport function provides means to transport or reroute a NAS message (e.g. for NAS mobility management) for a specific UE on the S1 interface.

19.2.1.7 NAS Node Selection Function (NNSF)

The interconnection of eNBs or HeNB GW, if deployed, to multiple MME/Serving S-GWs is supported in the E-UTRAN/EPC architecture. Therefore a NAS node selection function is located in the eNB or the HeNB GW, if deployed, to determine the MME association of the UE, based on the UE's temporary identifier, which was assigned to the UE by the CN node (e.g. MME or SGSN).

NOTE: In case the UE's temporary identifier is assigned by the SGSN, respective mapping rules are defined in TS 23.003 [26].

Depending on the actual scenario the NNSF determines the UE's MME association either based its S-TMSI (e.g. at service request) or based on its GUMMEI and selected PLMN (e.g. at attach or tracking area update in non-registered TA).

The NNSF in the eNB or HeNB GW, if deployed, may differentiate between a GUMMEI mapped from P-TMSI/RAI and a native GUMMEI as described in TS 23.401 [17].

This functionality is located in the eNB or in the HeNB GW, if deployed, and enables proper routing via the S1 interface. On S1, no specific procedure corresponds to the NAS Node Selection Function.

eNB selects serving MME based on the DCN-ID provided by the UE and the configuration in eNB if a serving MME corresponding to the information provided by the UE (e.g. GUTI, etc.) cannot be found by eNB as described in TS 23.401[17].

19.2.1.8 S1-interface management functions

The S1-interface management functions provide

- means to ensure a defined start of S1-interface operation (reset);
- means to handle different versions of application part implementations and protocol errors (error indication).

19.2.1.9 MME Load balancing Function

MME Load balancing is the function which achieves load-balanced MMEs with respect to their processing capacity within a pool area during system operation. The means to load-balance MMEs is to distribute UEs newly entering the pool to different MMEs in the MME pool. In addition the MME load balancing function is able to achieve equally loaded MMEs within a pool area after the introduction of a new MME and after the removal of a MME from the network.

The support of the MME load balancing function is achieved by indicating the relative MME capacity in the S1 Setup procedure to all eNBs served by the MMEs of the pool area per MME. In order to support the introduction and/or removal of MMEs the MME initiated S1 setup update procedure may be used by the operator indicating relative MME

capacity value changes. When there are more than one MME operational in the pool, the indicated relative MME capacity steers the UE assignment for UEs newly entering the MME pool. When there is only one MME operational in the pool, UEs may be assigned to this MME.

The MME Load balancing Function is described in detail in TS 23.401 [17].

When DCN are used, the MME Load Balancing function is only performed between MMEs that belong to the same DCN. The MME Load Balancing for DCN is described in TS 23.401 [17].

19.2.1.10 Location Reporting Function

The Location Reporting function supports the MME requests to the eNB to report the location information of the UE.

19.2.1.11 Warning Message Transmission function

The warning message transmission function provides means to transfer warning message via S1 interface.

19.2.1.12 Overload Function

The overload function comprises the signalling means:

- to indicate to a proportion of eNBs that the serving MME is overloaded;
- to indicate to the eNBs that the serving MME is back in the "normal operation mode".

19.2.1.13 RAN Information Management Function

The RAN Information Management (RIM) function is a generic mechanism that allows the request and transfer of information (e.g. GERAN System information) between two RAN nodes via the core network.

19.2.1.14 S1 CDMA2000 Tunnelling function

The S1 CDMA2000 Tunnelling function transports CDMA2000 signalling between UE and CDMA2000 RAT over the S1 Interface for mobility from E-UTRAN to CDMA2000 HRPD and CDMA2000 1xRTT and for circuit switched fallback to CDMA2000 1xRTT.

19.2.1.15 Configuration Transfer Function

The Configuration Transfer function is a generic mechanism that allows the request and transfer of RAN configuration information (e.g. SON information) between two RAN nodes via the core network.

19.2.1.16 LPPa Signalling Transport function

The LPPa Signalling Transport function provides means to transport an LPPa message on the S1 interface.

19.2.1.17 Trace Function

The Trace function provides means to control trace sessions in the eNB. The Trace function also provides means to control MDT sessions as described in TS 32.422 [30] and TS 37.320 [43] or Application Layer Measurement Collection, as described in clause 23.16.

19.2.1.18 UE Radio Capability Match

The UE Radio Capability Match function enables the eNB to provide an indication to the MME whether the UE radio capabilities are compatible with the network configuration for voice continuity.

19.2.1.19 Retrieve UE Information Function

The Retrieve UE Information Function enables the eNB to retrieve the UE information from MME.

19.2.1.20 UE Information Transfer Function

The UE Information Transfer Function enables the MME to send the UE information to the eNB.

19.2.1.21 Report of Secondary RAT data volumes Function

The Report of Secondary RAT data volumes Function enables the eNB to report Secondary RAT usage data information in case of EN-DC, either with a dedicated procedure or by including Secondary RAT usage data information in other messages.

19.2.2 S1 Interface Signalling Procedures

The elementary procedures supported by the S1AP protocol are listed in Table 1 and Table 2 of TS 36.413 [25].

19.2.2.0 General

19.2.2.1 Paging procedure

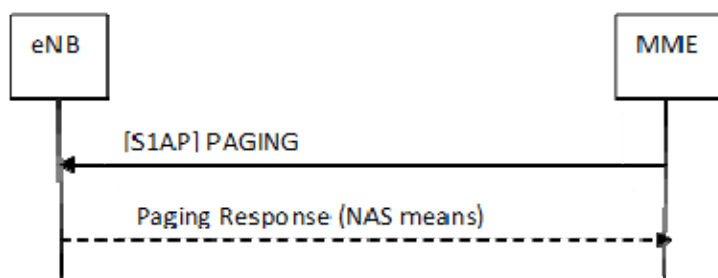

Figure 19.2.2.1-1: Paging procedure

The MME initiates the paging procedure by sending the PAGING message to each eNB with cells belonging to the tracking area(s) in which the UE is registered. Each eNB can contain cells belonging to different tracking areas, whereas each cell can only belong to one TA. In case MME initiates the paging procedure with eDRX configuration it shall include the S-TMSI in the PAGING message.

The paging response back to the MME is initiated on NAS layer and is sent by the eNB based on NAS-level routing information.

19.2.2.2 S1 UE Context Release procedure

19.2.2.2.0 General

The S1 UE Context Release procedure causes the eNB to remove all UE individual signalling resources and the related user data transport resources. This procedure is initiated by the EPC and may be triggered on request of the serving eNB.

19.2.2.2.1 S1 UE Context Release (EPC triggered)

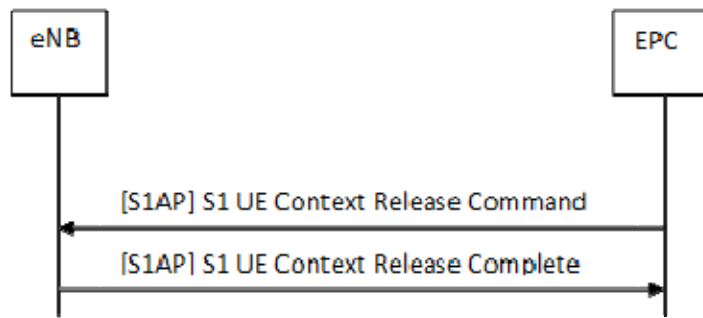

Figure 19.2.2.2.1-1: S1 UE Context Release procedure (EPC triggered)

- The EPC initiates the UE Context Release procedure by sending the S1 UE Context Release Command towards the E-UTRAN. The eNodeB releases all related signalling and user data transport resources.
- The eNB confirms the S1 UE Context Release activity with the S1 UE Context Release Complete message. The behaviour of the eNodeB in case of Control Plane CIoT EPS Optimization is specified in TS 23.401 [11].
- In the course of this procedure the EPC releases all related resources as well, except context resources in the EPC for mobility management and the default EPS Bearer/E-RAB configuration.

19.2.2.2.2 S1 UE Context Release Request (eNB triggered)

The S1 UE Context Release Request procedure is initiated for E-UTRAN internal reasons and comprises the following steps:

- The eNB sends the S1 UE Context Release Request message to the EPC.
- The EPC triggers the EPC initiated UE context release procedure.



Figure 19.2.2.2.2-1: S1 UE Context Release Request procedure (eNB triggered) and subsequent S1 UE Context Release procedure (EPC triggered)

If the E-UTRAN internal reason is a radio link failure detected in the eNB, the eNB shall wait a sufficient time before triggering the S1 UE Context Release Request procedure in order to allow the UE to perform the NAS recovery procedure, see TS 23.401 [17].

19.2.2.3 Initial Context Setup procedure

The Initial Context Setup procedure establishes the necessary overall initial UE context in the eNB in case of an Idle-to-Active transition. The Initial Context Setup procedure is initiated by the MME.

The Initial Context Setup procedure comprises the following steps:

- The MME initiates the Initial Context Setup procedure by sending INITIAL CONTEXT SETUP REQUEST to the eNB. This message may include general UE Context (e.g. security context, roaming and access restrictions, UE capability information, UE S1 signalling connection ID, CN assistance information, etc.), E-RAB context (Serving GW TEID, QoS information, Correlation id i.e. collocated L-GW TEID or GRE key in case of LIPA support or in case of SIPTO@LN with collocated L-GW support), and may be piggy-backed with the corresponding NAS messages. When there are multiple NAS messages in the INITIAL CONTEXT SETUP REQUEST message, the MME shall ensure that the NAS messages in the E-RAB to be Setup List are aligned in the order of reception from the NAS layer to ensure the in-sequence delivery of the NAS messages.
- Upon receipt of INITIAL CONTEXT SETUP REQUEST, the eNB setup the context of the associated UE, and perform the necessary RRC signalling towards the UE, e.g. Radio Bearer Setup procedure. When there are multiple NAS messages to be sent in the RRC message, the order of the NAS messages in the RRC message shall be kept the same as that in the INITIAL CONTEXT SETUP REQUEST message. If present, the eNB uses the CN assistance information as defined in TS 23.401[17] and propagates it during inter-eNB mobility.
- The eNB responds with INITIAL CONTEXT SETUP RESPONSE to inform a successful operation, and with INITIAL CONTEXT SETUP FAILURE to inform an unsuccessful operation.

NOTE: In case of failure, eNB and MME behaviours are not mandated. Both implicit release (local release at each node) and explicit release (MME-initiated UE Context Release procedure) may in principle be adopted. The eNB should ensure that no hanging resources remain at the eNB.

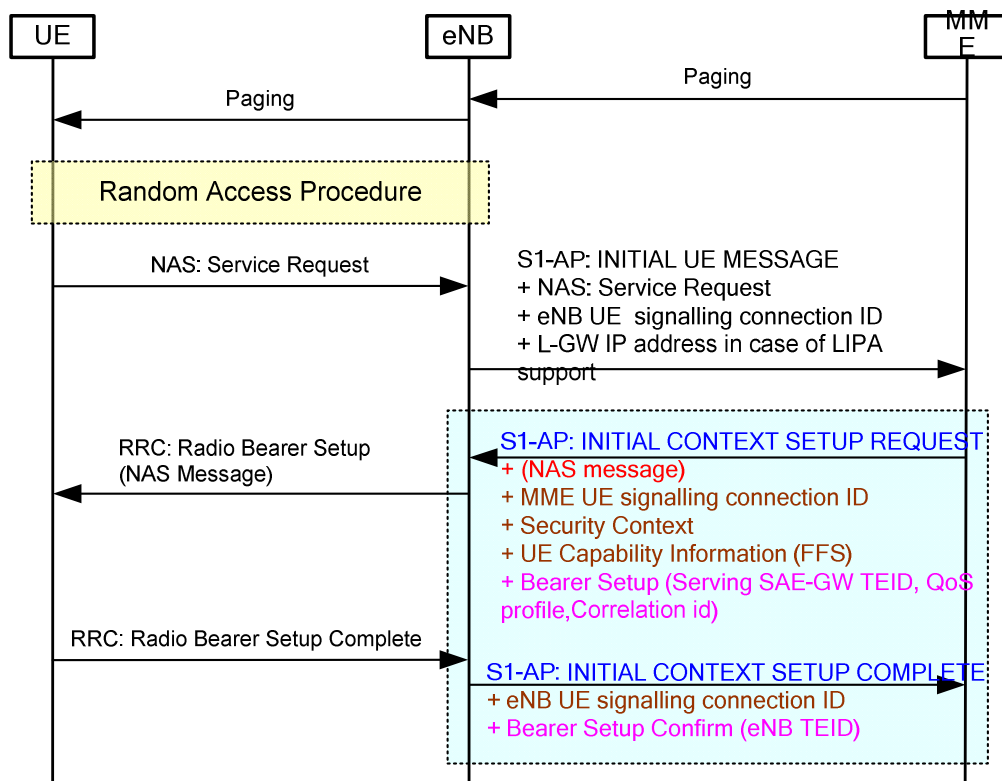

Figure 19.2.2.3-1: Initial Context Setup procedure (highlighted in blue) in Idle-to-Active procedure

19.2.2.3a UE Context Modification procedure

The UE Context Modification procedure enables the MME to modify the UE context in the eNB for UEs in active state. The UE Context Modification procedure is initiated by the MME.

The UE Context Modification procedure comprises the following steps:

- The MME initiates the UE Context Modification procedure by sending UE CONTEXT MODIFICATION REQUEST to the eNB to modify the UE context in the eNB for UEs in active state.

- The eNB responds with UE CONTEXT MODIFICATION RESPONSE in case of a successful operation
- If the UE is served by a CSG cell, and is no longer a member of the CSG cell, the eNB may initiate a handover to another cell. If the UE is not handed over, the eNB should request the release of UE context;
- If the UE is served by a hybrid cell, and is no longer a CSG member of the hybrid cell, the eNB may provide the QoS for the UE as a non CSG member.
- The eNB responds with UE CONTEXT MODIFICATION FAILURE in case of an unsuccessful operation.

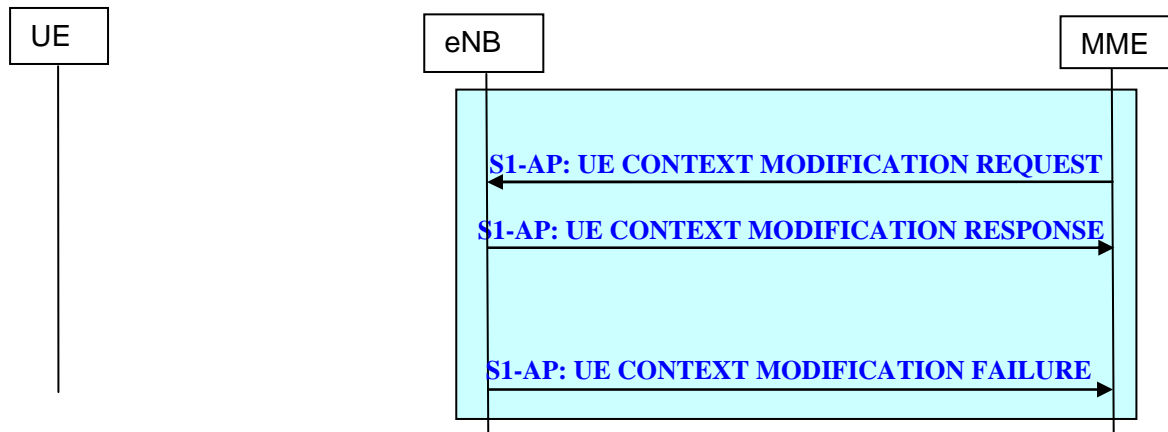

Figure 19.2.2.3a-1: UE Context Modification procedure

19.2.2.4 E-RAB signalling procedures

19.2.2.4.1 E-RAB Setup procedure

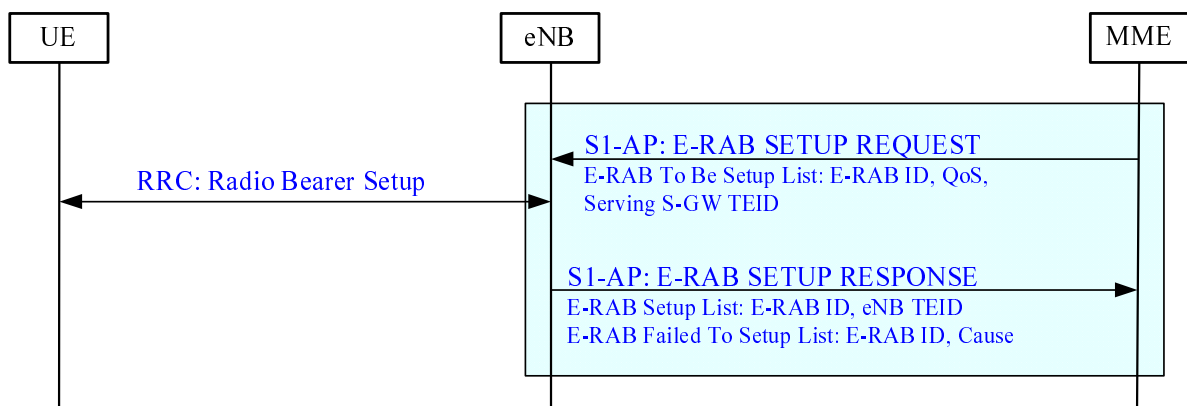

Figure 19.2.2.4.1-1: E-RAB Setup procedure

The E-RAB Setup procedure is initiated by the MME to support:

- Assignment of resources to a dedicated E-RAB.
- Assignment of resources for a default E-RAB.
- Setup of S1 Bearer (on S1) and Data Radio Bearer (on Uu).

The E-RAB Setup procedure comprises the following steps:

- The E-RAB SETUP REQUEST message is sent by the MME to the eNB to setup resources on S1 and Uu for one or several E-RAB(s). The E-RAB SETUP REQUEST message contains the Serving GW TEID, QoS

indicator(s) and the corresponding NAS message per E-RAB within the E-RAB To Be Setup List. It may also include the Correlation id i.e. collocated L-GW TEID or GRE key in case of LIPA support or in case of SIPTO@LN with collocated L-GW support. When there are multiple NAS messages in the E-RAB SETUP REQUEST message, the MME shall ensure that the NAS messages in the E-RAB to be Setup List are aligned in the order of reception from the NAS layer to ensure the in-sequence delivery of the NAS messages.

- Upon receipt of the E-RAB SETUP REQUEST message the eNB establishes the Data Radio Bearer(s) (RRC: Radio Bearer Setup) and resources for S1 Bearers. When there are multiple NAS messages to be sent in the RRC message, the order of the NAS messages in the RRC message shall be kept the same as that in the E-RAB SETUP REQUEST message.
- The eNB responds with a E-RAB SETUP RESPONSE messages to inform whether the setup of resources and establishment of each E-RAB was successful or unsuccessful, with the E-RAB Setup list (E-RAB ID, eNB TEID) and the E-RAB Failed to Setup list (E-RAB ID, Cause) The eNB also creates the binding between the S1 bearer(s) (DL/UL TEID) and the Data Radio Bearer(s).

Interactions with UE Context Release Request procedure:

In case of no response from the UE the eNB shall trigger the S1 UE Context Release Request procedure.

19.2.2.4.2 E-RAB Modification procedure

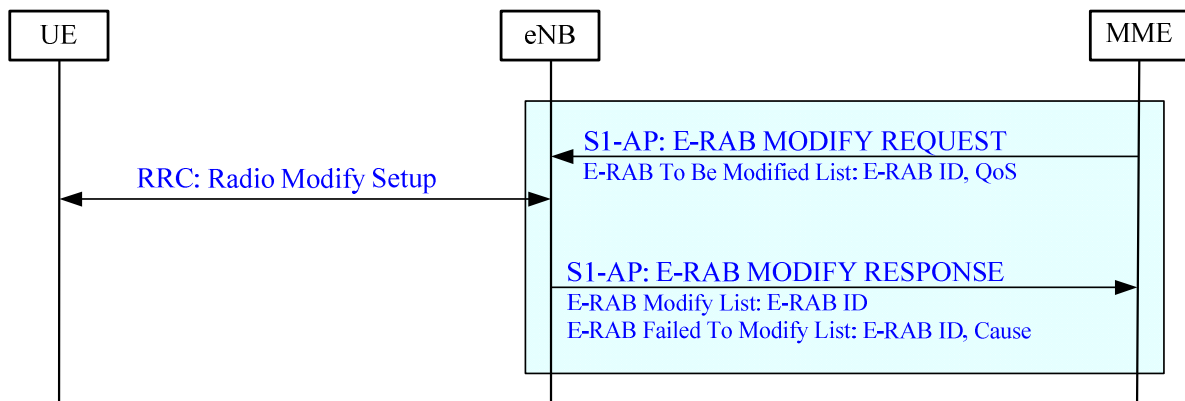

Figure 19.2.2.4.2-1: E-RAB Modification procedure

The E-RAB Modification procedure is initiated by the MME to support the modification of already established E-RAB configurations:

- Modify of S1 Bearer (on S1) and Radio Bearer (on Uu).
- S-GW relocation without UE mobility.

The EPS Bearer Modification procedure comprises the following steps:

- The E-RAB MODIFY REQUEST message is sent by the MME to the eNB to modify one or several E-RAB(s). The E-RAB MODIFY REQUEST message contains the QoS indicator(s), and the corresponding NAS message per E-RAB in the E-RAB To Be Modified List. When there are multiple NAS messages in the E-RAB MODIFY REQUEST message, the MME shall ensure that the NAS messages in the E-RAB to be Modified List are aligned in the order of reception from the NAS layer to ensure the in-sequence delivery of the NAS messages. The transport information for the new S-GW may be included in case of S-GW relocation without UE mobility.
- Upon receipt of the E-RAB MODIFY REQUEST message the eNB modifies the Data Radio Bearer configuration (RRC procedure to modify the Data Radio bearer). When there are multiple NAS messages to be sent in the RRC message, the order of the NAS messages in the RRC message shall be kept the same as that in the E-RAB MODIFY REQUEST message. In case of S-GW relocation without UE mobility, if transport

information for the new S-GW is included, the eNB ignores the included QoS indicator and NAS message and uses the included transport information for S-GW selection.

- The eNB responds with an E-RAB MODIFY RESPONSE message to inform whether the E-RAB modification has succeeded or not indicating with the E-RAB Modify list and E-RAB Failed to Modify list. With E-RAB ID(s) in the E-RAB Modify List or E-RAB Failed to Modify List the eNB identifies the E-RAB(s) successfully modified or failed to modify.

Interactions with UE Context Release Request procedure:

In case of no response from the UE the eNB shall trigger the S1 UE Context Release Request procedure.

19.2.2.4.3 E-RAB Release procedure

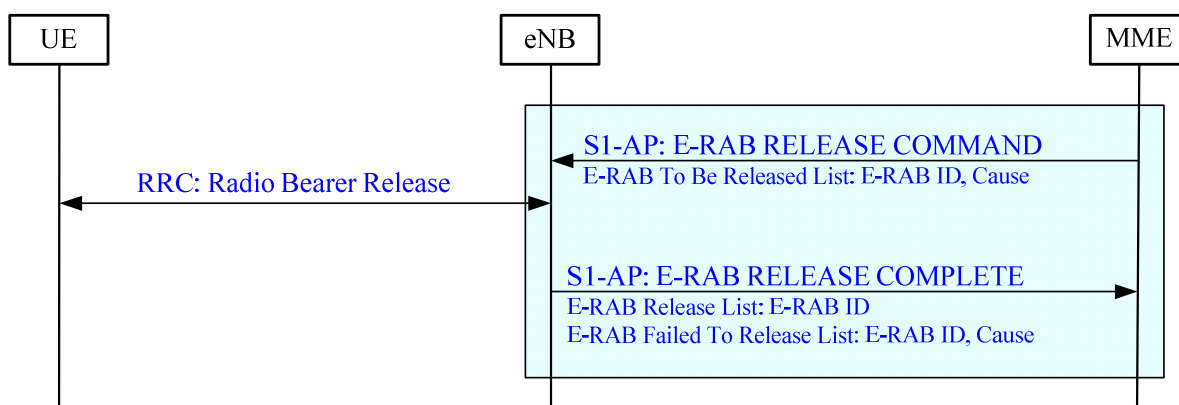

Figure 19.2.2.4.3-1: E-RAB Release procedure

The E-RAB Release procedure is initiated by the MME to release resources for the indicated E-RABs.

The E-RAB Release procedure comprises the following steps:

- The E-RAB RELEASE COMMAND message is sent by the MME to the eNB to release resources on S1 and Uu for one or several E-RAB(s). With the E-RAB ID(s) in the E-RAB To Be Released List contained in E-RAB RELEASE COMMAND message the MME identifies, the E-RAB(s) to be released.
- Upon receipt of the E-RAB RELEASE COMMAND message the eNB releases the Data Radio Bearers (RRC: Radio bearer release) and S1 Bearers.
- The eNB responds with an E-RAB RELEASE COMPLETE message containing E-RAB Release list and E-RAB Failed to Release list. With the E-RAB IDs in the E-RAB Release List/E-RAB Failed to Release List the eNB identifies the E-RAB(s) successfully released or failed to release.

Interactions with UE Context Release Request procedure:

In case of no response or negative response from the UE or in case the eNB cannot successfully perform the release of any of the requested bearers, the eNB shall trigger the S1 UE Context Release Request procedure, except if the eNB has already initiated the procedures associated with X2 Handover.

19.2.2.4.4 E-RAB Release Indication procedure

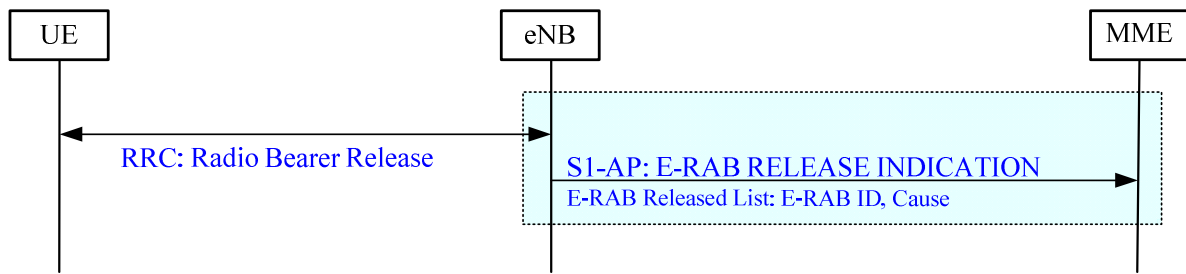

Figure 19.2.2.4.4-1: E-RAB Release Indication procedure

The E-RAB Release Indication procedure enables the E-UTRAN to send information about released resources for one or several E-RABs to the MME. The eNB initiates the procedure by sending the E-RAB RELEASE INDICATION message to the MME. The E-RAB ID(s) in the E-RAB Released List identifies the released E-RAB(s) in the eNB.

19.2.2.4.5 E-RAB Modification Indication procedure

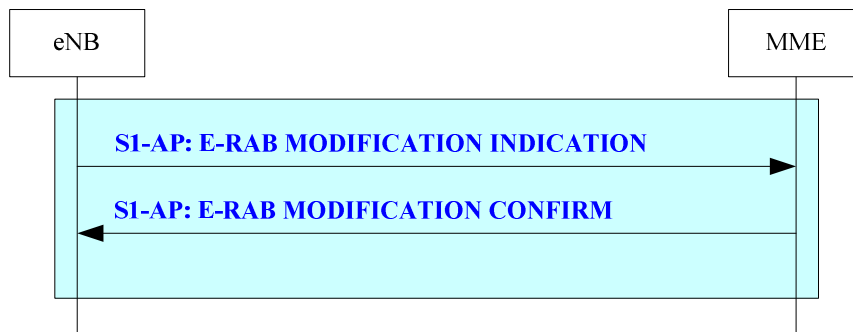

Figure 19.2.2.4.5-1: E-RAB Modification Indication procedure

The E-RAB Modification Indication procedure is initiated by the eNB to support the modification of already established E-RAB configurations and CSG membership verification. The current version of the specification supports the modification of the transport information and CSG membership verification. This procedure is used for DC if the SCG bearer option is applied.

If the EPC is able to apply the requested modification, the MME responds with the E-RAB MODIFICATION CONFIRM.

If the EPC is not able to modify a transport path as requested, the MME responds with the list of E-RABs failed in the E-RAB MODIFICATION CONFIRM, the MeNB either keeps the previous transport path unchanged and, if applicable, triggers to release the corresponding SCG bearers, or tears down the corresponding E-RABs.

19.2.2.5 Handover signalling procedures

19.2.2.5.0 General

Handover signalling procedures support both, inter-eNB handover and inter-RAT handover.

Inter-RAT handovers shall be initiated via the S1 interface.

Inter-eNB handovers shall be initiated via the X2 interface except if any of the following conditions are true:

- the source eNB is not an RN and there is no X2 between source and target eNB.

- the source eNB is an RN and there is no X2 between DeNB and the target eNB or between the source RN and the DeNB.
- the source eNB is an RN and the UE's serving MME is not included in the MME Pool(s) connected with the target eNB.
- the source eNB has been configured to initiate handover to the particular target eNB via S1 interface in order to enable the change of an EPC node (MME and/or Serving GW).
- the source eNB has attempted to start the inter-eNB HO via X2 but receives a negative reply from the target eNB with a specific cause value.

Inter-eNB handovers shall be initiated via the S1 interface, if one of the above conditions applies.

19.2.2.5.1 Handover Preparation procedure

The Handover preparation procedure is initiated by the source eNB if it determines the necessity to initiate the handover via the S1 interface.

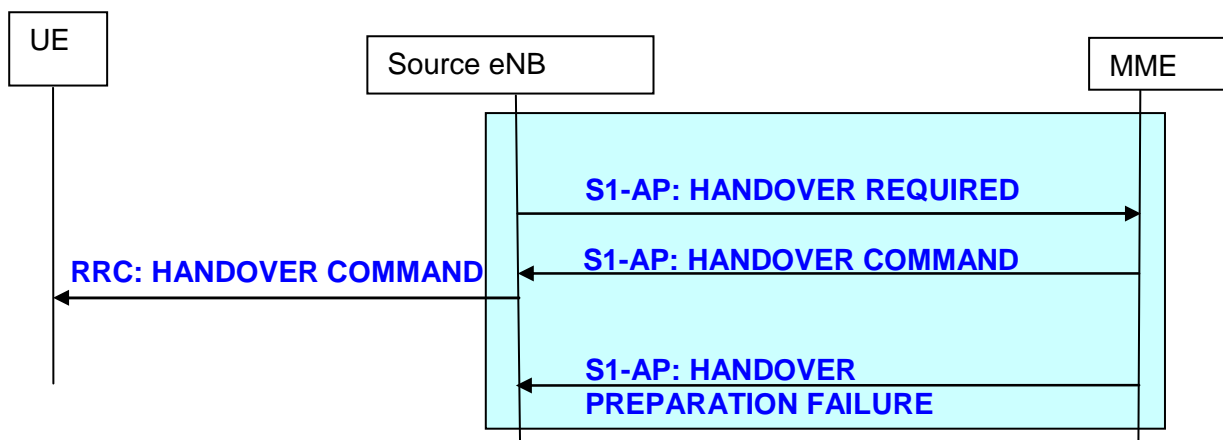

Figure 19.2.2.5.1-1: Handover preparation procedure

The handover preparation comprises the following steps:

- The HANDOVER REQUIRED message is sent to the MME.
- The source eNB shall ensure that the size of the Source to Target Transparent Container does not exceed the limits that can be handled by interfaces involved in the handover.

NOTE: For SRVCC handover, the size limit is 2560 octets (see AN-APDU in TS 29.002 [84]). For inter RAT PS domain handover, the size limit is 4092 octets (see TS 25.412 [85]).

- The handover preparation phase is finished upon the reception of the HANDOVER COMMAND message in the source eNB, which includes at least radio interface related information (HO Command for the UE), successfully established E-RAB(s) and E-RAB(s) which failed to setup.
- In case the handover resource allocation is not successful (e.g. no resources are available on the target side) the MME responds with the HANDOVER PREPARATION FAILURE message instead of the HANDOVER COMMAND message.

19.2.2.5.2 Handover Resource Allocation procedure

The handover resource allocation comprises the following steps:

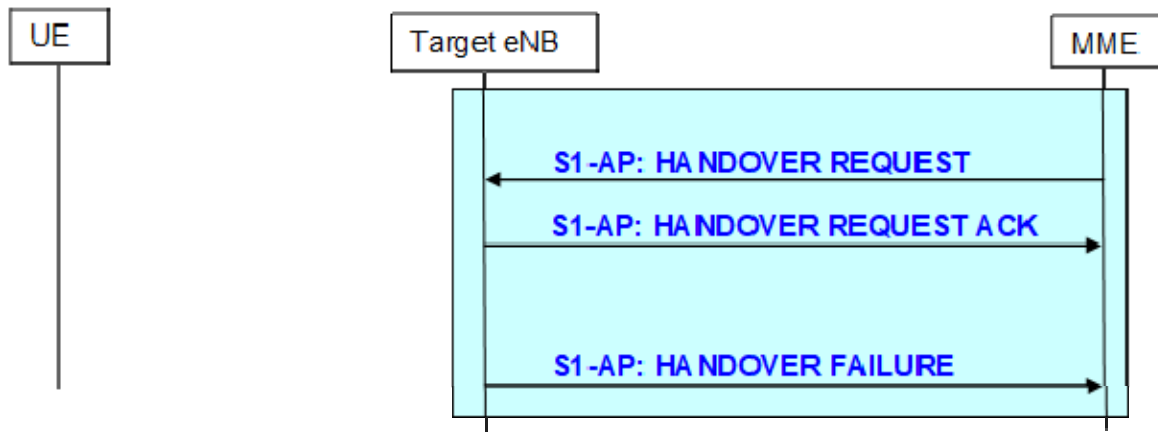

Figure 19.2.2.5.2-1: Handover resource allocation procedure

- The MME sends the HANOVER REQUEST message including the E-RAB(s) which needs to be setup by the target eNB.
- In the case of a UE performing handover toward an RN, the HANOVER REQUEST is received by the DeNB, which shall read the target cell ID from the message, find the target RN corresponding to the target cell ID, and forward the message toward the target RN.
- The target eNB responds with the HANOVER REQUEST ACK message after the required resources for all accepted E-RABs are allocated. The HANOVER REQUEST ACK message contains successfully established E-RAB(s), E-RAB(s) which failed to setup and radio interface related information (HO Command for the UE), which is later sent transparently via the EPC/CN from the target RAT to the source RAT.
- If no resources are available on the target side, the target eNB responds with the HANOVER FAILURE message instead of the HANOVER REQUEST ACK message.

19.2.2.5.3 Handover Notification procedure

The Handover Completion for S1 initiated handovers comprises the following steps:

- The HANOVER NOTIFY message is sent by the target eNB to the MME when the UE has successfully been transferred to the target cell. If the eNB supports SIPTO@LN with stand-alone gateway, the message shall include the LHN ID.

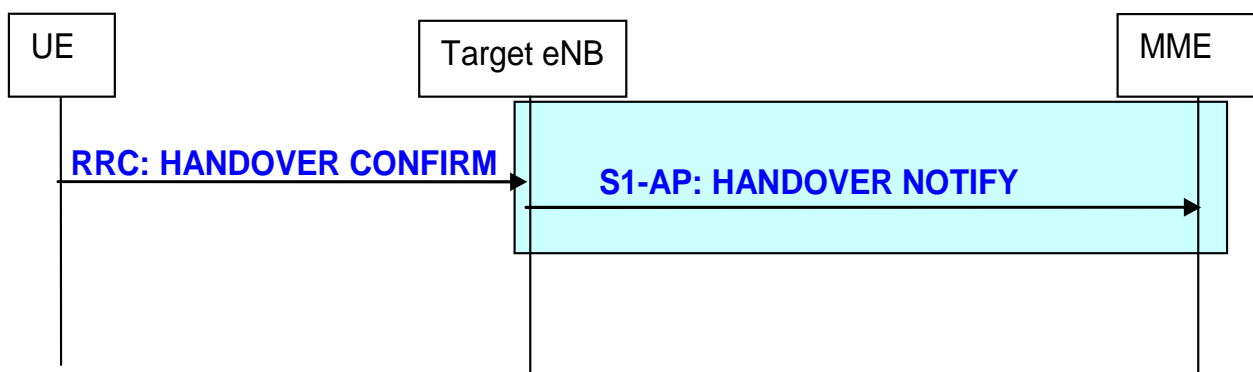

Figure 19.2.2.5.3-1: Handover completion procedure

19.2.2.5.4 Handover Cancellation

This functionality is located in the source eNB to allow a final decision regarding the outcome of the handover, i.e. either to proceed or to cancel the handover procedure.

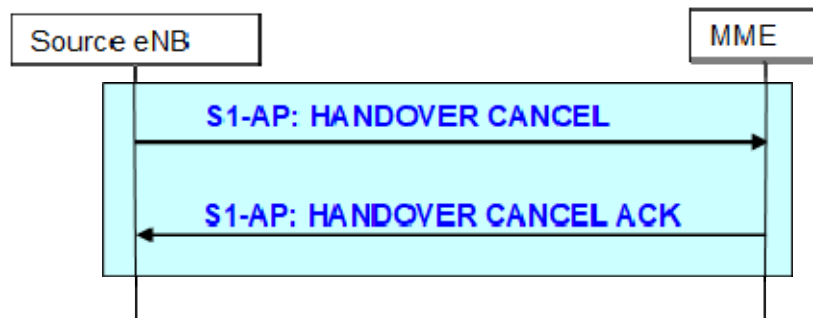

Figure 19.2.2.5.4-1: Handover cancellation procedure

- The source eNB sends a HANDOVER CANCEL message to the MME indicating the reason for the handover cancellation.
- The MME confirms the reception of the HANDOVER CANCEL message by returning the HANDOVER CANCEL ACK message.

19.2.2.5.5 Path Switch procedure

The handover completion phase for X2 initiated handovers comprises the following steps:

- The PATH SWITCH message is sent by the target eNB to the MME when the UE has successfully been transferred to the target cell. The PATH SWITCH message includes the outcome of the resource allocation: successfully established E-RAB(s). If the eNB supports SIPTO@LN with stand-alone gateway, the message shall include the LHN ID.
- The MME responds with the PATH SWITCH ACK message which is sent to the eNB.
- The MME responds with the PATH SWITCH FAILURE message in case a failure occurs in the EPC.

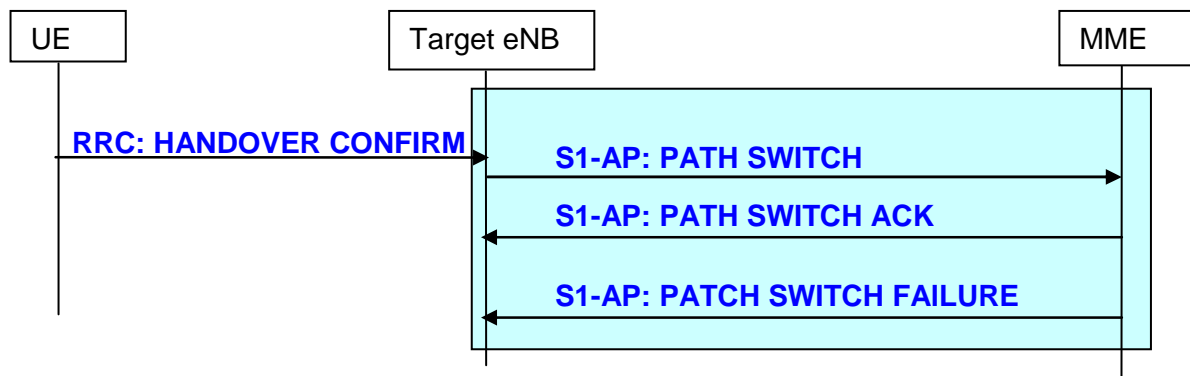

Figure 19.2.2.5.5-1: Path Switch procedure

19.2.2.5.6 Message sequence diagrams

This clause complements TR 25.922 [27] clause 5.1.7.2 regarding the E-UTRAN handling of containers.

Most RRC information is carried by means of containers across interfaces other than Uu. The following sequence diagrams illustrate which RRC information should be included within these containers used across the different network interfaces.

NOTE: In order to maintain independence between protocols, no requirements are included in the interface protocols that are used to transfer the RRC information.

SRVCC (see TS 23.216 [28]) is supported from EUTRAN to UTRAN or GERAN A/Gb mode and from UTRAN or GERAN A/Gb mode to EUTRAN.

There is no support for interworking between EUTRAN and GERAN Iu-mode and between EUTRAN and GAN.

Figure 19.2.2.5.6-1 and 19.2.2.5.6-1a illustrate the message sequence for handover from GERAN to EUTRAN procedure:

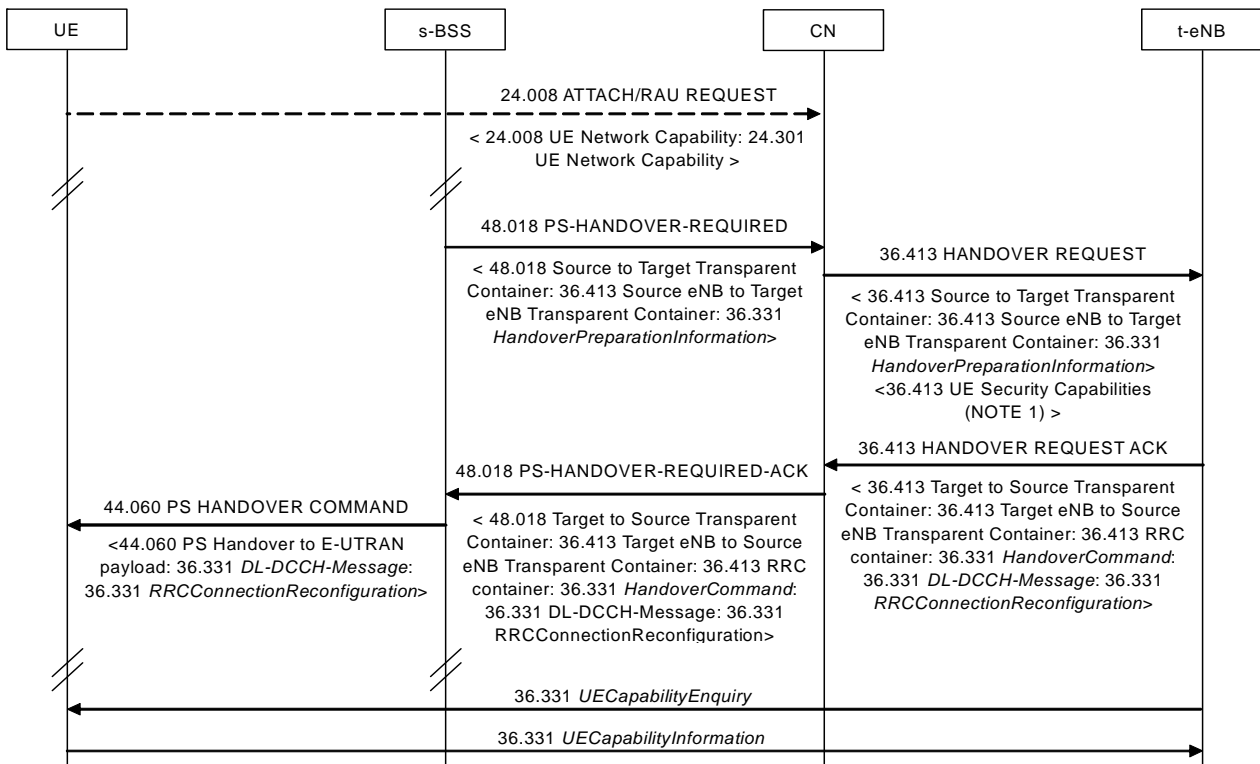

NOTE 1: The information included in this IE is derived from the information provided in the "UE Network Capability" IE during network attach / RAU

Figure 19.2.2.5.6-1. Handover of PS domain service from GERAN A/Gb mode to EUTRAN, normal flow

UE is not requested to provide E-UTRAN UE capabilities while in GERAN. Hence the HANDOVER REQUEST does not contain E-UTRAN UE capabilities, and the capabilities are fetched by Target eNB from UE after handover is completed.

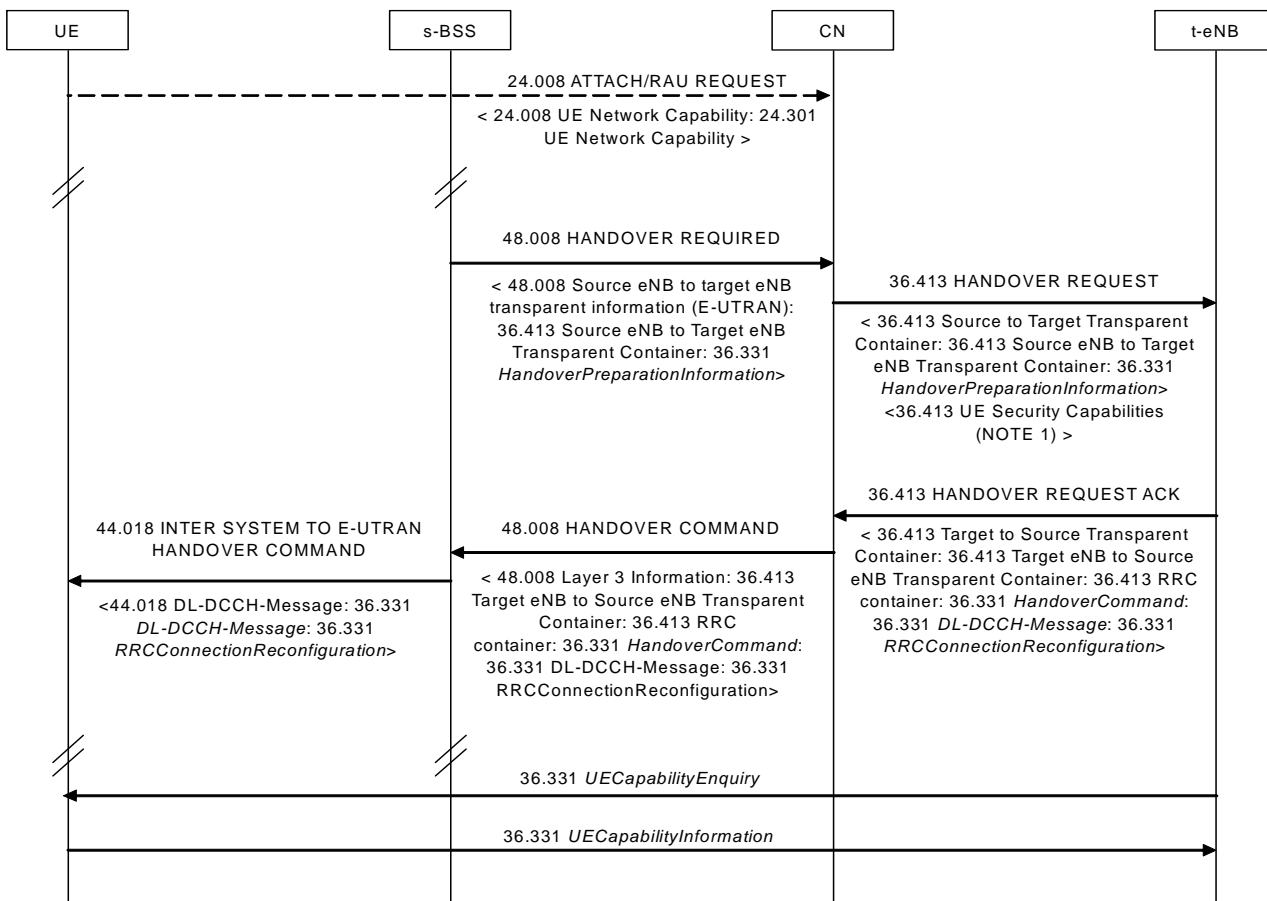

NOTE 1: The information included in this IE is derived from the information provided in the "UE Network Capability" IE during network attach / RAU

Figure 19.2.2.5.6-1a. Handover of CS domain service from GERAN A/Gb mode to PS-domain service in EUTRAN, normal flow

UE is not requested to provide E-UTRAN UE capabilities while in GERAN. Hence the HANDOVER REQUEST does not contain E-UTRAN UE capabilities, and the capabilities are fetched by Target eNB from UE after completed handover.

Figure 19.2.2.5.6-2 illustrates the message sequence for PS handover and CS handover from UTRAN to EUTRAN procedure:

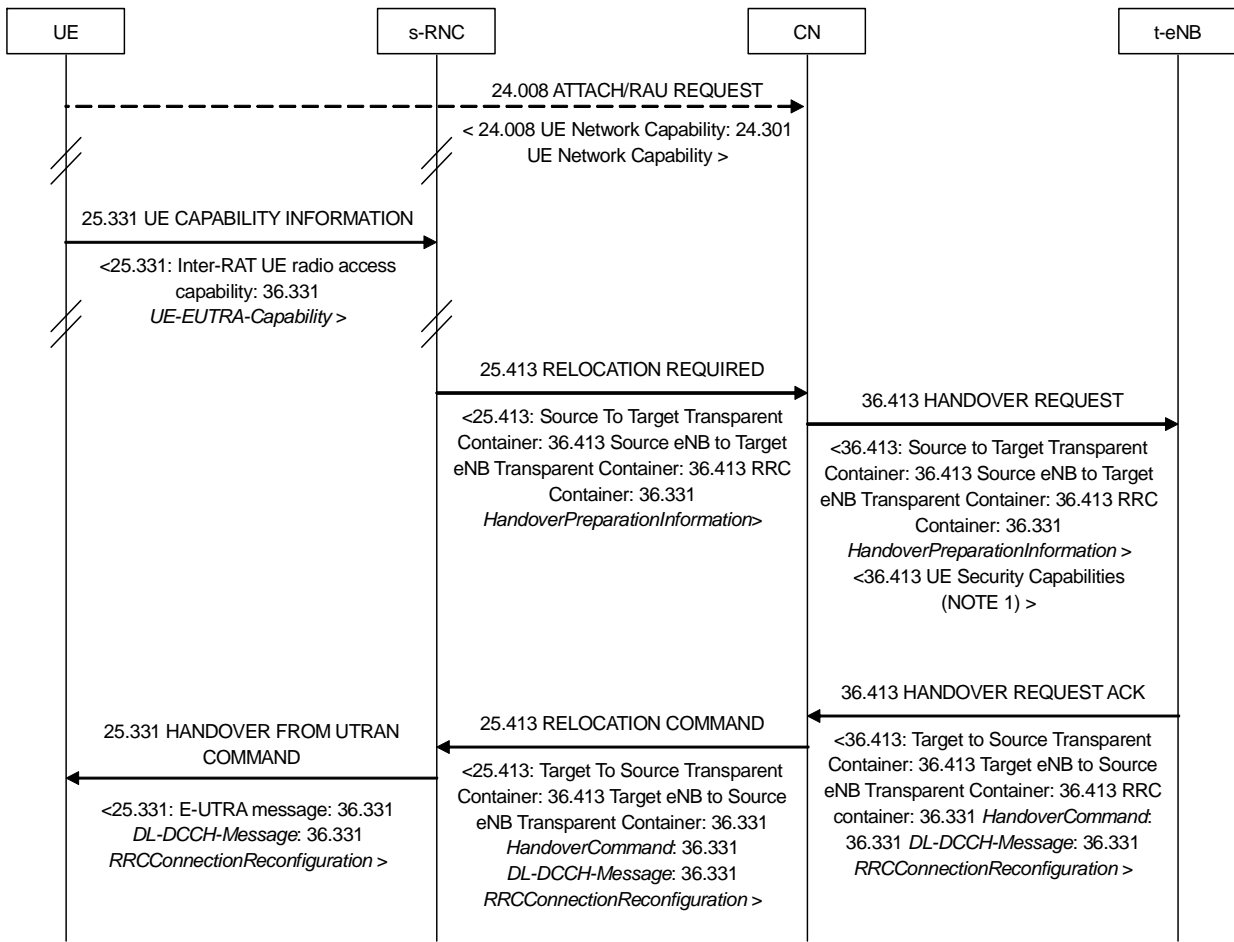

NOTE 1: The information included in this IE is derived from the information provided in the "UE Network Capability" IE during network attach / RAU

Figure 19.2.2.5.6-2: Handover of PS domain service and handover of CS domain service from UTRAN to EUTRAN, normal flow

Figure 19.2.2.5.6-3 to Figure 19.2.2.5.6-5 illustrate the message sequence for the handover from EUTRAN to GERAN A/Gb mode procedure:

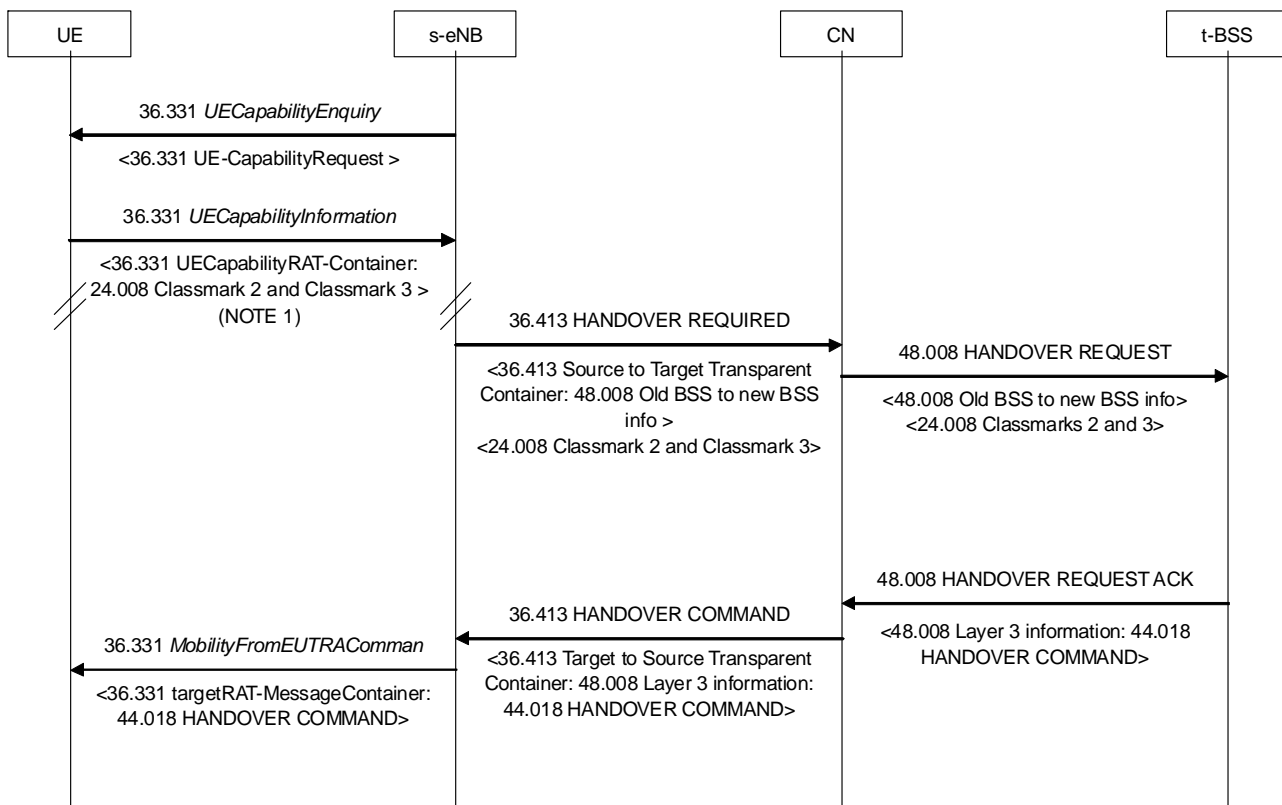

NOTE 1: the GERAN capabilities can be stored by the MME at an earlier opportunity, as shown in Figure 18-1, and transferred to the eNB at connection setup.

Figure 19.2.2.5.6-3: Handover of CS domain service from EUTRAN to GERAN A/Gb mode, normal flow

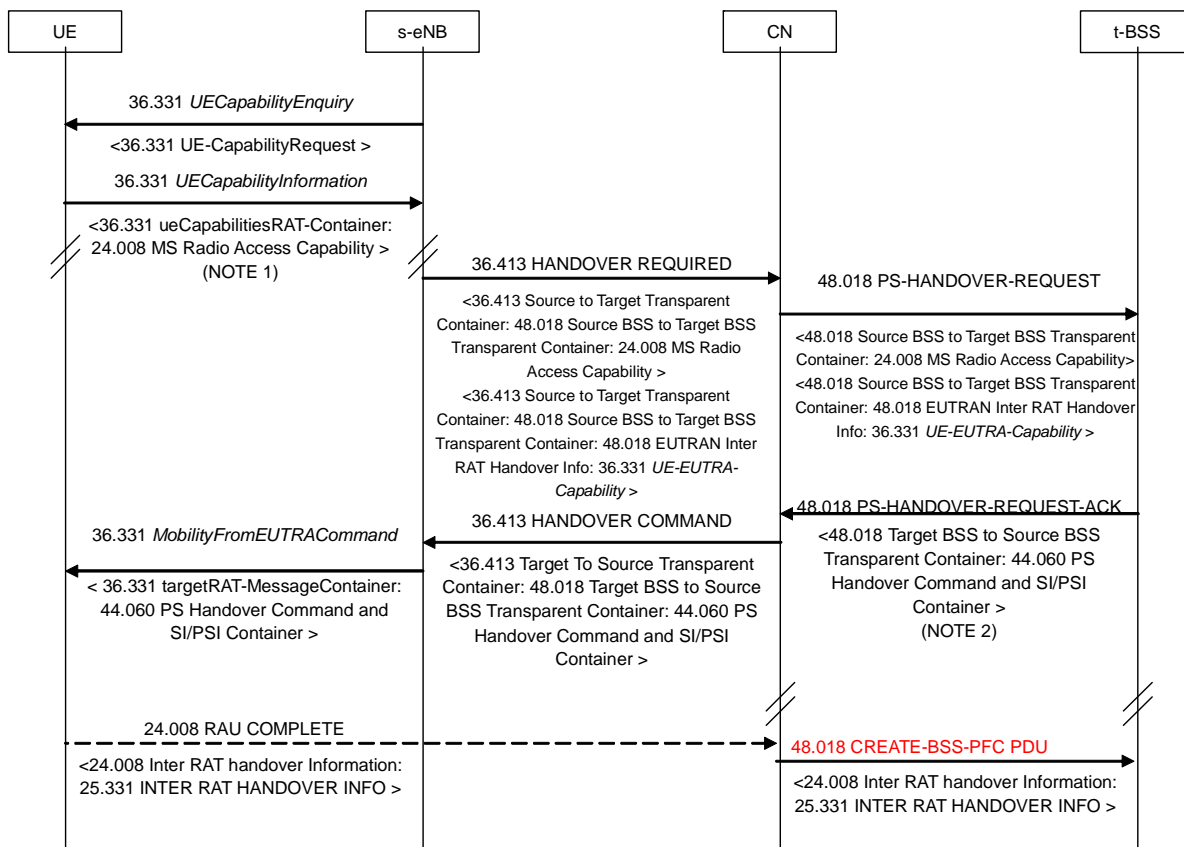

NOTE 1: the GERAN capabilities can be stored by the MME at an earlier opportunity, as shown in Figure 18-1, and transferred to the eNB at connection setup.

NOTE 2: the inclusion of GERAN SI/PSI is dependent on the PS Handover Indication in the Source BSS to Target BSS Transparent Container in the HANDOVER REQUIRED message.

Figure 19.2.2.5.6-4. Handover of PS domain service from EUTRAN to GERAN A/Gb mode, normal flow

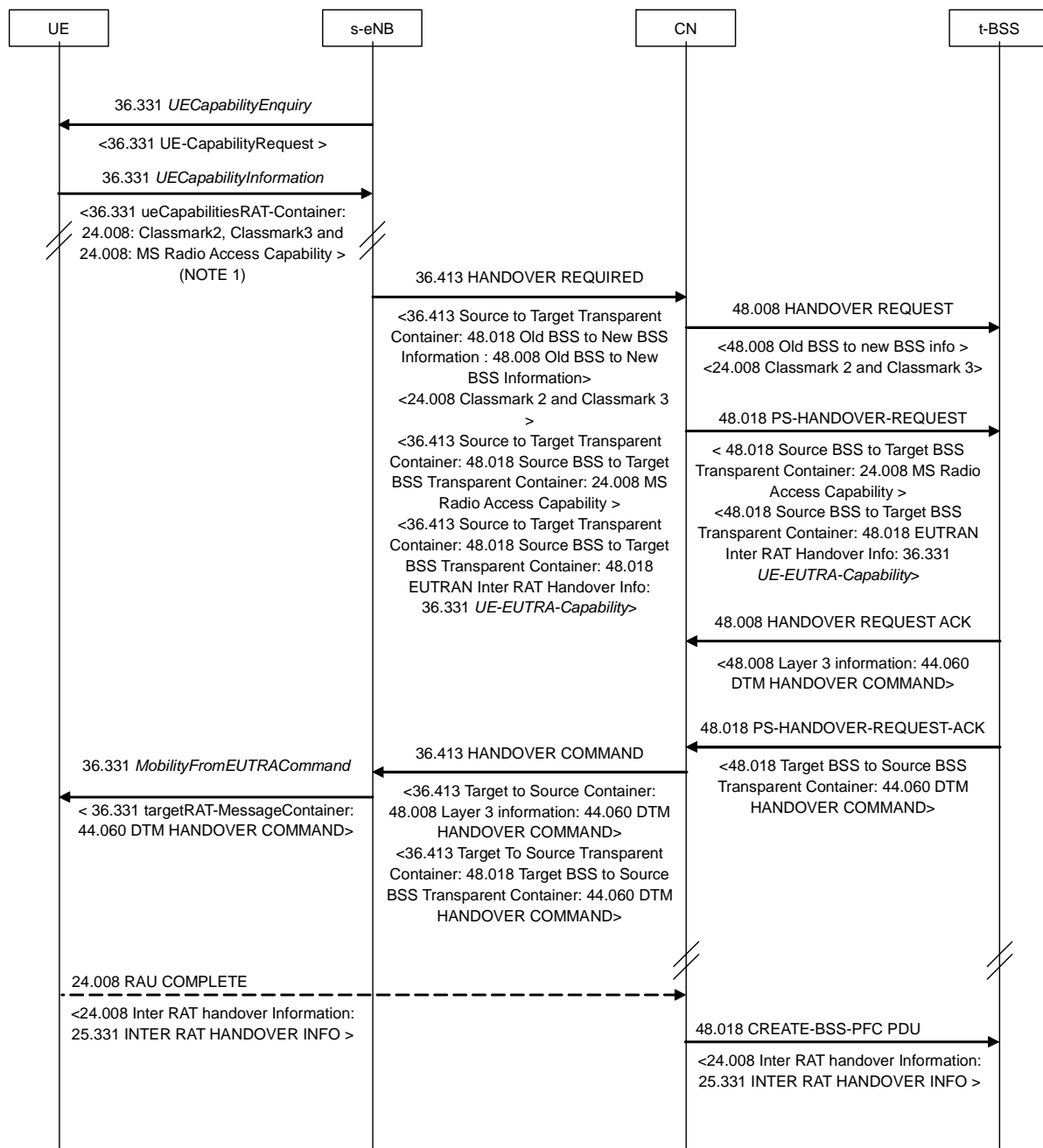

NOTE 1: the GERAN capabilities can be stored by the MME at an earlier opportunity, as shown in Figure 18-1, and transferred to the eNB at connection setup.

NOTE 2: the 36.413 HANDOVER COMMAND includes two identical copies of the 44.060 DTM HANDOVER COMMAND message i.e. the eNB can forward either of the two

Figure 19.2.2.5.6-5: Handover of CS and PS domain services from EUTRAN to GERAN A/Gb mode, normal flow

Figure 19.2.2.5.6-6 and Figure 19.2.2.5.6-7 illustrate the message sequence for the handover from EUTRAN to UTRAN procedure:

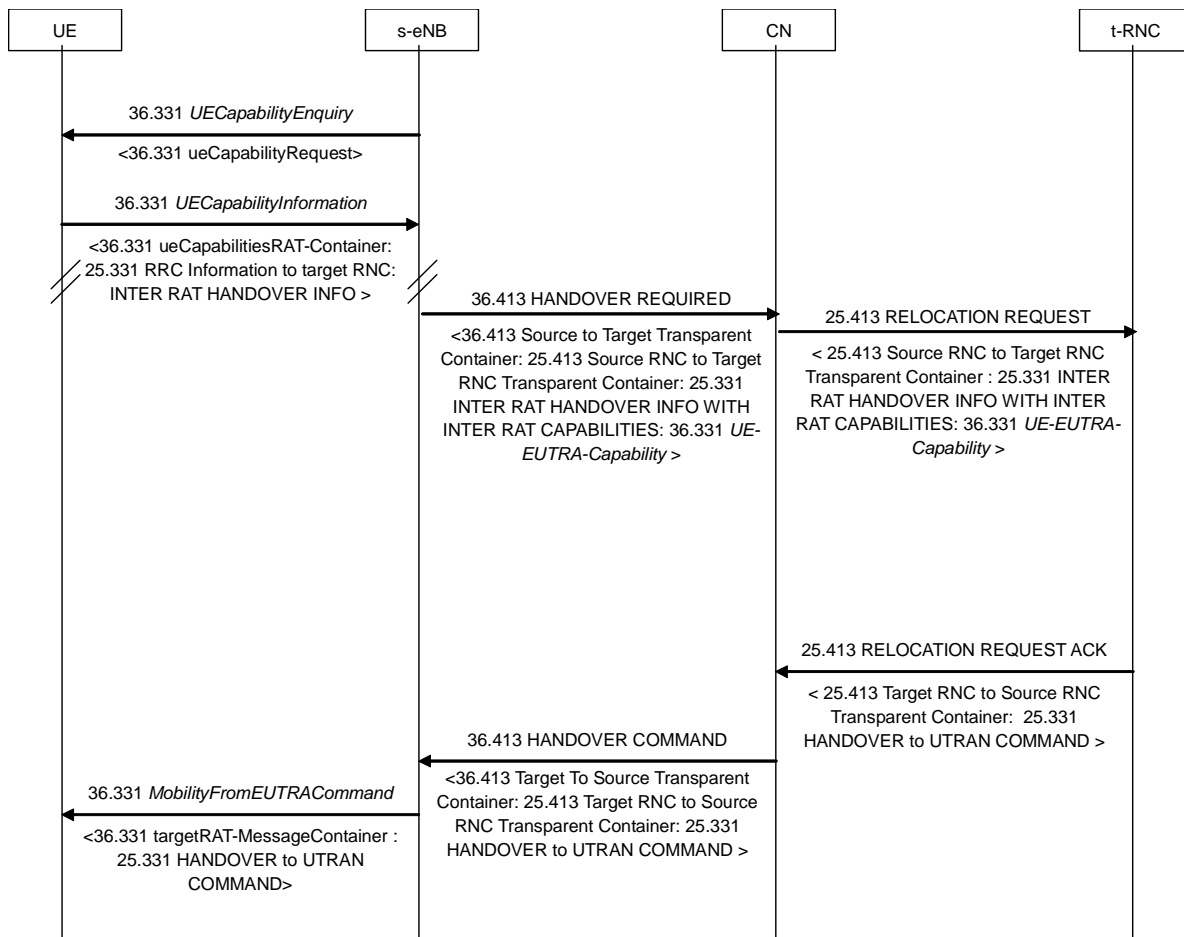

Figure 19.2.2.5.6-6. Handover of PS or CS domain service from EUTRAN to UTRAN, normal flow

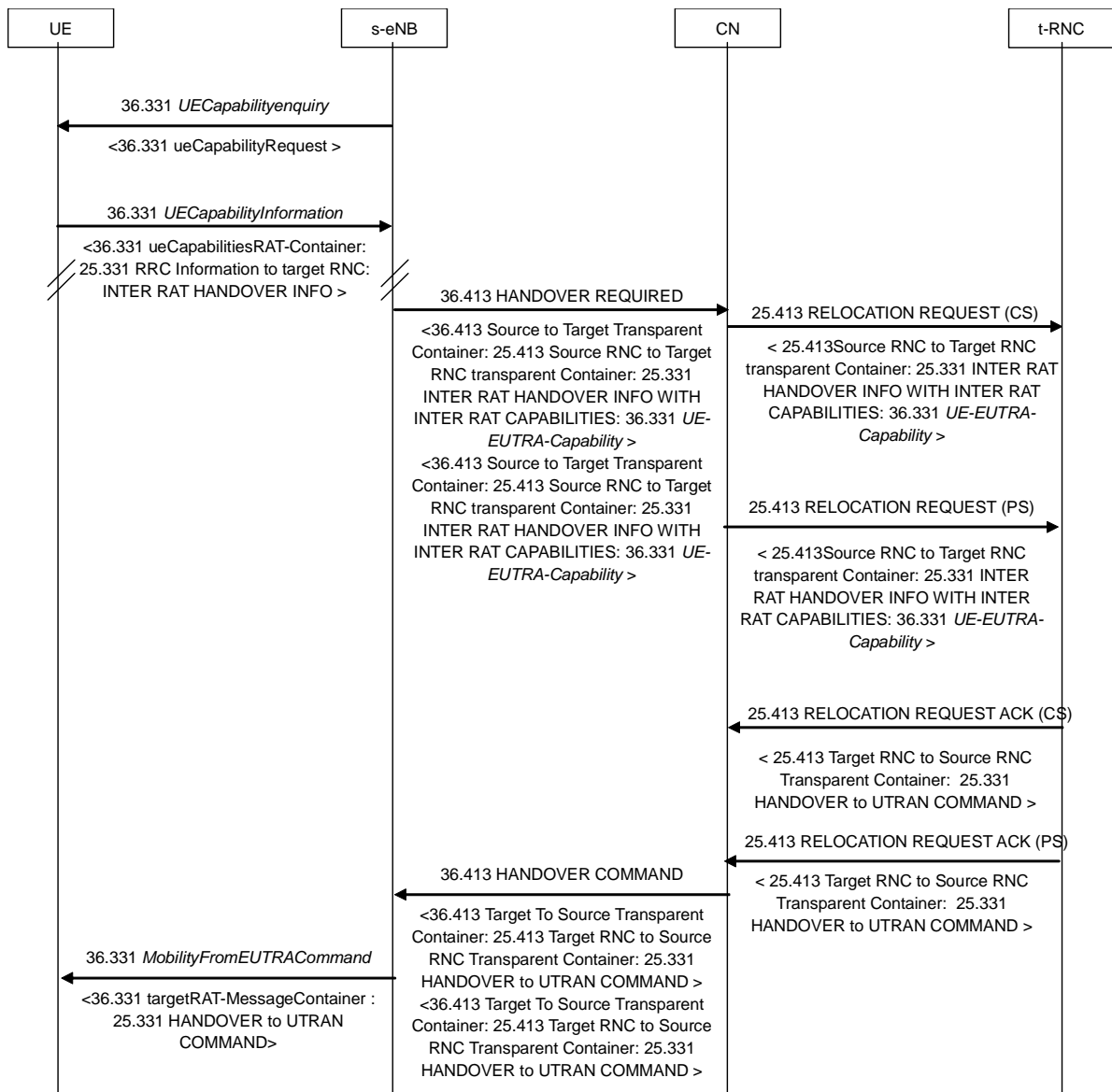

Figure 19.2.2.5.6-7. Handover of PS and CS domain service from EUTRAN to UTRAN, normal flow

19.2.2.5.7 eNB Status Transfer procedure

The purpose of the eNB Status Transfer procedure is to transfer the uplink PDCP SN and HFN receiver status and the downlink PDCP SN and HFN transmitter status from the eNB to the MME during an S1 handover for each respective E-RAB for which PDCP SN and HFN status preservation applies.

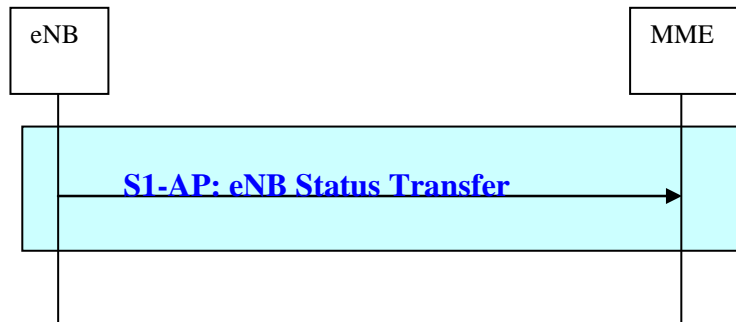

Figure 19.2.2.5.7-1: eNB Status Transfer

19.2.2.5.8 MME Status Transfer procedure

The purpose of the MME Status Transfer procedure is to transfer the uplink PDCP SN and HFN receiver status and the downlink PDCP SN and HFN transmitter status from the MME to the eNB during an S1 handover for each respective E-RAB for which PDCP SN and HFN status preservation applies.

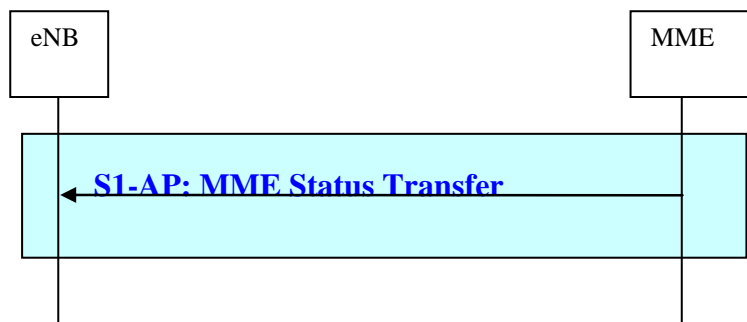

Figure 19.2.2.5.8-1: MME Status Transfer

19.2.2.6 NAS transport procedures

A NAS signalling message is transferred on the S1 interface in both directions. The procedures providing this functionality are:

- Initial UE Message procedure (eNB initiated);
- Uplink NAS transport procedure (eNB initiated);
- Downlink NAS transport procedure (MME initiated);
- Downlink NAS non delivery indication procedure (eNB initiated)
- Downlink NAS delivery indication procedure; (eNB initiated);
- Reroute NAS Request procedure.

i) Initial UE Message procedure

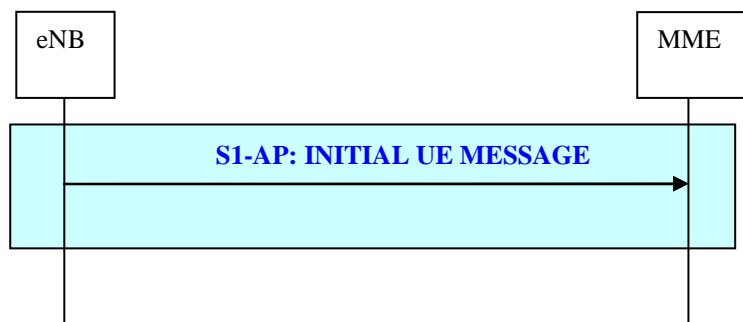

Figure 19.2.2.6-1: Initial UE Message procedure

- The INITIAL UE MESSAGE procedure is initiated by the eNB by sending the INITIAL UE MESSAGE message to the MME. The INITIAL UE MESSAGE contains a NAS message (e.g. Service Request), the UE signalling reference ID and other S1 addressing information. If the eNB is a HeNB supporting LIPA, the message shall include the HeNB collocated L-GW IP address to enable the establishment of a LIPA PDN connection. If the eNB supports SIPTO@LN with collocated L-GW, the message shall include the collocated L-GW IP address to enable the establishment of a SIPTO@LN PDN connection. If the eNB supports SIPTO@LN with stand-alone gateway, the message shall include the LHN ID. In case of UE access to a CSG cell the INITIAL UE MESSAGE contains the CSG id of the cell. In case of UE access to a hybrid cell the INITIAL UE MESSAGE contains the CSG id and Access Mode of the cell.

ii) Uplink NAS Transport procedure (eNB initiated)

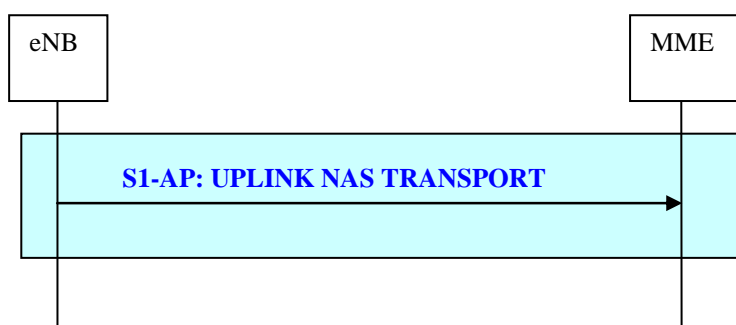

Figure 19.2.2.6-2: Uplink NAS Transport procedure

- The Uplink NAS Transport procedure is initiated by the eNB by sending the UPLINK NAS TRANSPORT message to the MME. The UPLINK NAS TRANSPORT message contains a NAS message, UE identification and other S1 related addressing information. If the eNB is a HeNB supporting LIPA, the message shall include the HeNB collocated L-GW IP address to enable the establishment of a LIPA PDN connection. If the eNB supports SIPTO@LN with collocated L-GW, the message shall include the collocated L-GW IP address to enable the establishment of a SIPTO@LN PDN connection. If the eNB supports SIPTO@LN with stand-alone gateway, the message shall include the LHN ID.

iii) Downlink NAS Transport procedure (MME initiated)

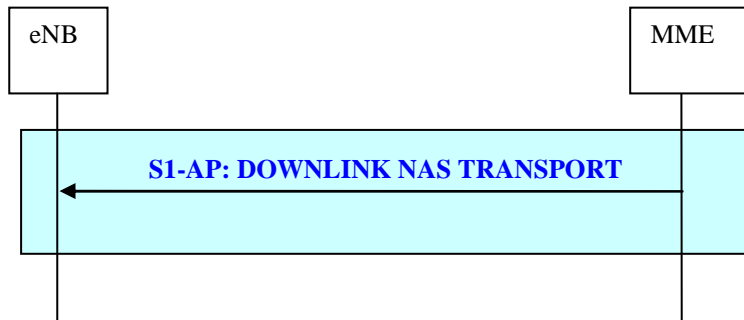

Figure 19.2.2.6-3: Downlink NAS Transport procedure

- The Downlink NAS Transport procedure is initiated by the MME by sending the DOWNLINK NAS TRANSPORT message to the eNB. The DOWNLINK NAS TRANSPORT contains a NAS message, UE identification and other S1 related addressing information and may contain the UE Radio Capability information. In addition a request to indicate the successful delivery of the Downlink NAS PDU to the UE may be included in the DOWNLINK NAS TRANSPORT message.

iv) Downlink NAS non delivery indication procedure

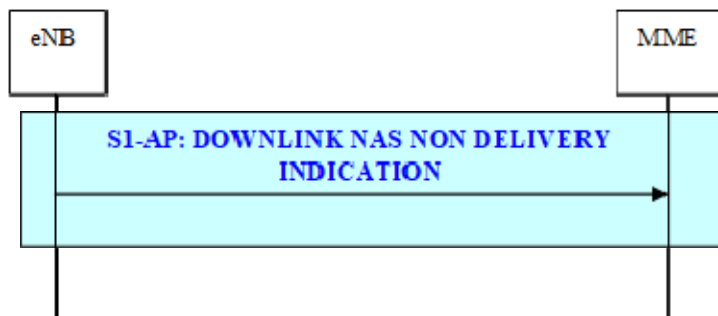

Figure 19.2.2.6-4: Downlink NAS Non Delivery Indication procedure

- When the eNB decides to not start the delivery of a NAS message that has been received from MME, it shall report the non-delivery of this NAS message by sending a DOWNLINK NAS NON DELIVERY INDICATION message to the MME including the non-delivered NAS message and an appropriate cause value.

v) Downlink NAS delivery indication procedure

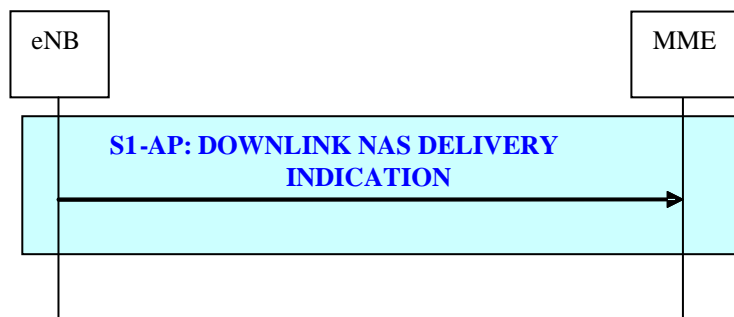

Figure 19.2.2.6-5: Downlink NAS Delivery Indication procedure

- The eNB may be requested by the MME to provide an indication whether the Downlink NAS PDU has been successfully delivered to the UE. The eNB then triggers the Downlink NAS Delivery Indication procedure per downlink NAS PDU provided in a DOWNLINK NAS TRANSPORT as specified in TS 23.401 [17].

vi) Reroute NAS Request procedure

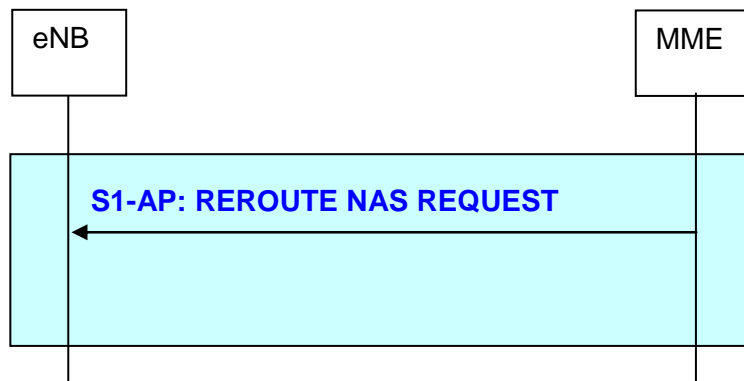

Figure 19.2.2.6-6: Reroute NAS Request procedure

The Reroute NAS Request procedure is used to reroute a NAS message (and there by a UE) to another MME when DCNs are used.

The procedure is initiated by the MME sending the REROUTE NAS REQUEST message. Upon receiving the REROUTE NAS REQUEST message, the eNB selects a MME in the indicated DCN and sends the INITIAL UE MESSAGE message to the new selected MME as described in TS 23.401 [17]. In case a UE-associated logical S1-connection was established between the MME and the eNB, upon sending (respectively receiving) the REROUTE NAS REQUEST message the MME (respectively eNB) shall locally remove the UE-associated logical S1-connection.

19.2.2.7 S1 interface Management procedures

19.2.2.7.1 Reset procedure

The purpose of the Reset procedure is to re-initialize the peer entity or part of the peer entity after node setup and after a failure event occurred. This procedure is initiated by both the eNB and MME.

19.2.2.7.1a eNB initiated Reset procedure

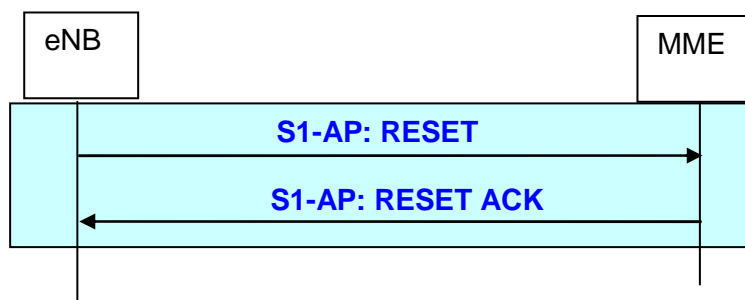

Figure 19.2.2.7.1a-1: eNB initiated Reset procedure

- The eNB triggers the RESET message to indicate that an initialisation in the MME is required. The MME releases the corresponding references and resources.
- Afterwards the MME sends the RESET ACK message to confirm that the resources and references are cleared.

19.2.2.7.1b MME initiated Reset procedure

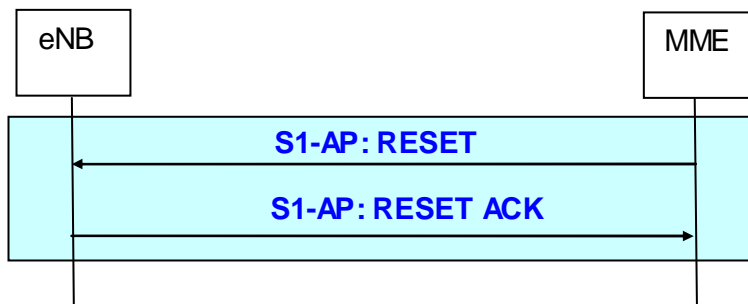

Figure 19.2.2.7.1b-1: MME initiated Reset procedure

- The MME triggers the RESET message to indicate that an initialisation in the eNB is required. The eNB releases the corresponding references and resources.
- Afterwards the eNB sends the RESET ACK message to confirm that the resources and references are cleared.

19.2.2.7.2 Error Indication functions and procedures

The Error Indication procedure is initiated by the eNB and the MME, to report detected errors in one incoming message, if an appropriate failure message cannot be reported to the sending entity.

19.2.2.7.2a eNB initiated error indication

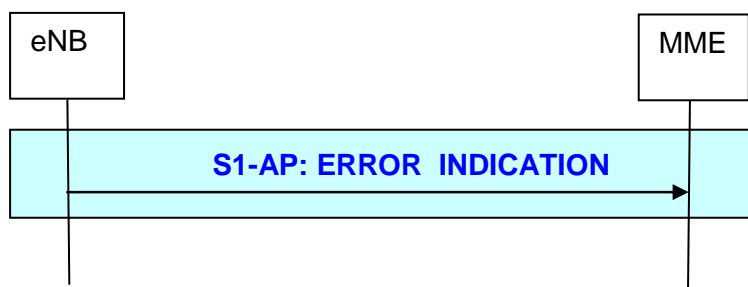

Figure 19.2.2.7.2a-1: eNB initiated Error Indication procedure

The eNB sends the ERROR INDICATION message to report the peer entity which kind of error occurs.

19.2.2.7.2b MME initiated error indication

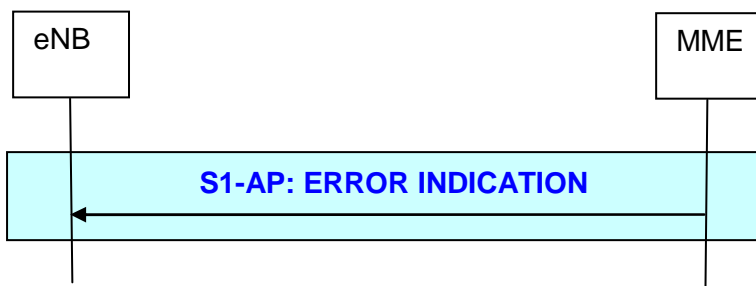

Figure 19.2.2.7.2b-1: MME initiated Error Indication procedure

The MME sends the ERROR INDICATION message to report the peer entity which kind of error occurs.

19.2.2.8 S1 Setup procedure

The S1 Setup procedure is used to exchange configured data which is required in the MME and in the eNB respectively to ensure a proper interoperation. The S1 Setup procedure is triggered by the eNB. The S1 Setup procedure is the first S1AP procedure which will be executed.

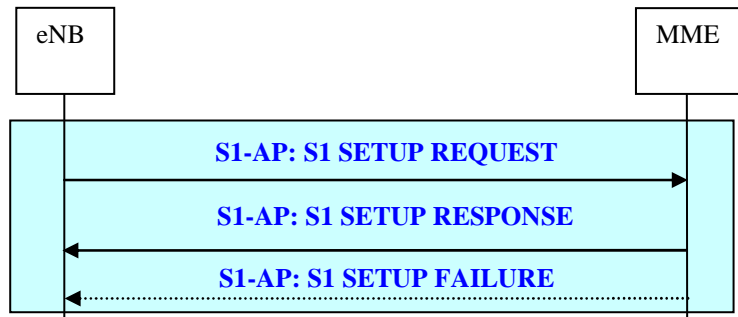

Figure 19.2.2.8-1: S1 Setup procedure

- The eNB initiates the S1 Setup procedure by sending the S1 SETUP REQUEST message including supported TAs and broadcasted PLMNs to the MME.
- In the successful case the MME responds with the S1 SETUP RESPONSE message which includes served PLMNs as well as a relative MME capacity indicator to achieve load balanced MMEs in the pool area.

The MME and the eNB may agree at the S1 Setup procedure that UE-related contexts and related signalling connection that have been existing before the S1 Setup shall not be affected. The MME or eNB or both may trigger an S1AP Reset procedure for any UE-related context and related signalling connection for UEs which could not be kept in ECM_CONNECTED and RRC_CONNECTED or for UEs for which the MME or the eNB decided to remove the UE-related context and related signalling connection. If either the MME and the eNB do not agree to keep the UE-related contexts (if any), then they are removed and all related signalling connections are erased.

- If the MME cannot accept the S1 Setup Request the MME responds with the S1 SETUP FAILURE message indicating the reason of the denial. The MME optionally indicates in the S1 SETUP FAILURE message when the eNB is allowed to re-initiate the S1 Setup Request procedure towards the same MME again.

19.2.2.9 eNB Configuration Update procedure

The eNB Configuration Update procedure is used to provide updated configured data in eNB. The eNB Configuration Update procedure is triggered by the eNB.

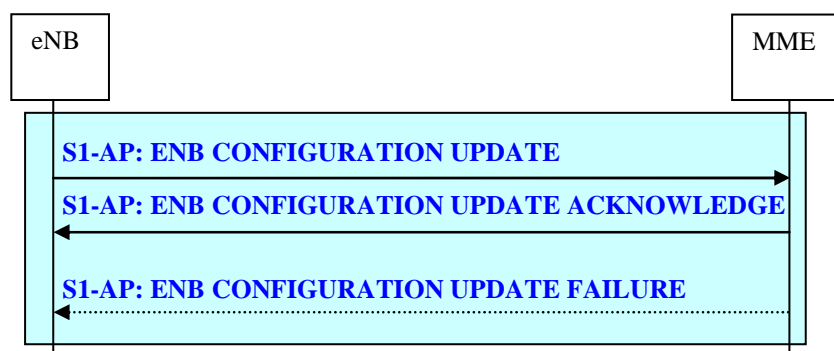

Figure 19.2.2.9-1: eNB Configuration Update procedure

- The eNB initiates the eNB Configuration Update procedure by sending the ENB CONFIGURATION UPDATE message including updated configured data like supported TAs and broadcasted PLMNs to the MME. In case one or more supported TA(s) needs to be updated, the eNB shall provide the whole list of TA(s), including those which has not been changed, in the ENB CONFIGURATION UPDATE message.

- The MME responds with the ENB CONFIGURATION UPDATE ACKNOWLEDGE message to acknowledge that the provided configuration data are successfully updated.
- The MME shall overwrite and store the received configuration data which are included in the ENB CONFIGURATION UPDATE message. Configuration data which has not been included in the ENB CONFIGURATION UPDATE message are interpreted by the MME as still valid. For the provided TA(s) the MME shall overwrite the whole list of supported TA(s).
- In case the MME cannot accept the received configuration updates the MME shall respond with the ENB CONFIGURATION UPDATE FAILURE message including an appropriate cause value to indicate the reason of the denial. The MME optionally indicates in the ENB CONFIGURATION UPDATE FAILURE message when the eNB is allowed to re-initiate the eNB Configuration Update procedure towards the same MME again. For the unsuccessful update case the eNB and the MME shall continue with the existing configuration data.

19.2.2.9a eNB Configuration Transfer procedure

The eNB Configuration Transfer procedure is initiated by the eNB to request and/or transfer RAN configuration information via the core network.

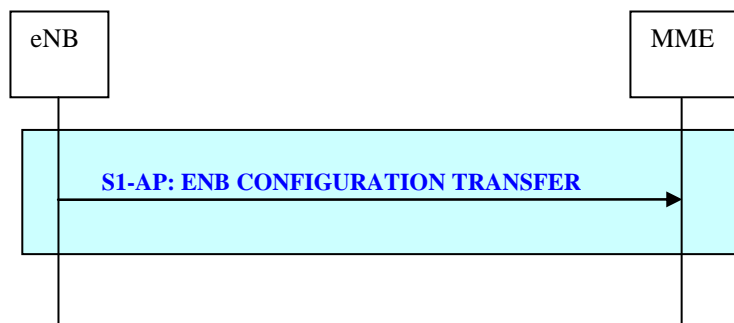

Figure 19.2.2.9a-1: eNB Configuration Transfer procedure

The eNB Configuration Transfer procedure is initiated by the eNB by sending the eNB CONFIGURATION TRANSFER message to the MME. The eNB CONFIGURATION TRANSFER message contains RAN configuration information (e.g. SON information) and other relevant information such as the routing address which identifies the final RAN destination node.

19.2.2.10 MME Configuration Update procedure

The MME Configuration Update procedure is used to provide updated configured data and changes of the relative MME capacity values in the MME. The MME Configuration Update procedure is triggered by the MME.

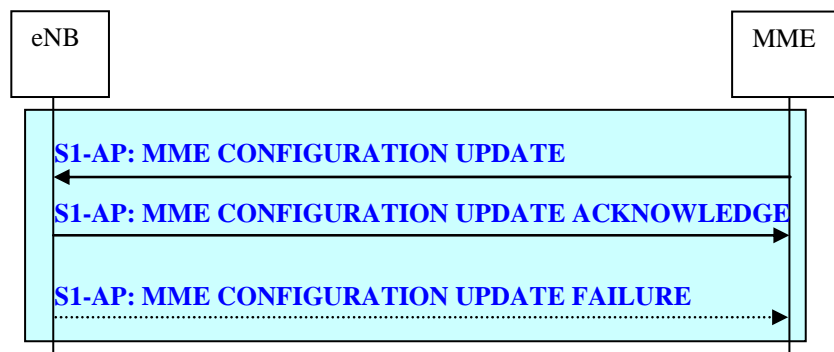

Figure 19.2.2.10-1: MME Configuration Update procedure

- The MME initiates the MME Configuration Update procedure by sending the MME CONFIGURATION UPDATE message including updated configured data like served PLMNs and changes of the relative MME capacity values to the eNB.

- The eNB responds with the MME CONFIGURATION UPDATE ACKNOWLEDGE message to acknowledge that the provided configuration data and the relative MME capacity values are successfully updated.
- The eNB shall overwrite and store the received configuration data and relative MME capacity values which are included in the MME CONFIGURATION UPDATE message. Configuration data which has not been included in the MME CONFIGURATION UPDATE message are interpreted by the eNB as still valid.
- In case the eNB cannot accept the received configuration updates the eNB shall respond with the MME CONFIGURATION UPDATE FAILURE message including an appropriate cause value to indicate the reason of the denial. The eNB optionally indicates in the MME CONFIGURATION UPDATE FAILURE message when the MME is allowed to re-initiate the MME Configuration Update procedure towards the same eNB again. For the unsuccessful update case the eNB and the MME shall continue with the existing configuration data and relative MME capacity values.

19.2.2.10a MME Configuration Transfer procedure

The MME Configuration Transfer procedure is initiated by the MME to request and/or transfer RAN configuration information to the eNB.

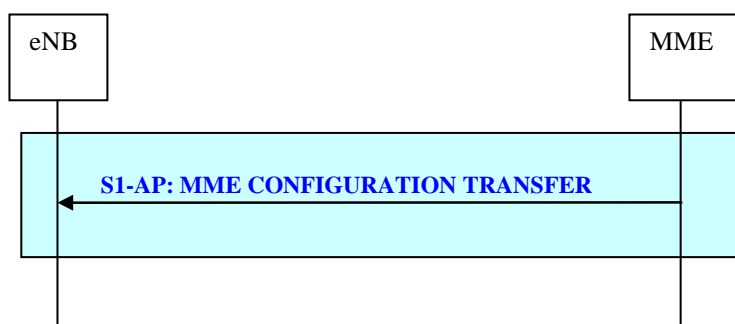

Figure 19.2.2.10a-1: MME Configuration Transfer procedure

The MME Configuration Transfer procedure is initiated by the MME by sending the MME CONFIGURATION TRANSFER message to the eNB. The MME CONFIGURATION TRANSFER message contains RAN configuration information (e.g. SON information) and other relevant information.

19.2.2.11 Location Reporting procedures

19.2.2.11.0 General

The Location Reporting procedures provide the means to report the current location of a specific UE.

The procedures providing this function are:

- Location Reporting Control procedure;
- Location Report procedure;
- Location Report Failure Indication procedure.

If DC is configured for a specific UE, the location reported refers to the cell served by the MeNB. If EN-DC is configured for a specific UE, the location reported refers to the cell served by the MeNB and, if requested, the PSCell at the en-gNB.

NOTE: The following S1AP procedures are able to provide location information without the reporting being triggered by the Location Reporting Control procedure:
S1 UE Context Release, UE Context Suspend, E-RAB Release, E-RAB Release Indication, Path Switch, Handover Notification, Initial UE Message, Uplink NAS Transport, Secondary RAT Data Usage Report.

19.2.2.11.1 Location Reporting Control procedure

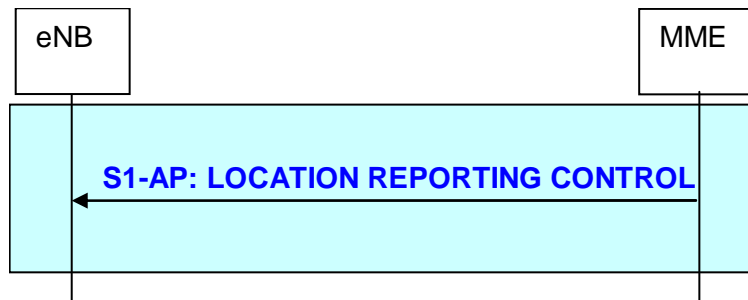

Figure 19.2.2.11.1-1: Location Reporting Control procedure

The Location Reporting Control procedure is initiated by the MME sending the LOCATION REPORTING CONTROL to the eNB to request the current location information, e.g. Cell ID, of a specific UE, and how the information shall be reported, e.g. direct report, report every cell change. The Location Reporting Control procedure is also used to terminate reporting on cell change.

If the Location Reporting Control procedure fails, e.g. due to an interaction with an initiated handover then the eNB shall indicate the failure using the Location Report Failure Indication procedure.

If the Location Reporting Control procedure is on going for a specific UE and the eNB received an UE CONTEXT RELEASE COMMAND message from MME this specific UE then the eNB shall terminate the on-going Location Reporting.

19.2.2.11.2 Location Report procedure

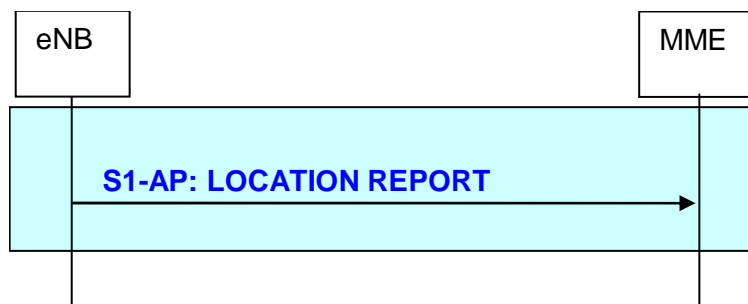

Figure 19.2.2.11.2-1: Location Report procedure

The Location Report procedure is initiated by the eNB by sending the LOCATION REPORT to the MME to report the current location information of a specific UE as a standalone report, or every time UE changes cell.

19.2.2.11.3 Location Report Failure Indication procedure

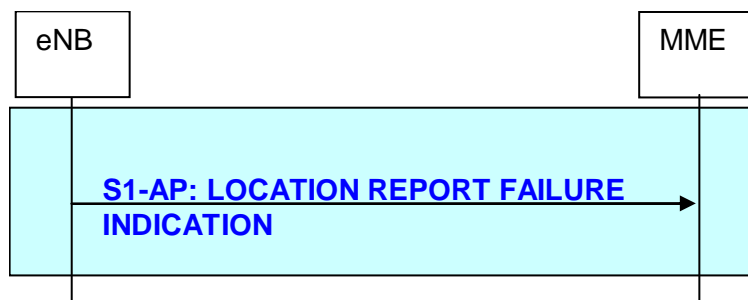

Figure 19.2.2.11.3-1: Location Report Failure Indication procedure

The Location Report Failure Indication procedure is initiated by the eNB by sending the LOCATION REPORT FAILURE INDICATION to the MME to indicate that the Location Report Control procedure has failed due to e.g. UE has performed inter-eNB handover.

19.2.2.12 Overload procedure

19.2.2.12.1 Overload Start procedure

The Overload Start procedure is used by the MME to indicate to a proportion of eNBs to which the MME has an S1 interface connection that the MME is overloaded. The Overload Start procedure is used to provide an indication of which type of RRC connections needs to be rejected/permited only.

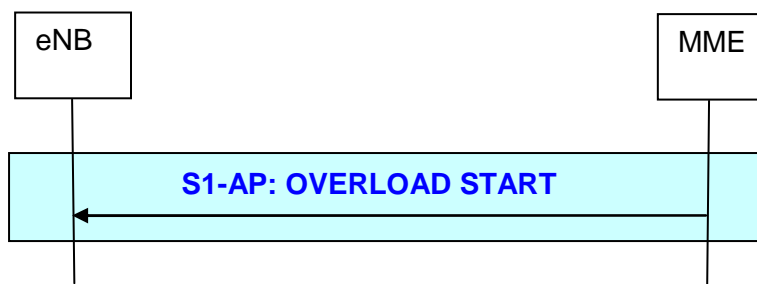

Figure 19.2.2.12.1-1 Overload Start procedure

If the OVERLOAD START message contains a list of GUMMEIs, the eNB shall select the new RRC connections to be rejected based on this list.

The eNB may also trigger EAB as specified in TS 23.401 [17] clause 4.3.7.4.1 and TS 23.251 [54] clause 4.6.

19.2.2.12.2 Overload Stop procedure

The Overload Stop procedure is used by the MME to indicate the concerned eNB(s) that the MME is no longer overloaded.

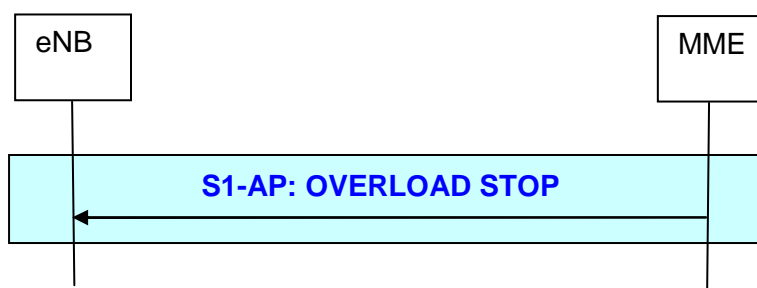

Figure 19.2.2.12.2-1: Overload Stop procedure

If the OVERLOAD STOP message contains a list of GUMMEIs, the eNB shall stop rejecting the new RRC connections corresponding to each received GUMMEI value if applicable.

The eNB may also stop ongoing EAB actions.

19.2.2.13 Write-Replace Warning procedure

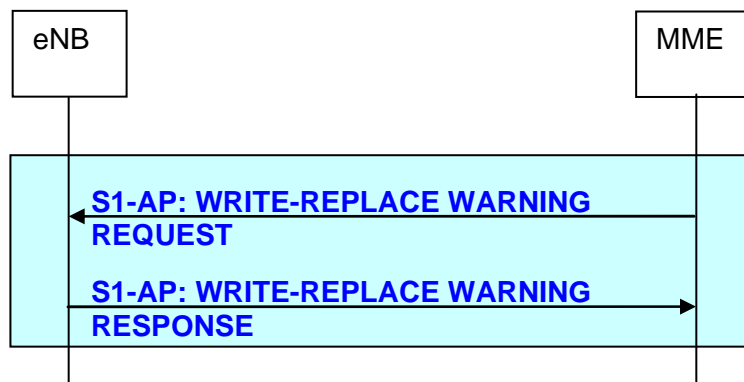

Figure 19.2.2.13.1-1: Write-Replace Warning procedure

The Write-Replace Warning procedure is used to start the broadcasting of a PWS warning message.

ETWS is an example of PWS warning system using this procedure where one message at a time can be delivered over the radio.

CMAS is another example of PWS warning system using this procedure which allows the broadcast of multiple concurrent warning messages over the radio.

The procedure is initiated by the MME by sending WRITE-REPLACE WARNING REQUEST message containing at least the Message Identifier, Warning Area list, information on how the broadcast should be performed, and the contents of the warning message to be broadcast.

The eNB responds with WRITE-REPLACE WARNING RESPONSE message to acknowledge that the requested PWS warning message broadcast was initiated.

ETWS and CMAS are independent services and ETWS and CMAS messages are differentiated over S1 in order to allow different handling.

In the case of ETWS, the Write-Replace Warning procedure can also be used to overwrite the ongoing broadcasting of an ETWS warning message.

19.2.2.14 eNB Direct Information Transfer procedure

The eNB Direct Information Transfer procedure is initiated by the eNB to request and transfer information to the core network.

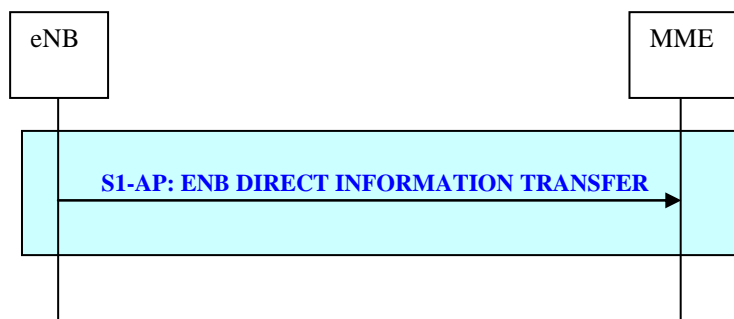

Figure 19.2.2.14-1: eNB Direct Information Transfer procedure

The eNB Direct Information Transfer procedure is initiated by the eNB by sending the eNB DIRECT INFORMATION TRANSFER message to the MME. The eNB DIRECT INFORMATION TRANSFER message contains RIM information and RIM routing address which identifies the final RAN destination node.

19.2.2.15 MME Direct Information Transfer procedure

The MME Direct Information Transfer procedure is initiated by the MME to request and transfer information to the eNB.

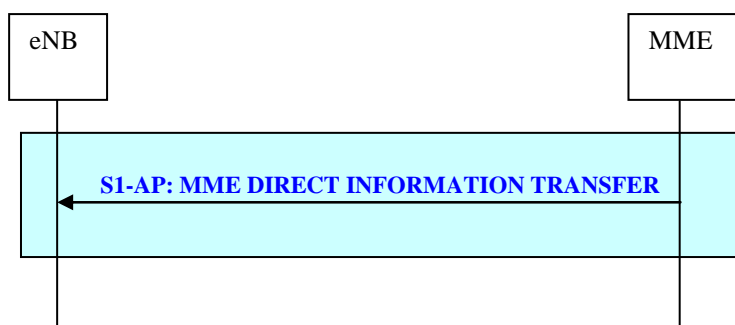

Figure 19.2.2.15-1: MME Direct Information Transfer procedure

The MME Direct Information Transfer procedure is initiated by the MME by sending the MME DIRECT INFORMATION TRANSFER message to the eNB. The MME DIRECT INFORMATION TRANSFER message contains RIM information.

19.2.2.16 S1 CDMA2000 Tunnelling procedures

The S1 CDMA2000 Tunnelling procedures carry CDMA2000 signalling messages between UE and CDMA2000 RAT over the S1 Interface. This includes signalling for pre-registration and handover preparation for optimized mobility from E-UTRAN to CDMA2000 HRPD, signalling for handover preparation for mobility from E-UTRAN to CDMA2000 1xRTT and signalling to support CS fallback to CDMA2000 1xRTT for mobile originated and mobile terminated CS domain services. The CDMA2000 messages are tunnelled transparently to the eNB and MME, however, additional information may be sent along with the tunnelled CDMA2000 message to assist the eNodeB and MME in the Tunnelling procedure. The procedures providing this functionality are:

- Downlink S1 CDMA2000 Tunnelling procedure;
- Uplink S1 CDMA2000 Tunnelling procedure.

19.2.2.16.1 Downlink S1 CDMA2000 Tunnelling procedure

The MME sends the DOWNLINK S1 CDMA2000 TUNNELLING message to the eNB to forward a CDMA2000 message towards an UE for which a logical S1 connection exists (see Figure 19.2.2.16.1-1 below).

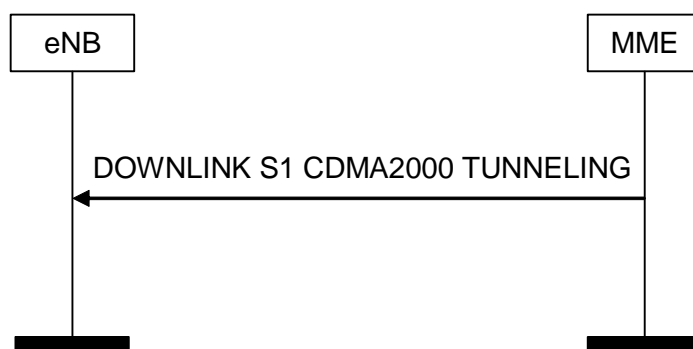

Figure 19.2.2.16.1-1: Downlink S1 CDMA2000 Tunnelling procedure

19.2.2.16.2 Uplink S1 CDMA2000 Tunnelling procedure

The eNB sends the UPLINK S1 CDMA2000 TUNNELLING message to the MME to forward a CDMA2000 message towards the CDMA2000 RAT (HRPD or 1xRTT) as depicted on Figure 19.2.2.16.2-1 below.

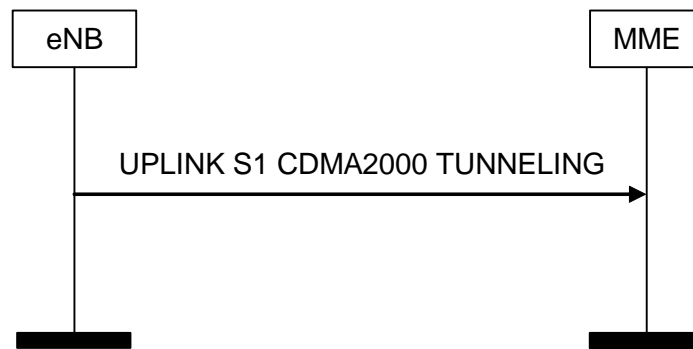

Figure 19.2.2.16.2-1: Uplink S1 CDMA2000 Tunnelling procedure

19.2.2.17 Kill procedure

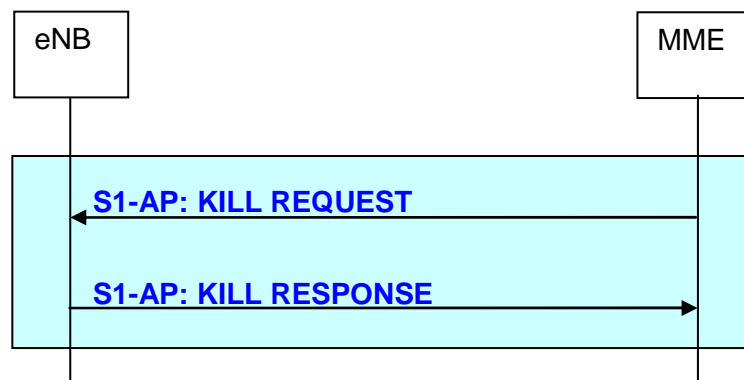

Figure 19.2.2.17-1: Kill procedure

The Kill procedure is used to stop the broadcasting of a PWS warning message or all PWS warning messages.

CMAS is an example of warning system using this procedure. The ETWS warning system doesn't use this procedure.

The procedure is initiated by the MME sending the KILL REQUEST message containing at least the Message Identifier and serial number of the message to be killed and the Warning Area List where it shall be killed.

The eNB responds with a KILL RESPONSE message to acknowledge that the requested PWS message broadcast delivery has actually been stopped.

19.2.2.18 LPPa Transport procedures

19.2.2.18.0 General

An LPPa signalling message is transferred on the S1 interface in both directions. The procedures providing this functionality are:

- Downlink UE Associated LPPa Transport procedure;
- Uplink UE Associated LPPa Transport procedure;
- Downlink Non UE Associated LPPa Transport procedure;
- Uplink Non UE Associated LPPa Transport procedure.

The UE-associated signalling is used to support E-CID positioning of a specific UE. The non-UE associated signalling is used to obtain assistance data from an eNodeB to support OTDOA positioning for any UE.

19.2.2.18.1 Downlink UE Associated LPPa Transport procedure

The Downlink UE Associated LPPa Transport procedure is initiated by the MME by sending the DOWNLINK UE ASSOCIATED LPPa TRANSPORT message to the eNB. The DOWNLINK UE ASSOCIATED LPPa TRANSPORT contains an LPPa message.

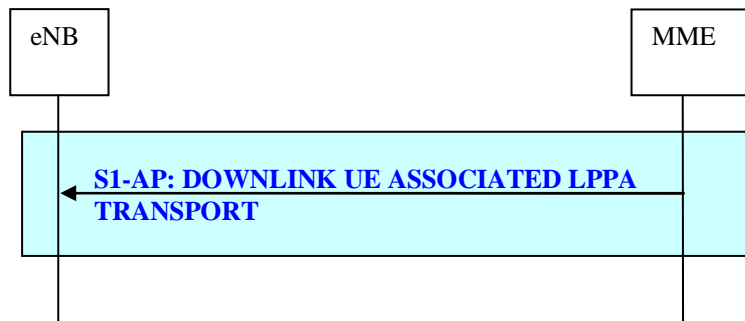

Figure 19.2.2.18.1-1: Downlink UE Associated LPPa Transport procedure

19.2.2.18.2 Uplink UE Associated LPPa Transport procedure

The Uplink UE Associated LPPa Transport procedure is initiated by the eNB by sending the UPLINK UE ASSOCIATED LPPa TRANSPORT message to the MME. The UPLINK UE ASSOCIATED LPPa TRANSPORT message contains a LPPa message.

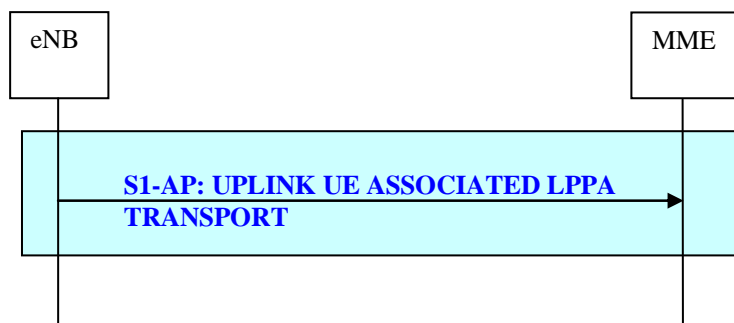

Figure 19.2.2.18.2-1: Uplink UE Associated LPPa Transport procedure

19.2.2.18.3 Downlink Non UE Associated LPPa Transport procedure

The Downlink Non UE Associated LPPa Transport procedure is initiated by the MME by sending the DOWNLINK NON UE ASSOCIATED LPPa TRANSPORT message to the eNB. The DOWNLINK NON UE ASSOCIATED LPPa TRANSPORT contains a LPPa message.

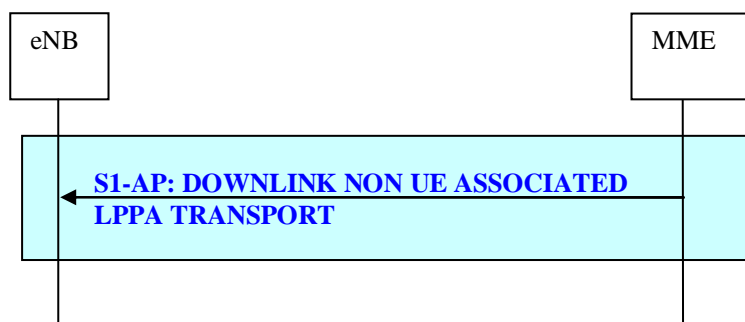

Figure 19.2.2.18.3-1: Downlink Non UE Associated LPPa Transport procedure

19.2.2.18.4 Uplink Non UE Associated LPPa Transport procedure

The Uplink Non UE Associated LPPa Transport procedure is initiated by the eNB by sending the UPLINK NON UE ASSOCIATED LPPa TRANSPORT message to the MME. The UPLINK NON UE ASSOCIATED LPPa TRANSPORT message contains an LPPa message.

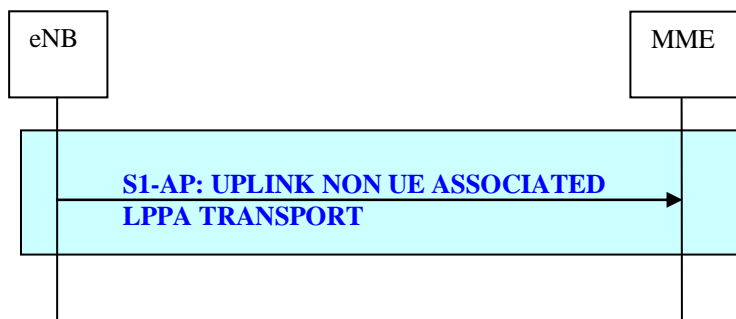

Figure 19.2.2.18.4-1: Uplink Non UE Associated LPPa Transport procedure

19.2.2.19 Trace procedures

19.2.2.19.0 General

The Trace procedures provide the means to control trace sessions and MDT sessions in the eNB for both signalling and management triggered sessions.

The procedures providing this function are:

- Trace Start procedure;
- Trace Failure Indication procedure;
- Deactivate Trace procedure;
- Cell Traffic Trace procedure.

19.2.2.19.1 Trace Start procedure

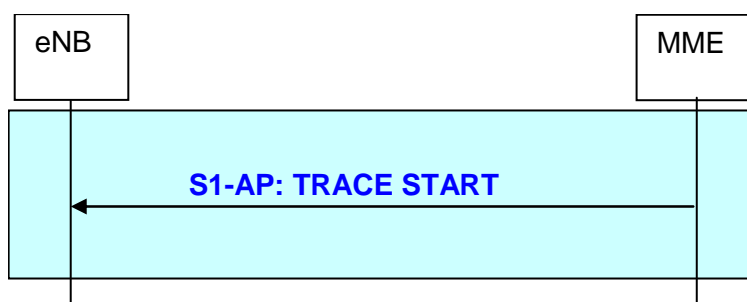
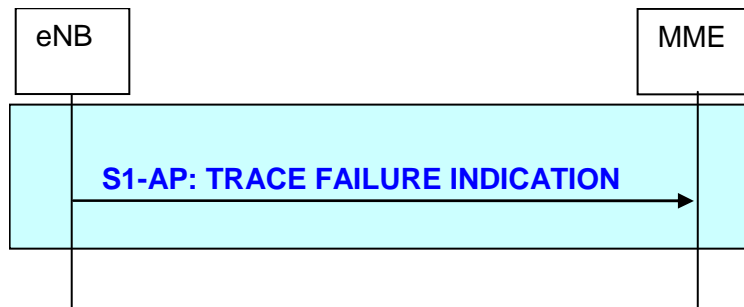

Figure 19.2.2.19.1-1: Trace Start procedure

The Trace Start procedure is initiated by the MME by sending the TRACE START message to the eNB in order to request the initiation of a trace session for a specific UE in ECM_CONNECTED mode or request the initiation of an MDT session for a specific UE.

19.2.2.19.2 Trace Failure Indication procedure

**Figure 19.2.2.19.2-1: Trace Failure Indication procedure**

The Trace Failure Indication procedure is initiated by the eNB by sending the TRACE FAILURE INDICATION message to the MME to report that a Trace Start procedure or a Deactivate Trace procedure has failed due to an interaction with a handover procedure.

19.2.2.19.3 Deactivate Trace procedure

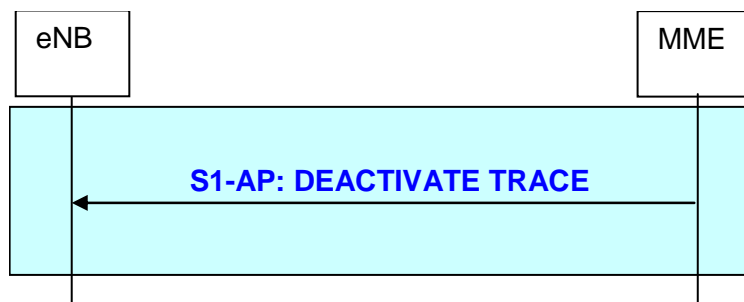
**Figure 19.2.2.19.3-1: Deactivate Trace procedure**

The Deactivate Trace procedure is initiated by the MME by sending the DEACTIVATE TRACE message to the eNB to request the termination of an ongoing trace session.

19.2.2.19.4 Cell Traffic Trace procedure

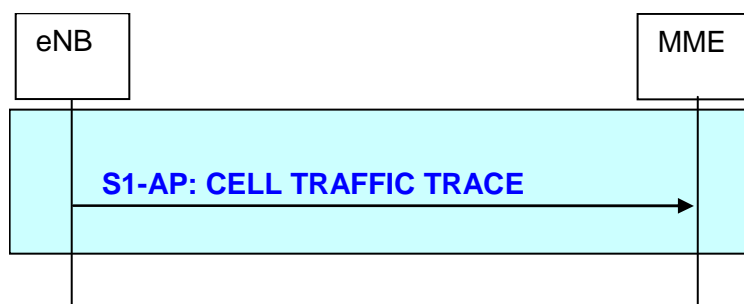
**Figure 19.2.2.19.4-1: Cell Traffic Trace procedure**

The Cell Traffic Trace procedure is initiated by the eNB by sending the CELL TRAFFIC TRACE message to the MME to report the allocated Trace Recording Session Reference and the Trace Reference to MME. This procedure is used to support management triggered trace.

19.2.2.20 UE Capability Info Indication procedure

The purpose of the UE Capability Info Indication procedure is to enable the eNB to provide to the MME UE capability-related information, as described in TS 23.401 [17].

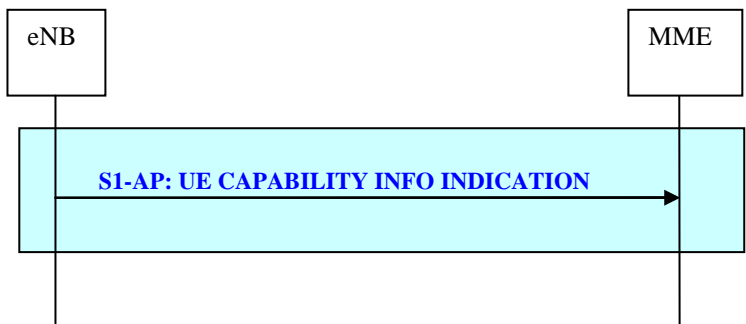

Figure 19.2.2.20-1: UE Capability Info Indication procedure

19.2.2.21 UE Radio Capability Match procedure

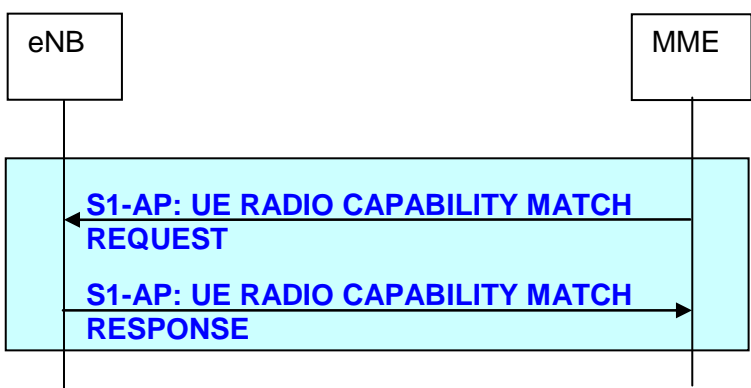

Figure 19.2.2.21-1: UE Radio Capability Match procedure

The UE Radio Capability Match procedure is initiated by the MME to request an indication on whether the UE Radio capabilities match the network configuration for voice continuity.

19.2.2.22 PWS Restart Indication procedure

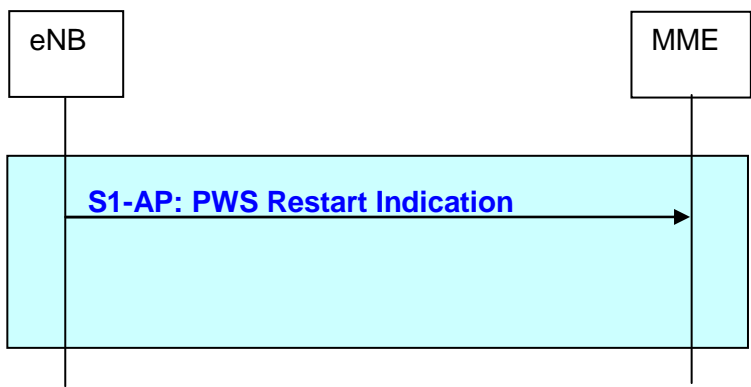

Figure 19.2.2.22-1: PWS Restart Indication procedure

The PWS Restart Indication procedure is used to inform the MME that PWS information for some cells or all cells of the eNB are available for reloading from the CBC if needed.

The procedure is initiated by the eNB sending the PWS RESTART INDICATION message.

19.2.2.23 PWS Failure Indication procedure

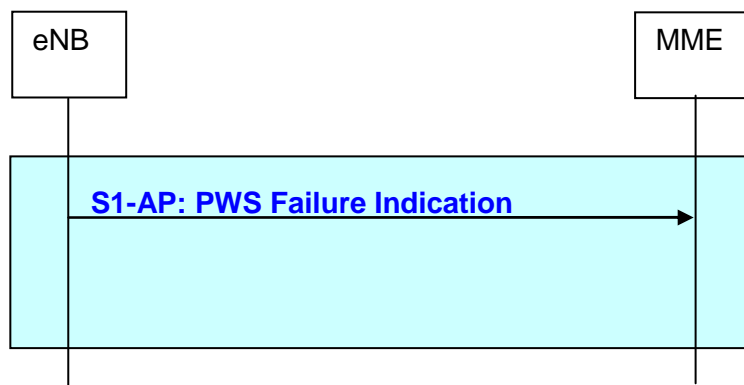

Figure 19.2.2.23-1: PWS Failure Indication procedure

The PWS Failure Indication procedure is used to inform the MME that ongoing PWS operation has failed for one or more cells.

The procedure is initiated by the eNB sending the PWS FAILURE INDICATION message.

19.2.2.24 UE Context Modification Indication procedure

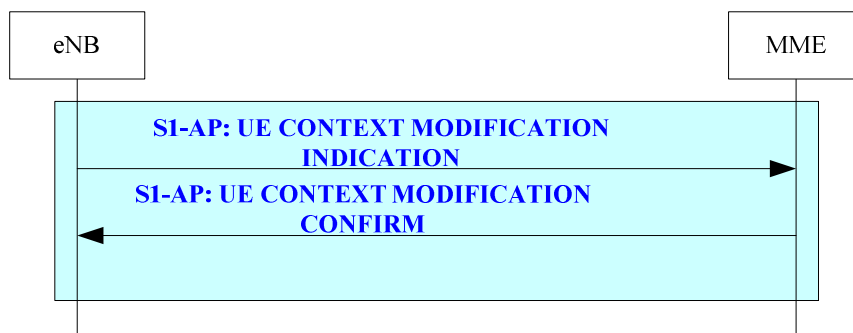

Figure 19.2.2.24-1: UE Context Modification Indication procedure

The UE Context Modification Indication procedure enables the eNB to request the modifications of the UE Context.

In the current version of the specification, the procedure is only used for CSG membership verification for Dual Connectivity.

This procedure is initiated by the eNB.

19.2.2.25 Connection Establishment Indication procedure

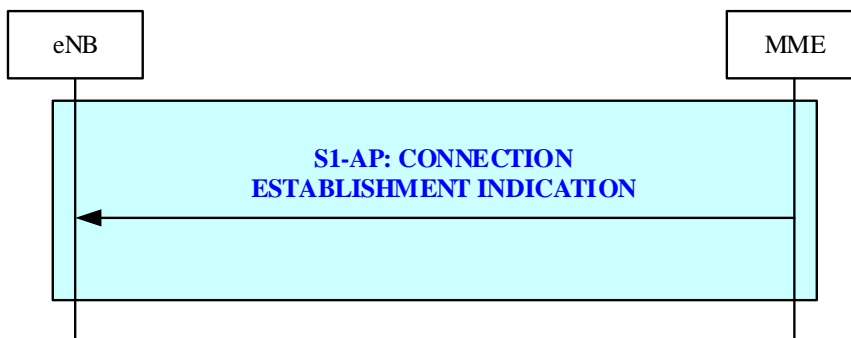

Figure 19.2.25-1: Connection Establishment Indication procedure

The Connection Establishment Indication procedure is used in case of CIoT EPS Optimization and it enables the MME to provide information to the eNB to complete the establishment of the UE-associated logical S1-connection and/or to trigger the eNB to obtain and report UE Radio Capability.

The MME may trigger Connection Establishment Indication procedure either

- after receiving INITIAL UE MESSAGE message, if the MME has no NAS PDU to send in DL in case of Control Plane CIoT EPS Optimization, or
- after receiving an eNB CP RELOCATION INDICATION message in case of Control Plane CIoT EPS Optimization, or
- when deciding to trigger the eNB to obtain and report UE Radio Capability.

The UE Radio Capability may be provided from the MME to the eNB in this procedure. If the UE radio capability is not included, this may trigger the eNB to request the UE Radio Capability from the UE and to provide it to the MME in the UE CAPABILITY INFO INDICATION message.

NAS-level security information may be provided from the MME to the eNB in this procedure in case the UE-associated logical S1-signalling connection is established for a NB-IOT UE using Control Plane CIoT EPS optimizations after the MME receives an eNB CP RELOCATION INDICATION message from the eNB, as described in TS 33.401 [22].

This procedure is initiated by the MME.

19.2.2.26 UE Context Suspend procedure

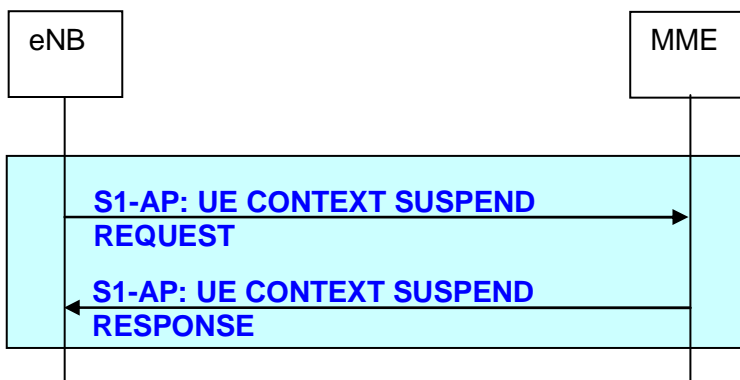

Figure 19.2.26-1: UE Context Suspend procedure

The UE Context Suspend procedure is initiated by the eNB to request the MME to suspend the UE context and the related bearer contexts in the EPC after which the eNB sends the UE to RRC_IDLE.

After successful completion of the UE Context Suspend procedure the UE-associated signalling connection is said to be suspended. The eNB and the MME keep all context data necessary to resume the UE-associated signalling connection so that there is no need to exchange information that has been provided to the respective node already before the UE-associated signalling connection has been suspended. Only the following S1AP procedures are allowed to take place on a suspended UE-associated signalling connection:

- UE Context Resume;
- S1AP UE Context Release (eNB and MME initiated);

19.2.2.27 UE Context Resume procedure

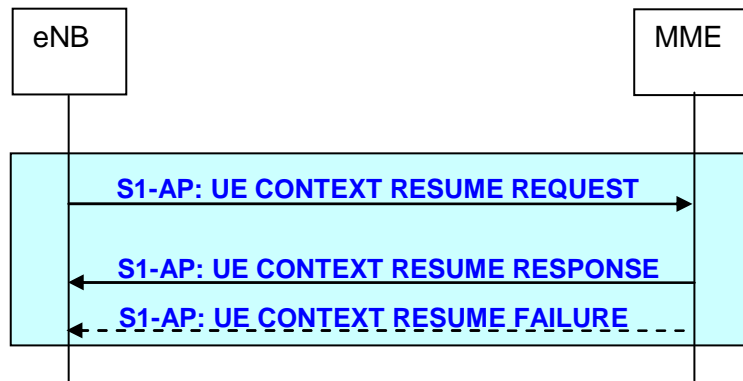

Figure 19.2.2.27-1: UE Context Resume procedure

The UE Context Resume procedure is initiated by the eNB to indicate that the UE has resumed the RRC connection and to request the MME to resume the UE context and related bearer contexts in the EPC. In case the UE context cannot be resumed in the EPC this is indicated by the MME by sending the UE CONTEXT RESUME FAILURE message.

19.2.2.28 Retrieve UE Information procedure

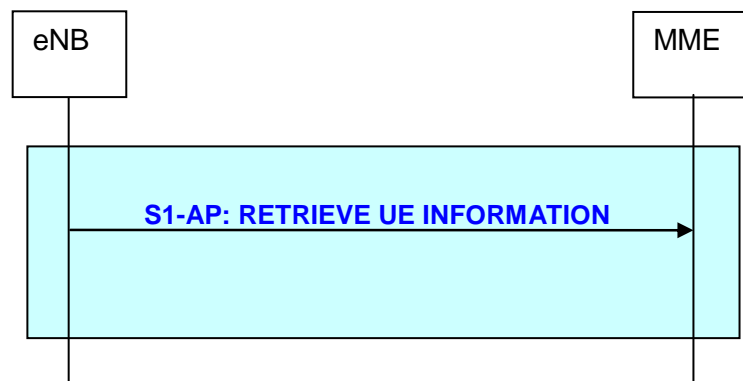

Figure 19.2.2.28: Retrieve UE Information procedure

The Retrieve UE Information procedure is initiated by the eNB to request the UE information (i.e. QoS parameters, UE capability) from MME for NB-IoT UE using Control Plane CIoT EPS Optimisation, as specified in TS 23.401 [17].

19.2.2.29 UE Information Transfer procedure

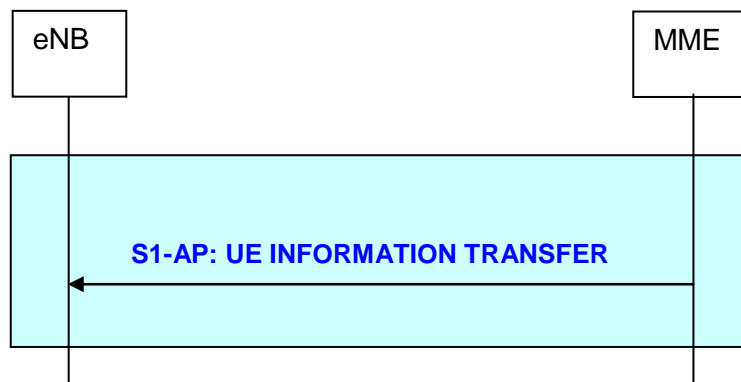

Figure 19.2.2.29: UE Information Transfer procedure

The UE Information Transfer procedure is initiated by the MME to send the UE information (i.e. QoS parameters, UE capability) to the eNB for NB-IoT UE using Control Plane CIoT EPS Optimisation, as specified in TS 23.401 [17].

19.2.2.30 eNB CP Relocation Indication

The eNB CP Relocation Indication procedure is only applicable for NB-IOT UEs using Control Plane CIoT EPS optimizations. The purpose of the eNB CP Relocation Indication procedure is to request the MME to authenticate the UE's re-establishment request as described in TS 33.401 [22], and initiate the establishment of the UE-associated logical S1-connection after the UE has initiated a RRC Re-establishment procedure in an eNB.

When the eNB receives the *RRCCConnectionReestablishmentRequest* message, it triggers the eNB CP Relocation Indication procedure including NAS-level security information received from the UE. If the MME authenticates the request, it initiates the Connection Establishment Indication procedure including NAS-level security information to be sent to the UE in the *RRCCConnectionReestablishment* message. In case the MME cannot authenticate the UE's request, the CONNECTION ESTABLISHMENT INDICATION message does not contain security information, and the eNB shall fail the RRC Re-establishment. In case of authentication failure, the eNB and the MME should locally release the allocated S1 resources, if any.

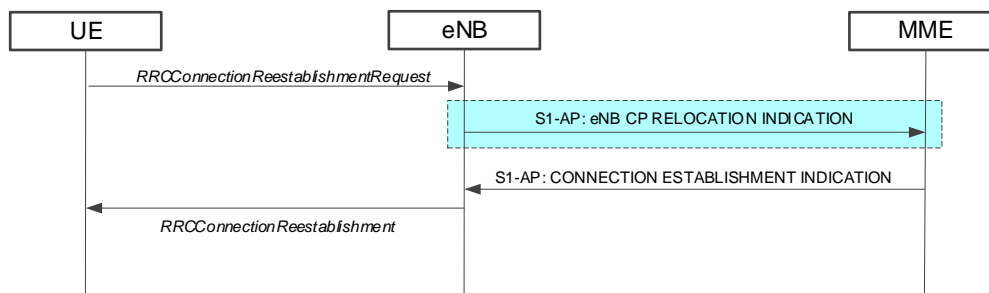

Figure 19.2.2.30-1: eNB CP Relocation Indication procedure (highlighted in blue)

Interactions with the MME CP Relocation and UE Context Release procedures:

In case of successful UE authentication, the MME initiates the UE Context Release procedure to release the UE's old S1-connection. The MME may initiate the MME CP Relocation procedure before the release procedure in order to trigger the return of non-delivered NAS PDUs to the MME.

19.2.2.31 MME CP Relocation Indication

The MME CP Relocation Indication procedure is only applicable for UEs using Control Plane CIoT EPS optimizations. The purpose of the MME CP Relocation Indication procedure is to inform the previously serving eNB that the UE's connection is to be relocated to a new eNB.

Upon reception of the MME CP RELOCATION INDICATION message, the old eNB shall terminate the delivery of downlink NAS PDUs towards the UE, and initiate NAS Non Delivery Indication procedure(s) to report the non-delivery of any NAS PDUs previously received from the MME.

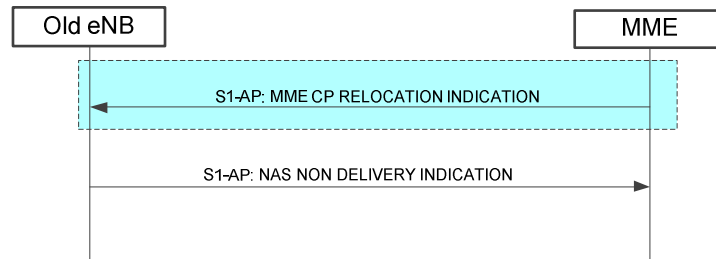

Figure 19.2.2.31-1: MME CP Relocation Indication procedure (highlighted in blue).

19.2.2.32 Secondary RAT Report

The Secondary RAT Report procedure is used by the eNB during mobility procedures or for periodic reporting to provide information on the used NR resources during EN-DC.

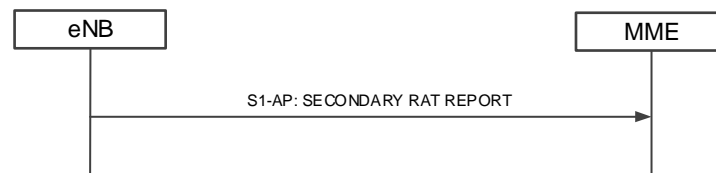

Figure 19.2.2.32-1: Secondary RAT Report Procedure.

20 X2 Interface

20.1 User Plane

The X2 user plane interface (X2-U) is defined between eNBs. The X2-U interface provides non guaranteed delivery of user plane PDUs. The user plane protocol stack on the X2 interface is shown in Figure 20.1-1. The transport network layer is built on IP transport and GTP-U is used on top of UDP/IP to carry the user plane PDUs.

The X2-U interface protocol stack is identical to the S1-U protocol stack.

For DC, if X2-U user data bearers are associated with E-RABs for which the split bearer option is configured, GTP-U conveys PDCP PDUs in uplink and downlink and a RAN Container containing flow control information. The RAN Container is carried in the "RAN Container" field of the GTP-U extension header.

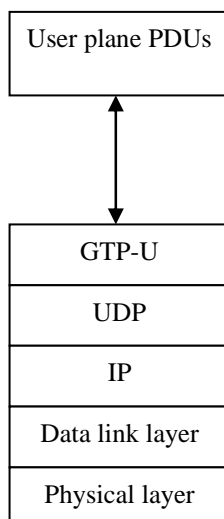

Figure 20.1-1: X2 Interface User Plane (eNB-eNB)

20.1.1 Flow Control Functions

The Flow Control function is applied when an E-RAB is configured for the split bearer option and only for DL i.e. the flow control information is provided only by the SeNB to the MeNB for the MeNB to control the downlink user data flow to the SeNB. The flow control function is further described in TS 36.425 [61].

20.2 Control Plane

20.2.0 X2-CP Overview

The X2 control plane interface (X2-CP) is defined between two neighbour eNBs. The control plane protocol stack of the X2 interface is shown on Figure 20.2-1 below. The transport network layer is built on SCTP on top of IP. The application layer signalling protocol is referred to as X2-AP (X2 Application Protocol).

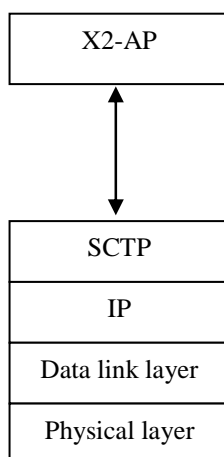

Figure 20.2-1: X2 Interface Control Plane

A single SCTP association per X2-C interface instance shall be used with one pair of stream identifiers for X2-C common procedures. Only a few pairs of stream identifiers should be used for X2-C dedicated procedures.

Source-eNB communication context identifiers that are assigned by the source-eNB for X2-C dedicated procedures, and target-eNB communication context identifiers that are assigned by the target-eNB for X2-C dedicated procedures, shall be used to distinguish UE specific X2-C signalling transport bearers. The communication context identifiers are conveyed in the respective X2AP messages.

RNs terminate X2-AP. In this case, there is one X2 interface relation between the RN and the DeNB.

20.2.1 X2-CP Functions

The X2AP protocol supports the following functions:

- Intra LTE-Access-System Mobility Support for UE in ECM-CONNECTED:
 - Context transfer from source eNB to target eNB;
 - Control of user plane tunnels between source eNB and target eNB;
 - Handover cancellation.
- Support of DC for UE in ECM-CONNECTED:
 - Establishment, Modification and Release of a UE context at the SeNB;
 - Control of user plane tunnels between MeNB and SeNB for a specific UE for split bearer and data forwarding;
 - Provision of the TNL information of the S1 user plane tunnels for SCG bearers.
- Support of EN-DC for UE in ECM-CONNECTED:
 - Establishment, Modification and Release of a UE context at the SgNB;
 - Control of user plane tunnels between MeNB and SgNB for a specific UE for split bearer, SCG split bearer and data forwarding;
 - Provision of the TNL information of the S1 user plane tunnels for SCG bearers and SCG split bearers.
- Support of inter-eNB UE Context Resume:
 - Retrieval of UE context for a UE which attempts to resume its RRC connection in an eNB different from where the RRC connection was suspended.
- Load Management;
- General X2 management and error handling functions:
 - Error indication;
 - Setting up the X2;
 - Resetting the X2;
 - Updating the X2 configuration data;
 - X2 Release;
 - X2AP Message Transfer;
 - Registration;
 - X2 Removal.
- Mobility failure event notification and information exchange in support of handover settings negotiation;
- Energy Saving. This function allows decreasing energy consumption by enabling indication of cell activation/deactivation.
- Support of cell resource coordination between eNB and en-gNB.

20.2.2 X2-CP Procedures

20.2.2.0 Overview of X2-CP procedures

The elementary procedures supported by the X2AP protocol are listed in Table 8.1-1 and Table 8.1-2 of TS 36.423 [42].

20.2.2.1 Handover Preparation procedure

The Handover preparation procedure is initiated by the source eNB if it determines the necessity to initiate the handover via the X2 interface.

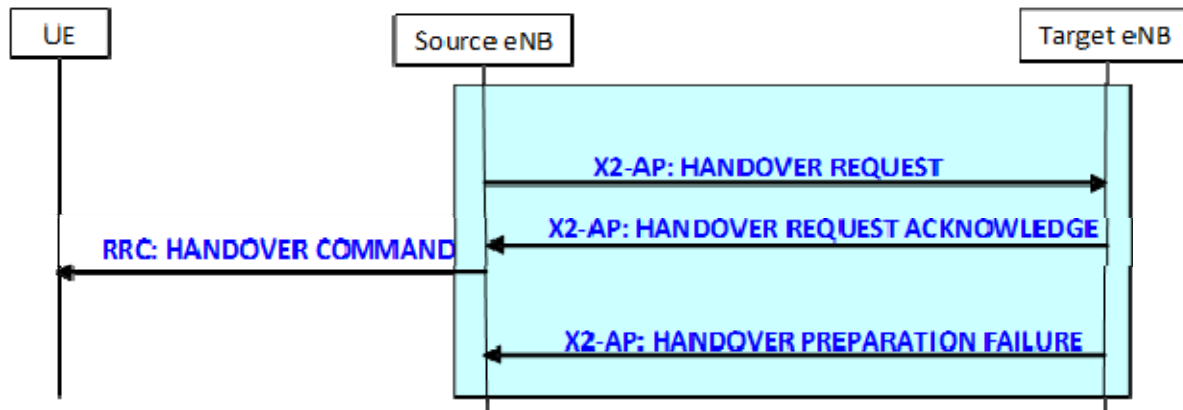

Figure 20.2.2.1-1: Handover Preparation procedure

The source eNB sends a HANDOVER REQUEST to the target eNB including the bearers to be setup by the target eNB.

The handover preparation phase is finished upon the reception of the HANDOVER REQUEST ACKNOWLEDGE message in the source eNB, which includes at least radio interface related information (HO Command for the UE), successfully established E-RAB(s) and failed established E-RAB(s).

In case the handover resource allocation is not successful (e.g. no resources are available on the target side) the target eNB responds with the HANDOVER PREPARATION FAILURE message instead of the HANDOVER REQUEST ACKNOWLEDGE message.

If eNB received NAS message from MME during X2 handover procedure, it shall be acted as specified in clause 19.2.2.6.

20.2.2.2 Handover Cancel procedure

This functionality is located in the source eNB to allow cancellation of the handover procedure.

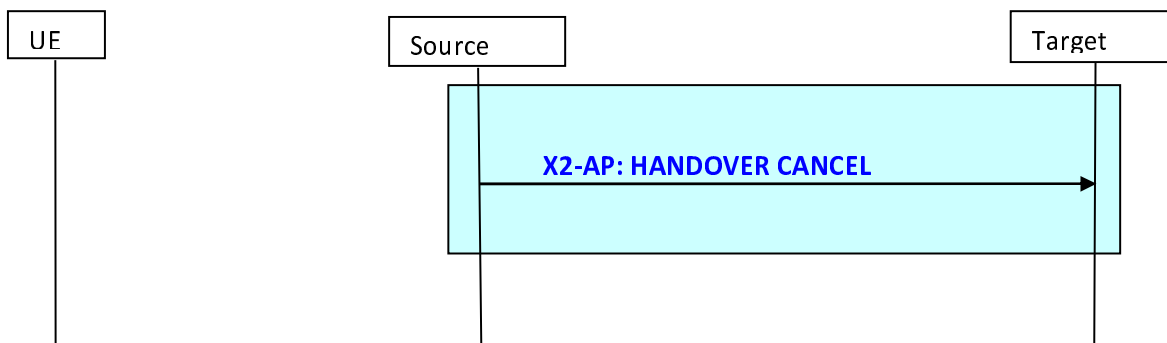

Figure 20.2.2.2-1: Handover Cancel procedure

The source eNB sends a HANDOVER CANCEL message to the target eNB indicating the reason for the handover cancellation.

20.2.2.2a SeNB Addition Preparation procedure

The SeNB Addition Preparation procedure is initiated by the MeNB to request the SeNB to allocate resources for DC operation for a specific UE.

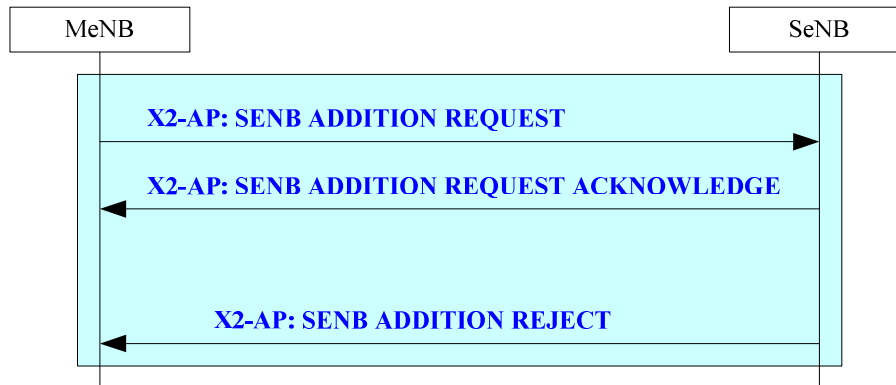

Figure 20.2.2.2a-1: SeNB Addition Preparation procedure

The MeNB sends an SENB ADDITION REQUEST message to the SeNB including the bearers for which DC shall be configured.

In case resource allocation at the SeNB has been performed successfully, the SeNB responds with an SENB ADDITION REQUEST ACKNOWLEDGE message, which includes radio interface related information, successfully established and failed to be established bearers for DC.

In case the SeNB addition is not successful (e.g. no resources are available on the SeNB side) the SeNB responds with the SENB ADDITION REJECT message instead.

20.2.2.2b SeNB Reconfiguration Completion procedure

The SeNB Reconfiguration Complete procedure is initiated by the MeNB to indicate to the SeNB that the UE has been successfully configured with the requested SeNB radio configuration.

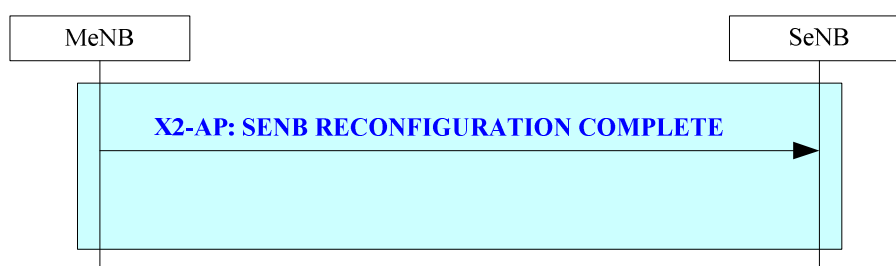

Figure 20.2.2.2b-1: SeNB Reconfiguration Completion procedure

The same procedure is also used by the MeNB to indicate that the MeNB finally decided to not request the UE to apply the radio configuration requested by the SeNB.

The SeNB Reconfiguration Completion procedure is used in the course of an SeNB Addition and in the course of an MeNB initiated SeNB Modification if the MeNB initiated SeNB Modification requires signalling towards the UE.

20.2.2.2c MeNB initiated SeNB Modification Preparation procedure

The MeNB initiated SeNB Modification Preparation procedure is initiated by the MeNB to request the SeNB to modify resources allocated for a specific UE at the SeNB.

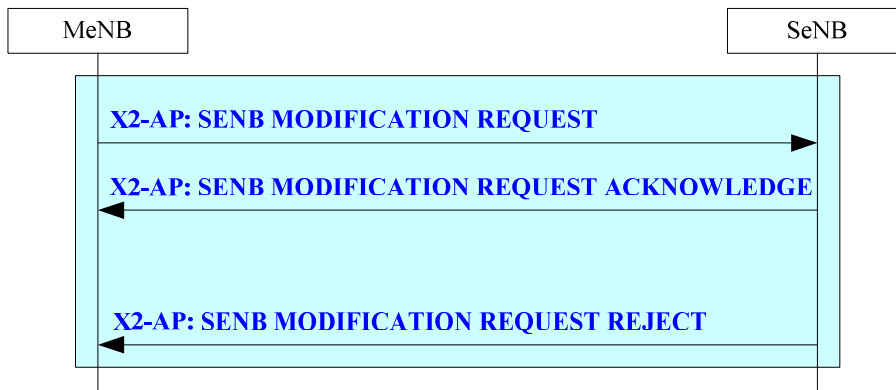

Figure 20.2.2.2c-1: MeNB initiated SeNB Modification Preparation procedure

The MeNB initiated SeNB Modification does not necessarily result in communication towards the UE.

In case resource modification at the SeNB has been performed successfully, the SeNB responds with an SENB MODIFICATION REQUEST ACKNOWLEDGE message.

In case the SeNB modification is not successful (e.g. no resources are available on the SeNB side), the SeNB responds with the SENB MODIFICATION REQUEST REJECT message instead.

20.2.2.2d SeNB initiated SeNB Modification procedure

The SeNB initiated SeNB Modification Preparation procedure is initiated to request the modification of the UE context at the SeNB.

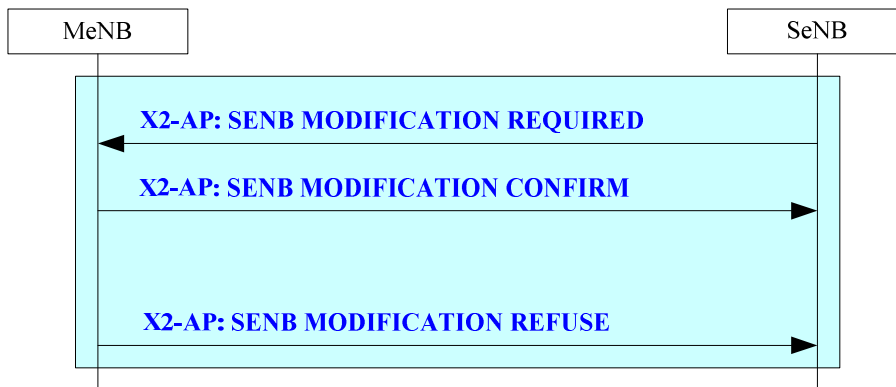

Figure 20.2.2.2d-1: SeNB initiated SeNB Modification procedure

The SeNB initiated SeNB Modification does not necessarily result in communication towards the UE.

If the MeNB decides to not follow the SeNBs request it replies with an SENB MODIFICATION REFUSE message.

20.2.2.2e MeNB initiated SeNB Release procedure

The MeNB initiated SeNB Release procedure is triggered by the MeNB to initiate the release of the resources for a specific UE at the SeNB.

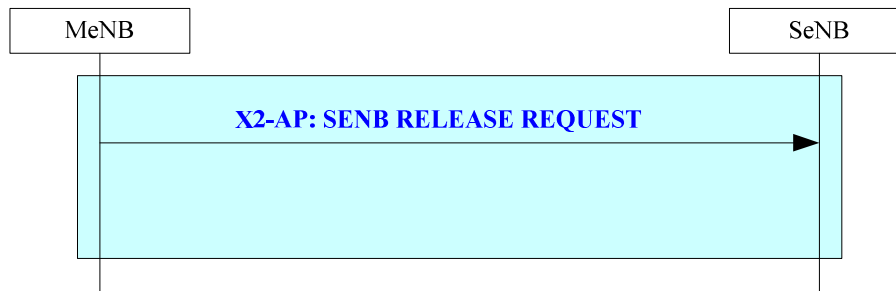

Figure 20.2.2.2e-1: MeNB initiated SeNB Release procedure

20.2.2.2f SeNB initiated SeNB Release procedure

The SeNB initiated SeNB Release procedure is triggered by the SeNB to initiate the release of the resources for a specific UE at the SeNB.

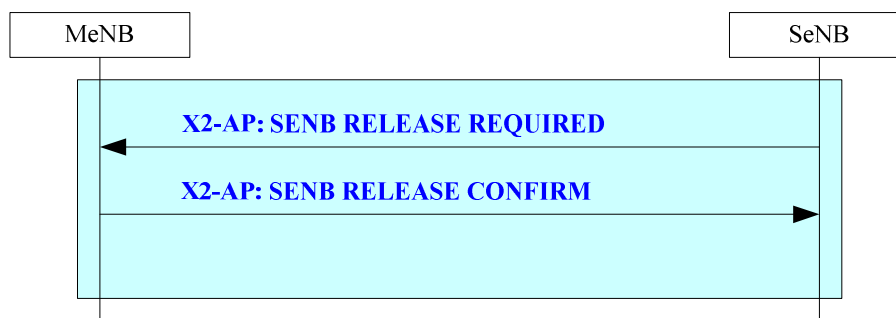

Figure 20.2.2.2f-1: SeNB initiated SeNB Release procedure

20.2.2.2g SeNB Counter Check procedure

The SeNB Counter Check procedure is initiated by the SeNB to request the MeNB to execute a counter check procedure to verify the value of the PDCP COUNTs associated with SCG bearers established in the SeNB.

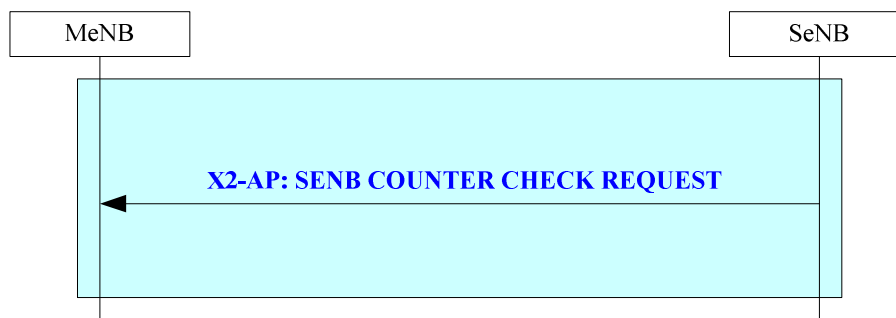

Figure 20.2.2.2g-1: SeNB Counter Check procedure

20.2.2.3 UE Context Release procedure

At handover, the UE Context Release procedure is initiated by the target eNB to signal to the source eNB that resources for the handed over UE context can be released.

For DC, the UE Context Release procedure is initiated by the MeNB to finally release the resources at the SeNB for the specific UE once either the SeNB initiated or the MeNB initiated SeNB Release Procedure has been performed.

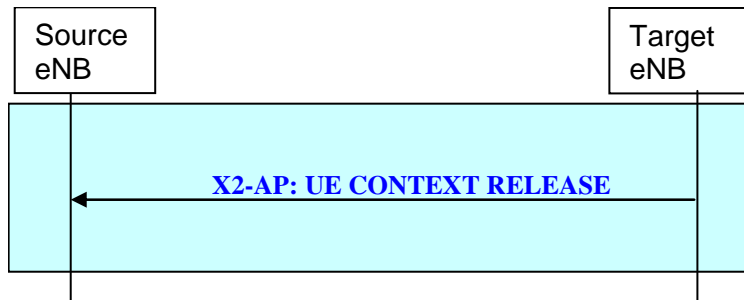

Figure 20.2.2.3-1: UE Context Release procedure for handover and DC.

At handover, by sending UE CONTEXT RELEASE the target eNB informs the source eNB of Handover success and triggers the release of resources.

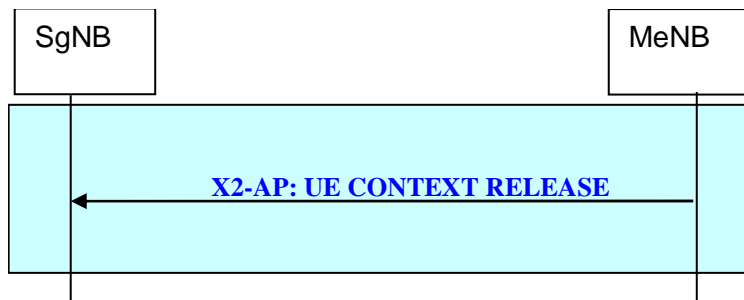

Figure 20.2.2.3-2: UE Context Release procedure for EN-DC.

For EN-DC, the UE Context Release procedure is initiated by the MeNB to finally release the UE context at the SgNB for the specific UE once either the SgNB initiated or the MeNB initiated SgNB Release Procedure has been performed.

20.2.2.4 SN Status Transfer procedure

The purpose of the SN Status Transfer procedure is to transfer the uplink PDCP SN and HFN receiver status and the downlink PDCP SN and HFN transmitter status from the source to the target eNB during an X2 handover, or between MeNB and SgNB involved in EN-DC, or between the old and the new eNB at RRC connection re-establishment for each respective E-RAB for which PDCP SN and HFN status preservation applies.

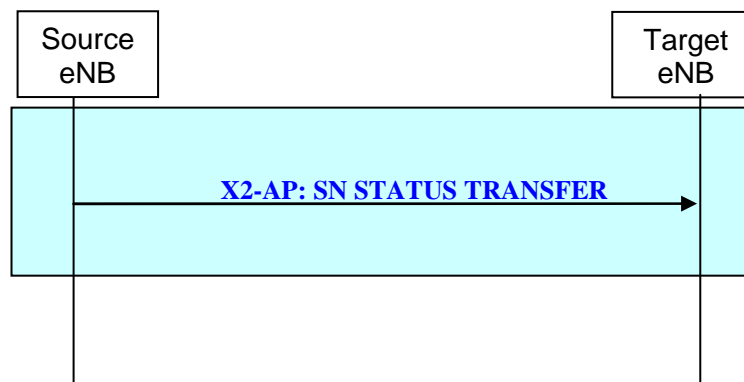

Figure 20.2.2.4-1: SN Status Transfer procedure for handover.

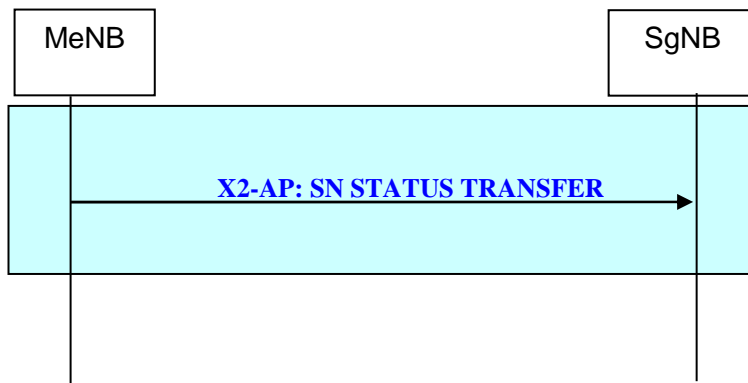

Figure 20.2.2.4-2: MeNB-initiated SN Status Transfer procedure for EN-DC.

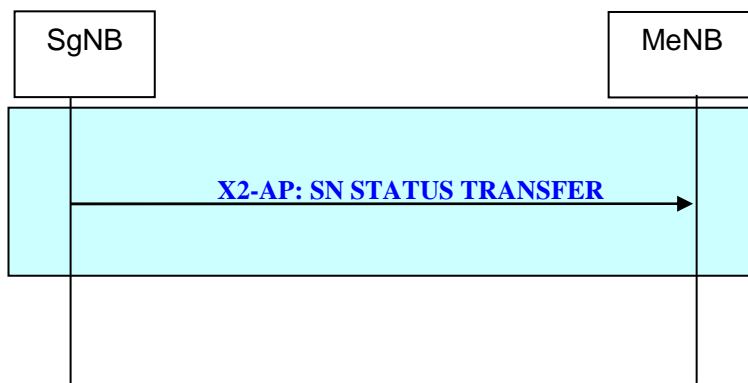

Figure 20.2.2.4-3: SgNB-initiated SN Status Transfer procedure for EN-DC.

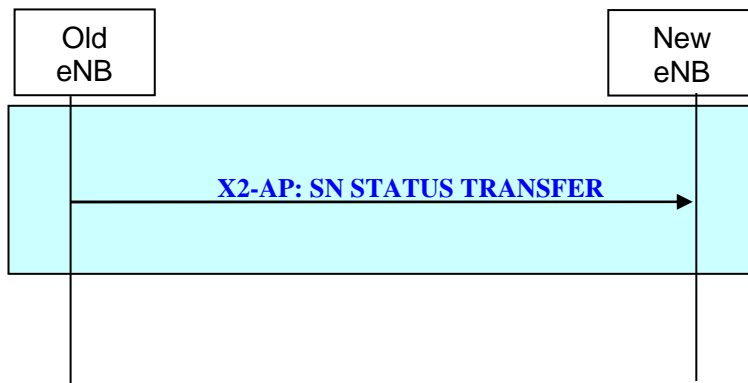

Figure 20.2.2.4-4: SN Status Transfer procedure for RRC Connection Re-establishment.

20.2.2.5 Error Indication procedure

The Error Indication procedure is initiated by an eNB or an en-gNB to signal to a peer E-UTRAN node an error situation in a received message, provided it cannot be reported by an appropriate failure message.

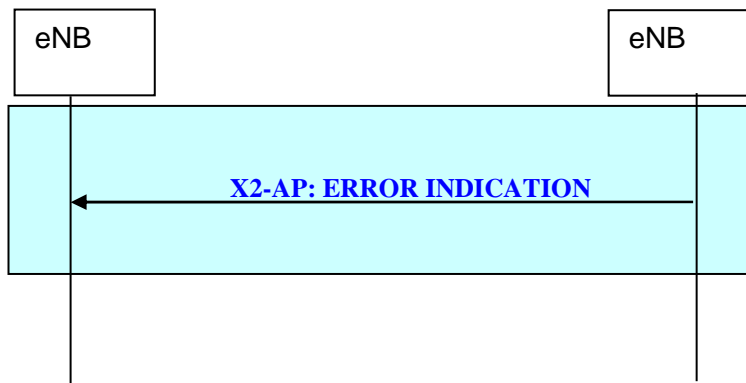

Figure 20.2.2.5-1: Error Indication procedure between eNB and eNB

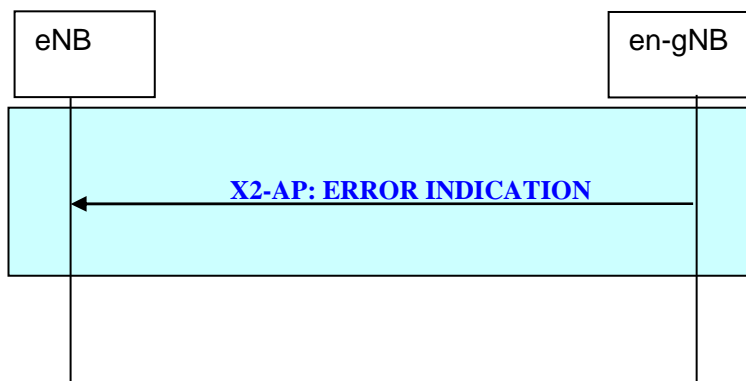

Figure 20.2.2.5-2: en-gNB-initiated Error Indication procedure between en-gNB and eNB

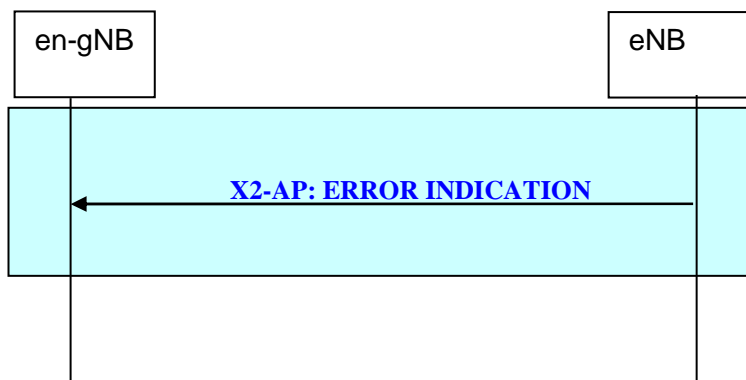

Figure 20.2.2.5-3: eNB-initiated Error Indication procedure between eNB and en-gNB

20.2.2.6 Load Indication procedure

Inter-cell interference coordination in E-UTRAN is performed through the X2 interface. In case of variation in the interference conditions, the eNB signals the new condition to its neighbour eNBs e.g. the neighbour eNBs for which an X2 interface is configured due to mobility reasons.

When the time-domain inter-cell interference coordination is used to mitigate interference, the eNB signals its almost blank subframe (ABS) patterns to its neighbour eNBs, so that the receiving eNB can utilize the ABS of the sending eNB with less interference.

NOTE: A typical use case of the time-domain solution of inter-cell interference coordination is the one where an eNB providing broader coverage and therefore being more capacity constrained determines its ABS patterns and indicates them to eNBs, providing smaller coverage residing in its area.

When inter-eNB CoMP is used, the eNB signals the CoMP hypotheses and associated benefit metrics to its neighbour eNB(s), so that the receiving eNB may take them into account for RRM.

The Load Indication procedure is used to transfer interference co-ordination information between neighbouring eNBs managing intra-frequency cells, and adjacent frequency TDD cells.

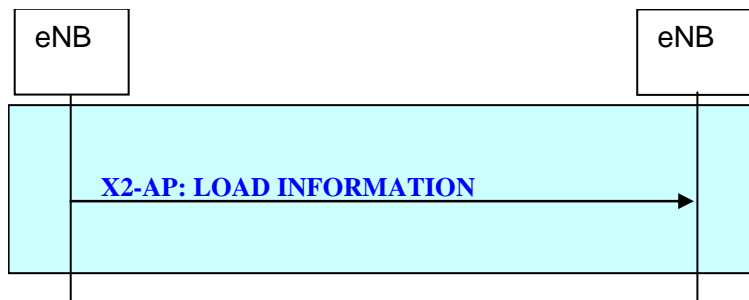

Figure 20.2.2.6-1: Load Indication procedure

20.2.2.7 X2 Setup procedure

The purpose of the X2 Setup procedure is to exchange application level data needed for two eNBs to interoperate correctly over the X2 interface.

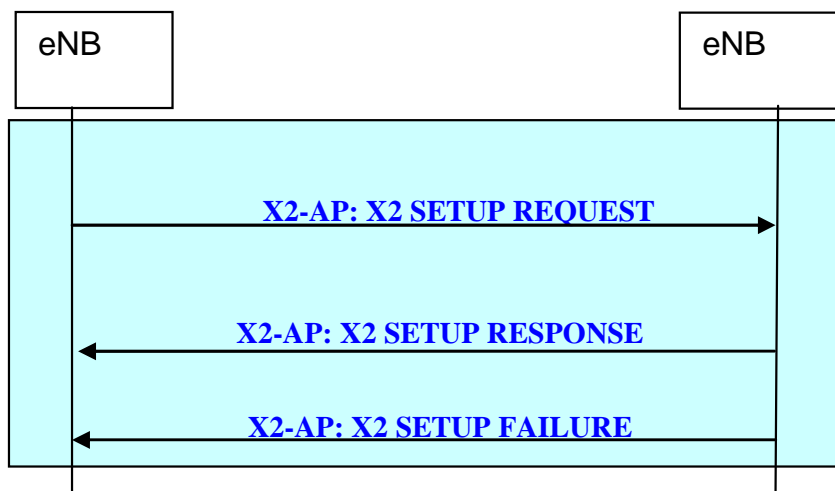

Figure 20.2.2.7-1: X2 Setup procedure

20.2.2.8 eNB Configuration Update procedure

The purpose of the eNB Configuration Update procedure is to update application level configuration data needed for two eNBs to interoperate correctly over the X2 interface.

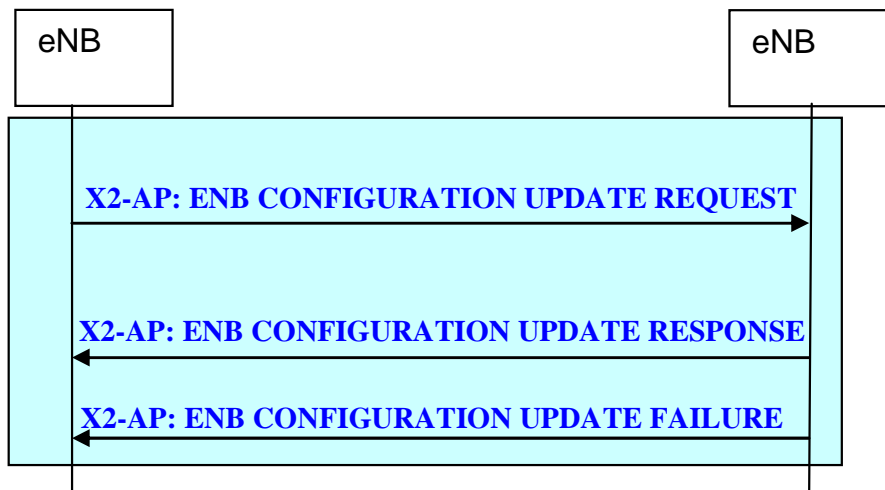

Figure 20.2.2.8-1: eNB Configuration Update procedure

20.2.2.9 Reset procedure

The Reset procedure is initiated by an eNB or an en-gNB to align the resources with a peer E-UTRAN node in the event of an abnormal failure. The procedure resets the whole X2 interface.

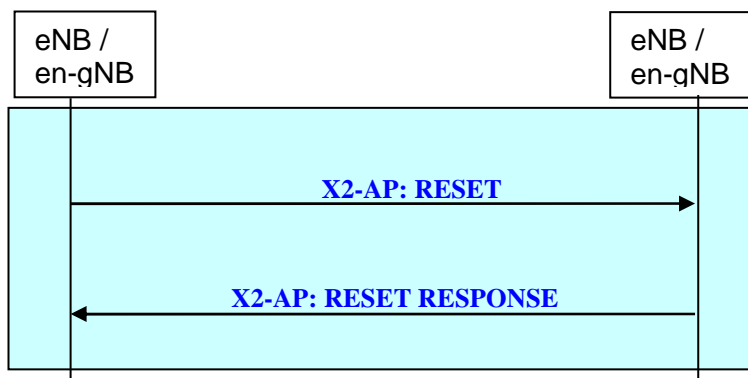

Figure 20.2.2.9-1: Reset procedure between eNBs

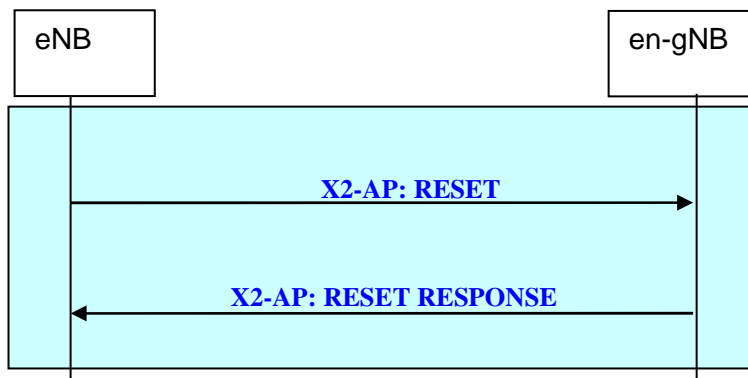

Figure 20.2.2.9-2: eNB-initiated Reset procedure between eNB and en-gNB

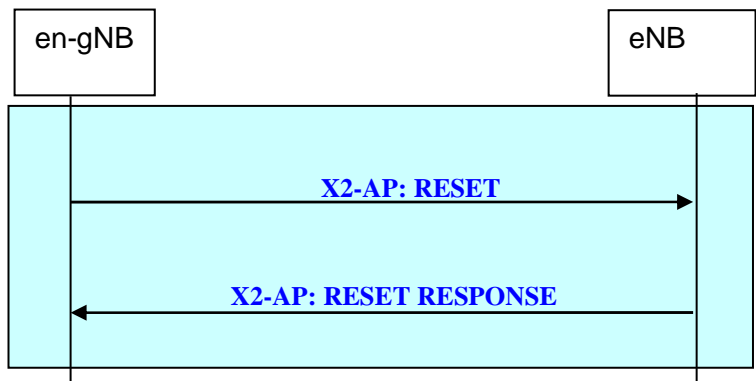

Figure 20.2.2.9-3: en-gNB-initiated Reset procedure between en-gNB and eNB

20.2.2.10 Resource Status Reporting Initiation procedure

The Resource Status Reporting Initiation procedure is used by an eNB to request measurements from another eNB.

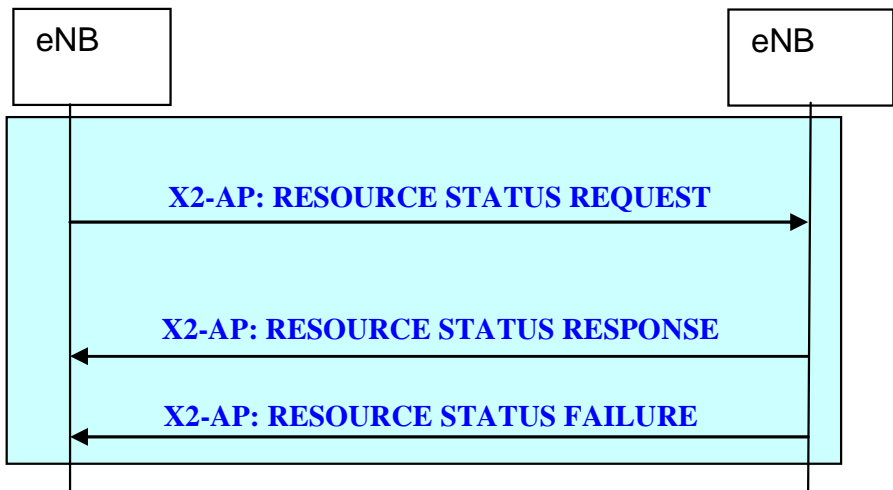

Figure 20.2.2.10-1: Resource Status Reporting Initiation procedure

20.2.2.11 Resource Status Reporting procedure

The Resource Status Reporting procedure reports measurement results requested by another eNB.

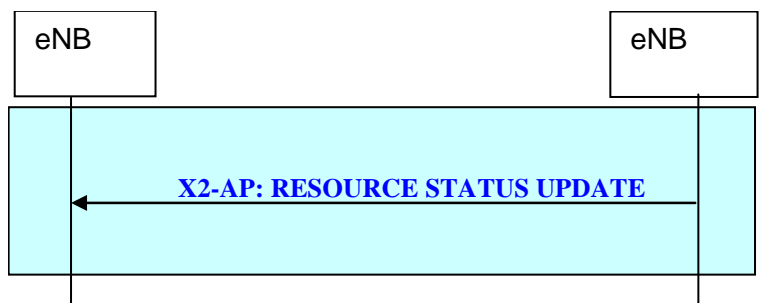

Figure 20.2.2.11-1: Resource Status Reporting procedure

20.2.2.12 Radio Link Failure Indication procedure

The purpose of the Radio Link Failure Indication procedure is to enable mobility robustness and radio link failure recovery improvement in E-UTRAN by passing information about a failure event over the X2 interface.

When a re-establishment request is received or a connection failure reported after RRC connection setup or an incoming successful handover, the eNB uses the cell identifiers provided by the UE to identify the potentially previous serving cell/eNB. The eNB that received the information about the failure sends a RLF INDICATION message to the concerned eNB(s). The previously serving eNB may then match the correct context, or use the information available in the RLF Report, if included in the RLF INDICATION message, to analyze the possible root cause of the failure. If the previous serving eNB matches the correct context, it may also trigger the Handover Preparation procedure towards the eNB that initiated the Radio Link Failure Indication procedure.

NOTE: When deciding whether to trigger the Handover preparation procedure the previously serving eNB may take into account a number of factors, e.g. the CSFB indicator in the UE Context.

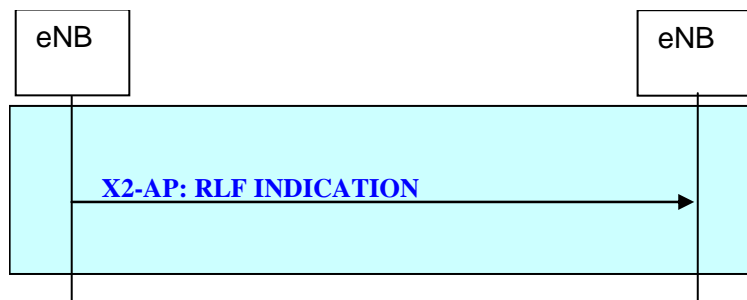

Figure 20.2.2.12-1: Radio Link Failure Indication procedure

20.2.2.13 Handover Report procedure

The purpose of the Handover Report procedure is to enable mobility robustness improvement in E-UTRAN.

The Handover Report procedure is used to pass information connected to the analysis of an RLF which occurred shortly after a successful handover.

The eNB where the RLF occurred (original target eNB) sends a HANOVER REPORT message to the original source eNB, identifying the source cell, the target cell, and the cell where re-establishment took place.

The Handover Report procedure is also used to pass information connected to potential inter-RAT ping-pong cases. The eNB that detected the potential ping-pong cases sends a HANOVER REPORT message to the source eNB of the first inter-RAT handover, identifying the source and the target cells of the first inter-RAT handover, and the target cell of the second inter-RAT handover.

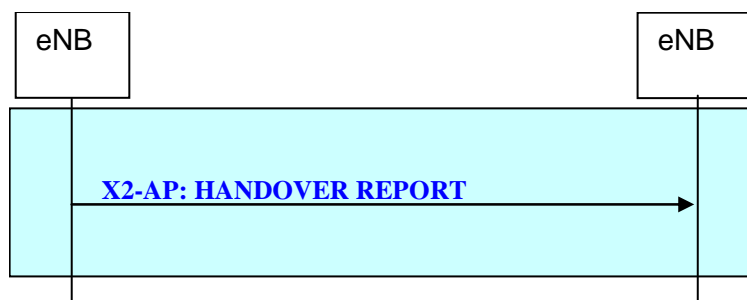

Figure 20.2.2.13-1: Handover Report procedure

20.2.2.14 Mobility Settings Change procedure

The purpose of the MOBILITY SETTINGS CHANGE procedure is to enable an eNB to send a MOBILITY CHANGE REQUEST message to a peer eNB to negotiate the handover trigger settings.

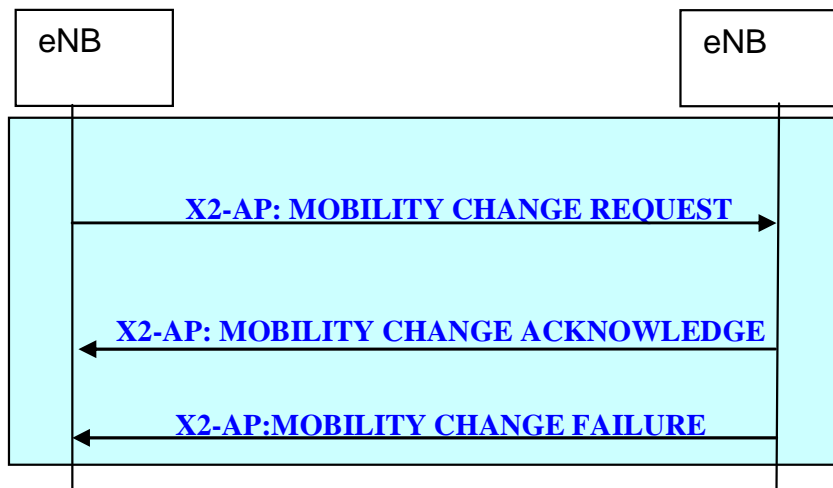

Figure 20.2.2.14-1: Mobility Settings Change procedure

20.2.2.15 Cell Activation procedure

The purpose of the Cell Activation procedure is to enable an eNB to send a CELL ACTIVATION REQUEST message to a peer eNB to request the re-activation of one or more cells, controlled by the peer eNB and which had been previously indicated as dormant.

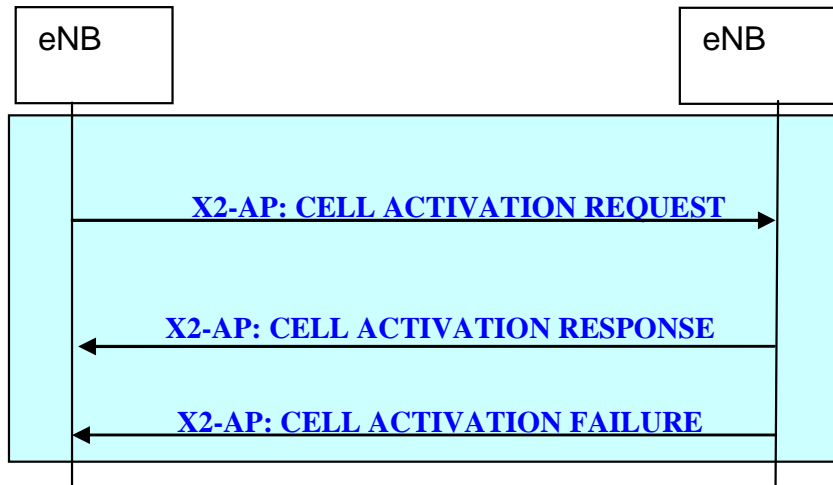

Figure 20.2.2.15-1: Cell Activation procedure

20.2.2.16 X2 Release procedure

The purpose of the X2 Release procedure is to enable an X2 GW to inform the relevant (H)eNBs that the signalling (i.e. SCTP) connection to a peer (H)eNB is unavailable.

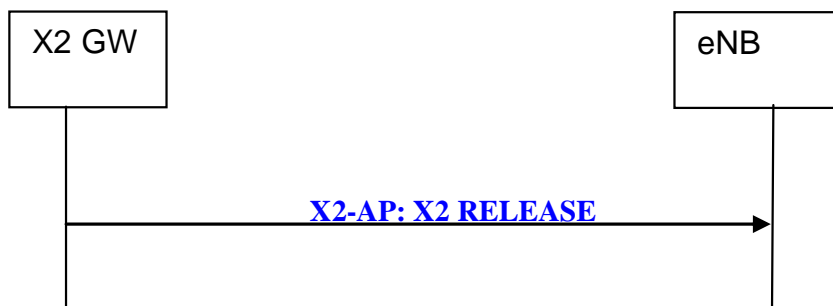

Figure 20.2.2.16-1: X2 Release procedure

20.2.2.17 X2AP Message Transfer procedure

The purpose of the X2AP Message Transfer procedure is to allow indirect transport of an X2AP message (except the X2AP MESSAGE TRANSFER message) between two (H)eNBs through an X2 GW, and to allow an (H)eNB to register with an X2 GW.

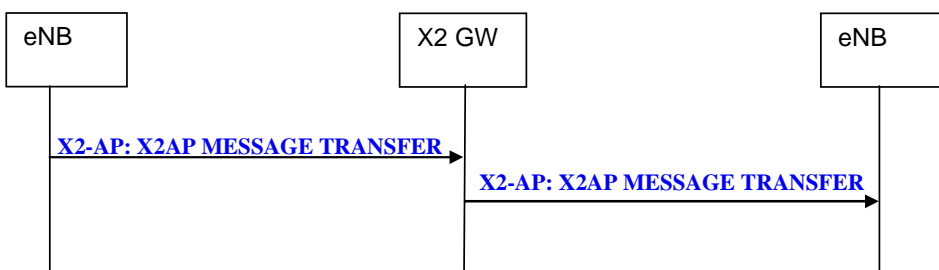

Figure 20.2.2.17-1: X2AP Message Transfer procedure

20.2.2.18 X2 Removal procedure

The purpose of the X2 Removal procedure is to perform the removal of X2 connectivity between two eNBs in a controlled manner. If the procedure is successful, the receiving eNB responds with the X2 REMOVAL RESPONSE message, after which both eNBs remove the X2 signalling connection between them and may release all associated resources. In case the receiving eNB cannot remove the X2 signalling connection (e.g. because of an ongoing procedure and/or due to local configuration), it responds with the X2 REMOVAL FAILURE message. The initiating eNB may include an X2 removal threshold for removal of a signalling connection.

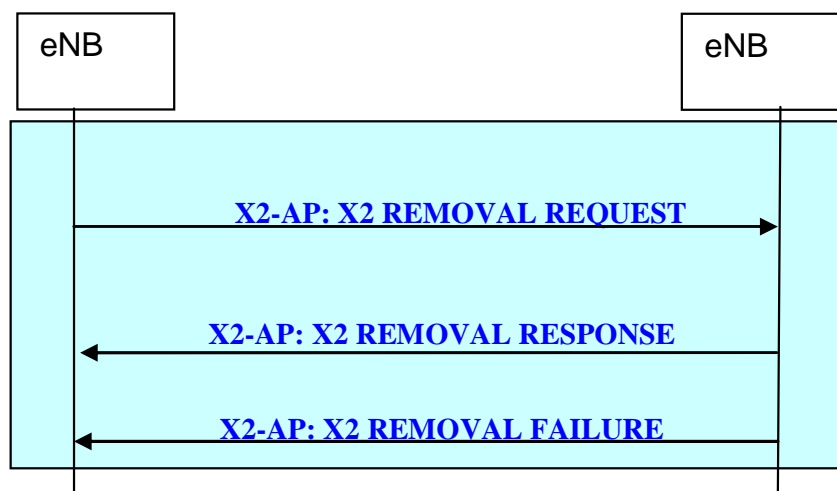

Figure 20.2.2.18-1: X2 Removal procedure

20.2.2.19 Retrieve UE Context

The purpose of the Retrieve UE Context procedure is to retrieve the UE context for a UE which attempts to resume its RRC connection in an eNB (the new eNB) different from the eNB (the old eNB) where the RRC connection was suspended or for a UE which attempts to re-establish its RRC connection in an eNB (the new eNB) different from the eNB (the old eNB) where the RRC connection failed, e.g. due to RLF.

If the new eNB is able to identify the old eNB based on the Resume ID or based on the Physical Cell ID received from the UE, it triggers the Retrieve UE Context procedure towards the old eNB.

If the old eNB is able to match the UE context with the Resume ID or with the ShortMAC-I, C-RNTI, failed PCI and new E-UTRAN Cell Identifier included in the RETRIEVE UE CONTEXT REQUEST message it responds with the RETRIEVE UE CONTEXT RESPONSE message containing UE context information.

Upon resumption of the UE Context in the new eNB, the new eNB resumes/re-establishes the RRC connection and performs the S1-AP Path Switch procedure to establish a S1 UE associated signalling connection to the serving MME and to request the MME to resume the UE context and related bearer contexts in the EPC (for resuming UEs) and update the downlink path (for resuming and re-establishing UEs). In case of re-establishment of the RRC connection, the new eNB may provide a data forwarding address per re-established E-RAB to the old eNB by means of the X2-AP Data Forwarding Address Indication procedure if DL forwarding was proposed by the old eNB. After the S1-AP Path Switch procedure the new eNB triggers release of the UE Context at the old eNB by means of the X2-AP UE Context Release procedure.

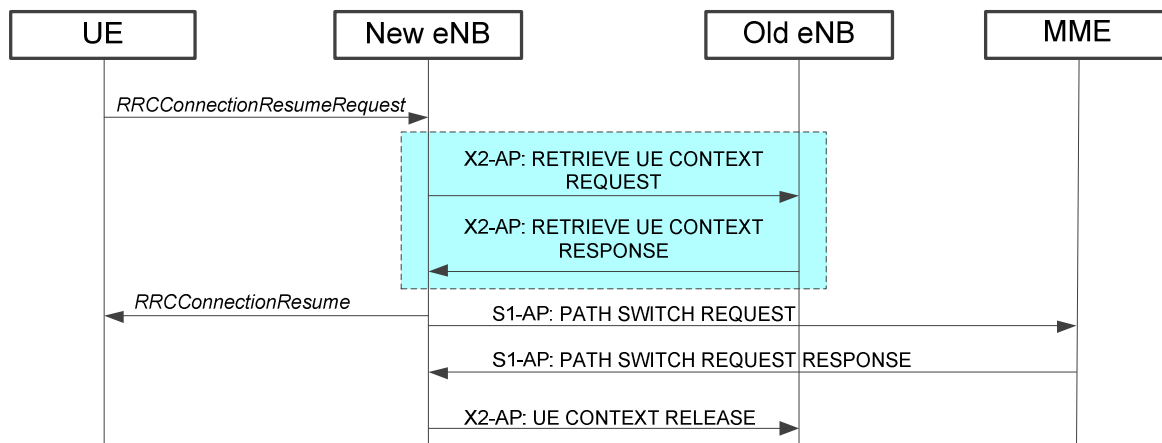

Figure 20.2.2.19-1: Retrieve UE Context procedure (highlighted in blue) for cases of UE context resumption. Successful case

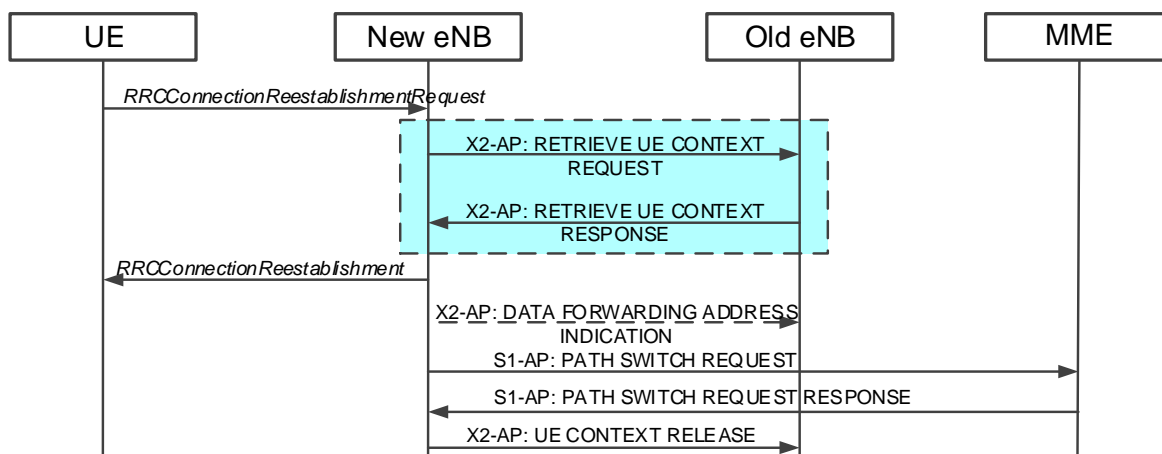

Figure 20.2.2.19-1A: Retrieve UE Context procedure (highlighted in blue) for cases of UE re-establishment. Successful case

In case the old eNB cannot find UE Context Information corresponding to the Resume ID or to the ShortMAC-I, C-RNTI, failed PCI and new E-UTRAN Cell Identifier received from the UE, it responds with the RETRIEVE UE

CONTEXT FAILURE message and the new eNB fails the RRC connection resume/re-establishment procedure as specified in TS 36.331 [16].

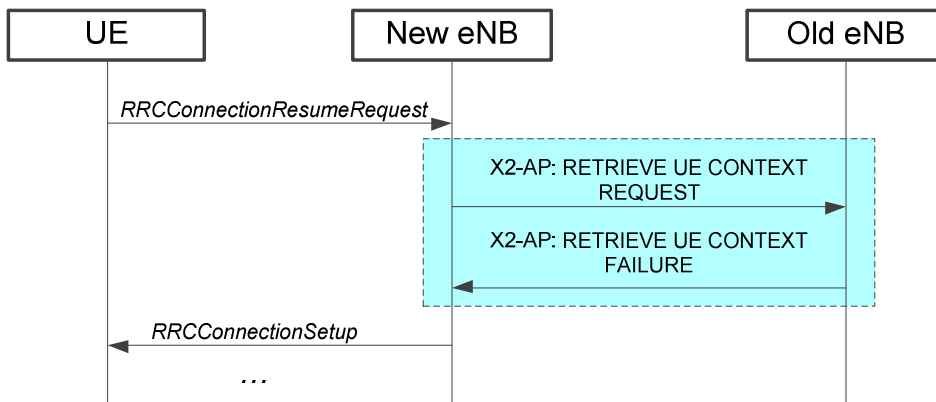

Figure 20.2.2.19-2: Retrieve UE Context procedure (highlighted in blue) for cases of UE context resumption. Unsuccessful case

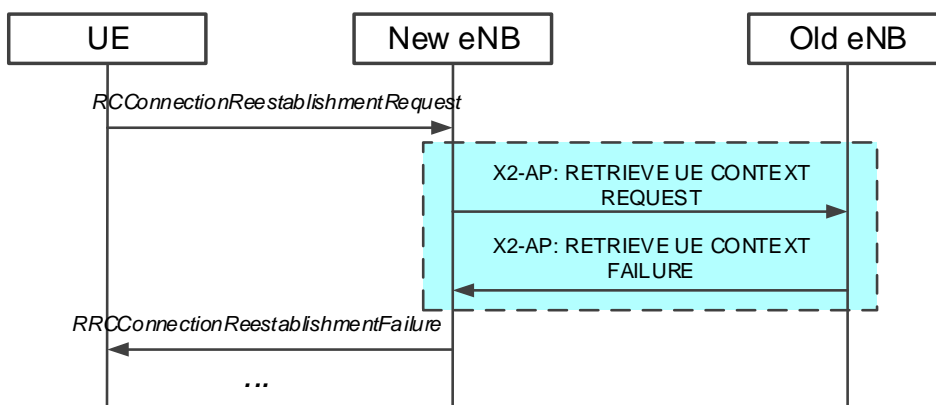

Figure 20.2.2.19-3: Retrieve UE Context procedure (highlighted in blue) for cases of UE re-establishment. Unsuccessful case

20.2.2.20 SgNB Addition Preparation procedure

The SgNB Addition Preparation procedure is initiated by the MeNB to request the SgNB to allocate resources for EN-DC operation for a specific UE.

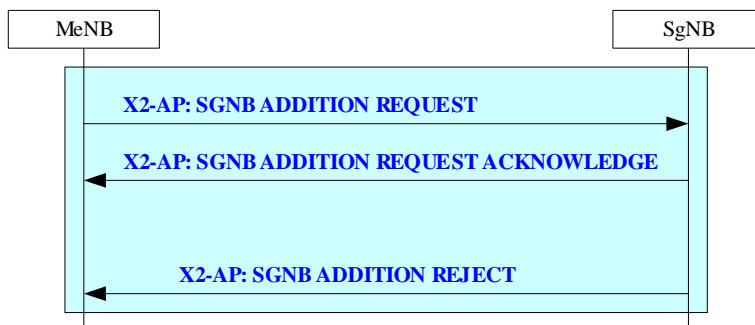

Figure 20.2.2.20-1: SgNB Addition Preparation procedure

The MeNB sends an SGNB ADDITION REQUEST message to the SgNB including the bearers for which EN-DC shall be configured.

In case resource allocation at the SgNB has been performed successfully, the SgNB responds with an SGNB ADDITION REQUEST ACKNOWLEDGE message, which includes radio interface related information, successfully established and failed to be established bearers for EN-DC.

In case the SgNB Addition is not successful (e.g. no resources are available on the SgNB side) the SgNB responds with the SGNB ADDITION REJECT message instead.

20.2.2.21 SgNB Reconfiguration Completion procedure

The SgNB Reconfiguration Complete procedure is initiated by the MeNB to indicate to the SgNB that the UE has been successfully configured with the requested SgNB radio configuration.

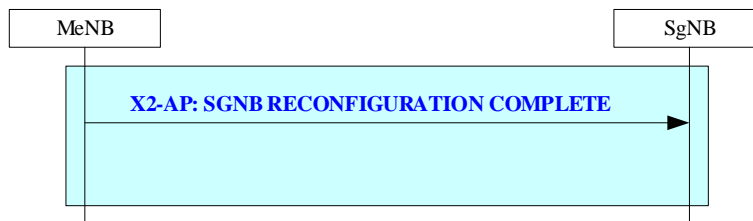

Figure 20.2.2.21-1: SgNB Reconfiguration Completion procedure

The same procedure is also used by the MeNB to indicate that the MeNB finally decided to not request the UE to apply the radio configuration requested by the SgNB.

The SgNB Reconfiguration Completion procedure is used in the course of an SgNB Addition and in the course of an MeNB initiated SgNB Modification if the MeNB initiated SgNB Modification requires signalling towards the UE.

20.2.2.22 MeNB initiated SgNB Modification Preparation procedure

The MeNB initiated SgNB Modification Preparation procedure is initiated by the MeNB to request the SgNB to modify resources allocated for a specific UE at the SgNB.

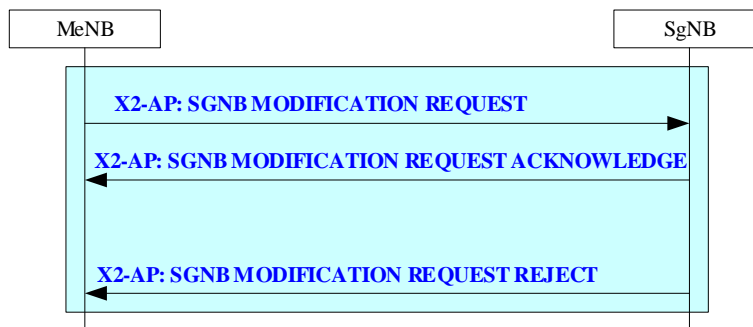

Figure 20.2.2.22-1: MeNB initiated SgNB Modification Preparation procedure

The MeNB initiated SgNB Modification does not necessarily result in communication towards the UE.

In case resource modification at the SgNB has been performed successfully, the SgNB responds with an SGNB MODIFICATION REQUEST ACKNOWLEDGE message.

In case the SgNB modification is not successful (e.g. no resources are available on the SgNB side), the SgNB responds with the SGNB MODIFICATION REQUEST REJECT message instead.

20.2.2.23 SgNB initiated SgNB Modification Preparation procedure

The SgNB initiated SgNB Modification Preparation procedure is initiated to request the modification of the UE context at the SgNB.

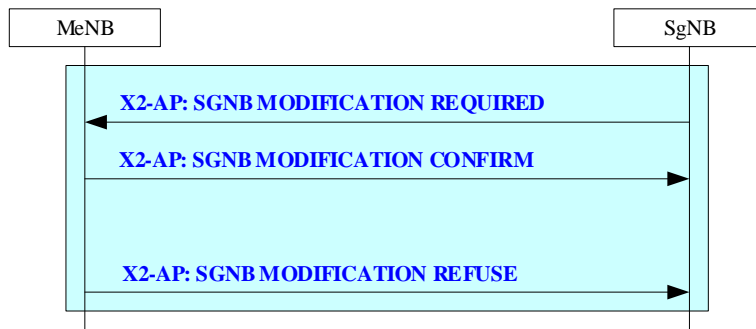

Figure 20.2.2.23-1: SgNB initiated SgNB Modification procedure

The SgNB initiated SgNB Modification does not necessarily result in communication towards the UE.

If the MeNB decides to not follow the SgNBs request it replies with an SGNB MODIFICATION REFUSE message.

20.2.2.24 MeNB initiated SgNB Release procedure

The MeNB initiated SgNB Release procedure is triggered by the MeNB to initiate the release of the resources for a specific UE at the SgNB.

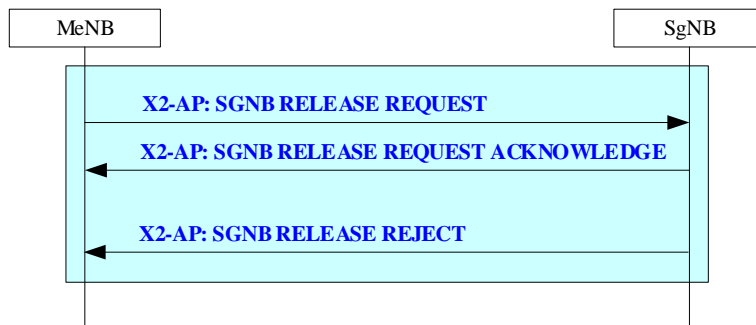

Figure 20.2.2.24-1: MeNB initiated SgNB Release procedure

20.2.2.25 SgNB initiated SgNB Release procedure

The SgNB initiated SgNB Release procedure is triggered by the SgNB to initiate the release of the resources for a specific UE at the SgNB.

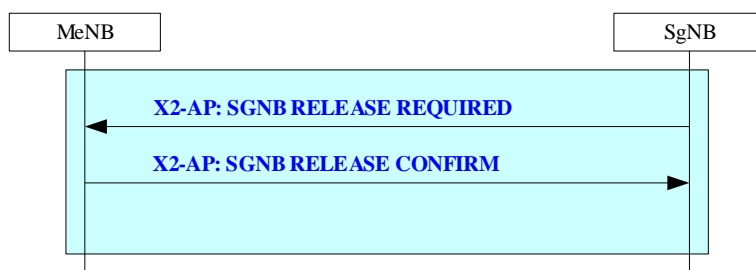

Figure 20.2.2.25-1: SgNB initiated SgNB Release procedure

20.2.2.26 SgNB initiated SgNB Change procedure

The SgNB initiated SgNB Change procedure is triggered by the SgNB to initiate the transfer of the resources for a specific UE at the SgNB to another en-gNB.

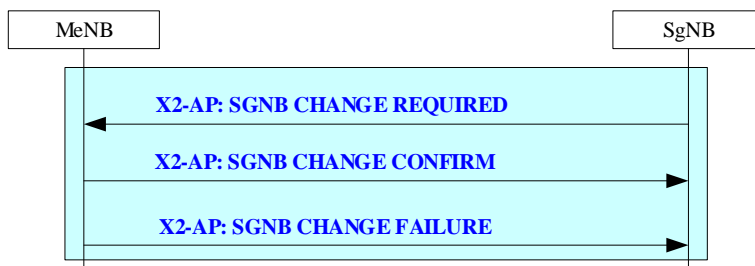

Figure 20.2.2.26-1: SgNB initiated SgNB Change procedure

In case the transfer of the UE context to the target en-gNB has been performed successfully, the MeNB responds with an SGNB CHANGE CONFIRM message.

If the MeNB is not able to transfer the UE context to the target en-gNB, it replies with an SGNB CHANGE FAILURE message.

20.2.2.27 SgNB Counter Check procedure

The SgNB Counter Check procedure is initiated by the SgNB to request the MeNB to execute a counter check procedure to verify the value of the PDCP COUNTs associated with SCG bearers or SCG split bearers.

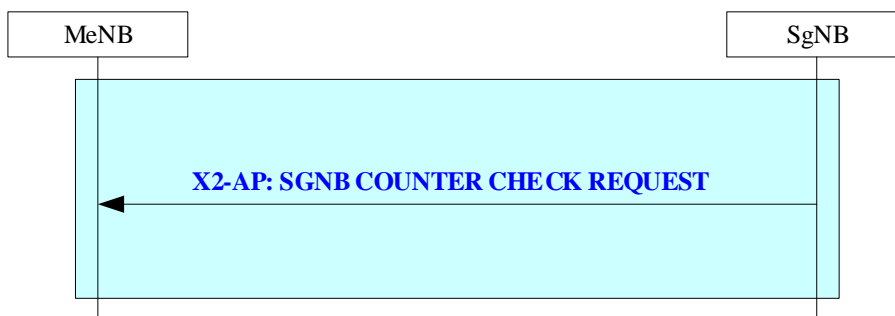

Figure 20.2.2.27-1: SgNB Counter Check procedure

20.2.2.28 EN-DC X2 Setup procedure

The purpose of the EN-DC X2 Setup procedure is to exchange application level data needed for an eNB and an en-gNB to interoperate correctly over the X2 interface in EN-DC case. The procedure is triggered by the eNB or by the en-gNB.

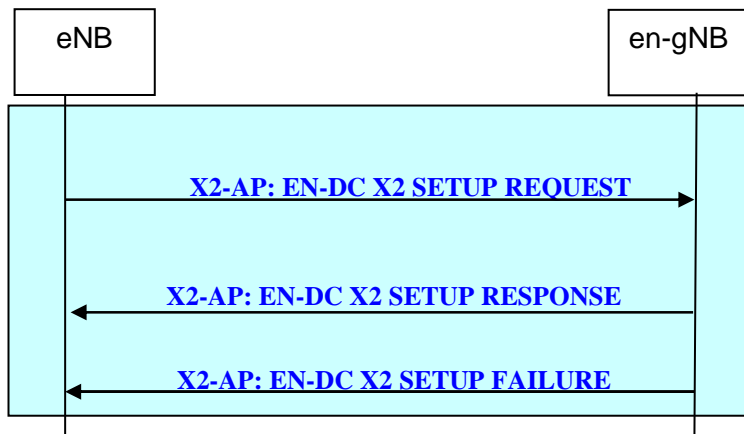

Figure 20.2.2.28-1: EN-DC X2 Setup procedure triggered by the eNB.

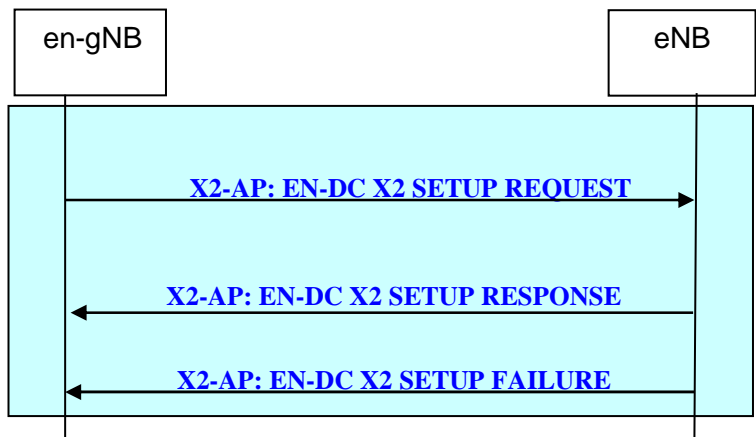

Figure 20.2.2.28-2: EN-DC X2 Setup procedure triggered by the en-gNB.

20.2.2.29 EN-DC Configuration Update procedure

The purpose of the EN-DC Configuration Update procedure is to update application level configuration data needed for an eNB and an en-gNB to interoperate correctly over the X2 interface in EN-DC case. The procedure is triggered by the eNB or by the en-gNB.

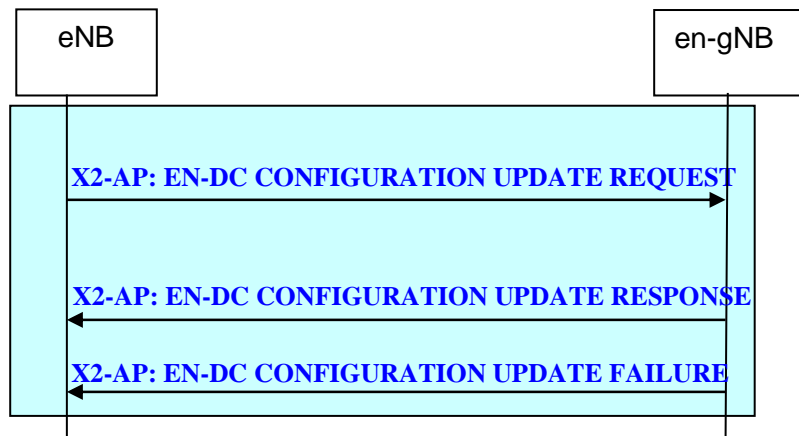

Figure 20.2.2.29-1: EN-DC Configuration Update procedure triggered by the eNB.

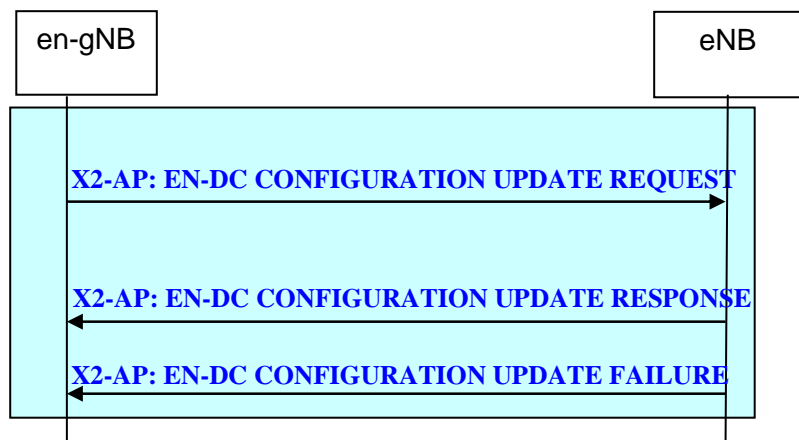

Figure 20.2.2.29-2: EN-DC Configuration Update procedure triggered by the en-gNB.

20.2.2.30 EN-DC Cell Activation procedure

The purpose of the EN-DC Cell Activation procedure is to enable an eNB to request the re-activation of one or more NR cells controlled by an en-gNB, and which had been previously indicated as dormant.

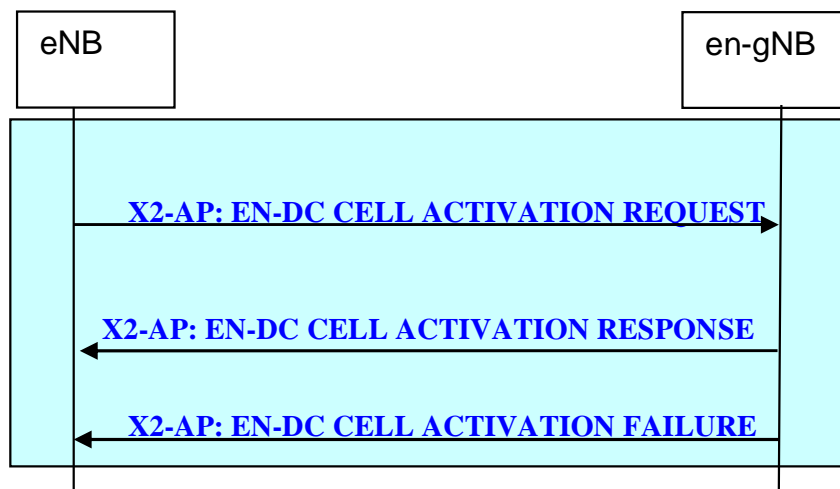

Figure 20.2.2.30-1: EN-DC Cell Activation procedure

20.2.2.31 E-UTRA - NR Cell Resource Coordination procedure

The purpose of the E-UTRA - NR Cell Resource Coordination procedure is to exchange information needed for an eNB and an en-gNB to coordinate cell resources when E-UTRA and NR cells are deployed on overlapping carrier. The procedure is triggered by the eNB or by the en-gNB.

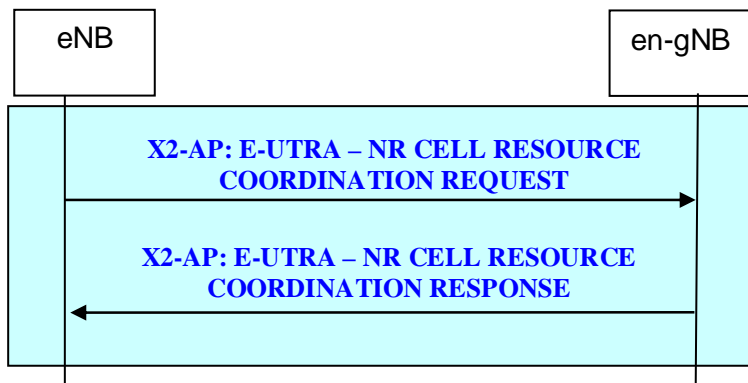

Figure 20.2.2.31-1: E-UTRA - NR Cell Resource Coordination procedure triggered by the eNB.

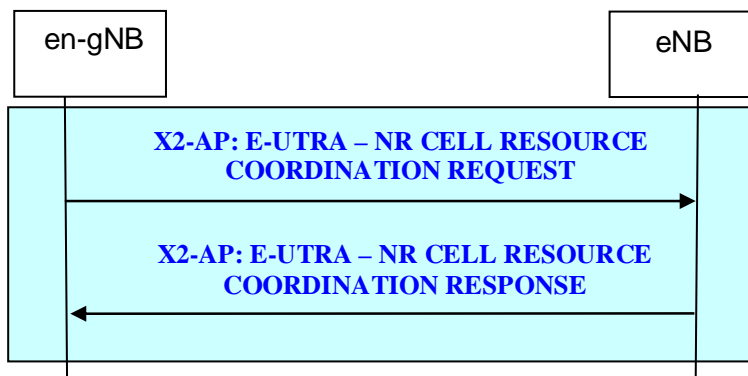

Figure 20.2.2.31-2: E-UTRA - NR Cell Resource Coordination procedure triggered by the en-gNB.

20.2.2.32 Partial Reset procedure for EN-DC

The Partial Reset procedure for EN-DC is triggered by the en-gNB or the MeNB to initiate the release of the resources for a list of UEs with the EN-DC configuration.

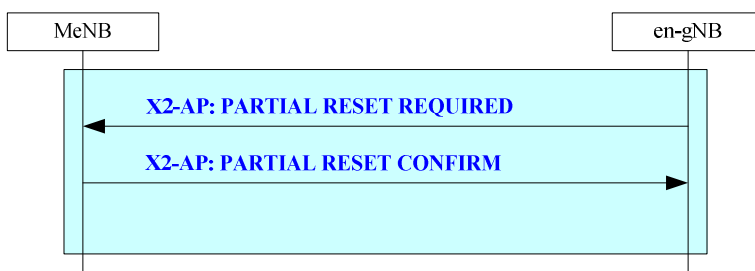

Figure 20.2.2.32-1: Partial Reset procedure for EN-DC (initiated at the en-gNB)

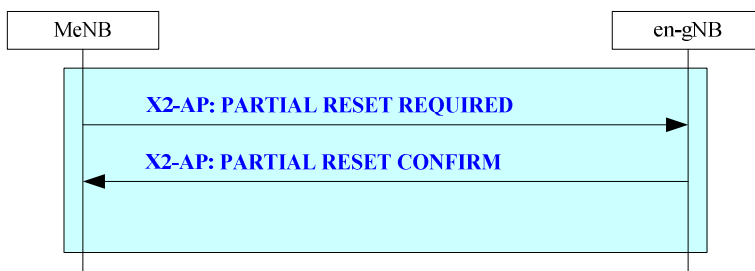

Figure 20.2.2.32-2: Partial Reset procedure for EN-DC (initiated at the MeNB)

20.2.3 Void

21 Void

21.1 Void

21.2 Void

21.3 Void

22 Support for self-configuration and self-optimisation

22.1 Definitions

This concept includes several different functions from eNB activation to radio parameter tuning. Figure 22.1-1 is a basic framework for all self-configuration /self-optimization functions.

Self-configuration process is defined as the process where newly deployed nodes are configured by automatic installation procedures to get the necessary basic configuration for system operation.

This process works in pre-operational state. Pre-operational state is understood as the state from when the eNB is powered up and has backbone connectivity until the RF transmitter is switched on.

As described in Figure 21.1, functions handled in the pre-operational state like:

- Basic Setup; and
- Initial Radio Configuration.

are covered by the Self Configuration process.

Self-optimization process is defined as the process where UE & eNB measurements and performance measurements are used to auto-tune the network.

This process works in operational state. Operational state is understood as the state where the RF interface is additionally switched on.

As described in Figure 21.1, functions handled in the operational state like:

- Optimization / Adaptation

are covered by the Self Optimization process.

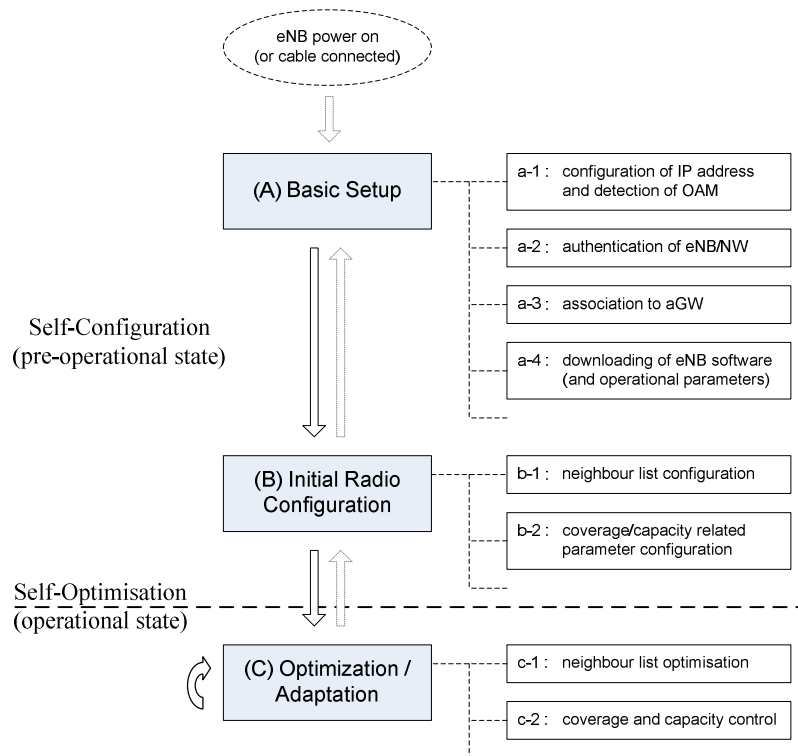

Figure 22.1-1: Ramifications of Self-Configuration /Self-Optimization functionality

22.2 UE Support for self-configuration and self-optimisation

UE shall support measurements and procedures which can be used for self-configuration and self-optimisation of the E-UTRAN system.

- UE shall support measurements and measurement reporting to support self-optimisation of the E-UTRAN system. Measurements and reports used for the normal system operation, should be used as input for the self-optimisation process as far as possible.
- The network is able to configure the measurements and the reporting for self-optimisation support by RRC signalling messages.

22.3 Self-configuration

22.3.1 Dynamic configuration of the S1-MME interface

22.3.1.1 Prerequisites

The following prerequisites are assumed:

- An initial remote IP end point to be used for SCTP initialisation is provided to the eNB for each MME. The eNB may be in pre-operational or operational state when this occurs.

How the eNB gets the remote IP end point(s) and its own IP address are outside the scope of this specification.

22.3.1.2 SCTP initialization

For each MME the eNodeB tries to initialize a SCTP association as described in IETF RFC 4960 [8], using a known initial remote IP Endpoint as the starting point, until SCTP connectivity is established.

- NOTE: The eNB may use different source and/or destination IP end point(s) if the SCTP establishment towards one IP endpoint fails.

22.3.1.3 Application layer initialization

Once SCTP connectivity has been established, the eNodeB and MME shall exchange application level configuration data over the S1-MME application protocol with the S1 Setup Procedure, which is needed for these two nodes to interwork correctly on the S1 interface.

- The eNodeB provides the relevant configuration information to the MME, which includes list of supported TA(s), etc.
- The MME provides the relevant configuration information to the eNodeB, which includes PLMN ID, etc.
- When the application layer initialization is successfully concluded, the dynamic configuration procedure is completed and the S1-MME interface is operational.

In addition, an eNB which has become X2-C connected to an en-gNB provides the connected en-gNB's Global en-gNB Identifier to the MME.

22.3.2 Dynamic Configuration of the X2 interface

22.3.2.1 Prerequisites

The following prerequisites are assumed:

- An initial local IP end point to be used for SCTP initialisation is provided to the eNB/en-gNB.
- For EN-DC, the en-gNB is provided with an initial remote IP end point of an eNB to be used for SCTP initialisation.

22.3.2.2 SCTP initialization

For candidate eNB/en-gNB the eNB/en-gNB tries to initialize a SCTP association as described in IETF RFC 4960 [8], using a known initial remote IP Endpoint as the starting point, until SCTP connectivity is established.

- NOTE: The eNB/en-gNB may use different source and/or destination IP end point(s) if the SCTP establishment towards one IP endpoint fails.

22.3.2.3 Application layer initialization

In the below, one of the involved eNBs (initiating or candidate eNB) may instead be an en-gNB.

- Once SCTP connectivity has been established, the eNB and its candidate peer eNB are in a position to exchange application level configuration data over the X2 application protocol needed for the two nodes to interwork correctly on the X2 interface.
 - The eNB provides the relevant configuration information to the candidate eNB, which includes served cell information, etc.
 - The candidate eNB provides the relevant configuration information to the initiating eNB, which includes served cell information, etc.
 - When the application layer initialization is successfully concluded, the dynamic configuration procedure is completed and the X2 interface is operational.

The following principles apply for the exchange of served cell information:

- eNBs shall keep neighbouring eNBs and en-gNBs updated with the complete list of served E-UTRA cells while the X2 interface is operational.
- en-gNBs shall inform neighbouring eNBs of the complete list of served NR served cell during application layer initialization, and keep neighbouring eNBs updated with the complete list of served NR served cells, or, if requested by the eNB, with a limited list of served NR cells, while the X2 interface is operational.

22.3.2a Automatic Neighbour Relation Function

The purpose of the **Automatic Neighbour Relation** (ANR) function is to relieve the operator from the burden of manually managing Neighbour Cell Relations (NCRs). Figure 22.3.2a-1 shows ANR and its environment:

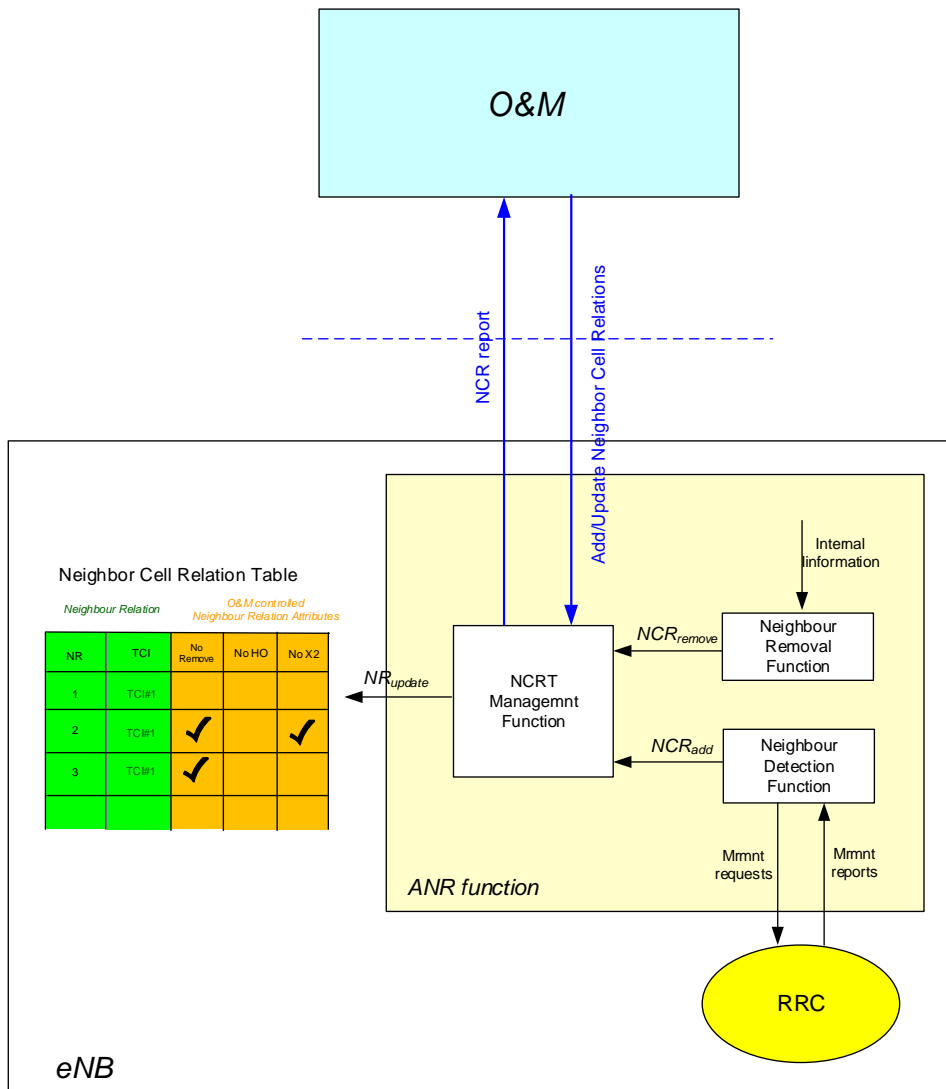

Figure 22.3.2a-1: Interaction between eNB and O&M due to ANR

The ANR function resides in the eNB and manages the conceptual Neighbour Cell Relation Table (NCRT). Located within ANR, the Neighbour Detection Function finds new neighbours and adds them to the NCRT. ANR also contains the Neighbour Removal Function which removes outdated NCRs. The Neighbour Detection Function and the Neighbour Removal Function are implementation specific.

A **Neighbour Cell Relation** (NCR) in the context of ANR is defined as follows:

An existing Neighbour Relation from a source cell to a target cell means that eNB controlling the source cell:

- a) Knows the ECGI/CGI and PCI of the target cell.
- b) Has an entry in the Neighbour Cell Relation Table for the source cell identifying the target cell.
- c) Has the attributes in this Neighbour Cell Relation Table entry defined, either by O&M or set to default values.

For each cell that the eNB has, the eNB keeps a NCRT, see Figure 22.3.2a-1. For each NCR, the NCRT contains the Target Cell Identifier (TCI), which identifies the target cell. For E-UTRAN, the TCI corresponds to the E-UTAN Cell

Global Identifier (ECGI) and Physical Cell Identifier (PCI) of the target cell. Furthermore, each NCR has three attributes, the NoRemove, the NoHO and the NoX2 attribute. These attributes have the following definitions:

- **No Remove:** If checked, the eNB shall not remove the Neighbour Cell Relation from the NRT.
- **No HO:** If checked, the Neighbour Cell Relation shall not be used by the eNB for handover reasons.
- **No X2:** If checked, the Neighbour Relation shall not use an X2 interface in order to initiate procedures towards the eNB parenting the target cell.

Neighbour Cell Relations are cell-to-cell relations, while an X2 link is set up between two eNBs. Neighbour Cell Relations are unidirectional, while an X2 link is bidirectional.

NOTE: The neighbour information exchange, which occurs during the X2 Setup procedure or in the eNB Configuration Update procedure, may be used for ANR purpose.

The ANR function also allows O&M to manage the NCRT. O&M can add and delete NCRs. It can also change the attributes of the NCRT. The O&M system is informed about changes in the NCRT.

22.3.3 Intra-LTE/frequency Automatic Neighbour Relation Function

The ANR (Automatic Neighbour Relation) function relies on cells broadcasting their identity on global level, E-UTRAN Cell Global Identifier (ECGI).

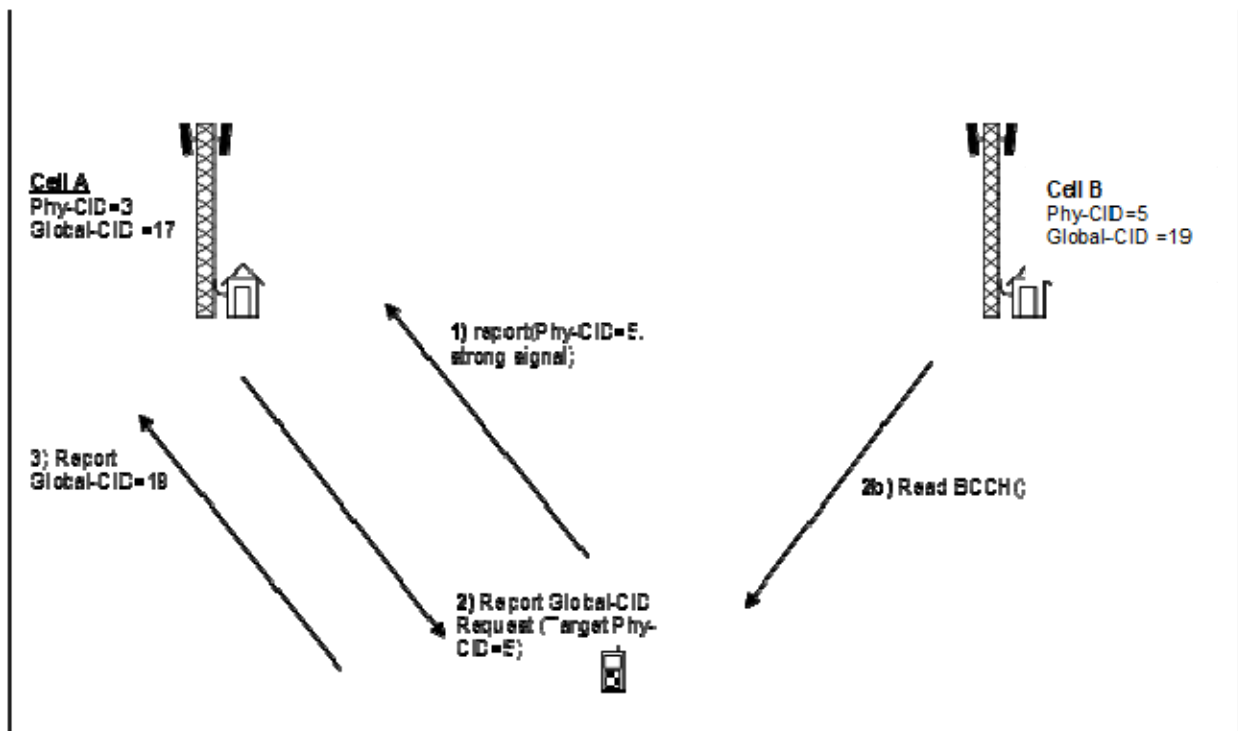

Figure 22.3.3-1: Automatic Neighbour Relation Function

The function works as follows:

The eNB serving cell A has an ANR function. As a part of the normal call procedure, the eNB instructs each UE to perform measurements on neighbour cells. The eNB may use different policies for instructing the UE to do measurements, and when to report them to the eNB. This measurement procedure is as specified in TS 36.331 [16].

1. The UE sends a measurement report regarding cell B. This report contains Cell B's PCI, but not its ECGI.

When the eNB receives a UE measurement report containing the PCI, the following sequence may be used.

2. The eNB instructs the UE, using the newly discovered PCI as parameter, to read the ECGI, the TAC and all available PLMN ID(s) of the related neighbour cell. To do so, the eNB may need to schedule appropriate idle

periods to allow the UE to read the ECGI from the broadcast channel of the detected neighbour cell. How the UE reads the ECGI is specified in TS 36.331 [16].

3. When the UE has found out the new cell's ECGI, the UE reports the detected ECGI to the serving cell eNB. In addition, the UE reports the tracking area code and all PLMN IDs that have been detected. If the detected cell is a CSG or hybrid cell, the UE also reports the CSG ID to the serving cell eNB.
4. The eNB decides to add this neighbour relation, and can use PCI and ECGI to:
 - a. Lookup a transport layer address to the new eNB.
 - b. Update the Neighbour Relation List.
 - c. If needed, setup a new X2 interface towards this eNB. The setup of the X2 interface is described in clause 22.3.2.

NOTE: The eNB may differentiate the open access HeNB from the other types of (H)eNB by the PCI configuration or ECGI configuration.

22.3.4 Inter-RAT/Inter-frequency Automatic Neighbour Relation Function

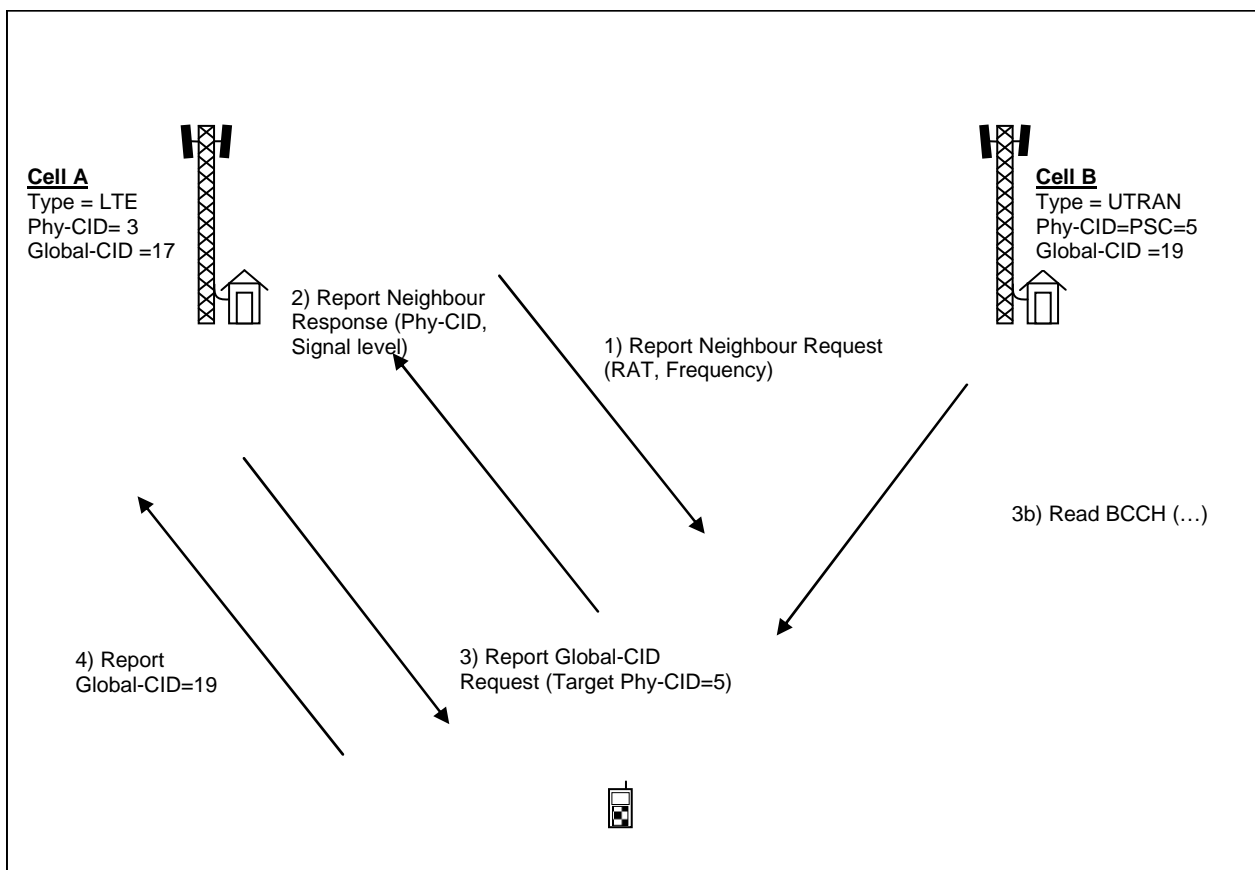

Figure 22.3.4-1: Automatic Neighbour Relation Function in case of e.g. UTRAN detected cell

For Inter-RAT and Inter-Frequency ANR, each cell contains an Inter Frequency Search list. This list contains all frequencies that shall be searched.

For Inter-RAT cells, the NoX2 attribute in the NCRT is absent, as X2 is only defined for E-UTRAN.

The function works as follows:

The eNB serving cell A has an ANR function. During connected mode, the eNB can instruct a UE to perform measurements and detect cells on other RATs/frequencies. The eNB may use different policies for instructing the UE to do measurements, and when to report them to the eNB.

- 1 The eNB instructs a UE to look for neighbour cells in the target RATs/frequencies. To do so the eNB may need to schedule appropriate idle periods to allow the UE to scan all cells in the target RATs/frequencies.
- 2 The UE reports the PCI of the detected cells in the target RATs/frequencies. The PCI is defined by the carrier frequency and the Primary Scrambling Code (PSC) in case of UTRAN FDD cell, by the carrier frequency and the cell parameter ID in case of UTRAN TDD cell, by the Band Indicator + BSIC + BCCH ARFCN in case of GERAN cell, by the PN Offset in case of CDMA2000 cell, and by the NR PSS/SSS in case of NR cell.

When the eNB receives UE reports containing PCIs of cell(s) the following sequence may be used.

- 3 The eNB instructs the UE, using the newly discovered PCI as parameter, to read the CGI and the RAC of the detected neighbour cell in case of GERAN detected cells, CGI, LAC, RAC and all broadcasted PLMN-ID(s) in case of UTRAN detected cells, CGI in case of CDMA2000 detected cells, and NCGI(s), TAC(s), RANAC(s), all available PLMN ID(s) and all available NR frequency band(s) in case of NR detected cells. For the Inter-frequency case, the eNB instructs the UE, using the newly discovered PCI as parameter, to read the ECGI, TAC and all available PLMN ID(s) of the inter-frequency detected cell. The UE ignores transmissions from the serving cell while finding the requested information transmitted in the broadcast channel of the detected inter-system/inter-frequency neighbour cell. To do so, the eNB may need to schedule appropriate idle periods to allow the UE to read the requested information from the broadcast channel of the detected inter-RAT/inter-frequency neighbour cell.
- 4 After the UE has read the requested information in the new cell, it reports the detected CGI and RAC (in case of GERAN detected cells) or CGI, LAC, RAC and all broadcasted PLMN-ID(s) (in case of UTRAN detected cells) or CGI (in case of CDMA2000 detected cells) or all broadcast NCGI(s), TAC(s), RANAC(s), PLMN-ID(s) and NR frequency band(s) (in case of NR detected cells) to the serving cell eNB. In the inter-RAT NR case, the UE may report *noSIB1* indication in case the detected NR cell does not broadcast SIB1, as described in TS 36.331 [16]. In the inter-frequency case, the UE reports the ECGI, the tracking area code and all PLMN-ID(s) that have been detected. If the detected cell is a CSG or hybrid cell, the UE also reports the CSG ID to the serving cell eNB.
- 5 The eNB updates its inter-RAT/inter-frequency Neighbour Cell Relation Table.

In the inter-frequency case and if needed, the eNB can use the PCI and ECGI for a new X2 interface setup towards this eNB. The setup of the X2 interface is described in clause 22.3.2.

NOTE: The eNB may differentiate the open access HeNB from the other types of (H)eNB by the PCI configuration or ECGI configuration.

22.3.4a Automatic Neighbour Relation Function towards NR

The ANR function described in clause 22.3.2 and 22.3.4 applies towards NR with enhancements as follows:

An existing NCR from a source E-UTRA cell to a target NR cell means that eNB controlling the source cell knows the NCGI and PCI of the target cell.

If an NCR from a source E-UTRA cell to a target E-UTRA cell exists, the eNB controlling the source cell has information whether the target E-UTRA cell has an existing NCR to a target NR cell for performing EN-DC.

An X2 link may be set up between eNB and en-gNB. The NoRemove, the NoHO and the NoX2 attributes apply when the en-gNB parents the target cell. Each NCR has the following additional attribute:

- **No EN-DC:** If checked, the Neighbour Cell Relation shall not be used by the eNB for EN-DC.

Each E-UTRA cell contains an Inter Frequency Search list. This list contains all frequencies that shall be searched.

The PCI is defined by the frequency of the SSB associated with SIB1, and NR-PCI.

22.3.5 Framework for PCI Selection

The eNB shall base the selection of its PCI either on a centralized or distributed PCI assignment algorithm:

[Centralized PCI assignment] The OAM signals a specific PCI value. The eNB shall select this value as its PCI.

[Distributed PCI assignment] The OAM signals a list of PCI values. The eNB may restrict this list by removing PCI-s that are:

- a) reported by UEs;
- b) reported over the X2 interface by neighbouring eNBs; and/or
- c) acquired through other implementation dependent methods, e.g. heard over the air using a downlink receiver.

The eNB shall select a PCI value randomly from the remaining list of PCIs.

22.3.6 TNL address discovery

22.3.6.1 TNL address discovery of candidate eNB via S1 interface

If the eNB is aware of the eNB ID of the candidate eNB (e.g. via the ANR function) but not a TNL address suitable for SCTP connectivity, then the eNB can utilize the Configuration Transfer Function to determine the TNL address as follows:

- The eNB sends the eNB CONFIGURATION TRANSFER message to the MME to request the TNL address of the candidate eNB, and includes relevant information such as the source and target eNB ID.
- The MME relays the request by sending the MME CONFIGURATION TRANSFER message to the candidate eNB identified by the target eNB ID.
- The candidate eNB responds by sending the eNB CONFIGURATION TRANSFER message containing one or more TNL addresses to be used for SCTP connectivity with the initiating eNB, and includes other relevant information such as the source and target eNB ID.
- The MME relays the response by sending the MME CONFIGURATION TRANSFER message to the initiating eNB identified by the target eNB ID.

22.3.6.2 TNL address discovery of a candidate en-gNB via the S1 interface

If the eNB is aware of the en-gNB ID of the candidate en-gNB but not a TNL address suitable for SCTP connectivity between the eNB and the en-gNB, then the eNB utilizes the Configuration Transfer Function to determine the TNL address as follows:

- The eNB sends the eNB CONFIGURATION TRANSFER message to the MME to request the TNL address of the candidate en-gNB. The eNB includes its own (source) eNB ID and the candidate (target) en-gNB ID.
- The eNB may include in the eNB CONFIGURATION TRANSFER message, if available,
 - a target eNB ID, if the eNB has knowledge that the target eNB ID is X2 connected to the candidate en-gNB;
 - a TAI associated with the target en-gNB, if the eNB has knowledge about a TAI broadcast in the coverage area of an NR cell served by the candidate en-gNB.
- The MME relays the request by sending the MME CONFIGURATION TRANSFER message to an eNB known to be connected to the candidate en-gNB.
- The eNB connected to the candidate en-gNB relays the request to the candidate en-gNB by means of the X2AP EN-DC Configuration Transfer procedure.
- The candidate en-gNB sends its X2 TNL Configuration Information to the same eNB using the X2AP EN-DC Configuration Transfer procedure, and identifying the initiating eNB as the target eNB ID.
- The eNB connected to the candidate en-gNB forwards the received X2 TNL Configuration Information to the MME in the eNB CONFIGURATION TRANSFER message.
- The MME relays the response by sending the MME CONFIGURATION TRANSFER message to the initiating eNB identified by the target eNB ID.

NOTE: An NR cell does not broadcast a Tracking Area Code applicable for the EPS. In case that inter-MME X2 TNL address discovery procedures are required, the source MME may use the available information to identify the target MME.

22.3.6.3 TNL address discovery of a candidate en-gNB via inter-system signalling

If the MME is aware that the en-gNB serves cells which provide access to 5GS, the MME may relay the request towards a suitable AMF via inter-system signalling based on a broadcast 5G TAC. Upon receiving a reply from the AMF, the MME may relay this reply to the target eNB using a MME CONFIGURATION TRANSFER message.

22.3.7 Dynamic configuration of the Xw-C interface

22.3.7.1 Prerequisites

The following prerequisites are assumed:

- An initial remote IP end point to be used for SCTP initialisation is provided to the eNB.

How the eNB gets the remote IP end point(s) and its own IP address are outside the scope of this specification.

22.3.7.2 SCTP initialization

For each WT the eNB tries to initialize a SCTP association as described in IETF RFC 4960 [8], using a known initial remote IP endpoint as the starting point, until SCTP connectivity is established.

22.3.7.3 Application layer initialization

Once SCTP connectivity has been established, the eNB and candidate WT shall exchange application level configuration data over the Xw-C application protocol with the Xw Setup Procedure, which is needed for these two nodes to interwork correctly on the Xw interface.

- The eNB provides the relevant configuration information to the WT, which includes the Global eNB ID.
- The WT provides the relevant configuration information to the eNB, which includes WLAN information, etc.
- When the application layer initialization is successfully concluded, the dynamic configuration procedure is completed and the Xw-C interface is operational.

22.4 Self-optimisation

22.4.1 Support for Mobility Load Balancing

22.4.1.1 General

The objective of load balancing is to distribute cell load evenly among cells or to transfer part of the traffic from congested cells. This is done by the means of self-optimisation of mobility parameters or handover actions.

Self-optimisation of the intra-LTE and inter-RAT mobility parameters to the current load in the cell and in the adjacent cells can improve the system capacity compared to static/non-optimised cell reselection/handover parameters. Such optimisation can also minimize human intervention in the network management and optimization tasks.

Support for mobility load balancing consists of one or more of following functions:

- Load reporting;
- Load balancing action based on handovers;
- Adapting handover and/or reselection configuration.

Triggering of each of these functions is optional and depends on implementation. Functional architecture is presented in Figure 22.4.1.1-1.

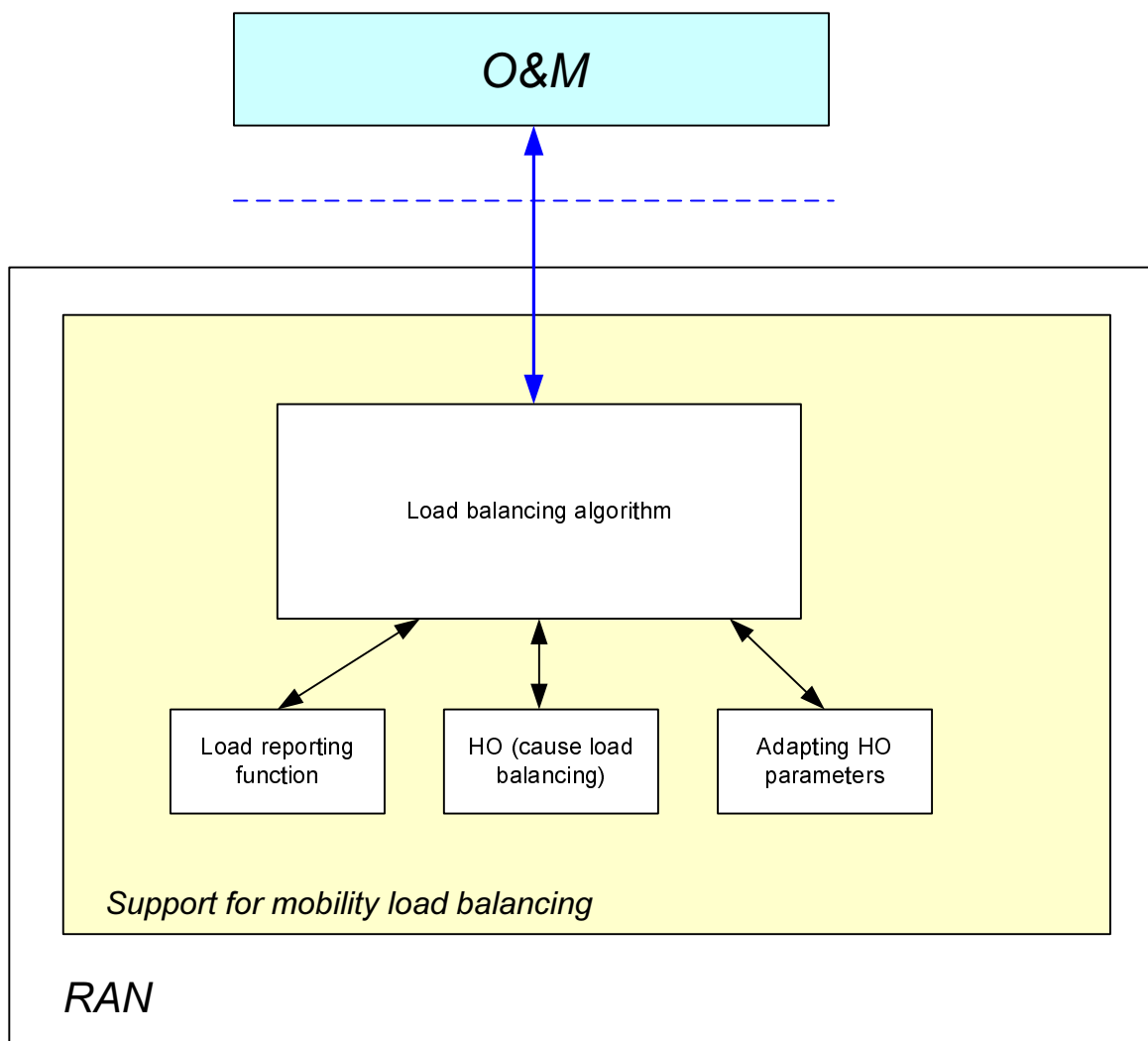

Figure 22.4.1.1-1: Functional architecture of SON load balancing

22.4.1.2 Load reporting

The load reporting function is executed by exchanging cell specific load information between neighbour eNBs over the X2 interface (intra-LTE scenario) or S1 (inter-RAT scenario).

22.4.1.2.1 Load reporting for intra-LTE scenario

The load information consists of:

- radio resource usage (UL/DL GBR PRB usage, UL/DL non-GBR PRB usage, UL/DL total PRB usage);
- HW load indicator (UL/DL HW load: low, mid, high, overload);
- TNL load indicator (UL/DL TNL load: low, mid, high, overload);
- (Optionally) Cell Capacity Class value (UL/DL relative capacity indicator: the same scale shall apply to E-UTRAN, UTRAN and GERAN cells when mapping cell capacities on this value);
- Capacity value (UL/DL available capacity for load balancing as percentage of total cell capacity).

NOTE 1: Capacity value is expressed in available E-UTRAN resources.

NOTE 2: A cell is expected to accept traffic corresponding to the indicated available capacity.

22.4.1.2.2 Load reporting for inter-RAT scenario

The load information consists of:

- Cell Capacity Class value (UL/DL relative capacity indicator: the same scale shall apply to E-UTRAN, UTRAN, GERAN and eHRPD cells when mapping cell capacities on this value);
- Capacity value (UL/DL available capacity for load balancing as percentage of total cell capacity).

NOTE 1: Capacity value is expressed in available E-UTRAN resources.

NOTE 2: A cell is expected to accept traffic corresponding to the indicated available capacity.

Event-triggered inter-RAT load reports are sent when the reporting node detects crossing of cell load thresholds.

Load information shall be provided in a procedure separated from existing active mode mobility procedures, which shall be used infrequently and with lower priority with respect to the UE dedicated signalling.

22.4.1.3 Load balancing action based on handovers

The source cell may initiate handover due to load (see clauses 10.1.2 and 10.2.2). The target cell performs admission control for the load balancing handovers. A handover preparation related to a mobility load balancing action shall be distinguishable from other handovers, so that the target cell is able to apply appropriate admission control.

22.4.1.4 Adapting handover and/or reselection configuration

This function enables requesting of a change of handover and/or reselection parameters at target cell. The source cell that initialized the load balancing estimates if it is needed to change mobility configuration in the source and/or target cell. If the amendment is needed, the source cell initializes mobility negotiation procedure toward the target cell.

The source cell informs the target cell about the new mobility setting and provides cause for the change (e.g. load balancing related request). The proposed change is expressed by the means of the difference (delta) between the current and the new values of the handover trigger. The handover trigger is the cell specific offset that corresponds to the threshold at which a cell initializes the handover preparation procedure. Cell reselection configuration may be amended to reflect changes in the HO setting. The target cell responds to the information from the source cell. The allowed delta range for HO trigger parameter may be carried in the failure response message. The source cell should consider the responses before executing the planned change of its mobility setting.

All automatic changes on the HO and/or reselection parameters must be within the range allowed by OAM.

22.4.2 Support for Mobility Robustness Optimisation

22.4.2.1 General

Mobility Robustness Optimisation aims at detecting and enabling correction of following problems:

- Connection failure due to intra-LTE or inter-RAT mobility;
- Unnecessary HO to another RAT (too early IRAT HO with no radio link failure);
- Inter-RAT ping-pong.

22.4.2.2 Connection failure due to intra-LTE mobility

One of the functions of Mobility Robustness Optimization is to detect connection failures that occur due to Too Early or Too Late Handovers, or Handover to Wrong Cell. These problems are defined as follows:

- [Too Late Handover] An RLF occurs after the UE has stayed for a long period of time in the cell; the UE attempts to re-establish the radio link connection in a different cell.
- [Too Early Handover] An RLF occurs shortly after a successful handover from a source cell to a target cell or a handover failure occurs during the handover procedure; the UE attempts to re-establish the radio link connection in the source cell.
- [Handover to Wrong Cell] An RLF occurs shortly after a successful handover from a source cell to a target cell or a handover failure occurs during the handover procedure; the UE attempts to re-establish the radio link connection in a cell other than the source cell and the target cell.

In the definition above, the "successful handover" refers to the UE state, namely the successful completion of the RA procedure.

In addition, MRO provides means to distinguish the above problems from LTE coverage related problems and other problems, not related to mobility.

Solution for failure scenarios consists of one or more of following functions:

- Detection of the failure after RRC re-establishment attempt;
- Detection of the failure after RRC connection setup;
- Retrieval of information needed for problem analysis.

Triggering of each of these functions is optional and depends on situation and implementation.

Detection of the failure after RRC re-establishment attempt:

Detection mechanisms for Too Late Handover, Too Early Handover and Handover to Wrong Cell are carried out through the following:

- [Too Late Handover]
If the UE attempts to re-establish the radio link connection in a cell that belongs to eNB B, indicating as the last serving cell a cell belonging to eNB A, different from eNB B, then eNB B may report this event to eNB A by means of the RLF Indication Procedure. eNB A may then use information in the RLF INDICATION message to determine whether the failure occurred in the serving cell.
- [Too Early Handover]
If the target cell belongs to an eNB B different from the eNB A that controls the source cell, the eNB B may send a HANDOVER REPORT message indicating a Too Early Handover event to eNB A upon eNB B receives an RLF INDICATION message from eNB A and if eNB B has sent the UE CONTEXT RELEASE message to eNB A related to the completion of an incoming handover for the same UE within the last Tstore_UE_cntxt seconds or there exists a prepared handover for the same UE in eNB B.
- [Handover to Wrong Cell]
If the type of the failure is Radio Link Failure and the target cell belongs to eNB B that is different from the eNB A that controls the source cell, the eNB B may send a HANDOVER REPORT message indicating a Handover To Wrong Cell event to eNB A upon eNB B receives an RLF INDICATION message from eNB C, and if eNB B has sent the UE CONTEXT RELEASE message to eNB A related to the completion of an incoming handover for the same UE within the last Tstore_UE_cntxt seconds or there exists a prepared handover for the same UE in eNB B. This also applies when eNB A and eNB C are the same. The HANDOVER REPORT message may also be sent if eNB B and eNB C are the same and the RLF Indication is internal to this eNB.
If the type of the failure is Handover Failure during a handover from a cell in eNB A, and the UE attempts to re-establish the radio link connection to a cell in eNB C, then eNB C may send a RLF INDICATION message to eNB A.

The detection of the above events, when involving more than one eNB, is enabled by the RLF Indication and Handover Report procedures.

The RLF Indication procedure may be initiated after a UE attempts to re-establish the radio link connection at eNB B after a failure at eNB A. The RLF INDICATION message sent from eNB B to eNB A shall contain the following information elements:

- Failure Cell ID: PCI of the cell in which the UE was connected prior to the failure occurred;

- Reestablishment Cell ID: ECGI of the cell where RL re-establishment attempt is made;
- C-RNTI: C-RNTI of the UE in the cell where UE was connected prior to the failure occurred;
- shortMAC-I (optionally): the 16 least significant bits of the MAC-I calculated using the security configuration of the source cell and the re-establishment cell identity;
- UE RLF Report Container (optionally): the RLF Report received from the UE, as specified in TS 36.331 [16];
- Reestablishment Cause (optionally): provided by the UE during the RRC connection re-establishment attempt.

eNB B may initiate RLF Indication towards multiple eNBs if they control cells which use the PCI signalled by the UE during the re-establishment procedure. The eNB A selects the UE context that matches the received Failure Cell ID and C-RNTI, and, if available, uses the shortMAC-I to confirm this identification, by calculating the shortMAC-I and comparing it to the received IE.

The Handover Report procedure is used in the case of recently completed handovers, when a failure occurs in the target cell (in eNB B) shortly after it sent the UE Context Release message to the source eNB A. The Handover Report procedure is also used when an RLF occurs before the UE Context Release message is sent, if the random access procedure in the target cell was completed successfully. The HANDOVER REPORT message contains the following information:

- Type of detected handover problem (Too Early Handover, Handover to Wrong Cell);
- ECGI of source and target cells in the handover;
- ECGI of the re-establishment cell (in the case of Handover to Wrong Cell);
- Handover cause (signalled by the source during handover preparation);
- C-RNTI allocated for the UE in the source cell (if available);
- Mobility Information (optionally);
- UE RLF Report (optionally): the RLF Report received from the UE and forwarded in the RLF INDICATION message.

UE may provide the RLF Report to the eNB after successful RRC re-establishment. The radio measurements contained in the RLF Report may be used e.g. to identify coverage issues as the potential cause of the failure. The cause for the RLF contained in the RLF Report may be used to identify the cause of the failure and exclude the events that are irrelevant for MRO evaluation.

Detection of the failure after RRC connection setup:

In case the RRC re-establishment fails or the UE does not perform any RRC re-establishment, the UE makes the RLF Report available to the eNB after reconnecting from idle mode. The RLF Report is described in clause 22.4.5. Availability of the RLF Report at the RRC connection setup procedure is the indication that the UE suffered from a connection failure and that the RLF Report from this failure was not yet delivered to the network. The RLF Report from the UE includes the following information:

- The E-CGI of the last cell that served the UE (in case of RLF) or the target of the handover (in case of handover failure). If the E-CGI is not known, the PCI and frequency information are used instead.
- E-CGI of the cell that the re-establishment attempt was made at.
- E-CGI of the cell that served the UE at the last handover initialisation, i.e. when message 7 (*RRCConnectionReconfiguration*) was received by the UE, as presented in Figure 10.1.2.1.1-1.
- Time elapsed since the last handover initialisation until connection failure.
- An indication whether the connection failure was due to RLF or handover failure.
- The radio measurements.
- C-RNTI allocated for the UE in the last serving cell.
- RLF trigger of the last RLF that was detected.

- Time elapsed from the connection failure till RLF Report signalling.

The eNB receiving the RLF Report from the UE may forward the report to the eNB that served the UE before the reported connection failure using the RLF INDICATION message. The radio measurements contained in the RLF Report may be used e.g. to identify coverage issues as the potential cause of the failure. The cause for the RLF contained in the RLF Report may be used to identify the cause of the failure and exclude the irrelevant events that are irrelevant for MRO evaluation.

Detection of Too Late Handover, Too Early Handover and Handover to Wrong Cell is carried out through the following:

- [Too Late Handover]
There is no recent handover for the UE prior to the connection failure i.e. the UE reported timer is absent or larger than the configured threshold, e.g. Tstore_UE_cntxt.
- [Too Early Handover]
There is a recent handover for the UE prior to the connection failure i.e. the UE reported timer is smaller than the configured threshold, e.g. Tstore_UE_cntxt, and the first re-establishment attempt cell is the cell that served the UE at the last handover initialisation.
- [Handover to Wrong Cell]
There is a recent handover for the UE prior to the connection failure i.e. the UE reported timer is smaller than the configured threshold, e.g. Tstore_UE_cntxt, and the first re-establishment attempt cell is neither the cell that served the UE at the last handover initialisation nor the cell that served the UE where the RLF happened or the cell that the handover was initialised toward.

The "UE reported timer" above indicates the time elapsed since the last handover initialisation until connection failure.

In case of Too Early Handover or Handover to Wrong Cell, the eNB receiving the RLF INDICATION message may use the HANDOVER REPORT message to inform the eNB controlling the cell where the mobility configuration caused the failure.

Retrieval of information needed for problem analysis

The information needed for detailed problem analysis may be retrieved from both, the UE and the network sides. The information that is collected at the UE is provided to the network with the RLF Report, which may be forwarded to the last serving node in the RLF INDICATION message and, in case of "Too Early HO" or "HO to Wrong Cell", further in the HANDOVER REPORT message.

In order to retrieve relevant information collected at the network side as part of the UE context, the UE provides C-RNTI used in the last serving cell. If the cause for the failure is identified as a "Too Early HO" or a "HO to Wrong Cell", the eNB controlling the last serving cell shall, if supported, include in the HANDOVER REPORT message the C-RNTI used in the source cell of the last completed handover before the failure. If the eNB controlling that source cell provided the Mobility Information, it is included in the HANDOVER REPORT message. If used, the Mobility Information is prepared at the source eNB of a handover and may refer to or identify any handover-related data at this eNB.

Handling multiple reports from a single failure event

In case the RRC re-establishment fails and the RRC connection setup succeeds, MRO evaluation of intra-LTE mobility connection failures may be triggered twice for the same failure event. In this case, only one failure event should be counted.

22.4.2.2a Connection failure due to inter-RAT mobility

One of the functions of Mobility Robustness Optimization is to detect connection failures that occurred due to Too Early or Too Late inter-RAT handovers. These problems are defined as follows:

- [Too Late Inter-RAT Handover] An RLF occurs after the UE has stayed in an E-UTRAN cell for a long period of time; the UE attempts to re-connect to a UTRAN cell.
- [Too Early Inter-RAT Handover] An RLF occurs shortly after a successful handover from a UTRAN cell to a target cell in E-UTRAN; the UE attempts to re-connect to the source cell or to another UTRAN cell.

The UE makes the RLF Report available to an eNB, when RLF happens in E-UTRAN and the UE re-connects to an eNB cell. Availability of the RLF Report at the RRC connection setup or at a handover to E-UTRAN cell is the indication that the UE suffered a connection failure and that the RLF Report from this failure was not yet delivered to the network.

The eNB receiving the RLF Report from the UE may forward the report to the eNB that served the UE before the reported connection failure using the RLF INDICATION message over X2 or by means of the eNB configuration transfer procedure and MME configuration transfer procedure over S1. If present in the RLF Report, the radio measurements may be used to identify lack of coverage as the potential cause of the failure. This information may be used to exclude those events from the MRO evaluation and redirect them as input to other algorithms.

Detection mechanisms for Too Late Inter-RAT Handover and Too Early Inter-RAT Handover are carried out through the following:

- [Too Late Inter-RAT Handover]
The connection failure occurs while being connected to an LTE cell, and there is no recent handover for the UE prior to the connection failure i.e., the UE reported timer is absent or larger than the configured threshold, e.g., Tstore_UE_cntxt, and the first cell where the UE attempts to re-connect is a UTRAN cell.
- [Too Early Inter-RAT Handover]
The connection failure occurs while being connected to an LTE cell, and there is a recent inter-RAT handover for the UE prior to the connection failure i.e., the UE reported timer is smaller than the configured threshold, e.g., Tstore_UE_cntxt, and the first cell where the UE attempts to re-connect and the cell that served the UE at the last handover initialisation are both UTRAN cells.

The "UE reported timer" above indicates the time elapsed since the last handover initialisation until connection failure.

In case the failure is a Too Early Inter-RAT Handover, the eNB receiving the RLF INDICATION message may inform the UTRAN node by means of the eNB Direct Information Transfer procedure over S1. The information contains:

- Type of detected handover problem (Too Early Inter-RAT Handover);
- UE RLF Report Container: the RLF Report received from the UE, as specified in TS 36.331 [16];
- Mobility Information (optionally, if provided in the last Handover Resource Allocation procedure from the UTRAN node);

22.4.2.3 Unnecessary HO to another RAT

One of the purposes of inter-RAT Mobility Robustness Optimisation is the detection of a non-optimal use of network resources. In particular, in case of inter-RAT operations and when E-UTRAN is considered, the case known as Unnecessary HO to another RAT is identified. The problem is defined as follows:

- UE is handed over from E-UTRAN to other RAT (e.g. GERAN or UTRAN) even though quality of the E-UTRAN coverage was sufficient for the service used by the UE. The handover may therefore be considered as unnecessary HO to another RAT (too early IRAT HO without connection failure).

In inter-RAT HO, if the serving cell threshold (E-UTRAN) is set too high, and another RAT with good signal strength is available, a handover to another RAT (e.g. UTRAN or GERAN) may be triggered unnecessarily, resulting in an inefficient use of the networks. With a lower threshold the UE could have continued in the source RAT (E-UTRAN).

To be able to detect the Unnecessary HO to another RAT, an eNB may choose to put additional coverage and quality condition information into the HANDOVER REQUIRED message in the Handover Preparation procedure when an inter-RAT HO from E-UTRAN to another RAT occurs. The RAN node in the other RAT, upon receiving this additional coverage and quality information, may instruct the UE to continue measuring the source RAT (E-UTRAN) during a period of time, while being connected to another RAT (e.g. UTRAN or GERAN), and send periodic or single measurement reports to the other RAT (e.g. UTRAN or GERAN). When the period of time indicated by the source RAT (E-UTRAN) expires, the RAN node in the other RAT (e.g. UTRAN or GERAN), may evaluate the received measurement reports with the coverage/quality condition received during the inter-RAT HO procedure and decide if an inter-RAT unnecessary HO report should be sent to the RAN node in the source RAT (E-UTRAN). The inter-RAT unnecessary HO report should include the following information:

- Handover type (LTE to UTRAN, LTE to GERAN);

- Type of detected handover problem (Unnecessary HO to another RAT);
- ECGI of the source cell in the handover;
- Cell ID of the target cell;
- A list of cells whose radio quality, as reported in the UE's first measurement report following the handover, exceeds the threshold indicated in the additional coverage and quality information in the Handover Preparation procedure.

The inter-RAT unnecessary HO report shall only be sent in cases where, in all UE measurement reports collected during the measurement period, any source RAT cells exceed the radio coverage and/or quality threshold (the radio threshold RSRP or/and RSRQ and the measurement period are indicated in the additional coverage and quality information in the Handover Preparation procedure). If an inter-RAT handover towards LTE is executed from RNC within the indicated measurement period, the measurement period expires. In this case, the RNC may also send the HO Report. No HO Report shall be sent in case no E-UTRAN cell could be included, or if the indicated period of time is interrupted by an inter-RAT handover to a RAT different than LTE or by an intra-UMTS handover with SRNC relocation or inter-BSS handover.

The RAN node in the source RAT (E-UTRAN) upon receiving of the report, can decide if/how its parameters (e.g., threshold to trigger IRAT HO) should be adjusted.

22.4.2.4 O&M Requirements

All automatic changes of the HO and/or reselection parameters for mobility robustness optimisation shall be within the range allowed by OAM.

The following control parameters shall be provided by OAM to control MRO behaviour:

- Maximum deviation of Handover Trigger
This parameter defines the maximum allowed absolute deviation of the Handover Trigger (as defined in 22.4.1.4), from the default point of operation defined by the parameter values assigned by OAM.
- Minimum time between Handover Trigger changes
This parameter defines the minimum allowed time interval between two Handover Trigger change performed by MRO. This is used to control the stability and convergence of the algorithm.

Furthermore, in order to support the solutions for detection of Too Late and Too Early HO, the parameter `Tstore_UE_cntxt` shall be configurable by the OAM system.

OAM may define multiple coverage configurations for each cell served by an eNB. The coverage configuration may also mean a cell is inactive (no coverage). The eNB may dynamically select the most appropriate coverage configuration for its served cells.

22.4.2.5 Inter-RAT ping-pong

One of the functions of Mobility Robustness Optimization is to detect ping-pongs that occur in inter-RAT environment. The problem is defined as follows:

- A UE is handed over from a cell in a source RAT (e.g. E-UTRAN) to a cell in a target RAT different from the source RAT (e.g. UTRAN), then within a predefined limited time the UE is handed over back to a cell in the source RAT, while the coverage of the source RAT was sufficient for the service used by the UE. The event may occur more than once.

The solution for the problem may consist of the following steps:

- 1) Statistics regarding inter-RAT ping-pong occurrences are collected by the responsible node.
- 2) Coverage verification is performed to check if the mobility to other RAT was inevitable.

The statistics regarding ping-pong occurrence may be based on evaluation of the *UE History Information* IE in the *HANDOVER REQUIRED* message. If the evaluation indicates a potential ping-pong case and the source eNB of the 1st inter-RAT handover is different than the target eNB of the 2nd inter-RAT handover, the target eNB may use the

HANDOVER REPORT message to indicate the occurrence of potential ping-pong cases to the source eNB. The HANDOVER REPORT message for ping-pong indication contains the following information:

- Type of detected handover problem (InterRAT ping-pong);
- ECGI of the source cell in the handover from E-UTRAN to UTRAN;
- ECGI of the target in the handover from UTRAN to E-UTRAN;
- Cell Identifier of the target UTRAN cell in the first inter-RAT handover;
- Cause of the first handover (signalled by the source during handover preparation).

If E-UTRAN coverage during the potential ping-pong event needs to be verified for the purpose of determining corrective measures, the Unnecessary HO to another RAT procedure may be used

22.4.2.6 Dynamic coverage configuration changes

Each eNB may be configured with alternative coverage configurations and an eNB may autonomously select and switch between these configurations, e.g. using the Active Antenna Systems functions.

An eNB may notify its neighbour eNBs about the coverage reconfiguration using the ENB CONFIGURATION UPDATE message with the list of cells with modified coverage included. The list contains the ECGI of each modified cell and its coverage state indicator. The indicator may be used at the receiving eNB to adjust the functions of the Mobility Robustness Optimisation, e.g. by using the indicator to retrieve a previously stored Mobility Robustness Optimisation state. If the list includes indication about planned reconfiguration and possibly a list of replacing cells, the receiving eNB may use this to avoid connection or re-establishment failures during the reconfiguration. Also, if the sending eNB adds cells in inactive state, the receiving eNB may use this information to avoid connection or re-establishment failures.

The receiving node may also use the notification to reduce the impact on mobility. For example, the receiving eNB should avoid triggering handovers towards cell(s) that are indicated to be inactive.

22.4.3 Support for RACH Optimisation

The setting of RACH parameters that can be optimized are:

- RACH configuration (resource unit allocation);
- RACH preamble split (among dedicated, group A, group B);
- RACH backoff parameter value;
- RACH transmission power control parameters.

RACH optimization is supported by UE reported information and by PRACH parameters exchange between eNBs.

UEs which receive polling signalling shall report the below information:

- Number of RACH preambles sent until the successful RACH completion;
- Contention resolution failure.

22.4.4 Support for Energy Saving

22.4.4.1 General

The aim of this function is to reduce operational expenses through energy savings.

The function allows, for example in a deployment where capacity boosters can be distinguished from cells providing basic coverage, to optimize energy consumption enabling the possibility for a E-UTRA or EN-DC cell providing additional capacity via single or dual connectivity, to be switched off when its capacity is no longer needed and to be re-activated on a need basis. The basic coverage may be provided by

- E-UTRAN, UTRAN or GERAN cells, in the case of E-UTRA cells;
- E-UTRA cells, in the case of EN-DC cells.

22.4.4.2 Solution description

22.4.4.2.1 E-UTRA cell case

The solution builds upon the possibility for the eNB owning a capacity booster cell to autonomously decide to switch-off such cell to lower energy consumption (dormant state). The decision is typically based on cell load information, consistently with configured information. The switch-off decision may also be taken by O&M.

The eNB may initiate handover actions in order to off-load the cell being switched off and may indicate the reason for handover with an appropriate cause value to support the target node in taking subsequent actions, e.g. when selecting the target cell for subsequent handovers.

All peer eNBs are informed by the eNB owning the concerned cell about the switch-off actions over the X2 interface, by means of the eNB Configuration Update procedure. The eNB indicates the switch-off action to a GERAN and/or UTRAN node by means of the eNB Direct Information Transfer procedure over S1.

All informed nodes maintain the cell configuration data, e.g., neighbour relationship configuration, also when a certain cell is dormant. If basic coverage is ensured by E-UTRAN cells, eNBs owning non-capacity boosting cells may request a re-activation over the X2 interface if capacity needs in such cells demand to do so. This is achieved via the Cell Activation procedure. If basic coverage is ensured by UTRAN or GERAN cells, the eNB owning the capacity booster cell may receive a re-activation request from a GERAN or UTRAN node by means of the MME Direct Information Transfer procedure over S1. The eNB owning the capacity booster cell may also receive from the sending GERAN or UTRAN node the minimum time before that cell switches off; during this time, the same eNB may prevent idle mode UEs from camping on the cell and may prevent incoming handovers to the same cell.

The eNB owning the dormant cell should normally obey a request. The switch-on decision may also be taken by O&M. All peer eNBs are informed by the eNB owning the concerned cell about the re-activation by an indication on the X2 interface. The eNB indicates the re-activation action to a GERAN and/or UTRAN node by means of the eNB Direct Information Transfer procedure over S1. The eNB owning the concerned cell may choose to delay or not to send indication(s) if the sending GERAN or UTRAN node has included the minimum activation time in the re-activation request.

22.4.4.2.2 EN-DC cell case

The solution applies to an en-gNB supporting EN-DC operation.

The en-gNB may autonomously decide to switch-off NR cells to lower energy consumption. MeNBs are informed by the en-gNB owning the concerned cell about the switch-off actions over the X2 interface, by means of the EN-DC Configuration Update procedure.

The en-gNB may initiate dual connectivity procedures towards the MeNB in order to off-load the cell being switched off, and may indicate the reason for release or modification with an appropriate cause value to support the master node in taking subsequent actions.

The MeNB may request a re-activation over the X2 interface if capacity needs demand to do so. This is achieved via the EN-DC Cell Activation procedure. The en-gNB owning the dormant NR cell should normally obey a request. The switch-on decision may also be taken by O&M. All peer eNBs are informed by the en-gNB owning the concerned NR cell about the re-activation by an indication on the X2 interface.

22.4.4.3 O&M requirements

Operators should be able to configure the energy saving function.

The configured information should include:

- The ability of an eNB to perform autonomous cell switch-off.
- The ability of an eNB to request the re-activation of a configured list of dormant cells owned by a peer eNB.

O&M may also configure

- policies used by the eNB for cell switch-off decision.
- policies used by peer eNBs for requesting the re-activation of a dormant cell.

22.4.5 Radio Link Failure report

The RLF Report from the UE can be used for both coverage optimization and mobility robustness optimization.

The UE stores the latest RLF or handover failure related information, and indicates RLF report availability at each subsequent LTE RRC connection (re-)establishment and handover to an LTE cell until the RLF report is fetched by the network or for 48 hours after the RLF or handover failure is detected.

The UE keeps the information during state transitions and RAT changes, and indicates RLF report availability again after it returns to the LTE RAT.

The UE only indicates RLF report availability and only provides the RLF report to the network if the current RPLMN is a PLMN that was present in the UE's EPLMN List or was the RPLMN at the time the RLF or handover failure was detected.

22.5 Void

22.6 Void

22A LTE-WLAN Aggregation and RAN Controlled LTE-WLAN Interworking

22A.1 LTE-WLAN Aggregation

22A.1.1 General

E-UTRAN supports LTE-WLAN aggregation (LWA) operation whereby a UE in RRC_CONNECTED is configured by the eNB to utilize radio resources of LTE and WLAN. Two scenarios are supported depending on the backhaul connection between LTE and WLAN:

- non-collocated LWA scenario for a non-ideal backhaul;
- collocated LWA scenario for an ideal/internal backhaul;

The overall architecture for the non-collocated LWA scenario is illustrated in Figure 22A.1.1-1 below where the WLAN Termination (WT) terminates the Xw interface for WLAN.

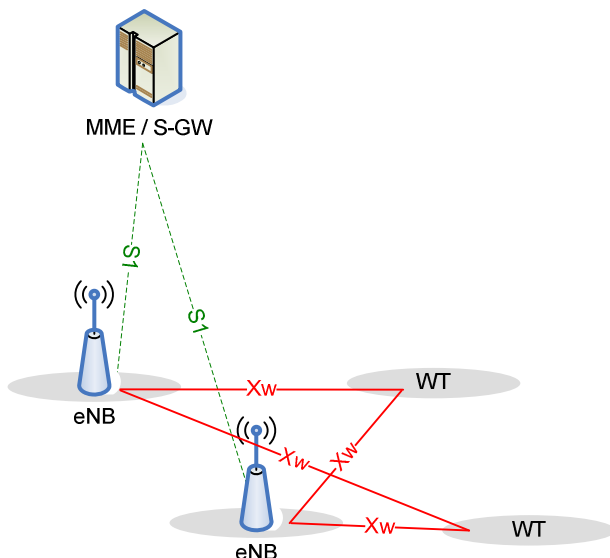

Figure 22A.1.1-1: Non-collocated LWA Overall Architecture

22A.1.2 Radio Protocol Architecture

In LWA, the radio protocol architecture that a particular bearer uses depends on the LWA backhaul scenario and how the bearer is set up. Two bearer types exist for LWA: split LWA bearer and switched LWA bearer. Those two bearer types are depicted on Figure 22A.1.2-1 for the collocated scenario and on Figure 22A.1.2-2 for the non-collocated scenario.

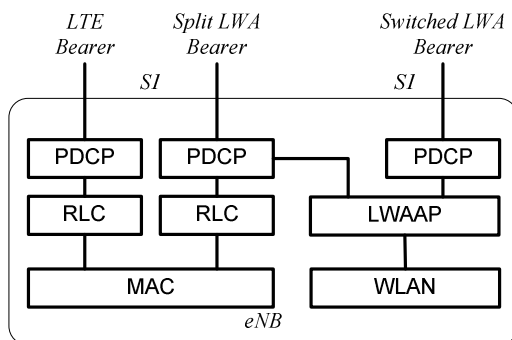

Figure 22A.1.2-1: LWA Radio Protocol Architecture for the Collocated Scenario

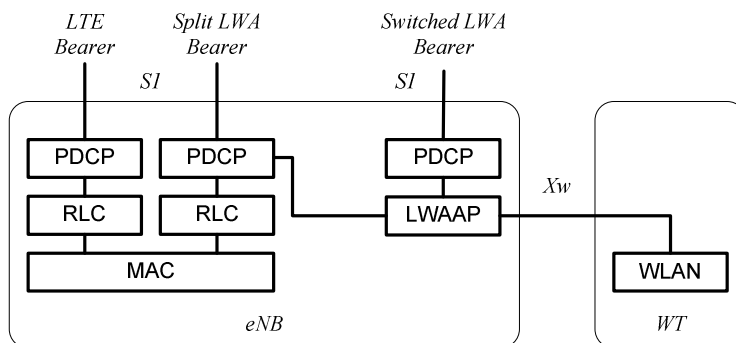

Figure 22A.1.2-2: LWA Radio Protocol Architecture for the Non-Collocated Scenario

In the downlink, for PDUs sent over WLAN in LWA operation, the LWAAP entity, as specified in TS 36.360 [66] generates LWAAP PDU containing a DRB identity and the WT uses the LWA EtherType 0x9E65 for forwarding the data to the UE over WLAN. The UE uses the LWA EtherType to determine that the received PDU belongs to an LWA bearer and uses the DRB identity to determine to which LWA bearer the PDU belongs to.

In the uplink, for PDUs sent over WLAN in LWA operation, the LWAAP entity in the UE generates LWAAP PDU containing a DRB identity and the UE uses the LWA EtherType 0x9E65 for sending the data over WLAN.

LWA supports split bearer operation where the PDCP sublayer supports in-sequence delivery of upper layer PDUs based on the reordering procedure introduced for DC.

The UE supporting LWA may be configured by the eNB to send PDCP status report or LWA status report, as specified in TS 36.323 [15], in cases where feedback from WT is not available.

Only RLC AM and RLC UM can be configured for an LWA bearer.

E-UTRAN does not configure LWA with DC, LWIP or RCLWI simultaneously for the same UE.

If LWA and RAN assisted WLAN interworking are simultaneously configured for the same UE, in RRC_CONNECTED, the UE only applies LWA.

For LWA bearer, if the data available for transmission is equal to or exceeds the threshold configured by E-UTRAN the UE decides which PDCP PDUs are sent over WLAN or LTE. If the data available is below the threshold, the UE transmits PDCP PDUs on LTE or WLAN as configured by E-UTRAN.

For each LWA DRB, E-UTRAN may configure the IEEE 802.11 AC value to be used for the PDCP PDUs that are sent over WLAN in the uplink.

For LWA bearer, for routing of UL data over WLAN, the WT MAC address may be provided to the UE by the E-UTRAN or using other WLAN procedure.

22A.1.3 Network Interfaces

22A.1.3.1 General

In the non-collocated LWA scenario, the eNB is connected to one or more WTs via an Xw interface. In the collocated LWA scenario the interface between LTE and WLAN is up to implementation. For LWA, the only required interfaces to the Core Network are S1-U and S1-MME which are terminated at the eNB. No Core Network interface is required for the WLAN.

NOTE 1: WT is a logical node and 3GPP does not specify where it is implemented.

NOTE 2: LTE-WLAN aggregation support at a WLAN does not preclude the implementation of legacy WLAN interworking (e.g. S2a, S2b or NSWO) in the same WLAN.

22A.1.3.2 User Plane

In the non-collocated LWA scenario, the Xw user plane interface (Xw-U) is defined between eNB and WT. The Xw-U interface supports flow control based on feedback from WT.

The Flow Control function is applied in the downlink when an E-RAB is mapped onto an LWA bearer, i.e. the flow control information is provided by the WT to the eNB for the eNB to control the downlink user data flow to the WT for the LWA bearer. The OAM configures the eNB with the information of whether the Xw DL delivery status provided from a connected WT concerns LWAAP PDUs successfully delivered to the UE or successfully transferred toward the UE.

The Xw-U interface is used to deliver LWAAP PDUs between eNB and WT.

For LWA, the S1-U terminates in the eNB and, if Xw-U user data bearers are associated with E-RABs for which the LWA bearer option is configured, the user plane data is transferred from eNB to WT using the Xw-U interface.

Figure 22A.1.3.2-1 shows U-plane connectivity of eNB and WT involved in LWA for a certain UE: the S1-U is terminated at the eNB; the eNB and the WT are interconnected via Xw-U.

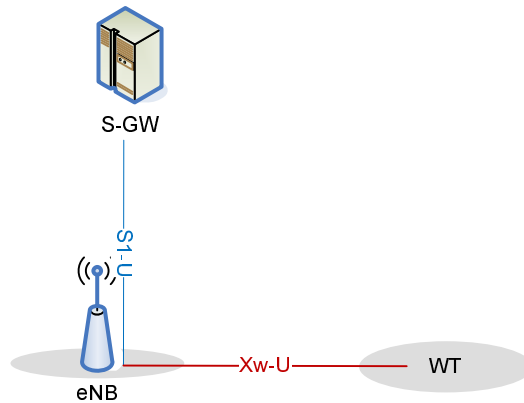

Figure 22A.1.3.2-1: U-Plane connectivity of eNB and WT for LWA

22A.1.3.3 Control Plane

In the non-collocated LWA scenario, the Xw control plane interface (Xw-C) is defined between eNB and WT. The application layer signalling protocol is referred to as Xw-AP (Xw Application Protocol).

The Xw-AP protocol supports the following functions:

- Transfer of WLAN metrics (e.g. bss load) from WT to eNB;
- Support of LWA for UE in ECM-CONNECTED:
 - Establishment, Modification and Release of a UE context at the WT;
 - Control of user plane tunnels between eNB and WT for a specific UE for LWA bearers.
- General Xw management and error handling functions:
 - Error indication;
 - Setting up the Xw;
 - Resetting the Xw;
 - Updating the WT configuration data.

eNB-WT control plane signalling for LWA is performed by means of Xw-C interface signalling.

There is only one S1-MME connection per LWA UE between the eNB and the MME. Respective coordination between eNB and WT is performed by means of Xw interface signalling.

Figure 22A.1.3.3-1 shows C-plane connectivity of eNB and WT involved in LWA for a certain UE: the S1-MME is terminated in eNB; the eNB and the WT are interconnected via Xw-C.

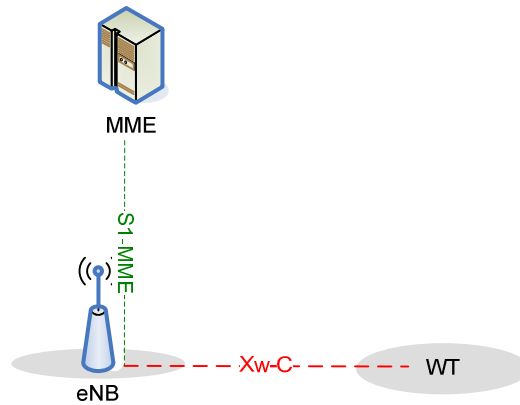

Figure 22A.1.3.3-1: C-Plane connectivity of eNB and WT for LWA

22A.1.4 Mobility

A WLAN mobility set is a set of one or more WLAN Access Points (APs) identified by one or more BSSID/HESSID/SSIDs, within which WLAN mobility mechanisms apply while the UE is configured with LWA bearer(s), i.e., the UE may perform mobility between WLAN APs belonging to the mobility set without informing the eNB.

The eNB provides the UE with a WLAN mobility set. When the UE is configured with a WLAN mobility set, it will attempt to connect to a WLAN whose identifiers match the ones of the configured mobility set. UE mobility to WLAN APs not belonging to the UE mobility set is controlled by the eNB e.g. updating the WLAN mobility set based on measurement reports provided by the UE. A UE is connected to at most one mobility set at a time.

All APs belonging to a mobility set share a common WT which terminates Xw-C and Xw-U. The termination endpoints for Xw-C and Xw-U may differ. The WLAN identifiers belonging to a mobility set may be a subset of all WLAN identifiers associated to the WT.

22A.1.5 WLAN Measurements

The UE supporting LWA may be configured by the E-UTRAN to perform WLAN measurements. WLAN measurement object can be configured using WLAN identifiers (BSSID, HESSID and SSID), WLAN carrier information and WLAN band (2.4GHz, 5GHz and 60GHz). WLAN measurement reporting is triggered using RSSI. WLAN measurement report contains, for each included WLAN, RSSI and WLAN identifier, and may contain WLAN carrier information, WLAN band, channel utilization, station count, admission capacity, backhaul rate and an indication whether the UE is connected to the WLAN.

WLAN measurements may be configured to support the following:

1. LWA activation;
2. Inter WLAN mobility set mobility;
3. LWA deactivation.

UE is configured with measurements for WLAN using IEEE terminology, as specified in IEEE 802.11, Part 11 [65], (e.g. 'Country', 'Operating Class', and/or 'Channel Number').

22A.1.6 Procedure for WLAN Connection Status Reporting

The purpose of the WLAN Connection Status Reporting procedure is to provide feedback to the eNB related to the WLAN status and operation. The WLAN Connection Status Reporting procedure supports the following indications:

1. WLAN connection failure;
2. WLAN connection success;
3. WLAN temporary suspension;

4. WLAN connection resumption.

When a UE configured with at least one LWA bearer becomes unable to establish or continue LWA operation, the UE sends the *WLANConnectionStatusReport* message to indicate "WLAN connection failure" to the eNB. When a UE configured with at least one LWA bearer is not able to support the LWA operation for a temporary duration, the UE may suspend the LWA operation by sending the *WLANConnectionStatusReport* message to indicate "WLAN temporary suspension" to the eNB.

The criteria to determine WLAN connection failure or WLAN temporary suspension is left for UE implementation. Upon WLAN connection failure or WLAN temporary suspension, the UE RRC connection re-establishment is not triggered, data reception on WLAN is suspended, and there is no impact to LTE part of the LWA split bearer. Upon WLAN temporary suspension, UE keeps the LWA configuration including LWA bearer configuration.

When a UE configured with at least one LWA bearer successfully connects to an AP, the UE sends the *WLANConnectionStatusReport* message to indicate "WLAN connection success", if configured by the eNB. When a UE configured with at least one LWA bearer that has previously indicated WLAN temporary suspension is able to resume the LWA operation, the UE shall send the *WLANConnectionStatusReport* message to indicate "WLAN connection resumption" to the eNB.

22A.1.7 LTE-WLAN Aggregation Operation

22A.1.7.1 WT Addition

The WT Addition procedure is initiated by the eNB and is used to establish a UE context at the WT in order to provide WLAN resources to the UE.

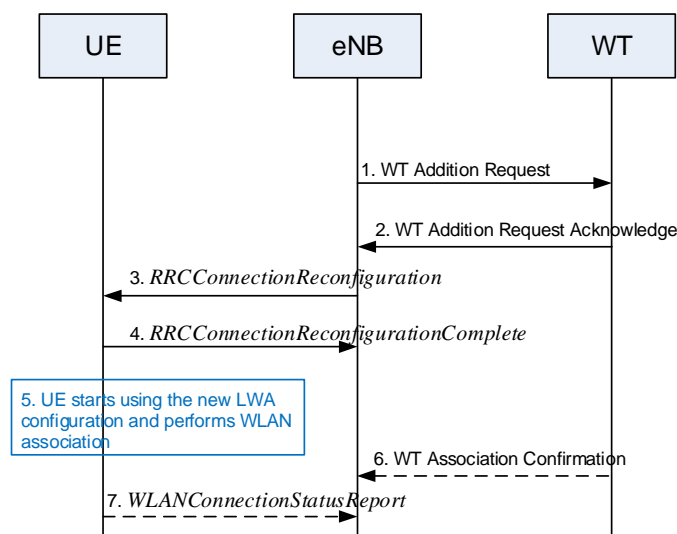

Figure 22A.1.7.1-1: WT Addition procedure

1. The eNB sends the WT Addition Request message to request the WT to allocate WLAN resources for specific E-RABs, indicating E-RAB characteristics. The WT may reject the request.

NOTE: The eNB may either decide to request resources from the WT of such an amount, that the QoS for the respective E-RAB is guaranteed by the exact sum of resources provided by the eNB and the WT together, or even more. The eNB's decision may be reflected in step 1 by the E-RAB parameters signalled to the WT, which may differ from E-RAB parameters received over S1.

2. If the WT is able to admit the full or partial WLAN resource request, it responds with the WT Addition Request Acknowledge message.

3. The eNB sends the *RRCConnectionReconfiguration* message to the UE including the new radio resource configuration. The eNB may include the Access Categories for uplink E-RABs, if received from the WT in step 2.
4. The UE applies the new configuration and replies with the *RRCConnectionReconfigurationComplete* message.
5. The UE performs WLAN Association.
6. The WT, if supported, sends the WT Association Confirmation message.
7. If configured by the eNB, the UE may send the *WLANConnectionStatusReport* message.

22A.1.7.2 WT Modification

The WT Modification procedure may be initiated either by the eNB or by the WT and be used to modify, establish or release bearer contexts or to modify other properties of the UE context within the same WT.

The WT Modification procedure does not necessarily need to involve signalling towards the UE.

eNB initiated WT Modification

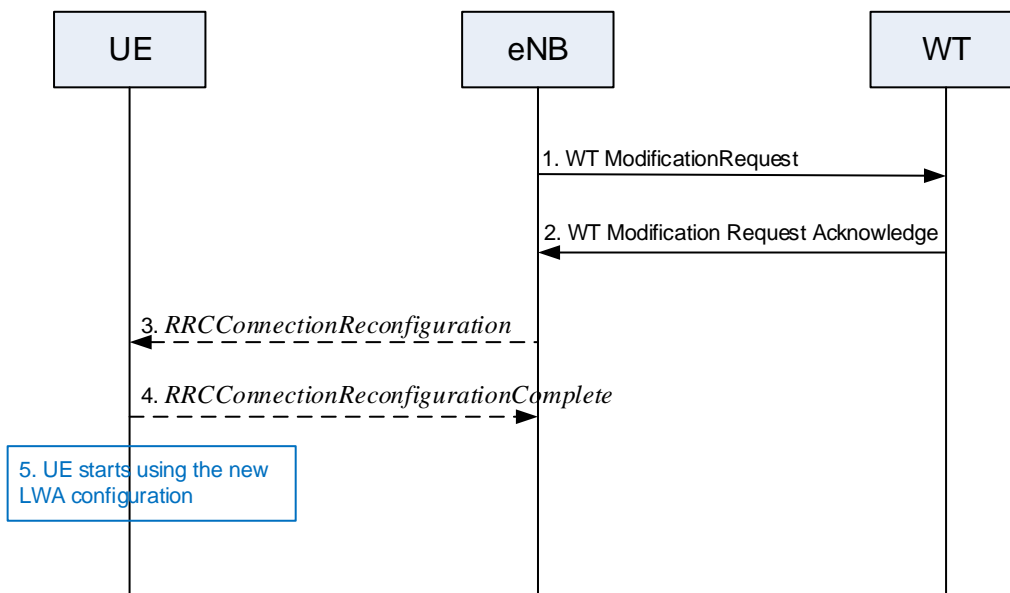

Figure 22A.1.7.2-1: WT Modification procedure – eNB initiated

1. The eNB sends the WT Modification Request message to request the WT to modify the WLAN resources for specific E-RABs.

NOTE: The eNB may either decide to request resources from the WT of such an amount, that the QoS for the respective E-RAB is guaranteed by the exact sum of resources provided by the eNB and the WT together, or even more. The eNB's decision may be reflected in step 1 by the E-RAB parameters signalled to the WT, which may differ from E-RAB parameters received over S1.

2. If the WT accepts the request, it applies the modified WLAN resource configuration and responds with the WT Modification Request Acknowledge message.
3. If the modification requires RRC configuration, eNB sends the *RRCConnectionReconfiguration* message to the UE including the new WLAN radio resource configuration. The eNB may include the Access Categories for uplink E-RABs, if received from the WT in step 2.
4. The UE applies the new RRC configuration and replies with the *RRCConnectionReconfigurationComplete* message.

- The UE starts utilizing the new LWA configuration.

WT initiated WT Modification

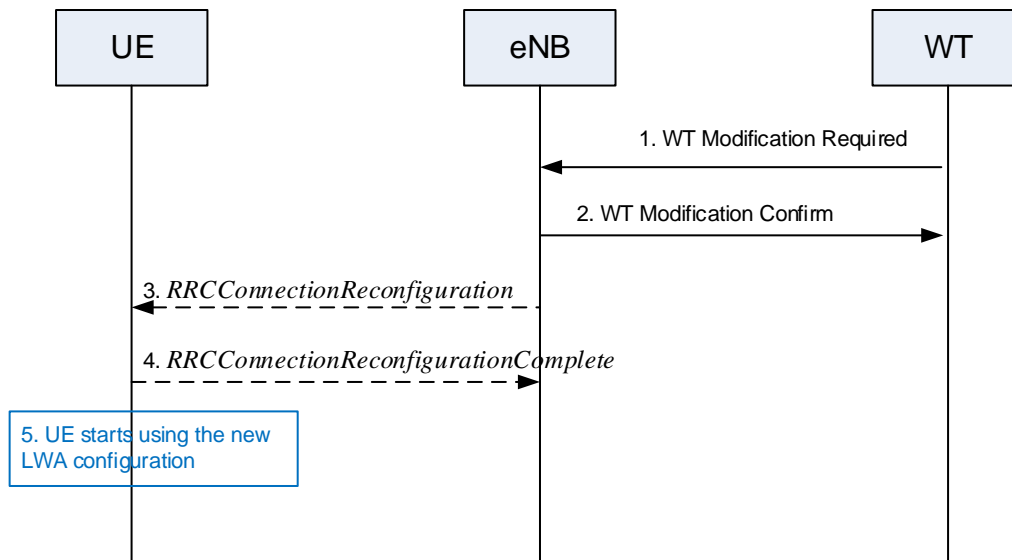

Figure 22A.1.7.2-2: WT Modification procedure – WT initiated

- The WT sends the *WT Modification Required* message to the eNB to modify the WLAN resources for specific E-RABs.
- The eNB replies with the *WT Modification Confirm* message.
- If the modification requires RRC configuration, eNB sends the *RRCConnectionReconfiguration* message to the UE including the new WLAN radio resource configuration. The eNB may include the Access Categories for uplink E-RABs, if received from the WT in step 1.
- The UE applies the new RRC configuration and replies with the *RRCConnectionReconfigurationComplete* message.
- The UE starts utilizing the new LWA configuration.

22A.1.7.3 WT Release

The WT Release procedure may be initiated either by the eNB or by the WT and is used to initiate the release of the UE context at the WT. The recipient node of this request cannot reject.

The WT Release procedure does not necessarily need to involve signalling towards the UE.

eNB initiated WT Release

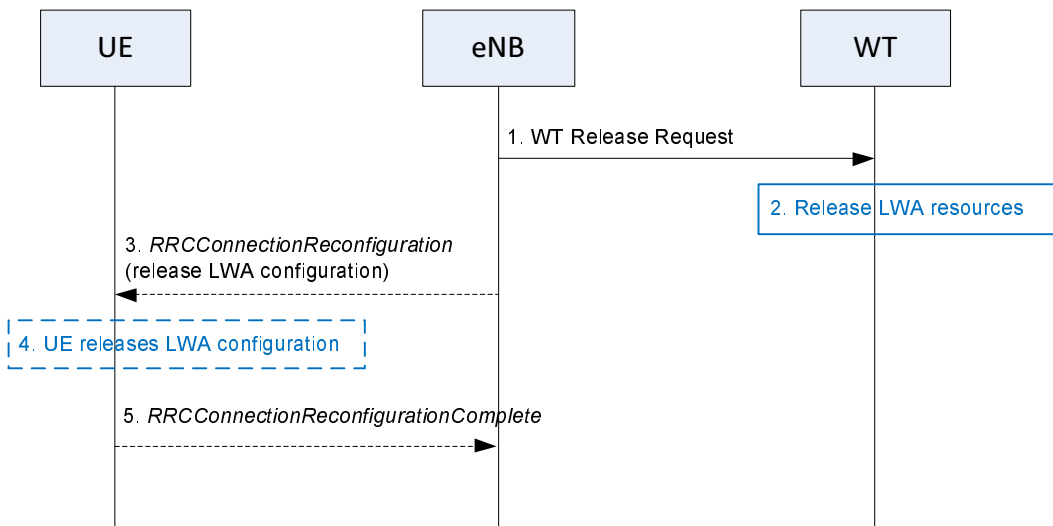

Figure 22A.1.7.3-1: WT Release procedure –eNB initiated

1. The eNB sends the WT Release Request message to request WT to release the allocated WLAN resources.
2. The WT initiates release of all allocated WLAN resources.
3. If required, the eNB sends the *RRCConnectionReconfiguration* message to the UE indicating the release of WLAN radio resource configuration.
4. The UE releases the LWA configuration.
5. The UE replies with the *RRCConnectionReconfigurationComplete* message.

NOTE 1: It is up to UE implementation what happens with WLAN association after LWA configuration has been released.

WT initiated WT Release

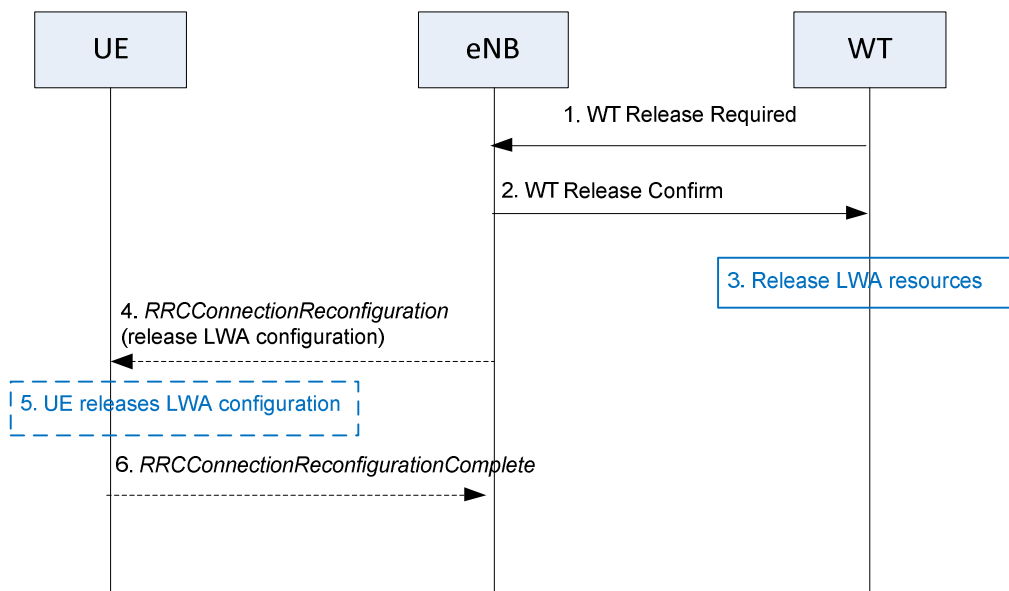

Figure 22A.1.7.3-2: WT Release procedure –WT initiated

1. The WT sends the WT Release Required message to the eNB to request the release of the allocated WLAN resources.
2. The eNB replies with the WT Release Confirm message.

3. The WT initiates release of all allocated WLAN resources.
4. If required, the eNB sends the *RRCConnectionReconfiguration* message to the UE indicating the release of WLAN radio resource configuration.
5. The UE releases the LWA configuration.
6. The UE replies with the *RRCConnectionReconfigurationComplete* message.

NOTE 2: It is up to UE implementation what happens with WLAN association after LWA configuration has been released.

22A.1.7.4 Change of WT

The change of WT procedure is initiated by eNB and used to transfer a UE context from a source WT to a target WT. This procedure can be realized using WT Release and WT Addition procedures.

22A.1.8 WLAN Authentication

For a UE supporting LWA, WLAN authentication is performed as follows:

If WT Counter is included in LWA Configuration in the RRC Connection Reconfiguration message, the UE shall start using the $S-K_{WT}$ derived using the WT Counter value and K_{eNB} as PMK or PSK as specified in TS 33.401 [22], clause G and TS 36.331 [16], clause 5.6.14.2. For a UE already authenticated with WLAN, configuration of a new PMK or PSK triggers refreshing the IEEE 802.11 security using the new PMK or PSK.

If WT Counter is not included in LWA Configuration in the RRC Connection Reconfiguration message:

- if WT Counter has not been previously configured for the UE, the UE which is not already authenticated with a WLAN in the WLAN mobility set shall use authentication methods specified in TS 33.402 [70], clause 6;
- if WT Counter has been previously configured for the UE, the UE which is not already authenticated with a WLAN in the WLAN mobility set shall keep using the $S-K_{WT}$ previously derived using the WT Counter value and K_{eNB} as PMK or PSK as specified in TS 33.401 [22], clause G and TS 36.331 [16], clause 5.6.14.2;
- the UE which is already authenticated with a WLAN in the WLAN mobility set continues using the previously configured authentication method and is not required to refresh IEEE 802.11 security.

22A.2 RAN Controlled LTE WLAN Interworking

22A.2.1 General

E-UTRAN supports E-UTRAN controlled bi-directional traffic steering between E-UTRAN and WLAN for UEs in RRC_CONNECTED: RAN Controlled WLAN Interworking (RCLWI). E-UTRAN may send a steering command to the UE indicating to steer traffic from E-UTRAN to WLAN or from WLAN to E-UTRAN. The upper layers in the UE shall be notified (see TS 24.302 [67]) upon reception of such a command. Upper layers determine which traffic is offloadable to WLAN. Similarly as for LWA, two scenarios are supported depending on the backhaul connection between LTE and WLAN (non-collocated RCLWI scenario for a non-ideal backhaul and collocated RCLWI scenario for an ideal/internal backhaul), and the overall architecture for the non-collocated RCLWI scenario is the same as illustrated for LWA in Figure 22A.1.1-1 above.

If the UE supporting RCLWI supports access network selection and traffic steering rules defined in TS 36.304 [11], the UE applies the rules in RRC_IDLE using WLAN identifiers provided in WLAN mobility set. If the UE supporting RCLWI and traffic steering rules defined in TS 36.304 [11], has not been configured with a WLAN mobility set, it applies the broadcasted WLAN identifiers. If the UE supporting RCLWI does not support the traffic steering rules defined in TS 36.304 [11], it keeps traffic on WLAN within the configured WLAN mobility set (if any) in RRC_IDLE until WLAN connection fails.

E-UTRAN does not configure RCLWI with DC, LWA or LWIP simultaneously for the same UE.

If RCLWI and RAN assisted WLAN interworking are simultaneously configured for the same UE, in RRC_CONNECTED, the UE only applies RCLWI.

22A.2.2 Network Interfaces

22A.2.2.1 General

Similarly as for LWA, in the non-collocated RCLWI scenario, the eNB is connected to one or more WT logical nodes via an Xw interface and in the collocated RCLWI scenario the interface between LTE and WLAN is up to implementation.

22A.2.2.2 User Plane Plane

There is no user plane interface defined between the eNB and the WT in RCLWI.

22A.2.2.3 Control Plane

In the non-collocated RCLWI scenario, the Xw control plane interface (Xw-C) is defined between the eNB and the WT and is similar to what is defined for LWA in clause 22A.1.3.3. LWA specific functions are not part of RCLWI.

22A.2.3 Mobility

A WLAN mobility set is a set of one or more BSSID/HESSID/SSIDs, within which WLAN mobility mechanisms apply while the UE has moved offloadable traffic to WLAN according to a steering command, i.e. the UE may perform mobility between WLAN APs belonging to the mobility set without informing the eNB.

22A.2.4 WLAN Measurements

The UE supporting RCLWI may be configured by the E-UTRAN to perform WLAN measurements. WLAN measurement object can be configured using WLAN identifiers (BSSID, HESSID and SSID), WLAN carrier information and WLAN band. WLAN measurement reporting is triggered using RSSI. WLAN measurement report contains, for each included WLAN, RSSI and WLAN identifier, and may contain WLAN carrier information, WLAN band, channel utilization, station count, admission capacity, backhaul rate and an indication whether the UE is connected to the WLAN.

22A.2.5 Procedure for WLAN Connection Status Reporting

The purpose of the WLAN Connection Status Reporting procedure is to provide feedback to the eNB related to the WLAN status and operation. The WLAN Connection Status Reporting procedure supports the following indications:

1. Failure of establishing/maintaining a WLAN connection.

When a UE configured to offload to WLAN becomes unable to establish or continue WLAN offloading, the UE sends the *WLANConnectionStatusReport* message to indicate to the eNB that the WLAN connection failed and the UE moves all the offloaded traffic to E-UTRAN (see TS 24.302 [67]).

The criteria to determine WLAN connection failure is left for UE implementation.

22A.2.6 Traffic Steering Operation

22A.2.6.1 Traffic Steering from E-UTRAN to WLAN

The traffic steering from E-UTRAN to WLAN procedure is initiated by the eNB.

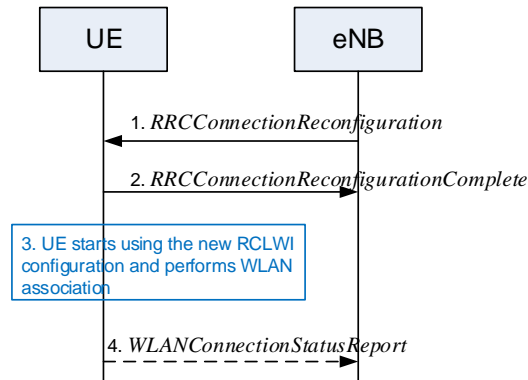

Figure 22A.2.6.1-1: Traffic steering from E-UTRAN to WLAN procedure

1. The eNB sends the *RRCConnectionReconfiguration* message to the UE indicating the UE to steer traffic from E-UTRAN to WLAN.
2. The UE forward the indication to upper layers and replies with *RRCConnectionReconfigurationComplete* message.
3. The UE performs WLAN Association and after successful connection to WLAN, steers traffic from E-UTRAN to WLAN (subject to upper layer).
4. If WLAN association failed, the UE sends *WLANConnectionStatusReport* message.

22A.2.6.2 Traffic Steering from WLAN to E-UTRAN

The traffic steering from WLAN to E-UTRAN procedure is initiated by the eNB.

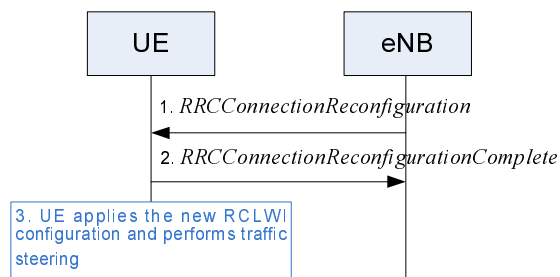

Figure 22A.2.6.2-1: Traffic steering from WLAN to E-UTRAN procedure

1. The eNB sends the *RRCConnectionReconfiguration* message to the UE indicating the UE to steer traffic from WLAN to E-UTRAN.
2. The UE forward the indication to upper layers and replies with *RRCConnectionReconfigurationComplete* message.
3. The UE steers traffic from WLAN to E-UTRAN.

22A.3 LTE/WLAN Radio Level Integration with IPsec Tunnel

22A.3.0 General

LTE/WLAN Radio Level Integration with IPsec Tunnel (LWIP) feature allows a UE in RRC_CONNECTED to be configured by the eNB to utilize WLAN radio resources via IPsec tunnelling.

The overall architecture for LWIP is illustrated in Figure 22A.3-1. Connectivity between eNB and LWIP-SeGW is provided by the Xw interface .

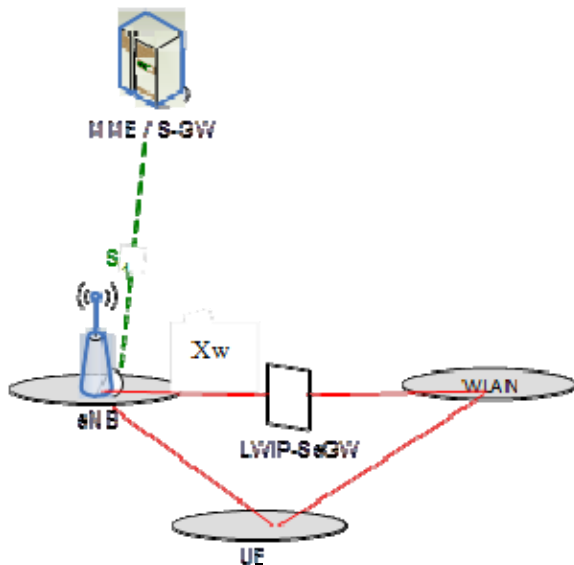

Figure 22A.3-1: LWIP Overall Architecture

The protocol architecture for LWIP is illustrated in Figure 22A.3-2.

The IP Packets transferred between the UE and LWIP-SeGW are encapsulated using IPsec, as specified in TS 33.401 [22], in order to provide security to the packets that traverse WLAN. The IP packets are then transported between the LWIP-SeGW and eNB via the Xw interface. The end to end path between the UE and eNB via the WLAN network is referred to as the LWIP tunnel.

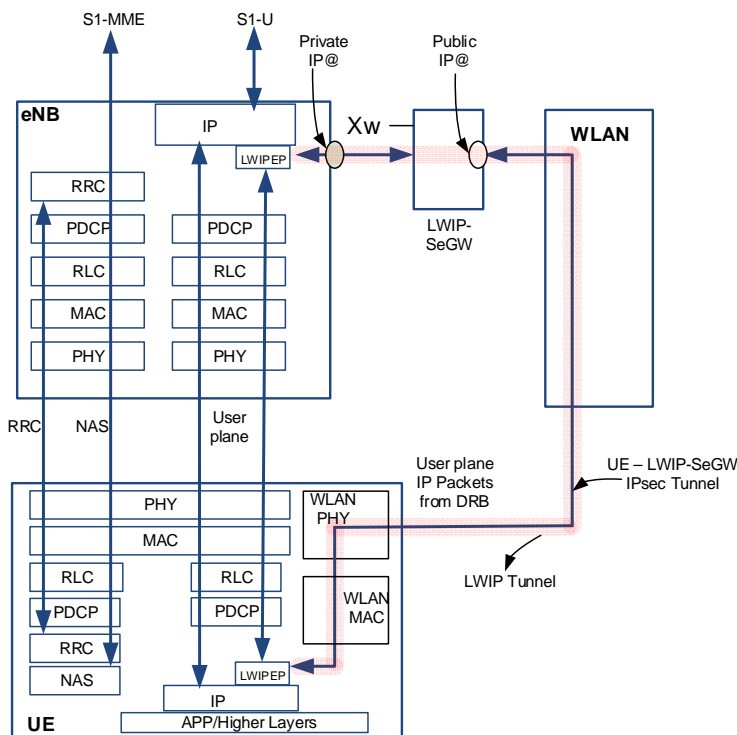

Figure 22A.3-2: LWIP Protocol Architecture

The end to end protocol stack for the bearer transported over the LWIP tunnel is illustrated in figure 22A.3-3.

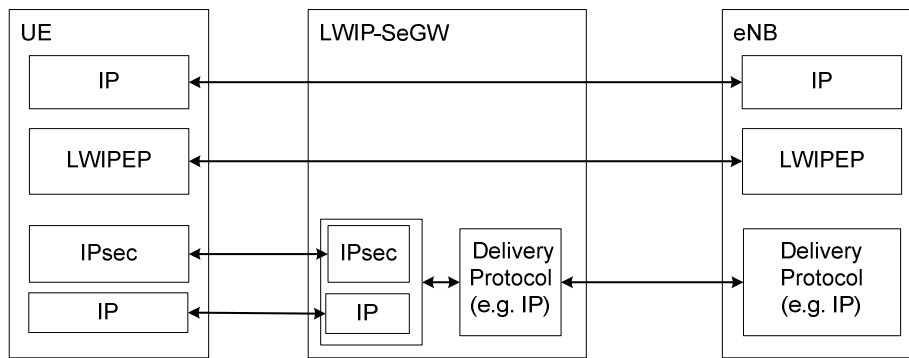

Figure 22A.3-3: Bearer over LWIP Tunnel - Protocol Stack

The RRCConnectionReconfiguration message provides the necessary parameters for the UE to initiate the establishment of the IPsec tunnel for the DRB. When the IPsec tunnel is established a data bearer can be configured to use LWIP resources. The DRB configuration on the LTE access corresponding to the data bearer using IPsec resources shall not be released. The data bearer refers to the EPS bearer mapped to the data radio bearer (DRB) which is maintained on the LTE side.

The IPsec tunnel is established following the exchange of security information between the eNB and LWIP-SeGW using the XwAP LWIP Addition Preparation procedure.

A single IPsec tunnel is used per UE for all the data bearers that are configured to send and/ or receive data over WLAN. The data corresponding to each IPsec Tunnel is transported over the Xw interface on a single GTP-U tunnel. Each data bearer may be configured so that traffic for that bearer can be routed over the IPsec tunnel in only downlink, only uplink, or both uplink and downlink over WLAN. SRBs are carried over LTE only. eNB configures specific bearer(s) to use the IPsec tunnel.

NOTE: If the IPsec tunnel is established then it is expected that eNB routes packets belonging to the data bearer via the LTE access or via the IPsec tunnel. If eNB implementation routes packets to both LTE Access and the IPsec tunnel simultaneously, then delivery of packets to upper layers at the UE may occur out of order.

For the DL of a data bearer, the packets received from the IPsec tunnel are forwarded directly to upper layers.

For the UL, the eNB configures the UE to route the uplink data either via LTE or via WLAN using RRC signalling. If routed via WLAN then all UL traffic of the data bearer is offloaded to the WLAN.

UL bearer packets sent over the LWIP tunnel are encapsulated using LWIPEP as specified in TS 36.361 [68] with the 'Key' field in the LWIPEP header populated with the DRB Identity associated with offloaded UL bearer.

If aggregation over LWIP is enabled in UL or DL, the corresponding (UL or DL) packets sent over the LWIP tunnel and LTE are encapsulated using LWIPEP as specified in TS 36.361 [68]. The LWIPEP layer assigns sequence numbers to all packets and uses this sequence numbers to populate the 'Sequence Number' field in the LWIPEP header. The 'Key' field in the LWIPEP header is populated with the DRB Identity of the associated DRB.

The release of the IPsec tunnel is initiated by the eNB. Upon receiving the Handover Command or on transition to RRC_IDLE state, the UE shall autonomously release IPsec tunnel configuration and the use of it by the data bearers.

A UE supporting LWIP may be configured for WLAN measurements as per clause 22A.1.5.

The same mobility concept as specified in 22A.1.4 for LWA is also used for LWIP. Since, WT node does not exist in LWIP operation, WT related description and procedures does not apply to LWIP. Mobility Set should be considered as the set of WLAN APs across which UE can perform mobility without informing the eNB, when applying the concept for LWIP operation.

E-UTRAN does not configure LWIP with DC, LWA or RCLWI simultaneously for the same UE.

If LWIP and RAN assisted WLAN interworking are simultaneously configured for the same UE, in RRC_CONNECTED, the UE only applies LWIP.

22A.3.1 LWIP Operation

22A.3.1.1 LWIP Tunnel Setup and Data Bearer Configuration

Figure 22A.3.1.1-1 shows the procedure of configuring a data bearer to be transported over the LWIP tunnel.

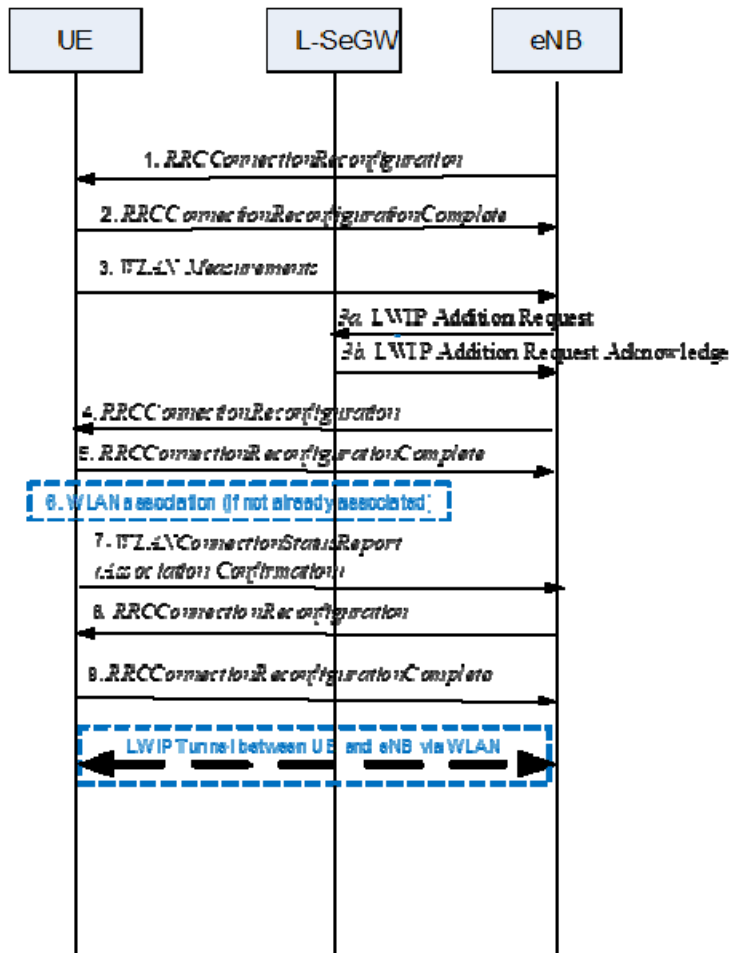

Figure 22A.3.1.1-1: LWIP Tunnel for data bearer setup procedure

1. The eNB configures the UE to perform WLAN measurements for LWIP operation.
2. The UE applies the new configuration and replies with *RRCConnectionReconfigurationComplete* message.
3. UE sends WLAN measurements to the eNB.
- 3a. The eNB sends the LWIP Addition Request message to request the LWIP-SeGW to allocate resources for a specific UE, including security material.
- 3b. If the LWIP-SeGW is able to admit the tunnel request, it responds with the LWIP Addition Request Acknowledge message.
4. The eNB sends the *RRCConnectionReconfiguration* message to the UE including the WLAN mobility set.
5. The UE applies the new configuration and replies with *RRCConnectionReconfigurationComplete* message.
6. UE associates with WLAN in consideration of the mobility set, if not already associated.
7. UE sends confirmation of the WLAN association to the eNB.
8. The eNB sends the *RRCConnectionReconfiguration* message to the UE including the necessary parameters to establish IPsec tunnel over WLAN and may, configure data bearers to utilise the IPsec tunnel.

9. The UE applies the new configuration and replies with *RRCCONNECTIONRECONFIGURATIONCOMPLETE* message.

The UE uses the parameters in the new radio resource configuration to setup the IPsec tunnel with the LWIP-SeGW to complete the establishment of the LWIP tunnel with the eNB over the WLAN access. eNB may add or remove data bearers to utilise the LWIP tunnel at any time after the establishment of the LWIP tunnel by sending the *RRCCONNECTIONRECONFIGURATION* message to the UE.

22A.3.1.2 Reconfiguration to Remove WLAN Resources from Data Bearer

Figure 22A.3.1.2-1 shows the procedure of re-configuring to remove the WLAN radio resources from the data bearer.

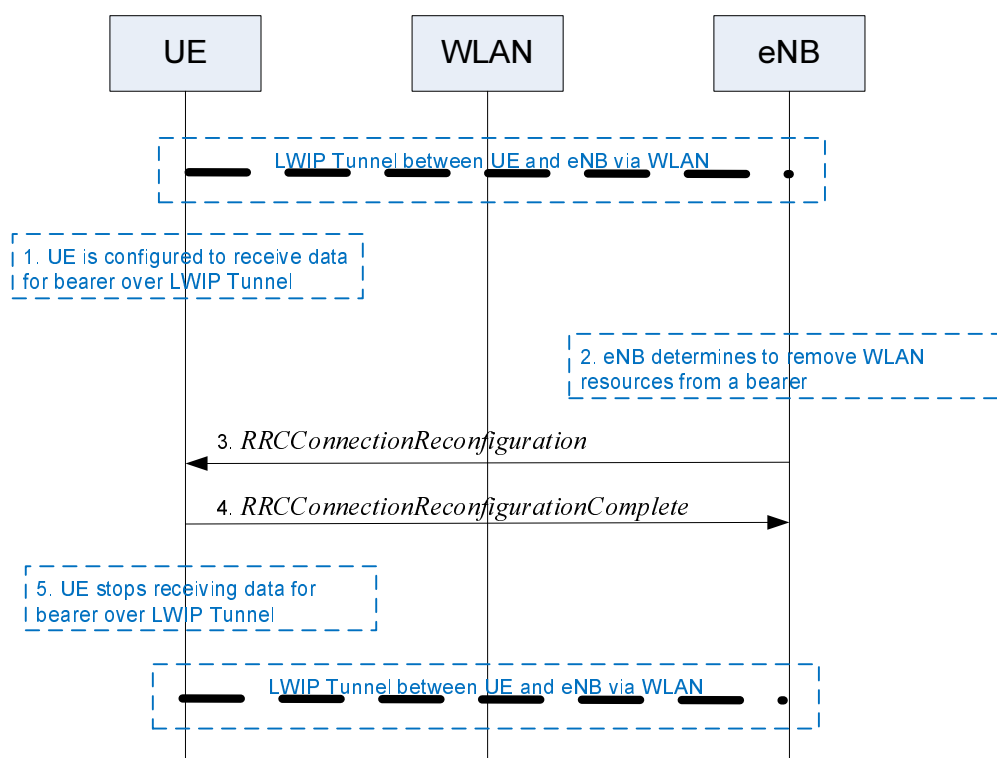

Figure 22A.3.1.2-1: Reconfiguration procedure to remove WLAN resources from a Data Bearer

UE and eNB have the LWIP tunnel setup via WLAN.

1. The UE is configured to receive data from a data bearer over the LWIP tunnel.
2. The eNB determines that it needs to remove the WLAN resources for the data bearer.
3. The eNB sends the *RRCCONNECTIONRECONFIGURATION* message to the UE including the necessary parameters to remove WLAN resources for the data bearer.
4. The UE applies the new configuration and replies with *RRCCONNECTIONRECONFIGURATIONCOMPLETE* message.
5. UE stops receiving data for the data bearer over the LWIP tunnel.

22A.3.1.3 LWIP Tunnel Release

Figure 22A.3.1.3-1 shows the procedure of eNB initiated LWIP tunnel release.

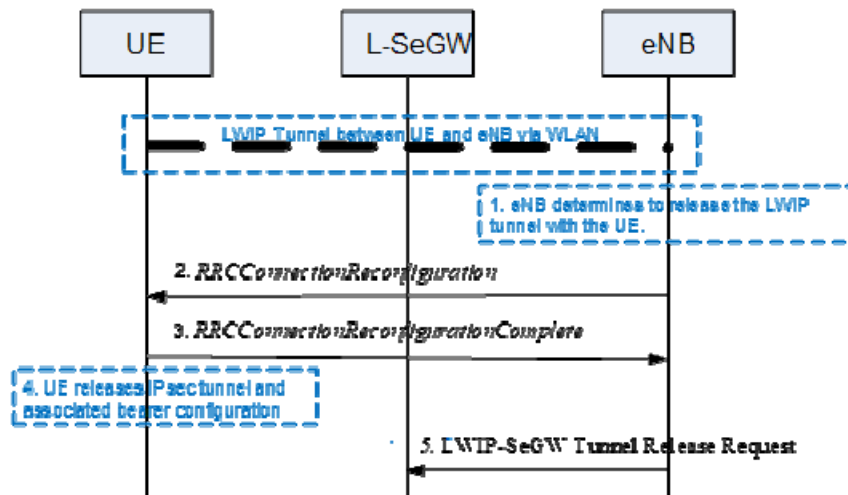

Figure 22A.3.1.3-1: LWIP tunnel release procedure

UE and eNB have the LWIP tunnel setup via WLAN.

1. The eNB determines that it needs to release the LWIP tunnel and initiates the release of the IPsec tunnel between the UE and LWIP-SeGW.
2. The eNB sends the *RRConnectionReconfiguration* message to the UE including the indication to release the LWIP tunnel.
3. The UE applies the new configuration and replies with the *RRConnectionReconfigurationComplete* message.
4. The UE releases the IPsec tunnel and associated data bearer configuration, and terminates the LWIP tunnel.
5. The eNB sends the LWIP-SeGW Tunnel Release Request message to release remaining resources at the LWIP-SeGW.

22A.3.2 Network Interfaces

22A.3.2.1 General

The eNB is connected to one or more LWIP-SeGWs via an Xw interface. In addition to the functionality described in this clause and in TS 33.401 [22], LWIP-SeGW supports the subset of WT functionality and additional functionality required to support LWIP.

22A.3.2.2 User Plane

The Xw user plane interface (Xw-U) is used between eNB and LWIP-SeGW. The Xw-U interface is used to deliver LWIPEP PDUs between eNB and LWIP-SeGW using a single tunnel for all bearers configured for LWIP. The Xw-U interface supports flow control based on feedback from LWIP-SeGW.

22A.3.2.3 Control Plane

The Xw control plane interface (Xw-C) is used between eNB and LWIP-SeGW.

The LWIP-SeGW supports the following functions:

- Transfer of WLAN metrics (e.g. bss load) from LWIP-SeGW to eNB;
- Support of LWIP for UE in ECM-CONNECTED:
 - Establishment, Modification and Release of a IPsec tunnel between the UE and the LWIP-SeGW;
- General Xw management and error handling functions:

- Error indication;
- Setting up the Xw;
- Resetting the Xw;
- Updating the configuration data.

22B Xw Interface

22B.1 User Plane

The Xw user plane interface (Xw-U) is defined between eNB and WT. The Xw-U interface provides non guaranteed delivery of user plane PDUs. The user plane protocol stack on the Xw interface is shown in Figure 22B.1-1. The transport network layer is built on IP transport and GTP-U is used on top of UDP/IP to carry the user plane PDUs.

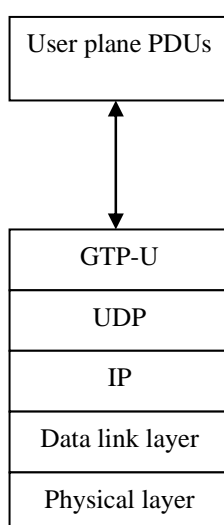

Figure 22B.1-1: Xw Interface User Plane

For LWA, if Xw-U user data bearers are associated with E-RABs for which the LWA bearer is configured, GTP-U conveys LWAAP PDUs and a RAN Container containing flow control information. The RAN Container is carried in the "RAN Container" field of the GTP-U extension header.

For the transfer of the uplink data, the WT may use either separate GTP-U tunnels as configured for each LWA bearer (based on the DRB Identity), or a single GTP-U tunnel. In the latter case, the WT shall use the tunnel associated with the lowest E-RAB ID.

22B.2 Control Plane

22B.2.0 General

The Xw control plane interface (Xw-C) is defined between an eNB and a WT. The control plane protocol stack of the Xw interface is shown on Figure 22B.2-1 below. The transport network layer is built on SCTP on top of IP. The application layer signalling protocol is referred to as Xw-AP (Xw Application Protocol).

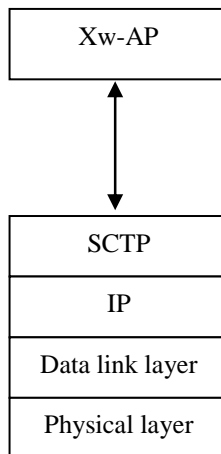

Figure 22B.2-1: Xw Interface Control Plane

22B.2.1 Xw-CP Functions

The elementary functions supported by the Xw-AP protocol are listed in TS 36.463 [69].

22B.2.2 Xw-CP Procedures

The elementary procedures supported by the Xw-AP protocol are listed in TS 36.463 [69].

22B.2.2.1 WT Addition Preparation procedure

The WT Addition Preparation procedure is initiated by the eNB to request the WT to establish LWA bearer(s) for a specific UE.

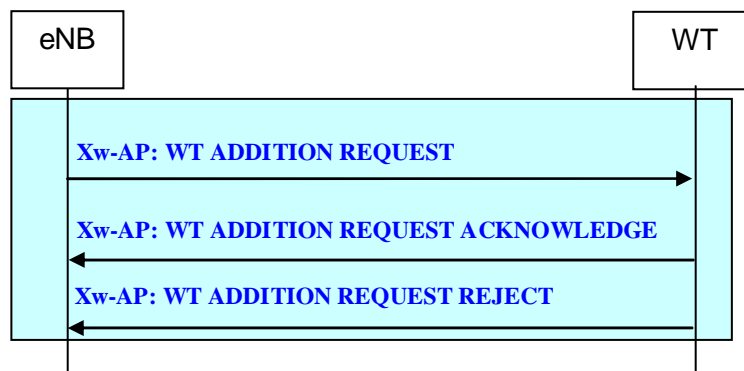

Figure 22B.2.2.1-1: WT Addition Preparation procedure

The eNB sends a WT ADDITION REQUEST message to the WT including the LWA bearer(s) for the specific UE.

In case one or more GTP tunnel(s) at the WT has been established successfully, the WT responds with a WT ADDITION REQUEST ACKNOWLEDGE message, which includes successfully established and failed to be established bearers for LWA.

In case WT addition is not successful, the WT responds with WT ADDITION REQUEST REJECT message instead.

22B.2.2.2 WT Association Confirmation procedure

The WT Association Confirmation procedure is initiated by the WT to give confirmation to the eNB about the association establishment between a specific UE and the WLAN.

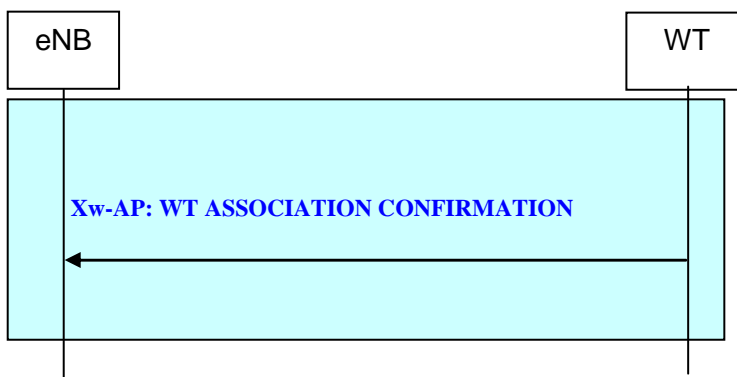

Figure 22B.2.2.2-1: WT Association Confirmation procedure

22B.2.2.3 eNB initiated WT Modification Preparation procedure

The eNB initiated WT Modification Preparation procedure is initiated by the eNB to request the WT to modify LWA bearer(s) for a specific UE at the WT.

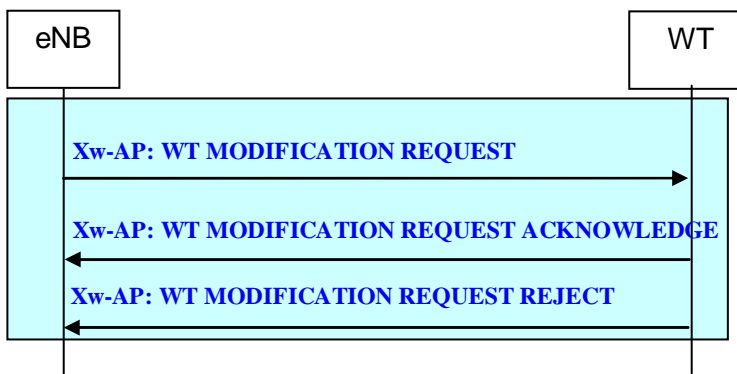

Figure 22B.2.2.3-1: eNB initiated WT Modification Preparation procedure

The eNB sends a WT MODIFICATION REQUEST message to the WT including the LWA bearer(s) for the specific UE.

In case resource modification at the WT has been performed successfully, the WT responds with a WT MODIFICATION REQUEST ACKNOWLEDGE message.

In case the WT modification is not successful the WT responds with a WT MODIFICATION REQUEST REJECT message instead.

22B.2.2.4 WT initiated WT Modification procedure

The WT initiated WT Modification Preparation procedure is initiated by the WT to request the eNB to modify the WLAN resources for the specific UE.

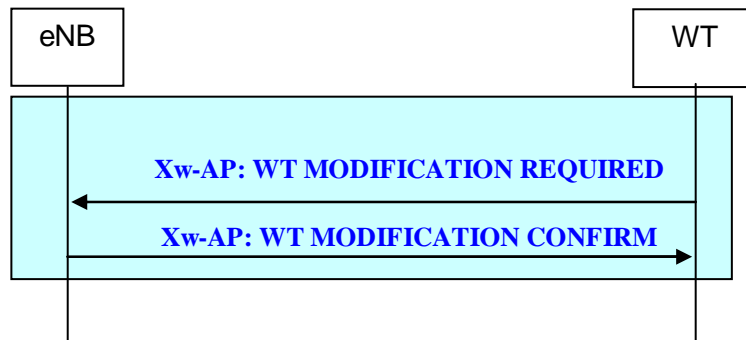

Figure 22B.2.2.4-1: WT initiated WT Modification procedure

The WT sends a WT MODIFICATION REQUIRED message to the eNB to request to modify the WLAN resources for the specific UE.

If the WT modification is successful, the eNB replies with a WT MODIFICATION CONFIRM message.

22B.2.2.5 eNB initiated WT Release procedure

The eNB initiated WT Release procedure is triggered by the eNB to initiate the release of the resources for a specific UE at the WT.

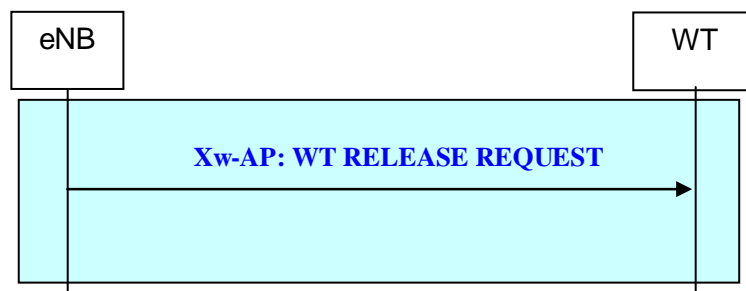

Figure 22B.2.2.5-1: eNB initiated WT Release procedure

22B.2.2.6 WT initiated WT Release procedure

The WT initiated WT Release procedure is triggered by the WT to initiate the release of the resources for a specific UE at the WT.

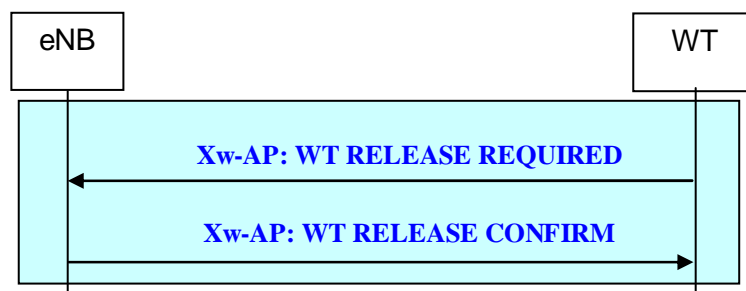

Figure 22B.2.2.6-1: WT initiated WT Release procedure

The WT sends a WT RELEASE REQUIRED message to the eNB to request the release of the allocated WLAN resources for the specific UE.

If the WT release is successful, eNB replies with a WT RELEASE CONFIRM message.

22B.2.2.7 WT Status Reporting Initiation

The WT Status Reporting Initiation procedure is used by the eNB to request measurements from the WT.

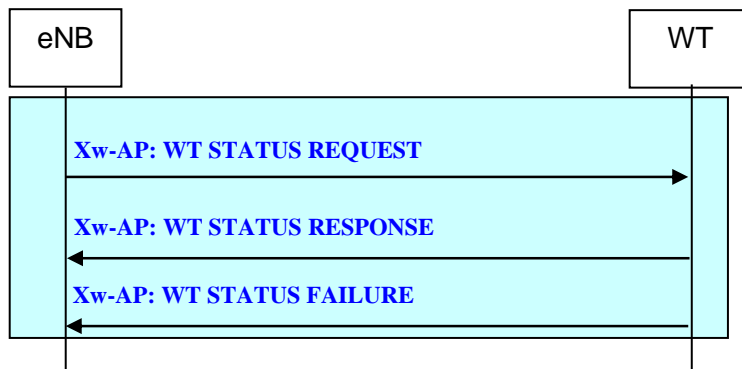

Figure 22B.2.2.7-1: WT Status Reporting Initiation procedure

The eNB sends a WT STATUS REQUEST message to the WT to request measurements from the WT.

In case the requested measurements are successfully initiated, the WT responds with a WT STATUS RESPONSE message.

In case none of the requested measurements can be initiated, the WT responds with a WT STATUS FAILURE message instead.

22B.2.2.8 WT Status Reporting

The WT Status Reporting procedure reports measurement results requested by the eNB as described in 22B.2.2.7.

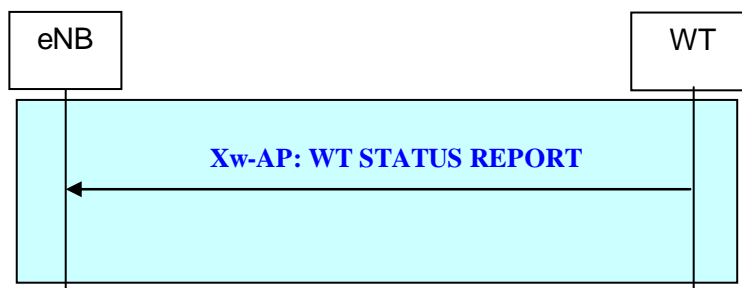

Figure 22B.2.2.8-1: WT Status Reporting procedure

22B.2.2.9 Xw Setup procedure

The purpose of the Xw Setup procedure initiated by the eNB is to exchange application level data needed for eNB and WT to interoperate correctly over the Xw interface. The Xw Setup procedure is triggered by the eNB. The Xw Setup procedure is the first Xw-AP procedure which will be executed.

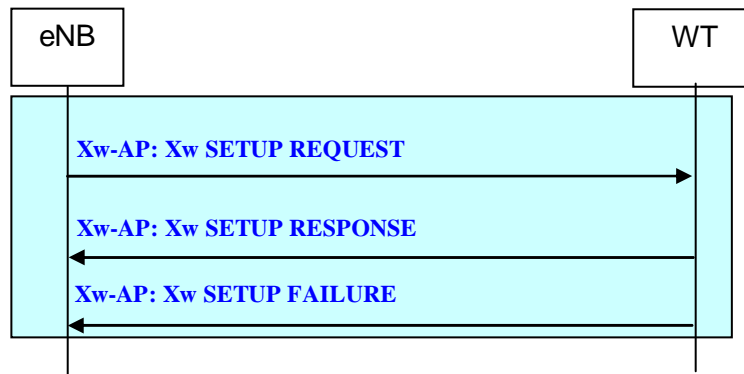

Figure 22B.2.2.9-1: Xw Setup procedure

The eNB sends an Xw SETUP REQUEST message to the WT.

In case Xw setup has been performed successfully by the WT, the WT responds with an Xw SETUP RESPONSE message.

In case Xw setup is not successful, the WT responds with an Xw SETUP FAILURE message instead.

22B.2.2.10 WT Configuration Update procedure

The purpose of the WT Configuration Update procedure initiated by the WT is to update application level configuration data needed for the WT to interoperate correctly over the Xw interface.

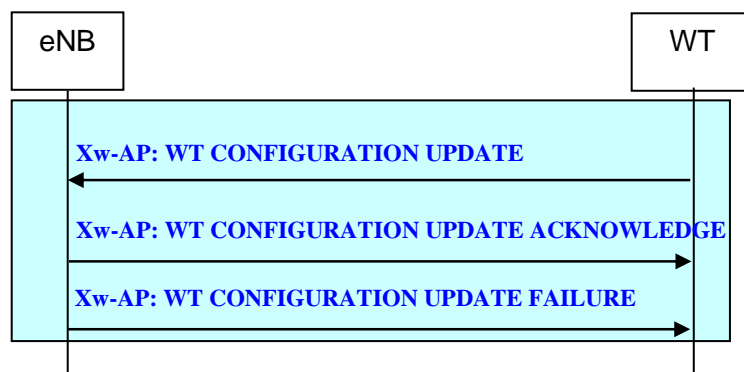

Figure 22B.2.2.10-1: WT Configuration Update procedure

The WT sends a WT CONFIGURATION UPDATE message to the eNB.

In case WT Configuration Update procedure has been performed successfully by the eNB, the eNB responds with a WT CONFIGURATION UPDATE ACKNOWLEDGE message.

In case WT Configuration Update procedure is not successful, the eNB responds with a WT CONFIGURATION UPDATE FAILURE message instead.

22B.2.2.11 Error Indication procedure

22B.2.2.11.0 General

The Error Indication procedure is initiated by the eNB or the WT, to report an error situation in a received message, provided it cannot be reported by an appropriate failure message.

22B.2.2.11.1 WT initiated error indication

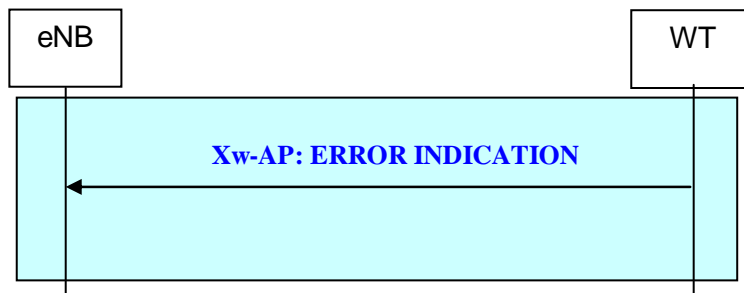

Figure 22B.2.2.11.1-1: Error Indication procedure initiated by WT

The WT sends the ERROR INDICATION message to report the eNB which kind of error occurred.

22B.2.2.11.2 eNB initiated error indication

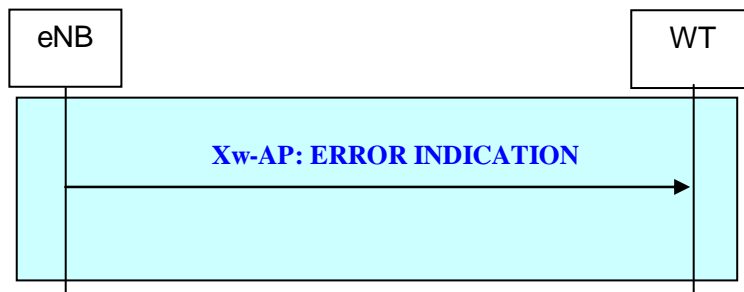

Figure 22B.2.2.11.2-1: Error Indication procedure initiated by eNB

The eNB sends the ERROR INDICATION message to report the WT which kind of error occurred.

22B.2.2.12 Reset procedure

22B.2.2.12.0 General

The Reset procedure is initiated by the eNB/WT to align the resources with the WT/eNB in the event of an abnormal failure. The procedure resets the whole Xw interface.

22B.2.2.12.1 WT initiated reset

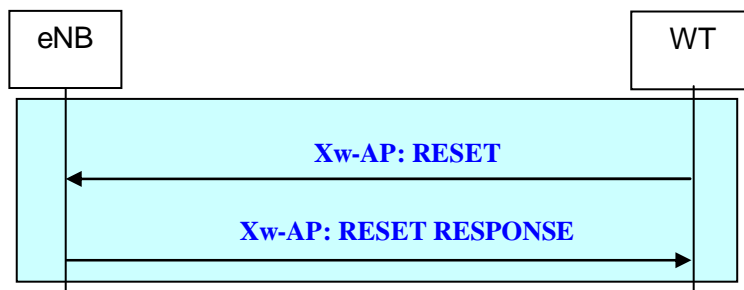

Figure 22B.2.2.12.1-1: Reset procedure initiated by WT

The WT triggers the RESET message to indicate that an initialisation in the eNB is required. The eNB releases the corresponding references and resources.

Afterwards the eNB sends the RESET RESPONSE message to confirm that the resources and references are cleared.

22B.2.2.12.2 eNB initiated reset

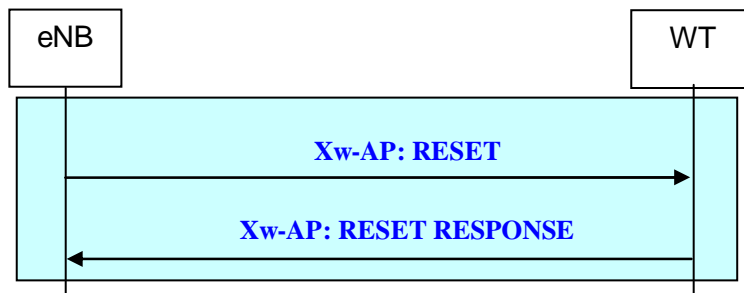

Figure 22B.2.2.12.2-1: Reset procedure initiated by eNB

The eNB triggers the RESET message to indicate that an initialisation in the WT is required. The WT releases the corresponding references and resources.

Afterwards the WT sends the RESET RESPONSE message to confirm that the resources and references are cleared.

22B.2.2.13 LWIP Addition Preparation procedure

The LWIP Addition Preparation procedure is initiated by the eNB to request the LWIP-SeGW to establish LWIP bearer for a specific UE.

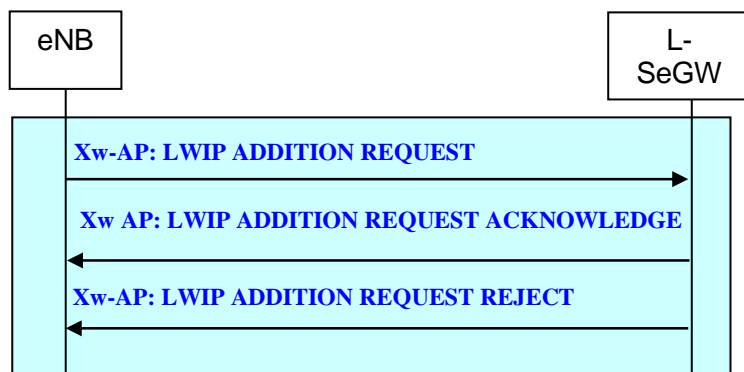

Figure 22B.2.2.13-1: LWIP-SeGW Addition Preparation procedure

The eNB sends a LWIP ADDITION REQUEST message to the LWIP-SeGW including security information for the specific UE.

In case the GTP tunnel at the LWIP-SeGW has been established successfully, the LWIP-SeGW responds with a LWIP ADDITION REQUEST ACKNOWLEDGE message.

In case LWIP-SeGW Addition is not successful, the LWIP-SeGW responds with LWIP ADDITION REQUEST REJECT message instead.

22B.2.2.14 eNB initiated LWIP Modification Preparation procedure

The eNB initiated LWIP Modification Preparation procedure is initiated by the eNB to request the LWIP-SeGW to modify resources for a specific UE at the LWIP-SeGW.

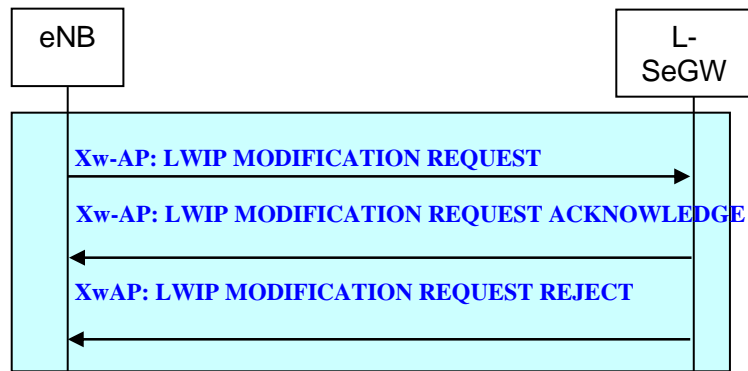

Figure 22B.2.2.14-1: eNB initiated LWIP-SeGW Modification Preparation procedure

The eNB sends a LWIP MODIFICATION REQUEST message to the LWIP-SeGW including requested modifications.

In case resource modification at the LWIP-SeGW has been performed successfully, the LWIP-SeGW responds with a LWIP MODIFICATION REQUEST ACKNOWLEDGE message.

In case the LWIP-SeGW modification is not successful the LWIP-SeGW responds with a LWIP MODIFICATION REQUEST REJECT message instead.

22B.2.2.15 eNB initiated LWIP Release procedure

The eNB initiated LWIP Release procedure is triggered by the eNB to initiate the release of the resources for a specific UE at the LWIP-SeGW.

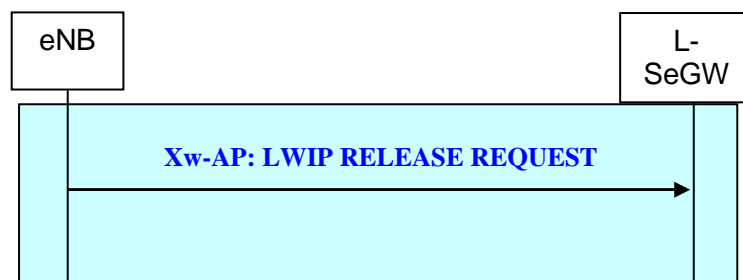

Figure 22B.2.2.15-1: eNB initiated LWIP-SeGW Release procedure

22B.2.2.16 LWIP-SeGW initiated LWIP Release procedure

The LWIP-SeGW initiated LWIP Release procedure is triggered by the LWIP-SeGW to initiate the release of the resources for a specific UE at the LWIP-SeGW.

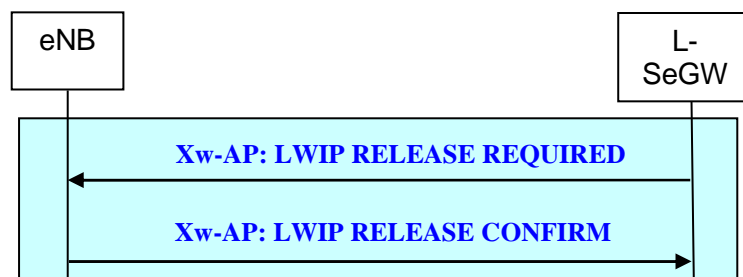

Figure 22B.2.2.16-1: LWIP-SeGW initiated LWIP-SeGW Release procedure

The LWIP-SeGW sends a LWIP RELEASE REQUIRED message to the eNB to request the release of the allocated WLAN resources for the specific UE.

If the LWIP-SeGW release is successful, eNB replies with a LWIP RELEASE CONFIRM message.

23 Others

23.1 Support for real time IMS services

23.1.1 IMS Emergency Call

IMS emergency calls are supported in this release of the specification and UE may initiate an IMS emergency call on the PS domain if the network supports it. IMS Emergency call support indication is provided to inform the UE that emergency bearer services are supported. This is sent via NAS messaging for normal service mode UE and via a BCCH indicator for limited service mode UE TS 23.401 [17]. The BCCH indicator is set to 'support' if any of the MMEs in a non-shared environment or one of PLMNs in a shared network environment supports IMS emergency bearer services.

If at the time of an IMS emergency call origination, the UE is already RRC connected to a CN that does not support IMS emergency calls, it should autonomously release the RRC connection and originate a fresh RRC connection in a cell that is capable of handling emergency calls. Call admission control for IMS emergency call is based on bearer QoS (e.g. the ARP).

Security procedures are activated for emergency calls. For UE in limited service mode and the UE is not authenticated (as defined in TS 33.401 [22], clause 15.2.2), 'NULL' algorithms for ciphering and integrity protection are used and the related keys are set to specified value and may be ignored by the receiving node. During handover from cell in non-restricted area to restricted area, security is handled normally with normal key derivation etc. for both the intra-LTE and inter-RAT handover. For inter-RAT handover from LTE, if 'NULL' Integrity Protection algorithms are used in LTE, security is stopped after the handover. For inter-RAT handover to LTE, security is activated after the handover with 'NULL' algorithms if security is not activated in the source RAT.

23.2 Subscriber and equipment trace

23.2.0 General

Support for subscriber and equipment trace for E-UTRAN and EPC shall be as specified in TS 32.421 [29], TS 32.422 [30] and TS 32.423 [31].

23.2.1 Signalling activation

All traces are initiated by the core network, even if the trace shall be carried out in the radio network.

If the eNB has received an UE CONTEXT RELEASE COMMAND message where the UE is associated to an E-UTRAN Trace Id then the eNB shall terminate the on-going Trace.

The following functionality is needed on the S1 and X2 interface:

- Support for inclusion of subscriber and equipment trace information in INITIAL CONTEXT SETUP REQUEST message over the S1 interface.
- Support for an explicit TRACE START message over the S1 interface.
- Support for inclusion of subscriber and equipment trace information in the HANDOVER REQUEST message over the X2 interface.
- Support for inclusion of subscriber and equipment trace information in the HANDOVER REQUEST message over the S1 interface.
- Support for TRACE FAILURE INDICATION for the purpose of informing MME that the requested trace action cannot be performed due to an on-going handover preparation over the X2 interface.

A trace setup in the radio network will be propagated at handover. If the eNB receives trace information for a given UE, and a handover preparation is not already ongoing for the same UE, it shall store the trace information and propagate it to the target eNB in the case of a X2 based HO. In the case of S1 based HO, the propagation is handled by the MME.

23.2.2 Management activation

All conditions for Cell Traffic Trace are defined by the O&M. When the condition to start the trace recording is fulfilled the eNB will allocate a Trace Recording Session Reference and send it together with the Trace Reference to the MME in a CELL TRAFFIC TRACE message over the S1 interface.

Cell Traffic trace actions will not be propagated on the X2 interface or on the S1 interface in case of handover.

23.3 E-UTRAN Support for Warning Systems

23.3.0 General

The E-UTRAN provides support for warning systems through means of system information broadcast capability. The E-UTRAN performs scheduling and broadcasting of the "warning message content" received from the CBC, which is forwarded to the E-UTRAN by the MME. The schedule information for the broadcast is received along with the "warning message content" from the CBC. The E-UTRAN is also responsible for paging the UE to provide indication that the warning notification is being broadcast. The "warning message content" received by the E-UTRAN contains an instance of the warning notification. Depending on the size, E-UTRAN may segment the secondary notification before sending it over the radio interface.

23.3.1 Earthquake and Tsunami Warning System

ETWS is a public warning system developed to meet the regulatory requirements for warning notifications related to earthquake and/or tsunami events. ETWS warning notifications can either be a primary notification (short notifications delivered within 4 seconds, see TS 22.168 [37]) or secondary notification (providing detailed information). The ETWS primary notification is broadcast in *SystemInformationBlockType10* while the secondary notification is broadcast in *SystemInformationBlockType11*.

23.3.2 Commercial Mobile Alert System

CMAS is a public warning system developed for the delivery of multiple, concurrent warning notifications (see TS 22.268 [34]). The CMAS warning notifications are short text messages (CMAS alerts). The CMAS warning notifications are broadcast in *SystemInformationBlockType12*. The E-UTRAN manages the delivery of multiple, concurrent CMAS warning notifications to the UE and is also responsible for handling any updates of CMAS warning notifications.

23.3.3 Korean Public Alert System

KPAS is a Korean public warning system developed for the delivery of multiple, concurrent warning notifications (see TS 22.268 [34]). The Korean Public Alarm System (KPAS) uses the same AS mechanisms as CMAS. Therefore, the E-UTRAN procedures defined for CMAS equally apply for KPAS.

23.3.4 EU-Alert

The European Union Warning System EU-Alert is a public warning system developed for the delivery of multiple, concurrent warning notifications (see TS 22.268 [34]). The EU-Alert warning system uses the same AS mechanisms as CMAS. Therefore, the E-UTRAN procedures defined for CMAS equally apply for EU-Alert.

23.4 Interference avoidance for in-device coexistence

23.4.1 Problems

In order to allow users to access various networks and services ubiquitously, an increasing number of UEs are equipped with multiple radio transceivers. For example, a UE may be equipped with LTE, WiFi, and Bluetooth transceivers, and GNSS receivers. Due to extreme proximity of multiple radio transceivers within the same UE operating on adjacent frequencies or sub-harmonic frequencies, the interference power coming from a transmitter of the collocated radio may be much higher than the actual received power level of the desired signal for a receiver. This situation causes In-Device Coexistence (IDC) interference and is referred to as IDC problems. The challenge lies in avoiding or minimizing IDC interference between those collocated radio transceivers, as current state-of-the-art filter technology might not provide sufficient rejection for certain scenarios (see TR 36.816 [50]). IDC problem can happen when the UE (intends to) uses WLAN on the overlapped carrier/band or adjacent carrier/band to the unlicensed carrier used for LAA operation, e.g. when related UE hardware components, such as antennas, are shared between LAA and WLAN operations. If there is a risk of IDC problem which cannot be avoided (e.g. by level of regulation), the IDC functionality for a UE should be configured by the eNB when the UE is configured for LAA operation.

23.4.2 Solutions

When a UE experiences IDC problems that it cannot solve by itself and a network intervention is required, it sends an IDC indication via dedicated RRC signalling to report the IDC problems to the eNB. The UE may rely on existing LTE measurements and/or UE internal coordination to assess the interference and the details are left up to UE implementation.

NOTE: For instance, the interference is applicable over several subframes/slots where not necessarily all the subframes/slots are affected and consists of interference caused by the aggressor radio to the victim radio during either active data exchange or upcoming data activity which is expected in up to a few hundred milliseconds.

A UE that supports IDC functionality indicates related capabilities to the network, and the network can then configure by dedicated signalling whether the UE is allowed to send an IDC indication. The IDC indication can only be triggered for frequencies for which a measurement object is configured and when:

- for the primary frequency, the UE is experiencing IDC problems that it cannot solve by itself;
- for a secondary frequency, regardless of the activation state of the corresponding SCell, the UE is experiencing or expects to experience upon activation IDC problems that it cannot solve by itself;
- for a non-serving frequency, the UE expects to experience IDC problems that it cannot solve by itself if that non-serving frequency becomes a serving one.

When notified of IDC problems through an IDC indication from the UE, the eNB can choose to apply a Frequency Division Multiplexing (FDM) solution or a Time Division Multiplexing (TDM) solution:

- The basic concept of an FDM solution is to move the LTE signal away from the ISM band by e.g., performing inter-frequency handover within E-UTRAN, removing SCells from the set of serving cells or de-activation of affected SCells, or in case of uplink CA operations, allocate uplink PRB resources on CC(s) whose inter-modulation distortion and harmonics does not fall into the frequency range of the victim system receiver.
- The basic concept of a TDM solution is to ensure that transmission of a radio signal does not coincide with reception of another radio signal. LTE DRX mechanism is used to provide TDM patterns (i.e. periods during which the LTE UE may be scheduled or is not scheduled) to resolve the IDC issues. DRX based TDM solution should be used in a predictable way, i.e. the eNB should ensure a predictable pattern of unscheduled periods by means of e.g. DRX mechanism or de-activation of affected SCells.

To assist the eNB in selecting an appropriate solution, all necessary/available assistance information for both FDM and TDM solutions is sent together in the IDC indication to the eNB. The IDC assistance information contains the list of E-UTRA carriers suffering from IDC problems, the direction of the interference and, depending on the scenario (see TR 36.816 [50]), it also contains TDM patterns or parameters to enable appropriate DRX configuration for TDM solutions on the serving E-UTRA carrier. Furthermore, the IDC indication can also be configured to include uplink CA related assistance information containing the victim system as well as the list of supported uplink CA combinations suffering from IDC problems. Furthermore, the IDC indication can also be configured to indicate that the cause of IDC problems

is hardware sharing between LAA and WLAN operation, in which case the UE may omit the TDM assistance information. The IDC indication is also used to update the IDC assistance information, including for the cases when the UE no longer suffers from IDC problems. In case of inter-eNB handover, the IDC assistance information is transferred from the source eNB to the target eNB.

IDC interference situation can be divided into following three phases as shown in Figure 23.4.2-1:

- Phase 1: The UE detects start of IDC interference but does not initiate the transmission of the IDC indication to the eNB yet.
- Phase 2: The UE has initiated the transmission of the IDC indication to the eNB and no solution is yet configured by the eNB to solve the IDC issue.
- Phase 3: The eNB has provided a solution that solved the IDC interference to the UE.

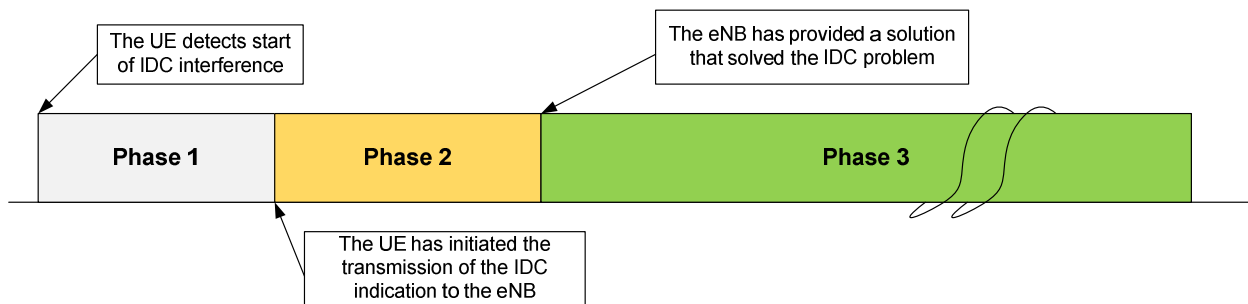

Figure 23.4.2-1: Different phases of IDC interference related operations by UE

In different phases, UE behaviours related to RRM, RLM, and CSI measurements are shown in Table 23.4.2-1.

Table 23.4.2-1: RRM/RLM/CSI measurements in different phases of IDC interference

Phases of IDC Interference	RRM Measurements	RLM Measurements	CSI Measurements
Phase 1	Up to UE implementation and RRM measurement requirements (see TS 36.133 [21]) apply	Up to UE implementation and RLM measurement requirements (see TS 36.133 [21]) apply	Up to UE implementation and CSI measurement requirements (see TS 36.101 [52]) apply
Phase 2	UE shall ensure the measurements are free of IDC interference and RRM measurement requirements (see TS 36.133 [21]) apply (NOTE 4)	UE shall ensure the measurements are free of IDC interference and RLM measurement requirements (see TS 36.133 [21]) apply (NOTE 1)	(NOTE 4)
Phase 3	UE shall ensure the measurements are free of IDC interference and RRM measurement requirements (see TS 36.133 [21]) apply	UE shall ensure the measurements are free of IDC interference and RLM measurement requirements (see TS 36.133 [21]) apply	
<p>NOTE 1: The UE should attempt to maintain connectivity to LTE in this phase meaning that RLM measurements are not impacted by IDC interference. If no solution is provided within a time which is up to UE implementation, the UE may need to declare RLF or it may continue to deny the ISM transmission. In DC, when the UE experiences IDC problems in SCG, if no solution is provided within a time which is up to UE implementation, the UE may need to declare RLF in SCG or it may continue to deny the ISM transmission in SCG.</p> <p>NOTE 2: If the UE determines in Phase 2 that the network does not provide a solution that resolves its IDC problems, it performs measurements as defined for Phase 1.</p> <p>NOTE 3: If the IDC indication message reports the IDC interference on a neighbour frequency, it performs RRM measurements for that frequency as defined for Phase 2.</p> <p>NOTE 4: When experiencing IDC problem caused by the hardware sharing between LAA and WLAN the UE shall be allowed to relax the existing RRM/CSI measurement requirement during phase 2 (see TS 36.133 [21]).</p>			

In addition, once configured by the network, the UE can autonomously deny LTE UL transmission in all phases to protect ISM in rare cases if other solutions cannot be used. Conversely, it is assumed that the UE also autonomously denies ISM transmission in order to ensure connectivity with the eNB to perform necessary LTE procedures, e.g., RRC connection reconfiguration and paging reception, etc. The network may configure a long-term denial rate by dedicated RRC signalling to limit the amount of LTE UL autonomous denials. Otherwise, the UE shall not perform any LTE UL autonomous denials.

23.5 TDD Enhanced Interference Management and Traffic Adaptation (eIMTA)

TDD enhanced Interference Management and Traffic Adaptation (eIMTA) allows adaptation of uplink-downlink configuration via L1 signalling. The E-UTRAN configures which UEs are subject to the TDD eIMTA operation.

For Uplink scheduling and HARQ timing, the UE follows the reference uplink-downlink configuration based on the one provided in SIB1. For Downlink HARQ timing, the UE follows the reference uplink-downlink configuration provided through dedicated signalling.

Downlink subframes in the reference configuration provided in SIB1 remain unchanged whereas only a subset of uplink and special subframes may be reconfigured to downlink subframes. E-UTRAN sends a L1 signalling to the UE on PCell PDCCH to indicate which uplink-downlink configuration defined in TS 36.211 [4] is currently used for one or more serving cell(s). This uplink-downlink configuration provided by the L1 signalling applies for a RRC-configured number of radio frames.

The UE uses the L1-signalled uplink-downlink configuration for (E)PDCCH monitoring and CSI measurements.

The UE RRM/RLM measurements are not affected by the TDD eIMTA configuration.

For DL CSI measurements of each serving cell, two subframe sets may be configured via RRC signalling.

For PUSCH/SRS UL power control of each serving cell, two subframe sets with separate power control parameters may be configured via RRC signalling.

Subframe-set dependent overload indication and uplink-downlink configuration intended to be used by a cell may be exchanged between eNBs over the X2 interface to facilitate the TDD eIMTA operation.

23.6 RAN assisted WLAN interworking

23.6.0 General

This clause describes the mechanisms to support traffic steering between E-UTRAN and WLAN.

23.6.1 General principles

This version of the specification supports E-UTRAN assisted UE based bi-directional traffic steering between E-UTRAN and WLAN for UEs in RRC_IDLE and RRC_CONNECTED.

E-UTRAN provides assistance parameters via broadcast and dedicated RRC signalling to the UE. The RAN assistance parameters may include E-UTRAN signal strength thresholds, WLAN channel utilization thresholds, WLAN backhaul data rate thresholds, WLAN signal strength thresholds and Offload Preference Indicator (OPI). E-UTRAN can also provide a list of WLAN identifiers to the UE via broadcast signalling. The UE uses the RAN assistance parameters in the evaluation of:

- Access network selection and traffic steering rules defined in TS 36.304 [11]; or
- ANDSF policies defined in TS 24.312 [58].

for traffic steering decisions between E-UTRAN and WLAN as specified in TS 23.402[19].

The OPI is only used in ANDSF policies as specified in TS 24.312 [58].

WLAN identifiers are only used in access network selection and traffic steering rules defined in TS 36.304 [11].

If the UE is provisioned with ANDSF policies it shall forward the received RAN assistance parameters to upper layers, otherwise it shall use them in the access network selection and traffic steering rules defined in clause 23.6.2 and in TS 36.304 [11]. The access network selection and traffic steering rules defined in clause 23.6.2 and in TS 36.304 [11] are applied only to the WLANs of which identifiers are provided by the E-UTRAN.

The UE in RRC_CONNECTED shall apply the parameters obtained via dedicated signalling if such have been received from the serving cell; otherwise, the UE shall apply the parameters obtained via broadcast signalling.

The UE in RRC_IDLE shall keep and apply the parameters obtained via dedicated signalling, until selection/reselection of another cell than the one where these parameters were received or a timer has expired since the UE entered RRC_IDLE upon which the UE shall apply the parameters obtained via broadcast signalling.

In the case of RAN sharing, each PLMN sharing the RAN can provide independent sets of RAN assistance parameters.

23.6.2 Access network selection and traffic steering rules

The UE indicates to upper layers when (and for which WLAN identifiers) access network selection and traffic steering rules defined in TS 36.304 [11] are fulfilled. The selection among WLANs that fulfil the access network selection and traffic steering rules is up to UE implementation.

When the UE applies the access network selection and traffic steering rules defined in TS 36.304 [11], higher layers perform traffic steering between E-UTRAN and WLAN.

23.7 Support of Low Complexity UEs

Low complexity UEs are targeted to low-end (e.g. low average revenue per user, low data rate, delay tolerant) applications, e.g. some Machine-Type Communications.

A low complexity UE has reduced Tx and Rx capabilities compared to other UE of different categories.

A Category 0 low complexity UE may access a cell only if SIB1 indicates that access of Category 0 UEs is supported. If the cell does not support access of Category 0 UEs, the UE considers the cell as barred.

The eNB determines that a UE is a Category 0 UE based on the LCID for CCCH and the UE capability.

The S1 signalling has been extended to include the UE Radio Capability for paging. This paging specific capability information is provided by the eNB to the MME, and the MME uses this information to indicate to the eNB that the paging request from the MME concerns a low complexity UE.

23.7a Support of Bandwidth Reduced Low Complexity UEs

A bandwidth reduced low complexity (BL) UE can operate in any LTE system bandwidth but with a limited channel bandwidth of 6 PRBs (corresponding to the maximum channel bandwidth available in a 1.4 MHz LTE system) in downlink and uplink.

To enable higher data rates a BL UE can optionally support a larger maximum PDSCH/PUSCH channel bandwidth of 24 PRBs in downlink and a non-BL UE operating in enhanced coverage can optionally support a larger maximum PDSCH/PUSCH channel bandwidth of 24 or 96 PRBs in downlink, and 24 PRBs in uplink in connected mode for unicast transmission. Table 23.7.a-1 summarizes the maximum PDSCH/PUSCH bandwidth in connected mode for unicast transmission depending on the UE category and enhanced coverage mode (see clause 23.7b). The maximum PDSCH/PUSCH channel bandwidth is configured separately for PDSCH and PUSCH via dedicated RRC signaling.

Table 23.7a-1: Maximum PDSCH/PUSCH bandwidth (in PRBs)

UE category/CE mode	CE mode A	CE mode B
BL (Category M1)	6/6	6/6
BL (Category M2)	24/24	24/6
Non-BL (Category 0 and higher)	96 (or 24)/24	96 (or 24)/6

A Category M2 BL UE supports a larger DL and UL maximum TBS size for unicast compared to a Category M1 BL UE. A Category M1 BL UE may support a larger UL maximum TBS size indicated by a separate UE capability.

A BL UE may access a cell only if the MIB of the cell indicates that scheduling information for SIB1 specific for BL UEs is scheduled. If not, the UE considers the cell as barred.

A BL UE receives a separate occurrence of system information blocks (sent using different time/frequency resources). A BL UE has a transport block size (TBS) limited to 1000 bit for broadcast. The BL UE determines the scheduling information for SIB1 specific for BL UEs based on information in MIB. Scheduling information for other SIBs is given in SIB1 specific for BL UEs. The BCCH modification period for BL UEs is a multiple of the BCCH modification period provided in SIB2. The SIB transmission occasions within an SI-window are provided in the SIB1 specific for BL UEs. A BL UE can acquire SI messages across SI windows. The maximum number of SI messages that can be acquired across SI windows is 4. A BL UE is not required to detect SIB change when in RRC_CONNECTED.

A BL UE is paged based on paging occasions in time domain, and paging narrowbands in frequency domain. The starting subframe of a paging occasion is determined in the same way as the paging occasion in the legacy paging mechanism.

A set of PRACH resources (e.g. time, frequency, preamble), each associated with BL UEs in normal coverage, is provided in SIB. Number of PRACH repetitions and number of maximum preamble transmission attempts for BL UEs in normal coverage are provided in SIB. Time/frequency resources and repetition factor for random access response messages for BL UEs are derived from the used PRACH resources.

23.7b Support of UEs in Enhanced Coverage

A UE in enhanced coverage is a UE that requires the use of enhanced coverage functionality to access the cell. In this release of the specification two enhanced coverage modes (mode A, mode B) are supported. The support of enhanced coverage mode A is mandatory for a BL UE. The maximum PDSCH/PUSCH bandwidth in connected mode for unicast transmission depends on the UE category and enhanced coverage mode as summarized in table 23.7a-1.

A UE may access a cell using enhanced coverage functionality only if the MIB of the cell indicates that scheduling information for SIB1 specific for BL UEs is scheduled. System information procedures for UEs in enhanced coverage are identical to the system information procedures for bandwidth reduced low complexity UEs. A UE capable of enhanced coverage acquires, if needed, and uses legacy system information when in normal coverage if it is not a BL UE. A UE capable of enhanced coverage acquires, if needed, and uses system information specific for UEs in enhanced coverage. A UE in enhanced coverage is not required to detect SIB change when in RRC_CONNECTED.

A set of PRACH resources (e.g. time, frequency, preamble); each associated with a coverage enhancement level, is provided in SIB. Number of PRACH repetitions and number of maximum preamble transmission attempts per coverage enhancement level are provided in SIB. UEs in same enhanced coverage level use random access resources associated with the same enhanced coverage level. Time/frequency resources and repetition factor for random access response messages for UEs in enhanced coverage are derived from the used PRACH resources.

A UE in enhanced coverage is paged using the same mechanism for paging BL UEs. The starting subframe of a paging occasion and the repetition pattern (in both time and frequency domain for downlink common control signaling) of that paging occasion are determined irrespective of the UEs enhanced coverage level.

The paging request from the MME for a UE supporting enhanced coverage functionality may contain enhanced coverage level related information and corresponding cell ID. If neither the UE Radio Capability for Paging IE nor the Assistance Data for Paging IE is included in the paging request from the MME, the eNB may need to page the UE in both PDCCH and MPDCCH.

A UE in RRC_IDLE does not inform the network when it changes the enhanced coverage level.

A UE in enhanced coverage camps on a suitable cell where S criterion for UEs in enhanced coverage is fulfilled. The UE shall re-select to inter-frequency cells in which it is able to operate in normal coverage over cells in which it has to be in enhanced coverage.

Connected mode mobility mechanisms such as measurement reporting, network controlled handover etc., are supported for UEs in enhanced coverage. At handover from a source cell in normal or enhanced coverage mode to a target cell in enhanced coverage mode, the network may provide SIB1-BR to the UE in the handover command. No additional mechanisms are introduced to support the use of enhanced coverage functionality to access an E-UTRA cell during inter-RAT handovers.

Reconfiguration of a UE in connected mode from normal to enhanced coverage mode (and vice versa) is supported by a means of intra-cell handover or RRC configuration without handover.

23.8 Support for Radio Interface based Synchronization

Radio-interface based synchronization (RIBS) enables an eNB to monitor the reference signals of another eNB for the purpose of over the air synchronization by means of network listening. This requires OAM to configure the eNBs with reference signal information, i.e. pattern, periodicity and offset, where the reference signals are available. The OAM should coordinate the reference signal information, for example via one to one mapping between stratum level and reference signal. To improve the hearability of reference signals, the listening eNB may request the interfering eNB(s) to enable subframe muting by means of network signalling.

23.9 Network-assisted interference cancellation/suppression

A UE that supports network assisted interference cancellation/suppression (NAICS) receiver functionality can mitigate PDSCH and CRS interference from aggressor cells in order to better receive a PDSCH from its serving cell.

The network may configure the UE with NAICS information of the aggressor cells in order to help the UE to mitigate the PDSCH and CRS interference of the aggressor cells. To support NAICS, an eNB may exchange NAICS information with its neighbour eNBs through X2 signalling.

23.10 Support for sidelink communication

23.10.1 General

Sidelink communication is a mode of communication whereby UEs can communicate with each other directly over the PC5 interface, as specified in TS 23.303 [62]. This communication mode is supported when the UE is served by E-UTRAN and when the UE is outside of E-UTRA coverage. Only those UEs authorised to be used for public safety operation can perform sidelink communication.

In order to perform synchronisation for out of coverage operation UE(s) may act as a synchronisation source by transmitting SBCCH and a synchronisation signal. SBCCH carries the most essential system information needed to receive other sidelink channels and signals. SBCCH along with a synchronisation signal is transmitted with a fixed periodicity of 40ms. When the UE is in network coverage, the contents of SBCCH are derived from the parameters signalled by the eNB. When the UE is out of coverage, if the UE selects another UE as a synchronisation reference, then the content of SBCCH is derived from the received SBCCH; otherwise UE uses pre-configured parameters. SIB18 provides the resource information for synchronisation signal and SBCCH transmission. There are two pre-configured subframes every 40ms for out of coverage operation. UE receives synchronisation signal and SBCCH in one subframe and transmit synchronisation signal and SBCCH on another subframe if UE becomes synchronisation source based on defined criterion, as specified in [16].

UE performs sidelink communication on subframes defined over the duration of Sidelink Control period. The Sidelink Control period is the period over which resources allocated in a cell for sidelink control information and sidelink data transmissions occur. Within the Sidelink Control period the UE sends sidelink control information followed by sidelink data. Sidelink control information indicates a Layer 1 ID and characteristics of the transmissions (e.g. MCS, location of the resource(s) over the duration of Sidelink Control period, timing alignment).

The UE performs transmission and reception over Uu and PC5 with the following decreasing priority order in case Sidelink Discovery Gap is not configured:

- Uu transmission/reception (highest priority);
- PC5 sidelink communication transmission/reception;
- PC5 sidelink discovery announcement/monitoring (lowest priority).

The UE performs transmission and reception over Uu and PC5 with the following decreasing priority order in case Sidelink Discovery Gap is configured:

- Uu transmission/reception for RACH;
- PC5 sidelink discovery announcement during a Sidelink Discovery Gap for transmission;
- Non-RACH Uu transmission;
- PC5 sidelink discovery monitoring during a Sidelink Discovery Gap for reception;
- Non-RACH Uu reception;
- PC5 sidelink communication transmission/reception.

23.10.2 Radio Protocol Architecture

23.10.2.0 General

In this clause, the UE radio protocol architecture for sidelink communication is given for the user plane and the control plane.

23.10.2.1 User plane

Figure 23.10.2.1-1 shows the protocol stack for the user plane, where PDCP, RLC and MAC sublayers (terminate at the other UE) perform the functions listed for the user plane in clause 6.

The Access Stratum protocol stack in the PC5 interface consists of PDCP, RLC, MAC and PHY as shown below in Figure 23.10.2.1-1.

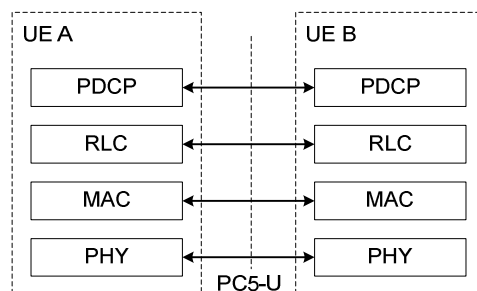

Figure 23.10.2.1-1: User-Plane protocol stack for sidelink communication

User plane details of sidelink communication:

- There is no HARQ feedback for sidelink communication;
- RLC UM is used for sidelink communication;
- A receiving UE needs to maintain at least one RLC UM entity per transmitting peer UE;
- A receiving RLC UM entity used for sidelink communication does not need to be configured prior to reception of the first RLC UMD PDU;
- ROHC Unidirectional Mode is used for header compression in PDCP for sidelink communication;

- UDC is not used for sidelink communication.

A UE may establish multiple logical channels. LCID included within the MAC subheader uniquely identifies a logical channel within the scope of one Source Layer-2 ID and Destination Layer-2 ID combination. Parameters for logical channel prioritization are not configured. The Access stratum (AS) is provided with the PPPP of a protocol data unit transmitted over PC5 interface by higher layer. There is a PPPP associated with each logical channel.

23.10.2.2 Control plane

A UE does not establish and maintain a logical connection to receiving UEs prior to one-to-many a sidelink communication. Higher layer establishes and maintains a logical connection for one-to-one sidelink communication including ProSe UE-to-Network Relay operation.

The Access Stratum protocol stack for SBCCH in the PC5 interface consists of RRC, RLC, MAC and PHY as shown below in Figure 23.10.2.2-1.

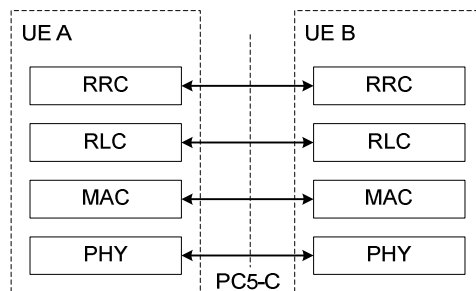

Figure 23.10.2.2-1: Control-Plane protocol stack for SBCCH

The control plane for establishing, maintaining and releasing the logical connection for one-to-one sidelink communication is shown in Figure 23.10.2.2-2.

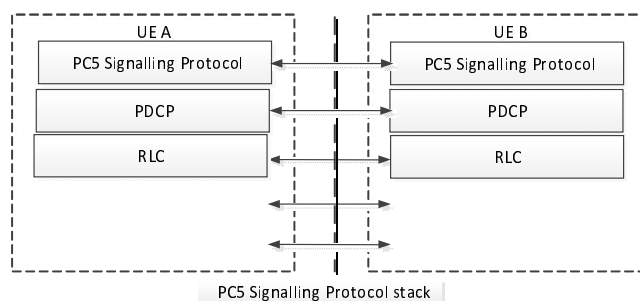

Figure 23.10.2.2-2: Control-Plane protocol stack for one-to-one sidelink communication

23.10.3 Radio resource allocation

23.10.3.0 General

The UE supporting sidelink communication can operate in two modes for resource allocation:

- Scheduled resource allocation is characterized by:
 - The UE needs to be RRC_CONNECTED in order to transmit data;
 - The UE requests transmission resources from the eNB. The eNB schedules transmission resources for transmission of sidelink control information and data;
 - The UE sends a scheduling request (D-SR or Random Access) to the eNB followed by a Sidelink BSR. Based on the Sidelink BSR the eNB can determine that the UE has data for a sidelink communication transmission and estimate the resources needed for transmission. eNB can schedule transmission resources for sidelink communication using configured SL-RNTI.

- UE autonomous resource selection is characterized by:
 - A UE on its own selects resources from resource pools and performs transport format selection to transmit sidelink control information and data;
 - There can be up to 8 transmission pools either pre-configured for out of coverage operation or provided by RRC signalling for in-coverage operation. Each pool can have one or more PPPP associated with it. For transmission of a MAC PDU, the UE selects a transmission pool in which one of the associated PPPP is equal to the PPPP of a logical channel with highest PPPP among the logical channel identified in the MAC PDU. It is up to UE implementation how the UE selects amongst multiple pools with same associated PPPP. There is a one to one association between sidelink control pool and sidelink data pool;
 - Once the resource pool is selected, the selection is valid for the entire Sidelink Control period. After the Sidelink Control period is finished the UE may perform resource pool selection again.

NOTE: The UE is allowed to perform multiple transmissions to different destinations in a single Sidelink Control period.

A UE in RRC_CONNECTED may send a Sidelink UE Information message to eNB when UE becomes interested in sidelink communication. In response eNB may configure the UE with a SL-RNTI.

A UE is considered in-coverage for sidelink communication whenever it detects a cell on a Public Safety ProSe Carrier as per criteria specified in, as specified in TS 36.331 [16]. The following rules apply for the UE:

- If the UE is out of coverage for sidelink communication it can only use UE autonomous resource selection;
- If the UE is in coverage for sidelink communication it may use scheduled resource allocation or UE autonomous resource selection as per eNB configuration;
- If the UE is in coverage for sidelink communication it shall use only the resource allocation mode indicated by eNB configuration unless one of the exceptional cases as specified in TS 36.331 [16] occurs:
 - When an exceptional case occurs the UE is allowed to use UE autonomous resource selection temporarily even though it was configured to use scheduled resource allocation. Resource pool to be used during exceptional case may be provided by eNB.

A UE that is camped or connected on one carrier frequency but interested in sidelink communication operation on another carrier frequency (i.e. Public Safety ProSe Carrier) shall attempt to find cells on the Public Safety ProSe Carrier.

- An RRC_IDLE UE camped on a cell in another carrier frequency, but in the coverage area of an E-UTRA cell on Public Safety ProSe Carrier may consider the Public Safety ProSe carrier to be the highest priority; and reselects to the cell on the Public Safety ProSe Carrier. UE may consider a frequency (non-Public Safety ProSe carrier) to be the highest priority if it can perform sidelink communication only while camping on the frequency.
- An RRC_CONNECTED UE served by a cell in another carrier frequency may send a Sidelink UE Information message to its serving cell when it wants to perform sidelink communication. The indication contains the intended Public Safety ProSe Carrier:
 - The serving cell indicates with the presence of SIB18 whether the UE is allowed to send a ProSe UE Information indication;
 - The serving cell may configure an inter-frequency RRM measurement on the Public Safety ProSe Carrier;
 - Once the UE enters coverage of a cell on the Public Safety ProSe Carrier, based on measurement report the eNB performs inter-frequency mobility to the Public Safety ProSe Carrier;
 - If inter-frequency mobility is not performed by the serving cell (e.g. the serving cell does not broadcast SIB18 or if handover fails), the UE may still perform sidelink communication using UE autonomous resource selection from the resource pools, if any, broadcasted by the detected E-UTRA cell on the Public Safety ProSe Carrier.
- If the UE does not detect an E-UTRA cell on the Public Safety ProSe Carrier, the UE can use Public Safety ProSe Carrier resources preconfigured in the UICC or ME for out of coverage sidelink communication;

- If the UE detects an E-UTRA cell on the Public Safety ProSe Carrier, the UE stops using resources preconfigured in the UICC or ME. UE may use UE autonomous resource selection from the resource pools, if any, broadcasted by the detected E-UTRA cell on the Public Safety ProSe Carrier.

NOTE: For Rel-12 all ProSe communication (for a UE) is performed on a single preconfigured Public Safety ProSe Carrier, which is valid in the operating region. Higher layers check validity of the Public Safety ProSe Carrier in the operating region.

The cell on the Public Safety ProSe Carrier may select one of the following options:

- The cell on the Public Safety ProSe Carrier may provide a transmission resource pool for UE autonomous resource selection in SIB18:
 - UEs that are authorized for sidelink communication may use these resources for sidelink communication in RRC_IDLE in the cell on the same carrier (i.e. Public Safety ProSe Carrier);
 - UEs that are authorized for sidelink communication may use these resources for sidelink communication in RRC_IDLE or RRC_CONNECTED in a cell on another carrier.
- The cell on the Public Safety ProSe Carrier may indicate in SIB18 that it supports sidelink communication but does not provide transmission resources. UEs need to enter RRC_CONNECTED to perform sidelink communication transmission. In this case the cell on the Public Safety ProSe Carrier may provide in broadcast signalling an exceptional transmission resource pool for UE autonomous resource selection, to be used by the UE in exceptional cases, as specified in TS 36.331 [16]:
 - A UE in RRC_CONNECTED that is authorized to perform sidelink communication transmission indicates to the serving eNB that it wants to perform sidelink communication transmissions;
 - The eNB validates whether the UE is authorized for sidelink communication transmission using the UE context received from MME;
 - The eNB may configure a UE by dedicated signalling with a transmission resource pool for UE autonomous resource selection; that may be used without constraints while the UE is in RRC_CONNECTED. Alternatively, the eNB may configure a UE to use the exceptional transmission resource pool for UE autonomous resource selection which the UE is allowed to use only in exceptional cases, as specified in TS 36.331 [16], and rely on scheduled resource allocation otherwise.

23.10.3.1 Resource Pool for sidelink control information

A set of transmission and reception resource pools for sidelink control information when the UE is out of coverage for sidelink communication is pre-configured in the UE.

The resource pools for sidelink control information when the UE is in coverage for sidelink communication are configured as below:

- The resource pools used for reception are configured by the eNB via RRC, in broadcast signalling;
- The resource pool used for transmission is configured by the eNB via RRC, in dedicated or broadcast signalling, if UE autonomous resource selection is used;
- The resource pool used for transmission is configured by the eNB via RRC, in dedicated signalling if scheduled resource allocation is used:
 - The eNB schedules the specific resource(s) for sidelink control information transmission within the configured reception pools.

NOTE: In order to perform communication even when some UEs are in-coverage and some UEs are out of coverage, all UEs (i.e. both in and out of coverage) should be configured with resource pools for reception of sidelink control information which are the union of the resource pools used for transmission of sidelink control information from a) the serving cell, b) neighbour cells and c) out of coverage (i.e. pre-configured transmission resource pools).

23.10.3.2 Resource Pool for sidelink data

A set of transmission and reception resource pools for data when the UE is out of coverage for sidelink communication is pre-configured in the UE.

The resource pools for data when the UE is in coverage for sidelink communication are configured as below:

- The resource pools used for transmission and reception are configured by the eNB via RRC, in dedicated or broadcast signalling, if UE autonomous resource selection is used;
- There is no resource pool for transmission and reception if scheduled resource allocation is used.

23.10.4 Sidelink Communication via ProSe UE-to-Network Relay

A ProSe UE-to-Network Relay provides a generic L3 forwarding function that can relay any type of IP traffic between the Remote UE and the network. One-to-one and one-to-many sidelink communications are used between the Remote UE(s) and the ProSe UE-to-Network Relay. For both Remote UE and Relay UE only one single carrier (i.e., Public Safety ProSe Carrier) operation is supported (i.e., Uu and PC5 should be same carrier for Relay/ Remote UE). The Remote UE is authorised by upper layers and can be in-coverage of the Public Safety ProSe Carrier or out-of-coverage on any supported carriers including Public Safety ProSe Carrier for UE-to-Network Relay discovery, (re)selection and communication. The ProSe UE-to-Network Relay is always in-coverage of EUTRAN. The ProSe UE-to-Network Relay and the Remote UE perform sidelink communication and sidelink discovery as described in clause 23.10 and 23.11 respectively.

The eNB controls whether the UE can act as a ProSe UE-to-Network Relay:

- If the eNB broadcast any information associated to ProSe UE-to-Network Relay operation, then ProSe UE-to-Network Relay operation is supported in the cell;
- The eNB may provide:
 - Transmission resources for ProSe UE-to-Network Relay discovery using broadcast signalling for RRC_IDLE state and dedicated signalling for RRC_CONNECTED state;
 - Reception resources for ProSe UE-to-Network Relay discovery using broadcast signalling;
 - The eNB may broadcast a minimum and/or a maximum Uu link quality (RSRP) threshold(s) that the ProSe UE-to-Network Relay needs to respect before it can initiate a UE-to-Network Relay discovery procedure. In RRC_IDLE, when the eNB broadcasts transmission resource pools, the UE uses the threshold(s) to autonomously start or stop the UE-to-Network Relay discovery procedure. In RRC_CONNECTED, the UE uses the threshold(s) to determine if it can indicate to eNB that it is a Relay UE and wants to start ProSe UE-to-Network Relay discovery;
- If the eNB does not broadcast transmission resource pools for ProSe-UE-to-Network Relay discovery, then a UE can initiate a request for ProSe-UE-to-Network Relay discovery resources by dedicated signalling, respecting these broadcasted threshold(s).
- If the ProSe-UE-to-Network Relay is initiated by broadcast signalling, it can perform ProSe UE-to-Network Relay discovery when in RRC_IDLE. If the ProSe UE-to-Network Relay is initiated by dedicated signalling, it can perform relay discovery as long as it is in RRC_CONNECTED.

A ProSe UE-to-Network Relay performing sidelink communication for ProSe UE-to-Network Relay operation has to be in RRC_CONNECTED. After receiving a layer-2 link establishment request or TMGI monitoring request (upper layer message), as specified in TS 23.303 [62], from the Remote UE, the ProSe UE-to-Network Relay indicates to the eNB that it is a ProSe UE-to-Network Relay and intends to perform ProSe UE-to-Network Relay sidelink communication. The eNB may provide resources for ProSe UE-to-Network Relay communication.

The remote UE can decide when to start monitoring for ProSe UE-to-Network Relay discovery. The Remote UE can transmit ProSe UE-to-Network Relay discovery solicitation messages while in RRC_IDLE or in RRC_CONNECTED depending on the configuration of resources for ProSe UE-to-Network Relay discovery. The eNB may broadcast a threshold, which is used by the Remote UE to determine if it can transmit ProSe UE-to-Network Relay discovery solicitation messages, to connect or communicate with ProSe UE-to-Network Relay UE. The RRC_CONNECTED Remote UE, uses the broadcasted threshold to determine if it can indicate to eNB that it is a Remote UE and wants to participate in ProSe UE-to-Network Relay discovery and/or communication. The eNB may provide, transmission

resources using broadcast or dedicated signalling and reception resources using broadcast signalling for ProSe UE-to-Network Relay Operation. The Remote UE stops using ProSe UE-to-Network Relay discovery and communication resources when RSRP goes above the broadcasted threshold.

NOTE: Exact time of traffic switching from Uu to PC5 or vice versa is up to higher layer.

The Remote UE performs radio measurements at PC5 interface and uses them for ProSe UE-to-Network Relay selection and reselection along with higher layer criterion, as specified in TS 23.303 [62]. A ProSe UE-to-Network Relay is considered suitable in terms of radio criteria if the PC5 link quality exceeds configured threshold (pre-configured or provided by eNB). The Remote UE selects the ProSe UE-to-Network Relay, which satisfies higher layer criterion and has best PC5 link quality among all suitable ProSe UE-to-Network Relays.

The Remote UE triggers ProSe UE-to-Network Relay reselection when:

- PC5 signal strength of current ProSe UE-to-Network Relay is below configured signal strength threshold;
- It receives a layer-2 link release message (upper layer message), as specified in TS 23.303 [62], from ProSe UE-to-Network Relay.

23.11 Support for sidelink discovery

23.11.1 General

Sidelink discovery is defined as the procedure used by the UE supporting sidelink discovery to discover other UE(s) in its proximity, using E-UTRA direct radio signals via PC5. Sidelink discovery is supported both when UE is served by EUTRAN and when UE is out of EUTRA coverage. Only ProSe-enabled Public safety UE can perform sidelink discovery when it is out of EUTRA coverage. For public safety sidelink discovery the allowed frequency is pre-configured in the UE, and is used even when UE is out of coverage of EUTRA in that frequency. The pre-configured frequency is the same frequency as the Public Safety ProSe Carrier.

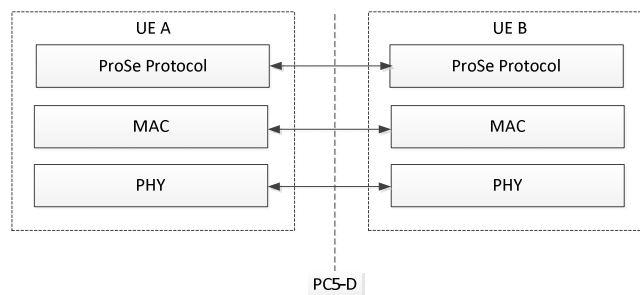

Figure 23.11.1-1: PC5 interface for sidelink discovery (see TS 23.303 [62])

Upper layer handles authorization for announcement and monitoring of discovery message.

Content of discovery message is transparent to Access Stratum (AS) and no distinction in AS is made for sidelink discovery models and types of sidelink discovery, as specified in TS 23.303 [62]. However higher layer informs whether the sidelink discovery announcement is related to public safety or non-Public safety discovery. Higher layer also informs whether the discovery announcement/monitoring is related to ProSe UE-to-Network Relay discovery or other public safety discovery.

NOTE 1: The ProSe Protocol ensures that only valid discovery messages are delivered to AS for announcement.

The UE can participate in announcing and monitoring of discovery message in both RRC_IDLE and RRC_CONNECTED states as per eNB configuration. The UE announces and monitors its discovery message subject to the half-duplex constraint.

The UE that participates in announcing and monitoring of discovery messages maintains the current UTC time. The UE that participates in announcing transmits the discovery message, which is generated by the ProSe Protocol taking into account the UTC time upon transmission of the discovery message. In the monitoring UE, the ProSe Protocol provides the message to be verified together with the UTC time upon reception of the message to the ProSe Function.

NOTE 2: UE may obtain UTC time from the RAN via SIB16 or from other sources such as NITZ, NTP, and GNSS depending on their availability.

In order to perform synchronisation UE(s) participating in announcing of discovery messages may act as a synchronisation source by transmitting SBCCH and a synchronisation signal based on the resource information for synchronisation signals provided in SIB19.

There are three range classes. Upper layer authorisation provides applicable range class of the UE. Maximum allowed transmission power for each range class is signalled in SIB19. UE uses the applicable maximum allowed transmission power corresponding to its authorised range class. This puts an upper limit on the determined transmit power based on open loop power control parameters.

23.11.2 Radio Protocol Architecture

The Access Stratum protocol stack for sidelink discovery consists of only MAC and PHY.

The AS layer performs the following functions:

- Interfaces with upper layer (ProSe Protocol): The MAC layer receives the discovery message from the upper layer (ProSe Protocol). The IP layer is not used for transmitting the discovery message;
- Scheduling: The MAC layer determines the radio resource to be used for announcing the discovery message received from upper layer;
- Discovery PDU generation: The MAC layer builds the MAC PDU carrying the discovery message and sends the MAC PDU to the physical layer for transmission in the determined radio resource. No MAC header is added.

23.11.3 Radio resource allocation

There are two types of resource allocation for discovery message announcement.

- UE autonomous resource selection: A resource allocation procedure where resources for announcing of discovery message are allocated on a non UE specific basis, further characterized by:
 - The eNB provides the UE(s) with the resource pool configuration used for announcing of discovery message. The configuration may be signalled in broadcast or dedicated signalling;
 - The UE autonomously selects radio resource(s) from the indicated resource pool and announces discovery message;
 - The UE can announce discovery message on a randomly selected discovery resource during each discovery period.
- Scheduled resource allocation: A resource allocation procedure where resources for announcing of discovery message are allocated on per UE specific basis, further characterized by:
 - The UE in RRC_CONNECTED may request resource(s) for announcing of discovery message from the eNB via RRC;
 - The eNB assigns resource(s) via RRC;
 - The resources are allocated within the resource pool that is configured in UEs for announcement.

For UEs in RRC_IDLE:

- The eNB may select one of the following options:
 - The eNB may provide resource pools for UE autonomous resource selection based discovery message announcement in SIB19. UEs that are authorized for sidelink discovery use these resources for announcing discovery message in RRC_IDLE;
 - The eNB may indicate in SIB19 that it supports sidelink discovery but does not provide resources for discovery message announcement. UEs need to enter RRC_CONNECTED in order to request resources for discovery message announcement.

For UEs in RRC_CONNECTED:

- A UE authorized to perform sidelink discovery announcement indicates to the eNB that it wants to perform sidelink discovery announcement. A UE can also indicate to the eNB the frequency(s) in which sidelink discovery announcement is desired;
- The eNB validates whether the UE is authorized for sidelink discovery announcement using the UE context received from MME;
- The eNB may configure the UE with resource pool for UE autonomous resource selection for discovery message announcement via dedicated signalling;
- The eNB may configure resource pool along with dedicated resource in the form of time and frequency indices for discovery message announcement via dedicated RRC signalling;
- The resources allocated by the eNB via dedicated signalling are valid until;
 - The eNB re-configures the resource(s) by RRC signalling or;
 - The UE enters RRC_IDLE.

Authorised receiving UEs in RRC_IDLE and RRC_CONNECTED monitor resource pools used for UE autonomous resource selection and resource pools for scheduled resource allocation. The eNB provides the resource pool configuration used for discovery message monitoring on intra frequency, inter frequency of same or different PLMNs cells in RRC signalling (SIB19). The RRC signalling (SIB19 or dedicated) may contain detailed sidelink discovery configuration used for announcement of sidelink discovery in cells of intra-frequency, inter-frequency of same or different PLMNs.

Synchronous and asynchronous deployments are supported. Discovery resources can be overlapping or non-overlapping across cells.

A UE, if authorised by the NW, can announce discovery messages in the same as well as other frequencies than the serving cell, in same or different PLMNs. The UE can monitor discovery resources in the same as well as other frequencies than the serving cell, in same or different PLMNs:

- The serving cell may provide in SIB19 a list of frequencies along with PLMN ID on which the UE may aim to monitor discovery message. The serving cell may provide in SIB19 a list of frequencies along with PLMN ID on which the UE is allowed to announce discovery message.
- The serving cell may not provide detailed sidelink discovery configuration and cell (re)selection parameters for other carrier frequencies of same or other PLMNs in RRC signalling.
- If detailed sidelink discovery configuration and cell (re)selection parameters for other frequencies of same or different PLMN is not provided by serving cell in SIB19, the eNB may indicate if the UE should read SIB19 and other relevant SIBs on other carriers or the UE should request detailed sidelink discovery configuration from serving cell, if it wants to perform discovery message announcement on those carriers of same or other PLMNs. A UE only reads SIB19 and other relevant SIBs of authorised carriers and authorised PLMN:
 - Obtaining sidelink discovery configuration by reading SIB19 (and other SIBs) of an inter-frequency and/or inter-PLMN cell shall not affect the UE's Uu reception on the serving cell(s).
- If a UE performs sidelink discovery announcement on another frequency, irrespective of whether the eNB provides cell (re)selection parameters for the other frequency of same or different PLMN, the UE follows the same legacy cell (re)selection procedure.
- If SIB19 is not broadcasted by the serving cell, the UE may perform sidelink discovery announcement and monitoring on another carrier of same or different PLMN that is authorised by the network, as long as it does not affect Uu operation.
- The UE is not expected to perform any PLMN change for the purpose of inter-PLMN sidelink discovery announcement.
- If the UE autonomously reads SIB 19 of the other carrier of same or different PLMN to acquire resource for sidelink discovery announcement and that carrier does not provide resources for sidelink discovery announcement in SIB19, then the UE shall not perform sidelink discovery announcement on that carrier.

- The UE performs intra-frequency and inter-frequency of same or different PLMN sidelink discovery announcement or monitoring in subframes in which a sidelink discovery resource pool is configured.
- To enhance intra-frequency and inter-frequency sidelink discovery performance for the non-dedicated transceiver case the eNB may provide gaps to the UE, so that RF transmitter/receiver chain can be reused for sidelink discovery transmissions/receptions:
 - The gaps provided for sidelink discovery transmission and/or reception takes into account any additional overhead (e.g. for synchronization, subframe offset between serving carrier and sidelink discovery carrier, interruption time for retuning). The eNB can deconfigure a configured sidelink discovery transmission and/or reception gaps.
 - Configured discovery gaps are applicable for all configured cells of a UE.
 - If SIB19 is not broadcasted by the serving cell the UE shall not enter RRC_CONNECTED on the serving cell to request gaps or resources for sidelink discovery announcement.
 - The eNB may indicate in broadcast or dedicated signalling if the UE can request gaps. Based on implementation the UE can trigger a gap request for sidelink discovery announcement or monitoring. In the request the UE informs the eNB of the subframes (with respect to the timing of serving cell) on which the UE needs gaps.

NOTE 1: The UE is not expected to monitor any physical downlink channels during sidelink discovery reception gaps. During transmission gap, the UE prioritizes discovery announcement over Uu uplink transmission and sidelink communication transmission only when a conflict with sidelink discovery announcement occurs. The UE prioritizes the RACH procedure over the sidelink gaps.

NOTE 2: Measurement requirements on the serving frequency should not be affected by sidelink gaps.

- If network does not configure transmission and reception gaps for sidelink discovery.
 - Intra-frequency, inter-frequency of same and other PLMN sidelink discovery announcement shall not affect Uu transmission:
 - Intra-frequency, inter-frequency and inter-PLMN sidelink discovery monitoring shall not affect Uu reception:
 - The UE shall not create autonomous gaps for announcement or monitoring of sidelink discovery.
 - The UE uses DRX occasions in RRC_IDLE and RRC_CONNECTED or second RX chain if it is available, for intra- frequency, inter-frequency and inter-PLMN discovery message monitoring;
- An RRC_CONNECTED UE sends a Sidelink UE Information message to the serving cell if it is interested or no longer interested in intra-frequency, inter-frequency or inter-PLMN discovery message monitoring.

If the S-Criteria on the ProSe carrier for Public Safety is not met, the UE can use Public Safety ProSe Carrier discovery resources preconfigured in the UICC or ME for out of coverage sidelink discovery.

NOTE 3: All sidelink discovery for Public Safety (for a UE) is performed on a single preconfigured Public Safety ProSe Carrier, which is valid in the operating region. Higher layers check validity of the Public Safety ProSe Carrier in the operating region.

23.12 Resource usage reporting for shared networks

The eNB may be configured to report the resource usage as data volume for the different PLMN identities of the operators in a shared network. The measurements, which are defined in TS 36.314 [63], are based on the QoS parameter values exchanged at E-RAB setup/modification.

OAM configures data volume reporting criteria. The configured data volume criteria define the PLMN IDs and the QoS profile criteria for the collection and reporting. The data volume reports are per configured PLMN ID and per configured QoS profile per DL/UL.

The QoS profile configuration shall be the same for all configured PLMN IDs and for all eNBs. The configured QoS profile criteria can differ in UL and DL in terms of GBR ranges. It shall be possible to collect and report up to 200 counter types and a maximum of 200 counter instances.

Data volumes for the DL/UL direction of a GBR bearer shall be collected within a given DL/UL GBR range if the DL/UL E-RAB guaranteed bit rate is within a configured DL/UL range delimited by a minimum and maximum value. The GBR ranges shall be five in number for DL and five in number for UL. GBR ranges shall be non-overlapping and configurable. The configured set of GBR ranges applies to the whole RAN and to all PLMN IDs in the RAN.

23.13 Optimising signalling load and resource usage for paging

23.13.1 General paging optimisation

Paging can be optimised by the MME and the E-UTRAN as described in TS 23.401 [17].

As a part of this, an eNB may inform the MME about a list of recommended eNBs for paging. If a recommended eNB in this list is a HeNB behind a HeNB GW, the paging target is identified by the TAI instead of the eNB identity.

Paging Attempt Information consists of a Paging Attempt Count and the Intended Number of Paging Attempts and may include the Next Paging Area Scope. If Paging Attempt Information is included in the Paging message, each paged eNB receives the same information during a paging attempt. The Paging Attempt Count shall be increased by one at each new paging attempt. The Next Paging Area Scope, when present, indicates whether the MME plans to modify the paging area currently selected at next paging attempt. If the UE has changed its mobility state to ECM CONNECTED the Paging Attempt Count is reset.

23.13.2 Paging optimisation for UEs in enhanced coverage

Information on the coverage enhancement (CE) level, if available for the UE, is provided transparently by the serving eNB to the MME at transition to ECM_IDLE together with the respective cell identifier and is provided to the E-UTRAN during paging. The Paging Attempt Information, as defined in 23.13.1, is always provided to all paged eNBs for UEs for which the information on the coverage enhancement level has been received.

23.14 Support for V2X services

23.14.1 General

23.14.1.0 Overview

Vehicular communication services, represented by V2X services, can consist of the following four different types: V2V, V2I, V2N and V2P, as specified in TS 22.185 [71].

V2X services can be provided by PC5 interface and/or Uu interface. Support of V2X services via PC5 interface is provided by V2X sidelink communication, which is a mode of communication whereby UEs can communicate with each other directly over the PC5 interface, as specified in TS 23.303 [62]. This communication mode is supported when the UE is served by E-UTRAN and when the UE is outside of E-UTRA coverage. Only the UEs authorised to be used for V2X services can perform V2X sidelink communication.

23.14.1.1 Support for V2X sidelink communication

The user plane protocol stack and functions, as specified in clause 23.10.2.1 for sidelink communication, are also used for V2X sidelink communication. In addition, for V2X sidelink communication:

- STCH for sidelink communication is also used for V2X sidelink communication.
- Non-V2X (e.g. Public Safety) data is not multiplexed with V2X data transmitted in resources configured for V2X sidelink communication.
- The Access Stratum (AS) is provided with the PPPP and PPRP of a protocol data unit transmitted over PC5 interface by upper layers. The packet delay budget (PDB) of the protocol data unit can be determined from the PPPP. The low PDB is mapped to the high priority PPPP value (TS 23.285 [72]).
- The Access Stratum (AS) is provided with a transmit profile (TS 23.285 [72]) of a protocol data unit transmitted over PC5 interface by upper layers.

- The logical channel prioritization based on PPPP is used for V2X sidelink communication.

Control plane protocol stack for SBCCH as specified in clause 23.10.2.2 for sidelink communication is also used for V2X sidelink communication.

The UE supporting V2X sidelink communication can operate in two modes for resource allocation:

- Scheduled resource allocation, characterized by:
 - The UE needs to be RRC_CONNECTED in order to transmit data;
 - The UE requests transmission resources from the eNB. The eNB schedules transmission resources for transmission of sidelink control information and data. Sidelink SPS is supported for scheduled resource allocation;
- UE autonomous resource selection, characterized by:
 - The UE on its own selects resources from resource pools and performs transport format selection to transmit sidelink control information and data;
 - If mapping between the zones and V2X sidelink transmission resource pools is configured, the UE selects V2X sidelink resource pool based on the zone UE is located in.
 - The UE performs sensing for (re)selection of sidelink resources. Based on sensing results, the UE (re)selects some specific sidelink resources and reserves multiple sidelink resources. Up to 2 parallel independent resource reservation processes are allowed to be performed by the UE. The UE is also allowed to perform a single resource selection for its V2X sidelink transmission.

In order to assist the eNB to provide sidelink resources, the UE in RRC_CONNECTED may report geographical location information to the eNB. The eNB can configure the UE to report the complete UE geographical location information based on periodic reporting via the existing measurement report signaling.

Geographical zones can be configured by the eNB or pre-configured. When zones are (pre)configured, the world is divided into geographical zones using a single fixed reference point (i.e. geographical coordinates (0, 0)), length and width. The UE determines the zone identity by means of modulo operation using length and width of each zone, number of zones in length, number of zones in width, the single fixed reference point and the geographical coordinates of the UE's current location. The length and width of each zone, number of zones in length and number of zones in width are provided by the eNB when the UE is in coverage and pre-configured when the UE is out of coverage. The zone is configurable for both in coverage and out of coverage.

For in coverage UE, when the UE uses UE autonomous resource selection, the eNB can provide the mapping between zone(s) and V2X sidelink transmission resource pools in RRC signalling. For out of coverage UEs, the mapping between the zone(s) and V2X sidelink transmission resource pools can be pre-configured. If a mapping between zone(s) and V2X sidelink transmission resource pool is (pre-)configured, the UE selects transmission sidelink resources from the resource pool corresponding to the zone where it is currently located. The zone concept is not applied to exceptional V2X sidelink transmission pools as well as reception pools. Resource pools for V2X sidelink communication are not configured based on priority.

For V2X sidelink transmission, during handover, transmission resource pool configurations including exceptional transmission resource pool for the target cell can be signaled in the handover command to reduce the transmission interruption. In this way, the UE may use the V2X sidelink transmission resource pools of the target cell before the handover is completed as long as either synchronization is performed with the target cell in case eNB is configured as synchronization source or synchronization is performed with GNSS in case GNSS is configured as synchronization source. If the exceptional transmission resource pool is included in the handover command, the UE uses randomly selected resources from the exceptional transmission resource pool, starting from the reception of handover command. If the UE is configured with scheduled resource allocation in the handover command, the UE continues to use the exceptional transmission resource pool while the timer associated with handover is running. If the UE is configured with autonomous resource selection in the target cell the UE continues to use the exceptional transmission resource pool until the sensing results on the transmission resource pools for autonomous resource selection are available. For exceptional cases (e.g. during RLF, during transition from RRC_IDLE to RRC_CONNECTED or during change of dedicated V2X sidelink resource pools within a cell), the UE may select resources in the exceptional pool provided in serving cell's SIB21 or in dedicated signalling based on random selection, and uses them temporarily. During cell reselection, the RRC_IDLE UE may use the randomly selected resources from the exceptional transmission resource

pool of the reselected cell until the sensing results on the transmission resource pools for autonomous resource selection are available.

In order to avoid interruption time in receiving V2X messages due to delay in acquiring reception pools broadcasted from the target cell, synchronisation configuration and reception resource pool configuration for the target cell can be signaled to RRC_CONNECTED UEs in the handover command. For RRC_IDLE UE, it is up to UE implementation to minimize V2X sidelink transmission/reception interruption time associated with acquisition of SIB21 of the target cell.

A UE is considered in-coverage on the carrier used for V2X sidelink communication whenever it detects a cell on that carrier as per criteria specified in TS 36.331 [16]. If the UE that is authorized for V2X sidelink communication is in-coverage on the frequency used for V2X sidelink communication or if the eNB provides V2X sidelink configuration for that frequency (including the case where UE is out of coverage on that frequency), the UE uses the scheduled resource allocation or UE autonomous resource selection as per eNB configuration. When the UE is out of coverage on the frequency used for V2X sidelink communication and if the eNB does not provide V2X sidelink configuration for that frequency, the UE may use a set of transmission and reception resource pools pre-configured in the UE. V2X sidelink communication resources are not shared with other non-V2X data transmitted over sidelink.

An RRC_CONNECTED UE may send a Sidelink UE Information message to the serving cell if it is interested in V2X sidelink communication transmission in order to request sidelink resources.

If the UE is configured by upper layers to receive V2X sidelink communication and V2X sidelink reception resource pools are provided, the UE receives on those provided resources.

Reception of V2X sidelink communication in different carriers/PLMNs can be supported by having multiple receiver chains in the UE.

For sidelink SPS, maximum 8 SPS configurations with different parameters can be configured by eNB and all SPS configurations can be active at the same time. The activation/deactivation of SPS configuration is signalled via PDCCH by eNB. The existing logical channel prioritization based on PPPP is used for sidelink SPS.

UE assistance information can be provided to eNB. Reporting of UE assistance information is configured by eNB for V2X sidelink communication. The UE assistance information used for V2X sidelink communication includes traffic characteristic parameters (e.g. a set of preferred SPS interval, timing offset with respect to subframe 0 of the SFN 0, PPPP, PPPR, Destination Layer-2 ID, and maximum TB size based on observed traffic pattern) related to the SPS configuration. The UE assistance information can be reported in case either SPS is already configured or not. Triggering of UE assistance information transmission is left to UE implementation. For instance, the UE is allowed to report UE assistance information when change in estimated periodicity and/or timing offset of packet arrival occurs. SR mask per traffic type is not supported for V2X sidelink communication.

The serving cell can provide synchronization configuration for the carrier used for V2X sidelink communication. In this case, the UE follows the synchronization configuration received from serving cell. In case there is no cell detected on the carrier used for V2X sidelink communication and the UE does not receive synchronization configuration from serving cell, the UE follows preconfigured synchronization configuration. There are three types of synchronization reference, namely eNB, UE and GNSS. In case GNSS is configured as synchronization source, the UE utilizes the UTC time and (pre)configured DFN offset to calculate direct frame number and subframe number. In case eNB timing is configured as synchronization reference to the UE, for synchronization and DL measurements, the UE follows the cell associated with the concerned frequency (when in-coverage on this frequency), or the PCell or the serving cell (when out of coverage on the concerned frequency). UE can indicate the current synchronization reference type it is using to the eNB. One transmission pool for scheduled resource allocation is configured, taking into account the synchronization reference of the UE.

For controlling channel utilization, the network is able to indicate how the UE adapts its transmission parameters for each transmission pool depending on the Channel Busy Ratio (CBR). The UE measures all the configured transmission pools including exceptional pool. If a pool is (pre)configured such that a UE shall always transmit PSCCH and PSSCH in adjacent resource blocks the UE measures PSCCH and PSSCH resources together. If a pool is (pre)configured such that a UE may transmit PSCCH and the corresponding PSSCH in non-adjacent resource blocks in a subframe then PSSCH pool and PSCCH pool are measured separately.

A UE in RRC_CONNECTED can be configured to report CBR measurement results. For CBR reporting, periodic reporting and event triggered reporting are supported. Two reporting events are introduced for event-triggered CBR reporting. In case PSSCH and PSCCH resources are placed non-adjacently, only PSSCH pool measurement is used for event-triggered CBR reporting. In case PSSCH and PSCCH resources are placed adjacently, CBR measurement of both the PSSCH and PSCCH resources is used for event-triggered CBR reporting. Event-triggered CBR reporting is

triggered by overloaded threshold and/or less-loaded threshold. The network can configure which of the transmission pools the UE needs to report.

A UE (regardless of its RRC state) performs transmission parameter adaptation based on the CBR. In case PSSCH and PSCCH resources are placed non-adjacently, only PSSCH pool measurement is used for transmission parameter adaptation. In case PSSCH and PSCCH resources are placed adjacently, CBR measurement of both the PSSCH and PSCCH resources is used for transmission parameter adaptation. When CBR measurements are not available, the default transmission parameters are used. The exemplary adapted transmission parameters include maximum transmission power, range of the number of retransmission per TB, range of PSSCH RB number, range of MCS, maximum limit on channel occupancy ratio. The transmission parameter adaptation applies to all transmission pools including exceptional pool.

A UE using scheduled resource allocation may be configured to perform sensing and periodically report the sensing result. The UE performs sensing only in the V2X sidelink transmission resource pool(s) for which reporting is configured.

For V2X sidelink communication, sidelink transmission and/or reception resources including exceptional pool for different frequencies for scheduled resource allocation and UE autonomous resource selection may be provided. The sidelink resources for different frequencies can be provided via dedicated signalling, SIB21 and/or preconfiguration. The serving cell may indicate to the UE only the frequency on which the UE may acquire the resource configuration for V2X sidelink communication. If multiple frequencies and associated resource information are provided, it is up to UE implementation to select the frequency among the provided frequencies. The UE shall not use preconfigured transmission resource if the UE detects a cell providing resource configuration or inter-carrier resource configuration for V2X sidelink communication. Frequencies which may provide V2X sidelink communication resource configuration or cross-carrier configuration can be signalled in SIB21 or pre-configured in the UE. The RRC_IDLE UE may prioritize the frequency that provides cross-carrier resource configuration for V2X sidelink communication during cell reselection.

If the UE supports multiple transmission chains, it may simultaneously transmit on multiple carriers via PC5. For the case where multiple frequencies for V2X are supported, a mapping between V2X service types and V2X frequencies is configured by upper layers. The UE should ensure a V2X service to be transmitted on the corresponding frequency. For scheduled resource allocation, the eNB can schedule a V2X transmission on a frequency based on the Sidelink BSR, as specified in TS 36.321 [13], in which the UE includes the Destination Index uniquely associated with a frequency reported by the UE to the eNB in Sidelink UE Information message as specified in TS 36.331 [16].

Carrier aggregation (CA) in sidelink is supported for V2X sidelink communication. It applies to both in coverage UEs and out of coverage UEs. For CA in sidelink, neither primary component carrier nor secondary component carriers are defined. Each resource pool (pre)configured for V2X sidelink communication transmission or reception is associated to a single carrier. When a UE supporting CA in sidelink uses autonomous resource selection, it performs carrier selection and may select one or more carriers used for V2X sidelink communication transmission. The carrier selection is performed at MAC layer, depending on the CBR of the (pre)configured carriers for V2X sidelink communication and the PPPP(s) of the V2X messages to be transmitted. The carrier reselection may be performed when resource reselection is triggered and is triggered for each sidelink process. In order to avoid frequent switching across different carriers, the UE may keep using a carrier already selected for transmission, if the measured CBR on this carrier is lower than a (pre)configured threshold. All selected carriers should have the same synchronization reference or the same synchronization priority configuration. For a UE using autonomous resource selection, logical channel prioritization is performed for a sidelink resource on a carrier depending on the CBR measured on the carrier and the PPPP of the sidelink logical channels as specified in TS 36.321 [13].

Sidelink packet duplication is supported for V2X sidelink communication and is performed at PDCP layer of the UE. For sidelink packet duplication for transmission, a PDCP PDU is duplicated at the PDCP entity. The duplicated PDCP PDUs of the same PDCP entity are submitted to two different RLC entities and associated to two different sidelink logical channels respectively. The duplicated PDCP PDUs of the same PDCP entity are only allowed to be transmitted on different sidelink carriers. A UE can activate or deactivate sidelink packet duplication based on (pre)configuration. Sidelink packet duplication does not apply to transmission with Rel-14 transmit profile (TS 23.285 [72]). The PPPR value(s) for which sidelink packet duplication is supported can be (pre)configured via a PPPR threshold. For UE autonomous resource selection and scheduled resource allocation, the UE shall perform sidelink packet duplication for the data with the configured PPPR value(s) until packet duplication is deconfigured for these PPPR value(s). For scheduled resource allocation, the UE reports the amount of data associated with one or more PPPR values, and the destination(s) to which the data belongs via sidelink BSR(s). A mapping of PPPR values to logical channel groups can be configured by the eNB, and the PPPR value(s) are reflected by the associated logical channel group ID included in the sidelink BSR(s). A list of PPPR value(s) may be reported in Sidelink UE information by an RRC_CONNECTED UE.

For a UE using scheduled resource allocation, two non-overlapped sets of carriers are configured by the eNB per Destination reported by the UE to the network, and they apply to all the PPPR(s) that are configured for sidelink packet duplication. The UE then associates two duplicated sidelink logical channels corresponding to the same PDCP entity respectively with the two sets of carriers configured for the Destination of the two sidelink logical channels. The association between the duplicated sidelink logical channel and the carrier set is up to UE implementation. Data of a duplicated sidelink logical channel can only be transmitted on the carrier(s) in the associated carrier set.

For V2X sidelink communication reception, packet duplication detection is performed at PDCP layer of the UE. Reordering function is also supported at PDCP layer and how to set the reordering timer at the PDCP layer is up to UE implementation. There are specific logical channel identities which apply to the sidelink logical channel used for sidelink packet duplication exclusively as specified in TS 36.321 [13].

The UE may receive the V2X sidelink communication of other PLMNs. The serving cell can indicate to the UE the resource configuration for V2X sidelink communication reception for inter-PLMN operation directly or only the frequency on which the UE may acquire the inter-PLMN resource configuration for V2X sidelink communication reception. V2X sidelink communication transmission in other PLMNs is not allowed.

When UL transmission overlaps in time domain with V2X sidelink transmission in the same frequency, the UE prioritizes the V2X sidelink transmission over the UL transmission if the PPPP of sidelink MAC PDU is lower than a (pre)configured PPPP threshold; otherwise, the UE prioritizes the UL transmission over the V2X sidelink transmission. When UL transmission overlaps in time domain with V2X sidelink transmission in different frequency, the UE may prioritize the V2X sidelink transmission over the UL transmission or reduce UL transmission power if the PPPP of sidelink MAC PDU is lower than a (pre)configured PPPP threshold; otherwise, the UE prioritizes the UL transmission over the V2X sidelink transmission or reduces V2X sidelink transmission power. However, if UL transmission is prioritized by upper layer as specified in TS 24.386 [75] or random access procedure is performed, the UE prioritizes UL transmission over any V2X sidelink transmission (i.e. irrespectively of the sidelink MAC PDU's PPPP).

Resource pool for transmission of pedestrian UE (P-UE) may be overlapped with resources for V2X sidelink communication. For each transmission pool, resource selection mechanism (i.e. random selection, partial sensing based selection or either random selection or partial sensing based selection), which is allowed to be used in this pool, is also configured. If P-UE is configured to use either random selection or partial sensing based selection for one transmission pool, it is up to UE implementation to select a specific resource selection mechanism. If the P-UE is configured to use partial sensing based selection only, the P-UE shall use partial sensing based selection in the pool. The P-UE shall not do random selection in the pool wherein only partial sensing is allowed. If the eNB does not provide a random selection pool, the P-UEs that support only random selection cannot perform sidelink transmission. In exceptional pool, the P-UE uses random selection. The P-UE can send Sidelink UE Information message to indicate that it requests resource pools for P2X-related V2X sidelink communication transmission as specified in TS 36.331 [16].

It is not mandatory for P-UE to support zone based resource selection. The P-UE reports whether it supports zone based resource selection as part of UE capability signalling. If the P-UE supports zone based resource selection, the network can provide zone based configuration via only dedicated signalling.

Power saving of P-UE can be achieved by UE implementation and upper layer mechanisms. P-UE does not perform CBR measurement. However, P-UE adjusts the transmission parameters based on the default transmission parameter configuration, which can be provided to the P-UE via RRC signalling.

To support the co-existence of CEN DSRC and V2X sidelink communication, the upper layers of the UE which is performing V2X sidelink communication send an indication to lower layers when the UE is within the proximity of CEN DSRC tolling station(s).

23.14.1.2 Support for V2X communication via Uu

For V2X communication in uplink, maximum 8 SPS configurations with different parameters can be configured by eNB and all SPS configurations can be active at the same time. The activation/deactivation of each SPS configuration is signalled via PDCCCH by eNB. The existing logical channel prioritization for Uu is used.

For V2X communication, UE assistance information can be provided to eNB. Reporting of UE assistance information is configured by eNB. The UE assistance information includes parameters (e.g. a set of preferred SPS interval, timing offset with respect to subframe 0 of the SFN 0, LCID and maximum TB size based on observed traffic pattern) related to the SPS configuration. Triggering of UE assistance information transmission is left to UE implementation. For instance, the UE is allowed to report the UE assistance information when change in estimated periodicity and/or timing offset of packet arrival occurs. For V2X communication via Uu, SR mask as per legacy mechanism can be used.

For unicast transmission of V2X messages, the V2X message can be delivered via Non-GBR bearers as well as GBR bearers. In order to meet the QoS requirements for V2X message delivery for V2X services, a Non-GBR QCI value and a GBR QCI value for V2X messages are used as specified in TS 23.285 [72].

For broadcasting V2X messages, SC-PTM or MBSFN transmission can be used. In order to reduce SC-PTM/MBSFN latency, shorter (SC-)MCCH repetition period for SC-PTM/MBSFN, modification period for SC-PTM/MBSFN and MCH scheduling period for MBSFN are supported. Reception of downlink broadcast of V2X messages in different carriers/PLMNs can be supported by having multiple receiver chains in the UE. A GBR QCI value is used for the delivery of V2X messages over MBMS bearers as specified in TS 23.285 [72].

23.15 Support for MMTEL voice and video enhancements

23.15.1 RAN-assisted codec adaptation

RAN-assisted codec adaptation provides a means for the eNB to send codec adaptation indication with recommended bit rate to assist the UE to select or adapt to a codec rate for MMTEL voice or MMTEL video. The RAN-assisted codec adaptation mechanism supports the uplink/downlink bit rate increase or decrease. For a bearer associated with configuration of MBR greater than GBR (see clauses 11.4 and 13.2), the recommended uplink/downlink bit rate is within boundaries set by the MBR and GBR of the concerned bearer.

For uplink or downlink bit rate adaptation, eNB may send a recommended bit rate to the UE to inform the UE on the currently recommended transport bit rate on the local uplink or downlink, which the UE may use in combination with other information to adapt the bit rate, e.g. the UE may send a bit rate request to the peer UE via application layer messages as specified in TS 26.114 [74], which the peer UE may use in combination with other information to adapt the codec bit rate. The recommended bit rate is in kbps at the physical layer at the time when the decision is made.

The recommended bit rate for UL and DL is conveyed as a MAC Control Element (CE) from the eNB to the UE as outlined in Figure 23.15.1-1.

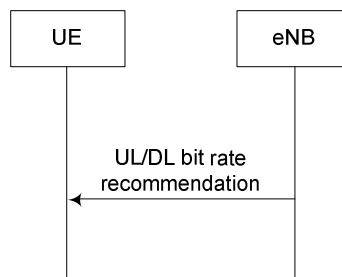

Figure 23.15.1-1: UL or DL bit rate recommendation

Based on the recommended bit rate from the eNB, a UE may initiate an end-to-end bit rate adaptation with its peer (UE or MGW). The UE may also send a query message to its local eNB to check if a bit rate recommended by its peer can be provided by the eNB. The UE is not expected to go beyond the recommended bit rate from the eNB.

The recommended bit rate query message is conveyed as a MAC Control Element (CE) from the UE to the eNB as outlined in Figure 23.15.1-2.

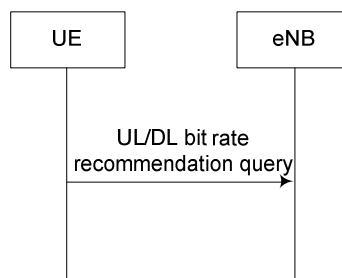

Figure 23.15.1-2: UL or DL bit rate recommendation query

A prohibit timer can be configured per logical channel by the network to limit UEs sending frequent query MAC CEs. Independent prohibit timers are used for each direction (uplink and downlink) to prohibit the UE from retransmitting exactly the same query MAC CE to the eNB during the configured time.

23.15.2 MMTEL signalling optimization

In case of network congestion (e.g. maximum number of users that can be connected, poor radio conditions, etc), an operator may want to prioritize MMTEL voice/MMTEL video access. For both type of accesses, the *MO voice call* cause value is used.

During the re-direction procedure, if the UE receives the RRC Connection Release message with redirection and the voice call is ongoing, the UE keeps the call in the application layer. After the UE re-accesses the network, the voice GBR bearer can be recovered immediately.

23.15.3 MMTEL voice quality/coverage enhancements

In order to enhance the voice quality and coverage, the techniques for PUSCH coverage enhancement introduced in Rel-13 for CE Mode A can be configured also for UEs in non-CE mode. These techniques are applied in a new PUSCH enhancement mode and include:

- PUSCH subframe repetition with intra-bundle or inter-bundle frequency hopping and
- UL asynchronous HARQ operation.

The PUSCH enhancement mode can be enabled only on PCell. In the PUSCH enhancement mode, the PUSCH maximum bandwidth is 20MHz. The UE transition between normal mode and PUSCH enhancement mode is controlled and triggered by RRC signalling. As part of the transition procedure, the UL HARQ operation switches between synchronous (normal mode) and asynchronous (PUSCH enhancement mode), with a partial MAC reset.

PUSCH coverage enhancement requires that air interface delay budget can be relaxed to increase the robustness of the transmission. Such relaxation may be achieved when a UE in good coverage indicates a preference to the eNB to reduce the local air interface delay by sending a *UEAssistanceInformation* message with *delayBudgetReport* set to *type1* to decrease the DRX cycle length, so that the E2E delay and jitter can be reduced. The peer UE in bad coverage can send a *UEAssistanceInformation* message with *delayBudgetReport* set to *type2* to its eNB to indicate a preference on Uu air interface delay adjustments, see TS 36.331 [16], TS 36.211 [4] and TS 36.213 [6]. Based on the UE report and other information, the E-UTRAN may configure the UE with coverage enhancement techniques. When the UE detects changes such as end-to-end MMTEL voice quality or local radio quality, the UE may inform the eNB its new preference by sending *UEAssistanceInformation* messages with updated contents.

23.16 Application Layer Measurement Collection

This function enables collection of application layer measurements from the UE. The supported service types are QoE Measurement Collection for streaming services and QoE Measurement Collection for MTSI services. The feature is activated by Trace Function from the MDT framework (see clause 19.2.1.17 and TS 37.320 [43]). Both signalling based and management based initiation cases are allowed. For the signalling based case, the Application Layer Measurement Collection is initiated towards a specific UE from CN nodes using the MDT mechanism as described in clause 5.1.3 of TS 37.320 [43]; for the management based case, the Application Layer Measurement Collection is initiated from OAM targeting an area (without targeting a specific UE).

Application layer measurement configuration received from OAM or CN is encapsulated in a transparent container, which is forwarded to UE in a downlink RRC message. Application layer measurements received from UE's higher layer are encapsulated in a transparent container and sent to network in an uplink RRC message, as specified in TS 36.331 [16]. The application layer measurement configuration and measurement reporting are supported in RRC_CONNECTED state only. E-UTRAN can release the application layer measurement configuration towards the UE at any time.

23.17 Support for Aerial UE communication

23.17.1 General

E-UTRAN based mechanisms providing LTE connection to UEs capable of Aerial communication are supported via the following functionalities:

- subscription-based Aerial UE identification and authorization, as specified in TS 23.401 [17], clause 4.3.31.
- height reporting based on the event that the UE's altitude has crossed a network-configured reference altitude threshold.
- interference detection based on a measurement reporting that is triggered when a configured number of cells (i.e. larger than one) fulfills the triggering criteria simultaneously.
- signalling of flight path information from UE to E-UTRAN.
- Location information reporting, including UE's horizontal and vertical velocity.

23.17.2 Subscription based identification of Aerial UE function

Support of Aerial UE function is stored in the user's subscription information in HSS. HSS transfers this information to the MME during Attach, Service Request and Tracking Area Update procedures.

The subscription information can be provided from the MME to the eNB via the S1 AP Initial Context Setup Request during Attach, Tracking Area Update and Service Request procedures. In addition, for X2-based handover, the source eNodeB can include the subscription information in the X2-AP Handover Request message to the target eNodeB.

For the intra and inter MME S1 based handover, the MME provides the subscription information to the target eNB after the handover procedure.

23.17.3 Height based reporting for Aerial UE communication

An aerial UE can be configured with event based height reporting. UE sends height report when the altitude of the aerial UE is above or below a configured threshold. The report contains height and location if configured as described in 23.17.6.

23.17.4 Interference detection and mitigation for Aerial UE communication

For interference detection, an aerial UE can be configured with RRM event A3, A4 or A5 that triggers measurement report when individual (per cell) RSRP values for a configured number of cells fulfill the configured event. Once such condition is met and a measurement report is sent, the list of triggered cells is updated when subsequent cell(s) fulfil the event, however further measurement reports are not sent while the list of triggered cells remains larger than the configured number of cells. The report contains RRM results and location if configured, as described in 23.17.6.

For interference mitigation an aerial UE can be configured with a dedicated UE-specific alpha parameter for PUSCH power control.

23.17.5 Flight path information reporting

E-UTRAN can request a UE to report flight path information consisting of a number of waypoints defined as 3D locations as defined in TS 36.355 [78]. A UE reports up to configured number of waypoints if flight path information is available at the UE. The report can consist also time stamps per waypoint if configured in the request and if available at the UE.

23.17.6 Location reporting for Aerial UE communication

Location information for Aerial UE communication can include horizontal and vertical speed if configured. Location information can be included in RRM report and in height report.

23.18 PDCP packet duplication

PDCP packet duplication is configured for a RB by RRC where two logical channels are configured for the RB. The two logical channels can either belong to the same MAC entity (referred to as CA duplication) or different MAC entities (referred to as DC duplication). When activated, PDCP packet duplication allows sending the same PDCP PDU on two independent transmission paths: via the primary RLC entity and a secondary RLC entity, thus increasing reliability and reducing latency.

PDCP packet duplication is supported in the following cases:

- for SRBs using RLC AM;
- for DRBs using RLC UM or AM.

For DRBs, duplication can be activated and deactivated by a MAC CE. In addition, for DRBs, PDCP packet duplication can be activated upon configuration by RRC signalling. For SRBs, once duplication is configured, it is always activated.

When PDCP packet duplication is activated, the associated logical channels are restricted to be sent only on certain serving cells to ensure the duplicates are sent on different serving cells. The restriction is lifted when PDCP packet duplication is deactivated. When CA duplication is configured for an SRB, one of the logical channels associated to the SRB is restricted to be sent only on the serving cells including PCell or PSCell.

At the receiver, PDCP enables reordering and duplication detection when PDCP packet duplication is configured.

When activating duplication for a DRB, E-UTRAN should ensure that at least one serving cell is activated for each logical channel of the DRB; and when the deactivation of SCells leaves no serving cells activated for a logical channel of the DRB, E-UTRAN should ensure that duplication is also deactivated.

24 Support for 5GC

24.1 General

The E-UTRA connected to 5GC is supported as part of NG-RAN. The E-UTRA can be connected to both EPC and 5GC.

The overall architecture of E-UTRA connected to 5GC as part of NG-RAN is described in TS 38.300 [79], where the term "ng-eNB" is used for E-UTRA connected to 5GC. However, in this specification the term "eNB" is used for both cases unless there is a specific need to disambiguate between eNB and ng-eNB.

E-UTRA connected to 5GC supports the following functions:

- 5G NAS message transport (see clause 7.3);
- 5G security framework (see TS 38.300 [79]), except that data integrity protection is not supported;
- Access Control (see TS 38.300 [79]);
- Flow-based QoS (see TS 38.300 [79]);
- Network slicing (see TS 38.300 [79]);
- SDAP (see TS 37.324 [80]);
- NR PDCP (see TS 38.323 [81]);
- Support of UEs in RRC_INACTIVE state.

24.2 Radio Protocol Architecture

24.2.1 User Plane

The figure below shows the protocol stack for the user plane, where SDAP, NR PDCP, RLC and MAC sublayers perform the functions listed in clause 6.5 of TS 38.300 [79], clause 6.4 of TS 38.300 [79], clause 6.3, and clause 6.2 respectively.

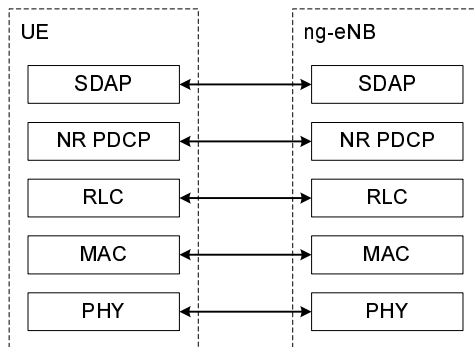

Figure 24.2.1-1: User Plane Protocol Stack

24.2.2 Control Plane

The figure below shows the protocol stack for the control plane, where:

- NR PDCP sublayer (terminated in ng-eNB on the network side) performs the functions listed for the control plane in clause 6.4 of TS 38.300 [79]. The UE uses only NR PDCP for both SRBs and DRBs when connected to 5GC;
- RLC and MAC sublayers (terminated in ng-eNB on the network side) perform the functions listed in clause 6.2 and 6.1;
- RRC (terminated in ng-eNB on the network side) performs the functions listed in clause 7;
- NAS control protocol (terminated in AMF on the network side) performs the functions listed in TS 23.501 [82], for instance: authentication, mobility management, security control.

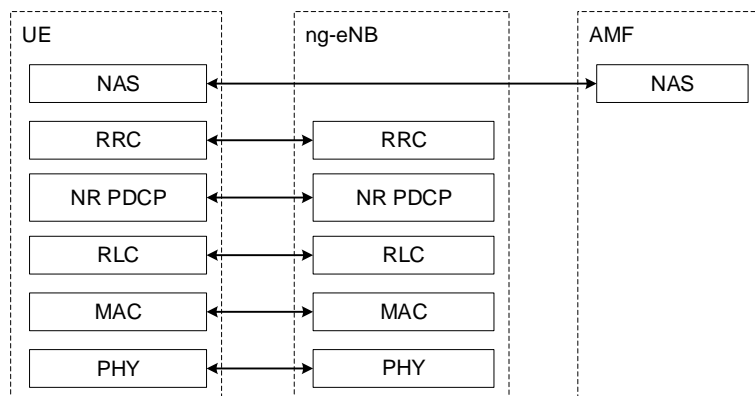

Figure 24.2.2-1: Control Plane Protocol Stack

24.3 Layer 2

The layer 2 of E-UTRA connected to 5GC is split into the following sublayers: Medium Access Control (MAC), Radio Link Control (RLC), NR Packet Data Convergence Protocol (PDCP) and Service Data Adaptation Protocol (SDAP).

- The physical layer offers to the MAC sublayer transport channels, see clause 5;
- The MAC sublayer offers to the RLC sublayer logical channels, see clause 6.1;
- The RLC sublayer offers to the NR PDCP sublayer RLC channels, see clause 6.2;
- The NR PDCP sublayer offers to the SDAP sublayer data radio bearers, and offers to the RRC sublayer signalling radio bearers, see TS 38.323 [81];
- The SDAP sublayer offers to 5GC QoS flows, see TS 37.324 [80].

24.4 CN Selection

For a cell that provides E-UTRA connectivity to both 5GC and EPC within a PLMN, the UE upper layer performs CN selection between EPC and 5GC. The UE AS layer indicates available CN type(s) to upper layers for CN type selection. The UE NAS layer indicates selected CN type (if available) with selected PLMN during PLMN selection procedure, as defined in TS 36.304 [11].

24.5 Mobility

Intra-EUTRA inter-system Handover (i.e., handover between E-UTRA connected to 5GC and E-UTRA connected to EPC) is described in clause 10.2.2c and in TS 23.502 [83].

The inter-RAT intra-5GC Handover (i.e., handover between E-UTRA connected to 5GC and NR connected to 5GC) is described in clause 9.3.1.2 of TS 38.300 [79].

Inter-RAT handover to/from GERAN/UTRAN/CDMA2000 and cell change order to GERAN with NACC are not supported, and CS fallback described in clause 10.2.5 is not applied except for the functionality of release with redirection to GERAN/UTRAN.

The following mobility procedures are supported:

- RRC Connection Release with Redirection to GERAN/UTRAN/CDMA2000/EUTRAN;
- Cell Change Order to GERAN without NACC.

When the UE is connected to E-UTRA/5GC, inter system fallback towards E-UTRAN is performed when 5GC does not support some services, see TS 23.501 [82]. Depending on factors such as CN interface availability, network configuration and radio conditions, the fallback procedure results in either RRC CONNECTED state mobility (handover procedure) or RRC IDLE state mobility (redirection), see TS 23.501 [82] and TS 36.331 [16].

In the N2 signalling procedure, the AMF based on support for emergency services, voice service, any other services or for load balancing etc, may indicate the target CN type as EPC or 5GC to the ng-eNB node. When the target CN type is received by ng-eNB, the target CN type is also conveyed to the UE in RRC Connection Release message.

The mobility in RRC_INACTIVE is described in clause 10.1.9.

For E-UTRA connected to 5GC, in RRC_IDLE the UE monitors the PCCH for CN-initiated paging information, in RRC_INACTIVE the UE monitors the PCCH for RAN-initiated and CN-initiated paging information. The RAN-initiated and CN-initiated paging occasions overlap and the same paging mechanism is used for both. The extended DRX (eDRX) is not used for E-UTRA connected to 5GC.

24.6 Slicing

E-UTRA connected to 5GC supports network slicing functionality. The details of network slicing are specified in TS 23.501 [82] and clause 16.3 of TS 38.300 [79].

24.7 Access Control

E-UTRA connected to 5GC supports unified access control (UAC) functionality. The details of UAC are defined in TS 38.300 [79].

For E-UTRA connected to both EPC and 5GC, E-UTRA broadcasts the access control information associated with EPC and 5GC separately and the UE AS uses the access control information associated with the core network type selected by NAS.

24.8 Radio access network sharing

E-UTRA connected to 5GC supports radio access network sharing as specified in TS 23.501 [82].

For E-UTRA connected to both EPC and 5GC, E-UTRA broadcasts the access control information associated with EPC and 5GC separately and the UE AS uses the access control information associated with the core network type selected by NAS.

If E-UTRA connected to 5GC is shared, system information broadcast in a shared cell indicates a TAC and a Cell Identity for each subset of PLMNs (up to 6). E-UTRA provides only one TAC and one Cell Identity per cell per PLMN.

Each Cell Identity associated with a subset of PLMNs identifies its serving ng-eNB node.

NOTE 1: How to manage the scenario where a different PLMN ID has been allocated by the operator for an ECGI is left to OAM and/or implementation.

NOTE 2: It is not precluded that a cell served by an eNB does not broadcast the PLMN ID included in the Global eNB ID.

Annex A (informative): NAS Overview

This clause provides for information an overview on services and functions provided by the NAS control protocol.

A.1 Services and Functions

The main services and functions of the NAS sublayer include:

- EPS Bearer control (see TR 23.401 [17]);
- ECM-IDLE mobility handling;
- Paging origination;
- Configuration and control of Security.

A.2 NAS protocol states & state transitions

The NAS state model is based on a two-dimensional model which consists of EPS Mobility Management (EMM) states describing the mobility management states that result from the mobility management procedures e.g. Attach and Tracking Area Update procedures, and of EPS Connection Management (ECM) states describing the signalling connectivity between the UE and the EPC (see TS 23.401 [17]).

NOTE: The ECM and EMM states are independent of each other and when the UE is in EMM-CONNECTED state this does not imply that the user plane (radio and S1 bearers) is established.

The relation between NAS and AS states is characterised by the following principles:

- EMM-DEREGISTERED & ECM-IDLE \Rightarrow RRC_IDLE:
 - Mobility: PLMN selection;
 - UE Position: not known by the network.
- EMM-REGISTERED & ECM-IDLE \Rightarrow RRC_IDLE:
 - Mobility: cell reselection;
 - UE Position: known by the network at tracking area level.
- EMM-REGISTERED & ECM-CONNECTED with radio bearers established \Rightarrow RRC_CONNECTED.
 - Mobility: handover;
 - UE Position: known by the network at cell level.

Annex B (informative): MAC and RRC Control

The E-UTRA supports control signalling in terms of MAC control signalling (PDCCH and MAC control PDU) and RRC control signalling (RRC message).

B.1 Difference between MAC and RRC control

The different characteristics of MAC and RRC control are summarized in the table below.

Table B.1-1: Summary of the difference between MAC and RRC control

	MAC control		RRC control
Control entity	MAC		RRC
Signalling	PDCCH	MAC control PDU	RRC message
Signalling reliability	$\sim 10^{-2}$ (no retransmission)	$\sim 10^{-3}$ (after HARQ)	$\sim 10^{-6}$ (after ARQ)
Control delay	Very short	Short	Longer
Extensibility	None or very limited	Limited	High
Security	No integrity protection No ciphering	No integrity protection No ciphering	Integrity protection Ciphering

The main difference between MAC and RRC control lies in the signalling reliability. Due to the signalling reliability, signalling involving state transitions and radio bearer configurations should be performed by RRC. Basically, all signalling performed by RRC in UTRA should also be performed by RRC also for E-UTRA.

B.2 Void

Annex C (informative):
Void

Annex D (informative):
Void

Annex E (informative):
Void

Annex F (informative):
Void

Annex G (informative): Guideline for E-UTRAN UE capabilities

Each radio access technology has defined specific "classes" of terminals in terms of radio capabilities. E.g. in GPRS the "multislot classes" are defined, in UMTS R'99 different dedicated bearer classes are defined and for HSDPA and HSUPA 12 respectively 6 physical layer categories are defined. The definition of UMTS R'99 UE classes lead to 7 DL classes and 7 UL classes for FDD out of which only 2 DL and 3 UL classes were commercially realized. Furthermore the lower end classes (e.g. 64 UL and 64 DL) disappeared from the market with commercialization of the UMTS networks quite soon. Besides these class definitions a huge number of possible parameter combinations (to achieve certain data rates) exist with UMTS R'99 which lead to the huge number of RAB and RB combinations defined. Further activities in the early phase of UMTS standardization aimed to reduce the number of possible combinations significantly.

For HSDPA two "simple" DL categories (11 & 12) with lowered complexity were defined with the intent to speed up commercialization of HSDPA. Originally those categories should have been removed for Rel-6. Out of the 12 defined categories only approx. 4 will be realized in commercial HSDPA platform products. A similar situation is likely for HSUPA as well as for the combinations of HSDPA/HSUPA.

Generally the aim to mandate certain essential functions/requirements can help to simplify the system definition as well as the realization options (e.g. mandating 20 MHz of DL reception as well as 20 MHz UL transmission bandwidth significantly reduced the E-UTRAN system complexity). Especially mandating certain terminal functions could be useful for the system design if a defined subset of parameter combinations are also supported by the systems, e.g. the eNB scheduler. However, there is also a risk that not all the defined E-UTRA features are deployed in the networks at the time when terminals are made commercially available on the market place. Some features are likely to be rather large and complex, which further increases the risk of interoperability problems unless these features have undergone sufficient interoperability testing (IOT) on real network equipment, and preferably with more than one network in order to improve the confidence of the UE implementation. Thus, avoiding unnecessary UE mandatory features but instead defining a limited set of UE radio classes allows simplification for the interoperability testing.

Given the discussion above, it seems beneficial for the introduction of E-UTRAN to limit the combination of radio capabilities to a clearly defined subset and ensure that a given set of parameters is supported by certain UE classes as well as networks for rapid E-UTRAN deployment. It seems unrealistic to mandate only one single UE class which always mandates the maximum capability.

In order to address the different market requirements (low end, medium and high end), the definition of the following UE classes are proposed:

Table G-1: E-UTRAN UE Classes

Class	UL	DL
A	[50] Mbps	[100] Mbps
B	[25] Mbps	[50] Mbps
C	[2] Mbps	[2] Mbps

NOTE 1: For simplification reasons, the table only depict the UE capabilities in terms of uplink and downlink peak data rates supported. However, it should be noted that further discussion on other features is expected once the work progresses.

It may require further discussion whether there be a need for an additional terminal class between 2 Mbps and 50 Mbps classes. It might make sense, since up to 5 MHz band allocations may be rather common in real deployments for several years. This would point to bit rate class of 25 Mbps in DL and 10 Mbps in UL.

The above given data rates are indicative and should be subject for further discussions in 3GPP RAN working groups. Depending on the different solutions to reach those data rates, the target should be to define [3..4] UE classes in different data rate ranges, and other parameters affecting device complexity and cost. The definition of the required parameters/features is for further study for each of the classes. For instance, half-duplex UEs form a specific category that may be frequency band specific.

NOTE 2: the support of half-duplex UEs is mandatory for the eNB where such a category is allowed in the frequency band supported by the eNB.

The aim is to ensure on the one hand that high end E-UTRAN UEs, supporting data rates representing state of the art level and competitive with other radio technologies are defined, while the medium and lower data rates aim to reduce implementation cost for chipset/terminal vendors and allow adoption of most cost efficient solutions for different market segments. It is expected that the support of the high end data rate terminals is ensured from the very beginning.

Another clear exception from this exercise is that on the low end very cheap product implementation is possible (e.g. for the machine-to-machine market or the voice and very low data rate only segment – to substitute GSM in the medium term) while top end performance is needed for data applications in notebooks, wireless gateways ("wireless DSL"), etc.

Another important aspect that must be ensured is that a higher capability UE can be treated in exactly the same way as for a lower capability UE, if the network wishes to do so, e.g., in case the network does not support some higher capability features. In HSDPA, there have been problems in this respect due to 2-stage rate matching in HARQ. Such problems should be avoided in E-UTRAN, and E-UTRAN UE capabilities should provide the compatibility to ease implementation and interoperability testing.

Annex H (informative):
Void

Annex I (informative): SPID ranges and mapping of SPID values to cell reselection and inter-RAT/inter frequency handover priorities

This Annex defines two ranges of SPID (Subscriber Profile ID for RAT/Frequency Priority) values, respectively Operator Specific and Reference values. The mapping at eNB of Reference SPID values to cell reselection and inter-RAT/inter frequency handover priorities is defined.

I.1 SPID ranges

Values 1- 128 - Operator specific SPID values;

Values 129 - 256- Reference values.

I.2 Reference SPID values

SPID = 256

Table I.2-1: eNB local configuration in idle and connected mode for SPID = 256

Configuration parameter	Value	Meaning
E-UTRAN carriers priority	high	The selection priorities for idle and connected mode of all E-UTRAN carriers are higher than the priorities for all UTRAN and GERAN carriers
UTRAN carriers priority	medium	The selection priorities for idle and connected mode of all UTRAN carriers are lower than the priorities for all E-UTRAN carriers and higher than the priorities for all GERAN carriers
GERAN carriers priority	low	The selection priorities for idle and connected mode of all GERAN carriers are lower than the priorities for all E-UTRAN and UTRAN carriers

SPID = 255

Table I.2-2: eNB local configuration in idle and connected mode for SPID = 255

Configuration parameter	Value	Meaning
UTRAN carriers priority	high	The selection priorities for idle and connected mode of all UTRAN carriers are higher than the priorities for all GERAN and E-UTRAN carriers
GERAN carriers priority	medium	The selection priorities for idle and connected mode of all GERAN carriers are lower than the priorities for all UTRAN carriers and higher than the priorities for all E-UTRAN carriers
E-UTRAN carriers priority	low	The selection priorities for idle and connected mode of all E-UTRAN carriers are lower than the priorities for all UTRAN and GERAN carriers

SPID = 254

Table I.2-3: eNB local configuration in idle and connected mode for SPID = 254

Configuration parameter	Value	Meaning
GERAN carriers priority	high	The selection priorities for idle and connected mode of all GERAN carriers are higher than the priorities for all UTRAN and E-UTRAN carriers
UTRAN carriers priority	medium	The selection priorities for idle and connected mode of all UTRAN carriers are lower than the priorities for all GERAN carriers and higher than the priorities for all E-UTRAN carriers
E-UTRAN carriers priority	low	The selection priorities for idle and connected mode of all E-UTRAN carriers are lower than the priorities for all GERAN and UTRAN carriers

SPID = 253

Table I.2-4: eNB local configuration in idle and connected mode for SPID = 253

Configuration parameter	Value	Meaning
automotive device subscriber	true	The selection provides information that subscriber is using an automotive device and is permitted to utilise a minimum of two Rx antenna ports for the NR bands where four Rx antenna ports are baseline as given in TS 38.101-1 [88].

Annex J (informative): Carrier Aggregation

J.1 Deployment Scenarios

Table J.1-1 shows some of the potential deployment scenarios for CA. In Rel-10, for the uplink, the focus is laid on the support of intra-band carrier aggregations (e.g. scenarios #1, as well as scenarios #2 and #3 when F1 and F2 are in the same band). Scenarios related to uplink inter-band CA are supported from Rel-11. For the downlink, all scenarios should be supported in Rel-10.

Table J.1-1: CA Deployment Scenarios (F2 > F1).

#	Description	Example
1	F1 and F2 cells are co-located and overlaid, providing nearly the same coverage. Both layers provide sufficient coverage and mobility can be supported on both layers. Likely scenario is when F1 and F2 are of the same band, e.g., 2 GHz, 800 MHz, etc. It is expected that aggregation is possible between overlaid F1 and F2 cells.	
2	F1 and F2 cells are co-located and overlaid, but F2 has smaller coverage due to larger path loss. Only F1 provides sufficient coverage and F2 is used to improve throughput. Mobility is performed based on F1 coverage. Likely scenario when F1 and F2 are of different bands, e.g., F1 = {800 MHz, 2 GHz} and F2 = {3.5 GHz}, etc. It is expected that aggregation is possible between overlaid F1 and F2 cells.	
3	F1 and F2 cells are co-located but F2 antennas are directed to the cell boundaries of F1 so that cell edge throughput is increased. F1 provides sufficient coverage but F2 potentially has holes, e.g., due to larger path loss. Mobility is based on F1 coverage. Likely scenario is when F1 and F2 are of different bands, e.g., F1 = {800 MHz, 2 GHz} and F2 = {3.5 GHz}, etc. It is expected that F1 and F2 cells of the same eNB can be aggregated where coverage overlaps.	
4	F1 provides macro coverage and on F2 Remote Radio Heads (RRHs) are used to improve throughput at hot spots. Mobility is performed based on F1 coverage. Likely scenarios are both when F1 and F2 are DL non-contiguous carrier on the same band, e.g., 1.7 GHz, etc. and F1 and F2 are of different bands, e.g., F1 = {800 MHz, 2 GHz} and F2 = {3.5 GHz}, etc. It is expected that F2 RRHs cells can be aggregated with the underlying F1 macro cells.	
5	Similar to scenario #2, but frequency selective repeaters are deployed so that coverage is extended for one of the carrier frequencies. It is expected that F1 and F2 cells of the same eNB can be aggregated where coverage overlaps.	

The reception timing difference at the physical layer of DL assignments and UL grants for the same TTI but from different serving cells (e.g. depending on number of control symbols, propagation and deployment scenario) does not affect MAC operation. A UE should cope with a relative propagation delay difference up to 30 μs among the component carriers to be aggregated in both intra-band non-contiguous and inter-band non-contiguous CA. This implies that a UE should cope with a delay spread of up to 30.26 μs among the component carriers monitored at the receiver,

since the BS time alignment is specified to be up to 0.26 μ s. This also implies that the UE should cope with a maximum uplink transmission timing difference between TAGs of 32.47 μ s for inter-band carrier aggregation with multiple TAGs.

When CA is deployed frame timing and SFN are aligned across cells that can be aggregated.

J.2 Void

J.3 Void

J.4 Void

J.5 Void

J.6 Void

Annex K (informative): Time domain ICIC

This Annex reflects the agreements reached on time domain ICIC that may not necessarily fit in the core of the specification but which needs to be captured in the absence of corresponding details in Stage 3 specifications.

K.1 Deployment scenarios

Two scenarios have been identified where conventional ICIC techniques are insufficient to overcome co-channel interference, the CSG scenario and the Pico scenario. The identified scenarios are examples of network configurations that are intended to depict the basic concept of time domain ICIC and it should be understood that other network deployment scenarios are also possible.

K.1.1 CSG scenario

Dominant interference condition may happen when non-member users are in close proximity of a CSG cell. Depending on network deployment and strategy, it may not be possible to divert the users suffering from inter-cell interference to another E-UTRA carrier or other RAT. Time domain ICIC may be used to allow such non-member UEs to remain served by the macro cell on the same frequency layer.

Such interference may be mitigated by the CSG cell utilizing Almost Blank Subframes to protect the corresponding macro cell's subframes from the interference. A non-member UE may be signalled to utilize the protected resources for cell measurements (RRM), radio link monitoring (RLM) and CSI measurements for the serving macro cell, allowing the UE to continue to be served by the macro cell under strong interference from the CSG cell.

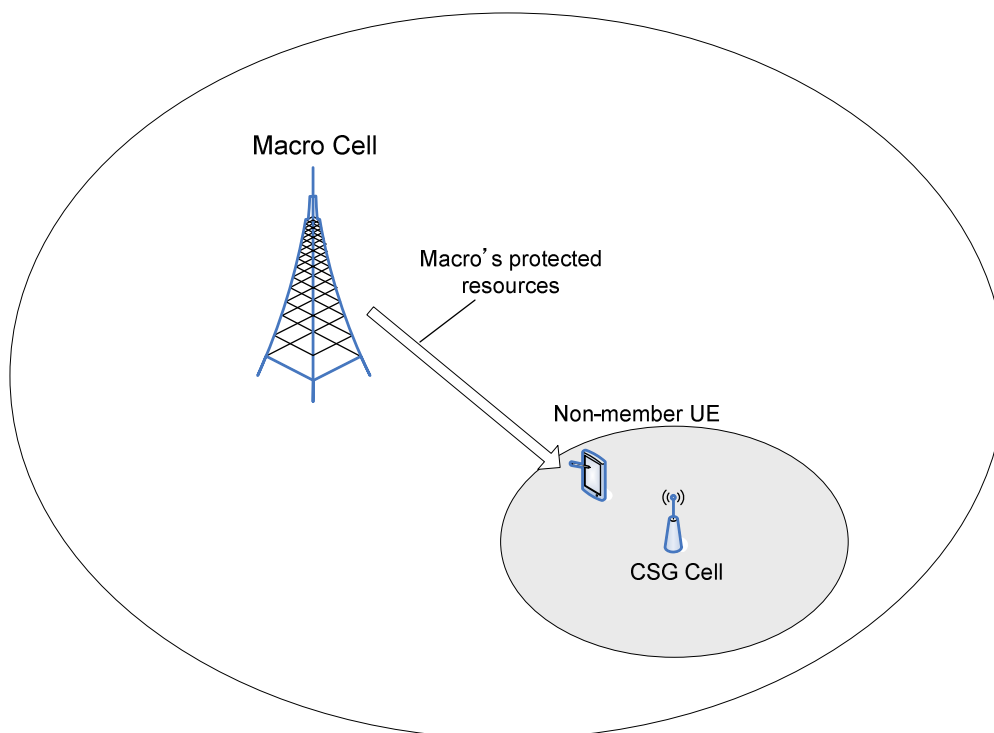

Figure K.1.1-1: Time domain ICIC: CSG scenario

In RRC_CONNECTED, the network can find out that the UE is subject to dominant interference from a CSG cell which the UE is not a member of through the existing measurement events (defined in release-8/9), at which point the network may choose to configure the RRM/RLM/CSI measurement resource restriction for the UE. The network may also configure RRM measurement resource restriction for neighbour cells in order to facilitate mobility from the serving macro cell. The network may release the RRM/RLM/CSI measurement resource restriction when it detects that the UE is no longer severely interfered by the CSG cell.

K.1.2 Pico scenario

Time domain ICIC may be utilized for pico users who served in the edge of the serving pico cell, e.g. for traffic off-loading from a macro cell to a pico cell. Time domain ICIC may be utilized to allow such UEs to remain served by the pico cell on the same frequency layer.

Such interference may be mitigated by the macro cell(s) utilizing Almost Blank Subframes to protect the corresponding pico cell's subframes from the interference. A UE served by a pico cell uses the protected resources for cell measurements (RRM), radio link monitoring (RLM) and CSI measurements for the serving pico cell.

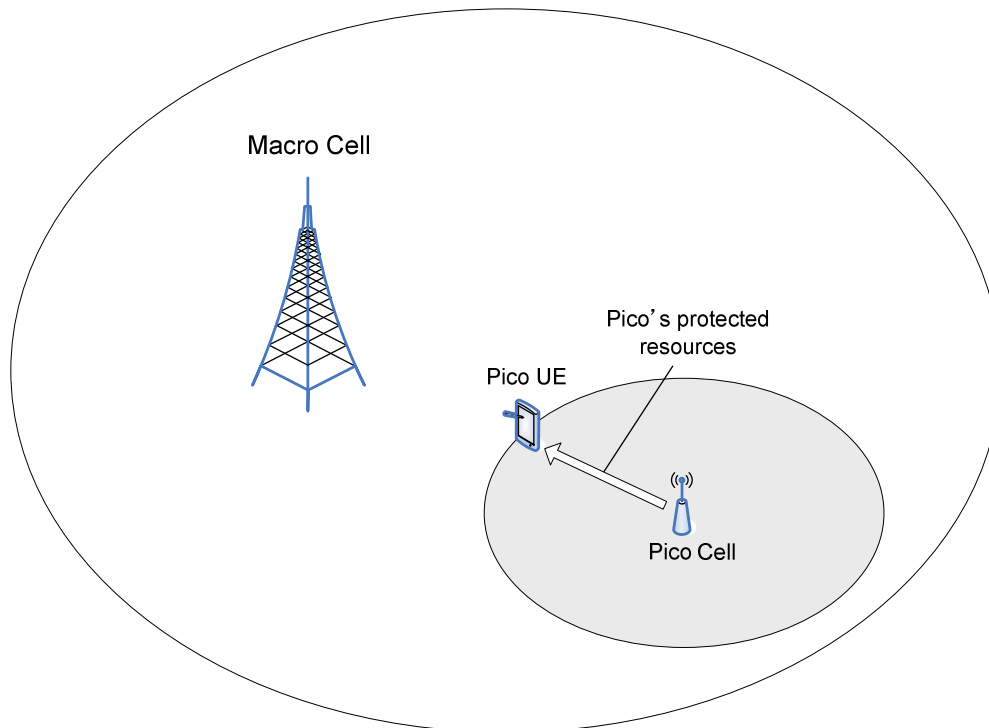

Figure K.1.2-1: Time domain ICIC: Pico scenario

For a UE served by a pico cell, the RRM/RLM/CSI measurement resource restriction may allow more accurate measurement of pico cell under strong interference from the macro cell(s). The pico cell may selectively configure the RRM/RLM/CSI measurement resource restriction only for those UEs subject to strong interference from the macro cell(s). Also, for a UE served by a macro cell, the network may configure RRM measurement resource restriction for neighbour cells in order to facilitate mobility from the macro cell to a pico cell.

Annex L (informative):
Void

Annex M (informative): Dual Connectivity

M.1 Dual Connectivity operation

For Dual Connectivity, the UE is configured with two cell groups (CGs). A CG may only include cells that are associated to the same eNB and those cells are synchronized at the eNB level similar as for carrier aggregation. Two operations are defined: synchronous and asynchronous DC. In synchronous DC operation, the UE can cope with a maximum reception timing difference up to at least 33 μ s and maximum transmission timing difference up to at least 35.21 μ s between CGs. In asynchronous DC operation, the UE can cope with a maximum reception/transmission timing difference up to 500 μ s between CGs.

When DC is deployed, frame timing and SFN are aligned among the component carriers to be aggregated within a CG, and may or may not be aligned between different CGs.

M.2 Operation Overview

Table M.2-1 below gives a network overview of the DC operations.

Table M.2-1: Dual Connectivity Operations

#	Network Action	Corresponding clause	Remarks
1	Intra-PCell Handover	10.1.2.8.2.1 Intra-MeNB handover involving SCG change	Causes also intra-PCell Change or Intra-SeNB Change. Also used for KeNB refresh. Done via Handover like in Rel-8; SCG can be retained during the Handover.
2	Intra-PCell SCG Change	10.1.2.8.2 SeNB Modification (MeNB initiated SeNB Modification) 10.1.2.8.2 SeNB Modification (SeNB initiated SeNB Modification)	Also used for S-KeNB refresh. Does not require intra-PCell Handover.
3	Intra-MeNB Handover	10.1.2.8.2.1 Intra-MeNB handover involving SCG change	Causes also intra-PCell Change or Intra-SeNB Change. Done via Handover like in Rel-8; SCG can be retained during the Change.
4	Intra-SeNB SCG Change	10.1.2.8.2 SeNB Modification (MeNB initiated SeNB Modification) 10.1.2.8.2 SeNB Modification (SeNB initiated SeNB Modification)	Requires SCG change but does not require intra-PCell Handover.
5	Inter-MeNB Handover	10.1.2.8.5 MeNB to eNB Change 10.1.2.8.7 eNB to MeNB change 10.1.2.8.8 Inter-MeNB handover without SeNB change	Done via Handover like in Rel-8; Involves SCG release, or intra SeNB Change or inter-SeNB Change.
6	Inter-SeNB SCG Change	10.1.2.8.4 Change of SeNB	Requires SCG change.
7	SCG addition by MeNB	10.1.2.8.1 SeNB Addition 10.1.2.8.7 eNB to MeNB change	Only the MeNB can request an SCG to be added.
8	SCG SCell addition by MeNB	10.1.2.8.2 SeNB Modification (MeNB initiated SeNB Modification)	Only the MeNB can request to add SCells to the SCG. If the SeNB wants to use the new SCell as PCell it needs to initiate an SeNB modification.
9	Non-last SCG SCell release by MeNB	10.1.2.8.2 SeNB Modification (MeNB initiated SeNB Modification)	For requesting the release of the last SCG SCell i.e. PCell, the MeNB has to request SCG release instead.
10	Non-last SCG SCell release by SeNB	10.1.2.8.2 SeNB Modification (SeNB initiated SeNB Modification)	For requesting the release of the last SCG SCell i.e. PCell, the SeNB has to request SCG release instead. The SeNB can request to release the PCell only if it also chooses a new PCell.

11	SCG release by MeNB	10.1.2.8.3 SeNB Release (MeNB initiated SeNB Release)	The MeNB can always request the release of the SCG and the SeNB has to comply.
12	SCG release by SeNB	10.1.2.8.3 SeNB Release (SeNB initiated SeNB Release)	The SeNB can always request the release of the SCG and the MeNB has to comply
13	SCG bearer addition by MeNB	10.1.2.8.2 SeNB Modification (MeNB initiated SeNB Modification) (10.1.2.8.1 MeNB initiated SeNB Addition)	If this is the first bearer to be added in the SeNB, SCG addition is used instead.
14	SCG bearer release	10.1.2.8.2 SeNB Modification (MeNB initiated SeNB Modification) 10.1.2.8.2 SeNB Modification (SeNB initiated SeNB Modification)	Allowed for both the MeNB and the SeNB, but the SeNB cannot request to release the last SCG bearer if that would result in no bearers in SeNB - SCG release should be used instead. The SeNB cannot initiate the release of an SCG bearer and make changes to <i>SCG-Config</i> at the same time e.g. change the configuration of the physical layer.
15	Split bearer addition by MeNB	10.1.2.8.2 SeNB Modification (MeNB initiated SeNB Modification)	
16	Split bearer release	10.1.2.8.2 SeNB Modification (MeNB initiated SeNB Modification) 10.1.2.8.2 SeNB Modification (SeNB initiated SeNB Modification)	Allowed for both the MeNB and the SeNB, but the SeNB cannot request to release the last split bearer if that would result in no bearers in SeNB - SCG release should be used instead. The SeNB cannot initiate the release of an SCG bearer and make changes to <i>SCG-Config</i> at the same time e.g. change the configuration of the physical layer.
17	MCG to SCG bearer type change (and vice versa)	10.1.2.8.2 SeNB Modification (MeNB initiated SeNB Modification) 10.1.2.8.2 SeNB Modification (SeNB initiated SeNB Modification)	Either the MeNB or the SeNB can request to release an SCG bearer. Done via SCG change, i.e. L2 reset is required for the UE. The SeNB can only request change from SCG to MCG by requesting release of SCG bearer. The MeNB makes the decision on whether to release the DRB entirely or change it to MCG bearer.
18	MCG to Split Bearer Change (and vice versa)	10.1.2.8.2 SeNB Modification (MeNB initiated SeNB Modification) 10.1.2.8.2 SeNB Modification (SeNB initiated SeNB Modification)	The SeNB can always request to release the SCG part of a split bearer. Done via SCG change, i.e. L2 reset is required for the UE. MeNB makes the decision on whether to release the DRB entirely or change it to MCG bearer.

Annex N (informative): Sidelink communication

N.1 Deployment Scenarios

Table N.1-1 shows scenarios for sidelink communication where UE A and UE B are located in-coverage /out-of-coverage of a cell. When UE A has a role as transmitter, UE A sends message and UE B receives it. UE A and UE B can change their transmission and reception role. The transmission from UE A can be received by one or more UEs like UE B.

Table N.1-1: Sidelink communication Scenarios

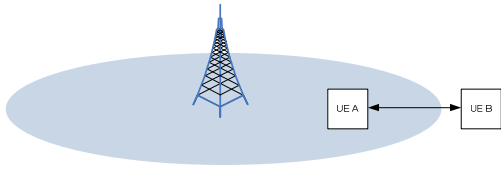
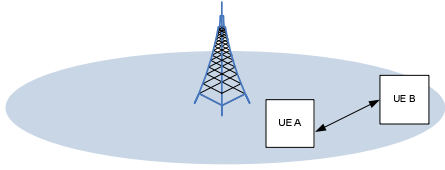
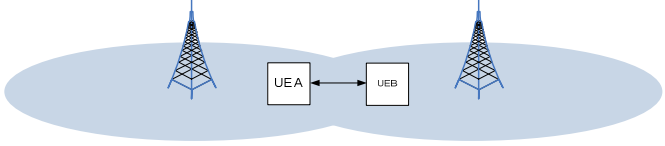
#	Description	UE A	UE B	Example
1A	Out-of-Coverage	Out-of-Coverage	Out-of-Coverage	
1B	Partial-Coverage	In-Coverage	Out-of-Coverage	
1C	In-Coverage-Single-Cell	In-Coverage	In-Coverage	
1D	In-Coverage-Multi-Cell	In-Coverage	In-Coverage	

Annex O (informative): E-UTRAN Architecture for Radio Access Network Sharing with multiple cell ID broadcast

Each E-UTRAN node serving a cell identified by a Cell Identity associated with a subset of PLMNs is connected to another E-UTRAN node via a single X2-C interface instance.

Each X2-C interface instance is setup and removed individually.

X2-C interface instances terminating at E-UTRAN nodes which share the same physical radio resources may share the same signalling transport resources. If this option is applied,

- non-UE associated signalling is associated to an X2-C interface instance by including an Interface Instance Indication in the X2AP message.

NOTE 1: The Interface Instance Indication is only included in EN-DC related X2AP messages.

- node related, non-UE associated X2-C interface signalling may provide information destined for multiple logical nodes in a single X2AP procedure instance once the X2-C interface instance is setup.

NOTE 2: If the Interface Instance Indication corresponds to more than one interface instance, the respective X2AP message carries information destined for multiple logical nodes.

- a UE associated signalling connection is associated to an X2-C interface instance by allocating the corresponding eNB UE X2AP IDs or en-gNB UE X2AP IDs so that they can be mapped to that X2-C interface instance.

NOTE 3: One possible implementation is to partition the value ranges of the eNB UE X2AP IDs or en-gNB UE X2AP IDs and associate each value range with an X2-C interface instance.

Annex P (informative): Change history

Change history (before approval)							
Date	TSG #	TSG Doc.	CR	Rev	Subject/Comment	Old	New
2006-06	RAN2 Ad.	R2-062020			First version.		0.0.0
2006-06	RAN2 Ad.	R2-062026			RLC operation clarified; High priority and low priority SRBs listed in RRC; New clause on RRC procedures; Organisation of paging groups explained; New clause on Support for self-configuration and self-optimisation.	0.0.0	0.0.1
2006-06	RAN2 Ad.	R2-062036			Four possible types of allocation added to clause 11; New clause for the support for real time IMS services.	0.0.1	0.0.2
2006-08	RAN2#54	R2-062206			Annex B on RRC and MAC control added. Minor editorial clarifications.	0.0.2	0.0.3
2006-09	RAN#34	RP-060603			Clause 4 on "Overall Architecture" reorganised; Details on RLC operation included (segmentation, PDU size); Overview of System Information and RACH procedure added.	0.0.3	0.0.4
2006-10	RAN2#55	R2-063012			Ciphering for RRC signalling required in eNB as agreed in SA3; Agreements on RLC operation included: concatenation, discard, polling and status reports; Agreed text proposal in R3-061428 on Self Configuration added to clause 19; Context transfer of header compression at UPE relocation listed as FFS. Outline of the RACH procedure described.	0.0.4	0.0.5
2006-10	RAN2#55	R2-063039			Miscellaneous editorial corrections; Agreed text proposal R3-061606 on Current status of E-UTRAN Architecture description added to clause 4; Agreed text proposal in R3-061613 on Support for self-configuration and self-optimisation added to clause 19. Agreed Physical layer model R2-063031 added to clause 5	0.0.5	0.1.0
2006-11	RAN2#56	R2-063656			Annex C on system information classification added (R2-063064); Integrity protection for the control plane only (SA3 agreement); Agreements on PDCP and RLC PDU structure/handling reflected; Decisions on mobility aspects such as load balancing, handover, radio link failure and random access procedure added; Agreed MBMS deployment scenarios listed together with MBMS transmissions and principles from 25.813; Agreed text proposal R3-061936 on Radio Resource Management added to clause 15; Agreed text proposal R3-061940 on RAN Sharing added to clause 10; Agreed text proposal R3-061943 on Roaming/Area Restrictions in SAE/LTE added to clause 10; Agreed text proposal R3-062008 on S1 C-Plane Functions and procedures added to clause 18; Agreed text proposal R3-062011 on X2 interface added to clause 19.	0.1.0	0.2.0
2006-11	RAN2#56	R2-063680			Incorporation of RAN1 agreement regarding the mandatory support of 20Mhz DL bandwidth for UEs i.e. removal of clause 16.1; Editorial corrections.	0.2.0	0.3.0
2006-11	RAN2#56	R2-063681			Removal of the SA3 agreement on integrity protection for the user plane; Addition of Annex D on MBMS Transmission; Editorial corrections.	0.3.0	0.3.1
2006-11	RAN#34	RP-060806			Clean version	0.3.1	0.3.1
2007-01	RAN2#56 bis	R2-070403			SA3 agreement on integrity protection for the user plane included (R2-070016); Annex E on drivers for mobility control added (R2-070276); Agreements on the details of the random access procedure added in clause 10.1.5 (R2-070365); New clause on UL rate control included (R2-070410); RRC security principles listed in clause 13.1 (R2-070044); Agreement on MAC security added to clause 13 (R2-062100); Basis for DL scheduling put in clause 11.1; Assumptions on neighbour cell list included in clause 10.	0.3.1	0.4.0
2007-02	RAN2#57	R2-070451			Number of bits for RACH in TDD clarified; Miscellaneous editorial corrections.	0.4.0	0.5.0
2007-02	RAN2#57	R2-071073			Architecture updated according to R3-070397; Agreements from R2-070802.	0.5.0	0.6.0

2007-02	RAN2#57	R2-071120			RACH model for initial access described; Mapping of the BCCH and System Information principles added; Agreements on DRX included in clause 12.	0.6.0	0.7.0
2007-02	RAN2#57	R2-071122			Miscellaneous clarifications	0.7.0	0.7.1
2007-02	RAN2#57	R2-071123			CCCH in DL listed as FFS; SAE Gateway ID removed from clause 8.2; PDCP for the control plane listed as FFS in clause 4.3.2; Agreements on intra-E-UTRAN handover procedure included in clause 10.1.2 (R3-062020).	0.7.1	0.8.0
2007-03	RAN2#57	R2-071124			Agreement on Radio Access Network Sharing (R2-070551) added to clause 10.1.7; Overview of the physical layer (R1-071251) included to clause 5; Agreed text proposals on <i>S1 interface</i> included in clause 19 (R3-070289, R3-070402); Agreed text proposal R3-070409 on <i>network sharing</i> included in clause 10.1.7; Agreed text proposal R3-070411 on <i>Area Restrictions</i> included in clause 10.4; Agreed text proposal R3-070448 on <i>Assembly of Intra-E-UTRAN handover command</i> included in clause 10.1.2.1.1; Agreed text proposal R3-070451 on <i>inter RAT HO principles</i> included in clause 10.2.2; Agreed text proposal R3-070472 on <i>Addressing on S1-C and X2-C</i> added to clauses 19.2 and 20.2; Agreed text proposal R3-070494 on <i>Initial Context Setup Function and Procedure</i> added to clause 19; Agreed text proposal R3-070495 on <i>S1 Paging function and procedure</i> added to clause 19 Figures for mapping between channels split into Uplink and Downlink parts in clause 5.3.1 and 6.1.3.	0.8.0	0.9.0
2007-03	RAN#35	RP-070136			S1-U and S1-MME used throughout the document; aGW replaced by EPC when still used; Clean version for information	0.9.0	1.0.0

Change history (after approval)							
Date	TSG #	TSG Doc.	CR	Rev	Cat	Subject/Comment	New version
2007-03	RP-35	RP-070136	-			Approved at TSG-RAN #35 and placed under Change Control	8.0.0
2007-06	RP-36	RP-070399	0001	1		Changes to management-, handover-, paging- and NAS functions, node-synchronization, X2 UP protocol stack, X2 inter cell load management, IP fragmentation, intra-LTE HO, and TA relation to cells in eNB	8.1.0
	RP-36	RP-070494	0002	1		Update on Mobility, Security, Random Access Procedure, etc...	8.1.0
	RP-36	RP-070399	0003	-		Update on MBMS	8.1.0
2007-09	RP-37	RP-070637	0004	1		Update on Security, System Information, Mobility, MBMS and DRX	8.2.0
	RP-37	RP-070637	0005	1		Correction of synchronization, handover, trace, eMBMS architecture, and S1 common functions and procedures	8.2.0
2007-12	RP-38	RP-070913	0006	1		Clean up and update on security, scheduling, mobility, MBMS and DRX	8.3.0
	RP-38	RP-070913	0007	-		Mobility management	8.3.0
	RP-38	RP-070913	0008	-		Correction of eMBMS functions and NAS handling during X2 handover	8.3.0
	RP-38	RP-071048	0009	-		Update of Stage 2 to incorporate Interworking with cdma2000	8.3.0
2008-03	RP-39	RP-080192	0010	-		CR to 36.300 on NAS States, Persistent Scheduling, C-RNTI Allocation at Handover...	8.4.0
	RP-39	RP-080192	0011	-		RAN3 corrections to 36.300 (CR0011)	8.4.0
2008-05	RP-40	RP-080406	0012	1		Introduction of optimized FS2 for TDD	8.5.0
	RP-40	RP-080406	0013	1		System Information, Mobilty, QoS and miscellaneous updates	8.5.0
	RP-40	RP-080406	0014	-		Updates to Stage 2 based on Stage 3 progress on CDMA inter-working	8.5.0
	RP-40	RP-080406	0016	1		CR 0016r1 to 36.300 on CSG mobility performance guidelines	8.5.0
	RP-40	RP-080406	0017	-		CR to 36.300 on AS-NAS interaction	8.5.0
	RP-40	RP-080420	0018	1		RAN3 agreed changes to TS 36.300	8.5.0
	RP-40	RP-080463	0019	-		Network Interface for ETWS support based on CBS solution	8.5.0
2008-09	RP-41	RP-080688	0020	-		Correction for Rename of L1/L2 control channel	8.6.0
	RP-41	RP-080688	0021	-		CR to 36.300 on Paging Channel Description	8.6.0
	RP-41	RP-080688	0022	-		Proposed updates to Stage 2 for CDMA2000 handover	8.6.0
	RP-41	RP-080688	0023	-		CR to 36.300 on Semi-Persistent Scheduling	8.6.0
	RP-41	RP-080688	0024	-		CR to 36.300 on System Information	8.6.0
	RP-41	RP-080688	0026	-		Clarification of PDCCH description	8.6.0
	RP-41	RP-080688	0027	-		Removal of DRX interval threshold in 36.300	8.6.0
	RP-41	RP-080688	0028	-		CR on Randon Access procedure	8.6.0
	RP-41	RP-080688	0032	1		Transport of NAS messages by AS during Handover	8.6.0
	RP-41	RP-080688	0034	-		CR to 36.300 capturing home eNB conclusions of RAN2 #63	8.6.0
	RP-41	RP-080688	0035	-		Changes to TS 36.300 agreed in RAN3#61	8.6.0

2008-12	RP-42	RP-081016	0036	-	CR0036 to 36.300 [Rel-8] on Contention Resolution	8.7.0
	RP-42	RP-081016	0037	-	CR0037 to 36.300 [Rel-8] on ETWS SIB	8.7.0
	RP-42	RP-081016	0038	-	Alignment of 36.300 with stage 3 on 1xRTT CSfallback	8.7.0
	RP-42	RP-081016	0039	1	Data handling in UE during Inter-RAT mobility	8.7.0
	RP-42	RP-081016	0040	-	Removing of end time for dedicated preamble	8.7.0
	RP-42	RP-081016	0041	-	Remove the Note about RA preamble for FS2	8.7.0
	RP-42	RP-081016	0042	-	Clarification of AS-NAS concatenation - Stage 2	8.7.0
	RP-42	RP-081016	0044	-	CR 0044 to 36.300 on Miscellaneous corrections	8.7.0
	RP-42	RP-081016	0046	1	Proposed CR to 36.300 [Rel-8] on Security Overview	8.7.0
	RP-42	RP-081016	0047	-	Proposed CR to 36.300 [Rel-8] on MBMS	8.7.0
	RP-42	RP-081016	0050	-	PDCP reordering function removal	8.7.0
	RP-42	RP-081016	0052	-	Align Number of Cell Identities	8.7.0
	RP-42	RP-081016	0055	2	Periodic Updates In Connected Mode DRX	8.7.0
	RP-42	RP-081016	0056	-	Cleaning of the figure w.r.t Handover Control Plane - CR to TS 36.300	8.7.0
	RP-42	RP-081016	0057	-	CR to 36.300 to capture measurement model for EUTRAN	8.7.0
	RP-42	RP-081016	0058	2	CSG Mobility Updates from RAN2 #63bis and RAN2 #64	8.7.0
	RP-42	RP-081016	0059	-	CR to 36.300 on Correction of the Description of FS2	8.7.0
	RP-42	RP-081016	0060	-	Changes to TS 36.300 agreed in RAN3#61bis and RAN3#62	8.7.0
2009-03	RP-43	RP-090123	0061	1	CR to 36.300 - Clarification on RAPreambles	8.8.0
	RP-43	RP-090123	0062	-	CR to 36.300 on E-UTRAN Identities	8.8.0
	RP-43	RP-090123	0063	1	CR to 36.300 - MME in temporary UE identity	8.8.0
	RP-43	RP-090123	0064	-	UE with SIM in EUTRA	8.8.0
	RP-43	RP-090123	0065	-	Collected 36.300 corrections	8.8.0
	RP-43	RP-090123	0066	-	CR for 36.300 on Local NACK feature	8.8.0
	RP-43	RP-090123	0067	-	CR for allowed CSG list	8.8.0
	RP-43	RP-090123	0068	3	UE capability transfer upon handover to E-UTRA	8.8.0
	RP-43	RP-090123	0069	1	Inter-RAT ANR Function for CDMA2000	8.8.0
	RP-43	RP-090123	0070	-	Corrections to Handover Scenario	8.8.0
	RP-43	RP-090123	0071	-	Corrections to Security for alignment with 33.401	8.8.0
	RP-43	RP-090134	0072	-	Establishment of X2 Interface to HeNB GW	8.8.0
	RP-43	RP-090134	0073	-	Clarification of PLMN id to be used in E-CGI and Global eNB ID	8.8.0
	RP-43	RP-090134	0074	-	Specification of UL PDUs handling	8.8.0
	RP-43	RP-090134	0075	-	Update of AMBR Concept with UE-AMBR and APN-AMBR	8.8.0
	RP-43	RP-090134	0076	-	Aligning E-RAB release request procedure with E-RAB release indication in 36.413	8.8.0
	RP-43	RP-090134	0077	-	Stage 2 CR on S1 CDMA2000 Tunnelling Function	8.8.0
	RP-43	RP-090134	0078	-	Finalisation of dynamic configuration of the X2 and S1 interfaces	8.8.0
	RP-43	RP-090134	0079	-	Addition and correction of X2 procedures in stage 2 specification	8.8.0
	RP-43	RP-090134	0080	-	NNSF Description	8.8.0
	RP-43	RP-090134	0081	-	Collection of minor corrections to 36.300 agreed by RAN3	8.8.0
	RP-43	RP-090134	0082	-	Data Forwarding Resource Release	8.8.0
	RP-43	RP-090134	0083	-	Support of Paging Optimisation for CSG cells	8.8.0
	RP-43	RP-090134	0084	-	Handling of trace session and location reporting during UE context release	8.8.0
2009-06	RP-44	RP-090507	0085	-	Proposed CR to 36.300 on RLC status report triggers	8.9.0
	RP-44	RP-090507	0086	2	Updates on UE capability transfer and container handling for E-UTRA	8.9.0
	RP-44	RP-090507	0089	-	Proposed CR to 36.300 Rel-8 on FFS and outdated statements	8.9.0
	RP-44	RP-090508	0096	-	Removal of no longer necessary notes	8.9.0
	RP-44	RP-090508	0097	-	Introduction of support for Cell traffic trace	8.9.0
	RP-44	RP-090508	0098	-	Correction the text about the UE History Information	8.9.0
	RP-44	RP-090538	0102	-	Configuration transfer	8.9.0
2009-06	RP-44	-	-	-	TS 36.300 v9.0.0 was created based on TS 36.300 v8.9.0	9.0.0
	RP-44	RP-090523	0087	1	MBMS baseline for Rel-9 LTE	9.0.0
	RP-44	RP-090524	0088	-	Idle mode requirements to support Hybrid Cells	9.0.0
	RP-44	RP-090523	0099	-	eMBMS Stage 2 description	9.0.0
	RP-44	RP-090523	0100	-	CR for eMBMS Deployment Alternatives in 36.300	9.0.0
	RP-44	RP-090534	0101	1	QoS support for Hybrid CSG cells	9.0.0
	RP-44	RP-090537	0103	-	TAI based handover routing for HeNBs	9.0.0
2009-09	RP-45	RP-090906	0106	1	Correction regarding SRVCC	9.1.0
	RP-45	RP-090906	0108	-	Clarification on UE behaviour in case of L2 buffer overflow	9.1.0
	RP-45	RP-090926	0112	1	IMS Emergency Call	9.1.0
	RP-45	RP-090927	0113	-	Introduction of position cause for dedicated PRACH allocation	9.1.0
	RP-45	RP-090929	0114	-	Adding Support for Explicit Congestion Notification	9.1.0
	RP-45	RP-090930	0115	2	Agreements on inbound mobility to CSG	9.1.0
	RP-45	RP-090934	0116	-	Alignment to the stage3 specification	9.1.0
	RP-45	RP-090928	0117	2	MBMS agreements RAN2#66bis and RAN2#67	9.1.0
	RP-45	RP-090934	0123	-	CR to 36.300 for Stage 2 alignment of Enhanced CSFB to 1xRTT	9.1.0
	RP-45	RP-090906	0129	-	Corrections to ECGI Specification	9.1.0
	RP-45	RP-090932	0130	-	Support for Mobility Robustness Optimization SON Function	9.1.0
	RP-45	RP-090919	0132	-	Addition of missing Resource Status Reporting procedures	9.1.0
	RP-45	RP-090931	0133	-	HeNB Access Mode Signalling	9.1.0

	RP-45	RP-090931	0134	-		QoS principles in Hybrid access cell	9.1.0
	RP-45	RP-090933	0136	-		Introduction of PWS (which includes ETWS and CMAS) delivery function	9.1.0
	RP-45	RP-090928	0137	1		Dynamic service multiplexing	9.1.0
	RP-45	RP-090928	0138	-		MBMS SYNC configuration	9.1.0
	RP-45	RP-090932	0140	-		Adding Mobility Load Balancing (MLB) use case to the SON clause	9.1.0
	RP-45	RP-090919	0141	-		Handling of Radio Link Failure and S1 UE Context Release Request	9.1.0
	RP-45	RP-090919	0142	-		Introduction of informative text on Initial Context Setup failure	9.1.0
	RP-45	RP-090931	0143	-		Support for paging optimization with CSG membership changes	9.1.0
2009-12	RP-46	RP-091314	0145	-		CR on the usage of Transparent Mode MAC	9.2.0
	RP-46	RP-091343	0146	2		Capturing HeNB inbound mobility agreements	9.2.0
	RP-46	RP-091331	0148	1		ETWS correction to 36.300	9.2.0
	RP-46	RP-091314	0150	-		Inclusion of INTER RAT HANDOVER INFO at HO from UTRAN to GERAN	9.2.0
	RP-46	RP-091341	0151	1		MBMS Agreements	9.2.0
	RP-46	RP-091346	0152	-		Measurement Overview	9.2.0
	RP-46	RP-091345	0153	1		High level feature description of CMAS	9.2.0
	RP-46	RP-091344	0154	1		RACH optimization in 36.300	9.2.0
	RP-46	RP-091314	0156	1		Correction on the precondition for cell reselection to HRPD	9.2.0
	RP-46	RP-091346	0158	1		Miscellaneous corrections to 36.300 (Rel-9)	9.2.0
	RP-46	RP-091343	0162	-		Renaming Allowed CSG List (36.300, Rel-9)	9.2.0
	RP-46	RP-091344	0165	-		The scope and method for HO negotiations	9.2.0
	RP-46	RP-091151	0166	1		Access control for handover procedures to LTE CSG/hybrid cells	9.2.0
	RP-46	RP-091341	0167	-		Admission Control in MCE	9.2.0
	RP-46	RP-091341	0168	-		Clarification on SFN Synchronization	9.2.0
	RP-46	RP-091341	0169	1		BMSC-MCE signaling synchronization in session start message	9.2.0
	RP-46	RP-091341	0170	-		CR on multiplexing decision and DSP length	9.2.0
	RP-46	RP-091237	0171	1		M3AP stage 2	9.2.0
	RP-46	RP-091150	0172	1		M2AP stage 2	9.2.0
	RP-46	RP-091340	0173	-		CR for Transportation support for LPPa	9.2.0
	RP-46	RP-091341	0174	-		Introduction of MBMS for LTE: C- and U-Plane synchronisation principles	9.2.0
	RP-46	RP-091341	0175	-		CR on Mechanism for Consecutive Packet Loss in 36.300	9.2.0
	RP-46	RP-091332	0177	-		Overload reduction	9.2.0
	RP-46	RP-091344	0178	-		The scope and method for HO negotiations	9.2.0
	RP-46	RP-091344	0179	-		Introduction of MRO procedures in stage 2	9.2.0
	RP-46	RP-091341	0180	1		MCE to MME session start response	9.2.0
	RP-46	RP-091332	0182	-		In order delivery of the multiple NAS PDUs	9.2.0
2010-03	RP-47	RP-100305	0183	-		Correction regarding support of multiple MBSFN areas	9.3.0
	RP-47	RP-100305	0184	1		Correction to MBMS terminology	9.3.0
	RP-47	RP-100305	0185	-		Corrections on eNB muting MBSFN transmission	9.3.0
	RP-47	RP-100305	0186	-		Corrections to TS 36.300 on MBMS	9.3.0
	RP-47	RP-100306	0187	-		CR capturing HeNB inbound mobility agreements	9.3.0
	RP-47	RP-100308	0188	-		Remove FFs from RAN2 specifications	9.3.0
	RP-47	RP-100296	0189	-		SIM based access for Emergency calls in LTE	9.3.0
	RP-47	RP-100304	0191	-		RA for Positioning	9.3.0
	RP-47	RP-100305	0192	-		Corrections to TS 36.300 on MBMS	9.3.0
	RP-47	RP-100308	0196	1		Stage 2 update for Full Configuration Handover for handling earlier eNB releases	9.3.0
	RP-47	RP-100296	0197	-		Handling Ksme mismatch for IMS Emergency calls	9.3.0
	RP-47	RP-100308	0199	-		Correction to MTU endpoint	9.3.0
	RP-47	RP-100307	0200	-		Stage 2 correction of Load Reporting for MLB	9.3.0
	RP-47	RP-100307	0201	-		CR for Allowed Range in Negotiation	9.3.0
	RP-47	RP-100307	0202	-		Clarification of definitions of HO failure cases	9.3.0
	RP-47	RP-100307	0203	-		Clarification on the usage of the mechanism to transfer IRAT MLB information	9.3.0
	RP-47	RP-100305	0204	-		MBMS Session Update in M3AP stage 2	9.3.0
	RP-47	RP-100305	0205	-		Correction on radio bearer configuration	9.3.0
	RP-47	RP-100305	0206	-		Correction to the MSAP occasion implied by SYNC timestamp	9.3.0
	RP-47	RP-100305	0207	-		MCCH related BCCH content	9.3.0
	RP-47	RP-100305	0208	-		MCCH update synchronization	9.3.0
	RP-47	RP-100305	0209	-		MBMS Session Update in M2AP stage 2	9.3.0
	RP-47	RP-100305	0210	-		CR for MBMS User Data flow synchronisation in 36.300	9.3.0
	RP-47	RP-100305	0211	-		MBMS User Data flow synchronisation	9.3.0
	RP-47	RP-100305	0212	-		Packet dropping	9.3.0
	RP-47	RP-100305	0213	-		SYNC sequence duration configuration in MCE	9.3.0
	RP-47	RP-100305	0214	-		Adding the description of simultaneously change of SIB13 and MCCH	9.3.0
	RP-47	RP-100305	0215	-		Addition u-plane protocol stack for M1	9.3.0
	RP-47	RP-100295	0217	-		Queue concurrent NAS messages if necessary for in seq delivery	9.3.0
	RP-47	RP-100295	0219	-		Support of X2 Inter-PLMN HO	9.3.0
	RP-47	RP-100300	0220	-		Clarifications on CSG process definition and mobility procedures	9.3.0
	RP-47	RP-100300	0221	-		Corrections of HeNB	9.3.0
	RP-47	RP-100300	0222	-		CSG expiry Handling	9.3.0

	RP-47	RP-100295	0224	-	eNB/MME Status Transfer procedure	9.3.0
	RP-47	RP-100308	0225	-	SPID implementation guidelines	9.3.0
	RP-47	RP-100308	0226	-	Handling of handover restriction for emergency call	9.3.0
	RP-47	RP-100300	0227	-	Some corrections for HeNB	9.3.0
2010-06	RP-48	RP-100556	0228	-	CR to 36.300 for CSFB to 1xRTT	9.4.0
	RP-48	RP-100554	0229	1	Proposed CR to 36.322 on RLC re-establishment for MBMS	9.4.0
	RP-48	RP-100551	0231	-	Stage2 correction for HeNB inbound handover	9.4.0
	RP-48	RP-100554	0235	-	CR to 36.300 on MBMS terminology	9.4.0
	RP-48	RP-100570	0238	1	Add MOBILITY SETTINGS CHANGE Procedure to X2-CP Procedure clause	9.4.0
	RP-48	RP-100556	0239	-	Introduction of trace functions and procedures in S1 clauses of 36.300 (contact: Motorola)	9.4.0
	RP-48	RP-100554	0240	-	Correction of Synchronization Sequence (contact: Alcatel-Lucent Shanghai Bell, Alcatel-Lucent)	9.4.0
	RP-48	RP-100552	0241	-	Clarification of CSG / Hybrid cell definitions (contact: Ericsson)	9.4.0
	RP-48	RP-100555	0242	-	SON stage 2 clean up (contact: Samsung, Nokia Siemens Networks)	9.4.0
	RP-48	RP-100555	0243	-	Updating Stage-2 on R9 Automatic Neighbour Relation Function (contact: ETRI, Samsung)	9.4.0
	RP-48	RP-100554	0244	1	Adding of description in EUTRAN for IP Multicast (contact: NEC)	9.4.0
	RP-48	RP-100556	0245	-	Correction of trace failure description in Stage 2 (contact: NEC, Motorola, Huawei)	9.4.0
	RP-48	RP-100554	0246	-	Correction of packet dropping (contact: Alcatel-Lucent Shanghai Bell, Alcatel-Lucent)	9.4.0
	RP-48	RP-100552	0247	-	Clarification of paging optimization (contact: Qualcomm)	9.4.0
2010-06	RP-48	-	-	-	TS 36.300 v10.0.0 was created based on TS 36.300 v9.4.0	10.0.0
	RP-48	RP-100561	0230	3	Stage 2 description of Carrier Aggregation	10.0.0
	RP-48	RP-100562	0232	1	Stage-2 description of relaying into 36.300	10.0.0
2010-09	RP-49	RP-100865	0248	4	Corrections and new Agreements on Carrier Aggregation	10.1.0
	RP-49	RP-100866	0249	1	36.300 CR for stage 2 RAN #70bis and #71 agreements of relaying	10.1.0
	RP-49	RP-100866	0255	-	Start-up procedure for relays	10.1.0
	RP-49	RP-100851	0257	-	Keeping neighbouring eNBs up-to-date with complete list of served cells (contact: NSN)	10.1.0
	RP-49	RP-100851	0259	-	Description of Energy Saving mechanisms (contact: Ericsson)	10.1.0
	RP-49	RP-100866	0260	-	Handover request routing toward RN (contact: Huawei)	10.1.0
	RP-49	RP-100853	0262	-	MBMS Session Update procedure (contact: Motorola)	10.1.0
	RP-49	RP-100860	0264	-	CS Fallback Indication and Handover Restriction List (contact: NEC)	10.1.0
	RP-49	RP-100866	0265	-	X2-AP non UE dedicated messages handling (contact: Huawei)	10.1.0
	RP-49	RP-100866	0266	-	Detach procedure for relays (contact: NTT DOCOMO)	10.1.0
	RP-49	RP-100866	0267	1	RN and DeNB OAMs should be able to exchange info (contact: Ericsson)	10.1.0
	RP-49	RP-100882	0268	-	CSFB summary	10.1.0
2010-12	RP-50	RP-101226	0269	2	Corrections and new agreements on Carrier Aggregation	10.2.0
	RP-50	RP-101206	0271	-	36300_CRxxx_Handover for Hybrid Cells	10.2.0
	RP-50	RP-101208	0273	-	Correction on MAC padding on MCH	10.2.0
	RP-50	RP-101228	0274	3	Additions and corrections to relaying description	10.2.0
	RP-50	RP-101231	0275	1	LTE - Stage 2 agreements on MBMS enhancement	10.2.0
	RP-50	RP-101214	0276	1	CR to 36.300 adding e1xCSFB support for dual Rx/Tx UE	10.2.0
	RP-50	RP-101214	0277	-	Editorial Clean-Up	10.2.0
	RP-50	RP-101229	0278	1	Introduction of enhanced ICIC	10.2.0
	RP-50	RP-101214	0285	2	Setting of Maximum Bit Rate (MBR) to be greater than the Guaranteed Bit Rate (GBR) over E-UTRA: MBR enforcement at eNB side.	10.2.0
	RP-50	RP-101214	0286	-	CR for Description of Energy Saving	10.2.0
	RP-50	RP-101228	0287	-	S1 non UE associated message handling	10.2.0
	RP-50	RP-101214	0288	-	Clarification to ANR Operation	10.2.0
	RP-50	RP-101228	0289	-	P-GW function embedded in DeNB and addressing requirements	10.2.0
	RP-50	RP-101228	0290	-	eNB Configuration Update procedure in RN startup and detach procedure	10.2.0
	RP-50	RP-101231	0291	-	Introduction of MCE initiated MBMS Session Start Request	10.2.0
	RP-50	RP-101228	0292	-	No NNSF function in RN	10.2.0
	RP-50	RP-101228	0293	-	S1 handover routing toward RN	10.2.0
	RP-50	RP-101228	0294	-	TNL address Handling	10.2.0
	RP-50	RP-101214	0295	-	Correction on SPID Transfer	10.2.0
	RP-50	RP-101231	0296	-	Support of ARP Pre-emption	10.2.0
	RP-50	RP-101231	0297	-	Support of MBMS Service Counting Report procedure	10.2.0
	RP-50	RP-101222	0298	-	Stage 2 for the X2 based mobility enhancement between HeNBs	10.2.0
	RP-50	RP-101230	0299	-	Introduction of event-triggered inter-RAT cell load reporting	10.2.0
	RP-50	RP-101216	0300	-	Introduction of LIPA function	10.2.0
	RP-50	RP-101228	0301	-	OAM requirements for QCI to DSCP mapping config for relays	10.2.0
	RP-50	RP-101228	0302	-	Non UE associated message handling	10.2.0
	RP-50	RP-101224	0303	-	Introduction of MTC Overload Support	10.2.0
	RP-50	RP-101228	0304	-	Relay Node Un Signalling Transport Support	10.2.0
	RP-50	RP-101214	0305	-	Complete S1 Interface Signalling Procedures	10.2.0

	RP-50	RP-101229	0306	1		X2 procedure and OAM requirements to support eICIC	10.2.0
	RP-50	RP-101228	0307	-		Stage-2 updates to RN initial attachment	10.2.0
	RP-50	RP-101230	0308	-		Functionality of SON MRO defined for Rel.10	10.2.0
2011-03	RP-51	RP-110280	0309	-		Enforcing uplink MBR in the eNodeB	10.3.0
	RP-51	RP-110291	0310	-		Implementation Updates on Non-UE associated S1X2 message Handling	10.3.0
	RP-51	RP-110292	0311	-		Introduction of 2 subsets for pattern 3	10.3.0
	RP-51	RP-110280	0312	-		MBR management for uplink grant	10.3.0
	RP-51	RP-110289	0313	-		Measurements in CA	10.3.0
	RP-51	RP-110289	0314	1		Annex J Clean Up	10.3.0
	RP-51	RP-110291	0317	-		Stage-2 relay updates	10.3.0
	RP-51	RP-110291	0320	2		stage-2 clarification on relay security	10.3.0
	RP-51	RP-110280	0321	-		stage-2 Clarification on handover and system information description	10.3.0
	RP-51	RP-110280	0324	-		CR to 36.300 adding UE capability indicator for dual Rx/Tx e1xCSFB	10.3.0
	RP-51	RP-110292	0328	1		Update of Inter-cell Interference Coordination Feature Description	10.3.0
	RP-51	RP-110292	0330	1		CR on ABS definition	10.3.0
	RP-51	RP-110280	0331	-		Fix incorrect name for CT4 GTP message in HO Procedure	10.3.0
	RP-51	RP-110280	0332	-		CR for MBMS User Data flow synchronisation	10.3.0
	RP-51	RP-110294	0333	-		Remove Procedure Lists for MBMS	10.3.0
	RP-51	RP-110283	0334	-		Routing functionality for X2 handover between HeNB	10.3.0
	RP-51	RP-110291	0335	-		Update to OAM Traffic QoS requirements	10.3.0
	RP-51	RP-110278	0336	-		Completion of LIPA feature	10.3.0
	RP-51	RP-110293	0337	-		Editorial update for inter-RAT load reporting	10.3.0
	RP-51	RP-110280	0338	-		Correction of MBMS Deployment consideration	10.3.0
	RP-51	RP-110292	0339	-		OAM requirement for time domain eICIC for macro-pico scenario	10.3.0
	RP-51	RP-110293	0340	-		Cleanup of MRO	10.3.0
	RP-51	RP-110291	0341	-		Stage-2 Updates of Relaying	10.3.0
	RP-51	RP-110278	0342	-		Clean up of LIPA	10.3.0
	RP-51	RP-110272	0344	-		Correction to usage of Handover Report for MRO	10.3.0
	RP-51	RP-110291	0345	-		Clarification of the RN authorisation	10.3.0
	RP-51	RP-110293	0346	-		Requirements for OAM control of MRO	10.3.0
	RP-51	RP-110278	0347	-		LIPA packets reordering in downlink	10.3.0
	RP-51	RP-110282	0348	-		Support for MDT	10.3.0
	RP-51	RP-110280	0349	-		Introduction of a Stepwise Load Reduction Indication for the Overload procedure in Stage 2	10.3.0
	RP-51	RP-110294	0350	-		Remove FFS on Differentiating the Receiving or Interested UEs	10.3.0
	RP-51	RP-110223	0352	-		Correction on MBMS Reset procedure	10.3.0
	RP-51	RP-110291	0353	-		Clarification of RN Architecture and Startup	10.3.0
	RP-51	RP-110291	0354	-		Miscellaneous small corrections to TS 36.300 on Relay	10.3.0
	RP-51	RP-110294	0355	-		Suspension and Resume function	10.3.0
	RP-51	RP-110280	0356	-		Correction on physical layer part on TS 36.300	10.3.0
	RP-51	RP-110405	0358	3		CSFB to GERAN	10.3.0
2011-06	RP-52	RP-110839	0359	-		clarification on redirection in 36.300	10.4.0
	RP-52	RP-110850	0360	-		CR to 36.300 for eICIC updates	10.4.0
	RP-52	RP-110836	0361	-		Update of the MCCH Structure description for CountingRequest message	10.4.0
	RP-52	RP-110839	0362	-		Miscellaneous corrections to 36.300	10.4.0
	RP-52	RP-110850	0363	1		Correctoin on eICIC description	10.4.0
	RP-52	RP-110839	0365	2		Some small corrections to 36.300	10.4.0
	RP-52	RP-110846	0369	-		UE receiver window for Inter-band non-contiguous CA	10.4.0
	RP-52	RP-110843	0370	1		Capture the stage2 RLF agreement	10.4.0
	RP-52	RP-110839	0372	-		Clarification on MME selection	10.4.0
	RP-52	RP-110839	0373	-		Correction on the Release of Supporting SRVCC	10.4.0
	RP-52	RP-110839	0374	-		Correction of the area restrictions description	10.4.0
	RP-52	RP-110839	0375	-		Correcting the Note regarding the usage of the GUMMEI	10.4.0
	RP-52	RP-110836	0376	-		Correction of Counting Function	10.4.0
	RP-52	RP-110836	0377	-		Correction of MBMS Service Suspension and Resumption Function	10.4.0
	RP-52	RP-110849	0378	-		Relaying Stage 2 Corrections	10.4.0
	RP-52	RP-110839	0379	-		Correction of Reset	10.4.0
	RP-52	RP-110839	0380	-		Cleanup general topics before Rel-10 closure	10.4.0
	RP-52	RP-110839	0381	-		Cleanup of HeNB related topics before Rel-10 closure	10.4.0
	RP-52	RP-110713	0382	-		Clarification to detection of unnecessary IRAT handover	10.4.0
	RP-52	RP-110714	0383	-		Release the UE context in the source HeNB-GW after HeNB-HeNB X2 HO	10.4.0
	RP-52	RP-110851	0384	-		Corrections of MRO	10.4.0
2011-09	RP-53	RP-111280	0388	-		RLC/MAC synchronization for MBSFN	10.5.0
	RP-53	RP-111297	0390	-		Miscellaneous correction to 36.300 on Security Overview	10.5.0
	RP-53	RP-111297	0391	-		Corrections to 1xRTT CS Fallback	10.5.0
	RP-53	RP-111287	0392	-		Corrections on MCCH and MBMS counting	10.5.0
	RP-53	RP-111297	0393	-		Correction on the MME Direct Information Transfer procedure	10.5.0
	RP-53	RP-111290	0394	-		Security Mechanism for H(e)NB "no-IPsec" usage option	10.5.0
	RP-53	RP-111287	0395	-		Correction of MBMS Suspension Function	10.5.0
	RP-53	RP-111288	0396	-		Cleanup of editor's notes for relay	10.5.0

	RP-53	RP-111292	0397	-		Correction on LIPA PDN Deactivation for X2 HO	10.5.0
	RP-53	RP-111290	0398	-		Correction of Release Indication	10.5.0
	RP-53	RP-111297	0399	-		Correction of Trace Function	10.5.0
	RP-53	RP-111288	0400	-		RN security correction	10.5.0
	RP-53	RP-111297	0401	-		Correction of Emergency Call	10.5.0
	RP-53	RP-111290	0402	-		Overload Handling by HeNB GW	10.5.0
	RP-53	RP-111287	0403	-		Synchronisation of MBMS Service Resumption	10.5.0
	RP-53	RP-111287	0404	-		Miscellaneous Correction for MBMS	10.5.0
	RP-53	RP-111291	0405	1		Small correction on unnecessary IRAT HO	10.5.0
	RP-53	RP-111297	0406	-		Clarification of TAI handling between MME and HeNB(-GW)	10.5.0
2011-12	RP-54	RP-111714	0411	-		Correction on RN security	10.6.0
	RP-54	RP-111711	0413	-		HeNB Architecture Clarification	10.6.0
	RP-54	RP-111604	0414	1		Correction of Support for RACH optimization	10.6.0
	RP-54	RP-111711	0415	-		Correction of inbound mobility	10.6.0
	RP-54	RP-111714	0416	-		Correction of MBMS Resumption Function	10.6.0
	RP-54	RP-111711	0418	-		Routing of MME Direct Information Transfer message	10.6.0
	RP-54	RP-111714	0419	-		Correction of support for Mobility Robustness Optimisation	10.6.0
	RP-54	RP-111714	0420	-		Clarification of MRO Unnecessary Handover	10.6.0
	RP-54	RP-111716	0421	-		Correction of the MRO stage-2 description	10.6.0
2011-12	RP-54	-	-	-		TS 36.300 v11.0.0 was created based on TS 36.300 v10.6.0	11.0.0
	RP-54	RP-111644	0417	1		MME behavior in case of broken SCTP connection	11.0.0
	RP-54	RP-111721	0422	-		Addition of M3 Setup	11.0.0
	RP-54	RP-111721	0423	-		Correction of MCCH Update Synchronization mechanism	11.0.0
2012-03	RP-55	RP-120327	0425	-		Correction to the handling of RRC container during the inter-RAT handover	11.1.0
	RP-55	RP-120329	0431	-		Correction on MME/eNB behaviour in case of broken SCTP connection	11.1.0
	RP-55	RP-120329	0432	-		Correction of Emergency Call	11.1.0
	RP-55	RP-120232	0434	-		Correction on unnecessary HO	11.1.0
	RP-55	RP-120326	0435	-		CR for clarification of eMBMS architecture description	11.1.0
	RP-55	RP-120326	0437	-		Restriction on Rel-10 X2-based handover between HeNBs	11.1.0
2012-06	RP-56	RP-120821	0439	3		Introduction of service continuity improvements for MBMS on LTE	11.2.0
	RP-56	RP-120807	0441	-		Clarification on networking sharing for MBMS	11.2.0
	RP-56	RP-120812	0444	-		Correction to Measurement Restriction Description of eICIC in 36.300	11.2.0
	RP-56	RP-120817	0445	-		Introduction of Absolute Priority Based Cell Reselection to CELL_FACH in 36.300	11.2.0
	RP-56	RP-120823	0446	1		Stage-2 CR on signalling and procedure for interference avoidance for IDC	11.2.0
	RP-56	RP-120822	0450	3		Stage 2 CR on eDDA UE assistance information	11.2.0
	RP-56	RP-120813	0452	1		Korean Public Alert System (KPAS) and EU-Alert in relation to CMAS	11.2.0
	RP-56	RP-120819	0453	1		Introduction of MDT enhancements - multi-PLMN RLF Report	11.2.0
	RP-56	RP-120811	0456	-		Correction on Session Start and Session Stop procedure	11.2.0
	RP-56	RP-120812	0457	-		Correction of the MRO definitions	11.2.0
	RP-56	RP-120812	0459	-		Clarification on MME's support for inter-PLMN handover to CSG and hybrid cells	11.2.0
	RP-56	RP-120811	0461	-		GUMMEI handling by RN and HeNB	11.2.0
	RP-56	RP-120811	0462	-		Clarification on TAC in X2 Setup	11.2.0
	RP-56	RP-120811	0463	-		Correction of Session Update	11.2.0
	RP-56	RP-120824	0464	-		Addition of Energy Saving function for Inter-RAT scenario	11.2.0
	RP-56	RP-120807	0465	-		MCE and MBSFN role for distributed MCE architecture	11.2.0
	RP-56	RP-120881	0470	1		PCI range note on RAN sharing	11.2.0
2012-09	RP-57	RP-121371	0472	-		Introduction of EAB	11.3.0
	RP-57	RP-121395	0475	-		Corrections to physical channels of RN and the number of measurement types	11.3.0
	RP-57	RP-121374	0476	1		Network Based Positioning Support	11.3.0
	RP-57	RP-121379	0481	-		36300_CR on the addition of the stage-2 agreements on IDC	11.3.0
	RP-57	RP-121377	0483	1		Introduction of Carrier aggregation enhancements	11.3.0
	RP-57	RP-121137	0493	-		Support of MBMS Service Continuity	11.3.0
	RP-57	RP-121140	0494	-		Correction of GUMMEI	11.3.0
	RP-57	RP-121382	0495	-		Verification of HeNB Identity	11.3.0
	RP-57	RP-121140	0496	-		Introduction of UE Radio Capability Match procedure	11.3.0
	RP-57	RP-121372	0497	-		Support for inter-RAT MRO	11.3.0
	RP-57	RP-121140	0498	-		EAB for CN Overload Control	11.3.0
	RP-57	RP-121372	0499	-		Description of the failure information retrieval function for SON MRO purposes	11.3.0
	RP-57	RP-121372	0500	-		Description of the inter-RAT ping-pong problem	11.3.0
	RP-57	RP-121138	0501	-		Addition of UE measurements solution for Inter-RAT energy saving scenario	11.3.0
2012-12	RP-58	RP-121953	0502	-		Addition of the stage-2 agreements on IDC	11.4.0
	RP-58	RP-121940	0503	-		Clarification on PCell SIB15	11.4.0
	RP-58	RP-121957	0504	-		Clarification on Radio link failure recovery	11.4.0
	RP-58	RP-121959	0505	-		CR to 36.300 on introducing ROHC context continue for intra-ENB handover	11.4.0

	RP-58	RP-121958	0506	-		Introduction of network sharing for CDMA2000 inter-working	11.4.0
	RP-58	RP-121932	0510	-		Correction on effect of MBMS on unicast mobility procedures	11.4.0
	RP-58	RP-121957	0512	-		Clarification on sending timing advance updates	11.4.0
	RP-58	RP-121957	0513	-		Clarification on inter-RAT handover	11.4.0
	RP-58	RP-121932	0518	-		Correction to padding on RLC UM PDU corresponding to MTCH/MCCH	11.4.0
	RP-58	RP-121952	0519	-		Stage 2 aspects of UE assistance information	11.4.0
	RP-58	RP-121950	0521	-		Stage 2 for the FeICIC	11.4.0
	RP-58	RP-121933	0528	-		correction for Inter-RAT ANR	11.4.0
	RP-58	RP-121955	0529	1		Introduction of CoMP	11.4.0
	RP-58	RP-121948	0530	-		HeNB Mobility enhancement	11.4.0
	RP-58	RP-121957	0531	-		Verification of HeNB	11.4.0
	RP-58	RP-121957	0532	-		Clarification of scenario for Handover Report procedure	11.4.0
	RP-58	RP-121957	0533	-		Correction of GUMMEI Type for RN	11.4.0
	RP-58	RP-121948	0534	-		UE context release in source HeNB GW after X2 handover from HeNB to eNB	11.4.0
	RP-58	RP-121947	0535	-		Update of the stage-2 MRO specification for inter-RAT failure detection	11.4.0
	RP-58	RP-121947	0536	-		Update of the stage-2 MRO specification for intra-RAT HetNet failure detection	11.4.0
	RP-58	RP-121947	0537	-		Update of the stage-2 MRO specification for inter-RAT ping-pong detection	11.4.0
	RP-58	RP-121936	0538	-		Restriction of Resource Allocation during SCell activation	11.4.0
	RP-58	RP-121932	0539	-		Misc corrections on MBMS	11.4.0
	RP-58	RP-121957	0540	-		Correction on UE Radio Capability Match	11.4.0
	RP-58	RP-121957	0541	-		Clarification on the use of HRL in GWCN scenarios	11.4.0
	RP-58	RP-121732	0542	-		Membership Verification for HeNB Enhanced Mobility	11.4.0
	RP-58	RP-121739	0543	-		New Information for BBF access	11.4.0
2013-03	RP-59	RP-130248	0544	2		Clarification on the ANR when UTRAN is shared	11.5.0
	RP-59	RP-130241	0545	-		IDC Problem Reporting	11.5.0
	RP-59	RP-130247	0548	-		Corrections on mobility to CSG and hybrid cells	11.5.0
	RP-59	RP-130248	0550	-		36300 CR(Rel-11)_Miscellaneous correction to 36.300 on handover	11.5.0
	RP-59	RP-130248	0551	-		Clarification on PS handover from GERAN to EUTRAN	11.5.0
	RP-59	RP-130241	0556	-		Introduction of EPDCCH in TS 36.300	11.5.0
	RP-59	RP-130241	0557	-		Clarifying the impact of PPI on QoS	11.5.0
	RP-59	RP-130241	0559	-		Correction of BBF Access Interworking	11.5.0
	RP-59	RP-130248	0560	-		Correction of GUMMEI Type mandatory inclusion	11.5.0
	RP-59	RP-130240	0561	-		Correction of IRAT MRO	11.5.0
	RP-59	RP-130248	0562	1		Clarification on the Absence of HRL	11.5.0
	RP-59	RP-130248	0563	-		Correction of update of MBMS parameters	11.5.0
2013-06	RP-60	RP-130809	0564	-		Introduction of SIB16	11.6.0
	RP-60	RP-130808	0565	-		Correction of timing reference of sTAG	11.6.0
	RP-60	RP-130809	0566	-		Correction on physical layer part on TS 36.300	11.6.0
	RP-60	RP-130805	0571	-		Correction to correlation ID in LIPA	11.6.0
	RP-60	RP-130804	0573	-		Correction on the another secured interface for LIPA	11.6.0
	RP-60	RP-130809	0574	-		Clarification on area restriction information propagation	11.6.0
	RP-60	RP-130809	0575	-		Correction on the update of time of MBMS data transfer	11.6.0
	RP-60	RP-130640	0577	-		Correction on RLF Indication procedure	11.6.0
	RP-60	RP-130809	0578	-		Clarification on the UE reported timer in MRO	11.6.0
2013-09	RP-61	RP-131315	0582	-		Modification to CA downlink timing difference	11.7.0
	RP-61	RP-131319	0583	-		Correction on the MBMS session update	11.7.0
	RP-61	RP-131315	0585	-		Transfer GRE key to MME for PMIP-based S5	11.7.0
	RP-61	RP-131319	0586	-		Correction of HeNB Verification	11.7.0
	RP-61	RP-131320	0587	-		Correction of Service Area Identity Null	11.7.0
	RP-61	RP-131152	0588	1		Correction of terminology concerning the mobility restriction function	11.7.0
2013-12	RP-62	RP-131995	0589	-		Clarification on Minimum Transport Block Size of Msg3	11.8.0
	RP-62	RP-131989	0593	1		Maximum uplink transmission difference	11.8.0
	RP-62	RP-131995	0604	-		Correction of Weight Factor	11.8.0
	RP-62	RP-132001	0597	-		Load reporting between LTE and eHRPD	12.0.0
	RP-62	RP-132002	0598	-		LAPI for NNSF	12.0.0
	RP-62	RP-132002	0599	-		Restoration of eMBMS Bearer Services	12.0.0
	RP-62	RP-131910	0600	-		Kill All Warning Messages	12.0.0
	RP-62	RP-131999	0602	-		Introduction of Collocated L-GW for SIPTO@LN	12.0.0
	RP-62	RP-131999	0603	-		Introduction of SIPTO@LN Stand-Alone in LTE Stage 2	12.0.0
	RP-62	RP-131916	0606	-		Support for connected mode inbound mobility to shared CSG/hybrid cell	12.0.0
2014-03	RP-63	RP-140353	0610	-		Introduction of CS to PS SRVCC	12.1.0
	RP-63	RP-140351	0615	-		Reporting of User Location Information at E-RAB release	12.1.0
	RP-63	RP-140360	0616	-		PWS Restart Indication	12.1.0
2014-06	RP-64	RP-140876	0616a NOTE	1		Update of CA deployment scenarios	12.2.0
	RP-64	RP-140892	0626	-		Outdated Statement on Security Key Corruption	12.2.0
	RP-64	RP-140884	0627	-		Stage 2 description of eIMTA feature	12.2.0
	RP-64	RP-140881	0628	-		Stage 2 description of Power Saving Mode feature for LTE	12.2.0

	RP-64	RP-140888	0630	-		Introduction of TDD-FDD CA into stage 2	12.2.0
	RP-64	RP-140883	0636	-		Stage-2 details of WLAN/3GPP Radio Interworking for LTE	12.2.0
	RP-64	RP-140884	0637	-		Introduction of LTE TDD eIMTA	12.2.0
	RP-64	RP-140891	0638	-		MBMS Bearer priority Update	12.2.0
	RP-64	RP-140886	0639	-		HeNB ID verification in PWS Restart Indication message	12.2.0
	RP-64	RP-140897	0640	-		Updating X2 GW Stage 2 Description	12.2.0
2014-09	RP-65	RP-141504	0642	-		Stage-2 details of WLAN/3GPP Radio Interworking for LTE	12.3.0
	RP-65	RP-141496	0645	-		Clarification on Service Continuity	12.3.0
	RP-65	RP-141506	0652	3		Stage 2 aspects of low complexity UE features	12.3.0
	RP-65	RP-141520	0653	-		Introduction of the UE history reported from the UE	12.3.0
	RP-65	RP-141498	0655	-		Corrections to MBMS SAI 0	12.3.0
	RP-65	RP-141509	0656	-		Introduction of inter-eNB CoMP	12.3.0
	RP-65	RP-141505	0657	-		Stage 2 alignment following introduction of context fetch	12.3.0
	RP-65	RP-141511	0658	-		Delete stage 3 detail on cause of the RLF	12.3.0
	RP-65	RP-141508	0659	-		Support of Radio-interface Based Synchronization by OAM configuration	12.3.0
	RP-65	RP-141518	0660	-		Introduction of CN assistance information	12.3.0
2014-12	RP-66	RP-142122	0661	-		Corrections for RAN assisted WLAN interworking	12.4.0
	RP-66	RP-142122	0663	-		Clarification on handling of dedicated parameters upon cell selection&reselection	12.4.0
	RP-66	RP-142128	0673	-		Stage-2 description of Increased Carrier monitoring feature	12.4.0
	RP-66	RP-142122	0665	-		Addition of SystemInformationBlockType17 into Stage 2 description	12.4.0
	RP-66	RP-142115	0670	-		Order of MCCH messages in a MAC PDU	12.4.0
	RP-66	RP-142132	0667	-		Stage-2 description of Small Cell Enhancements Physical Layer	12.4.0
	RP-66	RP-142139	0671	-		Introduction of NAICS	12.4.0
	RP-66	RP-142129	0666	-		Correction to stage 2 description of Low Complexity UEs	12.4.0
	RP-66	RP-142135	0675	-		Introduction of Dual Connectivity	12.4.0
	RP-66	RP-142137	0681	1		Introduction of ProSe	12.4.0
	RP-66	RP-142082	0683	-		Addition of RLF reporting over S1	12.4.0
	RP-66	RP-142132	0684	-		Further detail on the required OAM configuration to support RIBS	12.4.0
	RP-66	RP-142136	0685	-		Completion of stage-2 inter-eNB CoMP	12.4.0
	RP-66	RP-142093	0686	-		TNL address selection for HeNB scenario	12.4.0
	RP-66	RP-142094	0687	-		X2 Removal Signaling Description	12.4.0
	RP-66	RP-142140	0688	-		Clarification of the usage of radio measurements in the RLF report	12.4.0
2015-03	RP-67	RP-150374	0693	-		Corrections to stage 2 description of ProSe	12.5.0
	RP-67	RP-150373	0692	-		Addition of PDCP-PDU retransmission to PDCP functions	12.5.0
	RP-67	RP-150373	0691	-		Clarification on DC	12.5.0
	RP-67	RP-150373	0705	-		Clarification on SCG change definition	12.5.0
	RP-67	RP-150375	0700	-		Introduction of MBMS congestion management for Public Safety Group Call	12.5.0
	RP-67	RP-150348	0707	-		Correction of the Usage of the MultibandInfoList IE	12.5.0
	RP-67	RP-150373	0708	-		Clarification of the description of the NAICS procedure	12.5.0
	RP-67	RP-150373	0709	-		Correction on SeNB behaviour for distinguishing uplink PDCP PDUs	12.5.0
	RP-67	RP-150373	0710	-		Correction on DL Data Forwarding for Split Bearer	12.5.0
	RP-67	RP-150373	0698	1		Minor corrections on DC 36.300	12.5.0
2015-06	RP-68	RP-150921	0756	-		Resource pool for out of coverage UE	12.6.0
	RP-68	RP-150921	0757	-		Dual Connectivity Corrections	12.6.0
	RP-68	RP-150921	0758	-		Corrections on Stage-2 descriptions for ProSe	12.6.0
	RP-68	RP-150921	0759	1		Need for SIB18 in a cell on non-Public Safety ProSe Carrier	12.6.0
	RP-68	RP-150921	0761	-		Allocation of LCID in DC	12.6.0
	RP-68	RP-150921	0760	2		Addition of DC Operation Overview and Minor Clarifications	12.6.0
	RP-68	RP-150921	0763	-		Clarification on CQI reporting in dual connectivity	12.6.0
	RP-68	RP-150921	0764	-		Correction to the characteristics of SL-DCH	12.6.0
	RP-68	RP-150943	0712	1		Clarification on UE-AMBR for split bearer	12.6.0
	RP-68	RP-150921	0723	1		Introduction of Group Call eMBMS congestion management	12.6.0
	RP-68	RP-150921	0721	2		Correction on SeNB initiated SeNB Modification procedure	12.6.0
	RP-68	RP-150921	0733	-		Correction on MeNB behaviour for distinguishing downlink PDCP PDUs	12.6.0
2015-06	RP-68	RP-150946	0771	-		eMBMS Alternative IP Multicast distribution address	13.0.0
	RP-68	RP-150925	0711	4		Introduction of enhanced inter-eNB CoMP	13.0.0
	RP-68	RP-150945	0730	6		SON support for dynamic deployment changes	13.0.0
2015-09	RP-69	RP-151520	0792	-		Sidelink terminology alignment in TS 36.300	13.1.0
2015-12	RP-70	RP-152074	0796	-		Introduction of DC enhancement	13.2.0
	RP-70	RP-152075	0801	-		Introduction of RS-SINR measurements	13.2.0
	RP-70	RP-152053	0803	-		Corrections on sidelink related description in TS 36.300	13.2.0
	RP-70	RP-152077	0809	1		Introduction of LTE-WLAN Radio Level Integration and Interworking Enhancement stage-2	13.2.0
	RP-70	RP-152080	0799	1		Introduction of SC-PTM	13.2.0
	RP-70	RP-152081	0797	1		Removing SCG change restrictions regarding upon handover	13.2.0
	RP-70	RP-152075	0806	2		Introduction of MCLD	13.2.0
	RP-70	RP-152069	0810	2		Introduction of low complexity UE and enhanced coverage features	13.2.0
	RP-70	RP-152072	0820	-		Introduction of eD2D	13.2.0

	RP-70	RP-152080	0813	-		Introduction of SC-PTM	13.2.0
	RP-70	RP-152084	0814	-		Introduction of PWS Failure Indication message	13.2.0
	RP-70	RP-152084	0815	-		Addition of the information on the notification for planned reconfiguration	13.2.0
	RP-70	RP-152070	0816	-		Enhanced overload procedure in RAN sharing	13.2.0
	RP-70	RP-152081	0817	-		Tunnel Information of BBAI in Dual Connectivity	13.2.0
	RP-70	RP-152081	0818	-		Adding CSG support to DC	13.2.0
	RP-70	RP-152081	0819	-		Support of SIPTO@LN and LIPA for DC	13.2.0
	RP-70	RP-152070	0728	11		Monitoring traffic volume per QoS group per PLMN	13.2.0
	RP-70	RP-152081	0772	6		Introduction of handover enhancement for Dual Connectivity	13.2.0
	RP-70	RP-152067	0779	5		Introduction of Dedicated Core Network (DECOR) feature	13.2.0
	RP-70	RP-152076	0821	-		Introducing extended DRX	13.2.0
	RP-70	RP-152078	0798	2		Introduction of Licensed-Assisted Access using LTE	13.2.0
	RP-70	RP-152050	0794	1		IDC Overview Correction	13.2.0
	RP-70	RP-152083	0800	3		Introduction of Stage 2 text for LTE-WiFi integration for legacy WLAN	13.2.0
	RP-70	RP-151957	0822	-		36.300 CR for capturing B5C and PUCCH on SCell	13.2.0
2016-03	RP-71	RP-160470	0824	1		Clarification on SC-PTM	13.3.0
	RP-71	RP-160470	0825	1		Clarification related to SC-MCCH Change Notification	13.3.0
	RP-71	RP-160467	0827	-		Clarification on Split bearer	13.3.0
	RP-71	RP-160470	0829	3		IDC support in LAA	13.3.0
	RP-71	RP-160456	0830	-		Paging occasion monitoring when eDRX is configured	13.3.0
	RP-71	RP-160458	0839	4		Stage-2 text for LWIP Tunnel Clarifications	13.3.0
	RP-71	RP-160457	0840	2		TS 36.300 Stage-2 CR correction for LWA	13.3.0
	RP-71	RP-160454	0841	2		Clean up and corrections for eD2D	13.3.0
	RP-71	RP-160470	0842	1		Mapping between Channel Access Priority Classes and QCI values	13.3.0
	RP-71	RP-160470	0843	2		Multiplexing of data in LAA	13.3.0
	RP-71	RP-160470	0847	-		Clarification on the synchronized MBSFN transmission	13.3.0
	RP-71	RP-160467	0848	-		Maximum UL transmission timing reference in DC	13.3.0
	RP-71	RP-160457	0849	2		Stage 2 CR on LTE-WLAN Radio Level	13.3.0
	RP-71	RP-160470	0852	-		Correction on SC-MCCH change notification	13.3.0
	RP-71	RP-160457	0853	-		QoS parameters handling during LWA bearer establishment/modification	13.3.0
	RP-71	RP-160470	0854	-		Correction on overload enhancement	13.3.0
	RP-71	RP-160453	0855	-		Introduction of Paging Optimisation and Paging for Coverage Enhancement capable UEs	13.3.0
	RP-71	RP-160457	0856	-		Configuration of the flow control type	13.3.0
	RP-71	RP-160457	0857	-		Xw Dynamic Configuration	13.3.0
	RP-71	RP-160449	0858	-		UE context retention at SCTP recovery	13.3.0
	RP-71	RP-160449	0859	-		Addition of X2 Removal Threshold to the X2 Removal Request message	13.3.0
	RP-71	RP-160470	0860	-		SC-PTM reception on non-Pcell	13.3.0
	RP-71	RP-160451	0863	-		Correction on CSG and LIPA/SIPTO support to DC	13.3.0
2016-06	RP-72	RP-161080	0864	-		Corrections to MTCe in TS 36.300	13.4.0
	RP-72	RP-161080	0872	-		Measurement gap assisted intra-frequency measurement in case of narrowband operation	13.4.0
	RP-72	RP-161080	0875	-		Correction to eMTC message classes and logical channels	13.4.0
	RP-72	RP-161080	0865	-		Clarification on LWA	13.4.0
	RP-72	RP-161080	0869	-		Miscellaneous Stage-2 corrections for LWA	13.4.0
	RP-72	RP-161080	0873	-		Correction of RCLWI call flow	13.4.0
	RP-72	RP-161080	0866	-		Clarification on DC	13.4.0
	RP-72	RP-161080	0878	-		Stage 2 aspects of HARQ functionality for eMTC UEs	13.4.0
	RP-72	RP-161080	0867	-		Corrections for sidelink description	13.4.0
	RP-72	RP-161080	0868	1		Correction on conditions for Relay and Remote UE operation	13.4.0
	RP-72	RP-161080	0874	1		Correction on UL asynchronous HARQ	13.4.0
	RP-72	RP-161080	0879	1		Clarification on WLAN connection status reporting for RCLWI	13.4.0
	RP-72	RP-161080	0884	-		Correction on WT Association Confirmation	13.4.0
	RP-72	RP-161080	0885	-		Correction on WT initiated WT Modification procedure	13.4.0
	RP-72	RP-161080	0886	-		Correction on flow control	13.4.0
	RP-72	RP-161080	0881	1		Correction on DRS Duty Cycle	13.4.0
	RP-72	RP-161081	0880	3		Introduction of NB-IoT	13.4.0
	RP-72	RP-161081	0882	-		Introduction Control Plane ClIoT EPS Optimization	13.4.0
	RP-72	RP-161081	0883	-		Introduction of the UE context resume function	13.4.0
	RP-72	RP-161082	0887	-		Correction of Reroute NAS Request	13.4.0
2016-09	RP-73	RP-161757	0889	1		Clarification on LWIP	13.5.0
	RP-73	RP-161755	0890	1		Clarification on HARQ	13.5.0
	RP-73	RP-161756	0891	-		Small corrections to LWA	13.5.0
	RP-73	RP-161757	0893	2		Corrections to the coexistence of LWIP and DC, LWA, RCLWI, RAN assisted WLAN interworking	13.5.0
	RP-73	RP-161756	0894	1		Corrections to RCLWI procedure	13.5.0
	RP-73	RP-161756	0895	1		Corrections to WLAN measurement	13.5.0
	RP-73	RP-161756	0896	2		Corrections to WLAN connection status report for LWA	13.5.0
	RP-73	RP-161756	0897	2		Corrections to the coexistence of LWA, RCLWI and DC, LWIP, RAN assisted WLAN interworking	13.5.0

	RP-73	RP-161756	0898	1		Correction on WLAN authentication	13.5.0
	RP-73	RP-161755	0900	-		Clarification on system information	13.5.0
	RP-73	RP-161758	0903	1		Corrections to NB-IoT description in TS 36.300	13.5.0
	RP-73	RP-161762	0904	-		Introduction of EB/FD-MIMO Terminologies	13.5.0
	RP-73	RP-161759	0905	-		Keys storage on C-IoT optimizations for non-NB-IoT UE	13.5.0
	RP-73	RP-161756	0907	-		RCLWI traffic steering granularity	13.5.0
	RP-73	RP-161758	0909	1		Corrections to C-IoT optimisations in Stage-2	13.5.0
	RP-73	RP-161549	0912	-		Correction on CSG support in Dual Connectivity	13.5.0
	RP-73	RP-161759	0913	-		Correction of UE Radio Capability Information	13.5.0
	RP-73	RP-161756	0914	-		Correction on WT initiated WT modification procedure	13.5.0
2016-09	RP-73	RP-161745	0910	-		Stage 2 CR for eLAA	14.0.0
	RP-73	RP-161745	0911	-		IDC support in eLAA	14.0.0
	RP-73	RP-161746	0915	-		Introduction of V2V services based on LTE sidelink	14.0.0
2016-12	RP-74	RP-162314	0918	-		Clarification on DRX	14.1.0
	RP-74	RP-162318	0920	1		Clarification on Clot	14.1.0
	RP-74	RP-162313	0922	-		Corrections to stage 2 description for eMTC and NB-IoT	14.1.0
	RP-74	RP-162317	0924	1		Adding missing description of Frame structure type 3 for LAA	14.1.0
	RP-74	RP-162321	0926	-		Correction on cross carrier scheduling for eLAA	14.1.0
	RP-74	RP-162321	0927	-		Correction on LBT for eLAA	14.1.0
	RP-74	RP-162328	0930	1		Miscellaneous corrections on V2V	14.1.0
	RP-74	RP-162312	0932	-		eDRX correction on MME sending Paging message to eNB	14.1.0
	RP-74	RP-162310	0933	-		UL grant in Random Access Response from PCell and PSCell for SCell	14.1.0
	RP-74	RP-162316	0935	-		Clarifications on LWA and LWIP	14.1.0
	RP-74	RP-162324	0936	1		Introduction of SRS switching for LTE	14.1.0
	RP-74	RP-162327	0937	1		Stage-2 for LWIP aggregation	14.1.0
	RP-74	RP-162314	0939	-		Editorial correction for NB-IoT	14.1.0
	RP-74	RP-162311	0941	1		Correction for traffic steering granularity for RAN assisted WLAN interworking	14.1.0
	RP-74	RP-162314	0943	-		Definition of valid anchor and non-anchor carrier combinations	14.1.0
	RP-74	RP-162314	0945	-		Corrections to User Plane Clot optimisations	14.1.0
	RP-74	RP-162328	0946	1		Addition of UE geographical information reporting in 36.300	14.1.0
	RP-74	RP-162323	0948	2		Receive Only Mode for enTV	14.1.0
	RP-74	RP-162314	0951	-		Timing reference for NB-IoT UEs in multi-carrier operation	14.1.0
	RP-74	RP-162311	0954	-		Introduction of solution to solve CSFB setup delay problem	14.1.0
	RP-74	RP-162312	0956	-		Correction of eDRX Information	14.1.0
2017-03	RP-75	RP-170656	0950	3	A	Correction to CP only mode support in NB-IoT	14.2.0
	RP-75	RP-170642	0959	1	F	Clarification on the use of Explicit Congestion Notification (ECN)	14.2.0
	RP-75	RP-170657	0963	-	A	Correct that in NB-IoT PDCP linked to support of S1-U data transfer	14.2.0
	RP-75	RP-170626	0964	-	F	Correction on HARQ principles for eLAA	14.2.0
	RP-75	RP-170626	0965	-	F	Correction on LBT type for eLAA	14.2.0
	RP-75	RP-170643	0966	1	F	CR for the usage of transmission sidelink resource pools of the target cell	14.2.0
	RP-75	RP-170643	0967	1	F	Correction on exceptional pool's resource selection	14.2.0
	RP-75	RP-170630	0968	2	B	Introduction of RACH-less and make before break	14.2.0
	RP-75	RP-170636	0969	3	B	Stage 2 CR on FeMTC UE CE mode and maximum PDSCH/PUSCH BW preference	14.2.0
	RP-75	RP-170643	0970	1	F	Corrections on V2V description in TS 36.300	14.2.0
	RP-75	RP-170637	0971	2	B	Introduction of Rel-14 NB-IoT Enhancements	14.2.0
	RP-75	RP-170636	0972	2	B	Introduction of Rel-14 FeMTC	14.2.0
	RP-75	RP-170668	0973	-	B	Introducing 256QAM in UL	14.2.0
	RP-75	RP-170633	0974	1	B	Introduction of FeMBMS to 36.300	14.2.0
	RP-75	RP-170628	0975	1	B	Introduction of Enhanced LTE-WLAN Aggregation (eLWA)	14.2.0
	RP-75	RP-170638	0977	4	B	Introduction of Voice and Video enhancements for LTE	14.2.0
	RP-75	RP-170652	0979	-	A	Providing SIB1-BR via dedicated RRC signalling	14.2.0
	RP-75	RP-170635	0981	-	B	Introduction of MBMS deployment for V2X	14.2.0
	RP-75	RP-170637	0982	-	C	Handling of NB-IoT UE capabilities	14.2.0
	RP-75	RP-170642	0983	-	B	Reliable DL NAS delivery based on hop-by-hop acknowledgements	14.2.0
	RP-75	RP-170628	0984	-	B	Inter-eNB mobility with LWA active	14.2.0
	RP-75	RP-170628	0985	-	B	Enabling uplink data bearers for LWA	14.2.0
	RP-75	RP-170641	0986	-	B	Introduction of eDECOR in RAN	14.2.0
	RP-75	RP-170637	0987	-	B	Introduction of S1 UE information retrieve procedure	14.2.0
	RP-75	RP-170633	0988	1	B	PLMN ID Check and Enhanced TV Services	14.2.0
	RP-75	RP-170635	0989	-	B	Introduction of V2X feature in 36.300	14.2.0
	RP-75	RP-170550	0990	-	B	Introducing eLWIP enhancements	14.2.0
2017-06	RP-76	RP-171243	0995	2	A	Correction on radio protocol architecture for DC	14.3.0
	RP-76	RP-171244	0996	1	F	Correction on HARQ principles for eMTC	14.3.0
	RP-76	RP-171236	0997	2	F	Correction on eLWA	14.3.0
	RP-76	RP-171223	0999	3	F	Corrections to stage 2 description of FeMTC and eNB-IoT	14.3.0
	RP-76	RP-171235	1000	1	F	Corrections to stage 2 description for voice and video enhancements for LTE	14.3.0
	RP-76	RP-171224	1006	1	F	Corrections to NB-IoT Enhancements	14.3.0

	RP-76	RP-171226	1009	2	F	Indication of in proximity of CEN DSRC	14.3.0
	RP-76	RP-171223	1010	1	C	CE mode configuration/deconfiguration without handover	14.3.0
	RP-76	RP-171236	1014	r	F	Clarification of the end marker solution for eLWA	14.3.0
	RP-76	RP-171226	1017	2	F	CR to cell reselection for V2X in TS 36.300	14.3.0
	RP-76	RP-171243	1023	4	A	LAA/WiFi sharing indication	14.3.0
	RP-76	RP-171245	1024	1	A	Clarification of UE-AMBR support for NB-IoT	14.3.0
	RP-76	RP-171245	1027	-	A	Miscellaneous corrections for NB-IoT	14.3.0
	RP-76	RP-171224	1028	2	F	Resources selection for PRACH triggered by a PDCCH order in eNB-IoT(Option2)	14.3.0
	RP-76	RP-171227	1029	1	F	Editorial Corrections to Support of Multiple SPS Configurations	14.3.0
	RP-76	RP-171246	1034	1	B	EUTRAN sharing enhancement	14.3.0
	RP-76	RP-171224	1038	-	B	Introduction of RRC connection re-establishment for NB-IoT control plane	14.3.0
	RP-76	RP-171225	1040	1	F	Correction on UE-AMBR for NB-IoT UE using CP solution	14.3.0
	RP-76	RP-171224	1041	-	B	Support of RLF for CP ClOT Optimisation	14.3.0
2017-09	RP-77	RP-171915	1031	2	C	Support of RLC UM for LWA bearer	14.4.0
	RP-77	RP-171913	1032	4	F	Correction of RACH-less handover	14.4.0
	RP-77	RP-171915	1042	-	F	Correction on UE states for MBMS reception	14.4.0
	RP-77	RP-171915	1053	1	F	RAN-recommended bit rate restriction	14.4.0
	RP-77	RP-171910	1057	1	F	Correction of MBMS-dedicated cell definition	14.4.0
	RP-77	RP-171913	1058	2	C	Introduction of Release Assistance Indication	14.4.0
	RP-77	RP-171915	1059	-	F	Remove the description of Inter RAT Redirection value for MMTEL	14.4.0
	RP-77	RP-171919	1061	-	A	Clarification on SCell status during PUCCH SCell change/removal	14.4.0
2017-12	RP-78	RP-172615	1048	7	B	Introduction of the overheating indication	14.5.0
	RP-78	RP-172624	1055	4	A	Corrections on paging monitoring in RRC_CONNECTED in Rel-13 eMTC	14.5.0
	RP-78	RP-172617	1062	3	F	Corrections to V2X in TS 36.300	14.5.0
	RP-78	RP-172616	1066	1	F	Correction on TS 36.300 for support of larger maximum PDSCH/PUSCH channel bandwidth for feMTC	14.5.0
	RP-78	RP-172617	1083	1	F	Clarification to Mapping Between Service Types and V2X Frequencies	14.5.0
	RP-78	RP-172615	1085	-	F	Protection of Redirection to GERAN	14.5.0
2017-12	RP-78	RP-172614	1086	1	B	Baseline CR for Rel.15 NR (RAN3 part)	15.0.0
2018-03	RP-79	RP-180444	1088	-	A	CR on CBR measurement	15.1.0
	RP-79	RP-180444	1089	3	A	Miscellaneous correction to V2X in TS 36.300	15.1.0
	RP-79	RP-180445	1094	1	A	Missing description of RRC Connection Re-establishment for the Control plane	15.1.0
	RP-79	RP-180441	1101	1	A	Correction on the SI-RNTI for MPDCCH	15.1.0
	RP-79	RP-180440	1104	-	F	Clarification for the use of en-gNB in LTE Stage-2	15.1.0
	RP-79	RP-180441	1107	1	A	Measurement Requirements for LAA/WiFi Hardware Sharing Problem	15.1.0
	RP-79	RP-180443	1113	-	A	Reference Signals for MBSFN with 1.25kHz and 7.5kHz sub-carrier spacing	15.1.0
	RP-79	RP-180447	1116	-	F	RoHC support for Mission Critical services over MBMS	15.1.0
	RP-79	RP-180440	1117	-	F	Clarification on HRL for EN-DC	15.1.0
	RP-79	RP-180440	1118	-	F	Stage 2 alignment for NSA Energy Savings	15.1.0
	RP-79	RP-180442	1121	-	A	Paging failure in CE Capable UEs	15.1.0
	RP-79	RP-180440	1122	-	B	E-UTRA - NR Cell Resource Coordination	15.1.0
2018-06	RP-80	RP-181216	0998	6	B	Introduction of New Radio Access Technology in TS 36.300	15.2.0
	RP-80	RP-181222	1073	1	B	Introduction of QoE Measurement Collection for LTE	15.2.0
	RP-80	RP-181221	1076	4	B	Running 36.300 CR to introduce assistance information for local cache	15.2.0
	RP-80	RP-181218	1084	2	B	Introduction of shortened TTI and processing time for LTE	15.2.0
	RP-80	RP-181226	1090	3	B	Introduction of DEFLATE based UDC Solution	15.2.0
	RP-80	RP-181171	1102	5	A	Introduction of support for MAC PDU containing UE contention resolution identity MAC control element without RRC response message in NB-IoT	15.2.0
	RP-80	RP-181234	1124	2	A	Correction to V2X descriptions in TS 36.300	15.2.0
	RP-80	RP-181248	1126	3	B	Introduction of eV2X in TS 36.300	15.2.0
	RP-80	RP-181252	1127	3	B	Introduction of further NB-IoT enhancements other than EDT in TS 36.300	15.2.0
	RP-80	RP-181224	1128	3	B	Introduction of EDT for eMTC and NB-IoT enhancements in TS 36.300	15.2.0
	RP-80	RP-181224	1134	2	B	Introduction of enhancements for eMTC excluding EDT	15.2.0
	RP-80	RP-181214	1135	-	F	Adding en-gNB definition to LTE Stage-2	15.2.0
	RP-80	RP-181250	1137	1	B	Stage-2 description of euCA	15.2.0
	RP-80	RP-181228	1138	-	B	Enabling MBMS Bearer Event Notification	15.2.0
	RP-80	RP-181253	1139	4	B	Introduction on Rel-15 Aerial UE functionality	15.2.0
	RP-80	RP-181233	1141	1	F	Corrections on Delivering Data with Complete Message	15.2.0
	RP-80	RP-181233	1144	-	A	Introduction of UL skipping for latency reduction	15.2.0
	RP-80	RP-181216	1145	2	B	Introduce reportCGI towards NR neighbour cell	15.2.0
	RP-80	RP-181235	1147	-	A	Introduction of relaxed monitoring for NB-IoT and MTC	15.2.0
	RP-80	RP-181216	1148	2	F	Support for inter-RAT handover from EN-DC	15.2.0
	RP-80	RP-181234	1150	2	A	Corrections to V-RNTI Handling	15.2.0
	RP-80	RP-181223	1151	1	B	Introduction of E-UTRA connected to 5GCN	15.2.0
	RP-80	RP-181215	1152	-	F	X2 partial reset for EN-DC	15.2.0
	RP-80	RP-181215	1153	-	F	List of served cells for X2 connection between eNB and en-gNB	15.2.0
	RP-80	RP-181215	1154	-	F	Addition of 'No EN-DC' attribute for the Neighbour Relation Table	15.2.0

	RP-80	RP-181247	1156	1	B	Introduction of Ultra Reliable Low Latency Communication for LTE	15.2.0
	RP-80	RP-181232	1159	-	A	Clarification on Connection Establishment Indication procedure scenarios	15.2.0
	RP-80	RP-181228	1160	-	B	Triggering UE capability info retrieval using DL NAS TRANSPORT (Stage 2)	15.2.0
	RP-80	RP-181255	1162	-	A	UE Radio Access Capability Size Reduction	15.2.0
	RP-80	RP-181216	1163	3	F	ANR stage 2 clean up	15.2.0
	RP-80	RP-181228	1164	-	B	Retrieve UE Context at UE Re-establishment	15.2.0
	RP-80	RP-181249	1166	-	B	Introduce feLAA in TS 36.300	15.2.0
2018-09	RP-81	RP-181960	1140	1	B	Introduction of QoE Measurement Collection for MTSI services	15.3.0
	RP-81	RP-181939	1155	2	C	Clarification on LTE Overheating mechanism in EN-DC	15.3.0
	RP-81	RP-181949	1170	-	D	Independent cell (de)activation and duplication (de)activation	15.3.0
	RP-81	RP-181948	1171	1	F	CR on RAN1 synchronization agreement in 36.300	15.3.0
	RP-81	RP-181945	1172	-	F	Corrections to carrier definition for TDD in 36.300	15.3.0
	RP-81	RP-181944	1175	-	F	Minor corrections for TS 36300 for eMTC excluding EDT	15.3.0
	RP-81	RP-181946	1184	-	F	Miscellaneous correction to FeLAA in TS 36.300	15.3.0
	RP-81	RP-181950	1185	-	F	Stage 2 Changes based on CN type indication for Redirection from ng-eNB to E-UTRA	15.3.0
	RP-81	RP-181942	1186	1	F	Clarification on SCTP association establishment – for 36.300	15.3.0
	RP-81	RP-181963	1188	1	A	Correction on Authentication Failure handling in case of eNB CP Relocation	15.3.0
	RP-81	RP-181960	1189	1	F	Data forwarding for Retrieve UE Context in case of RRC connection re-establishment	15.3.0
	RP-81	RP-181942	1190	-	F	Corrections on resource coordination in stage-2	15.3.0
	RP-81	RP-181941	1192	-	F	[SON/ANR] Stage 2 updates	15.3.0
2018-12	RP-82	RP-182675	1182	6	F	Corrections on handover for E-UTRA connected to 5GC	15.4.0
	RP-82	RP-182678	1193		F	Correction for duplication based on Rel-14 TX profile	15.4.0
	RP-82	RP-182675	1195		F	Clarification of features not supported in NB-IoT	15.4.0
	RP-82	RP-182671	1197		F	EDT when resuming in a new eNB	15.4.0
	RP-82	RP-182678	1199		F	Correction on V2X sidelink communication in TS 36.300	15.4.0
	RP-82	RP-182675	1200		F	Inter-RAT Handover from GERAN or UTRAN to E-UTRA configured with EN-DC (36.300)	15.4.0
	RP-82	RP-182671	1201		F	Clarification on when UL data transmission in EDT is not considered successful	15.4.0
	RP-82	RP-182649	1202		F	Correction for E-UTRA connected to 5GC Stage-2	15.4.0
	RP-82	RP-182681	1203		F	Corrections on EDT	15.4.0
	RP-82	RP-182660	1206		F	Stage 2 CR on Measurement gap configuration scenarios	15.4.0
	RP-82	RP-182672	1207		B	MBMS reception in Receive Only Mode	15.4.0
	RP-82	RP-182676	1209		F	Removing NG-RAN specific statements	15.4.0
	RP-82	RP-182665	1210		F	Correction on ANR related information	15.4.0
	RP-82	RP-182665	1211		F	36.300 CR on Correction of Physical Layer Resource to Cell Resource	15.4.0
	RP-82	RP-182847	1212	2	B	Addition of an SPID value for vehicle UE subscriber	15.4.0
2019-03	RP-83	RP-190553	1213	1	F	Corrections to LTE Stage-2	15.5.0
	RP-83	RP-190552	1216	1	F	Cross-carrier scheduling configuration with shortened processing time	15.5.0
	RP-83	RP-190551	1219	2	F	Correction to EDT	15.5.0
	RP-83	RP-190549	1224	1	F	Correction for non-anchor carrier configuration for (CP) connection re-establishment	15.5.0
	RP-83	RP-190548	1226	-	A	Removal of 62MHz frequency separation restriction for LTE LAA DL operations	15.5.0
	RP-83	RP-190548	1227	-	F	Correction on eNB CP Relocation	15.5.0
	RP-83	RP-190544	1228	-	F	Introducing a target E-UTRA cell's NCR towards an NR cell for performing EN-DC	15.5.0
	RP-83	RP-190561	1229	-	F	Introduction of TNL Address discovery for EN-DC	15.5.0
	RP-83	RP-190553	1230	-	F	Adding the transfer of the PSCell information for LI purposes	15.5.0
2019-06	RP-84	RP-191387	1233	-	F	Miscellaneous corrections to LTE Stage-2	15.6.0
	RP-84	RP-191374	1234	-	F	No support of IRAT HO from NR to EN-DC	15.6.0
	RP-84	RP-191386	1235	1	F	CR on 36.300 for SRB cell mapping for CA duplication	15.6.0
	RP-84	RP-191387	1236	1	F	SN Status Transfer applicability for Re-establishment	15.6.0
	RP-84	RP-191383	1238	-	A	Multiple Cell ID broadcast for E-UTRAN sharing	15.6.0
	RP-84	RP-191428	1239	2	F	RAN sharing with multiple Cell ID broadcast	15.6.0
2019-09	RP-85	RP-192197	1241	1	F	Add new release 15 QCLs into CAPC mapping table	15.7.0
	RP-85	RP-192196	1243	1	F	Correction on EPS fallback for LTE-5GC	15.7.0
	RP-85	RP-192195	1245	1	A	Introduction of DL channel quality reporting	15.7.0
	RP-85	RP-192190	1249	-	F	Independent migration to IPv6 on S1-U for en-gNB's	15.7.0
	RP-85	RP-192194	1250	1	F	Location Reporting: effective PSCell ID reporting	15.7.0
2019-12	RP-86	RP-192941	1252	3	F	Correction on inter-frequency neighbour cell measurements	15.8.0
2020-03	RP-87	RP-200336	1262	1	A	Handling of UE Radio Capability for Paging in NB-IoT and eMTC	15.9.0
	RP-87	RP-200334	1272	-	F	Propagation of Roaming and Access Restriction information in E-UTRAN in non-homogenous eNB deployments	15.9.0
2020-07	RP-88	RP-201165	1288	-	F	Correction of connected en-gNB Identifier	15.10.0
	RP-88	RP-201165	1290	-	F	Correction for Network Sharing	15.10.0

	RP-88	RP-201168	1292	-	F	CR 36.300 for support of WUS	15.10.0
2020-09	RP-89	RP-201936	1264	4	F	System support for Wake Up Signal	15.11.0
	RP-89	RP-201936	1305	1	F	Corrections on idle mode measurements	15.11.0
2020-12	RP-90	RP-202788	1298	2	F	Clarification to completion of UP-EDT procedure when using RLC AM	15.12.0
	RP-90	RP-202788	1323	1	F	Miscellaneous Stage-2 corrections	15.12.0
2022-03	RP-95	RP-220472	1357	-	F	Clarification of RSRP measurement triggering for number of cells for UAVs	15.13.0

NOTE: The CR number, 0616 in RP-140876 was renumbered into 0616a in CR database since the CR number was double allocated in RP-140351 at RAN #63 and in RP-140876 at RAN#64.

History

Document history		
V15.2.0	July 2018	Publication
V15.3.0	October 2018	Publication
V15.4.0	April 2019	Publication
V15.5.0	May 2019	Publication
V15.6.0	July 2019	Publication
V15.7.0	October 2019	Publication
V15.8.0	January 2020	Publication
V15.9.0	April 2020	Publication
V15.10.0	July 2020	Publication
V15.11.0	November 2020	Publication
V15.12.0	January 2021	Publication
V15.13.0	May 2022	Publication